

OCTOBER · 1948

# electronics

A MCGRAW-HILL PUBLICATION



AIR SPEED STATIC

FOR CORRECT TIRE  
INFLATION PRESSURE  
SEE T.O. 04-10-1

RADIO-CONTROLLED  
JET FIGHTER

*In This Issue...* The Editors Report On **ELECTRONICS PARK**



# PICTURE PROJECTION

Perfected by *Norelco*



The 2½" magnetic projection triode 3NP4 has a face as small as a compact and is only 10½" long.

**HERE'S THE OPPORTUNITY THAT MANUFACTURERS OF TELEVISION RECEIVERS HAVE BEEN AWAITING!**

• • • • • **10 SIGNIFICANT FEATURES** • • • • •

- 1 Flat 16" x 12" non-reflecting picture provides fatigueless viewing from less than 5 feet and upward!
- 2 Wide-angle visibility — *square corners*.
- 3 True photographic black and white picture quality—no discoloration.
- 4 Compact unit—suitable for table model cabinets.
- 5 Long-life, low-cost picture tube.
- 6 Manufacturers can most economically extend their product range into projection television by adapting their 10" EM chassis for use with PROTELGRAM.
- 7 Easy to service.
- 8 High contrast ratio and broad gray tone range.
- 9 Simple optical adjustment system.
- 10 Quality built after more than 10 years of development.

NORELCO PROTELGRAM consists of a projection tube, an optical box with focus and deflection coils, and a 25 kv regulated high-voltage supply unit, making possible large-size home projection. More than ten years of exhaustive research resulted in this ideal system for reproducing a projected picture. The optical components are designed to produce perfected projection for a 16" x 12" image, the optimum picture size for steady, distant observation and also for proper viewing at less than 5 feet.



Other NORELCO products include standard 10" direct-viewing tubes and special-purpose cathode-ray tubes for many applications.

NORTH AMERICAN  
PHILIPS  
COMPANY, INC.



**PROTELGRAM**

**IS PICTURE PERFECTION IN PROJECTION**

**NORTH AMERICAN PHILIPS COMPANY, INC.**

DEPT. TE-10, 100 EAST 42ND STREET, NEW YORK 17, N. Y.

IN CANADA: PHILIPS INDUSTRIES LTD., 1203 PHILIPS SQUARE, MONTREAL \* EXPORT REPRESENTATIVE: PHILIPS EXPORT CORPORATION, 100 EAST 42ND STREET, NEW YORK 17, N. Y.



A-D  
1948 Electronics Mag.  
#5  
#15.00

# electronics

A McGRAW-HILL  
PUBLICATION



OCTOBER • 1948

**RADIO-CONTROLLED JET FIGHTER** ..... Cover  
Electronic equipment mounted in nose of P80 permits pilotless flights directed from truck in background and mother plane (see p 126)

**TELEVISION TRANSCRIPTIONS**, by Thomas T. Goldsmith, Jr. and Harry Milholland ..... 68  
Recording images on film, directly from a cathode-ray monitor

**SERRASOID F-M MODULATOR**, by J. R. Day ..... 72  
New phase-shift device with low distortion and noise for use in broadcasting

**THE EDITORS REPORT ON ELECTRONICS PARK** ..... 77  
The full story, with emphasis on the engineers, supervisors and workers on whom the future depends

**PEAK-TO-PEAK VOLTMETER**, by F. H. Shepard, Jr. and Edmund Osterland ..... 101  
Narrow voltage pulses are measured by stretching the pulses

**SATURABLE REACTORS AND MAGNETIC AMPLIFIERS**, by Frank G. Logan ..... 104  
Practical effect of materials on characteristics are discussed; illustrative applications show utility of these components

**TELEVISION SYNCHRONIZING SIGNAL GENERATOR**, by A. J. Baracket ..... 110  
Driving, blanking and sync signals to fit FCC and RMA specifications

**SINGLE-SIDEBAND CRYSTAL FILTERS**, by Paul K. Taylor ..... 116  
Multiple-section filters are used for the carrier frequency and the two sidebands

**TELE SERVICE AREAS**, by John H. Battison ..... 122  
Charts show approximate distances to 5,000  $\mu$ v per m and 500  $\mu$ v per m contours

**BUYERS' GUIDE ADDITIONS AND CORRECTIONS** ..... 244  
Changes and additions to be used as a supplement to the 1948-49 guide

BUSINESS BRIEFS ..... 64	ELECTRON ART ..... 128	NEW BOOKS
CROSSTALK ..... 67	NEW PRODUCTS ..... 132	BACKTALK
TUBES AT WORK ..... 124	NEWS OF THE INDUSTRY ..... 136	INDEX TO ADVERTISERS

**DONALD G. FINK**, Editor; **W. W. MacDONALD**, Managing Editor; John Markus, Vin Zeluff, Frank H. Rockett, A. A. McKenzie, Associate Editors; William P. O'Brien, Assistant Editor; Hal Adams, Jean C. Brons, Elaine Weber, Editorial Assistants; Gladys T. Montgomery, Washington Editor; Harry Phillips, Art Director; Eleanor Luke, Art Assistant; R. S. Quint, Directory Manager; John Chapman, World News Director; Dexter Keezer, Director Economics Department

**KEITH HENNEY**, Consulting Editor

**H. W. MATEER**, Publisher; **WALLACE B. BLOOD**, Manager; D. H. Miller, H. R. Denmead, Jr., New York; Wm. S. Hodgkinson, New England; F. P. Coyle, Warren Shew, Philadelphia; C. D. Wardner, Chicago; J. L. Phillips, Cleveland; J. W. Otterson, San Francisco; Carl W. Dysinger, Los Angeles; Ralph C. Maultsby, Atlanta; Paul West, London, England; J. E. Blackburn, Jr., Director of Circulation

Contents Copyright 1948, by McGraw-Hill Publishing Company, Inc. All Rights Reserved. McGRAW-HILL PUBLISHING COMPANY, INCORPORATED, JAMES H. McGRAW (1860-1948), Founder • PUBLICATION OFFICE 99-129 North Broadway, Albany 1, N. Y., U. S. A. EDITORIAL AND EXECUTIVE OFFICES, 330 West 42nd St., New York 18, N. Y., U. S. A.—Member A. B. P. Member A. B. C.

James H. McGraw, Jr., President; Curtis W. McGraw, Vice-President and Treasurer; Eugene Duffield, Executive Assistant for Publications; Nelson Bond, Director of Advertising; Joseph A. Gerardi, Secretary; and J. E. Blackburn, Jr., Director of Circulation.  
ELECTRONICS, October, 1948, Vol. 21, No. 10. Published monthly, with an additional issue in June, price 75c a copy for U. S. and possessions, and Canada; \$1.00 for Latin America; \$1.50 for all other foreign countries. Directory issue \$2.00. Allow at least ten days for change of address. All communications about subscriptions should be addressed to the Director of Circulation. Subscription rates—United States and possessions, \$6.00 a year, \$9.00 two years, \$12.00 for three years. Canada (Canadian funds accepted), \$7.00 a year, \$11.00 for two years, \$14.00 for three years. Latin American countries \$10.00 for one year, \$16.00 for two years, \$20.00 for three years. All other countries \$15.00 for one year, \$30.00 for three years. Please indicate position and company connections on all subscription orders. Entered as Second Class matter August 29, 1936, at Post Office, Albany, New York, under the Act of March 3, 1879. BRANCH OFFICES: 520 North Michigan Avenue, Chicago 11, Ill.; 68 Post Street, San Francisco 4; Aldwych House, Aldwych, London, W.C. 2; Washington, D. C. 4; Philadelphia 3; Cleveland 15; Detroit 26; St. Louis 8; Boston 16; Atlanta 3, Ga.; 621 So. Hope St., Los Angeles 14; 738-9 Oliver Building, Pittsburgh 22.



# MARION

• • • helps HASTINGS LABORATORIES

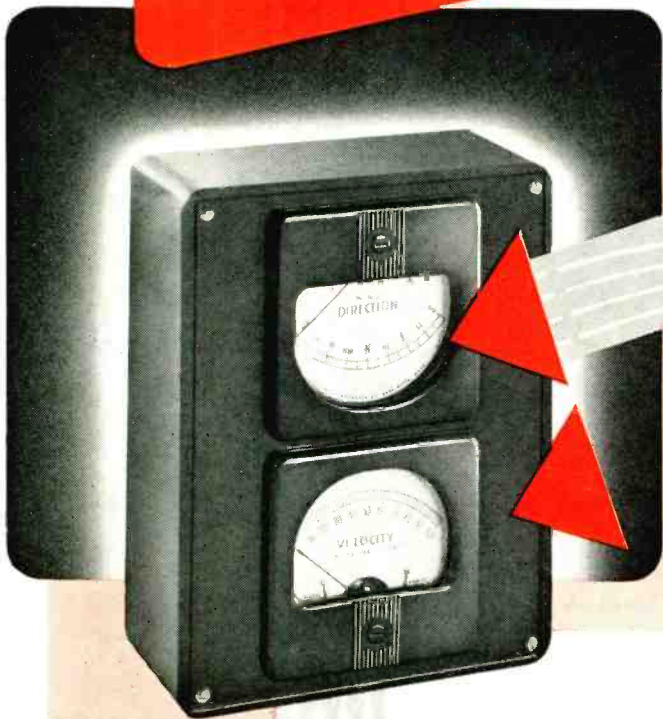

measure the wind

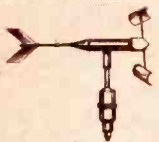

When Hastings Laboratories engineered a new, more precise type of anemometer some very real problems were encountered. One was to find an *inside* instrument that would accurately *indicate* the direction and velocity of the wind passing the anemometer located *outside*. Because of Marion's recognized reputation for manufacturing fool-proof, trouble-free meters and instruments, it was natural for Hastings to turn to Marion for this vital component.

Marion then designed, engineered and manufactured two matched meters for this purpose. Now, matched Marion meters and these matchless new Hastings anemometers are helping weather forecasters, air pilots and navigators measure the wind more accurately all over the world.

When you have a problem involving electrical measuring or indicating we will be glad to have you turn to us. We have helped others. And, because we know "Marion" means the "most" in meters, we believe we can help you.

**THE NAME MARION MEANS THE MOST IN METERS**

*Write for complete information*

**M·E·I**

**MARION ELECTRICAL INSTRUMENT COMPANY**

**MANCHESTER, NEW HAMPSHIRE**

Export Division, 458 Broadway, New York 13, U. S. A., Cables MORHANEX

IN CANADA: THE ASTRAL ELECTRIC COMPANY, SCARBORO BLUFFS, ONTARIO



# NOTICE

# PHOTACT

TRADEMARK ®

is a 

# TRADEMARK

PHOTACT is a K&E trademark that is registered in the United States Patent Office. It is the name given by KEUFFEL & ESSER CO., for the **partners in creating** protection of their customers, to certain papers and cloths and a developer and a fixer for making reproductions. The name PHOTACT may be properly used only in connection with genuine K&E products.

## KEUFFEL & ESSER CO.

EST. 1867

NEW YORK • HOBOKEN, N. J.

CHICAGO • ST. LOUIS • DETROIT • SAN FRANCISCO

LOS ANGELES • MONTREAL

*Drafting, Reproduction, Surveying*

*Equipment and Materials*

*Slide Rules      Measuring Tapes*





## How a quartz ring drove the first crystal clock in 1928

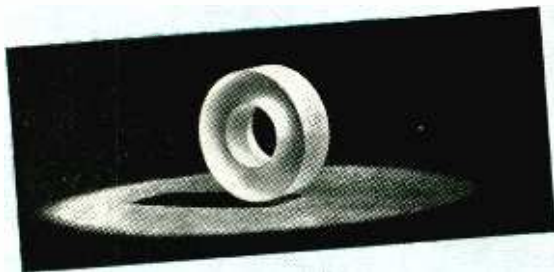

Heart of the crystal clock built 20 years ago at Bell Laboratories was this quartz ring, adjusted to a frequency of 100 kc. With the crystal cut to correct proportions in this annular

shape, positive and negative temperature coefficients of frequency effectively neutralized each other. Resultant temperature coefficient was less than 1 part in  $10^6$  per degree C.

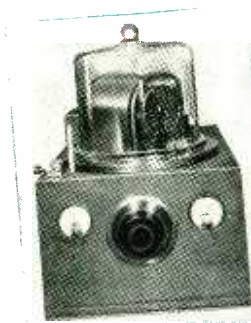

In the complete oscillator, the crystal was mounted inside a chamber in which the temperature was kept constant within  $0.01^\circ$  C, and placed in a hermetically sealed bell jar to maintain uniform pressure. The frequency of the oscillator output was reduced to 1,000 cycles by means of sub-multiple generators.



In the clock mechanism, a 1,000-cycle synchronous motor, driven by the output of the sub-multiple generators, was geared to the clock hands. Accuracy of this clock in 1928 was within 1 part in  $10^6$ . Accuracy of its present-day successor is of the order of 1 part in  $10^8$ —an advance made possible by continuing research.



## Where a second is

... in the clock that varies less than 1/1000th of a second a day

There's a clock at Bell Telephone Laboratories—evolved by the scientists there—that keeps accurate time within 0.001 second a day. It is the latest step in a series of developments that began 20 years ago when Bell Laboratories built the first crystal clock.

Why are the men of Bell Laboratories, whose basic interest is *communications*, so concerned with *time*? Because the study of communications is largely the study of frequency—and frequency is the inverse of time. To deal with frequencies in megacycles requires accurate measurement of fractions of micro-seconds.

In their early studies of piezoelectric crystals for frequency control, Bell scientists saw the desirability of using them also as a source of accurate time.

Two obstacles stood in the way of devising a crystal clock: the relatively high temperature coefficient of crystals, and the fact that their frequencies were too high to drive a synchronous motor. Annular crystals, with extremely low temperature coefficients, solved the first problem. Sub-multiple generators solved the second, accurately dividing the crystal frequency. Thus the barrier between *frequency* standards and *time* standards was finally broken down.



# BELL TELEPHONE LABORATORIES

World's largest organization devoted exclusively to research and development in all phases of electrical communications.



**PROGRESS REPORT  
ON  
P.E.C.\***

**How Allen-Howe — first to use  
"Printed Electronic Circuit" in hearing aids —  
depends on this Centralab development  
for smaller, finer units.**



*Models courtesy of Allen-Howe Electronics Corp.*

**\*Centralab's "Printed Electronic Circuit"  
— Industry's newest method for  
improving design and manufacturing efficiency!**

SIZE and weight are vital to Allen-Howe, hearing aid manufacturers. That's why this firm's engineers chose Centralab's *Printed Electronic Circuit* to help them design and build smaller, lighter, more efficient units. Just as important to Allen-Howe is product dependability. Months of actual experience using *Printed Electronic Circuits* have proved to them how very rugged these miniature audio-amplifiers are . . . just how well they resist humidity and moisture. That's why they continue to use Centralab's revolutionary P.E.C.

**INTEGRAL CERAMIC CONSTRUCTION:** Each *Printed Electronic Circuit* is an integral assembly of "Hi-Kap" capacitors and resistors closely bonded to a steatite ceramic plate and mutually connected by means of metallic silver paths "printed" on the base plate.

This outstanding hearing aid development, illustrated above, was the result of close cooperation between Centralab and Allen-Howe engineers. Working with your engineers, Centralab may be able to fit its *Printed Electronic Circuit* to your specific needs. Write for full information, or call your nearest Centralab Representative.

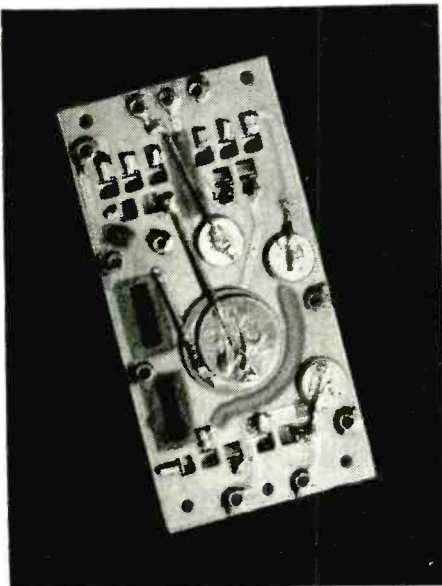

**TYPICAL "AMPEC"** — (actual size, back view) shows how you can get complete electrical circuits—tube sockets, capacitors, resistors and wiring—in one miniature Centralab amplifier unit.

**LOOK TO *Centralab* IN 1948!**

Division of GLOBE-UNION INC., Milwaukee



# New vital link

## ANNOUNCING THE GENERAL ELECTRIC S-T BROADCAST SYSTEM!

• With it—your signal from studio to transmitter now rides on air!

With it—your problems of outages due to weather or rugged terrain are solved! Sleet storms, fires or floods can damage studio to transmitter transmission lines or cables—but not micro-wave transmission from General Electric S-T broadcast system. There are no transmission lines or cables.

With it—you can select the best sites for your station and transmitter with increased assurance of reliable program service!

The new General Electric S-T Link equipment is easily installed and occupies remarkably little studio space. A product of the research and engineering skills assembled at Electronics Park, this system is another General Electric contribution to better broadcasting.

Broadcasters, station managers and engineers will want all the facts.

Your nearest G-E office can give them to you. Call there, or write: *General Electric Company, Transmitter Division, Electronics Park, Syracuse, New York.*

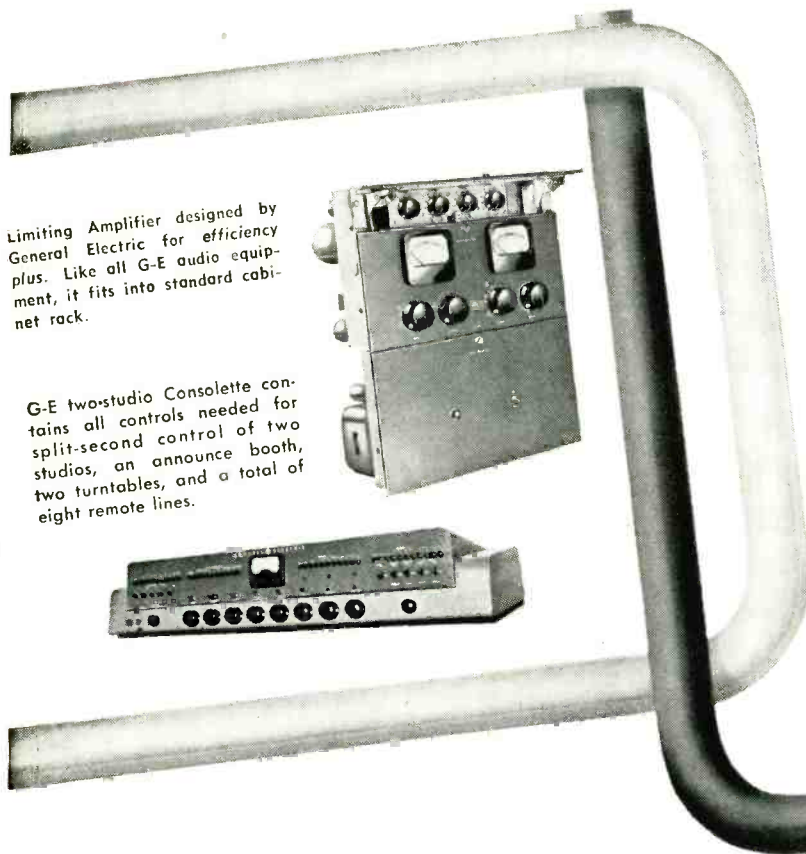

Limiting Amplifier designed by General Electric for efficiency plus. Like all G-E audio equipment, it fits into standard cabinet rack.

G-E two-studio Consolelette contains all controls needed for split-second control of two studios, an announce booth, two turntables, and a total of eight remote lines.

## S-T TRANSMITTER

- Conservatively rated 10 watts output. Continuously adjustable 1 to 10 watts for maximum tube life.
- Remarkably easy installation.
- Single unit. Entire transmitter is complete within its cabinet. All maintenance done under comfortable indoor conditions.
- Low power consumption: 675 watts total input.
- Can be tuned and adjusted without special test equipment.
- Instant accessibility. All meter and tuning controls immediately at hand when front doors are open.
- Rear doors interlocked for maximum safety to personnel.
- Simple and easy to change tubes.

## WHAT THE SYSTEM DOES FOR YOU . . .

- Operates in band 920 to 960 MC. This includes the band permanently assigned by FCC for S-T broadcast service.
- Permits you to meet all FCC FM broadcast system requirements.
- Remote controlled over single-pair telephone line.
- Uses standard type "N" RF fittings throughout.
- Provides high fidelity performance:
  - Less than 1% distortion from 50 to 15,000 cycles.
  - Noise level better than 65 db.
  - Frequency response well within  $\pm 1$  db from 50 to 15,000 cycles.
- Designed for unattended remote operation.

# for dependable broadcasting

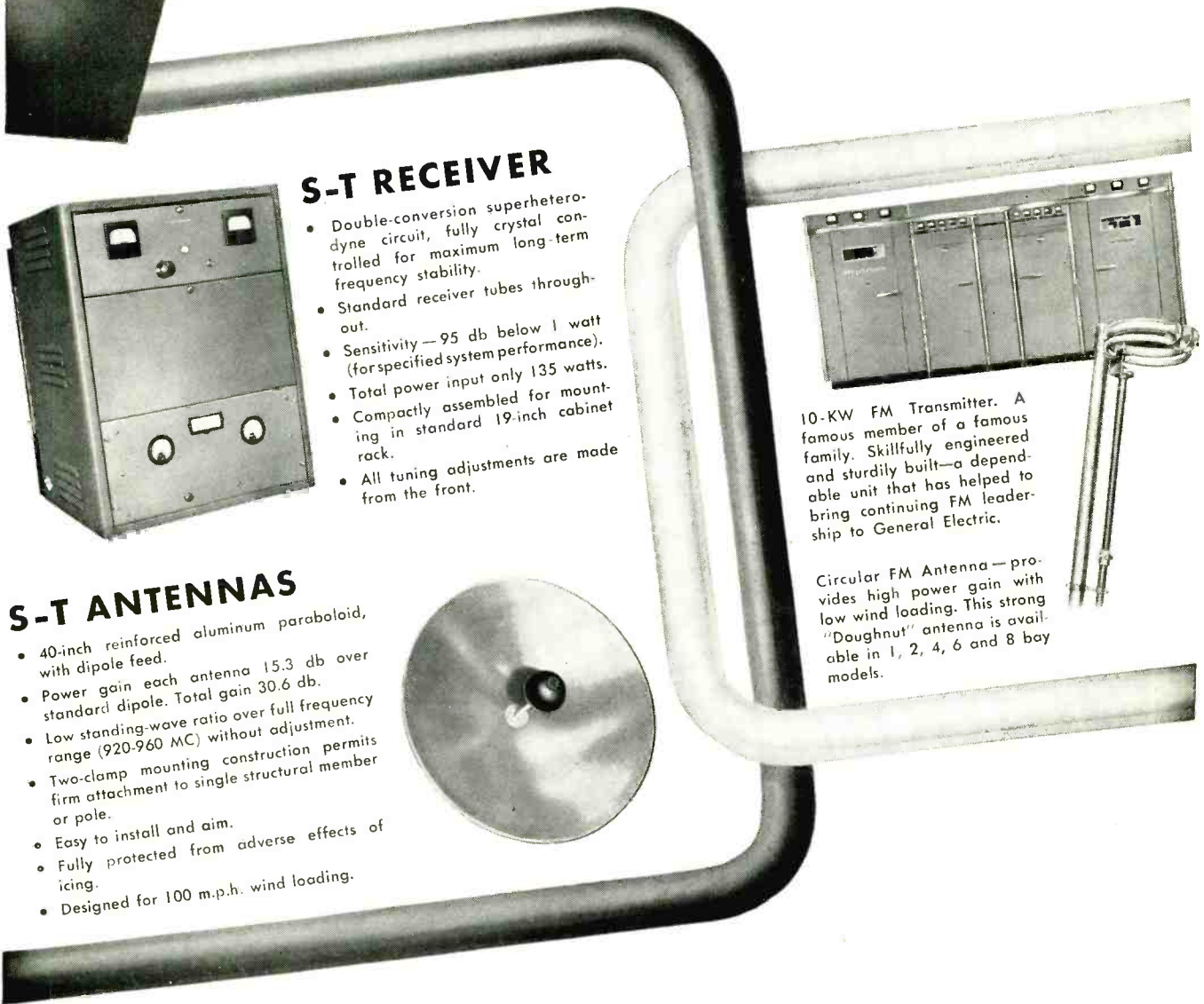

## S-T RECEIVER

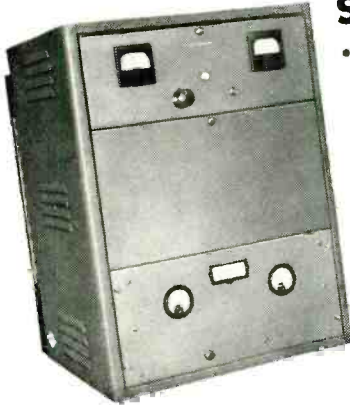

- Double-conversion superheterodyne circuit, fully crystal controlled for maximum long-term frequency stability.
- Standard receiver tubes throughout.
- Sensitivity—95 db below 1 watt (for specified system performance).
- Total power input only 135 watts.
- Compactly assembled for mounting in standard 19-inch cabinet rack.
- All tuning adjustments are made from the front.

## S-T ANTENNAS

- 40-inch reinforced aluminum paraboloid, with dipole feed.
- Power gain each antenna 15.3 db over standard dipole. Total gain 30.6 db.
- Low standing wave ratio over full frequency range (920-960 MC) without adjustment.
- Two-clamp mounting construction permits firm attachment to single structural member or pole.
- Easy to install and aim.
- Fully protected from adverse effects of icing.
- Designed for 100 m.p.h. wind loading.

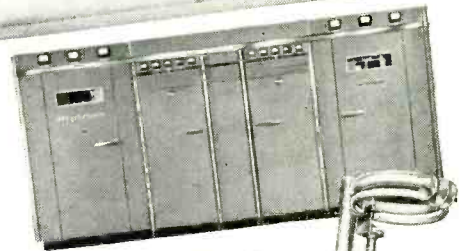
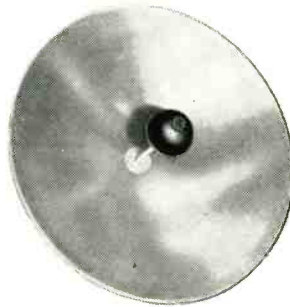

10-KW FM Transmitter. A famous member of a famous family. Skillfully engineered and sturdily built—a dependable unit that has helped to bring continuing FM leadership to General Electric.

Circular FM Antenna—provides high power gain with low wind loading. This strong "Doughnut" antenna is available in 1, 2, 4, 6 and 8 bay models.

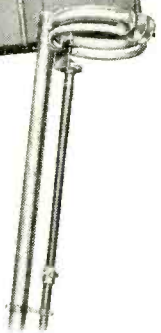

**ATLANTA 3, GA.**  
187 Spring Street N.W.  
Walnut 9767

**BOSTON 1, MASS.**  
140 Federal Street  
Hubbard 1800

**CHICAGO 54, ILL.**  
1122 Merchandise Mart  
Whitehall 3915

**CINCINNATI 2, OHIO**  
215 W. 3rd Street  
Parkway 3431

**DALLAS 2, TEXAS**  
1801 N. Lamar Street  
LD 224

**DENVER 2, COLO.**  
650 17th Street  
Keystone 7171

**KANSAS CITY 6, MO.**  
106 W. 14th Street  
Victor 9745

**CLEVELAND 4, OHIO**  
710 Williamson Bldg.  
Euclid & Public Square  
Superior 6822

**LOS ANGELES 14, CALIF.**  
Suite 1300-1301

Security Title Insurance Bldg.  
530 West Sixth Street  
Trinity 3417

**SALT LAKE CITY 9, UTAH**—200 South Main Street

**SYRACUSE 1, N. Y.**—Syracuse 6-4411

**MINNEAPOLIS 2, MINN.**  
12 Sixth Street  
Main 2541

**NEW YORK 22, N. Y.**  
570 Lexington Avenue  
Wickersham 2-1311

**PHILADELPHIA 2, PA.**  
1405 Locust Street  
Pennypacker 5-9000

**SAN FRANCISCO 4, CALIF.**  
235 Montgomery Street  
Douglas 3740

**SCHENECTADY, N. Y.**  
Bldg. 267, Rm. 209  
Schenectady 4-2211

**SEATTLE 4, WASH.**  
710 Second Avenue  
Main 7100

**WASHINGTON 5, D. C.**  
806 15th Street N. W.  
Executive 3600

For fast service  
call G.E.



LEADER IN RADIO, TELEVISION AND ELECTRONICS

# GENERAL ELECTRIC

160-G1E-6914



# Ultra Sensitivity

IN  
PORTABLE FORM

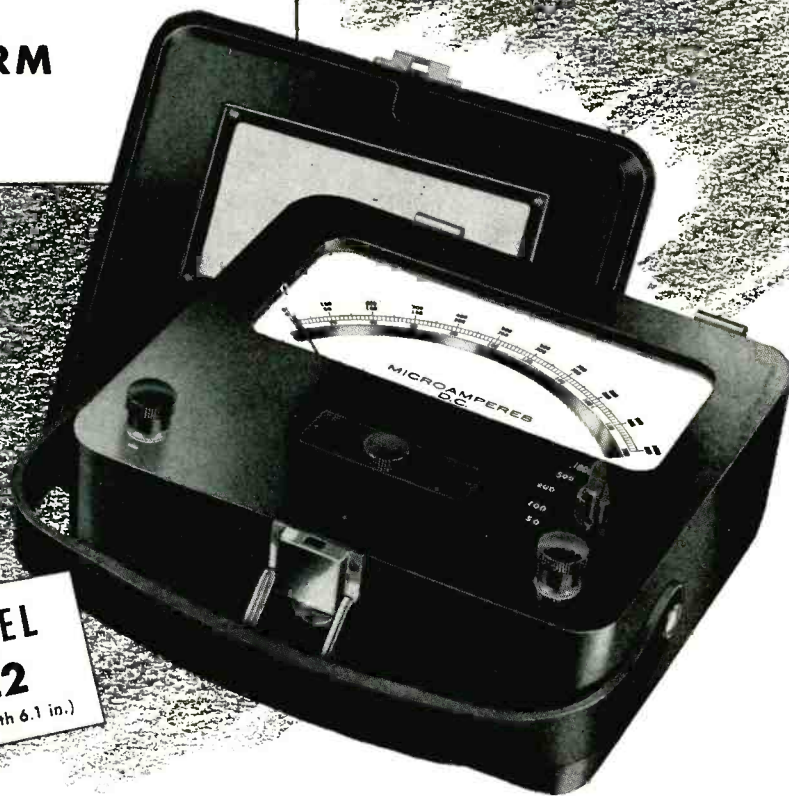

MODEL  
622  
(Scale length 6.1 in.)

Designed for a wide variety of laboratory measurements, especially those where high sensitivity and a long scale arc are required. Electrostatically and magnetically shielded, Model 622 is ideally suited for precise measurements of potential and current at the very low energy levels frequently encountered in nuclear physics, electronics and electro-chemical research. Microammeters, milliammeters, millivoltmeters and voltmeters are available in single and multi-range D-C types; milliammeters and voltmeters in thermo and rectifier types for RF and A-C.

Complete information on Model 622 is available from your nearest WESTON representative, or by writing... WESTON Electrical Instrument Corporation, 618 Frelinghuysen Avenue, Newark 5, N. J.

## WESTON

## Instruments

ALBANY · ATLANTA · BOSTON · BUFFALO · CHARLOTTE · CHICAGO · CINCINNATI · CLEVELAND · DALLAS · DENVER · DETROIT · HOUSTON · JACKSONVILLE · KNOXVILLE · LITTLE ROCK · LOS ANGELES · MERIDEN · MINNEAPOLIS · NEWARK  
NEW ORLEANS · NEW YORK · PHILADELPHIA · PHOENIX · PITTSBURGH · ROCHESTER · SAN FRANCISCO · SEATTLE · ST. LOUIS · SYRACUSE · TULSA · IN CANADA, NORTHERN ELECTRIC CO., LTD., POWERLITE DEVICES, LTD.

# WIRING

is the Life-Line of  
every electrical product



Whatever your product, you can more surely predict dependable performance-in-use when it is Rockbestos-wired.

For Rockbestos wires, cables and cords are permanently insulated with impregnated felted asbestos — the ageless, heat and flame resistant insulation that insures top wiring dependability under even the most gruelling conditions.

Protect *your* product's life line with the wire that does so much more for so little more . . . *Rockbestos*.

WRITE TODAY — for your copy of the new No. 10-F Catalog, sectioned for easy reference to Appliance, Aircraft, Electronic, Fixture, Switchboard, Lighting and Magnet Wires; Apparatus Wires and Cables; Power and Control Cables.

## ROCKBESTOS PRODUCTS CORPORATION

464 NICOLL ST., NEW HAVEN 4, CONN.

NEW YORK    CLEVELAND    DETROIT    CHICAGO    PITTSBURGH  
ST. LOUIS    LOS ANGELES    OAKLAND, CALIF.

# ROCKBESTOS



THE WIRE WITH PERMANENT INSULATION



# When Industry Puts on the Brakes

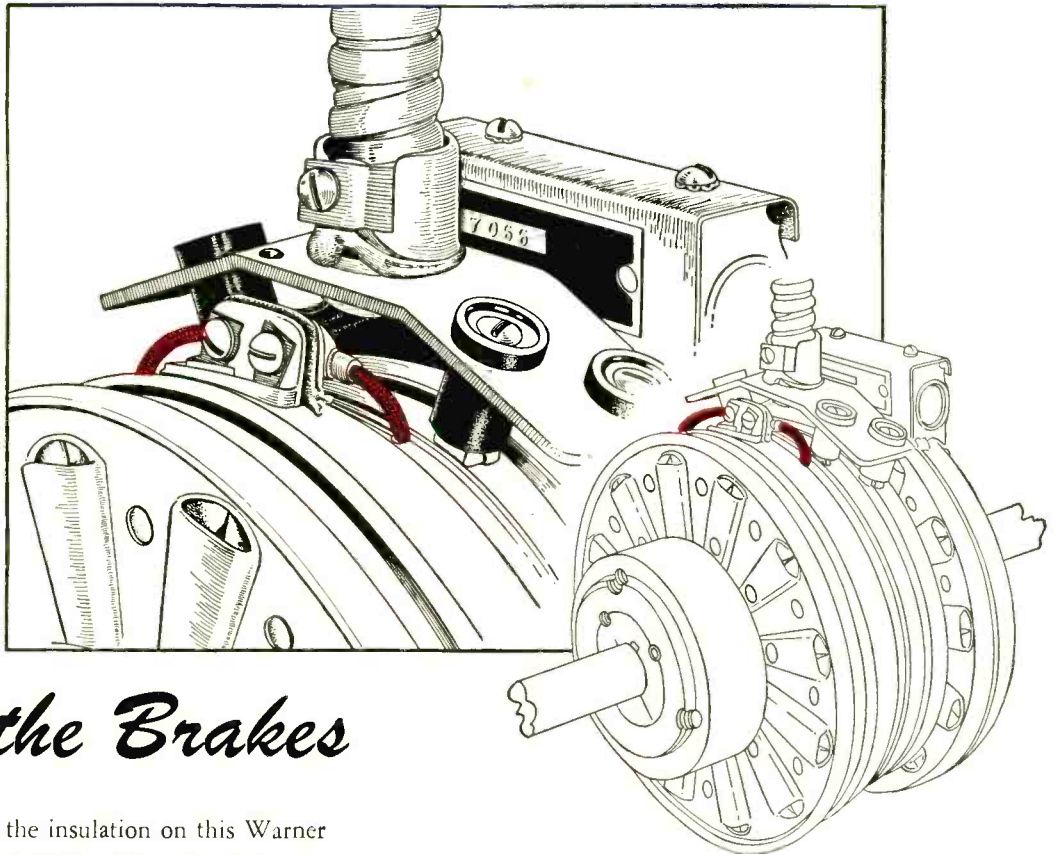

Take a close look at the insulation on this Warner "ICB" Electric Clutch-Brake. The wire that conveys the current from the collector ring to the magnet requires an insulation that is heat resistant to 300° F. at 110 v.

When the Warner Electric Brake Manufacturing Company put this problem up to Bentley, Harris, they got complete performance data on BH Extra Flexible Fiberglas Sleeveing and samples for laboratory test. Here is what they found:

"BH Fiberglas Sleeveing fully meets our requirements for insulation of electric brakes used on industrial machinery."

BH Fiberglas Sleeveings are made to meet specific requirements — double-braided, triple-braided, heat resistant to 1200° F. if necessary. Remarkably flexible — can be spread to cover knobs or terminals, cannot dry out. Non-fraying — without use of hardening varnish or lacquer.

If you have a problem of insulation breakdown caused by high heat, extreme cold, harmful gases, grease or moisture, try BH Fiberglas Sleeveing in your plant, in your product.

BENTLEY, HARRIS MFG. CO., CONSHOHOCKEN, PA.

## BH *Fiberglas\** SLEEVIINGS

\*BH Non-Fraying Fiberglas Sleeveings are made by an exclusive Bentley, Harris process (U. S. Pat. No. 2393530). "Fiberglas" is Reg. TM of Owens-Corning Fiberglas Corp.

----- USE COUPON NOW -----

Bentley, Harris Mfg. Co., Dept. E27, Conshohocken, Pa.

I am interested in BH Non-Fraying Fiberglas Sleeveing for \_\_\_\_\_ (product)

operating at temperatures of \_\_\_\_\_°F. at \_\_\_\_\_ volts. Send samples so I can see for myself how BH Non-Fraying Fiberglas Sleeveing stays flexible as string, will not crack or split when bent.

NAME \_\_\_\_\_ COMPANY \_\_\_\_\_

ADDRESS \_\_\_\_\_

Send samples, pamphlet and prices on other BH Products as follows:

- Cotton-base Sleeveing and Tubing
- Ben-Har Special Treated Fiberglas Tubing



# FM LEADER!

110-mc ring-seal power tetrode streamlined for new transmitters. Forced-air-cooled. A pair will put out more than 3 kw, with only 120 w drive required!

Also best for your final stage because...

1. Tube installation or replacement takes only a few seconds (see sketch).
2. Wide terminal-contact areas greatly increase h-f efficiency.
3. Internal shielding is complete... tube inductance low... little if any neutralizing is needed.



## GL-7D21

### RING-SEAL CONTACTS

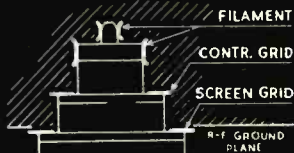

Sketch shows how easily the GL-7D21 can be plugged into a coaxial socket. Ring-seal design also provides ample contact surface for all terminals.

### CHARACTERISTICS

Filament voltage	6.3 v
Filament current	30 amp
Interelectrode capacitances:	
grid-plate	0.4 mmfd
input	39 mmfd
output	14 mmfd
Frequency at max ratings	110 mc
Type of cooling	forced-air
Max plate ratings, Class C telegraphy:	
voltage	4,000 v
current	1 amp
input	3,000 w
dissipation	1,200 w

**T**AILORED to your needs as builder or designer of new broadcasting equipment, Type GL-7D21 is the right tube for medium-power FM. Check the low drive requirement of 120 w—real economy!—against an output (push-pull in open-line circuits with proper external shielding) of well over 3 kw. Note the convenience of forced-air cooling!

Study the tube's other advantages given above, then add plus-features like silver-plated contacts to reduce r-f losses; strong, lasting Fernico metal-to-glass seals; trim contour and compact construction to match the other advanced components of your ultra-modern transmitter.

One of a distinguished family of ring-seal power tubes for FM and television, the GL-7D21's

brilliant all-around performance also marks these larger types:

**GL-5513.** A 220-mc forced-air-cooled triode, with typical Class C output (per tube) of 2.45 kw.

**GL-5518.** A 110-mc forced-air-cooled triode with typical Class C output (per tube) of 6.4 kw.

**GL-9C24.** A 220-mc triode, cooled by water and forced air, with typical Class C output (per tube) of 9 kw.

In this group is a tube directly suited to your requirements, no matter what type or size transmitter now is on your drawing-boards. For prices and detailed information phone your nearby G-E electronics office, or wire or write to: *Electronics Department, General Electric Company, Schenectady 5, New York.*

# GENERAL ELECTRIC

161-G-8850

FIRST AND GREATEST NAME IN ELECTRONICS



# Now—for AC operation MIDGET AC TELEPHONE TYPE RELAYS!

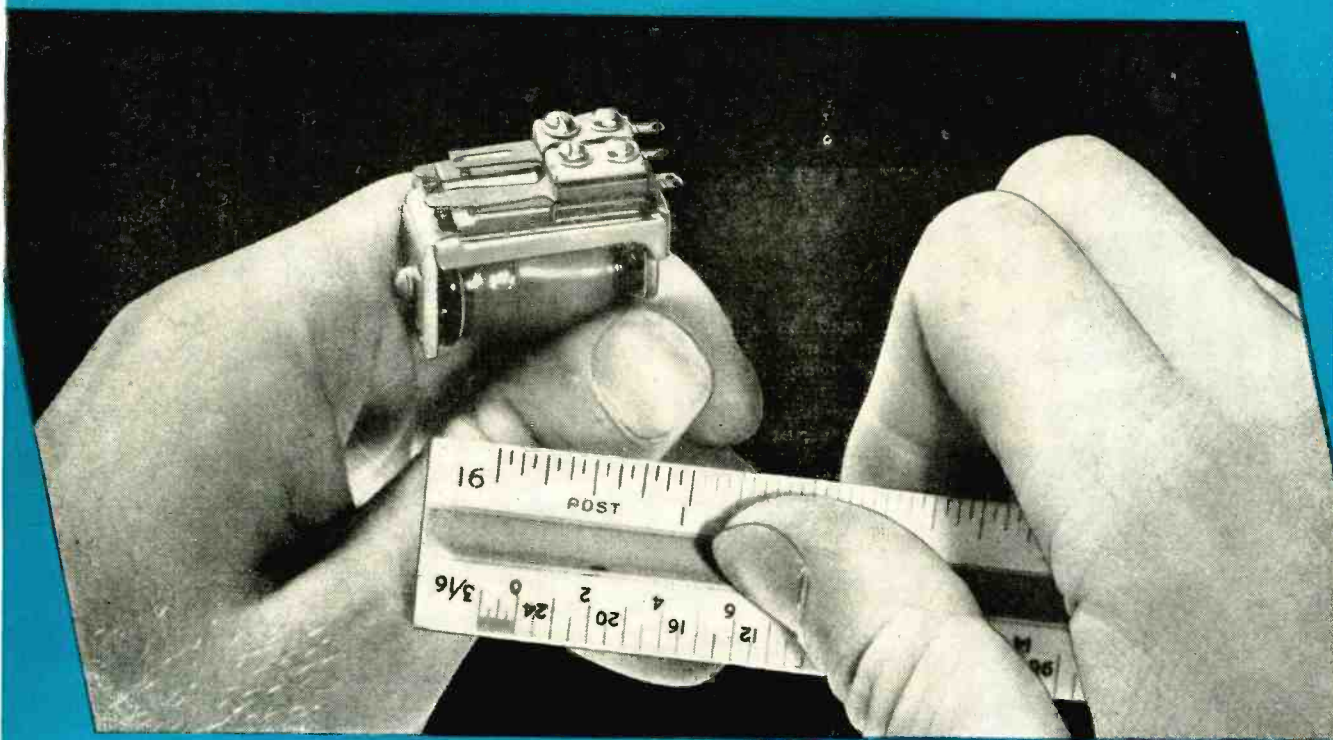

POTTER & BRUMFIELD, foremost supplier of relays to industry, now makes available for the first time their Series MTA telephone type relays for AC operation up to 220 volts 60 cycles. "Smaller than your thumb", this midget relay, weighing only 1-1/4 oz., measures 1-1/2" x 1-7/32" x 11/16".

With the MTA series, rectification is no longer needed to obtain chatter free operation. This relay is the same size as the long famous MT series which is supplied for DC operation.

The MTA is fitted with twin palladium contacts which will carry approximately 2 amperes non-inductive load and is available in single or double spring stack with any contact combination up to 12 springs. The baked varnish impregnated coil will stand constant duty with dissipation of only .50 to .75 watts and will operate on varying line source within 18% of rated voltage without hum.

Either the MTA for AC or MT for DC meet UL

and JAN specifications and are essentially shock or vibration proof. They are particularly suited to aircraft application.

Developed to meet the requirements of today's exacting miniaturization program, the MTA relay is only one of POTTER & BRUMFIELD'S answers to the demand for reliable miniature component parts for control equipment.

150 standard basic models for power, telephone, plate circuit, motor starting and all general applications, or we will design and produce practical relays for special requirements. Tear out this ad and pin it to your letterhead for *New Relay Catalog*.

## Potter & Brumfield

SALES COMPANY

549 WEST WASHINGTON ST., CHICAGO 6, ILLINOIS - FACTORY PRINCETON, INDIANA  
EXPORT 2020 ENGINEERING BLDG., CHICAGO 6, ILL. - CABLE ADDRESS ENOTS  
*Your Electronics Parts Distributor stocks many models of P & B relays*

# OUTSTANDING

Follow the Leaders to



The Eimac 4-125A

Look about you . . . check the equipment shows . . . thumb through the trade magazines . . . talk to design engineers . . . yes, the Eimac 4-125A power tetrode is the standout vacuum tube, accepted in all fields of electronic endeavor for its stability, long-life and dependability.

Each tube is backed by the combined engineering resources of Eitel-McCullough plus over a million hours of proven field-service. It's Pyrovac<sup>®</sup> plate is highly resistant to momentary overloads and contributes to the tube's long life. Processed grids control primary and secondary emission, providing a high degree of operational stability. The tube is ruggedly designed to withstand abnormal physical as well as electrical abuse.

Detailed data and application notes are immediately available and statistics for unusual applications will be supplied on request.

## EITEL-McCULLOUGH, INC.

204 San Mateo Ave., San Bruno, California

Export Agents: Frazer & Hansen, 310 Clay Street, San Francisco 11, California

\*Reg. Trade Mark

Filament: Thoriated tungsten	
Voltage	5.0 volts
Current	6.5 amperes
Grid-Screen Amplification Factor (Average)	6.2

RADIO FREQUENCY POWER AMPLIFIER AND OSCILLATOR		HIGH-LEVEL MODULATED RADIO FREQUENCY AMPLIFIER		AUDIO FREQUENCY POWER AMPLIFIER AND MODULATOR			
Class-C Telephony or FM Telephony Maximum Ratings (Key-down conditions, 1 tube)		Class-C Telephony (Carrier conditions unless otherwise specified, 1 tube)		Class AB <sup>1</sup> (Sinusoidal wave, two tubes unless otherwise specified)		Class-AB <sup>2</sup> (Sinusoidal wave, two tubes unless otherwise specified)	
D-C PLATE VOLTAGE	3000 MAX. VOLTS	2500 MAX. VOLTS		D-C PLATE VOLTAGE	3000 MAX. VOLTS	3000 MAX. VOLTS	
D-C SCREEN VOLTAGE	400 MAX. VOLTS	400 MAX. VOLTS		D-C SCREEN VOLTAGE	600 MAX. VOLTS	400 MAX. VOLTS	
D-C GRID VOLTAGE	-500 MAX. VOLTS	-500 MAX. VOLTS		D-C GRID VOLTAGE	-94	-96	
D-C PLATE CURRENT	275 MAX. MA.	200 MAX. MA.		MAX-SIGNAL D-C PLATE CURRENT, PER TUBE	225 MAX. MA.	225 MAX. MA.	
PLATE DISSIPATION	125 MAX. WATTS	85 MAX. WATTS		PLATE DISSIPATION, PER TUBE	125 MAX. WATTS	125 MAX. WATTS	
SCREEN DISSIPATION	20 MAX. WATTS	20 MAX. WATTS		SCREEN DISSIPATION, PER TUBE	20 MAX. WATTS	20 MAX. WATTS	
GRID DISSIPATION	5 MAX. WATTS	5 MAX. WATTS					
Typical Operation (Frequencies below 120 Mc.)				TYPICAL OPERATION			
D-C Plate Voltage	2500 3000 volts	2000 2500 volts		D-C Plate Voltage	2000 2500 volts	2000 2500 volts	
D-C Screen Voltage	350 350 volts	350 350 volts		D-C Screen Voltage	400 400 volts	350 350 volts	
D-C Grid Voltage	-150 -150 volts	-220 -210 volts		D-C Grid Voltage	-94 -96 volts	-45 -43 volts	
D-C Plate Current	200 167 ma.	150 152 ma.		Zero-Signal D-C Plate Current	50 50 ma.	72 93 ma.	
D-C Screen Current	40 30 ma.	33 30 ma.		Max-Signal D-C Plate Current	240 232 ma.	300 260 ma.	
D-C Grid Current	12 9 ma.	10 9 ma.		Zero-Signal D-C Screen Current	-0.5 -0.3 ma.	0 0 ma.	
Screen Dissipation	14 10.5 watts	11.5 10.5 watts		Max-Signal D-C Screen Current	6.4 8.5 ma.	5 6 ma.	
Grid Dissipation	2 1.2 watts	1.6 1.4 watts		Effective Load, Plate-to-Plate	13,400 20,300 ohms	13,600 22,200 ohms	
Peak R-F Grid Input Voltage (approx.)	320 280 volts	375 360 volts		Peak A-F Grid Input Voltage (per tube)	94 96 volts	105 89 volts	
Driving Power (approx.)	3.8 2.5 watts	3.8 3.3 watts		Driving Power	0 0 watts	1.4 1 watts	
Plate Power Input	500 500 watts	300 380 watts		Max-Signal Plate Dissipation (per tube)	125 125 watts	125 122 watts	
Plate Dissipation	125 125 watts	75 80 watts		Max-Signal Plate Power Output	230 330 watts	350 400 watts	
Plate Power Output	375 375 watts	225 300 watts		Total Harmonic Distortion	2 2.6 perct.	1 2.2 perct.	

NOW WITH . . . Pyrovac Plates • Processed Grids



for the BEST in reception and performance use

# "NOFLAME-COR"

the TELEVISION hookup wire

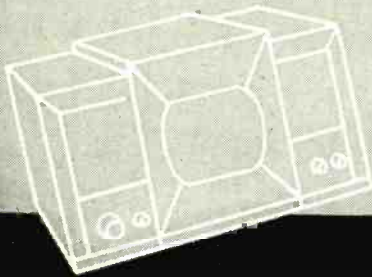

by



approved by  
Underwriters' Laboratories at

**90°** CENTIGRADE **600** VOLTS

- Flame Resistant
- Heat Resistant
- High Insulation Resistance
- High Dielectric
- Easy Stripping
- Facilitates Positive Soldering

- Also unaffected by the heat of impregnation—  
therefore, ideal for coil and transformer leads

Chosen after exhaustive tests by leading manufacturers of television, F-M, quality radio and all exacting electronic applications. Available for immediate delivery in all sizes, solid and stranded, in over 200 color combinations . . . ready to demonstrate anew the Efficiency and Economy of CORNISH WIRES AT WORK.

COMPLETE ENGINEERING DATA AND SAMPLES ON REQUEST

RUBBER	_____	75°
PLASTIC	_____	80°
<b>"NOFLAME-COR"</b>	_____	<b>90°</b>

*"made by engineers for engineers"*



## CORNISH WIRE COMPANY, Inc.

605 North Michigan Avenue,  
Chicago 11

15 Park Row, New York 7, N. Y.

1237 Public Ledger Bldg.,  
Philadelphia 6

MANUFACTURERS OF QUALITY WIRES AND CABLES FOR THE ELECTRICAL AND ELECTRONIC INDUSTRIES

# RELY ON alliance motors

FOR  
Fans • Room Heaters • Air Circulators • Air Conditioners •  
Gas and Oil Burners • Unit Coolers • Window Ventilators • Recorders

Alliance Model B is another new, 4-pole shaded type induction motor. It is especially adapted to fan blades and other mechanical loads. This motor is made in three standard stack thicknesses with variable horsepower ratings for particular operating conditions such as fan loads—other mechanical loads—continuous or intermittent duty. And to further meet varied load requirements, Alliance Model B can be supplied semi-enclosed as illustrated or completely enclosed with oil tubes and oilers.

With a range of power ratings from 1/100 h.p. up to 1/25 h.p. and a speed of 1550 rpm, Model B, like all Alliance motors lends itself to mass production at low cost.

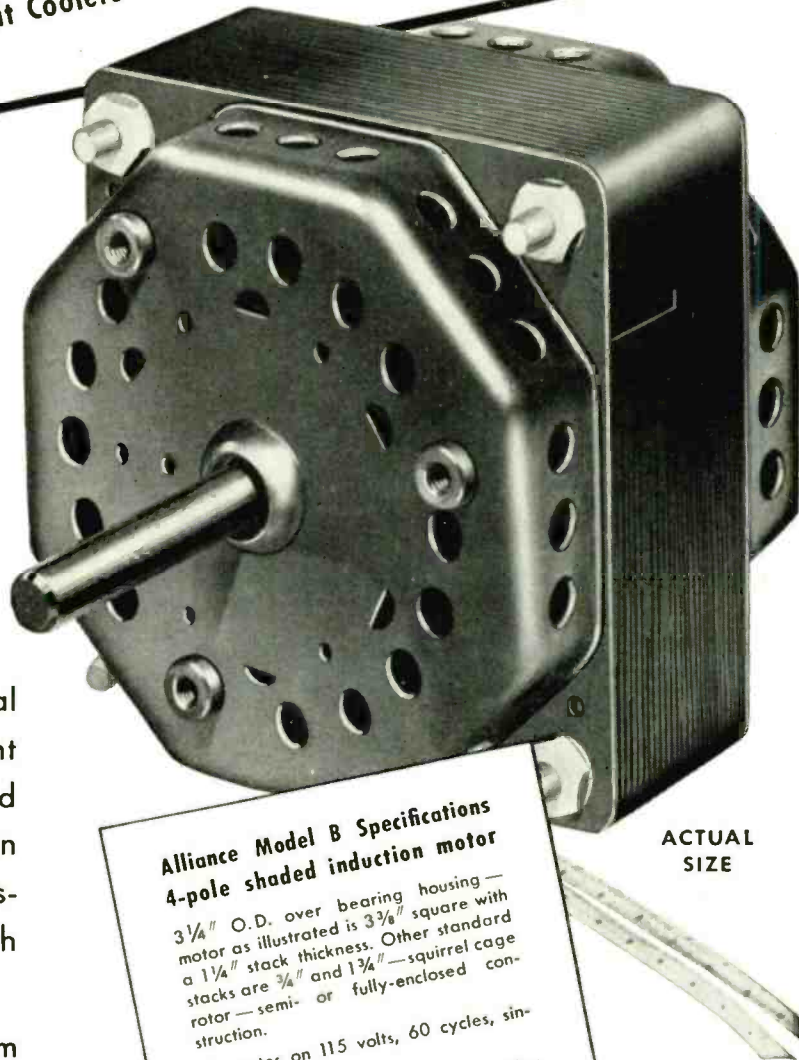

## Alliance Model B Specifications 4-pole shaded induction motor

3 1/4" O.D. over bearing housing—  
motor as illustrated is 3 3/8" square with  
a 1 1/4" stack thickness. Other standard  
stacks are 3/8" and 1 3/4"—squirrel cage  
rotor—semi- or fully-enclosed con-  
struction.

Operates on 115 volts, 60 cycles, sin-  
gle phase.

Weight as shown 4 1/2 lbs. Starting  
torque approx. 40% of torque at full  
load rating. Can be made with single  
or double 5/16" shaft. Construction is  
simple but rugged throughout.

WHEN YOU DESIGN—KEEP

# alliance

MOTORS IN MIND

ALLIANCE MANUFACTURING COMPANY • ALLIANCE, OHIO

Export Department: 401 Broadway, New York 13, N. Y., U. S. A.



# for mobile two-way radio

## ALLIED'S NEW CO-AXIAL RELAY

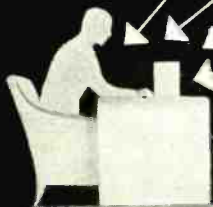
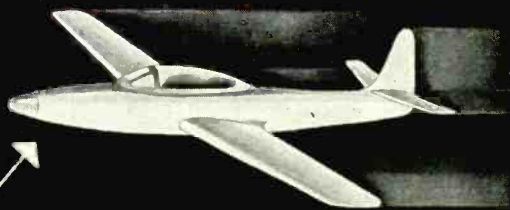
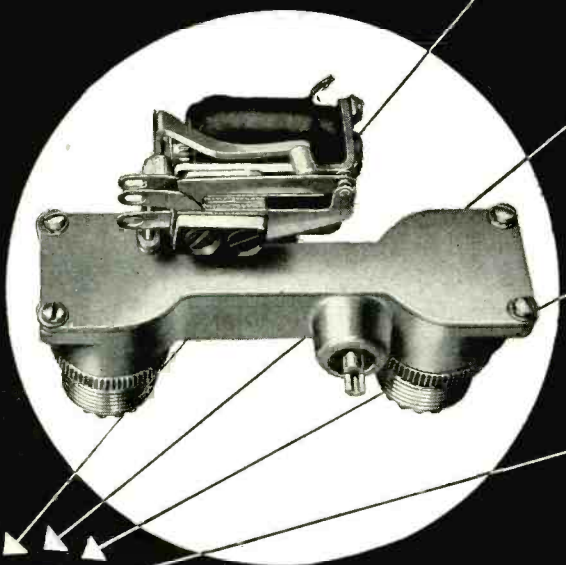

The new Allied "RA" relay transfers 52 ohm antenna transmission line (type RG-8U Cable) from receiving to transmitting position. It is now used in police car radios and is highly recommended for both mobile and stationary applications.

This new relay is equipped with two Co-Axial cable fittings and one insulated transmitter line terminal. Co-Axial fittings for antenna and receiver connection are die cast as part of the metal housing. They will accommodate Signal Corps cable connector PL-259. Auxiliary double-pole, double-throw contacts can be supplied when specified.

### NEW RELAY GUIDE

This new folder shows 24 small, compact Allied Relays with a carefully detailed table of characteristics and specifications. Write for YOUR free copy today.

### ENGINEERING FEATURES OF THE ALLIED TYPE "RA" RELAY

**Contact Rating:** Antenna transfer contacts will handle a maximum of 75 watts of radio frequency up to 150 megacycles when inserted in a properly terminated 52 ohm line. Auxiliary contacts have a non-inductive rating of 1 ampere at 24 volts D.C. or 115 volts A.C.

**Coil Rating:** Up to 110 volts D.C. and 115 volts A.C. 60 cycles.

Coil No.	D.C. Volts	D.C. Current	D.C. Resistance
31	6.	.46	13.
34	12.	.22	54.
38	26.5	.083	320.
40	48.	.060	800.
43	110.	.026	4100.

(This table is based on an average power rating of 2.5 watts. Minimum operating voltages are 80% of voltages shown above.)

**Dimensions:** 2" x 2<sup>7</sup>/<sub>8</sub>" x 1<sup>3</sup>/<sub>4</sub>". **Weight:** 4 oz.



**ALLIED CONTROL COMPANY, INC.**  
2 EAST END AVENUE, NEW YORK 21, N. Y.

# NOW

A NEW FLUX FOR CORED SOLDER

# "RESIN-FIVE"

*"Resin-Five" Is More Active . . . More Efficient . . . More Stable  
. . . Than ANY Rosin Flux . . . And Yet*

**NON-CORROSIVE      NON-CONDUCTIVE**



### ODORLESS!

. . . Yes—"RESIN-FIVE" is virtually without odor at relatively high temperatures!

### MOBILITY!

. . . "RESIN-FIVE" is so mobile it is highly effective in sweating seams. The activity and stability of "RESIN-FIVE" Flux make this an accomplished fact!



"Resin-Five" is Available In 5 Core Sizes with Varying Percentages of Flux Content. Diameters ranging from .010" to .250"—All Practical Alloys!

### ACTIVITY UNEQUALED!

. . . Just Think This—"RESIN-FIVE" will solder easily and readily such metals as Zinc, Brass, Nickel Silver, Nickel-Plate, Copper and Ferrous Alloys. REMEMBER "RESIN-FIVE" IS NOT CORROSIVE AND IS NOT CONDUCTIVE!

### STABILITY!

. . . "RESIN-FIVE" is STABLE under the most extreme soldering temperatures and the Flux still does the job!

Contact Kester's Technical Department and get the facts on this unusual product.

**NON-CORROSIVE      •      NON-CONDUCTIVE**

**KESTER  
SOLDER**

**KESTER SOLDER COMPANY**

4201 W. Wrightwood Avenue, Chicago 39, Illinois

Factories also at Newark, N. J. • Brantford, Canada





4-WINGED DRIVER CAN'T SLIP OUT OF PHILLIPS TAPERED RECESS

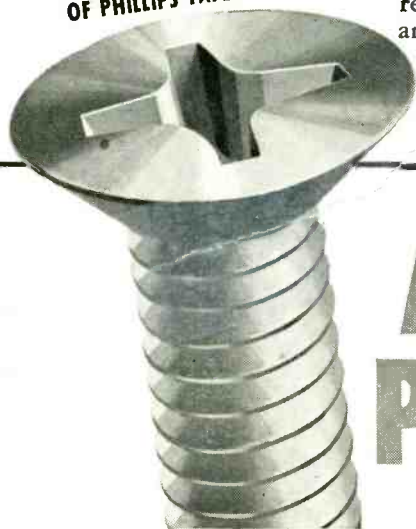

# HOW American Phillips Screws

## "Make Better Sport"

both for  
Makers and Users of  
Sporting Goods

**THEY MAKE WORK EASIER...** in fact, American Phillips Screws make assembly a *pleasure* because, as one user says: "*They're 3 times faster to find and drive!*" And they're far easier to handle, to drive at angles, and into cranky inside corners. Any worker who "goes crooked" with slotted screws will "go straight" with American Phillips... the only screw with the tapered, engineered recess. Fatigue is banished. Production stays up all day long. *And time-savings, too, stay up around 50%.*

**THEY MAKE SELLING EASIER...** American Phillips Screws look new, modern, craftsmanlike... plainly say: "*Here's a top-quality product!*" And when your dealers sell the whole story of American Phillips *extra* holding strength, vibration-resistance, and greater dependability in strenuous use... then watch sales-resistance melt away. Get these double-barrelled production and sales advantages for your product. **WRITE.**

**AMERICAN SCREW COMPANY, PROVIDENCE 1, RHODE ISLAND**  
Chicago 11: 589 E. Illinois St.      Detroit 2: 502 Stephenson Building

# AMERICAN PHILLIPS *Screws*



**ALL TYPES**  
ALL METALS: Steel, Brass, Bronze, Stainless Steel, Aluminum, Monel, Everdur (silicon bronze)

# Flexural and Compressive Strength

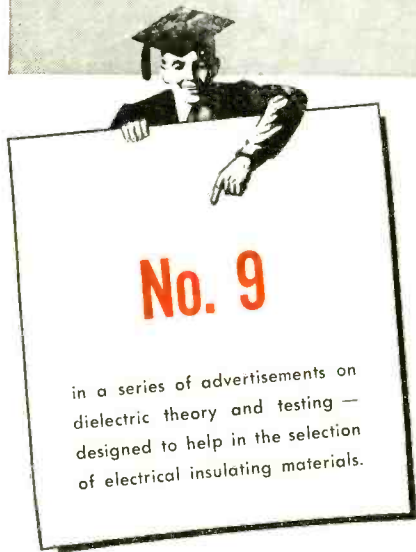

Mechanical and electrical stresses encountered in electrical equipment confront the designer with many factors to weigh in selecting the insulating material which will provide optimum performance characteristics.

In some applications, what might seem conservative design from the standpoint of electrical stress is explained by other performance essentials. Why, for example, for insulating commutator bars in small dc motors, should a material of such high dielectric strength as mica segment plate be used, when electrical stress between bars is only a few volts? The reasons are found in other requirements that only mica satisfies: temperature resistance, moisture resistance, non-carbonization under poor commutating conditions, a uniform rate of compression and ability to stay in place under repeated temperature fluctuations.

In large rotating machines, peripheral speeds are high: extreme compressive, flexural, tensile and abrasive forces are encountered. Voltage may also be quite high. Because efficiency depends upon the amount of conducting (and *not* insulating) material in the slots, electrical insulation must be quite thin yet possess high dielectric strength.

## WEIGH ALL FACTORS

Insulation performance requirements are as varied as the types of electrical equipment manufactured. Standard methods of testing established by the ASTM supply important values for comparison, specification and design.

### FLEXURAL STRENGTH TEST<sup>1</sup>

This test determines the load in pounds required to break a test specimen of sheet or plate material loaded at the center as a simple beam. Supports and loading nose of the testing apparatus have contact edges rounded to a radius of 1/8" for material 1/8" thick or over, and to a radius of 1/16" for thinner materials. Distance between the supports is 4" for edgewise tests and eight times material thickness for flatwise tests.

Test specimens are 1/2" in width, except for specimens over 1/2" thick being tested flatwise, where the width is made equal to the specimen thickness.

Test reports include: (1) directions of cutting and loading the specimen; (2) thickness and width of each specimen to the nearest .001"; (3) the room temperature; (4) breaking load in pounds; (5) maximum fiber stress in pounds per square inch calculated from the formula:

$$S = \frac{3Pl}{2bd^2}$$

where S = maximum fiber stress, P = breaking load in pounds, l = distance between supports, b = width of specimen, and d = depth of specimen.

### COMPRESSIVE STRENGTH TEST<sup>1</sup>

Apparatus for the compressive strength test is illustrated in Figure 1. Test specimen for sheets 1" thick or over is a 1" cube with faces flat and perpendicular

to the axis. Where sheets are less than 1" thick, the specimen consists of a pile of sheets 1" square at least 1" high.

Where material under compression fails by a shattering fracture, the compressive strength has a definite value. Where the material does not fracture, the value obtained for compressive strength is an arbitrary value, depending upon the degree of distortion allowed as indicating failure.

Test reports include: (1) significant dimensions of each specimen; (2) load on each specimen in pounds at time of failure; (3) ultimate compressive load strength in pounds per square inch calculated from measured area before load is applied; (4) description of material and how it acts under test; and (5) room temperature.

<sup>1</sup>ASTM Designation D229-46.

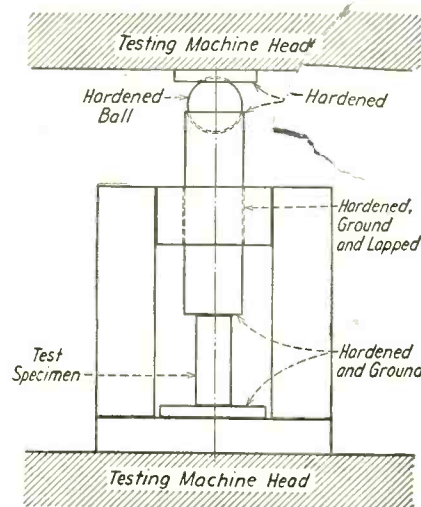

Figure 1 — Typical design of tool for making compressive strength tests.

### LAMICOID SHEETS — AVERAGE VALUES

NEMA GRADE	Flexural Strength, psi 1/16" to 1"	Compressive Strength		Dielectric Strength v/m, 1/16" to 1/8" Short Time
		Flatwise, psi 1/16" to 1"	Edge-wise, psi 1/16" to 1"	
X	23000	35000	500	
P	15000	22000	500	
XX	16000	34000	500	
XXP	16000	25000	500	
XXX	15000	32000	470	
XXXP	15000	25000	470	
C	20000	38000	150	
CE	17000	36000	360	
L	20000	35000	150	
LE	19000	37000	360	
A	16000	36000	160	
AA	20000	38000	50	





# ELECTRIC "LIFE BELTS"

**for domestic  
hot water  
heaters**

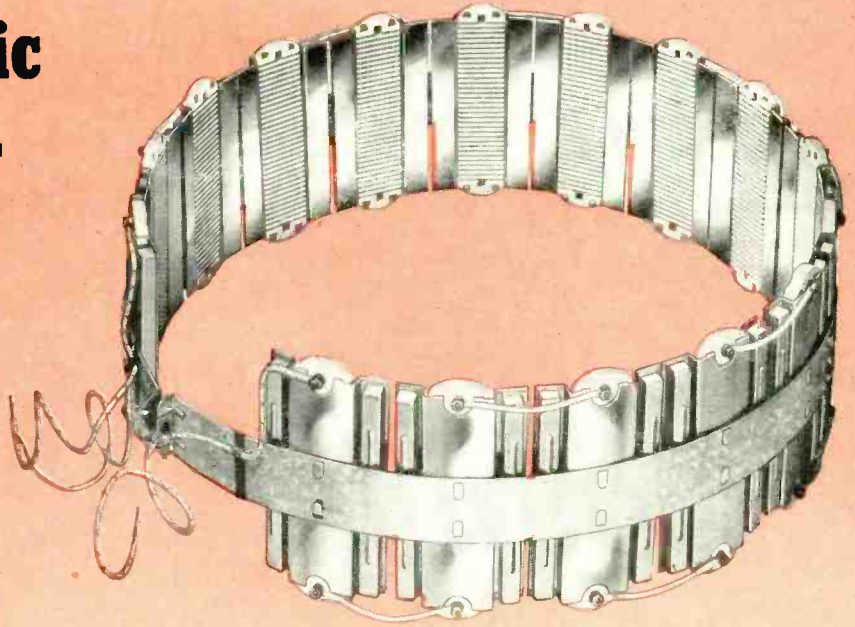
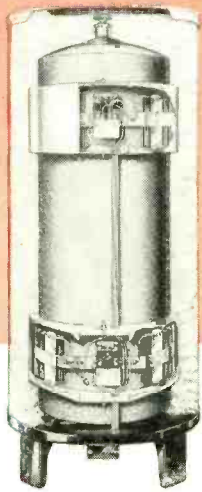

When water in municipal systems contains dissolved minerals and chlorine, it becomes a fairly efficient electrolyte.

To avoid electrolytic corrosion which may occur if dissimilar metals are in contact with the water, the Toastmaster Water Heater employs "LIFE BELT" heating elements attached to the outside of the tank. In such an application, the ability of the elements to give long, trouble-free, economical service rests solely upon the quality of the electrical resistance material used. To assure top-level performance for a lifetime, the McGraw Electric Co., maker of the Toastmaster Water Heater, specifies Nichrome.\*

The tank of the Toastmaster Heater is further protected by McGraw's new "Ionodic" system of corrosion prevention, where a magnesium

rod anode, immersed in the water, saves the cathodic material of the tank from electrolytic attack.

Thus the manufacturers are able proudly to state: "We guarantee the Toastmaster Electric Water Heater for 10 years, and we deem this to be a conservative commitment. Many water heaters made by this company are still in daily use after several times this length of service, and elements in the old water heaters show little wear and no loss of efficiency."

Profit by the example of the McGraw Electric Co. and specify Nichrome. And remember, Driver-Harris manufactures over 80 alloys designed to fill the numerous requirements of the Electrical and Electronic industries... fully described in our catalog R-46.

Nichrome is Manufactured only by

***Driver-Harris Company***

HARRISON, NEW JERSEY

BRANCHES: Chicago, Detroit, Cleveland, Los Angeles, San Francisco, Seattle

Manufactured and sold in Canada by

The B. GREENING WIRE COMPANY, LTD., Hamilton, Ontario, Canada





**RCA Type WX-2A**  
**540-1600 kc.**  
**Price \$575\***



*At Last—*

The new Portable Field-Intensity Meter, RCA Type WX-2—shown one-third actual size. A loop antenna is built right into the lid!

## **a truly portable Field-Intensity Meter**

● Weighing only 12½ pounds—including batteries, here's a small, compact field-intensity meter of high accuracy that carries around like a portable radio . . . and operates almost as simply. You tune in a signal, adjust a *built-in* calibrating oscillator and receiver gain . . . and *read signal intensity directly in microvolts-per-meter*. No charts, curves, or correction factors to worry about. No computations to make.

Designed with a wide sensitivity range of 10 microvolts/meter to 10 volts/meter, Type WX-2A enables you to make field-strength readings anywhere—from the very shadow of your transmitter, to the toughest location "down-in-the-

\*Subject to change without notice.

noise." Plenty of front-end selectivity, too. Loop antenna Q is approximately 100 at one megacycle; An r-f amplifier stage provides a very high order of image rejection.

Power supply; Ordinary flashlight dry cells for the quick-heating tube filaments—and a 67-volt battery of the size used in camera-type radios for the B supply.

A lot easier now to get the facts on your coverage, service area, and antenna efficiency . . . with RCA's new portable WX-2A. Ask your RCA Broadcast Sales Engineer for the facts. Or write Department 36-J, RCA Engineering Products, Camden, New Jersey.



**BROADCAST EQUIPMENT**  
**RADIO CORPORATION of AMERICA**  
**ENGINEERING PRODUCTS DEPARTMENT, CAMDEN, N.J.**

In Canada: RCA VICTOR Company Limited, Montreal



**Now! Specify**

# KENYON

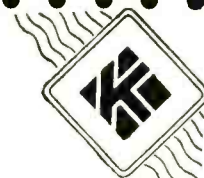

**KENYON** one of the oldest names in transformers, offers high quality specification transformers custom-built to your requirements. For over 20 years the KENYON "K" has been a sign of skillful engineering, progressive design and sound construction.

**KENYON** now serves many leading companies including: Times Facsimile Corporation, Western Electric Co., General Electric Co., Schulmerich Electronics, Sperry Gyroscope Co., Inc.

Yes, *electronification* of modern industrial machinery and methods has been achieved by KENYON'S engineered, efficient and conservatively rated transformers.

For all high quality sound applications, for small transmitters, broadcast units, radar equipment, amplifiers and power supplies — Specify KENYON! Inquire today for information about our JAN approved transformers.

*Check Your Requirements*

**"T" LINE TRANSFORMERS  
HERMETICALLY SEALED TRANSFORMERS  
"A" LINE TRANSFORMERS**

- |                           |                                  |
|---------------------------|----------------------------------|
| ✓ PLATE TRANSFORMERS      | ✓ INPUT & OUTPUT TRANSFORMERS    |
| ✓ FILAMENT TRANSFORMERS   | ✓ SPECIAL FREQUENCY TRANSFORMERS |
| ✓ REACTORS                | ✓ ISOLATION TRANSFORMERS         |
| ✓ CHOKES                  | ✓ AUDIO TRANSFORMERS             |
| ✓ MODULATION TRANSFORMERS | ✓ HUMBUCKING TRANSFORMERS        |
| ✓ INTERSTAGE TRANSFORMERS | ✓ AUTO TRANSFORMERS              |

Now — for the first time in any transformer catalog, KENYON'S new modified edition tells the full complete story about specific ratings on all transformers. Our standard line saves you time and expense. Send for the latest edition of our catalog now!

**SEND FOR OUR CATALOG NOW!**

KENYON Transformer Co., Inc.  
840 Barry Street, New York 59, N. Y.  
Send me the latest edition of your new catalog without obligation

Name..... Address.....  
Position..... City.....  
Company..... State.....

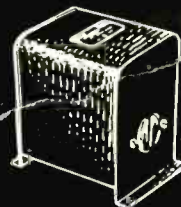
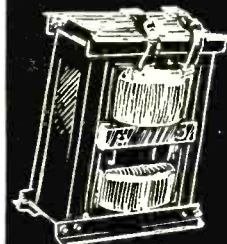
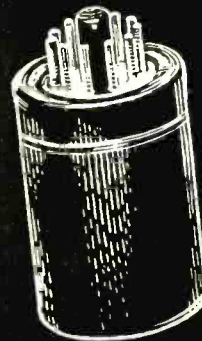
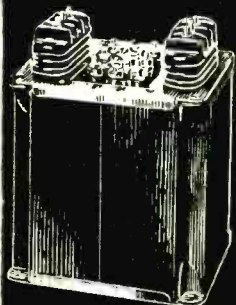
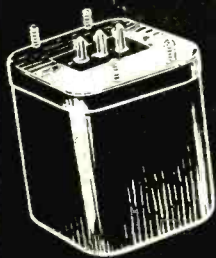
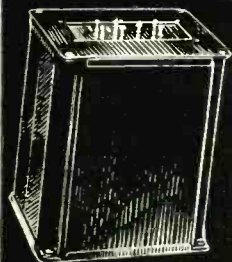

**KENYON TRANSFORMER CO., Inc.** 840 BARRY STREET  
NEW YORK 59, N. Y.

# Tests—Keys to Insulation Selection

## PERFORMANCE-PROVED ELECTRICAL INSULATION FOR EXACTING APPLICATIONS

A limiting factor in performance efficiency and service life of electrical equipment is the dependability of the insulating materials used. Electrical, chemical and physical environments each demand performance standards that make the selection

of the right material a difficult design problem. To meet varied needs, Mica Insulator Company has developed a complete line of products, each offering specific advantages depending upon requirements. Typical applications are illustrated.

**LAMICOID** brackets provide the high mechanical strength necessary for bracing end-windings against short circuit stresses. This thermosetting laminated material may be used for spacers placed at frequent intervals between coils, as well as for braces to which the coils are lashed with strong cords. Clamps or cleats of the same material may be attached to provide rigidity to prevent movement of the coils.

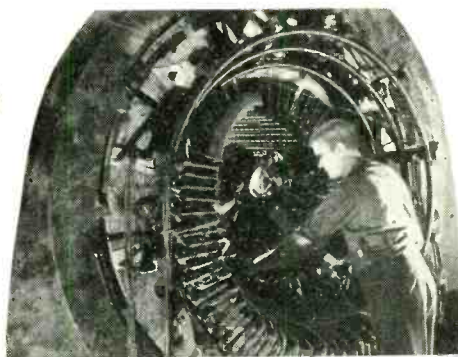

**MICANITE** segment plate composed of amber mica splittings, finds primary application in flush-type commutators, as in this dc motor, where mica and copper wear down uniformly. For under-cut commutators, Micanite composed of India mica splittings is more economical. Segment Micanite contains approximately 94% mica and 6% binder, and is manufactured for minimum compressibility under heat and pressure. Films do not slip or exude cement when properly assembled.

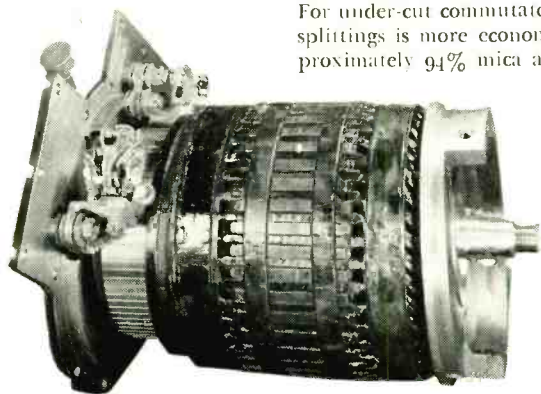

**EMPIRE** varnished Fiberglas provides high tensile strength, small stretch and flexibility needed when insulating leads to this 15,000 KVA, 3-phase, 60-cycle outdoor type transformer. Varnished Fiberglas is a Class B insulation which will withstand a "hottest-spot" temperature of 130° C (266° F). The impregnating varnish, from which electrical characteristics are derived, shows unusual resistance to corona and ozone, especially important for high-voltage applications. Varnished Fiberglas also resists moisture and most acids.

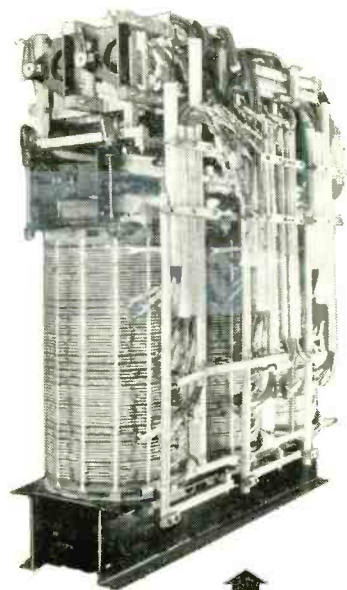

Fifty-five years of specialized experience in the development, manufacture and improvement of electrical insulating materials has enabled Mica Insulator Company to keep pace with the increasingly exacting requirements of electrical equipment builders. We welcome the opportunity to work with you in the selection and application of our complete line of materials. Consult our Technical Service Department on your insulating problems.

# Insulator COMPANY

SCHENECTADY 1, NEW YORK

Atlanta • Birmingham • Boston • Chicago • Cincinnati • Cleveland • Detroit • Houston  
Los Angeles • Milwaukee • New York • Philadelphia • Rochester • St. Louis • San Francisco



Trade mark



**WE CAN HELP YOU WITH**

# Energy-Storage Capacitors!

Our experience—in engineering, designing, and building performance into energy-storage and discharge capacitors—may provide just the help you are looking for.

Do you make discharge welding or photographic flash-tube equipment? Radar equipment? Flash beacons, aircraft signalling, or similar devices? Or research tools, from spectrosopes to cyclotrons? We have furnished a large proportion of the capacitors used for all of these applications.

Unusual applications, too—like those listed below—are a specialty with us. Whatever your problem, let our engineers give you a hand. Apparatus Dept., General Electric Company, Schenectady 5, N. Y.

**NEED SQUARE WAVES?** Pulse-forming networks can provide them. Networks are used where the normal capacitor discharge wave shape is not suitable and where an impulse must have definite energy content and duration. The Type E network, produced by General Electric, consists of capacitor and coil sections, adjusted to close tolerances, and hermetically sealed in single metal containers. Built by the thousands for radar, they are now available for commercial use.

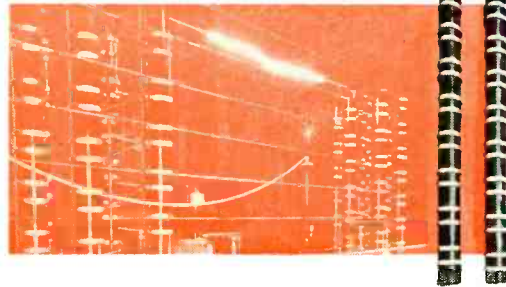
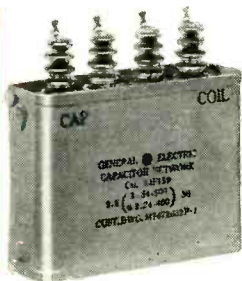
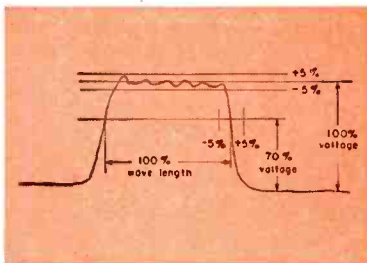

**NEED ARTIFICIAL LIGHTNING?** Potent artificial lightning bolts—at voltages up to 10,000,000—are not a usual need. But when required—for universities, laboratory testing, or exhibition—General Electric can build the capacitors. A typical example is the 100-kv d-c unit, about 3 feet in diameter and 2 feet high. Units can be stacked, as shown, for ease of installation and minimum space. In some instances as many as 100 separate units have been placed in series to produce 10,000,000 volt discharges.



**OR DO YOU WANT TO TAKE A PICTURE?** A maker of flash-tube photographic equipment wanted a lighter capacitor for his portable sets. Our designers went to work and came up with just what he desired—and one which he could use, also, for his studio equipment at a considerable saving in price. (In case you're interested, this capacitor is rated 14 muf, weighs 2½ lb, and delivers 43.8 watt-seconds with 1000 hour service life or 58 watt-seconds at 400 hours. Used in pairs, they replace a 28 muf-studio capacitor, save in cost too.)

**GENERAL  ELECTRIC**

407-175

*Specialty Capacitors*  
**FOR**

Motors  
Luminous-tube transformers  
Fluorescent lamp ballasts

Industrial control  
Radio filters  
Radar  
Electronic equipment  
Communication systems  
Capacitor discharge welding

Flash photography  
Stroboscopic equipment  
Television  
Dust precipitators  
Radio interference suppression  
Impulse generators

AND MANY OTHER APPLICATIONS

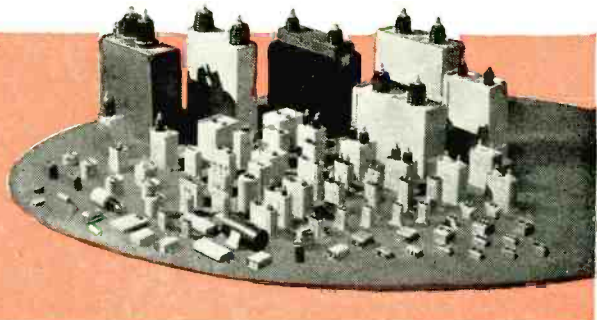

Some call it:  
**SLIP RING ASSEMBLY**

Some call it:  
**COLLECTOR RING ASSEMBLY**

Some call it:  
**ROTOR ASSEMBLY**

whatever you call it . . .

**it's a  
PMI  
SPECIALTY**

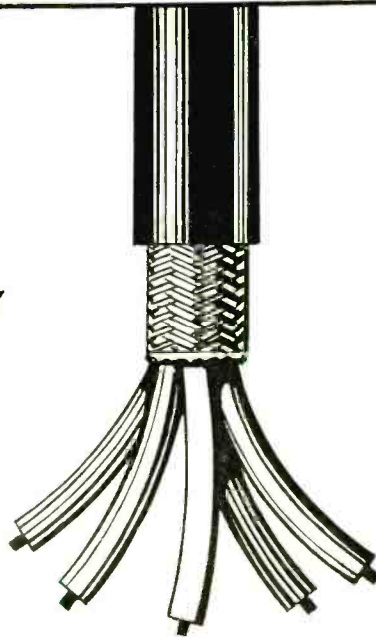

When you break wires to permit free rotation—that is where this PMI specialty comes in. We are currently handling all phases of this type of work, including design, manufacture of prototypes and production assemblies. PMI experience includes monitoring, video and power circuit requirements. We are manufacturing on a volume basis production assemblies ranging from 3-circuits to more than 200. Let us consult with you on your requirements.

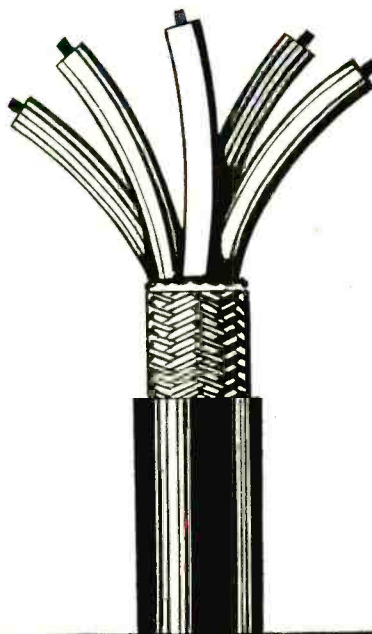

**PLASTIC MANUFACTURERS**  
INCORPORATED  
**STAMFORD CONNECTICUT**

INJECTION • TRANSFER & COMPRESSION MOLDING • COMPLETE ASSEMBLY



**TAP DRILL SIZES**

The values of standardizing the size of drill bits to use with the various sizes of hole are given in this table. The values are given in inches and millimeters. The values are given in inches and millimeters. The values are given in inches and millimeters.



Tap Size	Tap Size	Tap Size	Tap Size	Tap Size
No. 1	No. 2	No. 3	No. 4	No. 5
No. 6	No. 7	No. 8	No. 9	No. 10
No. 11	No. 12	No. 13	No. 14	No. 15
No. 16	No. 17	No. 18	No. 19	No. 20
No. 21	No. 22	No. 23	No. 24	No. 25
No. 26	No. 27	No. 28	No. 29	No. 30
No. 31	No. 32	No. 33	No. 34	No. 35
No. 36	No. 37	No. 38	No. 39	No. 40
No. 41	No. 42	No. 43	No. 44	No. 45
No. 46	No. 47	No. 48	No. 49	No. 50

# THE M-R WALL SHEET

**COPPER WIRE CARD**

Wire Size	Area	Weight	Resistance	Capacity
14	0.0370	0.0020	1.62	1.5
12	0.0541	0.0031	1.08	2.0
10	0.0773	0.0044	0.73	2.5
8	0.1104	0.0062	0.52	3.5
6	0.1590	0.0087	0.39	5.0
4	0.2243	0.0121	0.28	7.0
2	0.3217	0.0170	0.16	10.0
0	0.4415	0.0231	0.10	15.0
2	0.5963	0.0311	0.07	20.0
4	0.7973	0.0418	0.05	25.0
6	1.0603	0.0557	0.04	30.0
8	1.3923	0.0731	0.03	35.0
10	1.7923	0.0944	0.02	40.0
12	2.3523	0.1207	0.01	45.0
14	3.0723	0.1531	0.01	50.0
16	3.9523	0.1927	0.01	55.0
18	5.0723	0.2407	0.01	60.0
20	6.5323	0.2983	0.01	65.0
22	8.4323	0.3667	0.01	70.0
24	10.8723	0.4471	0.01	75.0
26	13.9523	0.5417	0.01	80.0
28	17.7723	0.6527	0.01	85.0
30	22.4323	0.7823	0.01	90.0
32	28.0323	0.9323	0.01	95.0
34	34.6723	1.1023	0.01	100.0
36	42.4523	1.2923	0.01	105.0
38	51.3723	1.5023	0.01	110.0
40	61.4323	1.7323	0.01	115.0
42	72.6323	2.0823	0.01	120.0
44	85.0723	2.4523	0.01	125.0
46	98.7523	2.8423	0.01	130.0
48	113.6723	3.2523	0.01	135.0
50	129.9323	3.6823	0.01	140.0
52	147.5323	4.1323	0.01	145.0
54	166.4723	4.6023	0.01	150.0
56	186.7523	5.0923	0.01	155.0
58	208.3723	5.6023	0.01	160.0
60	231.3323	6.1323	0.01	165.0
62	255.6323	6.6823	0.01	170.0
64	281.2723	7.2523	0.01	175.0
66	308.2523	7.8423	0.01	180.0
68	336.5723	8.4523	0.01	185.0
70	366.2323	9.0823	0.01	190.0
72	397.2323	9.7323	0.01	195.0
74	429.5723	10.4023	0.01	200.0
76	463.2523	11.0923	0.01	205.0
78	498.2723	11.8023	0.01	210.0
80	534.6323	12.5323	0.01	215.0
82	572.3323	13.2823	0.01	220.0
84	611.3723	14.0523	0.01	225.0
86	651.7523	14.8423	0.01	230.0
88	693.4723	15.6523	0.01	235.0
90	736.5323	16.4823	0.01	240.0
92	780.9323	17.3323	0.01	245.0
94	826.6723	18.2023	0.01	250.0
96	873.7523	19.0923	0.01	255.0
98	922.1723	19.9923	0.01	260.0
100	971.9323	20.9123	0.01	265.0

**COMMON FRACTIONS OF AN INCH TO MILLIMETERS**

Fraction	Millimeter	Fraction	Millimeter
1/16	1.5875	1/2	12.7000
1/8	3.1750	5/8	15.8750
3/16	4.7625	3/4	19.0500
1/4	6.3500	7/8	22.2250
5/16	7.9375	1	25.4000
3/8	9.5250		
7/16	11.1125		
1/2	12.7000		
9/16	14.2875		
5/8	15.8750		
11/16	17.4625		
3/4	19.0500		
13/16	20.6375		
7/8	22.2250		
15/16	23.8125		
1	25.4000		

**OHM'S LAW**

$$E = I \times R \quad I = \frac{E}{R} \quad R = \frac{E}{I}$$

E = Current strength in Volts  
I = Resistance in Ohms  
R = Resistance in Ohms

**ELECTRICAL SYMBOLS for ARCHITECTURAL PLANS**

Symbol	Description
Circle with dot	Light
Circle with cross	Ground
Circle with slash	Alarm
Circle with triangle	Door
Circle with square	Switch
Circle with diamond	Relay
Circle with star	Motor
Circle with plus	Transformer
Circle with minus	Generator
Circle with asterisk	Antenna
Circle with hash	Telephone
Circle with percent	Radio
Circle with dollar	Television
Circle with ampersand	Sound
Circle with at	Music
Circle with copyright	Copyright
Circle with registered	Registered
Circle with trademark	Trademark
Circle with service	Service
Circle with copy	Copy
Circle with all rights reserved	All rights reserved

**"EVERYTHING IN INSULATION"**

**Mitchell-Rand Insulation Co.**  
51 Murray Street, New York 7, N. Y.

**AS A SERVICE TO THE ELECTRICAL INDUSTRIES, MITCHELL-RAND OFFERS ITS WALL SHEET FREE UPON WRITTEN REQUEST**

**INCHES TO MILLIMETERS**

Inches	Millimeters	Inches	Millimeters
1/16	1.5875	1/2	12.7000
1/8	3.1750	5/8	15.8750
3/16	4.7625	3/4	19.0500
1/4	6.3500	7/8	22.2250
5/16	7.9375	1	25.4000
3/8	9.5250		
7/16	11.1125		
1/2	12.7000		
9/16	14.2875		
5/8	15.8750		
11/16	17.4625		
3/4	19.0500		
13/16	20.6375		
7/8	22.2250		
15/16	23.8125		
1	25.4000		

**LAW OF COSINES**

$$a^2 = b^2 + c^2 - 2bc \cos A$$

a = Side opposite angle A  
b = Side opposite angle B  
c = Side opposite angle C

**CONDENSED TABLE OF NATURAL VALUES OF TRIGONOMETRIC FUNCTIONS OF IMPORTANT ANGLES**

Angle	Sin	Cos	Tan	Cot	Sec	Csc
0°	0.0000	1.0000	0.0000	∞	1.0000	∞
15°	0.2598	0.9659	0.2679	0.3717	1.0321	1.0980
30°	0.5000	0.8660	0.5774	0.7071	1.1547	1.1547
45°	0.7071	0.7071	1.0000	1.0000	1.4142	1.4142
60°	0.8660	0.5000	1.7321	0.5774	2.0000	1.1547
75°	0.9659	0.2598	3.7622	0.2679	3.8637	1.0980
90°	1.0000	0.0000	∞	0.0000	∞	1.0000

**ALLOWABLE CURRENT-CARRYING CAPACITIES OF CONDUCTORS IN AMPERES**

Wire Size	Aluminum	Copper
14	15	20
12	20	25
10	25	30
8	30	35
6	35	40
4	40	45
2	45	50
0	50	55
2	55	60
4	60	65
6	65	70
8	70	75
10	75	80
12	80	85
14	85	90
16	90	95
18	95	100
20	100	105
22	105	110
24	110	115
26	115	120
28	120	125
30	125	130
32	130	135
34	135	140
36	140	145
38	145	150
40	150	155
42	155	160
44	160	165
46	165	170
48	170	175
50	175	180
52	180	185
54	185	190
56	190	195
58	195	200
60	200	205
62	205	210
64	210	215
66	215	220
68	220	225
70	225	230
72	230	235
74	235	240
76	240	245
78	245	250
80	250	255
82	255	260
84	260	265
86	265	270
88	270	275
90	275	280
92	280	285
94	285	290
96	290	295
98	295	300
100	300	305

**COMMON INSULATING MATERIALS**

Material	Dielectric Strength	Dielectric Constant
Asbestos	100-150	2.5-3.0
Cellulose	10-20	2.0-2.5
Enamel	100-200	2.5-3.0
Fiberglass	100-150	2.5-3.0
Glass	100-150	2.5-3.0
Insulating Paper	100-150	2.5-3.0
Mica	100-150	2.5-3.0
Oil	10-20	2.0-2.5
Paraffin	10-20	2.0-2.5
Resin	10-20	2.0-2.5
Silica	100-150	2.5-3.0
Sulfur	10-20	2.0-2.5
Talc	10-20	2.0-2.5
Wax	10-20	2.0-2.5
Wood	10-20	2.0-2.5

**MACHINE SCREWS**

Size	Length	Weight
No. 1	1/4"	0.0010
No. 2	1/4"	0.0015
No. 3	1/4"	0.0020
No. 4	1/4"	0.0025
No. 5	1/4"	0.0030
No. 6	1/4"	0.0035
No. 7	1/4"	0.0040
No. 8	1/4"	0.0045
No. 9	1/4"	0.0050
No. 10	1/4"	0.0055
No. 11	1/4"	0.0060
No. 12	1/4"	0.0065
No. 13	1/4"	0.0070
No. 14	1/4"	0.0075
No. 15	1/4"	0.0080
No. 16	1/4"	0.0085
No. 17	1/4"	0.0090
No. 18	1/4"	0.0095
No. 19	1/4"	0.0100
No. 20	1/4"	0.0105
No. 21	1/4"	0.0110
No. 22	1/4"	0.0115
No. 23	1/4"	0.0120
No. 24	1/4"	0.0125
No. 25	1/4"	0.0130
No. 26	1/4"	0.0135
No. 27	1/4"	0.0140
No. 28	1/4"	0.0145
No. 29	1/4"	0.0150
No. 30	1/4"	0.0155
No. 31	1/4"	0.0160
No. 32	1/4"	0.0165
No. 33	1/4"	0.0170
No. 34	1/4"	0.0175
No. 35	1/4"	0.0180
No. 36	1/4"	0.0185
No. 37	1/4"	0.0190
No. 38	1/4"	0.0195
No. 39	1/4"	0.0200
No. 40	1/4"	0.0205
No. 41	1/4"	0.0210
No. 42	1/4"	0.0215
No. 43	1/4"	0.0220
No. 44	1/4"	0.0225
No. 45	1/4"	0.0230
No. 46	1/4"	0.0235
No. 47	1/4"	0.0240
No. 48	1/4"	0.0245
No. 49	1/4"	0.0250
No. 50	1/4"	0.0255

**METRIC EQUIVALENTS**

Length	Area	Volume	Capacity	Weight
1/16"	0.000156	0.00000156	0.00000156	0.00000156
1/8"	0.000312	0.00000312	0.00000312	0.00000312
3/16"	0.000469	0.00000469	0.00000469	0.00000469
1/4"	0.000625	0.00000625	0.00000625	0.00000625
5/16"	0.000938	0.00000938	0.00000938	0.00000938
3/8"	0.001250	0.00001250	0.00001250	0.00001250
7/16"	0.001875	0.00001875	0.00001875	0.00001875
1/2"	0.002500	0.00002500	0.00002500	0.00002500
9/16"	0.003438	0.00003438	0.00003438	0.00003438
5/8"	0.004688	0.00004688	0.00004688	0.00004688
11/16"	0.006406	0.00006406	0.00006406	0.00006406



# Specify **Hi-Q** COMPONENTS for **DEPENDABILITY**

The dependability of **Hi-Q** components contained in your finished product will enhance your reputation as a manufacturer of *quality* equipment. The dependability of **Hi-Q** components is the result of meeting exacting specifications which insure their conformance to your requirements...temperature coefficients within recommended tolerances, insulation resistances to minimum standards, capacities as specified. **Hi-Q** dependability results from the use of highest quality materials and from constant surveillance throughout processing...your assurance of efficient, dependable service. Write for detailed information and engineering specifications.



## CERAMIC CAPACITORS



Hi-Q Ceramic Capacitors of unquestionable stability assure you the ultimate in performance for all electronic appliances. Let us assist you with your Ceramic Capacitor problems.

## CHOKE COILS



## STAND-OFF CONDENSERS

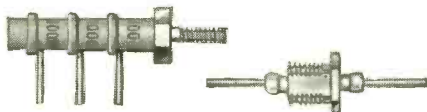

## WIRE WOUND RESISTORS



## Hi-Q COMPONENTS BETTER 4 WAYS

- PRECISION** Tested step by step from raw material to finished product. Accuracy guaranteed to your specified tolerance.
- UNIFORMITY** Constancy of quality is maintained over entire production through continuous manufacturing controls.
- DEPENDABILITY** Interpret this factor in terms of your customers' satisfaction . . . Year after year of trouble-free performance. Our Hi-Q makes your product better.
- MINIATURIZATION** The smallest BIG VALUE components in the business make possible space saving factors which reduce your production costs . . . increase your profits.

# Hi-Q

## Electrical Reactance Corp.

FRANKLINVILLE, N. Y.

Plants: FRANKLINVILLE, N. Y. — JESSUP, PA.

Sales Offices: NEW YORK, PHILADELPHIA, DETROIT, CHICAGO, LOS ANGELES





# Memo to... DESIGN ENGINEERS about... MYCALEX 410 - MOLDED NOW PRICED TO MEET RIGID ECONOMY REQUIREMENTS

In the design of components or complete equipment for industrial controls or communications—where insulation qualities are of critical importance—where mechanical precision must be a fixed factor—where strength is essential—where electrical characteristics must accurately meet high frequency circuit needs... then remember MYCALEX 410 as the insulation that designs-in with your most exacting requirements.

Various parts shown below are some of many made for special applications.

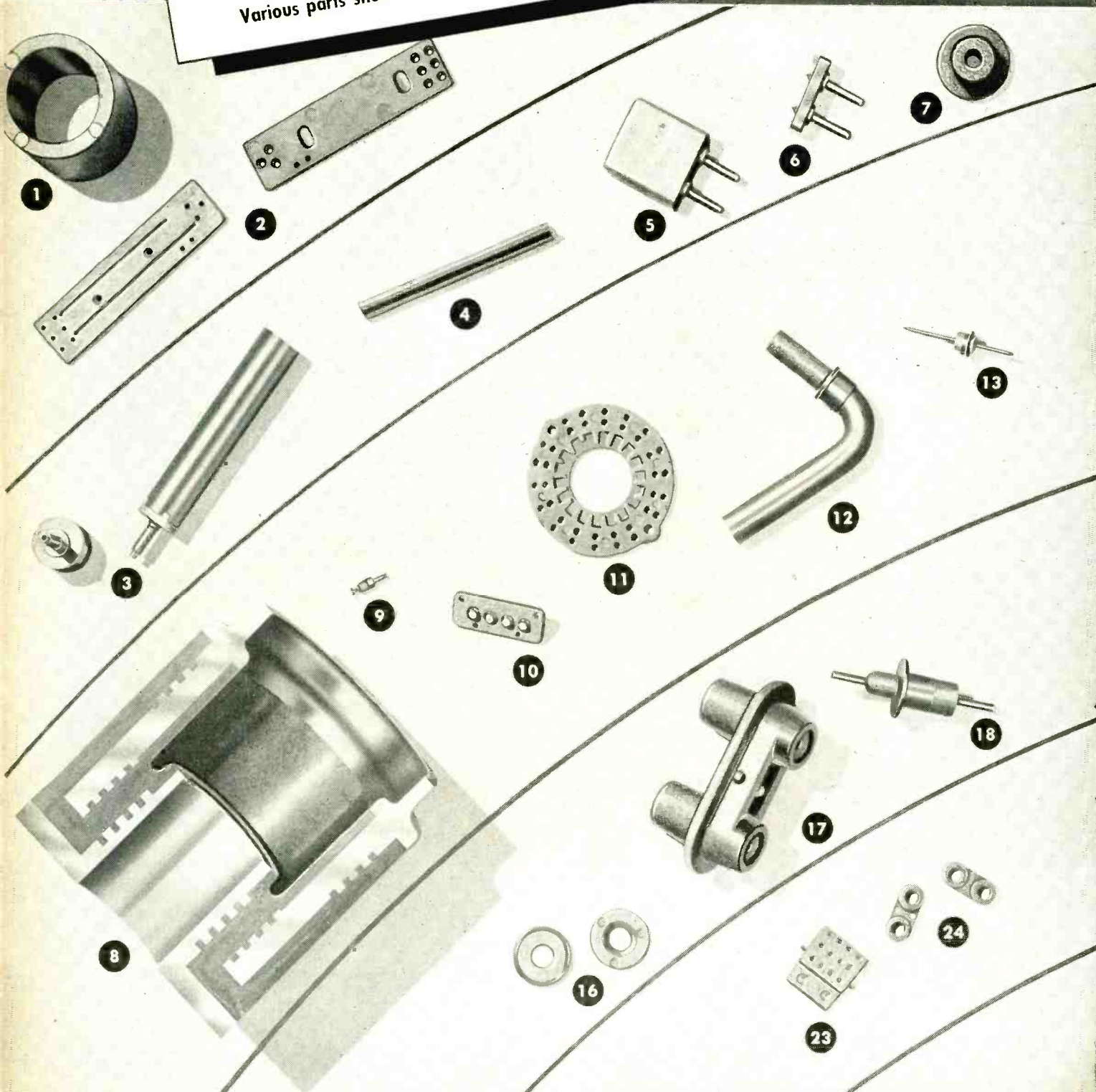



**M**YCALEX is today's improved insulation — designed to meet the exacting demands of all types of high-frequency circuits. MYCALEX is unusual in that it possesses a combination of peculiar characteristics that make it ideally suited for insulation in all types of electronic circuits. In tomorrow's designs for communications and industrial control equipment, MYCALEX 410 will be specified more than ever

before because of its . . . Low dielectric loss · High dielectric strength · High arc resistance · Dimensional stability over wide humidity and temperature changes · Resistance to high temperatures · Mechanical precision · Mechanical strength · Ability to mold metal inserts in place. If you have any insulation problems, our engineers will be glad to help you in their solutions.

## MYCALEX CORP. OF AMERICA

"Owners of 'MYCALEX' Patents"

Plant and General Offices: Clifton, N. J. Executive Offices: 30 Rockefeller Plaza, New York 20, N. Y.

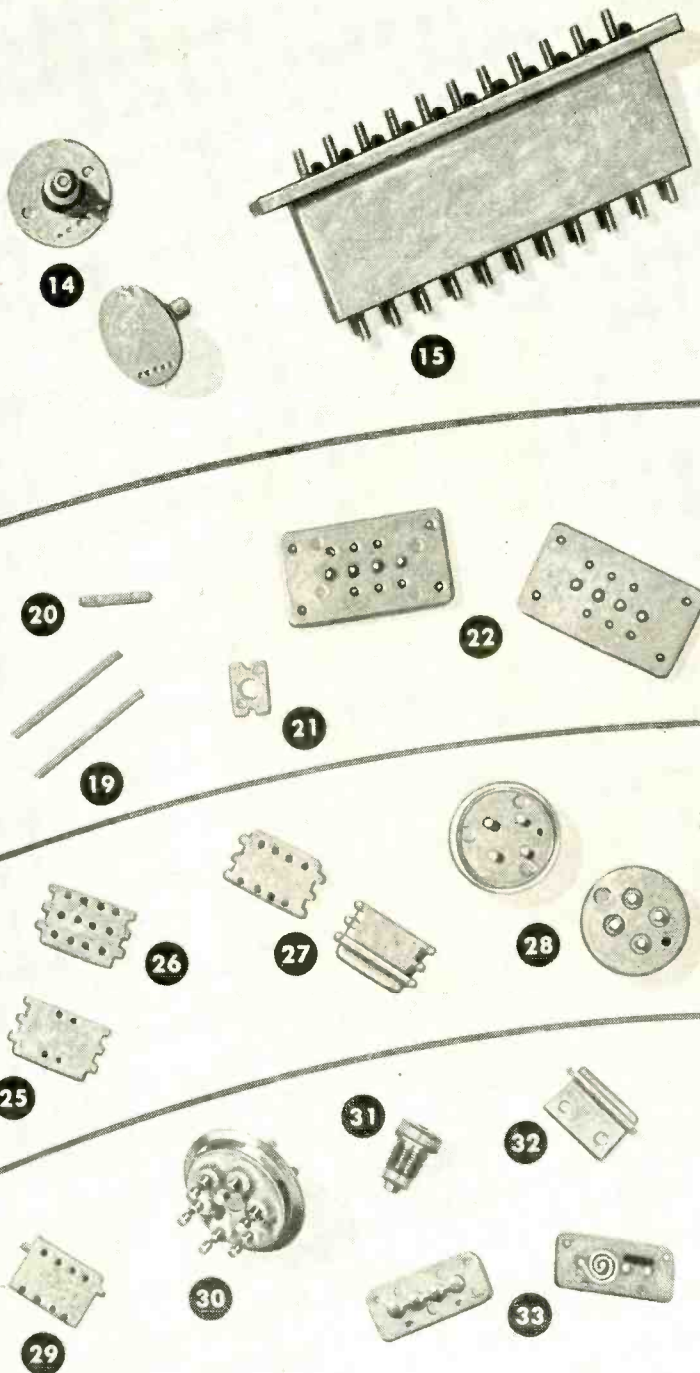

PART NAME	APPLICATION	INSERTS	MAX. DIMEN.
1 Bushing	Motor Generator	None	1.75"
2 Insulator	Electrical Instrument	None	3.18
3 End Seal	Thermostat Shell	Stainless Steel	3.75
4 Insulator	Electrical Instrument	None	3.00
5 Hermetic Seal	Crystal housing	Nickel and Copper	0.88
6 Hermetic Seal	Crystal housing	Copper	1.09
7 Insulator	Automobile Antenna	None	1.06
8 Bushing	Ignitron	Steel	4.50
9 Stand-Off Insulator	Electronics circuit	Brass	0.56
10 Panel	Television Selector Switch	Silver	1.38
11 Switch Wafer	Television Selector Switch	None	2.31
12 Elbow	Aircraft ignition	Steel and Brass	2.75
13 Lead	Transformer	Monel	1.75
14 Insulator	Polarizing relay	None	1.09
15 Lead through block	Oscillator	Brass	4.69
16 Insulator	Telephone Transmitter	None	0.88
17 Dual Bushing	Oil Burner Transformer	None	3.00
18 Lead	Transformer	Monel	2.50
19 Actuating Bar	Telephone relay	None	1.44
20 Actuating Bar	Telephone relay	None	0.78
21 Spacer	Radio vibrator	None	0.56
22 Panel	Television Selector Switch	None	1.75
23 Spacer	Telephone relay	None	1.00
24 Spacer	Relay	None	0.91
25 Spacer	Telephone relay	None	1.00
26 Spacer	Telephone relay	None	1.00
27 Clamping Plate	Telephone relay	None	1.00
28 Electrode Mounting	Level Indicator	Brass	1.13
29 Spacer	Telephone relay	None	1.00
30 Six Terminal Header	Transformer	Monel	1.42
31 Test jack body	High Frequency Circuits	Monel	0.75
32 Clamping Plate	Telephone relay	None	1.00
33 Printed Circuit Base	Experimental	Silver	1.38



Output of one of the marker oscillators used in setting sweep speeds to known values. This case represents 0.2 microsecond/inch.

1.2 lines of television signal. Horizontal synchronizing and blanking pulses at each end. Video modulation in center.

Fractional part of a line. Horizontal synchronizing and blanking are shown.

### OTHER FEATURES...

Provisions for attaching recording camera. Fine, clear focus over entire length of trace.

Y-axis: Any degree of attenuation between 1:1 and 1000:1; great expansion of negative polarity signal; undistorted deflection of at least 2"; frequency response within 3 db. from 10 cps. to 10 mc.

X-axis: Time-base duration variable from 1 to 15,000 microseconds. Horizontal deflection of at least 4". SRP-A Cathode ray Tube. 12,000 volt accelerating potential.

Time-base can correspond with any horizontal line in either or both interlaced fields. Calibrating generator for calibration of sweep-writing speeds by signals of 10, 1, and 0.2 microsecond/cycle.

Wide range of sweep-writing speeds; continuous variation between 0.25 and 3000 microseconds/in.

Delay ranges of 100 or 1000 microseconds selectable for linear time base.

Indication as to exact occurrence of time-base with respect to overall television picture.

Interval of 0.25 microsecond may be measured to plus/minus 0.01 microsecond.

Television waveforms selected even to the scanning line and fraction of that line, for critical study or recording, with the new

# DU MONT Type 280 *Cathode-ray* OSCILLOGRAPH

Vertical synchronizing and equalizer pulses as seen with 60-cycle-sweep repetition rate; used for checking interlace.

Fractional part of line near center of a test pattern where wedge elements are more closely spaced. Note loss in amplitude of modulation.

Trailing edge of horizontal synchronizing pulse.

Fractional part of line near center of line. Video modulation produced by wedge, is shown.

DU MONT proudly announces the new Type 280 Cathode-Ray Oscilloscope especially designed for television studio and transmitter installations. Here at last is a means for accurately determining the duration and shape of the waveform contained in the composite television signal, as well as the character of the picture-signal video in conjunction with transmitter operation, according to FCC standards and practices.

Excellent for research on all tele-

vision equipment. Also for study of wide-band amplifiers. Well suited for industrial use wherever high-speed single transients are studied. Consists of four units mounted on standard relay-rack type panels and chassis, and installed on mobile rack. Removable side and rear panels. Grouped controls for easy operation.

By virtue of its great range of applications, Type 280 becomes a "must" for television studio and research laboratory.

Further Details on Request!

© ALLEN B. DU MONT LABORATORIES, INC.

# DU MONT

## for Oscillography

ALLEN B. DU MONT LABORATORIES, INC., PASSAIC, N. J.  
CABLE ADDRESS: ALBEEDU, NEW YORK, N. Y., U.S.A.



**SMALLER** DIMENSIONS...  
**HIGHER** CURRENT RATINGS...  
**HIGHER** EFFECTIVE VOLTAGE RATINGS...  
 IN THE **NEW**  
**LAPP GAS-FILLED CONDENSERS**

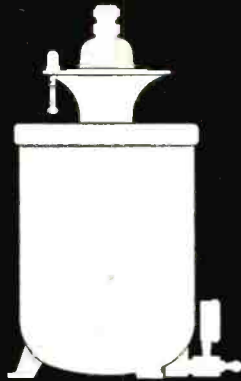

**PREVIOUS MODEL**  
 1000 mmf, 21 Kv peak, 40 amps RMS



**NEW MODEL**  
 1000 mmf, 23 Kv peak, 70 amps RMS

The new Lapp Gas-Filled Condensers save about 30% of space requirements as compared with previous units. Current paths are only one-third as long, with consequent lower losses. Current ratings, effective voltage ratings and safety factors have been increased. On variable models the tuning shaft is at ground potential, which eliminates need for special insulated tuning shafts. Puncture-proof. Constant capacitance without need for "warm-up." Lapp Gas-Filled Condensers are a source of proved dependability for capacitance at high voltages or high currents for radio or industrial electronic circuits. Write for bulletin No. 265.

# Lapp

LAPP INSULATOR COMPANY, INC., LEROY, NEW YORK



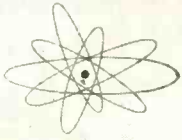

# Designers



*A panel instrument  
for every need*

These general-purpose panel instruments are particularly suitable for use in radio equipment and industrial applications where accuracy and quality are required and space is at a premium. Many of the instruments have been newly styled

for better readability and for the smooth, modern appearance that will help give your panels a well-engineered look.

Thermocouple-type instruments, for measurements of high-frequency alternating current in radio or other electronic circuits, are available. There is also a complete line of rectifier types (a-f), for measuring alternating current or voltage at high frequencies or where the source is not sufficient to operate conventional a-c instruments. Typical applications include television transmitters, radar wave meters, testing equipment for electronic circuits. For a full story of G-E instruments, send for Bulletin GEC-227.

GENERAL  ELECTRIC



# Digest

## TIMELY HIGHLIGHTS ON G-E COMPONENTS



### CAGED FOR PROTECTION

Suitable for wall or panel mounting, these cage-type, enameled resistor units employ a strong, high-heat-resisting silicate-compound body which withstands sudden and extreme temperature changes without weakening or in any

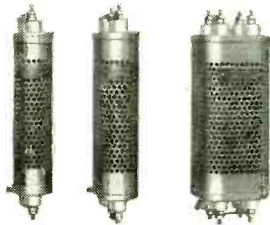

way being injured. The resistance wire has a low temperature coefficient so that the resistance remains nearly constant as the temperature increases. Ample protection to the units is provided by the perforated metal case. Each unit is rated at 85 watts and is available in resistance values from 0.5 to 100,000 ohms; one to four units in a cage. For more complete information please contact your G-E representative.

### NEED A "LOW VA" VOLTAGE STABILIZER?

General Electric's latest additions to its line of automatic voltage stabilizers are three 115-volt, 60-cycle designs in 15-, 25-, and 50-va ratings. Check the low prices—you may now be able to utilize the advantages of an automatic voltage control for your application. The price consideration plus the low case height and small size will make these units especially applicable to radio chassis and other shallow-depth installations. Other features include totally insulated design, which is necessary where isolation is required between primary and secondary circuits, and universal lead



construction which makes these units adaptable to various wiring and mounting arrangements. If you have an application problem, contact your G-E representative, or check bulletin GEA-3634B.

### SOMETHING NEW IN CIRCUIT CONTROL DEVICES

Simplify your circuit designs by replacing complicated and costly components with simple, economical G-E Thermistors. These electronic semiconductors are unique in that the resistance changes rapidly with slight variations in temperature—electrical resistance decreases as temperature rises, and increases as temperature falls. G-E Ther-



mistors give you these five advantages: flexible in application, small in size, available in various shapes, indefinitely stable, and they are economical. These new circuit devices are especially adaptable as sensitive elements in flow meters, liquid-level gages, time-delay relays, vacuum gages, switching devices, and modulating thermostatic circuits. Check coupon for technical report CDM-9.

### HERMETIC SEAL ELIMINATES MOISTURE PROBLEMS

The new cast-glass bushings with their sealed-in metal hardware can be readily welded, soldered, or brazed directly to the apparatus, thus eliminating gaskets and providing a better seal than ever before. The small, compact structure of the bushings often makes it possible to



reduce the overall size and weight of the electric apparatus. Bushings are practically unaffected by weathering, microorganisms, and thermal shock. Their great mechanical strength makes them well suited for use in airplanes, etc., where they are subject to continual vibration. Available in ratings up to 8.6 kv and for currents to 1200 amperes. Check bulletin GEA-5093.

### MORE SOLDERING WITH LESS POWER

G.E.'s midget soldering iron can do a big job for you with only one-fourth the wattage usually used. This handy 6-volt, 25-watt iron is only 8 inches long (with 1/8" or 1/4" tips) and weighs but 1 3/4 ounces. It was especially designed for close-quarter, pin-point precision soldering. The "midget" offers you all these advantages: low-cost soldering; "fingertip" operation; quick, continuous heat; easy renewal; long life; low maintenance. The iron is a real aid in manufacturing radios, instruments, meters, electric appliances, and many other products requiring precision soldering. Irons and specially designed 115/6-volt transformers are available from stock. Check bulletin GES-3488.



GENERAL ELECTRIC COMPANY, Section E642-18  
Apparatus Department, Schenectady, N. Y.

Please send me the following bulletins:

- |   |   |
|---|---|
| <input type="checkbox"/> GEC-227 Instruments            | <input type="checkbox"/> GEA-5093 Cast-Glass Bushings |
| <input type="checkbox"/> GES-3488 Midget Soldering Iron | <input type="checkbox"/> CDM-9 Thermistors            |
| <input type="checkbox"/> GEA-3634B Voltage Stabilizer   |   |

Name .....

Company .....

Address .....

City ..... State .....





**Towering**

**Above**

**Pittsburgh's**

**Civic**

**Center**

**F**or KDKA — "America's Pioneer Station" — Blaw-Knox — America's pioneer builder of radio towers recently furnished this 500 ft. H-40 heavy duty tower.

The location of the tower on a rise overlooking Pitt Stadium and adjacent to buildings of the University of Pittsburgh made it imperative that station engineers select a structure of sufficient built-in strength to provide a high factor of safety in this congested area.

The Blaw-Knox heavy duty H-40 tower, supporting an FM and television antenna is not only adequate to meet these provisions but is also rugged enough to take care of any reasonable changes in equipment which might arise in the future.

**BLAW-KNOX DIVISION**  
*of Blaw-Knox Company*  
2017 Farmers Bank Building  
Pittsburgh 22, Pa.

**BLAW-KNOX** *Antenna*  
**TOWERS**

# Here's Real News!

## AC-DC TELEVISION MADE POSSIBLE FOR THE FIRST TIME

### Trend Is to New Low Prices for Lighter, Smaller 7" and 10" TV Sets

### SMALL, COMPACT POWER SUPPLY HANDLES AM-FM-TV COMBINATION

#### All Resulting from Federal's New Miniature 500 MA Selenium Rectifier

YES, this mighty miniature makes big television headlines! Its hitherto unapproached power-handling capacity promises a virtual revolution in television design. Think of the possibilities... a single Selenium Rectifier power supply able to handle an AM-FM-TV combination... AC-DC television... drastic reductions in size, weight and price of 7" and 10" sets.

These important savings result not only from the small size of this new Federal Miniature Selenium Rectifier, but its elimination of large, heavy, expensive transformers and expendable rectifier tubes in the power supply. What's more, it can be used with smaller condensers with lower voltage ratings.

Here's the diagram of a suggested circuit for an AC-DC power supply for 7" and 10" electrostatic deflection tubes.



438D3428A

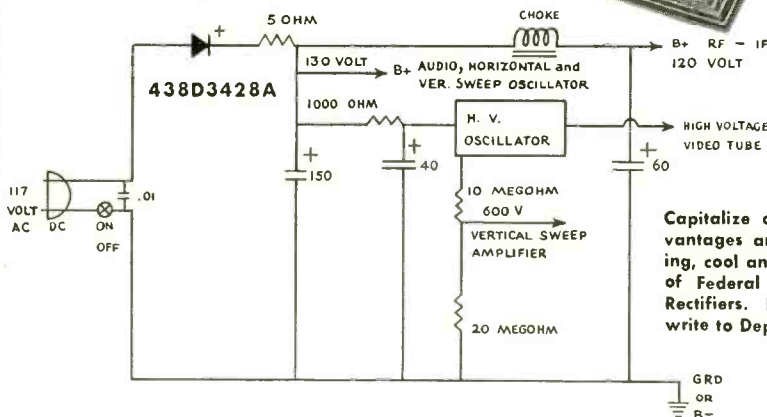

Capitalize on these design advantages and the instant starting, cool and efficient operation of Federal Miniature Selenium Rectifiers. For technical data, write to Department F213.



KEEPING FEDERAL YEARS AHEAD... is IT&T's world-wide research and engineering organization, of which the Federal Telecommunication Laboratories, Nutley, N. J., is a unit.

## Federal Telephone and Radio Corporation

SELENIUM and INTELIN DIVISION, 900 Passaic Ave., East Newark, New Jersey

In Canada: - Federal Electric Manufacturing Company, Ltd., Montreal, P. Q.  
Export Distributors: International Standard Electric Corp. 67 Broad St., N. Y.



# In the 1948 electronics Issue of the BUYERS' GUIDE the following list of 270 manufacturers' advertising appears

This list is indicative of the all-inclusive scope of specifying, buying and reference advertising of products which appears in the Buyers' Guide — and is convincing evidence of the industry-wide acceptance of the issue for its advertising value.

- Acme Electric Corp.  
Adams and Westlake Co.  
Advance Electric and Relay Co.  
Aircraft-Marine Products Inc.  
Airtron  
Allen Co., Inc., L. B.  
Alliance Manufacturing Co.  
Allied Control Co., Inc.  
Almetal Screw Products Co.  
American Gas Accumulator Co.  
American Lava Corporation  
American Phenolic Corporation  
American Platinum Works  
American Television and Radio Co.  
American Time Products, Inc.  
American Transformer Company  
Amperite Co.  
Arma Corporation  
Art-Lloyd Metal Products Corp.  
Art Wire and Stamping Co.  
Astatic Corporation  
Atomic Instrument Co.  
Audio Development Co.  
Audio Devices, Inc.  
Aviometer Div., Roanwell Corp.
- Ballantine Laboratories, Inc.  
Barber Labs., Alfred W.  
Barker and Williamson, Inc.  
Barry Corporation  
Beach-Russ Company  
Bead Chain Manufacturing Co.  
Bendix Aviation Corp., Red Bank Div.  
Benwood-Linze Co.  
Best Manufacturing Co., Inc.  
Beta Electronics Co.  
B-G Electronics, Inc.  
Biwax Corporation  
Biley Electric Company  
Boland and Boyce Inc., Publishers  
Boonton Radio Corporation  
Borg Corporation, George W.  
Borg Corporation, George W., Gibbs Div.  
Boston Insulated Wire and Cable Co.  
Bradley Laboratories, Inc.  
Bradshaw Instruments Co.  
Brainin Co., C. S.  
Brand and Co., William  
British Industries Corp.  
Brociner Electronics Laboratory  
Brown-Bridge Mills, Inc.  
Browning Laboratories, Inc.  
Buck Engineering Co., Inc.  
Burgess Battery Company  
Burnell and Company  
Bussmann Mfg. Co.
- Cambridge Thermionic Corp.  
Cannon Electric Development Co.  
Carter Motor Co.  
C-B Manufacturing Co.  
Cellusuede Products, Inc.  
Centralab, Div. of Globe-Union, Inc.  
Chatham Electronics, Inc.  
Chicago Transformer, Div. of Essex Wire Corporation  
Cinaudagraph Speakers, Div. of Aircon Mfg. Co.  
Cinch Mfg. Corp.  
Clark Crystal Company  
Cleveland Container Co.  
Collins Audio Products Co., Inc.  
Communication Products Co., Inc.  
Concord Radio Corporation  
Continental-Diamond Fibre Co.  
Cornish Wire Co., Inc.  
Cramer Co., Inc., R. W.  
Cross Co., H.
- DeCoursey Engineering Laboratory  
DeMornay Budd, Inc.  
Dial Light Company of America  
Drake Manufacturing Co.  
Driver Company, Wilbur B.  
Driver-Harris Company
- Eastern Air Devices Inc.  
Ebert Engineering and Mfg. Co.  
Edison, Inc., Thomas A., Instrument Div.  
Eisler Engineering Co., Inc.  
Eitel-McCullough, Inc.  
El-Tronics Inc.  
Electric Indicator Co.  
Electrical Industries, Inc.  
Electrical Reactance Corp.  
Electrocoil Transformer Co.  
Electro-Seal Corporation  
Electro-Tech Equipment Co., Inc.
- Electronic Controls Co., of New York  
Electronic Measurements Company  
Electronic Transformer Co., Inc.  
Elliott Manufacturing Co.  
Engineering Company, The  
Eric Resistor Corporation  
Essex Electronics
- Federal Telephone and Radio Corp.  
Ferranti Electric, Inc.  
Field Electrical Instrument Co.  
Fisher Radio Corporation  
Ford Instrument Co., Inc.  
Franklin Airloop Corp.  
Franklin Fibre-Lamitex Corp.  
Franklin Mfg. Corp., A. W.
- Gamewell Co.  
Gear Specialties  
General Aniline and Film Corp.  
General Cement Mfg. Co.  
General Ceramics and Steatite Corp.  
General Control Company  
General Electric Company  
General Electronics Inc.  
General Plate Div. of Metals and Controls Corp.  
General Radio Co.  
Globe Industries, Inc.
- Handy and Harman  
Harnett Electric Corp.  
Hassall, Inc., John  
Haydon Manufacturing Co., Inc.  
Haydu Brothers  
Heinemann Electric Company  
Herbach and Rademan, Inc.  
Hewlett-Packard Company  
Hillburn Electronic Products Co.  
Hunt Corporation
- Illinois Condenser Co.  
Indiana Steel Products Company  
Industrial Timer Corp.  
Inst-X Co., Inc.  
Instrument Parts Corporation  
Instrument Resistors Co.  
Insulation Manufacturers Corp.  
Insuline Corporation of America  
International Machine Works  
Irvington Varnish and Insulator Co.  
I-T-E Circuit Breaker Co.
- J-B-T Instruments, Inc.  
Jennings Radio Manufacturing Co.  
J. F. D. Manufacturing Co.
- Kahle Engineering Co.  
Karp Metal Products Co., Inc.  
Kay Electric Company  
Keithley Instruments  
Kenyon Transformer Co., Inc.  
Kepec Laboratories  
Kester Solder Co.  
Knights Co., James  
Kobzy Tool Co.  
Kollsman Instrument Div. of Square "D" Co.
- Kurman Electric Co., Inc.  
K-V Transformer Corp.  
Lampkin Laboratories Inc.  
Lapp Insulator Co., Inc.  
Lavoie Laboratories  
Legri S Co., Inc.  
Lenkurt Electric Co.  
Lord Manufacturing Co.  
Machlett Laboratories, Inc.  
Magnetic Core Corp.  
Makepeace Co., D. E.  
Mallory and Co., Inc., P. R.  
Marion Electrical Instrument Co.  
MB Manufacturing Co.  
Measurement Engineering Ltd.  
Measurements Corporation  
Millen Mfg. Co., Inc., James  
Mitchell-Rand Insulation Co., Inc.  
Moyen, C. P.  
Multicore Solders Ltd.  
Mycalex Corporation of America
- National Co., Inc.  
National Carbon Company, Inc.  
National Electronics Inc.  
National Moldite Co.  
National Varnished Products Corp.  
National Vulcanized Fibre Co.  
New York Transformer Co., Inc.  
Northern Communication Mfg. Co.  
Northern Radio Co., Inc.
- Ohmite Mfg. Co.
- Panoramic Radio Corp.  
Paper Machinery and Research, Inc.  
Par-Metal Products Corp.  
Phalo Plastics Corp.  
Phillips Control Corporation  
Pickering and Co., Inc.  
Polarad Electronics Company  
Polytechnic Research and Development Co., Inc.  
Potter Instrument Co.  
Precision Paper Tube Co.  
Premax Products, Div. of Chisholm-Ryder Co., Inc.  
Presto Recording Corp.  
Printloid, Inc.  
Production Engineering  
Pyroferic Co.
- Radio Corp. of America  
Radio-Music Corporation  
Radio Receptor Co., Inc.  
Raytheon Mfg. Co.  
Reeves-Hoffman Corporation  
Reeves Instrument Corporation  
Reeves Soundcraft Corp.  
Rex Rheostat Co.  
Robinette Co., W. C.  
Rogan Brothers  
Rome Cable Corporation
- Sag Harbor Industries, Inc.  
Schweitzer Inc., Peter J.  
Scientific Electric Div. of "S" Corrugated Quenched Gap Co.  
Scott, Inc., Herman Hosmer  
Seeburg Corporation, J. P.  
Selector Industries, Inc.  
Servo-Tek Products Co., Inc.  
Sherron Electronics Company  
Shurite Brothers, Inc.  
Shurite Meters  
Sidward Mfg. Co., Inc.  
Sigma Instruments, Inc.  
Signal Engineering and Mfg. Co.  
Smuckler and Co., Inc., A. F.  
Sorenson & Co., Inc.  
Sound Apparatus Co.  
Specialty Battery Co.  
Spellman Television Co., Inc.  
Sperry Gyroscope Co.  
Sprague Electric Company  
Standard Arcturus Corp.  
Standard Electrical Products Co.  
Standard Pressed Steel Co.  
Standard Transformer Corp.  
Star Expansion Products Co., Inc.  
Stevens Manufacturing Co., Inc., Geo.  
Super Electric Products Corp.  
Superior Electric Co.  
Superior Tube Company
- Tech Laboratories, Inc.  
Telechron Inc.  
Telex, Inc.  
Terminal Radio Corp.  
Tetrad Corporation  
Thermionic Engineering Corp.  
Thordarson Div., Maguire Industries  
Titeflex, Inc.  
Trans-sonics, Inc.  
Transvision Inc.  
Tung-Sol Lamp Works Inc.
- Union Carbide and Carbon Corp.  
United Condenser Corporation  
United States Television Mfg. Corp.  
United Transformer Co., Inc.  
Universal Winding Co.
- Vacuum-Electronic Engineering Co.  
Varflex Corporation  
Vickers, Inc.  
Vulcan Electric Co.
- Walker Co., George  
Walter Co., Inc., S.  
Ward Leonard Electric Co.  
Ward Products Corporation  
Waterman Products Co., Inc.  
Western Electric Company  
Westinghouse Electric Corp.  
Weston Electrical Instrument Corp.  
White Dental Mfg. Co., S. S.  
Williams and Co., C. K.  
Wilson Co., H. A.
- Zophar Mills, Inc.

THE BUYERS' GUIDE is the 13TH ISSUE OF electronics ...



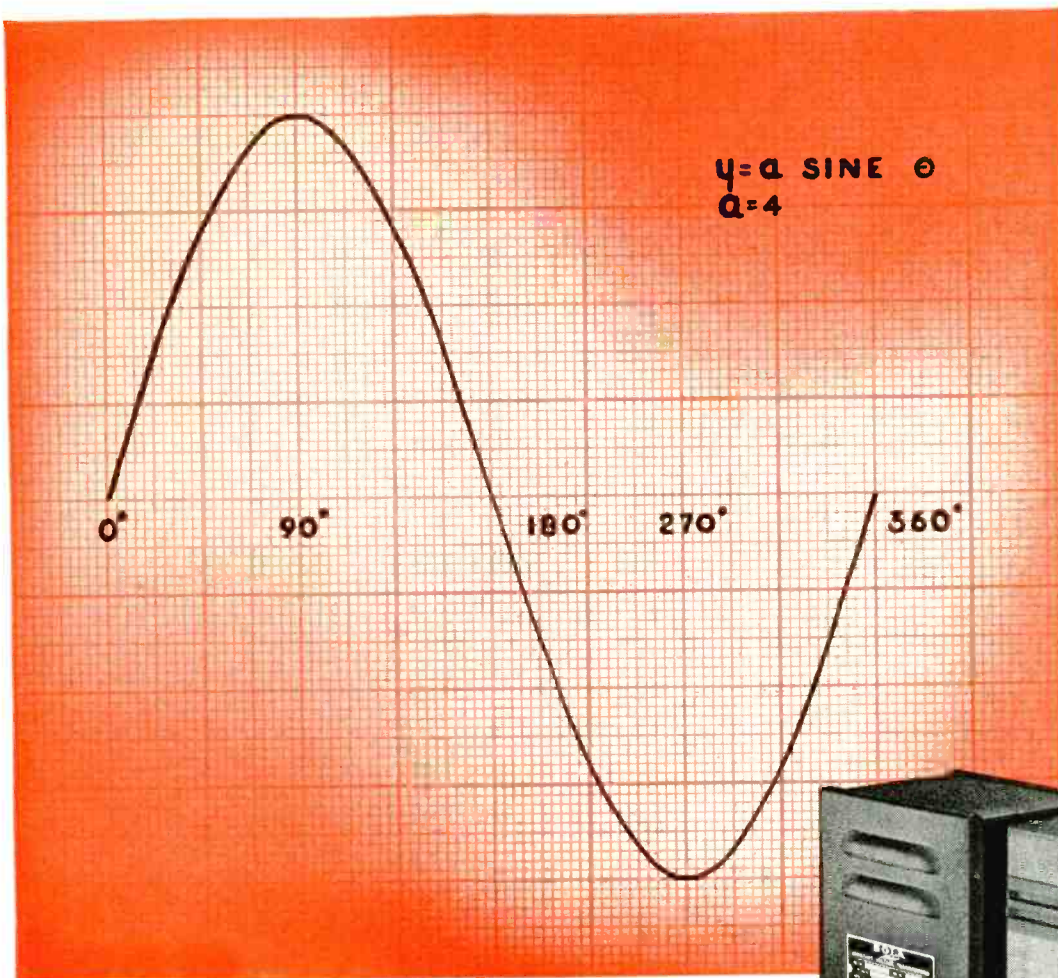

## CONSTANT VOLTAGE with low harmonic distortion



TYPE CVH, an important newcomer in a famous line—a SOLA CONSTANT VOLTAGE Transformer designed for use with equipment that requires a source of undistorted voltage. These new transformers, available in 250, 500 and 1,000 VA capacities, provide all of the voltage stabilizing characteristics of the standard SOLA Constant Voltage Transformer, with less than 3% harmonic distortion of the output voltage wave.

Since the output voltage wave is essentially sinusoidal, these transformers may be used for the most exacting applications such as general laboratory work, instrument calibration, precision electronic equipment or other equipment having elements which are sensitive to

power frequencies harmonically related to the fundamental.

As in all SOLA Constant Voltage Transformers the regulation is automatic and instantaneous. There are no moving parts, no manual adjustments and every unit is self-protecting against short circuit.

Type CVH represents an outstanding advance in automatic voltage regulation and an important contribution to precise electronic equipment.

### WRITE FOR THESE BULLETINS

**DCVH-136**—complete electrical and mechanical characteristics of the new Type CVH Constant Voltage Transformers.

**DCV-102**—complete engineering handbook and catalog of standard Constant Voltage Transformers available for remedial or built-in applications.

# SOLA *Constant Voltage* TRANSFORMERS

**Transformers for:** Constant Voltage • Cold Cathode Lighting • Airport Lighting • Series Lighting • Fluorescent Lighting • Luminous Tube Signs • Oil Burner Ignition • X-Ray • Power • Controls • Signal Systems • etc. • **SOLA ELECTRIC COMPANY, 4633 W. 16th Street, Chicago 50, Illinois**

*Manufactured under license by:* ENDURANCE ELECTRIC CO., Concord West, N. S. W., Australia • ADVANCE COMPONENTS LTD., Walthamstow, E., England • UCOA RADIO S.A., Buenos Aires, Argentina • M. C. B. & VERITABLE ALTER, Courbevois (Seine), France



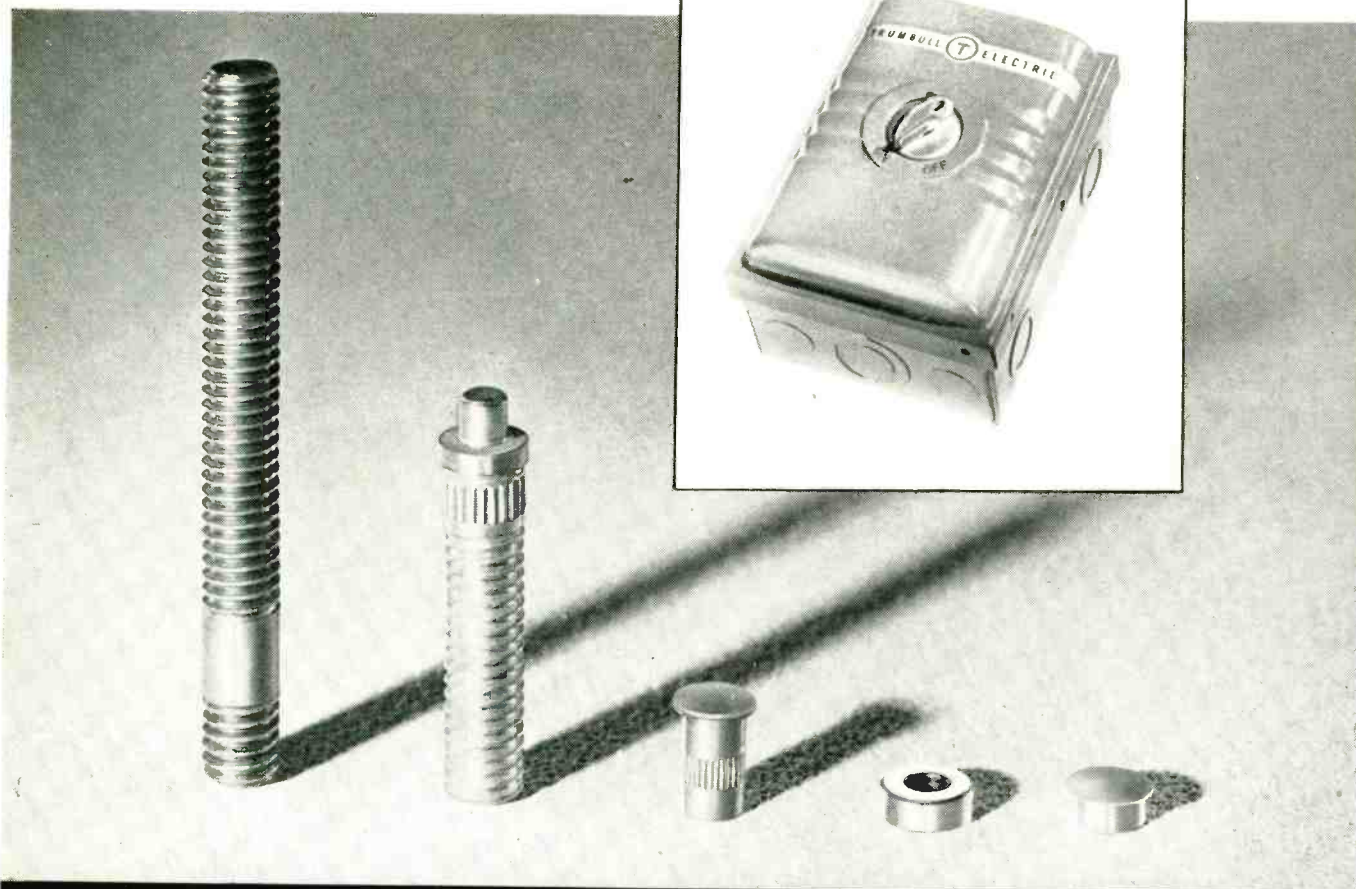

**IF YOU MACHINE COPPER—  
THIS REVERE METAL WILL SAVE YOU MONEY**

REVERE makes Free-Cutting Copper Rod, and if you are making electronic devices requiring machined copper parts of high conductivity, it will pay you to investigate the savings made possible by this metal. We would suggest that you make trial runs to prove what it will do under your own shop conditions. That was the procedure followed by The Trumbull Electric Mfg. Co., Plainville, Conn., with these results:

Part #18107 and 18108, contacts for the Type D switch illustrated, were designed around this alloy. Trumbull states: "On both these parts we found we could make them in one operation instead of two. That is, due to the smooth free cutting of the metal, it was unnecessary to perform a facing operation . . . Our Screw machine foreman advises that, in his opinion, both these parts could be made four times as fast as out of ordinary electrolytic copper rod."

#3731, 60 amp. post stud.—5,760 pieces run in 19.6 hours with no machine down-time; 10,425 pieces of ordinary copper rod run in 66.6 hours with 11.8 hours machine down-time. In addition to the extra time required, three sets of dies were used for the regular rod. "The savings of the free-cutting material over ordinary copper were figured at \$1.81 per thousand, including in these costs both material and direct labor."

#16552, space washer. "Savings per thousand over electrolytic copper were 77¢. This figure included the material differ-

ence and direct labor. In addition, there was an 18% saving in machine down-time."

#K-60-1A, 70-200 amp. stud. "The use of Free-Cutting Copper Rod on this part very definitely increased production and practically voided machine down-time."

In a letter to Revere, Trumbull added: "In general, at least for most of the parts we have used, we find that there is at least a 25% saving in machine time of free-cutting over regular copper. In addition, the workers are enthusiastic about this material, particularly when running studs, because of the fact that it is no longer necessary for them to keep a constant close watch on the machine to see that the turnings do not become tangled up with the moving parts of the machine."

The Trumbull experience is being duplicated in other machine shops. If you have not tried this Revere Metal, we suggest you get in touch with your nearest Revere Sales Office.

**REVERE**

**COPPER AND BRASS INCORPORATED**

*Founded by Paul Revere in 1801*

230 Park Avenue, New York 17, New York

*Mills: Baltimore, Md.; Chicago, Ill.; Detroit, Mich.; New Bedford, Mass.; Rome, N. Y. — Sales Offices in Principal Cities, Distributors Everywhere.*



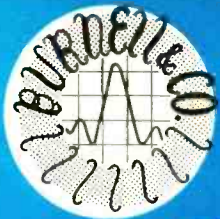

Exclusive Manufacturers of Communications Network Components

# TOROIDAL COIL FILTERS AND TOROIDAL COILS DESIGNED FOR CRITICAL APPLICATIONS

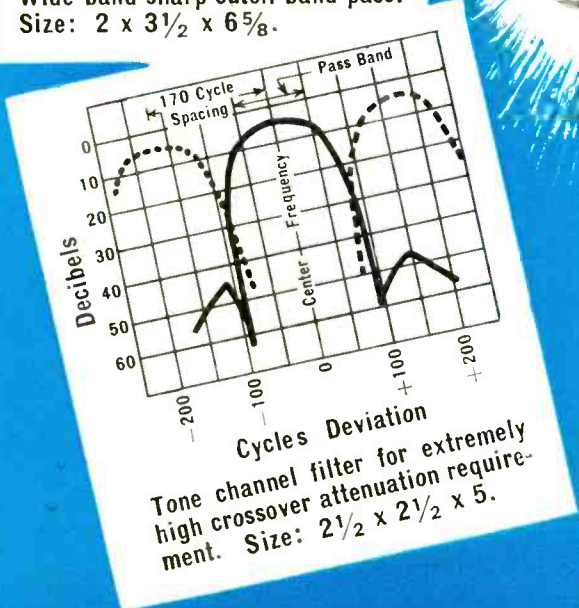
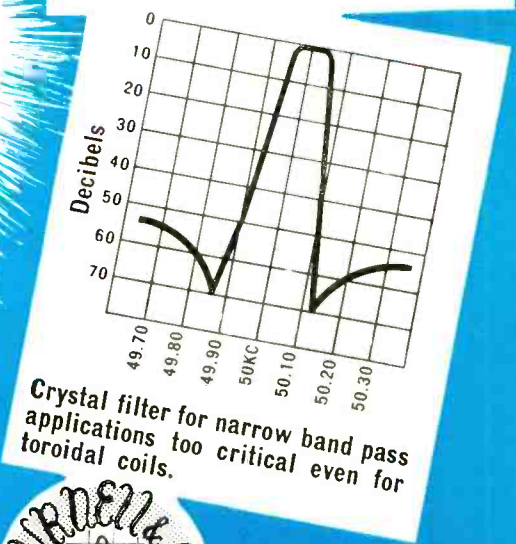
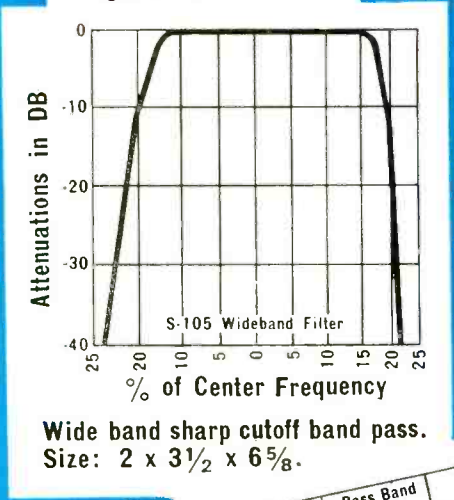
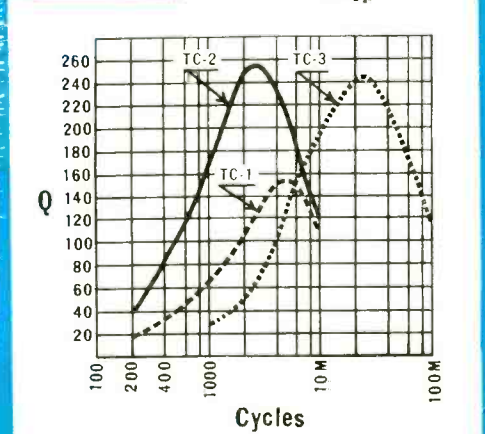
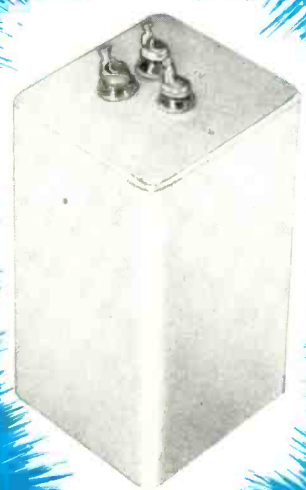
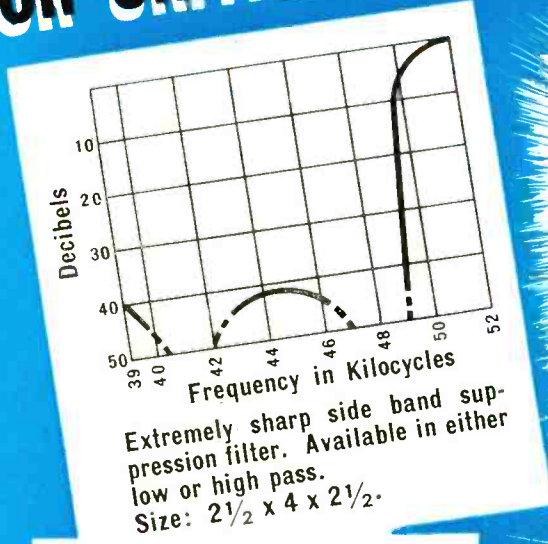
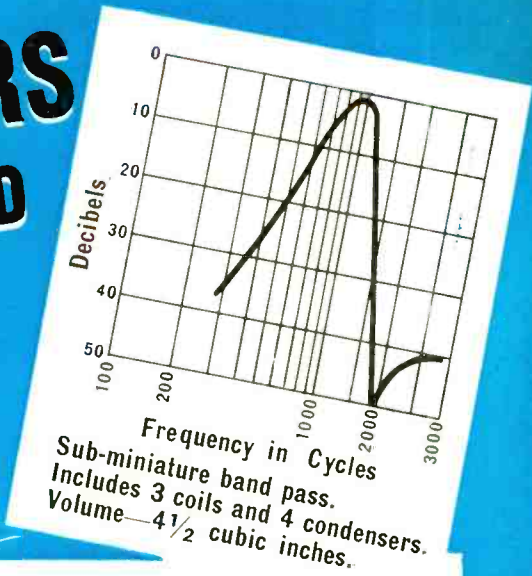

**Burnell & Company**  
YONKERS 2, NEW YORK  
CABLE ADDRESS "BURNELL"

ALL INQUIRIES WILL BE PROMPTLY HANDLED . . . WRITE FOR TECHNICAL INFORMATION



**For top-flight quality and rock-bottom economy  
in telecast programming . . . DU MONT Type 5130-B**

## **16mm SOUND**

# *Telecasting Projector*

▶ Superlative movie programming utilizing economical 16 mm sound films—that's the meaning of this latest Du Mont achievement.

Designed and built "from scratch" to meet the exacting needs of movie telecasting. Not to be confused with usual improvisations. Definitely, with this unique projector, movie telecasting comes of age.

Ready for the heavy-duty service normal to telecast operations. All parts readily inspected, checked, replaced, when needed. Self-contained. Fully enclosed. Streamlined. Smartly designed.

Better movie presentations over the air are bound to follow the installation of such equipment by telecasters seeking the largest audiences.

▶ *Details on request. Meanwhile, submit your telecasting problems and requirements.*

### **FEATURING . . .**

Complete with sound preamplifier and necessary power supplies.

Sound system response of 50 to 5000 cycles—quality of reproduction limited solely by film sound track.

Ample reel reservoir capacity permitting use of 4000 ft. feature movies.

Synchronous locking type driving motor ensuring perfect tie-in with television sync generator.

Lamp assembly and pull-down mechanism available for instant replacement.

Adjustment for both positive and negative film.

Light output far exceeds previous equipment, permitting use of low sensitivity pickup tubes even with narrow vertical blanking interval.

For direct throw on television mosaic or with intermediate translucent screen and prism for utilization of Image Orthicon Camera for film pickup.

Built for continuous use on an average of 20 hours weekly. At least 3000 hours' life expectancy for major components.

In sum, the stability and performance which television film pickup has needed for many years.

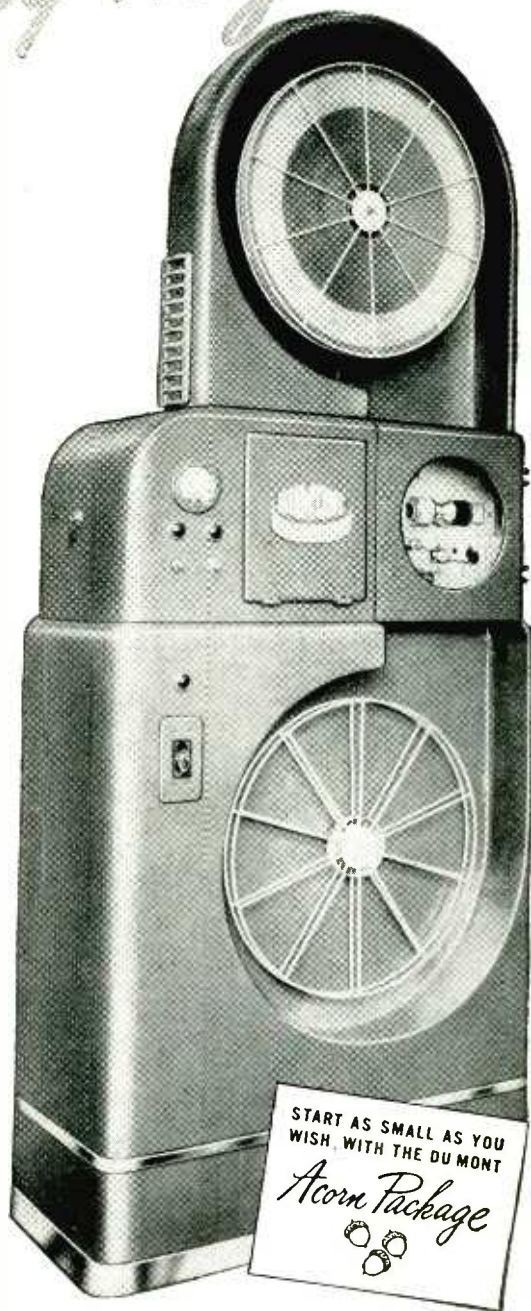

© ALLEN B. DU MONT LABORATORIES, INC.

# **DU MONT**

*First with the Finest in Television*

ALLEN B. DU MONT LABORATORIES, INC. • TELEVISION EQUIPMENT DIVISION, 42 HARDING AVE., CLIFTON, N. J. • DU MONT NETWORK AND STATION WABD, 515 MADISON AVE., NEW YORK 22, N. Y. • DU MONT'S JOHN WANAMAKER TELEVISION STUDIOS, WANAMAKER PLACE, NEW YORK 3, N. Y. • STATION WTTG, WASHINGTON, D. C. • HOME OFFICES AND PLANTS, PASSAIC, N. J.

**Finest Cored Solder  
in the World**

**ERSIN**



**The only 3 core solder made  
with ERSIN FLUX...the original  
non-corrosive, extra-active flux**

**TECHNICAL ADVANTAGES**

**Multicore Solder**

- Three separate cores of flux eliminate possibility of no flux in a portion of the wire, which may occur in single cored solder. Guaranteed continuity of the flux stream prevents "dry" joints, i.e. those having high electrical resistance.
- Although there are three cores of flux in Multicore, the total percentage of flux to solder is no greater than in single cored solder.
- Very rapid melting results from the multiple core construction which provides thinner walls of solder than are found in same gauge single cored solder.
- Multicore's unique properties make perfect joints possible on difficult metals and alloys, even if oxidized.
- Ability to tin rapidly produces perfect joints with less solder. Greater coverage per pound.

**Ersin Flux**

- Ersin Flux is an exclusive product of Multicore Solders Limited, and is only supplied as part of Multicore Solder. It is a high grade, water white rosin, homogeneously activated.
- Confers on rosin a vigorous fluxing action without affecting the non-corrosive and protected features of the original rosin.
- Soldered joints made with Ersin Flux do not corrode even after prolonged exposure to a degree of humidity.
- Reduces the surface tension of molten solder, causing it to wet metals rapidly, increasing speed of operation with resultant production economies.
- Free from objectionable odor. Non-toxic in use.
- Leaves nothing but pure rosin on the work after soldering, and may be used wherever plain rosin is specified.

**ALLOY AND MELTING POINTS OF ERSIN MULTICORE SOLDER**

Alloy Tin/Lead	Multicore Color Code	Solidus °C.	Liquidus °C.	Recommended bit temperature °C.	USES
60/40	Red	183°	190°	230°	High quality work requiring low melting point alloy.
50/50	Yellow	183°	212°	252°	Hand soldering, Radio, telephone and electrical equipment; batteries.
45/55	Crimson/Buff	183°	227°	267°	
40/60	Green	183°	238°	278°	Fuses, motors, dynamos.
30/70	White	183°	257°	297°	
20/80	Purple	183°	276°	316°	

**STANDARD GAUGES**

Standard Wire Gauge	Diameter in inches	Diameter in millimeters	Approximate Number of Feet per lb.					
			ALLOY					
			60/40	50/50	45/55	40/60	30/70	20/80
10	1.128	3.251	25.2	24.1	23.5	23.0	21.9	20.8
12	0.104	2.642	38.1	36.5	35.2	34.9	33.1	31.5
13	0.092	2.337	48.7	46.6	45.3	44.5	42.3	40.3
14	0.080	2.032	64.4	61.7	59.2	58.6	56.0	53.3
16	0.064	1.626	100.5	96.4	94.3	92.1	87.5	83.3
18	0.048	1.219	178.5	171.0	167.8	163.5	155.5	148.0
19	0.040	1.016	257.5	246.5	240.4	235.5	224.0	213.0
20	0.036	0.914	318.0	304.5	302.5	291.0	276.5	263.0
22	0.028	0.711	526.0	503.0	492.0	481.0	457.0	435.0

ERSIN MULTICORE SOLDER is made in a wide range of gauges, as shown. It can also be supplied in any intermediate size. For general radio and electronic production 13, 14, 16 and 18 S.W.G. are the most widely used gauges.

**FEDERAL SPECIFICATIONS**

ERSIN Multicore Solder meets all requirements of Federal Specification QQ-S-571-b September, 1947 entitled "Solders Soft Tin Lead" as certified by the New York Testing Laboratory Incorporated.

**ALL GAUGES AND ALLOYS READILY AVAILABLE FROM NEW YORK STOCK.**

Address U.S.A. and Canadian inquiries to:

**BRITISH INDUSTRIES CORP.**  
315 Broadway, New York 7, N. Y.

Inquiries regarding other territories to:

**MULTICORE SOLDERS LTD.**  
Mellier House, Albemarle Street, London, W. 1, England



Write for Helpful Booklet,  
"SOLDERS AND SOLDERING"



**PROBLEM:**

**How to produce better,**

**ANSWER:**

**...Westinghouse**

**FOR  
EXAMPLE:**

**Resistance Welding Controls**

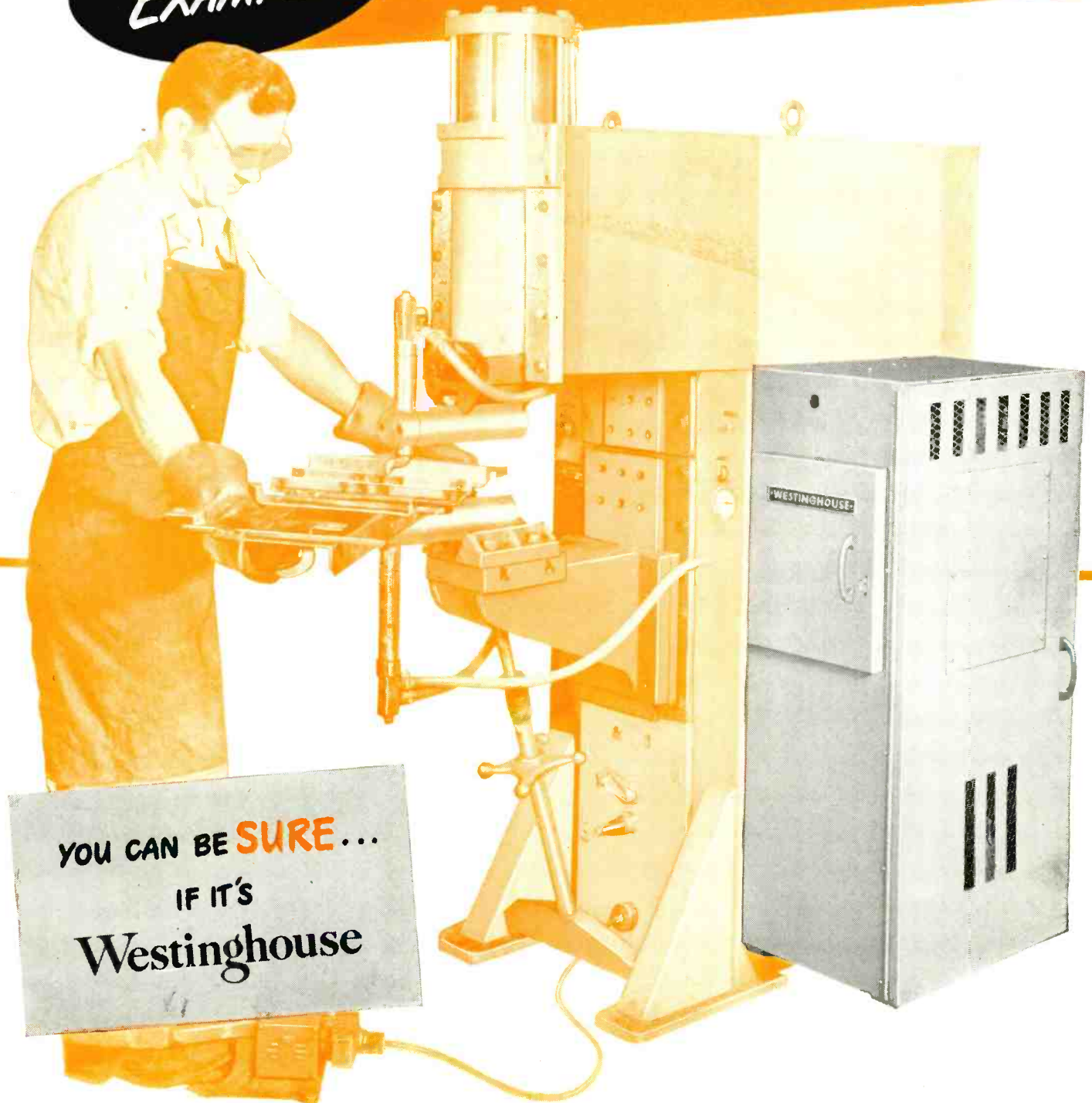

**YOU CAN BE SURE...  
IF IT'S  
Westinghouse**

**faster, cheaper**

# Electronic Controls

**Speed Production . . . . . Cut Costs**

Want to speed fabrication? Reduce handling and welding time? Get top-quality welds? Then investigate Westinghouse electronic resistance welding controls. You can select the basic patterns of controls you need—synchronous or non-synchronous. Each is a complete, unified, factory-assembled package that eliminates awkward, cumbersome equipment of the past. Every part has been especially designed for heavy-duty industrial use. Controls are within easy reach of the operator. Circuits have been simplified; troublesome gadgets eliminated; designs on-the-job tested and performance proved. Everything has been designed and built with one purpose in mind—to make resistance welding more practical . . . more efficient than ever before.

Check Westinghouse Electronic Welding Controls today. See their simplicity . . . their compactness. For complete detailed information, call your nearest Westinghouse representative or write to Westinghouse Electric Corporation, P. O. Box 868, Pittsburgh 30, Pennsylvania.

J-60681



## Synchro-Trol . . . Synchronous-Precision A-C Control for Resistance Welding

All timing and sequence functions in one factory-assembled and tested unit.

Synchronous-precision timing . . . more uniform welds . . . fewer rejects . . . lower costs.

Easy operation—finger-tip control where you want it.

Less floor space required—saves up to 50% of that formerly required.

Locking doors protect controls against unauthorized tampering.

Less skilled help needed for installation and operation.

## Weld-O-Timer . . . Non-Synchronous Control for Improved Welding

Unusual flexibility permits many combinations of standard sub-units in one factory-assembled unit for specific resistance welding requirements.

Installation is easy . . . units are supplied completely wired and factory-tested.

Tested, improved circuits provide timing consistency. Each sequence circuit is equipped with voltage regulating tubes. Standardized Weld-O-Timers are alike in design . . . well suited to modern plant layouts. Circuits and terminal markings, regardless of combination, are similar for all units.



**Westinghouse**  
PLANTS IN 25 CITIES . . . OFFICES EVERYWHERE

*Electronic Control*



# Wherever There's a CORE and COIL



## Choose

# FERRANTI

## Power and Audio Transformers Chokes • Filters

3 EXAMPLES OF OUR WIDE RANGE:

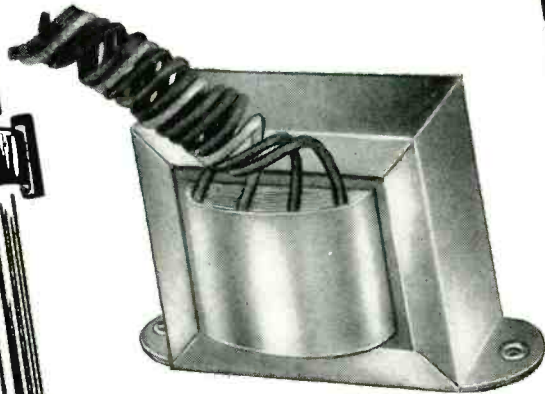

**OPEN FRAME TYPE** for mass production, minimum cost and weight for enclosed equipment.



**ENCLOSED CASE**, compound filled, for high moisture resistance. Standard cases up to 500 VA. Wide range of standard audio transformer units.

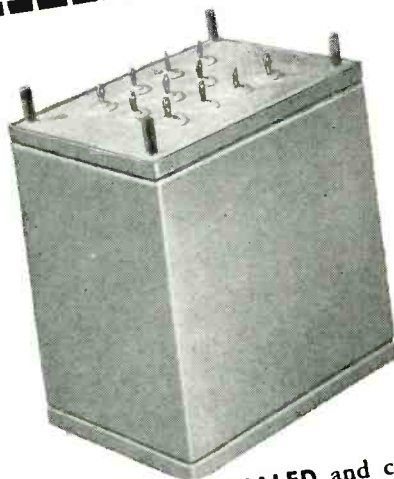

**HERMETICALLY SEALED** and compound filled cases. Glass or ceramic sealed terminals. Designed to meet JAN salt water immersion tests.

We offer ample modern facilities and intensive experience in up-to-date practice, including the latest core material developments, and components for 400 cycle power supplies. Our large accumulation of patterns, tools and dies often makes it possible to supply your specific requirements from standard parts, thus cutting your costs without sacrifice of quality. Whatever the type of unit, our bid will meet your needs. Submit your inquiries.

**POWER SUPPLY UNITS AND ELECTRONIC ASSEMBLIES TO SPECIFICATIONS**

## *Ferranti Electric, Inc.*

30-A Rockefeller Plaza • New York 20, N. Y.

# NOW! 10 cps to 10 mc

## ...with the New -hp- 650A RESISTANCE-TUNED OSCILLATOR



### SPECIFICATIONS

FREQUENCY RANGE: 10 cps to 10 mc  
FREQUENCY CALIBRATION: 0.9 to 10.

Multiplying factors are:

MF	Freq. Range
X10 cps	9 to 100 cps
X100 cps	90 to 1000 cps
X1kc	900 to 10,000 cps
X10kc	9 to 100 kc
X100kc	90 to 1000 kc
X1mc	0.9 to 10 mc

STABILITY:  $\pm 2\%$ , 10 cps to 100 kc;  $\pm 3\%$ , 100 kc to 10 mc including warmup, line voltage, and tube changes.

OUTPUT: 10 milliwatts or 3 volts into 600 ohm resistive load. Open circuit voltage is at least 6 volts. 600 ohm reflected impedance. Output impedance of 6 ohms also available.

FREQUENCY RESPONSE: Flat within  $\pm 1$  db, 10 cps to 10 mc.

DISTORTION: Less than 1% from 100 cps to 100 kc. Approx. 5% from 100 kc to 10 mc.

OUTPUT MONITOR: Vacuum tube voltmeter monitors output level in volts or db at 600 ohm level. Output response beyond monitor is accurate within  $\pm 5\%$  all levels and frequencies.

OUTPUT ATTENUATOR: Output level attenuated 50 db in 10 db steps, providing continuously variable output voltage from +10 dbm to -50 dbm, 3 volts to 3 millivolts, or down to 30 microvolts with voltage divider.

HUM VOLTAGE: Less than 0.5% below maximum attenuated signal level.

POWER SUPPLY: 115 volts 50/60 cps. Consumption 135 watts. Plate supply electronically regulated.

MOUNTING: Cabinet or relay rack. Panel size 19" x 10 1/2". Depth 13".

**HERE IT IS . . .** another -hp- "first" . . . a new resistance-tuned oscillator that not only covers a frequency range of 10 cps to 10 mc, but brings to the r-f and video field all the speed, accuracy and ease of measurement traditional to famous -hp- audio oscillators. And, this important addition to the -hp- line incorporates all the family characteristics of other -hp- oscillators . . . no zero setting, minimum adjustment during operation, virtual independence of line and tube characteristics, accurate calibration, and streamlined circuits for long, trouble-free performance.

The result is a highly stable, wide-band precision instrument which provides output flat within 1 db from 10 cps to 10 mc, and a voltage range of .00003 to 3 volts. Output impedance is 600 ohms or 6 ohms with output voltage divider.

**LIKE OTHER** -hp- resistance-tuned oscillators, the new 650A gives you the advantage of decade frequency ranges, a 94" scale length, and a 6 to 1 micro-controlled vernier drive. A complete vacuum tube voltmeter, included in the 650A circuit, monitors output in volts or db at the 600 ohm level. A continuously variable output voltage is obtained by means of an output attenuator of 50 db, variable in 10 db steps and an amplitude control which adjusts the level to the monitor vacuum tube voltmeter.

Where it is desirable that the measurements be made with a low source impedance, an output voltage divider unit is supplied. This attachment consists of a cable, which may be extended to the point of measurement and provides an internal impedance of 6 ohms. It also reduces the output voltage 100 to 1.

**THE COMPACT**, efficient -hp- 650A is available now for making a wide number of measurements . . . testing television amplifiers, wide-band systems, filter transmission characteristics, tuned circuits, receiver alignments. And . . . it serves admirably as a power source for bridge measurements or as a signal generator modulator.

For full information . . . write today

Hewlett-Packard Company • 1495A Page Mill Road • Palo Alto, Calif.

Attention FM Engineers!  
Full information on the new -hp-  
FM TEST EQUIPMENT  
Available on Request.  
Write Today!

**hp laboratory instruments**  
FOR SPEED AND ACCURACY



**we're**

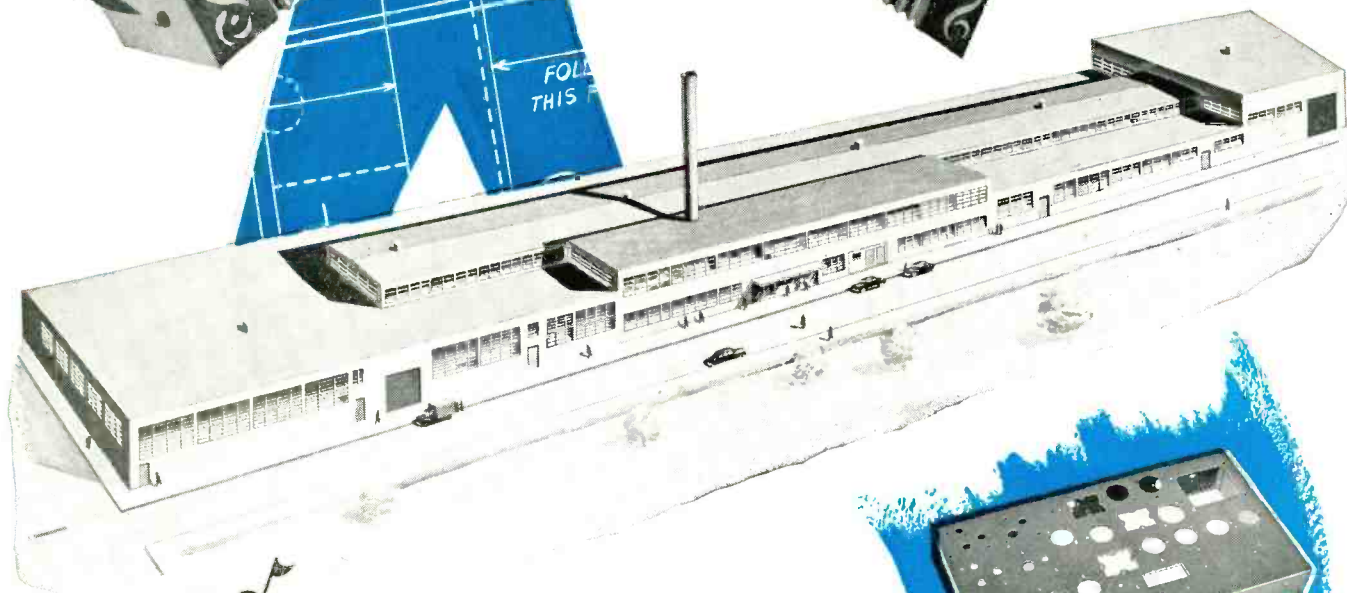
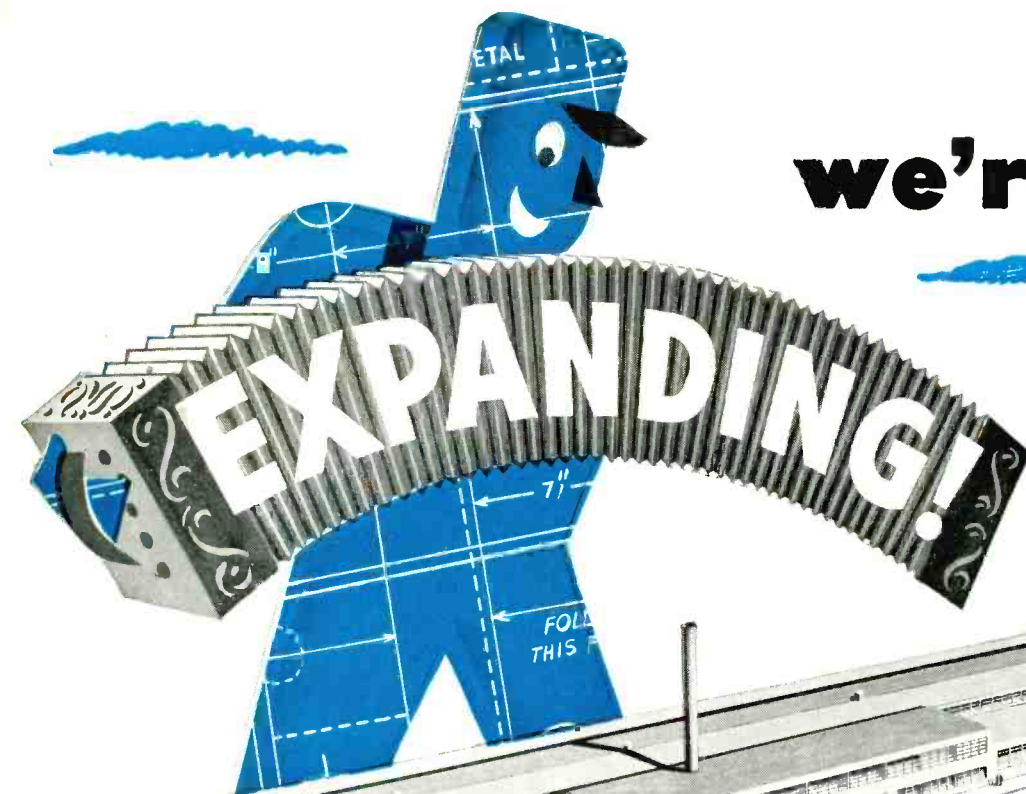

It's sweet music to us . . . and to our customers, we think, to know that Karp Metal Products Co., Inc., next month will move into a brand new streamlined building of 70,000 square feet of space, with a 600 foot frontage.

Our new plant will be the last word in modern manufacturing quarters, equipped with the newest and most efficient machinery and facilities, including the most complete and **up-to-date paint and finishing department**, scientifically air conditioned and dustproof. These advancements will enable us to extend the scope of the precision service we render the leaders of the radio and electronics industry.

Your loyal patronage has helped make possible this expansion, and you may be sure the favor will be returned in the form of greater production and better-than-ever Karp service . . . from the simplest chassis to the most elaborate console.

Ask For Our Informative New Catalog



**KARP METAL PRODUCTS CO., INC.**

215-63rd Street, Brooklyn 20, New York

*Custom Craftsmen in Sheet Metal*

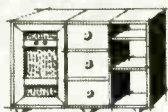

# Jensen Customode

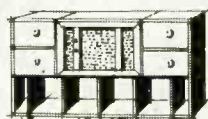
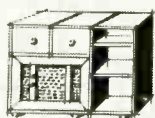

**The answer to your HOME ENTERTAINMENT CENTER.** Designed by leading furniture stylists and electronics engineers, CUSTOMODE custom cabinets give you hundreds of refined functional arrangements, enhancing all interior styles and requirements.

Four Basic Units: Reproducer Cabinet—Bass Reflex design utilizes any 15" speaker including Jensen coaxial speakers; Medium Utility Cabinet—for large equipment, communications receivers, television sets, amplifiers, etc.; Small Utility Cabinet—for tuner, amplifier, recorder, record changer, etc.; Record Cabinet—holding more than 200 records. Mahogany in Blond or Cordovan finish.

Customode's "building block" versatility enables you to create your own layouts as you wish, when you wish. Please accept our invitation to write today for free literature and scale cut-up illustration. Jensen Manufacturing Company, 6601 S. Laramie Ave., Chicago 38, Illinois.



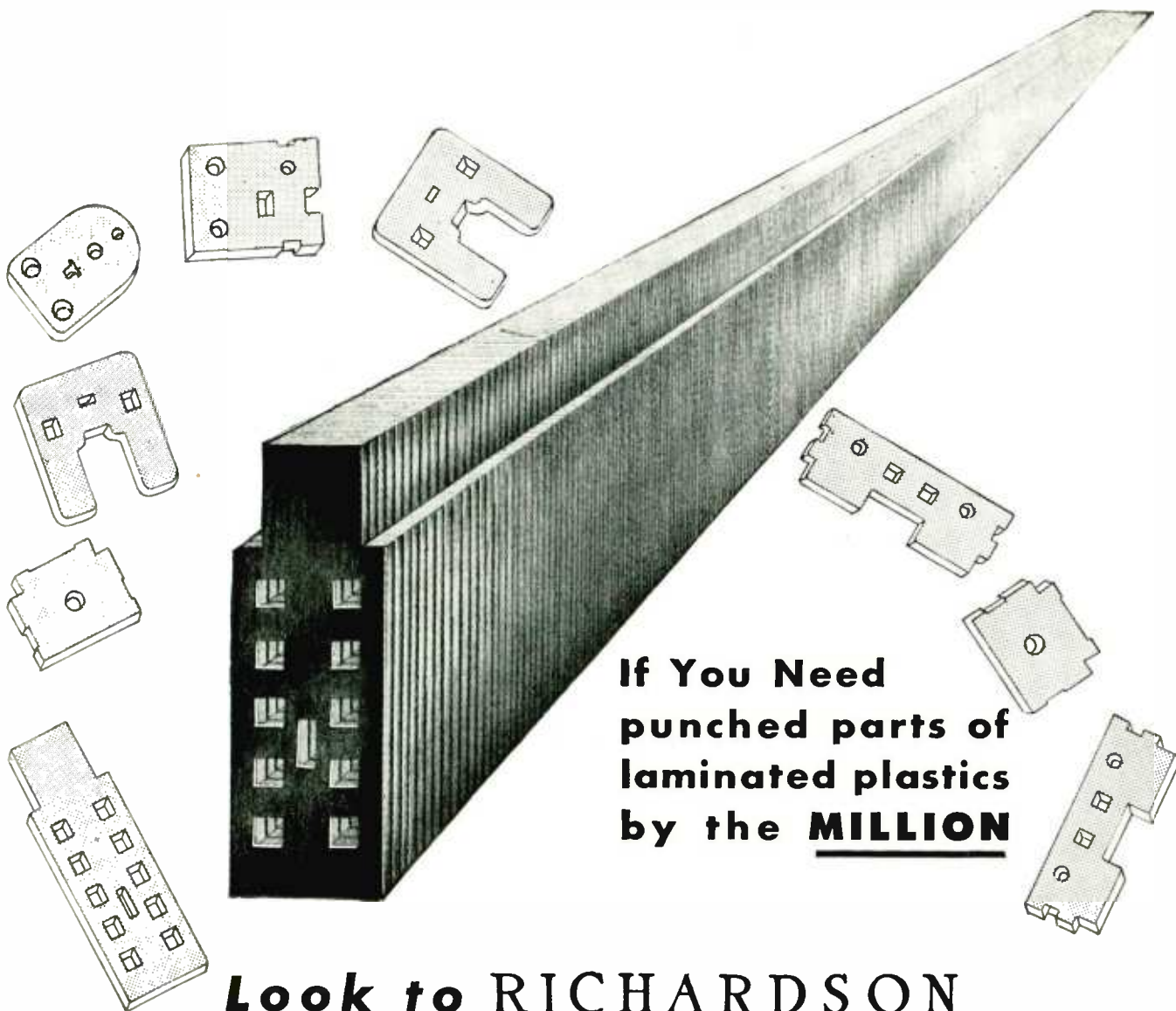

If You Need  
punched parts of  
laminated plastics  
by the **MILLION**

**Look to RICHARDSON**  
**Insist on INSUROK**

(REGISTERED TRADE MARK)

The Richardson Company offers you the services of an established, experienced, manufacturing organization with ample facilities for quantity production of Laminated **INSUROK**, proven by years of experience to be one of the world's truly fine punching stocks.

*The* **RICHARDSON COMPANY**

GENERAL OFFICES: LOCKLAND, OHIO • FOUNDED IN 1858  
Sales Headquarters: MELROSE PARK, ILLINOIS

CLEVELAND - DETROIT - INDIANAPOLIS - MILWAUKEE - NEW BRUNSWICK, N. J. - NEW YORK - PHILADFLPHIA - ROCHESTER - ST. LOUIS

# Glass bushings Now Available

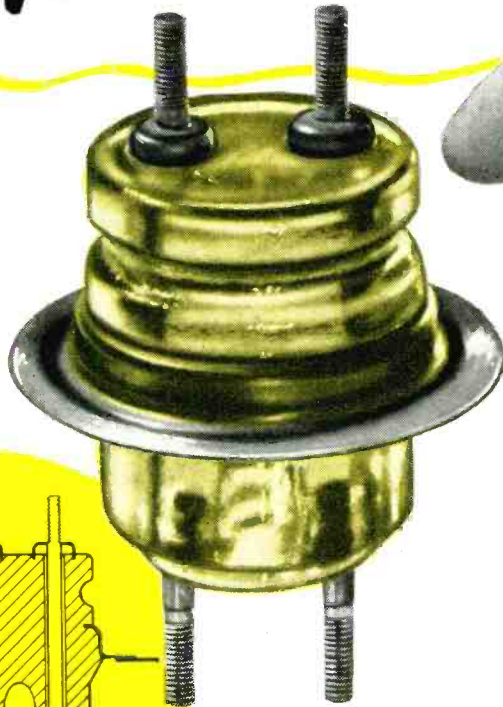

to manufacturers of  
electronic equipment

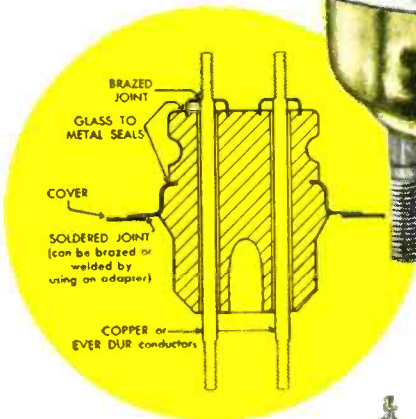

Can be welded, brazed, or soldered to case, forming a strong, permanent, hermetic seal that eliminates moisture problems and often permits more compact, light-weight design.

General Electric is now offering to other manufacturers the glass bushings that it has used so successfully on capacitors, rectifiers, modulator and instrument transformers, and other electrical equipment. These bushings are cast of an exceptionally stable, low-expansion glass. Metal hardware is a special nickel-alloy steel, fused to the glass in casting. Bushings are attached directly to the apparatus without gaskets—by soldering, welding or brazing the metal bushing flange to the metal case.

The resulting joint between bushing and equipment is permanent, vacuum-tight, and of high mechanical strength. It is especially desirable for equipment subject to vibration, shock, fungus growth or severe changes in temperature. These glass bushings are currently available to meet dry, 60-cycle, flashover values of from 10 to 50 kv, and in current ratings of 25 and 50 amperes (large sizes up to 800 amperes). They may be single or multi-conductor and can be provided with a top flange to permit mounting tube sockets directly on the bushings. Diameters range from  $1\frac{5}{8}$  to  $3\frac{3}{8}$  inches and weights from  $2\frac{1}{2}$  oz. to 4 lb.

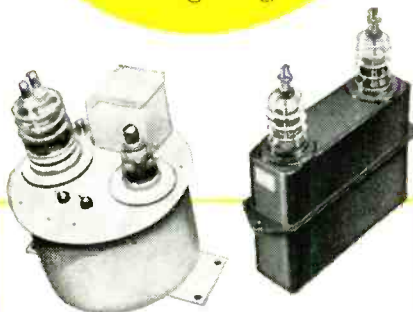

The best way to evaluate these glass bushings for capacitors, modulator transformers, and other electronic equipment, is to see them. If you will send us a sketch and ratings of bushings you are now using, we will furnish you with samples of one or more of our standard glass bushings. Or write for Bulletin GEA-5093 which contains complete listings of our standard designs, allowing you to select the particular bushing you require. Power Transformer Sales Division, General Electric Co., 16-215 Pittsfield, Mass.

GENERAL  ELECTRIC

401-53



Recommended for use under stringent conditions such as encountered in television, auto radio applications, and sets for export use.

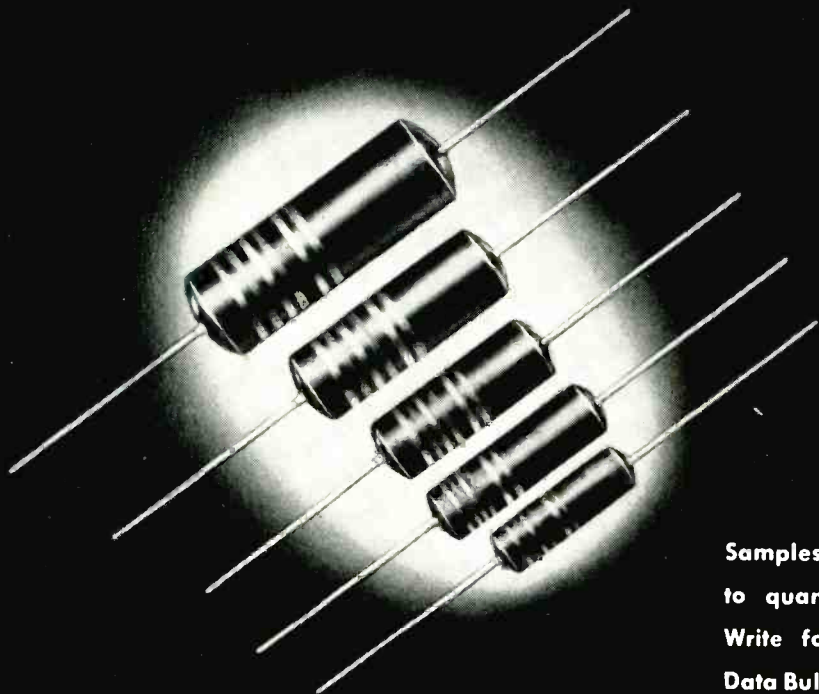

Samples on request to quantity users. Write for Sprague Data Bulletin 201A.

*Wherever small, paper capacitors are required to operate under exacting conditions of heat, moisture or vibration, Sprague Phenolic Molded Tubulars are setting new, higher standards of efficiency.*

SPRAGUE ELECTRIC COMPANY, NORTH ADAMS, MASS.

# SPRAGUE

PIONEERS OF

\* Trademark Reg. U. S. Pat. Office

ELECTRIC AND ELECTRONIC PROGRESS

CAPACITORS • KOOLOHM® RESISTORS



# Collins

## 3000A-1

### vhf communication package

● The Collins 3000A-1 provides radiophone facilities for transmission and reception in the frequency range of 118 to 136 mc. It is expressly designed for airlines and airport tower vhf communications.

The installation consists of a Collins 242B-1 vhf transmitter (r-f, modulator, relay control, and high and low voltage power supply units), and a Collins 51M-2 vhf receiver, all compactly integrated in a Collins cabinet.

The r-f section permits transmission on either of a pair of frequencies not more than 1% separated, anywhere within the band, and has a power output of 50 watts. The number of channels can be increased by the addition of r-f units, each unit having two channels. By selection of vhf units and a Collins remote control unit the installation can provide transmission on as many as eight frequencies.

The transmitter units are designed for 19" rack panel mounting. Convenience for maintenance has been an important design consideration. All tubes and adjustments are available from the front of the cabinet. Thorough engineering throughout insures dependable, uninterrupted performance at either a local or remote position.



The 51M-2 is a fixed channel crystal controlled dual-superheterodyne receiver, and is highly sensitive and selective. It includes all modern circuit features, such as flat avc, noise limiter, and squelch. Write us for further information.

IN RADIO COMMUNICATIONS, IT'S . . .

**COLLINS RADIO COMPANY, Cedar Rapids, Iowa**

11 West 42nd Street, New York 18, N. Y.

458 South Spring Street, Los Angeles 13, California





**the right material  
for your job**

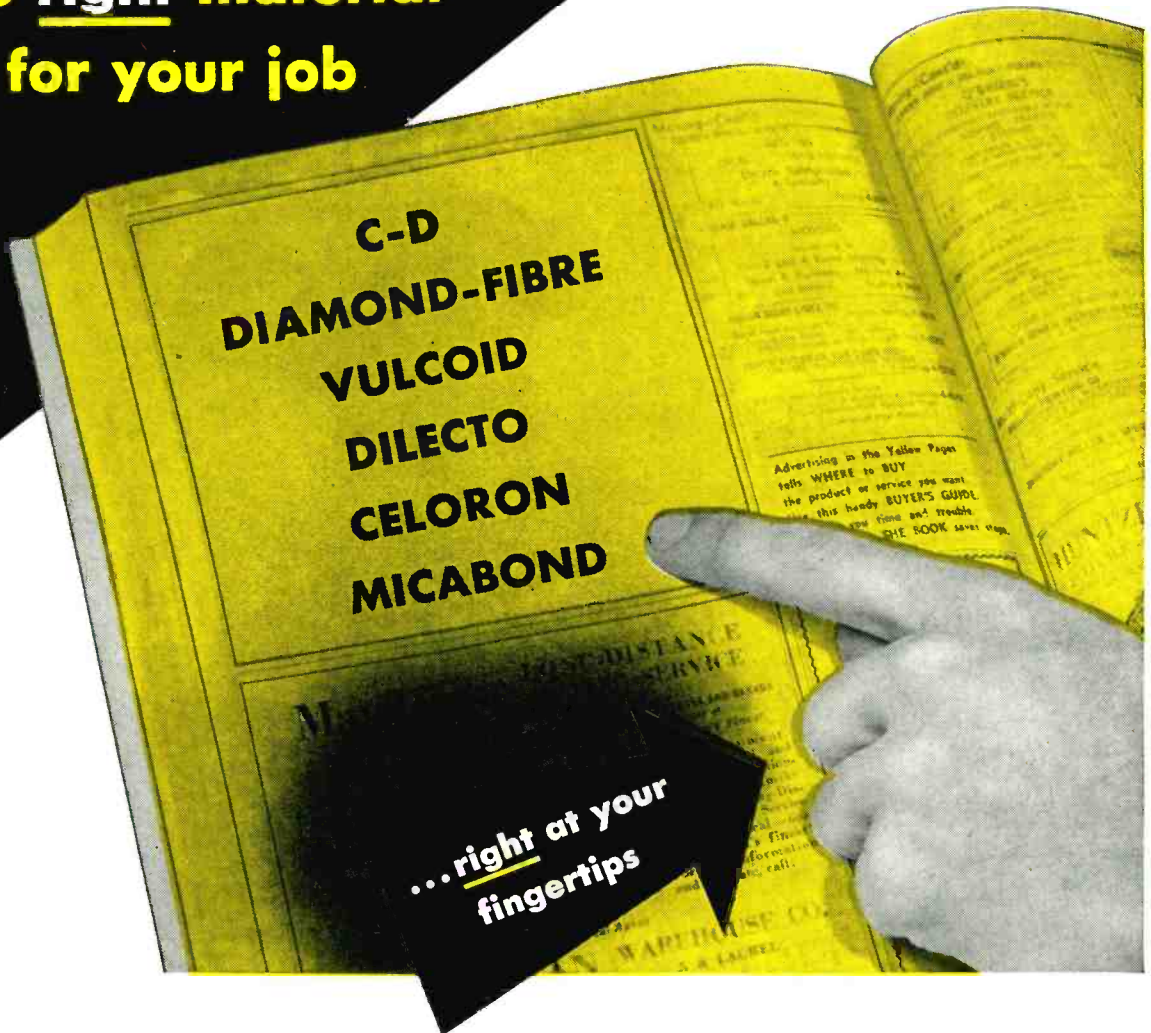

If you want to get the electrical insulating material best suited to improve product performance, here's an engineering service worth investigating. Experienced Continental-Diamond engineers will welcome the opportunity of working with you from the start of a job to its completion. Backing them up is a *complete* line of insulating plastics with unusual combinations of electrical, chemical and mechanical properties. There's *Diamond Fibre* for toughness, wear resistance, and light weight, *Vulcoid* for superb arc resistance, toughness, good dielectric strength and fair moisture stability, *Dilecto* for structural



strength and dimensional stability. All in all, there are five different C-D Plastics subdivided into grades to fit your specific application.

Take advantage of this complete plastics service designed to help you improve product performance, lower unit costs. For personal engineering help or prompt delivery of insulating plastics, call your nearest C-D office today.

**C-D HIGH-STRENGTH PLASTICS**

- Diamond Fibre**—Vulcanized Fibre
- Vulcoid**—Resin Impregnated Fibre
- Dilecto**—Laminated Thermosetting Plastic
- Celoron**—Molded High-Strength Plastic
- Micabond**—Bonded Mica Splittings

DE-5-48  
BRANCH OFFICES: NEW YORK 17 • CLEVELAND 14 • CHICAGO 11 • SPARTANBURG, S. C. • SALES OFFICES IN PRINCIPAL CITIES  
WEST COAST REPRESENTATIVE: MARWOOD LTD., SAN FRANCISCO 3 • IN CANADA: DIAMOND STATE FIBRE CO., OF CANADA, LTD., TORONTO 8

**Continental - Diamond FIBRE COMPANY**

Established 1895 . Manufacturers of Laminated Plastics since 1911—NEWARK 16 • DELAWARE

# You get all these features ONLY in the Western Electric 5A Monitor for FM Broadcasting

## CENTER FREQUENCY MONITOR:

Accuracy—better than  $\pm 500$  cycles. ( $\pm 200$  cycles if occasionally adjusted to agree with a primary standard)  
Meter Range— $\pm 3,000$  cycles  
Terminals for connecting remote meter

## MODULATION PERCENTAGE MONITOR:

Accuracy—better than 5% for all readings  
Modulation Range Capability—up to 133% ( $\pm 100$  kc)  
Terminals for connecting remote meter

## QUALITY DESIGN AND MANUFACTURE:

Designed by Bell Telephone Laboratories. Built by Western Electric, to Western Electric standards of quality.



## PROGRAM MONITORING CIRCUIT:

Output suitable for either aural program monitoring or FM noise and distortion measurements  
Frequency Response— $\pm 0.25$  db, 30 to 30,000 cycles, without de-emphasis; with de-emphasis, response is within  $\pm 0.5$  db of the standard 75 microsecond de-emphasis curve  
Audio Output Power—output level adjustable up to +12 dbm—permits direct switching of program monitor from transmitter input to 5A Monitor output  
Harmonic Distortion—less than 1/4 of 1% from 30 to 15,000 cps  
Output Noise—at least 75 db below signal at 100% modulation

## MODULATION PEAK INDICATOR:

Indication Lamp—flashes when a selected level of modulation is exceeded  
Peak Limit Range—continuously adjustable between 40% and 140% modulation

## AM NOISE DETECTOR:

An exclusive feature in the 5A Monitor. The output of this detector—which may be read directly on an electronic voltmeter or noise meter—is automatically referred to 100% amplitude modulation, thus simplifying measurement of transmitter AM noise.



**POWER SUPPLY:** Newly designed 20C Rectifier (furnished as a part of the 5A Monitor) provides electronically regulated d-c with less than 1 millivolt ripple from 105-125 volts a-c 60 cycles. May be remotely located if desired.

The 5A Monitor includes numerous other valuable features such as: dual thermostats and dual heaters for each crystal—means for checking the inherent noise level of the monitor from its input to output terminals—requires only a low RF input level (1 watt) which can vary from 0.3 to 3.0 watts; i. e., a 10 to 1 variation without affecting the performance of the monitor. To get the complete story on this outstanding monitor value, call your Graybar Broadcast Representative or mail the coupon below.

# Western Electric

Distributors: In the U. S. A.—Graybar Electric Company.  
In Canada and Newfoundland—Northern Electric Company, Ltd.

—QUALITY COUNTS—



Graybar Electric Company E-40  
420 Lexington Avenue, New York 17, N. Y.

Please send me Bulletin T-2437, including curves, schematics and block diagram of the 5A Monitor.

NAME \_\_\_\_\_

STATION \_\_\_\_\_

ADDRESS \_\_\_\_\_

CITY \_\_\_\_\_ STATE \_\_\_\_\_



*Applied  
Research  
Laboratories*

*specifies*

*Sorensen*

*electronic*

*voltage*

*regulation*

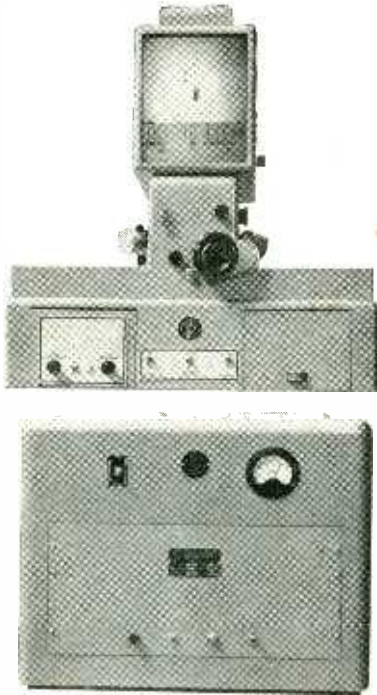

Only Sorensen electronic voltage regulators offer as much as 0.1% regulation accuracy under *simultaneous* line and load changes.

Shown above is the ARL Projection Comparator Densitometer. Applied Research Laboratories, internationally known manufacturers of precision spectographic and densitometric equipment, have standardized on Sorensen AC line voltage regulators because *only* Sorensen units provide the 0.1% regulation accuracy necessary for the scanning lamp. SIX IMPORTANT SORENSEN FEATURES: • *Precise regulation accuracy*; • *Excellent wave form*; • *Output regulation over wide input voltage range*; • *Fast recovery time*; • *Adjustable output voltage, that once set, remains constant*; • *Insensitivity to line frequency fluctuations between 50 and 60 cycles*.

If you calibrate meters, need quality control on test lines, work with X-ray equipment, or are a research physicist or chemist, there is a *standard* Sorensen AC or DC unit to solve your voltage problem. The Sorensen Catalog contains complete specifications on standard Voltage Regulators and Nobatrons. *It will be sent to you upon request.*

THE FIRST LINE OF STANDARD ELECTRONIC VOLTAGE REGULATORS.



**SORENSEN & Company, Inc.**

Stamford, Connecticut

*Represented in all principal cities.*

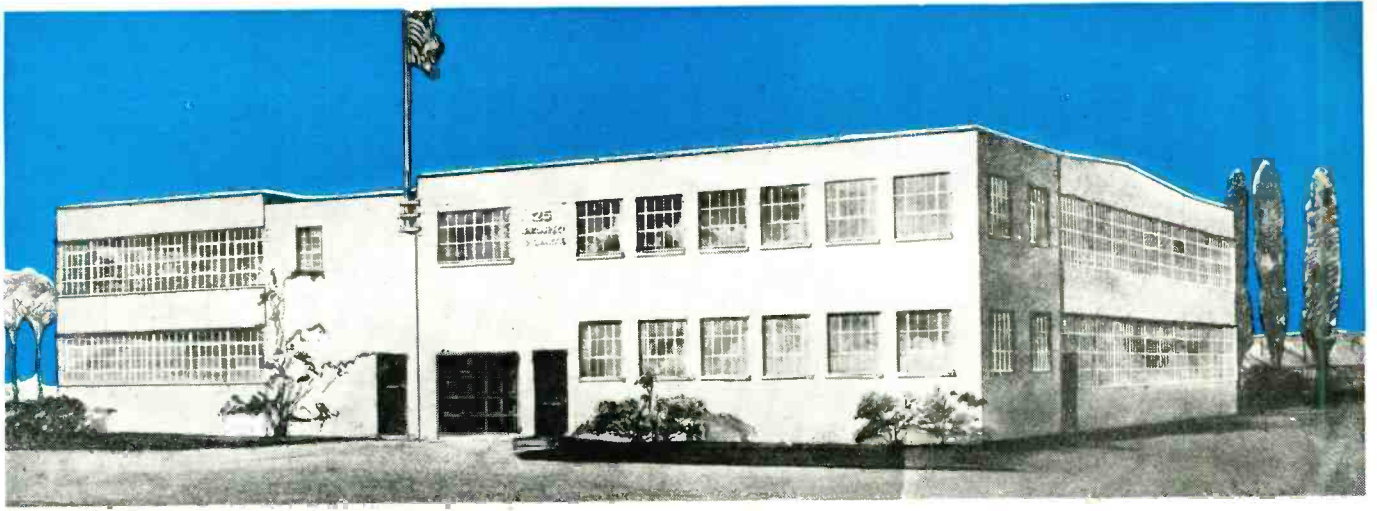

*Designers and Manufacturers of  
Communications, Microwave and Electro-Mechanical Equipment*

## **PRESS WIRELESS MANUFACTURING COMPANY, INC.**

*(Combining Press Wireless Manufacturing Corporation and Milliken Machine Company)*

A STATEMENT BY THE PRESIDENT



established concerns are now united under the name Press Wireless Manufacturing Company, Inc.

- To the many friends of Press Wireless Manufacturing Corporation and of Milliken Machine Company, we take pleasure in announcing that these two long
- The new company has continued intact the ex-

ceptional engineering staffs and production facilities of its predecessors and now offers to government and industry a complete service for the design and manufacture of a wide variety of communication, microwave and electro-mechanical equipment.

- Press Wireless Manufacturing Company, Inc., places at your disposal a coordinated and experienced team, which has consistently delivered successful military and commercial equipment and which knows how to interpret intangibles and create efficient designs where no precedent exists.

**WE WELCOME YOUR INQUIRIES**

*T. Mitchell Hastings*  
President



**PRESS WIRELESS MANUFACTURING COMPANY, INC.**

*First in "Packaged" Communications Equipment—from Antenna Tower to Operating Console  
Manufacturing Plants Located at Hicksville, L. I., and West Newton, Mass.*



# Centralab reports to

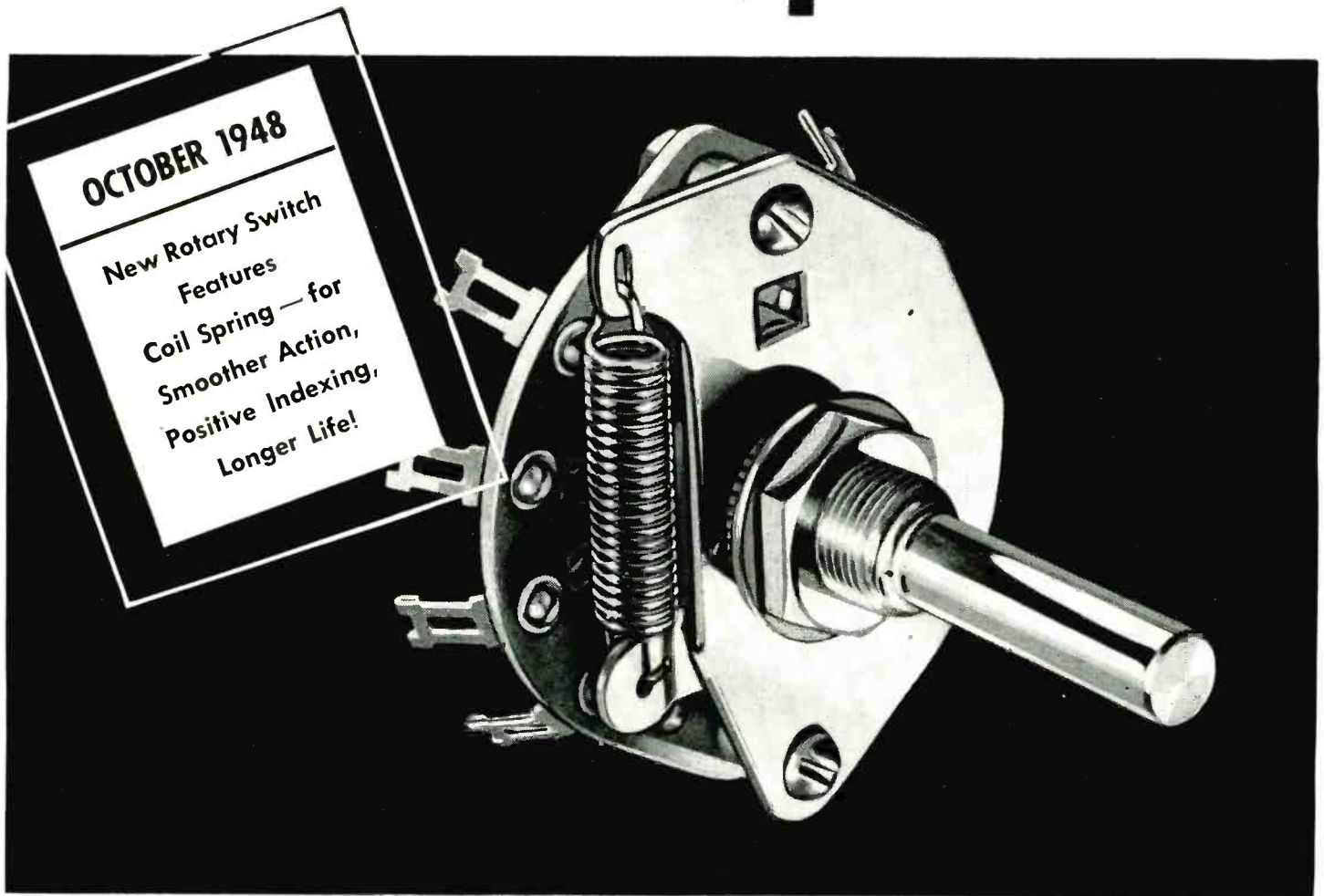

**I** Check the features of Centralab's revolutionary new Rotary Coil and Cam Index Switch. You'll agree it's one of the most important switch developments of the year! (1) New tested step-strength of 48 inch pounds. (Standard RMA step-strength—only

24 inch pounds.) (2) Guaranteed minimum life — 150,000 cycles (RMA Standard — 10,000 cycles.) (3) Removable spring can be replaced without removing switch from chassis. Get all the facts. Write for Bulletin 995.

## Four Positions Give You Wide Choice of Switching Combinations

PI — Positive Index      SR — Spring Return



**1** Two position positive index.

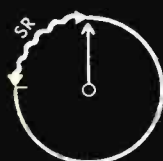

**2** Two position spring return, from counter-clockwise.

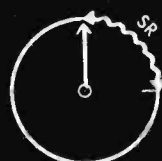

**3** Two position spring return from clockwise.

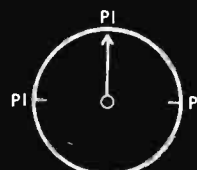

**4** Three position positive index.



**5** Three position spring return from both sides to center.



**6** Three position index — two positive spring return from counter-clockwise.

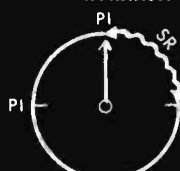

**7** Three position index — two positive spring return from clockwise.

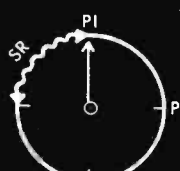

**8** Four position, three positive, spring return from counter-clockwise.

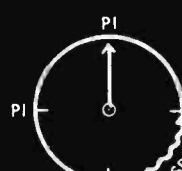

**9** Four position, three positive, spring return from clockwise.

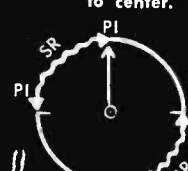

**10** Four position, two positive, spring return from clockwise, counter-clockwise.

# Electronic Industry

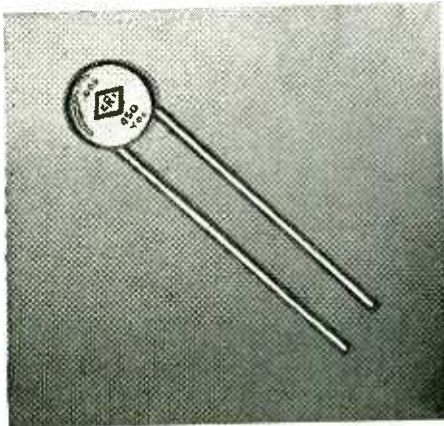

**2** For utmost reliability in small physical size, low mass weight, use CRL *Hi-Kaps* — miniature ceramic disc capacitors. Write for Bulletin 933.

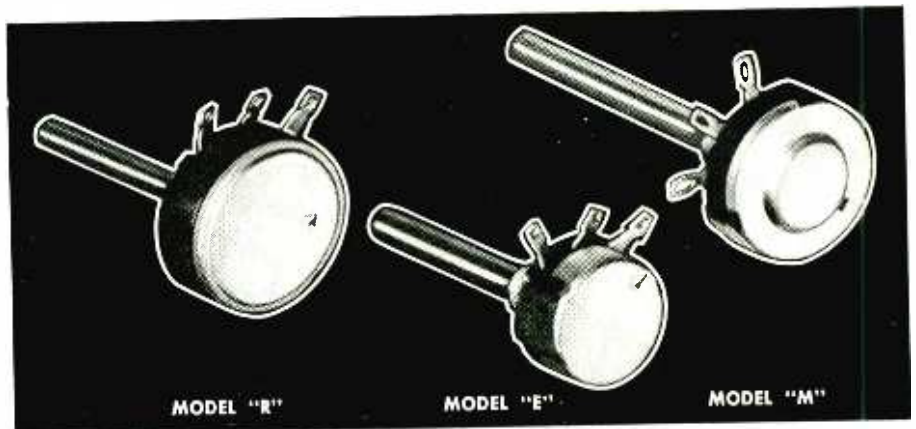

**3** Let Centralab's complete Radiohm line take care of your special needs. Wide range of variations: *Model "R"* — wire wound, 3 watts; or composition type, 1 watt. *Model "E"* — composition type, 1/4 watt. Direct contact, 6 resistance tapers. *Model "M"* — composition type, 1/2 watt. For complete information, write for Bulletin 697.

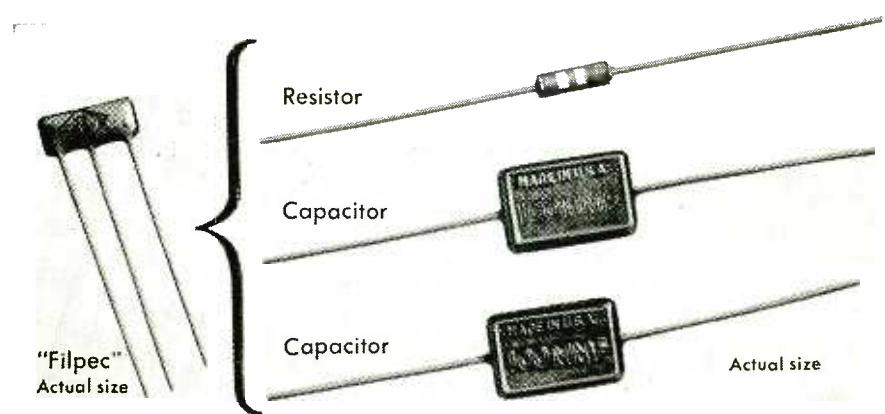

**4** Centralab's *Filpec* is designed for use as a balanced diode lead filter, combines up to three major components into one tiny filter unit, lighter and smaller than one ordinary capacitor. Capacitor values available from 50 to 200 mmf. Resistor values from 5 ohms to 5 megohms. For complete information write for Bulletin 976.

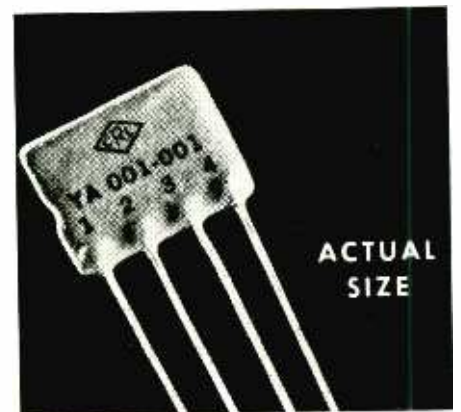

**5** CRL's *Couplate* consists of a plate lead resistor, grid resistor, plate by pass capacitor and coupling capacitor. Write for Bulletin 933.

**LOOK TO CENTRALAB IN 1948!** *First in component research that means lower costs for the electronic industry. If you're planning new equipment, let Centralab's sales and engineering service work with you. Get in touch with Centralab!*

# Centralab

DIVISION OF GLOBE-UNION INC., MILWAUKEE, WIS.



**IN THE BATTLE FOR THE LISTENER'S EAR...**

Here's increased coverage for your station!



*with the new*



# LIMITING AMPLIFIER

**F**ITS neatly into your audio cabinet—attractive, sturdy, quiet. But what a *wallop* it packs when you want attention from Mr. Big—the listener!

Based on engineering developments by CBS engineers, the Limiting Amplifier has been designed by General Electric to give you greater coverage and more potential listeners without changing your present transmitter or antenna.

For more information, call your nearest G-E broadcast equipment representative, or write us. *General Electric Company, Transmitter Division, Electronics Park, Syracuse, New York.*

## MEMO TO STATION MANAGERS:

- ▶ Increases modulation and thus makes signal reach farther, sound clearer.
- ▶ Raises effective signal strength—this means increased coverage.
- ▶ Low installation cost—quickly, easily mounted in G-E Audio Cabinet Rack.
- ▶ In FM, too—protect your listeners against receiver distortion caused by transmitter over-swing. Dynamic range, so important in FM, is maintained.

## MEMO TO ENGINEERS:

- ▶ Increases average level of modulation as much as 8 to 10 db.
- ▶ Anticipatory circuit prevents overmodulation—even on the first half cycle of the over-modulation peak. Automatic recovery time improves program fidelity!
- ▶ Prevents distortion and adjacent channel splatter.
- ▶ G-E popular hinged panel construction—easy to get at.
- ▶ Vertical mounted for better ventilation.

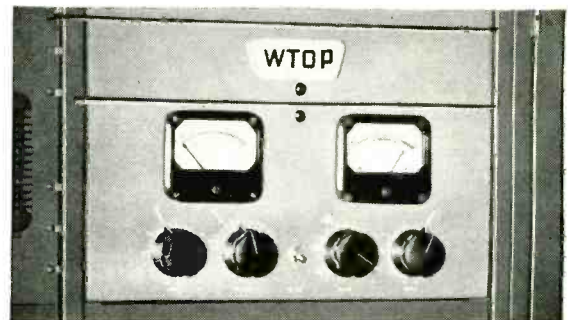

**G-E Limiting Amplifier at the 50,000 watt transmitter of WTOP, Washington, D. C.**

*You can put your confidence in—*  
**GENERAL  ELECTRIC**

160-G2A-6914



# OHMITE Resistance "Know-How"

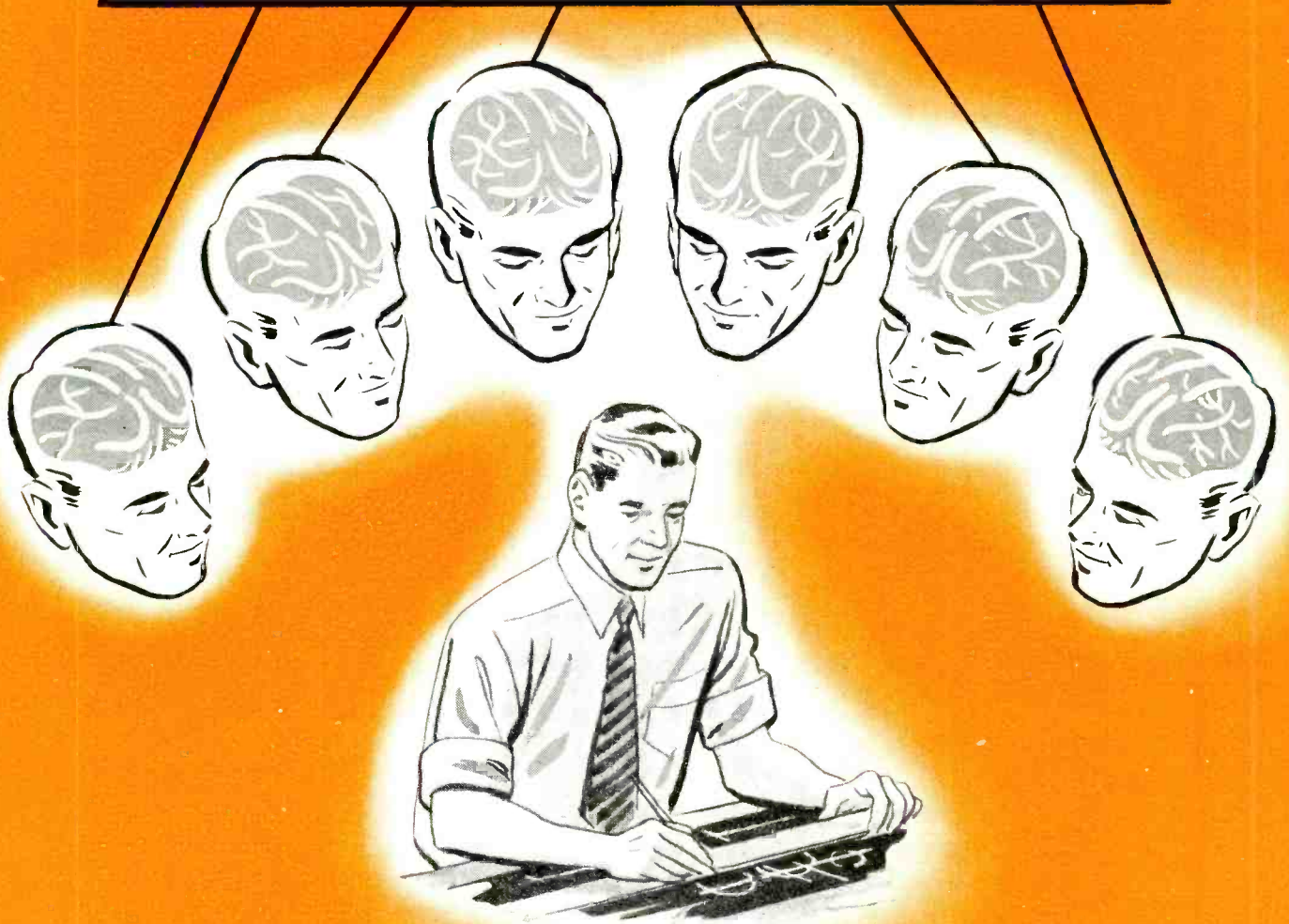

## HERE'S A VALUABLE SOURCE OF DESIGN INFORMATION

**I**F YOU have a design problem involving rheostats or resistors, call on Ohmite for assistance. The accumulated experience of the entire Ohmite engineering staff . . . the combined thinking of its many resistance specialists . . . are all available to you for the asking. Ohmite engineers are well qualified to help analyze your requirements and select the correct units to fit your specific application. Years of experience in building dependable rheostats and resistors, in helping others solve specialized resistance problems, is your assurance that Ohmite "know-how" can help you. We invite you to submit your problems to us.



RHEOSTATS



RESISTORS



TAP SWITCHES

Be Right with **OHMITE**



# OHMITE

ALL CERAMIC • POWER TYPE  
NON-SHORTING

## Tap Switches

MODEL 608

### FIVE SIZES

MODEL 412

MODEL 312

MODEL 212

MODEL 111

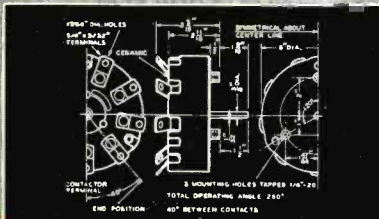

Model 608—100 Amp

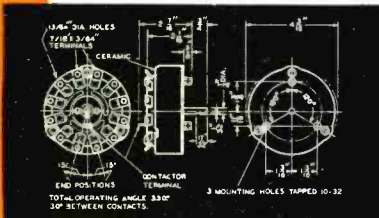

Model 412—50 Amp

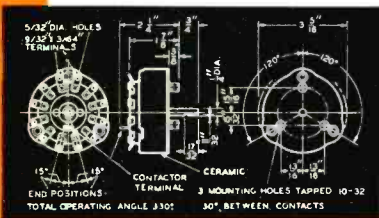

Model 312—25 Amp

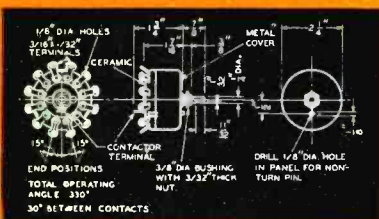

Model 212—15 Amp

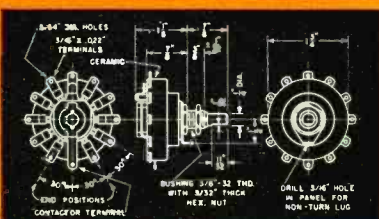

Model 111—10 Amp

Send for Catalog and  
Engineering Manual No. 40



Write now,  
on company  
letterhead,  
for your  
copy of this  
helpful 96-  
page Ohmite  
catalog.

OHMITE  
MANUFACTURING  
COMPANY

4817 Flournoy  
Chicago 44, Ill.

## Compact-Dependable

Here's a line of non-shorting, rotary tap switches that combine high current-capacity and a large number of taps, with unusual compactness. Their sturdy one-piece ceramic bodies provide permanent insulation, as the ceramic is not affected by arcing. The heavy silver-to-silver contacts have a self-cleaning action, and (except for Model 111) are totally enclosed and protected. Switch shafts are electrically dead—insulated by strong ceramic hubs. A positive cam-and-roller mechanism provides "slow-break quick-make" action—particularly designed for alternating current use. Two or three of these Ohmite tap switches can be mounted in tandem to form multiple-pole assemblies.



*Be Right with...*

**OHMITE**  
RHEOSTATS • RESISTORS  
TAP SWITCHES

*Industry's First Choice*

If Recorders came  
with Mileage Meters...



Presto 6N would be **MILES AHEAD**

Yes, day after day and year after year over 3,000 Presto 6N recorders are hard at work in broadcasting stations, recording studios, educational institutions and government agencies throughout the world.

6N recorders purchased ten years ago are performing as well today as when they were new. This outstanding record of the 6N recorder in action is proof again that Presto design is built for hard, continuous duty and Presto materials are the finest obtainable.

So when you're looking for a new recorder, remember: By actual test the best recorder for the most people is Old Faithful, the Presto 6N.



RECORDING CORPORATION, Paramus, New Jersey • Mailing Address: P. O. Box 500, Hackensack, N. J.

In Canada: WALTER P. DOWNS, Ltd., Dominion Sq. Bldg., Montreal

World's largest manufacturer of instantaneous sound recording equipment and discs



# For Any and All By-Passing Requirements **ERIE** **CERAMICONS®**

## MOLDED INSULATED TUBULAR GP CERAMICONS

Have extremely rugged, molded insulation, axial leads. Capacity range 10-5,000 MMF. Smallest size .250" x .562" max.



## DIPPED INSULATED GP CERAMICONS

For use where space is at a premium and radial leads are desired. Capacity range 10-15,000 MMF. Smallest size .240" x .460" max.



## NON-INSULATED GP CERAMICONS

Smallest size units. Have baked enamel coating, radial leads. Capacity range 10-15,000 MMF. Smallest size .200" x .400" max.



## INSULATED STAND-OFF CERAMICONS

Rugged, molded insulated construction. Mounts with 6-32 nut. Style 323 mounts 19/32" high above chassis. Capacity range 0.5-700 MMF. Style 324 mounts 27/32" high. Capacity range 710-1,500 MMF. Available with 20 gauge wire lead or post type top terminal.



## NON-INSULATED STAND-OFF CERAMICONS

Style 318 (left) mounts 1/2" high above chassis, has .032" diameter wire top terminal. Capacity range 1-560 MMF. Style 319 (right) mounts .520" high, has .067" diameter top terminal. Capacity range 2-1,000 MMF. Both styles have 3-48 thread.



## SIDE-LEAD STAND-OFF CERAMICONS

Wire leads are correct height from chassis for shortest possible connection to tube sockets. Style 2322 (left) 45/64" high. Capacity range 5-2,500 MMF. Style 2336 (right) 15/16" high. Capacity range 6-5,000 MMF.



## FEED-THRU CERAMICONS

By-pass R. F. to ground when feeding through chassis or metal can. Body length 3/8"; mounted with 12-28 nut. Type 362 (above) has 20 gauge feed-thru wire. Capacity range 5-1,500 MMF. Type 357 (below) has 0.55" diameter hooked ends feed-thru wire; capacity range 5-1,000 MMF.

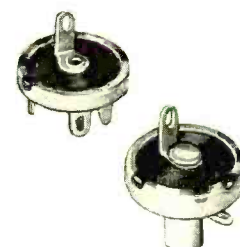

## FOR UHF COMMUNICATIONS EQUIPMENT ERIE BUTTON SILVER MICAS

These extremely compact silver mica condensers have 360° current path from short, heavy terminals to ground, providing very low inductance. Made in Stand-off and Feed-thru styles. Capacity range 15-1,000 MMF in .447" diameter, 1,000-6,000 MMF in .651" diameter.



*Electronics Division*  
**ERIE RESISTOR CORP., ERIE, PA.**

LONDON, ENGLAND • TORONTO, CANADA

# A REPORT TO SUBSCRIBERS ON THE 1948 electronics BUYERS' GUIDE

The ELECTRONICS Buyers' Guide, published annually for 5 years as a part of the regular June issue of ELECTRONICS, enters its 3rd year as an individual issue—a 13th issue included with every subscription. Like Topsy, it grew too big and too important to be included in the regular issue of ELECTRONICS. Therefore, every subscriber has for the past three years received this "extra" as a bonus issue.

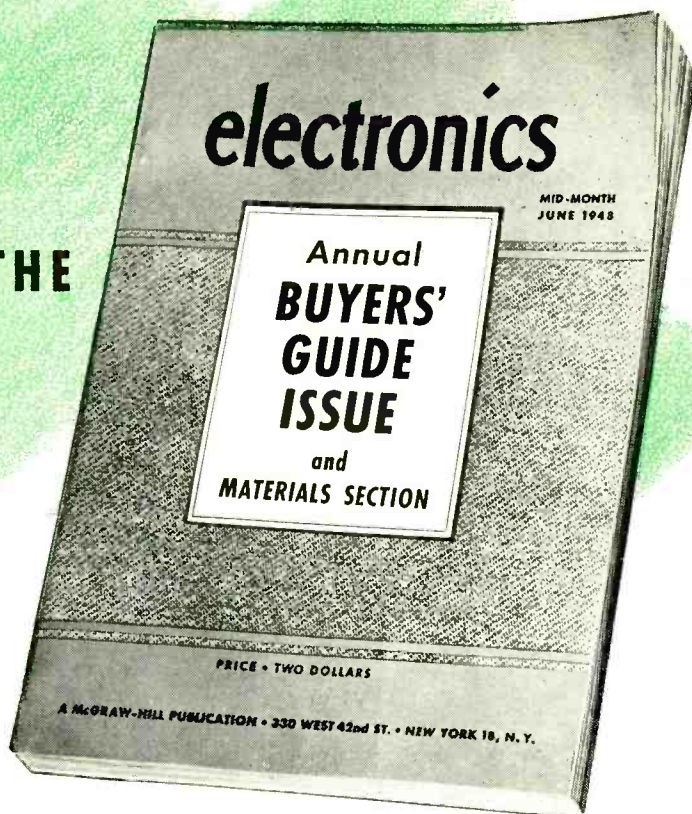

And this bonus has proved a boon to subscribers—if we can believe only half of what they tell us. Letters from all over the country, and abroad too, have literally poured in. The main themes have been the technical value of the Guide, its usability and the fact that it's so much of a time saver. Design engineers tell us they use it daily—keep it at their elbows—no longer have to thumb through countless individual company catalogues—purchasing agents use it for product sources, etc. And many large manufacturers\* have requested copies in lots of 25 to 100 to be used by their entire engineering staffs or in their reference libraries. Flattering? Yes, but more important to us is the fact that it indicates that it dovetails in with industries' needs.

That doesn't mean that our editors or researchers are going to rest on their laurels. Hardly. They look forward to and are now planning improvements and additions. You, the subscriber, can help by making suggestions, letting us know how you use the Guide, what we've omitted that you find necessary in your work. Remember it's YOUR BOOK—and your comments and suggestions are valuable yardsticks if we are to tailor the Guide more closely to your needs.

\*Names on request

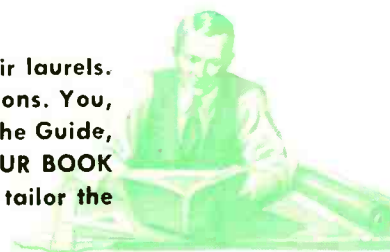

## TO ADVERTISERS

In making your 1949 advertising and promotion plans, we urge you to include adequate use of the 1949 Mid-June Buyers' Guide issue of ELECTRONICS. Remember—it is a 13th issue and should be included in your 1949 budget. You can get the complete facts regarding the Guide from your ELECTRONICS representative or write direct.

ABC

# electronics

ABP

A McGRAW-HILL PUBLICATION • 330 WEST 42nd STREET, NEW YORK 18, N. Y.

## .....A BONUS ISSUE... FREE TO ALL SUBSCRIBERS





electronics edition • October 1948

## DRY ELECTROLYTICS FOR TELEVISION RECEIVERS

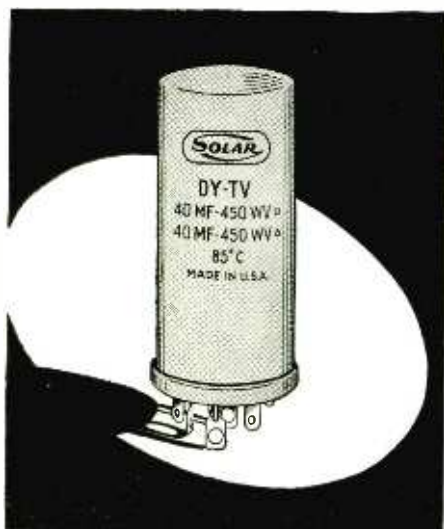

Solar's new Type DY-TV series of dry electrolytic capacitors assures dependable operation under the severest conditions found in television receivers.

An especially developed Solar processing technique makes possible small yet sturdy capacitors designed for high temperature operation with no sacrifice in long life or electrical characteristics.

Because of the remarkable film stability of Solar's DY-TV series of electrolytics, there is but an extremely small change in power factor and leakage current from room temperature to 85° C.

Type DY-TV capacitors, with their special film formation, do not "run away" when voltage is applied after idling under no-voltage conditions at 85° C. These characteristics are retained even after extended shelf life.

Investigate this remarkable achievement in capacitor design today! Write today for catalog.

Solar Manufacturing Corporation  
1445 Hudson Blvd., North Bergen, N. J.



# BUSINESS BRIEFS

By W. W. MacDONALD

Seems that a taxi equipped with radio came upon a car wedged between railroad tracks at a grade crossing. The cabbie called his dispatcher who called the telephone company, who called the railroad, who called the towerman, who flagged the oncoming fast freight in the nick of time.

TV set production continues to hold up while seasonal slump hits other lines. Six months production of TV among RMA member companies totalled 278,896, as against 659,313 fm-am sets, and 6,771,210 straight-am receivers. June video production was 64,353 for five weeks, a record high. The industry is now hoping to produce 850,000 units this year, and RCA predicts 1.6 million will be produced in 1949. Dollar volume in television will by then have outstripped income from sound-only sets, by a large margin.

A Correspondent wants to know who is making a predetermined electronic counter that will figure out a race horse's chances of winning from his past record. This is just one step from a predetermined horse race, which, we understand, is illegal. Anyone having such a gadget, please send us the plans in a plain envelope.

Now that High-Band television stations (channels 7 through 13) are getting on the air, there is a flurry of surveying to determine coverage compared with the low-band outlets. The N. Y. Daily News station, WPIX, on channel 11, reports 88.6 percent of set owners interviewed get station ok, other 11 percent cannot receive it.

Video in Hotels is having a big effect on the bell-boy business. A recent survey of New York Hotels shows that room service sales in video-equipped rooms increased from \$35 to \$175 per month following installation of teletests.

Question: Has room service added crackerjack, popcorn or peanuts to the menu? Answer: At those prices, it's not peanuts.

Current slump in the phonograph business has convened many a pow-pow in record circles. Columbia-Philco development of long-playing records (p 86, September) is one attempt to blow life into the business, would have more effect if whole industry adopted the system for future releases. As it is, record boys predict a big fight between LP and standard disks.

It was only a matter of time, etc. The roadside circuit now has the tele-juke, a box with records and video. A record for a nickle, or three minutes of visual entertainment. You takes your pick. For those who want the whole ball game, the machine will take up to 25 nickles at a crack. A side panel gives the customer access to the tuning control with a choice of four stations, but experience teaches that this little door should be kept locked tight, with the key in the hands of the brawniest bartender.

Latest version of the electronic rat trap (selling for \$198) is set over a rodent runway. An electric eye picks up the intruder, causes a pair of charged tongs to close, then lift sideways, depositing the lifeless body to one side. Whole cycle takes about 2½ minutes.

Technical writers with an engineering background, primarily communications, are needed by the Signal Corps. Salaries range from \$3,727 to \$5,232. Write Chief, Signal Corps Publications Agency, Fort Monmouth, N. J., or call Eatontown 3, 1060, ext. 767, S. S. Oliver.

Pulling power of "giveaway" radio programs was dramatically proved when Fred Allen's rating

fell to an all-time low in competition with "Stop The Music." Many broadcasters, usually alarmed at FCC meddling with program content, have applauded the Commission's recently proposed action against "lotteries." Seems we are all in agreement on this one.

**How Many People**, in which industries, could use a complete industrial television package consisting of transmitter and receiver, for what specific purposes, if the cost was under \$5,000? One of our readers thinks he can build a good rig for that price but wants to feel the water before jumping in. Any comment?

**New Business** tied in with the 70-group airforce is beginning to show in electronic circles. One concern reports new orders totaling \$900,000 in recent weeks, all from aircraft manufacturers, calling for electronic, electrical and mechanical gadgets.

**NAB group** worrying out playing-time versus fidelity of magnetic tapes has tentatively decided on two standards, with tops of 7,500 and 15,000 cycles. They hope to limit high-fidelity speed to between 15 and 22.5 inches per second with minimum playing time of about half hour per reel.

**Ten Years Ago**, we were amazed at fact that there were then more radio tubes in use than there were people in the country. Today, more than that many tubes are sold in a year. Six months total reported by RMA was just over 100 million bottles. About three quarters of these were for new sets, 20 million for replacement, nearly 7 million for export. Government agencies took half a million. These are big figures. But radio tube sales are dwarfed by electric bulbs. Total sales of latter in 1947: 1.6 billion.

**Hangover Cure** for 12-inch surplus cathode-ray tubes (type 12GP7) replacing conventional 7-inch types in television receivers (p 66, August) is to stick a

piece of blue cellophane over the screen. The big bottle uses two phosphors, blue for transients and yellow for persistency. An optical filter largely masks the latter.

**Rates for television transcriptions** (movies taken off picture tube screen suitable for rebroadcast, see p 68, this issue) have been issued by Paramount Pictures, Inc. They will record a ten minute show for \$200, and sell release prints on 35-mm film, with sound track at \$36.00 for 10 minutes in lots of 10 or more. Rates for an hour are \$550 and \$216 on the same basis. Also available at lower cost are 16-mm prints.

**Designers Planning** next year's radio cabinets may be interested in west coast reports from furniture buyers, indicating a strong swing to traditional styles, including French and American provincial. Darker finishes are in vogue in modern styles.

**Nick Lefor** (W2BIQ) says that 75 percent of the engineers employed by *Airadio* are amateurs, and that 75, 20 and 10-meter 'phone operators predominate.

**Television in Great Britain** is now dwarfed by Stateside industry. Licenses for television receivers, required of every set owner in England, totalled 54,850 at end of June, and are increasing at rate of 2,350 a month. Total sets in U.S.A. are now just over 500,000 and rate of increase is about 60,000 a month. All forms of broadcast set licenses in England now exceed 11,000,000. The British are bearing down on the license deal: 839 successful prosecutions for non-licensed reception in the month of June.

**Among recent college graduates** taken on by GE are 1046 electrical, mechanical and industrial engineers, 50 chemistry graduates, 15 physicists and 250 graduates of liberal arts and business courses. Looks like physics is still something of a specialty, despite big reputation physics majors got during the war at Radiation Laboratory and elsewhere.

*For extraordinary electrical performance*

# Use SILVER GRAPHALLOY\*

**GRAPHALLOY**  
TRADE MARK REG. U. S. PAT. OFF.

**THE SUPREME CONTACT MATERIAL**

**BRUSHES**

**CONTACTS**

**in BRUSHES**  
for high current density • minimum wear • low contact drop • low electrical noise • self-lubrication

**in CONTACTS**  
for low resistance • non-welding character

GRAPHALLOY works where others won't! Specify GRAPHALLOY with confidence.

\*A special silver-impregnated graphite

## GRAPHITE METALLIZING CORPORATION

1055 NEPPERHAN AVENUE, YONKERS 3, NEW YORK



# Better Sealing Means Longer Life for **MALLORY** Cardboard Tubulars

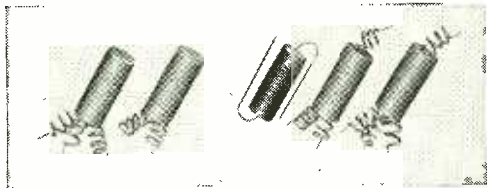
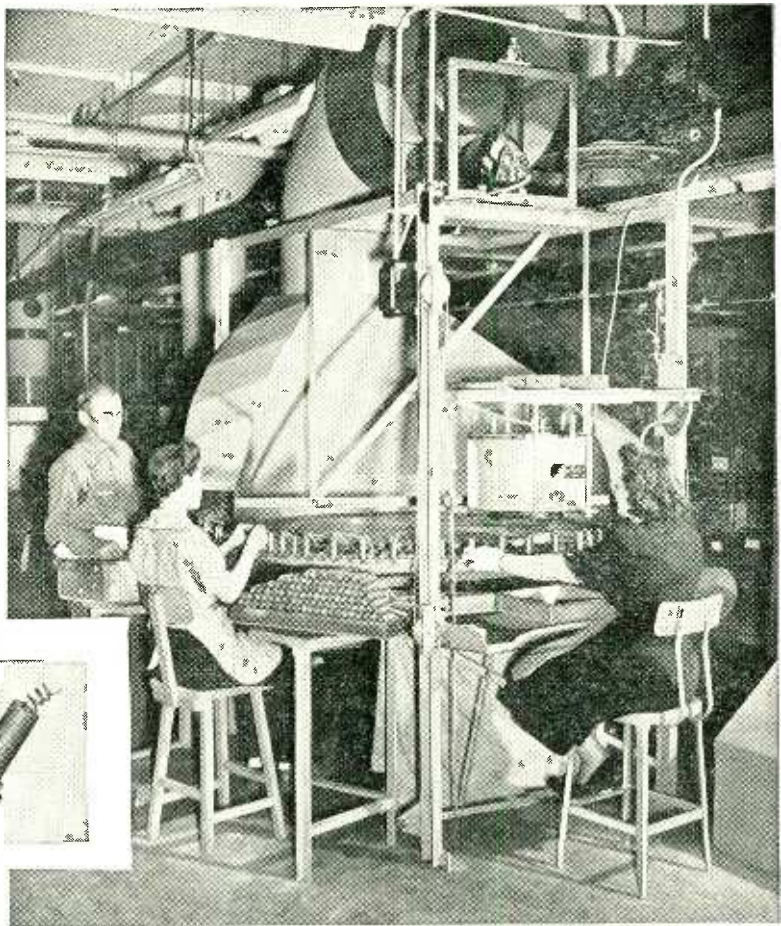

Careful pouring of end seals protects Mallory cardboard tubulars against impurities that cause deterioration.

**M**ALLORY cardboard tubular capacitors come in the standard types shown above—but their service potential is far above standard—thanks to the extra care used in their manufacture.

In an electrolytic capacitor, quality depends largely on purity. At Mallory, controlled freedom from contamination in handling, plus the precaution of carefully applied inner seal and generous end seals, provide the extra measure of quality you expect in Mallory Approved Precision Products.

Mallory cardboard tubulars are made and priced for trouble-free operation in low cost equipment. The complete line of Mallory Capacitors includes units for every type of service—all made to the high quality standards of Mallory Approved Precision Products.

*Buy Mallory Assured Quality At Regular Price Levels*

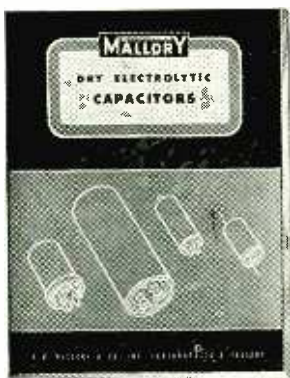

Send for the Mallory Capacitor Catalog which contains useful data on tubulars and on other Mallory electrolytic capacitors.

**P. R. MALLORY & CO. Inc.**

# MALLORY CAPACITORS

(ELECTROLYTIC, OIL and WAX)

**P. R. MALLORY & CO., Inc., INDIANAPOLIS 6, INDIANA**



# CROSS TALK

► **BITS** . . . Claude Shannon's articles in the *Bell System Technical Journal*, explaining at length the important new concepts on the bandwidth required to transmit intelligence in the presence of noise, are destined to become classics in the literature of communications. While not claiming to have mastered the subtleties of the argument at the present writing, we do want to pass on the new word "bit", a contraction of "binary digit" suggested by J. W. Tukey. Binary digits, or bits, are important because pulse circuits, whether used in pulse code modulation or in electronic computers, are most reliable when they operate, flip-flop fashion, with only two states, on and off. So the discipline of such circuits is most easily analyzed in binary notation. It turns out that a decimal digit is 3.32 bits. Accordingly the value of a twenty-five cent piece, being expressible in two decimal digits, is expressible in 6.64 bits. We thought it was two bits, but we failed to reckon with Shannon and Tukey.

► **DECIMAL** . . . An old-time contributor to this journal, Walther Richter, in a recent speech coined a neat phrase when he said that electrical engineers could be divided into two groups, those working on the right side of the decimal point, and those working on the left. The communications engineer is, very largely, a microwatt-microvolt-microampere man. The power engineer is, in contrast, a kilowatt-kilovolt-kiloampere character. To Mr. Richter's apt division, we would add the group of decimal-point straddlers, the industrial electronic engineers who progress from the right to the left side, taking a microwatt impulse and bringing it to bear on a kilowatt system. These electronic universalists are familiar with the left and the right, and their number grows. More power (megawatts) to them.

► **MKS** . . . The growing acceptance of MKS units in electronic practice is not without important excep-

tions. The IRE technical committee on electroacoustics has recently discovered that this system of units has, apparently, never been used in the acoustical field and has urged that this omission be rectified forthwith. Fortunately, the conversion from the metric units commonly used to MKS units is accomplished simply in powers of ten. But, unfortunately, there are no simple names for acoustic quantities expressed in these units. The acoustical ohm, for example, is translated literally into emkayess-ese as "joule per stere per stere per second", than which we cannot imagine a less handy term. The committee is now searching for suitable short-form names for MKS acoustic units, and will recommend the same for the forthcoming revised ASA standard terminology on this subject. This is good work. Other committees might well examine their fields for similar omissions.

► **GEO-RESCUE** . . . Some months ago we related the story of the Bell Labs engineer who, lost on the way to a dinner party, was "talked in" to his friend's house through mobile radio installed in his car. Now comes the story of the geophysical exploration party which, roaming over the flatlands searching for suitable test sites, become completely lost. Having explained their predicament to the field office by radio, the members of the party were instructed to explode a charge of dynamite, which they carried for seismic exploration, at a pre-arranged time. The blast, traveling through the earth, was intercepted by a pattern of geophones connected with the field office, while an oscillograph recorded the times of arrival of the shock wave at several locations. A short computation, essentially the loran problem worked backwards, revealed the location of the lost geophysicists. Informed by radio, the party took a bearing for home and got there. Readers will recognize this technique as a solid-land version of the sofar system, which locates ships at sea by precisely the same technique (June, 1948 issue, p 98).







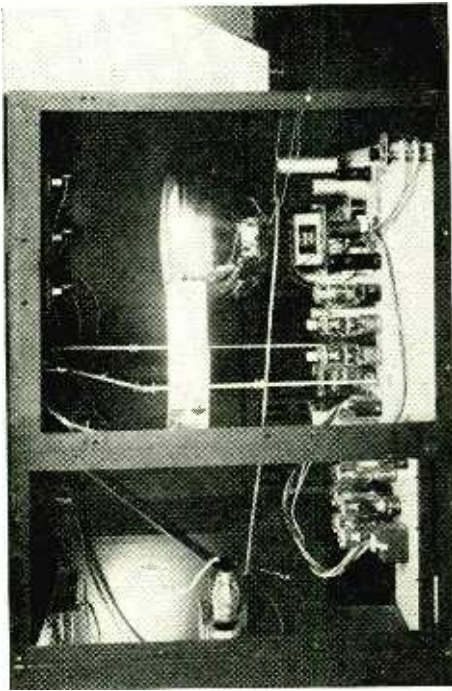

FIG. 2—Monitor with side panel removed to show mechanical arrangement

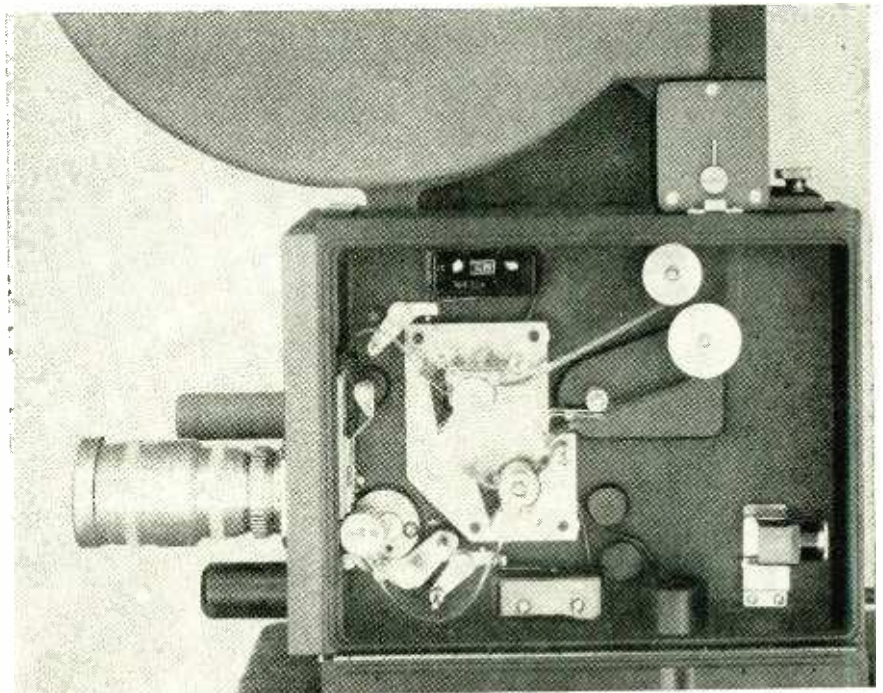

FIG. 3—Side view of the Eastman Kodak model of the camera. A rapid pull-down mechanism moves film between frames in less than 1/120th second

# TRANSCRIPTIONS

Recording television images on film, directly from a cathode-ray monitor, preserves programs for rebroadcast, legal records, and network syndication. Broadcast quality is achieved in equipment which transfers from the 30-frame rate of television to the 24-frame movie standard

tenance of the camera equipment. Using fine-grain stock, the film can be exposed and processed so as to retain the full detail of the image. Accordingly, 16-mm equipment was adopted in the equipment described.

An early attempt to solve the frame-synchronization problem resulted in a camera which operated at 15 frames per second, that is, one-half the television frame rate. The exposure time and the pull-down time of this camera were approximately equal, so it photographed one complete television frame and skipped the succeeding one while the film was being pulled down. This system produced a non-standard film which could not be used in standard 24-frame movie

projectors. Moreover, the film could not be used for rebroadcast at 30 frames, because of the flicker and discontinuity of motion caused by the missing frames.

This project was abandoned in favor of building a camera which would record directly at 24 frames per second from 30-frame television images. The process is essentially the inverse of the projection system used in televising standard 24-frame film. The 24-frame film may be used in standard 16-mm sound projectors for nontelevision uses, or in television projectors. The prototype camera was constructed. When the principle was proved, the prototype was taken to the Eastman Kodak Company, which produced a com-

mercial version of the camera.

The sound-recording aspect of teletranscriptions was also a matter requiring attention. Separate sound-on-film recording facilities are employed to assure high quality of reproduction. The two film records, one for picture and the other for sound, are processed separately, using process techniques best suited to each type of recording. The sight and sound portions are combined in a composite 24-frame film. For documentary purposes it may be satisfactory to employ a single camera with sound-recording facilities incorporated in it, the so-called single system, but the processing must then be a compromise between that for best picture and that for best



sound reproduction quality.

Figure 1 shows a general view of the transcription equipment. Two identical cameras and monitors are used to permit uninterrupted recording if the program lasts more than one-half hour. Each camera has reels which hold 1,200 feet of stock, which allows about 33 minutes of recording. When switching from one monitor-camera to the other, care is taken to assure that the average brightness of the two monitors is closely the same. This measurement is performed with a photographic exposure meter held successively in the same position before the two screens when both carry identical test patterns. Records are kept of power-supply voltages and beam currents in the monitor picture tubes to assure reproducible results from day to day.

#### Uniform Focus

The monitor circuits and picture tubes have been designed with particular care to remove imperfections that might be tolerated in a home receiver. For example, the high-voltage power supply has excellent regulation to avoid changes in picture size with changes in average brightness. The high-voltage supply is a 25,000-volt unit conservatively operated at 17,000 volts. The monitor picture tube is a 12-inch magnetically-focussed and deflected unit. The area scanned is 6 by 8 inches. This small area assures uniform focus and a flat field. The tubes are conventional, but are carefully selected to have uniform phosphors and good focus over the

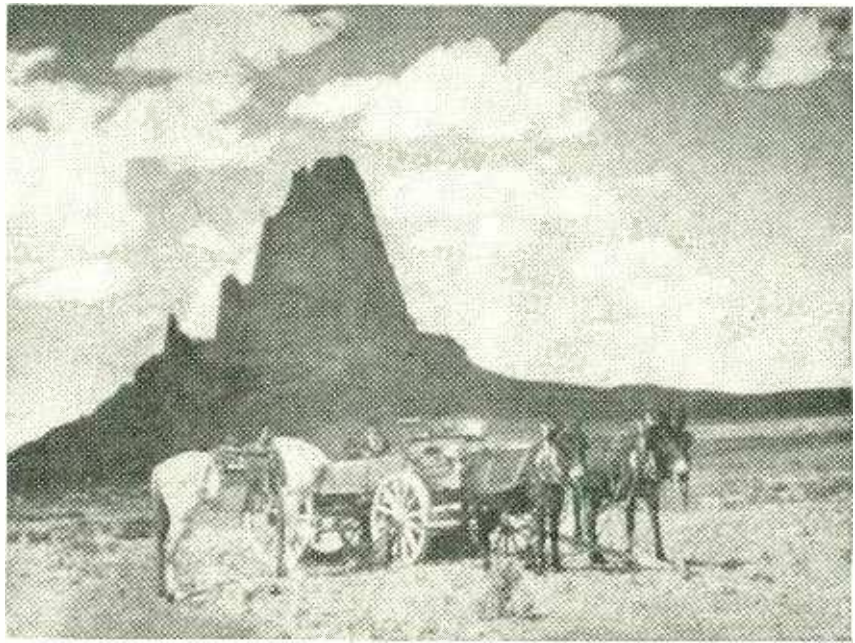

FIG. 5—Typical scene as reproduced on 35-mm movie film

area scanned.

It is possible to operate the system with negative or positive images on the monitor, but experience has proved the positive image preferable. The film image is then a negative and the composite print (made from the negative picture film and sound film) is a positive. If time is very short, the negative film image may be transmitted without making the composite positive print, merely by reversing the polarity of the television camera output. But the best quality has been found to result consistently from a composite positive print made from a negative.

To assure that the film shall not limit the resolution of the system,

very-fine-grain film is used, that is, positive stock ordinarily used for making projection prints. DuPont type 602A has been found highly satisfactory. This film, speed approximately Weston 8, is slow compared with negative stock and reversal film, but it has extremely fine grain and wide latitude. Also, it costs about one third as much as faster films, and this may be a very important factor in an extensive recording project. The same type of film is used for picture negative, sound negative and composite positive. A special processing technique, is used to develop the picture negative. Otherwise the processing is conventional.

To assure adequate exposure using slow film, a bright monitor image and fast lens are required. The image, produced on the 6-by-8-inch rectangle, has a highlight brightness above 100 foot-lamberts. The lens is a standard Kodak camera lens of two-inch focal length and maximum aperture f1.6. The lens is operated at fixed focus of five feet and a fixed aperture of f2. The latter setting is not changed, since it would change the cone of light within the camera and would interfere with the proper operation of the shutter. If any change in the aperture is required, neutral-density filters are placed on the lens as required. Optical resolution of the lens is not critical. Any good

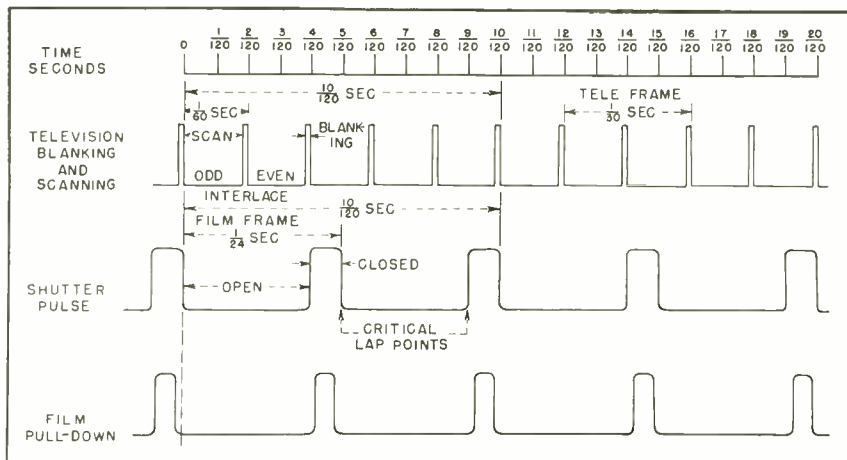

FIG. 4—Time relationships between television signal, shutter and pull-down mechanism. Accurate setting of shutter is essential to avoid overlapping or underlapping exposures



FIG. 6—Televised reproduction of scene shown in Fig. 5

taking lens is satisfactory but projection lens are to be avoided.

Using this optical system and film, the full horizontal resolution of the original television image is preserved in the film. In fact it is possible to identify in the film images the fine-structure noise present in the original television image. The contrast range of the system is likewise limited by the television image, not the film. Using a conventional photographic gray scale of 11 steps between black and white, the monitor has been found capable of rendering 7 steps of gray, plus black and white. The latitude of the film is sufficient to cover this range by a wide margin.

The monitor brightness and contrast controls are adjusted by eye to give the most even rendition of the gray scale, as viewed on the film after processing. This process matches the transfer characteristic of the television system to the gamma characteristic of the film. Electrical gamma-correction circuits are also available in the equipment. Particular care was taken in the design and adjustment of the scanning circuits in the monitor to preserve a high degree of linearity. Figure 2 shows an interior view of the monitor.

The camera employs a rapid pull-down mechanism and a specially designed shutter which exposes two complete fields of television scan-

ning on each frame of motion-picture film. An interior view of this camera is shown in Fig. 3. The shutter closes for exactly one-half of a television field, and the pull-down takes place in something less than one fifth of the complete pull-down-plus-exposure cycle. This cycle occurs at a rate of 24 frames per second, at a shaft speed of 1,440 revolutions per minute.

#### Sequence of Operation

The timing sequence and phase relationships of the television signal, the blanking cycle of the shutter, and the motion of the film during pull-down are shown in Fig. 4. At the top is a timing indication expressed in intervals of 1/120 second. This interval is a subdivision of both the 30-frame-per-second television-picture interval and the 24-frame-per-second film picture interval. The next line indicates the television blanking interval and the useful television picture interval. Here the television field interval of 1/60 second provides one half of the interlaced picture, and the succeeding 1/60 second field interval provides the other interlaced half. Accordingly, two fields of television scanning constitute one complete frame of television picture in an elapsed time of 1/30 second. On the next line is shown the camera-shutter characteristic, which must be very carefully adjusted. On the bot-

tom line the film pull-down cycle is illustrated.

The most critical characteristic in the recording camera is the timing of the shutter-blanking and exposure interval. The absolute intervals are the most important, and if they are appropriately adjusted the exact phase relationship is not very critical. As shown in Fig. 4, the phase relationship has been so adjusted that one of the points for opening (or closing) the shutter is placed directly under the television blanking interval. The other shutter-point occurs approximately in the middle of the television field interval. If this shutter is not adjusted correctly, a bar, caused by overlapping or underlapping exposures, is likely to appear in the recorded film picture. Such a bar is noticeable as a flicker of several lines in the picture.

It is customary to drive a recording camera by synchronous motor. If the television signal and the recording camera are controlled by the same power lines, the camera runs in exact synchronism with the television synchronizing generator. In many cases, however, it is necessary to record programs which have originated in a region beyond the limits of the synchronized power lines. On nonsynchronous power supplies, two regions of overlap may appear and move up or down the picture at a rate equal to the difference frequency between the 60-cycle supply controlling the synchronizing generator and the 60-cycle supply driving the synchronous motor of the camera.

Many films have been recorded in the nonsynchronous manner. To do so successfully it is desirable that the shutter angles be accurately adjusted so that the overlap bars are eliminated. It is better to have a slight overlap, rather than an underlap, to minimize the bar effect.

To show the quality of pictures obtainable, Fig. 5 is a blown-up print of an original photograph taken on 35-mm film, while Fig. 6 is a photograph of the same subject taken from the face of a cathode-ray tube. Very little difference exists between these two photographs.

The motion-picture film compares favorably with the results obtained with a still camera.



# SERRASOID

Design data for an improved four-tube phase-shift type modulator that initiates 100-percent modulation with noise 80 db down and 0.25 percent harmonic distortion in broadcast service. Low relative cost suggests potentially greater utilization of the educational frequencies. Variations of the basic circuit open new fields of application

By **J. R. DAY**

*Radio Engineering Labs., Inc.  
Long Island City, N. Y.*

**T**HE development of a simple f-m modulator has been one phase of a broad program to enlarge the technical horizons of f-m broadcasting. In particular, it was aimed at providing one solution to the problems of relay and chain broadcasting. Such service requires that the noise background and distortion be very low in the individual links so that the final signal may still meet the relatively high standards required for any f-m broadcasting system. Such chain systems have

been operated satisfactorily using available equipment, but it cannot be said that, in the more extensive chains, the limiting noise rests with the audio facilities at the origin. This latter condition has always been regarded as a minimum requirement of a really good f-m broadcast setup.

Careful examination of the problems in a reasonably extensive chain yields the conclusion that an 80 db ratio of 100-percent modulation to noise in the modulator would be satisfactory. In addition, a maximum figure of 0.25-percent harmonic distortion for 100-percent modulation with single tones from 50 to 15,000 cycles was set as a

correlative objective. Since a practical modulator involves accessory circuits such as an audio amplifier, which can be expected to make some definite though small contribution to the numbers above, the actual net requirements on the modulation process are somewhat more severe than the overall figures. It is evident that such performance will also be of significant application in a single f-m broadcast setup, apart from the special question of relaying.

Means of generating frequency-modulated currents fall into two general classes, the reactance-modulated type, and the phase-shift type. In the first, the frequency of an oscillator is caused to vary linearly with modulation through the agency of a reactance tube or its equivalent, which is an integral part of the frequency-determining circuit. Because of the modulation and linearity requirement such an oscillator in general is not stable enough for broadcast service. Automatic frequency control is therefore employed. In the phase-shift type of modulator the frequency of the carrier oscillator is not varied, and therefore a stiff control such as a quartz crystal can be used to secure the desired stability, which then is completely independent of the modulation process. Modulation of the frequency in such a system is secured by varying the phase of the frequency-stabilized wave. The frequency will be deviated from its controlled value only during the time the phase is changing, and the deviation, other things being equal, is proportional to the rate of change of phase.

The Serrasoid is the latter type. Although it is capable of broader

**The first successful method of producing frequency modulation was the phase-shift method. Despite certain shortcomings in inherent noise, distortion at the lower modulating frequencies, and a tendency of the center frequency to drift, it carried the burden of launching the f-m system successfully.**

• The invention of the double channel modulator, which was brought to a high degree of perfection through the work of John Bose, eliminated these difficulties. It, however, had the commercial disadvantage common to all frequency modulators of requiring a large number of tubes. This disadvantage is not of much importance in transmitters of powers above 1 kw, as the cost of the modulator then becomes a relatively small part of the total. For transmitters of low power, however, the modulator becomes a major item. Herein lies opportunity for great improvement.

• I have always felt that the phase-shift method of producing frequency modulation would be the surviving method and that someone some day would overcome its greatest weakness by finding the means of increasing the initial phase-shift without compromising any of the requirements of distortionless noise-free f-m.

• This James R. Day has done. Not only has he done it without compromise, but he has in fact improved performance to hitherto unattained levels.

• The significance of this development is that by its simplicity and reliability it has opened up all sorts of new broadcasting possibilities. One can visualize the operation of unsupervised transmitters of a few watts power, controlled from pulpits, schoolhouse assembly halls, and similar places, the transmitter requiring no more attention than the common, everyday public address system.

• The invention has opened up some amusing possibilities. If, as seems likely, the Serrasoid becomes the accepted method of producing frequency modulation, the phrase-makers who have dubbed the phase-shift method the "indirect method" will find themselves in an awkward situation. Some of us have lived long enough to recall the days when the automobile was referred to as the "horseless carriage."

—E. H. ARMSTRONG

# F - M MODULATOR

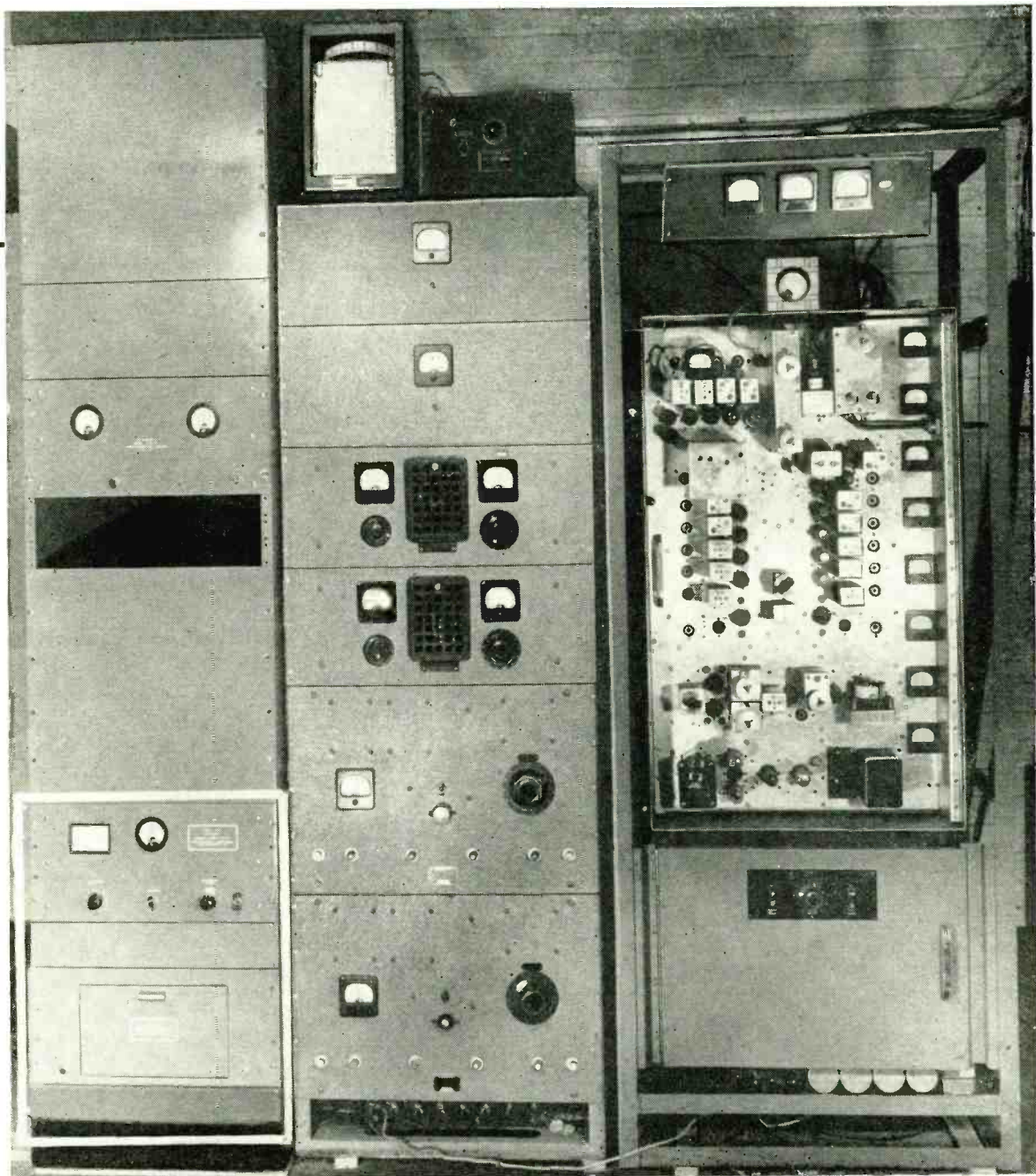

Size comparison between the Serrasoid modulator (outlined in white) and the original Dual-Channel modulator at the right. Center rack and upper section of left rack are used for other equipment. Photograph taken at the Armstrong f-m broadcast station W2XMN-W2XEA at Alpine, N. J. where the new modulator has been in service for six months

application, the numbers involved for the f-m broadcast case provide the clearest illustrative material. As noted above, frequency deviation is proportional to rate of change of phase. For sinusoidal modulation this is simply expressed by saying that the peak frequency deviation is equal to the product of the peak

phase shift and the modulating frequency. The new circuit is conservatively capable of a peak phase shift of  $\pm 150$  degrees, but  $\pm 90$  degrees or  $\pm 1\frac{1}{2}$  radians is used as the basis for 100-percent modulation at 50 cycles. For  $1\frac{1}{2}$  radians and 50 cycles the peak deviation therefore will be  $\pm 75$  cycles. Since 100-percent modu-

lation in f-m broadcasting is a deviation of  $\pm 75,000$  cycles, a frequency multiplication of 1,000 is indicated. Actually, 972 is used since it can be factored into a convenient assortment of doublers and triplers. In all that follows we shall discuss a modulator for a frequency of 97.2 megacycles which starts at



a base frequency of 100 kilocycles.

Figure 1 is a schematic diagram of the essential parts of a complete broadcast Serrasoid. Audio amplifiers and frequency multipliers have been omitted since they are conventional and employ small standard type tubes. Tube  $V_1$  is a pentode oscillator controlled by quartz crystal  $Y$ . The crystal operates very close to its series resonant frequency. The net reactance of the crystal arm may be conveniently varied by a series capacitor for fine frequency adjustment of about  $\pm 0.005$  percent. This crystal is oven controlled in the broadcast case to a net stability of  $\pm 0.0002$  percent, which is also the stability of the final carrier frequency. The operation of the oscillator is such that plate current is drawn only during a small part of the cycle. Negative going pulses shown in Fig. 2A are generated at the plate of  $V_1$ . These pulses are differentiated by  $C_3$ ,  $R_3$ , and grid-cathode conductance of  $V_{2A}$  to yield still shorter pulses several times the cutoff voltage of  $V_{2A}$ . The corresponding short positive pulses at the plate of this latter tube are bottom clipped (to clean the base line) by cathode follower  $V_{2B}$ . Resistor  $R_7$  is selected so that this tube is biased beyond cutoff between pulses by the automatic grid bias of  $C_4$  and  $R_6$ . The pulses at the cathode of  $V_{2B}$  appear as shown in Fig. 2B. The two halves of  $V_2$  perform the functions of a

single pentode that might have been used in the same place, with the additional advantage that the final waveform is developed in a lower impedance than is practicable with a pentode.

#### Linear Sawtooth Wave

According to the numbers of the illustrative case these pulses recur at a rate of 100 kilocycles, that is, corresponding points or events on consecutive pulses are 10 microseconds apart. Tube  $V_{3A}$  constitutes a nonoscillatory sawtooth generator timed by the pulses from  $V_{2B}$ . The slowly increasing portion of the sawtooth has a slope corresponding to the charging of  $C_7$  through  $R_{10}$  to the relatively steady voltage at the junction of  $R_9$  and  $R_{10}$ . This period coincides with the time between pulses at the grid of  $V_{3A}$ , cutoff bias having been developed on  $C_5$  by previous pulses. The quickly decreasing portion of the sawtooth occurs at the time of positive pulses on  $V_{3A}$ , when  $C_7$  is discharged nearly to cathode potential by the plate-cathode conductance. In round numbers the discharge point is about 5 volts from cathode or ground potential and  $R_{10}$  and  $C_7$  are adjusted to give a rising rate of about 4 volts per microsecond to the increasing portion of the wave. As will be shown the whole linearity of the modulation process depends on the straightness of this sawtooth wave. In its simple form, it would have

too much exponential curvature to be useful. This condition is corrected by the bootstrap connection comprising the cathode follower  $V_{3B}$ ,  $R_{11}$ ,  $C_6$ , and  $R_9$ . The normally constant voltage at the positive end of  $R_{10}$  has superimposed upon it the rising voltage on  $C_7$  so that the drop on  $R_{10}$  and hence the charging current is maintained practically constant. Resistor  $R_9$ , as in other bootstrap applications could be a diode with its anode at plate supply potential, but for the voltage magnitudes involved here the resistor is more than adequate. The d-c voltage at the junction of  $R_9$  and  $R_{10}$  is about +190 volts for a B+ value of 250 volts.

#### Pulses are Frequency-Modulated

The sawtooth wave thus developed is directly coupled to the grid of  $V_{4A}$ . This tube is cathode biased by its plate current so that conduction begins when the sawtooth is about half way up; the passage from the beginning of plate current flow to grid current consuming about 0.25 microsecond. Because  $C_8$  is large and holds the bias constant during the sawtooth period, grid current stops the charging of  $C_7$ , and the latter half of the sawtooth rise is clipped. The resulting waveform is shown in Fig. 2C the dashed line indicating the waveform without the direct coupling to the grid of  $V_{4A}$ . Thus, the plate current of  $V_{4A}$  flows only during the

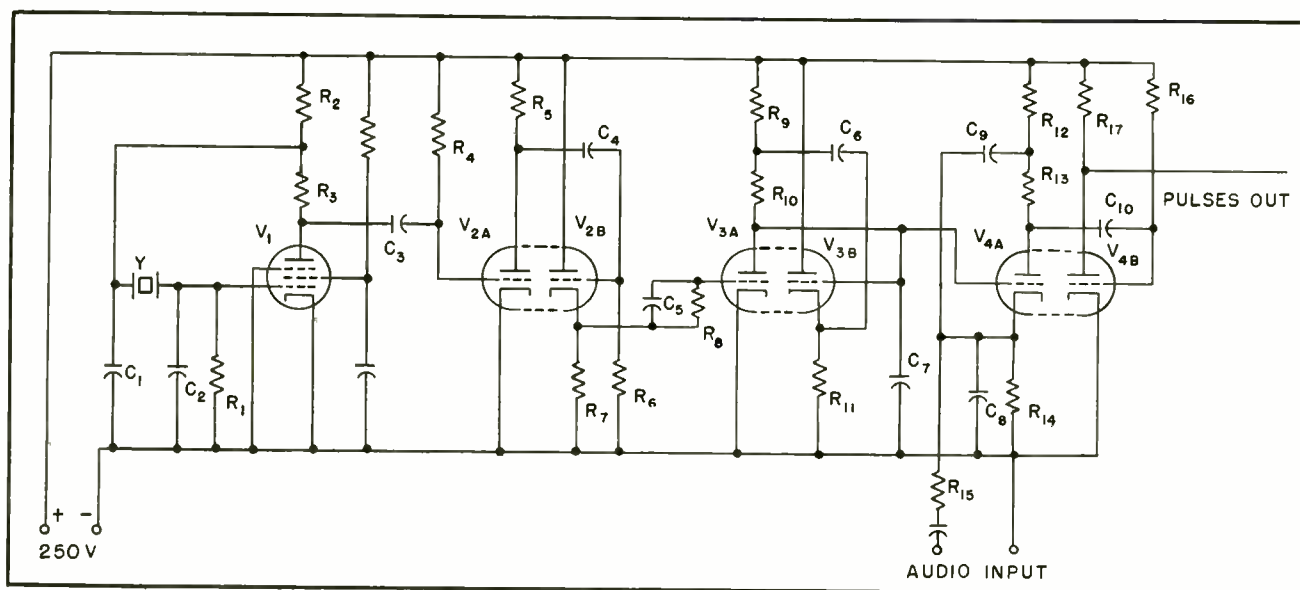

FIG. 1—The modulator proper showing the crystal oscillator, clipper, sawtooth generator and bootstrap cathode follower, and f-m pulse output tubes. The frequency multiplier stages that follow are conventional

latter half of the sawtooth wave. If the bias for  $V_{4a}$  is varied, the leading edge of this current pulse will vary in time or phase, an advance resulting from a lowering of the bias and a retardation from an increase. It is in this way that phase modulation in the unit is accomplished.

Audio or program is applied at the indicated terminals. Values of  $R_{15}$  and  $C_8$  are so proportioned that for constant audio input amplitude versus frequency, the resulting amplitude at  $C_8$  is inversely proportional to audio frequency over the range upward from 50 cycles. This circuit is included so that the peak phase shift shall be inversely proportional to modulating frequency and the resulting frequency response of the frequency modulation shall be flat. The function and the network are the familiar corrector present in all phase-shift type frequency modulators. In order that at 50 cycles the phase of the pulse edge be shifted  $\pm 1\frac{1}{2}$  radians, approximately 50 volts rms is required at the input to the corrector. In the complete modulator a two-stage amplifier provides the gain to raise the standard input of  $\pm 10$  dbm to this level. Since feedback is used in this audio amplifier to provide linearity, the effective modulation sensitivity is also stabilized to a marked degree. This sensitivity depends only on the audio gain and the stability of  $R_{10}$  and  $C_7$ , and ordinarily is stable to within 1 percent for the standard ranges of temperature, line voltage, and tube changes.

Figure 2D illustrates the waveform at the plate of  $V_{4a}$ , the dashed lines showing the extreme positions of the leading or negative going edge during 100-percent modulation at 50 cycles. For 100-percent modulation at 100 cycles the excursion is one half that shown, and so on. This wave is differentiated by  $C_{10}$ ,  $R_{10}$ , and the grid cathode conductance of  $V_{4b}$  so that the latter is cut off for a short time each cycle beginning at the leading edge. The resulting positive-going pulses at the plate of  $V_{4b}$  are shown in Fig. 2E. These pulses are frequency modulated approximately  $\pm 75$  cycles at 100-percent modulation. They are applied to the grid of the first of a string of frequency multipliers. The plate

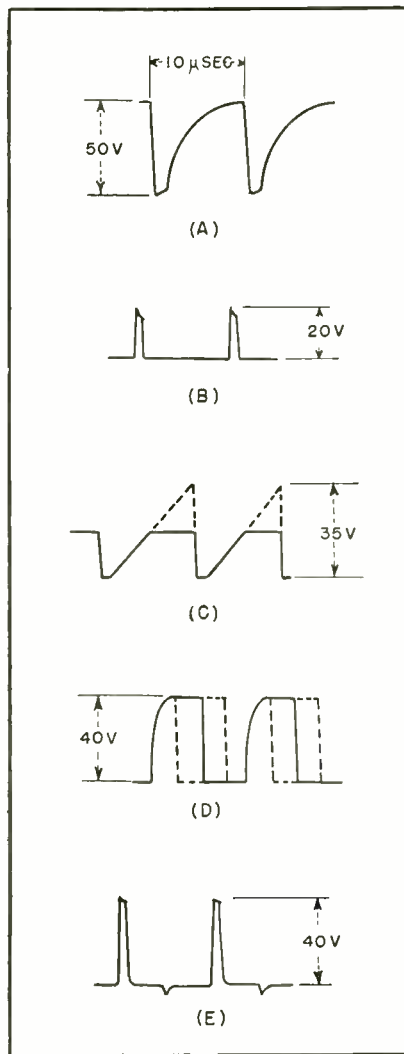

FIG. 2—Waveforms, oscillator to output

loads of this and subsequent multipliers are resonant at the various harmonics, and therefore, involve only sinusoidal c-w currents. In the broadcast version these multiplications are 3, 3, 3, 3, 2, 3, and 2, for a total of 972 times, yielding a carrier frequency in this illustration of 97.2 megacycles with a deviation of  $\pm 75$  kilocycles at 100-percent modulation.

#### Circuit Design Factors

Before proceeding to a discussion of distortion and noise in a system of this sort several salient features may be pointed out. First, in common with all phase-shift modulators, there is no interaction whatever between the functions of modulation and carrier-frequency control, and the final stability is exactly that of well engineered crystal control. Exclusive of the frequency control the modulation proc-

ess is accomplished in three standard receiving type tubes operating under cutoff to saturation or cathode follower conditions. As a result the process is remarkably independent of tube changes or aging. There are no resonant circuits and no reactances. Largely to eliminate the commercial tolerances of resistors and capacitors,  $C_3$ ,  $C_7$ ,  $C_{10}$ , and  $R_{14}$  are factory adjusted, and thereafter no adjustments even of a maintenance nature are necessary, except after outright component failure. Tubes  $V_1$  through  $V_4$  drain about 20 milliamperes at 250 volts.

#### Possible Variations

An interesting aspect of the development of this modulator lies in its apparent simplicity. Until certain special factors were fully appreciated performance was indifferent and the simultaneous attainment of low distortion and low noise hardly seemed practical without considerable elaboration. A good many detailed variations from the sample circuit shown are operative, and some yield high performance. But without the observance of certain principles, design can be surprisingly difficult. The important rules affecting linearity and noise are enumerated below.

Having selected the sawtooth output waveform as the basic timing or phase-shifting mechanism, it developed that linearity could not be preserved if it was amplified or caused to appear as a current variation in a plate-loaded tube, no matter how attractive such a step may have appeared at first. Other means of straightening the sawtooth beside the bootstrap arrangement shown are entirely practical provided the sawtooth waveshape as such is not amplified. In particular, in the modulation process the tube performing the timing,  $V_{4a}$ , cannot carry currents of sawtooth shape and still preserve linearity in the timing process. It was found also that the amplitude of the current pulses in  $V_{4a}$  should be constant during the modulation cycle. To insure this condition the plate supply voltage is maintained constant by  $C_6$ . The supply voltage is low, about 30 volts, giving a small cutoff voltage.

Noise arises in such a system in the form of random variations in



the time of occurrence of corresponding events in consecutive cycles. Such timing variations ordinarily are the result of superposition of noise voltages on the desired wave-form. The noise voltages originate either in tube current variations or as Johnson noise in resistors. The effects of both kinds of noise are reduced by increasing the time rate of change of voltage in the sides of the pulses, and by maintaining low circuit impedances at certain points. For instance, impedances controlled by  $R_3$ ,  $R_7$ , and  $R_{10}$  are in a position to contribute to the residual modulator noise unless maintained below values appropriate to the pulse amplitudes appearing across them. This is another way of saying that the circuit bandwidth should be as great as possible so that the pulse rise-time is short. Noise originating from uniformly distributed random voltage variations causes frequency modulation noise with a triangular distribution spectrum, extending linearly up from zero at zero modulating frequency. For the band up to 15,000 cycles the integrated noise power from a given resistance is approximately 44 db greater than would be the case for a flat noise spectrum. The 75 microsecond de-emphasis in the f-m receiver reduces this effect by 13 db. The reduction factor is different if the original noise is other than triangular. For instance, Johnson noise in  $R_{10}$  is modified in its spectrum by  $C_7$  before it can phase modulate pulses determined by the sawtooth. It is a straightforward matter to show by calculation that if the linearity were secured without the bootstrap or its low-voltage equivalent, that is, by making the supply voltage very high, the noise generated by the necessary large resistor would be excessive by a considerable factor. Thus it comes about that the bootstrap or its low voltage equivalent is uniquely essential to securing simultaneously low noise and low distortion. By similar reasoning it can be shown that the lowest noise is obtained when the corrector capacitor  $C_8$  is directly at the modulator cathode. If the corrector were to be located at a lower level in the audio section, tube and Johnson noise originating

after it would have a 31 db handicap and with practical tubes and circuit constants, this effect would be insurmountable. The possibility of noise phase modulation in the first tube after  $V_1$  is minimized by making this a frequency multiplier so that the noise deviations are multiplied by a smaller factor than those originating in  $V_1$  and earlier.

#### Performance

The general performance of the Serrasoid system in the particular case shown, and following the design rules noted can be summarized as follows. The linearity of the phase-shift process is readily made to be equivalent to less than 0.1-percent f-m distortion for peak phase shifts of  $\pm 135$  degrees. It should be noted that nonlinearity in the phase-shift process results in f-m distortion proportional to the order of the harmonic generated. Thus 1 percent third harmonic expressed as distortion of the phase shift is equivalent to 3-percent distortion measured as frequency modulation. In the commercial f-m broadcast modulator the distortion is largely controlled by the included audio amplifier, and the overall figure is held to less than 0.25 percent for 100-percent modulation at 50 cycles. At high frequencies where the peak phase shift is less the distortion falls until it is entirely accounted for in the audio circuits. At the upper end of the audio spectrum, distortion owing to tuned circuits in the frequency multipliers rises slightly, but by reasonable design is held below 0.25 percent, measured without de-emphasis. It is much easier to contrive that the distortion be this low than it is accurately to measure it once secured!

The f-m noise originating in the modulator and in the band from 50 to 15,000 cycles, measured with 75-microsecond de-emphasis is somewhat better than 80 db below 100-percent modulation. This noise is made up of approximately equal contributions from the crystal oscillator plate circuit and the plate circuit of  $V_{1A}$ . It can be reduced still farther by designing for greater pulse bandwidth and higher tube currents, and by the special artifices described below. Microphonism is no practical problem at all with non-

selected ordinary tubes. Because of the simplicity of the circuits involved shielding and isolation by ordinary means serves to suppress the noise effects of r-f feedback from high-level sections of the transmitter.

#### Increasing Phase Shift

There are two ways by which the total phase shift can be increased over the practical maximum of  $\pm 150$  degrees. One of these is by cascading, or iterated modulation. The pulses at the plate of  $V_{4B}$  are similar in form and amplitude to those at the plate of  $V_{2A}$ . If, instead of coupling here to the grid of a multiplier, these pulses are fed to a duplicate of the circuit extending from  $V_{2B}$  to  $V_{4B}$  inclusive, another complete modulation process will have been encompassed. One stage of such cascading doubles the peak phase shift with the same percentage of f-m distortion and yet raises the f-m noise by less than 3 db. Thus the effective signal to noise ratio is improved by at least 3 db. The price paid for this iteration is two and a half additional tubes and a doubling of the audio power required to modulate. The process can be extended beyond two modulations. The other method involves generating two or more interlaced sawtooths at submultiples of the crystal frequency by means of a step-counter frequency divider; separately modulating pulses from each of the proportionately longer submultiple sawtooths; and recombining the sets of modulated pulses. The submultiple frequency, of course, must be more than twice as high as the highest modulating frequency involved.

In general, by the use of cascading and interlacing, as noted, by the use of a modification of the scheme employed in the Armstrong dual channel phase shift modulator, and by several other arrangements too detailed to describe here, the application of this system can be extended to cover a very wide field.

Commercial versions of the new modulator have been in use for the past six months at W2XMN-W2XEA, Alpine, New Jersey, and in the studio-transmitter link used to program KSBR, Mount Diablo, California.

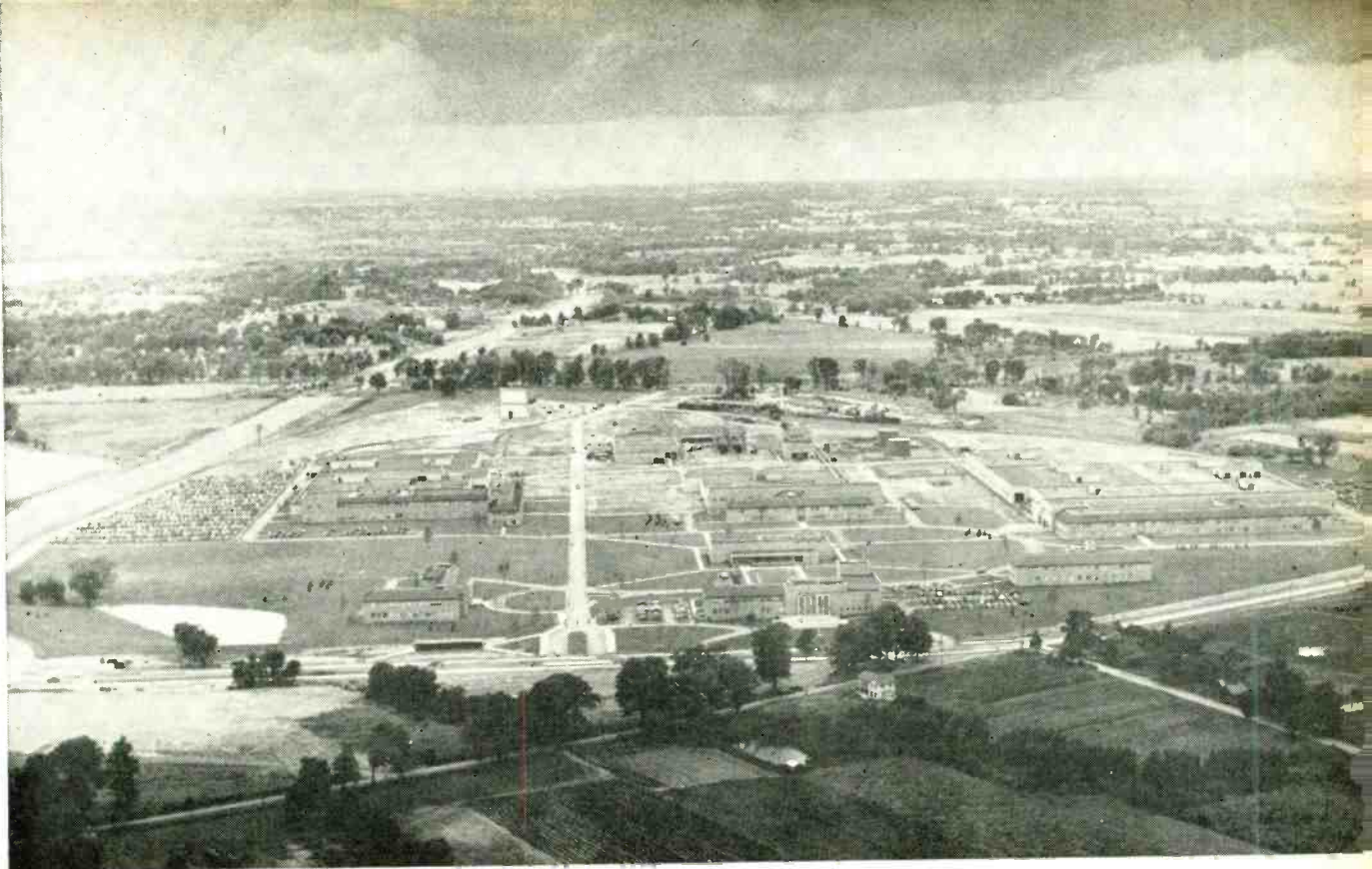

**BIRD'S-EYE VIEW**—From a low-flying helicopter, here is how Electronics Park looks to a camera aimed due west and downward. All visitors are welcomed at the Reception Building (middle foreground), where they receive a marked map of the Park

# The Editors Report on ELECTRONICS PARK

To build a combined headquarters, engineering heaven and de luxe manufacturing plant for its expanding electronics business, General Electric has invested heavily in a new plant at Syracuse. Here, along with the physical details, is the story of the people—the engineers, supervisors and workers—on whom hinges the future of Electronics Park

## PART I—The Park and Its People

**I**N the rolling farmland near Syracuse, N. Y., has arisen an industrial phenomenon, a 155-acre campus combining research, engineering and production on a scale never before seen in the electronics business. This is Electronics Park, the headquarters of the Electronics Department of the General Electric Company. Nine buildings have been completed, stocked with machinery and equipment, and brought to operating status.

The Park is no idle experiment in bigness. When the war ended, GE had a greatly expanded electronics business located in 22 plants—with no headquarters

plant. The company's long experience in the lamp business—and electronics closely parallels it in many respects—pointed the way to a headquarters plant for engineering, manufacturing, sales and marketing operations. And so Electronics Park may be said to be a modernized version of Nela Park. Both have the "campus" atmosphere, the last word in engineering facilities coupled with manufacturing operations and many satellite plants in various parts of the country.

Compared to competitors' plant facilities, the Park undoubtedly appears to be a "luxury" operation to many industry visitors. Contrasted to this attitude



is the GE philosophy as expressed by Dr. W. R. G. Baker, vice-president in charge, who explains that management merely has provided the best possible postwar facilities and atmosphere for its engineers, office and production workers, and salesmen—all of which has already resulted in improved productivity as compared to similar GE electronics operations before the war.

The editors of *ELECTRONICS* undertook some months ago to study the operations at the Park. This report results from weeks of interviewing the engineers, the executives and the production workers. Its purpose is to describe features of the organization, its systems, techniques, facilities and methods. Some of these ingredients of creative productivity are, of course, equally applicable to many another plant or laboratory in the industry, and may well be adopted with profit by others.

The genesis of the Park goes well back into GE history. Since the early experiments of Langmuir, Alexanderson, Hull, Dushman, White, Coolidge and Whitney, electronic theory and practice had an important place in the GE picture. But electronics manufacture never loomed large in dollar volume compared with the company's apparatus business, for example. For years GE was completely out of the radio receiver business and practically all other phases of the electronics industry with the exception of building transmitters and receivers for the government and a comparatively small amount of industrial electronics equipment.

This was the result of arrangements approved by the government under the consent decree of 1932 whereby GE voluntarily liquidated practically all its previous activities in the field, most of which went to RCA—patents, products, machinery and engineers. GE went back into receiver production in 1937 at Bridgeport, Connecticut, squeezing into the household appliance plant. Since then, the various divisions of the Electronics Department have been living in other peoples' attics scattered over the eastern half of the country.

The vast expansion of electronic production brought to GE by the war further decentralized production. Even before the war's end, it was clear that the scattered electronic manufacturing plants could not be brought back to Schenectady, which was already over-

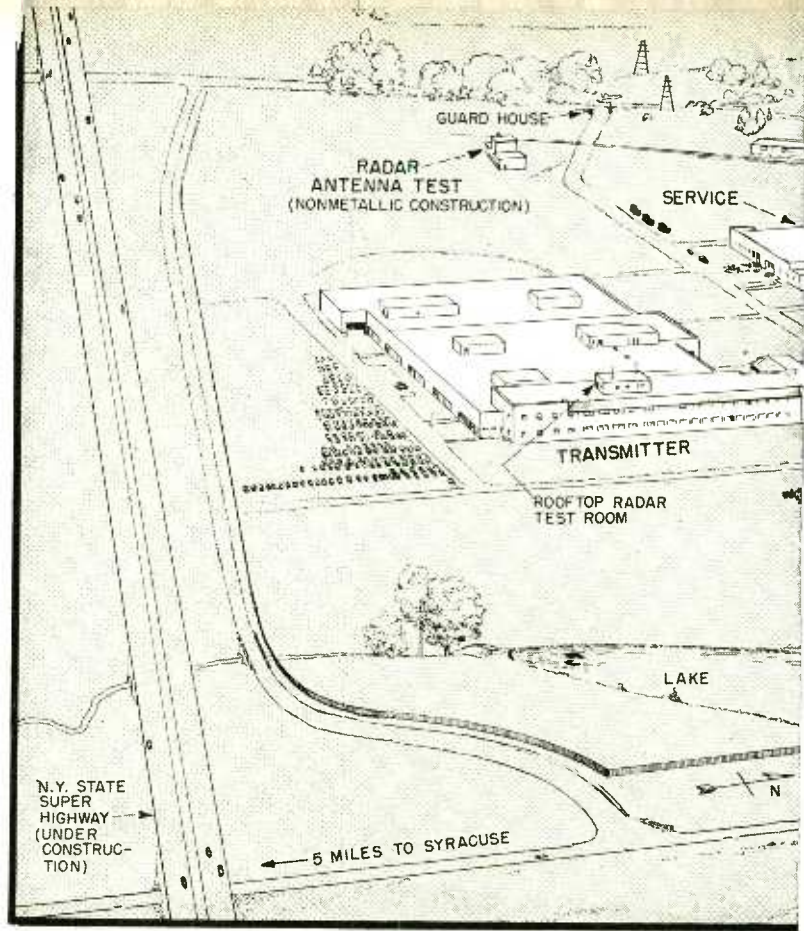

**THE PARK**—155 acres of upper New York State farmland were converted into Electronics Park, headquarters of GE's Electronics

crowded with nonelectronic activities. Planning for the Park began, in fact, as early as 1942.

#### Why Syracuse Was Chosen

The first big decision was to find a site that would serve as headquarters and an engineering center for the Electronics Department, and have a large enough manufacturing plant to take care of practically all business in a normal year. The four major considerations in choosing a location were: (1) availability of labor to support contemplated production; (2) availability of air, rail and highway transportation, hotels and other community facilities; (3) reasonably central location with respect to sources of raw materials and markets for finished goods; (4) sufficient nearness to the research centers of GE to permit frequent contacts.

*For the NEWS STORY with facts and figures, read*

**PART I—The PARK AND ITS PEOPLE . . . . . pages 77-84**

*For the picture of ENGINEERS at work, read*

**PART II—The ENGINEERING ORGANIZATION . . . . . pages 85-94**

*For PRODUCTION AND MANUFACTURING IDEAS, read*

**PART III—The PRODUCTION TECHNIQUE . . . . . pages 95-100**



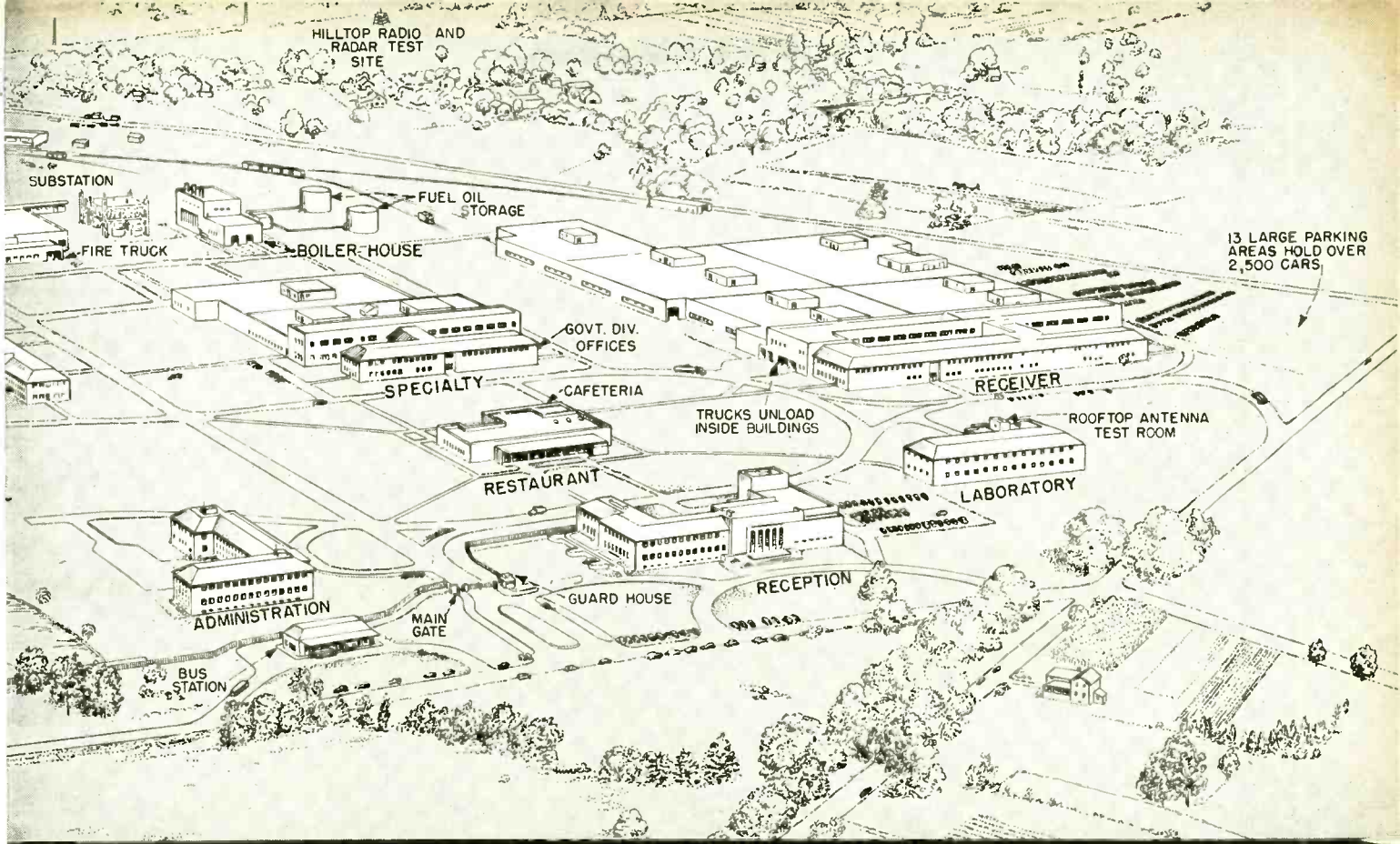

Department. Location is five miles northwest of heart of Syracuse and a half-mile from Liverpool. Of the nine buildings in the Park,

one commands and five serve the three biggest, in which the actual manufacturing is done

Over a hundred communities were considered, some of which met all of the above requirements. Syracuse, however, had two plus values—a large group of employees that had operated the GE war plants at Thompson Road and Wolf Street, and convenient means for graduate study by engineers and other employees at Syracuse University. Therefore, Syracuse was chosen.

The 200,000 population of Syracuse is large enough and its industry sufficiently diversified so the Park's activities will not seriously affect the economy of the community. The city has a record of favorable union relations, and careful analysis shows that the Park can take a maximum of about 6,000 workers from the area without disrupting labor conditions in other Syracuse industries.

The site was picked next—155 acres of farmland about 5 miles northwest of the heart of town, on good roads and within the freight yard limits of Syracuse. Architects were engaged and commissioned to give GE a modern plant designed specifically for its electronics business.

#### Construction Problems

No job of this size could be undertaken without running into the usual labor difficulties. For example, the building design called for 1,800,000 bricks—presenting a tremendous job to get from the area enough bricklayers to finish the project. It was necessary, in fact, to obtain men from surrounding cities to handle the job.

Grading for Electronics Park was started in the fall of 1944, but the contractor worked only a few days before snow came. The ground was not seen

again until the end of March, 1945. Construction started in September, 1945. In spite of difficulties of obtaining material as well as labor, the contractor started setting steel for the Transmitter Building in April, 1946. One year later this building was in operation, and production was humming. By early 1948 all main units were completed.

#### Units of the Park

The three largest units, the Receiver Building, Transmitter Building and Specialty Building, are combined engineering and sales offices and manufacturing plants devoted to their respective products. The remaining six buildings provide services and staff functions common to all activities. They include the Administration Building, Reception Building (which also includes an auditorium, the main hospital, employee relations offices, company store, classrooms, and a photo laboratory), the Laboratory Building, Service Building, Boiler House and Restaurant. Smaller units are available for special purposes, such as a hill-top test site for radar, and a nonmetallic building for testing radar antennas.

Construction of this plant required 500,000 blueprints, and over 100 engineers worked for a full year designing the layouts. Over 7,000 tons of steel were used in erecting the framework of the buildings and over 70,000 cubic yards of concrete were poured, much of it in bitter winter weather.

All offices and factory areas are air-conditioned. Fluorescent lighting and attractive tile floors are used in the offices and in all the factory buildings. The flooring in offices and labs is laid on concrete over a



system of six-inch floor ducts. This permits obtaining a new power or telephone outlet within a few inches of a desired new location anywhere on the floor. Partitions are the Hauserman metal type that can be set up, moved or removed almost overnight to accommodate the continually shifting office and lab requirements.

There are 57,000 square feet of windows in the Park. Supplementing the natural lighting are 28,000 lighting fixtures of the fluorescent troffer type, with 100-watt units in the factory areas and 40-watt units in office areas.

The roofing, except for copper flashing on the office buildings for appearance, is of precast concrete slabs and standard built-up tar felt and slack. A tunnel approximately a mile and a half in length interconnects all buildings and carries domestic water, steam, a condensate return and telephone lines.

At seven points in the Park there are driven grounds tied together by a 1/4-inch by 2-inch copper bus that runs through the tunnel system. Less than an ohm of resistance can be measured between any two of them. Each steel column in each building has its own copper conductor running to this ground system, as also do all water mains and all of the external shields for each shielded room.

The Boiler House has three 60,000 lb per hour oil-fired boilers which provide heating as well as process steam at an operating pressure of 75 lb. At present two 400,000-gallon fuel oil tanks are provided. Inasmuch as this huge project depends on a single 16-inch water line from Syracuse, a 1,200,000-gallon water reservoir will be installed to insure a continuous water supply for production needs and fire protection.

Power is received from the Central New York Power Corporation over two 115-kv lines. This voltage is reduced to 13.8 kv at a substation in the Park, for distribution to 35 unit substations located in penthouses

on factory roofs and in basements of office buildings.

Within the Park there is a total of 3 1/2 miles of track and interconnecting switches, arranged so that incoming material can be unloaded at the receiving dock in the desired building while other freight cars are being loaded at outgoing platforms. One GE 50-ton Diesel-electric locomotive handles traffic after receipt from the railroad.

Because the winters in this part of the country have low temperatures and occasional heavy snows, the service group has 3 V-plows, 2 Snogos that pick up and blow snow to the side of the road, a Jeep sidewalk plow, and several bulldozers. Adequate space surrounds each building and the roads so that snow will never have to be hauled away by trucks. Inside the Park are over 5 1/2 miles of road, all paved with concrete and blacktop, plus about a mile of concrete walks going across the lawns.

### The Management Team

By mid-1948 the Park was erected, staffed and operating. The plant is there, a large investment that has to be managed along creative, productive and profitable lines of action. The Park, in Dr. Baker's opinion, is only incidentally buildings, equipment and machinery. Primarily the Park is people—the ideas they have, the work they do, the decisions they make.

In an outfit of this size, decisions are always potentially dangerous. For example, it takes over 20,000 radio receivers of any new model merely to sample the Receiver Division's dealers. So the right decisions on chassis design, cabinet styling, quantities the market will absorb, and pricing all are extremely important.

The big decisions are made by the management team shown in the organization chart. The Electronics Department is one of the nine operating departments comprising GE, shown at the top of the diagram. Each

DECENTRALIZED OPERATION—Organization chart showing relationship of Dr. Baker's Electronics Department to the other eight

operating departments that constitute General Electric Company, with divisions under his wing shown in the lower rows

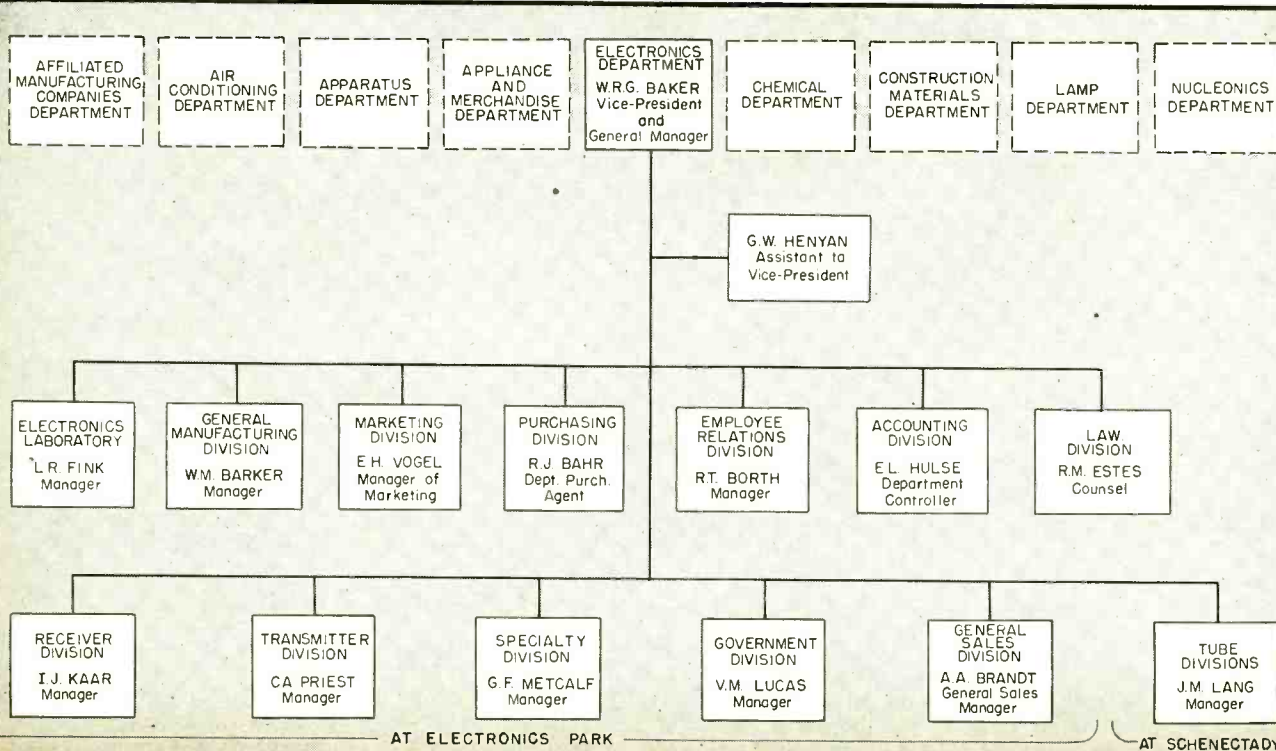





**THEY RUN THE SHOW**—Five engineers and a salesman, heading the world's largest concentration of electronic engineering and manufacturing facilities. Left to right: G. F. Metcalf of Speciality Division; A. A. Brandt, General Sales Manager; V. M. Lucas of

Government Division; vice-president W. R. G. Baker; C. A. Priest of Transmitter Division; I. J. Kaar of Receiver Division. Not pictured is J. M. Lang of Tube Divisions, located in Schenectady rather than in the Park

Department is in effect a separate business, independent in its engineering, manufacturing and sales, headed by a general manager who in most instances is a vice-president of GE. The departments are assigned budgets at the beginning of the year by the head office, and are responsible only for returning the budget, with a profit at the end of the year.

The Electronics Department management is divided into two teams, the staff divisions (advisory) and the operating divisions. The staff functions, shown in the third row of the diagram, include services common to all operations, and are largely nontechnical. For example, E. H. Vogel, manager of marketing on the staff, represents the vice-president and advises the operating divisions on such matters as general departmental and divisional sales policies, product planning and pricing, merchandising plans and programs, advertising for all products, and market research.

Similarly, the other staff divisions advise the operating divisions on all important decisions, and are brought into operation as their particular services and experience are needed.

The technical staff unit is the Electronics Laboratory, whose function lies midway between the pure research work carried on in Schenectady and the operating laboratories concerned with development specifically for production. Its job is to develop ideas from the pure research stage to the advanced develop-

ment stage, and it serves all the operating divisions.

The operating divisions at the bottom of the chart are, like the company's big departments, virtually independent businesses, working from a budget and returning it with a profit. Each division has its corps of engineers and production men, its own engineering labs and manufacturing plants, its own sales people. The heads of the divisions are thus primarily business men with broad management responsibilities. Like Dr. Baker, most of these men came up through the technical ranks of the company.

#### Operating Divisions

Largest of all the operating divisions is the Receiver Division, with close to 5,000 employees and about 1.5 million square feet of space. About half of these employees and 400,000 square feet of this floor space are in the Receiver Building in the Park, and the remainder is in satellite plants outside the park. This Division makes all kinds of radios and television sets en masse as its principal function and also supplies components, like loudspeakers, to other manufacturers.

Whereas many of its competitors procure the bulk of their engineering from the license laboratories to keep this expense at a minimum, the Receiver Division has preferred to stay in the engineering business and work to achieve the higher volume level required for the break-even point in order to absorb engineering costs. Since seasoned engineering organizations can-



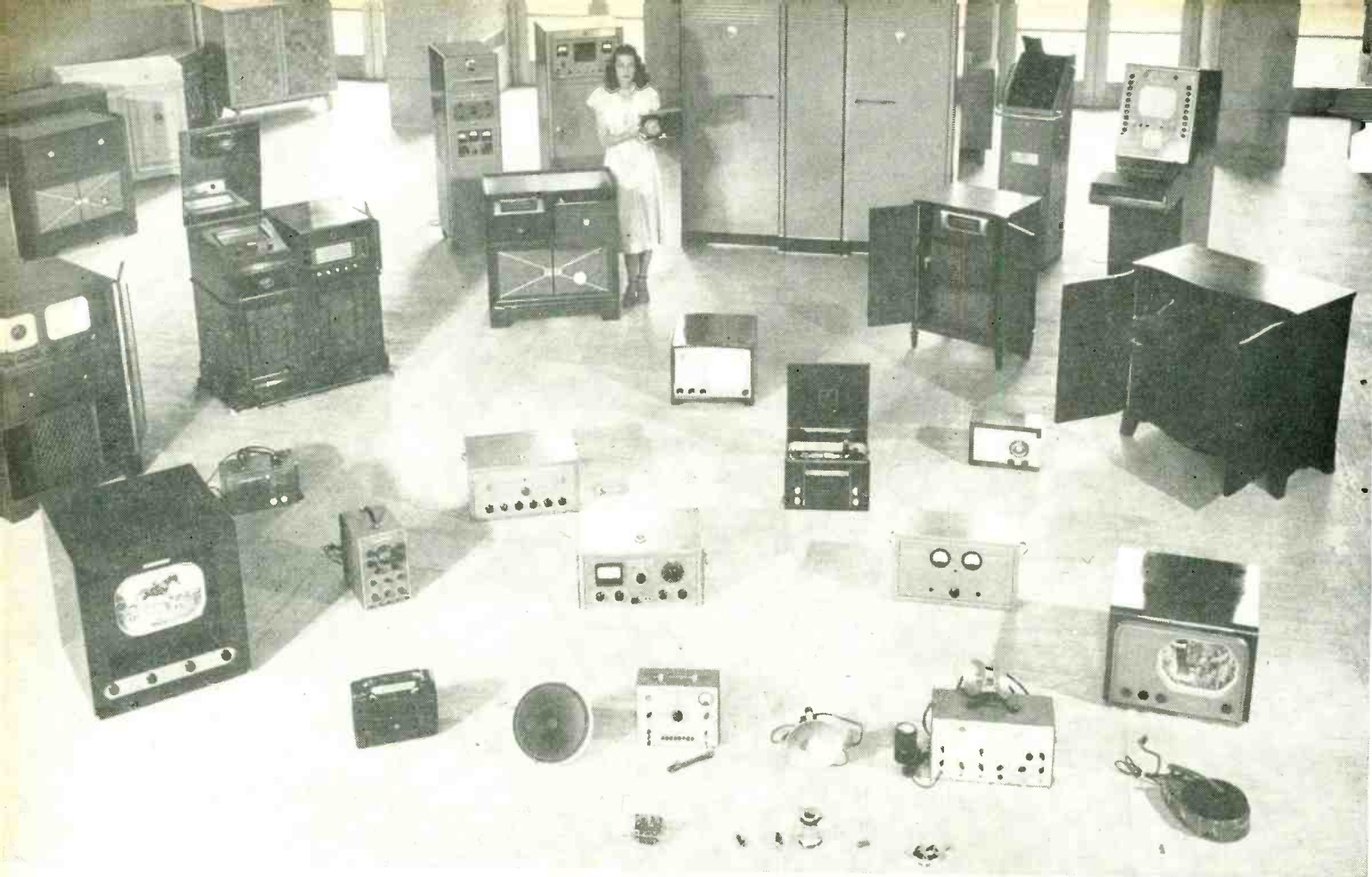

**OUTPUT**—Examples of many of the products made in the Park. In quantities ranging from one of a kind to hundreds of thousands, they fill freight cars and trailer trucks that leave the Park destined

for distributors and customers throughout the nation. Products like large international broadcast transmitters and shortwave receivers are delivered to International G.E. Co. for export

not be created overnight, the existence of a receiver engineering organization is important insurance for the future. Furthermore, GE derives a great deal of prestige, as well as some material gain, through introduction of engineering advances even though these are available immediately to competitors through cross-license agreements.

The receiver engineer must often work toward two entirely opposite goals at the same time. On the one hand, he tries to design a set so there are one or more subassemblies that can be put together separately out in the open, where the work is much easier than deep inside a crowded chassis. On the other hand, a subassembly involves extra expense for producing the separate chassis and for combining it with the main chassis, hence the ultimate goal is to get rid of separate units. The head end of a television receiver is an excellent example of a legitimate and economical subassembly because it involves assembling a dozen sets of tuned circuits positioned around a selector switch, followed by alignment of each tuned circuit.

The Transmitter Division, whose chief function is to build big electronisms, comes next with about 2,500 employees, 90,000 square feet of floor space for offices and development laboratories, and a manufacturing floor equal to 210,000 square feet. The Transmitter Division divides its allegiance approximately equally between government and commercial customers. This was the first of the manufacturing buildings in the Park to go into production.

Although deadlines, economic factors, and the matter of eye appeal plague engineers in the Transmitter Building, commercialism is not nearly so evident as in receiver engineering. The work of the transmitter engineer is more diversified. There are about 192 graduate engineers in this division, of which 126 are in the engineering groups, 37 in factory inspection and test groups, and 29 in field engineering.

The Specialty Division, with some 500 employees and over 100,000 square feet of space, makes special electronic items. Measurement equipment for the new field of nucleonics is now one of the items receiving high priority. The Specialty Building is in the center of the Park.

Finally there is the Government Division, which utilizes about 50,000 square feet of space throughout the Transmitter and Specialty Buildings, and, in addition, about 200,000 square feet in the Thompson road plant in Syracuse. It has every possibility of expanding as government contracts are received for electronic equipments needed by our armed forces. Most of this business involves radar and other highly complex electronic equipment; in line with tradition, GE accepts many tough engineering jobs from government agencies.

At the beginning of World War I GE was doing government electronic business and has been in it ever since. The Government Division is strictly a quality business in every sense of the word, since the best is none too good for our armed forces. Govern-

## THINGS AHEAD

IDEAS, some well along in development, that may become the products of tomorrow:

- Low cost, simplified television receivers
- Color television, electronically on a single picture tube
- Metal television picture tube
- Portable f-m receiver
- Radio remote control unit for appliances and for models
- Printed radio receiver, untouched by human hands
- Simplified superregenerative f-m receiver circuit
- High-frequency heater for thawing frozen foods in homes
- Microwave 60-second electronic range for restaurants and homes
- Electronic equipment for guiding and controlling missiles and rockets
- Pocket-size atomic radiation detectors with alarm
- All-electronic aerial superhighways for air navigation and traffic control
- Magnetic learn-to-read unit that pronounces words printed on keys which move pickup head to different parts of magnetized paper disc
- Advanced radar navigators for airplanes and ships
- Higher-powered television transmitters
- Super-powered broadcast transmitters
- Facsimile equipment for police, industry
- Personalized two-way radio sets

ment equipment is built to customer's specifications; there are no standard lines. The customer here always wants something new—rarely if ever is a product reordered, because by that time either the requirements have changed or there have been improvements in the design.

Government engineering occupies the entire second floor of the Specialty Building, with another wing downstairs for its executives. When a design is finished

RECEIVER BUILDING LAYOUT—Design engineers work upstairs, with production supervisors and the sales staff under them in the

and ready for production, some of the engineers move over to the Transmitter Building with it to see that production snags get ironed out promptly.

The General Sales Division management headquarters are in the Administration Building at the Park. It is responsible for the sale of the department's commercial products and for operation of the field sales organization in nine districts throughout the country, employing about 110 people. The manager of the division is also responsible for establishing adequate methods and channels of distribution, including distributor appointments and cancellations; for determining and administering commission plans for district managers and representatives; for the preparation of orders received and sales billed quotas for the districts and distributors; and for sales training programs for district representatives. He also shares with the product divisions the responsibility for product planning and pricing; merchandising plans and programs; production releases and scheduling.

Headquarters for the Tube Divisions of the Electronics Department are in Schenectady where one of the 5 tube factories of the divisions is also located. Original plans called for moving the divisions to the Park, in a separate building. The lack of labor available in Syracuse for all electronics manufacturing, and the cost of the move were heavy factors against it. Another factor was the close relationship between the industrial and power electronics tube work and the company's industrial machinery made or designed at Schenectady and sold through the Apparatus Department. These divisions make a large variety of industrial, transmitting, receiving and cathode-ray tubes in many satellite plants.

### Plans for Expansion

The Electronics Department's policy is definitely to limit the Park operations to a payroll of roughly 6,000

front of the building. All moving-conveyor assembly lines for radio and television receivers are in 55,000 sq ft center section

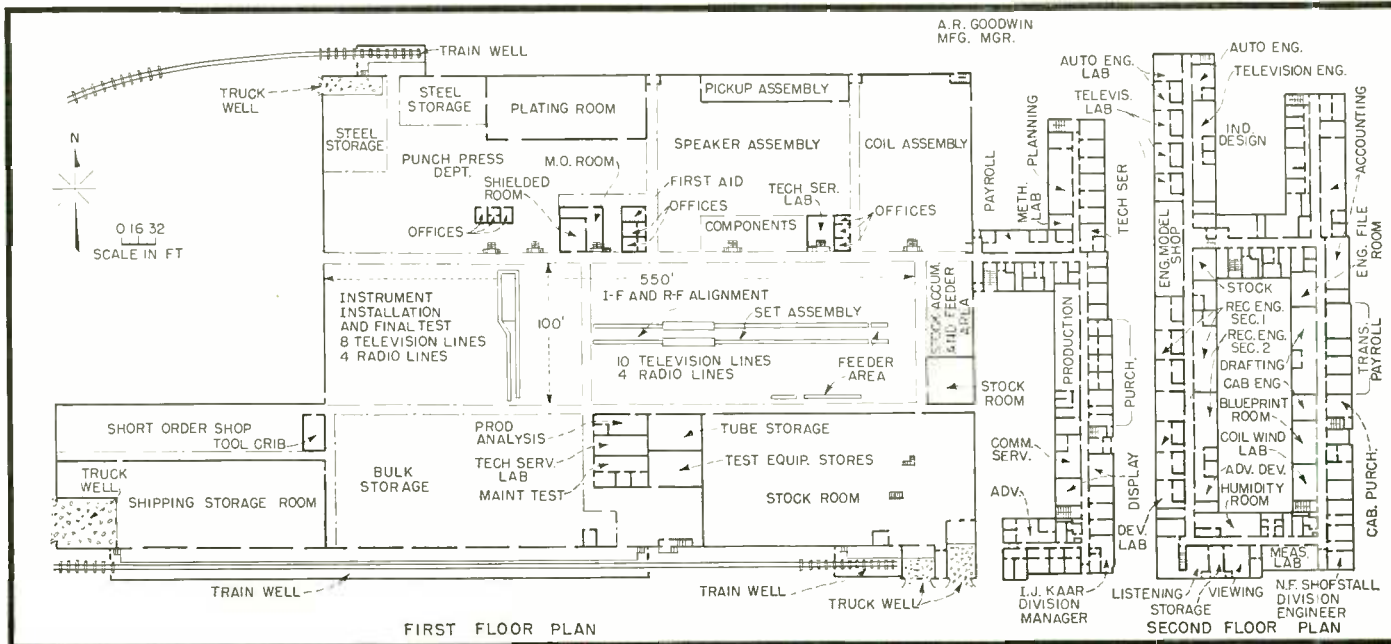



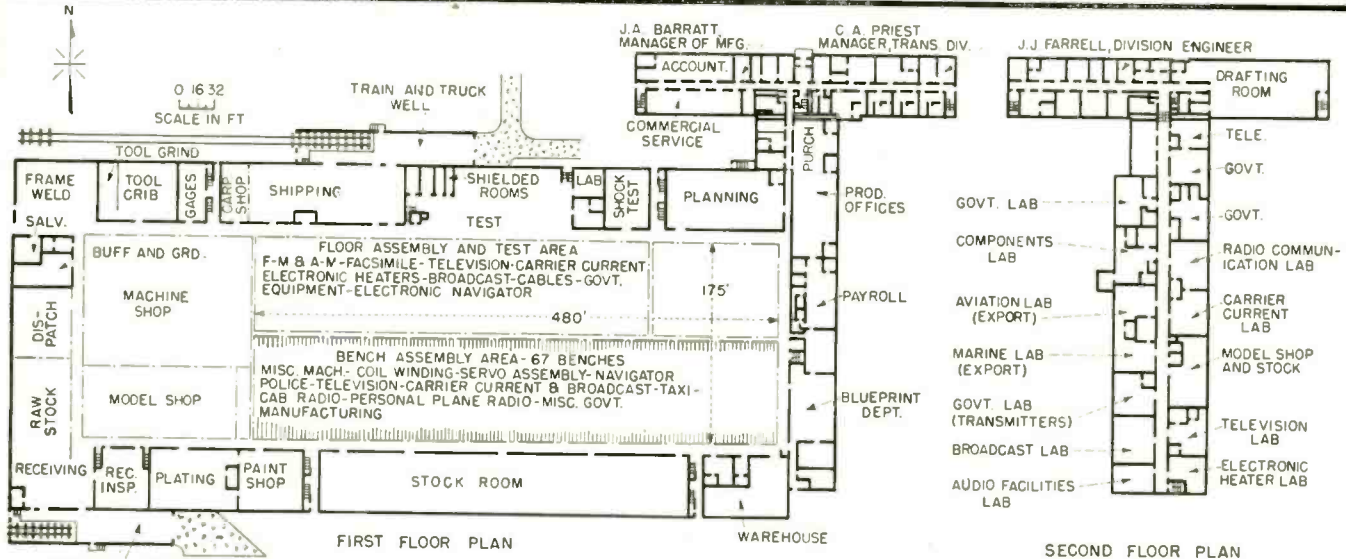

**TRANSMITTER BUILDING LAYOUT**—Engineers for the Transmitter Division are upstairs here, with supervisory and production plan-

ning offices for Transmitter under them in front of building. All assembly work is done either on the 67 benches or on the floor

employees, and to operate satellite plants for production beyond this point. For example, the Department has satellite plants in Buffalo, Clyde, Utica and Schenectady, N. Y., in Wabash, Indiana, in Owensboro, Ky., in Tell City and Huntingburg, Indiana, and in Irvington, N. J. These plants have, in all, 9,000 other employees and produce products like tubes, receivers and cabinets.

tion of development engineers to keep things running, production in the Park will benefit from the close proximity of the television engineering and manufacturing groups.

Expansion of the department's television receiver business this year has resulted in a plan to make all television receivers at the Park. By the year's end practically all radio receiver manufacture will be out of the Park in satellite plants and the entire Receiver Building manufacturing floor will be devoted to television. Since television receivers still need the atten-

The overall limitation placed on the Park's size by the availability of labor is an important advantage. The satellite plan of manufacture has an element of flexibility that would be missing in a larger concentration of facilities. Whenever more space is needed now, either temporarily or permanently, additional plants are acquired in cities having the required labor. Lines in heavy production, in which the engineering phases are essentially completed, get moved first to these outside plants.

**SPECIALTY BUILDING LAYOUT**—Specialty's engineers are downstairs, just off the manufacturing floor, because Government

Division offices and labs occupy the entire second floor. The Specialty Division factory is essentially a big job shop

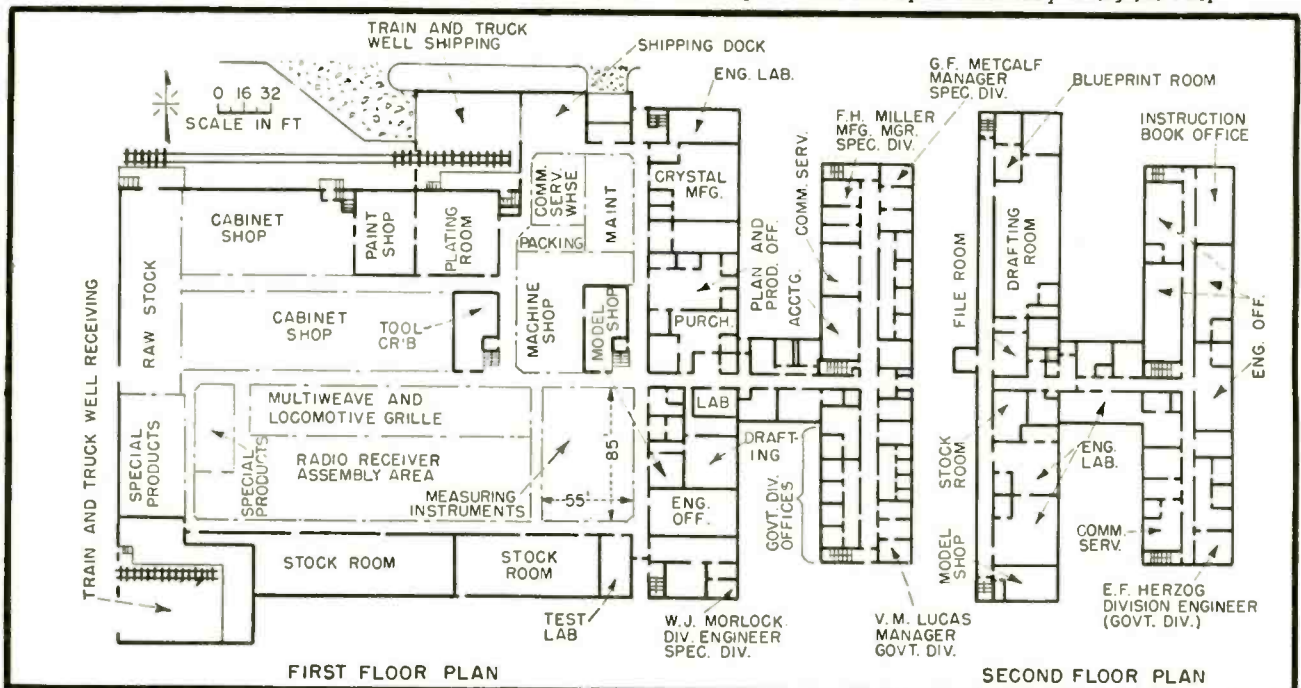

# PART II—The Engineering Organization



**TWO SIDES OF A WALL**—When a Receiver Division engineer becomes suspicious of a loudspeaker, he can bring it to this lab and run off a complete response curve in a few minutes. The loudspeaker is mounted in an opening in a wall between the



soundproof room and the measurement room, facing the microphone. A motor drive sweeps an audio signal generator gradually from 50 cycles to 20,000 cycles, while an inking pen traces on graph paper the amplified output of the microphone

**E**NGINEERING is one of the keystones of the structure of Electronics Park. The manpower devoted to engineering is a high proportion of the total working force. The manhours devoted to engineering, in development and production, are proportionately high, and engineering costs follow suit. Add to this the fact that in no other industry is the utility and cost of the end-products more closely tied to the technical skill of the men who design and make them.

It is not strange, therefore, that a major portion of the effort in planning the Park went into providing the best engineering facilities available. But facilities have to be operated, so the story of the engineering organization starts with the men. How are

they recruited and trained, how assigned to jobs, inspired to top effort? What are their pet gripes? These questions answered, it is pertinent to inquire what they have to work with, and what problems they wrestle with. In that order, then, let us consider the engineering organization of Electronics Park.

## Recruiting and Training Men

Except in unusual cases the newly graduated engineering student has never faced the basic engineering challenge: with data not known to be sufficient, and with a time schedule not known to be adequate, he must design equipment for some new application without losing sight of the basic requirements of cost,





**ENGINEERS IN CLOVER**—Favorite site for field tests of communication equipment is lawn surrounding the lake in the Park, giving

direct line-of-sight path to transmitting antenna atop Transmitter Building in background

efficiency, and dependability. GE has come to regard this aspect of an engineer's training as its own responsibility. Each year it absorbs into its laboratories, offices, and factories hundreds of young graduates from all parts of the country and from all types of colleges.

Channelizing such widely divergent backgrounds into occupations best suited for each calls for a flexible training program at all levels of aptitude and specialization. The best-known aspect of this is the Test Program. With few exceptions, most GE engineers select their specialized field via this medium.

#### Finding a Niche

For a period of from one to two years each newly-graduated student engineer is assigned to many of the major departments. His responsibility is to test the products manufactured by those departments, and during the course of this work he observes the problems and methods that are peculiar to each activity. The average assignment period is three months. By the end of his test period he can select with some confidence the kind of work that offers greatest interest and opportunity to him. The majority of engineers at the Park are graduates of the Test Program. This system provides the Electronics Department with a continuing influx of young men with new ideas.

Electronics Park is, of course, one of the major steps for Test Program engineers. In addition, the Park has its own Test Program wherein graduates

are transferred from building to building within the Park at approximately three-month intervals. This program is for those who have definitely chosen electronics as their life work.

Evening schedules of classes are provided at Syracuse University for engineers desiring to study toward their Master's and Doctor's degrees. These courses have been approved for benefits under the GI Bill. For other engineers, GE pays approximately two-thirds of their tuition if they complete their course satisfactorily. For those who do not, GE pays a third of the tuition. Courses are conducted at Electronics Park as well as in Syracuse University classrooms, and the thesis can be accomplished in any of the labs in the Park. At the present time, over 100 engineers at the Park are studying for advanced engineering degrees.

Another source for Electronics Department engineers is in Schenectady, where some thirty to fifty test engineers are selected throughout the company for an intensive course on engineering analytics. The course is a startling experience for every man who takes it. For four hours he is subject to intensive lectures by specialists called in from design sections or research laboratories. He is busy taking notes, for he knows that most of the material cannot be found in textbooks, and he likewise knows that the material might provide a clue to his weekly problem assignment—a clue which might reduce the 20 to 30 hours normally required for solution to 10 hours.





**THEY RUN THE ENGINEERS**—Reporting directly to division managers and responsible for the engineering of the Park's present and future products are these four division engineers and the manager of the Laboratory. Seated, left to right: J. J. Farrel of

Transmitter; L. R. Fink of Electronics Laboratory; W. J. Morlock of Specialty. Standing: E. F. Herzog of Government; N. F. Shofstall of Receiver. Not shown is O. W. Pike of the Tube Divisions. Section engineers report directly to their division engineers

Only about half of those who complete the first year of this advanced engineering training will continue with it. The elimination is carried out in a spirit of mutual agreement; some have found the going too stiff, while others have taken up permanent jobs in a GE division where additional training of this nature is not essential.

#### Types of Engineers

There are at least seven distinctly different categories in which the graduate of the Test Program or the engineering newcomer can end up: Research, advanced development, product design, manufacturing supervision, field engineering, sales engineering and commercial engineering. Each calls for its own particular combination of aptitudes, personality traits, and engineering knowledge. Furthermore, the duties of each vary greatly with the divisions—Transmitter, Specialty, Tube, Receiver, Government, Laboratory or Sales.

The chap whose interest is chiefly in the highly theoretical aspects of a problem, almost approaching

### ENGINEERS IN THE PARK

Design and Development Engineers.....	553
Engineers in Sales, Manufacturing, Etc.....	80
<b>Total Engineers.....</b>	<b>633</b>
<b>Total Employees at Park.....</b>	<b>6,200</b>

those of a physicist, invariably ends up as a research engineer in the Laboratory. He has few cost responsibilities, seldom a delivery date to think of and delves only into the laws of nature.

The fellow who likes to work with his hands may end up as a product design

engineer. In this category are most of the engineers in the Park. They take an idea and a blank piece of paper and produce working models and blueprints for production. They have to consider costs, eye appeal, delivery dates, and a multitude of related practical factors. A product design engineer, also known as a development engineer, is assigned to develop a particular product for which there is an order or a possible market, and he sticks to that job until a finished working sample is produced—or rather works on it whenever he gets a chance, because there is always a fire to be put out somewhere in connection with production of things he previously designed.

The organizing type of engineer is likely to end up as a manufacturing supervisor or section engineer because he likes to work with people. A factory train-



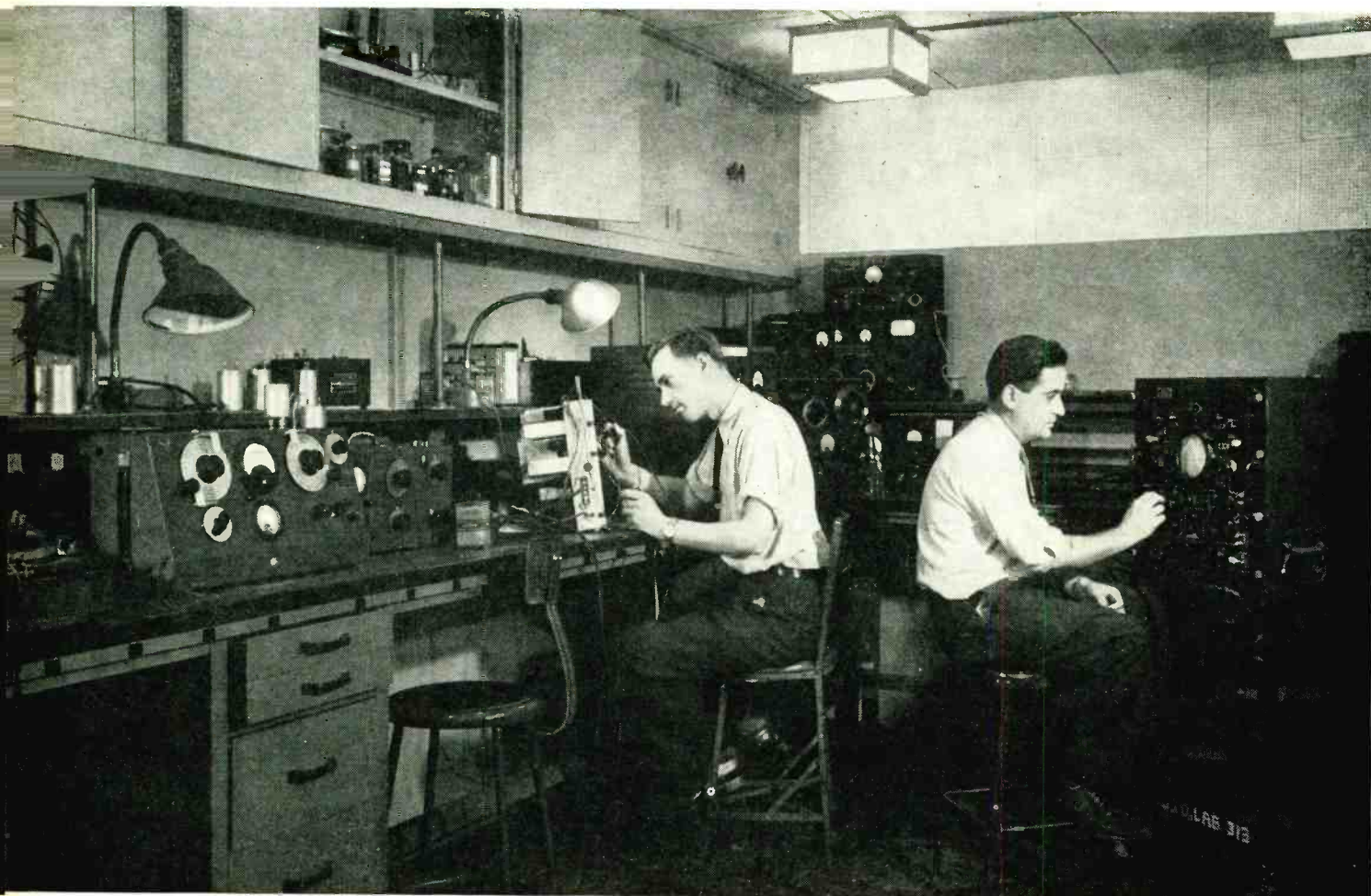

**WINDOWLESS HEAVEN**—Shielded room inside one of the Receiver Division laboratories, with desk lamps for delicate tests when

overhead fluorescents prove too noisy. All laboratories are air-conditioned, hence lack of windows here is no hardship

ing course is conducted for the express purpose of developing men interested in both engineering and production.

Combine an interest in people with good engineering know-how, plus a love for change and travel, and you have the making of a field engineer. Combine a liking of people with a dislike for the slide-rule engineering of his college days, and you have a sales engineer, simultaneously looked up to and down at by his fellow engineers. He can be as much as 75 percent engineer and still be a topnotch salesman because of the market nature of the product he sells.

Add diplomatic qualities and market analysis to an ability to look ahead and you have the commercial engineer, who provides liaison between engineering, sales and advertising and is broadly responsible for consumer acceptance of a product. He is a main source of ideas for new products because he is continually in touch with customers' needs. Part of his work involves writing the specifications he considers desirable for a new product, and later making sure that the final product is good enough to merit customer acceptance.

The engineer is encouraged and aided in obtaining professional recognition and prestige by membership and committee participation in engineering organizations, by delivering talks and papers before engineering

and other groups, and by writing articles and books.

The secret of getting top-level engineering productivity lies in morale, particularly in the inspiration which can be passed to and from the engineer and his immediate supervisor. Throughout the engineering organization at the Park, there are generally no more than 12 engineers, and often as few as 5, under each supervisor. This makes for rapid two-way communication of ideas, discussion of gripes, and correction of difficulties.

#### Morale-Building Techniques

Each supervisor is aided in working with his group by reference to a nine-point job program developed from a company-wide survey of employees. If productivity lags, the fault can usually be found in the fact that the company has not considered one or more of the nine elements inherent in a good job: Compensation, working conditions, supervision, job security, respect for basic human dignity, promotion practice, information on management aims, belief in the individual job's importance, and satisfaction in a job well done. Inevitably, GE loses some engineers to other firms. Such moves are seldom discouraged by the management, and as a result GE can claim to have trained the best engineers of many a competitor.

Beyond the salary question, the gripes are scattered



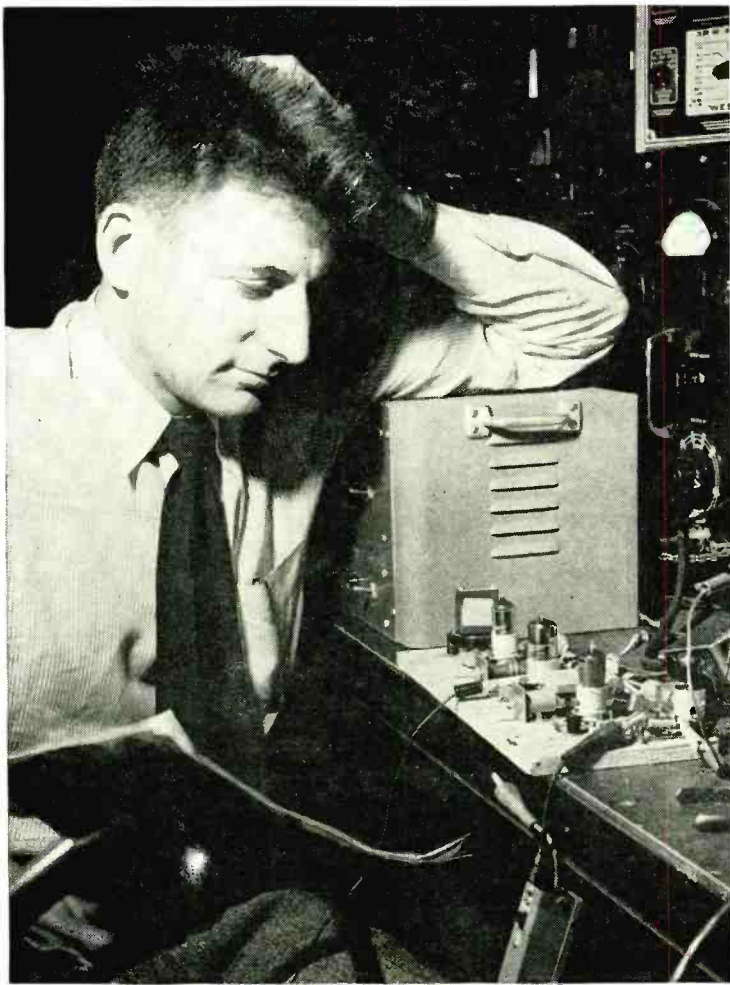

**FAMILIAR BREADBOARD**—A pause for meditation often pays during the breadboard stage of developing a new electronic product. Here is the true old fashioned breadboard, using wood screws to hold the parts on the wood base

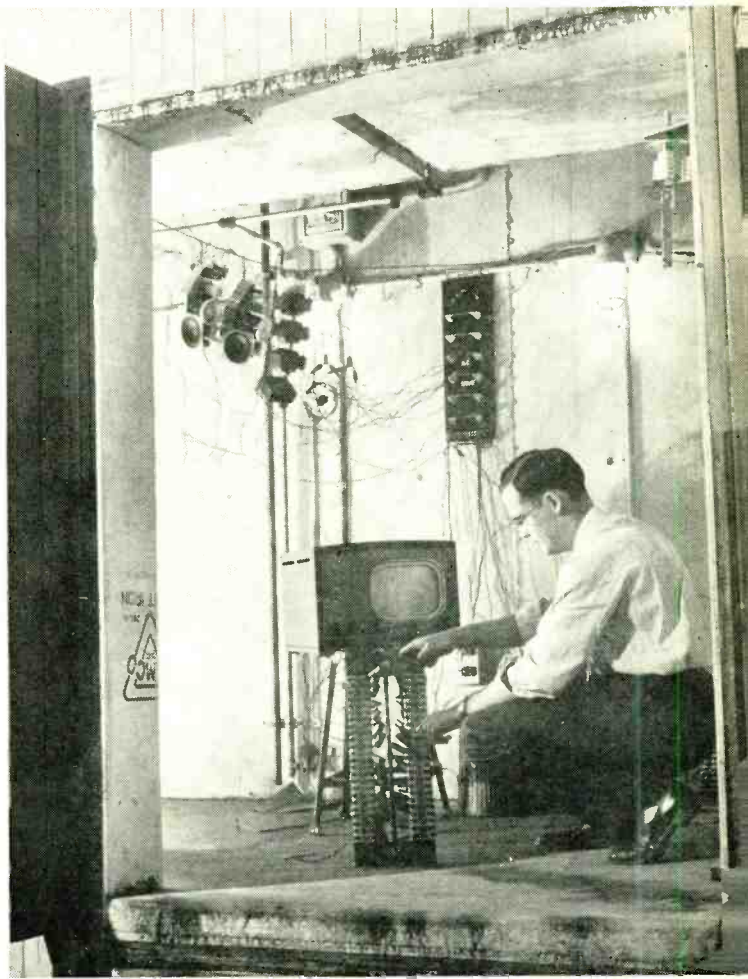

**HOT BOX**—Here receivers and components can be tested or operated for hours at temperatures up to 150 F and humidities up to 100 percent, to simulate ambient conditions encountered in any part of world where electronic equipment is used

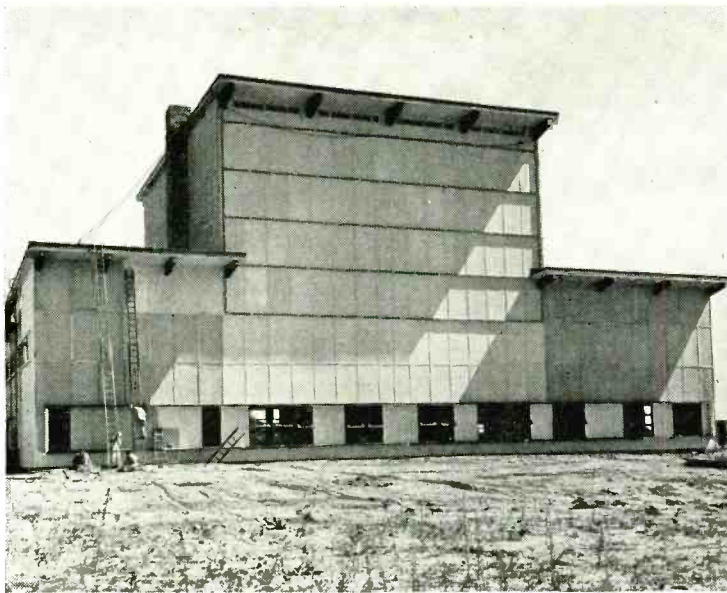

**ROOM FOR RADAR**—Nonmetallic structure nearing completion at back of Park, for testing huge radar antenna arrays regardless of outdoor weather conditions. Even sprinkler system inside is removable for sensitive tests

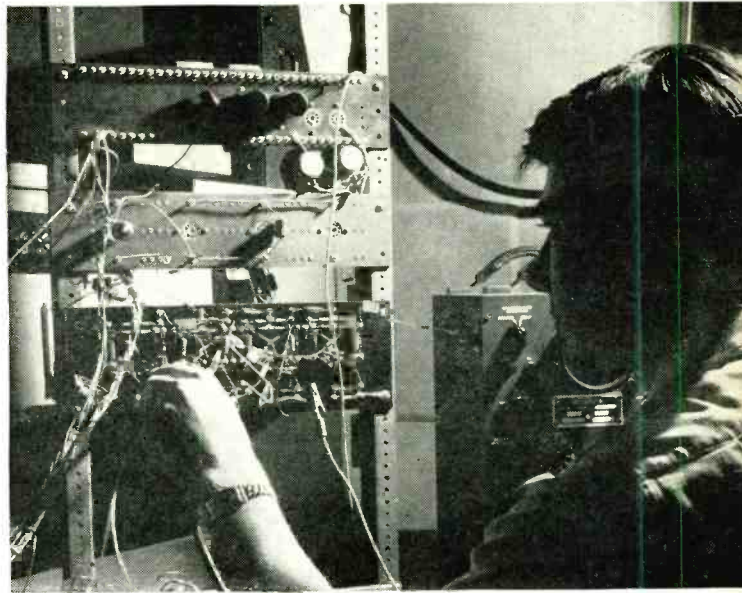

**REFINED BREADBOARD**—A communication engineer in the Electronics Laboratory likes his breadboard circuits to be up in the air, accessible from both sides and supported by a relay rack. Other engineers fasten panels to small wood blocks



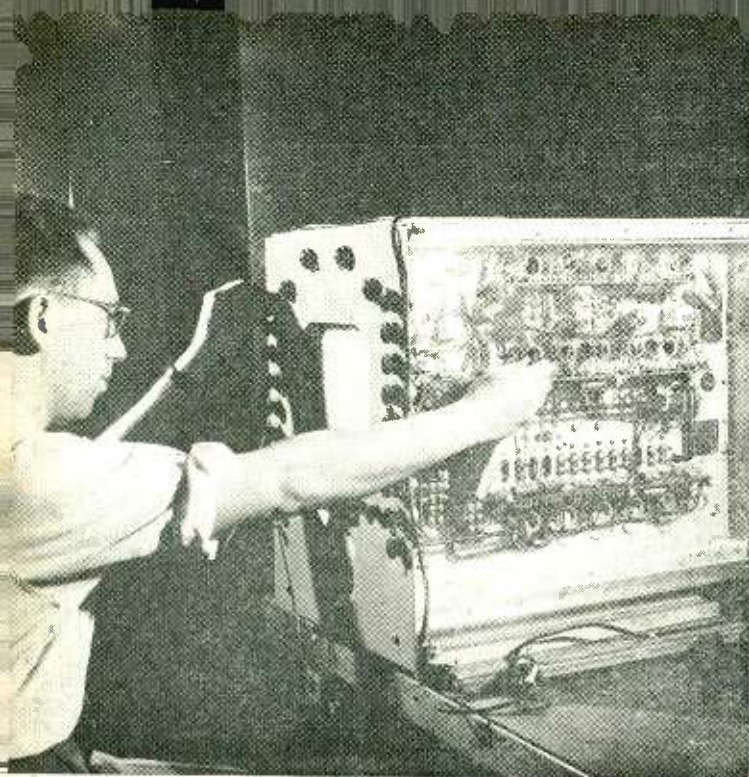

**MEASURING THROUGH LUCITE**—Test program engineer checking television monitor unit by inserting prods through holes over dangerous high-voltage terminals. Transmitter test section has now been in operation over a year without an accident



**HELP-YOURSELF STOCKROOM**—For engineers who like to pick and choose, this Transmitter Lab stockroom ranks tops in popularity. Cabinets have numbered drawers, and samples of parts are mounted on boards having corresponding drawer numbers

and to a large extent self-contradictory. One engineer goes so far as to measure with a recording thermometer the temperature of his air-conditioned office and to complain when it deviates beyond narrow limits, while another engineer objects that he cannot open the windows, sealed for the air-conditioning, to smell the clover on the Park grounds.

Regular meetings of all engineers in each division are held for discussions of any matter concerning the men and their relation to the company. Engineers interviewed say that these meetings are remarkable for their lack of double talk; an unpopular answer to a question is never evaded. Topics of discussion include salaries, employee benefits and services, the budget, profit and loss figures, plans for new products, and the competitive position of the Electronics Department with respect to the entire industry.

#### Engineering Facilities

The facilities for the engineering staff are of two types: an office and adjoining small laboratory where each engineer spends most of his working time, and specialized laboratories and a library.

The basic engineering office houses four to six men, and is approximately 12 by 23 feet in size. Adjoining it is a laboratory about 23 feet square, for the personal use of the men inhabiting the office. An elaborate system of conduits permits electric power of various voltages and frequencies to be brought out at each lab, as well as air under pressure, vacuum lines and specialized test signals, including video signals produced by the central video generator in the receiver plant.

The equipment in each lab depends on the particular problem at hand. In receiver development, signal generators, vacuum-tube voltmeters, Q-meters, and

oscilloscopes are to be found in nearly every lab, and more specialized equipment is available wherever needed. Each engineer is encouraged to requisition test equipment whenever and wherever it will fill a need.

Many of the specialized facilities are located in the Laboratory Building. These include the Park library, a model shop staffed with skilled mechanics and wiremen, a small chemical laboratory for testing materials, a plating laboratory, painting laboratory, welding laboratory, metallurgical laboratory and photographic darkrooms.

Most of the development laboratories, particularly those devoted to receiver development, have individual shielded rooms within which may be found electrical quiet, so elusive near manufacturing plants. Specialized antenna erecting and testing facilities are also available in profusion. On top of the Receiver and Transmitter Buildings' roofs are a number of 30-foot steel poles mounted on gear-and-crank mechanisms which permit a single man to raise or lower them. A special nonmetallic building 60 feet high, for testing radar antennas without interference from metal objects, is located in one corner of the Park. This contains a steel monorail crane support and a sprinkler system, but these may be temporarily removed. Radar and similar line-of-sight transmitters may be tested in the clear at a site on top of a nearby hill.

One objection many engineers have to working in a large organization is the tendency toward excessive standardization of equipment and methods. The Park management has attempted to avoid this pitfall, as witness the case of the lab benches. Five distinctly different styles of lab bench are in use, one for each of the four divisions and one for the laboratory. One design could have been imposed by the management,



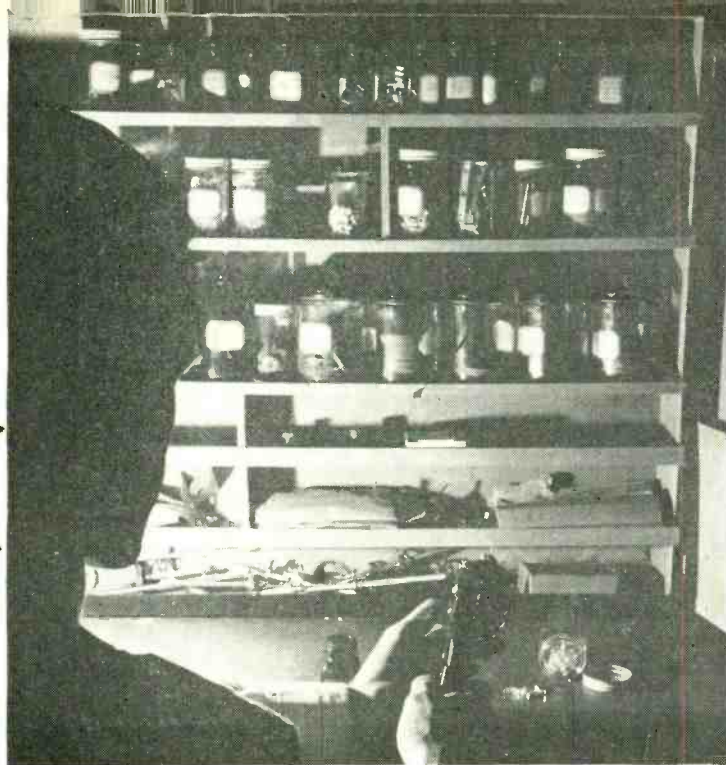

**SWITCHES TO ORDER**—Instead of ordering specially made samples of complicated wafer switches and waiting weeks for shipment, engineers in one Receiver lab assemble their own at this cabinet, which contains all necessary parts

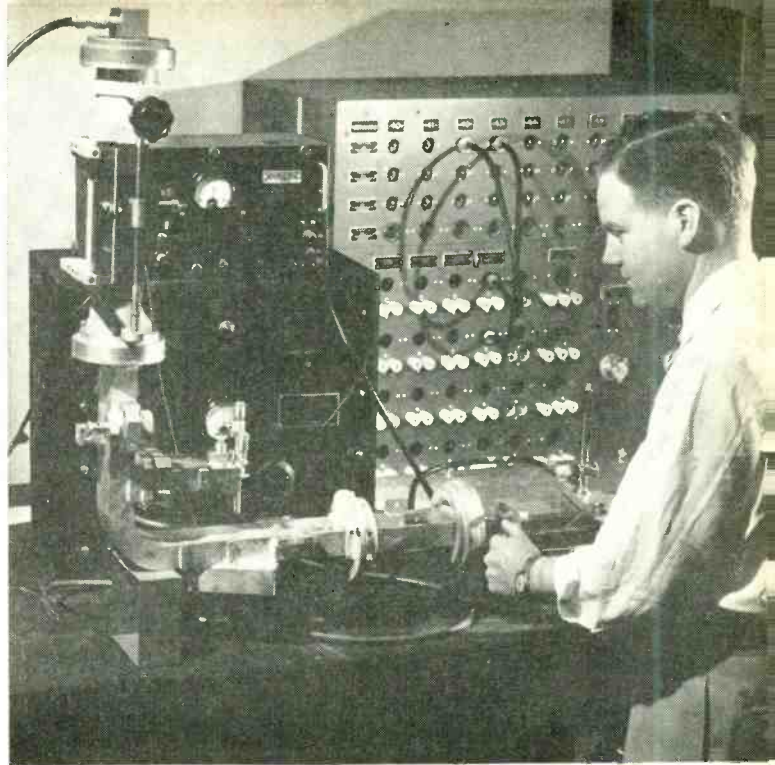

**PLAYING WITH PLUMBING**—Typical workbench scene in Government Division lab assigned to microwave development problems. Jumpers can be inserted in power panel at rear to feed any desired type of power to any particular bench

but the engineers couldn't get together on one design so Dr. Baker approved them all. Receiver benches are eight feet long, while Specialty benches are five feet long with drawers underneath at the right. The Receiver boys are quick to point out that the Specialty drawers are usually blocked by a soldering iron cord.

Six to twelve engineers share the same stenographer, an arrangement made possible by the fact that few of the engineers dictate correspondence and reports, preferring to write them out longhand for retyping. The stenographer is her own boss, an arrangement that avoids conflicting directions and leads to a display of tact on the part of the engineers.

#### Getting a Project Started

Ideas for new or improved products come from many sources. Perhaps the most valuable are those relayed from the consumer to the engineering staff via the commercial, field and sales engineering forces. Three noteworthy engineering developments of the Electronics Department, the self-contained antenna in standard radio sets, the variable-reluctance pickup and the high-brightness television picture tube, all started with suggestions from customers. Not infrequently the engineers themselves come up with an idea for a new product, but usually the engineer thinks in terms of improvements rather than innovations.

Whatever the source, the idea for a new or improved product is channelled initially to the commercial engineers and the sales department. This custom is a reflection of Dr. Baker's settled policy of developing only products that can be sold at a profit. The commercial and sales groups, aided by the staff's marketing manager, study the suggestion, calculate its ultimate selling price, then judge whether the market will take it at that price. If the answer is

favorable, the idea achieves the status of an engineering project involving analysis, circuit design and breadboard-building to see whether the idea can be reduced to practice.

The projects thus approved go on a waiting list, from which they are removed in a priority rotation established by the division manager and his project committee. One of the divisions keeps track of available project engineers on a wall chart which shows the week-to-week progress of current work and thus gives some advance prediction of availability of engineers.

Often the work may be assigned to a project team, since it is not always possible to get the required combination of leadership, cost consciousness, engineering talent and originality in a single individual.

When the project engineer gets the project, with it goes a definite time schedule and cost budget. He is responsible to his supervisor for putting the project through within these established time and money limits, or else he must do a sales job to get more of each. The project engineer then requests other engineers to assist him in the work, and he's off to the races.

The first duty of a project engineer is to query the Laboratory in the Park to see if any new ideas are at hand or in the offing that can be applied to the job at hand. The Research Laboratory at Schenectady is also approached for this purpose, as is everyone else in the Park who may have thoughts or ideas to contribute. All this is routine, made compulsory to insure that the development team starts where others left off, rather than from scratch. Commercial engineers in that particular activity are asked what competitors are doing. Competitive products may even be purchased and dissected as a prelude to creative development work.

With all the facts at hand, actual design starts. Mak-





ROOFTOP PANORAMA—Radio communication test point on Transmitter Building roof, with land-line telephone "just in case"

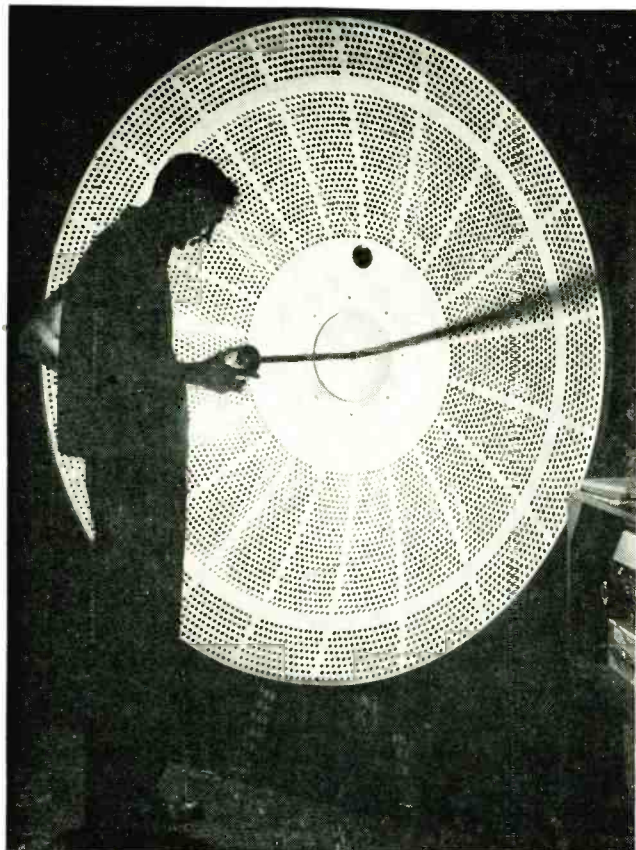

FOR TELEVISION RELAYING—Parabolic reflector for microwave television relaying, ventilated to catch less wind. Engineer holds waveguide terminus that bounces signals back to reflector

ing it work comes first, and here each engineer has his own preferred type of breadboard. Some like to work on a flat metal panel supported by wood blocks. Some like their panels to be vertical, mounted on relay racks. Some simply let the parts flop around on the workbench for the early hook-ups, so changes can be made more readily. The higher the frequency, however, the more nearly must the breadboard version approach the final precisely machined layout.

Engineers having specialized knowledge and experience with components, cabinet design, mechanical design, theoretical principles and mathematical procedures are always available to help the engineer who is in charge of a project. In the component parts sections of the divisions are other specialists, thoroughly familiar with all parts available from other GE departments and from outside manufacturers.

Technical assistants perform the many routine time-consuming tests associated with development work. These are in no sense flunkies, however; each engineer is expected to clean up his own workbench, put away his own tools and instruments and run his own errands.

Sometimes the engineer builds in finished model-shop form the product that he designed. This is authorized on small rush jobs where there isn't time available to train others, or where the quantity needed is so small that it wouldn't pay to train others.

#### Transition to Production

As the project proceeds, there comes a time when the development engineer has to quit shelling corn, and



pass on whatever he's got to the next team in line. Separating the engineer from his brain child often requires real ingenuity on the part of the supervisor. No one can predict in advance how long it will take a particular engineer to develop an unknown new product to the stage where it is ready for production. Early estimates must be revised frequently as work progresses, and each revision makes the engineer less respectful of deadlines.

An engineer's goal is perfection. Knowing this, and knowing that perfection is never achieved, the wise supervisor works close enough with his men to know when the product is good enough, then takes it away by one means or another. It is rumored that one supervisor actually stole the finished sample while the engineer was out to lunch, and turned it over to production minus last-minute finishing touches.

The philosophy of the supervisor is to encourage his engineers to make and discover enough mistakes fast enough so that they can all be cleared up before production starts. Allowing an engineer to scratch his head carefully for an extra seven months during development is expensive, yet gives no insurance whatsoever against production troubles. Engineers are helped in this activity by an industrial design section which is primarily responsible for final appearance of the product, but also contributes to initial design innovations before the bugs are ironed out. Responsible to the manager of marketing, this section makes

plastic pre-production models of portable radios and clay transmitter models, for instance. The hope and dream of the supervisor is that all early design bugs be little ones, such as are caused by tolerance clashes or mechanical misfits.

With electronic manufacturing back to its highly competitive pre-war status, quality of performance is no longer enough to insure sales. Overall appearance and styling must likewise be top-notch in the eyes of the customer, whether the product be a receiver, a transmitter, a tube tester, or even a tube. Today no design is permitted to leave a design section in the Park until it has been made up in model form from wood or plaster.

Even in the professional field of precision instruments, the engineer is faced with the problem of building a unit which will work and at the same time be commercially attractive. In time an engineer acquires this ability—a "must" to satisfy the commercial people and his designer's instinct.

#### Field Engineering Procedures

Whereas the Receiver Division sends out service manuals to take care of its troubles in the field, the Transmitter Division sends out a service man instead—an engineer who applies on the job those final touches that design engineers would like to do themselves. Field engineering achieves its greatest importance in the Transmitter Division, where each customer is fol-

#### EVOLUTION OF A RADIO RECEIVER

The development engineer here was asked to produce a table model set that would outperform competitive models. With a close deadline, the logical approach was to put in extra tubes and parts whenever in doubt. The resulting chassis, at extreme left, worked beautifully and was put into production, but manufacturing costs were out of this world because the chassis was flush level full of parts.

The engineer was kept on the job. One by one he removed bypass capacitors and isolation resistors, measuring effect on performance each time. At regular intervals a cost-reduction committee met to evaluate accumulated savings. By the time the engineer had half-emptied the chassis, the committee authorized launching of a new model (center chassis), and the assembly line was reprocessed for it.

Still costs were too high, so the project was continued. Soon the version at the right, stripped down almost to the bare chassis, will go into production

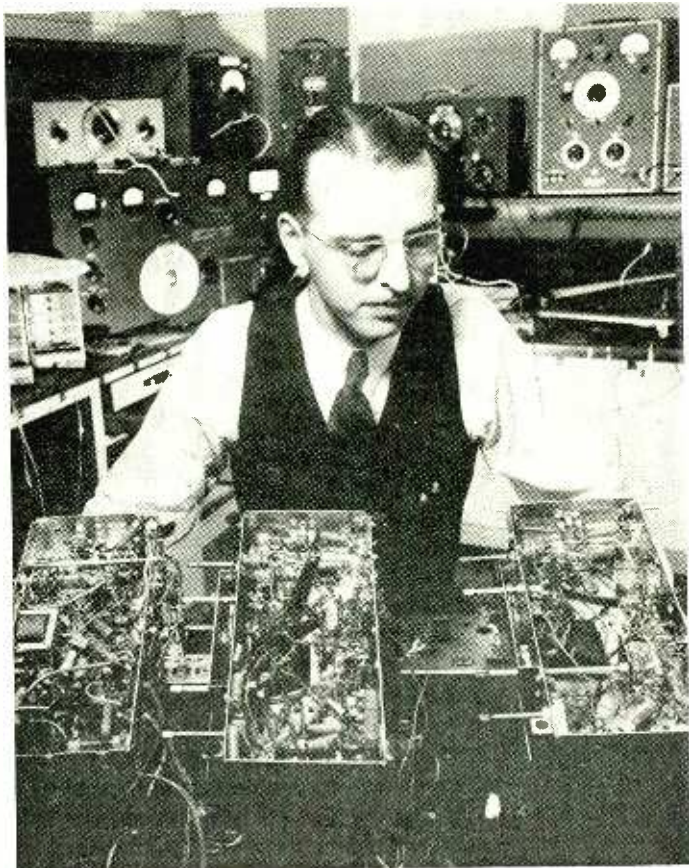



lowed up and served directly by the factory personnel.

The field engineer by necessity has a degree in electrical engineering, plus at least a year in the test course. His job is to supervise the installation of GE transmitters and other equipment, as well as to take care of troubles that develop in the field. Thus, a high degree of tact and diplomacy is required.

Knowing the field engineer's aversion to red tape, GE requires reports only once a week. Longhand reports in pencil are okay, with no copies. When these reports come in, they are typed up and copies are routed to all interested persons. They may suggest design improvements and point out defects just as would a supercritical customer. The tough job at headquarters is to determine who or what is at fault—engineering, production, the tubes in the product, or the customer.

### Responsibilities of the Laboratory

Between the fundamental work of the Research Laboratory at Schenectady and the applied development of the Division engineers lies the field of activity of the Electronics Laboratory. Here programs of advanced development or applied research are generated in all lines of the Department's activities, working about three years ahead of production.

The Laboratory was started during the war years, and much of its effort is still concentrated on development programs for the military. It is growing at a rate determined by its ability to recruit and absorb men with the peculiar qualifications for advanced development. The present staff consists of approximately 80 people, of whom about 40 hold engineering degrees. The remainder are laboratory assistants, model shop mechanics, and the necessary clerical help. In addition, there is continuing rotation of from 6 to 12 assigned people from the company's training programs. While most of them move on to new three-month assignments elsewhere in the Department or in the company, all are candidates for replacement in the Laboratory.

The responsibility of development engineers in the Laboratory Building is to think first of the future and to take calculated risks in reducing research to practice as fast as possible, for the advancement of the electronic art and for the overall profit of the Department's operations. It is not expected that everything tried will work, nor is it expected that everything which works will get into production. All that is expected of the Laboratory is a continued output of ideas, ready for the next stage of development by the operating divisions.

**PATENT LOG BOOK**—Each engineer has one, in which circuits, ideas for new products, mathematical developments, and inventions are jotted down for possible use by patent department. Each

patent application is good for a \$25 bonus. Top man patentwise at the Park is Bob Dome, with 52 to his credit. Patent logs are examined regularly by men assigned to patent department liaison

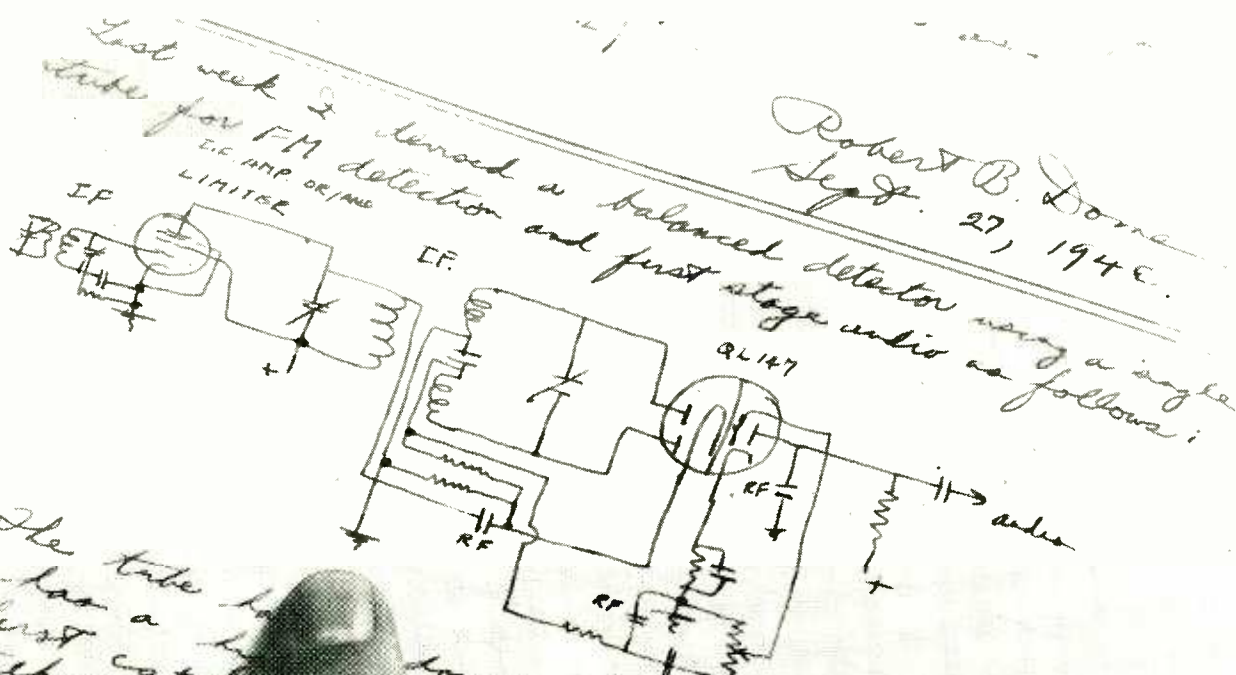

*Robert B. Dome  
Sept. 27, 1940.*

*The tube has  
and has a  
be first cat  
talked to  
built me 4  
6-147.*

*double diode and common cathode  
triode with separate cathode from  
this circuit was shown to R.E. Mee.  
Raytheon about the tube and  
10-2-40. They are called*

*Robert B. Dome  
October 3, 1940.  
to: Robert C. ...  
to: October ...*



## PART III—The Production Technique

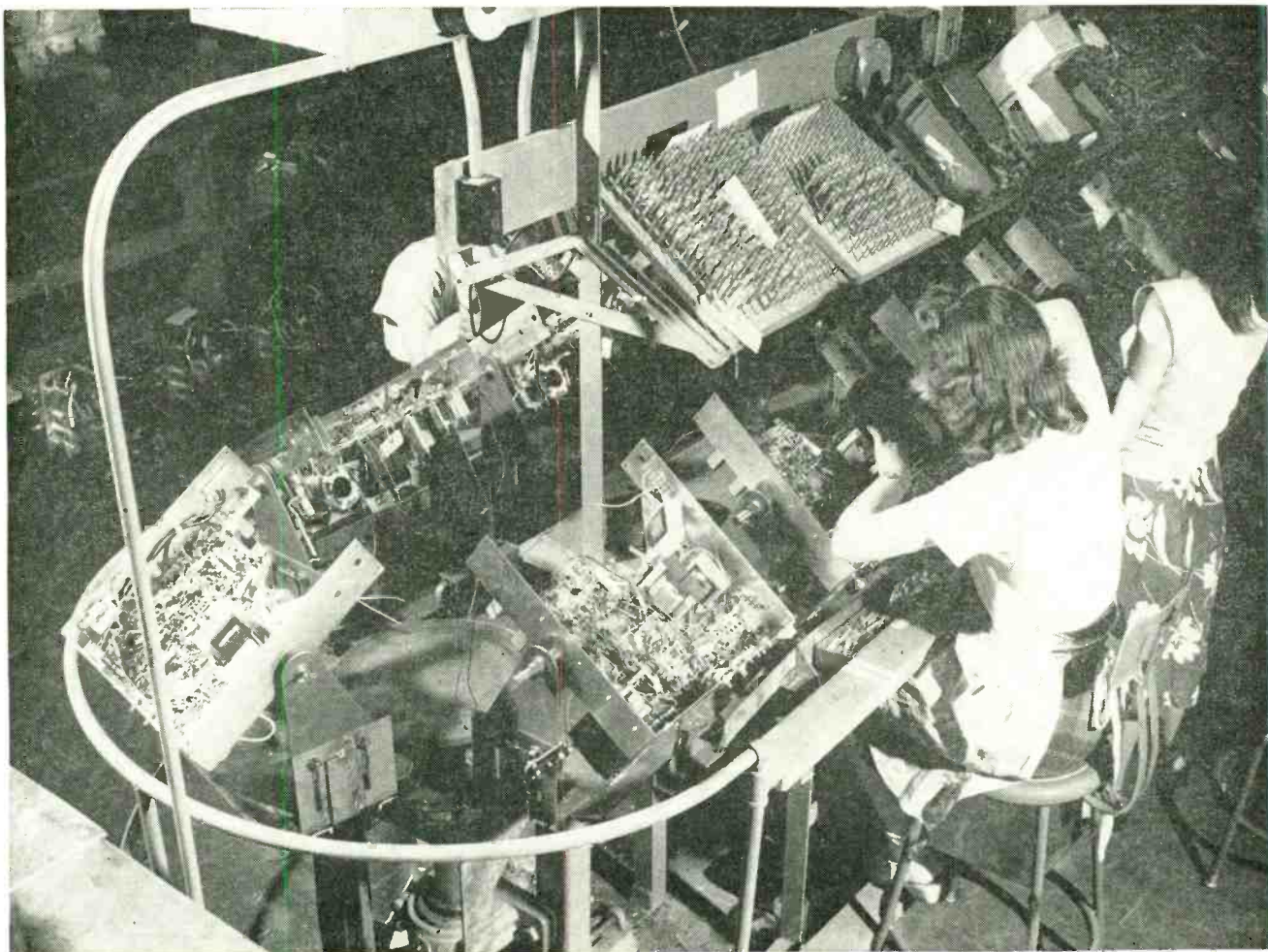

**TELE COMING 'ROUND THE BEND**—Chassis for 10-inch table model is two-thirds completed as it comes around this endless link-chain conveyor. Special jig on conveyor, fitting into holes

punched in chassis for the purpose, permits setting chassis at various angles and turning it over whenever necessary as it moves down the line

**F**INAL production blueprints are converted into finished products in the Receiver, Transmitter and Specialty Buildings. The differences in manufacturing techniques in these three buildings are directly related to the type of product manufactured. A girl on a receiver line may do her assigned work in 30 seconds, whereas a girl at a bench in the Transmitter Building may work for days on the same unit.

In discussing production at the Park, certain definitions are necessary. *Production* means getting ready for manufacturing—doing everything except putting together the product. It is primarily moving of materials so they will be at the right places at the right time. The receiving room and the stock room are in charge of the Production Supervisor. *Manufacturing* is making things. Production starts long before manufacture and goes on concurrently with manufacture. *Inspection* is mechanical, involving checking of such things as dimensions, finishes and tolerances. *Test* is both electrical and mechanical, involving checking of electrical values or electrical performance characteristics of individual components and both physical and electrical specifications of the finished products.

All four of these elements, integrated throughout all buildings, are the Park's manufacturing technique.

Broad decisions as to which division will make a particular product or line of products are made generally by the vice-president in consultation with the interested division managers and their staffs. Within each division, committees headed by the manager and containing members of commercial, sales and engineering sections meet weekly to determine the future of a product. One purpose of these meetings is to schedule future production so as to keep labor requirements as nearly uniform as possible and within the allocated labor quota for the division. One rigidly enforced rule is that every promise of delivery of a design or a production quota must be confirmed in writing if initially made verbally. Enough differences of opinion rise in the normal course of events without having arguments over who promised what.

### Incentive Pay

In all Divisions, as many assembly workers as possible are employed on a basis whereby they can earn extra pay for extra output. During the period when



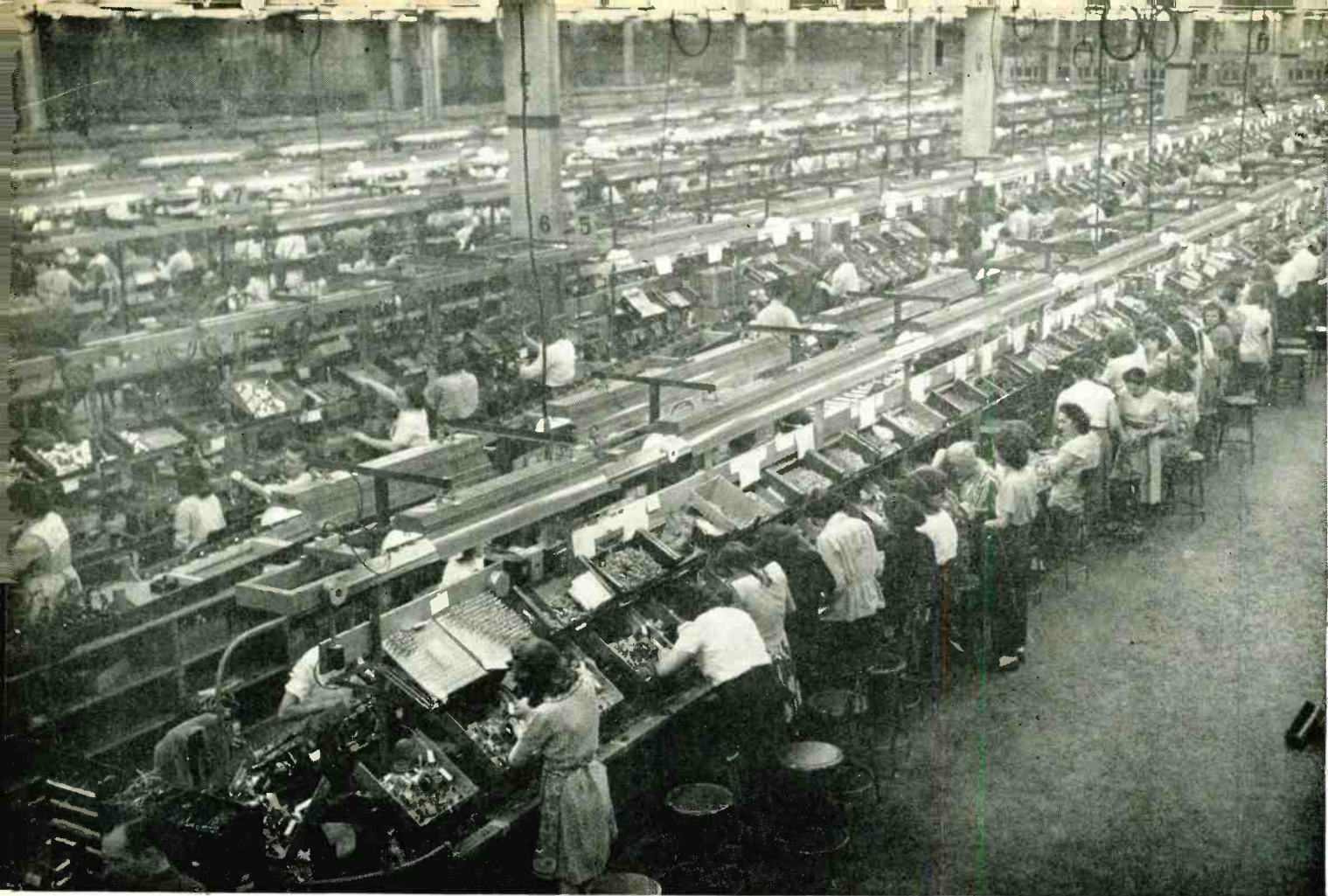

**MASS PRODUCTION**—General view of manufacturing floor of Receiver Building, with television receiver assembly lines in foreground. By Christmas every line here will be making tele

sets, and ordinary receiver production will be transferred to outlying satellite plants. Fluorescent lamps directly over each line and ceiling fluorescents provide 50 foot-candles at working level

they are training for a particular assembly operation, they receive a guaranteed hourly rate. Their earning climbs gradually as they acquire proficiency in doing their assigned work. On operations involving teamwork of many employees, group incentive pay is used.

Prices for incentive work are set either by time studies, by tables, or by comparison. All three methods take into consideration the native and acquired skill and knowledge of the employees, the amount of past training and education required, and the effort required in applying the skills on the job. The perfect system for measuring the relative amount of mental and physical effort required on various jobs has not yet been devised; perhaps it will never be, but the manufacturing staff is constantly working toward that end.

### **CUTTING RECEIVER ASSEMBLY COSTS**

Steady introduction of manufacturing shortcuts, like welding of resistor leads and ground straps to chassis, does not offset increased hourly rates for labor.

Automatic receiver-building machines based on printing and spraying techniques are under investigation, but the high initial investment required is a major problem.

Simplifying and cleaning up circuit design is therefore the most fruitful avenue of cost reduction.

Standardization on higher-rating components permits high-volume purchasing savings that often actually reduce cost. Thus, half-watt resistors are the smallest used in receivers, and 600-volt paper capacitors are standard except for cathode and avc circuits

There is no attempt to lure labor from other manufacturers in Syracuse by offering higher wages. Records show scores of cases where workers left for higher wages only to come back a few weeks later to the clean working conditions, good lighting, air-conditioned comfort, and straightforward management at the Park.

### **Inspection of Parts**

Inspectors in all divisions are on hourly pay to insure careful work, and many of them are engineering graduates. Inspection is based on modern techniques of statistical quality control sampling. As an example, if an incoming shipment contains 100 units the inspector will test 20 and pass all if there are no rejects. If there is one reject he tests 40 more, and passes the remainder if these 40 are all good. If he



finds more than one reject in the first 60, however, he either makes a 100-percent test or rejects the entire lot, depending on how badly the parts are needed.

Vendors who sell parts to the Park are rated every month on the quality of their product. Since the goal in the purchasing department is to have as many reliable vendors as possible on tap, for protection against shutdowns in any one vendor's plant, the purchasing staff will usually send representatives to the vendor's plant for a detailed look into the situation before black-balling.

#### Receiver Division Problems

The job of the Receiver Division is to manufacture radio and television receivers of uniformly high quality, according to schedules and at or below standard cost. After a receiver sample is delivered by Engineering, the Planning Section writes a detailed "process" (schedule of operations) and sets up the necessary physical facilities on the floor to care for the production of a given model. This process is based upon standard times and upon time studies made by the Wage Rate group. Concurrently Production takes over the vendors which have been established by the Purchasing group, schedules them and expedites material deliveries to meet the line schedules. As each given model progresses it is the responsibility of the Test and Inspection group to obtain, in conjunction with Planning, the necessary test and inspection facilities to care for the model adequately.

Before all the service divisions have completed their work, pre-production samples are built according to process insofar as possible and delivered to Engineering. Within two or three weeks thereafter a pilot run of 50 receivers is manufactured, using all the production facilities which will finally carry the processes, to check the equipment, allow training time for working leaders, and provide Test and Inspection Section with finished receivers for training purposes. This permits doing on a planned basis what is sometimes done on an unplanned basis at considerable extra cost.

After the pilot run, the line is manned. It becomes the responsibility of the Manufacturing Group to train new operators and to bring the line up to speed. Each line is provided with an organization chart showing the number of operators processed for the line, plus a line buildup schedule showing how many sets should be produced each hour during the period when the line is coming up to schedule. This training schedule is the result of considerable research; it is based on a formula which has been empirically derived to take into account such factors as the time-cycle, skill of workers, and rate of production desired.

Each line is divided into groups of ten to fourteen operators in charge of a working leader. These working leaders do the majority of training on the line. Absenteeism is cared for by training two or more girls to do the same job, enabling breaches in the line to be filled effectively.

Every attempt is made to allow nothing but quality

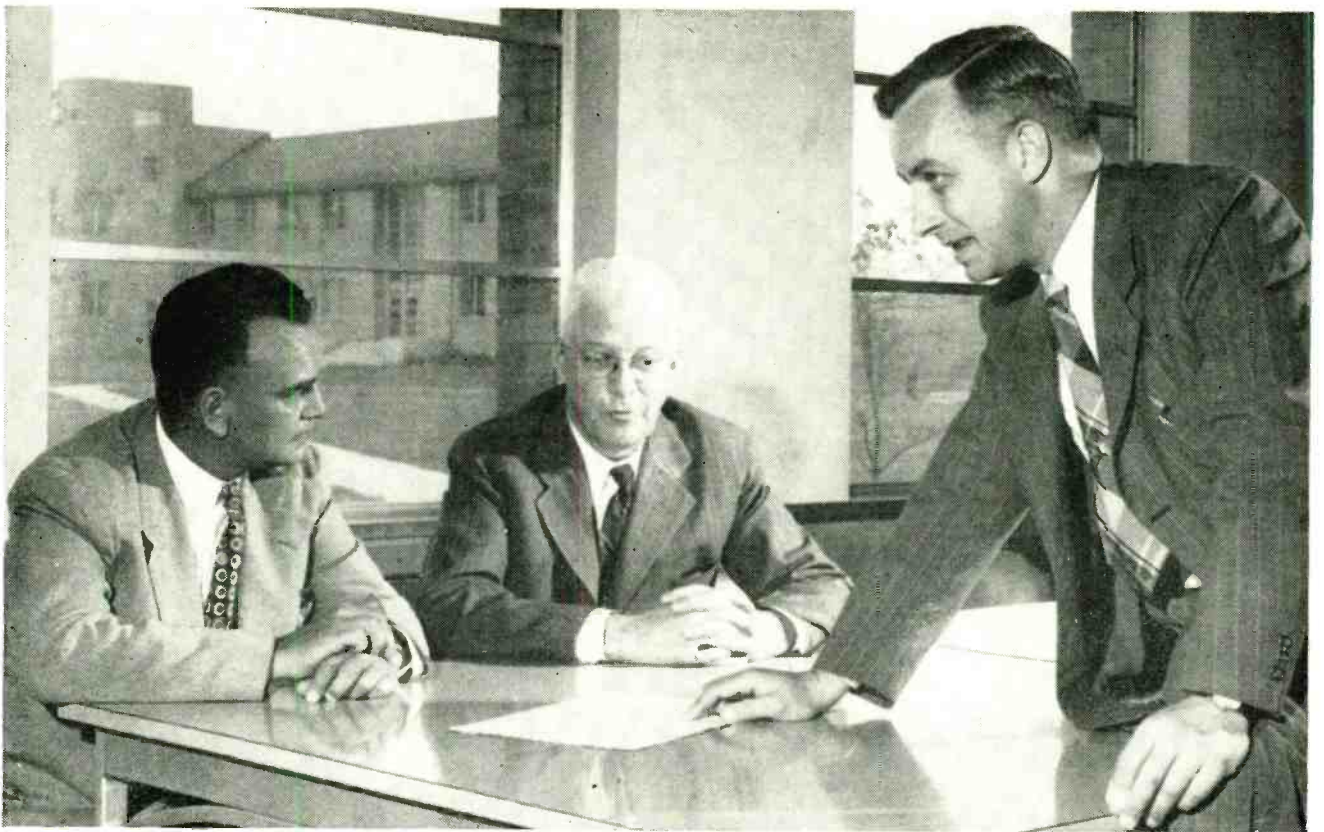

THEY RUN PRODUCTION—Managers of manufacturing, left to right: Harold Miller of Specialty, A. R. Goodwin of Receiver, and J. A. Barratt of Transmitter. W. B. Gillen, not shown, has cor-

responding Tube Divisions job at Schenectady. Meeting production schedules, keeping costs down, keeping quality up and keeping workers satisfied are just a few of their responsibilities



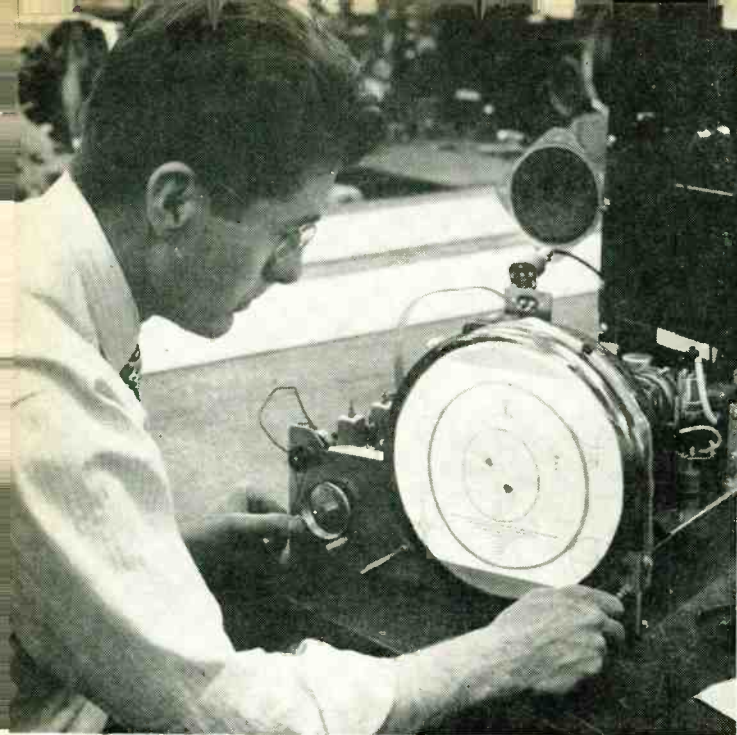

**IT WORKS**—Adjusting horizontal and vertical linearity controls of new table-model television receiver, using video signal and 400-cycle tone obtained from central signal source through coaxial lines. Picture tube is inserted only for alignment and test here, as sets are shipped without the tube



**WELDING REPLACES SOLDERING**—With electronically controlled resistance welding, this operator is able to weld 15 grounding ribbons and one resistor lead to the chassis of a television set during the two-minute time cycle. A snap-action switch built into the welding electrode applies current automatically

products to leave the assembly line. This is done by check and repair and repeated inspection both in and after the line. Receivers which are in difficulty are analyzed as rapidly as possible and sent to the repair group for modification. The controlling factor in the speed of all lines is quality. A line must stay below 10 percent rejections, and speed is held down until that quality level is realized. It has been found, however, that running a line below half speed does not accomplish a great deal in the way of training; the training is principally for speed, and not simply for memorizing a relatively simple operation.

Inspection cannot in itself insure quality because there is still the possibility of human error in the inspectors and final test men. Therefore, sampling inspection techniques are employed in the shipping room, where sealed cartons are actually opened and sets are tested again. This final inspector has the authority to shut down the entire production line until the trouble has been corrected if he discovers defective sets ready for shipment. Of course, he must be pretty sure of his ground when he shuts down a line because this makes many people above him unhappy.

Getting a television line started, as many manufacturers have learned, is more involved than ordinary radio production. To obtain large-scale manufacture for example, one line at the Park was re-processed four times, resulting in many new work assignments and redistribution of operators' positions. The final setup, however, employing three moving conveyor lines in series was soon producing 400 sets a day.

#### Transmitter Division Production

In contrast to the Receiver Division which deals in mass production for orders frequently running to hundreds of thousands of units, the Transmitter Division

rarely has an order for over a hundred units. Furthermore, some of these units sell to the customer for well over \$500,000 each. The transmitter manufacturing organization employs about 2,000 workers and has approximately 20 workers under each supervisor.

The two main types of products are radar units, communication transmitters and special electronic items for Government use, and a wide variety of products for commercial use, including broadcast equipment (a-m, f-m, television), communication equipment such as taxicab, police, aircraft and marine sets, carrier current communication and controls, electronic navigators, electronic heaters, and facsimile equipment.

Most of the component items required in the Transmitter Building are specially designed and must be made or procured in small quantities. The production section has the responsibility of procuring all items called for on the material lists furnished by the Engineering Section.

On items to be manufactured in the shop, the Planning Section works out each individual step in producing the item and sets a price for producing the item. From this, the price allowed each employee per piece for each step is set and vouchers are made up for use by the employees as pay vouchers. At the same time, raw materials needed are accumulated in the stock room after careful incoming inspection test.

The foreman in charge of assembly of a unit now has on hand the needed raw material, the components purchased outside, and the pay vouchers covering manufacture of components and assembly work. He starts one or two people on the smallest assembly, gradually building up his group to the required size for the order on hand. Finished subassemblies are



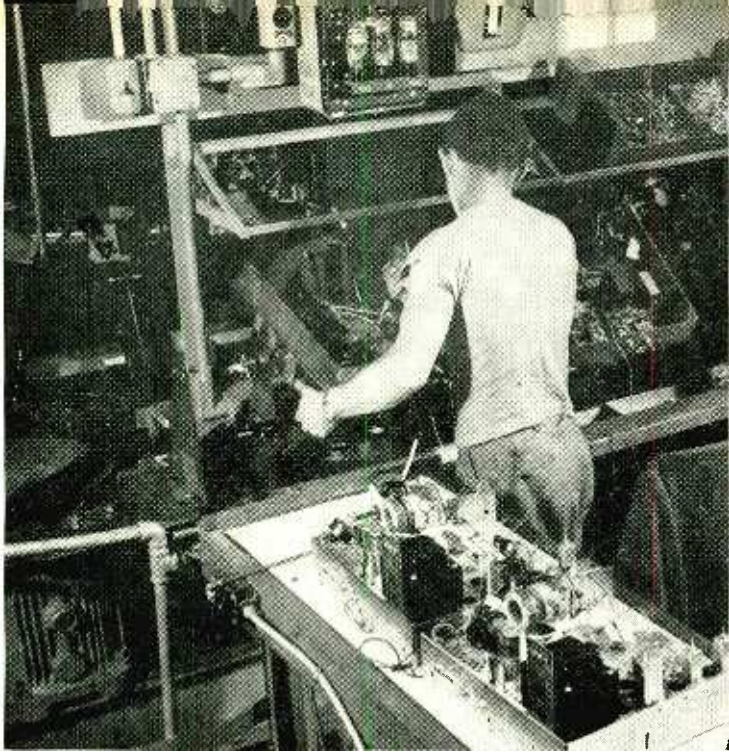

**ELECTRONICS DOES IT**—Thyratron-tube control for drive motor of endless conveyor on television line (above head of man, with cover removed). Speed control knob is alongside. Crossover conveyor in foreground brings sets from end of first line (off picture at lower right) to start of second line

inspected and tested, and assembly of the complete unit is started. When finished, the Test Section proceeds to operate, adjust and test the unit in accordance with instructions issued by the Engineering Section. Most of the test work is done by Test Course engineers, working closely with supervisors. After satisfactory completion of tests, the manufacturing group gets a last chance for final mechanical inspection and touchup of the finish before the unit is shipped.

The test power house in the Transmitter Building provides a variety of voltages and frequencies, and these can be fed through a well-planned cable system to any test setup on the factory floor. Three temperature chambers are available for operating tests at extremes of cold, heat and humidity, as required for most government equipment and for some commercial equipment. Vibration and tilt tables that can duplicate the roll and pitch of a battleship, the vibration of an airplane engine, or the bouncing of a jeep over rough country are available for testing commercial as well as military equipments under simulated field operations. Shielded rooms permit measuring sensitivity and noise right on the factory floor. Dual lighting systems are provided in these rooms; fluorescent lights are normally used, but for delicate tests incandescent lamps can be turned on.

To insure maximum protection to the operator while conducting tests on live circuits, interlocked test cages, safety shields, a central grounding system, and many other safety devices are used. The success of these safety measures is indicated by the transmitter test section's record for 14 months of work—534,250 man-hours without a single lost-time accident among the employees.

Even the huge broadcast and shortwave transmitters are produced on an individual piecework basis computed according to the number of screws, wire, and parts each man installs. Workers with two distinct kinds of aptitude are used here. The true mechanic, who likes to mount things precisely and make them line up, is called an assembler and is used to do all of the mechanical assembly of a transmitter. The electrician type, on the other hand, likes to hook things up according to circuit diagrams; he is called a wire-

### SCOREBOARDS FOR MISTAKES

Before each worker on every moving production line is a score card. Whenever an inspector or supervisor discovers a mistake, she goes right over to the worker responsible for that particular operation, and makes a mark on her score card. The psychology of this silent rebuke has been carefully analyzed; comparative tests made with and without the score cards show the system to be highly effective in keeping down rejects. A master scoreboard is kept for each line, in view of all workers, so they can see their hourly output and total rejections at a glance





man and follows the assembler to complete the job.

The Specialty Division is essentially a big job shop, where the setup of a mechanical machine like a drill press or milling machine is changed as often as 20 times a day. It uses few mass-production techniques; just as soon as a product develops enough sales volume to become interesting to another operating division, it may be snatched away from Specialty. Here the men usually work from samples rather than detailed drawings.

The goal is to get the time cycle for a particular operation down to a minimum. In the Specialty Division this can be anywhere from 3 minutes to 40 hours, in contrast to the Receiver Division's average cycle of less than a minute. The number of workers assigned to a particular order depends on daily production requirements as well as on the size of the order. So flexible is production planning here that a rush job can be got out practically overnight if need be.

Small orders, up to the limit of 25 units, are produced in Specialty's model shop, just off the production floor, where everybody is paid on an hourly basis.

The secret of efficient production in Specialty's model shop is elimination of the paper work associated with planning of production and setting of piecework rates. An engineer develops a new product and turns it over to a wire man. He in turn wires up and builds a production sample, then teaches girls to

make the rest of the run. All planning is done in the head of the wireman, with the girls memorizing their duties and using the production sample as their guide. With runs under 25, it costs more to break down the job on paper into individual assignments than the job is worth.

#### Conclusion

These, then, are the men and the facilities of Electronics Park. On them lies the responsibility and the challenge to substantiate Dr. Baker's theory that one can have the excellent accommodations of the Park and still meet competition. So far, the theory has stood the test of performance.

An article of this detailed nature, covering such intangibles as how engineers think, would have been impossible without the cooperation of a large number of people. A complete list of the names of those who contributed so freely of their time, their ideas and their data would fill this page, hence only a few can be mentioned. Appreciation is expressed to Dr. W. R. G. Baker for making this article possible; to E. L. Robinson for making preliminary arrangements; to Andy Tobin for scheduling the interviews and serving as guide during the entire period; to George Burns of Schenectady for photography; and to practically everyone in the organization chart of the Park for their help.—J. M.



**ORGAN-TYPE CONSOLE**—For small production runs in Transmitter Building, long time cycles are most economical. Here one operator

does practically the entire job of assembling personal aircraft radios, working from a sample and eye-level instruction sheets

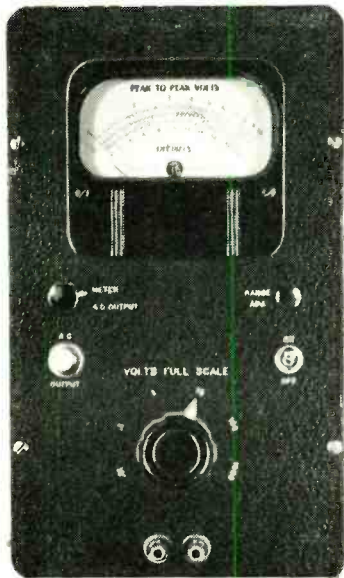

Controls and switches on panel

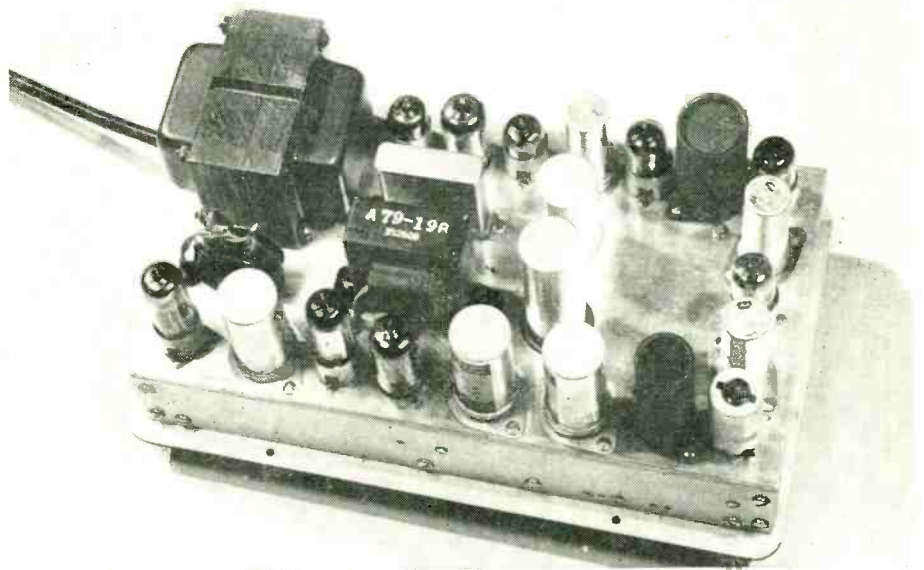

Chassis of electronic portion of the wide-range voltmeter for measuring narrow pulses

# Peak-to-Peak Voltmeter

Pulses and transients of short duration are measured by an instrument having extremely high input impedance. Pulse-stretching circuits are used and an amplifier feedback arrangement provides substantially zero-impedance output

By **F. H. SHEPARD, Jr.** and **EDMUND OSTERLAND**

*Consulting Engineer  
Summit, New Jersey*

*Ballantine Laboratories, Inc.  
Boonton, New Jersey*

**I**N THE DESIGN of electronic a-c voltmeters and ammeters, a desirable trend has been toward development of average or rms-reading instruments in order that the measurements may more accurately indicate actual power regardless of frequency or waveform.

There is also an increasing demand for instruments yielding peak or peak-to-peak indication of repetitive waveforms. This requirement is a more particular one in the instance where the average value over one cycle is negligibly small, as in the case of television synchronizing pulses, and in a wide variety of timing and controlling operations. Here, the energy level as represented by rms values may be unimportant, and the maximum (or minimum) excursion

of the wave is the dimension to be measured together with wave shape and timing information.

In the design of electronic equipment such as high quality amplifiers, modulators, transmitters and recorders, it is the peak values of signal that extend beyond the linear range and cause undesirable transients, distortion and intermodulation. If the transients are of short duration, they are not measured by rms meters.

Measurement of the absolute indication of narrow voltage pulses imposes a rather difficult requirement on available materials and techniques. The voltmeter, to justify the term, must fully respond to the pulse without consuming it. The difficulty becomes immediately apparent when the usual

diode peak-reading voltmeter is connected to a source of pulses of 2 microseconds width which are repeated say 10 times per second. Since the storage capacity in the diode circuit must be great enough to keep the output ripple small, the total energy continually dissipated by the diode load resistor must be supplied in less than 2 microseconds.

For example, if the peak 2-microsecond pulse voltage being measured is 10 volts, the energy in a 1-megohm diode load resistor will be  $1 \times 10^{-4}$  watt. This continuous power must be supplied in a small percentage of the time (0.002 percent). To supply this continuous diode load power, the source being measured must supply an instantaneous power of 5 watts. Since this



is a rather high power level, neither the source being measured nor the diode of the voltmeter will handle it and the reading will be in error.

As the pulse width or the repetition rate is further diminished, the error is greater still. The effect is also more pronounced when the peak voltage being measured is below about 5 volts since then the curvature of the diode characteristic makes the diode impedance abnormally high and still further limits its peak power-handling capability. The combined effects described limit the best conventional diode peak voltmeter to measurements above a few volts and having a duty cycle not less than 0.1 per cent.

The modern cathode-ray oscillograph yields both voltage and wave shape indications and with proper amplification and intensified trace formation, this instrument can identify practically any recurrent wave to the user when suitably calibrated. However, the combination of a stable electronic circuit and a precision meter will afford indications that can be made reliable within one or two percent whereas an accepted reading error of 5 percent accompanies the oscillograph indication. The latter figure may easily rise to 10 percent when the factors of calibration source error and its associated reading error are taken into account.

The basic design of the peak-reading voltmeter under consideration is the amplifier-rectifier type such as has been popular for a-c measurements in the past decade<sup>1</sup>. Each portion of the present instrument, however, demands a new approach to secure the desired response to steep wavefronts and narrow peaks.

#### Rectifier

The circuit employed to increase the rectified energy available for driving the output meter is illustrated in Fig. 1. The input wave encounters a typical diode rectifier in the first stage. Capacitor  $C_1$  is, however, smaller and higher in impedance than is usual, permitting the grid of triode  $T_2$  to rise to the peak value of a sharp spike without rounding it off. This diode and capacitor combination functions as

a pulse stretcher, the output voltage being depicted in Fig. 1, along with the graphical representation of voltages in the other stages. The time scale shown is an approximate one but serves to indicate the effective increase in energy.

Since the impedance of the voltage source at the grid of  $T_2$  is relatively high,  $T_2$  is used as an impedance step-down repeater amplifier to drive a second conventional

diode rectifier  $T_3$  with the relatively long-duration (stretched) pulse to charge its output load capacitor  $C_2$ . Since the signal pulse has been appreciably lengthened, the duty cycle of diode  $T_3$  has been improved considerably and no difficulty is had charging  $C_2$  to the full peak value of the signal voltage. Triode  $T_4$  repeats this d-c voltage into a low-impedance measuring meter.

Capacitor  $C_2$ , together with  $R_2$ ,

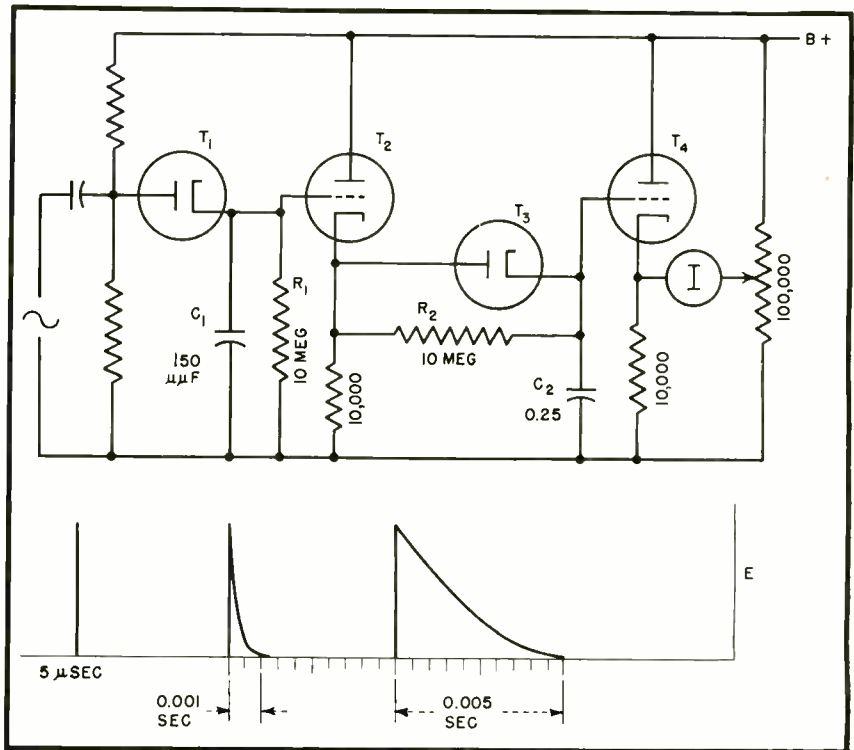

FIG. 1—Circuit and waveforms of pulse stretchers and impedance step-down repeaters

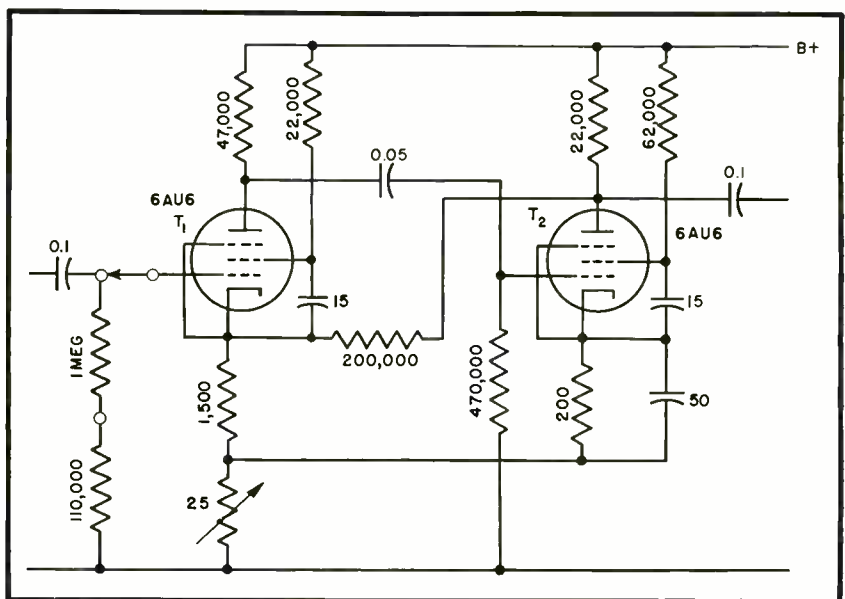

FIG. 2—In the preamplifier circuit, the use of feedback permits the amplifier to have substantially zero output impedance

determines the time constant of the meter circuit and at the same time, the low-frequency limit of operation. With the component values shown, this circuit responds uniformly to pulses of the same peak level when the pulse width varies from a maximum (square wave) to a minimum of less than 2 microseconds at 20 pps.

To adapt this rectifier circuit to the widest variety of applications, an amplifier preceding it is a necessity. The amplifier designed for this purpose provides wide input voltage range coverage with simple switching, uniformly high input impedance and low output impedance, adequate output voltage swing and high stability.

The amplifier is required to produce a linear output versus input relationship over a 10 to 1 amplitude range to satisfy the decade switching feature (the indicating meter is of the logarithmic scale type calibrated from 1 to 10). Furthermore, the low-voltage limit must exceed several volts to avoid encountering the curved portion of the diode characteristic. Finally, the stability must be such as to introduce negligible errors when factors of line voltage variation and tube changes are considered.

The present design yields a peak-to-peak voltage swing of 9 to 90 volts and the sensitivity of the meter circuit is adjusted so that these figures correspond to minimum and maximum scale deflection respectively. The incorporation of about 25 db negative voltage feedback insures amplifier stability equivalent to the attenuator and output indicating meter tolerances ( $\pm 1$  percent).

#### Design of Amplifier

Initial experiments with the rectifier section showed that the signal voltage source impedance to the rectifier must be kept low if optimum peak response is to be had.

This factor demands the application of an amplifier ahead of the rectifier section even if only as an impedance transformer. It further requires the amplifier to have an output impedance of about 100 ohms if  $C_1$  is to charge up to the peak value of a 1- $\mu$ sec pulse in 0.01  $\mu$ sec (or 1 percent of this pulse in-

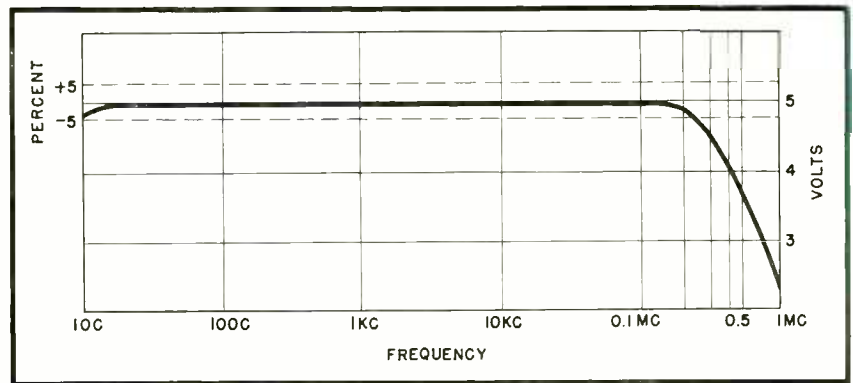

FIG. 3—Wide-band operation is indicated by voltage-versus-frequency characteristic

interval). The latter figures do not include the forward resistance of the diode or inductance of wiring and circuit elements.

The requirement of low driving impedance has been met by a method which has received relatively little attention. By its use, the apparent output impedance of the amplifier may be reduced to zero (or may be made negative if desired to compensate for positive resistance in the diode).

Figure 2 shows the basic amplifier circuit. Negative feedback from the plate of output tube  $T_2$  to the cathode of the first amplifier stage  $T_1$  causes output load variations to be reflected through the nominally high impedance of  $T_2$  into the amplifier circuit. In this way, the cathode current at the output stage is effectively modulated by output load variations.

If the output load is low, the output current and cathode current of  $T_2$  will be increased. The increased cathode current of  $T_2$  results in an increased positive feedback voltage from the cathode of  $T_2$  to the cathode of  $T_1$ . This acts to effectively increase the output current. The reverse of the above is true when the output load impedance is high. The proper amount of positive feedback as shown enables the amplifier to have substantially zero output impedance within the output current limits of  $T_2$ .

The principle employed in reducing the output impedance of the amplifier had been suggested some years ago<sup>2,3</sup> and had also seen practical application in loudspeaker amplifiers where excellent damping of cone resonances was observed<sup>4</sup>. A typical voltage versus frequency characteristic for a sine-wave input

is shown in Fig. 3.

#### Second Amplifier

Additional gain is obtained by a two-stage preamplifier similar to that shown in Fig. 2 but omitting the positive feedback feature. The use of two separate, independent, cascaded amplifiers of two stages each permits use of an attenuator between the units.

The range switch includes a section which is interposed between the units and provides 10:1 step-down from maximum gain. By employing this arrangement as the first step of the attenuator, any slight noise or hum appearing in the input tube is thus reduced 20 db on all ranges but the first. The other ranges are accommodated by attenuation in the input to the amplifier. With the proper choice of compensated resistor elements, this has been found to be a most reliable method of range multiplication.

In the final version of the voltmeter, a full-wave meter rectifier circuit is used so that peak to peak values are indicated by the meter. This is believed to be of greater interest in the majority of cases than half-wave operation where polarity of only one sign would be registered. The instrument shown covers a range of 0.001 volt to 1,000 volts peak to peak or 0.00035 to 355 volts in terms of rms values of a sine wave.

#### REFERENCES

- (1) S. Ballantine, Electronic Voltmeter Using Feedback, *ELECTRONICS*, p 33, Sept. 1938.
- (2) H. Bartels, *Elek. Nach. Tech.*, 9, p 319, Sept. 1934.
- (3) G. S. Brayshaw, Regeneration in Linear Amplifiers, *Wireless Eng.*, 14, p 597, Nov. 1937.
- (4) H. P. Mayer, Control of Amplifier Internal Impedance, *Proc. I.R.E.*, 27, 1776, Mar. 1939.



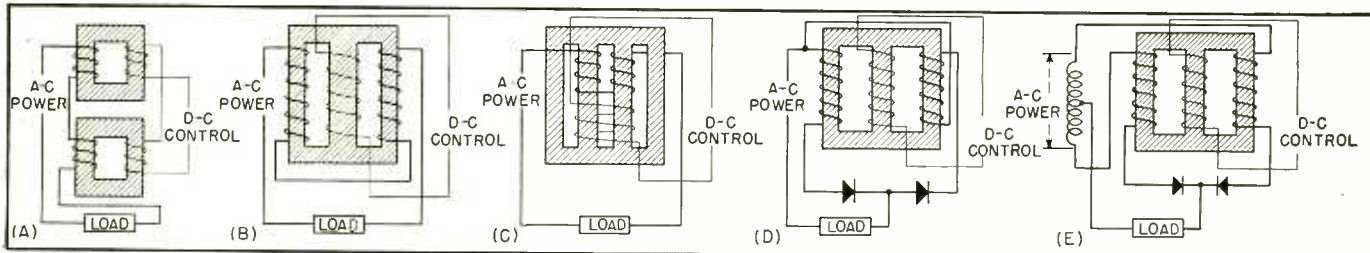

FIG. 1—Presaturated reactors can be variously arranged. The simplest form is two identical units (A), but equivalent results are obtained by winding the coils on one core (B) and (C). This configuration (B) can be combined with rectifiers to produce a doubler

# Saturable Reactors

By **FRANK G. LOGAN**

*Vice President and General Manager  
Vickers Electric Division, Vickers, Inc.  
Saint Louis, Missouri*

**B**EFORE launching into a discussion of the subject, it is desirable to distinguish between saturable reactors and magnetic amplifiers. Without attempting to formulate definitions of these established terms it is, nevertheless, desirable to review some of the accepted differences recognized by workers in this field. It is impractical, even artificial, to distinguish between these devices on the basis of construction, function, or circuitry. To delineate the areas covered by the two terms on the basis of common usage is futile because they are used interchangeably, the older term, saturable reactor, being the more widely recognized.

A clear means of demarcation seems to be that every magnetic amplifier includes, as an essential component, a ferromagnetic device with adjustable inductance. Commonly, the amplifier is supplied with power from an alternating current source so that this ferromagnetic device can be a saturable reactor, or transducer as it is termed in Europe. From this viewpoint, a saturable reactor is a part of a magnetic amplifier. This viewpoint is not essential, but if followed consistently could avert ambiguity.

## Saturable Reactors

Several simple saturable reactor arrangements are shown in Fig. 1. The one in Fig. 1A can be made by

connecting a pair of conventional two-winding transformers. The a-c or power windings may be connected in series or in parallel. The d-c or control windings are wound and connected with respect to the a-c windings that no net voltage of the fundamental power frequency appears across the control circuit terminals. The arrangements shown in Fig. 1B and 1C are quite similar in control characteristics to that at Fig. 1A. There are, however, slight differences involving transients and leakage reactances. Many variations of this basic circuit are possible, but all have similar performance characteristics. The manner of operation of the simple saturable reactor has been amply discussed in the literature and need not be reviewed nor enlarged upon here. The self-saturating type of reactor is of greater interest and, although it has been discussed in the literature, a brief explanation of Fig. 2 will show the essential features of its operation.

The circuit of Fig. 2A serves to demonstrate the operation of self saturation. While the circuit itself is of little practical value, it is the simplest self-saturating type of reactor circuit, and its oscillograms showing the effect of control pre-magnetization apply almost exactly to practical circuits. The circuit consists of a saturable reactor, a rectifier, a load and an a-c source all in series. The reactor has an auxiliary winding which is supplied with control current from a high-impedance source. The oscillograms in Fig. 2B show the load and supply voltages as functions of time and

indicate the manner in which the load voltage can be adjusted by means of the control pre-magnetization. (The resemblance of this type of control to thyatron control is obvious.) Corresponding magnetic conditions in the core are shown in the lower oscillograms (Fig. 2C), which illustrate the effect of the control current on the minimum or initial flux density  $B_{0i}$ , and also upon the unidirectional pulsating load current. Adjustment over the range of control shown in the diagram (Fig. 2D) is effective in changing the output in a 100-ohm load from 1.5 milliamperes to 150 ma. It should be noted that the maximum flux density at the minimum current or cut-off condition (Fig. 2E) is so adjusted that the hysteresis loop is symmetrical and shows a total excursion of flux density of just less than twice the saturation flux density of the material.

There is a rather sharp increase of the load current as the core flux density reaches saturation. Because of this action the circuit yields to analysis on the basis of sharp firing. Such analyses have been made and give calculated waveforms and transfer curves that are in fair agreement with measurements.

As previously mentioned, the single reactor is of little practical value unless provision is made for minimizing the fundamental component of current induced into the control

This article, submitted June 20, 1948, is based on the paper presented by the author at the Symposium on magnetic materials sponsored by the Naval Ordnance Laboratory and held in Washington, D. C., June 15, 1948.

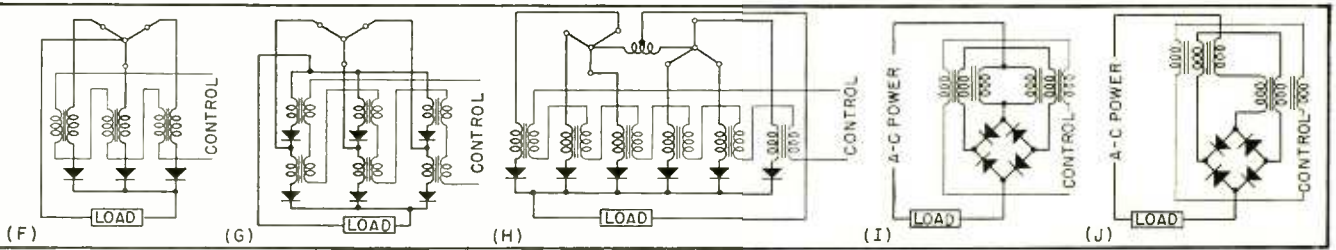

(D) or a full-wave circuit (E). These elements can be grouped (F), (G) and (H) for three-phase operation. Further elaboration of the single-phase circuits to obtain continuous rectified feedback current (I) and (J) results in the self-saturating magnetic amplifier

# and Magnetic Amplifiers

Use of saturable reactors as components of magnetic amplifiers is described. The author discusses effects on performance of core material and assembly, and points out importance of reproducibility of core materials and rectifier properties. Applications are described

winding. This may be done by inserting a high impedance in the control circuit or by connecting two reactors or arranging several windings in such a way that the induced current is minimized. The last alternative is illustrated by the circuits of Fig. 1D and 1E. The circuit of Fig. 1D is called a doubler; it gives alternating-voltage output. The circuit of Fig. 1E is called a full-wave circuit; its output is d-c.

### Effect of Core Material

The contrast between the sensitivity of the simple saturable reactor circuit and that of the self-saturating type may be seen in Fig. 3A. The transfer curves shown in this diagram were taken for two sets of reactors of approximately the same mean flux path, one constructed with standard E-I silicon steel laminations and the other with gapless medium-nickel iron alloy (Allegheny Ludlum 4750) ring laminations. In each case, data is shown for both the simple reactor circuit and the self-saturating type.

Two important differences are evident: (1) the increased sensitivity of the self-saturating circuit and (2) the improvement of performance obtainable with the better steel. With silicon steel, the self-saturating circuit is five times more sensitive than the simple reactor, while with the 4750 nickel steel gap-

less core, the self-saturating circuit for which data is shown is about 50 times more sensitive than the simpler circuit using the same core. Furthermore, in this same circuit, the 4750 iron has an advantage of 40 times in sensitivity over silicon iron. This makes evident the superiority of the better steel. Of course, the data are not strictly comparable because of the difference in geometry of the cores, but the curves shown may be taken as representative of conditions obtained in two types of cores which do have approximately the same mean magnetic path length. The peak ampere-turns of the load current is over 1,000 times the control ampere-turns for saturation for the self-saturating circuit with nickel-steel core, while the ratio in the case of the same circuit with the air-gap silicon steel core is approximately five for the particular set of data shown in Fig. 3A.

Similar contrasts of the sensitivity of the self-saturating circuit for other core materials, such as Permalloy, Permenorm 5000-Z and Supermalloy show increases in sensitivity over 4750 of the order of 2.5 times for the Permalloy and about 25 times for Permenorm.

The single-phase doubler and full-wave circuits may be arranged for polyphase operation. Several such circuits are shown in Fig. 1F, 1G,

and 1H. The first (Fig. 1F) is a simple 3-phase Y-connection with the control windings arranged so that no voltage component of fundamental frequency appears at the control circuit terminals. Other circuits shown include (Fig. 1G) the 3-phase full-wave circuit and (Fig. 1H) the 6-phase circuit with inter-phase transformer. The polyphase circuits are commonly used for larger power outputs, particularly where fast response and optimum utilization of reactor structure are important. The latter condition develops in virtue of the fact that the several polyphase circuits have different internal impedances when made with identical reactors, permitting the load impedance, which may be fixed by external consideration, to be matched more closely.

### Magnetic Amplifiers

Because the change in load current can be greater than the change in control current that produced it, saturable reactors can be used as amplifiers. To improve their performance, feedback is commonly used, particularly in the simple circuits that do not employ self-saturation. Usually the load current is rectified in a full-wave bridge and introduced in a special feedback winding on the reactor structure in such a manner as to aid the control current ampere-turns. Two single-



phase feedback circuits are shown at Fig. 1I and 1J. As in the simple reactor circuits, the main windings may be connected in series or in parallel, and the load may be placed in either the a-c or d-c circuit.

Transfer curves of a reactor with adjustable feedback are shown in Fig. 3B. The effect of increasing the positive feedback factor is shown by the increased slope of the transfer characteristic. Of course, this increase in sensitivity with positive feedback is obtained at the expense of the speed of response of the reactor circuit and the stability of the system in which the reactor is used. Negative feedback results in an extended range of linearity of the transfer curve.

In both cases, window space is occupied by the feedback winding, so that the reactor structure must be derated by an amount which increases with the degree of feedback. As an example, in order to provide 100-percent feedback, (feedback turns equal to main turns), a simple reactor would have to be derated by 50 percent. For simple reactors without self-saturation, the use of feedback permits convenient adjustment of sensitivity in the range between that of the simple reactor and that of the self-saturating type and even beyond. The characteristics of the rectifiers are not critical.

The use of large amounts of positive feedback results in a trigger action that is apparent in the +2 curve of Fig. 3B. This trigger action can be exploited to advantage, as in the use of reactor circuits to give relay action which is quite sensitive and capable of high speed, shock-proof operation.

The performance of a magnetic amplifier system, particularly one

of the self-saturating type, depends on the properties of the components which are used. The possibilities of the various circuit arrangements have been explored and the limitations on performance are known. In the self-saturating circuit, performance depends as much on the characteristics of the rectifier as it does on the properties of the magnetic core material. In discussing the performance of magnetic amplifier circuits, I shall mention the effect of both rectifier and core material characteristics and I shall attempt to do so upon two different levels: (1) what is now commercially feasible with normal manufacturing and quality-control techniques and (2) what seems to be the ultimate in performance of the best of present materials on a laboratory basis.

The principal performance characteristics of magnetic amplifiers include power gain, power output, speed of response, and weight per unit output. Other factors which may be of interest are shock resistance, ambient temperature limits, stability and linearity.

For optimum performance, the magnetic core material should have the following characteristics: (1) high saturation induction for low pounds per watt, (2) high differential permeability in the second and third quadrants of the hysteresis loop for maximum sensitivity, (3) high resistivity and ability to be made in thin laminations for low eddy-current shielding to give fast response, and (4) stability of magnetic characteristics under changing temperature and mechanical strain and shock conditions.

To be suitable for use in the commercial manufacture of reactors for magnetic amplifier circuits, the core

material should have other characteristics in addition to those required for optimum performance. In the first place, it is of the utmost importance that the magnetic core material have properties which are reproducible between different batches and are the same for all the material in each batch. This is the single most important requirement for high-permeability core material for magnetic amplifiers.

### Core Assembly

Considerable handling is involved in stacking laminations and in placing a winding upon the stacked core, therefore, it is desirable that the core materials be reasonably free from adverse effects resulting from moderate mechanical stresses. It does not seem feasible at present to consider the use of toroidally-shaped tape cores for low-level amplifiers (0.1 to 10 watts output) and there is no method presently available, to my knowledge at least, of obtaining satisfactory stacking factors with unit cores that are assembled before annealing and are used just as they come from the oven.

It is also necessary that the laminations have adequate interlamination resistance, which may be developed in stacks made of laminations with commercially available film coatings of the oxide type. Present practice consists of insulating the laminations before assembly with clear lacquer or impregnating the core after assembly with a wax.

The structure of magnetic amplifier cores has been a matter of discussion for some time. Performance-wise, there are only minor differences between the core-type reactor arrangement, the three-legged reactor, and the four-legged reactor. For laminated, gapless cores, the simple arrangement using core-type reactors seems most practical. The limits on performance of circuits using reactors of this kind, particularly those made with high permeability core materials, are fairly well known, and the effects of core and copper geometry upon the various performance factors are understood in a general way. While the question of core and copper geometry for optimum performance remains an open one, rather definite conclusions may be eventually

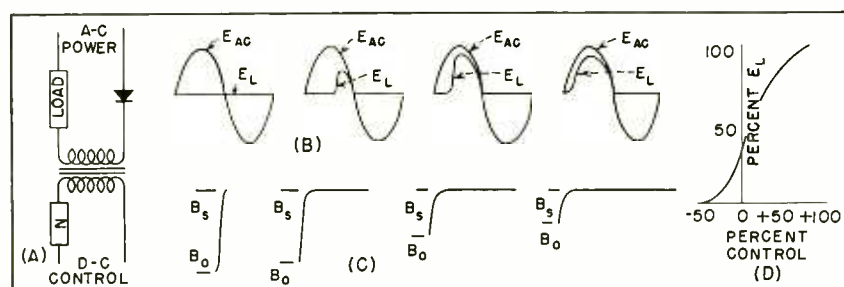

FIG. 2—Action of presaturation can be visualized from a reactor having control and power windings (A). Different values of control current produce different intervals during which voltage appears across load (B) because they shift operating position on the hysteresis curve (C) giving response shown at (D)

reached following a critical study of the problem. Early work along these lines indicates the feasibility of such a study.

Development work has been done on the basis of somewhat more limited objectives. A time constant of 1 cycle on a power supply period basis for the transient response of practical amplifiers is the present limit, while power gain, which is affected by the desired time constant, may be approximately one or two thousand if quick response is not desired. The watts per pound figure may be taken as approximately thirty for low-level 400-cycle reactor circuits. With rectifiers, mounting brackets and resistors included in an amplifier assembly, the watts per pound may become ten or fifteen for low-level, 400-cycle units. If these three factors are the only ones of importance, that is if cost and space are not involved, it seems quite feasible to reach rather definite conclusions concerning optimum core geometry. If, on the other hand, space is also important and high gain may be sacrificed, the rectifiers would be of different design, as would the optimum core shape.

#### Reproducible Core Material

The importance of the reproducibility of magnetic characteristics of the core material for magnetic amplifiers is shown by Fig. 3C. This graph shows measured magnetization curves of several samples of high permeability core materials, all of approximately eighty-percent nickel. The solid lines represent the catalog information given by the manufacturer as the average and extremes of the normal magnetization curve. The dashed-line curves show several measured curves for cyclic magnetization and indicate that the extremes given by manufacturer are not at all pessimistic. A range of maximum reversible permeability of 85,000 to 25,000 is seen to exist in the measured curves, which were taken for representative samples. A range of maximum normal permeability of 300,000 to 60,000, or 5:1, is shown in the data.

The sensitivity of a magnetic amplifier circuit using reactors made with Hymu 80 or Mumetal, materials similar to that of Fig. 3C, depends on the slope of the upper

branch of the hysteresis loop, particularly in the region of zero magnetic flux density and the coercive force value of magnetic intensity. The slope of this portion of the hysteresis loop is dependent to a large extent upon the maximum value of the normal permeability. Changes of normal permeability in the ratio of 5 to 1 result in changes of magnetic amplifier sensitivity of approximately the same ratio. This condition is intolerable from the standpoint of large-scale manufacture of magnetic amplifier systems with fixed or published characteristics. Variations of this kind and magnitude are not amenable of compensation by other than laboratory methods which are often too costly for this type of product.

I think it safe to state that those who are interested in the manufacture of magnetic amplifier components and systems would be gratified if means were found to manufacture a core material with characteristics reproducible to plus or minus ten or even twenty percent, even if this were done at the expense of radically reduced values of maximum permeability and increased cost. As a matter of fact, I feel that this would be a more valuable contribution to the art than the development of core materials of even greater permeability than those presently available.

#### Characteristics of Rectifiers

The performance of the rectifiers used in saturable reactor systems, particularly those employing the self-saturation feature, affects the characteristics of the circuit. The question of rectifier performance is one which parallels in importance that of the magnetic properties of the core materials. Explicit characteristics desired of rectifiers for magnetic amplifier applications are: (1) sturdiness and (2) low forward combined with high back resistance.

Sturdiness, reliability and long life are essential because magnetic amplifier applications often involve conditions of high-intensity shock and require operation without replacement of parts or servicing for 10,000 hours or more. Because none of the components, except possibly the rectifier, are difficult of manufacture to meet these requirements,

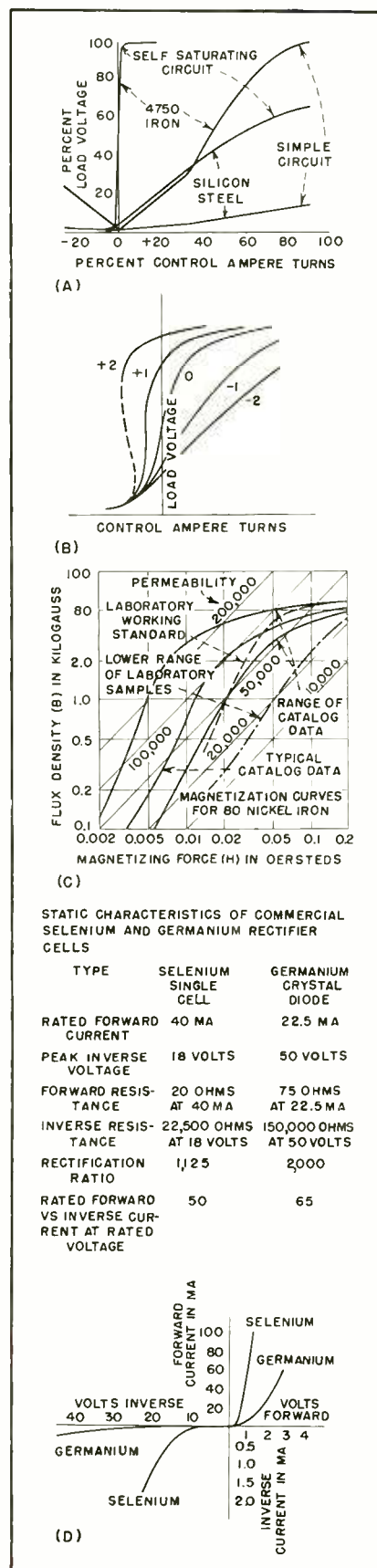

FIG. 3—(A) Core material and circuit determine response of amplifier. (B) Positive feedback gives snap action; negative feedback improves linearity. (C) Properties of cores vary between samples. (D) Rectifiers are also important



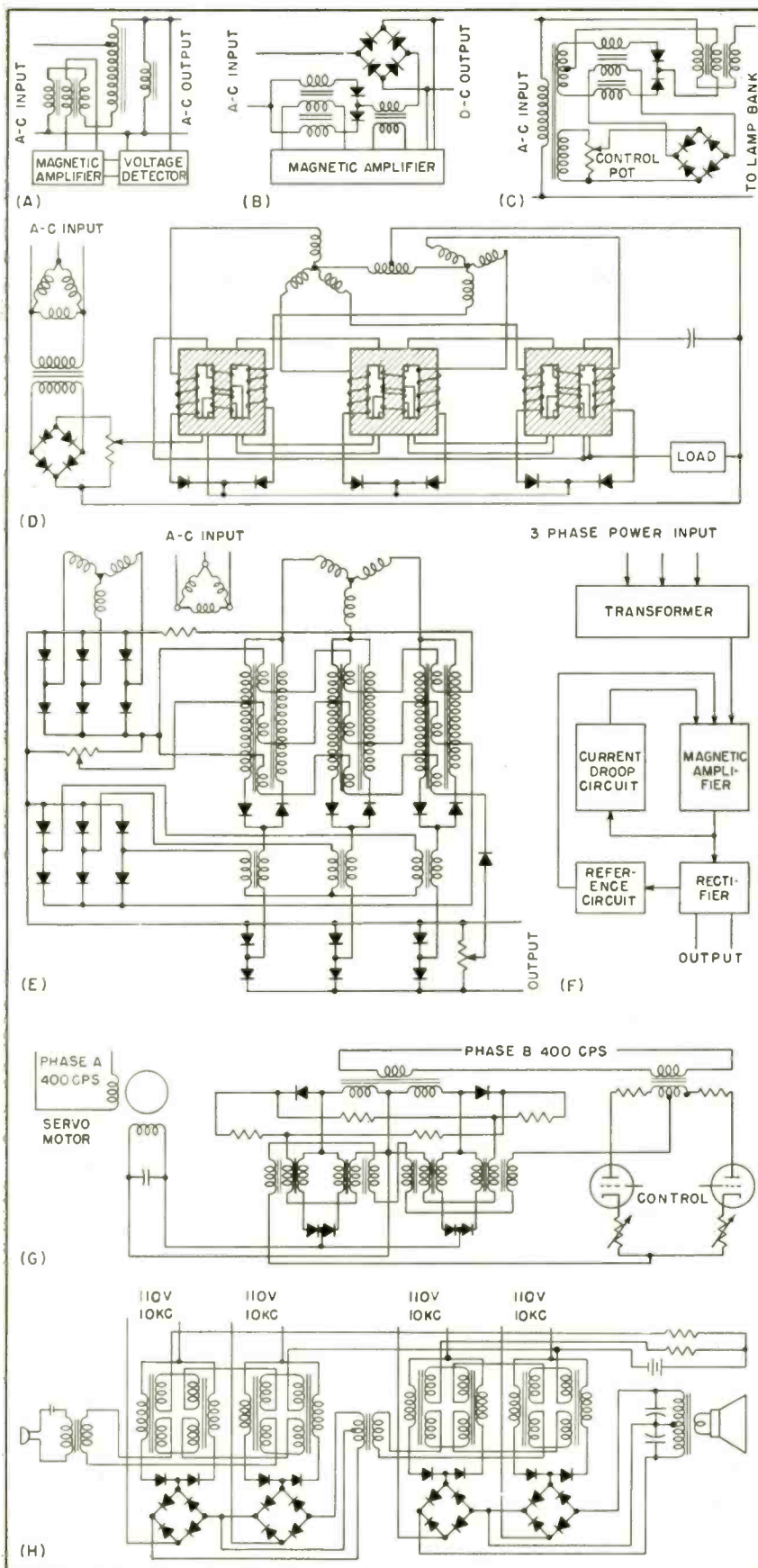

FIG. 4—Presaturated reactors and magnetic amplifiers have been used in various applications, as these simplified diagrams show: (A) line voltage regulator, (B) automatic battery charger, (C) theater lighting control, (D) constant potential rectifier, (E) welding rectifier, also shown in block form (F), (G) servo motor power amplifier, and (H) two-stage audio amplifier

the use of dry-disc rectifiers rather than electronic units is usually indicated. At any rate, they are in common use in magnetic amplifier circuits.

Low forward resistance and high inverse resistance are desirable for obtaining maximum sensitivity consistent with the properties of the magnetic core material. Low forward resistance results in an increase of output for a given control signal. The lower back current resulting from the use of high inverse resistance rectifiers results in less demagnetization output for a given control current.

Figure 3D shows the characteristics of two small, commercial rectifiers. The rectification ratios are seen to lie between 1,000 and 2,000, while the forward-versus back-current ratios are 50 and 65. It is desirable for magnetic amplifier circuits that the current ratio be raised to 500 to 1,000. Such a ratio is not considered unobtainable for special-purpose units by rectifier manufacturers. Commercial requirements in the field of dry-disc rectifier units have been so unlike those for the special units discussed, that there has been little development work aimed at the special characteristics required of rectifiers for reactor circuits. No doubt such improvement in rectifiers can be made without an overly extended development program.

Rather large changes of operating temperature should not be reflected in equivalent changes of electrical characteristics of the rectifiers, particularly the inverse resistance, nor should the rectifier characteristics change radically over the period of their useful life. Rectifiers should have the maximum inverse voltage rating consistent with a high value of forward-versus back-current ratio so that they are light in weight and give optimum amplifier sensitivity. They should not change when unused or should recover rapidly from nonuse such as shelf storage or equipment idleness. Like core materials, rectifiers for magnetic amplifiers should have reproducible characteristics as commercially available units with published resistance characteristics. This requirement is particularly true of the low-level units, espe-

cially sensitive types, but is not of great consequence at higher power levels, present published rating data being sufficient.

#### Applications of Magnetic Amplifiers

Just as the saturable reactor is a basic component of the magnetic amplifier, so the magnetic amplifier can be used as a basic subassembly in various equipments. The characteristics of the amplifier will be determined by the equipment with which it is to be used, and the amplifier will have to be designed accordingly.

One of the commonest applications of saturable reactors is for line voltage regulation in which the self-adjusting property of the reactor is used in place of a manually adjusted tap on a transformer to compensate for input voltage or load current changes. The next step in complexity beyond a single saturable reactor is to substitute a separately controlled reactor (Fig. 4A). Line-to-line voltage regulation is obtained by an autotransformer a portion of which is a presaturated reactor controlled by a magnetic amplifier operating from voltage changes across the output. A bleeder reactor prevents the regulator from losing control at no load.

Automatic battery chargers have long used magnetic amplifiers, especially in Europe. In this application the requirement is to maintain constant charging voltage and to limit the current (at the beginning of the charging cycle) to a safe value. A doubler circuit (Fig. 1D) and a full-wave rectifier can be combined to perform this function (Fig. 4B). Variations in output voltage and input current (coupled to the magnetic amplifier through a transformer) operate the control winding.

Another popular application is in theatre lighting control (Fig. 4C). A low-power control circuit, excited from the power line, produces the direct current to govern a magnetic amplifier of the full-wave type (Fig. 1E), which is also excited from the power line. The output of the amplifier in turn regulates the saturation of the main reactor in series with the lamp bank. Because the primary control circuit and the magnetic amplifier are both excited

from the same power line, effects of fluctuations in supply voltage can be counter-acted to some extent. The line voltage has to be about 10 percent higher than the rated operating voltage of the lamp bank to allow for the drop in the main reactor.

The functions of voltage regulation and rectification can be combined in a single unit. A 3-phase unit, suitable for such applications as controlling the speed of a large d-c motor, (Fig. 4D), obtains the fixed reference voltage through a constant voltage transformer across one of the power phases. This voltage is rectified and the current so obtained is used to control three full-wave magnetic amplifier operating from a 3-phase transformer and interphase transformer (compare with the single-phase circuit of Fig. 1E). To increase the sensitivity of the system, positive feedback is used, and to improve transient response, damping windings in series with a capacitance are added. The output voltage (motor speed) can be controlled by the potentiometer in the constant-voltage circuit.

Some applications require that the output be stabilized against several possible variations. The battery charger (Fig. 4B) is one example of this case. The welding rectifier (Fig. 4E) is another example. The output current must be stabilized against changes in output load (current and voltage) and line voltage. The 3-phase doubler circuit has three control windings. One winding is excited by rectified 3-phase voltage from the supply line, the second is excited by current proportional to the load current, and the third by current proportional to the load voltage. All of these control currents pass through a common potentiometer by which the welding current can be set. A potentiometer across the output further provides adjustment of the voltage-proportional control current for no-load reference. Four sets of rectifiers are required: the self-excitation rectifiers of the doublers, the power rectifiers in the output, and the two sets of rectifiers (for input voltage and output current) for the control windings. A single rectifier suffices for the output volt-

age control circuit because it is already across the power rectifiers (but a rectifier is necessary to provide high impedance to induced reverse currents). A block diagram (Fig. 4F) shows the nature of the feedback paths of this system.

The foregoing systems have operated at 60 cps. Fast response is not required of them and it is most convenient to excite all elements of the system from the same supply. However, if fast response is necessary, a higher operating frequency should be used because then, for the same impedance, the inductances of the windings can be less, which reduces the time constant of the system. In general, equivalent magnetic amplifiers operating at different frequencies can respond in the same number of cycles, thus the higher frequency unit has the faster response.

A fast-acting servo amplifier can be operated from a 400-cps. source (Fig. 4G). A 2-phase system is frequently used with a 2-phase induction motor, although a 3-phase system would be similar. Doublers in push-pull with each other produce a null so that the system has a quiescent point between forward and reverse motor drive. The control windings are excited by electronic tubes; the rheostats in the cathodes permit balancing the amplifier at the required null, or varying the null. Primary control of the amplifier is, as usual, through the grids of the tubes.

An audio amplifier (Fig. 4H) illustrates the use of high-frequency excitation to obtain fast response. Essentially each of the two stages is a carrier-type amplifier. Two pairs of doublers, connected in push-pull to reduce even harmonic distortion as well as to provide symmetrical operation, are excited from a 10,800-cps source (180th harmonic of 60 cps). These two stages are connected by an interstage transformer. Pairs of full-wave rectifiers are used before the interstage and output transformers. A single-button carbon microphone feeds the 5-milliwatt input transformer to develop full power in the 5-ohm 6.5-watt voice coil of the loudspeaker. The operating points of the reactors of each stage are set by a bias battery and biasing resistors.



# Television Synchronizing

Horizontal and vertical driving pulses, the composite blanking signal and the composite synchronizing signal, all within FCC and RMA specifications, are produced. Linearity test signals can be mixed with blanking for testing picture monitors and receivers; simultaneous cathode-ray monitoring of all frequencies is provided

**T**HE instrument to be described provides the means for insuring synchronism between the scanning of a picture at the receiver and the scanning of a subject at the transmitter. Features are provided that are not usually found in a synchronizing generator which are specific aids in television station operation and maintenance.

The generator meets the RMA recommendations for the standard signal, that is, the horizontal and vertical driving pulses, the composite blanking signal and the composite synchronizing signal.

Linearity test signals are provided at 900 cycles and at 157.5 kc mixed with blanking by means of a switch for use in testing scanning

linearity of picture monitors and television receivers. These produce 15 horizontal bars and 10 vertical bars on a raster permitting a rapid check of sweep linearity. In addition, the 157.5-kc test signal serves as an accurate 10 percent H (6.35  $\mu$ sec), electronic marker for use with an ordinary oscillograph in the precise setting of pulse widths and front porch.

The leading edges of the equalizing pulses are also the leading edges of horizontal and vertical synchronizing pulses, thus insuring perfect interlacing.

Two 3-inch cathode-ray tubes permit simultaneous monitoring (without switching) of all frequencies in the synchronizing gen-

erator. Thus, frequency counts may be checked or adjusted without the use of an external oscilloscope.

A crystal oscillator at 157.5 kc or a highly stable self-excited oscillator at 157.5 kc may be selected by a switch for the master oscillator. The self-excited oscillator is used in synchronizing the generator, by means of the provided lock-in circuit to the 60-cycle power line or to a remotely generated synchronizing signal.

Negative feedback is used in many of the circuits to minimize the effect of changes in tube characteristics and variations between tubes. A double-regulated supply is used having an internal impedance of less than 0.15 ohm.

## Circuit Breakdown

The generator consists of the following units:

1. Timing generator
2. Blanking-driving unit
3. Sync shaping unit
4. Regulated low-voltage supply
5. High voltage supply for the cathode-ray monitors
6. Power control panel containing switches and fuses.

Figure 1 is a block diagram showing the interrelation of the units in the development of the standard signals. Accurately timed signals at 157.5 kc, 31,500 cycles, 15,750 cycles, 900 cycles and 60 cycles are developed in the timing generator for use in the other units.

The blanking unit utilizes the 60-cycle signal and the 15,750-cycle signal in the development of verti-

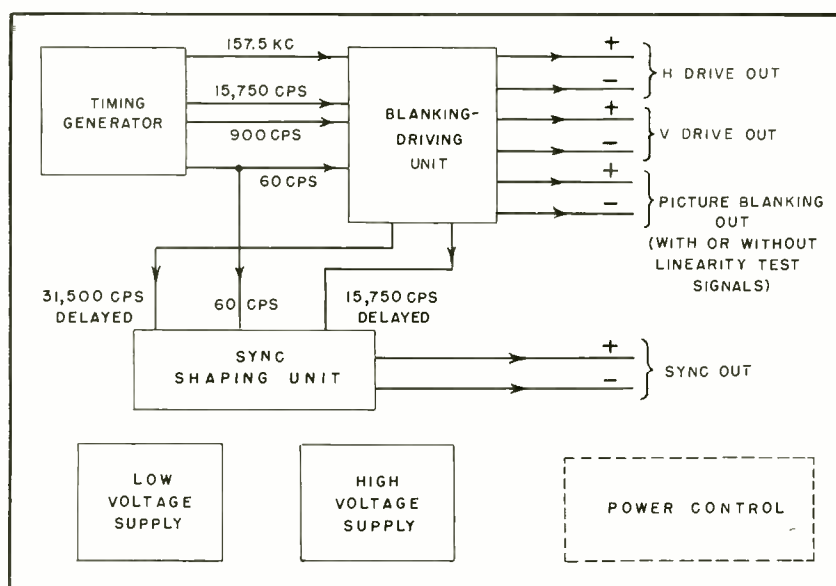

FIG. 1—Interrelation of units forming the sync generator

# Signal Generator

By **A. J. BARACKET**

*Head of Television Video Development Section  
Television Transmitter Division  
Allen B. DuMont Laboratories, Inc.  
Clifton, New Jersey*

cal driving and horizontal driving pulses and in the development of the composite blanking signal. It also uses the 157.5-kc signal and the 900-cycle pulses in the development of the composite linearity test signal which becomes available mixed with blanking.

The sync shaping unit utilizes the 31,500-cycle pulses and the 15,750-cycle pulses with suitable delays (for accurate synthesis of the horizontal and vertical sync pulses) in a specially designed delay line contained in the blanking-driving unit for the formation of the high-frequency components of the composite synchronizing signal. The 60-cycle pulse from the timing generator is used undelayed in the development of the low-frequency component of the composite synchronizing signal.

To meet the severe requirements of the RMA-recommended synchronizing signal generator signals, there must be precise time relationship among the pulses developed by the timing generator. This may be obtained by starting at a high frequency and by suitable frequency division deriving the lower frequency pulses. An alternate method is to begin with the lowest frequency and obtain the higher frequency signals by suitable frequency multiplication. In the timing generator shown in Fig. 2, the former method is used because it may be effected by simpler circuits.

In the circuit diagram of Fig. 2, the two basic oscillators are the 6AC7 crystal oscillator and the 7F8 master oscillator, both operating at

157.5 kc. The 6SN7 blocking oscillator frequency dividers are used to derive the lower frequencies required. The first division is by 5 to 31.5 kc, the equalizing pulse frequency. From 31.5 kc there is one division by two to 15,750 cycles, the horizontal rate, and another division by seven to 4,500 cycles. The frequency of 4,500 cycles is divided by five to 900 cycles, one of the linearity test signal frequencies.

Division of 900 cycles is done by five to 180 cycles which is in turn divided by three to 60 cycles, the field repetition rate. Sawtooth wave forms at 60 cycles and at 900 cycles are fed respectively to the deflecting plates of the low-frequency and the high-frequency cathode-ray monitors, to serve as time bases for the presentation of the count-down frequencies on the monitor screens.

## Frequency Indicators

Figure 3 shows the presentation on the screens of the cathode-ray tubes. The left-hand screen is that of the high-frequency monitor whose horizontal time base is 900 cycles. The dots represent the master oscillator or crystal oscillator frequency 157.5 kc. There are five dots along each line or step in the vertical "ladder" indicating a division from 157.5 kc to 31,500 cycles.

The bright dots on the high-frequency monitor correspond to the 15,750-cycle horizontal repetition rate. There are seven steps in each of the ladders, indicating a frequency division from 31,500 cycles

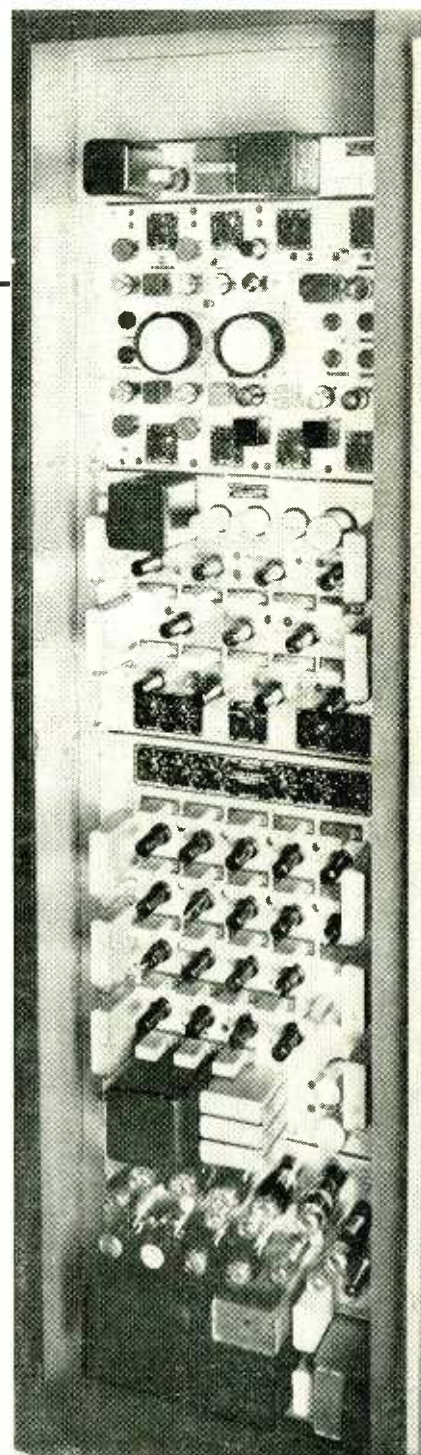

Complete synchronizing signal generator

to 4,500 cycles; in other words each ladder represents 4,500 cycles. The presence of five ladders for each cycle of the time base points to a frequency division from 4,500 cycles to the time base frequency of 900 cycles.

On the right-hand or low-frequency monitor, the ladder steps represent 900 cycles. Since there are five of them to each ladder, the indication is frequency division



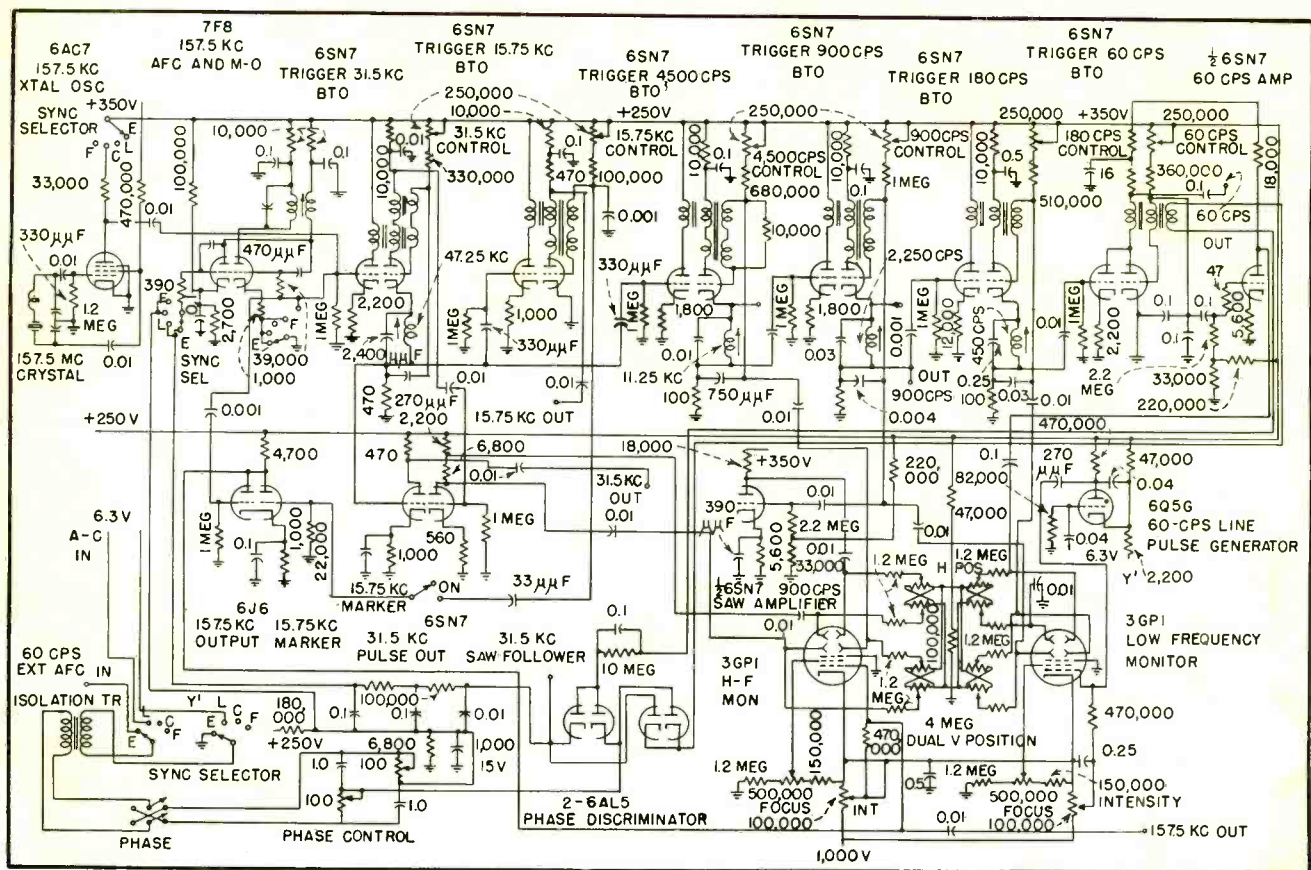

FIG. 2—Timing generator circuits of the Du Mont TA107 A/B sync generator

from 900 cycles to 180 cycles. The three ladders per cycle of the time base indicate a frequency division from 180 cycles to 60 cycles.

The blanked out section in the middle of the low-frequency scan being derived from the power line further confirms the time base of 60 cycles and indicates synchronism with the line. When the generator is not locked to the 60-cycle power line, the blanked out section moves across the time base. This presentation has been found highly useful in the analysis at a glance of synchronizing generator failures due to improper timing.

The type of blocking oscillator frequency divider circuit used is the cathode-tuned-circuit-stabilized type, Fig. 4. Firing of the blocking oscillator results in a surge of current through the cathode circuit which is normally tuned to a frequency half that of the trigger repetition rate. This results in a ringing of the tuned circuit due to its Q. The cathode voltage wave form is that of a damped sine wave lasting for  $2\frac{1}{2}$  cycles (for a 5 to 1 count down) before the blocking oscillator fires again. The grid to ground and

the grid to cathode voltage waveforms are shown in the diagram of Fig. 4. As indicated, discrimination is very good against all trigger pulses other than the one producing proper count down.

In the design of the timing circuits, extreme care was taken to minimize any possibility of frequency modulation of the timing pulses. Considerable attention was paid to the chassis layout especially

with respect to keeping high level pulse points away from the afc circuit. The blocking oscillator grids are returned to +250 volts giving a steep capacitor voltage discharge waveform and consequently improving freedom from jitter.

The source of B voltage is a double-regulated power supply with an output impedance of less than 0.15 ohm. This eliminates the possibility of extraneous signals modu-

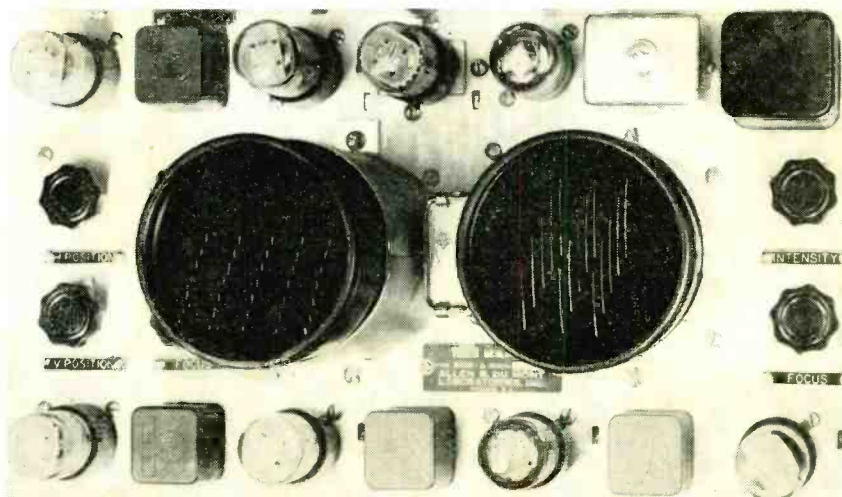

FIG. 3—Presentation of count-down frequencies on cathode-ray monitors

lating the blocking oscillator grid base, a common source of frequency modulation.

The 157.5-kc and 900-cycle outputs of the timing generator are fed directly to the blanking unit for use in the production of a linearity test signal mixed with blanking. The 60-cycle pulse output of the timing generator is routed to the blanking-driving unit and the sync shaping unit for use in the generation of RMA driving pulses, and the low-frequency components of RMA blanking and sync pulses.

To conform to the strict requirements of the RMA recommended synchronizing signal, it is good design practice to use the same signal for the formation of the leading edges of all of the pulses which make up the synchronizing signal. In the synchronizing signal generator under discussion, the leading edges of the equalizing pulses are used to form the leading edges of the horizontal and the vertical synchronizing pulses. This is done by adding a horizontal component and a vertical component, both of which

have been delayed a precise time by a lumped LC delay line in the blanking unit, to the equalizing pulses and clipping the result as indicated in Fig. 5.

Two separate delay lines are used, one for the 31,500-cycle signal and the other for the 15,750-cycle signal. Each line consists of 70  $\pi$  sections with a total delay of 10 percent of the horizontal period or approximately 6.3 microseconds. Provisions are made for tapping connections in any one of the sections in both lines. This permits very accurate shaping of the sync pulses as well as very precise setting of the front porch. Multivibrator stability is in part a function of the trigger pulse rise time. To maintain as short a rise time as practical in the delayed 15,750 and 31,500-cycle trigger pulses, the delay line is designed for a frequency band of over three megacycles. Figure 6 shows the schematic of a single section of the delay line.

#### Equalizing Pulses

The equalizing pulses shown as G in Fig. 5 are generated directly by multivibrator  $V_{17}$  in the sync shaping unit, block diagram of Fig. 5. They are amplified and limited by  $V_{18}$  and mixed with the

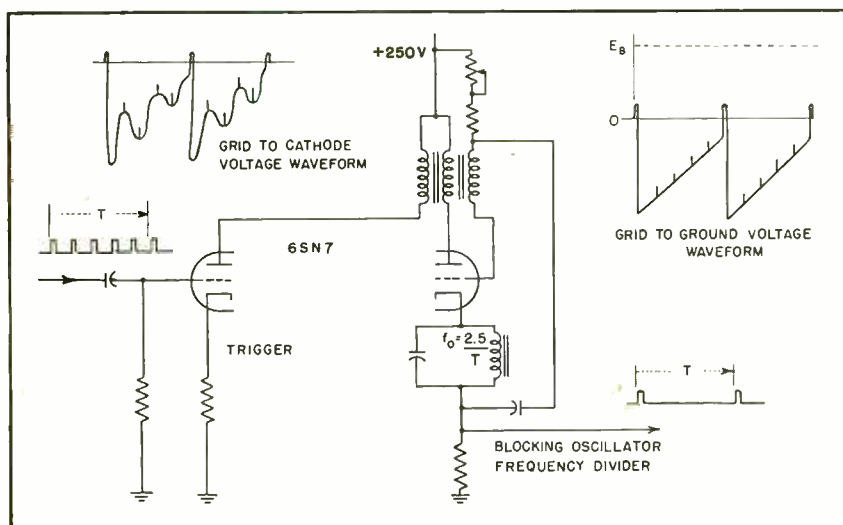

FIG. 4—Cathode-stabilized blocking oscillator frequency divider

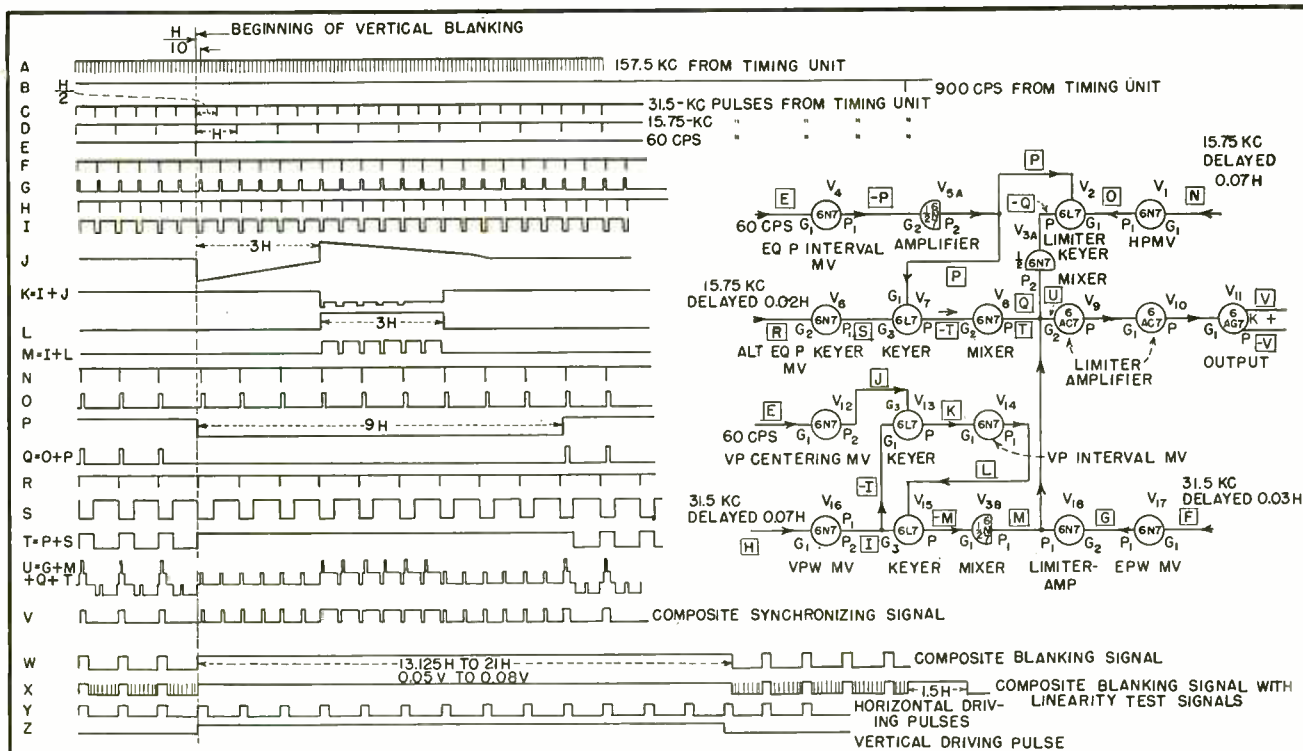

FIG. 5—Timing diagram shows the formation of the composite synchronizing signal and block diagram of sync shaping unit



other synchronizing signal components in the plate circuits of  $V_{12}$ ,  $V_8$ , and  $V_3$ .

### Horizontal Pulses

Figure 5 is a timing diagram indicating the synthesis of the composite synchronizing signal from its various components. The horizontal pulses are formed by adding delayed 15.750-cycle pulses to the equalizing pulses, amplifying, limiting and keying-out undesired 31,500-cycle pulses. The result before final clipping is shown at  $U$  of Fig. 5.

Tube  $V_1$  in Fig. 5 is the horizontal pulse multivibrator whose output ( $O$  in Fig. 5) is permitted to clear through  $V_2$  only during the horizontal pulse interval.

The 15,750 cycle pulses ( $Q$  in Fig. 5) are then amplified and limited in  $V_3$  and mixed in the common plate circuit of  $V_{12}$  and  $V_8$  with the vertical and equalizing pulse components of the composite synchronizing signal.

The first and last sections of  $U$

in Fig. 5 show the horizontal component of the mixed signal at  $V_8$ . The raised portion of this component indicates the overlap between the equalizing pulse and the delayed horizontal pulse. This is later clipped off in limiters  $V_9$  and  $V_{10}$  as shown in the first and last sections of  $V$  in Fig. 5.

The keying out of the horizontal pulses during the equalizing pulse interval is accomplished by the gating of keyer tube  $V_2$  by pulse  $P$  in Fig. 5 derived from the equalizing pulse interval multivibrator  $V_4$  through amplifier  $V_5$ . The elimination of unwanted equalizing pulses is obtained by first pushing them down into a region lower than that of the desired horizontal pulses by means of 15,750-cycle pulses shown as  $T$  in Fig. 5 and later removing them by clipping. Waveform  $T$  is derived from the alternate equalizing pulse keying multivibrator  $V_6$  through keying tube  $V_7$  and amplifier-limiter  $V_8$ . The pushed down equalizing pulse is shown in the first and last sections of  $U$  in Fig. 5.

The elimination of alternate equalizing pulses must not take place during the equalizing pulse interval. For this reason keying tube  $V_7$  by means of the equalizing interval pulse  $P$  permits the alternate equalizing pulse keying signal  $S$  to be applied only during the horizontal pulse interval. The output of  $V_7$  is  $T$  in Fig. 5. The duration of the

horizontal pulses in the output signal  $V$  is 8 percent of  $H$  (+0 -1 percent).

### Vertical Pulses

The vertical pulses in the composite synchronizing signal consists of a group of six at a 31,500-cycle rate. The group repeats itself once each scanning field, see center section of  $V$  in Fig. 5. The duration of each pulse is 43 percent of  $H$  where  $H$  is the line period and the group must appear during the vertical blanking interval between the first and second group of six equalizing pulses.

The timing of the vertical pulse interval is determined by the trailing edge of a pulse,  $J$  in Fig. 5, three lines wide from the 60-cycle vertical pulse centering multivibrator  $V_{12}$ . The vertical pulses are generated at a 31,500-cycle rate in the vertical pulse multivibrator  $V_{12}$ . These are shown at  $I$  in Fig. 5. One of its pulses, upon coincidence with the trailing edge of the vertical centering pulse  $K$ , is permitted by keyer tube  $V_{13}$  to trigger the vertical pulse interval 60-cycle multivibrator  $V_{14}$ , whose pulse width is normally set equal to three horizontal lines or the interval required by six vertical pulses at the 31,500-cycle rate.

Waveform  $L$  in Fig. 5 is the output of  $V_{14}$ . The vertical pulse interval gate, in turn, permits the vertical pulses to be amplified by keyer tube  $V_{15}$  only during the vertical pulse interval. The result is  $M$  in Fig. 5. In turn, the six vertical pulses during the vertical pulse interval are amplified and limited by tube  $V_8$  and appear in the common plate circuit of  $V_3$ ,  $V_8$  and  $V_{12}$ . Thus, into a common plate load are fed the horizontal pulses during the horizontal pulse interval from tube  $V_3$ , the equalizing pulses during the equalizing pulse interval from tube  $V_{12}$  and the six vertical pulses during the vertical pulse interval from tube  $V_8$ . The mixed signal,  $U$ , is amplified and limited by  $V_9$  and  $V_{10}$ , and appears at the cathode and plate of output tube  $V_{11}$  as a positive and negative composite synchronizing signal. Figure 5 shows the final sync output signal at  $V$ .

The block diagram of the blanking-driving unit is shown in Fig. 7.

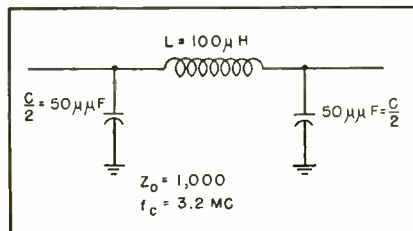

FIG. 6—Single pi section of delay line

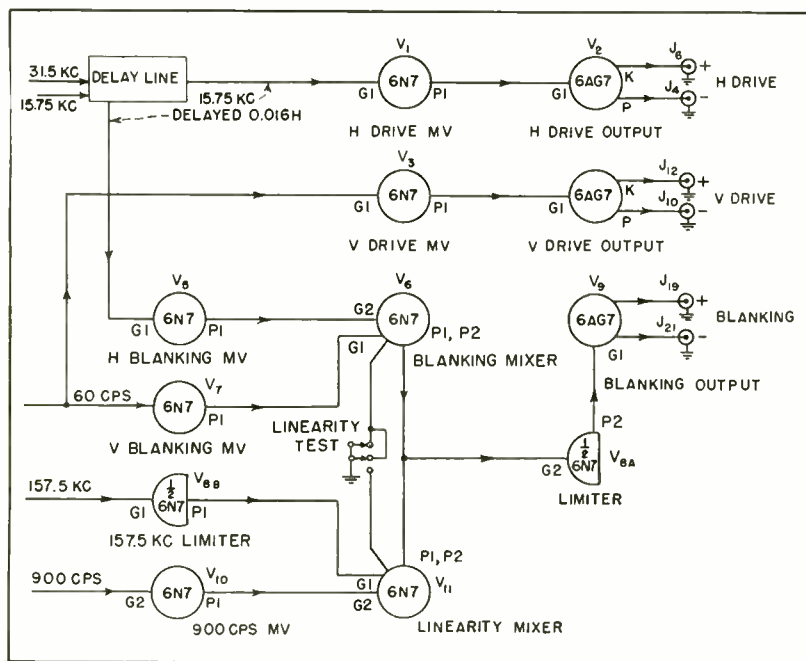

FIG. 7—Functions of stages in the blanking-driving unit

The 15,750-cycle pulses trigger the horizontal blanking multivibrator  $V_6$  whose output is fed into blanking mixer  $V_6$ . The 60-cycle pulses trigger the vertical blanking multivibrator  $V_7$  whose output is fed to the grid of the second triode of blanking mixer  $V_6$ . In the blanking position of the linearity test switch, the mixed vertical and horizontal blanking signals are limited and amplified in tube  $V_{11}$  and applied to the grid of blanking output tube  $V_{10}$ . At the cathode and plate of output tube  $V_{10}$ , appear respectively the positive and negative composite blanking signals.

The 157.5-kc signal derived from the timing generator is amplified and shaped in  $V_8$  and mixed in  $V_{11}$  with the 900-cycle pulse derived from multivibrator  $V_{10}$ . In the *blanking and linearity bars* position of the linearity test switch, these are inserted into the blanking signal in the common plate load of blanking mixer  $V_6$  and linearity mixer  $V_{11}$ . The mixed blanking and linearity test pulses are clipped in limiter  $V_4$  and applied to the grid of output tube  $V_{10}$ . In this position of the switch the output signals at  $J_{10}$  and  $J_{21}$  consist of the composite blanking signal mixed with vertical and horizontal linearity signals. In the *linearity bars* position of the selector switch only linearity test signals are permitted to appear at

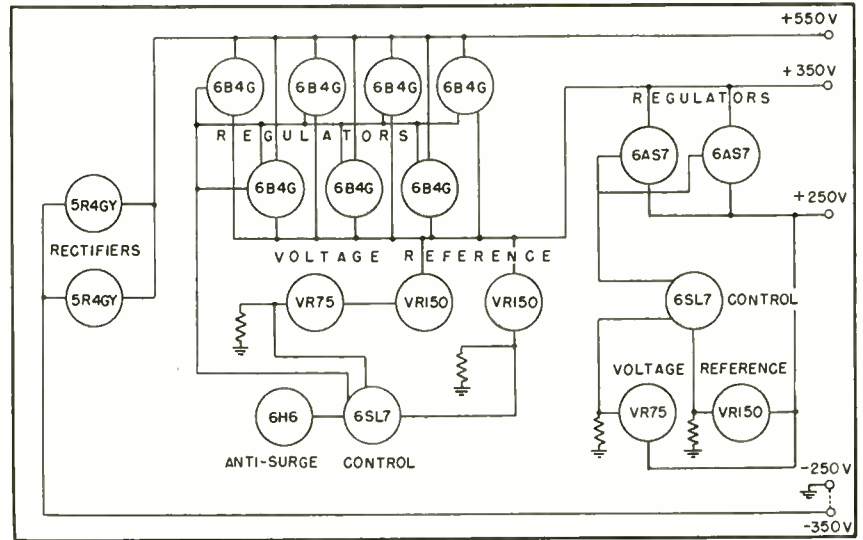

FIG. 9—Block diagram of low-voltage power supply

the blanking signal output jacks. Figure 8 shows a test pattern generated by an iconoscope film chain driven by the sync generator. The linearity test switch is in the *blanking and linearity bars* position.

The horizontal driving pulses originate in the 15,750-cycle multivibrator  $V_1$  and are directly applied to the grid of the horizontal drive output tube  $V_2$ . They appear as positive and negative horizontal driving signals respectively at  $J_6$  and  $J_4$ . In a similar manner the vertical driving pulses originate in the 60-cycle multivibrator  $V_3$ ; the output is applied directly to the grid of vertical output tube  $V_4$ . Vertical

driving pulses appear in positive and negative polarity at jacks  $J_{12}$  and  $J_{10}$ . At  $Y$  and  $Z$  of Fig. 5 are shown the waveforms of the horizontal and vertical driving pulses produced by the circuits.

#### Power Supplies

The high-voltage supply is used to provide the accelerating potential for the cathode-ray tube monitors in the timing generator.

A double-regulated low-voltage supply is used to provide 250 volts and 350 volts for the three signal units. This supply has an output impedance of less than 0.15 ohm at 1,000 cycles. The change from no load to full load at 400 milliamperes results in a change of only 0.1 volt at the output. A block diagram of the low-voltage supply is shown in Fig. 9. Transients from the ordinary power supply filter circuit are eliminated by use of an "electronic choke" in the form of a first regulator for the 350 volts ahead of the final regulator for the 250 volts.

A number of these synchronizing generators have been in operation during the past two years with excellent results.

#### Acknowledgment

Acknowledgment is made to the following men of the Du Mont Laboratories who took part in the development and product design of the synchronizing generator: H. Beste, L. Durgin, C. Quirk and L. Spooner, and to N. Accardo and M. Demeyer, who aided materially in the test of models.

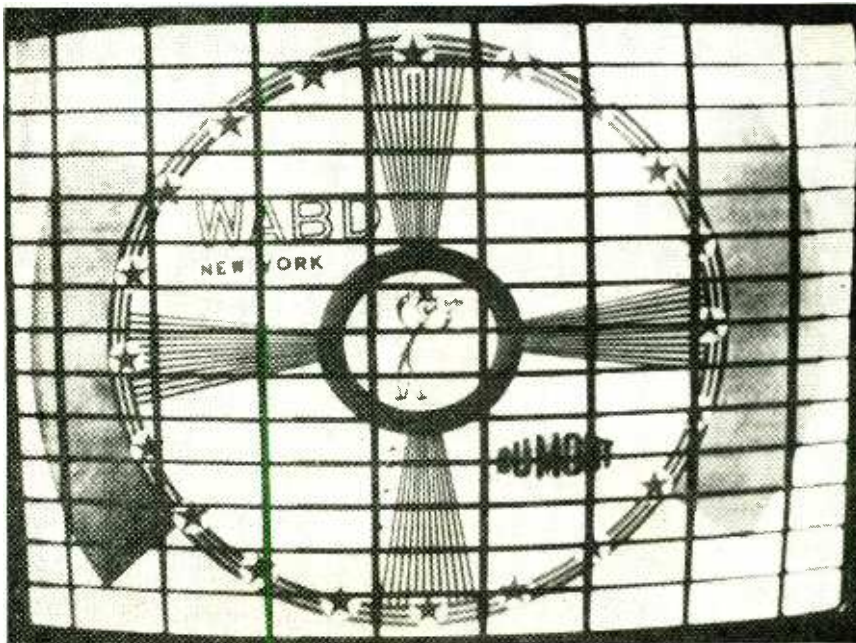

FIG. 8—Camera chain output picture signal with the linearity test switch of sync generator set at blanking and linearity bars for adjustment of monitor sweep linearity



# Single-Sideband CRYSTAL FILTERS

X-cut crystals are used in multiple-section filters for the upper and lower sidebands and the carrier frequency. The carrier filter has a passband 16 cycles wide between 3-db points and the sideband filters are flat within 0.6 db for nearly 6 kilocycles

ONE PROBLEM involved in the development of an improved type of radio receiver for twin-channel, single-sideband reception was the design and construction of three crystal filters.

These were used to separate the carrier from the sidebands of an amplitude-modulated wave train at an intermediate frequency of 100 kc and to isolate each of the two sidebands.

Specifications called for a carrier filter less than 25 cycles wide at points whose response was 3 db down from maximum, and 175 cycles wide at points 50 db down, with a maximum attenuation of over 70 db available.

Since both speech and musical programs were to be received with high fidelity, each sideband (channel) filter was specified to have a passband 6 kc wide, flat within  $\pm 0.5$  db except at the edges where a 2-db drop from maximum response could be tolerated. These edges were taken to be 100 cycles and 6 kc respectively from the intermediate carrier frequency of 100 kc.

A maximum relative attenuation of at least 85 db was desired at all frequencies separated by more than 4 kc from the passband midfrequency. This would provide for a 40-db attenuation of adjacent-channel signals of equal strength in addition to a possible unfavorable selective fading differential of 45 db between the two channels.

A piezoelectric crystal such as quartz acts electrically<sup>1</sup> like the LC circuit shown in Fig. 1. For a range near the resonant and antiresonant frequencies of this electrically

By **PAUL K. TAYLOR**

*Government Sound Engineering Section  
Engineering Products Dept.  
RCA Victor Division  
Radio Corporation of America  
Camden, New Jersey*

equivalent circuit, the crystal presents a reactance whose variation is shown by the full-line graph of Fig. 4. Suppose that two crystals are so cut that the resonant frequency of one coincides with the antiresonant frequency of the other. The reactances of both crystals are then as depicted by the full-line and dashed-line graphs of Fig. 4.

## Theory

If these crystals be connected in a bridge circuit similar to Fig. 6, or its equivalent lattice, Fig. 2, we have the structure of a simple narrow bandpass filter. The dashed-lines in Fig. 2 indicate lattice arms of the same type as those actually shown. In Fig. 6, the dashed-lines indicate that  $XX$  are the two halves of a single crystal having divided plating. Likewise for  $YY$ .

The bridge circuit of Fig. 6 is that of a pure reactance bridge. This will be perfectly balanced when the reactance between points 1 and 2 of the circuit is equal to that between 1 and 4 and of the same sign. The same is true for the reactance between 2 and 3 and that between 3 and 4. There are two frequencies at which this will occur. On Fig. 4, these are designated  $f_{\infty_1}$ , and  $f_{\infty_2}$ , for the attenuation (theoretically) reaches an infinite value at these frequencies. Actually, the attenuation will

merely rise to a maximum value, called an attenuation peak, at each of the two frequencies of balance as shown in Fig. 5. As the frequency of an input signal is increased from  $f_{\infty_1}$ , toward  $f_A$ , the attenuation will continuously decrease until it (theoretically) reaches zero at  $f_A$ , the series-resonant frequency of one of the pairs of crystals.

For frequencies between  $f_A$  and  $f_B$  the reactances of the two pairs of bridge arms are at each point of opposite sign. Hence, signals whose frequencies lie within this range will pass through the filter (theoretically) with no attenuation. Actually some attenuation is experienced in this range, the amount depending on the Q factor of the crystals and associated circuit elements. For this reason, characteristics of the filters developed in this work are shown as relative attenuation versus frequency rather than actual attenuation. The region between  $f_A$  and  $f_B$ , as shown in Fig. 5, is the passband of the filter.

In practice, capacitors  $C_A$  are placed in parallel with input and output terminals of the filter. Others,  $C_B$ , of much smaller capacitance, are connected from input to output as bridging capacitors.

The parallel capacitors adjust the separation between resonant and antiresonant frequencies of the bridge arms and hence control the width of the passband. The bridging capacitors change the shapes of the reactance graphs of the bridge arms somewhat, thereby changing the frequencies at which the two reactance curves cross where of like

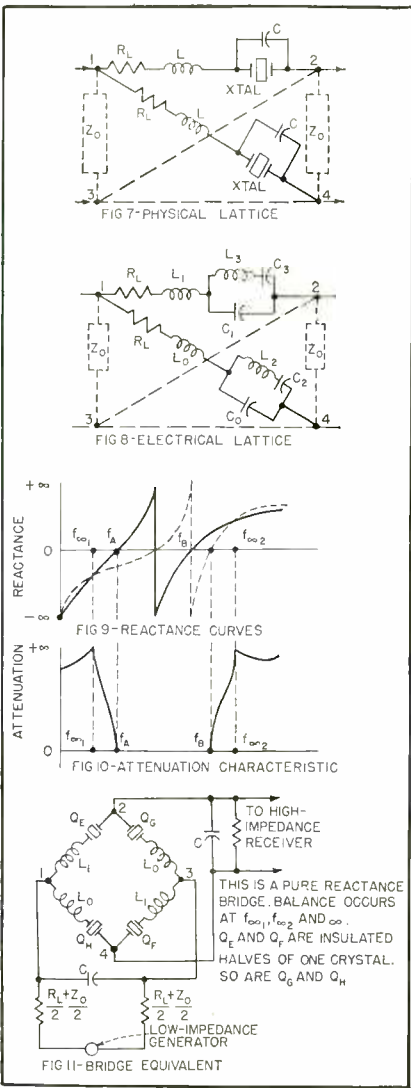
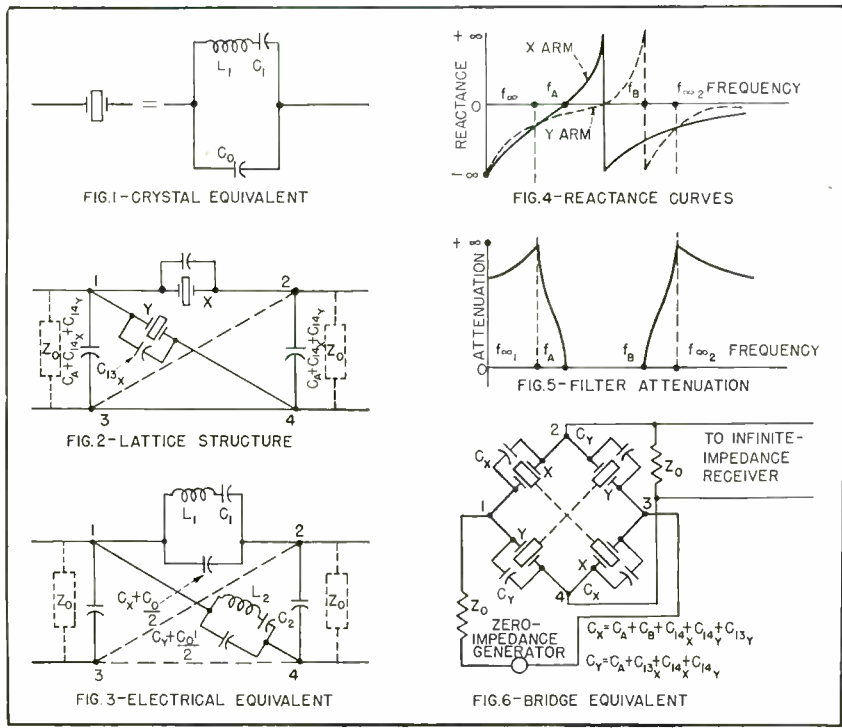

Table I—Effect of Temperature on Attenuation Characteristic

db Down	Frequency (kc) of Lower Side		Difference cps	Frequency (kc) of Upper Side		Difference cps
2	93.92	93.93	+10	99.890	99.868	-22
6	93.58	93.62	+10	100.060	100.035	-25
10	93.41	93.44	+30	100.152	100.127	-25
20	93.29	93.35	+60	100.300	100.278	-22
30	93.16	93.21	+50	100.405	100.360	-15
40	93.16	93.21	+50	100.505	100.480	-25
	Average		+38	Average		-27

sign. Adjustment of the bridging capacitors, therefore, controls the frequencies of the attenuation peaks of Fig. 5.

The resonant and antiresonant frequencies of a quartz crystal are separated by only about 0.4 percent of resonant frequency (for X-cut crystal). Since, as seen in Fig. 4, the passband is only double this amount, some other circuit element must be introduced if wide passbands are desired. Such an element may be an inductance placed in series or in parallel with each crystal of the circuit. These two types of connection result in filters having low image impedance and high image impedance, respectively.

To avoid stray couplings in the channel filters herein described, a reasonably low image impedance was chosen. This choice called for a coil to be connected in series with

each crystal of the filter circuit. The widening of the filter passband by the use of coils is due to the fact that their addition produces a large increase in the separation of resonant and antiresonant frequencies of the bridge arms and furthermore extends the upper edge of the passband considerably beyond the higher of the two antiresonant frequencies of the bridge circuit, Fig. 9 and 10.

For the passband region, the image impedance of the filter is a pure resistance whose value changes from near zero at the passband edges to a maximum midway between them. Terminating resistances considerably lower than the midband impedance are used in the filters actually built to secure a better average impedance match over the whole passband.

If all the coils used in the wide-

band filter are wound to have equal resistances, or if supplementary resistors are inserted to make all arms of the equivalent bridge circuit have equal resistances, it is possible to consider these resistances as being brought outside the bridge circuit proper and incorporated in the terminating resistors. This leaves the bridge as a pure reactance bridge. Under this condition neither the sharpness of the cutoff at the passband edges, nor the steepness of the attenuation characteristic of the filter is impaired by the resistances of the coils inserted in the filter lattice.

Mason<sup>1</sup> has given mathematical formulas from which the values of the circuit components of a filter section can be computed after certain constants have been chosen. These are (1) the frequencies of the edges of the passband, (2) the



frequencies of the peaks of infinite attenuation, and (3) the midband image impedance of the desired filter. The formulas refer to the electrical equivalents of the crystal filter lattice as shown in Fig. 3 and 8.

A sample 6-kc filter calculation using the wideband filter formulas, resulted in the following values. Chosen

$$\begin{aligned} Z_0 &= 2,000 \text{ ohms} \\ f_A &= 99.50 \text{ kc}; f_B = 106.70 \text{ kc} \\ f_{\infty_1} &= 98.70 \text{ kc}; f_{\infty_2} = 107.50 \text{ kc}; \\ f_{\infty_3} &= \infty \end{aligned}$$

Having obtained the values of the equivalent electrical components of a crystal filter section, the next step is to transfer the computed series resonant frequencies  $f_2$  and  $f_3$  of the crystals to actual dimensions of the quartz crystals themselves. Equations for accomplishing this depend upon the type of crystal cut decided upon.<sup>1, 3</sup>

Calculated

$$\begin{aligned} L_0 &= L_1 = 44.22 \text{ mh} \\ C_0 &= 52.84 \mu\mu\text{f}; C_1 = 54.88 \mu\mu\text{f} \\ L_2 &= 20.73 \text{ h}; C_2 = 0.1206 \mu\mu\text{f}; f_2 = \\ &100.70 \text{ kc} \\ L_3 &= 18.53 \text{ h}; C_3 = 0.1234 \mu\mu\text{f}; f_3 = \\ &105.28 \text{ kc} \end{aligned}$$

The -18.5-deg X-cut crystal had previously been generally used as a filter crystal due both to its high Q and freedom from the troublesome face shear mode of oscillation. However, this cut has quite a large temperature coefficient of over 20 parts per million per degree centigrade.

The +5-deg X-cut crystal with a width-to-length ratio of 0.35 has a temperature coefficient of only about 4 parts per million per degree centigrade.<sup>4</sup> Moreover, it is easily cut from the mother quartz (involving rotation only about the X or electrical axis). It has the disadvantage of having a relatively large coupling to the face shear mode when wide crystals are used.

Because of the two advantages mentioned, the +5-deg X-cut crystal was chosen for the present filter construction. A single-section channel filter was found to have a spurious resonance due to the coupling to the shear mode. The response occurred at a frequency approximately 116 percent of the passband midfrequency and reduced the attenuation to within 11 db of that of the passband itself.

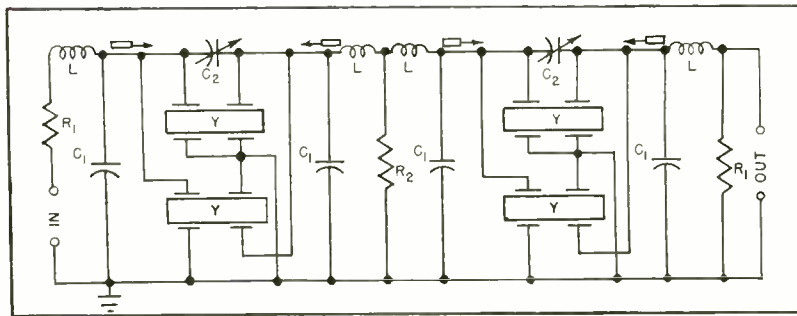
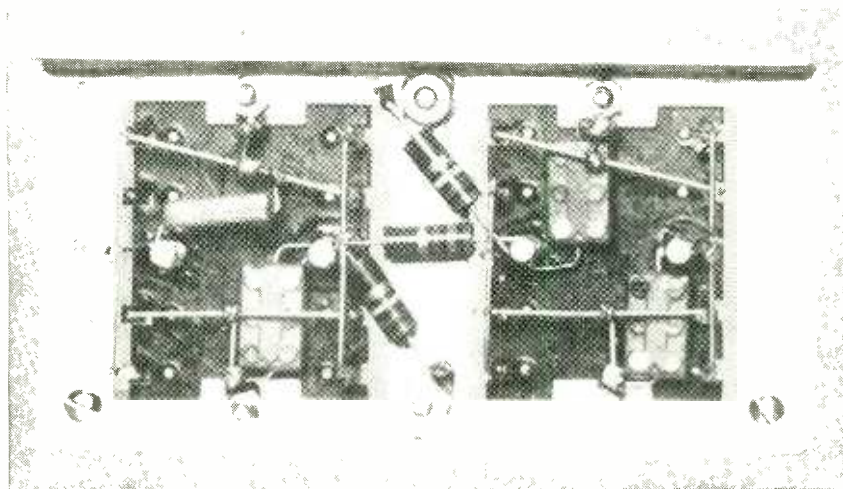
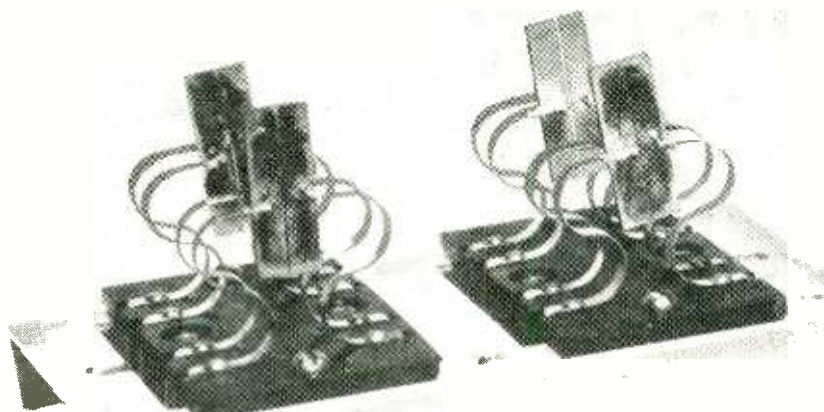

FIG. 12—A double-section 6-kc-channel crystal filter. Capacitors  $C_1$  permit fine adjustment of passband width,  $C_2$  fine adjustment of attenuation peaks,  $L$  are passband widening coils,  $R_1$  are terminating resistors,  $R_2$  are interstage impedance-matching resistors and  $Y$  are +5-deg X-cut crystals

When a filter of four sections was tested, however, no observable indication of any secondary response at all was present. This is evident in the graphs of Fig. 14 and Fig. 15 where the attenuation is 87 db or greater for all frequencies more than 1.2 kc (1.1 percent) higher

than the upper edge of the passband. This desirable result was due to the slight differences in crystal frequencies for the four filter sections resulting from the choice of different peaks of maximum attenuation for each section.

By the use of equations given by



Top and bottom views of two-section 6-kc bandpass crystal filter chassis

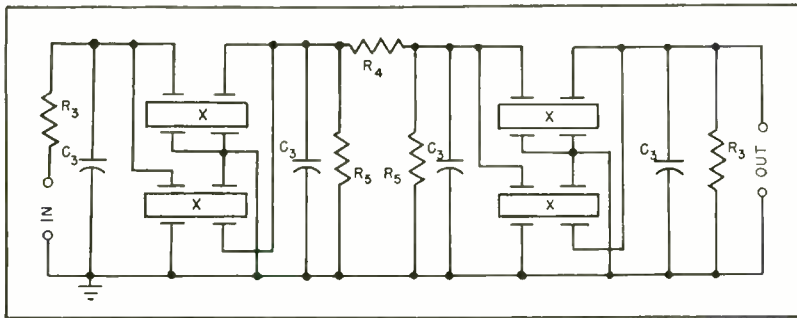

FIG. 13—A double-section 20-cycle crystal filter. Capacitors  $C_3$  control passband width,  $R_5$  are terminating resistors,  $R_4$  and  $R_3$  are interstage impedance-matching resistors and X are +5-deg X-cut crystals. These components are shown in the illustrations on this page

Atwood<sup>3</sup> we find for the +5-deg X-cut crystal that  $f = 110.5/y'$  kc.

This equation is strictly accurate for only very narrow crystals, of which  $y'$  is the length. The crystals were designed to have a width/length ratio of about 0.35 in order to secure the +5-deg X-cut

crystal minimum temperature coefficient of 4 parts per million per degree centigrade previously mentioned. As X-cut crystals of larger and larger widths are used, the crystal frequency constant decreases somewhat from that of a very narrow crystal.<sup>3</sup> For a width/

length ratio of 0.35 the decrease is 1.8 percent. Hence the equation is modified for the crystals used in the present project to

$$f = 108.5/y' \text{ kc}$$

A preliminary study of the effect of interelectrode and stray capacitances together with midband frequency and bandwidth requirements for the 6-kc bandpass filters dictated the use of very thin crystals. Having chosen a minimum feasible thickness and a width/length ratio of around 0.35 the equivalent motional capacitance of a sample crystal was found by measurement of its static capacitance together with its resonant and antiresonant frequencies. Substitution of this value for  $C_2$  or  $C_3$  in Mason's equations determined the image impedance  $Z_o$  of the filter. This value of  $Z_o$  was, therefore, used in calculating all the electrical components of the 6-kc bandpass filters.

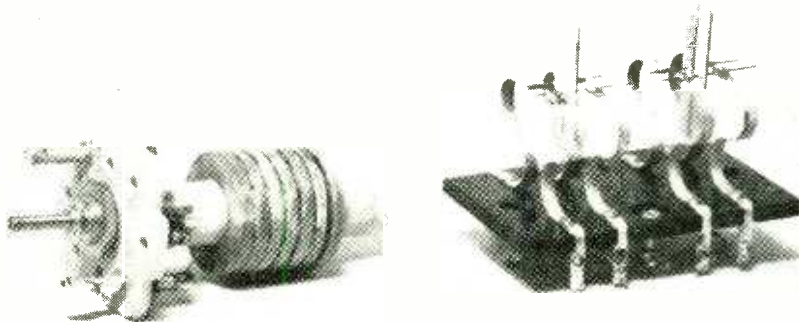

Crystal mounting and coil details for 6-kc bandpass crystal filter

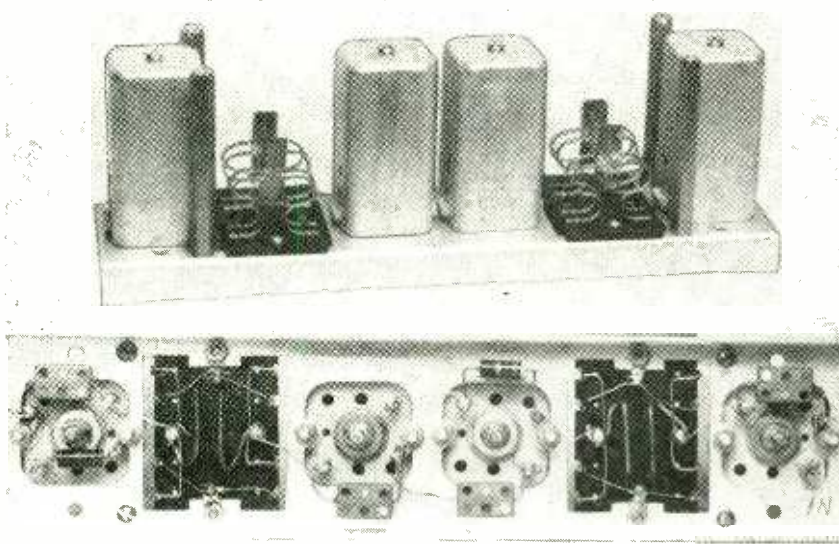

Top and bottom views of two-section 20-cycle filter chassis for 100-kc carrier

#### Construction of Channel Filters

To obtain the sharp cutoff and large attenuation required by the specifications, a filter of four sections was built for each of the 6-kc channel filters. Two shielding cans were used as containers for each complete filter, each can containing two filter sections. After the filter was mounted, dry air was passed through the can which was then hermetically sealed.

Each single-filter section consists of two crystals with divided plating, two coils in shielding cans, each equipped with adjustable powdered-iron cores, two small, fixed, molded-mica capacitors and a tiny bridging capacitor. The latter is formed by two short lengths of bus bar mounted about 1/4-inch apart on the bottom of the Bakelite crystal mounting base.

The circuit of each double-section filter is shown in Fig. 12. Resistor  $R_3$ , shunted between the interconnection of each two sections and the chassis, together with the resistances of the input and output coils, provides a T pad to serve for interstage impedance matching. External terminations were used with each double section filter.

Each series coil is a universal-wound coil on a 1/2-inch-diameter



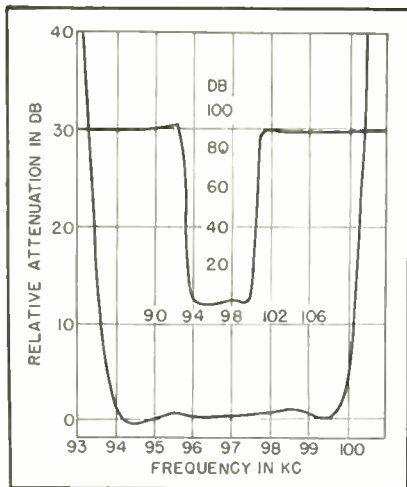

FIG. 14—Attenuation characteristic of a four-section crystal channel filter for 94-99.9 kc

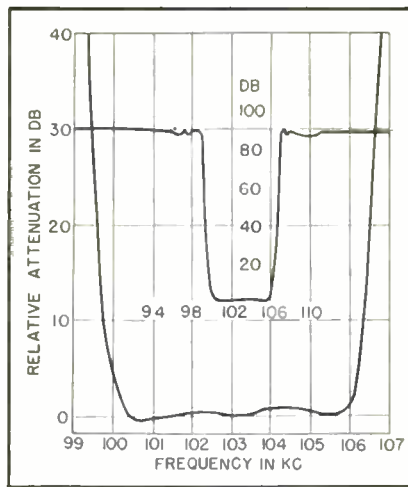

FIG. 15—Attenuation characteristic of a four-section crystal channel filter for 100.1-106 kc

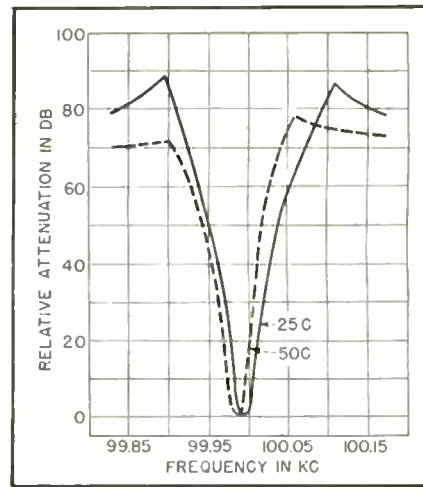

FIG. 16—Attenuation-frequency characteristic and effect of temperature change on the 100-kc 2-section carrier filter

Insulantite form. The coil is equipped with an adjustable powdered-iron core, and in use is mounted in the shielding can.

#### Construction of Carrier Filter

The narrow-band filter for the 100-kc intermediate-frequency carrier was much simpler in design and construction than the channel filters described above.

Calculated values of the motional capacitance together with the chosen theoretical passband width of 40 cycles, and the chosen frequencies of the attenuation peaks, determined the value of image impedance.

Here, again, as for the 6-kc channel filters, terminating resistors of smaller size than the image impedance were used to give a better impedance match throughout the passband. Figure 13 is a schematic diagram of the wiring of this double-section narrow-band filter.

Each single section consists merely of two divided-plating crystals, two small mica capacitors and the terminating resistors. The three resistors (at the center of the under-chassis view) constitute a pi-type attenuation pad of about 7 db between the two sections. Input and output terminating resistors are mounted externally to the shield can.

#### Results and Conclusions

Each of the two complete four-section 6-kc channel filters had an insertion loss within the passband

itself of about 24 db. To compensate for this loss, the filter was fed from and into vacuum-tube circuits. The tube supplying the signal to the input of the filter was a 6J5 used in a cathode-follower circuit for easy impedance matching. The output of the filter was fed to a 6SK7 pentode amplifier. The result was a gain within the passband of 1.5 db measured from input to cathode follower to output of the pentode amplifier. The same type of tube-circuit arrangement was used with the carrier filter.

The attenuation characteristics of the lower and upper channel four-section crystal filters are shown in Fig. 14 and 15. The average characteristics are as follows:

Width of passband between points 2 db down, 5.94 kc; 2-db point adjacent to carrier, 134 cycles from carrier, passband flat within  $\pm 0.6$  db over a bandwidth of 5.73 kc; bandwidth at 85 db down, 8.10 kc; attenuation greater than 87 db for all frequencies separated more than 4.17 kc from the passband midfrequency. Tests of the 6-kc channel filters at 25C and 50C respectively show a slight narrowing of the passband with rise in temperature averaging about two-and-one-half cycles per centigrade degree of temperature change. This is shown in Table I.

In Fig. 16 are shown two passband and attenuation characteristics of the double-section carrier filter. These were measured re-

spectively at 25C and 50C. A rise of temperature is observed to cause the characteristic as a whole to shift to slightly lower frequencies. The shift averages only 0.44 cycles per deg. The bandwidth of the filter characteristic measured at room temperature is 16 cycles at a relative attenuation of 3 db, 22 cycles at 6 db, 86 cycles at 50 db and 180 cycles at 78 db. The latter attenuation is maintained for all frequencies outside the 180-cycle band mentioned.

The author desires to express his appreciation for helpful guidance, valuable suggestions, and continued interest to E. D. Blodgett, Thomas Jacobi and L. L. Lakatos of the Engineering Products Department of the RCA Victor Division. He is also thankful to the staff of the RCA Crystal Engineering Department for preparation and mounting of the crystals, and to the RCA-Victor Division of the Radio Corporation of America at Camden, New Jersey, whose facilities made possible the development herein described.

#### REFERENCES

- (1) W. P. Mason, "Electromechanical Transducers and Wave Filters," Chap. VIII, D. Van Nostrand Co., Inc., 1942.
- (2) E. A. Guillemin, "Communication Networks," Vol. II, Chap. VIII, Art. 6; Chap. X, Art 2, John Wiley and Sons, 1935.
- (3) J. B. Atwood, The Equivalent Electrical Circuit of Quartz Crystals, RCAC Eng. Report E-72-7, 1/19/39, Sheets 6, 12, and 15.
- (4) R. A. Heising, "Quartz Crystal Applications," p 538, D. Van Nostrand Co., Inc., 1946.
- (5) W. P. Mason, Electrical Wave Filters Employing Quartz Crystals as Elements, *B.S.T.J.* 133, p 410, July 1934.

# Now available

PRODUCTION TOOLED

## CINCH-ERIE "Plexicon" EXP 8365 Miniature Tube Socket



A joint development of ERIE RESISTOR CORP.  
and CINCH MANUFACTURING CORPORATION

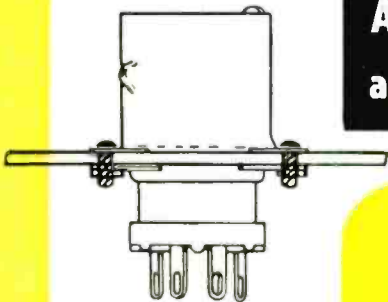

Bayonet shield base when shielding of tube is necessary.



Three lengths of shield cans are available:  
No. 8660, height 1 3/8"  
No. 8661, height 1 3/4"  
No. 16G12564, height, 2 1/4"

With built-in Ceramic Condensers, Plexicon Tube Sockets provide the most effective method of by-passing . . . with condenser close to tube element providing shortest path to ground. Capacity up to 1,000 MMF — any tube element may be coupled or by-passed as desired.

Any or all terminals of this socket may be by-passed to ground or coupled.

Also available in Octal, Loktal and Noval type sockets.



Mounting Strap, EXP 8556



Erie Ceramic Condensers

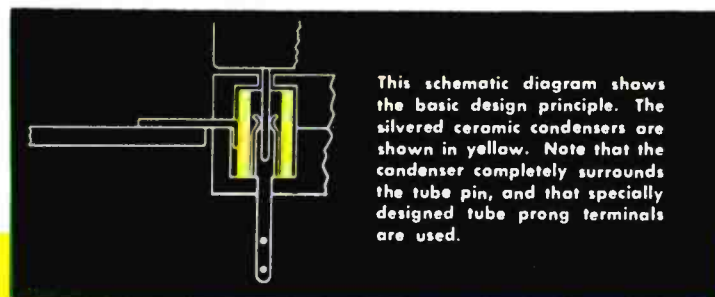

This schematic diagram shows the basic design principle. The silvered ceramic condensers are shown in yellow. Note that the condenser completely surrounds the tube pin, and that specially designed tube prong terminals are used.

Write for detailed information, and in ordering specify capacities required and position of condensers.

AVAILABLE AT LEADING ELECTRONIC JOBBERS . . . everywhere

### CINCH MANUFACTURING CORPORATION

2335 WEST VAN BUREN STREET CHICAGO 12, ILLINOIS

Subsidiary of United-Carr Fastener Corporation - Cambridge 42, Massachusetts





# Tele Service Areas

By JOHN H. BATTISON

*Allocations Engineer  
American Broadcasting Co., Inc.  
New York, N. Y.*

**T**HE accompanying charts, based upon FCC assumptions and data, provide a quick approximation of television service areas for the 5,000  $\mu$ v per meter (solid line) and 500  $\mu$ v per meter (dashed line) contours. Receiving antenna height is assumed to be 30 feet above average terrain.

To determine the distance from a channel 20-kw transmitter 2,000 feet above average terrain to the 5,000  $\mu$ v per meter contour, enter the appropriate chart at the left and follow the effective radiated power line across to its junction with the solid curve for 2,000 feet. Then read off the distance in miles (29 miles, in this case) from the scale at the top of the graph. The 500  $\mu$ v contour from a similar transmitter would be found at 60 miles, using the dashed line for height and the lower scale of miles.

Power and antenna height necessary for desired coverage can also be determined from the charts.

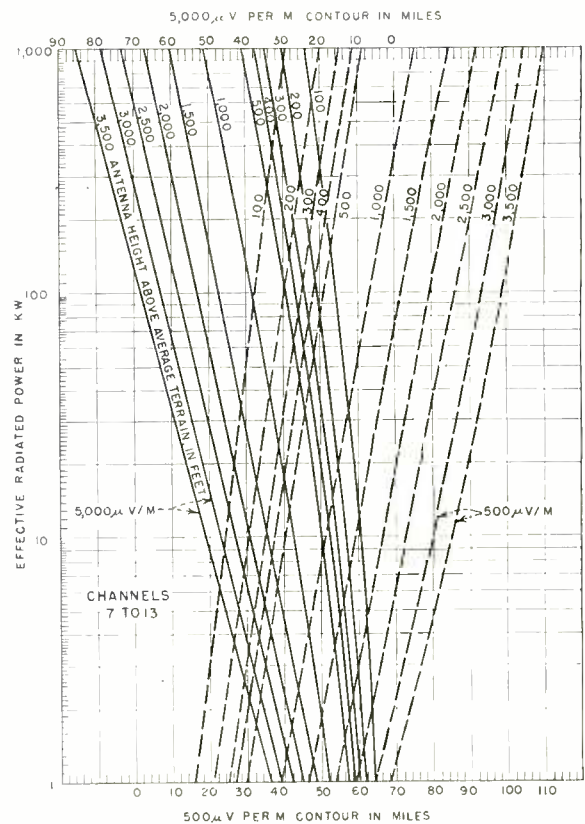
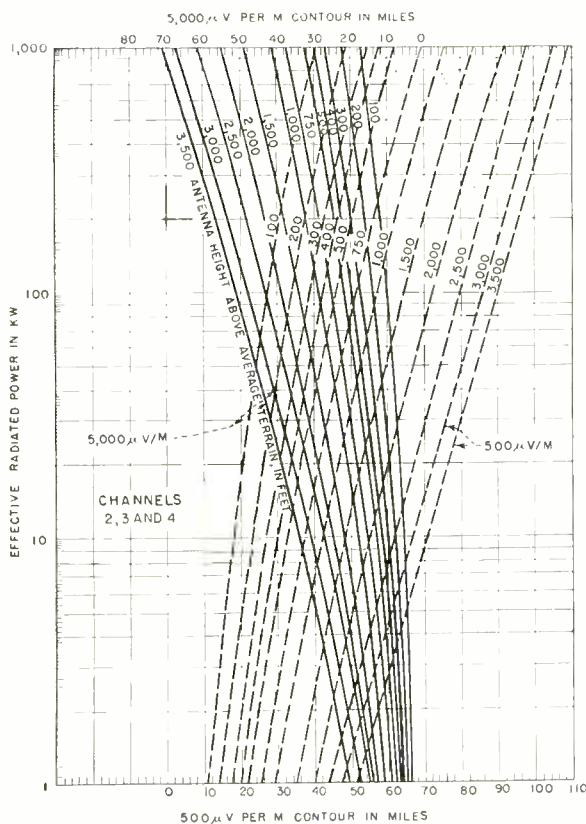
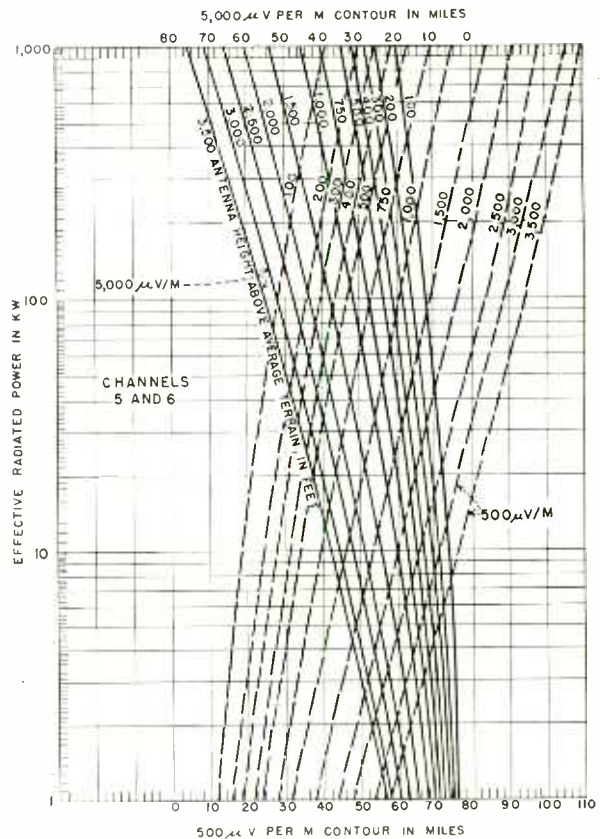

# Meet P.R. MALLORY & CO. Inc. MALLORY Midgetrol

*The First All New Variable Resistor in Years*

This is  
the **SIZE**

15  
/ 16  
"

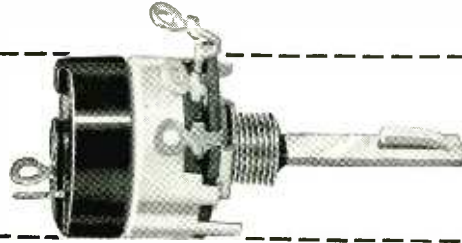

These are  
the **FEATURES**

- **LOW NOISE LEVEL**—both mechanically and electrically—stays quiet, too, even after tens of thousands of cycles.
- **HIGHER STANDARDIZATION**—faster delivery schedules—thanks to new design.
- **NEW TERMINALS**—you can bend or twist terminals without breaking them.
- **NEW TERMINAL LOCATION**—farther away from mounting surface—eliminates need for extra insulation.
- **ADAPTABLE TO TELEVISION**—voltage characteristics make it adaptable for television receivers as well as radio sets and all applications requiring variable resistors.
- **SAVES SPACE**—can be specified where a larger control ordinarily would be needed.
- **LIGHT**—ideal for portable radio applications.
- **FLAT SHAFT**—for standardization and uniformity in production—adaptable to any type knob now used.
- **NEW SWITCH**—specially designed to give long, trouble-free life.

This is **IT**

This quiet, smooth working control is the first really new design in years—and behind it are years and years of Mallory experience and diversified manufacturing facilities in metallurgy and electronics. You can specify the Midgetrol with complete confidence. Write today for Technical Information Bulletin and Specification Sheet.

P.R. MALLORY & CO. Inc.  
**MALLORY** CAPACITORS . . . CONTROLS . . . VIBRATORS . . .  
SWITCHES . . . RESISTORS . . . RECTIFIERS . . .  
VIBRAPACK\* POWER SUPPLIES . . . FILTERS

\*Reg. U.S. Pat. Off.

**APPROVED PRECISION PRODUCTS**

**P. R. MALLORY & CO., Inc., INDIANAPOLIS 6, INDIANA**



# TUBES AT WORK

Including INDUSTRIAL CONTROL

Edited by VIN ZELUFF

Airborne Magnetometer .....	124
RPM Counter .....	144
Metal Picture Tube .....	152
Amplitude-Selective Amplifier .....	156

## Airborne Magnetometer

MEASUREMENTS accurate to one part in 50,000 of the earth's magnetic field are made with the airborne magnetometer developed by the Gulf Research and Development Co. engineers and geologists and recently demonstrated at Westchester County airport. The instrument is currently being used in prospecting for oil and mineral deposits. The odds of finding oil have been improved from approximately 16:1 to 5:1 by the use of such reconnaissance tools as airborne magnetometers, gravimeters and seismographs. Novel magnetic and circuit techniques are used in the magnetometer to obtain its high sensitivity.

### Operating Principle

Geologists have used the correlation between the magnetic field of

the earth at its surface and the underground rock formations for many years. For these measurements on the ground, a delicately balanced instrument was used, but to survey large or rugged areas took a great deal of time and effort.

Several difficulties arise if a conventional magnetometer is used in an aircraft. Accelerations of the instrument must be counteracted. This requirement limits the design to one having no moving parts. Because of the speed of motion, the instrument must be automatically recording; an operator could not take readings fast enough in a plane flying at 120 mph. The magnetic fluctuations to be measured are so slight that they could be masked by unbalanced magnets and currents, so the instrument must be suspended a considerable dis-

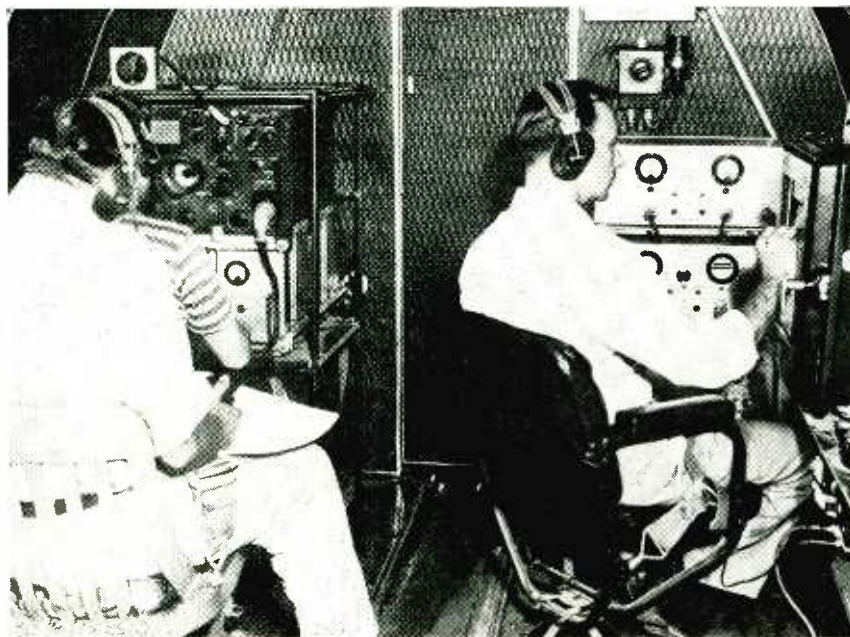

In flight, the magnetometer operator at the right makes notations on the magnetic record of information provided by the sensing unit. At left, an operator checks the shoran pulses while the flight director corrects the course flown and advises the pilot

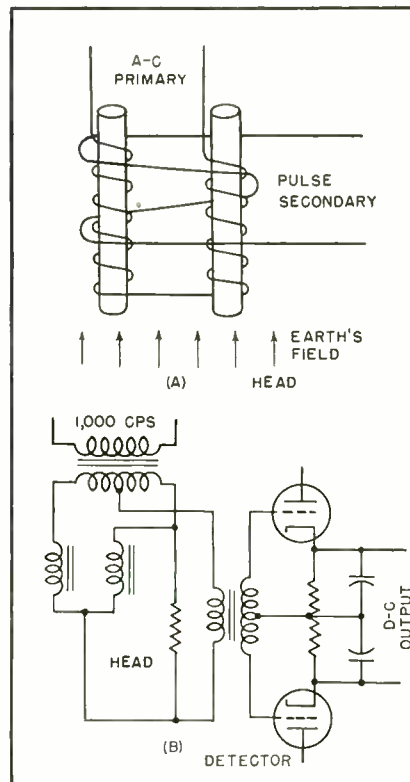

FIG. 1—Magnetometer head depends for its action on the change in inductance as the core becomes saturated (A). The pulses produced by the head are converted to direct current and combined to give a signal proportional to the magnetic field

tance from the mother plane.

To meet these requirements, a sensing element of the flux-gate type was developed, and by 1941 had been perfected sufficiently for airborne use. During the war the instrument was used for locating submerged submarines, for which application it needed to be sensitive only to short, intense discontinuities in magnetic field. It has been further refined to give an absolute indication and to hold its calibration.

Basically the sensing element consists of two thin cores of highly permeable alloy on which are wound two separate coils as shown in Fig. 1A. The sensitivity of the element is obtained by exciting these identical coils with alternating current (1,000 cps).

As long as the impedances presented by both coils are equal, the voltages across the two primaries will be equal, whether the cores are saturated or not, because both cores will become saturated simultaneously, although with opposite polarities. However, if the element is placed in a fixed magnetic field, the

**THE IMC ENGINEER IS**

*On Your Staff*



**but not on your payroll**

**TUNE IN THE  
ELECTRICAL  
INSULATION  
HEADQUARTERS**



Because your IMC engineer represents not just one, but most of the recognized leading manufacturers of electrical insulation—each specializing in his own particular product—his experience in the insulation field is more complete. As a specialist in electrical insulation, he and the IMC organization behind him are qualified to . . .

1. Assist you in the selection of the best insulating materials for the job.
2. Familiarize you with their proper application.
3. Suggest ways to eliminate waste.
4. Increase your production.

**PRODUCTS LIST:** Macallen Mica Products—Vartex Varnished Cloths and Tapes—Varslot Combination Slot Insulation—Fiberglas Electrical Insulation—Manning Insulating Papers and Pressboards—Dow

Corning Silicones—Dieflex Varnished Tubings and Saturated Sleeveings—National Hard Fibre and Fishpaper—Phenolite Bakelite—Permacel Adhesive Tapes—Asbestos Woven Tapes and Sleeveings—Inmanco Cotton Tapes, Webbing, and Sleeveings—Pedigree Insulating Varnishes—Wedgie Brand Wood Wedges.

# INSULATION

**MANUFACTURERS CORPORATION**

\*CHICAGO 6  
565 W. Washington  
Boulevard

MILWAUKEE 2  
312 East Wisconsin  
Avenue

DETROIT 2: 15 Lawrence Avenue

\*Local Stocks Available

Representatives in:

MINNEAPOLIS 3: 1208 Harmon Place PEORIA 5: 101 Heinz Court



\*CLEVELAND 14  
1231 Superior  
Ave., N. E.

DAYTON 2  
1315 Mutual Home  
Building





Sensing element of the airborne magnetometer and the gimbal mounting for positioning the unit parallel to the earth's magnetic field

two cores will become magnetically biased so that one will enter saturation in the direction of the external field before the other enters saturation in the opposite direction. Thus there will be a moment when the two coils do not present equal impedances.

A short voltage pulse will occur across a secondary winding (or its electrical equivalent) because of the phase shift of the moment of passing the knees of the magnetization curves of the two cores. For small external fields, the amplitude of this pulse is proportional to the field strength (The Gulf Airborne Magnetometer, R. D. Wyckoff, Geophysics, p 182, April, 1948).

#### *Auxiliary Circuits*

To use such an element in an airplane requires several auxiliary circuits. Figure 1B shows the detector circuit with which the pulses are picked off the sensing element by a differential transformer and converted to direct current by cathode followers. By design of the sensing circuit and coupling transformer, sufficient voltage is obtained at the input to the differential cathode-follower circuit so that no subsequent amplification is necessary.

Because of the permeability of the cores of the magnetometer head, the unit is saturated by relatively weak fields. To prevent saturation and also to provide a range

(continued on p 140)

## THE FRONT COVER

**E**LECTRONIC EQUIPMENT mounted in the nose of this P80 jet fighter permits the operation of all flight controls by radio from the ground during takeoff and landing and within easy radar range of the field. On longer flights control may be taken over by a mother plane.

Principal use planned for this drone is the conducting of tests considered too hazardous for a pilot to undertake, such as power dives requiring pullout at speeds no human can withstand. Tests of this nature are scheduled to take place at Muroc Air Force Base in California in the near future.

Space normally occupied by the engine in conventional ships contains, in this case, about three times as much equipment as that visible in the accompanying photograph. It includes an f-m transmitter and receiver, telemetering and television equipment.

A television camera monitors an instrument panel set up in the forward portion of the nose. The panel contains the attitude gyro, airspeed indicator, altimeter, tachometer, magnetic compass, accelerometer, elevator trim tab position, correlating counter, dive flap down light and fire warning light.

Four motion picture cameras in the plane are started and stopped by remote control. One is in the cockpit to photograph the regular instrument panel, one alongside the television camera in the nose and two mounted in the fuselage to photograph either wing tip.

The correlating counter on the instrument panel in the nose is used, along with pips entered at intervals directly on movie film in each camera, to correlate all movies with the plane's actions at a given moment and also with a fifth camera photographing the television receiver screen in the truck. By use of television, the plane can be flown by remote control from inside the truck, except for take-off and landing.

Pictured testing the electronic equipment is civilian radio-control engineer Richard W. Hill, of the instrumentation section of the Flight Test Division at Air Materiel Command headquarters, Wright-Patterson Air Force Base, Ohio. U. S. Air Force photo by CWO Stephen P. Mongelluzzo.

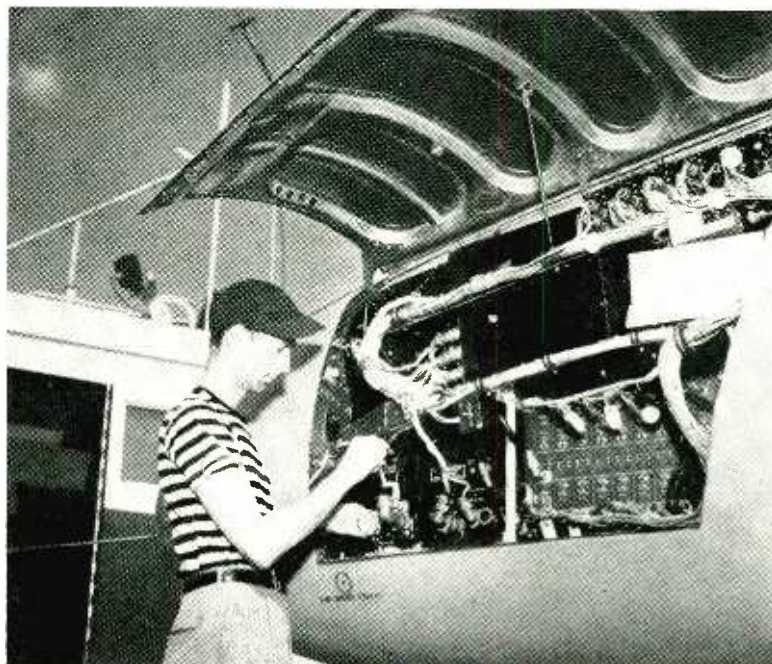

# Pick the *POWER* you need

take the performance for granted

8 WATTS



755A

Combines outstanding quality with low cost and small space requirements. Frequency range 70 to 13,000 cycles. Coverage angle 70°. 8 $\frac{3}{8}$ " in diameter, 3 $\frac{1}{8}$ " deep. Requires only 2 cubic feet of enclosure space.

20 WATTS



756A

Ample power capacity for the great majority of applications—*plus peak* performance. Frequency range 65 to 10,000 cycles. Coverage angle 60°. 10 $\frac{1}{4}$ " in diameter, 3 $\frac{1}{4}$ " deep. Enclosure space 2 $\frac{1}{2}$  cubic feet.

30 WATTS



728B

Ideal for use wherever extra high power is needed. Frequency response 60 to 10,000 cycles. Coverage angle 50°. 12  $\frac{11}{32}$ " in diameter, 3  $\frac{25}{32}$ " deep. 3 cubic feet of enclosure space.

THESE THREE direct radiators will meet practically all your requirements—in broadcast stations, wired music, program distribution and sound systems, high-quality home radios and record players. Pick the ones you need on the basis of *power requirements*. You'll find superior *quality of reproduction* in all of them.

Get the full story of this Western Electric line from your local Graybar Broadcast Representative—or write Graybar Electric Company, 420 Lexington Avenue, New York 17, N. Y.

DISTRIBUTORS: IN THE U. S. A. — Graybar Electric Company.  
IN CANADA AND NEWFOUNDLAND—Northern Electric Company, Ltd.



## Western Electric

—QUALITY COUNTS—



# THE ELECTRON ART

Edited by FRANK ROCKETT

Magnetic Field Patterns Shown by Electron Microscope.....	128
The Eriscope Camera Tube.....	130
The Miller F-M Circuit.....	130
Precision Circuit Printing.....	190
The Synchrostab Timer.....	196
Survey of New Techniques.....	200

## Magnetic Field Patterns Shown by Electron Microscope

EXTENSION of the experimental method adapted at the National Bureau of Standards for visually studying magnetic fields provides a powerful means for investigating space-charge fields, fields produced by contact potentials, configurations inside waveguides, and the microstructure of metals. The method, developed by L. L. Marton, is the electronoptical analogy of the Schlieren effect in optics. By it, static magnetic and electric fields can be examined without the disturbing effects of probes; it is being used to measure the magnetization of wire used for sound recording and for storing data to be used by electronic computers.

### Dark-Field Image

Figure 1A shows an image produced by the modified electron microscope used in the quantitative study of magnetic fields. The electronoptical arrangement by which this image is produced is shown in Fig. 1B. Electrons from source *A* are normally brought to a focus by lens *C* at point *D*. However, if there is a disturbing field at *B* such

as a magnetized wire, it will distort the electron trajectories so that a dark image of the obstruction will be formed on screen *E* placed in the conjugate plane. The lens will also bring to focus on this plane an image of the disturbing field. A stop intercepts the undisturbed electrons focused at *D*. The dark-field image at *E* is made visible by a fluorescent screen or is recorded as a micrograph. Figure 1C is an approximate picturization of the action involved.

Figure 2 shows the image produced when a presaturated thin laminar steel sample with a feather edge is placed in the electron microscope between the source and the lens. The objective lens was slightly misaligned in making this picture to bring one edge of the objective parallel to the observed edge. In this way the direct rays were intercepted by the objective aperture, only the electrons scattered at the edge of the specimen reaching the final image plane to form the image. The faint pattern at right angles to the edge of the bright line, visible wherever the line is in-

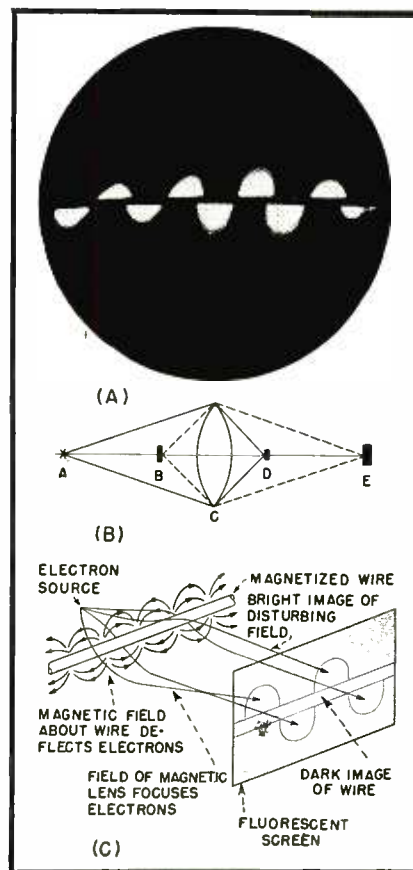

FIG. 1—(A) Opposite polarities of adjacent magnetized regions on both sides of a wire deflect electrons of microscope to produce bright semicircles on a fluorescent viewing screen. The optical system (B) intercepts direct rays unaffected by field of wire as shown by solid lines; dashed lines show how field of wire is focused on screen by same lens. An approximate perspective drawing (C) shows paths of deflected electrons. This electron analogy of the optical Schlieren effect adds another type of object, namely fields, that can be observed in electron microscopes

terrupted, is assumed to be due to the fringe field of ferromagnetic domains or of grain boundaries. In this way a visual representation of fringe fields from the small domains of spontaneous magnetization in ferromagnetic materials is

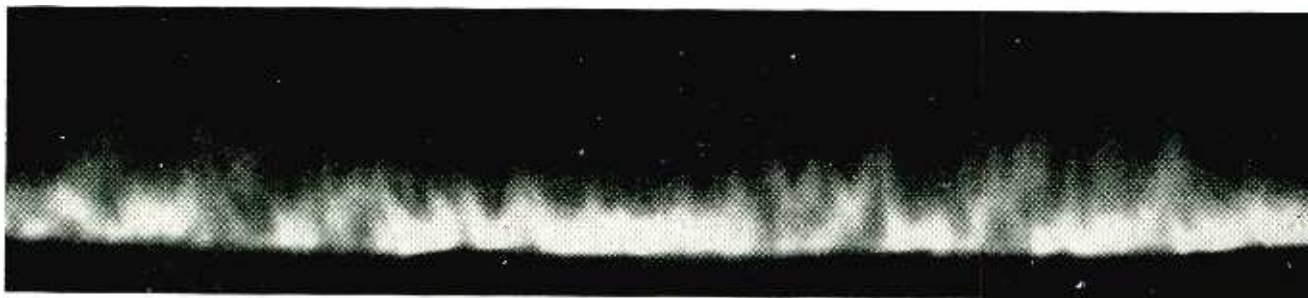
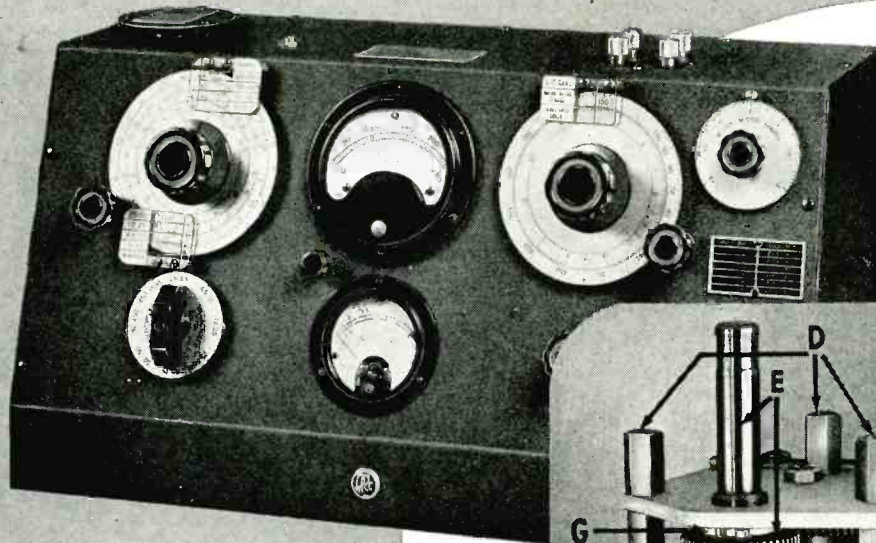
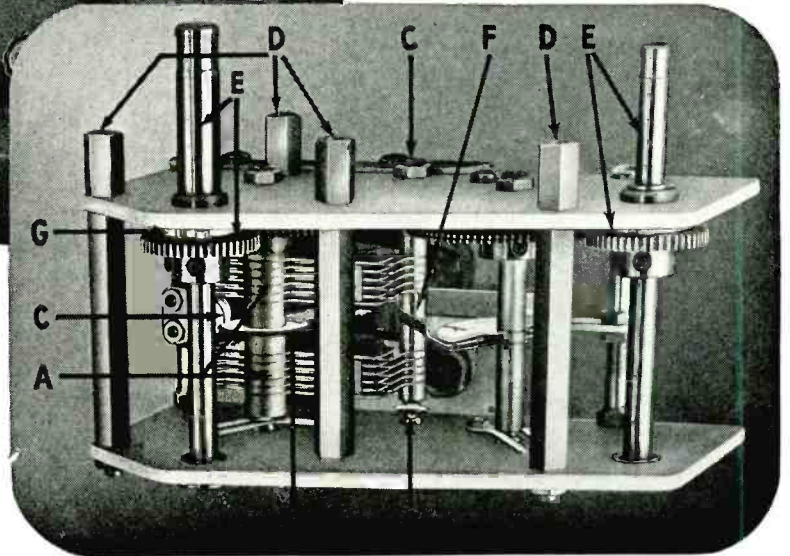

FIG. 2—Micrograph made with modified electron microscope of the fringe field along the edge of a steel sheet indicates that magnetic domains or grain boundaries are a few microns apart (magnification about 50,000 diameters)

# For the MEASUREMENT of Q, INDUCTANCE and CAPACITANCE



The  
**160-A Q-METER**  
50 KC. to 75 MC.



Radio frequency circuit design often requires the accurate measurement of Q, inductance, and capacitance values. For this application, the 160-A Q-Meter has become the universal choice of radio and electronic engineers throughout the country.

Each component part and assembly used in the manufacture of this instrument is designed with the utmost care and exactness. Circuit tolerances are held to values attainable only in custom built instruments.

Consider, for example, the Q tuning capacitor assembly of the 160-A Q-Meter, specially manufactured for maximum range, low loss, and minimum residual inductance. The ultimate design of this unit was reached only after months of intensive engineering research to produce the finest in performance, quality, and workmanship.

This is but one of the many desirable features of the 160-A Q-Meter which contribute to its outstanding accuracy and dependability.

Be sure to include the 160-A Q-Meter in your new equipment plans for 1948.

Write for Catalog "E"

**BOONTON RADIO**

BOONTON · N · J · U · S · A ·

*Corporation*



Shown above is the Q tuning capacitor assembly of the 160-A Q-Meter. Note the following design features of this unit—features which insure reliable, trouble-free operation.

- A. Parallel connection of dual rotor and stator assemblies minimizes internal inductance and resistance.
- B. Spring silver fingers contact both sides of silver disc to provide low series resistance.
- C. Three point pyrex ball stator suspension reduces losses and permits accurate stator alignment.
- D. Four point panel mounting designed to produce maximum structural rigidity and capacitance stability.
- E. Precision-cut brass spur gears and stainless steel shafts, mounted in oversize bearings, assure long, trouble-free service.
- F. Common stator mounting for main and vernier stator plates reduces loss and internal series resistance of vernier capacitor section.
- G. Positive shaft stop protects main rotor assembly and gears against mechanical overload.

#### SPECIFICATIONS

Oscillator Frequency Range: 50 kc. to 75 mc. in 8 ranges.

Oscillator Frequency Accuracy:  $\pm 1\%$ , 50 kc.—50 mc.  
 $\pm 3\%$ , 50 mc.—75 mc.

Q Measurement Range: Directly calibrated in Q, 20-250. "Multiply—Q—By" Meter calibrated at intervals from x1 to x2, and also at x2.5, extending Q range to 625.

Q Measurement Accuracy: Approximately 5% for direct reading measurement, for frequencies up to 30 mc. Accuracy less at higher frequencies.

Capacitance Calibration Range: Main capacitor section 30-450 mmf, accuracy 1% or 1 mmf whichever is greater. Vernier capacitor section  $\pm 3$  mmf, zero,  $-3$  mmf, calibrated in 0.1 mmf steps. Accuracy  $\pm 0.1$  mmf.

DESIGNERS AND MANUFACTURERS OF THE Q METER · QX CHECKER  
FREQUENCY MODULATED SIGNAL GENERATOR · BEAT FREQUENCY  
GENERATOR AND OTHER DIRECT READING INSTRUMENTS



obtained from which the field distribution and domain sizes can be computed.

## The Eriscope Camera Tube

By **BOYD FRANCE**

*McGraw-Hill World News  
Paris, France*

HIGH RESOLUTION AND SENSITIVITY are obtained in the French television camera tube called the eriscope. Like the image orthicon, this tube separates the functions of forming and scanning the image.

Comparative tests of the eriscope and the image orthicon conducted at the Zurich Polytechnical School

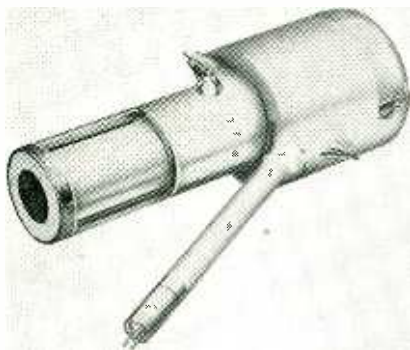

Like image orthicon, formation of electrical image and scanning are separate operation in eriscope; signal is amplified externally

indicated that the eriscope had the greater resolution; it produced sharper images with greater tonal range and half-tone definition and less spotting. All tubes now coming from the production line of the Society Radio Industrie de France have a definition of 800 lines, some are capable of 1,000 lines. All these tubes being made currently are for the state television company. The tests also showed that the image orthicon is the more sensitive. For picking up outdoor scenes with the eriscope, 100 lux is sufficient. Under artificial light it is necessary to increase the illumination to 500 lux because the tube is less sensitive to red than to blue light.

### *Forming and Scanning the Image*

By separating the functions of converting light images into electrical ones and of scanning the electrical images, the elements of the

camera tube can be designed independently for maximum efficiency. The transparent photosensitive cathode, whose position is shown in the accompanying diagram, is an alloy of cesium and antimony. The optical image is formed on the interior surface of this cathode thus emitting electrons in proportion to the incident photons. These electrons are accelerated by an anode at 500 volts above the photocathode, the two electrodes forming a divergent lens for the electrons. A magnetic focusing coil gives the electrons a trajectory such as that shown in the diagram.

In this way the optical image has been converted into an electrical image, which in turn has been focused on the scanning target at the far end of the tube. The target is a semiconductor made of a sheet of mica coated thinly with metallic cesium. The electrons from the photocathode form an electrical image on this target corresponding to the optical image. The target is then scanned by a beam of electrons from an electron gun in the arm of the tube. This beam is magnetically focused to a spot whose size determines the resolution of the tube, and is magnetically scanned

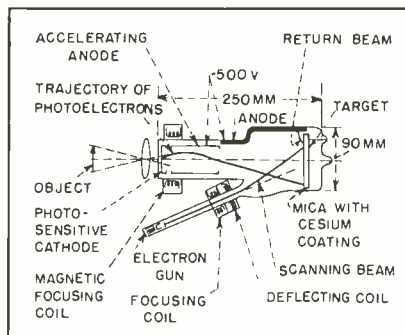

Because image target has no mosaic, resolution is only limited theoretically by focus of scanning beam

over the image on the target. With a beam 0.10 millimeter in diameter it is possible to obtain a definition of 400 lines using an 80 square millimeter target. Higher resolutions are obtained by finer focusing.

The beam is charged to the same potential as the target. As it reaches the target, electrons are deflected from it in proportion to the surface charge of the target. These

deflected electrons are picked up by an anode on the surface of the tube producing the output signal, which is amplified externally. The undeflected portion of the beam momentarily erases the target image.

## The Miller F-M Circuit and Its Use in Railroad Radios

By **P. L. BARGELLINI**

*Florence, Italy*

THE INCREASING DEVELOPMENT of communication systems using frequency or phase modulation has stimulated the invention of several forms of modulators. In practical use these modulators suffer from poor carrier stability or great complexity in their stabilizing circuits, and limited ranges of linearity. Because of inadequacies in the reactance-tube modulators being used in experiments with railroad radiophones, especially microphonics in the reactance tube, another type of frequency modulation circuit was devised.

### *Miller-Effect Modulator*

Important properties of a frequency modulator are: (1) inertialess linear frequency controlling element, (2) simple production and injection of voltage for stabilizing carrier frequency, and (3) stability in the presence of mechanical vibration. Requirement (1) calls for an electronic modulating element of considerable simplicity. (The reactance tube suffers from the fact that it can never be a pure reactance, always having some residual resistance.) Requirement (2) is more simply satisfied if the frequency modulation is produced directly rather than indirectly as in some systems. A triode more adequately fills requirement (3) than a multigrid tube.

The means taken to meet these requirements is shown in Fig. 1A. By it, a pure reactance can be injected into the oscillatory circuit. The quadrature current is simply obtained from the grid-cathode space current of a triode that is excited by the controlled resonant L-C circuit and that has a purely resistive load. Analysis of the cir-

(continued on p 186)

*achieving a new 'high' of efficiency!*

**U.I.C.**

**CERAMIC *Hi-Load* CAPACITORS**

Designs registered U.S.A., U.K. and other territories.

**for R.F. Heaters  
and Transmitters**

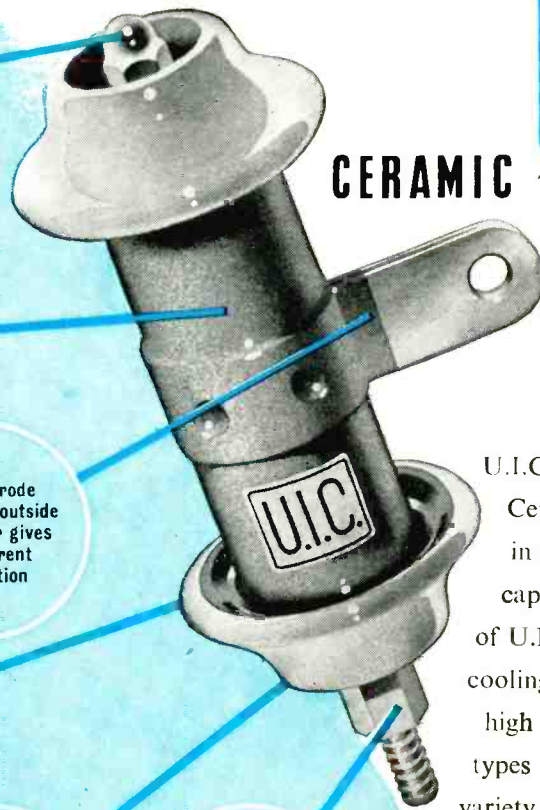

Special silver layer gives low-loss high conductivity electrode surfaces

Special ceramic body gives low losses under R.F. load

Tag electrode soldered to outside silver layer gives even current distribution

Glazed sheds give ample flash-over path in all conditions of humidity

Aero-dynamic shape gives improved cooling, particularly with forced draught

Heavy rod with double spider mounting gives reliable heavy current connection to inside silver layer

TAG MOUNTING TYPE

U.I.C. of England, pioneers in the manufacture of Ceramic Transmitter Capacitors, are foremost in the application of aerodynamic principles to capacitor design. The new aerodynamic shape of U.I.C. "Hi-Load" Capacitors gives optimum cooling in still air. With forced draught their high R.F. ratings can be multiplied. All three types of mounting assist cooling and cater for a variety of applications, such as single stand-off tag fitting, parallel and series banking for very large powers, and lead-through types for anode by-pass.

*Examples from a wide range of Types*

Type	HLS203I	HLT202I	HLT202I	HLC201I	HLC2014★
Capacitance	125pF	300pF	600pF	800pF	1000pF
Max. R.F. Load	70KVA	50KVA	50KVA	25KVA	40KVA
Peak Voltage	7.5KV	7.5KV	7.5KV	7.5KV	7.5KV
Max. R. F. Current	30 Amps.	30 Amps.	30 Amps.	30 Amps.	30 Amps.
Body Dimensions	1 3/8" x 3 1/2"	1 3/8" x 3 1/2"	1 3/8" x 3 1/2"	1 3/8" x 3 1/2"	1 3/8" x 3 1/2"

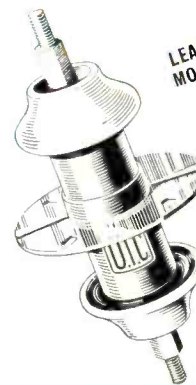

LEAD-THROUGH MOUNTING TYPE

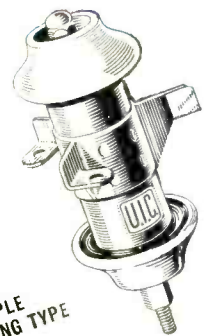

TRIPLE MOUNTING TYPE

★ Lead-through type, all other examples tag type.

**UNITED INSULATOR CO. LTD**

TOLWORTH · SURBITON · SURREY · ENGLAND

CABLES: CALANEL · SURBITON · SURREY

**U.I.C.**  
Unsurpassed In Ceramics



# NEW PRODUCTS

Edited by A. A. McKENZIE

**New equipment, components, tubes, testing apparatus and products closely allied to the electronics field. A review of catalogs, handbooks, technical bulletins and other manufacturers' literature**

## Polystyrene Capacitors

SOLAR MFG. CORP., 1445 Hudson Blvd., North Bergen, N. J., now has available a complete line of polystyrene-film dielectric capacitors. Typical applications include timing and integrating circuit capacitors, r-f padding capacitors

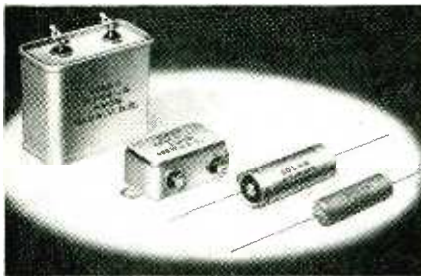

and coupling capacitors in extremely high-gain amplifiers. Complete list of standard ratings is given in catalog bulletin SPD-600.

## Klystrons

RADIO CORP. OF AMERICA, Harrison, N. J. First of a line of Klystron tubes for use in microwave relay



equipment are types 2K26 and 2K25. These tubes can be used both for transmission and reception, serving as local oscillator in the latter service.

## Conical Antenna

TELREX INC., 26 Neptune Highway, Asbury Park, N. J. Model 4XTV an-

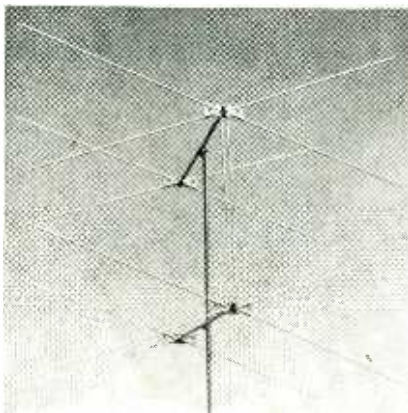

tenna gives conical performance without the bulk of solid spinnings. It features gain, bandwidth and resolution.

## Impedance Meters

SPERRY GYROSCOPE Co., Great Neck, N. Y., announces a series of nine instruments for determining impedance by measuring standing wave ratios and node positions in microwave transmission lines.

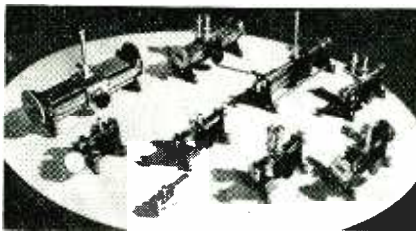

They can also measure relative power, attenuation and wavelength in the line. Accuracy is 2 percent for 650 to 40,000 mc. Catalog sheets are available.

## Molded Transformer Cores

STACKPOLE CARBON Co., St. Mary's Pa. Cores are available for horizontal deflection and flyback transformers. Two standard types

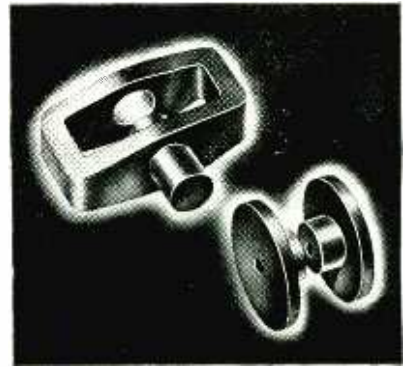

are available. Type 10034 is a large rectangular unit with sliding hub designed for universal use with any television tube. A smaller spool type 10748 is recommended for tubes smaller than 10 inches where space is at a premium.

## F-M Tape Recorder

AMPEX ELECTRIC CORP., 125 Howard Ave., San Carlos, Calif. De-



signed expressly for f-m broadcast service, the new Ampex tape recorder has a response within plus or minus 1 db between 30 and 15,000 cycles as well as other features designed for broadcast facility. Tape speed is 30 inches per second and the unit has a time capacity of 35 minutes.

## Keyboard Oscillator

WEINSCHEL ENGINEERING Co., Dept. E, 123 William St., New York 7, N. Y. This stable oscillator with low distortion is of the resistance-tuned type using negative feedback. Pushbuttons on the panel provide frequency variation. The unit

# 6 REASONS WHY 6,000,000\* RAYTHEON SUBMINIATURE TUBES Are Working For American Industry Today



- 1. REDUCED PRODUCT SIZE . . . INCREASED PRODUCT ACCEPTANCE.** Raytheon filamentary Subminiatures are flat. Batteries can be little instead of big because of extremely low filament drain.
- 2. PLUG INTO STANDARD SOCKETS — OVER ONE AND ONE-HALF MILLION IN USE.** All Raytheon Subminiatures can either be soldered or welded into the circuit, or plugged into the sockets available from several manufacturers.
- 3. NINE YEARS CONTINUOUS PRODUCTION EXPERIENCE.** Total customer returns of defective tubes in 1947 just under 1% of sales.
- 4. SUBMINIATURE TUBE APPLICATION ENGINEERING** available nationally since 1939.
- 5. READILY AVAILABLE FROM STOCK IN NEWTON, CHICAGO AND LOS ANGELES.** Over half a million of the tubes described below are available at all times. They are standard throughout the world.
- 6. AT YOUR LOCAL DISTRIBUTOR.** Over three hundred Raytheon Special Purpose Tube distributors stand ready to serve you quickly and intelligently.

\*More than all other makes combined!

Characteristics of Representative RAYTHEON Subminiature Tubes

Type No.	Remarks	Maximum Diameter Inches	Maximum Length Inches	Filament Or Heater		Mutual Conductance Umhos	Power Output MW	TYPICAL OPERATING CONDITIONS				
				Volts	Ma.			Plate Volts	Ma. Screen	Ma. Screen	Grid Volts	
<b>HEATER CATHODE TYPES</b>												
CK5702/CK605CX	Characteristics of 6AK5											
CK5703/CK608CX	Triode UHF Oscillator, 3/4 watts at 500 Mc	0.400	1.5	6.3	200	5000		120	7.5	120	2.5	-2.0
CK5704/CK606BX	Diode, equivalent to one-half 6AL5	0.400	1.5	6.3	200	5000		120	9.0			-2.0
CK5744/CK619CX	Triode High mu.	0.315	1.5	6.3	150			150ac	9.0			
CK624CX	Characteristics of 6AS6	0.400	1.5	6.3	200	4000		250	4.0			-2.0
<b>FILAMENT TYPES</b>												
2E31-32	RF Pentode for pocket radio					3200		120	5.2	120	3.5	-2.0
2E35-36	Output Pentode for pocket radio	0.300x0.400	1.56	1.25	50	500		22.5	0.4	22.5	0.3	0
2E41-42	Diode Pentode for pocket radio	0.290x0.390	1.56	1.25	30	385	1.2	22.5	0.27	22.5	0.07	0
2G21-22	Triode Heptode for pocket radio	0.290x0.390	1.56	1.25	30	375		22.5	0.35	22.5	0.12	0
		0.300x0.400	1.56	1.25	50	75		22.5	0.20	22.5	0.30	
RK61	Gas Triode, Exp. Radio Control					conv. cond.						
CK502AX	Output Pentode	0.550	1.81	1.4	50			45.0	1.5	Special Circuit		
CK503AX	Output Pentode	0.285x0.385	1.5	1.25	30	550	6.0	45.0	0.6	45.0	0.15	-1.25
CK505AX	Voltage Amp. Pent.	0.285x0.385	1.5	1.25	30	550	9.5	45.0	0.8	45.0	0.25	-2.0
CK506AX	Output Pentode	0.285x0.385	1.5	0.625	30	385		22.5	0.125	22.5	0.04	-0.625
CK510AX	Double Space Charge Tetrode Amplifier	0.285x0.385	1.5	1.25	50		25.0	45.0	1.25	45.0	0.40	-4.5
CK512AX	Low microphonic voltage amplifier	0.285x0.410	1.25	0.625	50	150†		45.0	0.06			0
CK522AX	Output Pentode 20 ma. filament	0.285x0.385	1.25	0.625	20	37†		22.5	0.125	22.5	0.04	-0.625
CK523AX	Output Pentode	0.285x0.385	1.5	1.25	20	450	1.2	22.5	0.30	22.5	0.08	0
CK524AX	Output Pentode	0.285x0.385	1.5	1.25	30	360	2.5	22.5	0.30	22.5	0.075	-1.2
CK525AX	Output Pentode	0.285x0.385	1.5	1.25	30	300	2.2	15.0	0.45	15.0	0.125	-1.75
CK526AX	Output Pentode	0.285x0.385	1.5	1.25	20	325	2.2	22.5	0.25	22.5	0.06	-1.2
CK527AX	Output Pentode 1.5 ma filament	0.285x0.385	1.5	1.25	20	400	3.75	22.5	0.45	22.5	0.12	-1.5
CK529AX	Shielded Output Pentode	0.285x0.385	1.5	1.25	15	225	0.75	22.5	0.10	22.5	0.025	0
CK551AXA	Diode Pentode	0.290x0.390	1.5	1.25	20	275	1.2	15.0	0.20	15.0	0.05	-1.5
CK553AXA	RF Pentode	0.300x0.400	1.56	1.25	30	235		22.5	0.17	22.5	0.043	0
CK5672	Output Pentode	0.300x0.400	1.56	1.25	50	550		22.5	0.17	22.5	0.13	0
CK5676, CK556AX	Triode, UHF Oscillator for radio use	0.285x0.385	1.5	1.25	50	625	60.0	67.5	2.75	67.5	1.0	-6.25
CK5677/CK568AX	Triode, UHF Oscillator for radio use	0.300x0.400	1.5	1.25	120	1600		135.0	4.0			-5.0
CK5678/CK569AX	RF Pentode	0.300x0.400	1.5	1.25	60	650		135.0	1.9			-6.0
CK5697/CK570AX	Electrometer Triode Max. grid current 5x10 <sup>-12</sup> amps.	0.300x0.400	1.5	1.25	50	1100		67.5	1.8	67.5	0.48	0
CK571AX	10 ma. filament electrometer tube, I <sub>g</sub> =2x10 <sup>-12</sup> amps.	0.285x0.410	1.25	0.625	20	1.5†		12	0.22			-3.0
CK		0.285x0.410	1.5	1.25	10	1.6†		10.5	0.20			-3.0

†Voltage Gain (times)

**RAYTHEON MANUFACTURING COMPANY**  
SPECIAL TUBE SECTION  
Newton 58, Massachusetts

RADIO RECEIVING TUBES • SUBMINIATURE TUBES • SPECIAL PURPOSE TUBES • MICROWAVE TUBES



*Excellence in Electronics*



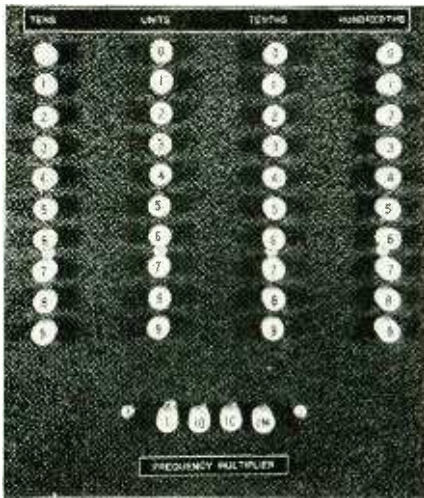

can be used as a signal source for distortion or bridge measurements, and also as an interpolation oscillator. Frequency range is from 1 cycle to 100 kc.

### Capacitance Bridge

GENERAL RADIO Co., 275 Massachusetts Ave., Cambridge 39, Mass. Type 1611-A capacitance test bridge measures over the range 1  $\mu\mu\text{f}$  to 10,000  $\mu\text{f}$ . Accuracy of  $\pm$  (1 percent + 1  $\mu\mu\text{f}$ ). Dissipation factor range is 0 to 60 percent. Frequency

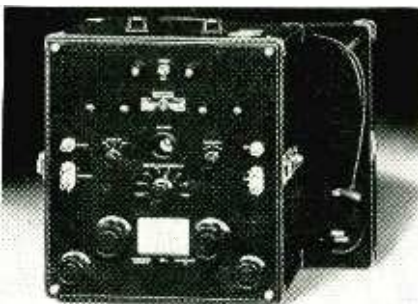

of the test voltage is 60 cycles. A feature of the bridge is the zero-compensating circuit that balances out the initial capacitance and dissipation factor at zero setting of the dials.

### Variable Waveform Generator

CENTRO RESEARCH LABORATORIES, Briarcliff, N. Y. The variable waveform generator is an audio generator whose output waveform is built up by addition of a fundamental wave and four sequential harmonics. The harmonics are precisely synchronized and variable over 360

degrees. Level of the fundamental and of each of the harmonics is independently variable.

### Rodent Control

LFC CORP., 65 Broad St., Rochester 4, N. Y. The Guard consists of a metal case housing a framework that supports electronic unit, motor for driving the electrocuting arms, mirrors for the light system, and other components. In action, the unit is placed over a rat run and is actuated by breaking of a light beam by a passing animal. It is

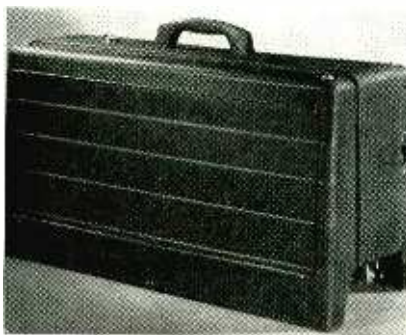

gently squeezed, electrocuted, and ejected to the side. Total death cycle is about 2½ minutes.

### Visual Alignment Generator

PHILCO CORP., Philadelphia, Pa., Model 7008 is a new visual alignment generator equipped with crystal-diode high-frequency probe for use in examining the response curve of individual stages and the 4.5 mc video trap. It can also be used to obtain correct termination of r-f transmission lines or measure standing wave ratio.

### Portable Tape Recorder

WEBSTER ELECTRIC Co., Racine, Wisconsin. The Ekotape recorder and reproducer uses magnetic tape with a fast forward speed and fast re-

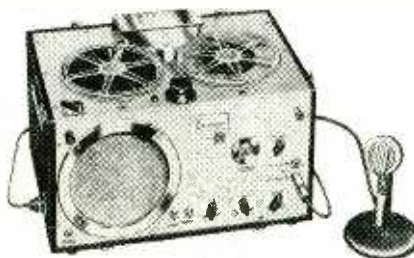

wind. It is equipped with an 8-inch speaker and an oversize motor with high inertia flywheel. Motor drive and capstan operate continuously so that tape starts and stops instantaneously.

### Electronic Thermostat

SPENCER-KENNEDY LABS., INC., 10 Follen St., Cambridge, Mass. Model 400A bridge-controlled thyatron thermostat is designed for use with furnaces, molds, chemical baths, ovens, and similar devices. Two types of control are possible, by means of a resistance thermometer,

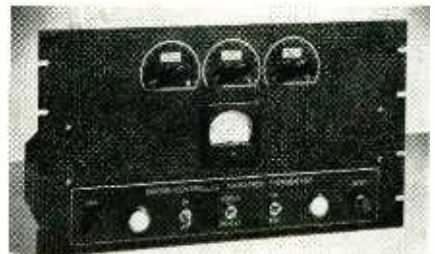

or by change of resistance of the heater winding itself. Temperatures from 20 to 1,200 C can be maintained to an accuracy of plus or minus 0.1 C when a resistance thermometer is used.

### Projection System

RADIO CORP. OF AMERICA, Camden, N. J. Model TLS-86 is a reflective optical projection system employing an all-electronic tuning system.



Life-size pictures for large audiences are then projected either on a reflective-surfaced opaque screen or on a translucent screen.

### Television Signals

TELEQUIP RADIO Co., 1901 South Washtenaw Ave., Chicago 8, Ill. A combination sync generator, mono-

(Continued on p 206)

# PRICES AND AUDIODISCS

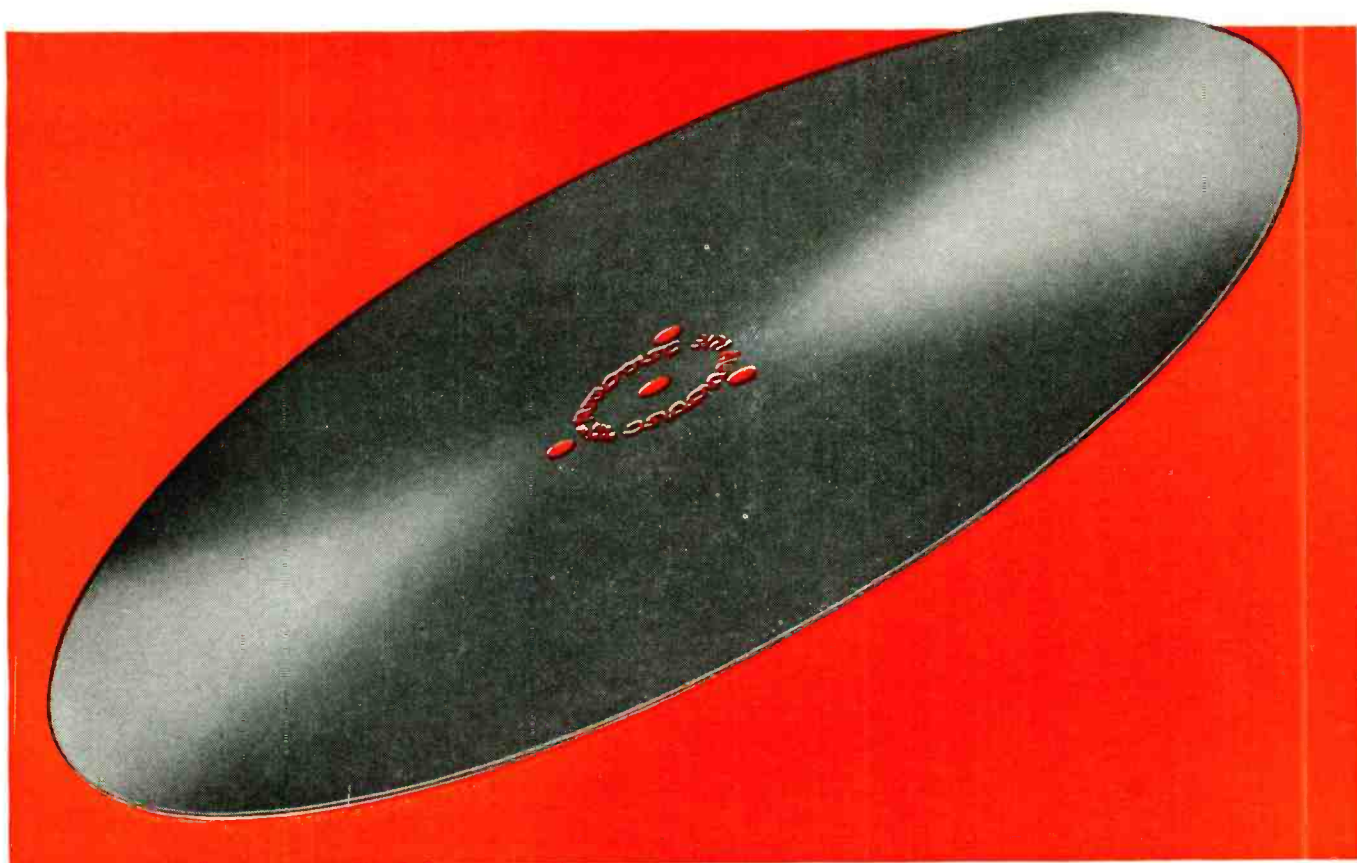

## *A Statement On Our Price Policy*

As of September 1st, aluminum prices are again increased. This means higher cost for the principal raw material used in the manufacture of AUDIODISCS. In fact, the cost of the aluminum base has always been the main item in the cost of production. Thus, any increase in aluminum prices is of major importance.

But beyond the cost of raw materials and labor there is a basic factor which determines the cost of manufacturing professional recording discs. This factor is the extent to which the particular process of manufacture enables the producer to turn out a large proportion of first quality discs. There are several methods of production used. None of these will give anything like a 100% yield. It is, however, obvious that as the percentage of yield increases there is a resulting drop in the average cost of aluminum, lacquer and labor.

Fortunately, our patented, precision-machine process—now used for over a decade and continuously improved—gives a more consistent yield of high quality discs than any method of production now used. And we have tested every other process in use.

So our position with respect to the present increase in aluminum prices is this:

1. We are *not* increasing prices of AUDIODISCS as of September 1st.
2. We shall make every effort to absorb this new aluminum price raise and thus continue our prices at the present level. Our calculations indicate that with some improved efficiency, now under way, and continued large volume production, we shall be successful in this hold-the-price effort.

*Audioidiscs are manufactured in the U.S.A. under exclusive license from PYRAL, S.A.R.L., Paris.*

**Audio Devices, Inc., 444 Madison Ave., N.Y. C.**

EXPORT DEPT: ROCKE INTERNATIONAL, 13 EAST 40TH STREET, NEW YORK 16, N. Y.



*they speak for themselves* **audioidiscs**



# NEWS OF THE INDUSTRY

Edited by JOHN MARKUS

**Australia's rural radiophone; course in automatic control; radio net for India planned; radio license increase**

## West Coast IRE Convention

THE PROGRAM of technical sessions of the IRE West Coast Convention to be held September 30 to October 2, 1948, at the Hotel Biltmore, Los Angeles, Calif., has been announced as follows:

Thursday, Sept. 30

1:00 P.M. to 4:45 P.M.—Chairman—Bernard Walley of RCA Victor, Los Angeles:

A Low Cost Program Switching System, by I. Gifford and A. P. Chesney of Langevin.

Antenna Input Systems for Television Receivers, by D. E. Foster of Hazeltine Research, Inc., California.

Operation of AM Broadcast Transmitters into Sharply Tuned Antenna Systems, by W. H. Doherty of Bell Telephone Laboratories, Whippany, N. J.

1:15 P.M. to 4:45 P.M.—Chairman—A. R. Willson of Boeing Aircraft Company, Seattle:

The Outlook for Electronic Computers, by J. L. Barnes of the University of California at Los Angeles.

Input and Output Equipment for Electronic Computers, by C. H. Page of the Bureau of Standards.

Electronic Techniques Applied to Analog Methods of Computation, by D. G. McCann, C. H. Wilts, and B. M. Locanthi.

Design and Use of the Reevac, a General Purpose Electronic Digital Computer, by Dr. Herbert Zagor of Reeves Instrument Corporation, New York City.

8:00 P.M. to 10:30 P.M.—Audio Symposium—Chairman—E. S. Naschke, Chairman Sacramento Section IRE.

Friday, Oct. 1

9:00 A.M. to 11:40 A.M.—Chairman—O. A. Steele, Chairman Portland Section IRE:

A New Type of Direct Reading R. F.



Final details for West Coast IRE Convention are discussed by L. W. Howard (left) president of Triad Transformer and West Coast Electronics Manufacturers president, Robert L. Sink (standing) of Consolidated Engineering, and Convention chairman Lloyd Sigmon, chief engineer at KMPC

Phase Meter for Low Level Signals, by M. K. Goldstein of Naval Research Laboratory.

The Determination of the Shunt Resistance of Cavity Resonators by Means of an Electrical Network Analyzer, by F. W. Schott and K. R. Spangenberg of Stanford University.

A Method of Obtaining the Product of Two Voltages, by M.A.H. El-Said. Paper presented by D. E. Sinclair of General Radio.

Propagation Measurements at High Radio Frequencies over Flat Desert Terrain, by J. P. Day and L. C. Trolese of Naval Electronics Laboratory.

2:30 P.M. to 5:15 P.M.—Chairman—L. E. Reukema of University of California,

## RMA Board of Directors for 1948-1949

Ray H. Manson	Ernest Searing	E. A. Nicholas	J. J. Kahn	R. E. Carlson Vice President Chairman, Tube Division	W. J. Barkley Vice President	G. M. Gardner Vice President Chairman, Set Division	Frank M. Folsom	R. C. Sprague	Larry F. Hardy	Benjamin Abrams	
H. C. Bonfig	W. A. MacDonald	Joseph Gerl	Walter Evans	W. R. G. Baker Director Engineering Dept.	Leslie F. Muter Treasurer	Paul V. Galvin	E. Aischuler	F. R. Lack	G. W. Thompson		
H. C. Mattes	Thos. A. White	Ray F. Sparrow	J. H. Stackpole	Allen Shoup Vice President	A. D. Plamondon, Jr. Vice President Chairman, Parts Division	W. P. Hilliard	Allen B. DuMont	G. Richard Fryng	H. L. Hoffman		
H. J. Hoffman	Herbert W. Clough	S. Insull, Jr.	A. Blumenkrantz	John W. Craig	Bond Geddes Executive Vice Pres. General Manager	John W. Van Allen General Counsel	George Lewis	Lloyd N. Coffin	David Wald	George R. Maase	Harry G. Sparks

THE *Motorola* "HANDIE-TALKIE" UNIT IS  
**SMALLER, LIGHTER,  
 BECAUSE...**



*...it uses 2  
 Sylvania  
 Germanium  
 Diodes!*

The Motorola "Handie-Talkie" unit has a range in excess of *two miles*. Yet it weighs less than ten pounds; overall dimensions are only 10" by 12<sup>5</sup>/<sub>8</sub>" by 3<sup>1</sup>/<sub>8</sub>".

An important factor in the smallness and lightness of this efficient unit is the use of two Sylvania Germanium Diodes in the receiver discriminator circuit. These diodes not only eliminate extra tubes, but, by reducing current drain, permit the use of smaller, lighter batteries. Motorola's own estimate of the difference if tubes were used instead: 10% increase in size, 15 to 20% in weight!

Perhaps you too, like Motorola and many others, can simplify the design of your equipment—or improve its performance—through the use of Sylvania Germanium Diodes. Start your planning by getting our literature.

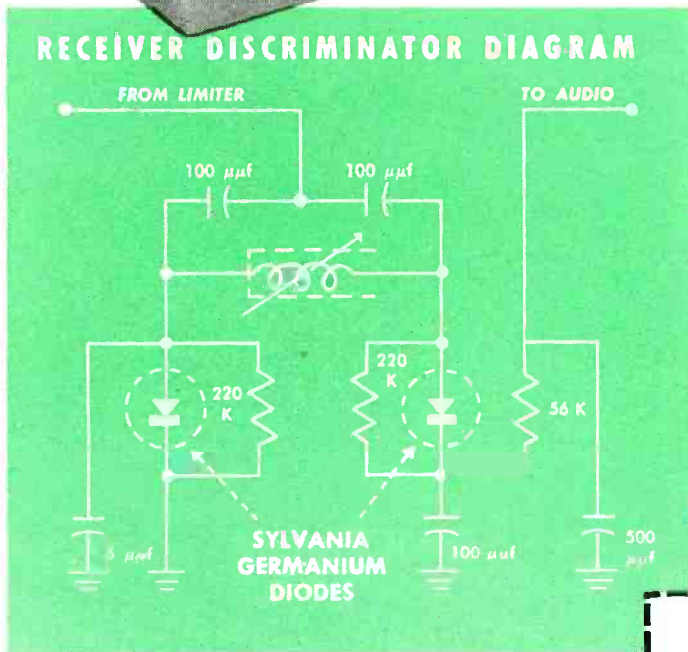

**SYLVANIA  
 ELECTRIC**

*Electronics Division, 500 Fifth Avenue, New York 18, N. Y.*  
 ELECTRONIC DEVICES; RADIO TUBES; CATHODE RAY TUBES; PHOTOLAMPS;  
 FLUORESCENT LAMPS, FIXTURES, WIRING DEVICES; ELECTRIC LIGHT BULBS

**SEND FOR NEW DATA  
 ON TV APPLICATIONS**

Sylvania Electric Products Inc.  
 Electronics Division, Dept. E-1010  
 500 Fifth Avenue, New York 18, N. Y.

Gentlemen:

Please send me your literature on Germanium Diodes and Duo-diodes, including the new series of Engineering News Letters showing their applications in television circuits.

I am also interested in receiving literature covering applications of your other products in the field of (check one):

- Communications
- Radar and Microwaves
- Radioactivity
- Industrial Electronics

Name.....

Position.....

Company.....

Street Address.....

City..... Zone #..... State.....



Berkeley, Chairman San Francisco Section IRE:

Signal to Noise Ratios of Linear Detectors, by R. H. DeLano of Hughes Aircraft Co.

A Mass Spectrometer Designed for Industrial Use, by C. E. Berry, R. L. Sink, and Carl Spaulding of Consolidated Engineering Corp.

Problems in the Design of Megawatt Output Klystrons for Pulsed Operation, by Marvin Choderow and E. L. Ginzton of Stanford University.

Application of Microwave Spectroscopy to Determination of Interatomic Distances in Molecules, by D. K. Coles of Westinghouse Research Laboratory.

Saturday, Oct. 2

9:00 A.M. to 12:00 Noon—Chairman—C. N. Tirrell, Naval Electronics Laboratory, San Diego; Chairman San Diego Section IRE:

Systems Engineering Aspects in Military Communications, by W. S. Marks of U. S. Signal Corps Laboratories, Fort Monmouth.

The V.H.F. Omnidirectional Range, by C.A.A. Radio Development Division representative, R. E. McCormack.

Design of a Radar Set for Commercial Airlines, by F. G. Suffield, consulting engineer.

Design of Antennas for Optimum Directivity, by T. T. Taylor of Hughes Aircraft Co.

Band Width Reduction in Communication Systems, by W. G. Tuller of Melpar, Inc.

## Television for Australia

TELEVISION ISN'T QUITE Down Under yet. The Commonwealth Postmaster General has invited bids for two experimental television transmitters, one each for Sydney and Melbourne. These would bring a third of Australia's population within line of sight.

A home television set with a 9-inch screen could be produced by Philips' Australian branch plant in about a year for \$325, a spokesman of the company stated. But before the sets can be built, the government must promulgate transmission standards.

There is every indication that both television and f-m are to be a state monopoly; a-m radio is not completely nationalized yet, and a large number of commercial stations remain in operation.

## Short-Wave System for East Africa

CONSTRUCTION WORK has begun on the first of 48 Marconi shortwave transmitters to be installed in East Africa to provide ground-to-air

(Continued on p 258)

## MEETINGS

SEPT. 27-29: FM Association Second Annual Convention, Sheraton Hotel, Chicago, Ill.

SEPT. 27-OCT. 1: Third National Plastics Exposition, Grand Central Palace, New York.

SEPT. 30-OCT. 2: Pacific Electronic Exhibition and IRE west coast Annual Convention, Biltmore Hotel, Los Angeles, Calif.

OCT. 4-7: 53rd annual meeting of International Municipal Signal Assn., Inc., Hotel Statler, Buffalo, N. Y.

OCT. 5-7: AIEE Middle-Eastern District Meeting, Washington, D. C.

OCT. 7-9: Second joint meeting, URSI and IRE, National Bureau of Standards, Washington, D. C.

OCT. 12-16: Fifth National Chemical Exposition, Coliseum, Chicago, Ill.

OCT. 18-22: AIEE Midwest Fall General Meeting, Hotel Schroeder, Milwaukee, Wisconsin.

OCT. 23-29: Annual convention, American Society for Metals, Benjamin Franklin Hotel, Philadelphia.

OCT. 25-28: Annual Fall meeting of the Institute of Metals, Division American Institute

of Mining and Metallurgical Engineers, Hotel Adelphia, Philadelphia.

OCT. 25-29: National Metal Exposition, Commercial Museum and Convention Hall, Phila.

OCT. 25-29: Annual Convention, American Welding Society, Bellevue-Stratford Hotel, Philadelphia.

OCT. 25-29: 64th semiannual convention, Society of Motion Picture Engineers, Hotel Statler, Washington, D. C.

OCT. 27-28: Annual Convention, Society for Non-Destructive Testing, Hotel Adelphia, Philadelphia.

Nov. 4-6: National Electronics Conference, Edgewater Beach Hotel, Chicago.

Nov. 8-10: Twentieth Rochester Fall Meeting of members of IRE and RMA Engineering Dept., Sheraton Hotel, Rochester, N. Y.

Nov. 29-DEC. 1: Conference on electronic instrumentation in nucleonics and medicine, sponsored by IRE and AIEE, Engineering Societies Building, New York City.

Nov. 29-DEC. 4: 18th National Exposition of Power and Mechanical Engineering, Grand Central Palace, New York.

## PLASTIC BOMBPROOF FOR VIDEO

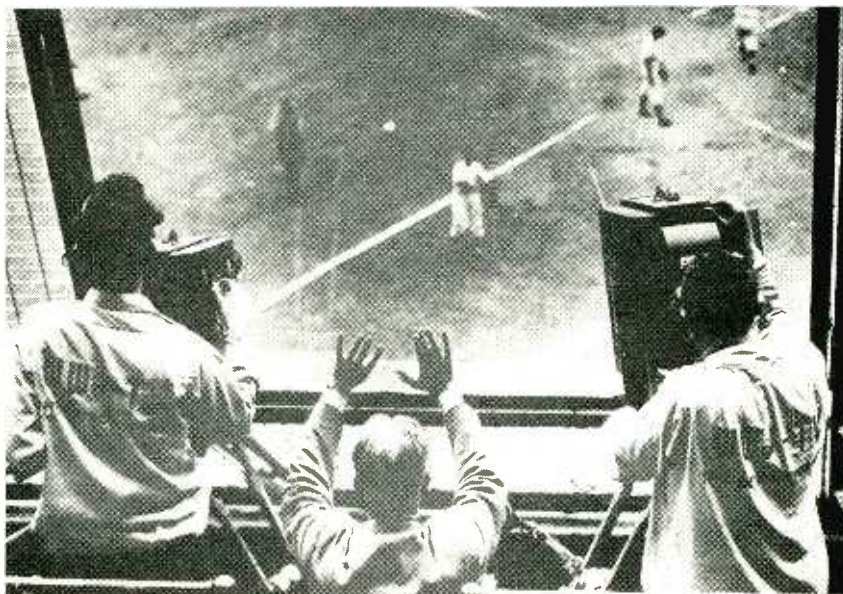

This 7 x 8-ft slab of Plexiglas was recently installed by the Cadillac Plastic Co. of Detroit at Briggs Stadium in that city as a protection for television equipment. The 1/2-inch sheet will offset the impact of a 9-ounce ball travelling at over 100 miles per hour, according to researchers at Rohm & Haas Co., Philadelphia, makers of Plexiglas



# AUDIO TRANSFORMERS for [ UNIFORM RESPONSE LOW DISTORTION

*Write for Catalog  
showing complete  
new stock line*

## IN 3 FREQUENCY RANGES

### Full Frequency Range

**30 to 15,000 Cycles**, provides uniform response over this entire band with  $\pm 1/2$  db up to 10 watts of audio power, within  $\pm 1$  db over 10 watts. Standard RMA impedances. Hum balancing coil structures and nickel alloy shielding. Included are Input, Output, Driver, and Modulation Transformers; Modulation Reactors. *Sealed in Steel* construction, stud mounting, with pin-type terminals.

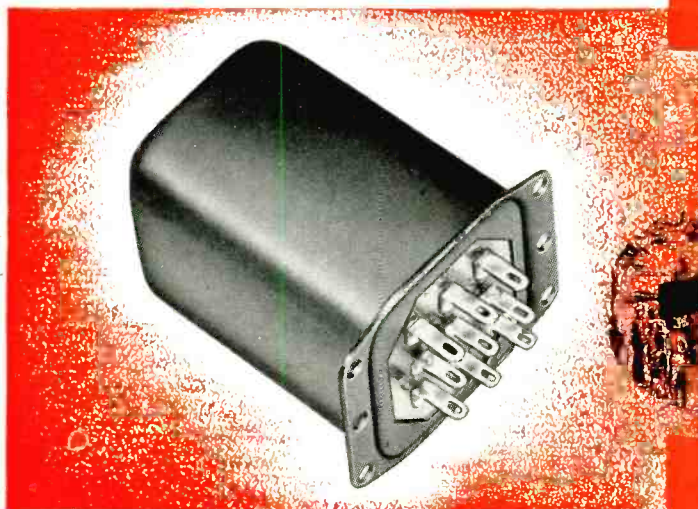

### Public Address Range

**50 to 10,000 Cycles**, frequency response within  $\pm 1/2$  db up to 10 watts of power, within  $\pm 1$ db over 10 watts, throughout this range. Secondary impedances match 600 and 150-ohm lines, 16, 8 and 4-ohm reproducing systems. Listed are Driver and Output Transformers. *Sealed in Steel* construction, flange mounting, with solder lugs or wire leads.



### Communications Range

**200 to 3,500 Cycles**, affords response with variations not exceeding  $\pm 1$  db over the range of voice frequencies. For use with 600 or 150-ohm lines. Input, Output, Driver and Modulation Transformers offered. *Sealed in Steel* construction, flange mounting, with wire leads or solder lugs.



# CHICAGO TRANSFORMER

DIVISION OF ESSEX WIRE CORPORATION

3501 ADDISON STREET • CHICAGO 18, ILLINOIS



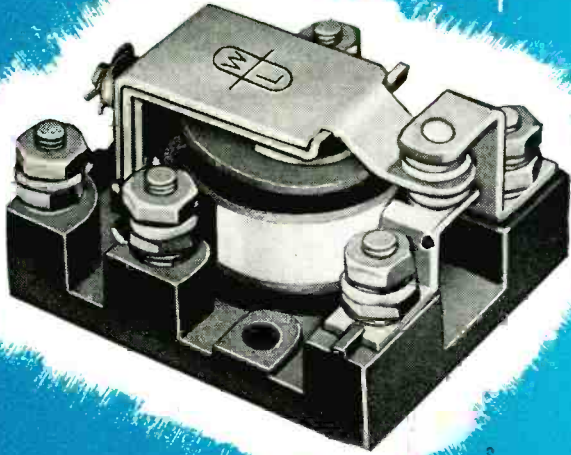

## "FREEZING" is expensive

WHERE  
BASIC  
DESIGNS  
IN  
ELECTRIC  
CONTROLS  
ARE  
RESULT-  
ENGINEERED  
FOR  
YOU

### Unique design and spring suspension prevent it in this Ward Leonard Relay

The generous wipe imparted to the contacts of Ward Leonard Heavy Duty (105) Relay by its unique design and spring suspension, results in freedom from contact "freezing" or welding.

This mighty midget will perform motor starting functions ordinarily assigned to larger relays.

Ward Leonard relays are "Result-Engineered". By modifying a basic design, Ward Leonard can give you the results of a special . . . for the price of a standard.

Write for Relay Catalog. Ward Leonard Electric Co., 31 South St., Mount Vernon, N. Y. Offices in principal cities of U. S. and Canada.

# WARD LEONARD ELECTRIC COMPANY

RESISTORS • RHEOSTATS • RELAYS • CONTROL DEVICES



TUBES AT WORK  
(continued from p 126)

control, a direct current is fed to an auxiliary coil on the head to buck out a portion of the earth's field. Thus the magnetometer is

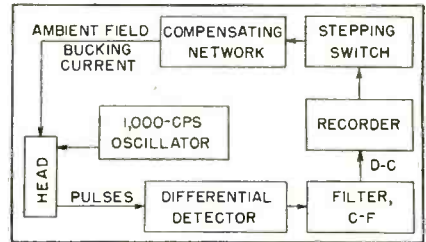

FIG. 2—Block diagram shows how pulses from sensing element are converted into direct current and fed to the recorder, and how a balancing current is obtained to restrict the range over with the head must operate

called upon only to measure the small unbalanced field. This bucking current is obtained automatically by a stepping switch actuated by the recording galvanometer as it reaches the end of its scale, shown in Fig. 2.

It is necessary that the sensing element be always oriented parallel to the earth's field for the recordings to have significance. This positioning is accomplished by a pair of orienting servos driving gimbals that are at right angles to each other. The sensing element is mounted on these gimbals.

Two auxiliary sensing elements can be used to detect the orientation of the earth's field. If the output from one of these auxiliary units is zero, it must necessarily be perpendicular to the earth's field. Thus these units are mounted mutually perpendicular to the sensing unit. The servo motors drive the auxiliary units to the positions at which their outputs vanish, thus placing the sensing unit parallel to the field. To avoid difficulties from the aircraft's magnetic field, the sensing element and its associated orienting mechanism are housed in a bomb-shaped "bird" that is lowered by its connecting cable to about 65 feet from the plane. The measuring and controlling circuits and recorder are carried in the cabin.

### *Reconnaissance Technique*

Airborne magnetometers are calibrated at the laboratory and sent out to the field to be used in locating areas that can be expected to

# Have the facts at your fingertips

**CHEMICAL ANALYSES & PHYSICAL PROPERTIES of TAM Products**

**THE TITANIUM ALLOY MFG. CO.**

**TITANIUM AND ZIRCONIUM PRODUCTS**

REG. U.S. PAT. OFF.

With this compact folder, you can obtain information on TAMCO products readily. When you want approximate physical properties, a chemical analysis, or commercial applications of specific products—clear concise charts provide them at a glance. That's why you will want this helpful booklet whether you are interested in TAM ceramic, chemical or metallurgical products. Address your request to our New York City office.

More detailed information on Titanium or Zirconium products is available also upon request. These data have been compiled to meet the demand for authentic information on these products from the source most closely identified with their development. It may prove advantageous to discuss certain problems and applications with our sales engineers.

★ When you write for your reference folder, let us know if our Field Engineering can be of assistance at this time.



TAM and TAMCO are registered trademarks.

**TITANIUM ALLOY MANUFACTURING COMPANY**  
 Executive and Sales Offices: 111 BROADWAY, NEW YORK, N. Y.    General Offices and Works: NIAGARA FALLS, N. Y.





## RADIO MANUFACTURERS:

Take Advantage of  
**SAMS' EXPERT SERVICE DATA PREPARATION FACILITIES**

If you are interested in effecting significant economies in the preparation and printing of your service data manuals, you will want to follow the lead of other major manufacturers. More and more manufacturers of radio receivers, record changers, recorders and similar equipment, are turning to us for the preparation and publication of service manuals and literature. Our laboratories prepare complete, accurate, logical service data, relieving your service and engineering divisions of all burdensome details. Specimens of current work prepared for major manufacturers are available on request. Inquiries invited.



Address Your Inquiries

to

**Howard W. Sams & Co., Inc.**

**Indianapolis 7, Indiana**



IF YOU NEED  
**TIME DELAY = AGASTAT**  
 IS WHAT YOU NEED

**AGASTAT** relay is an important instrument in electronic circuits requiring *time delay* . . . from .1 second to 5 or more minutes.

Instantaneously recycling, reliable and efficient. Available in standard types and with special mounting and terminal arrangements. Mounting and contact information, type description, etc. on request. Address Agastat Division.

**A'G'A**  
**AMERICAN GAS ACCUMULATOR COMPANY**  
 1027 NEWARK AVENUE • ELIZABETH 3, NEW JERSEY

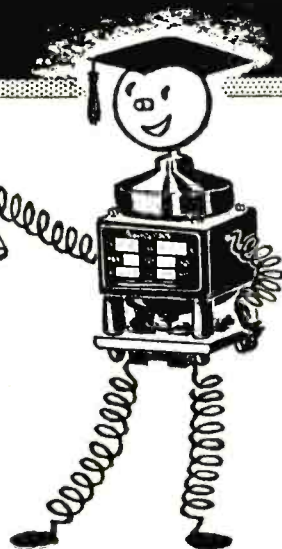

# Truarc saves 5 minutes, 9 cents in materials per unit without re-design of electric sanders

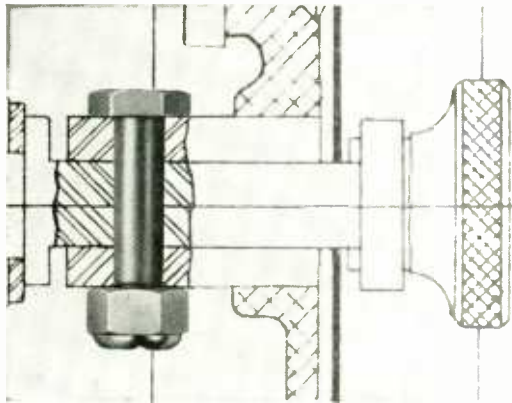

## OLD WAY

Special 1/4" cap screw and 1/4-28 fibre-insert nut holds idler arm and pulley assembly on Model A3 "Take-About" Sander, Porter-Cable Machine Company.

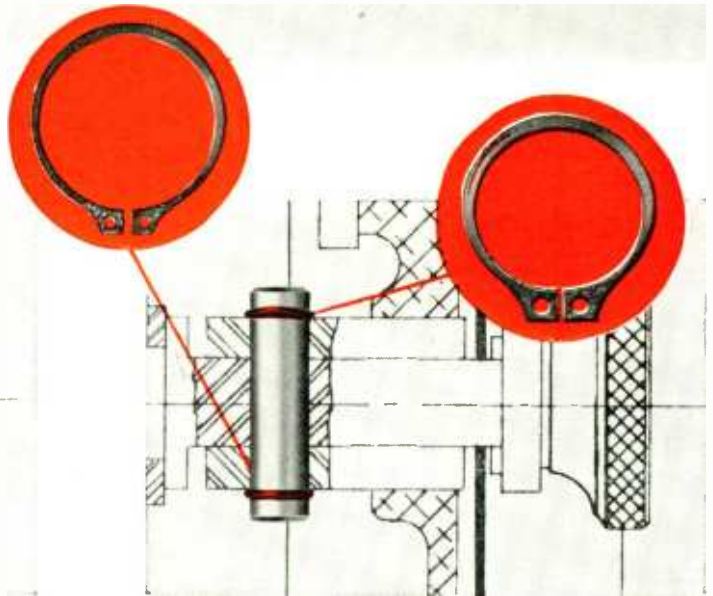

## NEW WAY

Simple 1/4" C.R. shaft, grooved in automatic screw machine, equipped with Waldes Truarc Retaining Rings. Bowed external ring (#5101-25) at top exerts resilient pressure taken up by Standard external ring (#5100-25) at bottom. Assembly is secure against vibration, can be easily taken apart and re-installed many times with same Truarc rings.

Every sander through the production lines costs 9 cents less for materials, requires 5 minutes less labor—with just the simple change from cap screw and nut to Waldes Truarc rings by Porter-Cable Machine Company, Syracuse, New York. The change to Truarc required no new design, no alterations in castings, but just the reappraisal of old methods.

Truarc can help you cut costs and increase produc-

tion, too. Wherever you use machined shoulders, nuts, bolts, snap rings, cotter pins—there's a Truarc ring that does a better job of holding parts together. All Waldes Truarc Retaining Rings are precision engineered, remain always circular to give a never-failing grip.

Send us your drawings. Waldes Truarc engineers will be glad to show how Truarc can help you.

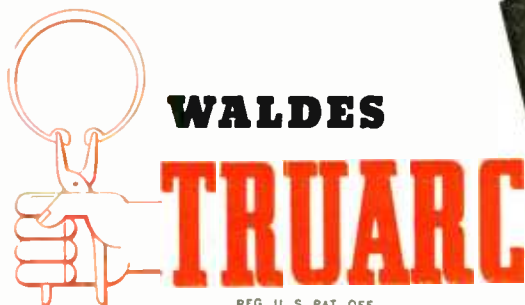

**WALDES**  
**TRUARC**

REG. U. S. PAT. OFF.

**RETAINING RINGS**

WALDES KOHINOOR, INC., LONG ISLAND CITY 1, NEW YORK

WALDES TRUARC RETAINING RINGS ARE PROTECTED BY U. S. PATS. 2,302,948; 2,026,454, 2,416,852 AND OTHER PATS. PEND.



Waldes Kohinoor, Inc., 47-10 Austel Place E-10  
Long Island City 1, N. Y.

Please send 28-page Data Book on Waldes Truarc Retaining Rings.

Name \_\_\_\_\_

Title \_\_\_\_\_

Company \_\_\_\_\_

Business Address \_\_\_\_\_

City \_\_\_\_\_ Zone \_\_\_\_\_ State \_\_\_\_\_



# NEW

## SHURE "900MG"

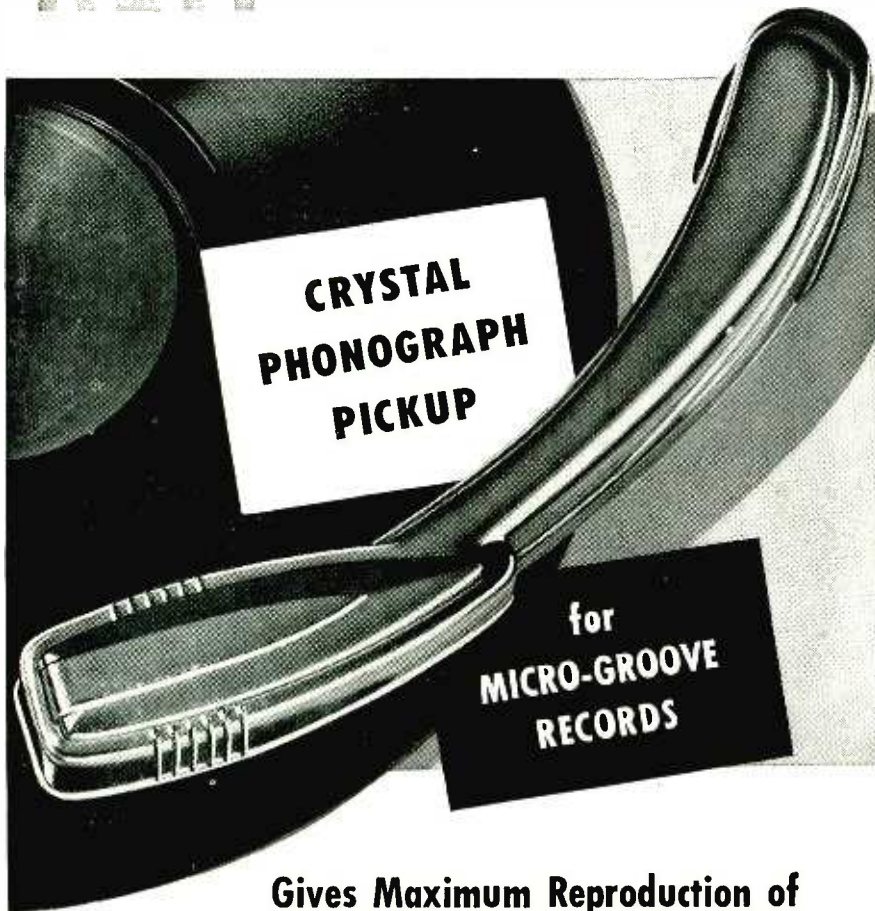

### Gives Maximum Reproduction of Micro-Groove Record Fidelity

The Shure "900MG" Pickup is an ideal instrument for tracking on the new micro-groove records. It tracks at 7 grams . . . has a needle force of 9 grams as added safety factor . . . uses a special offset osmium-tipped needle with a point radius of only .001" . . . and has an output of 1 volt! The Shure lever system has been adapted in the development of this new pickup —providing a high needle compliance. Listen to it—you will be thrilled with the results!

**Model "900MG" Code: RUZUZ List Price: \$12.50**

Shure Patents Issued and Pending. Licensed under the Patents of the Brush Development Co.



## SHURE BROTHERS, Inc.

*Microphones and Acoustic Devices*

225 W. HURON ST., CHICAGO 10, ILL. • CABLE ADDRESS: SHUREMICRO

TUBES AT WORK

(continued)

contain oil-bearing strata. A flight crew surveys a region by flying a grid pattern consisting of flights about 75 miles long and a mile or so apart. The pilot flies the plane back and forth along such a grid, keeping accurately on course by means of two transportable shoran stations. The flight director aboard the craft constantly checks the shoran indications so that later, in plotting the measurements on a map, they can be accurately located. To further correlate the plane's position with ground position, a continuous strip film picture of the terrain is made so that land marks can be readily identified. The shoran indications, strip film and magnetometer recordings are all correlated by recording identical serial numbers at each position at regular intervals.

Later the measurements are transferred to maps thus forming magnetic profiles of the district. On the assumption that the magnetic fluctuations that have been observed are caused by changes in the depth of the igneous bed (or basement) rock, the geologist predicts in what places domed formations likely to contain oil will be found. Of course other magnetic disturbances might have produced the observed contours. The know-how of geologists consists in recognizing the characteristics of the different factors that influence the slight local field contours.

Once a region has been located that appears a likely prospecting area, seismographic parties make detailed examinations to verify the inferences. These two techniques, magnetometer and seismograph surveying, relying heavily on electronics, are proving extremely valuable in the race to find oil as fast as it is being consumed.

### RPM Counter

TURBINE components for new jet engines are whirled at close to 100,000 rpm and in temperature of 1,750 degrees F at Boeing Airplane Co. propulsion laboratory in proving jet engines under development.

An electronic rpm counter measures the speed of the wheel as it spins. One end of the spinning

# Whatever the requirements

## — there's an AMERTRAN for every electronic application

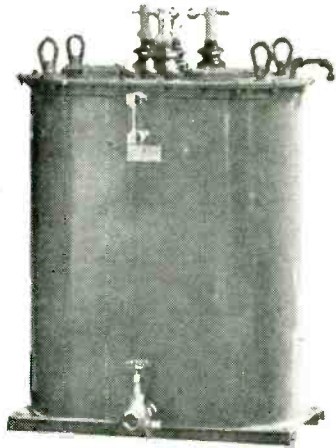

**Liquid Immersed Plate Transformers**—AmerTran oil and Abestol immersed, for indoor and outdoor service—precise overvoltage protection by means of bushing mounted sphere gaps.

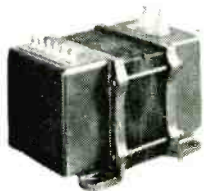

**"W" Dry-Type Transmitter Components**—Economical self-cooled transformers and reactors—for more efficient rectifier operation.

**Hermetically Sealed Transformers**—Highly resistant to moisture, shock, pressure and temperature variation. Either liquid-immersed or compound filled.



**Transtat Type TH for .3 to 20 KVA**—Manually operated a.c. voltage regulator providing arcless, stepless control. Brush track on coil periphery where it may be banded to insure trouble-free operation under exacting conditions of service.

**PERHAPS** your transformer problem calls for design and development. Maybe you require large transformers in small quantities. Or possibly you'd like to obtain the benefits of mass production and need transformers in large quantities.

No matter what your transformer requirements, you will find AmerTran engineers can solve them—efficiently and economically.

In almost half a century of specialization, we have acquired a "know-how" and "can do" which are unsurpassed in the transformer industry. Typical applications of this background are the transformers shown on this page.

Our experience is ready and waiting to go to work on *your* transformer problem. Call in AmerTran today to tell you how we can give you *the* transformers you need . . . when you need them . . . at prices made possible only by real manufacturing efficiency

**AMERICAN TRANSFORMER COMPANY**  
178 EMMET STREET • NEWARK 5, N. J.

# AMERTRAN

REG. U.S. PAT. OFF.  
MANUFACTURING SINCE 1901 AT NEWARK, N. J.

Pioneer Manufacturers of Transformers, Reactors and Rectifiers for Electronics and Power Transmission





Over 20 years of fabricating experience

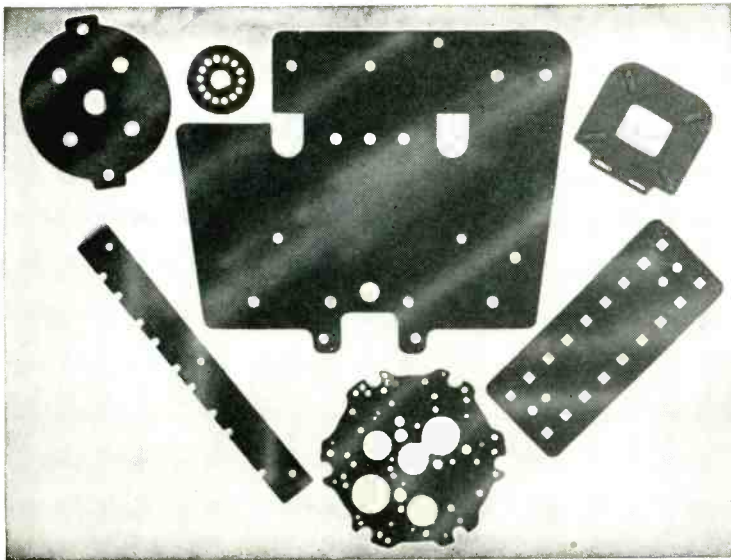

## • PLASTIC FABRICATING •

BAKELITE AND FIBRE FABRICATED PARTS  
PUNCHING, DRILLING, MILLING, AND ENGRAVING

• BAKELITE SHEETS, RODS, TUBES •

Mail Us Your Prints or Samples for Quotations

**ELECTRICAL INSULATION CO., INC.**

12 VESTRY ST.

NEW YORK 13, N. Y.



## STANDARDIZED <sup>READY-TO-USE</sup> METAL EQUIPMENT

ADAPTABLE FOR EVERY REQUIREMENT

Par-Metal Equipment offers many features, including functional streamlined design, rugged construction, beautiful finish . . . plus ADAPTABILITY. Eliminate need for special made-to-order units on many jobs.

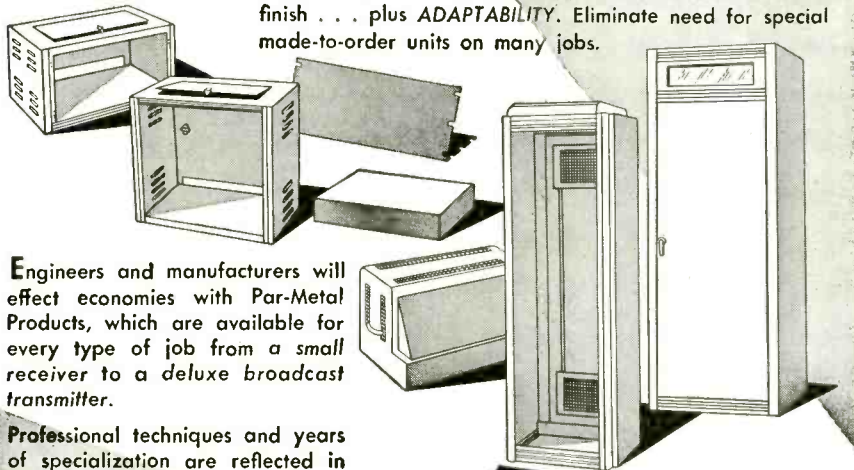

Engineers and manufacturers will effect economies with Par-Metal Products, which are available for every type of job from a small receiver to a deluxe broadcast transmitter.

Professional techniques and years of specialization are reflected in the high quality of Par-Metal. . .

**CABINETS • CHASSIS  
PANELS • RACKS**

*Write for Catalog*

**PAR-METAL  
PRODUCTS CORPORATION**  
32-62 - 49th STREET  
LONG ISLAND CITY 3, NEW YORK  
Export Dept.: Roche International Corp.  
13 East 40 Street, New York 16

## DIRECT WRITING RECORDERS

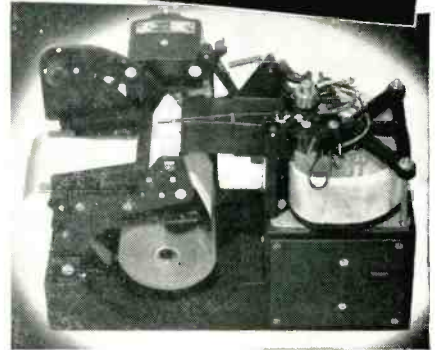

Galvanometer available separately if desired

PERMANENT

Records

•

NO INK

•

RECTILINEAR

Writing

•

RUGGED

Construction

with

EXTREMELY HIGH

torque movement

(200,000 dyne cms

for 1 cm deflection)

While designed primarily for use in the Sanborn direct-writing electrocardiograph (the Viso-Cardiette) this assembly (or the galvanometer alone, if desired) has sufficient potential value for varied industrial applications to warrant this announcement of availability for non-medical uses.

The complete unit illustrated comprises the galvanometer and writing arm, with associated paper drive (No. 572M-500). The galvanometer and

writing arm are available as a separate unit (No. 572M-300). Recording styli available in two types; fine line writing approximately 1/3 mm; wide line writing approximately 1 mm. Recording paper can be furnished in 200 ft rolls, 6 cm wide (No. 572-737-P3).

### TABLE OF CONSTANTS

Sensitivity	10 ma/1 cm.
Coil resistance	3,000 ohms, center tapped for push-pull operation.
Critical damping resistance	500 ohms.
Undamped fundamental frequency	45 cycles/sec.
Stylus heater requires from external source	1.25 volts, 3.5 amps, AC or DC
Maximum undistorted deflection	2.5 cm. each way from center
Marker requires from external source	1.25 volts, at 1.5 amps, AC or DC
Paper speed	25 mm/sec.
Chart ruling	1 mm intervals

In the development stage are other Sanborn "medical recording" instruments which have apparent industrial applications. These include an Electromanometer for direct measurement of "pressures", and several models of multi-channel (2 to 6) recorders, both direct recording and photographic.

*For complete information write, giving details of proposed application to*

INDUSTRIAL DIVISION  
**SANBORN COMPANY**  
39 Osborn St.  
Cambridge 39, Massachusetts

# NEW...! the Roto Ranger

—automatically rotates one of 18 separate scales into position as you select the range.

## SIMPSON MODEL 221 ROTO-RANGER HIGH-SENSITIVITY A.C.-D.C. VOLT-OHM-MILLIAMMETER

Here is the only multiple scale test instrument of its kind in the world. It definitely reduces the possibility of errors by providing a single scale for each range of this finest of volt-ohm-milliammeters. As the selector switch is moved to the range desired, an ingenious gearing mechanism rotates a drum, bringing into place behind the meter window the proper scale for that range. Here is the equivalent of 25 separate instruments combined in one sturdy and compact unit. (18 scales; 7 additional direct reading ranges through use of high voltage and output jacks.) The patented Roto-Ranger principle eliminates the confusion of numerous readings on one scale, and the multiplying factors common to ordinary multi-range testers, by providing a separate scale for each range. There are no cramped calibrations in these full sized Roto-Ranger scales. Each is designed as it would be for a separate instrument.

SIMPSON ELECTRIC COMPANY  
5200-5218 W. Kinzie St., Chicago 44, Ill.  
In Canada: Bach-Simpson, Ltd.,  
London, Ontario

*Simpson*  
INSTRUMENTS THAT STAY ACCURATE

### Ranges

20,000 Ohms per Volt D.C., 1,000 Ohms per Volt A.C.  
Volts, A.C.: 2.5, 10, 50, 250, 1000, 5000  
Volts, D.C.: 2.5, 10, 50, 300, 1000, 5000  
Milliamperes, D.C.: 10, 100, 500  
Microamperes, D.C.: 100  
Amperes, D.C.: 10  
Output: 2.5, 10, 50, 250, 1000  
Ohms: 0-2000 (12 ohms center), 0-200,000 (1200 ohms center), 0-20 megohms (120,000 ohms center).  
Size: 12<sup>3</sup>/<sub>4</sub>" x 10<sup>1</sup>/<sub>8</sub>" x 5<sup>3</sup>/<sub>8</sub>"  
Weight: 8 lbs. 9 oz.  
Price, complete with test leads and 28-Page Operator's Manual..... \$69.85

High voltage probe (25,000 volts) for TV, radar, x-ray and other high voltage tests, also available.

Ask your Jobber, or write for complete descriptive literature





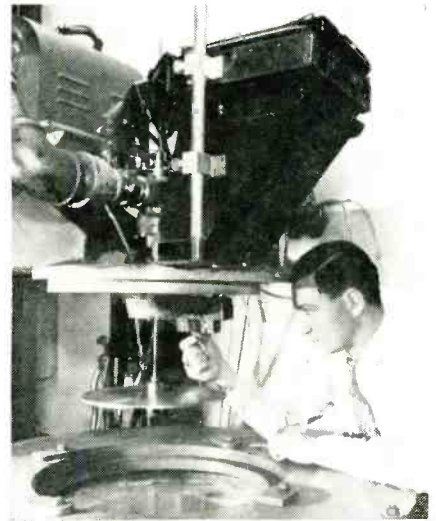
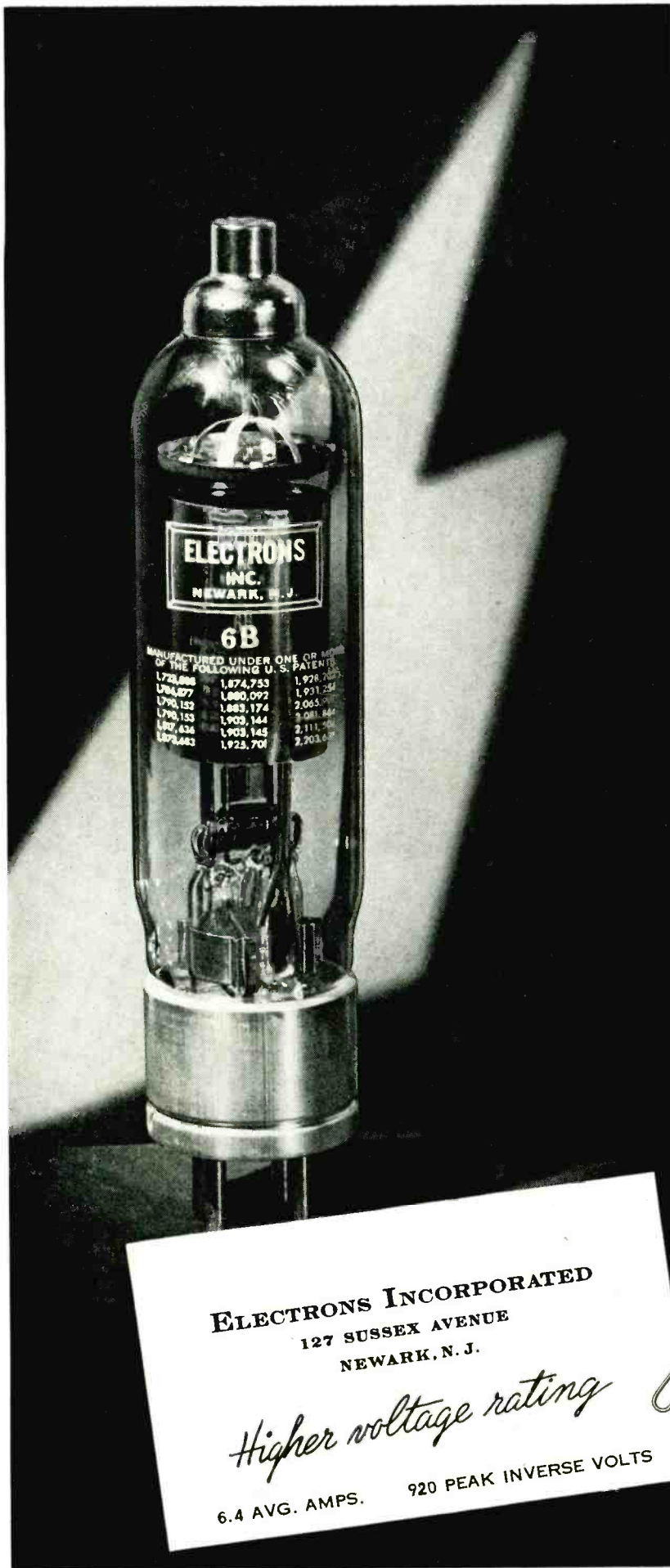

Spin pit for testing turbine parts. Speed is measured by an electronic rpm counter. The mercury flash lamp held by the Boeing engineer permits photographs at 0.2-micro-second exposure

turbine shaft is divided into two sections, half black, half white. A phototube, focused on the shaft, sends a current impulse to recording instruments each time the black portion passes its scanner. Timed and checked electrically, the speed is controlled within one-half of one percent accuracy.

The spinning is done in pits made up of layers of steel plate, with maple blocks on the inside. The steel shells test turbine components. Power for the tests is derived from compressed air, driving a small turbine which, through a shaft, is attached to the test article. A hoist supports the heavy weight of the cap plate, air turbine and accessories. The entire assembly is lowered into the pit, clamped in place and the air evacuated.

One pit has built-in heating coils of nichrome steel wire imbedded in clay holders to maintain constant temperatures of up to 1,750 deg F. Automatic controls keep temperature to preset levels and also record the whole test. Highspeed rotation and extremely high temperatures combine to prove each new development in turbine parts before incorporation in an actual engine.

High-speed photographs, made with an ordinary 8x10 view camera, enable engineers to study test wheels as they break. A small mercury lamp is the light source for the one five-millionths of a second flash. The tripper con-



# product

**IS MORE SALEABLE WITH**



*Quietones*  
Reg. U.S. Pat. Off.

You may build the best appliance of its kind on the market — but if it sets up local radio interference—you'll have tough sledding against today's keen competition. Your customers are *demanding* radio noise-free performance in the electrical equipment they buy.

The answer, of course, is to equip *your* products with C-D Quietones. Why Quietones? First, because they're the best-engineered noise filters — second, because they guard your product's reputation by

giving long trouble-free service — third, because they're designed and built to meet manufacturers' specific needs — efficiently and economically.

Speed up sales — build prestige — boost profits with C-D Quietones. Your inquiries are invited. Cornell-Dubilier Electric Corporation, Dept. K-10, South Plainfield, New Jersey. Other large plants in New Bedford, Brookline and Worcester, Mass., and Providence, Rhode Island.

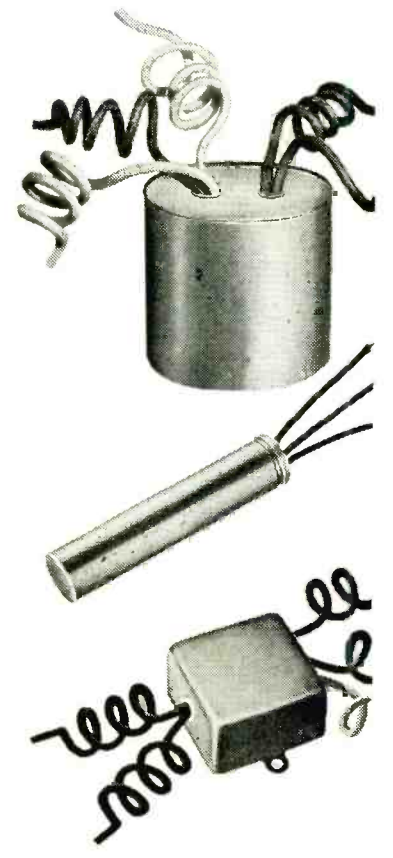

*Make Your Product More Saleable with C-D Quietone Radio Noise Filters and Spark Suppressors*

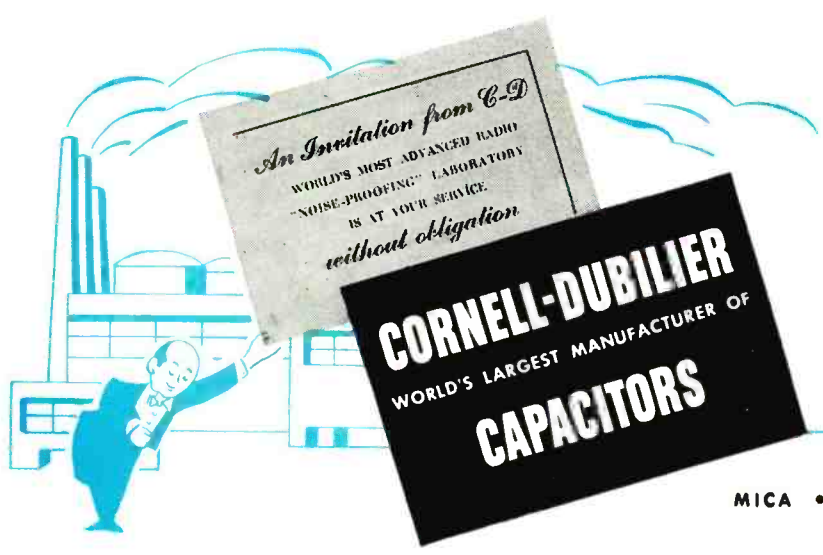

**CORNELL-DUBILIER**  
WORLD'S LARGEST MANUFACTURER OF  
**CAPACITORS**

MICA • DYKANOL • PAPER • ELECTROLYTIC



**The Shape and Size YOU need!**

**PARAMOUNT**  
SPIRAL WOUND **PAPER TUBES**

**All Sizes in Square and Rectangular Tubes**

Leading manufacturers rely on the quality and exactness of PARAMOUNT paper tubes for coil forms and other uses. Here you have the advantage of long, specialized experience in producing the exact shapes and sizes for a great many applications. *Hi-Dielectric, Hi-Strength.* Kraft, Fish Paper, Red Rope, or any combination. Wound on automatic machines. Tolerances plus or minus .002". Made to your specifications or engineered for YOU.

**SEND FOR ARBOR LIST OF OVER 1000 SIZES**

Inside Perimeters from .592" to 19.0"  
Convenient, Helpful. Lists great variety of stock arbors and tube sizes. Includes many odd sizes. Write for Arbor List today.

**PARAMOUNT PAPER TUBE CORP.**

616 LAFAYETTE ST., FORT WAYNE 2, IND.

*Manufacturers of Paper Tubing for the Electrical Industry*

**New . . . Improved ATTENUATORS**  
by **TECH LABS**

**TYPE 800 and 900**

Type 800

Type 900

"New Times—New Modes", says old proverb. These new attenuators were born to meet new war-created demands. They represent a new medium frame size: Type 800 (2 1/4" dia.) and a larger size: Type 900 (3" dia.). The Type 800 is supplied as potentiometer, rheostat, ladder and T-pad up to 20 steps. The larger size Type 900 is similarly furnished with up to 45 steps. Write for new bulletin.

**TECH**  
LABORATORIES, INC.

Manufacturers of Precision Electrical Resistance Instruments  
337 CENTRAL AVE. • JERSEY CITY 7, N. J.



ACTUAL SIZE

**CARBY**

MANUFACTURERS OF PRECISION

**EYELETS and MULTIPLE PLUNGER PRESS PRODUCTS**

The Carby Manufacturing Company, specialists in small diameter and long draw, through years of experience, engineering "know-how" and excellent production facilities, can accurately produce to the most rigid requirements every electronic requirement for . . .

- GROMMETS
- EYELETS
- SOLDERLESS LUGS
- TERMINALS
- FERRULES

**EYELETS:** Eyelets can be produced with square, hexangular or round barrels with heads to match or in any wanted combination.

**METALS:** Available metals in .006 to .032 AWG. Accurately fabricated on eyelet machines or by plunger press to meet any requirements in . . .

ALUMINUM                  COPPER  
BRASS                      STEEL  
NICKEL-SILVER

**DELIVERY:** Prompt delivery is a specialty of Carby. Our production facilities, modernly managed, is at your command to meet any reasonable requirement.

**STANDARD OR MADE TO SPECS . . .**

Many standard shapes in stock but we specialize in fabricating special needs. Send in your blueprints for prices, deliveries, and engineering advice.

**CARBY MFG. CO., INC.**

62 COTTAGE PLACE  
WATERBURY 5, CONNECTICUT

Another **FEDERAL** First!  
**INTELIN K-109**  
Crimped Type Coax

... for permanent automotive lead-ins

**Efficiency** – combining low loss and low capacity for high fidelity transmission with minimum attenuation and signal distortion

**Flexibility** – new ease of handling, installing and maintaining

**Shielding** – for freedom from interference

**Permanent Conductor Set** – for electrical and mechanical stability

**Spring Action** – Eliminates necessity for providing slack in conductor when connecting terminals. Minimizes conductor breakage at the terminals.

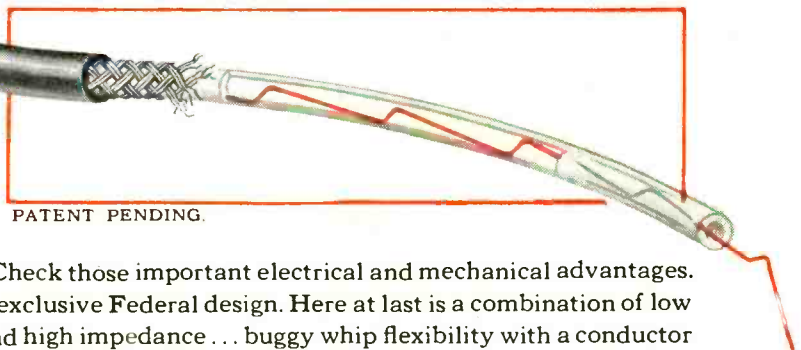

PATENT PENDING.

Check those important electrical and mechanical advantages. Check the exclusive Federal design. Here at last is a combination of low capacity and high impedance ... buggy whip flexibility with a conductor that soaks up vibration and won't break away from terminals.

Federal's new Intelin K-109 Crimped Type Coax has everything for rugged service. It is also recommended for aircraft and marine antenna lead-ins ... for inter-stage audio connections in general radio and electronic equipment.

Perhaps you see other uses for K-109. For full technical information and prices, write to Department D-613.



KEEPING FEDERAL YEARS AHEAD... is IT&T's world-wide research and engineering organization, of which the Federal Telecommunication Laboratories, Nutley, N. J., is a unit.

*Federal Telephone and Radio Corporation*

SELENIUM and INTELIN DIVISION, 900 Passaic Ave., East Newark, New Jersey

In Canada: Federal Electric Manufacturing Company, Ltd., Montreal, P. Q.  
Export Distributors: International Standard Electric Corp. 67 Broad St., N. Y.



# Want the MOST EFFICIENT TRANSMISSION LINE for Your Station?



WTAD-FM did. That's why they selected Andrew 6 1/8" coaxial transmission line. In spite of the 800 ft. long run, including a 750 ft. run up the tower, the overall efficiency is 90%!

Not only is this 6 1/8" line the most efficient standard RMA line used in broadcasting, but it offers the additional advantage of very high power handling capacity. It will handle up to 166,000 watts at 100 MC with unity standing wave ratio, allowing a wide margin for future power expansion.

Fabricated by Andrew in twenty foot lengths with connector flanges brazed to the ends, sections can be easily bolted together with only a couple of small wrenches. Flanges are fitted with gaskets so that a completely solderless, gas-tight installation results.

Still another advantage to buying Andrew equipment is that Andrew engineers are available to properly install it. NO OTHER TRANSMISSION LINE MANUFACTURER OFFERS YOU THIS COMPLETE INSTALLATION SERVICE!

Here's what Mr. Leo W. Born, Technical Director of WTAD-FM, writes about Andrew installation service:—

*"You will be interested to know that the installation of the Andrew coaxial line made by your organization has been giving us trouble-free performance of high efficiency in the daily operation of WTAD-FM.*

*Knowing the great difficulties involved in the installation of such a large line on a 750 foot tower over a period of such inclement weather conditions, I feel that the excellent operation of the line is indeed a tribute to the men of your company who were on the job. Such performance is not accidental and we congratulate you on a tough job well done."*

This again emphasizes Andrew's unique qualifications:—Unsurpassed equipment and complete engineering service.

**WANT THE MOST EFFICIENT ANTENNA EQUIPMENT FOR YOUR STATION? WANT EXPERIENCED ENGINEERS TO INSTALL IT? WRITE ANDREW TODAY!**

The 750 ft. high tower of WTAD-FM, Quincy, Illinois — one of America's finest FM Stations—showing 6 1/8" copper coaxial transmission line manufactured and installed by Andrew.

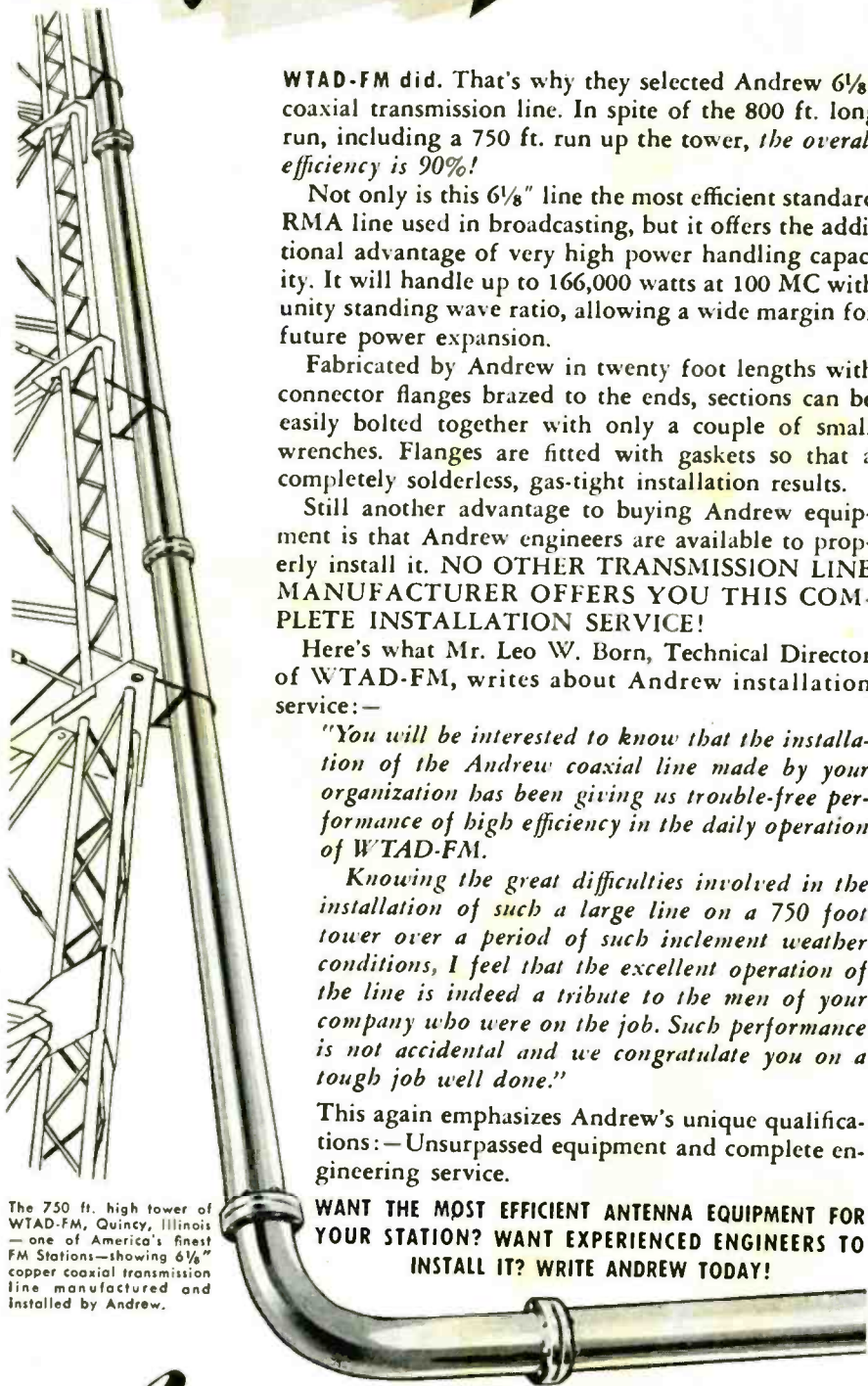

## Andrew CORPORATION

TRANSMISSION LINES  
ANTENNA EQUIPMENT

363 EAST 75TH STREET, CHICAGO 19 • EASTERN OFFICE: 421 SEVENTH AVENUE, NEW YORK CITY

sists of double concentric copper screens which line the test pit. At burst, the pieces of the test wheel crash into the screens, pushing them into contact and completing the flash circuit. By this technique, any portion of the wheel which breaks loose under such punishment immediately takes its own picture and establishes the point of failure.

The spin pits test the turbine wheels for the effects of weight and tensile strength of the materials; for rim-loading by their blades; profile, or cross-sectional shape; design of the shaft holes in their hubs.

### Metal Picture Tube

A sixteen-inch cathode-ray tube having a metal shell is being made available to receiver manufacturers.

The envelope of the new tube consists of a cone of spun chrome steel alloy. A glass neck houses the electron gun assembly to permit customary mounting and operation of the focusing and deflection coils. The glass neck flares outward to a diameter of about four inches and meets the metal cone in a butt joint. Sealing the metal, which has the same coefficient of expansion as the glass, is accomplished with the aid of induction heating.

The glass front of the picture tube is drawn glass, polished on both sides, and this too is sealed to the metal cone with induction heating. The curvature of the glass face is such that nearly



New metal-shell picture tube



# ONE-PIECE NYLON SUPPORT NUT

## simplifies coil assembly... speeds up production

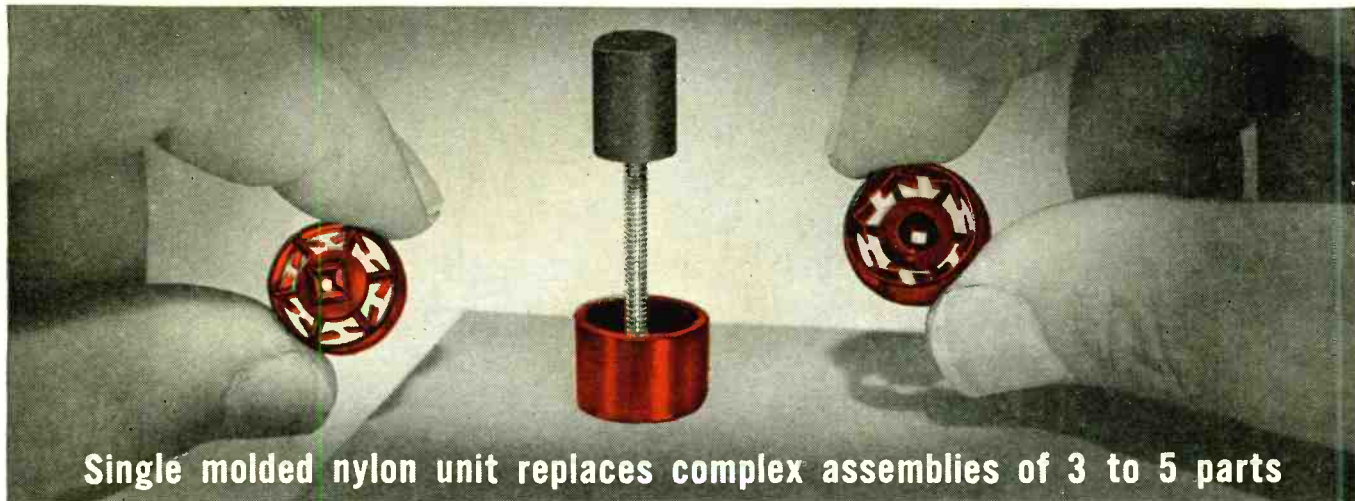

Single molded nylon unit replaces complex assemblies of 3 to 5 parts

*Nylon coil-support nut manufactured by Elastic Stop Nut Corporation of America, Union, New Jersey*



**Square shank of nylon nut**, molded as one unit but consisting of four separate prong-shaped legs, is inserted in square hole of supporting plate. Since nylon itself is an insulator, the nut does not require a grommet. And Du Pont nylon remains stable at temperatures ranging from  $-60^{\circ}\text{F.}$  to  $200^{\circ}\text{F.}$

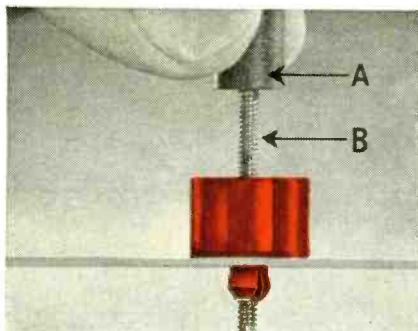

**Tuning slug (A)** and screw (B) are rotated, impressing thread shape of screw into nylon shank. Prong-shaped legs of shank flare outward, securing nut to plate. Nylon develops torque on screw thread to hold slug in adjusted position, despite vibration and variations in plate thickness and size of hole.

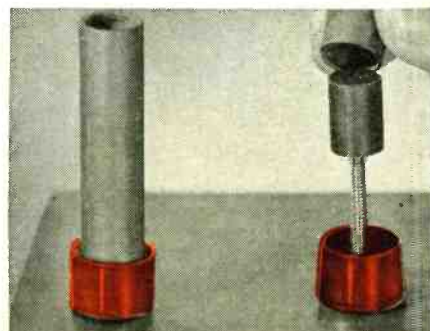

**Coil form fits snugly** in nylon nut... firmly gripped externally by six thin, flexible "fingers" on the inside wall of the support nut. The hollow tube is held securely in place by pressure of the nylon "fingers," although wall thicknesses of the tube may often vary as much as  $1/32$  of an inch.

### CAN NYLON HELP YOU MAKE A BETTER PRODUCT?

Here's a new, all-nylon coil support for radio and television sets. It does the same job that once required a complex assembly of 3 to 5 parts... yet it consists of only *one molded nylon nut!* The result—reduced parts inventory, quicker assembly, faster production.

In developing this new product, the manufacturer found all the desired properties in Du Pont nylon. Its light weight, strength in thin sections, resiliency, stability and insulating properties permit a new, multi-purpose design. And nylon's unique workability assures efficient, economical molding of the intricately shaped unit. *It's one more case* where an electrical manufacturer makes a better product with Du Pont nylon.

This Du Pont plastic can be molded or extruded. When designing electrical parts or wires, don't overlook its remarkable properties. Write

for free booklet, "65 Success Stories of Product Improvement." Filled with helpful facts. Just address: E. I. du Pont de Nemours & Co. (Inc.), Plastics Department, Room 1410, Arlington, N. J.

#### CHECK THESE 7 BASIC FEATURES OF NYLON FOR ELECTRICAL USES

- 1 Good flexibility
- 2 High tensile strength
- 3 Extreme toughness
- 4 Abrasion resistance
- 5 Resistance to permanent set
- 6 Chemical resistance
- 7 Ability to be molded or extruded

**DU PONT**

REG. U. S. PAT. OFF.

**Plastics**

BETTER THINGS FOR BETTER LIVING...  
...THROUGH CHEMISTRY



# PRECISION POTENTIOMETERS

Toroidal and Sinusoidal

For use in computing and analyzing devices; generation of low frequency saw tooth and sine waves; controls for radio and radar equipment; position indicators; servo-mechanisms; electro medical instruments, measuring devices—telemetry; gun fire control where 360° rotation, high precision and low noise levels are essential.

The type RL14MS sinusoidal potentiometer is illustrated. It is wound to a total resistance of 35,100 ohms and provides two voltages proportional to the sine and cosine of the shaft angle. It will generate a sine wave true within  $\pm 0.6\%$ . Overall dimensions are  $4\frac{3}{8}$ " diameter x  $4\frac{11}{32}$ " long plus shaft extension  $\frac{1}{4}$ " diameter x  $1\frac{1}{2}$ " long.



Write for Bulletin F-68

**THE GAMEWELL COMPANY**

Newton Upper Falls 64, Massachusetts



## FABRICATED SHEET METAL PRODUCTS

to your specifications . . .

COMPLETE facilities under one roof for quantity mass production—including welding, baking and finishing. Whistler and Wiedermann equipment for short runs. Tool and die engineering and designing.

Substantial sheet steel inventories permit speed, service and cooperation. Large assortment of stock and special dies for the radio and electronic field. Production and engineering under the personal direction of Mr. E. B. Gunzburg, president—who has had 34 years' experience in sheet metal fabrication.

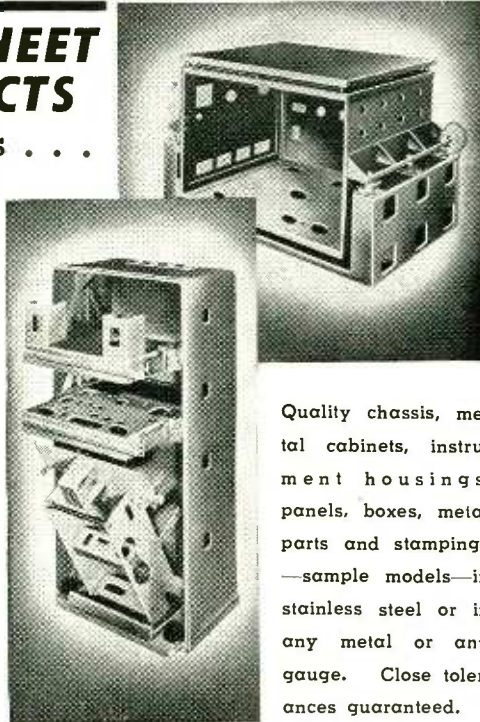

Quality chassis, metal cabinets, instrument housings, panels, boxes, metal parts and stampings—sample models—in stainless steel or in any metal or any gauge. Close tolerances guaranteed.

Send your blueprints and requests for prompt attention and quotations.

**ART-LLOYD METAL PRODUCTS CORP.**

2973 Cropsey Ave.

Brooklyn 14, N. Y.

Telephone: ESplanade 3-2400

## Tracing cloth that defies time

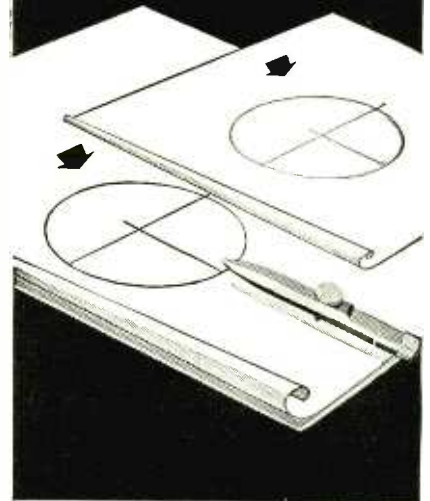

● The renown of Imperial as the finest in Tracing Cloth goes back well over half a century. Draftsmen all over the world prefer it for the uniformity of its high transparency and ink-taking surface and the superb quality of its cloth foundation.

Imperial takes erasures readily, without damage. It gives sharp contrasting prints of even the finest lines. Drawings made on Imperial over fifty years ago are still as good as ever, neither brittle nor opaque.

If you like a duller surface, for clear, hard pencil lines, try Imperial Pencil Tracing Cloth. It is good for ink as well.



## IMPERIAL TRACING CLOTH



SOLD BY LEADING STATIONERY AND DRAWING MATERIAL DEALERS EVERYWHERE



PICK A NUMBER  
 ANY FREQUENCY FROM 10 TO 1,000

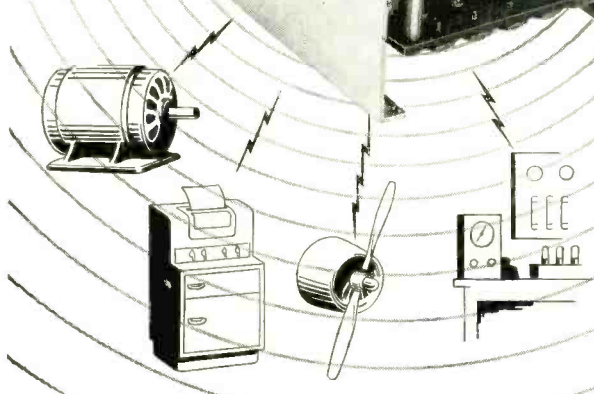
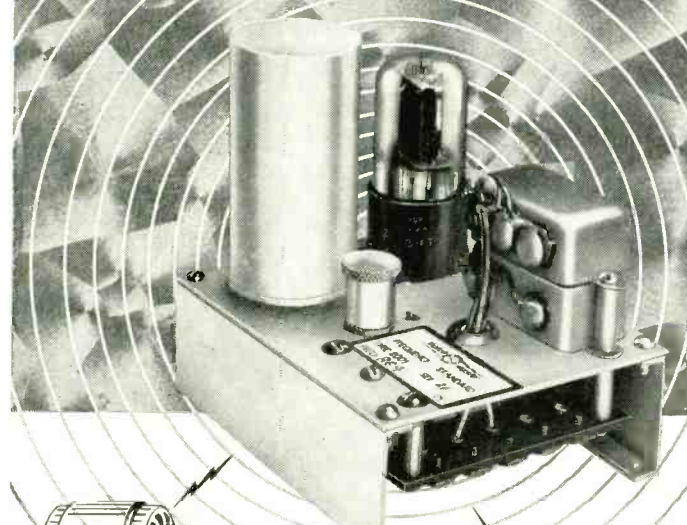

Pictured here is a tuning-fork frequency standard with accuracy guaranteed to one part per million per degree Centigrade. The fork is temperature-compensated and hermetically sealed against variations of barometric pressure. This standard, when combined with basic equipment, facilitates accurate speed and time control by mechanical, electrical, acoustical or optical means.

The unit is available separately or in conjunction with complete timing instruments. Our engineers are ready to cooperate on any problem.

MOTORS • FACSIMILE • AIRCRAFT • LABORATORIES

# American Time Products, Inc.

580 Fifth Avenue

New York 19, N.Y.

OPERATING UNDER PATENTS OF THE WESTERN ELECTRIC COMPANY



# PRECIOUS METAL LAMINATED RINGS



Where electrical contact is required to a moving part, laminated precious metal rings offer unusual operating characteristics at a real saving in cost over solid precious metal rings.

Silver or Gold, or Platinum, or Palladium, or their alloys, bonded to the required base metal, such as copper or bronze alloys, make possible . . .

- . . . **Uniform contact resistance**
- . . . **Low noise level**
- . . . **Selected temper for essential wearing quality**
- . . . **Mechanical strength**
- . . . **Corrosion resistance**

These rings are now being used in special electric motors, calculators, and computers, Radar, and fire control instruments, potentiometers, and other electro mechanical devices.

Our engineers will be pleased to make recommendations to meet your requirements. We would also be pleased to submit quotations to cover your specifications.



**Makepeace PRODUCTS**

SHEETS • WIRE • TUBING • SOLDERS • FABRICATED PARTS AND ASSEMBLIES

**D. E. MAKEPEACE COMPANY**

Main Office and Plant, Attleboro, Massachusetts

NEW YORK OFFICE, 30 CHURCH ST. • CHICAGO OFFICE, 55 EAST WASHINGTON ST.

TUBES AT WORK

(continued)

150 sq in. image area is provided.

The 16-inch tube has a deflection angle of 53 degrees and, for critical resolution, deflection coils designed for this angle are recommended. However, coils designed for conventional tubes having a deflection angle of 50 degrees have been found to provide good resolution. Operating voltage of the second anode is recommended at about 10 kv although the tube is tested at 15 kv.

The potential of the steel shell is also 10 kv and it is planned to make available an insulating sleeve. A Tenite coating on the sleeve and an Aquadag layer might then be used to form a filter capacitor for the high-voltage power supply as is conventional practice with the 10BP4 and 10FP4. (ELECTRONICS, p 186, April 1948).

The metal tube is manufactured by Tel-O-Tube Corp. of America, at Paterson, N. J. and is used in a table model receiver of Starrett Television Corp. of New York.

## Amplitude Selective Amplifier

By CHARLES E. LOWE  
*Fenton, Michigan*

IN THE development of a servo-system for operation of a drag cup motor in response to the output signal of a magnetic bridge, it was found that the use of an amplitude-selective amplifier overcame many irritating and vexing problems.

Slight modification in normal resistance-coupled amplifier performance enables such amplitude discrimination to be obtained with few additional parts. Although in ordinary amplifier usage such a condition is known as bad transient response, in this application it acted as a cure-all with no ill effects.

The output signal of the magnetic bridge contained much second harmonic of the motor operating frequency throughout the near-balance condition of the bridge and through the null point of the operating signal. This unwanted harmonic content tended to mask the null point as it decreased the sensing efficiency of the overall system at the critical time of balance indication. At the same time, the non-linear operation of the bridge magnetic elements combined with the

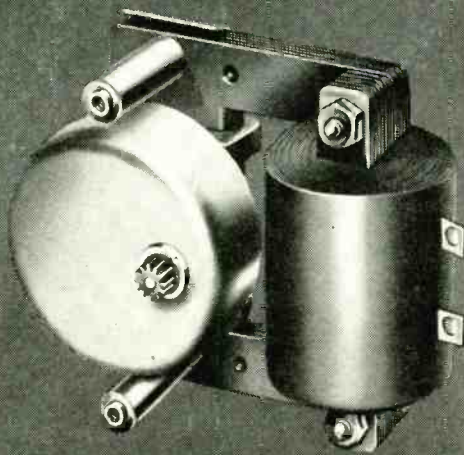

Telechron H-4 Synchronous Motor.  
Terminal-shaft speeds 3 to 6 rph.

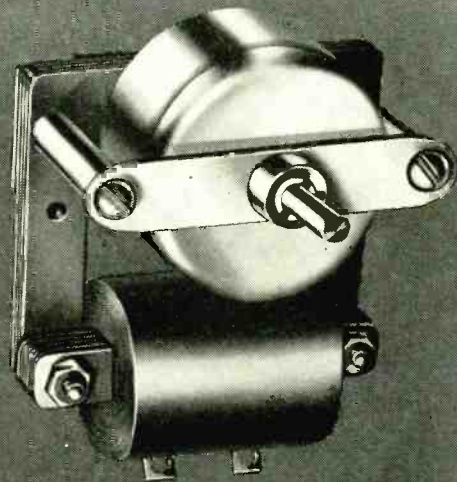

Telechron H-5 Synchronous Motor.  
Terminal-shaft speeds 1 to 6 rph.

## Give your timers **extra life** with Telechron motors

There's longer service in any time switch or timer powered with an H-4 or H-5 Telechron synchronous electric motor. Efficient, dependable lubrication is assured by a special terminal-shaft bearing incorporating an oil gland that extends motor life.

These dependable, self-starting motors are designed for general-purpose time switches, dishwasher timers, stoker and oil-burner controls, appliance timers, defroster

timers, fast battery chargers and many other timing and switching devices. They operate in perfect synchronism with any commercial frequency . . . can't run fast or slow.

The H-4 motor is available in terminal-shaft speeds from 3 to 6 rph. The H-5 motor is available in terminal-shaft speeds from 1 to 6 rph. Their conservative torque ratings at 60 cycles range from .20 pound-inch at 6 rph. to .50 pound-

inch at 1 rph. Like all Telechron motors, they are precision-built for long, dependable service by the largest producer of synchronous electric timing motors for over 25 years. Every one is Underwriters Laboratories approved. Why not talk over your special needs with Telechron's application engineers? Address Motor Advisory Service, Dept. M, Telechron Inc., Ashland, Massachusetts. A General Electric Affiliate.



**THE FIRST AND FAVORITE SYNCHRONOUS ELECTRIC TIMING MOTOR**

ELECTRONICS — October, 1948





**ANOTHER SPECIAL BY PROGRESSIVE**

**QUALITY PROMCO BRAND**

ACTUAL SIZE      ENLARGED FOR DETAIL

**CATALOG SHOWS DOZENS MORE**  
 Special heads, threads and finishes on any metal or alloy adapted to cold upset. Weekly output: 25,000,000 pieces. Many specials, suggesting production savings for you, illustrated in latest catalog. Includes weights per 1M standard pieces, dec. equivs. of fractions, other purchasing and engineering helps. Write for Catalog 19.

**The PROGRESSIVE MFG. CO.**  
 50 NORWOOD ST.      TORRINGTON, CONN.

**AMPERITE**

**THERMOSTATIC METAL TYPE DELAY RELAYS**

**PROVIDE DELAYS RANGING FROM 1 TO 120 SECONDS**

**FEATURES:**—Compensated for ambient temperature changes from  $-40^{\circ}$  to  $110^{\circ}$  F . . . Hermetically sealed; not affected by altitude, moisture or other climate changes . . . Explosion-proof . . . Octal radio base . . . Compact, light, rugged, inexpensive . . . Circuits available: SPST Normally Open; SPST Normally Closed.

PROBLEM? Send for "Special Problem Sheet" and Bulletin.

**AMPERITE REGULATORS**

**BATTERY VOLTAGE**

VOLTAGE OF 24V BATTERY & CHARGER VARIES APPROX. **50%**

WITH AMPERITE VOLTAGE VARIES ONLY **2%**

Amperite REGULATORS are the simplest, lightest, cheapest, and most compact method of obtaining current or voltage regulation . . . For currents of .060 to 8.0 Amps . . . Hermetically sealed; not affected by altitude, ambient temperature, humidity.

Write for 4-page Illustrated Bulletin.

**AMPERITE CO., 561 Broadway, New York 12, N. Y.**

In Canada: Atlas Radio Corp., Ltd., 560 King St., W. Toronto



**WHEN SPACE IS A FACTOR . . .**

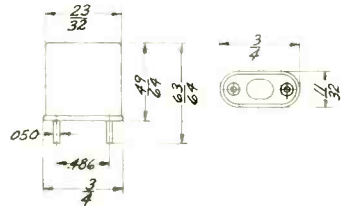

**TYPE 20 by STANDARD** is the answer. Superior engineering, hermetic sealing and filling with dry nitrogen result in a highly stable plated type, wire mounted crystal unit.

Fundamental frequencies from 1mc. to 20mc. Harmonic mode. 15mc. to 75mc. Tolerances from .02% to  $\pm 0.003\%$  over temperature range  $-55$  to  $+90^{\circ}$  C.

This unit can also be supplied in CT and D'T cur, center mounted, plated crystals in the frequency range from 200kc. to 1000kc.

Let us send you our FREE catalog showing the STANDARD line of frequency control units. For special problems, our engineering department offers consultation service with no obligation.

We manufacture quality Super-sonic and Ultra-sonic crystals.

**STANDARD PIEZO CO.**

Office & Development Laboratories

CARLISLE, PENNA.

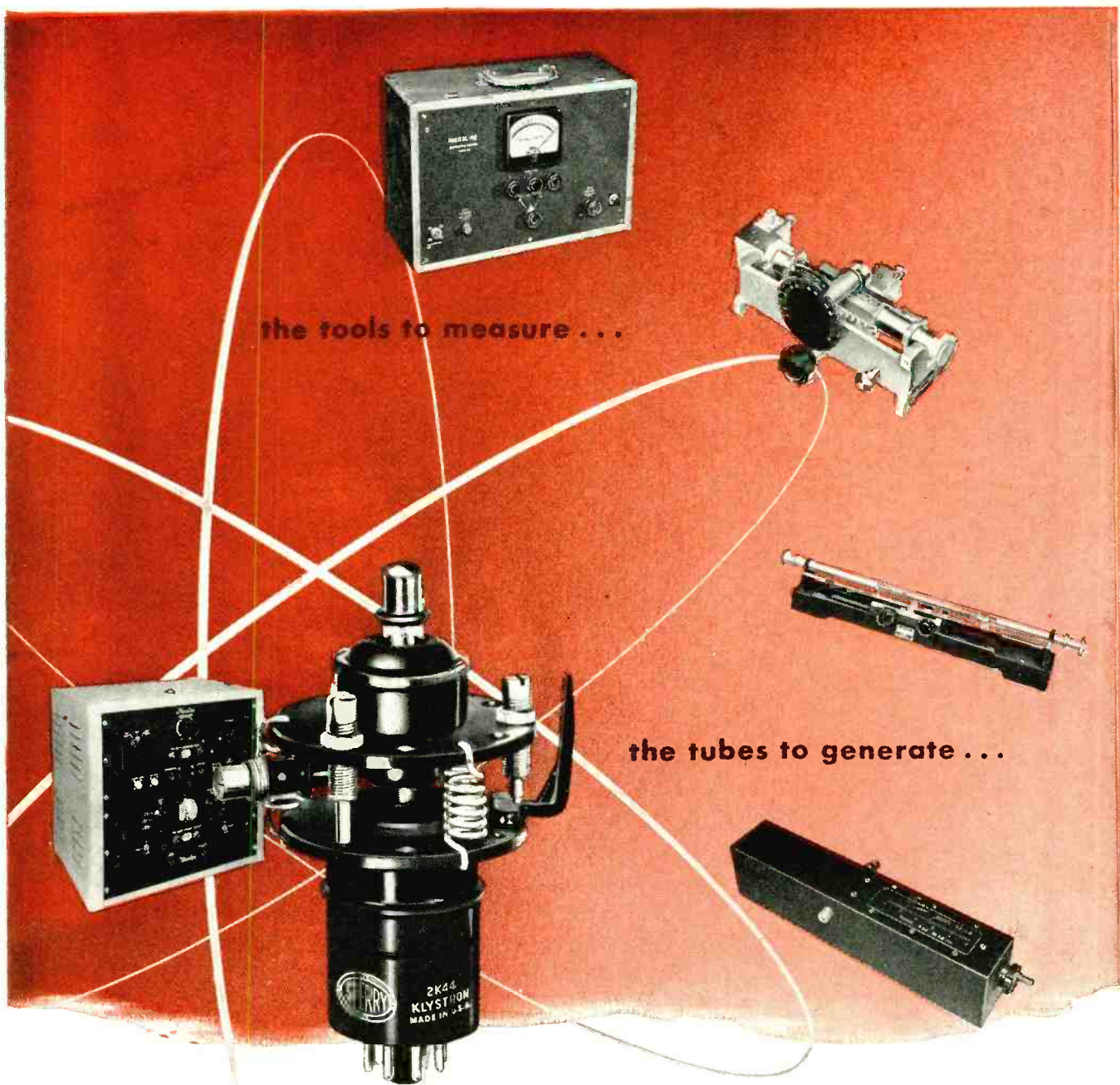

# *microwave Energy*

The Sperry Klystron Tube to generate ultra-high-frequency microwaves . . .

The Sperry Klystron Signal Source to "power" them . . .

The Sperry Microline to test and measure them . . .

These Sperry products equip the research or development engineer with every essential for development or design in the microwave field.

The Sperry Klystron Tube has already opened up new vistas in

navigation, aviation, medicine, radio, telephone, telegraph and other major applications. It is ready for many new local oscillator or high power uses.

The Sperry Microline includes practically every type of instrument for quick precision measurements in the microwave frequency bands.

This Sperry service — beginning with a source of microwave energy, the Klystron, and following through with every facility for measuring microwaves — opens up almost unlimited possibilities for industry.

We will be glad to supply complete information.



**SPERRY GYROSCOPE COMPANY**

**DIVISION OF THE SPERRY CORPORATION • GREAT NECK, N. Y.**  
 NEW YORK • LOS ANGELES • SAN FRANCISCO • NEW ORLEANS • CLEVELAND • SEATTLE





Engineered to the Highest FM and AM Broadcast Standards

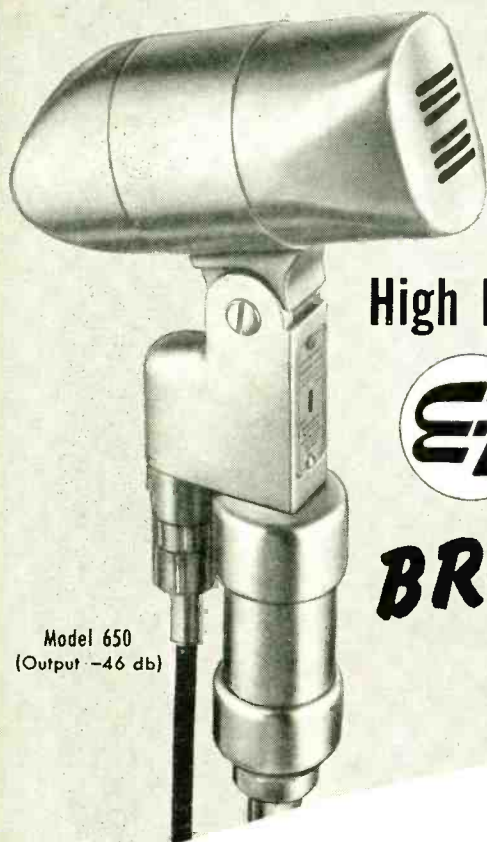

Model 650  
(Output -46 db)

# NEW!

## High Fidelity Dynamic



# BROADCAST Microphones

**FEATURES LIKE THESE  
WIN TOP RATING**

*by Station and Network Engineers!*

*Flat out to 15 kc! Extremely high output! Impedance selector! Dual-type shock-mount! Remarkably rugged! Individually calibrated!*

Developed in cooperation with station and network engineers, the new "650" and "645" meet exacting requirements of modern high fidelity FM and AM broadcast service. Proved in studio and remote use. Polar pattern is non-directional at low frequencies, becoming directional at high frequencies. Recessed switch gives instant selection of 50 or 250 ohms impedance. Exclusive Acoustalloy diaphragm withstands toughest use. Many other important features assure the ultimate in broadcast quality. Satin chromium finish. Fully guaranteed.

Model 650. Output level -46 db. List . . . . . \$150.00

Model 645. Output level -50 db. List . . . . . \$100.00

*Broadcast Engineers: Put the "650" or "645" to the test in your station. Know the thrill of using the newest and finest. Write for full details.*



Model 645  
(Output -50 db)

NO FINER CHOICE THAN

# Electro-Voice

ELECTRO-VOICE, INC., BUCHANAN, MICHIGAN

Export: 13 East 40th St., New York 16, U.S.A. Cables: Arlab

TUBES AT WORK

(continued)

differentiation through the mutual inductance of the output winding, coupled to the bridge proper, created an output signal inconsistent in waveform. As a result, the speed of the motor did not bear a simple direct relationship to the primary control displacement and the final calibration of the system became partially dependent upon an unreliable and erratic variable.

Presence of the second harmonic of the bridge excitation frequency in the bridge output signal was a necessary evil of the bridge design. Since it was designed to respond to minute direct currents in its input winding and to sense their direction as well as their amplitude, it was necessary to polarize the bridge arms with direct-current magnetization. In this way the aiding or opposing of this steady flux by the flux set up by the small current from the primary conversion element produced effects that indicated the direction of such current by the phase relationship of the output signal to the bridge excitation frequency. This latter frequency was also one of the phases of the motor excitation.

The sensing of reversal of input current direction by the bridge was indicated to the drag cup motor by a 180-degree change in phase of output signal. A balance for the bridge occurred with no incoming current from the conversion element or with the bridge input terminals shorted. At balance, the opposing alternating-current fluxes from the two bridge arms failed to give zero signal balance indication.

Since each half cycle of the opposing fluxes operated in separate directions along the B-H curve of the core from the operating point set up by the d-c polarization, the peak amplitudes of each half cycle of flux were not equal. Because of this difference, cancellation was not complete, and during every half cycle of the excitation frequency such a left-over bundle of flux appeared to cyclically excite the output winding. Thus, a second harmonic signal is generated. This signal reached its maximum value at the time of the null for the motor-operating signal.

In this application, the drag cup

# For the answers to your ELECTRONIC-MECHANICAL PROBLEMS...

## CONSULT SHERRON'S ANALYTICAL ENGINEERING-MANUFACTURING SERVICE

### VIEW OF SHERRON ELECTRO- MECHANICAL LABORATORY

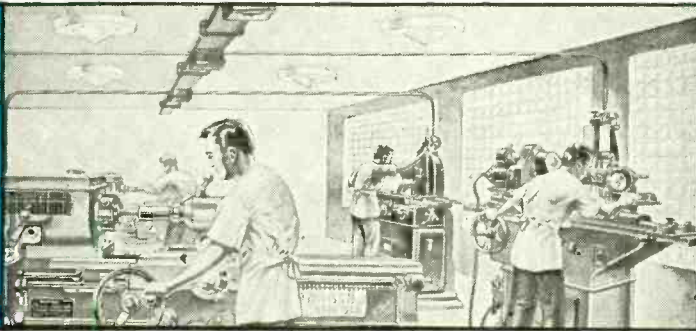

In the completeness of its departments, manpower and the skills and experience of its personnel, the Sherron Electronics Co. is organized to meet any challenge in the design, development and manufacture of:

Communications equipment . . . Electronic Control equipment . . . Vacuum Tube Circuit development . . . Control of Measuring Devices . . . Instrumentation . . . Television Transmitters . . . Television Test equipment . . . Test Equipment for Components.

### VIEW OF SHERRON ELECTRONICS LABORATORY

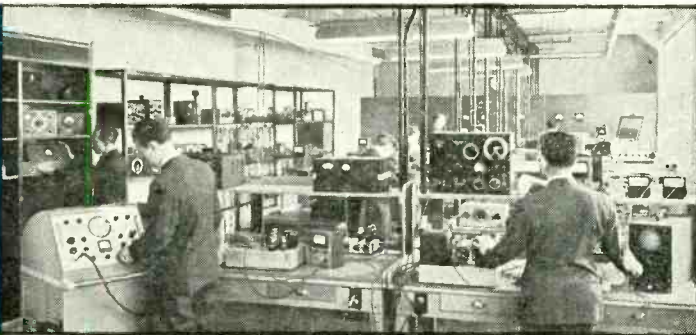

In broad terms, Sherron's Analytical Engineering-Manufacturing Service means . . . complete design, development, engineering and manufacturing of "precision electronics" equipment. Comprehensive, confidential — this service is exclusively for manufacturers. It is defined by these facilities, personnel and operations:

**DEVELOPMENT-DESIGN:** Initiated in our electronics laboratory by experi-

enced physicists, engineers and technicians.

**ELECTRO-MECHANICAL LABORATORY:** Staffed by graduate mechanical engineers fully conversant with the requirements for "precision electronics."

**COMPLETE SHEET METAL FACILITIES**

**WIRING DEPARTMENT:** Headed by production electrical engineers.

### RECENT SHERRON PROJECTS RELATING TO ELECTRONICS AND OTHER INDUSTRIES

#### COMMUNICATIONS

- Trans-Receiver for various uses
- Television — FM — AM — Transmitters
- Navigational Devices, including Homing Equipment, Radar, etc.
- Micro-wave techniques and Radio Relay Links
- Ample Test Equipment to assure successful operation of above

#### ELECTRONIC CONTROL EQUIPMENT FOR

- Drone Aircraft Guided Missiles
- High Gain Amplifiers
- Computers and Calculators
- Servo Equipment
- Velocity Propagation measurement
- Test Equipment including Instrumentation for above

#### VACUUM TUBE CIRCUIT DEVELOPMENT

- New applications for existing vacuum tubes
- Precision test equipment for vacuum tubes

#### CONTROL OF MEASURING DEVICES

- Flow indicators
- Sorting, Counting
- Measurement of chemical titrations
- Surface strains, stresses, etc.

#### INSTRUMENTATION

- Bridge measurements
- Null detectors
- Vacuum tube voltmeter-ammeters
- Multi-wave shape generators

#### TELEVISION

- Television Signal Synthesizer Sync Generators
- Monoscope
- Shapers — Timers
- Wide band oscilloscopes
- Air monitors
- Field intensity equipment
- Television test equipment



## SHERRON ELECTRONICS COMPANY

DIVISION OF SHERRON METALLIC CORPORATION

1201 FLUSHING AVENUE • BROOKLYN 6, NEW YORK



**IT'S NEW!**

**IT'S BETTER!**

**IT'S YN-25!**

# New! FORMICA YN-25

ELECTRICAL INSULATION

## 200 Times Better Insulation Resistance

The specifications for Formica "YN-25" tell their own amazing story far better than adjectives. Note particularly that impact strength is 10 times greater... insulation resistance 200 times higher than standard electrical grades of laminated insulation.

PROPERTY	VALUE
Power Factor @ 1 megacycle.....	.014
Dielectric Constant @ 1 megacycle.....	3.9
Insulation Resistance after 96 hrs. @ 95% R.H. @ 90° F.....	Over 50,000 megohms
Impact strength Flatwise.....	10 ft. lbs. per inch of notch
Edgewise.....	6 ft. lbs. per inch of notch

Excellent machining, punching and post-forming characteristics mean limitless variety of possible sizes and shapes.

Write for full engineering data to Formica, 4640 Spring Grove Avenue, Cincinnati 32, Ohio.



**FORMICA "YN-25"—200 TIMES BETTER INSULATION RESISTANCE**

**NOW**

## a really high-powered **RADIO ENGINEERING LIBRARY**

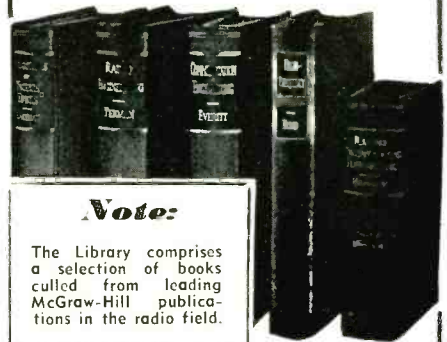

**Note:**

The Library comprises a selection of books culled from leading McGraw-Hill publications in the radio field.

- especially selected by radio specialists of McGraw-Hill publications
- to give most complete, dependable coverage of facts needed by all whose fields are grounded on radio fundamentals
- available at a special price and terms

These books cover circuit phenomena, tube theory, networks, measurements, and other subjects—give specialized treatments of all fields of practical design and application. They are books of recognized position in the literature of the field—books you will refer to and be referred to often. If you are a practical designer, researcher or engineer in any field based on radio, you need these books for the help they give in hundreds of problems throughout the whole field of radio engineering.

**5 volumes, 3559 pages, 2558 illustrations**

- Eastman's **FUNDAMENTALS OF VACUUM TUBES**, 2nd edition
- Terman's **RADIO ENGINEERING**, 2nd edition
- Everitt's **COMMUNICATION ENGINEERING**, 2nd edition
- Hund's **HIGH FREQUENCY MEASUREMENTS**
- Henney's **RADIO ENGINEERING HANDBOOK**, 3rd edition

**SPECIAL LOW PRICE • EASY TERMS**

Special price under this offer less than cost of books bought separately. In addition, you have the privilege of paying in easy installments beginning with \$2.50 in 10 days after receipt of books, and \$5.00 monthly thereafter. Already these books are recognized as standard works that you are bound to require sooner or later. Take advantage of these convenient terms to add them to your library now.

**FOR 10 DAYS' EXAMINATION SEND THIS**

**ON-APPROVAL COUPON**

McGraw-Hill Book Co., Inc., 330 W. 42nd St., N. Y. 18  
Send me Radio Engineering Library for 10 days' examination on approval. In 10 days I will send \$2.50 plus few cents postage, and \$5.00 monthly till \$27.50 is paid, or return books postpaid. (We pay postage on orders accompanied by remittance of first installment.)

Name .....

Address .....

City ..... Zone ..... State .....

Company .....

Position ..... L-10-48

## Do you need a DRY BATTERY you can't find?

**There is a SPECIALTY DRY BATTERY for your special need**

If you are looking for hard-to-get or special dry batteries, write us. We design, create and manufacture to your requirements.

SEND FOR THIS FREE CATALOG

# SPECIALTY BATTERY COMPANY

A SUBSIDIARY OF THE **RAY-O-VAC** RAY-O-VAC COMPANY

MADISON 4, WISCONSIN

The latest  
**COSSOR CONTRIBUTION**  
 to electronic technique!

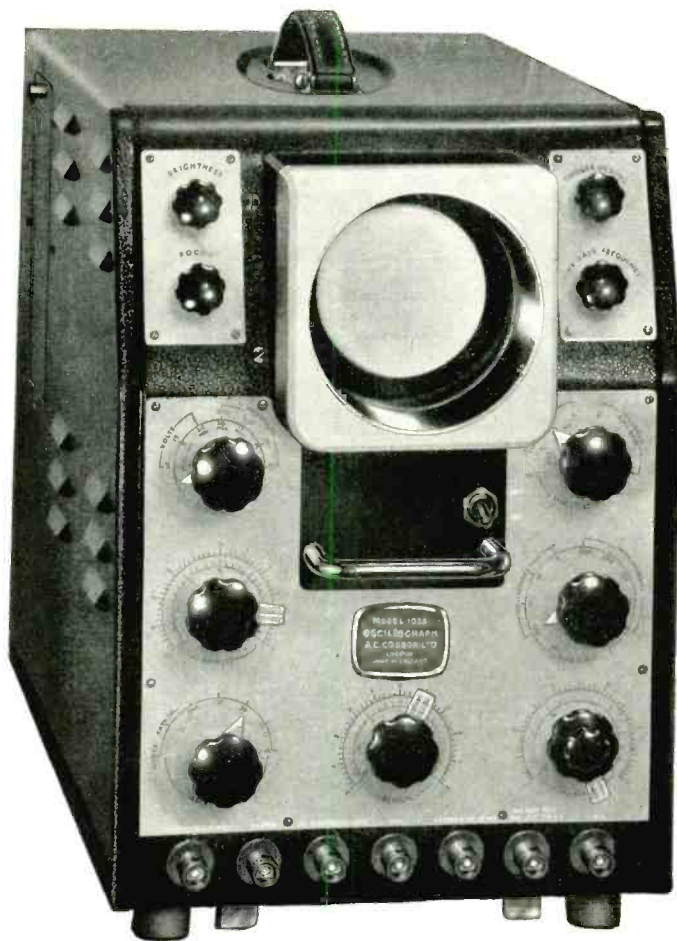

**DIRECT** measurement of voltages  
**DIRECT** measurement of time intervals  
**FLAT FACE TWIN BEAM TUBE**

**COSSOR\***  
**TWIN-BEAM**  
**OSCILLOGRAPH**  
**MODEL 1035**

A. C. Cossor Ltd., pioneers in the fields of advanced electronic equipment, including the development of the cathode ray tube, now, with pardonable pride, offer the COSSOR TWIN-BEAM OSCILLOGRAPH to the electronic industries of North America.

In all fields of modern research and in all industrial laboratories — in fact, anywhere where competent quantitative measurements and immediate waveform analysis are a necessity, the Cossor Twin-Beam Oscilloscope, Model 1035, is essential equipment.

The instrument design incorporates a high speed, linear repetitive time base, featuring "Flyback" suppression with further facilities of external triggering from both positive and negative synchronizing voltages. The time scale is liberally spread over 9 convenient ranges, 150 milliseconds to 15 microseconds, and the time base waveform may be fed out for use with other equipment.

Other important factors which make this a really unique oscilloscope, are the two independent systems of amplification with similar calibration arrangement. Voltage scale of amplifier Y1 covers 7 ranges, 50 volts to 50 millivolts, having an efficient frequency response of 10 mcs. to 20 cps. Voltage scale of Y2 covers 5 ranges, having a frequency response of 100 kcs. to 20 cps.

*\*The A. C. Cossor organization has won world-wide recognition for its pioneer development of the X-Ray Tube, the Cathode Ray Tube and the Cathodic Ray Oscilloscope. It also developed the first Radar Receiver and the first commercial Television Receiver.*

Still another major technical advancement lies in the electrically shielded new Cossor type 89 Double-Beam tube, 4 inches in diameter, with a FLAT FACE, eliminating all possibility of distortion created by the conventional curved-faced type, and, in addition, the graticule is engraved on both sides eliminating the common optical aberrations of parallax.

The instrument provides for mounting a camera directly to the face of the Cathode tube thus providing a permanent record of the waveform displayed.

Mains voltages may be adjusted between 105 to 255 volts and frequency between 50-100 cycles; power consumption 170 watts.

\$505.00 f.o.b. Montreal  
 (U. S. Funds)

COSSOR OFFERS MUCH MORE — COSTS MUCH LESS.  
 IMMEDIATE DELIVERY FROM STOCK.  
 Write us for further details of both the new Cossor Oscilloscope Model 1035 and camera attachment.

**COSSOR (CANADA) LTD.**  
 621 CRAIG STREET W, Montreal 3, Canada



# While it's "in the Design Stage"...



look to

# Leach

The time to select relays is at the start of circuit design. Frequently, manufacturers save time and money—develop a better product, by consulting Leach during the first stages of their designing. Here's how—

Leach manufactures thousands of types of relays, for thousands of applications. Many are production items which may offer you savings in delivery time and unit cost. Through a slight change in circuit design you may gain the advantages of a standard type, at considerable savings *and* do a better job.

For your specific requirements, consult the competent staff of Leach electrical engineers. Custom designs are their stock in trade. Remember, for Better Controls through Better Relays, *look to Leach*. Write today.



## LEACH RELAY CO.

5915 AVALON BOULEVARD, ★ LOS ANGELES 3, CALIF.

TUBES AT WORK

(continued)

motor is subject to a braking action in the presence of such harmonics, distortion, or spurious frequencies, and mainly suffers a loss of efficiency and is not made unusable. Because of the limitations on the amplifier at a time when its sensitivity should be increased and the very irregular action of the servo-system as the control signal waveform varied, steps were taken to eliminate this nuisance.

Application of tuned circuits and of notch filters helped but reliability under varied conditions of operation was not obtained.

### Circuit Operation

In the process of amplitude discrimination, the output signal of the bridge is first amplified and then the fundamental frequency is separated from the envelope of the second harmonic. The output of the amplifier goes through essentially the same waveform changes as the input signal with the exception that the output signal change occurs long before the same degree of input signal change. Watching the input and output signal simultaneously on a pair of oscilloscopes, one can observe only a slight change in the waveform of the input signal while the output signal is changing from complete second harmonic to complete fundamental. The change in output signal during the transition is continuous in that one frequency increases in amplitude while the other is decreasing.

At bridge balance, the amplifier still passes second harmonic signal, however, it is now limited to a much narrower range in the bridge calibration. The increased sharpness of bridge balance indication welcomes the damping action induced on the motor armature by the second harmonic drag. Thus the braking action of the second-harmonic signal of the motor operating frequency may be used for slight anti-hunting purposes to inhibit overshooting.

### Bridge Signals

Figure 1 shows the changes in the bridge output from a balanced condition to one of complete unbalance. At Fig. 1A, the balanced bridge indication is an approximate sine wave, a second harmonic

# AM · FM · TV RAYTHEON SPEECH EQUIPMENT

For the last word in complete, up-to-the-minute facilities  
... or simple, low-cost equipment to suit your limited requirements ...

## Look to RAYTHEON for All Your Needs



**RC-11 STUDIO CONSOLE**

**NOW WITH CUE POTS FOR TWO TURNTABLES**

Provides complete high-fidelity speech input facilities with all control, amplifying and monitoring equipment in one cabinet. Seven built-in pre-amplifiers, nine mixer positions, cue attenuators for two turntables. Simple, positive controls reduce operational errors. Frequency response—2 DB from 30 to 15,000 cycles; Distortion—less than 1% from 50 to 10,000 cycles; Noise Level—minus 65 DB's or better. Meets all FCC requirements for FM.

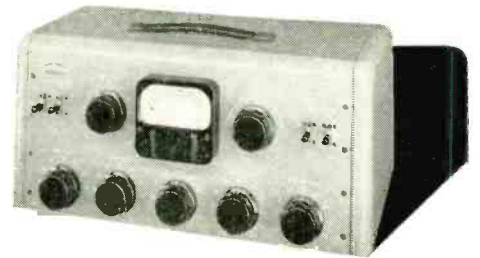

**RPC-40 PORTABLE CONSOLE**

Ideal for remote pickups yet complete enough to serve as a studio console. Four input channels for microphones or turntables, high level mixing, two output lines. Two RPC-40's interconnected provide 8-channel mixing—a feature of special interest to new TV stations planning future expansion.



**RR-30 REMOTE AMPLIFIER 3 CHANNEL**

A lightweight, easy-to-carry combination of amplifier and power supply—simple and quick to set up. Provides three high-fidelity channels, excellent frequency response, high over-all gain.

**RR-10 REMOTE AMPLIFIER  
SINGLE CHANNEL**

A complete, self-contained unit with built-in power supply. An excellent low-cost amplifier for remote pickups requiring only one high-fidelity channel.

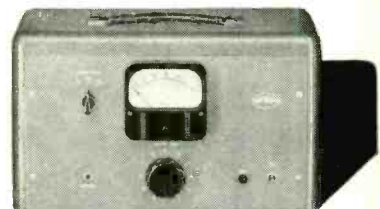

**RL-10 VOLUME LIMITER**

Engineered for high-fidelity AM, FM or TV speech input. Increases average percentage modulation without distortion.



**RZ-10 PRE-AMPLIFIER**

A plug-in type pre-amplifier or booster for microphones or turntables. Handles high input level. Noise level below 85 db from 0 vu output. Low distortion. Plug-in construction permits using one to four units for maximum flexibility.



**RP-10 PROGRAM AMPLIFIER**

A high-fidelity, single-unit amplifier and power supply. Over-all gain, 65 db; frequency response flat from 30 to 15000 cps; distortion less than 2% at +30 vu. Designed for rack or cabinet mounting.



**RPL-10 LINE AMPLIFIER**

A single-control, two-stage amplifier featuring wide frequency response, low distortion, low noise level, freedom from RF pickup. Push-pull through-out. Mounts in standard rack or cabinet.

**RAYTHEON MANUFACTURING COMPANY**  
WALTHAM 54, MASSACHUSETTS

**EXPORT SALES AND SERVICE IN FOREIGN COUNTRIES**  
Raytheon Manufacturing Company  
50 Broadway, New York 4, N. Y., WH. 3-4980



DESIGNED FOR DISCRIMINATING MANUFACTURERS

*Leakproof*

**ENAMELED  
MAGNET  
WIRE**

A product, resulting from many years of research in the field of fine wire manufacture, that meets the most rigid requirements of radio and ignition coils.

A new coating method gives a smooth, permanently - adherent enameling, and mercury-process tests guarantee perfect uniformity. Great flexibility and tensile strength assure perfect laying, even at high winding speeds. If you want reduction in coil dimensions without sacrificing electrical values, or seek a uniform, leakproof wire that will deliver extra years of service, this Hudson Wire product is the answer.

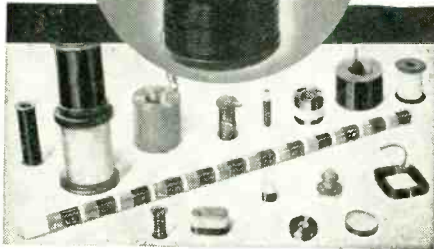

**QUALITY**

**UNIFORMITY**

**SERVICE**

Also manufacturers of high grade cotton and silk covered wires, cotton and silk coverings over enamel coated wires, and all constructions of Litz wires. A variety of coverings made to customers' specifications, or to requirements determined by our engineers. Complete design and engineering facilities are at your disposal; details and quotations on request.

*Winsted*  
**HUDSON WIRE CO.**  
*Division*

WINSTED • CONNECTICUT



**GENERAL ELECTRIC  
THERMOCELLS  
for  
ACCURACY**

G-E thermocells are as small as it is practical to make them and still retain all of the advantages which broaden their field of application and simplify the problems of design engineers.

Design engineers will appreciate especially the octal base feature. Add in these other major advantages in G-E thermocells—then specify them for every job you have under consideration.

1. G-E thermocells are filled with an inert gas and sealed to inhibit atmospheric contamination of both crystal and thermostat contacts.
2. Warm-up time is extremely short because of the low thermal capacity of the unit as a whole.
3. The heat loss is low, which permits low operating power and consequently less load and longer life for the thermostat contacts. Radiant heat loss is minimized by the polished chromium-plated shell.
4. Durable platinum-iridium thermostat contacts are used in G-E thermocells.

A typical example of the G-E line of thermocells is the Type G31:

Frequency Range . . . . . 2500-10,000 K.C.  
Size and Shape . . . . . Same as 6L6  
Freq. Adj. at Normal  
Ambient Temperature . . . . . .0015%  
Ambient Temp. Operating Range . . 0 to 55°C.  
Long Time Frequency Stability  
better than . . . . . .001%  
Heater Power . . . . . 2.6 Watts  
Crystal Cuts Normally Used . . . . . AT & BT  
Electrodes and Mounting . . . . . Pressure Airgap  
Warm-up Time . . . . . 15 Minutes

For further information on this and other G-E thermocells, quartz crystals and germanium diodes write today to: General Electric Company, Electronics Park, Syracuse, New York.

185-G2

**GENERAL ELECTRIC**

**SYNCHRON**  
TRADE MARK  
**TIMING MOTORS  
AND  
TIME MACHINES**



*Synchronous  
Self-starting  
Self-oiling*

**For Sustained Accuracy and Full  
Rated Power on Quick Starts**

Ask any time machine maker—any electric clock repair man—what motor outlasts all others, and he'll say "SYNCHRON". In these tiny motors, all pinions and shafts are of steel, operating against polished brass gears—for least possible wear. All bearings are genuine Babbitt, lubricated by a sealed-in supply of oil surrounding all moving parts (patented process). SYNCHRON timing motors and time machines are designed, patented, and built for dependable, trouble-free service.

A new catalog containing engineering data on SYNCHRON Motors, Timing Machines, and Clock Movements will give you detailed information. Write for it.

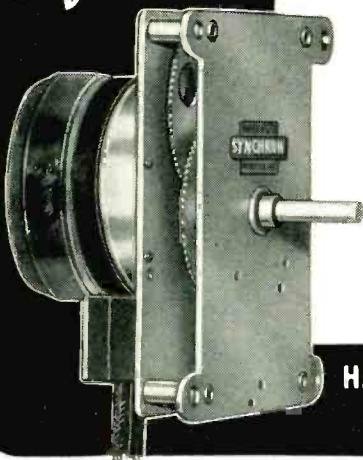

**HANSEN MANUFACTURING CO., INC.**

Princeton 10, INDIANA

*Established 1907 - a Pioneer in Synchronous Motors*

# POPULATION - 0

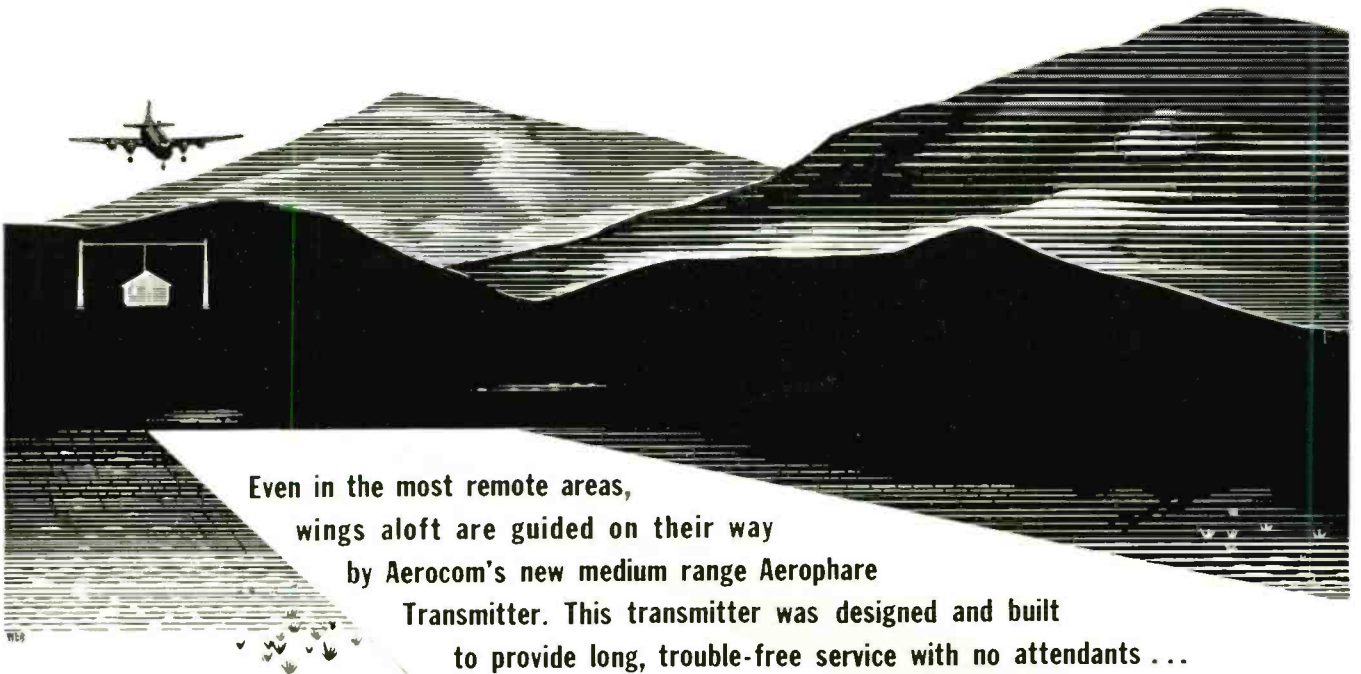

Even in the most remote areas,  
wings aloft are guided on their way  
by Aerocom's new medium range Aerophare  
Transmitter. This transmitter was designed and built  
to provide long, trouble-free service with no attendants ...  
even where the total population is Zero.

## AEROPHARE

The 100 Watt Aerophare illustrated consists of the following units-- AK-3 automatic keyer; Model 100XL transmitter, (100 Watt carrier power, minimum of 30%-high level tone modulation for identification but with no provision for voice modulation); and antenna matching unit.

The smaller unit is similar, except transmitter is of 50 Watts carrier power with 90% high level tone modulation for identification, or, 90% high level voice modulation. Microphone P-T-Switch, when depressed interrupts tone, permitting voice operation. This feature makes this unit ideal for airport operation where both aerophare and traffic control are needed.

Both units are completely "tropicalized" to allow operation under unusual climatic conditions. Each unit is ruggedly constructed and conservatively rated, providing low operating and maintenance costs. Engineering data on both units upon request.

CONSULTANTS, DESIGNERS AND MANUFACTURERS OF STANDARD OR SPECIAL  
ELECTRONIC, METEOROLOGICAL AND COMMUNICATIONS EQUIPMENT.

**AER - O - COM**  
Reg. U. S. Pat. Off.

**AERONAUTICAL COMMUNICATIONS EQUIPMENT, INC.**  
3090 Douglas Road, Miami 33, Florida

DEALERS: Equipeleto Ltda., Caixa Postal 1925 Rio de Janeiro,  
Brasil ★ Henry Neuman, Jr., Apartado Aéreo 138, Barranquilla, Colombia







# MOSINEE

*"More than Paper"*

In the field of electronics and the electrical goods industry, MOSINEE stands for paper-base processing materials with scientifically controlled chemical and physical properties, high quality standards and dependable uniformity... with good dielectric strength, high tensile or tear strength; proper softness or stiffness; creped with controlled stretch or flexibility; specified pH for maximum-minimum acidity or alkalinity; accurate caliper, density, liquid repellency or absorbency... or other technical characteristics vital to your quality standards and production requirements.

**MOSINEE PAPER MILLS COMPANY • MOSINEE, WIS.**

*"Essential Paper Manufacturers"*

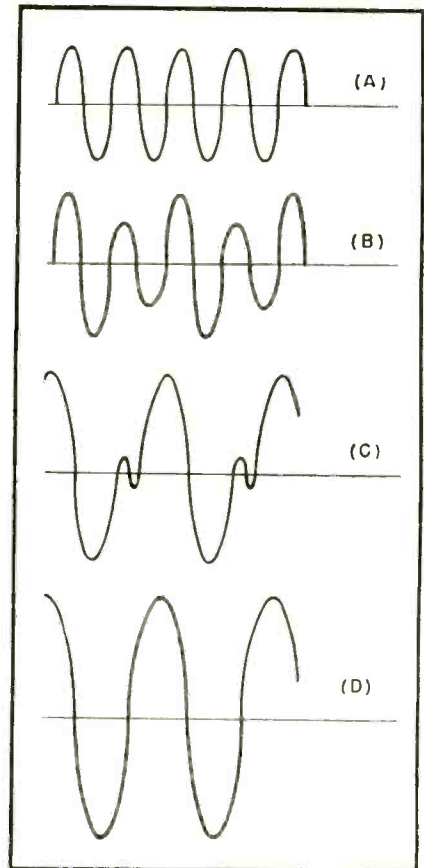

FIG. 1—Bridge output signals showing transition from second harmonic to fundamental to indicate various degrees of unbalance

of the bridge excitation frequency. All of these peaks are of equal height. In Fig. 1B the peaks alternate in height and indicate a slight bridge unbalance for this is a sign of the fundamental making its appearance from the null value. In Fig. 1C, the unbalance has progressed to almost complete disappearance of the second harmonic component. In Fig. 1D, the final output of complete unbalance is an approximate sine wave which has a phase determined directly by which of the alternate set of peaks in Fig. 1B increased in height. If the bridge unbalance had progressed in the opposite direction, the resulting complete unbalance signal would have had a phase difference of 180 degrees from the phase shown.

A slight phase shift in the fundamental frequency occurs as the fundamental takes form. The shift makes this degree of reversal possible from the low and high peaks transition into the final frequency. This shift occurs as the fundamental slides over sidewise on the time

# Ringling the Bell



Winding time and handling time are nicely synchronized on these No. 102 Universal Coil Winders—turning out ringer coils and relays at Federal Telephone and Radio Corporation—so that neither the finished coil nor the operator has to wait, one for the other.

One operator supervises the three winding heads simultaneously, and winding is so scheduled that while manual operations are being performed on one head, the other heads are producing.

This arrangement makes the most efficient use of both machine and operator. Further time-savers are the following:

1. Electrically-controlled counter stops each head upon completion of coil—no operator attention needed.
2. Common setting for all heads in respect to wire traverse length and number of wire turns per layer.
3. Traverse length readily adjustable to maximum of  $2\frac{3}{8}$  in.—without changing cams.
4. Flexibility in wire turns per layer through standard change gears.
5. Steel-strap control on unrolling tensions facilitates handling of even finest wires, and in-built calibration permits recording settings for re-use.
6. Winding speeds from 500 to 2500 rpm can be arranged.

Write for Bulletin 102L.

**UNIVERSAL WINDING COMPANY, P. O. BOX 1605, PROVIDENCE 1, R. I.**

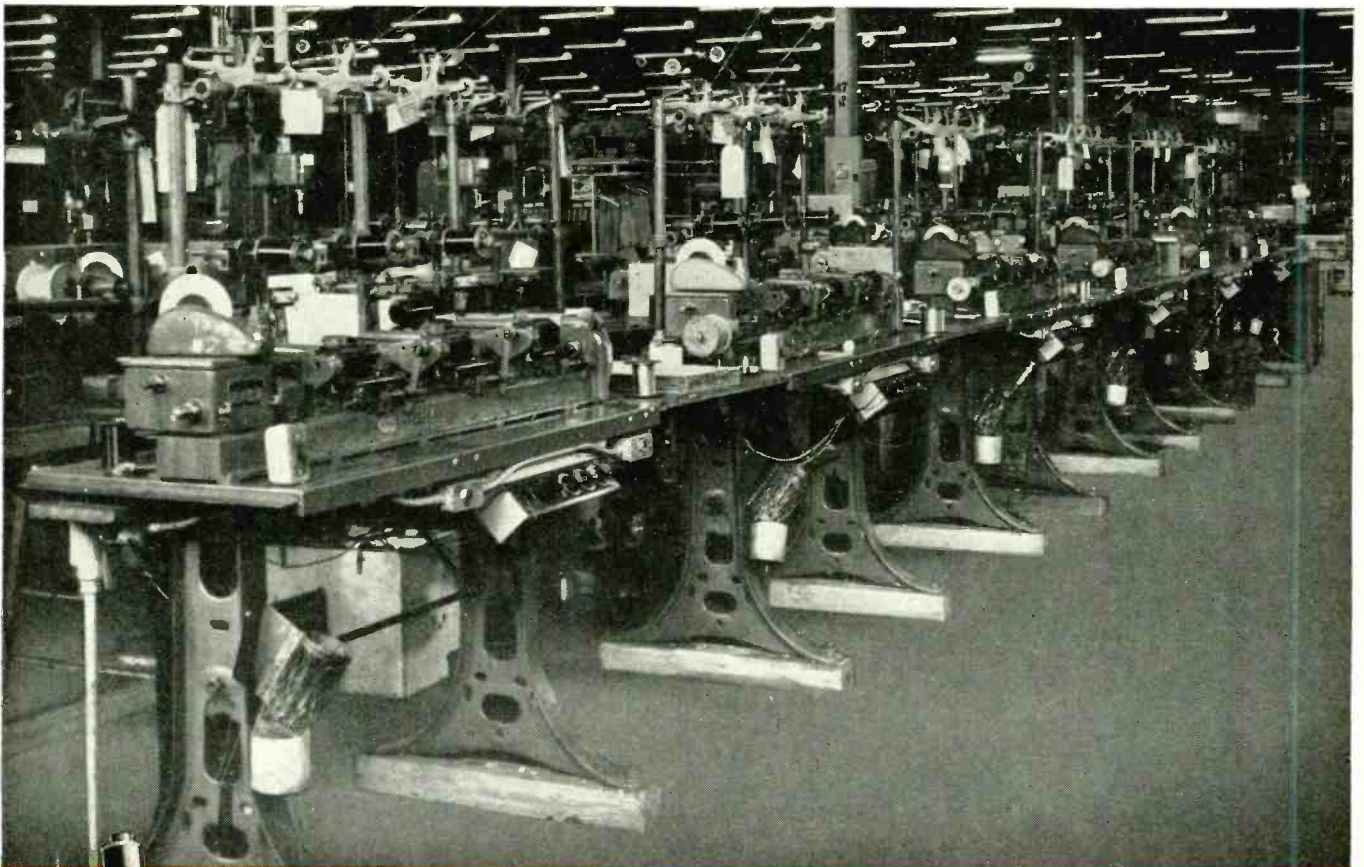

**FOR WINDING COILS IN QUANTITY  
ACCURATELY . . . AUTOMATICALLY  
USE UNIVERSAL WINDING MACHINES**



# Linde SYNTHETIC SAPPHIRE

## Has High Electrical Resistance

LINDE synthetic sapphire offers specific advantages for electronic uses. Sapphire maintains these properties at elevated temperatures.

Dielectric Constant	7.5 to 10
T. Point	1,214 deg. C. to 1,231 deg. C.
(Temperature at which resistance becomes 1 megohm)	
Melting Point	2,030 deg. C.
Thermal Conductivity	0.015
(cal. sec. <sup>-1</sup> cm. <sup>-1</sup> deg. C. <sup>-1</sup> at 500 deg. C.)	
Thermal Expansion Coefficient	8.3 to 9.0
(per deg. C. x 10 <sup>6</sup> at 1,000 deg. C.)	

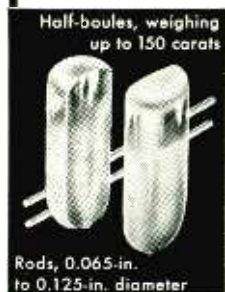

Half-boules, weighing up to 150 carats

Rods, 0.065-in. to 0.125-in. diameter

Write for the LINDE Synthetic Sapphire Technical Data Sheet No. A-1.  
**THE LINDE AIR PRODUCTS COMPANY**  
 Unit of Union Carbide and Carbon Corporation  
 30 East 42nd Street  New York 17, N. Y.  
 In Canada:  
 Dominion Oxygen Company, Limited, Toronto

The word "Linde" is a trade-mark of The Linde Air Products Company

# precision-fabricated PLASTIC DIALS



**QUALITY and SERVICE  
 AT A PRICE  
 THAT'S RIGHT**

You can't go wrong when you depend on Sillcocks-Miller for plastic dials. These experienced engineers are recognized throughout the industry for their ability to fabricate plastic materials to close tolerances. The combination of this skill and complete production facilities provides a dependable source for the quality and service you want—at a price that's right.

Write for illustrated booklet or phone South Orange 2-6171 for quick action.

**THE SILLCOCKS-MILLER CO.**  
 10 West Parker Avenue, Maplewood, N. J.  
 Mailing Address: South Orange, N. J.

**SPECIALISTS IN HIGH QUALITY, PRECISION-MADE PLASTICS FABRICATED FOR COMMERCIAL, TECHNICAL AND INDUSTRIAL REQUIREMENTS.**

# COOLER OPERATION KOTRON STRIP-TYPE SELENIUM RECTIFIERS

PATS. PEND.



## 100 MA. UNIT

- Max. A. C. line input 130 volts rms
- Max. inst. peak current 1000 Ma.
- Max. inverse peak voltage 360
- Average operating temp. 105°F
- Dimensions: 4-1/16" x 1-1/16" x 5/32"
- Other Sizes: 75 Ma. and 200 Ma.

Kotron's metallic rectifying elements are mounted in one plane. Plates cannot contribute heat to each other. Result—Cooler Operation . . . longer life . . . increased circuit efficiency. Wafer-thin Kotron saves space, mounts easier.

Write for Complete Technical Data, Prices and Delivery

**STANDARD ARCTURUS CORPORATION**  
 54 CLARK STREET • NEWARK 4, NEW JERSEY  HUmboldt 2-2400

The three G-E permanent magnets shown below produce an automatic braking effect in the new Bristol Electromatic Reel manufactured by the Horton Manufacturing Co., Bristol, Conn.

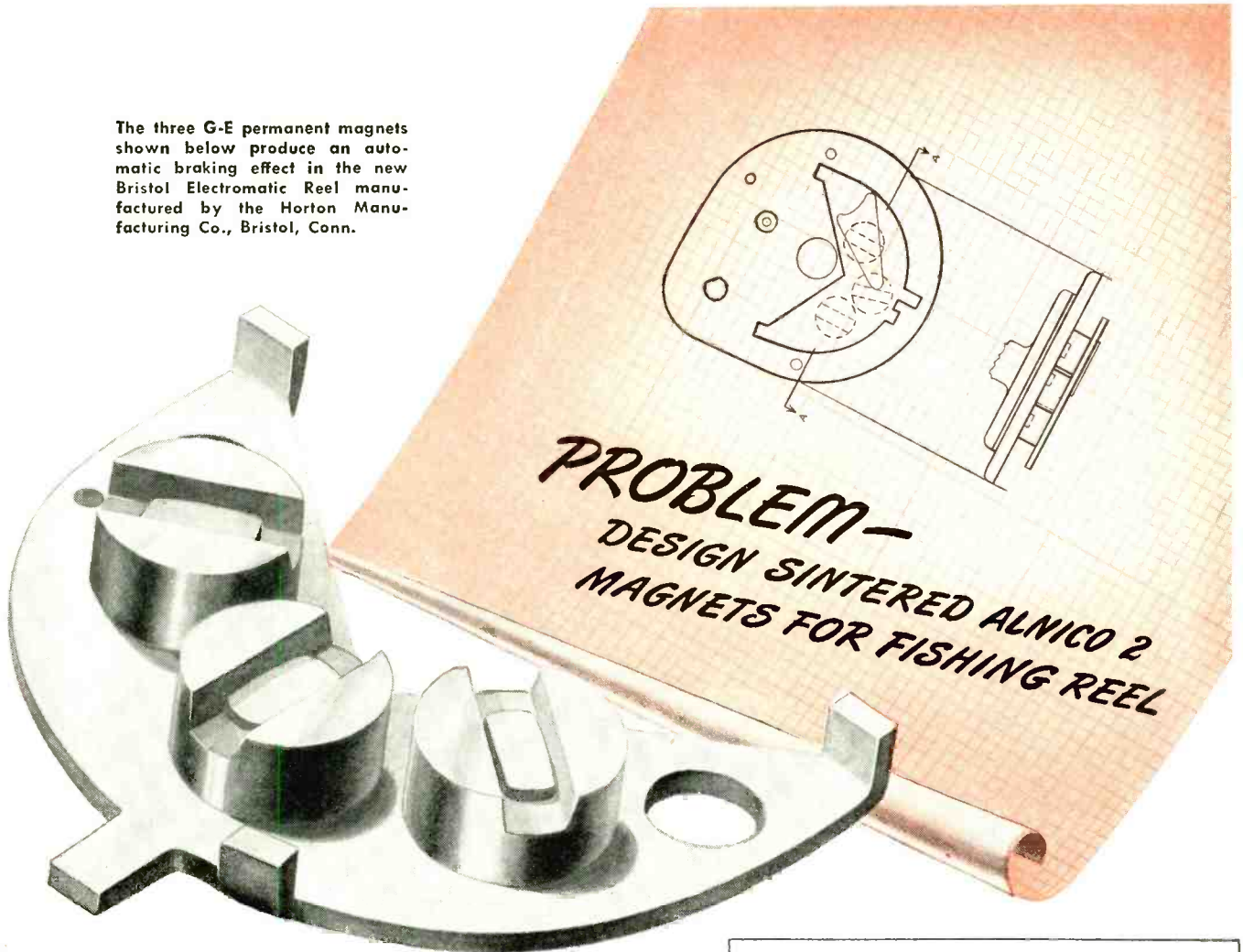

## The magnets that brake your reel

Now it's G-E permanent magnets for greater accuracy in casting. The permanent magnets shown above develop a non-friction braking action directly in proportion to the speed of the plug. Maximum braking is applied at the start of the cast and, as the spool is slowing down, the braking effect decreases automatically.

G-E permanent magnets are continually finding wide application in many fields. The magnetic reel is but one example of the adaptation of an industrial magnet engineering principle to an entirely different field.

Perhaps there's a use for G-E permanent magnets in your product. Or, you may wish to improve your present magnet design for greater efficiency. Our engineers will be glad to work with you to improve your product. For details and your free copy of CDM-1, G-E PERMANENT MAGNETS, write Metallurgy Division, Section CM-10, Chemical Department, General Electric Company, Pittsfield, Mass.



**PERMANENT  
MAGNETS**

**GENERAL  ELECTRIC**

CD48-V4

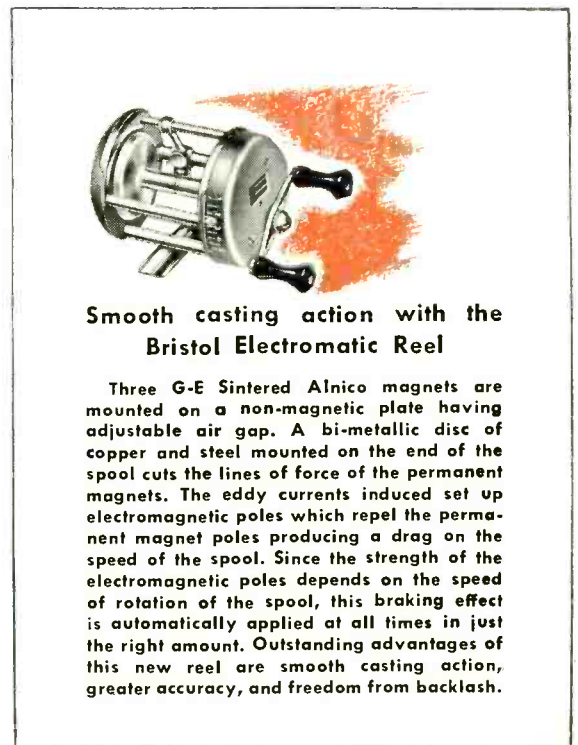

Smooth casting action with the Bristol Electromatic Reel

Three G-E Sintered Alnico magnets are mounted on a non-magnetic plate having adjustable air gap. A bi-metallic disc of copper and steel mounted on the end of the spool cuts the lines of force of the permanent magnets. The eddy currents induced set up electromagnetic poles which repel the permanent magnet poles producing a drag on the speed of the spool. Since the strength of the electromagnetic poles depends on the speed of rotation of the spool, this braking effect is automatically applied at all times in just the right amount. Outstanding advantages of this new reel are smooth casting action, greater accuracy, and freedom from backlash.



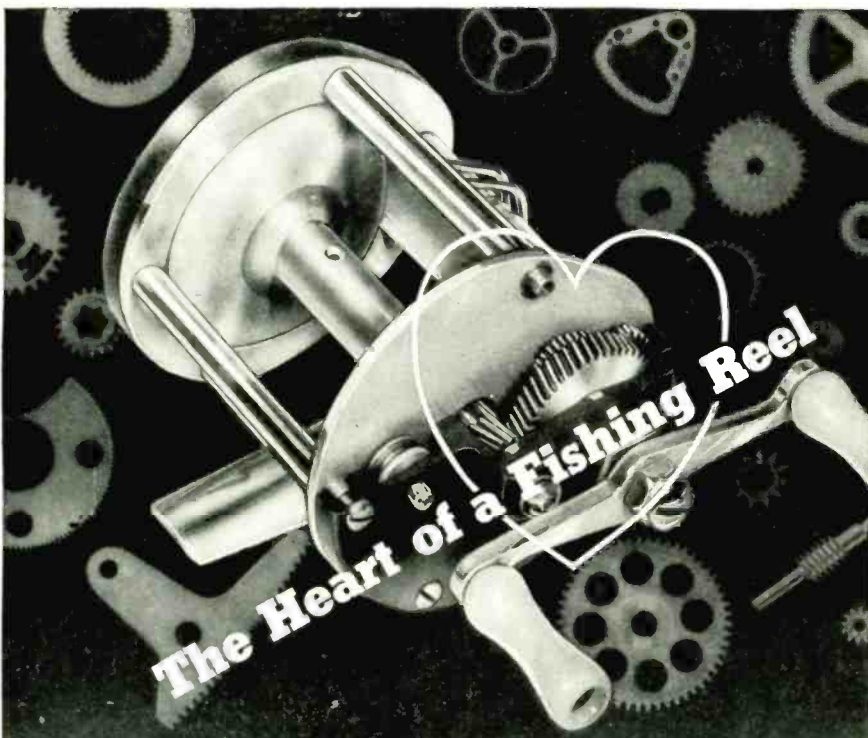

Fishing reel gears must operate smoothly at a speed of 3000 revolutions per minute or more, when a cast is executed. These gears must also withstand the strain of hauling in a fighting fish of unpredictable size and strength, thus rendering a dual purpose: speed and velvety smoothness in one direction—strength and durability in the other.

Instruments and machines have individual gear problems. For over a quarter of a century, Quaker City Gear Works has solved thousands of them and produced millions of gears of every description up to 60" in diameter for manufacturers in many diversified industries.

Aircraft controls, dental drills, electric clocks, gauges, indicators, heat controls, machine tools, radar, radios, washing machines and motion picture projectors are but a few of the many conveniences of modern progress which depend upon the heartbeat of Quaker City Gears. Your gear problem is our business, our large productive capacity is at your service.

YOUR INQUIRIES WILL RECEIVE PROMPT ATTENTION

*The heart of the Outdoorsman Castomatic reel illustrated above is but one of many gear trains developed by our engineers and produced in our fully equipped plant.*



**Quaker City Gear Works**

INCORPORATED

1910 N. Front Street, Philadelphia 22, Pa.

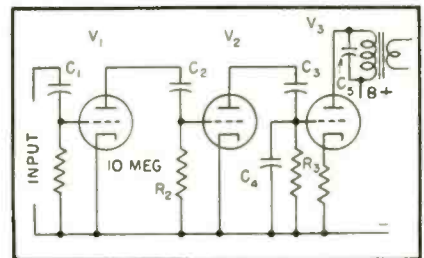

FIG. 2—Essential portions of amplitude discriminator amplifier showing cascaded discriminators and pulse reshapers

axis to help eliminate the second harmonic. This particular servo-system was designed to be a null-seeking self-balancing device and these slight phase errors only slightly affect motor speed and do not affect calibration. Otherwise the application of amplitude discrimination might not be permissible to such a system.

#### Discriminator Amplifier

In the circuit of Fig. 2, the first stage, tube  $V_1$ , can be used for amplification, or it may be identical in action with the following stage, including tube  $V_2$ , in which amplitude discrimination takes place. In this manner, both stages together may give a cascaded type of discriminator action to extra large signals. However, it will be shown that amplification ahead of the discriminator is most desirable in that it increases the rapidity with which the circuit indicates unbalance. This is similar to increasing the  $Q$  of a tuned circuit. Tube  $V_3$  is a driver for the motor-operating stage. It delivers a sine wave at the output of the driver transformer  $T_1$  for the rectangular input from the effects of amplitude discrimination ahead of it. This motor-operating sine-wave output remains almost constant up to the point of complete bridge balance at which time it rapidly changes to second harmonic of the bridge excitation frequency.

The motor-operating signal had a frequency of 60 cycles to be adaptable to standard power line supply as well as portable power generation. Tubes  $V_1$  and  $V_2$  are normally biased by the contact potentials developed at their grids. However, in operation the positive peaks of the signal may draw grid current and so bias the grids to a value below cut-off in an amount

**RAYTHEON** **AM-FM & TV**  
**TRANSMITTERS**  
 are equipped with  
**Adlake Relays**

RAYTHEON Manufacturing Company's AM, FM and TV transmitters, including the famous "RF-3" 3-KW FM, "RA-5" 5-KW AM and the new "RTV-500" 500 watt TV and "RTV-5" 5000 watt TV equipment, employ Adlake Relays for CONTROL.

*Silent and chatterless*, Adlake Mercury Plunger Type Relays are an integral part of these streamlined transmitters which produce high fidelity modulation with a low noise level.

*Besides* silent operation, Adlake Relays bring these advantages to *any* job where relays are used:

- Hermetically sealed contact mechanism is impervious to dust, dirt and moisture.
- Liquid mercury-to-mercury contact prevents burning, pitting and sticking.
- Adlake design armors relays against outside vibration or impact; they are usable on either stationary or fixed equipment.

Whatever your relay needs are, there's an Adlake Relay to do the job. You'll like our free, illustrated folder giving full details. Write for it today to: The Adams & Westlake Company, 1107 N. Michigan, ELKHART, Indiana.

**THE**  
**Adams & Westlake**  
**COMPANY**

Est. 1857 • ELKHART, INDIANA • New York • Chicago

Manufacturers of Adlake Hermetically Sealed Mercury Relays for Timing, Load and Control Circuits

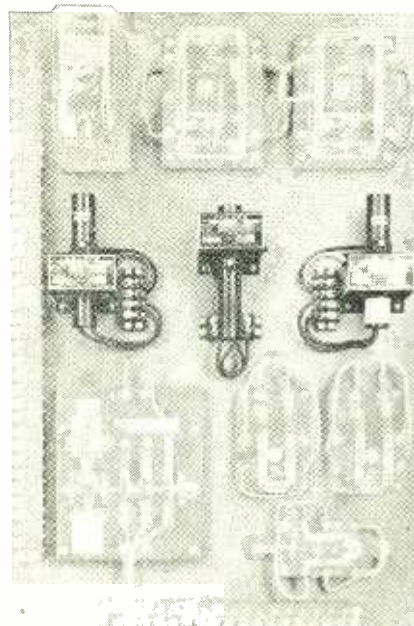

(Above) Relay panel in Raytheon's RF-3A 3-KW FM AMPLIFIER (shown below)

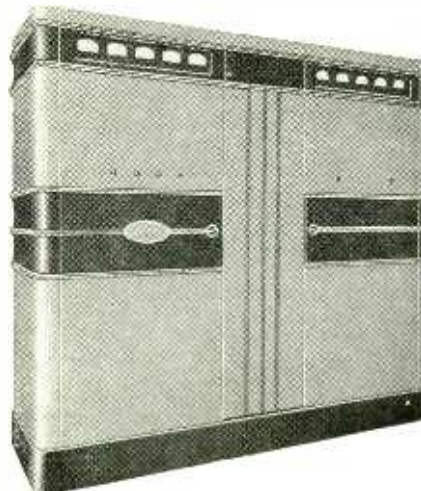





# PILOT LIGHT ASSEMBLIES

**PLN SERIES—Designed for NE-51 Neon Lamp**



### Features

- THE MULTI-VUE CAP
- BUILT-IN RESISTOR
- 110 or 220 VOLTS
- EXTREME RUGGEDNESS
- VERY LOW CURRENT

*Write for descriptive booklet*

## The DIAL LIGHT CO. of AMERICA

FOREMOST MANUFACTURER OF PILOT LIGHTS

900 BROADWAY, NEW YORK 3, N. Y.

Telephone—SPring 7-1300

# ZOPHAR Waxes, Compounds and Emulsions



Materials for potting, dipping or impregnating all types of radio components or all kinds of electrical units. • Tropicalized fungus proofing waxes. • Waterproofing finishes for wire jackets. • Rubber finishes. • Inquiries and problems invited by our engineering and development laboratories.

Zophar Mills, Inc. has been known for its dependable service and uniformity of product since 1846.

## ZOPHAR MILLS, Inc.

ESTABLISHED 1846

117 26th STREET, BROOKLYN 32, N. Y.

## Save Time... Speed Assembly with CTC ALL-SET Boards!

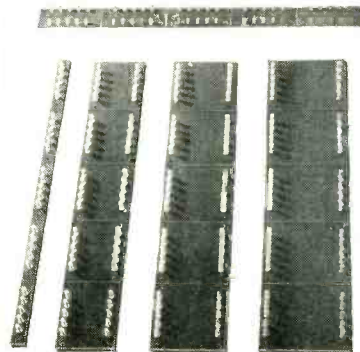

On the assembly line and in the laboratory, CTC ALL-SET Boards are valuable time-savers.

With Type 1558 Turret Lugs, a new board now offers mounting for miniature components. 1 1/16" wide, 3/32" thick, only. (Type X1401E.)

With Type 1724 Turret Lugs, boards come in four widths: 1/2", 2", 2 1/2", 3" — in 3/32", 1/8", 3/16" thicknesses.

With the addition of the new miniature board, CTC ALL-SET Boards now cover the entire range of components.

All boards are of laminated phenolic, in five-section units, scribed for easy separation. Each section drilled for 14 lugs. Lugs solidly swaged into precise position... whole board ready for your assembly line.

### SPECIAL PROBLEMS

Custom-built boards are a specialty with CTC. We're equipped to handle many types of materials including the latest types of glass laminates... many types of jobs requiring special tools... and all types of work to government specifications. Why not drop us a line about *your* problem? No obligation, of course.

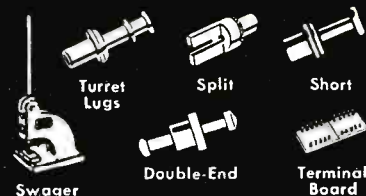

*Custom or Standard  
The Guaranteed  
Components*

CAMBRIDGE THERMIONIC CORPORATION

437 Concord Avenue, Cambridge 38, Mass.

**The Cord**  
**On Your Product**  
**MAKES**  
**A DIFFERENCE**

DISAPPOINTMENT



SATISFACTION



CORDITIS-FREE CORDS

BY **Belden**

WIREMAKER  
FOR INDUSTRY

© 1948, Belden Manufacturing Co., Chicago, Ill.





**SINGLE SIDEBAND SELECTOR  
TYPE YRS-1**



## **SINGLE SIDEBAND SELECTIVITY** *with* **NO LOSS of AUDIO RESPONSE**

**W**HEN connected to a conventional communications receiver, the General Electric Single Sideband Selector Type YRS-1 permits single sideband reception of modulated, unmodulated (CW) or single sideband transmissions. Although the system provides the effect of extreme selectivity, the audio fidelity of the selected sideband is restricted only by the fidelity characteristics of the receiver itself. Interference on either sideband can thus be minimized without impairing the quality of the signal you are trying to copy.

- Single sideband reception of modulated, unmodulated (CW) or single sideband transmissions.
- Provides the effect of extreme selectivity without restriction of audio fidelity.
- Push-button selection of either sideband—other sideband attenuated.
- Audio distortion associated with selective fading is greatly reduced.
- Intelligibility of fading signals is improved.
- Can be connected to practically any communications receiver having an intermediate frequency of approximately 455 KC.
- Normal operation is in no way disturbed when single sideband selector is not in use.

For complete information on the single sideband selector write: *General Electric Co., Electronics Park, Syracuse, N. Y.*

165-G5

**GENERAL  ELECTRIC**

essentially equal to the signal amplitude. The time constants of  $R_1C_1$  and  $R_2C_2$  should correspond to a frequency much lower than the frequency to be passed by the amplifier. A time constant of 0.1 second was found to be satisfactory in discriminating out a 60-cps signal from the envelope of the second harmonic.

Values of  $C_3$  and  $C_4$  are equal and their time constant individually in connection with resistor  $R_3$  should correspond to a frequency of thirty cycles. The value of  $C_5$  is found by experiment. In combination with the inductance presented by  $T_1$  it reshapes the output signals of the transformer to the closest approximation of a sine wave that conditions permit.

### *Amplifier Operation*

If the output signal of the bridge to the amplifier is as shown in Fig. 3A, then the output of tube  $V_1$  acting as an amplifier is an amplified replica of the signal at the input to the grid of the following tube  $V_2$ . This is indicated by Fig. 3B.

The output of  $V_2$  appearing across  $R_3$  in the absence of the integrating capacitor,  $C_4$ , is as shown at Fig. 3C. This signal may have almost exactly rectangular waveform as indicated since the tips of the positive peaks are flattened by grid current into the high-resistance grid circuit. Also, the small portion of the waveform between cut-off bias and zero bias intercepted on the transfer characteristic of the tube has its curved sides straightened by the curvature of the characteristic.

The introduction of the integrating capacitor,  $C_4$ , changes the vertical edges of the rectangular pulses to exponential type curves. This is shown by the difference between the dashed lines and the solid curved lines in Fig. 3D. The combined effect of  $C_5$  and the inductance of  $T_1$  are shown by the approximate sine waves of Fig. 3E as they finish the reshaping of the pulses into a motor-operating signal of greater efficiency. This signal has its phase directly related to the higher peaks of the second harmonic signal. In this manner the bridge output phase relationship is maintained so as to provide directional response of the

**IT'S GLASS...**



that gives extra performance

to **VITROTEX**\* **MAGNET WIRE**

ANACONDA VITROTEX magnet wire withstands temperatures up to 130° C., is highly flexible and has a remarkable space factor. All this is made possible by insulation of alkali-free glass—the ideal insulating material that is soft as silk and is comparable to steel in tensile strength.

Besides, Vitrotex offers high dielectric strength and a smooth surface that is resistant to moisture, acids, oils and corrosive vapors. For tighter, safer coils, to operate in confined spaces under high heat, make windings of Vitrotex. For details on the complete line of Anaconda Magnet Wire, write to Anaconda Wire and Cable Company, 25 Broadway, New York 4, New York.

45442

\*Reg. U. S. Pat. Off.



*Anaconda*

**VITROTEX**

THE GLASS INSULATED  
MAGNET WIRE



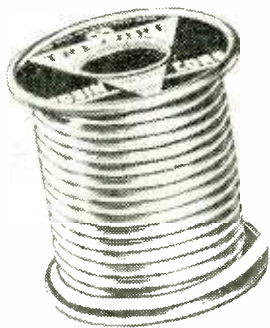

TRAP FOR A PROFIT-SNATCHER

# ALPHA TRI-CORE *Rosin-filled* SOLDER

save time • save materials • save money

Hard to imagine how a minor operation like soldering can cut into profits, or effect savings? Don't imagine! Look at the facts, as one manufacturer recently did in his own plant. By test, he found that Alpha Tri-Core Rosin-Filled Solder saved him 22% in time and 26% in materials, as compared with ordinary single core solders. Make your own comparative tests. They cost you nothing... and you save dollars! Send today for a sample supply or trial order.

NO OTHER SOLDER HAS THESE ADVANTAGES

## ALPHA TRI-CORE ROSIN-FILLED SOLDER

- 3 flux cores of 99.9% pure, non-plasticized, water-white rosin for the price of 1!
- More useful solder in every pound; even distribution of flux throughout; no fluxless areas to waste soldering time or solder!
- Faster fluxing; narrow wall between cores and outside diameter speeds action, requires less heat! No toxic odors!
- Solderers prefer Alpha, 6 to 1, by actual test.
- Greater efficiency in small soldering operations, less heat, quicker acting.
- In addition, Tri-Core permits the use of lower-tin-content alloys with superior soldering results to that obtained from ordinary solders with 5-15% more tin.
- Tri-Core available in diameters as large as  $\frac{1}{4}$ ", and heavier—down to .020" and finer.



SOLDER SPECIALISTS  
FOR OVER 58 YEARS

# Alpha

ALPHA METALS, INC., 371 HUDSON AVENUE, BROOKLYN 1, NEW YORK

other ALPHA PRODUCTS include:  
TRI-CORE "ENERGIZED" ROSIN-FILLED SOLDER;  
TRI-CORE "LEAK-PROOF" ACID-FILLED SOLDER;  
SOLID SOLDER WIRE; PREFORMS (rosin and acid-filled); BAR SOLDER, ANDES AND FOIL.

TUBES AT WORK

(continued)

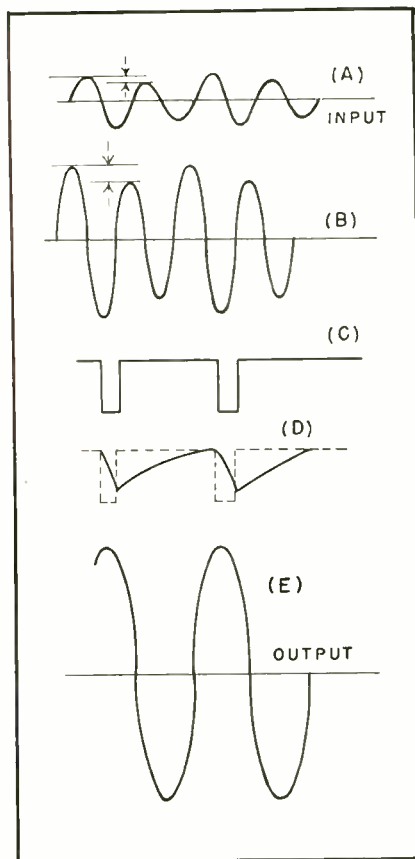

FIG. 3—Bridge signals of slight unbalance indication passing through the discriminator amplifier to be discriminated into a signal of complete unbalance

drag cup motor to the direction of bridge unbalance.

### Advantages

From the change in the output to input signal waveform of Fig. 3, it will be noted that only a slight bridge unbalance is needed to give the identical change of signal arrived at through complete bridge unbalance as shown in Fig. 1. Although straight amplification of the null signal along with automatic control of amplifier gain might give almost equivalent results, if the unwanted harmonic signals are first removed, there are other important advantages of this system that make it very desirable.

If a measure of the sensitivity of the bridge circuit is assumed to be in the displacement of the bridge variable necessary to change the output signal from a complete null for the fundamental frequency, while the harmonics are present at a maximum, to the condition where the fundamental is a maximum and no harmonics are present, then, amplification of the bridge output signal is obtained in terms of a small-

# Your Choice

## of oscilloscope to fit any job or budget

... with new versatility, stamina, accuracy, speed



**Heavy-duty, general purpose (WO-60C)**—A “work horse” that withstands shock, dampness, dirt, fluctuating voltages. Plug-in (5") C-R tube permits change to various screen persistencies. Vertical and horizontal amplifiers practically identical. *Useful range:* 0.5 to 300,000 cycles. *Frequency response:*  $\pm 10\%$  from 5 to 80,000 cycles. *Sensitivity:* 0.056 peak-to-peak volt per inch. Exceptionally good phase-shift characteristics. Shown above measuring the vibration of a synchronous motor.



**Portable, wide range (WO-79A)**—Packed with laboratory features. Ideal for h-f circuits, television. *Range:* vertical amplr.  $\pm 2$  db from 10 cycles to 5 mc. *Horizontal amplr:*  $\pm 2$  db from 10 cycles to 500 kc. *Vertical deflection sensitivity:* 0.18 rms. volt per inch. New (3") C-R tube features small bright spot and distortionless focusing. Triggered sweep with delay network . . . saw-tooth time base. Easy signal expansion to twice screen diameter. Shown above testing a television receiver.



**D-c and low-frequency a-c (WO-27A)**—This oscilloscope also observes a-c and d-c simultaneously. *Frequency range:* 0 (d-c) to 100,000 cycles. Flat to zero cycles. Uses direct-coupled balanced amplifiers. *Timing range:* 1 to 30,000 cycles. Single-sweep and blanking circuits permit observation and photographic recording of one-time, high-speed transients. *Vertical amplifier sensitivity:* 0.084 volt (d-c) per inch. Shown in picture above measuring strain of test specimen in tension.



**Last word in versatility (Laboratory-type 715-B)**—Permits close study of very short, sharp-fronted pulses and unusual wave forms. Steady, clear traces even of random signals. *Vertical amplr:*  $\pm 1$  db from 5 cycles to 11 mc. *Horizontal amplr:*  $\pm 2$  db from 3 cycles to 500 kc. *Vertical deflection sensitivity:* 0.06 rms. volt per inch . . . saw-tooth and triggered sweep . . . time-interval markers (one microsecond). Handles almost any job in oscillography. Shown aligning a distribution amplifier.

Available from your RCA Laboratory Measuring Equipment Distributor, or write Dept.37-J



**RADIO CORPORATION of AMERICA**  
TEST AND MEASURING EQUIPMENT  
HARRISON, N. J.



# TIME as a factor of CONTROL in Industry

## THERMEX opens up new opportunities in Plastics Molding...TIMED by CRAMER

Almost instant heating of preforms prior to molding is possible with the Thermex Red Head high frequency dielectric heating unit, a development of The Girdler Corp. for use in the molded plastics industry.

This device produces high frequency heat that originates in the material instead of being applied to it, resulting in a more uniform, stronger product . . . as well as increased production, simplified operations . . . reduced time and unit costs.

The Thermex unit is equipped with a Cramer Running Time Meter and two type TEC Time Delay Relays that control the heating cycle with two distinctly different characteristics and in any selected sequence. Another instance where accurate control, dependable performance are assured by Cramer Timing.



TIME DELAY RELAY



RUNNING TIME METER

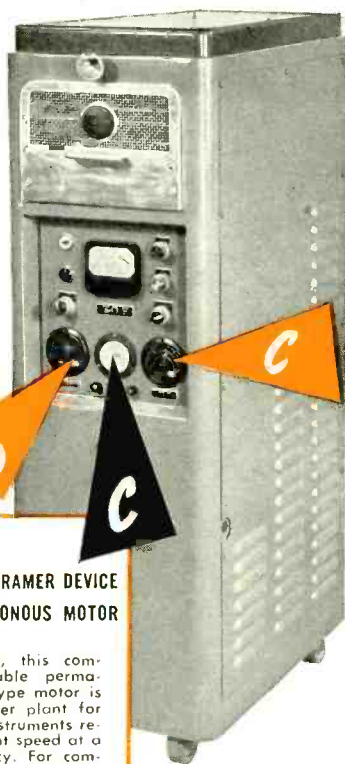

### A WIDELY USED CRAMER DEVICE . . . THE SYNCHRONOUS MOTOR

Precision built, this compact, dependable permanent magnet type motor is the ideal power plant for time control instruments requiring constant speed at a given frequency. For complete information, write for Bulletin 10A.

IF THE PERFORMANCE OF YOUR PRODUCT DEPENDS ON PRECISION TIMING, CONSULT . . .

# Cramer

THE R. W. CRAMER COMPANY, INC.  
Box #3, Centerbrook, Conn.

3CR48

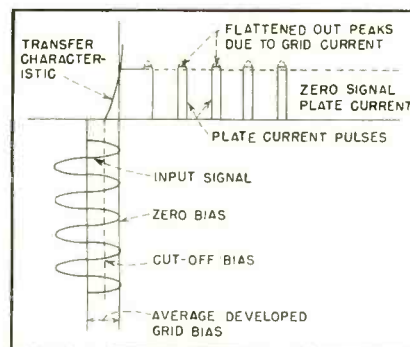

FIG. 4—Discriminator action allowing input frequency to pass through amplifier

er displacement producing a given change of signal. Or in other words, the Q of the bridge is increased.

The circuit automatically introduces gain control in that the grid bias continually adjusts itself to signal levels. Final maximum output is soon reached with a small input signal and overloading of the output does not occur on larger signals. But perhaps the greatest good is achieved because the tips of the peaks of waveforms of radically different shapes can be somewhat depended upon to produce pulses in the discriminator plate circuit of the same phase and shapes. Hence, a certain amount of flexibility is added to the servo-system in allowing the input to the amplifier to operate at different levels of signal distortion.

#### Discriminator Action

The dynamic transfer characteristic of the discriminator tube is shown in Fig. 4 and 5 to clarify the separation of signals by this action. In Fig. 4, the peaks of the incoming signal are all of equal amplitude. These peaks manage to maintain the grid bias sufficiently low enough to permit the positive tips to just exceed zero bias and

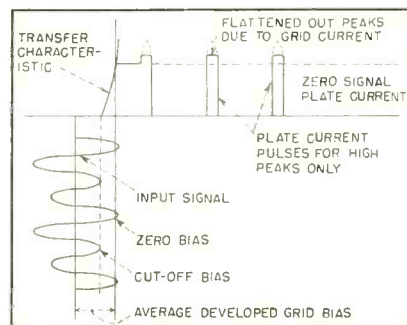
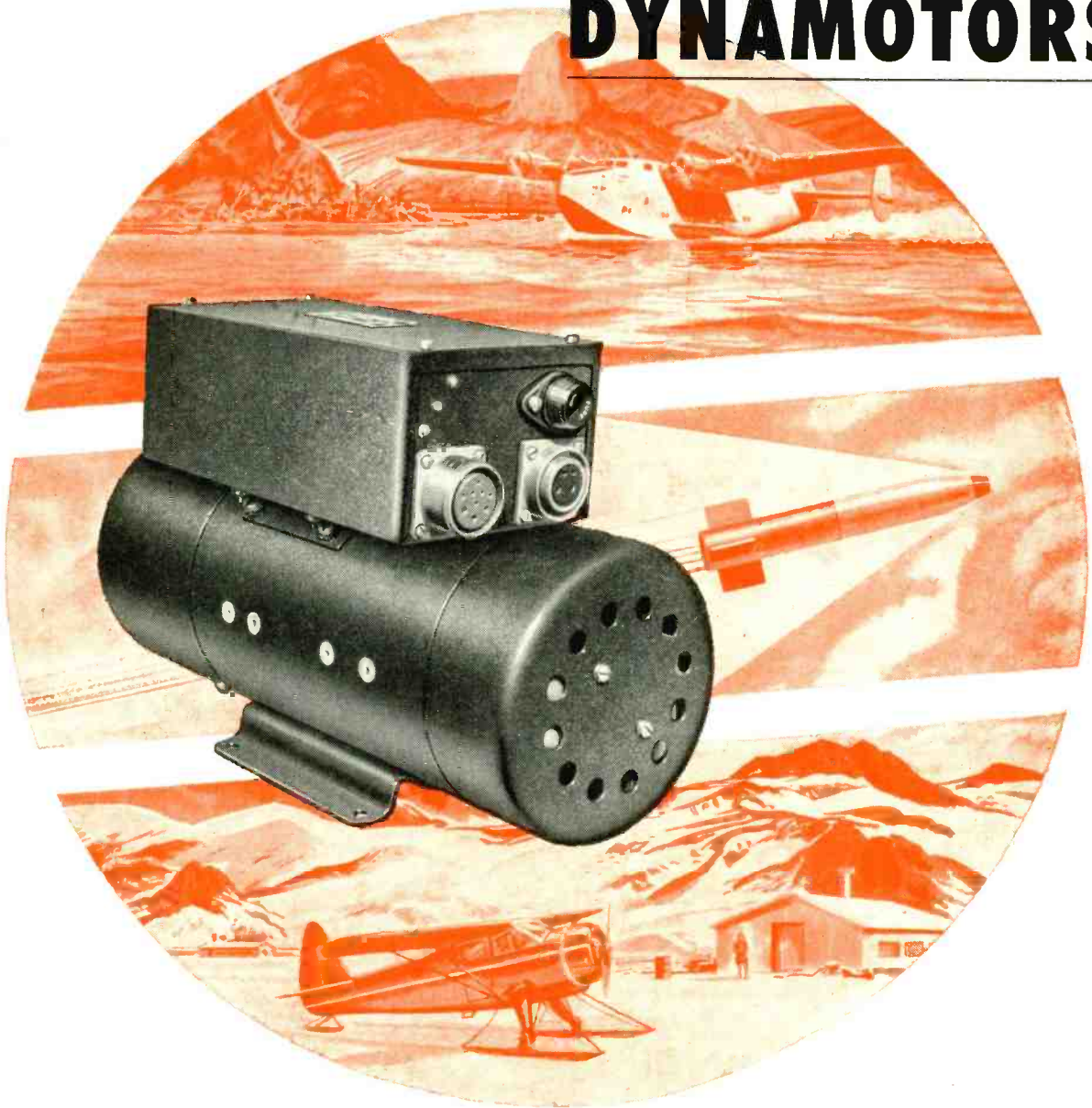

FIG. 5—Discriminator action allowing only input frequency of highest peaks to pass through amplifier

# *Bendix* **REGULATED** **DYNAMOTORS**



## MAKE A BIG DIFFERENCE IN RELIABILITY . . . ECONOMY . . . WEIGHT

Under the most severe conditions in which your electronic installations are expected to operate, Bendix\* regulated dynamotors will deliver dependable, uniform voltage. You can count on them to last longer, too, because they are manufactured with the same painstaking care which has made Bendix Aviation equipment famous for quality all over the world. Before you design, write our engineering department for detailed information on Bendix regulated dynamotors.

Dynamotors • Inverters • Convertors • D.C. Motors • Carbon Pile Voltage Regulators

**RED BANK DIVISION of**  
RED BANK, N. J.



- Output voltage constant within plus or minus 2.5% at rated load, with as much as 30% input voltage variation.
- Consistent efficiency of associated equipment under extremes of temperature, humidity, altitude and vibration.
- Allows the use of smaller, lighter, less expensive components in design of electronic equipment.
- Tube life materially lengthened due to narrow voltage tolerances.

\*TRADEMARK



# NEW! ...the Roto Ranger

— automatically rotates one of 18 separate scales into position as you select the range.

Simpson Model 221 Roto-Ranger  
High-Sensitivity A.C.-D.C. Volt-Ohm-Milliammeter

Here is the only multiple scale test instrument of its kind in the world. It definitely reduces the possibility of errors by providing a single scale for each range of this finest of volt-ohm-milliammeters. As the selector switch is moved to the range desired, an ingenious gearing mechanism rotates a drum, bringing into place behind the meter window the proper scale for that range. Here is the equivalent of 25 separate instruments combined in one sturdy compact unit. (18 scales; 7 additional direct reading ranges through use of high voltage and output jacks.) The patented Roto-Ranger principle eliminates the confusion of numerous readings on one scale, and the multiplying factors common to ordinary multi-range testers, by providing a separate scale for each range. There are no cramped calibrations in these full sized Roto-Ranger scales. Each is designed as it would be for a separate instrument.



**A separate scale for every range — automatically!**

**Large 5 1/2" meter, with 18 separate, full length scales!**

**Ask your jobber, or write for literature**

**RANGES**

Model 221 Volt-Ohm-Milliammeter

20,000 Ohms per Volt D.C., 1,000 Ohms per Volt A.C.  
Volts, A.C.: 2.5, 10, 50, 250, 1000, 5000  
Volts, D.C.: 2.5, 10, 50, 300, 1000, 5000  
Milliamperes, D.C.: 10, 100, 500  
Microamperes, D. C.: 100  
Amperes, D.C.: 10

Output: 2.5, 10, 50, 250, 1000 Ohms: 0-2000 (12 ohms center), 0-200,000 (1200 ohms center), 0-20 megohms (120,000 ohms center).  
Size: 12 3/4" x 10 1/8" x 5 9/16"  
Weight: 8 lbs. 9 oz.  
Price, Complete with test leads and 28-Page Operator's Manual ..... \$69.85

High voltage test probe for TV, radar, x-ray and other high voltage tests, also available.



SIMPSON ELECTRIC COMPANY  
5200-5218 W. Kinzie St., Chicago 44, Ill.  
In Canada: Bach-Simpson, Ltd., London, Ontario

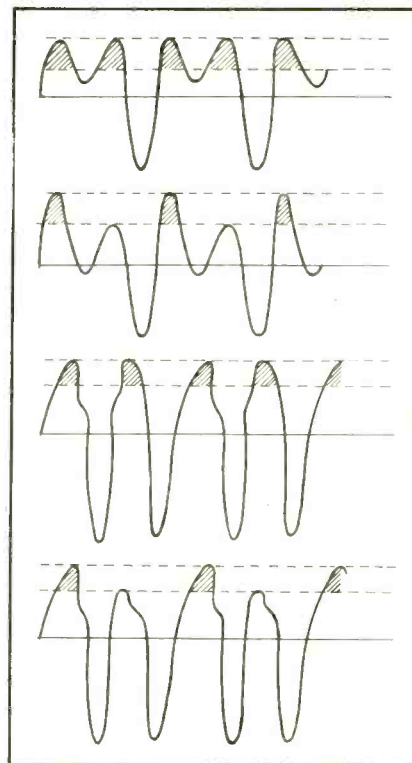

FIG. 6—Different waveforms react the same to discrimination producing almost identical pulses

so draw grid current to recharge the grid circuit negatively. Only that portion of the waveform projecting above the cut-off bias is capable of influencing the plate current of the tube.

In Fig. 5, the positive peaks of the signal alternate in amplitude. If the lower peaks are below cut-off bias they have no effect upon plate current. The higher peaks manage to exceed the zero bias value and draw grid current to maintain an average grid bias proportional to their amplitude. In this case the frequency of the output plate current pulses corresponds to the frequency of the fundamental modulating the envelope of the second harmonic, and no second harmonic is present in the output since there are no plate current pulses to represent it.

The smaller the percentage of the signal amplitude that corresponds to five volts the sooner the early stages of bridge unbalance indication can be completely amplitude discriminated. With the circuit shown it was possible to cause all vestige of second harmonic to disappear and the fundamental to become a maximum with one twentieth of the former required pri-

**MORE THAN 50 GRADES OF G-E TEXTOLITE LAMINATED PLASTICS ARE AVAILABLE**

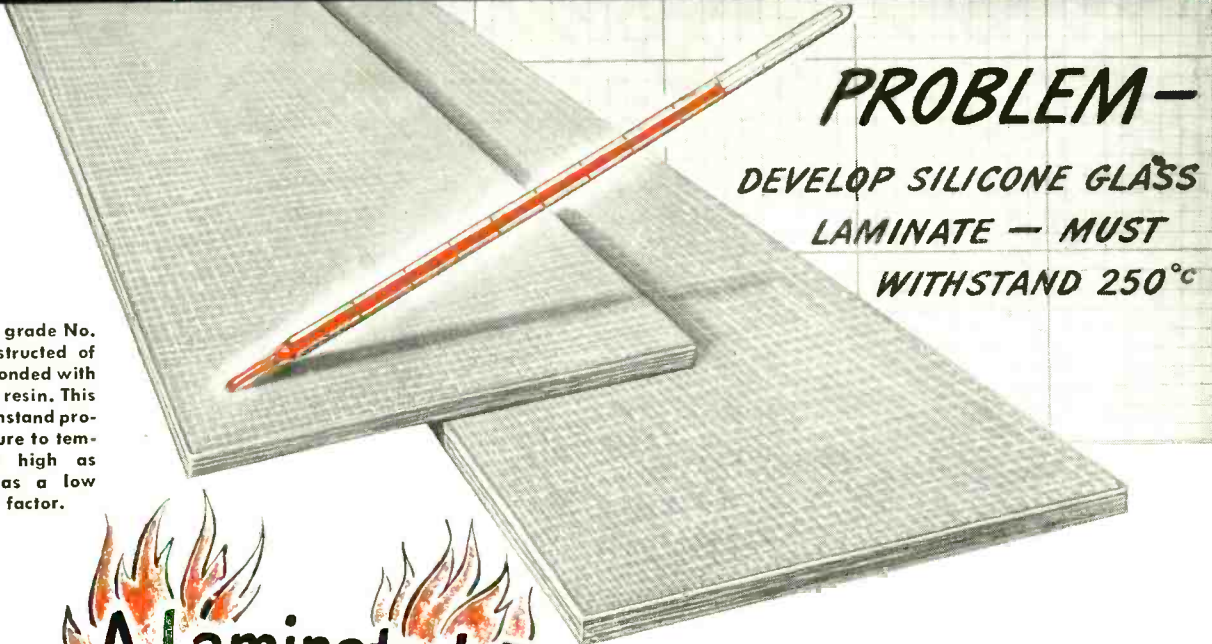

**PROBLEM—  
DEVELOP SILICONE GLASS  
LAMINATE — MUST  
WITHSTAND 250°C**

G-E Textolite grade No. 11514 is constructed of glass fabric bonded with a G-E silicone resin. This grade will withstand prolonged exposure to temperatures as high as 250°C and has a low dielectric loss factor.

**Now... A Laminated Plastics that likes the  
HOT SPOTS**



**TEXTOLITE LAMINATED IS SUPPLIED  
IN FIVE FORMS**



**SHEETS, TUBES, AND RODS**  
—These standard shapes are available in thousands of sizes. Up-to-date manufacturing methods facilitate quick deliveries.

**FABRICATED PARTS—G.E.** has modern fabricating equipment to machine Textolite laminated plastics parts to your own specifications.



**MOLDED-LAMINATED PARTS**—Textolite is custom molded directly to shape. Molded laminated products are among the strongest plastics parts produced.

**LOW-PRESSURE MOLDED PARTS**—Extremely large and irregular Textolite shapes are custom molded by the low-pressure laminating process.



**POST-FORMED LAMINATES**  
—Sheets of Textolite laminated plastics are custom formed into simple shapes by this very inexpensive method.

If you are looking for an excellent high-temperature insulation, G-E Textolite grade 11514 is your answer. But there are other grades of Textolite, too . . . over fifty in fact, and EACH grade has an INDIVIDUAL COMBINATION of properties. None is exactly alike.

It is this wide selection of materials that really can help you. You can choose a grade which has exactly the right properties to accurately fill your particular requirements. A better product, produced at less cost, is often the result.

Investigate the varied grades of Textolite and the five forms in which it is produced. You'll profit. Plastics Division, Chemical Department, General Electric Company, Pittsfield, Mass.

**GET THE COMPLETE STORY!**

Send for the new bulletin G-E TEXTOLITE LAMINATED PLASTICS which lists grades,

properties, fabricating instructions and detailed information about the five forms of Textolite. Fill in and mail the coupon below for your free copy.

**PLASTICS DIVISION, CHEMICAL DEPARTMENT  
GENERAL ELECTRIC COMPANY (BA-10)  
ONE PLASTICS AVE., PITTSFIELD, MASS.**

Please send me the new G-E Textolite laminated plastics bulletin.

Name.....

Firm.....

Address.....

City..... State.....

**GENERAL  ELECTRIC**

CD-48-M3



**-Bliley-**  
CRYSTALS

**MILITARY**  
**COMMERCIAL**



with type **BH6**  
Bliley engineering  
has anticipated  
your **VHF**  
requirements...

Type BH6 is available up to 100 MC and can be furnished to meet all standard specifications, military or commercial. This means your design considerations can be simplified by elimination of unnecessary multiplier stages. Write for information covering latest recommended oscillator circuits and associated crystal data.

**-Bliley-**  
CRYSTALS

BLILEY ELECTRIC COMPANY  
UNION STATION BLDG. • ERIE, PA.

TUBES AT WORK

(continued)

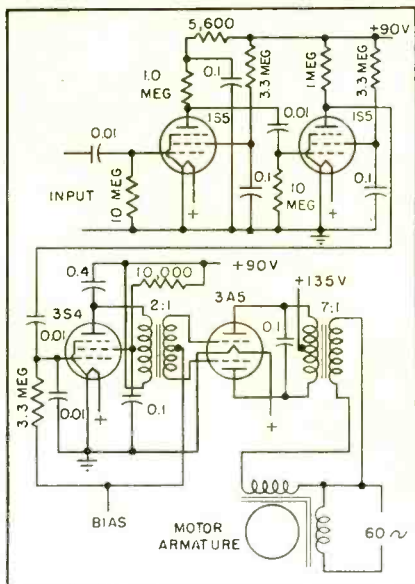

FIG. 7—Experimental circuit of amplifier for portable use

mary control displacement at the bridge input.

Stray 60-cycle pickup was not the nuisance under this system that it was under ordinary voltage amplification. Such pickup did not modulate the second harmonic nor could it otherwise interfere with the higher level grid signals put into use by this method.

Radically different waveshapes may give fundamentally the same output pulses in the discriminator plate circuit. The curves that are shown in Fig. 6 show how this may be possible. Those parts of the curves between the two lines representing cut-off bias and zero bias determine the frequency of the output pulses. The tips of such wave variations are very similar in shape and become even more so in the plate circuit of the discriminator as they draw grid current and are altered by curvature of the transfer characteristic.

In Fig. 7 an experimental circuit for adaptation to portable use is given with the values for circuit components. Only the amplifier unit alone is shown since the input and output controls are part of other developments.

To one accustomed to thinking of amplification strictly in terms of actual amplitude or power increase, it is surprising to see the output signal anticipate the input signal in changing its waveform while no apparent change occurs in the input.

**JOHNSON**  
a famous name in Radio

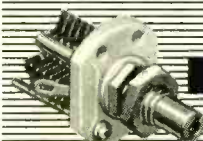

**SINGLE**

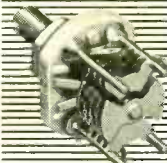

**BUTTERFLY**

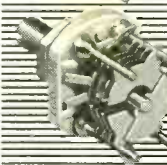

**DIFFERENTIAL**

**SMALLEST**  
**AIR VARIABLES**  
**EVER PRODUCED**

Pictured are three of the smallest air variables ever produced. Each of the three types is available in four different capacities.

**SINGLE TYPE**—Takes the place of adjustable padders for trimming RF and IF oscillator circuits. Available in four models: 1.55 to 5.14 mmf, 1.73 to 8.69 mmf, 2.15 to 14.58 mmf and 2.6 to 19.7 mmf.

**BUTTERFLY TYPE**—Applicable wherever a small split stator tuning condenser is required. Available in four models: 1.72 to 3.30 mmf, 2.10 to 5.27 mmf, 2.72 to 8.50 mmf, and 3.20 to 11.02 mmf.

**DIFFERENTIAL TYPE**—For switching capacity from rotor to either of two stators, and for shifting tap on capacity divider. Available in four models: 1.84 to 5.58 mmf, 1.98 to 9.30 mmf, 2.32 to 14.82 mmf, and 2.67 to 19.30 mmf.

For Full Details  
Write For Latest **JOHNSON** Catalog

**E. F. JOHNSON CO.**  
WASECA, MINNESOTA



# ONLY PHILLIPS RECESSED HEAD SCREWS



**AUTOMOTIVE**



**RAILWAY CARS**



**MARINE**



**PLASTICS**

**ARE ACCEPTED AS STANDARD IN ALL INDUSTRIES**

One cross recessed head screw, PHILLIPS, is the accepted standard throughout industry. In the 13 years since its introduction, its many advantages have been recognized and applied in every field of manufacture.

For example, virtually the entire automobile industry has standardized on Phillips Screws—lists them in their Standards Book. Similarly, Phillips Screws are standard in most of the largest aircraft plants. Manufacturers of every type of screw-fastened assembly, large and small, use Phillips Screws exclusively.

Such universal acceptance by industry is the best possible evidence that Phillips Screws alone have all the qualifications essential to a standard cross recessed head screw. For unequalled mechanical advantages, for dependable uniformity, for unlimited supply potential, for universal acceptance, you can depend on PHILLIPS.

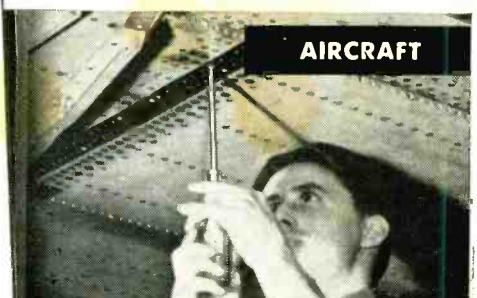

**AIRCRAFT**



**FURNITURE**

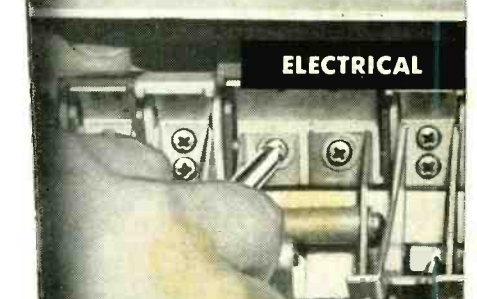

**ELECTRICAL**

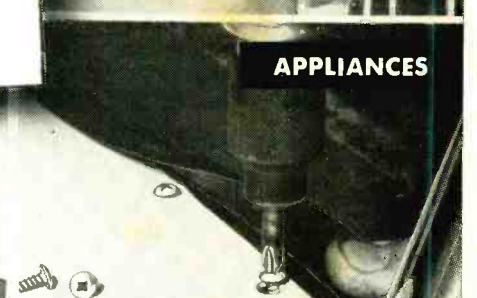

**APPLIANCES**



... AND EVERY OTHER SCREW USING INDUSTRY

**GET ALL THE ADVANTAGES OF ASSEMBLY WITH CROSS RECESSED HEAD SCREWS...**

**GET**

## PHILLIPS Recessed Head SCREWS

Wood Screws • Machine Screws • Self-tapping Screws • Stove Bolts

- American Screw Co.
- Camcar Products Co.
- Central Screw Co.
- Continental Screw Co.
- Corbin Screw Div. of American Hdw. Corp.
- Elo Tool & Screw Corp.
- The H. M. Harper Co.
- Lamson & Sessions Co.
- Millford Rivet and Machine Co.
- National Lock Co.

**27 SOURCES**

- National Screw & Mfg. Co.
- New England Screw Co.
- Parker-Katon Corporation
- Pawtucket Screw Co.
- Phenix Manufacturing Co.
- Reading Screw Co.
- Rockford Screw Products Co.

- Russell Burdshall & Ward Bolt & Nut Co.
- Seovill Manufacturing Co.
- Seaboard Screw Corp.
- Shakeproof Inc.
- The Southington Hardware Mfg. Co.
- The Steel Company of Canada, Ltd.
- Sterling Bolt Co.
- Stronghold Screw Products, Inc.
- Wales-Beech Corp.
- Wolverine Bolt Company

GET THIS NEW BOOKLET of facts that prove the top value, top economy of Phillips Recessed Head Screws. It's free... use the coupon.



Phillips Screw Mfrs., c/o Horton-Noyes Co. 1800 Industrial Trust Bldg. Providence, R. I.

Send me the new booklet—"How to Select Recessed Head Screws for Practical Production Driving".

Name .....

Company .....

Address .....

E-34



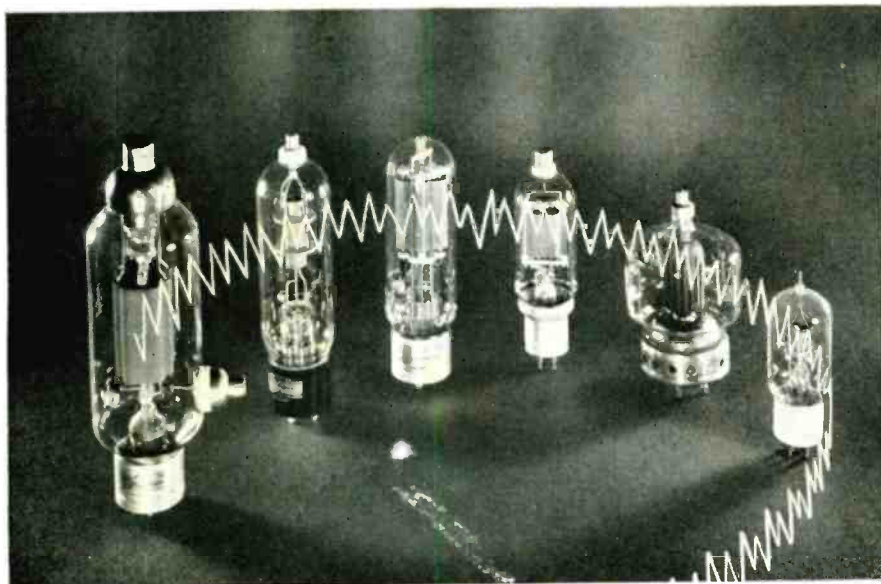

Look for **GRAPHITE ANODES** when you're looking for **BETTER TUBES!**

Extensive research, production and testing by the United Electronics Company and other tube manufacturers working jointly with Speer, has revealed that graphite — the only real low temperature anode — provides these outstanding advantages in transmitting tubes:

1. **Higher Ratings**—Tubes with Speer Graphite Anodes radiate heat faster, handle 200 to 300% more power than anodes made of popular metals.
2. **Greater Stability at High Inputs** — Even when tubes are operated in the neighborhood of 100 Mc's or over, Speer Graphite Anodes will not warp.
3. **Longer Life** — Even under continued severe usage, Graphite Anode tubes last longer than metallic anode tubes because they operate at lower temperatures.

To meet the demands of modern equipment for superior tube performance, leading manufacturers use Speer Graphite Anodes for oscillators, amplifiers, doublers, modulators and rectifiers—your assurance of cooler, more efficient tube operation.

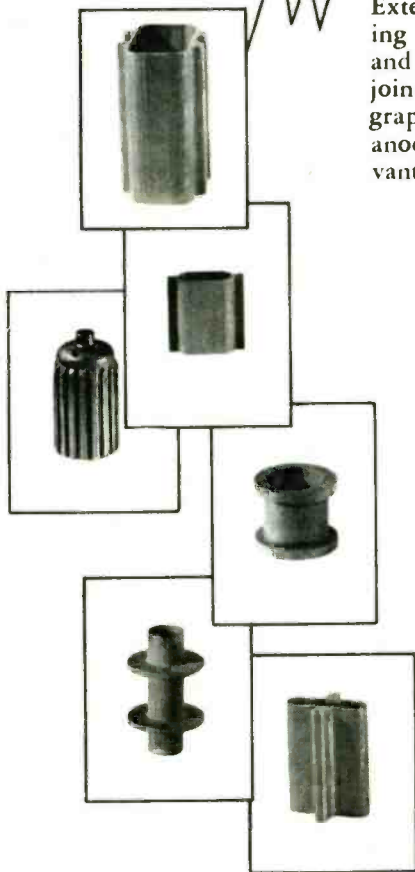

**Speer**

CARBON COMPANY  
ST. MARYS, PENNA.

brushes · contacts · welding electrodes · graphite anodes · rheostat discs · packing rings · carbon parts  
CHICAGO · CLEVELAND · DETROIT · MILWAUKEE · NEW YORK · PITTSBURGH

4523

**THE ELECTRON ART**

(continued from p 130)

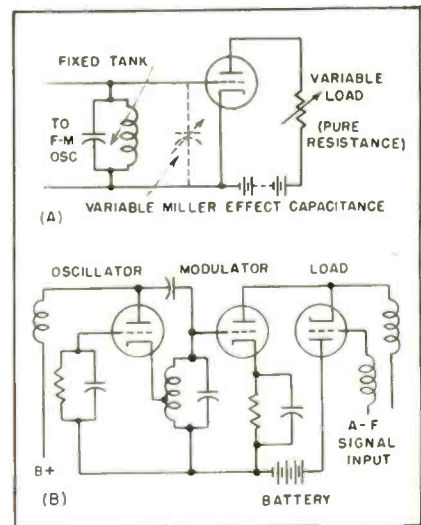

FIG. 1—(A) Basic principle of Miller effect frequency modulator circuit depends on variation of load resistance of tube reflecting a variable capacitance across its input. In practical adaptation of this principle (B) modulator tube is placed across oscillator and has a vacuum tube for load

circuit shows that, in the general case, the input admittance between grid and cathode has both real and imaginary components. But if the load is purely resistive, as in this special case, and the grid-plate and grid-cathode capacitances are of the same order of magnitude and the product of frequency, grid-plate capacitance, plate resistance and load resistance is considerably less than unity, the input becomes purely capacitive. This input capacitance is equal to  $C_{GK} + C_{GP}(1 + A)$ , and its dependence on the amplification factor of the tube and plate circuit conditions is familiarly known as the Miller effect.

Pure negative (capacitive) reactance can thus be injected into the tank circuit without the need for phasing circuits or multigrid tubes; the only requirement is that the plate load be purely resistive. To produce the frequency modulation, the gain  $A$  of the tube is varied by the additional elements shown at Fig. 1B. The amplification of the modulator tube is varied by placing in its plate circuit another tube as load which behaves as a variable resistance dependent on the audio-frequency signal voltage. The oscillator tube is connected in a Hartley circuit.

Because both cathode and grid of the load tube operate at r-f potentials, it is necessary to use





## MEASURE HIGH VACUUM ACCURATELY, EASILY, ECONOMICALLY, WITH DPA-37 our newest Ionization Gauge Control Circuit

The DPA-37 is DPI's newest Ionization Gauge Control Circuit. It measures all the pressures commonly met in high-vacuum diffusion pump work. And it incorporates all the desirable features you would look for. For example:

**DPA-37 is sensitive**—Using the highly sensitive VG-1A Ionization Gauge Tube, DPA-37 measures from .0025 mm to .0000005 mm of Hg in four ranges by means of a specially designed amplifier circuit. The zero setting may be checked instantly without interrupting normal operations.

**DPA-37 is easy to operate**—There are a minimum of steps necessary for taking a pressure reading. Just two dial adjustments—and the pressure is

obtained by multiplying the dial reading by the scale factor. No calibration charts needed.

**DPA-37 is easy to maintain**—All circuit tubes and nearly all other parts are standard radio type for simple, inexpensive maintenance. Less-than-normal loads on component parts assure long life for the circuit.

**DPA-37 is economical**—Lower fila-

ment current (only 2 MA) and a built-in automatic overload relay result in maximum life for the VG-1A Ionization Gauge by protecting it from the most abrupt surges of pressure.

The price for the DPA-37 panel mounted is \$350. The cabinet mounted model illustrated is \$365. DPA-37 gives you more per dollar—costs less in the long run. For a more complete description of its features, write—

*Vacuum Equipment Division*

**DISTILLATION PRODUCTS, INC.**

727 RIDGE ROAD WEST • ROCHESTER 13, N. Y.



570 Lexington Avenue, New York 22, New York  
135 South LaSalle Street, Chicago 3, Illinois

*Manufacturers of Molecular Stills and High-Vacuum Equipment; Distillers of Oil-Soluble Vitamins and Other Concentrates for Science and Industry*





# IN *all* ITS FORMS

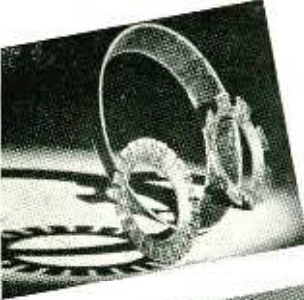

That is, all for the moment, but next week or next month we may receive blueprints and specifications calling for still another form — different in shape, thickness, flexibility, dielectric or other characteristics — to be added to the hundreds of processing operations which always start with Mica and end up with MACALLEN Mica — precisely made for customers' specifications, but to our own high quality standards. We have done so much with Mica, processed it in so many ways, and brought that processing to such standard forms and uniformity, that anything new seems almost inconceivable — nevertheless, our business is not static.

## MACALLEN MICA

dependable beyond any question of doubt — uniformity in day-to-day production — saves trouble, speeds assembly.

# MACALLEN MICA

ALL FORMS, ALL QUANTITIES — ALL DEPENDABLE

when you think of MICA, think of MACALLEN

**THE MACALLEN COMPANY** • 16 MACALLEN ST., BOSTON 27, MASS.

CHICAGO: 565 W. WASHINGTON BLVD. • CLEVELAND: 1231 SUPERIOR AVE.

r-f chokes to separate the r-f and a-f portions of the circuit. The battery provides the proper bias for maximum linearity between a-f input, internal resistance of the load tube, and frequency deviation

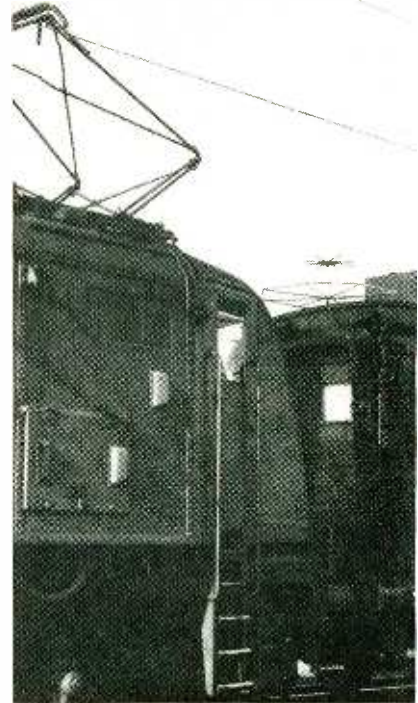

FIG. 2—Frequency modulation radiotelephone train antenna was located near locomotive to create most adverse noise problem for purposes of testing

of the oscillator. Drift of the oscillator's center frequency is easily counteracted by superimposing a compensating voltage obtained by usual automatic frequency control techniques on the battery voltage. Although the frequency stability of this circuit is inherently comparable to that of all direct f-m circuits, the simplicity of this circuit reduces the difficulties of stabilizing frequency. Of course, the frequency of the oscillator can be stabilized by a quartz crystal, in which case the Miller effect modulator can produce phase modulation, which can be used directly or fed to multiplier stages.

### *Experiments with Radiophone*

This new modulator circuit has been used in equipment built for the Italian State Railways to determine the feasibility of very high frequency radiotelephone communications between a moving train and a fixed ground station. Troubles from microphonics en-

# 4 microphones in one

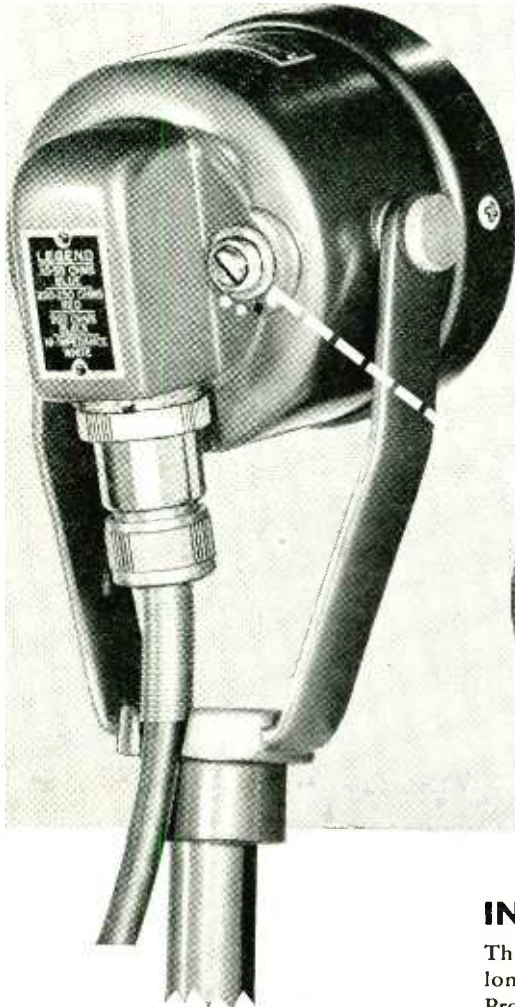

**TURNER "U9S" DYNAMIC  
... WITH NEW, IMPROVED,  
HEAVY DUTY IMPEDANCE SWITCH**



*Adjustable saddle permits semi- or non-directional operation. Fits any standard microphone stand. {Desk stand as shown at extra cost.}*

**MODEL "U9S"**

**LIST PRICE: \$40.00**

Complete with 20-ft. balanced line quick-change shielded cable set.



*Microphones* **BY TURNER**

## INSTANT SELECTION OF FOUR IMPEDANCES

The outstanding dynamic in its field, made even better with a new, long-life, trouble-free metal switch, designed exclusively for Turner. Professional in appearance and performance. High in convenience. Built-in tapped multi-impedance transformer with improved 4-position switch gives positive selection of 50, 200, 500 ohms, or high impedance output. *One microphone serves any standard equipment.* Voice coil and transformer leads are insulated from ground and microphone case. Line is balanced to the ground. Engineered with smooth wide-range response from 40 to 9000 c.p.s. Level: 52 db below 1 volt/dyne/sq.cm. at high impedance. Richly finished in baked gun-metal.

The Turner "U9S" is widely recommended for broadcast, public address, communications, sound systems, recording, and general purpose applications.

**THE TURNER COMPANY**  
905 17th Street N. E. Cedar Rapids, Iowa

Licensed under U. S. patents of the American Telephone and Telegraph Company, and Western Electric Company, Incorporated.



# For AIRCRAFT RADIO



## Standardize on RH-7 Crystal Units

For the first time you can standardize on only one crystal holder for every aircraft radio application. Hermetically sealed and shock mounted, RH-7 miniature holders cover a frequency range from 1 to 75 mc with tolerances of  $\pm .005\%$ . These CAA-approved crystal units operate in a temperature range from  $-55^{\circ}\text{C}$  to  $+90^{\circ}\text{C}$  and are designed to withstand even the most severe operating conditions. Available with pins or wire leads.

Standardize now with RH-7.



Write for Bulletin RHC-X

**REEVES**  **HOFFMAN**  
**C O R P O R A T I O N**  
CHERRY AND NORTH STREETS • CARLISLE, PA.

counted with reactance-tube modulators were eliminated by using the Miller effect modulator and frequency stability was better. These tests were made on carrier frequencies around 110 mc with 40 watts output from the transmitters. For tests the antenna on the train was purposely placed on the coach next to the electric locomotive, as shown in Fig. 2. The electrified sections of the right-of-way use 3,000-volt overhead lines; a train is drawn by a 3,000 hp locomotive.

The transmitter consisted of a Miller effect modulator using a 12J5GT and a 12AH7GT, a 12A6 oscillator multiplier, 12A6 frequency doubler, 832 frequency tripler, and 829B power amplifier. A total frequency multiplication of 18 is obtained to produce a modulation index of 4, which is sufficient to give suitable noise suppression despite the adverse antenna location and the change in signal strength because of the cuts and built-up suburban districts through which the 24 miles of track between Rome and Tivoli pass.

Repeated tests on this line have consistently indicated the possibility of establishing satisfactory commercial quality radiophone communication between the moving train and a fixed station at Rome with the exception of those places where the line enters tunnels of considerable length near Tivoli.

### Precision Circuit Printing

By CLIFTON TUTTLE

Vice President, Research & Development  
Kenyon Instrument Co., Inc.  
Huntington Station, N. Y.

PRINTING ELECTRONIC CIRCUITS has two advantages: it decreases the size and weight of the circuit chassis and components, and it makes production more economical through elimination of wire soldering and lessening of the numbers of units rejected because of errors in manual assembly. Both advantages are either directly or indirectly enhanced by the ability to reproduce conductive patterns with geometrical precision.

The process developed by this company is capable of high resolution of details in the production of

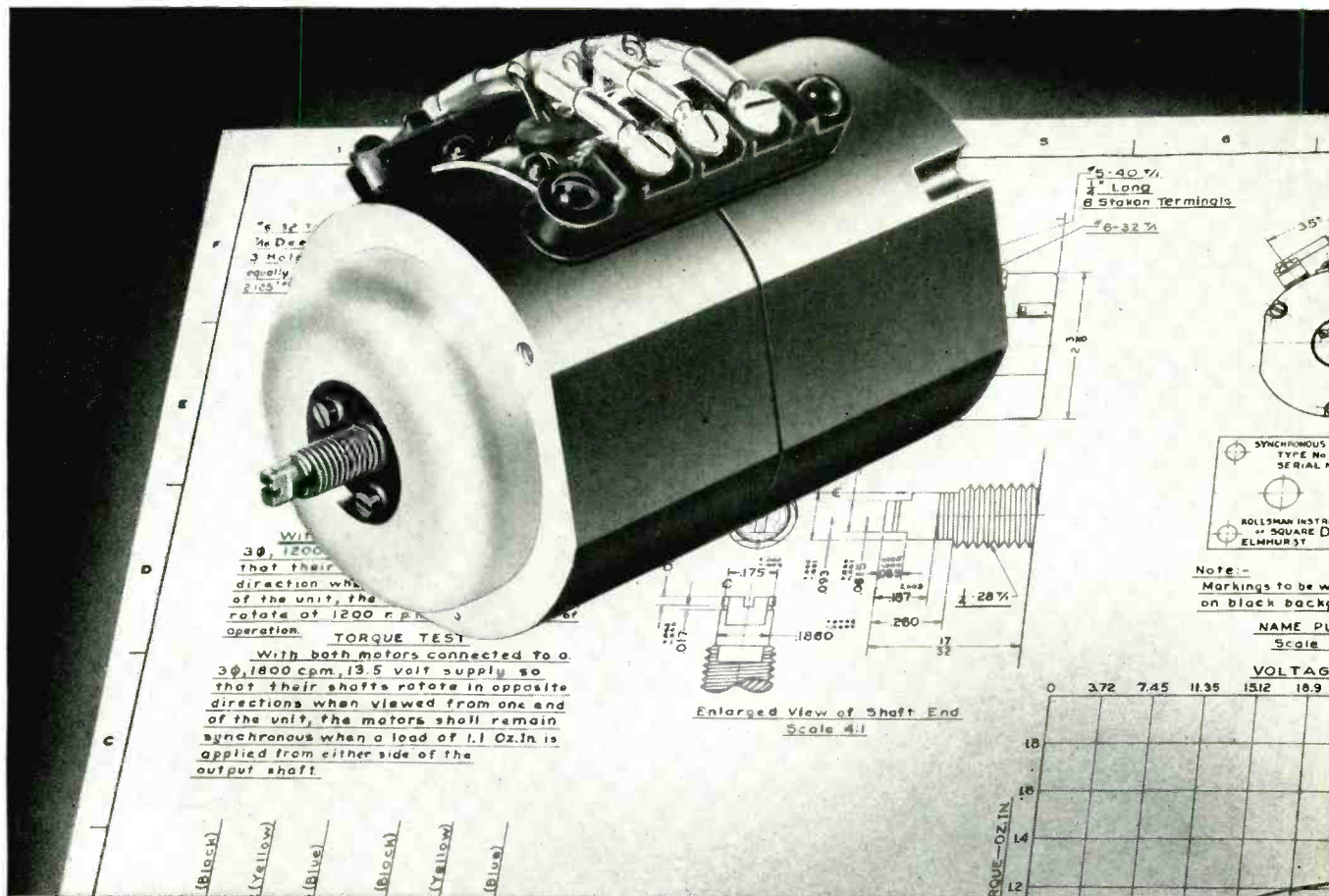

Shown actual size • Weight: 28 oz.

*Announcing*

## THE KOLLSMAN SYNCHRONOUS DIFFERENTIAL

The Kollsman Synchronous Differential solves many difficult problems for the design engineer. It is an electro-mechanical error detector with mechanical output for use in position or speed control servo systems.

This unit is composed of two small synchronous motors and a mechanical differential in a completely enclosed frame. The 1/4" threaded output shaft turns at a rate equal to 1/2 the difference of the individual speeds of the two motors. When the input frequencies are equal, the shaft remains stationary.

The efficiency of this unit is greatly increased by the use of hysteresis-type motors. These

motors yield the greatest running torque found in self-starting synchronous motors. The units now being produced are designed to operate from a three-phase source over a 15-60 cycle frequency range with an input voltage of .007 times the frequency, in cycles-per-minute. Similar units wound for higher voltages and two- or single-phase operations are also available.

The Synchronous Differential is but one of a complete line of special purpose motors developed by Kollsman for remote indication and control applications. Write for further information to: Kollsman Instrument Division, Square D Company, 80-64 45th Avenue, Elmhurst, N. Y.

**KOLLSMAN INSTRUMENT DIVISION**

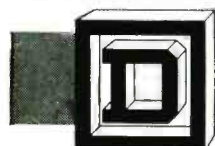

**SQUARE D COMPANY**

ELMHURST, NEW YORK

GLENDALE, CALIFORNIA



✓ Check  
these outstanding  
IMPROVEMENTS

**ADC**  
**JACKS**

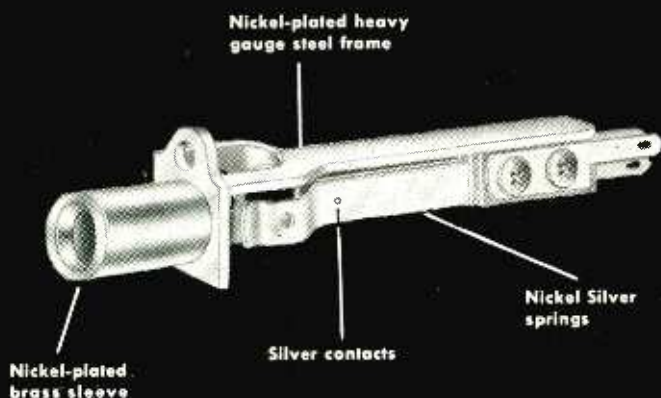

*Now, Your Customers Get*  
**ALL THESE BENEFITS**

ALL ADC JACK  
PANELS NOW CONTAIN  
THESE NEW ADC JACKS

- Greater Strength & Rigidity!
- Less Corrosion!
- Better Contacts!
- Longer Life!

**Jobbers!** Send for  
Catalog and samples  
TODAY!

The new streamlined design of ADC Jacks uses heavier gauge metal for *greater strength*. The frame is die-formed and press-welded for utmost rigidity and dimensional accuracy.

Silver-alloy contacts and genuine Nickel Silver springs guarantee corrosion resistance, even under the most humid conditions.

All the way through, the new ADC is a better jack! If you require top quality and precision-made components, ADC Jacks merit your *first* consideration.

**ADC**

**Audio DEVELOPMENT CO**  
*Audio Develops the Finest*  
2847 13th AVE. SOUTH • MINNEAPOLIS 7, MINN.

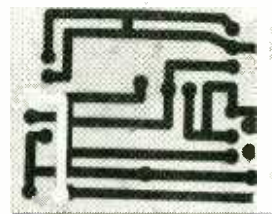

A commutator formed in ceramic and a circuit formed on top and bottom of a thin, transparent plastic sheet

patterns because it is basically a photographic reproduction method. Commercial photographic materials usable in this process are capable of resolving lines less than 0.0005 inch in width which are separated by spaces of the same width. This inherent dimensional accuracy of the photographic material may be realized in accuracy of circuits or other patterns reproduced by the method.

*Description of the Process*

The first steps in the process are merely the following of the standard procedure of photography: printing opaque and transparent copies either by contact or by optical projection (at any desired reduction ratio) onto a commercial silver halide emulsion. This emulsion may be coated either as a photographic plate or film. Following exposure, the image is developed in the conventional manner, resulting in the reduction of the silver halide to metallic silver particles imbedded in the gelatine. These silver particles, because they are buffered by nonconductive gelatine do not form a conductive layer. In fact, the resistance of the conventional photographic image area is of the same order of magnitude as that of the nonimage area.

The next step in the process is one of physical replacement of the image areas by other materials. Silver, carbon, graphite, or other substances obtainable in finely divided powder form can be used. By this replacement the original base material, glass or film, bears a

*Inside this*  
**"TIP-TOE" IRON**  
insulation must stand  
**HEAT and**  
**FLEXING**

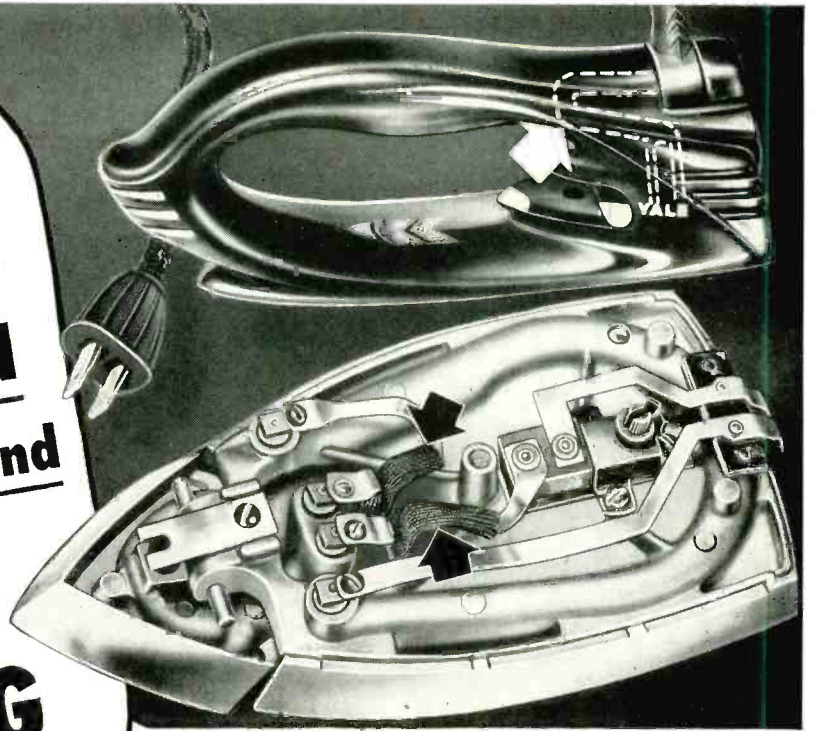

## Varglas Non-Fray Sleeving

**Chosen by Yale & Towne Mfg. Co. for Articulated Iron**

On the leads across the jointed sections of a hot iron is a "hot spot" for insulation. High temperatures and frequent flexing combine here to make the insulation job especially difficult. Yale & Towne Mfg. Co. found the answer in VARGLAS Non-Fray Sleeving, Type HP.

VARGLAS HP Non-Fray Sleeving is formed of Fiberglas braid. Durability, especially under flexing, is increased through the "normalizing" process. A color is added to the Fiberglas for identification purposes. The satisfactory per-

formance of the "Tip-Toe" Irons supports Yale & Towne's selection of VARGLAS.

For insulation problems of even more difficult nature, VARGLAS Silicone-impregnated Sleeving and Tubing offer a range of reliable, super-performance insulating materials that successfully work through temperatures from 500° F down to -85° F. These war-developed insulators won their ratings through meeting the drastic demands of military aircraft for high dielectric, low-space, dimensionally stable insulating media that could serve in all temperatures encountered from sea-level to stratosphere zones. We also supply VARGLAS treated and untreated Lite-wall Sleeveings (ECC-A and ECC-B).

*Write for free samples and specifications of these Fiberglas and Silicone Sleeveings.*

**Varflex**  
**CORPORATION**

*Makers of*  
**Electrical Insulating**  
**Tubing and Sleeveing**

**VARFLEX Corporation, 308 N. Jay St., Rome, N. Y.**

Please send me your free folder containing samples of your different types of electrical insulation. I am particularly interested in samples suitable for

Name.....  
 Company.....  
 Street.....  
 City..... State.....



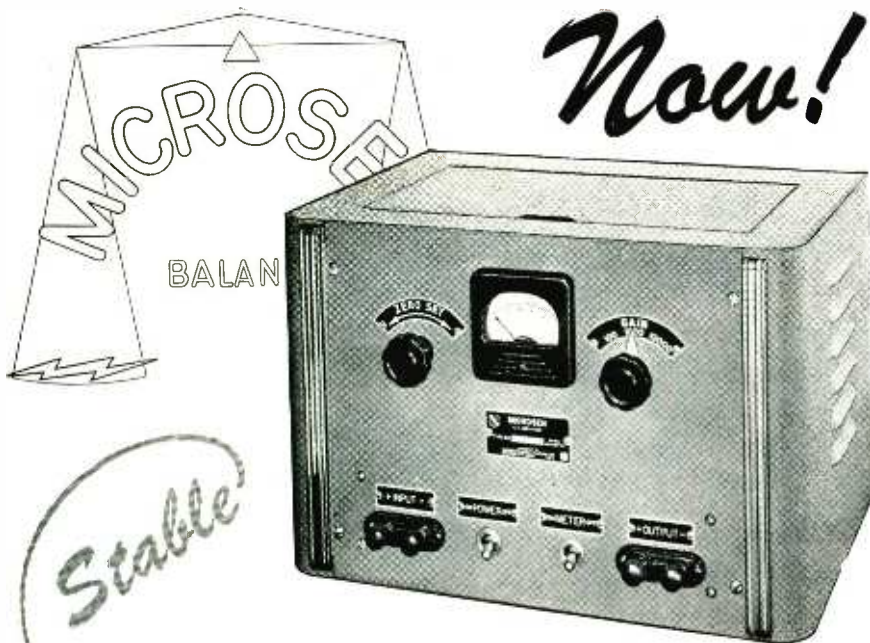

## D. C. AMPLIFICATION at moderate cost

The Microsen Balance principle, developed in our electrical instrument laboratory, makes possible for the first time at moderate cost, a D. C. Amplifier incorporating High Stability, Fast Response, Isolated Input, and Versatility.

Models available include Voltage, Current and Potentiometer Type Amplifiers, Direct Current Converters, Direct Current Transformers, and Engineered Designs to meet special requirements.

Line voltage variations of 15% cause output changes of less than .5%. No mechanical rectifiers or choppers. Standard tubes. Time constant from .001 to .2 seconds. Drift less than 5 Microvolts per day. Not affected by temperature variations.

May we send you our bulletin 143-E.



## MICROSEN D. C. AMPLIFIER

*A Product of*

**MANNING, MAXWELL & MOORE, INC.**  
BRIDGEPORT 2, CONNECTICUT

Makers of 'American' Industrial Instruments, Hancock Valves, Ashcroft Gauges, Consolidated Safety and Relief Valves. Builders of 'Shaw-Box' Cranes, 'Budgit' and 'Load-Lifter' Hoists and other lifting specialties.

faithful and strongly adhering replica of the original image in relief. The definition of detail in this new pattern is influenced only by the photographic image definition and the fineness of the powder used in the replacement step. At this point in the process, the pattern, if it is conductive, can be electroplated to build any desired thickness.

Because the original base, film or plate, is usually mechanically or electrically unsuitable for the ultimate use of the circuit or pattern, a final step is usually required. The entire pattern is transferred to a new base material. Several different types of transfer material are possible. It may be a thermoplastic or thermosetting resin or a ceramic.

Most experience has been with transfer to a thermosetting polyester resin. The resin may be clear or mixed with a filler such as asbestos fiber. To accomplish the transfer step, the image-bearing film is placed face upwards on a flat or curved plate. A hollow rectangle of polyvinyl-alcohol sheeting is placed around the part to serve as a dam for the viscous casting resin, and the polyester co-polymer with a slight amount of added catalyst is poured over the surface. The material, while in its viscous state, fills the interstices between the pattern segments. After the resin sets, the pattern becomes mechanically imbedded and probably chemically bonded to the polyester resin.

As a final step, the casting is lifted from the base plate and the original film base is removed with a differential solvent which leaves the resin base untouched. The pattern surface is then flush with the base surface in which it is imbedded.

Aside from the obvious applications of the described technique to the now conventional printed circuit production, it is possible that other uses may occur to the engineer. There may be, for instance, some applications in the scientific instrument and optical fields.

A few of the applications that have been considered are: (1) formation of complicated conductive patterns to be used as commutators, (2) making tapered re-

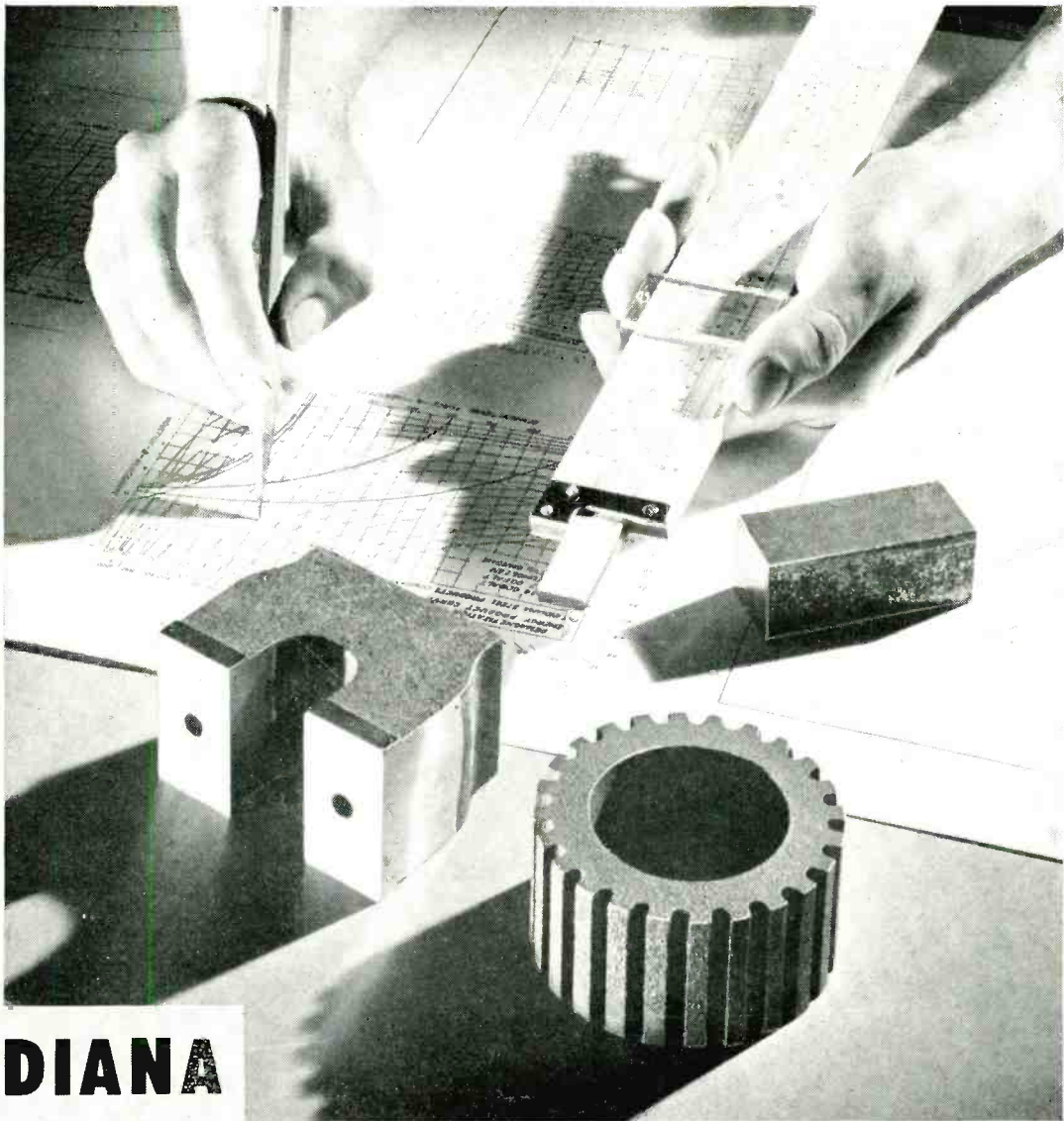

# INDIANA PERMANENT MAGNETS may be your answer, too...

## "Packaged Energy" Saves Size, Weight, and Cost

Every day, *Indiana* permanent magnets are opening new fields, bringing new opportunities to science and industry. From magnetic can openers to cosmic ray research, these permanent magnets—of new designs and increased efficiency—enable equipment to do a *better job*. They add new functions . . . step up performance . . . *cut costs*. These magnet developments can mean extra profits for *you*—for "packaged energy" may have direct application to *your own* methods and products.

Our specialists have a complete range of magnetic alloys for casting, sintering, or forming permanent magnets as large or as small as you need. Strict supervision of *every step* in production assures magnets of *exact* characteristics, both magnetic and mechanical. The experience and know-how of more than 25,000 different applications are at your service. Let us help you with *your* magnetic problems, too. Write today.

● *Indiana*—world's largest exclusive producer of permanent magnets—is the *only* manufacturer furnishing *all* commercial grades of permanent magnet alloys. The most commonly used are:

**CAST:**

Alnico I, II, III, IV, V, VI, and XII;  
Indalloy; Cunico; Cobalt.

**SINTERED:**

Alnico II, IV, V; Indalloy; Vectolite.

**DUCTILE:**

Cunico; Cunife I and II; Silmanal.

**FORMED:**

Chrome; Cobalt; Tungsten.

*Ask for free Book No. 4-E10 — our new permanent magnet reference manual. A note on your company letterhead will bring a copy to your desk.*



## THE INDIANA STEEL PRODUCTS COMPANY

PRODUCERS OF "PACKAGED ENERGY"

6 NORTH MICHIGAN AVENUE · CHICAGO 2, ILL.

SPECIALISTS IN PERMANENT MAGNETS SINCE 1908

PLANTS: VALPARAISO, INDIANA; CHAUNCEY, N. Y.



\*Here's your supply of N.Y.T

# TELEVISION COMPONENTS

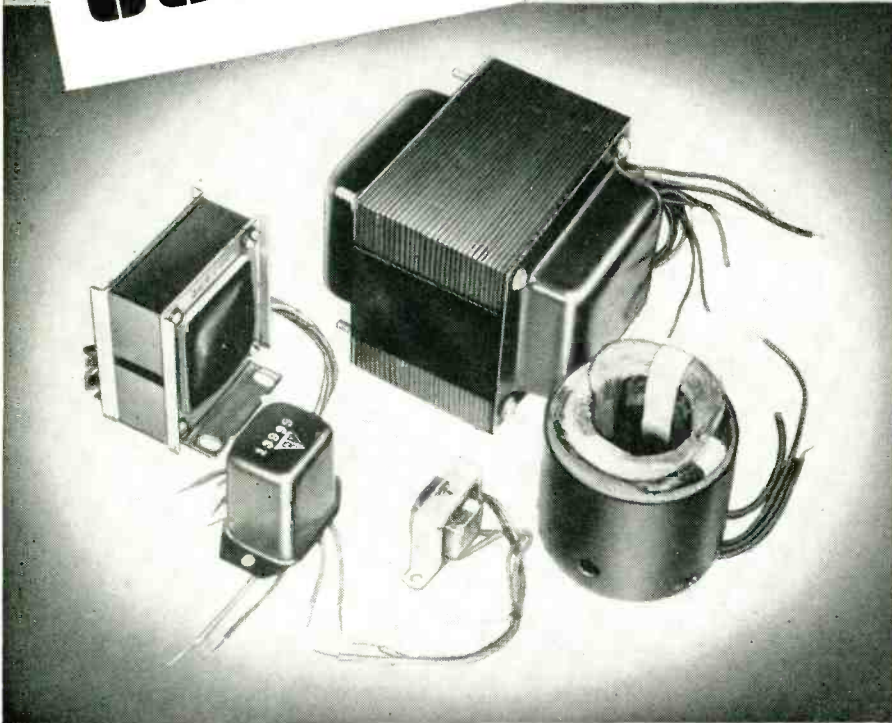

## Available Now!

- ★ TELEVISION POWER TRANSFORMERS
- ★ DEFLECTION COILS
- ★ VERTICAL OUTPUT TRANSFORMERS
- ★ HORIZONTAL BLOCKING OSCILLATOR TRANSFORMERS
- ★ VERTICAL BLOCKING OSCILLATOR TRANSFORMERS

N.Y.T. facilities are now expanded to supply all types of inductive television components in quantity. Estimates will be supplied promptly on standard units or types wound to your exact specification. In addition to television components, N.Y.T. offers complete manufacturing service on power transformers, chokes, and audio transformers. Modern plant and winding equipment assures finest quality at low cost. Call or write today for information.

\* IN ANY QUANTITY!



## NEW YORK TRANSFORMER CO.

ALPHA • NEW JERSEY

sisters of any complex function for resistance pots in computer systems. (3) making durable and decorative nameplates and dials for instruments, (4) making grid patterns for radioactivity and x-ray screens, using lead, gold or the new Hevimet alloy as the powdered metal, (5) making thermocouple or thermistor-bolometer elementary mosaics, and (6) production of optical grids of greater durability and stability than photographic grids. The first two applications require smoothness durability of the conductive coatings to withstand the action of a moving stylus. Tests have been carried up to several hundred thousand actuations of a rheostat stylus over such surfaces with success.

A dividend of the method, not stressed in the above description, is economy on short runs made possible by lowered (almost negligible) tool costs. Practically the only expense in changing from one part to another or from one circuit configuration to an entirely different one is the draftman's work of drawing new copy.

Photographic illustration of the results of this process are not particularly informative because the finished product looks like the original drawing. The accompanying photograph serves chiefly to indicate the type of circuits than can be rendered in this medium. The author expresses his gratitude for the cooperation and support of the Squier Laboratory of the Signal Corps in the pursuit of this project.

## The Synchrostrob Timer

By WALTER R. BERG

*Ordinance Research Laboratory  
The Pennsylvania State College  
State College, Pennsylvania  
(Now with Dictograph Products, Inc.  
Jamaica, N. Y.)*

IN VIEWING rotating machines by standard stroboscopic methods constant manipulation of the light source frequency is necessary in order to prevent the stroboscopic image from changing position. Furthermore, it is practically impossible to orient the image to a specified angular position manually. The circuit shown in Fig. 1 automatically holds the stroboscopic image at a

# ARNOLD

**Specialists and  
Leaders in the  
Design,  
Engineering  
and  
Manufacture  
of  
PERMANENT  
MAGNETS**



Arnold's business is permanent magnets, *exclusively*—a field to which we have contributed much of the pioneering and development, and in which we have set peak standards for quality and uniformity of product.

Our service to users of permanent magnets starts at the design level and carries on to finish-ground and tested units, ready for your installation. It embraces all Alnico grades and other types of permanent magnet materials—any size or shape—and any magnetic or mechanical requirement, no matter how exacting.

Let us show you the latest developments in permanent magnets, and how Arnold products can step up efficiency and reduce costs in your magnet applications. Call for an Arnold engineer, or check with any Allegheny Ludlum representative.

**THE ARNOLD ENGINEERING CO.**

Subsidiary of  
**ALLEGHENY LUDLUM STEEL CORPORATION**  
147 East Ontario Street, Chicago 11, Illinois



*Specialists and Leaders in the Design,  
Engineering and Manufacture of PERMANENT MAGNETS*

W&D 1100



# New! All inclusive!



## STANDARD LINE OF TRANSMITTER COMPONENTS

FOR AM, FM AND TV—LABORATORY AND INDUSTRIAL APPLICATIONS

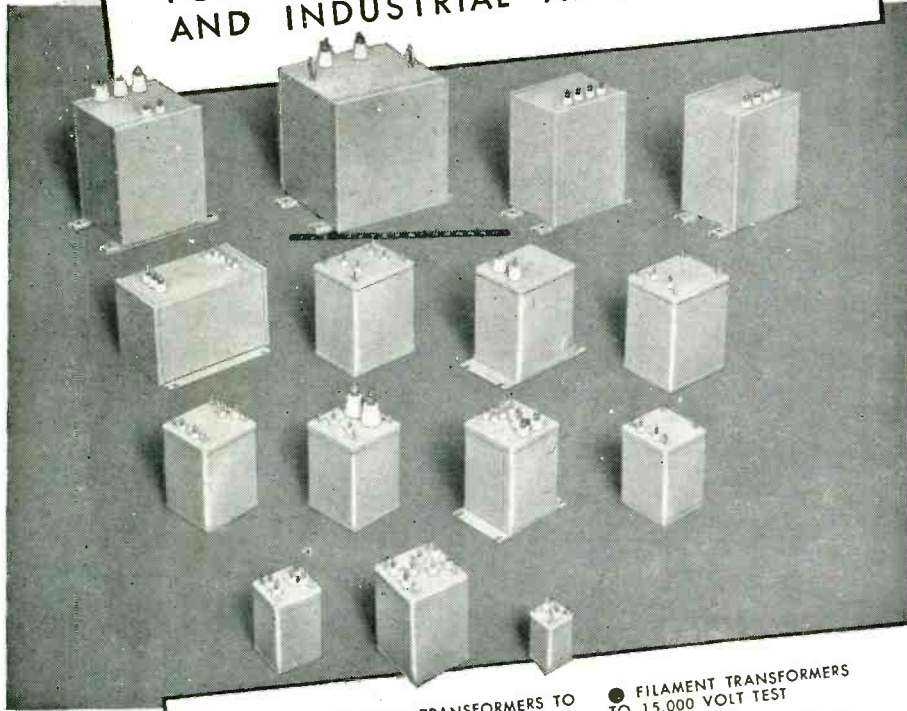

**INCLUDING —**

**FEATURING —**

- PLATE TRANSFORMERS TO 10 KVA
- FILTER REACTORS
- 115/230 VOLT, 50/60 CYCLE SUPPLY
- RUGGED INTERNAL CONSTRUCTION, SUPPORTED CORE STRUCTURE
- EYE BOLTS ON LARGE UNITS FOR EASY HANDLING
- FILAMENT TRANSFORMERS TO 15,000 VOLT TEST
- PLATE FILAMENT TRANSFORMERS LOW VOLTAGE
- AIEE SURGE TEST ON HIGH VOLTAGE UNITS
- EFFICIENT MAGNETIC AND ELECTRO-STATIC SHIELDING
- UNIFORM STREAMLINED APPEARANCE
- STURDY STEEL CASES

Here is one of the finest and most complete lines of standard transmitter components available today. Built to the same well-known high standards as N·Y·T custom-built units, they bring to the design engineer the full economy of standardized construction. Superbly constructed, inside and out, each unit fully reflects the years of experience that have made the name NEW YORK TRANSFORMER synonymous with quality, integrity and dependability wherever inductive components are used.

WRITE FOR CATALOG

**NEW YORK TRANSFORMER CO., INC.**  
ALPHA, NEW JERSEY

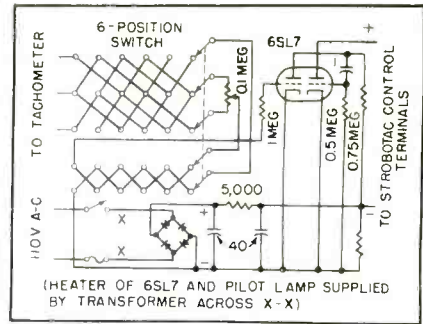

FIG. 1—Circuit diagram of synchronizer that provides phase adjustment throughout 360 degrees

fixed angular position over wide variations in the speed of the rotating member. By means of coarse and fine phase shift controls the stroboscopic image can be held in any position over the entire 360 degrees.

A three-phase generator must be coupled to the shaft of the rotating member. The coarse phase shift, which is a six-position switch, selects each of the generator's three phases at 0 or 180 degrees, which affords a total variation of 360 degrees in six discrete steps of 60 de-

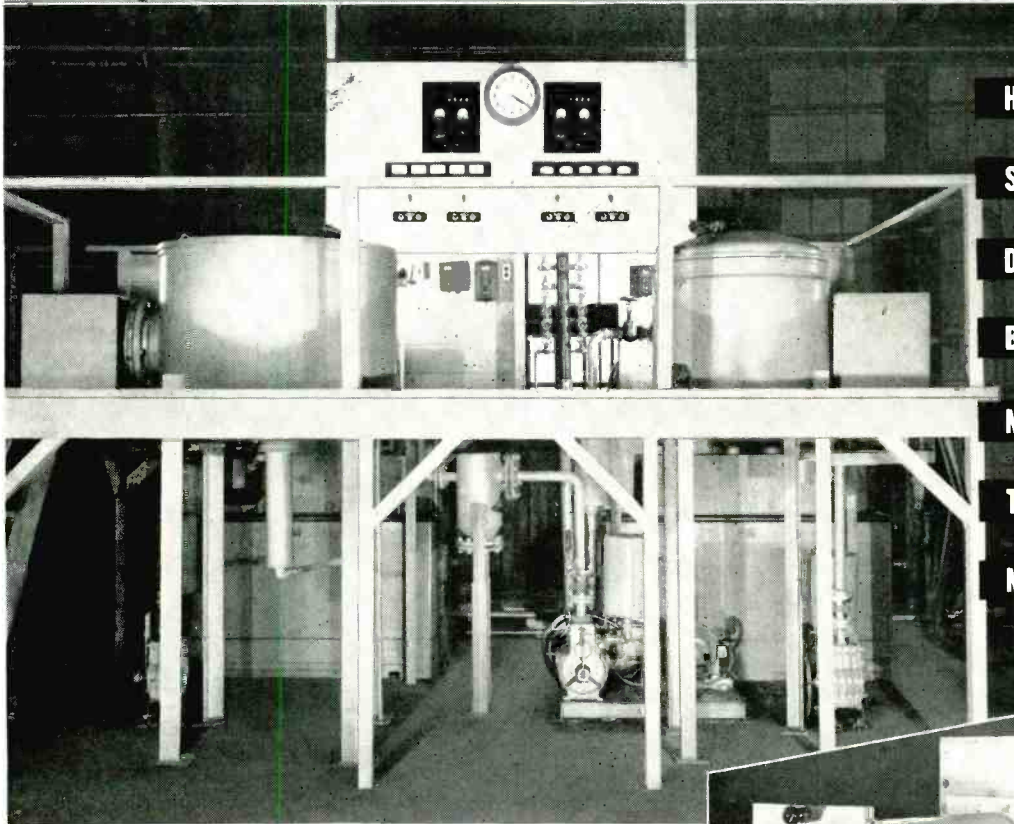

FIG. 2—The Synchrostab is used with a tachometer and a Strobotac to observe rotating machinery

grees each. The fine phase shift control is a potentiometer which allows complete phase variation over any 60-degree step. By means of a double triode the voltage from the phase shift network is half-wave grid rectified, amplified, and clipped. The resulting wave form has the steep wave front that is necessary to trigger most types of stroboscopic circuits.

The Synchrostab was designed to trigger the contactor input of a General Radio Strobotac which, in turn, can be used to trigger a General Radio Strobotron if greater light intensities are desired. Other

# High Vacuum FURNACES



**HEAT TREATING**

**SINTERING**

**DEGASSING**

**BRIGHT SOLDERING**

**METAL DISTILLATION**

**THERMAL REDUCTION**

**MELTING and CASTING**

**PRODUCTION FURNACES — MELTING AND CASTING**

High Vacuum Metallurgy is not new as laboratory technique. It *is* new as a practical industrial operation.

For the first time, National Research Corporation offers its services to design and build, to your requirements, furnaces which operate in the micron pressure range. Pressures run as low as  $10^{-4}$  mm. Hg. absolute.

Six years' experience in the engineering and construction of High Vacuum metallurgical equipment is at your disposal. Write National Research Corporation.

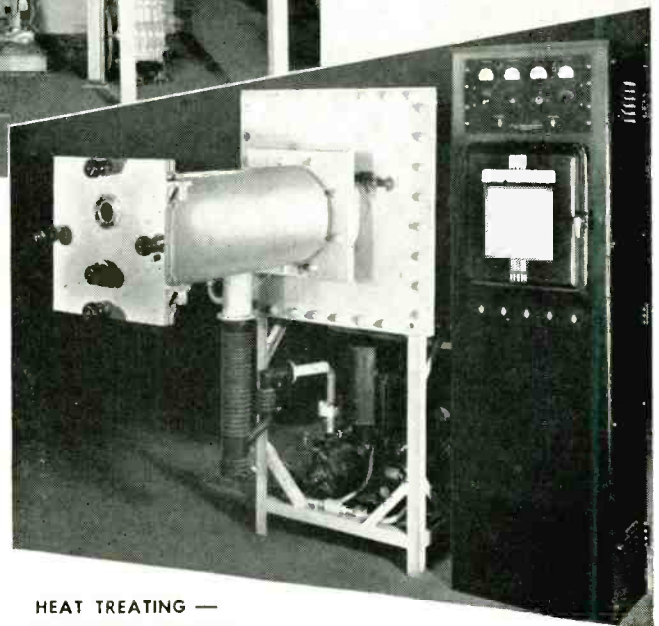

**HEAT TREATING —  
DEGASSING FURNACE**

Write to { VACUUM ENGINEERING DIVISION,  
National Research Corporation,  
Cambridge 42, Massachusetts

HIGH VACUUM FOR INDUSTRY  
**NATIONAL RESEARCH CORPORATION**  
*Vacuum* ENGINEERING DIVISION



types of stroboscopic light sources can also be triggered with this circuit.

### SURVEY OF NEW TECHNIQUES

TRACERS FOR INDUSTRIAL RESEARCH are being used in a large scale experiment conducted in the Cleveland plant of Republic Steel Corp. by Arthur D. Little Inc. Although 75 percent of radioactive tracers are still used in biological work, this industrial study is indicative of the potentiality of tracer technology in other fields. The experiment was conducted to determine methods for keeping undesirable sulfur out of steel. Sulfur enters steel from the coke, with the ore, limestone, scrap, or fuel oil. Some of it leaves the furnace in slag and flue gases. To tell where the sulfur in the finished steel came from, radioactive sulfur was introduced into the coke. The portion of sulfur in the finished steel that was radioactive was then known to have come from the coke. In this manner the contributions made by the various sources can be assessed. The tests indicated that there is no advantage in buying low sulfur coal from which to make the coke. Other applications of radioactive tracers in industry include automatically controlling Bessemer converters by introducing a known percent of radioactive phosphorus and metering the process to determine when the proper grade steel had been obtained. The major advantage of radioactive tracer research in industrial plants is that the experiments are carried out in the plant at operating scale; small scale laboratory experiments do not always correlate with factory results.

SYNTHETIC MICA, known as fluorine-phlogopite mica, has the desirable characteristics of muscovite and phlogopite forms of natural mica and is suitable for use as insulator and dielectric. Inherent in the synthetic process is the possibility that further research may reveal ways of directly fabricating mica components. The research and development program for the production of synthetic mica, jointly sponsored now by the Office of Naval

# Cannon Plug



TYPE  
AN3106  
PLUG



TYPE AN3102  
RECEPTACLE

STANDARD ON  
AMERICAN AIRCRAFT  
SINCE THE DC-1

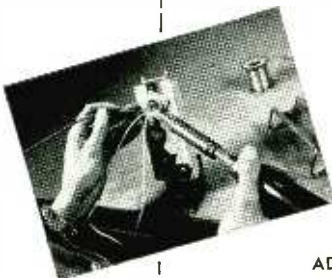
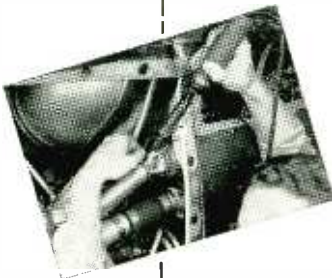

ADDRESS DEPARTMENT J-120  
FOR INFORMATION



## CANNON ELECTRIC DEVELOPMENT COMPANY

3209 Humboldt Street, Los Angeles 31, California  
Canada & British Empire — Cannon Electric Co., Ltd., Toronto, Ontario • World Export  
Agents (excepting British Empire) Frazer & Hansen, 301 Clay St., San Francisco 11, Calif.



# NEW OSCILLATOR with Greater Accuracy • Less Distortion • Better Zero Adjustment • New Operating Conveniences

## CHECK THESE SPECIFICATIONS

- ✓ **FREQUENCY RANGE:** 20 to 20,000 cycles.
- ✓ **FREQUENCY CONTROL:** main dial true logarithmic scale 12 inches long. Frequency-increment dial calibrated from +50 to -50 cycles.
- ✓ **FREQUENCY CALIBRATION:** can be standardized within 1 cycle at any time by setting instrument to line frequency or zero beat.
- ✓ **ZERO BEAT INDICATOR:** neon lamp for zero beat at line frequency or zero scale.
- ✓ **FREQUENCY STABILITY:** drift from cold start less than 7 cycles in first hour and completed in 2 hours.
- ✓ **OUTPUT IMPEDANCE:** 600 ohms, either grounded or balanced-to-ground, and essentially constant at all output voltages.
- ✓ **OUTPUT VOLTAGE:** approximately 25 volts open circuit. For matched resistive load voltage varies less than  $\pm 0.25$  db between 20 and 20,000 cycles.
- ✓ **OUTPUT CONTROL:** calibrated from +25 db to -20 db referred to 1 milliwatt into 600 ohms.

THE Type 913-A Beat-Frequency Oscillator, introduced by General Radio in 1942 immediately set a standard of excellence because of its high frequency stability, low distortion and constant output. Since then two improved models have increased its utility and acceptance.

The new Type 1304-A Oscillator is so different from the original that it is essentially a new instrument with many refinements in the circuit, in the oscillator, addition of buffer amplifiers, improved mixer and new amplifier. It is the finest beat-frequency oscillator obtainable.

Included in the features of the new instrument are:

- **Cycles Increment Dial.**
- **Higher Accuracy of Calibration** — adjusted to  $\pm(0.5 \text{ cycle} + 1\%)$  . . . closer than zero beat can be established with the beat indicator.
- **More Accurate Zero Adjustment** — line voltage is fed into beat-indicator circuit, permitting oscillator output to beat with line frequency to calibrate instrument within 1 cycle.
- **Improvement in Distortion Below 100 Cycles** — through new circuits and buffer amplifiers.
- **New Gear-Drive Dial** — better bearings . . . smoother running gears . . . less backlash . . . illuminated dial.

Check the abridged specifications at left. You'll agree that you cannot buy a more adaptable instrument.

**TYPE 1304-A BEAT-FREQUENCY OSCILLATOR**  
\$450.00



**GENERAL RADIO COMPANY** Cambridge 39, Massachusetts

90 West St., New York 6

920 S. Michigan Ave., Chicago 5

950 N. Highland Ave., Los Angeles 38



Wilco Announces

R-16

## New Bimetallic TRIP-ELEMENT for High Capacity CIRCUIT BREAKERS



The H. A. Wilson Company announces an important new addition to its "R" series of WILCO Thermometals (thermostatic bimetals) . . . R-16.

### Advantages of R-16

Useful Deflection	— 100 to 500° F.	Modulus of Elasticity	19,500,000
Maximum Sensitivity	50 to 350° F.		
Flexivity	F .0000144	70° F.	16
	K .0000072	Resistivity at 300° F.	20 ohms (sq. mil-ft.)
		500° F.	25
A	560		
B	78,000,000	70° F.	20
		Resistivity at 300° F.	25 ohms (cir. mil-ft.)
		500° F.	32
C	.00091		
X	410	Max. Operating Temp.	500° F.
Y	450,000		
		Heat Treatment	one hour at 550° F.

● These and other advantages particularly commend WILCO R-16 for application in high ampere rated circuit breakers and similar devices where low electrical resistance is required.

R-16 joins a large family of WILCO Thermometals which have the *adaptability* to meet every condition of bimetal application . . . the *quality* to meet the highest standards of precision performance . . . plus *availability* in every desirable shape.

**WILCO PRODUCTS INCLUDE: THERMOSTATIC BIMETALS:** All temperature ranges, deflection rates and electrical resistivities. **ELECTRICAL CONTACTS:** Silver, Platinum, Tungsten, Alloys, Sintered Powder Metal. **SILVER CLAD STEEL:** For industrial use. **NI-SPAN C\*** Constant Modulus Alloy; also low and high expanding Ni-Span Alloys. **JACKETED WIRE:** Silver on Steel, Copper, Invar and many other combinations. **SPECIAL ALLOYS:** Including high conductivity, high strength, Copper Alloys. **ROLLED GOLD PLATE AND GOLD FILLED WIRE.**

\*Reg. Trade Mark, The International Nickel Co., Inc.

#### THE H. A. WILSON COMPANY

105 Chestnut Street, Newark 5, New Jersey  
Branch Offices: CHICAGO, DETROIT, LOS ANGELES, PROVIDENCE



SPECIALISTS FOR 34 YEARS IN THE MANUFACTURE OF THERMOMETALS - ELECTRICAL CONTACTS - PRECIOUS METAL BIMETALLIC PRODUCTS AND SPECIAL ALLOYS

Research, the Navy Bureau of Ships and the Army Signal Corps, was initiated at the Colorado School of Mines; the Owens-Corning-Fiberglas Corp. is retained under a consulting contract, and pilot plant production is being conducted by the Interior Department's Bureau of Mines Electrotechnical Laboratory, Norris, Tenn. Knowledge of the production of silicate mineral crystals large enough to be split into sheets at the Kaiser-Wilhelm Institute and the Siemens-Halske Concern in Germany has encouraged this development of synthetic mica.

INFRARED SPECTROSCOPY has been simplified by the development of a method for growing large crystals containing 42 percent thallium bromide and 58 percent thallium iodide by Francis Phelps and of polishing the soft semiplastic crystals by Edgar Robertson, both of the National Bureau of Standards. The prism so made has the large index of refraction of 2.6 in the visible region and 2.2 at 40 microns. The refraction changes greatly with temperature. This new prism extends the observable range to 40 microns (potassium bromide crystals permitted observation only to about 24 microns). Investigations in this unexplored region have already shown polystyrene and polyethylene to be very transparent and that many compounds containing chlorine, bromine, and sulfur have bands in this region.

EXPERIMENTS in pulse code modulation can be readily carried out by a technique developed by D. B. Smith working under Prof. W. H. Radford at MIT. In place of the pulse coding tube developed by Bell Labs. (ELECTRONICS, p 126, Dec., 1947), a conventional cathode-ray tube can be used to code the signal. A coding mask, cut the same as the aperture plate, is placed in front of the cathode-ray tube screen. A phototube receives coded impulses of light as the beam sweeps across the screen at levels determined by the instantaneous sampled amplitude of the signal. With this relatively simple apparatus one can study pulse code modulation systems. At MIT the equipment is being used to investigate the trans-

**NOW...**

# Oil-filled



# Hermetically sealed...

**to stay on the job a long . . . long . . . time**

Now, to help you fight corrosion, dust, lint, fungus, and heat, General Electric announces a completely new line of selenium rectifier stacks. Each stack in this new line is a complete unit—ready for immediate installation—immersed in oil, hermetically sealed in a metal container, and protected by a tough, over-all coating.

For cool operation, the oil in these new General Electric rectifiers flows freely around the rectifier cells to dissipate heat during continued service. For easy assembly, the units have tinned soldering lugs, glass welded for a tight seal.

\*TRADE-MARK REG. U.S. PAT. OFF.

### Tell G.E. your problem of d-c supply

Whenever you strike the problem of deciding *which type* of rectifier is best for your purpose—call on General Electric for an answer. General Electric engineers can give you an impartial solution, because G.E. makes all three—selenium, copper-oxide, and Tungar\*—and now the new oil-filled selenium rectifiers.

For information on rectifiers—from the size of an aspirin to the size of a garage—or for data on the new, oil-filled, hermetically sealed selenium rectifiers, write to Section A21-1031, Construction Materials Department, General Electric Company, Bridgeport 2, Connecticut.



**G.E. makes all three**

**SELENIUM • COPPER-OXIDE  
TUNGAR**

**and the new  
oil-filled**

**RECTIFIER STACKS**

# GENERAL ELECTRIC



# KINNEY

## HIGH VACUUM PUMPS

**MAKING OLD THINGS  
BETTER**

**MAKING NEW THINGS  
POSSIBLE**



**ELECTRONIC TUBES**



**(COATED LENSES)**



**MIRACLE DRUGS**



**SINTERED METALS**



**DEHYDRATED FOODS**



**ATOMIC ENERGY**

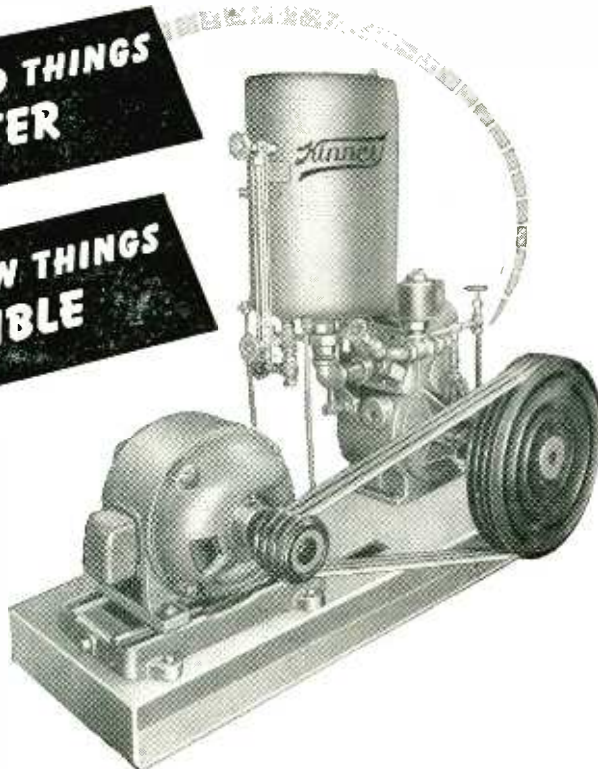

Have you considered the possibilities of vacuum processing in your manufacturing? Perhaps your product can be produced better, faster, more profitably with the help of Kinney High Vacuum Pumps. Whatever the quantity and degree of vacuum you require, Kinney Pumps will deliver it on a production basis, dependably and economically.

Low pressure processing with Kinney High Vacuum Pumps has made possible the large-scale production of many of today's wonder products.

Whether your vacuum requirements are measured in inches or microns, look to Kinney for reliable low pressure performance. Kinney Single Stage Vacuum Pumps will produce low absolute pressures to 10 microns or better; Compound Pumps to 0.5 micron or better.

Write for Bulletin V45.

### KINNEY MANUFACTURING COMPANY

3565 WASHINGTON ST., BOSTON 30, MASS.

NEW YORK • CHICAGO • PHILADELPHIA • LOS ANGELES • SAN FRANCISCO  
FOREIGN REPRESENTATIVES

General Engineering Co. (Radcliffe) Ltd., Station Works, Bury Road, Radcliffe, Lancashire, England  
Horrocks, Roxburgh Pty., Ltd., Melbourne, C. I. Australia  
W. S. Thomas & Taylor Pty., Ltd., Johannesburg, Union of South Africa

**WE ALSO MANUFACTURE LIQUID PUMPS, CLUTCHES AND BITUMINOUS DISTRIBUTORS**

THE ELECTRON ART

(continued)

mission of music by a 5-pulse code.

CORONA at high altitude can be suppressed, in the case of ceramic bushings and other insulations upon which are imposed high potential gradients, by application of a semiconducting coating to the entire exposed insulation surfaces. The technique may be applied to such high-voltage equipment as radar and is particularly advantageous when used on airborne electronic equipment where space and weight must be held to a minimum. Coating solder-seal bushings of hermetically sealed components with material having a surface resistivity of about 3,000 megohms per square inch sufficiently distributes voltage stress to increase the high altitude a-c corona starting voltage by 200 percent or more and the average flashover voltage by 120 percent; d-c corona and flashover points are raised 70 percent. Similar improvements are produced on bushings at sea level. The magnitude of the resistivity of the semiconducting coating is such that there would be no serious current drain on actual electronic equipment treated in this manner.

Methods of detecting inception of corona, measurements of improvements obtained, and an analysis of electrostatic field configurations in the vicinity of a typical bushing have been described in High Altitude Flashover and Corona Correction on Small Ceramic Bushings, by W. W. Pendleton, *A.I.E.E. Proc.*, 1947.

HIGHEST POWERED MAGNETRON developed so far for microwaves produces 50 kilowatts at 1,000 megacycles (1 kmc). Unlike most conventional tubes, the cathode is unheated, emission being produced by cathode bombardment with high-speed electrons each one of which releases three or four secondary electrons. The water-cooled tube was developed by the General Electric Research Laboratory under Signal Corps contract. Dr. R. B. Nelson, G. E. scientist, told a group of vacuum tube researchers convened at Ithaca in June that the limit to the power that can be produced at this high frequency is not yet in sight.

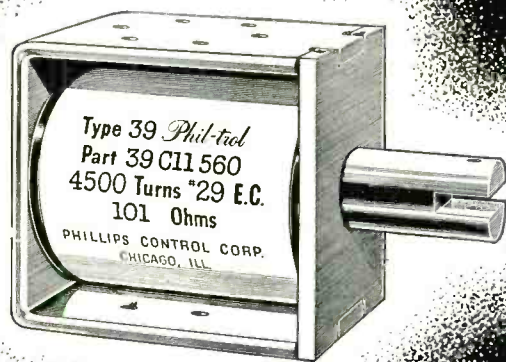

*Phil-trol*

## ACTUATORS

... Designed for POWER

For maximum power, reliable operation and efficient performance, specify Phil-trol Actuators. Exclusive design features incorporated in one-piece solid frame construction make Phil-trol Actuators strong, durable units for a wide range of solenoid uses.

Outstanding construction features include: One-piece 1/8" iron frame, dovetailed and staked into end plate for a secure bond and extra strength; Plunger and plunger stops are made from specially processed steel and are available in three types of end shapes; Standard coils are fiber bobbins wound with enameled copper wire, and impregnated with insulating varnish; Entire frame and plunger stop are cadmium plated and plunger is chrome plated for smooth operation.

Five standard sized Phil-trol Actuators are available in either A. C. or D. C. desired voltage. Designed for "pull" application, they may be converted to "push" with but slight efficiency loss.

Phillips engineers, located in cities listed below, will be glad to assist you in determining solenoid requirements. Special Phil-trol Actuators are designed to specification.

Send for Phil-trol Actuator Bulletin



*Phil-trol* PRODUCTS

Relays, Actuators, Solenoids, Contactors, Starting Switches, Focus Coils, Ion Traps and Special Process Control Assemblies.

PHILLIPS CONTROL CORPORATION • 612 N. MICHIGAN AVENUE • CHICAGO 11, ILLINOIS

PLANT: Joliet, Illinois • SALES OFFICES: New York, Boston, Philadelphia, Buffalo, Cleveland, Charlotte, St. Louis, Kansas City, Los Angeles, Toronto

ELECTRONICS — October, 1948

*Phil-trol* AC-DC END PLATE DESIGN  
AC PLUNGER STOP DESIGN

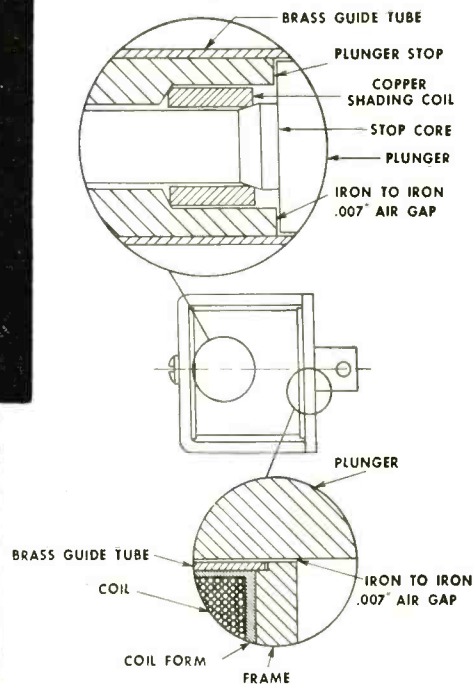

*Phil-trol*  
STANDARD PLUNGERS

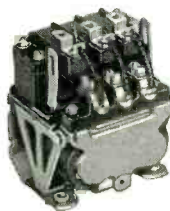
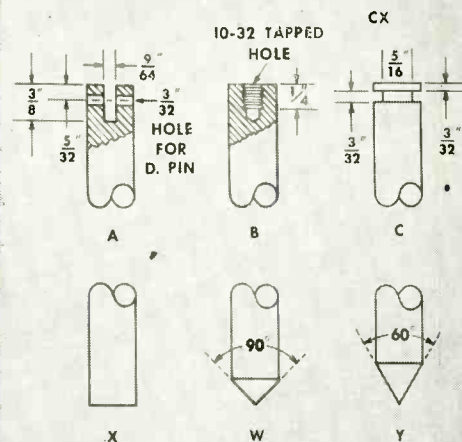

Type 27

### *Phil-trol* RELAYS:

There is a complete line of Phil-trol Relays, all engineered to the highest standards, for electronic and industrial control, signal and traffic control, radio, communication, aircraft and other applications. Send for new Relay Catalog.



PRODUCT OF NATIONAL RESEARCH

# National SWITCH INSULATION

Remarkable  
ARC RESISTANCE  
plus  
DIMENSIONAL  
STABILITY



National Switch Insulation is a highly efficient "sandwich" material consisting of a Phenolite core—for dimensional stability even under humid conditions—permanently bonded and molded with Peerless Insulation (Fish Paper) surfaces, to provide high arc (tracking) resistance.

This product is used effectively to insulate electrical switches and equipment where high dimensional stability and arc resistance are required in proximity to current-carrying components.

For full details call or write

**NATIONAL VULCANIZED FIBRE CO.**

WILMINGTON 99,  
Offices in the



DELAWARE  
Principal Cities

## NEW PRODUCTS

(continued from p 134)

scope, picture generator, and distribution panel is available in combination or separately. The equipment produces synchronizing, driving, and blanking signals useful to manufacturers of television receivers. Two monographs giving further details have been published.

### Pilot Light

DIAL LIGHT CO. OF AMERICA, INC., 900 Broadway, New York 3, N. Y. Designed particularly for use with the NE-51 neon lamp, the new Multivue cap refracts light in such a



way as to improve effectiveness of the low-wattage neon lamp in pilot light service.

### Loudspeaker Baffle

VIBRALOC MFG. CO., 3597 Mission St., San Francisco, Calif. The new general purpose loudspeaker baffle with Acousticurve design is adaptable to table, wall, or corner mounting. It may be had in a variety of

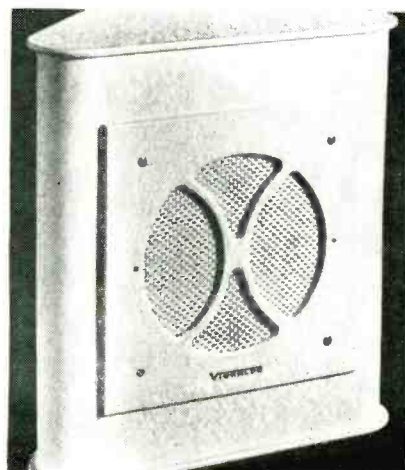

# PLASTICON CAPACITORS

## HI VOLT POWER SUPPLIES



Designed to transform 118 V AC to high voltage—low current DC for use in radiation counters, oscilloscopes, dust precipitators, projection television sets, spectrographic analysers, photoflash equipment, etc. Hi Volt Power Supplies are self-contained in hermetically sealed steel containers.

### HIVOLT

Cat. No.	VDC	Dimensions	Your Cost
PS-1	2400	3 1/2 x 3 3/4 x 5 1/2"	\$11.14
PS-2	2400	3 3/8 x 3 3/4 x 5 1/2"	15.14
PS-5	5000	4 1/2 x 3 3/4 x 6 1/2"	38.22
PS-10	10000	4 3/8 x 3 3/4 x 8"	58.80
PS-30	30000	7 x 7 x 7"	147.00

## PHOTOFLASH CAPACITORS

For the best in photoflash capacitors, specify PLASTICONS for faster discharge and more light. Type AOCOE are the lightest photoflash capacitors made. More flexible to use, safer and more economical than single high capacitance large block.



### PHOTO FLASH

Cat. No.	Watt Sec.	Pk. Chg. V.	Dimensions	Your Cost
AOCOE22C3	7.6	2250	4x2x1 1/4"	\$2.92
AOCOE3M2	9	3000	4x2x1 1/4"	3.00
AOCOE4M1.5	12	4000	4x2x1 1/4"	3.20
AOCOE55C1	15.1	5500	4x2x1 1/4"	3.56
AOCE4M12	100	4000	4 1/2 x 4 1/2 x 3 3/4"	27.17
AOCE4M24	200	4000	8x4 1/2 x 3 3/4"	38.81

## PLASTICONS

By the use of synthetic plastic film dielectrics, PLASTICONS can be made smaller, lighter, more efficient and more economical than older types of capacitors made with paper and mica insulation. Plasticon films are chemically purer and more uniform. Plasticon capacitors have a longer life and can operate under more severe conditions.

### SPECIAL PLASTICONS

Taking advantage of the wide variety of plastic film dielectric characteristics, Plasticons are engineered to meet many special applications. We can furnish capacitors for 200°C; for pulse network duty; close tolerances; ultra high resistance. Send us your specifications.

## GLASSMIKES ASG



Type ASG are Plasticon A dielectric-silicone fluid impregnated capacitor elements in hermetically sealed glass tubes. Temperature range — 60°C to +125°C. The smallest and lightest high voltage capacitors made. Type ASG are ideal for DC and low frequency AC applications.

Cat. No.	Cap. Mfd.	Volts D.C.	Dimensions	Your Cost
ASG 1	.01	600	1 1/2 x 1 1/2"	\$ .88
ASG 2	.02	600	1 3/8 x 1 1/2"	1.04
ASG 3	.05	600	1 3/8 x 1 1/2"	1.03
ASG 4	.1	600	1 3/8 x 1 1/2"	1.15
ASG 5	.25	600	1 3/8 x 2 1/4"	1.32
ASG 6	.5	600	1 3/8 x 2 1/4"	1.53
ASG 7	.005	1,000	1 3/8 x 1 1/2"	.88
ASG 8	.01	1,000	1 3/8 x 1 1/2"	.94
ASG 9	.02	1,000	1 3/8 x 1 1/2"	1.00
ASG 10	.05	1,000	1 3/8 x 1 1/2"	1.09
ASG 11	.1	1,000	1 3/8 x 1 1/2"	1.26
ASG 12	.25	1,000	1 3/8 x 2 1/4"	1.47
ASG 13	.002	2,000	1 3/8 x 1 1/2"	1.12
ASG 14	.005	2,000	1 3/8 x 1 1/2"	1.21
ASG 15	.01	2,000	1 3/8 x 1 1/2"	1.32
ASG 16	.02	2,000	1 3/8 x 1 1/2"	1.47
ASG 17	.05	2,000	1 3/8 x 1 1/2"	1.66
ASG 18	.1	2,000	1 3/8 x 2 1/4"	1.88
ASG 19	.25	2,000	1 3/8 x 2 1/4"	2.18
ASG 20	.001	3,000	1 3/8 x 1 1/2"	3.03
ASG 21	.002	3,000	1 3/8 x 1 1/2"	3.09
ASG 22	.005	3,000	1 3/8 x 1 1/2"	3.18
ASG 23	.01	3,000	1 3/8 x 1 1/2"	3.28
ASG 24	.02	3,000	1 3/8 x 1 1/2"	3.44
ASG 25	.05	3,000	1 3/8 x 2 1/4"	3.62
ASG 26	.1	3,000	1 3/8 x 2 1/4"	3.82
ASG 27	.001	5,000	1 3/8 x 1 1/2"	3.82
ASG 28	.002	5,000	1 3/8 x 1 1/2"	3.94
ASG 29	.005	5,000	1 3/8 x 1 1/2"	4.09
ASG 30	.01	5,000	1 3/8 x 1 1/2"	4.26
ASG 31	.02	5,000	1 3/8 x 2 1/4"	4.50
ASG 32	.05	5,000	1 3/8 x 2 1/4"	4.79
ASG 33	.1	5,000	1 3/8 x 2 1/4"	5.35
ASG 34	.001	7,500	1 3/8 x 1 1/2"	4.12
ASG 35	.002	7,500	1 3/8 x 1 1/2"	4.26
ASG 36	.005	7,500	1 3/8 x 1 1/2"	4.44
ASG 37	.01	7,500	1 3/8 x 1 1/2"	4.44
ASG 38	.02	7,500	1 3/8 x 2 1/4"	4.79
ASG 39	.05	7,500	1 3/8 x 2 1/4"	5.44
ASG 40	.0005	10,000	1 3/8 x 1 1/2"	4.29
ASG 41	.001	10,000	1 3/8 x 1 1/2"	4.41
ASG 42	.002	10,000	1 3/8 x 1 1/2"	4.59
ASG 43	.005	10,000	1 3/8 x 1 1/2"	5.29
ASG 44	.01	10,000	1 3/8 x 2 1/4"	6.17
ASG 45	.02	10,000	1 3/8 x 2 1/4"	7.35
ASG 46	.03	10,000	1 3/8 x 3 1/2"	8.82
ASG 47	.06	10,000	1 3/8 x 3 1/2"	10.29
ASG 60	.0005	15,000	1 3/8 x 2 1/4"	8.53
ASG 48	.001	15,000	1 3/8 x 2 1/4"	8.70
ASG 49	.002	15,000	1 3/8 x 2 1/4"	9.12
ASG 50	.0005	20,000	1 3/8 x 3 1/2"	11.47
ASG 51	.001	20,000	1 3/8 x 3 1/2"	12.05
ASG 52	.0005	30,000	1 3/8 x 3 1/2"	13.24

## RF GLASSMIKES



Plasticon I film-silicone fluid impregnated in Glassmike style case. Type L5G has Q of 2500 to 5000. Rated at 3500 WV—7500 V. Test. Lower losses, more easily mounted, smaller and more economical than mica capacitors.

Cat. No.	Cap. Mfd.	Dimensions OD Length	Your Cost
L5G500	.00005	1 3/8 x 1 1/2"	\$ .88
L5G101	.0001	1 3/8 x 1 1/2"	.88
L5G251	.00025	1 3/8 x 1 1/2"	.88
L5G501	.0005	1 3/8 x 1 1/2"	.88
L5G102	.001	1 3/8 x 1 1/2"	1.00
L5G202	.002	1 3/8 x 1 1/2"	1.44
L5G502	.005	1 3/8 x 1 1/2"	2.06
L5G602	.006	1 3/8 x 1 1/2"	2.20
L5G103	.01	1 3/8 x 1 1/2"	2.50

## INDUSTRIAL and TRANSMITTING



Plasticon A element, mineral oil impregnated in sturdy lead coated steel containers. Smaller, lighter and more economical than paper capacitors. Temperature range — 40°C to +105°C. Type AOC—rectangular; Type AOC0—flattened oval. Type ASC and ASCO (not listed) have Plasticon A element, silicone impregnated. Same dimensions as corresponding AO types. Temperature range — 60°C to +125°C; greater capacitance stability. Prices on application.

## DC RECTANGULARS

Cat. No.	Cap. Mfd.	Volts DC	Dimensions	Your Cost
AOC6C1	1.0	600	2 1/2 x 1 3/4 x 1 7/8"	\$2.19
AOC6C2	2.0	600	2 3/4 x 1 3/4 x 1 7/8"	2.65
AOC6C4	4.0	600	3 1/4 x 2 1/2 x 1 7/8"	3.30
AOC6C8	8.0	600	4 x 3 1/4 x 1 7/8"	5.98
AOC6C10	10.0	600	4 3/8 x 3 3/4 x 1 3/4"	5.60
AOCIM1	1.0	1,000	2 3/4 x 1 3/4 x 1 7/8"	3.37
AOCIM2	2.0	1,000	3 x 1 3/4 x 1 7/8"	3.85
AOCIM4	4.0	1,000	4 x 2 1/2 x 1 3/4"	5.43
AOCIM8	8.0	1,000	4 3/8 x 3 3/4 x 1 3/4"	6.27
AOCIM10	10.0	1,000	4 3/8 x 3 3/4 x 1 3/4"	6.27
AOC2M05	0.5	2,000	2 3/8 x 1 3/4 x 1 7/8"	2.84
AOC2M1	1.0	2,000	3 1/8 x 1 3/4 x 1 7/8"	3.47
AOC2M2	2.0	2,000	3 1/2 x 2 1/2 x 1 3/4"	4.02
AOC2M4	4.0	2,000	3 3/8 x 3 3/4 x 1 3/4"	5.43
AOC3M1	1.0	3,000	4 x 2 1/2 x 1 3/4"	7.12
AOC3M2	2.0	3,000	4 x 3 1/4 x 1 3/4"	9.05
AOC3M4	4.0	3,000	4 3/8 x 3 3/4 x 2 1/4"	12.52
AOC4M1	1.0	4,000	4 x 3 3/4 x 1 3/4"	16.17
AOC4M2	2.0	4,000	4 x 3 3/4 x 1 3/4"	19.40
AOC4M4	4.0	4,000	4 x 3 3/4 x 4 3/8"	29.64
AOC5M1	1.0	5,000	4 x 3 3/4 x 1 3/4"	19.40
AOC5M2	2.0	5,000	3 1/2 x 3 3/4 x 4 3/8"	24.25
AOC75C1	1.0	7,500	3 1/2 x 3 3/4 x 4 3/8"	29.11
AOC10M1	1.0	10,000	4 x 3 3/4 x 4 3/8"	51.74

## DC OVALS

Cat. No.	Cap. Mfd.	Volts D.C.	Dimensions	Your Cost
AOC06C2	2.0	600	2 1/2 x 2 1/2"	\$2.59
AOC06C4	4.0	600	2 x 2 1/2"	3.11
AOC01M4	1.0	1,000	2 3/8 x 2 1/2"	2.26
AOC01M2	2.0	1,000	3 1/2 x 2 1/2"	3.04
AOC03M01	0.1	3,000	2 3/8 x 2 1/2"	4.46
AOC05M01	0.1	5,000	2 3/8 x 2 1/2"	8.28
AOC05M025	0.25	5,000	3 1/2 x 2 1/2"	9.05
AOC05M05	0.5	5,000	4 1/2 x 2 1/2"	10.68
AOC08M005	0.05	8,000	2 3/8 x 2 1/2"	9.83
AOC08M01	0.1	8,000	3 1/2 x 2 1/2"	9.83
AOC010M005	0.05	10,000	3 1/2 x 2 1/2"	11.32

## LABORATORY CAPACITORS

Type LAG (Glassmike style) and Type LAC (Rectangular can) have the lowest dielectric absorption of any capacitor made. Residual charge is .01 — .02%. Dissipation factor at 1 MC is .0002 to .0003. Capacitance and Q is constant from DC to 100 KC. Resistance averages one million megohms per microfarad. Standard capacitance tolerance is ± 5%. Type LA units are used for timing and integrating circuits.

Cat. No.	Cap. Mfd.	Dimensions	Your Cost
LAG101	.0001	1 3/8 x 1 1/2"	\$1.76
LAG201	.0002	1 3/8 x 1 1/2"	1.76
LAG501	.0005	1 3/8 x 1 1/2"	1.76
LAG102	.001	1 3/8 x 1 1/2"	1.76
LAG202	.002	1 3/8 x 1 1/2"	2.06
LAG502	.005	1 3/8 x 1 1/2"	2.88
LAG103	.01	1 3/8 x 1 1/2"	3.94
LAG203	.02	1 3/8 x 1 1/2"	5.12
LAG503	.05	1 3/8 x 2 1/4"	6.17
LAG104	.1	2 1/4 x 1 3/4 x 1 1/8"	9.23
LAC204	.2	2 1/2 x 2 1/2 x 1 1/8"	9.82
LAC504	.5	4 x 2 1/2 x 1 1/8"	12.35
LAC105	1.	4 x 3 1/4 x 1 1/8"	18.87
LAC205	2.	4 x 3 1/4 x 2 1/4"	30.16
LAC505	5.	6 x 3 3/4 x 4 3/8"	57.98

The above condensed version of the Plasticon Line will appear in the new catalogs of leading electronic distributors. Plasticons are manufactured by Condenser Products Company, Chicago 22, Illinois





## For PERFORMANCE That Is *Precisely Predictable*

Special purpose transformers which meet the most rigid specifications are a Raytheon specialty. What more exacting test can you imagine than wartime service in naval SG and SO radar . . . for which Raytheon Transformers were used exclusively?

Raytheon can furnish custom-engineered transformers designed to fit your special needs . . . in the size, type and quantity you require. As one of the oldest and largest producers, Raytheon has the experience and facilities to design, test and deliver transformers that you can incorporate in your product or equipment with complete confidence.

More than 30,000 successful designs have proved that Raytheon quality means peak performance. May we prove it to you with sample models engineered precisely for your most exacting requirements? Handy forms in Bulletin DL-K-301 make it easy to specify your needs. Write for your copy.



*Excellence in Electronics*  
**RAYTHEON MANUFACTURING CO.**  
Waltham 54, Massachusetts

# RAYTHEON

*Custom-Engineered* TRANSFORMERS

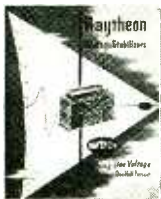

### ...and VOLTAGE STABILIZERS

Bulletin DL-V-304 tells the complete story on the new line of high performance, space and weight saving Raytheon Voltage Stabilizers. Write for it today.

#### NEW PRODUCTS

(continued)

sizes and finishes. A catalog sheet is available.

### Portable Sound System

RADIO CORP. OF AMERICA, Camden, N. J. Type SP-15A portable sound system consists of an aerodynamic mike, a high-output amplifier and a

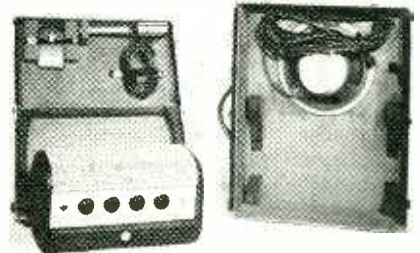

heavy-duty alnico permanent magnet speaker. It operates on 100-watt, 50 to 60-cycle power supply. Complete system weighs 45 pounds.

### Tube Base Diagrams

RADIO CORP. OF AMERICA, Camden, N. J. The new Triple Pindex is actually three separate booklets in one spiral-bound cover, permitting instant location and simultaneous



study of any three tube base diagrams from over 475 types. Listings are arranged in dictionary fashion. Price is 75c from distributors.

### Industrial Rectifier

NATIONAL ELECTRONICS, INC., Batavia Ave., Geneva, Ill. Type NL-649 is a 2-ampere, single-ended industrial rectifier tube. It is mercury vapor filled permitting a peak inverse voltage rating of 900 volts and can be used in 250-volt d-c ap-

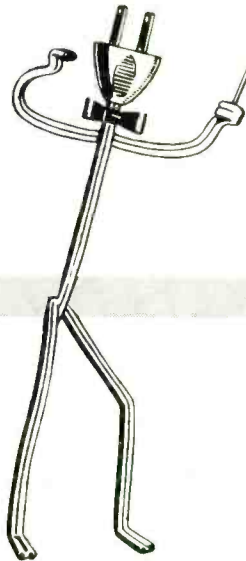

*Here Are . . .*

## IMPORTANT MEMBERS

of the

# PHALO FAMILY

PHALO  
TWIN TRANSMISSION LINE  
75-150-300 OHM



PHALO  
RAINBOW CABLE



PHALO  
COAXIAL CABLE

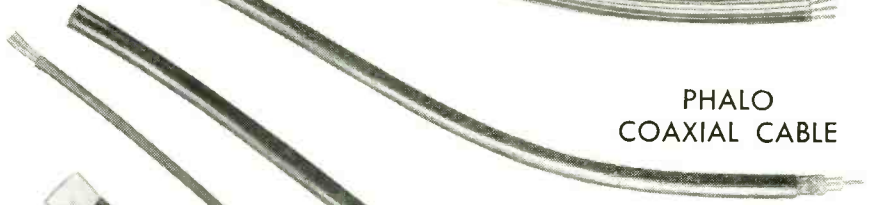

PHALO  
MICROPHONE CABLE

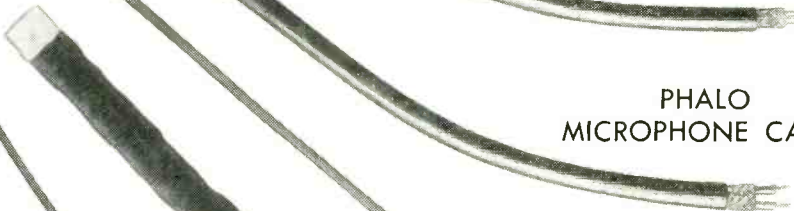

PHALO RIGHT ANGLE  
PLUG AND CORD SET



PHALO  
MULTICONDUCTOR  
PLASTIC  
JACKET INTER-  
COMMUNICATION  
OR CONTROL  
CABLE



PHALO 2/C  
PARALLEL  
SHIELDED INTER-  
COMMUNICATION  
CABLE

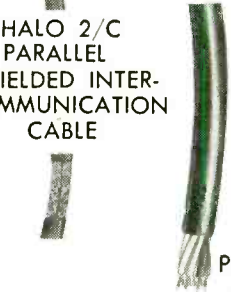

PHALO RADIO HOOK-UP  
AND FIXTURE WIRE



PHALO MULTICONDUCTOR  
INTERCOMMUNICATION CABLE  
(ALL-OVER BRAID)

PHALO HEAVY DUTY CORD  
SET AND MOLDED PLUG

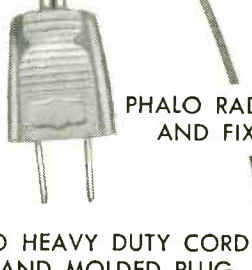

# PHALO

*Plastics Corporation*

For complete "PHALO FAMILY STORY"  
Ask for the NEW 22 Page illustrated PHALO catalog

25 Foster St., Worcester 8, Mass.

Manufacturers of Insulated Wire, Cables, Cord Sets  
and Thermoplastic Tubing.





## Astatic FL-33 PICKUP FOR COLUMBIA MICROGROOVE RECORDS

*Astatic* takes extreme pride in presenting its PICKUP for use with the sensational new Columbia LP Records. This is not just another version of what related equipment for Microgroove Records should be—but the actual playing arm designed to meet the precise requirements of Columbia's new recordings. The new pickup is manufactured to meet the specifications by Columbia to insure maximum quality performance of the Columbia LP Microgroove Record. Available, then, in the Astatic FL-33 Pickup and LP-33 Crystal Cartridge, is the ultimate of Microgroove companion equipment. Here is the professional playing arm, and its replacement cartridge, alone capable of getting the most out of LP Records. And that "most" is truly incomparable—a reality, depth and clarity of tone, a flawless fidelity of reproduction never before obtainable from commercial records.

### FEATURES OF ASTATIC'S FL-33 PICKUP—THE PERFECT COMPANION FOR COLUMBIA LP RECORDS

1. Five-Gram Needle Pressure, of prime importance with the new, lower-radius needle tip. 2. Permanent Sapphire Needle with .001" Tip Radius. 3. Approximately One-Half Volt Output. 4. Frequency Range 30 to 10,000 c.p.s. 5. Novel Design at Base Eliminates Tone Arm Resonances and Assures Perfect Tracking. 6. LP-33 Cartridge, with Permanent Sapphire Needle, instantly replaceable in FL-33 Pickup on slip-in principle of modern fountain pen. "LP" means long playing, low pressure.

**ALSO AVAILABLE** is the LP-78 Cartridge that fits the FL Arm, but having a .003" radius needle; thereby, playing 78 RPM Records. By merely slipping in either cartridge you have the proper pickup for 78 or 33-1/3 Records.

### FL FILTER

An important accessory that goes hand-in-glove with Astatic's FL-33 Pickup, for best performance with high quality speakers, is the FL Filter. Controls pickup response—Eliminates high frequency peak.

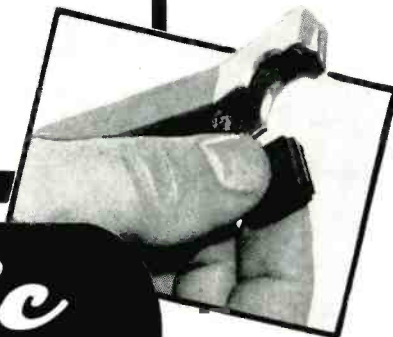

**THE Astatic CORPORATION**  
ASTATIC  
CONNEAUT, OHIO  
IN CANADA CANADIAN ASTATIC LTD. TORONTO, ONTARIO

Astatic Crystal Devices Manufactured Under  
Brush Development Co. Patents

Listed in the Radio  
Industry Red Book

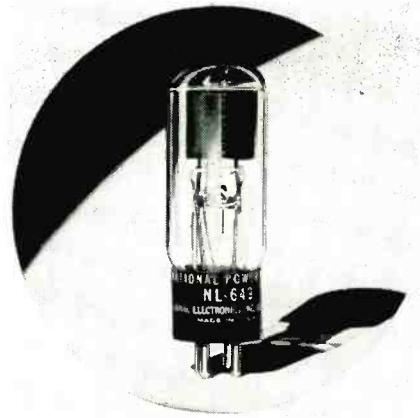

lications. Filament voltage is 2.5; filament current, 7 amp; d-c output, 2 amp; peak-current output, 10 amperes.

### Industrial Timers

MONTGOMERY MFG. Co., 549 W. Washington Blvd., Chicago 6, Ill., has introduced two synchronous program timers, models TP and TS, designed especially for manufacturing establishments where permanent conduit or BX installations in standard switch box cases are desired. Model TP, for bell ring-

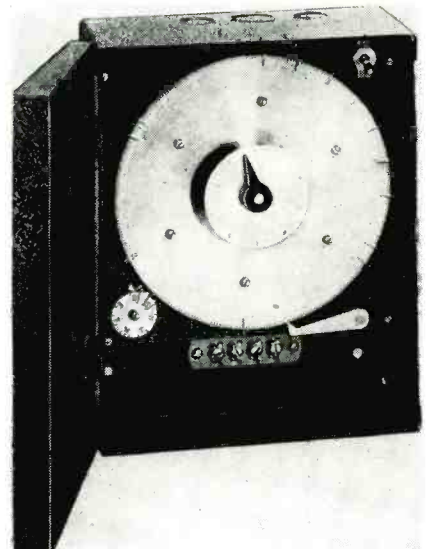

ing, can make a single circuit contact at any 5-minute interval in 24 hours and repeat each day. Model TS incorporates a holding circuit which it closes on the first impulse and opens on the succeeding impulse.

### Radio Noise Filters

THE FILTRON Co., 38-25 Bell Blvd., Bayside, L. I., N. Y. Type FA204



**WILCOX** - *First Choice of*  
**PIONEER** *Air Lines*

PIONEER EQUIPS GROUND \*STATIONS WITH  
 Wilcox Type 378A Package Radio

**PACKAGE DESIGN SPEEDS YOUR INSTALLATIONS**

The Type 378A is complete from microphone to antenna, ready for connection to power mains. It is designed for aeronautical VHF ground-air communications at smaller traffic centers.

**PROVEN COMPONENTS INSURE QUALITY AND PERFORMANCE**

The Type 305A VHF Receiver and Type 364A VHF Transmitter (50 watts) are the principal components of the 378A. Long used separately and field-tested by leading airlines, these units are now available in package form.

**NEW AIDS TO CONVENIENT OPERATION**

The telephone handset with its convenient push-to-talk button, serves as both headphone and microphone, with an auxiliary loudspeaker for incoming calls. The 378A includes desk front, message rack, and typewriter space — there are no accessories to be added.

**LOCAL OR REMOTE CONTROL**

If desired, the control panel can be removed and the 378A remotely controlled, either by re-installing the panel at the operating position or by simple adaptation to your existing control equipment.

*\*Pioneer aircraft are also 100% equipped with the new WILCOX Type 361A Airborne VHF Communication System.*

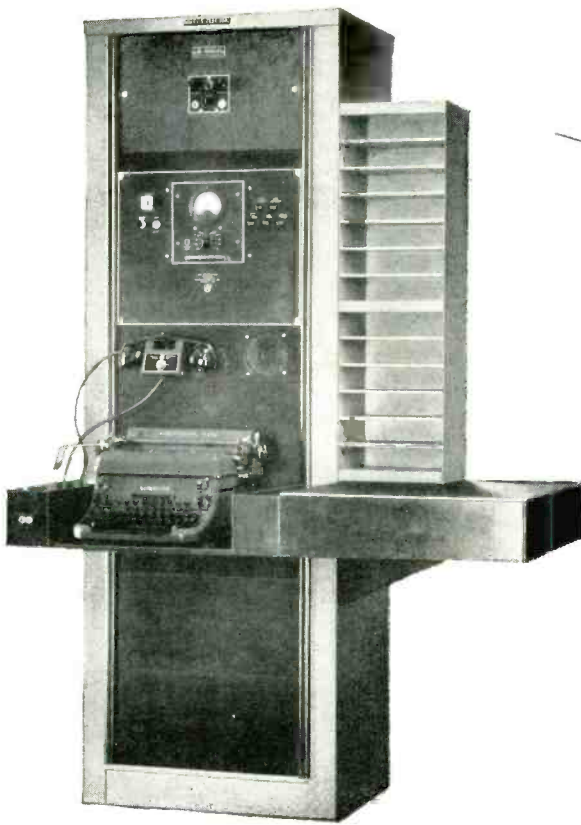

**WILCOX ELECTRIC COMPANY**  
 KANSAS CITY 1, MISSOURI  
 WILCOX Means Dependable Communication

*Write today* for complete information



# No Rabbits!



... but we do make  
coil windings . . .

Magic has no place in our scheme of things. We make no extravagant claims. We DO wind the best coils which 31 years of experience, skilled operators, latest equipment and professional know-how can produce. We should like to serve YOU.

**Are you fussy?  
Then try us!**



**COTO-COIL CO., INC.**  
COIL SPECIALISTS SINCE 1917  
65 Pavilion Ave., Providence 5, R. I.

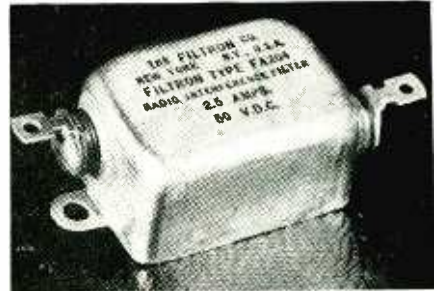

radio interference filter is but one of a wide variety of Filtrons for suppression of noise. Featured are high attenuation, small size, light weight, and hermetic sealing. Rating of the unit illustrated is 2.5 amperes, 50 volts d-c.

### C-R Stethoscope

FEILER ENGINEERING Co., 947 George St., Chicago, Ill. The new five-inch cathode-ray oscilloscope combined with stethoscope is designed for f-m and television serv-

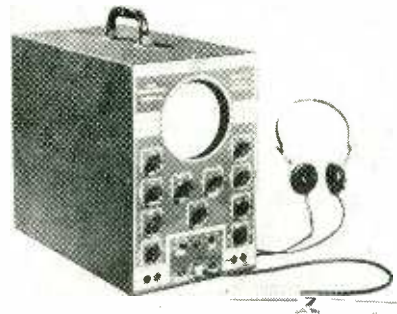

icing. It can also be used for a-m and audio work. Price is \$89.95 list.

### A-F Microvolter

GENERAL RADIO Co., 275 Massachusetts Ave., Cambridge 39, Mass. Type 546-C Microvolter represents a redesign to standardize its output level at 600 ohms. Sensitivity, frequency response, and distortion

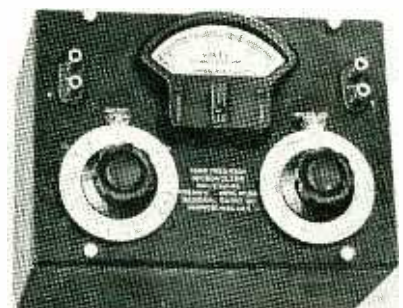

**Use one alone—**

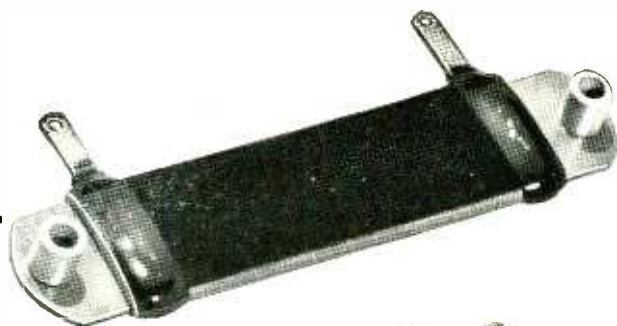

**or stack 'em like hot cakes...**



# I-T-E OVAL RESISTORS SAVE SPACE!

When space is limited—as in aviation, sound, or electronics applications—I-T-E Oval Resistors and Oval Resistor Assemblies may be the solution you're looking for.

Specially designed to meet the exacting and changing needs of the electronics industry, these modern, wire-wound power resistors are distinguished by their high unit-area wattage ratios, which are due in part to the heat dissipation qualities of the mounting brackets.

An I-T-E Oval Resistor—or an assembly of I-T-E Oval Units—has a much higher wattage rating than that of a conventional round resistor of comparable size. You save space and, at the same time, gain the dependable performance of I-T-E *quality* resistors.

No matter what your resistor problem is—space, exacting service, or dependable performance—be sure to investigate I-T-E Oval Resistors. Complete technical information, as well as valuable application data, are contained in the new I-T-E Resistor catalog. Send for it today.

***There's an I-T-E Resistor for Every Purpose—>***

I-T-E OVAL RESISTORS				
Type	Watts	Length	Maximum Recommended Resistance	Mounting Centers
108 Oval	30	1 1/4"	10000	2"
200 Oval	40	2"	15000	2 3/4"
316 Oval	55	3 1/2"	25000	4 1/4"
424 Oval	65	4 3/4"	35000	5 1/2"
600 Oval	75	6"	50000	6 3/4"



## **POWER RESISTORS**

*The Leader In Technical Excellence*

I-T-E CIRCUIT BREAKER CO., RESISTOR DIVISION, 19TH & HAMILTON STREETS, PHILADELPHIA 30, PA.

SWITCHGEAR • UNIT SUBSTATIONS • AUTOMATIC RECLOSING CIRCUIT BREAKERS • RESISTORS • SPECIAL PRODUCTS



# Only AIR EXPRESS gives you all these advantages

A combination you don't get  
with other air-shipping methods

- 1.** Special pick-up and delivery *at no extra cost*. Your shipments are picked up promptly when you call; fast delivery to consignee's door.
- 2.** You get a receipt for every shipment. One-carrier responsibility. Complete security.
- 3.** Assured protection, too—free valuation coverage up to \$50; 10 cents for each additional \$100 or fractional part.

These advantages, plus 21 others, make Air Express the best and fastest way to ship. Your shipments go on every flight of the Scheduled Airlines—repair parts, equipment, finished items *keep moving* to where they're needed. Reach any U.S. point in hours. Phone local Air Express Division, Railway Express Agency, for fast shipping action. Specify "Air Express" on orders for quickest delivery.

#### FACTS on low Air Express rates

22 lbs. machine parts goes 700 miles for \$4.73.  
10 lbs. printed matter goes 1000 miles for \$3.31.  
30-lb. carton of new fashions goes 500 miles for \$1.61.  
*Same day delivery in all these cases if you ship early.*

**SPECIFY**  
**AIR EXPRESS**  
**GETS THERE FIRST**



Rates include pick-up and delivery door to door in all principal towns and cities



AIR EXPRESS, A SERVICE OF RAILWAY EXPRESS AGENCY AND THE  
**SCHEDULED AIRLINES OF THE U.S.**

NEW PRODUCTS

(continued)

characteristics have also been improved. Output voltage range is 0.1 microvolt to 1.0 volt open circuit for an input of 2.2 volts across 600 ohms. Accuracy is  $\pm$  (3 percent + 0.5  $\mu$ v) for output levels above 1 microvolt at frequencies below 20,000 cycles. Up to 100,000 cycles the accuracy is  $\pm$  5 percent. Distortion introduced by the instrument is about 0.2 percent.

#### Variable Resistor

P. R. MALLORY & Co., INC., Indianapolis, Indiana. The new Midgetrol measures 15/16 inch and has a number of other features such as a

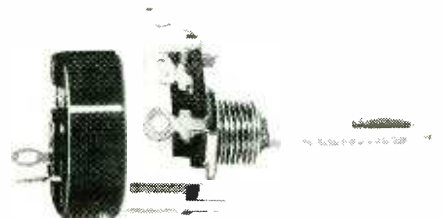

flat shaft, or a special phenolic shaft for television applications. Specification sheets and a descriptive folder are available.

#### Crystal Oven

JAMES KNIGHTS Co., Sandwich, Ill. A new crystal oven recommended for broadcast or standard frequency applications has a large 7-pin base.

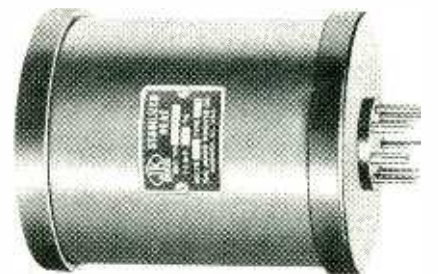

6.3-volt heater, and operating temperature  $50 \pm 1$  C. The crystals are electrostatically shielded.

#### Pressure Element

COMMERCIAL RESEARCH LABORATORIES, INC., 20 Bartlett Ave., Detroit 3, Mich. A new Type 5 direct pressure element replaces type 3 pressure element and type 3 gas sampling valve. Owing to the new design, the element is open for less

# The NEW "dag" CRT Wall Coating . . .

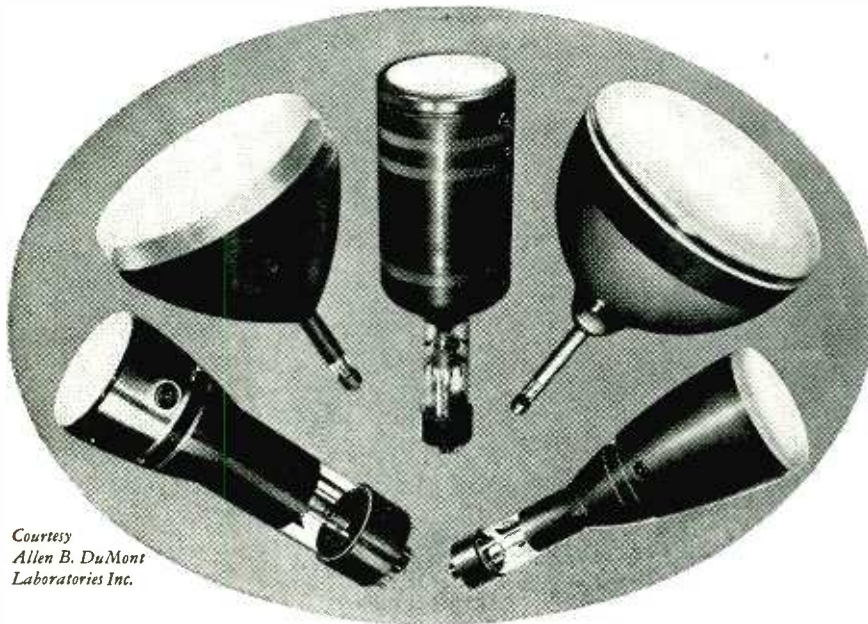

Courtesy  
Allen B. DuMont  
Laboratories Inc.

for all  
CRT  
glass  
envelopes

Here's an entirely new CRT Wall Coating, developed by Acheson Colloids specifically and solely for use on CRT glass envelopes.

"dag" CRT Wall Coating is very easily applied . . . adheres tenaciously to all types of glass . . . does not yield objectionable by-products on heating.

Prominent cathode-ray tube manufacturers have already found this opaque, electrically conductive "dag" CRT Wall Coating eminently satisfactory, especially in tubes intended for television reception.

Let Acheson Colloids help you with your CRT wall coating problem. Mail the coupon today for information on this or other electronic applications of "dag" colloidal graphite dispersions.

Give me information on "dag" colloidal graphite dispersions for:

- Wall coating of CRT's
- Electrostatic shielding
- Corona prevention
- Dry-film lubrication
- Copper oxide rectifier disc coating
- Electrical resistances
- Filament cement

MMS

40th Anniversary Year

## Acheson Colloids Corporation

Port Huron



Michigan



Would

# INSTANTANEOUS

recording of electrical phenomena from  
D. C. to 100 c.p.s. help in your research?

It's a fact — permanent, instantaneous  
ink-on-paper recordings by Brush Oscillographs  
make their use almost unlimited!

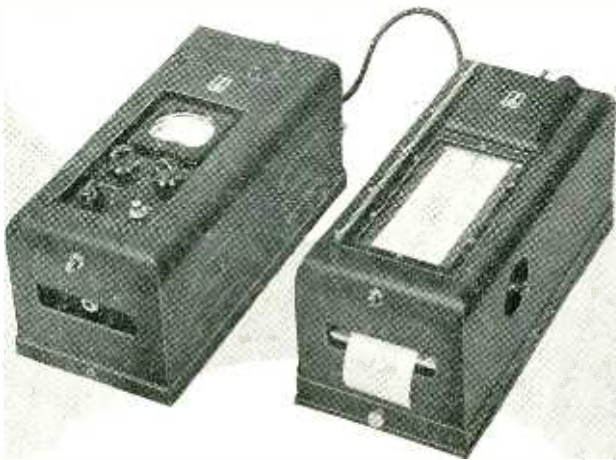

Accurate recordings of voltages, pressures,  
radiation intensity and countless other phenomena can  
be made over a frequency range of D.C. to 100 c.p.s.  
Either A.C. or D.C. signals can be measured.  
Whenever desired, recordings may be stopped for  
notations on chart-paper.

Investigate Brush measuring devices  
before you buy . . . they offer  
more for your money.  
Why not have a Brush repre-  
sentative call? At no obligation,  
of course.



Just call or write — today — you'll find it worth a few  
seconds' time!



THE **Brush** 3405 Perkins Avenue • Cleveland 14, Ohio, U.S.A.  
DEVELOPMENT CO. MAGNETIC RECORDING DIV. • ACOUSTIC PRODUCTS DIV.  
INDUSTRIAL INSTRUMENTS DIV. • CRYSTAL DIVISION

Canadian Representative: A. C. Wickman, (Canada) Ltd., P. O. Box 9, Station N, Toronto 14

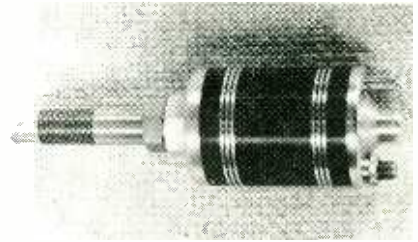

than 0.001 second permitting its  
use in tests on high-speed engines  
over the whole engine cycle.

## Television Capacitors

SPRAGUE ELECTRIC Co., North  
Adams, Mass. A new line of capaci-  
tors designed for television serv-

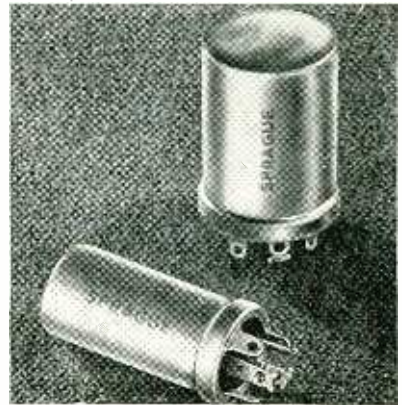

ice is rated at 85 C up to 450 volts.  
Shelf life of these electrolytic units  
has been improved.

## LP Needles

ELECTROVOX Co., INC., 66 Franklin  
St., East Orange, N. J. Microgroove  
needles of sapphire and osmium



alloy needed for the new long play-  
ing records are available in two  
styles illustrated.

## Signal Generator

FERRIS INSTRUMENT Co., Boonton,  
N. J. Model 24-B a-m and f-m sig-  
nal generator provides frequencies  
from 5 to 220 mc with either in-  
ternal or external modulation. It is  
designed primarily for production  
checking f-m and television receiv-  
ers. Any seven spot frequencies in  
the range are available with an

# The Weather-Proof Link ~



## TIME SHARING MULTIPLEX

Even where climates quickly kill cables, the ether is always ready to carry a *Standard Multiplex Telephone Trunk Link*.

The system is easy to install, thoroughly reliable in operation, and simple to service.

Each equipment deals with up to 24 channels which handle any kind of A.F. traffic in the 300-3400 c/s range, including teleprinter and automatic telephone signals.

Time-sharing Multiplex ensures low crosstalk and noise levels, and fading does not affect speech levels.

A UHF carrier is used and the normal line-of-sight range may be extended by automatic repeaters.

Complete terminal equipment occupies a double cabinet 7' wide x 2' 4" deep x 6' 6" high, and aerials may be up to 100' away from the equipment.

*Write for our Bulletin No. 511 which gives further facts and figures.*

***Standard Telephones and Cables Limited*** *Radio Division*  
OAKLEIGH ROAD, NEW SOUTHGATE, LONDON, N.11, ENGLAND



**for POWER, SIGNAL and  
CONTROL CIRCUITS  
in AIRCRAFT and  
ELECTRONIC EQUIPMENT**

**AMPHENOL  
"A N" CONNECTORS**

**Ruggedness for  
AIRCRAFT SECURITY . . .**

Stronger shells, stronger insulation, lowest resistance contacts with wiring solder pockets aligned for quick, convenient connections. Built to quality standards beyond the already rigid specifications for AN Connectors. Amphenol pioneered in the engineering of this rugged and efficient line of connectors for use in military aircraft. To be sure of top performance, specify Amphenol AN Connectors and Fittings.

*Write for the new AN Catalog A-1. It's abundant with the latest connector information and contains timesaving listings and indexes for the engineer and buyer. Mail your request on company letterhead to Department 13-B.*

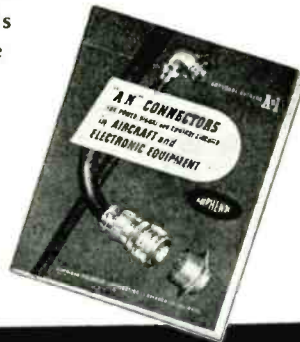

**AMERICAN PHENOLIC CORPORATION**  
1830 SOUTH 54TH AVENUE, CHICAGO 50, ILLINOIS  
COAXIAL CABLES AND CONNECTORS • INDUSTRIAL CONNECTORS, FITTINGS AND  
CONDUIT • ANTENNAS • RADIO COMPONENTS • PLASTIC FOR ELECTRONICS

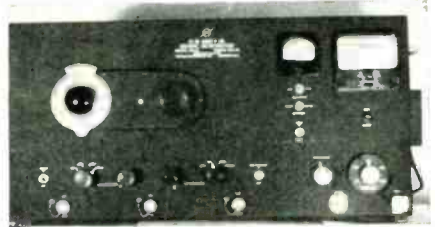

additional number by changing coil drums. The instrument has a built-in power supply. Details of the various features are available.

**Special Amplifier**

BROWNING LABORATORIES, INC., Winchester, Mass. Amplifier TAA-16 is used in the determination of voltage standing wave ratio when used with square law detector probes and slotted waveguides. Two inputs are available. Operations can



be wide band or highly selective as needed. There is an integral power supply, electronically regulated. Full-scale meter readings are obtained with 15 microvolts input under wide band operation.

**Isolation Transformer**

RADIO CORP. OF AMERICA, Camden, N. J. The type WP-24A Isotap variable-voltage isolation transformer has been designed for speedy receiver servicing. Choice of test voltages provided consists of 117-





**THEY HAVE IT**

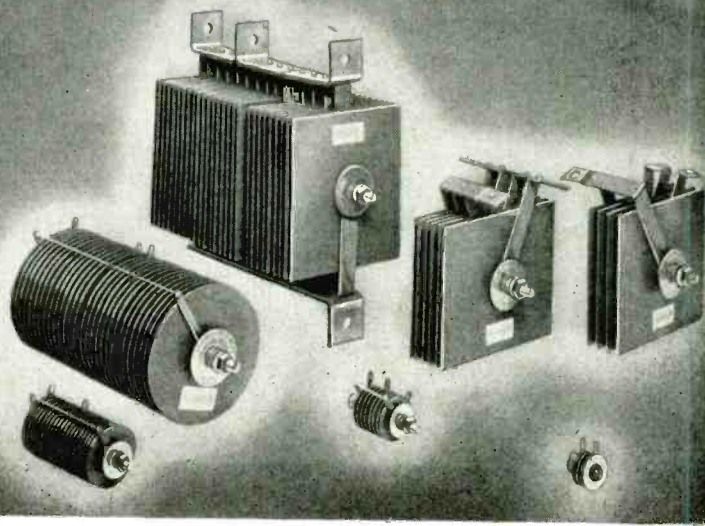

**Seletron**  
SELETRON SELENIUM RECTIFIERS

**Built on Aluminum**

**T**HE pinch hitter who swats the ball over the heads of the outfielders for a homer has "the extra something that spells top performance."

In any field it's the *extra something* that makes top performance possible.

Nowhere is this rule more forcefully demonstrated than in Seletron Selenium Rectifiers. Their extra rugged construction and high precision standards have enabled them to establish unbeatable performance records in every type of application. Efficient—dependable—durable, under the severest service conditions.

Leading engineers and designers specify and recommend Selenium Rectifiers.

Furnished in a wide range of voltages and currents to meet individual requirements.



In addition to the power stacks illustrated Seletron Selenium Rectifiers are furnished in small sizes. Specify SELETRON SELENIUM RECTIFIERS FOR RADIO AND TELEVISION APPLICATIONS.

CODE NUMBER	5L1	5M1	5P1	5R1	5Q1
Current Rating	75 ma.	100 ma.	150 ma.	200 ma.	250 ma.
Plate Height	1"	1"	1 3/16"	1 1/2"	1 1/2"
Plate Width	7/8"	1"	1 3/16"	1 1/4"	1 1/2"

Write today for catalog. Address Dept. ES-10

SELETRON DIVISION  
**RADIO RECEPTOR COMPANY, Inc.**  
Since 1922 in Radio and Electronics  
 251 WEST 19TH STREET, NEW YORK 11, N. Y.



# Professional TAPE RECORDING

with FM QUALITY  
and EASY PORTABILITY

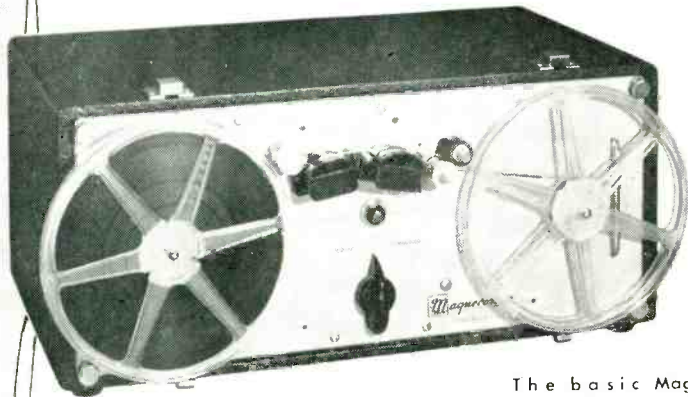

The basic Magnecorder recorder mechanism (PT6-A)

## The New 3 Element MAGNECORDER

The Magnecorder meets the highest broadcast standards, and it costs you less. You buy and combine only the units you need:

**Magnecorder (PT6-A)** — Basic recorder mechanism.

**Portable Mixer-Amplifier (PT6-P)** — Recording and reproducing portable field amplifier. Can be used as high-quality remote amplifier. Mixes three low-level microphones.

**Rack Mount Amplifier (PT6-R)** — Recording and reproducing amplifier for studio rack mounting. With PT6-A makes complete studio recorder-reproducer.

*It's Portable! It's Flexible!*

**Weight** — PT6-A, 23 pounds; PT6-P, 29 pounds.

**Wow and Flutter** — .2%

**Frequency Response** — 40 to 15,000 cycles; + or - 2 db.

**Tape Speed** — 15 inches or 7½ inches per second (Interchangeable).

**Motor** — Synchronous 1/50 HP.

**Single Control**

**Rewind** — 45 seconds.

**Reels** — Standard 7-inch 8MM film reels.

Current failure never throws tape. Instantly interchangeable from portable to rack mounting.

*Write today for detailed specifications*

# Magnecorder

INCORPORATED

360 N. Michigan Ave.

Dept. E

Chicago 1

NEW PRODUCTS

(continued)

volt normal supply, 105-volt low supply or 130-volt high supply, under medium-load conditions. The instrument also gives protection against shocks from a-c and d-c chassis to ground and prevents damage to test equipment.

### Grid-Controlled Rectifier

ELECTRONS, INC., 127 Sussex Ave., Newark, N. J. announce development of the type 5528 (C6L) temperature-free grid-controlled rectifier tube designed especially for high power servomotor control or

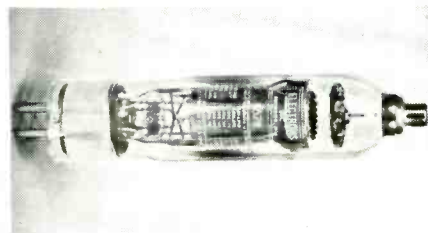

inverter applications which must operate at up to 800 cycles. It features 60 second heating time, a peak inverse voltage of 500 v, 6.4 amperes steady d-c current, and 77 amperes peak.

### Magnetometers

THOMAS E. SMITH, 122 East 42nd St., New York 17, N. Y. Presence and polarity of magnetic fields can be determined using model GW-2

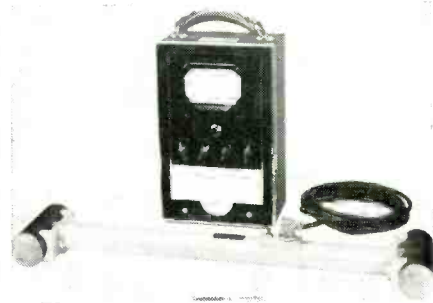

gradientometer that can also be switched for use as a magnetometer. The device has been designed for investigating magnetic fields in aircraft frames.

### New-Record Pickup

ASTATIC CORP., Conneaut, Ohio. Type FL-33 pickup and LP-33 crystal replacement cartridge have been designed particularly for use with new long-playing records. The



They all belong  
to the Same  
Cost-Cutting Family...



## GENERAL PLATE *Laminated* STOCK

No one is in a better position to cut your electrical contact and precious metal costs than General Plate . . . pioneers in laminated metals. Through long years of experience in the manufacture of precious to base metal combinations . . . and work with leading manufacturers of electrical and industrial products, General Plate gives you laminated metals that provide economical solutions to your problems.

General Plate Laminated Stock saves money because it eliminates a large waste of expensive silver. By

bonding silver or other precious metal to inexpensive base metal you get the high cost metal only where it's needed. The laminated construction not only lowers costs but increases operating life and makes fabrication of parts easier.

General Plate Laminated Stock is available in sheet, inlaid stripes, elevated stripe, edgelay, as well as tube and wire . . . buttons for spot welding or soldering; rivets — or as completely fabricated parts made to your specifications. Write for information or engineering assistance.

### GENERAL PLATE DIVISION

of Metals and Controls Corporation

310 FOREST STREET, ATTLEBORO, MASSACHUSETTS

1-348

50 Church St., New York, N. Y. • 205 W. Wacker Drive, Chicago, Ill. • 757 W. Third St., Mansfield, Ohio • 36 Eastern Ave., Pasadena, Calif.



# 3 Outstanding COSMALITE\* COIL FORMS

Each specially designed and produced by us to give exceptional performance, and at a saving in cost to this country's leading manufacturers of radio and television receivers.

Your specifications as to punching, threading, notching and grooving are followed with the most exacting care. Ask about our many stock punching dies available to you.

Are you familiar with our #96 COSMALITE for coil forms in all standard broadcast receiving sets; SLF COSMALITE for permeability tuners; COSMALITE deflection yoke shells, cores and rings?

Spirally wound kraft and fish paper Coil Forms and Condenser Tubes.

\* Trade Mark Registered

## The CLEVELAND CONTAINER Co.

6201 BARBERTON AVE. CLEVELAND 2, OHIO

- All-Fibre Cans - Combination Metal and Paper Cans
- Spirally Wound Tubes and Cores for all Purposes
- Plastic and Combination Paper and Plastic Items

PRODUCTION PLANTS also at Plymouth, Wis., Ogdensburg, N.Y., Chicago, Ill., Detroit, Mich., Jamesburg, N.S.  
PLASTICS DIVISION at Plymouth, Wis. • ABRASIVE DIVISION at Cleveland, Ohio  
SALES OFFICES: Room 5632, Grand Central Term. Bldg., New York 17, N.Y., also 647 Main St., Hartford, Conn.  
CANADIAN PLANT: The Cleveland Container Canada, Ltd., Prescott, Ontario

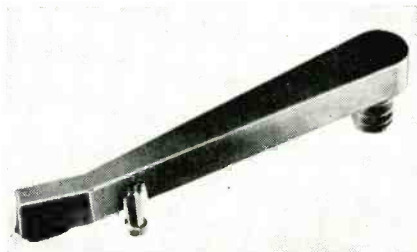

cartridge can be quickly interchanged with another that is suitable for the more conventional 78-rpm discs. An accessory filter type FL is also available.

### Test Instrument

SIMPSON ELECTRIC Co., 5200 West Kinzie St., Chicago 44, Ill. Model 221 Roto-Ranger is a high-sensitivity a-c and d-c volt-ohm-milliammeter equipped with rotating dials.



Its many applications include measurements of a-c diode balancing circuits, grid currents of oscillator tubes and power tubes, a-c diode currents and high- $\mu$  plate voltage. Direct-current sensitivity is 20,000 ohms per volt.

### Microcurrent Measurement

WALLACE & TIERNAN PRODUCTS, INC., Belleville 9, N. J. announce a portable d-c recorder for measuring microcurrents and voltages where exact range may be selected

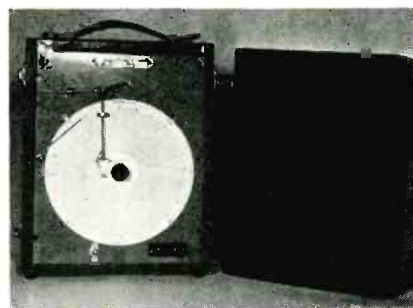



# DeJUR INSTRUMENTS

... designed for exacting performance

**DeJUR**—one of America's foremost names in high precision electrical components is now able to make prompt deliveries on standard and special types of equipment. Every instrument built conforms with JAN I-6 and JAN R-19 specifications as well as A.S.A. standards.

Functional designing, ruggedness, accuracy and dependability are all

characteristic DeJUR features. Among the many types of precision instruments offered are:

- Voltmeters
- Ammeters
- Milliammeters
- Microammeters
- Volume Indicators
- Potentiometers
- and many others.

We solicit your inquiries and the coupon below is for your convenience.

### DeJUR RHEOSTAT-POTENTIOMETERS

There are models for electronic devices, radio transmitters, dynamic voltage control, portable power amplifiers, mixing panels, spot welding, motor control, etc. Available in standard, multiple or ganged units, and units with special resistance values and tolerances.

### DeJUR ELECTRICAL INSTRUMENTS

The DeJUR 1 1/2-inch Model 112 Meter, measuring only 1 3/4 inches square and 25/32-inch deep is capable of doing a man-sized job where space is at a premium. This meter is built with fine watch precision. Available in standard ranges.

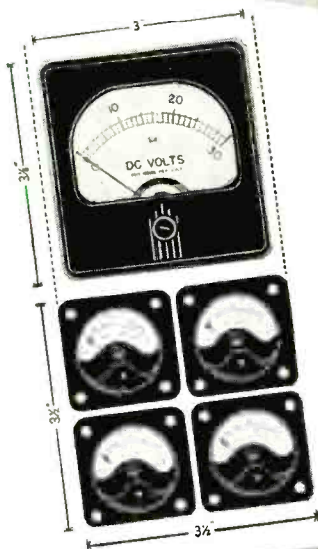

## DeJUR-AMSCO CORPORATION

Manufacturers of precision equipment  
for over a quarter century

#### DeJUR-AMSCO CORPORATION

45th St. and Northern Blvd., Long Island City 1, N. Y.

Please send me information regarding the instruments indicated:

- |  |  |
|--|--|
| <input type="checkbox"/> Voltmeters    | <input type="checkbox"/> Microammeters     |
| <input type="checkbox"/> Ammeters      | <input type="checkbox"/> Volume Indicators |
| <input type="checkbox"/> Milliammeters | <input type="checkbox"/> Potentiometers    |
| <input type="checkbox"/> Other.....    |  |

Name.....

Firm.....

Street.....

City..... State.....



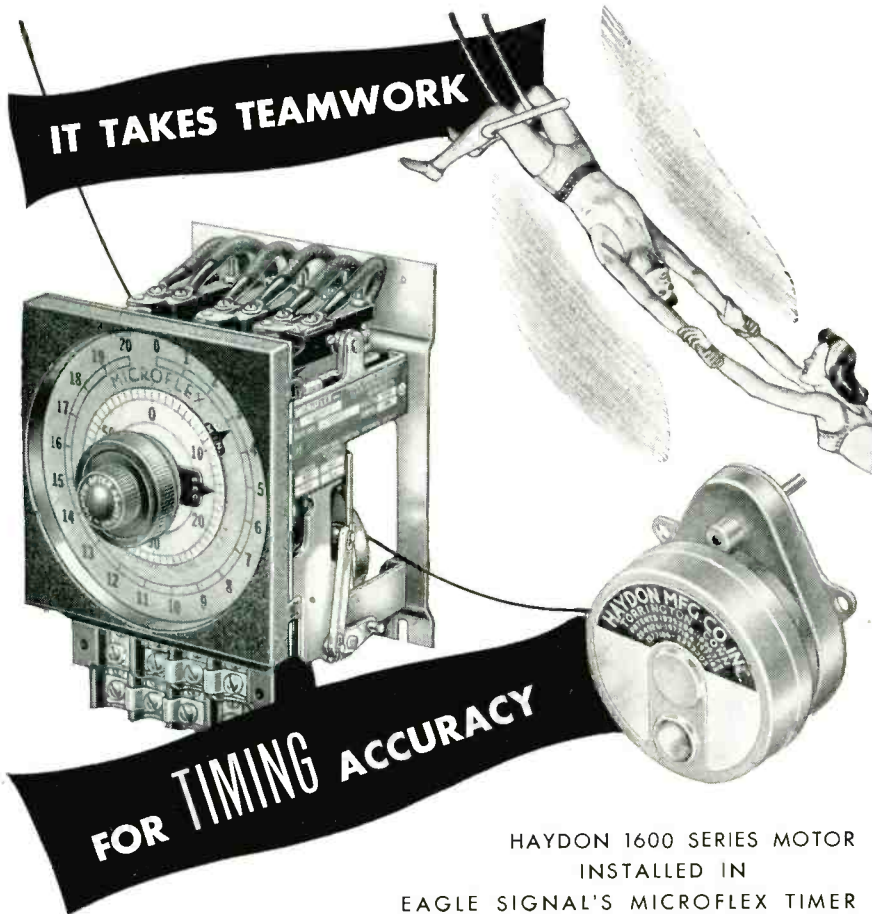

HAYDON 1600 SERIES MOTOR  
INSTALLED IN  
EAGLE SIGNAL'S MICROFLEX TIMER

Haydon engineers, in conjunction with the Eagle Signal Corporation, specified and produced to order the timing motor used in the Eagle's Microflex timer. The Microflex provides an exact adjustable delay between the closing of a control circuit and the subsequent opening or closing of a load circuit . . . a timer for industrial use where accuracy and dependability are paramount. The Microflex is but one example of Haydon's timing flexibility . . . based on teaming timing needs with such standard features of all Haydon motors as:

- Adaptability for individual requirements . . . 60 standard speeds and other variations.
- Accuracy for all timing purposes
- Ruggedness for maximum service

Thousands of industrial applications have proved the advantages of Haydon timing motors . . . designed to fit your particular timing needs . . . showing that it takes teamwork to make timing accuracy profitable.

If it's time for timing, it's time for Haydon. Engineering Data Catalog and expert field service available on request. For immediate reference, see Haydon Catalog, Sweet's File for Product Designers.

Write 2410 Elm Street, Torrington, Connecticut

# HAYDON

MANUFACTURING COMPANY, INC.

TORRINGTON



CONNECTICUT

HARNESS TIME TO

YOUR PRODUCTS

SUBSIDIARY OF GENERAL TIME INSTRUMENTS CORPORATION

by the user. The unit is of the moving magnet, interchangeable coil type and is designed for continuous duty. Minimum full scale range is 0 to 0.1 milliamperes and maximum is 0 to 12 amperes. Sensitivity is 1 part in 1,000.

## Transcription Player

CALIFONE CORP., 1041 N. Sycamore Ave., Hollywood 38, Calif. introduce a new portable transcription player. It reproduces with both 16-in. transcriptions at 33 $\frac{1}{3}$  rpm and regular phonograph records at 78 rpm. It features a wow-free



9-in. turntable, a pickup with replaceable permanent needle, a wide range amplifier and a heavy duty 6-in. speaker.

## Small Radiation Meter

TRACERLAB, INC., 55 Oliver St., Boston 10, Mass. The Model SU-1A small portable radiation survey meter facilitates measurement of radiation in places difficult of ac-



# KAY ELECTRIC COMPANY

## KAY INSTRUMENTS COVER ALL BANDS

Including the proposed HF-TV Bands (475-890 MC)

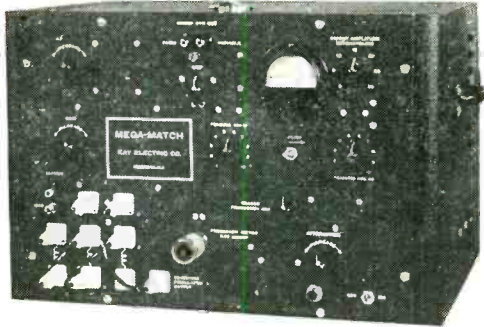

**The MEGA-MATCH  
(Standard)**

Simultaneous visual display of reflected energy from antennas and terminations when used with standard oscilloscopes. Band width of display 30 mc anywhere between 10 and 250 mc. Completely electronic. Includes no slotted lines, moving parts, bridges or other frequency sensitive devices. Oscilloscope display indicates amount of reflected energy vs frequency. Precision frequency meter indicates frequency anywhere along the oscilloscope display. Reflection coefficients as low as 0.01 can be observed. Internal delay cable allows display of energy from terminations of nominal 53.5 ohm impedance. External delay cable may be used to display reflected energy from terminations of any practical impedance. Reflection coefficients, standing wave ratios, absolute value of terminating impedance can be calculated from display—By use of auxiliary variable frequency signal source, the phase angle of the reflection coefficient and resistive and reactive components of terminating impedance may be calculated.

Price \$695 f.o.b. factory



**THE MEGA-MATCH  
(Modified)**

The Mega-Match (Modified) meets all of the specifications and includes all the features of the standard model between 10 to 500 mc. With a slight increase in minimum observable reflection coefficient, this model can be used up to 1000 mc. Hence a visual display of reflected energy over band width up to 30 mc can be obtained from 10 to 1000 mc. This performance provides an instrument suitable for use in testing antennas, terminations, and r.f. input circuits in the proposed high frequency television bands and for other high frequency work. A convenient panel connector makes the Mega-Sweep which forms part of both the standard and modified models of the Mega-Match available as a sweeping oscillator.

Price \$895 f.o.b. factory

Note: Standard models now in customers' hands modified at factory at price of \$200 f.o.b. factory.

### MEGA-SWEEP pulse modulated by the MEGA-PULSER



**THE MEGA-SWEEP**

The Mega-Sweep, a wide range sweeping oscillator has been widely used as a source of frequency modulated test signal. Its features include a wide sweep (up to 30 mc), low amplitude modulation while sweeping (less than 0.1 db. per megacycle), negligible output signal at frequencies other than swept band, low output impedance (50 ohms) and numerous others. It has been advertised as covering the frequency range of 50 kc to 500 mc since this range covered most requirements. By simple internal adjustment which can be made either by the customer or at our factory, its range can be extended to 1000 mc. The Mega-Sweep is therefore applicable to the proposed high frequency television bands and other high frequency work. By simple connections and adjustments the Mega-Sweep can serve as a carrier source when pulse modulated by the Mega-Pulsar, providing ultra narrow pulsed r.f. at any frequency to 1000 mc.

Price \$395 f.o.b. factory

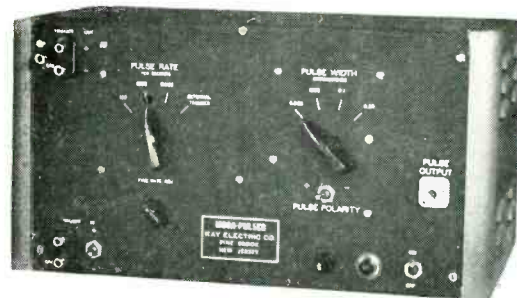

**THE MEGA-PULSER**

Provides very narrow pulses (0.025, 0.05, 0.1 and 0.25 microseconds wide), amplitude 100 volts positive or negative across 50 ohms, repetition rate from internal trigger 100, 1000, 2000 pps. Output pulse delayed 0.25 microseconds from trigger pulse available (positive or negative) for starting sweep of auxiliary oscilloscope. Can be externally triggered by either positive or negative pulses. Output pulses .05 microseconds and greater flat-top, rise and fall time all output pulses 0.01 microseconds. Provides a spectrum which more than covers present or proposed television video amplifiers. The Mega-Pulsar may be used to pulse modulate the Mega-Sweep with sweep width adjusted to zero. This combination provides a pulse modulated carrier up to 1000 mc for studying transient response of broad band r.f. circuits.

Price \$195 f.o.b. factory

WRITE FOR FULL SPECIFICATIONS

**KAY ELECTRIC CO., 25 MAPLE AVE., PINE BROOK, N. J.**

Telephone: CAldwell 6-3710

INSTRUMENTS



# A Ballantine ELECTRONIC VOLTMETER

For every requirement

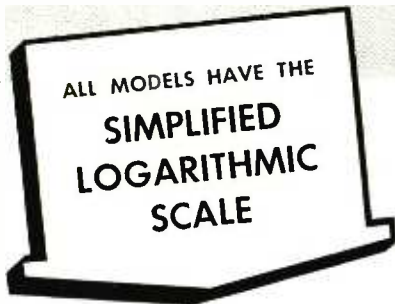

STANDARD  
Model 300

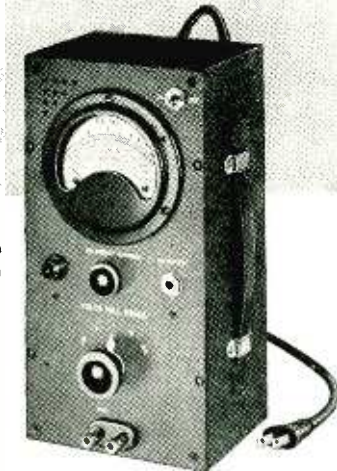

Ideal for the *Accurate* measurement of AC voltages in the Audio, Supersonic, Carrier Current and Television ranges.

Use of Logarithmic voltage scale assures uniform accuracy of reading over whole scale while permitting range switching in decade steps.

Each Voltmeter equipped with an output jack so that the instruments can be used as a high-gain stable amplifier.

## SPECIFICATIONS

### MODEL 300

RANGE—.001 to 100 volts.  
FREQUENCY—10 to 150,000 cycles.  
ACCURACY—2% at any point on scale.  
AC OPERATION—110-120 volts.

### MODEL 304

RANGE—.001 to 100 volts.  
FREQUENCY—30 c.p.s. to 5.5 megacycles  
ACCURACY—0.5 DB.  
AC OPERATION—110-120 volts.

### MODEL 302

RANGE—.001 to 100 volts  
FREQUENCY—5 to 150,000 cycles.  
ACCURACY—2% at any point on scale.  
DC OPERATION—self-contained batteries.

Send for Bulletin for further description



Model 304  
R-F  
VOLTMETER

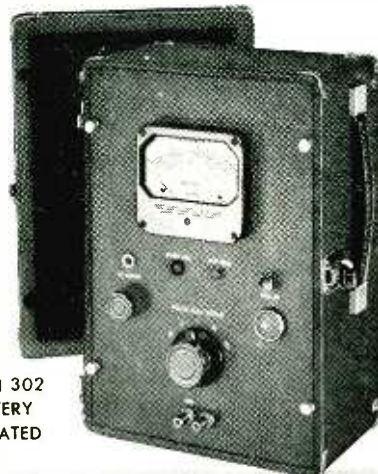

Model 302  
BATTERY  
OPERATED



## BALLANTINE LABORATORIES, INC.

BOONTON, NEW JERSEY, U. S. A.

NEW PRODUCTS

(continued)

cess. The unit has three full-scale ranges of approximately 25, 250 and 2,500 milliroentgens per hour. It is powered by ten small batteries mounted in a replaceable lucite enclosure within the main instrument case.

### Regulated Power Supply

THE HOWARD Co., 934 Argyle Road, Drexel Hill, Pa. The new 300-volt, 200-ma power supply is regulated



within 1 volt from zero to full load with line voltage variation from 105 to 125 volts. Ripple is less than 10 millivolts at full load with 115 volts input.

### Microgroove Changer

WEBSTER-CHICAGO CORP., 5622 Bloomingdale Ave., Chicago 39, Ill. Model 133 has been designed to play new long-playing records at



33.3 rpm. The unit will handle up to ten 12-in. or twelve 10-in. records for a total playing time of four hours. Retail price is \$38.75.

### High-Fidelity Recording

PRECISION AUDIO PRODUCTS, INC., 1133 Broadway, New York 10, N. Y. The Wiremaster, a new wire recorder, has 13 tubes with push-pull 6V6 output and records and reproduces a frequency response of 40 to 10,000 cycles. Its 8-in. extended

AIRCRAFT MANUFACTURERS  
RELY ON...

# FILTRONS

...TO SOLVE THEIR  
RADIO NOISE PROBLEMS



Shielded Spherical-Seal Terminal Filtron—designed for continuous high attenuation from 150 kc to well above 200 mc



2.5 amp Filtron for 50 V.D.C. operation size 1 3/4" x 1 1/4" x 7/8"

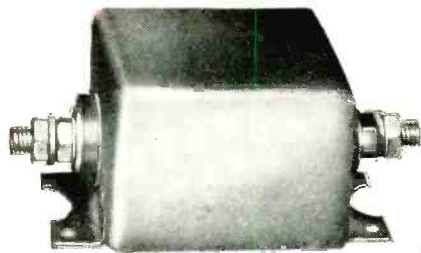

100 amp & 200 amp 50 Volt Aircraft Filtrons, size 3 1/2" x 3 1/2" x 2 1/2"

## FILTRONS OFFER:

- Low Cost • High Attenuation
- Dependability • Light Weight
- Small Size • No Maintenance
- Hermetically Sealed

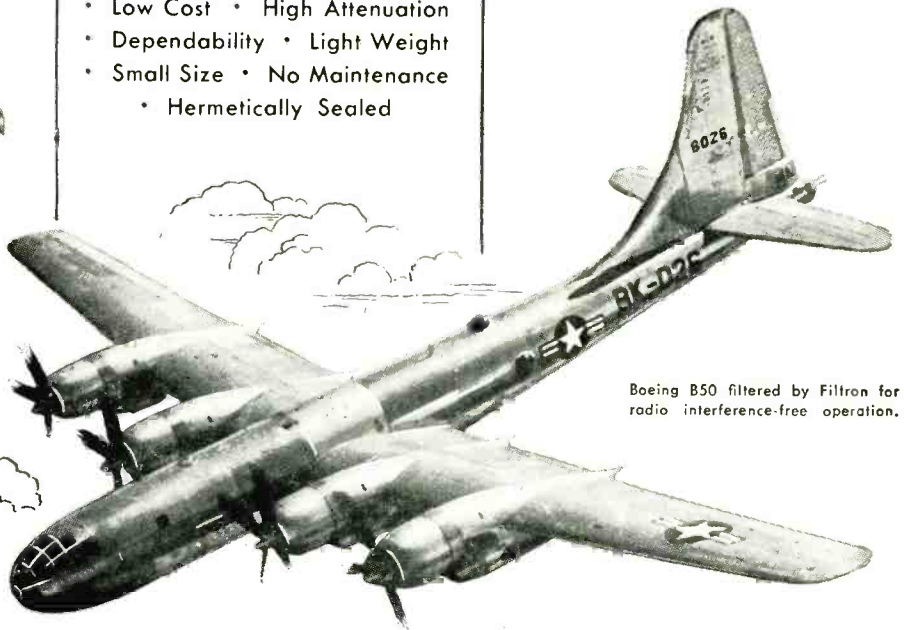

Boeing B50 filtered by Filtron for radio interference-free operation.

# FILTRONS STOP CONDUCTED AND RADIATED INTERFERENCE AT THE SOURCE

**THOUSANDS OF FILTRONS**—radio interference filters—are standard equipment on the majority of current Aircraft production. Thousands of others are in use in vital equipment where radio interference must be suppressed.

Filtron's experienced Engineers, recognized authorities in the noise-suppression field, are available—immediately—to measure the RF interference caused by your product, and to specify a standard Filtron, or design the proper filter to meet Army, Navy, Air Force or FCC interference specifications.

Filtron will design the RIGHT filter for your circuit conditions, with exactly the right attenuation, ampere rating, voltage drop, temperature rise, mechanical arrangement, and space and weight limitations. Filtrons of any current or voltage

rating will be designed to meet your application.

Filtron's production capacity and skill will meet your delivery requirements.

All measurements are made in our new modern specially-designed shielded Radio Noise Suppression Laboratory.

"Filtron," the largest exclusive manufacturer of Radio Noise Filters, offers you the PROMPT services of their Engineers and facilities to make your product "Noise Free."

## RADIO NOISE FILTERS FOR:

Electric Motors	Signal Systems
Electric Generators	Business Machines
Electronic Controls	Electronic Heating Equipment
Electronic Equipment	Electric Appliances
Fluorescent Lights	Electronic Signs
Oil Burners	

THE **FILTRON** CO.  
INCORPORATED

38-25 BELL BOULEVARD  
BAYSIDE, NEW YORK CITY, N. Y.

SEND FOR CATALOG  
AND ENGINEERING MANUAL No. FC-20  
Write for catalog on your letterhead — it contains complete electrical and mechanical characteristics of standard Filtrons.

**LARGEST EXCLUSIVE MANUFACTURER OF RADIO NOISE FILTERS**



# At long last—

The G.M. counter tube reaches maturity  
in the new all metal \***THYRODE 1B85**

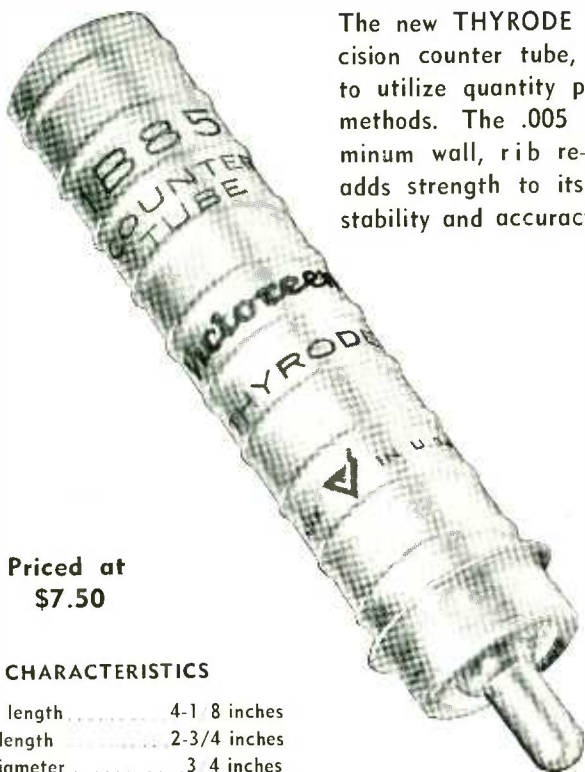

Priced at  
**\$7.50**

#### CHARACTERISTICS

Overall length ..... 4-1 8 inches  
Active length ..... 2-3/4 inches  
Shell diameter ..... 3 4 inches  
Absorption ..... 30 mgm/cm<sup>2</sup>  
Operating voltage ..... 900 volts  
(center of plateau)  
Plateau length ..... 200 volts  
Plateau slope ..... 3% / 100 volts  
Temperature range ..... 5° C. to 70° C.  
Life ..... 10<sup>6</sup> counts

The new THYRODE is a precision counter tube, designed to utilize quantity production methods. The .005 inch aluminum wall, rib re-enforced, adds strength to its inherent stability and accuracy.

#### \***THYRODE**

A Victoreen trademark for radiation counter tubes

Victoreen radiation measuring instruments for laboratory and field determinations together with such components as the VX series subminiature electrometer tubes, vacuum sealed hi-meg resistors and G-M counter tubes have made notable contributions to the present refinement of radiation instrumentation.

**Victoreen** 5806 Hough Avenue  
Cleveland 3, Ohio



range speaker is in a separate cabinet to avoid vibration and acoustical feedback. By panel controls the user can record on wire directly from the self-contained radio or phonograph. Spools are available in 15, 30 and 60-minute lengths.

## Literature

**House Organ.** Micro Switch, Freeport, Ill. Micro Tips, vol 1, no. 2 contains a number of suggestions for use of snap action switches including one for pushing the dog out after dinner.

**Portable Flaw Tester.** Sperry Products Co., Danbury, Conn. The new portable SR05 Supersonic Reflectoscope is pictured in reprint 3013 and further described in bulletin 3001.

**Wire Dereelers.** Rea Magnet Wire Co., Inc., Fort Wayne, Indiana, has put out a two-color, 4-page brochure on a line of magnet wire dereelers that load quickly and give visibility in the running position.

**Special Tools.** Palnut Co., 61 Cordier St., Irvington 11, N. J. Special adaptors for many ordinary hand tools to adapt them to speedier assembly with Palnuts only are described in a 4-page brochure.

**General Price List.** Andrew Corp., 363 E. 75th St., Chicago 19, Ill. Bulletin 10A is a comprehensive tabulation of all transmission

# MAILING LISTS THAT WORK . . .

McGraw-Hill Industrial Mailing Lists are a direct route to today's purchase-controlling executives and technicians in practically every major industry.

These names are of particular value now when most manufacturers are experiencing constantly increasing difficulty in maintaining their own lists.

Probably no other organization is as well equipped as McGraw-Hill to solve the complicated problem of list maintenance during this period of unparalleled changes in industrial personnel. These lists are compiled from exclusive sources, based on hundreds of thousands of mail questionnaires and the reports of a nationwide field staff, and are maintained on a twenty-four hour basis.

Investigate their tremendous possibilities in relation to your own product or service. Your specifications are our guide in recommending the particular McGraw-Hill lists that best cover your market. When planning your industrial advertising and sales promotional activities, ask for more facts or, better still, write today. No obligation, of course.

*for Results*



**Mc GRAW-HILL**  
**DIRECT MAIL LIST SERVICE**

**McGraw-Hill Publishing Co., Inc.**  
*DIRECT MAIL DIVISION*

330 West 42nd Street

New York, 18, N. Y.



### OSCILLOSYNCHROSCOPE

Model OL-15B

Designed for maximum usefulness in laboratories doing a variety of research work, this instrument is suited to radar, television, communication, facsimile, and applications involving extremely short pulses or transients. It provides a variety of time bases, triggers, phasing and delay circuits, and extended-range amplifiers in combination with all standard oscilloscope functions.



#### THESE FEATURES ARE IMPORTANT TO YOU

- Extended-range amplifiers: vertical, flat within 3 db 5 cycles to 6 megacycles; horizontal, flat within 1 db 5 cycles to 1 megacycle.
- High sensitivity: vertical, 0.05 RMS volts per inch; horizontal 0.1 RMS volts per inch.
- Single-sweep triggered time base permits observation of transients or irregularly recurring phenomena.
- Variable delay circuit usable with external or internal trigger or separate from 'scope.
- Sawtooth sweep range covers 5 cycles to 500 kilocycles per second.
- 4,000 volt acceleration gives superior intensity and definition.

For complete data, request Bulletin 4810-MO

### SWEEP CALIBRATOR



Model GL-22

This versatile source of timing markers provides these requisites for accurate time and frequency measurements with an oscilloscope:

- Positive and negative markers at 0.1, 0.5, 1.0, 10, and 100 microseconds.
- Marker amplitude variable to 50 volts.
- Gate having variable width and amplitude for blanking or timing.
- Trigger generator with positive and negative outputs.

Further details are given in Bulletin 4810-MC.

### SQUARE-WAVE MODULATOR AND POWER SUPPLY



Model TVN-7

Here is the heart of a super high frequency signal generator with square wave, FM, or pulse modulation. Provides for grid pulse modulation to 60 volts, reflector pulse modulation to 100 volts, square wave modulation from 600 to 2,500 cycles. Voltage-regulated power supply continuously variable 280-480 or 180-300 volts dc. For additional data and application notes, see Bulletin 4810-MM.

### STANDING WAVE RATIO METER AND HIGH GAIN AUDIO AMPLIFIER

Model TAA-16



Write for Bulletin 4810-MA containing full details of this useful instrument.

- Standing wave voltage ratios are read directly on the panel meter of this sensitive, accurate measuring instrument.
- Frequency range 500 to 5,000 cycles per second.
- Two input channels with separate gain control for each.
- "Wide-band" sensitivity 15 microvolts full scale.
- "Selective" sensitivity 10 microvolts full scale.
- Bolometer/crystal switch adjusts input circuit to signal source.

In Canada, address Measurement Engineering Ltd., Arnprior, Ontario.



**BROWNING**  
Laboratories, Inc.  
Winchester, Mass.  
ENGINEERED FOR ENGINEERS

line, antenna, and related equipment, with type numbers, descriptions and prices for over 600 items. A cross index is enclosed with the bulletin.

Fiber. Spaulding Fibre Co., Inc., 310 Wheeler St., Tonawanda, N. Y. Various types and grades of fiber rod are summarized and listed in a recently issued brochure.

Fasteners. Shakeproof Inc., 2501 North Keeler Ave., Chicago 39, Ill., has issued a booklet entitled "Fastening Suggestions" that describes a number of special fastener problems and their solution.

Shielded-Section Capacitor. Cornell Dubilier, South Plainfield, N. J. A shielded multiple section capacitor type MC-9A63 has four 0.02-microfarad sections with voltage ratings for 500 v d-c. Details are given in sheet NB-107.

Rectifier. National Electronics, Inc., Geneva, Ill., has recently released full technical information on the new single ended 2-ampere industrial rectifier tube type NL-649.

Brushes. Stackpole Carbon Co., St. Marys, Pa. A 44-page "Fractional Horsepower Equipment User's Guide" just issued contains helpful information on selecting and applying brushes for longer life and better performance.

Battery Terminal. James A. Stanley Co., 277 Broadway, New York 7, N. Y. A brochure can be had describing the new B-319 battery terminal that employs a spring-tension connection to a storage battery terminal post. The new terminal is particularly useful in mobile radio installations.

A-C Motor Control. Louis Allis Co., Milwaukee 7, Wis. Characteristics of the Ajusto-Spede are presented in four pages. The device is characterized as an a-c motor having infinitely adjustable speed.

Photoelectric Counter. Photo-switch, Inc., 77 Broadway, Cambridge 42, Mass. Bulletin PA482

# MEMO TO PRESIDENTS WHO WATCHED THE BAND GO BY!

**H**ERE'S ONE parade that isn't "all over but the shouting" after the band has passed. It's the Payroll Savings Plan for the regular purchase of U. S. Security Bonds by employees.

Though the formal spring campaign to sell Bonds is over, any company can still move forward with the parade. Right now thousands of companies are putting *additional push* behind their Payroll Savings Plans. Managements of many companies that have not yet participated are *now installing* the Plan.

It's a "look-ahead" plan, that benefits employee, company, and nation. Every \$3 invested in Bonds pay \$4 at maturity. Personnel records in the plants with active P. S. P. programs show improved employee attitudes—evidenced by less absenteeism and fewer accidents—as the individual's sense of security grows with Bond purchases. And every Security Bond dollar built up in the Treasury retires a dollar of the national debt that is potentially inflationary. It means less bidding-up of prices. Moreover, Bond buyers are better citizens because they have a tangible stake in the nation's future.

It's just as easy to take action now as when the campaign was at its height. Just call your Treasury Department's State Director, Savings Bonds Division, and ask for the material that helps to get a Payroll Plan started or to keep it rolling.

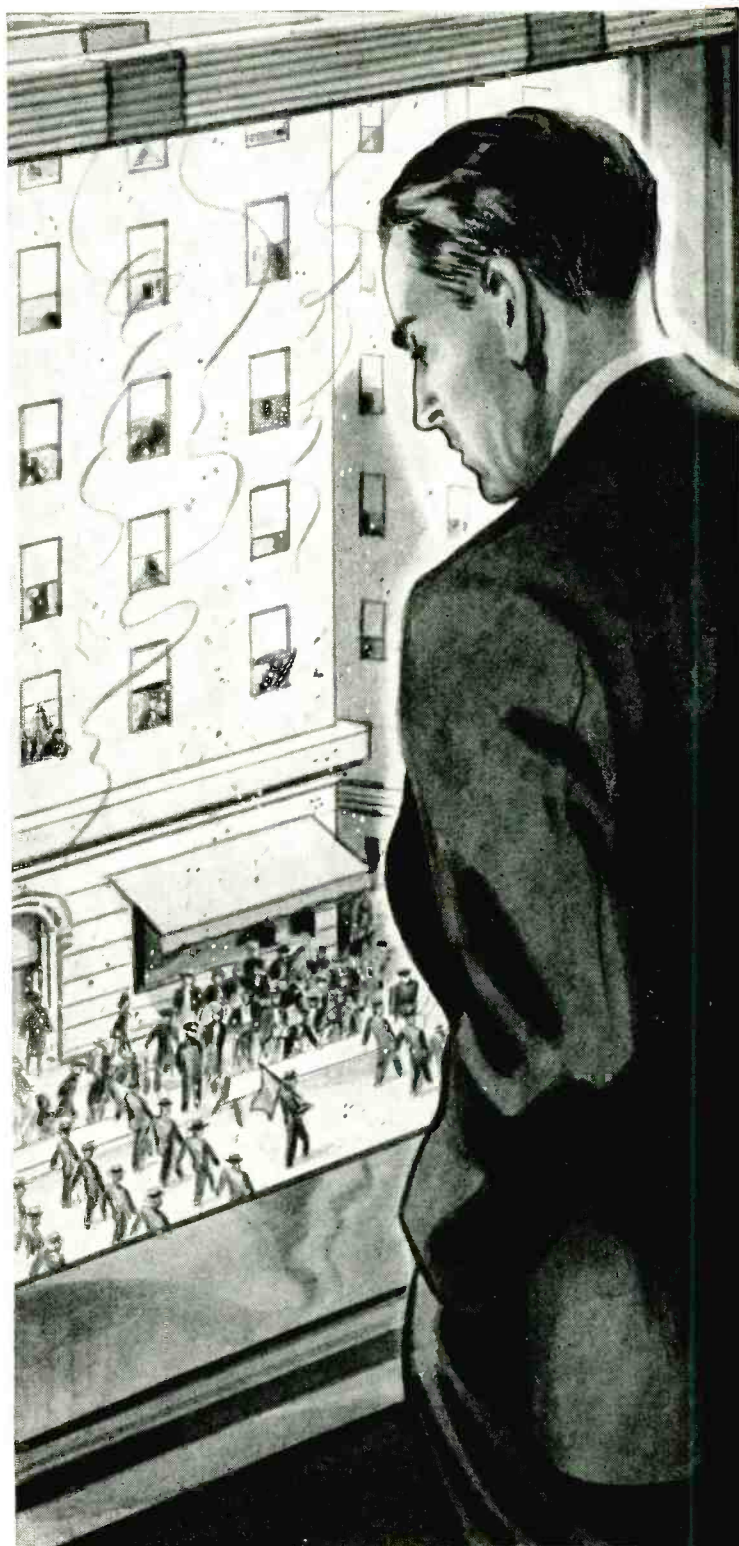

---

The Treasury Department acknowledges with appreciation the publication of this message by

## ELECTRONICS

This is an official U. S. Treasury advertisement prepared under the auspices of the Treasury Department and the Advertising Council.





# OSCILLOGRAPHS

By **HATHAWAY**  
for **EVERY** purpose

**S8-B** General Purpose, 12 to 24 elements, for laboratory or field use, quick-change transmission for wide range of record speeds, automatic tiling and numbering, automatic record-length control, tuning fork time marker, galvanometer attenuators, governor motor.

(Bulletin SP165)

**S8-C** General Purpose, 24 to 36 elements, otherwise same as type S8-B.

(Bulletin SP165)

**S8-D** General Purpose, 12 to 24 elements, similar to type S8-B except without automatic controls.

(Bulletin SP175)

**S12-A** Small Portable, General Purpose, the smallest complete 12-element oscillograph.

(Bulletin SP167)

**S6-A** Geophysical, 12 elements.

**S6-B** Geophysical, 24 elements.

**S14-A** Student's Oscillograph, 6 to 12 elements, ultra-simple, low in cost.

(Bulletin SP183)

**S15-A** Portable Self-Powered, 6 elements, for use where very small size is essential and power is not available.

(Bulletin SP193)

**SC16-A** Cathode Ray, 6 elements, very high frequency response and writing speed, record speed to 6000 inches per second.

(Bulletin SP194)

**RS9-A** Automatic Oscillograph, 12 elements, for switchboard or portable use, for automatic recording of faults or staged system testing, high-speed starting.

(Bulletin SP196)

WHATEVER YOUR REQUIREMENTS MAY  
BE THERE IS A  
HATHAWAY OSCILLOGRAPH FOR YOU

**WRITE FOR  
TECHNICAL BULLETIN**

*Hathaway*  
**INSTRUMENT COMPANY**  
1315 SO. CLARKSON STREET • DENVER 10, COLORADO

shows the various uses for type 20 AP5 photoelectric counter designed particularly for case and bottle counting, textile and leather piece goods, as well as freshly painted and hot objects.

**Electrosensitive Papers.** Alfax Paper and Engineering Co., 40 Riverside Ave., Brockton 27, Mass. Papers for all kinds of recording devices that employ electrolytic papers are described in a mimeographed brochure that gives characteristics and prices.

**Hardware and Parts.** General Cement Mfg. Co., Rockford, Ill. A new 64-page catalog recently issued lists radio and electronic products, chemicals, hardware, kits, insulation, and other items of interest in the electronics field.

**Meters.** Millivac Instruments, PO Box 3027, New Haven, Conn. Type MV717A vacuum-tube millivoltmeter and type MV73A multipurpose vacuum tube meter are both pictured in brochures recently made available from the company.

**Marking Machines.** Adolph Gottscho, Inc., 1 Hudson St., New York 13, N. Y. An 8-page catalog describes 18 different marking and code-dating machines that are useful in packaging all types of electronic equipment.

**Molded Cores.** Lenkurt Electric Co., 1113 County Road, San Carlos, Calif. "Trancors by Lenkurt" is the title of a new 24-page folder describing a complete line of molded magnetic cores, core assemblies, coil assemblies, and filters.

**Speaker Folder.** Altec Lansing Corp., 250 West 57th St., New York 19, N. Y. A two color folder announces a new line of general purpose loudspeakers. Frequency response curves and methods of obtaining the curves are presented. Available cabinets are also illustrated.

**Contactors.** Ward Leonard Co., 31 South St., Mount Vernon, N. Y. For the bigger transmitters and heavy industrial control equipment engineers will want to see

**Tough Material...  
but not too tough  
for  
WATERTOWN**

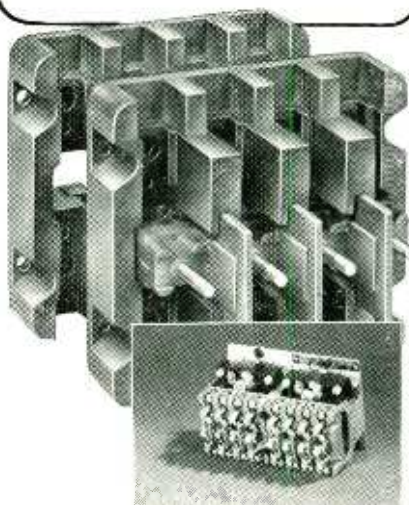

For years, Watertown has been tackling jobs like this one for R-B-M Division of Essex Wire Corporation, Logansport, Indiana, and coming up with the right answer.

R-B-M needed molded plastic parts for two new devices recently announced — reversing and non-reversing industrial contactors. These contactors are used on hoists, overhead doors, machine tools and other industrial equipment where long dependable service is mandatory.

Melamine was selected for the job — it safely withstood all the elements of tropical warfare in vital aircraft engine parts, and its high arc resistant characteristic makes it ideally suited for electrical insulation.

Melamine, while more difficult to mold and machine than phenolic or cold molded insulation, is preferred as its slightly higher cost is more than offset by its superior insulating quality. Watertown engineering developed a method to mold these complex parts with all their slots, holes, recesses, studs, bosses and metal inserts at a reasonable price.

Experience since 1915 with every type of plastic and countless jobs involving compression, transfer or injection molding enable Watertown engineers to tackle just about anything involving plastics. Perhaps you have a problem, too.

**THE WATERTOWN MANUFACTURING CO.  
777 ECHO LAKE RD., WATERTOWN, CONN.**



*Introducing*

# VARIAN ASSOCIATES

Specialists in research, development, and pilot manufacture of vacuum tubes and other devices in the electronic, microwave, and physical research fields.

Technical staff includes:

RUSSELL H. VARIAN	SIGURD F. VARIAN
H. MYRL STEARNS	ELLIOTT LEVINTHAL
FRED L. SALISBURY	DON L. SNOW

Consultants and directors comprise scientists who participated in the original klystron and microwave research and development and in important phases of nuclear physics.

*Incorporated April 20, 1948*

**ELECTRONIC TESTING AND TUBE FABRICATION  
LABORATORY • MODEL MACHINE SHOP**

98 WASHINGTON STREET

SAN CARLOS, CALIFORNIA

*Measure  
Frequencies*



- **INSTANTLY** ... direct reading. No computation.
- **ACCURATELY** ... to a frequency determination of 0.05%.
- **VISUALLY** ... at the turn of the dial indicator knob.

Used effectively in leading laboratories, such as: Harvard University, Bell Aircraft Corp., and Hamilton Standard Propellers... for measuring natural frequencies or speed of rotating objects, checking or calibrating tachometers, oscillators, impulse generators, similar equipment.

**C. G. CONN LTD., DEPT. 1012  
ELKHART, IND.**



*Write for  
Free Folder*



Please send *free* Strobocorr folder containing information about operation and application of this new precision instrument. I understand this places me under no obligation.

Name \_\_\_\_\_ Position \_\_\_\_\_  
Company \_\_\_\_\_  
Address \_\_\_\_\_  
City \_\_\_\_\_ Zone \_\_\_\_\_ State \_\_\_\_\_



## FOR FINER LATERAL REPRODUCTION

(and other benefits explained in Bulletin No. 3)  
COLUMBIA BROADCASTING SYSTEM  
and  
AMERICAN BROADCASTING COMPANY  
(as well as hundreds of independent stations)  
have placed

## GRAY TRANSCRIPTION ARMS and EQUALIZERS

on every transcription table

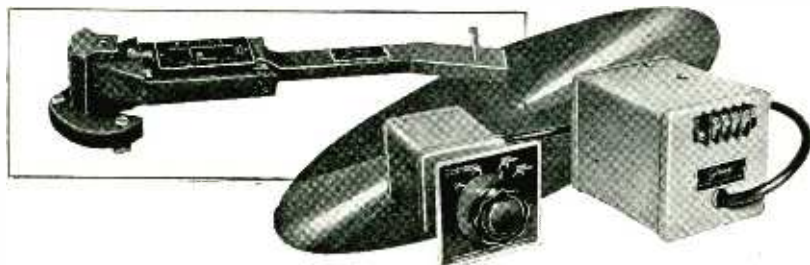

**Ideal for the New Long Playing Micro-Groove Records**  
The Gray Transcription Arm gives you improved quality of reproduction, greatly extended life of stylus and recordings, economical operation, as well as low first cost. Due to such features as adjustable stylus pressure, frictionless motion, self-leveling base and the accommodation of any standard cartridge, arm obsolescence is precluded.

The Gray #601 4-position Equalizer for GE Cartridge, finest performance and workmanship, ideal response curves. Matches pickup to microphone channel.

Write for our Bulletin #5 on Selected GE Reproducers, with Diamond Stylus for almost unlimited life.

## GRAY RESEARCH & DEVELOPMENT COMPANY, Inc.

16 ARBOR STREET

HARTFORD 1, CONN.

## Keep high voltage off your test instruments!



## use REINER HIGH VOLTAGE MULTIPLIER LEADS

accurate within 2%

You can make high voltage and television measurements on a low voltage multimeter with complete safety if you use these Reiner H. V. M. leads. They have special high-voltage type resistors built into the prod handles. The entire voltage drop is virtually complete

before the wire lead of the cord is reached, leaving the tip of the lead relatively "cold". Supplied in standard scale ranges from 5,000 to 30,000 volts and in sensitivities of 5,000 to 25,000 ohms per volt. Write for price and application chart—bulletin #111.

REINER H. V. M. LEADS are available in the necessary ranges for all popular V. T. Voltmeters. Special ranges and sensitivities can be supplied on order. WRITE FOR BULLETIN #111.

**Reiner**  
ELECTRONICS CO., INC.  
152 West 25th St., New York 1, N. Y.

## SAFE...SIMPLE

HIGH VOLTAGE TV TESTS  
TO 30,000 VOLTS  
WITH THE NEW  
PRECISION SERIES TV  
Super High Voltage Safety Test Probes



Now... the TV high voltage test problem solved with safety and operational confidence.

A super high voltage, custom-molded test probe, "Application Engineered" for the job... tested on the job... approved for the job.

Designed for SAFETY FIRST.

Rapid removal and interchange of the cartridge multiplier permits the TV probe to be used with more than one multi-range test set, via purchase of appropriate cartridge.\*

Series TV High Voltage Test Probes are now on display at leading radio parts distributors and are available as follows:

TVP—High Voltage Test Probe LESS multiplier cartridge. \$12.35 Net

TV-1—Model TVP WITH Cartridge for Precision Series EV-10 VTVM. \$15.45 Net

TV-2—Model TVP WITH Cartridge for Precision (or any) 20,000 ohms per volt test set with built-in 6000 V. D.C. range. \$15.45 Net

\*Stock and special value multiplier cartridges available to match popular high sensitivity test sets.

Series TV High Voltage Test Probes provide direct kilovoltmeter facilities with existing high sensitivity test sets, and VTVM's such as the "Precision" models described below: Write for illustrated 1948 catalog describing complete line of electronic test instruments.

### —MODEL 85—

Lab. Type 20,000 ohms per volt AC-DC test set. 34 rotary selective ranges to 6000 V., 60 Megs., 12 Amps., 70 DB, 4½" meter. \$38.75

### —MODEL 858-L—

20,000 ohms per volt Multi-Master, AC-DC V-O-M. 54 push-button operated ranges to 6000 V., 600 Megs., 12 Amps., 70 DB, 4½" meter. \$54.10

### —MODEL EV-10-MCP—

Multi-range, zero-center VTVM plus AC-DC V-O-M facilities to 6000 V., 2000 Megs., 12 Amps., 70 DB. With large 7" meter. \$89.95

### —MODEL 10-54-P—

Electronic Tube Tester, and 20,000 ohms per volt AC-DC V-O-M. Ranges to 6000 V., 12 Amps., 60 Megs., 70 DB, 4½" meter. \$134.40

**PRECISION**  
APPARATUS CO., Inc.  
92-27 Horace Harding Blvd.  
Elmhurst 10, N. Y.

Export Division, 458 Broadway, New York City,  
U. S. A. Cables, MORHANEX

copies of bulletins 4452 and 4453 describing heavy-duty solenoid contactors.

**High-Frequency Resistors.** International Resistance Co., 401 N. Broad St., Philadelphia 8, Pa. Complete specifications and characteristics for type MP high-frequency resistors are given in a 4-page technical data bulletin F-1.

**Motor Controls.** Square D Co., 4041 N. Richards St., Milwaukee 12, Wis. New products and modified listings for holders of the Electric Motor Control catalog were issued as of July 28, 1948.

**Crystals.** Reeves-Hoffman Corp., 321 Cherry St., Carlisle, Pa. A catalog covers the complete line of quartz crystal units for calibration, mobile, aircraft, and commercial crystal applications. Bulletin RHC features a small universal holder for frequency coverage from 50 kc to 100 mc.

**A-M Transmitters.** Radio Corp. of America, Camden, N. J. A 24-page descriptive brochure provides comprehensive information on 5-kw and 10-kw a-m broadcast transmitters. It is profusely illustrated with schematic diagrams, specifications, layouts, and photographs. Write Department 516.

**Capacitor, Tetrode, and Socket.** Eitel-McCullough, Inc., San Bruno, Calif. Variable vacuum capacitors that can be mounted singly or in gangs, the type 4-400A r-f amplifier power tetrode, and the special air-system socket are all pictured in brochures available from the company.

**Metal Problems.** International Nickel Co., Inc., 67 Wall St., New York 5, N. Y. A new booklet entitled "66 Practical Ideas for Metal Problems in Electrical Products" should be interesting reading for the designer of electronic products with problems in choice of proper metal for fabrication.

**Assorted Instruments.** Kalbfell Laboratories, Inc., 1076 Morena Blvd., San Diego 10, Calif. A heterodyne detector, bridged-T filter, decade amplifier, and the

# CURRENT CONVERSION

## ATR STANDARD AND HEAVY DUTY INVERTERS



**For Inverting D. C. to A. C. . . .**

Specially Designed for operating A. C. Radios, Television Sets, Amplifiers, Address Systems, and Radio Test Equipment from D. C. Voltages in Vehicles, Ships, Trains, Planes and in D. C. Districts.

**ATR** New Models

**AUTO RADIO VIBRATORS**

A Complete Line of Vibrators . . .

Designed for Use in Standard Vibrator-Operated Auto Radio Receivers. Built with Precision Construction, featuring Ceramic Stack Spacers for Longer Lasting Life.

**ATR VIBRATOR GUIDE**  
a complete line

New 36 page VIBRATOR GUIDE FREE

**ATR** New Models

**"A" BATTERY ELIMINATORS**

For DEMONSTRATING AND TESTING AUTO RADIOS

New Models . . . Designed for Testing D. C. Electrical Apparatus on Regular A. C. Lines. Equipped with Full-Wave Dry Disc Type Rectifier, Assuring Noiseless, Interference-Free Operation and Extreme Long Life and Reliability.

**NEW MODELS**  
**NEW DESIGNS**  
**NEW LITERATURE**  
See your jobber or write factory

**AMERICAN TELEVISION & RADIO Co.**  
Quality Products Since 1931  
SAINT PAUL 1, MINNESOTA-U.S.A.





Custom Build  
Your Own  
Terminal Blocks  
with  
**CURTIS TYPE "M"**  
Build-Up  
**TERMINAL BLOCK  
KITS**

Type "M" Blocks are designed with ample clearance and creepage distances for use in circuits carrying up to 300 volts, 15 amps.

Curtis Type "M" Terminal Blocks are now available in convenient kits . . . with sufficient components to make up a number of custom or one-time blocks. Easy and quick . . . you can build blocks with an assortment of terminals from 2 to 12. Molded terminals provide ample insulation from metal base. Type "M" kits are the answer for engineering, research, maintenance and repair. Order your supply today!

Write for  
your copy  
of Bulletin  
DS-122

**CURTIS DEVELOPMENT & MFG. CO.**

Terminal Block Sales  
5 North Crawford Avenue  
Chicago 24, Illinois

*Separate  
voltage  
supplies  
eliminated*

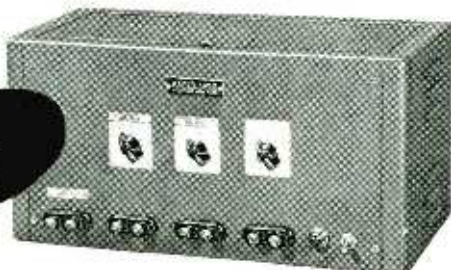

Four commonly used voltages from a single compact unit! Separate voltage supplies, ordinarily derived from three or four cumbersome power units, now concentrated in one! That is what the Kepco Multiple Power Supply brings to busy engineers in the industrial laboratory, for greater convenience and speed in experiments and research work.

Any voltage you need is instantly available through the Kepco Multiple Power Supply—for heater, plate and grids—for studying the characteristics of vacuum and gas filled tubes. Contains:

Two continuously variable B supplies from 0 to 300 volts or currents up to 120 ma. One continuously variable C supply from minus 50 to plus 50 volts at 5 ma. One heater supply delivering 6.3 volts at 5 amperes.

The two B supplies originate from a common power transformer; the C supply

**Kepco  
MULTIPLE POWER  
SUPPLY**

originates from a separate power transformer and rectifying circuit. B supplies cannot be burned out even if terminals are shorted. Control circuit eliminates the use of heavy duty power potential dividers.

Complete voltage control from front panel, including power switch and pilot light indicating "Off" and "On." All voltages brought out to binding posts along lower edge of front panel.

Strong construction; all component parts of highest quality. Dimensions: Length 16"; height 8"; depth 8 3/4". Weight 28 lbs.

Complete details  
on request

**Kepco Laboratories,  
Inc.**

149-14 41st Avenue,  
Flushing, N. Y.



**FASTER, SIMPLER  
AUDIO ANALYSIS  
with Model AP-1**

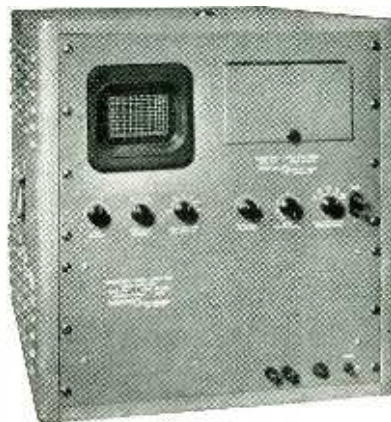

**PANORAMIC  
SONIC ANALYZER**

Reduce time, complexity and cost of making audio measurements with the unusual advantages offered by the Panoramic Sonic Analyzer. By resolving a complex audio wave into a spectrograph showing the frequency distribution and voltage amplitude of the components, Model AP-1 . . .

- Eliminates slow point-by-point frequency checks • Provides a quick overall view of the audio spectrum
- Enables determination of changes in waveform content while parameters are varied • Furnishes simple presentations for production line testing.

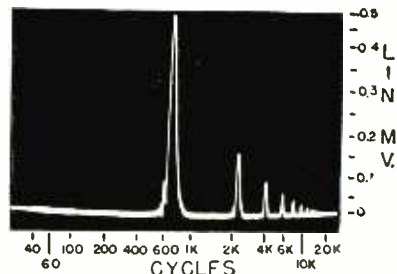

Panoramic Sonic Spectrograph of  
750 cps square wave.

Use Model AP-1 for analyzing . . .

- Harmonics • Intermodulation • Vibration • Noise • Acoustics • Materials

**Features . . .** Continuous scanning from 40-20,000 cps in one second • Wide input voltage range • Linear and log voltage scale • Closely logarithmic frequency scale • Built-in voltage and frequency calibrator • Simple operation.

Visit our Booth #7

National Electronics Conference



micro-miker are briefly listed on a specification sheet.

**Components.** Aircraft Radio Corp., Boonton, N. J. A series of bulletins made up in catalog form covering a wide variety of test equipment, microwave accessories and electronic component parts. Photographs and mechanical drawings are included.

**Wire Catalog.** Alpha Wire Corp., New York 13, N. Y. A complete line of wire and wire products for the radio, automotive and electrical industries is covered in the twelve-page catalog no. 48. Specifications for each type are given.

**Coil Winding.** Universal Winding Co., P.O. Box 1605, Providence 1, R. I. Information covering improvements in coil winding equipment and new ideas in the winding operation may be found in a series of single sheet publications.

**Capacitor Information.** Herlec Corporation, 422 North Fifth St., Milwaukee 3, Wisconsin, recently issued two new catalog sheets. One deals with types, physical dimensions and standard values of bypass and audio coupling capacitors together with diagrams of "Bulplates," incorporating several capacitors. The other gives a general description, specifications, and instructions for ordering metal cup capacitors.

**Antennas.** Trieraft Products Co., 1535 N. Ashland Ave., Chicago 22, Ill., presents in a 16-page booklet the electrical performance data on the models 300 and 400 all-wave television and f-m antennas. Two descriptive catalog leaflets are also included.

**Machining Plastics.** Monsanto Chemical Co., Springfield, Mass. Bulletin 52 tells how to do it if the cost of a polystyrene plastic article is below that warranting the use of an expensive mold.

**Tube Applications.** Radio Corp. of America, Harrison, N. J. Several new tube application notes numbered AN-134 through AN-137 have recently been issued dealing with adjustment of filament voltage

# Naturally...



**Finished speaker test for buzz, spurious response and acoustical characteristics.**

## SELECTION by TEST means FINER SPEAKERS for YOU

FROM the primary elements that enter into the assembly of a General Electric speaker, down to the completed unit, tests are made continuously to maintain quality standards.

Before it is shipped, every G-E speaker is given a final test—buzz, spurious response and acoustical characteristics are carefully checked.

Every speaker must meet that final test satisfactorily before it can be shipped. Such care in checking results in greater acceptance, customer satisfaction—and volume sales for you.

To all the outstanding features in G-E speakers add the one element that assures those features—for your benefit . . . for customer confidence . . . Tests.

Write today for all the information you require on G-E quality speakers—or enclose your order. *General Electric Company, Electronics Park, Syracuse, New York.*

# GENERAL ELECTRIC

168 GE



# NEW R-F OSCILLATOR

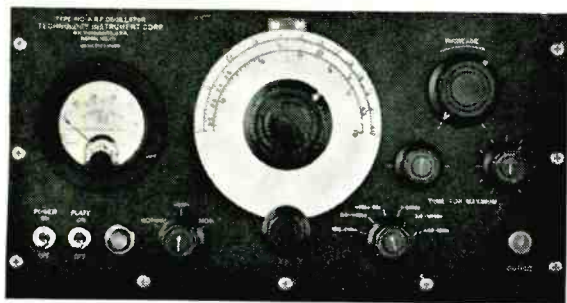

for general laboratory use and as a signal source for R-F bridges

Write today for Bulletin 408 containing complete information and specifications on the Type 410-A R-F Oscillator

## NOTE THESE FEATURES

- 100 kc to 10 Mc
- High output—approximately 30 volts
- 50-60  $\Omega$  output impedance
- Internal modulation
- Output voltmeter
- Excellent stability
- Accurate, individually - calibrated frequency scale.
- Expanded frequency scale.

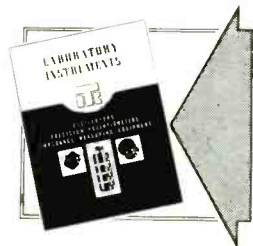

**TECHNOLOGY INSTRUMENT CORPORATION**  
 1058 MAIN STREET, WALTHAM 54, MASS.  
 Midwest Office: Alfred Crossley & Associates, 549 W. Randolph St., Chicago 6, Ill.  
 STAt 7444

*ALTEC LANSING NOW "PACKAGES" ALL COMPONENTS FOR A COMPLETE HIGH FIDELITY RADIO-PHONOGRAPH SYSTEM TO BUILD INTO YOUR HOME*

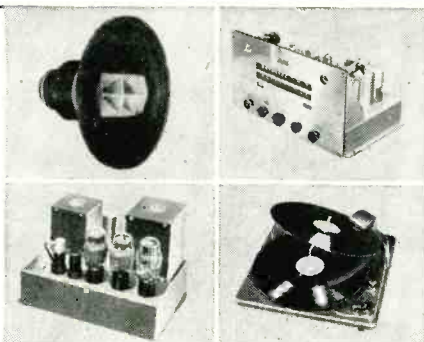
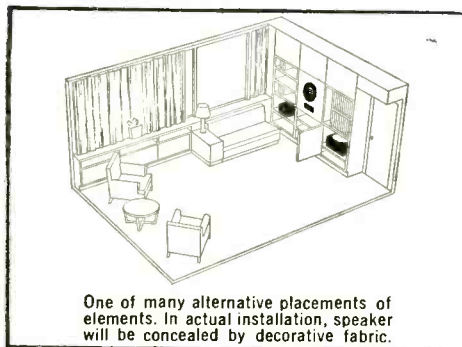

The Altec Lansing Custom-in-Built Music System consists of the famous Altec Lansing Duplex speaker, a special Altec Lansing amplifier, a newly designed TRF Altec Lansing AM-FM tuner, and the Webster 70 record changer with GE variable reluctance pick-up. Integrated with the structure of your room, this system transcends completely the inherent acoustical and electronic limitations of conventional radio-phonographs, eliminates radio "furniture," and reproduces the

full range of sound (35 to 16,000 cycles). It achieves the highest faithfulness to living sound now known to science. Built-in Altec Lansing Daylight Television can also be included. Complete installation instructions come with each system.

*A brochure will be sent on request.*

**ALTEC**  
 LANSING  
*custom-in-built  
 home music system*

161 Sixth Avenue,  
 New York 13, N. Y.  
 1161 N. Vine Street,  
 Hollywood 38, Calif.



Where SPACE and PERFORMANCE are Vital DUMONT OFFERS *The* TINYMITE

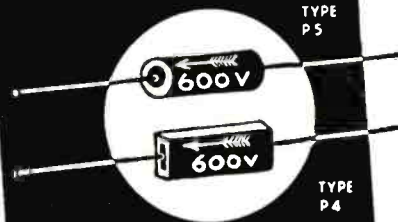

SMALLEST PAPER CAPACITOR  
 yet 100% MOISTUREPROOF



*Proof of the pudding is in the eating.*

## TINYMITES

are the largest selling miniature paper capacitors in the world.

- Good for 100°C
- Leads CANNOT pull out
- CAP. from .0001 to 2 MFD from 100 volts to 1000 volts.

Send for List and prices.

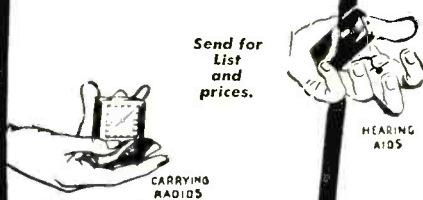

**DUMONT**  
 ELECTRIC CORP.  
 MFR'S OF CAPACITORS FOR EVERY REQUIREMENT  
 308 DYCKMAN ST., NEW YORK, N. Y.

of the 1B3 by observation of filament temperature, reduction in peak inverse voltage rating, overload protection for horizontal deflection circuits, and single-section filament operation of 3S4 and 3V4.

**Marine Radiophones.** Rex Bassett, Inc., Fort Lauderdale, Fla. A folder lists the various two-way marine radiotelephones for tug boats, fishing vessels, tankers and yachts.

**Tubes.** Radio Corp. of America, Harrison, N. J. Specification sheets on the type 812-A power triode, type 672-A thyratron, and the type 4X500A power tetrode are now in printed form.

**High-Power Solenoid.** B/W Controller Corp., Birmingham, Mich. Bulletin SOL-2 devotes four pages to an illustrated description of the Hi Power small space, a-c solenoid. Specifications, charts and dimensional drawings are included.

**Cast Parts.** Austenal Laboratories, Inc., 224 E. 39th St., New York 16, N. Y. A 16-page booklet entitled "New Horizons with Microcastings" contains a number of interesting examples of parts produced by the Microcast process for use in the electronics field.

**Synthetic Elastics.** E. I. duPont de Nemours and Co., Inc., Fairfield, Conn. Properties and uses of Fairprene, a synthetic elastic composition are described in a 12-page manual. Each of the three groups of Fairprene products is illustrated.

**Air-spaced Cables.** Transradio Ltd., 138A Cromwell Road, London SW7, England. Publication 27 lists new types of Co-Ax air-spaced articulated r-f cables. They can be used for flexible high-power transmission lines, very low-capacitance cables, and photo-cell leads.

**Transformers.** Electro Engineering Works, 6021 College Ave., Oakland 11, Calif. Using modern techniques, this company makes all types of radio, industrial, audio, and other transformers as

*S.S. White* **MOLDED RESISTORS**  
*The All-Weather Resistors*

**INSURE ACCURACY AND RELIABILITY**  
**IN *Hipot* INSULATION TESTERS**

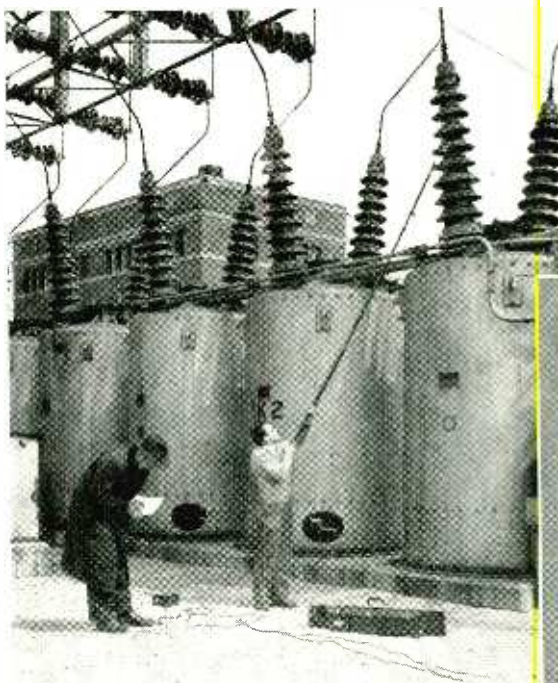
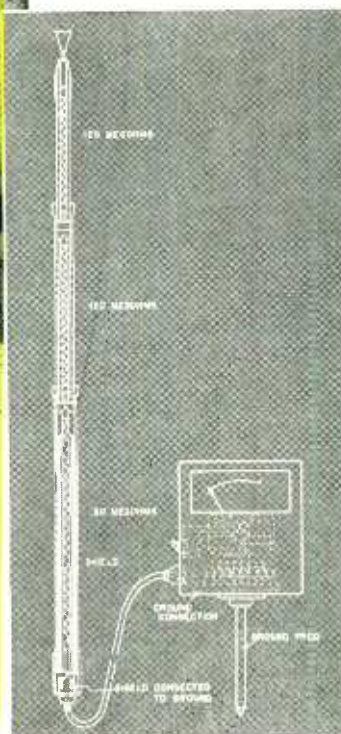

Photo and Illustration courtesy of Canadian Line Materials, Ltd. Toronto, Canada



The "Hipot" Test Stick is used to test Bushings and Insulators on high voltage transmission lines from 11 to 230 KV. It consists of telescoping bakelite stick sections each containing a series of S.S.White Resistors to step the voltages down to minute values for measurement.

The manufacturer, Canadian Line Materials, Ltd., Toronto, Canada says — "We have always found S.S.White Resistors of highest quality. They have characteristics which insure consistently accurate and dependable readings on the indicating instruments."

WRITE FOR BULLETIN 4505

It gives essential data about S.S.White Resistors including construction, characteristics, dimensions, etc. Copy with price list on request.



**S.S. WHITE INDUSTRIAL DIVISION**  
 THE S. S. WHITE DENTAL MFG. CO. DEPT. R 10 EAST 40th ST., NEW YORK 16, N. Y.



FLEXIBLE SHAFTS • FLEXIBLE SHAFT TOOLS • AIRCRAFT ACCESSORIES  
 SMALL CUTTING AND GRINDING TOOLS • SPECIAL FORMULA RUBBERS  
 MOLDED RESISTORS • PLASTIC SPECIALTIES • CONTRACT PLASTICS HOLDING



 Cyclohm 2500 Motors are designed with greater precision and compactness than any other motors of their type—and the result is greater output . . . perfect rigidity . . . quieter performance. Synchronous type for instruments, timing devices and facsimile operations . . . Non-Synchronous for general applications . . . Speed Reducer for work requiring slow speeds and high torques. Ball bearings or sleeve bearings.

**300 IN. OZ. AT 1 RPM**  
with gear unit

Various speeds, voltages and frequencies available. Write for complete information.

**CYCLOHM MOTOR CORP.**

Division Howard Industries, Inc.  
5-17 46th Road, Long Island City 1, N. Y.

**PRECISION**  
**COMPACTNESS**

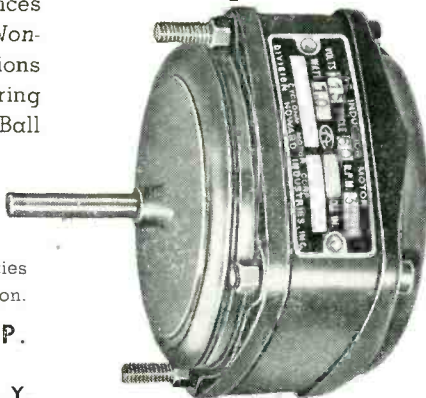

**Cyclohm**  
SYNCHRONOUS • NON-SYNCHRONOUS • SPEED REDUCER  
MOTORS

**HEAT RESISTANT WIRES FOR EVERY APPLICATION . . .**



**TOUGH**  
and  
**RUGGED**

Do your new circuit designs call for heat resistance wire that's tough and rugged—wire that can take it day after day through countless hours of operation? Then check Lewis Asbestos Covered Wire before you specify. Regardless of what your wire problem is—dropping excessive voltages—filament dropping resistor in the line—high current conductors, it doesn't matter, just . . .

- HEATING UNITS
- HEATING ELEMENTS
- RESISTANCE LINE CORD
- THERMOCOUPLE WIRE
- ASBESTOS LEAD & FIXTURE WIRE
- INSULATED RESISTANCE WIRE
- FIBERGLAS INSULATED WIRE
- WIRE TO ANY SPECIFICATIONS

**Let Lewis Build The Wire For You**

Send your electronic control, communications or appliance wiring specifications for a recommended solution by our engineers.  
FOR A TRIAL ORDER OR A CARLOAD consult



**THE LEWIS ENGINEERING CO.**

Wire Division  
NAUGATUCK CONNECTICUT

**If** you need  
**Radio Parts...**



in quantities  
suitable to Volume  
Production...it may  
pay you to call upon

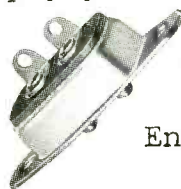

the Design  
Engineers of

United-Carr and its  
subsidiaries. They  
have helped many  
manufacturers



- ★ CUT COSTS
- ★ SPEED PRODUCTION
- ★ TURN OUT FINER FINISHED PRODUCTS

**UNITED-CARR**  
**FASTENER Corp.**  
CAMBRIDGE 42, MASSACHUSETTS

MAKERS OF **DOT** FASTENERS

well as magnets and saturable reactors, according to a catalog sheet just issued.

**Industrial Glass.** Kopp Glass, Inc., Swissvale, Pa. A new 24-page bulletin just printed in color describes glass products for industry, including some for the electronics field.

**Vibration Control.** Vibrashock Division of Robinson Aviation, Inc., Malcolm Ave., Teterboro, N. J., announces a new catalog, particularly for product design engineers, showing complete suspensions for the mounting of equipment in standard and special sizes. The many factors entering into vibration control are treated.

**Insulation Testing.** Associated Research, Inc., 231 S. Green St., Chicago 7, Ill. Bulletin 302 explains the applications and use of the model 404 Hypot, an instrument which independently tests breakdown, leakage, and shorting of insulation with the use of lights to discriminate between them. Range is from 0 to 4,000 volts.

**Plastics.** General Electric Co., Chemical Dept., Pittsfield, Mass. Bulletin CDP-578 is a 15-page illustrated description of molded and laminated plastics. Also discussed are sealing caps and sleeves, mycalex, silicone rubber, and h-f insulation. Property tables are included for reference.

**Permanent Magnets.** General Electric Co., Chemical Dept., Pittsfield, Mass. CDM-12 is an eight-page illustrated bulletin describing cast and sintered Alnico, Cunife, Cunico, Vectolite, Silmanal and various permanent magnet holding assemblies. Special alloys are also discussed.

**Interlock Switch.** Micro Switch, Freeport, Ill. Data sheet no. 45 describes the 1AC1 and 1AC2 interlock door switches designed for use on h-f radio, radar, x-ray and television equipment cabinets, induction heating equipment, and electronic controls of all types.

**Electromatic Tester.** Tinius Olsen Testing Machine Co., 1022 Easton Rd., Willow Grove, Pa. Bulletin 37

# HARDWICK, HINDLE

## Tubular Rheostats

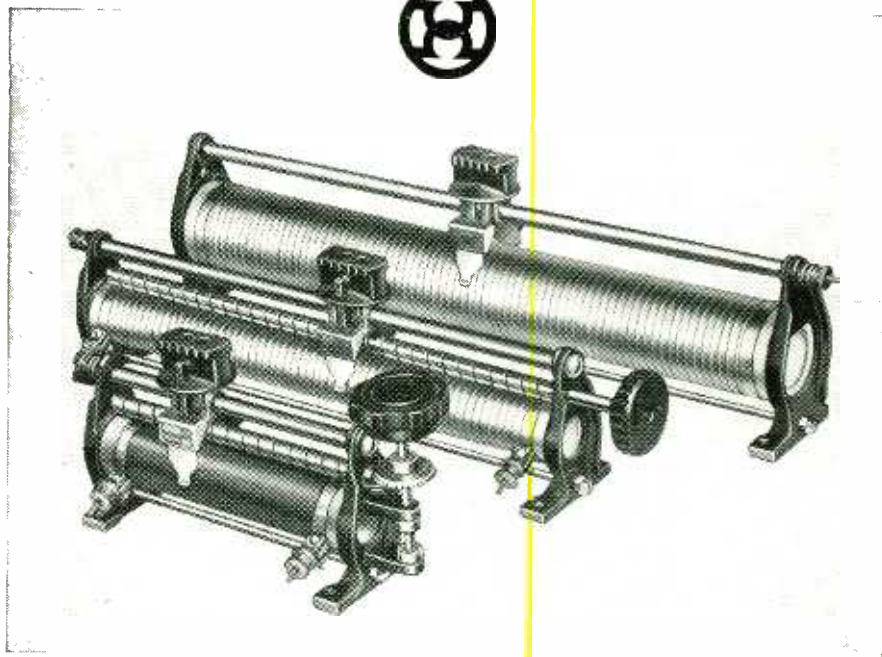

**T**HESE FINE SLIDING contact rheostats are widely used in laboratories. They serve as rheostats or potentiometers;—portable, easily mounted, with fine gradations of adjustment.

These sturdy, improved tubular rheostats are used for accurate adjustment of voltage or current in meter-checking laboratories;—as field rheostats for generator and motor control;—as filament and plate control in radio and audio transmitting and amplifying apparatus;—for control of illumination and heat control in electric furnaces and ovens; as well as in general laboratory use.

Available in 3 sizes: 200, 400 and 750 watts with any one of 3 types of control.

Hardwick, Hindle resistors and rheostats offer many exclusive advantages. We ask you to give our engineers an opportunity to discuss your specific requirements.

## HARDWICK, HINDLE, INC.

### Rheostats and Resistors

Subsidiary of

**THE NATIONAL LOCK WASHER COMPANY**

NEWARK 5, N. J.      Established 1886      U. S. A.



# The Advance Hermetically Sealed Relay



Hermetically sealed **ADVANCE** relays maintain their original efficiency under conditions that soon ruin or dangerously impair other types of relays. Dust, moisture, oil, or fungus cannot reach precisely adjusted parts.

There can be no failure due to arcing, or condensation in the low atmospheric pressure of high altitudes. Important, too, is the fact that these relays are "Tamper-Proof"!

ANY Advance relay can be furnished in hermetically sealed containers on special order.

Built to Army and Navy specifications upon request. Write today for further details and catalog of complete line.



## Advance Relays

**ADVANCE ELECTRIC & RELAY CO.**  
1260 West 2nd Street, Los Angeles 26, Calif.

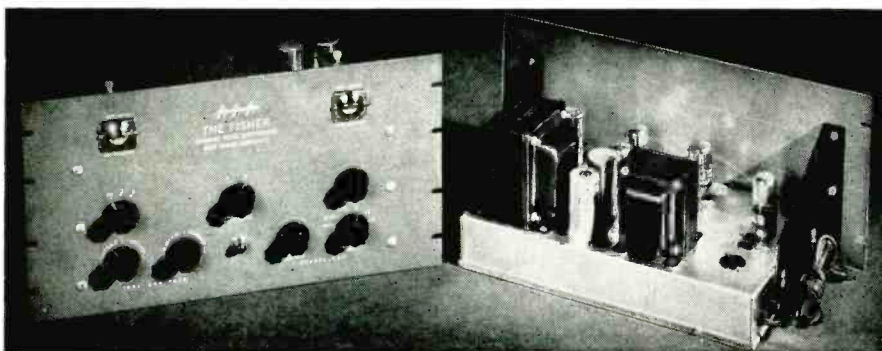

## By a Wide Margin—the BEST!

# The Fisher

### NOISE SUPPRESSOR\* AND AMPLIFIER

■ For the *ultimate* in record reproduction without scratch, without rumble, coupled with an amplifier of *professional* quality, there can only be one choice—THE FISHER. Less than 1% distortion at 20 watts, 17 tubes, two-chassis construction, two gate indicators, high quality preamplifier for G.E. and similar pickups, three inputs, uniform response 20-20,000 cycles. Available for 10-day trial, if desired.

PRICE \$254.50 • IMMEDIATE DELIVERY • WRITE FOR DETAILS

\* Licensed under Hermon Hosmer Scott pat. pdg.

FISHER RADIO CORPORATION • 45 East 47th St., N. Y.

**MANUFACTURERS:**

**QUICKER!**

**MORE ACCURATE!**

## TELEVISION SET

### Alignment & Adjustment

## TIC PRECISION GENERATORS

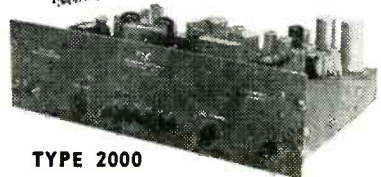

TYPE 2000

### BAR & DOT GENERATOR

Efficient push-button unit for swift, precise adjustment of horizontal & vertical sweep linearity of television receivers. Used in conjunction with Standard Synchronizing Signal and Monoscope Generator or other pattern or picture signal generator. Requires only 5 1/4" of standard rack space. Five convenient push-buttons allow instantaneous selection of:

- Standard blanking
- Vertical bars only
- Horizontal bars only
- Vertical & horizontal bars
- Complete dot pattern.

Has phasing control for adjustment of vertical bar position. Power supply is self contained.



TYPE 1900

### CRYSTAL CONTROLLED MULTI-FREQUENCY GENERATOR

A 10 frequency, 400 cps modulated crystal controlled oscillator, ideal for production line adjustment of stagger tuned I.F. amplifiers in television sets. Available with crystals ranging from 17 to 40 mc. provided to exact frequency and in sequence specified by customer. Each frequency is immediately selectable by means of a push button. Output adjustable. Power supply is self contained.

Write for bulletins 2000 & 1900

## TEL Instrument Co. Inc.

50 PATERSON AVE.  
East Rutherford, New Jersey  
Rutherford 2-9720

is a four-page folder devoted to the Electromatic low-capacity universal testing machine. The unit gives wide spread ranges of 250 to 1, extension ranges of 200 to 1 and straining ranges of 400 to 1. Complete specifications are listed.

**Waterproof Connectors.** Cannon Electric Development Co., 3209 Humboldt St., Los Angeles 31, Calif. A new 6-page bulletin W-248 gives dimensional data on the three sizes of type W waterproof connectors, together with photos of underwater geophysical applications. These plugs and receptacles are built to withstand pressures up to 250 pounds or approximately 550 ft underwater for all types of circuits in radio, sound, or power.

**Electrical Connectors.** Mines Equipment Co., Dept. 12, 4215 Clayton Ave., St. Louis 10, Mo. Bulletin MC108 illustrates and describes in detail a line of molded neoprene rubber electrical connectors and associated equipment. Products are identified by short three-letter symbols. Tabular index is included.

**Cylindrical Capacitors.** Cornell-Dubilier Electric Corp., South Plainfield, N. J. Descriptive bulletin NB-105 treats of the compact cylindrical-type capacitors, RC-111 and RC-112. Ratings are 0.005  $\mu$ f at 6,000 volts d-c and 0.05  $\mu$ f at 6,000 volts d-c, respectively. They are designed for safe operation from -55 to +100 C, are hermetically sealed, and Dykanol impregnated and filled.

**Technician's Catalog.** Walter L. Schott Co., 9306 Santa Monica Blvd., Beverly Hills, Calif. The 1948 catalog lists and describes a complete line of hardware, chemicals, tools, finishing materials, and service items for the electronic technician. Prices are included.

**Insulation Tester.** Herman H. Sticht Co., Inc., 27 Park Place, New York, N. Y. Illustrations, general description, outstanding features and specifications of the Minor Megohmer insulation tester are found in bulletin 450. The portable instrument weighs three pounds. It has a d-c generator with a 500-volt d-c output, and measures up to 50 megohms.

# TUBING THIN AS A HAIR

## Accurate to the Nth Degree

Here is tubing—Precision Tubing—so fine that its inside diameter is hardly visible to the naked eye. Yet this same tubing is dimensionally accurate to the Nth degree. Such extremes in meeting tubing specifications are made possible by Precision's unique production methods and tungsten carbide tooling . . . the same methods used to produce tubing in the sizes, shapes, and alloys you specify.

Precision Tubing is available in outside diameters ranging from 0.500" to 0.010", wall thicknesses down to 0.0015". Whatever non-ferrous metal you require—aluminum alloy, brass, copper, nickel, or monel—Precision Tubing can be formed exactly to the shape you specify . . . ready on good delivery.

When Precision Counts . . . Count on Precision

# PRECISION TUBE CO.



Factory: 3824-26-28 TERRACE STREET, PHILADELPHIA 28, PA.



# Additions and Corrections

## PRODUCT LISTINGS

The following listings are to be used in conjunction with the June 1948-1949 ELECTRONICS BUYERS' GUIDE for information on manufacturers' names, addresses and products omitted or incorrectly listed in that issue.

Designed for



Application

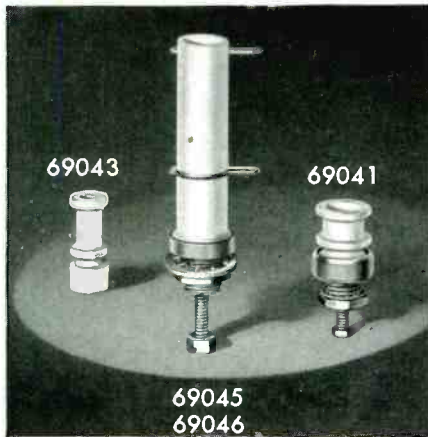

The No. 69040 Series  
of  
PERMEABILITY TUNED  
CERAMIC FORMS

In addition to the popular shielded plug-in permeability tuned forms, 74000 series, the 69040 series of ceramic permeability tuned unshielded forms are available as standard stock items. Winding diameters and lengths of winding space are  $\frac{13}{32} \times \frac{7}{32}$ ;  $\frac{1}{4} \times \frac{3}{8}$ ; and  $\frac{1}{2} \times \frac{1}{16}$ , for the 69041, 69043 and 69045 respectively. Nos. 69043 and 69046 have powdered iron slugs while Nos. 69041 and 69045 have copper slugs.

**JAMES MILLEN  
MFG. CO., INC.**

MAIN OFFICE AND FACTORY  
MALDEN  
MASSACHUSETTS



### AMPLIFIERS—Audio Frequency

Allied Radio Corp., 833 W. Jackson Blvd.,  
Chicago 7, Ill.  
Planet Radio Mfg. Corp., 6508 Euclid  
Ave., Cleveland 3, Ohio

### AMPLIFIERS—Audio Input Systems

Allied Radio Corp., 833 W. Jackson Blvd.,  
Chicago 7, Ill.

### AMPLIFIERS—Decade

Keithly Instrument Co., 1508 Crawford  
Road, Cleveland 6, Ohio

### AMPLIFIERS—Facsimile

Acme Teletronix, Div. of NEA Service  
Inc., West Third and Lakeside, Cleve-  
land 13, Ohio

### AMPLIFIERS—Peak Limiting

Acme Teletronix, Div. of NEA Service  
Inc., West Third and Lakeside, Cleve-  
land 13, Ohio

### AMPLIFIERS—Photocell

Acme Teletronix, Div. of NEA Service  
Inc., West Third and Lakeside, Cleve-  
land 13, Ohio

### AMPLIFIERS—Wideband

Tel-Instrument Company, Inc., 50 Pater-  
son Ave., East Rutherford, N. J.

### ANTENNAS—Television

Intra-Video Corp. of America 851 Madis-  
son Ave., New York 21, N. Y.

### ATTENUATORS

Shalleross Mfg. Co., 10 Jackson Ave.,  
Collingdale, Pa.

### CAPACITORS—Oil Impregnated

Crown Capacitor Corp., Minot & Depot  
Sts., Wrentham, Mass.

### CAPACITORS—Paper Tubular

Crown Capacitor Corp., Minot & Depot  
Sts., Wrentham, Mass.

### CAPACITORS—Wax Impregnated

Crown Capacitor Corp., Minot & Depot  
Sts., Wrentham, Mass.

### CHOKES—Filter

Empire Coil Co., Inc., 238 Huguenot St.,  
New Rochelle, N. Y.

### COIL ASSEMBLIES

Fugle-Miller Laboratories, 398 Main St.,  
Metuchen, N. J.

### COILS—Antenna

Fugle-Miller Laboratories, 398 Main St.,  
Metuchen, N. J.

### COILS—Choke

Empire Coil Co., Inc., 238 Huguenot St.,  
New Rochelle, N. Y.  
Fugle-Miller Laboratories, 398 Main St.,  
Metuchen, N. J.

### COILS—Magnet

Fugle-Miller Laboratories, 398 Main St.,  
Metuchen, N. J.

### COILS—Multiple Wound

Fugle-Miller Laboratories, 398 Main St.,  
Metuchen, N. J.

### COILS—Pickup

Fugle-Miller Laboratories, 398 Main St.,  
Metuchen, N. J.

### COILS—Power & a-f Coils & Windings

Fugle-Miller Laboratories, 398 Main St.,  
Metuchen, N. J.

### COILS—r-f & i-f Receiving & Trans- mitting

Fugle-Miller Laboratories, 398 Main St.,  
Metuchen, N. J.

### COILS—Relay & Solenoid

Fugle-Miller Laboratories, 398 Main St.,  
Metuchen, N. J.

### COILS—Television Focusing

Fugle-Miller Laboratories, 398 Main St.,  
Metuchen, N. J.

### COILS—Transformer Coils & Windings

Fugle-Miller Laboratories, 398 Main St.,  
Metuchen, N. J.

### COMMUNICATION SYSTEMS—Fac- simile

Acme Teletronix, Div. of NEA Service  
Inc., West Third and Lakeside, Cleve-  
land 13, Ohio

### CONNECTORS—Cable Connectors & Couplings

Electro-Connector Corp., 110 W. Oxford  
St., Phila. 22, Pa.

### CONTROLS—Alarm System

Photobell Company, 116 Nassau St., New  
York 7, N. Y.

### CONTROLS—Counter

Photobell Company, 116 Nassau St., New  
York 7, N. Y.

### CONTROLS—Fluid Conductivity

General Controls Co., Glendale, Califor-  
nia

### CONTROLS—Inspection

Photobell Company, 116 Nassau St., New  
York 7, N. Y.

### CONTROLS—Photoelectric

Photobell Company, 116 Nassau St., New  
York 7, N. Y.

### CONTROLS—Skew

Acme Teletronix, Div. of NEA Service  
Inc., West Third and Lakeside, Cleve-  
land 13, Ohio

(Continued on page 247)

For new simplicity, wide range, and high accuracy in the control of modern electronic circuits...



Cutaway view of the HELIPOT (Model A—10 Turn—1 3/4" Diameter)

## THE BECKMAN Helipot

(Trademark of the HELical POTentiometer)

Provides many times greater resistance control in same panel space as conventional potentiometers!

IF YOU are designing or manufacturing any type of precision electronic equipment be sure to investigate the greater convenience, utility, range and compactness that can be incorporated into your equipment by using the revolutionary HELIPOT for rheostat-potentiometer control applications...and by using the new DUODIAL turns-indicating knob described at right.

Briefly, here is the HELIPOT principle... whereas a conventional potentiometer consists of a single coil of resistance winding, the HELIPOT has a resistance element many times longer coiled helically into a case which requires no more panel space than the conventional unit. A simple, foolproof guide controls the slider contact so that it follows the helical path of the resistance winding from end to end as a single knob is rotated. Result...with no increase in panel space requirements, the HELIPOT gives you as much as 12 times\* the control surface. You get far greater accuracy, finer settings, increased range—with maximum compactness and operating simplicity!

### COMPLETE RANGE OF TYPES AND SIZES

The HELIPOT is available in a complete range of types and sizes to meet a wide variety of control applications...

**MODEL A:** 5 watts, 10 turns, 46" slide wire length, 1 3/4" case dia., resistances 10 to 50,000 ohms, 3600° rotation.

**MODEL B:** 10 watts, 15 turns, 140" slide wire length, 3 1/4" case dia., resistances 50 to 200,000 ohms, 5400° rotation.

**MODEL C:** 3 watts, 3 turns, 13 1/2" slide wire length, 1 3/4" case dia., resistances 5 to 15,000 ohms, 1080° rotation.

**MODEL D:** 15 watts, 25 turns, 234" slide wire length, 3 1/4" case dia., resistances 100 to 300,000 ohms, 9000° rotation.

**MODEL E:** 20 watts, 40 turns, 373" slide wire length, 3 1/4" case dia., resistances 150 to 500,000 ohms, 14,400° rotation.

Also, the HELIPOT is available in various special designs... with double shaft extensions, in multiple assemblies, integral dual units, etc.

Let us study your potentiometer problems and suggest how the HELIPOT can be used—possibly is already being used by others in your industry—to increase the accuracy, convenience and simplicity of modern electronic equipment. No obligation, of course. Write today outlining your problem.

\*Data for Model A, 1 3/4" dia. Helipot. Other models give even greater control range in 3" case diameters.

# THE Helipot CORPORATION, SOUTH PASADENA 2, CALIFORNIA

Due to circumstances beyond control the above advertisement did not appear in the 1948 Buyers' Guide issue of ELECTRONICS. You may wish to file this data with your Buyers Guide issue

## THE BECKMAN Duodial



The inner, or Primary dial of the DUODIAL shows exact angular position of shaft during each revolution. The outer, or Secondary dial shows number of complete revolutions made by the Primary dial.

A multi-turn rotational-indicating knob dial for use with the HELIPOT and other multiple turn devices.

THE DUODIAL is a unique advancement in knob dial design. It consists essentially of a primary knob dial geared to a concentric turns-indicating secondary dial—and the entire unit is so compact it requires only a 2" diameter panel space!

The DUODIAL is so designed that—as the primary dial rotates through each complete revolution—the secondary dial moves one division on its scale. Thus, the secondary dial counts the number of complete revolutions made by the primary dial. When used with the HELIPOT, the DUODIAL registers both the angular position of the slider contact on any given helix as well as the particular helix on which the slider is positioned.

Besides its use on the HELIPOT, the DUODIAL is readily adaptable to other helically wound devices as well as to many conventional gear-driven controls where extra dial length is desired without wasting panel space. It is compact, simple and rugged. It contains only two moving parts, both made entirely of metal. It cannot be damaged through jamming of the driven unit, or by forcing beyond any mechanical stop. It is not subject to error from backlash of internal gears.

### TWO SIZES—MANY RATIOS

The DUODIAL is now available in a 2" diameter model and soon will also be available in a new 1 3/4" diameter model for main control applications. Standard turns-ratios include 10:1, 15:1, 25:1 and 40:1 (ratio between primary and secondary dials). Other ratios can be provided on special order. The 10:1 ratio DUODIAL can be readily employed with devices operating fewer than 10 revolutions and is recommended for the 3-turn HELIPOT. In all types, the primary dial and shaft operate with a 1:1 ratio, and all types mount directly on a 1/4" round shaft.

### Send for this HELIPOT AND DUODIAL CATALOG!

Contains complete data, construction details, etc., on the many sizes and types of HELIPOTS... and on the many unique features of the DUODIAL. Send for your free copy today!





# BETA HIGH VOLTAGE POWER SUPPLIES

**PROBLEM:** A group of physical chemists doing research in semi-conductor properties required a very low ripple compact adjustable power supply, capable of providing 0-30 KV DC.



**BETA Built it!**

### MAJOR SPECIFICATIONS

Input: 115 volts, 50/60 cycles; 150 volt-amperes  
 Output Voltage: Low range, 0-3 KV  
 High range, 3-30 KV  
 Positive grounded  
 Output Current: 75  $\mu$ a available at 30 KV.  
 Ripple: Less than 0.01% at 50  $\mu$ a and any voltage.  
 Size: 21" x 15" x 15"

Power supplies up to 200,000 volts DC, regulated or unregulated, built to specifications. Compactness, low cost and rapid delivery featured.

Submit your high voltage power supply requirements to us for a prompt bid on price and delivery.

### OTHER BETA PRODUCTS INCLUDE:

**KILOVOLTMETERS:** Up to 50 KV at 50,000 ohms per volt, 20  $\mu$ a drain.

**PORTABLE POWER SUPPLIES:** Adjustable from 0 to 30 KV DC. Regulated and unregulated units available.

**ELECTRONIC MICROAMMETERS:** 0.01  $\mu$ a full-scale to 100  $\mu$ a full-scale in 5 decade ranges. Cannot be damaged by overload.

**ELECTRONIC RHEOSTATS:** Resistance continuously variable from above 100,000 megohms to below 100,000 ohms. Good for voltages up to 15 KV.

Send for descriptive literature

Sales Engineers throughout the country are at your service to discuss our products more thoroughly with you.

**BETA  
ELECTRONICS CO.**  
1762 Third Ave., New York 29, N. Y.

# Smooth

SMOOTH WIRE

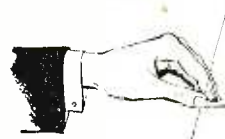

SMOOTH WINDING

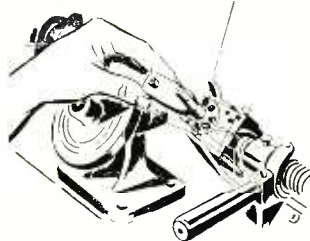

SMOOTH OPERATION



From every angle you'll find Essex Extra Test Magnet Wire a smooth product to use in your winding department. In the battle for profitable production it minimizes time lost because of hard and springy wire... tacky insulation film... poor size uniformity from spool-to-spool... and frequent tension adjustments. The chances are, Essex Extra Test Magnet Wire can prove its superiority for you. (

## ESSEX WIRE CORP.

FORT WAYNE 6, INDIANA

Plants: Anaheim, Calif.; Detroit, Mich.; Fort Wayne, Ind. Warehouses\* and Sales Offices: \*Atlanta, Ga.; \*Boston, Mass.; \*Chicago, Illinois; \*Cleveland, Ohio; \*Dallas, Texas; \*Dayton, Ohio; \*Detroit, Mich.; \*Kansas City, Mo.; \*Los Angeles, Calif.; \*Milwaukee, Wis.; \*Newark, N. J.; \*Philadelphia, Pa.; \*Portland, Oreg.; \*St. Louis, Missouri; \*San Diego, Calif.; \*San Francisco, California



EXPORT SALES OFFICE—LIONEL-ESSEX INTERNATIONAL CORPORATION, 15 E. 26th ST., NEW YORK 10, N.Y.

## BAACH-INTERNATIONAL

### EIGHT HEAD HOT-CUT FLARE MACHINE

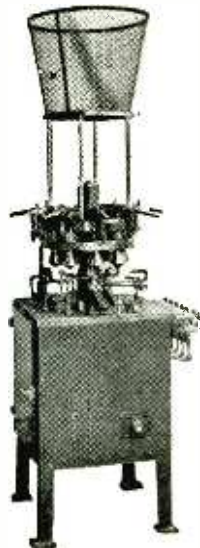

Dimensions  
24"x24"x72" high

Automatic throughout.

Can be synchronized with automatic Stem machine.

Cuts off and flares in one operation.

Production 1250 flares per hour. For miniature flares, fluorescent starters, standard size lamps, fluorescent and radio tubes.

**RANGE OF MACHINE**  
Glass tubing  
27 to 45 gauge

Length of flares  
5 mm. to 80 mm.

Forms flares up to  
47 mm. diam.

Net weight, 960 lbs.  
Gross weight  
1450 lbs.

### INTERNATIONAL MACHINE WORKS

Manufacturers of High Vacuum Pumps, Automatic Machinery for Incandescent Lamps, Electronic Tubes since 1916.

2027 - 46TH STREET  
NORTH BERGEN, N. J., U. S. A.

Tel. UNion 3-7412,  
Cable Address "Intermach" North Bergen, N. J.



## ECLIPSE

ANNOUNCES

### A NEW LINE OF DELUXE DESK PANEL CABINET RACKS

- Available in six sizes from 8 3/4" panel space to 35". All units 15" deep.
- Black or grey ripple finish, as specified.
- Rigidly constructed of 16 gauge steel.
- Panel mounting holes tapped 10-32 for either Western Electric or Amateur notched panels.
- All doors provided with flush catches.

These cabinet racks are the newest product in a quality line of metal equipment. A partial list of products includes chassis, panels, cases, standard and deluxe cabinets, sloping front cabinets, amplifier foundations and standard and deluxe cabinet racks. Each item is made in a variety of stock sizes, and is adaptable to fit every requirement.

CATALOG SENT ON REQUEST

### ECLIPSE MANUFACTURING CO., INC.

CABINETS • PANELS • CHASSIS  
294 East 137th Street New York 54, N. Y.



ADDITIONS AND CORRECTIONS (continued)

**CONVERTERS—f-m**

Acme Telectronix, Div. of NEA Service Inc., West Third and Lakeside, Cleveland 13, Ohio

**FILTERS—Band Elimination**

Filtron Co., The, 38-25 Bell Blvd., Bay-side, Long Island, N. Y.

**FILTERS—Band Pass**

Filtron Co., The, 38-25 Bell Blvd., Bay-side, Long Island, N. Y.

**FILTERS—Electric Wave Section**

Filtron Co., The, 38-25 Bell Blvd., Bay-side, Long Island, N. Y.

**FILTERS—Noise**

Filtron Co., The, 38-25 Bell Blvd., Bay-side, Long Island, N. Y.

**FILTERS—uhf & vhf**

Filtron Co., The, 38-25 Bell Blvd., Bay-side, Long Island, N. Y.

**FORKS—Electrically Driven Tuning**

Acme Telectronix, Div. of NEA Service Inc., West Third and Lakeside, Cleveland 13, Ohio

**GALVANOMETERS**

Acme Telectronix, Div. of NEA Service Inc., West Third and Lakeside, Cleveland 13, Ohio

**GENERATORS, SIGNALS—r-f**

Tel-Instrument Company, Inc., 50 Pater-son Ave., East Rutherford, N. J.

**GENERATORS, SIGNAL—Sweeping**

Tel-Instrument Company, Inc., 50 Pater-son Ave., East Rutherford, N. J.

**GENERATORS, SIGNAL — Television Synchronizing**

Tel-Instrument Company, Inc., 50 Pater-son Ave., East Rutherford, N. J.

**GENERATORS — Television Linearity Checking**

Tel-Instrument Company, Inc., 50 Pater-son Ave., East Rutherford, N. J.

**HEARING AID CHOKES**

Microtone Company, The, 4602 Nicollet Ave., Minneapolis 9, Minn.

**HEARING AID TRANSFORMERS**

Microtone Company, The, 4602 Nicollet Ave., Minneapolis 9, Minn.

**HEARING AIDS**

Microtone Company, The, 4602 Nicollet Ave., Minneapolis 9, Minn.

**LOUDSPEAKERS**

Best Manufacturing Co., Inc., 1200 Grove St., Irvington 11, N. J.

**LUGS AND TERMINALS**

Sheffco Mfg. Co., 116 W. Ruby Ave., Palisades Park, N. J.

**METAL PARTS — Small Metal Stampings**

Sheffco Mfg. Co., 116 W. Ruby Ave., Palisades Park, N. J.

**METERS—Photoelectric Reflection**

Acme Telectronix, Div. of NEA Service Inc., West Third and Lakeside, Cleveland 13, Ohio

**MICROWAVE TRANSMISSION LINKS & MICROWAVE ACCESSORIES**

Technicraft Laboratories, Inc., Box 1908, Waterbury, Conn.

ELECTRONICS — October, 1948

*Back of every Racon product*

**ADVANCED ENGINEERING**

When you invest in a Racon Horn or Speaker you get all-around super-efficiency—qualities that can not be duplicated by units of conventional type. Such units may resemble Racon units externally but only a Racon has the internal construction features that bring you top performance. Racon superiority is the result of Advanced Engineering — improvements developed in the Racon Laboratories by Racon Engineers through tireless research and testing. For unmatched performance, long life and economy install a Racon.

**RACON DOUBLE RE-ENTRANT TRUMPET**  
*(Illustrated above)*

An excellent example of Racon scientific engineering. Designed to deliver highly concentrated sound over long ranges with maximum efficiency. Seven models, ranging in length from 6-5/8" to 28". All with aluminum casting inside tone arm and bell of heavy gauge aluminum spinning. Large sizes built with center reflecting section of Racon Acoustic material for preventing resonant effects. Smaller sizes have heavy gauge aluminum spinning for center section. Strong construction, practically abuse proof. Fitted with swivel mounting ratchet wall bracket. For larger sizes U-bracket mounting will be supplied on request, at no extra cost.

**PERMANENT MAGNET HORN UNITS**

These units, highly popular in all types of service, embody many improvements. Two groups, with Alnico V Magnets and Alnico Blue Dot Magnets. All steel parts plated to prevent corrosion. Also fitted with corrosion proof metal or plastic diaphragms. Voice coil impedance on all units: 15 ohms, except dwarf size—which is 8 ohms. Special ohmages on request.

**NOW FURNISHED WITH WATERPROOF CASING**

All units, from junior to giant size, may now be had with heavy spun aluminum case, forming a close fitting hermetically sealed, watertight housing for outdoor use. Waterproof type at slight extra cost.

Write for Catalog or Complete Racon Line  
**RACON ELECTRIC CO., INC.**  
52 E. 19th Street, New York, N. Y.

**RACON** *Speakers Horn Units Horns*



**Convenient  
Decimal Scale  
Registration!**

**For Radioactivity  
Measurements!**



- ★ Direct Decimal Scale Registration
- ★ Scaling Factors of 10, 100 and 1000
- ★ Low Resolution Time — 5 Microseconds
- ★ Self-Contained Mechanical Register
- ★ Regulated High Voltage Power Supply
- ★ Provision for Clock Timer
- ★ High Sensitivity — 0.25 Volt
- ★ Stable, No Adjustments
- ★ High Quality Construction

**THE NEW POTTER  
DECADE SCALER  
Model 2092—\$495.00**

FOR COMPLETE LITERATURE OR CONSULTATION ON HIGH SPEED COUNTING, TIMING AND CONTROL PROBLEMS CALL OR WRITE DEPARTMENT 6P, TODAY.

**POTTER INSTRUMENT COMPANY  
INCORPORATED**  
136-56 ROOSEVELT AVENUE • FLUSHING, NEW YORK



ADVANCE — AMPHENOL — AEROVOX — ASTATIC  
ALTEC-LANSING BRUSH  
B & W-BUD BLILEY  
BIRN BACH BROWNING  
BURGESS CARDWELL-DRAKE  
CENTRALAB — CIN AUDAGRAPH — CORNELL — DUBLIER  
EIMAC — ELECTROVOICE — GE — JFD — IRC — JENSEN  
MALLORY — LITTLEFUSE — MEISSNER — MILLEN  
MILLER — NATIONAL — OHMITE — RCA — SANGAMO  
SHURE — UTAH — STEVENS — STANCOR — WELLER  
UNIVERSITY — SYLVANIA — THORDARSON — WEBSTER  
PICKERING — ICA — PRECISION — UNITED ELECT.  
CALL JACK KIRSCHBAUM AT DIGBY 9-4714

**ARROW ELECTRONICS**  
INCORPORATED  
82 CORTLANDT STREET, NEW YORK 7, N.Y.

**3 steps**  
to  
**HIGHER  
PRODUCTION**  
and  
**LOWER  
COST**

**1. Consult** the Milford  
free engineering service



**2. Choose** one of 15  
basic  
Milford  
rivet setting  
machines —  
offering  
unlimited  
versatility.



**3. Select** exactly the  
right semi-  
tubular or split  
rivet or cold-  
headed  
fastener from  
Milford's  
complete line.



**MILFORD**

**RTV-TT**  
& MACHINE COMPANY

1000 MERWIN ROAD,  
MILFORD, CONN.

1000 WEST RIVER ST.,  
ELYRIA, OHIO

ADDITIONS AND CORRECTIONS (continued)

**MOTORS—Servo**

Hansen Mfg. Co., Inc., Princeton, Indiana

**MOTORS—Synchronous**

Hansen Mfg. Co., Inc., Princeton, Indiana

**MOTORS—Timing**

Hansen Mfg. Co., Inc., Princeton, Indiana

**MULTIVIBRATORS**

Acme Telectronix, Div. of NEA Service Inc., West Third and Lakeside, Cleveland 13, Ohio

**MUSIC SYSTEMS—Industrial & Commercial**

Allied Radio Corp., 833 W. Jackson Blvd., Chicago, 7, Ill.

**OPTICAL EQUIPMENT AND OPTICAL SPECIALTIES**

Acme Telectronix, Div. of NEA Service Inc., West Third and Lakeside, Cleveland 13, Ohio

**OSCILLATORS—Audio Fork Controlled**

Acme Telectronix, Div. of NEA Service Inc., West Third and Lakeside, Cleveland 13, Ohio

**OSCILLOGRAPHS—Recording**

Acme Telectronix, Div. of NEA Service Inc., West Third and Lakeside, Cleveland 13, Ohio

**PHONOGRAPHS—Electric Phonographs & Record Players**

Shevers Inc., Harold, 33 W. 46th St., New York 19, N. Y.

**PICKUPS—Photoelectric**

Acme Telectronix, Div. of NEA Service Inc., West Third and Lakeside, Cleveland 13, Ohio

**PLUGS AND JACKS**

Electro-Connector Corp., 110 W. Oxford St., Phila. 22, Pa.

**POTS—Soldering**

Tech Laboratories, Inc., 337 Central Ave., Jersey City 7, N. J.

**POWER PACKS**

Electronic Controls Co. of New York, 3124 Avenue I, Brooklyn 10, N. Y.

**POWER SUPPLIES**

Electronic Controls Co. of New York, 3124 Avenue I, Brooklyn 10, N. Y.  
Fugle-Miller Laboratories, 398 Main St., Metuchen, N. J.

**POWER SUPPLIES—Electronically Regulated**

Acme Telectronix, Div. of NEA Service Inc., West Third and Lakeside, Cleveland 13, Ohio  
Fugle-Miller Laboratories, 398 Main St., Metuchen, N. J.

**POWER SUPPLIES—High Voltage**

Fugle-Miller Laboratories, 398 Main St., Metuchen, N. J.

**POWER SUPPLIES—Voltage Regulated**

Acme Telectronix, Div. of NEA Service Inc., West Third and Lakeside, Cleveland 13, Ohio

**RECEIVERS—a-m Fixed Frequency**

National Electronics Laboratories, Inc., 200 King St., Alexandria, Va.

ELECTRONICS — October, 1948

There's a True Thrift Lesson in—

*The Case of the Canceled Check*



**Office Manager:** Guess I've thrown away a canceled check I need badly to prove payment of a bill!

**Draftsman:** We have similar trouble. Instead of using permanent Arkwright Tracing Cloth for every drawing, we use temporary tracing paper. Then — when we happen to need it again, it has been discarded or has become brittle, opaque and useless in the file!

If a drawing is worth keeping — it is worth making on dependable Arkwright Tracing Cloth. The trifling extra cost insures years of permanence — no chance of becoming dogeared and torn by use nor opaque and illegible by age, as perishable tracing paper is apt to do. Arkwright is woven, bonded and processed for enduring transparency. It is real economy — good business — to use Arkwright, always!

Send for generous working samples of Arkwright and judge its superiority over any substitute. Arkwright is sold by leading drawing material dealers everywhere. Arkwright Finishing Co., Providence, R. I.

**The Big Six Reasons Why Arkwright Tracing Cloths Excel**

1. Erasures re-ink without feathering.
2. Prints are always sharp and clean.
3. Tracings never discolor or go brittle.
4. No surface oils, soaps or waxes to dry out.
5. No pinholes or thick threads.
6. Mechanical processing creates permanent transparency.



**ARKWRIGHT**  
**TRACING CLOTHS**  
AMERICA'S STANDARD FOR OVER 25 YEARS





**PIPE COUPLINGS**



**ELECTRICALLY HEATED PRESSURE HEADS**



**CONTINUOUS FILM RECORDING CAMERAS**

**AND EQUIPMENT FOR CATHODE RAY**

**OSCILLOGRAPHY, ETC.**



We undertake the Design, Development and Manufacture of any type of Optical-Mechanical-Electrical Instrument. Including Cameras for special purposes.

*Avimo Limited, Taunton, England • Telephone Taunton 3634*

**MODEL 204A REGULATED POWER SUPPLY**

**0-500 VOLTS D.C. AT 300 MA. WITH POSITIVE OR NEGATIVE GROUND**

The Model 204A Regulated Power Supply will provide from 0-500 volts of well regulated and well filtered D.C. The output voltage is continuously variable without switching and either positive or negative side may be grounded.



**SPECIFICATIONS:**

**OUTPUT VOLTAGE**  
High Voltage: 0-500 Volts D.C. continuously variable (Without switching).  
Current: 300 Ma.  
Low A.C. Voltage: 6.3 Volts A.C. at 6 amps. center-tapped, unregulated

**REGULATION**  
Within 1% for voltage between 30-500 volts, from no load to full load.  
Within 1% for line voltage variations from 105 to 125 volts at full load current for any voltage between 30-500 volts and within 2% at 10 volts.

**HUM VOLTAGE**  
Within 10 Millivolts at any voltage or load within ratings.

**LINE INPUT**  
105-125 Volts A.C. 50-60 cycles.

**OUTPUT TERMINATIONS**  
High and low voltage outputs available from front and rear of unit. Positive or negative terminal of high voltage output may be grounded as desired.

Detailed specifications will be forwarded upon request without obligation.



**ELECTRONIC MEASUREMENTS COMPANY**  
RED BANK • NEW JERSEY

*What are Your*  
**TRANSFORMER SPECIFICATIONS?**

Would a slight change from the "standard" electrical specifications improve the performance of your finished product? If so, get in touch with Acme Electric engineers for assistance in designing a "special" transformer from standard parts.

For television, radio, and other electronic applications, Acme produces a wide variety of transformers all with different specifications from standard parts. This means better performance, better quality and often at economy prices.



**ENCLOSED TYPES**



The dies for making transformers that fit into this enclosed case, alone would cost you thousands of dollars. Acme produces to save you this expense.



Here is a typical air-cooled design which can be produced to meet a variety of applications. Write for Bulletin 168A for further details.

**ACME ELECTRIC CORP.**  
3110 Water St. Cuba, N. Y.

**Acme Electric**  
TRANSFORMERS

**RECEIVERS—*a-m/f-m* Communication**

National Electronics Laboratories, Inc.,  
200 King St., Alexandria, Va.

**RECEIVERS—*f-m***

National Electronics Laboratories, Inc.,  
200 King St., Alexandria, Va.

**RECEIVERS—*Fixed Frequency***

National Electronics Laboratories, Inc.,  
200 King St., Alexandria, Va.

**RECEIVERS—*Police & Fire***

National Electronics Laboratories, Inc.,  
200 King St., Alexandria, Va.

**RECEIVERS—*Television***

Shevers Inc., Harold, 33 W. 46th St.,  
New York 19, N. Y.  
Tele King Corp., 601 W. 26th St., New  
York 1, N. Y.  
Telcor Corp., 351 Madison Ave., New  
York 21, N. Y.

**RECEIVERS—*uhf***

National Electronics Laboratories, Inc.,  
200 King St., Alexandria, Va.

**RECEIVERS—*vhf***

National Electronics Laboratories, Inc.,  
200 King St., Alexandria, Va.

**RECEIVERS, HOME—*a-m/f-m* Combina-  
tions**

Shevers Inc., Harold, 33 W. 46th St.,  
New York 19, N. Y.

**RECORDERS—*Facsimile***

Acme Telectronix, Div. of NEA Service  
Inc., West Third and Lakeside, Cleve-  
land 13, Ohio

**RECORDERS—*Film***

Acme Telectronix, Div. of NEA Service  
Inc., West Third and Lakeside, Cleve-  
land 13, Ohio

**RECTIFIERS—*Dry Disc***

Electronic Controls Co. of New York,  
3124 Avenue I, Brooklyn 10, N. Y.

**RESISTORS—*Temperature Sensitive***

Carborundum Co., Globar Div., Niagara  
Falls, N. Y.

**RESISTORS—*Voltage Sensitive***

Carborundum Co., Globar Div., Niagara  
Falls, N. Y.

**SCANNERS—*Reflected & Transmitted  
Light***

Acme Telectronix, Div. of NEA Service  
Inc., West Third and Lakeside, Cleve-  
land 13, Ohio

**SOCKETS—*Tube***

Electro-Connector Corp., 110 W. Oxford  
St., Phila., 22 Pa.

**SOUND SYSTEMS—*Complete***

Allied Radio Corp., 833 W. Jackson Blvd.,  
Chicago 7, Ill.  
Planet Radio Mfg. Corp., 6508 Euclid  
Ave., Cleveland 3, Ohio

**STANDARDS—*Frequency***

Acme Telectronix, Div. of NEA Service  
Inc., West Third and Lakeside, Cleve-  
land 13, Ohio

**STANDARDS—*Laboratory Time***

Acme Telectronix, Div. of NEA Service  
Inc., West Third and Lakeside, Cleve-  
land 13, Ohio

Joint Army-Navy R93 Specification  
**COMPARATIVE  
DATA**

TYPE  
1196

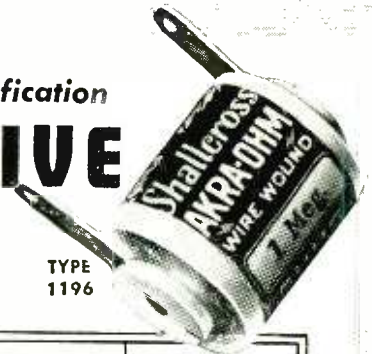

JAN Style Numbers RB	JAN Power Ratings Watts	Shallcross Type Numbers	Shallcross Power Ratings Watts
RB10	0.25	173 176*	0.25 0.25
RB11	1/3	183 183-A 186*	0.5 0.5 0.5
RB12	0.5	193*	1.0
RB13	0.5	196 1196**	1.0 1.0
RB14	1.0 1.0	116 1110**	2.0 2.0
RB20	0.75	100	1.0
RB21	Suggest JAN 20 or JAN 22		
RB22	1.5	110	2.0
RB40	0.4	120	0.25
RB41	0.5	140	0.5
RB42	0.6	160	1.0
RB51	0.25	181-A	0.5

NOTE: \* Indicates Maximum JAN Dimensions.  
\*\* Indicates Hermetically Sealed Resistor.

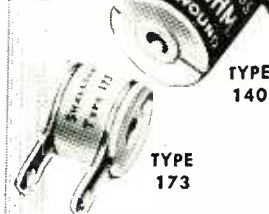

**JAN R93 and  
SHALLCROSS  
Akra-Ohm**

**Accurate Fixed Wire Wound  
RESISTOR TYPES**

Write today for Shallcross Resistor Engineering Bulletin R giving full details on Akra-Ohm Resistors for every need and including mounting and terminal designs; dimensions; power dissipation; resistance alloys; moisture and fungus-proofing and hermetic sealing data; temperature coefficient of resistance and maximum resistance charts.

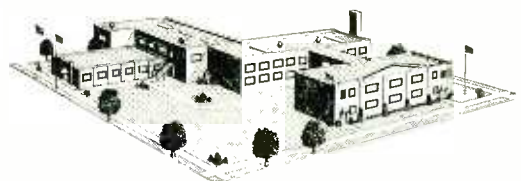

**SHALLCROSS MFG. CO.**

*Engineers • Designers • Manufacturers*

DEPT. E-108, COLLINGDALE, PA.



## Announcing

*A New Product by*

*Chicago Condenser Corporation*

*We have been licensed to manufacture  
Fabricated Plate Electrolytic Condensers*

*For all purposes*

*We are now ready to supply your needs*

*Your specifications for quotations will be  
given prompt attention*

*Chicago Condenser Corporation.*

*3255 West Armitage Ave. • Chicago 47, Ill.*

## POWDERED METAL CORES *PyroFerric's*

EXCLUSIVE SPECIALTY



Since 1933 PYROFERRIC has been the standard source for IRON CORES manufactured to desired permeability, frequency, "Q", resistance and physical strength . . . to fit any circuit.

*PYROFERRIC, with its background of research and experience, will gladly consult with you on your IRON CORE requirements.*

# PYROFERRIC Co.

621 EAST 216 ST., NEW YORK 67, N. Y.

# TO CHARGE MAGNETS!

ECONOMICALLY!

EFFICIENTLY!

QUICKLY!

SAFELY!

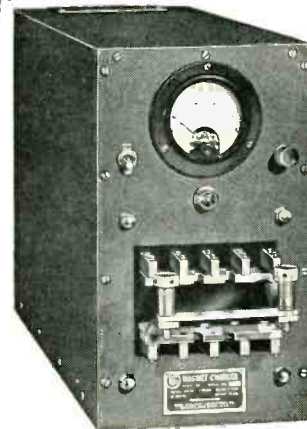

## MORE AND MORE COMPANIES ARE ADOPTING THE RFL MODEL 107 CHARGER

This portable, packaged unit will charge all kinds and shapes of magnets. Unique "flux-guide" fixtures developed by our engineers take full advantage of the charging current and accommodate multipole and oddly shaped magnets.

The charger weighs 75 pounds, can be moved about, and saves much valuable space. Plugging into any 110 volt AC outlet, it is completely safe and simple to operate for production charging by unskilled personnel.

The descriptive folder, E-10, gives complete information on the charger, shows typical fixtures and lists some of the many manufacturers, airlines, repair services and laboratories who use the Model 107. Write for this folder today and feel free to outline your magnet charging problems without obligation.

RADIO FREQUENCY



LABORATORIES, INC.  
Boonton, New Jersey

**SWITCHES—Mercury**

General Electric Co., Tube Div., Schenectady 5, N. Y.

**SYNCHRONIZERS—Electronic**

Acme Telectronix, Div. of NEA Service Inc., West Third and Lakeside, Cleveland 13, Ohio

**TELEVISION SYSTEMS—Industrial**

Telcor Corp., 851 Madison Ave., New York 21, N. Y.

**TESTERS—Microwave Radar Testing Equipment**

Technicraft Laboratories, Inc., Box 1908, Waterbury, Conn.

**TOOLS—Soldering Guns**

Weller Mfg. Co., 806 Packer St., Easton, Pa.

**TRANSFORMERS—Microwave**

Technicraft Laboratories, Inc., Box 1908, Waterbury, Conn.

**TRANSMITTERS—f-m**

National Electronics Laboratories, Inc., 200 King St., Alexandria, Va.

**TRANSMITTERS—Facsimile**

Acme Telectronix, Div. of NEA Service Inc., West Third and Lakeside, Cleveland 13, Ohio

**TRANSMITTERS—Fixed Frequency**

National Electronics Laboratories, Inc., 200 King St., Alexandria, Va.

**TRANSMITTERS—Fixed Station Communication**

National Electronics Laboratories, Inc., 200 King St., Alexandria, Va.

**TRANSMITTERS—Portable and Mobile Radio-Telephone**

National Electronics Laboratories, Inc., 200 King St., Alexandria, Va.

**TRANSMITTERS—Pulse Time Modulation**

National Electronics Laboratories, Inc., 200 King St., Alexandria, Va.

**TRANSMITTERS—Radio Range**

National Electronics Laboratories, Inc., 200 King St., Alexandria, Va.

**TRANSMITTERS—uhf**

National Electronics Laboratories, Inc., 200 King St., Alexandria, Va.

**TRANSMITTERS—vhf**

National Electronics Laboratories, Inc., 200 King St., Alexandria, Va.

**TUBE PARTS**

**Bases**

General Electric Co., Tube Div., Schenectady 5, N. Y.

**Caps**

General Electric Co., Tube Div., Schenectady 5, N. Y.

**Cathode Sleeves & Tubes**

General Electric Co., Tube Div., Schenectady 5, N. Y.

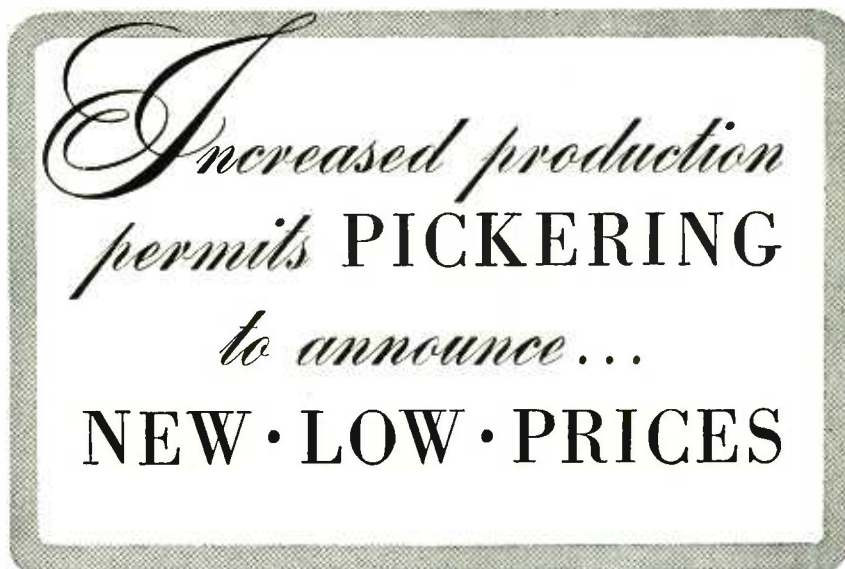

PICKERING reproducers have always been built to the highest standards of the critical listener willing to pay a premium for excellence in record reproduction.

The growing demand for Pickering quality and the resulting increase in production have made possible substantial price reductions.

Revised manufacturing techniques have enabled us to actually improve quality and lower prices at the same time.

We take great pleasure in giving our customers the benefit of lower production costs.

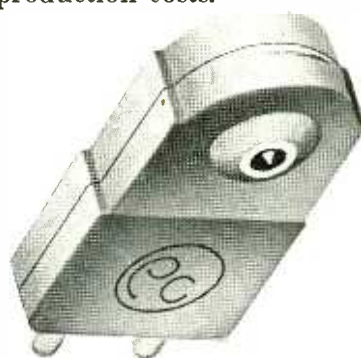

**Model S-120M**  
with .0027" Sapphire Stylus  
Former List Price—\$25.00  
Now \$16.50

**Model D-120M**  
with .0025" Diamond Stylus  
Former List Price—\$60.00  
Now \$41.50

**NEW...**

to the line of Pickering Cartridge Reproducers is the Model D-140S for the new long playing, MICROGROOVE type disc recordings. The D-140S has a diamond stylus of .001" radius, tracks with a pressure of 5 grams and, like all Pickering Cartridges, incorporates all of the known requirements for perfect tracking, minimum record and stylus wear, and distortion-free reproduction.



**Model D-140S with .001" Diamond Stylus \$60.00 List**

**Oceanside, Long Island, N. Y.**



**NEVER BEFORE  
AT ANY PRICE**



**SUCH VHF  
VERSATILITY!**

**THE NEW  
NATIONAL HFS  
\$125**  
(power supply extra)

**Complete Coverage  
27 mcs-250 mcs!**

Covers all mobile communication services, as well as fixed services. Receives CW, AM OR FM! Superheterodyne with superregenerative 2nd detector.

**Mobile, Portable  
or Fixed!**

Operates from standard 110 volt, 60 cycle National 5886 power supply, National 686S 6-volt vibrator-type power supply or batteries! Built-in speaker. Light.

See your nearest National dealer listed in the classified section of your 'phone book.



**ADDITIONS AND CORRECTIONS (continued)**

**Cathode Ray Tube Side Contacts**

General Electric Co., Tube Div., Schenectady 5, N. Y.

**Grids and Supports**

General Electric Co., Tube Div., Schenectady 5, N. Y.

**Heat Radiators**

General Electric Co., Tube Div., Schenectady 5, N. Y.

**Metal Supports**

General Electric Co., Tube Div., Schenectady 5, N. Y.

**Mica Supports**

General Electric Co., Tube Div., Schenectady 5, N. Y.

**Water Jackets**

General Electric Co., Tube Div., Schenectady 5, N. Y.

**Wire Parts**

General Electric Co., Tube Div., Schenectady 5, N. Y.

**TUBES—Phototubes and Photocells**

American Scientific Co., P. O. Box 1, High Bridge Station, New York 52, N. Y.

**WASHERS—Metal**

Sheffco Mfg. Co., 116 W. Ruby Ave., Palisades Park, N. J.

**WAVEGUIDES—Flexible**

Technicraft Laboratories, Inc., Box 1908, Waterbury, Conn.  
Titeflex, Inc., 410 Frelinghuysen Ave., Newark 5, N. J.

**WAVEGUIDES—Rigid**

Technicraft Laboratories, Inc., Box 1908, Waterbury, Conn.

**WIRE—Fine Wire Specialties**

Sheffco Mfg. Co., 116 W. Ruby Ave., Palisades Park, N. J.

**NAMES and ADDRESSES  
ADDITIONS and CORRECTIONS**

- Acme Telectronix, Div. of NEA Service Inc., West Third and Lakeside, Cleveland 13, Ohio
- Allied Radio Corp., 833 W. Jackson Blvd., Chicago 7, Ill.
- American Scientific Co., P.O. Box 1, High Bridge Station, New York 52, N. Y.
- De Jur-Amsco Corp., Northern Blvd. at 45th St., Long Island City 1, N. Y.
- Electro-Connector Corp., 110 W. Oxford St., Phila. 22, Pa.
- Electronic Controls Co. of New York, 3124 Avenue I, Brooklyn 10, N. Y.
- Electronic Instrument Co., Inc., 377 Blake Ave., Brooklyn, N. Y.
- Filtron Co., The, 38-25 Bell Blvd., Bay-side, Long Island, N. Y.
- Fugle-Miller Laboratories, 398 Main St., Metuchen, N. J.
- General Electric Co., Tube Div., Schenectady 5, N. Y.
- Hansen Mfg. Co., Inc., Princeton, Indiana
- Intra-Video Corp. of America, 851 Madison Ave., New York 21, N. Y.
- Kurman Electric Co., Inc., 35-18 37th St., Long Island City 1, N. Y.
- Microtone Company, The, 4602 Nicollet Ave., Minneapolis 9, Minn.
- Photobell Company, 116 Nassau St., New York 7, N. Y.
- Planet Radio Mfg. Corp., 6508 Euclid Ave., Cleveland 3, Ohio
- Sheffco Mfg. Co., 116 W. Ruby Ave., Palisades Park, N. J.
- Shevers Inc., Harold, 33 W. 46th St., New York 19, N. Y.
- Technicraft Laboratories, Inc., Box 1908, Waterbury, Conn.

**The latest—  
LOCKSEAM\*  
RECTANGULAR  
NICKEL  
CATHODES**

Here are the "new shapes", in which Superior Lockseam\* nickel cathodes are available. Full information on dimensions, tolerances and materials will be supplied upon request.

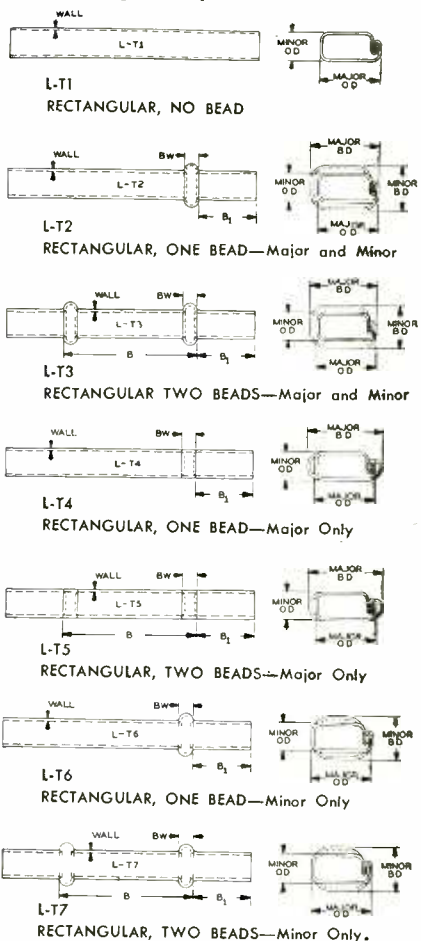

For other electronic and non-electronic tubing applications, use Superior Seamless and WELDRAWN†—and save!



**SUPERIOR TUBE CO.  
ELECTRONICS DIVISION**  
2500 Germantown Avenue  
Norristown, Pa.

\*Superior Tube Co. Patents  
†Reg. U. S. Trade Mark  
For Superior tubing on the West Coast, call PACIFIC TUBE COMPANY, 5710 Smithway Street, Los Angeles 22, Calif. ANgels 2-2151.

# POLARAD

TELEVISION *Equipment*

for studio • laboratory • manufacturer

## SYNCHRONIZING GENERATOR

Model PT 101—Television

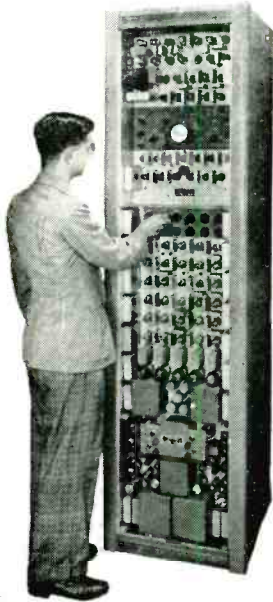

### FEATURES

- Built-in 3" oscilloscope with synchronized sweeps for viewing Timing and Video Output pulse wave forms.
- Synchronized marker system for checking pulse width and rise time.
- Extreme stability, insured by deriving all pulses from leading edge of master oscillator pulse.
- Means for checking synchronizing pulses in odd and even fields.

### SPECIFICATIONS

525 line, interlaced, 60 fields, 30 frames, RMA Synchronizing pulses held to tolerance specified in the NITFB report of 1945. Output Pulses: Synchronizing, Video Blanking, Camera Blanking, Horizontal Driving, Vertical Driving Pulses. 5 volts across 100 ohm termination. Dual output jacks. 115 volts 50/60 cps. Complete with tubes.

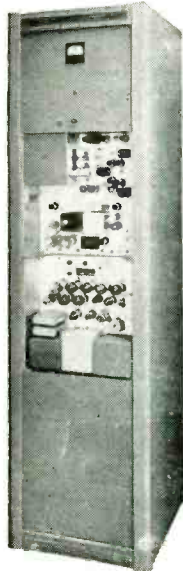

## TELEVISION MONOSCOPE SIGNAL SOURCE

Model PT 102

- Composite Video Signal
- Wide Band Video Amplifier, 6 DB down at 10MC
- Dual outputs for feeding two 75 or 100 lines
- Black positive or Black negative output
- Resolution greater than 600 lines

INPUT: Vertical and Horizontal Driving pulses. Camera and Kinescope Blanking Pulses.

OUTPUT: Composite Video Signal, 3 volts, 100 ohm line 115 volts 50/60 cps. Complete with tubes and including high and low voltage power units.

9 FERRY STREET,  
NEW YORK 7, N. Y.

# Polarad

Electronics Company

Television engineers and consultants to the nation's great television stations.

THIS SELF-LOCKER  
*won't* SHAKE LOOSE!

# UNBRAKO

Reg. U.S. Pat. Off.

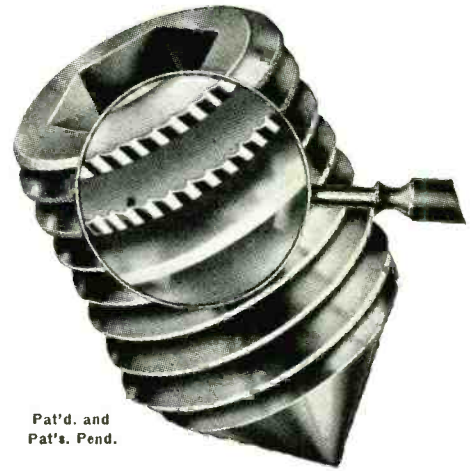

Pat'd. and  
Pat's. Pend.

The Knurling of this "Unbrako" Socket Set Screw, as shown, "swages the threads", so that it becomes a most excellent "Self-Locker" . . . for use with the 5 standard points that do not lend themselves to knurling. This "Unbrako" Socket Set Screw positively will not shake loose, regardless of the most chattering vibration. Sizes available from #4 to 1½" diameter, and in a full range of lengths. Ask for your copy of the "Unbrako" Catalog . . . it is useful and informative.

Our patented "Unbrako" Self-Locking Knurled Socket Set Screws and Stripper Bolts lock in most any industrial screw application. They won't shake loose. Millions and millions in use.

Write us for the name and address of your nearest "Unbrako" Industrial Distributor and your copy of the "Unbrako" Catalog.

Knurling of Socket  
Screws originated with  
"Unbrako" in 1934.

OVER 45 YEARS IN BUSINESS

## STANDARD PRESSED STEEL CO.

JENKINTOWN, PENNA.

BOX 596

CHICAGO • DETROIT • INDIANAPOLIS • ST. LOUIS • SAN FRANCISCO

# —high accuracy plus!

TYPE BX—  
1 WATT



NON-  
INDUCTIVE

MAX. RES: 1.5 Megohm (33I Alloy)  
1.0 Megohm (Nichrome)  
30,000 Ohms (Manganin)

BODY SIZE: 1" lg. by 9/16" diam.

TOLERANCE: STANDARD 1%  
(TO 1/10% at Slight Extra Cost)

TYPE CX—  
½ WATT



NON-  
INDUCTIVE

MAX. RES: 750,000 ohm (33I Alloy)  
500,000 ohm (Nichrome)  
15,000 ohm (Manganin)

BODY SIZE: 5/8" lg. by 9/16" diam.

TOLERANCE: STANDARD 1%  
(TO 1/10% at Slight Extra Cost)



For Instrumentation  
and other critical  
applications

IN-RES-CO wire wound resistors are engineered for the manufacturer maintaining a reputation of top quality and performance in his equipment. They cover a full range from 1 watt to 10 watts and .01 ohm to 1.5 megohm. Conservative ratings assure maximum long life; trouble free service. Write for catalog today on company letterhead.

# IN-RES-CO

APPLICATION-DESIGNED  
**RESISTORS**



INSTRUMENT RESISTORS CO., 1056 COMMERCE AVE., UNION, N. J.



For **LONG**

**TROUBLE-FREE OPERATION**

*Specify*

**N·W·L**

**CUSTOM-BUILT TRANSFORMERS**

**AND ELECTRICAL COILS**

Over 25 years' experience in the manufacture of specials at cost that compares favorably with standard types. Built-in quality proved by years of actual use.

**PROMPT DELIVERIES!**

From 10VA to 300 KVA Dry-Type Only, Both Open and Encased, 1, 2, & 3 Phase 15 to 400 Cycles.



**NOTHELPER**

**WINDING LABORATORIES**

9 ALBERMARLE AVE., TRENTON 3, N. J.



**IF IT'S ELECTRONIC...  
B&W CAN MAKE IT FOR YOU!**

**NOW IN PRODUCTION  
AT B & W**

- COMPLETE RADIO TRANSMITTERS • DUAL DIVERSITY CONVERTERS, CONTROL UNITS and FREQUENCY SHIFT EXCITERS FOR RADIO TELETYPE TRANSMISSION • SPECIAL TEST EQUIPMENT
- REDESIGN, MODERNIZATION AND MODIFICATION OF EXISTING EQUIPMENT • MACHINE WORK
- METAL STAMPING
- COILS • CONDENSERS
- OTHER ELECTRONIC DEVICES IN A WIDE RANGE OF TYPES

From small electronic components up to carefully engineered test equipment and complex electronic devices, Barker & Williamson can engineer and manufacture high quality products to your specifications.

Three B&W plants, comprising 150,000 square feet, completely equipped with a competent engineering staff, machine shop, tool room (including all machines for drilling, milling, turning, stamping and forming metals and plastics), and a complete wood-working shop are at your disposal. Your inquiries are welcome. Write Department EL-108 for prompt reply.



PLANT No. 2  
BRISTOL, PA.

**BARKER & WILLIAMSON, Inc.**  
237 FAIRFIELD AVENUE  
UPPER DARBY, PA.

**ADDITIONS AND CORRECTIONS (continued)**

Tele King Corp., 601 W. 26th St., New York 1, N. Y.  
Telcor Corp., 851 Madison Ave., New York 21, N. Y.  
Tel-Instrument Co., Inc., 50 Paterson Ave., East Rutherford, N. J.  
Weller Mfg. Co., 806 Packer St., Easton, Pa.

**TRADE NAMES**

**ADDITIONS and CORRECTIONS**

**AMERTRAN**

American Transformer Co.

**DURATIP**

Weller Mfg. Co.

**EMPIRE**

Empire Coil Company, Inc.

**FLEXITIP**

Weller Mfg. Co.

**INDUSTRIAL TELECEIVERS**

Industrial Television, Inc.

**KNIGHT**

Allied Radio Corp.

**MULTIVIDEO**

Industrial Television, Inc.

**SOLDERLITE**

Weller Mfg. Co.

**SPEED IRON**

Weller Mfg. Co.

**SYNCHRON**

Hansen Mfg. Co., Inc.

**TECH LAB**

Tech Laboratories, Inc.

**TELEPHOTO**

Acme Electronix, Div. of NEA Service Inc.

Due to an error, the listings of the General Controls Co. of Glendale, California, incorrectly referred to an advertisement on page 111 which was an advertisement of the General Control Company, 1204 Soldiers Field Road, Boston 34, Mass. There is no connection between the two companies.

Due to an error, the listings of the Northern Radio Co., 314 Bell St., Seattle 1, Wash. incorrectly referred to an advertisement on pages 190 and 191 which was an advertisement of Northern Radio Co., Inc., 143-145 W. 22nd St., New York 11, N. Y. There is no connection between the two companies.

Electronic Controls Co. of New York advertisement incorrectly listed as Page 224 instead of Page 244.

Manufacturers of glass bonded mica were incorrectly listed; they should have only included the following:

Electronics Mechanics, Inc.,  
70 Clifton Blvd.,  
Clifton, N. J.

General Electric Co.,  
Chemical Dept.,  
Pittseld, Mass.

Mycalex Corp. of America,  
60 Clifton Blvd.,  
Clifton, N. J.



# RAWSON METERS

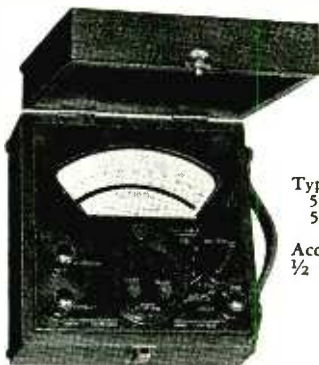

Types:  
501A  
501C  
Accuracy  
1/2 of 1%

## MULTIMETERS and REGULAR METERS

AC and DC types, high accuracy, multiple ranges, 2 microamperes to 1 ampere DC. 2 milliamperes to 3 amperes AC.

## ELECTROSTATIC VOLTMETERS

Ranges 150-v. to 35,000-v. AC or DC. Resistance exceeds million megohms. Can measure static electricity.

## FLUXMETERS

Laboratory and production measurements on magnets and magnetic circuits. Single push button return-to-zero.

## WATTMETERS

High sensitivities, low power factors. New types soon to be announced.

*Special apparatus built to order*

## RAWSON ELECTRICAL INSTRUMENT COMPANY

111 Potter St. Cambridge, Mass.  
Representatives  
Chicago Los Angeles New York City

# K O B Z Y Quality GETS WIDE APPROVAL . . .

LAMINATIONS . . HOUSINGS . . CONTACTS . . LUGS  
MISCELLANEOUS METAL STAMPING PARTS . . . .

Here is the quality that comes from years of experience and modern facilities. We work very closely with our customers, designing to their specifications. Our mechanical engineering department is able to tool up for special parts. Put your needs up to us for entirely satisfactory results.

Send for your copy  
of our new catalog.



**K O B Z Y**  
TOOL COMPANY  
1539 DAYTON ST. CHICAGO 22, ILL.

**PROMPT DELIVERY!**

## Stainless Steel MACHINE SCREWS and Rivets

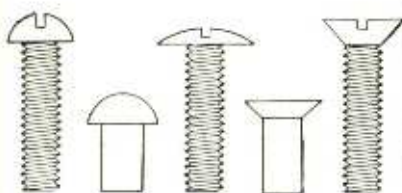

**S**CREWS, nuts, washers, pins — Allmetal carries the largest stock in the country of stainless steel fasteners and screw machine parts. Our complete facilities for heading, tapping, drilling, reaming, slotting, turning, stamping, broaching and centerless grinding make possible prompt delivery of specials, too. Write for our free 83-page catalog today.

**We also carry:**

Cap Screws	Nuts	Taper Pins
Bolts	Socket Screws	Cotter Pins
Washers	Wood Screws	Pipe Fittings

Send for **FREE CATALOG**

Allmetal Screw Products Co., Inc.  
33 Greene Street, New York 13, N. Y.

*Now you can have*

## \*DYNAMIC NOISE SUPPRESSION

with Your Present Radio-phonograph or Amplifier

These 3 simple steps add realism to your music reproduction.

1. Plug in the "Little Wonder" \*Dynamic Noise Suppressor between your pick-up and amplifier.
2. Plug in the socket adapter to the power-tube socket.
3. Insert the matched low-needle-talk pick-up in your pick-up arm.

That's all that is necessary to reduce background noise with negligible loss of depth and brilliance . . . giving you a gratifying sense of "presence" in your music reproduction.

**LOW PRICE . . . . . \$82.50 list**

*Includes tubes, matched pick-up, remote control, cables, fittings, adapters, instructions.*

*\*Licensed under U.S. and foreign patents pending and issued.*

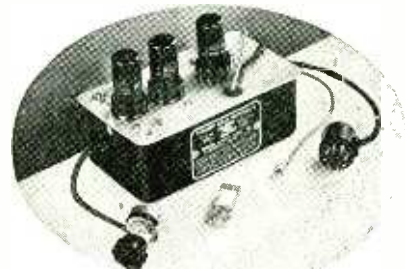

The remote control, for setting the exact degree of suppression you find most pleasing, can be mounted wherever you wish . . . at the instrument or even in another part of the room. The 3-tube suppressor unit can be placed anywhere in the cabinet.

The "Little Wonder" realizes the full capabilities of your present equipment; can be used, with suitable pick-up, on the new, long-playing records, too. For full specifications, write Dept. EL. Or, even better, hear a demonstration at your distributor's.

**HERMON HOSMER SCOTT, INC.**  
"PACKAGED ENGINEERING"  
385 PUTNAM AVE. • CAMBRIDGE 39, MASS.



# Automatic Frequency Control

## on DC to AC CONVERTERS

AVAILABLE IN 22 TYPES  
AND 3 FRAME SIZES BY

*Gothard*



DC to AC Rotary Converters having Automatic Frequency Control are now being offered in all models. Input voltages from 6 to 230 V DC; output: 110 to 1000 VA at 60 cycles, 90 to 800 VA at 50 cycles.

*SPECIALLY DESIGNED* for Television Sets, AC Radios, Radio-Phonographs and Recorders. For use where the power source is direct current: such as ships, vehicles, trains, office buildings, and urban DC areas.

Write today for  
illustrated cata-  
log #48 on:  
DYNAMOTORS  
CONVERTERS  
GENERATORS

### GOTHARD Manufacturing Co.

714 Clear Lake Ave.

Springfield, Illinois

Export Division: 25 Warren St., New York 7, N. Y.

NEWS OF THE INDUSTRY  
(continued from page 138)

and point-to-point communications for the rapidly expanding civil aviation services and for administrative, public and meteorological traffic. The new system will operate throughout Kenya, Uganda and Tanganyika.

Two of the latest types of Marconi transmitters have been chosen for the service: type TGS. 541—a 200-watt transmitter with a frequency range of 1.5 to 23 mc; and type TGS. 501—a 100-watt set covering the 1.5 to 13-mc range. Special features include crystal control with provision for rapid selection of any one of six working frequencies.

### Australia's Rural Radiophone

FIRST INSTALLATIONS are now being made in the Broken Hill district in New South Wales, of a radiophone set which will link Australian ranchers to the telephone network. The equipment was developed by the research laboratories of Electronics Industries Ltd., Melbourne, in cooperation with the Commonwealth Postmaster General's Department.

The subscriber merely lifts a standard telephone handset from the instrument and depresses a key to connect him with the operator. Calls are accepted for any point in Australia and most overseas countries.

The base station transmitter is amplitude-modulated and has an output of 200 watts. It covers subscribers within a range of 200 miles. Subscriber sets are operated from a 12-volt storage battery and transmission is also by a-m.

### Automatic Control Course

INSTRUMENTATION FOR the process industries will be the subject matter of a third short course to be conducted by Texas A & M College in cooperation with several industrial concerns at College Station, Texas, October 26-28. Manufacturers of instruments and automatic controls are participating by showing educational exhibits.

The program will be of special value to instrument, process design

For Faster, Neater  
Equipment Marking, Use

# DECALS

Decimeter Decals provide the newest, most convenient and economical method for marking electronic equipment.

They are easy to apply—no holes to drill—and they adhere to any surface, including wrinkle and crackle finishes. Decals often fit spaces too small for other types of marking. Decimeter Decals are inexpensive—a wide assortment can be stocked for low cost.

Decimeter Decals are printed in neat, opaque letters in a tough, clear protective coating of outstanding durability. They have a high degree of resistance to wear and abrasion. Over 275 different decals are available, including television titles, dial plates, radio titles, call letters and high-voltage signs for safety. Decimeter Decals are of the self-adhering "slip-off" type, and require no cement.

Speedy application plus the low cost of individual Decimeter Decals mean substantial savings in marking any type of electronic equipment. Write for folder 4B which lists complete line available and net prices. We will also enclose handy order form for your convenience in selecting your own assortment.

**DECIMETER**  
INC.  
1430 MARKET ST. DENVER 2, COLO.



**COILS**

**QUALITY COILS  
TO  
YOUR SPECIFICATIONS**

We manufacture quality coils for the radio and electronics industry. Universal, bank-wound, universal-progressive or solenoid coils made to JAN specifications. Let us know your requirements: We will quote promptly.

**FUGLE-MILLER LABORATORIES**

METUCHEN NEW JERSEY  
398 Main St. Me 6-2245



**Littelfuse Makes Headline News  
with "In-Line" Fuse Retainer**

Littelfuse's latest development: the "in-line" fuse retainer for fingertip ease in fusing. Precisely molded of high impact bakelite and designed primarily for low voltage applications: car radios, heaters, spot lights and other automotive trouble spots where a fool-proof easy-to-handle fuse installation is desired. The strongly spring-locked retainer opens with a "push-and-twist" of the finger tips. Inside, the fuse rests against knife-edged, cup contacts that assure greatest degree of contact with lowest voltage drop. Doubled wall thickness at juncture of shoulder and lower body.

Available for all standard automotive fuse sizes. Retainer may be had with or without wire leads and terminals, with or without fuses.



**LITTELFUSE Incorporated**  
4769 N. RAVENSWOOD AVE., CHICAGO 40, U. S. A.  
MITE-T-LITE • SWITCH-LITE • IGNITION FRIZZ • NEON INDICATORS  
SWITCHES • CIRCUIT BREAKERS • FUSES • MOUNTINGS AND ACCESSORIES

**ULTRA SENSITIVE D. C. AMPLIFIER**



**An Electronic  
Replacement  
For Sensitive  
Galvanometer  
Systems**

The Model 53 Breaker-type D.C. Amplifier was developed for the measurement of d. c. and low frequency a. c. voltage in the microvolt and fractional microvolt region. It is compact, portable, and makes an excellent replacement for the suspension galvanometer. The output of the amplifier is sufficient to operate standard meters and recording devices directly.

It has been employed for the amplification of infra-red detectors, thermocouples, voltaic photocells, and the like, both in research and industrial applications.

Among the advantages of this amplifier are the following:

1. Noise level that approaches the theoretical limit imposed by Johnson noise.
2. Extremely low zero drift (less than .005  $\mu$  V after warmup).
3. Freedom from the effects of vibration such as found in moving vehicles.
4. Response characteristics permitting overall amplification flat from 0 to 10 cycles per second.
5. Reliability, as demonstrated by units which have been in continuous operation for several years.

**THE PERKIN-ELMER CORPORATION**



GLENBROOK • CONNECTICUT

For Complete Information Write Dept. 50.

**A wealth of data to help you  
plan—design—construct  
MICROWAVE EQUIPMENT**

HERE'S a goldmine of data that saves you time and effort—puts at your fingertips the *specific* material you want when you're planning, designing and constructing microwave equipment. This book is packed from cover to cover with authoritative reference data on coaxial lines and flexible cables—practical structures and components of wave guides—dielectric materials and their properties—cavity resonators, etc. . . . all considered from the ultra-high-frequency point of view.

*Just published!*

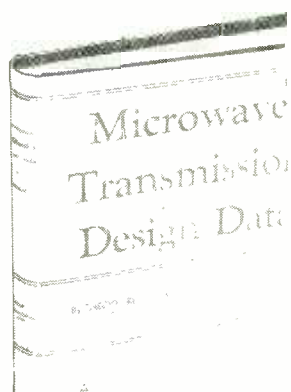

**MICROWAVE TRANSMISSION  
DESIGN DATA**

By THEODORE MORENO, Project Engineer, Sperry Gyroscope Company; Research Associate, Massachusetts Institute of Technology. 250 pages, 202 illustrations, \$4.00

THIS book brings you vital information to aid you in the engineering design of all kinds of microwave equipment. It discusses briefly transmission line theory—from the high frequency point of view—then brings you the practical working data you need on the job. Over two hundred diagrams—graphs—charts—tables, etc., illustrate the text matter, making it clear and easy-to-follow. The material is concise—well-organized—useable . . . the kind of information an engineer must have to design a transmission system employing waveguides.

**Read the chapter headings.**

1. General Considerations for Microwave Transmission Lines
2. Attenuation, Impedance Matching, and Reflections on Transmission Lines
3. Impedance Relations on Transmission Lines
4. General Formulas for Coaxial Lines
5. Flexible Cables
6. Coaxial Line Structures and Transformers
7. General Formulas for Wave Guides
8. Attenuation in Wave Guides
9. Obstacles, Discontinuities, and Junctions
10. Miscellaneous Waveguide Structures
11. Wave Guides Filled with Dielectric Material
12. Dielectric Materials
13. Cavity Resonators

**SEE IT 10 DAYS FREE • MAIL COUPON**

McGraw-Hill Book Co.,  
330 W. 42nd Street, NYC 18

Send me Moreno's MICROWAVE TRANSMISSION DESIGN DATA for 10 days' examination on approval. In 10 days I will send \$4.00, plus a few cents postage, or return the book postpaid. (Postage paid on cash orders.)

Name .....

Address .....

City and State .....

Company .....

Position .....

L-10-48



# HARVEY HAS THE TOPS

**FM TRANSLATOR**  
General Electric Model XFM-1



Post-war version of the old G.E. J.F.M-90 Translator which was used and enjoyed by tens of thousands of discriminating radio listeners.

Covers 88-108 mc range, dial 12 inches long, uses guillotine tuning for highest efficiency, high stability. Designed for export, has power inputs for 110 to 250 volts, 50/60 cy. Used in conjunction with good audio section or separate amplifier will provide best FM listening you ever heard. In attractive natural walnut cabinet — 10 3/4" high x 15 3/4" wide x 11 3/8" deep, complete with 8 tubes. Tropic-proof construction. Quantity limited, no more available. Get your order in while they last!

Special price ..... \$49.50



## GE PRE-AMPLIFIER

Just arrived in stock, the new GE Phonograph Pre-Amplifier with built-in power supply for use on 105-125 V. AC only. Does not use AC-DC type power circuit, has self-contained power, transformer and is completely isolated from power line. For use with GE Variable Reluctance Cartridge. Net..... \$9.57

## MICRO-GROOVE CARTRIDGE

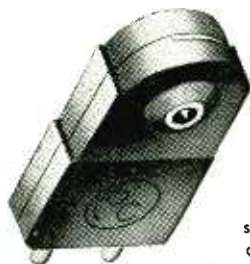

Get set to use those new micro-groove records. All you need is this new Pickering Diamond Paint cartridge with the 1-mil

stylus. Pickering cartridge fits your present arm. With this accurately shaped diamond stylus you can play the new micro-groove records at once... \$36.00

Telephone: **7 LOnacre 3-1800**

**HARVEY**  
RADIO COMPANY INC.  
103 West 43rd St., New York 18, N. Y.

and operating engineers. Lectures have been scheduled to cover such subjects as measurement and control of temperature, pressure, liquid level and time.

Registration fee is \$5.00. Further information may be obtained by writing Professor P. G. Murdoch, Chemical Engineering Department, Texas A & M College, College Station, Texas.

## Plan Radio Net for India

TO RELIEVE the overburdened telegraph system in India, a radio communications network covering the ten leading cities is due to be set up shortly. Official estimates are that initial cost will be about \$1,300,000 and annual recurring costs about \$210,000.

Each of the ten cities will have a 10-kw high-speed short-wave transmitter and a triple diversity receiver. Both will be teleprinter-equipped.

## Radio License Increase

MORE THAN 635,000 separate radio authorizations, covering stations and operators, were outstanding with the FCC at the close of the fiscal year. This represents an increase of nearly 90,000 over the previous year. Breakdown is as follows:

	STATIONS	
	As of June 30, 1947	As of June 30, 1948
<b>Broadcast</b>		
A-M .....	1,795	2,034
F-M .....	918	1,020
TV .....	66	109
TV (experimental) .....	81	124
Educational .....	38	46
International .....	37	37
Remote Pickup .....	583	571
Other .....	33	26
<b>Totals .....</b>	<b>3,551</b>	<b>3,967</b>
<b>Nonbroadcast</b>		
Aeronautical .....	15,843	20,858
Marine .....	10,755	15,024
Public Safety .....	4,257	4,903
Land		
Transportation ..	1,792	3,122
Industrial .....	1,571	2,855
Miscellaneous .....	1,919	1,648
Amateur .....	*75,000	78,434
<b>Totals .....</b>	<b>112,137</b>	<b>126,844</b>
	OPERATORS	
Amateur .....	*80,000	77,923
Commercial .....	*325,000	*347,000
Aircraft .....	*25,000	79,924
<b>Totals .....</b>	<b>430,000</b>	<b>504,847</b>

\* Estimated.

The station figures do not represent the actual number of transmit-

# BRADLEY RECTIFIERS

**INSTRUMENT RECTIFIERS**  
FOR BETTER  
A.C. SCALE

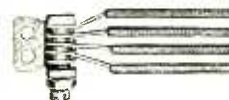

For really accurate determination of very low A.C. current—use Bradley "Coprox" instrument rectifiers. Especially designed for use where stability and permanence of calibration are important. Shown above: CX-2E Series. Vacuum-processed, gold-coated, full-wave bridge. Rated 4.5 volts A.C. 3 volts D.C. 5 milliamperes D.C.

# PHOTO CELLS

**SIMPLIFY PHOTO-ELECTRIC APPARATUS**



Luxtron\* photo cells convert light into electrical energy. No external voltage is required to operate meters and meter relays directly from Bradley photo cells, improving control over your processes, reducing your costs. Housed model shown. Many different sizes and shapes, mounted and unmounted.

\* T M REG. U. S. PAT. OFF

Our engineers will select or develop rectifiers or photo cells to meet your needs exactly. Write for BRADLEY LINE showing basic models.

**BRADLEY**  
LABORATORIES, INC.  
82 Meadow St. New Haven 10, Conn.

# Vital Aids TO

## MANUFACTURERS OF MINIATURE TUBE RADIOS AND EQUIPMENT



★ Star Miniature Socket Wiring Plugs for accurate alignment of miniature socket contacts during wiring. Precision cast of zinc base alloy—pins of stainless steel. #JE-9 (9 pin); #JE-10 (7 pin).

★ Star Miniature Tube Pin Straighteners (with stainless steel insert) to obtain a perfect fit when the tube is placed in the equipment. #JE-15 (9 pin); #JE-13 (7 pin).



Scientifically designed — Precision made  
Immediate Delivery in Any Quantities

★ **STAR** EXPANSION PRODUCTS CO., INC.

147 CEDAR STREET, NEW YORK 6, N. Y. (

## TELEVISION HIGH VOLTAGE METER 0 to 30 KV



AN ABSOLUTE  
MUST FOR  
TELEVISION  
WORK

### METER SPECIFICATIONS

**Voltage Range:** 0-30 Kilovolts at 50,000 ohms per volt sensitivity. Measures high voltage circuits with very light loading.

**Polarity Reversing Switch:** Permits measuring of positive or negative voltages from ground with maximum safety. Switch may be operated without arcing while the voltage is being applied. Off position of this switch locks the sensitive meter movement for transportation.

**Special Terminals:** Provided for oscilloscope connection to observe percentage of ripple, also waveform and frequency of ripple while checking voltage. The circuit used permits scope readings over an extremely wide frequency range.

▲ Square case 4" meter with an easy to read scale. Overall Size of Case: 7" wide, 9" long, 5" high. Net Price ..... \$67.50  
Includes 25% Deposit with Order, Balance C.O.D.

Pioneers in Projection Television  
**SPELLMAN TELEVISION CO., INC.**  
130 WEST 24th STREET • NEW YORK 11, N. Y.

## PROOF OF PERFORMANCE...

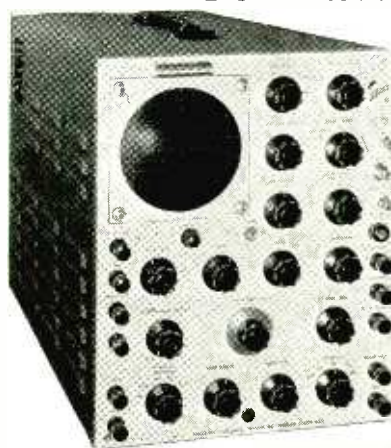

The fact that over 50% of the purchasers of the Tektronix Type 511 Oscilloscope have re-ordered additional instruments after having placed a Type 511 in service provides positive evidence of the usefulness and value of this instrument.

The above category of Type 511 users includes the foremost Universities, Nuclear Physics groups, Industrial and Governmental research organizations throughout the country. A list of those in your vicinity will be provided upon request.

### TYPE 511 FEATURES

- Continuously variable sweep speed, 1/10 second to 1 microsecond (10 cm).
- Direct reading sweep speed indication.
- Sweep magnifier for any 20% of normal sweep.
- Triggered, recurrent or single sweeps.
- Vertical deflection sensitivity: 0.27V to 200V per cm. (peak to peak).
- Vertical amplifier band pass, 10 mc. 1 stage; 8 mc. 2 stages.
- Fully compensated for optimum transient response.
- Self contained, total weight 65 lbs.

Price \$795.00 f.o.b. Portland

Your inquiry will bring more detailed information and name of the nearest Field Engineering Representative.



Phone, EAst 6197  
Cables, TEKTRONIX

712 S. E. Hawthorne Blvd.  
Portland 14, Oregon

## SMALL FORMED PARTS

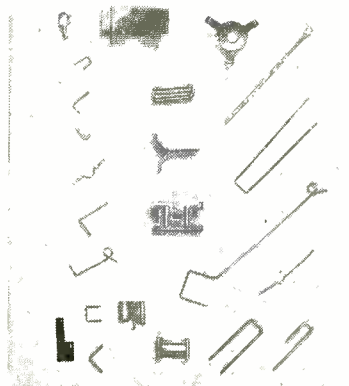

Wire, flat strip and tubing, formed parts in nickel, molybdenum, tungsten, kovar and tantalum, etc., to your specifications. For electronic tubes and allied uses.

Complete precision tool and machine shop facilities for accurate production of small dimension parts in all metals. Fast deliveries.

Write for Quotations



**HAYDU BROTHERS**

Plainfield, New Jersey

## RESEARCH & DEVELOPMENT ENGINEERS

PhD's, Master, Bachelors in Physics or E. E.

Long established electro-mechanical engineering organization is expanding its electronic department to include research and development on missiles, microwave systems, radar, communications, navigational devices, antennas, and associated equipment.

A few exceptional positions are open for top-flight senior engineers. Must have extensive experience on analysis of electronics systems, and ability to create new basic approaches to involved engineering problems. Commercial and university background desired. Please furnish complete resume, salary requirements and availability to: Personnel Manager

Engineering Division

**W. L. MAXSON CORPORATION**

460 West 34th Street

New York 1, New York



# NEW! FEATHER WEIGHT SOLDERING IRON

## BANTAM

PATENT  
PENDING

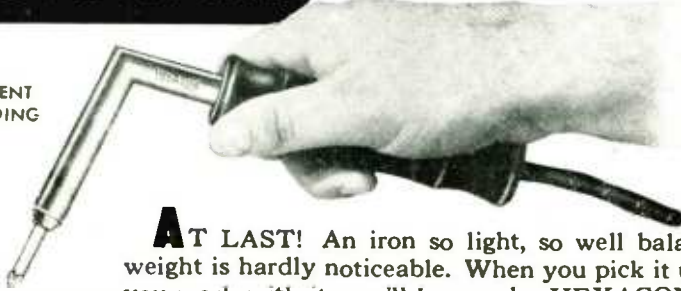

**AT LAST!** An iron so light, so well balanced its weight is hardly noticeable. When you pick it up, when you work with it, you'll know why HEXACON calls it **FEATHER WEIGHT**. It's the perfect iron for long, delicate work where fatigue works against quality. It can work for you—improving and speeding production. More comfortable and practical than a pencil iron. No transformer required. Price only \$5.00.

**HEXACON MODEL 30H.** Weight 5½ oz. (less cord). 40, or 60 Watts. Both ⅛" and ¼" tips furnished. Ask for literature on complete line of screw tip, plug tip and hatchet irons.

**HEXACON ELECTRIC CO.**

130 W. CLAY AVE., ROSELLE PARK, N. J.



## U. H. F. STANDARD SIGNAL GENERATOR MODEL 84

### SPECIFICATIONS

**CARRIER FREQUENCY:** 300 to 1000 megacycles.

**OUTPUT VOLTAGE:** 0.1 to 100,000 microvolts.

**OUTPUT IMPEDANCE:** 50 ohms.

**MODULATION:** SINEWAVE: 0—30%, 400, 1000 or 2500 cycles. PULSE: Repetition—60 to 100,000 cycles. Width—1 to 50 microseconds. Delay—0 to 50 microseconds. Sync. input—amplifier and control. Sync. output—either polarity.

**DIMENSIONS:** Width 26", Height 12", Depth 10".

**WEIGHT:** 125 pounds including external line voltage regulator.



Laboratory  
Standards

**MEASUREMENTS CORPORATION**  
BOONTON • NEW JERSEY

ters, since a single authorization can cover a number of associated mobile units. Year-end figures for mobile units are not available.

### BUSINESS NEWS

**BROCINER - MASS INSTRUMENTS, INC.**, New York City, has been organized for the development and manufacture of photoelectric colorimeters, photometers and related equipment in the electronic instrument and clinical fields.

**MAYFLOWER ELECTRONIC DEVICES, INC.**, West New York, N. J., has formed a client research department to engage in research on dielectric heat and electronic sealing.

**ELTRAN CORP.**, St. Anne, Illinois, has purchased the business of **Radell Corp.**, Indianapolis, Indiana, to complete its line of loudspeakers.

**CUTLER-HAMMER, INC.**, Milwaukee, Wisconsin, manufacturers of electrical apparatus, has acquired the business of the **West Electric Products Co.**, Los Angeles, Calif.

**COOK RESEARCH LABORATORIES**, Chicago, Ill., has begun construction of a one-story addition to its present facilities. The new building will



Sketch of new Cook Research Lab

approximately double the floor space available for design, development, instrumentation and testing.

**INTERNATIONAL TELEVISION CORP.** recently purchased the **Minerva Radio Corp.** plant at 238 William Street, New York City. The additional 50,000 sq ft of space will facilitate full-scale production of a complete line of television receivers.

**AMERICAN STANDARDS ASSOCIATION, INC.**, is the new name of the **ASA**, New York City. The incorporation recognizes the enlarged activities

**EISLER  
ELECTRICAL & ELECTRONIC  
EQUIPMENT  
ELECTRONIC TUBE EQUIPMENT**

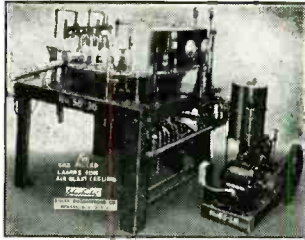

**36 HEAD  
RADIO TUBE  
EXHAUSTING  
MACHINE**

We Make Complete Equipment For The Manufacture Of Incandescent Lamps Radio and Electronic Tubes.

**TRANSFORMERS OF ALL TYPES**

For LIGHTING POWER FURNACES PHASE CHANGING DISTRIBUTION ETC.

Air, Oil, or Water Cooled

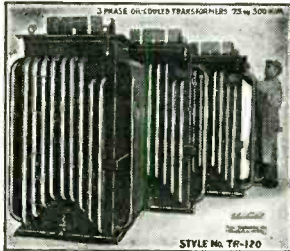

SIZES 1/4 to 250 KVA  
**SPOT WELDERS**  
OF ALL TYPES FOR ALL PURPOSES  
SIZES 1/4 to 250 KVA  
Butt Welders - Gun Welders  
Arc Welders  
Neon Sign Units  
Fluorescent Tube  
Manufacturing Equipment



**CHAS. EISLER  
EISLER ENGINEERING CO., INC.**  
751 So. 13th St. (Near Avon Ave.), Newark 3, N. J.

**PRECISION**



HASN'T "SQUARED THE CIRCLE" BUT HAS "SQUARED THE BOW"



producing

**DI-FORMED PAPER TUBES**

at no extra cost!

Precision DI-FORMED Paper Tubes have made a most important improvement throughout coil industry. Now ALL coil manufacturers and users can take advantage of the opportunity to obtain Precision DI-FORMED square and rectangular paper tubes for coil bases, at no extra cost!

Results: greater strength—automatic stacking—elimination of coil forming after winding—closer engineering of coils, saving wire. Precision characteristics, spiral winding, better insulation, space and weight saving are improved. Tubes also made round, oval, any shape.

Write for samples—also new Mandrel List. Many new sizes.

**PRECISION PAPER TUBE CO.**

2041 W. Charleston St., Chicago 47, Ill.  
79 CHAPEL ST., HARTFORD, CONN.

PLANT NO. 2

Ideal for  
**ANTENNA CONNECTIONS  
PHOTO-CELL WORK  
MICROPHONE CONNECTIONS**

**JONES  
SHIELDED TYPE  
PLUGS & SOCKETS**

LOW LOSS PLUGS AND SOCKETS FOR HIGH FREQUENCY CONNECTIONS. SUPPLIED IN 1 AND 2 CONTACT TYPES:

101 Series can be furnished with 1/4", .290", 5/16", 3/8" or 1/2" ferrule for cable entrance. Knurled nut securely fastens unit together. Plugs have ceramic insulation and sockets have bakelite. Quality construction. Fine finish. Assembly meets Navy specifications.

For full details and engineering data ask for Jones Catalog No. 16.

**JONES MEANS  
Proven QUALITY**



**HOWARD B. JONES DIVISION**  
Cinch Mfg. Corp.  
2460 W. GEORGE ST. CHICAGO 18, ILL.

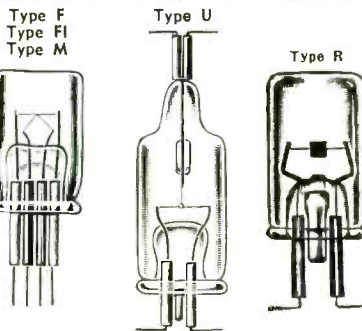

**FIELD VACUUM THERMOCOUPLES**

- TYPE F, contact type, and TYPE FI, with insulated heater, available in ranges of 1.2 milliamperes and over.
- TYPE M, contact type, 25 MV output, constructed in ranges of 100 milliamperes and over.
- TYPE U, with insulated heater, for measurements at ultra-high frequencies, made in ranges of 3 milliamperes and over. Streamlined to make convenient use in coaxial cables or fittings possible.
- TYPE R, for radiant energy measurements.

Write Department VE for latest informative bulletins

**FIELD ELECTRICAL  
INSTRUMENT COMPANY**

109 E. 184 ST. • NEW YORK 53, N. Y.

The theory and application of electronics in industry

**INDUSTRIAL ELECTRONICS  
REFERENCE BOOK**

By Electronics Engineers of the Westinghouse Electric Corp.

This book was compiled to answer the need for complete and clear information on the application and design of industrial electronic equipment. Written by a group of engineers, each an expert in his particular branch of electronics, the *Industrial Electronics Reference Book* contains the most recent information on the subject. The material is directed at the practicing engineer. Its aim is to give him a better understanding of the scope and limitations of electronic apparatus as it is applied to industrial processes.



1948 680 Double-column Pages \$7.50

**ON APPROVAL COUPON**

**JOHN WILEY & SONS, INC.**  
440 Fourth Ave., New York 16, N. Y.  
Please send me, on 10 days' approval, a copy of **INDUSTRIAL ELECTRONICS REFERENCE BOOK**. If I decide to keep the book, I will remit \$7.50 plus postage; otherwise I will return the book postpaid.

Name .....  
Address .....  
City ..... Zone ..... State .....  
Employed by .....  
(Offer not valid outside U. S.) E-10-48



# High Sensitivity . . . Logarithmic AC VOLTMETER

50 MICROVOLTS TO 500 VOLTS  
MODEL 47 VOLTMETER

SELF-CONTAINED  
ALL AC OPERATED UNIT

An extremely sensitive amplifier type instrument that serves simultaneously as a voltmeter and high gain amplifier.

- Accuracy  $\pm 2\%$  from 15 cycles to 30 kc.  $\pm 5\%$  from 30 kc. to 100 kc.
- Input Impedance 1 meg-ohm plus 15 uuf. shunt capacity.
- Amplifier Gain 40000

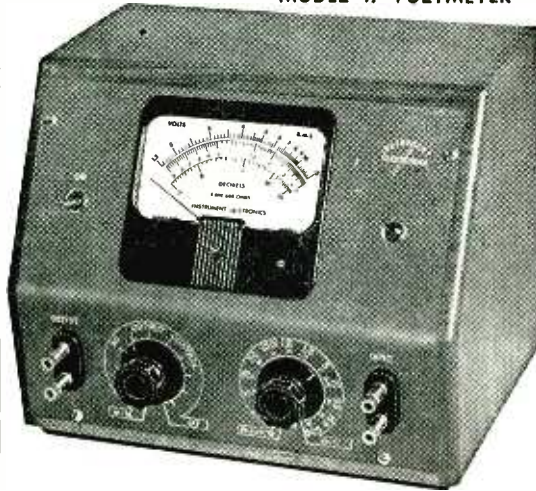

Also MODEL 45  
WIDE BAND  
VOLTMETER  
.0005 to 500 Volts!  
5 Cycles 1600 kc.

*A few of the many uses:*

- Output indicator for microphones of all types.
- Low level phonograph pickups.
- Acceleration and other vibration measuring pickups.
- Sound level measurements.
- Gain and frequency measurements for all types of audio equipment.
- Densitometric measurements in photography and film production.
- Light flux measurements in conjunction with photocells.

*Write for Complete Information*

## Instrument Electronics

41-17A Douglaston Parkway  
DOUGLSTON, L. I., N. Y.

and responsibilities of the organization.

PICKARD & BURNS, INC., consulting engineers, recently moved to new quarters at 240 Highland Ave., Needham, Mass.

GENERAL INSTRUMENT CORP., radio and television components manufacturer, is now controlled by a group headed by C. Russell Feldman, founder of Transitone, and Richard E. Laux, formerly vice-president in charge of operations of Colonial Radio Corp., Buffalo, N.Y.

GENERAL ELECTRIC Co., Electronics Park, now has a new division called the Industrial and Transmitting Tube Division. It will consolidate all sales, design engineering and manufacturing activities related to the former Power Electronics Division.

SPERRY PRODUCTS, INC., manufacturers of ultrasonic instruments and hydraulic remote controls, have moved from Hoboken, N. J., to new quarters in Danbury, Conn.

GENERAL ELECTRIC X-RAY CORP., Milwaukee, Wisc., has furnished a two-million-volt x-ray machine for The Babcock & Wilcox Company to examine welds in high-pressure, high-temperature boiler drums  $4\frac{1}{2}$  to  $6\frac{1}{2}$  inches thick. The machine's exposure time for a  $5\frac{1}{2}$ -inch plate is 6 minutes when using a film distance of 6 feet. It is the first of its size to be used exclusively for testing welds in pressure vessels. The special new 70 by 30-ft building in which it is housed will accommodate drums up to 13 ft in diameter and 70 ft long.

WHEELCO INSTRUMENTS Co. recently opened a new office at 138 East Becher St., Milwaukee 7, Wisconsin.

### PERSONNEL

MARTIN KIEBERT, JR. recently joined Raymond Rosen & Co., Philadelphia, to take charge of the engineering, design and sale of all telemetering equipment.

ELTON W. JONES, formerly assistant professor of electrical engineering

# Baer

offers accurate fabrication of  
phenol and vulcanized fibre!



\* Baer facilities are unexcelled for stamping, punching, drilling, tapping, shaving, milling, shearing and sawing.



**SEND BLUEPRINTS  
AND SPECIFICATIONS—  
NO OBLIGATION!**

Check BAER FIBRE for accurate dimensioning, uniform surface, mechanical and electrical qualities, and *low cost per piece*. See how efficiently a BAER FIBRE terminal board, bushing, gasket, washer or other shape can simultaneously solve your electrical or mechanical problem...improve your product...and save you money! BAER FIBRE is precision fabricated to your specifications.

LITERATURE ON REQUEST

## N. S. BAER COMPANY

MONTGOMERY ST., HILLSIDE, N. J.

# ILLINOIS CONDENSERS BELONG IN THE BEST Electronic Sets

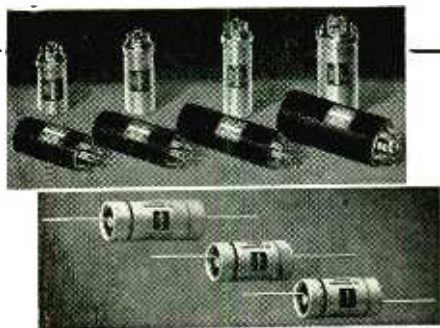

The Trade Mark of  
"Time Tested Quality"

● Look to Illinois for a complete line of electrolytic capacitors for every electronic application. When you need a capacitor that has superior ability to withstand extreme temperature changes; that's manufactured to exacting specifications; that's time tested through 14 years of high quality production experience—you want an Illinois condenser!

● Write for our latest catalog.



**ILLINOIS CONDENSER CO.**  
1616 NORTH THROOP STREET • CHICAGO 22, ILL.

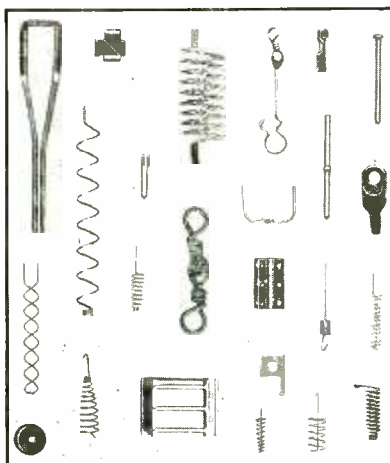

## SMALL PARTS

Filaments, anodes, supports, springs, etc. for electronic tubes. Small wire and flat metal formed parts to your prints for your assemblies. Double pointed pins. Wire straightened and cut diameter up to 1/8-inch. Any length up to 12 feet.

LUXON fishing tackle accessories.  
Inquiries will receive prompt attention.

## ART WIRE AND STAMPING CO.

227 High St. Newark 2, N. J.

"Where  
Professional  
Radiomen  
Study"



## CAPITOL RADIO ENGINEERING INSTITUTE

An Accredited Technical Institute  
16th and Park Rd., N.W. Dept. E-10  
Washington 10, D.C.

Advanced Home Study and  
Residence Courses in Practi-  
cal Radio-Electronics and  
Television.

Approved for Veteran Training.

## DUAL SPEED HYSTERESIS

## Synchronous Motors

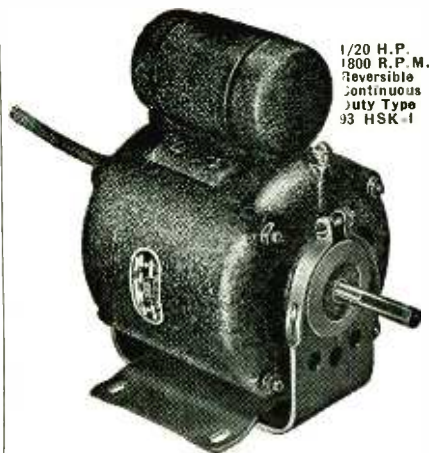

1/20 H.P.  
1800 R.P.M.  
Reversible  
Continuous  
Duty Type  
93 HSK-1

- NO NOISE
- NO VIBRATION
- HUNT and "WOW" ELIMINATED
- INDEPENDENT of LOAD INERTIA

### Applications:

Disc, wire and film recorders  
Sound cameras and projectors  
Facsimile equipment  
Television equipment  
Timing devices  
Stroboscopic work  
Teletype equipment

We can furnish on quantity orders  
COMBINATIONS of any two of the  
following speeds:

600 R.P.M.  
900 R.P.M.  
1200 R.P.M.  
1800 R.P.M.  
3600 R.P.M.

Instantly reversible with D.P.D.T.  
switch! H.P. ratings 1/150 to 1/30  
depending on speed combination se-  
lected. Round Frame, Resilient  
Mount, Rigid Base.

The hysteresis design of these new  
Synchronous Motors lowers noise and  
vibration level to a fraction of that  
normally present in conventional sali-  
ent pole construction. Unaffected by  
load inertia.

These Hysteresis Motors are now  
standard equipment on many high  
quality Recorders.

What are your requirements?

**EASTERN AIR DEVICES, INC.**  
130 FLATBUSH AVENUE  
BROOKLYN 17, NEW YORK



# WIRE-WOUND CONTROLS

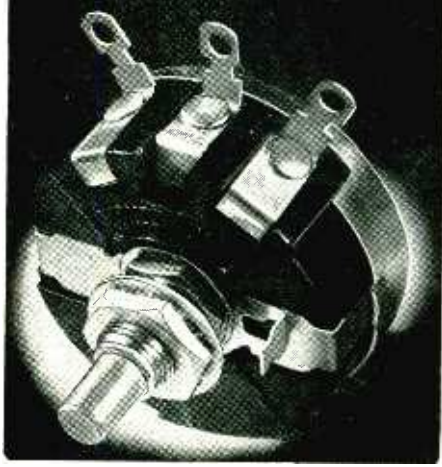

★ Of course those are *Clarostat* wire-wound potentiometers and rheostats in the best radio-electronic assemblies — in fine instruments — in broadcasting station and network control rooms.

*Clarostat* Series 58 (illustrated) controls are standard with critical equipment builders and users, because of positive conductivity and minimized "noise", smoother rotation, longer life.

Linear: 1 to 50,000 ohms, 3-watt rating. Tapered, 5 to 25,000 ohms, 2-watt rating. Maximum resistance for any 10% change of total rotation. 5,000 ohms. Tolerance, 10% plus/minus of total resistance and linearity, standard; to 1%, special.

★ Descriptive bulletin 118 on request. Let us quote on your needs.

**CLAROSTAT**

*Controls and Resistors*

CLAROSTAT MFG. CO., Inc. · 285-7 N. 6th St., Brooklyn, N. Y.

In Canada: CANADIAN MARCONI CO., Ltd. Montreal, P.Q., and branches

at Pennsylvania State College, was recently named associate professor at Illinois Institute of Technology.

R. JACK WEST, associated with Wired Radio of Canada Ltd. since 1935, was recently appointed vice-president of the company.

CHARLES A. NUEBLING, formerly with Servo Corp. of America and Sperry Gyroscope Co., is now director of electronics for W. L. Maxson Corp., New York City, which recently expanded its engineering activities to include radar and associated high-frequency research and development.

GEORGE M. LEBEDEFF, quality control specialist and formerly chief engineer of Heintz & Kaufman Ltd., has joined Lenkurt Electric Co., San Carlos, Calif., as a carrier engineer.



G. M. Lebedeff



L. Marton

LADISLAUS MARTON, chief of the electron physics section, National Bureau of Standards, has spent the summer in Europe surveying current work in the field of electron microscopy.

LEONARD MILTON, formerly senior engineer at Solar Mfg. Corp., North Bergen, N. J., is now chief engineer at Filtron Co., Inc., Bayside, New York.

HAROLD W. SCHAEFER, until recently in charge of engineering development and research, has been appointed assistant manager of the Westinghouse Home Radio Division, Sunbury, Pa. During the war he was associated with the OSRD in charge of engineering manufacturing of the proximity fuze.

R. W. FERRELL, former counsel for General Electric's Electronics Department at Syracuse, N. Y., has been appointed assistant manager



**IN JUST 5 SECONDS!**

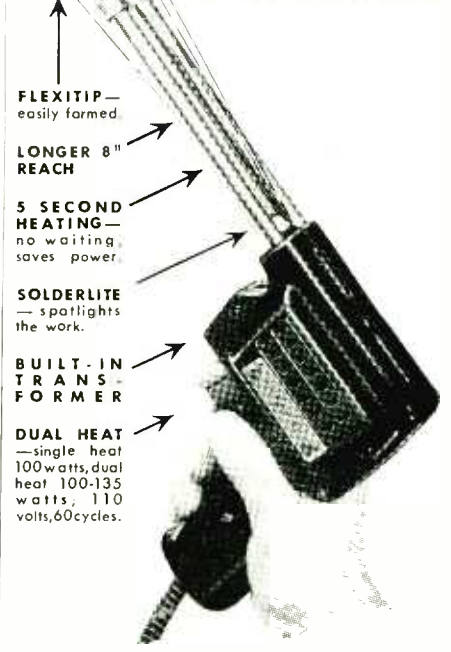

**FLEXITIP** — easily formed.

**LONGER 8" REACH**

**5 SECOND HEATING** — no waiting, saves power.

**SOLDERLITE** — spotlights the work.

**BUILT-IN TRANSFORMER**

**DUAL HEAT** — single heat 100 watts, dual heat 100-135 watts, 110 volts, 60 cycles.

That's all the time it takes for a Weller Soldering Gun to heat. Pull the trigger switch, make contact, and you solder. Then release the trigger and off goes the heat—automatically. No wasted time. No wasted current. No need to unplug the gun between jobs. The Weller Gun's Flexitip heats only when in use—no retinning or redressing when properly used with genuine Weller Tips. This intermittent 5-second heating saves hours and dollars—your Weller Gun will pay for itself in a few months.

Other advantages? Just check the features of the Weller Gun illustrated. See why it's called the "handful of soldering convenience".

Solderlite, extra length, and the easily shaped Flexitip means real soldering ease. And because the transformer is built in—not separate—the Weller Gun is a complete, self-contained unit, compact, convenient, safe.

For laboratory and maintenance work, we recommend the efficient 8" model—DX-8 with dual heat; or 4" types S-107 single heat and D-207 dual heat. Order from your distributor or write for bulletin direct.

**WELLER**  
MANUFACTURING COMPANY  
806 Packer Street · Easton, Pa.

*Metal Merchandisers  
SELL YOUR PRODUCT  
Constantly*

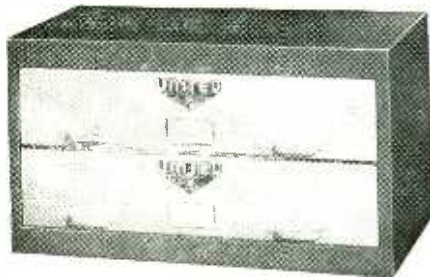

Focus attention at the point of sale with Central's custom-built "spot" merchandisers. These self-sufficient silent salesmen identify your product, create a desire for it . . . and sell! Any size, shape or style can be created for you by our master designing department . . . creators of metal products and displays for top manufacturers for over 36 years.

Write today for descriptive folder.

**CENTRAL**  
Sheet Metal Works, Inc.  
2645-49 Clybourn Ave.  
Chicago 14, Ill.

**FREE**  
**ALLIED'S**  
**NEW 1949**  
**RADIO**  
**CATALOG**

Everything in Radio  
and Electronic Supplies

Complete, Expert Service  
for Radio Engineers

You'll find everything you need in radio and electronic equipment for laboratory and development work, in the new 180-page ALLIED Catalog. Rely on *one* dependable source for the world's largest stocks—thousands of parts, tubes, tools, books, test instruments, sound apparatus—ready for instant expert shipment at lowest market prices. Write today for your FREE copy of ALLIED's newest Buying Guide.

**ALLIED RADIO**

ALLIED RADIO CORP., Dept. 11-K-8  
833 W. Jackson Blvd., Chicago 7, Ill.

Send FREE New ALLIED Catalog.

Name.....  
Address.....

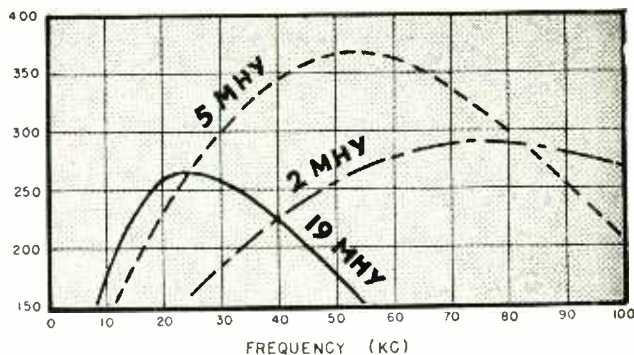

For  
**OUTSTANDING  
CORE  
PERFORMANCE**



Lenkurt Trancors are now being made to the remarkable Q characteristics above. Infinite care is required to make such parts. Available in a broad variety of low-cost standard cores and assemblies, or special items.

Write for catalog

**LENKURT ELECTRIC CO.**  
SAN CARLOS, CALIFORNIA

**LENKURT KNOWS HOW**

*Preferred*

as a source of precision-made  
**WASHERS** and  
**STAMPINGS**  
manufactured to  
your specifications

**CUP WASHERS**  
for Binding Screws

**WHITEHEAD STAMPING CO.**  
1691 W. Lafayette Blvd. Detroit 16, Michigan

**PROFIT IN A COIL?**

Yes . . . if it's the right coil

The right coil, free from defects, tested by capable inspectors, and properly manufactured to fit each job specification is the **DANO COIL**. Engineers know that Dano quality means profit in a coil.

Every job made to individual specification.  
**TRANSFORMERS MADE TO ORDER**

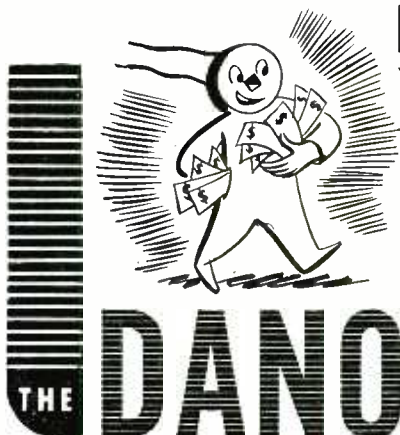

**ELECTRIC CO.** 93 MAIN ST. WINSTED, CONN.



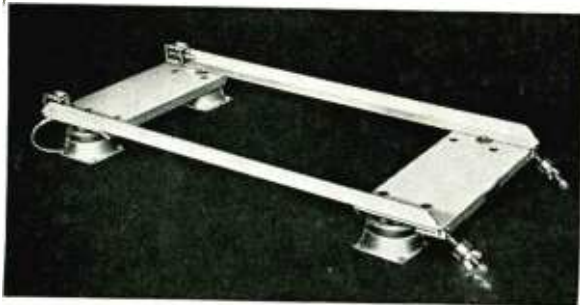

**Barrymount  
Type M-114**  
Standard Aircraft  
Mounting Rack for  
Electronic Equip-  
ment. Sizes per  
Specification JAN-  
C-172.

## BARRYMOUNTS Control VIBRATION and IMPACT

. . . with special emphasis  
on the field of electronics

We offer a complete line of highly engineered Vibration and Impact isolators for commercial, industrial, and military applications . . . also an engineering consulting service on special problems.

Catalog on Request

A letter from you will give us the opportunity to demonstrate how we can help you.

**THE BARRY CORPORATION**  
Formerly L. M. BARRY CO., INC.  
★ 177 SIDNEY STREET  
CAMBRIDGE, MASS.

of the receiver division at Electronics Park.

EDWIN F. STEVENS, formerly chief engineer of International Electronic Laboratories and Lon-Ga-Tone, Inc., is director of sales engineering and research of the newly formed client research department at Mayflower Electronic Devices, Inc., West New York, N. J.

HOBART C. MCDANIEL, formerly commercial engineer with Westinghouse Lamp Division in Bloomfield, N. J., has been appointed manager of the technical press service in the public relations department of Westinghouse Electric Corp., Pittsburgh, Pa.

A. A. EMLER, formerly vice-president in charge of engineering at American Transformer Co. and then at Newark Transformer Co., has joined the engineering staff of the Peerless Electrical Products Division of Altec Lansing Corp., New York City.



A. A. Emler



A. E. Cullum, Jr.

A. EARL CULLUM, JR. has been awarded the Presidential Certificate of Merit for meritorious service from August 1942 to February 1946 in his work in radio and radar countermeasures as associate director of the Radio Research Laboratory at Harvard University.

BENJAMIN A. FISHER, formerly professor of electrical engineering at the University of Denver, was recently appointed associate professor at Illinois Institute of Technology.

MAXWELL K. GOLDSTEIN, associated with the Naval Research Laboratory since 1939, has been named to organize and direct the Programs Research Unit of the Research Group of the Office of Naval Research. He holds the Distinguished Civilian

A WELL KNOWN NAME IN RADIO FOR OVER A QUARTER OF A CENTURY

**Carter Motorola**

**PREFERRED POWER**  
of America's Foremost  
Mobile Transmitters

**RELIABILITY** . . . Designed especially for mobile transmitter use. Specified and preferred by Police Networks for over 14 years!

**INSTANT POWER** . . . Only CARTER GENEMOTOR delivers full output in less than 3/10 second! The fastest starting Dynamotor made.

**SMALL SIZE** . . . Simplicity of design permits minimum mounting space, high efficiency.

**INSULATION** . . . Finest laminated slot insulation, double varnished. Triple insulated windings. Transformer grade laminations.

**BRUSHES** . . . Size and grade designed for long brush and commutator life. Beryllium springs.

**COMMUTATORS** . . . Hard drawn copper silver alloy bars.

**CARTER** . . . The oldest name in Rotary Power Supplies for mobile radio! Write for free Bulletin.

Logos: RCA, HAR-CAM, COMCO, FEDERAL GUARANTEE, FTR, GE, K&R ENGINEERING CO., RAJ JEFFERSON, INC., Doolittle, Marconi, Carter Motor Co. Chicago, Illinois, HAIN-WELLS.

2646 N. MAPLEWOOD AVENUE • CABLE: GENEMOTOR

# REVOLUTIONARY New SOLDERING IRON

## TRANSVISION Soldetron

Trade Mark Reg., U.S. Pat. Off., Pat. Pend.

- Weighs only 3 ounces, yet it can do the job of a 200 watt iron
- Readily interchangeable tip-heads; no cleaning or filing.
- Easy to use for every type of soldering.

*Fingertip control . . . Permits long periods of soldering without fatigue*  
*. . . High working output . . .*  
*Low current drain.*



Ready for attachment and operation on 110 V A.C., 50-60 cycles, through transformer supplied with iron, or 6-8 volt A.C. or D.C. without transformer (from an automobile battery).

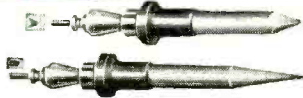

**IDEAL FOR PRECISION WORK:** Revolutionary in design, this featherweight precision iron has all the advantages of light weight and small size, making it ideal for fine precision work in "hard-to-reach" places.

**NEW FEATURES:** Weighs only 3 ounces . . . Heats up in 20 seconds from a cold start . . . Fingertip button permits control of temperature to suit any operation . . . Retains heat with switch off up to one minute, then requires only 3 seconds to reheat for operation at maximum efficiency . . . Bakelite handle with cork grip.



Overall size 9 1/4" x 15 1/8"; ship. wt. approx. 4 lbs.

**EFFICIENT, ECONOMICAL:** The "Soldetron" pays for itself in a few months . . . Intermittent control feature minimizes tip corrosion and eliminates the need for frequent cleaning . . . Long, thin tip permits soldering in inaccessible places as in instrument work, etc. . . . Tip-heads are interchanged in a jiffy . . . Various types are available, and can be removed and inserted in one easy motion . . . No more fussing with frozen tips . . . Heater element is incorporated in each tip-head . . . To test the life of the tip-heads they were heated to approximately 1800°F.; during this severe test, the tip-heads did not burn out.

PRICE, including transformer and Tip-Head "A", \$13.95.

See your distributor, or for further information write to:

**TRANSVISION, INC., Dept. E. D. NEW ROCHELLE, N. Y.**



MODEL 2B U-45  
Actual size illustrated

RECHARGEABLE • NON-SPILL

## VITAMITE

1 OZ. BATTERIES

(Smaller Than 2 Pen-Lights)

### IDEAL FOR USE WITH

Miniature And Sub-Miniature Filament Type Tubes for HEARING AIDS, PORTABLE EQUIPMENT, ETC.

LARGER MODELS ALSO AVAILABLE

Write for Data and Literature

**THE VITAMITE COMPANY**

227 West 64th Street

New York 23, N. Y.

## WASHERS • SMALL STAMPINGS • WIRE PARTS

TO YOUR SPECIFICATIONS

LONG OR SHORT RUNS

- any quantity
- any material
- any finish

- For prices and delivery send blue-print or sample.

**Sheffco Manufacturing Co.**

116 W. RUBY AVE. • PALISADES PARK, N. J.

## 4 TERRIFIC BUYS!

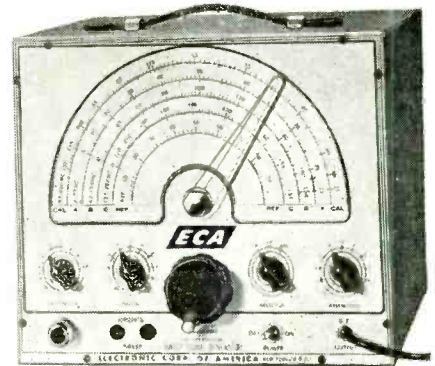

### FM and TELEVISION SWEEP SIGNAL GENERATOR \$34.95

Accurate!—Aligns FM and television receivers, Frequency range 2-227 MC. Output modulated or unmodulated. High frequency insulation throughout, built-in power line filter and special Midline capacity tuning condenser. Easy to operate—use it to adjust to new TV channels. AC only. Exceptional opportunity to purchase instrument of this kind direct from manufacturer at a tremendous saving!

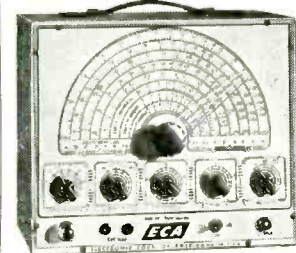

### AM SIGNAL GENERATOR \$32.50

8 RF bands. Frequency coverage 100 KC, 75 MC. Ultra stable 2 terminal RF oscillator, internal modulator. 3 step RF attenuator. Cathode follower output tube. AC only. An indispensable service shop instrument.



### 2-WAY INTERCOM SYSTEM \$14.95

Master and sub in black plastic with 50 feet of cable. Has 4" PM speaker and 3 tube amplifier. 105-125 Volts. AC-DC. (Formerly priced at \$37.50) Lots of 6 - \$12.95

### DYNAMOTOR

\$5.95

For transmitters of Public Address Outfits; Mobile or Yacht Installations. Output 500 Volts at 200 MA continuous or 400 MA intermittent. Input 12 or 24 Volts. DC. Type PE 135AX; power supply for BC223.

All Items Backed by ECA with RMA Guarantee

Enclosed find check (or money order)  in full  20% deposit, bal. COD for the following: Send me FREE ECA Bargain Bulletin.

..... FM Sig. Generator \$34.95 ..... Dynamotor \$5.95  
 ..... AM Sig. Generator \$32.50 ..... Intercom \$14.95

Name .....

Address .....

City..... State.....

**ELECTRONIC CORP. OF AMERICA**

353 W. 48th St.

New York 19, N. Y.



# THE SUPERIOR

5  
Way

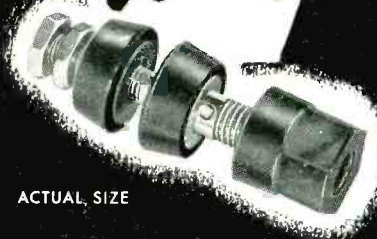

ACTUAL SIZE

## BINDING POST

AVAILABLE  
NOW WITH  
CAPTIVE HEAD

The Superior Electric Company has developed this binding post to give complete insulation, 30 ampere current capacity and 1000 volt working voltage. The captive 1/2" hexagonal head eliminates fumbling—makes a fast, complete, multi-purpose electrical connector.

### Features Five Connections

1. Permanent clamping of wire up to #12 through center hole.
2. Looping of wire around center shaft and clamping.
3. Plug-in of standard 3/4" banana plug.
4. Clip-lead connection by turning hex-shaped head to end of shaft.
5. Spade lug connection.

The 5-WAY Binding Post, available in tough red or black phenolic plastic, is offered for immediate delivery. Write for descriptive literature today.

THE  
SUPERIOR ELECTRIC  
COMPANY

410 Meadow Street  
BRISTOL, CONN.



Service award for his work on the radio direction finder and a commendation from the Chief of Naval Research for his contribution to navigation systems in all-weather flying.

CARL D. PIERSON, JR. has been appointed instructor in electrical engineering at Illinois Institute of Technology. From 1941 to 1948 he was senior engineer and division engineer of the Belmont Radio Corp. in research and development.

LEANDER W. MATSCH, former supervisor in electrical engineering research at the Armour Research Foundation, is the recently appointed professor of electrical engineering at Illinois Institute of Technology.

A. M. ZAREM, inventor of the Zarem camera used in the photographic microtime technique developed at the Navy Test Station in Pasadena, Calif., has been appointed chairman of physics research and manager of the new Los Angeles Division of the Stanford Research Institute.

RAY DAVIS KELL, director of television research at the RCA Laboratories, Princeton, N. J. was the 1948 recipient of the Stuart Ballantine Medal of the Franklin Institute for outstanding pioneer work in television and for his efforts in the development of color television.

### METEOR HUNTER



Electronic metal-detecting wheelbarrow used by H. O. Stockwell for fragments of a meteor reported to have exploded in mid-air in Norton, Kansas

WOLLASTON PROCESS WIRE

drawn as small as .000010";  
Made to your specifications  
for diameter and resistance

WRITE for list of products.

**SIGMOND COHN CORP.**  
44 GOLD ST., NEW YORK

SINCE 1891

# TECHNICAL MANUALS

**CUSTOM DESIGNED  
TO YOUR SPECIFICATIONS**

Planned, written and illustrated by a select staff . . . experts in creating radio and electronic manuals for civilian & military use.

When you call upon Boland & Boyce to create your manuals you are relieved of every detail in their preparation. The entire operation is taken over and completed by a specialized staff with years of experience in publishing books & manuals.

First the requirements for your manual are completely surveyed. The working conditions to which they will be put are studied and the operations or equipment described in the manual are thoroughly analyzed. A complete outline is then prepared and submitted for your approval, along with a dummy of the manual as it will appear when finished. Upon your approval the job is completed and delivered with your satisfaction guaranteed.

Boland & Boyce manuals incorporate only the most modern editorial and illustrative style. Each project is treated with individual attention in technique of presentation and editorial approach. The Boland & Boyce military and civilian manuals now in use throughout the world are our best recommendations.

U. S. Navy  
U. S. Signal Corps.  
Sylvania Electric Products, Inc.  
The National Company  
Western Electric Co.  
Bell Telephone Laboratories  
Maguire Industries, Inc.  
Allen B. Dumont Laboratories, Inc.  
General Electric Co.  
Mine Safety Appliances Co.

Write or wire Boland & Boyce today for more information.

**BOLAND & BOYCE INC., PUBLISHERS**

Radio Maintenance  
Technical Manuals  
Manual Division M-3  
CHICAGO: 228 No. LaSalle St.

Radio Data Book  
Video Handbook  
Montclair, N. J.

## NEW BOOKS

### Alternating-Current Circuit Theory

BY MYRIL B. REED, *Prof. of Elec. Eng., Univ. of Ill. Harper & Brothers, New York, 1948, 603 pages, \$5.50.*

THIS FIRST VOLUME in Harper's new Electric Power Series is intended as a textbook for the third-year engineering course in a-c theory. Its content was developed over a ten-year period of alternate writing and classroom testing, to provide a basic text that would serve as a background for all the major fields of specialization in electrical engineering.

Topics covered include sine wave and vector representation of a-c, algebra of complex numbers,  $I$ ,  $E$ ,  $P$  and energy relations in  $R$ ,  $C$  and  $L$ , solution of circuits, Fourier series, transients, mesh equations, network theorems, wye and delta connections, measurements, matrices, steady state operation of transmission lines, and electric filters. Many problems are provided, including some that are intentionally made too long or too difficult for the usual homework assignment; these require extra time or extra help from the instructor.—J.M.

### Elements of Electrical Engineering

BY WALTER J. CREAMER, *Professor of Communication Engineering and Head of the Department of Electrical Engineering, University of Maine. McGraw-Hill Book Co., Inc., New York, 344 pages, \$4.00.*

THE transition from abstract science courses to applied engineering courses is made less abrupt by this book. It contains a fusion of basic and applied material, presented to guide students in learning to approach concrete problems from their background of fundamental concepts.

The first two chapters concern electrical quantities and laws, and the second two concern conductors, insulators, and methods of measuring networks. Thus from chapter to chapter there is a progression from the abstract to the applied. Also within chapters the same development has been followed. The chapter on electromechanical action, for example, begins with con-

Problem:

To hold "Nominal  
Voltages" to within  
 $\pm 0.1$  volts.....

Solution:

Use STABILINE IE



Your utility company may quote a nominal voltage—but power suppliers are allowed to vary, within certain limits, from the nominal. This condition, plus load changes in your own operation, results in voltages other than nominal. A STABILINE Automatic Voltage Regulator Type IE in your power line assures you of constant voltage. It's *instantaneous* in action — completely *electronic* in operation. Holds delivered voltages to within  $\pm 0.1$  volts, regardless of line variation . . . within  $\pm 0.15$  volts for any load current change or load power factor change from lagging .5 to leading .9. Maximum waveform distortion never exceeds 3 percent.

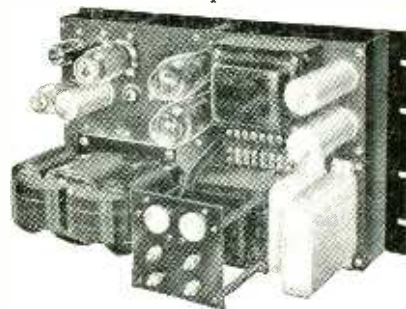

Rear View STABILINE Type IE

Bulletin 547 gives you information on this and other Superior Electric voltage control equipment. Write for your copy today.

THE  
**SUPERIOR ELECTRIC  
COMPANY**  
410 Meadow Street  
BRISTOL, CONN.







from **FLAT SURFACES**

TO **INTRICATE SHAPES**

with the New **DI-ACRO BRAKE**

- **ROK-LOK**—new sensitive material clamp increases accuracy
- **DOUBLE-EDGED FORMING BLADE** allows close reverse bends
- **NEW PRECISION STOPS** accurately control angularity of bends

This versatile metal forming machine was developed for use in model shops, experimental laboratories and production departments where it often replaces dies for all types of precision forming operations. Di-Acro Brakes will form a great variety of materials including bronze, stainless steel, aluminum and bi-metals.

**WRITE FOR CATALOG.** New edition of 40-page Di-Acro Catalog contains detailed information on all Di-Acro Brakes, Shears, Benders, Notchers, Rod Parters, Punches and illustrates how these precision machines can be used individually or cooperatively for "DIE-LESS DUPLICATING".



◀ **DI-ACRO** is Pronounced "Die-Ack-RO"



**O'NEIL-IRWIN MFG. CO.**

321 8TH AVE., LAKE CITY, MINNESOTA

Introducing...

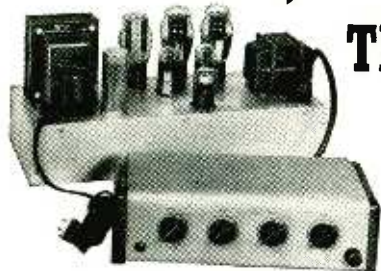

## The NEW Brook 10 WATT All-Triode Amplifier

**Model 12A3**—Two-unit remote-control amplifier. Decorator-styled control cabinet for living-room use. Also available as Model 12A2 for table or rock operation.

**H**ERE it is at last—an amplifier of incomparable performance—built up to the highest standards of Brook engineering—in the moderate price field.

Within the range of its power rating the new Model 12A3 is equal in all respects to the world-renowned Brook 30-watt amplifiers.

The use of low- $\mu$  triodes in all stages, together with Brook-designed transformers available in no other amplifier, permits the cleanest amplification ever achieved with

intermodulation and harmonic distortion reduced to the vanishing point at any power up to maximum. Frequency response is flat within 0.2 DB from 20 to 20,000 cycles.

Now for the first time, the distortion-free all-triode performance which the Brook Amplifier alone provides is available at a new low cost. Orders will be filled as rapidly as production permits.

Write **TODAY** for copy of detailed *Distortion Analysis and Technical Bulletin BK-10!*

Dealer Inquiries Invited — Standard Discounts Apply

# The BROOK High Quality Amplifier

— Designed by LINCOLN WALSH



**BROOK ELECTRONICS, Inc.,**

34 DeHart Place, Elizabeth 2, N. J.

siderations of ionic formation and concludes with the cause, effect, and cure of electrolytic corrosion of buried pipes; the bulk of the chapter is devoted to batteries.

This book is also indicative of the growing importance of electronics. The title and position of the author in his department are significant; also, in this book the bulk of which is devoted to electric machines the concluding chapter is on electronics for both communication and industrial applications.—  
F. H. R.

### Books Received for Review

**IONOSPHERIC RESEARCH AT WATHERLOO OBSERVATORY, WESTERN AUSTRALIA, JUNE 1938-JUNE 1946.** By L. V. Berkner and H. W. Wells, Carnegie Institution of Washington Publication 175, Washington, D. C., 1948, 425 pages, paper binding \$2; in cloth, \$2.50. Devoted mainly to tables of results, this volume includes a summary of results together with brief description of equipment and methods used. A bibliography of publications on ionospheric research by authors in the Department of Terrestrial Magnetism is also furnished.

**RADAR.** By Orrin E. Dunlap, Jr. Harper & Brothers, New York, 1948 (revised), 268 pages, \$3.00. A popular account of all types of radar equipment and the story of its development. The revised edition explores postwar advances and indicates the many peace-time uses of the technique.

**TELEVISION . . . HOW IT WORKS.** By John F. Rider and others. John F. Rider Publisher, Inc., New York 1948, 203 pages, \$2.70. A paper bound volume printed on 8½ x 11 in. stock. Elements of transmitting equipment are described in order to facilitate an explanation of the overall system. The bulk of the material covers different aspects of receiving equipment from the point of view of the service man.

**ANTENNA MANUAL.** By Woodrow Smith, Editors and Engineers, Ltd., Santa Barbara, Calif., 1948, 306 pages, \$3.50. Written for the average radioman rather than the engineer, this book sums up the elements of propagation before launching into a nonmathematical description of many types of antennas and methods of feeding power to them. Waveguides and antennas for microwaves are purposely omitted.

**TELEVISION ENCYCLOPEDIA.** By Stanley Kempner. Fairchild Pub. Co., N. Y., 1948, 415 pages, \$6.50. Chronological history of television from 600 BC to 1947—42 pages; biographical sketches of contributors to development of television—93 pages; definitions of technical and nontechnical terms used—256 pages; Sylvania market survey—7 pages; bibliography—17 pages.

**BATTLEFRONTS OF INDUSTRY.** By David O. Woodbury. John Wiley & Sons, Inc., New York, N. Y., 1948, 342 pages, \$3.50. Role of Westinghouse in World War II, covering design and production of everything from electric torpedoes to the machinery for producing the atomic bomb, with anecdotes of problems encountered and solved in the labs, in the factories, and on the warfronts.

**WORTERBUCH DER ELEKTROTECHNIK, ENGLISCH-DEUTSCH.** By G. Swoboda and R. Filipowsky. Manzsche Verlagshandlung, Wien I, Kohlmarkt 16, Austria, 1948, 312 pages, paper cover, \$4.30. Pocket-size dictionary listing electronic terms alphabetically in English, each followed by the equivalent German term.

# PREMAX

Covers All Twelve Channels



## The Profitable TV Antenna

Premax No. T-448 Television Antenna is radically new and has been severely simplified in design for quick, easy assembly and erection—for its rugged strength and service—plus a low cost that means real profit for the dealer or service man.

It covers ALL 12 CHANNELS! Tests show a relative response (db.) of about 1 to 3.25 on Channels 2 to 6, with a drop from 0 to -8 after 90 meg. — coming back to +2 to 3.5 on Channels 7 to 13.

Consists of two separate arrays on same mast, each fully adjustable in vertical and horizontal planes. Interconnected by a NEW circuit licensed under AA&K patents. Can be had for all frequencies or either band.

Write for complete details and price.

**PREMAX PRODUCTS**  
DIVISION CHISHOLM-RYDER CO., INC.

4902 Highland Ave., Niagara Falls, N. Y.

## Lavite STEATITE CERAMIC

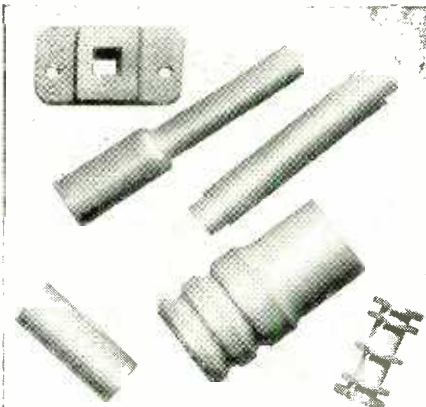

Design engineers and manufacturers in the radio, electrical and electronic fields are finding in LAVITE the precise qualities called for in their specifications . . . high compressive and dielectric strength, low moisture absorption and resistance to rot, fumes, acids, and high heat. The exceedingly low loss-factor of LAVITE plus its excellent workability makes it ideal for all high frequency applications.

Complete details on request

**D. M. STEWARD MFG. COMPANY**

Main Office & Works: Chattanooga, Tenn.  
Needham, Mass. • Chicago • Los Angeles  
New York • Philadelphia

# Only Barnstead

## Can Offer You "GRADED WATER" for Parts Rinsing and Screen Processing

With Barnstead Water Stills or Demineralizers (or a combination of both) you can be assured of a constant unvarying supply of high resistance water exactly fitted to your needs. Where the use requires only the removal of mineral content, Barnstead 2-Bed, 4-Bed or Type "R" Upflo Models provide rinse water that leaves no harmful salt residue.

If the requirements demand elimination of organic impurities as well as inorganic, Barnstead Water Stills provide the surest and most economical answer. For such exacting uses as on screens of cathode ray tubes it may be necessary to de-ionize the water first and then distill it — as many leading tube manufacturers do.

TYPE "SS" WATER STILL



In any event, Barnstead Equipment is your safest solution. And remember, only Barnstead offers you both distilling and demineralizing equipment — and are thus able to handle all situations. Put your pure water problems in the hands of a Barnstead Engineer and have a single responsible authority for their solution.

We will be glad to supply recommendations for your particular problem without obligation.

TYPE "R" UPFLO DEMINERALIZER



**Barnstead**  
STILL & STERILIZER CO.

228 Lanesville Terrace, Forest Hills, Boston 31, Mass

PURE WATER SPECIALISTS FOR OVER 70 YEARS

## COMPOUNDS

Scientifically compounded for specific applications from waxes, resins, asphalt, pitches, oils, and minerals. Available in wide range of melting points and hardnesses. Special potting compounds are heat conducting and crack resistant at extremely low temperatures. Recommendations, specific data, and samples will be furnished on request.

for

### IMPREGNATING

radio coils  
transformer coils  
ignition coils  
wire coverings  
paper tubes and forms  
porous ceramics

### DIPPING

Coils  
Transformers  
Condensers

### SEALING

condensers  
batteries  
switch base terminals  
socket terminals  
light fixtures

### POTTING

Radio Transformers  
Light Units  
Loading Coils  
Condensers



**BIWAX CORPORATION**

3445 HOWARD STREET  
SKOKIE, ILLINOIS

COMPLETE WITH  
FOOT SWITCH  
and Low Voltage  
TRANSFORMER

## SQUEEZ-HEAT!

ELECTRIC

PAT. PEND.

### WIRING and SOLDERING PLIERS

Designed for FASTER assembling. • No elements to burn out. • Instant ON and OFF action. • Can't shock operator. • No current used until switch is closed.

Here's how FAST they work—Grip connection to be made . . . step on foot switch . . . apply solder . . . release switch . . .

AVAILABLE  
NOW

SOLDER STAYS ON  
WORK, WILL NOT CLING  
TO ALUMINUM ALLOY JAWS

Superflexible  
Cord

A PRODUCT OF  
**DURST MANUFACTURING CO.**  
11110 1/2 Cumpston Street • North Hollywood, California



Ballostran  
Ft. Wayne

RED STREAK  
TAPE

**Red Streak**  
Acid-Free  
Electrical Tapes  
and Flat Papers

Emerson Radio  
& Phonograph Corp.

New York  
Freed Transformer Co.  
New York

Todd Products Co.  
Mt. Vernon, N. Y.

... for coil forms, wrappings, etc.

Red Streak Acid-Free tapes and flat papers are uniform in thickness and will conform to your most critical specifications. Tests for free acids and alkalines are made by pH method. In use by prominent manufacturers everywhere. Available in materials and thicknesses listed below. Write us direct or contact your paper merchant.

- .005 Gummed White Flexible Holland
- .005 Gummed Red Rope
- .002 Gummed Glassine
- .003-.004-.005-.006-.007-.010 Gummed Kraft
- .005-.007-.010 Gummed Dark Gray Fish

The Right Acid-Free Tape for you is . . .

**RED STREAK**

**The Brown-Bridge Mills, Inc.**

CHICAGO 608 S. Dearborn	Troy, Ohio	NEW YORK 389 Fifth Ave.
ST. LOUIS 4053 Lindell Blvd.	SAN FRANCISCO 430 Market St.	SEATTLE 2416 First St.
BALTIMORE 2, MD. C. Wilson Wood, Inc. 705 Garrett Building	PHILADELPHIA 2, PA. C. Wilson Wood, Inc. 2203 Packard Bldg.	

## Backtalk

This department is operated as an open forum where our readers may discuss problems of the electronics industry or comment upon articles which **ELECTRONICS** has published.

**Wow**

DEAR SIRs:

IN the article "Wow Meter for Turntable Testing" in the March issue, Messrs. Sansbury and Pappenfus discuss the many sources of audible wow in phonograph record reproduction. While the elimination of wow in the mechanism used to drive records is important, it is far more important at this stage of development of the record art to give attention to the wow resulting from eccentricity in the centering of the record spindle hole with respect to the grooves, a fault given only passing mention in the article.

I am not sufficiently familiar with the production techniques of the industry to be able to say just why it is that so many commercial records are so noticeably defective in this respect, but there are few defects more in need of correction. The authors set up a criterion of a permissible frequency variation of three tenths of one percent.

This means that at a radius of five inches on a record, the eccentricity of the spindle hole would have to be kept within about one sixty-fourth of an inch in order that there should be no perceptible wow. At smaller distances from the center the tolerance is proportionally reduced.

When one notes that eccentricities of as much as one thirty-second of an inch are common and even larger amounts not infrequent, it is readily understood that wow should be so often evident. It is my guess that by far the greatest amount of wow found in home reproduction and in broadcast records is due to this eccentricity.

I believe further that a great deal of poor reproduction not ordi-

3½ KW  
VACUUM TUBE  
**BOMBARDER**  
or  
INDUCTION  
HEATING UNIT



**Only \$975**

Never before a value like this 3½ KW bombarder or high frequency induction heater . . . for saving time and money in surface hardening, brazing, soldering, annealing and many other heat treating operations. Is

Portable . . . mounted on four rubber coasters. Width 14½"; depth 27"; height 42½"; weight 300#.

Operates from 220 volt line. Complete with foot switch and one heating coil made to customer's requirements. Send samples of work wanted. We will advise time cycle required for your particular job. Cost, complete, only \$975. Immediate delivery.

Scientific Electric Electronic Heaters are made in the following ranges of power: 1-2-3-5-7½-10-12½-15-18-25-40-60-80-100-250. KW.

*Scientific  
Electric*

Division of

"S" CORRUGATED QUENCHED GAP CO.

105 - 119 Monroe St., Garfield, N. J.



**NEW!**  
 VITREOUS ENAMELED  
 ROUND RHEOSTAT  
 7 SIZES 50 TO 500 WATT  
 PROMPT SHIPMENTS  
 WRITE FOR CATALOG

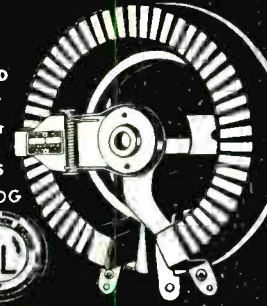

**SLIDE-CONTACT  
 RHEOSTATS  
 AND  
 RESISTORS**  
 6 SIZES 120 DIFF. UNITS

**REX RHEOSTAT CO.**  
 BALDWIN, L. I., N. Y.

**MICROMETER  
 FREQUENCY  
 METER**

for Checking Transmitters  
 from 100 Kc to 175 Mc.  
 within 0.01 per cent.

**LAMPKIN LABORATORIES, INC.**  
 Bradenton, Fla., U. S. A.

**FLUXES**  
 SODERING  
 BRAZING & WELDING

L. B. ALLEN CO. INC. Chicago 37, Ill.  
 6571 Bryn Mawr Ave.

**Custom Built Equipment**

Mechanical-Electrical-Electronic  
 Complete Units. Metal Parts  
 Cabinets, Chassis, Boxes

**BUCK ENGINEERING Co., Inc.**  
 34-37 Marcy St. FREEHOLD, N. J.

**ELECTRO ENGINEERING WORKS**  
 8021 COLLEGE AVENUE - OAKLAND 18, CALIFORNIA

Specializing in High Voltage Filament and  
 Plate Transformers for Electronic Projects  
 Prompt Deliveries

**LOCKING TYPE  
 Stainless Steel  
 TUBE CLAMPS**

Send for illustrated catalog and engineering data

**THE GEORGE S. THOMPSON CORPORATION**  
 South Pasadena, California

**BALL BEARINGS**

MPB makes more than **40** different types and sizes . . .

For precision instruments, laboratory equipment, electronic devices, to minimize friction, space, weight, and to overcome starting torque specify MPB bearings.  
 Radial · Pivot · Angular Contact · Thrust  
 Promptly Available · Ask for catalog EL-2

**MPB MINIATURE Precision BEARINGS**  
 INCORPORATED  
 KEENE, NEW HAMPSHIRE, U.S.A.

**CONTACTS**  
 FOR THE FIELD OF ELECTRONICS

**Kahle**

**ELECTRON TUBE  
 MACHINERY  
 OF ALL TYPES**

**STANDARD  
 AND SPECIAL  
 DESIGN**

We specialize in  
 Equipment and Methods  
 for the manufacture of  
 RADIO TUBES  
 CATHODE RAY TUBES  
 FLUORESCENT LAMPS  
 INCANDESCENT LAMPS  
 NEON TUBES  
 PHOTO CELLS  
 X-RAY TUBES  
 GLASS PRODUCTS

Production or Laboratory Basis

**Kahle ENGINEERING CO.**  
 1309 SEVENTH STREET  
 NORTH BERGEN, N. J., U. S. A.

**FINE RIBBONS  
 OF  
 TUNGSTEN and MOLYBDENUM**

Quality and accuracy in our fabrication of Tungsten & Molybdenum Ribbons have characterized our service to the Electronic industry.

A development of  
**H. CROSS Co.**  
 15 Beekman St., New York 7, N.Y.

Ideal tool for manufacturers, electricians, maintenance men,

**"SPEEDEX" Wire Stripper**

Strips insulation from wire sizes #8 to #30 . . . 750 to 1000 wires per hour.  
 No. 733—12 to 20 wire—List \$6.00  
 Other types available.

"Speedex" Wire Stripper Kit—complete with wire stripper and 7 interchangeable blades in special, permanent steel box.  
 No. 744K—De Luxe Speedex Stripper Kit—complete with Automatic Model Tool and all blades . . . List \$17.00  
 No. 733-K—Standard Speedex Stripper Kit complete with all blades . . . List \$15.00  
 Write today for catalog of 3,000 electronic products.

**GENERAL CEMENT MFG. CO.**  
 Rockford, Illinois, U. S. A.

**WE manufacture a complete line of equipment**

SPOT WELDERS, electric from ¼ to 50 KVA  
 TRANSFORMERS, special and standard types  
 INCANDESCENT LAMP manufacturing equipment  
 FLUORESCENT TUBE MAKING EQUIPMENT  
 ELECTRONIC EQUIPMENT, vacuum pumps, etc.  
 WET GLASS SLICING and cutting machines for laboratory use  
 GENERAL GLASS working machines and burners  
 COLLEGE GLASS WORKING units for students and laboratory

**EISLER ENGINEERING CO.**  
 731 So. 13th St. (near Avon Ave.) Newark, New Jersey

Antenna Coils, Grid Clips, Dial Cord Springs and Precision Springs of all types pertaining to RADIO and TELEVISION.

Your inquiries invited

**WEBSTER SPRING CORPORATION**  
 97 South 5th Street Brooklyn 11, New York

Join with **GARDINER Solder!**  
 BRAND

A free flowing and easy-to-use ROSIN CORE SOLDER for electrical work that must withstand corrosion. You don't have to add any flux . . . the flux is in the solder. Comes in all commercial sizes and quantities.

**Federated METALS DIVISION**

**AMERICAN SMELTING AND REFINING COMPANY**  
 WHITING, INDIANA (CHICAGO)



COLLINS ANNOUNCES:

# COLLINS CUSTOM COMPONENTS

A complete high fidelity radio receiving system from antenna to loud speaker matched by engineers.

FM • AM • TV • PHONO

Matched units—May be purchased separately or as a complete package—Add-a-unit system.



## THE COMPLETE SYSTEM COMPRISES:

1. New, improved Collins 19 tube FM/AM tuner with Bass and Treble tone controls, FM squelch, Pickup equalizer tube.
2. High fidelity amplifier (12 watts, triode output)
3. Record Changer (intermix, with G.E. cartridge)
4. 12" P.M. speaker (wide range)
5. Antenna system (for FM and TV)
6. Transcription player (dual-speed, precision arm)
7. Television chassis (12" and 15" screen)

Write for interesting brochure describing this wonderful equipment. Learn how you may obtain the very finest radio receiving equipment—all from one source. No more haphazard purchasing of different makes of equipment with matching problems. COLLINS CUSTOM COMPONENTS are matched at the factory for top-notch, efficient operation. You will save money, too.

## COLLINS AUDIO PRODUCTS CO., INC.

P. O. BOX 368

WE-2-4390

WESTFIELD, N. J.

narly attributed to wow should be so attributed. Wow is most evident when sustained musical notes are being reproduced. For music without sustained notes or for speech, the only audible effect for a nonexpert may be a sense of flatness or general displeasure.

For these reasons, and because it seems to me that there should be no great technical obstacles preventing it, the record manufacturers should make a determined effort to improve hole centering accuracy and should reject as defective any records not passing a reasonable specification for it.

T. H. PROJECTOR  
National Bureau of Standards  
Washington, D. C.

## Citizens Transceivers

DEAR SIRS:

IT HAS BEEN called to my attention, relative to my article on Citizens Band Transceivers in August 1948 ELECTRONICS, that the BC-645, under conditions of extremes of temperature or humidity, variations of plate voltage or filament voltage, or ageing, may shift its transmitted frequency beyond the maximum specified for FCC Class B equipment. This has not been verified by the author, but any prospective users of this equipment should be warned that such shifts may exist. It must be borne in mind, in fact, that the frequency-determining elements of the BC-645 transmitter are solid, tuned lines, not crystals, and that crystal stability cannot be expected of this equipment.

I do not believe that the statements in my article are erroneous, but no attempt was made to subject the equipment to a complete set of tests representative of those required for FCC type approval of commercial equipment.

WILLIAM B. LURIE  
Bronxville, N. Y.

THE EDITORS are often called upon to forward mail to authors . . . a recent epistle turned out to be a wedding invitation from a reader, a high government official of a European country, who recognized the byline of his distant relative.

**CONTINENTAL**  
*Leads Again*  
With **SMALLEST End-On**  
**Lead Sulfide Tube Ever**  
Put Into Steady Production

\*LITTLE MINIATURE IN ELECTRONIC  
FIELD READY FOR BIGGEST JOBS

**T**HE New Continental CE-703 End-on Lead Sulfide cell will revolutionize Electronic Equipment manufacture. It will have the instant approval of equipment designers who have long sought a practical sub-miniature cell in applications where banking of numerous cells in a small space is required. It will open up new fields in the designing of photoelectric equipment at a great saving on materials and space. It's of the photoconductive type with high voltage sensitivity and good response to infra-red radiation up to  $3\mu$ .

\*Can be made as small as  $\frac{3}{16}$ " dia. by  $\frac{1}{2}$ " in length. Standard size  $\frac{1}{4}$ " x  $\frac{3}{4}$ ". Write for data on any larger sizes required.

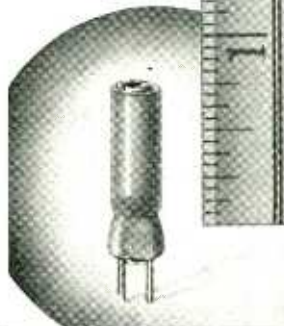

## CONTINENTAL ELECTRIC CO.

America's Leader in Quality Electronic Tube Manufacture  
GENEVA, ILLINOIS

# PROFESSIONAL SERVICES

Consulting — Patents — Design — Development — Measurements

in

Radio, Audio, Industrial Electronic Appliances

## THE BARRY CORPORATION

VIBRATION Specialists in the Control of IMPACT NOISE

*Engineering Development  
Manufacturing*

179 Sidney Street Cambridge, Mass.  
Telephones: ELIot 0861-0140

## Professional Assistance . . .

*in solving your most difficult problems in the specialized field of electronic devices is offered by consultants whose cards appear on this page.*

## LERU LABORATORIES, INC.

Design and Development of Electronic Equipment for industrial and scientific purposes

Special experience in microwaves, spectrum analyzers, photo-electric circuits, test equipment, etc.

360 Bleecker Street  
New York 14      WAtkins 9-4194

## H. RUSSELL BROWNELL

*Consultant*

Specializing in Measurements & Testing Instruments & Techniques - Electrical - Electronic - Magnetic

188 West 4th St. New York 14, N. Y.  
Chelsea 2-4208

## ERCO RADIO LABORATORIES, INC.

*Radio Communications Equipment*

Engineering - Design - Development - Production

Pioneers in Frequency Shift Telegraph

Garden City • Long Island • New York

## MEASUREMENT ENGINEERING LIMITED

Consultants on Special Equipment for measurements and production tests, communications and audio systems.

Arnprior, Ont.      2235 Addington Ave.  
61 Duke St. Toronto, Ont.      Montreal, Que.

## CANOGA CORPORATION

*Electronic Engineers*

Radar, Pulse Techniques, MTI Systems, Pulse and Television Receivers, Video Amplifiers, Test Equipment, Microwave Antenna Applications, Electronic Controls, and Microwave Equipment.

SHOP AND LABORATORY FACILITIES  
14315 Bessemer St. Van Nuys, Calif.  
STate 6-9722

## FRANKEL & NELSON

*Consultants in Mathematical Physics*

7716 Firenze Ave. Los Angeles 46, Calif.

Granite 6970

## Eugene Mittelman, E.E., Ph.D.

*Consulting Engineer & Physicist*

High Frequency Heating — Industrial Electronics  
Applied Physics and Mathematics

549 W. Washington Blvd. Chicago 6, ILL.  
State 8021

## EDGERTON, GERMESHAUSEN & GRIER, Inc.

*Consulting Engineers*

Research, Development and Manufacture of Electronic and Stroboscopic Equipment

Specialists in High-Speed Photography

155 Massachusetts Avenue, Cambridge 39, Mass.

## GENERAL INSTRUMENT & ENGINEERING

CONSULTATION RESEARCH DEVELOPMENT

IN

ELECTRONICS, E. E., PHYSICS

100 Barr Building Washington 6, D. C.

## ALBERT PREISMAN

*Consulting Engineer*

Television, Pulse Techniques, Video Amplifiers, Phasing Networks, Industrial Appliances

Affiliated with  
MANAGEMENT-TRAINING ASSOCIATES  
3308-14th St., N.W. Washington 10, D.C.

## ELECTRO IMPULSE LABORATORY

*Consulting Physicists*

Radio Interference and Noise Meters; Interference Suppression Methods for Ignition Systems and Electrical Devices.

P. O. Box 250 Red Bank, New Jersey  
Red Bank 6-4247

## PAUL E. GERST & CO.

CONSULTING ENGINEERS

Specialists in  
*Electrical Product Design*

El. Machinery Apparatus & Applications  
El. Appliances, Hi-Frequencies Apparatus  
Electronics, Radio Communications

11 So. Desplaines St. Chicago 6, Ill.

## RADIO ENGINEERING COMPANY

*Design and Development*

R.F. IF, Osc. Coils      Stable Oscillator Circuits  
Test Equipment      Instrumentation  
Measurements      Frequency Calibration

F.M.-A.M. Receivers—High Fidelity Audio Systems

COMPLETE LABORATORY FACILITIES  
8 State Street, New York 4, N. Y. Whitehall 4-5266

## ELECTRO-MECHANICAL RESEARCH INC.

*Specialized Research and Manufacture*

High and Low Frequency Circuit Development

Electronic Measuring and Test Equipment

Optical and Infra-Red Studies

Special Geophysical Equipment

Magnetic Susceptibility Meters

Ridgefield, Conn.

## GLOBE PRODUCTS CORPORATION

*Electronic Division*

Specializing in Test Methods and Techniques—  
Development and Design of Electronic Test and  
Measurement Equipment—Automatic and Manual  
—Production and Laboratory types.

870 Maplewood Ave. Bridgeport, Conn.  
P.O. Box #7

## A. F. SMUCKLER & CO.

*Electronic Engineers*

Electronic Product Manufacturing  
Contractors to United States Government

338-346 East 23rd St. New York 10, N. Y.  
GRamercy 5-8151

## ELECTRODYNE CO.

*Electronics Mechanics Optics*

RESEARCH AND DEVELOPMENT

Cathode ray recorders custom built to your own specifications. Prompt delivery.

Specialists in psychological and biological instrumentation and industrial problems.

Literature available on request.

899 Boylston St. Boston 15, Mass.      Phones Copley 7-0055  
Copley 7-0056

## PAUL GODLEY CO.

*Consulting Radio Engineers*

GREAT NOTCH, N. J.

Est. 1926      Little Falls 4-1000

## SPECTRUM ENGINEERS

Electronic & Mechanical Designers

540 North 63rd St., Philadelphia 31, Pennsylvania  
GRanite 2-2333; 2-3135

## ELECTRONIC ENGINEERING CO. of CALIFORNIA

Radio and Electronic Consulting and Designing.

2008 W. Seventh St. Los Angeles  
DRixel 8323      California

## HANSON-GORRILL-BRIAN INC.

*Product & Mfg. Development*

ELECTRICAL - ELECTRONIC  
HYDRAULIC - MECHANICAL

One Continental Hill Glen Cove, N. Y.  
Glen Cove 1922

## TELEREGISTER LABORATORIES

Development — Design  
Studies and Investigation  
Automatic Data Handling Storage  
Digital Computers  
Coded Pulse Techniques

157 Chambers Street New York City  
DIgby 9-4440





## ENGINEERS PHYSICISTS

The establishment of a new section in our research laboratory requires the services of Electronic Engineers, Servo Engineers, and Physicists.

**POSITIONS AVAILABLE AT ALL LEVELS!**

An excellent opportunity exists to grow with this expanding group and receive responsibilities commensurate with your ability and experience.

Microwave radar, television, telemetering, ultra-high frequency communication, cryogenic, high altitude physics, auto-pilot, and computer experience is especially valuable.

### EMPLOYMENT SECTION

#### BENDIX AVIATION CORPORATION

Research Laboratories  
4855 Fourth Avenue  
Detroit, Michigan

### WANTED

## SENIOR ELECTRICAL ENGINEER OR PHYSICIST

M. S. preferred with experience in development of radar, television or digital computer circuits and systems.

Here is an excellent position with future opportunity for the right man in a rapidly expanding aggressive engineering firm. We now have over 150 graduate engineers and scientists engaged in research and development in the field of communications, computing systems, and electro-mechanical devices. Furthermore, it is a thrill to live in Minnesota in the Land of 10,000 Lakes.

Write for application giving a brief outline of scholastic and employment background.

#### ENGINEERING RESEARCH ASSOCIATES, INC.

1902 W. Minnehaha Avenue  
ST. PAUL 4, MINN.

## Radio and Radar Development and Design Engineers

Openings at

### HAZELTINE ELECTRONICS CORPORATION

Please furnish complete resume of experience with salary expected to:

Director of Engineering Personnel

#### HAZELTINE ELECTRONICS CORPORATION

Little Neck, L.I., N.Y.

(All inquiries treated confidentially)

### CHIEF ELECTRICAL ENGR PROJECT ENGRS SENIOR ENGRS

Must have extensive experience in home radio receivers and/or television, design & development.

Address Replies To

Vice President in Charge Engineering

**AIR KING PRODUCTS CO., INC.**  
170-53rd St. Brooklyn, N. Y.

### TELEVISION ENGINEERS

A well established electronics manufacturer, located in the suburban New York City area, is interested in locating high grade television development engineers. This company is expanding its television activities and seeks capable men with backgrounds sufficiently complete to merit responsible positions.

Please give all details concerning yourself, your background and your previous earning capacity. Address your letter to the "Chief Engineer".

P-6212 Electronics

330 West 42 St., New York 18, N. Y.

REPLIES (Box No.): Address to office nearest you  
NEW YORK: 330 W. 42nd St. (18)  
CHICAGO: 520 N. Michigan Ave. (11)  
SAN FRANCISCO: 68 Post St. (4)

### POSITIONS VACANT

TECHNICAL WRITERS, to 30 years. Knowledge of electronics required, also apprentice writers with basic radio experience. Boland & Boyce Publishers, 460 Bloomfield Ave., Montclair, N. J.

### EMPLOYMENT SERVICES

SALARIED POSITIONS \$3,500-\$35,000. If you are considering a new connection communicate with the undersigned. We offer the original personal employment service (33 years recognized standing and reputation). The procedure, of highest ethical standards, is individualized to your personal requirements and develops overtures without initiative on your part. Your identity covered and present position protected. Send only name and address for details. R. W. Bixby Inc., 266 Dun 131d., Buffalo 2, N. Y.

EXECUTIVES \$3,000-\$25,000. This reliable service, established 1927, is geared to needs of high grade men who seek a change of connection under conditions assuring, if employed, full protection to present position. Send name and address only for details. Personal consultation invited. Jira Thayer Jennings, Dept. E, 241 Orange St., New Haven, Conn.

### POSITIONS WANTED

EXECUTIVE ASSISTANT, 33, business administration, education, radio and electronic parts experience. Ex-Army Instructor. Knowledge all phases electronics. PW-6306, Electronics.

ELECTRONICS ENGINEER, Spanish speaking, desires position in Latin America, preferably Mexico or Central America. E.E. plus twelve years experience in all phases of radio communications in responsible positions. Now available. PW-6312, Electronics.

### TELEVISION ENGINEERS

The Crosley division, Avco Manufacturing Corporation is expanding its television receiver activities on a long term basis, creating a few positions for qualified supervisory and senior engineers.

Requirements: College degrees. Three or more years' experience in television and radar design and development of which at least two years have been spent in advanced or product development of television receivers. Specialists in circuit elements will be considered.

Ideal working conditions in well equipped modern laboratories with unlimited opportunities for advancement. Forty hour week, insurance, hospitalization and pension plans. Responsibilities and excellent salaries based on experience and ability.

Replies (which will be kept confidential) stating age, experience, education and salary requirements should be addressed to:

Director of Research and Engineering  
CROSLLEY DIVISION

**AVCO MANUFACTURING CORPORATION**  
1329 Arlington St. Cincinnati 25, Ohio

### PROJECT ENGINEERS

Real opportunities exist for Graduate Engineers with design and development experience in any of the following: Airplane Stability and control, Servomechanisms, radar, microwave techniques, microwave antenna design, communications equipment, electron optics, pulse transformers, fractional h.p. motors.

Send complete resume to employment office.

**SPERRY GYROSCOPE CO.**  
DIVISION OF THE SPERRY CORP.  
GREAT NECK, LONG ISLAND

(Continued on opposite page)



## WANTED ELECTRONIC ENGINEER

B. S. in Electrical Engineering or Physics with some experience in electronic circuit design work. Should be familiar with wide band amplifiers and pulse techniques.

Electronic Design and Development Engineer—M. S. or Ph.D. degree in Electrical Engineering or Physics—will require a minimum of approximately eight years of extensive original electronic design experience in fields of radar or pulse techniques.

Electrical Engineer—5 to 8 years experience in low wattage, wide band amplifiers, subminiature tubes and pulse technique. Location: Southeast, local area housing available.

We need three of the Electronic Engineers with B.S. degrees; one of the Design and Development Engineer; and one Electrical Engineer with five to eight years experience.

P-6363, Electronics  
330 West 42nd Street, New York 18, N. Y.

## WANTED RADIO AND TELEVISION ENGINEERS

The RCA Industry Service Laboratory (formerly License Laboratory), New York, has positions open for engineers having qualifications for development and consultation work. Good technical education and some experience required. Interesting work, broadening experience, and wide contacts.

Write fully to

**DIRECTOR, INDUSTRY  
SERVICE LABORATORY  
RCA LABORATORIES DIVISION**  
711 Fifth Avenue, New York 22, N. Y.

## GRADUATE PHYSICIST

or Electronics Engineer with good background in gaseous conduction wanted by established New England radio tube manufacturer, for development work on gas filled tubes.

P-6352, Electronics  
330 West 42nd Street, New York 18, N. Y.

### POSITIONS WANTED (Continued from opposite page)

RESEARCH AND Development Engineer. BSEE 7 yrs director of insulation developments in wire, cable and equipment field. Also 3 yrs. development and manufacturing experience in incandescent and fluorescent lamps. Able administrator. Midwest preferred. PW-6040, Electronics.

ELECTRONIC ENGINEER, experienced in radio, radar and television, desires position combining technical knowledge with background of 10 years manufacturing and top business management. PW-6143, Electronics.

ENGINEER SEEKS position as Assistant to Executive in Los Angeles area or as salaried Field Engineer with manufacturer or representative headquartered in Los Angeles. 17 years application, design, development and supervisory experience in radio, electronic and electrical equipment. 2½ years field engineering. Employed. PW-6251, Electronics.

### SELLING OPPORTUNITIES WANTED

SALES REPRESENTATIVE—Excellent contacts with Chicago area radio and electrical manufacturers. Desires to represent established concern either full time or as agent. RA-5624, Electronics.

ENGINEER ACTIVE and experienced in electrical, radio and electronic fields with headquarters in San Francisco or Los Angeles or both is available on Pacific coast to represent eastern or midwestern manufacturer saleswise and intechanical capacity. RA-6088, Electronics.

### SAVE RESEARCH TIME BY CONSULTING The Indispensable Bibliographical Reference ELECTRONIC ENGINEERING MASTER INDEX

Descriptive Literature on Request  
ELECTRONICS RESEARCH PUBL. CO.,  
2 W. 46th St., N. Y. 19

## AVAILABLE FOR IMMEDIATE DELIVERY DYNAMOTORS BLOWERS

NEW

Government Inspected  
Notionally Known Manufacturers  
TYPE DA-3A 28V  
SPECIAL! \$9.95

Input 28VDC 10.5 Amps  
Hi Volt Output 300VDC .260 Amps  
Med. Volt Output 150VDC .010 Amps  
Low Volt Output 14.5VDC 5.0 Amps  
Temp. Rise 40° C Duty Continuous RPM 4700

### MODEL D-104 12V

Input #1 12VDC RPM 4700  
Input #2 12VDC Duty Cont.  
Output #1 225VDC 100 Amp  
Output #2 440VDC 200 Amp

### MODEL 5053

DC Input 28V, 1.40 Amps  
DC Output 250V, .060 Amps \$3.95

WRITE PHONE VISIT

For Complete Listings and Detailed Information

## Components Supply Company

168 Washington St. N. Y. 6, N. Y.

Beekmon 3 8717-8-9

Open Account Shipment To Rated Concerns. Others C. O. D.

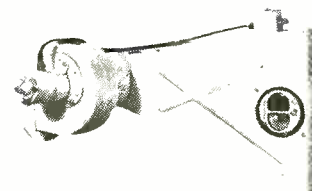

250 CFM—24-28 volts—operates on AC or DC made for ordnance department, originally used for air conditioning in tanks.

Price Each \$12.95

### ALSO IN STOCK

Electrolytics, Capacitors, Micacs, Pots, Rheostats, Wire, Trimmers, Special Purpose Tubes and many other hard to get items. All Nationally Known Brands.

## FOR SALE

### 200-Foot Self-Supporting Triangular Wooden Tower



Built for microwave research . . . capable of withstanding wind velocity of 100 miles per hour . . . suitable for many uses. Triangular base 40 feet per side. Includes 180 feet of Cyclone fence, tubular steel elevator tower, 3 hp. elevator motor, approved lightning rod system . . . enclosed room at top. Readily demountable for shipment. Address inquiries to Radio Sales Department

*Federal Telephone and Radio Corporation*

100 Kingsland Road, Clifton, New Jersey

## RADIO CABINETS

and wood cabinets of all types built to your specifications.

"Engineered Wood Production"

THOMAS MANUFACTURING CO.  
NEENAH, WISCONSIN

### SERVOMECHANISMS

The book AUTOMATIC REGULATION is a distinct aid to anyone engaged in the study, design, analysis, specification, or test of servo-mechanisms. Vol. 1. 207 pages, 6 x 9, cloth, 160 graphs and illustrations, including 530 response curves. \$3.50

AHRENDT & TAPLIN

Box 4673

Washington, D. C.

## Chief Engineer

Available

Graduate: Thoroughly experienced in design, development and production of Television, Home Receivers and Electronic Equipment. Cost conscious, sales minded, production-wise. Capable Executive, Engineer and Development Worker. Employed at present by Radio-Television manufacturer in above capacity. Will move to East or West coasts. Finest trade references.

PW-5821, Electronics

330 West 42nd Street, New York 18, N. Y.

Northern Ohio  
SALES REPRESENTATIVE  
Solicits connection with manufacturers of high quality electronic components and equipment.

Fully experienced

J. R. DANMILLER  
ASSOCIATES

4334 Groveland  
Cleveland 18, Ohio





LARGEST STOCK OF TUBES IN THE COUNTRY

ALL BRAND NEW—STANDARD BRAND

MINIMUM ORDER \$5.00
QUANTITY PRICES ON REQUEST

Table with 16 columns: Type, Price, Type, Price, Type, Price, Type, Price, Type, Price, Type, Price, Type, Price, Type, Price. Lists various vacuum tube models and their prices.

(ALL TUBE TYPES IN STOCK NOW—SUBJECT TO PRIOR SALE—PRICES SUBJECT TO CHANGE WITHOUT NOTICE)

20% DEPOSIT WITH ORDERS UNLESS RATED

NIAGARA RADIO SUPPLY CORP.

160 GREENWICH STREET

NEW YORK 6, N. Y.

Phone Dlgby 9-1132-3-4 All Prices F.O.B. N. Y. C.



## YOUR HEADQUARTERS FOR INDUSTRIAL EQUIPMENT

### RCA 630 T.S. POWER TRANSFORMER



This transformer designed for heavy duty television service. Primary 115 V. 60 cy. Sec. #1 325-0-325V. @ 400 ma. Sec. #2 5 V. 3 amps. Sec. #3 12.6 C. T. @ 10 amps. Sec. #4 6.3 V @ 7 amps. List price \$10.00. Your cost..... **\$18.25**

No. T 4106

### FILAMENT TRANSFORMER

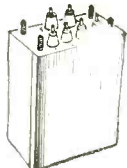

HERMETICALLY SEALED 115V. 60 CYC. PRIMARY Sec. No. 1 6.3 @ 3 Amp. Sec. No. 2 2.5 volts @ 2 Amps. Western Electric D Spec 161917 insulated for high voltage inverse peaks—designed to light scope tube and 2x2 tube. 5 1/2" high x 2 3/4" x 4 1/2" **\$3.95**

### PLATE TRANSFORMER



Primary 220 or 110V., 50/60 Cy Sec. 2050 CT @ 1 amp. Used in a bridge circuit, this transformer will deliver 2000 V. DC @ 487 ma **\$17.95**

No. T-4640

### TRANSFORMER



Here is a rugged transformer built to Army specs. Hermetically sealed with Franklyn Terminals for easy soldering. Primary 115 v. 60 cycles. Sec. No. 1 815 v. vt @ 58 ma. Sec. No. 2 5.4 v. @ 3 a. Sec. No. 3 6.3 v. @ 4 a. Weight 10 lbs. Your cost..... **\$2.49**

### TRANSFORMER



Here is a transformer versatile enough to run almost any piece of surplus gear—gives you B-, bias and fil. voltages. Pri. 110/220 V. 60 cy. Sec. #1—325-0-325 V. @ 250 ma. Sec. #2—0-180 V. @ 40 ma. Sec. #3—5 V. 3 amps. Sec. #4—6.3 @ 3 amps. Sec. #5—12 V @ 10 amps. A real steal **\$7.95**

### TRANSFORMER

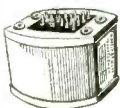

Pri. 110 V. 60 cy—Sec #1 850 V. C. T. @ 142 ma Sec #2 65 V. @ 142 ma; Sec #3 6.3 V. @ 10 amps; Sec #4 6.3 V. @ .6 amps; Sec #5 5V C. T. @ 3 amps—Hermetically sealed—A good buy. **\$5.50**

### INPUT TRANSFORMER



Western Electric Spec. #D168816 600 OHM Line to single grid—3 3/4" wide x 4 1/2" high x 1 3/4" deep.... **\$1.85**

### DMDFX618



Heavy Duty continuous—28 Volts input @ 18 amps. DC output 1000 Volts @ 150 ma. —also 380 Volts @ 400 ma. Complete with filter—while they last..... **\$19.95**

## SELSYN MOTORS

CLOSE OUT



### SPECIAL

Synchronous Type

Pair in Series for 110 v. AC.

Type I—5 1/4" long, 3" dia.—50 v. AC. 50 cy.—4 lbs. **\$9.95 pr.**

Type II—6 1/4" long, 4 1/4" dia.—115 v. AC. 50 cy. 11 oz. **\$12.95**

### SYNCHRO—DIFFERENTIAL

Model #1943—C78249-CAL-11280 Bendix Aviation 115 v.—60 cy. 6" length to end of shaft x 4 1/4" diameter. **\$9.95**

### ANTENNA MANUAL



Here is the latest dope on antennas. 350 full pages on beams, stacked arrays, colinear arrays, etc.—how to match them to feed lines—a wonderful manual without mathematics so anybody can understand how and why **\$3.50**

### DO YOU OWN AN SCR-522?

We have a complete power supply, including a separate voltage regulated bias supply chassis and schematic—all in kit form. This kit will supply all voltage necessary for operation of the set. All parts guaranteed. Complete at the amazingly low price of **\$14.95**

### IT'S SENSATIONAL

Hottest Item Out! Make your SCR-522 Receiver operate on 144 to 148 MC with ONE DIAL control in less than 1 hour! Parts and instructions.... **\$3.00**

Model 200-EA. 5-ELEMENT 2 METER BEAM KIT. Folded di-pole driven element. All aluminum construction. Feed with low impedance coaxial cable. Amateur net price.... **\$8.40**

### A-BT-Cut Xtal



1000 KC mounted in a holder—very few left—practically no drift **\$4.95**

### RELAY



Telephone Type—dual coil relays, designed for two separate circuits—200 OHMS per coil—Type 1—Double pole, single throw, I make, I break. #D-6637. Type 2—Four pole, single throw. #D-6636. Each... **\$2.49**

### METER



8 1/2" Marion—0 to 1 MA. Model 57S. A beautiful meter for laboratory or shop use, large enough to read from several feet away—a good value @ **\$12.00**

Can also be provided in 400 microamps @ **\$13.00**

### FIELD STRENGTH METER



Frequency range 3.5 through 148 mc.—panel switched (8 bands) complete with tube and telescopic ant. Will measure standing waves—quite sensitive at upper frequencies..... **\$29.95**

### CONDENSER



4 Mfd.—1500 Working Volts—DC 3 7/8" wide x 4 5/8" high x 1 1/4" deep. Each **\$2.95**

### CONDENSER



Pyranol—Catalog #23F49—G2 1 Mfd. 5000 Volts—DC working—3 1/2" wide x 4 1/4" high x 4 1/2" deep..... **\$5.50**

### ANTENNA

#### LEAD IN BOWLS

Made of genuine Pyrex—3" in diameter; brass rod 5 1/2" long—complete with hardware and waterproof rubber gaskets.



Special—**\$1.49**

### SPEAKER



6" Speaker Complete with Output Transformer—1500 OHM Field—Complete with single Output—5000 OMS for 6V6, 43 etc.—a good buy @ each **\$2.30**

### POWER TRANSFORMER



700 Volts DC transformer—Pri. 117.5 Volts—

Sec. #1 6.3 V. @ 1.2 amps. Sec. #2 725-0-725 V. @ 60 ma. Sec. #3 5V. @ 3 amps **\$2.95**

### OVERCURRENT RELAY

No. R-3001 Automatic reset—Overload coil is 3000 ohms—Can be shunted for any current simply—Protect those expensive final amplifier tubes, to reset simply press a button. reset coil is 110 v. 60 cycles..... **\$2.49**



### INDUSTRIALS—LABS—SCHOOLS—AMATEURS

Let us quote on components and equipment that you require. We have too many items to be listed on this page. Place your name on our mailing list now for new catalog.

20% DEPOSIT WITH ORDERS UNLESS RATED

# NIAGARA RADIO SUPPLY CORP.

160 GREENWICH STREET

NEW YORK 6, N. Y.

Phone Dlgby 9-1132-3-4  
All Prices F. O. B. N. Y. C.





# SEARCHLIGHT SECTION



**REMOTE CONTROL EQUIP SCR573&574**  
 CRB23367 Selector Control Unit op 110V/60cys  
 CRB23368 Selector Control Unit op 24V/DC  
 Designed to generate & transmit over telephone line signals to actuate CRB23368 Selector RCVR permitting actuation of Two Transmitters & Receivers providing Automatic SEND-RECEIVE switching on either of two channels also permits modulation of remote Transmitter selected, also telephone inter-communication with remote station. AUDIO MONITOR & AMPLIFY speech signals received from remote station over telephone line. Cased RACK MTG per Set ..... \$39.95



**CONSTANT V'REGULATOR NEW RAYTHEON**  
 in 95-130V/60 cy; Output 115V/60 Watt Cased ..... \$10.95  
 RAYTHEON in 198 to 242 Vmpt/50-60 cys; Output 220V/500 Watts/0.5% Rgltn Rack mtg. 36.00  
 SGLA CONSTANT V'REGLTR USN Cased in 95 to 150V/50-60 cys; Outpt 125 to 220V 2KW/17.4 Amps/Constant Duty. LN\* ..... \$130.00  
 SAME UNIT NEW. USN Cost \$369. SPECIAL. \$162.00



**CONDENSER VARIABLE 360° SINEWAVE** 4 taps 90° QUADRANTS for SINEWAVE freqs generator ..... \$2.39  
 Meter GE/DO 58/200 microamp VOM scale /4" sq ..... 6.95  
 METER 50 microamp/VOM scale /4" sq ..... \$8.95  
 METER W.E. 0-200 or 0-500V/1000 ohms p/v ..... \$4.95  
 WESTON SQ 3/2" B/C/476/15VAC METER. \$3.98  
 WSTGHSE 0-150VAC/.25 to 125 cycles. Meter. \$3.95  
 WSTGHSE RA 35 SQ 3/2" B'/476/7.5VAC ..... \$4.50  
 Meter ..... \$1.98  
 WESTON 2 1/2"/Tuning Meter 5ma movement. \$3.95  
 GERF 0-1 Amp/2 1/2" B'Cor 5 amp each. \$3.95  
 WSTGHSE 0-100 & 100-0-100 microamp/DUALAN. \$2.95

**HEINEMAN MAGNETIC BKRS** 10 ma. 220 ma 3, 5, 10, 15, 20, 30, 40, 80 & 180 amps New, each 1.95; Asstd. 10 for \$18.00  
 SQ'D, KLIXON & CH 5, 10, 20, 25, 33, 35 & 60 70 Amps, 98¢ each. 10 for \$8.00  
 THERMOSTAT 85°F/20A adjustable. 49¢

**RECTIFIERS BRIDGE**  
 IN OUT AMPS PRICE IN OUT AMPS PRICE  
 18 14 1.35 2.49 36 28 1.5 3.95  
 18 14 3.5 3.49 36 28 3.5 6.75  
 18 14 5. 4.85 36 28 5. 7.50  
 36 28 .320 1.49 90 75 150. 1.49  
 210 190 .04 .79 Write for LIST



**STANDARD ELECTRIC SI TIMER**  
 ACCY .005 Sec 1/100 Secd & 60 Secd DIAL 24V DC Clutch switch NEW. \$45.00  
 BAROMETRIC POTENTIOMETER, ALTITUDE CON. TROL Sensitive bellows mfrd COOK R-142/55586/AB Control .175 meg. \$1.98  
 TRUMPET & DRIVER/35 to 55 Watts W.E. blast & moisture proof head 3/2" L/15" D \$28.75 @ 2 for \$55.  
 TRUMPET & DRIVERS multicellular 250 Watt 9 Unit W.E. blast & moisture proof \$125.00  
 W.E. Diaphragms for above Trumpets \$3.95  
 MOTOR 1 HP/3 PH/Cont Duty/3450RPM LN\* \$29.95

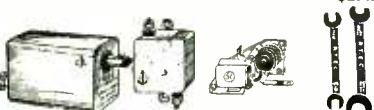

**NAVY LINE FILTERS** 10 amp/130V AC DC Cased filters 0.1 to 1000 mc/USN. \$1.29  
 TOBE 30 amp/250V AC DC filters 0.15 to 1000 mc/USN Cased Cont duty \$4.50@; TWO for \$8.00  
 GE 100 amp filter & 2x5 mfd/50V/pyranol Condors works 110V AC DC SPECIAL. \$1.98  
 Hrdnd ELEC WRENCHES 9 & 11/32, 1/4 & 15/64 ..... \$2.50



**PRECISION RESISTORS "TAB" SPECIALISTS IN PRECISION RESISTORS**  
 Write Qty \$ "NO MFGRS CHOICE, We ship types in stock"

.116	179	680	2600	13500
.42	182	684	2635	14000
.425	199	689	2700	14400
.607	200	697	2850	14440
.7	209.4	700	2860	14460
1.01	216	733	2900	14500
1.3	220	750	3000	15000
1.75	220.4	800	3100	15500
3	225	806	3290	16500
3.83	230	854	3384	17000
4	235	900	3500	17500
4.35	240	910	3509	18000
5	245.4	917	3700	18380
5.025	255.8	946	3730	18500
6	260	978	3760	19000
6.25	271	1000	4000	19500
7	275	1030	4200	20000
7.5	280	1058	4280	20520
7.8	286	1070	4300	21000
7.9	289	1100	4314	21500
8	299	1110	4440	22000
10	300	1150	4444	22500
10.38	310	1155	4500	22990
10.48	311.5	1162	4720	23000
11.25	320	1175	4750	23150
12	325	1200	4850	23325
13.52	340	1225	4885	23400
14.2	350	1250	4900	24000
14.5	366.6	1260	5000	24600
15	370	1322	5100	25000
16	375	1350	5210	25210
16.37	380	1355	5235	25400
17	390	1400	5200	26600
20	400	1495	5500	27500
21	410	1500	5600	29000
22	415	1510	5700	29500
25	414.3	1510	5700	29500
26	418.8	1518	5800	29900
30	425	1600	6000	30000
37	426.9	1640	6140	31000
48	427	1646	6200	33000
50	440	1650	6300	35000
50	450	1670	6300	37000
51.78	452	1680	6500	38140
55	470	1710	6840	38500
60	475	1740	6990	39500
68	478	1770	7000	40000
71.4	480	1800	7500	43000
74	487	1818	4700	47000
75	500	1830	7930	48000
80	520	1865	8000	48660
81.4	525	1900	8250	49000
89.8	540	1910	8500	50000
90	550	1960	8700	52000
95	575	2000	9000	54000
100	580	2045	9000	56000
101	600	2080	9445	60000
105	607	2095	9500	61430
105.7	612	2145	9710	62000
107	625	2160	10300	64000
113.1	633	2195	10400	65000
120	640	2200	10500	68000
121.2	641	2250	10600	70000
125	649	2300	11000	72000
147.5	650	2400	11400	75000
150	657	2450	11500	80000
160	665	2483	11600	84000
165	669	2485	12000	90000
170	670	2490	12600	91000
175	675	2500	13200	95000

ABOVE SIZES EACH 30¢ @...TEN FOR \$2.50

100000	155000	240000	353500	575000
110000	167750	245000	380000	600000
115000	169380	250000	400000	620000
120000	180600	265000	402000	621000
125000	185000	268000	422000	654000
130000	201000	275000	458000	750000
135000	220000	294000	478000	761300
140000	225000	307500	500000	800000
145000	229000	314000	520000	900000
147000	235500	330000	521000	930000
150000	238000	333500	570000	950000

ABOVE SIZES EACH 40¢.....TEN FOR \$3.50

1 Meg	2 Meg	3.5 Meg	4.23 Meg	10 Meg
1.2	2.855	3.673	5	11.5
1.5	3	3.9	5	12.83
1.8	3.673	4	9.05	20

**Vacuum Precision Hivolt Resistors (C)**  
 .12, .25, .6, .75, .83, .99 megohms  
 1, 1.5, 2, 3, 3.75 megohms 0.5% accuracy  
 SPECIAL \$1.00@.....TEN FOR \$7.50  
 SEALED 10 or 12 Meg/10KV/9W \$1.35@ 10for \$10.00  
 MVZB/20Watt/30Megohms/25KV \$1.98@ 6 for \$10.00  
 MFB/105/1Meg/5%accy/YTC SP9 \$1.98@ 6 for \$10.00  
 Type 2/20Meg/1ANR29/20KV/0.5%accy ..... \$29.95  
 200B/175Watt/0-135V GR ..... 10.95  
 200C/860Watt/0-135V GR ..... 16.50  
 100R/0-2300r/270/2KW/115or220Vin ..... 39.95  
 AN/APR4 RECEIVER & COILS Write for details  
 OIL 5MFD/600WV/220VAC/brckts 2 for .98  
 ELECTROLYTIC CAPACIAL  
 FP Type 30mfd/450V&2x20mfd25V also One10mfd/450V&2x20mfd/25V Both for .59

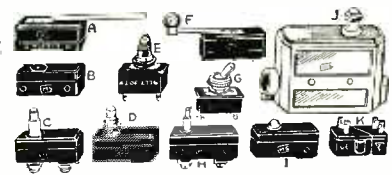

**SWITCHES, MICRO, TOGGLE, etc.**  
 (A) MU/Leaf Switch 3/2"/DPNO & NC/15A 1/2" @ .98  
 (B) MICROSWITCH Pin Plunger SPDT 10A @ .54  
 (C) MICROSWITCH Plunger SPDT/10A @ .59  
 (D) MICROSWITCH Plunger SPNO/10A @ .69  
 (E) ARROW H & H PLUNGER SPNO/6A @ .39  
 (F) MICROSWITCH ROLLER SPNC 10A @ .89  
 (G) AH & H Toggle 6A/DPDT 30¢ @ 4 for .1.00  
 (H) MICROSWITCH PLUNGER SPNO'NC @ .59  
 (I) MICROSWITCH PLUNGER Button SPDT @ .69  
 (J) MICROSWITCH SPNO/30 Amp/Cased @ .1.25  
 (K) SWITCHETTE DPNO & NC 30¢@; SPNO @ .25



**BATTERYS STORAGE & DRY TYPES**  
 (A) BR18/BB52/5oz/36V minSBaty \$1.49 @. 8 for .....\$10.00  
 (B) BURGESS 3V F2BP/dated 6/47 Special 5 for .....\$1.00  
 (C) GOULD 6V/15AH S'Baty USN New...\$3.98  
 (D) BB54/2V 27 amp WILLARD S'Baty...\$1.98  
 (E) WILLARD 4V/40AH/TBY S'Baty.....\$5.95  
 (F) BB206V/2V 11AH WILLARD S'Baty...\$1.89



**POCKET VOM**  
 1maMTR1000 ohm/pv  
 OHMETER ZERO  
 Same Both Ranges  
 MOLDED CASE  
 3/8 x 5/8 x 2 1/4"  
 ETCHED PANEL  
 WHITE LETTERS  
 6ACVOLTRANGES  
 0-15/30/150/300 &  
 1500 & 3000 VOLTS  
 6DC VOLT RANGES  
 0-7.5/15/75/150 &  
 750 & 1500 VOLTS  
 4 DC CURRENT R's  
 0-1.5/15/150 ma &  
 0-1.5 Amps  
 2 OHMETER Rngs  
 500 ohm & 1 meg-ohm  
 COMPLETE BAT & Test leads. \$13.90  
 That's A Buy



**NEW TUBE TESTER**  
 CHECKS OCTAL, LOKTAL BANTAM, PEANUT, TELEVISION MIN, MAGIC I THYRATRONs & OTHERS CHECKS FOR SHORTS & leakage up to 5 megs. CHECKS INDIVIDUALLY Diode, Triode, Pentode sections of multipurpose TUBES. RMA Switching COMPLETE IN OAK CASE SLIPON HINGED COVER 10 3/4 x 8 3/4 x 5/4 Obsolescence Safety factor with new element selector switching keeps tester up to date! SPEEDREAD CHART COMPLETE .....\$29.90



**RF SIGNAL**  
 GENERATOR FM-TEL-IV-AM 150KC to 50 mc's on fundamentals & 11 to 50 mc's harmonics modulation on & off, positive ATTENUATOR Stable GndP osc PORTABLE BATTERY operation Complete 1 1/2 V & 45V baty&leads \$27.75



**HIPOWER VARIABLE ANTENNA MATCHING NETWORK 1001A/1KW RF**  
 NEW 1.5 to 7 mc's convertible to Hifreqs. PiNetwork adjustable IN & Output Cased 15 x 15 x 23" RACK MTG Ribboncoil & 250mmf/7000V Vcondsr RF mtr. Insltrs Techmanual will match most ANTS. NEW requires recementing coil turns SPECIAL .....\$9.95

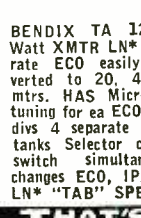

**BENDIX TA 12/100 Watt XMTR LN\* Separate ECO easily converted to 20, 40, 80 mtrs. HAS Micrometer tuning for ea ECO/3000 divs 4 separate output tanks Selector channel switch simultaneously changes ECO, IPA & Output tanks with tubes used LN\* "TAB" SPECIAL .....\$36.00**



**"TAB" MONEY BACK GUARANTEE**  
 \$3 MIN. ORDER F.O.B. N.Y.C. ADD SHIPPING CHARGES AND 25% DEPOSIT. PHONE.WO.2-7230

**"TAB" MONEY BACK GUARANTEE**  
 \$3 MIN. ORDER F.O.B. N.Y.C. ADD SHIPPING CHARGES AND 25% DEPOSIT. PHONE.WO.2-7230  
 DEPT. 11 SIX CHURCH ST. NEW YORK 6, N.Y., U.S.A. - CORNER CHURCH & LIBERTY STS. ROOM 205





**COLLINS ART13 AMP.** Dynamic or Carbon mike or line inpt. Out to PP class "B" Grids. Noise level down-55Db & adj audio osc Amp & Hd-phone monitor Jack less tubes & pwr sun wt 5Lbs 7 1/2 L3 1/2 W5 "H" SPECIAL \$5.95 KIT 872A TUBES & TRANSFORMER GE 115VAC/50-60cys. In-stnd 12.5KV wko Sockets & TUBES SPECIAL \$12.95

**KIT 866A TUBES & TRANSFORMER** inpt 115VAC/50-60cys. Outpt 2.5VCT/10A 10KV insltn. Sockets SPECIAL \$5.95 KIT 872A TUBES & TRANSFORMER GE 115VAC/50-60cys. In-stnd 12.5KV wko Sockets & TUBES SPECIAL \$12.95



**FOXBORO GRAPHIC TAPE RECORDER** 115V 60cy RECORDING & integrating Mechanical Program Cams & counting mechanism Adaptable to Mechanical & Electric Recording New \$39.95

**BC968A Trainer TAB SPECIAL**

**XTAL DIODES & THERMISTORS NEW**  
 1N34S1.08@, 2for\$2.10, 10for\$9.85  
 1N21.21A, 22, 23, 23A each \$1. 12for\$10.00  
 1N23B, 1N26 @ \$2. 10for\$17.50  
 D168391 Compensator THERM \$2@; 3for\$5  
 D170396 HF pwr meas 90°@; 3for\$2.50  
 1C Bulb Time Delay .90@; 3for\$2.50  
 GLYPTAL CEMENT JAR .35

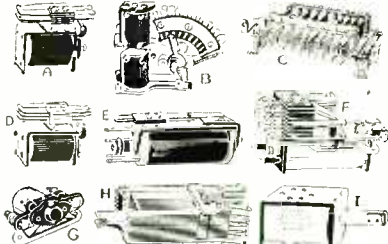

### RELAYS & SOLENOIDS

(A) WE D163482/4500ohm/SPDT adj. \$ .98  
 (B) AUTOMATIC RA74 Remote Control Reset Stepping Twin Coil 24to30V/DP 10 Circuit. 8.95  
 (C) W.E.263A Telephone 275ohm dual coil 2 section each 25 pole DTNO palladium cts. 10.95  
 (D) W.E. Tel D169316 1300ohm/DP1NO&INC. .98  
 (E) SB Telephone Coil100ohm&100ohm SPNC. .98  
 (F) CLARE A12280/115V-60cy/3SPDT & 3SPNC 2.98  
 (G) CLARE Octal based 115VAC/DPNC & SPNO 3.98  
 (H) CH/B8/operates to 24VDC/200to1200amps.298  
 (I) W.E. U682 Telephone coil 500 ohm 12PNO palladium contacts adjustable tension. 2.98  
 (J) PHILTROL SOLENOID 400524/1 1/2" CORE 2 1/4" stroke 24VDC 3.6 ohm Coil. 1.29  
**FIRE EXTINGUISHER** Carbon tetrachloride Mfrd PYRENE one gal Cap-200lb meter selfcharging LN\* shipped dry SPECIAL. 10.98  
**GALLON of CARBON TETRACHLORIDE.** 2.98  
**ANTENNA P108/16.5cmIth\*\*Coax Cnctrc. 1.98**  
**ANTENNA A1/APN2/30CM 12"lth\*\* Coaxial Cnctrc, waterproof gasket&flange mobile mtg SPECIAL \$1.49@ with PL259. 1.75**  
**ANTENNA AN30 Telescopic whip 12"to9ft NEW O'SEAS packed each \$1.49, 2for\$2.49**  
**ANTENNA AN130B Spring Swiveled whip End Loaded 33"lth \$1.25 @; 2 for \$1.98 Ant MS49-54 whip 18ft lth .450**



GE GL434A similar to 7C29 TRIODE useable maxinpt 110 mc's UPTto1200 Watts input, UP to 600W output. 3 Terminal Grid & C.T. filament, forced air Cooling 75-200CFM, Ef 10-11V Dsgn for RADAR/BC-677 operated 215 mc's 12KV/310ma inpt "TAB" SPECIAL \$7.95  
 REL36ACORN similar 6J4. 1.98  
 9LP7 Magnetic DEFL&FOCUS Suitable for TELEVISION 3.98

### "TAB" STANDARD & JAN TUBES

OA4G. .... \$1.04	6N7. .... .85	866A. .... 1.35
OZ4. .... .85	6X7. .... .87	868. .... 1.85
1B3GT. 2.00	6SA7GT. .... .54	872A. .... 2.45
1B21 471. 2.95	6SC7. .... .71	884. .... .89
1B24. 2.95	6SF5. .... .60	918 CEIC. 1.49
1B27. 3.95	6SG7. .... .71	922. .... 1.49
1D5GP. 1.25	6SH7. .... .70	923. .... .75
1G6GT. .85	6SJ7. .... .72	931A. .... 3.95
1E7GT. 1.39	6SJ7GT. .... .58	954. .... .63
1L4. 1.00	6SK7. .... .85	955. .... .63
1L6. 1.00	6SL7. .... .85	956. .... .63
1LH4. 1.05	6SN7GT. .... .75	957A. .... .45
1LH5. 1.05	6SO7. .... .98	991. .... .63
1P5GT. .85	6SS7. .... .98	991. .... .75
1P24. 2.95	6V6GT. .... .70	1613 6F6X. .59
1R4 1294. 1.00	6V7G. .... .58	1614 6L6X. 1.5
2A1A. 2.85	6X4. .... .53	1616. .... 1.3
2A3. 1.90	6X5. .... .85	1619. .... .39
2C26. 1.50	6X7. .... .87	1622. .... 1.69
2C34 RK34. .55	6Z4 84. .... .68	1624. .... .98
2C40 446A. .81	6Z7GT. .... 1.23	1625. .... .45
2C43. 2.98	7B7P-1813 3.95	1626. .... .45
2D21. 1.49	7C29 434. 7.95	1629. .... .58
2E22. 1.45	7G4 1203. .98	1635. .... .58
2E25/HY65. 1.45	7J1P. .... 3.95	1641. .... .75
2J21 725. 12.95	9A7. .... 4.50	2050. .... .88
2J26. 12.95	9LP7. .... 4.85	2051. .... .88
2J30. 18.50	10Y. .... .68	9002. .... .38
2J31. 16.95	12A6. .... .49	8005. .... 4.70
2J32. 16.95	12AH7GT. .87	8012. .... 4.70
2J33. 14.50	12AR7. .... .95	8013A. .... 3.95
2J34. 18.95	12DP7. .... 14.75	8020. .... 3.49
2J42 700. 29.95	12CP7. .... 14.75	9001. .... .49
2J49. 29.95	12SA7GT. .68	9002. .... .59
2J55. 35.00	12SG7. .... .55	9003. .... .49
2J61A. 39.95	12SH7. .... .71	9004. .... .49
2K25. 9.95	12SK7. .... .58	9006. .... .45
2K28. 7.00	12S07. .... .58	C6J. .... 4.95
2K29. 6.95	12X3. .... .90	CE206. .... 3.95
2V3G. 1.05	15E. .... 1.39	CE215. .... 5.95
2X2. .54	24G 3C24. 2.65	UX6005. .... .35
3A4. .70	25Z5. .... .59	F127A. .... 18.00
3B7 1291. .95	35L6GT. .... .72	FG104. .... 14.95
3B24. 1.27	35Z5GT. .... .54	FG105. .... 11.95
3B71. 1.49	REL36/6J4. 1.98	FG166. .... 49.00
3BP1A. 2.95	47. .... .72	T200. .... 12.00
3C23. 4.95	47. .... .65	VR92. .... .74
3D6 1299. .85	50L6GT. .... .52	VR102. .... .39
3E29 829B 3.85	HY65/2E25 2.95	VR105. .... .74
3FP7. 3.98	80. .... .52	VR150. .... .90
3JP12. 2.95	117Z6. .... 1.10	WL468. .... 9.95
3S4. 39.95	205B/VT2. 1.98	WL531. .... 49.50
3J47. 39.95	21A. .... 2.65	UX6653. .... 9.95
5A1P. 2.75	215A. .... .89	WL531. .... 2.95
5B1P 5GPI 1.95	RX125. .... 7.95	TUNGAR*. .... 2.50
5BP4. 3.95	250TH. .... 19.49	20X672*. .... 2.95
5CP1. 3.85	250TL. .... 19.49	199698*. .... 2.95
5DP1. 19.00	304TH. .... 5.95	289881*. .... 2.50
5P7. 2.95	304TL. .... 1.98	MAZDA PL**. .... 0.60
5HP1. 4.95	307A/RX95. 2.25	NEON BLBS. .... 10.07
5R4G. 1.25	388. .... 1.08	64**/T4. .... .14
5T4. 1.25	393. .... .59	56**T4**. .... 1.14
5U4G. .53	450TH. .... 100W/	
5V4. .87	6C21. .... 24.90	.20V**. .... .25
5W4. .87	450TL. .... 29.95	313 28V**. .... 10
5Y3. .89	527 1000S. 1.95	323 3V**. .... 10
5Z3. .89	61P1 SN4 3.95	Aviation Lgts. .... 10
5Z4. .88	632A. .... 8.95	G1249/12V. .... 1.00
6A7. .98	701A. .... 3.95	G4-25for 1.00
6A8. .81	702A. .... 3.49	Sealed Beam. .... 1.49
6A9. .81	703A. .... 4.90	4522 250W. .... 1.49
6A10. 1.05	704. .... 1.75	4565 600W. .... 3.50
6A15. .98	705A. .... 2.25	NEON BLBS. .... 10.07
6AK5. .81	707B/2K28 6.95	NE2-. .... 2.50
6AL5. 1.05	710A 8011. 2.75	160Qty. .... 4.50
6B4G. 1.28	717A. .... 1.49	NE16 991. .... .25
6B8G. 1.05	722/287A. 9.95	NE51 NE20. .... .08
6C4. .49	728A. .... 5.50	Qry100. .... 6.00
6C5. .54	726A. .... 2.95	NE20. .... 6.00
6C6. .71	802. .... 2.95	SOCKETS for. .... .30
6C8G. 1.05	803. .... 7.95	2X2HV. .... .30
6D4. 1.85	804. .... 9.75	705 715. .... .69
6D6. .59	805. .... \$4.50	803 304T. .... .90
6E5. .74	807. .... 1.24	807. .... .27
6F6 1613. .69	808. .... 2.25	81. .... .69
6F8. 1.04	810. .... 6.95	829 832. .... .25
6G5 6U5. .85	811. .... 2.20	866. .... .24
6G6G. .86	813. .... 6.95	872 211. .... .49
6H6GT. .54	814. .... 4.50	ACORN. .... 1.00
6H6. .54	815. .... 2.49	5 for. .... 1.00
6I4. 5.95	816. .... 1.15	Dieteral. .... .60
6J5. .53	826. .... .72	Maginal. .... .69
6J6. .90	828. .... 10.00	Loktal. .... .69
6J7. .70	829B 3E29 3.95	49SSL. .... .24
6K5GT. .86	832. .... 3.75	Octal 7888. .... .06
6K6GT. .54	837. .... 1.12	Octal 495S8. .... .15
6K7. .837. .... 2.25	Min 5900. .... .12	
6K8. .86	845. .... 4.75	TUBES GTD. .... .25
6L6. 1.27	860. .... 2.49	except open FIL. .... .67
6L6G. 1.04	864. .... .67	& breakage. .... .67
6L7. .85	865. .... 1.95	Write Qty Pric. .... 1.95

GE RELAY AMPLIFIER NEW Contains 25 RELAYS including DP 10 pos. Reset latching Relay & 4 sensitive relays, parts Jacks, Rstrs, Condensers & Pots & Shock mtg SPECIAL \$18.95  
 PHOTOFLASH & 2 KRYPTON LAMPS NEW AIRCORPS 1503



SET CONTAINS PWR SUPPLY LAMPS Reflectors, HV rectifier, Condensers 2x25 mfd, HV transformer, Relay, light output 12,000 lumens, 15to30000flashes for Color&B/Wfilm KIT includes INSTRUCTIONS & PARTS to CONVERT 12to 24VDC unit for 115VAC OPERATION "TAB" SPECIAL \$59.95  
 PHOTOFLASH 1503 & RECTIFIED POWER SUPPLY for 115VAC operation READY TO WORK \$99.50  
 PHOTOFLASH KRYPTON LAMPS&Reflector 2 for \$21 PHOTOFLASH CONDENSERS 8mfdGE/660VAC/3000VDCintermittent 4for 11.95

16mfd/660VAC/3000VDCintermittent 7.95  
 15mfd/330VAC/2000VDCintermittent 4.50  
 25mfd/330VAC/2000VDCintermittent 7.95  
 16mm/PAN/50Film GSAP Camera 54for 8.98  
 16mm/PANfilm Gun Camera GSAP 10for 1.98  
 FUSES 3AG-1/8, 1/4, 1/2Amp.06c @ 20for 1.00  
 3AG-1.2, 3.4, 10, 15, 20Amp. 03c @ 40for 1.00  
 3AG-SloBlo 10, 20 Amp. 12c @ 10for 1.00  
 4AG-SloBlo 3, 5, 10, 15, 20Amp. 12c @ 10for 1.00  
 7AG-200mag10 @ 8AG-1/32, 1.09c @ 12 for 1.00  
 Little Fuse 1000V-3/8-1-Amp @30 @ 4for 1.00  
 BUSS 4000V-1/2Amp @75 @ 4for 2.25

### WRITE FOR OTHER SIZES

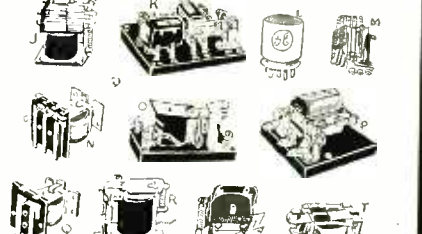

RELAYS  
 (J) GUARDIAN 500AC/op18-24VAC/4PSTNO/8A \$1.25  
 (K) S'DUNN 32AXX10 Reset&overload 10ma&115 VAC \$4.95  
 (L) GE Sealed plugin 2000ohm/SPDT/5A cts. 1.98  
 (M) ALLIED STK/6to12VDC DPDT&SPNO&NC .98  
 (N) ALLIED CONTROL STK/7.5to24VDC/SPDT .75  
 (O) GE CR2791B100J3 3PDT/24V/5A Contacts 1.39  
 (P) S'DUNN 17AXX109/115VAC/SPNO/6 to 30A cts 1.98  
 (Q) KURMAN 4maSens 650ohm/DP1NO&LNC V. 2.25  
 (R) GE CR2791-B10P3/24V DPDT/5Amp Cts .98  
 (S) GUARDIAN 125DC/4to12VDC/SPDT/8 Amp Cts .98  
 (T) GUARDIAN 4500ohmCoil/SPST/5 Amp Contacts .98  
 (U) LEACH 115VAC/DPDT/10AmpContacts. 1.98  
 (V) R22 12V/DPDT&SPNO/15AmpContacts. 1.69  
 (W) A Bradley 702/110VAC/3PSTDP break 25 Amp 4.49  
 (X) ALLIED BJ 6V/DPDT/5Amp Contacts. 1.89  
 (Y) ALLIED BJ/7.5VAC/DPDT 5AmpContacts. 1.98  
 (Z) ALLIED AS 24V/5A/SPDT/5 Amp Contacts .98  
 (AA) ADVANCE 4001B Antenna DPDT&SPNO 15 Amp Ceramic HF ins 75to110V\$2.75@&Rec 115 VAC 3.25  
 (AB) A Bradley Overload adj18.1 15.2/12/9&6.3

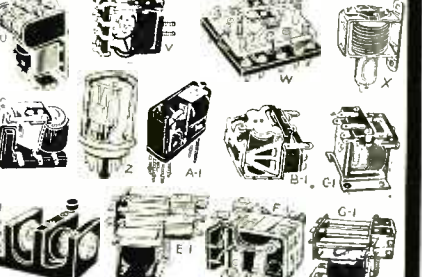

**"TAB" MONEY BACK GUARANTEE**  
 43 MIN. ORDER F.O.B. N.Y.C.  
 ADD SHIPPING CHARGES AND  
 25% DEPOSIT. PHONE WO. 7-7230

**THAT'S A BUY**

DEPT. 108 SIX CHURCH ST. NEW YORK 6, N.Y.U.S.A. • CORP. REG. U.S. PAT. & TM. OFF. •

**THAT'S A BUY**

**"TAB" MONEY BACK GUARANTEE**  
 43 MIN. ORDER F.O.B. N.Y.C.  
 ADD SHIPPING CHARGES AND  
 25% DEPOSIT. PHONE WO. 7-7230





**PARABOLOIDS**

Ideal for microwave experimental work.  
Spun Magnesium dishes  
Reinforced Perimeter  
17½" Diameter x 4" Deep  
Two sets mounting brackets on rear.  
Open center hole 1½" x 1⅝"

**Per Pair, Brand New . . \$8.75**

**MERCURY CONTACT RELAY**

Western Electric D-168479

For applications in all types of high speed switching devices. Long service life, high operating speeds. Large current and voltage handling capacity, uniform and constant operating characteristics under adverse atmospheric conditions. Hermetically-sealed mercury-wetted contacts in gas-filled glass envelope. Free from moisture, dirt, corrosion and atmospheric pressure. Single pole double throw contacts.  
1000 hours life at 60 operations per second. Two coils of 700 ohms, and 3300 ohms. Operating current, coils series aiding—6.6 ma. Release current, coils series aiding—5.2 ma. Four page Technical Data on request.



**Brand New in Original Cartons, \$4.75**

**STEPDOWN TRANSFORMERS**

Input: 115V.-60 cycles.  
Output: 20 V., at 10 amps.  
Also tapped at 6V., for pilot light. Ideal for Selenium Rectifier Applications, etc.

**Brand New \$2.45**



**SELENIUM RECTIFIER**

Bridge Type

Input: 36 V. AC  
Output: 28 V. DC., 1.1 Amps.

**Brand New \$2.75**



**PANORAMIC ADAPTER  
AN/APA-10**

Includes 21 tubes and 3" scope tube. Converted for operation 115 v. 60 cycles. Tested and guaranteed in perfect operating condition. . . \$149.50

**400-2600 CY.**

**POWER SUPPLY**

Input:  
80 or 115 volts,  
400 to 2600 cycles

Output:

1200 volts D.C. at 1.5 MA.  
400 volts D.C. at 130 MA.  
6.4 A.C. volts at 0.8 A. (rms. for 1500v. D.C.)  
Includes tubes: 1—5R4GY, 1—2x2, 1—6AK5, cathode ray tube socket, resistance capacitance filter, two focus controls, an intensity control and 6AK5 reinsertor circuit.  
Brand new. Complete . . . . . \$13.75



**SO-1  
Radar  
Antenna**

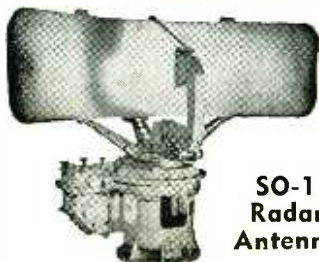

**RADAR ANTENNAS**

Following types available, brand new in original export packing cases:

- SO-1 (10 cm.) . . . . . \$149.50
- SO-3 (3 cm.) . . . . . \$139.50
- SO-8 (10 cm.) . . . . . \$139.50
- SO-13 (10 cm.) . . . . . \$129.00
- TDY (10 cm.) . . . . . \$95.00

**ALL BRAND NEW EQUIPMENT**

**PEAK-TO-PEAK V.T.V.M.**

Designed by Radiation Labs. M.I.T. for the U. S. Navy.

Type TS-487U

A portable instrument designed to measure peak-to-peak voltages of recurrent waves, particularly of the type normally found in radar video circuits. It is especially intended for use in setting the levels of video and synchronizing voltages in radar equipment where the relationships between these voltages are important to the operation of associated equipment.

**BRAND NEW Price \$69.50**



**MOTOR GENERATORS**

Brand New War Surplus Machines Built by Allis Chalmers Co. to U. S. Navy Specifications.  
Input: 115V. D.C. at 14 amps., 3600 rpm.  
Output: 120V A.C., 60 CY. 1 ph. at 10.4 amps. 1000 Watts continuous duty. Ball bearings.

Splashproof. Fully enclosed. Centrifugal starter.

Frequency adjustable to load.

Length 26"; Width 12⅞"; Height 13".

**Price \$125.00**

Same machine but for 230V. D.C. input.  
Price . . . . . \$125.00

Spare parts kit with extra brushes, brush-holders, field coils, bearings, etc., for either machine . . . . . \$29.50

**RADAR EQUIPMENT**

Radar Repeater Adapters, Antenna Control units with P P I units, Transmitter-Receiver units, etc. for SO Radar.

All Brand New Equipment.  
Complete Set SO-3 Tender Spares comprising a complete 3 CM Radar installation and large quantity of spares. Consists of 39 cases of equipment.

**Brand New . . . . . \$2,500.00**

Spare parts for SG 1 Radar in stock

**RADAR TUBES**

4C35, 2J62, 3B24, 3C45, 7BP7, 9LP7, etc.



**VOLTAGE  
REGULATOR  
UNIT**

Any unfiltered source of 350-400 volts DC may be connected to this unit to provide filtered and regulated output at 150 and 300 volts. Contains 12 Hy choke; 3-4 mfd. capacitors; bleeder, divider and current limiting resistors, etc. Ideal in the Lab for experimental set-ups. Complete, brand new with 2-VR 150 tubes.

**\$7.95**

**SYNCHROS**

(Selsyns, Autosyns, etc.)

Navy types: 1F, 5B, 5CT, 5DG, 5G, 5F, 5SDG, 5SG, 5SF, 6DG, 7G, etc.

Army types: 2J5FB1, 2J5S1, 2J1F3, CAL 18300, C 78414, C 78863, C 78411, etc.

**Also:**

Pioneer Precision Autosyns type AY 101D, brand new available in quantity.

**KOLLSMAN COMPASSES**

Type B-16 complete with spare pilot lamp  
**BRAND NEW \$9.75**

**METER SHUNTS**



10 Amp. 50 Mv.  
**BRAND NEW \$1.00**

**DYNAMOTORS—500 Watt  
Navy Type CAJO-211444**

Input: 105-130 Volts D.C., 6 amps. Output 13 or 26 Volts D.C. (26 V. at 20 amps. in series of 13 V. at 40 amps. in parallel). Designed for radio use, fully R.F. filtered, complete with separate Square D line switch box.

**BRAND NEW \$59.50**

Prices FOB, Tuckahoe, N. Y.  
Subject to Change Without  
Notice. 20% With Order on  
C.O.D. Shipments.

**ELECTRONICRAFT**

INC.

All merchandise guaranteed. Immediate delivery, subject to prior sale.

**5 WAVERLY PLACE**

**PHONE—TUCKAHOE 3-0044**

**TUCKAHOE 7, NEW YORK**



## "TWO-IN-ONE" CRYSTAL UNITS

TYPE MX-9E

BRAND NEW!

ACTUAL SIZE COVER CUT AWAY TO SHOW INTERIOR

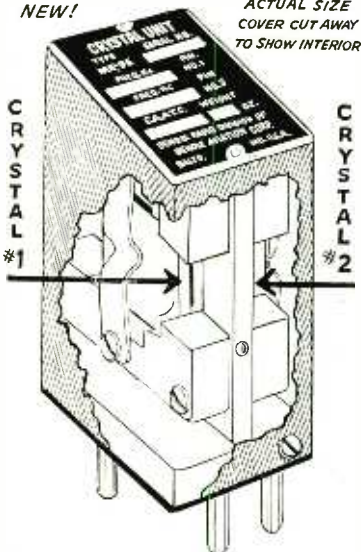

Each unit contains two 3/4" sq. crystals differing in frequency by 455 k.c. The following combinations are available:

Kilocycles	Kilocycles
(1183.0 and 1638.0)	(4287.5 and 4742.5)
(2407.0 and 2862.0)	(4310.0 and 4765.0)
(2457.0 and 2912.0)	(4360.0 and 4815.0)
(2481.0 and 2936.0)	(4435.0 and 4890.0)
(2530.0 and 2985.0)	(4702.5 and 5157.5)
(2539.0 and 2994.0)	(4713.0 and 5168.0)
(2560.0 and 3015.0)	(4930.0 and 5385.0)
(2562.5 and 3017.5)	(4935.0 and 5390.0)
(2915.0 and 3370.0)	(4975.0 and 5430.0)
(2945.0 and 3400.0)	(5080.0 and 5535.0)
(3820.0 and 4275.0)	(5217.0 and 5672.0)
(3860.0 and 4315.0)	(5235.0 and 5690.0)
(4002.5 and 4457.5)	(5490.0 and 5945.0)
(4175.0 and 4630.0)	(5835.0 and 6290.0)
(4205.0 and 4660.0)	(6485.0 and 6940.0)
(4242.5 and 4697.5)	(6515.0 and 6970.0)

All above units are brand new, individually packed with frequencies marked on containers and with manufacturer's inspection tags attached.

Priced at a fraction of the cost of the holder alone. Brand new . . . \$1.95  
3 prong Micalox sockets for above crystal units . . . . .50c each

## SHOCK MOUNTS



A	B	C	D	E
A. Lord #20. 3" x 3" x 1 1/4" . . . . .40	B. U. S. Rubber #5150 C 2 3/8" x 2 3/8" x 1 1/4" . . . . .30	C. Lord #15 2 3/8" x 2 3/8" x 1 1/4" . . . . .25	D. Lord #10 1 1/4" x 1 1/4" x 3/8" . . . . .10	E. Lord #3 1 1/4" x 1 1/4" x 3/8" . . . . .10

BRAND NEW

All prices quoted are fob Tuckahoe, N. Y. About 20 miles N. of N. Y. C.

## Raytheon RECTICHARGERS

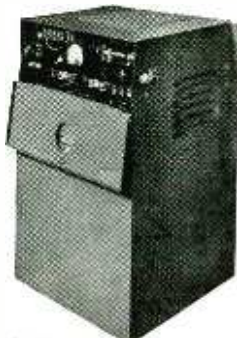

Input: 115 volts AC, 60 cy., 1 Ph. . . . .  
Output: 48 v. DC at 3 amperes regulated and adjustable. Charges 23 to 24 cell battery or may be used direct as battery eliminator.

The Raytheon Recticharger is designed to supply current at constant voltage to any load within its rating, and in addition to supply current to a storage battery connected across its load, of sufficient amount to maintain full charge. The current of the battery is to supply surge current due to sudden changes in load and to supply current above the rating of the Recticharger for temporary overload, and to act as a "stand-by" source of power in event of commercial power failure.

BRAND NEW . . . . \$69.50

## GE BATTERY CHARGER



Input: 115 V, 60 cy., 1 Ph. . . . .  
Output: Charges 54 cell battery at from 1 to 10 ampere rate.

Complete with spare fan and fuses. Brand new in original packing cases. Shipping wt. approx. 305 lbs.

The model 6 RC 89F16 Copper Oxide Battery Charger consists of a transformer, a secondary reactor, a copper oxide rectifying element, a ventilating fan, control circuits and auxiliary equipment necessary for proper operation. Transformer tapped for various supply voltage. Eight secondary taps for adjusting charging rate.

BRAND NEW . . . \$155.00

## Western Electric POTENTIOMETER

No. KS 15138



The d-c potentiometer consists of a closed type die-cast aluminum alloy frame consisting of a continuous resistance winding to which electrical power is supplied through two fixed taps 180 degrees apart. Two rotating brushes (180 degrees apart and bearing on the resistance winding) and two take-off brushes are provided for the output voltage. Varying the position of the brushes varies the output voltage in accordance with a linear sawtooth wave. The potentiometer is excited with 24-volt direct current, is arranged for panel or bracket mounting, is approximately 3-11/16 inches in diameter, 3 inches deep, 4 1/2 inches long, and has an approximate weight of one pound. External connections are made through a standard AN type connector.

Brand New \$5.75

## ALL-WAVE BANDSWITCH ASSEMBLY

Used in Hi-Quality Communications Receiver

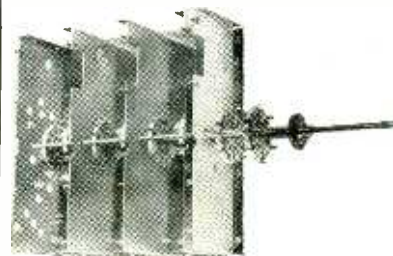

8 gang ceramic switch on silver plated chassis. Overall size 15" L x 8 3/4" W x 4" H.

Brand New . . . . . \$3.75

## SOUND POWERED TELEPHONES



Type TP-3

For two-way signalling or voice communication. No batteries needed. May be used on metallic or grounded circuits, open-wire lines, cables or circuits using

ring-down trunk circuits of common battery switchboards, etc. Contained in treated waterproof fabric cases with adjustable carrying straps.

Brand New . . . . . \$49.50

## R. F. LINE FILTERS

Solar Elimostats  
115 volts, 20 amperes.

Brand new . . . . . \$2.25

## ACME HI-VOLT TRANSFORMERS

Primary: 115 V, 60 cycles.  
Secondary: 8000 V., C.T., 800 V.A.

Brand new in sealed cans . . . \$27.50

## POTENTIOMETER



20,000 ohms, complete with engraved dial assembly.

Brand New . . \$2.75

## PHONE JACK ADAPTER P-106



Phone jack, one end. Coax Receptacle other end. Price \$1.35

## 400 CYCLE SERVO AMPLIFIER

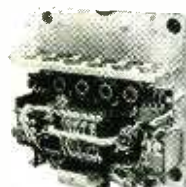

G. E. Type 2CV1C1

Brand New . . . . . \$29.50

## SOUND POWERED TELEPHONE HANDSETS



W. E. Type TS-10M.  
Complete with 7 ft. cord.

Brand New . . . \$16.95

## 10 CM WAVEGUIDE



Solid bronze, 90° elbow flatwise bend.

Brand New \$20

# ELECTRONICRAFT

INC.

5 WAVERLY PLACE

PHONE—TUCKAHOE 3-0044

TUCKAHOE 7, NEW YORK





## MICROWAVE PLUMBING

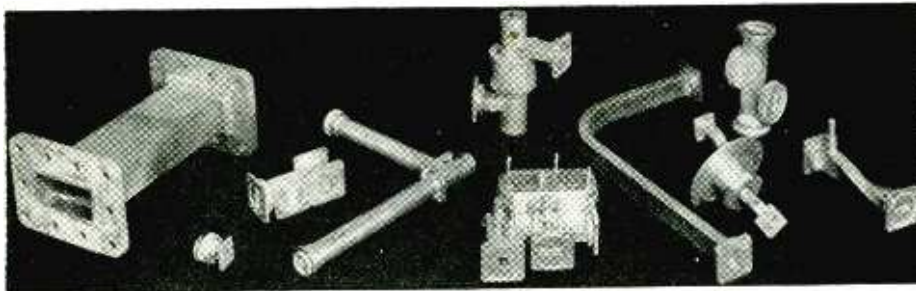

### MICROWAVE PLUMBING 10 CENTIMETER

- MAGNETRON TO WAVEGUIDE coupler with 721-A duplex cavity, gold plated.....\$45.00
- 10 CM WAVEGUIDE SWITCHING UNIT, switches 1 input to any of 3 outputs. Standard 1 1/2" x 3" guide with square flanges. Complete with 115 vac or dc arranged switching motor. Mfg. Raytheon. New and complete.....\$135.00
- 10 CM. END FIRE POLYRODS.....\$1.75 ea.
- "S" BAND Mixer Assembly, with crystal mount, pick-up loop, tunable output.....\$3.00
- 721-A TR CAVITY WITH TUBE. Complete with tuning plungers.....\$5.50
- 10 CM. McNALLY CAVITY Type SG.....\$3.50
- WAVEGUIDE SECTION, MC 445A, rt. angle bend, 5/8" ft. OA. 8" slotted section.....\$21.00
- 10 CM OSC. PICKUP LOOP, with male Homedell output.....\$2.00
- TS115/APS-2F 10 CM ANTENNA in lucite ball, with type "N" fitting.....\$4.50
- 0A1 NAVY TYPE CY66ADL ANTENNA in lucite ball, with Sperry fitting.....\$4.50
- 10 CM. FEEDBACK DIPOLE antenna, in lucite ball, for use with parabola.....\$8.00
- 7/8" RIGID COAX—3/8" I.C.
- RIGHT ANGLE BEND, with flexible coax output pick-up loop.....\$6.00
- SHORT RIGHT ANGLE bend, with pressurizing pin.....\$2.00
- RIGID COAX to flex coax connector.....\$3.50
- STUB-SUPPORTED RIGID COAX, gold plated 5' lengths. Per length.....\$5.00
- RT ANGLES for above.....\$2.50
- 7/8" COAX ROTARY JOINT.....\$2.00
- FLEXIBLE SECTION, 1/2" L. Male to female.....\$4.25
- MAGNETRON COUPLING to 3/8" rigid coax 1/2" IC line, less "M" nut, with TR pickup loop, gold plated.....\$7.50
- 7/8" RIGID COAX—1/4" I.C.
- SHORT RIGHT ANGLE BEND.....\$3.00
- ROTATING JOINT with deck mounting.....\$5.00
- RIGID COAX slotted section, CP-60/AP.....\$5.00

### 1.25 CENTIMETER

- MITRED ELBOW cover to cover.....\$4.00
- TR/ATR DUPLEX SECTION choke to cover.....\$4.00
- FLEXIBLE SECTION 1" choke to choke.....\$5.00
- KBAND Rotary joint.....\$45.00
- ADAPTER, rd. cover to sq. cover.....\$5.00
- S SECTIONS choke to cover.....\$4.50

### MICRO WAVE GENERATORS

- AN/APS-15A "X" Band compl RF head and modulator, incl. 725-A magnetron and magnet, two 723A/B klystrons (local osc & beam), 1B24 TR, revr-ampl, duplexor, HV supply, blower, pulse xfmr. Peak Pwr out: 45 KW adx. Input: 115, 400 cv. Modulator, pulse duration 5 to 2 micro-sec, adx. 13 KV pk Pulse. Compl with all tubes incl. 715-B, 829B, RKR 73, two 72's. Compl pkg. new.....\$210.00
- APS-15B. Complete pkg, as above, less modulator.....\$150.00
- "S" BAND AN/S-2. Complete RF head and modulator, including magnetron and magnet, 1E-1A mixer, TR, receiver, duplexor, blower, etc., and complete pulsar. With tubes, used, fair condition.....\$75.00
- 10 CM. RF Package. Consists of: 80 Xmt, receiver using 2J27 magnetron oscillator. 2500 KW peak input. 707-B receiver-mixer.....\$150.00
- Modulator-motor-alternator unit for above.....\$75.00
- Receiver-rectifier power unit for above.....\$25.00
- Rotating antenna with parabolic reflector for above. New.....\$75.00

### COAX CABLE

- RG 18/U, 52 ohm imp. armored.....\$51/ft.
- RG 23/U, twin coax, 125 ohm imp. armored.....\$50/ft.
- RG 28/U, 50 ohm imp. pulse cable, Corona min. starting voltage, 17 KV.....\$50/ft.
- RG 35/U, 70 ohm imp. armored.....\$50/ft.

### COAX CONNECTORS

- 831R.....\$3.35
- 831SP.....\$3.35
- 831AP.....\$3.35
- 831HP.....\$3.15
- HOME DELL male to type "N" male adapter.....\$1.25
- RT ANGLE Sperry fittings.....\$1.00
- UG 21/U.....\$3.85
- UG 86/U.....\$3.95
- UG 254/U.....\$3.75
- UG 255/U.....\$3.85
- D-168519.....\$3.95
- D-162482.....\$3.00
- D-99136.....\$2.55
- D-162356.....\$1.50
- D-16187A.....\$2.85
- D-99946.....\$2.00

### VARIATORS—W. E.

- D-171121.....\$3.95
- D-171631.....\$3.95
- D-167176.....\$3.95
- D-170223.....\$3.95
- D-168687.....\$3.95
- D-171812.....\$3.95
- D-171528.....\$3.95
- D-163298.....\$3.95
- D-166228 (button).....\$3.95
- D-166382 (tube).....\$3.95
- D-167018 (tube).....\$3.95

### THERMISTORS—W. E.

- D-167332 (bead).....\$3.95
- D-170396 (bead).....\$3.95
- D-167613 (button).....\$3.95

### 3 CM. PLUMBING (STD. 1" x 1/2" GUIDE UNLESS OTHERWISE SPECIFIED)

- 3" FLEX SECTION. Sq. flange to circ. Flange adapter.....\$7.50
- "X" BAND WAVEGUIDE, 1 1/4" x 3/4" OD, 1/16" wall, aluminum.....per ft. \$3.75
- WAVEGUIDE, 1" x 3/4" I.D. per ft.....\$1.50
- TR CAVITY for 721-A TR tube, transmission or absorption types.....\$3.50
- TR tube (41-TR-1).....\$2.50
- WAVEGUIDE SECTION, CG 251/APS-15A, 26" long choke to cover, with 180 deg. bend of 2 1/2" rad. at one end.....\$6.00
- ROTARY JOINT with slotted section and type "X" output pickup.....\$8.50
- WAVEGUIDE SECTION, 12" long choke to cover, 45 deg. twist & 2 1/2" radius, 90 deg. bend.....\$4.50
- STABILIZER CAVITY feedline waveguide section, with filtered output and attenuating slugs.....\$20.00
- SLUG TUNER/ATTENUATOR, W.E. guide, gold plated.....\$6.50
- TR/ATR DUPLEXER section with iris flange.....\$4.50
- TWIST, 5" 90 deg. choke to cover.....\$5.00
- WAVEGUIDE SECTIONS 2 1/2 ft. long, silver plated, with choke flange.....\$5.75
- WAVEGUIDE, 90 deg. bend E plane, 18" long.....\$4.00
- ROTARY JOINT, choke to choke.....\$6.00
- ROTARY JOINT, choke to choke, with deck mounting.....\$6.00
- S-CURVE WAVEGUIDE, 8" long cover to choke.....\$3.50
- DUPLEXER SECTION for 1B24.....\$10.00
- CIRCULAR CHOKE FLANGES, solid brass......55
- "T" SECTION (TR-ATR) choke to choke, supplied with circ. or sq. flanges.....\$3.50

APS-10 MIXER 2K25/723AB. X band local oscillator mount with (1) choke coupling to beacon reference cavity; (2) choke coupling to TR and receiver; (3) Iris coupling with AFC attenuator to antenna waveguide; (4) Radar AFC crystal mount; (5) Receiver crystal mount; (6) Attenuating slugs. Mfg. DeMornay, Budd.....\$22.50

TR/ATR Duplexer section for above.....\$4.00

- 2" FLEXIBLE SECTION, cover to cover.....\$5.00
- SHORT ARM "T" section, with additional choke output on vertical section.....\$4.00

### MAGNETRONS

TUBE	FREQ.	RANGE PK.	PWR OUT.	PRICE
2J311	2820-2860 mc.	265 KW.	\$15.00	
2J311-A	9345-9405 mc.	30 KW.	\$25.00	
2J32	3267-3333 mc.	265 KW.	\$15.00	
2J26	2992-3019 mc.	275 KW.	\$15.00	
2J27	2965-2992 mc.	275 KW.	\$15.00	
2J32	2780-2820 mc.	285 KW.	\$15.00	
2J38 Pkg.	3249-3263 mc.	5 KW.	\$25.00	
2J39 Pkg.	3267-3333 mc.	8.7 KW.	\$25.00	
2J55 Pkg.	9345-9405 mc.	50 KW.	\$25.00	
3J31	24,000 mc.	50 KW.	\$35.00	
714AY			\$15.00	
720BY	2800 mc.	1000 KW.	\$50.00	
725-A			\$25.00	
730-A			\$25.00	
KYLSTONS: 723A/B			\$12.50	
726-A			\$15.00	
707B W/CAVITY			\$20.00	

### MAGNETS

- For 2J21, 725-A, 2J22, 2J26, 2J27, 2J31, 2J32 and 3J31.....Each \$8.00
- 4850 Gauss, 3/4" bet. pole faces, 3/8" pole diam. \$8.00
- 1500 Gauss, 1 1/2" bet. pole faces, 1 1/8" pole diam. \$8.00

### TUNABLE PKG'D "CW" MAGNETRONS

- QK59 2975-2900 Mcs. QK61 2975-3200 Mcs.
- QK60 2800-3025 Mcs. QK62 3150-3375 Mcs.
- New—\$45 each New—\$55 each

### MICROWAVE TEST EQUIPMENT

- W. E. I. 138 A. Signal generator, 2700 to 2900 Mc range. Lighthouse tube oscillator with attenuator & output meter. 115 VAC input, reg. Pwr. supply. With circuit diagram.....\$50.00
- TS-238 PG, 10 cm. Echo box with resonance indicator and micrometer adjust cavity, 2700 to 2900 Mcs calibrated.....\$85.00
- 3 cm. wavemeter: 9200 to 11,000 mc transmission type with square flanges.....\$15.00
- 3 cm. stabilizer cavity, transmission type.....\$20.00
- 3 cm. Wavemeter, Micrometer head mounted on X-Band guide. Freq. range approx. 7900 to 10,000 Mc.....\$75.00

## PULSE EQUIPMENT

### MODULATOR UNIT BC 1203-B

Provides 200-4,000 PPS. Sweep time 100 to 2500 microsec. in 1 step. Fixed mod. pulse, suppression pulse, sliding modulating pulse, blanking voltage, marker pulse, sweep voltages, calibration voltages, ill. voltages. Operates 115 vac 50-60 cy. Sliding pulse variable in phase up to 2500 microsec. Amplitude of suppression pulse adjustable between 30 and 35 v, and width variable between the limits of 10 microsec. or less to 1800 microsec. or more at a recurrence rate between 200 and 300 cps. Provides various types of voltage pulse outputs for modulation of a signal generator such as GR #804B or 804C. New.....\$125.00

### MIT MODEL 3 HARD TUBE PULSER

Output Pulse Power: 144 KW (12 KV at 12 amp). Duty Ratio: .001 max. Pulse duration: .5, 1, 1.0, 2.0 microsec. Input voltage: 115 v, 400 to 2400 cps. Uses 1-715-B, 1-829-B, 3-72's, 1-73. New.....\$110.00

APQ-13 PULSE MODULATOR, Pulse Width .5 to 1.1 Micro Sec. Rep. rate 624 to 1348 Pps. Pk. Pwr. out 35 KW. Energy 0.018 Joules.....\$49.00

TPS-3 PULSE MODULATOR, Pk. Power 50 amp, 24 KV (1200 KW pk); pulse rate 200 PPS, 1.5 micro-sec; pulse line impedance 50 ohms. Circuit—series charging version of DC Resonance type. Uses two 705-A's as rectifiers. 115 v. 400 cycle input. New, with all tubes.....\$49.50

### PULSE NETWORKS

G.E. #25E5-1-350-50P2T, 25 KV, 5 sections, "E" circuit, 1 microsecond pulse length, 350 PPS, 50 ohms impedance.....\$45.00

G.E. #6E3-5-2000-50P2T, 6KV, "E" circuit, 3 sections, .5 microsecond, 2000 PPS, 50 ohms impedance.....\$6.50

### PULSE TRANSFORMERS

W.E. #D166173 Hi-Volt input transformer, W.E. Impedance ratio 50 ohms to 900 ohms. Freq. range: 10 kc to 2 mc. 2 sections parallel connected, potted in oil.....\$12.00

W.E. KS 9800 Input transformer. Winding ratio between terminals 3-5 and 1-2 is 1:1:1, and between terminals 6-7 and 1-2 is 2:1. Frequency range: 380-520 c.p.s. Permalloy core.....\$2.00

G.E. #K2731 Repetition Rate: 635 PPS, Pri. Imp: 50 ohms. Sec. Imp: 450 ohms. Pulse Width: 1 Microsec. Pri. Input: 2.5 KV PK. Sec. Output: 28 KV PK. Peak Output: 800 KW. Bifilar 2.75 Amp.....\$19.50

W.E. #D169271 Hi Volt input pulse Transformer.....\$9.95

G.E. K2450A Pri. secondary delivers 14KV. Peak power out 100KW GE.....\$15.00

G.E. #K2748A Pulse Input, line to magnetron.....\$12.00

Utah Pul or Blocking Oscillator Transformer Freq. limits 790-810 cy-3 windings turns ratio 1:1:1 Dimensions 1 13/16 x 1 1/4" 19/32.....\$1.50

WE # KS 9948 Imp ratio 700 to 50 ohms 18 KVDC. Unpotted.....\$6.50

## MICROWAVE ANTENNAS



AN MPG-1 Antenna. Rotary feed type high speed scanner antenna assembly, including horn parabolic reflector. Less internal mechanisms. 10 deg. sector scan. Approx. 12'L x 4'W x 3'H. Unused.....\$200.00

APS-4 3 cm. antenna. Complete. 1 1/2" dish. Cutler feed dipole directional coupler, all standard 1 1/2" waveguide. Drive motor and gear mechanisms for horizontal and vertical scan. New, complete.....\$65.00

AN/TPS-3. Parabolic dish type reflector approx. 10' diam. Extremely lightweight construction. New, in carrying cases.....\$89.50

RELAY SYSTEM PARABOLIC REFLECTORS; approx. range: 2000 to 6000 mc. Dimensions: 4 1/2" x 3", rectangle, new.....\$85.00

TDY "JAM" RADAR ROTATING ANTENNA, 10 cm. 30 deg. beam, 115 v.a.c. drive. New.....\$100.00

SO-13 ANTENNA, 24" dish with feedback dipole 360 deg. rotation, complete with drive motor and selsyn. New.....\$75.00 Used.....\$45.00

DBM ANTENNA. Dual, back-to-back parabolas with dipoles. Freq. coverage 1,000-4500 mc. No drive mechanism.....\$65.00

AN/128A ANTENNA. Two Vertical dipoles working against a square reflector apx. 3' x 4'. Range: 140-200 mc.....NEW \$40.00

AS 125/APR CONE type receiving antenna, 1000 to 3200 megacycles. New.....\$4.50

140-600 MC. CONE type antenna, complete with 25' sectional steel mast, guys, cables, carrying case, etc. New.....\$49.50

131-E

ALL MERCHANDISE GUARANTEED. MAIL ORDERS PROMPTLY FILLED. ALL PRICES, F.O.B. NEW YORK CITY. SEND MONEY ORDER OR CHECK. SHIPPING CHARGES SENT C.O.D. RATED CONCERNS SEND P. O.

Cable

Liberty St.,  
New York, N.Y.

# COMMUNICATIONS EQUIPMENT CO.

"Comsup"  
Digby 9-4124



## SCR 610 11-10 METER PORTABLE/MOBILE XMTR-RCVR.

SCR 610 portable transmitter-receiver, 27 to 38.9 mc. crystal controlled, using FM for efficient operation. Unit consists of Xmtr-rcvr BC 659 and power supply PE 97 . . . operating from 6 or 12 vdc. Slightly used, excellent condition. Less xtals. . . . \$21.00

## SB 19/GT CONSOLE



Supervisors Panel. Includes jack and key panels, relays, and line terminating facilities. Originally used to monitor and patch up lines in plotting shelter, and to switch outside to lines. Used with radar set AN/CPS-5. Dimensions: 60" H x 28" L x 18" W. New, export packed.

## RADAR SETS

**RC 145 IFF SET.** Consists of BC 1267 xmtr-rcvr, remote antenna controller and indicator I-221, power supply RA 105-A. 1 kw. pulse oscillator operates on 154-186 mc. Operates from 117 v., 60 cy. New. . . . \$190.00  
**SN RADAR-GE.** low power, 5 and 25 miles ranges. Uses GL446 as pulsed oscillator. 5" A scope. "S" band. Extremely compact, ideal for demonstration and laboratory work. 115V 60C operation. Used. Excel. cond. . . . \$600.00  
**SE 10 CM. SURFACE SEARCH RADAR, W.E.** 20,000 to 80,000 yds. range. 250 KW. pk. power input to 706 magnetron. Thyatron modulator, variable pulse rate. Complete set including spare parts, tubes, waveguide and fittings. Send for price and additional information.

## TELESCOPIC 30 FT. MAST SETS

Heavy duty rugged plywood. Crated in 3 sections with coupling and rigging material. Two masts per set for flat-top antenna. Unused. . . . \$40.00 per set

## JUST ARRIVED!!

**600,000 AIRCRAFT BULBS**  
**MAZDA #623, 24-28VDC, 6C.P.**  
**TUNG-SOL #1251, 24-28VDC, 3C.P.**

## VIBRATORS

TR 1210, 12 vdc, 5 pin  
 OAK V-6675, 24-32 vdc, 7 pin  
 Mal. Type G534-C, 12 vdc, 5 pin  
 Mal. Type G629-C, 12 vdc, 4 pin

**PRICE . . . \$1.00 EA.**

MFR'S. QUANTITIES AVAILABLE

## GREAT TUBE VALUES

O1-A	\$.45	7E5	1.00	814	4.95
1A3	.70	7E6	.72	815	2.50
1B24	4.85	10Y	.60	836	1.15
1H5	.55	12A6	.35	837	1.95
1N5	.69	12G7P7	14.95	843	.59
1T4	.59	12XV	.65	860	15.00
2C21	.69	12SR7	.49	861	40.00
2C22	.69	12SR7	.72	874	1.95
2J21-A	25.00	15R	1.40	876	4.95
2J22	15.00	28D7	.75	889R	78.50
2J26	15.00	30 (Spec)	.70	1005	.35
2J27	15.00	35L6	.69	1613	.95
2J31	25.00	35Z5	.66	1619	.21
2J32	15.00	45 (Spec)	.59	1624	.85
2J38	25.00	50L6	.79	1629	.35
2J39	25.00	39 44	.49	1961	5.00
2A55	25.00	35 51	.72	8012	3.95
3J31	25.00	21A	.75	9002	.65
2K2/879	.69	227A	3.85	9006	.47
3A4	.65	225	8.00	9006	.47
3BP1	2.25	250R	7.95	CEQ 72	1.95
3C24	.60	268-A	20.00	EF 50	.79
3C30	.70	285-A	19.50	E-1148	.75
3D6	.79	417A	2.50	F-127	20.00
3CP1 S1	3.50	330	2.50	FC 258A	165.00
3D21-A	1.50	531	45.00	FC 271	10.00
3D1A	2.25	532	3.95	GL 562	75.00
3FP1	2.95	559	4.00	GL 623	75.00
3FP7	1.20	562	90.00	GL 697	75.00
3CP1	3.50	615	.89	ML 100	60.40
3Q5	.79	703-A	7.00	OK 59	45.00
5BP1	1.20	704-A	.75	OK 60	45.00
5BP4	4.95	705-A	2.85	OK 61	55.00
5CP1	3.75	707-B	120.00	OK 62	55.00
5FP7	3.50	714AY	15.00	RCA 932*	.65
5FP2	8.00	715-B	12.00	VR 91	1.00
5J30	39.50	720BY	50.00	VR 130	1.25
6AC7	1.00	720CY	25.00	VR 131	1.25
6AK5	.69	721-A	3.60	VR 137	1.25
6C4	.58	723-A B	7.75	VR 150-30	.75
6C	2.00	724B	1.75	VR 120	1.00
6J6	1.00	724-D	2.50	VT 134	1.00
6K7	.55	725-A	25.00	WT 532	4.75
6L6GA	1.00	726-A	10.00	WN 150	3.00
6SC7	.70	800	2.25	WT 260	5.00
6SL7	1.00	801-A	1.10	† With Cavity	
6V6GT	.79	804	.95	* Photocell.	
7C4	1.00	811	1.95		

## CROSS POINTER INDICATOR

Dual 0-200 microamp. movement in 3" case. Each movement brought out to 6-term receptacle at rear. Originally used in ILS equipment. New. . . . \$2.50

## VOLTAGE REGULATORS

Mfg. Raytheon: Navy CRP-301407; Pri: 92-138 v., 15 amps. 57 to 63 cy, 1 phase. Sec: 115 v., 7.15 amp. .82 KVA. .96 PF. Contains the following components:



**REGULATOR TRANSFORMER:** Raytheon UX-9545. Pri: 92-138 v., 60 cy, 1 PH. Sec: 200/580 v., 5.5/5.26 amps, 4000 v rms test.  
**FILTER REACTOR:** .156 hy, 5 amps, 4000 v test. Raytheon UX 9547.

**TRANSFORMER:** Pri: 186 v., 5 amps; Sec: 115 v., 7.2 amps. Size: 12" x 20" x 29". Net Wt. approx. 250 lbs.  
 Entire unit enclosed in grey metal cabinet with mounting facilities. New, as shown. . . . \$99.50

## POWER EQUIPMENT

Step down transformer: Pri: 410/220/110 volts a.c. 60 cycles, 3 KVA. Sec. 115 v. 2500 volt insulation. Size 12" x 12" x 7". . . . \$40.00

**PLATE TRANSFORMER.** Pri: 117 v., 60 cy. Sec. 17-000 v @ 144 ma. with choke. Oil immersed. Size: 26" x 29" x 13" Amertran. . . . \$65.00

**PH. Transformer:** Pri: 220 v.a.c., 60 cy; .05KVA. sec: 5 v.c.t., 34,000 v. test. . . . \$24.50

**PH. Trans. UX689.** Pri: 115V, 60 cy. Sec: Two 5V 5.5A windings 29 KV Test . . . . \$24.50  
**Plate Transformer:** Pri: 115/230 v.a.c., 50-60 cy. sec: 21,000 v., 100 ma. . . . \$145.00  
**Voltage Reg. Transtat "Amertran" type PH 2KVA** load. Input 90/130 v., 50/60 cycle output 115 v. \$40.00

## OIL CONDENSER STANDARD BRANDS

1 mfd. 10 KVDC #14191 . . . . \$15.00  
 .06 mfd. 15 KVDC, 25F585-G2 . . . . \$ 8.70  
 1.5 mfd. 6000 vdc . . . . \$12.50  
 .25 mfd. 20,000 vdc . . . . \$17.50  
 10 mfd. 1000 VDC . . . . \$ 1.79  
 3x10 mfd. delta connected synchro-capacitor, 90 . . . . \$ 4.95  
 60 cycles. . . . \$ 3.85  
 1 mfd. 6000 vdc. 25F500G2 . . . . \$ 3.85

## POWER CHOKES

Swink. Choke: 4.5 to .8 hy; .2 to 1 amp. . . . \$10.95  
 .03 hy, 2 amp. . . . \$1.45  
 8.5 hy, 125 ma. . . . \$1.50  
 25 hy, 65 ma. . . . \$1.10  
 6 hy, 150 ma. . . . \$1.50  
 Dual 7 hy, 75 ma, 11 . . . . \$1.65  
 hy, 60 ma. . . . \$1.65  
 Dual 2 hy, 100 ma. . . . \$ .75  
 .116 hy, .15 amp. . . . \$4.50  
 .01 hy, 2.5 amp. . . . \$ 1.50  
 .35 hy, .35 amp. . . . \$ 7.50



## TRANSTATS (AMERTRAN)

Input: 0.115 v., 50-60 cycle. Max. output: 115 v., 100 amp. All units guaranteed . . . . \$75

## 400 CYCLE TRANSFORMERS

352-7179: Pri: 115 v., 400 cy. Sec: 6.3 v., 2.7 amp; 6.3 v., .66 amp; 6.3 v., 21 amp. . . . \$2.95  
 32332: Pri: 115 v., 400-2400 cy. Sec: 400 vct. .35 ma; 6.4 v., 2.5 amp; 6.4 v., .15 amp. . . . \$2.25  
 35-7179: Pri: 115 v., 400-2400 cy. Sec: 6.5 v., 12 amp ct. 250 v., 100 ma; 5 v., 2 amp. . . . \$3.50  
 #9069: Pri: 115/80 v., 400-2600 cy. Sec: 650 vct. 50 ma; 6.3 vct, 2 amp; 5 vct, 2 amp. . . . \$2.15  
 1.75 amp, 3 KV ins; 5 v., 3 amp; 6.5 v., 6.5 amp. 6.5 v., 1.2 amp. . . . \$3.95  
 352-7096: Pri: 115/80 v., 400-2400 cy. Sec: 2.5 v., 1.75 amp, 3 KV ins; 5 v., 3 amp; 6.5 v., 6.5 amp. 6.5 v., 1.2 amp. . . . \$3.95  
 KS 9607: Pri: 115 v., 400-2400 cy. Sec: 731 vct. 177 ma, 1710 vct. 177 ma. . . . \$5.95  
 D-166333: Pri: 115 v., 400-2400 cy. Sec: 6.3 v., 0.9 amp. 1.7 v., 0.365 amp. . . . \$2.79  
 GE # 7471957: Pri: 100/110/120/130 v., 400-2400 cy. Sec: 2.5 v., 20 amp, 11V ins. . . . \$4.85  
 D-163254: Pri: 115 v., 400 cy. Sec: 6.3 v., 12 amp. 6.3 v., 2 amp; 6.3 v., 1 amp. P/O AN/YATQ-3. \$5.95  
 KS 9685: Pri: 115 v., 400-2400 cy. Sec: 6.4 vct, 7.5 amp; 6.4 v., 3.8 amp; 6.4 v., 2.5 amp. . . . \$4.35  
**PLATE XFMR:** Pri: 115 v., 400 cy. Sec: 9800 v. or 8000 v. @ 32 ma dc. . . . \$12.50  
 #12033. Plate Xfmr, Pri: 115 v., 800 cy. Sec: 4550 vct. 250 ma. . . . \$4.50  
 KS 9445. Pwr Xfmr, Pri: 115 v., 400-2400 cy. Sec: 592 vct. 120 ma, 6.3 v., 3 amp; 5 v., 2 amp. \$3.50  
**PLATE XFMR:** Pri: 115 v., 400-2400 cy. Sec: 4500 v., 6 ma . . . . \$6.50  
 #7143. Pri: 115 v., 400 cy. Sec: 6.3 v., 7 amp. 8.3 v., 3.5 amp. 6.3 v., 1.3 amp. . . . \$2.50  
**FIL XFMR:** Pri: 115 v., 400 cy. Sec: 6.3 v., 9 amp. 6.3 vct, 65 amp, 2.5 v., 3 amp. 25 v., 2.5 amp. \$3.85  
 KS 9584. Pri: 115 v., 400 cy. Sec: 5,000 v., 290 ma; 5 v., 10 amp, size: 7" x 10" x 6". . . . \$15.00  
 Pri: 115 v., 380-2800 cps. Sec: 2200 v., 350 VA, open frame . . . . \$3.95  
**PLATE XFMR:** Pri: 115 v., 400 cy. Sec: 1150-0-1150 v., 40 ma, GE. 68G631. . . . \$1.75

## INVERTERS

PE 206-A. Input: 28 VDC @ 38 amp. Output: 80 volts @ 500 volt-amps, 800 cycles. Leland, New. complete with enclosed relay, filter, instruction book . . . . \$12.50  
 PE 218: Input: 25-28 VDC @ 92 amps. Output: 115 volts @ 1500 volt-amps, 380-500 cycles. Poor physical but good running condition. . . . \$15.00

## STANDARD BRANDS PRECISION CAPACITORS

D-160270: 1 mfd @ 200 vdc, -40 to plus 65 deg C  
 D-161659: 4 mfd @ 400 vdc, -50 to plus 85 deg C  
 D-163707: 0.4 mfd @ 1500 vdc, -50 to plus 85 deg C  
 D-163035: 0.1 mfd @ 600 vdc, 0 to plus 65 deg C  
 D-170908: 0.152 mfd, 300 v., 400 cy, -50 to plus 85 deg C  
 D-164960: 2.04 mfd @ 200 vdc, 0 to plus 55 deg C  
 D-168344: 2.16 mfd @ 200 vdc, 0 to plus 55 deg C  
 D-161555: .5 mfd @ 400 vdc, -50 to plus 85 deg C  
 #D-166602: 16 mfd @ 400 vdc, temp comp 50 to 85 deg C  
 D-161270: 1 mfd @ 200 vdc, temp comp -40 to plus 85 deg C  
**QBG-1.** Echo Ranging Driver-Receiver, underwater sound signal transmission and reception unit with range of 200 to 600 yds. and freq. range of 16 to 27 kc. New, with battery box, less projector. \$85.00

## 30000 SHOCK-MOUNTS STANDARD BRANDS AVAILABLE IN 20 WEIGHTS & SIZES SEND YOUR REQUIREMENTS

## BIRTCHE TUBE CLAMPS



926-A  
 926-A2  
 926-B  
 926-B1  
 All sizes. . . . \$14 Each  
 Many other types and sizes available.  
 Send your inquiries.

## WIRE WOUND POTENTIOMETERS

20,000 ohms, 10%, 8 watt. . . . \$ .95  
 5,000 ohms, 10%, 8 watt. . . . \$ .95  
 15,000 ohms, 10%, 4 watt. . . . \$ .69  
 Dual 250 ohms, 25 watt. . . . \$ .98  
 50 ohms, 25 watt. . . . \$ .69  
 1000 ohms, 50 watt, mod J. . . . \$ .98  
 800 ohms, 50 watt mod J. . . . \$ .98  
 5 ohms, 250 watt, mod L. . . . \$3.25

## RELAY DPDT, 12 V. D.C. DUNCO #CX3190 B

CONTACTS 16 V. @ 6 AMP D.C. Latching Type \$2.25 ea.  
 A Complete Line of D.C. Relays in Stock.  
 Send for Listing.

## DYNAMOTORS



Type	Input Volts	Input Amps	Output Volts	Output Amps	Radio Set	Price*
BD 77KM	14	40	1000	.350	BC 191	\$20.00 N \$14.00 LN
PE 73	28	19	1000	.350	BC 375	\$24.50 N
DM 21	14	3.3	235	.090	BC 312	\$3.45 LN
DM 21CX	2x	1.6	235	.090	BC 312	\$3.45 N
DM 25	12	2.3	250	.050	BC 367	\$2.49 LN
DM 28R	2x	1.25	275	.070	BC 348	\$5.75 N
DM 33	28	7	540	.250	BC 456	\$5.50 N
DM 42	14	46	1515	.110	SCR 506	\$6.50 LN
			2/8			
PE 55	12	25	500	.400	SCR 245	\$5.25 LN
PE 86	2x	1.25	250	.060	RC 36	\$3.95 N
PE 101 C	13/26	12/6	400	.135	SCR 515	\$5.25 N
			6.3	800	.020	
			9 A C	1.12		
BD'AR 93	28	3.25	375	.150		\$4.95 N
23350	27	1.75	285	.075	APN-1	\$3.50 N
35X045B	28	1.2	250	.060		\$3.50 N
ZA 0515	12/24	4/2	500	.050		\$3.95 N
B-19 pack	12	9.4	275	.110	Mark II	
			500	.050		\$9.95 N

## MISCELLANEOUS COMPONENTS

SEL. RECTIFIER: Input: 115 vac, 60 cy. Out: 120 vdc, 1.06 amps. Full Wave Bridge, P. T. & R. #DE11 . . . . \$9.95  
 SEL. RECTIFIER: Input: 30 vac, 60 cy. Out: 24 vdc, .5 amp. Full wave bridge, GE #SC10. . . . \$1.50  
**POWER SWITCH,** 4 pos, 60 amps, 600 vac. Arrow . . . . \$4.25  
**ROTARY SPARK GAP,** 24 vdc motor, 4 spark gap electrodes, d/o Xmtr BC 1081-TG. . . . \$5.50  
**TELETYPE TAPE,** Gummed, 3/8" WD, 4" Rolls, \$10 Roll  
**SELSYNS,** 110 v., 60 cy, sizes. . . . \$7.75 per pair

131-E

ALL MERCHANDISE GUARANTEED. MAIL ORDERS PROMPTLY FILLED. ALL PRICES, F.O.B. NEW YORK CITY.  
 SEND MONEY ORDER OR CHECK. SHIPPING CHARGES SENT C.O.D. RATED CONCERNS SEND P.O.

Liberty St.  
 New York, N.Y.

# COMMUNICATIONS EQUIPMENT CO.

Cable  
 "Comsupo"  
 Ph. Digby 9-4124  
 MR. CHAS. ROSEN



**SAVE - Brand New and Fully Guaranteed****SYNCHROS**

IF Special Repeater, 115 volts, 400 cycle. Will operate on 60 cycle at reduced voltage.

Price \$15.00 each net.

IG Generator, 115 volts, 60 cycle.

Price \$17.50 each net

ICT Control Transformer, 115 volts, 60 cycle.

Price \$22.50 each net.

2JIG1 Control Transformer, 115 volts, 400 cycle.

Price \$2.00 each net.

5G Generator, 115 volts, 60 cycle.

Price \$25.00 each net.

5SG Generator, 115 volts, 400 cycle.

Price \$10.50 each net.

**PIONEER AUTOSYNS**

AY1, 26 volts, 400 cycle.

Price \$4.00 each net.

AY20, 26 volts, 400 cycle.

Price \$4.50 each net.

AY30, 26 volts, 400 cycle.

Price \$10.00 each net.

**PIONEER PRECISION AUTOSYNS**

AY101D, new; calibration curve.

Price—Call or Write.

AY131D, new; calibration curve.

Price—Call or Write.

**GENERAL ELECTRIC****D. C. SELSYNS**

8TJ9-PDN Transmitter, 24 volts

Price \$3.00 each net.

8DJ11-PCY Indicator, 24 volts.  
Dial marked  $-10^{\circ}$  to  $+65^{\circ}$ .

Price \$4.00 each net.

8DJ11-PCY Indicator, 24 volts.  
Dial marked 0 to  $360^{\circ}$ .

Price \$6.50 each net.

Resistor and Rectifier for operation from 110 volts, 60 cycle source.

Price \$1.00 each net.

**PIONEER TORQUE UNITS**

12602-1-A.

Price \$30.00 each net.

12606-1-A.

Price \$35.00 each net.

12627-1-A.

Price \$70.00 each net.

**PIONEER TORQUE UNIT AMPLIFIERS**

12073-1-A. \$17.50 each net.

**RATE GENERATORS**

PM2, Electric Indicator Company, .0175 V. per R. P. M.

Price \$7.00 each net.

F16, Electric Indicator Company, two-phase, 22 V. per phase at 1800 R. P. M.

Price \$14.00 each net.

B-68, Electric Indicator Company, Drag Cup, 110 volts, 60 cycle, one phase. \$14.00 each net.

**INVERTERS**

12117-4, Pioneer. Input 24 volts D. C. Output 26 volts, 400 cycle.

Price \$12.00 each net.

12117, Pioneer, Input 12 volts D. C. Output 26 volts, 400 cycle.

Price \$15.00 each net.

12123-1-A, Pioneer. Input 24 volts D. C. Output 115 volts, 400 cycle, 3 phase. Voltage and frequency regulated. 100 V. A.

Price \$70.00 each net.

153F, Holtzer Cabot. Input 24 volts D. C. Output 26 volts, 400 cycle, 250 V. A., and 115 volts, 400 cycle, 3 phase, 750 V. A. Voltage and frequency regulated.

Price \$150.00 each net.

MG750, Wincharger, PU16. Input 24 volts D. C. Output 115 volts, 400 cycle, 1 phase, 6.5 amps. Voltage and frequency regulated.

Price \$35.00 each net.

149H, Holtzer Cabot. Input 28 volts at 44 amps. Output 26 volts at 250 V. A. 400 cycle and 115 volts at 500 V. A. 400 cycle.

Price \$39.00 each net.

149F, Holtzer Cabot. Input 28 volts at 36 amps. Output 26 volts at 250 V. A. 400 cycle and 115 volts at 500 V. A. 400 cycle.

Price \$29.00 each net.

661102, Sperry Phase Adapter. 115 volts, 400 cycle. Used for operating 3 phase equipment from a single phase source.

Price \$12.75 each net.

WRITE FOR COMPLETE LISTINGS

**SINE-COSINE GENERATORS (Resolvers)**

FJE 43-9, Diehl, 115 volts, 400 cycle.

Price \$20.00 each net.

**DUAL AUTOSYN INDICATOR**

Type 5003A, contains 2 autosyns, one of which may be removed and used as a transmitter making an ideal position indicator. Dial 2  $\frac{3}{4}$ " diameter, 32V. 60 Cy.

\$7.50 Ea.

**D. C. ALNICO FIELD MOTORS**

5069600, Delco, 27.5 V., 250 R.P.M.

Price \$4.00 each net.

5069466, Delco, 27.5 V., 10,000 R. P. M.

Price \$2.85 each net.

5068571, Delco, 27.5 V., 10,000 R. P. M.

Price \$3.70 each net.

SS-FD6, Diehl, 27.5 V., 10,000 R. P. M.

Price \$3.65 each net.

**D. C. SERIES MOTORS**

5BA10AJ18D, General Electric, 27 volts, 0.7 amp., 110 R. P. M.

Price \$2.80 each net.

C-2BP-1A, John Oster, 27 V., 7,000 R. P. M. .7 amps., 1/100 H. P.

Price \$3.75 each net.

**D. C. SHUNT MOTOR**

5066665, Delco, Reversible, 27.5 V., 4000 R. P. M. Flange mounted.

Price \$4.50 each net.

**A. C. MOTORS**

5069625, Delco, Constant Speed, 27.5 V. A. C. or D. C., 120 R. P. M. Has built-in reduction gears and governor

Price \$4.25 each net.

5071930, Delco, 115 V., 60 cycle, 7,000 R. P. M.

Price \$4.25 each net.

36228, Hayden Timing Motor, 115 V., 60 cycle, 1 R. P. M.

Price \$2.75 each net.

Two-phase low-inertia motors, Pioneer, Diehl and Minneapolis-Honeywell.

Price—Call or Write.

**INSTRUMENT ASSOCIATES**

147-57 41st AVENUE Telephone INdependence 3-1919 FLUSHING N. Y.

# SURPLUS NEW EQUIPMENT

## MOTOR GENERATOR

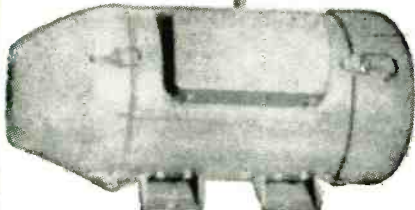

**OUTPUT**—120 volt 10.4 Amps 60 cycle 1.250 KVA 80% P.F. Cont. Duty.  
**INPUT**—115 Volt 14 Amps D.C.  
 Centrifugal starting, frequency adjustable to load, ball bearings, 3600 R.P.M. Fully enclosed splash-proof housing—measures approx. 28" L x 13" H x 13" W.  
 Mfg. by Allis Chalmers to rigid Navy Specs. @ \$100.00

## BOWL INSULATORS



Clear glass, Corning Glass Works No. 67076. Type C. Compromises flanged bowl 3 3/4" h x 6-15/16 O.D. at base. Center lead-in pin 3/8" dia. x 1 1/2" long. Mounts by means of 6 studs through mounting flange. Overall dia. 8 3/4" S.C. Stock No. 302-1830-67076.1 @ \$6.00

## METER RECTIFIER

Full Wave Weston part number D89367. For use with model 301 meters. Terminals marked A.C. plus and minus @ \$1.50  
 (Ten for \$12.50)

## STRIP HEATERS



50 Watt, 115 Volt, 250 Ohms, 1 1/2" x 1/2" x 6" G.E. Catalog No. 2A301. Minimum order 10 pieces at 60c each.

## TACHOMETER GENERATOR

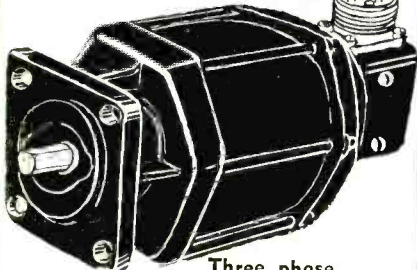

**Three phase**  
 .64, .65 & .89 volts at 1000 RPM 1 M.A. A.C.  
 G.E. Type CM 5 Model 2CM5AEA @ \$9.50

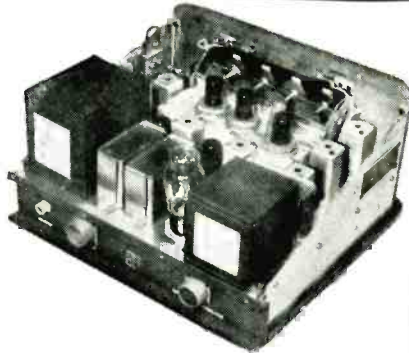

## BC-1161-A RADIO RECEIVER

150 to 210 Megacycles. Operates off 115 volt 60 cycle Power supply. Inductance tuning for R.F. Antenna, detector and oscillator. With a few modifications this unit makes an ideal F.M. Receiver. Each set complete with circuit diagram and the 14 following tubes: 1—6SN7 Cathode Follower; 1—6H16 second Detector; 2—6SH7 1st and 2nd R.F. Amp.; 1—6X17 Video Amp.; 3—6AC7/1852 1st, 2nd, 3rd IF Amp.; 2—6AB7/1853 4th, 5th IF Amp.; 1—9006 Mod.; 1—6J5 Osc.; 1—5U4G Rect.; 1—8E5 Tuning Indicator.  
 Complete in a metal cabinet 10" high 16 1/2" wide and 15" deep. @ \$34.50

## BC-1160-A TRANSMITTER

157 to 187 Megacycles. Operates off 117 Volt 60 cycle. Contains 115 volt, 1525 R.P.M. Blower. General Radio 200 R 1.5 Amp. Variac 10 tubes, 0-5 Kilovolt 3 1/2" meter transformers, relays, circuit breakers too numerous to list. Complete in metal cabinet 17 1/2" x 18 1/2" x 18" with circuit diagram. @ \$29.50

## CODE TRAINING SET AN/GSC-T1

Made by T. R. McElroy, Boston.  
 Operates off 6, 12, 24 or 110 V D.C. or 110 V or 230 Volt, 60 cycle.  
 An excellent unit for schools or clubs for code training. This unit is designed for group training of telegraph code to students whereby each student sends a message from any prepared text to the instructor. It provides a visual signal through a blinker or an audible signal through a monitoring speaker. Has volume control, variable frequency oscillator, a phone jack for a monitoring headset, pitch and tone control, rotary switch for selecting the operating voltage and power supply.  
 Complete with spare fuses, power cord and battery adapter; 10 Telegraph Keys with 10' line each, 1 #6 x 5 tube and 2 #6AG6 tubes.  
 Complete in chest 10 1/2" x 17" L x 13 1/2" H—Net wt. 49 lbs.  
 Can be used anywhere—batteries, A.C. or D.C. Durable—Good for a lifetime of Service! NET @ \$24.50

## SPECIAL METERS

Frequency Meter—Dual Range—covers frequency ranges from 48 to 52 cycles and 53-62 cycles—J.B.T. 30-F—Dual element, Vibrating Reed type—115 V—3 1/2" rd fl metal case. @ \$5.95

## PHASE ROTATION INDICATOR

A rotating mechanical meter designed to indicate phase rotation on 110, 220 and 550 volt 25-60 cycle A.C. lines. Greatly simplifies the determination of the direction of rotation of motors, operation of controls, etc. A small portable 3 1/2" round meter with push-for-test button and 36" three wire test leads.  
 Western Electro-Mechanical Co., Catalog #4600 @ \$4.50

Voltage Polarity Phase Rotation Tester—Triplett 337 AVI—Checks 115, 220 and 440 line voltage—locates open circuits, blown fuses, damaged wiring, etc. Indicates whether A.C. or D.C. and polarity of D.C.—Checks phase rotation to determine direction of rotation of motors, operation of controls, etc.—Consists of a 3" square meter and a small polarized vane movement in a small handy size case—Complete with 56" leads with test prods \$8.50  
 HOUR METER Totals to 99,999.9 hrs & resets WHI NH-35, 3 1/2" rd fl case. Operates on 230 volt 60 cycle @ \$8.50  
 D.C. MILLIAMMETER Weston 271 fan type, 1-0-1 MA & 60-0-60 M.V. mvt. Scale cal 600-0-600 RPM @ \$12.50

## PORTABLE CHRONOMETRIC TACHOMETER

To measure speeds from 0 to 20,000 R.P.M. with scale calibrations in 10 R.P.M. divisions. Divide scale reading by 2 when using the peripheral wheel and you can read surface speeds up to 10,000 F.P.M.  
 3 1/2" open face dial provides unequaled readability. Each division on large dial indicates 10 R.P.M. & each division on small dial indicates 1000 R.P.M. Readings are similar to those made on kilowatt hour meters. Results of tests remain on dial until next test taken.  
 Complete with 2 tips, peripheral wheel, & operating instructions—No stop-watch or other timing mechanisms required. Made by Jaeger Watch Co. model 43 A-6. Complete in velvet lined case 5" x 3 1/2" x 1 1/2". List price \$75.00 @ \$24.50

## MULTIPLE RANGE, CONTINUOUS INDICATING PORTABLE TACHOMETER

Three ranges in R.P.M. & three ranges in F.P.M. 300-1200, 1000-4000, 3000-12,000 R.P.M. Large 4" dial shows INSTANTANEOUSLY & CONTINUOUSLY the speed or change in speed of any revolving shaft or surface.  
 Complete with 4 tips, peripheral wheel, extension rod and operating instructions. No stop watch or other timing mechanism required.  
 Made by Jones Motorola, Stamford, Conn. Comes complete in velvet lined case 7 1/2" x 4" x 5". List price \$75.00. @ \$24.50

## RADIO SET SCR 518 HIGH ALTITUDE ALTMETER

0-20,000 (& 30,000) feet, 515 m.c. 24 volt 300 watts. Complete with 29 tubes and accessories with OPERATING INSTRUCTIONS AND CIRCUIT DIAGRAMS @ \$24.50

## ACROSS-THE-LINE-STARTER

Manually operated, with adjustable compensated overload relay, and manual start and stop features. Adjustable compensation relay for 90, 100 and 100% overload. Supplied with one thermal overload element for motor rating of 1.32 Amps min. and 1.42 amps maximum. Can be used for any motors with ratings up to 17.2 Amps, and up to 440 volts, single or 3 phase with the use of the proper thermal elements. A complete list of elements available and a connection diagram is mounted inside of drip proof box which measures 7 1/2" H x 5 1/2" W x 5 1/2" D.  
 Cutler Hammer type 6922HIA—meets Navy Specs. 17C10 @ \$4.50

## TERMINAL BOARDS

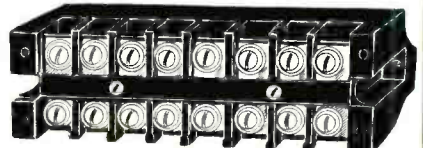

4—Terminal Connections 3 1/4" L x 2" W x 1 1/2" H with cover, G.E. @ 40c  
 6—Terminal Connections 4 1/2" L x 2" W x 1 1/2" H no cover, G.E. @ 60c  
 8—Terminal Connections 5 1/2" L x 2" W x 1 1/2" H with cover, G.E. @ 80c

## AUTOMOTIVE GENERATOR

Autolite #GAF 4001, 6 Volt D.C. Approx. 12 Amps at 1200 R.P.M. Counter Clockwise rotation 1/2" shaft on one end and right angle gear drive for distributor timing on other end. With 6 volt cut-out and mounting base for 4 3/8" bolts. @ \$15.00

## COMBINATION OFFER



150 VOLT A.C. METER  
 Triplett 331-JP, 3 1/2"  
 Rd flush case  
 30 AMP A.C. METER  
 Triplett 331-JP, 3 1/2"  
 Rd flush case

Both meters for \$7.95

All items are Surplus—New—Guaranteed. C.O.D.'s not sent unless accompanied by 25% Deposit. Orders accepted from rated concerns, public institutions, etc., on open account. The above is only a partial listing of the many items we have in stock. Send for free circular. MANUFACTURERS, EXPORTERS, DEALERS—we invite your inquiries.

# MARITIME SWITCHBOARD

336 Canal Street      Worth 4-8217      New York 13, N. Y.

We carry a complete line of surplus new meters suitable for every requirement, such as portable, panel, switchboard, laboratory standards, etc.

## OVER 50,000 METERS IN STOCK

We also have in stock various surplus components, tubes, code keying and recording units, code training sets, tachometers, analyzers, tube testers, converters, Precision resistors, current transformers, transmitters, receivers, condensers, and other electronic units, parts and accessories.



**MICROMAX POTENTIOMETERS  
L & N INDICATORS — CONTROLLERS — RECORDERS**

**Model S—RECORDER—CONTROLLER**

2 Thermocouples—one control point—2 sets  
H.C.L. Contacts—115 V. AC motor.  
Ranges  
0-1200°F C/A  
0-1800°F C/A

**\$195.00**

**Model S—RECORDER—CONTROLLER**

Single Point—Chart tear-off feature—  
H.C.L. Contacts—115 V. AC Motor.  
Range  
0-1500°F C/A

**\$195.00**

**Model S—RECORDER—CONTROLLER**

H.C.L. Contacts—115 V. AC motor  
Extra set on-off contacts.  
Range  
0-1500°F C/A

**\$195.00**

**SELENIUM RECTIFIERS**

New—Fresh Stock—Not over 6 mos. old.  
Full wave bridge . . . single phase . . . resistive  
inductive load . . . continuously rated . . .  
conservative design.

Type	Max. R.M.S. Input	Max. D.C. Output at 35° C	Price
5B-1	24	18 V @ 3.1 A	\$5.03
5B-1	24	18 V @ 5.2 A	6.73
10B-1	24	18 V @ 10 A	8.71
1B-1	24	19 V @ 1.6 A	4.04
16B-1	24	19 V @ 16 A	16.40
24B-1	24	19 V @ 24 A	23.76
1B-2	48	37 V @ 1.2 A	7.21
3B-2	48	37 V @ 3.1 A	9.60
5B-2	48	37 V @ 5.2 A	13.37
10B-2	48	37 V @ 10 A	17.18
16B-2	48	37 V @ 16 A	30.89
24B-2	48	37 V @ 24 A	44.67
5B-6	144	110 V @ 5.2 A	35.70
2B-6	144	112 V @ 2.4 A	21.86
1B-6	144	114 V @ 1.2 A	17.34
2B-7	168	131 V @ 2.4 A	25.51
1B-7	168	133 V @ 1.2 A	19.68
5B-7	168	133 V @ 5.2 A	41.10

**MICROVOLTER—FERRIS Model 20B**

.2 to 100,000 microvolts output, continuously  
variable . . . operates on 115 V. 60 cycle AC  
. . . push button selector for 18 frequencies  
from 455 K.C. to 22 M.C. . . with or without  
400 cycle 30% modulation . . . frequency may  
be varied ±2% by screwdriver adjustment.

**Your Price . . . . \$100.00**

**WHSE PORTABLE GALVANOMETER**



Type PX-12-7 M.A. move-  
ment, special scale, solid  
connecting terminals, con-  
tains a 1 volt internal cell  
which can be easily re-  
moved for conversion to DC  
AMMETERS & VOLTMET-  
ERS, with leather case &  
canvas carrying strap.

**A buy at \$4.95**

**AGASTAT TIME DELAY RELAY**

Type ND-21, Diagram type, 24 V. mom. coil.  
SPDT, 0-5 sec. cont. duty, up to 15 sec. inter-  
mittent duty.  
Dimensions 2 1/2" x 2 3/4" x 4 1/4" for 24 V. DC  
operation.

**Price \$4.50**

**Model S—RECORDER—CONTROLLER**



H.C.L. CONTACTS—115  
V. AC Motor.

Ranges  
0-1000°F C/A  
0-1500°F C/A  
0-1800°F C/A  
200-2000°F C/A  
1000-2000°F C/A

Model S **\$210.00**



**MODEL R  
RECORDER—  
CONTROLLER**

H.C.L. Contacts—  
115 V. AC motor.

Ranges  
0- 800°F C/A  
700-1400°F I/C

Model R **\$175.00**

**RECTIFIER TRANSFORMERS**

**PRI—105/110/115/120 V.—50/60**

**Cycles—Open Frame Construction**

SEC—18 V @ 2.5 Amps	4 lbs	\$3.35
18 V @ 5 Amps	5.5 lbs	5.25
18 V @ 10 Amps	10 lbs	6.75
18 V @ 25 Amps	25 lbs	14.95
18 V @ 50 Amps	30 lbs	24.75
36 V @ 2.5 Amps	7.5 lbs	5.25
36 V @ 5 Amps	10 lbs	6.50
36 V @ 10 Amps	20 lbs	10.95
36 V @ 25 Amps	30 lbs	22.50

**PRI—115 Volts—50/60 Cycles**

**Open Frame Construction**

SEC—135/145/155/165 V @ .5 Amps	5 lbs.	5.25
135/145/155/165 V @ 1.5 Amps	15 lbs.	7.95
135/145/155/165 V @ 2.5 Amps	25 lbs.	13.50
135/145/155/165 V @ 5 Amps	35 lbs.	24.50

**HIGH VOLTAGE CAPACITORS**

1 MFD 20 KV DC 18"x13 1/2"x5"	\$25.00
.1 MFD 25 KV DC-13"x7"x4"	9.85
.001 MFD 50 KV DC-5 1/2"x7 3/4"x4" insu- lators 4" dia. x 7" high	12.50
Cap. Mfd. Volts D.C. Height Width Length Price	
10 1000 5-7 8 x 1-3 4 x 3-7 8"	\$1.85
4 1000 5-7 8 x 2-3 4 x 1-1 4"	.85
1 1000 3-5 7 x 2 x 1-1 16"	.50
1 500 2" x 1-1 4" x 1-1 16"	.25
.25 1000 1-1 2 x 1" x 3 4"	.25
.001 Mfd.—50 K.V. DC.—5 1/4" x 7 3/4" x 4"	\$12.50
Insulators 4" Dia. x 7" High.	
.1 Mfd.—25 K.V. DC.—13" x 7" x 4"	\$9.85

**RHEOSTAT**

Ohms	Amps	Size-Diam	Price
.87	2	3 1/2"	\$2.50
6	13	1 1/2"	1.75
10	9	1 1/2"	5.95
22	4.5-3.1	6"	6.50
30	1.7-.9	2 1/2"	1.50
32	2.4	3 1/2"	4.95
40	1.12	2"	2.50
50	1.11	2"	2.50
75	3.5	6"	7.50
100	1	3"	2.95
200	.25	1 1/2"	.75
250	2.5-.51	6"	7.50

**HEINEMAN CIRCUIT BREAKER**

For use with low voltage, D.C., 100 Amps.  
Dimensions: 3 1/4" H x 4" D x 1" W . . . . \$1.75  
15 Amp, 115 V AC, Curve 3, CAT.AM 2511-15  
\$1.75  
35 Amp, 120 V AC, Curve 2, CAT.AM 1510R-35  
\$1.75  
1.5 Amp, 117.5 V AC, Instant Trip . . . . \$1.75

**MODEL S—2 PT. RECORDER**

110 V. AC Motor Range 0-1800°F C/A  
**\$235.00**



**MODEL C—  
INDICATOR—  
CONTROLLER**

H.C.L. Contacts—115 V.  
AC Motor Ranges: 0-  
1500°F I/C, 0-1800°F  
C/A, 0-2000°F C/A, 200-  
2000°F C/A.

Model C **\$135.00**

**MODEL S—RECORDER**

with alarm feature using relay & cam oper-  
ated contacts. Can be used as on-off con-  
troller without temperature setting device.  
115 V. AC motor.  
Range 0-1800°F C/A.

**\$180.00**

**GE STEPDOWN TRANSFORMER**

PRI 115/230 V 60 cycles.  
SEC 32 V. Rating .5 KVA  
Isolation type cat 61G60 enclosed, bell end,  
cont. duty.

**Your Price . . . . . \$7.50**

**STRUTHERS-DUNN RELAYS**

D.P.S.T., Normally open, 115 V, 60 Cycle, A.C.  
coil, 30 Amp contacts, fibre base with 4 holes  
for mounting. Dimensions, 4 1/2" L x 3" W x  
3 3/4" H.

**A Real Buy At . . . . . \$2.50**

**STEPDOWN TRANSFORMER—SPECIAL**

Made by GE . . . heavy duty . . . considerable  
over-design . . . open frame . . . ideal for recti-  
fier application . . . size 3 1/2" x 3 1/2" x 4".  
Primary—115 V 60 cycles.

SEC—15 V. @ 12 amps . . . a buy at . . . \$3.75  
SEC—10 V. @ 18 amps . . . a buy at . . . 3.75

**HEAVY DUTY STEPDOWN  
TRANSFORMERS**

Input: 115 V. (with 8 taps in primary).  
Output: from 16 to 10.5 V. (in 8 steps).  
Capacity: 1.25 KVA—Sec. Amps: 100.  
Size: 13"x10"x5". Approx. Weight: 30 Lbs.  
Open Frame Construction.

**Your Cost . . . . . \$12.50**

**10 for . . . . . \$100.00**

**POWER TRANSFORMER**

Pri.—440/220 V 60 Cy Sec—125/115/105 V  
Rating, 8 KVA RCA Open construction.  
Bracket mounted, pri & sec terminal board.  
Overall dimensions: 5 3/4" H x 7 3/4" W x 8" D.  
Mounting dimensions: 6" x 5 3/8".

**Price . . . . . \$12.50**

**TRANSTATS—3 K. V. A.**



Type RH Input: 115  
V. 10%. Output: 115  
V. Max. Amps: 26 A.  
Made as a line vol-  
tage corrector 10% of  
input voltage, or can  
be connected to give  
plus 20% or minus  
20% of input. Can

also be reconnected to be used as an isolated  
type stepdown with variable secondary. In-  
put: 115 V. Output: 0-30 Volts at 30 Amps.  
No Knob.

**A Real Buy at . . . . \$18.00**

(same type but .25 KVA. Input: 103-126 V.  
Output: 115 V.-2.17 A.)

**Price . . . . . \$6.50**

**ALL PRICES INDICATED ARE FOB, OUR WAREHOUSE, NEW YORK, N. Y.**

Shipments Transportation Charges Collect Will Be Made Via Railway Express Unless Sufficient Postage Is Included, Or Other Instructions Issued. We Will Refund Excess Postage In Stamps.

**POWERTRON Electrical Equipment Co.**

117 LAFAYETTE STREET

Phone: WOrth 4-8610

NEW YORK 13, N. Y.

**BC 454**  
ARCS RECEIVER  
3-6Mc.  
Less Dynamotor

## \$3.95

P.A. Coil Assy. (BC459) 7-9mc  
Variable link w/plate leads,  
caps, parasitic Suppressors  
Brand New **\$29.95**

### 1 K.W. POWER SUPPLY KIT

2500-0-2500 Volts @ 500 MA  
or  
2000-0-200 Volts @ 500 MA  
(oil-filled Xformer from BC610) **\$39.95**

- 1—Swinging choke . . . . . 14.95
- 1—Smoothing choke . . . . . 7.95
- 1—Filament Xformer . . . . . 9.95
- 2—2 Mfd.—3000 v. Condensers, ea . . . . . 3.45
- 2—872A Tubes . . . . . each 1.95
- 2—Plate Caps for 872A . . . . . each .20
- 2—Sockets for 872A . . . . . each 1.19
- 2—Hash Filter Chokes . . . . .

pr. .79 **\$79.50**  
All parts New! Reduced to

### TUBES (BRAND NEW)

(STANDARD BRANDS)

1B24 . . . . . \$1.95	726A . . . . . \$8.95	800 . . . . . 1.75
1B26 . . . . . 4.95	801A . . . . . 1.75	802 . . . . . 2.95
1B29 . . . . . .89	803 . . . . . 5.95	805 . . . . . 4.49
1N21xtal . . . . . .59	807 . . . . . 1.25	808 . . . . . 2.25
1N23xtal . . . . . .59	809 . . . . . 1.50	810 . . . . . 5.95
1N34xtal . . . . . 1.60	811 . . . . . 1.49	812 . . . . . 1.98
1P4 . . . . . 2.99	813 . . . . . 5.25	814 . . . . . 3.69
2A1P . . . . . 2.99	815 . . . . . 1.75	816 . . . . . 1.49
2C22-7193 . . . . . .29	817 . . . . . 1.49	818 . . . . . 1.49
2C26 . . . . . .29	819 . . . . . 1.49	820 . . . . . 1.49
2C30 . . . . . .89	821 . . . . . 1.49	822 . . . . . 1.49
2C44 . . . . . 1.39	823 . . . . . 1.49	824 . . . . . 1.49
2C46-2C43 . . . . . 4.95	825 . . . . . 1.49	826 . . . . . 1.49
2D21 . . . . . 12.95	827 . . . . . 1.49	828 . . . . . 1.49
2D22 . . . . . 12.95	829 . . . . . 1.49	830 . . . . . 1.49
2D26 . . . . . 12.95	831 . . . . . 1.49	832 . . . . . 1.49
2D31 . . . . . 24.95	833 . . . . . 1.49	834 . . . . . 1.49
2D32 . . . . . 24.95	835 . . . . . 1.49	836 . . . . . 1.49
2D33 . . . . . 18.95	837 . . . . . 1.49	838 . . . . . 3.25
2D39 . . . . . 18.95	839 . . . . . 3.25	840 . . . . . 3.25
2D40 . . . . . 24.95	841 . . . . . .50	842 . . . . . .59
2D46 . . . . . 18.95	843 . . . . . .59	844 . . . . . 3.98
2D49 . . . . . 34.95	845 . . . . . 39.50	846 . . . . . 3.98
2D51 . . . . . 18.95	847 . . . . . 1.98	848 . . . . . 1.98
2D54B . . . . . 18.95	849 . . . . . 1.98	850 . . . . . 1.98
2D55 . . . . . 24.95	851 . . . . . 1.98	852 . . . . . 1.98
2K25-723AB . . . . . 8.95	853 . . . . . 1.98	854 . . . . . 1.98
2K28 . . . . . 16.90	855 . . . . . 1.98	856 . . . . . 1.98
2V3G . . . . . .98	857 . . . . . 1.98	858 . . . . . 1.98
2X2 . . . . . .59	859 . . . . . 1.98	860 . . . . . 1.98
3A1P . . . . . 2.95	861 . . . . . 1.98	862 . . . . . 1.98
3BP1 . . . . . 2.95	863 . . . . . 1.98	864 . . . . . 1.98
3B22 . . . . . .69	865 . . . . . 1.98	866 . . . . . 1.98
3B24 . . . . . .69	867 . . . . . 1.98	868 . . . . . 1.98
3B26 . . . . . 3.95	869 . . . . . 1.98	870 . . . . . 1.98
3CP1 . . . . . 2.95	871 . . . . . 1.98	872 . . . . . 1.98
3C22 . . . . . 12.95	873 . . . . . 1.98	874 . . . . . 1.98
3C23 . . . . . 2.95	875 . . . . . 1.98	876 . . . . . 1.98
3C24-24G . . . . . .59	877 . . . . . 1.98	878 . . . . . 1.98
3C30 . . . . . .69	879 . . . . . 1.98	880 . . . . . 1.98
3C31 . . . . . 1.49	881 . . . . . 1.98	882 . . . . . 1.98
3D1P . . . . . 2.95	883 . . . . . 1.98	884 . . . . . 1.98
3D21A . . . . . 2.95	885 . . . . . 1.98	886 . . . . . 1.98
3D29-829B . . . . . 3.49	887 . . . . . 1.98	888 . . . . . 1.98
4B24 . . . . . 3.95	889 . . . . . 1.98	890 . . . . . 1.98
4B27-257B . . . . . 11.95	891 . . . . . 1.98	892 . . . . . 1.98
5AP4 . . . . . 4.95	893 . . . . . 1.98	894 . . . . . 1.98
5BP1 . . . . . 1.98	895 . . . . . 1.98	896 . . . . . 1.98
5BP4 . . . . . 4.95	897 . . . . . 1.98	898 . . . . . 1.98
5CP1 . . . . . 3.95	899 . . . . . 1.98	900 . . . . . 1.98
5D21 . . . . . 18.95	901 . . . . . 1.98	902 . . . . . 1.98
5FP7 . . . . . 11.95	903 . . . . . 1.98	904 . . . . . 1.98
5J1P . . . . . 11.95	905 . . . . . 1.98	906 . . . . . 1.98
5J29 . . . . . 18.95	907 . . . . . 1.98	908 . . . . . 1.98
5J30 . . . . . 18.95	909 . . . . . 1.98	910 . . . . . 1.98
5J31 . . . . . 18.95	911 . . . . . 1.98	912 . . . . . 1.98
5LP1 . . . . . 11.95	913 . . . . . 1.98	914 . . . . . 1.98
5P4GY . . . . . .98	915 . . . . . 1.98	916 . . . . . 1.98
5P4 . . . . . 1.19	917 . . . . . 1.98	918 . . . . . 1.98
5U4G . . . . . .49	919 . . . . . 1.98	920 . . . . . 1.98
5V4 . . . . . .79	921 . . . . . 1.98	922 . . . . . 1.98
5Y3 . . . . . .59	923 . . . . . 1.98	924 . . . . . 1.98
5Y4 . . . . . .39	925 . . . . . 1.98	926 . . . . . 1.98
5Z3 . . . . . .59	927 . . . . . 1.98	928 . . . . . 1.98
5Z4 . . . . . .79	929 . . . . . 1.98	930 . . . . . 1.98
6AB7 . . . . . 1.05	931 . . . . . 1.98	932 . . . . . 1.98
6AC7 . . . . . .79	933 . . . . . 1.98	934 . . . . . 1.98
6AK5 . . . . . .89	935 . . . . . 1.98	936 . . . . . 1.98
6AL5 . . . . . .69	937 . . . . . 1.98	938 . . . . . 1.98
6C4 . . . . . .25	939 . . . . . 1.98	940 . . . . . 1.98
6D4 . . . . . 1.99	941 . . . . . 1.98	942 . . . . . 1.98
6J4 . . . . . 3.95	943 . . . . . 1.98	944 . . . . . 1.98
6J6 . . . . . .89	945 . . . . . 1.98	946 . . . . . 1.98
6Q5G . . . . . 1.25	947 . . . . . 1.98	948 . . . . . 1.98
7EP4 . . . . . 17.95	949 . . . . . 1.98	950 . . . . . 1.98
10Y . . . . . .89	951 . . . . . 1.98	952 . . . . . 1.98
12A6 . . . . . .25	953 . . . . . 1.98	954 . . . . . 1.98
12DP7 . . . . . 14.95	955 . . . . . 1.98	956 . . . . . 1.98
12GP7 . . . . . 14.95	957 . . . . . 1.98	958 . . . . . 1.98
15E . . . . . .89	959 . . . . . 1.98	960 . . . . . 1.98
15R . . . . . .89	961 . . . . . 1.98	962 . . . . . 1.98
75TL . . . . . 3.75	963 . . . . . 1.98	964 . . . . . 1.98
100TH . . . . . 9.95	965 . . . . . 1.98	966 . . . . . 1.98
211 . . . . . .75	967 . . . . . 1.98	968 . . . . . 1.98
227A . . . . . 3.95	969 . . . . . 1.98	970 . . . . . 1.98
231D . . . . . 2.49	971 . . . . . 1.98	972 . . . . . 1.98
249C . . . . . 1.75	973 . . . . . 1.98	974 . . . . . 1.98
250TH . . . . . 19.50	975 . . . . . 1.98	976 . . . . . 1.98
304TL . . . . . 1.49	977 . . . . . 1.98	978 . . . . . 1.98
304TH . . . . . 7.95	979 . . . . . 1.98	980 . . . . . 1.98
316A . . . . . 2.95	981 . . . . . 1.98	982 . . . . . 1.98
327A . . . . . 4.95	983 . . . . . 1.98	984 . . . . . 1.98
350B . . . . . 2.95	985 . . . . . 1.98	986 . . . . . 1.98
368AS . . . . . 6.95	987 . . . . . 1.98	988 . . . . . 1.98
371B . . . . . 1.98	989 . . . . . 1.98	990 . . . . . 1.98
450TH . . . . . 24.95	991 . . . . . 1.98	992 . . . . . 1.98
327 . . . . . 8.95	993 . . . . . 1.98	994 . . . . . 1.98
531 . . . . . 5.95	995 . . . . . 1.98	996 . . . . . 1.98
559 . . . . . 1.49	997 . . . . . 1.98	998 . . . . . 1.98
703A . . . . . 4.95	999 . . . . . 1.98	1000 . . . . . 1.98
705A/8021 . . . . . 1.95	1001 . . . . . 1.98	1002 . . . . . 1.98
706CY . . . . . 18.95	1003 . . . . . 1.98	1004 . . . . . 1.98
714AX . . . . . 7.95	1005 . . . . . 1.98	1006 . . . . . 1.98
715B . . . . . 9.95	1007 . . . . . 1.98	1008 . . . . . 1.98
715C . . . . . 18.95	1009 . . . . . 1.98	1010 . . . . . 1.98
717A . . . . . 1.29	1011 . . . . . 1.98	1012 . . . . . 1.98
721A . . . . . .59	1013 . . . . . 1.98	1014 . . . . . 1.98
723A/B . . . . . 5.95	1015 . . . . . 1.98	1016 . . . . . 1.98
724A/B . . . . . 1.95	1017 . . . . . 1.98	1018 . . . . . 1.98
725A . . . . . 7.45	1019 . . . . . 1.98	1020 . . . . . 1.98

### TRANSFORMER—115 V. 60 Cy.

#### HI-VOLTAGE INSULATION

1120-0-1120 @ .5A., 2.5v CT @ 10A., 32v @ 025A. 16v @ 2.5A. 12v @ 14.2A Pri 105 tapped to 250v AC **\$24.95**

3710v @ 10 ma.; 2x2½v @ 3A. **9.95**

2500v @ 15 ma. **6.50**

2500v @ 4 ma.; 2½v @ 2A. 6.3v @ 1 amp. **7.95**

2150v @ 15 ma. **5.50**

1750v @ 4 ma.; 6.3v @ 3A **6.50**

1600v @ 4 ma.; 700v CT @ 150 ma.; 6.3v @ 9A. **7.95**

525-0-525v @ 60 ma.; 925v @ 10 ma.; 2x5v @ 3A; 6.3v @ 3.6A; 6.3v @ 2A; 6.3v @ 1A **7.95**

515-0-515v @ 175 ma.; 5v @ 3A; 2.5v @ 5A **5.95**

500-0-500v @ 25 ma.; 262-0-262v @ 55 ma.; 6.3v @ 1A; 2x5v @ 2A **4.49**

500-0-500v @ 100 ma.; 5v CT @ 3A **4.95**

450-0-450 @ 200 ma.; 315v @ 10 ma.; 6.3v @ 7A; 5v @ 3A; 5v @ 2A; 110/220v Pri. **10.95**

425-0-425 @ 200 ma.; 150-0-150 @ 100 ma.; 40v @ 1A; 6.3v @ 3A; 5v @ 3A; 110/ Dual Pri. tapped **7.50**

400-315-0-100-315v @ 200 ma.; 2.5v @ 2A; 5v @ 3A; 6.3v @ 9A; 6.3v @ 1A **6.50**

400-0-400v @ 200 ma.; 5v @ 3A **4.95**

350-0-350v @ 150 ma.; 5v @ 3A; 6.3v @ 6A; 78v @ 1A **4.95**

385-0-385-550v @ 200 ma.; 2½v @ 2A; 5v @ 3A; 3x6.3v @ 6A—PRI 110/220 **7.95**

350-0-350v @ 150 ma.; 5v @ 3A; 6.3v @ 7.5A; 6.3v @ 3A **4.99**

350-0-350v @ 35 ma. **1.45**

340-0-340v @ 300 ma.; 1540v @ 5 ma. **5.95**

335-0-335v @ 60 ma.; 5v @ 3A; 6.3v @ 2A; 0-13-17-21-23v @ 70 ma.—PRI 110/220 **4.95**

325-0-325v @ 120 ma.; 10v @ 5A; 5v @ 7A **3.49**

300-0-300v @ 65 ma.; 2x5v @ 2A; 6.3v @ 2½A; 6.3v @ 1A **3.49**

250-0-250v @ 100 ma.; 2x6.3v @ 4A; 6.3v @ 5A; 6.3v @ 1A **4.95**

150-0-150 @ 80 ma.; 150 @ 40 ma.; 6.3v @ 3.5A; 6.3v @ 1A **1.98**

150v @ 55A; 150v @ 2.13A; 5v @ 5A **5.95**

120-0-120v @ 50 ma. **.98**

80-0-80v @ 225 ma.; 5v @ 2A; 5v @ 4A **3.50**

24v @ 6A **3.95**

3x18v @ 2A **2.95**

13.5v CT @ 3.25A **9.95**

3x10.3v @ 7A; CT **7.95**

12.6v CT @ 10A; 11v CT @ 6.5A **4.95**

3x6.3v @ 1A; 2x6.3v @ 2A; 10v CT @ 10A **3.95**

12.6v CT @ 1A **3.50**

6.3v @ 12A; 6.3v @ 2A; 115v @ 1A **3.45**

6.3v @ 10A; 6.3v @ 1A **3.49**

6.3v @ 1A; 2½v @ 2A **5.95**

5v @ 20A; Dual 110v PRI **1.98**

6.3v @ 2½A; 6.3v @ 2A; 2½v @ 2A **1.98**

5v—190A **\$17.50** 6.3v @ 1A **.98**

5v—115A **14.95** 8v CT 1A **.98**

2.5v @ 20A **3.49** 6v @ 15ARMS **2.98**

6.3v CT @ 3A; 5v CT @ 4A **4.25**

### SELENIUM RECTIFIERS

#### Full Wave Bridge Type

INPUT		OUTPUT		
up to 18v AC	up to 12v DC	½ Amp.	\$0.98	
up to 18v AC	up to 12v DC	1 Amp.	1.95	
up to 18v AC	up to 12v DC	3 Amp.	3.45	
up to 18v AC	up to 12v DC	5 Amp.	4.45	
up to 18v AC	up to 12v DC	10 Amp.	7.45	
up to 18v AC	up to 12v DC	15 Amp.	9.95	
up to 18v AC	up to 12v DC	30 Amp.	14.95	
up to 36v AC	up to 28v DC	1 Amp.	3.45	
up to 36v AC	up to 28v DC	5 Amp.	7.45	
up to 36v AC	up to 28v DC	10 Amp.	12.45	
up to 36v AC	up to 28v DC	15 Amp.	18.95	
up to 115v AC	up to 100v DC	.25 Amp.	2.95	
up to 115v AC	up to 100v DC	.6 Amp.	6.95	
up to 115v AC	up to 100v DC	5 Amp.	19.95	
up to 115v AC	up to 100v DC	3 Amp.	12.95	

### OIL CONDENSERS

#### NATIONALLY ADVERTISED BRANDS

All Ratings D. C.

2x.1mfd. 600v \$0.35	1mfd. 2000v \$0.95	1mfd. 2000v 1.75
.25mfd. 600v .35	1mfd. 2000v 3.75	1mfd. 2000v 3.75
.5mfd. 600v .35	15mfd. 2000v 4.95	4mfd. 2500v 3.98
1mfd. 600v .35	4mfd. 2500v 2.49	2mfd. 2500v 1.25
4mfd. 600v .60	1mfd. 2500v 1.45	5mfd. 2500v 1.75
8mfd. 600v 1.10	25mfd. 2500v 1.95	.05mfd. 3000v 2.25
10mfd. 600v 1.15	1mfd. 3000v 2.65	1mfd. 3000v 3.50
3x.1mfd. 1000v .45	12mfd. 3000v 6.95	2mfd. 4000v 5.95
.25mfd. 1000v .45	2mfd. 4000v 4.95	1mfd. 5000v 2.95
1mfd. 1000v .60	1mfd. 7000v 4.95	3mfd. 4000v 6.95
2mfd. 1000v .70	2mfd. 3000v 3.45	2x.1mfd. 7000v 3.25
4mfd. 1000v .90	2x.1mfd. 7000v 3.25	.02mfd. 12000v 9.95
1mfd. 1000v 1.95	.02mfd. 20000v 11.95	
10mfd. 1000v 2.10		
15mfd. 1000v 2.25		
20mfd. 1000v 2.95		
24mfd. 1500v 6.95		
1mfd. 1750v .89		
1mfd. 2000v .95		
.25mfd. 2000v 1.05		



Finest of surplus  
at a fraction of cost

# PEAK ELECTRONICS CO.

Industrials  
Schools - Labs

### 1.5 KV PLATE TRANSFORMER

1500-0-1500 volts at 1.5 amps. Tapped at 1350 and 1250. Pri. 110/220 volts 50/60 cycles in 2 Separate windings. Built to rigid Navy specs by Amertran. Suitable for broadcast transmitters, induction heating, etc. Size 10" x 10" x 7" s.w. 125 lbs. \$67.50 each.



### VARIABLE CERAMICON TRIMMERS

1.5 to 7 MMF.....	.24	4 to 30 MMF.....	.24
3 to 13 MMF.....	.24	7 to 45 MMF.....	.24
5 to 20 MMF.....	.24	10 to 110 MMF.....	.39

### AMERTRAN FILAMENT TRANS.

5.25 volts at 21 amps. plus 2 x 7.75 v at 6 amps. Pri. 110 v 60 cy. H.V. Ins. 6" x 5 1/2" x 4 1/2" 7.75

### SOLA CONSTANT VOLTAGE

Transformer, input 95 to 130 output 115v. 350 VA. 2.9 amps. .... 29.95

### RECTIFIER FILAMENT

Trans. 2.5 v 10A Pri. 110 v. 60 cy. H. V. Insulation. Cased ..... 4.95

### AMERTRAN 500 VOLT PLATE

1000 volt ct at 300 ma. Pri. 110 v. 60 cy. 6" x 5 1/2" x 4 1/2" cased ..... 7.95

### FILAMENT TRANSFORMER

6.3 v 21 amps. Hermetically sealed, 110 v 60 cy Pri. .... 4.75

### GENERAL RADIO VARIAC 2 KVA

Model 100 Q. 110 v. 60 cy. Inp. 0-135 v. out. 18 amps. .... 39.50

### 4 QUADRANT PHASING CONDENSER

4 Stator Single Rotor. 0-360 Degrees Rotation ..... Only 2.95 each

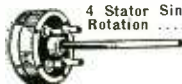

### STEPDOWN TRANSFORMER

220/110 volts. 100 watts. Fully enclosed. 5/8 x 4/4 x 5/8. 110V. 60 cycle ..... \$2.49 each

### WIRE WOUND RESISTORS

#### Standard Make

5 Watt type AA, 20-25-50-200-470-2500-4000 ohms	.09 ea.
10 watt type AB, 25-40-84-400-470-1325-1900-2000-4000 ohms	.15 ea.
20 watt type DG, 50-70-100-150-300-750-1000-1500-2500-2700-5000-7500-10000-16000-20000-30000 ohms	.20 ea.
30 watt type DI, 100-150-2500-3000-4500-5300-7500-18000-40000 ohms	.24 ea.

### 1% PRECISION RESISTORS

#### Standard Make

200-2500-5000-8500-10000 ohms	\$.39 ea.
50000-750000 ohms	.49 ea.
100000-950000-1 meg	.89 ea.

### U. H. F. COAX. CONNECTORS

UG12U-831R-831J-UG21U-831AP-831SP .39 ea.

### W. W. POWER RHEOSTATS

25 Ohm 25 Watt	.39
300 Ohm 50 Watt	.69
50 Ohm 50 Watt	.69
150 Ohm 50 Watt	.69
Dual 200 Ohm 50 Watt	.89

### H. V. VARIABLES

#### Steatite Insulation

150 MMF .5 Spacing	\$17.50
250 MMF .5 Spacing	19.50
75 MMF .3 Spacing	9.50
250 per section .051	3.95
250 per section .1	5.95

### 50 MICRO AMP METER



This is the exact meter utilized in the General Electric model YMW-1A Lab-Type Unimeter.

- 50 Microamp Movement ± 2%
- 2500 Ohms Resistance ± 2%
- Knife Edge pointer
- Uncrowded Multi-Range Scale
- 4 x 4 1/2" Black Bakelite Case
- 50 Microamp scale available at 25c additional

BRAND NEW only \$9.75 ea.

### METER SPECIALS

- |                                    |        |
|------------------------------------|--------|
| 1 1/2" GE 0-1 MA Basic             | \$3.95 |
| 2" GE 0-30 amps, D.C.              | 2.95   |
| 2" GE 0-1 amp RF (internal thermo) | 2.95   |
| 2" GE 0-5 ma (amp scale)           | 1.95   |
| 2" GE 0-1.2 ma (0-100 scale)       | 2.49   |
| 2" GE 0-1 ma (volt scale)          | 2.95   |
| 2" Gruen 0-3V DC (1000 ohms-volt)  | 2.45   |
| 2" Weston 150-0-150 Microamps      | 3.49   |
| 2" GE 0.30 volts D.C.              | 2.95   |
| 3" Weston -10 to 4 DB              | 5.45   |
| 3" Westinghouse 0.50 amps AC       | 4.95   |
| 3" Triplett 0-75 amps. AC          | 3.95   |
| 3" WE 0-80 ma DC                   | 2.95   |
| 3" GE 200-0-200 volts DC           | 2.95   |
| 3" McClintock 0-1 ma               | 3.95   |
| 3" Westinghouse 0-2 ma DC          | 3.95   |
| 3" Westinghouse 0-20 ma DC         | 3.95   |
| 3" GE 0-15 ma DC (square)          | 3.95   |
| 3" Westinghouse 0-150V AC          | 3.95   |
| 3" GE running time, 110 v. 60 cy.  | 7.95   |

### DAVEN AUDIO FREQUENCY METER MODEL 837E



Direct readings from 0-30 KC in 4 separate ranges on 6" Weston Model 271 Fan Meter. Built-in voltage regulated power supply operates from 115 volts 60 cycles, has high input impedance. With pick-up can be used to determine frequency in vibration tester. With suitable mixer can check deviation of R.F. carrier from standard. Mounts of 8 1/4" x 10" rack panel. Complete with tubes. Slightly used but perfect. Only ..... \$59.50

### "A POWERFUL BABY"

This plate transformer built to rigid Signal Corps spec. input 118 volts, 25 to 60 cycles. Has 2 separate 118 volt primaries and can be used on 110 or 220 volts. Secondary 800 volts center tapped at 775 volts. Exceptional regulation even when loaded to 900 mills! Fully cased—4 mtg. holes. 37 lbs. net wt. 6 1/2 x 6 1/2 x 7 1/8. Peak value at 7.95. 10 for \$70.00

### "BRUTE FORCE"

This fully enclosed choke 6 Henry at 550 mills. 28 ohms dc resistance. Built to rigid Signal Corps specs. Net weight 16 lbs. 5 1/2 x 4 1/4 x 5 1/8. A great buy at \$4.95 each. 10 for \$40.00.

### FILAMENT TRANSFORMER

Two separate 118 volt. 25 to 60 cycle primaries. Can be used on 110 or 220 volts. Secondary 5 volts at 15 amps. Built to Signal Corps specs. Fully enclosed. 5 x 4 1/4 x 5 1/8. Net wt. 10 lbs. \$3.75 each, 10 for \$30.00.

### VERSATILE POWER

These transformers have many uses—filament, isolation, stepdown, bias, etc. All have 2 separate primaries for 110/220 volt 25-60 cycle operation. Primaries. Can be used in series or parallel.

3 Choices of Secondaries:  
Type 501 115 volts 500 mills and 6.3 volts 5 amps.  
Type 505—115 volts 900 mills and 6.3 volts 2 amps.  
Type 502—0.70-75 volts at 2.5 amps. (35-37 v. in. series)  
Fully enclosed—4 mtg. holes, 5/8 x 4/4 x 5/8.  
Your cost any type \$1.95 each  
10 for \$17.00

### AN/APT—2 AIRCRAFT RADAR JAMMER



425-750 mcs. Contains 10 tubes:  
(1)—807 (2)—703A (2)—6AC7 (2)—6A57 (2)—5R4GY (1)—2X2 (1)—931A  
Unit has blower motor and 400 cycle pwr supply complete with all tubes etc.  
BRAND NEW ..... \$19.95 each

### MEGOHM METER

Industrial Instruments Model L2AU 110/220 volts 60 cycle input. Direct reading from 0-100000 megohms on 4" meter. Can be extended to 500000 megohms with external supply. Sloping hardwood cabinet 15"x8"x10". Brand new with tubes plus running spare parts including extra tubes. Great value only \$69.95.



### SPERTI RF

### VACUUM SWITCH

9200 volts peak, 8 amps. Used as antenna switch in Collins ART 13. BRAND new ..... \$1.75



### CHOKE BARGAINS

W.E. 4.3 hy 620 42 ohms	\$.495
N.Y.T. 8 henry 160 ma. 140 ohms D.C.	1.39
C.T.C. 1.5 henry 250 ma. 72 ohms	.60
R.C.A. 50 henry, 680 ma. high voltage	19.50

### POWER PLANT (PE 197)

4-cylinder Hercules Gas driven engine. Output 110 volts 60 cycle, voltage regulated, 5KW-6.3KVA at 80% Pwr. Pfr. Single phase, complete with running spare parts, meter panel, battery, tools, remote cables, etc. Weight 1200 lbs. Export Packed. Excellent for emergency power. Brand new ..... \$575.00

Scope Transformer hermetically sealed 1,800 volts, 4 ma, 6.3 volts, 9 amp., 2 1/2 volts, 2.5 amps., 5 x 3 1/4 x 3 1/4 ..... \$5.95

Precision 15 Meg. 1% Accuracy Resistor. Non-inductive, 1 watt, hermetically sealed in glass .39c each; 10 for \$3.50.

### OIL CONDENSERS

11 mfd 250 vac—.85	.IX.1 mfd 7000 vdc	—\$2.45
5 mfd 150 vac—.49	.1 mfd 7500 vdc—1.95	
1 mfd 600 vdc—.29	.15/.15 mfd 8000 vdc	
2 mfd 600 vdc—.39	4 mfd 8 kv dc—19.95	
4 mfd 600 vdc—.59	.01/.01 mfd 12 kv dc—5.75	
3/3 mfd 600 vdc—.79	.005/.01 mfd 12 kv dc—5.50	
10 mfd 600 vdc—.95	.03 mfd 16 kv dc—5.75	
14 mfd 600 vdc—1.35	.65 mfd 12,500 vdc	12.95
2 mfd 1000 vdc—.79	.75/.35 mfd 8/16 kv—12.95	
4 mfd 1000 vdc—.95	.02 mfd 20 kv dc—7.95	
15 mfd 1000 vdc—2.95		
2 mfd 1500 vdc—1.25		
1 mfd 2000 vdc—1.45		
2 mfd 4000 vdc—5.50		
3 mfd 3600 vdc—3.95		
1 mfd 5000 vdc—4.50		

### 1 KW TRANSTAT

### or Stepdown Transformer

110/220 volts 60 cycle input. Output variable plus or minus 10% of 115 volts at 8.5 amps. Also can be connected to give different voltage combinations. Brand new ..... Special 9.95



### MIDGET VARIABLE BARGAINS

Hammerlund MC 250S 250 mmf	\$.60
Hammerlund MC 320S 320 mmf	.79
Hammerlund APC 100 100 mmf	.39
Bud MC 913 35 mmf. D.S.	1.25
Hammerlund HF 15 15 mmf.	.39
National TMS 150 mmf.	.79

Tremendous stocks on hand. Please send requests for quotas. Special quantity discounts. Price f.o.b. N. Y. 20% with order less rated, balance C. O. D. Minimum order \$3.00.

**PEAK ELECTRONICS CO.**  
188 Washington St., New York 7, N. Y.

PHONE CO-7-6443  
DEPARTMENT EA  
SEND FOR BULLETIN

# NEW GUARANTEED SURPLUS

## AIRCRAFT AMPLIDYNES

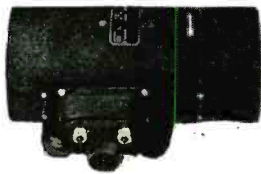

G.E.

5AM31NJ18A. Input 27 V.D.C. @ 44 amps. Output 60 V.D.C. @ 8.8 amps. max 530 watts. Stock #SA-111. Price \$14.50 ea. 5AM31NJ9—Similar to above. Stock #SA-196. Price \$14.50 ea.

### Servo Motor

Pioneer Type CK-2. 2 phase 400 cycle. Fixed phase 26 V., var. phase. 49 V. max. 1.05 oz/in. stall torque. Stock #SA-97. Price \$4.75 ea. net.



## RATE GENERATORS

Elenco PM-2

2.0 v. DC per 100 rpm. Use to 2000 rpm. Stock #SA-53. Price \$7.50 ea. ELINCO F-16. 2 Phase AC. 1.3 v AC per 100 rpm. 60 cy. output at 1800 rpm. Stock #SA-193. Price \$12.50 each.



SPERRY PHASE ADAPTOR—661102 115 volts 400 cy. Used for operating 3 phase equipment from single phase source. Stock #SA-194. Price \$6.75 each.

### Delco PM Motor—5068571



Alnico field. 27 v. DC. 10,000 rpm. 1" x 1" x 2" lg. 0.125 diam. shaft. 21/32" lg. Stock #SA-151. Price \$3.75 each.



## 400 CYCLE WESTINGHOUSE FL BLOWER

115 v. 400 cy. 17 c.f.m. Includes capacitor. Stock #SA-144. Price \$6.75 each.

## SWEEP GENERATOR CAPACITOR



Hi-speed bearings. Split stator. Silver plated coaxial type. 5-10 mmf.

Stock #SA-167. Price \$2.75 each.

TWX Pat-199.

Write for complete listing, or call ARMORY 4-3366

4 Godwin Ave.

## DYNAMOTORS



D-101. 27 v. DC in @ 1.5 amps. DC output 285 v. @ .060 amps. Stock #SD-187. Price \$1.50 each. DM-40A. 14 v. DC in @ 3.4 amps. DC output 172 v. @ .138 amps. Stock #SA-188. Price \$3.25 each.

## MICROWAVE ANTENNA—

AS-217A/APG 15B. 12 Cm dipole and 13 inch Parabola housed in weatherproof Radome 16" diam. 24 V. DC spinner motor for conic scan. Stock #SA-95. Shipping wt. 70 lbs.

Price \$9.50 ea.



Remote Position Indicating System



6-12 V. 60 cycles 5 inch indicator with 0 to 360° dial. Heavy duty transmitter. Stock #SA-115. Price \$9.95 per system



## 12 V D.C. MOTOR John Oster B-9-2

1.4 amps. 5600 rpm.

1 1/4" Diam. x 3 3/4" Lg. Spline shaft. C. W. rotation. Stock #SA-46. Price \$3.75 each



## Timing Motor Synchron 10 RPM

24 V. DC. Hanson Mfg. Co.

Stock #SA-110. Price \$3.75 each.

DC Timing Motor—Hayden 1/4 rpm. 29 volts. 100 mils. Stock #SA-157. Price \$3.95 ea.



## 28 VOLT DC DELCO CONSTANT SPEED MOTOR A-7155

1/30 hp. 3600 rpm. Cont. duty. 2 1/2" diam. x 5 1/2" lg. 5/8" shaft extension. 5/32" diam. 4 hole base mounting. Stock #SA-94. Price \$6.50 each.

## NOTE

All merchandise is new and guaranteed to meet manufacturer's specifications. Delivery from stock.

## SELSYN SPECIAL



W.E. KS-5950-L2 Size 5. 115 v. 400 cycles. Use on reduced 60 cycles. Stock #SA-182. Price \$3.75 each



## Blower Assembly MX-215/APG

John Oster C-2P-1L 28 V. DC. 7000 RPM 1/100 H.P. #2 L-R Blower.

Stock #SA-202. Price \$3.75 each.



## G.E. 10 rpm dc Motor 5BA10FJ12

Output 40 lb. in at 10 rpm. 24 V. @ 1.1 amps. Series-wound. 3 wire reversible.

Ideal for relay servo-systems. Stock #SA-17. Price \$8.75 each.

Phase Shift Capacitor—4 stator single rotor 0-360° phase shift. (Use in complex wave synthesis.) Stock #SA-114. Price \$4.75 ea.

## 400 Cycle Inverters

Pioneer—12116-2-A, 12123-1-A. Holtzer Cubot—MG-149F. MG-149H. General Electric—5D21N13A, 6AS131JJ-11A. Leland—10563 and PE-218.

INVERTER—Wincharger PU7/AP—Input 28 v. DC at 160 amperes. Output 115 v. 400 cy. @ 2500 V.N. Voltage and frequency regulated. Cont. duty. Wt. 75 lbs. Stock #SA-164.

## 800 Cycle Inverter

Navy Type CRV-21AAR. GE. 5AS121LJ2. 27 v. DC input @ 45 amps. 120 v. 800 cy. output @ 750 V.A. P.F. 0.90. Wt. 22.5 lbs. Stock #SA-192. Price \$39.50 each.

## LP-21-LM Compass Loops



New

Original Cartons Stock #SA-99.

Price \$9.50 each.

## 110 RPM MOTOR

G.E. 5BA10J18D. 27 V. @ 0.7 amps. 1 oz/ft. torque. 1 1/2" diam. x 3 1/2" lg. Operates on AC or DC. Stock #SA-98.



Include 15¢ for P.P. and handling Price \$2.95 ea. net

Open account shipments to rated concerns.

All prices F.O.B. Paterson, N. J.

**SERVO-TEK**  
PRODUCTS CO.  
Incorporated  
Surplus Division

Paterson, N. J.



# RELIANCE HAS WHAT YOU WANT TOO — IN ELECTRONIC SPECIALS



## OIL FILLED CAPACITORS

.1 mfd 25,000 V.DC	\$14.95	.2 mfd 750 V.A.C	
.1 mfd 12,000 V.DC	4.95	(2,200 V.DC)	\$4.99
.2 mfd 10,000 V.DC	4.25	10 mfd 2,000V.DC	4.25
.1 mfd 7,500 V.DC	1.95	2 mfd 2,000 V.DC	2.65
.1-1 mfd 7,000 V.DC	2.45	4 mfd 1,000 V.DC	1.00
.1 mfd 7,000 V.DC	1.95	3 mfd 1,000 V.DC	.80
.1 mfd 6,000 V.DC	1.65	1 mfd 800 V.DC	.40
.03-.03 mfd 6,000 V.DC	1.65	10 mfd 600 V.DC	1.35
.01-.03 mfd 6,000 V.DC	1.60	4 mfd 600 V.DC	.69
.01 mfd 6,000 V.DC	1.45		

## BC 1072A IFF X'MITTER

in MAPLE CHEST 150 to 200 Mcs  
115 V., 60 Cyc.  
POWER SUPPLY gives: 0-5000 v.d.c. (variatic control) 312 v.d.c., 700 v.d.c., 6.3 v.d.c. Also contains: 11 tubes 6J5, 826, 6SN7, 5U4G, etc.), 5 KV meter, Blower, Condensers and many other useful parts too numerous to list. Shipping Wt. 245 lbs.  
Only (slightly used) \$22.50

## FILAMENT TRANSFORMER

WESTINGHOUSE #6D4298  
Tested at 34,000 volts  
Pri. 115 V.A.C., Sec. 5V @ 6.5 Amp.  
ONLY \$8.50



## RG 8/U NEW-UNUSED

### 52 OHM COAXIAL CABLE

4¢ a foot

500-2,500 feet	\$40.00 per M
3,000-5,000 feet	35.00 per M
5,500-10,000 feet	30.00 per M
10,500-20,000 feet	27.50 per M
over 20,000 feet	25.00 per M

No charge for reels.

### COAXIAL FITTINGS

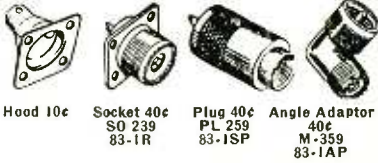

PL259A, 83-18PN, 83-1J, UG21U, UG22U, CUF 49190 (83-18P with small hole for RG59U Coaxial Fittings), UG85U Baby "N" plug, UG27U .40c each  
UG87U Baby "N" Socket, Gold Plated with Hood Attached .50c each  
83-1T—Tee Connector .125 each

## RELAYS

Coil	Contacts	Size (inches)	Stock No.	Price
10,000 ohm—10 Ma	Make-Break	1 1/2x1 1/2x2 1/8	1033 G.E.	\$.75
7,000 ohm—2 1/2 Ma.	SPDT	4x1 1/4x2	1012	1.20
1,800 ohm—20 Ma.	SPDT (2A)	2 3/4x2 1/2x1 5/8	1031 (Adjustable)	1.50
2,000 ohm—5 Ma.	SPDT	2 5/8x2 5/8x1 1/2	1034 (Adjustable)	1.50
1,200 ohm—10 Ma.	SPDT	7/8x7/8x1 3/8	1032 Sigma	.55
1,200 ohm—10 Ma.	3 PST (N.O.)	4x1 3/4x1 1/2	1022	.75
250 ohm—25 VDC	DEST (N.O.)	2 3/4x1 3/4x1 1/2	1014 (Ceramic)	.80
200 ohm—25 VDC	4 PDT	1 3/4x1 3/4x1 5/8	1015 (Bakelite)	.75
60 cy. 115 VAC	4 PDT (6A)	3 1/2x3 1/4x2	1000 Struthers	2.95
60 cy. 60 VAC	4 PST (N.O.)	3 1/8x3 1/8x1 1/2	1002 Leach	1.25

Stepping Relay—6 Pole, 11 Position, 24 VDC coil, Federal  
Dual Air Valve—close one of other. 2000 ohm, 100 VDC coils

## HARDWARE

HOSE CLAMPS—AERO SEAL, QS 100M4—1/2" nom. dia. or QS100M3—3/4" nom. dia. . . . .50/\$2.50  
UNIVERSAL JOINT, Aluminum, 1 3/4" long x 3/4" I.D. . . . .35c  
G. R. BANANA Plugs and Jacks small, uninsulated 6c dr.  
SLUG Tuned Coil forms, 1/2" x 3 3/16" with very finely powdered iron slug (50 Mc) . . . . .10/\$1.00  
Motor BRUSHES with pig tails and springs:  
(A) 1/2" x 1/2" x 3/4", BP20 (B) 3/16" x 3/16" x 3/4"  
3/16" x 3/4" x 1/2", V4 3/32" x 3/4" x 7/16"  
5/32 x 1/4" x 7/16" 3/16" round x 3/4"  
Thousands in stock. . . . .20/\$1.00  
Insulated Holders for (BP20) or (B) . . . . .each 10c  
TELEPHONE FIELD WIRE (W-110-13). One Mile spools. 2 twisted wires, each 4 strands steel and 3 strands copper. Only . . . . . \$14 per mile



## PRECISION RESISTORS

1% or better  
Any Order For  
100 pieces . . . . .10% OFF  
1000 pieces . . . . .20% OFF

1/4 WATT—25¢			
6.68	12.32	16.37	123.8
10.48	13.02	20.	147.5
10.84	13.52	62.54	220.4
11.25	13.99	79.81	301.8
11.74	14.98	105.8	366.6

1/2 WATT—25¢			
.250	2.04	97.8	4.451
.334	2.25	125	5,000
.502	11.1	180	723.1
.557	13.15	210	6,500
.627	46	235	2,500
.76	52	260	2,850
1.01	55.1	270	3,427
1.53	75	298.3	4,000

1 WATT—30c				
10,000	15,000	17,000	25,000	100,000
14,825	15,750	20,000	37,000	150,000

1 WATT—40¢				
18,000	30,000	55,000	70,000	75,000
20,000	50,000			

## POSTAGE STAMP MICAS

5MMF	56MMF	220MMF	650*MMF	.003*MFD
8.2	80	300	880	.0033
70	65	360	890	.0039
20*	82*	390	820*	.0047
25*	90*	400	.001MFD	.0068
32*	110*	470	0015	.0082
38*	120*	500*	.0016	.01
39	150	510	.002	
47	185	525*	.0022	
60	200	630*	.0027	

\*Silver Mica  
Price schedule  
5 MME to .001 MFD —5¢ Silver Mica 10¢  
.0012MFD to .0027MFD—7¢ Silver Mica 20¢  
.0029MFD to .0068MFD—12¢ Silver Mica 50¢  
.0082MFD —16¢ .01MFD 18¢

## PULSE TRANSFORMERS

Western Electric Permalloy core 1 3/32", 150 turns No. 33 AWG each pri. & sec. 2 Toridal Windings, D 166638, 1 3/4x1 1/4x2 1/4" fully cased \$1.25  
Western Electric Permalloy core, KS9800—A45, 1 3/4x1 3/4x3 1/2" fully cased, 3 windings ratios 1+0.1, 1+02 2.00  
Westinghouse 352-7250-2A, 15/16 dia. x 1 5/8" high, DC Resistance 10 ohm 3 1/2 ohm, sine wave response—3db 140 cy to 175 kc. 1.25  
Westinghouse 352-7287 Hypersil core, two windings,—3db 50 kc. to 330 kc., core approximately 1 1/2 x 7/8 x 7/16", fosterited 1.25  
G.E. 7472407 two windings, core 5/8 x 1 3/8 x 3/16" 1.25  
UTAH 9280 or 9282 1.50  
G.E. 7467888, 3 windings, DC 1/2 ohm, 10 ohm, 20 ohm, 1 1/8 x 1 3/8 x 2 5/16" fully cased, rise time, 0.1 micro seconds 1.25  
800 KVA, G.E. No. 7710417, 50 ohms pulse cable connection, 450 ohm output; 9.500 volt input. 19.50  
28,000 V. pk. output, Billar 81  
300 KVA, G.E. 7557296, 50 ohm pulse cable connection; 3.850 V. in 17,300 V out (250 KVA @ 1/4 micro second) cost \$226, our price only 15.00

## GEARS

Cat. No.	Pitch	Teeth	P.D.(In.)	Face(In.)	Hole(In.)	Material	Price
2301 Miter	48	18	3/8	7/64	3/16	Stainless	\$.20
2304 Miter	48	18	3/8	7/64	1/8	Brass	.10
2308 Worm	48	1	5/16	9/16	3/16	Stainless	.25
2310 Helical 45°	8	5/16	3/8	3/16	3/16	Steel	.15
2314 Helical (fts 2310)	18	23/32	1/4	1/4	1/4	Steel	.15
2334 Worm Gear (Anti backlash)	32	48	1 1/2	1/8	1/4	Brass	.40
2312 Worm (fts 2334)	32	4	9/16	9/16	1/4	Steel	.20
2330 Spur & Hub	48	78	1 5/8	5/64	3/16	Stainless	.20
2332 Spur (Anti backlash)	48	72	1 1/2	1/16	1/4	Stainless	.35
2340 Spur & Hub	48	36	3/4	1/8	3/16	Fibre (Alum. Hub.)	.10
2352 Spur & Hub	48	57	1 3/16	1/8	1/4	Fibre (Alum. Hub.)	.10
2336 Spur & Hub	48	24	1/2	3/16	1/4	Brass	.10
2338 Spur & Hub	48	36	3/4	1/16	3/16	Aluminum	.10
2342 Spur & Hub	48	40	15/16	1/8	1/2	Steel	.10
2348 Spur & Hub	48	54	1 1/8	1/16	1/8	Brass	.15
2350 Spur	48	60	1 1/4	1/16	1/2	Stainless	.10
2356 Spur	48	60	1 1/4	1/8	1/4	Brass	.10
2370 Spur	48	102	2 1/8	5/64	1/2	Brass	.15

Cat. No.	Pitch	Teeth	Face (In.)	Stem (In.)	Material	Price
2321 Stem pinion	48	12	13/32	11/16x3/16	Stainless	\$.10
2322 Stem pinion	48	10	3/16	1 11/32x3/16	Stainless	.10
2324 Stem pinion	48	15	1/8	27/32x3/16	Stainless	.10
2328 Stem pinion	32	16	3/16	13/32x5/32	Stainless	.10

Special sample offer—2 each of above, plus 25 other types gears, bushings and bearings—A REAL BUY—\$6.50.

## SELSYNS ONLY



ONLY  
\$7.25 pair  
#C78248

115 V., 60 Cyc., 3 3/4" dia. x 4 3/2" body. Used in Pairs for Remote Control.  
Also 50 V., 50 Cyc. \$4.75 pair.

SELSYN DIFFERENTIAL ONLY #C78249 \$2.25 ea.



115 V., 60 Cyc.  
Used between two #C78248's as dampener. Can be converted to a 3600 RPM Motor in 10 Minutes. Conversion sheet supplied.  
Also 50 V., 50 Cyc. \$1.50 ea.

# RELIANCE Merchandizing Company

f.o.b. PHILA., PA. Arch St. Cor. Croskey, Philadelphia 3, Pa. MINIMUM \$3 ORDER  
Telephone RIttenhouse 6-4927

# BIG VALUES IN SURPLUS

## G. E. Motor Starting Reactors



**Type 11K2840G2**  
 Rated at 440 Volts, 3 Phase, 60 Cycles, 16.8 Amperes, 15-20 HP. Waterproof steel case. 17" x 15" x 10". Brand New! In original factory cases.

**\$9.90**

## "TRANSTATS"

Amertran Voltage Regulator

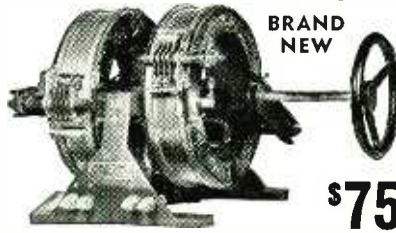

BRAND NEW

**\$75**

11.5 KVA; 50/60 cy. Commutator Range 0-115 V. Max. Amp. 100. Can be reconnected for 230 volts @ 50 AMP.

## Vibrator Power Supply

PE-204A

Input Voltage:  
12 Volts DC  
 Output Voltages:  
Two windings  
4.3 VDC @ 50 MA  
Two windings  
45VDC @ 0.5 MA  
Two windings  
85VDC @ 5.0 MA

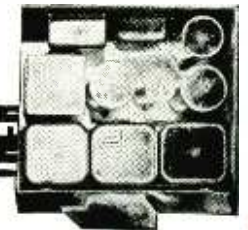

Parts alone worth double the money.

BRAND NEW **\$1**

## Inter-Communication Sets Manufactured by Dictograph



Designed to bring to homes and offices the convenience of two-way conversation without the use of telephone, household electric current, or radio.

It can be set up in any two rooms you wish . . . being limited only by the length of the wire you use. Inter-Communication Sets will operate efficiently up to 300 feet using 14-gauge wire.

BRAND NEW, Pair

**\$9.95**

## MOTOR GENERATORS

Input: 115 Volts, DC at 14 amperes, 3600 speed, ball bearings. Output: 1.25 KVA; 80% P.F.; 120 VAC, 60 cy. single ph., 10.4 Amperes. With resistive control of voltage output and frequency built-in and with Centrifugal automatic controller built-in, permitting line-start operation. Fully enclosed. Splash-proof.

BRAND NEW!  
In Original  
Factory Cases

Price  
**\$100**

Same machine for 230  
Volts, D. C. Operation

**\$120**

Built by Allis-Chalmers to  
U. S. Navy Specifications

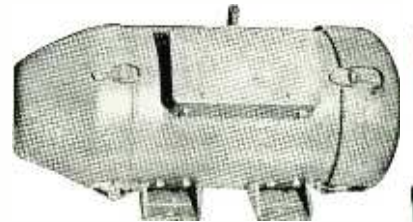

Spare parts kit of brushes, brushholders, ball bearings, field coils, etc. in steel case. Price \$10.

## ALL ITEMS LISTED BELOW ARE "BRAND NEW" UNLESS OTHERWISE SPECIFIED

### SYNCHRO'S

- Ford Instrument Synchro Generator, 7G, MK111 Mod. 3 115/90 Volts 60 Cycles. Price \$16.50
- Arma Corp. Synchro Differential Generator, Type 5DG MK4 Mod. 1 90/90 Volts 60 Cycles Price \$7.95
- Diehl Synchro Transmitter, Type C78414 115 Volts 60 Cycles Price \$4.35
- Control Instrument Synchro Motor, Type 5F MK4 Mod. 3 115/90 Volts 60 Cycles. Price \$26.25
- Sperry Gyroscope Voltage Receiver, 76166, 115 Volts 60 Cycles Price \$4.35
- Delco Synchro Transmitter, C79331, Type 1.4, 115 Volts, 60 Cycles Price \$4.35

### MOTORS AND GENERATORS

- Western Electric Motor, KSS624, 20 VAC, 200 Cps, 2 Ph. 9000 RPM. Price \$4.95
- Oster Shunt Motor, Type B-7-5, 27 1/2 Volts DC, 1/20 HP 3650 RPM. Price \$7.50
- Oster Series Motor, Type C-2BP-1A, 27.5 Volts DC, 1/100 HP 7000 RPM. Price \$2.50
- Universal Electric Shunt Motor, K85603L02, 28 Volts, .6 Amps, 5000 RPM. Price \$2.00
- Westinghouse Series Motor, 1171391, 27 Volts 0.5 Amps. 1/4 HP 5800 RPM. Price \$8.00
- Elinco AC Generator, Type F-16 2 Phase, 1.3 Volts per 100 RPM Price \$7.95
- Elinco DC Generator, Type PM-2, 1.75 Volts per 100 RPM. Price \$5.75
- G. E. Permanent Magnet Generator, 5BY9E8, 140 Volts DC .025 Amps, 1800 RPM. Price \$5.50
- G. E. Motor, Mod. 5BA10AJ18D, 27 Volts 0.7 Amps. 1 oz/ft torque 110 RPM. Price \$1.00
- Emerson Electric Motor, Style 1610212, 24 Volts 160 oz/ft 27 Amps. 100 RPM. Price \$8.95
- Electric Specialty Co. AC Motor, Type BP51R, 440/3/60cy, 2.5 HP, 1750 RPM. Price \$28.50
- G. E. Motor, Type BC 115 VDC 1/8 HP 1225 RPM Comp. wound Rebuilt. Price \$9.50
- G. E. Series Motor, Mod. 5P856HC18, 60 VDC 1/20 HP, 1.4 A. 5500 RPM. Price \$2.85
- G. E. Motor, 230 Volts DC, 6.75 HP, 1100 RPM flange mounting. Price \$50.00
- General Industries Phono Motor, 23200, 115 VAC, 60 cy, 0.5 A. 80 RPM. Price \$5.75
- General Industries Phono Motor, 23200, 115/220 VAC, 60 cycle, 0.5 Amps, 80 RPM. Price \$6.35
- Universal Electric Co., 115 VDC, 500 RPM, .12A Price \$4.50

### INVERTERS AND DYNAMOTORS

- PE103 Ballentine Dynamotor, input 6-12 Volts, output 500 Volts, 160 Ma. without filter. Price \$9.95
- PE206 Inverter, input 27 Volts DC, output 80 Volts, 800 Cycle, 500 VA. Price \$9.95
- PE218 Inverter, input 27 Volts DC, output 115 Volts, 400 Cycle, 1500 VA Rebuilt Like New Price \$22.50
- Dynamotors for SCR-522, input 28 Volts DC, output 13-150-300 Volts. Rebuilt Like New Price \$3.25
- G. E. Dynamotor, 5D48B8A, input 14 Volts DC, output 1000 Volts at 350 Ma. complete with filter. Price \$5.00
- MG-132A Inverter, input 11.5 Volts DC, output 140 Volts AC, 1.2 Amps, 350 Cycle, 1800 RPM, 100% 1P Price \$19.95

### METERS

- Bristol Pyromaster Potentiometer Type 440MFL, 115 Volts, 60 Cycles, Range 0-2000° F. Used but Guaranteed Price \$125.00
- Hoyt Portable Ammeter, Mod. 515, 0-15 Amperes DC, complete with test leads. Price \$4.95
- G. E. Voltmeter, Mod. AB-13, 0-150 Volts AC, 400 Cycle, 4 1/2" sq. complete with external resistor. Price \$14.95

### MAGNETRONS

- 2126 2992-3019 mc 275 KW. Price \$10.00
- 2127 2985-2992 mc 275 KW. Price \$10.00
- 2131 2820-2860 mc 285 KW. Price \$15.00
- 2161 3020-3100 mc 35 KW. Price \$25.00
- 700 A, B, C, D, West. Elec. 100 KW. Price \$25.00
- 720 AY, GY, West Elec. 1000 KW. Price \$25.00
- 728 AY, BY, CY, DY, EY, FY, GY, 300 KW Price \$25.00

### KLYSTRONS

- Westinghouse, Type 417A. Price \$9.00
- Westinghouse, Type 723A/B. Price \$5.00

### TRANSFORMERS

- Stepdown Transformer 575/230/115, 60 cycle, 100 VA, air-cooled. Price \$3.10
- Westinghouse Transformer Primary 110 Volts, 60 cycle, Secondary 20 Volts, 200 watts Price \$3.95

### BATTERIES

- 8 Volt Dewar Wet Cell Battery, 15 amp.-hours. Complete with electrolyte and filler syringe. May be used as four 2 volt batteries Price \$8.00
- 2 Volt Willard Battery, replacement for G. E. portable radio model LB530. Price \$1.50
- 4 Volt Searchlight Battery, 80 Ampere hours (all batteries shipped dry) Price \$10.65

### AMPLIDYNES

- G. E. Amplidyne, Mod. 5AM450B20, input 115 Volts, single phase, 60 Cycle 5.0 Amps, output 250 Volts, 0.6 Amps, 150 watt, 3450 RPM, continuous duty. Price \$53.50
- G. E. Amplidyne, Mod. 5AM21A17, input 27 Volts, DC, 16 Amps, 4600 RPM, output 60 Volts, 2.5 Amps, 150 watt. Price \$9.95

### VOLTAGE REGULATORS

- Eclipse Voltage Regulator, Type 1001, set at 115 Volts AC. Price \$3.25
- Eclipse Voltage Regulator, Type 1002, set at 27.7 Volts DC. Price \$1.75
- Leland Voltage Regulator, 11651, set at 18 volts Price \$1.29

### An Outstanding Value

List price \$3000—Our price **\$475**  
**WESTINGHOUSE INDUCTION HEATER**  
 450 KC, 10 KW, Radio Frequency Generator.  
 450 MC, 140 Amps. Input 220/440V 3 Ph. 60 cy. 43" W x 48" H x 30" D complete with following tubes: 1 WL-5004, 3 WL-872, 3 WL-678, 15W4 Water-cooled, USED  
**BUT LOOKS LIKE NEW. \$475**

IMPOSSIBLE TO LIST ALL OF OUR ITEMS AND COMPONENTS. TELL US YOUR NEEDS.  
 All prices F.O.B. Boston. Orders accepted from rated concerns on open accounts. Net 30 days.

Write for 112 Page Catalog on company letterhead



Dept. E-10, 110 Pearl Street, Boston 10, Mass.



# Build YOUR OWN TEST EQUIPMENT

**\$39.50**

*Nothing ELSE TO BUY*



## NEW 1948 HEATHKIT 5" OSCILLOSCOPE KIT

A necessity for the newer servicing technique in FM and television at a price you can afford. The Heathkit is complete, beautiful two color panel, all metal parts punched, formed and plated and every part supplied. A pleasant evening's work and you have the most interesting piece of laboratory equipment available.

Check the features — large 5" 5B1 tube, compensated vertical and horizontal amplifiers using 6SJ7's, 15 cycle to 30 M cycle sweep generator using 884 gas triode, 110V 60 cycle power transformer gives 1100 volts negative and 350 volts positive.

Convenient size 8 1/2" x 13" high, 17" deep, weight only 26 pounds.

All controls on front panel with test voltage and ext. syn post. Complete with all tubes and detailed instructions. Shipping weight 35 pounds.

Order today while surplus tubes make the price possible.

## HEATHKIT SINE AND SQUARE WAVE AUDIO GENERATOR KIT

The ideal companion instrument to the Heathkit Oscilloscope. An Audio Generator with less than 1% distortion, high calibration accuracy, covering 20 to 20,000 cycles. Circuit is highly stable resistance capacity tuned circuit. Five tubes are used, a 6SJ7 and 6K6 in the oscillator circuit, a 6SL7 square wave clipper, a 6SN7 as a cathode follower output and 5Y3 as transformer power supply rectifier.

The square wave is of excellent shape between 100 and 5,000 cycles giving adequate range for all audio, FM and television amplifier testing.

Either sine or square waves available instantly at a toggle switch. Approximately 25V of sine AC available at 50,000 ohm output impedance. Output +1 db. from 20 to 20,000 cycles. Nothing else to buy. All metal parts are punched, formed and cadmium plated. Complete with tubes, all parts, detailed blueprints and instructions.

## HEATHKIT SIGNAL TRACER KIT

Reduces service time and greatly increases profits of any service shop. Uses crystal diode to follow signal from antenna to speaker. Locates faults immediately. Internal amplifier available for speaker testing and internal speaker available for amplifier testing. Connection for VTVM on panel allows visual tracing and gain measurements. Also tests phonograph pickups, microphones, PA systems, etc. Frequency range to 200 Mc. Complete ready to assemble. 110V 60 cycle transformer operated. Supplied with 3 tubes, diode probe, 2 color panel, all other parts. Easy to assemble, detailed blueprints and instructions.

Small portable 9" x 6" x 4 3/4". Wt. 6 pounds. Ideal for taking on service calls. Complete your service shop with this instrument.

## HEATHKIT SIGNAL GENERATOR KIT

Every shop needs a good signal generator. The Heathkit fulfills every servicing need, fundamentals from 150 Kc. to 30 megacycles with strong harmonics over 100 megacycles covering the new television and FM bands. 110V 60 cycle transformer operated power supply.

400 cycle audio available for 30% modulation or audio testing. Uses 6SN7 as RF oscillator and audio amplifier. Complete kit has every part necessary and detailed blueprints and instructions enable the builder to assemble it in a few hours. Large easy to read calibration. Convenient size 9" x 6" x 4 3/4". Weight 4 1/2 pounds.



**\$24.50**

*Nothing ELSE TO BUY*

## THE NEW HEATHKIT VACUUM TUBE VOLTMETER KIT

The most essential tool a radio man can have, now within the reach of his pocketbook. The Heathkit VTVM is equal in quality to instruments selling for \$75.00 or more. Features 500 microamp meter, transformer power supply, 1% glass enclosed divider resistors, ceramic selector switches, 11 megohms input resistance, linear AC and DC scale, electronic AC reading RMS. Circuit uses 6SN7 in balanced bridge circuit, a 6H6 as AC rectifier and 6 x 5 as transformer power supply rectifier. Included is means of calibrating without standards. Average assembly time less than four pleasant hours and you have the most useful test instrument you will ever own. Ranges 0-3, 30, 100, 300, 1000 volts AC and DC. Ohmmeter has ranges of scale times 1, 100, 1000, 10M and 1 megohm, giving range .1 ohm to 1000 megohms. Weight 8 lbs.



**\$19.50**

## HEATHKIT CONDENSER CHECKER KIT

A condenser checker anyone can afford to own. Measures capacity and leakage from .0001 to 100 MFD on calibrated scales with test voltage up to 500 volts. No need for tables or multipliers. Reads resistance 500 ohms to 2 megohms. 110V 60 cycle transformer operated complete with rectifier and magic eye indicator tubes.

Easy quick assembly with clear detailed blueprints and instructions. Small convenient size 9" x 6" x 4 3/4". Weight 4 pounds. This is one of the handiest instruments in any service shop.

**\$34.50**

*Shipping Wt., 13 lbs.*

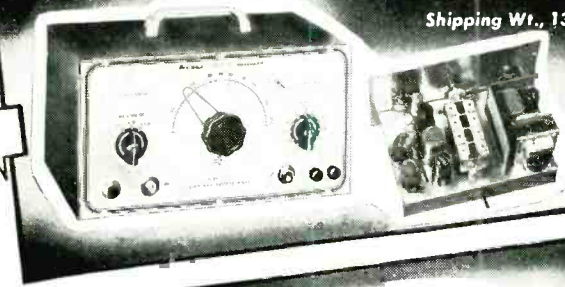

**\$19.50**

*Nothing ELSE TO BUY*



**\$19.50**

*Nothing ELSE TO BUY*

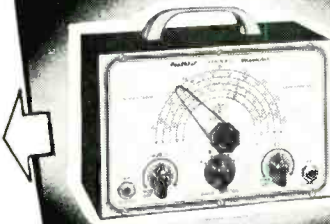

The **HEATH COMPANY**

DEPT. E . . . BENTON HARBOR, MICHIGAN

# Sales Bulletin

Desirable Select Surplus Items of Electronic Equipment, New, Unused



## BC-375E TRANSMITTERS

TYPE BC-375E AIRCRAFT RADIO TRANSMITTERS, 100 WATT FREQUENCY RANGE 200-500 KC AND 1,500-12,500 KC EACH. Complete as follows:

Quan.	Type No.	Description
1	BC-375E	Transmitter
1	FT-115-B	Mount
1	FT-151-A or C	Mount
1	TU-5B	Tuning Unit (1500-3000 KC.)
1	TU-6B	Tuning Unit (3000-4500 KC.)
1	TU-7B	Tuning Unit (4500-6200 KC.)
1	TU-8B	Tuning Unit (6200-7700 KC.)
1	TU-9B	Tuning Unit (7700-10000 KC.)
1	TU-10B	Tuning Unit (10000-12500 KC.)
1	TU-26B	Tuning Unit (200-500 KC.)
1	BC-306-A	Antenna Tuning Unit
1	FT-142	Mount
1	PE-73-C	Dynamotor
1	FT-107	Mount
2	PL-59	Plug
2	PL-61	Plug
1	PL-64	Plug

war surplus units all new and packed in original crate.

## NAVY TDE TRANSMITTER

Navy Model TDE Radio Transmitter is designed for medium and short wave telegraph and telephone operation. Frequency range 300 to 18,000 Kc. Output CW 125 watts. Phone 25 watts operates on 230 volts D.C. Transmitter motor generator filters and controls all located in one steel cabinet as shown in illustration.



## GASOLINE AND DIESEL ENGINE GENERATORS



We have available gasoline and Diesel engine generators of all types. Contact us if interested in any of these remarkable new surplus units.

## RADIO TELEGRAPH TRANSMITTER MODEL ET-8023 D1

This Radiomarine Transmitter has a power output of 200 watts and is either master oscillator or crystal control in operation. Emission CW or MCW. Frequency range 2,000 to 24,000 Kc. in nine overlapping bands. New in original export packing. Supplied complete with one set of operational tubes and typewriter table.

All material offered subject to prior sale

# FRENCH-VAN BREEMS, Inc.

630 FIFTH AVENUE

NEW YORK 20, N. Y., U. S. A.

CABLE ADDRESS, FREXVAN, N. Y.

*Electronic Engineering Experts*





## RELAYS FOR EVERY PURPOSE Over a Million in Stock!

Whether you require large quantities of relays for production runs or single units for laboratory or amateur work, Wells can make immediate delivery and save you a substantial part of the cost.

Our capable engineering staff is prepared to offer assistance in the selection of correct types to suit your exact requirements.

Each relay is brand new, standard make, inspected, individually boxed and fully guaranteed.

The following list represents only a tiny portion of our relay stock. Write or wire us for information on types not shown.

### STANDARD DC TELEPHONE RELAYS

Stock No.	Operating Voltage	Coil Resistance	Contacts	Manufacturer	Net Each
R-101	24V	1500	DPST (NO)	Auto. Elec.	\$1.35
R-102	24V	400	SPDT	Auto. Elec.	1.10
R-103	24V	DUAL-1000	3PST (NO)	Auto. Elec.	1.35
R-105	24V	600	3PST (NO)	Clare	1.20
R-106	24V	1300	3PST (NO)	Clare	1.25
R-152	12V	50	DPDT-SPST (NO)	Guardian	1.10
R-153	12V	200	SPDT-SPST (NO)	Stromberg	1.25
R-154	12V	200	SPST (NO)	Clare	1.20
R-155	12V	100	SPST (4NO4NC)	Auto. Elec.	1.15
R-158	6V	50	4PST (NO)	Stromberg	1.10
R-159	6V	50	DPST (NO)	Stromberg	1.10
R-160	6V	12	3PDT-3PST (NO)	Auto. Elec.	1.05
R-161	6V	10	3PST (2NC 1NO)	Auto. Elec.	1.05
R-121	150V	5000	DPST (NO) SPDT	Clare	1.75
R-123	150V	6300	SPST (NO)	Clare	1.75
R-602	150V	6500	3PST (NO)	Clare	1.75
R-515	24V	750	SPST (NO)	Clare	1.25
R-517	12V	250	DPST (NO)	Clare	1.20
R-519	250V	14000	SPDT	Auto. Elec.	1.95
R-520	250V	14000	DPDT	Auto. Elec.	1.50
R-112	32V	1000	DPDT	Kellogg	1.20
R-521	24V	DUAL-200	DPDT-SPST (NO)	Stromberg	1.59
R-168	24V	DUAL-200	4PST (NO)	Auto. Elec.	1.20
H-240	250 350V	40000	DPST (NO)	Auto. Elec.	2.95
H-241	48V	650	SPDT-SPST (NO)	Clare	1.25

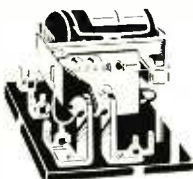

### SENSITIVE DC RELAYS

Stock No.	Operating Voltage	Coil Resistance	Contacts	Manufacturer	Net Each
R-218	4-6V	1800	SPDT	Kurman 220C	\$1.95
R-220	75V	5000	SPDT	Allied Cont.	1.15
R-221	18 24V	5000	SPST (NO)	Allied Cont.	1.15
R-174	250V	5000	DPST (NO)	G.M.	1.85
R-175	350V	11000	DPDT-SPST (NO)	G.M.	2.95
R-176	24V	250	DPST (NO)	G.M.	1.50
R-177	24V	300	4PDT	G.M.	1.65
R-600	8-12V	5090	SPDT	S-Dunn-KS	2.10
R-507	24-48V	1000	SPDT-DPST (NC)	Guardian	1.15

### TYPE 18 DC TELEPHONE RELAYS

Stock No.	Operating Voltage	Coil Resistance	Contacts	Manufacturer	Net Each
R-109	24-48V	4000	SPDT	Auto. Elec.	\$1.50
R-110	24-32V	3500	SPDT	Auto. Elec.	1.50
R-112	50-120V	6500	SPST (NC)	Auto. Elec.	1.75
R-114	24V	500	4PST (NO)	Auto. Elec.	1.30
R-603	24V	400	DPST (NO)	Auto. Elec.	1.25
H-238	24V	150	DPDT-SPST (NC)	R.B.M.	1.25
H-239	24V	180	DPST (NO)	Auto. Elec.	1.25



### SEALED DC TELEPHONE RELAYS

Stock No.	Operating Voltage	Coil Resistance	Contacts	Manufacturer	Net Each
R-125	24V	300	DPDT	Clare	\$2.75
R-126	90-120V	2000	DPDT	Clare	3.00
R-504	24-70V	2800	SPDT	GE-C103C25	3.00

### V TYPE DC TELEPHONE RELAYS

Stock No.	Operating Voltage	Coil Resistance	Contacts	Manufacturer	Net Each
R-164	24-32V	1000	SPST (NO)	W. E.	\$1.20
R-512	24-48V	3500	DPDT	W. E.	1.30
R-513	12-24V	300	DPDT-SPST (NC)	W. E.	1.20
R-514	4-6V	60	SPDT	W. E.	1.05
R-526	6V	35	DPDT-SPST (INC-NO)	W. E.	1.05

### AC-STANDARD TELEPHONE RELAYS

Stock No.	Operating Voltage	Coil Resistance	Contacts	Manufacturer	Net Each
R-212	90-135V	—	NONE	Clare	\$0.95
R-213	5-8V	—	DPST (NO)	Clare	1.50
R-605	24V	—	3PST (NO)	Auto. Elec.	.95
R-606	24V	—	DPST (1NO-1NC)	Auto. Elec.	.95
R-607	24V	—	SPST (NO)	Auto. Elec.	.95



### DIRECT CURRENT MIDGET RELAYS

Stock No.	Operating Voltage	Coil Resistance	Contacts	Manufacturer	Net Each
R-132	24V	300	DPDT	Clare	\$1.20
R-134	24V	300	NONE	Clare	.60
R-134	24V	250	4PDT	Clare	1.20
R-135	24V	300	SPST (NC)	Clare	1.15
R-137	24V	300	SPDT	Clare	1.15
R-138	24V	300	4PST (NO)	Clare	1.15
R-139	24V	200	4PDT	Clare	1.15
R-140	24V	280	SPDT	R.B.M.	1.15
R-141	24V	280	3PST (NO)	R.B.M.	1.15
R-142	24V	400	DPDT	Allied Cont.	1.20
R-143	24V	280	SPST (NO)	R.B.M.	1.15
R-144	24V	250	SPST (NO)	Allied Cont.	1.15
R-145	24V	300	DPST (NO)	Allied Cont.	1.15
R-146	12V	125	DPST (1NO) (1NC)	Allied Cont.	1.10
R-147	9-14V	75	SPDT	Guardian	1.05
R-148	12V	100	DPDT-SPST (NC)	Price Bros.	1.10
R-149	6-8V	45	SPST (NC)	Clare	1.00
R-150	6V	30	SPST (NO)	E-7 Elec.	.95
R-522	2-6V	2	SPST (NO)	R.B.M.	.65
R-523	90-125V	6500	DPDT	R.B.M.	1.90
R-222	12V	100	DPST (NO)	P & B	.95
H-242	24-32V	300	DPDT	R.B.M.	1.20
H-243	24-32V	300	4PDT	R.B.M.	1.20

### TYPE 80 DC RELAYS

Stock No.	Operating Voltage	Coil Resistance	Contacts	Manufacturer	Net Each
R-169	24V	250	SPST (NO)	Allied Cont.	\$1.95
R-171	24V	230	DPDT	Allied Cont.	2.15
R-172	5-8V	30	DPDT-SPST (NO)	Allied Cont.	1.70
R-173	2-6V	5	SPST (NO)	Allied Cont.	1.25
R-529	24-48V	1000	DPDT	Allied Cont.	2.50

### TYPE BJ DC RELAYS

Stock No.	Operating Voltage	Coil Resistance	Contacts	Manufacturer	Net Each
R-204	12V	65	DPST (NO)	Allied Cont.	1.25
R-205	24V	260	DPDT	Allied Cont.	1.25
R-224	12V	75	SPST (NO)	Allied Cont.	1.15
H-237	27V	230	DPDT	Allied Cont.	1.25

### HEAVY DUTY KEYING RELAYS

Stock No.	Operating Voltage	Coil Resistance	Contacts	Manufacturer	Net Each
R-248	28V DC	150	SPST (NO) 10A	Guard 36471	\$1.05
R-244	75V AC	265	SPST (NO) 20A	Leach 1327	1.75
R-206	24V DC	150	SPDT-3 AMP	P&B-KL	1.10
R-207	24V DC	210	4PDT-3 AMP	P&B-KL	1.10
R-219	50V DC	1500	DPST (NO) 15A	P&B-SP	1.25
R-217	115 AC	600	SPDT-10 AMP	St. Dunn IXAX2	2.25
R-525	24V DC	200	DPDT-10 AMP	Guard 34464	1.25
R-508	110 AC	600	SPDT-6 AMP	Guard 37189	1.95
R-506	24V DC	300	DPST (NO) 6A	—	.95
R-510	24V DC	200	3PDT-10 AMP	Coat 516983	1.05
R-604	24V DC	200	SPST (NO) 30A	St. Dunn-B2A	1.25
H-608	115 AC	—	SPST (NO) 20A	St. Dunn-IHXK2	2.25
R-620	12V DC	35	3PST (NO) 10A	Guard-BK2	1.05
R-223	28V DC	150	SPST (NO) 40A	Price Bros.	1.35
H-230	12-24V DC	80	DPST (NO) 10A	—	1.20
H-231	24V	230	DPST (NO) 5A	R.B.M.	1.15

### DC-TYPE 76 ROTARY RELAYS

Stock No.	Operating Voltage	Coil Resistance	Contacts	Manufacturer	Net Each
R-197	9-16V	70	DPDT	Price Bros.	\$1.65
R-198	9-16V	125	6PST (3NO) (3NC) SPDT	Price Bros.	1.65
R-199	24-32V	250	SPDT-DPST (NC)	Price Bros.	1.65
R-200	24-32V	275	3PDT-SPST (NC)	Price Bros.	1.65
R-201	24-32V	250	DPST (NO) SPDT (NC) DPDT	Price Bros.	1.65
R-601	9-14V	60	3PST (NO)	Price Bros.	1.65



### DIRECT CURRENT KEYING RELAYS

Stock No.	Operating Voltage	Coil Resistance	Contacts	Manufacturer	Net Each
R-190	12V	65	DPDT 10 AMP	Advance Elec. Type 2000-A	\$1.15
R-191	28V	125	DPDT 10 AMP	Guardian	1.20
R-192	12V	44	3PDT 10 AMP	Allied Cont. Type NB5	1.35
R-193	5-8V	11	DPDT 10 AMP	Leach Type 1027	1.05
R-194	24V	265	DPST (NO) 10 AMP	Leach Type 1054SNW1	25
R-195	6V	32	DPDT 3 AMP	G.E. Co.	1.15
R-196	12V	50	DPDT 10 AMP SPST (NC)	Guardian	1.15
R-242	24V	170	SPDT 2 AMP	Leach	1.15
H-236	5-8V	18.5	SPDT 10 AMP	Type 1253DEW1	25

### CUTLER HAMMER HEAVY DUTY CONTACTORS



Stock No.	Operating Voltage	Coil Resistance	Contacts	Manufacturer	Net Each
R-178	24V DC	100	SPST (NO) 100A	6141H34A	\$3.85
R-179	6V DC	6.5	SPST (NO) 50A	6041H83A	3.00
R-180	12V DC	25	SPST (NO) 50A	604H308	3.25
R-181	24V DC	65	SPST (NO) 100A	6041H88	3.85
H-232	24V	55	SPST (NO) 50A	Metal Cased	3.25
H-233	6V	15	SPST (NO) 50A	Metal Cased	3.15
H-235	24V	70	SPST (NO) 100A	Type B6	3.85

### DIRECT CURRENT AIRCRAFT CONTACTORS

Stock No.	Operating Voltage	Coil Resistance	Contacts	Manufacturer	Net Each
R-182	28V	80	SPST (NO) 25 A	Guardian	\$1.85
R-183	24V	60	DPDT 6 AMP	Allen Bradley Type B6A	2.75
R-184	28V	50	SPST (NO) 100A	General Elec. Leach 5055ECR	2.95
R-185	24V	100	SPST (NO) 50 A	Leach 7220-3-24350	2.75
R-187	24V	100	SPST (NO) 50 A	Allen Bradley	2.95
R-188	24V	200	SPST (NO) 75 A	Allied Cont.	2.95
H-234	14V	45	SPST (NO) 30 A	—	1.65

### ANTENNA CHANGEOVER RELAYS

Stock No.	Operating Voltage	Coil Resistance	Contacts	Manufacturer	Net Each
R-192	6 1/2V DC	44	2PDT 10 AMP	Allied-NB5	\$1.35
R-231	12V DC	100	DPDT 6 AMP	G. E.	1.95
R-256	24-32V DC	—	SPDT-DPST (NC) 1KW	Guardian	1.45
R-501	110 AC	4	DPDT (1KW)	G. E.	2.45
R-503	12-32V DC	100	SPDT-5PST	G. E.-500 W.	1.95

### COMBINATION PUSH BUTTON AND REMOTE RELAY

Stock No.	Operating Voltage	Coil Resistance	Contacts	Manufacturer	Net Each
H-244	12-24 V DC	Dual-60	SPDT	CR2791-R106C8	\$1.65

### ADJUSTABLE TIME DELAY RELAY

Stock No.	Operating Voltage	Coil Resistance	Contacts	Manufacturer	Net Each
R-246	115 AC	—	SPST (NO) or (NC) 10 AMPS	R. W. Cramer 1-120 Sec.	\$8.95

### DC MECHANICAL ACTION RELAYS

Stock No.	Operating Voltage	Coil Resistance	Contacts	Manufacturer	Net Each
R-245	12V	25	4' Lever	G.M.	\$0.95
R-527	6-12V	200	2" Lever	—	.95

### TYPE C.M.S. RELAY

Stock No.	Operating Voltage	Coil Resistance	Contacts	Manufacturer	Net Each
R-511	24V DC	200	MICRO-SW. SPST (NO)	Clare	\$2.45

### DC CURRENT REGULATOR

Stock No.	Operating Voltage	Coil Resistance	Contacts	Manufacturer	Net Each
R-509	6-12V DC	40	SPST (NC)	G. E.	\$0.85

### LATCH AND RESET RELAY

Stock No.	Operating Voltage	Coil Resistance	Contacts	Manufacturer	Net Each
R-500	12V DC	10	DPDT-10 AMP	St. Dunn-CX-3190B	\$2.85

### DC-ROTARY STEP RELAY

Stock No.	Operating Voltage	Coil Resistance	Contacts	Manufacturer	Net Each
R-621					

**HUNDREDS OF GREAT VALUES AT NEWARK**



**TRANSMITTING and SPECIAL PURPOSE TUBES**

**BIG SAVINGS NOW on Top Grade Tubes from our Tremendous Stock! All Brand New—All JAN Inspected—All made by Leading Manufacturers to Signal Corps specifications. Stock up NOW!**  
 3C24/24G. Transmitting Triode. Each **39¢** 6 for **\$1.80**

E1148*	\$0.95	5BP4	\$3.95	807	\$1.15	954	\$0.49
EF50*	.79	5CP1*	3.75	809	1.65	955	.49
HY615*	.95	5D21*	8.95	810	6.95	957	.49
VR105*	.89	6AK5	.89	811	1.79	958A	.49
VR150*	.89	10Y	.59	813	7.95	959*	.49
2AP1	2.49	211	.69	814	2.95	1616*	2.95
2C40	.89	285A*	.75	815	1.69	1619	.49
2C43*	4.95	286A*	.69	826	.79	1624*	.90
2C44	1.35	304TH*	3.95	829B	4.95	1625	.49
2D21	.98	304TL	1.39	830B	3.95	1626	.49
2E22	1.50	331A/805*	4.95	832A	2.65	1665/2050*	1.18
2X2A*	.99	705A	2.95	836*	1.25	2051*	.69
2X2/879	.49	717A	1.65	838	3.95	7193	.49
3AP1	2.39	723AB*	5.95	843	.45	8005*	4.95
3B24	1.95	801A	1.49	845W	3.45	9001	.49
3CP1	.99	803	8.95	866A*	.98	9002	.69
3CP1SI	.89	804	8.95	872A	1.75	9003*	.49
3E29	3.49	805	4.95	931A	2.39	9004	.69
6AC7/1852	.99	6C4	.29	12A6	.29	9006	.49
6AG5	.99	6J6	.89				

\* Available From New York Only

**TRANSFORMER SPECIALS**

**POWER TRANSFORMER**—Pri: 120V, tapped at 110V, 60 cycles. Sec: 768V, CT at 305 Ma. Electrostatically shielded. Flush Type Mtg. 4 1/4" x 3 3/4" x 5 1/2" overall Hgt. 12 lbs. **No. S-851 \$3.95**

**FILAMENT TRANSFORMER**—Electrostatically shielded. Flush mtg. Pri: 117V, 60 cycles. Sec: 5V at 6 amps, and 6.3V at 6 amps. 3 1/4" x 3 3/4" x 3 1/4" H overall. 5 lbs. **No. S-852 \$1.95**

**CHOKE**—4.2 Hy at 300 Ma. DCR 78 ohms. Fully enclosed in metal case. Four stud mtg. 2500V breakdown. 4 x 4 x 4 1/2" H. 8 lbs. **No. S-853 \$2.95**

**50 MA POWER TRANSFORMER**—Fully enclosed, flush mtg. Socket for 5Y3 Rectifier built into top and internally wired. Pri: 117V, 60 cy. Sec. #1: 530 V, CT at 50 ma. Sec. #2 supplies 5V at 2 amps, to socket. Sec. #3: 6.3V at 1.9 amps. Electrostatically shielded. 2 1/2" x 3 x 3 1/4" above chassis. 8 lbs. **No. S-837 \$2.19**

**UNIVERSAL 55 MA POWER XFORMER**—Has Tap Switch to adjust primary input from 110 to 245 volts, 60 cycles, in 6 stages. Fully enclosed, flush mtg. Sec: 530V, CT at 55 Ma, 5B at 2 amps.; 6.3V at 3.15. Electrostatically shielded. Mtg. Cntrs. 2 1/2" x 2 1/4". 5 lbs. **No. S-835 \$2.49**

**160 MA POWER XFORMER**—Pri: 110V, 60 cycles. Sec: 720V, CT at 160 Ma; 6.3V at 4 amps.; 5.0V at 3 amps. Fully enclosed, flush mtg. Overall: 4 1/4" x 3 3/4" x 3 1/4". 8 lbs. **No. S-793 \$3.49**

**POWER TRANSFORMER**—1345V each side of CT at 500 ma. Primary tapped 105/115/125V. Fully enclosed, inverted flange mtg. Screw Terminals. **No. S-877 \$14.95**

**MULTIPLE FILAMENT TRANSFORMER**—Primary 105/115/125V at 60 cycles. 6 separate secondaries all CT as follows: 3 windings at 6.4V at 8 amps.; 2 windings at 2.6V at 2.5 amps.; 1 winding at 2.6V at 10 amps. Inverted flange mtg. 4 1/4" x 5 x 5 1/4" H. 14 lbs. **No. S-880 \$5.95**

**FREE!**  
 Use Newark's Big NEW CATALOG as your Buying Guide for Thousands of Radio, Sound, Electronic and Television Values. Write Today!

**NEWARK ELECTRIC CO.** maintains the Largest Stock in the Country of Standard Equipment including...

- Aerovox • Amphenol
- Atlas • Alliance
- American TV & Radio
- Astatic • Arrow H & H
- Audio Devices
- Audak • Brush
- Altec-Lansing
- Barker • Williamson
- Burgess • Bliley
- Barker & Howard
- Belden • Bogen
- Browning Labs.
- Cornell-Dubilier
- Cannon • Cinch
- Centralab • Collins
- Continental Carbon
- Croname • Drake
- Dumont • Elincor
- Eby • Esico
- Federal • Greenlee
- Gordon Specialties
- General Industries
- Garrard • Guardian
- GE • General Cement
- Gothard • Hickok
- Hammarlund
- Hallcrafters
- IRC • Jeffers
- Johnson • Jones
- Jensen • Jackson
- Kester • Littlefuse
- Masco • Mallory
- McMurdo Miller
- Millen • Mueller
- Meissner • National
- Ohmite • Par Metal
- Park • Pickering
- Precision • RCA
- Rider • Rek-O-Kut
- Reeves • Rauland
- Simpson • Shure
- Sylvania • Stancor
- Supreme • Sonar
- Stephens • Turner
- Transvision • Triplet
- Thordarson • UTC
- University • Ward
- Vibroplex • Weller
- Webster • Weston
- etc.

**NEW DUAL SPEED PHONO-MOTOR**  
 For Recording or Playback!



Heavy Duty, Rim Drive Motor—built by a leading mfr. for RCA. Will Play or Record on either 33 1/2 or 78 RPM. Ideal for playing new Micro-Groove records. Weighted 10" Turntable assures good recording and playback. Complete parts including Motor, Turntable, switch, drive wheels etc. less mtg. plate. Sensational value! **Cat. No. \$5.95 S-895**

**Sensational General Electric FM TUNER**

Model XFM-1

**\$49.50**

Complete with 8 Tubes



This amazing new GE FM Tuner is a superb instrument, offered by Newark at a sensational price! It's easily connected to any AM receiver or audio amplifier. Covers complete F-M range from 88 to 108 Mc. Full view 12" slide rule dial. Two controls: on/off, volume-control, and tuning. Handsome cabinet 15 3/4" W, 10 3/4" H, 11 1/2" D. Universal 6 tap Power Trans, for all line voltages 103 to 260 volts 50/60 cycles, A.C. Shpg. wt. 20 lbs. **Cat. No. A-302.**

**SPECIAL VALUES—PANEL METERS**

Cat. No.	Description	EACH
S-614	0-8V AC 3" Rd. Bakelite Case Weston Type 476.	<b>\$2.99</b>
S-615	50-0-50 Ma. DC, Zero Center, 3" rd. Bakelite Case.	<b>\$2.95</b>
S-616	0-1 amp. RF—3" square Bakelite Case.	<b>\$4.45</b>
S-437	0-150 DC Microamps 2" rd. Bakelite Case.	<b>\$3.45</b>
S-777	0-100 DC Ma 2" rd. Bakelite Case.	<b>\$2.95</b>
S-166	150-0-150 DC Microamps, Zero Center, Bakelite Case (Separate blank scale supplied).	<b>\$3.95</b>
S-664	0-10 DC Ammeter, 3" rd. Bakelite Case. Switchboard type.	<b>\$2.95</b>
S-874	0-5 ma. DC 4" square. Bakelite Case. (Scale marked 0-150%).	<b>\$5.95</b>
S-875	0-500 ma. DC 2" rd. Bakelite Case.	<b>\$2.95</b>
S-917	0-1 amp. 4" square Bakelite Case. 3 3/4" Body dia.	<b>\$5.95</b>

**NEWARK TV ANTENNAS**

Cover all 13 Channels. Hairpin type dipoles with reflectors—high over low frequencies. Sturdy, tempered aluminum elements. 5 ft. mast, with hardware and instructions. 10 lbs. **No. A-30400 \$9.71**

**High Frequency Attachment** Hairpin Dipole and Reflector (Channels 7-13) for any standard antenna. 14" mast, hardware, instructions. 5 lbs. **No. A-30401 \$3.83**

Send Orders to New York or Chicago

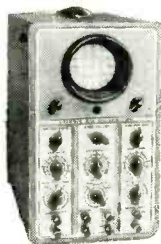

**Famous Make 3" SCOPE**

Reduced to **\$84.50** Reg. \$115.00 **SAVE \$30.50**

We made a fortunate purchase from a world-famous manufacturer of test equipment! Now you can afford this fine instrument... save \$30.50! This oscilloscope has many outstanding features not found in run-of-the-mill scopes — such as: Built-in Light Shield, and Removable Graph Screen. Sweep frequency 10 cps to 60 kc. Sine Wave response of vertical amplifier ±10% from 10 cps to 40 kc. Usable range 10 cps to 200 kc. Grey crockle cabinet 14 1/4" D x 8 W x 14 3/4" H. Shpg. Wgt. 30 lbs. No. A-2

**Terrific Television Buy!**

**Tech-Master 630-TK 10" Kit**

Complete with All Parts, Instructions, and 30 RCA Tubes (including 10-BP4.) Duplicates in every respect the famous RCA 630TS, generally accepted as best engineered TV set available!

**\$198.50**

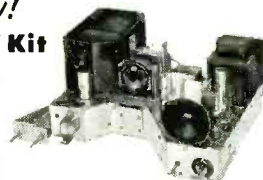

This Soundview 630TK kit is an exact copy of famous RCA 630TS Television set. Contains efficient RCA front end 13-channel tuner—completely factory wired and aligned with 3 RCA matched tubes, plus built-in wave trap. Complete with 30 RCA tubes (12" or 15" tube can be substituted for 10BP4 if desired). Dual controls for picture and FM sound, and for horizontal and vertical control. Kit is supplied with RCA schematic and service manual, but less wire, solder, and mtg. screws. **Cat. No. A-19752. Shpg. wt. 85 lbs.**

Hand Rubbed Walnut Cabinet No. A-19753 **\$42.50**

**LOWEST PRICES**

**IMMEDIATE DELIVERY**

**24 Hour Service on Mail Orders**

**FREE!**  
 Use of Our New TELEVISION SERVICE LABORATORY  
 ... to Test, Service or Align TV Kits purchased at Newark ... At All Our Stores!

Include Postage  
 All Prices F.O.B.  
 New York or Chicago  
 Send 20% Deposit with C.O.D. Orders

**NEW YORK**  
 Offices & Warehouse  
 242 W. 55th St., N.Y. 19

**NEWARK ELECTRIC COMPANY, INC.**  
**CHICAGO**  
 323 W. Madison St.  
 Chicago 6, Ill.

Send Orders To  
 242 West 55th St.  
 New York 19, N. Y.  
 or  
 323 W. Madison St.  
 Chicago 6, Ill.

New York City Stores: 115-17 W. 45th St. & 212 Fulton St.





## SURPLUS MATERIAL—Shipped Immediately

Thousands of Relays Available—Send for Complete Listings

### TUBES! GUARANTEED!

TYPE	PRICE	TYPE	PRICE
1LA6	\$1.65	841	.65
1L4	.65	843	.65
1V	.65	851	\$49.50
2X2/879	.65	860	2.75
3A4	.45	864	.65
5R4GY	.95	866A	.75
6AC7	.95	872A	1.65
6AG7	.95	954	.45
6C4	.45	957	.45
6F8	.95	968	.25
6G6G	.85	1613	.85
6H6GT	.55	1616	.95
6L6	1.10	1626	.45
6SA7	.65	1629	.18
6SD7	.45	1632	.18
6SQ7	.65	1641/RK60	.65
6SJ7	.65	1644	1.25
6Y6	.75	1294/IR4	.65
6X5	.65	3D6/1299	.65
7B7	.65	388A	3.95
7C7	.95	394A	2.95
7F8	.95	9002	.35
7N7	.85	9003	.25
7Y4	.75	9006	.35
12A6	.18	8013	2.35
12K8	.95	RK60/1641	.65
12Q7	.55	RK72	.75
12SL7	.65	RK73	.45
12SN7	.65	2C46	3.95
30 SPECIAL (VT67)	.45	3B27/836A	.95
32	.65	3C23	2.95
25V5	.85	4B27	2.95
25Z6	.75	4C33	2.95
35L6	.65	4D32	9.50
38	.65	14E6	.55
45 SPECIAL (VT52)	.35	23D4	.45
56	.55	28D7	.45
210	.65	5C1P	.45
250	.65	2J1005	.35
350B	4.95	Amperite Voltage Regulator 13-4	.25
801	.95	Hytron Ballast	
807	.95	100-79	.25
814	4.95	E1148	.95
826/2J	.95	VR78	.45

### STANDARD BRAND PRECISION RESISTORS

Types WW3, WW4, and WW5

Following sizes are in 1% and 2% tolerance Price \$.35

1 meg	66,000	1500
.8 "	54,500	1400
.75 "	46,000	1200
.7 "	40,000	1000
.6 "	33,000	750
.268 "	13,300	235
122,000	12,000	130
120,000	7,500	110
109,000	4,500	55
100,000	4,300	22
95,000	4,000	20
92,000	2,500	14
84,000	2,250	12
82,000	2,200	10
80,000	1,700	6

Following sizes are 5% or better tolerance, Price \$.15

22,000	50	35
		30

The following sizes 1% or better. Price \$.10

41,808	105.8	4.4
4,285	53.32	4.3
1,123	33.22	3.94
988	23.29	3.5
414.3	13.52	1.563
366.6	13.333	.29
220.4	10.2	.268
147.5	5.1	.25

### RADIO NOISE FILTERS

These line noise filters are available in large quantities and priced for quick sale.

Malloy NP 12-6E3—Housed in a bathtub type container and rated at 7 amps, 50 volts D.C. Solder lug terminals ..... Price \$.35

Malloy NF7-3A—Housed in silver-plated rectangular case 3 3/4" x 1 1/2" x 2 1/2" with male and female amphenol AN3108 plugs ..... Price \$.95

Malloy NF7-4—Housed in rectangular case 3" x 1 1/2" x 7 1/2". Internal screw terminals. Rated at 12 amperes—35 V.D.C. .... Price \$.95

Bendix—model 3937—Generator Filter—50 amps, 120 Volts D.C.—Housed in shielded containers 4" x 3 3/4" x 8" ..... Price \$1.25

Line Noise Filter—Unshielded and mounted on a bracket suitable for use on regular power lines—Consists of two .01 molded condensers and 140 turn solenoid choke coil ..... Price only \$.10

### TRANSTAT VOLTAGE REGULATORS

Model #29144  
Fixed Winding 115 Volts—60 cycles  
Commutator range 75-120 Volts  
Maximum output .25 KVA  
Housed in shielded case 6" x 6" x 6" Price \$6.95

Type RH  
Fixed Winding 115 Volts—400 cycles  
Commutator ranges 75-120 Volts  
Load—.72 KVA  
Housed in Shielded case 5 1/2" x 6" x 6 1/2" Price \$1.95

### 4000-6000 VOLT LOW CURRENT DC SUPPLY

Brand new completely wired and tested. Ready to operate from 115 volt power line. D.C. output is filtered. Price Complete \$12.50

2000-3000 Volt D.C. Supply similar to above, but with lower output voltage. Ready to operate from 115 Volt power line. Price Complete \$7.95

Write for Latest Catalog

## EDLIE ELECTRONICS, INC.

154 GREENWICH STREET

TELEPHONE DIgby-9-3143

NEW YORK 6, N. Y.

### A LEEDS LEADER

- 50 microamp movement ± 2%
- 2500 ohms DC Resistance ± 2%
- Knife Edge Pointer
- 4x4 1/2" Black Bakelite Case
- Easily Read Multitester Scale



This is the exact meter utilized in the G.E. YMW-1A Lab Type Unimeter.  
A Great Special ..... Each \$9.75



### SELSYN MOTORS

Just Arrived

115 Volt AC 60 cycles. Transmitters only. Can be used to turn small beam antenna or as indicators only 3 1/2" Diameter x 5 1/2" High. Shipping Weight 10 lbs. Per Pair. Special \$5.95 Per Pair

### FULL WAVE BRIDGE SELENIUM RECTIFIER

68 Volts A.C. Input 48 Volts D.C. Output at 500 Ma. .... Each \$1.50

### CS Differential

Dual coil with armature pivoted between coils. All contacts normally open. Operates 220-250 Volts, 8000 Ohms each coil, contacts S.P.D.T. Controls rated 2 amps. at 110 VAC. Ideally suited for balanced or bridge type circuits where limited current or power is available. Will withstand 12 G Vibration up to 60 cycles at 35,000 feet altitude. Special low price ..... 95¢



### WIRE WOUND POTENTIOMETER

100,000 ohm, precision made. G.R. type, 25 watt, 8" diameter. Brand New ..... \$1.95



## SUPERIOR POWERSTATS

Variable Transformer for precise Voltage Control. Excellent mechanical construction, design, and durability.



### VARIABLE TRANSFORMERS

TYPE 20: 115V. input, 0-135 V. output @ 3.0 amps. 0.4 KVA	\$12.50
TYPE 116: Mounted; 115V input, 0-135 V. output @ 7.5 amps. 1.0 KVA	23.00
TYPE 116U: Unmounted; 115V. input, 0-135 V. output @ 7.5 amps. 1.0 KVA	19.00
TYPE 1126: 115V. input, 0-135 V. output @ 15.0 amps. 2.0 KVA	46.00
TYPE 1226: 230V. input, tapped at 115 V., 0-270 V. output @ 9.0 amps. 2.4 KVA	46.00
TYPE 1156: 115V. input, 0-135 V. output @ 45.0 amps. 6.1 KVA	118.00

If not rated 25% with order, balance C.O.D. All prices F.O.B. our warehouse New York. We ship to any part of the globe. Write Dept. EL



75 VESEY STREET  
CORtlandt 7-2612 N. Y. C. 9

# DIVERSITY RECEIVING EQUIPMENT

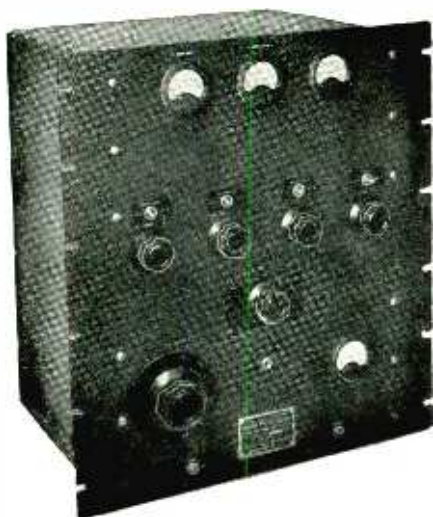

Complete Descriptive Literature Available

**BRAND NEW! EXPORT PACKED!**

**OVERCOMES FADING IN RADIO TELEGRAPH COMMUNICATION AT HI-FREQUENCIES**

- Lots of extra parts, Meters, Condensers, Transformer, etc.
- 2 extra sets of spare tubes (Besides set in unit)
- Designed to operate from a 100-260 volt, 25-60 cycle single phase power source
- Power consumption approximately 70 to 80 watts
- Front panel finished in baked black wrinkle lacquer
- Tube line up: 3-6A6; 1-77; 1-IV; 1 neon; 1-80; 1-6F8G; 2-6SJ7; 1-VR150/30
- Overall dimensions: 19" wide x 14" deep x 21" high—Export packed 21" wide x 20" deep x 36" high
- Equipment weight: 111 lbs. Export packed 211 lbs.

2 COMPLETE INSTRUCTION BOOKS SUPPLIED WITH EACH UNIT.

PRICE  
**Special \$149.50**

## BRAND NEW BC 223AX

Latest model of the 223 series. Has built-in phantom antenna. Frequencies from 2 to 5.25 mc with three plug-in tuning units, complete as shown less xtals, tubes, and power supply. Tube line up consists of 2-801A and 3-46; output 25 watts CW, 10 watts phone. Shipping wt. 160 lbs.

**SPECIAL \$29.95**

Complete set of tubes for above unit \$4.95



**BRAND NEW ATR DC. AC. INVERTER**

Specially designed for operating AC Radios, Public Address Systems, Small Television Sets, Amplifiers, Intercall Systems and Radio Test Equipment from 12 Volt DC source. 125 Watt, 60 Cycle, 110V output.

**SPECIAL \$19.95**



### T17B MIKE

S.B. carbon with push-to-talk switch on handle. Brand new. Shpg. wt. 3 lbs.

**Special \$1.25**

Case of 40 \$48.00 *Outstanding buy*

### MISCELLANEOUS

MC131 Ringers.....	79 ea.
100 ohm Reactors.....	29 ea.
3 Wire tinned cords, rubber covered .....	29 ea.
Vibrators, 6V. 4 prong.....	79 ea.
Broad Band IF Transformer, Slug Tuned .....	98 ea.

**UTAH BRAND NEW**  
HIGH-IMPEDANCE  
9200 OHM  
With 6 ft. CORD

This is without a doubt one of the finest headphones produced for the U.S. Government during the war. Extremely sensitive.

ea. **\$2.49**  
Case of 40 phones \$86.00

### TUBES!

2X2	.59
2x2A	.69
3B24	1.25
4AP10	5.95
5AP1	4.50
5AP4	4.95
5CP1	3.45

### TUBES!

5CP1A	5.45
9LP7	3.95
12GP7	12.95
304TH	6.95
293A	6.95
394A	3.95
371A	2.25

### TUBES!

559	.75
800	1.95
864	.59
878	1.95
954	.65
1630	6.95
8013	1.95

### TUBES!

HY115	.95
ML501	150.00
ML502	200.00
ML503	150.00
MX408U	.50
WL468	9.95

# MARINO RADIO CO.

203 GREENWICH STREET

*"Since Radio Began"*

NEW YORK 7, N. Y.









## RADIOMEN'S HEADQUARTERS \* WORLD WIDE MAIL ORDER SERVICE !!

**BUFFALO RADIO SUPPLY, ONE OF AMERICA'S LARGEST ELECTRONIC DISTRIBUTORS, IS IN A POSITION TO SUPPLY MOST OF THE REQUIREMENTS OF FOREIGN PURCHASERS, DIRECTLY FROM ITS GIGANTIC STOCKS OR THOSE OF ITS AFFILIATES. EXPORT INQUIRIES ARE SOLICITED BOTH FROM EXPORT HOUSES AND FROM FOREIGN GOVT. PURCHASING COMMISSIONS HERE AND ABROAD. EXPENSE CAN BE REDUCED AND REQUIREMENTS FILLED WITH A MINIMUM OF DELAY BY CONTACTING BUFFALO RADIO SUPPLY INITIALLY.**



### GENERAL ELECTRIC 150 WATT TRANSMITTER

**Cost the Government \$1800.00 • Cost to You—BRAND NEW—\$100.00**

This is the famous transmitter used in U.S. Army bombers and ground stations, during the war. Its design and construction have been proved in service, under all kinds of conditions, all over the world. The entire frequency range is covered by means of plug-tuning units which are included. Each tuning has its own oscillator and power amplifier coils and condensers, and antenna tuning circuits—all designed to operate at top efficiency within its particular frequency range. Transmitter and accessories are finished in black crackle, and the milliammeter, voltmeter, and 25 ampere are mounted on the front panel. Here are the specifications: **FREQUENCY RANGE:** 200 to 500 KC and 1500 to 12,500 KC. (Will operate on 10 and 20 meter band with slight modification for which diagrams are furnished). **OSCILLATOR:** Self-excited, thermo compensated, and hand calibrated. **POWER AMPLIFIER:** Neutralized class "C" stage, using 211 tube and equipped with antenna coupling circuit which matches practically any length antenna. **MODULATOR:** Class "B"—uses two 211 tubes. **POWER SUPPLY:** Supplied complete with dynamotor which furnishes 1000V at 350 MA. from either 12 or 24 volts. Complete instructions are furnished to operate set from 110V AC. **SIZE:** 21 1/2 x 23 x 9 1/4". Total shipping wgt. 300 lbs., complete with all tubes, dynamotor power supply, seven tuning units, antenna tuning unit and the essential plugs.

### GENERAL ELECTRIC RT-1248 15-TUBE TRANSMITTER-RECEIVER

**TERRIFIC POWER**—(20 watts) on any two instantly selected, easily pre-adjusted frequencies from 435 to 500 Mc. Transmitter uses 5 tubes including Western Electric 316 A as final. Receiver uses 10 tubes including 955's, as first detector and oscillator, and 3—7H7's as IF's with a 4 slug-tuned 40 Mc. IF transformers, plus a 7H7, 7E6's and 7E7's. In addition unit contains 8 relays designed to operate any sort of external equipment when actuated by a received signal from a similar set elsewhere. Originally designed for 12 volt operation, power supply is not included, as it is a cinch for any experimenter to connect this unit for 110 AC, using any supply capable of 400 DC at 135 FA. The ideal unit for use in mobile or stationary service in the Citizen's Radio Telephone Band where no license is necessary. Instructions and diagrams supplied for running the RT-1248 transmitter on either code or voice in AM or FM transmission or reception, for use as a mobile public address system, on 80 to 110 Mc, as an FM broadcast receiver, as a Facsimile transmitter or receiver, as an Amateur Television transmitter or receiver for remote control relay hookups, for Geiger-Mueller counter applications. It sells for only \$29.95 or two for \$53.90. If desired for marine or mobile use the dynamotor which will work on either 12 or 24V DC and supply all power for the set is only \$15.00 additional.

### BRAND NEW

### BC-221 FREQUENCY METERS

with calibrating Crystal and calibration charts. A precision frequency standard that is useful for innumerable applications for laboratory technician, service man, amateur, and experimenter at the give away price of only \$75.00.

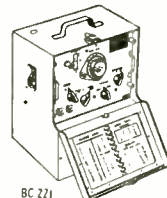

BC 221

### 1949 MODEL MUTUAL CONDUCTANCE TUBE TESTER

No possibility of good tubes reading "Bad" or bad tubes reading "Good" as on dynamic conductance tube testers. Attractive panel and case equal to any on the market in appearance. . . . Large 4 1/2" meter . . . Calibrated Micromho scale as well as a Bad-Good scale . . . Front panel fuse . . . Individual sockets for all tube base types—voltages from .75 volts to 117 volts and complete switching flexibility allow all present and future tubes to be tested regardless of location of elements on tube base . . . Indicates gas content and detects shorts or opens on each individual section of all local, octal and miniature tubes including cold cathode, magic eye and voltage regulator tubes as well as all ballast resistors. Name of the nationally kn reading "Good" as on dynamic conductance testers or other Model "C"—Stopping front counter case . . . \$49.95 Model "P"—Handsome hand-rubbed portable case . . . \$49.95 Built-in roll chart with either of above \$5.00 extra.

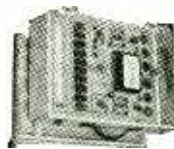

## \$5<sup>95</sup> Takes Both BIG BARGAINS

- 1. ALUMINUM GEAR BOX** 18x8x7 that contains two powerful electric motors and two matched gear trains, 62 gears in all varying in size from 1/2 to 4 inches in diameter. This unit is readily converted to rotate a beam antenna or any other similar use . . . \$3.00
- 2. SENSATIONAL FASCINATING, AMAZING SELSYNS.** Brand new selsyns made by G. E. Co. Two or more connected together work perfectly on 110 VAC. Any rotation of the shaft of one selsyn and all others connected to it will rotate exactly as many degrees in the same direction, following unerringly as if the units were connected together by shafting instead of wires. This is true whether you twist the shaft of the master unit a fraction of a revolution or many revolutions. Useful for indicating the direction of weather vanes, rotating directional antennas, or controlling innumerable operations from a distance. Complete with diagram and instructions. Per matched pair . . . \$4.95

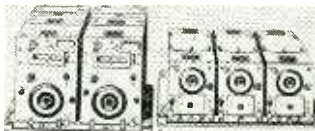

## SCR-274N COMMAND SET

The greatest radio equipment value in history. A mountain of valuable equipment that includes 3 receivers that use plug-in coils, and consequently can be changed to any frequencies desired without conversion. Also included are two Tuning Control Boxes; 1 Antenna Coupling Box; four 28V Dynamotors (easily converted to 110V. operation); two 40-Watt Transmitters including crystals, and Pre-amplifier and Modulator. 29 tubes supplied in all. Only a limited quantity available, so get your order in fast. Removed from unused aircraft and in guaranteed electrical condition. A super value at \$34.95, including crank type tuning knobs for receivers.

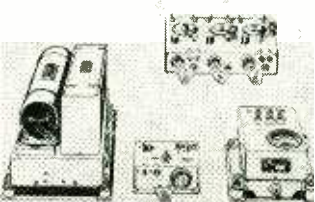

**RT1711 Brand New 12 Tube, 110 Volt Receiver-Indicator-Oscilloscope** complete with all tubes and power supply. Has telescoping hood over scope tubes, which is equipped with a detachable calibrated screen. Has centering and amplitude controls and two video inputs. A natural for television. . . . \$39.95

RT-1579 consists of a three stage, cascade 6S17's and 6P6 output stage high gain, high fidelity amplifier with 60 cycle, 110V power supply on the same 13 1/2 x 1 1/2 chassis, which is protected by a substantial steel cover over tubes and parts. Made by Western Electric with typical quality components such as a husky power transformer and oil condensers, this unit is obviously intended to give years of trouble-free service with no more need for repairs than a telephone. Disconnecting one wire each, from the special input and output filters, will result in as high a fidelity amplifier as can be obtained. Your cost with tubes, diagram and parts list included—\$14.95.

Super Special\*\*\*Highest quality all chrome bullet shaped **CRYSTAL MIKE** of topflight nationally known brand—\$5.95

## TERRIFIC VALUE—PORTABLE ELECTRIC DRILL

(Sold at less than established factory price so we cannot mention brand name.) Only \$21.95 equipped with 3/4" Jacobs Gearing Chuck and Key. Not an intermittent duty drill, but a full size rugged tool. Most convenient type switch, natural grip handle, and balance like a six-shooter. Precision cut gears—turbine type cooling blower—extra long brushes. No stalling under heaviest pressure because of powerful 110 Volt AC-DC motor and multiple ball thrust bearing. Other bearings self-aligning life-time lubricating Chrysler Oilite type. Made for toughest year-in and year-out service in plant or on construction jobs. Amazing perpetual factory guarantee assures you of a lifetime of trouble-free use. 25% deposit on C.O.D.'s. Full refund if returned prepaid within five days.



## 1000 CYCLE AUDIO FILTERS

Navy PD52010-1 low pass audio filters as mentioned in the "Peaked Audio" article in June CQ, and designated by the above number, are the exact electrical and physical equivalent of commercial audio filter units selling for \$35.00 wholesale. They are infinitely better than the surplus "Radio Range Filters" being sold for reducing QRM, and at 2 KC of resonance for example, a 2 section filter using PD52010-1 is capable of twice the selectivity available through the use of the Q5'er, (the BC453 section of the 274N which has provided the amateur's previous highest standard of interference elimination). **EXTRA SPECIAL—NAVY PD52010-1 with diagram.—\$5.00.**

## SPLATTER CHOKES

These Tapped "SPLATTER CHOKES" are used between Class C stage and Modulator to eliminate objectionable side band splatter. DC resistance 50 ohms. Our part No. 8660—\$1.50

## PE-109 32-VOLT DIRECT CURRENT POWER PLANT

This power plant consists of a gasoline engine that is direct coupled to a 2000 watt 32 volt DC generator. This unit is ideal for use in locations that are not serviced by commercial power or to operate many of the surplus items that require 32 volts DC. The price of this power plant is only \$75.00. We run and test every unit before shipment. We can also supply a converter that will supply 110 V AC from the above unit or any 16-32 V DC source for \$12.95.

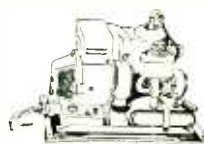

Cable Address: BUFRAD FOB BUFFALO UNLESS NOTED Minimum order \$3.00—All prices subject to change—25% deposit with COD orders.

**BUFFALO RADIO SUPPLY, 219-221 Genesee St., Dept. 9-E BUFFALO 3, N. Y.**





## Industrial Power Supply Equipment

### TUBES

TRANSMITTING	THYRATRONS	RECTIFIERS
RK75/307A ..... 4.50	2D21 Min..... 1.25	FG32 ..... 4.00
450TH/6C21 ..... 22.50	3C23 ..... 4.75	371B ..... 5.95
750TL ..... 47.50	FG81A ..... 4.75	531 ..... 18.00
WL533 750W U.H.F. Triode ..... 17.50	C6A ..... 8.50	872 ..... 1.75
714AY Magnetron ... 9.50		3B22 ..... 2.95
730A Magnetron ..... 10.75		4B28/289414 6 Amp. Rectigon ..... 3.95

*All Tubes New, Boxed and of Standard Mfg.*

### RECTIFIERS — Dry Disc Type — Continuous Duty Ratings

- 3.5V. A.C. 1.8V. D.C. 1.0 Amps Full Wave Bridge ..... 90
- 6.5V. A.C.—2.2 V. D.C. @ 3.0 Amps. Full Wave Center Tap ..... 1.20
- 36V. A.C. 200 Mil D.C. H.W. .... 75
- 36V. A.C. 2.2 Amps. D.C. Full Wave Bridge ..... 3.75
- 54V. A.C.—1.6 Amps. D.C. G.E. Full Wave Bridge ..... 4.40
- 154V. A.C.—600 Mil D.C. Full Wave Bridge ..... 6.85
- 180V. A.C.—400 M.A. D.C. G.E. Full Wave Bridge ..... 6.90

### CONDENSERS

- 500 Mfd 200V dry Electrolytic..... 95
- 2 Mfd 600V Tubular Oil..... 39
- 10 Mfd 600V Oil..... 95
- 2 Mfd 2500V Oil..... 2.40
- 2 Mfd 3000 Oil..... 2.75
- .25/.25 6000V D.C. or .125 Mfd—  
12000V D.C. Oil..... 3.75
- 1.0 Mfd 25 KV..... 36.00
- .001/25 KV Mica..... 25.00
- 50 MMF 32 KV Tubular vacuum..... 4.95

### RELAY

RC-117—Westinghouse Time Delay Current Relay, Type SC-M. 2 to 1 amp A.C. or D.C. .8 amp continuous rating. Rating 20-40% drop out ratio. Net Wt. 3 lbs. Dim. 3" W x 5" D x 5 1/2" H..... 12.95

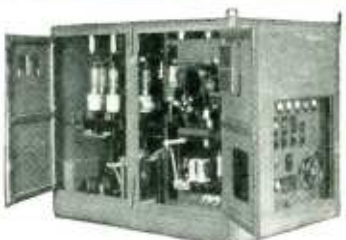

### NEW RA38 POWER SUPPLIES

115V., 60 cyc. input adjustable output 0-15,000V. A.C. or D.C. @ 500 Mils. Complete with extra set of new tubes and remote control. Shipping weight 2100 lbs. **\$250.00**

### METERS

Weston Model 476-3" A.C. Ammeter, 3 Amps. full scale, Calibrated 0-120 Amps., with 40/1 current trans. .... \$8.50  
Net wt. 3 pounds

M-143 A.B. Weston Kilovoltmeter-3". Model 301, 20 KV. @ 1000 ohms per volt, flush type calibrated for steel panel mountings with 20 meg. 20 KV Weston resistor complete with clips and standoff insulators. .... \$18.00  
Net wt. 4 pounds.

Multimeter, Supreme model 543-S \$12.95  
R. F. ammeter Weston 425-0-3 amps \$5.95

### TRANSTATS

- 115 V. 50/60 cycle input 103-126 V. output @ 2.17 amps..... \$9.50
- 115/230 V. 50/60 cycle input 0-260 V. output @ 2 1/2 amps..... \$21.50
- GR Variac, 115 volts 50/60 cycle input 0-135 V output @ 5 amps cased. \$14.50
- 115 V. 50/60 cycle input, 0-135 V. output @ 10 amps..... \$24.50

**THERMOSTAT SWITCH**  
Fenwall —50° +400° F. 110-220 V. 2500 watt contacts, adjustable. .... \$1.60  
KV Meter Multiplier resistor 1 meg. 1/10% noninductive Wire Wound. .... \$1.25

### TRANSFORMERS



T-103—Voltage regulator Transstat, American Transformer Co. Spec. 29145 Max KVA output 11.5 50/60 cyc. 0-115 V. 100 amps. or 230 V. 50 amps. **\$75.00**

Net Wt. 134 lbs. Dim. 25" W x 16" D x 17 1/2" H (Encl. S\* shaft ext.)



T-102—Filament Transformer, American Transformer Co. Spec. 29106, Type WS .050 KVA, 50/60 cyc. Single phase, 35 KVA test, 12 KV D.C. operating. Primary 115 V., secondary 5 V., 10 amps with integral standoff insulator and socket for 250T, 371, 872, 5563, etc rectifier tubes **\$12.50**

Net Wt. 15 1/2 lbs. Dim. 6 1/2" W x 6" D x 12" H. O.A.

### MOTOR GENERATORS

- G.E. Type CC-21991 Input 115 volts D.C., @ 5.7 amps. Output 115 V. A.C. 60 cycle, single phase 350 V.A. @ 85% ..... \$58.00
- G.E. Type CC-21990 Input 32 V. D.C. @ 22 amps. Output 115 V. A.C. 60 cycle, single phase, 350 V.A. @ 85% P.F. .... \$63.00
- Leland Type CLL-21985 Input 115 V. D.C. @ 4.2 amps. Output 115 V. A.C. 60 cycle, single phase, 240 V.A. @ 86% P.F. .... \$47.00

All merchandise in "as new" condition. Add approximately 20% to net weights for estimated shipping weights. Terms are 30% with order, balance C.O.D. All prices f.o.b. Los Angeles Warehouse. Write for additional detailed information on any of the above items and for special quantity discounts.

1527 E.  
Seventh Street

**EPCO**

Los Angeles  
21, California

# LIFE ELECTRONIC SALES



## OFFERS

### "UHF" COAXIAL CABLE CONNECTORS



No.	An. No.	Description	Price
83-1SP	(PL259)	Plug.....	ea. 22¢
83-1SP	(PL259A)	Plug.....	ea. 22¢
83-168	(UG176U)	Reducing adapter for RG 29, 55 and 58L. Use with 83-1SP or 83-1SPN.....	ea. 12¢
83-1R	(S0239)	Receptacle.....	ea. 28¢
83-1AP	(M359)	Angle Plug adapter.....	ea. 22¢
83-1T	(M358)	Connector.....	ea. 98¢
83-22R	(UG103U)	Receptacle.....	ea. 35¢
83-22SP	(UG102U)	Plug.....	ea. 35¢

Minimum Quantity — 100 of a type

### COAXIAL CABLES



RG5U.....	per 1000 ft.....	\$ 45.00
RG8U.....	per 1000 ft.....	\$ 40.00
RG11U.....	per 1000 ft.....	\$100.00
RG12U.....	per 1000 ft.....	\$175.00
RG22U.....	per 1000 ft.....	\$125.00
RG29U.....	per 1000 ft.....	\$ 37.50
RG58U.....	per 1000 ft.....	\$ 59.00
RG59U.....	per 1000 ft.....	\$ 45.00
RG62U.....	per 1000 ft.....	\$ 45.00

Prices based on minimum quantity of 500' of a type.

### BIRTCHEr TUBE CLAMPS

926 A.....	19¢ ea.	926 B5.....	19¢ ea.
926 A2.....	19¢ ea.	926 B33.....	19¢ ea.
926 B.....	19¢ ea.	926 C.....	19¢ ea.
926 B1.....	19¢ ea.	929 1.....	29¢ ea.

### TYPE F2L MICA CAPACITORS CM 70 TYPE

.024 MFD 1500 Volts Wkg.....	ea. 75¢
.033 MFD 1500 Volts Wkg.....	ea. 75¢
.056 MFD 1500 Volts Wkg.....	ea. 75¢
.0001 MFD 5000 Volts Wkg.....	ea. 75¢

**LIFE ELECTRONIC SALES**  
91 GOLD STREET, N. Y., N. Y.  
TELEPHONE DIGBY 9-4154-5

**X BAND VSWR TEST SET TS-12/AP.** complete with linear amplifier, direct reading VSWR meter, slotted waveguide with gear driven traveling probe, matched termination and various adapters with carrying case, new.

**X BAND PICK-UP HORN AT-4S/UP.** with coaxial fitting.....\$5.00

**X BAND POWER METER, TS-36/AP.** new.

**X BAND WAVE METER, TS-33/AP.** new.

**X BAND POWER LOAD, TS-108/AP.** new.

**TUNING UNITS** for APR-4 and APR-1 receivers, TN-19 975-2100 mc and TN-54 2100-4000 mc, new.

**10 Cm OSCILLATOR BC-1096-B** with 30 mc pre IF amplifier 1078 B, klystron power supply and 417-A klystron, 110 v 60 cps, new in transit-case, p/o SCR 584.....\$125.00

**CALIBRATED S BAND** fixed attenuator, 19.8-20-2 db, type N fittings.....\$10.00

**MICROWAVE TEST CABLE, 15' RG-9U** cable with UG-24U connectors 15 feet long.....\$4.00, 8 feet long \$3.50

**LOSSY CABLE, 10 db** at 3300 megacycles, type N connectors .....\$3.00

**TYPE N CONNECTORS AND ADAPTERS,** UG-10, 12, 21, 22, 24, 25, 27, 29, 30, 58, 59, 83, 86, 167, 190, 201, 245, and UHF Connectors SO-239, PL-259, 83, 1A P, UG-266, complete with center contacts, immediate delivery.

**S-BAND RECEIVER TRANSMITTER RT-72/UPN-1,** less tubes, for battery operation.

**RADAR JAMMER, T-26/APT-2,** 435-715 megacycles, 110 volts, 400 cps. new .....\$40.00

**SD-3 SHIPBOARD RADAR EQUIPMENT,** complete with all accessories, operates on 115 volts, 60 cps, new.

**SA-1 RADAR TRANSMITTER,** Receiver and Indicator, 115 volts, 60 cps, new.

**RADAR RECEIVER, BC 1068-A,** 150 2/60 megacycles, individual tuning for the r.f. stages, bandwidths 4 megacycles, 115 volts, 60 cps, 14 tubes.....\$45.00

**GENERAL RADIO PRECISION WAVE-METER,** type 724A, range 16 kc to 50 megacycles, 0.25% accuracy, V. T. V. M. resonance indicator, complete with accessories and carrying case, new.

## ELECTRO IMPULSE LABORATORY

66 Mechanic St., Red Bank, N. J.  
Red Bank 6-4247

# SELENIUM RECTIFIERS AND SPECIALIZED ELECTRONIC COMPONENTS

Full Wave Bridge Types		
Input Type#	Current	Output Price
0-18VAC		0-13*VDC
B1-250	250 MA.	5.98
B1-500	500 MA.	1.95
B1-1	1 AMP.	2.49
B1-1X5	1.5 AMP.	2.95
B1-3	3 AMP.	3.49
B1-5	5 AMP.	5.95
B1-7X5	7.5 AMP.	7.95
B1-10	10 AMP.	9.95
B1-15	15 AMP.	13.95
B1-20	20 AMP.	15.95
B1-25	25 AMP.	22.95
B1-30	30 AMP.	24.95
B1-40	40 AMP.	27.95
B1-50	50 AMP.	32.95
B1-60	60 AMP.	36.95

Full Wave Bridge Types		
Input Type#	Current	Output Price
0-54VAC		0-40*VDC
B3-150	150 MA.	1.25
B3-250	250 MA.	1.95
B3-500	500 MA.	3.25
		0-54*VDC
B4-1X2	1.2 AMP.	8.75
B4-3X5	3.5 AMP.	15.95
B4-5	5 AMP.	17.95

Full Wave Bridge Types		
Input Type#	Current	Output Price
0-36VAC		0-26*VDC
B2-150	150 MA.	8.98
B2-250	250 MA.	1.25
B2-300	300 MA.	1.50
B2-450	450 MA.	2.25
B2-600	600 MA.	2.95
B2-1	1 AMP.	3.95
B2-3	3 AMP.	4.95
B2-5	5 AMP.	6.95
B2-7	7 AMP.	9.95
B2-10	10 AMP.	10.95
B2-15	15 AMP.	13.95
B2-20	20 AMP.	15.95
B2-25	25 AMP.	17.95
B2-30	30 AMP.	21.95

Three Phase Bridge Types		
Input Type#	Current	Output Price
0-126VAC		0-130*VDC
3B7-4	4 AMP.	\$32.95
3B7-6	6 AMP.	48.90
3B7-11	11 AMP.	65.00

Full Wave Bridge Types		
Input Type#	Current	Output Price
0-115VAC		0-110*VDC
B6-150	150 MA.	\$1.95
B6-250	250 MA.	2.95
B6-400	400 MA.	4.95
B6-600	600 MA.	5.95
B6-800	800 MA.	7.95
B6-1X2	1.2 AMP.	9.95
B6-2	2 AMP.	12.95
B6-3X5	3.5 AMP.	21.95
B6-5	5 AMP.	24.95
B6-7X5	7.5 AMP.	32.95
B6-10	10 AMP.	36.95

CENTER TAPPED TYPES		
Input Type#	Current	Output Price
12 0-12VAC		0-8*VDC
C1-10	10 AMP.	\$7.95
C1-20	20 AMP.	12.95
C1-30	30 AMP.	17.95
C1-40	40 AMP.	21.95
C1-50	50 AMP.	25.95
C1-80	80 AMP.	34.95
C1-120	120 AMP.	46.95

\* Select Proper Capacitor From List Shown Below, to Obtain Higher D.C. Voltages Than Indicated

RECTIFIER MOUNTING BRACKETS	
For Types B1 through B6, and Type C1.....	\$ .35 per set
For Types B13.....	.36 per set
For Types 3B.....	1.20 per set

RECTIFIER CHOKES	
Type#	Amps. Price
HY2 .03 Hy	2 \$2.25
HY3 .03 Hy	3 2.95
HY5 .02 Hy	5 3.25
HY5X5 .02 Hy	8.5 7.95
HY10 .02 Hy	10 9.95
HY12 .125Hy	12 12.95
HY15 .015Hy	15 13.95

RECTIFIER CAPACITORS	
CF-13 6000 MFD	10VDC \$2.49
CF-14 3000 MFD	12VDC 1.69
CF-15 6000 MFD	12VDC 2.95
CF-1 1000 MFD	15VDC .98
CF-2 2000 MFD	15VDC 1.69
CF-3 1000 MFD	25VDC 1.69
CF-4 2X3500 MFD	25VDC 3.45
CF-18 10000 MFD	25VDC 4.95
CF-5 1500 MFD	30VDC 2.49
CF-6 4000 MFD	30VDC 3.25
CF-7 3000 MFD	35VDC 3.25
CF-8 100 MFD	50VDC .98
CF-16 2000 MFD	50VDC 3.25
CF-17 50 MFD	150VDC .59
CF-9 200 MFD	150VDC 1.69
CF-10 500 MFD	200VDC 3.25
CF-11 100 MFD	350VDC 2.25
CF-12 125 MFD	350VDC 2.49

Rectifier Transformers			
Type#	Volts	Amps.	Price
NP10-18	10	18	\$3.95
XF15-12	15	12	3.95
TXF36-2	36	2	3.95
TXF36-5	36	5	4.95
TXF36-10	36	10	7.95
TXF36-15	36	15	11.95
TXF36-20	36	20	17.95

All Primaries 115VAC 50 60 Cycles

All TXF Types are Tapped to Deliver 32, 34, 36 Volts.

RECTIFIER CHOKES			
Type#	Amps.	Price	
HY2 .03 Hy	2	\$2.25	
HY3 .03 Hy	3	2.95	
HY5 .02 Hy	5	3.25	
HY5X5 .02 Hy	8.5	7.95	
HY10 .02 Hy	10	9.95	
HY12 .125Hy	12	12.95	
HY15 .015Hy	15	13.95	

RECTIFIER CAPACITORS			
CF-13 6000 MFD	10VDC	\$2.49	
CF-14 3000 MFD	12VDC	1.69	
CF-15 6000 MFD	12VDC	2.95	
CF-1 1000 MFD	15VDC	.98	
CF-2 2000 MFD	15VDC	1.69	
CF-3 1000 MFD	25VDC	1.69	
CF-4 2X3500 MFD	25VDC	3.45	
CF-18 10000 MFD	25VDC	4.95	
CF-5 1500 MFD	30VDC	2.49	
CF-6 4000 MFD	30VDC	3.25	
CF-7 3000 MFD	35VDC	3.25	
CF-8 100 MFD	50VDC	.98	
CF-16 2000 MFD	50VDC	3.25	
CF-17 50 MFD	150VDC	.59	
CF-9 200 MFD	150VDC	1.69	
CF-10 500 MFD	200VDC	3.25	
CF-11 100 MFD	350VDC	2.25	
CF-12 125 MFD	350VDC	2.49	

ELECTROLYTIC CAPACITORS			
	100 MFD	50 VDC	Price
lots of 10			\$2.20
lots of 100			\$19.00
	50 MFD	150 BDC	2.00
	8-8 20 MFD	350,150 VDC	4.70 43.00
	*20-20 MFD	400,250 VDC	4.50 38.00
	10 MFD	450 VDC	2.50 20.00
	15 MFD	450 VDC	2.50 20.00
	15-15 MFD	450 VDC	3.00 22.00
	40 MFD	450 VDC	4.20 36.00

\* 4 prong plug-in type.

METERS	
O-1 MA.D.C. Weston /506 2" Rd., Bakelite case	\$2.95
O-15 MA.D.C. Weston /506 2" Rd	2.95
O-30 A.D.C. Weston W shunt 2 1/2" Rd., aircraft type	2.95
O-50 A.D.C. Weston /301 3 1/2" Rd., Enclosed shunt	5.50
O-60 A.D.C. West. w. shunt, 2 1/2" Rd., aircraft type	3.25
O-120 A.D.C. West. w. shunt, 2 1/2" Rd., aircraft type	4.95
O-8 V.A.C. G.E. 3 1/2" Round	3.95
O-30 V.D.C. West. 2 1/2" Rd., aircraft type	2.95

METERS	
O-1 MA.D.C. Weston /506 2" Rd., Bakelite case	\$2.95
O-15 MA.D.C. Weston /506 2" Rd	2.95
O-30 A.D.C. Weston W shunt 2 1/2" Rd., aircraft type	2.95
O-50 A.D.C. Weston /301 3 1/2" Rd., Enclosed shunt	5.50
O-60 A.D.C. West. w. shunt, 2 1/2" Rd., aircraft type	3.25
O-120 A.D.C. West. w. shunt, 2 1/2" Rd., aircraft type	4.95
O-8 V.A.C. G.E. 3 1/2" Round	3.95
O-30 V.D.C. West. 2 1/2" Rd., aircraft type	2.95

### MOTOROLA HEATERS



Ideal for boats, aircraft, fets, dark-rooms, trailers, cabins, trucks, etc. The G-2 is 24A Heat- is of the internal combustion type using gasoline as fuel. This unit operates in 24 VDC and is thermo-controlled to use minimum electrical power. Self contained tank holds fuel for 6-7 hours of operation with heat output of 15,000 B.T.U. The blower, which supplies 125 cubic ft./min. of heated air, can be used as a cool air circulator during warmer weather. Supplied with remote control unit, flexible stainless steel exhaust, air duct elbow, and spare parts.

With instruction and maintenance manual.

Specially priced  
**\$19.50**

### "A" ELIMINATOR KIT #KC 1-10



A well engineered six volt direct current power unit, for Auto-Radio and similar service work, has always been in the high priced range. Now, for the first time, we are presenting a fine quality unit in kit form, embodying the essential components necessary to easily construct an "A" eliminator at a price that will meet with the approval of the most thrifty. We feel sure that this unit will fulfill a long-standing need of every serviceman and technician. This kit is designed to operate from a 115 V.A.C. 50/60 cycle source and delivers 4 V.D.C., well filtered, at eight amperes, with a peak rating of ten amperes. Complete with simplified instructions.

**Price \$19.50**

To avoid shipping errors, kindly order by type #. All prices subject to change without notice.

**ATTENTION !!!**  
INDUSTRIALS, EXPORTERS, SCHOOLS  
GOV'T AGENCIES, LABORATORIES  
Our engineering staff is at your service to facilitate the application of rectifiers for your specific requirements.  
Write for quantity discount on company letterhead.

## OPAD-GREEN COMPANY

71 Warren St. Phone: BEekman 3-7385 New York 7, N. Y.





An amazing value for

## RADAR RESEARCH and EXPERIMENTAL LABORATORIES

### Type TS-100/AP TEST OSCILLOSCOPE for pulse timing and test applications

Original Gov't. Cost \$750.00

A rare value at only **\$240**

F. O. B. Boston

Price includes tubes, spare fuses, co-ax test cables, and circuit plan.



This versatile, accurate, precision built instrument is designed for precise measurement of short time intervals with circular sweep, and for test scope applications with linear sweep.

#### CIRCULAR SWEEP

Sweep rate: 1.5 microseconds per inch; 12.2 microseconds per revolution.  
Sweep accuracy: -0.03 microseconds; stable crystal oscillator holds sweep accuracy.  
Range of measurement: time intervals from 0.5 to 600 microseconds can be measured by utilizing the delayable intensity gate and selecting any one of the first 100 revolutions after triggering.  
Trigger voltages: 120 volts positive; 75 volts negative; duration— $\frac{3}{4}$  microseconds.  
Trigger stability: 0.1 microseconds with respect to circular sweep; can be operated at recurrence frequencies from 300 to 1500 per second.  
Synchronization: event whose time duration is to be measured must be triggered from the test oscilloscope.  
Signal deflection: radial by center wire; sensitivity—225 volts per inch.  
With circular sweep, the TS-100/AP is useful for calibrating pulsers and coincidence circuits, for measuring radar ranges (to an accuracy of 5 yards), for measuring delay lines, pulse lengths, pulse separations, and for measuring time duration of any event not exceeding 600 microseconds.

#### LINEAR SWEEP

Sweep rate: 12, 120, and 360 microseconds for 3-inch sweep.  
Sweep accuracy: -2%.  
Sweep synchronization: sweep starts at trigger or after delay adjustable from 2 to 500 microseconds.  
Internal triggering: from self-contained source of 120 volts positive or 75 volts negative providing  $\frac{3}{4}$  microseconds trigger at 300-1500 pulses per second.  
External triggering: requires positive 15 volts at 10,000 ohms with 100 volt/microseconds rise, or negative 50 volts at 500 ohms with 200 volts/microseconds rise.  
Deflection: 150 volts/inch thru condensers for either vertical plate, or to upper plate thru single-stage amplifier having gain of 12, upper frequency cut-off at 3 mc., lower frequency cut-off at 100 cycles; maximum peak input  $2\frac{1}{2}$  volts, -3 $\frac{1}{2}$  volts.  
With linear sweep, the TS-100/AP is useful for testing synchronizers, testing radar sets, lining up receivers, and for measuring pulse lengths up to 1200 microseconds. Availability of the sweep voltage makes this instrument applicable to electronic modulation of FM oscillators for modulator measurements.

Self-contained in louvered metal case 8" wide, 12 $\frac{1}{2}$ " high and 16 1/2 inches deep; removable cover protects the control panel when the instrument is not in use; the cover contains spare fuses, test leads and power cord.

Quantity limited—ORDER NOW—get your TS-100/AP while this offer lasts. Give complete shipping instructions with your order.

## The RADIO SHACK Corp.

CABLE ADDRESS: RADIOSHACK  
167 WASHINGTON ST., BOSTON, MASS., U. S. A.

## ATTENTION

### LABORATORIES AND ENGINEERS

HIGH-QUALITY FILTERS—BRAND NEW  
—AT A FRACTION OF ORIGINAL COST

Dimensions  $2\frac{1}{2} \times 2\frac{1}{2} \times 1\frac{1}{2}$

1000 Cycle Narrow Band Pass Audio Filters, made by UTC for the Flux Gate Compass.

#### CHARACTERISTICS:

- 1—Intended to work from a cathode follower or low impedance winding into a class "A" grid.
- 2—Tunable over a narrow range around 1000 cycles. Can be adjusted for zero phase shift at one frequency in the pass band.
- 3—Attenuation approx. 40 db. at 500 cycles and 2000 cycles.
- 4—NO insertion loss—actual voltage step-up in the pass band, due to filter configuration.

Price \$3.45 Each

SPECIAL — Western Electric Filter D163972. New—Each .....\$10.

Many W.E. Tubes In Stock—Inquiries answered. 12,000 volt test DC RC Raytheon choke—30 Henry —.03 amps. Type UX-887D—New—Each...\$4.95

New Bulletin off press—write

## GREENWICH SALES CO.

59 Cortlandt St.

Tel. Digby 9-3813 New York 7, N. Y.

## FOR SALE

### TEST EQUIPMENT

- 1—Ferris Generator Model 18B
- 1—H.P. Distortion Meter Model 325B
- 6—GR. Output Meters—Model 583A
- 4—Daven Output Meters Model O.P.961
- 4—Boonton QX Checkers With Coils
- 4—G.R. Variable Inductance Models J, K, L, and D
- 5—R.N.I. Wheatstone Bridges Made By Industrial Instruments
- 2—G.R. Precision Condensers Model 722M
- 2—Rubicon Potentiometers Model 2701
- 1—Lavoie Wave Meter Model 105
- 2—G.R. Resistance Decade Boxes Models 602D and 602F

Many Others.

Write for free circular—Apply

## ELECTRONIC CORPORATION OF AMERICA

353 West 48th St., New York 19, N. Y.  
Phone—CI rcle 6-1985

## MEMOVOX

### REFERENCE RECORDING EQUIPMENT

- Record 62 $\frac{1}{2}$  Minutes on each side of a 16 $\frac{1}{2}$ " MemoDisc.
- 4 Model AA Dual Rack-Mounted continuous recorders.
  - 3 Model AP Portable Recorders. Complete with Playbacks, Monitors, etc., and a large quantity of MemoDiscs.

WRITE FOR COMPLETE INFORMATION AND PRICES

THE NATIONAL INSTRUMENT CO.  
FAR ROCKAWAY NEW YORK



**Below Wholesale Cost!!!**  
**WESTERN ELECTRIC**  
 BRAND NEW

**\$19.95**

35-watt—will handle up to 55



A sensational buy in quality Reflex Speakers. Blasting and blaring completely eliminated by a heavy gauge metal main trumpet section. The Western Electric driver unit, rated at 35 watts will handle 55 watts safely without blasting. A new plastic diaphragm replaces the standard metal type and is unconditionally impervious to climatic changes and free from atmospheric corrosion. Minimum power—Maximum coverage, reduces cost of installation.

- Full frequency response driver unit complete with projector
- Excellent for concessions, ball parks, mobile, P.A. Work.

**BRAND NEW WESTERN ELECTRIC**  
**35 Watt Driver Unit**  
**FULL FREQUENCY RESPONSE**  
 Orig. Gov't Cost \$40.00  
 8 Ohm Voice Coil  
 Will Handle Up to 55 Watts

Built to the highest standards of electrical and mechanical tolerances to insure peak efficiency and perfect alignment for greater efficiency. A break-down proof diaphragm of plastic replaces the old metal type. Completely impervious to climatic changes and corrosion. The most rugged unit ever built, shock-proof construction, can be used as Tweeter with your Woofer or as a driver with your own projector outdoors or indoors.  
 In Lots of 10—\$49.50  
 20% Deposit with order—Balance C.O.D.

**\$5.95** Each

**MANUEL KLEIN**  
 74 Cortlandt St. New York 7, N. Y.

**GRAIN of WHEAT LAMPS**

Photograph 3 times actual size  
 Glass bulb 3/8" x 3/8"  
 Soldering iron removes lamp from base

Mazda G. E. 323 3v. .19A  
 Used for illuminating Meters, Compass Dials, and Airplane Instruments.  
 Great for Models, Doll Houses, Miniature Trains, etc.

Dozen..... **\$1.50** Post Paid  
 Also have G.E. 328 6v. .2A and 322



3 1/2" x 1 3/8"

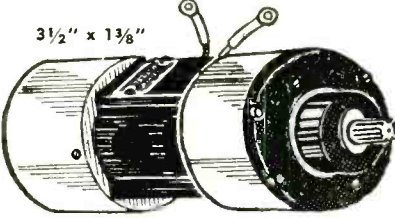

Operates on Flashlight batteries, speed depending on the voltage. Fairly strong on 6 volts, full power and speed on 27 volts. Designed to be used in bombights, automatic pilots, etc., 250 RPM. FEW MORE AT..... **\$5.00**

12 Volt. 100 Watt Soldering Iron..... **\$1.30**

**HAYDON SYNCHRONOUS MOTOR**  
 to operate switches, etc., can be had either 1 Rev. per hour or 1 Rev. per minute at this

**SPECIAL PRICE \$3.85**

Many other speeds available at \$4.95

EST. 1923 **BLAN** EST. 1923  
 Experimenters and Inventors Supplies  
 64 Dey St., New York 7, N. Y.

## TELEMARINE'S SELECTED ELECTRONIC SURPLUS

**5-Meter Walkie-Talkie**  
 Model BC-322 Transceiver; simple, popular communications unit. Freq. range 22-85 mc. Uses only two tubes, types 33 and 30. Includes a 5 MC crystal in a crystal callibrator circuit. Range 5 to 50 miles, depending upon location and altitude. Operates from single battery block (not supplied) available from mfr., or other sources. Supplied with handset, less antenna. battery. Excellent condition.

**PRICE, EACH \$20.95**  
 Telescopic Antenna, for above. Each \$2.00

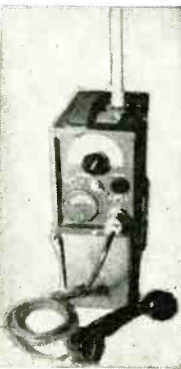

**SCR-536 HANDY-TALKIES**

We have just a few of these popular Handy-Talkies, and they won't last long. All are in very excellent condition, and complete with crystals (receiving and transmitting) and batteries. All are in top operating condition and preset at various operating frequencies ranging from 3.5 to 6.0 mc. Some available for operation in 80 meter ham band. We will supply units with matched frequencies as long as quantity permits. First come, first served!

**PRICE, EACH \$50.00**  
 Extra Set Batteries (A&B) \$3.00



**FREQUENCY METER TS-69/AP**

Frequency range 400 mc to 1,000 mc, continuous. Ideal for labs, schools, or for hams experimenting with eqpt. for civilian phone band. Black-crackle finished metal case, dim. 6"x6"x2 1/2", contains variable-length coax resonating cavity with crystal rectifiers and 0-200 microammeter, Veeler-Root counter and calibration charts insure extreme precision. Telescopic antenna, and coax line probe, with metal carrying case for entire equipment. New equipment.

**COMPLETE, EACH \$42.50**



**32 VDC 110 AC CONVERTER**

Mfd. by Kato Engineering, for marine or farm installation. Rotary type, compact and ruggedly built for continuous duty. Rubber shock mounting on filter case, with complete input and output filtering. Output-110 volts, 60 cycles AC. 225 KVA, but, will operate efficiently on loads up to 300 watts. New units only.

**PRICE, EACH \$39.95**  
 Quantities, 10 or more, Each \$34.95



**AMPLIDYNE MG SET**  
**Motor 110/220, 60 C. A. C.**

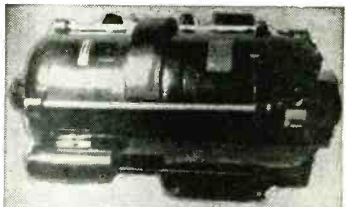

**RADIO TRANSMITTERS**  
*Immediate Delivery from Stock*

BC-325 Transmitter. 400W. .A1, 100 W. .A2 & A3. 1.5 to 18.0 mc. M.O. or X'tal control on 6 frequencies. Operates from 110/220/1/60c. AC. With tubes in excellent condition.

**PRICE, EACH \$500.00**

TCR—Radiomarine Transmitter, 125 watts (conservative) A1, A2, & A3.

For ship or shore station radio telephony, 6 channels in 2 to 3 mc band controlled by remote control box supplied. Complete RF, modulator and power supply (for 110 or 220 V. 50/60 cycles AC) in one cabinet. Excellent condition, with tubes

**EACH \$600.00**

For Automatic or Remote Control of heavy equipment. Mfd. by General Electric. Generator is Type V-5875677, motor 73AB58; Navy type CG-21ABU. Generator delivers 250 volts, DC, 375 watts. Motor—115 or 230 volts 1-phase, 60 cycles AC, rated at 3/4 HP RPM-1725. Includes capacitor for starting, and instructions for 115 or 230 volt connections. Generator section can be removed, and entire assembly shortened to make valuable 3/4 H. P. AC motor. Quantity sufficient to warrant this conversion.

**PRICE, EACH \$60.00**

**DECK ENTRANCE INSULATORS**  
**Bowl and Flange Type**

Manufactured by OHIO BRASS CO. for Army and Navy use. Has heavy galvanized metal flange 8 3/4" diameter, porcelain bowl set in rubber gaskets, top bell is 6 3/4" in diameter. Brass feed-thru rod 1 1/2" long. Insulator on distance between top bell and flange is 4 1/2". Individually packed in cartons. Quantities available.

**NEW, price each \$3.00**  
 Spare porcelain bowl, only, each \$ .75

CAPACITORS—1600 mfd 12WV electrolytic condensers..... EACH 0.35

All Prices F.O.B. N.Y.C. All Material Offered Subject to Prior Sale

## TELEMARINE COMMUNICATIONS COMPANY

Phone—LONgacre 4-4490-1 280-Ninth Ave., N. Y. 1, N. Y.





**\$3.95**  
 10 for \$35.00  
**PORTABLE  
 D. C. AMMETER**  
 HOYT TYPE 515  
 RANGE 0—15 AMPS

Mirrored scale 3 1/2" long, knife-edge pointer. Molded bakelite case dimensions 4 1/4" x 5 1/4" x 2 1/4". Snaps in place in black wrinkle-finished steel case 5 1/4" x 6" x 2 3/8". Furnished with 3 ft. color-coded rubber insulated clip leads.

Basic movement—approximately 12.5 ma. Shunt readily replaced permitting conversion to lower range scale.

Individually packaged in moisture-vaporproof packing.

- |   |         |   |         |
|---|---------|---|---------|
| TV and SCOPE POWER TRANSFORMER—Pri 117V 60 cy, Secondaries—2000 10Ma, 1000 VCT 2000MA, 5V 3A, 2 1/2V 2A, 6.3V 1A, 12.6 VCT 4A ..... | \$7.88  | EAD J-36 Rate Generator .....   | \$7.00  |
| AN/APS-15 3 CM ANTENNA ASSEMBLY, \$33.25  |         | TRANSFORMER—Westinghouse hypersil core—Pri 115 V 60 cy, 3/4 KVA, Sec. #1 240V 1.56A, Sec. #2 240V 1.56A ..... | \$11.50 |
| HYDRAULIC SERVO CONTROLS—Sperry Type R or equivalent. Set (Transmitter and Receiver) .....  | \$20.00 | FILTER CHOKE—Hermetically sealed 10H at 400 MA DC .....   | \$3.85  |
| ELINCO PM-2 Rate Generator .....  | \$6.00  | GENERAL ELECTRIC Liquid Level Transmitter .....   | \$2.44  |
| WESTERN ELECTRIC SOUND POWERED HANDSET .....  | \$14.88 |   |         |
| WESTERN ELECTRIC SOUND POWERED CHEST SET .....  | \$14.88 |   |         |

**TUBES**

1B24 .....	\$2.21	5HP4 .....	\$2.40	724B .....	\$3.22	1620 .....	.29	8020 .....	.07
2x2/879 .....	.49	1G 1/2 .....	14.80	811 .....	1.71	1636 .....	\$3.77	9001 .....	.42
3A1P .....	2.41	204A .....	17.90	82A .....	2.31	2050 .....	.81	9002 .....	.39
3C1P .....	1.87	PC 25A .....	42.50	82A .....	2.25	2051 .....	.49	9003 .....	.39
5B1H .....	1.45	WE-249C .....	1.88	1625 .....	.19	7193 .....	.18	9004 .....	.29
5L1P .....	.88	304TL .....	1.88	1626 .....	.23	8013 .....	.92	9005 .....	.29

WRITE FOR OUR BARGAIN BULLETIN

## LECTRONIC RESEARCH LABORATORIES

5832 Hegerman St. Philadelphia 24, Pa.  
 Phone—Cumberland 8-4737

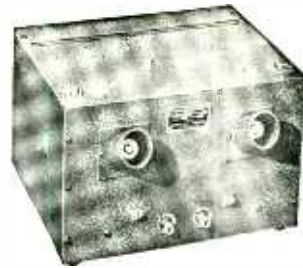

### BOONTON 120A VHF CIRCUIT CHECKER

This instrument was developed by the Boonton Radio Corp. to permit checking at VHF: Capacitance, inductance and complete Resonant Circuits. Ideal for Television and FM Tuners, Quality control, etc. Three Frequency Ranges. Available for immediate delivery.

Catalog price is \$320.00—Our price is \$150.00 f.o.b. N.Y.C. Reconditioned, in good operating condition, subject to prior sale.

**THE NATIONAL INSTRUMENT CO.**  
 FAR ROCKAWAY, N. Y.

### UNUSUAL BARGAINS

#### VIBRATOR

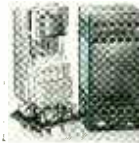

Hi-freq. extra-heavy duty, Rauland #JV-0014. Input 6, 12 or 24 volts; output 200 cycles ±1%; 20 extra-heavy contacts, rated at 35 amps continuous duty, each brought to separate base pin. In case 2 1/2" x 2 1/2" x 5 1/2".

BRAND NEW, in orig. boxes. . \$4.95

#### ANTENNA SWITCH, 3PDT

Extra-heavy contacts porcelain stand-offs; on base 7" x 8" x 1 1/4"; insulators alone worth more than price of switch.

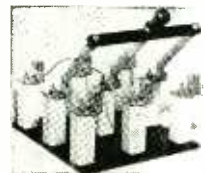

Per dozen \$9.95  
 EACH . . . . .99

### ELECTRONIC SUPPLIES

317-E East 2nd St. Tulsa 3, Oklahoma

#### BOONTON

**140-A BEAT FREQUENCY GENERATOR**  
 Range 20 CPS to 5 MC. Output Voltage 1 MV to 32 Volts. We have one unit for immediate delivery.  
 RECONDITIONED GUARANTEED  
**THE NATIONAL INSTRUMENT CO.**  
 FAR ROCKAWAY NEW YORK

#### SHEET METAL MACHINERY

NEW and Used — Brakes — Shears  
 Forming Rolls — Folders — Punches —  
 Di-Acro, Pexto, Niagara & Whitney Equip-  
 ment.  
**R. D. BROOKS CO., INC.**  
 Han. 3226  
 361 Atlantic Ave., Boston, Mass.

#### WANTED

## WANTED

Western Electric Carrier Telephone, Carrier Telegraph Equipment and Components. Filters, repeating coils, transformers, equalizers. Types CF1, CF2, H, C, and other carrier equipment. Telephone and telegraph repeaters.

W-1435, Electronics  
 330 West 42nd Street, New York 18, N. Y.

#### WANTED

### TEST EQUIPMENT

All types of Laboratory Test Equipment, new, used or surplus. Send description to

W-4861, Electronics  
 330 West 42nd Street, New York 18, N. Y.

### WANTED, AIRCRAFT RADIOS

AN/ART-13, BC-348, RTA-1B, AN/APN-9, R5A/ARN-7, AN/ARC-1, AN/ARC-3, SCR-718, BC-788-C, I-152, MN-26-C. Test Sets with TS- or I- prefix. State quantity, condition and best price first letter.

**HI-MU ELECTRONICS**  
 BOX 105, NEW HAVEN, CONN.

# ELECTRONIC SPECIALS

- RA-34 power supplies—0-1000V-350MA-12V-2A-DC-12V-14A-AC .....
- \$95.00
- RA-38 power supplies—0-15000V-500MA .....
- \$275.00
- RA-58 power supplies—0-15000V-35MA .....
- \$140.00
- Switches for above—15000V-1.5Amp, Oil filled—110VAC .....
- \$42.50
- Relays—6VDC-5PST & 5PDT-120 ohms-2200 turns .....
- \$1.25
- Relays—Sensitive-8000 ohms-SPDT-Silver contacts .....
- \$1.75
- Relays—Aircraft Radio Antennae—24VDC SPDT-Silver contacts .....
- \$ .95
- Relays—Allied Control—DPDT-24VDC-.079A-Type BJ .....
- \$ .95
- Condensers — WE - D168574 - 16MFD-120 VAC 400 Cy-400VDC .....
- \$2.75
- Condensers—3x8mfd 600V 65c—3x2mfd 4000V .....
- \$2.75

- DAK—Direction Finders — complete — Cables etc. ....
- \$375.00
- Phone cord extensions—10 ft. with PL55 & JK26 .....
- \$ .60
- Tuning units—GP "A"—(Contains several HV micas.) .....
- \$1.50
- LABORATORY SPECIAL — WE K58801 Precision Potentiometer—110VAC motor drive with selsyn .....
- \$37.50
- MANUFACTURERS SPECIAL — 10,000 7E5 high Frequency triodes, good up to 750 mc. JAN inspected. For the lot at, each .....
- \$ .28
- Transformers—3000 items of transformers in stock.
- Test equipment—Over a thousand items in stock of practically every type. Let us know of your needs. We specialize in hard to get electronics.

MONEY BACK GUARANTEE ON DEFECTIVE MATERIAL SUBJECT TO PRIOR SALE.

## VETERANS SALVAGE CO., INC.

9 Kulik St. Passaic—3-6370 Clifton, N. J.

**FOR SALE  
TRANSFORMERS**

Western Electric transformer 223A per D-163041 torroid type core impedance 600 to 600 ..... \$1.95  
 W.E. transformer D-161929 torroidal core ..... \$ .95  
 W.E. transformer D-161634 torroidal core ..... \$ .95  
 W.E. retard coil 307B per D-161818B, 10 henries ..... \$1.00  
 W.E. telephone induction coil 178A per D-162927A ..... \$1.95

**FILTERS**

W.E. 128B per D-165796 V.F. low pass 600 ohm impedance ..... \$3.95  
 W.E. D-165627 band pass 600 ohm impedance ..... \$1.95

**MICA CONDENSERS**

.0005 CD 5000 test transmitting type per 100 ..... \$19.50  
 .0002 CD 1000 test transmitting type per 100 ..... \$19.50  
 .02 CD 1000 test transmitting type per 100 ..... \$29.50

**SILVERED MICAS**

W.E. .0994 type AR per D-162051 ±½% 250 wvdc ..... \$1.95  
 W.E. .0002 402D 300 wvdc per 100 ..... \$9.50

**MICELLANEOUS**

W.E. regulated power supply KS15036, 115 VAC operated, 135 volt, DC output, complete with tubes ..... \$25.00  
 Varistor 34A per D-162482 ..... \$1.95  
 Telephone switchboard cords, 2-conductor tinsel rubber covered 6½" long, both ends lugged, per 100 ..... \$4.00  
 per 1000 ..... \$35.00

Write for Quantity prices  
 No orders less than \$5.00 accepted

**RAILWAY COMMUNICATIONS, INC.**

P. O. Box 1783 Phone 2-6487  
 Lincoln, Nebraska

**TELEVISION  
CAMERA EQUIPMENT**

Available for immediate delivery.  
 DUMONT Type 5027-A IMAGE ORTHICON PICKUP HEADS, with type 5047-A ELECTRONIC VIEW FINDERS, complete with all tubes,—including 2P23 Image Orthicons.

Factory Reconditioned—Perfect Condition  
 i.o.b. N.Y.C. Subject to prior sale.

WRITE FOR COMPLETE INFORMATION

**THE NATIONAL INSTRUMENT COMPANY**  
 FAR ROCKAWAY, NEW YORK

**FOR SALE  
SYNCHROS**

**FORD INSTRUMENT CO.**  
 Navy Type 5 SDG

(400 cy. Differential Generators)  
 250 available. Brand new in original sealed containers.

Priced right for quick sale.

FS-6327, Electronics  
 330 West 42nd Street, New York 18, N. Y.

**ELECTRONIC TUBE-MAKING  
MACHINERY**

For manufacturing radio tubes, electronic tubes, cathode-ray tubes, lamps. New and used. Reasonably priced, satisfaction guaranteed.

**AMERICAN ELECTRICAL SALES CO.**  
 67 E. 8th St. New York, N. Y.

**BUY  
COMET**

**OUTSTANDING VALUES!**

**Sensational Value!  
NAVY ENTERING  
TYPE INSULATOR**



Porcelain-flanged bowl with brass rod and fitting and aluminum shield. Dimension of bowl, 4 3/8" high, 6 5/16"OD at base ..... \$3.95  
 Spare bowl ..... 50c

**SPECIAL!  
FOR THIS MONTH  
ONLY**



**FAMOUS TOM THUMB ATTP**  
 • Recharges its own Dry Batteries  
 • Operates on Battery — A.C.-D.C.

**LESS BATTERIES  
25.95  
DEALER PRICE**

**CAPACITOR**

Bath Tub	Mfd	VDC	Ea.	ten	of
.05	MFD	600	\$ .10	\$ .08	
.5	MFD	600	.20	.15	
1	MFD	600	.40	.35	
4	MFD	50	.65	.60	
2 X .25	MFD	600	.20	.15	
6	MFD	600	.65	.60	
8	MFD	600	.80	.75	
10	MFD	600	1.00	.95	
0008	MFD	15000			
	VDC GE.		6.95	6.50	
<b>Electrolytic and Paper</b>					
25	MFD	25	VDC	\$0.15	
50	MFD	25	VDC	.15	
150	MFD	50	VDC	.25	
500	MFD	200	VDC	1.50	
<b>Oil filled</b>					
.01	Mfd	1000	Vdc	\$ .35	\$ .30
.05	Mfd	600	Vdc	.25	.20
.05	Mfd	1000	Vdc	.35	.30
.1	Mfd	500	Vdc	.20	.15
1	Mfd	7500	Vdc	1.50	1.35
.5	Mfd	500	Vdc	.35	.20
.5	Mfd	1000	Vdc	.35	.30
.5	Mfd	2000	Vdc	.50	.45
1	Mfd	500	Vdc	.30	.25
2	Mfd	600	Vdc	.35	.30
2	Mfd	1000	Vdc	.55	.50
4	Mfd	600	Vdc	.60	.55
5	Mfd	600	Vdc	.60	.55

**PLUGS**

JK-26 & PL-55 on 67" cord	\$0.49
PL-55 on 35" cord	.23
PL-150 Plug for dynamotor socket on Xmitter RC	.39

**POTENTIOMETERS TAPER: All linear except .2772**

Cat. No.	(F)	Bush-	ing	Shaft	Mfrg.	ea.	ten
WW	Ohms	Watts					
.004B8	10000	3	3/8"	2"	Trefz	\$ .29	\$ .24
.005B10	25000	3	1/2"	3/8"	Trefz	.30	.25
.036B3	1000	4	3/8"	1 3/8"	Trefz	.26	.21
.149B1	5000	4	1/2"	3/8"SL	Trefz	.28	.23
.025B1	15000	4	1/2"	1 3/8"	Trefz	.30	.25
.083Z1	20000	4	Panel		Dejur	.80	.75
.172Z1	20000	10	Panel		Muter	2.50	2.00
.048B1	50	25	3/8"	1 3/8"	Dejur	.50	.40
.147B1	200	25	3/8"	3/8"SL	Dejur	.55	.45
.032B1	500	25	3/8"	1 3/8"	Dejur	.60	.50
.178B1	1000	25	3/8"	1 3/8"	Dejur	.55	.45

**MICROWAVE  
EQUIPMENT**

10.3—9.7 CM echo box with wave guide, antenna, accessories, and spares.  
**NEW \$110.00**  
 10CM rotating antenna assembly, 24" parabola in turret—360° scan at 12 RPM—DC motor control—motor reversing switch for clockwise and counter-clockwise rotation.  
**NEW \$75.00**

**AUTOMATIC  
AUTO RADIO**



- Six Tube Superheterodyne
- 3 Gang Condenser
- Powerful Long Distant Reception
- Fits All Cars
- Easy Installation

**Only 29.75 DEALER PRICE**

**TUBES**

1R24	\$2.50
3 X 2 879	.75
3B7 1291	.98
3E29	4.95
3E27	8.50
15E	1.10
33	.98
45 type	.49
830 TH	7.95
551	39.95
713A	1.35
805	4.75
807	1.20
813	6.95
815	2.10
830 B	5.00
1203A	.98
1616	1.15
2050	.88
9006	.49
915	11.95
HY69	2.25
RK73	3.95
10T1 amperite	.39
31P1	2.45
5B1P1	3.45
5B1P4	4.95
6CP1	3.45
5F7	3.45
1J6G	.98
6AC7W	1.15
6H6 GT	.50
6SU7	.50
6Y6G	.88
6F6	.75
6L6	1.35
6SK7	.59
6S7	.59
12SN7	.75
25L6GT	.60
5T4	1.39

**SWITCHES**

Microphone switch, wipng type, 2 circuit to GND \$0.25  
 Toggle 3 PDT 10A 250 VAC ..... .65  
 Micro roller leaf BRP2 ..... .49  
 Toggle DPDT 20A 125v AC ..... .59  
 One pole moment. cont. Toggle DPDT 5A 250V 10A 125V ..... .49

**SPECIAL!  
SCR-522**

Famous SCR-522 VHF transmitter and receiver freq. range 100-156 mcs. four channel push button operation—crystal controlled—less cables and dynamotor.  
 NEW ..... \$49.95  
 Used good condition ..... \$34.95

**A NATURAL!!!**

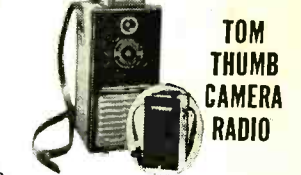

- TOM THUMB CAMERA RADIO**
- The Ideal Companion for Outdoor Activities
  - A Year Around Must
  - Precision Built — Beautifully Designed
  - Excellent Tone Quality
  - Portable Battery Operated Radio
  - Reflex Type Camera

**16 Pictures LESS BATTERIES on Standard #127 Film**  
**26.57 DEALER PRICE**

**INSULATORS**

Strain, Rectangular, ceramic, 6" long, 1"x1 1/2", glazed ..... 12c each  
 12 for \$1.20  
 Strain, porcelain, 3 3/4" long, Thomas #301 ..... 18c each  
 36 for \$5.40  
 Spreader, round, ceramic, glazed, 12" long, 3/4" dia., 3/8" hole through side near each end ..... 12c each  
 12 for \$1.20  
 Glass, Pyrex #63, 1" pin hole for 8000 volt power line ..... 18c each  
 8 for \$1.20

**SPECIALS!**

Klystron Tube 417 A ..... \$ 8.50  
 Magmatron 2122 ..... 21.95  
 Magnet for magmatron ..... 9.95  
 715 A Tube ..... 16.95  
 Vibrator ATK-2410 24VDC Output 100V, 100W ..... 2.95  
 Copper oxide rectifier 45VAC, 25VDC 4A ..... 7.95  
 50 MMF 3200 VAC Vacuum capacitor ..... 4.95

**SPECIALS!**

IC-412 OSCILLOSCOPE 5" USED, EXCELLENT COND ..... \$79.00  
 GN-45 Hand Generator GV 3A 500V, 14A New ..... \$4.00  
 Used; good condition ..... \$2.95  
 Filter choke coil 12HY .09 amp, 215 ohms DC ..... \$1.39  
 T-30 throat microphone ..... .20  
 P-23 Headset high impedance, cord and PL-55 ..... \$1.18

**TERMS** Mail orders promptly filled—all prices F.O.B. Boston, Mass. Send M.O. or check. Shipping charges sent C.O.D. Minimum order \$5.00. 25% deposit required with all orders.

**SEND FOR OUR  
CATALOGUE NOW!**

**COMET ELECTRONIC SALES CO.**  
 Inquiries from Dealers, Schools and Industrial Firms Invited  
 NOTE OUR NEW ADDRESS  
 24 TREMONT ST. BOSTON 8, MASS.





# ALLEN BRADLEY

AND OTHERS

## RESISTORS and POTENTIOMETERS

## CAPACITORS

all makes

mica,  
silvermica,  
button mica,  
ceramic,  
oilfilled tubular.

best quality only.

fast deliveries from  
immense stocks.

recognized as source of  
supply by the "blue chips"  
of the electronic industry.

NAMES ON REQUEST

# LEGRI S CO.

INCORPORATED

130 West 102 St.

New York 25, N. Y.

\* we are supplier of many Universities, Research Laboratories and fill Government Orders per JAN Specifications.

Mica Insulator Company ..... 48, 49  
Milford Rivet and Machine Co. .... 248  
Millen Mfg. Co., Inc. .... 244  
Miniature Precision Bearings, Inc. .... 275  
Mitchell-Rand Insulation Co., Inc. .... 52  
Mosinee Paper Mills Company ..... 168  
Multicores Solders Limited ..... 15  
Mycalex Corp. of America ..... 51, 55

National Company, Inc. .... 254  
National Research Corp. .... 199  
National Vulcanized Fibre Co. .... 206  
New York Transformer Co. .... 196, 198  
North American Philips Co., Inc. .... Inside Front Cover  
Nothelfer Winding Laboratories ..... 256

Ohmite Manufacturing Co. .... 32A, 32B  
O'Neil-Irwin Mfg. Company ..... 272

Panoramic Radio Corp. .... 236  
Par-Metal Products Corp. .... 146  
Paramount Paper Tube Corp. .... 150  
Perkin-Elmer Corp. .... 259  
Phalo Plastics Corp. .... 209  
Phillips Control Corp. .... 205  
Phillips Screw Manufacturers ..... 185  
Pickering and Company, Inc. .... 253  
Plastic Manufacturers, Inc. .... 51  
Polard Electronics Company ..... 255  
Potter and Bramfield Sales Co. .... 38  
Potter Instrument Co., Inc. .... 248  
Precision Apparatus Co., Inc. .... 234  
Precision Paper Tube Co. .... 263  
Precision Tube Company ..... 243  
Premax Products, Div. Chisholm-Ryder Co., Inc. .... 273  
Press Wireless Mfg. Co., Inc. .... 29  
Presto Recording Corporation ..... 33  
Progressive Mfg. Company ..... 158  
Pyroferic Company ..... 252

Quaker City Gear Works, Inc. .... 172

Racon Electric Company, Inc. .... 247  
Radio Corp. of America, 45, 179 Back Cover  
Radio Frequency Laboratories, Inc. .... 252  
Radio Receptor Company, Inc. .... 219  
Railway Express Company, Air Express Division ..... 214  
Rawson Electrical Instrument Co. .... 257  
Raytheon Manufacturing Co. .... 133, 165, 208  
Reeves Hoffman Corp. .... 190  
Reiner Electronics Co., Inc. .... 234  
Revere Copper and Brass, Inc. .... 12  
Rex Rheostat Co. .... 275  
Richardson Company ..... 22  
Rockbestos Products Corp. .... 35

Sams and Company, Inc., Howard W. .... 142  
Sanborn Company ..... 146  
Scientific Electric, Div. of "S" Corrugated Quenched Gap, Co. .... 274  
Scott Incorporated, Hermon Hosmer ..... 257  
Shalleross Manufacturing Co. .... 251  
Sheffco Manufacturing Company ..... 269  
Sherron Electronics Company ..... 161  
Shure Brothers, Inc. .... 144  
Sillecks-Miller Company ..... 179  
Simpson Electric Company ..... 147, 182  
Sola Electric Company ..... 11  
Solar Manufacturing Corp. .... 64  
Sorensen and Company, Inc. .... 28  
Specialty Battery Company ..... 162  
Speer Carbon Company ..... 186  
Spellman Television Co., Inc. .... 261  
Sperry Gyroscope Company ..... 159  
Sprague Electric Company ..... 24  
Standard Arcturus Corp. .... 170  
Standard Piezo Company ..... 158  
Standard Pressed Steel Co. .... 255  
Standard Telephones and Cables, Ltd. .... 217  
Star Expansion Products Co., Inc. .... 261  
Steward Manufacturing Co., D. M. .... 273  
Superior Electric Company ..... 270, 271  
Superior Tube Company ..... 254  
Sylvania Electric Products, Inc. .... 137

Tech Laboratories, Inc. .... 150  
Technology Instrument Corp. .... 238  
Tektronix, Inc. .... 261  
TEL Instrument Company, Inc. .... 242  
Telechron, Incorporated ..... 157  
Thompson Corp., George S. .... 275  
Titanium Alloy Mfg. Company ..... 141  
Transvision, Incorporated ..... 269  
Turner Company ..... 189

Union Carbon and Carbide Corp. .... 170  
United-Carr Fastener Corp. .... 240  
United Insulator Co., Ltd. .... 151  
United Transformer Co., Inside Back Cover  
Universal Winding Company ..... 169



## The NEW General Electric Variable Reluctance Cartridge for Long Playing Records!

- Specifically designed for the new long playing records... high compliance... low mass stylus assembly
  - Equipped with 1 mil tip radius sapphire stylus
  - Can be used with standard G-E preamplifiers
- Place your order today!

General Electric Company  
Electronics Park  
Syracuse, New York

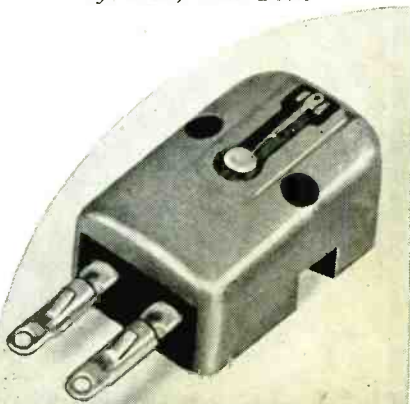

168-G10B

You can put your confidence in  
**GENERAL**  **ELECTRIC**



# Audax

TRADE MARK

## TUNED-RIBBON reproducers



other models  
for every purpose

**MICROGROOVE**—LM-79  
**VERTICAL**—Studio 99  
**LATERAL**—Studio 81

The finest performing reproducers—barring none  
"The Standard by Which Others Are Judged and Valued"

MUSIC CRITIC AND  
REVIEWER OF RECORDS  
"My new AUDAX reproduces  
better than anything else I have  
heard, — anywhere."

A RADIO STATION  
Received the SA-79 AUDAX  
units and are very well satisfied  
with them. They are much better  
than anything we have ever  
used."

RADIO STATION: Our experience  
with TUNED-RIBBON lateral re-  
production compels us to seek  
improvement in our vertical re-  
production as well, by a change  
to your STUDIO-99. Please ship  
us one.

"Can you do us a big favor and  
ship duplicate TUNED-RIBBON  
order Thursday sure? We are  
your biggest boosters."

"The new AUDAX units have  
seen hard service, being handled  
by people who mishandle them,  
but they keep on delivering."

Meets every requirement

- NO INTER-MODULATION DISTORTION
- Your EARS will easily know the difference!

Any "permanent" needle—diamond, sapphire or metal—plays only a limited number of discs, after which it erodes the grooves.—Therefore, needle changing is important.—Write for complimentary pamphlet on this important subject.

## AUDAK COMPANY

500 Fifth Avenue

New York 18

"Creators of Fine Electro-acoustical Apparatus since 1915"

Vartex Corporation	193
Varian Associates	233
Vietreen Instrument Company	228
Vitamite Company	269
Vulcan Electric Company	142

Waldes Robinson, Inc.	143
Ward Leonard Electric Co.	140
Watertown Mfg. Company	233
Webster Spring Corp.	275
Weller Manufacturing Company	266
Western Electric Co.	4, 5, 27, 127
Westinghouse Electric Corp.	16, 17
Weston Electrical Instrument Corp.	10
White Dental Mfg. Company, S. S.	239
Whitehead Stamping Company	267
Wilcox Electric Company	211
Willay and Sons, Inc., John	263
Wilson Company, H. A.	202

Zophar Mills, Inc.	174
--------------------	-----

PROFESSIONAL SERVICES	277
-----------------------	-----

### SEARCHLIGHT SECTION (Classified Advertising)

EMPLOYMENT	
Positions Vacant	278
Positions Wanted	279
Selling Opportunities Wanted	279
Employment Services	278
SPECIAL SERVICES	
Contract Work	279
EDUCATIONAL	
Books	279
BUSINESS OPPORTUNITIES	
Offered	279
EQUIPMENT	
(Used or Surplus New)	
For Sale	279, 309
WANTED	
Equipment	308
ADVERTISERS INDEX	
Air King Products Co., Inc.	278
Ahrendt & Taplin	279
American Electrical Sales Co., Inc.	309
Bendix Aviation Corp.	278
Blan	307
Brooks Inc., B. D.	308
Buffalo Radio Supply	302, 303
Comet Electronic Sales Co.	309
Communications Equipment Co.	286, 287
Components Supply	279
Crosley Div. Avco Mfg. Corp.	278
Dannemiller Assoc., J. R.	279
EPCCO	304
Edlie Electronics Inc.	300
Electro Impulse Laboratory	305
Electro Sales Co.	295
Electronicraft, Inc.	284, 285
Electronic Corp. of America	306
Electronics Research Publ. Co.	279
Electronics Supplies	308
Engineering Research Associates, Inc.	278
Federal Telephone & Radio	279
French-Van Breems, Inc.	297
Greenwich Sales Co.	306
Hazeltine Electronics Corp.	278
Heath Company	296
Hi Mu Electronics	308
Instrument Associates	288
Klein, Manuel	307
Lectronic Research Laboratories	308
Leeds Radio Co.	300
Leru Laboratories Inc.	302
Life Electronics Sales	304
Maass, C. F.	302
Marino Radio Co.	301
Maritime Switchboard	289
National Instrument Co.	302, 306, 308, 309
Newark Electric Co., Inc.	299
Niagara Radio Supply Corp.	280, 281
Opad-Green Co.	305
Peak Electronics Co.	292
Powerton Electrical Equipment Co.	290
Precision Electrical Instrument Co.	302
Radio Ham Shack, Inc.	291
Radio Shack Corp.	306
Railway Communications Inc.	309
RCA Laboratories Division	279
Reliance Merchandising Co.	294
Saint Louis Microphone Co.	302
Servo-Tek Products Co., Inc.	293
Spectra Products	302
Sperry Gyroscope Co.	278
Tab	282, 283
Telemarine Communications Co.	307
Thomas Mfg. Co.	279
Universal General Corp.	302
Veterans Salvage Co., Inc.	308
Wells Sales Inc.	298



# Linear Standard Units...

## THE ULTIMATE IN QUALITY...

UTC Linear Standard Audio Transformers represent the closest approach to the ideal component from the standpoint of uniform frequency response, low wave form distortion, high efficiency, thorough shielding and utmost dependability.

### UTC Linear Standard Transformers feature...

- **True Hum Balancing Coil Structure**... maximum neutralization of stray fields.
- **Balanced Variable Impedance Line**... permits highest fidelity on every tap of a universal unit... no line reflections or transverse coupling.
- **Reversible Mounting**... permits above chassis or sub-chassis wiring.
- **Alloy Shields**... maximum shielding from inductive pickup.
- **Hiperm-Alloy**... a stable, high permeability nickel-iron core material.
- **Semi-Toroidal Multiple Coil Structure**... minimum distributed capacity and leakage reactance.
- **Precision Winding**... accuracy of winding .1%, perfect balance of inductance and capacity; exact impedance reflection.
- **High Fidelity**... UTC Linear Standard Transformers are the only audio units with a guaranteed uniform response of  $\pm 1$  DB from 20-20,000 cycles.

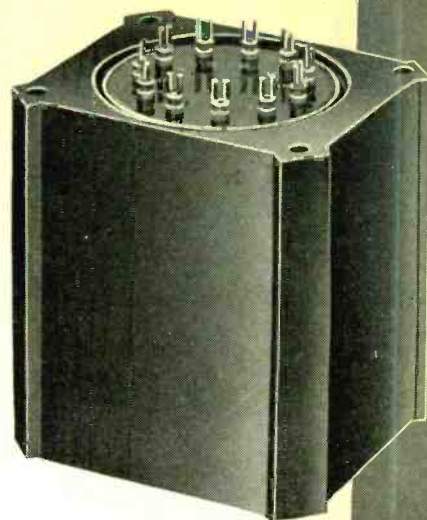

## TYPICAL LS LOW LEVEL TRANSFORMERS

Type No.	Application	Primary Impedance	Secondary Impedance	$\pm 1$ db from	Max. Level	Relative hum pickup reduction	Max. Unbalanced DC in prim'y	List Price
LS-10	Low impedance mike, pickup, or multiple line to grid	50, 125, 200, 250, 333, 500/600 ohms	60,000 ohms in two sections	20-20,000	+15 DB	-74 DB	5 MA	\$25.00
LS-10X	As Above	As above	50,000 ohms	20-20,000	+14 DB	-92 DB	5 MA	32.00
LS-12	Low impedance mike, pickup, or multiple line to push pull grids	50, 125, 200, 250, 333, 500/600 ohms	120,000 ohms overall, in two sections	20-20,000	+15 DB	-74 DB	5 MA	28.00
LS-12X	As above	As above	80,000 ohms overall, in two sections	20-20,000	+14 DB	-92 DB	5 MA	35.00
LS-26	Bridging line to single or push pull grids	5,000 ohms	60,000 ohms in two sections	15-20,000	+20 DB	-74 DB	0 MA	25.00
LS-19	Single plate to push pull grids like 2A3, 6L6, 300A. Split secondary	15,000 ohms	95,000 ohms; 1.25:1 each side	20-20,000	+17 DB	-50 DB	0 MA	24.00
LS-21	Single plate to push pull grids. Split primary and secondary	15,000 ohms	135,000 ohms; turn ratio 3:1 overall	20-20,000	+14 DB	-74 DB	0 MA	24.00
LS-22	Push pull plates to push pull grids. Split primary and secondary	30,000 ohms plate to plate	80,000 ohms; turn ratio 1.6:1 overall	20-20,000	+26 DB	-50 DB	.25 MA	31.00
LS-30	Mixing, low impedance mike, pickup, or multiple line to multiple line	50, 125, 200, 250, 333, 500/600 ohms	50, 125, 200, 250, 333, 500/600 ohms	20-20,000	+17 DB	-74 DB	5 MA	25.00
LS-30X	As above	As above	As above	20-20,000	+15 DB	-92 DB	3 MA	32.00
LS-27	Single plate to multiple line	15,000 ohms	50, 125, 200, 250, 333, 500/600 ohms cycles	30-12,000	+20 DB	-74 DB	8 MA	24.00
LS-50	Single plate to multiple line	15,000 ohms	50, 125, 200, 250, 333, 500/600 ohms	20-20,000	+17 DB	-74 DB	0 MA	24.00
LS-51	Push pull low level plates to multiple line	30,000 ohms plate to plate	50, 125, 200, 250, 333, 500/600 ohms	20-20,000	+20 DB	-74 DB	1 MA	24.00
LS-141	Three sets of balanced windings for hybrid service, centertapped	500/600 ohms	500/600 ohms	30-12,000	+10 DB	-74 DB	0 MA	28.00

## TYPICAL LS OUTPUT TRANSFORMERS

Type No.	Primary will match following typical tubes	Primary Impedance	Secondary Impedance	$\pm 1$ db from	Max. Level	List Price
LS-52	Push pull 2A5, 250, 6V6, 42 or 2A5 A prime	9,000 ohms	500, 333, 250, 200, 125, 50, 30, 20, 15, 10, 7.5, 5, 2.5, 1.2	25-20,000	15 watts	\$28.00
LS-55	Push pull 2A3's, 6A5G's, 300A's, 275A's, 6A3's, 6L6's	5,000 ohms plate to plate and 3,000 ohms plate to plate	500, 333, 250, 200, 125, 50, 30, 20, 15, 10, 7.5, 5, 2.5, 1.2	25-20,000	20 watts	28.00
LS-57	Same as above	5,000 ohms plate to plate and 3,000 ohms plate to plate	30, 20, 15, 10, 7.5, 5, 2.5, 1.2	25-20,000	20 watts	20.00
LS-58	Push, pull parallel 2A3's, 6A5G's, 300A's, 6A3's	2,500 ohms plate to plate and 1,500 ohms plate to plate	500, 333, 250, 200, 125, 50, 30, 20, 15, 10, 7.5, 5, 2.5, 1.2	25-20,000	40 watts	50.00
LS-6L1	Push pull 6L6's self bias	9,000 ohms plate to plate	500, 333, 250, 200, 125, 50, 30, 20, 15, 10, 7.5, 5, 2.5, 1.2	25-20,000	30 watts	42.00

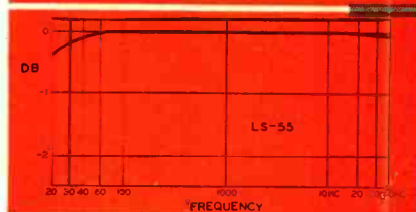
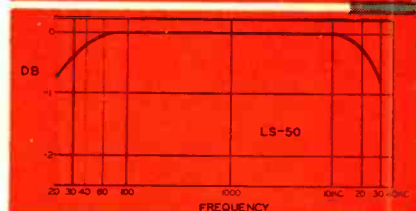
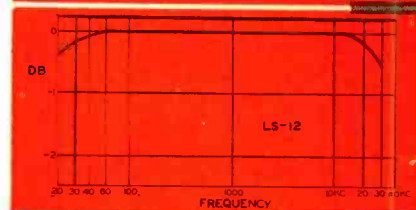
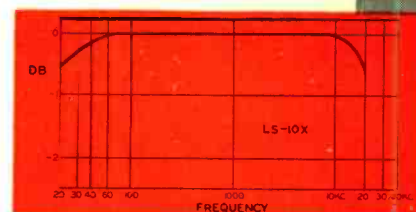

Write for our Catalog PS-408

*United Transformer Co.*  
 150 VARICK STREET NEW YORK 13, N. Y.  
 EXPORT DIVISION: 13 EAST 40th STREET, NEW YORK 16, N. Y., CABLES: "ARLAB"



*RCA—the pioneer in miniatures—*

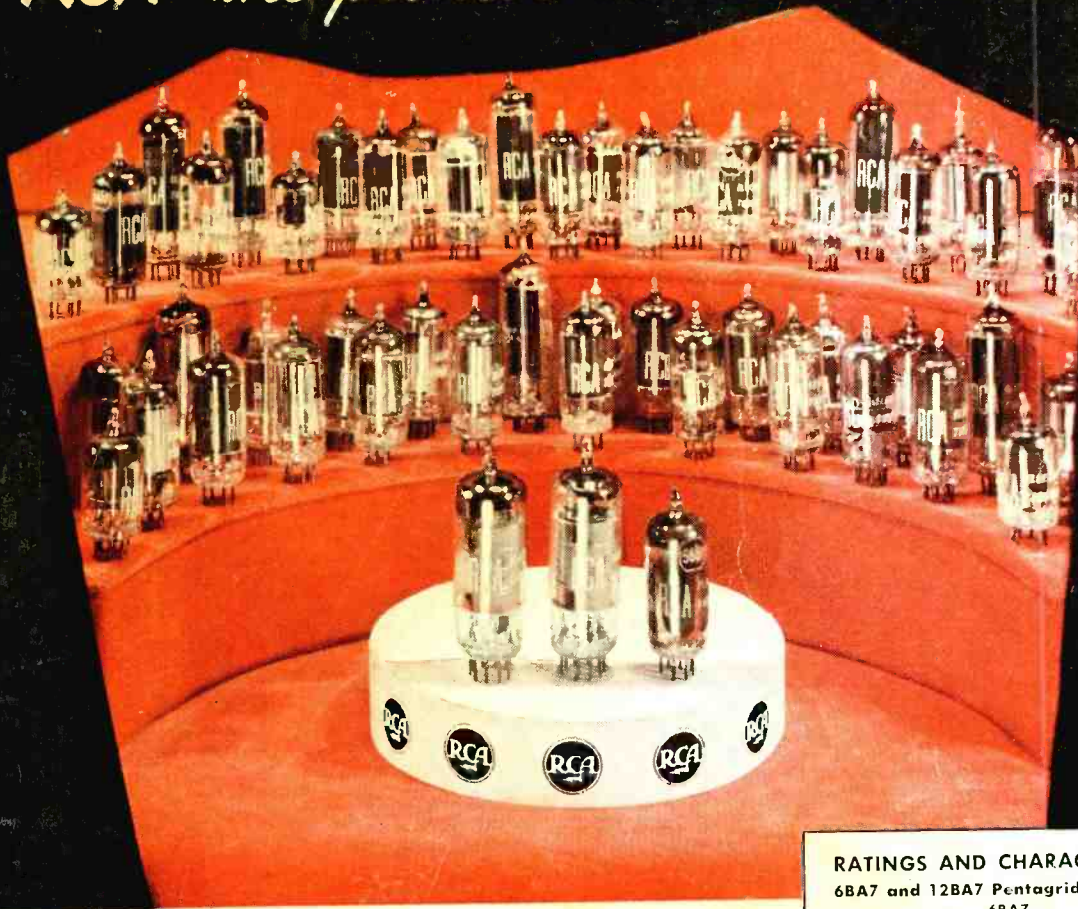

## ... presents three new types of major importance

● Here are three new miniature tubes... additions to RCA's large family of miniature types... that have particular significance in FM receiver design and voltage reference applications.

RCA 6BA7 and 12BA7 are pentagrid converters—alike except for heater ratings. They have high conversion transconductance; and a separate connection for direct grounding of the suppressor. These features in combination with the short internal leads characteristic of miniature tubes, result in efficient operation of either type in the 88 to 108-megacycle FM band. In addition to realizing substantial gains at the higher frequencies, the RCA 6BA7

and 12BA7 contribute a highly favorable signal-to-noise ratio.

RCA-5651 is a voltage reference tube of the cold-cathode, glow-discharge type. It maintains a dc operating potential of 87 volts, has an operating current range of 1.5 to 3.5 ma., an operating characteristic essentially independent of ambient temperature, and a voltage stability at any current level of better than 0.1 volt.

RCA Application Engineers will be pleased to consult with you on the incorporation of these new miniatures in your equipment designs. For further information write RCA, Commercial Engineering, Section JR40, Harrison, N. J.

THE FOUNTAINHEAD OF MODERN TUBE DEVELOPMENT IS RCA

### RATINGS AND CHARACTERISTICS

#### 6BA7 and 12BA7 Pentagrid Converters

	6BA7	12BA7
Heater Voltage (ac or dc)	6.3	12.6 Volts
Heater Current	0.3	0.15 Ampere
<b>Characteristics — Separate Excitation*</b>		
Plate Voltage	100	250 Volts
Grid No. 5 and Internal Shield	Connected directly to ground	
Grids No. 2 and No. 4	100	100 Volts
Grid No. 3	-1.0	-1.0 Volt
Grid No. 1 Resistor	0.02	0.02 Megohm
Plate Resistance (Approx.)	0.5	1.0 Megohm
Conversion Transconductance	900	950 Micromhos
<b>Conversion Transconductance (approx.)</b>		
Grid No. 3 at -20 volts	3.5	3.5 Micromhos
Plate Current	3.6	3.8 Ma.
Grids Nos. 2 and 4 Current	10.2	10 Ma.
Grid No. 1 Current	0.35	0.35 Ma.
Total Cathode Current	14.2	14.2 Ma.

\*Characteristics correspond very closely with those obtained in a self-excited oscillator circuit operating with zero bias.

#### 5651 Voltage-Reference Tube

	Min.	Av.	Max.
DC Starting Voltage	—	107	115 Volts
DC Operating Voltage	82	87	92 Volts
DC Operating Current	1.5	—	3.5 Ma.
Regulation (1.5 to 3.5 Ma.)	—	—	3 Volts
Stability*	—	—	0.1 Volt
Ambient Temperature Range	-55 to +90° C		

\*Defined as the maximum voltage fluctuation at any current level within operating current range.



**TUBE DEPARTMENT**

**RADIO CORPORATION OF AMERICA**

**HARRISON, N. J.**