

JUNE · 1947

electronics

A MCGRAW-HILL PUBLICATION

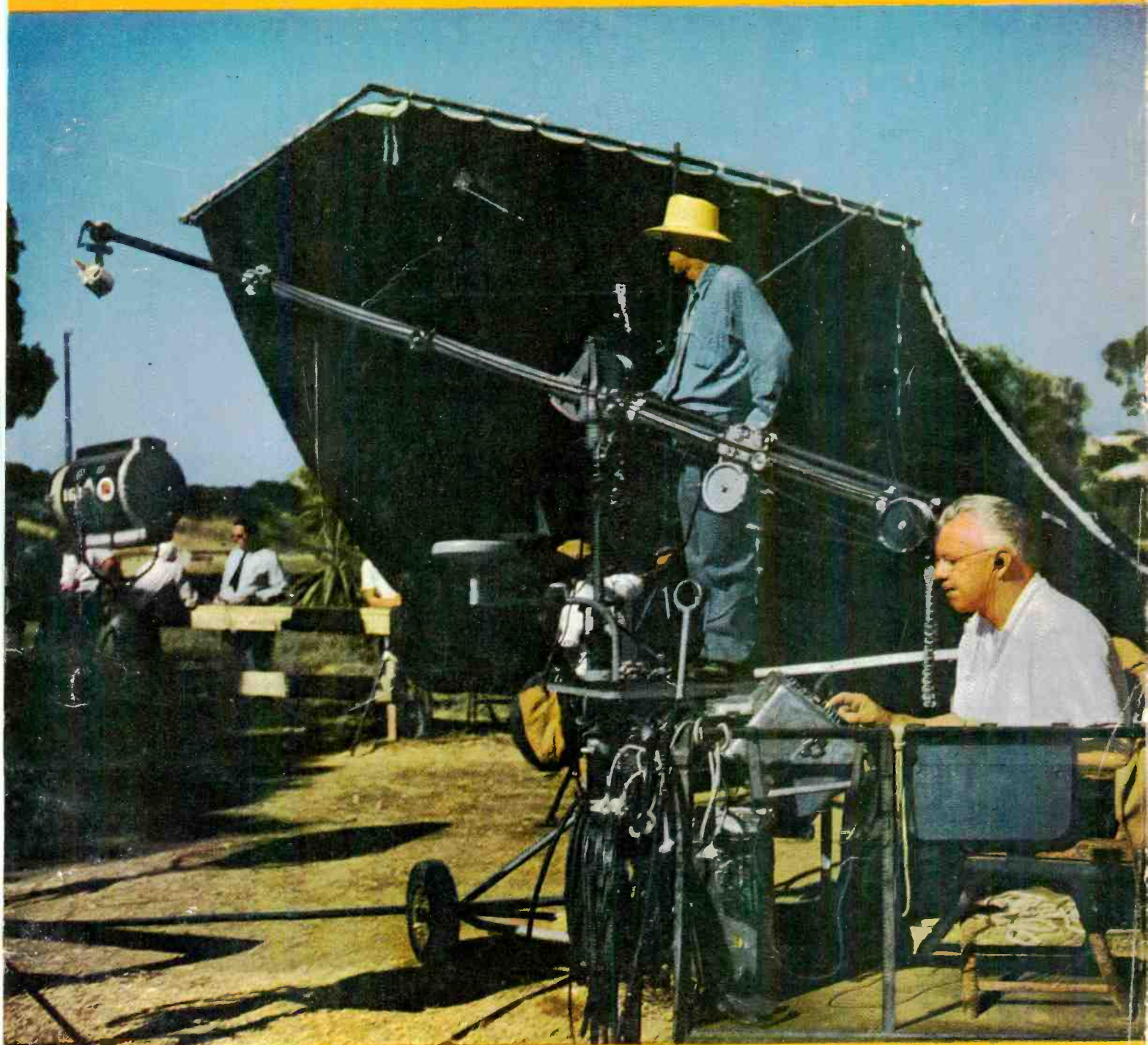

Electronics in Hollywood

THE OPERATION

BROADCASTING that earns the approval of station managers and listeners alike under any and all local conditions for reliability, efficiency and economy.

THE EQUIPMENT

COLLINS 21A 5Kw Air Cooled BROADCAST TRANSMITTER made by **COLLINS RADIO COMPANY**, 11 West 42nd Street, New York-38, N. Y.

The new Collins 21A has been the choice of keen executives for close to a score of installations in recent months. Knowledge and experience gained by Collins engineers during war time are reflected in improved design, longer life, higher safety factors and unusual standards of trouble free operation.

THE AMPEREX tubes THAT DO THE JOB!



AMPEREX experience in communication goes back a quarter of a century. The same record of performance, long life and economy marks Amperex tubes for industrial, rectification, electro medical and special purpose use. As tube specialists concerned with all electronic developments Amperex engineers are in a position to give detached counsel and information

Write Application Engineering Department.

POWER TUBE SPECIALISTS SINCE 1925

COMMUNICATION
RECTIFICATION
INDUSTRIAL
ELECTRO-MEDICAL
SPECIAL PURPOSE

AMPEREX
ELECTRONIC CORPORATION



25 WASHINGTON STREET, BROOKLYN 1, N. Y., CABLES: "ARLAB"

In Canada and Newfoundland: ROGERS MAJESTIC LIMITED, 622 Fleet Street West, Toronto 28, Canada

electronics

A McGRAW - HILL
PUBLICATION

JUNE • 1947

ELECTRONICS IN HOLLYWOOD	Cover
Engineer operates sound-mixer panel on outdoor set during filming of the Twentieth-Century-Fox picture "The Homestretch"	
NUCLEONICS AND ELECTRONICS, by Keith Henney	80
How the two technologies are allied	
STAMPED WIRING	82
New technique permits 90 percent of the wiring in an electronic device to be stamped out by dies	
TELEVISION RECEIVERS IN MASS PRODUCTION	86
Circuits and design details of seven-inch ten-inch, and projection models	
ELECTROLYTIC INTEGRATING TUBE, by Jens Sivertsen	92
Explosions of oxygen and hydrogen at regular intervals provide a timing device	
DIODE-CONTROLLED VOLTAGE REGULATORS, by Leo Helterline	96
Filament of temperature-limited diode serves as controlling element of bridge-type regulator circuit	
STATIC FOR RADIO RECEIVER TESTS, by J. C. R. Licklider and E. B. Newman	98
Click, thunderstorm, hiss, or grinder static may be simulated in the laboratory	
PRECISION ENERGY-STORAGE SPOT WELDER, by Rufus Briggs and Hans Klemperer	102
Tube controlled 200-microfarad storage provides precise energy levels for welding thin metal sheets and wires	
OVERVOLTAGE TESTING OF CAPACITORS, by R. J. Hopkins	105
Testing equipment and techniques for voltage tests up to 35,000 volts	
HIGH-FIDELITY REPRODUCTION OF MUSIC, by Emerick Toth	108
Practical suggestions for minimizing six forms of audio distortion occurring in a-m and f-m receivers	
FCC FREQUENCY MEASUREMENT TECHNIQUES, by Alfred K. Robinson	114
Quick and accurate frequency comparison is accomplished using oscilloscope patterns for zero-beat indication	
VANE-ACTUATED CONTROLLER, by W. H. Wannamaker, Jr.	117
Double-triode r-f oscillator for industrial control provides snap action of relay for 0.002-inch movement of vane	
SIMPLIFIED TELEVISION FOR INDUSTRY, by R. E. Barrett and M. M. Goodman	120
Complete circuit of a 250-line 60-frame system using the new type 5527 iconoscope	
NOISE-FREE CODE RECEPTION, by D. L. Hings	125
Damped waves are discriminated against so that c-w signals can trigger an a-f oscillator	
SELF-SWITCHING R-F AMPLIFIER, by H. M. Wagner and J. F. Herrick	128
Multivibrator-amplifier switches circuits operating between 20 and 60 mc to produce square pulses	
TRANSIT-ANGLE SUPPRESSION IN MICROWAVE TUBES, by J. Owen Harries	132
Method of suppressing secondary emission offers increased output, higher efficiency and simpler construction	
CATHODE-FOLLOWER NOMOGRAPH FOR PENTODES, by Melvin B. Kline	136
Relates gain, transconductance, and cathode load resistance to facilitate use of pentodes in circuit design	
BUSINESS BRIEFS	74
CROSSTALK	79
TUBES AT WORK	138
ELECTRON ART	142
NEW PRODUCTS	146
NEWS OF THE INDUSTRY	152
NEW BOOKS	265
BACKTALK	268
INDEX TO ADVERTISERS	283

DONALD G. FINK, Editor; **KEITH HENNEY**, Consulting Editor; **W. W. MacDonald**, Managing Editor; **John Markus**, Vin Zeluff, Associate Editors; **Frank Rockett**, **A. A. McKenzie**, Assistant Editors; **Gladys T. Montgomery**, Washington Editor; **William P. O'Brien**, Make-up Editor; **Dexter Keezer**, Director, Economics Department; **John Chapman**, World News Director; **Harry Phillips**, Art Director; **Eleanore Luke**, Art Assistant

H. W. MATEER, Publisher; **WALLACE B. BLOOD**, Manager; **D. H. Miller**, **H. R. Denmead, Jr.**, New York; **Wm. S. Hodgkinson**, New England; **F. P. Coyle**, **R. E. Miller**, Philadelphia; **C. D. Wardner**, Chicago; **E. J. Smith**, Cleveland; **J. W. Otterson**, San Francisco; **Roy N. Phelan**, Los Angeles; **Ralph C. Maultsby**, Atlanta; **Paul West**, London, England; **J. E. Blackburn, Jr.**, Director of Circulation

Contents Copyright, 1947, by McGraw-Hill Publishing Company, Inc. All Rights Reserved. McGRAW-HILL PUBLISHING COMPANY INCORPORATED, JAMES H. McGRAW, Founder and Honorary Chairman • PUBLICATION OFFICE 99-129 North Broadway, Albany 1, N. Y., U. S. A. EDITORIAL AND EXECUTIVE OFFICES 330 West 42nd St., New York 18, N. Y., U. S. A.—Member A. B. P. Member A. B. C.

James H. McGraw, Jr., President; Curtis W. McGraw, Senior Vice-President and Treasurer; Nelson Bond, Director of Advertising; Eugene Duffield, Editorial Assistant to the President; Joseph A. Gerardi, Secretary; and J. E. Blackburn, Jr., Vice-President for circulation operations. ELECTRONICS, June, 1947, Vol. 20; No. 6. Published monthly, with an additional issue in June, price 75¢ a copy. Directory issue \$2.00. Allow at least ten days for change of address. All communications about subscriptions should be addressed to the Director of Circulation. Subscription rates—United States and possessions, \$6.00 a year, \$9.00 for two years, \$12.00 for three years. Canada (Canadian funds accepted) \$7.00 a year, \$11.00 for two years, \$14.00 for three years. Pan American countries \$10.00 for one year, \$16.00 for two years, \$20.00 for three years. All other countries \$15.00 for one year, \$30.00 for three years. Please indicate position and company connection on all subscription orders. Entered as Second Class matter August 29, 1936, at Post Office, Albany, New York, under the Act of March 3, 1879. BRANCH OFFICES: 520 North Michigan Avenue, Chicago 11, Ill.; 68 Post Street, San Francisco 4; Aldwych House, Aldwych, London, W.C. 2; Washington, D. C. 4; Philadelphia 3; Cleveland 15; Detroit 26; St. Louis 8; Boston 16; Atlanta 3, Ga.; 621 So. Hope St., Los Angeles 14; 738-9 Oliver Building, Pittsburgh 22.

NEW MINIATURE CAPACITORS

for use with Miniature Tubes

Oil-impregnated Paper-dielectric capacitors molded in phenolic

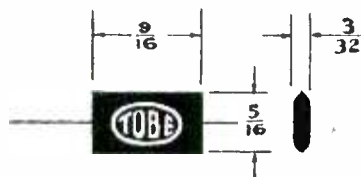
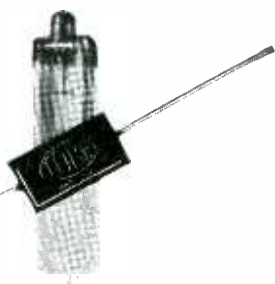

TO MEET REQUIREMENTS for miniature components for use in hearing aids, pocket radio receivers, airborne radio apparatus, and other devices in which economy of space is a primary factor:

SPECIFICATIONS

Impregnation: mineral oil.

Case: molded of mica-filled phenolic; sealed to withstand 90% relative humidity.

Terminal Leads: solid, tinned copper.

Operating Temperature: -55C to +65C; the .001 and .005 Mfd. ratings can be furnished for service up to 85C at slight additional cost.

Working Voltage: 75 volts d-c.

Capacitance Tolerance: +60%, -20%.

Type No.	Capacitance Mfd.	Case Size — Inches			Wire Size	
		Lgth.	Wdth.	Thk.	Dia.	Lgth.
HAC-001	0.001	9/16	5/16	3/32	0.025	1-1/8
HAC-005	0.005					
HAC-01	0.01					
APC-05	0.05	11/16	29/64	7/32	0.032	1-1/8



TOBE DEUTSCHMANN Corporation CANTON, MASSACHUSETTS

• Even K & E has never devised an instrument that would make it unnecessary to think. But we have spent 78 years designing and producing things that make it easier to act after thinking . . . drafting instruments and related materials that give the engineering hand and eye almost the same precision as the engineering brain. How well K & E products serve as partners in creating is shown by the reliance placed in them by engineers and draftsmen throughout the world.

So widely is this equipment used that practically every great American engineering project has been completed with the help of K & E. Could you wish any surer guidance than this in the selection of your own instruments and materials?

To make measurements with the greatest ease and the least chance of error, choose a WYTEFACE* steel tape or tape rule of the type made especially for your work. Their jet black markings against their white background are as easy to read in the brightest glare as in the dimmest light. They are readily kept clean, are rust-resisting and hard to kink. For full information about them write to your nearest K & E Distributor or to Keuffel & Esser Co., Hoboken, N. J.

*Trade Mark

WYTEFACE Steel Tapes and Tape Rules are protected by U. S. Pat. 2,089,209

partners in creating

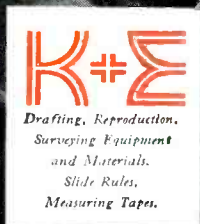
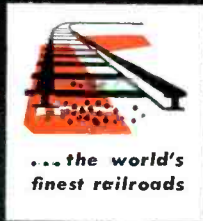
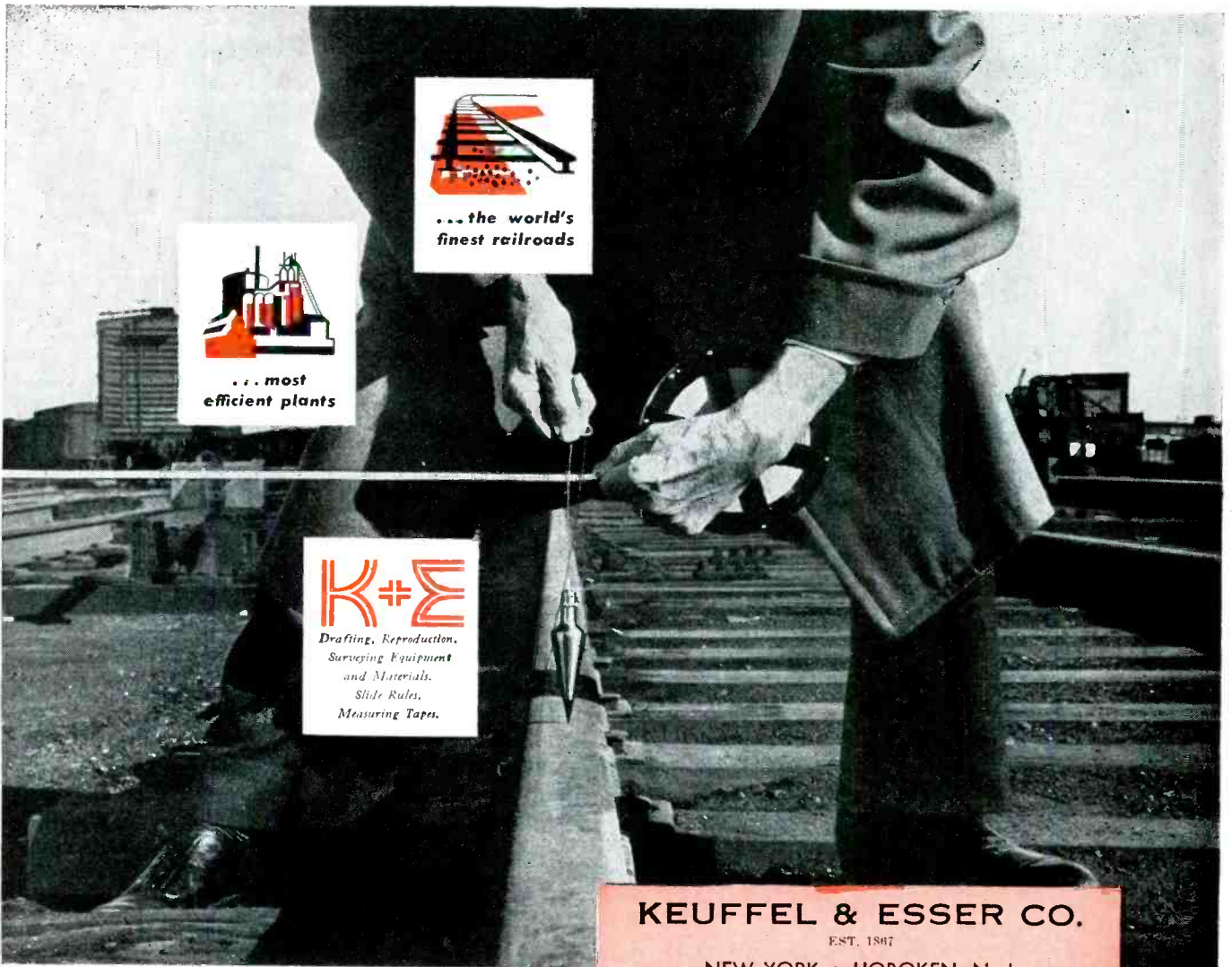

KEUFFEL & ESSER CO.
EST. 1867
NEW YORK • HOBOKEN, N. J.
CHICAGO • ST. LOUIS • DETROIT • SAN FRANCISCO
LOS ANGELES • MONTREAL

Why this team brings you better ELECTRON TUBES

1925. This was one of the earliest photoelectric cells. It was made by Western Electric for use in commercial picture transmission over telephone wires.



1918. This "peanut" tube, the Western Electric 215A, was developed for service in World War I. It was the first commercial tube whose filament was powered by a single dry cell... made possible compact, light weight radio equipment.

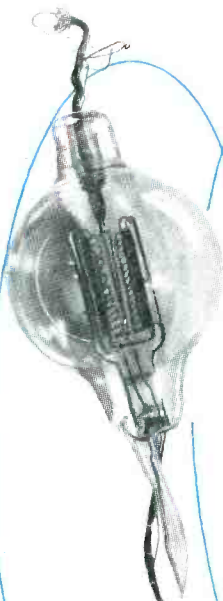

1912. The first effective high-vacuum tube, developed by the Laboratories for long distance telephony, was capable of operation at both audio and radio frequencies, and thus marked the beginning of modern electronics.

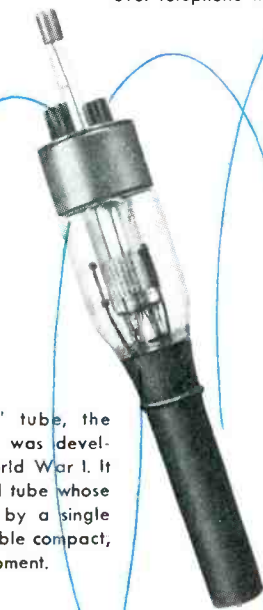

1919. The introduction of the copper-to-glass seal made water cooled tubes practical. The resulting high power tubes were used for broadcasting and for transoceanic radio-telephony.



1940. The beating oscillator, used in the great majority of radar systems. This tube generated a wave in the receiver with which the received microwave was reduced in frequency for amplification.

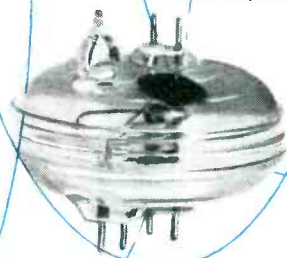

1937. This microwave generator, the 368A, was the first commercial tube to generate frequencies higher than 1500 mc. This type of tube was used by Western Electric in the first absolute altimeter.



—QUALITY COUNTS—

1940. Bell Laboratories produced the first American multicavity pulsed magnetron from a British model. The team of Western Electric and Bell Laboratories developed 75 new and improved magnetron designs by extending operation into the 10 cm, 3 cm and finally the 1 cm bands, and produced over 300,000 of these wonder tubes of World War II.

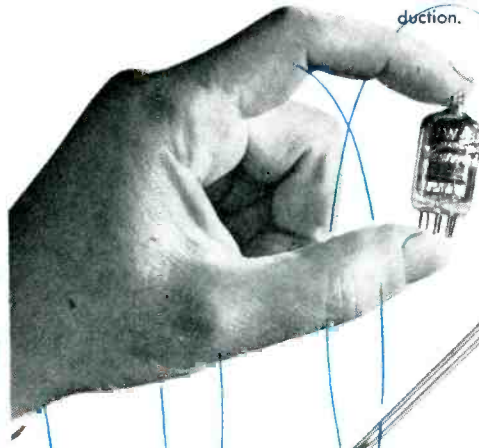

1942. This tiny 6AK5, operating in the vicinity of 400 mc, proved itself invaluable as an amplifier in radar receivers. Design specifications were supplied to other manufacturers by Western Electric to speed war production.

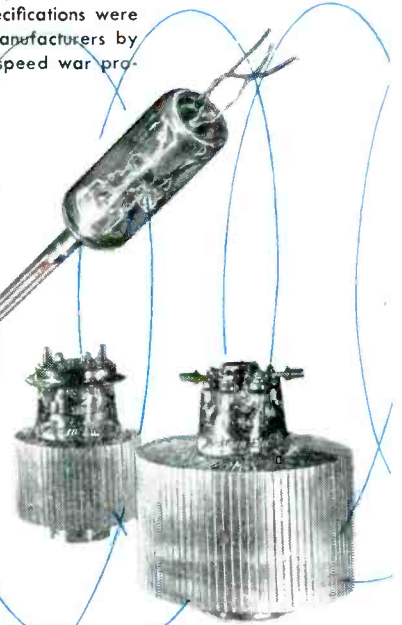

1945. The Bell Laboratories traveling wave tube, still in the research stage, amplifies over a band 40 times wider than present tubes—may be able to amplify dozens of color or black and white television programs simultaneously.

TODAY. These new forced air cooled FM transmitting triodes are among the latest in the line of tubes designed by Bell Telephone Laboratories and made by Western Electric. Their thoriated tungsten filaments, rugged construction, flexible terminal arrangements and many other features make them tops in performance in the 88 to 108 mc band.

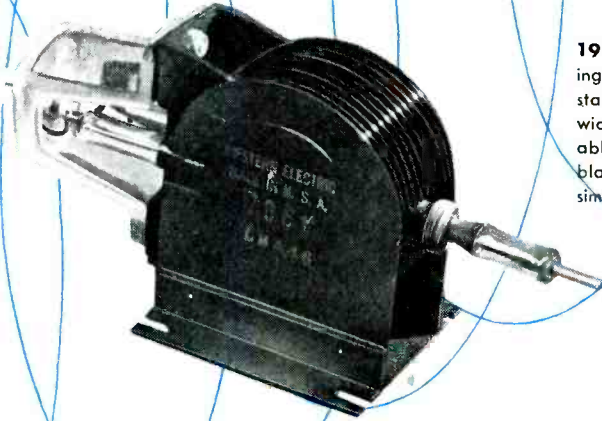

OVER 34 years ago in the laboratories of Western Electric, De Forest's Audion was improved and developed into the high vacuum tube and put to work for the first time amplifying telephone and radio frequency currents. And for over 34 years Western Electric and its research associate Bell Telephone Laboratories have been foremost in designing new and better electron tubes.

Every tube shown here and many developments basic to the tube art are examples of that leadership. More than 10 years ago, for instance, Bell Laboratories first used microchemistry to determine what gases were destructive to tube elements, and with Western Electric developed a manufacturing technique to keep these damaging elements out—thus increasing tube life many-fold.

Every one of the more than 300 codes of electron tubes now being made by Western Electric from Bell Laboratories' designs has the same unequalled background of research and manufacturing skill.



BELL TELEPHONE LABORATORIES

World's largest organization devoted exclusively to research and development in all phases of electrical communications.

Western Electric

Manufacturing unit of the Bell System and the nation's largest producer of communications equipment.

Tops in
Value

HQ-129-X



In the shack and on the air, you hear Hams talking about the HQ-129-X —“Best buy on the market.” “More for your money than anything I’ve seen.” “Real dollar value.” Yes sir, the top value of the HQ-129-X is best proved by the amateurs who own them.

And you get added value from any receiver by installing an FS-135-C Frequency Standard. When you zero beat the FS-135-C with WWV, you’ll know it’s “tops in accuracy.”

FS-135-C
FREQUENCY STANDARD

Tops in

Accuracy

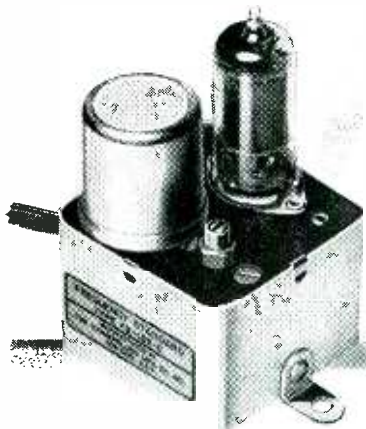

BACKED BY **37** YEARS OF KNOW-HOW

Now Available
At Your Dealer's

HAMMARLUND

THE HAMMARLUND MFG. CO., INC., 460 W. 34TH ST., NEW YORK 1, N.Y.
MANUFACTURERS OF PRECISION COMMUNICATIONS EQUIPMENT



New SILICONE* BUSHINGS..

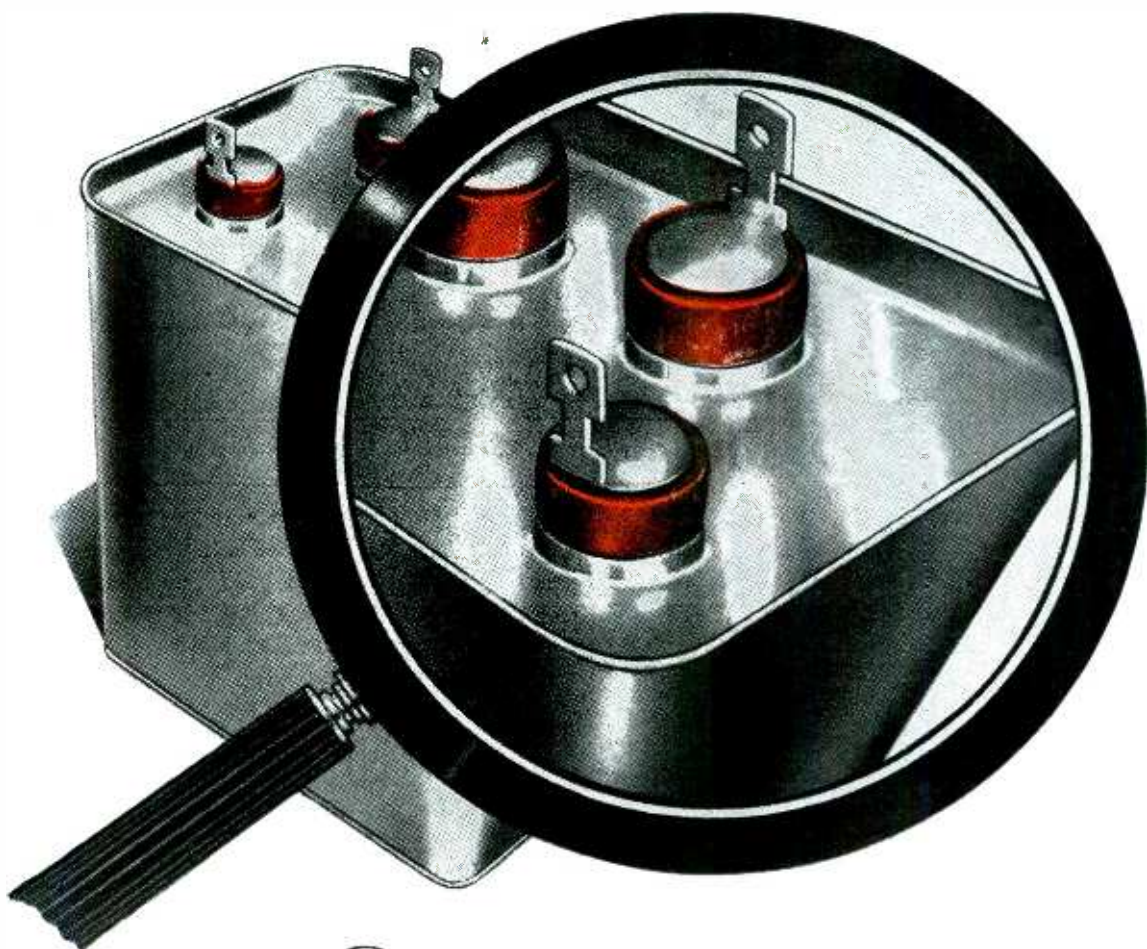

add to reliability of CAPACITORS

Here is a new development of importance to all users of specialty capacitors. It is General Electric's new silicone bushing—available only on G-E capacitors.

This new bushing gives greater dependability and longer life for capacitors. Being elastic, it is self-sealing—permanent, for all practical purposes, in both physical and dielectric properties. Inserted through the openings in the top of the capacitor casing, it seals by compression—without adhesives or gaskets. It retains its elasticity over a wide range of temperatures and will not shrink, pull away, or loosen during the life of the capacitor.

This bushing has other advantages—all of which add to the reliability of

G-E capacitors. The single piece construction provides permanently high dielectric strength and insulation resistance. It is highly resistant to oils, alkalis, and acids; it will not support fungus growth.

Silicone bushings will be used on all General Electric Pyranol* capacitors having solder-lug terminals. This new G-E first is one more reason for selecting General Electric capacitors. Others, all adding to dependability and long life, include the positive sealing of casings by double rolling or roll-crimping and soldering, the use of highest grade materials and superior processing methods, with strict quality control. *Apparatus Dept., General Electric Company, Schenectady 5, N. Y.*

*Reg. U.S. Pat. Off.

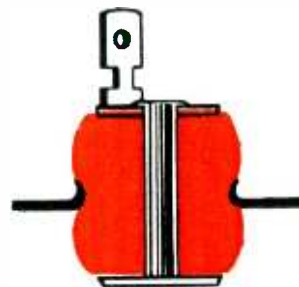

 This bushing represents one of the newest uses for the recently developed G-E family of chemicals called silicones. Permanently elastic, formed to close tolerances, it seals itself by compression to the capacitor casing.

GENERAL ELECTRIC

419-142

The Trend is Toward Ceramic Condensers For By-Pass Applications

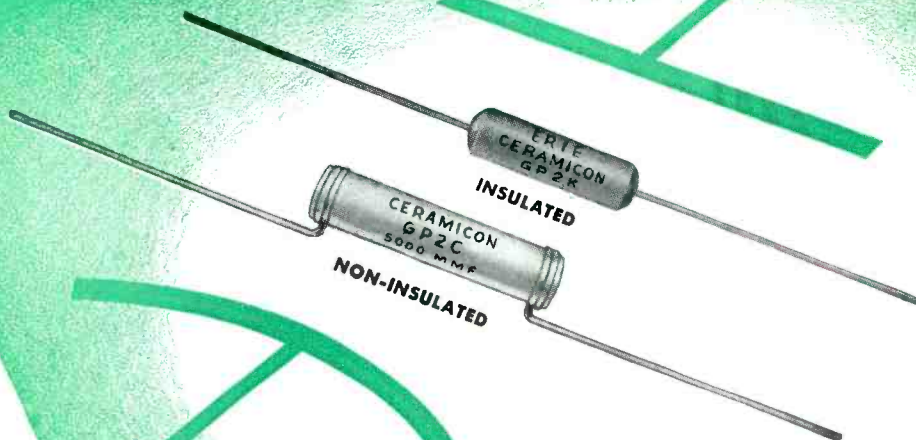

specify *Erie* "GP" *Ceramicons**
for best performance

The Erie line of General Purpose Ceramic Condensers has been set up to provide ceramic dielectric condensers quickly and economically for by-passing and coupling applications.

By "General Purpose" is meant those condensers which are not directly frequency determining, such as those used for AVC Filtering, Resistance-Capacitance Audio Coupling, Tone Compensation, Volume Control R.F. By-Passing, Audio Plate R.F. By-Passing, Oscillator Grid Coupling, R.F. Coupling, Antenna Coupling. In these applications, power factor is not critical and moderate capacity changes caused by temperature variations do not affect the proper functioning of the circuits.

The GP (General Purpose) line of Erie Ceramicons does not sacrifice quality in any way

whatsoever. Since the line of Erie GP Ceramicons is limited to definite capacity values, it is practical to manufacture large quantities of any given value at one time, with consequent saving in production costs.

Condensers classified as GP1 have a temperature coefficient between +/130 and -1600 P/M/°C and are available up to 510 MMF. Condensers classified as GP2, manufactured in capacities of 150 MMF and higher, may include all of the above dielectrics and, in addition, the Erie Hi-K type.

Erie GP Ceramicons are made in insulated styles in popular capacity values up to 5,000 MMF and in non-insulated styles up to 10,000 MMF. Write for full details.

*Ceramicon is the registered trade name of silvered ceramic condensers made by Erie Resistor Corporation.

Electronics Division

ERIE RESISTOR CORP., ERIE, PA.
LONDON, ENGLAND • • TORONTO, CANADA



Over 100 Stations Fully Equipped by Raytheon in Less Than One Year

An enviable record based on advanced engineering and modern design

More and more station owners every day are turning to Raytheon for the very finest in broadcast equipment. Raytheon is leading the way with simplified circuit design, thorough engineering and complete dependability.

Across the nation, enthusiastic station owners and engineers (both AM and FM) praise the high fidelity, servicing accessibility and low-cost maintenance of Raytheon broadcast equipment—from Single-Channel Remote Amplifiers to 5 KW Transmitters. With Raytheon equipment they find it far easier to set up programs—and operation is so simple and logical that errors are cut to a minimum.

Be sure you have *all* the facts before you buy. Investigate Raytheon's complete line of speech input equipment and both AM and FM Transmitters ranging from 250 to 10,000 Watts.

These superb Raytheon products assure the most practical application to *your* specific broadcast problem . . . bring you the finest in modern high fidelity and engineering excellence. Write or wire for illustrated specification bulletins, including complete technical data.

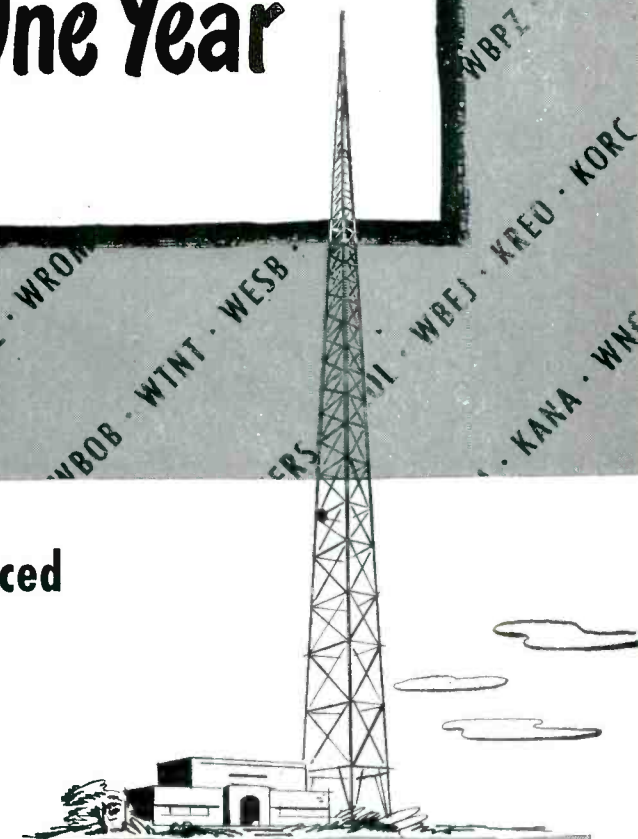

RAYTHEON

Excellence in Electronics

RAYTHEON MANUFACTURING COMPANY
BROADCAST EQUIPMENT DIVISION
7475 N. ROGERS AVE., CHICAGO 26

Devoted to Research and Manufacturing for the Broadcasting Industry

Centralab reports to

JUNE 1947

Revolutionary new
Slide Switch reduces
lead inductance for
improved AM-FM
performance!

Wide silver-plated
brass contacts for
low inductance.

Double-wipe clips assure
constant pressure and
low internal resistance.

Positive coil spring index.
 $\frac{1}{4}$ " slide movement
per position.

Flat, one-plane design
permits coil-mounting
directly over switch.

I Designed for peak AM and FM performance plus maximum reliability and long service life, Centralab's new slide switch now gives you flat, horizontal design that saves space, permits convenient location to coils, reduced lead inductances. "Twisted

car" mounting on base or panel from .038" min. to .052" max. Optional size or length of unit — min. 5 clips per side, max. 20 clips per side. 2 or 3 position, shorting type contacts. Movement of slide per position — $\frac{1}{4}$ inch. Send for bulletin 953.

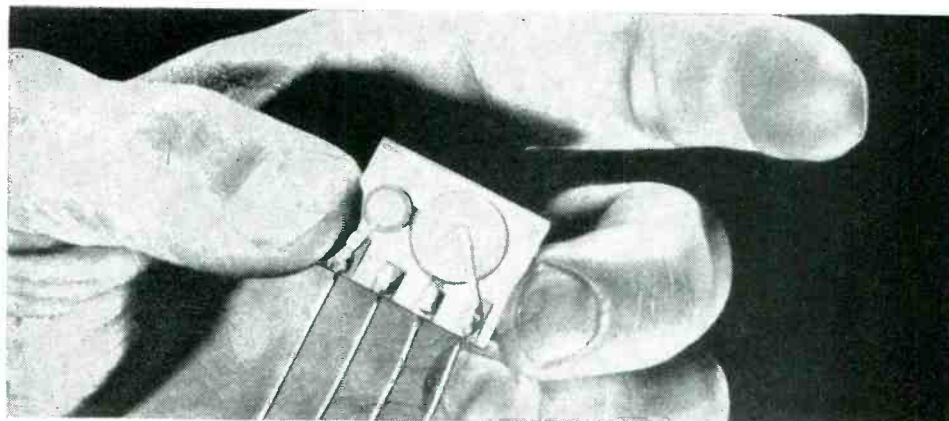
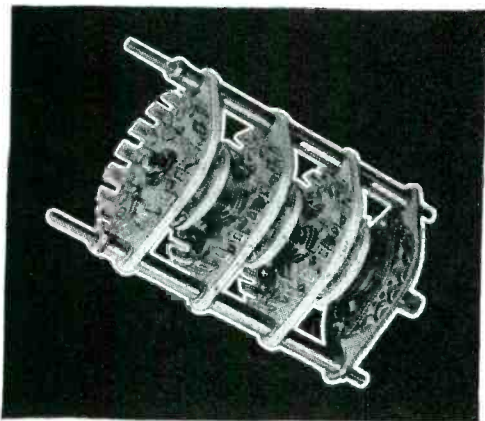

2 For transmitters, power supply converters, X-ray equipment, etc., CRL's medium-duty power switches are now available. Efficient performance up to 20 megacycles.

3 First commercial application of the "printed circuit" and now available for the first time, Centralab's new *Complate* offers a complete interstage coupling circuit which combines into one unit the plate load resistor, the grid resistor, the plate by-pass capacitor and the coupling capacitor.

Electronic Industry

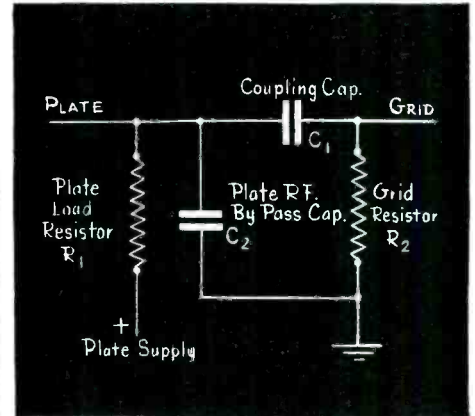
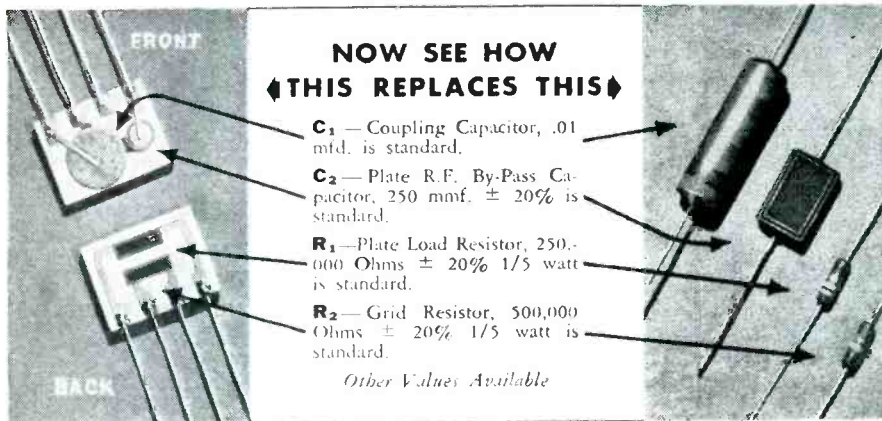

4 Integral Ceramic Construction: Each *Couplate* is an integral assembly of "Hi-KAP" capacitors and resistors closely bonded to a steatite ceramic plate and mutually connected by means of metallic silver paths "printed" on the base plate. Think of what that means in terms of time and labor savings! Send for bulletin 943.

5 Only four soldered connections are now required by the *Couplate* instead of the usual eight or nine . . . (see above). That means fewer errors, lower costs!

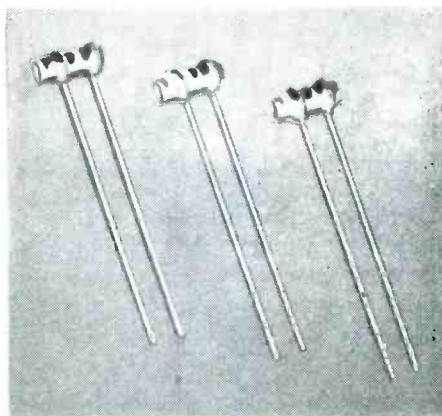

6 Watch for something new in CRL's line of dependable, high quality ceramic by-pass and coupling capacitors. Soon available at your nearby Centralab distributor!

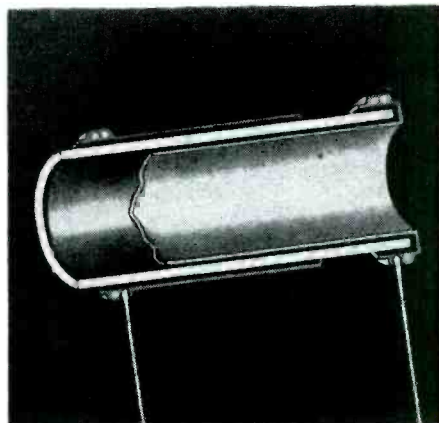

7 There's none better than this line of ceramic capacitors which combines economy, small size and extreme dependability.

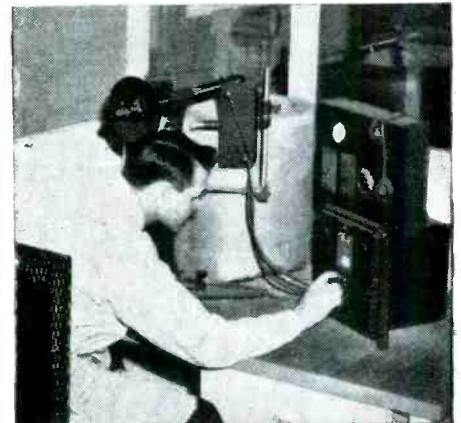

8 Made from Centralab's original Ceramic-X, this complete line is result of our continuing research in high dielectric constant ceramics. Order bulletin 933.

Look to Centralab in 1947! First in component research that means lower costs for electronic industry. If you're planning new equipment, let Centralab's sales and engineering service work with you. Get in touch with Centralab!

Centralab

DIVISION OF GLOBE-UNION INC., MILWAUKEE, WIS.

**IF HEAT
Hinders Performance
CUSTOMERS
GO COLD
on your products**



ROCKBESTOS WIRES AND CABLES *withstand heat, aging, flame and fumes*

Users of your products are not getting the benefits your advertising promises if wire failures from high operating or ambient temperatures are interrupting performance. Worse, when products "bounce back" for repairs, servicing or replacement you're losing more than money — you're losing sales-building prestige.

Many manufacturers of products as varied as radios and hot metal cranes, appliances and mining machines, have put a stop to *that headache* by wiring with Rockbestos wires, cables and cords! Here's what they get:

- *Permanent insulation* with impregnated felted asbestos (Best thing in the world to prevent wire failures caused by heat)
 - No rotting, blooming or swelling from oil, grease or corrosive fumes
 - No baking brittle from conductor-heating overloads
 - No destructive and expensive wire-fires
 - No deterioration from age or oxidation
 - Stepped up current carrying capacity via high heat resistance
- You'll protect performance, sales and profits when you make Rockbestos a "must" in your product wiring. 125 *permanently insulated* constructions from Firewall Hookup Wire to 5000 Volt Rockbestos A.V.C. Power Cable, comprise the Rockbestos line. Write for recommendations and catalog.

ROCKBESTOS PRODUCTS CORP., 448 Nicoll St., New Haven 4, Conn.

ROCKBESTOS

The Wire with Permanent Insulation

NEW YORK
CHICAGO PITTSBURGH

BUFFALO
ST. LOUIS LOS ANGELES

CLEVELAND
SAN FRANCISCO

SEATTLE

DETROIT
PORTLAND, ORE.

A few of the 125 permanently insulated wires, cables and cords developed by Rockbestos to protect product performance and give lasting service.



ROCKBESTOS FIREWALL HOOKUP WIRE

This heat, flame and moisture resistant wire, insulated with high dielectric tapes and impregnated felted asbestos and covered with color-coded, lacquered glass braid, has a maximum operating temperature of 125° C. Ideal for radios, television, amplifiers, calculators or small motor, coil, dynamotor and transformer leads. No. 22 to 4AWG in 1000 volt rating — No. 12, 14 and 16 AWG in 3000 volt rating.



ROCKBESTOS THERMOSTAT CONTROL WIRE

A multi-conductor control wire for fuel burner controls, safety pilots, intercommunications and signal systems. Its asbestos insulation and steel armor assure trouble-free circuits. Sizes No. 14 to 18 AWG in two to five conductors with .0125", .025" or (for 115 volt service) .031" of impregnated asbestos insulation.



ROCKBESTOS A.V.C. MOTOR LEAD CABLE

Use this 600 volt apparatus cable for coil connections, motor and transformer leads exposed to overloads and high ambient temperatures. Insulated with impregnated felted asbestos and varnished cambric, and covered with a heavy asbestos braid, it is heat-proof and resistant to oil, grease, moisture and flame. Sizes 18 AWG to 1,000,000 CM.



NOW!

A GREAT NEW OSCILLATOR FOR THE LOW-FREQUENCY FIELD

1/2 to 1000 CYCLES

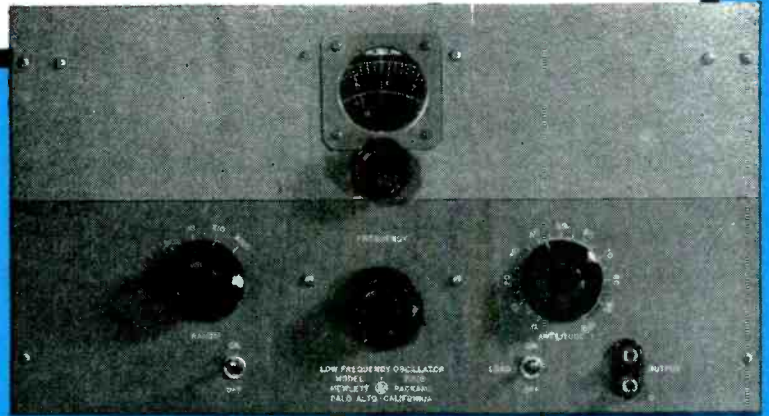

-hp- 202B LOW-FREQUENCY OSCILLATOR

Now, for the first time in history, you can make low frequency measurements with all the precision and stability associated with audio frequency work. This great new *hp*- oscillator blankets the low-frequency spectrum from 1/2 to 1000 cps. Throughout this range it provides better wave form, higher stability and greater measuring accuracy than any comparable in-

strument ever manufactured for industrial, field or laboratory use.

Compact, sturdy, easy-to-operate, this *hp*-202B spans the low-frequency band in 4 ranges. Frequency is read on a large, illuminated dial, which is controlled by a direct or a 6 to 1 vernier drive. Frequency stability is within $\pm 5\%$, including initial warm-up drift. Output is 10 volts maximum into a 1000 ohm resistive load.

The rugged practicality, low cost and unusual versatility of this brand new *hp*- oscillator make it an essential instrument for any operation involving low frequency work. The *hp*-202B is ready for early shipment. Write or wire for full information.

HEWLETT-PACKARD COMPANY
1470A Page Mill Road • Palo Alto, California

This *hp*- 202B gives maximum speed and accuracy for these important tests

Vibration or stability characteristics of mechanical systems

Electrical simulation of mechanical phenomena

Electro-cardiograph and electro-encephalograph performance

Vibration checks of aircraft structural components

Checking geophysical prospecting equipment

Response of seismographs

SPECIFICATIONS

FREQUENCY RANGE: 1/2 cps to 1000 cps in 4 ranges

Range	Frequency
A	1/2 - 1 cps
X1	1 - 10 cps
X10	10 - 100 cps
X100	100 - 1000 cps

FREQUENCY DIAL: 6" diameter. Reads directly in cps for two lower ranges. Dial is back of panel, illuminated, and is controlled by direct drive as well as a 6 to 1 vernier.

ACCURACY OF CALIBRATIONS: $\pm 2\%$

FREQUENCY STABILITY: $\pm 5\%$ under normal temperature conditions (including warm-up drift). Less than $\pm 1\%$ for power voltage changes of $\pm 10\%$.

OUTPUT: 10 volts into a 1000 ohm resistive load over the entire frequency range. Internal impedance approximately 25 ohms at 10 cps.

FREQUENCY RESPONSE: ± 1 db 10-1000 cps
 ± 2 db 1-1000 cps

DISTORTION: Less than 1% total distortion 1 cps to 1000 cps.

HUM VOLTAGE: Less than 0.1% of rated output voltage.

 **laboratory instruments**
FOR SPEED AND ACCURACY

Noise and Distortion Analyzers Wave Analyzers Frequency Meters
Audio Frequency Oscillators Audio Signal Generators Vacuum Tube Voltmeters
Amplifiers Power Supplies UHF Signal Generators Attenuators
Square Wave Generators Frequency Standards Electronic Tachometers

THIS IS THE WORLD'S FINEST SET TESTER

...because it is Simpson-built!

Simpson Model 260 Volt-Ohm-Milliammeter

There has never been any serious question, since its introduction several years ago, that the Simpson Model 260 is the world's finest high sensitivity set tester for television and radio servicing. It has always been in advance of its field because it has been kept there by Simpson design and Simpson manufacture. Today the statement we have often made is truer than ever: that you cannot touch its precision, its useful ranges, or its sensitivity in any other instrument of equal price or selling for substantially more.

You need only remove Model 260 from its handsome case of black, molded bakelite to see how it differs from other instruments. Look at the sub-panel—here are a score of small recesses, each one holding a separate resistor. All connections are short and direct, eliminating the need for cable wiring. Here is a kind of strength and firmness of assembly you will not see elsewhere, the finest of insulation with reduced chances of shorts, the highest degree of accessibility of components. The front panel shows similar refinements: pin jacks firmly set into molded recesses so that there are no exposed metal parts on the panel; all figures and symbols molded into the heavy bakelite panel, then filled with white, so that they have greatest legibility and longest wearing qualities.

These refinements are, of course, what you expect from a manufacturer able to produce a circuit design and meter movement construction that have made this the most wanted set tester ever marketed.

★ **All this, and the Roll Top Safety Case, too—**

Simpson has a new kind of answer to the carrying case problem—the Roll Top Safety Case. Here's how we do it: we take the Model 260, place it inside a housing of heavily molded bakelite, and permanently fasten it there. Instrument and case become one unit. Beneath the instrument is a compartment for test leads. Over the face of the instrument a roll top (of molded bakelite, too) slides up to open, down to close, the case. With a flick of the finger you roll it up and out of sight and the instrument is ready to use. Another flick, and the roll top is down and the instrument is ready to carry, and fully protected. With the Roll Top Safety Case you cannot leave your carrying case behind. It is never in the way. And you have constant, important protection to your 260 from damage, whether in use or not.

The Model 260, like other Simpson test equipment, is made almost entirely within the various Simpson plants. Each component part has been designed and completely tooled and manufactured in our own plants, with very unimportant exceptions. The Simpson Model 260 is not an assembly job, as is true of so many testers on the market. Its unvarying quality is the result of control at every minute step of its manufacture. That is why your investment in a Simpson Model 260 is a lifetime investment in that famous Simpson accuracy which lasts as long as the instrument itself.

SIMPSON ELECTRIC COMPANY
5200-5218 W. Kinzie Street, Chicago 44, Ill.
In Canada, Bach-Simpson, Ltd., London, Ont.

Simpson

INSTRUMENTS THAT STAY ACCURATE

SIMPSON 260, HIGH SENSITIVITY SET TESTER FOR TELEVISION AND RADIO SERVICING

Ranges to 5000 Volts—Both A.C. and D.C.
20,000 Ohms per Volt D.C.
1000 Ohms per Volt A.C.

At 20,000 ohms per volt, this instrument is far more sensitive than any other instrument even approaching its price and quality. The practically negligible current consumption assures remarkably accurate full scale voltage readings. D.C. current readings as low as 1 microampere and up to 10 amperes are available.

Resistance readings are equally dependable. Tests up to 20 megohms and as low as 1/2 ohm can be

made. With this super sensitive instrument you can measure automatic frequency control diode balancing circuits, grid currents of oscillator tubes and power tube, bias of power detectors, automatic volume control diode currents, rectified radio frequency current, high- μ triode plate voltage and a wide range of unusual conditions which cannot be checked by ordinary servicing instruments.

Model 260 \$38.95
Model 260, in Roll Top Safety Case . . . \$43.75
Both complete with test leads

ASK YOUR JOBBER



JUST ROLL IT UP





RANGES

Volts D.C. (At 20,000 ohms per volt)	Volts A.C. (At 1,000 ohms per volt)	Output	Milli- amperes D.C.	Micro- amperes D.C.	Ohms
2.5	2.5	2.5 V.	10	100	0-2000 (12 ohms center)
10	10	10 V.	100		0-200,000 (1200 ohms center)
50	50	50 V.	500		0-20 Megohms (120,000 ohms center)
250	250	250 V.		Amperes D.C. 10	
1000	1000	1000 V.			
5000	5000	5000 V.			(5 Decibel ranges: -10 to +52 DB)

PICK A NUMBER
 ANY FREQUENCY FROM 40 TO 1,000,000 C.P.S.

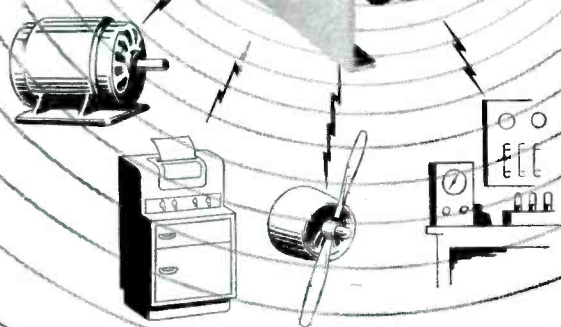
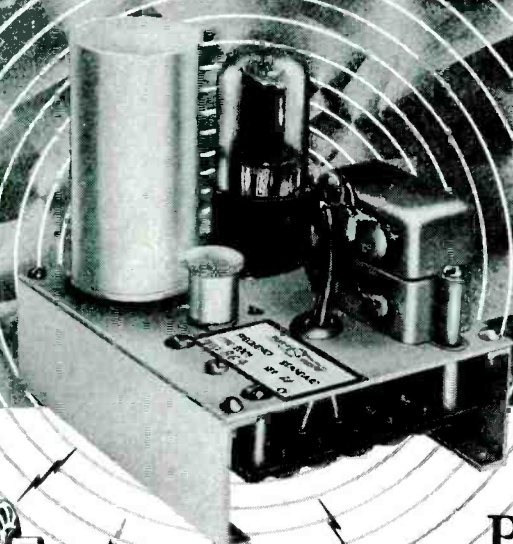

Pictured here is a tuning-fork frequency standard with accuracy guaranteed to one part per million per degree Centigrade. The fork is temperature-compensated and hermetically sealed against variations of barometric pressure. This standard, when combined with basic equipment, facilitates accurate speed and time control by mechanical, electrical, acoustical or optical means.

The unit is available separately or in conjunction with complete timing instruments. Our engineers are ready to cooperate on any problem.

MOTORS - FACSIMILE - AIRCRAFT - LABORATORIES

American Time Products, Inc.
 580 Fifth Avenue
 New York, N. Y.

OPERATING UNDER PATENT OF THE WESTERN ELECTRIC COMPANY

FIRST in discovering the laws of electrodynamics

André-Marie Ampère (1775-1836)

Called the "Newton of Electricity," this brilliant French physicist, inspired by the experiments of Oersted, constructed the first solenoid, the first electromagnet, and in 1820 created a new branch of physics—electrodynamics—and established its basic laws. Today his name is used as the symbol for the unit of electric current.

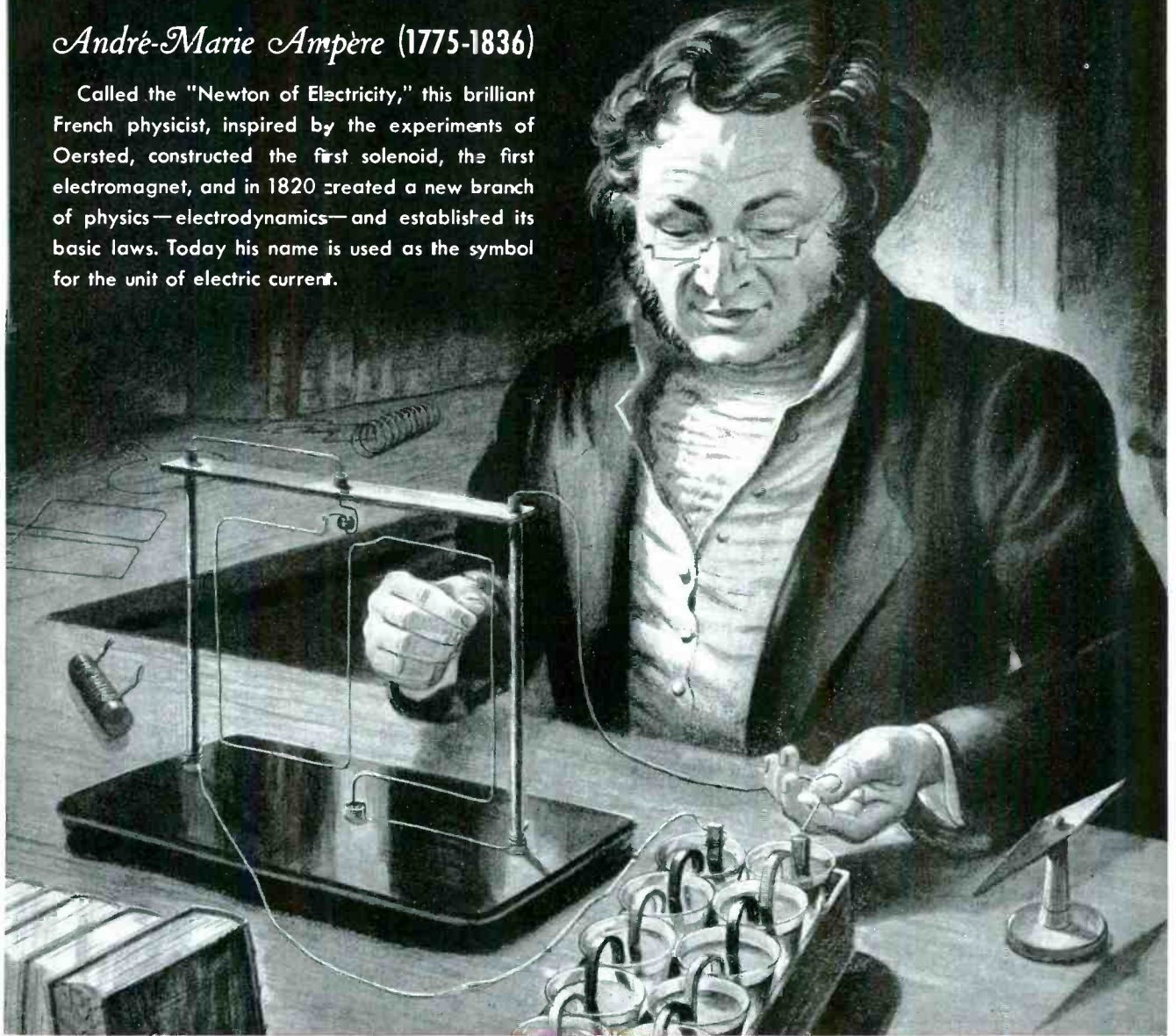

FIRST in Tap Switches...Today

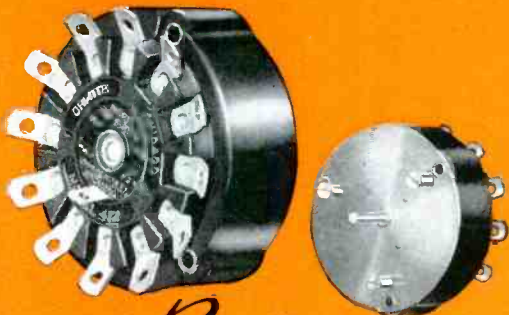

More manufacturers have standardized on Ohmite high-current tap switches for their products...more companies are buying these tap switches for their own use...than any other make on the market today. The primary reason for this industry-wide preference for Ohmite tap switches is their proved ability to give extra years of un failing, trouble-free service.

Be Right with...

OHMITE

RHEOSTATS • RESISTORS • TAP SWITCHES

OHMITE

ALL CERAMIC • POWER TYPE
NON-SHORTING

Tap Switches

MODEL 608

FIVE SIZES

MODEL 412

MODEL 312

MODEL 212

MODEL 111

Model 608—100 Amp

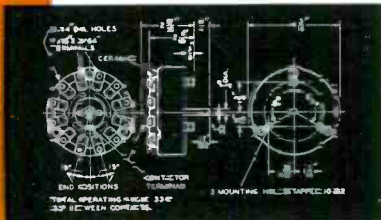

Model 412—50 Amp

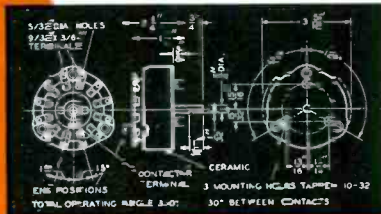

Model 312—25 Amp



Model 212—15 Amp

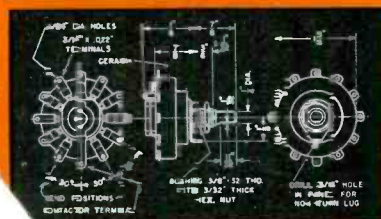

Model 111—10 Amp

Compact-Dependable

Here's a line of non-shorting, rotary tap switches that combine high current-capacity and a large number of taps, with unusual compactness. Their sturdy one-piece ceramic bodies provide permanent insulation, as the ceramic is not affected by arcing. The heavy silver-to-silver contacts have a self-cleaning action, and (except for Model 111) are totally enclosed and protected. Switch shafts are electrically dead—insulated by strong ceramic hubs. A positive cam-and-roller mechanism provides "slow-break quick-make" action—particularly designed for a alternating current use. Two or three of these Ohmite tap switches can be mounted in tandem to form multiple-pole assemblies.

Send for Catalog and
Engineering Manual No. 40



Write now,
on company
letterhead,
for your
copy of this
helpful 96-
page Ohmite
catalog.

OHMITE
MANUFACTURING
COMPANY
4818 Flournoy
Chicago 44, Ill.



Be Right with...

OHMITE
RHEOSTATS • RESISTORS
TAP SWITCHES

Industry's First Choice

SYLVANIA RESEARCH NEWS



JUNE

Prepared by SYLVANIA ELECTRIC PRODUCTS INC., Bayside, L. I.

1947

INTRICATE LABORATORY TECHNIQUES GUARD QUALITY OF TUNGSTEN IN SYLVANIA TUBES

Basic Studies of Wire Conducted at Each Stage of Production to Insure Electronic Tube Perfection

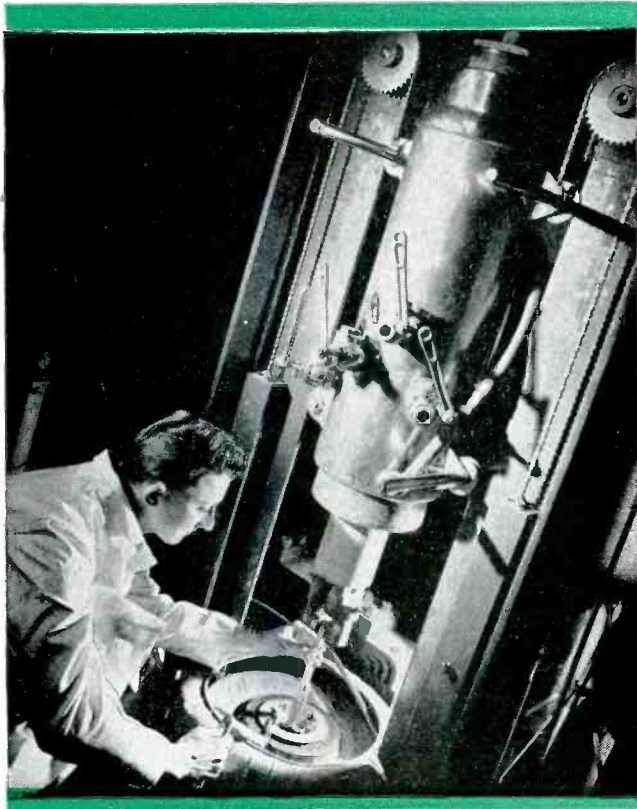

Tungsten for radio tubes (and incandescent lamps) is prepared by heating the powdered tungsten bars to incandescence in sintering bottle. Researcher is placing tungsten bar between electrodes which will pass 150 kw through slug and heat it to 6800° F. Hydrogen atmosphere prevents oxidation. During sintering operation the porous tungsten powdered bar is transformed into a homogeneous metallic slug which can be swaged and drawn down to wire of a diameter as low as .0004".

Two of the many metallurgical tests constantly carried on by Sylvania Electric are illustrated here.

To insure electronic tube perfection — to have Sylvania radio tubes measure up to long-established Sylvania standards — every important type of research technique is utilized.

Here electron microscopes, giving magnifications of thousands of times, are employed. Hardness testers, sag testers, gas analysis equipment, tensile testers are but a few of the methods used to guard the high quality of tungsten utilized.

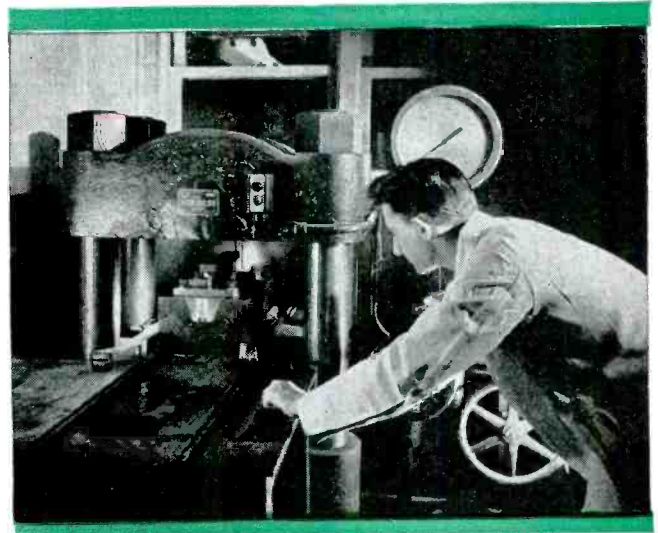

Prior to sintering operation shown at left, tungsten bars of approximately 1/2" square are prepared by pressing finely divided metal powder under hydraulic pressures of up to 300 tons. The equipment used to pursue such studies is illustrated in the above photograph.

Both of the photographs shown here are indicative of the fundamental studies that have resulted in the development and maintenance of tungsten wire of superior quality.

Radio Tube Division, Emporium, Pa.

SYLVANIA ELECTRIC

MAKERS OF RADIO TUBES; CATHODE RAY TUBES; ELECTRONIC DEVICES; FLUORESCENT LAMPS, FIXTURES, WIRING DEVICES; ELECTRIC LIGHT BULBS

LET BENTLEY, HARRIS WAR-TIME RESEARCH PAY DIVIDENDS FOR YOU TODAY.

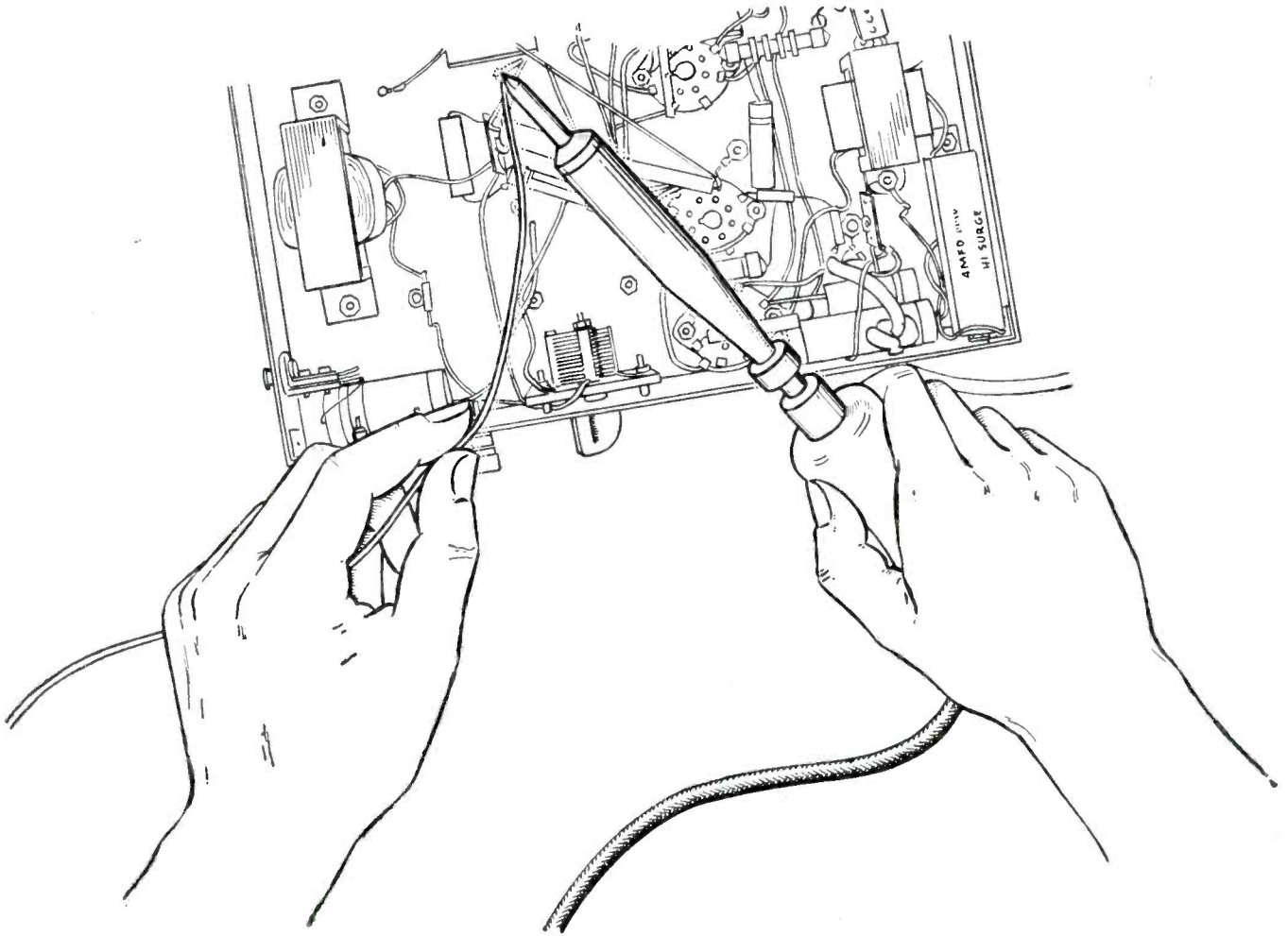

Soldering irons require an insulation of high dielectric strength that can stand temperatures up to 1200° F.—will not react to heat conducted through wire. Read the results obtained by a manufacturer who put this problem up to Bentley, Harris:

"We tested BH Fibreglas Sleevings in our soldering irons for over 1,000 hours of continuous duty, heating and cooling over 2,000 times. The results were entirely satisfactory without any defect in

heat resistance or in required dielectric strengths."

Test BH Fibreglas Sleevings in your own plant, in your own product—under actual service conditions. Compare it with ordinary saturated sleeving. See how it remains flexible as string and non-fraying. Learn why America's leading makers of home appliances, radios and industrial equipment have standardized on BH Fibreglas Sleevings in their plans for post-war production.

BENTLEY, HARRIS MFG. CO., CONSHOHOCKEN, PA.

BH *Fibreglas** SLEEVINGS

*BH Non-Fraying Fibreglas Sleevings are made by an exclusive Bentley, Harris process (U. S. Pat. No. 2393530). "Fibreglas" is Reg. TM of Owens-Corning Fibreglas Corp.

USE COUPON NOW

Bentley, Harris Mfg. Co., Dept. E-11, Conshohocken, Pa.

I am interested in BH Non-Fraying Fibreglas Sleevings for _____ (product)

operating at temperatures of _____°F. at _____ volts. Send samples so I can see for myself how BH Non-Fraying Fibreglas Sleevings stays flexible as string, will not crack or split when bent.

NAME _____ COMPANY _____

ADDRESS _____

Send samples and prices on other BH Products as follows:

- Magneto Varnished Tubing Grade "A"
- Flexible Varnished Tubing Grade "B"
- Saturated Sleevings Grade C-1
- Saturated Sleevings Grade C-2
- Saturated Sleevings Grade C-3

Truarc Beveled Ring takes up end-play, eliminates shims, saves 20 minutes' assembly time

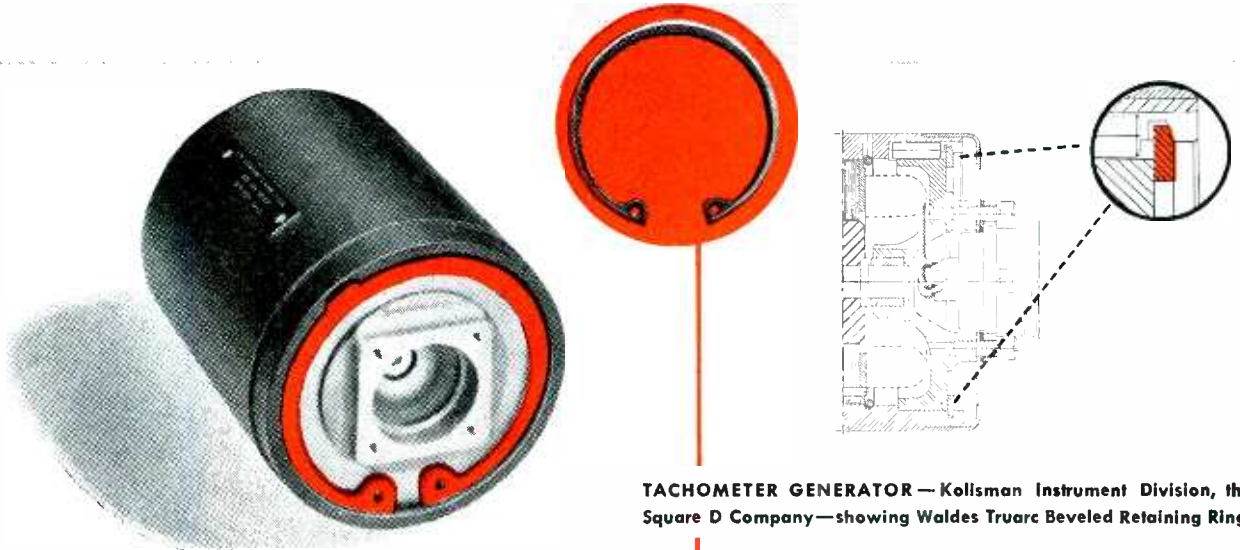

TACHOMETER GENERATOR—Kollsman Instrument Division, the Square D Company—showing Waldes Truarc Beveled Retaining Ring.

When installed in a groove with a corresponding bevel, the tapered edge of the Beveled ring acts like a wedge and rigidly bridges end-play. End-play can also be taken up resiliently by another type Truarc ring—the Bowed.

Wherever you use machined shoulders, nuts, bolts, snap rings, cotter pins—there's a Truarc ring that does a better job of holding parts together. All Truarc rings are precision engineered, easy to assemble and dis-assemble, always circular to give a never-failing grip. They can be used over and over again.

See what can be done for your product: send a drawing to Waldes Truarc Technical Service Engineers for individual attention without obligation.

One Waldes Truarc Beveled Retaining Ring gives Five big advantages:

- Secures the cover with its connecting parts in the housing against strong pressure, heavy vibration
- Absorbs accumulated tolerances up to .010 (ring diameter is 1.9375)
- Eliminates shims, saves material and weight
- Saves 20 minutes' assembly time
- Simplifies field maintenance by facilitating quick dis-assembly, re-assembly

**Mail this coupon today for your copy of "New Development in Retaining Rings"*

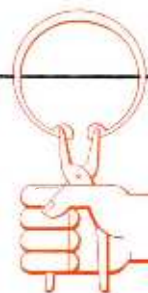

WALDES
TRUARC

Reg. U. S. Pat. Off.

RETAINING RINGS

WALDES KOHINOOR, INC., LONG ISLAND CITY 1, NEW YORK
Canadian Distrib.: Controlite Engineering & Sales Ltd., 20 Bloor Street W., Toronto 5



Waldes Kohinoor, Inc., 47-10 Austel Place 18-P
Long Island City 1, N. Y.

Please send booklet, "New Development In Retaining Rings" to:

Name _____

Title _____

Company _____

Business Address _____

City _____ Zone _____ State _____

WALDES TRUARC RETAINING RINGS ARE PROTECTED BY U. S. PATS. 2,302,948, 2,026,454; 2,416,852 AND OTHER PATS. PEND.

Powering the Fingers that Fish for Tin

DESIGN

MANUFACTURING

One of the largest placer dredges ever built in the United States is intended for tin mining service off the East Indies. Massive equipment of this order presents a problem in maneuvering, particularly under such variable conditions as dredging. Where loads are massive and maneuverability tough—the Ward Leonard system of control has always been recognized as the only truly dependable means of regulating motor speeds. Hence its selection for this particular job.

Result: highest over-all efficiency under a wide range of severe operating conditions.

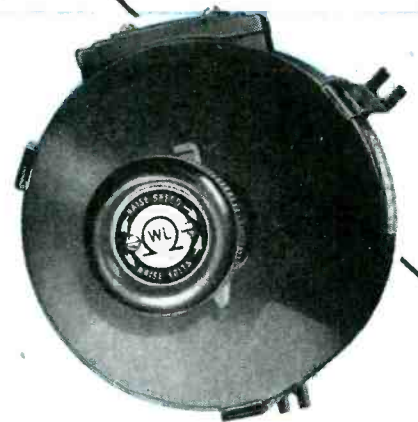

WARD LEONARD ELECTRIC CO.

Where Basic Designs in Electric Controls

TAPPED AND POWERED TO SUIT THE CASE

Ward Leonard Rheostats are the controlling elements in the Ward Leonard System of Control. Ward Leonard Field Rheostats are arranged with 72 to 165 steps of solid brass rectangular contacts and a copper graphite shoe providing the smoothest possible control. For generator fields they are available in several multiples of field resistance values and designed for a straight line relation between the steps of the rheostat and field current.

These rheostats are available in every known kind of mounting, in single and multiple plate, open or enclosed, manual or motor drive.

Result accurate selection of the right rheostat with complete confidence of trouble-free performance.

RESULT-ENGINEERED Without "CUSTOM-ENGINEERING" Costs

Knowing the result you want to obtain with an electric control, it is often possible to modify a Ward Leonard basic design to meet your specific requirements more efficiently and without the usual high cost of a "special".

BLUE MEANS **R**esult-**E**ngineering

In resistors, rheostats, relays and other electric controls, the distinctive blue identifies Ward Leonard "result-engineering".

FREE BULLETINS on "Result-Engineered" Rheostats

Please request on business letterhead, mentioning your title

WARD LEONARD ELECTRIC CO.

Mount Vernon, New York • Offices in principal cities of U. S. and Canada
RESISTORS • RHEOSTATS • RELAYS • CONTROL DEVICES

are "**R**esult-**E**ngineered" for You

"Drive Faster... set up solid, without burrs" says **EVINRUDE**



NO WOBBLY STARTS and slow driving to avoid skids here. Phillips Screws go in fast, set up tight and flush to hold cover of water jacket.

DRIVING TIME CUT 30% in fastening base plate to muffler assembly with Phillips Screws. Power driver centers and stays in recess—no slips.

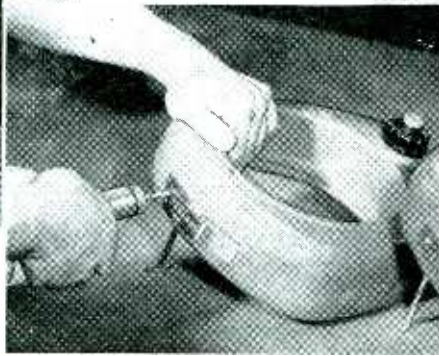

... Key points of another study of assembly savings made with Phillips Screws in leading plants; from report of James O. Peck Co. independent investigator.

"Obvious assembly savings prompted our use of Phillips Head Screws in the 'Zephyr' Outboard Motor," explained Evinrude's Works Manager, "and results are even better than expected."

"Phillips Screws make the most of power tool speed. No lost motion as when driving slotted screws. We just bring the driver bit down and it automatically centers and seats in the Phillips Recess. That makes for a

TIGHT FASTENING is essential in joining the two parts of die cast fuel tank, so Evinrude depends on Phillips Screws. Photo shows use of Phillips Screws for attaching nameplate where skids would mean expensive refinishing.

★ ★ ★

very fast operation...and an economical assembly. Also, we avoid driver skids, and subsequent expensive refinishing.

"We have to set 'em up solid, and the Phillips Recessed Head can take the necessary torque without breaking or burring. Outboards often get rough usage, and

Phillips Screw fastenings match the sturdiness of the overall construction.

"**Dangerous burrs avoided.** Workmen can get bad cuts on hands and arms from sharp burrs common to slotted screws. With Phillips Screws, that hazard is banished, and the burr-free, ornamental recess has a much more shipshape appearance.

You'll find good ideas for your assembly operations in the complete report of this and other assembly studies... on metal, wood, and plastic products. Inside facts on modern methods of America's best assembly engineers. **FREE**—use coupon.

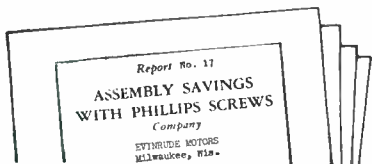

Phillips Screw Mfrs., c/o Horton-Noyes
1800 Industrial Trust Bldg.,
Providence, R. I.

PHILLIPS *Recessed Head* SCREWS

Wood Screws • Machine Screws • Self-tapping Screws • Stove Bolts

23 SOURCES

American Screw Co.
Central Screw Co.
Continental Screw Co.
Corbin Screw Div. of
American Hdwe. Corp.
The H. M. Harper Co.
International Screw Co.
Lamson & Sessions Co.
Milford Rivet and Machine Co.
National Lock Co.

National Screw & Mfg. Co.
New England Screw Co.
Parker-Kalon Corporation
Pawtucket Screw Co.
Pheoil Manufacturing Co.

Reading Screw Co.
Russell Burdall & Ward
Bolt & Nut Co.
Scovill Manufacturing Co.
Shakeproof Inc.
The Southington Hardware Mfg. Co.
The Steel Company of Canada, Ltd.
Sterling Bolt Co.
Stronghold Screw Products, Inc.
Wolverine Bolt Company

E-18

Send me reports on Assembly Savings with Phillips Screws.
Name
Company
Address

Resistance Control Problems

"Taper Off"

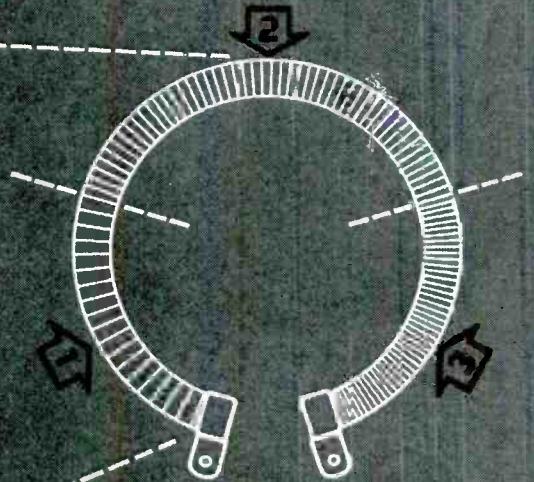
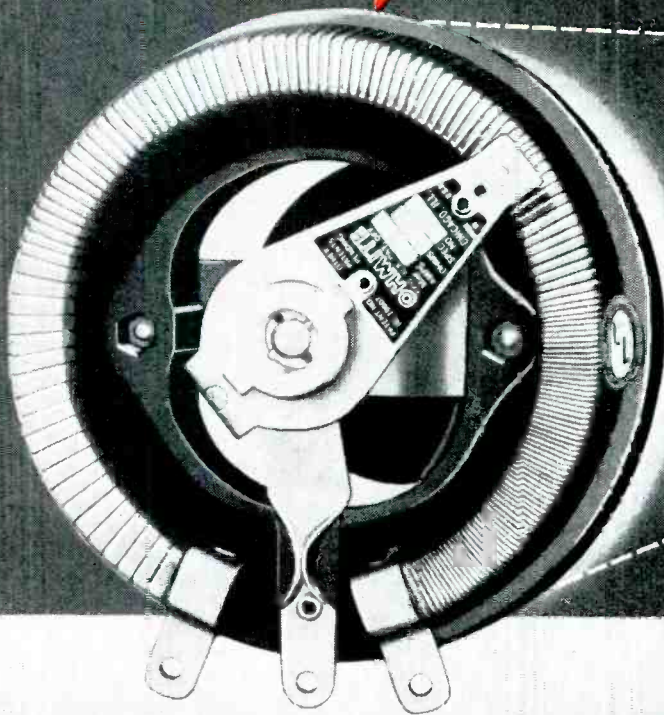

Note how three sectional windings of Driver-Harris nickel-chrome alloys: (1) No. 95, (2) *Advance*, and (3) *Nichrome*, are employed to obtain fine resistance shading.

When Rheostats are Sectionally Wound with **DRIVER-HARRIS** Alloys

To provide more uniform current control—and a rheostat of proportionately smaller size—the Ohmite Manufacturing Co. advocates tapered windings, involving the use of two or more sections of diminishing wire sizes. This construction is practical because only the first turn of any rheostat winding carries the maximum current. All succeeding turns carry constantly decreasing amounts.

In the 3-section, 500 watt Ohmite Model R Rheostat illustrated, three Driver-Harris nickel-chrome alloy wires—*Nichrome**—

*Advance**—and *No. 95* are employed to obtain the fine shading of resistance desired. For other resistance combinations, there are more than 80 Driver-Harris *electrical resistance alloys* specifically designed to fill the numerous requirements of the Electrical and Electronic Industries.

Backed by 46 years of specialized resistance-research experience, the Driver-Harris engineering staff is ready at all times to help you solve your electrical resistance problems. Why not get in touch with them for expert advice—or write for 71-page Resistance Handbook, R46.



Driver-Harris
COMPANY
HARRISON, N. J.

BRANCHES: Chicago • Detroit • Cleveland • Los Angeles • San Francisco • Seattle
The B. GREENING WIRE COMPANY, LTD., Hamilton, Ontario, Canada

*Trade Mark Reg. U. S. Pat. Off.

REVERE COPPER IN THIS 6C22



This type 6C22 vacuum tube was developed and is manufactured by the Federal Telephone and Radio Corporation, Clifton, New Jersey, and is rated at 1000 watts, plate dissipation at 600 mc.

THIS 6C22 tube, the result of a closely-guarded development during World War II, is a modified version of the tube used extensively for pulsing signals in radio transmission and may have had a vital influence in jamming enemy radar communications. Peacetime pursuits indicate that it will play an important part in furthering the development of television, having already proved of great value in a transmitter employed for color television. An unusual feature in the construction of this tube is to be seen in the one-piece formation of the anode and water-cooled radiator. The anode and grid ring are produced from Certified Oxygen Free High Conductivity Copper Bar, Revere Alloy 103-C, being formed by cold working in a 600-ton coining press.

Machining consists of drilling the center hole and milling the radiator slots. Each piece receives a special

rolling operation in the area where it is sealed to glass. The grid ring which extends through the glass structure performs a dual function in supporting the grid internally and providing an external connection. As in other types of vacuum tubes Certified Oxygen Free High Conductivity Copper is used for ease of out-gassing and excellent glass bonding characteristics.

REVERE

COPPER AND BRASS INCORPORATED

Founded by Paul Revere in 1801

230 Park Avenue, New York 17, New York

Mills: Baltimore, Md.; Chicago, Ill.; Detroit, Mich.; New Bedford, Mass.; Rome, N. Y.—Sales Offices in Principal Cities. Distributors Everywhere.

Here are two types of General Ceramics

STEATITE

SPECIAL SHAPES

1. STANDARD AND CUSTOM MOLDED PIECES IN ANY QUANTITY

Trimmer bases, coil mountings, tube bases and similar items—are produced in any volume to exact specification. Many standard pieces are available for selection to meet ordinary requirements with economy. Before specifying your insulating material, check up on the advantages and the cost reduction possibilities of General Ceramics Steatite components.



SEALEX BUSHINGS

2. HERMETICALLY SEALED LEADS AND MULTIPLE HEADERS

SEALEX Bushings provide an absolute hermetic seal that is unaffected by mechanical shock, thermal shock or continuous vibration. Every Bushing is pressure tested at 50 psi for proven dependability. SEALEX Bushings are manufactured in standard sizes from 0.5 to 20 amps, and flashover voltages range to 40 kv. Multiple lead types are included, and special types can be furnished to almost any specification.

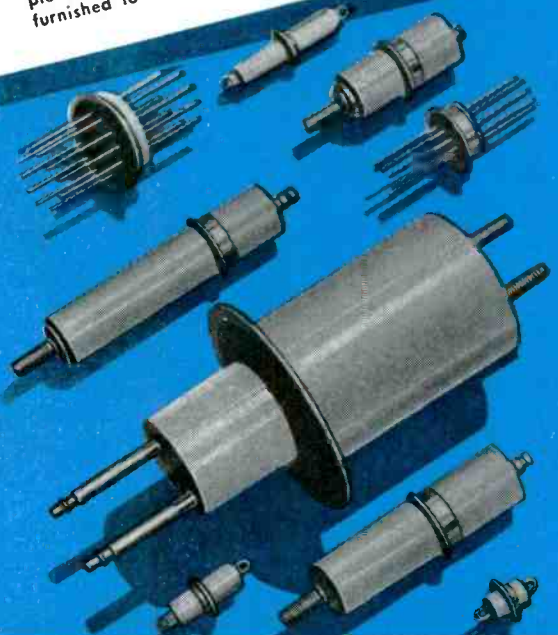

... that provide economical solutions to difficult insulating problems!

The advantages of steatite as an insulator are universally recognized. Chief factors responsible for this superiority are a very low loss factor, non-hygroscopic characteristics and ready adaptability to practically any shape or form.

Important to manufacturers interested in these excellent dielectric properties, is the fact that General Ceramics facilities are geared to supply steatite components in large or small quantities with unusual economy. Modern production techniques—

coupled with rigid quality control—result in all the usual advantages of volume production—fast delivery, low unit cost, and exact uniformity of every piece regardless of the size of run. Inquiries are invited.

WRITE FOR CATALOG

This informative catalog fully describes the facilities and products of the Steatite Division of General Ceramics. Complete technical data and design criteria concerning steatite and its application in the electrical and electronic fields. Write for your copy today on company letter-head, no obligation.



General CERAMICS and STEATITE CORP.

GENERAL OFFICES and PLANT: KEASBEY, NEW JERSEY

MAKERS OF STEATITE, TITANATES, ZIRCON PORCELAIN, ALUMINA, LIGHT-DUTY REFRACTORIES, CHEMICAL STONWARE

Better Understanding of Dielectric Strength Will

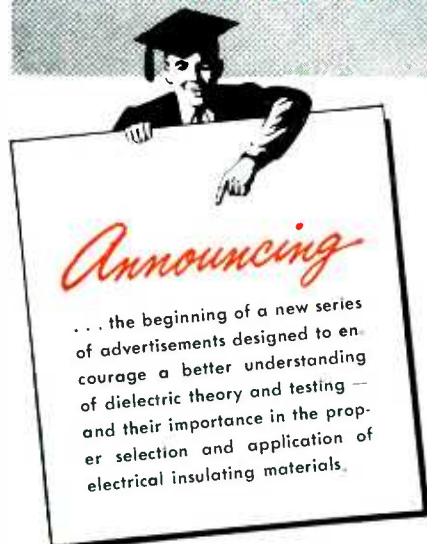

Insulation, due to the many variables in its make-up and to its inherent physical characteristics, is the most vulnerable component in electrical equipment. Thus its importance as an integral part of the design cannot be overstressed.

The dielectric strength of an insulation is comparable to the tensile strength of a structural material, since both represent the maximum stress value that can be imposed without breakdown. In the case of electrical insulation, however, it is the resistance to potential gradient (electrical stress) rather than to a mechanical force that is important. Numerically, this dielectric strength value, usually given in volts per mil (1 mil=.001"), is not strictly a constant since it depends on the material and thickness as well as on test methods and conditions.

For instance, dielectric strength is influenced by the duration and rate of rise of electrical stress, plus such other factors as frequency, temperature, ambient conditions and geometry of the electrodes.

The accompanying table gives the average dielectric strengths of several insulating materials, as measured by the short-time test. These values are important for comparison, specification and design purposes.

Material	Thickness In Inches	Dielectric Strength Volts/mil ASTM Short-Time Method*
Mica (Bengal ruby)	.002	2800
MICANITE (NEMA #3)	.015 and over	625
LAMICOID (NEMA Grade XX)	1/16 to 1/8	500
EMPIRE black bias-cut tape	.003	850

*All tests made in accordance with ASTM Methods

SHORT-TIME DIELECTRIC STRENGTH TEST¹

Since the dielectric strength of a material varies with changing conditions, standard test procedures for the application of voltage have been established by the American Society for Testing Materials. One of these, the short-time method, is discussed here. The step-by-

step method will be considered in the next advertisement in this series.

The electrical apparatus required to perform these tests consists of a step-up transformer of adequate size, an automatic circuit breaker, a dependable device for controlling the rate of voltage rise, a voltmeter, and electrodes of specified size.

The voltage applied to the material is increased from zero to breakdown at a uniform rate. In testing solid types of insulation, the rate of rise is generally 0.5 or 1.0 kv. per sec., depending on the total test time required and the voltage-time characteristic of the material. To determine the rate to use for a given material, reference should be made to the ASTM test specifications for that material.

The report on the test should include: (1) specimen thickness; (2) total volts at each puncture; (3) volts per mil at each puncture; (4) average, maximum, and minimum volts per mil per sample; (5) temperature of test specimen; (6) relative humidity of ambient atmosphere; (7) conditioning treatment; (8) duration of test; (9) size and type of electrodes.

¹ASTM Designation D149-44



Test Control Panel and Transformer
Photo Courtesy American Transformer Co.



Increase Efficiency and Safety of Electrical Equipment

APPLICATIONS OF DIELECTRIC STRENGTH THEORY

In nearly all electrical apparatus, the dielectric strength of the insulation used is one of the most important considerations in helping to insure maximum efficiency and safety of operation. By way of illustration, here are several widely diversified applications using different types of electrical insulation furnished by Mica Insulator Company...

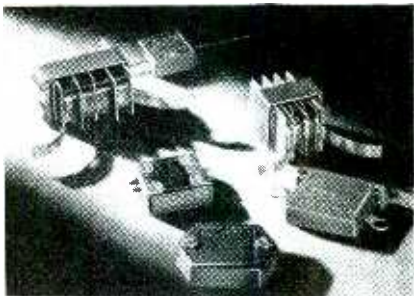

MUSCOVITE (WHITE) MICA serves exceptionally well as the insulation in a wide variety of small condensers and capacitors. The superior dielectric strength of thin mica films is particularly important where high voltages are involved.

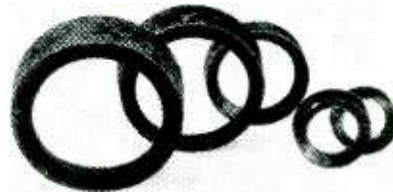

MICANITE AND SUPER-MICANITE, built-up Mica splittings bonded with selected resins, assure high dielectric strength and flexibility of design for all types of Commutator Vee rings and cones. They can be supplied as either one-piece or two-piece rings — or as sectional or fitted rings for very large commutators, where the expense of a one-piece mold is not justified.



EMPIRE BIAS-CUT VARNISHED TAPES, in thicknesses from 3 to 15 mils, made

by Mica Insulator Company, offer uniformly high dielectric strength. They are especially useful for irregularly shaped conductors, coils and similar applications where thin, space-saving insulation is required. Empire Bias-Cut Tape is tear resistant. And because of its elongation or stretch, may be wrapped helically without "coning."



LAMICOID, a thermosetting laminated plastic insulation, made of paper or cloth fillers bonded with quality resins, has good dielectric strength. It is recommended for use as terminal blocks, switch and instrument panels, coil ends, tube socket bases, armature slot wedges and many other uses where a combination of dielectric strength and mechanical strength is needed.

Information on any type of electrical insulation — as well as assistance in solving your particular insulation problems — may be had by contacting our Technical Service Department. Electrical specialists for over 50 years, Mica Insulator Company offers you a complete line of electrical insulating materials, backed by extensive research.

Insulator COMPANY
SCHENECTADY 1, NEW YORK

Atlanta • Birmingham • Boston • Chicago • Cincinnati • Cleveland • Detroit • Houston
Los Angeles • New York • Philadelphia • Rochester • St. Louis • San Francisco



Trade mark

your Noise Problems, too can be Solved Better with C-D Quietones



CORNELL-DUBILIER
world's largest manufacturer of
CAPACITORS

Just because Mom wants to bake a cake is no reason why she shouldn't hear her pet soap opera. And sooner or later she's bound to find out that *some* mixers *don't* cause radio interference. Mixers equipped with C-D Capacitors, for example.

C-D's experience in designing and building noise suppressors is unequalled in the capacitor industry. We are now manufacturing hundreds of types of noise filters for electrical appliances and equipment. It's possible, of course,

that the exact unit for solving *your* noise problem is not included. In that case, our engineers are ready and anxious to design and build the suppressor best suited to your specific requirements—*better, faster, more economically. Consult with them.*

Catalog of standard types will be mailed on request. Cornell-Dubilier Electric Corporation, Dept. K-6, South Plainfield, New Jersey. Other large plants in New Bedford, Brookline and Worcester, Mass., and Providence, R. I.

MICA • DYKANOL • PAPER • ELECTROLYTIC

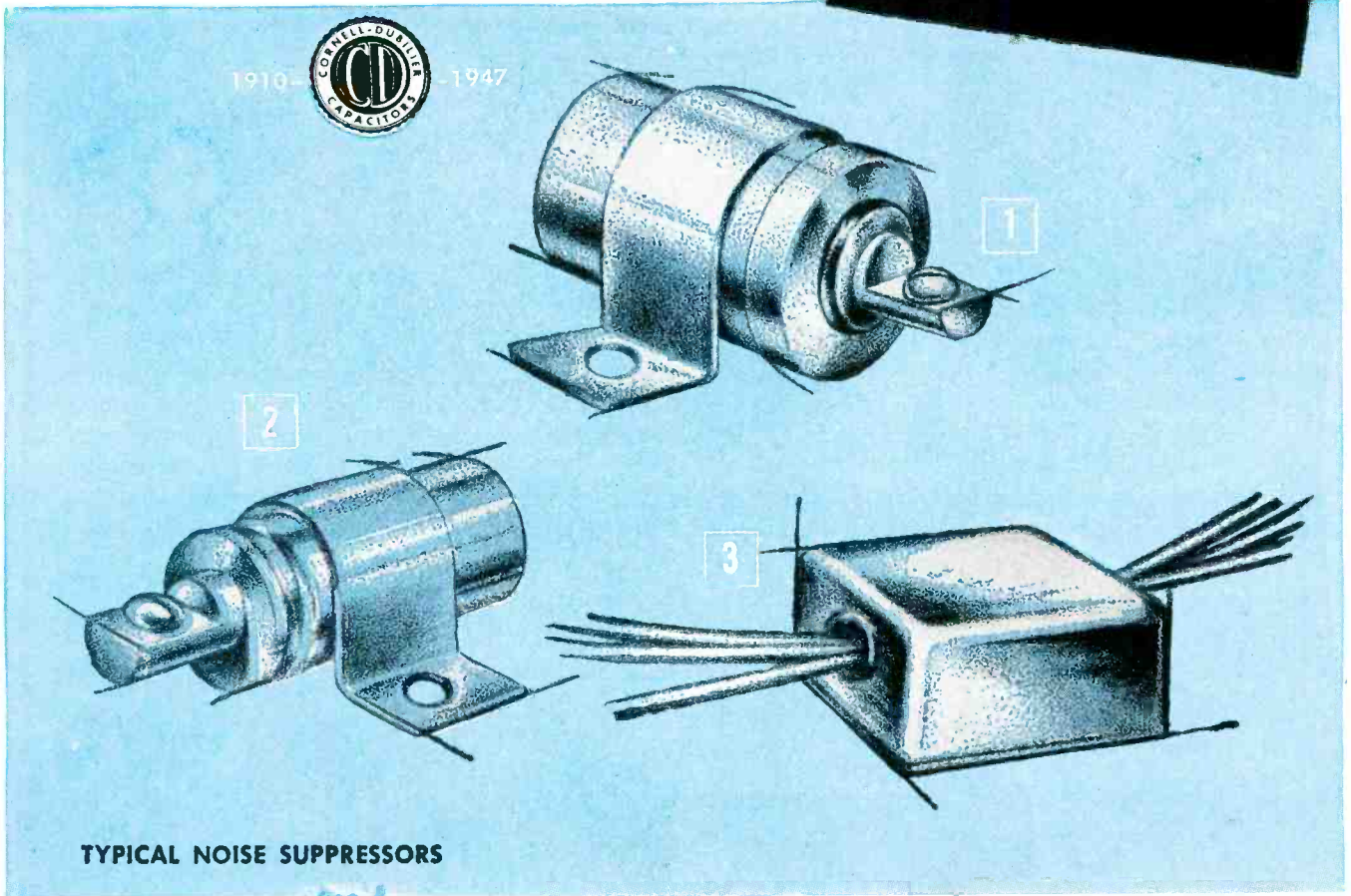

TYPICAL NOISE SUPPRESSORS

CAPACITORS #1 AND 2

Two of the Type MC Filter Capacitors designed for heavy duty service on buses, trucks, etc. for spark and noise suppression. Mechanically rugged, oil filled and impregnated and hermetically sealed.

CAPACITOR #3

A general purpose filter effectively controls radio noise energy created by fluorescent lamps. This capacitive - inductive type filter is compact and can be quickly installed in a variety of positions. Convenient leads simplify installation.

Announcing a new line of television capacitors

"HI-VO-KAPS"

made with Centralab's original Ceramic-X

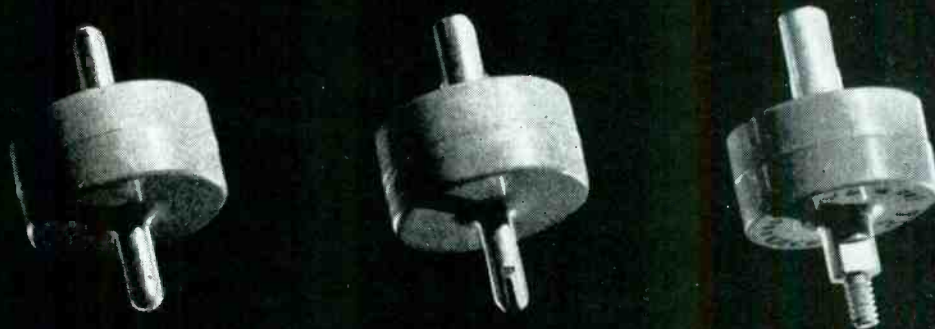

Three types of terminals for flexibility, convenience

ROD TYPE: .160" diameter rod type terminals. Designed for use with conventional fuse or clip-type connections. Terminals are solid brass, silver-plated and soldered directly to electrodes.

SLOT-AND-THREAD TYPE: .160" diameter with $\frac{1}{16}$ " x $\frac{3}{16}$ " slot in one terminal. Other terminal tapped 6-32, $\frac{3}{16}$ " deep for "twinning" or convenient chassis mounting.

DUO-THREAD TYPE: one terminal tapped 6-32, $\frac{3}{16}$ " deep full threads. Other terminal, 6-32, male thread $\frac{1}{4}$ " length. Designed for convenient series or tapped series connections.

Cutaway view shows integral ceramic construction

Solid brass terminals, soldered directly to electrodes.

Metallic silver electrodes fired directly to high dielectric constant Ceramic-X.

Low loss, mineral filled phenolic resin.

Three terminal types for strong, fast connections.

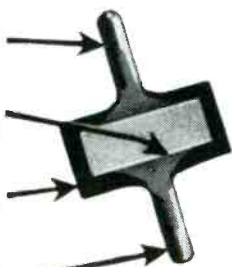

The smallest high voltage capacitors ever designed exclusively for television circuits!

ANOTHER "FIRST" for Centralab! "Hi-Vo-Kaps" are made with Centralab's original Ceramic-X, combining high voltage, small size and terminal connections to fit virtually any television application!

Designed and developed by Centralab in response to stated requirements of television project engineers, "Hi-Vo-Kaps" are for use as filter and by-pass capacitors in video amplifiers — for high DC voltages with small component AC voltages (not for use in temperature compensation or resonant circuits).

Ratings: 10,000 WVDC, 15,000 VDC flash test, 500 mmf., — 50% — 20% capacity at 1 megacycle (2 $\frac{1}{2}$ % higher at 1 kilocycle). *Dimensions:* diameter — .990", length — .510". Overall length varies with terminal types, maximum—1.597". Send for Bulletin 946.



Ceramic Trimmers
Bulletin 630



Ceramics
Bulletin 720



Variable Resistors
Bulletin 697

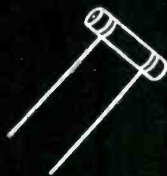

Ceramic Capacitors
Bulletin 630



Selector Switches
Bulletin 722

Centralab
Division of GLOBE-UNION INC., Milwaukee

HIGH VOLTAGE; NO DANGER

Portable - Rugged - Safe!

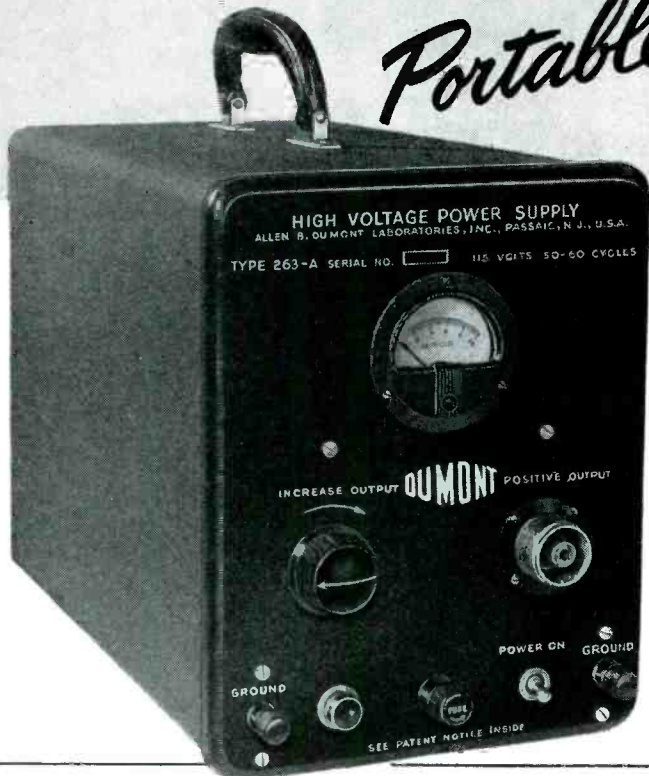

DU MONT Type 263-A HIGH-VOLTAGE POWER SUPPLY

► High voltage is the keynote of modern oscillography. Especially for brilliant traces at ultra-high speeds.

Type 263-A High-Voltage Power Supply was designed with present and future needs in mind. It provides a dependable yet inexpensive power supply for modernizing and extending the usefulness of certain types of cathode-ray oscillographs when examination of extremely high writing rates is required.

So here's a complete high-voltage power supply. Suitable for any application where high voltage at low current is called for. Consists of radio-frequency oscillator with its own power supply, an r.f. step-up transformer, a half-wave rectifier, and a high-voltage filtering and metering system.

Compact. Light. So designed that inexperienced personnel may handle it with safety. And it is made still safer in case of accidental contact with high voltage, because very little power is stored in its filtering circuit. Furthermore, no equipment damage will result if output is short-circuited. Rugged mechanical construction permits field or laboratory use.

Surely Type 263-A is a "must" instrument whether for high-voltage oscillography or general use!

► **Details on request!**

© ALLEN B. DUMONT LABORATORIES, INC.

Salient Oscillographic Features . . .

- ✓ 10,000 volt intensifier potential available for use with cathode-ray oscillographs.
- ✓ Visual observation of single transients hitherto invisible.
- ✓ Photography of extremely high writing rates (for example, 2000 km./sec. on SRP11 at 10 kilovolts).
- ✓ Observation of entire waveshapes of short duration on long persistence screens.
- ✓ Convenient use with Type SRP-A Multi-band High-voltage Cathode-ray Tube.

Working Details . . .

- ✓ Continuously variable d-c output from 5,000 to 10,000 volts with loads up to 200 microamperes.
- ✓ Regulation within 20% from no load to 200 microampere load.
- ✓ Ripple voltage on output less than 0.5%.
- ✓ Power supply: 115 volts, 50-60 cps.
- ✓ Power consumption: 100 watts.
- ✓ Dimensions: 10 $\frac{1}{2}$ " h. x 8 $\frac{1}{8}$ " w. x 14 $\frac{3}{4}$ " d.
- ✓ Weight: 24 pounds.

DUMONT

Precision Electronics & Television

ALLEN B. DUMONT LABORATORIES, INC., PASSAIC, NEW JERSEY • CABLE ADDRESS: ALBEEDU, PASSAIC, N. J., U. S. A.

SCA rectifiers of tomorrow

IN DESIGNS OF TODAY!

POWER RECTIFIERS

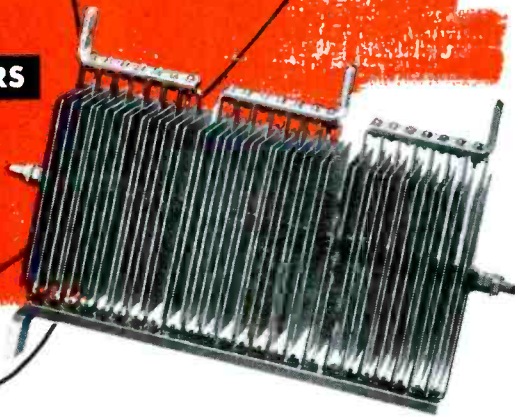
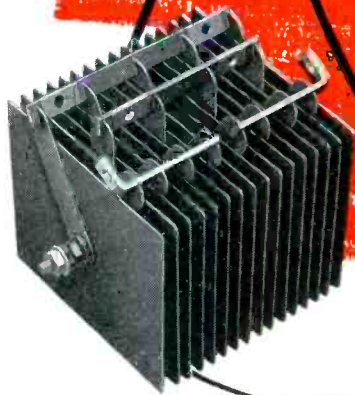

SCA Selenium Rectifiers are ENGINEERED FOR ENGINEERS. Improved performance at lower costs through ENGINEERED adaptability. Selenium Corporation of America meets exacting specifications of modern electronic developments. Manufacturers of a broad line of Selenium Power and Instrument Rectifiers, Self generating Photo-Electric Cells and allied scientific products.

Selenium Rectifiers are rapidly becoming standard in industry for all rectifier applications. Selenium Corporation of America's engineering experience can be called upon for the development and production of special rectifiers for any application.

CHECK THESE OUTSTANDING FEATURES:

- ✓ Permanent characteristics
- ✓ Adaptability to all types of circuits and loads
- ✓ Unlimited life—no moving parts
- ✓ Immunity to atmospheric changes
- ✓ High efficiency per unit weight
- ✓ From 1 volt to 50,000 volts rms.
- ✓ From 10 micro-amperes to 10,000 amperes
- ✓ Economical—simple to install—no maintenance cost
- ✓ Hermetically sealed units available

INSTRUMENT RECTIFIERS

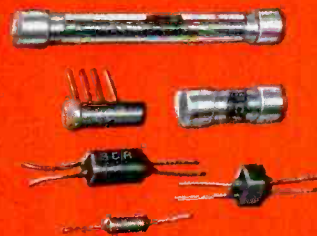

PHOTO-ELECTRIC CELLS



SELENIUM CORPORATION OF AMERICA

Affiliate of **VICKERS** Incorporated

2160 EAST IMPERIAL HIGHWAY • EL SEGUNDO, CALIFORNIA

Where **SPACE** and **PERFORMANCE** are Vital
DUMONT OFFERS

The **TINYMITE**

SMALLEST PAPER CAPACITOR . . .
yet 100%
MOISTUREPROOF

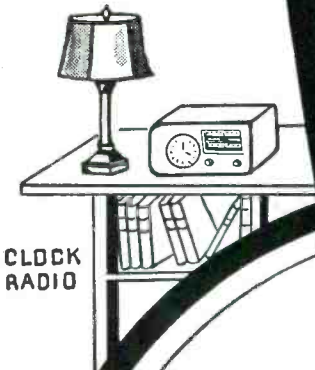
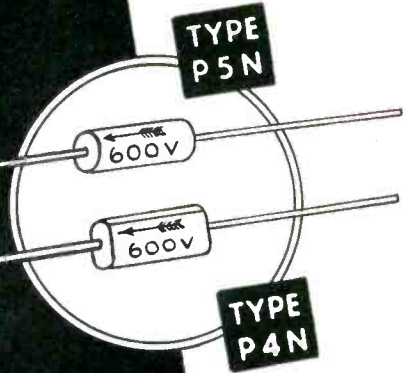

CLOCK RADIO

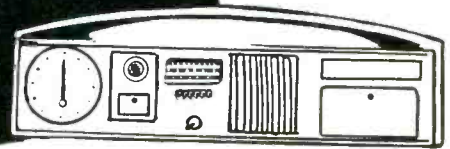

AUTO RADIOS

FEATURES

1. Bakelite Resinoid Ends. Lead wire cannot pull out, even under hot conditions.
2. Non-Inductive.
3. Excellent Temperature Coefficient.
4. Very high leakage Resistance.
5. Fine Power-Factor.
6. Range from 20 MMFD to .25 MFD.
From 150 volts to 600 volts.
7. Extremely moisture proof.
8. Heat-proof.



HEARING AIDS

PAT. PENDING

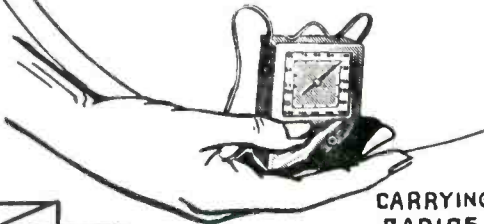

CARRYING RADIOS

DUMONT ELECTRIC CORP.
 MFR'S OF
 CAPACITORS FOR EVERY REQUIREMENT
 34 HUBERT STREET NEW YORK, N. Y.

SAMPLES AND PRICE LIST ON REQUEST

*Easier handling...
Lower cost assembly*

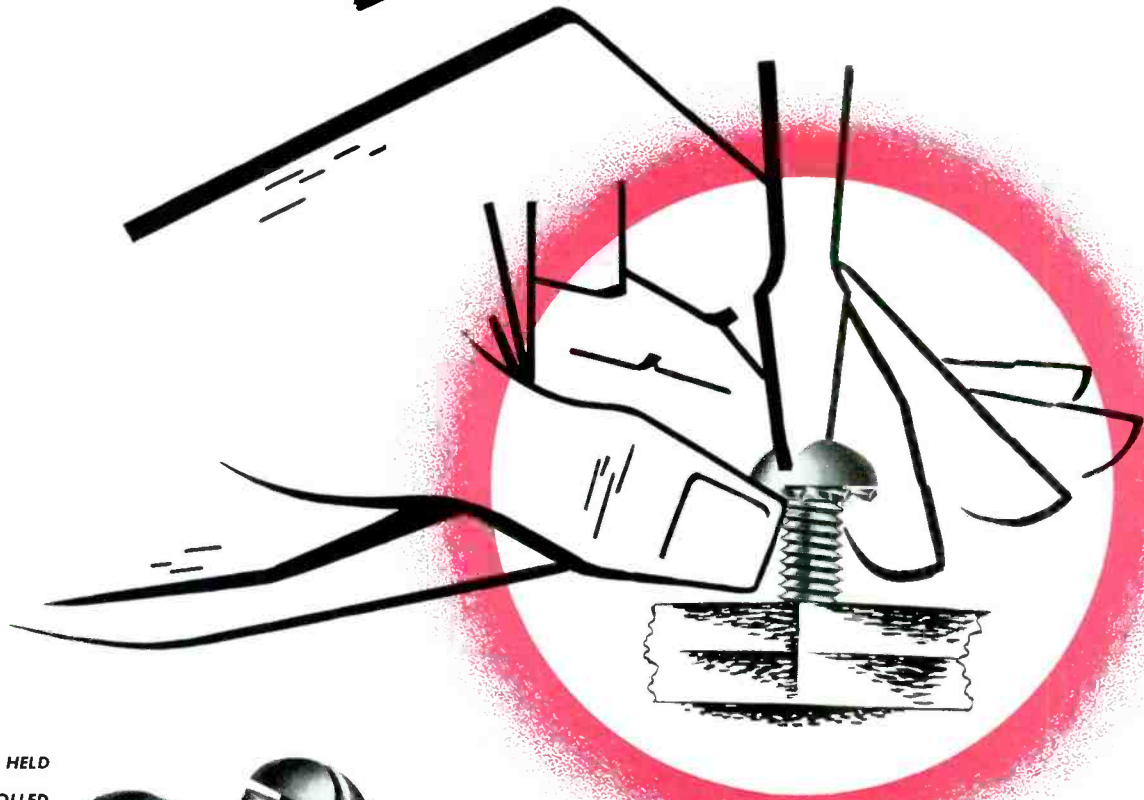

THE WASHER IS HELD
ON BY THE ROLLED
THREAD AND IS FREE
TO ROTATE!

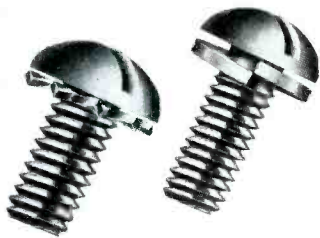

save money with **SEMS**

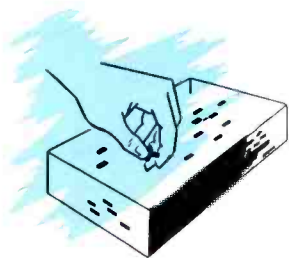

TWO PARTS PRE-ASSEMBLED; ONLY ONE
UNIT TO ORDER, STOCK AND HANDLE.



NO DROPPED OR WASTED WASHERS.
ASSEMBLY MOVES SMOOTHLY.

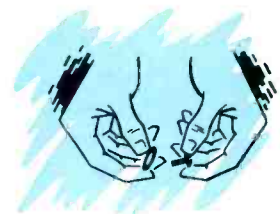

SEMS ELIMINATE COSTLY HAND
ASSEMBLY; SAVE TIME AND LABOR!

ANY OF THESE MANUFACTURERS WILL SEND YOU THE SEMS DATA BOOK, FREE!

National Lock Co.
Rockford, Illinois

The National Screw & Mfg. Co.
Cleveland, Ohio

New England Screw Co.
Keene, N. H.

Pheoll Manufacturing Co.
Chicago, Illinois

Russell, Burdsall & Ward
Bolt & Nut Co.
Port Chester, N. Y.

Scovill Manufacturing Co.
Waterville Division
Waterville, Conn.

Shakeproof Inc.
Division of Illinois Tool Works
Chicago, Illinois

Steel Co. of Canada, Ltd.
Hamilton, Ont., Can.

Stronghold
Screw Products Inc.
Chicago, Ill.

American Screw Co.
Providence, R. I.

Central Screw Co.
Chicago, Ill.

Chandler Products Corp.
Cleveland, Ohio

Continental Screw Co.
New Bedford, Mass.

Corbin Screw Division
The American Hardware Corp.
New Britain, Conn.

Eaton Manufacturing Co.
Reliance Division
Massillon, Ohio

The Lamson & Sessions Co.
Cleveland, Ohio

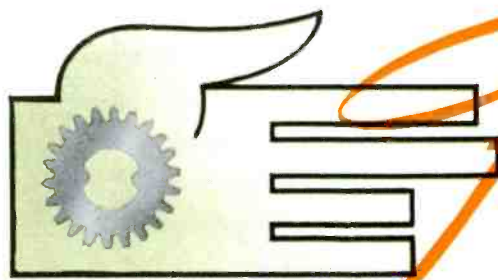

Precision Stampings

TO IMPROVE PERFORMANCE AND REDUCE COSTS!

SHAKEPROOF PRECISION STAMPED GEARS

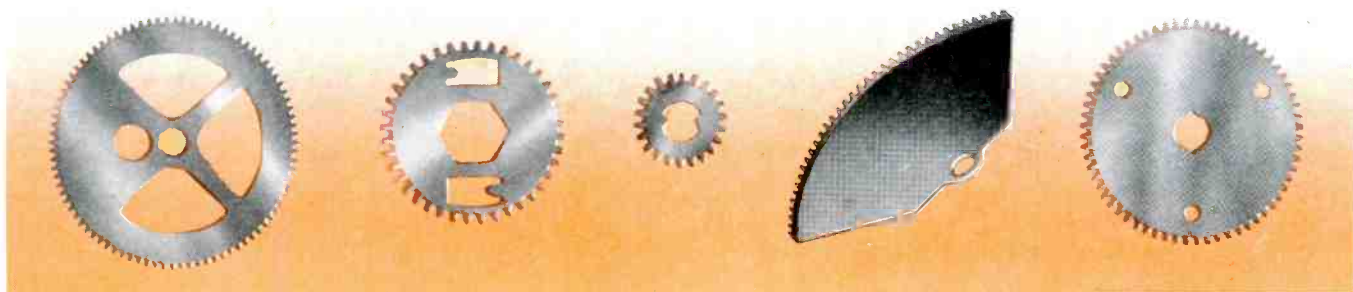

SHAKEPROOF ENGINEERED PARTS

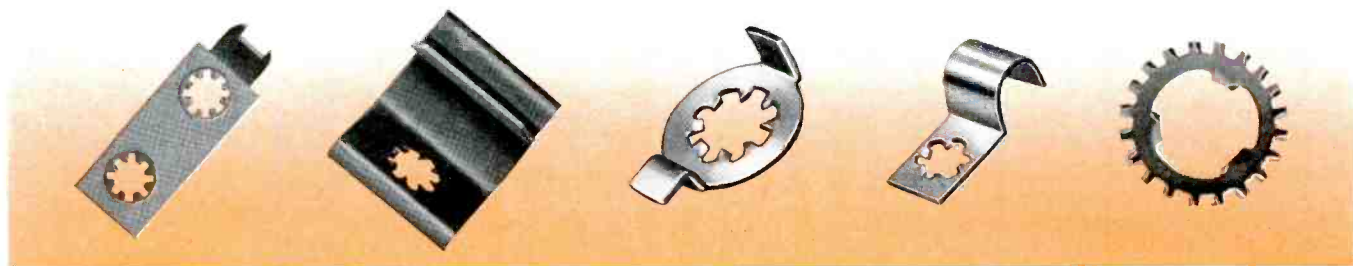

To high production users of metal stampings Shakeproof offers a precision stamping service founded on years of experience in building intricate, precision dies for Shakeproof Lock Washers. High quality Shakeproof Stamped Radio and Instrument Gears are produced to close tolerances on tooth shape, concentricity and tooth spacing and many are available from existing dies which can be modified, with a minimum of new tooling, to meet individual requirements.

Shakeproof Engineered Parts, which incorporate the famous Shakeproof tapered-twisted tooth principle, eliminate the need for separate lock washers. A wide variety of these Engineered Parts, and of plain stampings, are available from standard dies. Others will be made to specification. The entire Shakeproof engineering staff is available to assist you with your special stamping problems. Write for information, *today!*

SPECIAL STAMPINGS



SHAKEPROOF INC.
"Fastening Headquarters"

DIVISION OF ILLINOIS TOOL WORKS • 2501 NORTH KEELER AVENUE, CHICAGO 39, ILLINOIS • OFFICES IN PRINCIPAL CITIES
PLANTS AT CHICAGO AND ELGIN, ILLINOIS • IN CANADA: CANADA ILLINOIS TOOLS, LTD., TORONTO, ONTARIO

Making Broadcast History!



NEW RING-SEAL POWER TUBES FOR FM AND TELEVISION

**—110 to 220 mc frequency at max ratings
—1.5 to 6.4 kw typical Class C output**

GENERAL ELECTRIC'S great 1947 series of ring-seal power tubes spells more efficient performance to those who build—or use—FM and television transmitters. Modern as tomorrow's telecast, these v-h-f tubes need minimum neutralization . . . are directly designed for grounded-grid circuits . . . meet in every way the *new* requirements of *new* station equipment going into service.

Ring-seal design—a G-E development—makes it possible to plug in a tube quickly, so that time off the air is cut to seconds. Firm terminal

contacts with *wide surface areas* are another ring-seal advantage—moreover, all contacts are silver-plated to reduce r-f losses. An important aid to dependability and long life is the use, throughout the tube, of strong, enduring fernico metal-to-glass seals.

Your nearest G-E electronics office will be glad to give you prices and full information, as well as arrange for you to secure circuit application advice when desired. Or write direct to *Electronics Department, General Electric Company, Schenectady 5, N. Y.*

G. E.'s MANUAL OF TRANSMITTING TUBES IS YOUR MOST COMPLETE, UP-TO-THE-MINUTE GUIDE!

Profusely illustrated—packed with performance and application data. Comes to you for \$2. Also, for an annual service charge of \$1 new and revised pages will be sent you regularly as issued. Order direct from General Electric Company, enclosing payment, or giving authority on your company letterhead to invoice you.

OVER 600 LARGE PAGES \$2.00

GENERAL  ELECTRIC

161-F5-8880

FIRST AND GREATEST NAME IN ELECTRONICS

ELECTRONICS — June, 1947

GL-7D21

Tetrode, forced-air cooled. 10 mc frequency at max ratings. Typical power output (Class C telegraphy) 1,575 w.



GL-5513

Triode, forced-air cooled. 220 mc frequency at max ratings. Typical power output (Class C telegraphy, grounded-grid service) 2.45 kw.



GL-5518

Triode, forced air cooled. 110 mc frequency at max ratings. Typical power output (Class C telegraphy, grounded-grid service) 6 kw.



GL-9C24

Triode, water and forced-air cooled. 220 mc frequency at max ratings. Typical power output (Class C telegraphy, grounded-grid service) 6.4 kw.

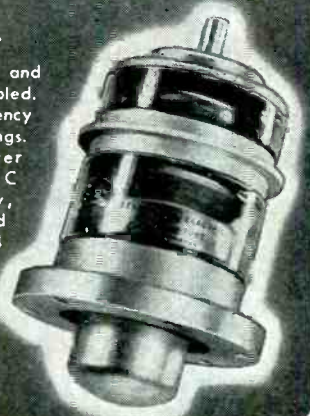

ARNOLD

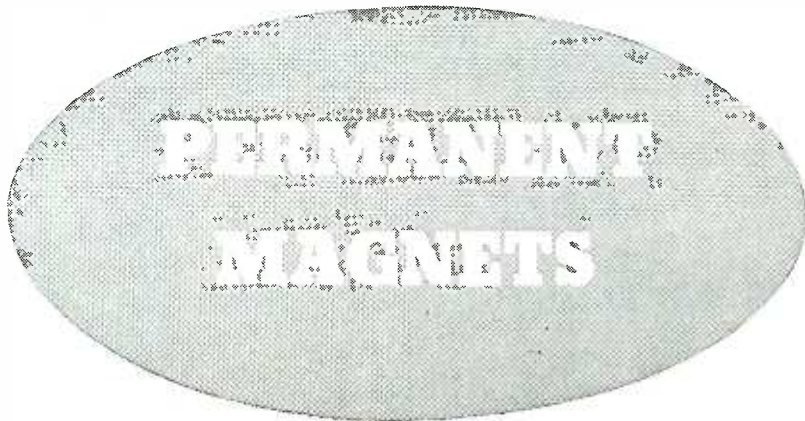

*Depend on them
for Uniformly
High Quality
in every
PHYSICAL, MAGNETIC
and METALLURGICAL
Characteristic*

You would find it hard to set a requirement on Arnold magnets that is not already exceeded in our regular production procedure.

All Arnold products are made on a basis of 100% quality-control at every step of manufacture. These rigidly maintained standards cover all physical, magnetic and metallurgical characteristics. . . you can place complete confidence in the uniformity and dependability of Arnold Permanent Magnets, and their resultant performance in your assemblies.

Remember, too, that Arnold's service covers all types of permanent magnet materials, any size or shape of unit, and any field of application. Our engineers are at your command—write us direct or ask any Allegheny Ludlum representative.

W&D 1098



THE ARNOLD ENGINEERING COMPANY

Subsidiary of

ALLEGHENY LUDLUM STEEL CORPORATION

147 East Ontario Street, Chicago, Illinois

Specialists and Leaders in the Design, Engineering and Manufacture of PERMANENT MAGNETS

COMPACT ENERGY FOR PHOTOFLASH CAPACITORS

Progress in practical flash photography has been greatly facilitated by new smaller, lighter capacitors incorporating the exclusive Sprague Vitamin Q impregnant. Write for engineering bulletin No. 201.

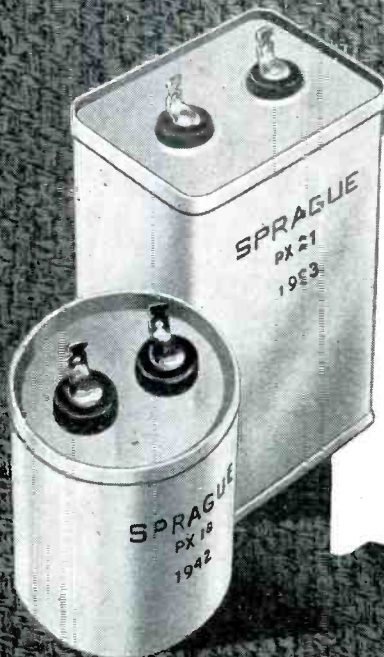
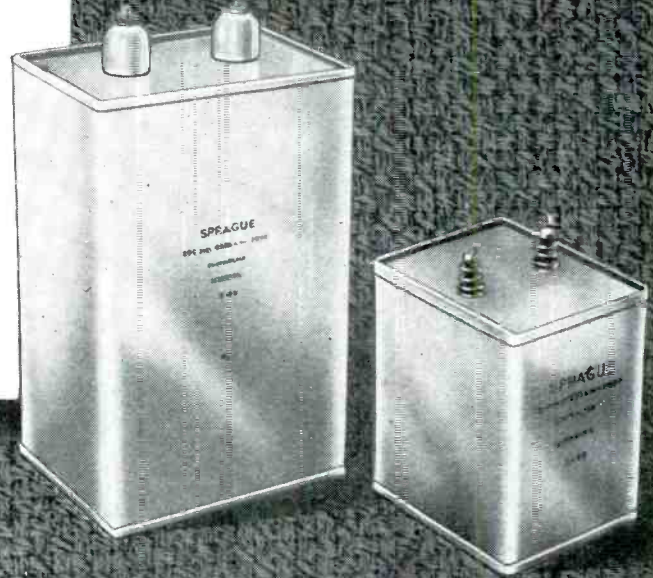

GUARDING AGAINST FLUORESCENT BALLAST FAILURES

A major fluorescent lighting problem has been one of finding ballast capacitors to withstand the combination of severe temperature and voltage conditions—and again Sprague Vitamin Q impregnant has proven the answer. Sprague Fluorescent Ballast Capacitors rated at 330v. AC not only give maximum life under normal temperature and voltage conditions, but can be operated at 460v. AC at 85° C. for 1,000 hours—without deterioration or major change in power factor. Thus they assure adequate safety factor under blink start conditions.

It's all done with *VITAMIN Q!



SPRAGUE

The history of capacitor progress is inseparably linked with the development of new and better dielectrics. Throughout the years, the aim has been to increase the amount of energy that can be stored in a capacitor of given size and to improve performance characteristics all along the line.

The most remarkable advance in these respects has come with the development of the exclusive oil dielectric—Sprague Vita-

min Q. Throughout industry, Sprague Capacitors impregnated with this material are setting new standards for smaller, lighter units for dependable operation at higher voltages and higher temperatures and for greatly improved insulation resistance.

The units illustrated are typical of the many new capacitor designs now available using Sprague Vitamin Q.

*Trademark Reg. U. S. Pat. Off.

ELECTRIC COMPANY, NORTH ADAMS, MASS.

How to have a Stamping Department

without

NEW BUILDINGS



NEW MACHINERY

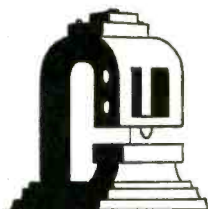

NEW PERSONNEL

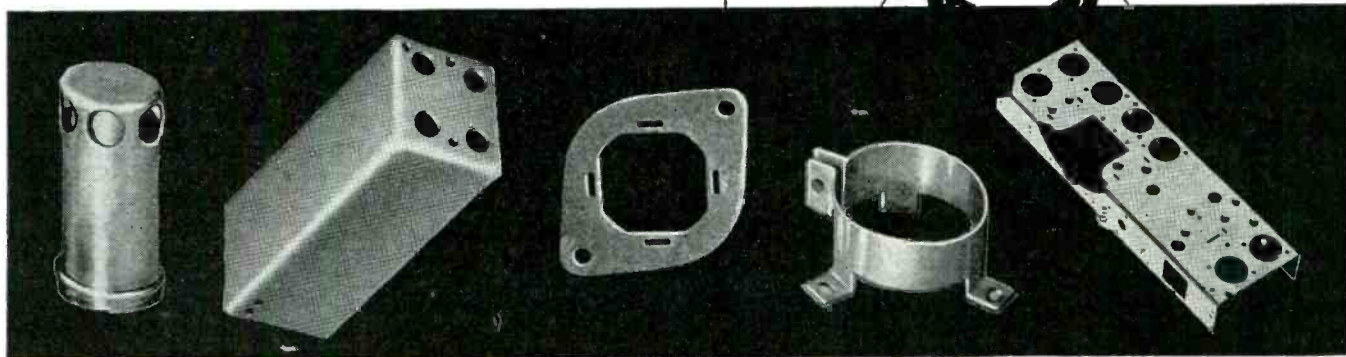
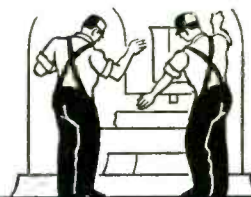

If you have a stamping problem that could be corrected by expansion of your facilities, get in touch with Paul and Beekman Division. Perhaps Paul and Beekman can act virtually as your own stamping department, thus eliminating the necessity for new buildings, new equipment, new personnel.

We make all types of stampings here . . . simple or complex, small or large . . . from mild steel,

stainless, copper, brass and aluminum. We specialize in precision, so we make stampings *right* . . . we specialize in volume, so we make them *fast*.

Paul and Beekman service, featuring skilled workmen, adequate equipment and organized planning, can help you with your stamping problem. Without obligation to you, we'll be glad to explain fully. Write us.

PAUL and BEEKMAN Division 1805 COURTLAND ST., PHILADELPHIA 40, PA.

PORTABLE PRODUCTS CORPORATION
 MANUFACTURERS OF: LAWN MOWERS • ELECTRICAL APPLIANCES • PRECISION STAMPINGS
 INDUSTRIAL INSTRUMENTS • RADIOS • SAFETY EQUIPMENT



BROADCASTERS—

Simplify

YOUR PROGRAM SWITCHING

...TO THE MOVEMENT OF A SINGLE KEY!

EVEN your most complicated program switching operations are reduced to the simple operation of *one* key—when you use Western Electric's new Relay Type Program Dispatching System. It speeds up the switching involved in serving several destinations with rapidly interchanged studio, line and transcribed programs, auditions and announcements—yet reduces operating errors.

Check these features against your operating requirements:

1. Provides simple, fool-proof method of pre-setting the next scheduled program condition—*leisurely*—while the present program is "on the air."
2. Operation of a single key instantly switches from the program "on the air" to the pre-set condition.
3. This one-key switching operation can be controlled from either the Master Panel or any selected control booth.
4. During light load periods, control of selected lines may be extended to any studio control booth.
5. "On Air" and pre-set circuit conditions—including point of release control—are positively indicated by lamps at all control points.
6. Any or all programs may be interrupted instantly for "flash booth" announcements without upsetting the existing studio circuit conditions.
7. System may be engineered and furnished to meet your *individual* operating requirements—regardless of number of program sources or outgoing lines.

For further details, call your local Graybar Broadcast Representative or write Graybar Electric Co., 420 Lexington Avenue, New York 17, N. Y.



Distributed by
Graybar
OFFICES IN 95 PRINCIPAL CITIES

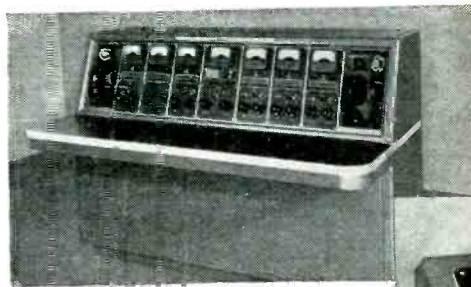

● Six-line Master Control Panel for Western Electric Relay Type Program Dispatching System.

● Below—Flash Booth Indicator Panel (at left) and Control Signal Indicator Panel (at right).



Western Electric
— QUALITY COUNTS —

It's a Joy Ride for Automakers

(FOR DRIVERS AND PASSENGERS, TOO)



...with **AMERICAN PHILLIPS SCREWS**
that keep brakes on costs, protect performance, speed up sales

"STEP ON THE GAS" IN PRODUCTION! Why put up with slow, slip-and-slash, "horse-and-buggy" fastening methods when AMERICAN PHILLIPS SCREWS can be driven at TOP SPEED. But speed is only part of the story. American Phillips Screws can't be fumbled, fingers can't be mangled, work can't be wrecked. And driving is automatically straight. So . . . TOTAL TIME-SAVINGS MOUNT AS HIGH AS 50%.

"STEP ON THE GAS" IN PROMOTION! American Phillips Screws give car, boat, appliance (or whatever you make), a "classy chassis" that means more sales thru more showmanship! Clothes and hose can't snag. And resistance to vibration makes another talking point. There's an American Phillips Screw in any type or metal which will win these production and promotion "extras" for you, your distributors and dealers.

AMERICAN SCREW COMPANY, PROVIDENCE 1, RHODE ISLAND
Chicago 11: 589 E. Illinois Street Detroit 2: 502 Stephenson Building

4-WINGED DRIVER CAN'T SLIP OUT
OF PHILLIPS TAPERED RECESS



AMERICAN PHILLIPS

Screws



ALL TYPES
ALL METALS: Steel, Brass, Bronze, Stainless Steel, Aluminum, Monel, Everdur (silicon bronze)

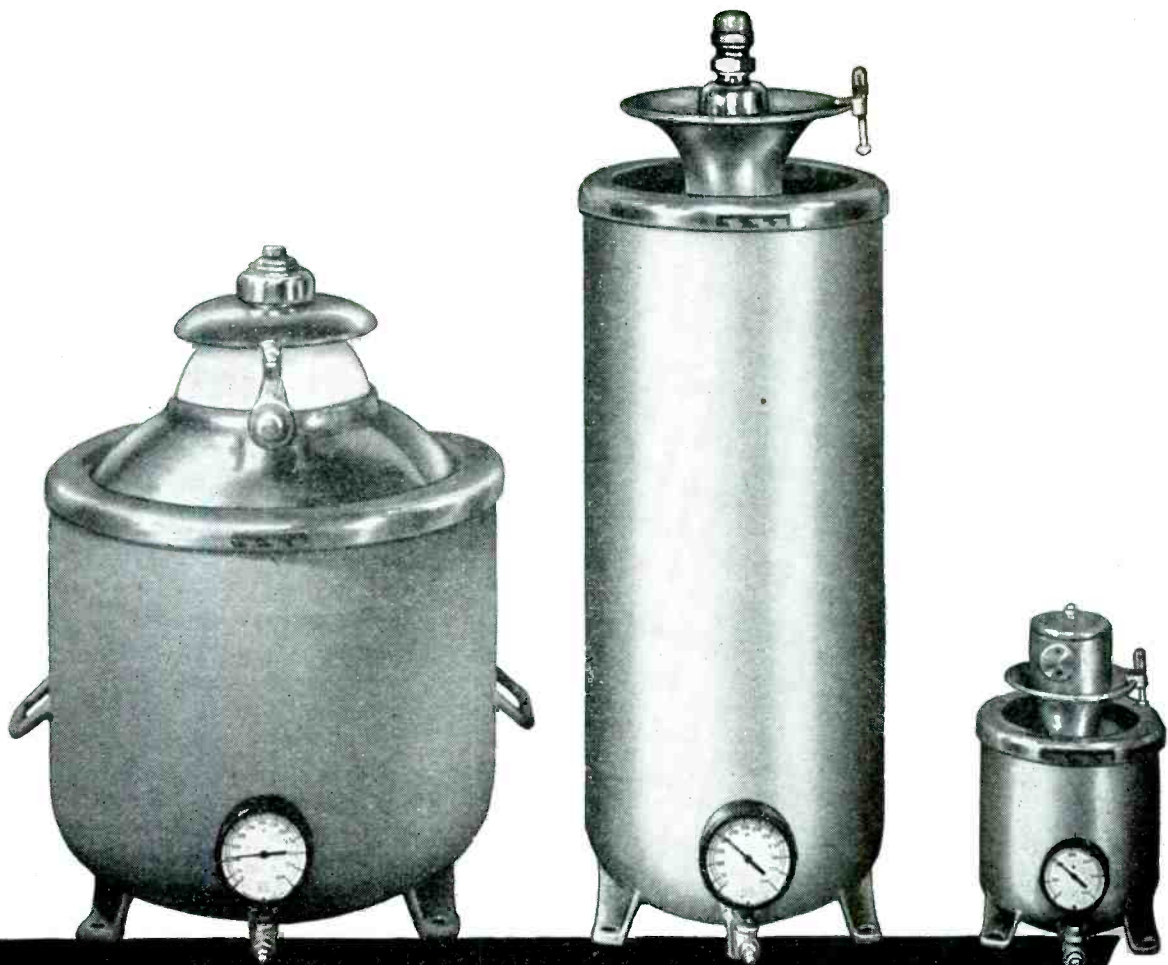

NO INCREASE IN PRICE

**LAPP GAS-FILLED CONDENSERS
AT PREWAR PRICES . . .**

There's good news for designers and builders of high voltage electronic circuits who find themselves caught in an inflationary spiral of costs. No advance in prices has been announced—none is contemplated—for Lapp Gas-filled Condensers. Known as the most satisfactory source of high current and high voltage capacitance, these units offer non-deteriorating, dependable performance; impossibility of punc-

ture; lowest loss with consequent economy of power; constant capacitance under temperature variation; and compact, space-saving design. Variable, adjustable, and fixed units are available with current ratings up to 500 amperes R.M.S., power ratings up to 60 Kv peak. Units now in service range up to 60,000 mmf. (fixed units), 16,000 mmf. (variable and adjustable units).

Lapp

LAPP INSULATOR COMPANY, INC., LE ROY, NEW YORK

GLOBAL TEMPERATURE SENSITIVE RESISTORS

Operate accurately over wide Temperature Range

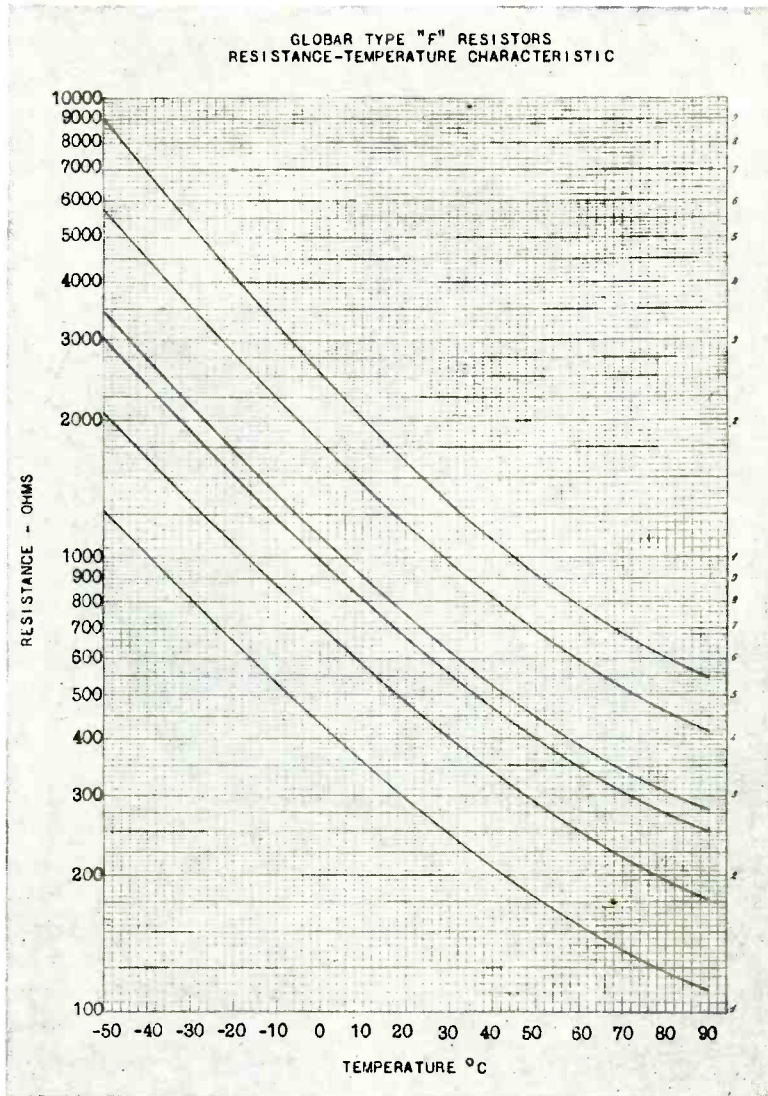

The steep negative curve of Globar Type F Resistors points up their sensitivity over a range from -50°C . to 100°C . Actually this range can be extended beyond 150°C . This pronounced and important characteristic of Globar Type F Resistors makes them particularly useful for stabilizing circuits possessing a positive temperature coefficient of resistance.

Functioning electrically, Globar Resistors have no mechanical parts to get out of adjustment. They retain their inherent characteristics over long periods of time. They may be used on A.C. or D.C. circuits. Typical applications are:

RADIO CIRCUITS—Type F Resistors eliminate the high initial inrush of current, preventing pilot light burnouts and insuring long tube life performance characteristics.

RESISTANCE THERMOMETER—Type F Resistors are ideal for Remote Control and Indication of Temperatures.

MOTOR GENERATORS—Globar Type F Resistors serve as voltage regulators by compensating for the positive temperature—resistance of copper field coils.

ELECTRIC METERS—Globar Type F Resistors provide automatic temperature corrections. To do the job most efficiently for which they are intended, Globar Resistors are designed to meet the specific needs of each application. This means that complete information on your circuit must be supplied. Globar Resistors can be made to specifications in a hurry. Working samples will be sent on request. The Carborundum Company, Globar Division, Niagara Falls, N. Y.

GLOBAR

Ceramic Resistors

BY **CARBORUNDUM**

TRADE MARK

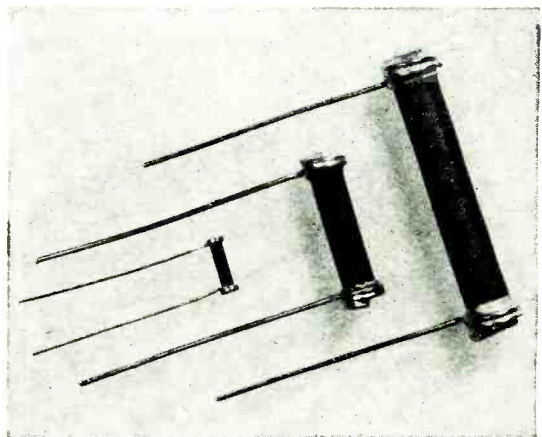

"Carborundum" and "Globar" are registered trademarks which indicate manufacture by The Carborundum Company

1950-1960 USA

MORE PEOPLE WORKING...

EACH PRODUCING MORE...

CAN TURN OUT ENOUGH
GOODS AND SERVICES...

FOR CONSUMERS, CAPITAL
INVESTMENT AND
GOVERNMENT

WITH THE RESOURCES
AVAILABLE...

TO MEET ALMOST ALL
OUR NEEDS

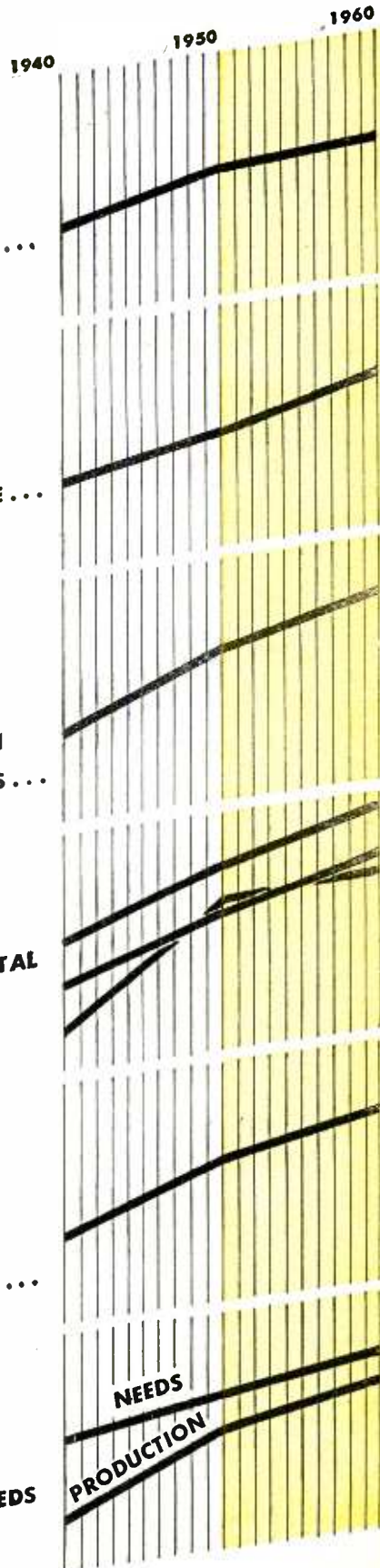

The Twentieth Century Fund, a privately-endowed research foundation, has just completed a monumental 875-page work called "America's Needs and Resources." In it is presented a detailed preview of what economic life in the U. S. A. during the 1950-60 decade will be like if we succeed in maintaining high-level employment. From the findings of the Twentieth Century Fund survey, the McGraw-Hill Department of Economics has prepared this synopsis, which highlights points of interest to readers of this magazine.

POPULATION

A nation's wealth depends more than anything else on the size and vigor of its population. Much of the increase in U. S. production during the past hundred years is a result of a rapid growth in population. This growth supplied manpower for farms and factories and provided an expanding market for consumer goods and services.

Growth was the outstanding fact about population before 1930. The birth rate was almost double the death rate and there was a heavy flow of immigrants. Between 1900 and 1930, the population increase averaged 15 million each decade. Immigration contributed a third of the increase.

But this trend was checked by the depression 30's which stemmed the flood of immigrants and cut the birth rate by forcing postponement of many marriages. As a result, fewer than 9 million persons were added to the population between 1930 and 1940. This was an important factor in prolonging the depression because it slowed the growth of consumer markets.

WARTIME MARRIAGE BOOM

War and postwar conditions have brought a boom in marriages. They have exceeded normal by more than 1,500,000 since 1940. There will be more newly-married couples in 1950 than ever before and the birth rate may be roughly 10% higher than in the early 1930's. So the 20th Century Fund looks for an increase of 12 million in total population between 1940 and 1950 and a further increase of 10 million in the 1950's.

This will mean a faster-growing market for homes, autos, food, clothing, and other consumer items than we had in the 1930's. It will mean crowded schools and more people seeking jobs.

There are four major population trends which will affect markets in the 1950's:

1. The number of families will continue to increase more rapidly than the number of people as families grow smaller. This is significant because the market for housing, appliances, and many other things depends more on the number of families than on the number of people.

2. Our population will be getting older. But it will not be getting less productive because the proportion of the population between the ages of 20 and 60 will be higher than in past decades. Still, the most striking increase will take place in the number of people over 60—from 14 million in 1940 to more than 20 million in 1960. This will bring greater demand for medical services and social security. An important cause of this trend is our success in controlling communicable disease. The following table shows how the death rate from selected causes has changed since 1900.

Death Rate Per 100,000 Persons

	1942	1900
Diseases of heart	295	137
Cancer and other malignant tumors	122	64
Influenza	56	202
Tuberculosis	43	194
Diarrhea and enteritis	9	143
Whooping cough	2	12
Diphtheria	1	40
Measles	1	13
Typhoid and paratyphoid fever	0.5	31
Scarlet fever	0.3	10
Other	505.2	873
	1035.0	1719

TWICE AS MANY PEOPLE

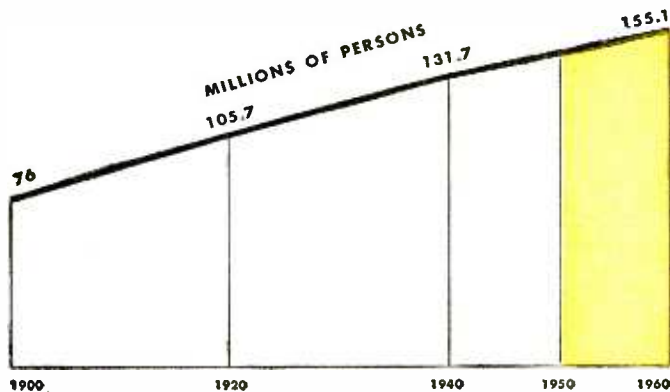

BUT THREE TIMES AS MANY FAMILIES

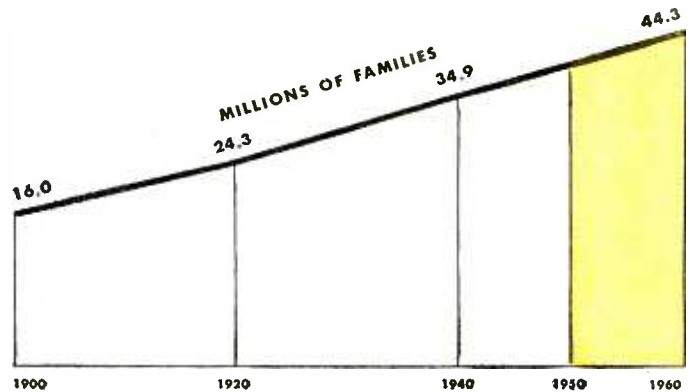

MORE OLDER PEOPLE

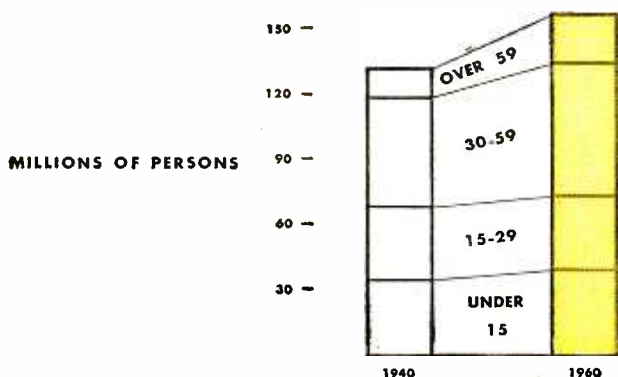

MORE CITY DWELLERS

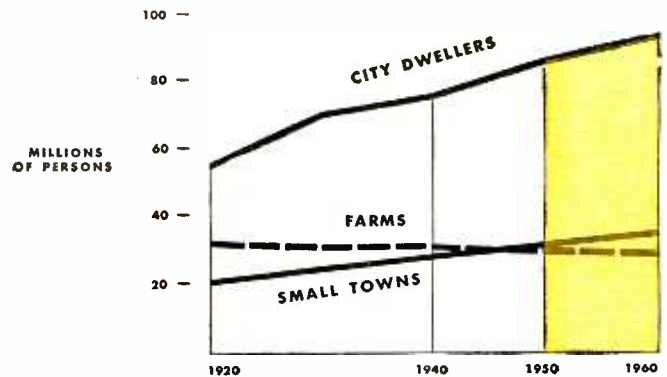

**MORE
PEOPLE
WORKING...**

MORE AND MORE WOMEN ARE SEEKING JOBS

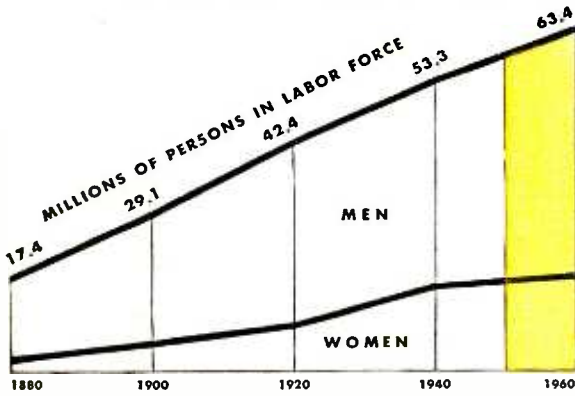

ANATOMY OF THE LABOR FORCE

THE LABOR FORCE IS GROWING MORE SKILLED

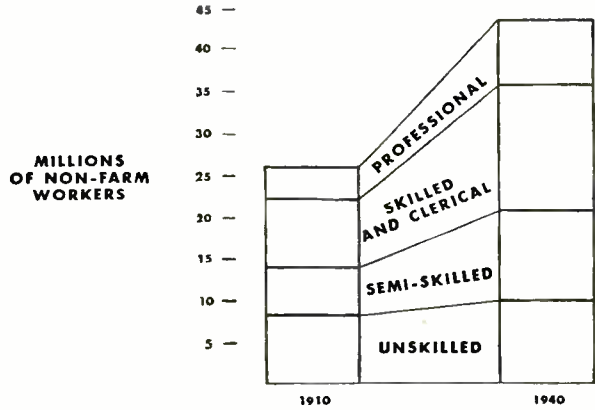

FARMING IS GIVING WAY TO OTHER OCCUPATIONS

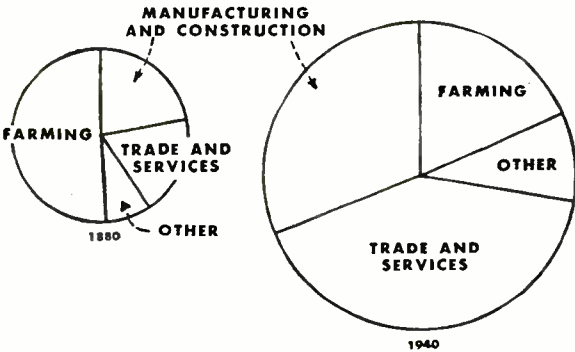

3. The population will continue to become more urbanized. Small and medium-sized cities will grow faster than the largest cities. The general westward migration which was accelerated by the war will continue.

4. Our people will keep on getting more homogeneous. There has been almost no immigration since 1929, so the number of immigrants who have been in the country for less than 20 years will make up less than one percent of the population in 1950 as against 10% in 1930.

An even more important factor in making the population all of a kind has been the growth of universal education. The proportion of children 14-17 years old attending high school doubled between 1920 and 1936. The rise of the radio, movies, and national magazines has also levelled us out. These developments not only raise the general educational level of the nation but also tend to standardize the public's tastes and attitudes.

LABOR FORCE

The volume of goods and services produced by 145 million persons in 1950 and 155 million in 1960 will depend on what share of the population is in the labor market and the amount of work those employed actually do. The proportion of the population in the labor force has shown little change in the past few decades. So the 20th Century Fund assumes that the relationship between labor force and population will be about the same in 1950 and 1960 as it was just before the war. On this basis 60 million people will be in the labor market in 1950 and 63.4 million ten years later.

As you can see from the charts, however, there will be several important changes in the composition of the labor force. More women will be working. In 1870 only one out of every eight worked. By 1940 the pro-

portion had grown to one out of four, and evidently will go on rising.

However, the increase in the number of women working will just about be offset by earlier retirements and longer schooling. This explains why there is little change in the ratio of labor force to population.

UNEMPLOYMENT

The effectiveness of the labor force depends not only on its size but on how fully it is employed. We have never had full employment in the sense that everyone able and willing to work had a job at the same time. Even in good years unemployment has seldom averaged less than 5% of the working force because workers are always moving from job to job. And in 1932, nearly one-fourth of all workers were unable to find jobs.

For this reason, the 20th Century Fund assumes that, even with good business in the 1950s, unemployment will average 5% of the labor force. This works out to 3 million unemployed in 1950.

In addition, the Fund expects the long down-trend in average weekly hours to continue. A century ago, workers put in a 12 hour day for 6 days a week. By 1940 the average work-week had declined to 44 hours in non-agricultural jobs and 52 hours in agriculture. If this trend continues, the average in non-farm jobs will be down to 38 hours a week in 1960, and farmers will work 48 hours.

Adding all this up, and allowing for vacations, absenteeism, and sickness, the 20th Century Fund estimates that the U. S. will put in 121 billion man-hours of work in 1950 and 118 billion in 1960. This compares with 105 billion in 1940 and with 154 billion at the peak of the war effort. The quantity of goods and services that can be turned out with this amount of labor effort will depend on average output per man-hour, or productivity.

PRODUCTIVITY

The key to our future economic welfare is productivity. It is the five-fold increase in output per man-hour that has made it possible for us to work shorter hours and still enjoy a rising standard of living. This increase in productivity has been accomplished not by working harder but by constantly inventing better machinery to supplement human energy with mechanical power.

Of course, in any specific factory at any given time, productivity depends largely on the willingness and ability of labor and management. But over the years, the actual effort of the individual worker becomes much less important than the effort of the machine. The most energetic and skilled blacksmith of a century ago could not remotely approach the productivity of today's semi-skilled worker operating automatic power-driven equipment.

In 1860, the average worker turned out 33¢ (in 1944 dollars) worth of goods in an hour. By 1940, this had grown to \$1.22. This sensational increase in productivity was due to the increased use of power-driven machines. In 1860, the average worker had the help of only half a horsepower of animal or mineral energy. In 1940, he had the use of 2.7 horsepower. To put it another way, if there

had been no increase in the use of mechanical power since 1850, it would have taken 290 million workers to turn out the amount of goods and services actually produced at the peak of the war effort by only 63 million workers.

EACH
PRODUCING
MORE ...

DO MACHINES KILL JOBS

Past history also shows that we need not fear the long run effects of the introduction of labor-saving machines. On the contrary, the only way we can improve the material welfare of everyone is to continue and even step up the rate at which we save labor by using machines.

Some people, it is true, are thrown out of work and a few of them may not be able to find other jobs easily. But mechanization more than compensates for "technological unemployment" by making it possible to produce more and better things for everyone—things that themselves create jobs. Development of the railroads and the automobile, for example, put a lot of canal boat and livery stable operators out of business. But it cut the cost of transportation and created many times more jobs than it eliminated.

The 20th Century Fund also points out that the most important reason that the technological revolution developed luxuriantly in the U. S. between 1850 and 1940 was that competitive enterprise provided a generally favorable climate. It is true that natural resources were plentiful and that the population was growing rapidly both in numbers and in skill. But what we had to a unique degree here was an atmosphere which favored risk-taking, fostered the vast capital investment necessary to harness and apply mechanical energy, and provided the incentives necessary to put capital and inventiveness to work.

No other economy has equalled ours in the ability to produce more and more with continually diminishing human effort. The test it now faces is whether it can eliminate the ups and downs in production and employment that have gone along with it. But an abundance of evidence indicates that we ran into

trouble after 1929 not because we developed too many labor-saving machines but because we didn't adjust our economic mechanism to keep the process going.

The key importance of mechanization is indicated by the fact that the increase in national production since 1860 closely parallels the increase in use of mechanical power. Between 1860 and 1940, both volume of production and use of energy multiplied about 11 times. It is clear that, in order to keep our standard of living rising, we must continue to apply more and more power to production.

Chief advantage of mechanical energy is, of course, its low cost. Electric energy is now delivered for as little as a cent a horsepower, while the same amount of human energy costs \$10.

And there are other important advantages. Mechanical energy can be delivered in greater concentrations than any other form. It is also more convenient, compact, mobile, and controllable. Consolidated Edison in New York delivers enough electricity in a day to do the work of 3 million draft horses.

These advantages are now so universally accepted that it's hard to realize how recently we left the horse and buggy era. At the turn of the century, animals and men provided more than half the energy used in production and transportation. It wasn't until World War I that trucks replaced horses in local hauling and tractors began to invade the farms. Here is how the use of mechanical energy has grown since 1850:

	Total Energy Output (Billions of Horsepower-Hours)	Percent Supplied by:		
		Mechanical Energy	Humans	Animals
1850	17.6	6	15	79
1860	25.2	7	14	79
1870	27.8	12	15	73
1880	39.9	17	14	69
1890	61.1	28	12	60
1900	82.9	38	10	52
1910	131.4	57	8	35
1920	197.4	73	6	21
1930	238.3	84	5	11
1940	289.4	90	4	6
1950	410.4	94	3	3
1960	489.8	96	2	2

PRODUCTIVITY IN THE FUTURE

Any attempt to predict future developments in productivity is complicated by the fact that the changes do not occur at an even rate. Between 1850 and 1940 the average increase in output per man-hour was 18% per decade. But the changes varied all the way from 3% between 1870 and 1880 to 42% for the decade ending in 1940. There is, therefore, no simple way to extend past trends to obtain a fool-proof figure for productivity at a future date.

For purposes of this study, however, the 20th Century Fund assumes that the average rate of increase since 1850 may be projected to estimate output per man-hour in 1950 and 1960. Thus, output per man-hour works out to \$1.44 in 1950 and \$1.70 in 1960 as against \$1.22 in 1940 (all in 1944 dollars).

As the Fund points out, this is a critical assumption, and it is further complicated by the fact that there is a wider possibility of error in this estimate than in most of the others in the study. If, for example, it is assumed that productivity will increase at the pace set from 1920 to 1940 which averaged 36% per decade, then 1960 production would be about double the 1940 level instead of only 157% of it, as the 20th Century Fund estimates.

A CENTURY OF ECONOMIC PROGRESS 1860 - 1960

OUTPUT PER MAN-HOUR SHOULD BE 5 TIMES AS GREAT

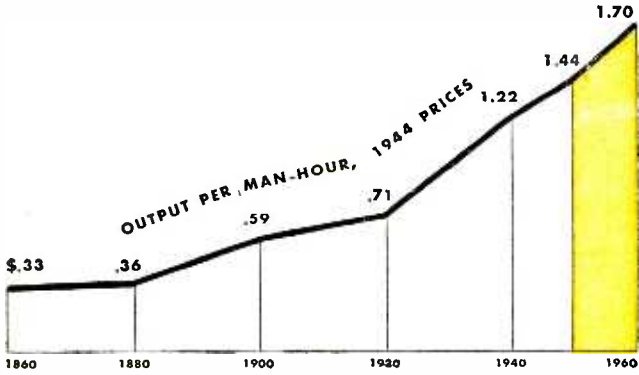

BECAUSE OF A STEADY GROWTH OF POWER AND MACHINES

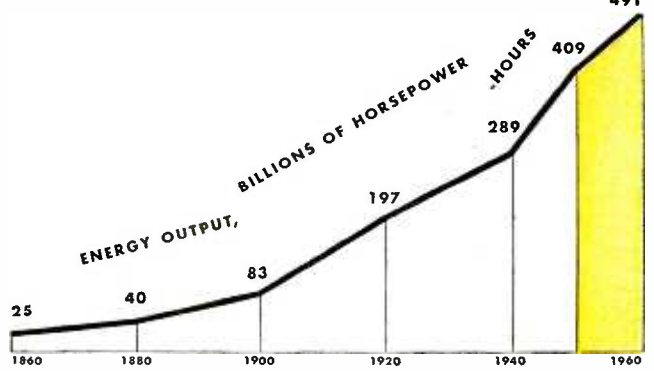

HUMAN WORKERS
MINERAL FUELS

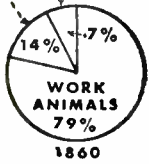

SO WITH LESS EFFORT

WORK ANIMALS HUMAN WORKERS

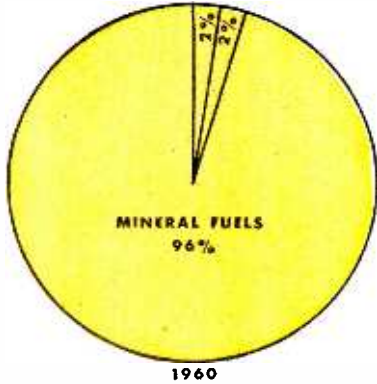

AND A SHORTER WORK WEEK

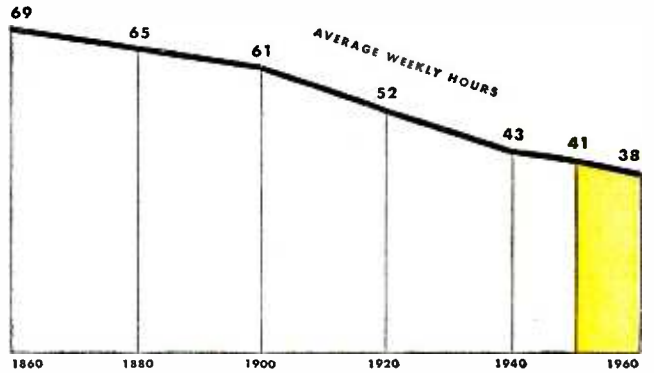

6 TIMES AS MANY WORKERS CAN PRODUCE 17 TIMES AS MUCH

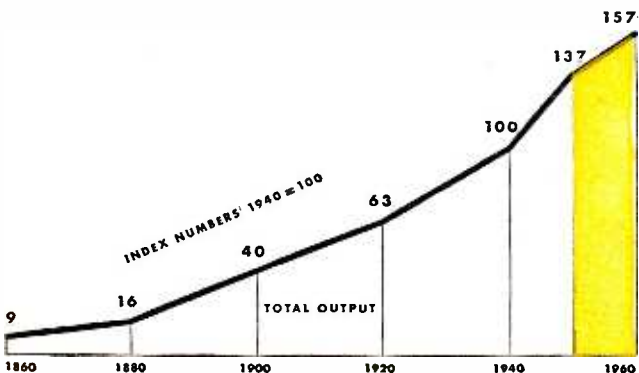

AND PROVIDE 3 1/2 TIMES AS MUCH OUTPUT FOR EACH PERSON

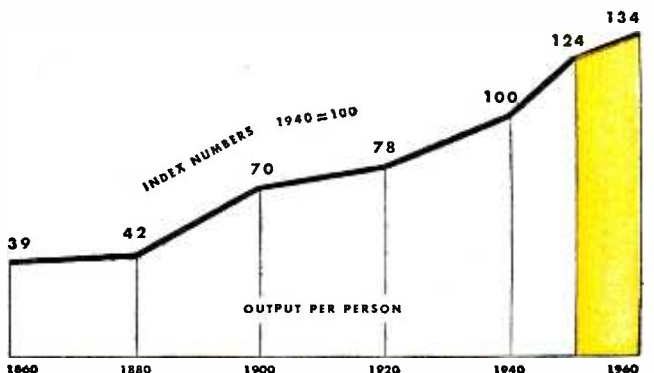

TOTAL NATIONAL OUTPUT

The potential volume of goods and services in 1950 and 1960 can be determined by simple arithmetic, using the assumptions outlined on the preceding pages. Of an estimated population of 145 million in 1950, about 60 million persons will be in the labor market and 57 million of them will have jobs if we succeed in keeping business activity at a high level.

This many people would work 121 billion man-hours. With output per man-hour estimated at \$1.44 (in 1944 dollars) the total value of goods and services produced, or the gross national product, would come to \$177 billion. Similar calculations yield a gross national product of \$202 billion for 1960.

As the 20th Century Fund emphasizes, these estimates are neither a forecast of actual production nor an appraisal of maximum potential production. They are merely an attempt to show in dollars and cents what can be achieved with high-level employment.

HIGHER LIVING STANDARDS

Compared with any prewar year, a gross national product of \$177 billion in 1950 and \$202 billion in 1960 would represent a handsome gain. It would make possible a substantial rise in living standards.

In 1950 we would produce a fifth more than in 1941.

However, the volume of goods and services turned out in 1950 would be only slightly higher than present production. This is because the number of persons at work today is 2 million above

the estimated normal for 1950, and average weekly hours are higher than they will be then. Almost a

**CAN TURN OUT
ENOUGH GOODS
AND SERVICES...**

million and a half of the emergency workers drawn into the labor force during the war are still at work and unemployment is lower than the figure assumed for 1950.

The estimates of 1950 and 1960 gross national product, as well as the figures for past years used in the chart, are expressed in 1944 prices. This is not a prediction that the price level will settle down to the 1944 level which would involve a drop of 18% in the cost of living and 26% in wholesale prices. It is merely a device to eliminate price fluctuations so that the figures will show only the actual changes in the physical volume of production.

Gross national product measures the total market value of everything the nation produces. All the goods and services produced are absorbed in one of three ways: by consumer expenditures; by expenditures for investment in capital goods or inventories; or by government expenditures.

HIGHER TAXES, LESS INVESTMENT

The division of total output among consumers, investment, and government will be somewhat different in 1950 and 1960 than in the past. About two-thirds of total output will go into consumer goods and services. This is about the same as the proportion in prewar years.

Government's share will continue to grow, however. It rose from 11% of total output in 1929 to 17% in 1940. At the peak of the war effort, half of all production went to Uncle Sam. Government expenditures have dropped to less than half the war peak and they will continue to decline slowly. But government's share will still run to around 20% in the 1950's. On the other hand, the ratio of investment to total output shows a slight long term decline.

HOW TOTAL OUTPUT IS DISTRIBUTED

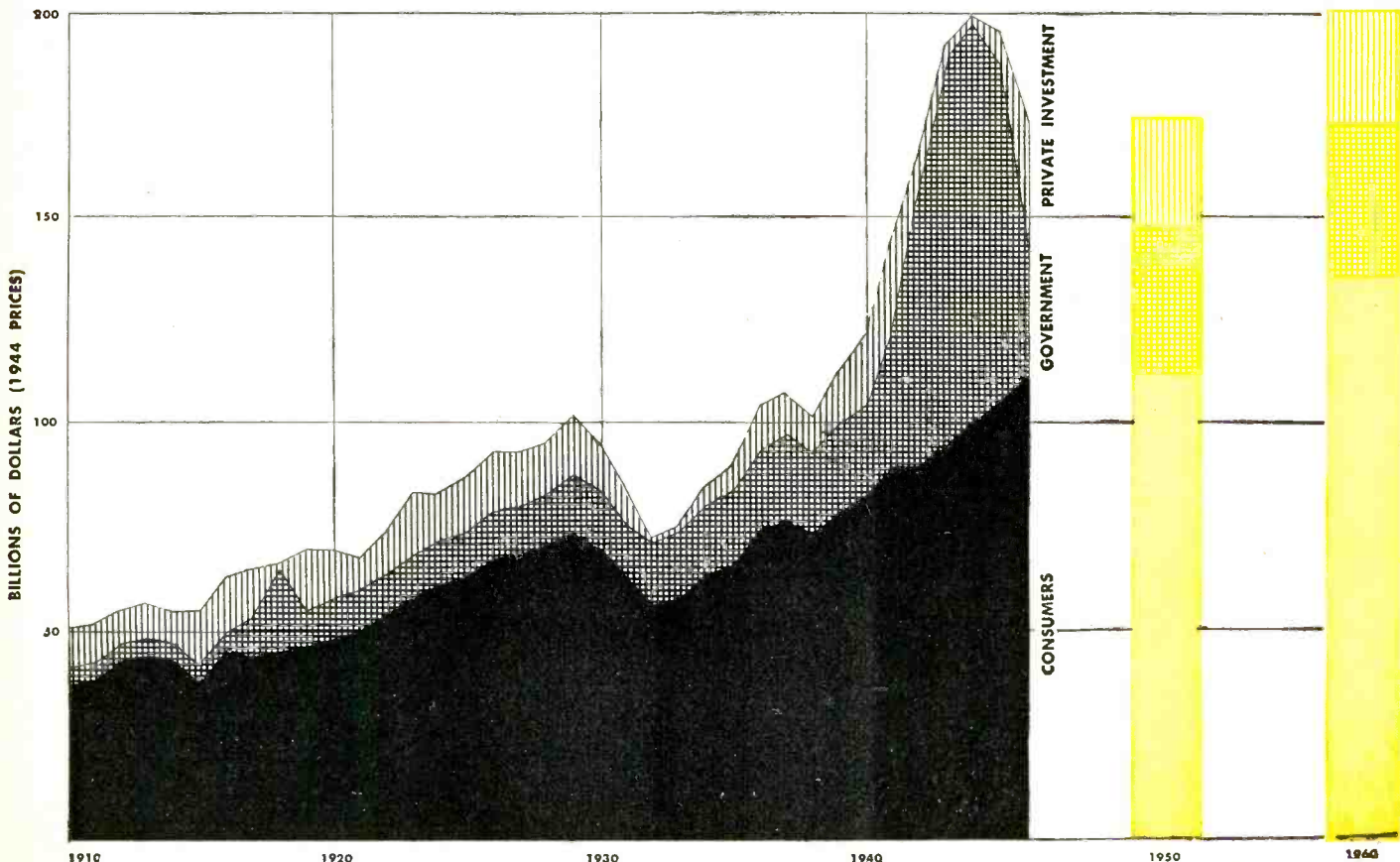

MORE CONSUMER PURCHASING POWER

CONSUMERS WILL BE ABLE TO BUY 50% MORE THAN IN 1930'S

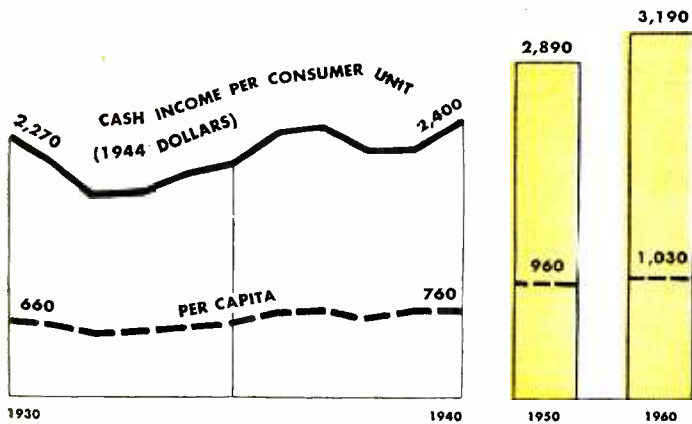

EVERY OTHER FAMILY... INSTEAD OF EVERY SIXTH FAMILY... WILL HAVE \$2,000 OR MORE TO SPEND.

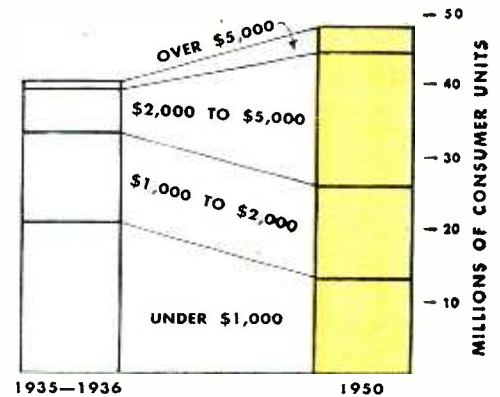

CONSUMER INCOME

U. S. business can look forward to a 1950 consumer market twice as large as in the worst year of the depression, half again as large as in 1929, and one-fifth larger than in 1941. That is the major conclusion of the 20th Century Fund's analysis of consumer purchasing power. Here are the steps by which it arrives at that conclusion:

1. With gross national product at \$177 billion in 1950, past experience indicates that income payments to individuals would run to \$138 billion.
2. Income tax rates are assumed to equal the 1942 schedules, so individuals would pay \$11 billion in taxes (as against \$19 billion in 1946).
3. Savings are estimated at \$12 billion, or about 9% of income after taxes.
4. Subtracting taxes and savings, consumer purchases of goods and services would total \$116 billion.

LOWER SAVINGS

Many experts would criticize the assumption that savings will amount to only 9% of income. Some of them look for a ratio as high as 20% in prosperous postwar years. The 20th Century Fund justifies the use of a low figure on three grounds: (1) people built up reserve of savings during the war; (2) expanding social security will reduce the need to save for old age; and (3) taxes will cut into savings. The Fund's estimate of savings plus taxes in 1950 adds up to a higher percentage of income than in prosperous prewar years.

The standard of living won't rise as rapidly as the total income going to consumers, because the increased income will be split up among more family units. But the average consumer unit (a family or a single person living alone) will be a third better off in 1960 than in the 1930's.

Shifts in the distribution of income will be even more important, from a marketing standpoint, than the general increase in over-all consumer income. More consumer units will be in the over-\$2000 brackets than ever before and this group will be receiving a much larger share of total consumer income.

Part of the apparent increase in income is cancelled out by higher prices. To show the actual increase in purchasing power, the figures should be

adjusted for an estimated one-third increase in the 1950 price level over that of the mid-1930's. This would mean that a \$2,650 income in 1950 would buy no more than a \$2,000 income in 1935-36. Even if this adjustment is made, the resulting figures still show a striking upward shift.

Income Class	Consumer Units in Millions		Cash Income in Billions	
	1935-56	1950	1935-36	1950
Total	39.2	47.9	\$85.0	\$135.0
Under \$1000	20.8	13.0	17.0	7.7
\$1000-2000	12.2	12.9	28.1	21.5
\$2000-5000	5.5	18.2	23.8	62.1
Over \$5000	0.7	3.8	16.1	43.7

In addition to dollar income, shown in the above table, consumers also receive "income in kind"—food and fuel produced by farmers for their own use, board and lodging received by domestic servants. Such income will have a value estimated at \$3.3 billion in 1950, most of which will supplement the \$7.7 billion received by those in the "under \$1000" bracket.

The urban market will continue to be far more important than the rural market. Consumer units in cities will receive cash incomes of \$3,445 on the average in 1950, more than twice the farm average of \$1,635 and almost twice the small town average of \$1,880.

THE FARM MARKET

These figures don't provide an accurate measure of the relative importance of the rural and urban markets because rural consumers pay a lot less for food, fuel, shelter and so have more to spend for other things. If there were any way to adjust for these things, the figures would show a smaller spread between the two markets, but the urban market will still be dominant.

All these figures underline a general upgrading in consumer demands which would accompany high-level production and employment. It will have a profound effect on marketing practices. The average person will eat better, dress better, and live in a better house with better equipment. And he will have more money to spend for travel, recreation, and luxuries.

FOR CONSUMERS...

CONSUMER MARKETS

The improvement in living standards during the 1950 decade will lead to important changes in the way consumers spend their dollars. Even though they will eat better, dress better, and live in better houses, a smaller share of the consumer dollar will be spent on food, clothing and shelter. A growing share will go for appliances, furniture, travel, and recreation.

This means that the fastest growing markets will be those providing what might be called "optional" goods and services — things which add to comfort and enjoyment but which are not strictly necessary. Markets for necessities, on the other hand, will expand at a slower rate than total consumer expenditures.

The growing importance of "optional" goods and services is one of the reasons why it's increasingly difficult to keep our economic machine going on an even keel. The purchase of "optional" goods can be postponed with little hardship. So anything that causes people to put off buying a new car, a new house, or a new radio has a far greater effect on production and employment now than it did when the major share of the consumer dollar went for necessities.

Some of the trends in major markets are summarized in the following sections.

FOOD

Although food is by far the largest item in the consumer budget, its relative importance is declining slowly as living standards rise. People eat the same number of pounds of food they ate in 1909 but the food is better from a nutritional standpoint and easier

STANDARD OF LIVING YARDSTICK: MORE OF THE CONSUMER DOLLAR GOES FOR THE COMFORTS OF MODERN LIFE

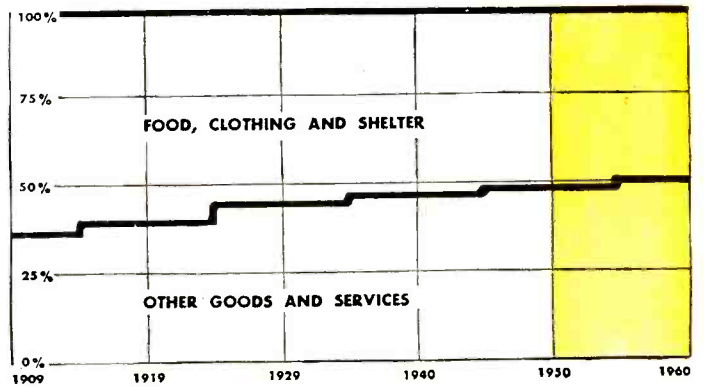

to prepare. Thus, the trend favors fruits, vegetables, and dairy products as against meat, potatoes, and bread.

More and more food is being processed in factories rather than in consumer kitchens. Improved methods of manufacture and distribution have transformed the luxury foods of yesterday into the standard foods of today. New kinds of processed foods — canned, frozen, and dehydrated — are appearing constantly.

CLOTHING

Three long term trends will shape the clothing market in the future: (1) the shift from home and custom to factory fabrication is almost complete;

WHERE CONSUMER DOLLARS GO

(Figures in Billions of Dollars)

	1909	1919	1929	1940	1941	(1944 Prices)	
						1950	1960
Total Consumer Expenditures	28.8	60.8	80.3	70.6	80.4	116.2	134.2
Food, Liquor, and Tobacco	9.9	22.3	23.7	21.9	25.3	36.2	41.1
Food	7.4	18.8	19.9	16.4	19.0	27.2	30.8
Liquor and Tobacco	2.5	3.5	3.7	5.5	6.3	9.0	10.3
Clothing and Personal Care	4.4	9.8	12.1	9.8	11.5	16.2	18.7
Housing	6.8	10.1	14.4	12.6	13.3	19.3	21.4
Rent a.	5.5	7.9	11.3	9.1	9.7	14.0	15.4
Fuel	1.0	1.5	1.7	1.7	1.8	2.5	2.8
Electricity	0.1	0.3	0.6	0.9	1.0	1.6	1.8
Household Equipment and Operation	2.8	6.2	10.6	8.7	10.3	15.0	17.4
Appliances	0.2	0.4	0.8	1.0	1.3	1.8	2.4
Consumer Transportation	1.6	5.2	8.6	7.3	8.6	12.7	16.4
Autos and Private Planes b.	0.6	3.5	6.0	5.7	6.8	9.6	12.7
Local Bus and Street Car	—	—	0.8	0.7	0.8	1.5	1.5
Intercity Bus	—	—	0.1	0.1	0.2	0.2	0.2
Airlines	—	—	c.	c.	c.	0.1	0.5
Railroads	0.4	0.8	0.6	0.3	0.3	0.4	0.3
Medical Care, Insurance, and Death Expenses ...	1.1	2.8	4.5	4.7	5.2	7.7	8.7
Recreation	0.9	2.1	3.8	3.3	3.7	5.7	6.9
Radio and Television Sets	0.2	0.7	1.0	0.6	0.8	1.1	1.3
Private Education, Religion, and Welfare	1.2	2.2	2.7	2.3	2.4	3.4	3.7

a. Includes Estimated Rent for Owner-Occupied Homes.

b. Includes Original Cost and Operating Expenses.

c. Less than \$50 Million.

CONSUMER MARKETS IN 1950 AND 1960: Percent Increase in Sales Over 1940

Bottom Segment Equals Percent Increase 1940-1950; Total Height Equals Percent Increase 1940-1960.

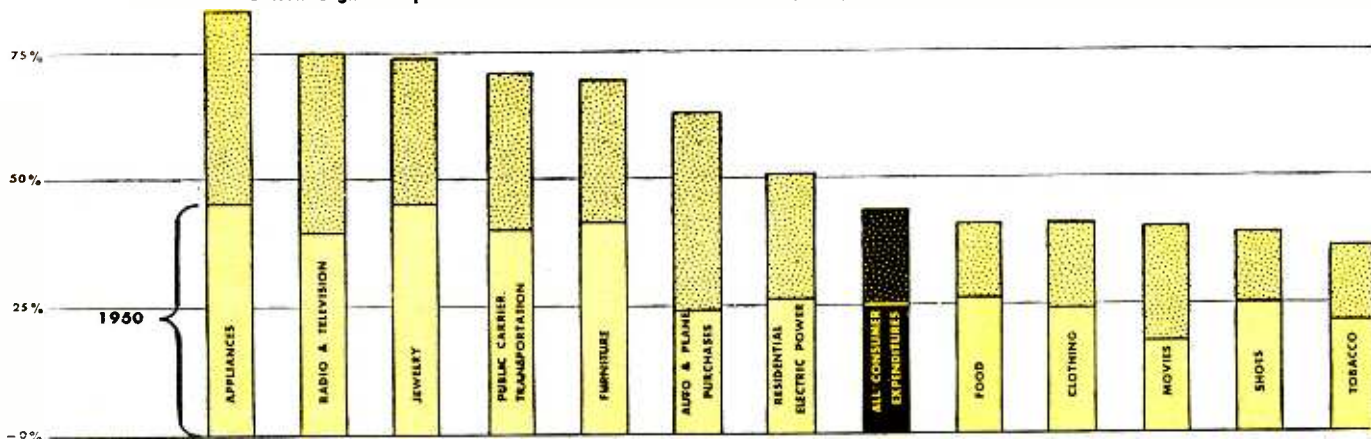

(2) synthetics, chiefly rayon and nylon so far, are replacing cotton, wool, and silk at an accelerating pace; (3) there's greater standardization of styles and a trend to lighter and simpler clothing.

In 1909 consumers spent 14% of their income for clothing but by 1940 the ratio had declined to 12%. However, this long run decline may be halted or reversed. The migration from farms to cities, the upgrading of incomes, and the growing demand for sports clothing will increase clothing expenditures.

HOUSING

The decline in the relative importance of housing expenditures — from 24% of consumer dollars in 1909 to less than 18% in 1940 — is expected to continue. The reason is that people feel they get more value

for their dollars in other things than housing. Nevertheless, the housing market should be much larger in the 1950's than in the 1930's because much of our housing needs to be repaired or replaced.

A Census survey in 1940 showed that 16 million of the nation's 37 million dwelling units needed to be replaced or needed major repairs. The 20th Century Fund estimates that the provision of adequate housing for everyone by 1960 would involve building 20 million new units and rehabilitating 5.4 million at a total cost of \$115 billion (1944 prices). The Fund also estimates that we will fall 15% short of this goal even with continued high-level employment.

HOUSEHOLD EQUIPMENT

More and more of the consumer dollar has gone for household equipment in the past four decades, largely because of the development of labor-saving appliances. The outlook is for a continuation of this trend. New appliances are being developed; and the large number of new houses slated to be built in the next few years, the wartime and postwar boom in the number of families, and the migration to the cities should add to appliance demand. The same factors should brighten the outlook for furniture, rugs, and other household items.

Some appliance markets may be saturated by the 1950's, however. A few years of high production would fill our homes with refrigerators, for example. However, replacement demand would run to 2.7 million units in 1960 and there would be a demand for 1.3 million refrigerators to equip new houses, so the market would still be bigger than in 1941 when 3.6 million were sold. However, new products must be developed if the industry is to keep up the pace it has set in the past.

TRAVEL

In 1916 the average person traveled 400 miles. By 1940 the average had grown to 2,400 miles, chiefly because of the rise of the automobile. The 20th Century Fund expects this growth to continue because as their incomes rise people spend more money traveling.

A good share of the increased spending will go to purchases of cars and planes. The Fund estimates that there will be 36 million cars on the road and 100,000 private planes in the air in 1950. The auto industry would be able to sell 5 million new cars a year after 1950 — 4 million for replacement and a million for population growth.

OUR CHANGING DIET: MORE MILK, FRUITS AND VEGETABLES LESS MEAT, POTATOES AND BREAD

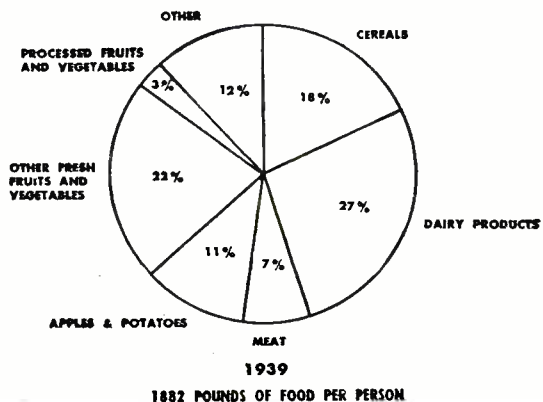
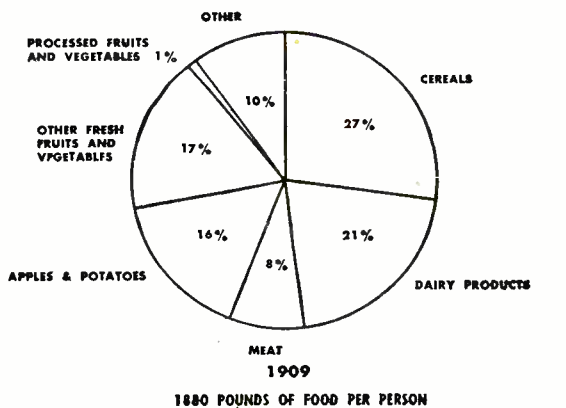

CAPITAL INVESTMENT

Investment plays a crucial role in our economy for two reasons. It is by plowing back part of our annual output that we are able to provide better machines and equipment to keep productivity rising. But the amount ploughed back varies widely from year to year. This unevenness of capital investment contributes to the instability of production and employment.

Because capital investment involves the purchase of durable goods, it can be postponed almost indefinitely when the outlook for profits darkens. Thus, capital investment plummeted from \$18 billion in 1929 to \$5 billion in 1933, a drop of 72%, whereas consumer spending fell only about half as fast in the same period.

MORE FOR EQUIPMENT

There has been an important shift in the relationship between construction and equipment, the two major types of investment. Before World War I, construction made up around three-fourths of total investment but the ratio declined to less than half in 1935-39. Part of the decline is, of course, explained by the fact that the depression left us with ample plant capacity but provided an incentive to buy more efficient machines to cut costs. Nevertheless, there is a well-defined trend towards allocating an increasing proportion of investment to equipment rather than to plant construction.

A little less than two-thirds of total investment goes into industrial plants and equipment. Housing and other consumer construction (hospitals, schools, churches) averaged 27% of total investment during the interwar period. Housing fell from a peak of \$6 billion in 1926 to \$4.7 billion in 1929 and \$600 million in 1933; and it had recovered only half the 1926 volume by 1940.

While other types of investment follow the ups and downs in general busi-

ness, investment in housing construction follows a cycle of its own. This housing cycle is determined by factors such as the vacancy rate, the level of rents, and that of construction costs, which may not follow the trend of general business. When a drop in general business activity takes place during a declining phase of the housing cycle, as it did in 1929, the result is a deep and prolonged depression.

Government investment, of which the largest component is highways, has been much more stable than other types but it doesn't swing enough weight to stabilize total investment.

Because of the wide fluctuations in capital investment, it's much more difficult to estimate future capital expenditures than future consumer purchases. In order to make a relatively stable forecast, the 20th Century Fund bases its estimates on the long term trend since 1879, which shows a slight decline in the share of total output going to capital investment. Thus, investment under conditions of stable prosperity in the 1950 decade is estimated at 16% of total output as compared with a ratio of more than 18% in the late 1920's. On this basis, estimated capital expenditures work out to \$28 billion for 1950 and \$33 billion in 1960. Our ability to maintain high employment and rising living standards will depend in large measure on our ability to invest that much profitably in new machinery and buildings.

CAPITAL NEEDS

Analysis of our capital needs lends little support to the idea prevalent during the 1930's that we had reached economic maturity so that there was no way to invest as much as we had in earlier decades. No one has ever made an estimate of how much it would cost to modernize our industrial plant, which is valued at around \$200 billion at prewar prices. If as much as a third of it needs to be replaced or rehabilitated, around \$100 billion (current prices) of additional investment will be required.

In addition, huge amounts of money need to be invested in housing and public works to raise the serv-

CAPITAL
INVESTMENT ...

WHERE INVESTMENT DOLLARS GO

(Figures in Billions of Dollars)

	(Annual Averages)						
	1920- 1924	1925- 1929	1930- 1934	1935- 1939	1940- 1944	(1944 Prices)	
						1950	1960
Total Capital Investment	\$12,428	\$17,186	\$8,215	\$10,445	\$12,340	\$27,700	\$33,000
All Industries	7,570	10,112	5,272	6,889	8,089	17,800	21,125
Manufacturing	1,996	2,362	1,074	1,610	3,731	4,200	5,025
Food	261	357	194	244		228	273
Textiles	227	212	92	117		175	210
Steel	138	188	110	192		853	1,021
Autos	105	150	78	146		369	441
Chemicals & Petroleum	70	95	68	142		928	1,111
Machinery	—	—	—	28		180	216
Other	510	625	213	409		1,462	1,750
Transportation	1,797	2,303	1,277	1,822	805	4,300	5,100
Commercial	1,196	1,940	777	719	833	1,950	2,300
Utility	693	999	483	422	780	1,500	1,625
Other	1,888	2,508	1,661	2,316	1,940	3,950	4,700
Consumer Construction	3,806	5,557	1,547	2,256	2,912	7,200	8,255
Government Construction	1,052	1,517	1,396	1,299	1,338	2,700	3,620

OVER THE YEARS ABOUT 1/5 OF TOTAL OUTPUT IS PLOWED BACK AS INVESTMENT

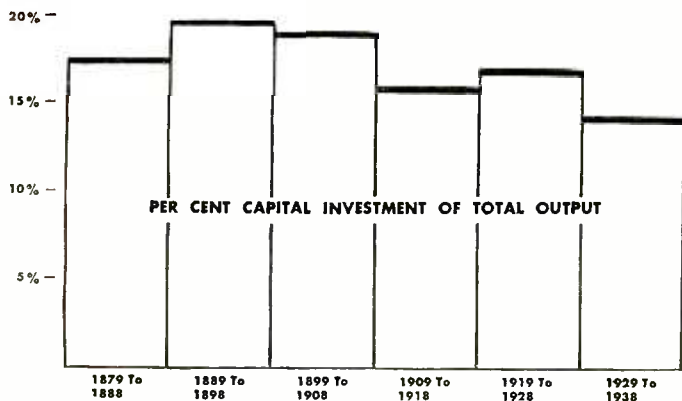

BUT THE AMOUNT PLOWED BACK VARIES GREATLY FROM GOOD YEARS TO BAD, ACCENTUATING THE SWINGS OF THE BUSINESS CYCLE

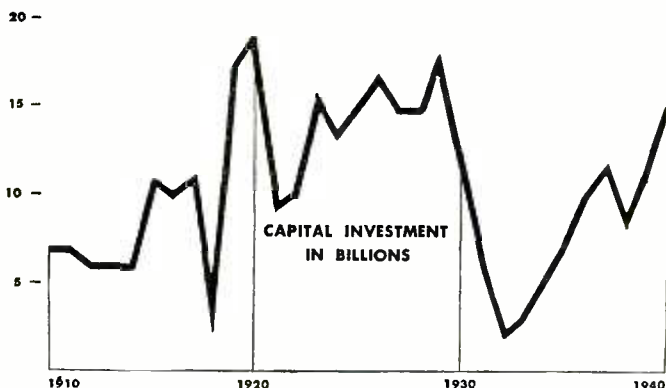

ices provided merely to adequate levels. The 20th Century Fund estimates that the cost of a 15 year program to modernize our city streets and rural highways would run to \$40 billion. To bring the nation's housing up to minimum standards of health and decency by 1960 would cost \$115 billion. To conserve our natural resources and develop our water power would cost \$27 billion over a 15 year period.

There seems to be little question that needs exist for all the capital investment we can make for a long time to come. The behavior of investment in the past strongly suggests that the problem is not one of lack of needs but one of finding ways to add to our capital in an orderly fashion. Capital investment has followed the boom and bust route in the past; what is wanted is a high but steady rate of investment.

WARTIME INVESTMENT DEFICIT

Demand for capital goods is stronger right now than ever before, largely because of the backed-up needs arising out of the war. Here is how wartime expenditures for capital goods which can be used in peacetime production compared with expenditures in the last 5 years of both the 1920's and 1930's: (Figures in billions of dollars)

	1925-1929	1935-1939*	1940-1944
Total Capital investment	\$86	\$65	\$49
Industrial	51	43	32
Manufacturing	12	10	14
Metals, chemicals, machinery, petroleum	6	6	11
All Other	6	4	3
Commercial	10	5	3
Railroads	5	3	3
Electric power	5	3	3
Consumer Construction	28	14	12
Public Works	7	8	5

* Adjusted to Wartime Prices

Wartime restrictions held investment in all civilian lines far below what would be spent in prosperous peacetime years. Thus, there was a backlog of investment needs at the end of the war which ran to more than \$30 billion, if the 1925-1929 demand can be taken as typical. Whatever the precise size of the backlog, it is clearly great enough, when added to the normal yearly demand for new investment, to keep the heavy goods boom going for some time to come. The test of our ability to stabilize capital investment will come later.

There is also a huge foreign demand for American capital. How far we will go toward meeting this depends largely on whether international political and

economic conditions are stable enough to make private foreign investment a good risk.

If we invest abroad in the same proportion we did in the late-1920's, our foreign investments will total \$1.6 billion during the year 1950 and \$1.5 billion in the year 1960. This will mean a net increase in our foreign holdings of \$15 billion during the 1950's, raising the total of such holdings to about \$25 billion, as against a total of \$10.6 billion in 1940.

To make that much foreign investment pay out, an expanding volume of world trade would be required. Foreign nations would have to get enough dollars not only to pay for goods they bought from us but also to pay interest and dividends on U. S. investments. If our overseas investments increase to \$25 billion by 1960, annual interest and dividends owed us will run to almost \$1 3/4 billion.

To pay us that much, foreign nations would have to sell much more in the U. S. than ever before. The 20th Century Fund calculates that imports of \$7.3 billion in 1950 and \$8.1 billion in 1960 would provide other countries with the dollars they need. Imports ran to \$2.5 billion in 1940 so we would have to buy 3 times as much abroad to keep expanding our foreign investments.

With good business, U. S. demand for imported goods should be well above prewar. Rising living standards will widen the market for such consumer items as British tweeds and French perfumes. Moreover, we will need to import more raw materials than ever before because we used up our natural resources at a prodigious pace during the war.

NEW INDUSTRIES

The new methods, materials, and products developed during the war may well have a more profound and lasting effect on future capital requirements than the backed-up demands accumulated in wartime. Here are some of the wartime developments which may have important peacetime applications: new chemical processes and products including synthetic rubber, plastics, synthetic fibers and fabrics; new food products and new methods of food processing; new uses for glass, plywood, and the light metals; tremendous advances in aviation; and new applications of atomic energy and fissionable products in power production and medicine.

Large capital expenditures will be required to push these developments further and adapt them to civilian use. New businesses and perhaps entire new industries will grow up, adding to the demand for capital goods for many years.

THE COST OF GOVERNMENT

To the traditional certainty of death and taxes can be added the certainty that the cost of government will take a much larger share of national income than ever before in peacetime. After the Civil War and again after World War I, federal expenditures moved up to a level four times prewar. And it is already clear that World War II is going to have about the same effect.

In 1940, federal, state, and local governments spent \$19 billion, of which a total of \$2.2 billion went for national defense, veterans, and interest on the war debt. By 1950, the 20th Century Fund estimates that all governmental units in the U. S. will be spending more than \$45 billion. Federal expenditures are estimated at \$27.6 billion in that year as against \$9 billion in 1940.

Part of the increase is explained by higher post-war prices. Adjusting for price changes would reduce the 1950 figure from \$45 billion to \$33.5 billion. This is still 80% above the 1940 level. Increased expenditures for public works, social insurance, and schools explain another small part of the rise.

But costs arising out of the war are by far the most important factor. Military and veterans' expenditures and interest on the war-swollen national debt will add up to over \$17 billion in 1950. This is only 10% less than total government expenditures in 1940.

The only major category of government expense which would be lower in 1950 is welfare. With high-level employment and more social insurance, relief and other welfare costs should run to \$2.5 billion in 1950 as against \$3 billion in 1941.

The following paragraphs describe important trends in the major items of government expense.

MILITARY

The 20th Century Fund assumes that we will maintain an armed strength of 2 million men (including trainees) and that it will cost \$3,300 to equip and maintain each man, so total military expenditures will run to \$6.6 billion. But even if we decide to maintain a smaller armed strength, the total cost might easily be at least \$6.6 billion because the present per serviceman cost of over \$6,000 a year may not decline.

VETERANS

It will cost at least \$2.9 billion to take care of veterans in 1950 even if benefits are not increased. That's 5 times the 1941 cost. Pensions for World War I veterans rose steadily

from \$116 million in 1924 to over \$300 million in 1945. That rise will continue for another 20 years. By far the largest expense will be for World War II pensions which are already costing \$900 million. Disability and death benefits will cost about \$1¼ billion in 1950; hospitalization will add another \$250 million; and insurance \$150 million.

SOCIAL SECURITY

Future expenditures for social security will depend on whether steps are taken to extend coverage and liberalize benefits. Over 60 million people are now covered so the cost is certain to increase rapidly as more of them begin to draw payments. With high-

WHY THE COST OF GOVERNMENT HAS INCREASED. The \$25.6 billion increase in cost from 1913 to 1941 was due to:

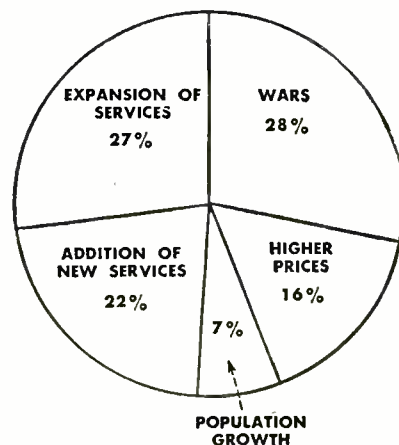

level employment in 1950, estimated old age and unemployment benefits under the present system would run to over \$5 billion. Expansion of benefits, as recommended by the Social Security Board, would raise the cost to over \$9 billion.

PUBLIC WORKS

Even an economy-minded Congress is almost certain to go along with expenditures for highways, airports, waterways, flood control and conservation. Thus, an increase in expenditures for transportation and natural resources from less than \$2.5 billion to over \$5 billion in 1950 seems probable.

SCHOOLS

Education ranks third among all government expenditures. In 1941 we spent almost \$2.5 billion—10% of all government dollars—on schools. Teachers' salaries account for almost three-quarters of the total cost so the trend towards higher salaries will boost the nation's bill for education.

WHERE TAX DOLLARS GO

(Figures in Billions of Dollars)

	1913	1932	1941	(1944 Prices)	
				1950	1960
All Government Expenditures	2.5	12.4	23.1	45.5	50.7
Federal	0.7	4.3	12.9	27.6	28.6
State	0.2	1.8	3.6	7.0	9.3
Local	1.6	6.3	6.6	10.9	12.8
Military	0.27	0.7	6.1	5.6	6.6
Veterans	0.18	0.8	0.6	2.9	3.2
Interest	0.15	1.3	1.7	7.9	8.1
Social Insurance	—	0.2	1.9	7.7	8.7
Welfare & Health	0.31	1.5	4.1	4.0	4.1
Education	0.65	2.5	2.7	3.7	4.3
Public Works	a.	a.	a.	5.6	7.1
Transportation	0.40	1.9	2.0	1.8	2.7
Natural Resources	0.03	0.6	1.4	1.2	1.1
Police & Fire	0.19	0.7	0.7	1.0	1.1
Other	0.40	2.4	2.0	3.0	3.6

a. Included in other groups.

AND
GOVERNMENT ...

NATURAL RESOURCES

The war left the U. S. with a depleted supply of most natural resources, and with critical shortages of some of the most essential minerals. Nevertheless, lack of natural resources should not be a limiting factor on our productive capacity. With relatively free access to world markets, we should be able to get all the raw materials we need. And, even if we were denied access to world markets, we could use our low-grade reserves and develop substitutes without causing a prohibitive reduction in our living standards, though everyone would feel the effects in one way or another.

The U. S. economy consumes about a billion and a half tons of raw materials each year, or about 11.5 tons per person. Of this 3.5 tons are coal, 1.5 tons are petroleum, and iron and copper ore each contribute about a half a ton. In 1939 the value of unrefined minerals output was \$4.2 billion and 2% of all workers were engaged in mining or lumbering.

FUTURE REQUIREMENTS

The level of industrial production projected by the 20th Century Fund would raise minerals requirements a third above 1940 by the year 1950 and 50% above 1940 a decade later. Here is how natural resources requirements in the 1950 decade would compare with 1940 and the wartime peak: (Index numbers, 1940 equals 100)

	Wartime Peak	1950	1960
All minerals	138	133	151
Metals	157	117	126
Fuels	130	141	164
Other	141	128	142
Lumber	126	93	76
Electric Power	159	173	224
Manufactured Gas	120	94	75

The capacity of our supplies of natural resources to support future levels of output cannot be determined with any great accuracy. It will depend on the size of our reserves and on our ability to use supplies more economically and develop substitutes.

Because there is no way to measure these factors with any degree of precision, all estimates of the number of year's supply are subject to wide errors. However, such estimates are useful in directing attention at those resources where every effort should be exerted to develop new

supplies, substitutes, and more economical methods of use.

BIGGEST PROBLEMS: LEAD AND ZINC

Commercial grades of zinc, lead, and bauxite will be exhausted before 1960 even if the rate of use is cut to half the wartime rate. Supplies of petroleum and natural gas — which furnish 40% of our energy — will last longer than 20 years but their partial depletion will raise many technical and economic problems long before that time. Possible exhaustion of high-grade deposits of such minerals as iron and copper in the foreseeable future will stimulate development of processes to use low-grade deposits.

We have been discovering more and more ways to stretch our supplies of natural resources, however. In the case of tin, the electroplating process saves 50%

of the tin used in tinsplate production. The electric power industry uses less than 40% as much coal per kwh now as in 1920. The development of new materials and new ways of using old materials also expands our resource capacity.

Our bituminous coal reserves are adequate for over a thousand years even at the wartime rate of use, though production costs might rise substantially as inferior coal beds were used. After that, there are huge deposits of sub-bituminous coal and lignite which could carry us along for another thousand years. In comparison, maximum petroleum reserves are minute, adequate only for about 30 years consumption at the current rate. That is why the experts are trying to find ways to produce oil from coal cheaply enough to be commercially feasible.

Even though we have been using up lumber faster than it grows, there is little doubt that enough will be available in the future to meet at least minimum needs. Annual timber growth runs to about 32 billion board feet. But we cut over 40 billion board feet a year before the war and lost another 6 billion through fire, insects, and disease. An adequate conservation program could increase annual growth enough to offset this depletion.

OUR NATURAL RESOURCE RESERVES
Years required to exhaust supplies

1940 RATE OF USE
WARTIME RATE

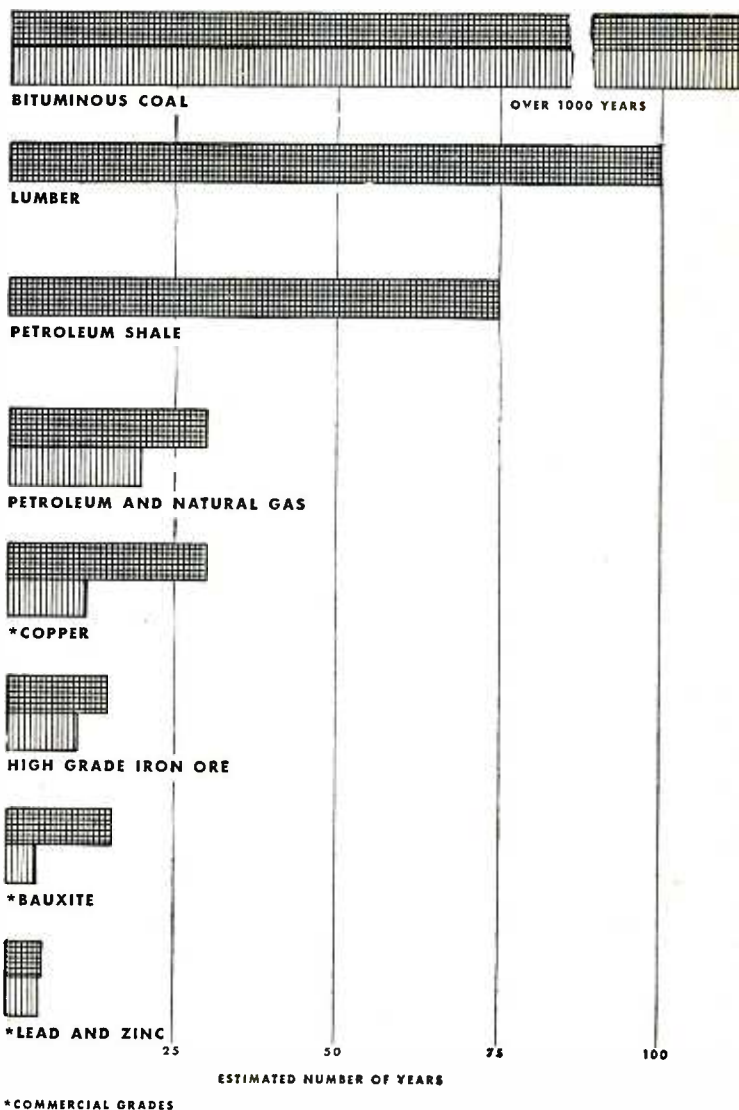

WITH THE
RESOURCES
AVAILABLE ...

PRODUCTION PROSPECTS: Estimated Percentage Increase in Industrial Activity Over 1940

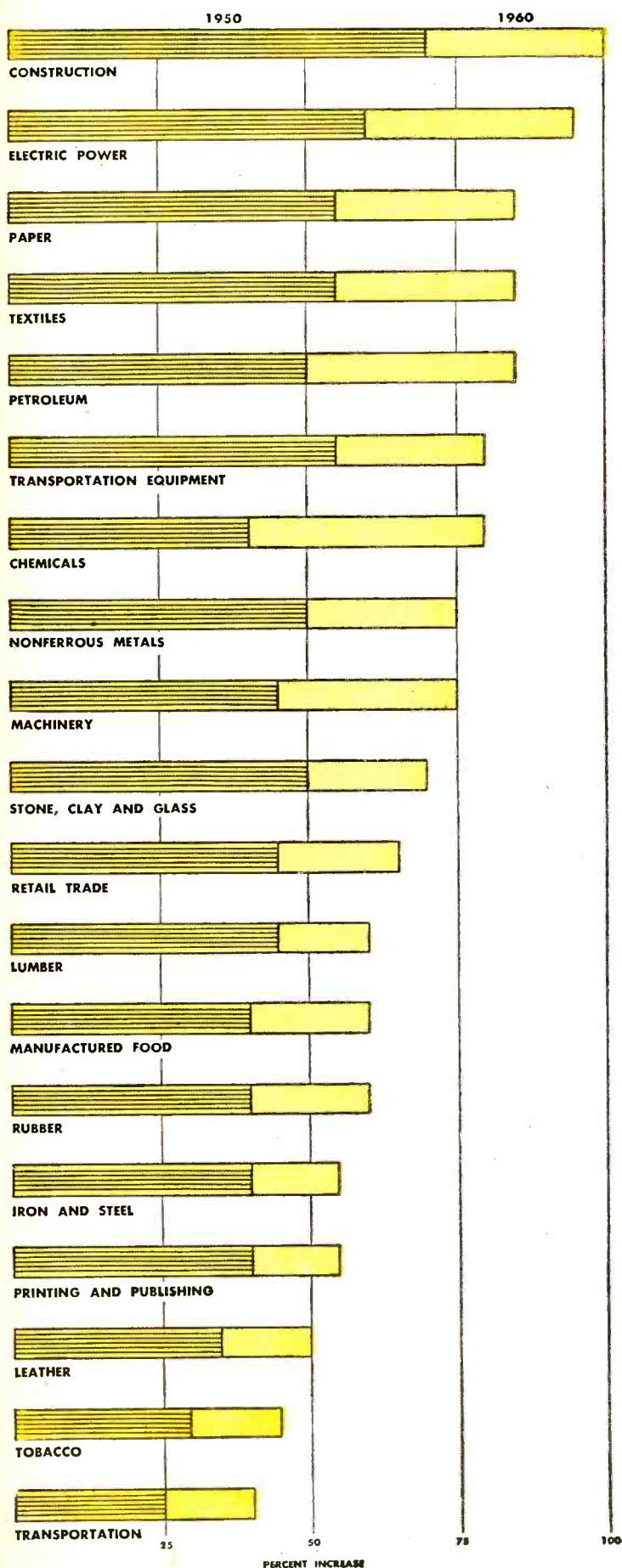

INDUSTRIAL CAPACITY

At the end of World War II U. S. industry found itself with surplus capacity in some lines and serious deficiencies in others. There was more than enough aircraft, machine tool, and synthetic rubber capacity but not nearly enough sheet steel, copper, or electrical machinery capacity to meet pent-up demands.

War experience showed, however, that industrial capacity can be expanded enormously in a few years, given the need and the funds. Thus lack of industrial capacity should not prove a bottleneck to meeting the demands of consumers in the 1950 decade.

A rough estimate places our total investment in industrial facilities (manufacturing, mining, transportation, and distribution) at \$200 billion. Just how much capacity industry as a whole, or any given industry, has is impossible to measure.

Capacity is a most elusive concept. In a technical sense, the capacity of an industry is the combined production of all its plants working 24 hours a day, 365 days a year, less an allowance for repairs, breakdowns, and other technical factors. Actual capacity is far less, however. Some facilities are obsolete or high-cost. Supplies of raw materials and components may be insufficient to keep assembly plants running full-steam. Moreover, demand for many products isn't great enough to support round-the-clock production.

PLENTY OF CAPACITY

During the past quarter century, however, experience shows that we have had more than enough overall capacity, and more than enough capacity in almost every industry, to meet all demands. An extensive study showed that even in 1929 only the steel and machine tool industries were definitely operating at capacity.

The growth of productivity as old machines are replaced with new and more efficient ones and as new techniques are developed is one of the main reasons why industrial capacity more than keeps pace with markets. The depression of the 1930's led to a net retirement of about 5% of total manufacturing facilities but manufacturing plants in 1939 could have turned out a quarter more than in 1929 because productivity was a third higher.

Whenever an industry's output begins to approach technical capacity, it becomes profitable to purchase new and more efficient equipment to replace or supplement existing machines so that a certain amount of excess capacity seems to be inevitable in a free enterprise system.

Estimates of the level of industrial production in different lines under conditions of high-level employment during the 1950 decade are shown in the chart. They assume that past trends will continue so that they give only a rough idea of what would happen to output in each industry. Unpredictable shifts of consumer demand or new product developments might cause a big change in the pattern of industrial production. Such estimates are, nevertheless, useful in that they provide a clue to lines where the largest increases may take place.

None of the projected increases are so large as to tax our ability to provide enough capacity. This is not to say that there will be no bottlenecks because of lack of capacity for certain components, for instance. However, we should be able to make good in short order any deficiencies of that sort that may develop.

DEMANDS VERSUS NEEDS

Despite the substantial increase in living standards which would be possible with high-level production and employment in the 1950 decade, many U. S. consumers will be unable to buy enough of life's necessities to maintain themselves at a health and decency level. Almost 30% of all families would receive less than \$1,000 a year cash income and one-third of this group would receive less than \$500.

The 20th Century Fund asked a series of experts to estimate the quantities of food, clothing, housing, medical care, and other things needed to provide a standard of living at a minimum health and decency level. The experts also figured out how much it would cost to bring everyone expected to be below that standard in 1950 and 1960 up to the calculated level. In other words, the estimates show the cost of establishing a "floor" for consumption without disturbing the spending patterns of those who received more than enough income to satisfy the calculated minimum needs.

ESTIMATES OF NEEDS

Any estimate of "needs" must rest upon someone's opinion as to what constitutes "health and decency" in this day and age. In the case of food, the nutritional requirements of a minimum health and decency standard can be determined accurately. In other fields, such as housing and education, even the experts would disagree over what constitutes a minimum standard.

However, what is important is not the precise size of the estimates but their general magnitudes. The conclusion that we would have to spend about 50% more on medical care than we are likely to in 1950 is important even if the experts' appraisals of the deficit range from as high as 60% to as low as 40%.

To fill total needs calculated in this manner would require production of \$200 billion of goods and services in 1950 or 13% more than the \$177 billion which would be turned out with high-level production and employment. In 1960, estimated production would fall short of needs by 8%. Food accounts for the biggest share of the deficit but needs outrun demand by important margins in housing, medical care, education, and social security.

To provide nutritionally adequate moderate-cost meals for those unable to afford them would add \$5.5 billion to the \$27.2 billion that would actually be spent on

food in 1950. This assumes no change in diets of those with adequate incomes despite the fact that many people in those groups do not eat what they should. If we all ate what we needed, we would consume twice as many fresh vegetables as in 1940, half again as much milk, more fruits and tomatoes; and we would eat smaller quantities of sugar, sirups, fats, and oils. This better diet would cost us less than we will actually spend for food in 1950.

So large a portion of our existing housing is unsatisfactory by any reasonable standards that it would take 10-15 years to provide everyone with adequate housing. One of the reasons why we don't have adequate housing is that many consumers cannot afford to pay enough rent to finance it. Estimated expenditures in 1950 for rent (including the estimated rental

value of owner-occupied homes) would run to \$14 billion as against an estimated need of \$16.4 billion.

Vast advances in medicine have gone far toward eliminating many diseases and have brought about a steady improvement in the standard of health. However, large numbers of people in the lower income groups cannot afford adequate medical care. Moreover, to supply good medical care for everyone under the traditional fee-for-service basis would cost several times more than consumers have ever spent for medical services even in prosperous years. Development of an effective form of group medicine, however, would make it possible to provide adequate care at a great saving over present costs, according to the 20th Century Fund.

HOW CONSUMPTION WOULD COMPARE WITH TOTAL NEEDS

(Figures in billions of dollars)

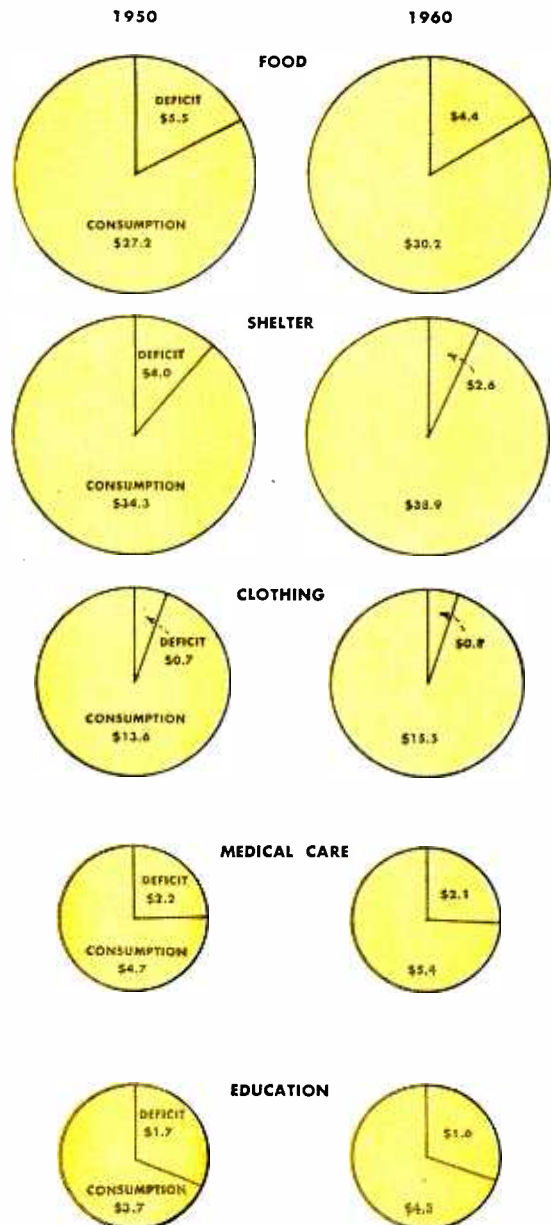

**TO MEET
ALMOST ALL
OUR NEEDS**

THE U. S. ECONOMY FACES A CHALLENGE

PRODUCTION HAS GROWN FASTER THAN POPULATION
GIVING PROMISE OF RISING LIVING STANDARDS

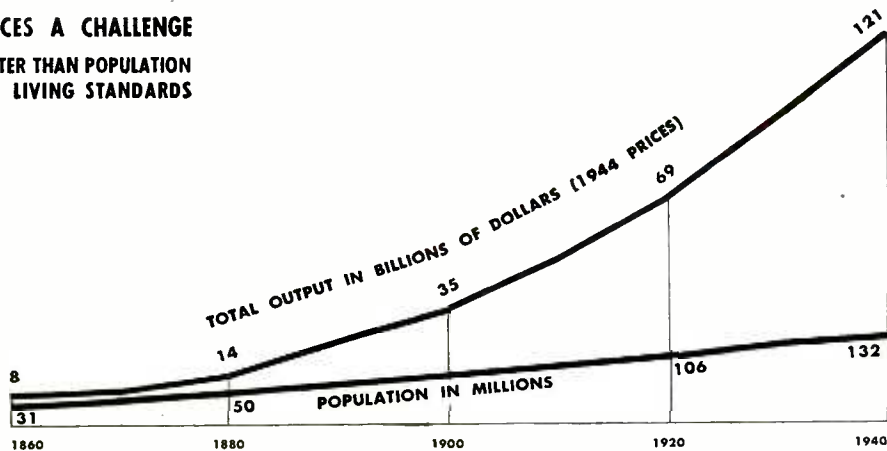

The major conclusion of the 20th Century Fund's survey of America's needs and resources is that we have reached a point where we can provide everyone with a decent living and most people with a living which, by any standards other than our own, is positively luxurious. With high-level employment, it would take only a 13% increase in total output in 1950, and an 8% increase in 1960, to lift everyone to a minimum health and decency standard of living.

We have more than enough industrial and agricultural capacity to support that much of an increase in total production. Lack of natural resources should not be a bottleneck, for with world trade on any sort of a reasonable basis we will be able to get all the raw materials we need.

The only limiting factor is the capacity of our labor force to produce. The 20th Century Fund assumes that productivity will advance at the average rate actually achieved during the past 9 decades (18%). But there is no technical reason why we cannot achieve an increase of more than 30%. That would make possible enough production to meet our minimum needs.

The U. S. economy has exhibited two dominant characteristics in the past century. Our productive capacity has expanded at a rate never approached elsewhere. But our economy has also been highly unstable. Our problem is to make the most of our unparalleled technological and productive know-how while minimizing the swings of the business cycle.

If we can meet that challenge, we can eliminate the specter of want and move on toward constantly rising living standards for everyone. Never before in history has a nation been so close to abolishing poverty and meeting the material demands of its citizens.

This is not to say that solving the problem of maintaining stable and expanding production would solve all our economic, social, and political problems. Nor is it to say that a solution of the problem of keeping our economic machine running on an even keel is at hand.

In the first place, the U. S. would not be a utopia even if we achieved the kind of high employment and production the 20th Century Fund is talking about. Many perplexing problems of how to best distribute our production would remain. Then there are a host of social and political problems which would still tax our efforts and ingenuity. Finally, there is the all-important question of how to maintain world peace.

Most people would agree that the problem of maintaining high employment and rising living standards is still far from solution. Our ability to mobilize and direct our economic resources so as to keep our

BUT THE GROWTH HAS FOLLOWED THE BOOM AND BUST ROUTE INVOLVING LONG PERIODS OF MASS UNEMPLOYMENT

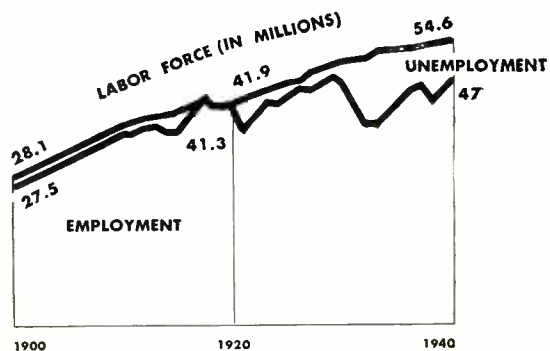

CAN THE ECONOMY PROVIDE STEADY EMPLOYMENT AND RISING LIVING STANDARDS?

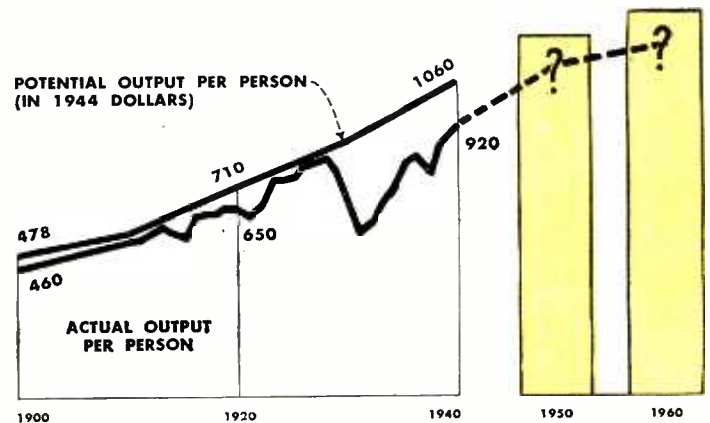

economy running on an even keel has lagged behind our ability to solve technical production problems. Each businessman, each worker, and each consumer must somehow learn to act differently in many ways than he has in the past if we are to solve our number one economic problem.

Just what changes in our economic life will be necessary no one knows. On our ability to find out these things and put them into practice in the next few years depends our success in meeting the challenge which the 20th Century Fund's study underlines. That challenge is that we have within our grasp the ability to eliminate actual want from the U. S. and to provide more and more things for better living for everyone.

MAKING TUBES IS EASY..

If YOU KNOW HOW!

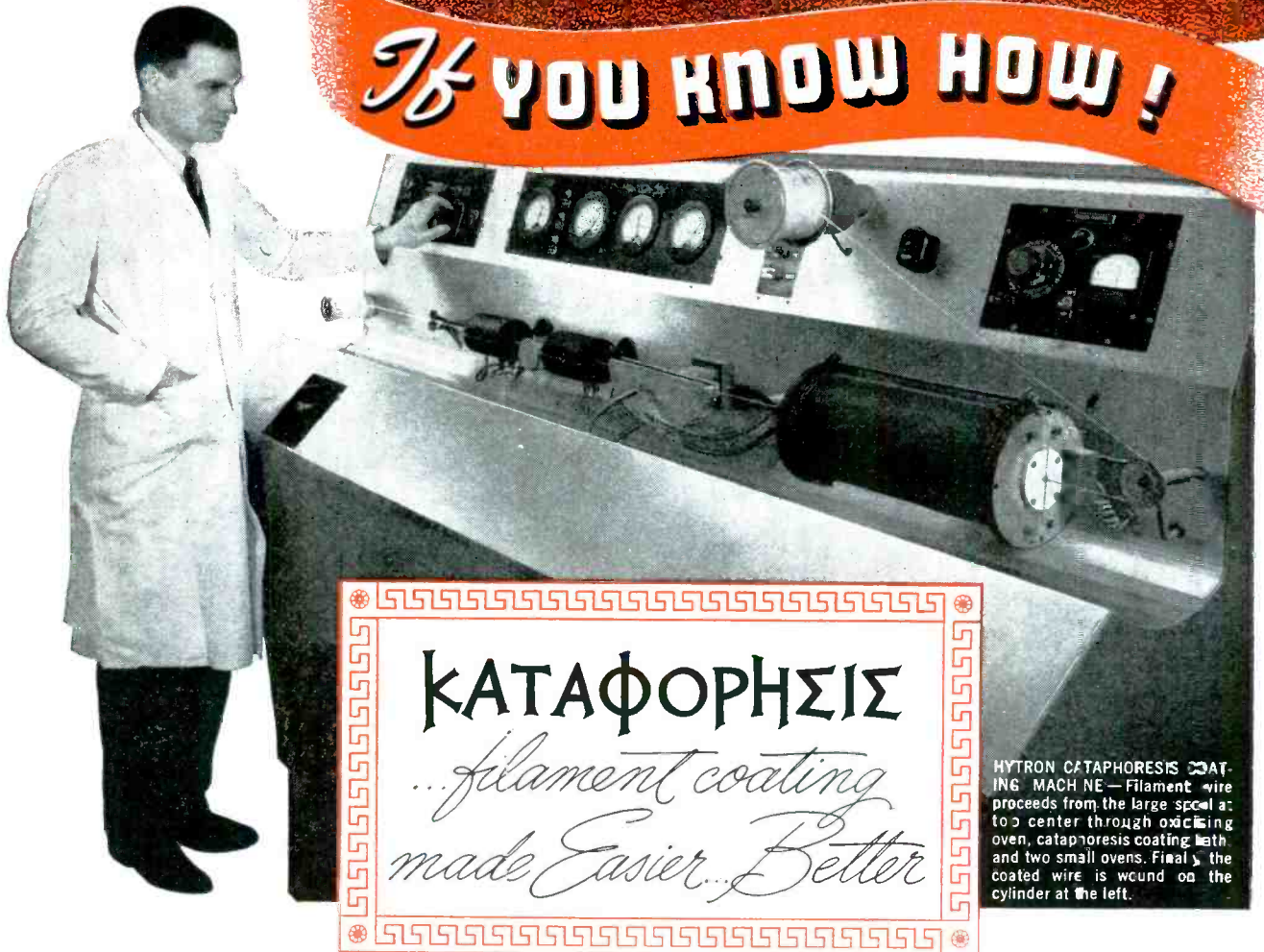

ΚΑΤΑΦΟΡΗΣΙΣ

*...filament coating
made Easier... Better*

HYTRON CATAPHORESIS COATING MACHINE—Filament wire proceeds from the large spool at top center through oxidizing oven, cataphoresis coating bath and two small ovens. Finally, the coated wire is wound on the cylinder at the left.

A jawbreaker from the Greek, cataphoresis means simply "the movement of suspended particles through a fluid under the action of an applied electromotive force." At Hytron, filaments are not *sprayed* with electron-emissive coating, because that way precise control cannot be achieved. Rather, coating is electrically deposited by the cataphoretic movement of the carbonate molecules.

Drawn through a special coating solution, the filament wire itself serves as the anode; and a metallic plate, as the cathode. The solution consists of a triple precipitate of barium, calcium, and strontium carbonates plus a binder—all suspended in a special organic medium. A precisely adjusted electromotive

force uniformly deposits and bonds the electrically-charged salts onto the filament wire. Baking problems are simplified; coated wire is spooled directly on a cylinder, ready for use.

This new Hytron method of filament coating is so simple, so precise as to texture, weight, and adhesion. One wonders why it is not universal. The answer is simple. Cataphoresis coating is easy *only* if you possess the trade secret of the Hytron coating formula. Also, the applied voltage, timing, and resultant control of texture and emissive qualities in mass production represent months of persistent research. You profit by superior performance from all Hytron coated-filament tubes.

SPECIALISTS IN RADIO RECEIVING TUBES SINCE 1921

HYTRON

RADIO AND ELECTRONICS CORP.

MAIN OFFICE: SALEM, MASSACHUSETTS



And now — Kilovolt ratings matching the elevated peaks and transients of television and other cathode-ray tube circuits . . .

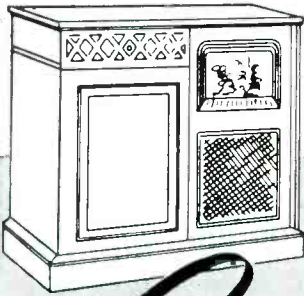

Typical high-voltage ratings—
Series "84" tubular paper capacitor rated at 10,000 volts DCW, and Series "89" midget oil-filled tubular rated at 3500.

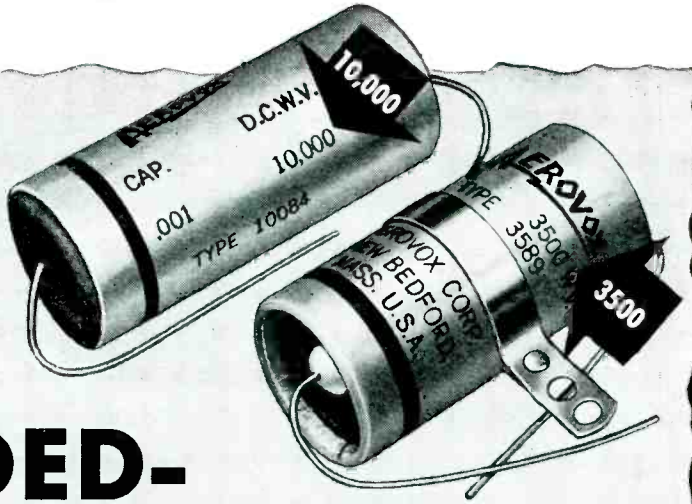

Aerovox

EXPANDED-VOLTAGE RANGE

Capacitors



Series "14" oil-filled capacitor, usually with single pillar terminal, now available in double-ended design for maximum insulation at higher potentials. This and the popular Series "12" double-pillar ribbed-cap oil capacitor, are available in voltage ratings up to 10,000 volts DCW.

• Before and since the advent of the first practical television receiver in 1939, Aerovox capacitors have marched along with the television pioneers.

Inherent Aerovox quality, PLUS Aerovox extra-generous safety factor, has successfully met the surges and transients, the heat and the humidity, and the other trying conditions of the twilight zone of television development. And that goes likewise for the severe service requirements of cathode-ray

oscillography.

With larger and more brilliant screen images calling for still higher working voltages, Aerovox is again ready with expanded voltage ratings. The Series "84" paper tubulars, the Series "89" midget oil capacitors, the Series "14" and other can-type oil capacitors are now available in higher voltage ratings to meet post-war television, oscillograph and other electronic needs.

• Submit your higher-voltage circuits and constants for our engineering collaboration, specifications, quotations. Literature on request.



FOR RADIO-ELECTRONIC AND INDUSTRIAL APPLICATIONS

AEROVOX CORPORATION, NEW BEDFORD, MASS., U.S.A.

SALES OFFICES IN ALL PRINCIPAL CITIES • Export: 13 E. 40th St., NEW YORK 16, N. Y.

Cable: 'ARLAB' • In Canada: AEROVOX CANADA LTD., HAMILTON, ONT.



THE VOICE COMES CLEARLY

... when the Microphone Cable is insulated with **Du Pont POLYTHENE**

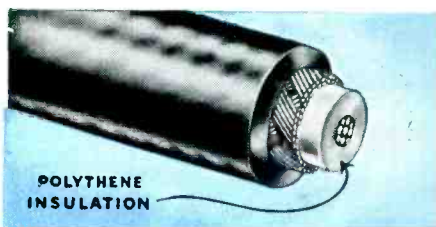

The chief function of the crystal microphone cable made by Lenz Electric Mfg. Co. is to carry the speaking voice over public address systems, in lecture halls, offices, factories. And the chief reason Lenz chose Du Pont Polythene for insulating this cable is this: *No matter whether the frequency is 60 cycles or 60 megacycles, the dielectric properties of polythene remain constant—bring the voice in clearly.*

Cross-section (4 times actual size) of microphone cable No. 1253-A made by Lenz Electric Manufacturing Co., 1751 North Western Ave., Chicago, Ill. Construction is as follows: Conductor stock—8 strands No. 36 AWG tinned copper, 2 strands No. 31 AWG phosphor bronze. 1/32-inch wall of polythene, applied to an O.D. of .082 inch. Shield of No. 36 AWG tinned copper, 4 ends. 1/32-inch wall outer jacket.

This constancy of polythene is *one* of the reasons polythene is widely used in television, in radar, in high-frequency cable of many other kinds. Other advantages of polythene are:

- Because of the high dielectric characteristics of polythene, only a minimum thickness is needed.
- The dielectric constant of polythene (2.2–2.3) and its power factor (less than 0.0005) remain almost constant in temperatures from –50°F. to 220°F.
- Polythene is chemically inert, and light in weight (specific gravity: 0.92).

- Polythene retains its toughness and flexibility at temperatures from –50°F. to 200°F.

For complete data on polythene, write E. I. du Pont de Nemours & Co. (Inc.), Plastics Dept., Room 146, Arlington, N.J.



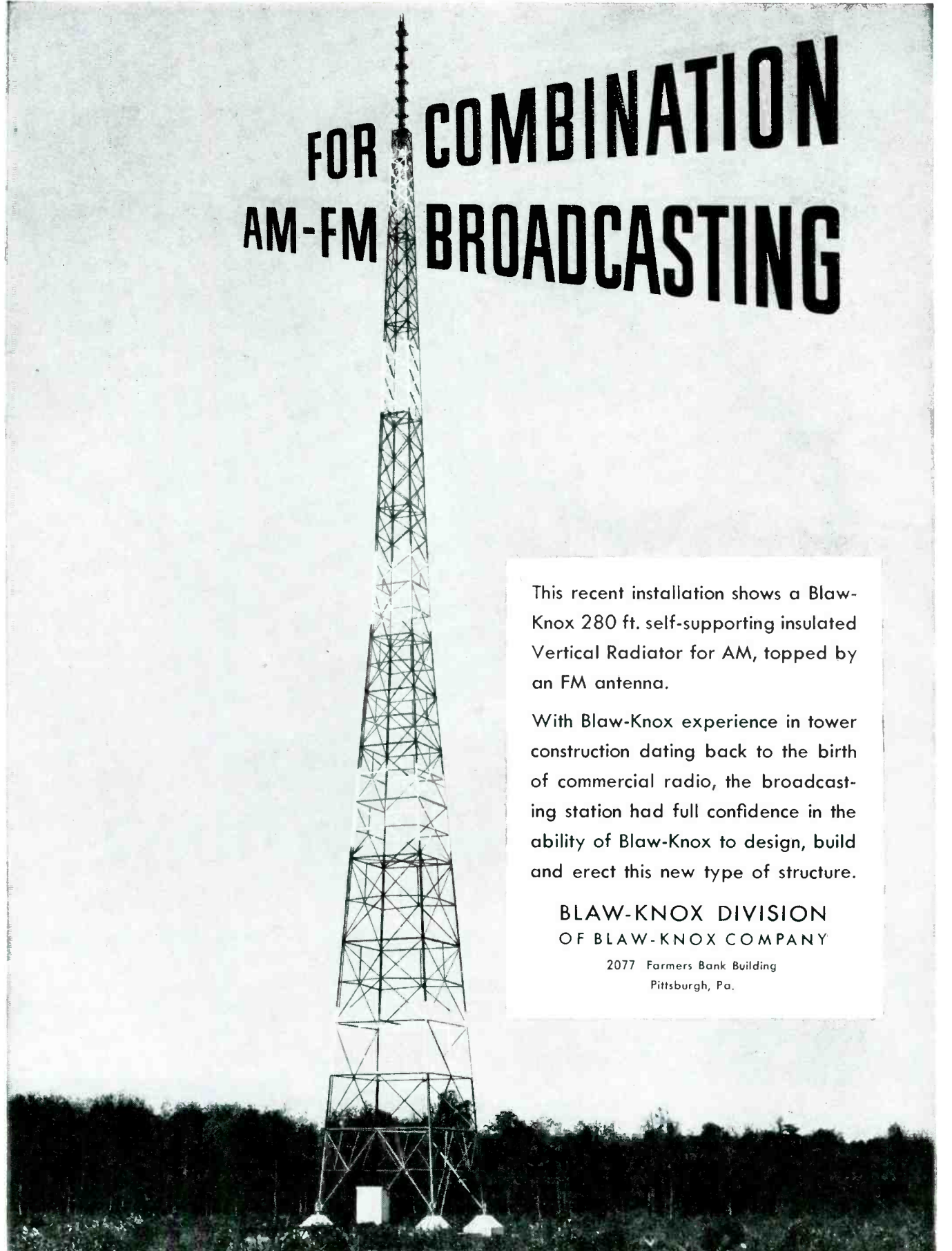

**FOR COMBINATION
AM-FM BROADCASTING**

This recent installation shows a Blaw-Knox 280 ft. self-supporting insulated Vertical Radiator for AM, topped by an FM antenna.

With Blaw-Knox experience in tower construction dating back to the birth of commercial radio, the broadcasting station had full confidence in the ability of Blaw-Knox to design, build and erect this new type of structure.

**BLAW-KNOX DIVISION
OF BLAW-KNOX COMPANY**

2077 Farmers Bank Building
Pittsburgh, Pa.

BLAW-KNOX ANTENNA TOWERS

HERE'S HELP

for your "Different" Insulation Problem



1. High Voltage Dilecto Cabinet Barrier
2. Vulcoid Insulator for Lighting Switch Panel
3. Dilecto Conduit Insulation Fitting
4. Dilecto Dryer Switch Insulator
5. Dilecto Terminal Block
6. Dilecto Resistance Panel
7. Dilecto Insulating Plate
8. Fibre Baffle Plate Support
9. Dilecto Insulator
10. Dilecto Reverse Switch Insulator
11. Dilecto Switch Operating Disc



Hardly a day passes without our engineering department being faced with some new electrical insulation problem. That's the reason for the C-D research laboratories manned by technicians whose job it is to find the solution to your "different" problem.

A glance at the photo and variety of applications listed will give you some idea of the many problems solved by C-D non-metallics. These versatile materials were used to supply the exact combination of electrical and mechanical properties to do their specified jobs.

There is experienced, seasoned engineering help available to advise you on the performance, safety and economic advantages of using C-D non-metallics for electrical insulation. Get in touch with Continental-Diamond for the help you need.

C-D NON-METALLIC PRODUCTS

DIAMOND VULCANIZED FIBRE

VULCOID—Resin Impregnated Vulcanized Fibre.

DILECTO—Thermosetting Laminated Plastics.

CELORON—A Molded Phenolic Plastic.

MICABOND—Built-up Mica Electrical Insulation.

HAVEG—Plastic Chemical Equipment, Pipe, Valves and Fittings.

STANDARD & SPECIAL FORMS

Available in Standard Sheets, Rods and Tubes; and Parts Fabricated, Formed or Molded to Specifications.

DESCRIPTIVE LITERATURE

Bulletin GF gives Comprehensive Data on all C-D Products. Catalogs are also available.

D-3-47

BRANCH OFFICES: NEW YORK 17 • CLEVELAND 14 • CHICAGO 11 • SPARTANBURG, S. C. • SALES OFFICES IN PRINCIPAL CITIES
 WEST COAST REPRESENTATIVES: MARWOOD LTD., SAN FRANCISCO 3 • IN CANADA: DIAMOND STATE FIBRE CO., OF CANADA, LTD., TORONTO 8

Continental - Diamond FIBRE COMPANY

Established 1895... Manufacturers of Laminated Plastics since 1911—NEWARK 16 • DELAWARE

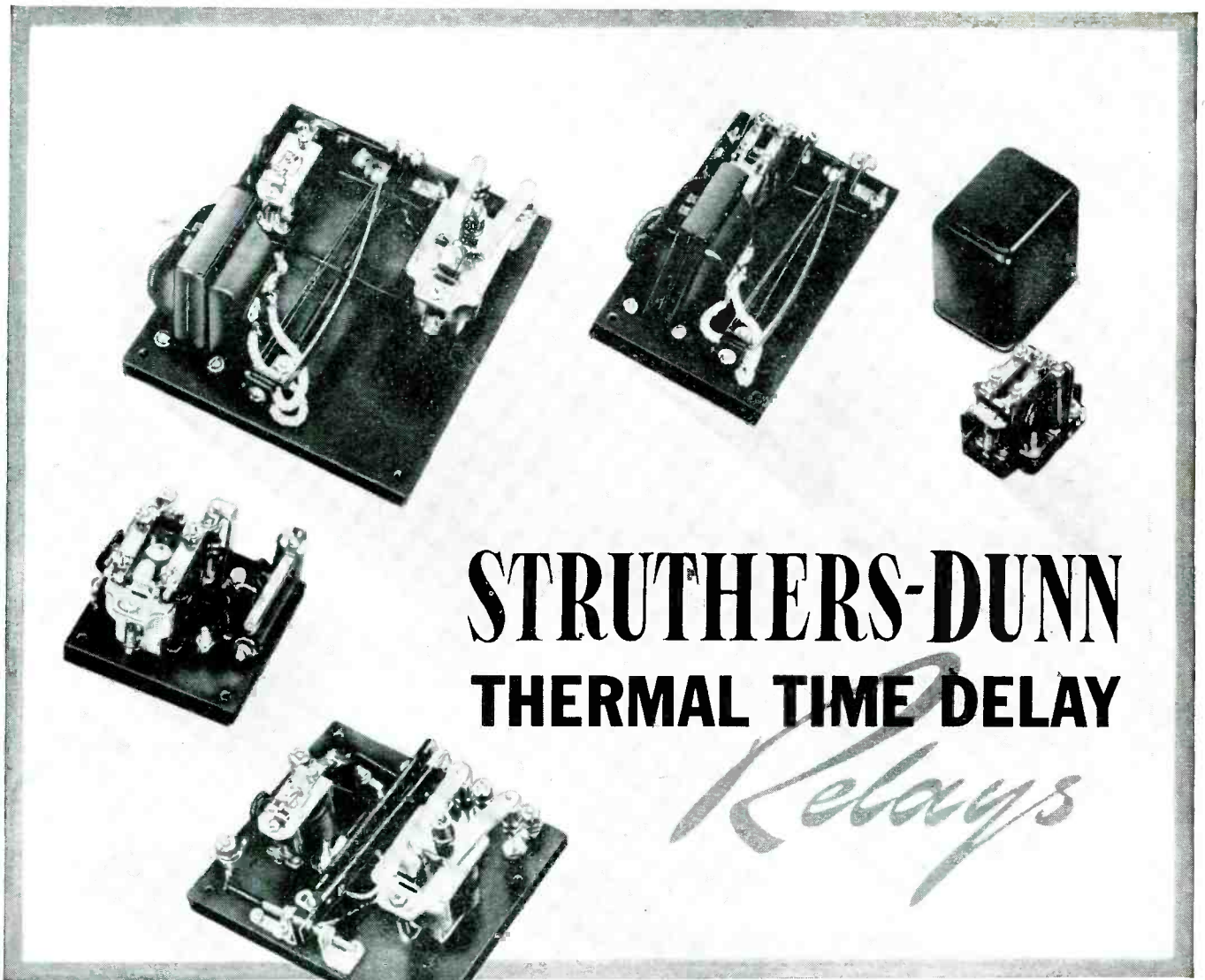

A Reliable, Inexpensive Answer to Non-Critical Timing Problems

Timing accuracy of approximately $\pm 10\%$ makes Struthers-Dunn Thermal Time Delay Relays eminently suited for operations that neither require the more precise timing nor justify the higher cost of motor-operated units. Many standard Relays in both immediate and non-immediate recycling types available. Write for Engineering Data Section 4672 for complete details.



5,346 RELAY
TYPES

STRUTHERS-DUNN, INC., 146-150 N. 13th St., Philadelphia 7, Pa.

ATLANTA • BALTIMORE • BOSTON • BUFFALO • CHICAGO • CINCINNATI • CLEVELAND • DALLAS
DENVER • DETROIT • HARTFORD • INDIANAPOLIS • LOS ANGELES • MINNEAPOLIS • MONTREAL
NEW YORK • PITTSBURGH • ST. LOUIS • SAN FRANCISCO • SEATTLE • SYRACUSE • TORONTO

Where there is Horsepower...

There is Wire



What has happened to transportation? A little over a hundred years ago Napoleon "sped" from Moscow to Paris at approximately 3 miles per hour. Today we talk of speeds of a thousand miles per hour.

Belden Manufacturing Company in its life of 40 years has witnessed and served a "transportation revolution." In that brief time, the automobile, the airplane, the diesel-electrics, and now the rockets, have taken their place in our living. All of these were made possible when wild horsepower ran into a trap of wire—and when other specialized products of the wiremakers served the inventors of our modern power.

Belden



WIREMAKER FOR INDUSTRY

Speer Graphite Anodes Add **BIG** features to **RAYTHEON** tubes

MIDGET SIZE

GIANT PERFORMANCE!



Actual Size

Tiny Cold Cathode Rectifier Delivers 1,200 Volts d.c.—Starts Instantly!

Look for graphite anodes when you're looking for better tubes.

An output of 2,400 volts d.c. in a voltage doubler circuit and two-second starting is the outstanding performance record of this small cold cathode rectifier recently developed by Raytheon Manufacturing Company for electronic photo flash equipment. Easily-degassed Speer Graphite Anodes contribute to this and other types of Raytheon tubes such important advantages as:

GREATER POWER—Extremely high emissivity coupled with high thermal conductivity enable Speer Graphite Anodes to radiate a maximum amount of heat from a given area—make it possible for tubes to handle up to three times as much input power as those equipped with metal anodes. Size is no handicap with Speer Graphite Anodes!

LONGER LIFE—Operating at lower temperatures, Speer Graphite Anode tubes last longer than metallic anode tubes even under continued severe usage. Cooler operation means less heating of associated tube parts.



Speer

CARBON COMPANY
ST. MARYS, PENNA.

brushes • contacts • welding electrodes • graphite anodes • rheostat discs • packing rings • carbon parts

CHICAGO • CLEVELAND • DETROIT • MILWAUKEE • NEW YORK • PITTSBURGH



GET SET

FOR COMPETITION

USE **alliance** MOTORS

Alliance Powr-Pakt Model MS motor is for 110 volts, 60 cycle operation. Model MS fills a growing need for small compact motors which increase the *motion* and *utility features* in thousands of new products.

For the designs of tomorrow, *Alliance Motors* mass produced at low unit cost, will be built with design variations to meet special small load operating conditions. They'll actuate controls, trip switches, move levers, cams and valves . . . perform thousands of tasks that require power at specific points!

Drive your products to market—use *Alliance Motors* to drive vital component parts. Big advantages for the Alliance Powr-Pakt line are compactness, light weight, versatile performance characteristics, and *mass production* at low cost.

Alliance Powr-Pakt Motors are rated from less than 1/400th h.p. on up to 1/20th h.p. They'll supply just the *right amount* of power at *strategic points* to impart automatic action, instant control and greater usefulness for your products and processes.

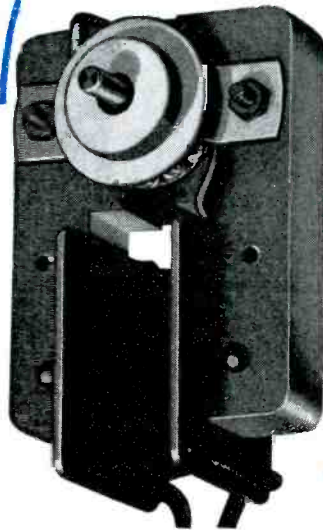

MODEL
MS

WHEN YOU DESIGN—KEEP

alliance

MOTORS IN MIND

ALLIANCE MANUFACTURING COMPANY • ALLIANCE, OHIO
EXPORT DEPARTMENT: 401 BROADWAY, NEW YORK 13, NEW YORK, U. S. A.

★ ANSONIA ★

Ankoseal

will not support Combustion

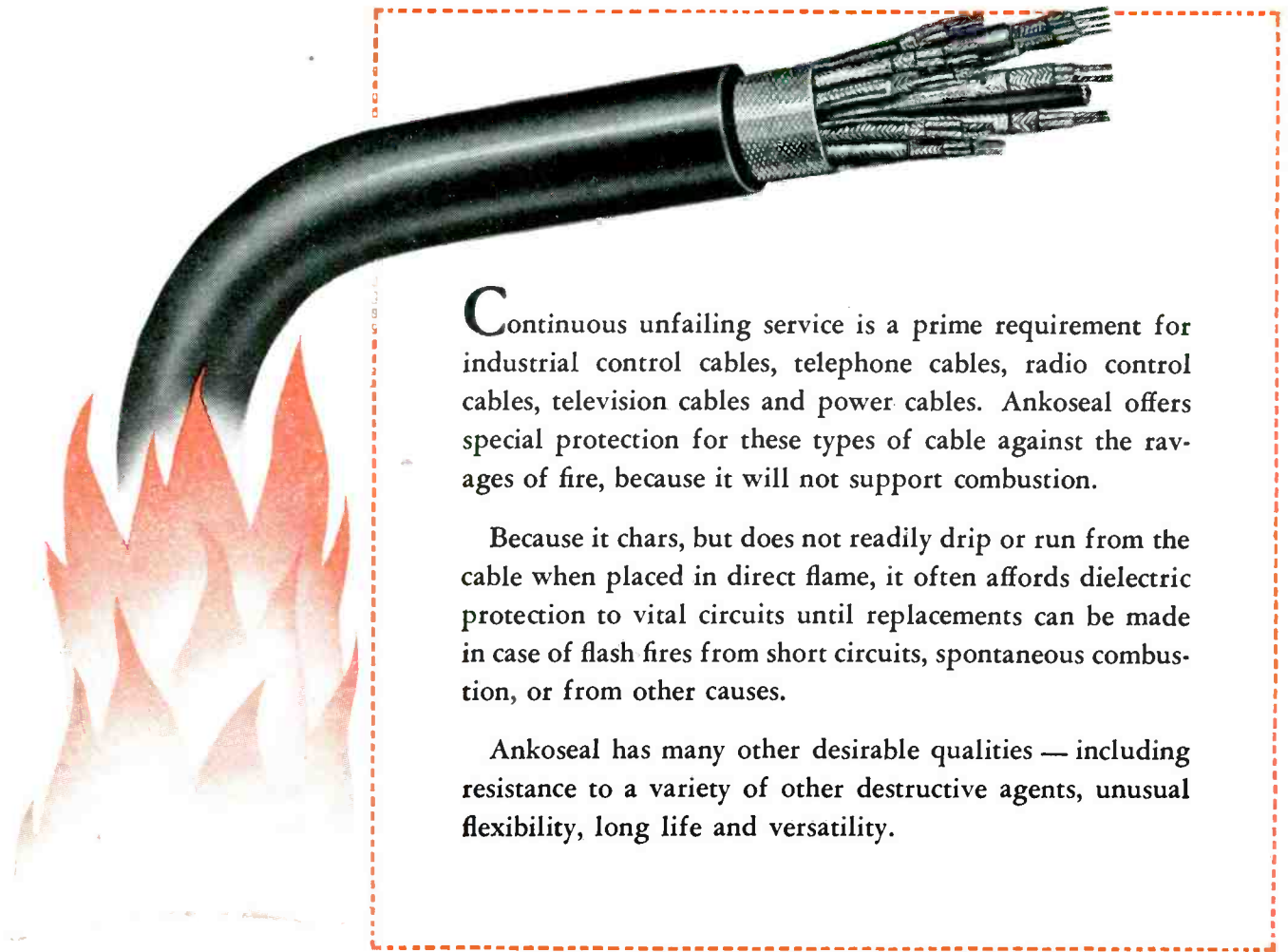

Continuous unfailing service is a prime requirement for industrial control cables, telephone cables, radio control cables, television cables and power cables. Ankoseal offers special protection for these types of cable against the ravages of fire, because it will not support combustion.

Because it chars, but does not readily drip or run from the cable when placed in direct flame, it often affords dielectric protection to vital circuits until replacements can be made in case of flash fires from short circuits, spontaneous combustion, or from other causes.

Ankoseal has many other desirable qualities — including resistance to a variety of other destructive agents, unusual flexibility, long life and versatility.

THE ANSONIA ELECTRICAL DIVISION

ANSONIA, CONNECTICUT of

NOMA ELECTRIC CORPORATION

Going places
(AGAIN)

hallicrafters



Hallicrafters famous radio equipment, sold and distributed around the world before the war and used with superb effectiveness in every theater during the war is once again on the move. Watch for latest details of the Gatti-Hallicrafters mobile radio equipped expedition to the Mountains of the Moon in deepest Africa—a new and exciting test for the ingenuity of hams and the performance of Hallicrafters equipment.

3 GREAT RECEIVERS designed and priced for hams who are going places, too



Model SX-42 Described by hams who have operated it as "the first real postwar receiver." One of the finest CW receivers yet developed. Greatest continuous frequency coverage of any communications receiver—from 540 kc to 110 Mc, in six bands. FM-AM-CW. 15 tubes. Matching speakers available. **\$27500**



Model S-40A Function, beauty, unusual radio performance and reasonable price are all combined in this fine receiver. Overall frequency range from 540 kc to 43 Mc, in four bands. Nine tubes. Built-in dynamic speaker. Many circuit refinements never before available in medium price class. **\$8950**

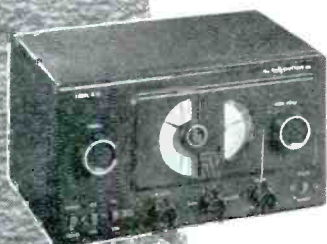

Model S-38 Overall frequency range from 540 kc to 32 Mc, in four bands. Self contained speaker. Compact and rugged, high performance at a low price. Makes an ideal standby receiver for hams. CW pitch control is adjustable from front panel. Automatic noise limiter. **\$4750**

Prices slightly higher in zone 2

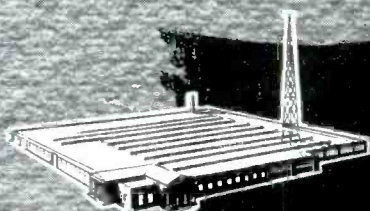

BUILDERS OF *Skyfone* AVIATION RADIOTELEPHONE
©1947

hallicrafters RADIO

THE HALLICRAFTERS CO., MANUFACTURERS OF RADIO AND ELECTRONIC EQUIPMENT, CHICAGO 16, U. S. A.
Sole Hallicrafters Representatives in Canada:
Rogers Majestic Limited, Toronto-Montreal

RAYTHEON . . . Headquarters for

COLD CATHODE GAS FILLED RECTIFIERS

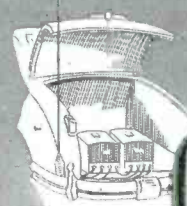
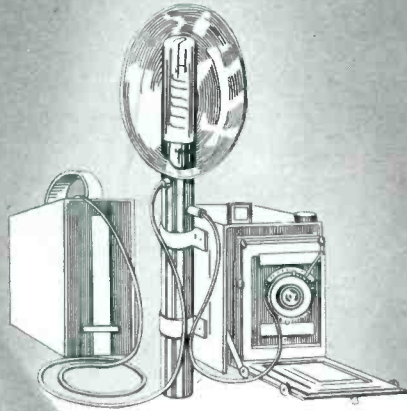
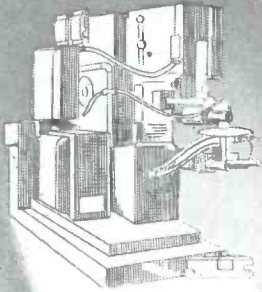

CK1006 . . . used to supply power for mobile radio telephones.



BH . . . originally designed for service in B battery eliminators and now improved for use in welding and other industrial controls.

5517/CK1013 . . . Features miniature size, and a starter electrode permitting firing at low ignition voltage. Two tubes will deliver up to 2400 volts D.C. from doubler circuit for battery operated photo-flash, Geiger-Mueller counters and other high voltage applications.

WHATEVER YOUR APPLICATION for Cold Cathode Rectifiers, your logical source of supply is Raytheon.

For twenty-four years Raytheon has been designing and producing this type of tube . . . has, in fact, manufactured more Cold Cathode Rectifiers than all other tube companies combined.

The three Cold Cathode Rectifiers featured reflect the result of this long, highly specialized experience. Note in the chart below the characteristics of these special purpose and other Raytheon Cold Cathode Rectifiers.

NO FILAMENT OR HEATER WINDINGS
REQUIRED
LOWER TUBE DROP
HIGHER DC OUTPUT VOLTAGE

RAYTHEON COLD CATHODE RECTIFIERS

TYPE NO.	CONSTRUCTION	MAX. PEAK INVERSE	MAX. PEAK CURRENT	OUTPUT CURRENT D.C.	AVERAGE TUBE DROP	OVER-ALL LENGTH	BASE
5517/CK1013	Half wave	2,800 volts	300 ma.	12 ma.	100 volts	2 1/4"	7 pin min.
CK1006	Full wave	1,600 volts	600 ma.	200 ma.	30 volts	4 1/8"	4 pin med.
BH	Full wave	1,000 volts	400 ma.	125 ma.	90 volts	4 3/8"	4 pin med.
CK1015	Full wave	2,000 volts	35 amp.	80 ma.	110 volts	2 1/4"	3 flexible leads
OZ4	Full wave	880 volts	270 ma.	90 ma.	24 volts	2 3/8"	5 pin octal
OZ4A 1003							

RAYTHEON

Eccellence in Electronics

RADIO RECEIVING TUBES

Write for Further Technical Data

RAYTHEON MANUFACTURING COMPANY

SPECIAL TUBE SECTION

Newton 58, Massachusetts

SPECIAL PURPOSE TUBES • MICROWAVE TUBES

More Broadcasting Stations . . .



1947
1946
1945
1944
1943
1942
1941
1940
1939
1938
1937
1936
1935
1934
1933
1932
1931
1930
1929
1928
1927
1926
1925
1924
1923
1922
1921
1920
1919
1918
1917
1916
1915
1914
1913
1912
1911
1910
1909
1908
1907
1906
1905
1904
1903
1902
1901
1900

. . . for more years . . .

. . . have used more
Presto 6 N's than any
other recorder

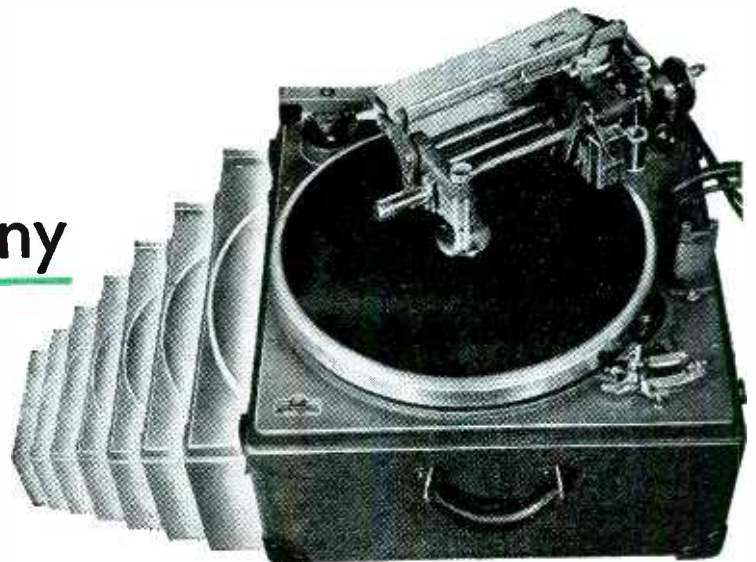

RECORDING CORPORATION • 242 WEST 55TH STREET • NEW YORK 19, N. Y.
Walter P. Downs, Ltd., in Canada
World's largest manufacturer of instantaneous sound recording equipment and discs

THE VITAL LINK IN EVERY INDUSTRY...

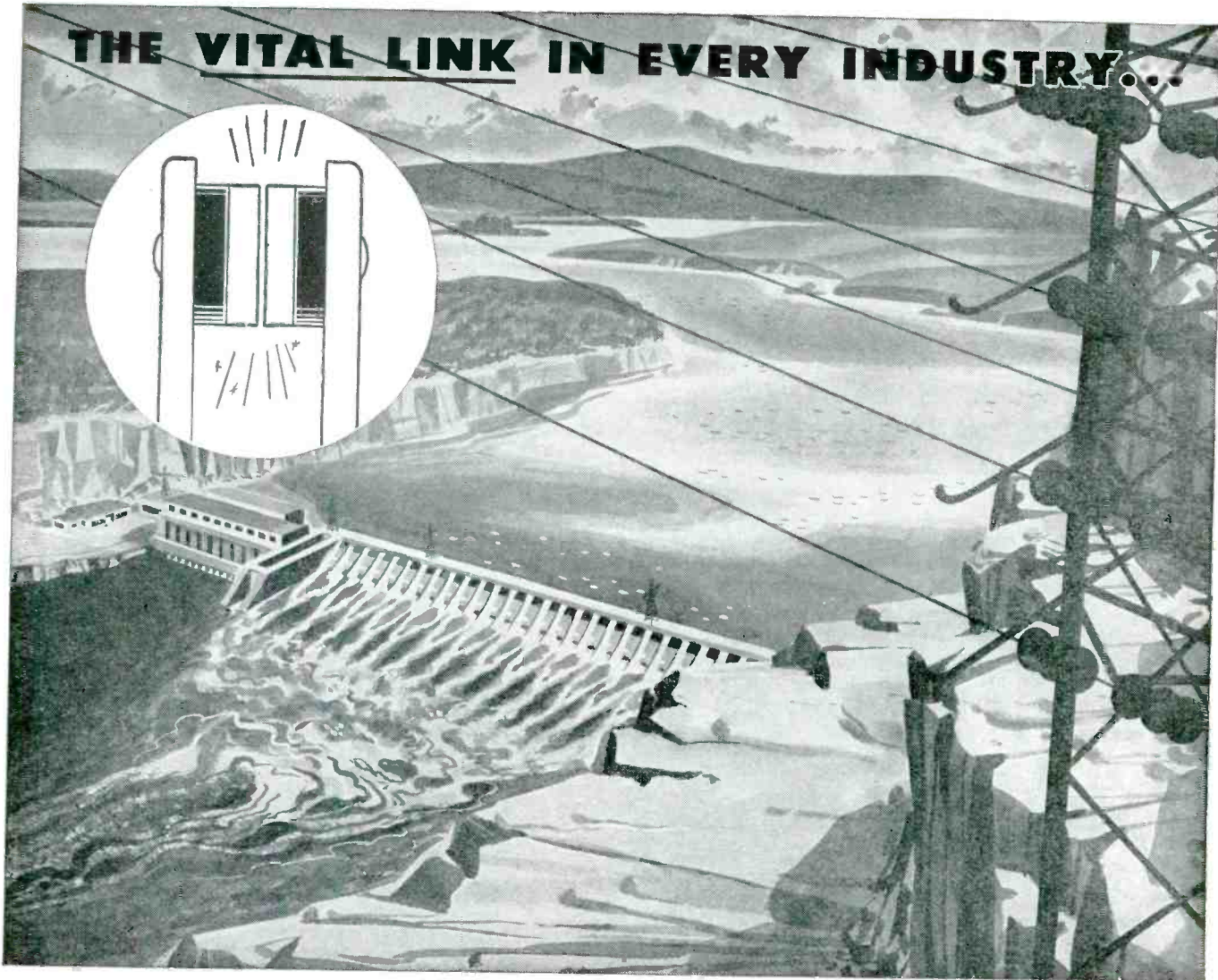

WILCO CONTACTS

They keep the power flowing!

WILCO PRODUCTS INCLUDE:

CONTACTS

Silver - Platinum - Tungsten - Alloys
Sintered Powder Metal

THERMOSTATIC BIMETAL

All temperature ranges, deflection
rates and electrical resistivities.

SILVER CLAD STEEL

JACKETED WIRE

Silver on Steel, Copper, Invar or
other combinations requested.

ROLLED GOLD PLATE AND WIRE

NI-SPAN C*

New Constant Modulus Alloy

SPECIAL MATERIALS

*Reg. Trade Mark. The International Nickel Co., Inc.



Modern industry utilizes WILCO CONTACTS in frequency operations of every range both because of their longer service life and because they assure maximum ductility, hardness, density, freedom from sticking, low metal transfer, high conductivity and arc-resistance.

These same peerless WILCO qualities of stamina and precision performance—assured by exclusive WILCO processes—will keep the power flowing in your products. WILCO engineers will gladly help you select from a great variety of available WILCO contact materials the particular contacts suited to your needs—or develop new alloys for special purposes.

THE H. A. WILSON COMPANY

105 Chestnut Street, Newark 5, N. J. • Branch Offices: Chicago, Detroit, Los Angeles, Providence

SPECIALISTS FOR 30 YEARS IN THE MANUFACTURE OF THERMOMETALS • ELECTRICAL CONTACTS • PRECIOUS METAL BIMETALLIC PRODUCTS

ANNOUNCING the ML-5604

(water cooled type ML-5619)

Specially designed to meet the severe conditions of RF heating service

Machlett Laboratories now makes available, for early delivery, two new tubes—the ML-5604 for forced air cooling and the ML-5619 for water cooling—both specifically designed to withstand the rigorous and non-uniform operation inherent in industrial heating applications. In the development of every feature of these tubes, such conditions as widely varied loads, severe vibration, heavy irregular physical shocks and operation by personnel untrained in electronics, have been given full consideration.

- A.** Heavy wall high conductivity copper anode—specially processed.
- B.** One piece high conductivity copper grid and filament support terminals... for maximum strength, minimum lead resistance and elimination of electrode distortion.
- C.** Improved filament spring design. Minimizes bowing and increases filament life.
- D.** Chemically cleaned, vacuum fired internal parts for longer life and stable operation.
- E.** Stronger self-supporting grid for uniform electron control.
- F.** Rugged kovar grid and filament seals.
- G.** Rigidly supported grid and filament assemblies. Glass surfaces completely shielded against electron bombardment and radiant filament energy.
- H.** Glass contour provides long leakage path and more efficient cooling.
- I.** Rugged kovar plate seal located in air stream.
- J.** Gold plated contact surfaces. Insure permanent low contact resistance.

These completely new tubes are an outstanding contribution to industrial electronics. They may, of course, also be used for communications purposes. For further information, write Machlett Laboratories, Incorporated, Springdale, Conn.

MACHLETT

50 YEARS OF ELECTRON TUBE EXPERIENCE

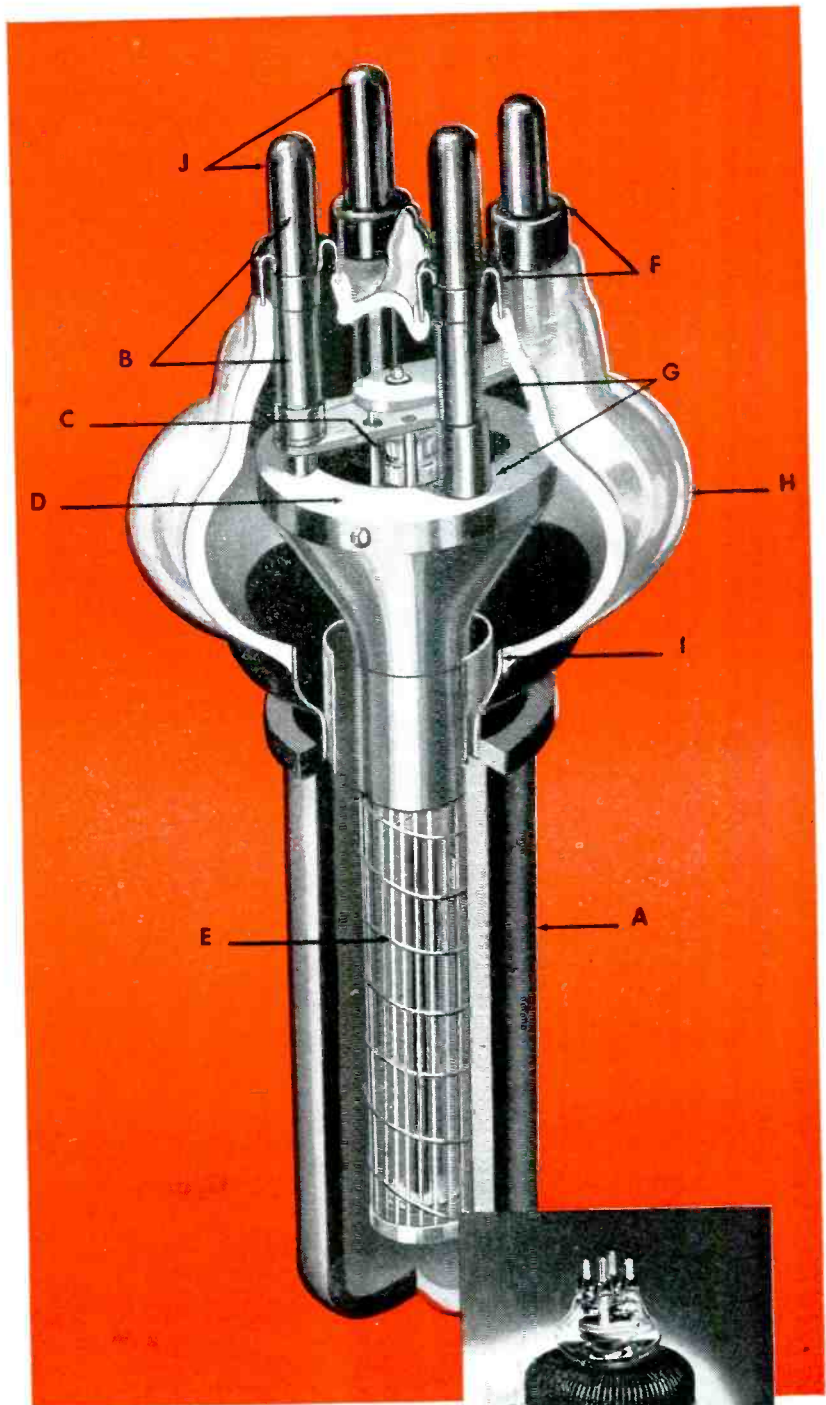

ML-5604

TRIODE R.F. HEATING OSCILLATOR AND POWER AMPLIFIER

Filament	Tungsten
Voltage	11.0 a.c. Volts
Current	180 Amps.
Starting: The filament current must never exceed 270 Amps., even momentarily.	

AMPLIFICATION FACTOR: 18.5 DIRECT INTERELECTRODE CAPACITANCES:

Plate to Grid	25 mmfd
Plate to Filament	1.25 mmfd
Grid to Filament	30 mmfd

COOLING: Minimum air flow through radiator 750 c.f.m. @ 1.25" back pressure.
Minimum air flow of 15 c.f.m. from 3" nozzle on center of dish.

OPERATION:

Maximum ratings, Absolute values:	
D.C. Plate Voltage	(Note 1) 10000 max. Volts
D.C. Grid Voltage	2000 max. Volts
D.C. Plate Current	2.75 max. Amps.
D.C. Grid Current	.40 max. Amps.
Plate Input (Note 2)	27.5 max. KW
Plate Dissipation (Note 3)	10 max. KW
Max. Frequency for full ratings	30 mc
Max. Anode Temperature	230° C
Max. Glass Temperature	160° C

(Note 1): For operation below 5 mc. 12,500 max. I.C.C. plate volts may be used.
(Note 2): For operation below 5 mc. Plate Input may be 32.5 KW max.
(Note 3): Plate Dissipation water-cooled (Type ML-5619) 20 KW max.

New Xenon Thyatron

FOR A WIDE RANGE OF AMBIENT TEMPERATURE

CHATHAM 5594

.. requires no heater, blower or thermostat to regulate bulb temperature!

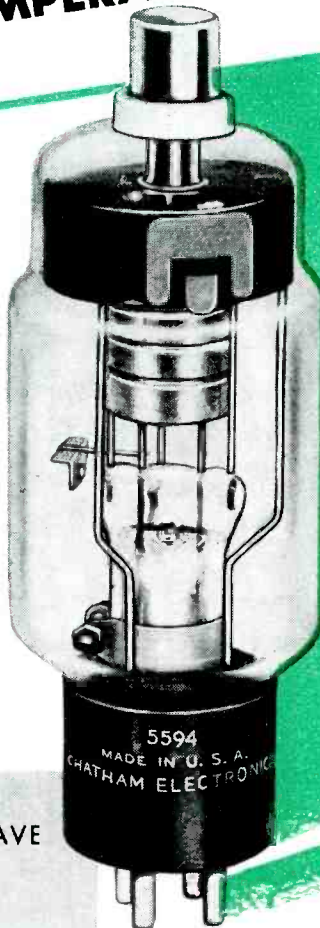

MAXIMUM RATINGS

PEAK FORWARD ANODE VOLTAGE: 2500 VOLTS
 PEAK INVERSE ANODE VOLTAGE: 5000 VOLTS
 AVERAGE ANODE CURRENT: 0.5 AMPERES
 PEAK ANODE CURRENT: 2.0 AMPERES
 FILAMENT VOLTAGE: 2.5 VOLTS
 FILAMENT CURRENT: 5.0 AMPERES

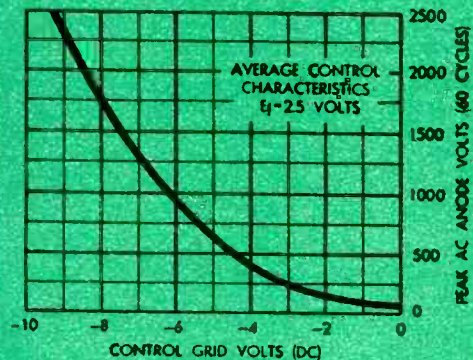

WRITE FOR CATALOG

Type 5594, an exclusive development of CHATHAM ELECTRONICS, is an Xenon filled thyatron with characteristics suitable for diversified applications. Xenon gas eliminates the need for auxiliary equipment to maintain bulb temperatures and also removes most of the limitations usually associated with mercury vapor rectifiers. The 5594 operates through an ambient temperature range of from -55°C . to $+90^{\circ}\text{C}$. For complete information on this tube or any other in the complete line of CHATHAM rectifiers and thyatrons, call or write today; there is no obligation.



3B28 XENON HALF-WAVE RECTIFIER

Maximum Ratings:

PEAK INVERSE ANODE VOLTAGE 10,000 VOLTS
 AVER. ANODE CURRENT .25 AMPS
 PEAK ANODE CURRENT 1.0 AMP
 AMB. TEMP. RANGE -55°C to $+90^{\circ}\text{C}$



4B32 XENON HALF-WAVE RECTIFIER

Maximum Ratings:

PEAK INVERSE ANODE VOLTAGE 10,000 VOLTS
 AVER. ANODE CURRENT 1.25 AMPS
 PEAK ANODE CURRENT 5.0 AMPS
 AMB. TEMP. RANGE -55°C to $+90^{\circ}\text{C}$



CHATHAM ELECTRONICS

475 WASHINGTON ST., NEWARK 2, NEW JERSEY

KENYON has a "REP" ..

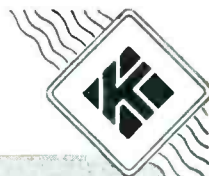

everywhere!



TEXAS, ARKANSAS,
OKLAHOMA
Mr. ROBERT A. CAMPION
Campion Sales Co.
P.O. Box 4116, Station "A"
Dallas, Texas
Dallas 9-3545

ILLINOIS, WISCONSIN,
MINNESOTA, INDIANA
Mr. HARRY HALINTON
Harry Halinton
612 North Michigan Ave.
Chicago 11, Ill.

CONNECTICUT, RHODE ISLAND,
NEW HAMPSHIRE, VERMONT,
MASSACHUSETTS, MAINE
Mr. MORRILL P. MIMS
Morrill P. Mims Co.
43 Leon Street
Boston, Mass.
Garrison 0456

CALIFORNIA, ARIZONA
Mr. ERNEST V. ROBERTS
E. V. Roberts & Associates
6516 Selma Avenue
Hollywood 28, Calif.

PENNSYLVANIA, NEW JERSEY,
DELAWARE, MARYLAND,
DIST. OF COLUMBIA,
NEW YORK STATE (except N.Y.C.)
Mr. ADOLPH SCHWARTZ
Adolph Schwartz
Room 2210
220 Broadway
New York 7, N. Y.
COrtland 7-0011

OREGON, IDAHO, MONTANA,
WASHINGTON; PROVINCE OF
ALBERTA, BRITISH COLUMBIA,
CANADA AND ALASKA
Mr. HARRY TARBELL
Magneon Company
907 Terminal Sales Bldg.
1220 S.W. Morrison St.
Portland 5, Oregon
ATwater 4107

MR. E. J. SCHNEIDER
Magneon Company



GEORGIA, FLORIDA, ALABAMA,
(Except MOBILE & BALDWIN);
EAST TENNESSEE,
N. CAROLINA, S. CAROLINA
Stanley K. Wallace
Sales Agency & Representatives
Mr. STANLEY K. WALLACE
Lutz, Florida
Tampa 99-144

Mr. V. HUTTO
2555 Mathews Ave., N.E.
Atlanta, Ga.
CRescent 4691
(S. K. Wallace
Georgia "Rep")

Mr. AL MANASSA
2130 E. 5th Street
Charlotte, N. C.
(S. K. Wallace "Rep"
for N. Carolina, S. Carolina
and Eastern Tennessee)

Mr. H. J. ODOM
106 Howard Drive
College Park, Ga.
(S. K. Wallace
Alabama "Rep")

MR. W. C. JAUDON
Lutz, Fla.
(S. K. Wallace "Rep")

NEBRASKA, KANSAS,
MISSOURI, IOWA
Mr. F. C. SOMERS
F. C. Somers & Co.
18th & Grand Avenue
Kansas City 8, Mo.
GR 1355

Mr. F. C. SOMERS, JR.
Kansas City 8, Mo.

MISSISSIPPI, LOUISIANA,
MOBILE & BALDWIN, ALABAMA;
ESCAMBIA, SANTA ROSA &
PENSACOLA, FLORIDA;
WEST TENNESSEE
Mr. GEORGE H. PIERCE
George H. Pierce Co.
715 Camp Street
New Orleans 12, La.

*Jobbers!
Manufacturers!*

Contact the
Representative of
KENYON
QUALITY TRANSFORMERS
in Your
Territory
Now!

KENYON TRANSFORMER CO., Inc. 840 BARRY STREET
NEW YORK, U. S. A.

New mobile studio



RCA image-orthicon cameras, standard equipment for the new truck, rival the human eye in sensitivity—eliminate fading of sports events. Shown above as used by Philco's WPTZ to pick up a Penn game at Franklin Field, Phila.

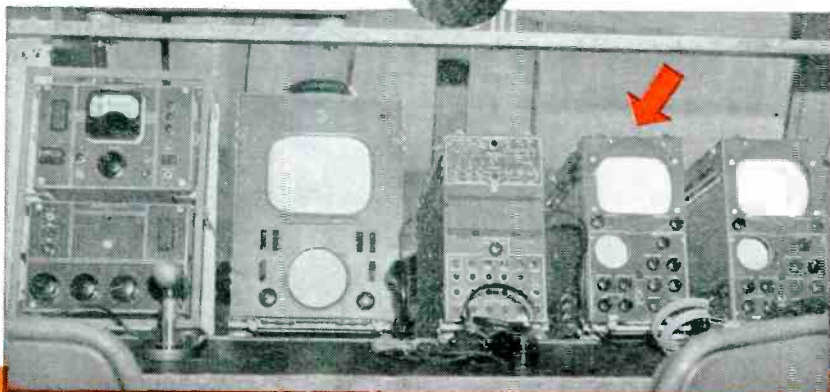

REMOVABLE, SUITCASE-TYPE CONTROLS SPEED SPECIAL SETUPS

Where advantageous, all necessary equipment can be easily removed from the truck, carried to program areas, and quickly set up by means of plug-in type connectors. View at

simplifies at-the-scene telecasting

Opens up a wealth of diversified, low-cost program material

Here, in one compact unit, is a complete television "studio on wheels." With it you can move rapidly to the places where local events are taking place and, with minimum effort, pick up and relay the action to your station. Picture quality is comparable to that obtained with studio equipment.

The truck body, designed by RCA engineers to provide maximum convenience and working space to operators, is mounted on a standard 1½ ton Chevrolet chassis. It carries everything you need to operate a three-camera television chain.

The control desk is at the back of the truck, flanked on three sides with large full-vision windows. These can be darkened by means of draw curtains when desirable.

Monitors, camera controls, a switching unit, and an audio amplifier and mixer are conveniently mounted on an inclined support at the back of the desk; pulse formers,

shapers, and power supplies are installed underneath. All units are of the removable, suitcase type.

Shock-mounted lockers provide ample storage space for cameras, tripods, microwave relay transmitter, and other gear.

The roof of the truck has been strongly reinforced for use as an operating platform, when needed. Access is via a removable ladder inside the truck and a roof hatch. However, the cameras can be operated as far as 500 feet from the vehicle, if desired. Four cable reels, mounted on swinging arms in the rear truck compartment, permit easy unwinding and storage of camera cable. Each has a 200-foot capacity.

Here, we believe, is a real opportunity for diversified programming—a quick, convenient method of making remote pick-ups. It will pay you to include such a unit in your television plans. Write Dept. 30-F



TELEVISION BROADCAST EQUIPMENT

**RADIO CORPORATION
of AMERICA**

ENGINEERING PRODUCTS DEPARTMENT, CAMDEN, N. J.

In Canada: RCA VICTOR Company Limited, Montreal

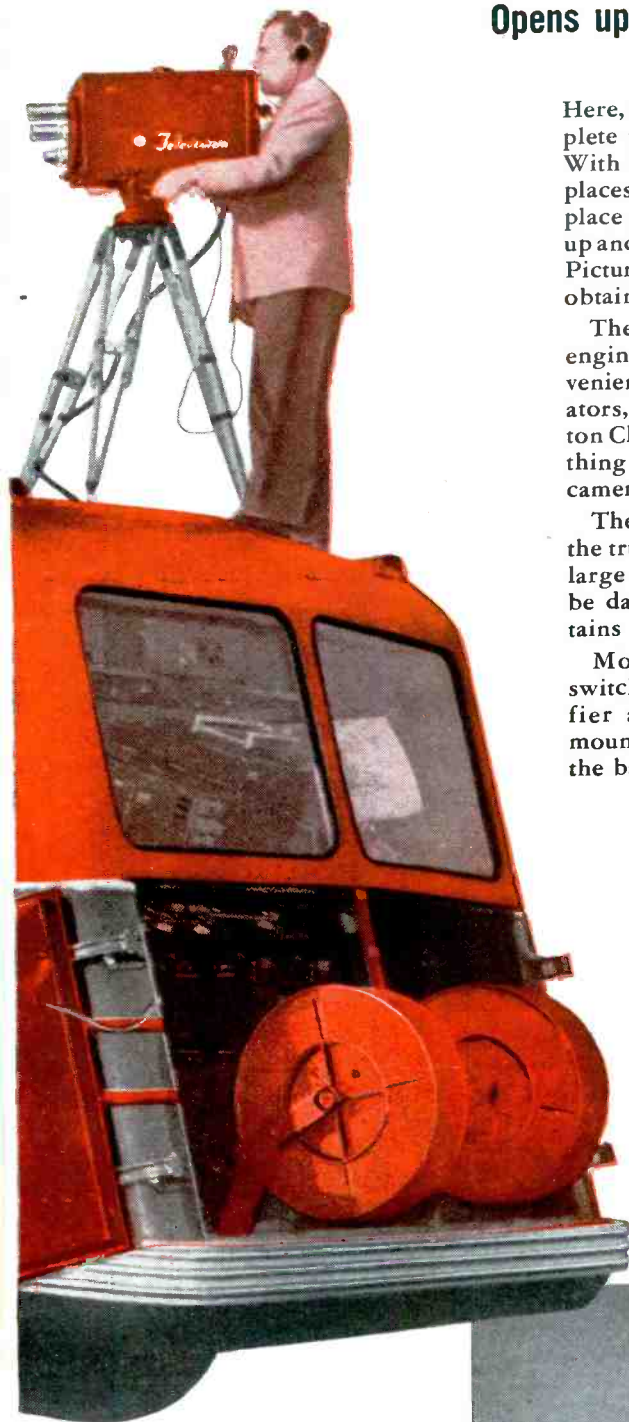

left shows suitcase-type units as installed at the rear of truck. View at right shows how such equipment is set up by WMAL, Washington, D. C., for an indoor television pick-up.

NATVAR *in* ARGENTINA



This ad, showing typical uses for Natvar insulating materials, was made up and used by PRODELEC, an authorized distributor for Argentina. Natvar Sales Agent for Argentina is Casa Rand, P. O. Box 942, Buenos Aires.



Natvar Products

- Varnished cambric—straight cut and bias
- Varnished cable tape
- Varnished canvas
- Varnished duck
- Varnished silk
- Varnished special rayon
- Varnished Fiberglas cloth
- Silicone coated Fiberglas
- Varnished papers
- Varnished tubings and sleeveings
- Varnished identification markers
- Lacquered tubings and sleeveings
- Extruded vinyl tubing
- Extruded vinyl identification markers

Ask for Catalog No. 20

THE NATIONAL VARNISHED PRODUCTS

TELEPHONE
RAHWAY 7-2171

CABLE ADDRESS
NATVAR: RAHWAY, N. J.

Corporation

201 RANDOLPH AVENUE ★ WOODBRIDGE NEW JERSEY

6-NVP-2

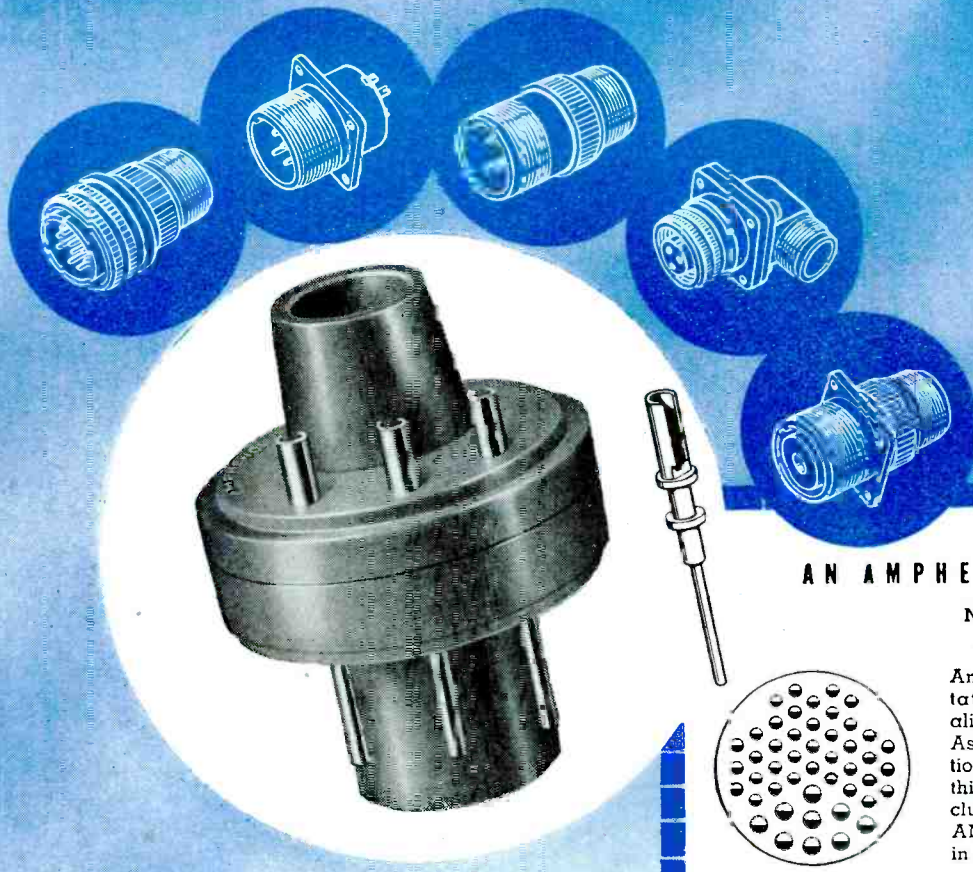

The new 9728-410P high voltage AN connector insert, newest addition to the Amphenol family. It is one of more than 200 types available for use with the five basic shells shown.

AN AMPHENOL EXCLUSIVE

Non-rotating solder terminals and caged solder wells

Amphenol terminals do not rotate, and they are properly aligned for fast, easy soldering. Ask the men on your production line how many hours a day this feature will save. Other exclusive features of Amphenol AN connectors will be described in a later issue.

How **AMPHENOL** AN Connectors Step Up Your Profit Potential

Standardized AN connectors provide a fast, fool-proof way to connect any industrial electronic equipment which frequently must be disconnected from associated equipment or power source.

Their use also permits the prefabrication of associated wiring to accommodate one or many circuits. This greatly simplifies and lowers the cost of electronic installations. AN connectors also permit such equipment to be completely tested at the factory before shipment to user. Upon arrival it then can be connected for operation in minutes.

These advantages combine to widen the field in which electronics may practicably be applied. Thus they offer an increased sales and profit potential to makers of electronic devices.

The Amphenol AN connector family offers you a number of important points of mechanical and electrical superiority. It is comprised of over 200 styles of dielectric inserts. These are interchange-

able in any of the five major Amphenol metal shell designs (each of which is available in eighteen sizes). The practically endless variety of possible combinations offers an efficient solution to any industrial electronic connector problem.

Amphenol inserts handle currents up to 200 amperes, voltages up to 22,000. Housings include types which are pressure-proof, moisture-proof and explosion proof. Standard elements also are available for thermocouple installations.

Amphenol, long the leading builder of AN connectors for aircraft, ships, tanks and ordnance, is still completely tooled for large scale production. This makes these connectors available to industry at costs far below prewar levels. Write today for complete technical and cost data.

AMERICAN PHENOLIC CORPORATION
1830 SOUTH 54TH AVENUE, CHICAGO 50, ILLINOIS

COAXIAL CABLES AND CONNECTORS • INDUSTRIAL CONNECTORS, FITTINGS AND CONDUIT • ANTENNAS • RADIO COMPONENTS • PLASTICS FOR ELECTRONICS

PROFESSIONAL PERFORMANCE—that keeps the original sound alive!

*Always
on the nose*

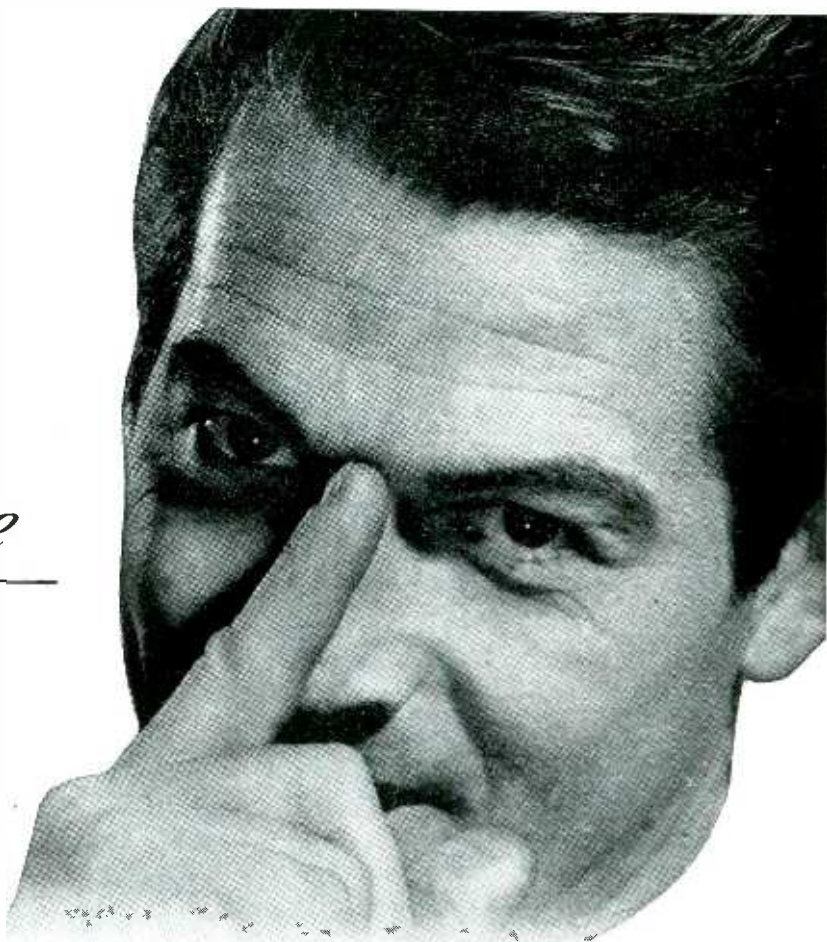

—with split-second timing at 33.3 rpm



The way to a listener's pocketbook is through his ears. Give him the last full note of every record . . . a natural unhurried ending to every story on the program — and you'll keep him in a receptive mood for your spot commercials.

But cut his entertainment short; or mar its quality with speedups or slowdowns to compensate for faulty drive timing — and you'll never get his pocketbook open.

Professional recording and playback require precision timing. In maintaining broadcasting schedules, where seconds count, you're offered the positive Fairchild direct-from-the-center turntable drive, shown above. Rim or belt driven tables cannot duplicate Fairchild's split-second timing. The 33.3 rpm speed is obtained through a gear-and-worm reduction of its 1,800 rpm synchronous motor speed. The 78 rpm speed is obtained through a precision friction-ball-race stepup.

Fairchild's precision timing is available on Transcription Turntables, Studio Recorders and Portable Recorders designed in close collaboration with AM and FM broadcast and recording engineers to meet and exceed very exacting professional requirements for lateral recording on acetate or wax masters at 33.3 and 78 rpm. For complete information — including prompt delivery — address: 88-06 Van Wyck Boulevard, Jamaica 1, New York.



Transcription Turntables
Studio Recorders
Magnetic Cutterheads
Portable Recorders
Lateral Dynamic Pickups
Unitized Amplifier Systems

 *Fairchild* CAMERA
AND INSTRUMENT CORPORATION



verter

rectifier

Versatility

roller



...built by Western Electric using *Callite* tube components

Western Electric's Type 354A thyatron is equally adept as a relay, inverter or rectifier. Because of these diverse applications, the 354A is built with particular emphasis on ruggedness, long life and trouble-free performance.

Callite cooperates with Western Electric, as well as other leading tube manufacturers, in the solution of metallurgical problems dealing with vacuum tubes where engineering skill and precision are required. We process seven distinct types of tungsten wire for filaments of electronic tubes and lamps. Also available are tungsten and molybdenum alloys for supports, hooks and grids.

Irrespective of how complex or how simple your metallurgical problem may be — it will pay you well to investigate our

complete range of metallurgical components — our specialty for over a quarter-century. Descriptive catalog No. 156 available on request from Callite Tungsten Corporation, 544 Thirty-ninth Street, Union City, New Jersey. Branches in Chicago and Cleveland.

Callite
TUBE COMPONENTS

Hard glass leads, welds, tungsten and molybdenum wire, rod and sheet, formed parts and other components for electronic tubes and incandescent lamps.





FORMICA TOOL OF THE ATOMIC AGE

Long before Oak Ridge, production engineers were controlling the streaming particles of the invisible world of atoms, electrons, protons and waves of heat, light, sound and energy. Specialized insulating materials were, and increasingly will be, the engineer's indispensable tools for preventing some of these forces from interfering with others. Formica has the physical properties, mechanical strength, durability, and machinability to serve today's and tomorrow's needs

in more ways than you may be familiar with. The fires of war have tested and proved the superior fitness of old specifications for their more familiar uses, beyond all possible doubt. The wartime research has given you new grades for new uses.

Why not state the insulating job you have in mind and let us suggest a material that your experience might easily prove to be the most perfect tool you have yet found for your purpose.



THE FORMICA INSULATION COMPANY, 4661 SPRING GROVE AVENUE, CINCINNATI 32, OHIO

The most
complete
line of
Loud Speakers
and Reproducers
is illustrated
and described
in the new
Jensen
catalog



JENSEN MANUFACTURING CO.
6607 SOUTH LARAMIE
CHICAGO 38, ILLINOIS

Please send me a copy of the 1947 Jensen catalog as soon as it comes from the press.

NAME _____

ADDRESS _____

CITY _____ ZONE _____ STATE _____

1550 MILES A SECOND!!

That's the writing rate recordable with

DU MONT'S Type 5RP CATHODE-RAY TUBE

operating at 25,000 volts accelerating potential!

➤ The speed at which this Du Mont tube clearly writes with adequate brilliance is indicative of the trend in modern oscillography toward high accelerating potentials without loss of deflection sensitivity. A total of 25,000 volts accelerating potential is applied by dividing that potential across multi-band intensifiers.

As exemplified by the Type 5RP, adequate brilliance is obtained from signals which cannot be seen on an ordinary cathode-ray tube, *without serious loss of deflection sensitivity and practically no distortion with Eb3/Eb2 ratios as high as 10!* For high-frequency signals, the Du Mont 5RP is especially useful because of its low-capacitance deflection system.

➤ **Write for descriptive literature.**

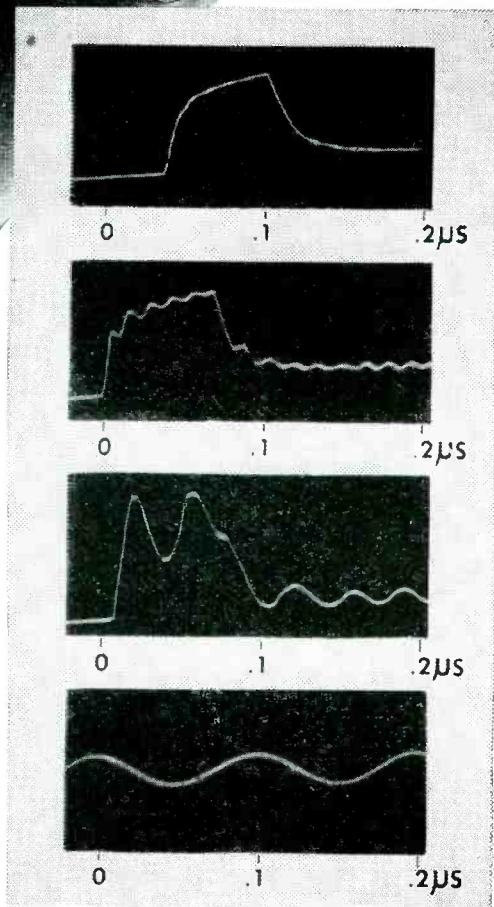

Typical high-speed single-transient recordings with 5RP at 18,000 volts accelerating potential. (Courtesy of Prof. M. Newman, Institute of Technology, University of Minnesota.)

ALLEN B. DU MONT LABORATORIES, INC.

DU MONT

Precision Electronics & Television

ALLEN B. DUMONT LABORATORIES, INC., PASSAIC, NEW JERSEY • CABLE ADDRESS: ALBEEDU, PASSAIC, N. J., U. S. A.





Put the "finger" on PROBLEMS like these!

How?—by selecting and applying the *right* "dag" dispersion for each job. And it's as simple as it sounds except for one fact: while most engineers and plant men do know what "dag" colloidal graphite is, many of them are unaware of *all* the dispersions available or *all* the diverse industrial applications for which they are designed.

Actually there are seventeen "dag" suspensions, in carriers as diverse as water, oils, alcohol and volatile hydrocarbons. Each possesses not only the many unique properties of graphite itself (in what amounts to true liquid form) but also the valuable special characteristics of its liquid carrier. As a consequence, uses are much

more numerous than is generally known.

And that's just why the booklets listed below have been compiled—to tell the men who need to know exactly *how*, exactly *why* and exactly *where* "dag" colloidal graphite dispersions can profitably assist in specific industrial operations.

They're free, of course, and are mailed to you without obligation as part of Acheson Colloids' broad service activities.

ACHESON COLLOIDS CORPORATION
PORT HURON, MICHIGAN

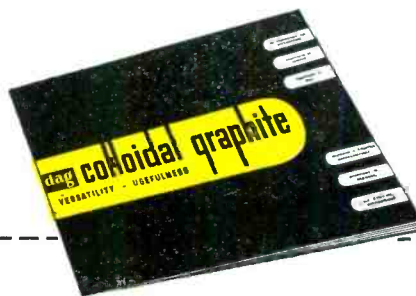

This new literature on "dag" colloidal graphite is yours for the asking:

- 460** A data and reference booklet regarding "dag" colloidal graphite dispersions and their applications. 16 pages profusely illustrated.
- 421** Facts about "dag" colloidal graphite for ASSEMBLING AND RUNNING-IN ENGINES AND MACHINERY.
- 422** Facts about "dag" colloidal graphite as a PARTING COMPOUND.
- 423** Facts about "dag" colloidal graphite as a HIGH TEMPERATURE LUBRICANT.
- 431** Facts about "dag" colloidal graphite for IMPREGNATION AND SURFACE COATINGS.
- 432** Facts about "dag" colloidal graphite in the FIELD OF ELECTRONICS.

ACHESON COLLOIDS CORPORATION
PORT HURON, MICHIGAN DEPT. MM-5

Please send me without obligation, a copy of each of the bulletins checked.

- 460** NAME _____
- 421** POSITION _____
- 422** FIRM _____
- 423** ADDRESS _____
- 431** CITY _____ ZONE _____ STATE _____
- 432** OUR PRESENT OIL SUPPLIER IS _____
(Lubricants containing "dag" colloidal graphite are available from major oil companies.)

SAME TRANSMITTER
SAME ANTENNA
but **MORE POTENTIAL LISTENERS**

How?

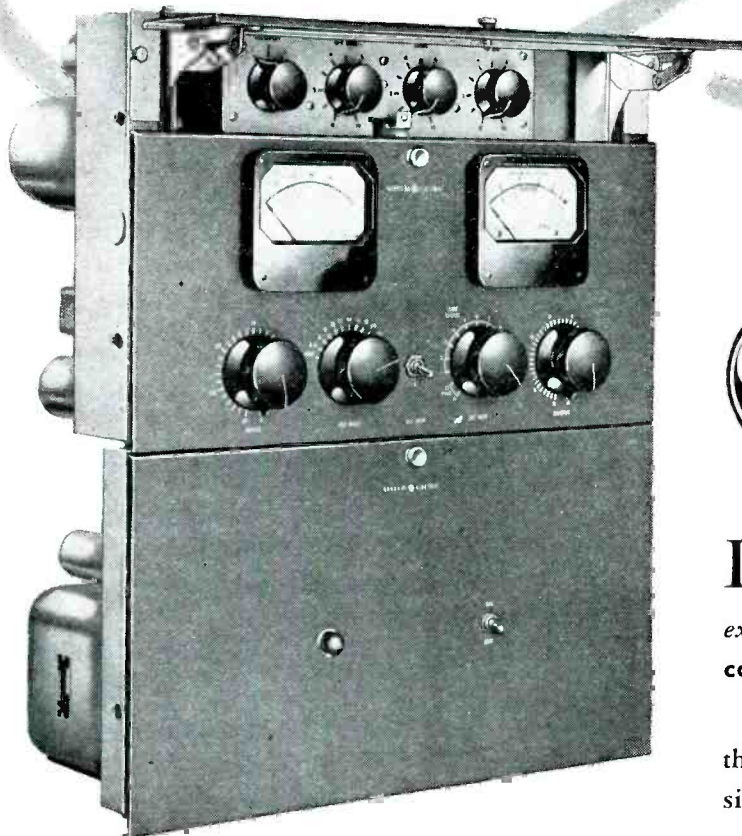

with the new



LIMITING AMPLIFIER

IN AM, you will maintain higher modulation levels, protected against sharp peaks—an *extra margin of power* that means **increased coverage for your station.**

Based on developments by CBS engineers, the Limiting Amplifier BA-5-A has been designed by General Electric for *efficiency plus.*

THESE ARE UNIQUE FEATURES:

- Fast attack reduces program distortion.
- Exclusive "anticipator" circuit.
- Higher compression ratio for higher average modulation.
- Automatic control of recovery time for smoother limiting—greater listening pleasure.
- Less critical gain-riding necessary.
- Protects against overmodulation flashover at transmitter.
- Instant accessibility, of course.

AND IN FM, TOO,

your listeners are protected against receiver distortion caused by transmitter overswing. Amplifier controls may be set so that program dynamic range, so important in FM, is maintained.

MANAGERS, ENGINEERS:

Write today for EBR-99, descriptive specification of this new Limiting Amplifier. Address your local General Electric broadcast equipment sales engineer, or write to General Electric Company, Electronics Department, Syracuse 1, N.Y.

LEADER IN RADIO, TELEVISION AND ELECTRONICS

GENERAL  ELECTRIC

160-F3-6914

W2XMN, Alpine, New Jersey
The Pioneer
FM Station of the World
ALSiMag Insulated

ALSiMAG

REGIONAL OFFICES:
(See Telephone Book)
NEW YORK
BOSTON
PHILADELPHIA
WASHINGTON
CLEVELAND
CHICAGO
ST. LOUIS
SAN FRANCISCO
LOS ANGELES



ALSiMag

... the pioneer antenna structure for FM (frequency modulation) transmission erected by Major E. H. Armstrong at Alpine, New Jersey is equipped with Super Low-Loss ALSiMag 196 Insulators. You, too, can use this fine Sialite material at no increase in price over the ceramic material you are now using. Ask for our new trade literature. It contains helpful, money saving suggestions.

SIALITE

AMERICAN
LAVA
CORPORATION
CHATTANOOGA
TENN.

COMMUNICATIONS FOR DECEMBER 1939

ALSiMAG INSULATION IN THE PIONEER FM ANTENNA STRUCTURE

STILL GOING STRONG!

This page advertisement in electronic and communications magazines in 1939 announced that Major Edwin H. Armstrong's pioneer antenna structure for FM transmission was equipped with ALSiMag 196 insulators.

Most of the original ALSiMag insulators in W2XMN are still in use today. They are giving entire satisfaction in spite of the fact that one of the transmission lines up the tower, originally designed for 42 megacycles, is carrying 92 megacycles.

There has been no electrical failure of any ALSiMag insulator in W2XMN. A few have been replaced after

heavy ice falls. There is no insulator in existence today which will stand up when squarely hit by a heavy ice fall with drops of several hundred feet. That is one of the problems challenging our Research Division.

In the spring of 1947, W2XMN will replace the vertical transmission line conductors with conductors of considerably larger size. These new and larger conductors will have new and larger insulators . . . of ALSiMag. Perhaps that is the best evidence of the satisfactory performance of ALSiMag insulators in the World's Pioneer FM Station.

ALSiMAG
SIALITE

46TH YEAR OF CERAMIC LEADERSHIP
AMERICAN LAVA CORPORATION
CHATTANOOGA 5, TENNESSEE

SALES OFFICES: ST. LOUIS, MO., 1123 Washington Ave., Tel: Garfield 4959 • NEWARK, N. J., 671 Broad St., Tel: Mitchell 2-8159 • CAMBRIDGE, Mass., 38-B Brattle St., Tel: Kirkland 4498
CHICAGO, 9 S. Clinton St., Tel: Central 1721 • SAN FRANCISCO, 163 Second St., Tel: Douglas 2464 • LOS ANGELES, 324 N. San Pedro St., Tel: Mutual 9076 • PHILADELPHIA, 1649 N. Broad St.

Seeburg's ON RECORD WITH THREE FINE CHANGERS!

You know how much a dependable record changer can contribute to the performance of a radio-phonograph combination. Then why not go on record with Seeburg Changers in the phonographs you manufacture?

Seeburg produces three changers—the new intermix “M”, the “L” and the “K”.

While each is designed for combinations of varying price range, all three are engineered to provide the last word in listening pleasure. When the changer is a Seeburg, you can count on quiet, simple operation . . . constant, sustained speed . . . minimum time between changes . . . long record life.

Seeburg “M” Three-post construction. CAPACITY: fourteen 10-inch records, or twelve 12-inch records, or twelve 10 and 12-inch records intermixed. SIZE: 14¼ x 14¼ inches.



Seeburg “L” Two-post construction. CAPACITY: fourteen 10-inch records, or ten 12-inch records. SIZE: 14¼ x 14¼ inches.

Seeburg “K” Two-post construction. CAPACITY: fourteen 10-inch records, or ten 12-inch records. SIZE: 12½ x 12½ inches.



Seeburg
RECORD CHANGERS ★ MUSIC SYSTEMS

J. P. SEEBURG CORPORATION
1500 N. Dayton Street • Chicago 22, Ill.

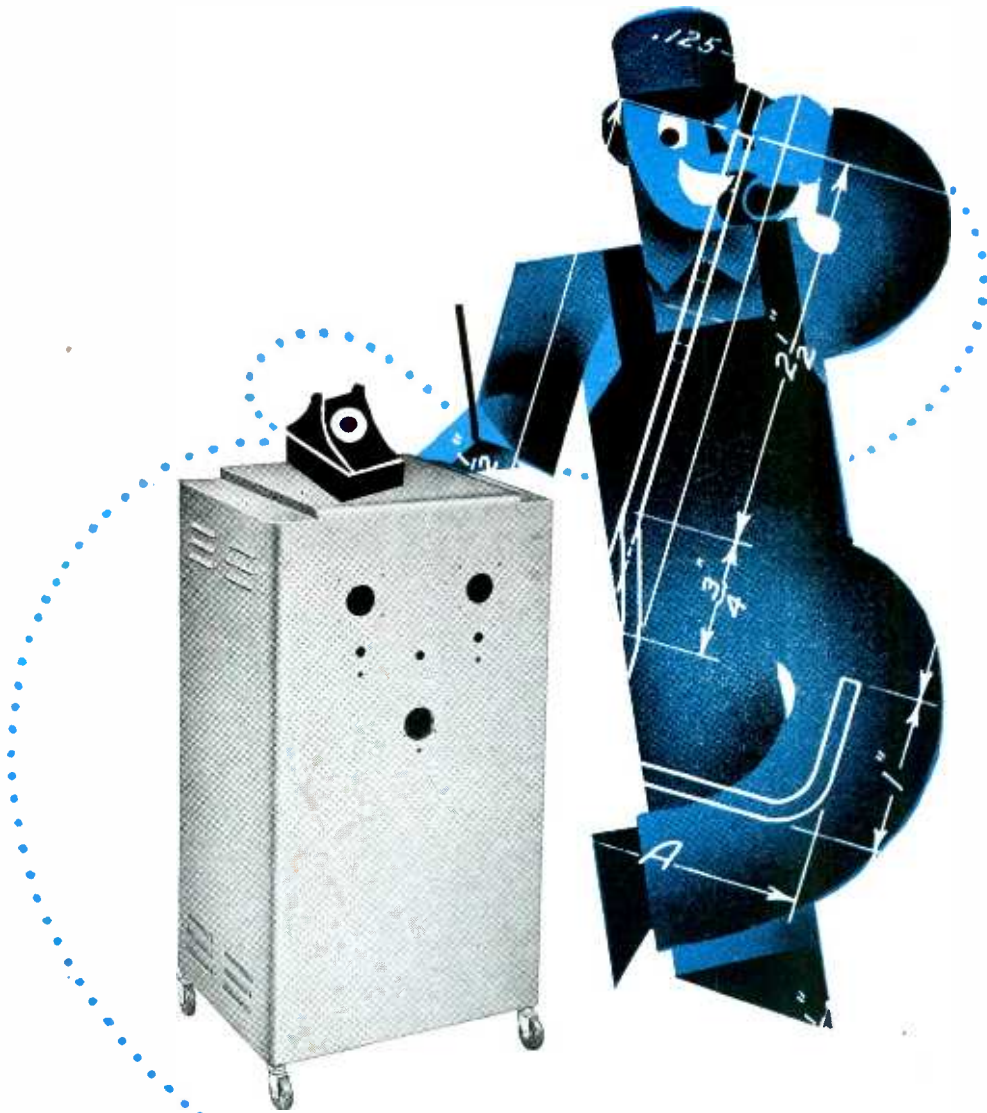

YOU'VE GOT THE RIGHT NUMBER

When you contact KARP for sheet metal fabrication, you have the right connection. You're in touch with highest quality custom craftsmanship — at prices comparable with stock items.

You're doing business with an organization with 22 years experience in specially fabricated sheet metal cabinets, chassis, housings, racks and enclosures for manufacturers of electronic, radio and electrical apparatus.

You're getting the benefit of a valu-

able amount of "know-how" in engineering and design . . . suggestions to help you keep your assemblies a step ahead in streamlined styling and long service life. You have at your disposal a large accumulation of dies and tools which may cut your costs considerably.

Give us a call on your next job. And if you can't call, write.

*Any Metal • Any Gauge • Any Size
Any Finish • Any Quantity*

Karp

METAL PRODUCTS CO., INC.

Custom Craftsmen in Sheet Metal

124 - 30th STREET, BROOKLYN 32, NEW YORK

The IMC Engineer



...on your staff

but not on your payroll....

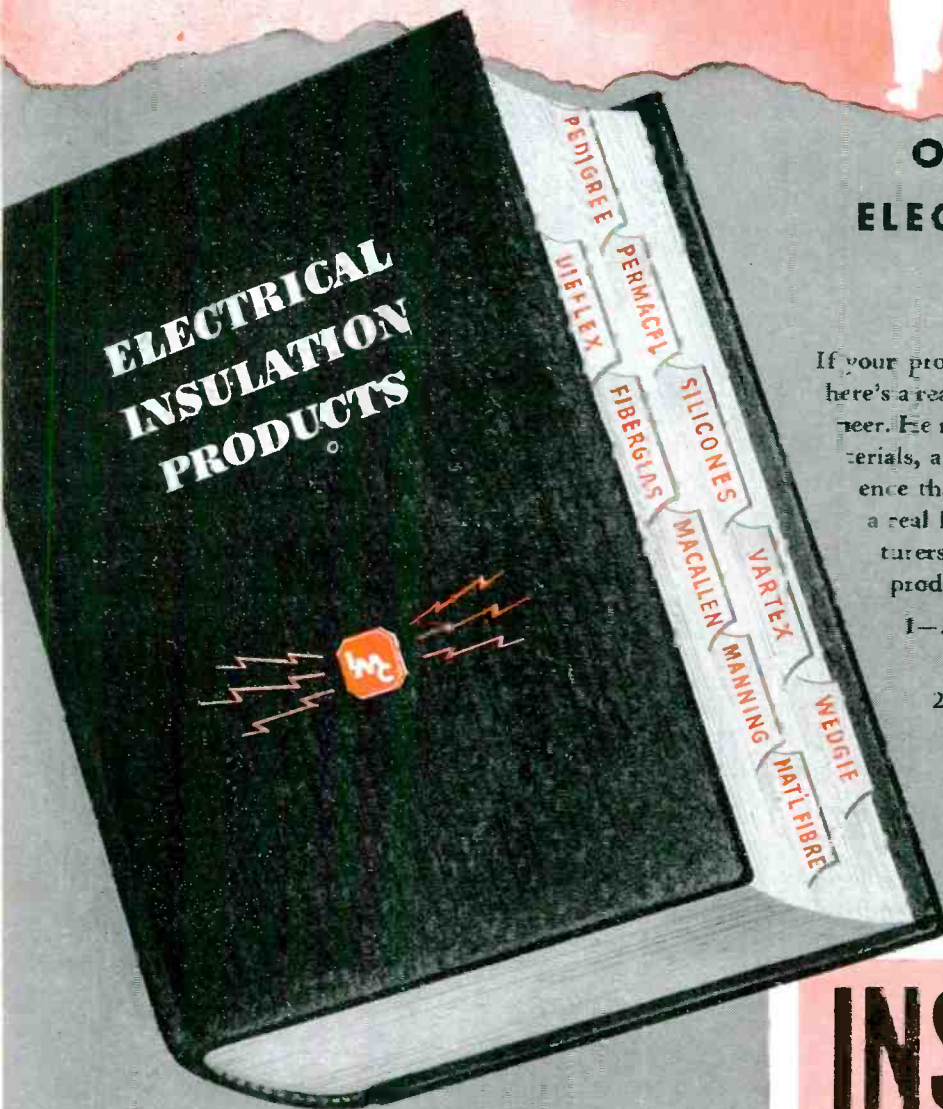

OFFERS EXPERIENCED ELECTRICAL INSULATION ASSISTANCE...

If your problem is increased cost and assembly time, here's a ready answer. Call on your nearest IMC Engineer. He represents a complete line of insulating materials, and he's backed up with a wealth of experience that can help solve your problems. He can be a real help because he represents many manufacturers, and therefore can offer you the right product to best meet your needs. Ask him to...

- 1—Assist you in the selection of the best insulating material for your job.
- 2—Familiarize you with the proper method of application.
- 3—Suggest ways to eliminate waste.
- 4—Help increase your production.

IMC PRODUCTS: Macallen Vico Products—Vartex Varnished Cloth and Tapes—Varslat Combination Set insulator—Vermehoe Silk and Paper—Fiberglass Electrical Insulation—Manning Insulating Papers and Pressboards—Dow Corning Silicones—Diellex Varnished Tubings and Saturated Sleeveings of Cotton and Fiberglass—National Hard Fibre and Fishpaper—Phenolic Bakelite—Permacel Adhesive Tapes—Asbestos Woven Tapes and Sleeveings—Cotton Tapes, Webbing, and Sleeveings—Pedigre Insulating Varnishes—Wedgie Brand Wood Wedges.

INSULATION

MANUFACTURERS CORPORATION

*CHICAGO 6
565 West Wash-
ington Blvd.

MILWAUKEE 2
312 East Wisconsin
Avenue



*Local Stocks Available

*CLEVELAND 14
1231 Superior
Ave., N. E.

DAYTON 2
1315 Mutual Home
Building.

Representatives in: **DETROIT 2:** 11541 Woodward Avenue; **MINNEAPOLIS 3:** 1208 Harmon Place; **PEORIA 5:** 101 Heinz Court

WORLD LEADERSHIP...

Our Duty and Our Opportunity

CAPITALISM in Europe and the rest of the world is challenged by a real and formidable rival, communism. For capitalism to thrive a reasonable amount of prosperity is essential. Communism uses poverty to advance itself.

Except for the Western Hemisphere, most of the world came out of the war poor. Two years after V-E Day it is still poor. It needs dollars. It needs credit. It needs capital. It needs trade. It needs technical and managerial skills.

If we in America are to help the rest of the world back to its feet, starting it again on the road to peace and a free economy, we should try to supply those needs within the limits of our capacity.

We must not overtax our own strength. For the first requirement of a stable world is a strong United States. But we must accept leadership in international economic recovery—in our own self-interest.

What can the United States do to help men back to prosperity in a world economy which will allow them *freedom and incentive*? There are many things. But here are two of the most important:

1. The United States, through Congress, must determine the pattern and the total of the foreign loans or grants it can afford. We must answer three questions. How much will the new program cost? Can we afford it? Have we the technicians and managers to watch the loans, assuring their fruitful use?
2. We must demonstrate that we do not intend to raise our tariff walls to prohibitive heights when our debtors begin to repay us in goods and services, which is the only practical way they can pay us. Otherwise our loans will become losses.

If the United States is to meet even the minimum requirements of world rehabilitation, Congress eventually must authorize more advances than those to Greece and Turkey. The \$400 million for those two countries will not do the over-all job of political and economic defense which we have begun. A min-

imum of \$5 billion, if promptly and wisely applied in eight to ten countries, might suffice. BUT this \$5 billion will be on top of approximately \$16.8 billion which we have spent or earmarked during the past two years for use abroad, including our full share of the World Bank and Fund. We shall do a faster and more effective job if Congress will thus add up the foreseeable total of our international aid, and, even though the total looks imposingly large, commit us to it, with proper collateral safeguards from the debtor nations.

Congress need not try to foretell all contingencies, like last winter's weather in Britain, and it certainly should not create the impression that nations need only ask for billions to receive them. On the other hand, the war should have taught us the miserable consequences of "too little and too late." The President should have learned that he engenders skepticism by going to Congress with parts of a program, as he has done in the British, Grecian and Turkish loans. Within the limits of our capacity, we must make the decision now to see the whole job through—or throw in the sponge.

In the interest of the debtor nations—as well as in our own interest—the loan program should be hard-boiled. Rehabilitation loans must really rehabilitate. They must produce a state of economic health which will permit the World Bank and private capital to take over the task of financing world recovery—as perhaps can be done today in France and the Low Countries.

The loans, therefore, must be within the limits of our technical and managerial ability to implement them. Without technical help, Greece can not use its loan effectively—to rebuild railroads, clear ports, revive agriculture. Without skilled supervisors, Germany can not be made to pay its way. Money alone won't pull China from the brink of economic chaos.

Our lending calls for more than money. It calls for trained personnel to help the recipients utilize the loans effectively—geologists, construction and sanitary engineers, monetary experts, and management and agricultural specialists.

Loans are necessary but they are only a first step. A long-range program requires the opening of the half-closed doors of world trade—our own door, too.

We will have to get used to the idea that, when our debtors pay us, they must pay us largely in goods and services. Refusal to permit such repayments in the twenties helped start the world depression in the thirties—and the loss of our investments. *Imports do tend to raise living standards, and a two-way trade program need not require us to slash our present tariff rates.*

The complexion of our foreign trade has changed since the war. Our manufacturing capacity has increased and our raw-material self-sufficiency is tending to decline. For example, we probably shall have to continue importing copper and zinc and to increase our prewar dependence on imported lead. We may soon have to depend heavily on imported oil, and—gradually—on a growing volume of iron ore from abroad. Our normal dependence on imports for commodities like rubber, tin and silk will continue.

Our population has gone up 10 million in the last decade, and we now have a \$176 billion national income, making room for more imports.

As a result of every nation's recent attempts to make itself secure and self-sufficient by slamming its trade door, a world-wide series of quotas and restrictions is blocking international trade. Even more, government buying and selling threaten to take commerce out of the hands of private traders, placing it in the uninspired care of bureaucratic negotiators.

Our government has taken the lead in calling the conference of 18 nations, now meeting at Geneva, to open as many trade doors as possible. The American delegates will bargain product by product and country by country—all summer, if necessary—for

lower tariffs, fewer quotas and a free flow of *private* trade. The task is a long one, and the results are as yet uncertain, but, if success is achieved, an immense opportunity for good works and good earnings will lie before American businessmen.

This is no picayunish opportunity. Authoritative estimates put our 1947 exports at \$11 billion and our imports at \$6 billion. That's substantial. It is greater than the value of all crops grown on our farms (\$10½ billion) and exceeds the value of all shipments of industries such as automobiles (\$9 billion), textiles (\$8 billion) and chemicals (\$8 billion).

International trade is vital, not to be shrugged off, not to be kicked around as a football of party politics. Republicans and Democrats agree on a non-partisan foreign political policy. They should agree also on a non-partisan foreign economic policy. The foreign relations of the United States, political or economic, can no longer be log-rolled hither and yon.

A general program for international recovery, outlined here, will bring its full quota of aches and pains. But lack of a program will produce economic and political troubles

on a vast scale; timid retreat will invite economic disaster and war.

By an intelligent, bold and resourceful program, we have a chance to win through to a long peace in the kind of world we want. *Unless America provides the leadership, there can be no such program.* Then Communism merely needs to hang around long enough to pick up the pieces.

Ours is the responsibility and the opportunity.

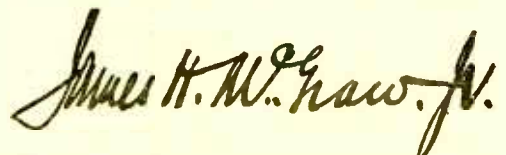

President McGraw-Hill Publishing Company, Inc.

A NEW ENTERPRISE

Advocacy by the McGraw-Hill Publishing Company, in the accompanying editorial, of an effective world economic policy is not a mere verbal exercise. In the faith that we as a nation shall develop such a policy, this Company, following a trail blazed by leaders in American industry and finance, is expanding its operations overseas.

A newly created McGraw-Hill International Corporation will push forward the frontiers of our technical magazine and book publishing business throughout the world. The new Corporation comprises:

Eight international magazines—the McGRAW-HILL DIGEST, THE AMERICAN AUTOMOBILE and EL AUTOMOVIL AMERICANO, PHARMACY INTERNATIONAL and EL FARMACEUTICO, INGENIERIA INTERNACIONAL CONSTRUCCION, INGENIERIA INTERNACIONAL INDUSTRIA, THE MACHINIST.

A newsgathering agency, McGRAW-HILL WORLD NEWS, specializing in industrial and engineering coverage with correspondents in 36 world centers.

McGraw-Hill Publishing Company, Ltd. (London), serving the special needs of Britain and western Europe and publishing THE MACHINIST (London).

Five buyers' guides—AUTOMOTIVE EQUIPMENT (in English and Spanish), CONSTRUCTION EQUIPMENT, INDUSTRIAL MACHINERY and PHARMACEUTICALS (all in Spanish).

In addition, the McGraw-Hill Book Company has an overseas network for the distribution of its books.

WORKHORSE for INDUSTRY

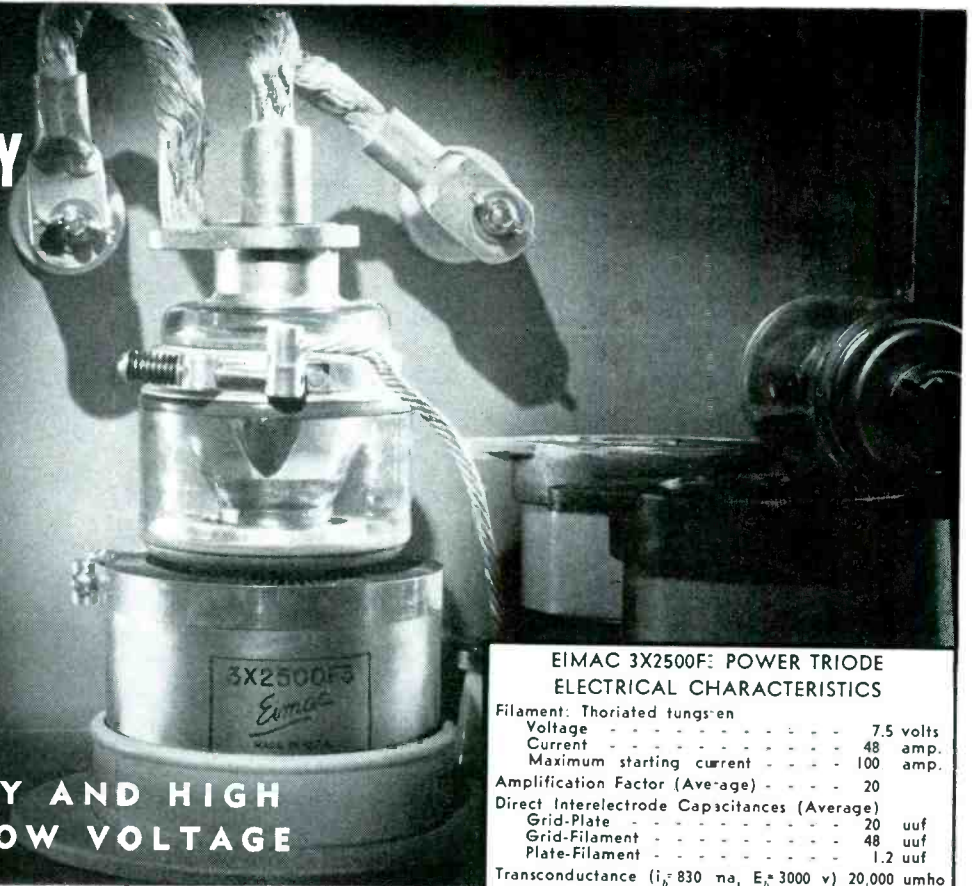

HIGH EFFICIENCY AND HIGH POWER WITH LOW VOLTAGE

HERE'S AN EIMAC TRIODE . . . THE 3X2500F3 . . . specially designed to deliver 5 kw into industrial loads with a plate voltage of only 3500 volts. This low plate voltage contributes to safety as well as reliability of equipment. The tube operates at efficiencies as high as 80 per cent, not only in induction heating service at 200-500 kc, but also in dielectric heating service at 1.5-40 Mc. Operation at 5000 plate volts gives an output of 7.5 kw.

Physically the 3X2500F3 bears the following specific advantages for industrial application:

- COOLER** Unusually efficient..only 74 cfm of air at ambient temperature of 25 C and static pressure of 1 in. of water required to keep cooler core at rated 150° C.
- TERMINALS** Flexible leads..convenience and economy of mounting and connection. Rugged design for rough service.
- FILAMENT** Thoriated tungsten gives required electron emission with minimum power consumption and long useful life. Operates at 7.5 volts, 48 amp.

PRICE \$165 each

Further details on this useful new triode, the 3X 2500F3, are yours for the asking. Write:

EITEL-McCULLOUGH, INC.
1721 San Mateo Ave., San Bruno, California

EXPORT AGENCY: FRAZAR & HANSEN
301 Clay St., San Francisco 11, California, U.S.A.

EIMAC 3X2500F3 POWER TRIODE ELECTRICAL CHARACTERISTICS

Filament: Thoriated tungsten	
Voltage	7.5 volts
Current	48 amp.
Maximum starting current	100 amp.
Amplification Factor (Average)	20
Direct Interelectrode Capacitances (Average)	
Grid-Plate	20 uuf
Grid-Filament	48 uuf
Plate-Filament	1.2 uuf
Transconductance (i_p : 830 ma, E_p : 3000 v)	20,000 umho

RATINGS AND OPERATION

Class-C Grounded-Filament R-F Oscillator
or Power Amplifier

Maximum Ratings Below 40 Mc

D-C Plate Voltage	5000 volts
D-C Plate Current	2 amp
Plate Dissipation	2500 watts
Grid Dissipation	150 watts

Typical Operation Below 40 Mc, per tube

D-C Plate Voltage	3500	4000	5000	volts
D-C Plate Current	1.8	1.6	2.0	amp
D-C Grid Voltage	-420	-360	-400	volts
D-C Grid Current	0.5	0.4	0.5	amp
Peak R-F Grid Input Voltage	735	630	710	volts
Driving Power (Approximate)	325	237	337	watts
Grid Dissipation	120	88	148	watts
Plate Input	6.3	6.4	10	kw
Plate Dissipation	1.3	1.4	2.5	kw
Plate Power Output	5	5	7.5	kw

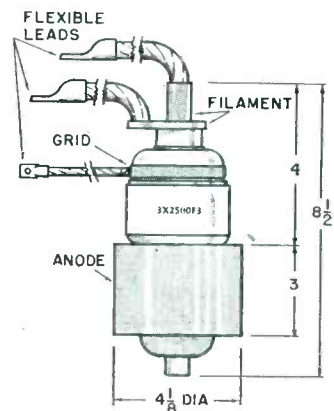

Follow the Leaders to

Eimac
REG. U. S. PAT. OFF.
TUBES

The Power of Industry

NOW! miniature dry electrolytics that are STARTLINGLY small

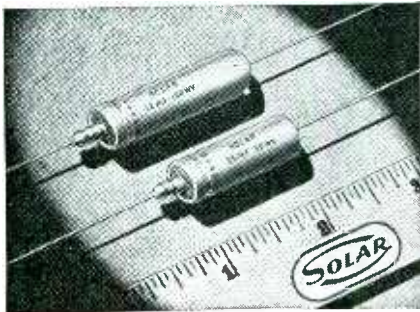

SOLAR'S newest development in dry electrolytics is the sensationally small Type LB design.

Basis of the great size reduction is a new method of producing unprecedentedly high-gain and stable etched foil, product of a long-time Solar research program.

By using Type LB capacitors, circuit designers will no longer be hampered by the space limitations of conventional electrolytics when they specify high values of capacitance for bypass, coupling, and audio filter applications.

Standard d-c working voltage ratings for "LITTLE ELLBEES" range from 1.5 to 150 volts. The maximum a-c ripple voltage which may be applied to 100, 125, and 150 volt capacitors is 7 volts at 60 cycles or 3.5 volts at 120 cycles.

Maximum capacitances for each working voltage in the standard $\frac{3}{8}$ " x $1\frac{1}{8}$ " and $\frac{3}{8}$ " x $1\frac{1}{2}$ " tube sizes is as follows:

WVDC	Max. Cf. $\frac{3}{8}$ " x $1\frac{1}{8}$ " Tube	Max. Cf. $\frac{3}{8}$ " x $1\frac{1}{2}$ " Tube
150	8	12
125	10	15
100	12	18
70	18	25
50	25	35
25	35	50
15	80	120
1.5	200	300

Type LB miniature dry electrolytics are the answer to many hitherto unsolvable design and manufacturing problems where space counts. Investigate today!

SOLAR MANUFACTURING CORPORATION
 "QUALITY ABOVE ALL"
 285 MADISON AVENUE
 NEW YORK 17, N. Y.

BUSINESS BRIEFS

By W. W. MacDONALD

Recording Devices that can be hitched up to a telephone represent a new market that will reach sizeable proportions if an FCC decision, momentarily awaited, is favorable. From what we hear via the grapevine it appears that such use of electronic equipment will be okehed, provided a warning tone is used to indicate that conversation is being taken down.

Electronic Cooking has railroad people interested, and there are good economic reasons why it should. It seems that they rarely do better than break even on dining-car service because the heating and other gear they have to carry in the kitchen eats heavily into space available for tables. Electronic ranges, or frozen-food defrosters, or heaters, can be made very compact, and turn out food in a hurry. The combination of compactness and speed is particularly desirable for railroad application, and cost is a secondary factor.

Magnetostriction Transducers, widely used during the war for converting electrical into ultrasonic sound power or vice versa in underwater signalling apparatus, appear to have a bright future commercially. Instrument makers, particularly, are becoming interested, and an oil company reports that units in an experimental telemetering system designed to indicate liquid level or pressure at remote points appear to be efficient, simple, and rugged.

Shortwave Tuning will be dropped from most home radio receivers now being designed, according to sales managers queried on this point by ELECTRONICS. Reasons are as follows:

(1) F-M is a better sell-up feature. (2) Foreign reception is of lasting interest to very few customers. (3) Even the \$2 to \$6 cost of including such tuning bulks large at a time when consumer resistance to higher list prices is feared.

There is some reason for the inclusion of the C-band in receivers

destined for use out in remote regions of the country where daytime coverage by standard-band broadcast stations is shaky. However, this market can be satisfied with just one model per manufacturer. And those dark spots are filling in rapidly with new f-m and a-m stations.

Statistics that are *not* printed sometimes do more good than those that are. That's why we omit prognostications regarding the number of f-m receivers likely to be made this year from *Business Briefs* this month, numerous as they are.

Production figures and guesstimates on the number of sets likely to be shipped in 1947 just don't jell. If all those sets are really to be made before Christmas rolls around somebody will have to get started producing them in one devil of a hurry.

Labor Efficiency is showing signs of improvement. A large manufacturer of power tubes reports that just a few weeks ago not one reject reached the end of the production line during a five-day run, something that never happened before in the firm's long history. Improved manufacturing and testing equipment and techniques are undoubtedly to some extent responsible, but it still could not have happened had labor been lax.

Miniature Tubes, useful in all but high-power applications, are coming into widespread use in industrial as well as communications equipment. Designers of airborne gear, particularly, are partial to them. One manufacturer is planning a line of premium types having more uniform characteristics. Another, centering its promotional campaign around miniatures, produced less than 25,000 a year before the war but expects to sell eight million in 1947.

Subminiature types, pushed into the limelight by their use in proximity fuse equipment during the war and since boosted along by the recent surge in demand for elec-

Audax

Trade Mark

TUNED-RIBBON reproducers

MUSICALLY . . . *The Tuned-Ribbon message in a few words . . .*

“Startlingly Realistic”

One of the many superlatives used by Electronic Industries magazine* in an editorial describing this new development.

It brings to reproduced music something that was not there before.

TECHNICALLY . . . *The Tuned-Ribbon Reproducer actually meets the long sought for theoretical ideal of —*

- Near-zero mass • Linear response to 15 k.c.
- Practical output (about — 30 db)
- Point Pressure 14 grams • Jewel point
- **NO** torsional action



TUNED-RIBBON Pickup
model **STUDIO-81**
(actual size — special
arm not shown)

• A model for every
purpose

*Send for complimentary
reprint of this editorial

AUDAK COMPANY

500 Fifth Avenue

New York 18

CREATORS OF FINE ELECTRO-ACOUSTICAL APPARATUS SINCE 1915

CURRENTLY

SORENSEN & COMPANY, INC.
Manufacturers of
VOLTAGE REGULATORS, NOBATRONS & ELECTRONIC APPARATUS

FROM
SORENSEN
AT
STAMFORD



POWERFUL NEWS! SORENSEN SYSTEM NOW APPLIED TO DC VOLTAGE REGULATION

The Sorensen system of AC electronic voltage regulation provides quick, accurate response to even the smallest voltage change with a minimum wave distortion and a regulation accuracy of 1/2 of 1%.

Arrange now to receive your personal copy of the Sorensen electronics journal "Currently", published bi-monthly.

This same electronic regulation system has been incorporated into the Nobatron, providing a source of regulated DC voltage at currents and stabilities that, in the

past, was available only with batteries.

This new source of stabilized DC voltage is obtainable in six standard models operating on a 95-125 AC source of 50 to 60 cycles.

Among the more important uses for Nobatrons are DC ammeter calibration in experimental and quality control laboratories, testing of components in the automotive and aircraft industries in battery-operated relays and in other applications where it is desirable to replace a battery to guarantee continuous regulated power supply.

GENERAL AC REGULATOR SPECIFICATIONS

Input Voltage Range	(-1 model) .. 95-125
	(-2 model) .. 190-250
Output Voltage Range	(-1 model) .. 110-120
	(-2 model) .. 220-240
Load Range 25-30,000 V. A.
Regulation Accuracy 1/2 of 1%
Harmonic Distortion 5% Max. (2% in "S" Models)
Input Frequency Range 50-70 cycles
Inductive Power Factor Range Down to 0.7 P.F.

For standard voltage regulation, Sorensen Model 500 is a proven leader in its field—compact, accurate and dependable. This model typifies the Sorensen line of AC and Nobatron all-purpose voltage regulators. Let a Sorensen engineer help you with your next voltage regulation problem.

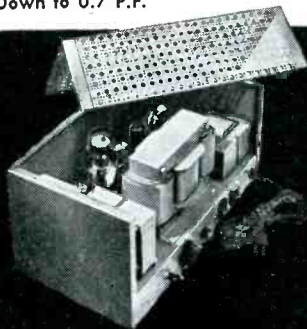

SORENSEN & COMPANY, INC.
375 FAIRFIELD AVENUE • STAMFORD, CONNECTICUT

tronic hearing aids, are also increasing in popularity. One large manufacturer not making such types before the war now has a complete line of experimental types. Another, long active in the field, has sold over four million for commercial use.

Employers Of Engineers select men after considering the following factors, listed in order of importance:

- (1) Personality
- (2) Scholastic record
- (3) Engineering experience
- (4) Evidence of ability to cooperate with others
- (5) Recommendation of qualified persons
- (6) Indicated promise for executive development
- (7) Standing of college from which candidate graduated
- (8) Salary requested

So says the Engineers Joint Council at the conclusion of a survey covering 19 fields of industry.

German Engineers imported at the close of the war to work on rockets are now offering their services to universities and to industry. It seems, says our Washington informant, that they've been drained of useful data but the Army still wishes to keep them on tap.

The idea isn't working so well. American engineers apparently feel that they will have enough competition in the years immediately ahead without importing it.

Labor-Saving Devices are becoming of greater interest to broadcast station owners as well as to men managing electronic equipment factories. They are putting the heat on suppliers to come up with new consoles, transcription turntables, monitors, and controls having more automatic features.

Suppliers are responding by putting their design engineers to work. And the result will soon be seen, in descriptions of tricky new gear within the pages of ELECTRONICS for example.

Supersonic Power is doing wonderful things in laboratories and under water. It has also been applied with reasonable success to some out-and-out industrial jobs but, by and large, applications involving large objects or quantities so far seem best served by simpler mechanical and/or electrical

shake-'em-up devices. Homogenizing of milk is a good example.

Electronics has a bright enough future doing things that simply cannot be accomplished by other methods, or doing things cheaper or better. Attempts to push the art further or faster than it should go are detrimental rather than helpful to its commercial acceptance and, hereafter, we propose to lay that thought right on the line-type once in awhile.

First Quarter Production of radio receivers by RMA members totalled 4,231,415. Sales in the initial three months of 1947 reflected declining consumer interest in table types, increasing interest in consoles and combinations.

Television receivers totalled 18,329, and a-m and f-m types 172,176.

Radio Dispatching for taxicabs pays off. The company about which we wrote a few months ago (p 97, March) reports that business is up 45 percent as against last year, and attributes most of the increase to its ability to handle more calls.

Phonograph Record Production will probably reach 400 million in 1947. Popular records accounted for approximately 70 percent of the volume last year, with juke boxes representing the largest single market.

Master Antennas for television (see p 96, May) are badly needed, now that New York realtors have turned down the Television Broadcasters Association interim plan which would have permitted several apartment house tenants to use one dipole. The realtors may eventually relent, but it is obvious that the final answer is still in the mind of some bright designer . . . perhaps one who will read this reminder that his work will command a premium if not too long delayed.

We Watched a basketball game relayed from Washington to New York the other night by television and were very much impressed. Interference developed somewhere along the line at times, however, and the herringbone pattern that resulted reminded us that we need a new suit.

Type Y6-4F-3H
(List \$6.97
less contacts
and plug)

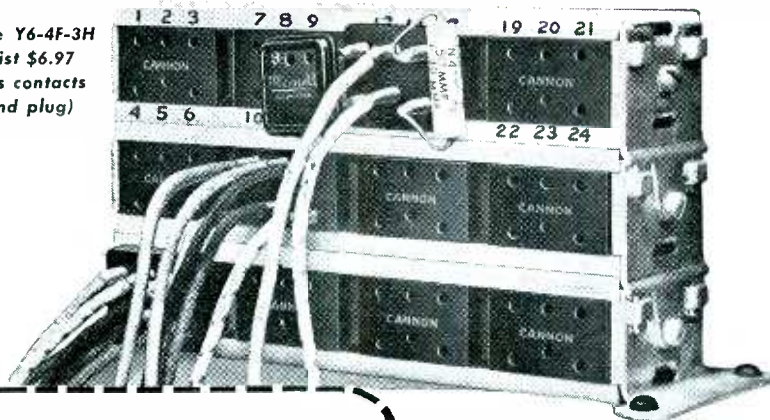

New
**TERMINAL
BLOCK**
**MULTIPLE-TO-SINGLE
DISCONNECT**



Six 5-amp. contact Plug (List 86¢)

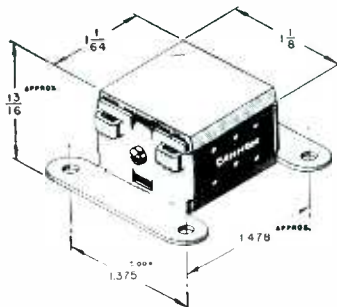

Basic Unit Y6-1F-1H (List 89¢)



Single contacts—5-amp. (List 64 ea.)

**FOR RADIO and
LOW AMPERAGE
CIRCUITS**

TYPE Y6

This compact and flexible terminal block for radio equipment and other low amperage circuits handles single-to-single and multiple-to-single or multiple-to-multiple circuits easily and quickly. Circuits may be bussed, or used with resistors or capacitors in many combinations.

**VERTICAL OR HORIZONTAL
UNITS MAY BE ADDED.**

A desirable feature is the ease of adding units, starting with the basic single unit, Y6-1F-1H, shown at left. The Tenite strip, which also serves as an interlocking part, may be lettered or numbered by the user as required. (See above.)

SPECIFICATIONS. Foot and side brackets are steel; unit terminal blocks and six contact plugs are molded phenolic. Contacts are brass, silver plated, and will accommodate No. 16 B&S stranded wire for 5 amperes. Solder pots are tinned.

Available through jobbers located in all principal cities, or through Cannon Electric Engineering Representatives. Bulletin Y6-2 available upon request. Address Dept. F-120, Cannon Electric manufactures a complete line of multi-contact disconnect plugs and receptacles for radio, power, batteries, radar, television, instruments, sound, microphones, general electrical equipment. Also hospital signal equipment.



**CANNON ELECTRIC
DEVELOPMENT COMPANY**

3209 Humboldt Street, Los Angeles 31, California
Canada & British Empire—Cannon Electric Co., Ltd., Toronto, Ontario • World Export
Agents (excepting British Empire) Frazer & Hansen, 301 Clay St., San Francisco 11, Calif.

All Along The Line...



One of the "Motorola" Production Lines

You Expect More and Get More From FP CAPACITORS

Exactly ten years have elapsed since the Mallory FP—first capacitor to use fabricated plate—was introduced. Today, as then, it is accepted as the standard of the industry: the standard for quality, dependability and ease of assembly.

The Galvin Manufacturing Company, pioneers in auto radio equipment and makers of the well known "Motorola" home and car radio line, were among the first to recognize the time-saving mounting features of Mallory FPs—the superior workmanship and materials, too.

Today not only Motorola, but many other responsible manufacturers of radio, television and electronic equipment, choose Mallory FPs with safety and confidence. They expect more and get more from this famous capacitor.

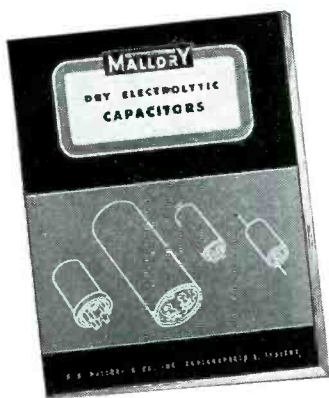

Everything you want to know about Mallory electrolytic capacitors—types, sizes, characteristics—even data on test measurements and mounting hardware. Send for your free copy.

P. R. MALLORY & CO. Inc.
MALLORY CAPACITORS
(ELECTROLYTIC, OIL and WAX)

P. R. MALLORY & CO., Inc., INDIANAPOLIS 6, INDIANA



CROSS TALK

► **NUCLEONS** . . . Industrial sciences have a habit of crystallizing about words which express the central core of their activity. The word in our case is "electron", coined in 1874 by G. Johnstone Stoney. "Electronics" came along 56 years later. Now come two new words of equal import, "nucleon" and "nucleonics". To the best of our knowledge, the latter term came first. Zay Jeffries who, as chief of General Electric's chemical department, now operates the Hanford plutonium plant, suggested last year that a word was needed for the science and technology growing out of our new knowledge of, and control over, the atomic nucleus. The word caught on. Reasoning that nucleonics must deal with nucleons, physicists bethought themselves what a nucleon might be. We first encountered the term in the current issue of the *American Scientist*, in which Princeton's Professor John A. Wheeler defines nucleon as a general term for the nuclear particles, protons and neutrons. As Keith Henney points out in his essay on p 80 of this issue, when **ELECTRONICS** started in 1930, the neutron had not been discovered. Now, less than two decades later, we have the words, and the techniques, on which to build a new industrial science. We can only hope that our political wisdom will soon meet the challenge of tame nucleons in an untamed world.

► **CREDITS** . . . Readers of technical magazines, we are told, want to know who takes responsibility for published statements. So we label every full-length article with the author's by-line and his affiliation. Material written by members of the editorial staff is likewise identified but, perhaps, not so clearly. When the article is the staff member's original contribution, and his authority for it is on a par with that of any other author, he rates a by-line. When, however, the editor is acting merely as a reporter, putting into words material originating elsewhere, he signs his initials at the end of the article. Some of

our readers find this confusing, particularly those compiling file references and bibliographies. We also find it confusing in many borderline cases. So, suggestions please! Should we disregard this subtle distinction between author and reporter? And should we undertake the real headache of getting up a biography on each author?

► **WARNING** . . . A needed invention of long standing is a gadget which will warn the listener that an announcement of unusual interest is about to be made so he will turn on his radio set and listen to it. This was an attractive possibility before the days of supersaturated news programs and neutral gray entertainment. Now that radio engineers are distinguished by the amount of time they spend away from the loudspeaker, there seems little urgency to find the long-sought sensitive device that waits and watches without consuming power. But up comes television and the need reappears. Several times now, the NBC television station in New York has sprung unannounced coverage of important news events, while the largest part of the audience was doing the dishes, blissfully unaware that exciting signals were titillating the dipole. To be sure, films are taken and repeats provided during scheduled hours, but it ain't the same, McGee. How about it? We'll settle for a gadget consuming 5 watts, same as an electric clock. Can do?

◀ **CO-OP** . . . A group of thirty engineers at the Airborne Instruments Laboratory have pooled their interests in the conversion of war surplus radar gear into television receivers. Working in spare time, the group has separate teams organized for purchasing, converting r-f, i-f, video circuits, sweep circuits, and so on. Starting with 30 Mickey Mouse radars (3,000-mc, gun-fire ranging sets) plus a few extra parts, this gang is well on its way to 30 complete video sets, each with 10-inch tube and plenty of gadgets.

NUCLEONICS and

By KEITH HENNEY

DEFINITION

NUCLEONICS: *A generic name for atomic energy and related subjects . . . a field of endeavor of tremendous implication in biology, medicine, metallurgy, chemistry, geophysics, and in the production of power*

SEVENTEEN years ago, when the first issue of *ELECTRONICS* appeared, the world of the atomic nucleus was still largely unexplored and uncontrolled. The forces and laws governing the electronic envelope of the nucleus, however, were being fully explained by physicists in terms of the new quantum mechanics, and engineers were busily using free electrons to create a major industry.

In 1931 our knowledge of the nucleus was limited to what we could learn from the natural radioactive elements and by means of optical and mass spectroscopy. Neutrons had not yet been discovered, and it was still believed that the nucleus was made up of protons and electrons. This was because the interactions of nuclear particles were only partially observable, and completely uncontrollable. The interactions of electrons, on the other hand, were easily observed and controlled with vacuum-tube devices and circuits.

The discovery of the neutron by Chadwick in 1932 was a decisive breakthrough by physicists in the mounting assaults on the mysteries of the nucleus. Being uncharged, the neutron could be easily shot

into the heart of the nucleus to initiate nuclear reactions, unhindered by the positive and negative charges of the atom. Here was a powerful tool for the control of nuclear interactions, comparable to the discovery and use of thermionic emission in the realm of electronics. All the chemical elements were now bombarded with neutrons. Hundreds of new nuclear disintegrations and transmutations were produced and studied. The dark world within the nucleus was brought progressively further into the open and under the control of the men behind the cyclotrons, Geiger counters, and other electronic tools of the physicist.

Under the mass assault of scientists all over the world, the story unfolded. The fission of the uranium 235 nucleus under bombardment of slow neutrons, the confirmation of Einstein's classic postulate of the equivalence of mass and energy, the release of unbelievably tremendous nuclear energies, the terrible destruction of the atom bombs—all this is known. No longer do we simply experiment, observe, and understand nuclear phenomena. Now we can control and utilize them. In short, the sci-

ence of nuclear physics, once a field in which few could toil, has given birth to a technology—nucleonics. At once we have something for engineers to work with; something which, like electronics, will affect every man, woman and child on this earth.

What is nucleonics?

As defined by Zay Jeffries, vice-president of the General Electric Company's Chemical Department, nucleonics is "a generic term for atomic energy and related subjects." Zay Jeffries shares the opinion that the release of atomic energy represents the greatest technological stride in recorded history. The possible ramifications of this accomplishment are, as yet, beyond our capacity to imagine. Already, however, many useful applications of nuclear knowledge are known. A bird's eye view of this field can be obtained from the chart on the opposite page, produced by Walter M. DeCew.

Electronics and nucleonics are intimately related. One technology is based upon our ability to control and to put to work the electrons which surround the atomic nucleus. The other is a technology based on our ability to control and utilize the other parts of the atom, that is, those parts which constitute the nucleus. Only by the development of superlatively sensitive and powerful electronic instruments was our conquest of the nu-

ELECTRONICS

Nucleonics, a new technology based upon the control and utilization of neutrons and protons, supplements electronics in bringing under man's guidance all parts of the atom. Electronics is essential to the observation and use of nuclear phenomena.

Thus the two technologies are closely allied

deus made possible. Conversely, the increasing utilization of nuclear phenomena will bring about the necessity for even more complex and diversified electronic apparatus.

Since the future development of nuclear chemistry, nuclear biology, nuclear medicine, nuclear metallurgy and nuclear power is dependent on the creation of progressively

more sensitive and powerful electronic instruments and controls, the electronic engineer is faced with unlimited opportunities—and great responsibilities.

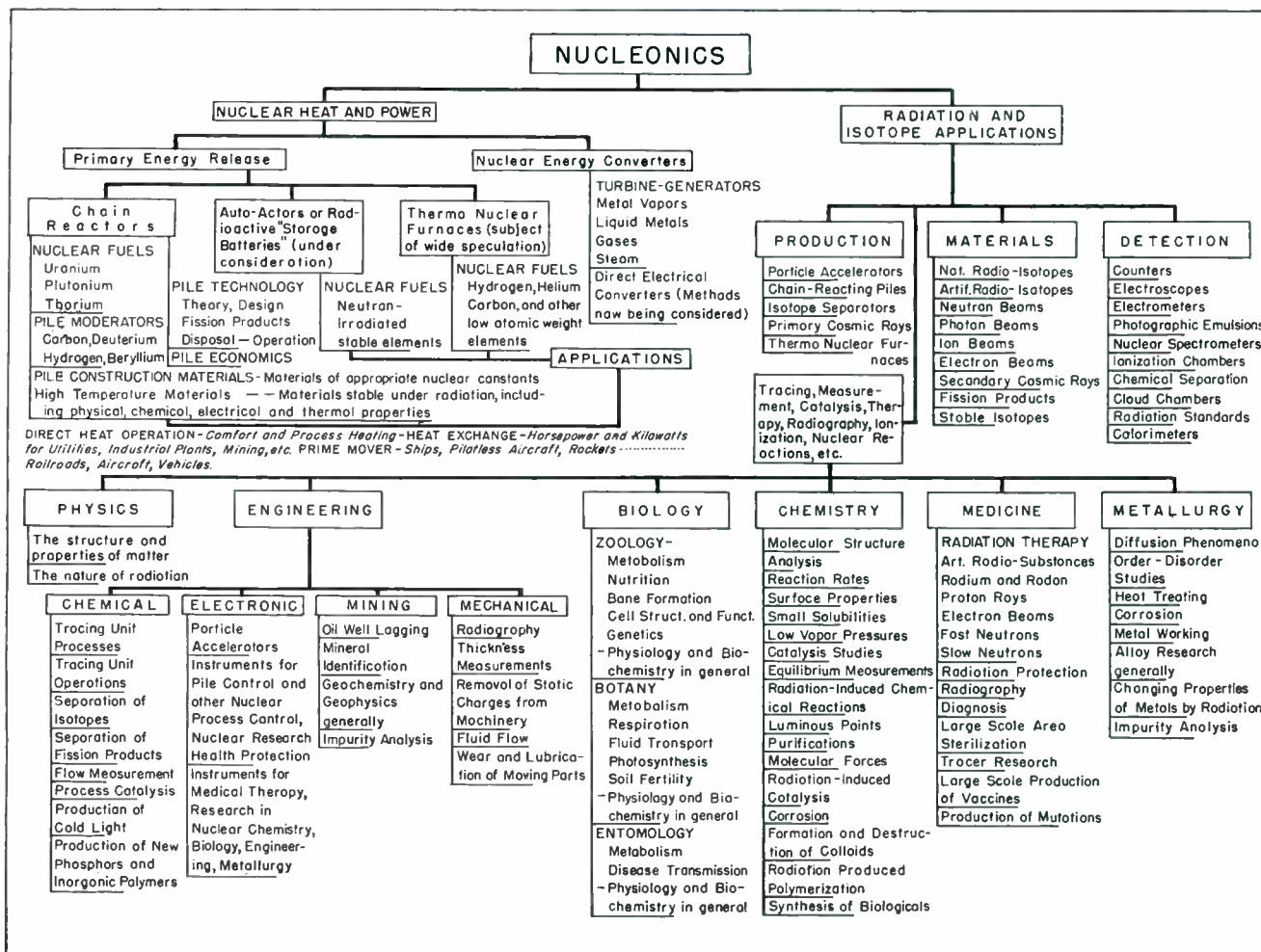

STAMPED WIRING

New mass-production technique permits 90 percent of the wiring in an average electronic device to be stamped out by dies. Most component parts may be connected in one operation by induction soldering. Substantial savings in material, and in alignment and testing, as well as in assembly, are the developmental objectives

THE AVERAGE radio receiver contains 150 soldered connections. Wires must be laboriously cut to length, skinned, and individually fastened in place. Modern television receivers frequently have over 500 connections, and some of the electronic control apparatus now finding its way into industry is equally complicated from a wiring standpoint. For years engineers have worked

to develop something resembling packaged wiring. Early electrical and electronic equipment used rigid bus-bar that was hard to handle and harder still to keep in place during shipment. This soon gave way to flexible wiring and cabling techniques, but even the latter required many individually soldered joints. During the war printed circuits came into use. Since then cast conductors somewhat reminiscent of processes tried in this country back in the 20's have been introduced in England.

A number of new packaged wiring ideas are in the experimental stage. Some are well along in development. One such idea involves stamped wiring, originated by A. W. Franklin, president of The Franklin Airloop Corporation of New York, which appears to lend itself to mass production methods since a basic wiring package can be turned out for manufacturers of many kinds of electronic gear. Alterations in the basic package are readily made by means of dies, so that 90 percent of the wiring within the average device can be stamped out. Furthermore, most component parts may be connected to the wiring in one operation by dip or induction soldering. Substantial savings in material, and in alignment and testing, as well as in assembly, seem likely.

Basic Idea

Basically, stamped wiring consists of a thin sheet of insulation with a series of parallel conductors running in a horizontal direction on one side and a series of vertical conductors on the other side. Interconnection between horizontal and

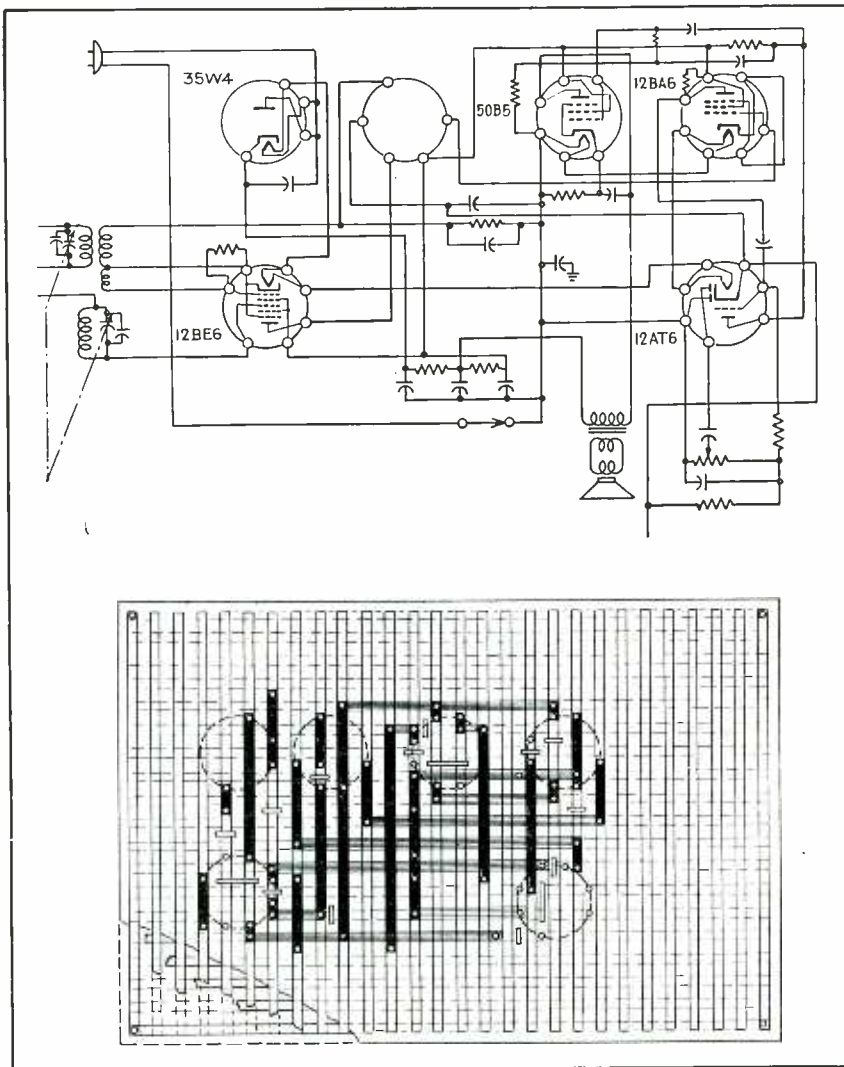

Electronic circuit, showing the manner in which a schematic may be converted into a stamped wiring deck layout by interconnecting and/or cutting conductors on obverse and reverse sides of the deck. Tube and transformer placement are indicated. Other component parts may be similarly shown

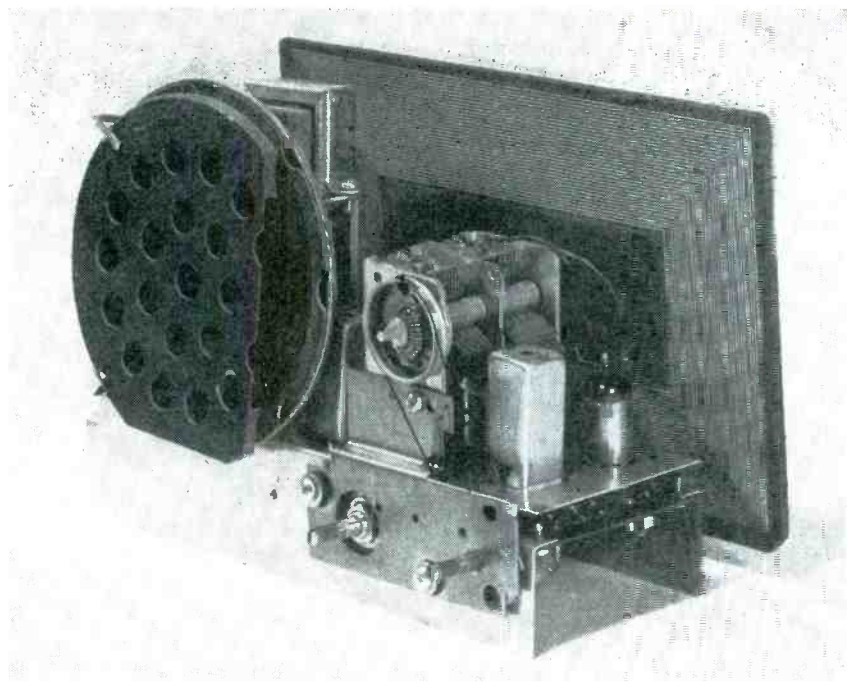

Table-type radio set, using stamped wiring. One edge of the wiring deck may be seen just beneath the metal chassis

vertical conductors is accomplished by punching through the insulation intervening between such conductors and then joining them by means of an eyelet or pin. A method of interconnection which requires neither form of fastening, just pressure and heat, is also being developed.

Where connection to a single horizontal or a single vertical conductor is desired, without interconnection, an eyelet or pin may be punched into the selected conductor at a point which causes it to miss metal on the reverse side. Where breakup of a single horizontal conductor or single vertical conductor into several horizontal or vertical conductors is required this may be accomplished by the simple process of cutting the conductors at one or more points along their length or height.

Electronic equipment circuit diagrams consist essentially of horizontal and vertical lines, with crossovers and interconnections. Stamped wiring consists of horizontal and vertical conductors, with the insulation between them constituting an inherent crossover, and eyelets, rivets or some other type of fastening providing interconnection. Thus it is readily possible for

an engineer-draftsman to make the transition from schematic to stamped wiring drawing, as shown on the opposite page. Location of eyelets or pins, points at which conductors should be cut, and placement

of parts is also planned at this time.

Such questions as the type of fastenings used for interconnection of conductors, whether eyelets, pins, or the conductors themselves are used as terminals for component parts, and whether short conductors are stamped out that way or produced subsequently by stripping away unused metal from longer conductors are dependent upon what the equipment assembler wishes to buy, and upon what the supplier of packaged wiring ultimately finds it most desirable to deliver. Developmental work is still proceeding at a pace which suggests that such details will soon be standardized.

Stamped Wiring Deck

A typical stamped wiring deck developed for a 5-tube table-model

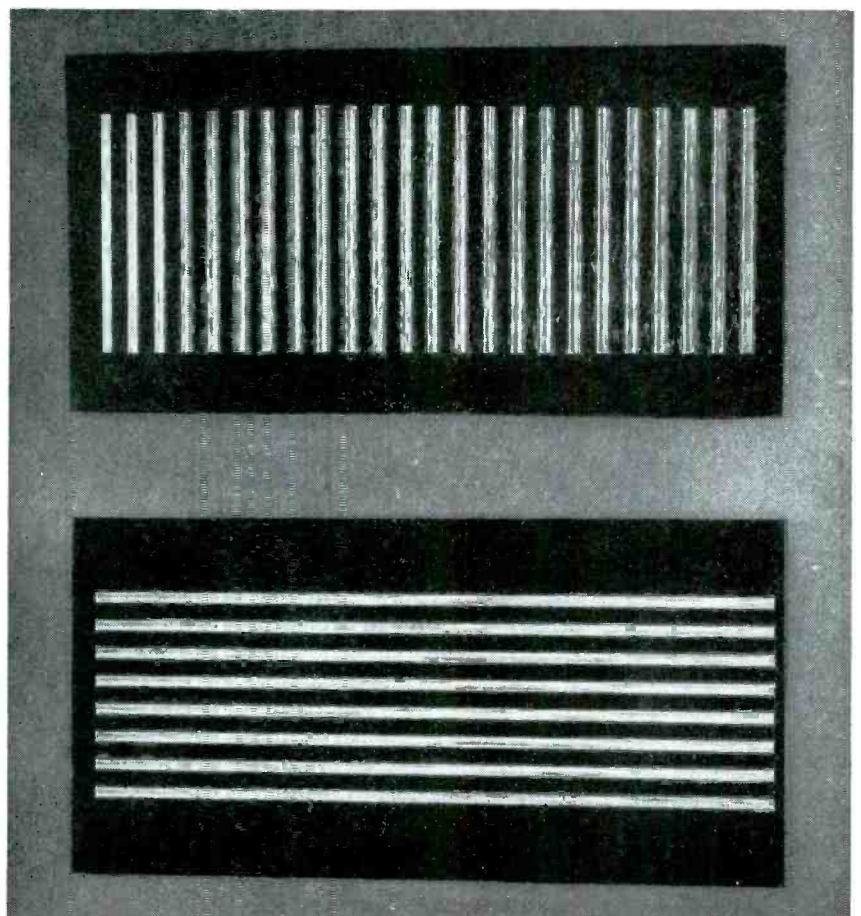

FIG. 1—Basic stamped wiring deck, with horizontal conductors on one side and vertical conductors on the other

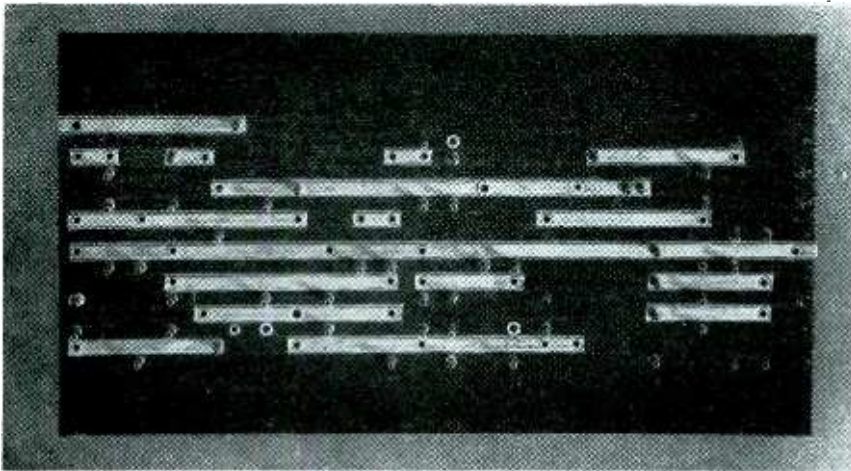

FIG. 2—One side of a stamped wiring deck, with conductors cut, eyelets and pins installed. Either type of connection may be used between conductors on the two sides of the deck. Connections are made to a conductor on one side by punching through at a place which misses metal on the back. Holes in eyelets and pins are used as terminals for component parts

radio having a conventional circuit is at present made as follows:

Sheets of single-x $\frac{1}{8}$ -inch Bakelite punching stock, similar to that used in the manufacture of wafer-type tube sockets, are sheared to 3 x 9-inch size.

A roll of 5-mil pure electrolytic-type oxygen-hydrogen-free copper, tinned on both sides, is coated on one side with U. S. Rubber's Kotol thermoplastic cement.

Insulation and copper are fed to a 150-ton Standard automatic toggle press, containing a shearing and forming die. When the press is operated the die cuts the copper into conductors $\frac{1}{8}$ -inch wide, with equal spacing between conductors, and presses their edges and ends $\frac{3}{1,000}$ -inch into the insulation. The die is heated electrically to 230 F and softens the insulator sufficiently to facilitate locking of the conductors securely in place. The heat simultaneously sets the thermoplastic cement so that the conductors are both mechanically locked and cemented to the insulation. The process is similar to that used in the manufacture of the Franklin "Airloop."

The press turns out some 20 decks per minute, with conductors on one side. (Conductors may eventually be placed on both sides at once by using upper and lower dies.) Both sides of a typical deck are pictured in Fig. 1.

The deck next goes to a punch press, where all holes for eyelets and pins are knocked out in a single operation. The holes in this particular case are $\frac{96}{1,000}$ -inch in diameter and take pins similar to those used in the manufacture of octal tube bases. In still another press, eyelets and pins flow from hoppers through feeder tubes to deck holes, as in the manufacture of tube sockets, and are clinched in place. Heating by conduction, or induction, may be used to sweat conductor and eyelet and/or pin tinning together.

The stamped wiring deck is now complete, and ready to receive component parts. See Fig. 2.

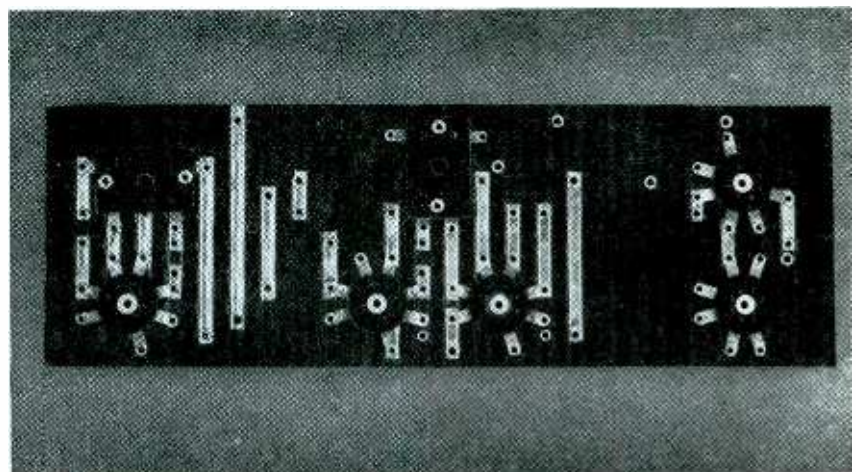

FIG. 3—Tube and transformer sockets in place. In this instance they are held in place by eyelets. In other developmental models use of female connectors permits them to be simply shoved down over deck pins

Wire leads of fixed capacitors, resistors, and coils are bent or preformed so that they may be dropped into eyelet or pin holes in the stamped wiring. This may be done manually or by the hopper method, depending upon the ingenuity of the assembler and production requirements. Normally, most component parts are placed beneath the deck. Thus these parts may be soldered in place by the induction method, in one operation.

Tube and i-f transformer sockets having female connectors are inserted on the top side of the deck over pins, or otherwise fastened in place, as in Fig. 3. The deck is then installed beneath a metal chassis having cutouts through which tubes and i-f transformers may be inserted from above. See Fig. 4. A self-tapping screw in each corner of the deck holds the deck securely in place beneath the chassis.

Gang tuning capacitor, loudspeaker, and controls are mounted on the metal chassis by conventional methods. Flexible leads from these component parts, of which there are few, are pushed down through chassis cutouts to deck pins, where contact is made by means of female connectors. They could, of course, be soldered.

Performance and Cost

Performance tests are being made on equipment using stamped wiring. At this writing it appears that little or no circuit modification is

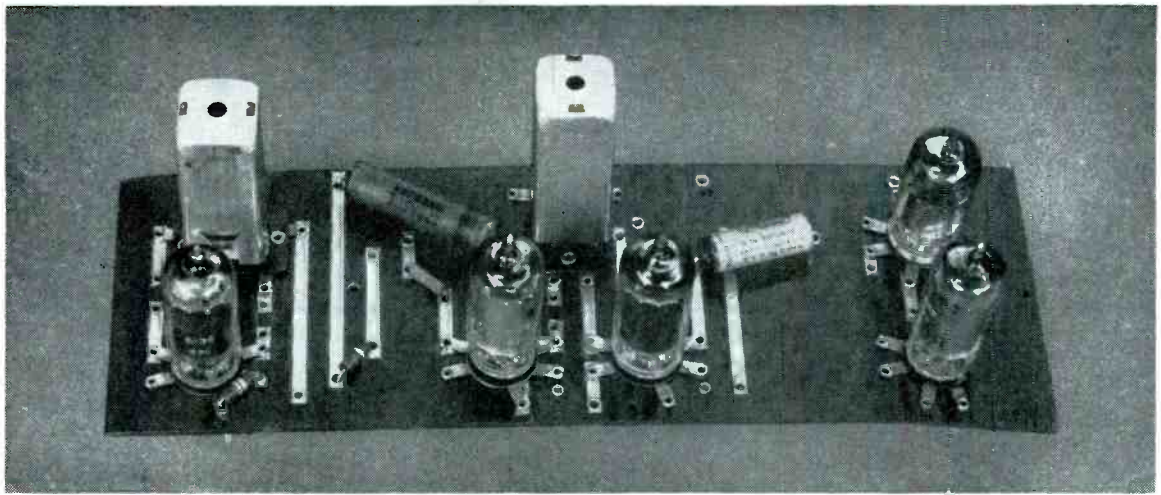

FIG. 4—Deck ready for insertion in metal chassis having cutouts to admit tubes and transformers. The few flexible wires from chassis-mounted speaker, tuning capacitor, and other controls pass through cutouts to stamped wiring deck pins, and are held in place by female connectors

required where it is to be employed. Developmental radio receivers, such as the one shown in Fig. 5, perform quite as well as conventionally-wired sets with respect to sensitivity and selectivity. There is reason to believe that the fixed nature of the wiring, plus the fact that necessarily careful planning of both the wiring and placement of parts, may make it possible to operate tubes nearer the spill-over or hot point in production models, with resultant improved performance.

Alignment of circuits in production should be materially simpler than where conventional wiring is used, since wiring stamped out by a die will not vary from set to set. This factor should prove of particular interest to manufacturers of television equipment.

Cost determination must wait until a sufficient number of units employing stamped wiring are manufactured to permit accurate cost accounting, since material, and alignment and test labor, as well as assembly labor, is involved. Then too, die cost will vary depending upon the size of the deck required, upon the relative complication of the wiring to be stamped, and upon the volume achieved by supplier and assembler.

FIG. 5—Radio receiver chassis seen from underneath, showing new and old methods of wiring

Substantial savings should be possible. One clue is the fact that Franklin believes it will be possible to supply stamped wiring decks for

5-tube table model radios, with tube sockets built in and ready to receive component parts, for about double present cost of sockets.—W. MACD.

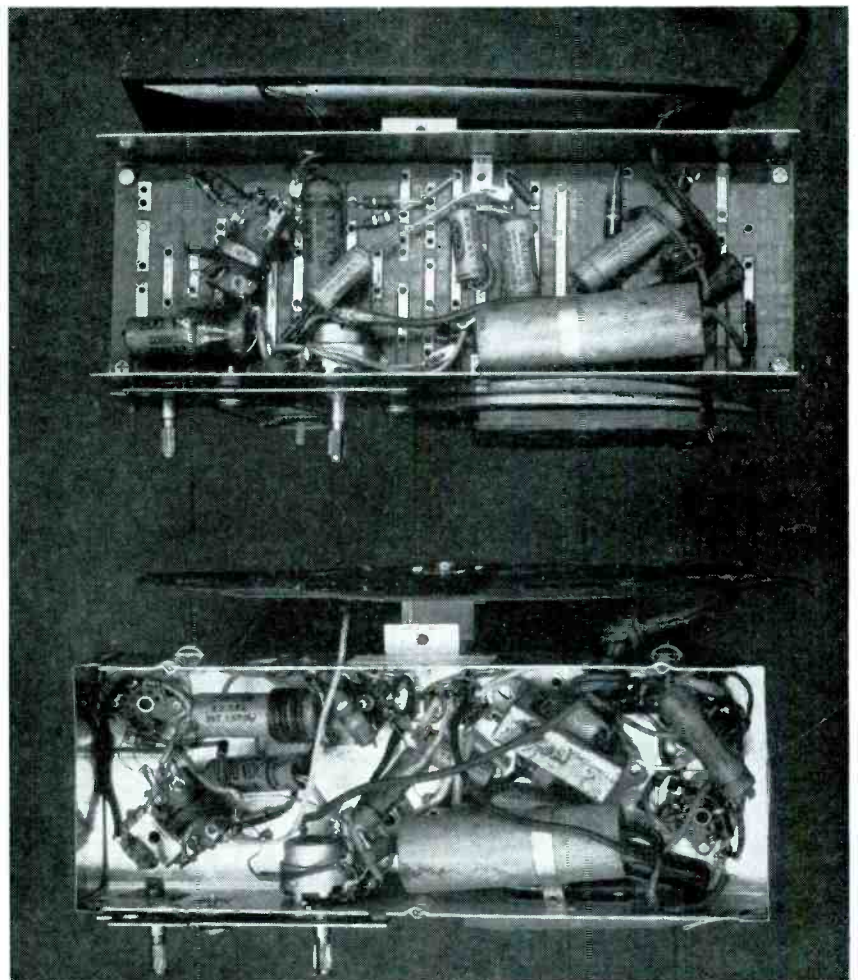

TELEVISION

Design features of the first postwar video receivers to go into large-scale production, the RCA Victor seven-inch, ten-inch and projection models, reported from the IRE presentation by Wright and Clark

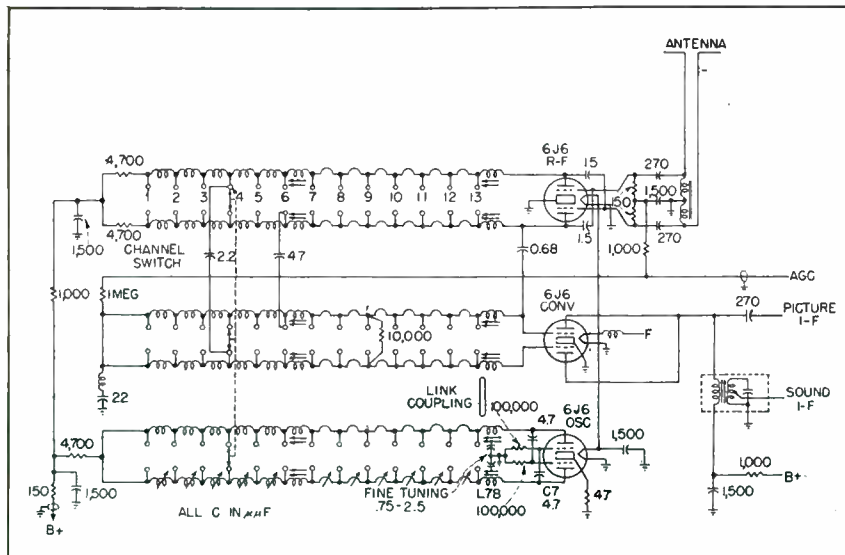

FIG. 1—The r-f amplifier, converter, and local oscillator used in all RCA Victor production models. It tunes all of the 13 television channels

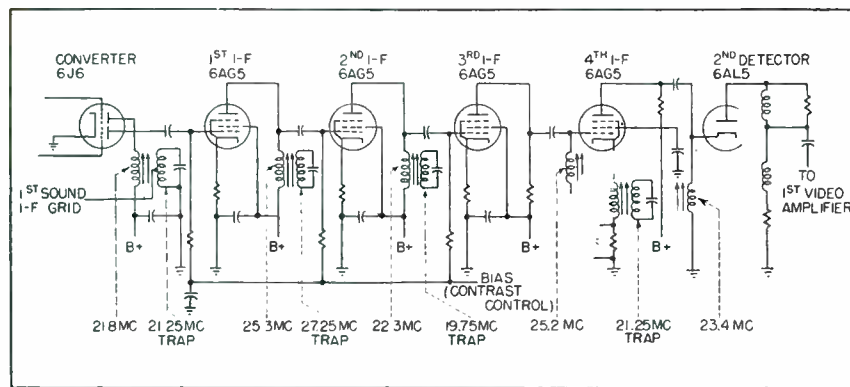

FIG. 2—Stagger-tuning is used in the picture i-f amplifier to simplify alignment and lower costs. Inductively coupled traps attenuate accompanying and adjacent sound channels

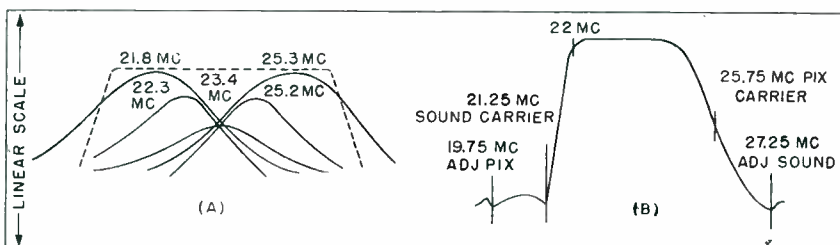

FIG. 3—(A) Resonance curves of the five interstage coupling units in the picture i-f amplifier. (B) Overall response curve of the i-f amplifier

Three production-type television receivers, embodying many new circuits and components, have been described recently at a number of IRE section meetings by Messrs. Antony Wright and Edwin Clark of the RCA Victor Division. The following report was compiled from their presentation before the New York Section.

The receivers represent three distinct approaches to meet public demand at various price levels, ranging from an inexpensive model employing a 7-inch picture tube to a carriage-trade console receiver producing a 15-by-20-inch projected image. In all of the designs particular attention was paid to producing brighter images than were available in prewar sets, as well as clearer and steadier images.

The receivers described have the following specifications: The seven-inch table model, type 621-TS, employs electrostatically focused magnetically deflected picture tube, type 7DP4. It incorporates 21 tubes, has a power drain of 260 watts, and gives substantially noise-free reception from an input signal of 500 microvolts at the antenna terminals. Trigger-type sync operation is employed. This system, while not as free from the effects of interference as the afc sync used in the other models, nevertheless provides solid synchronization with an input of 150 microvolts. The r-f, i-f and video circuits of the seven-inch model are similar to those of the other models, and receive all 13 channels, from 44 to 216 mc.

The 10-inch table model, type 630-TS, uses 30 tubes and consumes 380 watts of power. Its picture tube, type 10BP4, is magnetically focused and deflected, and operates

RECEIVERS

in Mass Production

at approximately 9,000 volts second-anode potential. This type of operation provides very high brightness in the highlights, approximately 60 footlamberts as compared with 5 to 10 footlamberts from the 12AP4 tube in the prewar model TRK-12. The area contrast of the 10BP4 picture has a maximum value of 90 to 1.

The 10-inch receiver provides a substantially noise-free picture with 500 microvolts input, and a satisfactory picture with 150 microvolts. The picture will remain in satisfactory sync with an input as low as 50 microvolts. The receiver is produced in two models, the type 630-TS table model and a console with am-fm-phono chassis. In the latter set, an automatic-gain-control circuit is provided; otherwise the television circuits are identical.

The projection model, type 648-ure by projection with a reflective-type optical system of effective aperture $f/0.8$. The projection tube, type 5TP4, operates at a second-anode potential of 28,000 volts, and employs an aluminum-backed phosphor screen.

The projected image is reflected from a 45-degree mirror within the cabinet onto a translucent viewing screen of special construction. By the application of a pressed plastic coating, this screen is given a highly directional characteristic, restricting the angle of view to 50 degrees in the horizontal plane and 30 degrees in the vertical plane. This new screen reflects only 15 percent of the ambient light and transmits 85 percent of the image illumination.

As a result of all these contributions to high optical efficiency, the highlight image brightness is 50



Direct-viewing combination console with ten-inch picture tube. All direct-viewing types have a safety glass panel mounted in front of the picture tube

footlamberts and the area contrast 40 to 1. This performance is very nearly equal to that of the direct-view 10-inch model and far superior to the projected images previously demonstrated by RCA. The type 648-PTK set uses a total of 48 tubes (including 8 in the b-c, s-w, f-m receiver and 4 in the common audio system) and consumes 530 watts.

The radio-frequency circuits,

identical in all the models, are a pushpull 6J6 double triode, fed from 300-ohm ribbon transmission line through an untuned input circuit. Tuning is accomplished by the station-selector switch which inserts additional series inductance between the r-f tube plates. The converter is similar, employing a 6J6 tube in pushpull with similar switching for station selection. The r-f stage and converter are capa-

citively coupled at several points.

The local oscillator is another 6J6 pushpull circuit, tuned by inserting successively larger inductance between plates. The local oscillator output is link coupled to the converter. Tuning of the larger individual inductances is accomplished by metal slugs, while continuous fine tuning of the local oscillator is provided by a trimmer capacitor between oscillator plates. Some of the inductance elements are wound in figure-eight fashion. Since the figure-eight coil has an inductance determined solely by the length of wire, such windings permit more accurate proportioning of inductance.

The picture i-f amplifier, shown in Fig. 2, is likewise identical in the 630TS and larger models. It consists of four stages, type 6AG5, coupled by five single-tuned circuits stagger-tuned to provide a nominal bandwidth of four mc. This is an adaptation of an i-f amplifier technique developed during the war for radar receivers. It provides about 80 percent of the gain possible from stages double-tuned to the same frequency (non-staggered), but the loss is more than offset by ease of alignment, lower cost, and

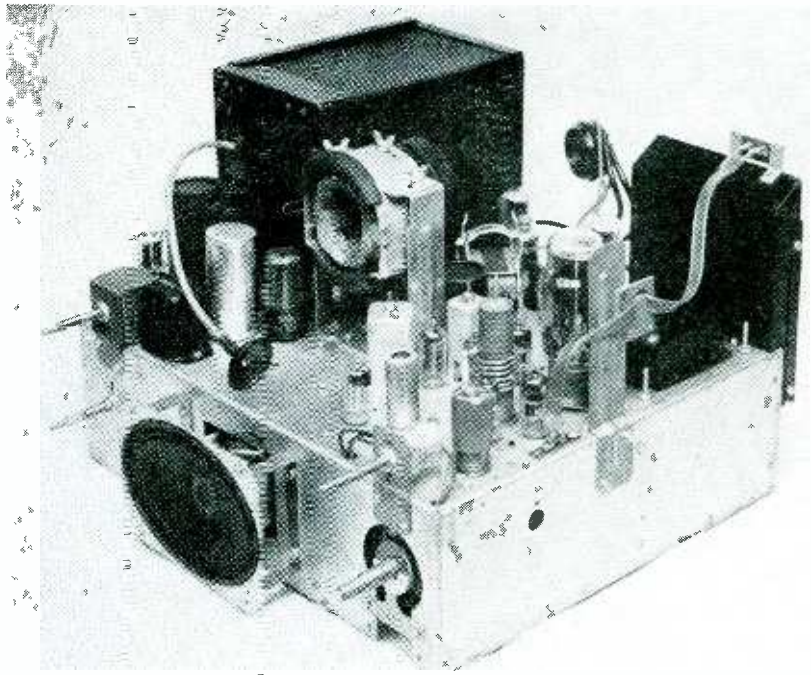

Chassis of the seven-inch table model receiver with picture tube removed

freedom from regeneration. Figure 3 shows the resonance curves of the five individual interstage couplings and the overall response.

To reduce cost, the 7-inch receiver has only three stagger-tuned i-f stages. The i-f bandwidth is 3 mc to obtain required amplification.

The intermediate frequencies used are 21.25 mc for the sound and 25.75 mc for the picture. These compare with the prewar values of 8.25 mc and 12.75 mc respectively. The higher values are used to reduce image-response interference. The picture i-f amplifier (Fig. 2) employs four trap circuits to eliminate interference from the associated sound channel on 21.25 mc and the adjacent sound channel at 27.25 mc. These traps are high-Q parallel tuned circuits which surround and are inductively coupled to the interstage coupling coils. The traps are tuned by adjustable metal slugs.

The picture detector is one-half of a 6AL5 double diode, the other half being used as a d-c restorer following the final video amplifier, as shown in Fig. 4. Two video amplifiers are used, the video coupling being of the shunt-series inductively-compensated type. One of the video stages limits the amplitude of noise pulses to the peak level of the sync pulses. Thus the noise energy passed to the sync circuits is limited and tendency of the sync circuits to follow noise pulses is much reduced. The sync circuit drive is taken directly from the plate of the d-c restorer diode.

Sync Circuits

A synchronizing chain of three stages (Fig. 5) performs amplitude separation of the sync pulses

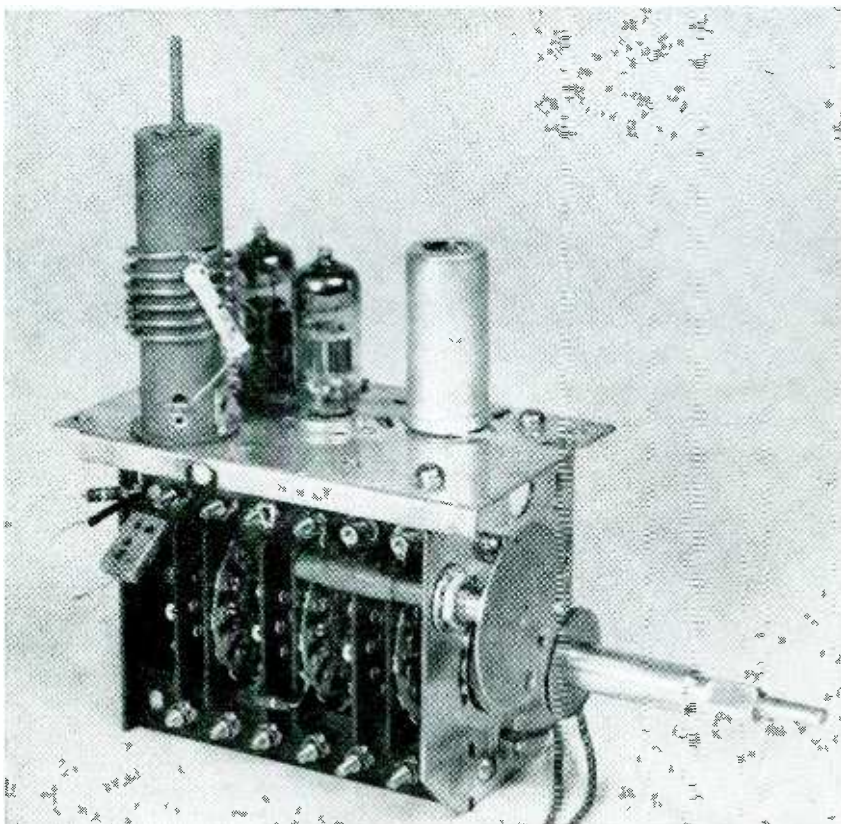

Thirteen-channel pushpull front end

and clips each separate pulse at top and bottom. For horizontal sync-couplings and the overall response, applied to the automatic-frequency-control circuit shown in Fig. 6. This afc sync circuit, by introducing a "fly-wheel" stabilization to the horizontal deflection oscillator, prevents a noise from affecting the position of individual lines of the image. The circuit consists of a 6K6 Hartley oscillator which produces sine waves at the horizontal deflection frequency, 15,750 cps. This sinewave is fed to a circuit resembling an afc discriminator, through a center-tapped transformer secondary connected to two diodes.

The incoming sync pulses are applied to the center tap, so they are superimposed on the sinewaves as shown at the bottom of Fig. 6. If the sinewave oscillator frequency and the incoming sync pulse frequency are the same, and their relative phase is as shown at (A), the average value of current passed by each of the diodes is the same, and no net d-c bias is developed at the diode output.

However, if the sinewave frequency tends to get out of phase with the sync pulses, as at (B), the sync pulse "rides up" on one sine-wave while it recedes on the other. Hence the upper diode passes more current and a positive d-c bias is developed. If the sinewave phase departs from the sync pulse phase in the opposite direction, as at (C), the lower diode passes more current and a negative d-c bias is developed.

The net bias, including fixed bias applied to the diodes, is applied to the grid of a reactance tube connected across the tank circuit of the sinewave oscillator. The reactance thereby reflected to the oscillator circuit has the proper sign to shift the sinewave frequency in the direction to restore the in-phase relationship with the sync pulses, as at (A). An RC time-constant circuit in the reactance-tube grid causes the correction to the oscillator frequency to occur over a period of many lines, so that any noise pulses fed in from the sync chain are averaged and hence have but small effect on the oscillator frequency. The plate of the sine-

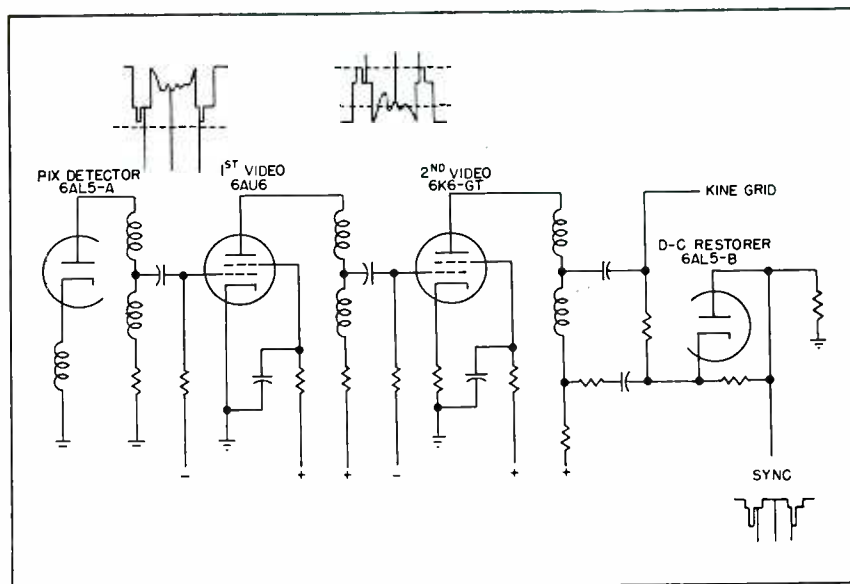

FIG. 4—Video detector, amplifiers and d-c restorer circuit. Two video stages are used to permit limiting noise peaks prior to sync separation

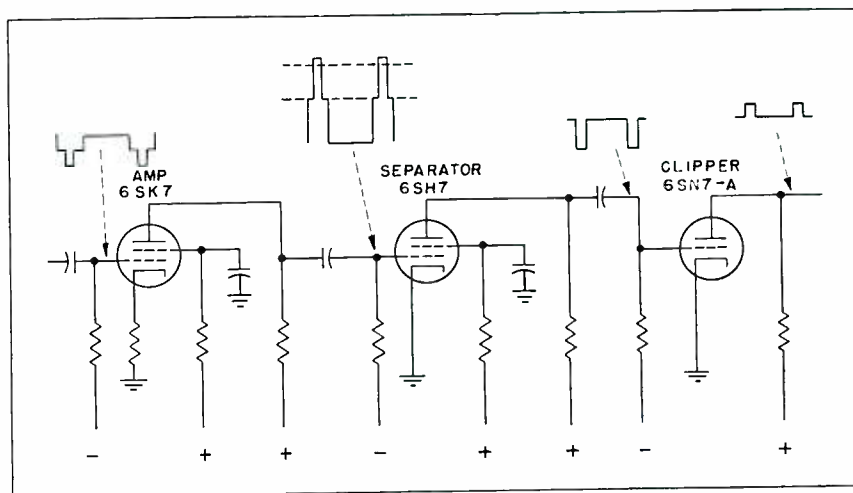

FIG. 5—The synchronizing chain, consisting of a polarity-reversing amplifier, amplitude separator, and clipper

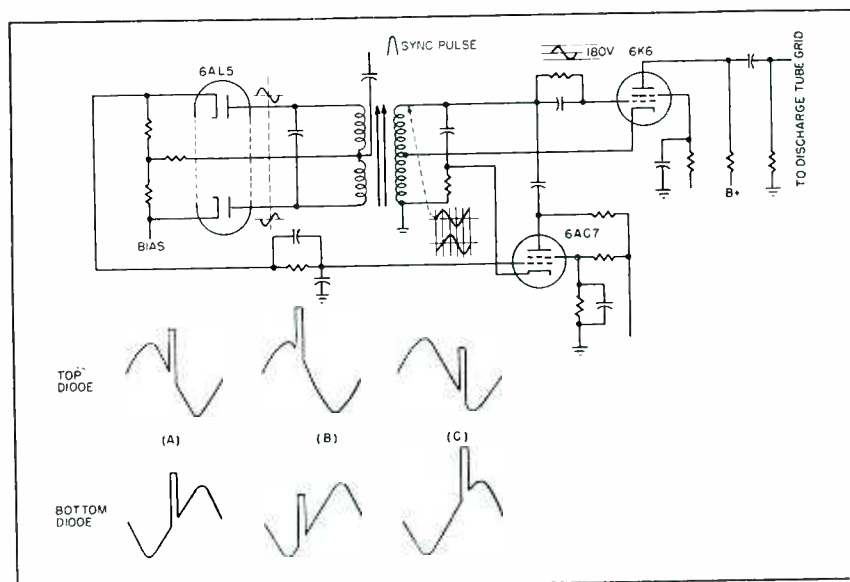

FIG. 6—Automatic-frequency-control sync circuit, applied to the horizontal deflection system. This circuit is used in the 10-inch and projection models

wave oscillator is connected to the horizontal deflection generator.

In this manner the horizontal deflection is constrained to follow the sine wave frequency, with its inherent fly-wheel stability, and the sine wave frequency is slowly corrected if it departs from the phase established by the incoming sync pulses. This afc circuit is employed only in the 10-inch and projection models, since the extra tubes and components could not be accommodated in the low-cost 7-inch design.

Deflection Systems

The horizontal deflection system used in the 10-inch models, shown in Fig. 7, has several interesting new features. To achieve the high value of scanning current necessary for the short-length c-r tube, the horizontal deflection amplifier is a heavy current tube, type 6BG6-G, which resembles the type 807 beam-power tube. This tube is driven by sawtooth voltage waves (top of Fig. 9) from a discharge tube, which produces sawtooth current waves in the inductive circuit connected to the 6BG6-G plate, the horizontal deflection output transformer. One secondary of this transformer drives the horizontal deflection coil. To remove residual oscillations at the base of the retrace voltage pulse, a 5V4-G power rectifier is connected as shown. The voltage developed across this rectifier is passed in series with the B supply, through a filter, back to the primary of the output transformer, thus adding about 50 volts to the B supply of the deflection tube. This regenerative use of the damped-out

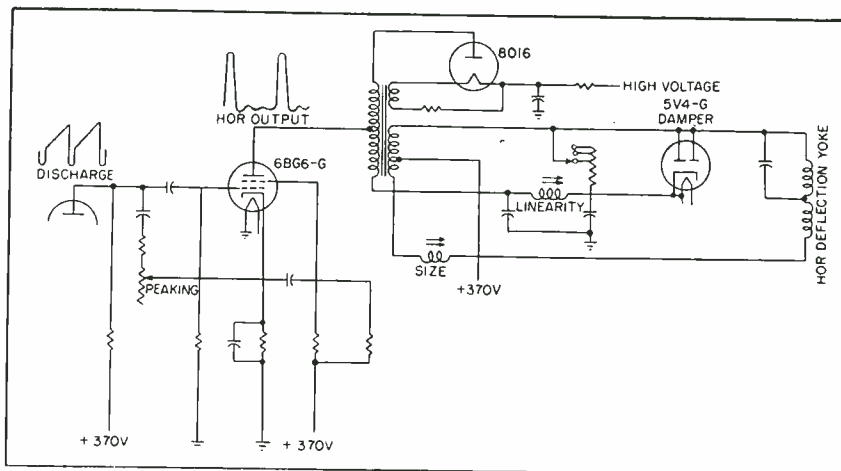

FIG. 7—Horizontal deflection amplifier and high-voltage system of the 10-inch models. The voltage peak generated during the retrace is stepped up and rectified to provide the second-anode voltage for the picture tube

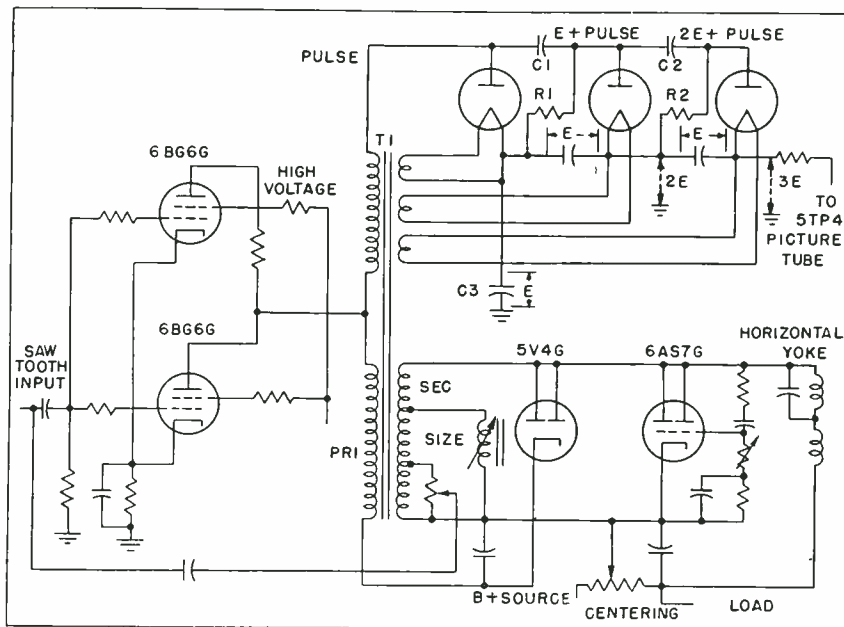
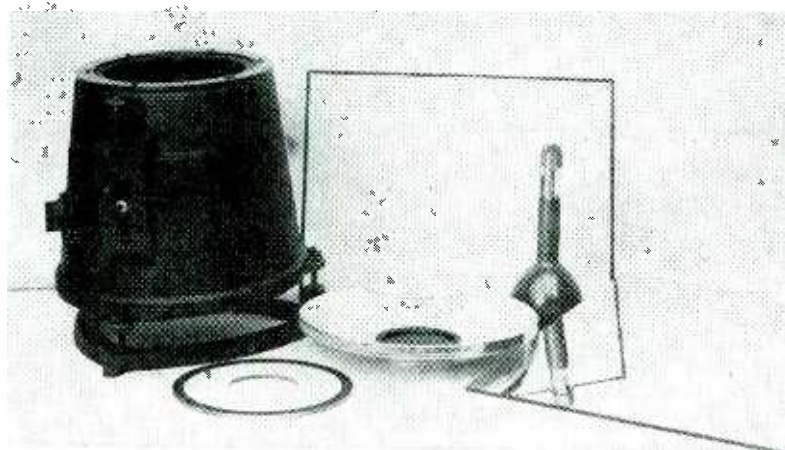

FIG. 8—Horizontal deflection system and voltage-tripler high-voltage source of the projection model. As in the 10-inch chassis (Fig. 7), the voltage across the damper, lost in prewar designs, is fed back to the deflection amplifier



Optical elements of the projection system. The 45-degree mirror is at right

oscillations adds to the available deflection amplitude without the cost of additional components.

When the deflection amplifier is cut off at the end of each line, the sudden cessation of current through the transformer primary produces a pulse of the order of 5,000 volts. The 6BG6-G tube is constructed to stand this voltage, and the voltage pulses are rectified to provide the second-anode potential for the picture tube. The voltage pulses are first stepped up to about 9,000 volts by an autotransformer winding on the output transformer primary, and then passed to the type 8016

rectifier, which derives its filament power from an auxiliary secondary on the deflection output transformer.

The horizontal deflection system of the projection receiver, shown in Fig. 8, operates on the same principle. Since the projection tube operates at 28,000 volts, a large amount of deflection power is required. This is supplied by two type 6BG6-G deflection amplifiers in parallel. The B supply of these tubes is applied in series with the 5V4-G damping tube, so the voltage consumed by the damper is conserved, as in the 10-inch circuit, Fig. 7. An additional damper, a 6AS7G is connected directly across the deflection transformer secondary. The grid bias of this tube controls linearity of the sweep.

The sweep waveforms of the circuit are shown in Fig. 9. The sawtooth waveform which drives the deflection amplifier is shown at the top. The current waveform at the output of the deflection amplifier, shown just below, is not linear, the start of the sweep being delayed due to bias and curvature of the 6BG6-G characteristic near cutoff. A compensating non-linearity is introduced by the damping tubes, so the sum of the two waves, shown at the bottom, is a linear sawtooth current wave.

The high-voltage supply is similar to that in the 10-inch model; that is, the voltage pulses produced during the retrace of the horizontal sweep are rectified. An autotransformer winding steps up the voltage pulses to about 9,500 volts. The pulses are applied to a voltage-

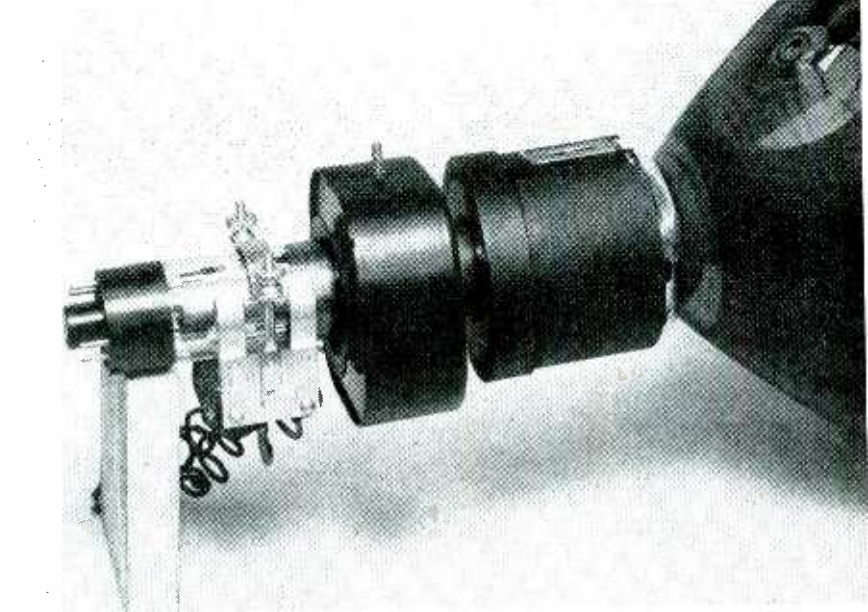

Deflection units mounted on the gun of the projection tube are, left to right, ion trap, focus coil, and deflection coil

tripler rectifier, consisting of three 8016 rectifiers. When a pulse passes through the first rectifier, at the left in Fig. 8, it charges capacitor C_3 in the cathode circuit to the peak level. The same pulse, passed by C_1 to the second rectifier, charges the capacitor between the cathodes of the first and second rectifier, raising the cathode of the second tube to twice the peak voltage of the pulse. Similarly the pulse is passed to a third rectifier, charging another capacitor between the cathodes of the second and third tube. Hence the cathode of the third tube, at the right, is raised to three times the peak voltage or about 28,000 volts. The regulation of this supply is remarkable good; it will supply 50 microamperes with only 10-per-

cent reduction from the no-load voltage.

The ion spot usually formed on the screen of a magnetically-deflected picture tube has been eliminated by an ion trap in the directly-viewed tubes.

The ion trap, shown in Fig. 10, is built into the electron gun of the 7DP4 and 10BP4 tubes. A magnet is placed near the gun, external to the tube, and its position varied until a spot of maximum brightness

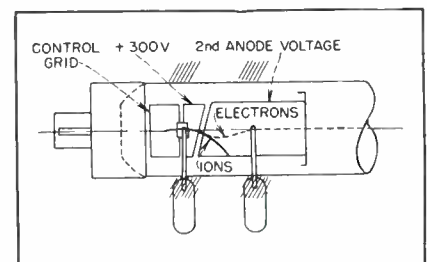

FIG. 10—An obliquely placed electrostatic lens deflects electrons and ions, so ions are trapped in electron gun.

is produced. The electrostatic lens between first and second anode is constructed with an oblique gap which causes both electrons and ions to be deflected at right angles to the gap. The magnet structure applies a compensating deflection to the electrons so that they proceed from the gun toward the screen in the normal manner. The more massive ions remain substantially undeflected by the magnetic field and hence are collected by the second anode.—D.G.F.

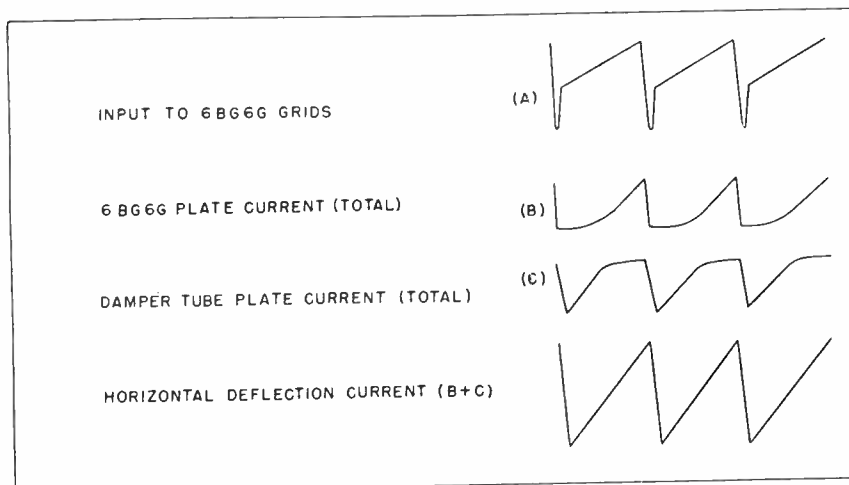

FIG. 9—Compensating non-linearity is provided in the damper circuit of Fig. 8 to produce highly linear deflection current through the deflection coil

ELECTROLYTIC

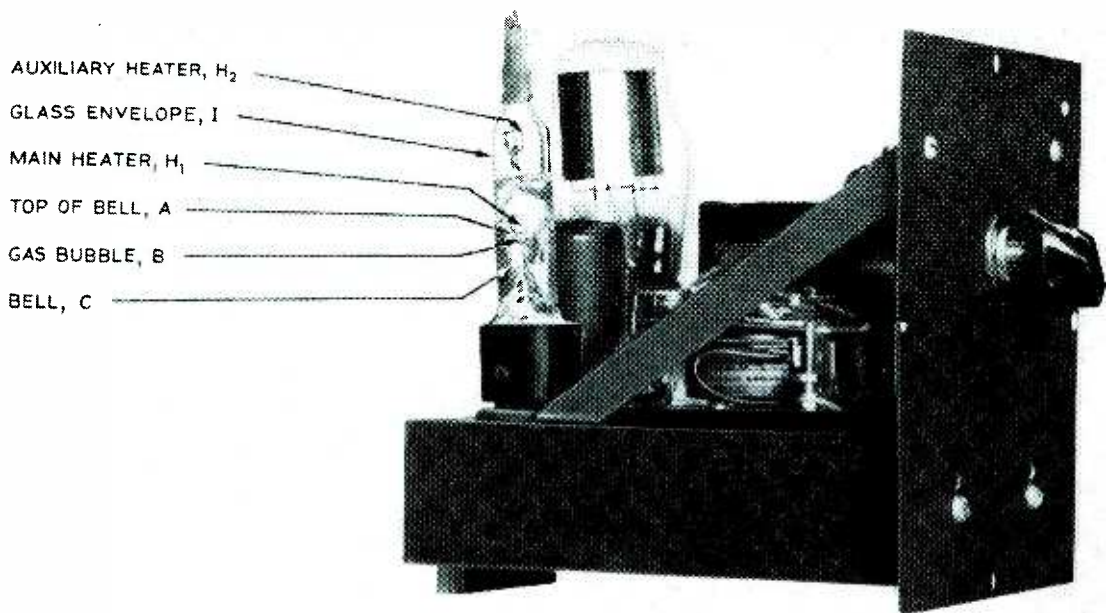

FIG. 1—Arrangement of electrodes and heater elements in the electrolytic integrating tube

THE INTEGRATING TUBE to be described possesses some refinements which were necessary to consistently maintain the desired accuracy during more than 100,000 repetitive operations. Previous systems applied a displaced mercury column for contact to terminate each operation. The presently described system derives its termination from a sharp rise in the apparent internal impedance of the integrator tube.

When an electric current is passed through a weak acid or alkaline water solution such as H_2SO_4 , or $NaOH$, hydrogen will be generated at the cathode and oxygen at the anode in the ratio of two molecules of hydrogen to one of oxygen, $2 H_2 + O_2$.

The number of water molecules derived from the process is determined only by the product of current and time. Temperature, pressure or even the acidity of the solution have no influence upon the speed of the electrolytic process. This law was discovered by Faraday, and is valid for all electrolytic processes.

$$Q = FxN = \int idt$$

where Q is the amount of electricity measured in coulombs and equals the time-current integral, N is the

number of chemical equivalents released, and F is Faraday's constant.

One Faraday is equal to 96,500 coulombs. This law is the basis of the international ampere, one ampere being the current which will deposit 0.00118 gram of silver per second. For very accurate current measurement in the laboratory, this method is still used.

Attempts have been made to apply the law technically as an ampere-hour meter. Butler (1880) and W. B. Thorpe (1908) in London, England patented ampere-hour meters based on Faraday's law. Others have tried to use the system for timing purposes (J. W. Dehn and O. Myers, New York 1937) but apparently the fundamental difficulties in the system were not realized and overcome.

Construction of Tube

Figure 1 shows a chassis with an integrator tube. It consists of a glass tube I , closed at the bottom and having a cathode and anode located inside a small inverted glass bell A to C . The bell is open at the bottom and is surrounded by the liquid within the large tube. The tube is filled with an acid solution. When current is passed between the cathode and anode, the oxygen

and hydrogen which is generated form a gas bubble B inside the bell and as the bubble expands downward the liquid is forced out and eventually the two electrodes are almost dry.

Figure 2 shows the tube in diagrammatic form. When the electrodes are out of the solution, the apparent resistance across them increases sharply as the electrode current I_1 approaches 0. The voltage across relay R_2 was $E_2 = E - R_1(I_1 + I_2)$ where I_2 was negligible relative to I_1 due to the high resistance of the relay. When the current I_1 through the electrode disappears (when the electrodes are dry), we have $E_2 = E - RI_2$ and the relay current $I_2 = \left(\frac{E}{R_1 + R_2} \right)$. This relay current is sufficient to energize the relay and close the contact for the heater current which heats the filament H_1 located inside the bell. (This current also heats the filament H_2 , which will be discussed later.)

The hot wire H_1 ignites the hydrogen-oxygen mixture above the electrodes inside the bell and the gas mixture explodes and becomes a water vapor which immediately condenses. The vacuum space is immediately filled by the liquid rushing back, filling the bell. The elec-

INTEGRATING TUBE

Continuously repeated explosions of oxygen and hydrogen produced by electrolysis of an acid solution provide a method of duplicating time cycles or integrating the flow of liquid or gas. Accuracy as high as 0.25 percent is obtained when atmospheric pressure changes are compensated

By JENS SIVERTSEN

Chief Engineer
George E. Fredericks Co.
Bethayres, Pennsylvania

trollysis process starts again, while the relay deenergizes and the heater current is automatically broken.

Application

If the tube is used as outlined above we have an automatic recycling timer with an inherent accuracy equal to that of the voltage E . If only one operation or cycle is desired, we arrange the relay interlocking, so that one operation will stop the process and a button must be pressed to start the next cycle.

When the resistor R_1 is made variable, we have a simple way of adjusting the period of the timing cycle. If the resistor is arranged to be continuously varied by the indicating mechanism of an instrument, the time between operations will vary inversely proportional to the average current during the time integral of the current, which is constant. This constant depends on the volume of the bell down to the level where the electrodes become dry, and is the significant constant for the tube.

In this way, the tube can integrate the product of time and any other quantity which can be translated into electric current, either directly or by controlling a potentiometer or rheostat.

A tube manufactured according to the preceding description will work well for quite a number of repeat operations, but after awhile it will be noticed that the solution does not fill the bell completely after each explosion of the gas bubble. It will be found that after the explosion some gas is left inside the bell and this gas will diminish the

amount of hydrogen-oxygen mixture necessary to be generated before the next explosion. This will shorten the timing cycle with each operation and the desired accuracy is not obtained.

The explanation for this action is found to be a number of disturbing secondary actions. The most important of these factors seems to be that the explosion, which happens very rapidly (approximately 0.01 second) does not result in a complete combustion. Some unexploded oxygen or hydrogen is forced out of the bell, leaving a surplus of one or the other. This condition is eliminated by an automatic valve which opens due to the pressure from the explosion.

The valve in the newest type of tube consists of a small opening at

the top of the bell. Normally the opening is closed by the capillary action of the liquid in the tube. The unexploded oxygen or hydrogen is forced through this valve with each explosion into the upper part of the glass tube where the second heater filament H_2 is located. The gases collect in this section of the tube, and when the filament H_2 is lighted during the following explosion, the gases will convert to water vapor.

Accuracy

Faraday's law stated that the number of molecules generated by the electric current is not affected by any other physical conditions, such as temperature or pressure, and because of this independence we have the basis for an accurate measuring device. However, the bell

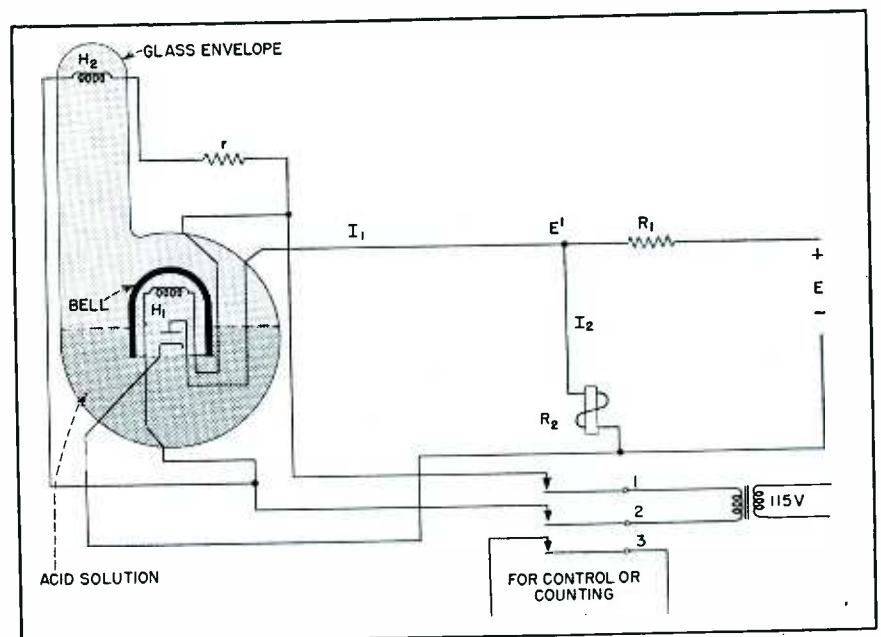

FIG. 2—Periodic explosions inside the glass bell of the integrating tube take place according to Faraday's law

which is used to measure the gas mixture does not actually count the number of molecules but rather measures volume. The gases expand one part in 273 for each degree C rise in temperature (under constant pressure). This corresponds to an error of approximately 10 percent for each 27.3 degrees C. The glass bell itself will also expand somewhat and therefore will tend to decrease the error with the result that the combined error is approximately one percent per 3.5 degrees C temperature change. If, in series with the current, we arrange a resistor (R , in Fig. 2) having a positive temperature coefficient of 0.035, this error is eliminated. This is accomplished by using a composite component in which one resistor is made of nickel wire.

The integrating tube I (Fig. 1) is sealed with a cap at the top. This seal, however, is not complete as a small vent is provided, which will open for internal overpressure.

The reason for this automatic valve is interesting. A number of tubes were manufactured and tested for constancy of integrating time T . They were completely sealed. Some had in operation the second heater H_2 and some did not. It was found that the time interval

increased steadily with a number of operations. Sometimes 10,000 consecutive operations increased the integrating time only 10 percent while at other times 1,000 operations would triple the time interval.

In all cases it was found that the intervals ultimately were three or four times what they were at the beginning of the test. The current was held constant and the timing cycles were recorded on a Brown Elektronik potentiometer which clearly indicated the increase in time. In all cases, the completely sealed cap on the top of the tube blew off if the top heater H_2 was not in operation. With the top heater H_2 in operation, the timing cycles remained constant within 20 percent and no caps popped off.

It was also found that with the heater H_2 operating, the timing interval would increase much more slowly, and later during the test even would decrease at times. However, the timing never became shorter than it was at the beginning of the test. The reason for this is clearly shown in the following table, showing the relative solubility of hydrogen and oxygen in water. Not only are oxygen and hydrogen produced by the electrolytic process, but these gases are also present, dissolved in the liquid.

Temperature, degrees C	O Saturation H Saturation
0	2.275
10	1.916
20	1.706
30	1.535
40	1.403
50	1.300
60	1.207
70	1.147

Outgassing the water does not solve the remaining problem because the solution acquires new gas from the electrolytic process. The relative solubility of the gases varies widely with temperature; they are therefore present in the solution, for our purpose, in a purely arbitrary ratio—not the 2:1 mathematical ratio which will explode into water vapor. There are also other gases, such as nitrogen, dissolved in the liquid.

Degree of Error

It is not certain that all the oxygen and hydrogen generated at the electrodes reach the upper part of the bell jar to form the gas bubble. Some of it is dissolved in the water if the temperature is such that the solution is not saturated. At other times the solution will release parts of the gas to the bubble and it will not release the gases in the proper ratio. In reality, the process is more complicated than this. We should assume that at all times some of the generated gas is taken by the solution before it reaches the bell jar, and other gases are released from the solution at the same time.

We have, therefore, a dynamic equilibrium which apparently tries to upset the mathematical accuracy of the process. This error is very small for a few operations and disappears when room temperature is constant (which can not be assumed). However, this small error is cumulative for a number of consecutive operations.

The fact that we have opened the small vent in the cap to the outside atmosphere assures that the gas collected within the tube will be at substantially constant pressure P .

$$P = P_1 + A + h$$

where P_1 equals the small pressure required to open the vent. Atmospheric pressure is represented by A . The height of the water solution from the bottom of the bell is



FIG. 3—Complete vacuum-tube integrator. Maximum and minimum limit controls are on the front panel

represented by h . The height of the water solution varies slightly during one operation but this change is very small and is the same for each operation and is, therefore, without significance. The pressure required to open the vent is also very small and substantially constant.

Atmospheric pressure, therefore, is the only significant varying factor and, contrary to what is believed, will vary widely in some localities—as much as plus or minus five percent on some days during the year. The average pressure from month to month, however, is within 0.1 percent of any other month during the year.

We can, therefore, consider three different types of operation:

(1) A long range operation where we are only interested in the total integral over a relatively long period of time. According to the theory of probability, the errors will cancel each other out.

(2) A short time operation where we demand less accuracy than plus or minus five percent, the maximum error for the worst days of the year from the standpoint of atmospheric pressure change. In this case, the instrument can be used without compensation.

(3) Where a relatively high accuracy ranging from $\frac{1}{4}$ to two percent is required it is necessary to compensate for atmospheric pressure changes. This was accomplished in the same manner as the temperature compensation, with a series resistor in the anode circuit. This resistor is varied by a bellows which will change the total resistance plus or minus five percent—corresponding with atmospheric pressure changes. The resistance will increase when the atmospheric pressure is decreasing and will decrease for rising pressure.

It may seem that a permanent changing calibration can take place because of the slowly disappearing head of water solution during the long time operation. Experience has shown that this change is less than two mm over a six months period of time. Atmospheric pressure corresponds to 10 meters and therefore the error caused by the changing head within the tube is less than 0.02 percent and is negligible. The amount of moisture released

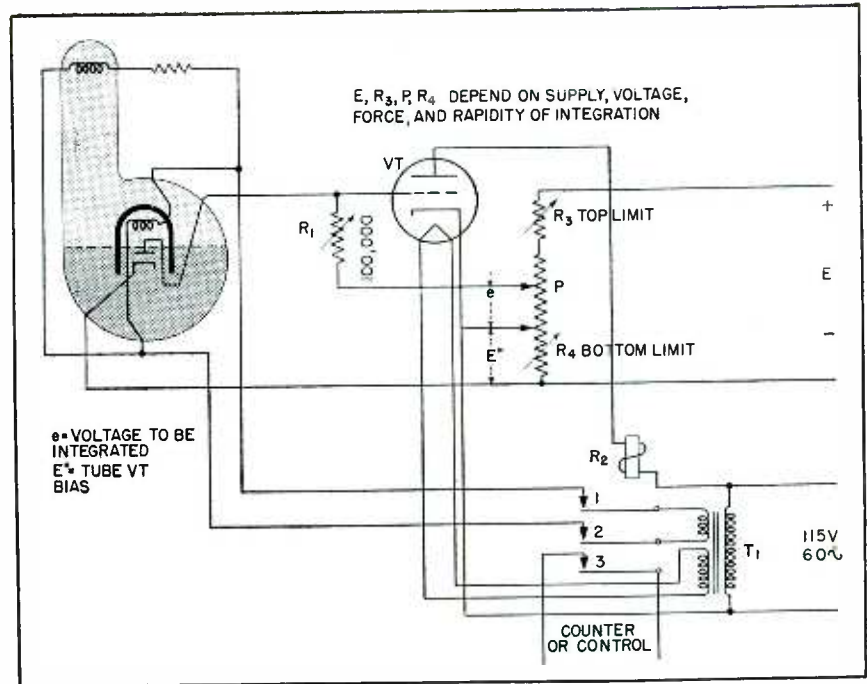

FIG. 4—Integrator circuit with vacuum-tube amplifier

through the vent in the cap is so small compared with the normal moisture content in the air that it will not have any measurable effect inside a cabinet which is open to the air.

Circuit Values

The circuit shown in Fig. 2 is practical for an adjustable timer in the ratio of 5:1 by making the resistor R_1 variable—or preferably by varying both R_1 and R_2 by introducing a series resistor in the relay branch. The relay is designed for low current and high resistance. A 4.5-ma, 4000-ohm relay gives excellent results over the range stated. This 5:1 ratio is limited to short timing intervals of 15 seconds to $1\frac{1}{2}$ minutes and corresponds to an electrolysis current of 80 to 15 ma as can be seen from the table below.

For longer range timing and integration, the instrument shown in Fig. 3 has proven useful. This applies the circuit shown in Fig. 4 and may also be used for short time operation. It contains a tube grid in place of the relay coil—the action is practically the same.

The electrolysis voltage is substantially constant, around 2.5 volts. When the gas bubble fills the bell, this voltage will rapidly rise several volts until the relay operates. The value depends upon the supply voltage E , other circuit constants and

at what voltage the relay acts. The electronic tube which is biased to cutoff, with its grid connected to the anode of the integrator, will become positive and pass a substantial current through the relay.

The tube as presently manufactured has a constant of approximately 1.2 coulombs or 1,200 milliampere-seconds. The following table shows the time between integrals based on average current between each explosion.

Average Current (ma)	Time (sec.)	Time (min.)
80.	15	1/4
40.	30	1/2
20.	60	1
10.	120	2
5.	240	4
1.	1200	20
0.5	2400	40
0.1	12000	200
0.05	24000	400

Work is progressing to develop tubes capable of one to two million operations with a spark gap instead of the heater wire to ignite the oxygen-hydrogen mixture. The associated equipment, however, will not be quite as simple as it is with the heater wire arrangement. It is felt that the present system, with a heater wire for ignition, is simple and well suited for industrial equipment. After 100,000 operations, a replacement of the integrator tube is desirable.

DIODE-CONTROLLED

Filament of temperature-limited diode serves as controlling element of bridge-type regulator circuit that holds a-c output voltage constant within 0.2 percent over 10 to 1 load range. Stability of d-c version equals that of batteries

THE BASIC diode-controlled a-c voltage-regulating arrangement shown in Fig. 1 employs a primary source of voltage reference, sufficient gain to keep the reference and the controlled voltage within very narrow limits, simple correcting circuits not limited by power-handling capacity or response time, and a sensing element which is not forced to operate in any given range of voltages or currents.

A special temperature-limited diode V_1 having operating characteristics represented by the curves in Fig. 2 and 3 acts both as sensing element and as the primary reference of voltage and at the same time gives a large gain.

The diode is treated basically as a triode having a very large voltage gain, where filament voltage rather than grid voltage is employed as the controlling element and R_p is a very strong function of the filament voltage.

In the circuit of Fig. 1, assuming there is 1,000 volts across the bridge, a change of 0.1 volt in the filament of this type of temperature-limited diode causes unbalances of 8 or 9 volts in the bridge. Inasmuch as it is desirable to maintain the bridge at relatively high impedance, this voltage is fed into the grid of a subsequent beam-power tetrode. The output of this tube can then be used in a multitude of ways to control circuits which correct the voltage being controlled.

Since temperature-limited diode emission characteristics determine the characteristics of any regulation unit using this principle, the criterion of final performance is determined by the factors involved in processing these tubes. Thermal inertia for this type of tube has been reduced to a minimum, consistent with good tube manufacturing practice. Great care has

been exercised in processing and stabilizing these tubes so that they maintain a long-term life characteristic and a response time of 0.1 second, particularly when operated in the temperature-limited condition. The plate resistance is generally employed at a relatively high level because filament voltages are of such a magnitude that the operating temperature of the filament is very low. Since the life of a tungsten filament is a multiple-powered function of the operating temperature, the tubes have a long life expectancy.

The beam-power tube is employed to control a saturable-core reactor which in combination with an autotransformer allows control of a-c voltages, thus obtaining an a-c voltage regulator capable of high accuracies and virtually independent of input line frequency, power factor, or load, and having a load range limited only by the charac-

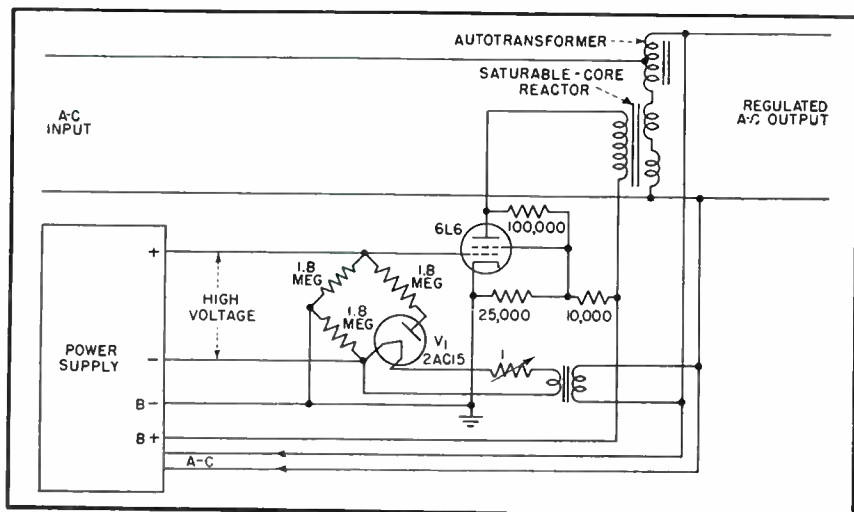

FIG. 1—Basic diode-controlled a-c voltage regulator circuit for providing low values of voltage at high current with stability comparable to that of storage batteries

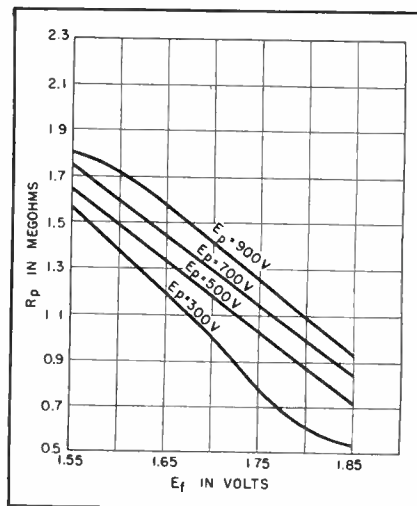
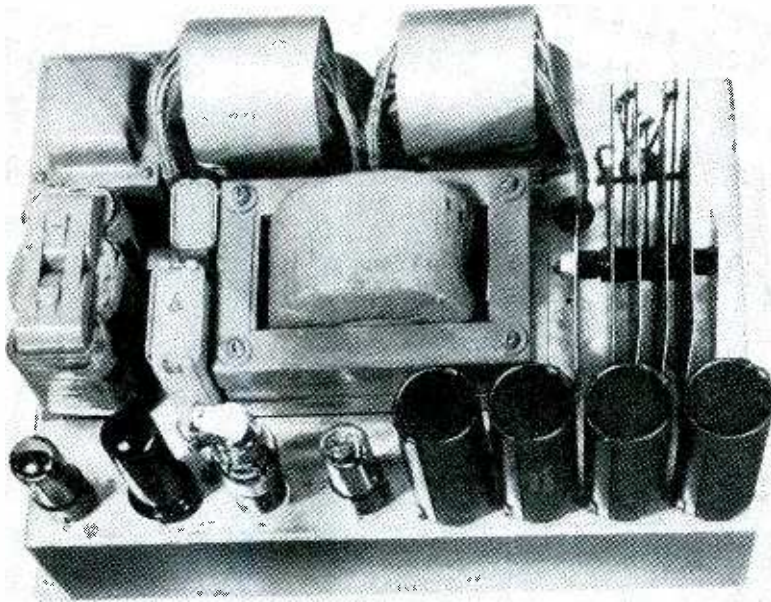

FIG. 2—Variation of plate resistance with filament voltage for Sorensen 2AC15 diode

VOLTAGE REGULATORS

By LEO HELTERLINE

Chief Engineer
Sorensen & Co., Inc.
Stamford, Conn.



Complete diode-controlled voltage regulator unit

teristics of the saturable-core reactor.

Typical accuracy for units of this type is 0.2 percent over a 10 to 1 load range with input voltages from 95 to 125 volts. Voltage distortions of less than 5 percent, using only a slight degree of circuit attenuation, have been obtained by a proper combination of the autotransformers and saturable-core reactors.

A second adaptation of the basic principles, shown in Fig. 4, feeds the a-c output into a rectifier. The diode is actuated by the output of the rectifier circuit. This arrangement, called the Nobatron, is especially valuable at high currents and low voltages, and maintains its output at plus or minus 0.5 percent over its rated load range.

In still another adaptation of the basic circuit, the output of the

control circuit is fed into a phase-shifting circuit. This may be a saturable-core reactor phase shift network which can, in turn, control the output of a grid-controlled thyatron power supply. This type of application offers extreme versatility since the temperature-limited diode may be actuated by a-c, d-c, or r-f power, thus providing a means of controlling virtually all high power and high current.

Application possibilities for a diode-controlled regulation unit are widespread since such a unit will operate on frequencies between 50 and 60 cycles while still maintaining voltages within the rated accuracies. It will provide high inherent accuracies and give a truer wave form even over wide load fluctuations. Finally, it allows an adjustable voltage output when desired.

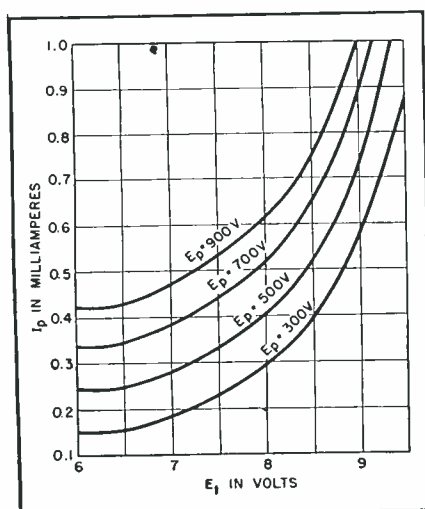

FIG. 3—Variation of plate current with filament voltage for Sorensen 8DC15 diode

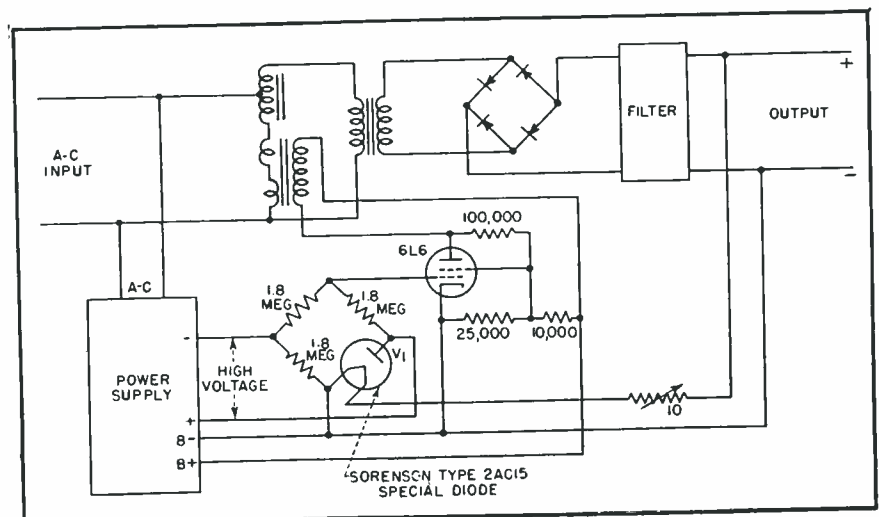

FIG. 4—Nobatron circuit, using dry-disk rectifier in conjunction with temperature-limited diode for regulating high values of direct current at low voltage

STATIC

for Radio Receiver Tests

A fluctuating audio signal from a gas tube is peaked, amplified, and applied to a spark coil that discharges at irregular intervals. The resulting r-f signal may be used to simulate click, thunderstorm, hiss or grinder static

By
J. C. R. LICKLIDER
 and
E. B. NEWMAN
Psycho-Acoustic Laboratory
Harvard University,
Cambridge, Mass.



Listeners, developing data during articulation tests in which atmospheric static, such as that from lightning discharges, is artificially simulated under controlled laboratory conditions

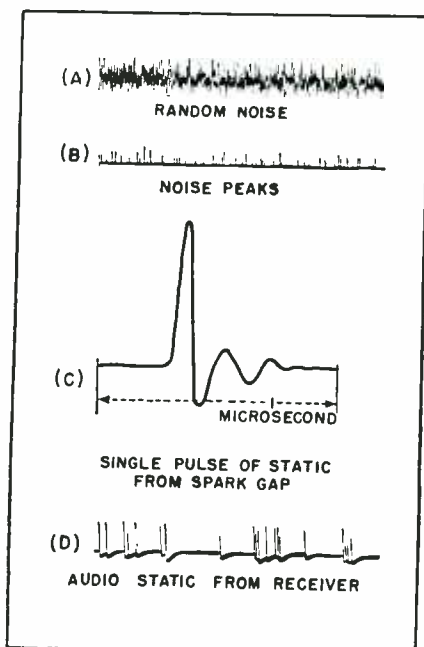

FIG. 1—Random noise (A) is put through a circuit which passes only noise peaks (B). The peaks are amplified and activate a spark gap. One pulse of the resultant r-f static has, when observed on a video oscilloscope, the waveform shown at (C). The audio static output of a receiver under test (D) results from a series of pulses

GOOD PERFORMANCE is based on good testing. In no field is this statement truer than it is in the design of radio receivers. Receiver performance has improved at a pace set by the development of testing methods and equipment.

One big gap in radio testing procedures became evident during the war. There were no established methods of imitating atmospheric static in the laboratory. This paper describes methods which were developed to fill in the gap. It presents a simple quantitative method of specifying the characteristics of static which are important for receiver design, and it describes ap-

paratus which simulates the various types of static.*

Characteristics of Static

The intense static from local thunderstorms, and probably most other types of atmospheric static, arises from very brief electrical or electro-magnetic disturbances. These disturbances are transients of extremely short duration. They often occur in bursts, trains, or crashes. Their times of occurrence are highly irregular, if not completely random. They are irregular also in amplitude. Each pulse scatters energy continuously through a wide band of the radio-frequency spectrum.

The atmospherics encountered at any given station depend not only

*This work was begun under Contract OEMar-658 between OSRD and Harvard University, where it is continuing under Contract N5ori-76 with the U. S. Navy Office of Naval Research.

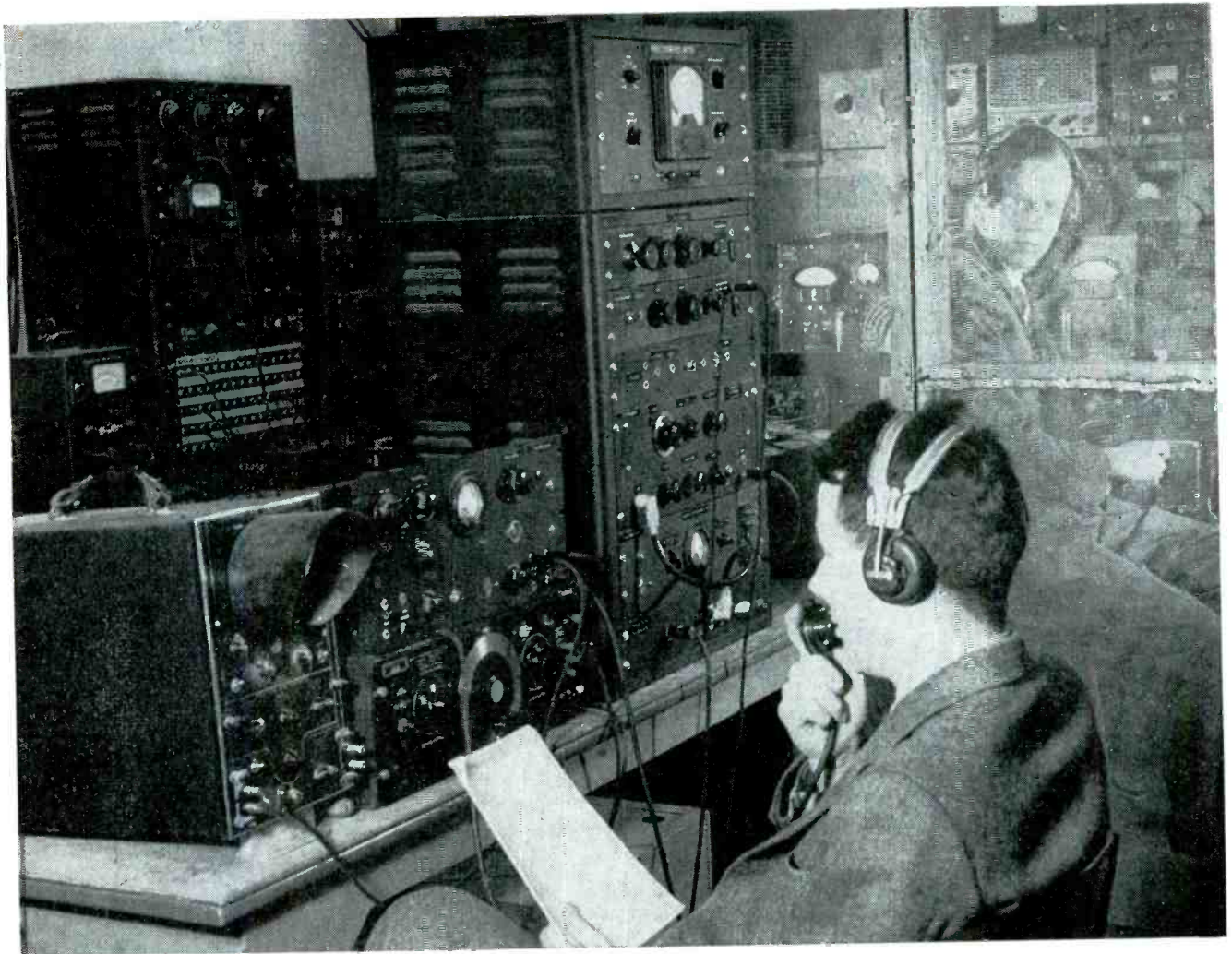

Author Newman serves as a talker. To his left is the monitor oscilloscope. Static-generating circuits and wide-band monitor receiver are in the rack on the right side of the table, with a pulse counter on top of the rack. Author Licklider is inside the shielded cage, with the receiver under test, r-f generator, and mixing circuits

on local conditions but also upon conditions in remote regions, especially upon propagation between these regions and the receiving station. For this reason the characteristics of atmospheric static are by no means simple. They vary from one geographical location to another and from one frequency band to another. They vary with the time of day, from day to day, and from season to season.

Measurements of intensity alone fail to indicate just what static is. Equivalent microvolts do not tell what a burst of static will do to a sensitive radio receiver.

Static Density

It is most useful for the present purpose to think of atmospheric static as a series of transient im-

pulses which set resonant circuits into oscillation. The important characteristics of the impulses are, first, their intensity, and, second, their spacing or distribution in time. If the impulses follow one another closely, we speak of *dense* static; if they occur so infrequently that the after-effects of one impulse are gone before the next impulse comes along, we speak of *sparse* static. The significance of static density in determining its interference value has not always been well understood, and contradictions have resulted from failure to specify the density of the static under discussion.

Static density may be designated conveniently in terms of a notation borrowed from radar: pulse repetition frequency. Although the num-

ber of pulses per second may vary within quite wide limits, it is possible to think of a particular sample of static as having an average prf. For various samples, the average prf may range from near zero to exceedingly high values. When the prf is low and the pulses are widely spaced, the intermittent character of static is emphasized. On the other hand, when the prf is high and the pulses are closely spaced, static takes on the character of fluctuation noise (recently called white noise).

The static density determines the way in which we must look at receiver performance. When it is dense and is observed through a narrow-band receiver, the individual pulses are broadened by passage through the narrow-band cir-

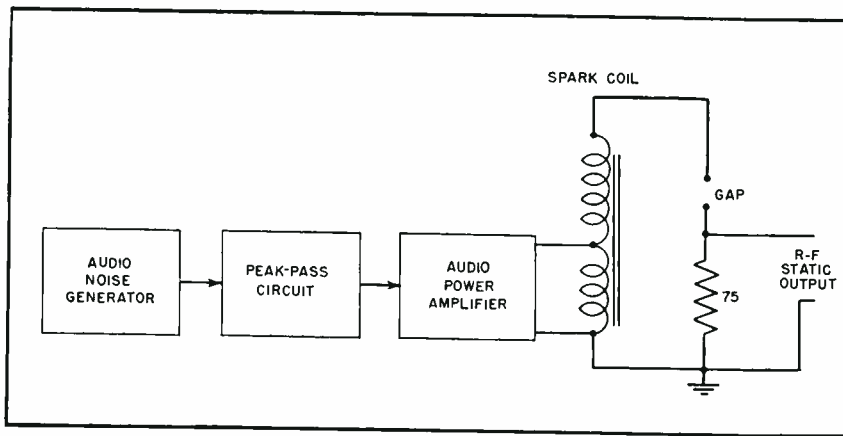

FIG. 2—Block diagram of the static generator

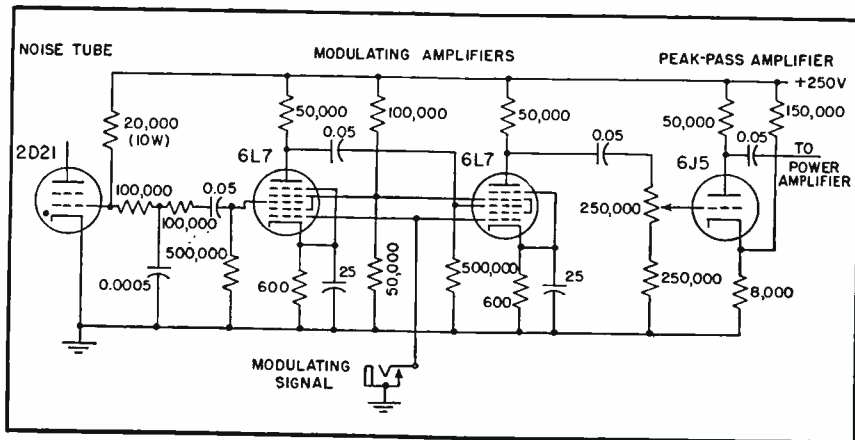

FIG. 3—Schematic diagram of the audio noise generator and peak-pass circuit

cuit and pile up on each other's heels. Dense static gives rise, therefore, to an irregularly fluctuating wave instead of an irregular sequence of spikes. With dense static, consequently, receiver performance can be predicted fairly accurately by assuming that we have an r-f carrier modulated by a continuous spectrum of noise. Sparse static, on the other hand, brings into play the time constant of each of the circuits in the receiver. The ring time

of resonant circuits, the time constants of squelch circuits, AVC circuits, and noise limiters, the regulation of the power supply, are all interrelated in the transient response of the receiver.

For most tests of radio receivers, the shape of the static spectrum is quite unimportant. The passband is always narrow relative to the overall frequency range covered by the static, and within the passband the average distribution of static en-

ergy is essentially uniform. It is ordinarily not necessary, therefore, in simulating static for receiver tests, to match the spectrum of natural atmospherics.

Standards for Measuring Static

The following procedure has been adopted as a standard method of specifying atmospheric static. If the static is relatively homogeneous, it is expressed in terms of two measures: (1) the intensity in a band 10 kilocycles wide, centered at the frequency to which the receiver is tuned, and (2) the average prf. The first quantity is usually calculated from measurements made with a receiver of known selectivity. The second quantity is determined with the aid of a pulse-counting meter and a wide-band receiver.

The relation between designations based on this method of specification and the nomenclature which has been used widely in previous discussions of atmospheric interference is fairly direct. The correspondence is approximately as follows: *click static*—weak, very low prf; *lightning* and *local thunderstorm static*—intense, low or medium prf; *hiss static*—weak, very high prf.

To describe the static frequently referred to as *grinders*, a third characteristic of natural static must be taken into account. Grinders are essentially bursts of pulses. In specifying the characteristics of grinders, the measures of intensity and density can be either short-time averages within bursts or long-time averages including a number of bursts. In either instance, it is necessary to describe the static in terms, for example, of the per-

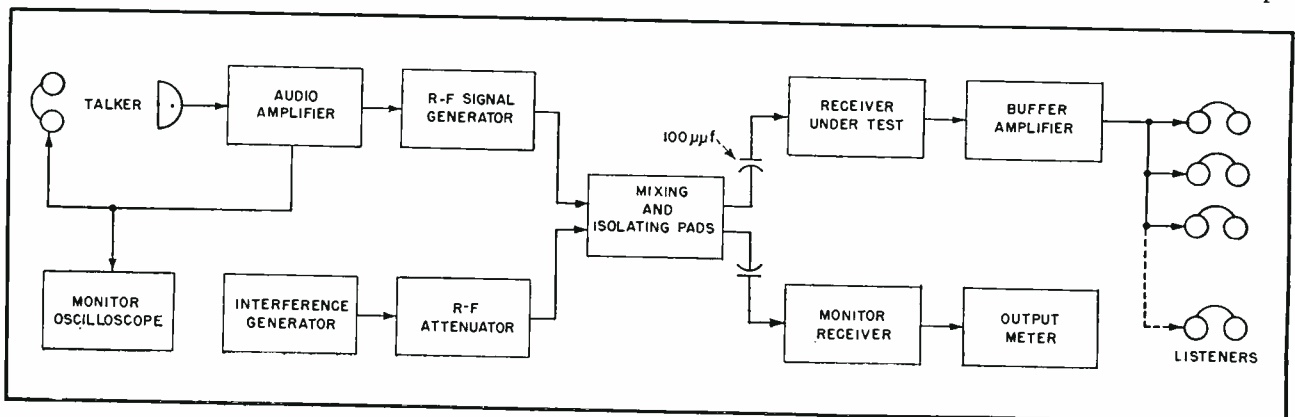

FIG. 4—Setup used in articulation tests of radio receivers. One such test is shown in progress in the two photographs which appear elsewhere in these pages

centage of the time occupied by bursts and their average frequency of recurrence.

Simulation of Local Static

The method used in simulating local thunderstorm static and click static is illustrated schematically in Fig. 1. A block diagram of the apparatus is shown in Fig. 2, and the circuits of the audio noise generator and the peak-pass amplifier are shown in Fig. 3.

As indicated (Fig. 1) the first step involves the production of a fluctuating audio-frequency wave (A) provided by a gas-tube noise generator. This wave is fed into a peak-pass amplifier, which gives it the form shown at (B), and then is applied to the primary of a spark coil. The secondary of the spark coil is connected through a small series resistance to a spark gap. When the voltage developed across the gap by the secondary reaches the breakdown value, there is a very brief surge of current through the gap and through the resistor. The voltage thus developed across the resistor is a series of very short pulses (C) which occur at irregular intervals and which vary irregularly in amplitude.

The irregularity in time and in amplitude is derived from a random noise wave containing only audio - frequency components, whereas the sharpness of the output pulses (which accounts for the fact that the spectrum extends high into the radio-frequency range) is due primarily to the suddenness with which the resistance of the spark gap breaks down when the critical voltage is exceeded.

The intensity of the simulated

static is adjusted by means of a video attenuator of conventional design, and the intensity level per cycle (or per 10-kilocycle band) is determined with the aid of a receiver of known selectivity, by measuring the equivalent noise side-band input and correcting for bandwidth. The density of the simulated static is controlled by adjusting the gain of the peak-pass amplifier. When the gain is increased, more of the peaks of the voltage wave from the gas-tube generator are passed, and more output pulses are produced.

The average prf is indicated by a pulse-counting circuit connected to the output of a wide-band monitor receiver. With very low prf, the interference consists of a succession of randomly spaced clicks. With prf's between 20 and 2,000 pulses per second, the interference sounds like typical thunderstorm static.

Simulation of Other Types

To provide simulated static of the grinders type, it is necessary only to introduce slow, random, amplitude modulation of the audio noise delivered to the peak-pass amplifier. This is done by applying an irregularly fluctuating wave to the No. 1 grids of the 6L7 amplifiers (Fig. 3). With this arrangement, the equipment under test may be subjected to irregular bursts of static pulses very similar to natural grinders. These irregular bursts are useful in showing up irregularities of performance due to unstable avc circuits.

Hiss static can be simulated with the spark-gap generator by applying high-prf excitation and thus forcing almost continuous dis-

charge, but under these conditions the output is not stable. For hiss static, therefore, it is better to take advantage of the fact that when viewed through circuits of limited bandwidth irregularly spaced pulses at very high prf resemble fluctuation noise. Methods of generating wide-band fluctuation noise with the aid of gas-filled tubes were developed during the war in connection with radar jamming.¹

Use in Receiver Tests

The simulated static has been used extensively in laboratory tests designed to evaluate the performance of radio receivers and of noise-reducing circuits. In most of the work, articulation tests have been used to measure the intelligibility of speech transmitted over a radio link of which the receiver or the noise-reducing circuit comprised a part.

By way of illustration, a typical test setup is shown in Fig. 4, and the results of a typical test are presented in Fig. 5. The receiver under test was equipped with a Wasmansdorff series-diode audio noise limiter which could be switched on or off.² The aim of the test was to measure the effectiveness of the limiter in overcoming the effects of impulsive static with an average prf of 1,000 pulses per second. Two talkers alternately read standardized lists of words (the Psycho-Acoustic Laboratory PB Lists) over the test circuit to a group of experienced listeners who recorded the words as they heard them. Tests were conducted with various r-f carrier-to-interference ratios, half of the tests with the limiter operating and half with the limiter disconnected.

As shown, the listeners were able to understand many more of the words when the limiter was used; the advantage provided by the limiter was approximately equal to that which would have resulted from a 10-db increase in carrier power.

REFERENCES

- (1) J. D. Cobine, Noise Output of the Sylvania 6D4 Gas Triode at Audio and Supersonic Frequencies, Harvard University Radio Research Lab. Report 411-92, 1944. (Available through the Office of Technical Services, U. S. Dept. of Commerce, Washington, D. C., PB 14163)
- (2) Emerick, Foth, Noise and Output Limiters, *ELECTRONICS*, p 114, Nov. 1946.

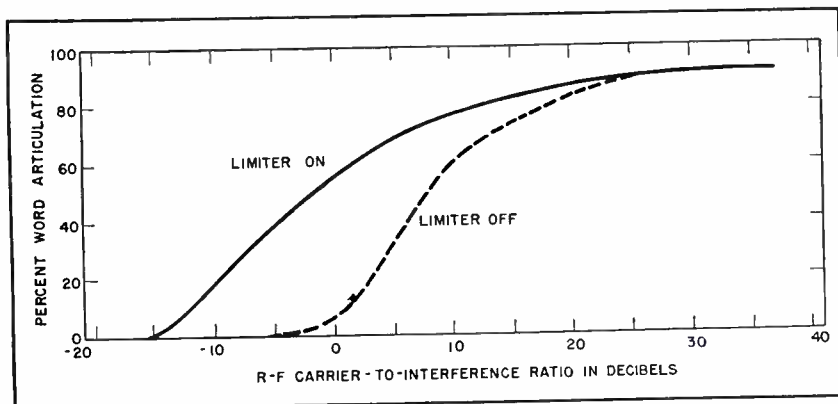

FIG. 5—Results of a series of tests on a receiver employing a series-diode noise limiter

Precision

By RUFUS BRIGGS
and HANS KLEMPERER

Raytheon Manufacturing Co.
Waltham, Mass.



Bench-size precision spot welder for light-gage materials, with special welding head that holds weld pressure constant after weld is initiated

INDUSTRIAL use of precision spot welding requiring large installations of equipment is well known. These installations are capable of welding the heavy gages with great success. However, only slight attention has been given to precision welding of light-gage metal parts.

Precise energy levels for welding may be obtained in several ways: (1) Precision timing of the power taken from an unvarying power source; (2) Precision compensated timing of a variable power source; (3) Precision controlled discharge of a storage system; (4) Precision charging of a storage system having a uniform but uncontrolled discharge. The last method is flexible, capable of precision control by simple electronic means, and reduces the power line demand.

In a capacitor-type energy storage system whose storage level is precisely controlled, the following requirements have to be fulfilled in order to deliver a precise level of energy for welding: (1) The storage elements have to be held at a precise energy level prior to weld-

ing; (2) During the weld, the storage bank must be discharged either to zero or to a predetermined level; (3) Addition of line energy to the stored energy during the discharge must be prohibited; (4) Random losses in circuit elements have to be avoided. Among the causes of such losses are saturation of the welding transformer, overloading of the discharge tube, and loss at joints.

Control of Storage Energy Level

The equipment to be described and discussed has a maximum storage energy level of 225 watt-seconds and uses a storage bank having 200 μ f maximum capacitance. The complete circuit is given in Fig. 1.

The energy level is controlled and maintained by simple yet accurate means. The line voltage is stepped up by plate transformer T_1 to a voltage considerably in excess of the ultimate voltage level across storage capacitor bank C_5 . A pair of grid-controlled thyratrons connected for full-wave rectification rectifies the output of this transformer and charges the capacitor bank.

The grids of the rectifiers are controlled by the voltage drops across grid-to-cathode resistors R_1 and R_4 , as a result of currents flowing in the grid control circuits. A grid control circuit consists, for example, of a glow lamp G_3 , a resistor R_2 , a phase-shifted alternating voltage, and a reference direct voltage all in series. The phase-shifted a-c voltage is obtained from transformer T_2 and network C_2 and R_3 . The reference d-c voltage is a selected fraction of the voltage across the storage capacitor bank.

At no charge, the thyatron grids are connected to cathodes through the grid resistors. As the capacitor bank gains charge, a point is reached where the instantaneous sum of the d-c reference voltage and the a-c phase-shifted voltage exceeds the flash voltage of the glow lamp. At this point voltage builds up across the grid resistors until

FIG. 1—Circuit of precision electronically-controlled capacitor-type spot welder

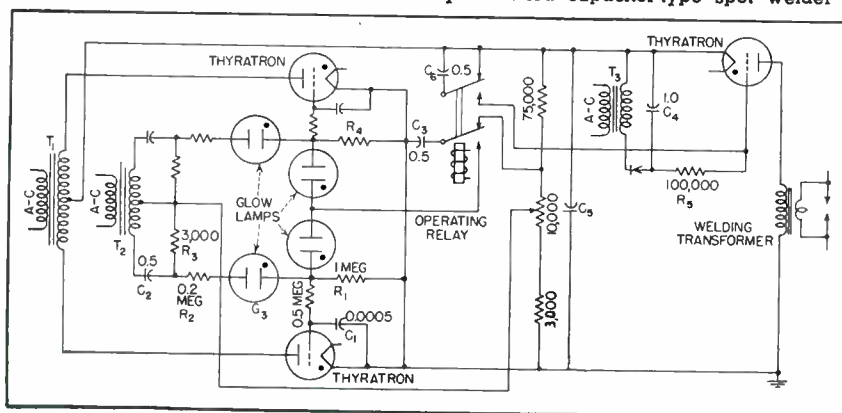

Energy-Storage SPOT WELDER

Technical details of a compact capacitor-type spot welder for light-gage sheet metal and wire. A tube-controlled 200-microfarad storage bank provides a maximum storage energy level of 225 watt-seconds. Tubes also terminate the discharge and block line power

the cutoff point of the thyratrons is reached.

The phase-shifted a-c voltage insures that this cutoff does not happen suddenly, but at a steadily reducing current rate. With this current rate reduced to a very small value the charge never comes to zero completely. This trickle charge is sufficient to maintain an exact preselected level of voltage across the capacitor bank and replace bleeder losses. It operates continuously, as shown in the oscillogram in Fig. 2, at the very last part of every cycle.

Minute differences among the individual resistances or tubes have the effect of causing the trickle charging to be done by one rectifier in preference to both.

The use of the glow lamp in the grid control circuit results in many major advantages over other methods. First, it greatly multiplies the accuracy of the control of the capacitor bank voltage. (The d-c reference voltage should approximate the flash voltage of the lamp.) Second, it allows independence from line voltage variation. A close analysis shows that even line voltage variations in the phase-shifted a-c voltage are balanced out by the glow lamps because they operate intermittently and not continuously. Variations in the magnitude of this phase-shifted voltage cause very slight alteration of the conducting time of the glow lamp, and hence very slight alteration in the grid-controlling action. It has been shown that this arrangement will maintain the capacitor bank volt-

age to ± 2 percent with ± 15 percent variation in the power supply.

Discharging to a Predetermined Level

The capacitor bank in Fig. 1 is connected to the welding transformer through a grid-controlled thyatron. The grid is kept highly negative by the voltage across capacitor C_1 . When the operating relay is energized, the relay contact connects capacitor C_2 across C_1 through resistor R_2 . C_2 acts to charge C_1 and for a short interval all of the voltage on C_1 appears across R_2 . As a result, the grid voltage goes to zero and the thyatron fires, connecting the capacitor bank to the welding transformer.

The complete picture of the currents and voltages prior to, during, and following a welding operation is given in the oscillograms of Fig. 2. It will be observed that since the series or discharge thyatron is a one-way conducting device the capacitor bank is left with a re-

verse charge determined by the constants of the circuit. As long as the constants remain the same each discharge will result in the same transfer of energy from the capacitor bank to the welding transformer.

Blocking of Line Power During Welding

A common source of irregularity is random addition of line power to the stored energy during the discharge. This fault is corrected in the equipment under discussion by blocking the rectifiers through the use of recharge delay circuits.

Capacitor C_3 in Fig. 1 is charged by a voltage taken off the voltage divider through a normally closed contact on the operating relay. When the relay is operated this capacitor is connected to the grid circuits of the rectifiers. The impressed negative voltage is sufficiently high to break down the glow lamps and hence the rectifiers are blocked until the charge on C_3

Successful Applications of Precision Spot Welding

Nickel, 0.01 to 0.08 wire or flat, to 0.04 and smaller nickel
Nickel, 0.01 to 0.08 wire or flat, to 0.06 and smaller molybdenum
Nickel, 0.01 to 0.08 wire or flat, to 0.03 and smaller tantalum
Nickel, 0.01 to 0.08 wire or flat, to 0.05 and smaller tungsten
Nickel, 0.01 to 0.08 wire or flat, to 0.032 and smaller copper
Nickel, 0.01 to 0.08 wire or flat, to 0.025 and smaller Dumet
Steel, 0.001 to 0.032 low carbon, to 0.125 and smaller low-carbon steel
Steel, 0.001 to 0.032 low carbon, to 0.02 Nichrome
Steel, 0.001 to 0.032 low carbon, to 0.062 Invar
Aluminum, 0.001 to 0.015 flat, to itself
Aluminum alloys, 0.005 to 0.025, to themselves
Gold, 0.003 to 0.025 wire or flat, to itself
Platinum, 0.003 to 0.03, to itself

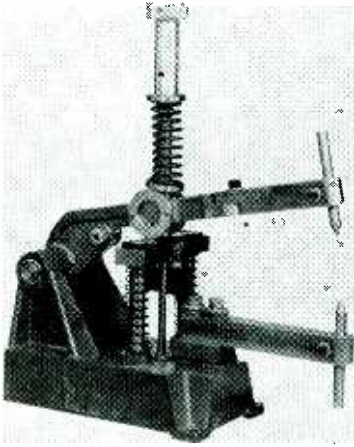

Welding head with cover removed

has been dissipated through R_1 and R_2 , sufficiently to allow the glow lamps to go out. The charge delay time is fixed by the time constant of the discharge circuit of C_2 and by the voltage level at which it has been charged. Thus, the charge delay is self-compensating as the capacitor storage bank energy level is varied.

It will be noted from the oscillograms that the charge delay is adjusted to positively exclude random additions of power. Although the weld is over in approximately one cycle, the charging is delayed 20 cycles. Charging occurs on 22 cycles and is followed by the trickle until the next operation.

Random Losses

The biggest source of random losses in energy storage welding is the saturation of the welding transformer.¹ Such saturation will occur on transformers of conventional design when rapidly repeating unidirectional pulses of energy are applied. Of the many ways in which this undesirable saturation can be prevented, the most practical solution for small energy storage units is use of a large-section core transformer having a carefully selected air gap. To keep the weight and size of this transformer down as much as possible, Hypersil cores are often employed.

By careful transformer design the discharge current into the welding transformer is kept within the rating of the series or discharge tube. Within the useful life of the tube, therefore, it will not be a

cause of random energy loss during the weld operation.

The value of the d-c pulse with its steep current wave front has been well established for welding materials having high thermal conductivity.² Such a wave front has the inherent capacity to produce steep thermal gradients and at the same time allow a controlled total level of energy independent of the steepness of the wave front.³

By comparison the output wave front of conventional a-c welding equipment delivering equal levels of total energy is much less steep, and any change in the energy level is accompanied by a change in the slope of the wave front. As a result the d-c pulse coupled with suitable welding mechanisms can and does weld high thermal conductivity materials even in very small gages. It produces a weld section which meets the high standards established by contemporary studies made of welds produced by equipment serving the heavy gage field.

Welding Head

The pressure program adopted involves use of a welding head that allows pressure on the welded joint

to rise to a preselected value at which welding energy is applied. This pressure is held constant after the weld is initiated. The head will operate correctly with wide variations in electrode adjustments or stock thickness, and is independent of variations in manual operation. A most desirable feature is the elimination of any pressure stop mechanism.

The upper welding arm is pivoted in two separate roller bearings and is held up by return springs under an anvil which is free to slide up and down two control posts. Since the anvil is pinned to the center control rod, the upper arm will follow the anvil as it is moved downward by the control rod. This is because the upper arm is held against the anvil by the locked-in pressure of the weld pressure spring. This pressure also is holding four cramp plates (two on each side) flat against the anvil. The downward motion of the anvil is possible only as long as these cramp plates are lying flat.

As soon as the electrodes touch the work, further downward motion of the upper arm ceases and, as the anvil continues downward, the cramp plates are lifted by the spring in the anvil on one side and on the other side by a spring in the operating rod of a normally closed precision snap-action firing switch. The shoulder on the control rod tips the cramp plates and they lock on the two control posts. At this point the operating rod on the firing switch has risen far enough to cause the switch to operate, and the welding energy is applied to the weld. The operator can not bring the control rod down any farther and hence cannot increase the weld pressure. This action starts only when the electrodes have touched the work and is not dependent upon the relative point in the operation at which this touching occurs. The only mechanism left to move during the follow-up period of the weld is the upper arm and pressure spring.

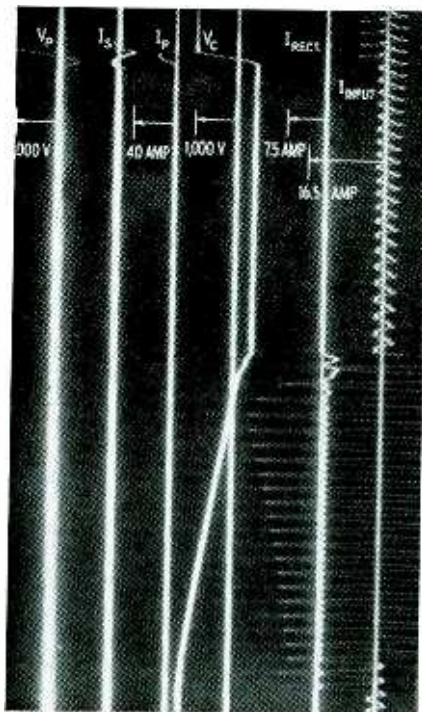

FIG. 2—Slow-speed oscillogram showing one complete cycle of welder operation. All scale values are peak. Frequency of input current curve at right is 60 cycles

REFERENCES

- (1) H. Klemperer, Capacitor-Discharge Welding Systems, *ELECTRONICS*, p 118, May 1944.
- (2) G. L. Rogers, Energy Storage Welding Controls, *ELECTRONICS*, p 63, Dec. 1942.
- (3) H. Klemperer, and J. W. Dawson, Variable Waveform Unit for Testing Aluminum, *ELECTRONICS*, p 62, Feb. 1943.

OVERVOLTAGE TESTING of Capacitors

Methods and equipment for testing paper-dielectric liquid-filled capacitors for direct-current service are described. In addition to precautions for personnel safety, testing techniques should limit charging and discharging currents and prevent oscillation

By **R. J. HOPKINS**

*Capacitor Engineering Division
General Electric Company
Pittsfield, Mass.*

INCREASED USE of electronic devices in all types of equipment during the past few years has resulted in an increased demand for liquid-filled paper-dielectric capacitors for use in d-c circuits. With many new manufacturers purchasing capacitors for installation in their equipment, questions have arisen concerning the methods of making acceptance tests on capacitors and the proper test voltages to be used. Included in this article are suggestions for methods of sampling, types of testing equipment, precautions to be observed, and test voltages to be used.

Sampling

Because, in general, manufacturers of high-voltage capacitors electrically test 100 percent of their products, repetition of these tests by customers on 100 percent of their incoming capacitors should be unnecessary. Sampling procedures that insure a satisfactory average quality level (AQL) have been developed on a statistical basis and have been widely accepted by industry for quality control purposes.

A typical sampling schedule similar to that used by the U. S. Army for acceptance of d-c rated paper-dielectric capacitors is given in Table I. In the event that the number of defective capacitors in any sample quantity exceeds that allowed by the table, the lot from



For voltage tests up to 5,000 volts, test prods handled by an operator can be safely used. Buttons on the handles of the prods control application and removal of test charge

which the sample was taken can be tested 100 percent.

Overvoltage tests on capacitors include the following:

DIELECTRIC TEST: Voltage is applied from terminal to terminal, across the active dielectric.

GROUND TEST: Voltage is applied from each terminal to case where

the case is not a terminal, and thus across the major insulation between dielectric assembly and case, including bushings.

MULTIPLE SECTIONS TEST: Voltage is applied between sections where there are more than one independent section in the same case.

When making terminal-to-ter-



Testing of capacitors at voltages in excess of 5,000 volts is done in a test cage. Doors are closed and voltage applied. Opening doors turns off high voltage and discharges capacitor

minimal or dielectric tests, it is of greatest importance that charging and discharging currents be non-oscillatory. Direct-current capacitors are designed to operate with much higher voltage stresses across their dielectric than are a-c rated capacitors, and oscillation of either charging or discharging currents impresses oscillatory voltages across the capacitor which may exceed the a-c breakdown strength of the capacitor, thus causing failure.

Even though the charging and discharging currents are nonoscillatory, there is danger of damage due to high peak currents. Most capacitors designed for ordinary d-c operation are not intended to withstand high current surges, and such surges may cause arcing at the foil electrodes. This possibility of damage is recognized by various standards issued during the war to cover hermetically sealed paper capacitors. For example, AWS C-75.16 and JAN C-25 specify that charging and discharging currents be limited to one ampere. This limit has been widely adopted by the capacitor industry. The resistance required to hold the capacitor current within this limit is more than sufficient to suppress oscillations in the test circuits described later.

When testing, it is possible to allow the capacitor to remain charged but disconnected from the voltage

source for the duration of the test. However, under these circumstances failure may occasionally occur at the instant of discharge after the test, even though the discharge current is nonoscillatory and limited to one ampere. It has been shown that these failures do not occur if the capacitor remains connected during the test.

Test Prod Type Equipment

Simplest and least expensive type of equipment for making tests at voltages below 5,000 volts d-c is the so-called test prod or test-sticker type of test set. This equipment includes a full-wave rectifier with plate voltage control to cover the voltage range desired, and a suitable voltmeter, with two test leads brought through flexible armor to a pair of insulated test handles. Rather than moving the work to the test leads, the prods can be used by the operator to apply voltage to a large number of capacitors without handling each individual capacitor.

For the sake of safety, the cabinet access doors are usually interlocked, and the low-voltage supply circuit to the plate transformer is usually brought through a pair of push button contacts on each test handle, convenient to the operator's thumbs during normal use of the prod. It is thus difficult to obtain voltage at the test handles unless the operator has one in each hand.

A schematic diagram for such a test set is given in Fig. 1. This set uses 115-volt 60-cps power, brought through a cabinet door interlock and fuse block to a motor-driven time-delay relay that prevents application of power to the plate

transformer until the tube filaments are heated. Provision is made so that filament power is on as long as the main line switch is closed independently of the plate power. Control of the plate voltage is obtained by a variable-voltage autotransformer in the low-voltage supply. Plate voltage is switched on and off by means of the two push-buttons in the low-voltage supply, which are physically located in the handles of the test prods.

The full-wave rectifier uses GL-866-A mercury-vapor tubes, and the d-c supply is filtered. A voltmeter and voltmeter multiplier, in this case a one-milliamperemeter and five-megohm resistor, are connected across the test leads. Between the rectifier and the filter, and between the filter and the test prod, 5,000-ohm resistors have been installed to limit charging current to one ampere. The 60,000-ohm resistor connected across the test leads provides a discharge path for the test capacitor after the plate voltage is removed. This resistor is larger than is necessary to limit the discharge current to one ampere because, as it is permanently connected across the d-c output, it must be high enough to keep the current that is drawn to a fraction of the available rectifier output.

When testing with this type of equipment, the voltage must first be preset to the desired test level. This presetting is simplified by providing protective scabbards for the test prods, close enough together so that the operator can press both buttons in the handles with one hand, leaving the other free to adjust the voltage control. The prods are then applied de-energized to

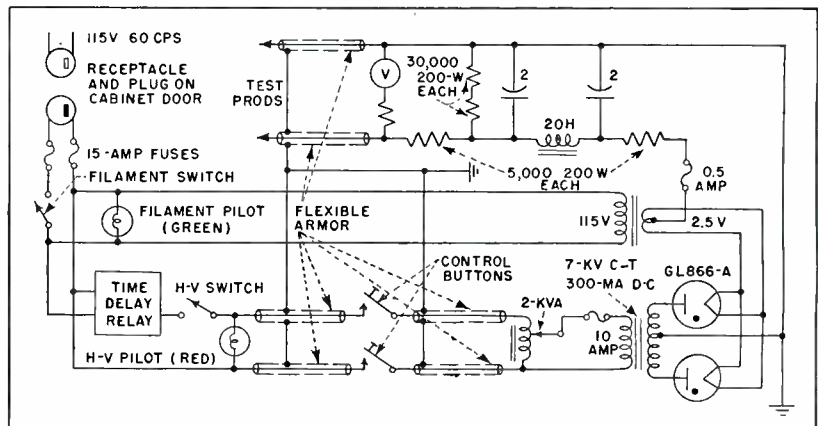

FIG. 2—Interlocks are major circuit features of this test cage equipment

the terminals of the capacitors to be tested, and the buttons on the handles depressed, after which the voltage rises to the preset level. After the required time of application of test voltage, plate voltage is removed by releasing the buttons in the handles, and the capacitor discharges through the resistor connected across the test leads.

Test Cage Type Equipment

For making tests above 5,000 volts, the interests of safety to the operator dictate using a test set with an interlocked test cage in which one capacitor at a time can be connected to the test leads. The wiring diagram of such a test set, rated 35 kv maximum, is Fig. 2.

This set includes a half-wave Kenotron rectifier, supplied through a variable-voltage transformer from a 115-volt 60-cps source. Failure protection is provided by both fuses and circuit breakers. Start and stop push buttons with suitable indicating lights are supplied to control the coil current to two contactors in series with the plate supply. Two contactors are provided to protect the operator in case one contactor sticks. Door and test cage interlocks open the coil circuit of these contactors.

Resistors are provided in series with the high-voltage lead between filter and discharge switch and between discharge switch and the test leads to limit charging and discharging currents to one ampere. An additional series resistance of 800,000 ohms is provided to limit the total plate current to the rating of the tube. In this set the discharge path is a solenoid-operated

Table I—Capacitor Sampling Table for Overvoltage Tests

Lot Size	Number of Samples			Allowable Rejects	
	First Sample	Second Sample	Combined Samples	First Sample	Combined Samples
Up to 299.....	25	50	75	0	1
300-499.....	35	70	105	0	2
500-799.....	50	100	150	1	3
800-1,299.....	75	150	225	2	4
1,300-3,199.....	100	200	300	2	6
3,200-7,999.....	150	300	450	3	9
8,000-21,999.....	200	400	600	4	11

If rejects from first sample exceed the allowable limit for a first sample, but do not exceed the allowable limit for combined samples, take second sample. If rejects from first sample or combined samples exceed the allowable limit for combined samples, reject lot for 100 percent tests.

switch between the high-voltage lead and ground. The voltmeter has 10-kv and 35-kv scales with a solenoid-operated multiplier switch.

Testing with this type of set is quite simple. After the filament of the rectifier has been heated, one capacitor at a time is connected to the test leads. With the gate and the plate circuit closed, voltage is raised slowly to the desired level by means of the variable-voltage transformer and is held at that level for the desired time. At the end of the desired holding time, the voltage control is turned to the zero position and the plate power removed by pushing the off button. This button also closes the discharge switch, thus draining the charge on the capacitor quickly enough so that substantially no charge remains by the time the operator has opened the cage to change connections.

With this type of set, capacitors should not be connected in parallel for test. With two or more capacitors connected in parallel, failure of one capacitor allows the other parallel-connected capacitor to discharge

through the resultant short circuit, with a discharge both oscillatory and of a high peak current.

Standard Test Voltages

Voltages to be used for over voltage testing of d-c capacitors have been standardized satisfactorily in the last few years. These voltages are now shown in proposed JAN C-25 Amendment 1, and it is anticipated that these same values will be recommended in industrial standards now being designed to cover capacitors for commercial use. Such test voltages include:

TERMINAL - TO - TERMINAL TEST VOLTAGE: 200 percent of rated d-c volts for 15 seconds, or 250 percent of rated d-c volts for one second.

TERMINAL-TO-CASE VOLTAGE: 400 percent of rated d-c volts for capacitors rated 600 volts d-c and below, and 200 percent of rated volts plus 1,000 volts for capacitors rated above 600 volts. The time of application of full test voltage is one second.

TEST VOLTAGE BETWEEN MULTIPLE SECTIONS: 200 percent of rated d-c voltage for a period of one second.

If capacitors are not purchased in accordance with the specifications listed above, recommended test values should be obtained from the capacitor manufacturer. If test voltages that are used are in accordance with applicable specifications, if precautions are taken never to exceed a charging or discharging current of one ampere, and if the test voltage source remains connected to the capacitor under test throughout the test, there will be little trouble from damage or failure of properly designed and constructed capacitors.

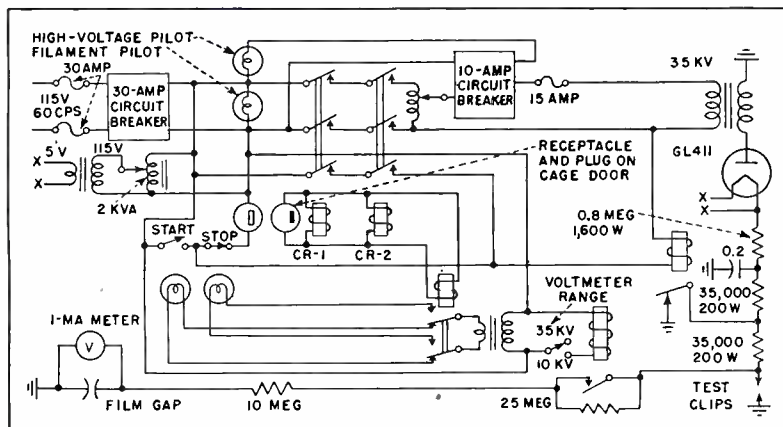

FIG. 1—Rectifier and controls of test prod equipment are straightforward

High-Fidelity

By EMERICK TOTH

Radio Techniques Section
U. S. Naval Research Laboratory
Radio Division II
Washington, D. C.

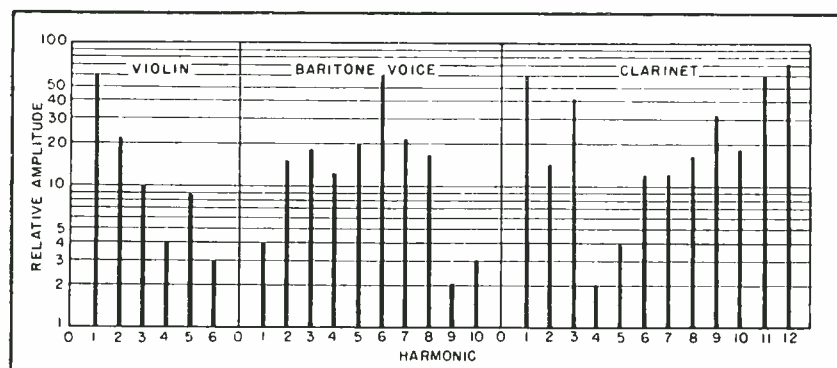

FIG. 1—Typical spectra of representative musical sounds

THE WAVESHAPES of sounds produced by single musical instruments are usually very complex, and the simultaneous sounding of large and diverse groups of such instruments, as in a symphony orchestra, produces wavetrains of tremendous intricacy and rapidly changing pattern. Typical spectra for single tones of three common musical instruments, the violin, the human baritone voice, and the clarinet, are shown in Fig. 1.¹ Even if only these three are sounded together, quite a problem in reproduction results. Furthermore, all musical instruments produce complex transients during attack, the initial surge with which the production of a musical sound often begins.

In quantitative evaluation of the sound-reproducing ability of receiving equipment, the receiver engineer may inject sine waves or square waves into the equipment one frequency at a time. He may even try to make measurements with two frequencies injected simultaneously, but all these tests will usually fall far short of indicating performance under actual conditions of use. Ultimately, he must rely heavily on listening tests.

Listening Test Considerations

The receiver engineer must know what he should expect to hear during a listening test. Program material (broadcasts or recordings) used for such tests should be faithful to the original sounds, but verification of this point is often difficult. Whenever possible, programs of high quality originating in local

broadcast studios of major stations should be used, rather than network programs which suffer various distortions during long-lines distribution.

The various forms of audio distortion are to a considerable extent interdependent, but in general for listening test purposes, it can be said that definition, that characteristic of reproduction which permits hearing four separately perceptible and distinct voices in a quartet even when they sound the same note together, is dependent on adequate high-frequency range. Depth or fullness of tone depends on adequate low-frequency reproduction. Smoothness depends on the freedom of the frequency characteristic overall from serious peaks and valleys of response and on low harmonic distortion. Absence of fuzziness depends on negligible intermodulation effects, and freedom from blurring (hangover on tones) is the result of good transient reproduction.²

With good reproduction, the listener should be conscious of a well-defined, full and smooth sound picture which recreates the essential character of the original sound pattern, even as a good color photograph creates the effect of fidelity to the original scene without necessarily giving a complete illusion of reality. And just as such a photograph need not provide the full range of light intensities encountered in the original, nor necessarily provide third-dimensional effects, so the sound-picture does not normally need the full amplitude range of the original

sounds and the presence of binaural effects to provide a high degree of psychological satisfaction.

Six Types of Distortion

In the course of designing a fine radio receiver, the engineer will inevitably have to contend with many forms of distortion. These can be more or less segregated as modulation distortion, frequency distortion, harmonic distortion, intermodulation (or cross-modulation), phase distortion, and transient distortion.³

Modulation Distortion

Modulation distortion is a form of harmonic distortion which in receivers occurs prior to the audio amplifier. It can be due either to the i-f (or r-f) amplifier preceding the final detector in an a-m receiver or that detector itself, or both. A common offender in the a-m receiver is the i-f amplifier stage driving the final detector; the plate current swing that the last i-f tube is required to provide is often such that it limits on modulation peaks.

Modulation distortion can frequently be detected in measurements by running an avc-on resonant overload characteristic (audio-output voltage vs signal-input voltage to the receiver) with constant 70-percent 1,000-cps modulation of the carrier and with the a-f output control retarded so that audio overload does not occur at any level of receiver input up to one or more volts of carrier.

Distortion can sometimes be detected even with only 30-percent modulation in such a curve. It will usually manifest itself as an irregularity in the resonant overload characteristic, generally in the form of an unwarranted rise. Figure 2 shows such a resonant over-

Reproduction of Music

Practical suggestions for minimizing modulation distortion, frequency distortion, harmonic distortion, intermodulation, phase distortion, and transient distortion in a-m and f-m receivers and in phonograph record reproduction. Listening tests are final criterion

load curve for 20-db reduction of a-f gain, along with the corresponding overall harmonic distortion curve and a curve of overload at full a-f gain for comparison.

The remedy for modulation distortion usually is to remove all or most of the avc control from the final i-f amplifier tube and to adjust the avc delay voltage downward, at the same time making certain that the a-f gain following the detector is of such a value as to allow audio output overload with 10 to 20 percent modulation of a strong carrier (about 1,000 microvolts) at the maximum gain position of the a-f gain control. All this, of course, presupposes that the final i-f amplifier is inherently capable of driving the detector without appreciable distortion. It is occasionally necessary to provide only half avc control on the next-to-last i-f stage in vhf and uhf receivers, with no avc on the final i-f tube.

Modulation Distortion in A-M Detectors

The final detector in an a-m receiver is a nonlinear device in terms of amplitude response, but is intended to respond linearly to the modulation envelope of the desired

carrier. Remarkably enough, it manages to do this quite well, and modulation distortion due to the detector in such a receiver generally appears mainly at the higher levels of modulation, usually above 50 percent.

Low modulation-depth distortion may be encountered with low carrier-level operation of the detector, but with avc operation the carrier levels at the detector are generally such as to insure low values of modulation distortion per se.

A primary cause of amplitude distortion at levels above about 50 percent modulation is a detector load circuit with a value of a-f load impedance considerably less than the d-c load resistance. The modulation depth at which this difference in loading will be effective in causing distortion is, with efficient detection, approximately the ratio of total a-f load impedance to the d-c load resistance. This distortion can be minimized by making the volume control, grid resistor, and other components generally connected across the detector load resistor have a composite impedance ten or twenty times as great as the detector load resistance. Alternatively, the detector

d-c load value may be reduced.

The r-f bypass capacitance across the detector load should also be kept as low in value as possible consistent with detector efficiency and preceding i-f (or r-f) amplifier stability. This will have the effect of reducing frequency distortion and maximizing recovery of the detector from surge input.

It is desirable to keep modulation distortion under 1 percent up to 70 percent modulation or higher if high-quality reproduction is desired. Higher distortion is tolerable between 70 and 100 percent modulation, however, since this range represents only about 3 db amplitude variation and on a statistical basis is utilized only on occasional very high peaks in properly monitored programs.

Modulation Distortion in F-M Detectors

Modulation distortion in an f-m detector is much more likely to occur for reasons outside the control of the designer than in an a-m system. The f-m detector is usually a two-step device; it first converts the carrier frequency variations into amplitude variations, then separates the resultant amplitude modulation from the carrier. Since the first conversion is practically always dependent on the alignment and tuning of some combination of tuned circuits, initial misalignment of the discriminator on the manufacturer's assembly line and mistuning of the receiver by the user can cause modulation distortion far beyond the designer's original figures. Temperature, humidity, line voltage variations, and aging effects can also ruin a beautiful discriminator characteristic through the medium of tuned-circuit frequency drifts.

Granting that alignment and

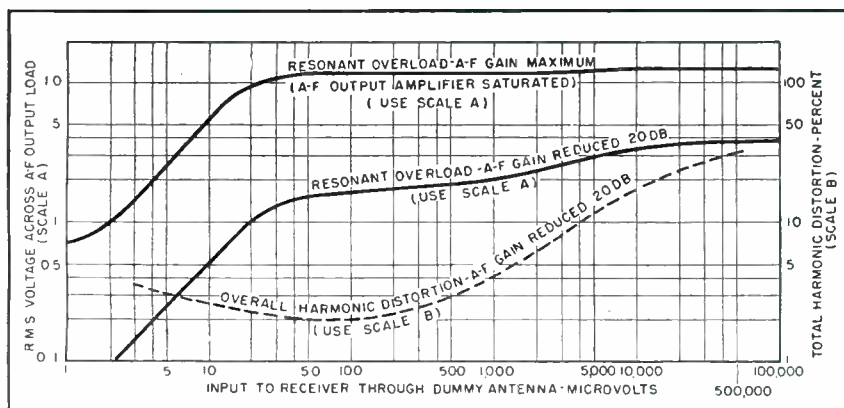

FIG. 2—Typical resonant overload and harmonic distortion characteristics of a-m receiver having undesirable i-f limiting. Carrier is modulated 30 percent at 1,000 cps

tuning are both excellent, so that the detector output-amplitude vs carrier-frequency deviation characteristic is symmetrical and the desired signal is accurately centered thereon, modulation distortion will then depend on the linearity of that characteristic and the portion about the center of the characteristic over which the desired signal sweeps in frequency. If that sweep should exceed the limits of the frequency deviation for which the discriminator is designed and reach into the two regions where the characteristic is reentrant or returns toward zero output, rather peculiar and serious harmonic distortion will result. The linearity of the amplitude-sensitive portion of the f-m detector will also be a factor to consider, particularly on small frequency deviations.

Frequency Distortion

Frequency distortion occurs when a constant sine-wave input voltage does not produce a constant output voltage over the frequency range of importance for the purpose intended. That range for essentially complete delineation of musical sound, including bow-scraps of string instruments and the click of valves on the wind instruments, extends from 20 or 30 cps to about 15,000 or 16,000 cps. The upper limit may be reduced to about 8,000 or 10,000 cps to largely eliminate these unpleasant noises without losing much of the desirable emission of musical instruments, although there is room for argument on this point.

Any deviation from constant amplitude in the useful range of the amplitude-vs-frequency characteristic will be evident as distortion of greater or lesser degree. When the deviation takes the form of smooth cutoff, without irregularities, it will have the effect of changing the harmonic distribution of musical instrument reproduction without introducing any new harmonics not present in the original. This apparent distortion is due mainly to reduction in amplitude of fundamental tones without equivalent reduction in

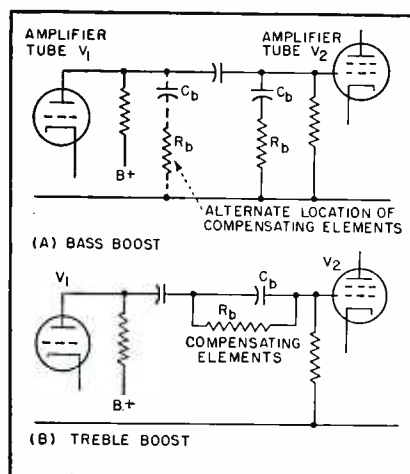

FIG. 3—Simple compensation networks for bass and treble boost

harmonic content and results in the type of thin and reedy reproduction generally obtained with small receivers on bass tones.

When cutoff occurs in the higher-frequency region (above 3,000 or 4,000 cps), with a continuous smooth decrease in response above the cutoff frequency, purification of musical tones by reduction of the harmonic content thereof results, a point of importance when spurious harmonics have been generated by nonlinear amplitude response, intermodulation, and other causes. This is probably the main reason why, usually in the presence of distortion, the human ear instinctively welcomes the so-called mellow reproduction resulting when the frequency range is decreased by gradual attenuation of the higher frequencies.

Frequency-Compensation Circuits

By judiciously offsetting the attenuation below 100 cps and above 4,000 cps, resulting from selective attenuation in pickup and transmission and sideband cutting due to insufficient bandwidth in the selective circuits preceding the final detector, the receiver designer can often modify the frequency characteristic of his audio systems to advantage. Such correction requires intelligent boosting of the low and high ends of the audio frequency-response characteristic, but at the high end this can be done safely only in the absence of appreciable other distortions.

Figure 3 illustrates the simplest and most satisfactory means for accomplishing these boosts; resistive and capacitive elements are used, largely avoiding the damped oscillations encountered with inductive elements which generally have appreciable Q and which tend to resonate with the unavoidable circuit capacitances.

The equations for the circuits shown are somewhat complex, but excellent universal curves are available to facilitate solution.⁴ Care should be taken to allow for the reduction in stage amplification associated with use of these networks, and to ascertain that permissible plate-current swings are not exceeded interstage before overload of the output stage occurs.

The design engineer would do well to consider the input capacitance and resistance of each tube in a new audio amplifier design at several frequencies, starting at the output stage and working toward the final detector, with the aid of the well-known equations.

$$C_i = C_{gk} + C_{gp} (1 + A \cos^2 \theta) \quad (1)$$

$$R_i = -\frac{1}{\omega C_{gp}} / A \sin \theta \quad (2)$$

where C_i = input capacitance, R_i = input resistance, C_{gk} = grid-to-cathode capacitance, C_{gp} = grid-to-plate capacitance, A = voltage amplification from input to output, θ = phase angle of output load, and $\omega = 2\pi \times$ frequency. R_i will generally be of importance only at the low and high ends of the audio frequency range, or at the frequencies where the fidelity curve departs from linearity by a substantial amount. This information is often of great assistance in the choice of amplifier tube types and in initial computation of compensation-circuit values.

Any frequency compensation incorporated in a design will be a compromise since some of the factors making it desirable are variable and out of the receiver engineer's control. The final characteristic evolved should be carefully checked by listening tests and should be incorporated in the design in fixed form so that the tendency on the user's part to mix

his own is avoided as much as possible.

Harmonic Distortion

When a transmission network, such as an audio amplifier, does not produce the same proportionate increment of output for a given increment of input at all input levels, amplitude or harmonic distortion results. This generally manifests itself by the appearance of harmonics not present in the original signal. It is no longer a matter of merely change in relative amplitude of the harmonics, as is the case with frequency distortion. Rather, new and disturbing harmonics also appear which cause the tonal quality of the music to change as its instantaneous amplitude varies. This can be quite an intolerable form of distortion, usually most evident at high audio output levels.

The major cause of this form of distortion (other than modulation distortion) is almost invariably nonlinearity of that portion of the amplifier tube plate current-grid voltage characteristic actually utilized in each individual amplifier stage. The only safe course for the designer to follow is to use tube types, plate loads, and operating potentials which insure plate current excursions well within the linear portion of each individual tube's plate current-grid voltage characteristic. Harmonic distortion is usually cumulative, although cancellation effects are occasionally obtained in several stages.

It is usually best to use triodes for the output stage and the one preceding it. For a given amount of distortion, the distribution of harmonics will be such that the reproduction is less harsh to the ear with triode output tubes than with tetrodes or pentodes. Relatively heavy inverse feedback may be employed with tetrodes or pentodes to produce performance equivalent to triode output stages, but with certain disadvantages. No shunt capacitors, for instance, seem to be needed at the plates of triode output tubes for stability with light feedback, whereas heavy feedback with a pentode output

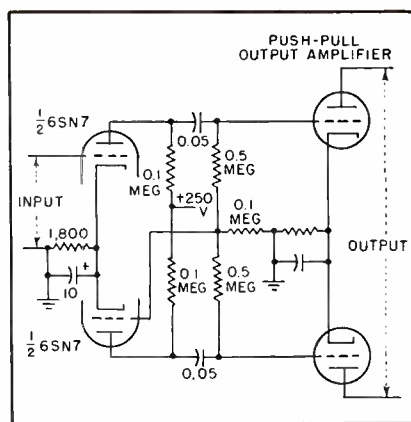

FIG. 4—Amplifier with RC network providing pushpull output from single input

stage may necessitate shunt plate capacitors and other corrective measures to overcome low and high frequency instabilities caused by feedback phase-angle shifts.

Push-pull operation, with its attendant cancellation effects on even-numbered harmonics, is advantageous for the output stage and may then be a necessity for the preceding stage. Figure 4 shows one of the simplest and cheapest ways of providing push-pull operation using R-C load elements only.

The a-f load presented to the plate circuits of the audio amplifiers preceding the output stage should not be much lower than the d-c plate load, otherwise distortion similar to (although not as serious as) that encountered with low a-c to d-c load ratios in the detector will occur.

Lower-pitched or bass instruments usually have the greater amplitude swings and generally are richer in harmonics. These consequently are the most likely to be subjected to the addition, both in number and magnitude, of spurious harmonics by harmonic distortion in reproduction. In addition, the bass tones may cause harmonic distortion of the smaller-amplitude treble tones whose wave-trains "ride" up and down the lower-frequency peaks.

Intermodulation

The condition of nonlinearity with regard to amplitude response which generally produces harmonic

distortion will also tend to cause intermodulation. This effect results from modulation of a wave of one frequency by one of another frequency. It is usually present with harmonic distortion, even though the two are separate effects. When the resultant modulation products are inharmonic, the distortion will not only change the tonal quality but also make it unpleasant. While harmonic distortion is harmonious up to perhaps the fifth harmonic, the intermodulation products are generally inharmonic or discordant, with higher-order products particularly annoying. Even in an otherwise excellent reproducing system, the intermodulation products may appear as a sort of shimmering acoustic fuzz of very high spurious audio frequencies, which changes with the instantaneous loudness of the music.

The same precautions which reduce harmonic distortion will also help eliminate intermodulation. Each stage in the audio system must be carefully checked by the designer as regards linearity, even to the extent of considering some inverse voltage feedback in individual stages where the likely plate-current swings warrant or allow. Intermodulation effects usually are more serious with tetrodes or pentodes than with triodes.

Phase Distortion

Phase distortion is generally said to occur when the relative time relationships between the fundamental and the various harmonics of a sound are modified in reproduction. If the fundamental is reproduced and the inception of the second, third, and other harmonics is progressively advanced or retarded, a peculiar distortion which can be very disturbing to the listener occurs. Fortunately, the human ear is tolerant of phase shifts of this type, even though the condition of two ears feeding information into one brain seems to allow the instantaneous comparison of minute phase differences which produces the effect of binaural hearing. An occasional individual can detect small phase

shifts in musical chords that are not apparent to the average listener. Phase distortion will often be masked by other distortions to the extent that it is no longer apparent.

Phase distortion in receiving equipment usually occurs mainly after demodulation in the final detector, and is generally associated with frequency distortion caused by inadequate coupling and filter capacitances in the audio system and by shunting capacitances interstage. Boosting of the low and high-frequency ends of the amplitude-vs-frequency characteristic of the audio system will help to correct for cumulative phase shifts occurring therein; over-compensation will additionally tend to correct for phase displacements external to the receiver.

Transient Distortion

All audio amplifier networks incorporate both reactive and resistive elements and are therefore capable of some degree of oscillation due to the storage and discharge of electrical energy. This is especially evident with LC circuits, but can also occur with RC elements exclusively, as evident in relaxation oscillators and in motor-boating effects. A steep wavefront, such as that generated by percussion instruments, may set up several cycles of spurious oscillation under suitable conditions even in a resistance-coupled amplifier system. The designer must be on his guard against such a possibility, especially at the lower audio frequencies, where common coupling may exist due to use of a single power supply source for plate voltage or insufficient isolation of cascaded stages from each other.

Any abrupt rise and fall of the amplitude-vs-frequency characteristic amounting to more than 1 db above the average level in its vicinity should be viewed with suspicion. This includes the loudspeaker, which is almost always characterized by many such peaks and valleys indiscriminately distributed over its useful spectrum, with amplitudes often 5 to 10 db above or below the average level.

The engineer can counteract

transient distortion to a considerable extent by:

(a) Use of an output stage with a low plate impedance approximately matching the load resistance of the loudspeaker through a good transformer. This generally dictates triode rather than tetrode or pentode output tubes.

(b) Incorporation of considerable negative voltage feedback, as nearly as possible from output to input of the entire audio amplifier system (in addition to use of triode output tubes).

(c) The use of two or more similar loudspeakers of slightly different acoustic characteristics, such as are obtained by small differences in the resonant frequency of their diaphragms. This difference will displace the peaks of the loudspeakers relative to each other, so that the tendency will be for the peaks of one to fill in the valleys of the other. Also, the smaller diaphragms then possible (for a given acoustic power output) will behave more nearly like simple pistons.

The first two methods will pro-

duce damping effects on the loudspeaker voice-coil system and will tend to level off the peaks and valleys by maintaining constant voltage output across the voice coil despite variations of voice coil impedance with frequency. Any bass and treble boosts become less evident as the amount of inverse feedback is increased but still serve, if properly proportioned, to correct interstage phase shifts which would otherwise displace the feedback voltage angle near the frequency limits of amplifier response. Any boost incorporated prior to the point of application of feedback voltage to the input of the amplifier will usually remain effective.

The need for adequate baffling with cone-type loudspeakers has been stressed a good deal in the past. Perhaps the best system devised to date is the totally enclosed infinite-type baffle wherein no opening is provided for radiation from the rear of the loudspeaker diaphragm. It is essential that an adequate volume be provided in the enclosure, with wall reflections minimized to a reasonable degree by suitable damping materials.

Adequate baffling, by providing better acoustic loading of the loudspeaker, will aid in the reduction of transient distortion, as well as in improving frequency-response characteristics. Proper acoustic loading of the diaphragm increases loudspeaker efficiency and reduces the tendency for movement of the voice coil out of the uniform flux region of its associated magnetic circuit, a condition often encountered with even moderate output levels when the acoustic loading (or the magnetic circuit) is inadequate and the audio amplifier provides good bass response.

Inverse Feedback

The most potent single tool available to the designer of high-fidelity receiving equipment is inverse or degenerative voltage feedback. Through its use, practically all the various forms of distortion discussed above (except modulation distortion) may be reduced to a very considerable extent with little complication of design.

Since phase relations are in-

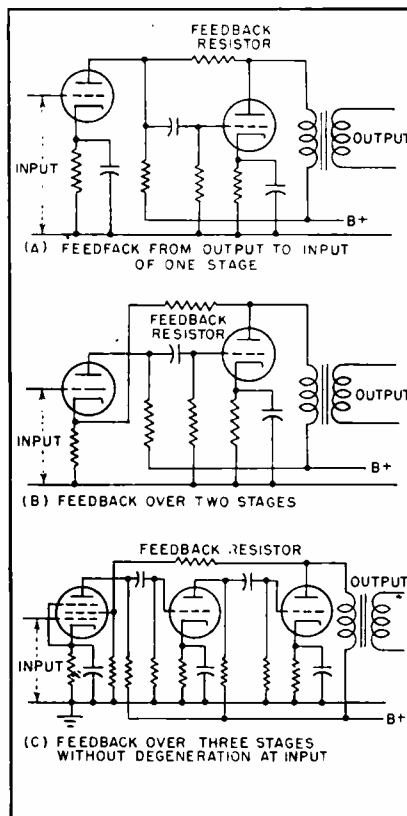

FIG. 5—Inverse feedback circuits employing only resistance in the feedback path. Plate circuit isolation filters and other conventional details are not shown

volved in an overall feedback loop, phase distortion may be a cause of difficulty. If corrective measures such as bass and treble boost networks are provided, the main item of concern will usually be the feedback path itself. Fortunately, it is quite easy to provide feedback paths that are essentially nonreactive, and consequently substantially free of phase-shifts in themselves. A few of these are shown in Fig. 5; they are all characterized by employing only resistance in the feedback circuit proper. These circuits therefore cost little to add and require practically no additional space, although the consequent reduction in audio amplification should be allowed for in the design.

Since a sufficient degree of inverse voltage feedback will make the output voltage quite independent of the value of output load impedance, it will allow the addition of one or more loudspeakers in parallel without affecting the output level appreciably at any unit already connected, assuming the output amplifier can provide the necessary power through an output transformer of suitable design (no taps are necessary). This effect is illustrated in Fig. 6, where the addition of 19 more 600-ohm loudspeaker units on the output line of this particular receiver drops the output line voltage level less than 25 percent. Thus the listener at any operating unit will hardly notice the connection (or disconnection) of any of these added units.

Phonograph Record Reproduction

When the amplifier and loudspeaker system are matched by a properly compensated phonograph pickup which has a wide frequency response free of peaks in the useful frequency range, two effects should be noted. The first will be good reproduction with good recordings. The second, perhaps unexpected, will be the substantial disappearance of the needle-scratch problem, except with very old or poor records. Needle scratch appears to be an impact-excitation phenomenon, in which record surface irregularities set up oscillations in the overall reproducing

system at frequencies corresponding to the peaks in overall response. On a statistical basis, peaks in pickup response can increase overall noise level without a corresponding apparent increase in loudness of desired sounds, because surface noise excites the peaks constantly but desired tones occur at peak frequencies only occasionally. Freedom from such peaks provides remarkable immunity from needle-scratch effects and will generally make scratch-filtering networks unnecessary.

Conclusions

Evaluation of a radio receiver as a device for reproducing music should be based primarily on its ability to present a full, well-defined, smooth sound-picture, similar by analogy to a good color photograph in the field of visual reproduction.

If distortion of the sound-pattern (other than amplitude-compression) is present which cannot for good and sundry reasons be eliminated, the only possible choice for the average listener is restriction of high-frequency response. Smooth, clean reproduction up to 4,000 or 5,000 cps is vastly to be preferred, in most instances, to a 10,000 or 15,000-cps range with perceptible distortion.

If the average well-qualified listener shows strong preference for a restricted frequency range, it is excellent prima-facie evidence of excessive distortion in reproduction, regardless of measured characteristics of the system. Conditioning effects of long-term exposure to poor reproduction must be kept in mind, however, along with the fact that individual hearing capabilities vary considerably. Professional musicians may not be too good a choice for listening tests, since their main concern is usually the emotional content of the music.

The possible advantage of f-m systems in providing high-quality reproduction of music may be abrogated or lost by inadequate discriminator design, tuned-circuit drifts, and structures not allowing precise mechanical tuning or accurate indication of centering of the signal on the discriminator characteristic.

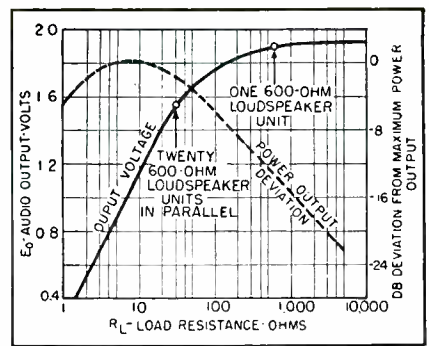

FIG. 6—Effect of large degree of inverse voltage feedback on audio output voltage and power, for feedback arrangement of Fig. 5B. Audio gain is adjusted to provide 6 milliwatts output into 600 ohms

Measurements of modulation distortion and harmonic distortion at various audio frequencies and over a range of 1 to about 2,000,000 microvolts carrier input should be considered as routine as the more usual amplitude-vs-frequency measurements for both a-m and f-m receiver equipment.

The design of receivers capable of giving very satisfactory reproduction of music is not unusually difficult nor expensive, but does require good acoustic or musical judgment on the part of the designer because of the great difficulty of evaluating overall performance with presently available equipment and methods.

The writer hopes that in the near future many more receivers will become available to the public, at reasonable prices, which recreate the snap, sparkle, and rich beauty of music. The presently available reproduction is in too many cases entirely inadequate, and often unnecessarily so. There is little hope of getting consistently good transmission and recording of music from the broadcasters and record-makers until the receiver designers and manufacturers make it possible to reproduce the quality even now available in the better programs and recordings.

REFERENCES

- (1) John Redfield, "Music: A Science and an Art", Alfred A. Knopf, 1928.
- (2) Harvey Fletcher, "Hearing—the Determining Factor for High-Fidelity Transmission," *Proc. IRE*, June 1942.
- (3) K. R. Sturley, "Radio Receiver Design, Part I", John Wiley and Sons, Inc., 1943.
- (4) K. R. Sturley, "Radio Receiver Design, Part II", Chapman and Hall, Ltd., 1945.

FCC FREQUENCY Measurement Techniques

Received signals up to 500 mc are quickly referred to markers emanating from a standard that is accurate to better than one part in ten million. Frequency subdivision to 50 cycles allows comparison between the standard and time signals. Sense of the final interpolation between 10-kc markers is by means of a lower frequency standard

By

ALFRED K. ROBINSON

*Radio Engineer, Federal Communications
Commission
Santa Ana Primary Monitoring Station
Santa Ana, Calif.*

ONE DUTY of the Federal Communications Commission is measuring frequencies of radio transmitters at central monitoring stations. It is important, therefore, that the accuracy of the reference standard surpass the frequency tolerance required of the transmitting stations and that the means of comparing the received signal with the standard be simple, quick, and accurate.

Basically, the system used depends upon a primary standard that will maintain an accuracy of better than one part in ten million over long periods of time, and is capable of being compared frequently with time signals from the Naval Observatory. In practice, 10-kilocycle markers are derived from the primary standard by frequency division and the incoming signal is caused to beat with the nearest marker. The beat note, always less than 5,000 cycles, is measured by an audio interpolation oscillator.

Accurate Comparison

Audio comparison can be made at any frequency by use of an audio-frequency oscillator, similar to the General Radio type 617, variable from 0 to 5,000 cycles. This instru-



Santa Ana Monitoring Station, showing disposition of a few of the antennas

ment has a maximum error of plus or minus 2 cycles throughout the range and the error remains constant regardless of the frequency of measurement. However, even this slight error can be reduced if outputs from the standard at 1,000 cycles and 50 cycles are made available for interpolation. The only remaining source of error is the ability of the engineer to match the audio tone (resulting from the nearest standard 10-kc point beating with the signal) to the audio interpolation oscillator. This error can be serious and depends largely upon the experience of the engineer in matching tones and the care he takes. Even experienced engineers have frequently matched the second harmonic of one tone with the fundamental of another.

Complete elimination of the human error in matching these tones therefore represents a definite for-

ward step in measurement work. The system devised to eliminate this error entails energizing the vertical plates of an oscilloscope with the i-f signal from the last i-f amplifier stage of the receiver and sweeping horizontally with the audio-frequency voltage from the audio interpolation oscillator. Proper adjustment of the scope amplifiers (it is only necessary to preset this adjustment once for all signals) will result in a trapezoid pattern when the difference between the incoming signal and the closest standard 10-kc point is matched by the audio frequency of the interpolation oscillator. This trapezoid will result only when the two frequencies are identical, thereby eliminating the error possible from use of a meter indicator by comparing the audio frequency with a harmonic or subharmonic of the fundamental frequency.

When the trapezoid is stationary on the screen the two signals are matched. Any difference between them will cause the pattern to revolve one way or another. Accordingly, the engineer has merely to stop this pattern to obtain exact zero beat. Actual frequency comparisons using this method are practical when the difference between the standard and signal are as low as 5 cycles using a 5-inch Dumont oscilloscope. This is true even on comparatively weak signals. As it is easy to count accurately well beyond this figure it is obvious that the so-called blind spot (10 to 50 cycles), where receiver audio systems and human hearing are undependable, is completely eliminated together with all the auxiliary apparatus necessary to overcome it by other means.

Overmodulation Check

The usefulness of such a system in the accurate measurement of broadcast station frequencies or any station with close tolerance requirements is readily apparent. Proper adjustment of the standard

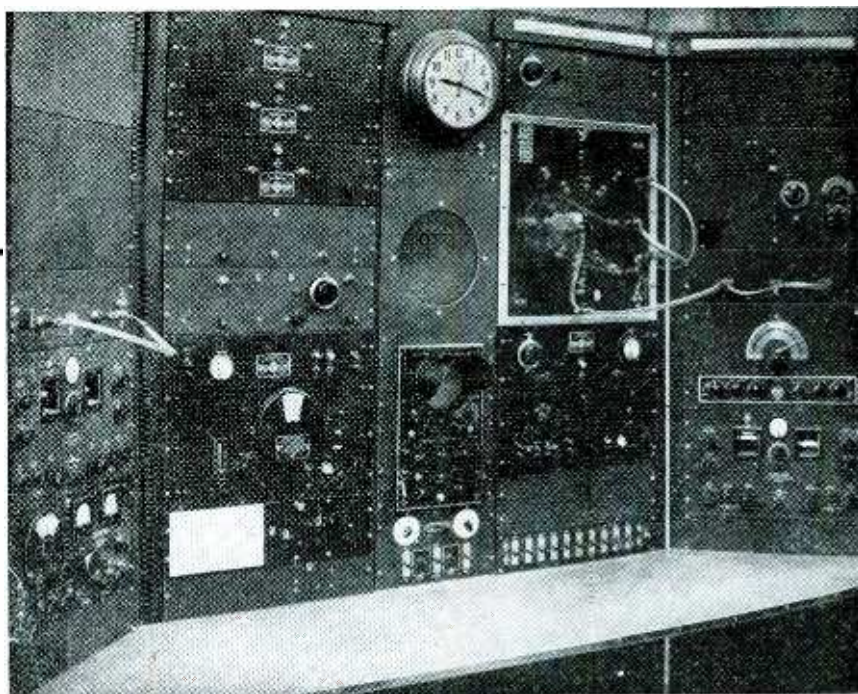

FIG. 1—Block diagram showing the primary standard and divider chain that permits arrangement for maximum flexibility and speed

signal level will result in blanketing a large portion of the modulation of A3 signals, thus permitting a sharply defined trapezoid even under heavy modulation. Any type of A0, A1, or A3 signal can be measured in this fashion.

Further advantage results from the fact that the signal being measured can be continuously monitored at the audio output of the receiver, and that overmodulation present in an A3 signal is immediately apparent. The scope pictures the radio-frequency envelope of the signal in

much the same manner as if the equipment were coupled directly to the transmitter.

Local Substitution Oscillator

When the signal is on for an extremely short interval as is the case with aircraft transmissions, the above procedure cannot be employed. The length of time required to turn the audio oscillator from one end of the dial to the other is greater than the time the station remains on the air. In such cases a heterodyne frequency meter is used. This equipment comprises a stable calibrated oscillator whose fundamental or a harmonic is tuned to the frequency being measured. The output from this oscillator must be evenly controlled and injected into the receiver in the same manner as the standard. Once the signal from this oscillator is at zero beat with the station signal the oscillator frequency is measured in exactly the same manner as an A0 signal at the received signal frequency. The calibration of the oscillator is therefore unimportant except to indicate the order of harmonic and for identification of 10-kc points in the very high frequency range as explained later. The errors in setting this oscillator to zero together with that introduced by possible interim drift are

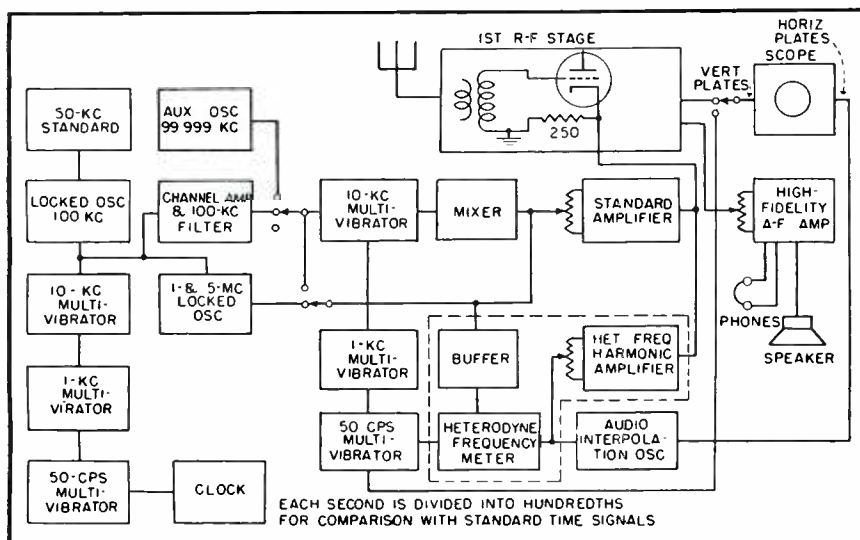

FIG. 1—Block diagram showing the primary standard and divider chain that permits comparison with Naval Observatory time signals. The auxiliary oscillator is used to determine sense of the final audio interpolation

much greater than by a direct comparison of the standard with the signal. However, in the event of off-frequency operation the frequency may be checked exactly by setting up according to the heterodyne frequency meter measurement technique and remeasuring on the next transmission using the direct beat method. The audio interpolation oscillator dial would only have to be shifted slightly to obtain the trapezoid. This same method can be used in the case of A2 or carrier shift signals. Exact measurements follow the preliminary heterodyne frequency measurement technique whenever greater accuracy is desired.

Identifying Markers

It is noteworthy that the only computation necessary in this method of measurement is that of identifying the nearest 10-kc point. The point is checked by counting the number of 10-kc points above or below the nearest 100-kc point, which in turn is readily identified from the receiver calibration or from the nearest 1,000-kc marker. This method can be used up to approximately 50 mc. Above this frequency it is best to use the heterodyne frequency meter technique by zero-beating at a harmonic of the heterodyne meter, measuring the fundamental of the heterodyne frequency, and then multiplying by the harmonic order. The actual frequency can be measured with the same degree of accuracy by beating directly against the standard once the 10-kc point used is identified. To simplify computation the tenth harmonic of the heterodyne frequency oscillator is normally used.

The useful output from the conventional multivibrator is limited to approximately 15 mc. This range was formerly extended to perhaps 25 mc by the use of tuned r-f amplifiers. There are several disadvantages to such tuning. The principal ones are the time element, the variable level due to tuning, and the inconvenience of adjustment.

Harmonic Amplifier

To provide strong, clean standard 10-kc points up into the ultrahigh-frequency range without tuning, a harmonic or distortion high-gain

amplifier was designed. The principal design characteristics are in accordance with published¹ high-frequency resistance-coupled amplifier requirements with the exception that here high distortion is desirable as a harmonic producer. The unit comprises three stages of amplification with a single bias control that gives smooth 100 percent control. Output levels of individual harmonics of the standard are largely constant irrespective of frequency.

Bias control is the principal one for all measurements. Once a signal is tuned in, the standard injection level is set by means of this control to the same as that of the signal, thereby modulating the incoming signal at the audio-frequency difference. This difference is then matched by means of the audio interpolation oscillator as explained previously. The audio difference as matched is plus or minus from the nearest 10-kc point.

Determination of the sense is quickly found by throwing a switch marked standard-auxiliary to the auxiliary position. In this position the standard has been disconnected and an auxiliary crystal oscillator slightly lower in frequency is connected. All multivibrator outputs are shifted a like percentage. Therefore the beat between the nearer 10-kc marker and the station signal will increase or decrease in frequency depending upon whether the station is high or low in frequency.

When the audio beat is as high as 4,000 cycles, this slight change in tone may be hard to detect by ear. Readjustment of the audio interpolation oscillator to obtain the stationary trapezoid in the auxiliary position will give the same sense indication by an increase or decrease in dial setting. Determination of the 10-kc point used can be checked by counting to the nearest 100-kc marker.

Zero beating the heterodyne frequency meter with the signal requires that strong clean harmonics be available. Since a sine-wave output is available, whereas the standard multivibrators have a distorted wave to start with, a four-stage untuned harmonic generating amplifier was found neces-

sary to extend the useful range of this instrument from 10 mc to well above 500 mc. Bias for level adjustment is controlled in exactly the same manner as on the standard.

Practical Measurement Techniques

Many refinements have been added to fit the particular needs of the monitoring station. For example, both the standard and heterodyne frequency meter outputs are injected into the receivers at the cathode of the first r-f tube. Several gains important to monitoring station operation are thus realized. Interunit connections are made at low impedance and the cathode connection isolates the standard and heterodyne meter outputs from the antenna circuit. Undesirable radiation that might interfere with reception at other monitoring positions is eliminated. The cathode connection also allows the antenna or grid circuit of the receiver to be shorted, eliminating the incoming signal while still permitting the heterodyne frequency meter and standard outputs to be mixed in the receiver.

Another useful refinement allows switching the 50-cycle multivibrator output (that drives the primary standard clock) to the vertical plates of the scope, and switching the output from the 50-cycle multivibrator (used for audio interpolation) to the horizontal plates. As each of these units is controlled in turn by successive multivibrators a quick check is possible of the correct operation of all control equipment. The figure on the scope is almost a perfect square which remains absolutely fixed providing all apparatus is functioning normally.

The inputs and outputs of all apparatus are brought to a central switching panel in front of the engineer, permitting instantaneous operation of various receivers, disc and tape recorders, filters, and other special equipment. An antenna switching arrangement in use at one of the monitoring stations permits pushbutton selection of any antenna on the reservation.²

REFERENCES

- (1) F. E. Terman, "Radio Engineers' Handbook", McGraw-Hill Book Co., New York, 1943.
- (2) Alfred K. Robinson, Automatic Antenna Switching, *QST*, p 38, April 1945.

VANE-ACTUATED CONTROLLER

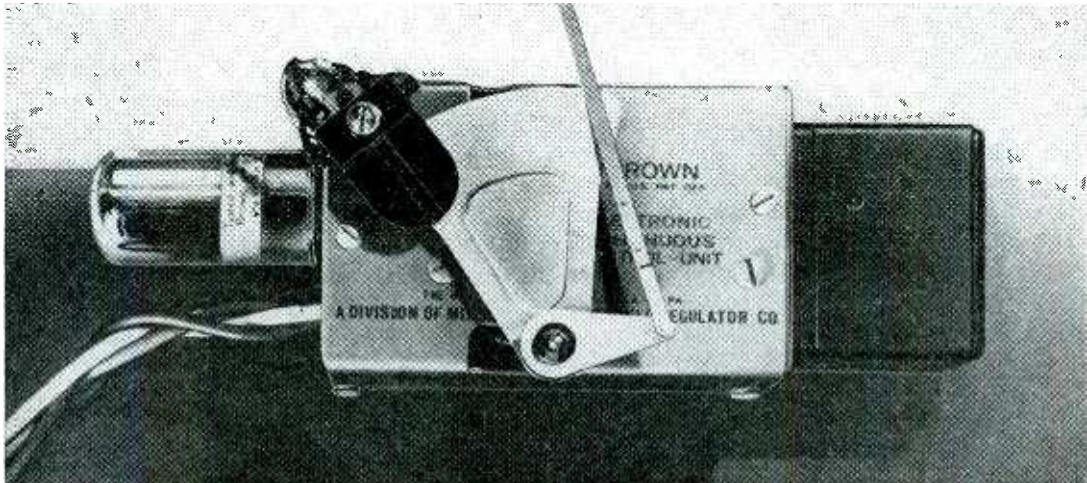

Complete control unit, with double-triode oscillator tube at left, plastic-imbedded coils between which vane sector moves, and relay in plastic housing at right. Lever goes up to recording pen or to other mechanical sensing element that is to initiate control action

A double-triode r-f oscillator changes its plate current suddenly as a vane moves between the coils, giving snap action of the output relay for industrial control applications involving float, feeler gage, or other sensing elements moving as little as 0.002 inch

By **W. H. WANNAMAKER, Jr.**

*The Brown Instrument Co.
Philadelphia, Pa.*

ON-OFF, two-position and three-position controllers are often used for control and limit type signalling applications because of their simplicity and low cost. An on-off controller will result in control action such that the measured variable will exhibit periodic cycling about a set point. The magnitude of this cycling and the extent of departure of its average value from the set point can be reduced by the use of more responsive measuring and controlling means. The effect of any remaining cycling may be of no practical significance in many processes, but where it cannot be tolerated, more sophisticated controllers are available which employ some combination of control forms

having proportional, floating, and rate action.^{1, 2, 3} The units dealt with herein are designed for use either as on-off, two-position or three-position controllers.

Vane-operated electric control systems are not of recent origin, having been used in various ways for a period of years.^{4, 5, 6} More recently, specialized forms employing the oscillator principle have been described^{7, 8, 9, 10} and a number of patents have been granted on different commercial adaptations.^{11, 12, 13}

Theory of Circuit

The control unit described in this article utilizes a double-triode tube. One section of the tube works as a

constant grid potential oscillator. Its average current plus that of the second section, which is connected in parallel, is used to control the energization of an electro-mechanical relay. The nature of this oscillator circuit is such that the average current output of the tube is a discontinuous function of the amount of mutual coupling existing between the control coils, and does not depend upon change in tuning of any circuit. This results in snap action of the relay, independent of the speed with which the vane may pass through the control zone, and also results in long-time stability of the controller. Any tendency of the relay to chatter due to mechanical vibration of

the vane within the coils is suppressed.

Referring to the equivalent r-f circuit in Fig. 1, a difference can be seen between this and a conventional tuned-plate or Hartley oscillator for the reason that any r-f current flow in the coupling coil results in a degenerative voltage drop which has a stabilizing action. It can be shown that the criteria for sustained oscillation, where the mutual coupling M is the variable, may be substantially described by the equation given in that figure. The negative sign denotes that the cathode connection must be of the same instantaneous potential sign by induction as is the plate coil connection.

In such an oscillator the grid-to-plate and grid-to-cathode interelectrode capacitances, which are fixed, only affect the frequency of oscillation, while the starting or stopping of oscillation for effecting relay operation is entirely controlled by variation in the positive feedback voltage. In consequence, the resultant action is extremely sharp and, in fact, is discontinuous. The differential movement of the vane to secure operation of the relay is of the order of 0.002 inch in the design under discussion.

Circuit Constants

The actual circuit diagram is given in Fig. 2. The oscillator, which operates at 30 mc, is composed of a fixed tuned-plate circuit with a tickler coil in the first tube section cathode circuit which provides not only voltage feedback but also degeneration due to the impedance drop occurring for current flow. The second parallel tube section has its grid connected to the oscillator grid so that the average current thereof is also controlled in accordance with the vane position, although this section does not oscillate. The use of this second parallel triode results in about 60 percent more current being available for relay operation, thereby providing greater power output and permitting use of a lower-resistance relay coil with consequently larger wire size.

Capacitor C_s is an r-f bypass shunting the d-c load and plate supply source. C_s , acting in paral-

lel with the plate-to-grid and plate-to-ground stray capacitances, forms the capacitance of the oscillator plate tank circuit, the effective value of which is of the order of ten micromicrofarads for 30 mc.

Capacitor C_1 affords an r-f grounding means for the grid. It also permits the average grid potential to become highly negative during the oscillation mode when the cathode fluctuates in its potential, causing the grid circuit to draw current. The combination of C_1 and R_1 introduces some time delay for relay closure to occur, and is selected as required to prevent relay chatter under cases of vibration often encountered in industrial applications. This portion of the circuit may be easily altered to produce other values of time delay. For reasons of safety the cathode bias resistor R_2 is chosen to limit

permissible current of the nonoscillating triode section and is held to somewhat closer tolerances (5 percent) than is the grid resistor or other components (20 percent). If the emission of the oscillator section falls below a fixed minimum, or its continuity is broken, sufficient current cannot flow to hold the relay closed. Moreover, the use of safety bias resistor R_2 and operation of the oscillator as a series-fed type insure that the relay cannot be energized should any coil, transformer winding, or coil lead become open-circuited.

Inductance coils L_1 and L_2 are conventional pancake coils, with the number of turns chosen to provide satisfactory oscillator characteristics and allow the relatively large dimensional spacing of 0.150 inch between coils. Such a space factor permits the coils to be impregnated

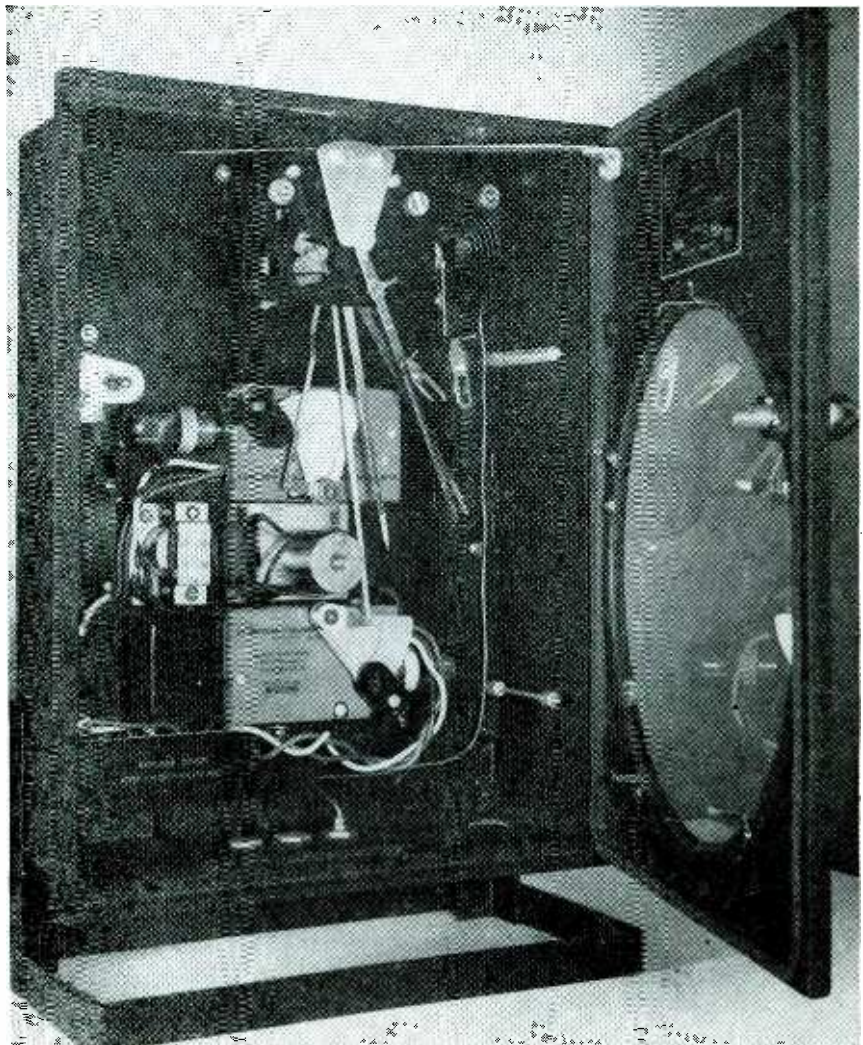

Duplex vane-actuated controller being used with recording thermometer from which chart and chart plate have been removed to show the control units. Each of the two recording pens is mechanically linked to one of the vanes

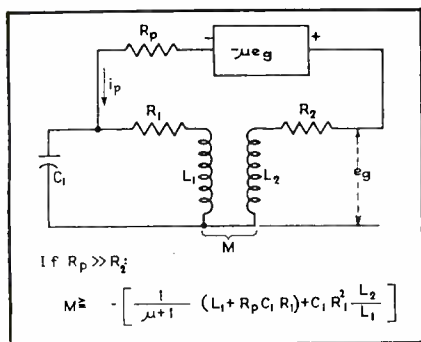

FIG. 1—Equivalent r-f circuit of controller, with criteria for sustained oscillation

directly within a form of plastic material having low water absorption properties. Ample space through which the control vane can move is provided without close dimensional tolerances being imposed on the associated mechanical components.

With reference to the mathematical expression in Fig. 1, the factor R_1 is seen to be present in the expression for the mutual inductance required for oscillation. Inasmuch as leakage around the coil and dielectric losses caused by moisture enter into this factor, it is important to prevent moisture absorption, which tends to cause control point shift or unsafe failure.

Capacitor C_2 , utilized as a ripple filter across the relay coil, is of the electrolytic type. The filtering problem is not severe because of the snap action inherent in the constant grid potential oscillator.

Mechanical Arrangement

In order to facilitate control point alignment with the actual control zone within the coils during assembly, the base of the vane is held against a shoulder on its driving shaft by means of a friction clutch so that its relative angular position with respect to its actuating lever may be shifted manually. This also permits a single standard unit to be used for either direct or reverse control action, as might be required for refrigeration applications, and still provides the maximum in safeness of operation.

A mechanical differential linkage arrangement is used in the instrument so that the vane position is a function both of the control index setting and the instrument pen position. The index setting can be

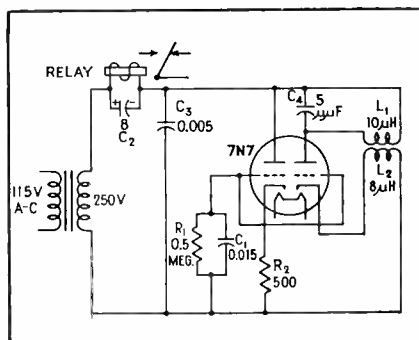

FIG. 2—Complete circuit of vane-actuated controller operating directly from a-c line

manually changed by means of a knurled knob above the instrument chart plate, accessible when the door is opened. The setting can be shifted to any position of the scale. No mechanical restraint upon the recorder pen movement is imposed by the control unit because the vane width is somewhat greater than the angular distance it moves for full scale pen travel. The use of the differential mechanical control point setting means permits the oscillator coil assembly to be fastened permanently in place so that it leads require no flexing during operation.

Operation

In Fig. 3 the current for effecting relay actuation is plotted against the position of the controlling vane edge. The abrupt change in this current at the critical vane position is readily apparent. The actual vane movement differential to effect relay operation is represented by the distance between the vertical dotted lines. These curves were obtained using an average tube in regard to mutual conductance. Tests indicate that the same type of curves is obtained on all similar tubes, even those having operated many thousands of hours. However, from tube to tube the control point was found to deviate ± 0.012 inch from an average value—equivalent to one percent full scale movement of the control index. Accordingly, a small auxiliary adjusting knob was included in the index setting means to permit easy realignment of the control index when tubes are replaced.

The control point is constant to within better than 1/6th percent of

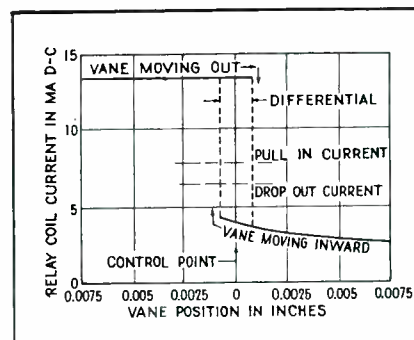

FIG. 3—Performance characteristics; 0.002 inch vane movement gives snap action

full-scale pen movement with a line voltage variation from 100 to 135 volts. The sensitivity of the unit remains better than 1/5th percent of full-scale pen movement throughout this voltage variation. In all cases, the same type of discontinuous or snap action characteristic curves is obtained. No appreciable control point shifts are experienced for changes in ambient relative humidity about the instrument.

In conclusion, it has been found possible to design a simple electronic control unit which is adaptable to various types of control for industrial applications and which will give long, dependable service. Among the merits of this controller are the snap action of the enclosed contacts, precision, safeness, avoidance of any electrical adjustments, and sufficient speed of response without being subject to vibration. These qualities are obtained without in any way affecting the measuring ability of the instrument.

REFERENCES

- (1) T. J. Rhodes, "Industrial Instruments for Measurement and Control," McGraw-Hill Book Co., 1941.
- (2) E. S. Smith, "Automatic Control Engineering," McGraw-Hill Book Co., 1944.
- (3) D. P. Eckman, "Principles of Industrial Process Control," John Wiley & Sons, 1945.
- (4) Alfred N. Goldsmith, British Patent 149,283, July 15, 1920.
- (5) Robt. R. A. Hoffman, German Patent 366,223, Sept. 17, 1920.
- (6) Walter O. Lum, U. S. Patent 1,944,988, Jan. 30, 1934.
- (7) Induction Pick-Up Regulates Temperature, ELECTRONICS, p 34, Oct. 1938.
- (8) Fred B. MacLaren, Pyrometer Control Circuit, ELECTRONICS, p 50, Nov. 1941.
- (9) T. A. Cohen, Electronic Devices for Process Control, Issue 3 and 4, Chem. and Met. Engr., 1942.
- (10) T. A. Cohen, Electronic Mechanism Development for Process Plant and Laboratory, Proc. Nat. Electronics Conference, Vol. 1, 1944.
- (11) T. A. Cohen, U. S. Patent 2,228,163, Jan. 7, 1941.
- (12) Fred B. MacLaren, U. S. Patent 2,234,184, March 11, 1941.
- (13) T. A. Cohen, U. S. Patent 2,411,247, Nov. 19, 1946.

SIMPLIFIED

A new iconoscope makes possible circuit simplification and permits reproduction on the receiving cathode-ray tube screen comparable to newspaper half tones. Complete circuit details are given for the 250-line 60-frame system

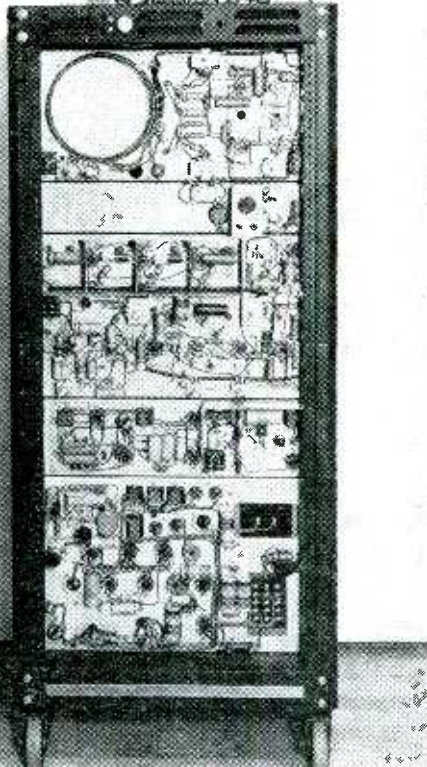

FIG. 1—Television camera and picture system chassis in a 4-foot rack

THE USE OF a television system to view dangerous operations at Bikini without endangering human life effectively demonstrated that there exists an important use for television other than entertainment. Industry could use a simplified system advantageously, and so could schools and experimenters.

A major step toward reducing the cost of a television system has been made with the introduction of a new two-inch iconoscope, the RCA 5527. It is relatively inexpensive and has been designed so that the equipment associated with it can be compact, simple, and economical. For a satisfactory picture with this pickup tube, only about 1,000 foot-candles of incident illumination are required. This amount of light is roughly the same as that used in present television broadcasting studios and can be obtained with three 200-watt lamps placed four feet from the subject. An outdoor scene televised by the 5527 on a normal sunny day produces a picture, when viewed on a 7GP4 directly-

viewed kinescope, comparable in quality to a newspaper reproduction of a photograph.

Although the tube is designed to operate with 800 volts on the accelerator electrode, it will perform satisfactorily at 600 volts with only a slight loss in picture definition. The small area of the mosaic permits the use of a low-cost lens such as the lens of a 35-mm camera having a speed of F:3.5 or greater.

Many of the new techniques learned during experimentation with military tubes were used to great advantage in the design of this tube, making it superior to the now obsolete forerunner, type 1847. A new method of mosaic treatment, for example, permits the transmission of a greater amount of light to the photosensitive surface and, consequently, improved sensitivity is achieved. Greater signal output is obtained by the use of a high-capacitance mosaic which older-type tubes could not support. A direct contact to the mosaic signal plate, instead of the capacitive coupling used in type 1847, improves the low-frequency response.

Although the tube uses electrostatic deflection rather than the more expensive and cumbersome electromagnetic deflection system, good picture definition is obtained through the use of the wartime-

developed fine-spot cathode-ray gun with balanced deflection. The resolution capabilities of the tube are exceptionally good, and as measured by television standards, (lines per picture height) are 250 lines. The difficulty from non-uniform background signals, or dark spots found in all iconoscopes, is ordinarily not troublesome in industrial applications and, therefore, very satisfactory pictures are obtained without the use of shading signals. In addition, the tube does not require keystone correction.

The system illustrated in Fig. 1 contains all of the components necessary to give a good television picture and can be adapted to a transmitting and receiving system. The sensitivity and resolution of the system, together with the modest cost of components, make it applicable to many uses in both the industrial and educational fields. The adaptability of the system and its excellent performance make the system extremely versatile and provide a wide range of possible applications.

The complete system includes the camera and monitor as illustrated in the block diagram of Fig. 2. The scene to be televised is converted to an electrical signal by the pickup tube. This signal is then amplified and reproduced on the screen of the kinescope. The

TELEVISION for Industry

By R. E. BARRETT
and M. M. GOODMAN

Tube Department
Radio Corporation of America
Lancaster, Pennsylvania

necessary synchronizing circuits, blanking amplifiers, and power supplies are included.

Camera System

The components contained in the camera are the two-inch iconoscope, a four-stage video preamplifier, and the lens mounting. The entire camera housing is made of 1/16-inch copper and a partition of the same material separates the camera tube from the video preamplifier. This type of shielding is necessary, since the presence of spurious signals on the kinescope

can be very annoying and detract from the quality of the picture produced.

Care should also be taken if long cables are used between the

camera and the monitor to filter all electrode voltages properly and to carry a good low-resistance ground between the two pieces of equipment. All of the shields for the cables and the camera housing should be returned to the monitor rack and a solid connection made at one point only. This will eliminate possible pickup loops due to nonuniform ground potentials.

It is recommended that the camera tube be operated with its second anode at ground potential and its cathode at a high negative potential. This method of operation eliminates the need for a high-voltage input capacitor to the grid of the first preamplifier stage, since the signal plate of the iconoscope operates at second-anode voltage. Operating the iconoscope in this manner also eliminates the possibility of coupling hum from the high-voltage power supply into the input of the video preamplifier.

The video preamplifier, dia-

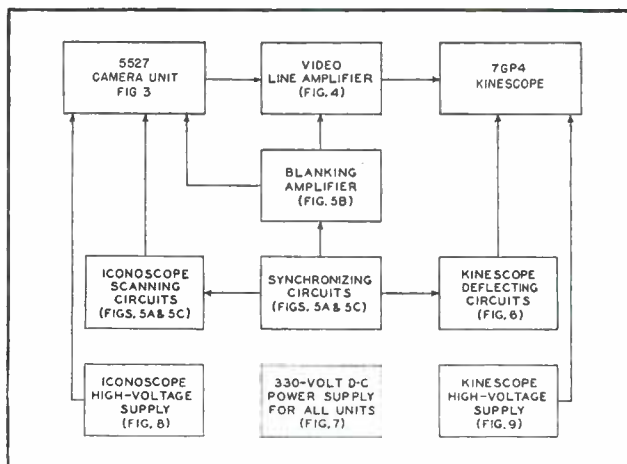

FIG. 2—Block diagram of television camera and complete picture system



Capabilities of the system are illustrated by this same-size reproduction of a photograph taken of the screen of the 76P4 kinescope

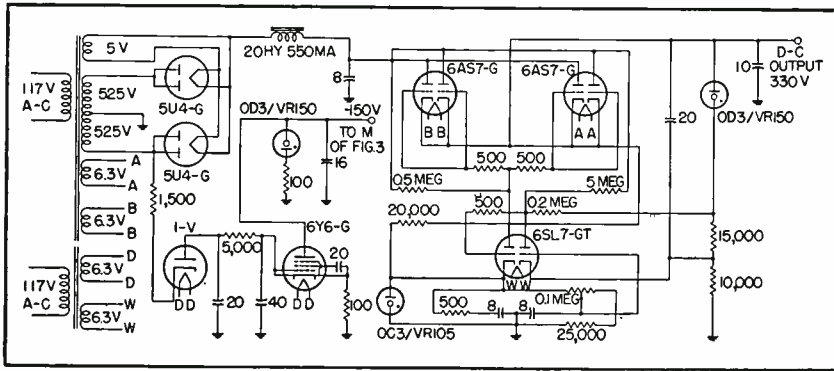

FIG. 7—Electronically regulated d-c power supply

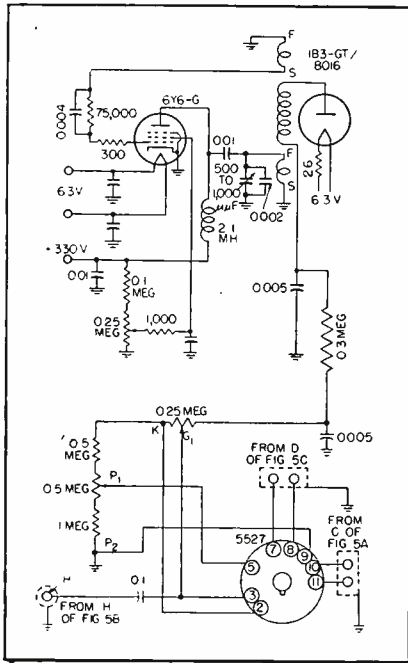

FIG. 8—Circuit of r-f operated high-voltage supply for the 5527

developed. In the plate circuit of the horizontal multivibrator, a similar straight-sided negative pulse is produced. These two pulses are combined in the 6SL7-GT pulse-mixer tube, Fig. 5B, and then amplified in the 6SL7-GT blanking amplifier. The kinescope mixed blanking voltage is developed across the cathode resistor of the blanking amplifier and fed into the second stage of the video line amplifier. The iconoscope mixed blanking voltage is taken from the plate of the blanking amplifier and fed to grid 1 of the iconoscope. Since the vertical and horizontal blanking pulses are derived from the same oscillators that produce the driving pulses for the scanning circuits, the blanking time is not sufficient to eliminate the bright edges which appear on the sides of the scanned raster. This effect is not desirable

but it does not detract too much from the quality of the picture produced.

Deflection Circuits for Kinescope

The electrostatic deflection for the 7GP4 kinescope is developed from the horizontal and vertical timing oscillators. These driving pulses are coupled into the grid circuits of a pair of 6J5 discharge tubes, Fig. 6, which produces horizontal and vertical saw-tooth voltages. The horizontal and vertical saw-tooth voltages developed in the plate circuits of the 6J5 discharge tube are coupled to a pair of 6SN7-GT phase inverter and push-pull output tubes. The width control is in the plate circuit of the horizontal

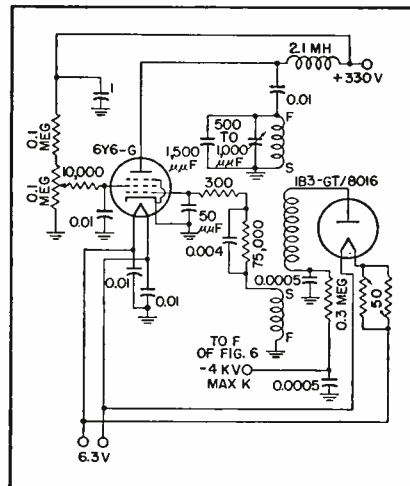

FIG. 9—R-f-operated high-voltage supply for the 7GP4

discharge tube, and the height control is in the plate circuit of the vertical discharge tube.

Power Supplies

The direct-current power supplies for the complete television system consist of a 330-volt, 300-milliam-

pere electronically regulated supply, two r-f operated high-voltage supplies, and two glow tube regulated supplies. The 330-volt d-c supply, Fig. 7, operates the deflection circuits, the video amplifiers, the blanking amplifier, and the oscillators for the high-voltage supply. One r-f high-voltage supply, Fig. 8, operates at -1 kilovolt maximum and is capable of one milliamperere current drain. This supplies the focus and P_2 voltage for the iconoscope. The second r-f high-voltage supply, Fig. 9, operates at -three kilovolts and supplies focus and P_2 voltages for the 7GP4 kinescope. The two glow-tube regulated supplies, Fig. 10, operate at -75 volts and -105 volts and produce electrostatic centering voltages for the iconoscope and kinescope.

All of the components in this simplified television system may easily be mounted on a standard rack measuring 22 x 47 x 17 inches. The camera unit, however, may be mounted separately in a small compartment 4 x 12 x 6 inches and cabled to the monitor rack. All of the components may be cabled together by means of Jones plugs or Amphenol connectors. In this way, any components may be removed from the rack for servicing or study without unsoldering any connections.

Operating tests have proved that this television equipment is reliable and stable. Under proper lighting conditions, it is possible to obtain a good television picture with sufficient detail to meet the requirements of most industrial or educational needs. The equipment is small and compact and because of its simplicity, does not require highly trained personnel.

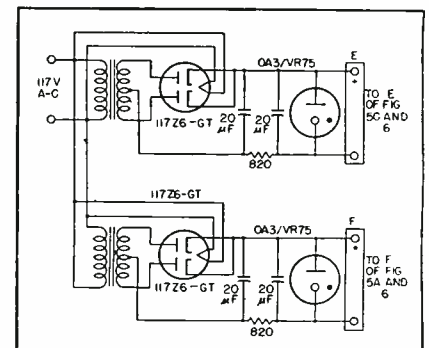

Fig. 10—Horizontal and vertical centering supplies

Noise-free CODE RECEPTION

Discrimination between the time constants of signal and noise allows continuous waves to trigger an audio tone generator feeding the loudspeaker. Amplitude and frequency variations have little influence on circuit operation

By D. L. HINGS

*Electronic Laboratories of Canada, Ltd.
Vancouver, B. C.*

NEED for improved reception of continuous-wave signals at lower threshold levels, or in greater levels of impulse wave interference, has been felt by all communication men for many years. The various expedients to reduce shock from impulse waves, in the form of limiters, have proven this. Although limiters are very effective in some cases, it has been obvious that tone heterodyning from a beat-frequency oscillator was entirely unsatisfactory for noise-free or automatic communications under impulse interference of atmospheric or a man-made nature.

In the approach to this development, it was considered that the fundamental problem with present-day reception systems was involved in discrimination between the similar wave trains produced by noise and c-w signals. Therefore, if detection were possible when only one form of energy existed, this problem would be solved. This might be possible if receivers were made sufficiently sensitive and detection of amplitude changes during the signal interval were non-existent.

It was further reasoned that electrical interference energy existed at all times in a communications receiver, either from antenna pickup or from front-stage noise in the receiver. A c-w signal is continuous, having on and off intervals and fading characteristics. Interfering impulse noise by contrast is discon-



The noise-discriminating system developed by the author is used in conjunction with a conventional communications receiver

tinuous and the duration of the interfering impulses is much shorter than even high-speed c-w intervals.

Static impulses, ignition interference, and discharge interference have extremely short time constants at the antenna, but after amplification through r-f and i-f amplifiers these constants are increased several hundred times.

Pulse Action

The effect of interference impulses on the receiver tuned circuits ahead of the detector is shown in Fig. 1. An impulse (A) will ring the tuned circuits of the first r-f amplifier to many times the dura-

tion of the initial impulse (B). This in turn excites the next stage which rings for a still longer duration, depending on the Q of the tuned circuits, and so on. (C).

The r-f and i-f amplifier circuit time constants will prevent the original impulse from being amplified, and instead of an impulse appearing at the second detector, there will be a wave train (D) that rises in amplitude in accordance with the circuit constants which remains for the duration of the ringing of the tuned circuits, falling to zero as dictated by the circuit characteristics. This may take from fifty to several hundred microseconds, depending on the amplitude

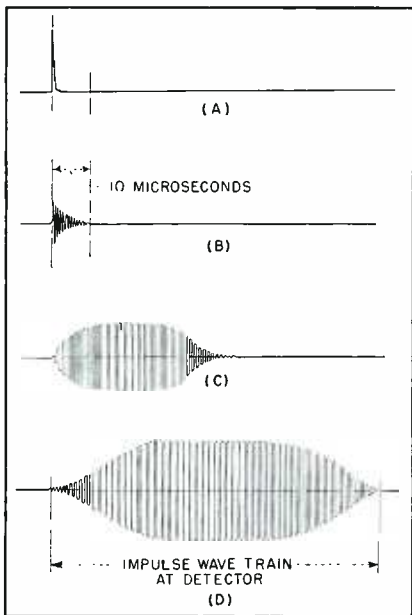

FIG. 1—Analysis of the action of an impulse through the tuned circuits of a receiver

of the original impulse, whereas this initial impulse duration (A) may be only a fraction of a microsecond.

In referring to impulse interference at the detector, it is necessary therefore to consider these interferences as discontinuous wave trains that vary in length in accordance with the amplitude of the original impulse. It is these receiver-generated wave trains that cause portions of the intelligence waves to be obliterated from the detector when the amplitude or audio beat is being detected.

In receiving locations having a high ambient impulse background noise, it would seem that these wave trains could be frequent enough to create a continuous wave if they followed each other very closely. Considering that each wave train, or circuit ring, is started by an impulse, and these impulses have no phase relation to each other, then it will follow that the random phase relation will cause conflicting phase angles between each wave train and, therefore, cannot make up a continuous wave. These phase differences between wave trains cause the amplitude to fall between each wave train. This condition marks the distinction between reception of a continuous wave and that of impulse wave trains at the detec-

tor circuit in receivers of conventional design.

If a c-w receiver is subjected to heavy ignition noise with repetition times of two or three hundred cycles per second, there will exist at least an equal number of wave trains, or even more if several arcs occur on one ignition discharge. This means that c-w intervals will be separated by a large number of wave trains of shorter duration.

The detector voltage from the discontinuous wave trains may be considerably greater than the voltage from the continuous waves, thereby preventing the use of an avc system. The amplitude of the discontinuous waves may be much greater than the continuous waves, thereby preventing a readable note from a bfo detector.

The fundamental difference between the discontinuous waves and the continuous waves is their relative duration. This phenomenon is illustrated in Fig. 2, showing the difference between continuous and discontinuous wave trains at (A).

When the rise and fall of the detector voltage produces audio energy, the greatest voltage change occurs when only the impulse wave trains exist. The detector audio voltage during the c-w intervals is produced by the impulse wave trains amplitude modulating the continuous waves.

To permit a clean demarkation between the marker and spacer intervals, it is necessary to erase this modulation during the marker, as it provides less audio energy than the spacer. Erasing c-w of the discontinuous wave trains necessitates very heavy limiting at the second detector, so that continuous waves will not permit a change in the detector audio voltage during the marker interval as illustrated in Fig. 2(B).

With satisfactory limiting of the detector, there will exist audio energy from the rise and fall of each end of a discontinuous wave train and a silent period during the relatively long c-w marker interval (C). This form of limiting permits clean demarkation between c-w and impulse noise. However, the audio energy obtained during the spacer

interval does not have constant frequency characteristics, making it unsuitable for direct reproduction.

Triggered Audio Signal

To reproduce the marker time interval, the spacer audio energy must be amplified, limited (D), rectified (E), then the d-c component used to trigger an audio tone generator to produce marker (F) or spacer tone intervals. The d-c may also be used to operate a teletype machine directly.

A simple method of producing a tone for the marker interval involves utilization of the d-c voltage that is derived from the spacer audio energy for biasing an audio tone amplifier to cutoff. Then the

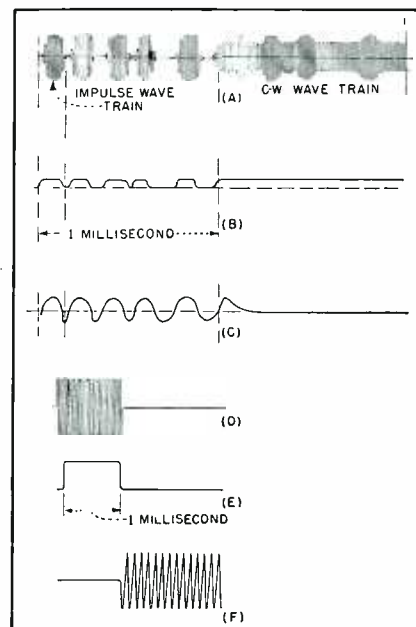

FIG. 2—Steps in the limiting and detection of a c-w signal

c-w interval interrupts the d-c voltage and the amplifier produces the desired tone.

In the practical application of this system, it is found desirable to have two or three filter time-constant adjustments in the d-c generating circuit. This provides for various speeds of reception so that even when, for example, one hundred words per minute cannot be received due to very heavy impulse noise, a setting is available for lower speeds. Adjustable tone frequency is also provided to prevent operator fatigue. The receiving accuracy of the system is dependent

Self-Switching

CERTAIN TYPES of electronic equipment require the switching of radio-frequency energy between two circuit elements. Examples of such equipment are radio direction finders and beacons, for which various mechanical and electronic means have been employed to accomplish the desired switching.

This paper presents a few of the observed and measured characteristics of a particular multivibrator type of switch, including the measurement of the instantaneous input resistance. While the measurements reported were made at frequencies between 20 and 60 megacycles per second, the same general type of circuit can be used at lower or higher frequencies.

Description of Circuit

A schematic diagram of the electronic switch on which tests and observations were made is shown in Fig. 1. The tubes function both as an amplifier for radio frequencies in the range from 20 to 60 megacycles per second and as an audio-frequency generator at ap-

Multivibrator circuit using two pentodes amplifies and automatically switches two circuits into common indicator for direction finding and similar uses. Design considerations, switching ratios, and input resistance variations are discussed

By **H. M. WAGNER** and **J. F. HERRICK**

*Signal Corps Engineering Laboratories
Evans Signal Laboratory
Belmar, N. J.*

*Institute of Experimental Medicine
Mayo Foundation
Rochester, Minn.*

proximately 200 cycles per second. The circuit appears similar to that of a conventional r-f amplifier. However, in contrast to regular r-f amplifiers having fixed operating potentials, the amplification here is accompanied by cyclical changes in bias and operating potentials imposed by the voltages of multivibration.

A resistor R in series with capacitor C form the audio-feedback path between the plate-screen of each tube and the grid of the other tube. This resistor serves the dual purpose of preventing r-f coupling be-

tween tubes and of limiting the d-c grid current. Its value has an important effect both on the multivibrator wave shape and on the input impedance of the switch. If r-f decoupling were the only consideration, a choke might be used in place of this resistor. A bypass capacitor from the screen-grid to ground is needed for r-f amplification but tends to reduce the sharpness of the square wave multivibrator voltages. The capacitor used should be large enough to provide r-f bypassing but small enough to maintain square-wave sharpness.

Multivibrator Voltage and Wave Forms

Before studying the performance of the multivibrator switch at radio frequencies, it is advisable to examine the performance of the switch simply as an audio-frequency oscillator. In order to do this, oscillograms of the voltage pattern at each electrode (anode, screen and control grid) of one tube, and at the junction of the feed-back capacitor C and resistor R were recorded. Separate tests were made using values of 100,000 ohms, 820,000 ohms and 2 megohms for R . The results for the first two cases are shown in Fig. 2 and 3. Horizontal lines in each oscillogram represent fixed voltages applied for calibration purposes. All voltage outputs were applied directly to the plates of an oscilloscope having 20 megohms internal resistance.

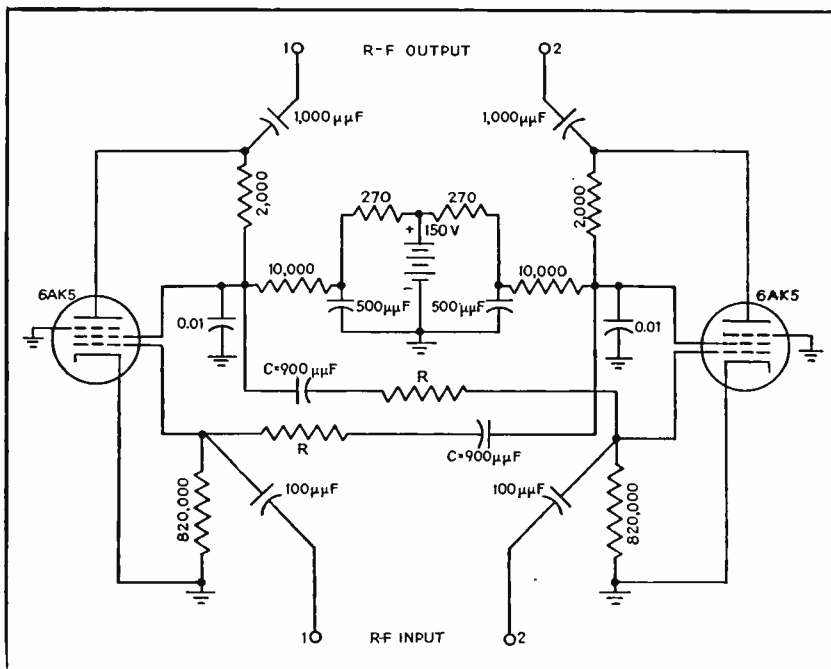

FIG. 1—Schematic circuit diagram of multivibrator switch

R-F Amplifier

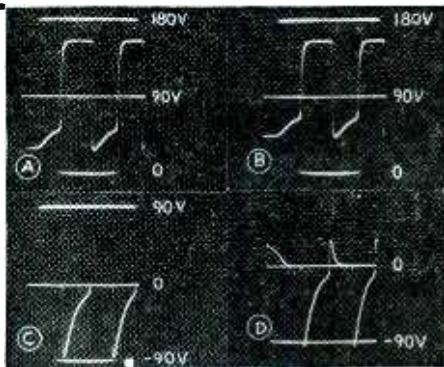

FIG. 2—When R is 100,000 ohms the multivibrator voltages are as shown: (A) at anode, (B) at screen, (C) at grid, (D) at junction of R and C

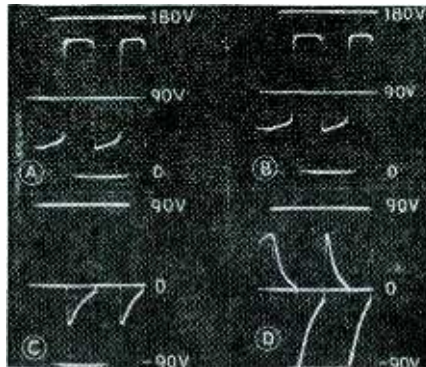

FIG. 3—When R is 820,000 ohms the multivibrator voltages are as follows: (A) at anode, (B) at screen, (C) at grid, (D) at junction of R and C

The high plate potentials of approximately 150 volts correspond to the cutoff condition of the tube. The low plate potentials correspond to the operating interval. The potentials on the tube during the conducting period determine at any instant its operating characteristics as an amplifier.

The contour of the grid voltage variation demonstrates the grid-voltage limiting action which tends to maintain nearly zero bias on the grid during the conducting period. During the conducting period the input resistance of the control grid is low in comparison to the current-limiting resistance R ; and the grid voltage goes positive only a very small fraction of the voltage applied at the other end of R (compare Fig. 2 C and D or Fig. 3 C and D). It is desirable to keep this positive swing as small as possible, both for the sake of the a-f waveform and to minimize r-f input circuit loading that increases with the grid current. The grid current may be determined from the oscillograms which give the voltages at either end of resistor R . The peak grid currents are 300 microamperes, 75 microamperes and 33 microamperes when R is 100,000 ohms, 820,000 ohms, and 2 megohms respectively. (The variations in grid current throughout the conducting portion of the cycle are shown in Fig. 7C. The magnitude of the peak grid current and the rate at which the

grid current drops throughout the cycle increase as the value of R is decreased.)

Amplification Characteristics

Since the state of multivibration imposes varying potentials of appreciable magnitude on the electrodes of the tube, the r-f amplification may be expected to vary also. The amplification has been investigated using the arrangement shown in Fig. 4. Because the r-f voltages used are at too high a frequency to apply directly to the usual oscilloscope, the output of the switch is first fed to a superheterodyne receiver that converts the r-f to a lower frequency.

Figure 5 is a typical oscillogram obtained when the input signal is from a low impedance source (R , approximately 20 ohms). Under these conditions the input signal

remains practically constant and independent of the connected load. Hence, any variation in signal output results from the amplification characteristics of the switching tube. The variations in height of the r-f envelope presented on the scope indicate the variations in r-f amplification of the switch. As can be seen, the amplification remains relatively constant throughout the conducting portion of the multivibrator cycle, in spite of the appreciable variations in plate and screen voltages (shown in Fig. 2 and 3). The waveform of the r-f envelope is essentially rectangular and has steeper sides than those of the corresponding multivibrator plate and screen voltages.

Switching Ratio Characteristics

Switching ratio is defined as the on-off ratio of r-f voltage appearing at the output circuit, and is measured from an oscillogram such as Fig. 5. Dimension A corresponds to the r-f voltage available when the switch is closed; when the tube is functioning as an r-f amplifier. The distance B corresponds to the r-f voltage leaking through the switch when it is open; that is, when the tube is cut off.

One technique used in measuring switching ratios involves the measurement of four factors as shown in the following

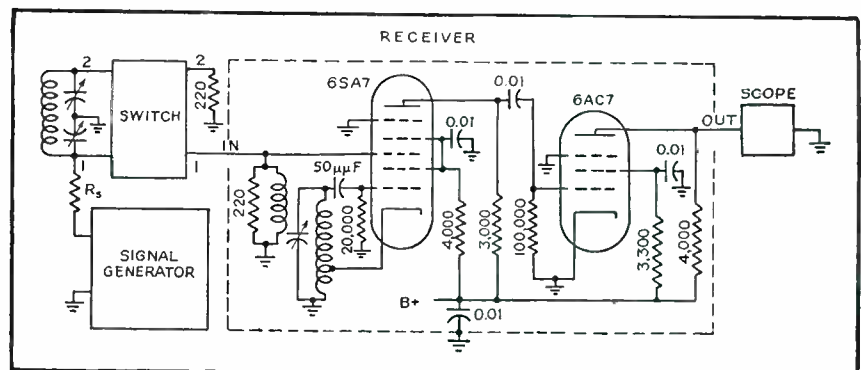

FIG. 4—Schematic circuit diagram of the receiver used for measuring characteristics of the switch, and block diagram of test connections

$$\text{switching ratio} = (A/B)(E_n/E_A) \quad (1)$$

in which A and B are the measured oscilloscope deflections indicated as A and B in Fig. 5, and E_A and E_B are the output readings of the signal generator in microvolts when measuring the heights of A and B respectively.

If desired, the measurements can be reduced to two quantities as follows: The deflections A and B may be measured for a constant signal-generator voltage ($E_A = E_B$), or the signal-generator voltages, E_A and E_B , may be recorded for equal oscilloscope deflections ($A = B$). The former procedure presented a practical difficulty because the deflection B was smaller than the thickness of the normal oscilloscope trace. In the latter procedure the deflection should be chosen so that its magnitude insures reliable readings without overloading the receiver. Under the conditions of this particular experiment it was found advisable to measure all four quantities.

As a check on the method used, the switching ratio was measured under simulated conditions with multivibration stopped by biasing one tube to cutoff. The factor by which the signal had to be increased in order to equal the height of the oscillogram when the tube was operating as an r-f amplifier was taken as the switching ratio. The results were approximately the same as those measured under conditions of multivibration.

Representative values for switching ratios obtained with the circuit arrangement used (Fig. 4) were

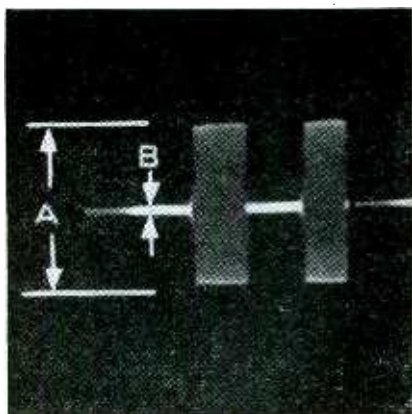

FIG. 5—Amplification characteristics and off-on ratio of the switch at 60 mc when R is 820,000 ohms

170 at 28 megacycles and 65 at 60 megacycles per second.

Input Resistance

When the output impedance of the source of constant signal is made comparable to the input impedance of the switch, for example, by inserting a series resistor, the r-f envelope departs considerably from that obtained when the source impedance is negligible. Figure 6 shows pairs of oscillograms which demonstrate such departures. The left-hand oscillograms designated by the letter A show the characteristic amplification pattern with R , approximately 20 ohms, which is negligible; the right-hand oscillograms designated by the letter B show the corresponding results when R , equals 3,000 ohms. In the latter case, R , and the input resistance of the switch form a voltage divider that reduces the r-f voltage available for amplification. The input resistance of the switch varies continuously throughout the

except for a slight variation in input capacitance during the switching cycle, and the resistive component of the input impedance is measured.

The input resistance actually measured is that between one end of the tuned circuit and ground rather than that across the tuned circuit. It is the combined load of operative tube, inoperative tube, and circuit. Care was taken to balance the input circuit and the switch. The input resistance is measured in the following manner: first a signal voltage is applied directly to input 1 or input 2 (Fig. 4) from a generator of negligible internal impedance. The microvolt reading of the signal generator is the actual voltage applied. The height of the resulting square wave envelope is observed on the oscilloscope. Then a known resistance is placed in series with the signal generator and input 1 or input 2, thus producing an oscillogram having a fishtail contour. If the generator

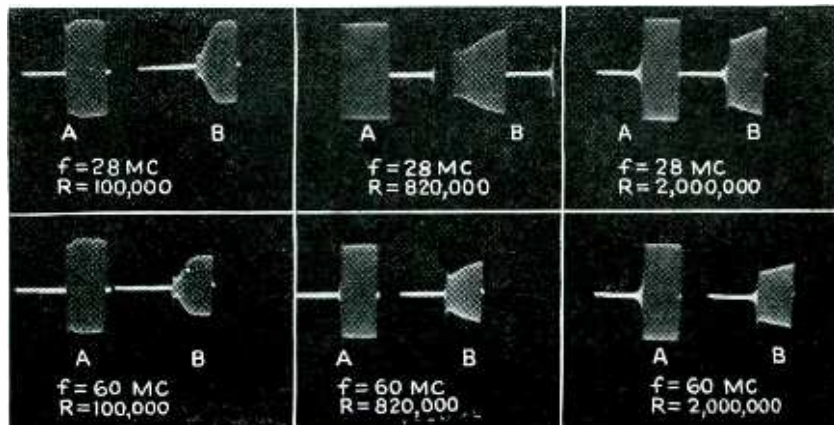

FIG. 6—Radio-frequency envelopes produced by switch under varying circuit conditions. Each left-hand picture (A), was obtained with the switch input connected to a low-impedance source, while at the right (B) it was connected to a 3,000-ohm source

conducting portion of the multivibrator cycle as demonstrated by the fishtail shape of the right-hand oscillograms.

The particular application contemplated when this investigation was undertaken was such that the switch input would come from a push-pull circuit tuned to the r-f signal. For this reason a tuned input circuit (Fig. 4) was chosen to simulate the expected condition of operation. Since the circuit is tuned to the signal frequency, the reactive component is tuned out,

microvolt-reading is kept the same as before, then the difference between the height of the square wave and the height of the fishtail at any instant serves as a measure of the voltage drop across the known resistance in series with the signal generator. These data may be used to calculate the input resistance of the switch at any instant of the cycle, as given by the following equation

$$\text{Input resistance} = \frac{R_s}{[(H_o/H_n) - 1]} \quad (2)$$

in which H_o is the height of the

Transit-Angle

Control of phase of uhf field near slotted carbonized copper anode is new method of suppressing secondary emission at microwavelengths, offering high power-output efficiency for microwave tubes now using inductive output, as well as transverse control tubes

IN tubes designed to operate at microwavelengths, such as klystrons, secondary emission from the anode or equivalent electrode is undesirable because it reduces power-output efficiency. Secondary electrons emitted from the anode may remain in the radio-frequency field for appreciable fractions of a period and complicate the energy relations.

The problem of secondary emission is sometimes avoided altogether in microwave tubes such as the klystron or RCA 825 by causing the electron beam to pass through apertures in the two output electrodes across which the output circuit is connected. This scheme is often referred to as inductive output and is illustrated in Fig. 1A, where the output circuit (which at these wavelengths is usually a resonant cavity) is connected as shown. When the electron beam has passed through the apertures it is usually collected in a cup electrode which may be maintained at a comparatively low potential. The method has mechanical and electrical disadvantages, but is used effectively in many tubes.

Inductive output is not readily adaptable to microwave tubes in which a beam of electrons is transversely deflected alternately onto two push-pull output systems or anodes. It is difficult to arrange the necessary electron beam focussing and deflecting arrangements so that the beam is deflected between two such output systems without striking an electrode in the process and so causing the undesirable effects of unsuppressed secondary electrons to occur.

Another attempt to minimize effects of secondary electrons, shown in Fig. 1B, involves adding to the anode of a tetrode an array of slots intended to trap the secondary

electrons. Since secondary electron emission occurs most strongly in the direction from which the primary electrons arrive, this device is not successful.

Experimental Program

It had been suspected by the author for some years that if the transit angle between an accelerating electrode and an anode exceeded a more or less critical value, then secondary electrons emitted from the anode would experience an ultrahigh-frequency field of such phase and magnitude that they would be driven back to the anode and suppressed. The apparatus illustrated in Fig. 2 was used in a program of research on this subject.

A modulated beam of electrons was passed through an aperture in a plate called the subanode, corresponding to the screen grid of a tetrode. This modulated electron beam then travelled for a distance d to the surface of an

interchangeable target or anode. A resonant cavity was provided to act as an output circuit and was tuned to the wavelength at which the beam of electrons was modulated.

The r-f power transferred from the modulated beam of electrons to the resonant cavity was measured by recording the readings E_{rel}^2 of the diode and multiplying them by k_2 , a constant computed from the geometrical dimensions of the cavity, its losses due to skin ef-

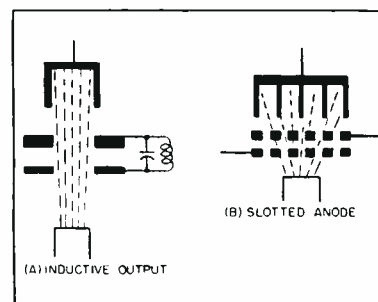

FIG. 1—Inductive output avoids effects of secondary emission. Slotted anode alone is unsatisfactory

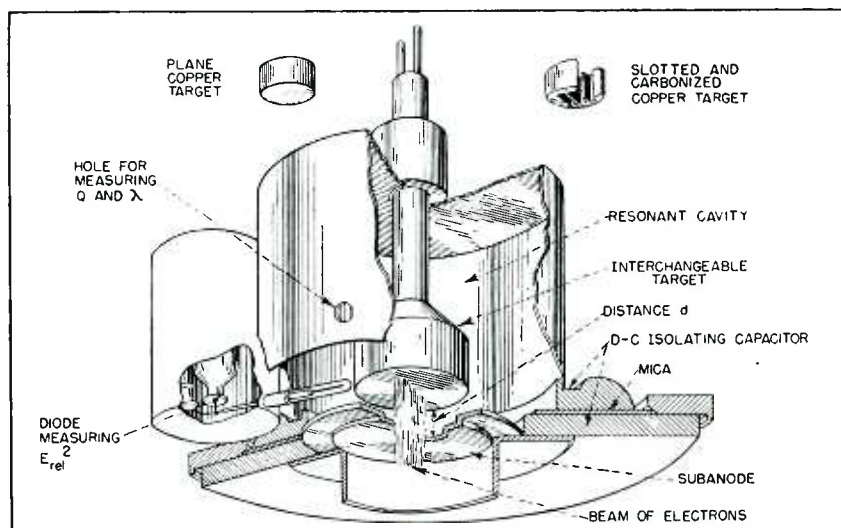

FIG. 2—Experimental setup used to demonstrate how power-output efficiency can be made nearly equal to theoretical maximum at microwavelengths by controlling transit angle, which essentially is ratio of transit time to time of one cycle of oscillation

Suppression in Microwave Tubes

By

J. H. OWEN HARRIES

London, England

fect, and a measurement of the peak a-c component of the electron beam current. The d-c power input P_b to the subanode and target was also measured. The power output efficiency η_o was then evaluated from

$$\eta_o = E_{rc}^2 k_o / P_b \quad (1)$$

The transit angle ϕ in radians is equal to 2π times the ratio between the time taken for the electrons to travel across the distance d and the periodic time of each oscillation of the resonant cavity. The periodic time in seconds is

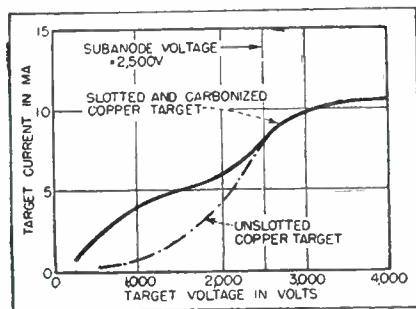

FIG. 3—Static characteristic of microwave tube using transit angle suppression of secondary emission from anode

equal to λ/c where c is 3×10^{10} cm per sec. The velocity in cm per sec of the electron beam through the slot in the subanode is approximately equal to $5.95 \times 10^7 V_b^{3/2}$, where V_b is the target and subanode voltage. The complete expression for the transit angle ϕ in radians then is

$$\phi = \frac{10^3 d}{\lambda V_b^{3/2}} \pi \quad (2)$$

At long wavelengths the electrons travel across any practical distance (such as d) in a vacuum tube in such a short time (compared with the operating periodic time) that ϕ is almost zero. The larger the value of ϕ , the more complex the electron energy relations in the system become. At microwavelengths, however, ϕ is appreciable, and may be so great that the volt-

age along the distance d in Fig. 2 may reverse completely during the time an electron takes to travel from the subanode to the target.

Quantitative tests were carried out on wavelengths of the order of 40 centimeters. It would appear that the conclusions apply down to at least the shortest microwavelengths currently used. A number of alternative configurations of targets were used.

The target voltage-target current characteristic of the apparatus shown in Fig. 2 is plotted in Fig. 3. Because the apparatus is similar to a tetrode, the target current fell sharply when the target voltage dropped below the subanode voltage.

As in an ordinary tetrode, when the d-c target voltage is equal to the d-c subanode voltage, no appreciable power-output efficiency is obtained at low frequencies where the transit angle ϕ tends to be zero.

The apparatus of Fig. 2 may be operated over a wide range of transit angles by varying d and/or V_b . In practice, the engineering limitations of focussing the beam of electrons limits the practical variation of d . In most of the tests, V_b was maintained at 2,500 volts. The d-c target current did not exceed the order of 50 ma. Space charge retarding potentials, which are due to the presence of the electrons themselves in the beam, were therefore negligible.

The results of the experiments are summarized in Fig. 4, in which power-output efficiency η_o is plotted as a function of transit angle ϕ , with the target voltage equal to

the subanode voltage. Three different kinds of target configuration were tried.

Theoretical curve 1 was computed on the assumption that no secondary electrons were present and for sinusoidal 100-percent modulation of the electron beam. At low transit angles the theoretical maximum efficiency η_o has the familiar value of 50 percent, and falls off slowly when the transit angle exceeds about 0.3π .

The measured curve for a plane polished copper target has a negligible efficiency until the transit angle exceeds about 0.3π , and has an optimum at about 0.5π . The maximum efficiency at this optimum is only about 28 percent.

Polished copper targets varied from time to time in the degree of suppression obtained. This was due apparently to variations of secondary electron performance with contamination of the surface. The reason why the effect seems to have escaped attention in the past is perhaps because the almost inevitable contamination from getters or cathode coatings in normal tubes would make secondary emission so great that any suppression effect would be inappreciable.

A plane copper target, if roughened and carbonized, was reliable and gave a slightly improved maximum efficiency. A slotted and carbonized copper target gave stable performance which was only a little short of the theoretical maximum efficiency at transit angles of about 0.3π .

The slotted and carbonized type of target therefore constitutes a useful engineering embodiment of the needed new solution to the problem of secondary radiation on microwavelengths. Considerable variation in the slots is permissible. In Fig. 2 the slots are backed by

a flat surface, but if desired the electrons may travel right through the target and be caught in a low-potential cup, much as in Fig. 1A.

All the measured curves exhibit an unstable part, but not over the range of practical interest.

When the transit angle is to the right of the knee of the measured curves in Fig. 4, secondary electron emission is suppressed not only when the d-c target voltage is equal to the d-c subanode voltage (which is the condition in which Fig. 4 was plotted), but also when the d-c target voltage is less than that of the subanode. In the case of the apparatus illustrated in Fig. 2, this was the case from zero target voltage upwards.

Applications

It is convenient to refer to the new phenomenon by the name transit angle suppression. It can be used for all the purposes for which inductive output is at present employed, and results in appreciable mechanical simplification. In addition, it appears to be the only method of solving the secondary radiation suppression problem at microwaves in transverse control tubes.

Modulation of the beam of electrons in Fig. 2 was performed by transverse control, which has certain advantages over velocity modulation. Beam modulation by transverse control may be made as good as 95 percent, whereas that due to velocity modulation (bunching and catching) cannot be as good, because of the proximity effects of electrons. The power-output efficiencies of transverse control tubes can therefore approach the theoretical maximum much more closely than is the case with velocity-modulated tubes.

In the course of the research, in addition to computing the energy relations between two output electrodes (the subanode and target shown in Fig. 2) when no secondary electrons are produced (theoretical curve 1 in Fig. 4), a computation was made which assumed that secondary electrons were emitted from the target. Contrary to the actual properties of secondary electron radiation, it was assumed that the secondary

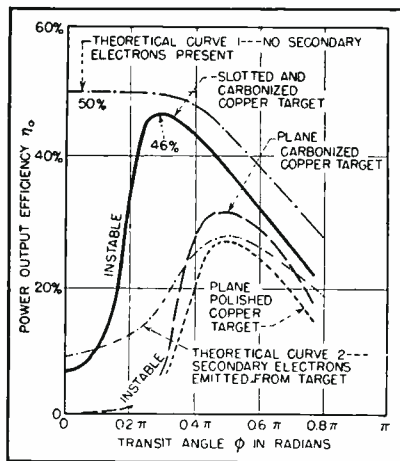

FIG. 4—Theoretical and actual performance curves for tubes using transit angle suppression

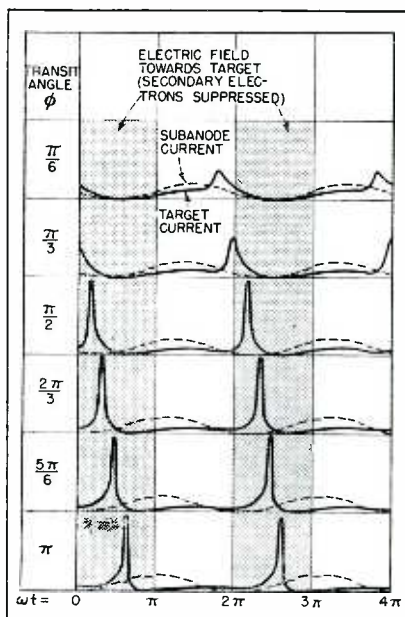

FIG. 5—Theory of secondary electron suppression by control of transit angle

electrons were all emitted instantaneously with zero velocity in the direction from which the primary electrons travel. An attempt has been made in Fig. 5 to represent the theory of transit angle suppression which resulted from this analysis.

In Fig. 5, the dotted lines represent plots of the primary electrons that pass through the slot in the subanode in Fig. 2 as a function of angular velocity ωt . The full-line curves represent the number of primary electrons which arrive at the target after travelling across the distance d and are also plotted as a function of angular velocity ωt . These curves are for

six different transit angles, varying from $\phi = \pi/6$ to $\phi = \pi$. The shaded half-periods of ωt in Fig. 2 are those half-periods when the electric field is directed towards the target and when, in accordance with the simplifying assumptions above, secondary electrons are driven back to the target and suppressed. During the unshaded half-periods, the electric field is directed away from the target and the secondary electrons are then assumed not to be suppressed.

As the transit angle ϕ is increased, the primary electron current wave (full lines) at the plane of the target is severely distorted from the sinusoidal shape of the entrance wave (dotted lines). A sharp peak appears in the full-line curves when the transit angle exceeds about $\pi/3$.

According to the simplifying assumptions, then, the efficiency of transfer of power from the beam of primary electrons to the field of the resonant cavity will be reduced in the proportion of the area of the full-line wave in the unshaded half-period to the total area of each wave. On this basis power-output efficiency η_0 was plotted against transit angle ϕ to obtain curve 2 of Fig. 4.

The stable results and high efficiency of the slotted target appear to be explainable by the fact that most of the primary electrons strike this target at the bottom of the slots. Most of the secondary electrons are emitted straight back along the path of the primary electrons and will therefore be driven back to the target and suppressed by the electric field which is in the same direction. The lesser but appreciable number of secondaries which are emitted sideways and which cannot be harmlessly reversed in direction by the electric field because it has no sideways component are caught by the sides of the slots.

The program of research described in this paper was carried out in the Electronics Department of Rediffusion Limited, London.

BIBLIOGRAPHY

- (1) J. H. Owen Harries, Secondary Electron Radiation, *ELECTRONICS*, p 100, Sept. 1944.
- (2) J. H. Owen Harries, Resonant Cavities and Electron Beams, *Wireless Engineer*, March, April, May, 1947.

Cinch

MINIATURE TUBE SHIELD *and* MOUNTING BASE



60 M 12322

20 K 12323



53 C 12136



IT LOCKS ON!

● Shield fits over and outside of retaining spring—no projecting fingers—retaining indentation on shield locks into ridge on base. A positive lock! Base is made of hardened carbon steel, supplying adequate spring retentivity on shield. The opening at the top of the shield permits speedy heat dissipation. Mounting holes coincide with those for miniature sockets as set up by RMA specifications.

The Cinch Miniature Tube shield and Mounting Base is a post war development designed for commercial use.

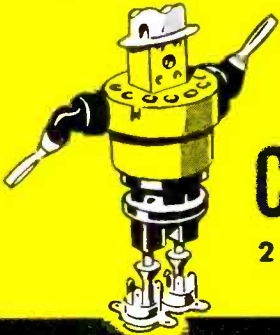

CINCH MANUFACTURING CORPORATION

2335 WEST VAN BUREN STREET, CHICAGO 12, ILLINOIS

Subsidiary of United-Carr Fastener Corporation, Cambridge 42, Mass.

CINCH PARTS ARE STANDARD

By **MELVIN B. KLINE**
 Senior Electronic Engineer, Research and Development Division
 Allen B. Du Mont Laboratories, Inc., Passaic, N. J.

Cathode Follower NOMOGRAPH for PENTODES

Gain, transconductance, and cathode load resistance are related in this second of a series of three nomographs

WHEN USING PENTODES as cathode followers, it is generally easier to work with transconductance than with amplification factor in computing gain and output impedance. The gain A of a cathode follower is

$$A = \frac{E_o}{E_i} = \frac{\mu R_k}{r_p + R_k(\mu + 1)} \quad (1)$$

where μ is the amplification factor of the tube, r_p is the tube plate resistance, and R_k is the cathode resistor value. Dividing both numerator and denominator of this equation by r_p and substituting $g_m = \mu/r_p$, the equation for gain becomes

$$A = \frac{g_m R_k}{1 + g_m R_k + (R_k/r_p)} \quad (2)$$

Since most pentodes are characterized by a relatively large plate resistance, and since within the normal range of cathode resistance $R_k \ll r_p$, this equation may be simplified to

$$A = \frac{g_m R_k}{1 + g_m R_k} \quad (3)$$

A nomograph for this equation is given. While it assumes R_k to be much smaller than r_p , actually little error is made in using Eq. 3 instead of Eq. 2 even when R_k is as large as r_p . Also, little error is made even up to several mc despite neglect of effects of shunt capacitances across R_k .

The cathode-follower nomograph in a preceding issue related gain, amplification factor, and the ratio of cathode load resistance to tube plate resistance. The final nomograph relates output impedance, transconductance, and cathode load resistance.

g_m IN MICROMHOS

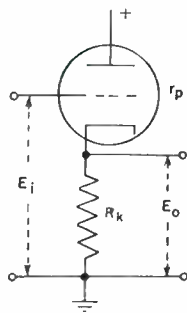
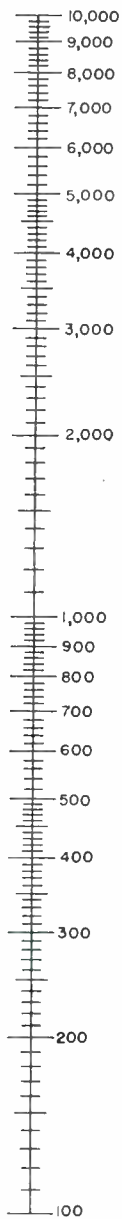

R_k IN OHMS

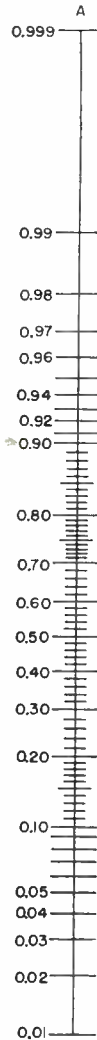
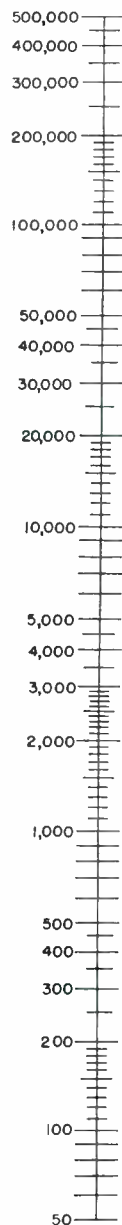

Compact Design... Unlimited Circuits...

*...plus terminals
that really stay put!*



THEY'RE small, they're flexible, they're ruggedly designed. That's the story of the RS 50 and RS 60—two Mallory switches especially designed for radio receiver applications where low torque indexing is required.

An outstanding feature of these switches is the two-point stapling which assures that terminals won't work loose. The terminals themselves are made of heavy spring brass for strength, silver plated, formed for flexibility, insuring low contact resistance.

Many other features are notable too: the improved low-loss phenolic in stator and rotor . . . the star wheel ball indexing with 30° between positions . . . silver-to-silver double wiping contacts . . . where desired the exclusive Mallory silver-indium treatment may be applied to rotor segments permitting higher contact pressure with lower, smooth operating torque and a minimum of contact resistance with extremely low noise level and long life.

The RS 50 is made with from 2 to 10 positions—the RS 60 with from 2 to 5. For more details, write for engineering data folder.

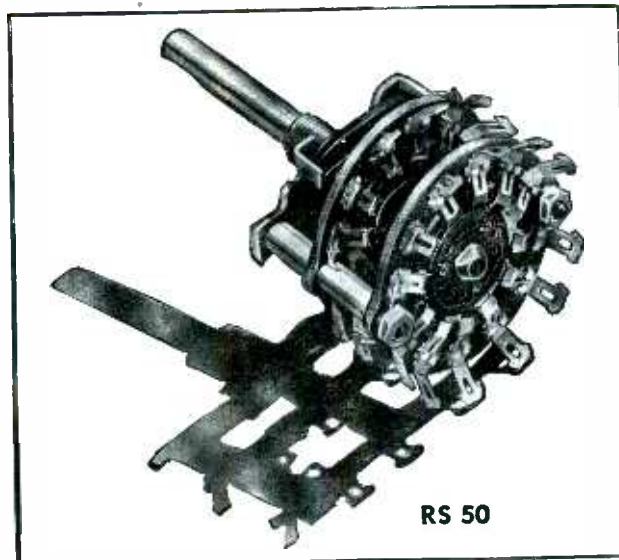

RS 50

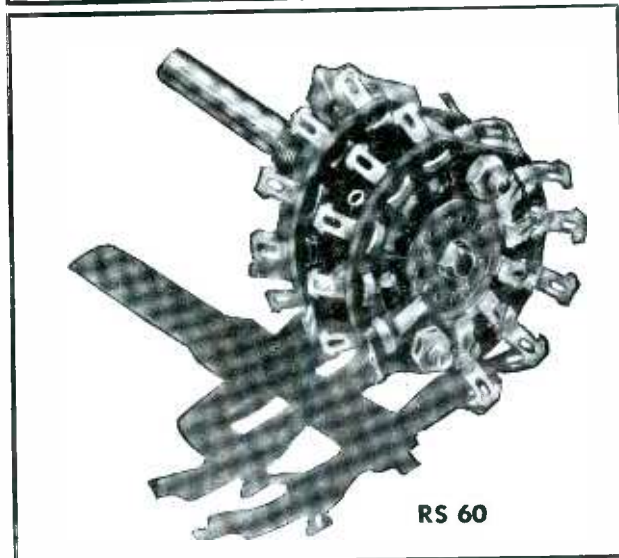

RS 60

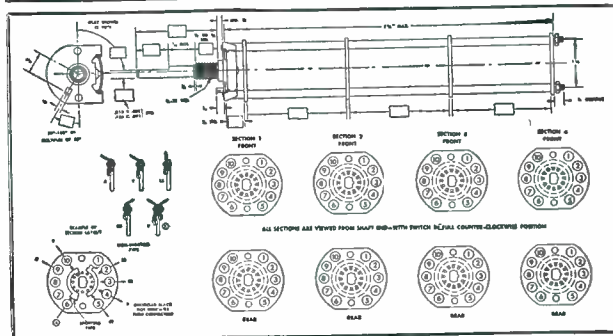

Ask for RS Specification Sheets

Printed on thin paper to permit blueprinting, these sectional drawings indicate standard and optional dimensions—make it easy for you to specify Mallory RS switches built to meet your circuit requirements. Ask your nearest Mallory Field Representative or write direct for a supply.

P. R. MALLORY & CO. Inc.
MALLORY SWITCHES
(ELECTRONIC, INDUSTRIAL and APPLIANCE)

P. R. MALLORY & CO., Inc., INDIANAPOLIS 6, INDIANA

TUBES AT WORK

Including INDUSTRIAL CONTROL

Edited by VIN ZELUFF

Stabilized D-C Amplifier with High Sensitivity.... 138
 Electronic Cooking Goes Commercial..... 140
 Subminiature Printed Transmitters and Receivers.. 160
 Localized Heating of Milk Can Necks..... 172
 Frequency Control for Low-Impedance Oscillator
 Tanks 174
 Temperature Controller..... 178

Stabilized D-C Amplifier with High Sensitivity

By H. S. ANKER

Department of Biochemistry
 University of Chicago

THIS amplifier is designed to measure very small currents or voltages from a high-impedance source. Special features incorporated are a new input tube, increased linearity,

ing point, the plate voltage is 12 volts, the screen voltage (grids 2 and 4) is approximately 7.5 volts, and the control grid (grid 3) is negatively biased to 2.5 volts. Grids

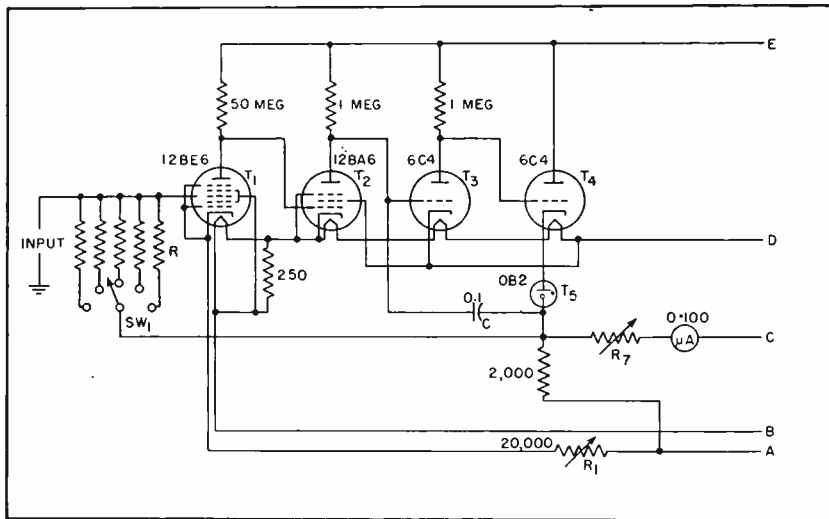

FIG. 1—Input ranges are determined by choosing values of R from 10 to 100,000 megohms. Lettered leads correspond to those shown in Fig. 2

good stability, and a regulated power source.

The input tube of the amplifier was carefully selected, as low grid current is necessary and high amplification desirable. Of many tube types tested, the miniature tube 12BE6 was found to be the most suitable. It has a grid current only slightly higher than that of special electrometer tubes and at the same time has the advantage of a high amplification factor in addition to being generally available and much less expensive. Only small variations were found in the operating characteristics of the several tubes tested.

At the most satisfactory operat-

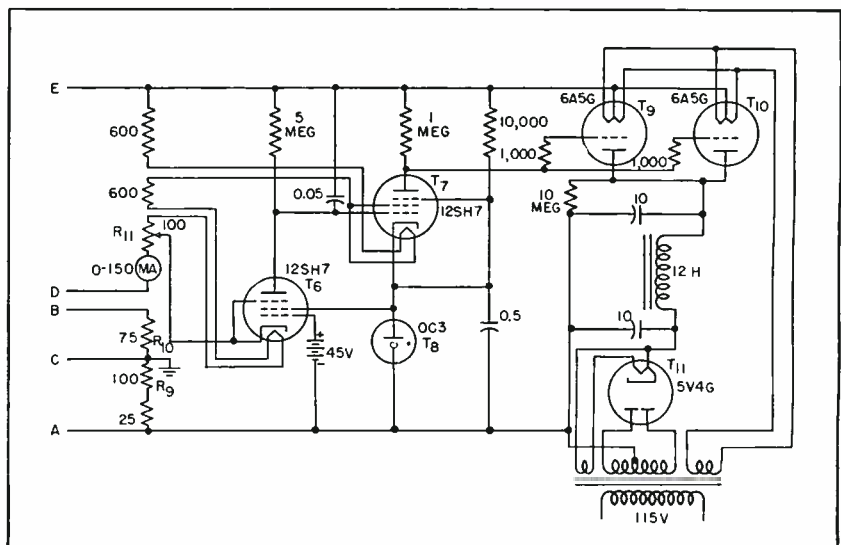

FIG. 2—Stabilization ratio greater than 25,000 is provided by this power supply

1 and 5 are connected to the cathode. The heater current is reduced to 105 ma. Under these conditions, the grid current is about 10^{-18} to 10^{-14} amperes and the amplification factor is between 200 and 300. The tube must be well shielded from light and coated to prevent surface leakage.

Amplifier

The amplifier circuit shown in Fig. 1 is based on an amplifier described by Roberts¹. Three stages of voltage amplification are used, following by a cathode follower as the last stage. For stability, the tubes are heated from the regulated power source.

The sensitivity is changed by a Shallcross No. 4765 switch in which the bakelite baseplate has been replaced by one of polystyrene. Zero adjustment is made by means of R_1 . The meter together with the series resistor R_7 forms a 1.0-volt meter. A 100- μ a d'Arsonval type meter is satisfactory but the author prefers to use a galvanometer such as Leeds and Northrup No. 2420, especially when using the decade to be described, because the galvanometer can withstand a substantial overload without being damaged.

For more accurate readings, a decade may be inserted into the power source bleeder, and R_7 changed to make a 0.1-volt meter. The decade replaces part of R_9 for a positive or part of R_{10} for a negative input such that its total resistance is adjusted to give a voltage drop of one volt,

GUARDIAN'S "Robot" ACCUMULATOR

WITH A MEMORY

...WITH A PULSE

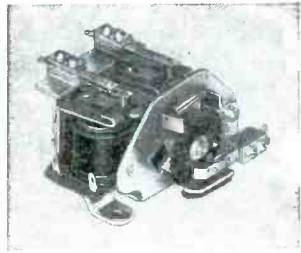
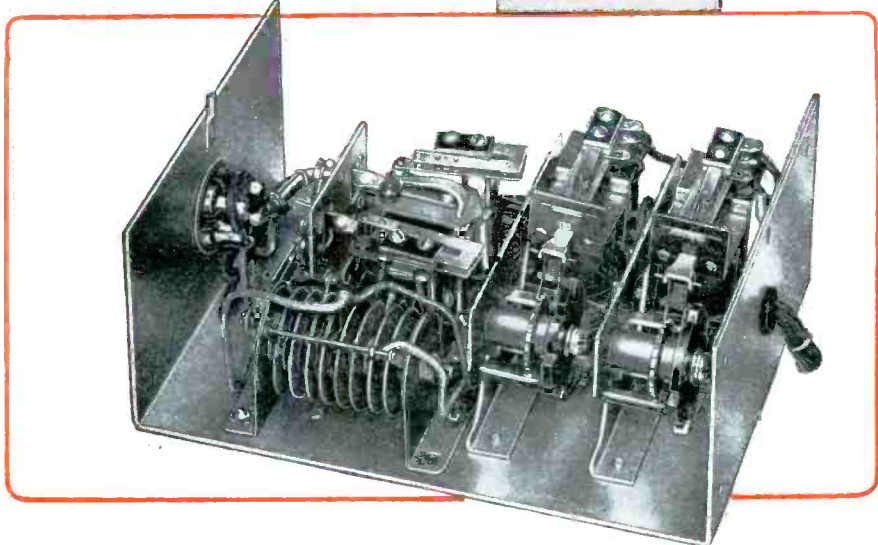
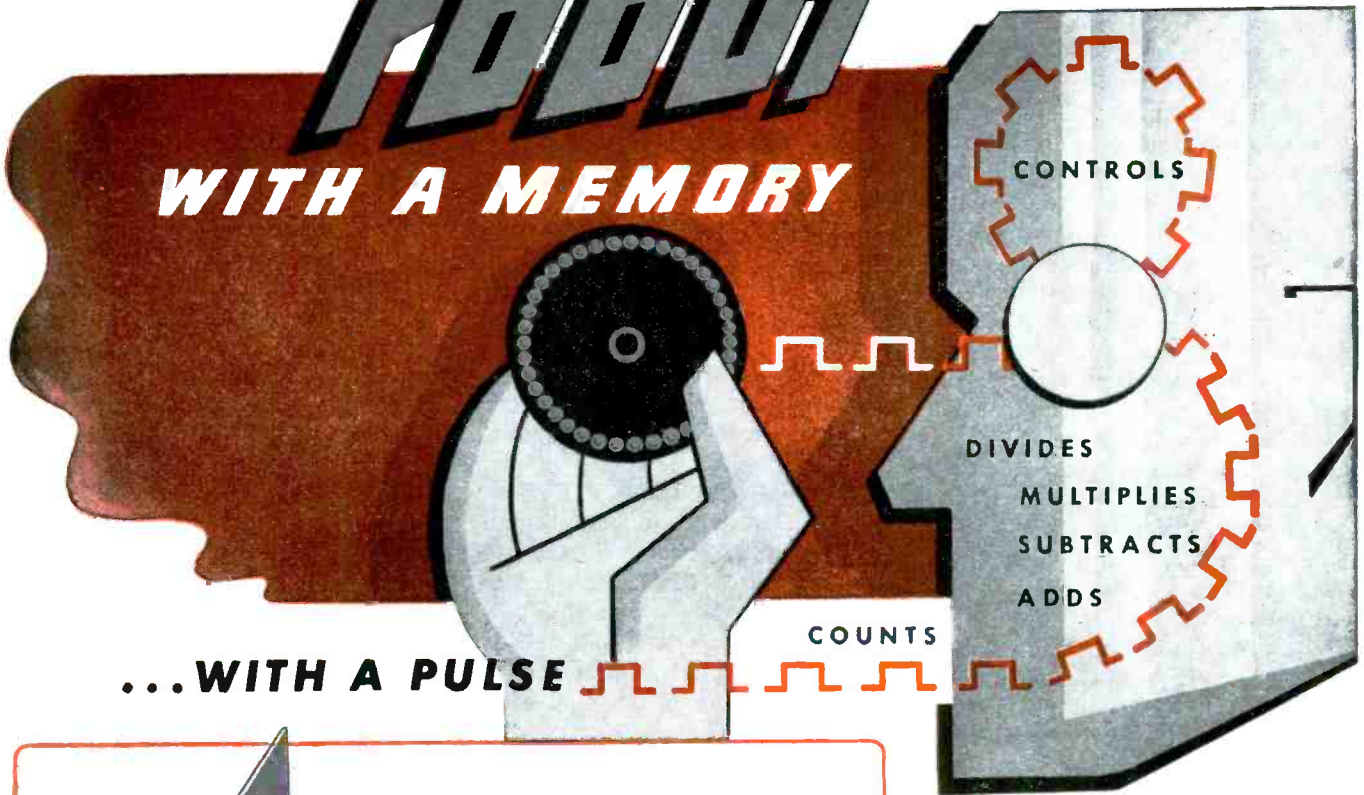

SERIES M-AS
STEPPING RELAY

SERIES S-300
PULSING RELAY

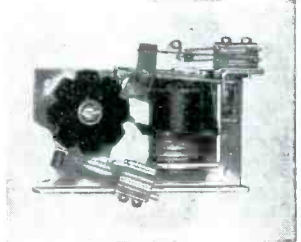

Originated by **GUARDIAN**

Almost human — The Guardian accumulator is a device that employs Guardian Pulsing Relays and a Guardian Stepper for storage and release of impulses. It is capable of receiving electrical pulses from a number of remote stations and storing them until each station completes its cycle or function. It can register pulses of various numerical values; for example, if three pulses are received within the accumulator and the first pulse represents a numerical value of "one", then one impulse is registered on the Stepping relay. If the second pulse has a value of "two", then two impulses are added to the previous impulse, making a

total of three. If the third pulse represents a value of "five", then the five impulses are added to the three already registered, making a total of eight. The assembly will control the operation of a machine in proportion to the total number of impulses established. In the example above, the machine would be energized for eight cycles . . . one cycle for each impulse established. Unit suggests many industrial applications for Guardian Pulsing Relays and Guardian Steppers. For further information and a new cost-free Guardian Relay Catalog, write

GUARDIAN ELECTRIC

1625-G W. WALNUT STREET

CHICAGO 12, ILLINOIS

A COMPLETE LINE OF RELAYS SERVING AMERICAN INDUSTRY

permitting partial backing out of the signal. Each step of the decade corresponds to a voltage change of 0.1 volt. Under these conditions, the galvanometer will be on scale for only one setting of the decade for any input current. This setting of the decade is the first digit of the reading, the second and third digits being read on the galvanometer.

The input tube is washed carefully with absolute alcohol and dipped into polystyrene lacquer. It must be well shielded against stray pick-up, light, and protected from sudden temperature changes. It is preferable to mount the input tube inside an evacuated vessel. A polystyrene tube socket is used for it, and all input leads are insulated by means of polystyrene.

Capacitor *C* is used to quench oscillations. Depending on the layout, it may be necessary to change the connections and/or size of this capacitor to suppress oscillations.

Power Source

All supply voltages are obtained from the regulated source shown in Fig. 2 which is powered from the 115-volt a-c line. The filaments of the regulator tubes in the source as well as the filaments of the tubes in the amplifier form part of the bleeder.

The limiting factors of the stabilization obtainable are the temperature variations of the resistors and of the characteristics of T_0 . To minimize these effects, the resistors, particularly those in the bleeder, were Advance wire wound. If it is desirable to increase the stabilization still further the power supply and the amplifier would have to be placed in a constant temperature chamber.

The stabilization ratio is greater than 25,000. If slightly reduced performance can be tolerated, the battery may be eliminated and the grid of T_0 returned to the midpoint of a 100,000-ohm resistor connected across T_0 . The stabilizer current through the milliammeter is adjusted by varying R_{11} , and should be set to operate at 135 ma.

After preliminary adjustment of the power source, it and the amplifier should be allowed to run for 24 hours. During this baking period the tube characteristics will largely

stabilize. Final adjustment can then be made. If the instrument is to be used continually, it is best to operate it 24 hours a day as there tends to be a small drift during the first

two hours of operation. Variation in line voltage of 10 percent has a negligible effect.

(1) S. Roberts: *Rev. Sci. Inst.* 10, p. 181 (1939).

Electronic Cooking Goes Commercial

DEVELOPMENT of the magnetron and horn antenna technique for cooking used in the sandwich-type Radarange (ELECTRONICS, p 178 November 1946) has resulted in a practical design of a model having a larger oven 13 inches wide, 14 deep and 15 inches high. A number of the new models are now operating in and around Boston.

One unit is installed in a White Tower restaurant, one of a chain that specializes in hamburgers and frankfurters. With Raytheon Radarange electronic cooking, a raw hamburger with onion on a roll is cooked in 20 seconds as compared with seven minutes on a conventional grill. A frankfurter in bun takes ten seconds and four of them cook in 35 seconds, instead of five minutes by conventional cooking.

Another advantage of electronic cooking is that, for take-out service, hamburgers and frankfurters can be wrapped and placed in buns and then cooked in the bag. As a result of its experiments, the White Tower

management is considering enlarging its menu of foods. It has found that in three seconds an apple turnover can be thoroughly heated and then topped with ice cream. Study is being made of frozen foods with the idea of serving complete meals which can be cooked in less than a minute.

Special dishes are now served through a Radarange at a United Farmers restaurant. These include steak plate dinners, hot pastrami, chop suey, macaroni, spaghetti and meat balls, stews, and omelets. In the baking of cakes, muffins, or biscuits, the texture of the finished product is found to be far lighter than is possible in any other method of baking due to the rapidity with which the heat is introduced into the dough at a uniform rate throughout.

According to Charles Paino, executive of United Farmers, "People in general much prefer the electronic method of preparing and

(Continued on p 158)



High-speed electronic cooking is done in a few seconds at this White Tower restaurant near Boston

NOW YOU CAN USE THERMISTORS

(Thermal Resistors)

Some Suggested Uses

CHEMICAL AND FOOD PROCESSING

Local and Remote Temperature Indication
Detector in Infrared Spectrometry
Automatic Temperature Control
Gas Detectors
Refrigeration Control
Pyrometry
Vacuum Gauges
Temperature Compensation
Calorimetry
Infrared Spectrophotometry

COMMUNICATIONS

Automatic Gain Regulators
Volume Limiters
Overload Protectors
Compressors and Expanders
Power Indicators
Ambient Temperature Compensation
Amplitude Stabilized Oscillators
Voltage Regulators
Switching Devices
Remote Controlled Resistances
Time Delay Devices
Negative Resistances
Transmission Networks

TRANSPORT

Engine Temperature Measurement and Control
Cabin Temperature Control
Meteorological Equipment
Flow Meters
Test Equipment
Switching and Signalling Devices
Differential Temperature Controllers
Fire Protection and Safety Devices

HOUSING AND HOUSEHOLD APPLIANCES

Air Conditioning Systems
Automatic Room Temperature Control
Fire Protection Devices
Automatic Switches
Gas Detectors
Furnace Controls
Oven Temperature Control
Refrigeration Control
Thermal Insulation Testing
Thermal Conductivity Testing

MANUFACTURING OPERATIONS

Quality Control
Temperature Measurement and Control
Fire Protection Devices
Pyrometry
Automatic Switching and Time Delay Devices
Voltage Regulators
Surge Suppressors
Anemometry
Vacuum Gauges
Flow Meters
Differential Temperature Controllers

MINING AND METALLURGY

Fire Protection and Safety Devices
Gas Detectors
Local and Remote Temperature Measurement and Control
Pyrometry
Quality Control
Calorimetry
Time Delay Devices
Geological Surveys

PUBLIC UTILITIES

Voltage Regulation
Switching Devices
Time Delay Devices
Power Indicators
Warning Devices
Temperature Compensation of Instruments
Gas Detectors
Pyrometry
Calorimetry
Flow Meters
Anemometry
Chemical Analysis and Control

... to give greater Accuracy and Dependability to your Products and Processes

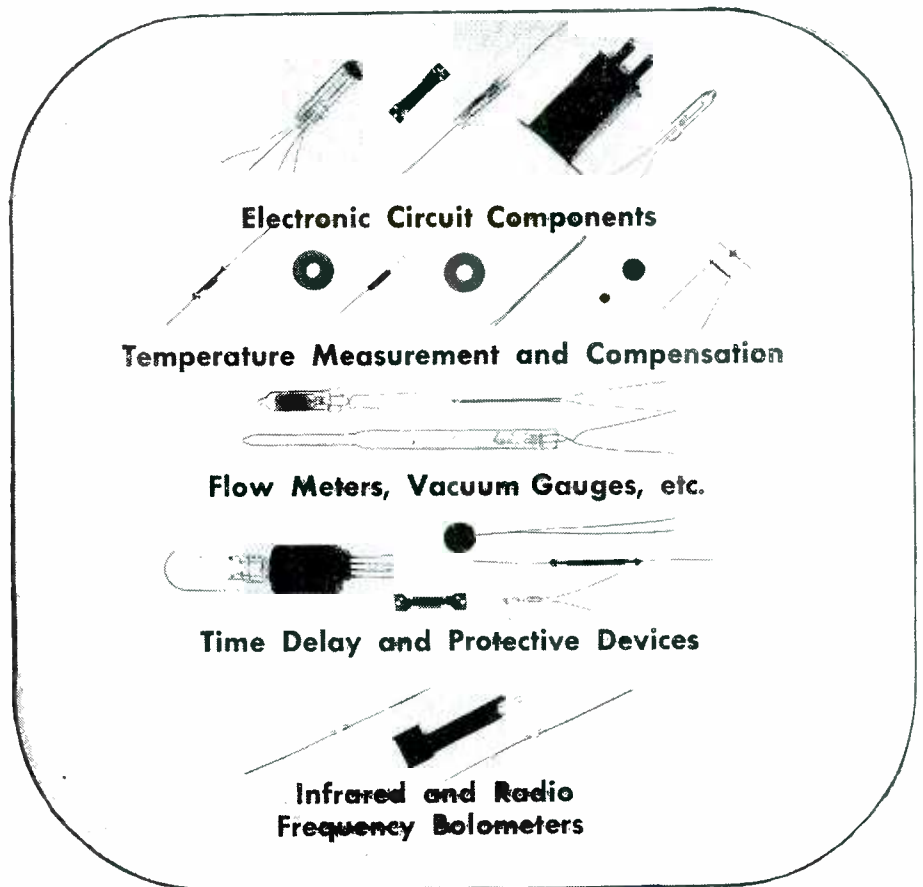

When you take advantage of the unique electrical characteristics of thermistors, you can use simpler, more economical circuits than are possible with conventional components.

Made of semi-conducting metallic oxides, the resistance of these thermistors varies inversely with temperature.

As their temperature rises, their resistance *decreases*—as their temperature goes down, their resistance *increases*.

For literature giving details of thermistor applications, call the nearest office of the Graybar Electric Company—or mail the coupon below.

Western Electric



— QUALITY COUNTS —

Graybar Electric Company
420 Lexington Avenue
New York 17, N. Y.

Please send me Bulletin T-2288 describing applications of Western Electric Thermistors

Name _____

Address _____

City _____ State _____

THE ELECTRON ART

Edited by FRANK ROCKETT

Concealed Radio Receivers.....	142
Background Noise Suppressor.....	142
Radio Control Circuit.....	144
Federal Technical Services.....	144
Optical Techniques for Improving Television Pictures.....	188
Multireflection Klystron.....	192
Survey of New Techniques.....	200

Concealed Radio Receivers

DURING GERMAN OCCUPATION radio receivers were confiscated. Urgent need for hearing allied news spurred many to build receivers that could readily be concealed. Most popular circuit was the reflex type in which one tube serves both as r-f and audio amplifier, having two different inputs and outputs. Dual type tubes were preferred in the miniature or acorn varieties. Restricted space necessitated use of trimmer capacitors for tuning thus limiting reception to the 30, 40, and 50 meter bands. However jamming on these frequencies forced use of fixed tuned receivers on 1,500 meters.

The number of such sets that were built can be estimated from the fact that electrolytic capacitors of small size were specially developed for power supply filters. Heater current was obtained by a small step-down transformer in which case, should the a-c power be interrupted, the set could be oper-

ated from a 6-v a-c bicycle generator connected across the 6-v side of the power transformer, the transformer then acting to step up this voltage for the plate supply. A lamp bulb could be used to drop the power-line voltage for use on the heater, in one case the receiver being built into the base of a reading light. Either acorn tubes or small selenium rectifiers were used in power supplies.

Sets were variously concealed in candy boxes, books, or other common household articles. In one instance, to send a receiver to a prisoner of war at a German camp, the set was built into a tin of vegetables. After the circuit had been assembled it was weighted to bring the total weight to the proper value with the center of gravity at its normal position. The inside of the tin was lined so it would produce the normal sound if tapped. It was safely received and put to good use at the camp.



Receiver was assembled in baby's powder duster. Power line was camouflaged by knitting and used as girdle on mother's dressing gown. Earphone was covered with knitting and hung in the cradle as baby's rattle. Need for news resulted in engineers of Philips at Eindhoven producing many sets through personal initiative for use by the Netherlands during German occupation

Background Noise Suppressor

HIGH-FREQUENCY NOISE is bypassed in the absence of high-frequency signals by a reactance-tube circuit, but when desired high-frequency audio signals are present, a disabling network renders the bypassing circuit inoperative. The suppressor can be used to remove record surface noise and noise introduced by the phonograph pickup. Under such conditions, h-f audible noise is constant and readily determined. During reproduction of quiet passages, noise is objectionable and therefore is suppressed. However, during passages when h-f signals of appreciable amplitude are present, noise is sufficiently below the reproduction level to be unobjectionable. A two-tube circuit

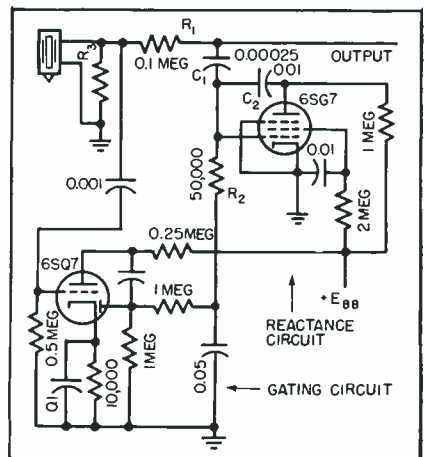

Reactance tube 6SG7 bypasses high-frequency noise. Gating tube 6SQ7 disables the shunting action of the reactance tube when h-f signals are present

acts to suppress background noise during such quiet passages, but to pass desired high frequencies if they are present at amplitudes above the noise level. The circuit is similarly applicable in any audio channel in which the noise level is constant.

Disabling Circuit

In the accompanying circuit diagram, a crystal phonograph pickup delivers a signal to the output. A circuit associated with the 6SG7 provides capacitive reactance between output and ground, which, in conjunction with series resistor R_1 , acts as a low-pass filter. The circuit associated with the 6SQ7 acts to gate the reactance tube, de-

A New L-C Dial for



TYPE 160-A

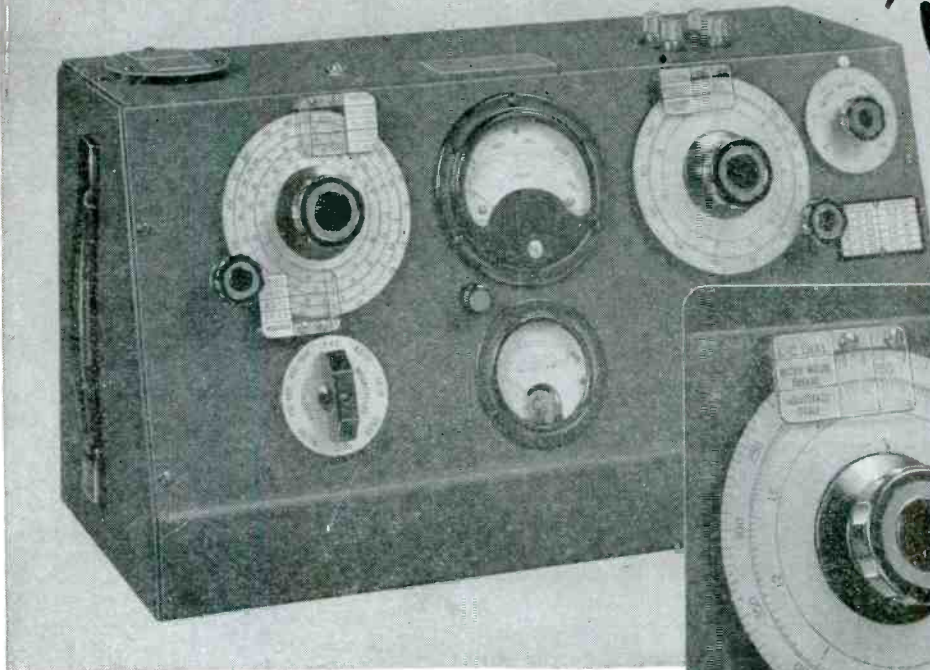

NEW INDUCTANCE SCALE ON Q-METER CAPACITOR DIAL NOW PERMITS DIRECT DETERMINATION OF EFFECTIVE INDUCTANCE VALUES BETWEEN 0.1 MICROHENRY AND 100 MILLIHENRIES.

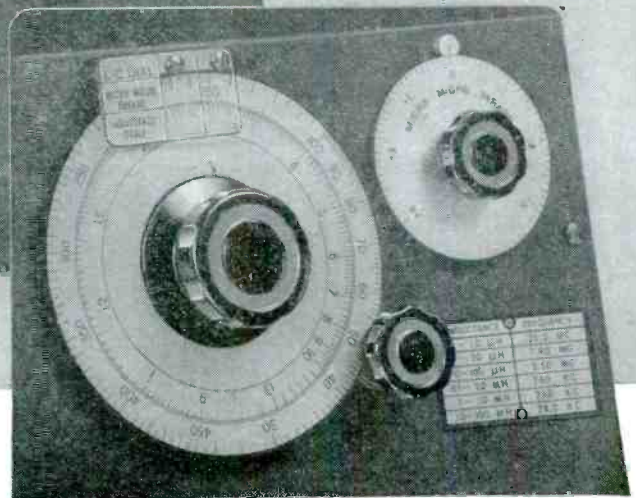

ENLARGED VIEW OF NEW L-C DIAL SHOWING EFFECTIVE INDUCTANCE SCALE. REFERENCE PLATE MOUNTED DIRECTLY BENEATH VERNIER CAPACITOR DIAL SHOWS INDUCTANCE TUNING RANGE OBTAINABLE AT INDICATED SPOT FREQUENCIES.

The 160-A Q-Meter is universally recognized as a rapid and simple means for measuring effective inductance. The customary method of measurement employed by engineers is to resonate the coil under test at a known frequency using a known capacitance, and thus obtain the effective inductance value of the coil by calculation. The use of the new L-C dial, as explained below, further increases the speed and versatility of the 160-A Q-Meter by eliminating the necessity for inductance calculations.

Since the Q capacitor of the 160-A Q-Meter has a capacitance range of somewhat more than 10:1, it is evident that inductance values over a 10:1 range can be resonated at any single frequency. It is, therefore, possible to include on the Q capacitor dial a single decade inductance scale reading directly in terms of effective inductance provided that the proper measurement frequency is selected. The new L-C dial is based on this principle.

Write for Catalog "D"

An inductance-frequency reference plate has been provided on the front panel which shows the proper frequency to which the RF oscillator should be set in order to obtain the inductance measurement range desired. Any one of six consecutive inductance tuning ranges may be selected, permitting overall inductance measurements of from 0.1 microhenry to 100 millihenries to be made.

For those 160-A Q-Meter owners who wish to equip their own instruments with the new L-C dial, a dial conversion kit, Type 560-A, is available which contains complete parts, hardware, and instructions for installing this dial without disturbing the calibration of the 160-A instrument.

L-C DIAL CONVERSION KIT TYPE 560-A

This conversion kit is available in a unit package, complete with all items required to install the L-C dial on your present 160-A Q-Meter.

Further details upon request.



DESIGNERS AND MANUFACTURERS OF THE "Q" METER . . . QX-CHECKER . . . FREQUENCY MODULATED SIGNAL GENERATOR . . . BEAT FREQUENCY GENERATOR . . . AND OTHER DIRECT READING TEST INSTRUMENTS

creasing its capacitance to ground in the presence of high frequencies to the left of R_1 .

A resistance-capacitance divider so proportioned that it passes only high frequencies feeds the grid of the 6SQ7. Likewise the bypassing capacitor for the self-biasing cathode resistor of the 6SQ7 is proportioned to shunt only high frequencies so that the triode is degenerated for low frequencies but amplifies high frequencies. Also the diode-section anode of the 6SQ7 is driven from the triode-section anode through a high-pass resistance-capacitance network. These three high-pass R-C networks pass only frequencies above approximately 600 cps to the rectifier.

The diode section of the 6SQ7 develops a direct-current bias that disables the reactance tube in the presence of high frequencies. To delay the disabling action until the h-f amplitude exceeds the noise level (that is, until wanted signals are present), the cathode resistor of the 6SQ7 is made quite large, the exact magnitude depending on the noise level into the channel. The diode charges a capacitor in the grid circuit of the 6SQ7 to provide a negative biasing potential that reduces the tube's gain in the presence of frequencies above about 600 cps and at intensities higher than the noise level below which quieting is required and in proportion to the amplitude of these signals.

Electronic Low-Pass Filter

Resistance R_1 and vacuum tube 6SQ7 constitute a low-pass filter of variable cut-off frequency. Capacitor C_1 is a coupling capacitor, and C_2 is a feedback coupling from anode to grid to enhance the reactive effect of the 6SQ7 at higher frequencies. Furthermore, the capacitor between screen and cathode is small so that at low frequencies the gain of the pentode is degenerated by its screen, but at high frequencies the screen is held at ground potential, permitting normal tube gain. The capacitance (as distinguished from capacitive reactance) of the tube is thus a function of frequency.

In addition, the gain of the 6SQ7 is controlled by the gating

action of the disabling circuit so as to adjust the h-f shunting effect of the tube. The time constant of the grid biasing circuit is relatively short so that disabling bias can be rapidly applied and as quickly removed.

Although the switching action is so fast as to be substantially imperceptible to the human ear, the control action is relatively slow compared to the period of the frequencies being gated so that there is negligible distortion.

Coupling resistance R_2 between the disabling circuit and the reactance circuit serves two purposes. It is made sufficiently small so that the apparent level of the output from the complete suppressor circuit is not appreciably changed as the reactance tube becomes more or less capacitive. In addition, R_2 with C_1 acts as the usual tone compensating network used with crystal phonograph pickups to reduce the midfrequencies in proportion to the reduction of low frequencies provided by resistor R_3 .

Should cathode bias be necessary in the reactance tube, the screen bypass capacitor is grounded instead of being connected to the cathode. Furthermore, the cathode bypass capacitor is made small so that at low frequencies there is cathode degeneration. The result is that the impedance of the reactance tube to low frequencies is very high and to high frequencies is quite low in the absence of a disabling bias from the gating circuit. Usual precautions of h-f circuits should be observed in the layout and wiring of the suppressor. (U. S. Patent 2,369,952 granted Feb. 20, 1945 to George F. Devine, assignor to General Electric Co.)

Radio Control Circuit

MODEL AIRCRAFT AND BOATS can be remotely controlled by radio. A circuit suitable for such applications where economy of space, weight, and battery drain is essential is shown in Fig. 1. The subminiature RK61 thyatron is used in a self-quenching superregenerative detector to operate a high resistance re-

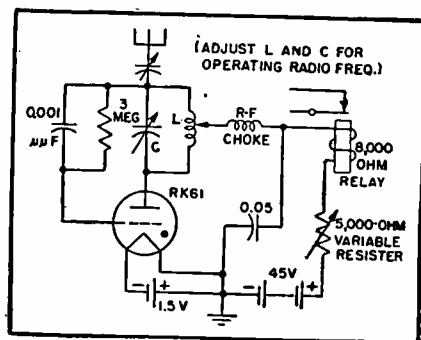

FIG. 1—Remotely controlled radio circuit uses subminiature tube

lay upon reception of a radio signal. Sufficient series plate load resistance must be used to limit the anode current to less than two milliamperes; greater tube life will be obtained at lower currents.

In the circuit either a 45-v battery or raw a-c can be used for the plate supply; the filament requires 1.4 v at 50 ma. In the absence of a radio signal the circuit is oscillating at audio frequency. When the r-f is received, a-f oscillations stop with a decrease in anode current from between 1.0 and 1.5 ma to between 0.1 and 0.5 ma. Average anode current can be increased by increasing antenna coupling, decreasing the L/C of the tank circuit, or both. Maximum controllable current can be increased by increasing the anode bypass capacitance, decreasing the grid-leak resistance, or both. If the capacitance of the anode bypass capacitor is reduced and the relay replaced by headphones, the Raytheon RK61 krypton and xenon filled thyatron will operate in this circuit as a conventional superregenerative converter with an anode supply as low as 30 v. It is not recommended for use above 100 mc.

Federal Technical Services

TECHNICAL AND BUSINESS services are provided to industry by several departments of our federal government. In particular the Department of Commerce promotes domestic commerce, manufacturing, and international trade. In carrying out its activities, the department performs many functions of interest to electronic engineers. For example, information on German industrial

(Continued on p 184)

Power Resistors on Short Delivery Cycle

Whatever your needs in power resistors there's an IRC resistor to do the job... readily available for immediate delivery. Four types of power wire wound resistors... each particularly suited to certain circuit or design applications... all unexcelled in essential electrical and mechanical characteristics... provide proven solutions to voltage dropping problems where power dissipation is necessary. Write for complete information regarding specifications, characteristics and delivery, stating products in which you are interested. International Resistance Company, 401 N. Broad Street, Philadelphia 8, Pennsylvania. In Canada: International Resistance Company, Ltd., Toronto, Licensee.

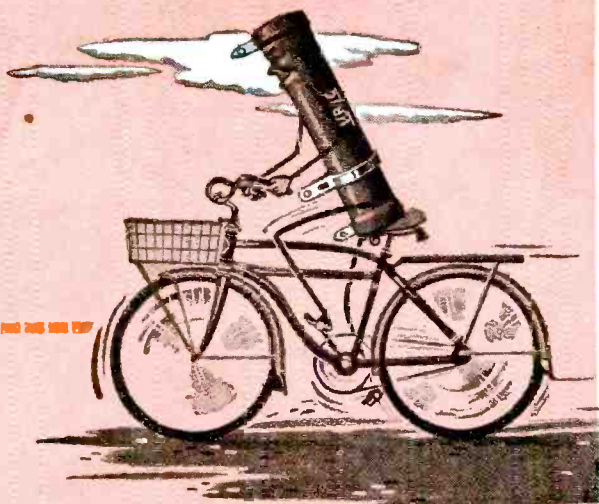

PWW Resistors

For exacting heavy-duty applications. Tubular power wire wounds of extreme mechanical strength. Available in two coatings for high temperature or high humidity conditions. Fixed, adjustable and non-inductive types in full range of sizes, ohmic values and terminals.



FWW Resistors

For voltage dropping in limited space applications. Flat power wire wounds of lightweight construction. Designed for vertical or horizontal mounting singly or in stacks. Mounting brackets serve as conductors of internal heat. Fixed adjustable and non-inductive types in full range of sizes and ohmic values.

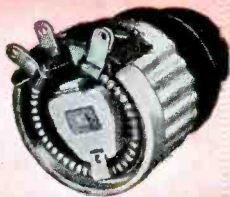

PR Rheostats

All metal construction permits operation at full load with as little as 25% of winding in use, with only slight increase in temperature rise. Available in 25 and 50 watt ratings. Type PR-25: diameter 1²¹/₃₂"", depth behind panel 3¹/₃₂"", standard resistance values 1 to 5,000 ohms. Type PR-50: diameter 2²³/₃₂"", depth behind panel 1³/₈"", standard resistance values 0.5 to 10,000 ohms (higher values on special orders).

$$I = \frac{E}{IRC}$$



MW Resistors

For applications where low temperature rise, space and weight are vital factors. Encased in special phenolic compound for complete protection. Unique design of mounting bracket aids rapid heat dissipation. Multi-section feature permits exceptional flexibility for voltage dividing applications.

INTERNATIONAL RESISTANCE COMPANY

Power Resistors • Precisions • Insulated Composition Resistors • Low Voltage Wire Wounds • Rheostats • Controls • Voltmeter Multipliers • Voltage Dividers • HF and High Voltage Resistors

NEW PRODUCTS

Edited by A. A. MCKENZIE

New equipment, components, packaged units, allied products; new tubes. Catalogs and manufacturers' publications reviewed.

All-Band Transmitter (1)

HAMMARLUND MFG. Co., 460 W. 34th St., New York 1, N. Y. The Four-20 transmitter combined with the Four-11 modulator constitute a continuously variable single-control multiband amateur transmitter with a power output on phone or c-w



of about 20 watts. The ingenious tuning system allows compact construction and ease of operation. The modulator is easily modified to serve either as an audio amplifier or driver for a more powerful modulator.

Ships Call Alarm (2)

BRELCO ELECTRONICS Corp., 55 Vandam St., New York 13, N. Y. The Brelco-McGoffin alarm model 297 is primarily designed to assist the

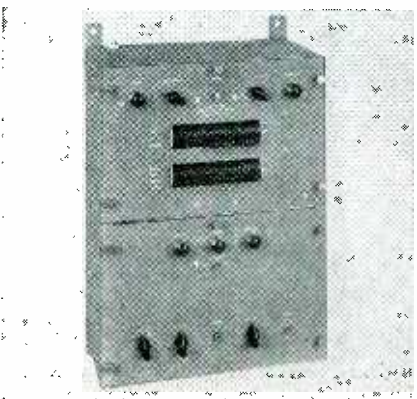

radio operator in maintaining a watch on the 500 kc calling frequency while he is busy or off duty. An ingenious relay system that can be set up to respond to assigned call letters or any other number or letter code is common to all equipments and can be reset to another combination in a few moments. Audible and visual alarms indicate the reception of a call.

Portable Storage Cell (3)

THE VITAMITE Co., 227 W. 64th St., New York, N. Y. The nonspill, rechargeable battery model 2A045 illustrated weighs one ounce, has a

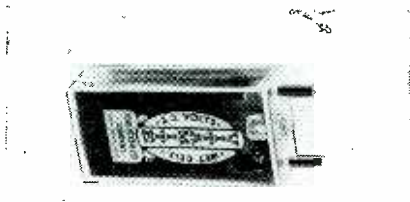

voltage of 2.2 volts, a capacity of 450 milliamperes-hours, and measures $\frac{1}{8} \times \frac{7}{8} \times 1\frac{1}{8}$ inches.

USING THE NUMBERS

Readers desiring further details concerning any item listed in the New Products department can obtain the information by using the cards furnished as a stiff, colored insert elsewhere in this department.

Place the number (appearing to the right of the heading) of one item in which you are interested in a circle and then fill out the balance of the card according to directions appearing on the colored sheet. Unnumbered items listed at the end should be procured direct from the manufacturer or publisher upon payment of the fee noted.

Marine Radar (4)

DEMORNAY-BUDD, Inc., 475 Grand Concourse, New York 51, N. Y. Intended primarily for use on ocean freight and passenger vessels, the marine radar has a range of from

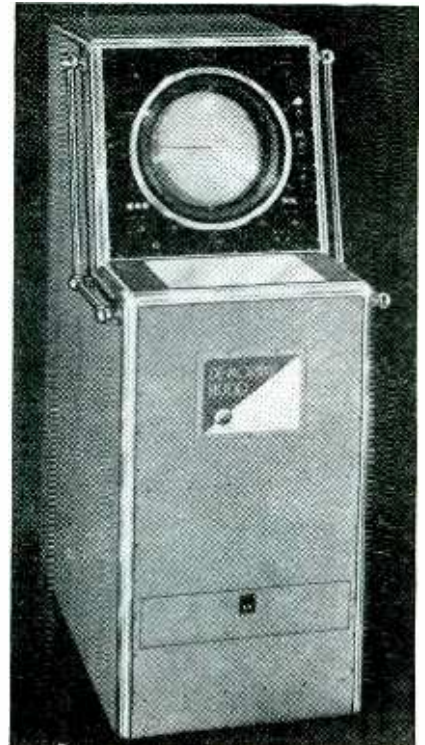

100 yards to 32 miles. It exceeds the specifications of the Coast Guard for class A equipment, operates in the band assigned by the Federal Communications Commission for marine navigation (approximately 9,300 megacycles) and has a peak pulse power output of 18 kilowatts. Microfilm copies of geodetic charts made on 70-mm color film are projected on a screen for comparison with indications on the 12-in radar screen.

Standing-Wave Meter (5)

M. C. JONES ELECTRONICS Co., 96 N. Main St., Bristol, Conn. The Micromatch is a device for deter-

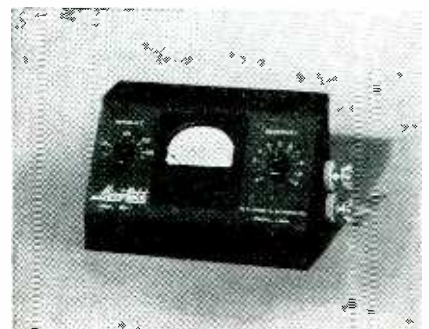

mining the standing-wave ratio and the r-f power in the transmission line in which it is connected. It will operate on frequencies between 3 and 30 megacycles, in a transmission line with a surge impedance from 70 to 300 ohms using power from 10 to 1,000 watts.

High-Vacuum Furnace (6)

EITEL-MCCULLOUGH, Inc., 1570 San Mateo Ave., San Bruno, Calif. A new type of high-vacuum furnace is capable of continuous operation at temperatures in the region of 1,800 C. Three chambers make it



possible to keep material in various phases of the treatment. A vacuum as high as 5×10^{-6} millimeters of mercury is quickly attained. Furnace heating is accomplished with large-diameter tungsten elements using low voltage.

Damping Material (7)

COOK LABORATORIES, 139 Gordon Blvd., Floral Park, N. Y. Audiod A is a long-life synthetic used to compensate the mechanical frequency responses of devices such as cutting heads, pickups, and microphones. It is easily cut or shaped, and is now available in $\frac{1}{8}$ or $\frac{1}{16}$ sheet for laminating to desired thickness.

High Frequency Signal Generator (8)

HARVEY RADIO Laboratories, Inc., 439 Concord Ave., Cambridge 38, Mass. A c-w signal variable over the range 140 to 170 mc and cali-

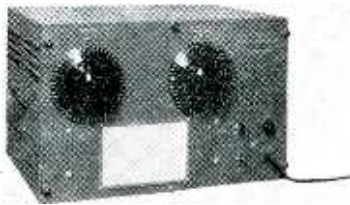

brated every megacycle can be obtained using a new generator with an attenuator adjustable from 20 to 134 db below 1 volt. A calibrated dial drives a piston attenuator. Gears are chosen such that the dial calibrations are 1 db apart. Changes in attenuation have negligible effect upon frequency and vice versa.

Impedance-Phase Meter (9)

TECHNOLOGY INSTRUMENT Corp., 1058 Main St., Waltham, Mass. Impedance and phase angle measurements over the frequency range of 30 to 20,000 cycles in the field of



electrical and electroacoustic instrumentation is possible with the type 310-A Z-Angle Meter. Balance is accomplished by means of a single dial that reads directly in impedance and the phase angle is indicated on a direct-reading meter.

Power Triode for F-M (10)

FEDERAL TELEPHONE AND RADIO Corp., Newark, N. J. The type 7C27 power triode designed for f-m service in the 88- to 108-mc band, with

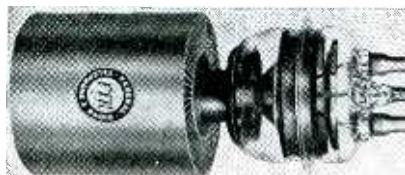

a maximum output up to 110 mc provides 10 kw output from a push-pull final amplifier stage. The required air flow for cooling, at maximum output, is 175 cfm. The maximum plate dissipation is 3,000 watts, filament voltage is 16 volts, and filament current is 28.5 amperes.

Beam Transmitting Tetrode (11)

SYLVANIA ELECTRIC PRODUCTS Inc., 500 Fifth Ave., New York 18, N. Y. A new beam power tetrode type 3D24 designed for amateur, marine and mobile service performs satis-

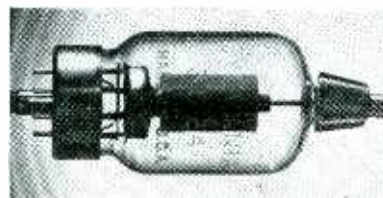

factorily at frequencies up to 125 megacycles. Typical operating conditions follow: plate, 2,000 v; control grid, -300 v; screen grid, 375 v; plate current, 90 ma; full driving power, 4 watts; power output, 140 watts.

Coaxial Switch (12)

GENERAL COMMUNICATION Co., Boston, Mass. A new weatherproof remote control microwave switch has been announced for antenna switch-



ing and remote control instrumentation. It has a minimum reflection loss up to 5,000 megacycles. The voltage standing wave ratio curve is almost flat from 500 to 4,000 megacycles. At 3,000 megacycles it is less than 1.2. Its characteristic impedance is 50 ohms, insertion

DE MORNAY • BUDD STANDARD TEST EQUIPMENT

For Precision Measurements in the Microwave Field

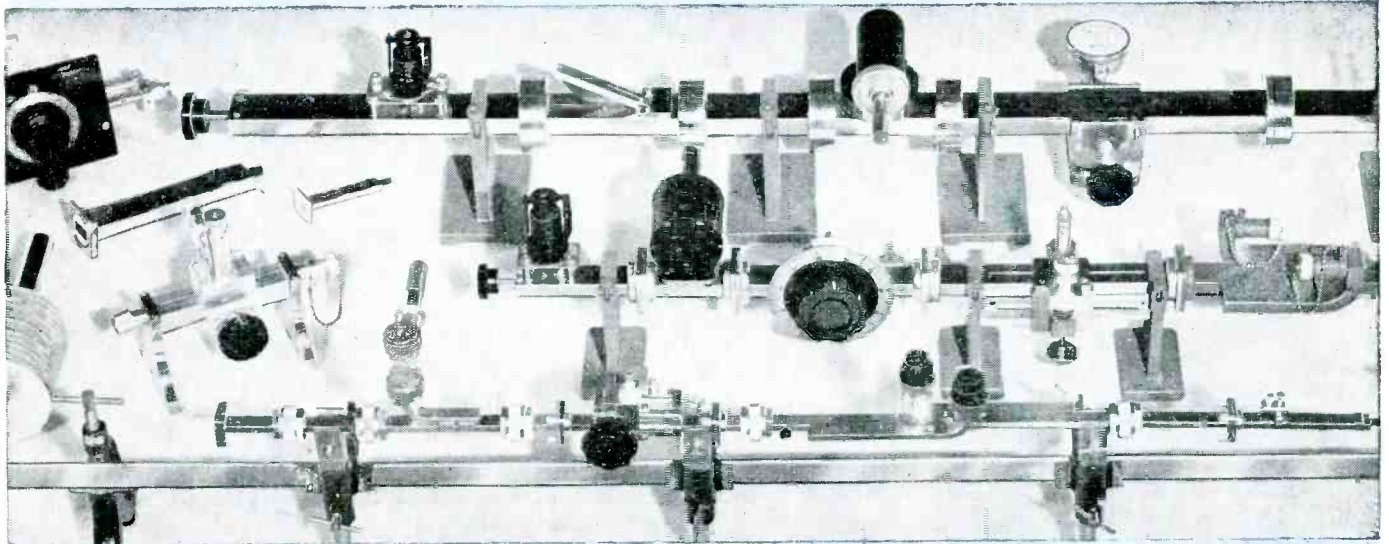

The complete line of De Mornay-Budd standard test equipment covers the frequency range from 4,000 mcs. to 27,000 mcs. It provides all R. F. waveguide units necessary for delicate, precision test work requiring extremely high accuracy in attenuation measurements, impedance measurements, impedance matching, calibration of directional couplers, VSWR frequency measurements, etc.

To eliminate guesswork, each item of this De Mornay-Budd test equipment is individually

tested and, where necessary, calibrated, and each piece is tagged with its electrical characteristics. All test equipment is supplied with inner and outer surfaces gold plated unless otherwise specified.

NOTE: Write for complete catalog of De Mornay-Budd Standard Components and Standard Bench Test Equipment. Be sure to have a copy in your reference files. Write for it today.

The three test set-ups illustrated above include:

Tube Mount
Flap Attenuator
Frequency Meter
Calibrated Attenuator
Tee
Stub Tuner

Tunable Dummy Load
Standing Wave Detector
Type "N" Standing Wave Detector
Directional Coupler
High Power Dummy Load
Cut-Off Attenuator

Stands, etc.

DE MORNAY
BUDD

EQUIPMENT
FOR
97% OF ALL
RADAR SETS

DE MORNAY • BUDD INC., 475 GRAND CONCOURSE, NEW YORK 51, NEW YORK. CABLE ADDRESS "DEMBUD," N. Y.

loss 3 db at 3,000 megacycles, power rating 100 watts at 3,000 megacycles, voltage rating 500 volts peak, and crosstalk 60 db. This equipment is distributed through Hastings Sales Engineering Company, 532 Commonwealth Ave., Boston 15, Mass.

Servomotors (13)

FAIRCHILD CAMERA and Instrument Corp., 88-06 Van Wyck Blvd., Jamaica 1, N. Y. Two servomotors designed for thyatron control operation from 115-volt, 60- or 400-cycle a-c weigh less than a pound, have a

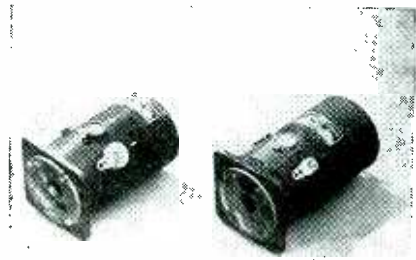

72-to-1 gear reduction and are useful in follow-up or computing systems.

Shielded F-M and Television Line (14)

ANACONDA WIRE AND CABLE Co., 25 Broadway, New York 4, N. Y. ATV 150 Shielded is a flat oval cable consisting of twin parallel stranded bare copper conductors (7-x No. 28), polyethylene insulation, bare copper braid, and Densheath jacket

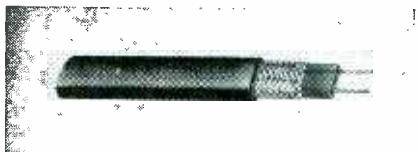

overall. This design permits conservation of both insulation and jacket material, thus making the cable considerably less expensive than the standard round coaxial cable. The characteristic impedance is 150 ohms.

Miniature Lug (15)

CAMBRIDGE THERMIONIC Corp., 445 Concord Ave., Cambridge, Mass. A new terminal lug has a base diam-

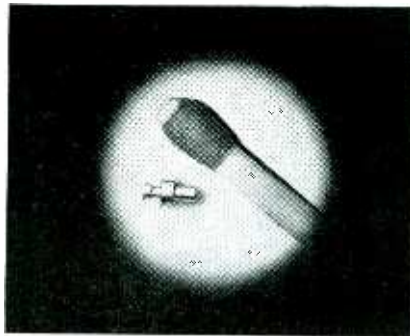

eter of $\frac{3}{8}$ inch and projects an equal distance above the mounting board. The standard mounting shank is 0.025 inch long. Fabricated from silver-plated brass, the lug is expected to be used in wiring miniature carbon resistors and ceramic capacitors in small units.

Vacuum Capacitor (16)

AMPEREX Electronic Corp., 25 Washington St., Brooklyn, N. Y. A new vacuum capacitor VC-50 rated 30,000 volts maximum peak voltage and having a capacitance of 50 micromicrofarads ± 2 percent has maximum rms current ratings



of 65 amp at 10 mc and 40 amp at 60 mc, based on a maximum glass-to-metal seal temperature of 150 C. Internal losses are largely ohmic and decrease as the frequency decreases. Maximum overall length is 6.6 in., and the diameter is 2.5 in.

Direction-Indicating Potentiometer (17)

OHMITE MFG. Co., 4855 Flournoy St., Chicago 44, Ill. The model RB-2 direction indicating potentiometer has been developed for use with a rotary-beam antenna element. When connected to an ordinary 0-1 milli-ampere d-c meter with a specially marked scale, change in the posi-



tion of the antenna is directly indicated on the meter. Complete circuit and other information is contained in Bulletin 128.

Illuminated Meters (18)

SIMPSON ELECTRIC Co., Chicago, Ill. A new line of illuminated meters is available in 2- and 3-inch sizes with either rectangular or round cases. Light from a recessed bulb



in the back of the instrument is carried through a Lucite cone that entirely surrounds the dial face.

Super Grid-Dip Meter (19)

MEASUREMENTS CORP., Boonton, N. J. The model 59 Megacycle Me-



(continued on p 204)

MORE THAN 50 GRADES OF G-E TEXTOLITE LAMINATED PLASTICS ARE AVAILABLE



**PROBLEM—
DEVELOP A LAMINATED
PLASTICS MATERIAL HAVING
VERY HIGH DIMENSIONAL
STABILITY—EXCELLENT
INSULATING PROPERTIES**

G-E Textolite, grade No. 2029, has very high electrical insulating values. It machines excellently and can be punched hot in simple forms. High dimensional stability and low moisture absorption make it ideal for applications where it is vital to maintain small initial clearances. 2029 is also used for jobs requiring immersion in oil and where high dielectric strength parallel to laminations is required.

**TEXTOLITE LAMINATED IS SUPPLIED
IN FIVE FORMS**



SHEETS, TUBES, AND RODS
—These standard shapes are available in thousands of sizes. Up-to-date manufacturing methods facilitate quick deliveries.

FABRICATED PARTS—G.E. has modern fabricating equipment to machine Textolite laminated plastics parts to your own specifications.



MOLDED-LAMINATED PARTS—Textolite is custom molded directly to shape. Molded laminated products are among the strongest plastics parts produced.

LOW-PRESSURE MOLDED PARTS—Extremely large and irregular Textolite shapes are custom molded by the low-pressure laminating process.



POST-FORMED LAMINATES
—Sheets of Textolite laminated plastics are custom formed into simple shapes by this very inexpensive method.

JUST ONE OF THE MANY

G-E Textolite grade No. 2029 was developed to meet the above specifications. But it is just one of the many high-quality grades available—there are over fifty, and like the alloys of metals, each has a special combination of properties. This variety of grades is your assurance that the one specified for your application will do the job. For to be successful in any application a laminated plastics must have the correct properties . . . with Textolite you get a choice.

Then, too, G-E Textolite is supplied in many forms—sheets, tubes, and rods; fabricated parts; molded-laminated parts; low-pressure molded parts; post-formed laminates. Again, you get a choice . . . another essential factor to be considered if the laminated plastics assignment is to be accomplished in the best and most economical way.

GENERAL ELECTRIC  **ELECTRIC**
CD47-E1

GET THE COMPLETE STORY!

Send for the new bulletin G-E TEXTOLITE LAMINATED PLASTICS which lists grades, properties, fabri-

cating instructions and detailed information about the five forms of Textolite. Fill in and mail the coupon below for your free copy.

**PLASTICS DIVISION (AC-6), CHEMICAL DEPARTMENT
GENERAL ELECTRIC COMPANY
ONE PLASTICS AVE., PITTSFIELD, MASS.**

Please send me the new G-E Textolite laminated plastics bulletin.

Name.....

Firm.....

Address.....

City..... State.....

NEWS OF THE INDUSTRY

Edited by JOHN MARKUS

FCC allocates new heating frequencies; low-power f-m for colleges; telephone recorders approved; new television test standards

FCC Makes Allocations for Short-Distance Communication

ALLOCATION of 166 additional frequencies for short-distance radio-telephone services in the 152-162 megacycle portion of the spectrum became effective May 15. Although 60 of these frequencies had been previously allocated to the railroads, these are now finalized by the Commission's action and are not likely to be further changed. This should encourage larger investment in railroad radio equipment and further use of railroad radio, especially for improving safety of operation.

Agencies making use of these frequencies include state police and forestry conservation services, state highway maintenance services, urban transit systems, power and petroleum utilities, intercity busses and trucks, and various types of vessels. Satisfactory equipment for practical everyday use operating on these frequencies became available in recent months. A full-sized antenna here need be no longer than 18 inches, a distinct advantage

in mobile service. Eventual transfer of all short-distance marine communication to frequencies in the 152-162 mc band is expected to relieve the severe long-distance interference usually encountered on the lower maritime frequencies.

Studies are still in progress relating to more permanent allocations of frequencies to systems now operating on experimental or developmental authorizations, such as taxicab radio and public telephone service to automobiles, boats, and aircraft. Any increase in point-to-point radio station facilities operating on these frequencies to provide short-distance toll telephone service where wire lines are not available is discouraged by the Commission. While a few present installations of this type will be permitted to continue in operation, no new facilities will be authorized except for operation on much higher frequencies, commonly termed microwaves.

Science Legislation

CHANCES for passage of National Science Foundation legislation in this session of Congress have greatly improved as a result of the compromise bill recently reported out of the Senate Labor and Public Welfare Committee. S. 526, as amended, contains the following provisions:

It would set up a National Science Foundation to develop a national policy for basic research, with no attempt to dictate or control Federal research. Basic research would be made available to all persons in a position to utilize it, consistent with national security.

The Foundation would be directed by a board of 24 members, appointed by the President and confirmed by the Senate. The members, composed of scientists, educators and men of public affairs, would be chosen from all areas of the country and would be on call by the chairman once a year, or more if necessary. The terms of office would be staggered so that after the initial establishment of the Foundation, one quarter of the members would be appointed every two years.

The bill provides for a 9-man executive committee, elected from the 24-member board to meet at least 6 times during the year at the call of the chairman. This committee would appoint a Director and

\$25,000,000 ELECTRONICS PARK BEGINS PRODUCTION OF TRANSMITTERS



Production of radio transmitters is now under way in the large building in the foreground, first of the nine units of General Electric's mammoth electronic manufacturing and research center to get under way. Construction status early in March is shown in this air view of the 155-acre tract located about 5 miles north of Syracuse, N. Y.

**0.001%
ACCURACY**

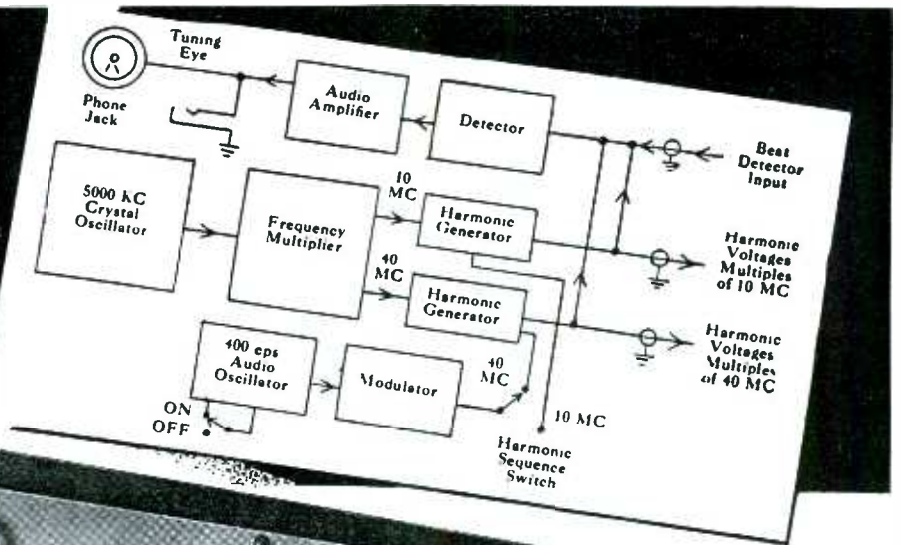

**BLOCK
DIAGRAM**

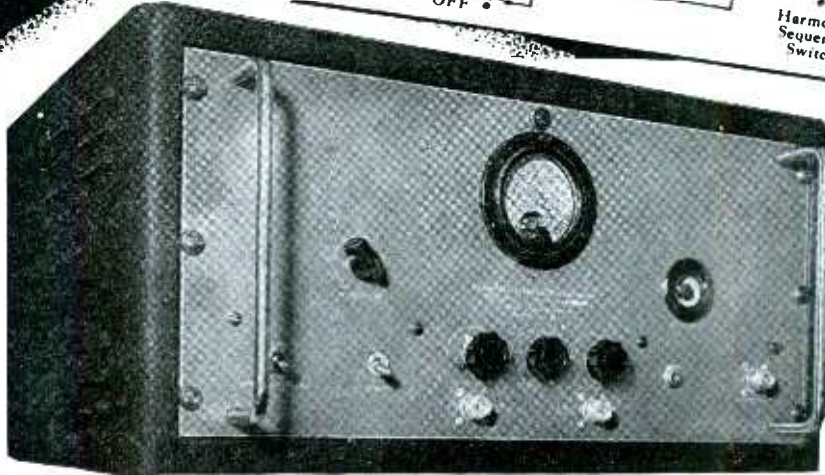

with the IMPROVED LAVOIE C-200 HARMONIC FREQUENCY GENERATOR

The Harmonic Frequency Generator has been improved for frequency standardization of receivers and frequency meters up to and beyond 2000 Megacycles. Also, by means of a beat detector built into the instrument, it is possible to standardize oscillators and signal generators with equal facility.

Further circuit refinements have produced a frequency accuracy of 0.001%, which extends from 100 Megacycles to 2000 Megacycles in either 10 Megacycle or 40 Megacycle steps.

The output voltage is supplied at a UG-58/U 50-ohm connector with output coupling controls to obtain peak performance for a given harmonic. A milliammeter is incorporated in the instrument to facilitate easy adjustment of the output controls. The output voltage may be either unmodulated or modulated with 400 cps internal oscillator. The generator provides output voltages every 10 Megacycles or every 40 Megacycles. This selection is made by a

switch on the front panel. The harmonic voltage is in the order of thousands of microvolts for each harmonic with a value of approximately 50,000 microvolts at 100 Megacycles and 1500 microvolts at 1000 Megacycles.

Provision is made for the standardization of signal generators and oscillators by the incorporation of a beat frequency detector in the generator. The output of this beat frequency detector may be monitored, either aurally or visually with a tuning eye indicator.

To facilitate harmonic identification, frequency identifiers can be supplied for any harmonic frequency (multiple of 10 Megacycles) between 100 and 1000 Megacycles. The identifier is adjusted at our factory.

This instrument is supplied with accessories needed for its operation, including tubes, 5 Megacycle crystal, output coupling cable and instruction book.



Write for Illustrated
Descriptive Folder

Lavoie Laboratories

RADIO ENGINEERS AND MANUFACTURERS
MORGANVILLE, N. J.

Specialists in the Development and Manufacture of UHF Equipment

confirm his appointment of a Deputy Director.

The Foundation would consist initially of five divisions: (1) medical research; (2) mathematical, physical, and engineering sciences; (3) biological sciences; (4) National Defense; (5) scientific personnel and education.

Scholarships and graduate fellowships would be awarded for scientific study to accredited colleges and universities, both American and foreign. The Foundation would utilize appropriations for research by making grants to qualified organizations, agencies, and institutions and by giving aid to individuals engaged in independent research.

The patent policy provides that the interests of the Government and equities of individuals be protected by operating within existing patent practices of the Government until such time as Congress or the President revises them. This provision would permit the Foundation to take into consideration each project as it comes up.

Weather Maps by Wire

WEATHER reports will be delivered to Army Air Force pilots in the form of wire photographs when in-

stallation of a nationwide network of Facsimile Set AN/TXC-1A is completed. Present plans call for dividing the entire United States into four large networks, each covering approximately 1,000 square miles. Weather analysts in a centrally located station will prepare maps, insert them into the transmitter, and relay copies to stations all over the country. The system will provide even the smallest airfields of the network with the services of the most skilled weather forecasters assigned to the AAF.

New Heating Frequencies

TO PROVIDE additional frequencies needed by the industrial, scientific, medical service, the FCC proposed on April 14 the allocation of five additional frequencies throughout the radio spectrum to this service. One of these, in the vicinity of 6 mc, is tentative, and a specific value will be assigned after the forthcoming Radio Administration Conference of the International Telecommunications Union. This frequency would be intended to accommodate all radiating devices used in this service which cannot be adequately shielded and which require frequencies below 13.66 mc.

This action of the Commission,

if and when fully implemented, following any oral argument which may be held and following this summer's international conferences, will result in the following complete family of frequencies for the industrial, scientific, medical service:

6	mc	±	2.5	kc
13.66	mc	±	7.5	kc
27.32	mc	±	160	kc
40.98	mc	±	20	kc
915	mc	±	25	mc
2,450	mc	±	50	mc
5,850	mc	±	75	mc
10,600	mc	±	100	mc
18,000	mc	±	150	mc

The wider band at 27.32 mc is effective immediately, however. Whereas emissions were previously limited to the band 27.185-27.455 mc, such emissions may now extend to the limits of the wider band, 27.160-27.480 mc. The amateur band that formerly shared all of this industrial, scientific, medical band is shifted to the lower-frequency end of the new band, the new limits being 27.160-27.430 mc.

F-M for Colleges

USE OF the modulator section of a large f-m transmitter as a low-power station for noncommercial educational broadcasting at colleges is proposed by G-E as a means of eliminating the cost barrier to wide-scale establishment of educational f-m stations. The 2.5-watt power output of such a station would provide coverage of five to six miles, which is enough to cover most college campuses, fraternity and sorority houses, dormitories, and surrounding student homes. The transmitter itself would draw only about 250 watts.

British Radio Exhibition

WARTIME advances in British radio and electronic technology will be highlighted at the fifteenth National Radio Exhibition, organized by the British Radio Industry Council, which will be held at London's Olympia exhibition hall from September 30 to October 11 this year.

This first postwar national exhibition will show latest types of broadcast receiving and record-reproduction equipment and their components, radio and television

(continued on p 249)

TELERAN FLIGHT SIMULATOR



Special installation of Teleran receiver in cockpit of flight simulator brings this air navigation aid to the second of three major steps in its development program by RCA. Final step is actual flight test, scheduled to start in Washington, D. C. in the fall. The system utilizes television and radar to provide the pilot with an aerial roadmap combining traffic, route, weather, and other vital information

This **HEINEMANN**
MAGNETIC
CIRCUIT BREAKER

**bares its
Mechanical
Heart**

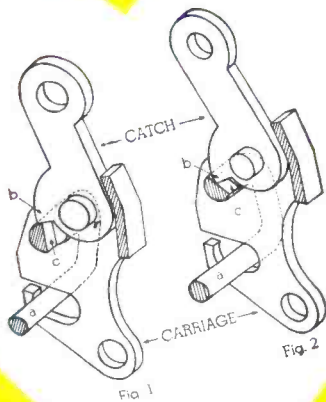
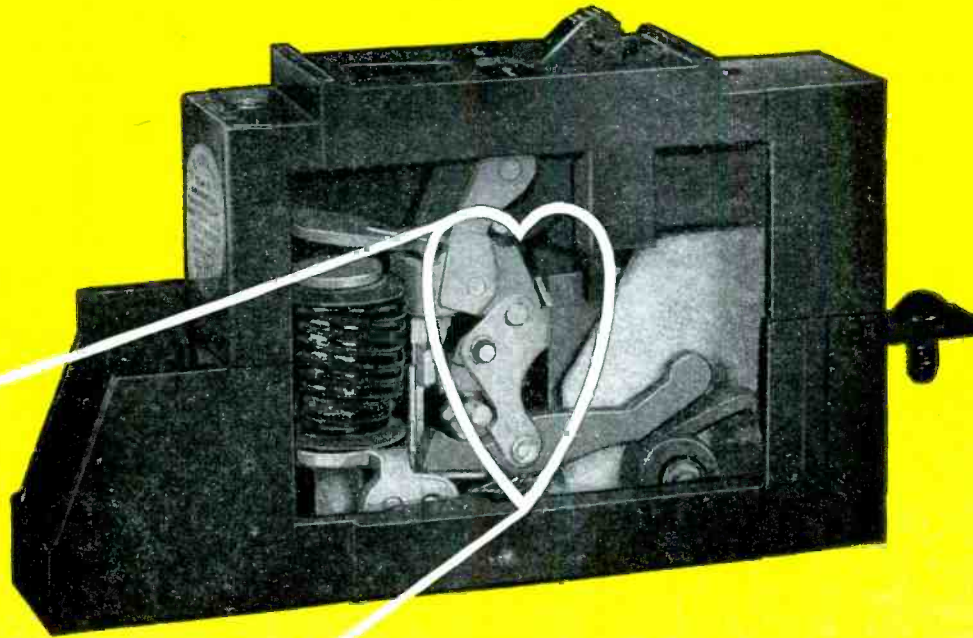

This MECHANICAL HEART
(or Latch Mechanism) does double duty . . .

No. 1 *It opens breaker with least mechanical delay . . .*

When the armature engages the lower leg of the lock (a) it rotates the lock enabling the tooth of the catch (b) to pass through the cut portion of the lock (c), thereby breaking the toggle and releasing the contacts which are under heavy spring pressure. *Of all known latches, this mechanism operates with the least amount of friction.*

No. 2 *It opens breaker independent of handle operation.*

The relative position of the catch to the carriage remains the same as in Fig. 1 whether the handle is in the "on" position or turned to the "off" position, when the contact is broken manually. The latch collapses only under overload or short circuit conditions—and it does that even if the handle is purposely held in the "on" position. Fig. 2 shows the latch on its way to the collapsed position.



HEINEMANN ELECTRIC COMPANY

Established 1888

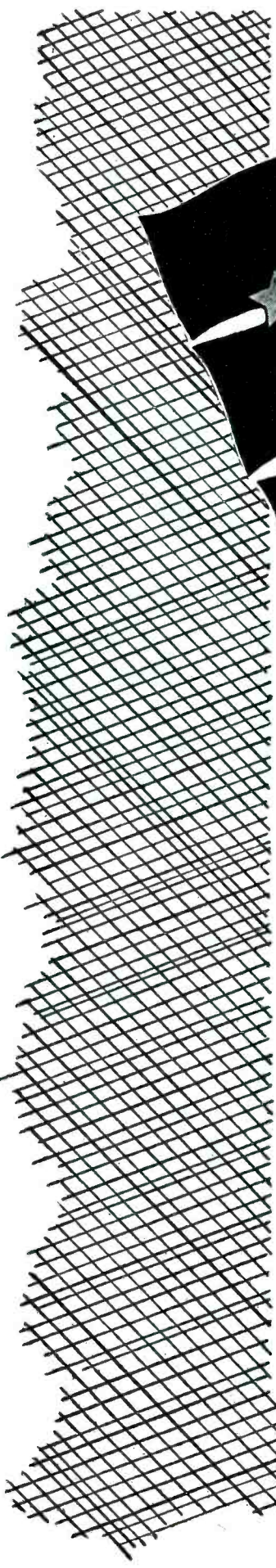

97 PLUM STREET

TRENTON, N. J.



**SEE
YOUR
DISTRIBUTOR**

**for
electronic**

-  There are still millions of dollars worth of war surplus transmitters, receivers, tubes and various other types of electronic equipment being offered for sale to manufacturers, jobbers and wholesalers.
-  This may be your once-in-a-lifetime opportunity to take advantage of these bargains. All you do is contact one of War Assets Administrations approved distributors and learn what is available.
-  For your convenience we are listing the names and addresses of those companies appointed to serve you. They will be happy to quote items, price and delivery. Just call, write, or phone and see how *you* can "Save with Surplus."



OFFICE OF AIRCRAFT AND ELECTRONICS DISPOSAL

WAR ASSETS ADMINISTRATION



Offices located at: Atlanta • Birmingham • Boston • Charlotte • Chicago
Cincinnati • Cleveland • Denver • Detroit • Grand Prairie, Tex. • Helena
Houston • Jacksonville • Kansas City, Mo. • Los Angeles • Louisville • Minneapolis
Nashville • New Orleans • New York • Omaha • Philadelphia • Portland, Ore.
Richmond • St. Louis • Salt Lake City • San Antonio • San Francisco • Seattle • Spokane • Tulsa



equipment

American Condenser Co.
4410 No. Ravenswood Avenue
Chicago 40, Illinois

Automatic Radio Mfg. Co., Inc.
122 Brookline Avenue
Boston 15, Massachusetts

Belmont Radio Corporation
3633 So. Racine Avenue
Chicago 9, Illinois

Carr Industries Inc.
1269 Atlantic Avenue
Brooklyn 16, N. Y.

**Communication Measurements
Laboratory**
120 Greenwich Street
New York 6, New York

Cole Instrument Co.
1320 So. Grand Avenue
Los Angeles 15, California

Electronic Corporation of America
353 West 48th Street
New York 19, N. Y.

Electro-Voice, Inc.
Carroll & Cecil Streets
Buchanan, Michigan

Emerson Radio & Phonograph Corp.
76 Ninth Avenue
New York 11, N. Y.

Essex Wire Corporation
1601 Wall Street
Ft. Wayne 6, Indiana

General Electric Company
Building 267, 1 River Road
Schenectady 5, New York

General Electronics Inc.
1819 Broadway
New York 23, N. Y.

Hammarlund Mfg. Company, Inc.
460 West 34th Street
New York 1, New York

Hoffman Radio Corporation
3761 South Hill Street
Los Angeles 7, California

Hytron Radio & Electronics Corp.
76 Lafayette Street
Salem, Massachusetts

Johanns & Keegan Inc.
62 Pearl Street
New York 4, N. Y.

E. F. Johnson Company
206 Second Avenue, S. W.
Waseca, Minnesota

National Union Radio Corporation
57 State Street
Newark 2, New Jersey

Navigation Instrument Co., Inc.
P. O. Box 7001, Heights Station
Houston, Texas

Newark Electric Co., Inc.
242 West 55th Street
New York 19, New York

Radio Parts Distributing Company
128 W. Olney Road
Norfolk 10, Virginia

Smith-Meecker Engineering Company
125 Barclay Street
New York 7, N. Y.

Southern Electronic Company
611 Boronne Street
New Orleans, Louisiana

Standard Arcturus Corporation
99 Sussex Avenue
Newark 4, New Jersey

Sylvania Electric Products, Inc.
Emporium, Pennsylvania

Technical Apparatus Company
165 Washington Street
Boston 8, Massachusetts

Tobe Deutschmann Corporation
863 Washington Street
Canton, Massachusetts

Tobe Deutschmann Corporation
6919 San Fernando Rd.
Glendale, California

Tung-Sol Lamp Works, Inc.
95 Eighth Avenue
Newark 4, New Jersey

W & H Aviation Corporation
Municipal Airport
Rochester 3, New York

DELIVERIES FROM STOCK

on all standard items—

Specials in less than a week if necessary

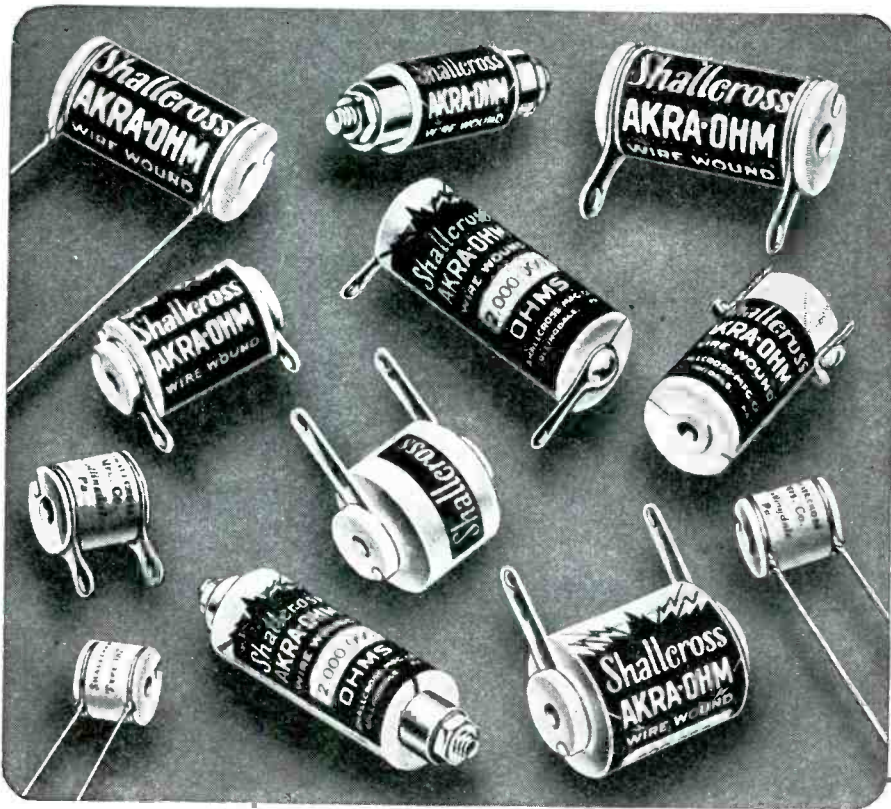

ACCURATE

to 0.05% when required

MOUNTING STYLES

to match any need

PHYSICALLY PROTECTED

to specifications

HERMETICALLY-SEALED and TROPICALIZED TYPES

for exacting applications

BULLETIN R

tells what you want to know about precision resistors. Write for your copy today.

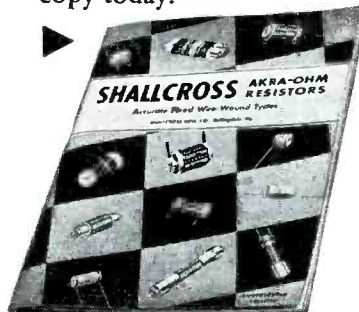

Shallcross Manufacturing Company

Dept. E-67 Collingdale, Pa.

SHALLCROSS AKRA-OHM PRECISION RESISTORS

Electrical Measuring Apparatus • Precision Switches
Electronic Engineering

TUBES AT WORK

(continued from p 140)

...serving food. It has speeded up our operation where we are now in a position to handle at least three times the number of customers in the same amount of time, thus reducing the waiting time by 80 percent. From an economic standpoint, this is most important because during the rush hours we can serve three times as many customers as was formerly possible."

At a recent Electronic Evening sponsored by the New York Railroad Club in New York City, blueprints and drawings of a proposed electronic dining car designed by American Car and Foundry engineers were shown. Instead of placing the kitchen (or galley) at the end of the car, it will be placed in the center. This would reduce the distance waiters must travel between the kitchen and table. The narrow passageway alongside the present kitchen, which is apt to be hot and uncomfortable for passengers awaiting their place in the diner, is eliminated.

The electronic dining car will have a seating capacity of 68 persons instead of the present standard dining car capacity of only 48. Not only can more passengers be served in much less time, but increased revenue will be earned for the railroads.

For demonstration, ten-ounce rare sirloin and tenderloin steaks were cooked on a Radarange in 50 seconds. Well-done steaks are cooked in 60 seconds. Pork chops, lamb chops and fish fillets require



For take-out service, raw hamburgers are first wrapped in paper, placed in the bag, and then cooked by the Radarange

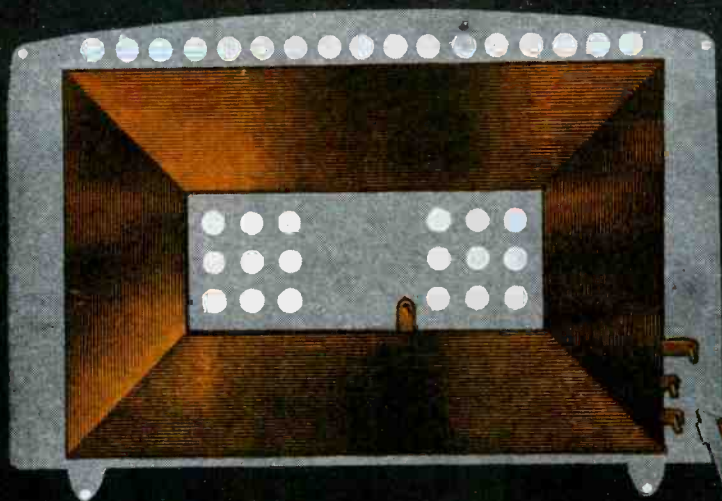

AIRLOOPS

ARE BEING ADVERTISED, DIRECT TO CONSUMERS



FRANKLIN



FRANKLIN AIRLOOP CORP., 43-20 — 34th ST., LONG ISLAND CITY, N. Y.

Why
OHIO
Application-Proved
MOTORS
 Better Your Product

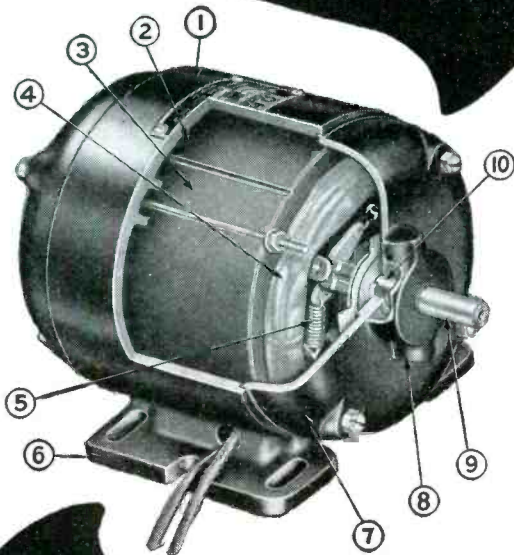

1. Extremely durable cast-iron frame assures accurate alignment of bearings.
2. Motor constantly cooled by correctly designed fan and air passages.
3. Permeability improved by carefully reannealing stator laminations.
4. Insulated windings are trouble-free.
5. Well designed starting switch is long-lived, quiet and positive of operation.
6. Heavy base cast integral provides strong, flat mounting surface.
7. Rugged cast end cover has drip-proof opening at bottom for ventilation.
8. Large oil reservoirs, packed with wool yarn, provide clean, reliable lubrication. Outer oil and dust seal prevents oil leakage.
9. Manganese alloy steel shaft has high-tensile strength.
10. Superior diamond bored sleeve bearings.

THE OHIO ELECTRIC MFG. CO.

CHESTER BLAND, Pres.

5908 MAURICE AVE. • CLEVELAND 4, OHIO

TUBES AT WORK

(continued)

50 seconds; 1.5 pound lobsters are broiled in 2.5 minutes; half a chicken is cooked in 2 minutes and a whole chicken in 4 minutes. Baked potatoes and baked apples require but 1.5 minutes; cup cakes, muffins and biscuits are baked in 30 seconds; layer cakes require 3 minutes per layer.

Subminiature Printed Transmitters and Receivers

FIGURES 1, 2, and 3 show a number of radio transmitters and receivers produced by the printed circuit technique at the National Bureau of Standards. The circuits are designed to operate in the band from 132 to 144 megacycles.

The transmitters shown in Figure 1 are single-tube grid-modulated units and require only con-

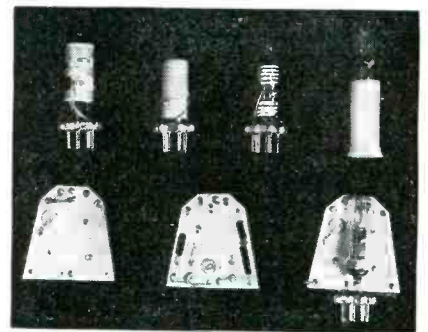

FIG. 1—Oscillator circuits of the two units at top left are printed on the outer surface of a steatite cylinder housing the subminiature tube. Next is a 6K4 with a painted circuit right on its glass envelope. Similar treatment was given the T-2 tube in the lipstick container at top right. Both sides of a steatite plate transmitter and the final assembly are shown at bottom. The silvered spirals form two chokes and the antenna coil

nection to modulator and battery to operate. The circuits of the transmitters are shown in Fig. 2 and 3. To provide a variation in the types of printed circuits presented two different circuits were used. In the two units at top left of Fig. 1 the oscillator circuit is printed on the outer surface of a thin steatite cylinder. The tube is inserted within the cylinder and the combination wired to a battery plug.

Also shown in Fig. 1 is a transmitter with circuit painted on the envelope of a subminiature tube, a 6K4, and a circuit painted on the glass envelope of a T-2 tube measuring one-quarter inch in diameter and one inch in length. A thin

* RICHARDSON MEANS *Versatility* IN PLASTICS

- ✓ SAW
- ✓ SAND
- ✓ TURN
- ✓ MILL
- ✓ ROUT
- ✓ FLY CUT
- ✓ DRILL
- ✓ TAP
- ✓ PUNCH
- ✓ SHAVE
- ✓ FORM
- ✓ BUFF
- ✓ SHEAR
- ✓ PRINT
- ✓ SLOT
- ✓ EDGE
- ✓ BRAND
- ✓ GRIND

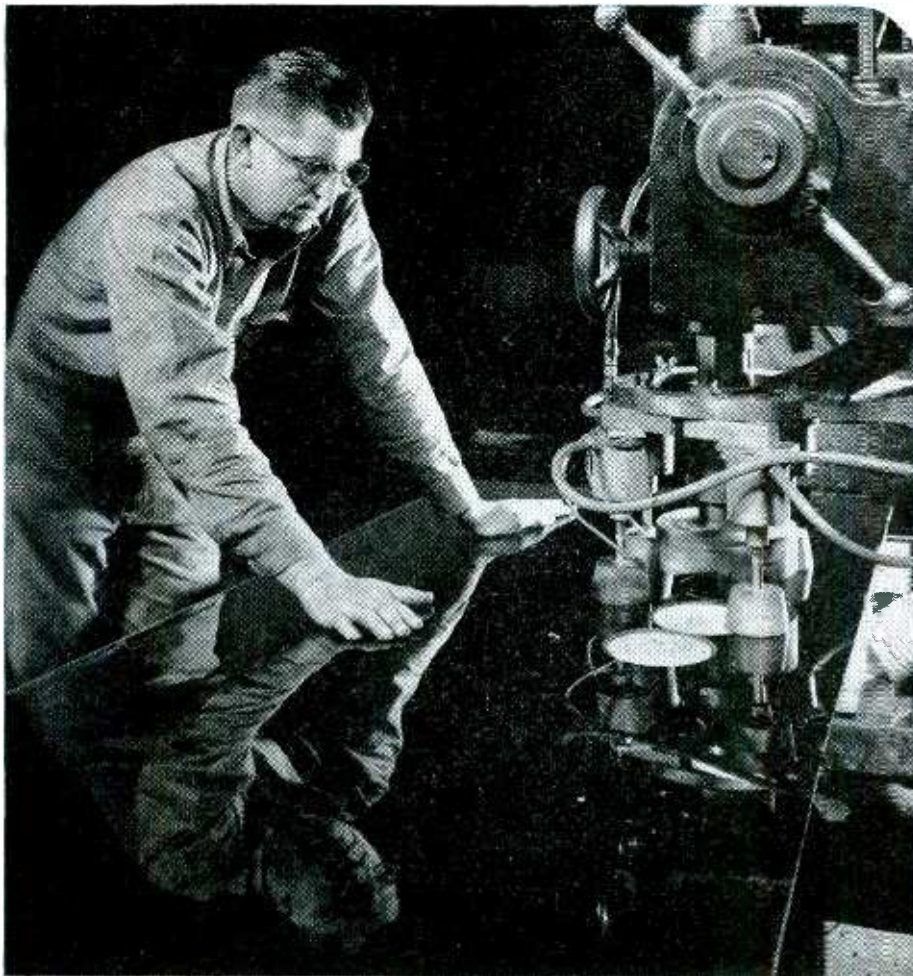

18 ways to fabricate your product!

Here is a fly cutter in action: knifing out plastic discs. It's just one of eighteen distinct fabricating operations available . . . to users of Laminated INSUROK.

The practices we recommend are universally accepted as standard in the industry. However, *Richardson Plastics* welcome the opportunity to work with you in developing specific methods to handle any new problems . . . without obligation.

So whether we do the job for you to your specifications, or it's done in your own shop, our experience in the technique of fabrication is at your service!

INSUROK *Precision Plastics*

The **RICHARDSON COMPANY**

Sales Headquarters: MELROSE PARK, ILL.

FOUNDED 1858

LOCKLAND, CINCINNATI 15, OHIO

NEW YORK 6, 75 WEST STREET
PHILADELPHIA 40, PA., 3728 NO. BROAD STREET
CLEVELAND 15, OHIO, 326-7 PLYMOUTH BLDG.

Sales Offices

DETROIT 2, MICH., 6-252 G. M. BLDG.

Factories: MELROSE PARK, ILL. • NEW BRUNSWICK, N. J.

ROCHESTER 4, N. Y., 1031 SIBLEY TOWER BLDG.
MILWAUKEE 3, WIS., 743 NO. FOURTH STREET
ST. LOUIS 12, MO., 5579 PERSHING AVENUE
INDIANAPOLIS, IND.



* RESEARCH

... a continuous transformation of possibilities into practical ideas in plastics.



* DESIGNING

... Artistic visualization. Creative engineering. Practical planning for efficient plastics production.



* PRODUCTION

... Complete machine shop facilities for manufacturing our own dies, molds, tools.



* LAMINATING

... Sheets, rods, tubes. Standard NEMA grades; over 100 special grades.

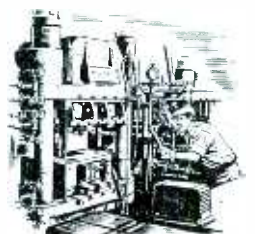

* MOLDING

... Rubber and bituminous plastics; and synthetic resin plastics... Beetle, Bakelite, Durez, etc.

THE BALLANTINE ELECTRONIC VOLTMETER,

DECADE AMPLIFIER

AND MULTIPLIERS

MODEL 300
ELECTRONIC
VOLTMETER



MODEL 220
DECADE
AMPLIFIER

MODEL 402
MULTIPLIER

**10 MICROVOLTS
to 10,000 VOLTS**

ONE BILLION TO ONE—This enormous range of AC voltages—is easily covered by the Model 300 Voltmeter, Model 220 Decade Amplifier and Model 402 Multipliers illustrated above. The accuracy is 2% at any point on the meter scale, over a frequency range of 10 cycles to 150 kilocycles. The Model 300 Voltmeter (AC operated) reads from .001 volt to 100 volts, the Model 220 Amplifier (battery operated) supplies accurately standardized gains of 10x and 100x and the Model 402 Multipliers extend the range of the voltmeter to 1,000 and 10,000 volts full scale.

Descriptive Bulletin No. 10 Available

BALLANTINE LABORATORIES, INC.

BOONTON, NEW JERSEY, U.S.A.

TUBES AT WORK

(continued)

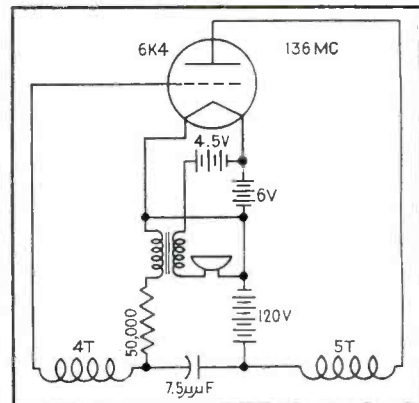

FIG. 2—Circuit of the 6K4 transmitter whose coils are painted on the tube envelope

layer of plastic cement has been applied to the tube and circuit to protect against rough handling and humidity. For additional protection the T-2 unit is housed in a lipstick container.

Circuit on Tube

The coils and small grid leak are painted on the glass envelope of the tube with silver and graphite paints respectively. The addition of a tiny high-dielectric ceramic capacitor completes the circuit.

If good adhesion of the circuit to the glass is desired, the tube envelope must be absolutely clean prior to painting. Although the coils may be painted free-hand, more uniform results can be obtained by applying the silver paint with a ruling pen mounted on a lathe while the tube held in the chuck is rotated by hand. Precise coils can be applied in this manner. Another variation involves the application of the coils to the tube envelope before the tube elements are inserted and sealed.

The 6K4 transmitter of Fig. 1 was made by first wrapping a stencil of the coil pattern around the tube using masking tape. The glass envelope was then etched in fumes of hydrofluoric acid (sand blasting could have been employed) which roughens the surface and allows excellent adhesion of the paint to the

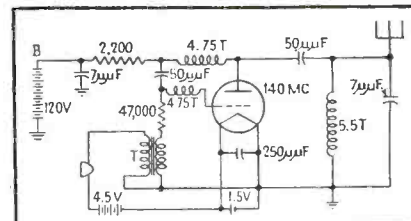
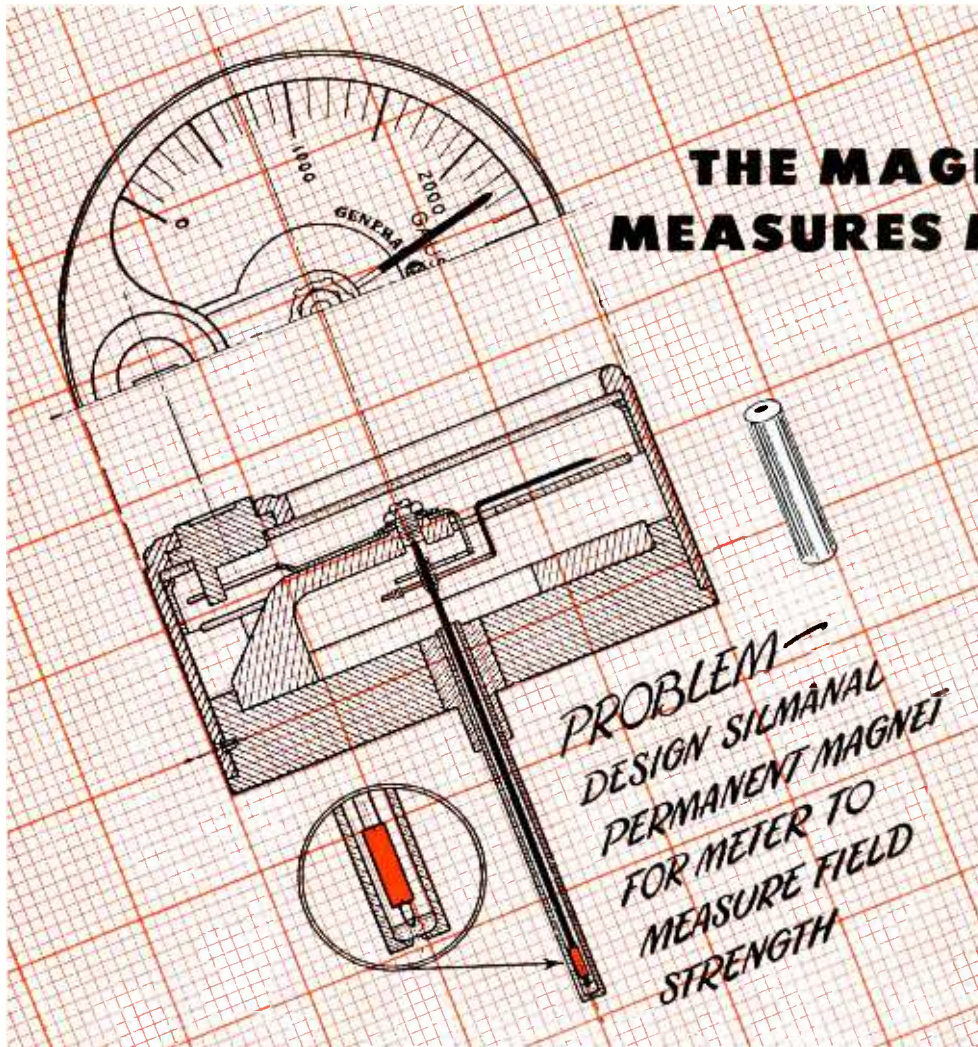

FIG. 3—Circuit of the steatite plate transmitter using a subminiature tube of the T-2 size

YOU GET QUALITY PLUS ENGINEERING SERVICE WITH G-E PERMANENT MAGNETS



THE MAGNET THAT MEASURES MAGNETISM



A tiny SILMANAL cylinder magnetized along a diameter is the heart of the G-E gauss meter. When the probe is placed in the field of a permanent magnet or a d-c electromagnet, the SILMANAL magnet on the shaft tends to line up with the flux. Flux density is measured by rotating the instrument until the pointer reaches its highest reading. This occurs when the probe-magnet flux is at right angles to the flux being investigated. The pointer when at zero scale position indicates flux direction.

Augmenting the many grades of sintered and cast ALNICO permanent magnets, four additional General Electric alloys—SILMANAL, CUNIFE, CUNICO, and VECTOLITE—now greatly extend magnet design possibilities.

So ductile and malleable that they can be machined as readily as soft steel, SILMANAL, CUNIFE and CUNICO possess outstanding properties suitable for a wide range of special applications. SILMANAL is particularly adapted to devices used in the presence of severe demagnetizing influences.

VECTOLITE, a sintered non-metallic mixture of iron and cobalt oxides, is amazingly lightweight. Because of its high electrical resistance, high coercive force and low eddy current loss, VECTOLITE has been used widely for rotor magnets.

Let us help you with your magnet application problems. General Electric Engineers, backed by years of research and magnet design experience, are at your service. *Metallurgy Division, Chemical Department, General Electric Co., Pittsfield, Mass.*



**PERMANENT
MAGNETS**

GENERAL ELECTRIC

CD47-JA4

SEND FOR NEW BULLETINS ON G-E PERMANENT MAGNETS

We shall be glad to send you upon request our new bulletins, CDM-1, "Permanent Magnets," and CDM-2, "Cast and Sintered Alnico, Catalog Supplement," both specifically designed to help you with your permanent magnet problems.

CDM-1 contains information about the characteristics and properties of G-E permanent magnet materials, their application and design. Listed in the catalog supplement, CDM-2, are sintered and cast Alnico permanent magnets available from stock. Proposed R.M.A. standard speaker magnets are included.

For your copies, please fill out the coupon below.

METALLURGY DIVISION
SECTION FA-4
CHEMICAL DEPARTMENT
GENERAL ELECTRIC COMPANY
PITTSFIELD, MASS.

Please send me your new bulletins CDM-1, and CDM-2, on G-E Permanent Magnets.



NAME.....
TITLE.....
COMPANY.....
ADDRESS.....
CITY..... STATE.....

ANDREW *Semi-Flexible* COAXIAL CABLE

BETTER ON 3 COUNTS

✓ **LOWER** loss than plastic 30% to 50% less loss than in plastic cables of same diameter.

✓ **GREATER** power capacity Insulation does not melt or soften . . . develops less heat than plastic cables.

✓ **LONGER** lasting Andrew cables are made entirely of copper and stone, two materials which have unlimited life and which impart the greatest resistance to crushing, corrosion and weathering.

ANDREW "FIRSTS" Here's proof of Andrew Leadership in the development of semi-flexible coaxial cables: 1) First to produce $\frac{3}{8}$ and $\frac{7}{8}$ inch soft temper cables in 100 foot lengths . . . 2) First to offer continuous coils of unlimited length with factory splicing . . . 3) First to offer lines shipped under pressure with all fittings attached.

Such continued leadership enables Andrew to offer *better* semi-flexible coaxial cables; cables that are better than those made from any other materials.

A complete line of coaxial cables, accessories, and other antenna equipment is produced by Andrew.

ANDREW CO.

363 E. 75th ST. • CHICAGO 19, ILL.

Pioneer Specialists in the Manufacture of a Complete Line of Antenna Equipment

These are the famous Andrew semi-flexible coaxial cables in $\frac{3}{8}$ and $\frac{7}{8}$ inch diameters (shown in actual size). Because of their better construction and design they are used throughout the world by thousands of broadcast, police, government, and military radio stations as the most efficient device for connecting antenna to transmitter or receiver.

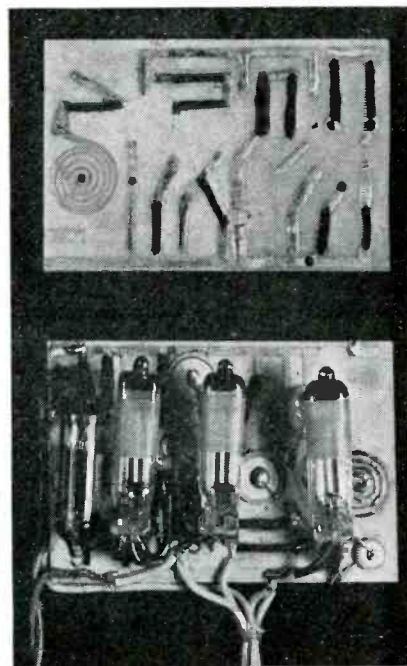
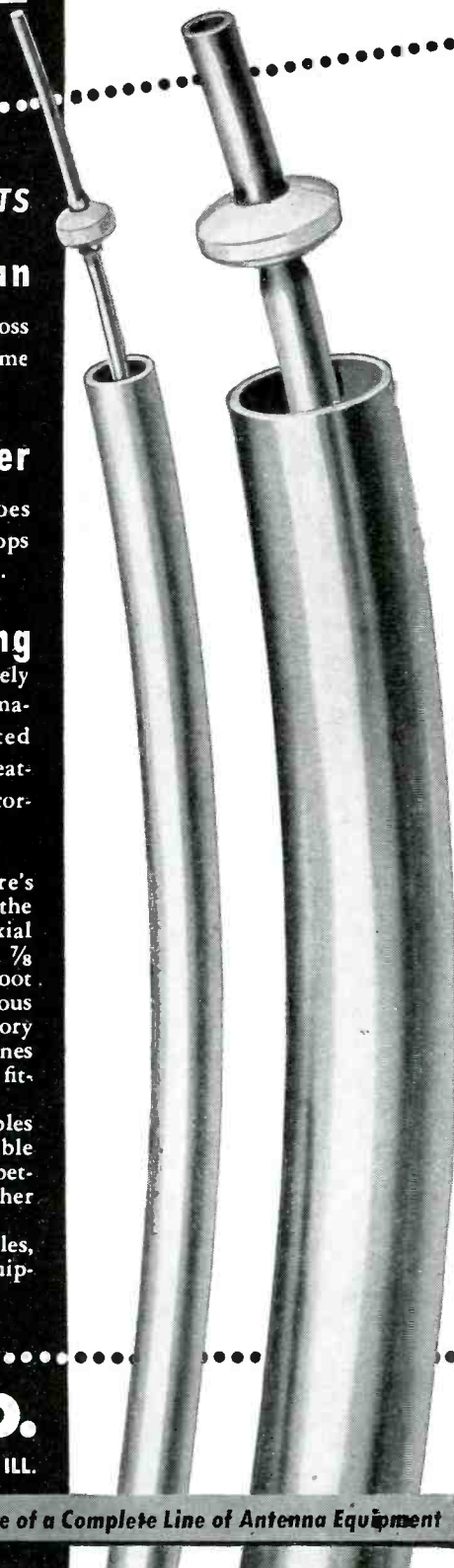

FIG. 4—Spiral coil, wiring, and resistors of the receiver on a steatite plate are shown at top of photo. The receiver at bottom needs only batteries and loudspeaker to be attached to the leads

envelope. After etching, the hydrofluoric acid was neutralized with strong caustic soda solution, and the envelope washed thoroughly with soap and water and rinsed in distilled water. Conducting paint was applied to the etched surface.

To improve the Q of the coil, it was silver plated in a silver-cyanide bath by applying a current of 0.2 ampere for 15 minutes depositing a layer approximately 0.003 inch thick. The grid-leak resistor was painted on using a resistance paint and dried at a temperature of 50 C under an infrared lamp.

The receivers shown in Fig. 4 and 5 are wired with the circuit of Fig. 6. The units shown in Fig. 4 are on steatite plates 2 x 3 inches and those of Fig. 5 are on a 2 x 5-inch Lucite plate and one large size steatite plate. They employ a square-law detector stage followed by two stages of pentode amplification and a triode output stage feeding the loudspeaker. Input tuning is broad for reception from 132 to 144 megacycles. If sharper tuning and additional sensitivity is desired, the input stage may be converted to one employing superregeneration.

The procedure used to print the transmitter and receiver circuits on steatite plates is the stencilled screen method. Although steatite

* UNEXCELLED



The 231D Autotune transmitter
2 kw Phone, 5 kw CW

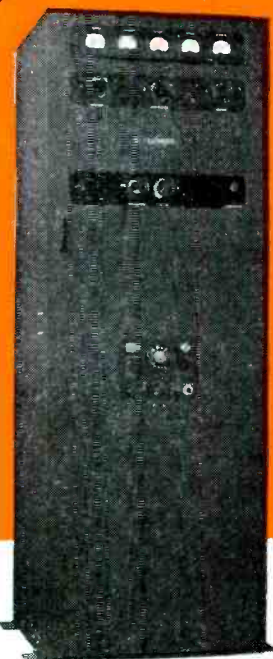

The 16F Autotune Transmitter
300 w Phone, 500 w CW



... for reliable communication

IMMEDIATE DELIVERY

You need a dependable, well engineered transmitter for point-to-point, ship-to-shore, or ground-to-plane commercial radio communication. The Collins 231D or the Collins 16F is the answer. These transmitters have proved themselves thoroughly reliable and efficient in all climates, and under difficult operating conditions.

Any one of eleven frequencies between 2.0 mc and 18.1 mc is available at the flip of a dial, with all circuits tuned and ready to operate. The widely acclaimed Collins Autotune system is utilized to shift the frequency quickly and accurately.

Compressor circuits are incorporated to raise the average modulation level during voice or MCW transmission. CW transmission is also available, with keying speeds of 60 wpm on MCW and 200 wpm on CW. Both transmitters can be adapted for frequency shift keying.

For dependable, trouble-free radio communication use either the 231D or the 16F. They are built for that purpose. Write today for free illustrated bulletins giving detailed information.

IN RADIO COMMUNICATIONS, IT'S . . .



COLLINS RADIO COMPANY, Cedar Rapids, Iowa

11 West 42nd Street, New York 18, N. Y.

458 South Spring Street, Los Angeles 13, California

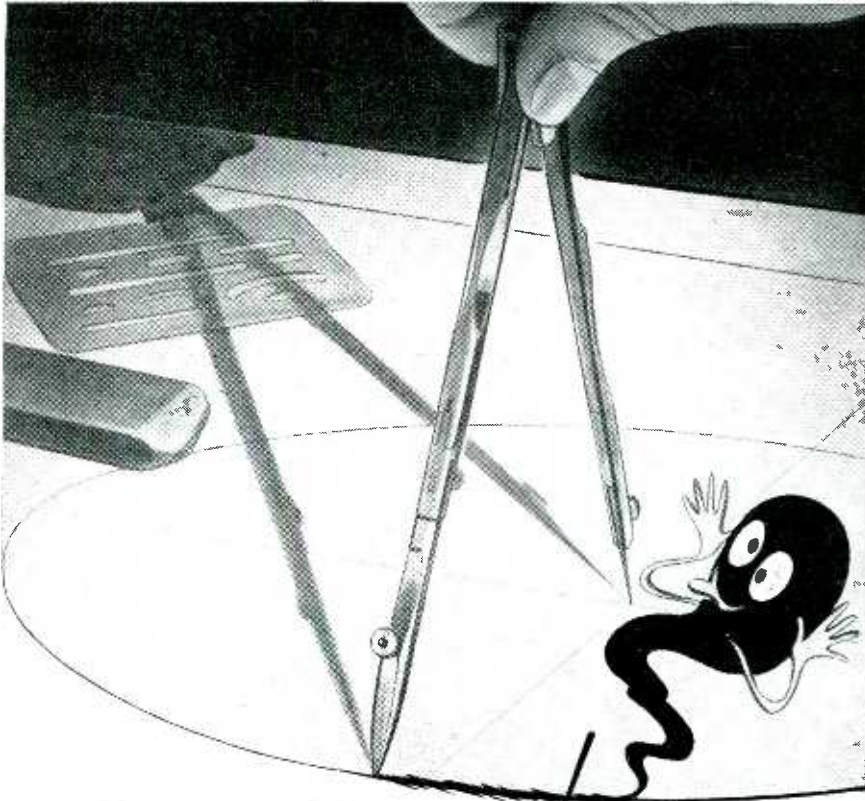

Scrub Happy!

● Somebody changed his mind a few times, or maybe the tracer was having a bad day. Just why isn't important. The point is the tracing had to be done over, because erasing had given it a distinctly "scrub happy" look. Arkwright would have saved all this. Erasures mean little to Arkwright. It takes erasure

after erasure without wearing through, without line feathering when you re-ink.

Why not check Arkwright's advantages yourself, in your own drawing room, at our expense. Send for generous working samples, free. Arkwright Finishing Company, Providence, R. I.

All Arkwright Tracing Cloths have these 6 important advantages

- 1 Erasures re-ink without "feathering".
- 2 Prints are always sharp and clean.
- 3 Tracings never discolor or become brittle.
- 4 No surface oils, soaps or waxes to dry out.
- 5 No pinholes or thick threads.
- 6 Mechanical processing creates permanent transparency.



Arkwright

TRACING CLOTHS

AMERICA'S STANDARD FOR OVER 25 YEARS

was used for the base plate, the process is applicable to such materials as glass, porcelain, Bakelite, Lucite, and other insulating surfaces.

The printed silver wiring is applied through a silk or metal screen stencil containing the appropriate pattern. The stencil is laid over the clean ceramic plate and silver ink brushed over it. For flat plates, a squeegee may be used to apply the paint. When the stencil is removed a pattern of silver lines representing the wiring of the circuit remains.

The three views at bottom of Fig. 1 show the development of the flat-plate transmitter. One side, at left of the figure, carries the three spiral coils and a 50 micromicrofarad coupling capacitor. The other side bears the remainder of the circuit wiring including three resistors (the dark rectangles) and four capacitors.

Composition of the silver paint can be very finely divided silver or silver oxide mixed with a binder to make a paste and thinned with a solvent such as acetone. On highly refractory surfaces, such as steatite, a flux of low temperature glass may be added to improve adhesion to the surface.

After impression of the pattern, the plate is heated to a temperature of 800 C to bond the silver permanently to the plate. Paints which do not require firing at high

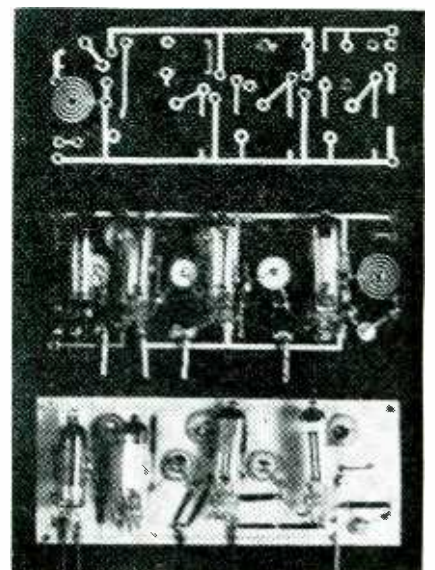

FIG. 5—The two views at top show both sides of a receiver built on a Lucite plate. The same receiver circuit on a steatite plate of the same size appears at bottom

THIS



IS A SPEED NUT

and

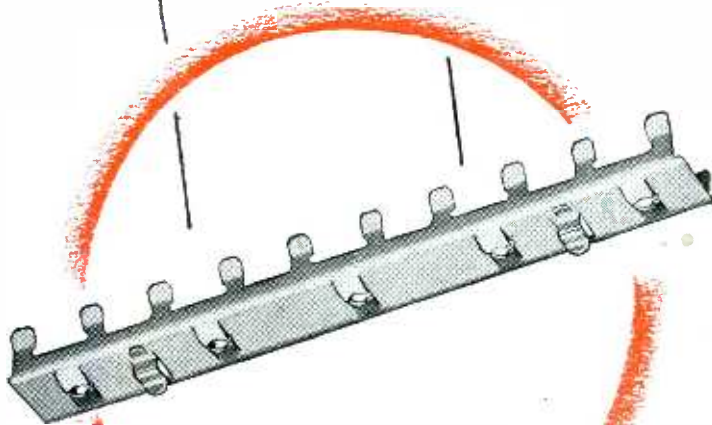

THIS is also a
SPEED NUT

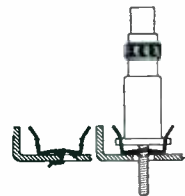

It looks more like a caterpillar than a nut, doesn't it? But a nut it is . . . or rather, five SPEED NUTS combined into one, to simplify and improve the assembly of multiple coil forms on radios.

This one ingenious fastener replaced eight separate parts formerly used and eliminated expensive drilling and tapping operations. It retains the tuning cores and screws, provides exactly the right tension on the screws, and its spring arms hold the plastic coil tubes securely in place.

This is just one example of hundreds where the basic SPEED NUT principle is applied to

develop a special fastener for better, more economical assembly. SPEED NUT brand fasteners may be the answer to your quest for lower assembly costs, so be sure to investigate these streamlined fastening devices. Write us today, including engineering details, and we'll give you a complete, no-charge analysis.

TINNERMAN PRODUCTS, INC.,
2106 FULTON ROAD • CLEVELAND, OHIO

In Canada: Wallace Barnes Co., Ltd., Hamilton, Ontario

In England: Simmonds Aerocessories, Ltd., London

In France: Aerocessoires Simmonds, S. A., Paris

In Australia: Aerocessories, Pty. Ltd., Melbourne

Speed



Nuts

PATENTED

*Trade Mark Reg. U. S. Pat. Off.

MORE THAN 4000

SHAPES AND SIZES

F A S T E S T T H I N G I N F A S T E N I N G S

SPECIFY **G.S.** SMALL GEARS FOR



If there was ever a place to get *better* Small Gears, *this is it!* . . . and for very good reasons, too. Throughout a quarter century of intensive specialization . . . years of constant research and progress . . . we've developed the art of engineering and producing Fractional Horsepower Gears to a degree of perfection generally considered impossible a short time ago.

When you specify "G.S." for instance, you employ extensive facilities and an experienced organization of Small Gear Craftsmen. They can lend you valuable aid, not only in turning out *uniform* production runs, but also in establishing the *one best* design for the job the gear has to do. So . . . whatever the problem . . . put it up to a G.S. Engineer! Let him help you achieve the finest performance you've ever known from a Fractional Horsepower Gear! Ideas, information and cost estimates are yours for the asking. Will you write or phone us today?

- 1 CORRECT DESIGN
- 2 EXTREME PRECISION
- 3 UNIFORM QUALITY
- 4 DEPENDABLE PERFORMANCE
- 5 ECONOMICAL PRODUCTION
- 6 EFFICIENT SERVICE

SEND FOR OUR 4-PAGE BULLETIN

The G.S. Bulletin describes many different types and applications of G.S. Small Gears. Please ask for a copy at a company stationery.



GEAR Specialties

Spurs • Spirals • Helicals • Bevels • Internals • Worm Gearing • Racks • Thread Grinding
2635 WEST MEDILL AVENUE • CHICAGO 47, ILLINOIS

MEMBER OF



WORLD'S LARGEST EXCLUSIVE MANUFACTURERS OF FRACTIONAL HORSEPOWER GEARS

An EFFECTIVE FLUX

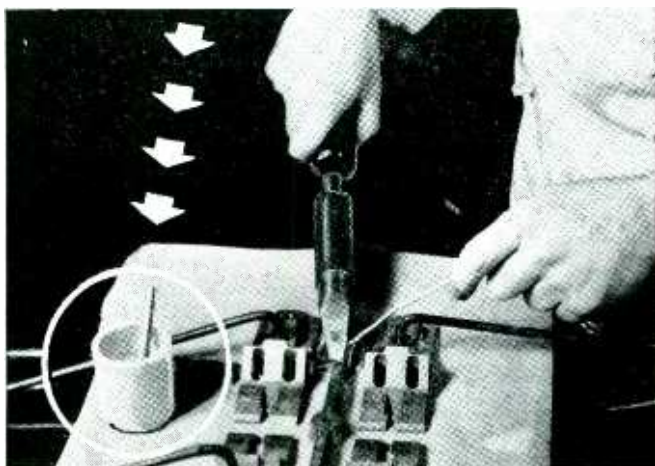

...For Every Soldering Job USE KESTER FLUXES

The use of wrong flux in any soldering operation means solder failure. Select your flux from Kester's complete high quality line and be sure you're using the chemically and physically correct flux for your particular soldering job.

Nearly half a century of practical experience has resulted in the development by Kester of efficient and effective fluxes for every soldering operation. Proven in industry, Kester Fluxes are your assurance of clean, tight solder bonds—solder bonds that hold tight against vibration, shock, twisting, bending, and expansion and contraction caused by temperature extremes.

Each one of the hundreds of Kester fluxes has been carefully tested in the laboratory and in practical application. Today, not only is the performance of each Kester flux definitely known, but also the circumstances under which each one should best be used.

So look to Kester Fluxes for the answer to any flux problem. Without obligation to you, Kester engineers will gladly specify the flux that fits your special needs.

KESTER SOLDER COMPANY

4204 Wrightwood Avenue, Chicago 39, Illinois

Eastern Plant: Newark, N. J. Canadian Plant: Brantford, Ontario



KESTER

Solder Fluxes

STANDARD FOR INDUSTRY

TUBES AT WORK

(continued)

titanates are next soldered into position. They range from $\frac{1}{8}$ to $\frac{1}{16}$ -inch in diameter and 0.02 to 0.04-inch in thickness. The capacitance is controlled by the mix, the thickness of the disc and the area of the silvering on the faces. Such capacitors, available in values from 6.5 to 10,000 micromicrofarads, are soldered to the plate with a low-temperature solder which allows soldering through them without adversely affecting the performance. A bismuth solder (110 C melting temperature) consisting of 40 parts bismuth, 40 lead and 20 tin is used. The subminiature tubes and leads for the antenna, batteries, and loud speaker are soldered directly to the silver wiring on the plate.

A simpler procedure may be followed if a plastic base is used. The wiring is applied through the stencil (as with the steatite plates), but paints are used which dry at room or slightly higher temperature. A suitable silver paint consists of powdered silver in lacquer solution, the consistency being adjusted with an acetate solvent. For best results, 65 percent of silver powder is used. Commercially available paints, mixed and ready for use, will dry on brief exposure at 50 C or overnight at room temperature.



Conductivity

Wiring applied in this manner is somewhat lower in conductivity than that of wiring applied by the firing process, but it is usually satisfactory. Conductivity of the spiral coil can be increased by silver plating. All wiring on the plate can be done in the same operation at a rate of 0.2 ampere for 15 minutes in a silver-cyanide bath. A satisfactory preparation for painting transmitter coils on the tubes is a sodium-silicate conducting paint known as Sauereisen Conductulute. This paint dries in air at room temperature and may be plated readily.

Although the silver wiring is applied in layers usually less than a mil in thickness, the current-carrying capacity exceeds that required in normal electronic circuits including filament supply leads. In tests at the Bureau a silver line 0.0005-inch thick and $\frac{1}{8}$ -inch in width carried over an ampere of current con-

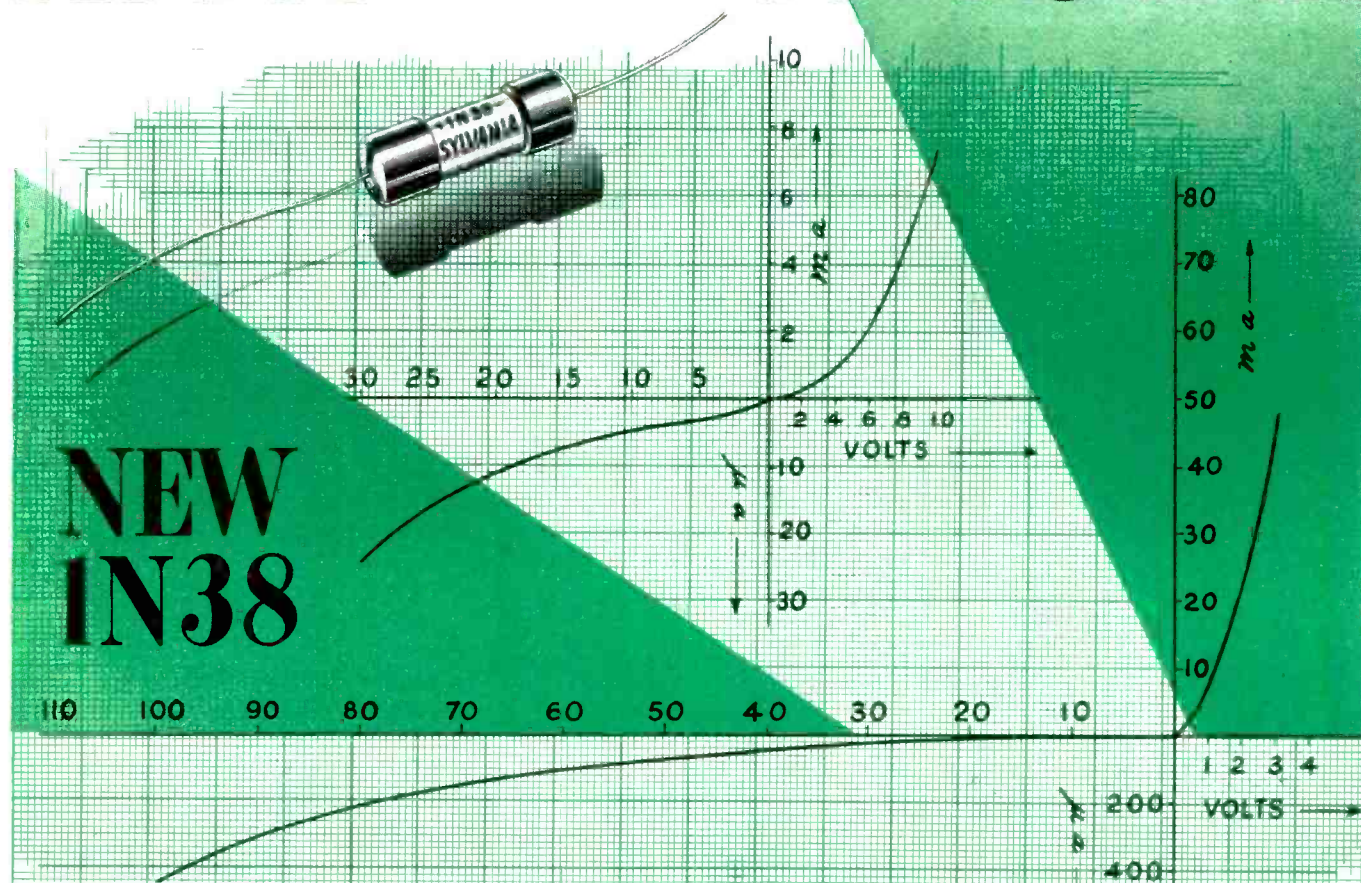
HIGH VOLTAGE FREQUENCY TEMPERATURE CRYSTAL



-  **HIGH VOLTAGE.** The new Sylvania 1N38 Crystal is designed for a back voltage of 100 volts maximum.
-  **HIGH FREQUENCY.** With its shunt capacitance of only 0.8 to 1.1 $\mu\mu\text{f}$, the 1N38 is ideal for high frequency use.
-  **HIGH TEMPERATURE.** Rectification efficiency decreases only .0007% per degree temperature rise from 27° to 75° C.

Newest addition to the Sylvania family of Germanium Crystals, the 1N38 is of compact, space-saving design. Pigtail leads permit easy soldering into position.

Back resistance is as high as 2½ megohms.

Minimum life is 5,000 hours at 22.5 ma DC.

Write for full details

Electronics Division, 500 Fifth Avenue, New York 18, N. Y.

SYLVANIA ELECTRIC



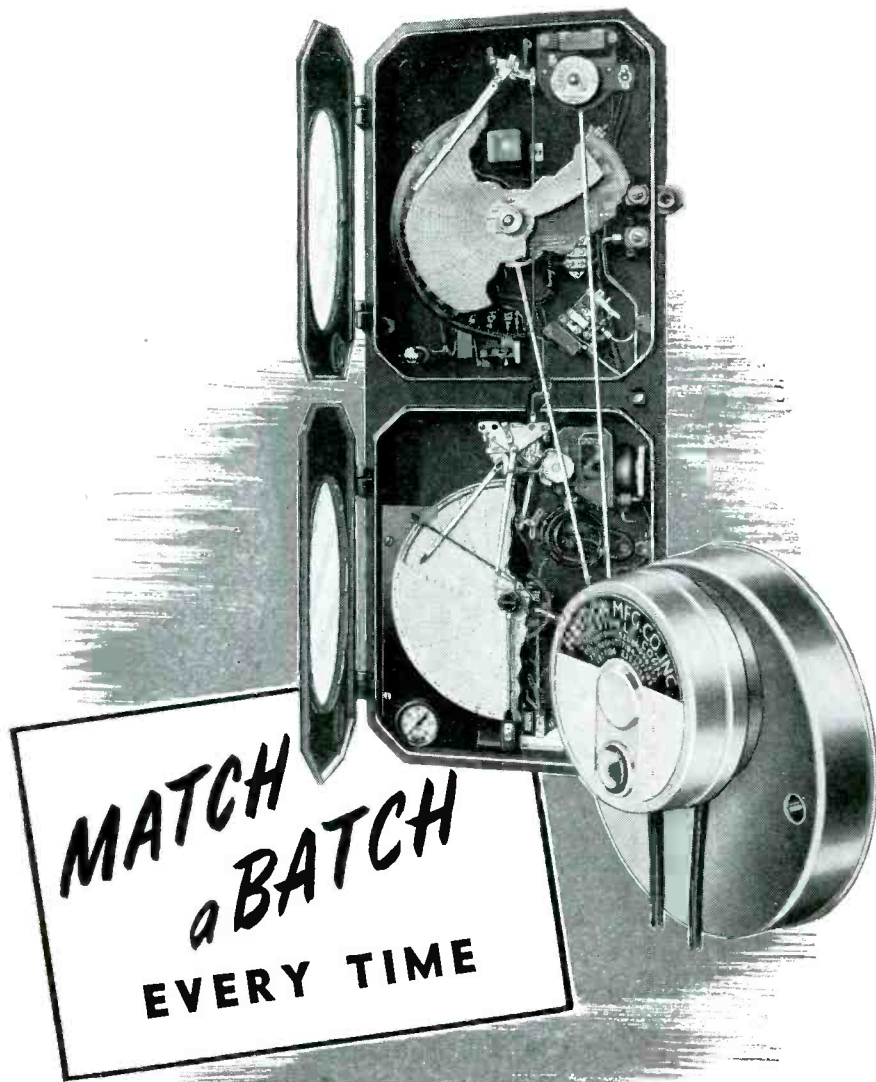

Textile, rubber, food, chemical, paper and petroleum industries are depending upon Taylor Time Schedule Controllers for complex batch processing . . . high-quality and economical production involving time with temperature, pressure, flow or liquid level.

To match a batch, three Haydon timing motors (two chart drives and one interrupter timer) are employed in the Taylor Schedule Controller. The Controller carries through a prescribed time interval and concludes automatically. During the process cycle, auxiliary devices are precisely synchronized and the controller resets itself for consistent and dependable production. This and many other Haydon applications are accounting for greater timing accuracies throughout industry.

If it's about time, rely on Haydon in Forestville, Connecticut to deliver. Write for free engineering catalog.

Haydon 2400 Forest Street, Forestville, Connecticut.

HAYDON

MANUFACTURING COMPANY, INC.

FORESTVILLE



CONNECTICUT

HARNESS TIME TO

YOUR PRODUCTS

SUBSIDIARY OF GENERAL TIME INSTRUMENTS CORPORATION

tinuously and satisfactorily. It required 18 amperes to puncture the line.

Studies by Cleo Brunetti and W. J. Cronin of the Bureau have disclosed at least six principal methods of printing electronic circuits. In addition to the painting method, they are: spraying, chemical deposition, vacuum methods, die stamping, and electro-photography. These methods are to be treated in detail in a circular to be issued by the Bureau shortly.

Localized Heating of Milk Can Necks

BEFORE the use of electronic induction heating in the manufacture of milk cans, the entire breast of a can had to be annealed in a gas-fired furnace although only the neck of the can needed to be heated. Then the entire neck of the can had to be pickled to remove the scale formed during the process. Increased can production, lessened fabrication cost, and a more durable finished product has resulted at Buhl Manufacturing Company of Detroit.

Now, two five-kilowatt General Electric electronic heaters anneal as little as an inch of the neck of the can. This can be brought to red temperature in 12 seconds. At the end of a heating cycle, a two-position transfer switch permits feeding the r-f current to a second



Necks of milk cans are now heated electronically without annealing the entire breast of the can and one man does the work of two formerly required in this and subsequent pickling operations

available **NOW**

THE NEW 1947

THORDARSON

*Transformer
Catalog*

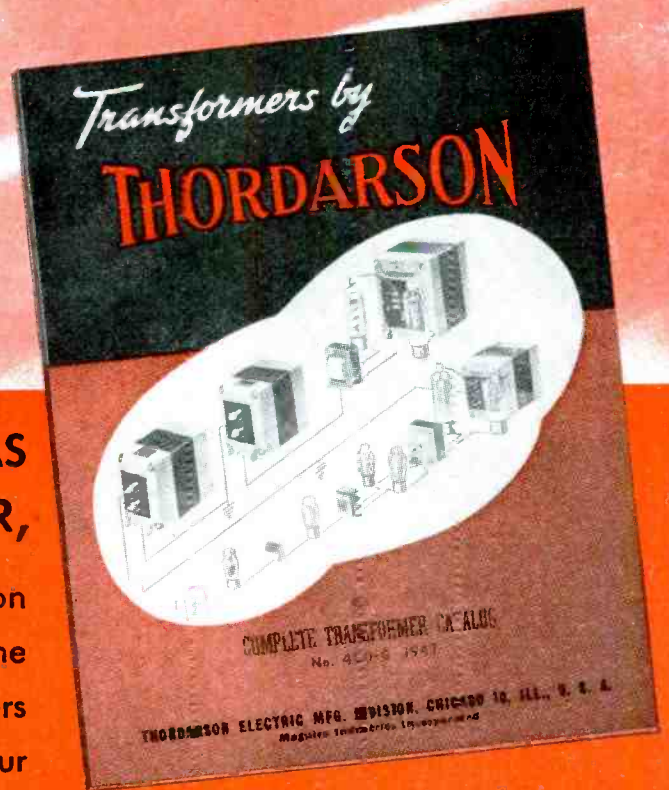

**ACCLAIMED EVERYWHERE AS
THE FINEST YET TO APPEAR,**

the new 1947 Edition of the Thordarson Catalog is now available. Describing the complete Thordarson line of transformers and chokes for replacement and amateur purposes, this up-to-date catalog also contains circuit diagrams, charts and curves showing applications for Audio, Power, Modulator, Output and Plate Transformers and Chokes . . . as well as complete circuit diagrams and application notes for photo-flash power supplies. Compiled by the engineering staff of America's oldest transformer manufacturing company, it is a worthy addition to your technical library.

SEND FOR YOUR FREE COPY TODAY

**ELECTRONIC DISTRIBUTOR & INDUSTRIAL SALES DEPT.
MAGUIRE INDUSTRIES INC. 936 N. MICHIGAN AVE., CHICAGO 11, ILL.**

PLEASE SEND MY FREE COPY OF THE NEW 1947
THORDARSON CATALOG, POSTPAID, TO THE ADDRESS BELOW.

NAME _____

STREET _____

CITY _____ STATE _____

THORDARSON

**ELECTRONIC DISTRIBUTOR &
INDUSTRIAL SALES DEPARTMENT**

MAGUIRE

INDUSTRIES, INC.

936 N. MICHIGAN AVENUE, CHICAGO 11, ILLINOIS

EXPORT: SCHEEL INTERNATIONAL, INCORPORATED
4237 N. LINCOLN AVENUE, CHICAGO 18, ILLINOIS, CABLE HARSHEEL.

You Need the EXTRA MARGIN of SAFETY You Get with Macallen Mica

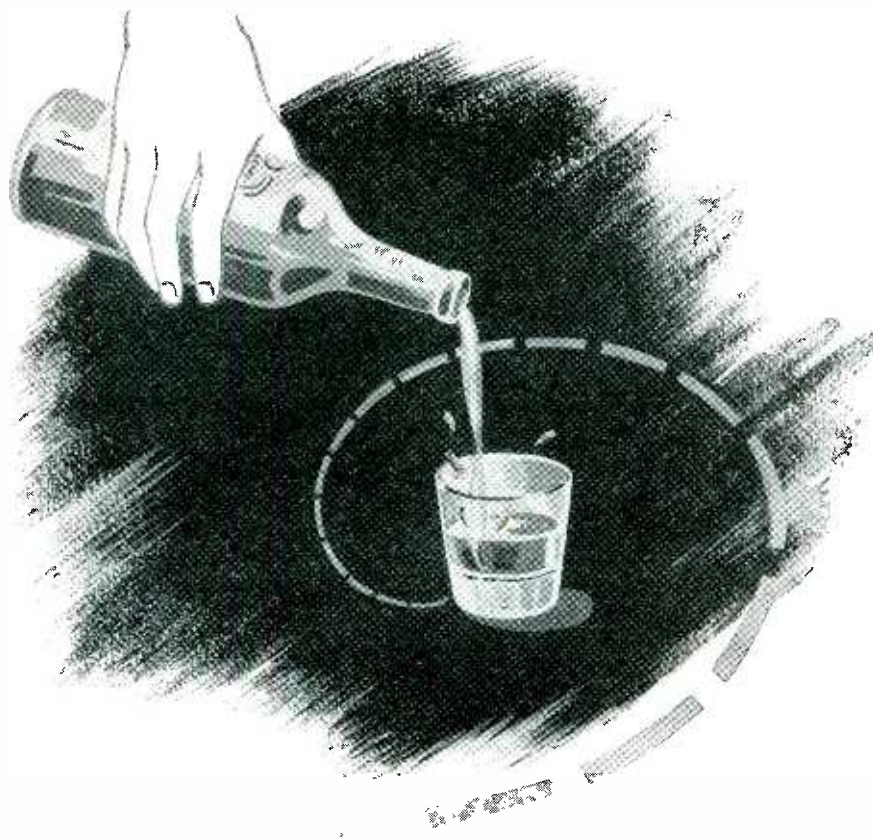

Let's get to the bottom of
THE FALSE BOTTOM!

Some things are built with a false bottom like the glass above, and deceive you into thinking you're getting more than you are. Substitutes for mica, too, sometimes appear to offer many of the unique advantages of mica. But don't be misled! Wherever insulation is important, beware of the false bottom every time. Because there is no substitute for mica; no substitute, either, for the experience, the resources and the service that are exclusive with Macallen Mica.



MACALLEN Mica

THE MACALLEN COMPANY, BOSTON 27, MASS.

CHICAGO: 565 W. Washington Blvd.

CLEVELAND: 1231 Superior Ave.

TUBES AT WORK

(continued)

operating position while the first position is being unloaded and loaded again.

Besides the direct saving in annealing time, additional time is saved because the electronic heater can be located right on the production line. Formerly the cans had to be removed from the line, moved to the annealing furnace, pickled, and returned to the line. One operator now anneals more cans than two men did using the former method.

Frequency Control for Low-Impedance Oscillator Tanks

By V. M. ALBERS

*Ordnance Research Laboratory
 The Pennsylvania State College
 School of Engineering
 State College, Pennsylvania*

THE CONVENTIONAL arrangement for a variable-resistance frequency control tube used to control the frequency of an oscillator is shown in Fig. 1. Tube *V* is in series with capacitor *C*, and varies the effective value of its capacitance as a part of the oscillator tank circuit as the control grid voltage of *V* is varied.

Figure 2 is a variation of the circuit in which a diode is used in place of the resistor in the plate circuit of the frequency control tube. The diode conducts during a part of the negative half-cycles of the oscillator, and causes a positive voltage to be developed at point *A* in Fig. 2. The voltage developed can leak to ground by way of the frequency control tube *V*₁ during the remainder of the cycle. The aver-

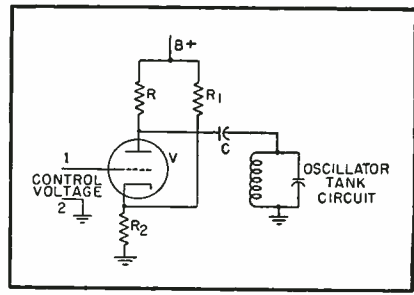

FIG. 1—Conventional circuit using a variable-resistance type frequency control tube

age potential which is retained at *A* is determined by the control voltage applied between points 1 and 2.

The effective value of *C* is then determined by the fraction of the negative half-cycle during which the diode conducts rather than by

BLILEY

Techniquality

CRYSTALS



• • • Make it a habit to consult Bliley, first, on all frequency control applications. When you specify Bliley "Techniquality," you automatically select the creative engineering and production talent and facilities that have built leadership in frequency control applications over the past fifteen years.

TYPE BH5 4000-11,000kc



Midget holder with aluminum plated crystal mounted between spring contacts on wire supports. Hermetically sealed metal case protects assembly. Recommended for use only with low power oscillator tubes and circuits where space is at a premium.

TYPE MC9 3000-11,000kc



Compact holder for multichannel portable equipment where space is a factor. Gasket sealed against moisture and humidity. Suggested for all vehicular and air-borne equipment having low power oscillator tubes and circuits.

TYPE SR5 3500-11,000kc

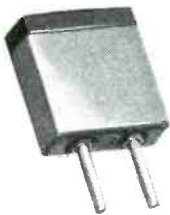

This unit is prototype of crystal stabilizer used in majority of AAF equipment. Case is gasket sealed at all openings for maximum protection. Suggested for multichannel operation in air-borne equipment.

TYPE MC7 1700-11,000kc



Gasket sealed holder with pressure airgap crystal assembly. Ideal for multichannel applications. Accommodates quartz plate up to .7" x .9" for adequate activity in medium power circuits. Used widely in marine radio-telephone equipment.

TYPE KV3 100-500kc



Compact unit features low drift, silver plated crystal mounted between wire supports soldered to plated surfaces. Design assures exceptional frequency stability. Recommended for use in low power oscillators where regeneration is employed.

TYPE ART 3000-11,000kc

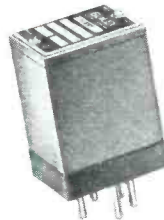

Constant temperature oven and crystal assembly in compact case. Heater current 1 ampere at 6.3 volts. Stabilizes crystal temperature at 70° C for close tolerance requirements in VHF services.

TYPE TC92 TEMPERATURE STABILIZER



Precision temperature control oven operates on 6.3 volts A.C., heater current 0.16 amperes. For use with type MC7, MC85, MO21 and AR Series crystals. Suggested for Broadcast Services, Frequency Monitors and Standards.

Bliley

CRYSTALS

BLILEY ELECTRIC COMPANY • UNION STATION BUILDING, ERIE, PENNSYLVANIA

Soundcraft

and
RECORDABLE AREA

SOUNDCRAFT guarantees maximum high fidelity recordable area for sound reproduction without jeopardizing quality or consistency.

- Because Soundcraft 'Broadcaster' discs have no ridge, they are usable out to the very edge. Up to 5% more recording time, and higher fidelity by maximum utilization of highest groove speeds.
- Uniform coating right to the edge is made possible by the exclusive Soundcraft coating process plus Soundcraft high-solids recording lacquer, a combination representing years of experimentation by those who really know the requirements of the industry.

- *The 'Broadcaster'*

8" 10" 12" 16"

- *The 'Playback'*

6½" 8" 10" 12" 16"

- *The 'Audition'*

6½" 8" 10" 12" 16"

- *The 'Maestro'*

12" 13¼" 17¼"



REEVES SOUNDCRAFT CORPORATION

10 East 52nd Street • New York 22, New York

• PROGRESS ALONG SOUND LINES •

TUBES AT WORK

(continued)

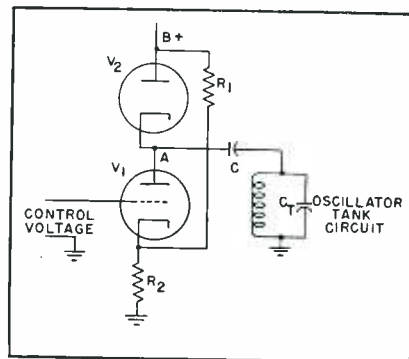

FIG. 2—Improved circuit using a diode in the plate circuit

the effective resistance in series with C . The value of C used is about 20 percent of the value of C_T which is the fixed tank circuit capacitance.

For low-impedance tank circuits, this frequency control circuit offers considerable improvement over that shown in Fig. 1. It does, however, cause some variation in the oscillator frequency for a given control voltage applied between terminals 1 and 2 when the heater voltage for tubes V_1 and V_2 varies.

Stabilizer

To eliminate the effect of variations of heater voltage, the device has been further modified by replacing tube V_2 by a copper-oxide rectifier. The rectifier used by the author is the Varistor D-157873, containing four rectifiers which can be connected in series. The use of four rectifiers in series decreases the voltage applied across each rectifier. Figure 3 shows a schematic of the circuit using this rectifier. The values of the resistors were chosen to set the frequency control tube at the center of its range when zero voltage is applied between terminals 1 and 2.

The curves in Fig. 4 indicate the

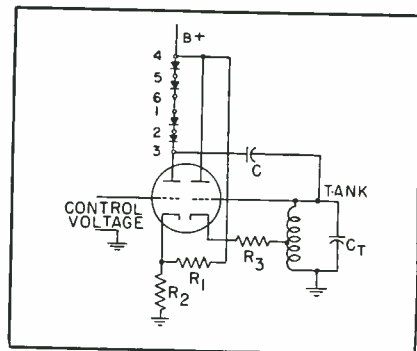
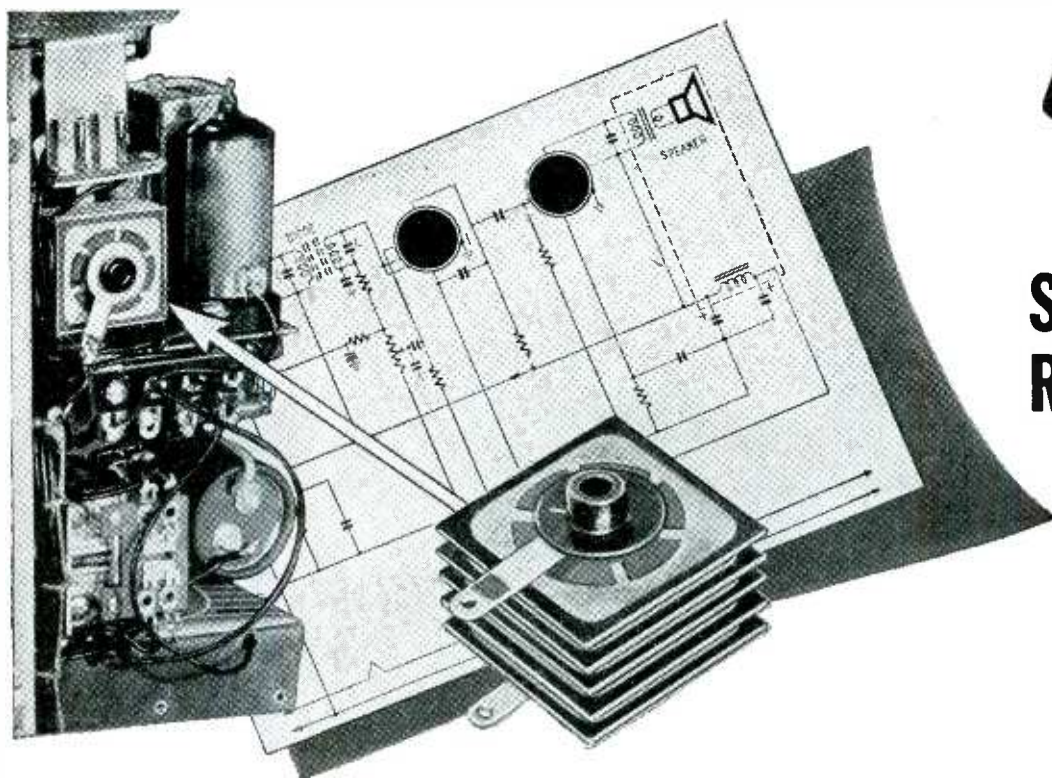

FIG. 3—Final circuit with the Varistor in the plate circuit. Values of R_1 and R_2 are 33,000 and 1,500 ohms respectively for a 6SN7 and 35,000 and 1,000 ohms for a 7F8. Numerals indicate Varistor terminals

simplifies design • saves installation time • cuts waste space



NEW



**SELENIUM
RECTIFIER**

Taking *less than one cubic inch* of space, this new General Electric selenium rectifier has been designed to give new economies, new design possibilities to manufacturers of small radio sets. It's a cost-saver in all stages of production from the drawing board to the assembly line. Available now, to help you cut costs, it gives you these three big advantages:

SIMPLIFIED DESIGN — A conventional circuit consists simply of a G-E selenium rectifier in series with a ballast resistor in one side of the line, feeding into a capacitor across the line.

SMALLER ASSEMBLIES — This baby rectifier fits into spaces where tubes and sockets just can't go. It lets you design for smaller assemblies, smaller cabinets — gives you more room for other parts.

LESS INSTALLATION TIME — Only two connections to make. Save time that's normally wasted in wiring

for sockets and tubes. Cut assembly-line breakage losses and slowdowns.

Built for ample current capacity, the new General Electric selenium rectifier can stand up to the inverse peak voltages obtained when rectifying (half-wave) 110-125 volts rms, and feeding into a capacitor.

Normal operating temperatures of small radios were taken into consideration in the designing of the General Electric selenium rectifier. Ratings are based on ambient temperatures of 50 C to 60 C. Heavy varnish coating and spring contact construction provide uniformity of performance against variations of humidity and temperature.

Write for information that will help you to utilize the advantages of General Electric selenium rectifiers in your designs. Section A71-631, Appliance and Merchandise Department, General Electric Company, Bridgeport 2, Connecticut.

GENERAL  ELECTRIC

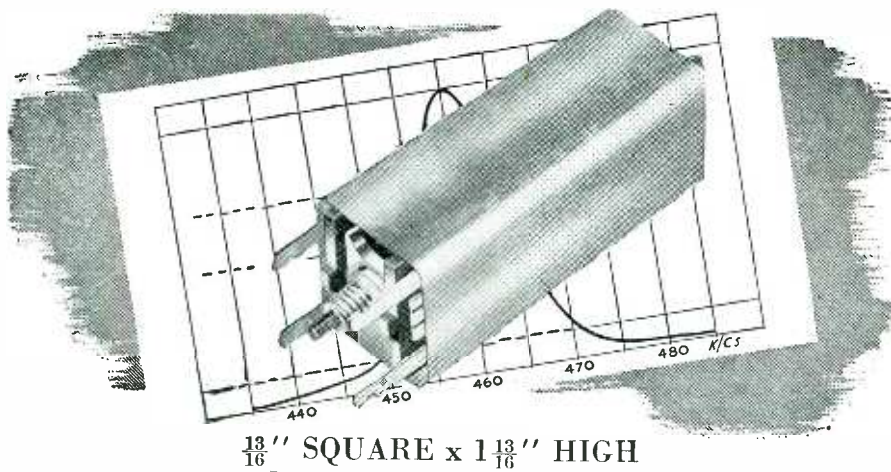

$\frac{13}{16}$ " SQUARE x $1\frac{13}{16}$ " HIGH

When space is valuable

THIS MINIATURE I.F. TRANSFORMER IS THE ANSWER...

In 'personal' receivers, "Walkie-Talkie", or any similar equipment where space is limited, the measurements of the WW Miniature I.F. Transformer settle your layout problem. Miniature in all but performance, they give you electronic reliability in small compass. Constructed throughout of the finest materials, allied to up-to-the-minute production technique, they pass rigid routine tests before despatch. Write to-day for full details . . . they'll interest you, Prompt deliveries can be guaranteed.

SPECIFICATION

Primarily designed for use with valves of the I.R5, I.T4 and I.S5 Series. High gain and selectivity with stability are obtainable. Permeability tuning is employed with enclosed type cores and the necessary fixed condensers 'built in'. Coils are impregnated and can be used with

confidence in the tropics. Available in the following preferred frequencies with various degrees of coupling:—460 Kc/s, 1.6 Mc/s, 2.1 Mc/s, 4.86 Mc/s. The response curve shown is for Type M400 and is typical of the whole series. Nominal frequency is 460 Kc/s but is adjustable from 420 to 530 Kc/s approx.



MINIATURE I.F. TRANSFORMERS

WRIGHT & WEAIRE LTD., GREAT PETER HOUSE, 2 LORD NORTH STREET, WESTMINSTER, LONDON, S.W.1. ENGLAND. CABLES: WRITWEA, LONDON

FACTORY: SIMONSDALE WORKS · SOUTH SHIELDS · CO. DURHAM · ENGLAND

★ This Trade Mark is well-known in Britain as that of a Company who are responsible for the Design, Development and Manufacture of Transformers, Vibrators, Switches and Coils. This particular component of real miniature dimensions, yet maintaining highest efficiency, is the latest development of their Engineering Dept. and is backed by 26 years experience in the manufacture of Radio and Electronic components.

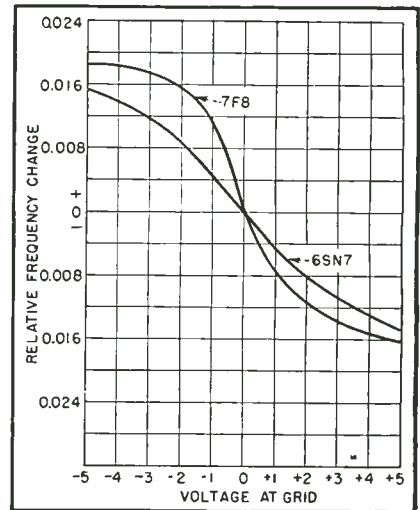

FIG. 4—Curves showing the variation of oscillator frequency as a function of control voltage

relative frequency change plotted as a function of the voltage applied to the frequency control tube grid for both the 6SN7 tube and the 7F8 tube. The sensitivity of the 7F8 tube is somewhat higher to small voltages applied to the control tube grid. However, the range of frequency control is about the same with either tube.

When the plate supply voltage was varied from 200 to 300 volts with the voltage applied to the frequency control tube grid maintained constant, the variation in oscillator frequency using the 7F8 tube was 0.07 percent, and using the 6SN7 tube the oscillator frequency variation was 0.02 percent. When the heater voltage was varied from 6.3 to 5.7 volts, the frequency change using the 7F8 tube was 0.2 percent, and using the 6SN7 tube it was 0.07 percent.

The 7F8 tube is a more sensitive frequency control tube than the 6SN7 but it has a correspondingly higher sensitivity to the effects of plate and heater voltage variation. These effects of heater and B-supply voltage variation are the combined effects on both the oscillator and frequency control sections.

Temperature Controller

By JOHN W. BANCROFT

*Design Engineer
Minneapolis-Honeywell Regulator Co.
Minneapolis, Minn.*

THE ELECTRONIC temperature controller circuit shown here maintains a constant temperature in the air-

IF YOU HAVE HEAT CONTROL PROBLEMS

Thermotechnics

(Fenwal CUSTOM THERMAL ENGINEERING)

CAN HELP YOU —

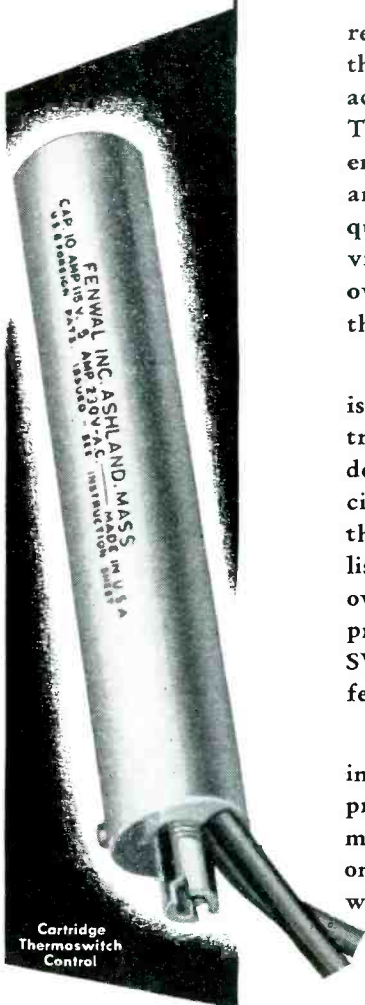

In every instance where detection or regulation of temperature is a factor, the art of Thermotechnics can help you achieve greater efficiency and economy. Thermotechnics, a development of Fenwal engineering research, is a method of analyzing and coordinating process requirements, heating means, control devices and product design to insure best over-all performance of the complete thermal-control system.

The primary factor of Thermotechnics is the Fenwal THERMOSWITCH* Control. This unique instrument has every desirable feature for trouble-free, efficient temperature regulation. Examine these features in the "14 Facts" check list . . . certain ones are essential to your own temperature control or detection problem. *Only* the Fenwal THERMOSWITCH* Control incorporates *all* these features.

Fenwal engineers will gladly assist you in custom engineering your product or process in accordance with sound Thermotechnic practice. Further information on Thermotechnics and Fenwal Controls will be sent upon request.



FENWAL INCORPORATED

43 PLEASANT STREET

ASHLAND MASSACHUSETTS

Thermotechnics for Complete Temperature Regulation

*Reg. Trade Mark U.S.A. Pat. Off.

FACTS IN FENWAL'S FAVOR

- 1 Instant temperature detection
- 2 Large heat sensitive area — small heat storage
- 3 Short heat transfer path
- 4 Small temperature differential
- 5 Built-in temperature anticipation
- 6 Enclosed assembly
- 7 Minimal vibration effects
- 8 Tamper proof
- 9 Rugged design
- 10 Adjustable over wide temperature range
- 11 Compact design
- 12 Fast response to radiant heat
- 13 Uniformity over wide temperature range
- 14 Ease of installation



LAMITEX Affords the Best Combination In Both High Dielectric and Mechanical Strength

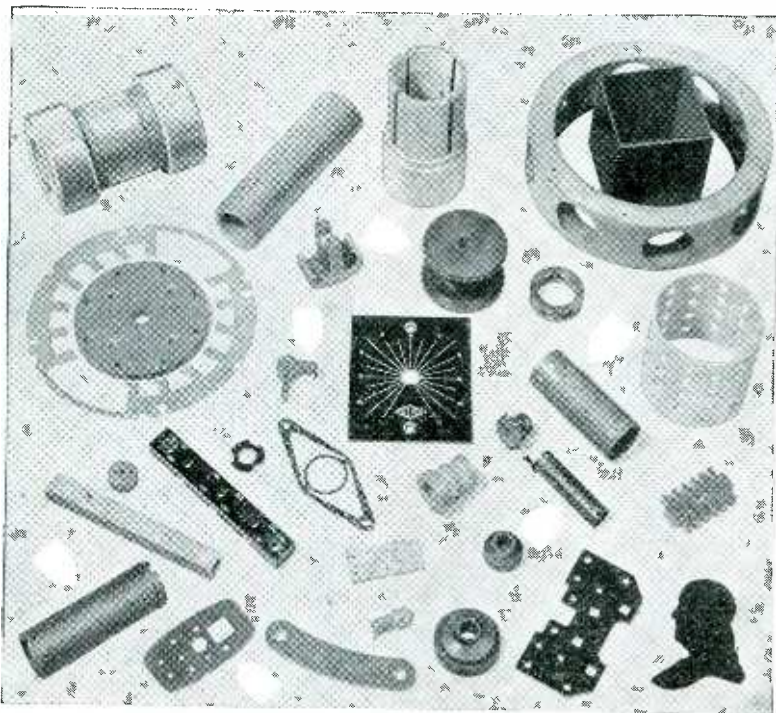

Indicated by arrows:

- ★ **LINEN LAMITEX** precision sprocket for motion picture developing apparatus is used extensively immersed in developing hypos without affecting its dimensional stability. High mechanical strength of small teeth, and their resistance to wear, is a particular advantage.
- ★ **LINEN LAMITEX** automotive distributor breaker-arm not only provides electrical insulation and inherent resistance to wear, but also reduces to a minimum wear of companion steel cam.
- ★ **GRADE X X X LAMITEX** coil forms used in communication and radio circuits where Low Moisture Absorption and high dielectric strength is a vital factor.
- ★ **GRADE XX LAMITEX** punched base for automotive cut-out in battery-generator circuit. Provides suitable mechanical and high dielectric qualities for this important application.

FRANKLIN LAMITEX and VULCANIZED FIBRE

... In Sheets, Rods and Tubes, Fabricated or Molded Parts

Low moisture absorption is only one of many advantages you get when FRANKLIN'S LAMITEX is specified for your job. This versatile material is highly machineable, or if you lack the proper facilities we will fabricate the parts for you. Both LAMITEX and FIBRE can be drilled, tapped, turned, threaded, punched, shaved, bored, reamed, sawed, milled or completely fabricated into automatic screw machine parts.

Send for Catalog Containing Complete Data

Check these FRANKLIN LAMITEX Characteristiss

• High dielectric strength • Low power factor • Low moisture absorption • Remarkable dimensional stability • High mechanical strength • Low co-efficient of thermal expansion • Low in weight (about half that of aluminum) • Unaffected by solvents and oils, most organic acids, dilute mineral acids or salt solutions.

FIBRE
HARD
VULCANIZED



FRANKLIN
FIBRE-LAMITEX CORP.
FRANKLIN FIBRE-LAMITEX CORP.
WILMINGTON, DEL. • 187 LAFAYETTE ST., NEW YORK 13



**LAMINATED
BAKELITE**

plane cabin by raising or lowering the heater discharge temperature according to cabin demand and fluctuations in outdoor temperature. The system measures not only cabin air temperature, but also outside air temperature and heater discharge temperature, and keeps them all in balance.

The temperature controller operates a heat control valve or damper by means of a two-phase reversible motor which is an integral part of the unit. This motor drives the balancing potentiometer and crank arm through a gear train. One field coil of the motor is energized by one winding of the transformer through a 0.3- μ f capacitor that serves to

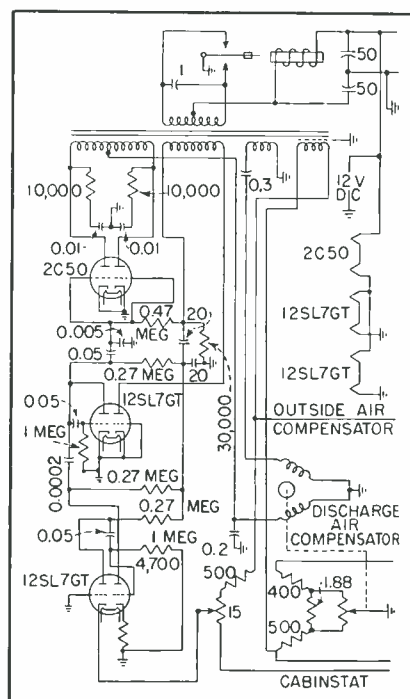

Complete circuit of cabin temperature controller operating from 12-volt vibrator-type power pack

shift the voltage across that field coil approximately 90 degrees out of phase with the transformer voltage. The other field coil is connected between the center tap of another secondary winding and ground.

Both cathodes of the 2C50 tube in the amplifier are also grounded. The plates of the 2C50 tube are connected to the two ends of the same transformer winding, and are therefore 180 degrees out of phase with each other. The grids of this tube are biased to cutoff so that no current flows in either half of the tube when the system is at rest.

The control bridge is energized by a third winding of the same

for **proved** performance
in **FM**



Specify These Federal Air Cooled Triodes
3,000 and 10,000 Watts per pair at 88 to 108 Megacycles

LEADING FM STATIONS all over the country report that these Federal triodes are not only living up to—but *far exceeding*—their exacting specifications, in day-after-day performance on the job.

To us at Federal, such service records are no surprise. Because long before these tubes were announced, they were subjected to the most rigorous and exhaustive development tests at the factory—for dependability, permanence of characteristics, overload capacity and long life. And in production, every tube is checked and double checked all along the line, from raw materials to finished product, to assure the utmost perfection of every detail. For complete information, write today to Dept. K-513.

<p>DATA—TYPE 7C26</p> <p>Frequency, 88-108 Megacycles (Max. Output up to 150 Mc)</p> <p>Maximum plate dissipation 1000 watts Filament voltage 9.0 volts Filament current 28.0 amp Amplification factor 22 Mutual conductance 20,000 Umhos Cooling air requirements at maximum dissipation 75 cfm</p>		
<p>DATA—TYPE 7C27</p> <p>Frequency, 88-108 Megacycles (Max. Output up to 110 Mc)</p> <p>Maximum plate dissipation 3000 watts Filament voltage 16.0 volts Filament current 29.0 amp Amplification factor 27 Mutual conductance 20,000 Umhos Cooling air requirements at maximum dissipation 175 cfm</p>		

Federal Telephone and Radio Corporation

In Canada:—Federal Electric Manufacturing Company, Ltd. Montreal.
Export Distributors:—International Standard Electric Corp. 67 Broad St., N. Y. C.



100 Kingsland Road,
Clifton, New Jersey

18

GOOD REASONS
FOR BUYING

Permanent Magnets

FROM

THOMAS & SKINNER



- 3½% CHROMIUM
- 6% CHROMIUM
- 6% TUNGSTEN
- 3% COBALT
- 17% COBALT
- 37% COBALT
- CUNIFE
- CUNICO
- ALNICO I
- ALNICO II
- ALNICO III
- ALNICO IV
- ALNICO V
- ALNICO VE
- ALNICO VI
- ALNICO XII
- COMOL (Remalloy)

Every one of these permanent magnet materials is different. And every one of them is "best" in some specific application—because it is the one material which will meet all performance requirements at the least material and fabrication cost. These are 17 good reasons for dealing with Thomas & Skinner—because Thomas & Skinner supplies magnets in all these materials—cast, formed or sintered.

The 18th good reason is the simple fact that Thomas & Skinner Steel Products Company has the longest record of service in the permanent magnet industry—46 years. And nowhere is experience of greater value than in the design and fabrication of permanent magnets.

Write for the new technical bulletin: "Use, Design and Fabrication of Permanent Magnets." Just fill out and mail the coupon.

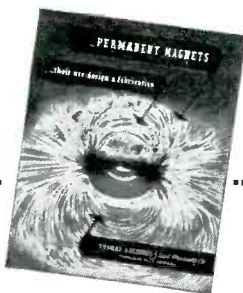

- Please send new Permanent Magnet Catalog
- Please have sales engineer call

NAME _____

COMPANY _____

CITY _____ STATE _____

THOMAS & SKINNER
STEEL PRODUCTS COMPANY

1122 EAST 23rd STREET, INDIANAPOLIS, INDIANA

TUBES AT WORK

(continued)

transformer, and the signals produced by any unbalance of the bridge are therefore in phase with one or the other of the two plates of

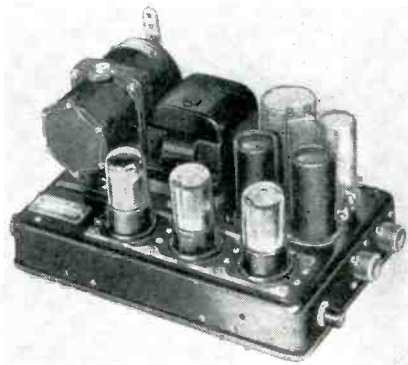

Aircraft cabin temperature controller, with damper motor at left on chassis

the 2C50 tube, depending on whether more or less heat is demanded. These signals, applied to one grid of one 12SL7 tube, are amplified twice by this tube and once by the other 12SL7 (of which one half serves as a rectifier), then applied to both grids of the 2C50 tube.

The action of the 2C50 tube is to pass current in half-wave pulses through whichever plate is in phase with the signal. Since the motor field coil is in both plate circuits, reversal of the phase of the signal shifts the voltage across the amplifier-controlled motor winding 180 degrees and produces corresponding reversal of motor rotation.

CITIZENS RADIO



Two-way portable for the Citizens band as engineered by Hallicrafters and encased in leather, metal, and plastic

AT **SHERRON** YOUR ELECTRONICS PROJECT

STARTS HERE — IN
THE LABORATORY

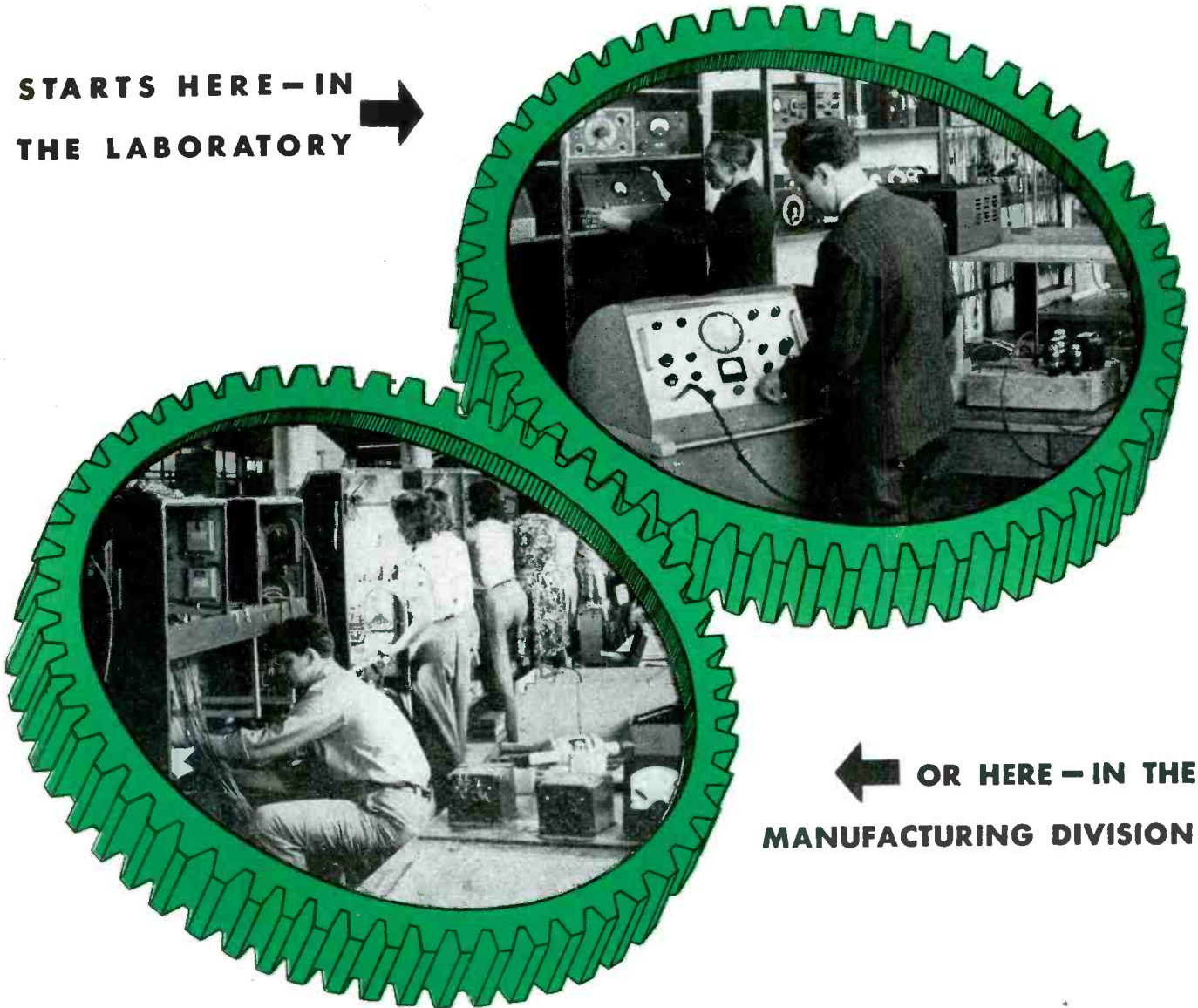

← OR HERE — IN THE
MANUFACTURING DIVISION

EITHER WAY . . . SHERRON CAN SERVE YOU ALL THE WAY . . .

Sherron is set to mesh gears with your production program at any level . . . research, design, development and — or manufacturing.

Our laboratory, particularly, is a highly developed facet of our service. The premises that assure manufacturing practicability are established here. The equipment used in this laboratory is the last word in electronic

research apparatus . . . and every laboratory worker is a thoroughly seasoned physicist, alert to the most advanced techniques.

The same complete operation, which has allied Sherron with some of the foremost electronics manufacturers, is available to a few additional manufacturers . . . Write for particulars of our definitive service to electronics manufacturers.



SHERRON ELECTRONICS CO.

Division of Sherron Metallic Corporation

1201 FLUSHING AVENUE • BROOKLYN 6, NEW YORK

Enjoy "next door" convenience with all your suppliers



It doesn't matter where the supplies and replacement parts you need are located. They can be delivered to you in hours when you specify Air Express. Air Express gives you same-day delivery between many towns and cities. Even overnight coast-to-coast shipments are now routine.

Air Express is a better value than ever at today's low rates. Planes are bigger and faster and schedules more frequent. So, serve your customers better, and keep profits high, too! Use the speed of Air Express regularly.

Specify Air Express—it's Good Business

- Low rates include special pick-up and delivery in principal U.S. towns and cities. • Moves on all flights of all Scheduled Airlines.
- Air-rail between 22,000 off-airline offices.
- Direct air service to and from scores of foreign countries.

Just phone your local Air Express Division, Railway Express Agency, for fast shipping action. . . . Write today for Schedule of Domestic and International Rates. Address Air Express, 230 Park Avenue, New York 17. Or ask for it at any Airline or Railway Express Office. Air Express Division, Railway Express Agency, representing the Airlines of the United States.

AIR EXPRESS
GETS THERE FIRST

Rates are low

For example: to Air Express a 22-lb. shipment 1100 miles costs only \$7.43. 10-lbs. for \$3.58. Other weights—any distance — similarly inexpensive.

ELECTRON ART (continued from p 144)

techniques (ELECTRONICS p 216 Dec 1946) is available through the Department of Commerce. To call attention to technical and business information facilities that this department maintains for the benefit of small industries and to promote full production and employment, some of the activities of the Department of Commerce are outlined below.

Divisions of Department of Commerce

The Dept of Comm is divided into several offices and bureaus some of which, such as the Coast and Geodetic Survey and the Weather Bureau perform essential but indirect national services, and others that serve industry and commerce directly. Those offices most likely to directly interest readers are listed below. Some of the divisions are well known and therefore their activities will only be mentioned briefly.

OFFICE OF TECHNICAL SERVICES was officially organized the first of July 1946. It collects and distributes scientific and technical information of interest to domestic business. More about this office is given below.

OFFICE OF INFORMATION is a general clearinghouse for the department. It distributes economic, scientific, and technical information resulting from research and analysis in the various other branches of the department.

CIVIL AERONAUTICS AUTHORITY operates through the Civil Aeronautics Administration, which develops, installs, and operates navigational facilities for airways and airfields, and the Civil Aeronautics Board, which regulates safety measures, air traffic and transportation, and investigates accidents.

BUREAU OF FOREIGN AND DOMESTIC COMMERCE, through its several offices, offers businessmen domestic and foreign statistics on business trends. Monthly, quarterly, and annual reports are published. The department serves chiefly those businesses too small to support their own market research, procurement, and economic advisory departments.

NATIONAL BUREAU OF STANDARDS performs fundamental research in science and engineering, is cus-

CONFUSING?

OR

AMUSING?

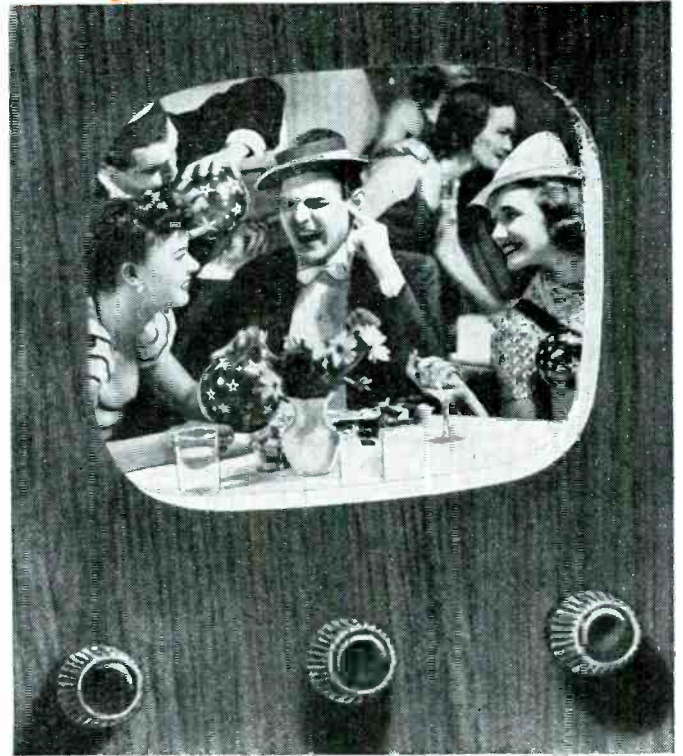
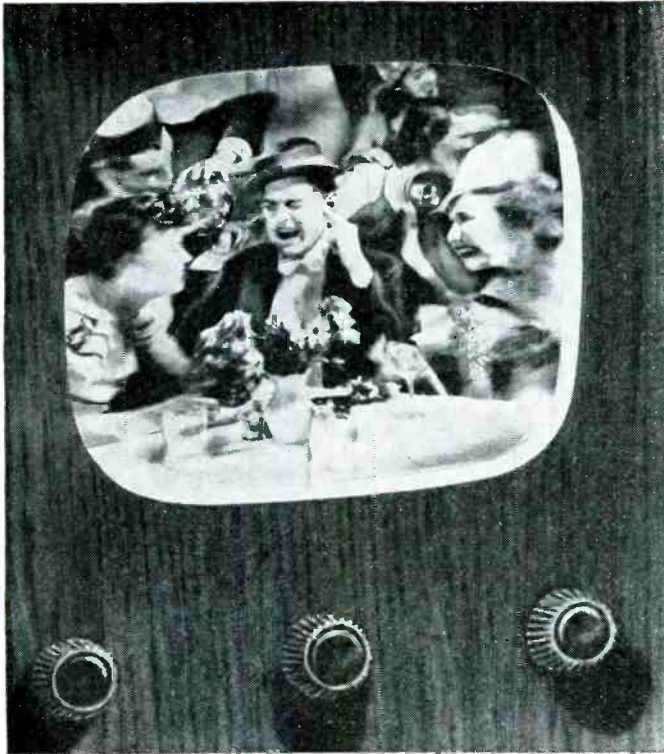

Lead-In Lines Play an Important Part in Television Reception

The effects of attenuation and impedance mismatch on FM and Television reception are minimized by Anaconda Type ATV* lead-in lines.

The satin-smooth polyethylene insulation of Type ATV line sheds water readily, thus avoiding subsequent impedance discontinuities. This material also has exceptionally high resistance to corrosion. Count on Anaconda to solve your high-frequency transmission problems—with anything from a new-type lead-in line to the latest development in coaxial cables. 47430

*An Anaconda Trade-Mark

**A Type ATV Lead-In
for Every Need**

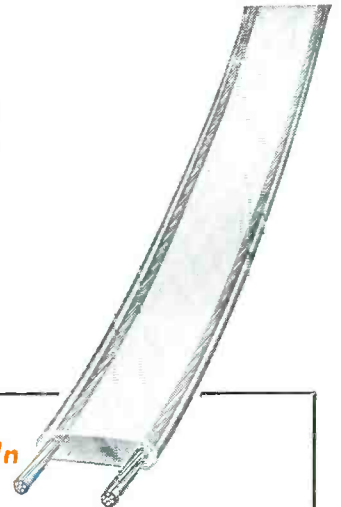

Anaconda offers a complete selection of Type ATV lead-in lines for 75, 125, 150 and 300 ohms impedance unshielded and 150 ohms shielded. For an electrical and physical characteristics bulletin, write to Anaconda Wire and Cable Company, 25 Broadway, New York 4, N. Y.



ANACONDA WIRE AND CABLE COMPANY



Silent and chatterless

...just like an Adlake Relay!

Silent, positive action is just one of many Adlake Relay advantages!

Other important ones are:

- Hermetically sealed contact mechanism—impervious to dust, dirt and moisture.
- Liquid mercury-to-mercury contact—no burning, pitting or sticking.
- Armored against outside vibration or impact—designed for either stationary or moving equipment.

Remember, *whatever* your relay needs may be, there's an *Adlake* Relay to do the job. So write today for free, illustrated folder. No obligation, naturally. Address: The Adams & Westlake Company, 1107 N. Michigan, Elkhart, Ind.



ADLAKE RELAY MODEL NO. 1040

THE Adams & Westlake COMPANY

Established 1857 • ELKHART, INDIANA • New York • Chicago

Manufacturers of Adlake Hermetically Sealed Mercury Relays for Timing, Load and Control Circuits

todian of national standards of measurements, develops and improves methods of testing and inspecting, and prepares codes for materials.

PATENT OFFICE administers the patent laws, examines, issues, and classifies patents. It publishes a weekly *Official Gazette* (annual subscription \$16 from the Superintendent of Documents, Government Printing Office) and prints full copies of all patents (\$0.25 each from the Commissioner of Patents, Patent Office), maintains a Register of Patents Available for License in which are listed those patents that patentees will grant licenses for or sell on reasonable terms, and maintains a Scientific Library and Reading Room open to the public in which are books and bound volumes of periodicals devoted to science and technology, official journals of foreign patent offices, and copies of domestic and foreign patents.

Office of Technical Services

Functions of most divisions of the Dept of Comm are familiar, but the activities of the Office of Tech Services, being the youngest division of the department, may not be known. The Office of Tech Services is the focal point for collection and dissemination of scientific and technical information of value to the American business community. It consists of five divisions.

TECHNICAL INDUSTRIAL INTELLIGENCE DIVISION studies enemy scientific, technical, and industrial developments and processes, selects and reports on the more valuable ones, and transfers the information into appropriate domestic channels. Currently some 200 investigators are in Germany culling material of interest to American industry.

BIBLIOGRAPHIC AND REFERENCE DIVISION disseminates material gathered by the Tech Ind Intell Div and other similar contributing agencies, and releases to industry declassified wartime technological developments, such as papers on atomic energy (*ELECTRONICS* p 154 March 1947), that were financed or sponsored by the federal government; reports are listed weekly in the *Bibliography of Scientific and Industrial Reports* (annual subscription \$10 from Superintendent

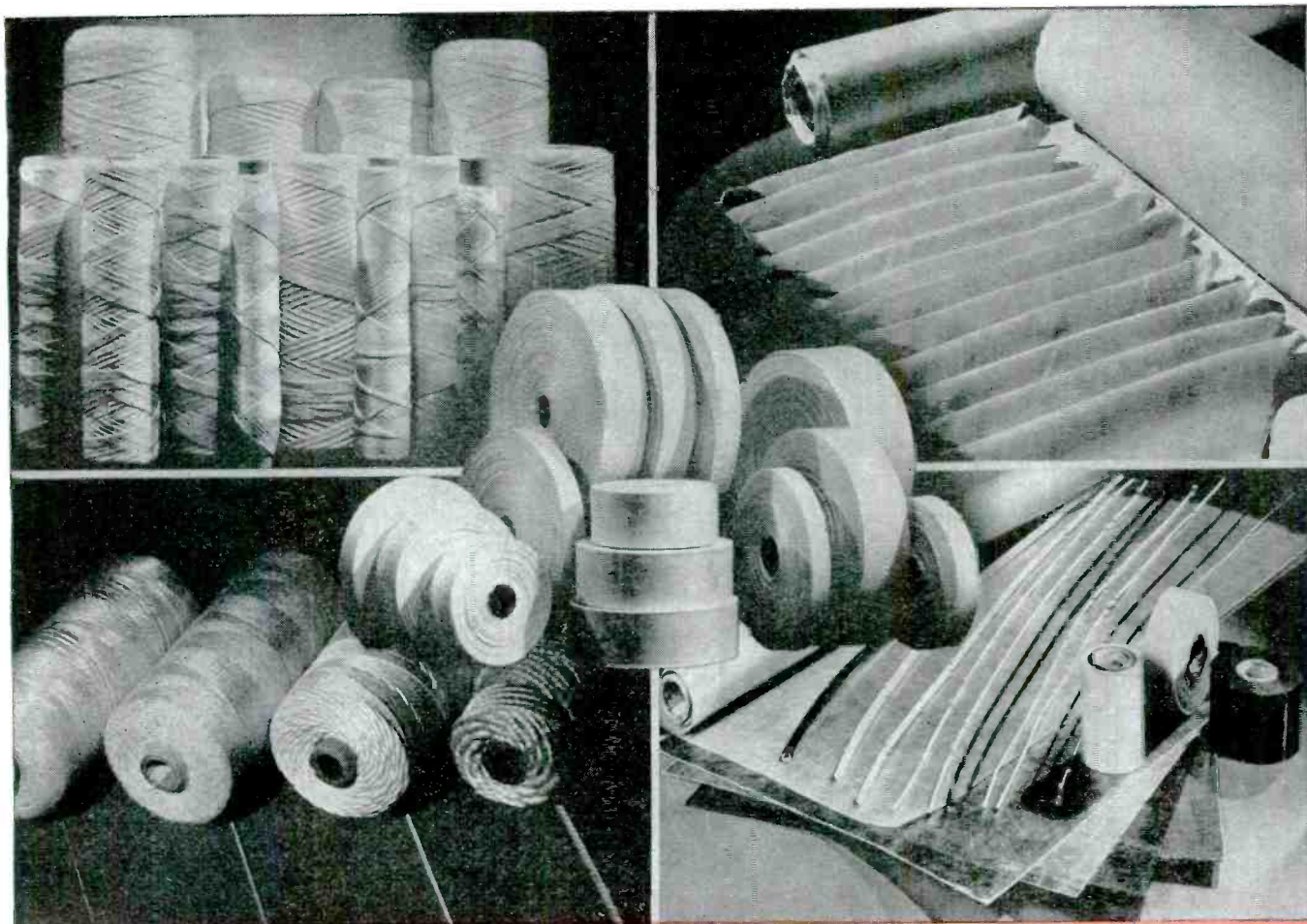

MIRAGLAS *is the name*

FOR WOVEN TAPES, TUBINGS, SLEEVINGS, CORDS, CLOTHS, OF FIBERGLAS YARN FOR EVERY ELECTRICAL INSULATION REQUIREMENT

MITCHELL-RAND, using Owens Corning Fibreglas yarn, processes and fabricates TAPES, TUBINGS, SLEEVINGS, CORDS and CLOTHS that are the optimum in electrical insulation . . . marketed under the trade name MIRAGLAS, they protect electrical equipment from the destructive forces that play havoc with ordinary electrical insulations; overloading, extreme high or low temperatures, moisture, corrosive acids, fumes or vapors, oils, grease, dust and dirt.

MIRAGLAS Fibreglas INSULATIONS have an amazing background of use throughout industry — wherever used they feature fewer break-downs, less maintenance, elimination of waste, savings in labor and materials and prove their standing as the optimum in electrical insulation protection.

Take note of the name MIRAGLAS . . . it stands for the ultimate in Fibreglas electrical insulations . . . TAPES, TUBINGS, SLEEVINGS, CORDS, CLOTHS, ETC. Write today for details and characteristics.

M - R THE
ELECTRICAL
INSULATION
HEADQUARTERS
FOR 58 YEARS.



MITCHELL-RAND INSULATION CO. Inc.

51 MURRAY STREET • Cortlandt 7-9264 • NEW YORK 7, N. Y.

A PARTIAL LIST OF M-R PRODUCTS: FIBERGLAS VARNISHED TUBING, TAPE AND CLOTH • INSULATING PAPERS AND TWINES • CABLE FILLING AND POTHEAD COMPOUNDS • FRICT ON TAPE AND SPLICING • TRANSFORMER COMPOUNDS • FIBERGLAS SATURATED SLEEVING • ASBESTOS SLEEVING AND TAPE • VARNISHED CAMBRIC CLOTH AND TAPE • MICA PLATE TAPE, PAPER, CLOTH, TUBING • FIBERGLAS BRAIDED SLEEVING • COTTON TAPES, WEBBINGS AND SLEEVINGS • IMPREGNATED VARNISH TUBING • INSULATED VARNISHES OF ALL TYPES • EXTRUDED PLASTIC TUBING

of Documents, Government Printing Office) for which a cumulative index has recently been issued. Photostatic or microfilmed copies of the reports can be obtained at cost through the Dept of Comm, Office of Tech Services.

INVENTIONS AND ENGINEERING DIVISION consists of engineering and industrial specialists who assist inventors in protecting and developing their devices, bring together inventors, researchers, and potential manufacturers, and also furnish business with results of research and manufacturing experience.

INDUSTRIAL RESEARCH AND DEVELOPMENT DIVISION negotiates technical and scientific contracts with government, university, private nonprofit, and industrial laboratories for projects that business is unable to sponsor and the successful culmination of which will benefit all or part of the nation.

INFORMATION STAFF disseminates the knowledge developed within the Office of Tech Services and other governmental departments and friendly foreign nations when such information has practical application in business and industry.

These services are maintained for you at your expense in the interest of promoting national industrial health. Their effectiveness depends on the extent to which you use them. In case you have forgotten, they all have main offices in Washington 25, D. C.; checks should be made payable to the Treasurer of the United States.

Optical Techniques for Improving Television Pictures

PROJECTION TELEVISION RECEIVERS for the most part make use of the Schmidt optical arrangement of a large concave spherical mirror to gather and reflect light from a cathode-ray tube and an aspheric corrector plate (lens) to compensate for spherical aberration introduced by the mirror. These optics are now being produced in quantity by the American Optical Co.

A 14-in. diameter mirror is used with a 5-in. diameter picture tube to produce on the screen a picture about 18 by 24 in. The concave face of the mirror, having a radius



WE HAVE WOUND MANY
Coils

.. to meet many problems

OUR reputation for superior windings is based upon 30 years of specialization . . . upon "know how", skill, close supervision and the most modern equipment.

We have served and are serving many manufacturers of electrical and electronic equipment whose requirements are most exacting. Whatever your coil winding requirements may be, we shall be glad to quote. Just send us your specifications.

COTO-COIL CO., INC.

65 PAVILION AVE. PROVIDENCE 5, R. I.

COIL SPECIALIST SINCE 1917

FEDERAL'S

BALANCED HF CABLE

KT-51

HAS THE RIGHT TWIST



**for Peak Performance
of FM and Television
Receivers**

HERE'S A NEW HF cable that will keep your FM and Television receivers working at peak performance—free from locally-induced interference, even in the most adverse locations. Where the performance of such costly equipment is at stake, it will pay you to specify Federal's KT 51—the finest high frequency lead-in cable available. More costly—but worth more!

The *twisted*, dual-conductor cable cancels any noise or signals not stopped by the double *braided shields*... because it's electrically balanced and stays that way in service, in any position. It's a rugged cable, too—remarkably resistant to abrasion, acids, alkalies, oils and greases, as well as smoky atmospheres and weather.

Don't let the lead-in wire be the "weak link" in otherwise perfect equipment. Be sure it's KT 51—the HF cable with the "right twist" to assure interference-free operation. For complete details, write to Dept. D-613.

ELECTRICAL CHARACTERISTICS

Nominal Attenuation (db/100 ft.)	Maximum Capacity Unbalance	1%
<i>Frequency</i>	<i>Attenuation</i>	Nominal Characteristic Impedance (ohms) 95
10 mc 0.9	Nominal Capacitance per ft. (uuf) 16	Volts (rms) 2000
30 mc 1.7		
100 mc 3.6		
300 mc 7.0		
400 mc 10.0		

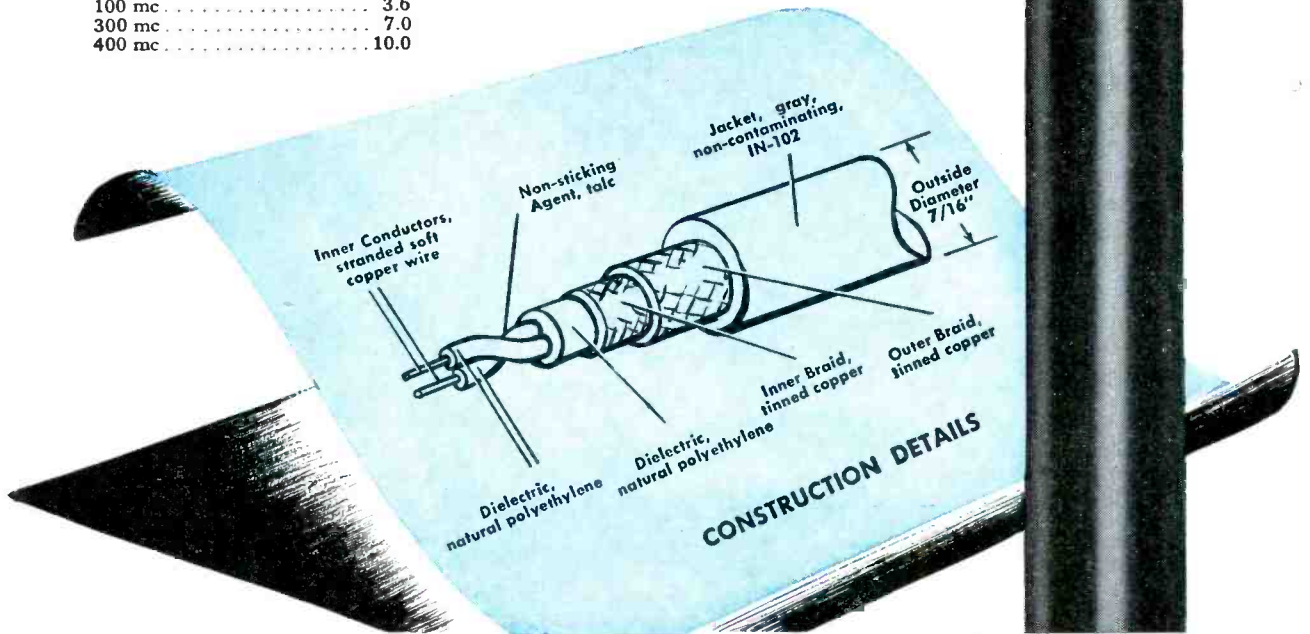

Federal Telephone and Radio Corporation

In Canada:—Federal Electric Manufacturing Company, Ltd., Montreal
Export Distributor—International Standard Electric Corporation, 67 Broad St., N. Y. C.



100 Kingsland Road,
Clifton, New Jersey

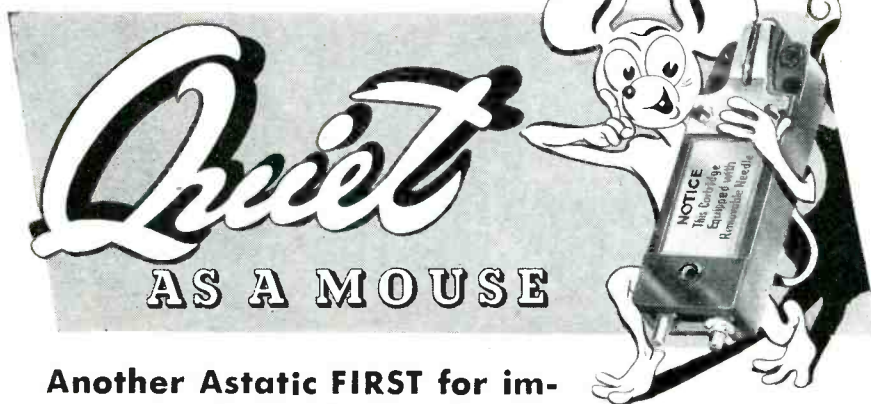

Another Astatic FIRST for improving the clarity and beauty of Phonograph Reproduction

Astatic
Patents
Pending

MODEL "QT" PHONOGRAPH CARTRIDGE

● With surface noise and needle talk VASTLY reduced by the revolutionary type needle mounting and design of this new cartridge, the proverbial mouse would lose his reputation for quietness by comparison. Increased vertical as well as lateral compliance of the replaceable needle used in the "QT" Cartridge has resulted in a great reduction in acoustic noises, which, together with an extremely low order of distortion, insures clearer, cleaner, and therefore more enjoyable "quiet talk" phonograph reproduction. The "QT" Cartridge is being extensively used in new equipment installations. Two models are available, "QT-M" with precious metal-tipped stylus and "QT-J" with jewel point.

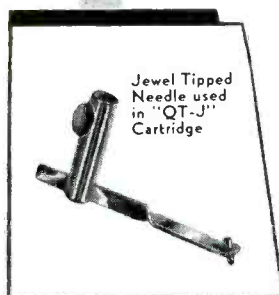
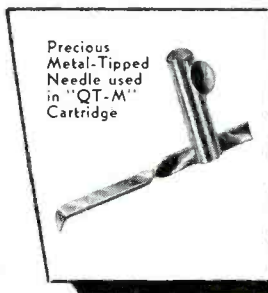

CHARACTERISTICS

Cartridge Models "QT-M" and "QT-J" have the following specifications: Minimum Needle Pressure, 1-1/4 oz.; output voltage .75, average at 1,000 c. p. s. on Audiotone 78-1 frequency test record; cutoff frequency, 5,000 c. p. s.; terminals, pin type.

THE
Astatic
CORPORATION
CONNEAUT, OHIO
IN CANADA: CANADIAN ASTATIC LTD., TORONTO, ONTARIO

Astatic Crystal Devices Manufactured
under Brush Development Co. patents.

Copyright Astatic

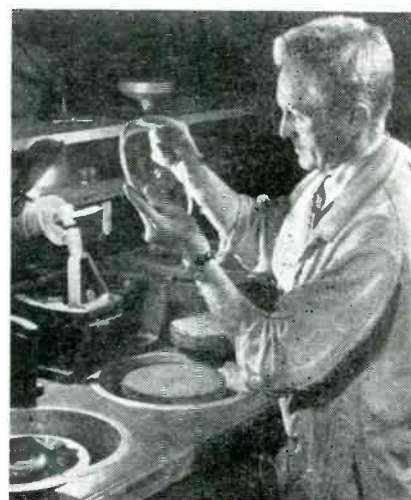

Glass correcting plates for optical systems were ground to shape by hand; they are now shaped by a dropping technique

of 13.7 in., is ground and polished on semiautomatic generating and polishing equipment. The surface is aluminized to increase its reflectivity and the aluminum surface coated by a protective material such as magnesium fluoride or quartz to prevent corrosion should the television receiver be used in a locale having adverse atmospheric conditions. The aluminum and film are applied in a vacuum chamber by evaporation. These mirrors, made for projection television receivers, are the largest so far attempted commercially in quantity.

Aberrations caused by the mirror



Spherical mirrors for projection television receivers are aluminized by evaporation in vacuum chambers

that is used to enlarge images are corrected by an aspheric lens. Whereas plastics had been used for this lens because of the difficulty of generating its surface, the 9.5-in. corrector plate is made of glass. A flat blank is heated until it flows

ERSIN

Multicore



**IS THE ONLY THREE CORE SOLDER
IN THE WORLD WHICH IS MADE WITH
EXTRA-ACTIVE NON-CORROSIVE
ERSIN FLUX**

which gives you guaranteed flux continuity and ensures a high standard of precision soldered joints. Three cores of flux in Ersin Multicore Solder give quick melting and more rapid soldering. The Multicore construction ensures flux continuity and the correct proportion of flux to solder. If you would like to know more about Ersin Multicore please write to us for detailed technical information.



Ersin Multicore Solder is made as standard in gauges between 10 and 22 S.W.G. (.128 - .028 ins., 3.251 - .711mm.) and in five standard antimony free alloys. Other gauges or alloys can be supplied to order. Only the finest tin and lead are used in the manufacture of Ersin Multicore Solder.

**ERSIN MULTICORE SOLDER GIVES YOU HIGH SPEED
PRECISION PRODUCTION - THE SECRET IS IN THE
ERSIN FLUX (EXCLUSIVE TO MULTICORE) COMBINED
WITH MULTICORE CONSTRUCTION.**

U.S.A. enquiries to
BRITISH INDUSTRIES CORP., 315, Broadway, New York 7, N.Y.

Canadian enquiries to
SNI-DOR RADIOELECTRIC LTD., 455 Craig Street West, Montreal

Enquiries regarding other territories to
MULTICORE SOLDERS LTD., Mellier House, Albemarle Street, London, W.1. England.
Tel.: REGent 1411. Cables: Dustickon, Piccy, London

HARDWICK, HINDLE

Resistors

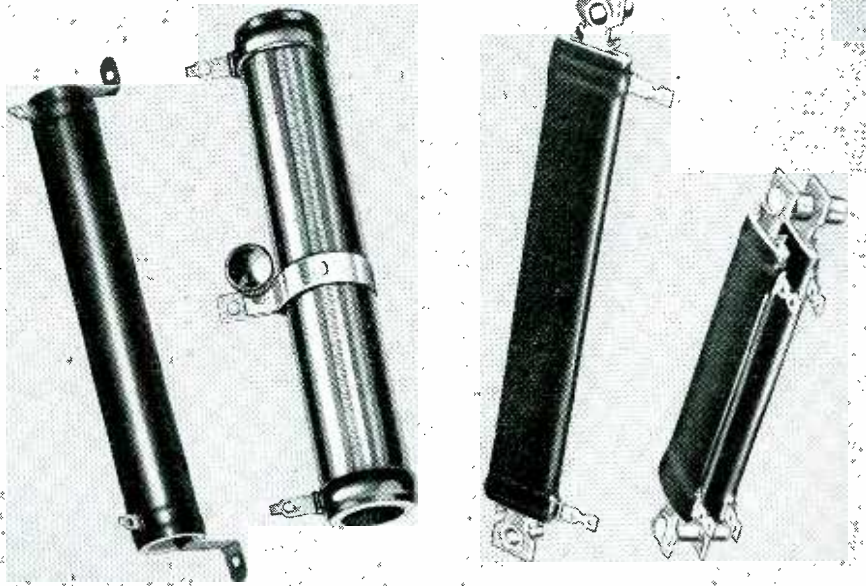

BY MAINTAINING even more rigid standards than ever before in our manufacturing and inspection we offer you exceptional resistors—exceptional in their rugged and dependable performance and long life.

We show here 3 of our standard types—a fixed; an adjustable; and our flat type Blue Ribbon—the first resistor made to depart from the conventional tubular form.

As one of the oldest manufacturers of resistors and rheostats we offer exclusive advantages in many types; and an engineering service that is always at your call. Write us today.

HARDWICK, HINDLE, INC.

Rheostats and Resistors

Subsidiary of

THE NATIONAL LOCK WASHER COMPANY

NEWARK 5, N. J. Established 1886 U. S. A.

ELECTRON ART

(continued)



Large mirrors are ground and polished to the required spherical contour used in the Schmidt projection system

into the curved surface of a refractory mold to which the glass does not adhere. The lens is then removed and polished, giving stable surfaces less affected by temperature and abrasion than that of a pressed plastic plate. Correcting lenses of this type were widely used in military infrared night viewing devices.

To further improve quality of the projected television picture, the face of the cathode-ray tube is coated as are lenses to reduce surface reflection. The coating need not be applied in vacuum chambers as done previously. The coating reduces false images produced by reflections from the outer surface of the face of the crt and increases the transmitted light available for producing the picture. As applied to a directly viewed crt, the coating reduces reflections in the glass face of the tube produced by lights in the room in which it is viewed.

Multireflection Klystron

DEVELOPMENT of the velocity modulated oscillator tube has progressed from the original drift tube type to the reflex type. In the reflex type, the electrons, after being velocity modulated by passing through the

FOR PRECISE MEASUREMENT OF INDUCTANCE

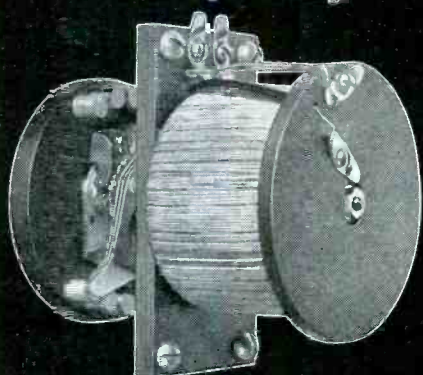
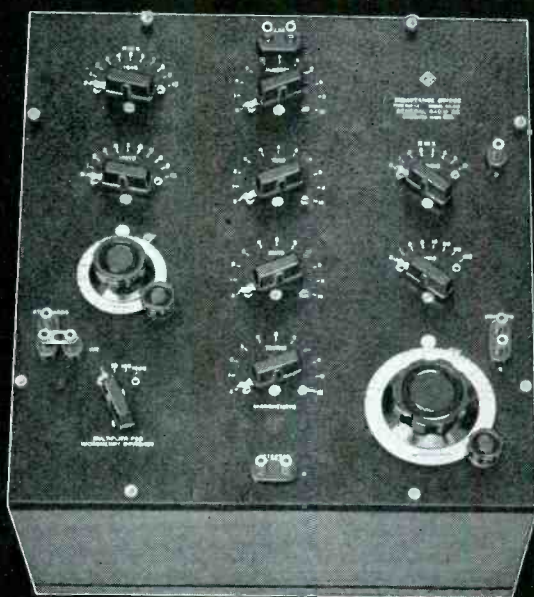
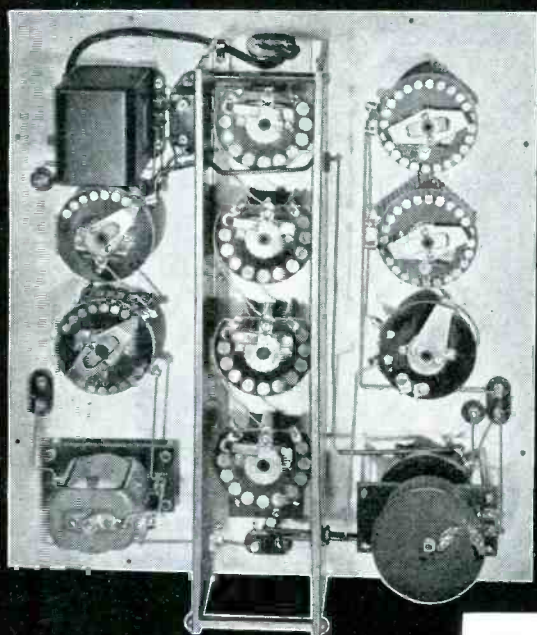

The 1-millihenry toroidially wound standard

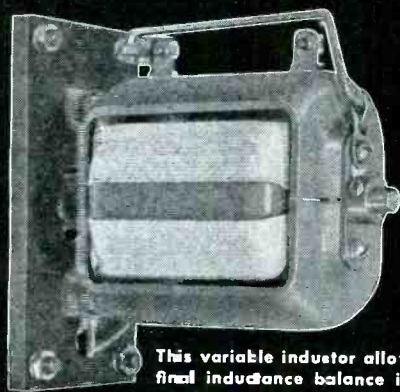

This variable inductor allows a final inductance balance independent of the resistive balance

FROM 0.1 MICROHENRY TO 1 HENRY

The Type 667-A Inductance Bridge is widely used in the laboratory and in production for precision measurements of the inductance of coils. It employs a standard bridge circuit with a number of unique design features which make it direct-reading, with high accuracy and convenience.

FEATURES

- **DIRECT READING** from 0.1 microhenry to 1 henry.
- **HIGH ACCURACY** — $\pm 0.2\%$ or $\pm 0.1 \mu\text{h}$ over major portion of its range.
- **RANGE** can be extended considerably with external standards.
- **CALIBRATED** for 1 kc use — can be used at frequencies between 60 cycles and 10 kilocycles with less accuracy.
- **VARIABLE RESISTORS** in standard and unknown arms inductance compensated to give constant inductance.
- **ERRORS** from sliding-zero balance have been eliminated.
- **INDUCTANCE BALANCE** independent of resistive balance.
- **STANDARD INDUCTOR** toroidially wound to minimize magnetic pick-up.
- **WITH AUXILIARY VARIABLE CONDENSER** can be converted into a resonance bridge — one of the most precise measuring techniques for determining resistance of inductors at audio frequencies.
- All four corners of the bridge available on panel. Bridge elements can be used to form a number of other circuits.

PRICE: Type 667-A Inductance Bridge \$400.00

(Accessories needed are oscillator, amplifier and head telephones)

**NOTE — A few in stock for immediate shipment —
ORDER NOW!**



GENERAL RADIO COMPANY

Cambridge 39,
Massachusetts

90 West St., New York 6

920 S. Michigan Ave., Chicago 5

950 N. Highland Ave., Los Angeles 38

NEW
TECH-LAB
DEVELOPMENT

For **RAPID**
MEASUREMENT
OF
AUDIO FREQUENCY
GAIN or LOSS

TYPE 1A
TRANSMISSION
MEASURING SET



Completely Self-Contained
PORTABLE • AC OPERATED

With this instrument it is possible to quickly and accurately analyze and service equipment in different locations without fuss in time consuming demounting and transportation of apparatus. It will thus pay for itself in a short time and no modern radio station can afford to be without it. It can also be used to good advantage in factory checking and inspection of audio equipment.

The set combines in a modern efficient manner an accurate vacuum tube voltmeter, an audio oscillator with four fixed frequencies and a precision attenuator all mounted in a handy cabinet easily carried by the operator.

SPECIFICATIONS

- **GAIN:** Up to 80 db.
- **LOSS:** 60 db. maximum.
- **VACUUM TUBE VOLTMETER:**
Range—40 to +40 db.
(1 mv. ref. level)
- **AUDIO OSCILLATOR:**
Freq. Range; 100 to
10,000.
- **PRECISION ATTENUATOR:**
Flat to 20 KC; 93 db.
in .1 db. steps.
- **DIMENSIONS:**
10 1/4" x 16 1/4" x 8 3/4"
- **WEIGHT:** 30 lbs.
- **INPUT:** 115 Volts.
60 cycles, 70 watts.



Manufacturers of Precision Electrical Resistance Instruments
337 CENTRAL AVE. • JERSEY CITY 7, N. J.

modulator as shown in Fig. 1, instead of continuing linearly forward in a field-free drift space until the velocity modulation has converted itself into density modulation and then passing through an inductor to release their energy, pass into a retarding electrostatic field so that they return to the modulator, which thus acts also as inductor, to give up their energy. After this second passage through the r-f field, the electrons leave the system by dispersion to the electrodes. In the multireflection tube,

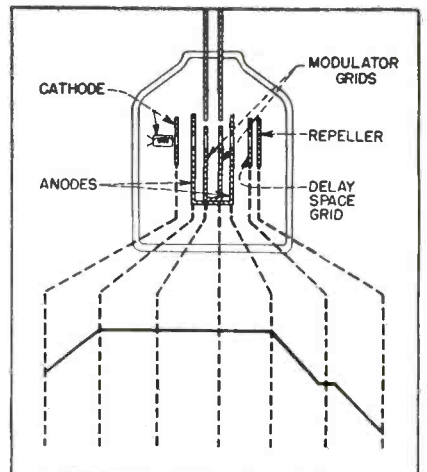

FIG. 1—At the top is shown the cross section of a reflex velocity modulation tube. Below is the potential distribution between electrodes

the electrons are retained in the system and repeatedly returned through the r-f field so as to release a greater portion of their energy and thus produce higher efficiency than is possible in simpler velocity modulation tubes. This multireflection is obtained by proper shaping of the electrostatic field of the reflex type tube.

Conditions for Multireflection

Efficiency of velocity modulated tubes is dependent on two factors: the ratio of r-f current induced into the modulator by the density modulated beam (output), or the equivalent component of r-f current in the beam itself, to the unmodulated beam current (input); and the ratio of r-f potential across the modulator to the electrostatic potential between modulator and cathode.

The first ratio can be made a maximum if transit time of all electrons retarded by the modulator is the same and if transit time of all electrons accelerated by the modu-

There are too many hands
and too many tools in this picture

Because... one hand and one tool
do your fastening-job better!



CHERRY BLIND RIVETS reduce pounding hours to fleeting minutes. There's no hammering or bucking because they are installed with a **controlled pull from one side of the work only.**

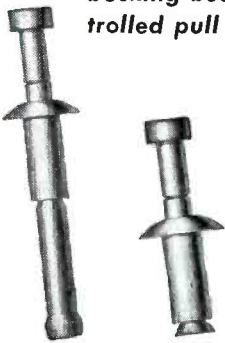

High-strength, self-plugging type Cherry Blind Rivet

Tight-clinching, pull-through hollow type Cherry Blind Rivet

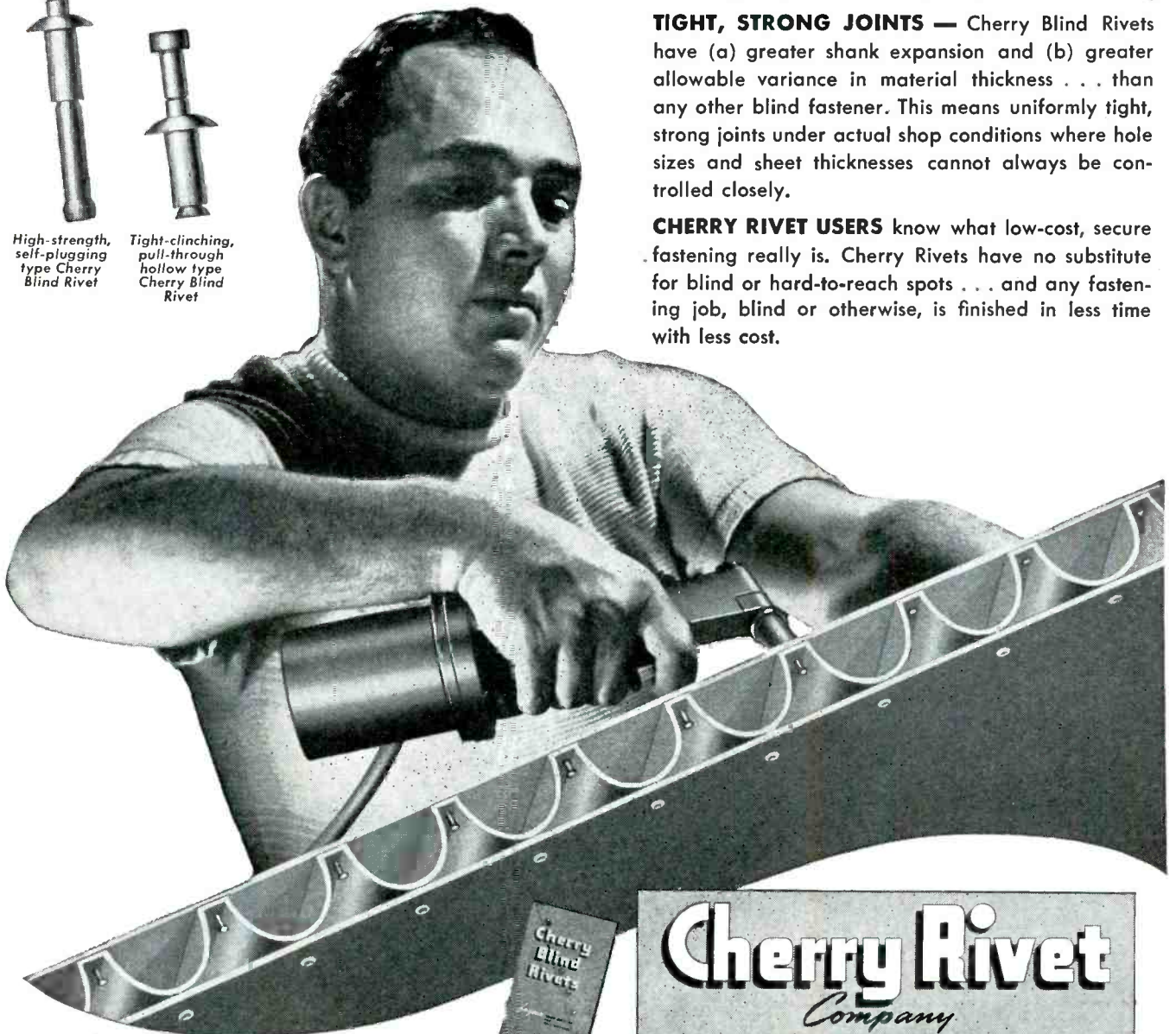

A SIMPLE ONE-HAND OPERATION vs. a tough two-man job. Installing a Cherry Blind Rivet is a fast, one-hand operation requiring only three simple steps: (1) inserting rivet in hole; (2) engaging the rivet; (3) actuating the gun. This adds up to speed, speed, speed.

TIGHT, STRONG JOINTS — Cherry Blind Rivets have (a) greater shank expansion and (b) greater allowable variance in material thickness . . . than any other blind fastener. This means uniformly tight, strong joints under actual shop conditions where hole sizes and sheet thicknesses cannot always be controlled closely.

CHERRY RIVET USERS know what low-cost, secure fastening really is. Cherry Rivets have no substitute for blind or hard-to-reach spots . . . and any fastening job, blind or otherwise, is finished in less time with less cost.



Cherry Rivet
Company
LOS ANGELES 13, CALIFORNIA

Get this Cherry illustrated manual. Write to Dept. F-120, Cherry Rivet Co., 231 Winston St., Los Angeles 13, Calif.

CHERRY RIVETS. THEIR MANUFACTURE & APPLICATION ARE COVERED BY U.S. PATS. ISSUED & PEND.

TEAMED FOR PERFECT HEARING COMFORT

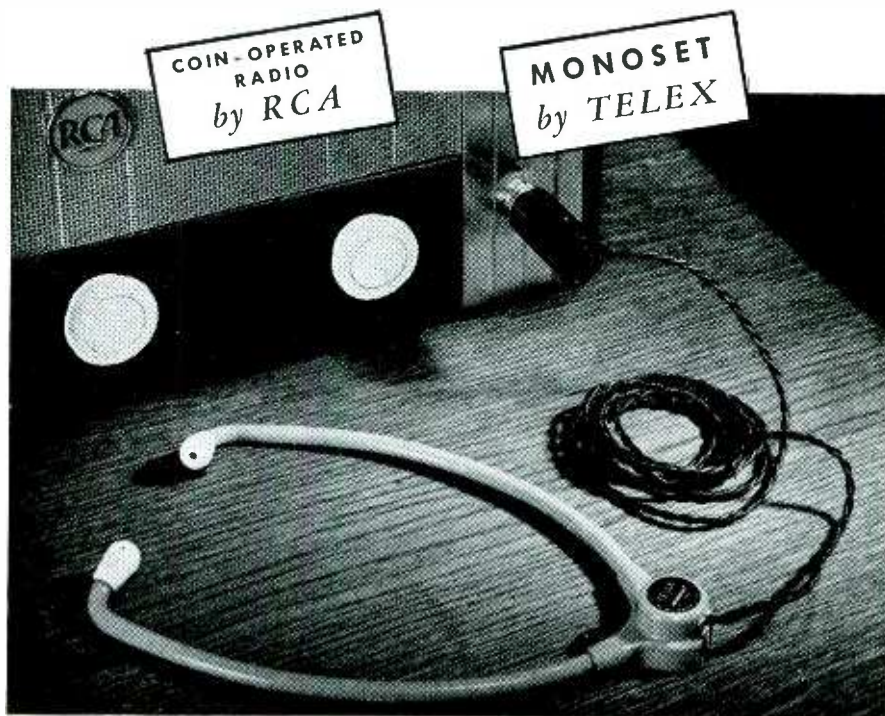

When RCA engineers checked headphones for their new hotel "coin-operated" radio, they quickly found what they wanted in the New TELEX Monoset. Today it's standard equipment on this RCA hotel model.

Take a "tip" from RCA and whenever comfortable hearing, fidelity and ease of use are needed for your sound equipment, specify the TELEX Monoset. It replaces old style, uncomfortable headphones. Light weight (1.2 oz.). Worn under the chin. Rugged Tenite plastic construction.

Write Department AA for information and quotations. We'll be happy to show you how the TELEX MONOSET can become part of your team for perfect hearing comfort.

Canadian Distributors:
Addison Industries, Ltd., Toronto



ELECTRON ART

(continued)

lator is also the same and a half period longer than that for the retarded electrons (ideal bunching). Best results are obtained when the transit time of retarded electrons is three to five half periods. Such transit times result in pulses of current passing back through the modulator in the proper phase to release energy to the r-f field.

The second ratio can be made large by repeatedly passing the velocity modulated electrons back and forth through the region of r-f field so that they develop as large an r-f potential as possible. However, density modulation, produced by the first reflection of the beam, must not be destroyed by subsequent reflections. That the bunches could become dispersed is apparent when it is realized that, although electrons are grouped closely together in a bunch, they are traveling at widely different velocities so that, in time, they will drift apart.

Only if the electrostatic reflecting potential on either side of the resonator increases with the square of the distance from the modulator-inductor will electrons be returned through the resonator in a bunch. In such a field the period of the individual electrons is independent of their velocities at the center of the force (resonator). That is, electrons execute simple harmonic motions of amplitudes independent of their instantaneous velocities through the resonator, but of identical periods.

Such a hyperbolic field would be difficult to obtain, but can be approximated as shown in Fig. 1. With such a field initial bunching necessary for tube operation would not be retained, each electron merely returning through the inductor at a changed velocity but without being closer to its neighbor than when it first passed through the modulator. However, accelerated electrons will pass further into the reflecting field than retarded ones. Therefore an additional reflecting field is added beyond that required for reflection of the unaccelerated electrons. The additional field is so proportioned that electrons entering it are delayed the prerequisite half period before returning. In this manner optimum beam current distribution is produced and

Can you use *tissue thin* electrical steel?

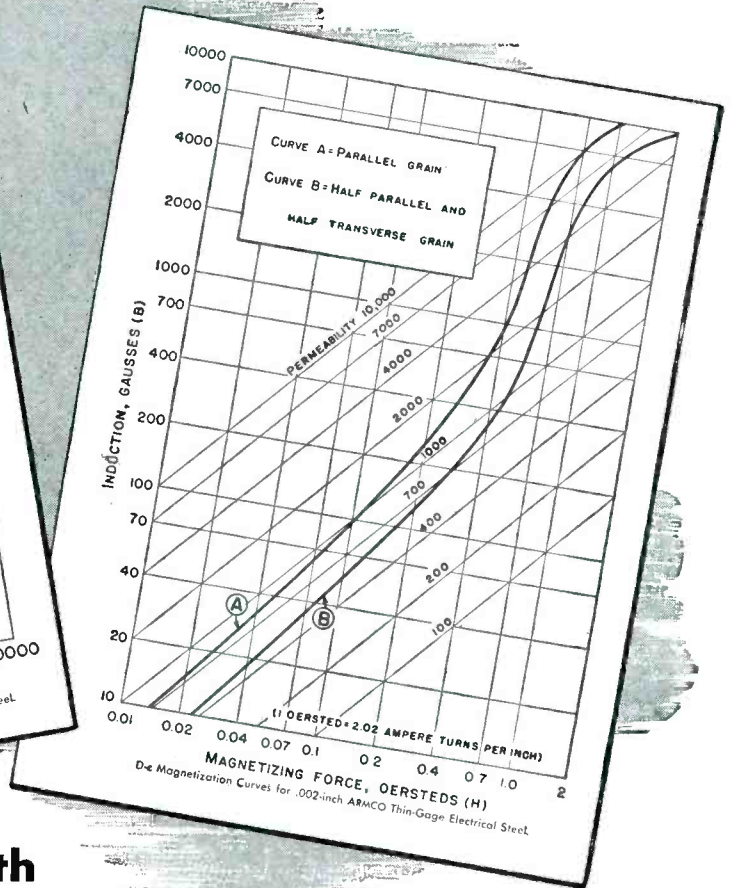
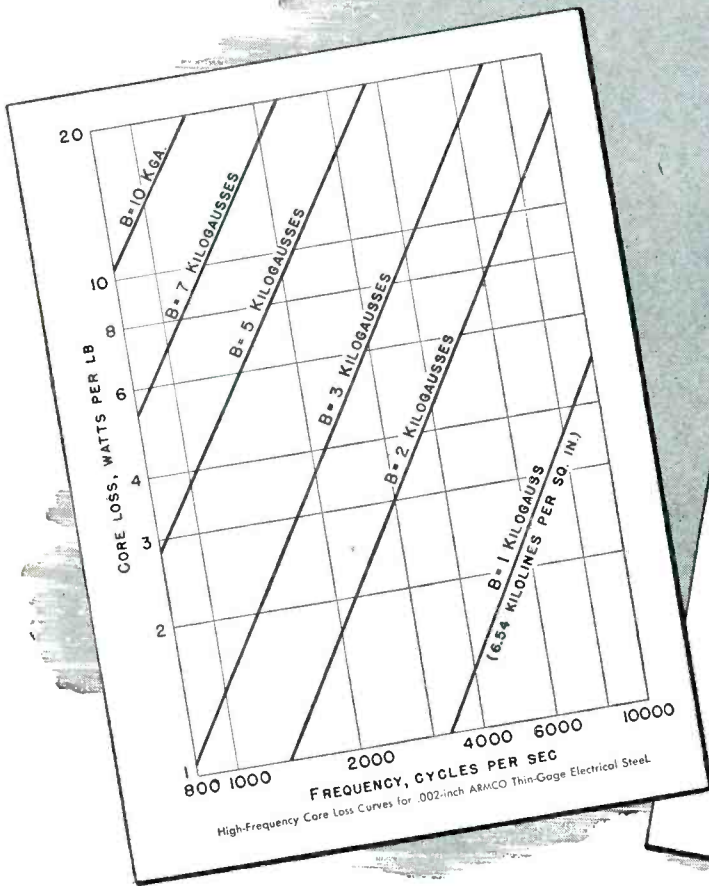

It Can be Supplied in a Width 12,000 Times Its Thickness!

Now you can get insulated electrical steel thinner than a human hair—steel of exceptional magnetic quality that is rolled to a remarkable gage-uniformity.

This is one of Armco's war-born developments that makes possible many new improvements in electrical equipment of all kinds. Peace-time uses include magnetic cores for television, high-frequency induction heating, radar, sonic detection, air-

borne electrical equipment and many other high-frequency devices.

If you make these or similar products, it may be possible to greatly improve their efficiency by using exceptionally thin insulated laminations in magnetic cores operating at high frequencies.

Low Energy Loss

Low energy loss and small, compact cores are two important advantages. For example, 100 kilowatt modula-

tors for radar systems with cores of .002-inch electrical steel now weigh only one-half pound. Earlier models had cores weighing 20 times as much.

Charts on this page show core loss vs. frequency for .002-inch silicon steel, and a d-c magnetization curve at low induction. Write us for other information pertaining to your specific products. Just address The American Rolling Mill Company, 681 Curtis Street, Middletown, Ohio.

The American Rolling Mill Company



Look first to ARMCO for Special-Purpose Electrical Steels

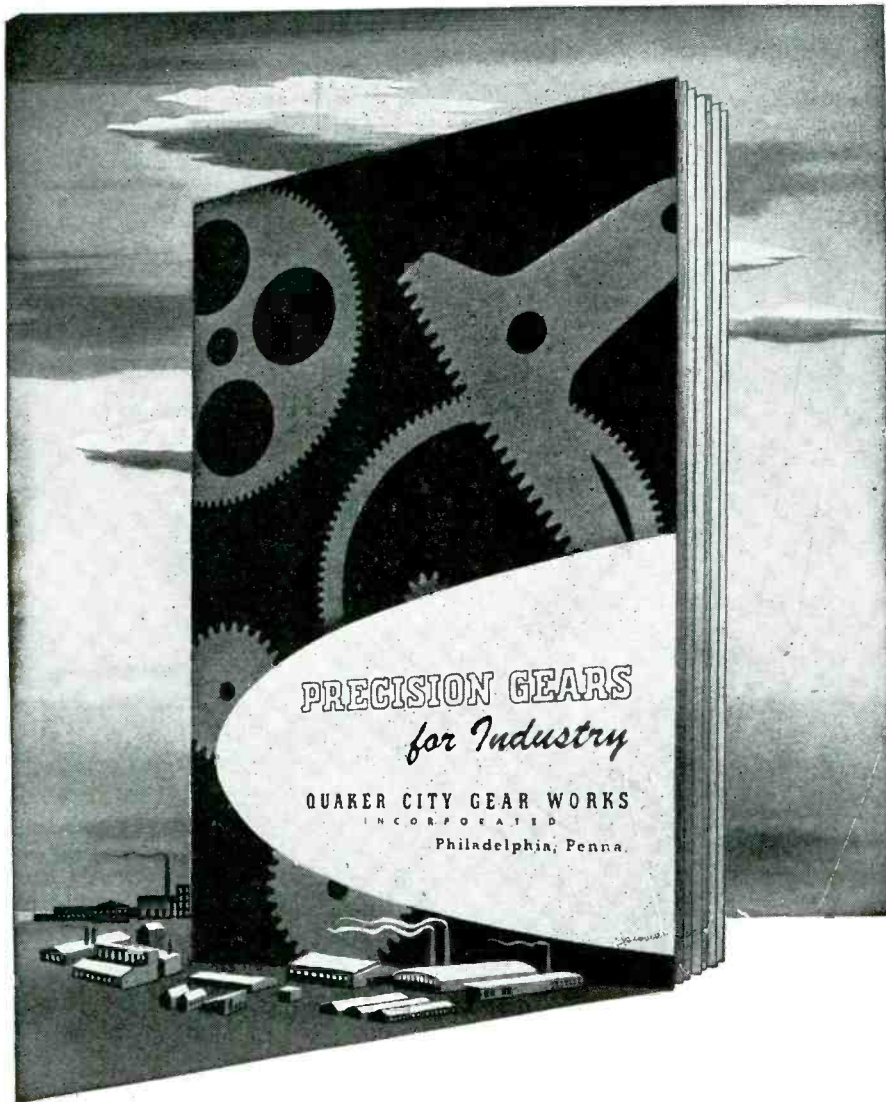

Yours for the asking

A new informative booklet on gears.

It has illustrated sections  on

practically every known form of gearing,

together with  many reference

tables and formulas. Write for your copy

today on your company stationery. 

 **Quaker City Gear Works**
INCORPORATED

1910 N. Front Street, Philadelphia 22, Pa.

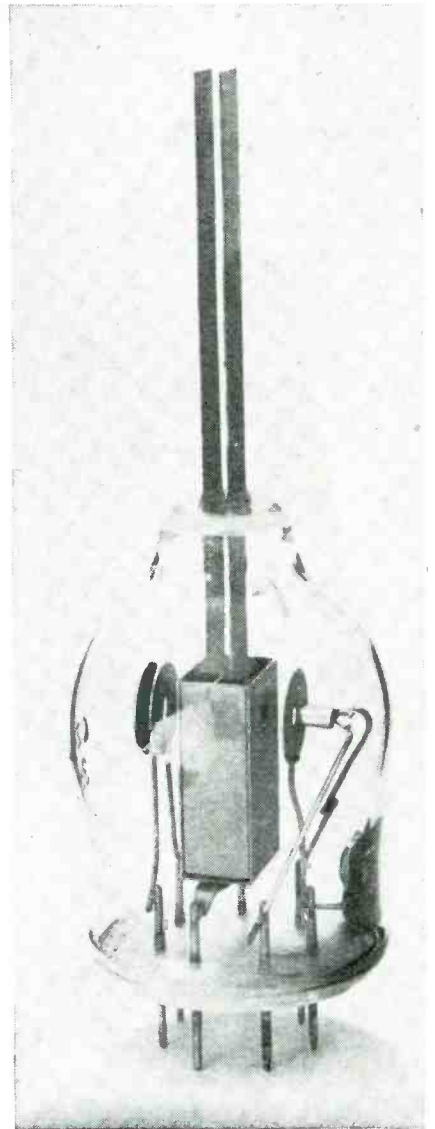

FIG. 2—Multireflection tube in glass envelope of 55 mm diameter produces 20 watts at 50 percent efficiency with magnetic focusing (not shown)

retained thus maximizing the ratio of output to input current as required for high efficiency. In addition, repeated transits of the bunched electrons through the r-f field are obtained.

Magnetic Focusing

A magnetic field in the direction of the electron beam opposes divergence of the beam so that mutual lateral forces between electrons do not drive them out of the path before they have released most of their r-f energy. Power output of the tube has a maximum at a critical magnetic field strength.

With the resonator detuned and the tube operating statically, critical magnetic field produces a maximum decrease in beam current. This field strength is that at which

NOW *One* INSTRUMENT FOR ELECTRONIC MEASUREMENTS

WESTON ELECTRONIC ANALYZER

Incorporating:

1. A conventional Volt-Ohm-Milliammeter with self-contained power source.
2. A high impedance electronic Volt-Ohmmeter using 115 volt, 60 cycle power.
3. A stable, probe-type, Vacuum Tube Voltmeter, for use to 300 megacycles.

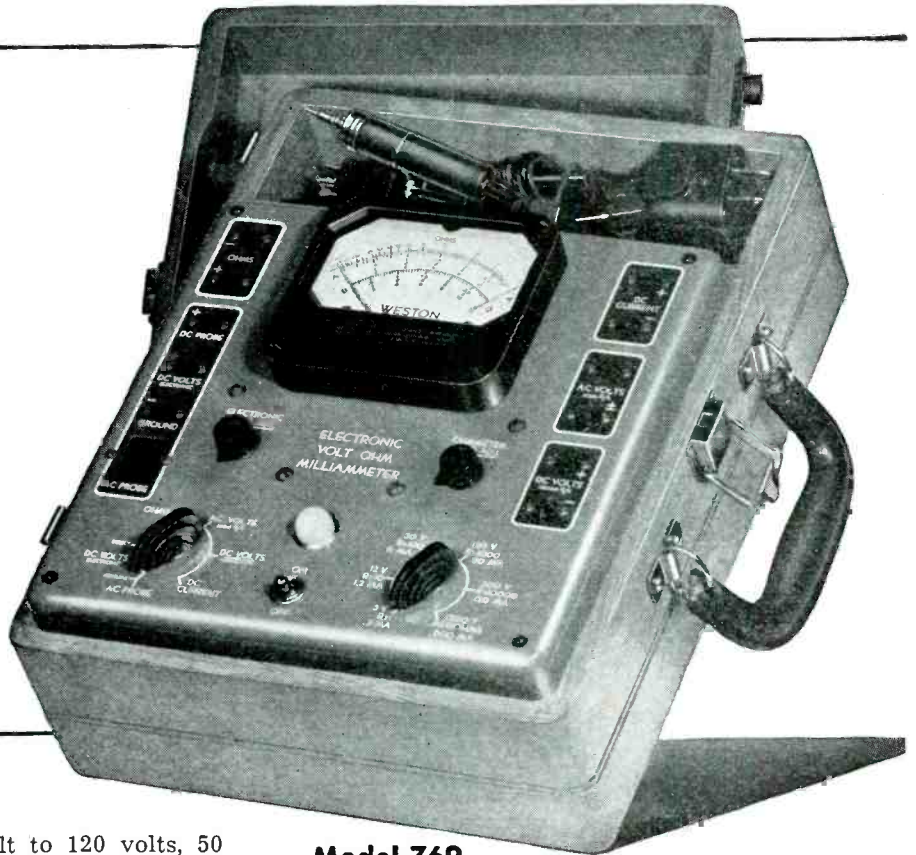

Model 769

Accurate a-c measurements .25 volt to 120 volts, 50 cycles to 300 megacycles.

Extremely small R.F. Probe (3½" x ¼" dia.). Probe constants, 5 megohms paralleled by 5 mmfd., approx.

New unity gain d-c amplifier provides absolute stability with line voltage variations from 105 to 130 volts.

D-C Electronic amplifier ranges 3 to 1200 volts at 15 megohms, resistance ranges 3000 ohms to 3000 megohms.

Conventional 10,000 ohm per volt d-c ranges 3 to 1200 volts, 1000 ohm per volt a-c rectifier ranges 3 to 1200 volts.

Resistance ranges 3000 to 300,000 ohms where a-c power is not available.

Entire Model 769 protected from external RF influences.

Uses standard commercial types of tubes replaceable without recalibration.

Size only 10" x 13" x 6½".

Full details from your jobber or local WESTON representative. Literature available... Weston Electrical Instrument Corporation, 618 Frelinghuysen Avenue, Newark 5, New Jersey.

WESTON

Instruments

ALBANY · ATLANTA · BOSTON · BUFFALO · CHARLOTTE · CHICAGO · CINCINNATI · CLEVELAND
DALLAS · DENVER · DETROIT · JACKSONVILLE · KNOXVILLE · LITTLE ROCK · LOS ANGELES
MERIDEN · MINNEAPOLIS · NEWARK · NEW ORLEANS · NEW YORK · PHILADELPHIA
PHOENIX · PITTSBURGH · ROCHESTER · SAN FRANCISCO · SEATTLE · ST. LOUIS
SYRACUSE · IN CANADA, NORTHERN ELECTRIC CO., LTD., POWERLITE DEVICES, LTD.



Offer low-cost Magnetic Recording ...Design for Brush Paper Tape

No matter what type of magnetic recorder you design, the low cost, excellent fidelity and uniformity of Brush Paper Tape make it your best all-round recording medium. With this new development by the pioneer and leader in the field of magnetic recording you can bring magnetic recording to the great mass market of all America! Brush Paper Tape will be furnished you either in bulk in varying widths or 1225 ft. 1/4-inch wide on a metal reel (standard item).

Look at these advantages of Brush Paper Tape...

- ✓ Easy to handle
- ✓ Extreme low-cost
- ✓ Can be edited... spliced
- ✓ Greater dynamic range
- ✓ Minimum wear on heads
- ✓ Excellent high frequency reproduction at slow speed
- ✓ Permanent... excellent reproduction for several thousand play-backs
- ✓ Easily erased

Other Brush developments in magnetic recording components include Plated Wire and vastly improved Tape and Wire Recording Heads and Cartridges.

Write today for further information

The Brush Development Co.
3405 Perkins Ave. • Cleveland 14, Ohio

the cathode is electron-optically projected back upon itself, the electrons leaving the cathode being returned to their identical emission points after reflection. The imaged space charge so produced in front of the cathode reduces emission and hence beam current.

In the oscillating tube, the same action takes place in the presence of the critical magnetic field, except that the modulated electrons, retarded by passage through the inductor, do not quite return to the cathode. However, any unmodulated electrons will return to the cathode to suppress emission. Thus cathode emission is nearly completely suppressed twice each cycle and at the time when it would contribute electrons to the beam that would be of minimum use in producing bunches.

The multireflections produced by the electrostatic field gradient thus increase the ratio of output r-f potential to d-c potential. The magnetic field increases the ratio of r-f beam current to d-c emission current. The increased efficiency brings the overall efficiency of the tube shown in Fig. 2 to about 50 percent, against about 5 percent without magnetic focusing and about 0.5 percent without multireflections or magnetic focusing. A maximum of 20 watts output is produced at 12 cm. (The Multireflection Tube—A New Oscillator for Very Short Waves, F. Coeterier, *Philips Technical Review*, p 257 Sept 1946).

Survey of New Techniques

NEW IDEAS AND METHODS are constantly being presented. In their early stages, before details have been worked out, there is little that can be said about them. Nevertheless, because to know what others are doing is both informative and stimulating, here briefly are some advances that affect the art of electronics.

Control of autopilots directly from signals developed by ground controlled approach radar is being developed at the Air Material Command's Watson Laboratories. Aircraft landing with these facilities can use either cross-pointer meters as now used with instrument land-

NOW AVAILABLE!

*New illustrated
technical booklet
on uses
of—*



PLASTICON* GLASSMIKES

Contains the following subjects:

- CHART OF RF CURRENT RATINGS
- Glassmike characteristics and design data
- Comparison of Glassmikes and Mica Capacitors
- Uses of Glassmikes for improved RF and Audio bypassing
- Use in Audio and RF coupling
- Glassmikes in television power supplies
- Video coupling
- Vibrator buffer applications
- Geiger Counter Capacitors
- Instrument capacitors
- and many other applications

Partial list of PLASTICON* users:

Argonne National Laboratory
Allis Chalmers Manufacturing Co.
Armour Research Foundation
Belmont Radio Corporation
Carnegie Institute of Technology
Dahlgren Proving Grounds
Eastman Kodak Company
Electronic Equipment Laboratory, Wright Field
Federal Telephone & Radio Corporation
Federal Telecommunication Laboratory
Farnsworth Television & Radio Corp.
Galvin Manufacturing Corporation
General Electric Company
Hazeltine Electronic Corporation
Humble Oil Company
Massachusetts Institute of Technology
Monsanto Chemical Company, Oak Ridge, Tennessee
National Advisory Council on Aeronautics
North American Philips Company
Naval Research Laboratory
Naval Ordnance Laboratory
National Research Council, Canada
Progressive Welder Company
Radio Corporation of America
Russell Electric Company
Radio Receptor Company
Rauland Corporation
Sciaky Brothers
Sylvania Electric Company
Sperry Gyroscope Company
University of California at Los Angeles
University of California
University of Michigan
Victoreen Instrument Company
Westinghouse Electric Company

* PLASTICONS: Plastic-Film Dielectric Capacitors

Enclose nominal charge of ten cents for handling and mailing when writing for this free booklet, or obtain from your local distributor.

Your Jobber stocks a complete line of
PLASTICONS* in metal cans and Glassmikes.



Condenser Products Company

1375 NORTH BRANCH STREET • CHICAGO 22, ILLINOIS

Designed for



Application

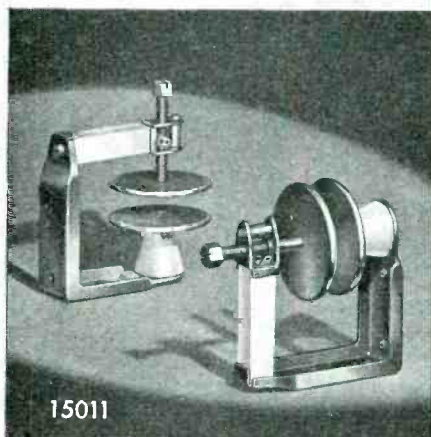

15011

**Disc Type
Neutralizing Capacitor**

Designed originally for use in our own No. 90881 Power Amplifier, the No. 15011 disc neutralizing capacitor has such unique features as rigid channel frame, horizontal or vertical mounting, fine thread over-size lead screw with stop to prevent shorting and rotor lock. Heavy founded-edged polished aluminum plates are 2" diameter. Glazed Steatite insulation.

**JAMES MILLEN
MFG. CO., INC.**

MAIN OFFICE AND FACTORY
**MALDEN
MASSACHUSETTS**



ing system radio beacons, or their automatic pilots. If not so equipped or if faulty operation develops, pilots can be talked down as is now done with ground controlled approach equipment. Additional equipment added to the normal ground controlled approach installation makes it possible to handle three planes simultaneously.

Dual modulation of microwave carriers can halve the bandwidth required for transmission of a given amount of information. The method proposed by Bendix Radio engineers is to frequency-modulate the radio carrier in addition to pulse modulation conventionally used at uhf, thus two types of modulation are used to carry two separate channels. The technique would be used with time-division multiplex channels for relaying.

In photographing rapidly moving solar prominences, astronomers are interested in changes of spectral color as well as mass movements. Recently developed crystal filters passing a narrow bandwidth of light are used. By changing the charge on the filter plate, the transmitted wavelength is changed without loss of optical quality. Transmission changes can be made in matters of microseconds enabling astronomers to take a sequence of detailed photographs at different wavelengths from which solar explosions can be carefully plotted thus improving long-range weather forecasting.

Surface roughness is measured by making a plastic replica of it and passing light through the replica to a photoelectric cell. The replica is vibrated, or if it is in the form of a long strip it can be wrapped on a drum and rotated. Variations in light reaching the cell are amplified and used to operate an indicating instrument. The instrument is calibrated using surfaces of known roughness as determined by microscopic measurement. This technique developed by The National Bureau of Standards has advantages of providing permanent records of surfaces, rapid evaluation of large areas, evaluation of surfaces of soft material without marring them, and possibility of transplating surfaces to be measured to the instrument.

What Makes A Mailing Click?

● Advertising men agree —the list is more than half the story.

McGraw-Hill Mailing Lists, used by leading manufacturers and industrial service organizations, direct your advertising and sales promotional efforts to key purchasing power. They offer thorough horizontal and vertical coverage of major markets, including new personnel and plants. Selections may be made to fit your own special requirements.

New names are added to every McGraw-Hill list daily. List revisions are made on a twenty-four hour basis. And all names are guaranteed accurate within two per cent.

In view of present day difficulties in maintaining your own mailing lists, this efficient personalized service is particularly important in securing the comprehensive market coverage you need and want. Ask for more detailed information today. You'll probably be surprised at the low over-all cost and the tested effectiveness of these hand-picked selections.



**McGRAW-HILL
DIRECT MAIL LIST SERVICE**

McGraw-Hill Publishing Co., Inc.

DIRECT MAIL DIVISION
330 WEST 42nd ST.
NEW YORK 18, N. Y.

What's your Fine Wire problem?



Problem 1

Mr. Big had scads of wire, but it was all too large for his use. He sent it to Fine Wire Headquarters. We put the wire through our machines and drew it to his specifications. We can do the same for you if you have or can obtain wire that does not meet your present requirements.

Problem 2

Mr. Round had to have some flat wire. So we put his wire stock through our rolling equipment after drawing it to proper size. Out came flat wire to his specification.



Problem 3

Mr. Silver had some wire that he wanted to plate. He sent it to Fine Wire Headquarters. We plated it and the wire came out with a uniformly dense coat of high lustre.

the answer

YES sir, the answer to all your fine wire problems is right here at Fine Wire Headquarters. You will never know how many ways we can help you until you ask. So—when you have a fine

wire problem—wire to be redrawn, flattened, plated or what have you—wire or write to North American Philips, makers of ELMET Tungsten and Molybdenum and NORELCO fine wires.

NORTH AMERICAN PHILIPS COMPANY, INC.

Dept. E-6, 100 East 42nd St., New York 17, N. Y.

**MIDGET
IN SIZE...**



**GIANT IN
APPLICATION**

**NEW G-E
GERMANIUM
CRYSTAL DIODE**

SMALL, versatile and durable, this new General Electric germanium diode has a wide variety of applications in the rectifier field. The design engineer will find it invaluable in projects where space is at a premium. Physically, it resembles the conventional 1/4 watt resistor and may be handled with no greater amount of care.

Check these advantages:

- Eliminates heater connections with associated 60-cycle hum.
- Eliminates multiple wiring (only two connections required).
- Eliminates tube sockets.
- Sudden applications of excessive voltage do not affect the germanium diode. It returns to normal quickly.
- May be used in high ambient temperatures.

Check these applications:

- FM and AM Receivers.
- Television.
- Frequency Standards and Measuring Equipment.
- Telephone apparatus.
- Telegraph apparatus.

For complete information, write to:
General Electric Company, Electronics
Department, Syracuse 1, New York.

160-F3

GENERAL ELECTRIC

NEW PRODUCTS
(continued from p 150)

ter comprises a compact oscillator connected to its power supply by a flexible cord. It serves as a variable-frequency oscillator, an absorption wavemeter, an oscillating detector, and a tuned absorption circuit detector. The handy device operates over the frequency range 2.2 to 400 megacycles with 7 plug-in coils.

F-M and Television

Antennas (20)

GENERAL ELECTRIC Co., Syracuse, N. Y. The folded-dipole elements making up new f-m and television antennas, Models UKA-002 and UKA-001 are constructed of reen-

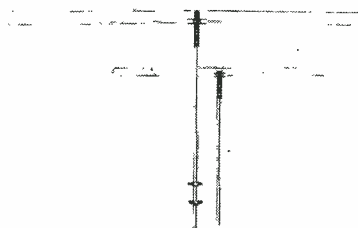

forced aluminum tubing, and are directional both front and rear broadside to the antenna. Both masts are five feet high and the television dipole's overall width is 96 inches while the f-m dipole's width measures 48 inches.

Power Rheostats (21)

GENERAL ELECTRIC Co., Syracuse, N. Y. New rheostats are wound with a special alloy wire on a ceramic frame. The winding form and mounting are fused together with vitreous enamel into one integral unit and fired at a high temperature, with a tempered steel contact arm giving uniform contact at all

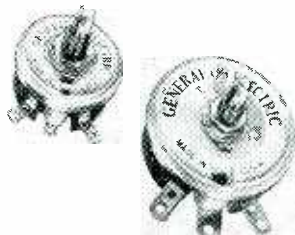

**MICRODIMENSIONAL
WIRE & RIBBON
FOR VACUUM TUBES**

Wires drawn to .0004" diameter.
Ribbon rolled to .0001" thickness.
Special Alloys for individual requirements.
WRITE for list of stock alloys.

SIGMUND COHN & CO
45 GOLD ST. NEW YORK
N.Y.

electronics READER SERVICE . . .

LITERATURE and NEW PRODUCTS

Manufacturers' Literature as well as further information on New Products described in this issue are important "working tools" for design and production departments. To make it easy to keep up to date, ELECTRONICS will request manufacturers to send readers the literature in which they are interested. Just fill out card as shown in the filled-in sample (right), being particularly careful to write out in full all the information called for in each section of each card that is used.

Write in circle number of item describing one item wanted → (14) Your Company Name <i>Jones Mfg. Co.</i> Address <i>3217 Lewis Ave. Chicago 13, Ill.</i> Your Name <i>Geo. Smith</i> Your Title <i>Chief Engineer</i> ELECTRONICS, 330 W. 42nd St., N. Y. 18	Write in circle number of item describing one item wanted → (22) Your Company Name <i>Jones Mfg. Co.</i> Address <i>3217 Lewis Ave. Chicago 13, Ill.</i> Your Name <i>Geo. Smith</i> Your Title <i>Chief Engineer</i> ELECTRONICS, 330 W. 42nd St., N. Y. 18
Write in circle number of item describing one item wanted → (37) Your Company Name <i>Jones Mfg. Co.</i> Address <i>3217 Lewis Ave. Chicago 13, Ill.</i> Your Name <i>Geo. Smith</i> Your Title <i>Chief Engineer</i> ELECTRONICS, 330 W. 42nd St., N. Y. 18	Write in circle number of item describing one item wanted → (49) Your Company Name <i>Jones Mfg. Co.</i> Address <i>3217 Lewis Ave. Chicago 13, Ill.</i> Your Name <i>H. S. Towne</i> Your Title <i>Adv. Mgr.</i> ELECTRONICS, 330 W. 42nd St., N. Y. 18

**SAMPLE
CARD
SHOWING
CORRECT
FILL-IN**



PLACE 1¢ STAMP ON CARD • DO NOT USE AFTER SEPTEMBER 1

HOW TO ORDER:

1. There are two postcards, each divided into four parts. Each of the four parts contains a box. You must write in this box the number that appears in this issue over the literature or new product item in which you are interested. Place one number only in each box.

2. Fill out completely (name, address, etc.) for each piece of literature or new product information you desire.

Do not say "same" in lieu of writing out full information called for when requesting more than one item.

3. This service applies only to literature and new product items in this issue. It does not apply to advertisements. Write directly to the company for information on its advertisements.

PLEASE NOTE: Requests for unnumbered items must be made direct to the manufacturer.

In the event this copy of ELECTRONICS is passed along to other members of your company, please leave this sheet in for their convenience. This assures everyone in your plant the opportunity to fill in their requests. When the round is completed, cards can then be detached along perforated lines and dropped in the mail. Each individual request will be mailed by us to the company offering the information and for that reason must be completely filled out.

Write in circle number of item describing one item wanted →

Your Company Name.....

Address.....

Your Name.....

Your Title.....

ELECTRONICS, 330 W. 42nd St., New York 18, N. Y.

Write in circle number of item describing one item wanted →

Your Company Name.....

Address.....

Your Name.....

Your Title.....

ELECTRONICS, 330 W. 42nd St., New York 18, N. Y.

Write in circle number of item describing one item wanted →

Your Company Name.....

Address.....

Your Name.....

Your Title.....

ELECTRONICS, 330 W. 42nd St., New York 18, N. Y.

Write in circle number of item describing one item wanted →

Your Company Name.....

Address.....

Your Name.....

Your Title.....

ELECTRONICS, 330 W. 42nd St., New York 18, N. Y.

Write in circle number of item describing one item wanted →

Your Company Name.....

Address.....

Your Name.....

Your Title.....

ELECTRONICS, 330 W. 42nd St., New York 18, N. Y.

Write in circle number of item describing one item wanted →

Your Company Name.....

Address.....

Your Name.....

Your Title.....

ELECTRONICS, 330 W. 42nd St., New York 18, N. Y.

Write in circle number of item describing one item wanted →

Your Company Name.....

Address.....

Your Name.....

Your Title.....

ELECTRONICS, 330 W. 42nd St., New York 18, N. Y.

Write in circle number of item describing one item wanted →

Your Company Name.....

Address.....

Your Name.....

Your Title.....

ELECTRONICS, 330 W. 42nd St., New York 18, N. Y.

An electronics service designed for **READERS and MANUFACTURERS**

FOR THE READER... ELECTRONICS fundamental policy has always been to supply its readers with all the pertinent and timely industry news. The ELECTRONICS Reader Service supplements this policy by offering the reader an easy and effective means of obtaining complete, up to the minute data on new products and of maintaining at his fingertips comprehensive, practicable information on "who's doing what" in the industry.

In every issue of ELECTRONICS there's complete coverage of the month by month development by manufacturers of new materials, components and equipment, as well as brief mention of all the important, new, manufacturers' technical pamphlets and catalogs. Some of these items will be of particular interest to specific design and plant engineers, buyers, executives and others of our readers. They will want to make further inquiry concerning the new products described or they will want to read and make a permanent part of their industrial library some of the manufacturers' literature and catalogs. ELECTRONICS

Reader Service makes it easy for them to obtain in readily accessible and usable form the information they desire.

PLACE 1¢ STAMP ON CARD • DO NOT USE AFTER SEPTEMBER 1



ELECTRONICS

330 WEST 42nd STREET

NEW YORK 18, N. Y.

6-1-47



ELECTRONICS

330 WEST 42nd STREET

NEW YORK 18, N. Y.

6-1-47

FOR THE MANUFACTURER...

ELECTRONICS Reader Service will also be welcomed by manufacturers who are desirous of placing the complete news of their product developments as well as their technical bulletins and catalogs in the hands of those members of the electronic industry... including design, electrical and production engineers, researchers, physicists, executives, and buyers—who have a particular interest in, or represent a potential buying power for, their products.

SUGGESTIONS FOR THE IMPROVEMENT OF OUR READERS' SERVICE ARE INVITED

ELECTRONICS is constantly seeking new and improved ways of providing its readers with the news and information they want and need, and of assisting the manufacturer in effectively delivering his message to electronic markets. If you have any ideas for us, send them along. They will receive prompt consideration.

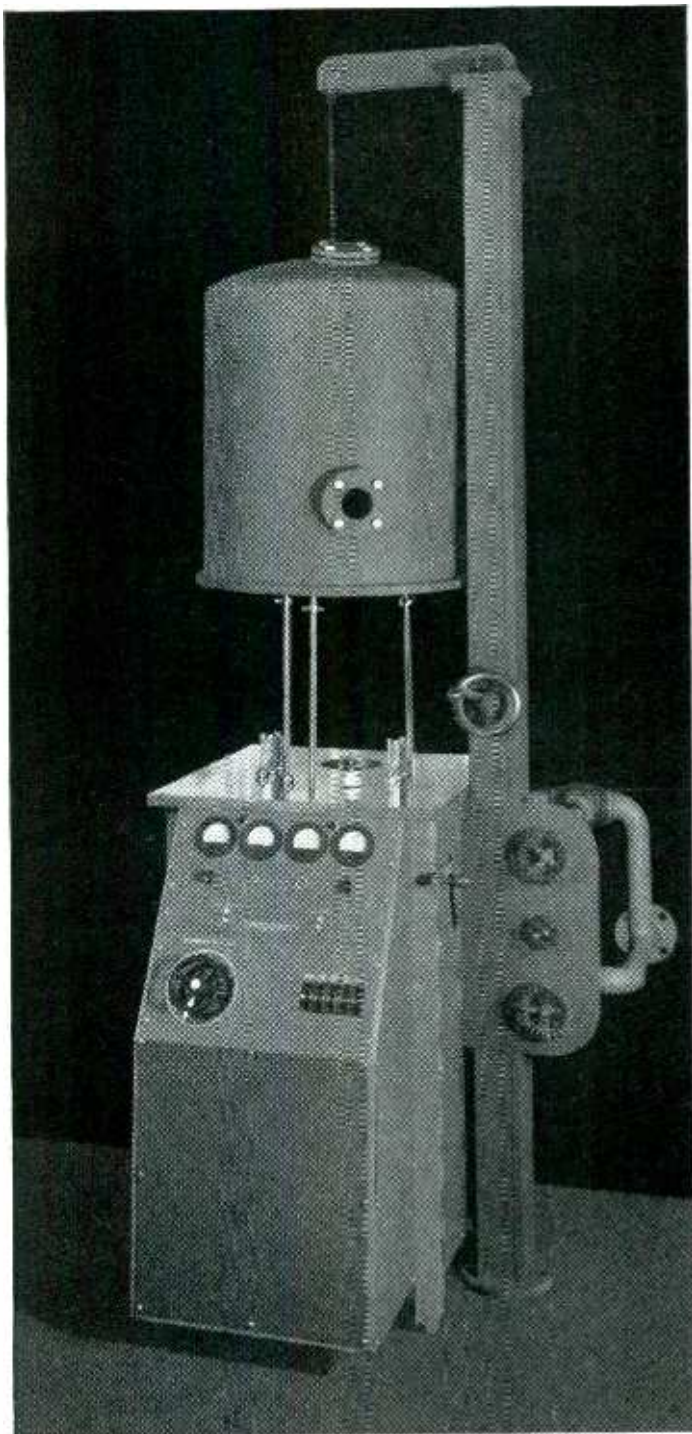

Type 3102

EVAPORATOR

A new high vacuum coating unit for optical work or other applications requiring low-pressure bell jar equipment.

This unit has high pumping capacity and a quick-acting high vacuum valve for rapid cycles. It is designed for use with bell jars up to 24" inside diameter. Complete facilities for coating, including filament power and high voltage clean-up, are provided.

The design of the Type 3102 Evaporator is the result of our experience in building coating equipment and in operating in the coating field since 1940. For full particulars, write VACUUM ENGINEERING DIVISION, National Research Corporation, Boston 15, Massachusetts.

We supply a complete line of diffusion pumps, vacuum gauges, valves, seals, coating equipment, dehydration equipment and special high vacuum apparatus.

HIGH VACUUM FOR INDUSTRY
NATIONAL RESEARCH CORPORATION
Vacuum ENGINEERING
DIVISION

Look to Western Electric for top quality AM at rock-bottom operating cost!

Today, as always, you get the most for your money with an AM transmitter made by Western Electric. Whether you want a 250 watt (shown), a 1 or a 5, or a 50 kw, you can count on maximum quality, dependability and economy of operation and maintenance. For full details, write Graybar Electric Co., 420 Lexington Ave., New York 17, N. Y., or . . .

ASK YOUR LOCAL
Graybar
BROADCAST REPRESENTATIVE



NEW PRODUCTS

(continued)

arm giving uniform contact at all times. The contact brush rides on a large flat surface and assures perfect contact with minimum wear on the wire. They are available in 25- and 50-watt sizes, in resistance ranges up to 5,000 and 10,000 ohms respectively.

Plastic Tubular Capacitors (22)

SANGAMO ELECTRIC Co., Springfield, Ill. A new paper tubular capacitor type 30 molded in plastic results in



low power factor, higher temperature operation, protection from humidity, and unchanging capacitance values. The capacitors are impregnated in Halo wax or Diaclor.

Oscillograph Amplifier (23)

BRUSH DEVELOPMENT Co., 3405 Perkins Ave., Cleveland 14, Ohio. The Model BL-913 d-c amplifier for use



with Brush magnetic direct inking oscillographs has a voltage gain of about 1,000, frequency response from d-c to 100 cps, and a sensitivity of 1 chart mm per millivolt. The input impedance is 10 megohms and the input voltage range, 0.001 to 200 volts.

Twin-Contact Relay (24)

C. P. CLARE Co., 4719 West Sunnyside Ave., Chicago 30, Ill. The type

Embossed Foil Dials

Tablet & Ticket Metal Foil Radio and Instrument Dials are fabricated from special dial board with foil laminated to both sides to eliminate warping — prevent moisture absorption. Processed in colors on either silver, gold or copper shades of foil, unusually rich combinations are readily obtainable at unbelievably low costs. Then, too, the exclusive T & T Perfect-O Cut Dial Process not only produces a third dimensional effect by high embossing but also assures absolute register because cutting die is an integral part of printing and embossing plate.

Write today to Dial Division —
Tablet & Ticket Co., 1021 West Adams Street, Chicago 7, for complete information.

The TABLET & TICKET CO.

New Conductive Tape!

PACIFIC ELECTRIC CLOTH

Here is a new electrically-conductive textile, available as yard goods or tape. It will meet many needs in the electrical field. Test a sample to see what it will do for you.

PACIFIC ELECTRIC CLOTH is an electrically conductive cloth available in several ranges of resistance with five broad FIELDS OF APPLICATION:

1. Shielding and electrostatic flux grading in high voltage transformers, generators, bushings, etc. Also shielding of radio and radar.
2. Elimination of electrical static from bags for explosives, sifting apparatus for fine powders, and electrical equipment.
3. Electrical heating without wires: Blankets, pads, wall panels and other space or radiant heating applications.
4. Fixed and variable resistors for electronic and communication circuits.
5. Outer conductor or current carrying element in coaxial lines for communication, electronic and high-frequency circuits.

PACIFIC ELECTRIC CLOTH has these six unusual CHARACTERISTICS:

1. Adheres and bonds to rubber and other plastic materials.
2. Has sufficient electrical conductivity to be useful as a current carrying element.

3. Permits electrical heating to be distributed uniformly over a surface or area.
4. Permits drainage of electrostatically induced charges that are obtained in industrial processes, thereby attaining greater safety.
5. Winds tightly and conforms snugly to irregular contours.
6. Has stretch, flexibility and resistance to tearing.

SOME FACTS

Thickness:	About 5 mils
Tensile strength:	About 45 lbs. per inch
Resistance:	Specific resistance (volume): Approximately 1 or 100 ohm inches now available.
Effect of oil:	Resistant
Effect of vulcanizing:	Stands up satisfactorily under vulcanizing temperatures and adheres to rubber insulation after vulcanizing.

Limited quantities of this new electrically-conductive cloth are now available for experimental purposes. Send for samples. Also ask for Pacific's "New Product Bulletin" describing in detail the specifications of this material.

PACIFIC MILLS, Industrial Fabrics Dept., 214 Church Street, New York 13 • *Pacific Mills is one of the oldest and largest textile manufacturers and finishers . . . a long-time supplier to the electrical trade.*

SEND FOR TEST SAMPLES and
NEW PRODUCT BULLETIN



PACIFIC MILLS

E.6

Industrial Fabrics Dept., 214 Church Street, New York 13

Gentlemen: Please send me test samples of your new Pacific Electric Cloth. Also send me your New Product Bulletin with full description.

Your name _____

Title _____ Dept. _____

Company _____

Street address _____

City _____ Zone _____ State _____



FOUND THESE

Here are two rare bargains for the engineer who needs them . . . and at a bargain! But that's the way Harvey operates . . . all the standard merchandise in stock . . . specials when they are real buys, or hard-to-get.

2.5 KW TRANSFORMER

Step-up or step-down power transformer, Type CRP-301223, made by Raytheon Mfg. Co. From 220/440 v. to 115 v., or from 115 v. to 220/440 v. Rated 2.5 kw. Measures 10½ inches square by 11½ inches high. Completely louvered and well insulated and shielded steel case with mounting brackets. Weighs app. 65 lbs. Harvey Special Price. \$49.50

CONSTANT VOLTAGE TRANSFORMER

Here's the item everyone has been waiting for . . . a constant voltage transformer very conservatively rated at 0.82 kw. Primary voltage 92-138 v. secondary voltage 115 ± ½ of 1%. Shipping weight app. 130 lbs. A rare bargain at \$135.00

Among the many stock items which Harvey always has in stock are test instruments and equipment. This sample is typical:

GE Electronic Switch, Type YE-9. This instrument was designed for special electrical studies of wave-form, phase, frequency relationship, etc. It will show the simultaneous observation, for comparison, of two or more independent signals on the screen of a cathode-tube oscilloscope. \$59.50

Note: All prices are Net, F.O.B. NYC and are subject to change without notice.

Telephone: **hrc** LO. 3-1800

HARVEY
RADIO COMPANY, INC.

103 West 43rd St., New York 18, N. Y.

NEW PRODUCTS

(continued)

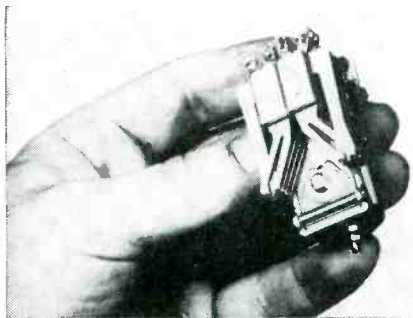

J d-c relay combines features of conventional telephone-type relays with those developed for aircraft use. Twin palladium contacts are used to assure connection. Operation is fast—a minimum of 1 to 2 milliseconds. The relays are available with either single or double arms with a maximum of 10 springs on each arm.

Tension Device (25)

PAPER MACHINERY AND RESEARCH, Inc., 1014 Oak St., Roselle, N. J. A new wire dereeling device will



maintain constant tension while winding wire of any size from 15 to 44 AWG. The wire runs over only one plastic pulley situated so as to actuate the releasing cam.

Appliance Tester (26)

TRIPLET ELECTRICAL INSTRUMENT Co., Bluffton, Ohio. The model 2470 circuit analyzer measures wattage, current, and line voltage of all household appliances and small motors under actual operating conditions. The ranges include five a-c watt scales, 0, 20, 40, 500, 1,000,

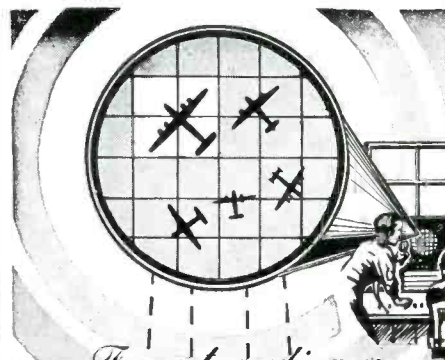

For extraordinary electrical performance

Use SILVER GRAPHALLOY*



THE SUPREME CONTACT MATERIAL

BRUSHES



CONTACTS



in BRUSHES

for high current density • minimum wear • low contact drop • low electrical noise • self-lubrication

in CONTACTS

for low resistance • non-welding character

GRAPHALLOY works where others won't! Specify GRAPHALLOY with confidence.

*A special silver-impregnated graphite

GRAPHITE METALLIZING CORPORATION

1055 NEPPERHAN AVENUE, YONKERS 3, NEW YORK

It stays awake to help you sleep

EVER see a blanket with a brain? This little bedside control case is the "brain" of the General Electric Automatic Blanket—the last word in sleeping comfort. It keeps the blanket at the right warmth, despite changes in room temperature. An important feature of the control case is the G-E Neon Glow Lamp that lights up when current is on and serves as a reminder to turn off the blanket in the morning. This tiny lamp uses less than two cents worth of current a year!

Successful appliances for every home use are similarly equipped with G-E Neon Glow Lamps—"the glow that lets you know."

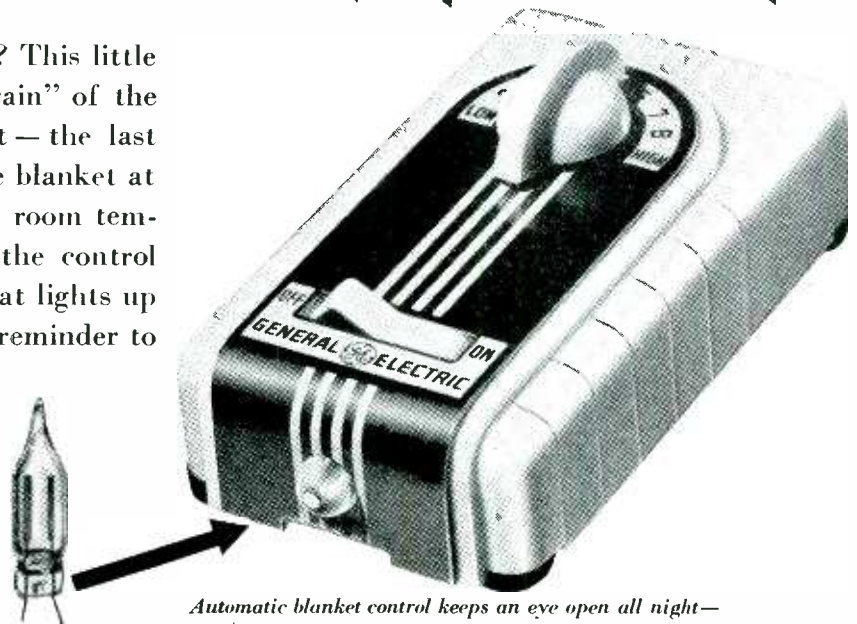

Automatic blanket control keeps an eye open all night—this tiny G-E lamp, that glows when blanket is "on."

...and it keeps an eye on profits too!

TYPICAL APPLIANCES USING G-E GLOW LAMPS



AUTOMATIC IRON uses glow lamp to indicate when heat is just right.

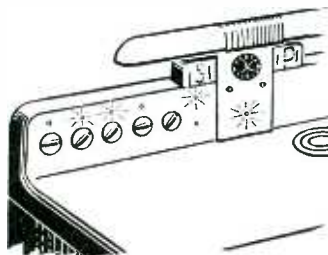

ELECTRIC RANGE. Glow lamps indicate when any switch or oven setting is "on."

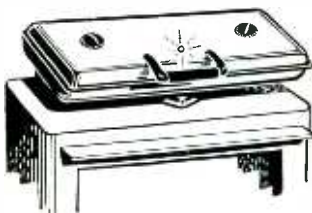

IRONER. Glow lamp pilot light helps to avoid leaving appliance "on" by mistake.



WATER HEATER. Glow lamp lights up when desired water temperature is reached.

THESE few appliances merely hint at the hundreds of ways General Electric Glow Lamps are used to add convenience, beauty, safety and sales appeal to electrical equipment of all kinds. Perhaps you, too, will find a valuable profit opportunity in the following G-E Glow Lamp features:

1. Distinctive orange-red glow—high visibility.
2. Dependable long life—NE-2, featured above, has life rating in excess of 25,000 hours.
3. Low current consumption—as little as 1/25 watt.
4. Low brightness, low heat.
5. High resistance to shock and vibration.
6. Can be installed in small space.
7. Variety of sizes and wattages.
8. Operate directly from regular 105-125 and 210-230 volt circuits, AC or DC.

REMEMBER—Every electrical device should have a live circuit indicator. G-E Glow Lamps are ideal for this purpose.

SEND FOR free bulletin containing full information on G-E Neon Glow Lamps and their application to your product.

G-E LAMPS

GENERAL ELECTRIC

Nela Specialty Div. Lamp Dept., 1 Newark St., Hoboken, N. J.

YES—IT'S TRUE!

Gothard INDICATOR LIGHTS ARE NOW A JOHNSON PRODUCT

NO CHANGE—IN PRODUCT. The same exclusive features such as. rigid non-short terminals, bakelite washers and others, standard in all Gothard Lights, will continue to insure above average service life and satisfaction. Just compare their superior workmanship.

NO CHANGE—IN POLICY. Standard basic prices and standard discounts will be adhered to in all cases.

NO CHANGE—IN CATALOG ITEMS. The current Gothard catalog is still in force.

REMEMBER—send your specifications for recommendations and your orders for Gothard Quality Lights to—

Gothard Division
E. F. JOHNSON COMPANY
Waseca, Minn.

JOHNSON
a famous name in Radio

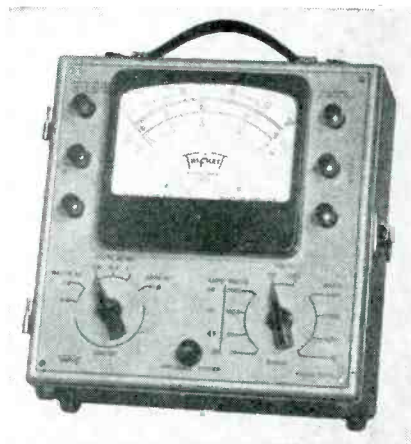
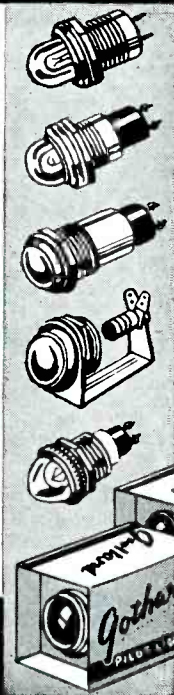

2,000, 4,000 at either 130 or 260 volts; four a-c current scales, 0 to 0.26 ampere at approximately 8 volts; 0 to 6.5 amperes at approximately 0.4 volts; 0 to 13 amperes at approximately 0.3 volt; 0 to 26 amperes at approximately 0.2 volt; two a-c/d-c volt scales, 0-130-260.

Aluminum Solder (27)

ALSO CO CORP., 10 East 52nd St., New York, N. Y. A simple soldering technique has been employed to

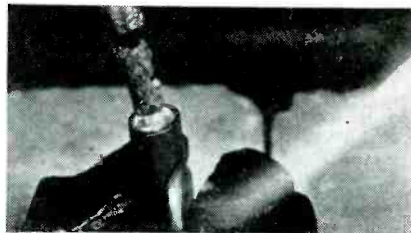

make the joint illustrated without flux. Electrical resistance at the junction is in the range of 20 microhms.

Geiger Tubes (28)

SYLVANIA ELECTRIC Products, Inc., 500 Fifth Ave., New York 18, N. Y. Two new types of Geiger tubes have been designed for use by physicists, biologists, chemists, physicians, engineers, and others engaged in the research and practical application of nuclear physics. The beta-ray tube is designed to admit the high-speed electrons constituting the beta-rays through a thin metal alloy window. The gamma-ray tube, which has no window, is primarily designed to detect the presence of the gamma rays emitted by radioactive sources, but

Baer*

offers accurate fabrication of phenol and vulcanized fibre!



SEND BLUEPRINTS AND SPECIFICATIONS—NO OBLIGATION!

Check BAER FIBRE for accurate dimensioning, uniform surface, mechanical and electrical qualities, and *low cost per piece*. See how efficiently a BAER FIBRE terminal board, bushing, gasket, washer or other shape can simultaneously solve your electrical or mechanical problem...improve your product...and save you money! BAER FIBRE is precision fabricated to your specifications.

LITERATURE ON REQUEST

N. S. BAER COMPANY

MONTGOMERY ST., HILLSIDE, N. J.

* Baer facilities are unexcelled for stamping, punching, drilling, tapping, shaving, milling, shearing and sawing.

Farnsworth

GUARANTEED*
VHF SYSTEMS
NOW AVAILABLE
for immediate installation

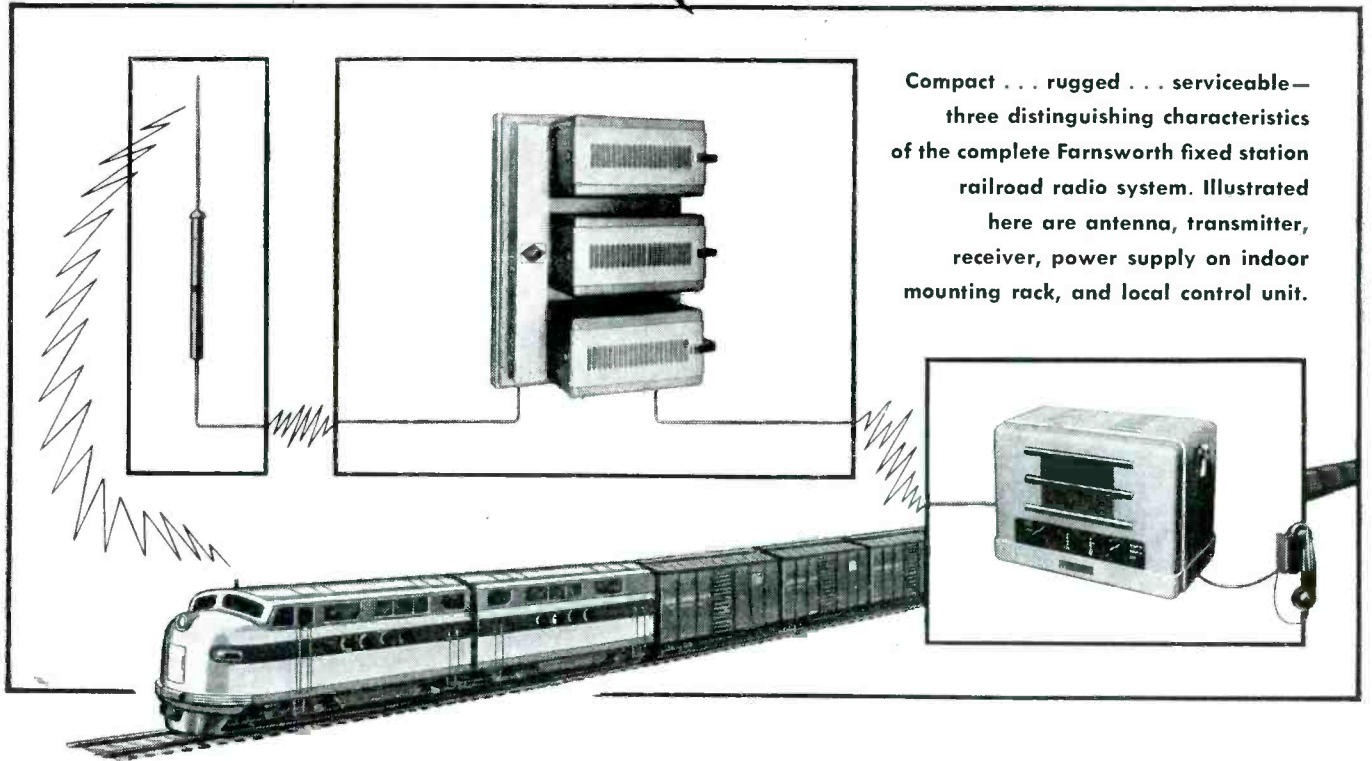

Compact . . . rugged . . . serviceable—
three distinguishing characteristics
of the complete Farnsworth fixed station
railroad radio system. Illustrated
here are antenna, transmitter,
receiver, power supply on indoor
mounting rack, and local control unit.

Progressive railroads have waited many years for railroad radio communications equipment in which they could invest with confidence.

Now Farnsworth engineers and designers—the same men who pioneered the adaptation of radio to rail communications—have developed practical, reliable, *guaranteed** railroad radio communications equipment which merits capital investments.

Farnsworth systems are *thoroughly engineered* to meet the unique and exacting standards of railway operation . . . *carefully designed* to provide maximum usefulness and flexibility . . . *comprehensively planned* to comply with regulations of the FCC and ICC, and the specifications of the AAR . . . *exhaustively field-engineered* over a period of years to guarantee simplified, low-cost maintenance. Developed systematically and without haste in one of the world's great

electronic laboratories, Farnsworth systems represent the best equipment designed and produced for this highly important service.

Write Dept. E-6, Farnsworth Television & Radio Corporation, Fort Wayne 1, Indiana.

* *Farnsworth guarantees this equipment for a period of one year against defective design, material and workmanship, and agrees to remedy any such defect in any railway electronic unit of its manufacture, provided that the unit is returned intact, bearing original serial number with all transportation paid, for Farnsworth's examination at its Fort Wayne, Indiana, factory within one year and thirty days from date of purchase. This warranty does not, however, extend to tubes or moving parts (components which carry the guarantee of the manufacturers thereof).*

Farnsworth
Television • Radio • Phonograph-Radio

Farnsworth Radio and Television Receivers and Transmitters • Aircraft Radio Equipment • Farnsworth Television Tubes • Mobile Communications and Traffic Control Systems for Rail and Highway • The Farnsworth Phonograph-Radio • The Capehart • The Panamuse by Capehart

precision-fabricated PLASTIC PARTS



**QUALITY and SERVICE
AT A PRICE
THAT'S RIGHT**

With more and more manufacturers switching to plastic parts to improve the appearance and performance of their products, it is significant that so many look to Sillcocks-Miller for the quality and service they want. This organization of specialists is recognized throughout the industry for its skill in fabricating plastic parts to close tolerances and its reputation for unvarying quality. With complete facilities to meet your requirements . . . no matter how large or small . . . Sillcocks-Miller offers you the dependable source you want for plastic parts and service, at a price that's right.

Write for illustrated booklet or phone South Orange 2-6171 for quick action.

THE SILCOCKS-MILLER CO.
10 West Parker Avenue, Maplewood, N. J.
Mailing Address: South Orange, N. J.

SPECIALISTS IN HIGH QUALITY, PRECISION-MADE PLASTICS FABRICATED FOR COMMERCIAL, TECHNICAL AND INDUSTRIAL REQUIREMENTS.

NEW PRODUCTS

(continued)

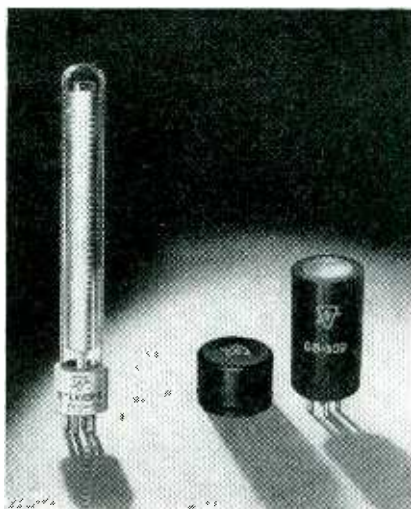

may also be used for cosmic rays, especially in coincidence work.

Noise Canceling Microphone

(29)

THE TURNER Co., Cedar Rapids, Iowa. The model 15D-NC hand-held microphone cancels out background noise, permitting only close-talking speech to be transmitted. An

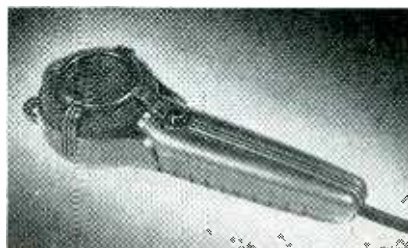

arrangement of the diaphragm balances out random sound arriving at a distance yet allows pickup of ordinary speech directed at the front. The microphone is available in 50, 200, or 500 ohms or high impedance.

Broadcast Limiting Amplifier

(30)

GENERAL ELECTRIC Co., Syracuse, N. Y. The Type BA-5-A limiting amplifier gives instantaneous con-



● The renown of Imperial as the finest in Tracing Cloth goes back well over half a century. Draftsmen all over the world prefer it for the uniformity of its high transparency and ink-taking surface and the superb quality of its cloth foundation.

Imperial takes erasures readily, without damage. It gives sharp contrasting prints of even the finest lines. Drawings made on Imperial over fifty years ago are still as good as ever, neither brittle nor opaque.

If you like a duller surface, for clear, hard pencil lines, try Imperial Pencil Tracing Cloth. It is good for ink as well.



**IMPERIAL
TRACING
CLOTH**



SOLD BY LEADING STATIONERY AND DRAWING MATERIAL DEALERS EVERYWHERE

JUST OFF THE
Press



... This New I-T-E RESISTOR CATALOG

It has 16 pages, packed with technical information on I-T-E standard fixed and adjustable power wire wound resistors. Each type is individually pictured with a listing giving complete details on sizes and ratings.

The catalog contents include resistor uses and applications, derating and size selection, construction, ordering information and the answers to many other important questions you may have.

I-T-E Resistors are made in a wide variety of types, sizes and ratings with mountings and terminals as specified. They have silver soldered connections, are locked and insulated with blue-black Vitreous enamel for fast heat-dissipation, and are held to close tolerances to meet critical conditions of atmosphere and usage. Ratings range from 5 to 215 watts in fixed and adjustable types and from 30 to 75 watts in oval types.

You'll find the complete story in the I-T-E Resistor Catalog—and it's yours for the asking. Just fill in and send the coupon below, or write to us on your company letterhead to the address below.

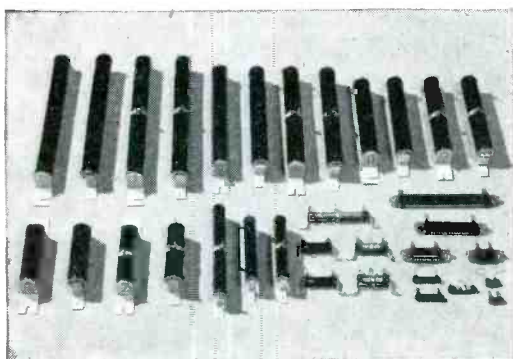

The center of Switchgear Progress

RESISTOR DIVISION, I-T-E Circuit Breaker Company

1898 HAMILTON STREET, PHILADELPHIA 30, PA.

Please send me a copy of the new I-T-E Resistor Catalog.

Name _____ Title _____

Company _____ Address _____

HEXACON ELECTRIC SOLDERING IRONS ..tagged for the big jobs!

TYPE P-150 (illustrated)

MINNEAPOLIS HONEYWELL
Westinghouse
Bendix
STROMBERG CARLSON
Western Electric

Follow the leaders—and use HEXACON! For rugged, heavy duty work or for light intricate work . . . here's the answer. One reason is "Balanced Heat"—dissipating excessive element-impairing heat—and minimizing element burn-outs and tip replacements. Another is their lightweight. Literature is available describing the complete HEXACON line of screw tip and plug tip irons from 40 to 700 watts, and with tip diameters ranging from 1/4" to 1 3/4".

HEXACON ELECTRIC CO.
130 W. Clay Ave., Roselle Park, N. J.

HEXACON

HIGH-QUALITY, LONG-LASTING SOLDERING IRONS

trol action with low transient waveform distortion and complete freedom from audible thumps in the program. Use of the device avoids danger of overmodulation of the associated transmitter on program peaks.

Feed Through Capacitor (31)

ERIE RESISTOR Corp., Erie, Pa. The type 362 Ceramicon capacitor is equipped with No. 20 soft wire pig-tails extending from either end of

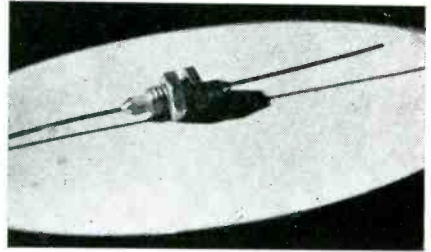

the capacitor, allowing either or both ends to be bent for point-to-point wiring. This type is available in the capacitance range from 7 to 1,500 micromicrofarads.

Loop Antenna Wire (32)

FEDERAL TELEPHONE and Radio Corp., Newark, N. J. A small-diameter polyethylene insulated wire, type K-1044, can be used for winding loop receiving antennas with

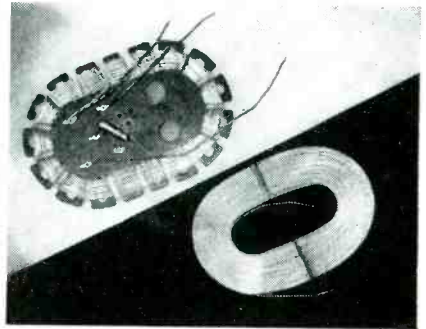

a Q of about 200. Owing to the thermoplastic properties of the insulation, the formed loop is merely heated, allowed to flow slightly and then hardens so that no other support is needed.

Tube Puller (33)

KELLEMS Co., Saugatuck, Conn. A highly effective device for removing all types of tubes and vibrator enclosures is illustrated. It consists

AMPERITE

THERMOSTATIC METAL TYPE DELAY RELAYS

PROVIDE DELAYS RANGING FROM 1 TO 120 SECONDS

FEATURES:—Compensated for ambient temperature changes from -40° to 110° F . . . Hermetically sealed; not affected by altitude, moisture or other climate changes . . . Explosion-proof . . . Octal radio base . . . Compact, light, rugged, inexpensive . . . Circuits available: SPST Normally Open; SPST Normally Closed.

PROBLEM? Send for "Special Problem Sheet" and Bulletin.

AMPERITE REGULATORS

BATTERY VOLTAGE

VOLTAGE OF 24V BATTERY & CHARGER VARIES APPROX. 50%

WITH AMPERITE VOLTAGE VARIES ONLY 2%

Amperite REGULATORS are the simplest, lightest, cheapest, and most compact method of obtaining current or voltage regulation . . . For currents of .060 to 8.0 Amps . . . Hermetically sealed; not affected by altitude, ambient temperature, humidity.

Write for 4-page Illustrated Bulletin.

AMPERITE CO., 561 Broadway, New York 12, N. Y.
In Canada: Atlas Radio Corp., Ltd., 560 King St., W. Toronto

*They Lick Humidity and Vibration
at High Frequencies*

STACKPOLE

Polytite TRIMMER ELECTRODE CORES

Placed in fitted metal sleeves, Stackpole Polytite Trimmer Electrode Core Forms serve as variable capacitors that assure honest-to-goodness capacity stability in high-frequency circuits where humidity and vibration must be considered. The molded Polytite has a high dielectric constant. Cores are moisture repellent and carry a heavy dielectric coating that establishes a path of high leakage resistance between the electrodes. Since these electrode surfaces have short, symmetrical current paths, the inductance may be kept low enough for use in the 200-megacycle range. Standard types provide easy capacity adjustment with a maximum from 20 to 40 mmf., depending on the size.

Write for Stackpole Polytite Trimmer Data Bulletin

STACKPOLE CARBON COMPANY
Electronic Components Division • St. Marys, Pa.

Stackpole Polytite Trimmer Electrode Capacitors are well suited for minimum capacity adjustments in tuned circuits, installed across the tuning capacitor as in Figure 1 or across the tuning inductance as in Figure 2. Trimmers may be mounted directly to the tuning capacitor.

A typical application using two Polytite Trimmer Electrode Capacitors in a circuit where band-spread tuning is desired. Various bands may be covered by the switching of coils and preadjusted trimmers.

RESISTORS • IRON CORES • SWITCHES

ATLAS
The Seal of
Sound Supremacy



REENTRANT PROJECTORS



DRIVER UNITS



BOOSTER UNITS



RADIAL PROJECTORS



"MIKE" STANDS

- Baffles
- Enclosures
- Desk Stands
- Speaker Stands
- Adaptors
- Wall Boxes
- Boom Stands

Write for illustrated catalog sheets

ATLAS SOUND CORPORATION

1449 39th Str., Brooklyn 18, N. Y.

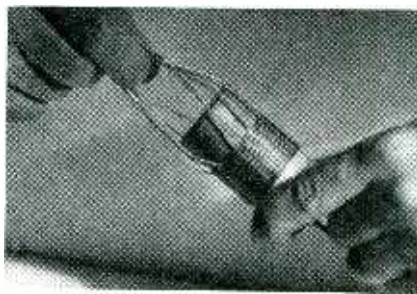

of a tubular wire mesh that can be slipped over the cylinder to be removed. A pull on the handle tightens the mesh. After the tube has been removed from a socket it is easy to slide the mesh off. Types 11-6, 100, 112, and 150 are used for peanut, metal, glass, and vibrator tubes respectively.

Magnetic Cutter Head (34)

FAIRCHILD CAMERA and Instrument Corp., 88-06 Van Wyck Blvd., Jamaica 1, N. Y. The magnetic cutter head Unit 541A has a frequency

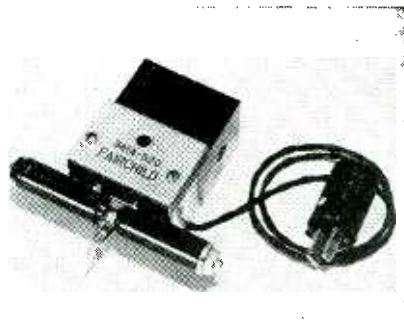

response of plus or minus 2 db over the range 30 to 8,000 cycles with distortion of less than a percent at 400 cycles. The head is supplied with a standard mounting plate for any current model sound recorder.

Beryllium Copper Springs (35)

INSTRUMENT SPECIALTIES Co., Inc., Little Falls, N. J. Savings in assembly and handling time are claimed

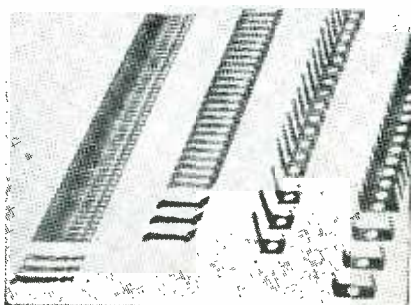

NOW
a really high-powered

RADIO ENGINEERING LIBRARY

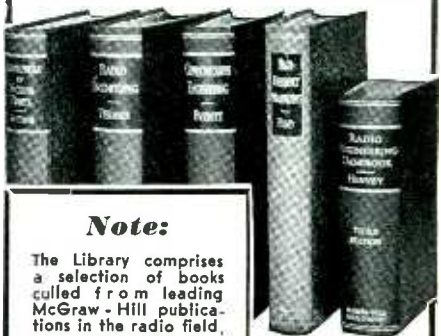

Note:
The Library comprises a selection of books culled from leading McGraw-Hill publications in the radio field.

- ◀ especially selected by radio specialists of McGraw-Hill publications
- ◀ to give most complete, dependable coverage of facts needed by all whose fields are grounded on radio fundamentals
- ◀ available at a special price and terms

These books cover circuit phenomena, tube theory, networks, measurements, and other subjects—give specialized treatments of all fields of practical design and application. They are books of recognized position in the literature—books you will refer to and be referred to often. If you are a practical designer, researcher or engineer in any field based on radio, you want these books for the help they give in hundreds of problems throughout the whole field of radio engineering.

5 volumes, 2559 pages, 2558 illustrations

Eastman's **FUNDAMENTALS OF VACUUM TUBES**, 2nd Edition

Terman's **RADIO ENGINEERING**, 2nd edition

Everitt's **COMMUNICATION ENGINEERING**, 2nd edition

Hund's **HIGH FREQUENCY MEASUREMENTS**

Henney's **RADIO ENGINEERING HANDBOOK**, 3rd edition

SPECIAL LOW PRICE • EASY TERMS

Special price under this offer less than cost of books bought separately. In addition, you have the privilege of paying in easy installments beginning with \$2.50 in 10 days after receipt of books and \$4.00 monthly thereafter. Already these books are recognized as standard works that you are bound to require sooner or later. Take advantage of these convenient terms to add them to your library now.

FOR 10 DAYS' EXAMINATION SEND THIS ON-APPROVAL COUPON

McGraw-Hill Book Co., 330 W. 42nd St., N.Y.C. 18
Send me Radio Engineering Library for 10 days' examination on approval. In 10 days I will send \$2.50 plus few cents postage, and \$4.00 monthly till \$26.50 is paid, or return books postpaid. (We pay postage on orders accompanied by remittance of first installment.)

Name

Address

City and State

Company

Position L 6-47

For Canadian price write Embassy Book Co., 12 Richmond Street E., Toronto 1

WILCOX 2500 WATT

Transmitter

*Performance
Easy Maintenance
Dependability*

The WILCOX 96C Transmitter is used throughout the world by the Army Air Force Communications System, and by foreign and domestic air-carriers. It has earned the respect of operators and engineers because:

- ✓ **1 SIMULTANEOUS CHANNEL OPERATION** on several frequencies brings new flexibility and operational ease; increases by 3 times the volume of traffic normally handled
- ✓ **2 INSTANTLY REMOVABLE COMPONENTS** make maintenance easy. The transmitter slides from its cabinet like a desk drawer. Plugs, receptacles, and clips make all components easily removable for servicing while adjacent channels continue to operate.
- ✓ **3 RESEARCH AND ENGINEERING** combined with modern production techniques have produced a transmitter capable of sustained operation through all conditions of temperature, humidity, and weather.

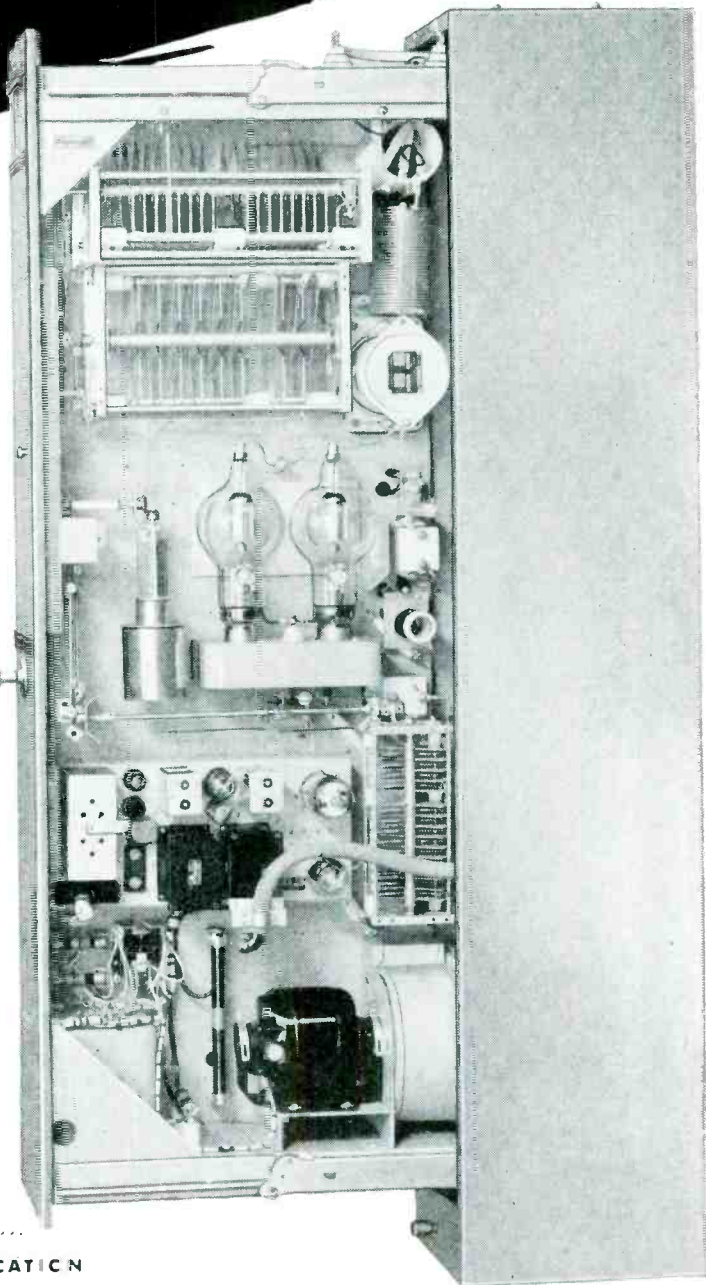

Write for Free Catalog...

DEPENDABLE COMMUNICATION

WILCOX ELECTRIC COMPANY, INC. • Kansas City 1, Missouri

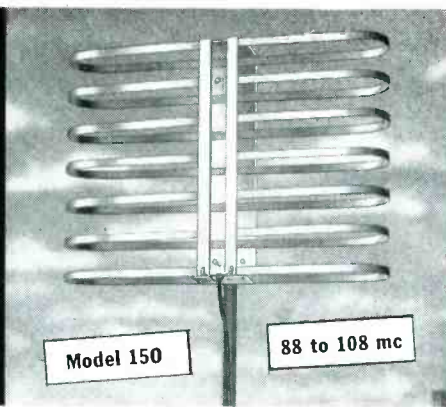
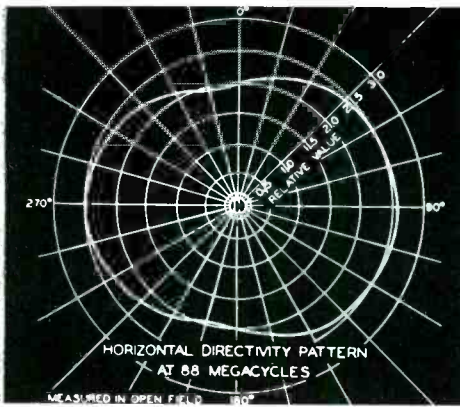

for a technique of furnishing small springs or stampings in lengths with sections between parts partially sheared through. After plating and inspection, the individual parts snap off easily for final assembly, as illustrated.

High-Voltage Coupling Capacitor (36)

SPRAGUE ELECTRIC Co., North Adams Mass. Capacitors used for coupling subscriber's telephone

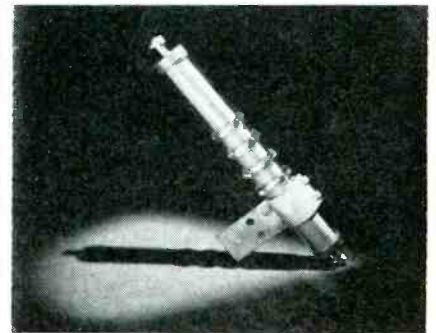

equipment to existing 7,200-volt a-c distribution lines are now available, rated for 8,700 volts, with a capacitance of 0.002 microfarad.

Midget Relay (37)

GUARDIAN ELECTRIC MFG. Co., Dept. 600, 1625 West Walnut St., Chicago 12, Ill. The series 600 relay comprises a coil assembly and a contact

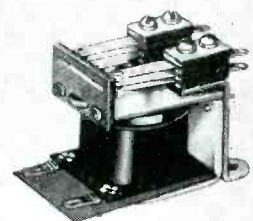

assembly, both of which are interchangeable. Contact combinations up to four-pole, double-throw and coils in ranges from 3 to 230 volts a-c and up to 110 volts d-c are available. Maximum contact current is 8 amperes.

Multimeter (38)

RMS ELECTRONICS, Inc., 73-39 68th Ave., Middle Village, N. Y. The Byohmmeter 796 multimeter has

The New Rauland Omni-directional* FM ANTENNA!

- Non-Directional Pickup Pattern
- High Sensitivity & Signal Strength
- Reduces Man-Made Noises
- Compact, Light-Weight, Sturdy
- No Special Orientation Required
- Low Standing-Wave Ratio
- All-Aluminum Construction
- Operates Indoors or Outdoors

FIRST NON-DIRECTIONAL DESIGN!

Graph above shows virtually circular horizontal directivity pattern at 88 mc; only slight elongation appears at 108 mc. Vertical directivity shows no response to automobile ignition and other man-made noises; gives maximum noise-reducing benefits.

*Patent Applied For

Here is the *first and only* FM Receiving Antenna that picks up signals from *all* directions . . . the *only* antenna that makes possible strong reception even at the outer limits of the FM broadcast range where ordinary antennas fail. The exclusive design features of the RAULAND Model 150 FM Antenna make it the ideal antenna for optimum FM reception. Attractive, compact and sturdy (free from wind noises and with low wind resistance), the Model 150 is easy to erect outdoors; conveniently installed indoors. Matches standard 300 ohm FM input. Protected against lightning. Offers the finest FM reception at the lowest antenna cost.

Rauland

Write for interesting descriptive bulletin . . .

THE RAULAND CORPORATION

4265 N. Knox Avenue, Chicago 41, Illinois

TODAY'S SCHOOLS...

must train for TOMORROW — a challenge intensified by the accelerating pace of scientific and engineering advance.

Specially designed to meet the needs of modern education, is the NEW . . .



TYPE S-14

STUDENT'S OSCILLOGRAPH

An Essential part of the modern college laboratory:

- Accuracy, for the critical researcher
- Simplicity, for the undergraduate student
- 6 to 12 channels, precision components

WRITE FOR TECHNICAL BULLETIN SP-183A

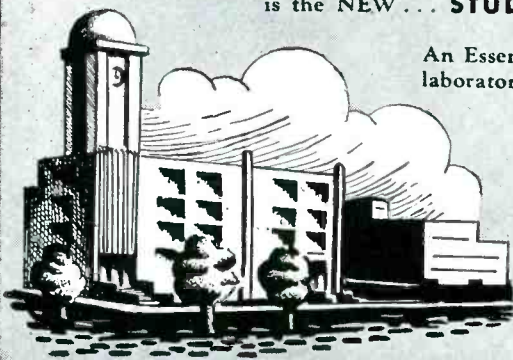

Hathaway INSTRUMENT COMPANY
1315 SO. CLARKSON STREET • DENVER 10, COLORADO

How to Tune in on Cost Cuts!

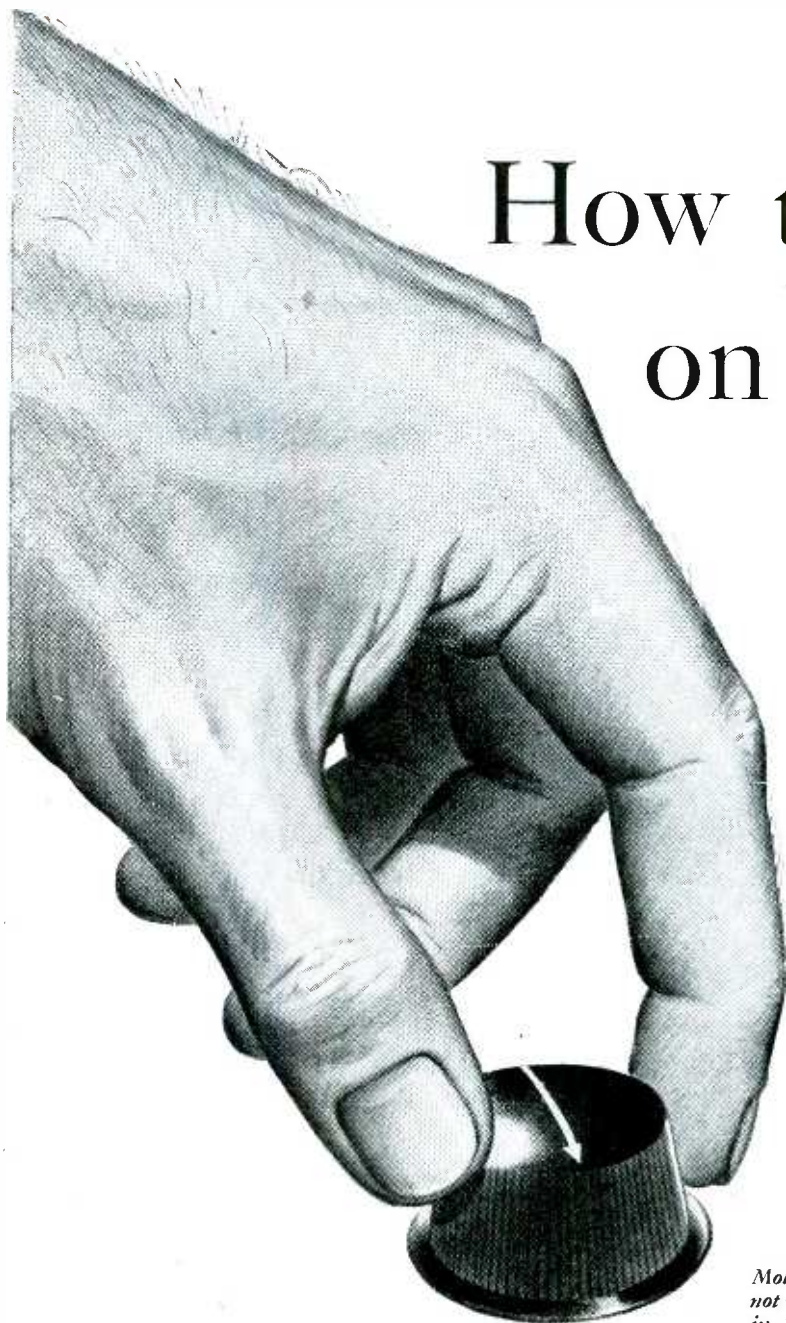

Molded plastic knobs and dials for radio—common now, but not when we introduced the first complete line of stock parts back in 1922. Here's another Kurz-Kasch "first" that paid off!

EVERYBODY'S shortcut to the production economies of tomorrow is *somebody's* pet bright idea today. There's a time lag before that idea gets around. Meanwhile, if you're the lucky customer of the originating molder, look at the pretty competitive position you'll be in!

We've done this for Kurz-Kasch customers time and time again—and we're resolved to keep on doing it, as our past and present performance might suggest. So let's get acquainted. Send for your copy of our free illustrated booklet, "A Businessman's Guide to the Molding of Plastics"—on your letterhead, please.



Kurz-Kasch

*For Over 30 Years
Planners and Molders in Plastics*

Kurz-Kasch, Inc., 1425 S. Broadway, Dayton 1, Ohio. *Export Offices:* 89 Broad Street, New York, N. Y.
Branch Sales Offices: New York • Chicago • Detroit • Los Angeles • Dallas • St. Louis • Toronto, Canada.

**SO
DEPENDABLE**



**PILOT
LIGHT
ASSEMBLIES!**

**They do the job better
and more economically**

DRAKE Socket and Jewel Light Assemblies are built to highest standards, yet cost no more than ordinary types. There is a COMPLETE selection of standard types, special types, "Underwriters Approved" Types, Bayonet, Screw and Bracket Types, Neon, Jewel Types... and hundreds of others. Or we can custom-build an Assembly for your special requirements.

→ ENGINEERS

Drake Assemblies are designed with a safety factor adequate to meet varying conditions. Materials and workmanship are highest grade. Our engineers will cooperate with you on your Pilot Light problems... no obligation.

→ MANUFACTURERS

Drake will supply your Pilot Light needs faster, better, more economically. Get the benefit of our patented features, of high speed precision methods and machinery developed thru 15 years of specializing in making Socket and Jewel Light Assemblies.

→ PRODUCT DESIGNERS

Add a DRAKE Light Assembly to your specifications. They often mean that "extra something" that clinches a sale. Use Drake Light Assemblies for on or off signals, for illumination, for warning signals. Be sure to "SPECIFY DRAKE", for the finest.

ASK FOR FREE CATALOG

**DRAKE
MANUFACTURING CO.**
1713 W. HUBBARD ST., CHICAGO 22

NEW PRODUCTS

(continued)

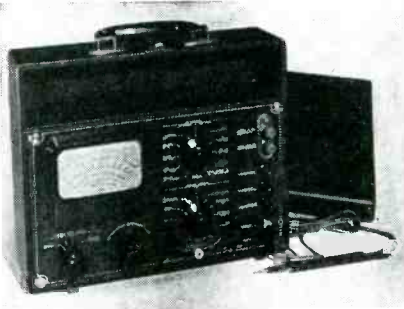

seven current ranges, six output voltage ranges, five decibel ranges, a resistance of 20,000 ohms per volt and top voltage scales at 10,000 volts, a-c and d-c.

High-Voltage Capacitor (39)

ERIE RESISTOR CORP., Erie, Pa. The type 3688 high-voltage capacitor can be used well above 50 kva at 15 mc in a temperature of 85 C under

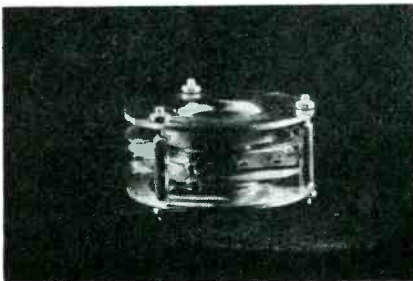

forced-air ventilation. Units are available for 500 and 1,000 micro-microfarads.

Thermocouple Indicator (40)

LEEDS AND NORTHRUP CO., 4934 Stenton Ave., Philadelphia 44, Pa. When a large number of thermocouple temperatures must be logged

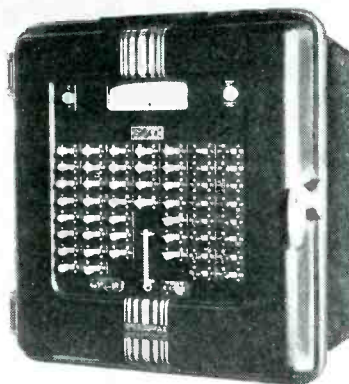

**Speakers make
the
DIFFERENCE**

**... and what a
DIFFERENCE!**

General Electric Speakers are built to be different—better. For warm, live, pulsating radio and record reproduction, specify speakers by General Electric.

- Better tone quality
- High wattage handling capacity
- No warping of voice coil
- Greater design possibilities
- Overall greater efficiency
- Better controlled air gaps
- Rigidity, strength, durability

Consult General Electric now for your Speaker requirements. Write to: *General Electric Company, Electronics Department, Syracuse 1, N. Y.*



166-FIA

GENERAL  ELECTRIC

NAME PLATE PROBLEMS?

Investigate the low-cost
high-speed application of
tough all-color, all-surface

MEYERCORD DECAL NAMEPLATES



Billions of Meyercord Decals are in use throughout the world. They provide a colorful, highly legible, permanent and easy method of applying any product identification, operating instructions, patent data, lubrication guides, and wiring diagrams. They save time, labor, and materials.

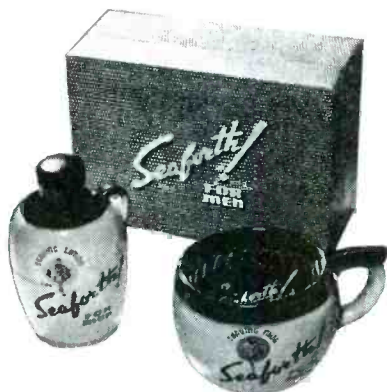

Meyercord Decal nameplates are vibration-proof, eliminate protruding edges and sharp corners, require no screws or rivets for application. Meyercord Decals are durable, washable, and can be produced in any size, colors or design. Popular water methods permit fast application.

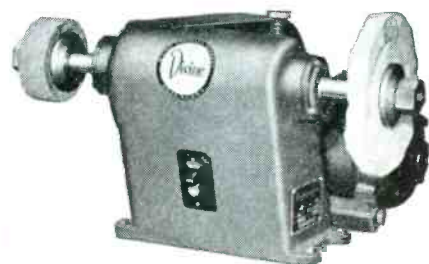

Easy-to-use solvents or cements are specified when required. Meyercord research has developed Decals resistant to acid, petroleum products, alkali, alcohol, abrasion, temperature extremes and moisture. Can be used on rough, smooth or crinkled surfaces, flat, concave or convex.



Over fifty years of actual use has demonstrated that genuine Meyercord Decals retain their color and legibility for years without cracking or peeling. There is no commercial surface known for which Meyercord engineers cannot design a Decal for complete and perfect surface adhesion.



Meyercord Decals offer a new efficiency in product identification. Years of experience in setting up high-speed production lines for the application of Decal nameplates have developed many new and different techniques, which are now available to Meyercord customers.

Technical consultation and
designing service is available
on request. Address
inquiries to Dept. 9-6

Founder Member Lithographic Technical Foundation

The MEYERCORD Co.

World's Largest Decal Manufacturer
5323 W. LAKE ST. CHICAGO 44, ILL.

Man Whata Switch!

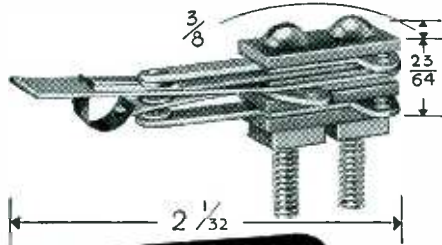

ACRO'S Snap Action ★ ★ Single Pole OPEN BLADE

Here is the Snap-Action Open Blade switch that is in a class by itself. Its patented Rolling Spring construction is the basis of almost unlimited variations as to length and shape of actuators, movement and pressure. Terminals may be at side or rear.

Many variations of this switch, at modest cost, already in use on various mass-production products. Rated at 15 amps. 125 volts A. C. Let us help you NOW in engineering your switch problems into a Rolling Spring Snap-Action design for better, more accurate performance and longer life.

ACRO ELECTRIC COMPANY
1316 SUPERIOR AVENUE • CLEVELAND 14, OHIO

in a short time, the Speedomax indicator can be used. To read a temperature, the operator flips a key switch marked for the desired thermocouple; the instrument's drum scale spins, to stop at the correct temperature. A single instrument handles more than 100 thermocouples. Key switches can be color-coded for convenience in identifying points. The amplifier unit uses standard vacuum tubes.

Temperature Control Units (41)

CLAUD S. GORDON Co., 3000 S. Wallace Street, Chicago 16, Ill. The new Xactline Capacitrol combines in one complete unit the features of the Xactline control unit and the Capacitrol. The integrated equipment holds temperature tolerances



as close as plus or minus 0.2 F and power on-off cycles as short as 3 seconds. The electronic control section has a direct-reading indicating scale, a separately enclosed measuring instrument, and interchangeable unit construction. Descriptive literature is available.

Metal Film Resistor (42)

CONTINENTAL CARBON, Inc., 13900 Lorain Ave., Cleveland, Ohio. The Nobleoy resistor, is now being made noninductive in resistance values ranging from 0.5 ohm to 50,000 ohms, depending on type, with a precision accuracy of 1 percent. The noninductive characteristic is made possible by the method of longitudinal grooving upon calibration. When used in d-c circuits or cir-

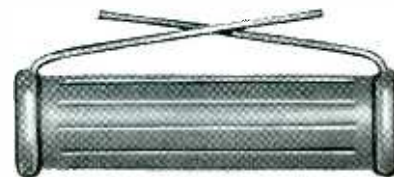

Acme Electric Corporation uses PARAMOUNT PAPER TUBES IN BALLASTS AND TRANSFORMERS

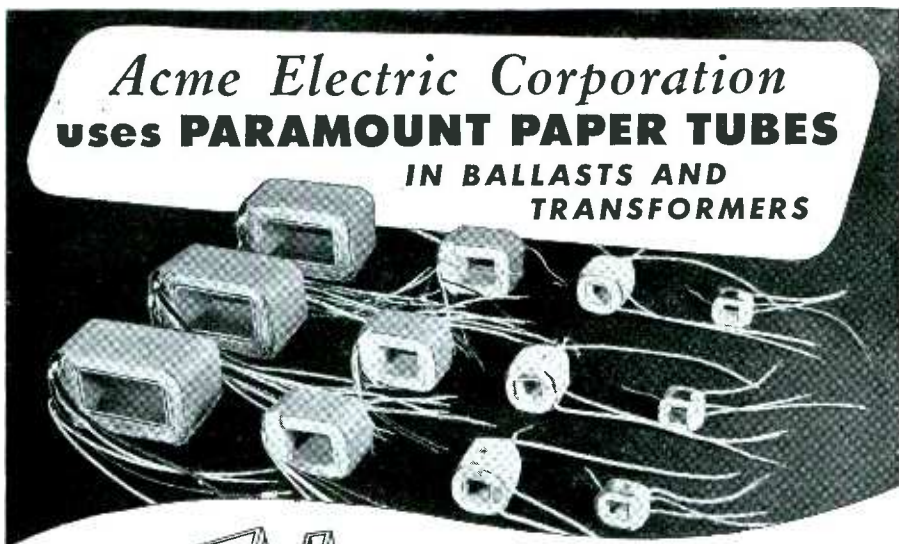

SEND FOR
ARBOR LIST OF
OVER 1000 SIZES

Lists great variety of stock arbors. Includes many odd sizes. Write for Arbor List today.

Inside Perimeters
from .592" to 19.0"

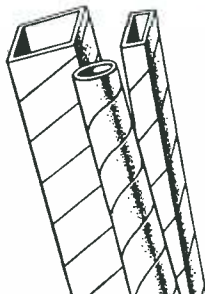

● This is typical of the wide use of PARAMOUNT paper tubes by leading manufacturers of electrical, radio and electronic products. With over 15 years of specialized experience, PARAMOUNT can produce exactly the shape and size tubes you need for coil forms or other uses. Square, rectangular, or round. *Hi-Dielectric*, *Hi-Strength*. Kraft, Fish Paper, Red Rope, or any combination, wound on automatic machines. Tolerances plus or minus .002". Made to your specifications or engineered for you.

PARAMOUNT PAPER TUBE CORP.

616 LAFAYETTE ST., FORT WAYNE 2, IND.

Manufacturers of Paper Tubing for the Electrical Industry

Model 2405 Volt • Ohm • Milliammeter

25,000 Ohms
per volt D.C.

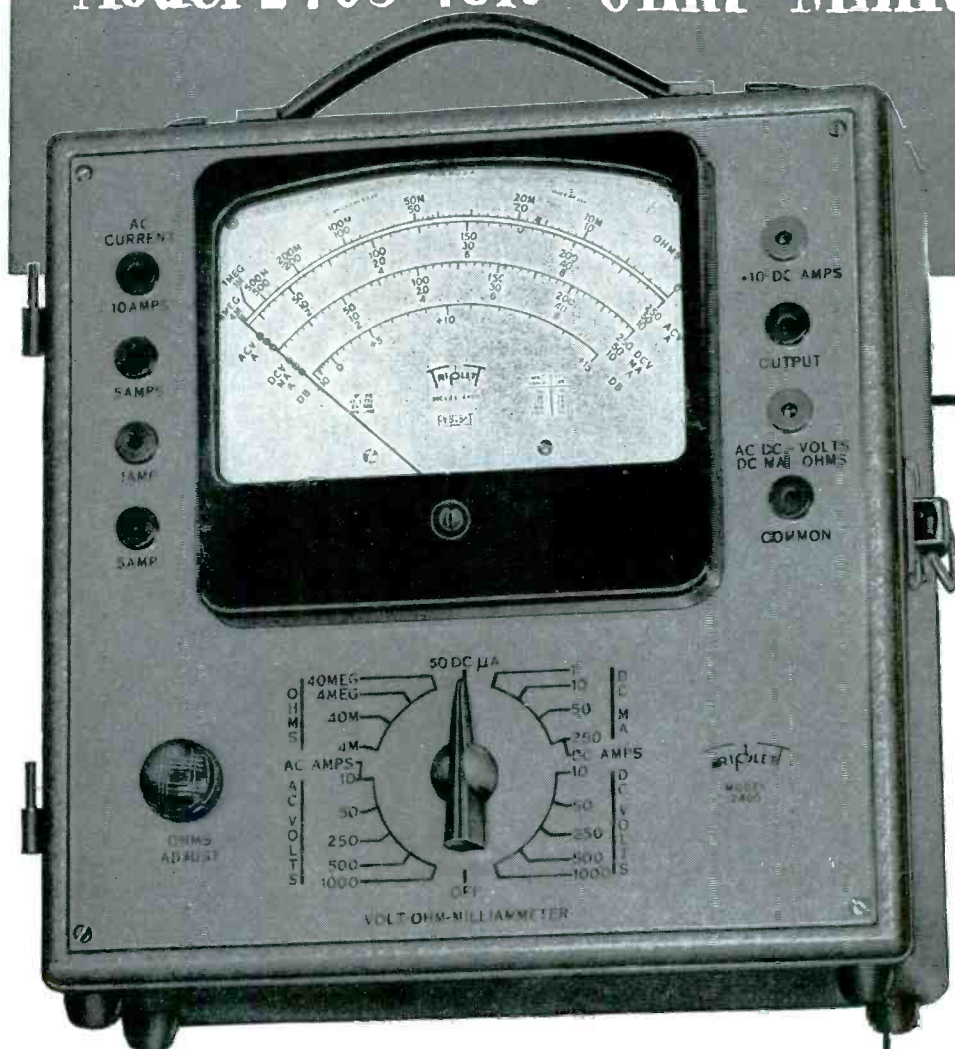

Specifications

NEW "SQUARE LINE" metal case, attractive tan "hammered" baked-on enamel, brown trim.

✓ **PLUG-IN RECTIFIER**

Replacement in case of overloading is as simple as changing radio tube.

✓ **READABILITY**

The most readable of all Volt-Ohm-Milliammeter scales—5.6 inches long at top arc.

✓ **RED • DOT LIFE-TIME GUARANTEE**

on 6" instrument protects against defects in workmanship and material.

New **ENGINEERING** • New **DESIGN** New **RANGES** •

(50 RANGES)

- Voltage:** 5 D.C. 0-10-50-250-500-1000 at 25000 ohms per volt.
5 A.C. 0-10-50-250-500-1000 at 1000 ohms per volt.
- Current:** 4 A.C. 0-.5-1-5-10 amp.
6 D.C. 0-50 microamperes—0-1-10-50-250 milliamperes—0-10 amperes
- 4 Resistance** 0-4000-40,000 ohms—4-40 megohms.
- 6 Decibel** —10 to +15, +29, +43, +49, +55.
- Output** Condenser in series with A.C. volt ranges.

Model 2400 is similar but has D.C. volts

Ranges at 5000 ohms per volt.

WRITE FOR COMPLETE DESCRIPTION.



Triplet



ELECTRICAL INSTRUMENT CO. BLUFFTON, OHIO

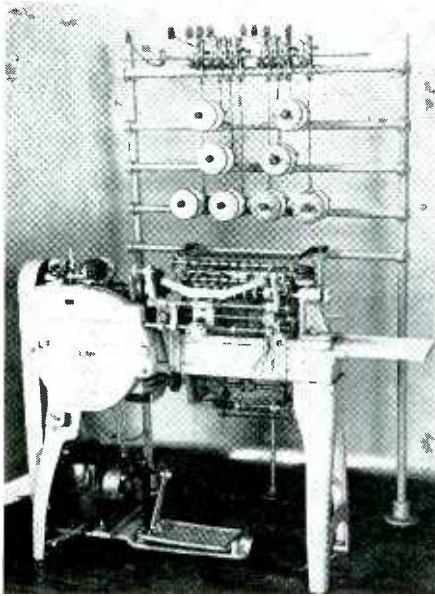

PAPER-INSULATED COILS

AUTOMATICALLY WOUND AT HIGH SPEED IN MULTIPLE FORM

Speeds as high as 2500 rpm are used with the No. 104 Universal Coil Winding Machine to produce paper-insulated coils in stick form without attention from the operator.

Automatic paper injection—various thicknesses, one- or two-ply.

Uniform overlap at all diameters—length of insert gradually increased.

Adjustable traverse mechanism—wire layer length adjusted without removing cams.

Compact supply—up to 14 wire spools.

Slow start—avoids wire breakage.

Rapid transfer—using secondary arbor.

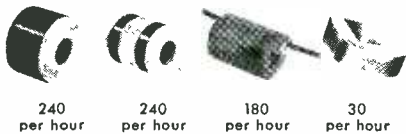

240 per hour

240 per hour

180 per hour

30 per hour

Write for Bulletin 104
Universal Winding Co.
P.O. Box 1605
Providence 1, R.I.

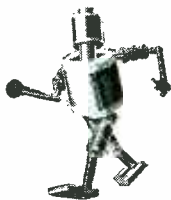

*For Winding Coils
in Quantity*

Automatically, Accurately—Use...

**UNIVERSAL
WINDING MACHINES**

NEW PRODUCTS

(continued)

circuits employing commercial frequencies, the method of calibration produces resistance values ranging from 0.5 ohm to 50 megohms.

Further information is available from the manufacturer.

Contamination Alarm (43)

INDUSTRIAL INSTRUMENTS, Inc., 17 Pollock Ave., Jersey City 5, N. J. The Solu-Bridge controller consists of an a-c Wheatstone bridge and a sensitive relay that operates when



the bridge is off balance to sound a warning bell or other alarm. A conductivity cell in the boiler return line continuously checks return steam condensate for contamination from heating tanks or kettles.

Motor-Driven Rheostat (44)

WARD LEONARD ELECTRIC Co., Mount Vernon, N. Y. The compact Bulletin 60A motor drive unit de-

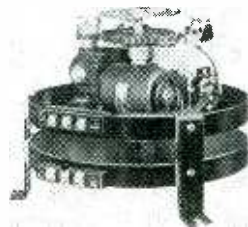

signed for remote and automatic operation of single or multiple rheostats is available for a-c and d-c 115- or 230-volt operation.

Photoelectric Actuator (45)

POTTER INSTRUMENT Co., 136-56 Roosevelt Ave., Flushing, N. Y. The Model 600 photoelectric actuator has a beam approximately $\frac{1}{8}$ inch wide and will respond to changes in light level as small as



The VX series of subminiature vacuum tubes are especially adaptable to electrometer applications in fine instrumentation and for circuits used in radiation measurement. Feature 10 ma. filament current, grid resistance of 10^{15} ohms. Unusually stable.

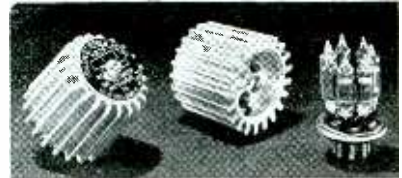

The voltage regulator unit consists of 7 subminiature gaseous voltage regulator tubes uniquely assembled in one unit as illustrated. Particularly adaptable where regulation requires a flat top (130 volts) with close accuracy and space conservation.



The Hi-megohm series of resistors cover a range from 100 to 10,000,000 megohms. Vacuum sealed in glass with special surface treatment they are designed to meet the resistor requirements of fine instrumentation.

Unusually stable over a voltage range of 1 to 100 volts.

THE VICTOREEN INSTRUMENT CO.
5806 HOUGH AVENUE
CLEVELAND 3, OHIO

**"SURE, SILVER
COSTS ARE HIGH—
BUT GENERAL PLATE
LAMINATED METALS CUT
COSTS BY PUTTING
SILVER ONLY WHERE
YOU NEED IT!"**



You can beat today's high silver costs and still get solid silver performance by using General Plate Laminated Metals in applications requiring silver.

Because General Plate Laminated Metals . . . sheet, wire and tube . . . are made by permanently bonding a thin layer of silver to a thicker layer of base metal, they give you solid silver performance where you need it. Thus you pay for a small quantity of silver plus the cost of inexpensive base metal . . . resulting in a large saving over solid silver. Re-

member, too, that the base metal adds strength, ease of fabrication and workability.

General Plate Laminated Metals have high corrosion resistance, better electrical conductivity, better spring properties, are easier to fabricate. Use them in such applications as chemical apparatus, electrical equipment, physical instruments, radio and electronic devices.

Write for complete information, today. Engineers are available for consultation; ask for their services.

GENERAL PLATE DIVISION

of Metals and Controls Corporation

A T T L E B O R O , M A S S A C H U S E T T S

50 Church St., New York, N. Y.; 205 W. Wacker Drive, Chicago, Ill.; 2635 Page Drive, Altadena, California; Grant Bldg., Pittsburgh, Pa.

"ELEPHANT BRAND" PHOSPHOR BRONZE

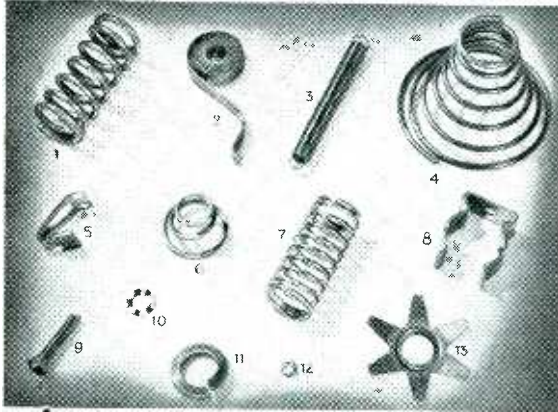

... an ideal
METAL for
SPRINGS



1. Compression Spring
2. Torsion Spring
3. Extension Spring
4. Involute Spring
5. Spring Contact
6. Involute Spring
7. Compression Spring
8. Fuse Clip
9. Extension Spring
10. Spring Washer
11. Lock Washer
12. Lock Washer
13. Spring Washer

Yes, because of its ability to withstand frequent "stress reversals", Elephant Brand Phosphor Bronze is really an "ideal" alloy for Springs, Expansion Bellows, Diaphragms, etc. Of course, its other well known and proven qualities are: Corrosion Resistance, Strength, Fatigue Resistance, Easy Workability, Low Friction Coefficient, Resistance to breakdown under arcing, an excellent Electrical Conductor, and Non-magnetic properties,—so, may we suggest that you look into the great advantages of "Elephant Brand", the *Pioneer Phosphor Bronze* . . . Send for the *Handbook* mentioned below.

RODS • WIRE • SHEETS • STRIPS • BUSHINGS • CASTINGS

The Phosphor Bronze Smelting Co.

Original Manufacturers of Phosphor

Bronze in U.S.A.

Established 1874

2200 WASHINGTON AVENUE

PHILADELPHIA 46, PA.



NEW PRODUCTS

(continued)



20 percent. Since complete interruption of the light beam is not required for normal operation, objects as small as ten thousandths of an inch have been counted with absolute accuracy. The unit also contains a capacitor discharge output circuit for the high-speed operation of control solenoids such as are required for deflector gates and packaging equipment.

Skeleton Snap Switch (46)

MICRO SWITCH, Freeport, Ill. A new unhused, skeleton-type snap-action switch known as the SK series, is particularly adapted to ac-

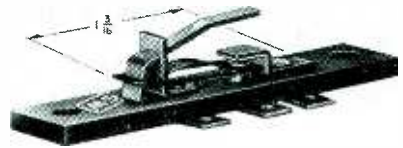

tuation by rotating or sliding cams. Costing less than encased units, the new switch's characteristics approximate those of the more conventional types.

P-A Amplifiers (47)

THORDARSON ELECTRIC Mfg. Div. of Maguire Industries, Inc., Chicago 11, Ill., has announced a line of public address amplifiers, a preamplifier and a booster. The 25-watt amplifier illustrated provides three input circuits, all of which may be electronically mixed to feed the output circuit. Two of these are designed for microphones and one for phonograph input. With the separate bass and treble tone controls in normal positions, frequency response is flat within 1 db from 30 to 15,000 cycles. Hum level is 65 db below rated output. The 8-watt and 50-watt models differ in several respects, peak output from the lat-

WHAT IS THE Second Necessity FOR PROFITABLE RADIO SERVICE?

Of course, the first requirement for profitable radio service is a good service man. The second necessity is good equipment. A good service man with poor equipment is a losing combination. Supreme test equipment has been proved accurate, dependable—"Supreme by Comparison" for nearly 20 years.



SUPREME MODEL 546-A OSCILLOSCOPE, above, is one of the more popular instruments in the complete new Supreme line. Ask your nearest Supreme jobber to show you and demonstrate this finer radio test equipment.

SUPREME

WRITE FOR
NEW
CATALOG

SUPREME INSTRUMENTS CORP., Greenwood, Miss., U.S.A.

Export Department: THE AMERICAN STEEL EXPORT CO., Inc.
1347 Madison Ave., New York 17, N. Y., U.S.A.



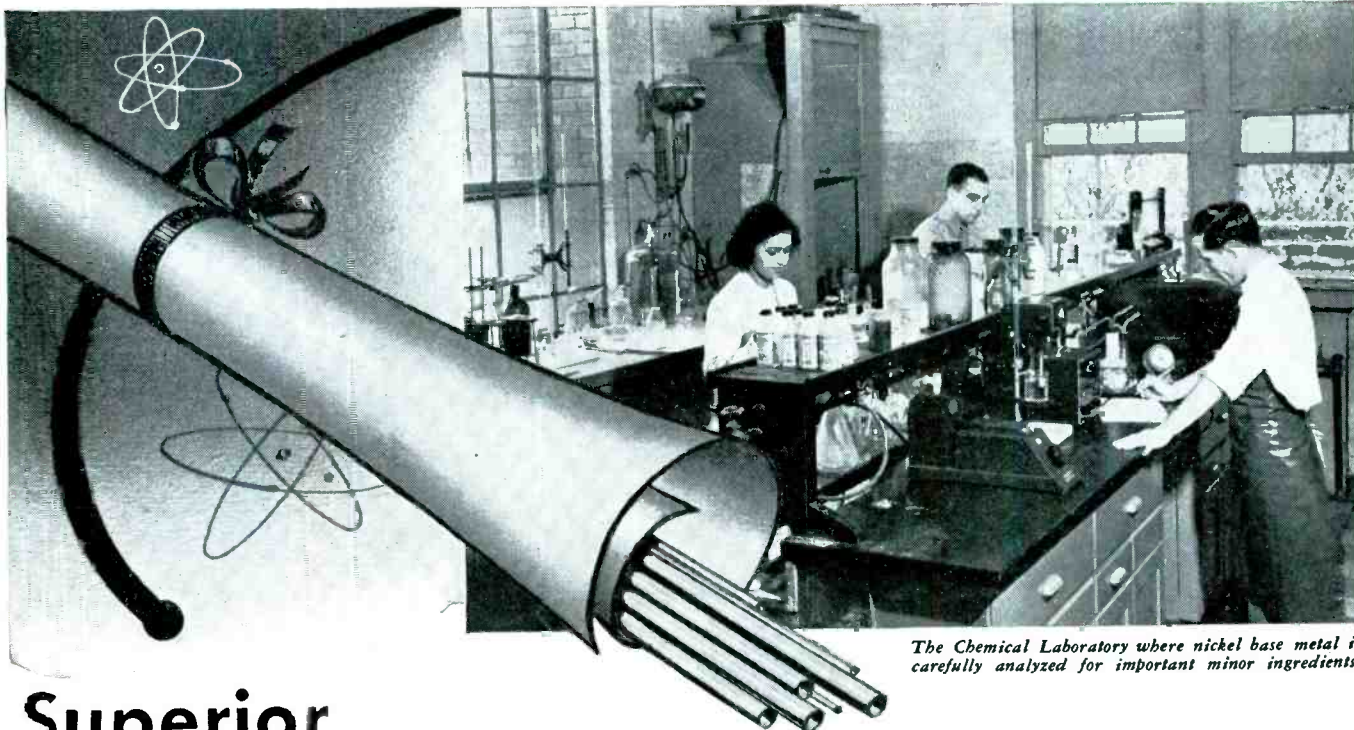

The Chemical Laboratory where nickel base metal is carefully analyzed for important minor ingredients.

Superior Electronic Tubing Gets its "Degree" in Chemistry



The micro-structure of nickel base material is checked constantly to insure selection of only the highest quality stock.

In no other class of metal tubing is chemical analysis and control so important as in tubing for electron tubes. Superior Tube Company has built up over the years a highly specialized Chemical Laboratory which has its finger on the pulse of production and research in a plant manufacturing most of the metal tubing used in electron tubes.

Why is this constant vigilance of benefit to you?

... because accurate analysis of cathode base metals is important insurance that later reaction with the active oxide coating will produce electron emission at the levels you require.

... because a dozen elements comprising less than one-half of one per cent of the total composition are responsible for large differences in cathode activity. Detailed analyses to .01% and better are imperative for maximum performance.

... because the Chemical Laboratory has developed improved drawing lubricants and cleaning methods which have been found to be essential in providing you with the best cathode emission.

... because your tube design requirements may demand a base metal of low, normal or high activity—any of which we can supply. You may have confidence that the cathode material is chemically controlled by our Laboratory from raw stock to finished product.

The Electronics Division of Superior Tube Company has achieved leadership in producing tubing for electron tubes of all types, by being equipped and staffed to carry on experimental work, while maintaining the highest day-by-day standards of low cost mass production.

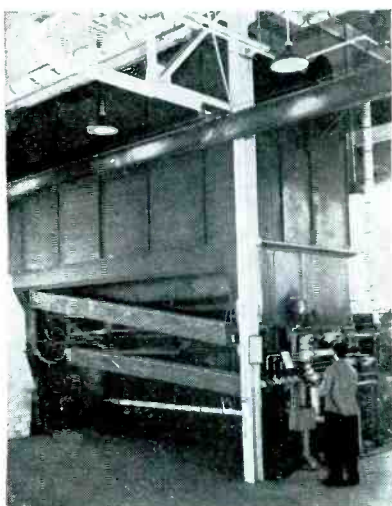

To guard against contamination of the nickel material by certain processing lubricants the tubing is thoroughly degreased before annealing operation.



THE BIGGER NAME IN SMALL TUBING
Superior

For Superior tubing on the West Coast, call PACIFIC TUBE COMPANY, 5710 Smithway Street, Los Angeles 22, California ANgeles 2-2151

**SUPERIOR TUBE COMPANY
ELECTRONICS DIVISION**

2500 Germantown Ave. • Norristown, Pennsylvania

ALLEN

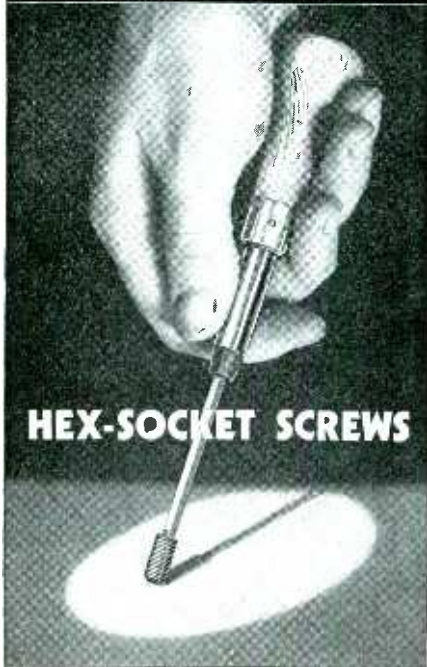

HEX-SOCKET SCREWS

Handiest where *hard-to-hold*

The small-size screws you so largely use can be held on the end of an Allen driver and started in the tapped hole instanter! Or they may be held on an Allen Hex Key and turned in places where thumb-and-finger work awkwardly if at all. *Fast in assembling!*

And for set-ups hard to hold under vibration, "Allens" have (1) STRENGTH for tight wrenching; (2) Accurate threading to a high Class 3 fit, for a high degree of frictional holding-power.

Your local Industrial Distributor supplies also Allen Socket Head Cap Screws, Flat Head Cap Screws, "Tru-Ground" Shoulder Screws and "Tru-Ground" Dowel Pins. Ask him for samples or demonstration.



THE ALLEN MFG. COMPANY
HARTFORD, CONNECTICUT, U. S. A.

NEW PRODUCTS

(continued)

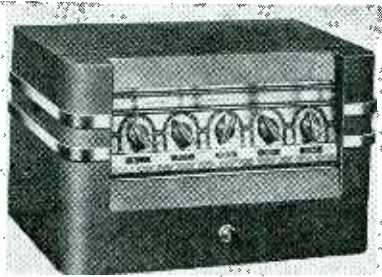

ter being 65 watts. Booster units can be rack mounted or located at the speaker end of a line from the central control. They are designed to give an output of 25 watts each when used with the rack-mounted preamplifier unit.

Heating Triode (48)

GENERAL ELECTRIC Co., Schenectady, N. Y. The new type GL-5549 triode is capable of furnishing 6 kilowatts of power output up to 50 mc. A pure tungsten filament al-



lows reduction of filament voltage during periods of no plate power, adapting the tube to intermittent service in dielectric heating applications.

Decade Amplifier (49)

KALBFELL LABORATORIES, 1076 Morena Boulevard, San Diego 10, Calif. A new decade amplifier having high gain and power output has an output impedance of less than 25 ohms and is used as a preamplifier for copper-oxide type voltmeters and for vacuum tube voltmeters. It will deliver up to 50 volts at 10 ma rms. It incorporates negative feedback



BRADLEY

PHOTO ELECTRIC CELLS



Reduce Production Costs

Bradley Luxtron* photocells improve control over manufacturing operations, reducing your costs. They meet the most exacting requirements. Advanced manufacturing techniques make light-actuated Bradley cells the choice all over the world.

Luxtron photocells convert light directly into electrical energy. No external source of voltage is required. Besides the housed model shown with its plug-in contacts, Bradley also offers tube socket, nut-and-bolt types and pigtail contact mountings. In addition, Luxtron unmounted cells are available in many different sizes and shapes.

* T. M. REG. U. S. PAT. OFF.

Illustrated literature, available on request, shows more models of Bradley photocells, plus a line of copper oxide and selenium rectifiers. Write for "The Bradley Line."

BRADLEY

LABORATORIES, INC.

82 Meadow St. New Haven 10, Conn.

VERSATILE NEW LINE OF...

A·C AND D·C RELAYS

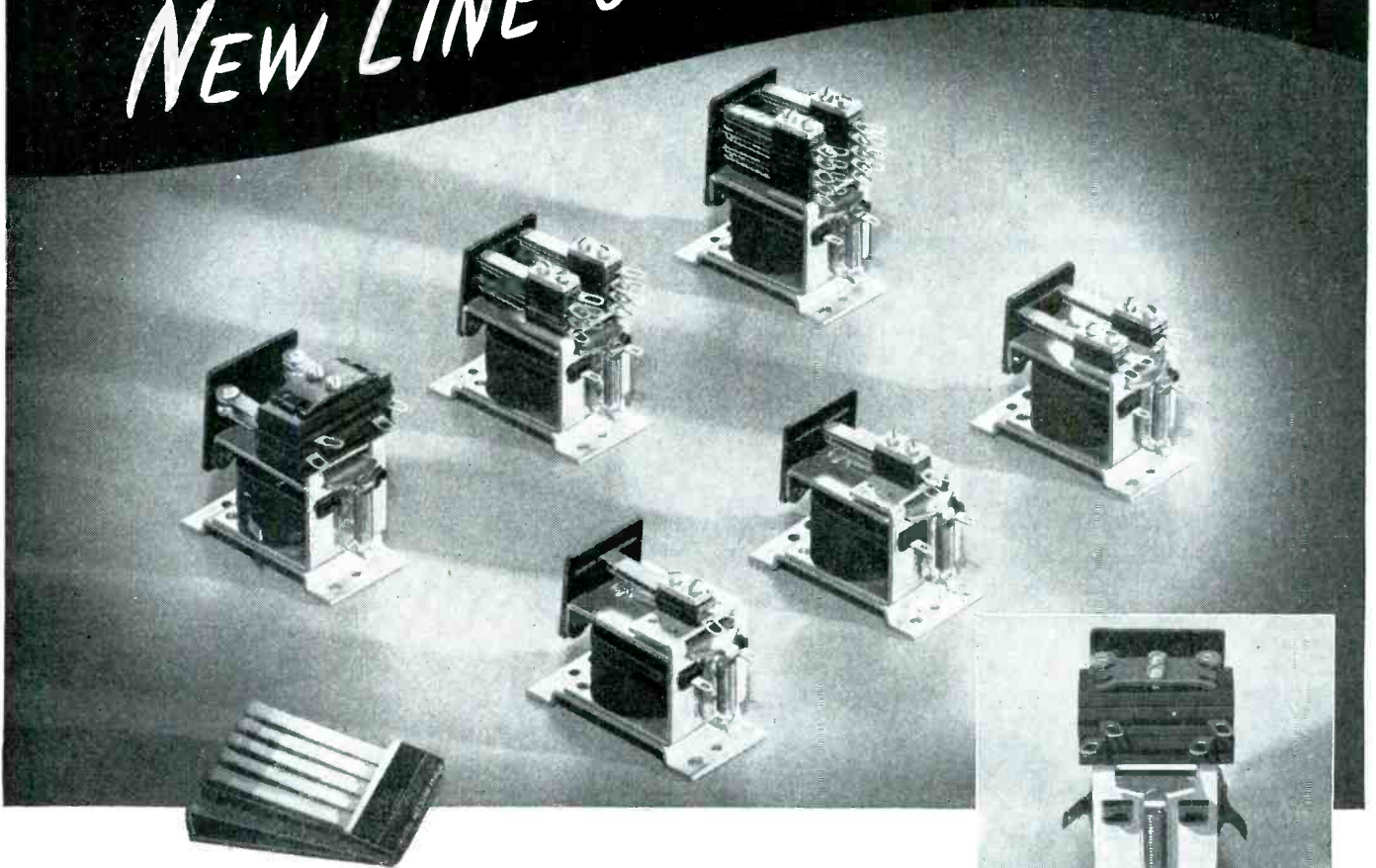

EXCEPTIONALLY SMALL AND COMPACT YET EXTREMELY RUGGED!

● R-B-M announces a new line of general purpose magnetic relays, with either A.C. or D.C. shunt coils or series coils, for electronic applications.

Relays are available in standard contact arrangement of single and two pole normally open, normally closed; or double throw with light and heavy contacts. Four and six pole double throw relays are available with 3 ampere contacts at 32 volts or less.

Insert shows double pole, normally open contactor rated 12 amperes, 115 volts, A.C., and 6 amperes at 230 volts, A.C. This relay is designed in accordance with Underwriters' specifications and will ultimately carry Underwriters' Approval for Small Devices classification. For further information write for Bulletin 570. Address Department A-6

R-B-M DIVISION
ESSEX WIRE CORPORATION
Logansport, Indiana

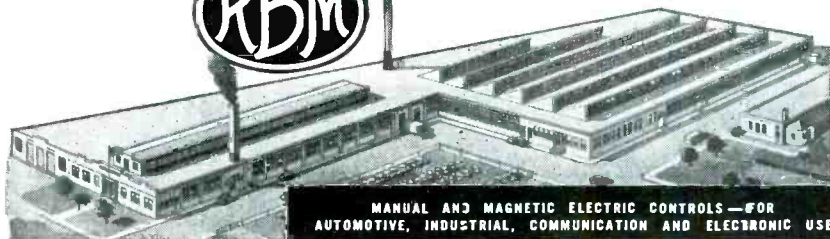
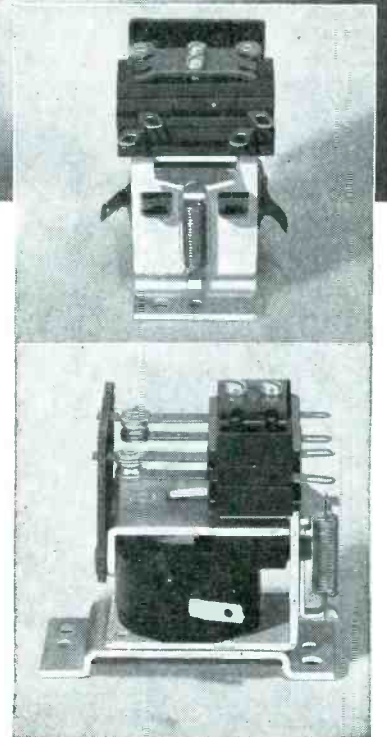

MANUAL AND MAGNETIC ELECTRIC CONTROLS—FOR
AUTOMOTIVE, INDUSTRIAL, COMMUNICATION AND ELECTRONIC USE

FASTENS DEEP, HOLLOW SHAPES

of metal, fabric, wood or plastic

**Typewriter Cases
Camera Carrying Cases
Lunch Boxes, etc.**

**faster, cheaper
stronger**
with semi-tubular or split rivets

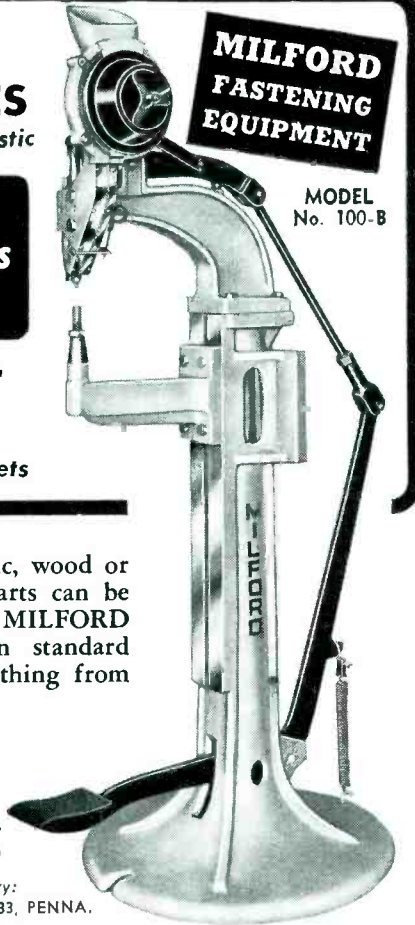

If your product — whether metal, fabric, wood or plastic — requires fastening and the parts can be brought to a machine, investigate MILFORD FASTENING EQUIPMENT. Fifteen standard models of rivet-setters to fasten everything from wrist watch bracelets to refrigerators.

THE MILFORD RIVET & MACHINE CO.

859 Bridgeport Avenue, Milford, Conn.
1002 West River Street, Elyria, Ohio

Inquiries may also be addressed to our subsidiary:
THE PENN RIVET & MACHINE CO., PHILADELPHIA 33, PENNA.

POWDERED METAL CORES

PyroFerric's

EXCLUSIVE SPECIALTY

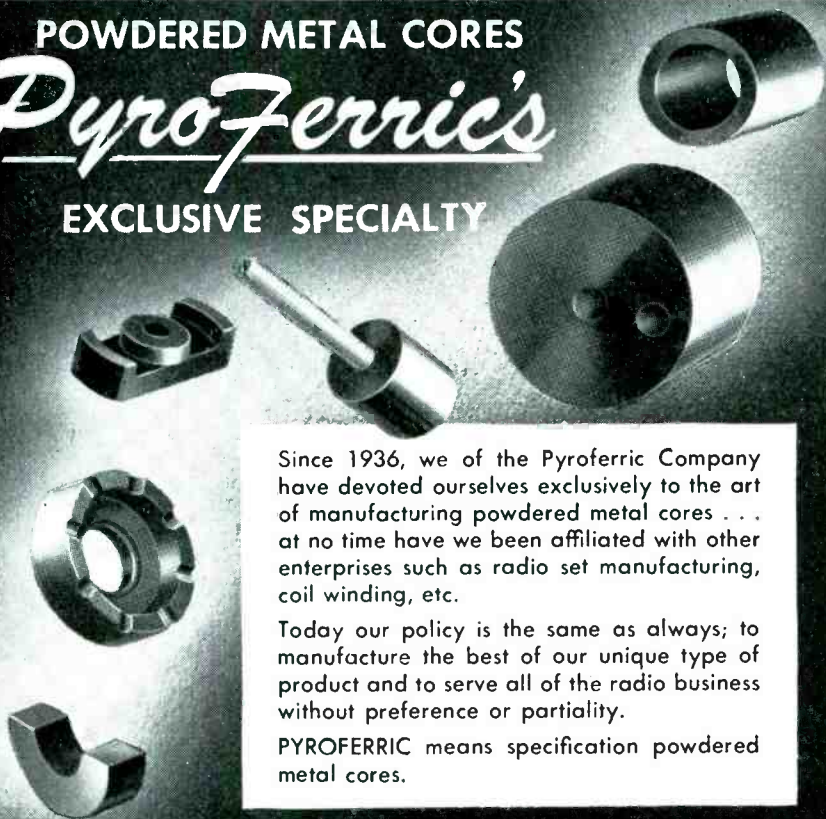

Since 1936, we of the PyroFerric Company have devoted ourselves exclusively to the art of manufacturing powdered metal cores . . . at no time have we been affiliated with other enterprises such as radio set manufacturing, coil winding, etc.

Today our policy is the same as always; to manufacture the best of our unique type of product and to serve all of the radio business without preference or partiality.

PYROFERRIC means specification powdered metal cores.

PYROFERRIC Co.

175 VARICK ST. NEW YORK 14, N. Y.

in addition to a fully regulated power supply and is flat within 1 db from below 10 cycles to 1 megacycle. The amplification factors are 100, 1,000 and 10,000 on its three ranges. It is described in a bulletin

Signal Generator (50)

GENERAL ELECTRIC Co., Syracuse, N. Y. The type YGS-3 signal generator combines r-f and a-f signal voltages, a 1-mc crystal calibrator

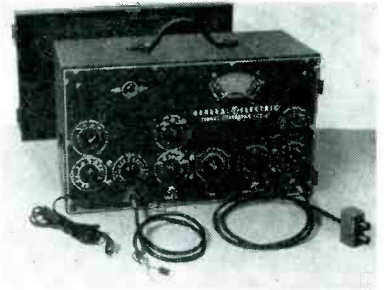

and a variable-frequency audio oscillator. Fundamental range of the r-f oscillator is 100 kc to 150 mc.

Frequency Standard Crystal (51)

JAMES KNIGHTS Co., Sandwich, Ill. A 100-ke frequency standard with silvered electrodes to which the



mounting wires are directly soldered is available in a completely sealed holder. Standard $\frac{3}{4}$ inch pin spacing is used. The unit complete with circuit diagram sells for \$6.95.

Defrosting Control (52)

BUSH MANUFACTURING Co., Hartford, Conn. An electronic control is now available for automatic water defrosting of refrigeration sys-



Skilled Operators winding voice coils, the heart of Magnavox dynamic speakers

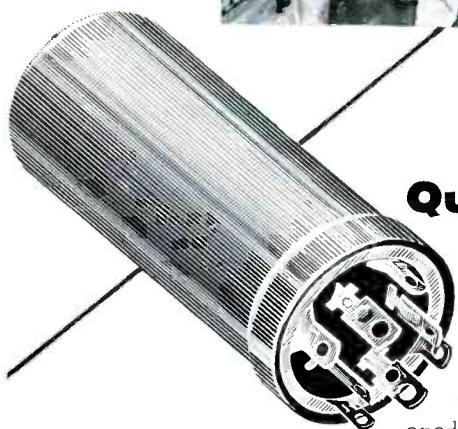

Electrolytic Capacitors—standardized into 8 container sizes to simplify design and assembly problems.

Quality, Economy, Dependability Assured — in Components by Magnavox

As the oldest and largest manufacturer of loud speakers, Magnavox has developed overall experience and skills, that are unsurpassed in the radio industry. Magnavox capacitors, speakers and other component parts are established as *the standard of quality*.

Today six acres of modern plant and equipment, a competent staff of trained engineers and designers, plus 32 years of research and development stand ready to

be applied to any of your component problems. Specializing in the quantity production of quality components for the manufacturing trade, Magnavox can meet your specifications *exactly!*

When you need component parts, specify the name Magnavox—symbol of quality in radio manufacturing since 1915. The Magnavox Company, Components Division, Fort Wayne 4, Indiana.



Magnavox

has served the radio industry for over 32 years

SPEAKERS • CAPACITORS • SOLENOIDS • ELECTRONIC EQUIPMENT

AT YOUR SERVICE

TO HELP YOU WITH YOUR SHEET METAL FABRICATION REQUIREMENTS.

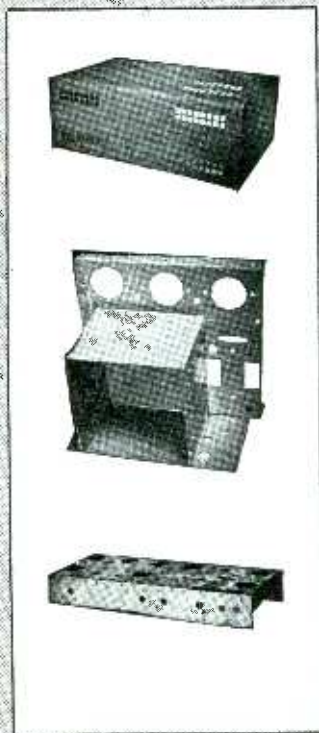

SHEET METAL PRODUCTS — such as: INSTRUMENT PANELS, RADIO COMMUNICATION CASES and ENCLOSURES, OSCILLATOR BOXES, CHASSIS and CABINET ASSEMBLIES RACKS and SPARE PARTS BOXES, WATERPROOF CABINETS and BOXES, METAL STAMPINGS, FORMING and WELDING of FERROUS and NONFERROUS METALS.

We can assure you of excellent workmanship and prompt deliveries. Send us your blueprints and specifications. We shall quote you immediately.

S. Walter Co.
PRECISION SHEET METAL PRODUCTS
144 - 146 CENTRE STREET
BROOKLYN 31, NEW YORK
Tel. MAin 4-7395

NEW PRODUCTS

(continued)

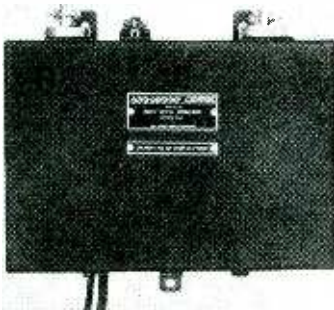

tems. Two control knobs are furnished to adjust the equipment to the motor used in the system and the amount of icing that can be tolerated.

Voltmeter for Audio Testing (53)

RADIO CORP. of America, Camden, N. J. An unusually sensitive audio voltmeter Type WV-73A operates successfully in the range 20 cycles

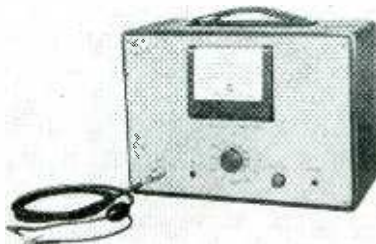

to 20 kilocycles and consists essentially of a precision attenuator, high-gain stabilized amplifier, balanced diode rectifier, d-c microammeter and a regulated power supply.

Radiation Thermocouple (54)

THE PERKIN-ELMER Corp., Glenbrook, Conn. A new radiation thermocouple combines the fast response characteristic of bolometers with a sensitivity and signal-to-noise ratio exceeding that measured for available vacuum thermocouples. The standard model, with a target size of 2×0.2 millimeters

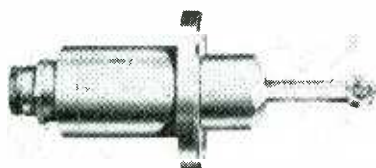

Low Cost Precision

METERS

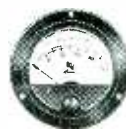

2 1/2" and 3 1/2" ROUND



2" and 3" SQUARE

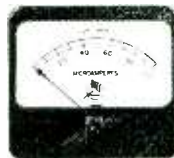

4 1/2" RECTANGULAR

Bridge type construction assures ruggedness and continued accuracy.

Manufacturers who use large quantities of meters are continually swinging over to DALE Instruments. In addition to our standard models, we also build meters to your specifications. Special dials—Special cases. PROMPT deliveries. You may depend upon our delivery promises. Prices you want to pay.

DALE
INSTRUMENTS

Div. of Electronic Development Co.
4408 N. 23RD ST.
OMAHA, NEBRASKA U.S.A.



Steatite-Insulated Connectors

Designed for aircraft use

No insulation damage from flashover

2 to 19 contacts

24 combinations

Floating contacts in Plugs

Small-size pin-plug contacts in Receptacles (shown below)



Two Views of Typical Receptacle



Two Views of Typical Plug

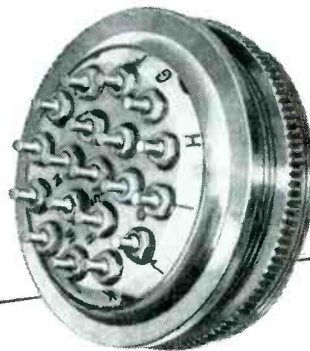

INDIVIDUAL PIN-PLUGS ARE ALSO AVAILABLE

Unique construction originated by A.R.C.

Used by the millions in war-time aircraft.

Minimum spring fatigue.

Conservatively rated at 10 amperes in small size, or 20 amperes in medium size.



(ACTUAL SIZE)

The beryllium-copper contact springs are riveted and soldered at the tip. The other ends are free yet are confined in an annular recess at the base of the Pin-Plug. The four springs provide eight wiping contacts.

Write on your letterhead for our Catalog describing these and our other Component Parts.

AIRCRAFT RADIO CORPORATION

DEPENDABLE ELECTRONIC EQUIPMENT SINCE 1928

Boonton, N. J.



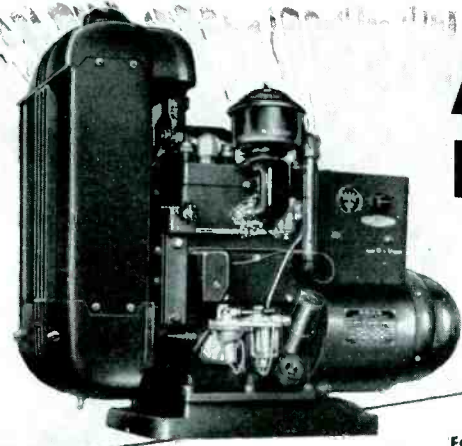

A.C. OR D.C. POWER

PORTABLE,
STANDBY OR
STATIONARY

You can simplify any power-for-electronics problem with an ONAN Electric Plant. A wide range of models and sizes makes it easy to choose the right plant for the particular application.

Lightweight one or two-cylinder air-cooled models for easy portability—A.C.—350 to 5,000 watts, D.C.—600 to 5,000 watts.

Onan two, four and six-cylinder water-cooled models are built for continuous heavy-duty operation, stationary or mobile. A.C.—3,000 to 35,000 watts, D.C.—3,500 to 10,000 watts.

ONAN Electric Plants: A.C.—350 to 35,000 watts in standard voltages and frequencies, D.C.—600 to 10,000 watts, 115 and 230 volts. Battery chargers—500 to 6,000 watts, 6 to 115 volts.

D.W. ONAN & SONS INC.
3563 Royalston Ave. Minneapolis 5, Minn.

- For—
- Radio Station Standby
 - Geophysical Survey
 - Railroad Radio
 - "Spot" Recording
 - Mobile Radio Units
 - Municipal Signal Standby
 - Amateur Radio

Write for Folder



ONAN ELECTRIC PLANTS

IT TAKES MORE THAN QUARTZ

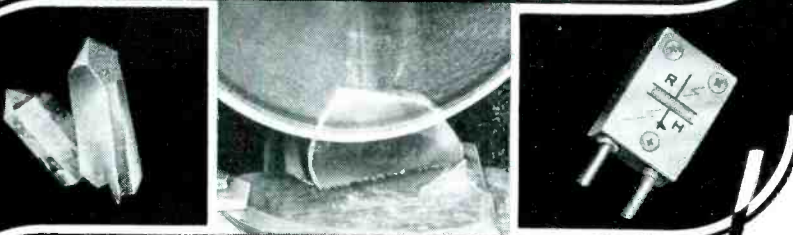

TO MAKE A CRYSTAL UNIT!

REEVES-HOFFMAN experience in the design of crystal units and the machinery to cut and lapp crystals is your assurance of precision, dependability, and economy.

REEVES-HOFFMAN production equipment enables you to get extreme precision crystals in quantity, and assures quick delivery.

REEVES-HOFFMAN can make crystal units to fit your circuits, to your specifications.



For specifications of standard Crystal Units write for Catalog RHC-1



REEVES-HOFFMAN CORPORATION

SALES OFFICE: 215 EAST 91 STREET, NEW YORK 28, N. Y.
PLANT: 321 CHERRY STREET, CARLISLE, PA.

and a resistance of 20 ohms, shows a sensitivity of 10 microvolts per microwatt and a speed of response such that the peak to peak output voltage is greater than 80 percent of the steady state voltage with 5-cycle modulation.

Pocket Ohmmeter (55)

SYLVANIA ELECTRIC Products Inc., 500 Fifth Ave., New York 18, N. Y. Preliminary isolation of electrical faults is easily accomplished with



a new ohmmeter that is direct reading between 0 and 10,000 ohms. The equipment illustrated uses a small Weston meter and a standard penlight dry cell.

Transmitter Capacitors (56)

INDUSTRIAL CONDENSER Corp., 3243 N. California Ave., Chicago 18, Ill. The new line of f-m and television

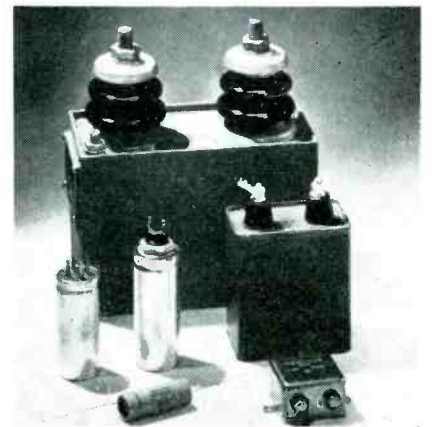

transmitter capacitors illustrated is described in catalog No. 1083.

Radar Transfer Switch (57)

RADIO CORP. of America, Camden, N. J. A new switch, type AVA-68, is electrically operated and makes possible the use of a single pair of antennas for operation of two sepa-

Tolerance is Important...

... Especially when it comes to radio parts. That's why National parts are precision-made with tolerances measured as close as .0002".

Operational results justify this close attention to detail for every National precision condenser is mechanically and electrically

interchangeable and can be depended upon to fit the specifications called for. Production flows smoothly when you use National parts because their closely-tooled tolerances and sturdy construction make replacements unnecessary...

Please write to Department 10, National Company, for further information

Send for your copy of the new National catalog containing over 600 parts today.

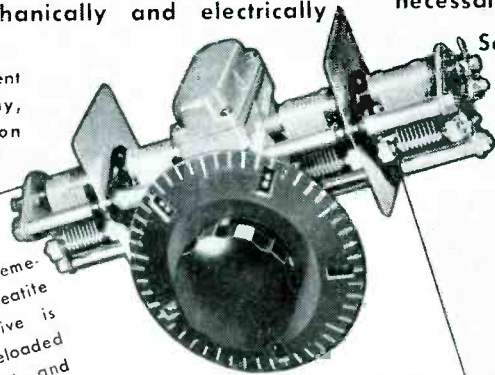

This PW Condenser is of extremely rigid construction with Steatite stator insulation. The drive is through an enclosed preloaded worm gear with 20 to 1 ratio and the rotor shaft is parallel to the panel. Plate shape is straight-line frequency when the frequency range is 2:1.

PW Condensers are available in 2, 3, or 4 sections in either 160 or 225 mmf per section. A single-section PW Condenser with

grounded rotor is supplied in capacities of 150, 200, 350 and 500 mmf, single spaced, and capacities up to 125 mmf, double spaced.

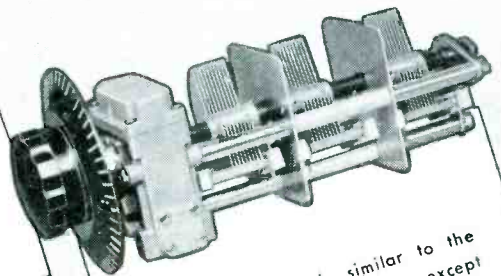

The NPW model is similar to the other PW Condenser models, except that the rotor shaft is perpendicular to the panel. Three sections... each 225 mmf.

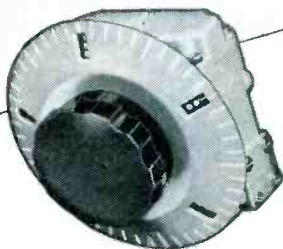

NPW-O uses parts similar to the NPW Condenser. Drive shaft perpendicular to panel. One TX-9 coupling supplied.

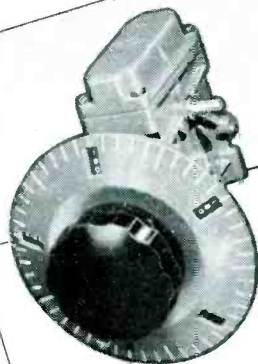

The PW-O uses parts similar to the PW Condenser. Drive shaft parallel to panel. Two TX-9 couplings supplied.

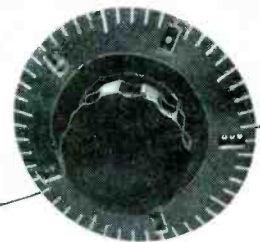

The PW-D micrometer dial can be read direct to one part in 500. It revolves ten times in covering the complete range and fits a $\frac{5}{16}$ " diameter shaft.



**National
Company, Inc.**
Malden, Mass.

MAKERS OF LIFETIME RADIO EQUIPMENT

**HOTFOOT
IN
HADES**

**2100° F
with JELLIFF
RESISTANCE WIRE**

**FOR RELIABLE HEATING
ELEMENTS and RESISTORS**

Even the devil himself could not withstand the extreme temperatures to which Jelliff resistance wires are subjected. Constant research, application study and controlled production assure you fine quality products of superior performance and long life.

Jelliff resistance alloys are used extensively for industrial, radio and electronic equipment; domestic appliances; instruments; transportation apparatus and materials handling equipment.



For specific engineering data applying to your problem, refer to the new and complete 56 page Jelliff Resistance Alloys Catalog.

Write Dept. 201 for Catalog No. 46

DIPPING BASKETS • LEKTROMESH • RESISTANCE WIRE

**The C. O. JELLIFF
MANUFACTURING
CORPORATION**

SOUTHPORT, CONN.

WIRE MESH PARTS • WIRE CLOTH • STRAINERS

WIRE PRODUCTS
SINCE 1880

NEW PRODUCTS

(continued)

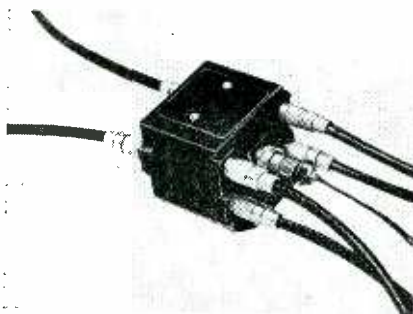

rate radar altimeters. The device is essentially a double-pole, double-throw coaxial switch.

Literature

(58)

Permanent Magnets. Thomas and Skinner Steel Products Co., 1034 East 23rd St., Indianapolis, Ind. Magnets and magnet chargers are this company's business. There are 16 pages of engineering information offered.

(59)

New Data Sheets. E. F. Johnson Co., Waseca, Minn. has data sheets available on the following equipment: f-m Iso-Coupler, phase sampling, tower lighting filters, support for open-wire transmission lines, pressurized capacitors, neutralizing capacitors, and inductors.

(60)

Liquid Level Controls. B/W Controller Corp., 2200 East Maple Road, Birmingham, Mich. Multiple pump controls, starter and relay combinations, electrodes, and the other equipment necessary to an all-electric floatless system are described in Catalog 147.

(61)

Drafting Material. Eastman Kodak Co., Rochester 4, N. Y. A new translucent tracing material is described in a 4-page pamphlet. Kodatracc is made of safety-base film tinted blue and given a fine grain matte surface.

(62)

Power Resistors. International Resistance Co., 401 N. Broad St., Philadelphia 8, Pa. Bulletin C-2 rounds up the line of power wire-wound resistors that can be obtained in ratings from 5 to 225 watts in all

**KIRKLAND
PILOT-LIGHTS**
ARE DISTRIBUTED
NATIONALLY BY

**GENERAL ELECTRIC
SUPPLY CORPORATION.**

**Graybar
ELECTRIC COMPANY, INC.**

**WESTINGHOUSE
ELECTRIC SUPPLY COMPANY**

No. 600 Unit

One of Many Kirkland Units

Underwriters' Approved heavy duty unit for 120V service. S6 bulb. Single hole mounting on 1-3/8" diameter hole. Overall length of threaded area 1-7/16". Also ideal for building Lamp Annunciators (furnished with flat lens for letters or numbers). Write for Catalogue.

THE H. R. KIRKLAND CO.
Morristown, N. J.

FINE INDICATING LIGHTS SINCE 1912

OVER 300 OFFICES... COAST TO COAST

**THE IDEAL PAIR
FOR RECORDING!**

For cutting —

**Brilliantone
RECORDING NEEDLE**

For cutting direct on all coated aluminum, paper or glass base discs. Machine-lapped to insure a mirror-like finish... a clean, quiet-cut groove.

For playback —

**Actone
TRANSCRIPTION NEEDLE
100% Shadowgraphed**

Made to fit the groove cut by the Brilliantone Recording Needle. Used by top radio stations and transcription companies.

Products of
Deeghauw
H. W. ACTON CO., Inc.
Sole Distributor
370 Seventh Ave., New York 1, N.Y.

Send for New Catalog "D" and Current Price Lists.



FRACTIONAL H.P. MOTORS

BLOWER UNITS

CONTROL COMPONENTS



73C & 74C SERIES

115-220 Volts—50, 60 and 400 cycles . . . Continuous duty. Sleeve Bearing . . . Fan Cooled . . . Totally Enclosed. Outside Diam. 3 1/8".

TYPE	H. P.	R.P.M. 60 Cy.
Capacitor	1/15, 1/20, 1/30	1600 & 3200
Shaded Pole	1/30, 1/50, 1/100	1500
Synchronous	1/50, 1/100	1800 & 3600

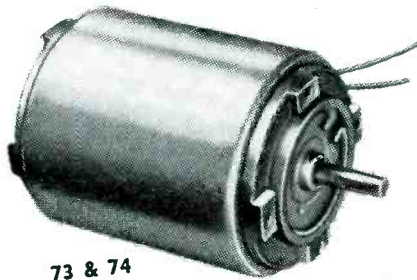

73 & 74 SERIES

115-200 Volts—50, 60 cycles. Fan or Intermittent duty . . . Sleeve Bearing . . . Totally Enclosed. Outside Diam. 3-5/16".

TYPE	H.P.	R.P.M. 60 Cy.
Capacitor	1/20, 1/30, 1/50	1600 & 3200
Shaded Pole	1/30, 1/50, 1/100	1500
Synchronous	1/50, 1/100, 1/200	1800 & 3600



71 SERIES

115-200 Volts—50, 60, 400 Cycles Continuous duty. Sealed Ball Bearings. Totally enclosed. Outside Diam. 3-5/16"—3 3/8".

TYPE	H. P.	R.P.M. 60 Cy.
Capacitor	1/15, 1/20, 1/30, 1/50, 1/100	1600 & 3200
Shaded Pole	1/30, 1/50, 1/100	1500
Synchronous	1/50, 1/100, 1/200	1800 & 3600

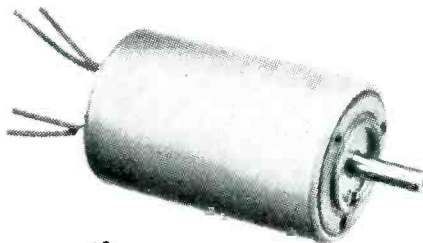

49 SERIES

115 Volts—50, 60, and 400 Cycles. Continuous duty . . . Ball Bearing. Totally enclosed. Outside Diam. 1 3/4".

TYPE	H.P.	R.P.M. 60 Cy.
Capacitor	1/100*, 1/250	2800 & 3100
Torque	5 Oz. In.	45° Only

*Intermittent Duty Only

TYPICAL APPLICATIONS

- Cameras and Projectors
- Chart Recorders
- Floor Fans
- Dispensing Machines
- Timing Apparatus
- Turntables
- Air Conditioning

Eastern Air Devices' units embody all of the important advances in design and construction made during the war. Included are such features as: replaceable "capsule" bearings, snap ring construction for easy disassembly, radically improved cooling means, insuring long life with minimum size and weight, etc. Let us fit an E. A. D. unit to your application.

EASTERN AIR DEVICES, INC.

585 Dean Street - Brooklyn 17, N. Y. Tel. Sterling 3-3408
EAD Foreign Dept.-70 Pine St., N.Y.C. Tel. Whitehall 4-8729



31 SERIES

115 Volts, 400 cycles, 1/25 to 1/100 H. P. Weight of units 15 oz. Diam. 1 15/16". Length 2 29/32".

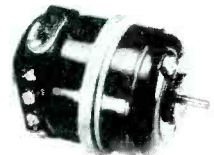

36 SERIES

D.C. Voltage Generators for Control and Tachometer applications . . . 2 Volts per hundred R. P. M. Permanent magnet field . . . weight, 20 oz. Diameter 2 1/4". Length 3".



ALTERNATORS

Special Alternators designed for any application. 20 to 1000 cycles up to 50 watts. Specialists in permanent magnet designs.

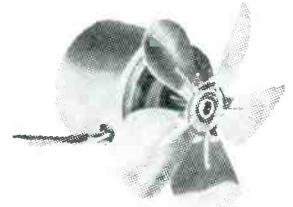

AXIAL FLOW BLOWERS

Numerous types for 50, 60 and 400 Cycle application. 170 to 800 C.F.M. (NEMA Code). 65 to 300 C.F.M. (NAFM Code). Designed for use in electronic or industrial equipment.

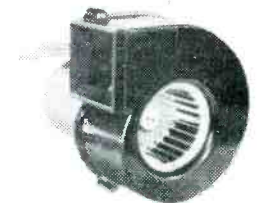

CENTRIFUGAL BLOWERS

Numerous Types for 50, 60 and 400 Cycle application. 60 to 110 C.F.M. For use in electronic or industrial equipment.

THE
ANSWER
TO YOUR
CONDENSER
Requirements

...is in YOUR HANDS

... when you use the handy BUD Catalog! In it, you find not only BUD precision-built Condensers for every application, but an almost limitless range of the latest-type radio and electronic parts. BUD keeps your requirements in hand by supplying them promptly. Build with BUD . . .

BUD Can Supply All Your Needs . . .

... with the latest types of equipment including: condensers — chokes — coils — insulators — Plugs — Jacks — switches — dials — test leads — jewel lights and a complete line of ultra-modern cabinets and chassis.

BUD

BUD RADIO, INC.
Cleveland 3, Ohio

the usual types, inductive or non-inductive, fixed or adjustable, high temperature or high humidity coatings.

(63)
Densitometers. L. J. Long Co., 198 Lorraine Ave., Montclair N. J. The model D-2 and D-4 photoelectric densitometers are described in a brochure that also indicates their uses.

(64)
Laboratory Equipment. Measurements Corp., Boonton, N. J. A new catalog-type 4-page folder describes signal generators, pulse generators and radio-frequency test equipment.

(65)
Control Instruments. Wheelco Instruments Co., 847 W. Harrison St., Chicago 7, Ill. Information contained in Bulletin No. 3-6400 is interestingly presented by means of photographs and drawings combined to show external appearance and working principles of a line of electronic controls.

(66)
Corrosion Proofing. Aircraft-Marine Products, Inc. 1523 N. 4th St., Harrisburg, Pa. Said to be an exclusive process for the protection of electrical connections against corrosion, the AMP system is described in a four-page folder.

(67)
Insulating Varnishes. General Electric Co., Pittsfield, Mass. A 40-page booklet contains specifications, electrical properties, film properties, cure and aging, chemical properties and baking and air drying cycles of each type of varnish and insulating enamel.

(68)
Electrical Test Equipment. Industrial Instruments, Inc., 17 Pollock Ave., Jersey City 5, N. J. Bridges, resistor decades, breakdown testers, and similar equipment are listed in Catalog 10.

(69)
Air Trimmer. North American Philips Co., Inc., 100 East 42nd St., New York, N. Y. A 4-page folder

Accurate Timing
Saves Money . . . Material . . . Manpower

Cut your production costs, increase your output by controlling process cycles with versatile, efficient electric synchronous motor timers. Use them in your own operations; specify Industrial Timers for your products. You get longer service and unquestioned accuracy with Industrial Timer equipment.

Two widely used Industrial Timers!

Time Delay Series—May be incorporated in assembly as a unit. Meter type mount allows flush panel installation. Automatic re-set, adjustable timing cycle up to 5 minutes. Small size. Both screw and solder type terminal connection. Available in various voltages and frequencies. Used on conveyors, molding presses, in diathermy and vacuum tube operation.

Automatic Re-Set Timer—P Series—Controls time of exposure to light, heat, electric current or agitation. Instant push-button operation—automatic re-set. Can be operated by remote control positions. Available in maximum time cycles from 15 seconds to minutes.

We manufacture more than 400 types of electric time controls for specific jobs. Write us your requirements.

INDUSTRIAL TIMER CORPORATION
111 EDISON PLACE • "KNOWN THE WORLD OVER" NEWARK, N. J.

**CORRECT
LIGHTING
IS *fitted*
TO THE PERSON
...TO THE JOB**

The man at the bench needs concentrated light. The typist wants illumination over a greater spread. The lighting *you* might prefer would probably differ from that suitable for an inspector, draftsman or operator of a bookkeeping machine. How, then, can you provide efficient localized lighting for such varied conditions?

You'll find your answer in the Dazor *Floating Lamp*. For Dazor lighting is individually fitted to the user, to the job. Each employee gets *enough* light for clear, easy seeing...light that is *properly placed* to free eyes from the strain of shadows and glare. With no more effort than pointing a flashlight, the hand *floats* the Dazor reflector to any desired position. Held firmly by the patented Dazor

Floating Arm, it stays until purposely shifted.

By installing this personalized lighting for precision work in shop or office you encourage higher production, curb errors and waste, promote well-being and safety. And note, please, that modern design makes the Dazor Lamp an *attractive* addition to your equipment.

Phone Your Dazor Distributor for more detailed information or a demonstration. If unacquainted with this distributor of improved lighting, write for his name to Dazor Manufacturing Corp., 4481-87 Duncan Ave., St. Louis 10, Mo. In Canada address inquiries to Amalgamated Electric Corporation Limited, Toronto 6, Ontario.

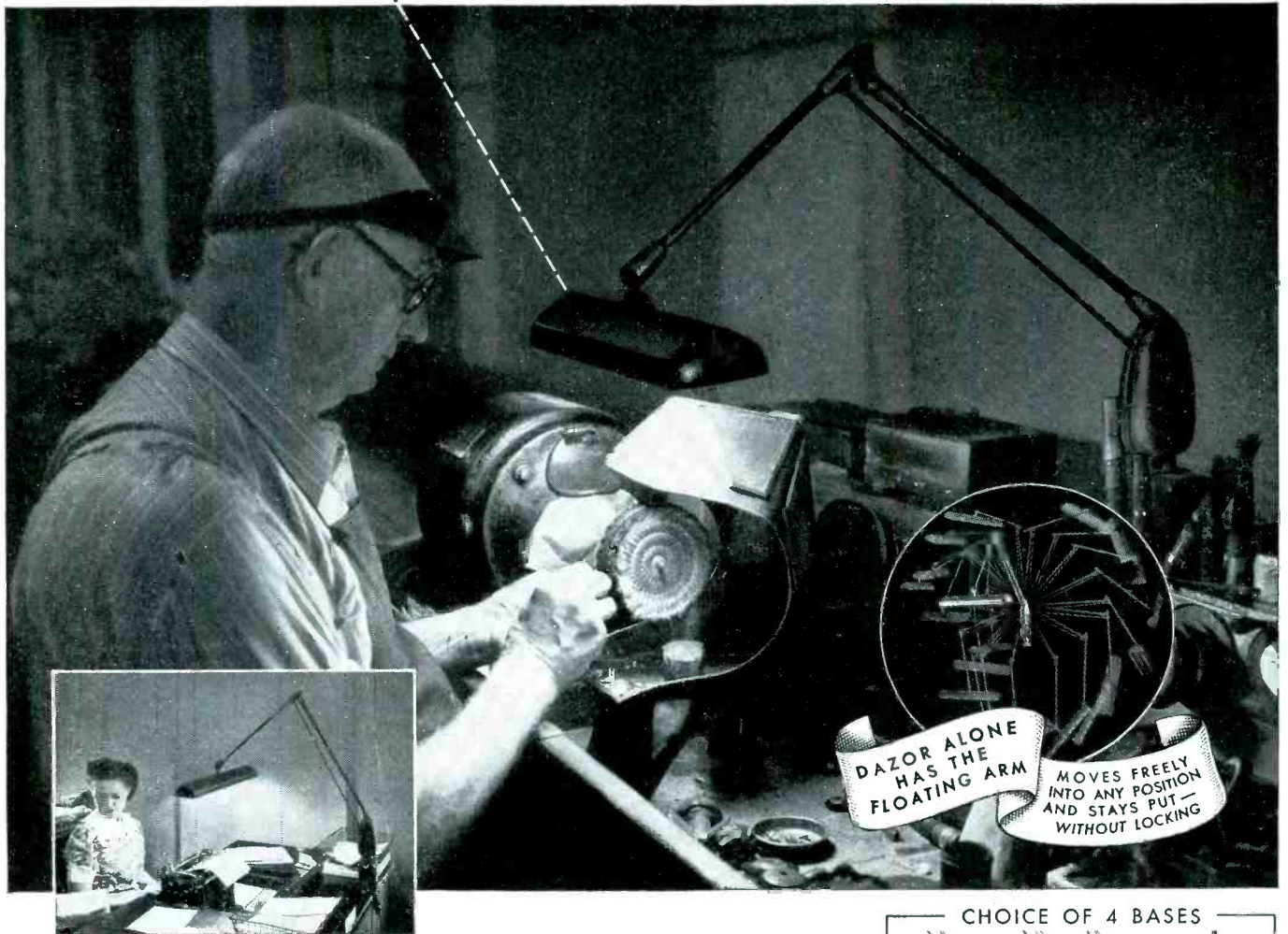

DAZOR FLOATING LAMPS

FLUORESCENT and INCANDESCENT

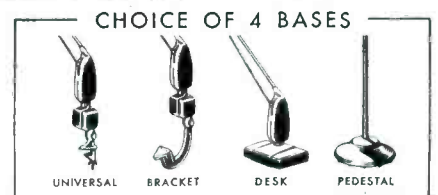

WANTED:

Chief Engineers Studio Engineers

Transmitter Engineers for 700 FM Broadcast Stations

—the F.C.C. predicts
will be in operation
by the end of 1947



YES, Plenty of Good-Paying Jobs ... But Only for Those Qualified

700 new FM stations says the F.C.C. By next year there will be 3 times as many broadcasting stations (AM, FM and TV), as there were before the war.

Radio is not only expanding in job opportunities, but it is also growing in technical complexity. Rapid developments in the field of radio-electronics are leaving many old-time radio men far behind the parade. These are the men who fail to realize that their technical knowledge must grow with the expansion of radio itself.

What does this mean to you? It means you must study to hold your job ... and to qualify for the better job you want. CREI modern technical training can (within a comparatively short time) enable you to step ahead of those who have failed to improve their ability through technical training.

Get all the facts today. Learn how CREI spare time technical training can help you as it has helped thousands of other professional radiomen advance to better jobs during the past twenty years.

**VETERANS! CREI training is
available under the G. I. Bill**

CAPITOL RADIO ENGINEERING INSTITUTE

An Accredited Technical Institute

Dept. E-6, 16th & Park Rd., N. W.
WASHINGTON 10, D. C.

**MAIL COUPON TODAY FOR
24 PAGE FREE BOOKLET!**

CAPITOL RADIO ENGINEERING INSTITUTE
16th & Park Road, N. W., Dept. E-6, Wash. 10, D. C.

Gentlemen: Please send me your free booklet, "CREI training for your better job in RADIO-ELECTRONICS", together with full details of your home study training. I am attaching a brief resume of my experience, education and present position.

CHECK PRACTICAL RADIO ENGINEERING
COURSE PRACTICAL TELEVISION
ENGINEERING

NAME

STREET

CITYZONE.....STATE.....

I am entitled to training under the G. I. Bill.

NEW PRODUCTS

(continued)

describes a new-type air trimmer capacitor that is simple to adjust, has high insulation resistance and a high Q.

(70)

Special C-R Tubes. Electronic Tube Corp., 1200 East Mermaid Ave., Chestnut Hill, Philadelphia 18, Pa. Detailed data sheets are now available on the new 3- and 5-inch cathode ray tubes of the polar co-ordinate type originally postulated by von Ardenne.

(71)

Magnetic Iron Powder. Geo. S. Mephram Corp., 2001 Lynch Ave., East St. Louis, Ill. Twenty-eight pages of a booklet are required to tell the story of various types of powder used in high-frequency cores.

(72)

Testing Equipment. Radio City Products Co., Inc., 127 West 26th St., New York 1, N. Y. Catalog 129 lists a variety of multitest meters and associated apparatus, including test leads.

(73)

Relays. R-B-M Division, Essex Wire Corp., Logansport, Ind. Bulletin 570 just issued covers the line of 9800 Series relays for a-c and d-c use.

(74)

Thermoswitches. Fenwal Inc., Ashland, Mass. Heat control and temperature detection devices are summed up in the latest catalog that includes dimensions and specifications for available apparatus.

(75)

Capacitors. Herlec Corp., 422 North Fifth St., Milwaukee 3, Wis. Letter catalog sheets may be had for the Type A ceramic trimmer and metal cup capacitors useful at high frequencies.

(76)

F-M Antennas. Ward Products Corp., 1523 East 45th St., Cleveland 3, Ohio. A new line of f-m dipoles and folded-dipole antennas for operation in the 88 to 108 mega-



It's a GREENOHM!

★ Specify "GREENOHMS" if you want the toughest things in power resistors. For Greenohms are those green-colored cement-coated power resistors found in the finest receivers, amplifiers, transmitters and other electronic assemblies.



Greenohms have proved that "they can take it" day after day, year in and year out. Handle heavy overloads without flinching. The exclusive cold-setting cement coating means that the wire winding is unimpaired in fabrication. Withstands high operating temperatures, sudden cooling, frequent on-off operation, without cracking, flaking, peeling. No tougher power resistors are made.



Fixed and adjustable types. In standard types, 5 to 200 watts. Special units to order.



★ Write for DATA . . .

Bulletin 113 sent on request. Contains all necessary engineering data on standard and special Greenohms to meet your resistance needs. Let us quote!



CLAROSTAT MFG. CO., Inc. · 285-7 N. 6th St., Brooklyn, N. Y.

Let's get together!
YOU have the spring problem

WE have the spring materials



Whatever combination of conditions your springs must fight...

CORROSION • RUST • HEAT • COLD • HIGH STRESS • FATIGUE

Whatever type of spring you need...

COMPRESSION • EXTENSION • TORSION • SPIRAL • FLAT • CLIP • RETAINER • GARTER • BANANA

Consider these alloys first...

MONEL* • "K" MONEL* • INCONEL* • "Z" NICKEL* • NICKEL

There is no need to put up any longer with repeated troubles that can be avoided by using INCO Nickel Alloy springs for corrosive conditions and elevated or sub-zero temperatures.

Now, rustless, high-strength springs can be made of five different INCO Nickel Alloys to withstand corrosive attack and temperatures up to 750°F. or even higher.

And they cost so much less than special alloy springs that it is practical to use them for any application where heat, corrosion or fatigue are causing you trouble with ordinary spring parts.

NICKEL  **ALLOYS**



HERE'S A CHANCE TO GET RID OF THE SPRING PROBLEM THAT HAS BEEN BOTHERING YOU

Send for "ANALYZING THE SPRING PROBLEM." When you get this simplified worksheet, jot down the data about your spring problem and what you want in a spring. The information you supply, plus our service records and test data, will enable us to judge which material can be recommended for your particular service. Then, we will cooperate with your spring manufacturer to work out the answer to your problem. That is all you need to do. Write today for "ANALYZING THE SPRING PROBLEM."

THE INTERNATIONAL NICKEL COMPANY INC., 67 WALL STREET, NEW YORK 5, N. Y.

ANOTHER SPECIAL BY PROGRESSIVE

QUALITY PROMCO BRAND

CATALOG SHOWS DOZENS MORE

Special heads, threads and finishes on any metal or alloy adapted to cold upset. Weekly output: 25,000,000 pieces. Many specials, suggesting production savings for you, illustrated in latest catalog. Includes weights per 1M standard pieces, dec. equivs. of fractions, other purchasing and engineering helps. Write for Catalog 18.

The PROGRESSIVE MFG. CO.
50 NORWOOD ST. TORRINGTON, CONN.

1. AMPLE POWER

2. CONSTANT SPEED WHETHER "HOT" OR "COLD"

3. DYNAMICALLY BALANCED

4. EFFECTIVE CUSHIONING

Model GI-RM 4
Recording Motor
(78 RPM)

Smooth Power... AND PLENTY OF IT!

These four important features of GI-RM4 Recording Motors assure high recording fidelity, because:

- 1. AMPLE SMOOTH POWER** meets every recording (or play-back) requirement.
- 2. CONSTANT SPEED**, whether motor is "hot" or "cold" prevents instantaneous speed changes.
- 3. DYNAMICALLY BALANCED**... each rotor is dynamically balanced in special built instruments.
- 4. EFFECTIVE CUSHIONING** throughout motor guards against vibration dangers.

Send for details on additional advantages of GI-RM4 Recording Motors... and on the complete *Smooth Power* line of phonomotors, recorders and combination record-changer recorders.

THE GENERAL INDUSTRIES CO.
DEPT. ME • ELYRIA, OHIO

NEW PRODUCTS

(continued)

300-ohm colinear transmission line. Catalogs are free.

(77)

Tubing Samples. Varflex Corp., Rome, N. Y. Twenty-five samples of various types of insulating sleeving give a clear picture of the character of the product. Availability and dimensions are listed in the folder.

(78)

Audio Equipment. The Daven Co., 191 Central Ave., Newark 4, N. J. A 12-page interim catalog covers a period between regular publications to list attenuators, networks, potentiometers, volume-level indicators and similar audio test equipment.

(79)

New Service Manual. John F. Rider Publisher, Inc., 404 Fourth Ave., New York 16, N. Y. Volume XV of the Rider Manual series is now available. Among other information included in the volume is data on record players and changers, ham receivers, and the Scott line of receivers.

(80)

Sheet Metal. Karp Metal Products Co., Inc., 139 30th St., Brooklyn, N. Y. A new two-color, 8-page brochure is devoted to illustrations of the types of jobs completed and the facilities available for making metal enclosures.

Components Catalog. General Instrument Corp., 829 Newark Ave., Elizabeth 3, N. J. A limited number of copies of a catalog listing capacitors, record changers, loudspeakers and engineering data, are available. Make requests on company stationery and give title.

Receiving Tubes. Sylvania Electric Products Inc., Emporium, Pa. A new 378-page manual with ring type plastic binder contains data for 545 tube types. Purchase this directly from the manufacturer (or a distributor) for 85¢.

Coil Reprint. General Radio Co., 275 Massachusetts Ave., Cam-



**Have you looked
inside your
loudspeaker lately?**

Let's look into the busy end of your radio . . . into the part that does the talking. The loudspeaker owes much of its fine, full, clear tone quality to the magic aid of the permanent magnet. Particularly in the construction of FM radios, where the finest acoustical quality attainable is desired, permanent magnet speakers are proving their excellence. The widespread popularity of permanent magnet speakers is well demonstrated by production records. Over 12 million speaker magnets such as those shown below have been made by *The Indiana Steel Products Company* since World War II.

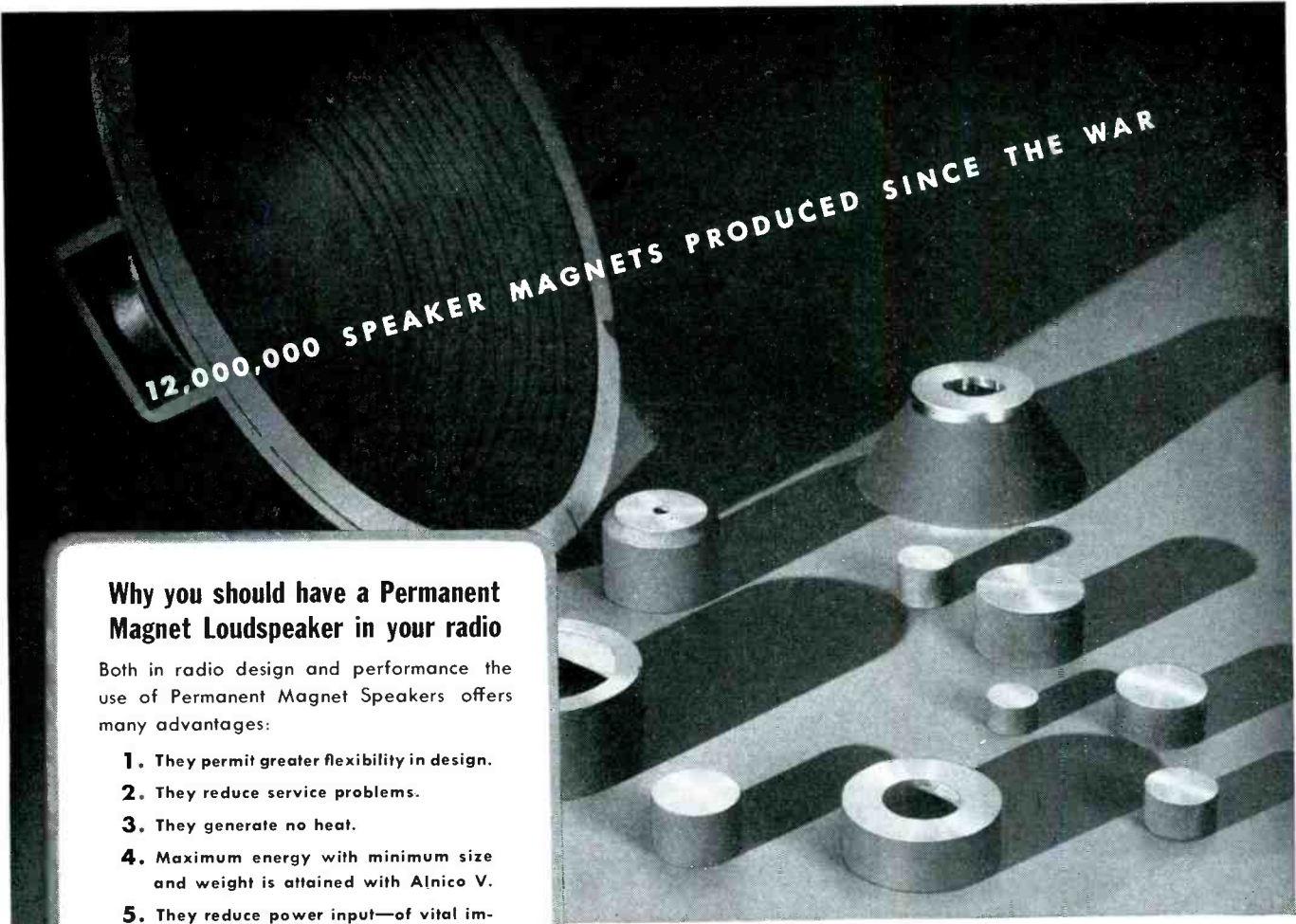

Why you should have a Permanent Magnet Loudspeaker in your radio

Both in radio design and performance the use of Permanent Magnet Speakers offers many advantages:

1. They permit greater flexibility in design.
2. They reduce service problems.
3. They generate no heat.
4. Maximum energy with minimum size and weight is attained with Alnico V.
5. They reduce power input—of vital importance in automobile radios. They avoid drain on car battery.

"THE FUTURE IS SOUND"

World War II brought many technological advances. New materials now make possible magnet designs which were formerly impractical. ALNICO V, undoubtedly the best known example, is now used almost universally in the manufacturing of speaker magnets.

Watch for INDALLOY.

©1947, The Indiana Steel Products Co.

Investigate the use of permanent magnets in your radio speaker. As the largest producer of permanent magnets for loudspeaker use, *The Indiana Steel Products Company* offers you an exceptional permanent magnet engineering design service . . . complete from plan to finished product. Versatile in finding the most practical solution to your magnet problem, whatever it may entail, our engineers welcome the opportunity to be of assistance.



★ **THE INDIANA STEEL PRODUCTS COMPANY** ★

PRODUCERS OF "PACKAGED ENERGY"
6 NORTH MICHIGAN AVENUE ★ CHICAGO 2, ILL.



SPECIALISTS IN PERMANENT MAGNETS SINCE 1910
PLANTS | VALPARAISO, INDIANA
| STAMFORD, CONN.

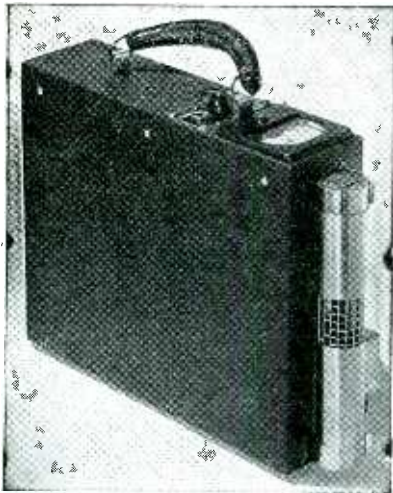

Model 263

A portable self-contained Geiger-Mueller counter for beta and gamma radiation. Geiger tube externally mounted and detachable from clip. Meter scale calibrated in 3 ranges with gamma radiation from radium. Equipped with head phones for aural counting. An instrument with a distinctive background of service.

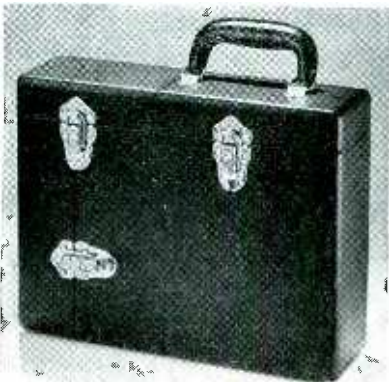

Model 262

The Radiation Meter is a roentgen calibrated instrument used to measure scattered radiation in the vicinity of x-ray or gamma ray equipment. The instrument is calibrated to indicate a top scale reading of two milli-roentgens per minute. It is ideal to spot check installations for scattered radiation to determine any need for additional protection.

THE VICTOREEN INSTRUMENT CO.
5806 HOUGH AVENUE
CLEVELAND 3, OHIO

NEW PRODUCTS

(continued)

bridge 39, Mass. GR will be glad to forward a copy of the reprint entitled "Iron-Cored Coils for Use at Audio Frequencies" provided the request is made direct to them on company letterhead.

Finishes For Aluminum. Reynolds Metals Co., Inc., 2500 So. Third St., Louisville 1, Ky. Two volumes present the story of aluminum finishes, the second being of somewhat greater interest to the engineer who will want to know how the different processes are accomplished. Send direct to Reynolds for your copies at \$2.00 the set.

Stroboscope Correction. Universal Microphone Co., Inglewood, Calif. Four circles divided for checking accurate speed of 78 and 33½ rpm turntables under 25, 50, or 60 cycle light are printed on a single 6-inch cardboard disc. Send 25¢ direct to the manufacturer for this item. Price quoted in the May issue of ELECTRONICS was in error.

Tube Registry

The information furnished by the RMA Data Bureau has been abridged and only the more significant dimensions are given.

Type 5527

Iconoscope, heater type, electrostatic focusing and deflection, 12-pin base. Maximum mosaic illumina-

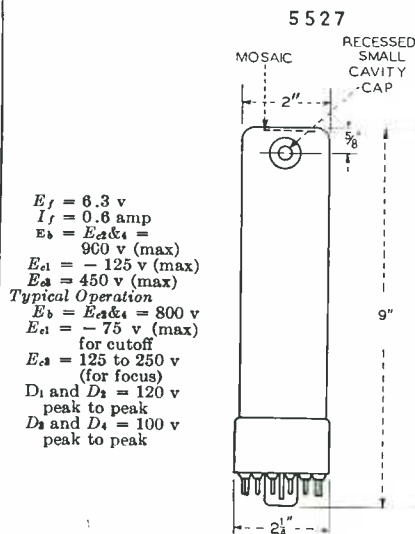

tion is 50 foot-candles and temperature 40 C. Minimum peak-to-



How fast can a screw go? Sounds screwy? It's not! There's a case of a large Eastern manufacturer of electrical appliances (name on request). His assembly line was hopelessly slowed down. Production was hitting new lows when he called in our Engineering Department. We designed new screw parts that could be assembled faster — thereby speeded up production. It also saved him money and resulted in a better product. Perhaps we can do as much for you. It costs nothing to find out.

NEW ENGLAND SCREW CO.
Manufacturers of Special Screws
KEENE, NEW HAMPSHIRE

TERMINALS
for **ELECTRIC WIRES**

Banding Clips
Small Metal Stampings

- *in accordance with Customer's Prints*
- **ACCURACY**
- **PRECISION**
- **REASONABLE DIE CHARGES**

Modern Equipment and Factory
No Screw Machine Parts

PATTON - MacGUYER COMPANY

17 VIRGINIA AVENUE
PROVIDENCE, R. I.

"QUIET JUNIOR! Daddy's doing his homework"



Junior's old gent is a busy man.

He has to have plenty of "know-how" to keep on top of his job.

Sometimes it takes home-work to keep abreast of things and right now he's reading this issue of this McGraw-Hill magazine—the one you are holding in your hand.

Obviously, he's not looking for glamour, amusement, or entertainment. *He is strictly on the make for ideas.*

He wants to know what the other fellow

is doing — what's new in methods and processes that will help him do a better job.

He's an avid reader of the ad-pages as well as the editorial content. The advertisements along industry's shopping street give him an opportunity to inspect the products and services of America's leading manufacturers — and he examines them with an eye to what they can do for him.

Yes — Junior's old gent is a busy man. But he never misses a trick!

To keep in touch with the parade . . . read the ads.

ALNICO

permanent MAGNETS

- Specialists in the production of highest grade Alnico Magnets.
- Production and material rigidly inspected to assure highest uniform quality.
- Castings made to order from customer's blueprints or sketches.
- Information and suggestions supplied on request.

Manufacturers of High Coercive Magnetic Alloys

GENERAL

10001 ERWIN AVENUE
DETROIT 5, MICHIGAN



MAGNETIC CORPORATION

ZOPHAR

Waxes, Compounds and Emulsions



Materials for potting, dipping or impregnating all types of radio components or all kinds of electrical units. • Tropicalized fungus proofing waxes. • Waterproofing finishes for wire jackets. • Rubber finishes. • Inquiries and problems invited by our engineering and development laboratories.

Zophar Mills, Inc. has been known for its dependable service and uniformity of product since 1846.

ZOPHAR MILLS, Inc.

ESTABLISHED 1846

117 26th STREET, BROOKLYN, 32 N. Y.

PREMAX



Tubular Vertical Types Designed in

Steel
Monel
Aluminum
Stainless Steel

Sturdy, rugged . . . yet light-weight Antennas that have stood the test in marine, commercial and amateur installations. Send for Catalog No. 11, describing the standard antenna styles, mountings and insulators.

Premax Products

Division Chisholm-Ryder Co., Inc.

4711 Highland Ave. Niagara Falls, N. Y.

THERE'S A DRAKE SOLDERING IRON FOR EVERY TYPE OF ELECTRONIC WORK

From that mighty mite



the Drake No. 400 to the high-speed production "honey"



the Drake No. 600-10 there is a high quality Drake Soldering Iron "just right" for the job.

Drake Heat Controls and the Drake "Magic Cup" Stand are important soldering aids.



SEE
YOUR RADIO
PARTS JOBBER

DRAKE ELECTRIC WORKS, INC.

3656 LINCOLN AVE. CHICAGO, ILL.

peak blanking voltage is 30 volts; signal output current is 0.025 μ amp; output resistor, 1 megohm.

Type 195

Triode power amplifier and oscillator, filament type. Maximum ratings up to 15 mc; resonant grid-

- $E_f = 10$ v
- $I_f = 3.25$ amp
- $\mu = 12$
- $g_m = 1,200$ μ mhos
- $C_{in} = 2.2$ μ mf
- $C_{out} = 1.2$ μ mf
- $C_p = 2.8$ μ mf
- $E_b = 3$ kv (rms)
- $I_b = 150$ ma (max)
- $E_c = -500$ v
- $E_o = 750$ v (r-f)
- $I_o = 40$ ma (d-c)
- $W = 125$ watts (max)

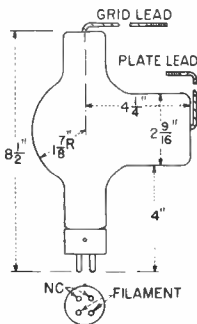

plate frequency approximately 200 mc.

Type 196

Triode power amplifier and oscillator, filament type. Maximum ratings up to 15 mc; resonant grid-plate frequency approximately 200 mc.

See illustration for Type 195 for dimensions.

- $E_f = 10$ v
- $I_f = 3.25$ amp
- $\mu = 35$
- $g_m = 1,600$ μ mhos
- $C_{in} = 2.4$ μ mf
- $C_{out} = 1.4$ μ mf
- $C_p = 3$ μ mf
- $E_b = 3$ kv (rms)
- $I_b = 150$ ma (max)
- $E_c = -500$ v (max)
- $E_o = 750$ v (r-f) (max)
- $I_o = 40$ ma (d-c) (max)
- $W_p = 125$ watts (max)

Type 3MP1

Cathode ray tube, heater type, electrostatic focusing and deflection, green fluorescence, medium persistence, small shell duodecal 12-pin base, type 12F.

- $E_f = 6.3$ v
- $I_f = 0.6$ amp
- Typical Operation*
- $E_{s2} = 2$ kv
- $E_{b1} = 400$ to 700 v
- $E_{c1} = 0$ to 126 volts (for cutoff)
- D_1 and $D_2 = 280$ to 380 v per in.
- D_2 and $D_3 = 260$ to 360 v per in.

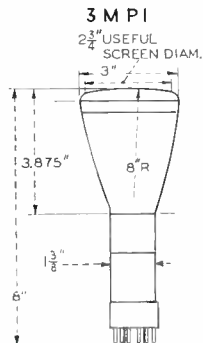

YOU GET BOTH WITH S.S. WHITE FLEXIBLE SHAFTS

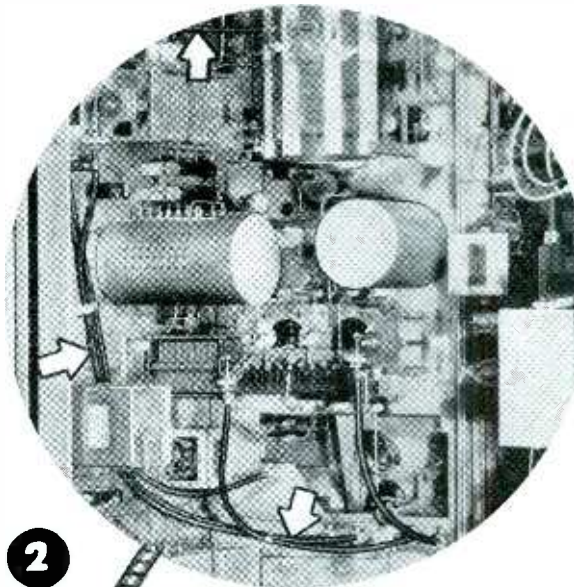

1 OPTIMUM CIRCUIT EFFICIENCY

2 MAXIMUM TUNING CONVENIENCE

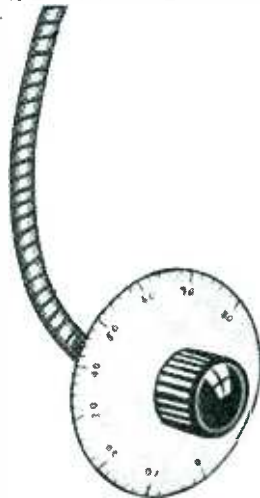

By using S. S. White remote control flexible shafts to couple variable elements to their control knobs, you gain **unrestricted freedom in placing both the elements and the knobs**. This allows the elements to be mounted in the most favorable position for circuit efficiency and ease of assembly and wiring, while the knobs can be centralized in the most convenient control position. And because these shafts are specially engineered for remote control duty, they operate as smoothly and sensitively as a direct connection. For the full story—

WRITE FOR THIS 260-PAGE FLEXIBLE SHAFT HANDBOOK

which completely covers the subject of flexible shafts and how to apply them. For your free copy write direct to us on your business letterhead and mention your position.



S.S. WHITE INDUSTRIAL DIVISION
THE S. S. WHITE DENTAL MFG. CO. DEPT. E, 10 EAST 40th ST., NEW YORK 16, N. Y.



FLEXIBLE SHAFTS - FLEXIBLE SHAFT TOOLS - AIRCRAFT ACCESSORIES
SMALL CUTTING AND GRINDING TOOLS - SPECIAL FORMULA RUBBERS
MOLDED RESISTORS - PLASTIC SPECIALTIES - CONTRACT PLASTICS MOLDING

One of America's AAAA Industrial Enterprises

HEAVY THRUST LOADS MICRO PIVOT BEARINGS

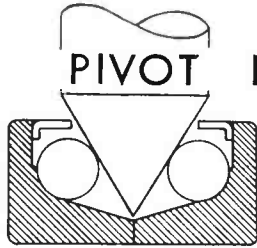

An extra-small unit providing:

- High load capacity
(Thrust, Radial, combined)
- Lowest Friction
- Precision Tolerances
- Dust Shield
- Unaffected by Misalignment

PIVOT BEARINGS
5/32" to 3/8"

RADIAL BEARINGS
1/4" to 3/8"

NEW HAMPSHIRE BALL BEARINGS, Inc.
3 MAIN STREET • PETERBOROUGH, NEW HAMPSHIRE, U. S. A.

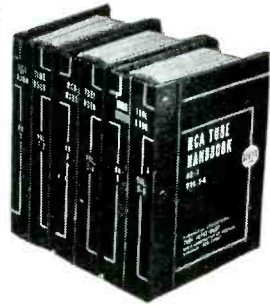

KEEP continually POSTED on ELECTRON TUBES

RCA HB-3 Tube Handbook Now in 3 Binders—6 Volumes

No other tube handbook provides as much up-to-the-minute technical data on tube types as the RCA HB-3 Handbook, which has been a standard technical reference book for over 15 years. Indexed contents include general data, characteristic curves, socket connections, outline drawings, price lists, preferred-type lists, etc., for the complete line of RCA tubes.

New Sheets Mailed Regularly. The U. S. subscription price of \$10.00 brings you the complete Handbook in three binders, plus supplementary sheets containing new or revised data as issued during the year. Annual service fee thereafter is \$2.00. (These prices apply only in the U. S. and its possessions.)

Subscribe Now. Insure early delivery. Mail your remittance today to: RCA, Commercial Engineering, Section W-40F, Harrison, N. J.



EISLER ELECTRICAL & ELECTRONIC EQUIPMENT ELECTRONIC TUBE EQUIPMENT

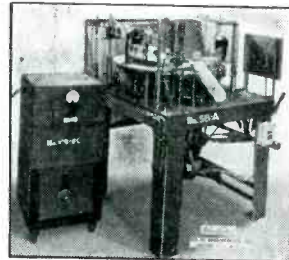

24 HEAD
RADIO TUBE
EXHAUSTING
MACHINE

We Make Complete Equipment For The Manufacture Of Incandescent Lamps and Electronic Tubes.

TRANSFORMERS OF ALL TYPES

For
LIGHTING
POWER
FURNACES
PHASE
CHANGING
DISTRIBUTION
ETC.

Air, Oil,
or Water
Cooled

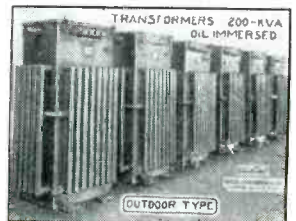

Sizes 1/4 To 250 KVA

**SPOT WELDERS
OF ALL TYPES
FOR ALL PURPOSES
SIZES 1/4 TO 250 KVA**

Butt Welders - Gun Welders
Arc Welders
Neon Sign Units
Fluorescent Tube
Manufacturing Equipment



**CHAS. EISLER
EISLER ENGINEERING CO., INC.**
751 So. 13th St. (Near Avon Ave.), Newark 3, N. J.

DESIGNED FOR DISCRIMINATING MANUFACTURERS

Leakproof

ENAMELED MAGNET WIRE

A product, resulting from many years of research in the field of fine wire manufacture, that meets the most rigid requirements of radio and ignition coils.

A new coating method gives a smooth, permanently-adherent enameling, and mercury-process tests guarantee perfect uniformity. Great flexibility and tensile strength assure perfect laying, even at high winding speeds. If you want reduction in coil dimensions without sacrificing electrical values, or seek a uniform, leakproof wire that will deliver extra years of service, this Hudson Wire product is the answer.

Winsted
HUDSON WIRE CO.
Division

WINSTED • CONNECTICUT



QUALITY

UNIFORMITY

SERVICE

Also manufacturers of high grade cotton and silk covered wires, cotton and silk coverings over enamel coated wires, and all constructions of Litz wires. A variety of coverings made to customers' specifications, or to requirements determined by our engineers. Complete design and engineering facilities are at your disposal; details and quotations on request.

NEWS OF THE INDUSTRY
(continued from p 154)

transmitters, telecommunication equipment, radar, and electronic equipment for industrial and commercial applications. Special emphasis will be given to welcoming overseas visitors and to reestablishing the high standard of British electronic engineering in export markets. Demonstrations of television equipment will be from a common antenna input.

Standard Electrical Symbols

A NEW master standard containing 152 basic graphical symbols for use in power, control, and communication has been issued by the American Standards Association. The symbols have previously been available in separate standards, but the new work makes it possible to build up practically any required symbol in the separate standards from the basic elements given in the master code. Thus, any complete tube symbol can be produced from the basic electrode symbols given.

The new standard, designated Z32.12-1947, "Basic Graphical Symbols for Electric Apparatus", is available at 40 cents from American Standards Association, 70 E. 45th St., New York 17, N. Y.

FCC Approves Recorders

THE COMMISSION on March 24 adopted a report looking toward authorization of recording devices in connection with interstate and foreign message toll telephone services, but postponed issuance of a final order pending a public engineering conference, scheduled for April 21, upon which engineering standards to cover the use of these devices can be based.

In its report the Commission found that there is a real and legitimate need for telephone recording devices, that their use does not impair the quality of telephone service, that parties to telephone conversations should have adequate notice that the same is being recorded, and that all such devices should be capable of being physically connected to and disconnected from the telephone line at the will of the user. Adequate notice would

new

CONCORD

Radio

Catalog



**Industrial
Electronic
and Test
Equipment**

free

Radio Hams • Servicemen • Engineers
Sound Men • Maintenance Men
Schools • Institutions • Manufacturers
THIS CATALOG IS FOR YOU!
Mail COUPON TODAY!

Radio Parts—Sets—Ham Gear—Amplifiers

It's here—ready for you now—the new, comprehensive, 1947 Concord Catalog displaying a vast, complete selection of everything in Radio and Electronics. Send for your copy now. Select your needs from value-packed pages showing thousands of items available for IMMEDIATE SHIPMENT—hundreds of them now available for the first time—featuring new, latest 1947 prices. See the new LOWER prices on finest-quality RADIO SETS, PHONO-RADIOS, RECORD CHANGERS, RECORD PLAYERS, PORTABLES, AMPLIFIERS, COMPLETE SOUND SYSTEMS, TESTERS. See complete latest listings of all the well-known, standard, dependable lines of radio parts and equipment—tubes, condensers, transformers, relays, resistors, switches, speakers—all available for IMMEDIATE SHIPMENT from huge stocks in CHICAGO and ATLANTA. Whatever your needs in Radio and Electronic Parts, Supplies and Equipment—before you buy—SEE THIS GREAT NEW CONCORD CATALOG. Mail coupon for your FREE copy now.



CONCORD
RADIO CORPORATION
CHICAGO 7 ★ ATLANTA 3
901 W. JACKSON BLVD. 265 PEACHTREE ST.
LAFAYETTE RADIO

Concord Radio Corporation, Dept. G-67
901 W. Jackson Blvd., Chicago 7, Ill.
Yes, rush FREE COPY of the comprehensive new Concord Radio Catalog.

Name

Address

City State

A New VULCAN PLUG TIP Soldering Tool

ALL PARTS REPLACEABLE

1 Remove
4 screws

and you can replace
Heating Element
in a few seconds

UL

5 SIZES

from 1/4" dia. tip to 1" dia. tip

STURDY · LONG LIVED
VERY EFFICIENT · LOW COST

VULCAN ELECTRIC COMPANY
DANVERS MASS.

Makers of a wide variety of Heating Elements for assembly into manu-
facturer's own products and of Heating Specialties that use electricity.

Send for descriptive
literature

PERMEABILITY TUNERS

SUPERHETERODYNE TUNERS

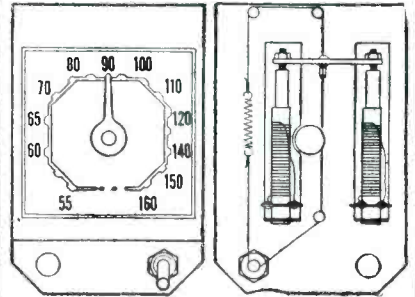

- 535 to 1660 KC Complete
- 3 Color Dial and Drive
- AH units Pre-Tracked at Factory

AERMOTIVE EQUIPMENT CORP.

1632 Central St. Kansas City, Mo.
New York Office
H. BRAVERMAN
161 Washington St. N. Y. 6, N. Y.

TRIODE PERFORMANCE

*The superiority of a
triode amplifier is
most apparent in the
final test...listening*



★TRIODE TUBES used throughout. 2—6B4G, 4—7A4, 2—7N7, 1—5U4G, 1—5Y3G.

★Three push-pull stages preceded by an inverter stage.

★Interstage transformer insures good push-pull balance.

★Flat within 1 db to 25 cycles at full power and to 4 cycles at reduced power.

★Flat within 0.2 db to 30,000 cycles.

★0.6% harmonic distortion and 0.2% intermodulation distortion at 5 watts.

★Rated power—30 watts at 2 1/2% total distortion.

★AUTOMATIC BIAS CONTROL greatly increases undistorted power at moderate cost.

★Gain—55 to 120 db in various models.

★Bass and treble compensation—Two-stage tapped condenser-resistor networks.

★Input—38, 150, 500/600 and 500,000 ohms. Output—1.5 to 30 ohms and 500 ohms.

★Power available for other units—250 volts, 0.090 A DC; 6.6 volts, 5 A.

★Fuses—Main power and 6B4G plate line.

★Attractively finished chassis. High quality components. Finest workmanship.

The BROOK HIGH QUALITY AUDIO AMPLIFIER



Designed by LINCOLN WALSH

BROOK ELECTRONICS, Inc., 34 DeHart Place, Elizabeth 2, N. J.

JONES 2400 SERIES PLUGS and SOCKETS



P-2406-CCT



S-2406-SB

A new series of Plugs and Sockets designed for highest electrical and mechanical efficiency. Improved Socket Contacts provide 4 individual flexing surfaces which make positive contact over practically their entire length.

The Contacts on both Plugs and Sockets are mounted in recessed

pockets greatly increasing leakage distance, increasing voltage rating. Molded BM 120

Bakelite insulation. Plug and Socket contacts are silver plated. The finished appearance of this series will add considerably to your equipment.

The 2400 Series are interchangeable with all units of the corresponding No. 400 Series.

Send today for general catalog No. 14 listing and illustrating our complete line of Plugs, Sockets and Terminal Strips.

HOWARD B. JONES DIVISION
CINCH MFG. CORP.
2460 W. GEORGE ST. CHICAGO 18

be given by the use of the automatic tone warning device, which would automatically produce a distinct signal that is repeated at regular intervals during the course of the telephone conversation when the recording device is in use.

Electronic Lab Expands

INDUSTRIAL and governmental demand for research in electronics has resulted in an expansion of the electronic laboratories of Battelle Memorial Institute, Columbus, Ohio, involving allocation of more space for electronic laboratories, purchase of extensive equipment, addition of new personnel, and centralization of facilities for electronic research.

Current research projects in the electronic field include a fundamental study of thermionic emitters and development of voltage regulator tubes that will hold the voltage constant under a wide range of loads.



Setup at Battelle electronic laboratories for measuring characteristics of glow discharges at reduced pressures in gases of high purity

Completed projects include development of an electrical micrometer for production of ultraprecise lathe spindles, a high-speed frequency-modulation dilatometer for research studies in steel metallurgy and welding, and a translucency meter for measuring the translucence of chinaware.

Restricted Operator Permits

SIMPLIFICATION of the FCC procedure for issuing restricted radio-telephone operator permits is em-

CORNISH

WIRES at work

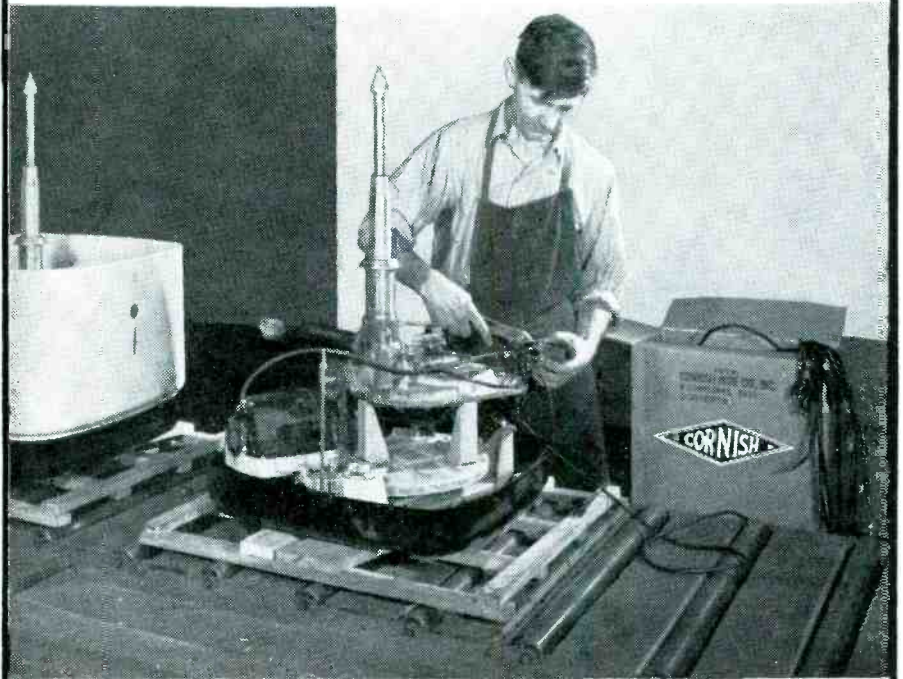

Courtesy HURLEY Machine Division, makers of THOR Washers

WHY ARE CORNISH WIRE PRODUCTS SPECIFIED BY THIS LARGE MANUFACTURER OF WASHING MACHINES?

- Because their ENGINEERING Department knows by test that they will give faithful and enduring performance . . .
- Because their PRODUCTION Department finds that they have those qualities essential for quick installation on their assembly line . . .
- Because their PURCHASING Department realizes that these Quality Products, backed by dependable service, are sold at prices that spell true economy . . .

CORNISH WIRE CO., INC.

15 Park Row • New York City, 7

4 Oscillograph traces on 70 mm. paper.

RECORDING TRANSIENT PHENOMENA

The behaviour of moving parts under actual working conditions may be studied by means of standard commercial oscillographs, which translate mechanical or electrical variations into evanescent traces on a fluorescent screen. Avimo cameras record these traces on continuous film or paper, so that they may be subsequently checked, examined, and measured. Write for Publication B-2, giving full details of AVIMO Cameras including types with built-in cathode ray tubes.



AVIMO Ltd., TAUNTON
(Eng.) Tel. 3634

Designers and Manufacturers of
Scientific Cameras

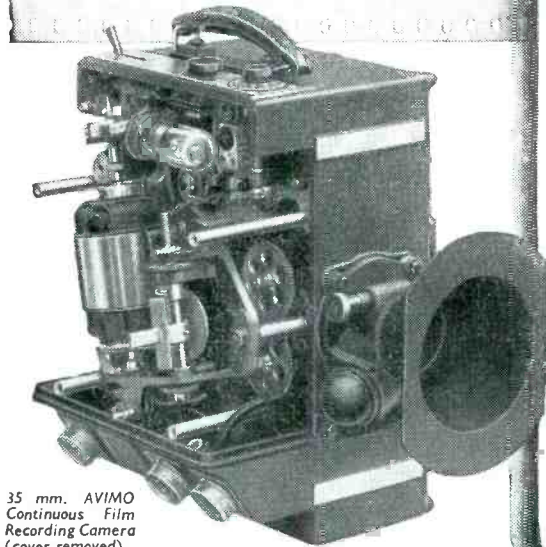

35 mm. AVIMO
Continuous Film
Recording Camera
(cover removed).

9016E

★ STAR

ADDS 2 NEW VITAL AIDS

for the

**Manufacturers of 9 pin miniature
tube — radios and equipment**



#JE-9—Star Miniature socket wiring plug for accurate alignment of miniature socket contacts during wiring. Precision cast of zinc base alloy—pins of stainless steel.

#JE-15 — Star Miniature tube pin straightener (with stainless steel insert) to obtain a perfect fit when the tube is placed in the equipment.

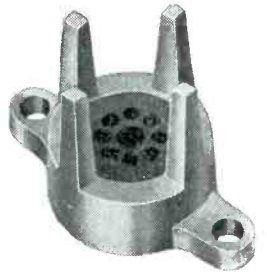

Scientifically designed—Precision made

**SOON READY FOR PRODUCTION
AND DISTRIBUTION**

STAR EXPANSION PRODUCTS CO. INC.

147 Cedar St.,

New York 6, N. Y.

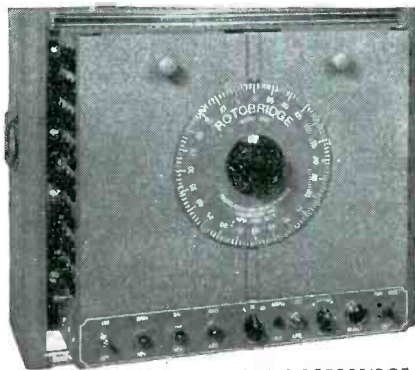

Model 1010 ROTOBIDGE

ROTOBRIDGE "The Automatic Inspector"

For radio and electronic manufacturers who require quick-shift inspection test equipment for relatively short runs of varied products. Tests up to 120 circuits on a single unit. Makes accurate bridge-type measurements for wiring errors, continuity and resistance values against predetermined standards and tolerances. Indicates and isolates defects by circuit number.

Rear View Showing Rotary
Selector Switch Mechanism.

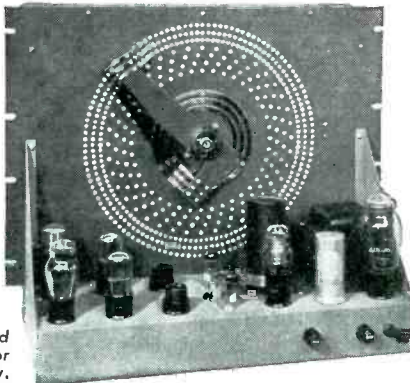

CUTS INSPECTION COSTS

- Makes tests at the rate of one circuit per second — automatically.
- Can be used successfully by unskilled employees.
- Can be changed from one job to another in a matter of minutes.
- Pays for itself by speeding up inspections and avoiding costly "adjustments" with customers over sub-standard products.

Available now in both cabinet and rack-and-panel models. Write for descriptive bulletin and prices today.



COMMUNICATION MEASUREMENTS LABORATORY, INC.
REctor 2-2080 Cable Address: "COMUNILAB" NEW YORK
120 GREENWICH STREET • NEW YORK 6, N. Y.

Crystals for the Critical



"STABILIZED"

H4 COMMUNICATIONS CRYSTAL

Can be supplied in a frequency range of 1800 kc to 20 mc. Pin spacing is 3/4" and pin diameter is 1/8". Quartz plates are pressure mounted between stainless steel electrodes. Unit will stand maximum vibration. Our "Stabilizing" process prevents frequency shifts due to age.

Send for Illustrated Catalog

The JAMES KNIGHTS CO.
SANDWICH, ILLINOIS

bodied in proposed amendments announced April 3 for FCC rules governing commercial radio operators. When adopted, no oral or written examination will be required for this permit.

If the application is properly completed and signed and if the applicant is found to be qualified, the permit may be issued immediately. Applicants are, however, required to certify in writing to a declaration stating need for the requested permit, ability to receive and transmit spoken messages in English, keep a rough written log in English or a language readily translatable into English, and certify to a knowledge of the provisions of all regulations governing the authority granted under the requested permit.

A similar procedure is already in effect for aircraft radio operator's permits required by private pilots. Here the applicant need only appear in any FCC field office or before any CAA flight examiner designated by the FCC to issue permits, prove he is a U. S. citizen, needs the permit, and understands the regulations.

Television Standards

OFFICIAL IRE recommendations on methods of measuring performance of visual transmitters and studio equipment are embodied in a recently released 24-page booklet entitled, "Standards on Television: Methods of Testing Television Transmitters, 1947", available at 75 cents per copy from The Institute of Radio Engineers, Inc., 1 E. 79th St., New York 21, N. Y.

Test procedures described include determination of sine-wave and transient response of video amplifiers and the overall transmitting system, determination of light-amplitude characteristic of the system up to the transmitter output, determination of signal-to-interference ratio in video systems, check of aspect ratio, linearity of scanning, and interlacing, measurement of average repetition rate of synchronizing pulses and rate of change of frequency of horizontal synchronizing pulses, measurement of slope, duration, and timing of synchronizing pulses, determination of variation of blanking and synchronizing

Electronic Regulated POWER SUPPLIES



PRECISION ACCURACY PERFORMANCE

Built to rigid U. S. Government Specifications

SPECIFICATIONS

INPUT—115 v. 56-60 cycle

REGULATIONS—Less than 1/20 volt change in output voltage with change of from 100-140 V.A.C. input voltage & from NO-LOAD to FULL-LOAD (over very wide latitude at center of variable range)

RIPPLE—less than 5 millivolts at all loads and voltages

DIMENSIONS—Fits any standard rack or cabinet (overall: 19 in. wide; 12 1/4 in. high; 11 in. deep; shipping wt.—100 pounds)

TYPE A—VARIABLE FROM 210 TO 335 V. D. C. @ 400 M. A.

TYPE B1—VARIABLE—TWO RANGES: 400-600 V. D. C. @ 125 M. A. and 600-890 V. D. C. @ 125 M. A.

CONSTRUCTION FEATURES

Weston model 301 (or equal) milliammeter and voltmeter • Separate switches, pilot lights, and fuses for FIL and PLATE VOLTS • All tubes located on shockmount assemblies • Fuses mounted on front panel and easily accessible • Can vary voltage by turning small knob on front of panel. Can easily modify Type B1 from POSITIVE to NEGATIVE output voltage • Individual components numbered to correspond with wiring diagram. Rigid construction: components designed to withstand most severe military conditions—physical and electrical; were greatly under-rated.

All units checked and inspected at 150% rated load before shipment.

Tube complement: {Type A: 2-836; 6-6L6; 2-6SF5; 1-VR150; 1-VR105
{Type B1: 2-836; 2-6L6; 2-6SF5; 1-VR150; 1-VR105

IMMEDIATE DELIVERY

TYPE A—\$189.00

NET PRICES—F. O. B. BALTIMORE, MD.

TYPE B1—\$185.00

Complete with tubes and ready to plug in—Prices subject to change without notice

NATIONAL RADIO SERVICE CO.

Reisterstown Rd. & Cold Spring Lane

Baltimore 15, Md.

SIGMA LATCHING RELAY

SERIES 6FZ

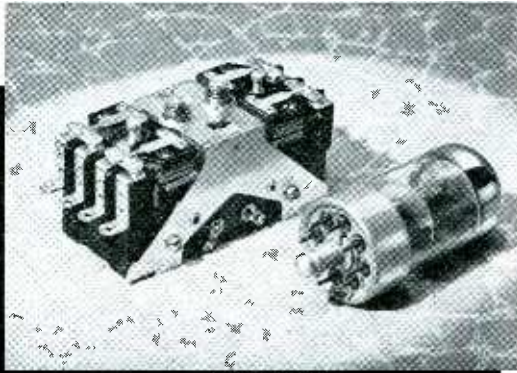

TYPE 6FZ2A2B

A substantial improvement over existing types of mechanical latch electrical reset relays.

- Perfectly balanced armature
- Unaffected by very severe vibration and shock
- Exceptional mechanical life; latching entirely unaffected by wear
- 8 separate contact positions available in any combination of Normally Open or Normally Closed circuits (Two N.O., Two N.C., — double break shown above.)
- Nominal rating per contact, 5 Amps. at 110V, A.C. (Modifiable upwards or downwards in accordance with conditions of use.)

OTHER NEW SIGMA RELAYS

- Multicontact sensitive relays, A.C. and D.C.
- Polarized relays including balanced armature 3 position (null holding) differential types with positive detent null or center.



Sigma Instruments, Inc.
Sensitive RELAYS
62 Ceylon St., Boston 21, Mass.

levels at transmitter output with change in picture, testing transmitting sideband filter, and measuring transmitter power output, amplitude linearity, and resolution.

Australian Aviation Aids

AUSTRALIA will spend about \$3 million equipping airports and other points with navigation aids and communication equipment to conform with recommendations framed by the technical committees of the PICA Regional Meeting at Melbourne. The \$250,000 lend-lease loran chain installed during the war in Australia's Northwest to aid homing operations will be shifted to sites on the Eastern Seaboard. The number of existing homing beacons will be increased and some of those already in operation will be brought up to the stipulated range of 300 miles over the sea.

Short-distance aids now in use will have to be changed to operate on omnidirectional ranges. Radar distance-measuring equipment of Australia's own light-weight design will be fitted on all aircraft, and the number of beacons will be greatly increased. The most expensive requirement will be the introduction of instrument landing systems (ILS) at four airdromes at a cost of \$100,000 each.

MEETINGS

JUNE 7: IRE Connecticut Valley Section annual meeting, New London, Conn.; symposium on f-m receivers in morning and trip to Submarine Base in afternoon.

JUNE 9-13: AIEE Summer General Meeting, Montreal, Quebec.

JUNE 10-13: RMA annual convention, Stevens Hotel, Chicago.

JUNE 12-13: ASME Wood Industries National Conference, Madison, Wis.

JUNE 16-19: ASME semiannual meeting, Stevens Hotel, Chicago.

JUNE 16-20: ASTM annual meeting, Atlantic City.

JUNE 23-25: ASME Applied Mechanics Division, meeting, Schenectady, N. Y.

AUG. 26-29: AIEE 1947 Pacific General Meeting, Hotel San Diego, San Diego, Calif.

SEPT. 1-4: ASME fall meeting, Hotel Utah, Salt Lake City.

SEPT. 8-9: ASME Industrial Instruments and Regulators Division, meeting, Chicago.

SEPT. 8-10: National Institute of Governmental Purchasing, annual conference and exhibit, Hotel Pennsylvania, New York City.

SEPT. 8-12: Second Annual Conference and



Cyclohm | SYNCHRONOUS
CAPACITOR TYPE
MOTOR

THIS new Cyclohm 29 size has no equal as a synchronous, capacitor type motor for recording, tape pulling, facsimile work and other jobs which require a quiet, smooth, vibrationless motor. Internal rotor slots permit a higher starting torque and a quieter performance. Substantial cap seats, turned in the frame and end caps, ensure perfect rigidity, accurate bearing alignment, uniform air gap, and a vibration-free motor. Supplied with either ball bearings or sleeve bearings—in ratings of 1/100, 1/75 and 1/50 horsepower, 1800 r.p.m., 115 volts, 60 cycles. Write for complete information.

CYCLOHM MOTOR CORPORATION
5-17 46TH ROAD, LONG ISLAND CITY 1, N. Y.



"WELL ...
WHADDA YA
KNOW!"

No — this man hasn't discovered who murdered the butler and stuffed his body in the bath-tub.

He's reading an advertisement in THIS magazine! He has his eye on a product that promises the answer to a brand new problem he's been sweating over.

Exaggerated? Not a bit! For the advertising pages of every McGraw-Hill publication are replete with ideas, products, services designed for the men who are responsible for design, production, maintenance, marketing — every specific operational phase of modern business and industry.

Month after month America's leading manufacturers are parading their newest and best wares before your eyes in THIS McGraw-Hill magazine. You're the judge and jury as to whether they can solve a problem — offer a short-cut — show a profit — for you.

To keep in touch with
the parade -----
READ THE ADS.

new

STREAMLINED



**SHIELDS FOR T-5 1/2
MINIATURE BULBS
SLIDE FIT FLUTES ELIMINATE
SOCKET CONTACT TROUBLES
CAUSED BY VIBRATION**

The shield is sized so that three of the flutes make a slide fit with the tube, supporting it throughout its length. A hardened and tempered spring steel clip locates the shield and holds the tube firmly in place.

These modern, streamlined shields combine eye appeal with low cost, effective shielding.

Due to the direct contact between the flutes of the shield and the glass surface of the bulb, the Goat G-1700 shield dissipates heat rapidly.

8



**METAL STAMPINGS, DIVISION OF
THE FRED GOAT CO., INC., 314 Dean Street, Brooklyn 17, New York**

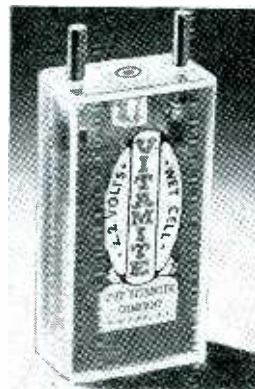

The "By-weight" Model
3A 0.45
Actual Size Illustrated

**RECHARGEABLE • NON-SPILL
VITAMITE**

1 OZ. BATTERIES
(Smaller Than 2 Pen-Lights)

IDEAL FOR USE WITH

Miniature And Sub-Miniature Filament Type Tubes
for HEARING AIDS, POCKET RADIOS, ETC.

LARGER MODELS ALSO AVAILABLE
Write for Data and Literature

THE VITAMITE COMPANY

227 West 64th Street New York 23, N. Y.



To your specifications

QUADRIGA Quality WASHERS

Fulfill the rigid standards of
electrical and electronic services

Make sure by entrusting your washer requirements to long experience, ample facilities. Any quantity small or large: Special Flat—Tension and Spring—Formed and Drawn—Cupped and Finishing—Friction—Irregular Contour—Dished Blanks, etc. Wire terminals. SMALL STAMPINGS, any design. Ask for catalog.

THE QUADRIGA MANUFACTURING CO.

Est. 1894 "Half a Century"

221A W. Grand Ave.

Chicago 10, Ill.



speed production — cut costs with **EJECT-O-MATIC** AUTOMATIC-FEED SOLDERING IRONS AND ACCESSORIES



HEAVY DUTY EJECT-O-MATIC

High-heat 100 and 150-watt models for general heavy electrical, electronic and repair work. Also available in long-nosed "instrument" model. Weight only 22 oz.



STANDARD EJECT-O-MATIC

Popular 50 and 75-watt models for general radio and electrical work. Special long-nosed models available for soldering inside deep receptacles, hard-to-get relays and assemblies. Weight only 18 oz.

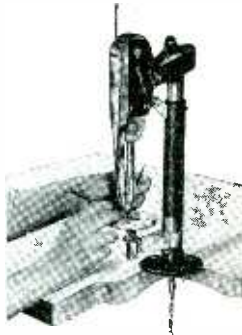

VERTI-MOUNT

Treadle operated — leaves both hands free to hold work. Pre-heats and solders work with one easy foot movement. Takes all Eject-O-Matic irons.

complete line now available

TIPS— Multi-clad tips available in eight different sizes and shapes.

SPECIAL TIPS DESIGNED—
MINIMUM 10 TO ORDER.

Send for new catalog and prices.

MULTI-PRODUCTS TOOL CO. 123 SUSSEX AVENUE, NEWARK, N. J.



ROBINSON BELT-DRIVE Precision Turntables

- ★ "Right angle" belt drive and patented "seismic" sub base motor mounting.
- ★ Instant, foolproof, lever shift from 78 to 33 1/3 R.P.M.
- ★ New micrometer speed adjustment and patented planetary ballbearing transmission.

NEW !!! Transcription Tone Arm with "GE" Variable Reluctance Cartridge

CONSOLE \$90

CHASSIS \$295

DUPLEX CONSOLE
\$150

TRANSCRIPTION
TONE ARM \$74.50

TWO STAGE
EQUALIZER
PRE-AMPLIFIER
(without power
supply)
\$27.50

IMMEDIATE
DELIVERY



ROBINSON RECORDING LABORATORIES

2022 Sansom Street, Philadelphia 3, Pa.

NEWS OF THE INDUSTRY (continued)

Exhibit of The Instrument Society of America, at Stevens Hotel, Chicago.

SEPT. 23-25: AIEE Middle Eastern District Meeting, Dayton, Ohio.

SEPT. 30-Oct. 11: National Radio Exhibition, Olympia Hall, London, sponsored by British Radio Industry Council and featuring new British radio, electronic control, radar, and television equipment.

OCT. 6-8: ASME Petroleum Mechanical Engineering Conference, Houston, Texas.

OCT. 16-17: annual meeting, National Conference on Industrial Hydraulics, Hotel Continental, Chicago; information from Dr. V. L. Streeter, Armour Research Foundation, Chicago.

OCT. 21-25: Pacific Chemical Exposition, San Francisco Civic Auditorium.

OCT. 30-Nov. 1: semiannual meeting, American Society of Tool Engineers, Boston, Mass.; information from H. B. Conrad, 1686 Penobscot Bldg., Detroit 26, Mich.

Nov. 3-5: National Electronics Conference, Edgewater Beach Hotel, Chicago.

Nov. 3-7: AIEE Midwest General Meeting, Chicago, Ill.

Dec. 1-5: 1947 annual meeting, ASME, Atlantic City, N. J.

BUSINESS NEWS

AIRBORNE INSTRUMENTS LABORATORY, Inc., Mineola, N. Y., has installed aircraft antenna radiation pattern measuring equipment (described in ELECTRONICS, May 1947) at its recently established field measurement laboratory located in Hangar 3 at 2627 No. Hollywood Way, Burbank, Calif. The new group offers complete field measurement service to broadcast, television, f-m, police and other radio stations as well as to aviation services.

RAYTHEON MFG. Co. announced plans to move its Broadcast Equipment Division from Chicago to its main plant at Waltham, Mass.

FEDERAL TELEPHONE AND RADIO CORP. has added approximately 600,000 square feet of floor space to its Clifton, N. J. plant to bring the



Aerial view of Federal's Clifton plant

total there to approximately 850,000 square feet now.

AMERICAN TIME CORP., Springfield, Mass., manufacturers of coin-operated, industrial, and photographic

QUIK-LABELS

CODE CARD SYSTEM

Removable Self-Starter Strip exposes ends of Labels for you to peel!

DON'T PICK. USE SELF-STARTER STRIP TO PEEL LABELS

FREE SAMPLES

DON'T PICK. USE SELF-STARTER STRIP TO PEEL LABELS

1 → PEEL 2 → APPLY 3 → IDENTIFY

LIKewise ON FLAT SURFACES

Patents Pending

QUIK-LABELS

Mark Your Wires Faster

QUIK-LABELS code Wires, Leads, Circuits, Relays Parts, etc., faster and cheaper. ● Pre-cut to exact size, QUIK-LABELS come on handy cards. ● Ready to use, they stick-quick without moistening, replace slow and costly string tags, roll tapes, decals, stencils, metal tabs, etc. ● Silicone plastic coated to resist dirt, grease, abrasion. ● Self Starter strip automatically expose ends of Labels for you to grasp instantly — no more finger-picking.

Write for Folder and FREE Sample Cards.

W. H. BRADY COMPANY

Established 1914

Manufacturers of Self-Sticking Tape Products

240 W. Wells St., Milwaukee 3, Wisconsin
Factory — Chippewa Falls, Wisconsin

REGULATED

"ARTIFICIAL D. C. POWER LINE"

For Production or Laboratory Tests Where D.C. Is Not Readily Available

For Testing:

- A.C.-D.C. RADIOS,
- SOUND EQUIPMENT,
- UNIVERSAL MOTORS, Etc.

115 V. A.C. source provides continuously adjustable A.C. and D.C. voltage from 0 to 135 volts. The D.C. voltage is electronically regulated to within 1% regardless of line or load variations. A.C. and D.C. voltmeters permit continuous observation of output voltages. Single switch controls both A.C. and D.C. outputs to receptacle on front of panel. Indicating pilot lights inform operator as to type of output current.



Two models available:

Model 310A
(as described and illustrated) \$330.00

Model 310B
(D. C. only) 280.00

Write for Circular 310



Electronic Instruments Designed for Your Special Requirements

FURST ELECTRONICS

806 W. NORTH AVENUE, CHICAGO 22, ILLINOIS

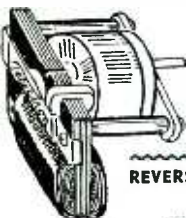

TELECHRON MOTOR
1 R.P.M. or 2 R.P.M.
3.85 LIMITED QUANTITY
REVERSIBLE GEARED MOTOR
ALNICO FIELD

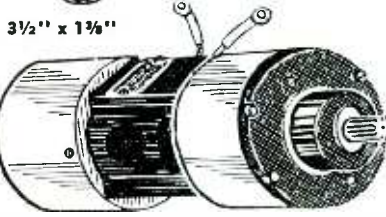

3 1/2" x 1 3/8"

Operates on Flashlight batteries, speed depending on the voltage. Fairly strong on 6 volts, full power and speed on 27 volts. Designed to be used in bombsights, automatic pilots, etc. 250 RPM. **\$5.00**
A bargain at

HAYDON SYNCHRONOUS TIMING MOTOR
to operate switches, etc. can be had either 1 Rev. per hour or 1 Rev. per minute at this **SPECIAL PRICE \$3.85**
Many other speeds available at \$4.95

EST. 1923 **BLAN** EST. 1923
Experimenters and Inventors Supplies
64 Dey St., New York 7, N. Y.



Preferred
as a source of precision-made WASHERS and STAMPINGS manufactured to your specifications

CUP WASHERS
for Binding Screws
WHITEHEAD STAMPING CO.
1691 W. Lafayette Blvd. Detroit 16, Michigan

WHAT MAKES A MAILING CLICK?

Advertising men agree . . . the list is more than half the story. McGraw-Hill Mailing Lists, used by leading manufacturers and industrial service organizations, direct your advertising and sales promotional efforts to key purchasing power.

In view of present day difficulties in maintaining your own mailing lists, this efficient personalized service is particularly important in securing the comprehensive market coverage you need and want. Investigate today.

McGraw-Hill Publishing Co., Inc.
DIRECT MAIL DIVISION
330 West 42nd Street New York, 18, New York

BRADLEY COPPER OXIDE RECTIFIERS

IMPROVE INSTRUMENTS AT LOW COST

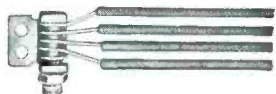

Vacuum-processed, gold-coated Bradley instrument rectifiers increase equipment efficiency. Especially designed for use where stability and permanence of calibration are important, "Coprox" rectifiers meet the most exacting requirements. Yet they cost no more than ordinary rectifiers — in most cases, less.

Temperature error is exceptionally low with Bradley rectifiers. Aging is practically nil. Pre-soldered leads. Rating of CX-2E series up to 4.5 volts A.C., 3 volts and 5 milliamperes D.C.

Illustrated literature, available on request, shows more models of copper oxide rectifiers, plus a line of selenium rectifiers and photocells. Write for "The Bradley Line."

BRADLEY LABORATORIES, INC.

82 Meadow St. New Haven 10, Conn.

NEWS OF THE INDUSTRY (continued)

timing devices, has purchased the Pond Engineering Co., Springfield.

REMCO ELECTRONICS INC., New York City, has issued a license on its cathode-follower circuit patents to the Bell System and Western Electric Co.

LENKURT ELECTRIC Co., San Carlos, Calif., is completing a new 20,000 square foot plant for manufacture

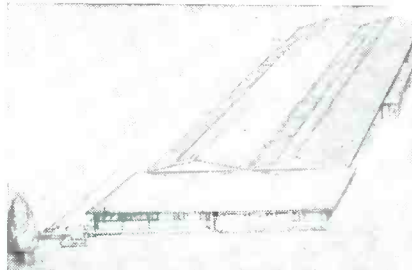

New Lenkurt plant

of carrier telephone equipment and powder-metal parts.

NATIONAL ELECTRONICS, INC., Geneva, Ill., has begun the manufacture of industrial power tubes, specializing in quick-heating gaseous types in the 0.5 to 15-ampere range.

GOZHARD MFG. Co., Springfield, Ill., has purchased the tools, equipment, and inventory for dynamotor, inverter, and motor-generator production from Pioneer Gen-E-Motor, Chicago, who are discontinuing manufacture of these items.

E. F. JOHNSON Co., Waseca, Minn. has purchased the tools, equipment, and inventory of the Gothard line of indicator lights from Gothard Mfg. Co. The latter firm will concentrate all facilities on dynamotor, inverter, and motor-generator production.

COLONIAL RADIO CORP., wholly-owned subsidiary of Sylvania Electric Products Inc., has begun pro-



Colonial's new California plant

duction of private-brand radio sets at its new Riverside, California plant.

GENERAL ELECTRONICS, INC. has

For Extra
Sales—Profits
it's **ATR**
Quality Products



ATR
"A"

BATTERY ELIMINATORS

FOR CONVERTING A.C. TO D.C. New Models . . . designed for testing D.C. electrical apparatus on regular A.C. lines. Equipped with full-wave dry disc type rectifier, assuring noiseless, interference-free operation and extreme long life and reliability.

- Eliminates Storage Batteries and Battery Chargers.
- Operates the Equipment at Maximum Efficiency at All Times.
- Fully Automatic and Fool-Proof.



ATR
AUTO
RADIO

Replacement Vibrators

Designed for Use in Standard Vibrator-Operated Auto Radio Receivers. Built with Precision Construction for Longer Lasting Life.

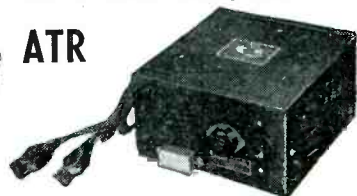

STANDARD AND HEAVY DUTY INVERTERS

FOR INVERTING D.C. TO A.C. Specially designed for operating A.C. radios, television sets, amplifiers, address systems, and radio test equipment from D.C. voltages in vehicles, ships, trains, planes, and in D.C. districts.

WRITE FOR NEW CATALOG—
JUST OFF THE PRESS

AMERICAN TELEVISION & RADIO CO.

Quality Products Since 1931

ST. PAUL 1, MINN.

U. S. A.

DEPENDABLE
Endurance Testing
With the NEW
WALCREST
MULTI-SPEED
Sequence Timer

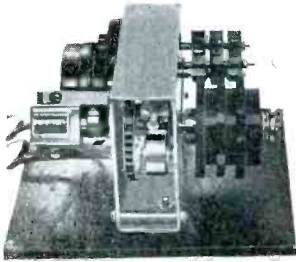

PERMITS WIDE SELECTION OF SWITCHING PERIODS. NOT A SPLIT SECOND DEVICE BUT A DEPENDABLE MULTI-SPEED TIMER.

\$25.

- 4 selectable speeds
- 3 snap action switches-10A125V AC
- Powerful synchronous motor
- Interchangeable motors for extended speed range
- Test 3 devices at once if necessary
- Cams easily notched for timing requirements
- Cams adjustable in phase relation
- Counter registers cam revs and speeds
- Stop-point stalls cams without stopping motor
- Intervals: 1 to 36 minutes

Will be shipped to accredited firms 30 days free trial, Complete with instructions.



WALLACE METAL
PRODUCTS CO., INC.

50 Greene St., New Haven, Conn.

Molded Phenolic
COIL FORMS • BOBBINS

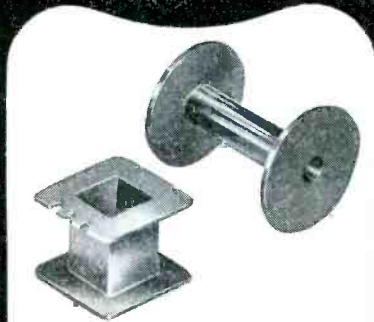

You can save on mold and piece charges at Mayfair

Coil forms or bobbins, made to your specifications. Our mold charges are lower than were formerly considered possible.

Send print for prompt quotation

Mayfair

MOLDED PRODUCTS CORPORATION
4440 Elston Avenue • Chicago 30

MOLDED
S.S. White **RESISTORS**
The "All-Weather" Resistors



- Noiseless in operation
- Strong and durable
- Good performance in all climates

STANDARD RANGE
1000 ohms to 10 megohms

- NOISE TESTED •

At slight additional cost, resistors in the Standard Range are supplied with each resistor noise tested to the following standard: "For the complete audio frequency range, resistor shall have less noise than corresponds to a change of resistance of 1 part in 1,000,000."

HIGH VALUES
15 to 1,000,000 megohms

S.S. WHITE INDUSTRIAL DIVISION
THE S. S. WHITE DENTAL MFG. CO. DEPT. K 10 EAST 40TH ST., NEW YORK 16, N. Y.



FLEXIBLE SHAFTS • FLEXIBLE SHAFT TOOLS • AIRCRAFT ACCESSORIES
SMALL CUTTING AND GRINDING TOOLS • SPECIAL FORMULA RUBBERS
MOLDED RESISTORS • PLASTIC SPECIALTIES • CONTRACT PLASTICS MOLDING

One of America's AAAA Industrial Enterprises

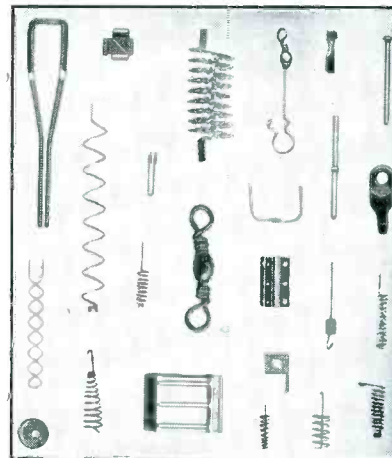

SMALL PARTS

Filaments, anodes, supports, springs, etc. for electronic tubes. Small wire and flat metal formed parts to your prints for your assemblies. Double pointed pins. Wire straightened and cut diameter up to 1/8-inch. Any length up to 12 feet.

LUXON fishing tackle accessories.

Inquiries will receive prompt attention.

ART WIRE AND STAMPING CO.

227 High St.

Newark 2, N. J.

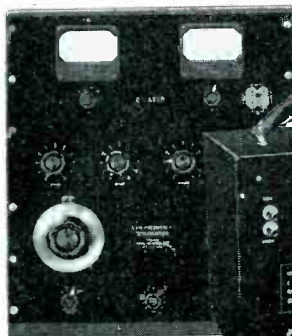

No. 1030 Direct Reading Low Frequency "Q" Indicator "Q" 5 to 500 Frequencies from 50-50,000 Cycles



No. 1020 Direct Reading Megohmmeter up to 1,000,000 megohms. Self Contained A.C. Operated

LABORATORY TEST EQUIPMENT
by **FREED**

Send for Descriptive Literature



No. 1050 60 Cycle Filter

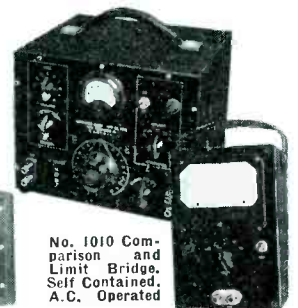

No. 1010 Comparison and Limit Bridge. Self Contained. A.C. Operated

No. 1040 Wide Range Vacuum Tube Voltmeter

FREED TRANSFORMER COMPANY, INC., 72-78 Spring Street, N. Y. C.

Midget telephone-type relay

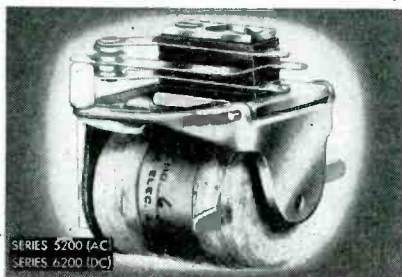

A new Advance relay. Series 5200 and 6200 are similar to series 5000 and 6000 but have single contacts. This compact relay is ruggedly made to withstand vibration. Operates on 1/10 to 2 watts of power. Thoughtful design, finest materials, and skilled craftsmanship make this the finest relay of its type.

SPECIFICATIONS:

- Any contact combination SPST to 4PDT • Pure silver contacts 1/8" to 3/16" • Universal wound, varnished, vacuum impregnated coil • 1 to 16000 ohms DC resistance • 1 to 220 volts AC or 1 to 150 volts DC • Phosphor bronze blades and armature pin • Pivot hinge with phosphor bronze bearing (low friction)

Write for new catalog, issued May, 1947



ADVANCE ELECTRIC & RELAY CO.
1260 West 2nd St., Los Angeles, California • Phone Michigan 9331

completed a new two-story building adjacent to its original plant in Paterson, N. J., adding 13,200 square feet of floor space for manufacture of electronic tubes.

NEW ENTERPRISES, INC., 84 State St., Boston, Mass. offers financial backing for development of untried business enterprises of a scientific nature.

SHURITE METERS, New Haven, Conn. has been organized to manufacture an extensive line of meters.

PERSONNEL

LEONARD MAUTNER has been placed in charge of the Television Transmitter Department at Allen B. Dumont Laboratories, Inc., Passaic, N. J.

AUSTIN C. LESCARBOURA, publicity-advertising consultant serving radio manufacturers, was awarded the order of *Officier de l'Instruction Publique* by the French government in recognition of technical services rendered.

P. J. SELGIN joined the staff of the National Bureau of Standards, and will work on development of electronic ordnance.



P. J. Selgin



G. R. Harrison

GEORGE R. HARRISON, dean of the School of Science at MIT, has been elected chairman of the American Institute of Physics.

LAN JEN CHU was appointed associate professor in the Department of Electrical Engineering at MIT.

LEO L. BERANEK, formerly with Harvard, has joined MIT as associate professor of communications engineering.

ADELBERT E. JOOST, an Army veteran formerly associated with Sylvania Electric Products, Inc., joined

FOR THE FIRST TIME HIGH SENSITIVITY IN A SELF-CONTAINED ALL AC OPERATED UNIT 50 MICROVOLTS TO 500 VOLTS

MODEL
47
VOLTMETER



An extremely sensitive amplifier type instrument that serves simultaneously as a voltmeter and high gain amplifier.

- Accuracy $\pm 2\%$ from 15 cycles to 30 kc.
 $\pm 5\%$ from 30 kc. to 100 kc.
- Input impedance 1 megohm plus 15 uuf. shunt capacity
- Amplifier Gain 40000

A few of many uses:

- Output indicator for microphones of all types
- Low level phonograph pickups
- Acceleration and other vibration measuring pickups
- Sound level measurements
- Gain and frequency measurements for all types of audio equipment
- Densitometric measurements in photography and film production
- Light flux measurements in conjunction with photocells

Write for Complete Information

Instrument Electronics

42-17A Douglaston Parkway
DOUGLSTON, L. I., N. Y.

ALLIED DISCS



and RECORDING EQUIPMENT

ALLIED Discs are favored by noted broadcasters and other users, for their high fidelity. Test them on your work. One of the first companies to make instantaneous recording equipment. ALLIED offers you the benefits of its seasoned skill.

Write for our New Descriptive Bulletin.

ALLIED

RECORDING PRODUCTS CO.

21-09 43d Ave., LONG ISLAND CITY 1, N. Y.

Solves the Problem of Mailing List Maintenance!

Probably no other organization is as well equipped as McGraw-Hill to solve the complicated problem of list maintenance during this period of unparalleled change in industrial personnel.

McGraw-Hill Mailing Lists cover most major industries. They are compiled from exclusive sources, and are based on hundreds of thousands of mail questionnaires and the reports of a nation-wide field staff. All names are guaranteed accurate within 2%.

When planning your direct mail advertising and sales promotion, consider this unique and economical service in relation to your product. Details on request.

for Results



McGraw-Hill
DIRECT MAIL LIST SERVICE

McGraw-Hill Publishing Co., Inc.

DIRECT MAIL DIVISION

330 West 42nd St., New York, 18, N. Y.

The Patent Guide You Have Been Waiting For!

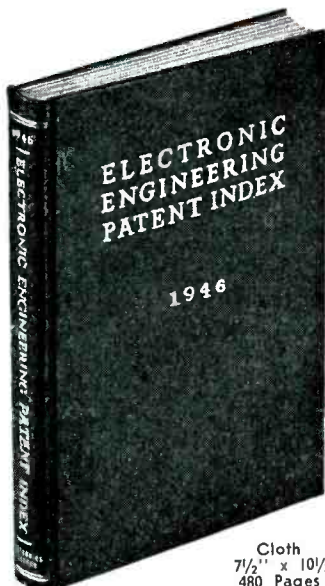

Cloth
7 1/2" x 10 1/3"
480 Pages

Order Now, Edition Limited

PRICE \$14.50

ELECTRONICS RESEARCH
PUBLISHING COMPANY

2 WEST 46TH ST.
NEW YORK 19, N. Y.

ELECTRONIC ENGINEERING PATENT INDEX, 1946

A master compilation of over 2000 electronics patents arranged for rapid reference

During 1946 the U. S. Patent Office granted over 2000 electronics patents. Here in this single volume is the complete collection reproduced in entirety from the 52 weekly issues of the Patent Office Gazette issued during 1946. Each electronic patent included gives patent title, number, inventor, assignee, illustrations, etc. All patents are conveniently arranged under more than 90 subject headings. Here is a wealth of new information on circuits, components, manufacturing methods, etc.

Descriptive circular on request

Now Available. The 1946 Edition of ELECTRONIC ENGINEERING MASTER INDEX

Covering the important one and one-half year period from July 1945 to December 1946, and including over 3000 miscellaneous entries, this supplement contains over 7500 new bibliographical listings arranged under more than 400 subject headings. A special feature is the 25 page classified compilation of MANUFACTURERS' CATALOGS.

Order Now. Edition Limited

230 pages \$14.50

Send for descriptive literature.

LAMINATED PLASTICS

Phenol Fibre . . . Water-, oil-, and chemical-resisting sheets of high dielectric strength. Supplied in black and natural color. Standard sheets approximately 49 x 49 inches. Thicknesses from .010 to 9 inches. Rods and tubes.

Vulcanized Fibre Remarkably uniform, high-grade, hard fibre in sheets 56 x 90 inches to save waste in cutting. Smaller sheets if desired. Also in standard-size rods.

FABRICATED PARTS • TAYLOR INSULATION • SILENT GEAR STOCK

We're ready whenever you are. Send blueprints.

TAYLOR FIBRE COMPANY Norristown, Pennsylvania

Pacific Coast Plant: La Verne, California • Offices in Principal Cities

PAMARCO DE-REELING TENSION

PAMARCO tensions are the perfect answer to lower coil winding costs!

- ★ FINGER-TIP TENSION CONTROL
- ★ OPERATOR MAKES OWN ADJUSTMENTS
- ★ NO TOOLS OR ACCESSORIES NEEDED
- ★ FITS ALL COIL WINDERS

The free-running action of the PAMARCO tension practically eliminates defective coils. Their compact size permits more simultaneous coil winds on any machine. Operator makes all adjustments for any gauge wire with simple thumbscrew.

Write for literature today

SHORT CUT TO PERFECT COILS!



PAPER MACHINERY & RESEARCH, INC.
1014 OAK STREET • ROSELLE, NEW JERSEY

**For Laboratory
and Industry . . .
VACUUM TUBE
MULTI-RANGE
METER**

WITH 7" ZERO-CENTER METER
Ranges to 6000 Volts
AC and DC
2000 Megs—12 Amps—70 DB



- The Precision EV-10-MCP is a bridge type vacuum-tube voltmeter combined with standard 1000-~/volt functions for direct application in industry, electronic maintenance and laboratory. Large 7-inch zero-center meter provides VTVM measurements in a single operation—indicating both magnitude and polarity.
- ● Eight distinct instrument functions for most all measurements in industrial electronics, radio, television and communications.
- ● AC and DC voltage ranges from ± 3 to ± 6000 ; resistance to 2000 megohms; DC current 0-600 microamps to 12 amps; output and decibels.
- Supplied complete with ohmmeter batteries; tubes and 3 sets of test leads. In heavy gauge steel case, $10\frac{1}{2} \times 12 \times 6$.
- Series RF-10 Vacuum Tube Probe, available as an accessory item, provides direct measurement of super-sonic, RF and UHF voltages.
- **EV-10-MCP, complete . . . \$69.81**
- **RF-10 Probe, additional . . . 13.31**
- *On display at all leading radio parts distributors or write for details.*

PRECISION
APPARATUS CO., Inc.
92-27 Horace Harding Blvd.
Elmhurst 10, N. Y.

NEWS OF THE INDUSTRY (continued)

the research staff of Battelle Institute, Columbus, Ohio and has been assigned to its division of industrial physics.

MYRON J. MORRIS now heads the Installation and Maintenance Department of United States Television Mfg. Corp., New York, N. Y.

GERALD DEAKIN was elected a director of IT&T. He has served as vice-president since 1932 and as vice-president and chief engineer since 1944.

JOHN H. BALDWIN is the first Westinghouse Fellow in Electrical Engineering at the University of Illinois.

JOE MARTY, Jr. is now manager of the Parts & Accessory Division at Admiral Corp., Chicago.



J. Marty, Jr.



W. J. Rooke

WILLIAM J. ROOKE is director of the newly organized Service Department at Hammarlund Mfg. Co., New York. During the war he served as Lieutenant Commander and commanding officer of a communications unit on Guadalcanal, assigned to set up radio transmitters on enemy-held islands under cover of fog and darkness to guide fleets of Navy and Marine bombers.

ELMER SCHNEIDER becomes vice-president and director of engineering at Wheelco Instruments Co., Chicago.

EUGENE W. BOEHNE has left G-E to become associate professor in the department of electrical engineering at MIT.

S. K. LACKOFF is now chief engineer of Eastern Amplifier Corp., New York City.

W. W. WATTS, vice-president in

HOLLOWELL

"SOCKET SCREW" KIT
with interchangeable bits

For men who like to have a handy, useful set of tools, yet dislike bulk and "tool hunting", Hollowell "Socket Screw" Kits are the answer. Their tread-grip, hollow red plastic handles contain interchangeable, high-grade steel bits for most all purposes where Phillips, Hex and Slotted Head Screws are used. Each has a swivel bit-chuck that locks securely in any one of five positions.

Hollowell "Socket Screw" Kits are made in 2 sizes: #25, medium; and #50, large. Other Hollowell Kits include: "Socket Wrench"; "Auto"; and "Home".

Obtainable at Industrial Distributors and Hardware Dealers throughout the country. If there is no Supplier in your locality, or he is sold out, send his name to us, along with yours, and you will be taken care of promptly.

An ideal gift or prize.

Kits: Patents Pending

Over 44 Years in Business

STANDARD PRESSED STEEL CO.
JENKINTOWN, PENNA., BOX 596

Boston • Chicago • Detroit • Indianapolis • St. Louis • San Francisco

charge of RCA Victor Division's Engineering Products Department, was elected a director of Radiomarine Corporation of America.

JENNINGS B. DOW, retired from Navy service with the rank of Commodore, was elected vice-president of Hazeltine Electronics Corp. Throughout the war he was Director of Electronics for the Bureau of Ships.



J. B. Dow



G. C. Southworth

GEORGE C. SOUTHWORTH of Bell Telephone Laboratories received the Stuart Ballantine medal of The Franklin Institute, awarded for the first time this year, "in consideration of his pioneer work in electromagnetic and microwave technique, a material contribution to the development of new systems of communication and reconnaissance radar."

HORACE R. DYSON is now manager of RCA's Government Radiation Section in Camden, N. J., concerned with all government radio transmitter and receiver, radar, sonar, and communications engineering. He joined RCA in 1931.

STANLEY W. COCHRAN was made manager of RCA's Government sound engineering section. He joined RCA in 1930, and during the war was in charge of all government sound equipment produced by RCA for the armed forces.

PAUL H. THOMSEN, formerly chief radio engineer at Air Associates, Inc. and prior to that vice-president in charge of engineering at Air Track Mfg. Corp., is now educational director for Radio Training Association of America, Hollywood.

VIRGIL E. TROUANT was made manager of RCA's Broadcast and Industrial Section in Camden, N. J. He has been with RCA since 1933, designing their first 50-kw broadcast

GIVE YOUR TRACING CLOTH the 1-2-3-test-

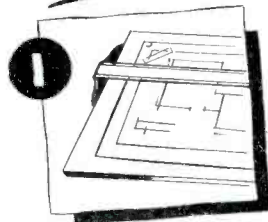

TRANSPARENCY

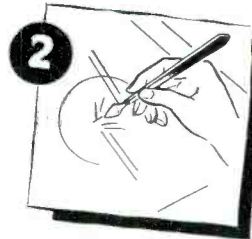

ERASABILITY

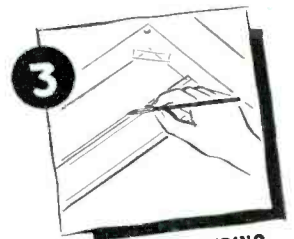

NON-FEATHERING

MICRO-WEAVE and PEL-X win on ALL three

Whatever you want most in a tracing cloth, you'll find it in these two great products of Holliston Mills. Try them both and you'll agree: it pays to make sure you get "all three": maximum transparency and maximum erasability and minimum feathering.

THE HOLLISTON MILLS, INC.
NORWOOD, MASSACHUSETTS NEW YORK CHICAGO

Send for Samples.



STROMBERG-CARLSON uses-

DINION

Transformers and Coils

- Photo Flash Control • Instrument • Television
- Radio • Electronics and Industrial Applications
- Electrical Coil Windings

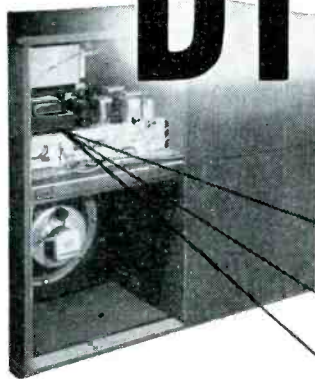

The stringent requirements of a radio of distinction call for high calibre transformers and electrical coil windings. For superior quality and production, manufacturers use Dinion Transformers and Coils.

Specialists in Difficult Designs



DINION COIL COMPANY, INC. CALEDONIA NEW YORK

WELLER *Soldering*

Gun

5 SECOND HEATING

Specially engineered lightweight transformer produces soldering heat in loop tip 5 seconds after trigger switch is closed. Acclaimed by radio servicemen nation-wide as a money maker.

DEPENDABLE

Always ready to use when picked up. Fast cooling makes it safe to lay down on bench.

TROUBLE FREE

Thousands in daily use without any maintenance—some as long as 5 years. Nothing to break or burn out.

Get a Weller Soldering Gun from your radio parts distributor or write direct for bulletin.

100 Watts
115 Volts
60 Cycles

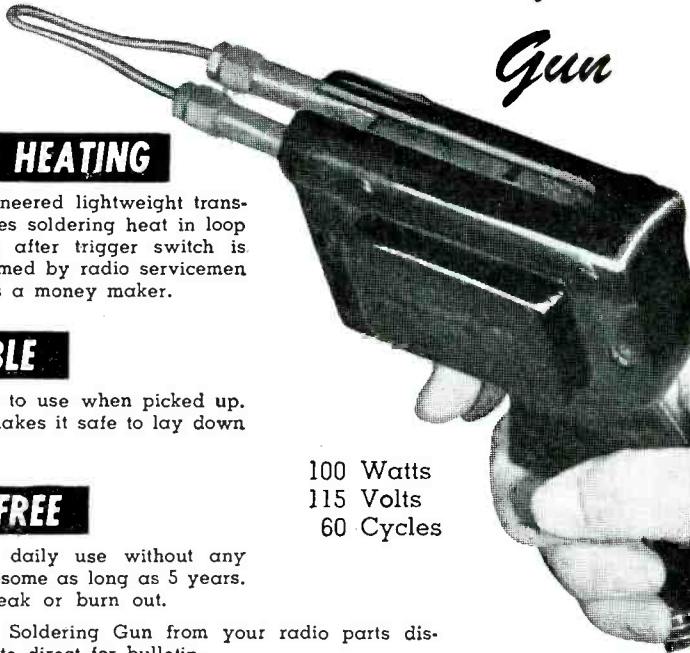

WELLER MFG. CO. 806 Packer St., Easton, Pa.

In Canada: Atlas Radio Corp., Ltd., 560 King St., N. W., Toronto, Ont.
Export Dept.: 25 Warren St., New York 7, N. Y.

at the helm
of the BAT BOMB

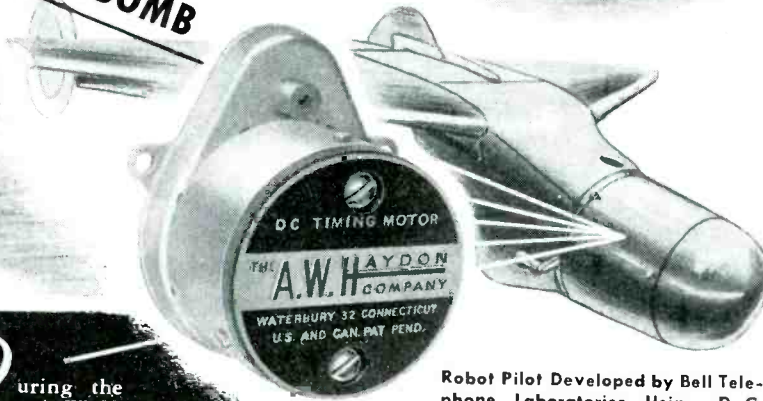

Robot Pilot Developed by Bell Telephone Laboratories Using D. C. Motor Designed by A. W. Haydon

During the war, A. W. Haydon designed a D. C. Motor that was a component of the robot pilot controlling the accurate flight of the "bat" from launching to point of impact as much as 5 miles distant on the target ship.

These same motors are now being manufactured for use in various aircraft and other applications. The engineering skill that designed these motors is at your service for the asking.



The
A.W. HAYDON
COMPANY

WATERBURY 32, CONNECTICUT

Design and Manufacture of Electrical Timing Devices

transmitter and their first high-frequency generator for industrial heating.

ROBERT R. WELSH becomes manager of RCA's Communications and Specialty Section in Camden, N. J. He joined RCA in 1930, was for four years chief engineer of RCA's Canadian plant, and went to London last year as technical adviser to the State Department for the PICAQ meetings.

CLARENCE A. GUNTHER, RCA assistant chief engineer and in charge of Government Equipment was recently made an engineering section manager. He has been with RCA since 1930, in communications and television engineering work.

C. W. DALZELL is now chief engineer of Franklin Transformer Mfg. Co., Minneapolis, Minn.



C. W. Dalzell

L. O. Grondahl

LARS O. GRONDAHL, director of research and engineering at Union Switch and Signal Co., Pittsburgh, received the George R. Henderson medal of The Franklin Institute "in consideration of his contributions over a period of years to the development which has resulted in making available a practical system of inductive train communication."

WILLIAM J. MORLOCK becomes manager of RCA's Distributed Products Section, including sound products, motion picture sound, and test equipment engineering. He has been in sound equipment work at RCA since 1930.

GEORGE A. SCHERRY has been appointed chief electrical engineer at the La Grange, Illinois plant of Grayhill, electrical switch manufacturer in Chicago. He was previously in charge of engineering and production for Garner Electronics Corp., Chicago.

NEW BOOKS

Radiography in Modern Industry

By STAFF MEMBERS, *Kodak Research Laboratories and Industrial X-Ray Division*. Published by Eastman Kodak Company, Rochester 4, N. Y., 1947, 122 pages, \$3.00.

IN A beautiful example of book making, Kodak offers through its x-ray dealers a large-format (8½ x 11 inches) slick-paper two-color text on the place of radiography in industry plus a great deal about x-ray techniques. There are 13 chapters, three appendices, a useful bibliography, and an index. The chapter headings include such subjects as geometric principles, factors governing exposure, radiographic screens, sensitivity and detail visibility, special techniques, and processing. The appendices give sensitometric data on Kodak films (including D-log E curves) and how to use such data, methods of protection against x-rays, and causes and remedies of unsatisfactory radiographs.

While the book deals with Kodak materials, as is natural, it is of such general interest that all who use or handle x-ray equipment should benefit from the practical techniques described and discussed. The illustrations, both line cuts and halftones, are models of clarity and interest.—K.H.

Proceedings of the National Electronics Conference

Volume II, covering 1946 Conference, 741 pages, \$3.50. Copies obtainable from R. E. Beam, Electrical Engineering Dept., Northwestern University, Evanston, Illinois.

OF THE 65 papers presented at the National Electronics Conference in Chicago Oct. 3-5, 1946, a total of 56 are presented in complete form and the remainder as abstracts. All papers are carefully edited, and both illustrations and typography attest to the diligence and competency of the publications committee headed by R. E. Beam. The volume is printed on high-grade coated paper giving excellent halftone reproduction, with a durable paper binding.

The nature of the contents is in-

NOW—A QUALITY 2-KW INDUCTION HEATING UNIT

For Only \$650.



Never before a value like this new 2-KW bench model "Bomber" or high frequency induction heater . . . for saving time and money in surface hardening, brazing, soldering, annealing and many other heat treating operations.

Simple . . . Easy to Operate . . .
Economical Standardization of Unit
Makes This New Low Price Possible

This compact induction heater saves space, yet performs with high efficiency. Operates from 110-volt line. Complete with foot switch and one heating coil made to customer's requirements. Send samples of work wanted. We will advise time cycle required for your particular job. Cost, complete, only \$650. Immediate delivery from stock. Scientific Electric Electronic Heaters are made in the following range of power: 1-3-5-7½-10-12½-15-18-25-40-60-80-100-250KW.—and range of frequency up to 300 Megs. depending on power required.

Scientific Electric

Division of

"S" CORRUGATED QUENCHED GAP CO.

107 Monroe St., Garfield, N. J.

for neat, speedy wiring VERSIFLEX PLASTIC WIRE AND CABLE HANGERS

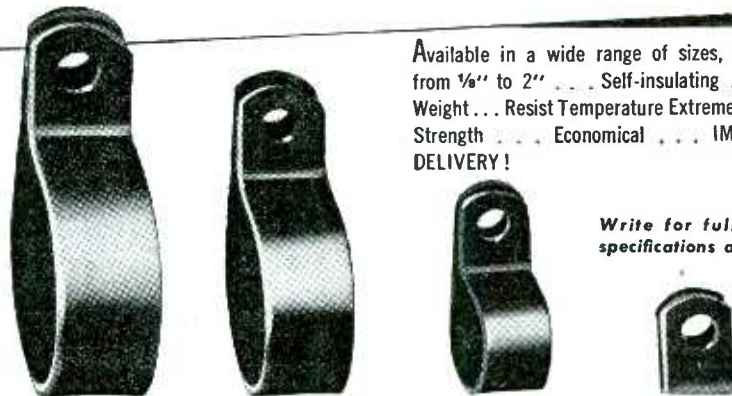

Available in a wide range of sizes, diameters from ¼" to 2" . . . Self-insulating . . . Light Weight . . . Resist Temperature Extremes . . . High Strength . . . Economical . . . IMMEDIATE DELIVERY!

Write for full details, specifications and prices.

BURNDY NEW YORK 54, N. Y.
CANADA: Canadian Line Materials, Limited, Toronto 13
FOREIGN: Philips Export Corporation, New York 17, N. Y.

**PRECISION
DECADE
RESISTOR UNITS**



**UNUSUAL BUYS
IN FINE AUDIO
ACCESSORIES**

Twenty-step decades. Splendid for labs, radio stations, recording studios—any place where precise units of resistance are required. Excellent for bridges, resistance standards, percentage controls (each step equals 5%), for meter multipliers etc. Four sizes available, as follows:

— QUANTITIES LIMITED — ORDER NOW.

Type A	2 ohms total — .1 ohm steps.....	\$3.75	each
Type B	40 ohms total — 2. ohm steps.....	2.75	each
Type C	800 ohms total — 40. ohm steps.....	2.75	each
Type D	16,000 ohms total — 800. ohm steps.....	4.75	each

All types complete with dust-proof cover and calibrated dial.

EXCLUSIVE Apex Cueing Discs

Broadcasters and recording studios have needed these for a long time. 18" Formica disc with flocking on one side—other side polished. Makes cueing simpler — prevents scratching acetates.



Price \$4.50 each

ALSO AVAILABLE FROM STOCK

Jacks and Jack Strips - Patch Cords - ADC Audio and Power Transformers - Variable Cut-off Filters - 12-volt DC Relay Power Supplies - 10-kc Beat-Note Filters

AUDIO EQUIPMENT SALES
923 EIGHTH AVENUE NEW YORK 19, N. Y.

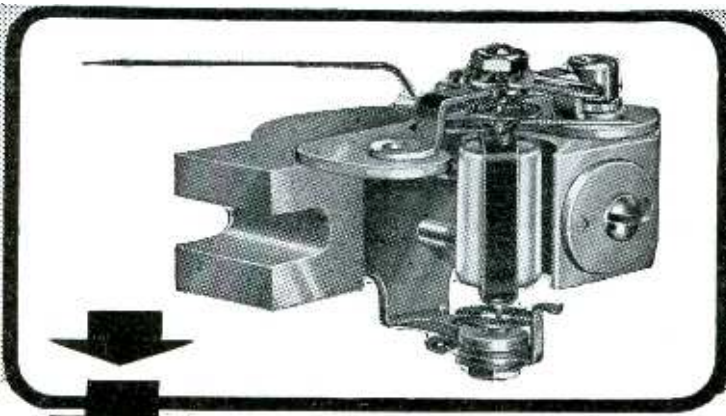

**Burlington
INSTRUMENTS**



Precision Movement • Dependability Unlimited

Alnico Magnets in all DC Instruments—Phosphor bronze control springs—perfectly aligned jewel supports—non-shifting balance weights—added to its many other superior construction features enables Burlington Instruments to maintain critical characteristics.

All ranges AC or DC available in 2½", 3½", 4½" sizes, rectangular and round.

Inquiries invited for your specific requirements.

BURLINGTON INSTRUMENT COMPANY 119 FOURTH ST. BURLINGTON, IOWA

dictated by the Conference program, published in Aug. 1946 Electronics, p 270-274. In compiling the proceedings, the papers were grouped in 16 logical classifications for easy reference. Brief biographies of all authors presenting papers, with photographs of most of them, are included in the appendix along with a complete list of registrants and exhibitors. All in all, this volume at its low price per page constitutes one of the best book buys of the year in the technical publishing field. The many papers constitute an up-to-date roundup of electronic progress well meriting addition to a reference library.—J.M.

Photoelectric Cells

By A. SOMMER. *Chemical Publishing Co., Brooklyn, New York, 1947, 104 pages, \$2.75.*

OPERATION, characteristics, and construction of photoelectric tubes (as distinguished from photoelectric cells, the former operating by emission, the latter by barrier layer or photoconduction—the misnomer in the title should be noted) are surveyed. Although some specific information on emitting materials and operating properties is given in this monograph, the tube designer, to whom it seems directed, will find it inconclusive.—F.R.

Electronics for Industry

By WALDEMAR I. BENDZ, *Westinghouse Electric Corp., Boston, Mass. John Wiley & Sons, Inc., New York 16, N. Y., 501 pages, \$5.00.*

WRITTEN for electrical engineers whose interest has become directed toward electronic apparatus, this book explains without resort to equations the fundamentals of electronic tubes and circuits, with emphasis on how these fundamentals are applied to industrial electronic equipment. A welcome feature for engineers grown unaccustomed to study of textbooks is a concise and clearly worded summary at the end of each chapter. Those desiring additional information on a particular subject will like equally well the chapter-end references to recent books and magazine articles.

The first ten chapters deal with

tubes—how they are made and how they work, with emphasis on industrial types. In logical order follow chapters on amplifier circuits, oscillator circuits, circuits for modulation and detection by carrier waves, high-frequency heating systems, basic electronic control circuits, industrial applications of electronic control, and electronic regulator circuits. Step-by-step procedures for determining the size of generator and the work coil design required to heat a particular shape of metal to a given temperature in a given time by induction heating are given, along with corresponding calculating procedures for dielectric heating. The book is a mature engineering work, deserving of a place in the library of an industrial application engineer.—F.R.

Directional Antennas

By CARL E. SMITH, published by Cleveland Institute of Radio Electronics, Cleveland, Ohio. 300 pages, \$15.00.

BROADCASTING antenna patterns are theoretically developed in Part I. In Parts II and III, 238 polar charts are presented for two and three tower arrays respectively. The charts were drawn by an electro-mechanical directional antenna calculator. The theoretical section presents material on vertical radiation patterns and radiator impedance. The latter part of the book constitutes a highly useful reference for determining antenna spacing to obtain desired broadcast station coverage and required guard of other stations.—F.R.

Musical Acoustics

By CHARLES A. CULVER. The Blakiston Co., Philadelphia, Pa., second edition, 1947, 215 pages.

TERMINOLOGY of sound, hearing, and music, and operating principles and tonal characteristics of various musical instruments, including brief mention of electronic types, are described for those unfamiliar with physics. Although the material is concise, it is comprehensive. However, because of excessive caution in being scientifically accurate, especially in details that the intended reader cannot appreciate, the lucidity of the introductory chapters suffers.—F.R.

WINCHESTER LIGHTWEIGHT CONNECTOR



A18S



A18P



CABLE CLAMP

Designed originally for Aircraft applications, this new WINCHESTER Connector is being used extensively in communications and industrial fields where reliability, compactness and light weight are important factors.

- WINCHESTER MONOBLOC* construction
- 18 Precision Machined Contacts
- Long Creepage Paths
- Compactness
- Melamine Insulation
- Light Weight

*Trademark

Write for Catalog Sheet Q 1-47

THE WINCHESTER COMPANY

6 EAST 46TH STREET

NEW YORK 17, N. Y.

EUGENE MITTELMANN, E. E., Ph. D.

*Consulting Engineer
and Physicist*

Formerly Director
of Electronic Research
and Development
ILLINOIS TOOL WORKS, CHICAGO

Announces

The opening of his Offices
and Laboratory
549 W. WASHINGTON BOULEVARD
CHICAGO 6, ILLINOIS

HIGH FREQUENCY HEATING
INDUSTRIAL ELECTRONICS
APPLIED PHYSICS
AND MATHEMATICS

STATE 8021



Lavite STEATITE CERAMIC

Properties and Characteristics of Our LAVITE S1-5 Steatite Ceramic Body

Compressive Strength	96,000 lbs. per square inch	Frequency of	1 megacycle
Tensile Strength	7,200 lbs. per square inch		
Flexural Strength	10,500 lbs. per square inch		
Modulus of Rupture	20,000 lbs. per square inch		
Dielectric Strength	235 volts per mil		
Dielectric Constant	6.42		
Loss Factor	2.90		
Power Factor	4.46		
Bulk Specific Gravity	2.664%		
Density (from above gravity)	0.096 lbs. per cubic inch		
Hardness (Mohr scale)	7.0		
Softening Temperature	2,350°F		
Linear Coefficient of Expansion	8.13x10 ⁻⁶		
Moisture Absorption (ASTM D-116-42-A)	0.009%		

Design engineers and manufacturers in the radio, electrical and electronic fields are finding in LAVITE the precise qualities called for in their specifications . . . high compressive and dielectric strength, low moisture absorption and resistance to rot, fumes, acids, and high heat. The exceedingly low loss-factor of LAVITE plus its excellent workability makes it ideal for all high frequency applications.

We will gladly supply samples for testing.

D. M. STEWARD MFG. COMPANY

Main Office & Works: Chattanooga, Tenn.
Needham, Mass. Chicago Los Angeles

SIMULTANEOUSLY

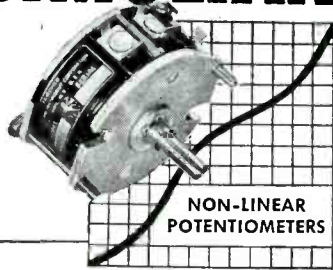

NON-LINEAR
POTENTIOMETERS

COMPUTING

4 Equations* with
34 Windings
(*10 Variables in all)

Unknowns: w, x, y, z
Variables: a, b, c, d, θ, B
Constants: K_1, K_2

$$w = (a^2 + b^2 + 2ab \sin \theta \cos B)^{1/2}$$

$$x = z^2 (K_1 bd w^{1/2} \cos \theta \cos B - K_2 \sin \theta) \\ C(1 + K_1 d w^{1/2} z)$$

$$y = K_1 bd w^{1/2} z^2 \sin B \\ C(1 + K_1 d w^{1/2} z)$$

$$z = c + z^2 (K_1 bd w^{1/2} \sin \theta \cos B - K_2 \cos \theta) \\ a - K_1 c d w^{1/2}$$

(maximum error never exceeds 1%)

Do you need simultaneous control of single or multiple variables or processes that determine the final solution or product quality? Fairchild Non-linear Potentiometers—used singly, ganged, connected electrically, or in combination with Servos—provide instant and continuous solutions to empirical or complex mathematical formulas and process controls. All computations can be done electrically without complex mechanical cams . . . special gears . . . lost motion . . . or non-linear scales. For immediate attention to your inquiry address: Dept. C, 88-06 Van Wyck Blvd., Jamaica 1, N. Y.



Fairchild CAMERA
AND INSTRUMENT CORPORATION

Backtalk

This department is operated as an open forum where our readers may discuss problems of the electronics industry or comment upon articles which ELECTRONICS has published.

Listening Tests

Dear Editor:

YOUR REQUEST for "more tests needed" which appeared with Webster's and Peak's "Experiments in Listening" in the April, 1947 issue of ELECTRONICS, is typical of the kind of prodding many researchers are receiving.

As you undoubtedly know, a considerable amount of work has already been done in the field of listening tests, particularly in search for listener esthetic preferences.

In nearly all reported manuscripts, gross errors of omission or commission were made in either one or more of the following:

1. Qualification of program material
2. Qualification of listeners
3. Qualification of test equipment
4. Qualification of testing technique
5. Interpretation of statistical data

You are undoubtedly aware of the statistician's technique of interpreting his data in accordance with some preconceived idea. Nearly all communication engineers involuntarily follow such fallacious interpretations. For example, Table 4 as reproduced on Page 95 of your last issue, appears to show overwhelming majority preferences for live music versus transcribed music.

While the writer has no fault to find with the listed preferences, the technique of compiling this statistical data does no justice to our engineering profession. Your experimenters ran three tests, two of which involved a choice of one or another type of live music. They then proceeded to add their totals for each test to produce their final statistical data, from which they assumed that live music is to be preferred.

It is quite conceivable that if

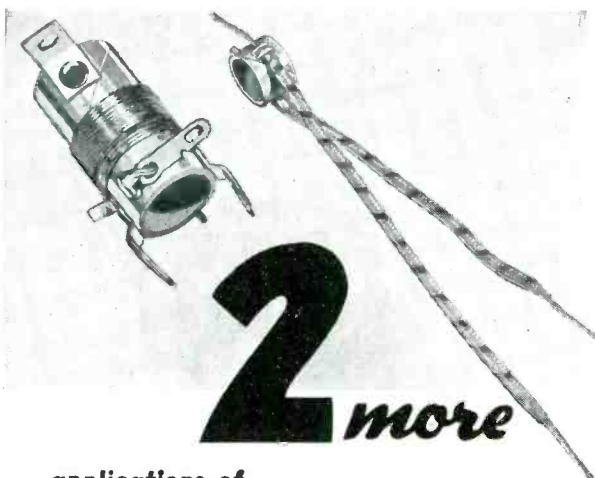

for experienced
cooperation
"call Cleveland"

applications of COSMALITE*

a spirally laminated paper base Phenolic Tube.

For coil forms in all standard broadcast receiving sets, specify #96 Cosmalite.

For permeability tuners, specify SLF Cosmalite.

LOWER COSTS . . . Quick Deliveries

Ask about our spirally wound kraft and fish paper Coil Forms and Condenser Tubes.

*Trade mark registered.



All-Fibre Cans
Combination Metal
and Paper Cans
Spirally Wound
Tubes and Cores
for All Purposes
Plastic and
Combination Paper
and Plastic Items

The **CLEVELAND CONTAINER Co.**
6201 BARBERTON AVENUE CLEVELAND 2, OHIO

PRODUCTION PLANTS also at Plymouth, Wisc., Ogdensburg, N. Y., Chicago, Ill., Detroit, Mich., Jamesburg, N. J.
PLASTICS DIVISIONS at Plymouth, Wisc., Ogdensburg, N. Y. • ABRASIVE DIVISION at Cleveland, Ohio
New York Sales Office—1186 Broadway, Room 223

IN CANADA—The Cleveland Container Canada Ltd., Prescott, Ontario

PROFESSIONAL SERVICES

Consulting — Patents — Design — Development — Measurements

in

Radio, Audio, Industrial Electronic Applications

H. RUSSELL BROWNELL

Consulting Engineer

Specializing in Measurements & Testing
Instruments & Techniques - Electrical - Elec-
tronic - Magnetic.

188 West 4th St. New York 14, N. Y.
Chelsea 2-4208

EDWARD J. CONTENT

Acoustical Consultant

and

Audio Systems Engineering, FM, Standard Broad-
cast and Television Studio Design.

Roxbury Road Stamford 3-7458
Stamford, Conn.

CONTROLS LABORATORIES, INC.

Consulting Division

EXCEPTIONAL FACILITIES

for

RESEARCH and DEVELOPMENT
Electrical and Mechanical Problems

SPECIAL PATENT SITUATIONS

Background of over 200 research projects.
Partial list of subjects available upon request
98 Union St. Worcester 8, Mass.

By reason of special training, wide
experience and tested ability,
coupled with professional integrity, the
consulting engineer brings to his client
detached engineering and economic ad-
vice that rises above local limitations
and encompasses the availability of all
modern developments in the fields where
he practices as an expert. His services,
which do not replace but supplement
and broaden those of regularly em-
ployed personnel, are justified on the
ground that he saves his client more
than he costs him."

ALBERT PREISMAN

Consulting Engineer

Television, pulse Techniques, Video
Amplifiers, Phasing Networks,
Industrial Applications

Affiliated with
MANAGEMENT-TRAINING ASSOCIATES
3308-14th St., N.W. Washington 10, D. C.

JOSEPH RAZEK, Ph. D.

Consulting Physicist

Electric and Mechanical Engineering Problems
Instruments and Control Devices Electronics
Specialists in Colorimetry, Spectrophotometry and
Industrial Color Control

Laboratory and Shop Facilities
202 Darby Road Llanerch, Pa.
Phone Hilltop 6810

INDUSTRIAL DEVELOPMENT ENGINEERING ASSOCIATES

Engineering Consultants

Electronic Control, Motion Picture &
Sound Equipment

Development—Design—Models
4125 E. 10th St. Indianapolis, Ind.

ARTHUR J. SANIAL

Consulting Engineer

Loudspeaker Design; Development; Mfg. Processes.
High Quality Audio Systems. Announcing Systems.
Test and Measuring Equipment Design.

168-14 32 Ave. Flushing 9-3574 Flushing, N. Y.

ELM LABORATORIES

ELECTRONIC-MECHANICAL
RESEARCH & DESIGN

Patented ELM Developments include

PROGRAMME Automatic Radio Program Tuner,
Famous "Gerty" Direction Finder Loop, Sealed
Xtal Holder, Home Receiver Designs.
20 South Broadway Debbs Ferry, New York
Phone Dobbs Ferry 4058

WINFIELD SCOTT McCACHREN

AND ASSOCIATES

Consulting Radio Engineers

TELEVISION SPECIALISTS

Philadelphia:
369B Windemere Ave. 410 Bond Building
Draxel Hill, Pa. Washington, D. C.
Sunset 2537-W District 6923

YARDENY ENGINEERING CO.

Remote Controls (Wires and Wireless)
Automatic Devices

Electronic • Electrical • Mechanical
Consultation • Designing • Manufacturing
Licensing

105 Chambers Street New York, N. Y.
Worth 2-3534, 3535

PAUL E. GERST CO.

CONSULTING ENGINEER

Specialists in
Electrical Product Design

El. Machinery, Apparatus & Applications
El. Appliances, Hi-Frequencies Apparatus
Electronics, Radio Communications

205 W. Wacker Dr. Chicago 6, Ill.

Eugene Mittelmann, E.E., Ph.D.

Consulting Engineer & Physicist

High Frequency Heating — Industrial Electronics
Applied Physics and Mathematics

549 W. Washington Blvd. Chicago 6, Ill.
State 8021

PAUL D. ZOTTU

Consulting Engineer

INDUSTRIAL ELECTRONICS

High Frequency Dielectric and Induction Heating
Applications, Equipment Selection, Equipment and
component Design, Development, Models.

272 Centre St. Newton, Mass.
BIQ-9240

THE

REAL

VALUE

of placing your unusual problem in
the hands of a competent consultant
is that it eliminates the elements of
chance and uncertainty from the
problem and provides real facts upon
which to base decisions.

CONTINENTAL ELECTRIC CO.

GENEVA ILLINOIS

"announces its BLUE SENSITIVE PHOTOTUBE"

It has duplicated the most popular of its red-sensitive

CETRON PHOTOTUBE types

by tubes with S4 (blue-sensitive) response

Red-Sensitive S1	CE-1	CE-1-V	CE-25	CE-25-V	CE-4
Blue-sensitive S4	CE-91	CE-61	CE-64	CE-34	CE-74
Min. sensitivity Class R, ua/l	90	25	65	17	80
Min. sensitivity Class Q, ua/l	180	55	130	36	160
Red-Sensitive S1	CE-3	CE-25	CE-30	CE-30-V	CE-31-V
Blue-sensitive S4	CE-83	CE-97	CE-33	CE-29	CE-99
Min. sensitivity Class R, ua/l	90	90	75	25	25
Min. sensitivity Class Q, ua/l	180	180	165	55	55

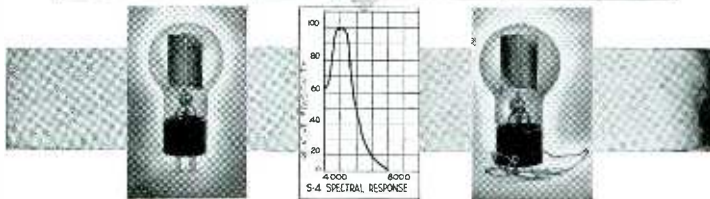

For technical data and special information write to

CONTINENTAL ELECTRIC CO., Geneva, Illinois

PLASTIC FABRICATING ...O.K!

BAKELITE SHEETS, RODS, TUBES
FABRICATED PARTS

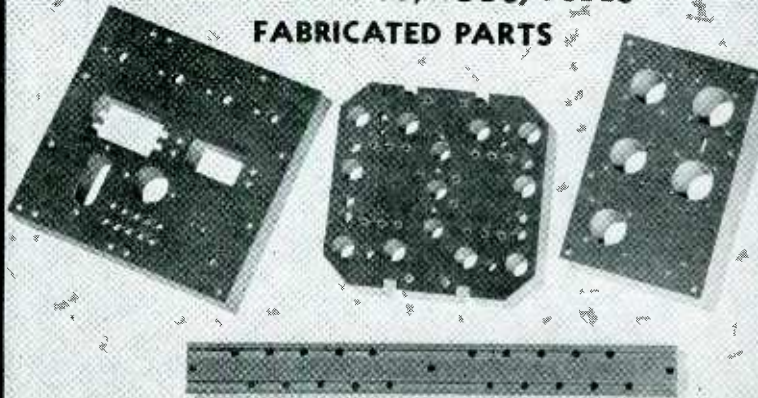

Twenty Years of Experience

ELECTRICAL INSULATION CO., INC.

12 VESTRY ST., NEW YORK 13, N. Y.

BACKTALK

(continued)

three tests were run, and two of which involved single or dual channel transcribed music, the totalling of the results may have reversed their final conclusion.

If, by analogy, we assume that the DuPont Company had decided to test the preferences between red and blue, and conducted tests along similar lines, wherein subjects were asked to select between spectral red and turquoise blue or pastel blue (because of some technical reason, spectral blue could not be produced), it is obvious that if all of the subjects were totally color-blind and that if a sufficient number of tests were made and averaged, 33 percent would select each of the tested colors. If the researcher then proceeded to add up the totals for turquoise blue and pastel blue, his final result would show 33 percent for spectral red and 66 percent for all blue, thereby proving "conclusively" that the majority preferred blue.

While this analogy may be strained, its end hypothesis parallels those of Webster and McPeak.

N. M. HAYNES
Vice-president in charge of
Engineering
Amplifier Corporation of America
New York, N. Y.

Paper Trouble

Dear Editor:

I SECOND the motion. Just retired after 46 years and 8 months with same concern—being a member of both AIEE and IRE—having been attending all sorts of lectures, on all sorts of subjects, for past 50 years—and now being in position to attend more of them—I object to many of them coming at the same time, on the same day.

I want to listen to more of those papers than is possible, because they come at the same time, on the same day. All the inspection trips start at the same time on the same day, so I can only go on one of them.

I am not a tired business man. I have nothing but time on my hands—and practically nothing to do except attend lectures of all the engineering societies I can get wind of.

Thank you for speaking out loud about it.

GORDON S. WALLACE
Brighton, Mass.

CONTACTS

FOR THE FIELD OF ELECTRONICS



FINE RIBBONS OF TUNGSTEN and MOLYBDENUM

Quality and accuracy in our fabrication of Tungsten & Molybdenum Ribbons have characterized our service to the Electronic industry.

A development of

H. GROSS Co.
15 Beekman St., New York 7, N.Y.

RADIO KNOBS **IMMEDIATE DELIVERY**



No. 1100 No. 1105 No. 1109
No. 1110

LARGE QUANTITIES for Manufacturers

Now available—variety of bakelite knobs in large quantities—set screw, knurl, or spring type—write for samples and quotations.

Write today for catalog of 3,000 electronic products.

GENERAL CEMENT MFG. CO.
Rockford, Illinois, U. S. A.

Kahle

ELECTRON TUBE MACHINERY OF ALL TYPES STANDARD AND SPECIAL DESIGN

We Specialize in Equipment and Methods for the Manufacture of

- RADIO TUBES
- CATHODE RAY TUBES
- FLUORESCENT LAMPS
- INCANDESCENT LAMPS
- NEON TUBES
- PHOTO CELLS
- X-RAY TUBES
- GLASS PRODUCTS

Production or Laboratory Basis

Kahle ENGINEERING CO.
1309 SEVENTH STREET
NORTH BERGEN, N. J., U. S. A.



WE manufacture a complete line of equipment



SPOT WELDERS, electric from ¼ to 50 KVA
TRANSFORMERS, special and standard types
INCANDESCENT LAMP manufacturing equipment
FLUORESCENT TUBE MAKING EQUIPMENT
ELECTRONIC EQUIPMENT, vacuum pumps, etc.
WET GLASS SLICING and cutting machines for laboratory use
GENERAL GLASS working machines and burners
COLLEGE GLASS working units for students and laboratory

AC ARC WELDERS from 100 to 400 Amps

EISLER ENGINEERING CO.
731 So. 13th St. (near Avon Ave.) Newark, New Jersey

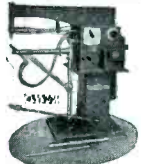

Prompt Deliveries Specializing in High Voltage Filament and Plant Transformers for Electronic Projects

ELECTRO ENGINEERING WORKS
6021 COLLEGE AVENUE - OAKLAND 11, CALIFORNIA

MICROMETER FREQUENCY METER for Checking Transmitters from 100 Kc to 175 Mc. within 0.01 per cent

LAMPKIN LABORATORIES
Bradenton, Fla. U. S. A.

High Speed Production Of Quality R. F. Coils and Sub-Assemblies, For Discriminating Manufacturers

Clippard INSTRUMENT LABORATORY, INC.
1125 Bank Street, Cincinnati 14, Ohio



PRINTED TAPE — For "Parts" Marking —

TOPFLIGHT TOOL CO.
Huber Bldg., York, Pa.

FILMGRAPH PAT'D **Conference Recorders**

UNINTERRUPTED Longtime (up to 12 hours) Conference & Telephone Recordings on Safety Film Models for Dictation "TALKIES"

ECONOMICAL PERMANENT INSTANTANEOUS PLAY-BACK

MILES REPRODUCER CO., INC. 812 BROADWAY, N.Y. 3

THIS CONTACTS SECTION

Supplements other advertising in this issue with these additional announcements of products essential to efficient and economical production and maintenance. Make it a habit of checking this page, each issue.

Classified Advertising Division

ELECTRONICS

AUDIO FREQUENCY DAMPING MATERIAL

AUDIROID A—Used in 3-A Feedback Recording System—Exclusive New Permanent Synthetic Viscous Damping for

- CUTTERS
- PICK-UPS
- REPRODUCERS
- LIGHT VALVES
- SPEAKER UNITS
- MICROPHONES

1/8" sheet—150 sq. in. . . . Min. Order. . . . \$5.00
1/16" sheet (for laminating)—250 sq. in. . . \$5.00

Postage prepaid in U. S. and Canada. Rates for special thicknesses or quantity orders on request.

Send name and address with check or money order to

COOK LABORATORIES
139 Gordon Boulevard
Floral Park, N. Y.

VITREOUS ENAMELED ROUND RHEOSTATS NEW SPRING-HINGED CONTACT ARM WRITE FOR CATALOG

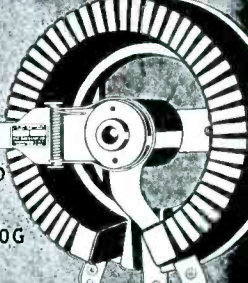

TUBULAR RHEOSTATS & RESISTORS

REX RHEOSTAT CO.
BALDWIN, L. I., N. Y.



SEARCHLIGHT SECTION

EMPLOYMENT • BUSINESS • OPPORTUNITIES • EQUIPMENT—USED or RESALE

UNDISPLAYED RATE:

90c a line, minimum 4 lines to figure advance payment count 6 average words as a line.

POSITIONS WANTED (full or part-time salaried individual employment only), 1/2 above rates.

PROPOSALS 75 cents a line an insertion.

INFORMATION:

BOX NUMBERS in care of any of our New York, Chicago or San Francisco offices count 10 words additional in undisplayed ads.

DISCOUNT of 10%, if full payment is made in advance for four consecutive insertions of undisplayed ads (not including proposals).

DISPLAYED—RATE PER INCH

The advertising rate is \$9.00 per inch for all advertising appearing on other than a contract basis. Contract rates quoted on request.

AN ADVERTISING INCH is measured 7/8 inch vertically on one column, 3 columns—30 inches—to a page. E

NEW ADVERTISEMENTS received by 10 A. M. June 7th will appear in the July issue, subject to limitation of space available.

POSITIONS VACANT

ASSISTANT OR Associate Professor wanted. Mechanical Engineer, graduate with some general experience to head Mechanical engineering Division of New Engineering School—Teaching experience preferred but not essential. Salary depending on qualifications. Send for application forms to Engineering Department, Arkansas State College, Jonesboro, Arkansas.

ASSISTANT OR Associate Professor wanted. Electrical Engineer, graduate with some experience to head Electrical Engineering Division of New Engineering School—Teaching experience preferred but not essential. Send for qualification forms to Engineering Department, Arkansas State College, Jonesboro, Arkansas.

ELECTRONICS ENGINEER wanted for responsible position in development of instruments for radiation measurement. Degree and several years experience plus initiative and ability to follow through are desired. Background in instrumentation, electronics associated with nuclear physics is advantageous. Address Laboratory Director, Victoreen Instrument Co., 8809 Hough Ave., Cleveland, Ohio. Electronics, 330 W. 42nd St., New York 18, N. Y.

TELEVISION FIELD service engineers—experience installation and repair—\$60 week opportunity advancement. Also men knowledge electronics preferably ex-Navy Chiefs—start \$45 week. Apply U. S. Television, 3 West 61st St., N. Y. Electronics, 330 W. 42nd St., New York 18, N. Y.

CHIEF ENGINEER and works manager wanted by first company to deliver projection television. Heavy experience Ultra High Frequency circuit characteristics, mechanical layout of radio chassis, production and testing techniques. U. S. Television, 3 West 61st St., N. Y., N. Y. Electronics 330 West 42nd St., New York 18, N. Y.

PROGRESSIVE FIRM of United Kingdom manufacturers able undertake repetition and light assembly work, with specialized knowledge in electrical instruments, radio and electronic fields, seek a sound tried-out line for exclusive manufacture in the United Kingdom. Director of the firm is due in the U. S. between May 20th and June 30th, and will be ready to investigate any interesting proposition on the spot. P-333, Electronics, 330 W. 42nd St., New York 18, N. Y.

GRADUATE ENGINEER or Physicist for design and development of electronic instruments is required by a large research laboratory. At least three years' experience in the field, familiarity with pulse technique and broad band amplifier design is essential. Living accommodation arranged. National Research Council, Chalk River, Ontario.

EMPLOYMENT SERVICES

SALARIED POSITIONS \$2,500 - \$25,000. This thoroughly organized confidential service of 37 years' recognized standing and reputation carries on preliminary negotiations for supervisory, technical and executive positions of the calibre indicated, through a procedure individualized to each client's requirements. Retaining fee protected by refund provision. Identity covered and present position protected. Send only name and address for details. R. W. Bixby, Inc., 278 Dun Bldg., Buffalo 2, N. Y.

EXECUTIVES \$3,000-\$25,000. This reliable service, established 1927, is geared to needs of high grade men who seek a change of connection under conditions assuring, if employed, full protection to present position. Send name and address only for details. Personal consultation invited. Jira Thayer Jennings, Dept E, 109 Church Street, New Haven, Conn.

(Continued on page 280)

CHIEF ENGINEER AND WORKS MANAGER

Wanted by first company to deliver projection television

Heavy experience Ultra High Frequency circuit characteristics, mechanical layout of radio chassis, production and testing techniques. Resourcefulness, initiative, foresight, sound judgment, willingness to assume responsibility for own decisions. Ability to enforce discipline, to locate and eliminate unnecessary overhead.

Salary high—only heavy weights need apply.

UNITED STATES TELEVISION MFG. CORP.

3 West 61st Street

New York City

CHIEF ENGINEER WANTED

★

FOR EASTERN MANUFACTURER OF RADIO AND SPECIALTY TRANSFORMERS

★

Unusual opportunity for man with experience and ability to assume full responsibility. Good salary plus incentive can be arranged. Our staff knows of this advertisement.

P-342, Electronics
330 West 42nd St., New York 18, N. Y.

AVAILABLE

EXECUTIVE - ENGINEER

With administrative, technical and sales experience in the design, development and manufacture of radar, radio and electronic equipment. Supervised development of radar and microwave equipment at government laboratory. Managed electronics department of development company with complete responsibility for sales, cost estimating, contract planning and technical execution of a variety of electronic projects. Chief engineer small manufacturer high frequency components. Former College Professor, M.S. degree, age 34, married. Interested in high executive position with permanency in progressive organization.

P-332, Electronics
330 West 42nd St., New York 18, N. Y.

WANTED

ELECTRONICS ENGINEER

Theoretical background in pulse circuits, and knowledge of laboratory technique, 8-10 years experience in applied electronics, wanted by New York City concern.

P-334, Electronics
330 West 42nd St., New York 18, N. Y.

WHEN
*Answering
Advertisements*

PLEASE do not send original letters, certificates or photographs. We cannot be responsible for their return. Please send photostat or carbon copies.

**Additional
Employment
Advertisements
will be found
on page 280**



WANTED: MEN WHO CAN FILL THESE JOBS!



FEDERAL'S NEW PLANT, at Clifton, N. J., is the last word in modern design, modern equipment, and modern methods for precision manufacture of tele-communication and electronic equipment. Remember, too, that Federal is an associate of the International Telephone and Telegraph Corporation—one of the oldest and most securely-founded organizations in the industry. A job with Federal is a job with an assured future!

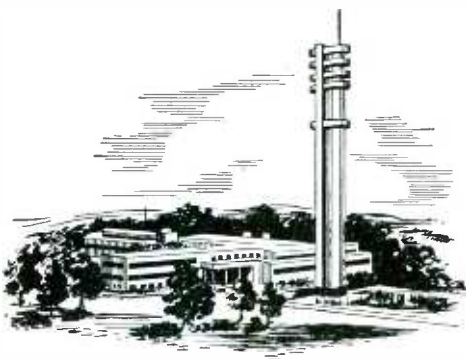

THE FEDERAL TELECOMMUNICATION LABORATORIES, at Nutley, N. J. represent the most modern laboratory and research facilities available anywhere. This, the American unit of IT&T's world-wide research and engineering organization, also represents the most advanced thinking in the field—pioneering that will shape the future of the radio and electronic industries. An affiliation with this organization offers great opportunities for the *right men!*

Federal now has openings for a few top-grade engineers who seek an unusual opportunity

IF YOU ARE an electronic or communication engineer with a really outstanding background—both academic and practical—this may be just the opportunity you've been looking for.

Federal now has a limited number of excellent jobs available for engineers with superior ability—men who want permanent positions with a company known the world over for its far-sighted research and development work in all fields of tele-communications and electronics.

Development engineers with 3 to 15 years experience in high-power and low-power transmitter design; engineers with 3 to 15 years experience in instrument landing of aircraft, mobile transmitters and receivers or wire transmission; telephone engineers with 3 to 15 years experience in circuits and equipment.

If you can meet these qualifications and want a job with an assured future, send complete resume giving educational background, job experience, age and salary requirements, to Federal Telephone and Radio Corporation, Clifton, New Jersey, attention of J. A. Abbott, Personnel Manager. All information will be kept in strict confidence.

Federal Telephone and Radio Corporation

In Canada: — Federal Electric Manufacturing Company, Ltd., Montreal.
Export Distributors: — International Standard Electric Corp. 67 Broad St., N. Y.



100 Kingsland Road,
Clifton, New Jersey

A Battery-operated
**INSULATION
TESTER!!**

200 MEGOHMS

At a Test Potential of

500 VOLTS D.C.

Supplied by built-in battery and vibrator power supply.

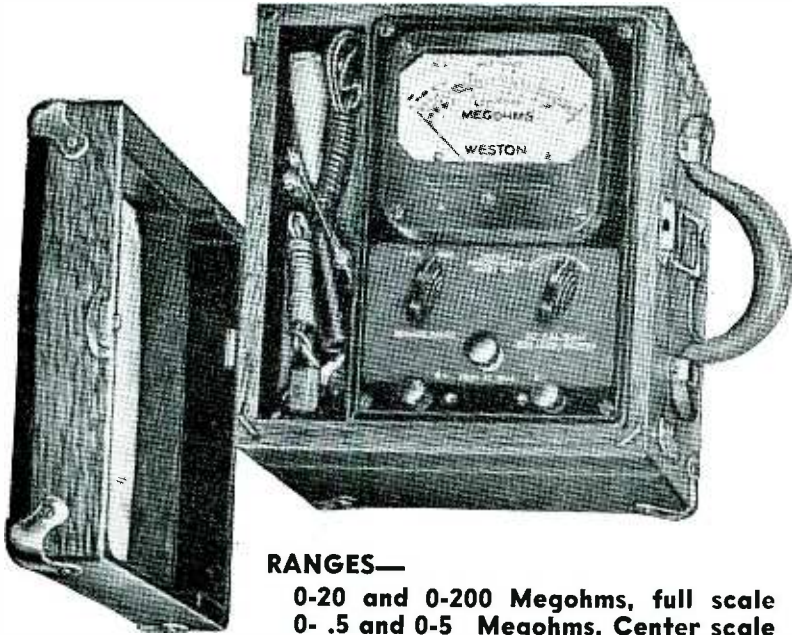

RANGES—

- 0-20 and 0-200 Megohms, full scale
- 0- .5 and 0-5 Megohms, Center scale

This unit was designed for the Navy to operate off eight 67½ volt batteries which provided a test potential of 350 to 500 Volts.

The original units have been modified slightly to operate off 2 inexpensive, (approximately 80¢) internal #6 standard 1½ volt dry cells and a vibrator power supply which provides a test potential of 500 volts. The use of the vibrator power supply eliminates the high replacement costs (approximately \$18.00) of the 67½ volt batteries.

- **NO HAND CRANKING**—The 500 volt potential is made instantly available by simply pressing a panel switch.
- **DIRECT READING**—All calibrations printed in large easy-to-read type enabling exact determination of leakages from 0 to 200 megohms.
- **PORTABLE**—Enclosed in a rugged hardwood carrying case 8¾" x 9½" x 8" deep with removable cover.
- **METER MOVEMENT**—A Weston Model 801 4½" Rect. 0-50 microampere meter guarantees extremely accurate readings on all ranges.

SURPLUS — NEW — GUARANTEED

Complete with leads, instructions, internal power supply, etc. Ready to use.

NET \$ 39.50

All prices F.O.B., N. Y.—25% Deposit required on C.O.D.'s. Orders accepted from rated concerns on open account Net 30 days.

PORTABLE METERS

Surplus—New—Guaranteed
GOV'T INSPECTED



PORTABLE A. C. AMMETER

ROLLER SMITH MODEL "STEEL SIX" (see illustration) 0-5 Amperes, accuracy within ½ of 1%; Hand Calibrated Mirror Scale 5 3/16" long with 100 scale divisions; Knife edge pointer; Moving Iron Vane type completely shielded from external magnetic fields. Dimensions 6"x6"x4".

ONLY \$19.50

PORTABLE A. C. VOLTMETER

WESTON MODEL 433 0-600 volt A.C., accuracy within ¾ of 1% from 25 to 125 cycles. Hand Calibrated Mirror Scale 4.04" long with 150 Scale divisions. Knife edge pointer. Moving Iron Vane type, magnetically shielded. Dimensions 5"x6"x3½". List Price \$59.50. **ONLY \$27.50**

PORTABLE D. C. VOLTMETER

ROLLER-SMITH "STEEL SIX" (similar to above illustration) DUAL RANGE 0-15 and 0-150 volt D.C. Accuracy within ½ of 1%; Hand Calibrated Mirror scale 5.18" long with 150 scale divisions; Knife edge pointer; magnetically shielded; 100 ohms per volt movement; Dimensions 6"x6"x4". List Price \$48.00. **ONLY \$21.00**



PORTABLE CURRENT TRANSFORMER

WESTON MODEL 461 TYPE 4 (see illustration). This unit can be used with any precision 5 Amperes A.C. Meter to extend the ranges of the meter to 50, 100, 200, 250, 500, or 1000 Amperes A.C. Accuracy within ¼ of 1%; Normal Secondary Capacity = 15 VA; Binding Posts for 50 Ampere tap; Inserted primary for 100, 200, 250, 500, and 1000 Amperes; Insulated for use up to 2500 volts. List Price \$98.00.

ONLY \$35.00

MARITIME SWITCHBOARD

338 Canal Street

Worth 4-8217

New York 13, New York

PORTABLE METERS



A. C.
AMMETERS
Surplus New
WESTON
MODEL 528

DUAL RANGE 0-3 Amp. and 0-15K Amp. full scale for use on any frequency from 25 to 500 cycles. The ideal instruments for all commercial, industrial, experimental, home, radio, motor and general repair shop testing. Comes complete with a genuine leather, plushlined carrying case and a pair of test leads. A very convenient pocket sized test meter priced at less than 50% of manufacturers list. Your cost ONLY \$12.50

Portable A. C. Voltmeters

(See Illustration of Ammeters)
**SURPLUS NEW WESTON
MODEL 528**

DUAL RANGE 0-15 and 0-150 volts for use on any frequency from 25 to 125 cycles. Complete with plushlined leather carrying case and a pair of test leads. This Voltmeter, with the matching model Ammeter as illustrated above, makes an ideal pair of test meters for any mechanic to carry around in his tool box... Only \$9.50 Combination Offer; 528 Voltmeter

528 Ammeter
BOTH For\$21.00



PORTABLE D.C. VOLT-AMMETER

WESTON MODEL 280, 0-3, 0-15 and 0-150 volts; 0-3, 0-15 and 0-30 Amps D.C. **SIX RANGES IN ONE INSTRUMENT**, Accuracy within 1%; Hand Calibrated Mirror scale 2.76" long with 60 Scale divisions; Knife edge pointer, magnetically shielded. Condition—Only very slightly used — like new. List Price\$43.00
Surplus Price\$15.00

CODE RECORDER BC-1016

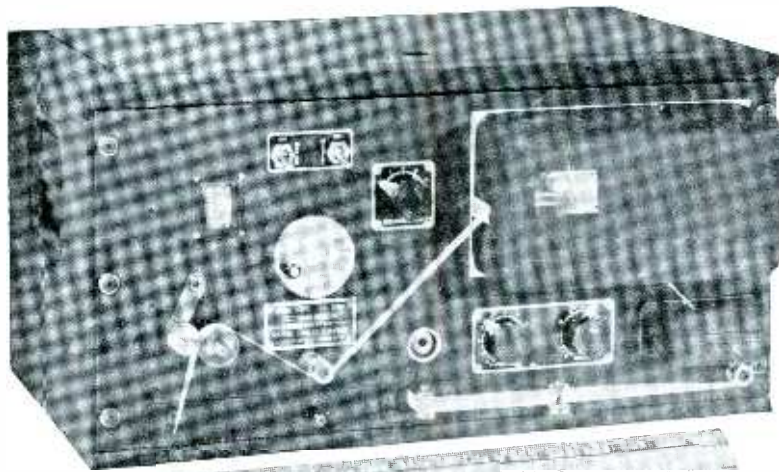

- **GENERAL**—Designed for ink recording of standard code signals at speeds up to 400 words per minute on a 3/8" paper tape. Made by Waters Conley Company, Rochester, Minnesota.
- **APPLICATION**—a) Designed primarily to be connected to the output circuit of a radio receiver. Operates on a signal from 0.15 to 50 volts, usually connected directly across the speaker voice coil so that signals may be heard as well as automatically recorded. Frequency response 500 to 5000 cycles per second.
b) Direct Keying recording from an automatic keyer or from a hand key to record messages for code practice, etc.
c) Can be operated from a telephone line which carries the radio signals to the recorder from a remote location.
- **POWER SUPPLY**—Operates on 117, 170, 210 or 240 volt 50-60 cycle alternating current or within 10% of those voltages.
- **POWER CONSUMPTION**—Approximately 140 watts operating; approximately 85 watts in standby.
- **COMPONENTS**—Fully equipped and assembled. Just connect to voice coil of the speaker on your receiver (or to a key for code practice) and plug into your power line.

Contains the following:

- Bodine variable speed drive motor with fan
- Three pens (use Higgins "Eternal Black" ink)
- Power Cord
- Technical manual with instructions and wiring diagrams
- 5 Spools of tape (1000' spools) These five spools can record up to 20,000 foot of message if necessary (extra tape available from radio supply houses)
- Amplification—bridge circuit with the following tubes
1 6SJ-7, 1 6SN-7, 2 5U4-G, 1 6H6, 3 6L6

Complete ready to use in Steel Cabinet 10 1/4" high 19 1/4" wide x 14 5/8" deep; wt. 80 lbs. Designed to fit any standard 19" rack. Height is 8 3/8" and wt. 65 lbs. when cabinet is removed for rack mounting.

SURPLUS — NEW — GUARANTEED

NET \$24.⁹⁵

All prices FOB, N. Y.—25% deposit required on C.O.D.'s. Orders accepted from rated concerns on open account Net 30 days

MARITIME SWITCHBOARD

338 Canal Street - - - Worth 4-8217 - - - New York 13, New York

"Communications"

**Specialists
in industrial Electronic — and
Microwave Parts.**

**ALL PARTS GUARANTEED FOR
DEPENDABLE PERFORMANCE**

MICROWAVE PLUMBING

A Complete and varied stock. Here are a few typical values:

10 Centimeters

- Sand Lead—Waveguide section, App: 23" high with cooling fins (Dummy Ant.)...\$35.00
- Wave Guide to Coax, with flange Gold plated 10 CM 25.00
- Standing Wave Detector, rigid coax 58 ohm. 5.00
- Coax rotary joint, with mounting plate.... 8.00
- Wave guide (16 ft. lengths) per foot 10 CM... 2.00
- Heavy Flange for mounting wave guide..... 2.00

3 CENTIMETERS

- Wave guide 90° bend E Plane, 18" long..... \$ 4.00
- Wave guide, 18" long S curve, cover to choke 3.50
- Rotary coupler, wave guide in and out, choke to choke 6.00
- Duplexer section using 1B24..... 10.00
- Wave guide 5 ft. length, per ft..... 1.95

1.25 CENTIMETERS

- T section choke to cover..... \$ 4.50
- Flexible section choke to choke..... 3.00
- Mitered elbow and S section cover to choke... 3.50

SEND FOR OUR NEW MICROWAVE FLYER

MICROWAVE TEST PARTS

- SPECIAL—3 cm. vernier drive dial, and resonant cavity Maguire Wavemeter & 153TFFX. 21GA\$20.00
- 4 inch directional coupler, 20Db drop.....\$20.00
- 3Cm. wave guide—in and out, coax probe.... \$5.50
- 8" long directional coupler, CU-90/UP-20Db drop has short right angle (10 cm)..... \$5.50
- 1-222A Signal Generator—8-15 MC and 150-200MC 5 MC crystal osc. for calibration power input 115 volts, 60 cycles A.C.....\$47.50
- W.E. Signal Generator I-138 A (10 cm) indicator is a 0 to 200 microammeter. Value \$400. Our price.....\$75.00

MICROWAVE ANTENNAS

- MICROWAVE RELAY SYSTEM—Parabolic Reflector Slatted aluminum, Range 2000 to 4000 MC. Dimensions—4.5' by 3'. New.....\$85.00
- Dipole for above.....\$5.00
- TYPE TDY (10 cm). Complete rotating Antenna Assembly 30 deg. beam. New.....\$100.00
- TYPE SO (10 cm) 12 deg. beam—includes: drive mech. radiating assembly dish. New.....\$90.00
- Used.....\$45.00

RADAR UNITS

- RC 148 IFF. Includes trans.-rec. RC1267 and pwr. unit RA105-A. Operation: 117v/60c—157.16 187 MC\$ 47.50
- SA RADAR, PPI Unit, from SA-2 Radar RCA 7 in scope..... 165.00
- SQ RADAR Complete Console, GE, B, PPI, or A presentation..... 250.00
- SLA PPI console, WE Radar, good cond.... 225.00
- AN/APG-5 Trans.-rec. 2500MC Range radar uses lighthouse tubes.....\$100.00
- SCR 518 RADAR ALTIMETER—20000 ft. range, 3" calibrated scale, 515MC, complete installation. New..... 279.00
- RANGE UNIT SCR268—Radar. 115v/60c... 15.00

MAGNETRONS

- 3J31 (1 cm) Magnetron \$20.00
- 3J31 Fil. Transformer \$6.50
- 2J32 (JAN) 10 cm. 300 Kw peak pulse listed \$200. OUR PRICE\$25.00
- 720—By Magnetron \$25.00
- ELECTRO - MAGNET for 720-BY.....\$13.50
- QK59, QK60, QK61, QK62 tunable Pkgs. Magnetrons 10 cm Band.....\$45.00

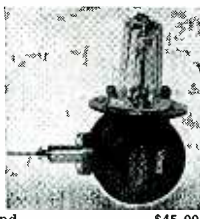

- Magnets for Magnetrons.....\$12.00
- KLYSTRON oscillator tubes 2K25/723 ab designed for 3 cm operation. New. With complete data. Listed at \$38.00, reduced to... 7.75
- McNally Klystron 707B (10 CM) with cavity 15.00
- Tunable Cavity for 707B..... 3.50
- 30 mc oscillator-amplifier with 2 6AC7's. Uses 723ab, Waveguide input, xtal detector: With 6AC7's 10.00
- With 6AC7's, 723ab and IN21..... 16.50
- Thermistor Beads (D-170396), for use with UHF and Micro-Wave Equipment (List \$7.00). In separate sealed containers.... .95
- Thermistor Buttons D 168391..... .95
- Magnet for 3 centimeter magnetrons, incorporating a magnetron stabilizer cavity Cinaudagraph Type UC 210..... 22.50
- WE Converter BC 437A..... 19.00
- 2 C40 Lighthouse tunable cavity, heavy silver plated casting, with attenuator..... 50.00

PULSE TRANSFORMERS

- GE Type K2450A. Will receive 13KV, 4 microsecond pulse on pri., secondary delivers 14 KV, Peak power out 100KW...\$15.00
- Hi Volt. Magnetron input transformer W.E. #D-166173 with cooling fins..... 12.00
- Raytheon UX 4298E—Pri. 4 KV, 1 microsecond Sec. 16 KV, 16 Amps, Fil. pri. 115V, 400 Cycle..... 15.00
- W.E. Hi Volt input pulse Transformer #D 169271..... 9.95
- GE Radar pulse Transformer K2731 Diameter App. 11" vertical cooling fins..... 19.50
- Utah Blocking oscillator transformer, 3 windings #9280 or 9318.....ea. .75

HI VOLT COMPONENTS

- 2KVA Transformer and choke—115v/50 to 70c Input, single phase. Output: 17,000v @ 144 mills Choke 4,000H. Dimensions: 26x29x13.....\$74.50
- FIL. TRANSFORMER 2900v test. Pri. 115v Sec. 5v @ 5 amp. Raytheon..... 24.50
- SANGAMO CAPACITOR G-3 .006mf. 10Kv. List \$87.50 17.50

OIL CONDENSORS

- 1 mf 300 vdc\$.20
- 2 mf 300 vdc25
- 4 mf 300 vdc30
- 4 mf 400 vdc50
- 5-5 mf 400 vdc 1.05
- 1 mf 500 vdc25
- 2 mf 550 vdc25
- .25 mf 600 vdc20
- .85 mf 600 vdc25
- 1 mf 600 vdc30
- .1-1 mf 700 vdc G.E. Pyr..... 2.00
- 2 mf 600 vdc35
- 4 mf 600 vdc60
- 10 mf 600 vdc85
- 1 mf 1000 vdc75
- 1 mf 1000 vdc25
- 2 mf 1000 vdc89
- 4 mf 1000 vdc 1.00
- 10 mf 1000 vdc 1.40
- 1 mf 1500 vdc95
- 4 mf 1500 vdc15
- 2 mf 660 ac/100085
- 4 mf 1500 vdc 1.20
- 1 mf 2000 vdc 1.00
- 1 mf 3000 vdc 3.45
- 1 mf 7500 vdc 12.50
- .25 mf 20,000 vdc 17.50
- 10-10-10-mf Synchro cap 90v/60c.....\$2.50

SO RADAR

- 10 CM SURFACE SEARCH RADAR SETS
- SO-9 new with spares—complete installations.
- SO-13 used, in excellent condition.

WRITE FOR PRICE AND DETAILS

400 CYCLE TRANSFORMERS

A COMPLETE STOCK. SEND US YOUR REQUIREMENTS

Surplus Equipment SALE

**HIGH VOLTAGE TRANSFORMERS, Pri-
mary 115 volts 60 cps**

7500 volts 35 ma ungrounded, suitable for voltage doubler Thordar-
sen\$10.00

6250 volts 80 ma ungrounded G. E. \$12.00

6000 volts 30 ma ungrounded G. E. \$10.00

5500 volts 2 ma, 6.3 volts 0.6 ma,
2.5 volts 2 amps potted.....\$10.00

1120 volts ct. 600 ma, 2x5 volts ct.
6.2 amps, 6.3 volts 3 amps, 6.3 volts
0.3 amps, potted.....\$12.50

2.5 volts 2.5 amps, 7 volts 7 amps,
16 kv insulation.....\$7.50

**CONSTANT IMPEDANCE CONNec-
TORS**

- UG21U75¢ UG27U\$1.00
- UG22U75¢ UG29U\$1.00
- UG24U75¢ UG30U\$1.00
- UG25U75¢ UG83U\$1.00
- UG58U75¢ UG86U\$1.75
- UG245U75¢ M359 50¢
- UG266U75¢ SO239 50¢

**GENERAL RADIO SIGNAL GENER-
ATOR Model 804C, 7.5-330 mega-
cycles 1-20,000 microvolts output,
good working order.....\$275.00**

**RADAR RECEIVER AN/APR-5A. 1000-
6000 megacycles, 15 tubes, 115 volts
60 cps, compact, new.....\$150.00**

**MICROWAVE COMMUNICATION
TRANSCIVER, line of sight trans-
mission at 2200-2400 mc, Navy type
MAF, 115 volts 60 cps, new complete
with antenna, reflector, power sup-
ply, microphone, phones, and cables
two for\$500.00**

**MUTUAL Inductance type VARIABLE
ATTENUATOR, rack and pinion
drive, type N connectors, suitable
for microwave use.....\$15.00**

**FIXED ATTENUATOR, TPS-51PB-20, 20
db attenuation, 50 ohms, type N con-
nectors at each end.....\$3.50**

**PANORAMIC ADAPTER BC-1032-A, in-
put frequency 5.25 mc, sweepwidth
1000 kc, 115 volts 60 cps, new, com-
plete\$75.00**

**MARINE RECEIVER, RCA AR8503, 15-
600 kc, with preselector 115 volts
60 cps\$50.00**

**VIBRATOR POWER SUPPLY, 7 or 14
volts dc to 3500 volts dc 10 ma.\$25.00**

**W. E. 704-A HIGH FREQUENCY DIODE,
plate to cathode capacity 0.55 mmfd.
1" x 3/8".....\$2.00**

**PULSE INPUT TRANSFORMER, permal-
loy core, 50-4000 kc, impedance ratio
120 to 2350 W. E. D161310....\$2.80**

**PULSE TRANSFORMER, three windings,
Westinghouse WD145\$2.50**

ELECTRO IMPULSE LABORATORY

BOX 250, RED BANK, NEW JERSEY

**Mail orders promptly filled. All prices F. O. B. New York City.
Send Money Order or Check. Shipping charges sent C. O. D.
Send for our latest microwave flyer, also our complete parts catalog.**

COMMUNICATIONS EQUIPMENT CO.

131-E LIBERTY STREET

NEW YORK CITY 7, N. Y.

Telephone Whitehall 4-7658

"TAB"

That's A Buy

ELECTRONIC PARTS

NEW GUARANTEED

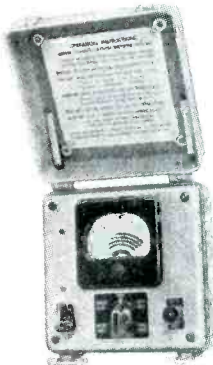

TEST SET 268/U
CRYSTAL
RECTIFIER
CHECKER. TESTS
CRYSTALS IN21,
21A, 21B, 23, 23A,
23B, 25 & OTHERS.
WESTON MULTI-
COLORED ENG-
LISH READING
SCALES ON 3/16"
SQ. BAKELITE
MTR. TESTER
CHECKS FOR-
WARD & BACK
RESISTANCE IN
KILOHMS & BACK
CURRENT CHECKS
BRITISH CRYSTALS.
TESTER
COMES COMPLETE
IN CRACKLE
FINISH NAVY
CAST ALUM.
CASE 3 3/4x7 1/2
WT 3LBS. SPARE
PARTS, GASKET,
etc.

WATERPROOF. INSTRUCTIONS, MANUAL BATTERY INCLUDED PACKED FOR OVERSEAS SHIPMENT NAVY INSP (G'COST \$125) GTD NEW SPECIAL \$15.95 CRYSTALS NEW IN21, 22, 23, 25 @ 35¢ IN34 SYLV \$1.35

- Dynmtr 12/24V Inpt 500V/50ma outpt. \$1.95
- Dynmtr 12/24V Inpt 275V/110ma & 12V/3A out. 1.95
- Dynmtr 12V Inpt/500V/50ma-275V/110ma Filtered. 4.95
- BLOWER *LN 115V/60c DUAL 200CUFTM. 13.95
- BLOWER 28VDC or AC 100CUFTM. 4.95
- KIT SILVER & MICA CONDERS. 50 for 2.00
- KIT ROTARY SWITCHES. 6 for 1.75
- KIT CONTROLS 50-2megohms POTS. 10 for 2.50
- KIT RESISTORS 1/2 & 1Watt 50to2megohms 100 for 2.50
- KIT VITREOUS WW RESISTORS. 20 for 1.00
- KIT SOCKETS 25 ASSTD (8-7-5-4P). 2.35
- KIT POWER RHEOSTATS 25&50Watt. 6 for 4.95
- KIT ROTARY SWITCHES. 6 for 1.75
- KIT KNOBS ASSTD WITH BUSH. 25 for 1.25
- KIT FUSES ASSTD BUSS & LITTLE-F 300 for 3.95
- KIT HARDWARE GOOD ASSMNT ONE LB. .99
- KIT MOTOR BRUSHES 100 ASSTD. .99
- KIT GROMMETS RUBBER 100 ASSTD. .99
- KIT SOLDER LEAD 2 pounds. .99

- TRANSF 115V/60c, 5V/115Amp KENYON \$7.95
- TRANSF 220/110V # adj TAPS 7Amp. 16.95
- TR 1000VCT/110ma, 6.3V/5A, 5V/3A, two 6.3/65A, 6.3V/1.25A Cased H.V. Insl. 4.25
- TR 840VCT/110ma, 530VCT/31ma, two5V/3A, 6.3V/1A, 6.4V/.6A, 115V/60cy Cased H.V. Insl. 2.95
- TR 1000V/45ma, 795VCT/80ma, 3x5V/3A, 6.3VCT/1A, 6.3V/3A HV Insl. 7.95
- TR 6200V/750ma, 115V/60c AMTRAN. 19.95
- TR 3800VCT/2.7A, 220, 440V/60c. 45.00
- TR 1100VCT/212ma, 115V/60c Cased. 6.50
- TR 1300VCT/350ma, 115V/60c Cased. 6.95

- CONDENSERS OIL GTD. RATED WVDC 4mfd/50VDC. TEN for \$2.00
- 2mfd/600, 2 for 79c; 4mfd/600. 2 for 1.25
- 10mfd/600, 2 for \$2.50; 20mfd/600. 2 for 4.95
- 3mfd/330VAC/1000WVDC GE Pyranol. 2 for 2.49
- 15mfd/330VAC/1000WVDC GE Pyranol. 2 for 2.95
- 2mfd/2000WVDC AVX&WEST. 2 for 4.25
- 3mfd/2000WVDC AVX&WEST. 2 for 5.00
- 6mfd/1500WVDC CD-Dyk. 2 for 4.50
- 0.5mfd/1500WVDC TLA Cd-Dyk. 2 for 1.10
- 2mfd/3000 \$3.60@; 4mfd/3000. 5.00
- 2mfd/5000 2 for \$14.50; 4mfd/5000@ 14.00
- 2mfd/12500 \$25@; 2mfd/5500. 8.00
- 1mfd/25000 \$75@; 1mfd/10000. 22.50
- 8mfd/660VAC/2000WVDC GE Pyranol. 2.95
- 32mfd/660VAC/2000WVDC GE 4sect. 7.95
- 1mfd/500 Ten for \$1; 0.1mfd/2000. 1.00
- 0.1mfd/3000 \$1.25@; .03mfd/7500. 1.98



T BY NAVY
TYPE CLG 20144
V I B A T O R
POWER AND
STORAGE BATTERY
CLG 19029
UNIT NEW
MANUALS. Hgt 4 3/4"
Dpth 6 9/16"
W Id th 9 3/4"
MFRD BY ELECTRONIC LABORATORIES & WILLARD STORAGE BATTERY CO RATED 4V/40AH NON-SPILLING BOTTLE OF ACID VIBRA-PACK Output Voltages Filtered DC 50V & 150V 30ma 3V/375 ma, 1.5V/200 ma, 7.5 V/20 ma Wgt 28 lbs. 2 units plug together, battery chg plug on side-battery rechargable from 6V stg bat. IDEAL PORTABLE SUPPLY

- "TAB" SPECIAL \$9.95
- Additional CK-1005 tube Vibrator & fuses. \$1.95
- TRANSF 1540V/240ma, 680VCT/240ma, Pri 115V/60cy Cased H.V. Insl. 2 for \$8.95

- KIT G&P Tube Grips 50 asstd. \$1.00
- 6AK5 BOXED @ 95¢ Five for \$4.45
- 6AZ7/1852 @ 95¢ Five for 3.75
- NE15&51 NEON Glolamp 1/25Watt. 10 for .75

- WE32A TRANSMISSION MEAS SET & WE51A OSCILLATOR...NEW GTD. \$150.00
- AUTOSYN BENDIX Ay-1 & Ay-5-18-24 VAC PER PAIR LN*. 3.95
- CRYSTAL STD 200RC 0.1% acy. 5.95
- CARRIER XTALS GE 92,120KC/0.1% acy, Vacuum. 4.95
- HAM XTALS 7010KC/0.1% acy. Two for 1.00
- AMATEUR CRYSTALS HAM B'DS 4 for 3.00

- Synch clock motor 60c/10V/24RPM. 2 for \$1.69
- CHOKE GE 0.5Hy/100ma. FOUR for .98
- MICROSWITCH-MU leaf SPDT 15A/125V. 2 for 1.08
- GE INTERLOCK SAFETY SWITCH TWO for 1.00
- SOCKETS AMPHENOL 78ST MICA'B. 25 for 1.50

- STROBFLASHCONDNR 32MFD/660VAC/2000WV/4SECT. \$7.95
- CHOKE CASED 50Hy/150ma H.V. INSL. 1.50
- TRANSF 115V/60c PRI, 1230VCT/262ma, R 6mfd Tube, Choke 8Hy, 2Condnsr oil 2mfd 1000V & 1l transf & chassis. 12.95
- TRANSFORMER ONLY 1230VCT/262ma. 5.98
- TRANSF 15000V/35ma, PRI 115V/60cy THORDAR. 15.95
- SELENIUM IT&T 6B8AV1 FV85V/2.4Amp 6.95

- TRANSF 115V/60cy, 500VCT/60ma, 6.3V/4A. \$1.49
- TR 115V/60c, 1350VCT/150ma, 6.3V/5A, 5V/2A. 7.50
- TR 115V/60c, 500VCT/60ma, 6.3V/4A Cased. 1.49
- HALLICRAFTERS HT4B-XTAL&RFCOILS 2-8mc. 30.00
- TR STROBFLASH 1540V PRI 115V/60cy. 4.95

RAYTHEON VOLTAGE REGULATOR

CASED NEW S.C. TROPICALIZED

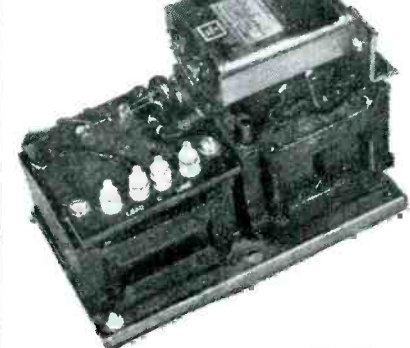

Adj. Voltage Inpt taps 95-130V/60cy. OUTPT 115V .58Amps ONE HALF 1/10% REGULATION. W720 lbs. 6-1/8x8 1/2 Lx1 1/2 W-OVER-LOAD PROTECTED, RUGGED DSGN. "TAB" SPECIAL \$14.95

- STROBOSCOPIC RELAY TUBE SN4. \$3.75
- CHOKE 3Hy/40ma Cased UTC. 3 for 1.00
- CHOKE 3Hy/400ma 150hms cased HV. 2.75
- CHOKE 8Hy/200ma Cased. Two for 2.89
- CHOKE Dual 2Hy/300ma cased. Two for 1.98

IF STRIP 60MC's/85DB gain mfrd by GALVIN for GE&WE. CONTAINS 8/6 AK5 & 1/6AL5 tubes compact 2x11 x2-3/8" Hot. Output Jack & Coaxial inpt plug complete. "TAB" SPECIAL \$9.49

SAME STRIP LESS TUBES. 3.49

TRANSF Outpt 6V6 PP/LINE/10Watts. 1.49

AUTOSYN 5F5G BENDIX 115V/60cy Two for 14.95

- Hi-Impedance 1000ohm headset same asWE 509 with 8ft cord & PLUG. \$2.95
- RELAY TIME DELAY 115V/10Amp. 1.49
- COILS F3-CW3 WILCOX RCVR 5.1/10mcs. 2.79
- ADDITIONAL SET SPARE TUBES CW3. 4.95

CW3 RECEIVER RELAY RACK MTG 3 1/2"x19" FIXED TUNED XTAL SUPERHER USES 6K7RF&1F, 6K8 MIXER, OSC, 6K7 IF, 6C8DET & OUTPUT, 6SN7BF0, 80RECT, 115V/60 PWR. CASE, COILS, Tubes, no xtal use as converter VFO, complete with Manual & Tubes-Fone & CW. \$13.95

\$2 Min. order FOB N.Y.C. Add Postage all orders and 25% deposit. Worth 2-7230. Send for catalog 99. Specialists in International Export, School, College & Industrial trade. Money-back "TAB" Guarantee.

- GYRO SERVO UNIT BENDIX 12,800 - 1B HORIZONTAL STABILIZER (G'COST NAVY \$1600) SCHOOLS COLLEGES, LABS, AMATEURS, EXP'S AN OPPORTUNITY TO HAVE A GYRO UNIT FOR YOUR WORKSHOP. ADAPTABLE FOR MODEL PLANES, ROCKETS & REMOTE MECHANISMS. WGT 12 lbs. 16"x6"x7" "TAB" SPECIAL \$14.49
- ANTENNA ENT INSULATOR 2 1/2" D & 6" Rod. 2 for \$3.98
- SYLVANIA IN34 CRYSTAL \$1.39 @, Two for \$2.40
- ANTENNA PARABOLIC RADAR ASSEMBLY 24" Dia. DRIVE & SELSYN MOTORS. Wave guide couplings ROTARY JOINT, including collar for mtg 360 Deg Horiz Control & adj Vertical (\$1200) 50MMF/20000V JENNINGS VC50/6 1/2" x 2 3/4" (LIST \$18) "TAB" SPECIAL \$6.95. 2 for \$12.95

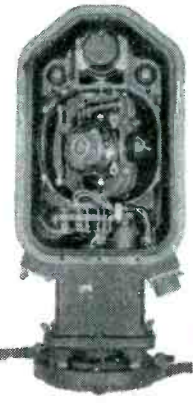

- PRECISION 1% WW 1 Meg RESISTORS 3 for \$2.10
- WE DYNAMIC MIKE & 20' CABLE. 3 for 7.95
- VACUUM CONDNR 100MMF/7500V \$4.95 2 for 8.95
- VACUUM CONDNR 50MMF/7500V \$4.50 2 for 8.40
- ANTENNA SCMS50/18 ft. & ins base & gnd mtg. 4.95
- ANT 30CM/AT5 with COAX/PL259 plug. .97
- ANT AN/30B-Swiveled 30-3/4" auto type. .97
- ANT COLLAPSIBLE TELESCOPIC 12" to 9 ft. 1.49
- ANT. SECTIONS SCM50/39 1/2". 12 for 1.00
- OSCILLOSCOPE 3" KIT INCLUDES 3BP1 TRANSF 115V/60cy pri, 375VCT/110ma, 1320V, 5V/3A, 2.5V/3-25A, 6.3V/2-75A, NEW tubes 3BP1, 5Y3GT, 2V3G, Condnsr, Choke low & HV dwr supply complete. 16.95

- TEST SET OSCILLATOR TM61056 RF SIG GENERATOR; 2 RANGES 15-25 MCS 180-230MCS, ATTENUATOR CAL -100,000microv, 400-8200cps MOD; 115 VAC/50-60cy op IN CARRYING CASE \$95.00
- NAVY SP3" SYNCHROSCOPE COMPLETE \$59.50
- FOXBORO MECHANICAL RECORDER WITH 110V/60cy GRAPHIC PEN-CHART MECHANISM & CAMS-CASED NEW GTD \$200 G'COST-MANY USES 39.50
- GR VARIAC 2000CU/860 WATT 0-135V. 14.95
- TRANSTAT 88/132V/18.2AMP/110V-IN. 29.50

- 304TL Gtd New. 2 for \$7.81
- 807 two for \$1.90 815. 2 for 4.39
- 829B/3E29/25.90 446A/2C40. 2 for 2.60
- 3BP1 \$2.99 5BP1or5CP1. 3.95
- 2C26/75c 1625. 2 for 1.30
- 845S two for \$8.95; 2AP1. 2.21
- 5BP4&S/56.95; 954. 5 for 2.00
- 955, 956, 957, 958A, 959 & socket each. 2 for 2.00
- 866A & socket. 2 for 5.75
- 3BP2/\$3.00; 2V3G. .75
- 6AG5/81c; 6V6/70c; 6SN7, 12SA7. .81
- 6SA7/61c; 6B8G/\$1.15; 6J5M/55c; 3A4/75¢; 6AL5/81c; 6SL7/\$1.00; 6C8/\$1.00; 6F7/\$1.00; 6K7, 6K8, 2050, 2x2, 1641, 6SL7, 1E7, 5016, 35Z5, 12SQ7, 12SH7. 2 for 1.80
- 808 two for \$5.00; UT127A. 2 for 5.98
- IN21, 22, 23, 25. 3 for 1.25

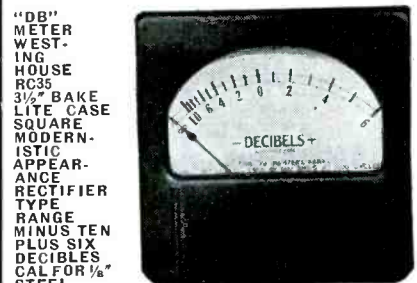

"DB" METER WEST-INGHOUSE RC35 3 1/2" BAKE LITE CASE SQUARE MODERN-ISTIC APPEARANCE RECTIFIER TYPE RANGE MINUS TEN PLUS SIX DECIBELS CAL FOR 1/2" STEEL PANEL 0-DB/6MW IN 6000HMS AT 1000CYS F.S. 3.79VAC NEW GTD IND. BOXED WITH HD-VARE SPECIAL \$4.95 @ TWO FOR \$9.00 TEN FOR \$42.50

"TAB" • Dept. 6E, Six Church Street, New York 6, N. Y., U.S.A. • "TAB" THAT'S A BUY • CORNER CHURCH & LIBERTY STS., ROOM 200 • THAT'S A BUY

Spot Delivery Suppliers to Electronic Manufacturers & Industrials at Surplus Prices. We Offer the Following at Unusual Prices:

- Tubular condensers dual .015 mfd. at 1500 volts 37.50 per M
- Tubular .008 mfd. at 400 volts 22.50 per M.
- Ceramic Capacitors in all capacities 15.00 per M
- Potentiometers, slotted shafts in 500, 1000, 5000, 10,000 and 50,000 ohms at .12 ea.
- Rheostats, IRC 15 ohm 25 watts with switch at .25 ea.
- Push pull outputs 6F6's .55 ea.
- Resistor, W. L. 10,000 ohms, 100 Watts, ferrule type price .35 ea.
- Insulated resistors A-B, IRC, etc. in all ohmage and wattages with tolerances to 1%, attractively priced.
- A large supply of desirable material available.
- Prompt replies to all inquiries.

RADIO DEALERS SUPPLY CO.
135 Liberty Street
NEW YORK, NEW YORK
BArclay 7-4859, 4763

FOR SALE
WESTINGHOUSE
(DUFUR)
OSCILLOGRAPH

Equipment for photographing single electrical transients of very short duration. Includes demountable cathode ray tube with mechanical and molecular pumps, film drum with high speed drive motor, 50 KV power supply, Norinder relay and timing circuits. Range markers down to .2 microseconds. Phenomena of 1 to 20,000 microseconds duration may be recorded. Maximum film drum speed 7,000 RPM. Unused.

Write for further information.

FS-331, Electronics
330 West 42nd St., New York 18, N. Y.

OIL FILLED
SWINGING CHOKES
15,000 VDC OPERATING
30,000 VRMS INSULATION

- * Oil filled.
- * Self cooling
- * High voltage insulation
- * Adjustable spark-gap protection
- * Made by AMERICAN TRANS-FORMER CO.

Inductance (48% ripple) 900 henries @ 0.020 Amp. 25 henries @ 0.520 Amp. Operating voltage 15,000 volts DC. Insulation test between winding and core 30,000 volts RMS. Ripple frequency 120 cps. DC resistance 149 ohms @ 75° C. Temperature rise 40°C. Oil content 6 gallons. Service Indoor. Overall dimensions 30" x 16" x 12". Net weight 266 lbs. Shipping weight in wooden case 335 lbs.

Stock No. LSO-42
Unit Price\$37.50 ea.
3 or more 33.75 ea.
FOB CORONA, N. Y.
Quantity Inquiries Invited

Dubin Electronics Co.
103-02 Northern Blvd., Corona, N. Y.
Wire Address: Dublectron, New York
Telephone: Illinois 8 - 3132

IN STOCK
For Immediate Delivery

- 16000 M359 right angle adapters (Amphenol 83-IAP)
- 3000 SO239 UHF connectors (Amphenol 83-IR)
- 1000 UG2 66U UHF connectors (HH Buggie B199) pressurized
- 2000 UG86U connectors, pressurized, gold plated
- 13500 Chassis connectors 5 pin, Monowatt AN3102-14S-5P
- 18300 Chassis connectors 4 pin, Amphenol 14S-2P
- 1000 Westinghouse type NX-35, O-350 volts dc meters, F.S. 0.1 ma, 3 1/2" bakelite case
- 1000 Marion sealed meters, type HM3, 100-0-100 ma, F.S. 1-0-1 ma, 3 1/2" bakelite case
- 1000 Copper oxide rectifiers, 40 ma 150 volts
- 5000 Copper oxide rectifiers, 1 ma 45 volts
- 1200 UG245U connectors

Electro Impulse Laboratory
Box 250, Red Bank, N. J.

25-MICRO BUTT
WELDERS

For steel or copper wire — .010" to .062" diameter. Model E-I-S made by Micro Products Co., Chicago, Ill. New. Can be inspected in Bronx. Furnished for either 110 V. AC or 440 V. 60C.S.P.

PRICE \$250.00 EA.

RALL SUPPLY CO.
110 E. 42 ST. N. Y. C. 17, N. Y.

REMOTE INDICATION
and CONTROL

Ample stock of synchros (Selsyns & Autosyns) and low-inertia servo motors.

Also complete design and fabrication of servo amplifiers and systems.

SERVO-TEK PRODUCTS CO.
247 CROOKS AVE. CLIFTON, N. J.

SWEEP GENERATORS

RCA 709B Surplus. Like New, with Marker. Limited Quantity. \$550.
VILLAGE RADIO EQUIPMENT CO.
201 West 16 St., New York

RADIO LAB EQUIPMENT

General Radio Inductance Bridge 667-A, Capacitance Bridge 716-B, Radio Frequency Bridge 916-A, Precision Condenser 722-D, Megohmmeter 729-A, Browning Synchroscope, Sylvania Synchroscope, 3-inch Hickok Oscilloscope, 2-inch Sherron oscilloscope, Boonton Pulse Generator, Ferris Crystal Calibrator, CML regulated Voltage Supply. All in perfect condition, like new; price, entire lot, \$1625.00 f.o.b.

Sola Constant Voltage Regulator, Catalog No. 3062, 3 K.V.A. capacity; \$135.00 f.o.b.

ELECTRONICRAFT, INC.
5 Waverly Place Tuckhoe 7, New York

SHEET METAL MACHINERY

NEW and Used — Brakes — Shears
Forming Rolls — Folders — Punches —
Di-Acro, Pexto, Niagara & Whitney Equip-
ment

B. D. BROOKS CO., INC.
Han. 5226
361 Atlantic Ave., Boston, Mass.

BY WISELY

advertising your used or surplus new equipment in the Searchlight Section you turn it into CASH.

“SEARCHLIGHT” is the recognized national center for the buying and selling of such equipment.

Information Cheerfully Given.
Address: Classified Advertising
Division

CLEARANCE Sale of SURPLUS ELECTRICAL INSTRUMENTS

MICROAMPERES D.C.

0-100 Microamps. Res: 100 Ohms—3" Rd. Westh. NX-35	\$7.95
(Ideal for pyrometry & Photo-electric work)	
0-150 Microamps. Res: 500 Ohms—2" Rd. G.E.-DW-51 or NX-33	\$3.75
100-0-100 Microamps (special scale GE-DO-58)	\$5.75
840-0-840 Microamps (blank scale) Weston 643—4" round—metal case	\$4.50

MILLIAMPERES D.C.

0-1 Mills—3" Rd. G.E.-DO-53	\$4.75
0-1 Mills—3" Rd. Weston 301	\$6.75
0-1 Mills—3" Rd. Weston 301 (scale: On 1.5 KV)	\$5.75
0-1 Mills—3" Rd. Marion (special scale)	\$3.25
0-1 Mills—2" Rd. G.E.-DW-41 (special scale)	\$1.95
0-5 Mills—2" Rd. Dejur S-210	\$2.15
0-15 Mills—2" Rd. Weston 506	\$3.25
0-500 Mills—2" Rd. G.E. AW-41	\$2.50
1-0-1 Mills—3" Rd. Western Electric Surface (scale 100-0-100)	\$1.35

AMPERES D.C.

0-1 Amp. 3" Rd. Weston 301	\$5.95
0-1.5 Amps. 4" Sq. Triplett #421	\$3.50
0-3 Amps. 4" Sq. Triplett #421	\$3.50
0-10 Amps. 3" Rd. Simpson #25	\$4.95
30-0-30 Amps. 3" Rd. Simpson #25	\$4.95
0-80 Amps. 2" Rd. Weston #506 (charging Amp. caption) (with ext. 50 MV Shunt)	\$3.25
0-300 Amp. 3" Rd. Roller-Smith Type TD with ext. 50 MV shunt	\$5.50
0-300 Amp. same as above (without shunt)	\$3.00
0-300 Amp. 4" Rd. Weston 643 (flush metal case.) Black scale—with ext. shunt	\$8.50
0-300 Amp. same as above (without shunt)	\$6.00

VOLTS D.C.

0-10 Volts 3" Rd. ElectroTec	\$3.75
0-20 Volts 3" Rd. Weston 506-1000 Ohms/V	\$3.50
0-50 Volts 4" Rd. Westh. NX-37-200 Ohms/V	\$6.00
0-150 Volts 3" Rd. G.E.-DO-41	\$4.75
0-150 Volts 3" Rd. Weston 301 200 Ohms/V (blk. scale)	\$4.95
0-150 Volts 4" Rd. Weston 643 (fl. metal case—black scale)	\$6.75

VOLTS A.C.

0-15 Volts 3" Rd. G.E.-AO-22 (black scale)	\$2.95
0-75 Volts 4" Weston #642 (surface mtg.)	\$7.25
0-150 V. 3" Sq. or Rd. Simpson #57 or #55	\$6.00
0-150 V. 2" Rd. Westh. NA-33	\$2.95
0-250 V. 4" Rd. Triplett #534-B (surface bakelite)	\$4.50
0-300 V. 4" Rd. Weston #642 (surface metal case)	\$9.00
0-300 V. 4" Sq. Triplett #431 Scale: 0-300/600	\$4.50

AMPERES A.C.

0-5 Amps. 4" Rd. Weston 642 (surface metal case)	\$7.95
0-5 Amps. 4" Sq. Triplett #431 (Fl. Bakelite case scale: 0-150/300)	\$3.75

SPECIAL METERS

D.B. Meter—Weston 506	\$4.95
0-10 Amp. R.F. Weston 425	\$6.95
0-15 Amp. R.F. Weston 507	\$3.50
Resistance Thermometer 30° F. to 230° F. with Res. Bulb. Weston # 727	\$6.00
Weston 637 Freq. Meter Aircraft case 3 1/2" Range 350-450 cycles, complete	\$4.95

WESTON MODEL 785 INDUSTRIAL CIRCUIT TESTER

For Industrial, Labs, Shops, etc., 27 Practical Ranges



This compact sturdy instrument provides all the ranges necessary for the measurements of voltages, currents and resistances in all types of electrical equipment, signal systems, electronic maintenance and production testing.

Ranges of Measurements: D.C. Voltage: 10 M.V. to 1000 Volts
A.C. Voltage: 0.1 to 750 Volts
D.C. Current: 0.5 Microamps to 10 Amps.
A.C. Current: 10 M.A. to 10 Amps.
Resistance: 0.5 Ohms to 30 Megohms
List: \$138.12 Your Cost \$73.50

WESTON MODEL 269—FAN SHAPED METER



One of the Weston popular fan shaped line. Exceptionally long scale for size of instrument. Accuracy—within 1%. Scale length—4". Spade pointer. Here is a good movement for special purpose instruments. Comes with blank scale with arc drawn in. Ready for plotting calibration points. Can be used to make up any range of volts, amps, M.A., etc.

Full scale deflection—5 M.A.—40 M.V. List: \$29.83 Your Cost: \$8.95 10 for \$75.00

WESTON MODEL #1

Portable D.C. Voltmeter—0-3/15/150 Volts—Triple Range.

Used as a reference standard. Accuracy unaffected by wide changes in temperature. Accuracy: 1/4 of 1%. Knife edge pointer—mirror scale. Scale length: 5.18". With genuine leather case.

List: \$117.13 Your Cost \$57.50



STEEL-SIX ROLLER SMITH



Portable D.C. Voltmeter. Dual range: 0-15 and 0-150 Volts—100 Ohms per Volt. Accuracy: 1/2 of 1%. Mirrored scale—5.18" long. Knife edge pointer. Dimensions: 6"x6"x4".

Your Cost: \$21.00

WESTON MODEL 372



Used, guaranteed. Accuracy within 1%. Electro-dynamometer type. Scale length 5.25 inches.

Ranges Available:—0 to .015 MMFD.
0 to .001 MMFD.
0 to .0075 MMFD.

Applied voltage 220 applied freq. 450-550
List: \$243.00 Your Cost: \$69.50

WHEELCO CAPACITROL #221



The original Wheelco electronically controlled temperature regulating pyrometer; cold junction compensated, high resistance movement. Scale length:

Ranges available:—0-400° F. 0-1200° F.
0-800° F. 0-2000° F.

Net Cost. \$150.00 Your Cost: \$98.75

BOONTON QX CHECKER—Type #110A—



Frequency Range 100KC—25MC

Built for the production line. Used, guaranteed. Used to compare fundamental characteristics of test components namely inductance, or capacitance and Q under factory conditions yet with a high degree of accuracy. Supplied with type 111A HI-F Coil.

Your Cost: \$125.00

ALL ITEMS LISTED IN THIS AD ARE NEW, UNLESS OTHERWISE SPECIFIED

POWERTRON ELECTRICAL EQUIPMENT COMPANY SURPLUS DIVISION

ELECTRO-TECH EQUIPMENT COMPANY, 119 Lafayette St.—New York 13, N. Y., Phone: WOrth 4-8610



JR ENGINEER AVAILABLE

**BEE Cooper Union June 1947
Married Age 28**

Major in Coast Artillery. Five years army experience. Staff and administrative duty. Harvard and MIT Radar Course

**WILLIAM HOLLANDER
65 BUSH ST., BROOKLYN 31, N. Y.**

Staff Radio Engineer Available

for Production, Coordination, Control and Efficiency. 20 year background in engineering production and coordination in receivers and electronics. College graduate.

PW-335, Electronics
330 West 42nd St., New York 18, N. Y.

POSITIONS WANTED

(Continued from page 272)

ADVERTISING MANAGER or contact—38, 15 years power and communications, 5 years sales and advertising. Now writing copy and planning campaigns for national food advertiser. Desire to utilize technical and executive background. Graduate Mark Wiseman Advertising. No travel. The Record, Middlebush, N. J.

GRADUATE ENGINEER experienced maintenance and design transmitters and receivers including two years design and installation of Naval Air Station equipment desires position in western town with population less than 200,000. PW-340, Electronics, 63 Post Street, San Francisco, Cal.

E.E. 15 YEARS association in the vacuum tube industry as design, project, and process engineer. Now desires association with company in any electrical parts manufacturing field as plant superintendent. PW-339, Electronics, 330 W. 42nd St., New York 18, N. Y.

TRANSFORMER ENGINEER, age 29, college graduate '39, 2 years experience physics research, 5 years experience all phases design, development, production of magnetic voltage stabilizers, various types small transformers including power to 25 kva., power supplies, etc., seeks permanent, responsible position, progressive company. Salary \$500-\$6000. PW-337, Electronics, 68 Post Street, San Francisco, Cal.

EXECUTIVE ENGINEER MS experience direction laboratory developing electronic equipment, computers, automatic telegraphy, will travel. PW-336, Electronics, 330 W. 42nd St., New York 18, N. Y.

SELLING OPPORTUNITIES WANTED

EXPANDING NEW ENGLAND distributor seeking additional lines. Offices, warehouse, showroom in the heart of Boston business district. Lines on commission, or financially able to handle own accounts. Salesmen now actively covering New England territory. RA-341, Electronics, 330 W. 42nd St., New York 18, N. Y.

TO RADIO & ELECTRONIC PARTS & INSTRUMENT MANUFACTURERS

Good old-fashioned selling is back again. Let us back your product with expert sales and engineering know how in East. We can sell your product and keep it sold. We know that 17 years sales experience, our own laboratory facilities, plus an aggressive personal approach will establish your product where you want it. Long acquaintance with principals and chief engineers in radio and electronic field assures you of results. Let us hear from you.

RA-333, Electronics
330 West 42nd St., New York 18, N. Y.

FOR SALE PATENTS

Pat #.	Description	Pat #.	Description
1899127	Piezo Electric Crystal Holder-precision type.	2404012	Radio Direction Finder—An improved Adcock type.
2123221	Radio circuit-method of receiving wide band transmissions.	2082812	Selective antenna—not affected by fading—loop type.
2003328	Traffic control system-major intersection-based on time interval between cars in one lane at a time.	2004147	Humidifying system—applicable to hot water or steam radiators any type.
2124600	Electric amplifying circuit—a D.C. Amplifier using A.C. methods	1940831	Crossroads traffic warning signal—minor intersections.
1961320	Horology system—a clock mechanism wound by A.C. with automatic correction each hour and spring to run it several hours after the power goes off.	1857422	Stroboscope Circuit.
1887705	Variable Speed Device—semi automatic gear shift—you are never out of gear while shifting.	2234998	Electro static shield—improved type for VHF use.
2002515	Colors in television—Means of providing a continuous color spectrum to the light beam and means of modulating same.	2219351	Signalling device for motor vehicles—automatic stop warning lite which is actuated when and only when the driver eases up on the foot throttle.

ROBERT H WORRALL

923 14th st CHA-3 Honolulu (60) T.H.

BELGIUM

American Firms desirous to extend their activity

to Belgium, are invited to contact with

SOCIETE INDUSTRIELLE ALFA

80, rue de la Senne

BRUSSELS

Oldest importer of American radio, electrical and electronic material.

SALES ENGINEER

Well established in the Mid-Western States, offers Radio Parts and Equipment Manufacturers genuine Representation of the highest calibre. Contact

IRVING W. ROSE
7752 Kingston Ave., Chicago 49, Ill.
Tel. SAGinaw 6295

Attention Importers

We buy and export large quantities of surplus radio and industrial materials direct from WAA at lowest prices. Our skilled buyers appraise condition and value of all merchandise. We handle Transmitters, Receivers, Components, Tubes, Test Equipment, Lighting and Power Plants, etc. Current price bulletin sent on request.

MARIZON AND ROSENBERG OVERSEAS, INC.

Industrial Dept. 225 W. 34 St., N. Y. C.
Cable: Marizrosen, New York

Delivery vs. Delay . . .

When knowing where to find what you need is the deciding factor between DELIVERY and DELAY . . . consult the advertising pages. If you do not find what you need . . . write

ELECTRONICS

for
PROMPT ANSWERS

to business problems

USE THE SEARCHLIGHT SECTIONS OF

- Air Transport
- American Machinist
- Aviation
- Aviation News
- Bus Transportation
- Business Week
- Chemical Engineering
- Coal Age
- Construction Methods
- Electrical Contracting
- Electrical Merchandising
- Electrical World
- Electronics
- Engineering News-Record
- Engineering & Mining Journal
- E & M J Markets
- Factory Management & Maint.
- Food Industries
- Power
- Product Engineering
- Textile World
- Welding Engineer

Classified Advertising Division
McGraw-Hill Publishing Co., Inc.
330 W. 42nd St. New York 18, N. Y.

NEW STEEL JUNCTION BOX. 14 ga. 17"x25"x6 1/2" with Screw Type Hinged Lid. Watertight.....\$2.75 each

T.B.K. TRANSMITTER. Less tubes and power supply\$400.00

CHROMALUX STRIP HEATER, 115V, 750W, Semi-Circular, 20 1/4"x1 1/2", \$1.00

FUSE G.E. U.L. Approved Renewable 10A, 600V, 4 15/16"x13/16". Box of 10, \$1.00

BATHTUB CONDENSERS AEROVOX
 3 x .1 mfd 400v 5¢ .25 mfd 400v 7¢
 .2 mfd 400v 6¢ .5 mfd 400v 8¢

ELECTROLYTIC CONDENSERS
 75 mfd 25v 15¢ 1000 mfd 15v Dual 40¢
 50 " 50v 10¢ 1000 " 15v 35¢
 40 " 25v 10¢ 1000 " 25v 40¢
 20 " 200v 15¢ 225 " 15v 10¢
 10 " 100v 10¢ 100 " 150v 20¢

G.E. PYRANOL Cond. .2 mfd., 750 V.A.C. 50c

SELSYN DIFFERENTIAL MOTOR. 115 V.A.C. Packed for overseas.....\$1.75

G.E. MOTOR, 1/6 H.P., 250 V.D.C. On armature 60 V.D.C., on field 1140 R.P.M. New\$16.00

RELAY Struthers-Dunn, 115 V.A.C., 4 P.D.T.\$2.65

TRANSMITTING MICA CONDENSERS FARADON
 .056 mfd 1000 working volts 16 A. 1000 kc 28¢
 .033 " 1500 " " 15 A. " " 28¢
 .024 " 1500 " " 15 A. " " 26¢

ALLEN HEAD SET SCREWS, TRANSFORMERS, SMALL AIR TRIMMERS, DYNAMOTORS—Minimum Order \$3.00, F.O.B., Phila., Pa.

RELIANCE MERCHANDIZING CO.
 Arch Cor. Croskey Sts. Phila. 3, Pa.

Immediate Delivery —

Pioneer—AY-101D Autosyns; CL-3 Magnesyns; CK-5 motors; 12116 & 12123 inverters, AY-1, AY-14, AY-20 and AY-43 Autosyns; 12077 amplifiers; various torque units, etc.

Complete Servo-Systems—Positional or directional systems for 115 volt 400 cycle operation.

Servo-Motors—DC motors with permanent magnet fields for thyatron servo control; 60 and 400 cycle low-inertia motors for ac servo-systems.

Synchros—Types 2JIMI, M, A, 1G, 1F, 1SF, 1CT, 5F, 5G, 5DG, 5CT, 5HCT, 6G, etc.

Call ARmory 4-2677

Servo-Tek Products Co.

247 Crooks Ave., Clifton, N. J.

MOTOR GENERATORS

Built by Allis Chalmers to rigid specifications of the U. S. Navy for fire control use.

Input: 115 volts D.C. at 14 amps. 3600 rpm.

Output: 120 volts A.C. 60 cycles at 10.2 amps., single phase, 1000 watts continuous duty.

Splashproof. Fully covered. Centrifugal starter. Ball bearings.

Brand new, packed in wooden boxes including spare parts kit.

Shipping weight, 290 lbs. Net weight 260 lbs. Price f.o.b. N. Y. \$87.50.

ELECTRONICRAFT, Inc.
 5 Waverly Place Tuckahoe 7, N. Y.

Write for Our 64-Page Catalog on Your Company's Letterhead

of Surplus Bargains in the Electronic, Radio and Electrical Fields.

ELECTRO SALES CO.
 110 Pearl Street Boston 10, Mass.

CAPACITORS

New Surplus 350 CD KGT-3500 50 ufd. 330 VAC Capacitors. \$4.00 each or \$3.00 each in lots of 50. FOB Dayton. New list \$29 each.

"Capacitors"

1652 Russet, Dayton 10, Ohio

BEST QUALITY, USED ELECTRON TUBE MACHINERY

Equipment for the manufacture of all kinds of electron tubes, radio tubes, incandescent lamps, neon tubes, photo electric cells, X-ray tubes, etc.

AMERICAN ELECTRICAL SALES CO., Inc.
 65-67 East 8th St. New York, N. Y.

Special Values

Panel & Portable Meters

D. C. Microammeters:
 50-100-200-500 microamps. High Resistance Voltmeters Vacuum Thermo-Couple Meters 3 1/2" & 4 1/2" Round & Rectangular

Multirange Portables:
 readings from 10 microamps. full scale

Precision Electrical Instrument Co.
 146 Grand Street New York 13, N. Y.

SELSYN GENERATORS

All sizes \$6 pr. up, frac. hp motors, focus coils, diesels, lighting plants, barometers, polaroid variable density filters, \$1.75, other surplus.

VILLAGE RADIO EQUIPMENT CO.
 201 West 16 St., New York

WANTED

WANTED

To purchase or license patents on patentable ideas on Transformers.

Particularly interested in ideas pertaining to Transformers and reactors for use with fluorescent lamps.

Advance Transformer Company
 1122 W. Catalpa Avenue
 Chicago 40, Illinois

WANTED - -

RADIO-ELECTRONIC SURPLUS
 TUBES—COMPONENTS
 OF EVERY DESCRIPTION—ANY QUANTITY
 W-308, Electronics
 330 West 42nd St., New York 18, N. Y.

Just say:

"Information,
 please"

whenever you need products or services not advertised in a particular issue of this magazine.

Each issue is only part of the complete service we are organized and glad to render to reader and advertiser, alike. We want you to consider Electronics your primary source of information in this field.

Departmental Staff,

ELECTRONICS,
 330 West 42nd St., New York

ATTENTION!

Purchasing Agents—Engineers — Industrials

Cut your cost on equipment and supplies. Get in our mailing list today. Clip and mail coupon for your copy of our latest bulletin Meters - Tubes - Transformers - Condensers - Test Equipment, Television kits and components, etc.

SEND THIS COUPON TO:

NIAGARA RADIO SUPPLY CORP.—E.
 160 Greenwich St.,
 New York 6, N. Y.

Name

Address

City State.....

K-TRAN



ECONOMICAL—K-TRANS cost less to purchase—less to use.

EFFICIENT—K-TRANS will duplicate or exceed the performance of your present i.f. transformers.

STABLE—Permeability tuning, magnetic shielding of windings, silver mica condensers combine to give a stability never before obtainable in a standard commercial i.f. Transformer.

VERSATILE—Four models of K-TRAN meet all 455 KC requirements. Also available for 262 K.C., and 10.7 M.C. for F.M. receivers.

AUTOMATIC
MANUFACTURING
CORPORATION

MASS PRODUCTION COILS & MICA TRIMMER CONDENSERS

900 PASSAIC AVE.

EAST NEWARK, N. J.

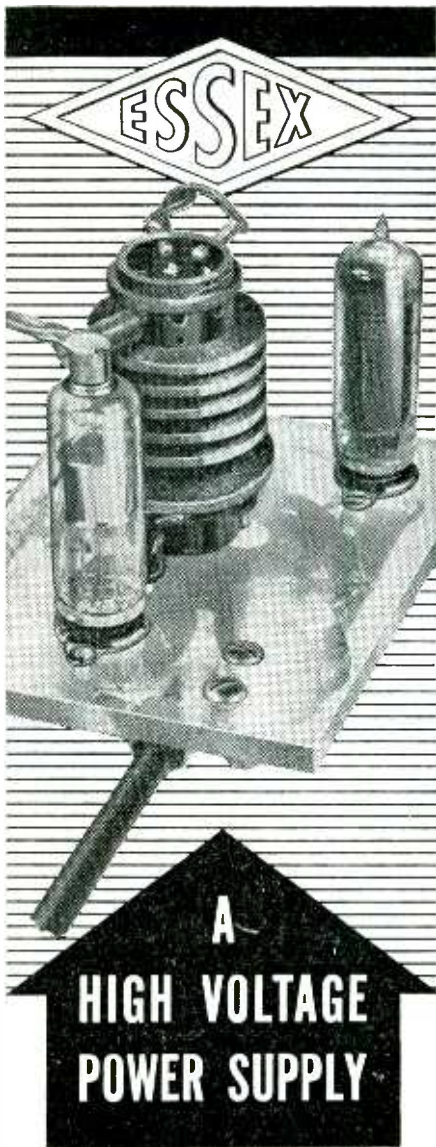

#B103—Provides from 1 KV to 5 KV D.C. at 1 ma. for Television Nuclear Research, etc.

External power required 6.3V 60 cycle A.C. and 250V D.C.

Entirely enclosed in Aluminum Case.... 3 5/8" x 4 3/4" x 4 3/4" high

Other voltages available #B101—10 KV • #B102—30 KV

Laboratory models available for prompt shipment. Inquiries for production runs are solicited.

Precision manufacturers of all types of IF and RF coils, chokes, and transformers.

ESSEX ELECTRONICS
Berkeley Heights, New Jersey

INDEX TO ADVERTISERS

Macallen Co.....	174	Sylvania Electric Products, Inc.	
Machlett Labs, Inc.....	55	Electronics Div.....	171
Magnavox Co.....	221	Radio Tube Div.....	17
Maguire Industries, Inc.....	173		
Mallory & Co., Inc., P. R.....	78, 137	Tablet and Ticket Co.....	206
Mayfair Molded Products Corp.....	259	Taylor Fibre Co.....	261
McGraw-Hill Book Co.....	216	Tech Laboratories, Inc.....	194
Meyercood Company.....	221	Telex, Inc.....	196
Mica Insulator Co.....	26, 27	Thomas & Skinner Steel Products Co.....	182
Milford Rivet & Machine Co.....	230	Tinnerman Products, Inc.....	167
Millen Mfg. Co., Inc., James.....	202	Top Flight Tool Co.....	271
Mitchell-Rand Insulation Co., Inc.....	187	Triplett Electrical Instrument Co.....	223
Mittlemann, Eugene.....	267		
Multicore Solders, Ltd.....	191		
Multi-Products Tool Co.....	256		
National Company, Inc.....	235	United Transformer Corp.....	
National Radio Service Co.....	253	Inside Back Cover	
National Research Corporation.....	205	Universal Winding Co.....	224
National Varnished Products Corp.....	60		
New England Screw Co.....	244		
New Hampshire Ball Bearings, Inc.....	248		
North American Phillips Co., Inc.....	203		
Ohio Electric Mfg. Co.....	160	Victoreen Instrument Co.....	224, 244, 263
Ohmite Mfg. Co.....	16A, 16B	Vitamite Co.....	255
Onan and Sons, Inc., D. W.....	284	Vulcan Electric Co.....	250
Pacific Mills.....	207	Waldes Kohinoor, Inc.....	19
Paper Machinery and Research, Inc.....	261	Wallace Metal Products Co., Inc.....	259
Paramount Paper Tube Corp.....	222	Walter Co., S.....	232
Patton-MacGyver Co.....	244	War Assets Administration.....	156, 167
Phillips Screw Mfrs.....	22	Ward Leonard Electric Co.....	20, 21
Phosphor Bronze Smelting Co.....	226	Weller Mfg. Co.....	264
Portable Products Corp., Paul & Beekman Div.....	36	Western Electric Co.....	4, 5, 37, 141, 206
Precision Apparatus Co., Inc.....	262	Weston Electrical Instrument Corp.....	190
Premax Products, Div. of Chisholm Ryder Co., Inc.....	246	Whistler & Sons, Inc., S. B.....	177
Presto Recording Corp.....	53	White Dental Mfg. Co., S. S.....	247, 259
Progressive Mfg. Co.....	242	Whitehead Stamping Co.....	267
Pyroferic Co.....	230	Wilcox Electric Co., Inc.....	217
		Wilson Co., H. A.....	54
		Winchester Co.....	267
		Wright & Weaire, Ltd.....	178
Quadruga Manufacturing Co.....	255	Zophar Mills, Inc.....	246
Quaker City Gear Works, Inc.....	188		
Radio Corp. of America, Victor Div.			
58, 59, 248, Back Cover			
Railway Express Agency, Air Express Div.....	184		
Rauland Corp.....	218		
Raytheon Mfg. Co.....	9, 52		
R-B-M Div., Essex Wire Corp.....	229		
Reeves-Hoffman Corp.....	234		
Reeves Soundcraft Corp.....	176		
Revere Cooper & Brass, Inc.....	24		
Rex Rheostat Co.....	271		
Richardson Company.....	161		
Robinson Recording Labs.....	256		
Rockbestos Products Corp.....	12		
Scientific Electric Div. of "S" Corrugated Quenched Gap Co.....	265		
Seeburg Corp., J. P.....	70		
Selenium Corp. of America.....	81		
Shakeproof, Inc.....	32A, 32B		
Shallcross Mfg. Co.....	158		
Sherron Electronics Co.....	183		
Sigma Instruments, Inc.....	254		
Sillocks-Miller Co.....	212		
Simpson Electric Co.....	14, 15		
Solar Mfg. Corp.....	74		
Sorensen & Company, Inc.....	76		
Speer Carbon Co.....	48		
Sprague Electric Co.....	35		
Stackpole Carbon Company.....	215		
Standard Pressed Steel Co.....	262		
Star Expansion Products Co., Inc.....	252		
Steward Mfg. Co., D. M.....	267		
Struthers-Dunn, Inc.....	46		
Superior Tube Company.....	227		
Supreme Instruments Corp.....	226		

SEARCHLIGHT SECTION (Classified Advertising)

BUSINESS OPPORTUNITIES.....	280
EMPLOYMENT.....	272, 273, 280
WANTED TO PURCHASE.....	281
PROFESSIONAL SERVICES.....	269
USED EQUIPMENT.....	274-281
Advance Transformer Co.....	281
American Electric Sales Co., Inc.....	281
Brooks Co., Inc., B. D.....	278
Capacitors.....	281
Communications Equipment Co.....	276
Dubin Electronics Co.....	278
Electro Impulse Laboratories.....	276, 278
Electroncraft.....	278, 281
Electro Sales Co.....	281
Maritime Switchboard.....	274, 275
Niagara Radio Supply Corp.....	281
Precision Electrical Instrument Co.....	281
Powertron Electrical Equipment Co.....	279
Radio Dealers Supply Co.....	278
Rail Supply Co.....	278
Reliance Merchandizing Co.....	281
Servo Tek Products Co.....	278, 281
Tab.....	277
Village Radio Equipment Co.....	278

TRANSFORMERS FOR EVERY APPLICATION

AR
DARD



RM
OY



RA
ACT



ERCIAL
ADE

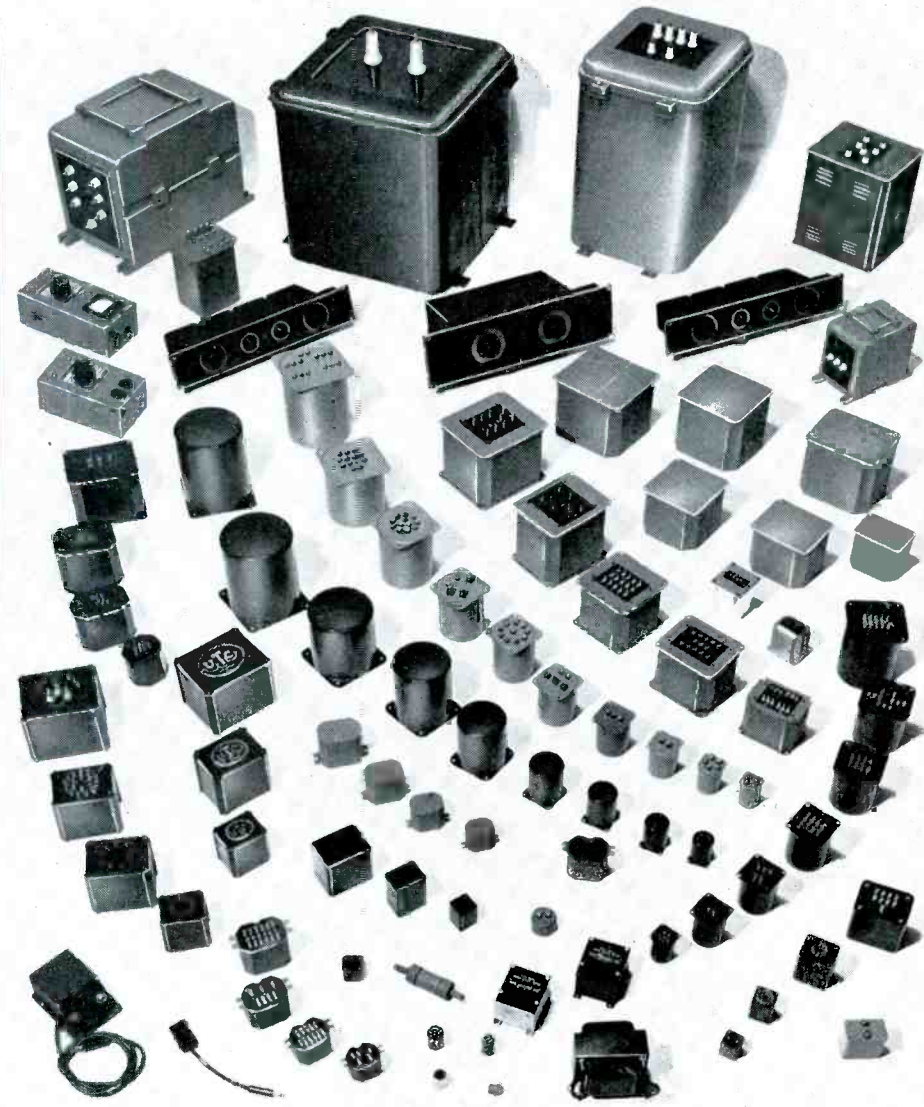

OUNCER



SUB
OUNCER



SPECIAL
SERIES



VARIABLE
INDUCTOR



Foremost Manufacturers of Transformers to the Electronic Industry

United Transformer Corp.

150 VARICK STREET • NEW YORK 13, N. Y.
EXPORT DIVISION: 13 EAST 40th STREET, NEW YORK 16, N. Y., CABLES: "ARLAB"

12

Reasons Why

it pays
equipment
manufacturers
to deal with
RCA

RCA LABORATORIES
PRINCETON, N. J.



RCA TUBE APPLICATION ENGINEERING SERVICE —

Twelve field engineering specialists devote their time *exclusively* to the design problems of equipment manufacturers. They're ready to pitch in and help you at any time.

RCA TUBE APPLICATION ENGINEERING LABORATORIES —

RCA maintains tube application laboratories at Harrison, Lancaster and Chicago. The services of these laboratories are at the disposal of all RCA tube customers.

RCA CIRCUIT INVESTIGATIONS —

RCA carries on independent research in circuit design for the exclusive benefit of its customers. Engineering reports are provided as a free service.

RCA TUBE DEVELOPMENT —

RCA works years ahead in tube design—anticipates future requirements. That's why you get the types of tubes you want *when* you want them.

RCA ENGINEERING LITERATURE —

As the fountainhead of modern tube development, you can look to RCA for the most authoritative and comprehensive technical literature on tubes.

RCA MANUFACTURING FACILITIES —

RCA tubes are manufactured in ultramodern plants equipped with RCA-designed, high-speed precision machinery—your assurance of uniform, dependable quality tubes of whatever type, in any quantity.

RCA QUALITY CONTROL —

Quality controls begin with the raw material and are followed through in every successive step of manufacture and assembly to the final tube. That's why RCA tubes are consistently good.

RCA SALES SERVICE —

A staff of seasoned sales representatives are within convenient reach. They're available *when* you want them.

RCA DISTRICT OFFICES —

RCA's Tube Department maintains four convenient district offices in Harrison, Cleveland, Chicago and Los Angeles to serve equipment manufacturers. You can get prompt service from the office nearest you.

RCA DISTRIBUTION —

RCA's Tube Department maintains bulk tube stocks in three warehouses strategically located in Jersey City, Chicago and Los Angeles for quick service.

RCA PRICING —

Mass-production techniques and the RCA "Preferred-Type Tube Plan" have consistently operated to reduce manufacturing costs—which means lower prices to you.

RCA ENGINEERING LEADERSHIP —

The vast resources of experience and ability that account for RCA's engineering leadership, are of direct benefit to RCA customers—a final reason why it pays to deal with RCA.

THE FOUNTAINHEAD OF MODERN TUBE DEVELOPMENT IS RCA



TUBE DEPARTMENT

RADIO CORPORATION of AMERICA

HARRISON, N. J.