



electronics

MAY · 1946

UHF COLOR
TELEVISION

A MCGRAW-HILL PUBLICATION



FOR HIPERM ALLOY TRANSFORMERS

The UTC Hiperm alloy audio transformers are specifically designed for portable and compact service. While light in weight and small in dimensions, neither dependability nor fidelity has been sacrificed. The frequency characteristic of the Hiperm alloy audio units is uniform from 30 to 20,000 cycles. These units are similar in general design and characteristics to the famous Linear Standard audio Series.

Hiperm Alloy Transformers Feature

- Hum Balancing Coil Structure** . . . maximum neutralization of stray fields.
- Balanced Variable Impedance Line** . . . permits highest fidelity on every tap of a universal unit . . . no line reflections or transverse couplings.
- Reversible Mounting** . . . permits above chassis or sub-chassis wiring.
- Shielding** . . . maximum shielding from induction pick-up.
- Multiple Coil, Semi-Toroidal Coil Structure** . . . maximum distributed capacity and leakage reactance.
- High Fidelity** . . . UTC Hiperm Alloy Transformers give a guaranteed uniform response of ± 1.5 DB from 20-20,000 cycles.



FOR IMMEDIATE DELIVERY

From Your Distributor

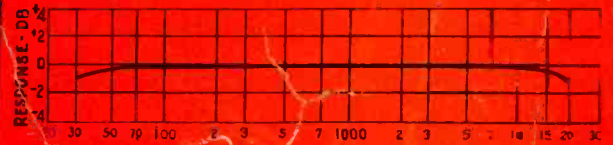

Typical Curve for HA Series

Type No.	Application	Primary Impedance	Secondary Impedance	± 1 db from	Max. Level	Max Unbal. DC in primary	List Price
HA-100	Low impedance mike, pickup, or multiple line to grid.	50, 125, 200, 250, 333, 500 ohms	60,000 ohms in two sections	30-20,000	+22 DB	5 MA	16.25
HA-100X	Same as above but with tri-alloy internal shield to effect very low hum pickup.	50, 125, 200, 250, 333, 500 ohms	120,000 ohms overall, in two sections	30-20,000	+22 DB	5 MA	20.90
HA-101	Low impedance mike, pickup, or multiple line to push-pull grids.	50, 125, 200, 250, 333, 500 ohms	60,000 ohms in two sections	30-20,000	+22 DB	5 MA	18.55
HA-101X	Same as above but with tri-alloy internal shield to effect very low hum pickup.	50, 125, 200, 250, 333, 500 ohms	120,000 ohms overall, in two sections	30-20,000	+22 DB	5 MA	23.20
HA-108	Mixing, low impedance mike, pickup or multiple line.	50, 125, 200, 250, 333, 500 ohms	135,000 ohms 1.5:1 ratio, each side	30-20,000	+22 DB	0	16.25
HA-106	Single plate to push-pull grids	8,000 to 15,000 ohms	50, 125, 200, 250, 333, 500 ohms	30-20,000	+22 DB	1 MA	13.90
HA-113	Single plate to multiple line.	8,000 to 15,000 ohms	50, 125, 200, 250, 333, 500 ohms	30-20,000	+22 DB	5 MA	15.55
HA-134	Push-pull 89's or 2A3's to line.	5,000 to 10,000 ohms	30, 20, 15, 10, 7.5, 5, 2.5, 1.2	30-20,000	+32 DB	5 MA	17.40
HA-135	Push-pull 2A3's to voice coil.	3,000 to 5,000 ohms	30, 20, 15, 10, 7.5, 5, 2.5, 1.2	30-20,000	+32 DB	5 MA	16.25

The above listing includes only a few of the many Hiperm Alloy Transformers available . . . write for catalog.

United Transformer Corp.

150 VARICK STREET

EXPORT DIVISION: 13 EAST 40th STREET, NEW YORK 16, N. Y.

NEW YORK 13, N. Y.

CABLES: "ARLAB"

electronics

A McGRAW-HILL
PUBLICATION

MAY • 1946

UHF COLOR TELEVISION	Cover
Driver and final r-f amplifier of the CBS color television transmitter developed by the laboratories of Federal Telephone and Radio Corporation	
PATENT PUZZLE, by Donald K. Lippincott	92
Over 6,000 microwave patent applications were filed during the war, and few were issued	
MEASUREMENT OF OCEAN WAVES GENERATED BY ATOMIC BOMBS, by Norman J. Holter	94
Bikini Atoll test plans, instruments and methods	
ENGINEERING APPROACH TO WAVE GUIDES, by Theodore Moreno	99
Advantages of guides at microwaves and the factors determining a proper choice of their dimensions	
WHERE COLOR TELEVISION STANDS, by Donald G. Fink	104
Suggestions for needed research, intended to clarify the technical factors behind an important controversy	
ELECTRONIC HEATING IN THE FURNITURE INDUSTRY, by E. S. Winlund	108
Fundamentals of applying high-frequency power to set bonding-glues in joints, core lumber and plywood	
JAPANESE MAGNETRONS, by Marvin Hobbs	114
Status of progress at war's end, with technical details of both experimental and production models for radar	
RECORDING CAA TRAFFIC CONTROL INSTRUCTIONS, by K. M. MacIvain	116
Flight instructions are automatically recorded on flexible belts suitable for permanent filing	
RADIOSONDE TELEMETERING SYSTEMS, by V. D. Hauck, J. R. Cosby and A. B. Dember	120
Details of latest transmitter circuits using temperature and humidity-responsive elements and dry-pack battery	
PULSE-MODULATED RADIO RELAY EQUIPMENT, by John J. Kelleher	124
Pulse-modulated eight-channel multiplex radio communication equipment for links up to 200 miles long	
DESIGN DATA FOR BEADED COAXIAL LINES, by C. R. Cox	130
Procedures for finding characteristic impedance, optimum insulator spacing, attenuation, and maximum power	
TWO-TERMINAL OSCILLATOR, by Murray G. Crosby	136
Feedback in a two-stage amplifier provides a convenient oscillator for various applications	
RADAR FOR BLIND BOMBING—PART I, by J. V. Holdam, S. McGrath and A. D. Cole	138
Technical details of H2X airborne microwave radar, including new phanastron circuit for precise time-delays	
GATE CIRCUIT FOR CHRONOGRAPHS, by L. B. Tooley	144
Two thyratrons provide a simple switching system controlling a succeeding amplifier	
2-MC SKY-WAVE TRANSMISSION, by J. A. Pierce	146
Timing accuracy to within a few microseconds over long distances is possible with the nocturnal E layer	
CIRCUITS FOR SUBMINIATURE TUBE	154
Circuits for very small triode suitable for lightweight, compact applications	
PHASE-SHIFTER NOMOGRAPH, by Raymond E. Lafferty	158
Simplifies design calculations for bridge-type phase-shifting network covering range from 0 to 180 degrees	
CROSSTALK	91
REFERENCE SHEET	158
INDUSTRIAL CONTROL	160
TUBES AT WORK	190
ELECTRON ART	208
NEW PRODUCTS	236
NEWS OF THE INDUSTRY	284
NEW BOOKS	320
BACKTALK	328
INDEX TO ADVERTISERS	337

KEITH HENNEY, Editor; **DONALD G. FINK**, Executive Editor; **W. W. MacDonald**, Managing Editor; **John Markus**, Vin Zeluff, Associate Editors; **Frank Rockett**, **A. A. McKenzie**, Assistant Editors; **J. A. Myers**, Chicago Editor; **Frank Haylock**, Los Angeles Editor; **Gladys T. Montgomery**, Washington Editor; **Jeanne M. Heron**, Make-up Editor; **Jeanne E. Grolmund**, Editorial Assistant; **Harry Phillips**, Art Director; **Eleanor Luke**, Art Assistant

H. W. MATEER, Publisher; **J. E. Blackburn, Jr.**, Director of Circulation, Electronics; **Stacy May**, Director of Economic Staff; **Wallace B. Blood**, Manager

D. H. Miller, **H. R. Denmead, Jr.**, New York; **Ralph H. Flynn**, **H. D. Randall, Jr.**, New England; **F. P. Coyle**, **R. E. Miller**, Philadelphia; **C. D. Wardner**, **A. F. Tischer**, Chicago; **E. J. Smith**, Cleveland; **J. W. Otterson**, San Francisco; **Roy N. Phelan**, Los Angeles; **Ralph C. Maultsby**, Atlanta

Contents Copyright, 1946, by McGraw-Hill Publishing Company, Inc., All Rights Reserved

McGRAW-HILL PUBLISHING COMPANY, INCORPORATED

JAMES H. McGRAW, Founder and Honorary Chairman

PUBLICATION OFFICE 99-129 North Broadway, Albany 1, N. Y., U. S. A.

EDITORIAL AND EXECUTIVE OFFICES 330 West 42nd St., New York 18, N. Y., U. S. A.

James H. McGraw, Jr., President; Curtis W. McGraw, Senior Vice-President and Treasurer; Howard Ehrlich, Vice-President and General Business Manager; Eugene Duffield, Editorial Assistant to the President; Joseph A. Garardi, Secretary; and J. E. Blackburn, Jr., Vice-President (for circulation operations).
ELECTRONICS, May, 1946, Vol. 19, No. 5. Published monthly, price 50¢ a copy. Directory issue \$1.00. Allow at least ten days for change of address. All communications about subscriptions should be addressed to the Director of Circulation.
Subscription rates—United States and possessions, Mexico, Central and South American countries, \$5.00 a year, \$8.00 for two years, \$10 for three years. Canada (Canadian funds accepted) \$5.50 a year, \$9.00 for two years, \$11.00 for three years. All other countries \$7.00 for one year, \$14.00 for three years. Please indicate position and company connection on all subscription orders. Entered as Second Class matter August 29, 1936, at Post Office, Albany, New York, under the Act of March 3, 1879. BRANCH OFFICES: 520 North Michigan Avenue, Chicago 11, Ill.; 68 Post Street, San Francisco 4; Aldwych House, Aldwych, London, W.C. 2; Washington, D. C. 4; Philadelphia 2; Cleveland 15; Detroit 26; St. Louis 8; Boston 16; Atlanta 3, Ga.; 621 So. Hope St., Los Angeles 14; 738-9 Oliver Building, Pittsburgh 22.

HERE ARE **2** WAYS
to Stop Radio Noise

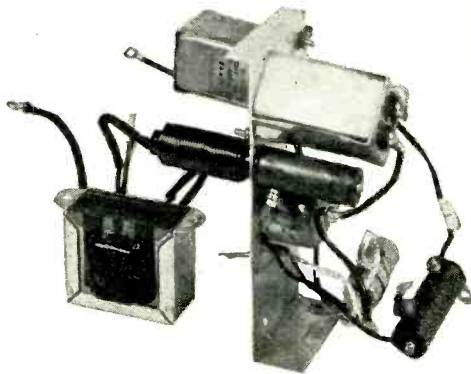

The Old Way

- 9 separate parts
 - 16 soldered connections
 - 14 mounting fastenings
 - 5 sources of supply
- UNCERTAIN RESULTS



The Tobe Way

- 1 compact unit
 - 4 simple connections
 - 1 convenient mounting
 - 1 responsible supplier
- GUARANTEED PERFORMANCE

Each of these two methods overcomes radio noise . . . but one makes needless work for your engineering, purchasing, and assembly departments, while the other relieves them of the entire burden of interference elimination. Tobe FILTERIZING makes your product radio-silent . . . simply, economically, dependably. And the "FILTERIZED" label, furnished free to Filterette users, helps build sales by telling the public that your product makes no radio noise. Ask us for details of this trouble-saving, sales-building service: we'll tell you all about it at no obligation.



TOBE DEUTSCHMANN CORPORATION - CANTON, MASSACHUSETTS

ORIGINATORS OF FILTERETTES . . . THE ACCEPTED CURE FOR RADIO NOISE

● "Impossible" is a word that is not recognized by engineers. To dam a mighty river, tunnel under it or suspend a bridge across it—things such as these that once seemed pure imagination were made possible by instruments devised to refine and extend human faculties, to translate the precision of engineering thought into action.

Keuffel & Esser Co. is proud to have played so large a part in making such instruments widely available. In this way K & E equipment and materials have been partners of the engineer and draftsman for 78 years in shaping the modern world. So universally is this equipment used, it is self-evident that K & E have played a part in the completion of nearly every engineering project of any magnitude. Could you wish any surer guidance than this in the selection of your own "partners in creating"?

Not only for construction and building, but for setting up precision machine tools and long production lines, in the fabrication of large ships and aircraft, experienced engineers know that they can rely utterly on K & E transits and levels. Coated lenses for increased light transmission, precision-ground adjusting screws, chromium-coated inner center and draw tubes, completely enclosed leveling screws, improved achromatic telescopes—all these typify the advanced design of these instruments.

partners in creating





... the world's
busiest tunnels



... largest
telephone system



Drafting, Reproduction,
Surveying Equipment
and Materials.
Slide Rules,
Measuring Tapes.

KEUFFEL & ESSER CO.
EST. 1867
NEW YORK • HOBOKEN, N. J.
CHICAGO • ST. LOUIS • DETROIT • SAN FRANCISCO
LOS ANGELES • MONTREAL

It's Easier

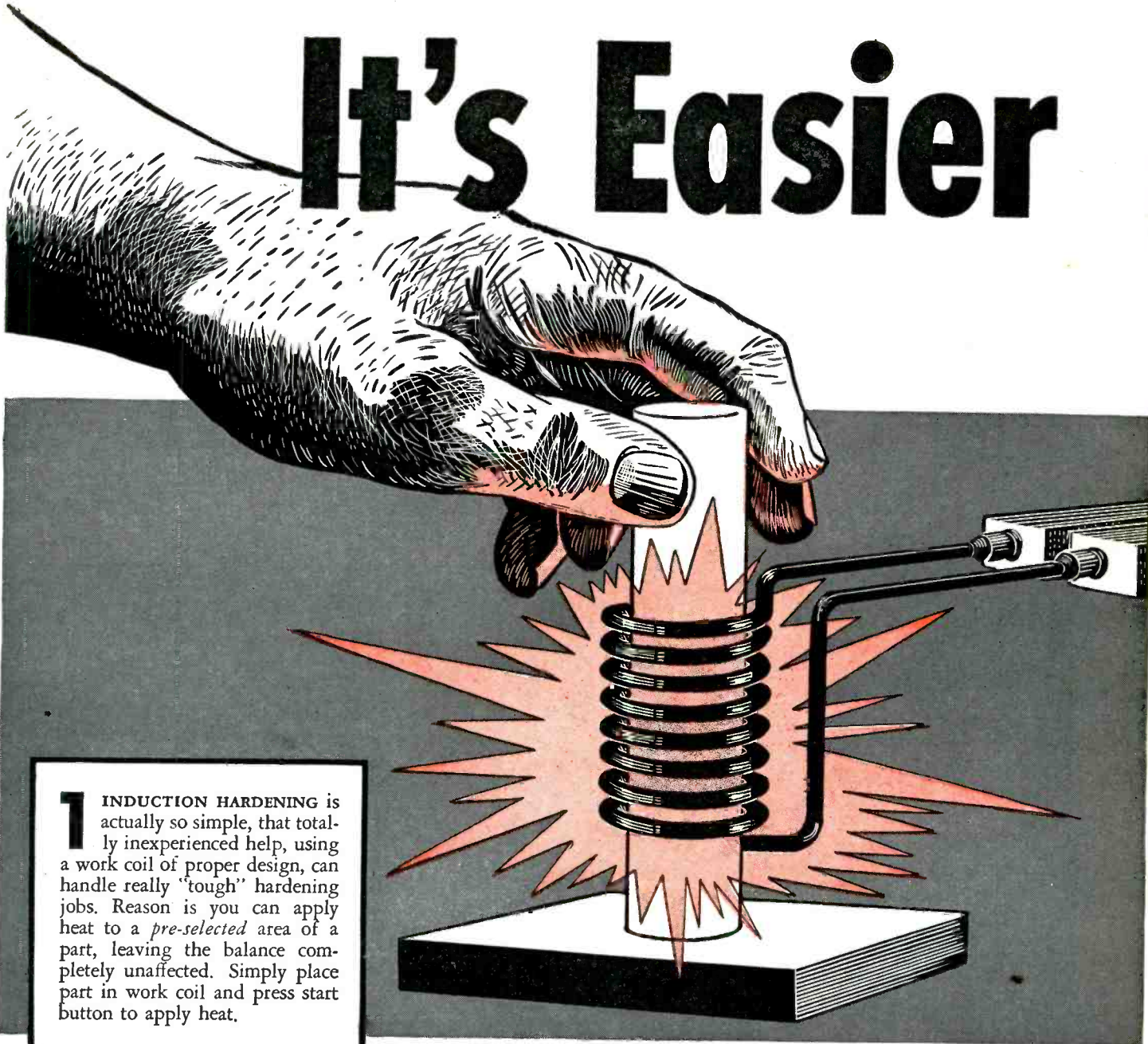

INDUCTION HARDENING is actually so simple, that totally inexperienced help, using a work coil of proper design, can handle really "tough" hardening jobs. Reason is you can apply heat to a *pre-selected* area of a part, leaving the balance completely unaffected. Simply place part in work coil and press start button to apply heat.

THESE FEATURES MEAN BETTER, LOWER COST PRODUCTION FOR YOU!

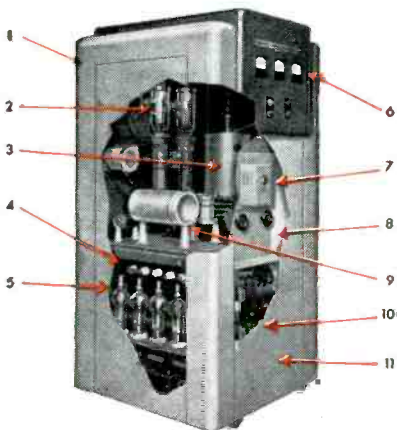

1 What's your heating problem? Brazing? Hardening? Soldering? Annealing? Melting? Heating for Forging? This new productive unit handles them all!

2 Sturdy, long-life Oscillator Tubes are fully protected against overloads.

3 New Coupling System developed by A-C keeps losses low and improves the output efficiency

4 Complete 3-Phase Power System with over 90% power factor.

5 Transformer is designed for heavy-duty 'round the clock production. Has large reserve capacity.

6 Large, easily read instruments show when power is on, also indicate grid and plate currents including filament voltage.

7 Automatic Timer controls heat sequence in split seconds from 2 seconds to 20 minutes . . . makes unit easy for unskilled operators to use. Also gives high product uniformity and reduces rejects.

8 All controls are on one panel . . . protected from tampering by door and lock.

9 Specially designed Choke Coil protects rectifier tubes from damage by high frequency radio currents.

10 Safety Features: Heavy-duty control; high water-temperature switch; fuses; interlocking switches on doors protect operators.

11 Attractive, Compact Steel Cabinet mounted on heavy-duty casters encloses unit. Provides shielding.

to Harden...

WITH ALLIS-CHALMERS GREAT NEW INDUCTION HEATER

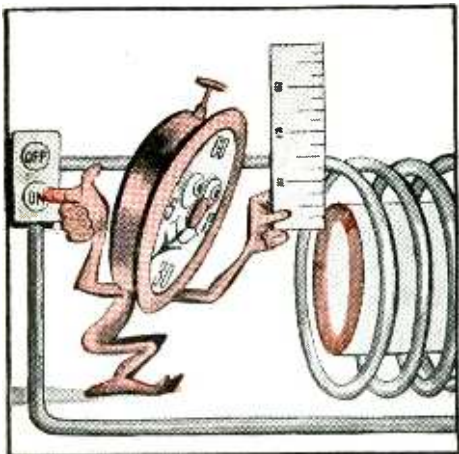

2 AUTOMATIC TIMER can be set for any heat sequence in split seconds from 2 seconds to 20 minutes. When the *exact amount* of heat has been applied at *exactly* the right *intensity*, timer turns off power. Each successive part receives the same amount of heat, resulting in a uniformity difficult to obtain with other heating methods.

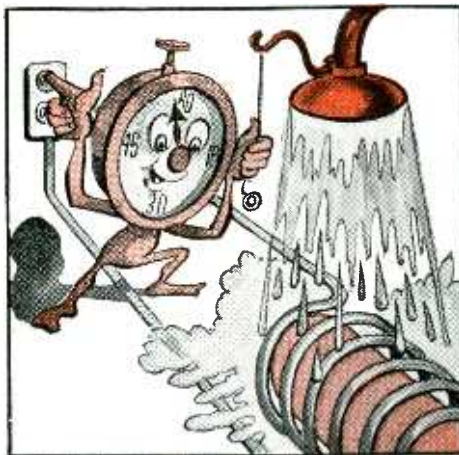

3 CONTROLLED QUENCHING is secret of uniform hardening! With Allis-Chalmers Induction Heater, water quench can be *direct connected* to Timer. Quenching operation and heat sequence are *identical* each time. This feature, plus design of work coil, completely controls hardness and depth of penetration within very close limits.

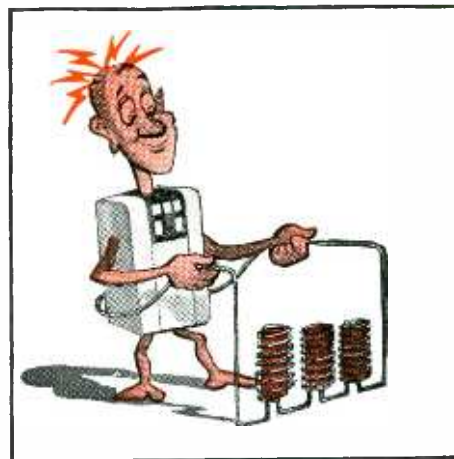

4 HARDENING SEVERAL pieces at the same time, coupled with simple, automatic handling equipment further increases production. A-C's Induction Heater is now being successfully used for lower cost hardening of a wide variety of items in many industries. Why not cut your production costs with this new electronic tool?

A 1997



NEW MOVIE EXPLAINS INDUCTION HEATING

This new A-C movie in full color and sound shows how a typical 5 minute hardening operation is completed in less than 5 seconds . . . other spectacular brazing operations! Contact your nearest A-C District Office for a showing, or write direct to Allis-Chalmers, Milwaukee 1, Wis. for a copy on loan. Film runs 12½ minutes on 16 mm sound projectors only. Offer limited to continental U.S.A.

ALLIS CHALMERS

MILWAUKEE 1, WISCONSIN

*One of the Big 3 in Electric Power
Equipment — Biggest of All
in Range of Industrial Products.*

HEAR THE BOSTON "POPS": Every Saturday Evening, American Broadcasting Co.

THE NEW "UHF-600" RECEIVER

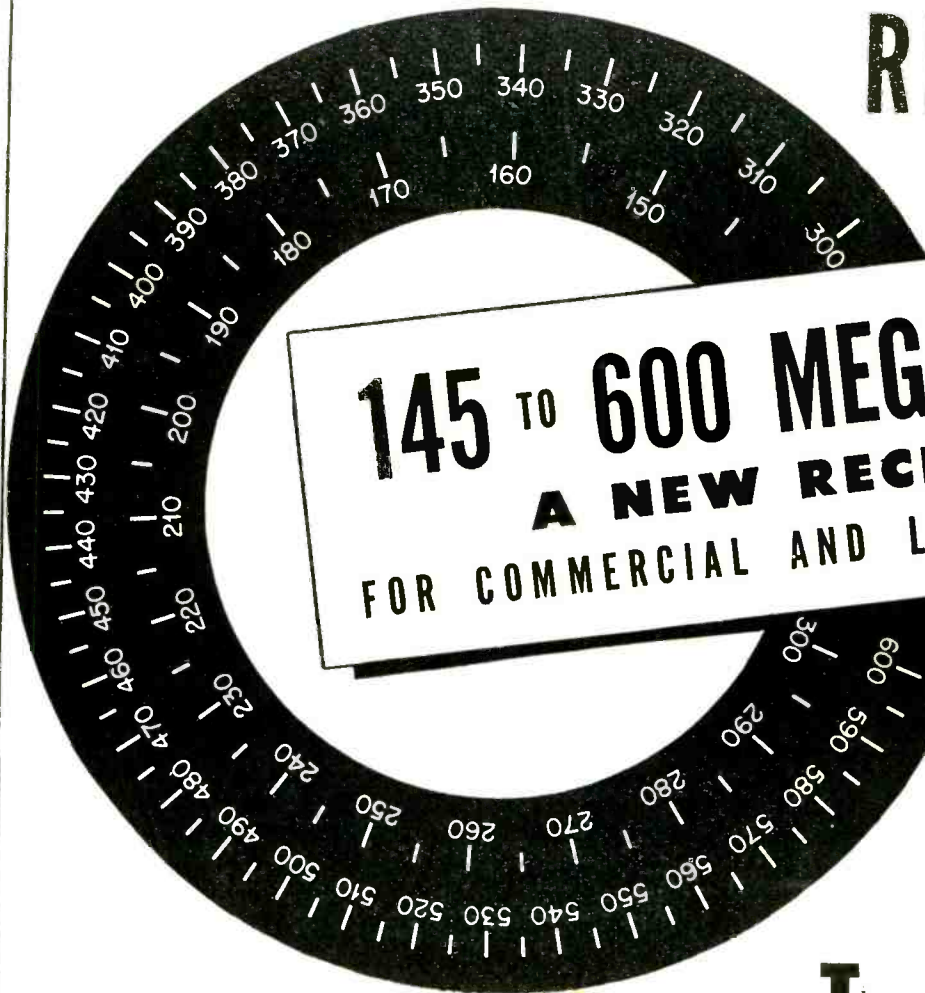

145 TO 600 MEGACYCLES
A NEW RECEIVER
FOR COMMERCIAL AND LABORATORY USE

← ACTUAL DIAL CALIBRATION

The new "UHF-600," AM-FM communications receiver, is designed to meet requirements of commercial services and laboratories doing exploratory research in the region of 145 (actually less than 144 mc.) to 600 megacycles.

The high precision construction and design of this new receiver make it ideally suited for use in conjunction with development programs where flexibility of equipment is important and where high cost per unit is not a major factor.

The "UHF-600" features AM-FM, phone, CW, high sensitivity, single dial control.

Inquiry is invited from any individual or organization requiring this type of wide-range UHF receiver.

Write for information on how this new receiver can be fitted into your VHF-UHF development program.



HAMMARLUND

THE HAMMARLUND MFG. CO., INC., 460 W. 34TH ST., NEW YORK 1, N. Y.
 MANUFACTURERS OF PRECISION COMMUNICATIONS EQUIPMENT



Typical 3 section set-up of Whistler multi-use punch and die units.

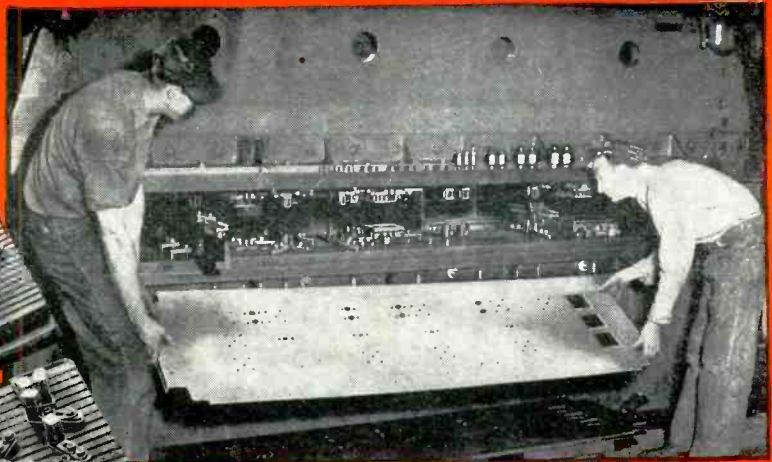

An example of piercing standard size holes, special shapes and corner notching with Whistler adjustable dies.

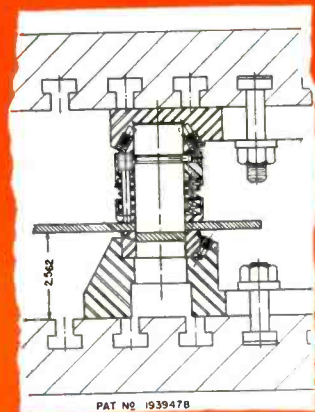

Sectional drawing illustrating simplicity of assembly of punch and die unit parts.

PIERCE 1/4" STEEL

WITH WHISTLER MULTI-USE ADJUSTABLE DIES

Here's another production time and money saving advantage from Whistler. Now you can use the SX series of heavy duty adjustable dies for piercing materials up to and including 1/4" steel.

Punches and dies are available from stock in all standard sizes from 1/8" to 3" diameters. No time lost in getting into production. Absolute precision on short or long runs. Rearrange the same units... combine with notching, special shape or group dies if called for... and go right ahead on the next job. Whistler adjustable dies have unlimited

use and pay for themselves over and over. Work in practically any type press and ordinary skilled workers can make set-up changes.

Whistler Adjustable Dies are being used by the top names in industry everywhere...there are reasons aplenty. Tell us about *your* piercing problems. Send blueprints. No obligation in finding out why Whistler Adjustable Dies should be working in *your* plant.

S. B. WHISTLER & SONS, Inc.
752-756 MILITARY ROAD BUFFALO 17, NEW YORK

Where **SPACE** and
PERFORMANCE are Vital
DUMONT OFFERS

The **TINYMITE**

**SMALLEST PAPER
CAPACITOR** . . .
yet **100%**
MOISTUREPROOF

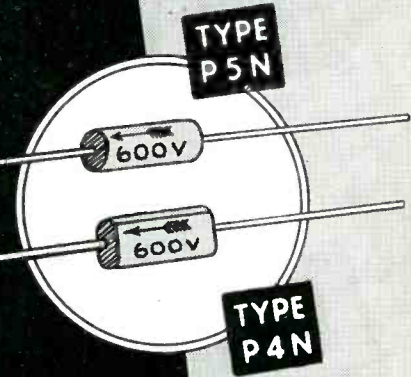

CLOCK
RADIO

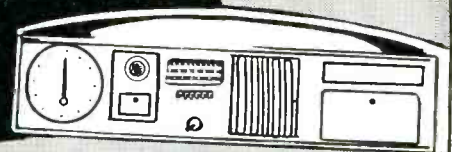

AUTO RADIOS

FEATURES

1. Bakelite Resinoid Ends. Lead wire cannot pull out, even under hot conditions.
2. Non-Inductive.
3. Excellent Temperature Coefficient.
4. Very high leakage Resistance.
5. Fine Power-Factor.
6. Range from 20 MMFD to .25 MFD. From 150 volts to 600 volts.
7. Types P4N, P5N for 100% humidity operation.
8. Types P4, P5 for 85% humidity operation.

Samples and price list on request



HEARING
AIDS

PAT.
P'END.

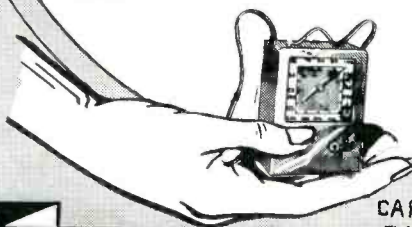

CARRYING
RADIOS

**DUMONT
ELECTRIC CORP.**
MFR'S OF
CAPACITORS FOR EVERY REQUIREMENT
34 HUBERT STREET NEW YORK, N. Y.

IT'S THE **MB ISOMODE** MOUNT FOR POSITIVE VIBRATION CONTROL . . .

STACK UP THESE PROPERTIES AGAINST YOUR DESIGN PROBLEMS

- Equal spring rates in all directions
- Non-directional—mount at any angle
- High load capacity in compact size
- Ample rubber for high deflection capacity
- Self-snubbing for overloading shocks
- Convenient mounting flange

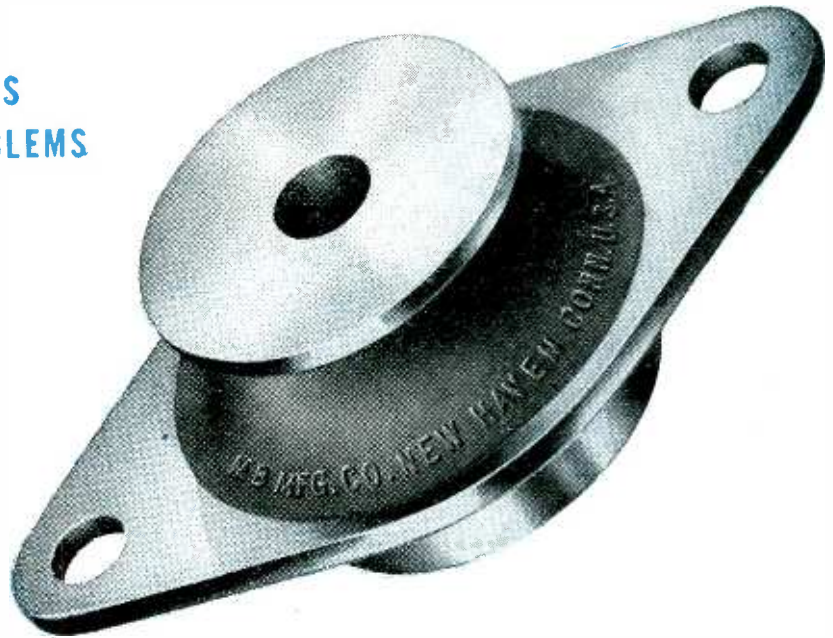

PREVENT TRANSMISSION OF ALL MODES of disturbing and damaging vibrations with these unusually effective MB mounts. Engineered by vibration specialists, Isomodes have the same softness axially and radially. They'll isolate, to a high degree, all modes of motion . . . horizontal, vertical and rocking. MB Isomodes come in a range of spring rates and sizes for your light, medium, and heavy-weight mechanisms. Let us show you how

Isomodes can fit into your present or proposed plans, save you considerable design effort, and assure top anti-vibration performance. Write for details.

"ISOLATE ALL MODES FOR POSITIVE VIBRATION CONTROL"*
*Copyright the MB Manufacturing Company, Inc.

**THE
MB
MANUFACTURING COMPANY, INC.**
Vibration Division
327 East Street, New Haven 11, Conn.



VIBRATION ISOLATOR UNITS AND MOUNTINGS • SPECIAL VIBRATION TEST EQUIPMENT

Another Helping Hand on Vibration Problems



MB VIBRATION PICKUP

Developed for both vibration detection and as an aid to its analysis, the MB Pickup features excellent response to very low amplitudes . . . exceptional durability under conditions of severe vibrations . . . negligible frictional effects . . . and calibration stability over broad temperature ranges. Output is proportional to vibratory velocity, with effective frequency range 5 to 1000 cps. The MB Pickup is usually operated as a seismic instrument, and is quickly converted for use in either horizontal or vertical plane without affecting calibration. Write for 4-page folder with full details and description.

Definitely in the Picture

FOR TELEVISION

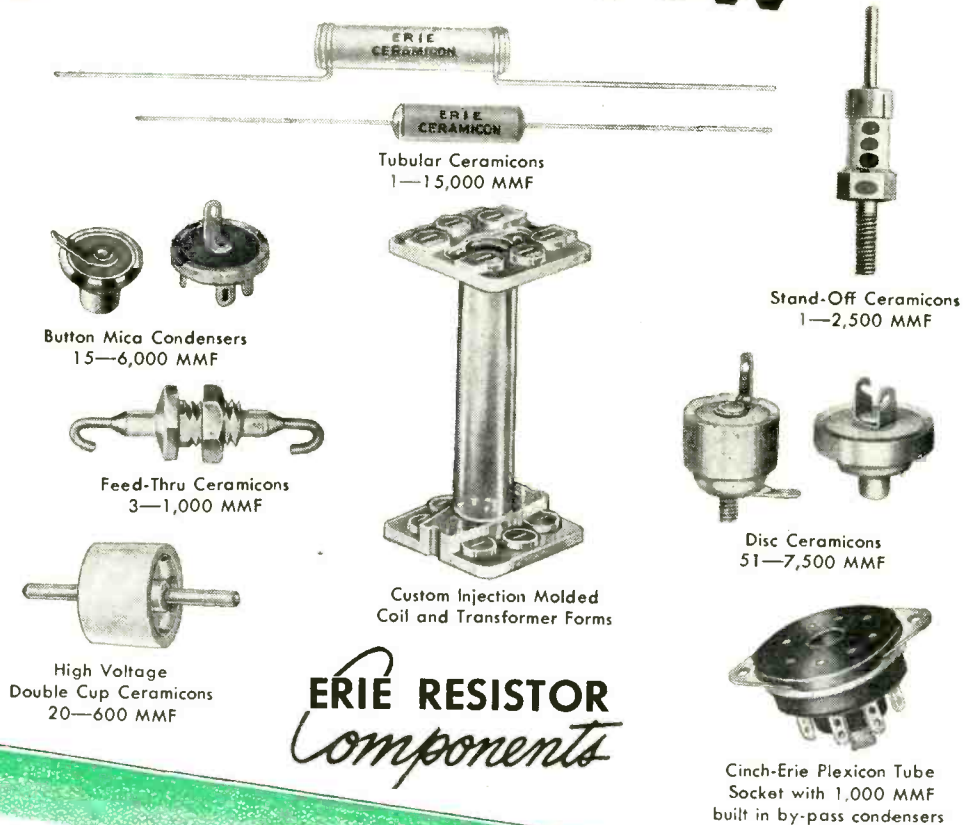

THE special problems inherent in television receivers have been given careful attention by Erie Resistor engineers in designing condensers for these applications.

The components illustrated above have been correctly designed for efficient operation at high frequencies. The condensers have low series inductance and incorporate specially designed terminals and mounting arrangements. Of special interest is the high voltage Erie Double Cup condenser for power supply

filtering circuits. Rated at 10,000 volts D.C., and having a capacity of .006 mfd. these units are unusually compact and economical. Plastic coil and transformer forms are custom injection molded to customer's specifications.

We will be glad to send you technical data and samples on any of the condensers shown above. Our engineers are at your service to develop special ceramic or mica condensers for television applications.

★
BUY VICTORY
BONDS
★

ERIE RESISTOR CORP.

ERIE, PENNSYLVANIA

LONDON, ENGLAND . . . TORONTO, CANADA



USE SPRING LOCK WASHERS

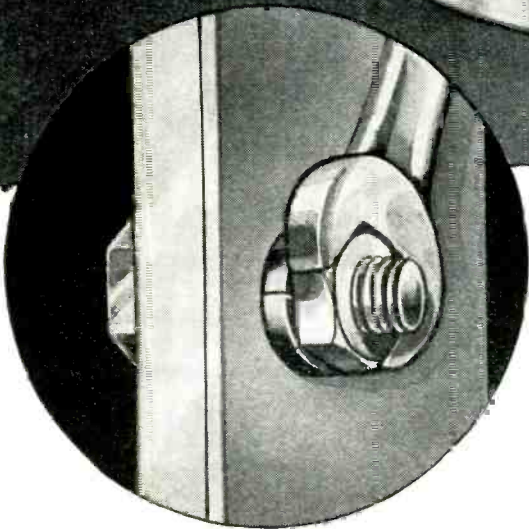
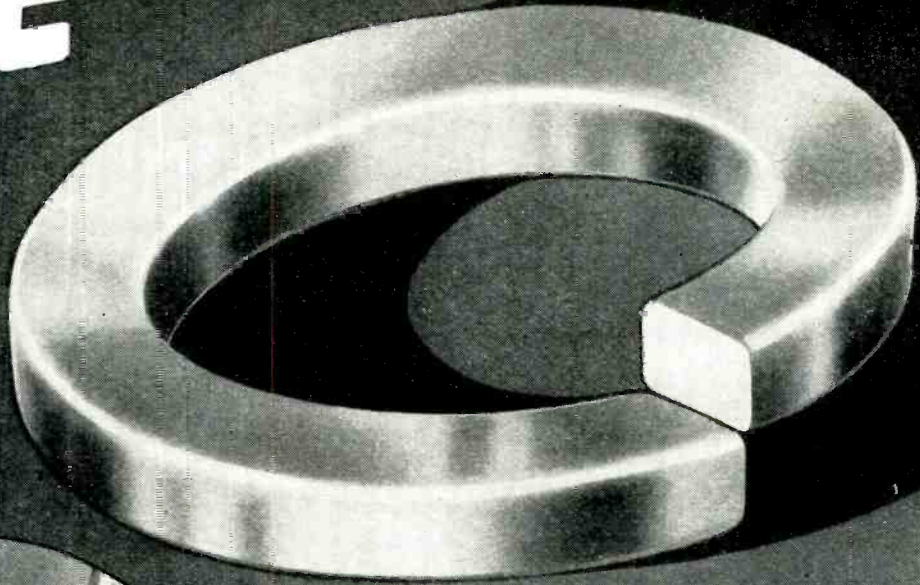

AS BEARINGS

For utility, economy and efficiency you can't beat a spring lock washer as a bearing. It acts as a thrust washer... prevents the assembly working loose... and at the same time is available at the lowest cost.

But there is a difference in lock washers. Try a Diamond G with Controlled Tension! Tension built right in it, and you'll know why. Diamond G Lock Washers provide positive spring tension... plus

a full surface to act as a thrust bearing. This permits full tightening of bolts or screws, safeguarding against excessive vibration, shock and wear.

Remember, for safety it's Diamond G! For quality it's Diamond G! For quick deliveries it's Diamond G! Write today for samples and the new folder giving you complete details on the new ASA and SAE specifications on spring lock washers.

GEORGE K. GARRETT CO., INC.

1421 CHESTNUT STREET, PHILADELPHIA 2, PA.
MANUFACTURERS OF



DIAMOND PRODUCTS

LOCK WASHERS • FLAT WASHERS • STAMPINGS • SPRINGS • HOSE CLAMPS • SNAP AND RETAINER RINGS

SPECIAL TRANSFORMERS?

You can have them constructed to your exact needs

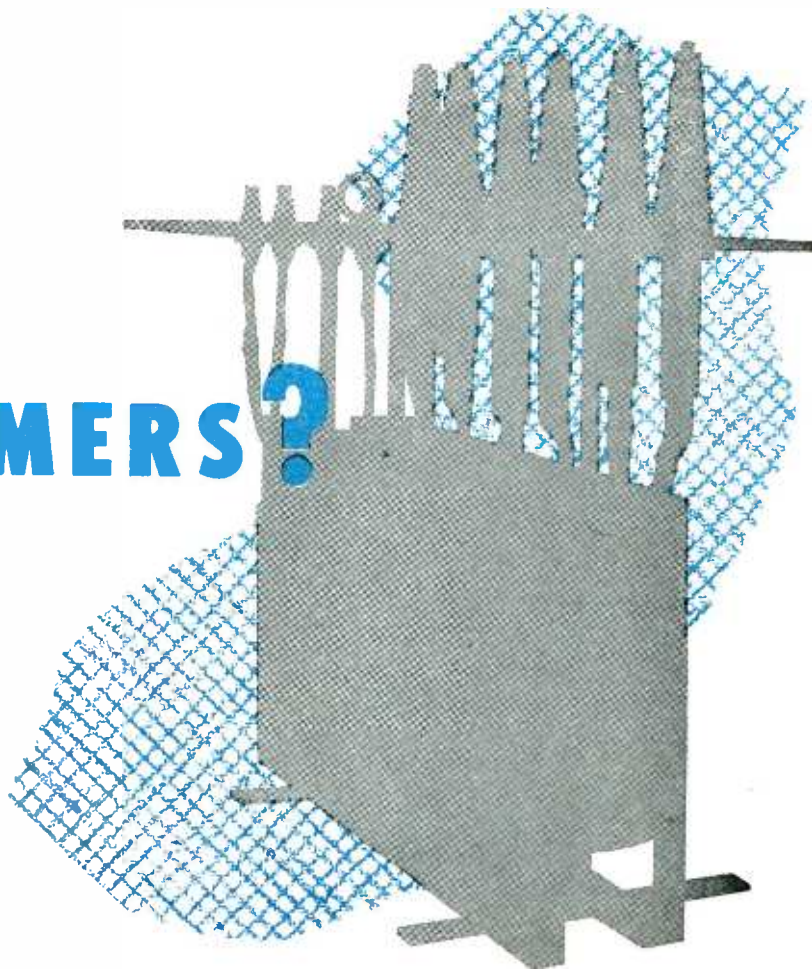

Why try to "get-by" with a transformer unsuited to your exact needs when you can have units designed and constructed — to the most precise specifications — which will meet your individual requirements and provide the utmost in transformer life and dependability.

If you need a transformer in a range of one-half to 100 K.W. Miller can make it. If it's a question of voltage — Miller has special X-ray transformers rated at 80,000 volts and more. If it's a question of dielectrics — Miller has designed many types to meet unusual dielectric requirements.

Perhaps your transformer requirements involve a question of size — perhaps they include moisture-proofing, special mounting, numerous taps or other troublesome specifications — but if it's a transformer problem, Miller can solve it. Whatever your demands even if only a few units of a special nature, write to us today for recommendations. Your inquiry will have our prompt attention.

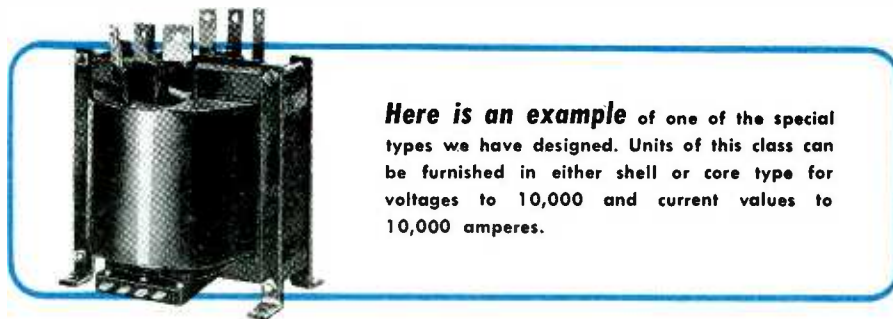

Here is an example of one of the special types we have designed. Units of this class can be furnished in either shell or core type for voltages to 10,000 and current values to 10,000 amperes.

B. F. MILLER TRANSFORMER CO. INC.

AM-100

TRENTON 4, NEW JERSEY

New! Spectacular! Complete!

CONCORD RADIO CATALOG



RADIO SETS

AMPLIFIERS

RADIO PARTS

ELECTRONIC EQUIPMENT

Mail
Coupon for
FREE
Copy!

WE HAVE WHAT YOU WANT!

The new Concord Catalog displays the most comprehensive stock in years! All well-known, standard lines are fully represented. Equipment—accessories—parts for all radio and electronic use...for building, repair, maintenance...for engineer, amateur, serviceman, soundman, retailer... complete lines of tubes, instruments, tools, speakers, condensers, resistors, relays, etc... PLUS a radio set department offering latest postwar models... PLUS the exciting line of MULTIAMP Add-A-Unit Amplifiers offering many innovations in public address units obtainable only from Concord.

Your copy of the complete, new Concord Catalog is ready! It offers you the latest, greatest selection of guaranteed quality RADIO SETS, PHONO-RADIOS, RADIO PARTS, TEST INSTRUMENTS, BOOKS, TOOLS, AMPLIFIERS AND ACCESSORIES, AMATEUR KITS AND SUPPLIES, ELECTRONIC EQUIPMENT...page after page of post-war-engineered equipment and parts you have long been waiting for. All standard, top-quality lines. Thousands of items. Money-saving prices. And fast service, direct from our two centrally located warehouses in CHICAGO and ATLANTA.

See the first peacetime line of Concord Radio Sets in new, modern cabinets with a host of post-war features. See the thrilling MULTIAMP *Add-A-Unit* Amplifiers, brand new in the field, with sensational new flexibility, fidelity, and power—EXCLUSIVE with CONCORD.

See the vast stock of everything you need in equipment and parts...see them in the new, comprehensive Concord Catalog, just off the press.

Your copy is ready...and it's FREE. Rush coupon today.

CONCORD

RADIO CORPORATION

LAFAYETTE RADIO CORPORATION

CHICAGO 7

ATLANTA 3

901 W. Jackson Blvd.

265 Peachtree Street

CONCORD RADIO CORPORATION

901 W. Jackson Blvd.

Dept. G-56, Chicago 7, Ill.

Yes, rush FREE COPY of the comprehensive new Concord Radio Catalog.

Name

Address

City State

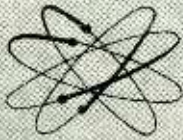

Designer's

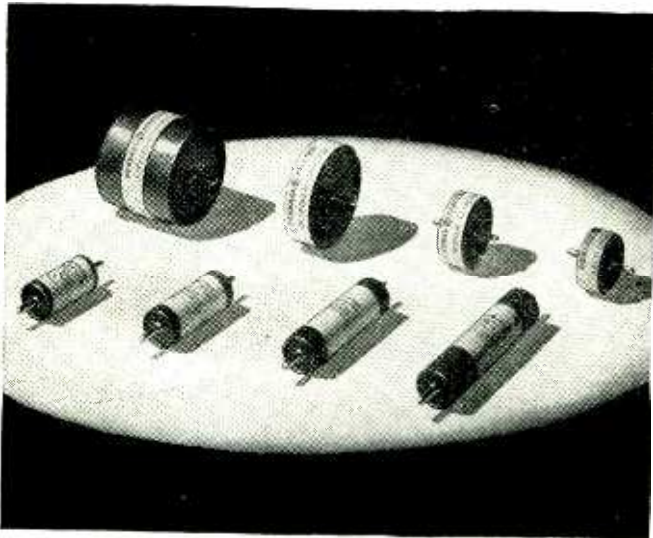

LECTROFILM *at a glance*

Lectrofilm is the name of a new synthetic-resin dielectric developed by General Electric Laboratories which combines a greater number of desirable mechanical and electrical properties than any other single capacitor dielectric material. It is admirably suited for use in dry-type, high-voltage capacitors because it—

- 1.** Withstands high and low ambient temperatures
- 2.** Has low power factor and its power factor decreases as temperature rises
- 3.** Has high dielectric strength and constant
- 4.** Is chemically stable
- 5.** Is strong and flexible
- 6.** Has uniform characteristics
- 7.** Is moisture resistant

New High-Voltage CAPACITORS for TELEVISION Pulse Rectifiers

To smooth out the rectified high-voltage power supply in television and similar electronic applications, G.E. has developed a new line of small, light-weight, high-voltage capacitors. These new components are specially designed to meet the exacting restrictions in size and weight made necessary by the compact design of modern television receivers.

Currently available in two widely usable designs—flat cylindrical and long cylindrical—these Lectrofilm* units are equipped with prong-type terminals, designed to meet the special mounting requirements of modern television receivers.

Constructed of thoroughly tested and proved materials, these new Lectrofilm capacitors make available to the television engineer the high quality and reliability demanded by today's television applications. Write for Bulletin GEA-4558.

G-E Lectrofilm capacitors, for use in television pulse rectifiers, are now available in the ratings given in the following table. (Other ratings and designs will be available on request.)

RATINGS AND DATA

Capacitance ratings: all sizes .0005 Mu-f. Capacitance tolerance; plus 35 per cent, minus 0 per cent.

Peak Working Voltage	Cat. No.	Maximum R-F Current (Milliamperes)			Net Wt. in Oz.	Approx. Dimensions in Inches	
		at frequencies of				Diameter	Length (Inc. terminals)
		20 Kc.	100 Kc.	300 Kc.			
FLAT CYLINDRICAL UNITS, with Terminals on Axis							
5000	29F201	15	50	150	1/2	1 1/8	1 1/8
7500	29F200	20	75	200	3/4	1 1/8	1 1/8
10,000	29F196	25	100	300	1 1/2	2 1/8	1 1/8
16,000	29F206	30	120	350	4/2	2 1/8	3 1/2
LONG CYLINDRICAL UNITS, with Terminals on Axis							
5000	29F203	10	40	100	3/4	1 1/8	2 1/2
7500	29F204	10	40	100	1	1 1/8	3
10,000	29F202	10	40	100	1 1/2	1 1/8	4
16,000	29F205	15	50	125	3	1 1/8	5

* General Electric's new synthetic-resin dielectric

GENERAL  ELECTRIC

Digest

TIMELY HIGHLIGHTS ON G-E COMPONENTS

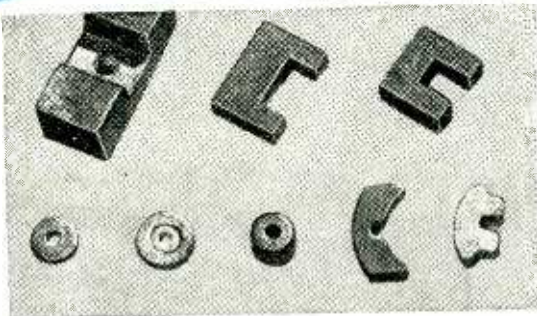

MORE MAGNET *in less space*

G-E alnico magnets are the answer to many a tough problem in design, where coercive force must be large, and the magnet small.

They are formed by the cast as well as the sintered process which makes possible rapid, large-scale, close-tolerance manufacture of both complex and simple shapes. Compact, with uniform flux distribution and great stability, these mighty midgets facilitate the design of small devices of high precision. Write for Bulletin GEA-3682A.

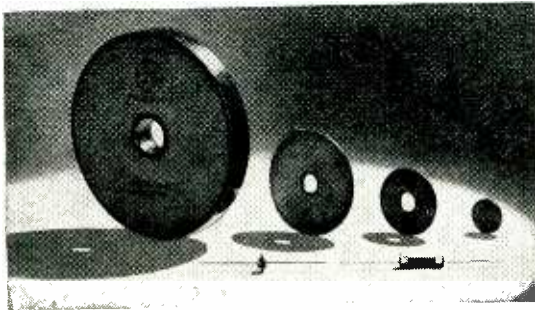

EVER NEED *a non-linear resistance?*

Frequently, electronic designers need a non-linear resistance to protect against voltage surges, to stabilize power voltages or to control voltage-selective circuits. In Thyrite*, General Electric's silicon-carbide resistance material, current varies as a power of the applied voltage. That is, I varies as E^n .

For example, with a Thyrite resistor whose exponent is 4, doubling the voltage multiplies the current by 2^4 or 16, whereas doubling the voltage applied to a wire-wound resistor merely doubles the current.

Thyrite resistors are supplied in discs or rods, in diameters from 0.25 in. to 6.0 in. Write for Bulletin GEA-4138A.

* Trade-mark Reg. U. S. Pat. Off.

TIGHT, FAST JOINTS

begin with the soldering iron

With the new line of G-E soldering irons, operators can solder just as fast as the nature of the job permits. Tips stay hot during constant use. The Calrod heating element close to the tip gives a short, low-loss heat path to the work.

Sturdy construction prevents work interruptions due to iron failure. Repairs are infrequent, even under severe conditions. Available in five sizes and types, from 75 to 300 watts, 115 volt or 230 volt. Write for Bulletin GEA-4519.



A LOT OF INSTRUMENT

in a little space

These thin, internal-pivot panel instruments have high torque, good damping, and a lightweight moving element that withstands vibration. They respond rapidly and accurately. They give you more instrument in less space, because the internal-pivot construction makes the entire element assembly 20 per cent thinner than most outside-pivoted types. Ask for details of the Type DW voltmeter or ammeter—milli, micro, or radio frequency. Bulletin GEA-4064.



REMOTE CONTROLS *that stay in step*

G-E selsyns stay synchronized; that is why they are so widely used for remote control and indication applications with single and multiple receivers.

Three sizes of high-accuracy selsyns give operation to within plus or minus 1 degree. Where plus or minus 5 degrees is close enough, use lower cost general-purpose selsyns.

Accuracy values are for 60 cycle, 110 volt operation. Write for Bulletin GEA-2176A.



General Electric Company, Sec. 642-11
Apparatus Dept., Schenectady 5, N. Y.

Please send me

- | | |
|---|----------------------------------|
| GEA-4558 (Lectrofilm capacitors) | GEA-4138A (Thyrite) |
| GEA-3682A (Sintered alnico magnets) | GEA-4519 (Soldering irons) |
| GEA-4064 (Panel Instruments) | GEA-2176A (Selsyns) |

NOTE: more data available in Sweets' File for Product Designers

Name

Company

Address

City State

★ Eliminate Inserts
★ Reduce Spoilage

WITH
PARKER-KALON TYPE "F-Z"
SELF-TAPPING SCREWS

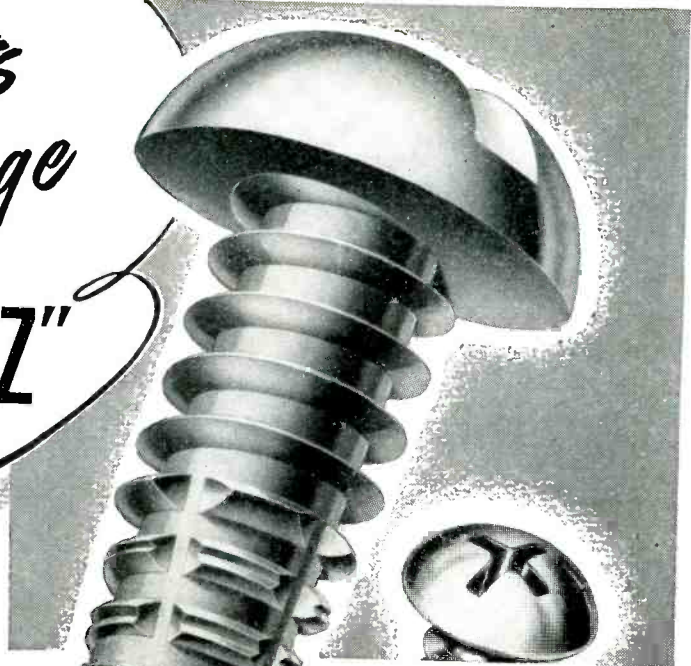

Designed especially for making fastenings to comparatively thin sections and bosses in friable and brittle plastics

Type "F-Z" Screws are not available from stock, but may be made up, quantity permitting, with slotted or Phillips Recessed Head.

★ **EXPERT PLASTIC DESIGNERS AGREE** that inserts should be avoided whenever possible because they slow down the molding cycle and add to the cost of materials and assembly.

P-K TYPES "Z", "F" and "U" Self-tapping Screws have permitted the elimination of inserts in thousands of plastic assemblies - with no sacrifice of strength, and at greatly reduced costs.

THE P-K TYPE "F-Z", which combines the coarse pitch thread advantages of the Type "Z" with the thread-cutting characteristics of the Type "F", permits the recognized savings of the Self-tapping Screw fastening method in a greatly increased range of plastic products.

FIVE CUTTING FLUTES distribute cutting pressure evenly - prevent localized pressure and cracking - especially in friable or brittle plastics, by permitting chips to drop to the bottom of the hole. The coarse threads eliminate binding by acting as an additional reservoir for the displaced material, and also offer greater resistance to stripping-out of the material.

PERMITS TROUBLE-FREE DESIGN. The minimum stresses set up as P-K TYPE "F-Z" screws are driven permit design of plastic shells with more uniform wall

sections. Excessive variation of thickness, as at bosses, often results in surface imperfections due to uneven curing. Fastenings with Type "F-Z" screws permit smaller bosses and thinner wall sections, with a resultant saving in material.

It may be the right answer to your problems of high molding costs and excessive spoilage. It's plain common sense to find out NOW how you can make the savings of 30 to 50 per cent often achieved with P-K Screws.

SEND FOR SAMPLES of this unique screw, compare! See for yourself. Parker-Kalon Corp., 200 Varick St., New York 14, N. Y.

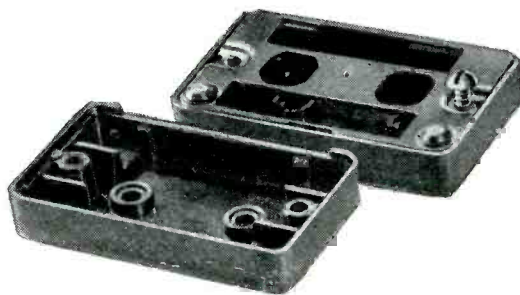

In this typical assembly P-K Type "F-Z" Screws replaced inserts and permitted the use of small, island-bosses without sacrifice of strength.

SOLD ONLY THROUGH ACCREDITED DISTRIBUTORS



TYPE "A"

TYPE "Z"

HEX HEAD

P-K



TYPE "F"



TYPE "U"



TYPE "Z" PHILLIPS

PARKER-KALON

SELF-TAPPING SCREWS

A FASTENING FOR EVERY METAL AND PLASTIC ASSEMBLY

THE LEAD-IN CABLE THAT MAKES THE DIFFERENCE

BETWEEN This-



AND This-

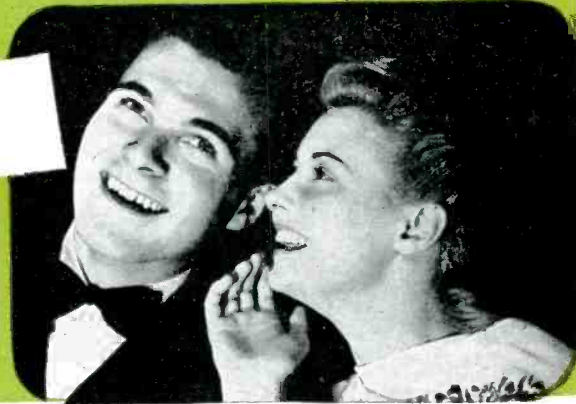

**INSULATED WITH
Du Pont POLYTHENE**

With the home television set, much of the attenuation and distortion of images that sometimes occurs on the screen may arise in the lead-in cable from the antenna to the instrument. But not with the new Type ATV cable shown here. With this cable, attenuation is minimized . . . images are strong and clear.

The unusual design of this new lead-in line deserves much credit for its high effectiveness. But note—what makes this design possible is the excellent electrical properties of the insulation, of Du Pont polythene.

Because of polythene's remarkable dielectric strength, a thin coating of it is all that is needed. Polythene's low power factor makes it unusually effective in every type of high-frequency circuit. Credit also polythene's light weight (specific gravity 0.92) and its ability to retain its toughness and flexibility over a wide range of temperatures.

For complete data sheet on polythene, write to E. I. du Pont de Nemours & Co. (Inc.), Plastics Dept. 155, Arlington, N. J.

Du Pont manufactures polythene molding powder.
Commercial extruders convert polythene into the form of



Type ATV two-wire polythene-insulated cable, for use as television lead-in line between antenna and receiver, made by Anaconda Wire & Cable Co. (Photo 2.5 times actual size.) This rugged, flexible cable, one of the lightest of its type, has an attenuation of 0.75 db/100 feet, and an impedance of 300 ohms at 50 megacycles.

**BETTER THINGS FOR BETTER LIVING
... THROUGH CHEMISTRY**

You Can Depend on These Famous Names

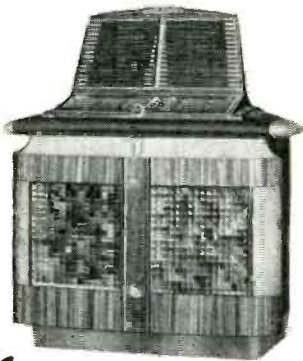

"Electronic" Tone Quality

Aireon Electronic Phonographs, achieve a tone quality never before approached in coin-operated music. Heart of their sensational performance is the specially designed 15-inch, 12,000 cycle Cinaudagraph Speaker which carries a maximum range of harmonics and tone.

The Aireon Manufacturing Corporation is proud of the enviable reputation Cinaudagraph Speakers have attained for high fidelity, superior performance and ruggedness. This standard of perfection will not only be maintained in Cinaudagraph Speakers but will be extended through the exceptional research, engineering and production facilities of Aireon. Recognition and acceptance of Cinaudagraph Speakers by leading radio manufacturers is an assurance of their high fidelity performance.

A complete line of speakers from two-inch units for portable radios to fifteen-inch models for commercial phonographs and public address systems is produced at the Slater, Missouri plant. Write us about your speaker requirements.

Cinaudagraph Speakers, Inc.

MANUFACTURED AT SLATER, MISSOURI

Subsidiary of **Aireon** Manufacturing Corporation

SALES OFFICES: 1401 FAIRFAX TRAFFICWAY,
KANSAS CITY 15, KANSAS



New Tetrode for Fixed or Mobile Use

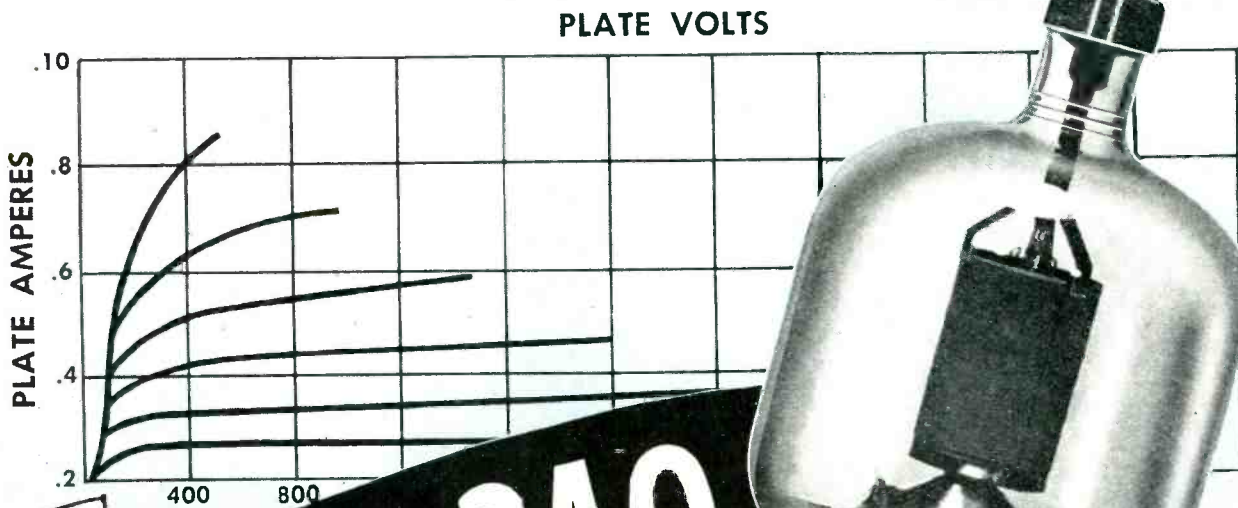

The New **AT-340**

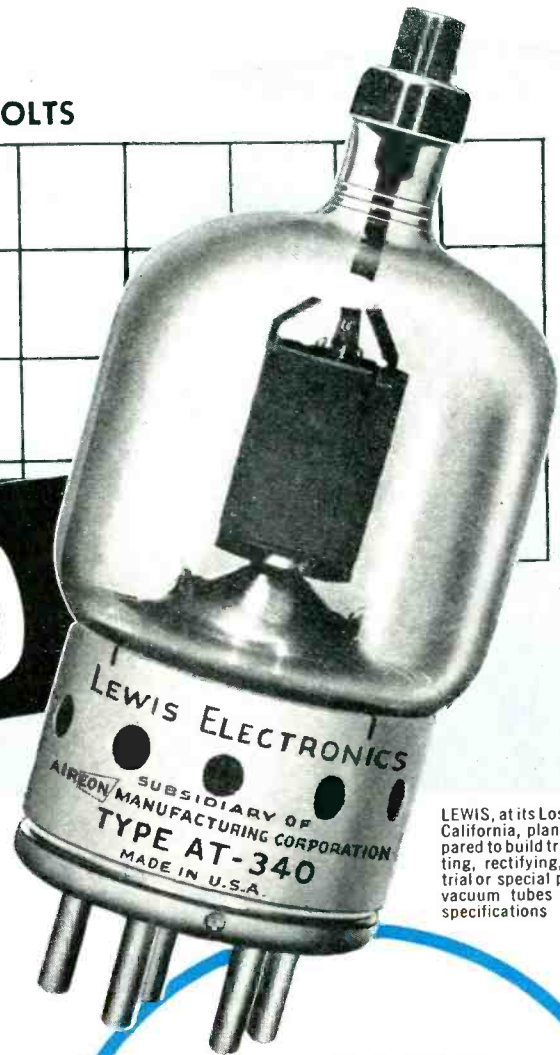

LEWIS, at its Los Gatos, California, plant is prepared to build transmitting, rectifying, industrial or special purpose vacuum tubes to your specifications

LEWIS AT-340 was designed with several specific ideas in mind. First, to give design engineers a rugged and versatile 150 watt class beam tetrode to simplify transmitter circuit design. Secondly, to develop to a high degree the inherent low driving power requirements of the beam tetrode. Thirdly, to accomplish both these ends at low "per-hour-cost" by conservative ratings and careful manufacture.

A minimum of structural insulation support enables operation under maximum conditions to 120 megacycles. Also permits high dissipation with a relatively small bulb cooled by convection only.

The AT-340 has a 5-pin metal sleeve base and top plate connection. Filament is thoriated tungsten at 37.5 watts, plate is molybdenum, dark body.

Tubes and catalogs are now ready.

MAXIMUM RATINGS

Class "C" Radio Frequency Power Amplifier and Oscillator

D-C Plate Voltage	4000 volts
D-C Plate Current	225 ma
Plate Input	750 watts
Plate Dissipation	150 watts
To 120 Megacycles	
Filament	5.0 volts, 7.5 amperes

Lewis

Subsidiary of **Aireon**
MANUFACTURING CORPORATION

ELECTRONICS
LOS GATOS • CALIFORNIA



The Mark of Quality

With the dawn of the new electronic era CENTRALAB again dominates the scene. The "CRL IN THE DIAMOND" identifies a group of QUALITY components engineered to the exacting requirements of the new electronic age . . . always specify CENTRALAB.

Centralab

Division of GLOBE-UNION INC., Milwaukee

PRODUCERS OF



Ceramic Trimmers
Bulletin 695



Variable Resistors
Bulletin 697

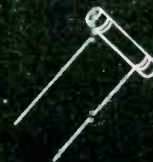

Tubular Ceramic
Capacitors
Bulletins 638 and 586



Selector Switches
Bulletin 722



Ceramic High Voltage Capacitors
Bulletin 814

"Must be somethin' he et!..."



THERE'S ALWAYS A GOOD REASON why one kid shoots up faster than all the others in the neighborhood. It isn't luck. Most likely, it's more vitamins, more sunshine and better care.

Companies like Cornell-Dubilier don't grow up overnight either. Experts like C-D engineers don't just "happen". Only here it isn't what you *eat* or *dream*; it's what you *do*. You dig behind what others have told you. That's research. You look beyond what others have seen. That's pioneering. You spend more time and money, than might seem immediately profitable, to become proficient in your field. And when the "unheard of" has to be done, industry expects you to do it.

When giant capacitors, that could handle severe temperatures without the use of water-cooling coils, were needed, they came to Cornell-Dubilier. And when capacitors were needed for the Proximity Fuze, in sizes so tiny they had never before been envisioned, C-D engineers were handed the problem.

Remember that when your plans call for the unusual in capacitor design and dependability.



Cornell-Dubilier Electric Corp. South Plainfield, New Jersey. Five other plants in New Bedford, Brookline, Worcester, Mass. and Providence.



CORNELL-DUBILIER

world's largest manufacturer of

CAPACITORS

MICA • DYKANOL • PAPER • ELECTROLYTICS

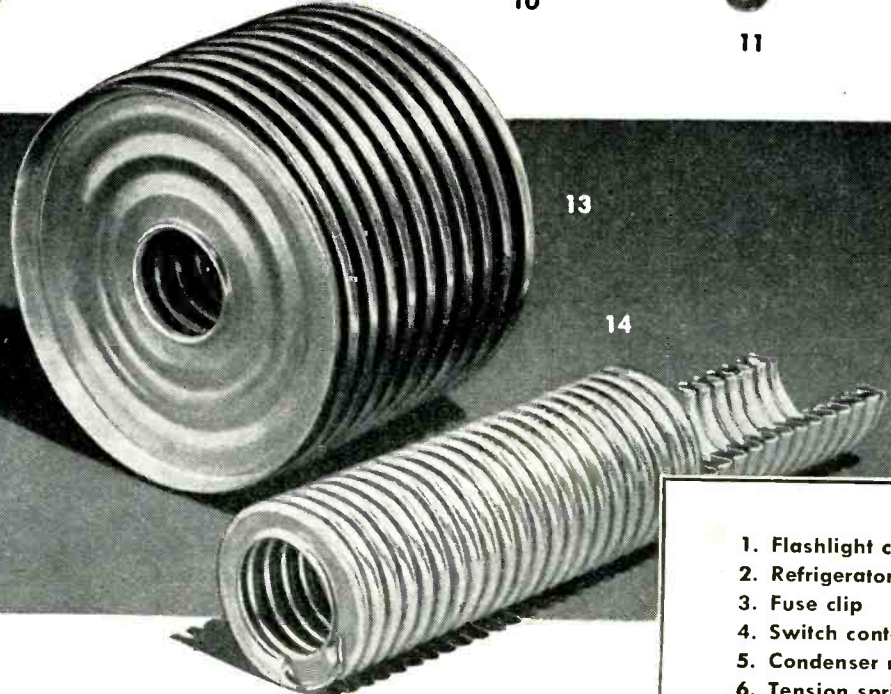
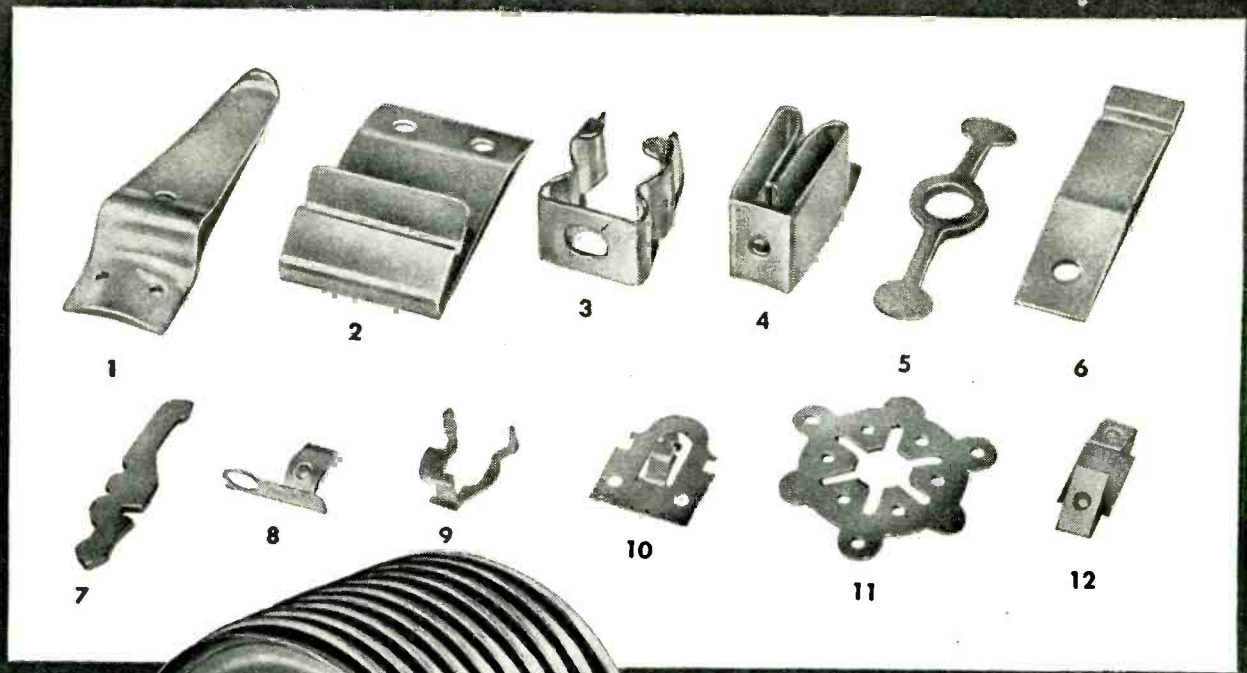

- 1. Flashlight clip
- 2. Refrigerator door catch
- 3. Fuse clip
- 4. Switch contact
- 5. Condenser member
- 6. Tension spring
- 7. Contact blade
- 8. Sliding contact
- 9. Guide fork spring
- 10. Switch tension spring
- 11. Spring pressure plate
- 12. 3-way plug contact
- 13. Tin-coated bellows
- 14. Flexible hose

REVERE PHOSPHOR BRONZES OFFER MANY ADVANTAGES

Strength — Resilience — Fatigue Resistance — Corrosion Resistance — Low Coefficient of Friction — Easy Workability — are outstanding advantages of Revere Phosphor Bronzes, now available in several different alloys.

In many cases it is the ability of Phosphor Bronze to resist repeated reversal of stress that is its most valuable property. Hence its wide employment for springs, diaphragms, bellows and similar parts. In addition its corrosion resistance in combination with high tensile properties render it invaluable in chemical, sewage disposal, refrigeration, mining and similar applications. In the form of welding rod, Phosphor Bronze has many advantages in the welding of copper, brass, steel, iron and the repair of worn or broken machine parts. Revere suggests you investigate the advantages of Revere Phosphor Bronzes in your plant or product.

REVERE
COPPER AND BRASS INCORPORATED
Founded by Paul Revere in 1801
 230 Park Avenue, New York 17, N. Y.
 Mills: Baltimore, Md.; Chicago, Ill.; Detroit, Mich.; New Bedford, Mass.; Rome, N.Y. —
 Sales Offices in principal cities, distributors everywhere.
 Listen to *Exploring the Unknown* on the Mutual Network every Sunday evening, 9 to 9:30 p.m., EDST.

SYLVANIA NEWS

CIRCUIT ENGINEERING EDITION

MAY

Prepared by SYLVANIA ELECTRIC PRODUCTS INC., Emporium, Pa.

1946

ANNOUNCING! EFFICIENT, NEW SYLVANIA R. F. AMPLIFIER TUBE



TYPICAL OPERATING CONDITIONS

Heater voltage	6.3 volts
Heater current	0.150 ampere
Maximum plate voltage	250.0 volts
Maximum plate dissipation	2.0 watts
Maximum screen grid voltage	250.0 volts
Minimum external negative grid voltage	1.0 volt
Maximum screen grid dissipation	0.75 watts
Maximum heater-cathode voltage	90.0 volts

Here's a new sharp cut-off r-f pentode amplifier designed especially for 6.3 volt and a-c/d-c series service in Television and Frequency Modulation receivers.

The tube may be operated with full plate voltage on the screen grid to produce high input resistance as a result of reduced electron transit

TYPICAL OPERATING CHARACTERISTICS OF TYPE 7AG7 AS A CLASS A1 AMPLIFIER

Plate current	6.0 Ma.
Plate resistance	0.75 megohm
Screen grid current	2.0 Ma.
Mutual conductance	4200 micromhos

Direct Interelectrode Capacitances

Grid to plate	.005 micromicrofarad Max.
Input	7.0 micromicrofarads
Output	6.0 micromicrofarads

time. Identical voltage requirements for plate and screen grid also eliminate the need of screen grid filter resistors and by-pass capacitors in some circuit applications.

Inquiries concerning the new Sylvania Type 7AG7 r-f pentode amplifier tube are invited. Write Sylvania Electric Products Inc., Emporium, Pa.

SYLVANIA ELECTRIC

Emporium, Pa.

MAKERS OF RADIO TUBES; CATHODE RAY TUBES; ELECTRONIC DEVICES; FLUORESCENT LAMPS, FIXTURES, WIRING DEVICES, ELECTRIC LIGHT BULBS

THE LITTLE RELAY WITH BIG FEATURES



The Bulletin 104 Relay is small, yes . . . but small only in size. It will do a big job for you . . . and right where a larger relay would be hard to get in.

Large wiping contacts that carry heavy loads . . . heavy contact pres-

VARIOUS ARRANGEMENTS

Bulletin No. 104 Relays are available in Single and Double Pole, Single and Double Throw, and with or without an auxiliary contact; with fixed, flexible or adjustable contacts, with Bakelite or Radio Frequency insulation.

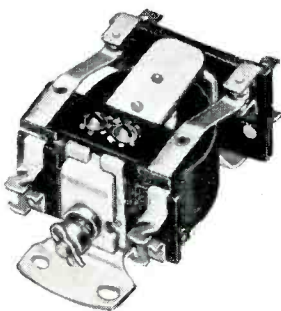

ures to reduce arcing and sparking . . . wide range of voltages for both D. C. and A. C.

These are but a few of the big features of the little 104 Relay . . . the relay designed to meet your heavy duty requirements where weight and space are prime factors.

Write for Bulletin 104 today.

WARD LEONARD

RELAYS • RESISTORS • RHEOSTATS

Electric control  devices since 1892

WARD LEONARD ELECTRIC COMPANY
32 SOUTH STREET, MOUNT VERNON, N.Y. • OFFICES IN PRINCIPAL CITIES



We're coming in...



A static has made a lot of "pick-ups" along the line and here we are ... breezing through the azure blue ... headed for the Show ... and you. It's going to be fun ... shaking hands with the old gang again ... and the new-comers, too. We'll be holding forth at the Stevens, where you'll find Astatic Microphones, Phono-graph Pickups and Cartridges ... including many new and improved models ... on display. We'll be seein' you!

Hotel Stevens

CHICAGO, ILL.
Headquarters for
Radio Parts National Trade Show
May 13, 14, 15 and 16

THE **ASTATIC**
Astatic
CORPORATION
CONNEAUT, OHIO

In Canada: Canadian Astatic, Ltd. . Toronto, Ont.

Now **SALES AND
FROM A**

THORDARSON

TRANSFORMERS
TRU-FIDELITY AMPLIFIERS

MEISSNER

COMPONENTS • KITS
SERVICE EQUIPMENT

Important!

● The Electronic Distributor and Industrial Sales Department of Maguire Industries, Incorporated, was formed primarily to offer better, faster service . . . to assume all merchandising, sales and customer relation duties and responsibilities essential in marketing the combined, precision-built products of the Thordarson Division, Meissner Division and Radiart Corporation.

RADIART

VIBRATORS
RUST-PROOF AERIALS

**ELECTRONIC DISTRIBUTOR AND
INDUSTRIAL SALES DEPARTMENT**

SERVICE... SINGLE SOURCE!

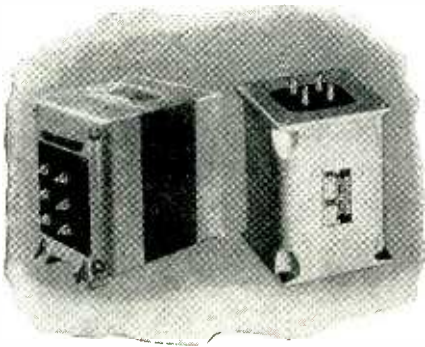

THORDARSON

QUALITY-BUILT ELECTRONIC PRODUCTS

TRANSFORMERS

- For all requirements... communications, sound amplifier, industrial, experimental and amateur.

TRU-FIDELITY AMPLIFIERS

- Advanced tone compensation, conservative ratings, multiple input channels, low hum level, etc.

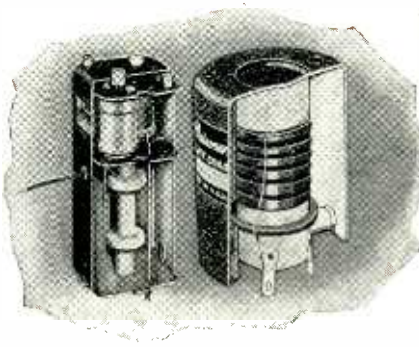
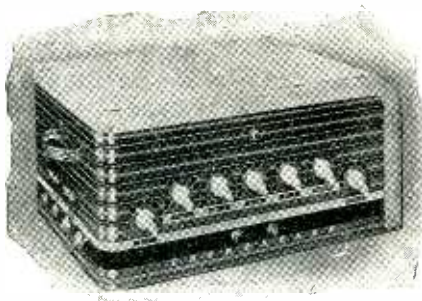

MEISSNER

COMPONENTS

- Standard, plastic and Ferrocarr transformers; antenna, R. F. and oscillator coils; accessories.

SERVICE INSTRUMENTS

- Meissner Analyst... a complete servicing instrument; Signal Calibrator... self-contained and portable.

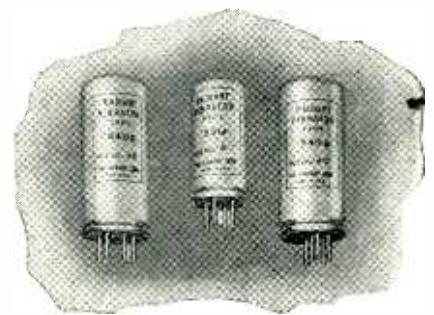
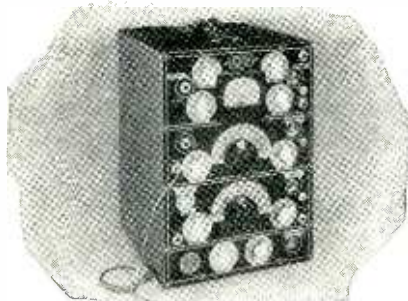

RADIART

VIBRATORS

- Exact duplicate Vibrators, individually engineered... long life, low noise level, minimum interference.

RUST-PROOF AERIALS

- A complete line, newly designed to fit all cars... cowl, hood and under hood types. Many exclusive features.

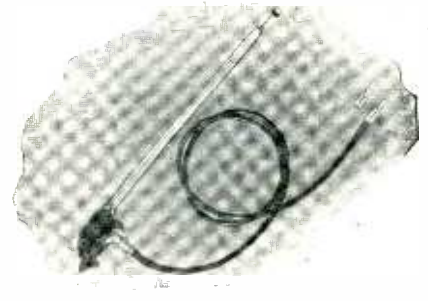

WRITE TO THE ADDRESS BELOW FOR MORE COMPLETE DETAILS!

MAGUIRE INDUSTRIES, INC.

936 NORTH MICHIGAN AVENUE, CHICAGO 11, ILLINOIS

Specify
*** VITAMIN Q**
for

HIGHER VOLTAGES

(Real space savers)

HIGHER TEMPERATURES

(De-rating factor much smaller)

HIGHER INSULATION RESISTANCE

(More than 20,000 meg. mfd. at room temperature)

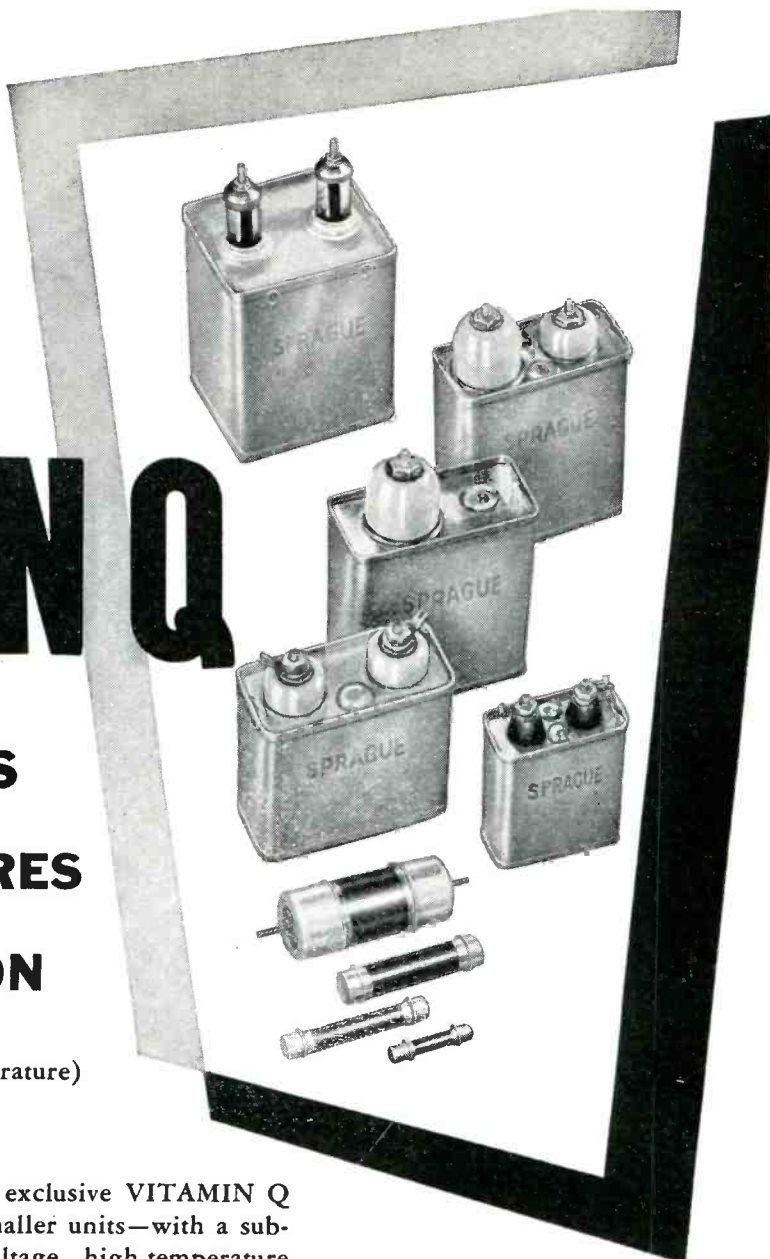

SPRAGUE CAPACITORS using the exclusive VITAMIN Q impregnant make possible the use of much smaller units—with a substantial safety margin—on numerous high-voltage, high-temperature applications ranging from transmitting to television. Where high temperature is not a factor, their unique characteristics assure materially higher capacity-voltage ratings for a given size.

Type 25P VITAMIN Q Capacitors operate satisfactorily at high voltages at ambient temperatures as high as 115° C. Insulation resistance at room temperature is *more than 20,000 megohm microfarads*. Throughout the temperature range of +115° C. to -40° C. they retain all virtues of conventional mineral oil-impregnated capacitors.

Sprague Electric Company, North Adams, Mass.

CAN TYPES 25P

Two standard types, one for 105° C. and one for 95° C. continuous operation. Other ratings available.

HERMETICALLY SEALED IN GLASS TUBES

Famous Sprague glass-to-metal end seals. Extended construction gives maximum flashover distance between terminals.



SPRAGUE

WRITE FOR CATALOG 20A . . .
 including all Sprague Paper Dielectric Capacitor types.

CAPACITORS • *KOOLOHM RESISTORS • *CEROC INSULATION

**Trademarks Registered U. S. Pat. Off.*

PRECISION

Electroforming

**Electroformed
RADAR
WAVE GUIDES**

WHERE PRECISION IS A MUST!

Perfection in control—precision results—and production thus Electroforming by Bone Engineering Corporation makes possible the formation of the most intricate parts and shapes on a production basis. Metal* deposits are rigidly controlled in physical properties with an exactness in pattern reproduction to within tolerances heretofore unobtainable.

*Metals include nickel, copper, iron, silver and various alloys.



RADAR WAVE GUIDES . . . produced by Bone Engineering Corporation, manufacturers of Radar and Electronics equipment.

CONSULTANTS to the Airborne Radar Division of the U. S. Naval Research Laboratory . . . we now invite you to profit by our experience as Consultants on Electroforming.

Bone

ENGINEERING CORPORATION

701 WEST BROADWAY, GLENDALE 4, CALIFORNIA

*A value range equal to
its frequency range...*

... A LABORATORY-TYPE SIGNAL GENERATOR FOR SERVICEMEN

We've been designing and producing signal generators for a good many years—each one the best we were able to produce in that year. They have always been pace-setters. Over the years they have become the standard of utility in such instruments for servicemen—distinguished always by that inbuilt Simpson accuracy that stays accurate. Every new model has stepped up the value, dollar for dollar, of the serviceman's investment.

Now this Model 415, with the widest frequency range of them all, tremendously widens the value range as well. Every dollar of its price buys more than a dollar ever bought before, even in a Simpson instrument. We know, for instance, of several

signal generators built for laboratories only, selling *at twice and three times the price* of the Model 415, that will do very little more than this new Simpson Wide Range Signal Generator for AM and FM. And no serviceman's instrument we know of even approaches Model 415 in range, control, constancy of output, completeness of attenuation and degree of utility. Here is another of Simpson's 1946 developments in instruments for radio and television servicemen, the product of long and rewarding research.

We offer Model 415 in the proud knowledge that it is not likely to see its peer for a long time to come.

1. Direct reading dial with continuous coverage from 70 Kilocycles to 130 Megacycles in the following ranges: 75-200; 200-600; 600-1750 Kilocycles and 1.5-4.5; 4-15; 14-30; 29-65; 58-130 Megacycles.
2. Model 415 is practically independent of line voltage fluctuation. Calibration is stable regardless of wide variations in line voltage.
3. RF output is controlled through its entire range, eliminating the necessity of a separate connection for high uncontrolled output as found in other signal generators.
4. RF output voltage is practically constant throughout the entire frequency range.
5. Modulation from 0 to 100% using either the 400 cycle internal sine wave or an external source. A range from 0 to over 20 volts of 400 cycle sine wave is available for external use.
6. High fidelity modulation up to 100% from below 60 cycles per second to over 10 Kilocycles per second.
7. No unwanted frequency modulation present.
8. Each Signal Generator is individually calibrated against a crystal controlled frequency standard.
9. Substantial construction assures maintenance of calibration accuracy indefinitely.

PANEL—Lustrous black anodized aluminum. Dial is encased in a molded bakelite escutcheon with glass covering for protection against damage and dirt. Functional switches and controls are mounted on engraved molded bakelite panels.

CASE—Steel, copper plated for shielding effect and finished in black durable wrinkled enamel. Leather carrying handle.

SHIELDING—In addition to the overall shielding offered by the case and panel, the coils and tuning condenser are individually shielded, then an additional shield is placed over these two assemblies. This series of shields together with other factors reduce leakage to an absolute minimum.

COILS—Low loss RF coils are individually calibrated by means of variable inductance and variable minimum capacitance. These adjustments provide the means for greatest possible accuracy in calibration.

BAND SELECTOR—The rotating turret coil assembly permits the use of shortest possible wiring, resulting in minimum circuit capacitance and permits quick selection of any frequency range.

CONDENSER—A two section tuning condenser using either one section or the other provides for ideal inductance to capacity ratio on all bands. Smooth vernier tuning permits accurate adjustment of the selected frequency.

Price\$115.00

ASK YOUR JOBBER

SIMPSON ELECTRIC COMPANY
5200-5218 W. Kinzie St., Chicago 44, Illinois

Simpson
INSTRUMENTS THAT STAY ACCURATE

**NEW SIMPSON
WIDE RANGE
SIGNAL GENERATOR
FOR AM AND FM**



WATCH FOR NEW SIMPSON DEVELOPMENTS... THEY ARE WORTH WAITING FOR



ELECTRONS INCORPORATED
127 SUSSEX AVENUE
NEWARK, N. J.

TYPE C16J
GRID CONTROL RECTIFIER 750 P.F.V. 12 AVG. AMPS.
100 PEAK AMPS.



Using Corrosion Resistance, Ease of Machining

A NEW WAY to locate oil makes use of waves originating from a detonation of dynamite. Wave reflections are picked up by flower-pot-like "ears" strategically buried over the suspect area and seismographically recorded.

The pot or case, containing a sensitive electro-magnetic element, can be made of various materials. With Synthane, however, no special

surface finish is required to resist corrosion. Synthane is also easily and quickly machined, and non-magnetic. In short, Synthane is *economically* better.

Is Synthane better for your job, too? Could be! Why not find out, preferably *before* you design? We're ready to help you with design, materials or completely fabricated parts.

SYNTHANE CORPORATION • 6 RIVER ROAD • OAKS • PENNSYLVANIA



SYNTHANE TECHNICAL PLASTICS • DESIGN • MATERIALS • FABRICATION



SHEETS



RODS



TUBES



FABRICATED PARTS



MOLDED-MACERATED

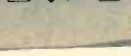

MOLDED-LAMINATED



MAYBE IT'S TIME TO RECONVERT THINKING, TOO . . .

By the time you read this, it's likely reconversion will be complete or nearly complete. *Plant* reconversion.

But before many a new product is born or an old product reborn, there will have to be a reconversion of thinking.

Some prewar notions about plastics and their limitations will have to be shelved, if they have not already been. Why? Because, even in the unspectacular technical plastics which we make, there have been important changes in resins and fillers. Low-loss and impact materials have been improved. Postforming of so-called thermosetting laminates is no longer a laboratory curiosity.

The old and erroneous habit of regarding plastics as ersatz materials has almost died out. Now it's the rule to use plastics where they rightfully belong, or not use them at all. As if to prove the point, there were so many legitimate uses for plastics during the war, plastics couldn't be

spared for service as substitutes.

Reconvert your thinking about plastics? Yes! By all means go over every single part of your product or equipment to see where the advantages of plastics can be properly used to *your* advantage.

If plastics offer all the properties you want, or more than you want, at a more *economical* cost—considering labor, material, ease of manufacture, length of life, sales appeal, replacement expense, customer satisfaction—then use plastics.

Should our own type of plastics—Synthane—seem to answer your purpose, let us help you investigate the use, find the right grade of Synthane for the job, and—if you desire—fabricate the material for you.

The complete Synthane catalog is packed with helpful information. Before you forget, tear out the coupon and send for your copy now.

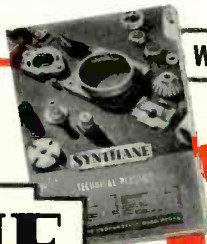

WRITE FOR IT TODAY

SYNTHANE

S

PLAN YOUR PRESENT AND FUTURE WITH SYNTHANE
TECHNICAL PLASTICS • SHEETS • RODS • TUBES • FABRI-
CATED PARTS • MOLDED-LAMINATED • MOLDED-MACERATED

SYNTHANE CORPORATION, 6 RIVER ROAD, OAKS, PA.

Gentlemen:

Please send me without obligation the complete catalog of
Synthane technical plastics.

NAME _____

COMPANY _____

ADDRESS _____

CITY _____

ZONE _____

STATE _____

What DOES Make a BETTER Loud Speaker?

WILL the possession of physical facilities and desire create a better product? No, because for all of their importance, these possessions are certainly not unique. All institutions have them to some degree. Is it fanciful claims and fluent use of superlatives in product description that make a product better? Obviously not. Is it the achievement of theoretically perfect performance in the laboratory? No, not that either, for perfection in such respects does not necessarily create the *practical ideal*.

The simple truth is that no product can be better than *know how* and the honest application of that *know how* as the product is created and its virtues described.

What is the yardstick of these ingredients in a product? The record of achievements and the list of contributions to the advancement of science and art is one good measurement. The First PM Speaker, the Bass Reflex Principle, the Hypex Formula are just a few of the advancements contributed to the industry by JENSEN. There is also the endorsement by those users and connoisseurs of Loud Speaker performance whose first and last emphasis is always on superiority. JENSEN Loud Speakers and Reproducers are the overwhelming choice of such people. Finally, and perhaps most important of all, there is the established custom of the manufacturer to make honest statements as to the *real ability* as well as *limitations* of the product. Here at JENSEN this has always been a fixed policy, an absolutely essential ingredient in *honesty of purpose*, even though by some standards it is called "selling down."

And so, a better Loud Speaker is created because of *know how*, achievement as shown by the record, significant endorsement and integrity of purpose from start to finish. JENSEN Loud Speaker Products, personnel and policy meet these requirements.

For those interested in the proper appraisal, selection, use and operation of Loud Speakers, JENSEN is publishing a series of Technical Monographs—of which five issues are now in print. Note the titles listed below and write for one or all of them.

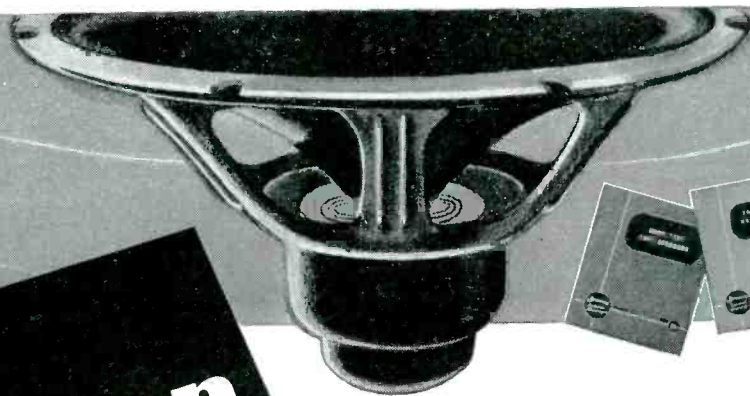

5 MONOGRAPHS AVAILABLE

1. Loud Speaker Frequency-Response Measurements
2. Impedance Matching and Power Distribution
3. Frequency Range in Music Reproduction
4. The Effective Reproduction of Speech
5. Horn Type Loud Speakers

FREE to the Armed Forces, Colleges, Technical Schools, Libraries

25c
Each

JENSEN RADIO MANUFACTURING CO.
6607 SO. LARAMIE AVENUE, CHICAGO 38, ILLINOIS
In Canada: Copper Wire Products, Ltd., 137 Oxford Street, Guelph, Ont.

Specialists in Design and Manufacture of Fine Acoustical Equipment

That hour-after-hour steady grind calls for
PERFORMANCE INSURANCE as provided by
AEROVOX Rating-plus CAPACITORS

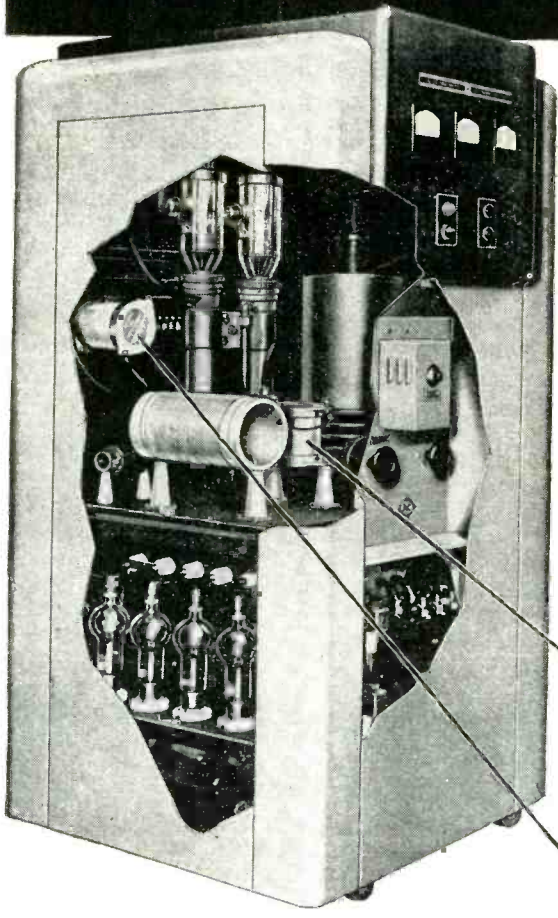

• This induction heating unit bears the name of a world-famous manufacturer. A great reputation is at stake. Such equipment *must* stand up—hour after hour, day in and day out, for months and years to come.

None but outstandingly dependable components can be risked in such equipment. And the selection of Aerovox Series 1940 stack-mounting capacitors is based on two good reasons:

First, Aerovox are *rating-plus* capacitors. A comparative study of specifications is invited. Second, Aerovox provides *Continuous Service Rating Data* for all its current-handling capacitors. The equipment designer knows precisely what such capacitors can and cannot do. These two points alone can write a *performance insurance* policy.

Continuous Service Rating Data
TYPES 1940-1950-1960-1970-1980
 Maximum Current in Amperes at an Ambient Temperature of 60° C.,
 Barometric Pressure 28 to 32 inches Mercury and Relative Humidity 10 to
 80%. Maximum Ambient Temperature 70° C.

Cap. Mfds.	Test Volts ER.	TYPE 1940 Catalog Number	3000	1000	300	100
			kc.	kc.	kc.	kc.
.000075	35,000					
.0001	35,000	1940-236	7.5	4.5	1.8	.6
.00015	35,000	1940-203	10.	6.	2.2	.8
.0002	35,000	1940-204	13.	8.	3.	1.2
.00025	35,000	1940-205	16.	12.	4.	1.5
.0003	35,000	1940-206	17.	13.	5.	2.0
.00035	35,000			15.	6.	2.4
.0004	35,000			15.	7.	2.5
.0005	35,000			16.	8.	3.3
.0006	35,000			20.	10.	4.
.0007	35,000			22.	10.	4.5
.0008	35,000				12.	5.
.001	35,000				12.	6.
.00125	35,000				14.	8.
.0015	35,000				15.	8.
.002	30,000				18.	8.
.0025	25,000				21.	10.
	25,000				22.	11.5
	25,000				25.	12.
	20,000				25.	13.
					30.	



• Interested in performance insurance protection for your assemblies? Then insist on *rating-plus* specifications and *continuous service rating data*—or simply specify AEROVOX. Literature on request.

FOR RADIO-ELECTRONIC AND INDUSTRIAL APPLICATIONS



AEROVOX CORPORATION, NEW BEDFORD, MASS., U.S.A.

SALES OFFICES IN ALL PRINCIPAL CITIES • Export: 13 E. 40th St., NEW YORK 16, N. Y.

Cable: 'ARLAB' • In Canada: AEROVOX CANADA LTD., HAMILTON, ONT.

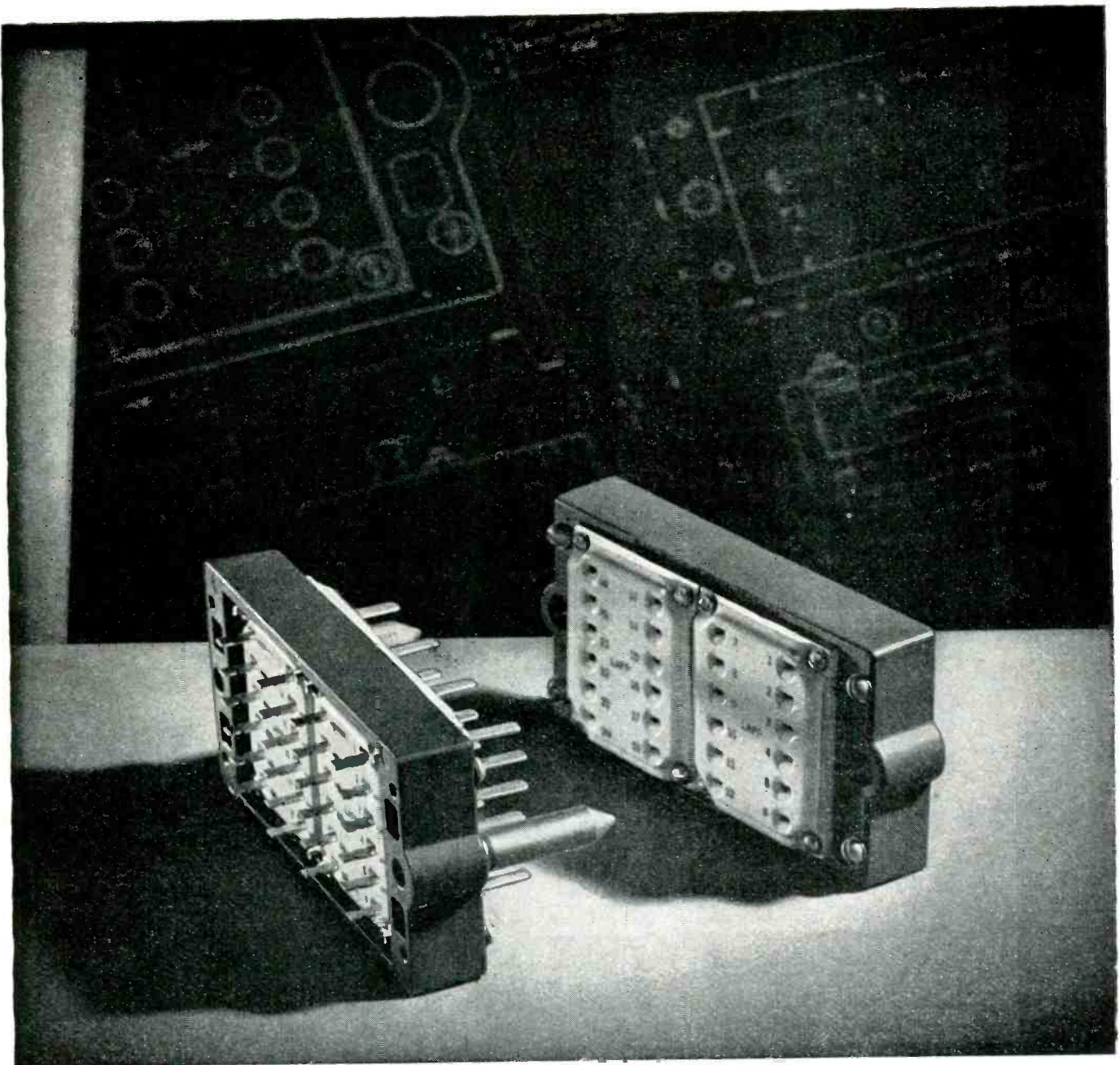

An Electronic Part ... ENGINEERED TO A SPECIFIC NEED

This is a special-purpose electronic part. It is a plug-receptacle assembly for use with rack-panel type of mounting. Twenty-four silver-plated phosphor-bronze contacts are provided, each male and female contact full floating between steatite plates. Heavy guide pins and matching holes in the frame assure perfect alignment.

We don't know that your product has any need for such a part as this. We do know, however, that this part is most exactly suited to its special requirement just as are hundreds upon hundreds of other parts which have been created through Lapp engineering and Lapp production facilities directed to the solution of specific problems.

With a broad basic knowledge of ceramics—their capabilities and their limitations—Lapp has been able to simplify and to improve many types of elec-

tronic equipment through engineering and production of sub-assemblies that make most efficient use of porcelain or steatite and associated metal parts.

There may be a way you can improve performance, cut costs and cut production time through use of Lapp-designed and Lapp-built sub-assemblies. We'd like to discuss your specific requirements with you. *Lapp Insulator Co., Inc., LeRoy, N. Y.*



Laminated Precious Metals

make these things possible . . .

- Desirable electrical, mechanical or chemical qualities of precious metals can be added to the strength or other desirable properties of base metals, precisely where and as required.
- Precious metal properties of corrosion resistance, electrical superiority, and durability can be obtained without solid precious metal costs.
- Finer, more lasting finishes than are otherwise obtainable in base metals.
- Uniform maintenance of lamination ratios with no porosity, pit marks or defects.

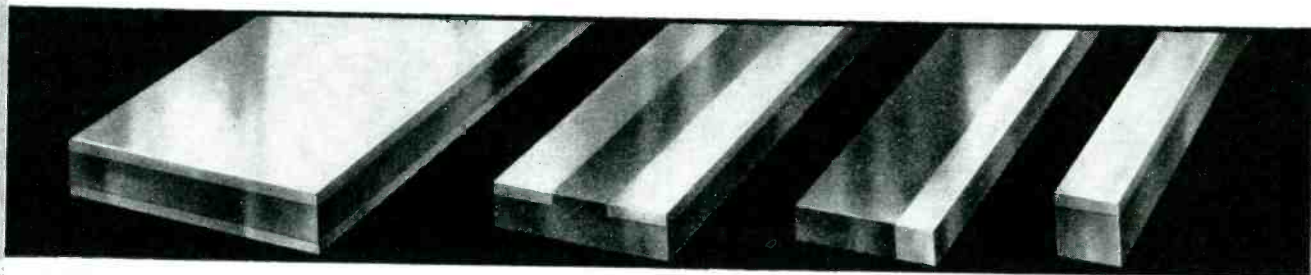

SHEET: Sheet is manufactured in any combination of metals and in any quality or ratio, single or double plate or striped. A recently developed specialty is edgelay. Laminated sheet can be produced as thin as .003 of an inch; in widths from 1/8 inch wide to 6 inches wide, and within tolerances of .0001" to .0002" depending on the material.

We are able to supply laminated or solid sheet with a fine mirror finish suitable for production of the finest precision parts or decorative pieces. Sheet or strip is supplied coiled or flat according to the customer's specifications and depending on the dimensions. From this sheet practically any form or type of product may be produced.

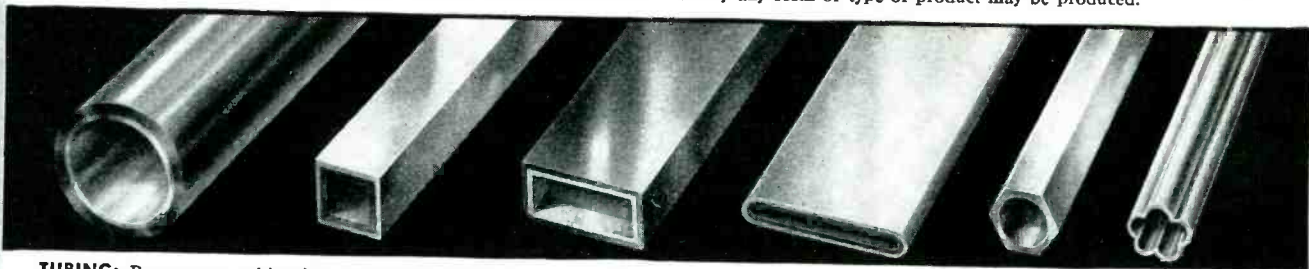

TUBING: Because our tubing is actually deep-drawn sheet, its quality is easily controlled. Dimensional limits lie between approximately .015" O.D. to 2" O.D. with wall thickness as small as .005". Very close tolerances can be maintained both on wall thickness and diameters. Laminated tubing is now used in the electrical industry, for electronic applications, high frequency radio parts, delicate instrument

assemblies and in the chemical industry, for non-corrosive containers and conveyors. In addition to round tubing, almost every other conceivable shape may be had, whether rectangular, octagonal, or star shaped, etc. Rings, sleeves and jackets are quickly and economically cut from laminated tubes. Machining and forming operations can often be eliminated or reduced by the use of specially shaped tubing.

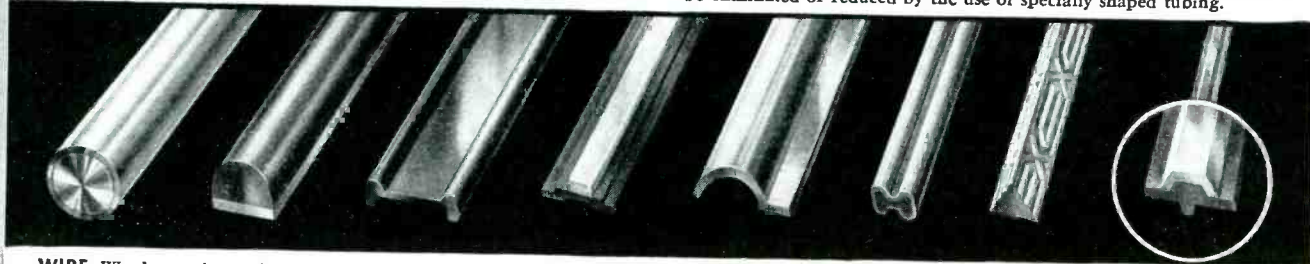

WIRE: We draw wire to diameters as fine as .005" to .006" depending on the material, and the precious metal thickness can be held to a tolerance of .0001". In spite of such small dimensions, such wires are often engraved for decorative purposes or shaped for industrial use. Laminated wires, available in every conceivable shape, are widely used

in spectacle frames, in various instruments, for formed plated springs, low cost electric wire (silver coated steel), radio electronic parts, where expansion must be held to a minimum (silver on invar), and in chemical apparatus when corrosion must be prevented. We also make solder wire and preformed rings for straight line production.

To assist you in the application of our products to your products we are maintaining a staff of thoroughly experienced metallurgists, chemists, designers and consultants . . . an up-to-date research and testing laboratory . . . and a splendidly equipped tool room. These are all at your service to cooperate with your own staff to the full extent of our facilities.

Your inquiries are cordially invited. Ask, too, for a copy of our new descriptive folder on silver solders.



Makepeace PRODUCTS

SHEETS • WIRE • TUBING • SOLDERS • FABRICATED PARTS AND ASSEMBLIES

D. E. MAKEPEACE COMPANY

Main Office and Plant, Attleboro, Massachusetts

NEW YORK OFFICE, 30 CHURCH ST. CHICAGO OFFICE, 55 EAST WASHINGTON ST.

COMING SOON!

A NEW, INEXPENSIVE
Cathode-ray
OSCILLOGRAPH
WITH A 5-inch CATHODE-RAY TUBE

- Ideal for school and college classroom demonstrations!
- A practical tool for the radio service man!

**WATCH FOR THE
DUMONT
TYPE... 274**

© ALLEN B. DUMONT LABORATORIES, INC.

DUMONT

Precision Electronics & Television

ALLEN B. DUMONT LABORATORIES, INC., PASSAIC, NEW JERSEY • CABLE ADDRESS: ALBEEDU, PASSAIC, N. J., U. S. A.

USE STANDARD PARTS—SAVE TIME AND MONEY



EXPERIENCE

For many years

Automatic has manufactured

Coils and Trimmers for manufacturers.

Our mass-production methods

will save you money and headaches.

*Order your Coils and Trimmers from
people who "know how".*



AUTOMATIC
MANUFACTURING
CORPORATION

MASS PRODUCTION COILS & MICA TRIMMER CONDENSERS

900 PASSAIC AVE.

EAST NEWARK, N. J.

NEW...

BEST!

H-f power tube for FM with RING-SEAL CONTACTS

- Tube can be installed or replaced in a few seconds
- Greater area of ring-seal contacts increases h-f circuit efficiency
- Superior electrical characteristics include (a) minimum inductance (b) no neutralization required (c) extremely low driving power
- A pair of GL-7D21's easily will handle output for a 3-kw FM transmitter

TRANSMITTER designers will welcome the new GL-7D21, most modern, most *practical* of FM power tubes. Ring-seal contacts—an important General Electric development—mean fast tube installation or replacement (therefore less time off the air) while providing generous terminal-contact areas. . . . Electrically, Type GL-7D21 is equally advanced. There is complete internal shielding of the 4 electrodes, and provision for a r-f ground plane makes possible external shielding as well. . . . The tube is designed with minimum internal inductance. Low grid-to-plate capacitance eliminates need for neutralization. Plate ratings (see right) give the GL-7D21 an output sufficiently large so that a pair will more than meet the needs of a 3-kw FM transmitter—with only 120 w driving power (for 2 tubes) required! . . . G-E tube engineers will be glad to assist you in applying this modern, compact, highly efficient tube to your latest FM circuit. See your nearest G-E office, or write to the *Electronics Department, General Electric Company, Schenectady 5, New York.*



TYPE
GL-7D21



Sketch shows how easily a GL-7D21 can be plugged in. The concentric ring-seal design provides ample contact-surface for all terminals.

RATINGS OF TYPE GL-7D21

Filament voltage	6.3 v
Filament current	30 amp
Frequency in megacycles at max ratings	110
Type of cooling	forced-air
Max plate ratings, Class C telegraphy:	
voltage	4,000 v
current	1 amp
input	3,000 w
dissipation	1,200 w

GENERAL ELECTRIC

161-E7-0050

FIRST AND GREATEST NAME IN ELECTRONICS



THE ROAD TO SUCCESS

has no Speed Limit . . .

IF you can manufacture your product as fast or faster than your competitors you'll find a clear road ahead . . . smooth sailing.

If you can't . . . look out for red lights! . . . and call for Atlas . . . YOUR INDUSTRIAL HIGHWAY SUPERVISOR.

Geared to this high speed age, the Atlas staff of more than 400 skilled Engineers, Machine and Product Designers and Toolmakers will make a careful study of your problems and not only suggest remedies but produce and test them as well.

Whether requirements necessitate re-design of product . . . tooling new equipment . . . special automatic machinery or production lines, the service is yours, partially or completely; in cooperation with your present staff or independently.

In addition, our plant has complete machine sections with every type of modern equipment for production, assembly and testing.

ATLAS METAL STAMPING COMPANY
ATLAS TOOL & DESIGNING COMPANY
CASTOR AND KENSINGTON AVES., • PHILADELPHIA 24, PA.

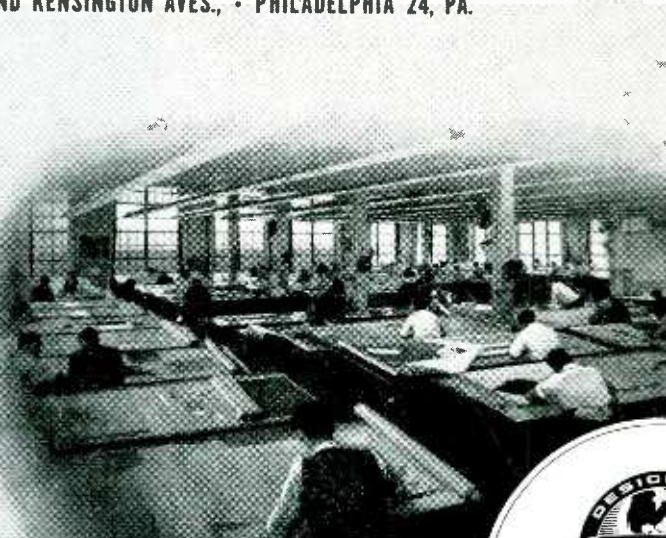

This service . . . second to none . . . is described and pictured in our Brochure "A Load off Your Shoulders onto Ours". Copy on request.



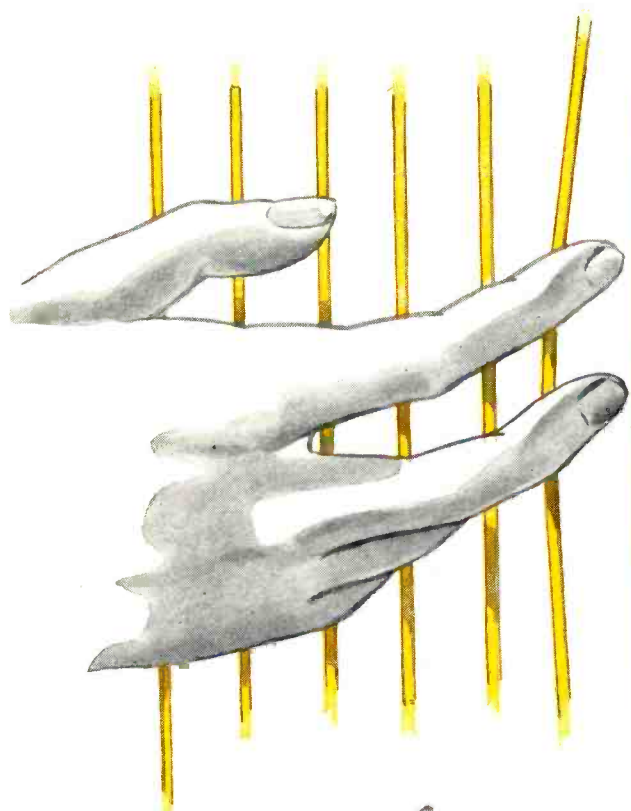

*Trained fingers Know
when it's an Eldorado!*

Typhonite Eldorado — the comfortable, trusted pencil whose purpose is to work with you! It brings out the best in every drawing and does a beautiful job on every job!

DIXON'S TYPHONITE
ELDORADO

PENCIL SALES DEPARTMENT, JOSEPH DIXON CRUCIBLE CO., JERSEY CITY 3, N. J.



DEPENDABLE

AUTOMATIC I.F. Transformers

NATVAR Varnished Paper

Exploded view of the Automatic Type 17xD00 Intermediate Frequency Transformer, showing the Natvar varnished kraft paper wrap used to insulate the current carrying parts from the shield. Sleeving is also Natvar.

Automatic Manufacturing Corporation, East Newark, N. J., wanted an insulating material with suitable power factor and resistance to moisture, high dielectric and uniformity, to provide *permanent* insulation under any operating conditions.

After exhaustive tests, Natvar varnished kraft paper was selected, and is used exclusively in the thousands of these transformers now being shipped daily.

If your requirements call for insulating materials of good physical and electrical performance characteristics — plus exceptional uniformity — plus prompt delivery — plus service, it will pay you to get in touch with your Natvar wholesaler or with us direct. Write, wire or phone.



- Varnished cambric — straight cut and bias
- Varnished cable tape
- Varnished canvas
- Varnished duck
- Varnished cellulose acetate
- Varnished special rayon
- Varnished Fiberglas cloth
- Varnished papers
- Varnished tubings and sleeving
- Varnished identification markers
- Lacquered tubings and sleeveings
- Extruded vinyl tubing
- Extruded vinyl identification markers

Write for Catalog No. 20

THE NATIONAL VARNISHED PRODUCTS

Corporation

TELEPHONE
RAHWAY 7-2171

CABLE ADDRESS
NATVAR: RAHWAY, N. J.

201 RANDOLPH AVENUE



WOODBIDGE NEW JERSEY

S-NVP-1

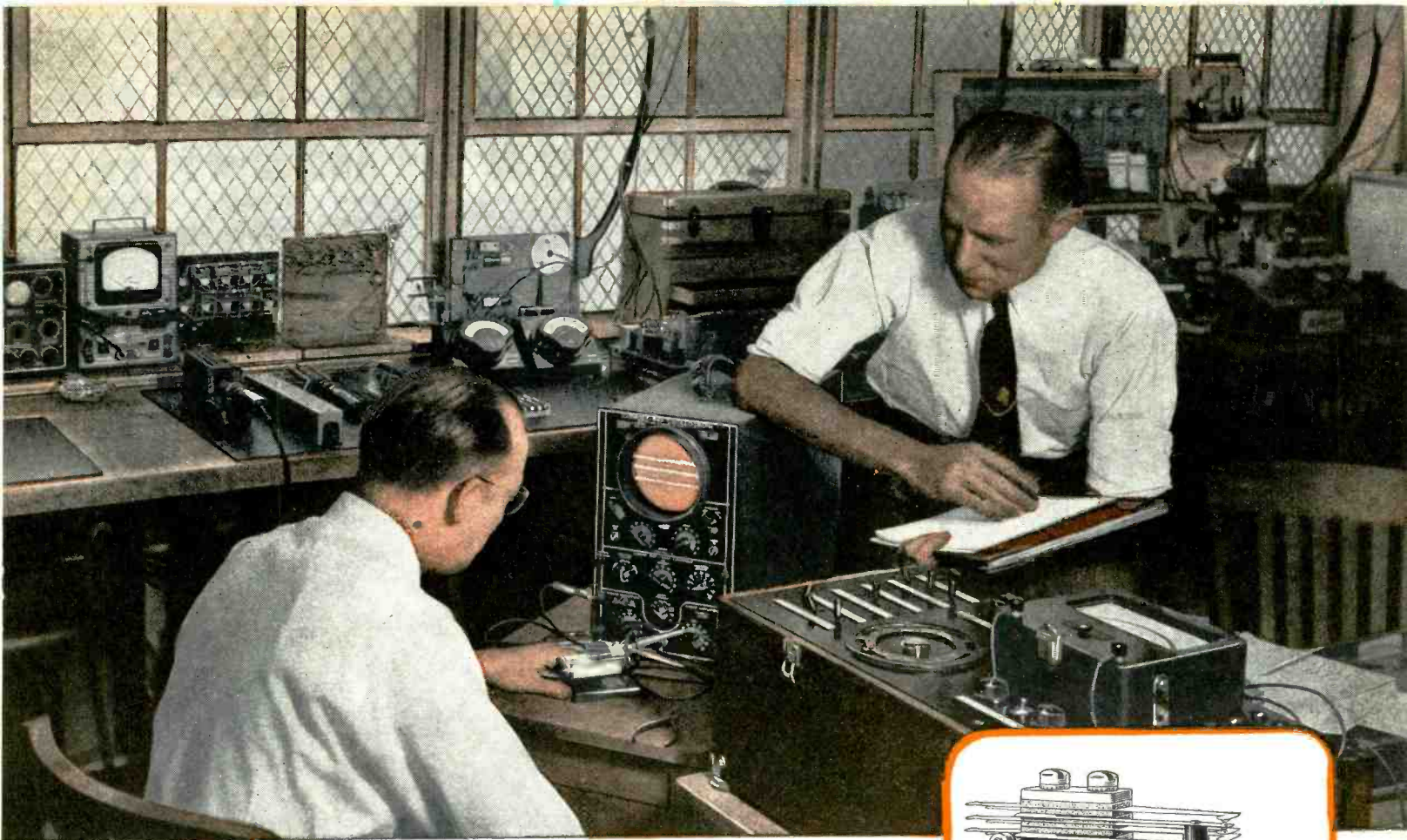

It's What's Behind CLARE RELAYS That Keeps Them in Front

●Clare Relay engineers have "thrown away the book." They are not restrained in their relay designs by hidebound ideas, outmoded methods.

From this modern equipped research laboratory, pictured above, come the forward looking Clare "Custom-Built" Relays that free design engineers from old-time relay limitations.

Products of a progressive company, entirely devoted to making relays to meet the most exacting applications, Clare "Custom-Built" Relays encourage engineers in every branch of industry to count on the flexibility of Clare Relays and the skill of Clare engineers to provide unusual, new, and improved features to meet every requirement.

Do you want smaller, more compact construction to fit into streamlined equipment? Is your need for more efficient operation . . . ability to withstand unusual vibration . . . new and different electrical characteristics? Look to Clare for all these things . . . and more.

Clare Sales Engineers are located in all principal cities to help with your relay problems. The Clare Engineering Data Book will be mailed at your request. Address: C. P. Clare & Co., 4719 W. Sunnyside Avenue, Chicago 30, Illinois. Cable address: CLARELAY.

CLARE RELAYS

"Custom-Built" Multiple Contact Relays for Electrical and Industrial Use

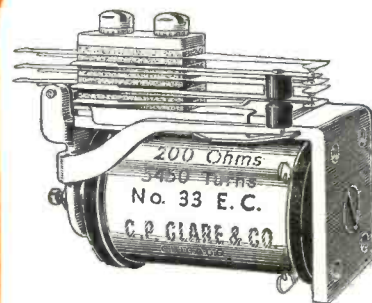

This Clare Type "G" d.c. Relay is a relay for the spot where inches and ounces count. Measures 2½" long.

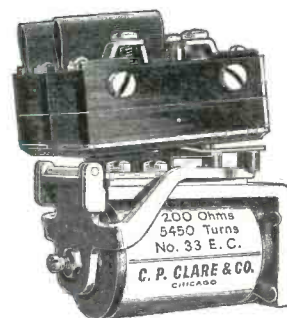

Clare Type "GMS" Relay uses standard Type "G" frame for operation of one or two snap-action switches.

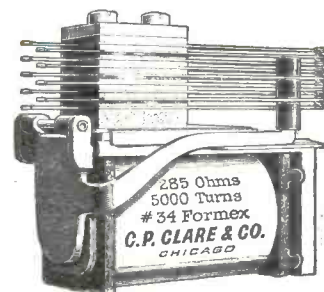

The Clare Type "GAC" Relay gives an equally compact relay for a.c. operation. Design permits very quiet operation.

ELECTROSTATIC VOLTMETER

*For
Accurate
Measurement
In High Impedance
Circuits*

**PORTABLE
PROJECTING
FLUSH**

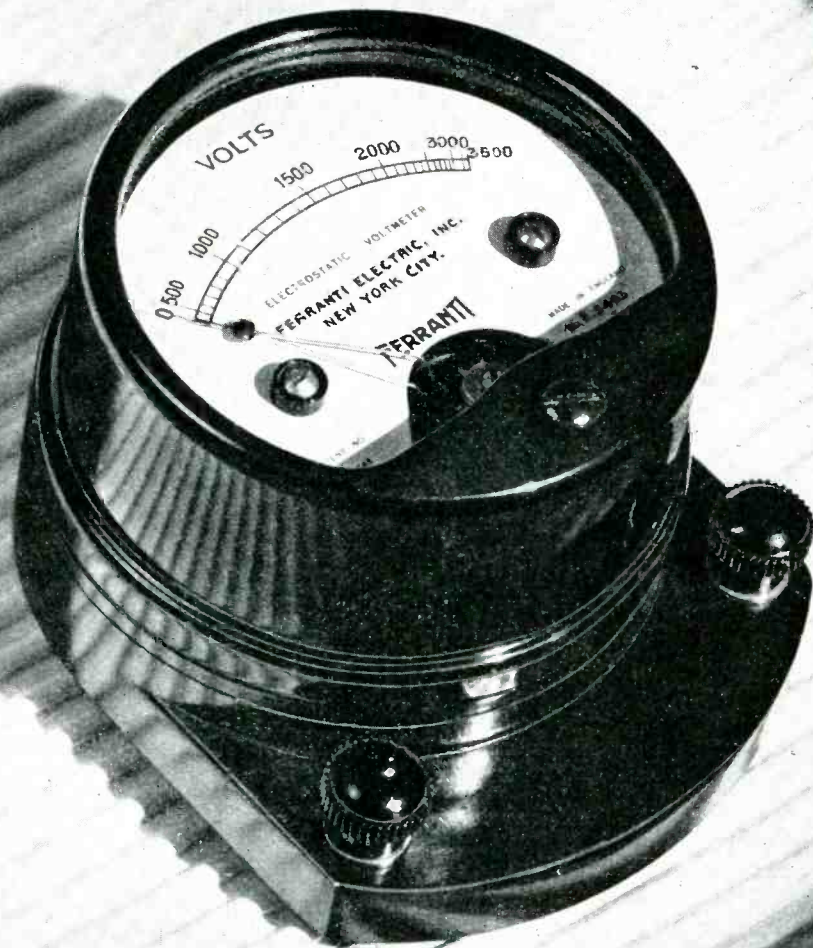

RANGES

- 0- 150 Volts
- 0- 300 Volts
- 0- 450 Volts
- 0- 600 Volts
- 0- 750 Volts
- 0-1000 Volts
- 0-1500 Volts
- 0-2000 Volts
- 0-2500 Volts
- 0-3000 Volts
- 0-3500 Volts

FERRANTI ELECTRIC, INC.

30 ROCKEFELLER PLAZA
NEW YORK, N. Y.

Ferranti Electric, Ltd., Toronto, Canada

Ferranti, Ltd., Hollinwood, England

Problems like these spell out **D-A-G**

UNDESIRABLE THERMIONIC EMISSIONS

NON-REFLECTIVE RAY-FOCUSING ANODES

VARIABLE CONDENSER LUBRICATION

DRAWING TUNGSTEN AND MOLYBDENUM



Problems like these spell out **D-A-G** in the electronics field—because the unique properties of that unique product, “dag” colloidal graphite, have spelled out their solutions so often.

“Dag” colloidal graphite has properties which make it ideal for very high and very low temperature lubrication, for parting and preventing seizure, for forming electrically conductive films, for coating and impregnation, and for a host of special

purposes. It is available as a stable dispersion in water, oils, volatile hydro-carbons, alcohols, glycerines, and other carriers. It finds as many uses in industry as 19 significant properties and 18 dispersions find functions to serve—and that’s scores.

For evaluating those 19 properties and 18 dispersions in terms of your interest, write for the specialized literature listed below—and see if your problems don’t spell out **D-A-G**.

colloidal products

ACHESON COLLOIDS CORPORATION, Port Huron, Mich.

This new literature on “dag” colloidal graphite is yours for the asking:

- 460** A data and reference booklet regarding “dag” colloidal graphite dispersions and their applications. 16 pages profusely illustrated.
- 421** Facts about “dag” colloidal graphite for ASSEMBLING AND RUNNING-IN ENGINES AND MACHINERY.
- 422** Facts about “dag” colloidal graphite as a PARTING COMPOUND.
- 423** Facts about “dag” colloidal graphite as a HIGH TEMPERATURE LUBRICANT.
- 431** Facts about “dag” colloidal graphite for IMPREGNATION AND SURFACE COATINGS.
- 432** Facts about “dag” colloidal graphite in the FIELD OF ELECTRONICS.

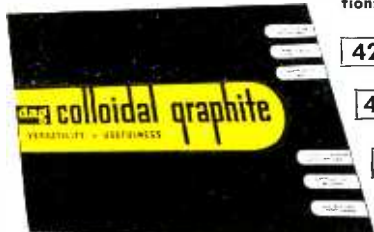

ACHESON COLLOIDS CORPORATION
PORT HURON, MICHIGAN DEPT. E E-5

JM1evA-E 1

Please send me without obligation, a copy of each of the bulletins checked:

NAME _____

POSITION _____

FIRM _____

ADDRESS _____

ZONE No. _____ STATE _____

OUR PRESENT OIL SUPPLIER IS _____

(Lubricants containing “dag” colloidal graphite are available from major oil companies.)

This is what you see



... This is what you get



Every genuine Lord Mounting carries the name "LORD" embossed in the rubber or in raised letters on the forgings.

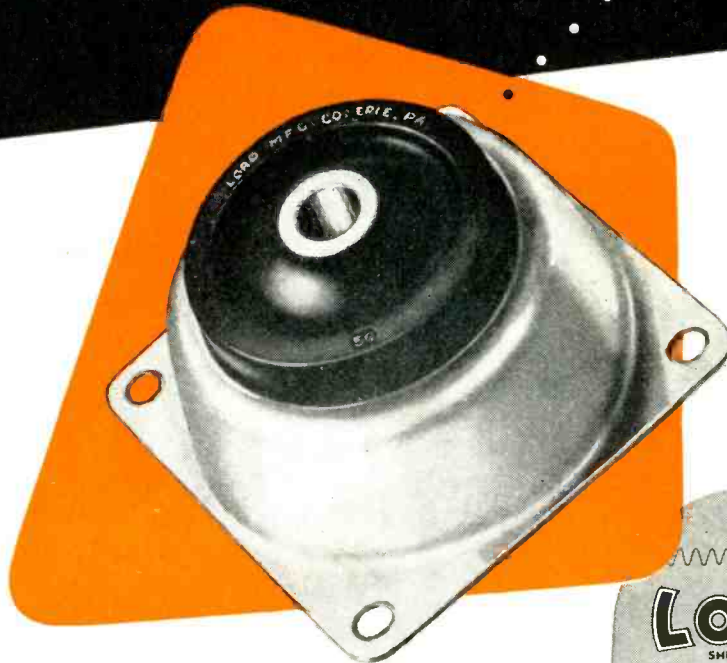

a flexible mounting which protects your equipment from shock and vibration; increases service life, improves accuracy, permits lighter construction and wider manufacturing tolerances, reduces noise and decreases personnel fatigue. It is compact in design and easy to install.

The picture shows a very simple looking little gadget, made of rubber and metal. It's a typical Lord Bonded Rubber Plate Form Mounting, of which millions are in use. They are produced to accommodate loads ranging from one half to several hundred pounds.

So far as application is concerned, it's just as simple as it looks. But years of study, research and experiment have gone into its construction and design. The development of a rubber to metal bond of great strength, enabled Lord to produce this mounting which utilizes the flexibility of rubber stressed in shear to isolate vibration.

When you come to Lord with your vibration problems, you are getting an answer that represents the last word to date in scientific research and development. Send for Bulletin 104.

★ BUY VICTORY BONDS ★

IT TAKES BONDED RUBBER *In Shear* TO ABSORB VIBRATION

LORD MANUFACTURING COMPANY
ERIE, PENNSYLVANIA

SALES REPRESENTATIVES
NEW YORK - 280 MADISON AVE.
CHICAGO - 520 N. MICHIGAN AVE.
DETROIT - 7310 WOODWARD AVE.
BURBANK, CAL. - 245 E. OLIVE AVE.
CANADIAN REPRESENTATIVES
RAILWAY & POWER ENGINEERING CORP., LTD.
TORONTO, CANADA

Originators of Shear Type Bonded Rubber Mountings

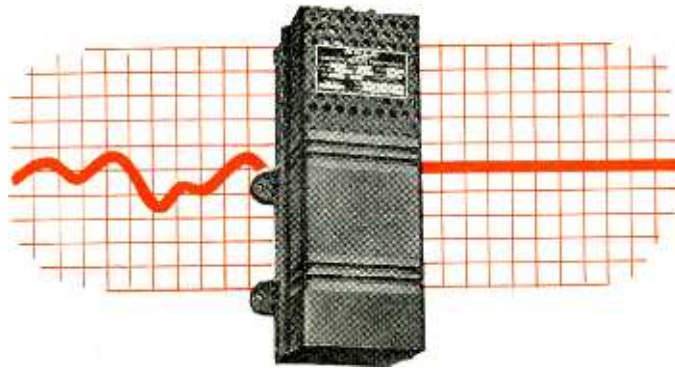

Constant Voltage

... is always available to equipment protected by a
SOLA CONSTANT VOLTAGE TRANSFORMER

Are you looking for new ways to—

1. Increase the efficiency of your product?
2. Lower its cost to the user?
3. Reduce maintenance expense?

Much of this can be accomplished with a SOLA Constant Voltage Transformer built into your product. Now, more than ever before, electrical equipment needs line-voltage protection.

Stable voltage, direct from supply lines, is *not* available to the users of your equipment. Voltage may vary as much as 15-20% from the rating on your label. *Your* equipment will be blamed for the inefficient operation that results.

Build a SOLA Constant Voltage Transformer into your equipment and operating voltages will always be within $\pm 1\%$ of rated requirements

regardless of line fluctuation as great as 30%.

There is a wide range of sizes and capacities in SOLA Constant Voltage Transformers which can be built specifically for your product. The savings you can make through the elimination of other components and anticipated service calls, plus greater operating efficiency and satisfaction to your users, merit your consideration of SOLA Constant Voltage Transformers as a component in your equipment design.

SOLA Constant Voltage Transformers are fully automatic with no tubes, or moving parts. They require no supervision or manual adjustments.

There's a new SOLA handbook that describes fully the theory, operation and use of SOLA Constant Voltage Transformers. Write for your copy.

Ask for Bulletin DCV-102

SOLA

Constant Voltage Transformers

Transformers for: Constant Voltage • Cold Cathode Lighting • Mercury Lamps • Series Lighting • Fluorescent Lighting • X-Ray Equipment • Luminous Tube Signs
Oil Burner Ignition • Radio • Power • Controls • Signal Systems • etc. **SOLA ELECTRIC COMPANY, 2525 Clybourn Avenue, Chicago 14, Illinois**

All

THESE FEATURES IN THIS ONE GREAT RELAY

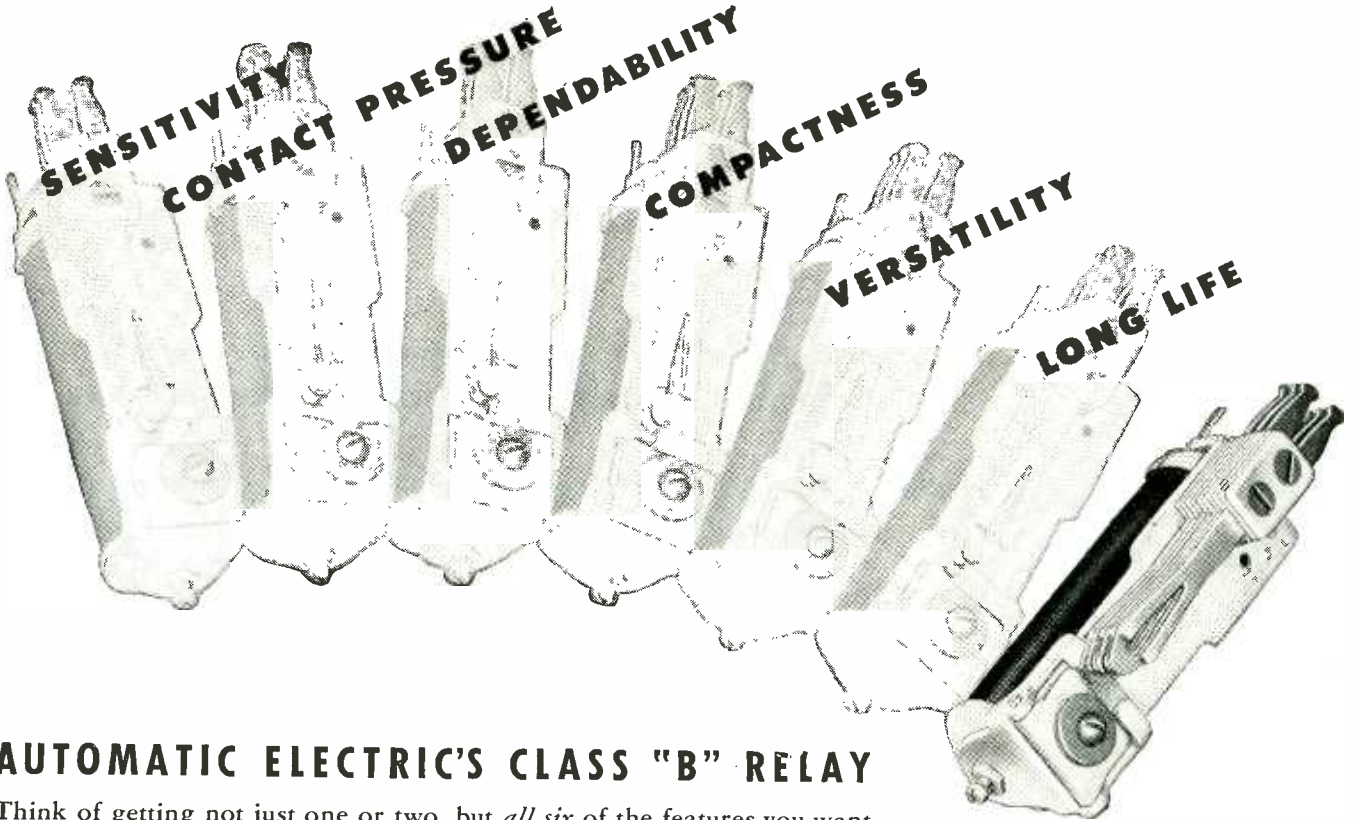

AUTOMATIC ELECTRIC'S CLASS "B" RELAY

Think of getting not just one or two, but *all six* of the features you want—combined in one relay! That's the new Automatic Electric Class "B" relay. It's a leader in every detail of design and construction—a relay to meet the most exacting service requirements, in a wide range of relay applications.

Because relay users know a good thing when they see it, our entire production for many months has already been spoken for. But you'll find the Class "B" relay well worth waiting for, with its unique combination of design details:

Independent twin contacts for dependable contact closure... efficient magnetic circuit for sensitivity and high contact pressure... unique armature bearing for long wear under severe conditions... compact

design for important savings in space and weight. Made for coil voltages to 300 volts DC and 230 volts AC, with capacities up to 28 springs, also with magnetic-shielding cover, when desired

The Class "B" relay, and many others, are shown in Catalog 4071. Write today for your copy.

Relays by

AUTOMATIC  ELECTRIC

AUTOMATIC ELECTRIC SALES CORPORATION
1033 WEST VAN BUREN STREET • CHICAGO 7, ILLINOIS
In Canada: AUTOMATIC ELECTRIC (CANADA) LIMITED, TORONTO

PARTS AND ASSEMBLIES FOR EVERY ELECTRICAL CONTROL NEED

Left: Federal's 5-KW Transmitter, Type 165A, in a pre-war installation at WDOD—a network station

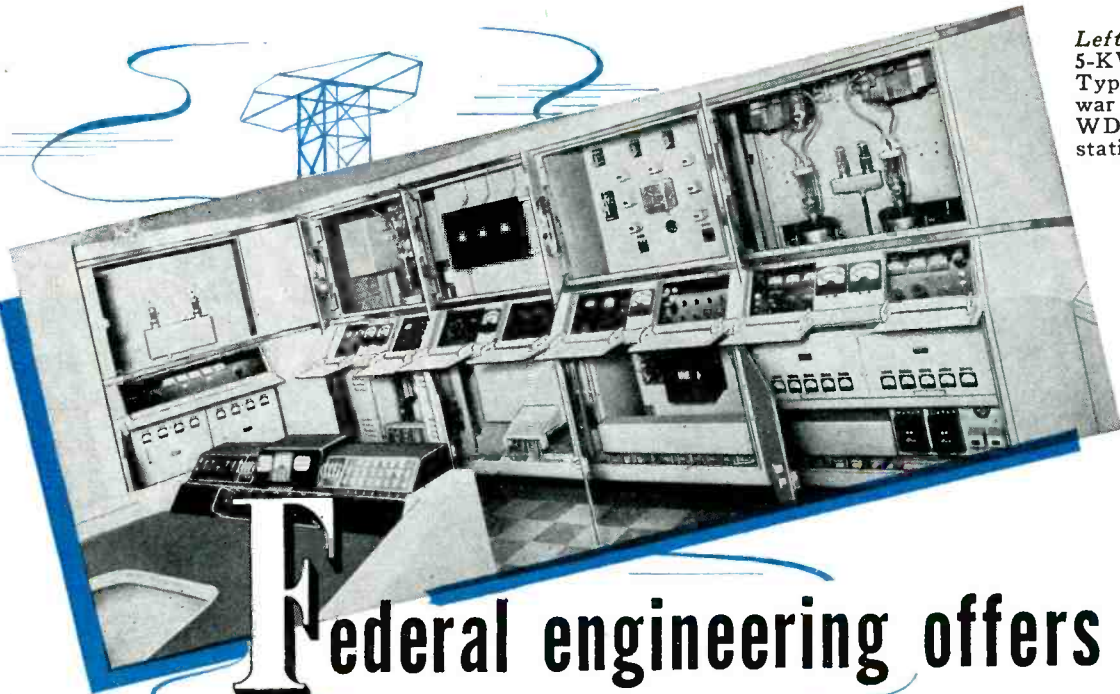

Federal engineering offers you

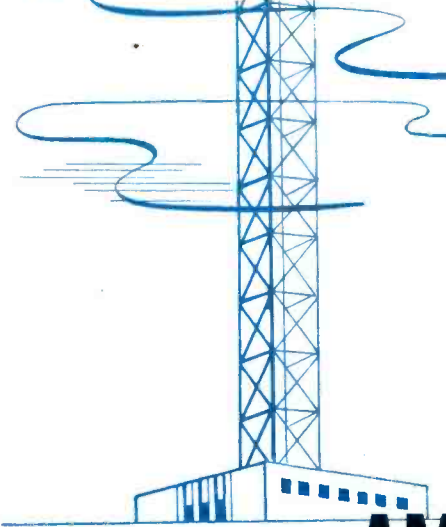

1. Modern Design
2. Higher Efficiency
3. Lower Operating Cost

... IN 5-, 10- AND 50-KW STANDARD AM BROADCAST TRANSMITTERS

Federal's vast time-tested engineering and manufacturing facilities are now engaged in production of standard AM radio transmitters for early delivery . . . 5, 10 and 50 KW . . . with station equipment from microphone to antenna. A Federal engineer will be glad to give you complete specifications. Write for bulletin.

Now in Production
for Early Delivery

Right: Federal's 50-KW Transmitter Type 162, installed at WABC. Similar installations built to your order.

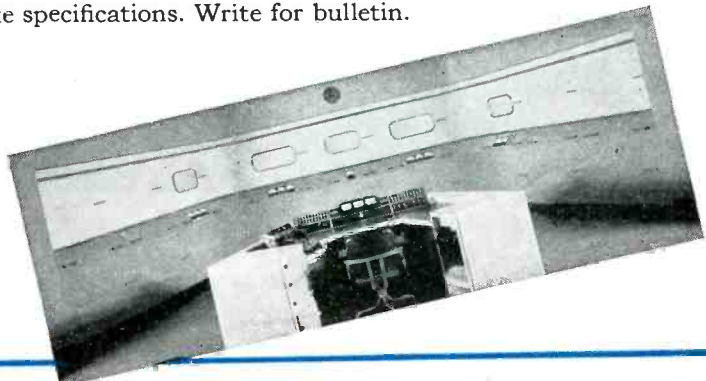

Federal Telephone and Radio Corporation

Export Distributor:
International Standard Electric Corporation

Newark 1, New Jersey



Overture

TO A NEW ERA IN SOUND

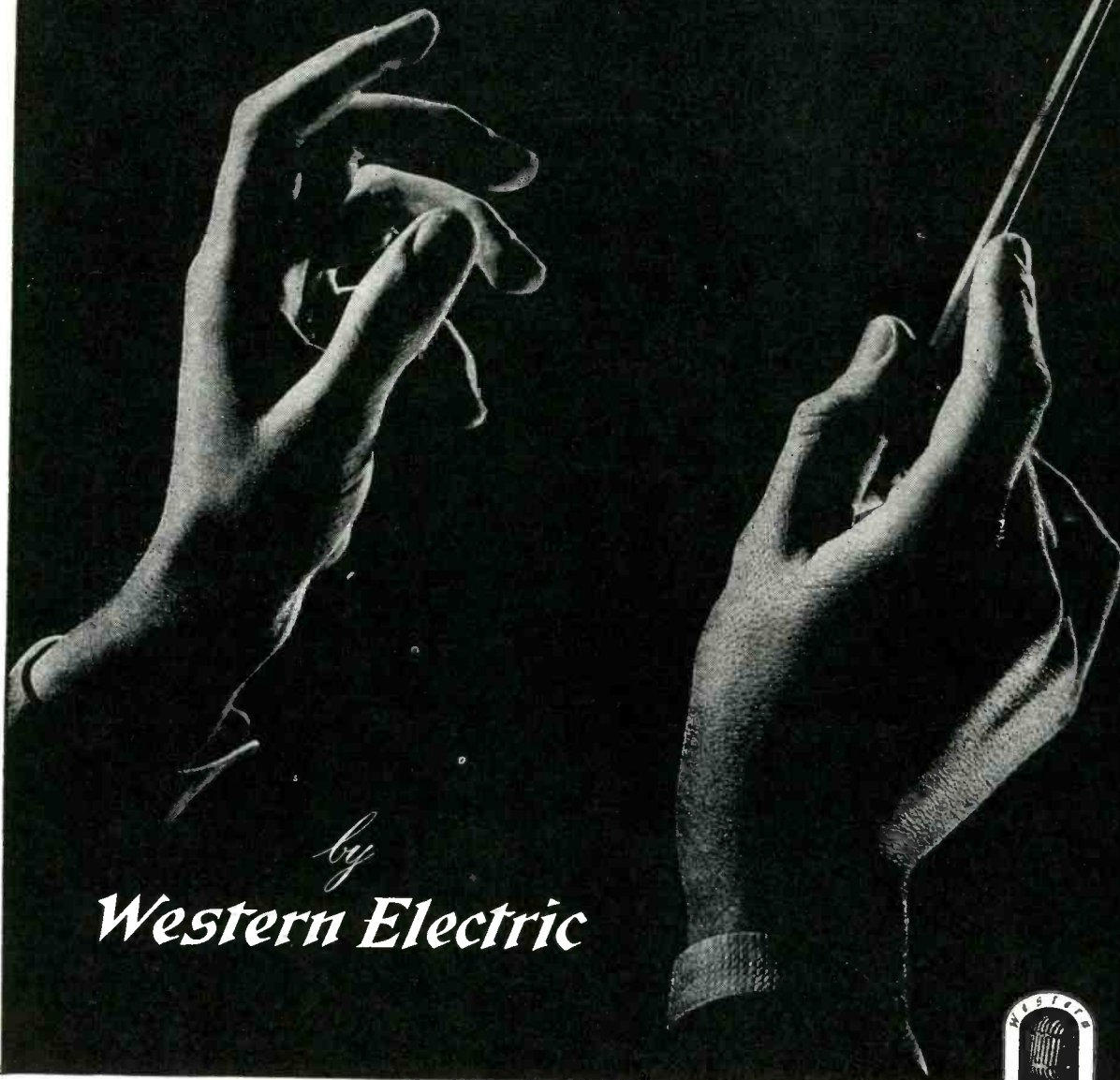

by
Western Electric



HAVE you ever heard a sound system with such natural tone, such emotional quality, such "presence" that you didn't know instantly that a sound system was in action? It's pretty safe to say you never have. But now you can!

Revolutionary advances born of wartime research have resulted in a new Western Electric

loudspeaker that reproduces speech and music with unsurpassed fidelity.

You'll find it hard to believe you are listening to *reproduced* sound rather than the original. That is why this new Western Electric loudspeaker is destined to open a new era in all fields of sound reproduction.

multiply
your
MOVES
with
alliance

P = POWER
D = DISTANCE
W = WEIGHT

$$P \times D = W \times D^2$$

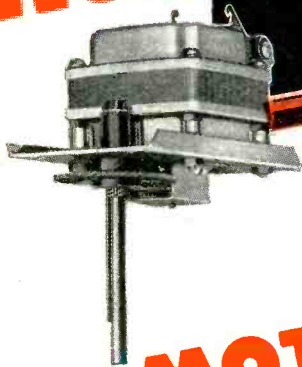

Model RR enclosed split-phase Reversible Motor. Alliance Motors are rated from less than 1-400th up to 1-20th H.P. With or without integral gears.

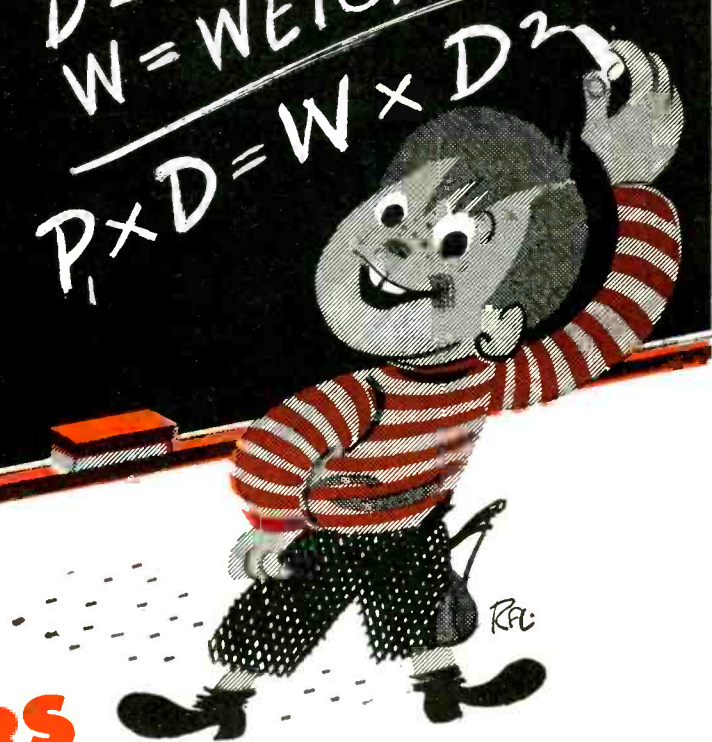

POWR-PAKT MOTORS

To get more motion—remote control—automatic action—that's the aim of most modern designs!

Alliance miniature Powr-Pakt Motors—light weight, compact, easy to install, grew from the millions of Alliance Phonomotors made for the radio industry.

As vital component power links in every electronic, radio and heating control sequence, they'll reduce waste motion, manual effort, and *Multiply Your Moves!*

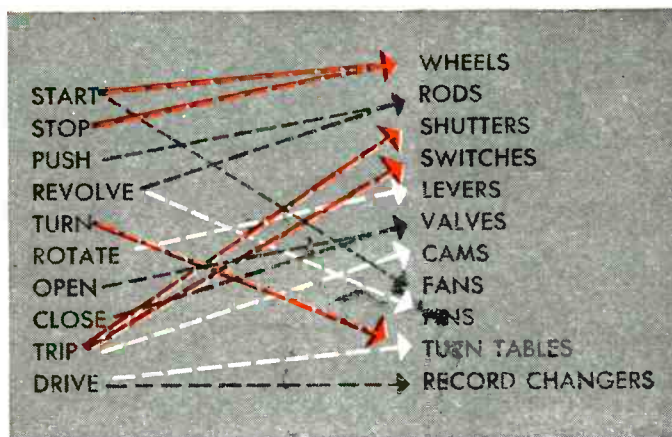

WHEN YOU DESIGN — KEEP

IMPORTANT! See the Alliance exhibit at the Chicago Radio and Electric Equipment Show, Hotel Stevens, May 13-16, Booth #98

alliance

MOTORS IN MIND

ALLIANCE MANUFACTURING COMPANY • ALLIANCE, OHIO

ALLIANCE TOOL AND MOTOR LTD., TORONTO 14, CANADA

STUPAKOFF

HERMETIC SEALS

meet exacting demands of
MODERN ELECTRONIC DEVELOPMENTS

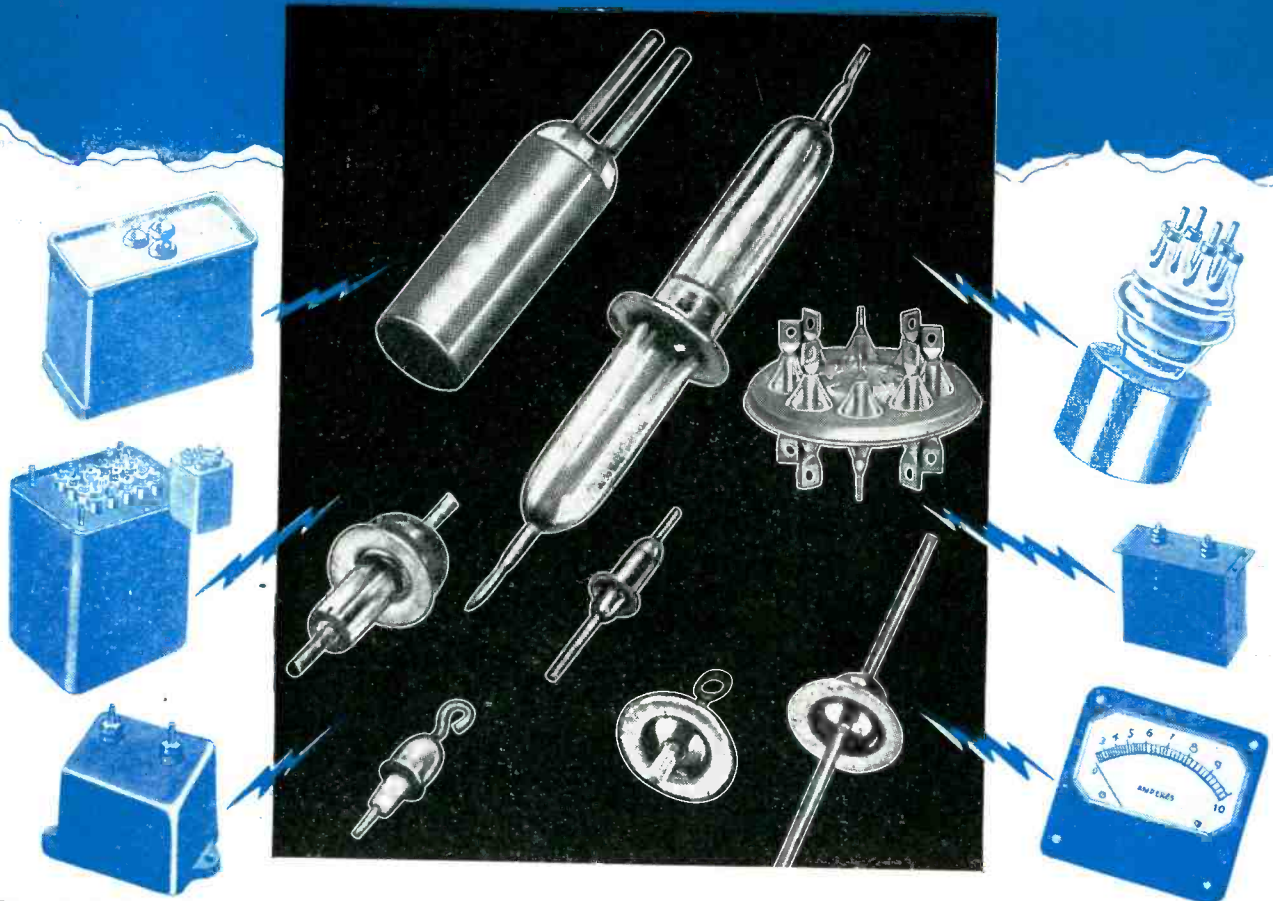

Stupakoff Kovar* glass seals provide permanently vacuum and pressure tight, insulated electrical lead-ins on products which must be sealed from the atmosphere, even under the most adverse climatic conditions.

Metal-glass terminals are available, or can be made in shapes and sizes to suit your needs . . . with single or multiple, hollow or solid electrodes.

Kovar alloy is also available in the form of sheet, rod, wire, tubing and special shapes for the

manufacturers of electronic tubes and others who have their own glass working facilities.

A line from you as to your sealing problems will enable us to make specific recommendations and supply the applicable literature.

*Reg. U. S. Pat. Off.

Trade Mark No. 337962

Visit Booth 138 at RMA Exhibit, Chicago — May 13-16

STUPAKOFF

CERAMIC AND MANUFACTURING CO. • LATROBE, PA.

EXPORT DEPARTMENT 13 E. 40TH ST., NEW YORK 16, N. Y. CABLE ADDRESS ARLAB ALL CODES

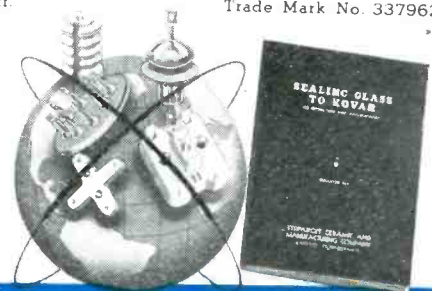

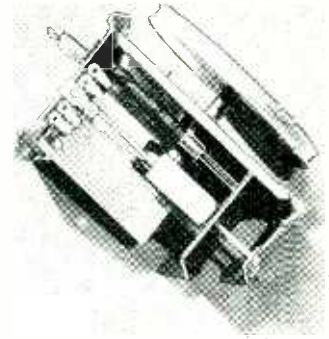
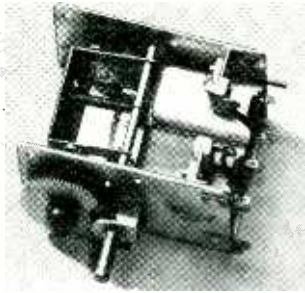
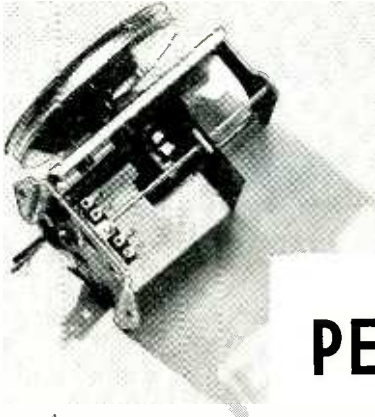

PERMEABILITY TUNING



PIONEERS

ORIGINATORS

✓ Aladdin *First* Recognized the advantages of P. T. conceived by Johnson Laboratories

✓ P. T. has meant Aladdin ever since that time

✓ Aladdin's *Persistent* Research has made Commercial Permeability Tuning Practical

✓ The Priceless *Skill* and *Knowledge* of this Pioneer Organization is available to you



Aladdin Radio Industries,

INCORPORATED

Licensee of Johnson Laboratories

501 West 35th Street

Chicago 16, Ill.

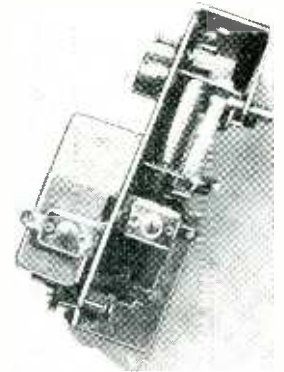
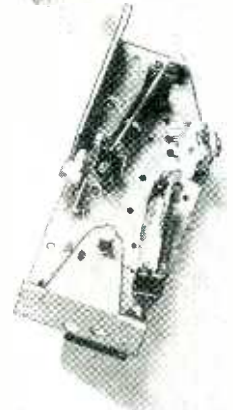
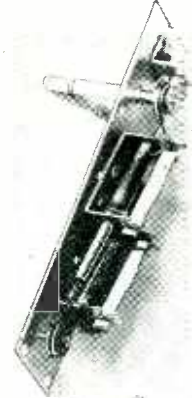

TO OPERATE AN AC RADIO ON DC...

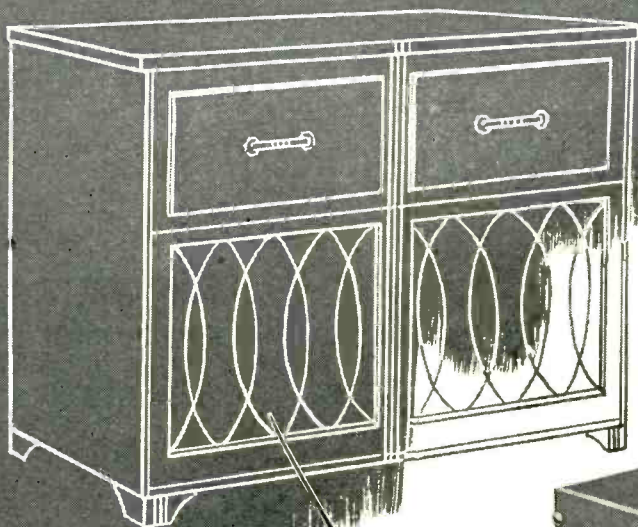

E·L

ENGINEERED THIS INVERTER



MODEL 204

● Retailers and distributors of radios, appliances and similar products can now use to better advantage the storage and floor space once needed for special DC models.

And manufacturers can now say goodbye to the time-wasting labor once required in providing special models for the limited "DC market".

These great benefits are made possible and *practical* by E·L's complete line of Vibrator Inverters . . . *efficient* DC to AC conversion units that give longer service and increased capacity at lower cost.

Proved in thousands of applications in war and peace, E·L Vibrator Inverters are extremely simple in design, have only *one* moving part, and are precision-constructed in every detail. The absence of brushes, armatures and bearings eliminates lubrication and other routine maintenance.

Get all the facts on E·L Vibrator Inverters! For products with new or unusual requirements, E·L engineers are equipped and ready to design special power supplies.

Electronic

LABORATORIES, INC.

INDIANAPOLIS

OFFICES IN 22 CITIES



DC-AC INVERTERS

There is an E·L VIBRATOR INVERTER for each important application

Involving radios, appliances, communications equipment, electric motors, coin-operated equipment, public address systems, neon signs, electric razors and other products.

(Typical of 26 E·L Models available to meet your requirements)

MOD. NO.	INPUT VOLTS DC	OUTPUT VOLTS AC	OUTPUT WATTS	LOAD P.F. (%)	DIMENSIONS (in.)	WT. (lbs.)	PRINCIPAL APPLICATIONS
307	6	115	100	80-100	10 3/4" x 7 1/2" x 8 1/4"	23 1/2	Radio Receivers, Appliances
507	12	115	150	80-100	10 3/4" x 7 1/2" x 8 1/4"	25	Radio Receivers, Transmitters, Appliances
146	32	115	350	80-100	16" x 10" x 8 1/4"	48	Receivers, Transmitters, Coin
204	115	115	150	80-100	3 3/4" x 6 3/8" x 4 3/4"	12 1/2	Phonographs, Radio Receivers, Appliances
268	115	115	750	80-100	20 3/8" x 11 3/4" x 7 1/2"	66	Motors, Communications Equipment

VIBRATORS AND VIBRATOR POWER EQUIPMENT FOR LIGHTING, COMMUNICATIONS, ELECTRIC AND ELECTRONIC APPLICATIONS

IF IT'S A SMALL GEAR PROBLEM

Ask

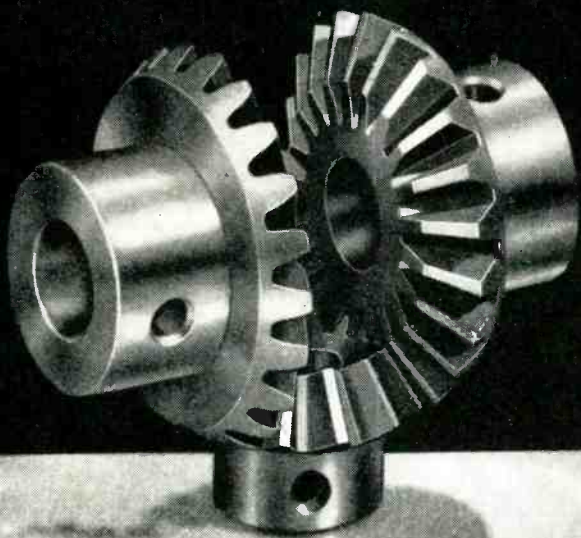

Many of America's most critical buyers specify "G.S." when they want small gears. They have learned to depend upon our craftsmen for a degree of *uniform* excellence unequalled in the history of small gear manufacture. You see, G.S. *specializes* in the design and manufacture of Fractional Horsepower Gears exclusively! Our entire time and effort is devoted to doing this one job *better*. If you have a plan or a product in which the quantity production of precision small gears is involved, for your own best interests discuss it with a G.S. engineer. Discover the unusual efficiency and economy of our methods developed thru a quarter century of intensive specialization in custom-building Fractional Horsepower Gears.

GEAR Specialties

Spurs • Spirals • Helicals • Bevels • Internals • Worm Gearing • Racks • Thread Grinding
2635 WEST MEDILL AVENUE • CHICAGO 47, ILLINOIS

WORLD'S LARGEST EXCLUSIVE MANUFACTURERS OF FRACTIONAL HORSEPOWER GEARS

NO CROWDING, PLEASE!

Everyone can see!



**DU MONT
15AP4
offers a picture
9" x 12"
PLUS**

► **BIG NEWS!** A large screen television receiving tube with all the advantages of direct viewing—high picture definition and more than adequate brightness for demonstrating under usual showroom lighting conditions. Measures only 20 inches long to permit graceful cabinet design.

OTHER IMPORTANT FEATURES . . .

1. Essentially flat face
2. 7.5 – 10 KV anode supply
3. All-magnetic deflection and focusing
4. No ion trap

LET DU MONT'S REPRESENTATIVE PROVE THIS IS YOUR "BEST BUY!"

© ALLEN B. DU MONT LABORATORIES, INC.

DU MONT

Precision Electronics & Television

ALLEN B. DUMONT LABORATORIES, INC., PASSAIC, NEW JERSEY • CABLE ADDRESS: ALBEEDU, PASSAIC, N. J., U. S. A.



See the Turner Exhibit at the Parts Show,
Booth 49, Stevens Hotel, Chicago, May 13 to 16.



SWING OUT WITH TURNER

COLORTONE

Microphones

Turner pioneers again! *Colortones* are here to bring distinctive beauty to microphone applications.

Especially created for bands, television studios, entertainment spots and home recorders, these rugged plastic microphones come in a range of gem-like colors.

Their lustrous, streamlined beauty will blend, harmonize or contrast with any setting.

And new inside too! Improved crystal and dynamic circuits result in smoother, more accurate reproduction.

Write for complete specifications and information on *Colortone* colors now available.



Designed by
ARTHUR HAGGSTROM,
Noted Industrial Designer

The TURNER Company
905 17th Street, N. E., Cedar Rapids, Iowa

**TURNER-Pioneers in the
Communications Field**



Licensed under U. S. Patents of the American Telephone and Telegraph Company, and Western Electric Company, Incorporated.
Crystals licensed under patents of the Brush Development Company

THEY GIVE YOUR DESIGN

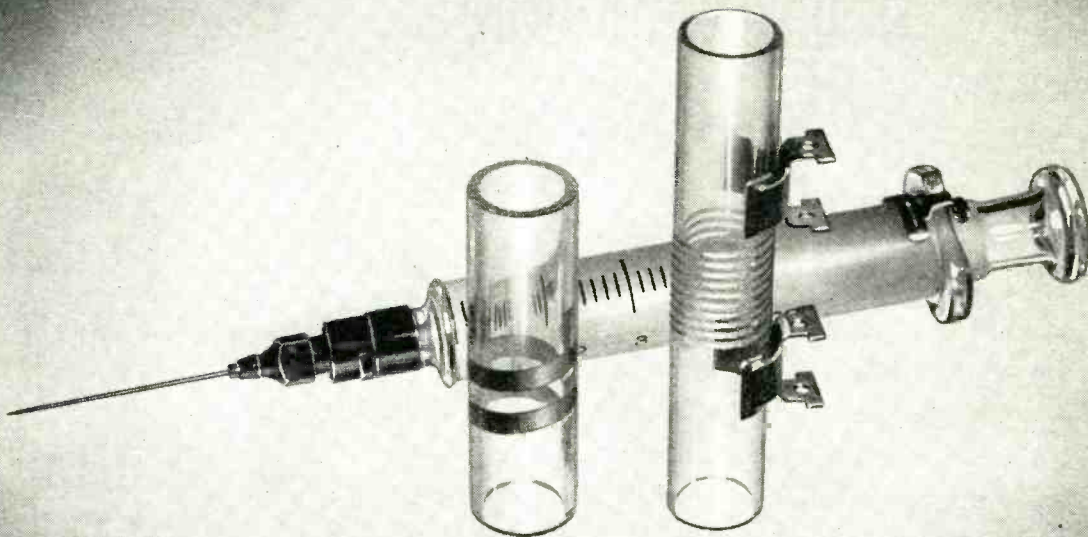

CORNING
means
Research in Glass

A SHOT IN THE ARM!

IT ISN'T every product you can say that about. But Corning Coil Forms are something special. Functionally they can add flexibility to your designs and improve performance. One type, for ordinary frequencies, carries the conductor in a groove with metallized tabs for connections. Another type, for high frequencies, employs the metallizing itself as the conductor. They have a low loss factor. The glass surface resists contamination, is chemically stable and is unaffected by weathering. And they are available with many different terminals and mounting fixtures.

One of the most interesting things about these Coil Forms is their dimensional stability and their electrical properties over a wide range of temperatures and frequencies. Best of all, you can have them made out of Corning's 96% silica glass No. 792, which has extremely low loss characteristics from 60 cycles to 3000

megacycles. Yet this glass stands extreme thermal shock; in many cases it can be used at 900° C.

Coil Forms are only one of the ingenious and highly perfected electronic products made from glass by Corning. Some others are shown below. One of them or an adaptation may be just what you need to speed assembly or improve designs or secure hermetic seals. If so, write, wire or phone Electronic Sales Department, E-5, Technical Products Division, Corning Glass Works, Corning, New York. One of our engineers will call on you promptly.

NEW BULLETINS on Corning's Glass Components, Metallized Glassware and Vycor Brand 96% Silica Glass for The Electronic Industry are now available. A note on your business letterhead will bring your free copy of one or all of them by return mail.

NOTE—The metallized Tubes and Bushings, Headers and Coil Forms below are all made by the famous Corning Metallizing Process. Can be soldered into place to form true and permanent hermetic seals. Impervious to dust, moisture and corrosion.



Metallized Tubes for resistors, capacitors, etc. 20 standard sizes $\frac{1}{4}$ " x 2" to $1\frac{1}{4}$ " x 10". Mass-produced for immediate shipment.

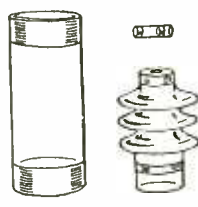

Metallized Bushings. Tubes in 10 standard sizes, $\frac{1}{8}$ " x $\frac{15}{16}$ " to 1" x $4\frac{1}{2}$ " in mass production for immediate shipment.

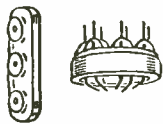

Headers—The best way to get a large number of leads in a small space for assembly in one operation.

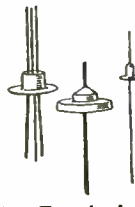

Eyelet Terminals—Single or multiple eyelets permit design flexibility. Standard items readily available in quantity.

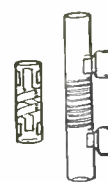

Coil Forms—Grooved for ordinary frequencies—metallized for high frequencies. In various designs and mountings.



VYCOR Brand cylinders—very low loss characteristics. Stands thermal shock up to 900°C. Can be metallized.

"VYCOR", "CORNING" and "PYREX" are registered trade-marks and indicate manufacture by Corning Glass Works, Corning, N. Y.

Electronic Glassware



Asbestos

OF

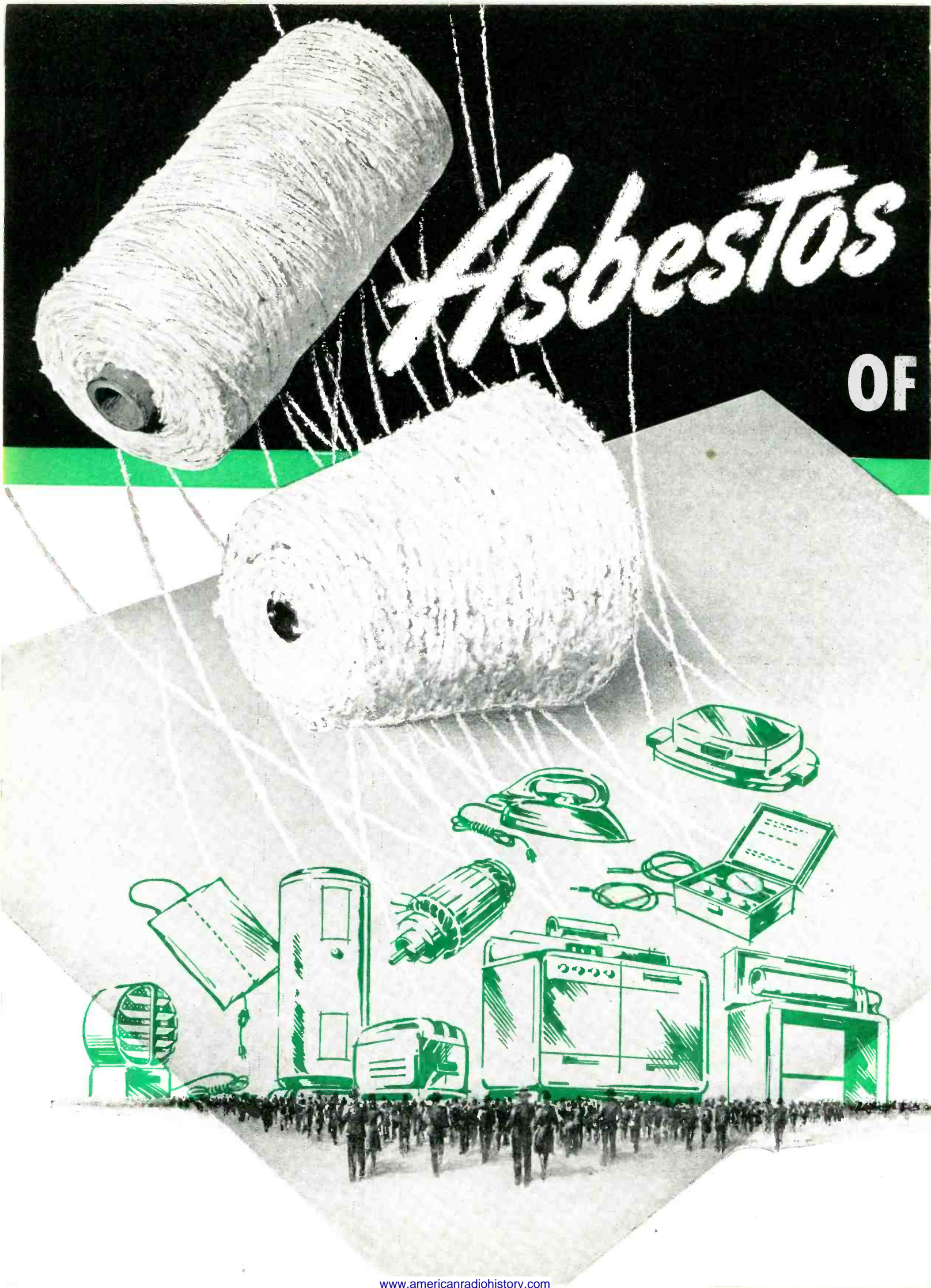

Insulated WIRES AND CABLES

GENERAL CABLE QUALITY

Products of the same reliability which protected lives aboard the thousands of navy and merchant ships during the war. The Company's war-stimulated production capacity, with improved manufacturing techniques and experienced craftsmanship, makes General Cable your logical source of supply for All-Asbestos and Asbestos-VC Wire and Cable needs... Phone, write or telegraph the nearest General Cable office. Catalogs available for your advance information.

GENERAL CABLE CORPORATION

Manufacturers of Bare and Insulated Wires and Cables for Every Electrical Purpose

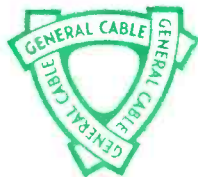

Headquarters at 420 Lexington Avenue, New York 17, N.Y. General Cable Corporation Sales Offices are located at: Atlanta, Boston, Buffalo, Chicago, Cincinnati, Cleveland, Dallas, Detroit, Houston, Kansas City, Los Angeles, New York, Philadelphia, Pittsburgh, Rome, N.Y., St. Louis, San Francisco, Seattle, Washington, D. C.

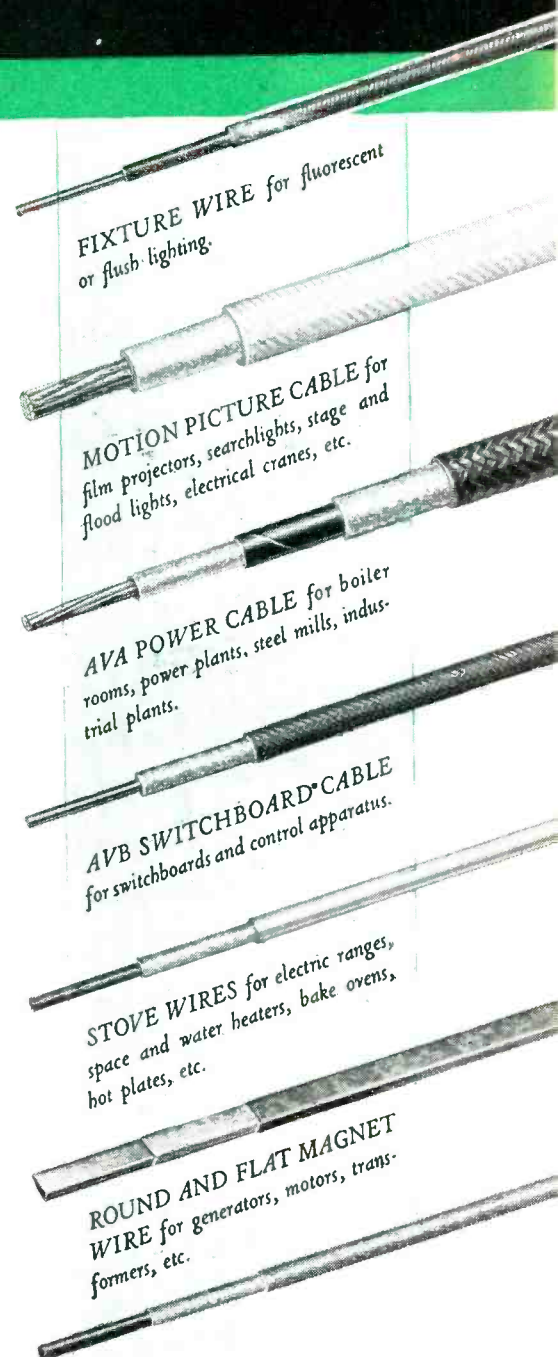

STRUTHERS-DUNN

"Memory Relays"

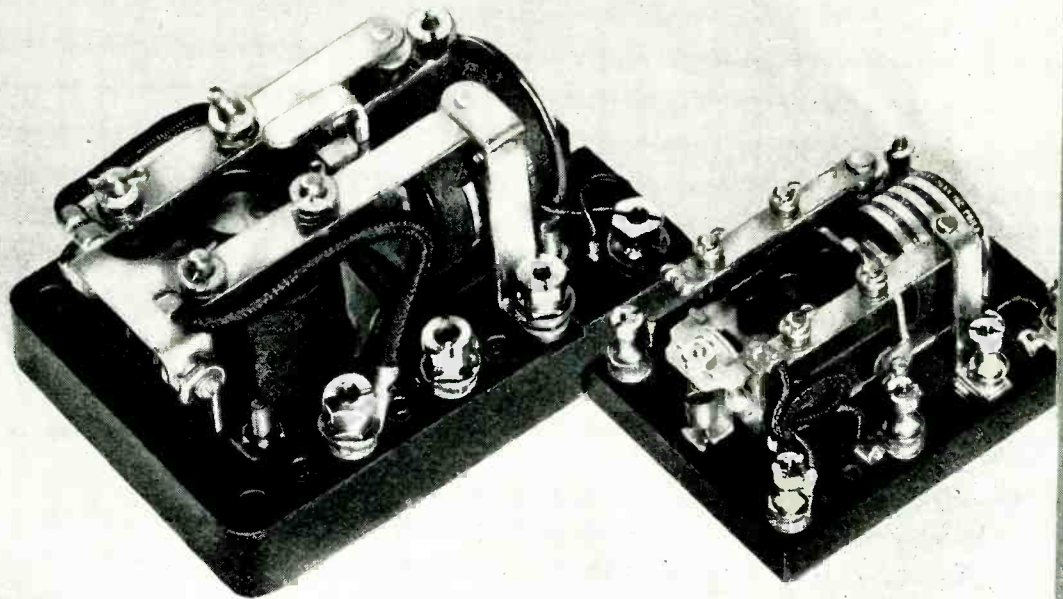

MECHANICAL LATCH-IN ELECTRICAL RE-SET TYPES

- Contacts "remember" which coil was last energized—by interlocking mechanically in position until they are released by energizing the other coil.
- Will not open in the event of power failure.
- Ideal for battery circuits. Contacts "stay put" without consuming any power.
- Standard and midget types for either AC or DC, and with any required contact or mounting arrangement.

STRUTHERS-DUNN, Inc., 1321 Arch St., Phila. 7, Pa.



ATLANTA • BALTIMORE • BOSTON • BUFFALO • CHICAGO • CINCINNATI • CLEVELAND • DALLAS
DENVER • DETROIT • HARTFORD • INDIANAPOLIS • LOS ANGELES • MINNEAPOLIS • MONTREAL
NEW YORK • PITTSBURGH • ST. LOUIS • SAN FRANCISCO • SEATTLE • SYRACUSE • TORONTO

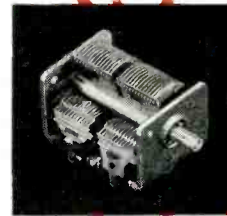
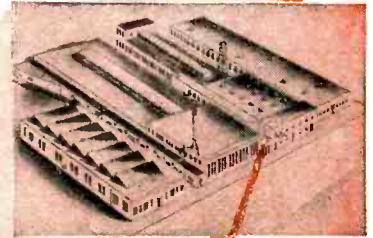
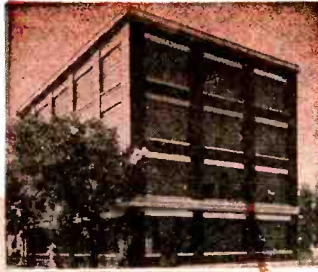

R/C

VARIABLE CAPACITORS ...direct to you...from the plant nearest you

Where is the supplier located? What about shipping costs? How fast deliveries? What about specialized engineering assistance?

R/C has solved problems such as these for its clients by maintaining, in addition to its big Camden, N. J. plant, an affiliate in the Middle West and a subsidiary in Toronto, Canada.

These plants, servicing sales offices from New York to California and Canada assure utmost efficiency from any standpoint you can name.

Service *direct to you, from the plant nearest you*, is the aim of Radio Condenser Company—and this is backed by strategically placed sales office service literally at your fingertips.

WATSEKA, ILL.

TORONTO

CAMDEN, N. J.

RADIO CONDENSER CO., Camden, N. J. • Radio Condenser Co., Ltd., Toronto, Canada

RADIO CONDENSER COMPANY

SUPPLIERS TO SET MANUFACTURERS ONLY

COME TO THE "Information Center"

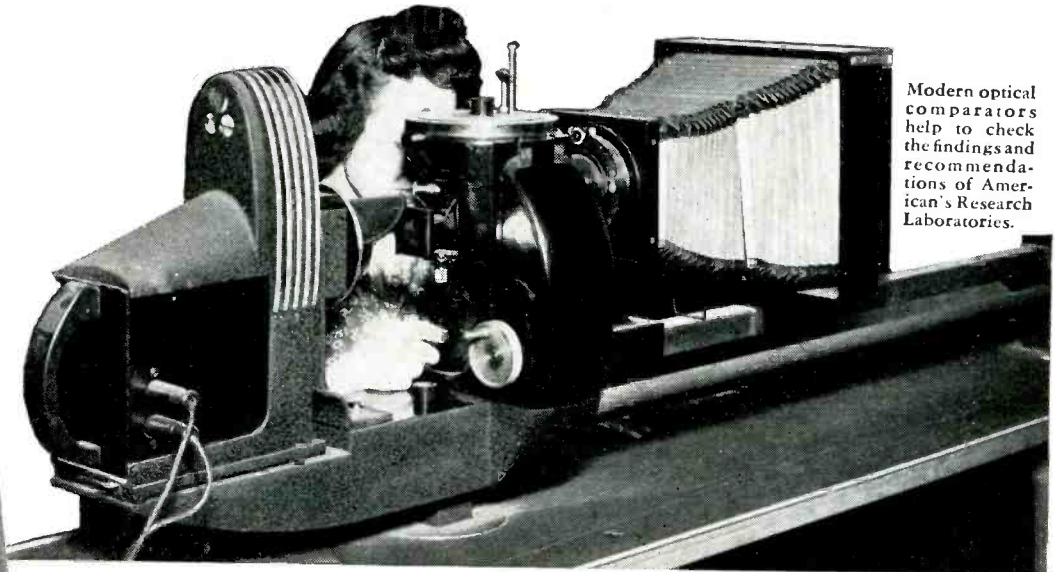

Modern optical comparators help to check the findings and recommendations of American's Research Laboratories.

... for recommendations on **AMERICAN PHILLIPS SCREWS** of the right type and metal for your job

Here in American Screw Company's Engineering Research Department are the technicians, equipment and experience to work out for you, quickly, the right answer to the question: "What kind of American Phillips Screw ... standard or special ... is the best one for *my* job?"

The complete American line includes all types of screws, in all the metals listed below. And if your fastening problem involves any of the *rust-resistant metals*, then American's advice is especially valuable. For American specializes in these metals,

and particularly in stainless steels of many different analyses.

So bring your problem to the "Information Center," and let American give you extra, *engineered savings* in design and metallurgy ... in addition to the time-savings (up to 50%) which you always get from the American Phillips Recessed Head: Automatically straight driving, slash-proof protection for work-surfaces, and top speed and ease in handling the 4-winged driver, which fits firmly in the recessed screwhead. Write *now* to the Engineering Research Dept. of:

AMERICAN SCREW COMPANY, PROVIDENCE 1, RHODE ISLAND

Chicago 11: 589 E. Illinois Street

Detroit 2: 502 Stephenson Building

4-WINGED DRIVER CAN'T SLIP OUT
OF PHILLIPS TAPERED RECESS

AMERICAN PHILLIPS

Screws



ALL TYPES
ALL METALS: Steel,
Brass, Commercial
Bronze, Stainless
Steel, Aluminum,
Monel, Everdur (silicon bronze)

SOLD THROUGH INDUSTRIAL SUPPLY DISTRIBUTORS

TINY OR TITANIC

**No Job in Metal is Too Big
or Too Small for KARP**

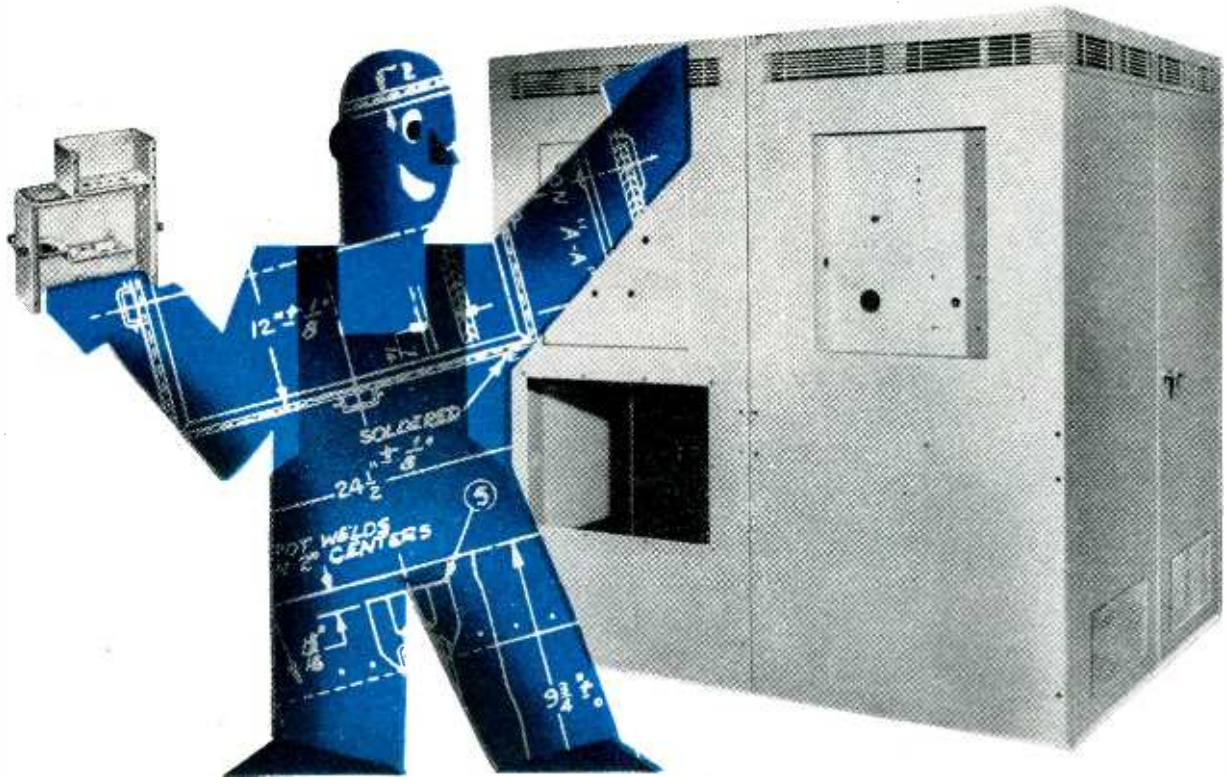

Bring your metal fabrication problems to KARP . . . and enjoy the superior individualized services of an organization that has been solving the toughest problems in precision metal craftsmanship for more than 20 years. Whether it's a tiny chassis, shield, or cabinet . . . or a giant rack or housing for broadcast or induction heating apparatus, KARP has the skill, the engineering "know how" and the plant facilities to serve you . . . and to assure you of reasonable delivery time. KARP ideas often effect important savings in both materials and machine tool time. KARP'S extensive stocks of dies often result in custom-made jobs at "ready-made" economies.

ANY METAL • ANY SIZE • ANY FINISH

KARP



124-30th Street, Brooklyn 32, N. Y.

METAL PRODUCTS CO., INC.

Custom Craftsmen in Metal

VIBRATION

IS TOUGH TO
LICK, TOO



...but these "Little Fellows" do it!

Yes, the #4 Knurled Point "Unbrako" Socket Set Screws look mighty small and insignificant . . . but they can easily lick the toughest vibration because they are Self-Lockers—the knurled points dig-in and hold firm, against even the most stubborn vibration! Yet this screw can easily be backed-out with a wrench and used again and again. Made in smallest sizes for the convenience of the electronics and smaller instrument fields.

In sizes from #4 to 1½"; full range of lengths. Write today for your free copy of the "Unbrako" Catalog. "Unbrako" and "Hallowell" products are sold entirely through distributors.

UNBRAKO

Reg. U.S. Pat. Off.

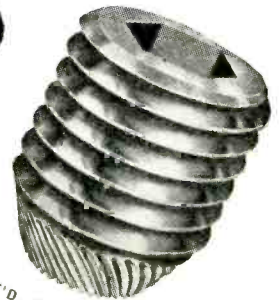

PAT'D. & PATS. PEND.

Knurling of Socket
Screws originated with
"Unbrako" in 1934.



OVER 43 YEARS IN BUSINESS

STANDARD PRESSED STEEL CO.

JENKINTOWN, PENNA. BOX 596 • BRANCHES: BOSTON • CHICAGO • DETROIT • INDIANAPOLIS • ST. LOUIS • SAN FRANCISCO

NOW.. all electrical tubing insulation requisites with this exclusive varnish impregnant —

TURBOTUF



UNAFFECTED!

TURBOTUF withstands repeated 180° twisting and bending without trace of cracking



DAMAGED!

Illustration shows cracking of conventional insulating varnishes under bending stress

**Non-cracking,
non-peeling, non-chipping —
whatever the angle
of bend or twist!**



**A knock-out
to usual insulation
breakdown causes**

**NEW! TURBOTHERM
Plastic Insulated Wire**

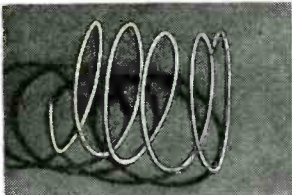

Specialized in Gauge Nos. 18 to 30 stranded and solid conductor construction.

Bend it, crease it, twist it—subject it to any turn or bend — and you'll see that something new has been added to this quality insulation tubing and sleeving. TURBOTUF — an exclusive new development, constituting a genuine advance in the art, eliminates the hazard of cracking insulation, with subsequent wiring failure or service interruption.

Now when you specify TURBOTUF, you get these additional TURBOTUF advantages:

increased, stabilized dielectric strength; higher temperature resistance; decreased moisture-absorption factor; unaffected by proximity to soldering heat; etc.

TURBO products include Flexible Varnished Tubing, Thermoplastic Insulated Wire known as Turbotherm, Extruded tubing, Saturated Sleeving, Fibrous Glass Tubing, Varnished Tapes and Cambrics, Mica and Mica Products. Write for free Specimen Board today.

WILLIAM BRAND & COMPANY

276 FOURTH AVE., NEW YORK 10, N. Y. • 325 W. HURON ST., CHICAGO 10, ILL.

REMEMBER.. IF IT'S *TURBO* ..IT SAFEGUARDS!.

PERMANENT MAGNETS MAY DO IT BETTER

FLUXMETER CLOSED
CIRCUIT TEST



Testing magnet in
an assembly similar
to the finished unit.

ACCURATE TESTING OF PERMANENT MAGNETS

Because the permanent magnet is one of the most vital parts of the instrument or apparatus in which it is used, testing methods of the mechanical and magnetic properties must be comparable to the actual working condition of the magnet.

Our testing department is equipped with every facility to insure accurate mechanical inspection. Every magnet is tested to magnetic specifications, so that they will function properly in their final assembly . . . reducing customers' inspections.

Fluxmeters, ballistic galvanometers, test fixtures and all associated precision apparatus used in testing and inspecting are constantly checked to maintain absolute uniformity.

Over 24,000 applications of permanent magnets have been developed by *Indiana Steel Products Company*, specialists in permanent magnets for over 35 years. You are invited to consult with our engineers. For data on magnet applications, write for new "Permanent Magnet Manual."

Producers of "PACKAGED ENERGY"

★ ★ ★ **THE INDIANA STEEL PRODUCTS COMPANY** ★ ★ ★

6 NORTH MICHIGAN AVENUE, CHICAGO 2, ILLINOIS



SPECIALISTS IN PERMANENT MAGNETS SINCE 1910

O.K.

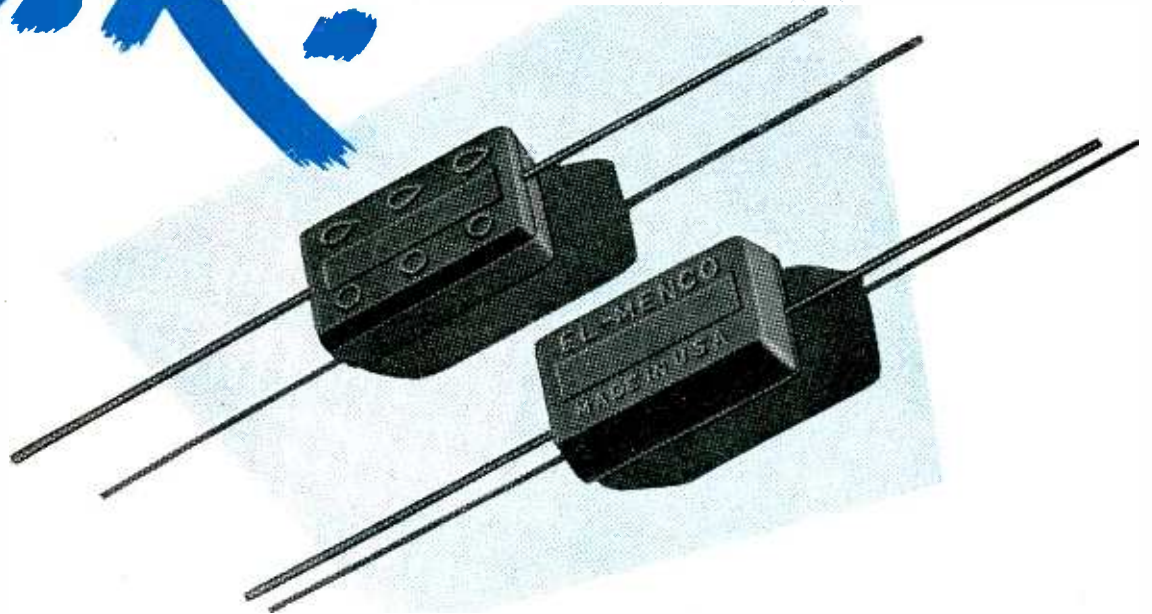

Leading Electronic Equipment
Manufacturers Testify To
The *Superiority* of:

EL-MENCO CAPACITORS

As a direct result of its constant laboratory research and experimentation, the Electro Motive Manufacturing Company maintains the leading position as a source of supply for the electronic equipment industry.

Precision marks every step in the manufacture of El-Menco Capacitors. They are designed especially for maximum performance in specific applications. And manufacturers *know* they can *depend* on El-Menco products under any and all conditions.

Send—on firm stationery—for new El-Menco catalog.



The Electro Motive Mfg. Co., Inc.
Willimantic, Connecticut

MOLDED MICA

EL-Menco

MICA TRIMMER

CAPACITORS



**ANOTHER HISTORIC EVENT
— ON *audiodiscs***

RADAR contact with the moon, broadcast over the nation-wide facilities of the Mutual Broadcasting System on Sunday, January 27th, emphasized once again the essential value of recording in radio broadcasting.

* * * *

From their Belmar, New Jersey laboratories, engineers of the Army Signal Corps made this memorable contact early in the morning of January 27th, while in the studios of WOR-New York, the Special Features Division of MBS were recording the event on an AUDIODISC. A few hours later, at a more appropriate time, the recorded program was broadcast to the nation.

* * * *

In this, as in countless other instances, AUDIODISCS have made it possible for radio listeners to hear a history-making event exactly as it occurred with all the true fidelity of a "live" broadcast.

AUDIO DEVICES, INC.,

**444 Madison Avenue,
New York 22, N. Y.**

*Audiodiscs manufactured in
U. S. A. under exclusive license
from La Societe Des Vernis Pyro-
lac—France.*



... they speak for themselves **audiodiscs**



INDIA

SUPERB SPECIMENS



AFRICA



NORRISTOWN, PENNA.

"CAT-HEAD"

Made by Taylor Fibre for SQUARE D COMPANY

Used in mechanism for switch equipment. Material is Phenol Fibre core, with Taylor Vulcanized Fibre surface sheets on both sides. This combines the strength and dimensional stability of Phenol Fibre with the high electrical and arc-resisting properties of Taylor Vulcanized Fibre.

Light in weight, high in dielectric strength and moisture-resistance . . . this "cat-head" is a good example of Taylor's specialized service to the electrical industry. In addition to its combination of desired electrical properties, Taylor Fibre is *fast* in production . . . and *accurate* in dimensions on any production process. The "cat-head," for instance, is rough-sawed from pressed sheets, then precision-shaved in production runs to Square D Company's specifications.

Whatever your problem, our engineers will gladly tell you, without obligation, exactly what Taylor Laminated Plastics can contribute to its solution. Write us today, sending sketch or blueprint . . . or outlining the characteristics you have in mind.

TAYLOR FIBRE COMPANY

LAMINATED PLASTICS: PHENOL FIBRE · VULCANIZED FIBRE—Sheets, Rods, Tubes, and Fabricated Parts
NORRISTOWN, PENNA. **Offices in Principal Cities** **Pacific Coast Plant: LA VERNE, CAL.**

Yes Sir!

Jack & Heintz is on the job

JACK & HEINTZ postwar production lines are rolling right now. The men who threw the rule books away, simplified designs, figured out new methods of manufacture and assembly and licked dozens of war-time production bottlenecks, have done it again. And here's what we're making:

J & H Fractional Horsepower Electric Motors. More compact and lighter in weight than conventional electric motors, they're being built in $\frac{1}{6}$, $\frac{1}{4}$, $\frac{1}{3}$ and $\frac{1}{2}$ horsepower sizes.

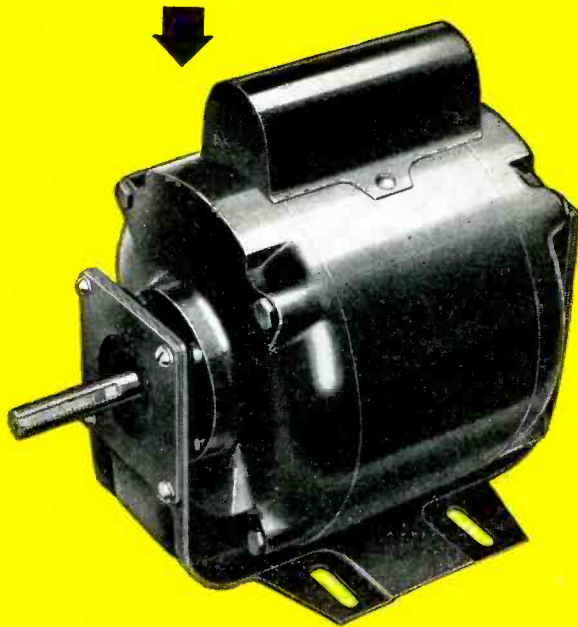

J & H Ball Bearings. Utilize the experience of men whose ultra high precision training makes them talk in $\frac{1}{100,000}$ of an inch. You can be assured that there will be no better ball, and later on, straight and tapered roller bearings, on the market than those made by J & H. In fact, we make and use our own electronic precision measuring gages which, incidentally, are purchased and used by other manufacturers of precision products.

J & H Aircraft Products. We're continuing the manufacture of all well-known Jack & Heintz aircraft products—

The 2500 volt ampere Inverter that tips the scales at only 54 lbs., and provides a continuous and dependable source of 400 cycle, 115 volt AC power of the quality required for aircraft, radio and electronic applications.

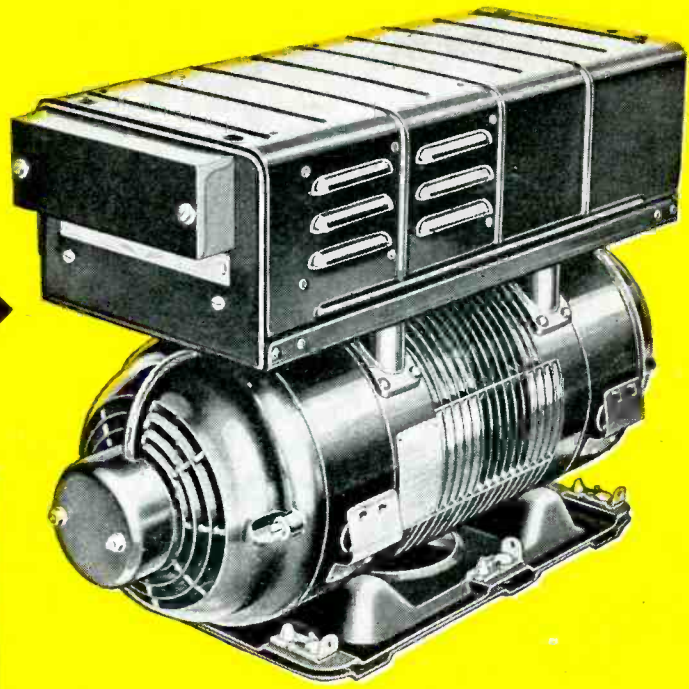

J & H Electronic Gages. Such as the widely used comparator that measures to millionths of an inch.

J & H Engines. Now undergoing tests. Will be suitable for automobiles, trucks and stationary usages, and will deliver more horsepower per pound or cubic inch displacement than any comparable engine on the market.

Lightweight universal aircraft electric starters with a heavyweight punch, capable of cranking the largest engines, yet light enough for smaller engines.

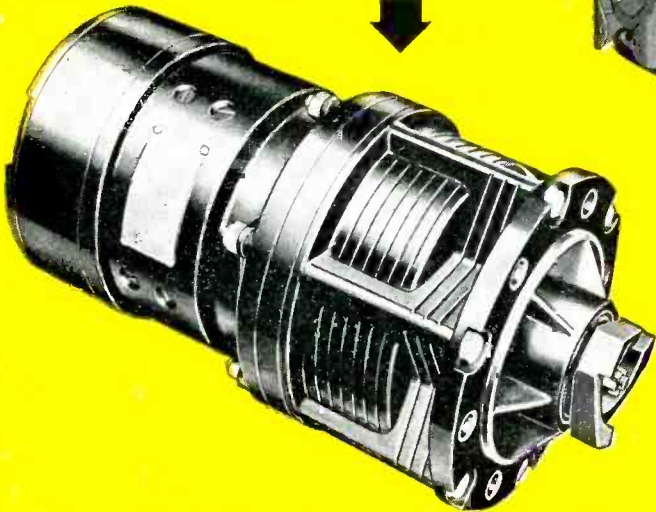
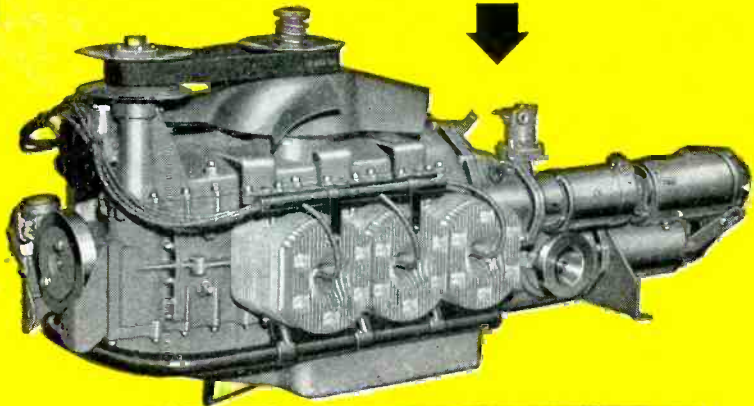

Yes Sir! Jack & Heintz is on the job! JACK & HEINTZ PRECISION INDUSTRIES, INC., CLEVELAND 1, OHIO

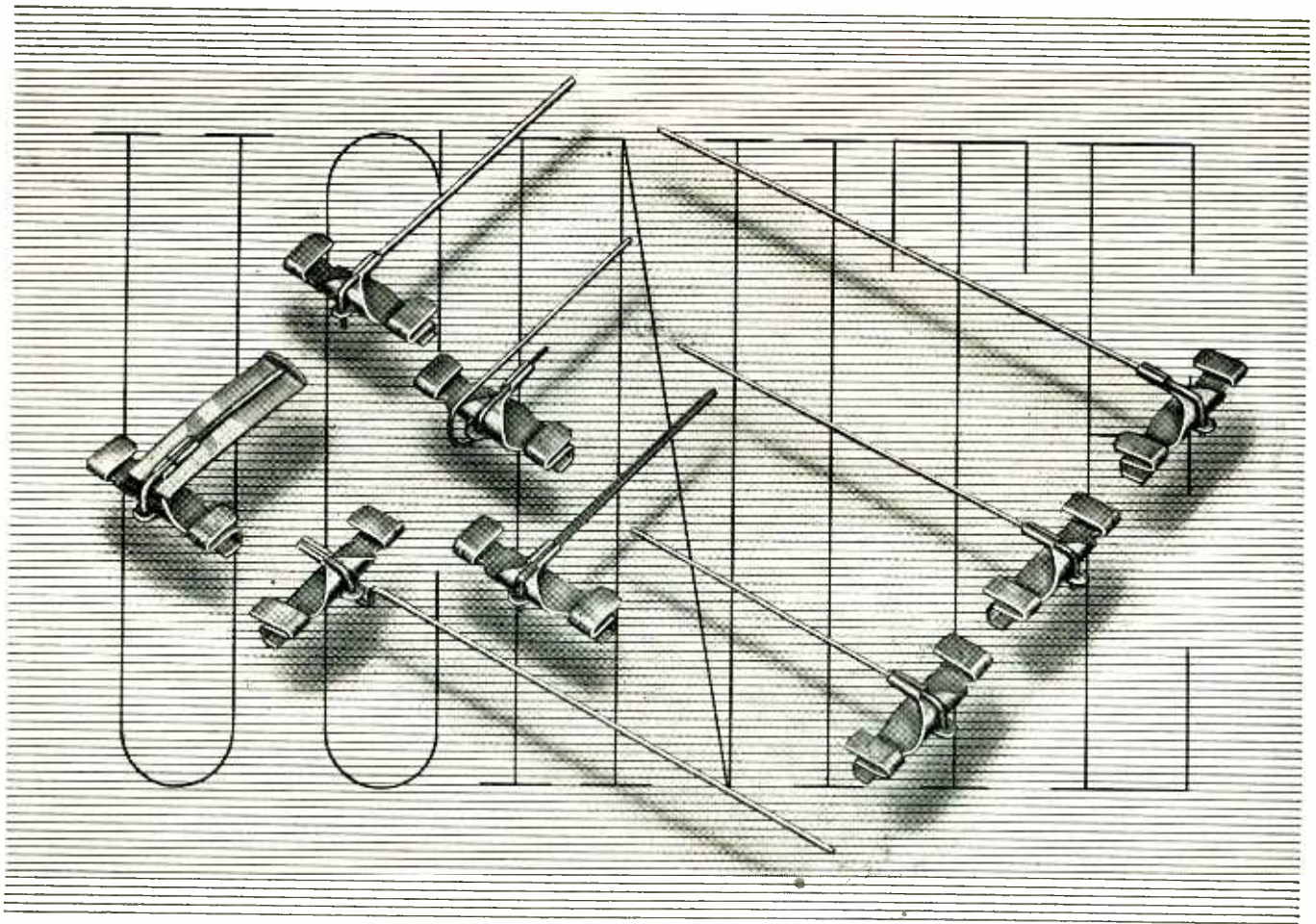

Number one on your dial



Here's a mighty versatile pointer we're currently producing for slide-rule type radio dials. The standard body design shown above is the result of 10 years of experiment and experience. It's readily adaptable for use on an inverted track . . . suitable for attachment of fluorescent-impregnated plastic materials. The pointer wire can be supplied in any form to meet your specifications—any length . . . any color . . . round or flat . . . bent to any required shape . . . or mounted with a white background for use with transparent dials.

This jack-of-all-pointers is but one instance of the many flexible standard assemblies we've developed for a wide variety of electronics uses. One or more of them might be just what you need to give added impetus to your production schedules.

The UCINITE CO.

Newtonville 60, Mass.

Division of United-Carr Fastener Corp.

Specialists in RADIO & ELECTRONICS
LAMINATED BAKELITE ASSEMBLIES
CERAMIC SOCKETS • BANANA PINS &
JACKS • PLUGS • CONNECTORS • ETC.

BUILT TO ORDER

Designers of mobile equipment and amateur vhf enthusiasts asked for this driver tube. The 2E30 (outgrowth of the Hytron development type HD59) is a filamentary-type beam tetrode. Standby current is eliminated. Yet the 2E30 is ready to operate a second after electrode potentials are simultaneously applied.

In vhf equipment, the 2E30 is ideal as a class C oscillator, frequency multiplier, or audio frequency amplifier. Important to you—the 2E30 is a transmitting tube—not just a re-hashed receiving type.

Check its versatility and its many features. Quite possibly you will discover that the 2E30 was built to order for you too.



HYTRON TYPE 2E30

Instant-Heating Miniature Beam Tetrode

GENERAL CHARACTERISTICS

Filament	Oxide coated
Potential, a-c or d-c	6.0 ± 10% volts
Current	0.7 ampere
Grid-plate capacitance	0.5 mmfd
Input capacitance	10.0 mmfd
Output capacitance	5.0 mmfd
Max overall length	2 5/8 in.
Max diameter	3/4 in.
Base	T-5 1/2 min button 7-pin

ABSOLUTE MAXIMUM RATINGS

D-c plate potential	250 volts max
D-c screen-grid potential	250 volts max
D-c plate current	60 ma max
D-c screen-grid input power	2.5 watts max
Plate dissipation	10 watts max

OUTPUT—TYPICAL OPERATION

Output, class A1 power amplifier	4 watts
Output, class C oscillator	7.5 watts†
Output, class C doubler (80 to 160 mc)	3 watts†

†Useful power output delivered to load under normal circuit efficiency. Total plate power output (including power actually lost in circuit and by radiation) is at least two watts higher.

FEATURES THE 2E30 OFFERS YOU

- Designed, manufactured, and tested for transmitting
- Special testing controls assure interchangeability*
- Oscillator, frequency multiplier, or a-f amplifier
- Filament power is fully adequate for transmitting
- 1/10 watt driving power for 4 watts output at 80 mc
- 10 watts plate dissipation—surplus reserve for vhf
- Miniature bulb saves space and has low base losses
- Low lead inductance and capacitance—ideal for vhf
- High efficiency at low plate potential—250 volts
- Instant-heating filament—approximately one second

*For example, characteristics are tested at positive grid potentials.

TYPICAL CIRCUIT FOR VERSATILE HYTRON 2E30

Extremely Compact Driver Giving 3 Watts to Load at 160 Mc

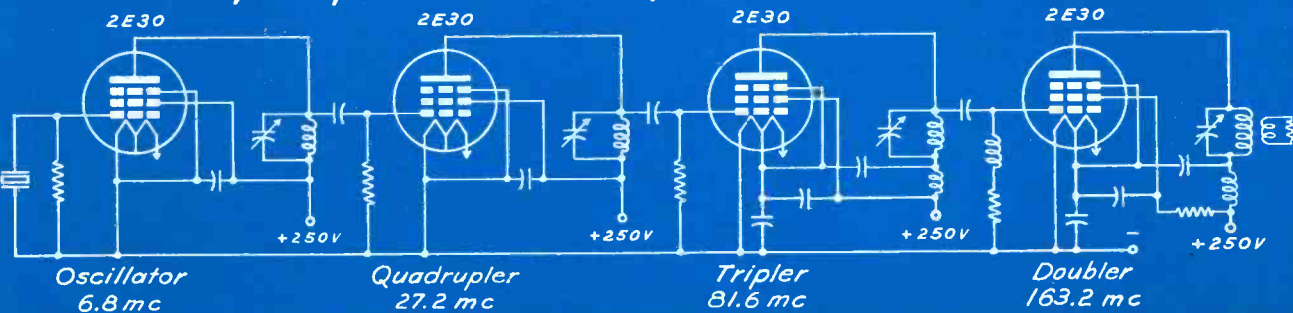

OLDEST MANUFACTURER SPECIALIZING IN RADIO RECEIVING TUBES



HYTRON

RADIO AND ELECTRONICS CORP.



MAIN OFFICE: SALEM, MASSACHUSETTS

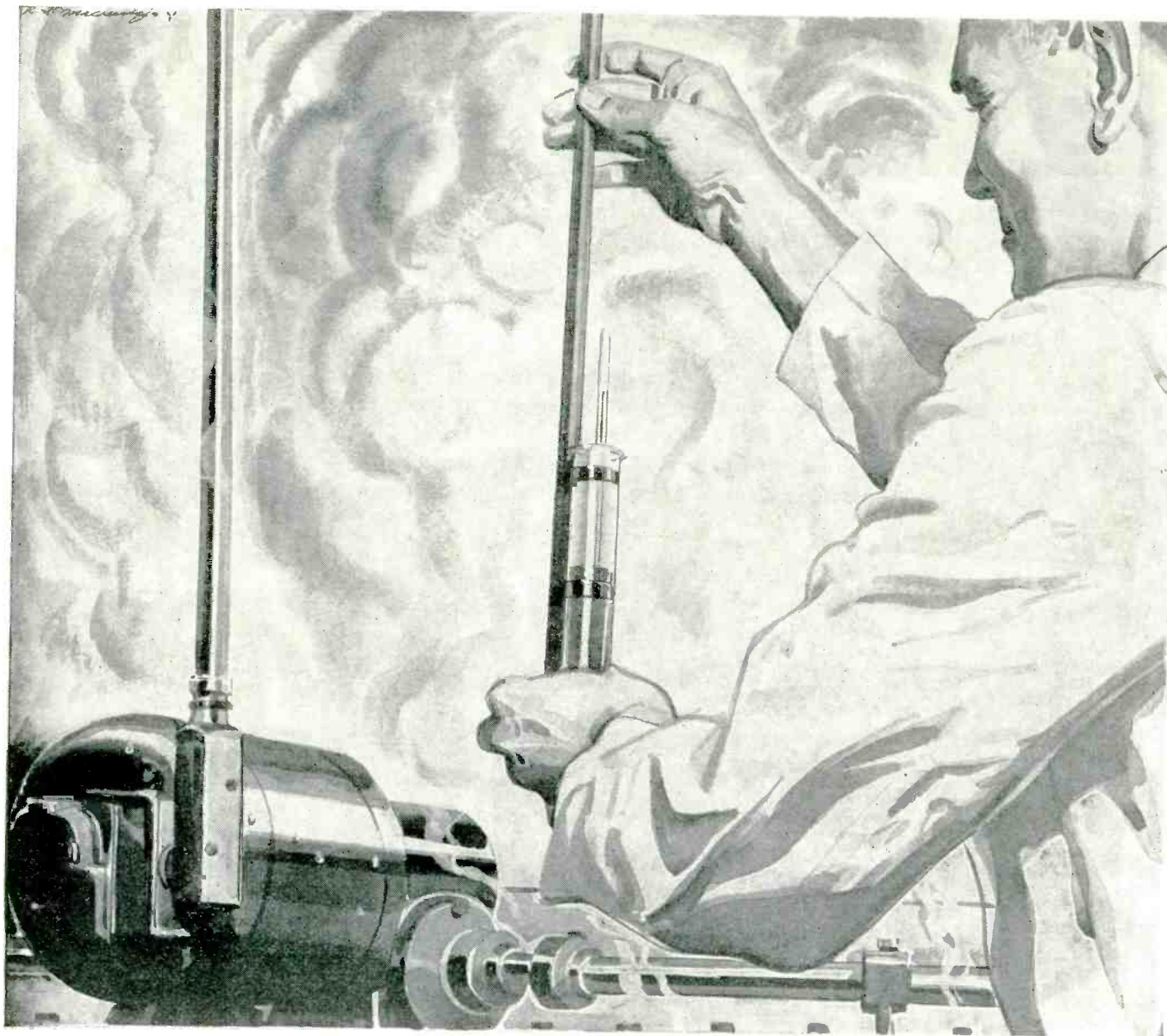

... don't let moisture soak up your profits

Unnecessary motor maintenance expense and reduced production efficiency *soak up profits*.

One easily avoidable loss—motor failures caused by excessive moisture—is being minimized by using Fiberglas* High-Safety-Factor Electrical Insulation. Properly impregnated, Fiberglas resists the effects of moisture and also provides “extra protection” against the other principal causes of motor failure, such as overloads, heat, oil and corrosive vapors.

For example, a midwestern concern uses a $\frac{1}{4}$ hp., 440-volt, 3-phase, 1750 rpm motor to drive agitator paddles in an annealing tank. Moisture and high heat caused failure of the organic insulation and burnouts occurred approximately every six months. The motor was rewound with Fiberglas Electrical Insulation and has been in operation for over three years, on a 24-hour, 7-day a week schedule.

Put profits back—where they belong. Investigate the *use economies* of Fiberglas Electrical Insulation in *your* motors.

For additional information, consult your Fiberglas Distributor. Descriptive catalog data may be obtained by writing Owens-Corning Fiberglas Corporation, Dept. 860, Toledo 1, Ohio.

In Canada, Fiberglas Canada Ltd.,
Oshawa, Ontario

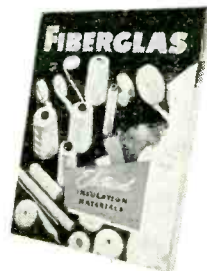

OWENS-CORNING
FIBERGLAS
THE FIBERGLAS COMPANY

OTHER FIBERGLAS PRODUCTS: THERMAL INSULATION MATERIALS • DUST-STOP* AIR FILTERS • FIBERGLAS YARNS AND CLOTHS • FIBROUS GLASS MATS

These Distributors can Make Fast Deliveries of Fiberglas Electrical Insulation Materials NOW!

- | | | |
|--|--|--|
| <p>ATLANTA, GEORGIA
Insulation & Wires Inc.</p> <p>BLUEFIELD, WEST VIRGINIA
National Electric Coil Co.</p> <p>BOSTON, MASSACHUSETTS
Insulation & Wires Inc.
Mica Insulator Co.</p> <p>CHICAGO, ILLINOIS
Insulation Mfrs. Corp.
Mica Insulator Co.
Prehler Electrical Insulation Co.</p> <p>CLEVELAND, OHIO
Insulation Mfrs. Corp.
Mica Insulator Co.
Prehler Electrical Insulation Co.</p> <p>COLUMBUS, OHIO
National Electric Coil Co.</p> <p>DALLAS, TEXAS
Summers Electric Company</p> | <p>DETROIT, MICHIGAN
Insulation & Wires Inc.</p> <p>HOUSTON, TEXAS
Insulation & Wires Inc.</p> <p>LOS ANGELES, CALIFORNIA
Electrical Specialty Co.
Triangle Pacific Company
Tri-State Supply Corp</p> <p>MINNEAPOLIS, MINNESOTA
Insulation Mfrs. Corp.</p> <p>NEW YORK, NEW YORK
Mica Insulator Co.
Mitchell Rand Insulation Co., Inc.</p> <p>PHILADELPHIA, PENNSYLVANIA
National Electric Coil Co.</p> <p>PITTSBURGH, PENNSYLVANIA
Earl B. Beach Co.</p> | <p>PORTLAND, OREGON
Electrical Specialty Co.,</p> <p>SAN FRANCISCO, CALIFORNIA
Electrical Specialty Co.
Triangle Pacific Company
Tri-State Supply Corp</p> <p>SEATTLE, WASHINGTON
Electrical Specialty Co.
Tri-State Supply Corp</p> <p>ST. LOUIS, MISSOURI
Insulation & Wires Inc.
White Supply Co.</p> <p>TRAFFORD, PENNSYLVANIA
Westinghouse Electric Corp.</p> <p>WILLIAMSPORT, PENNSYLVANIA
Lowry Electric Co., Inc.</p> <p>WESTINGHOUSE ELECTRIC CORP.
Branches in Principal Cities</p> |
|--|--|--|

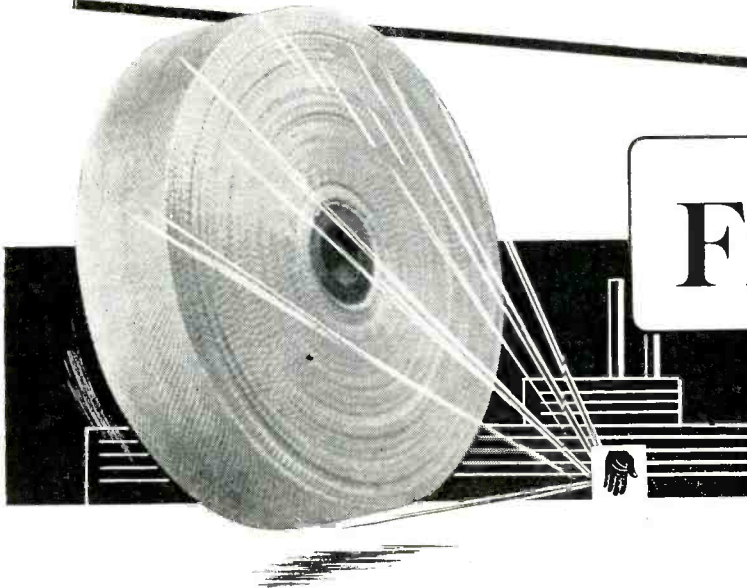

OWENS - CORNING
FIBERGLAS
TM REG US PAT OFF

YARNS—TAPES—CORDS—SLEEVINGS

Cloth and other forms: Magnet wire, Lead wire, Special wires, Varnished cloth and tape, Mica combinations, Laminates, Saturated sleeveings, Varnished tubings, Pressure-sensitive tapes, Special products.

FOR SAFE, ECONOMICAL, AUTOMATIC *Power Control at All Times...*

GET ADLAKE PLUNGER-TYPE RELAYS!

HERE'S WHY Adlake Plunger-Type Mercury Relays assure safe, economical, automatic power control under any condition:

All contact mechanism is *hermetically sealed* in armored glass or metal cylinders so dirt, dust, moisture or oxidation can't possibly interfere with operation.

Liquid metal mercury is *positive* in action, chatterless, silent, impervious to burning, pitting or sticking.

They're absolutely *safe*, and since they're hermetically sealed, Adlakes perform without servicing or maintenance—no periodic cleaning of contacts needed.

And Adlakes are *dependable*—simple in design and principle, no complicated parts to wear out or get out of order!

There's an Adlake Relay for every need. May we suggest the type best suited for yours? Write today for free bulletin.

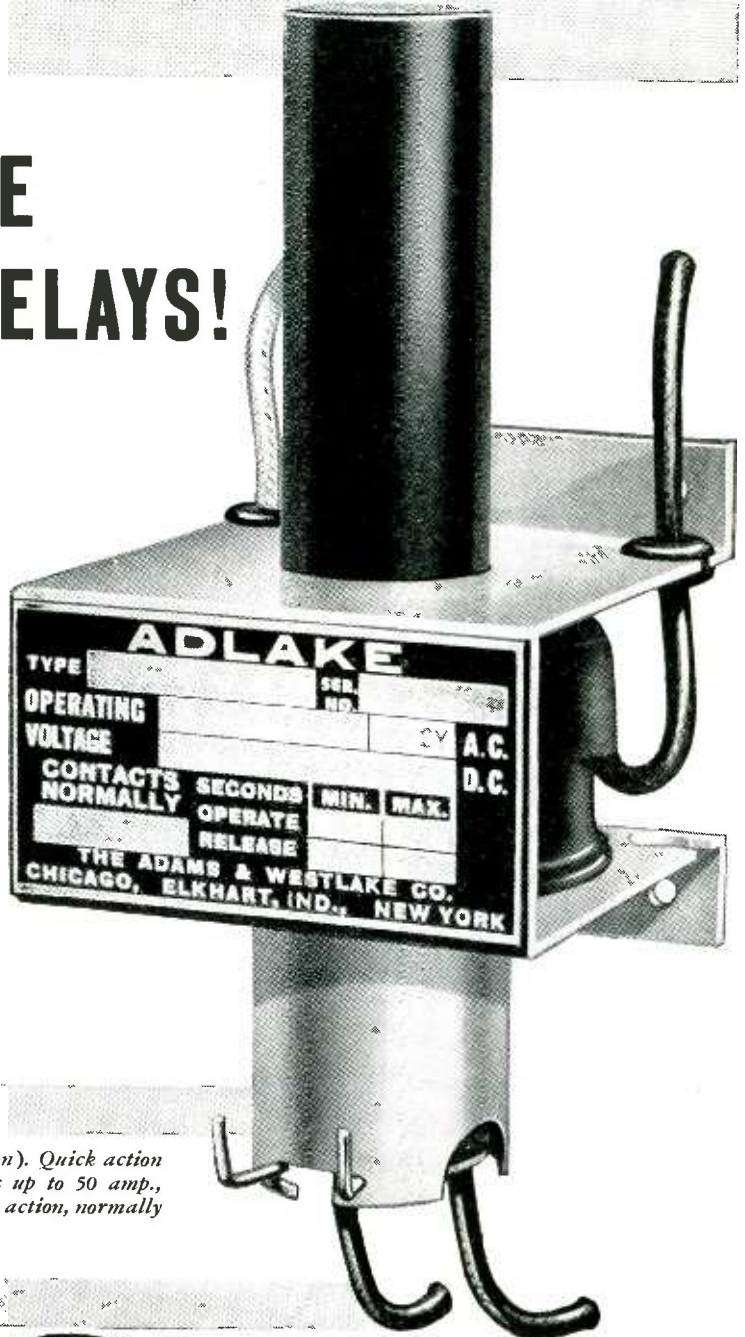

Model 1040 (for A. C. operation). Quick action available with contact ratings up to 50 amp., A. C. Either quick or time delay action, normally open or closed.



THE ADAMS & WESTLAKE COMPANY

ESTABLISHED IN 1857

ELKHART, INDIANA

NEW YORK • CHICAGO

Manufacturers of Adlake Hermetically Sealed Mercury Relays for Timing, Load and Control Circuits

THE ELECTRICAL INSULATION
HEADQUARTERS
MR
FOR 57 YEARS

FREE FOR THE ASKING!

Write today for your Free Varnished Tubing samples ranging from size 0 to 20 to fit wires from .032 to .325 inches . . . other valuable aids, are the M-R Guide Book of Electrical Insulation . . . the Wall Chart with reference tables, electrical symbols, allowable capacities of conductors, dielectric averages, thicknesses of insulation and tap drill sizes . . . and the M-R Wax and Compound Guide Book . . . they are full of valuable information . . . write for them on your letterhead.



MITCHELL-RAND INSULATION COMPANY, INC.

51 MURRAY STREET

COrtlandt 7-9264

NEW YORK 7, N.Y.

HARD MAPLE WEDGES
 MASKING TAPES
 EXTRUDED PLASTIC TUBINGS
 CREPED KRAFT PAPER TAPES
 FIBERGLAS SATURATED SLEEVINGS
 FIBERGLAS BRAIDED SLEEVINGS
 TINNED STEEL BANDING WIRE
 IMPREGNATED VARNISHED TUBINGS
 EBONY AND TRANSITE ASBESTOS WOOD
 INSULATING VARNISHES OF ALL KINDS
 FIBERGLAS TAPES AND TYING CORDS
 DUXSEAL PLUGGING COMPOUND
 RUBBERSEAL CLOTH AND TAPE
 TRANSFORMER COMPOUNDS
 COMBINED SLOT INSULATIONS
 FRICTION TAPES AND SPLICE
 VULCANIZED SHEET FIBRE
 ASBESTOS SLEEVING AND TAPES
 INSULATING PAPERS AND TWINES
 FIBERGLAS VARNISHED CLOTH AND TAPES
 VARNISHED CAMBRIC CLOTH AND TAPES
 COTTON TAPES, WEBBINGS AND SLEEVINGS
 CABLE FILLING AND POTHEAD COMPOUNDS
 MICA PLATE, TAPE, PAPER, CLOTH AND TUBINGS

One more step in AMERTRAN CARE

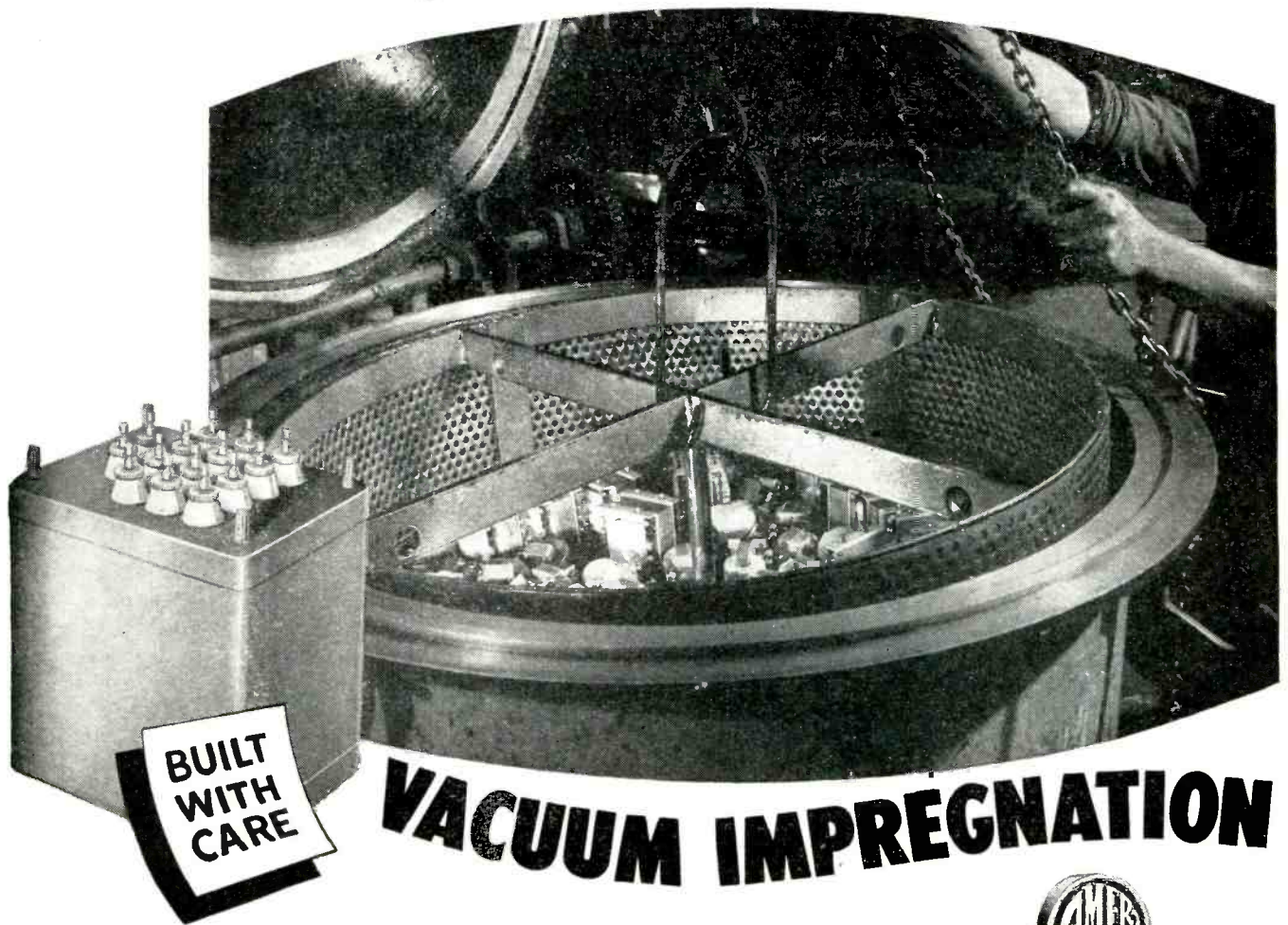

VACUUM IMPREGNATION

Vacuum impregnation helps to stabilize the performance characteristics of AmerTran Transformers. Each unit is subjected to both heat and a vacuum process to withdraw all moisture. While still in the vacuum chamber, the compound is introduced and forced into every interstice and around all surfaces of the windings.

This process eliminates trouble from deterioration of insulation and corrosion of windings due to moisture. It insures continuous conduction of heat to outer surfaces, resulting in a cooler unit—or a smaller transformer for a given temperature rise. It provides permanent protection from moisture.

AMERTRAN

MANUFACTURING SINCE 1901 AT NEWARK, N. J.

Pioneer Manufacturers of Transformers, Reactors and Rectifiers for Electronics and Power Transmission



AMERICAN TRANSFORMER CO.,
178 Emmet St., Newark 5, N. J.



The AmerTran trademark is found on...

Audio Transformers and Reactors
Modulation Transformers (to 500 KVA)
Hermetically Sealed Transformers
Plate and Filament Transformers
Filter Reactors
Wave Filters, High Voltage Rectifiers
Microphone and Inter-stage Transformers
Transtat A. C. Voltage Regulators
Other Electronic and Industrial Transformers

Not jet propelled . . .

PRESTO 8-D

but just as NEW!

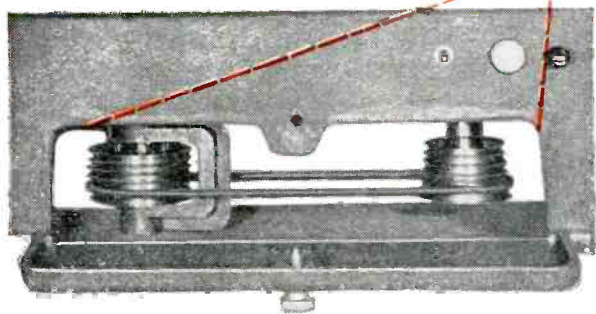
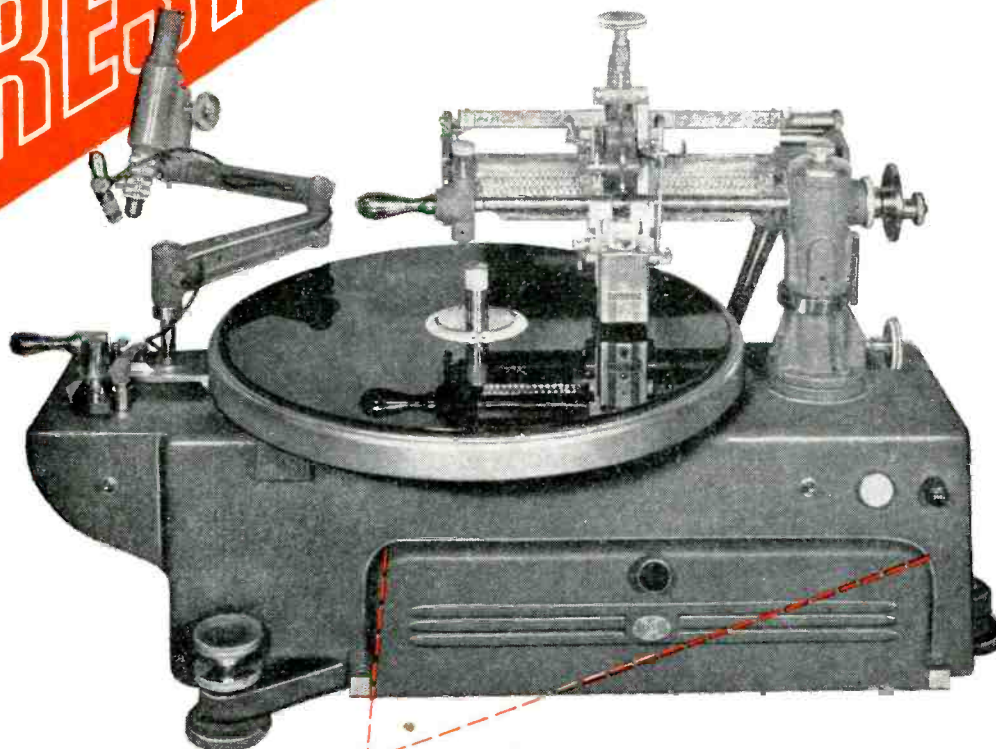

The belt on step pulleys slips instantly to any position to set cutting pitch at 96-104-112-120-128 or 136 lines per inch. Other pitches available on special order.

PRESTO'S newest *turntable* . . . for highest quality master or instantaneous recordings. The 8-D features instantaneous change of cutting pitch. An improved cutting head provides higher modulation level, more uniform frequency response and retains its calibration under all normal temperature conditions.

The heavy cast-iron turntable and mounting base insure exceptionally low background noise. Adjustable feet permit accurate leveling on bench or stand at a height to suit the operator.

**PRESTO**

RECORDING CORPORATION
242 West 55th Street, New York 19, N. Y.
WALTER P. DOWNS, Ltd., in Canada

WORLD'S LARGEST MANUFACTURER OF INSTANTANEOUS SOUND RECORDING EQUIPMENT AND DISCS

*To avoid damage
from Oxidation . . .*

protect with NITROGEN

LINDE Nitrogen provides an ideal means of protection against oxidation and corrosion by air. For packaging dehydrated foods; for deaerating, processing, storing and packaging fats and oils of all kinds; or for providing an inert atmosphere, free of impurities, for the complete protection of practically any material susceptible to oxidation, use LINDE Nitrogen.

LINDE Nitrogen is 99.7% pure, but is also available bone dry and at higher purity for special applications. It is supplied as a compressed gas in cylinders containing 244 cu. ft. each, or in bulk in tank-truck and tank-car lots as a liquid which is converted into gaseous nitrogen as required. LINDE Nitrogen in bulk offers remarkable savings in cost and eliminates cylinder handling.

Write or call the Linde office nearest you.

THE LINDE AIR PRODUCTS COMPANY

Unit of Union Carbide and Carbon Corporation



30 E. 42nd St., New York 17, N. Y. • Offices in Other Principal Cities

The words "Linde" and "Prest-O-Lite" are registered trade-marks.

Linde HYDROGEN · NITROGEN · OXYGEN
ARGON · HELIUM · KRYPTON · NEON
XENON — *Prest-O-Lite* ACETYLENE

LINDE has offices in Principal Cities

Eastern States

Baltimore, Md.
Boston, Mass.
Buffalo, N. Y.
Charleston, W. Va.
New York, N. Y.
Philadelphia, Pa.
Pittsburgh, Pa.

Central States

Chicago, Ill.
Cincinnati, Ohio
Cleveland, Ohio
Detroit, Mich.
Indianapolis, Ind.
Milwaukee, Wis.
Minneapolis, Minn.
St. Louis, Mo.

Southern States

Atlanta, Ga.
Birmingham, Ala.
Jacksonville, Fla.
Memphis, Tenn.
New Orleans, La.

Southwestern States

Dallas, Texas
Denver, Colo.
Houston, Texas
Kansas City, Mo.
Tulsa, Okla.

Western States

Butte, Mont.
El Paso, Texas
Los Angeles, Calif.
Phoenix, Ariz.
Portland, Ore.
Salt Lake City, Utah
San Francisco, Calif.
Seattle, Wash.
Spokane, Wash.

There is a DRIVER-HARRIS ALLOY for Every Electrical Resistance Requirement



NICHROME* & NICHROME V for winding large value resistors where space factors call for compactness in design without sacrificing dependability. Available in all shapes and sizes drawn down to the extremely fine gauge of .001" diameter—67 miles to the pound.



MANGANIN for precision bobbins, Wheatstone Bridges, Decade Resistance Boxes, Potentiometers and National Bureau of Standards type resistance standards which require fixed stability and constant resistance under normally variable operating conditions and negligible thermal e.m.f. against copper.



Also the time-tested standard alloys for all vitreous enamel resistor requirements due to the complete absence of occluded gases. **NICHROME V** is particularly recommended when a more constant resistance at variable temperatures is specified.

ADVANCE* for winding precision resistors used in electric meters and laboratory testing devices. In finer sizes its negligible temperature coefficient of resistance ($\pm .00002$) combined with high resistivity makes it the most desired alloy for this use.

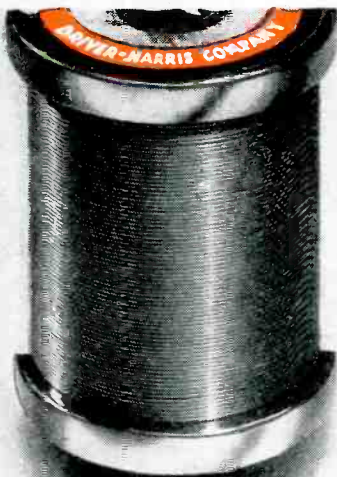

In addition to these we manufacture over 80 different electrical heat and corrosion-resistant alloys. If your resistance requirements are different tell us about them and depend on it... Driver-Harris will develop the alloy best suited to your specifications.

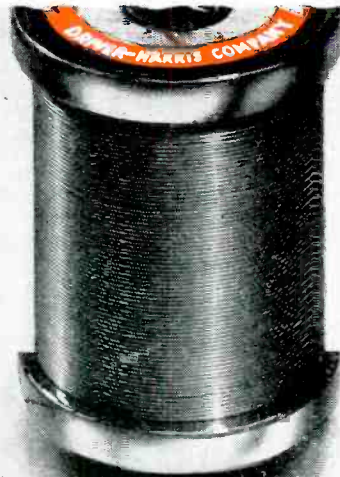

Nichrome is made only by

Driver-Harris
COMPANY

HARRISON • NEW JERSEY

*Trade Mark Reg.
U.S. Pat. Off.

BRANCHES: Chicago • Detroit • Cleveland • Los Angeles • San Francisco • Seattle

Data for all designers

CARBONYL IRON POWDER

comes in 5 different grades

L C E TH SF

For use in cores for different applications the powders are processed:

1. With different amounts of particle-to-particle insulation,
2. With different types of insulation or bonding material,
3. With different ratios of iron to inert material,
4. With different pressures to different densities, and
5. With different form factors and shapes.

To obtain exactly specified:

1. Permeability
2. Q value
3. Eddie current loss
4. Hysteresis loss
5. Temperature coefficient



Data for circuit & coil designers



COMPARISON OF AIR-CORED AND CARBONYL IRON CORED COILS: For Medium Frequencies

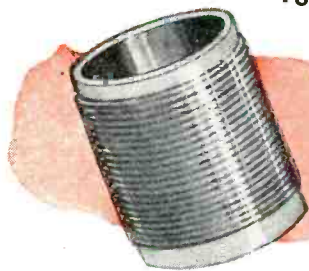

Specification	Typical air-cored coil	Typical CARBONYL IRON cored coil	Thus: CARBONYL IRON
VOLUME	0.61 cubic-inches	0.12 cubic-inches	Saves 80% of Space
WEIGHT Exclusive of Housing, Mounting, etc.	1.5 ounces	1.0 ounces	Saves 33% of Weight
WIRE-LENGTH	25 feet	11 feet	Saves 60% of Wire
INDUCTANCE	117 Micro-Henries	169 Micro-Henries	Increases Inductance 40%
Q Value at 1.0 Mc	94	260	Increases Q Value 170%

For further data write: General Aniline & Film Corp., Special Products Sales Department,
270 Park Avenue, New York 17, N. Y.

G.A.F.



UNITED *Announces*

THE GREATEST DEVELOPMENT IN GRAPHITE ANODE TUBES!

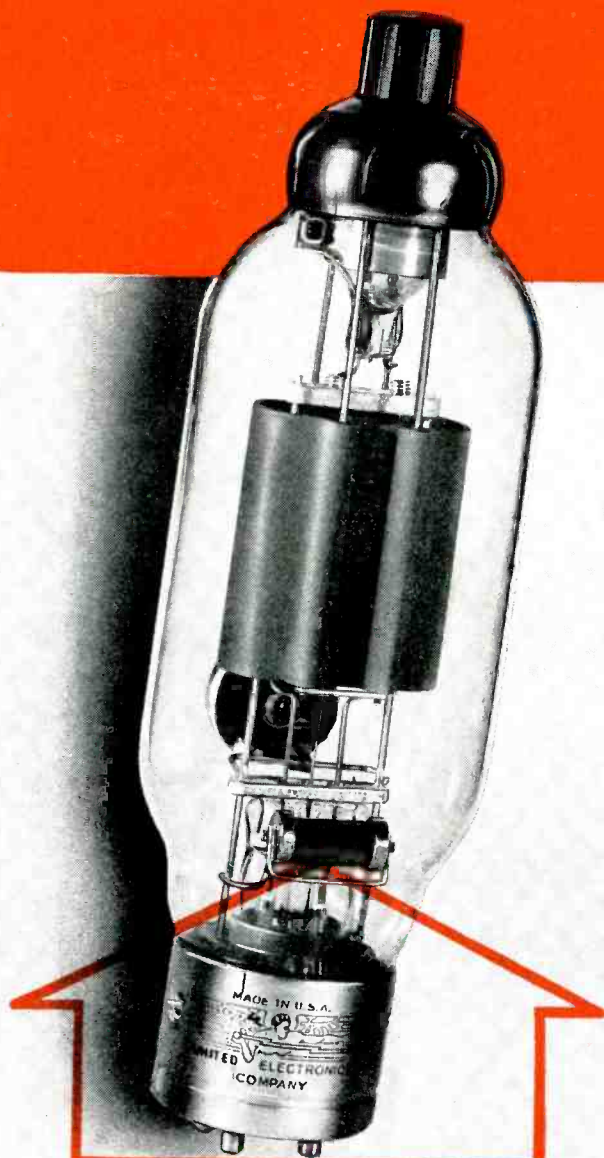

LOOK FOR THIS
"GETTER TRAP"
on all UNITED TUBES

Forecasting Higher Input and Efficiency Ratings

It is the consensus of opinion among electronic engineers, as a result of war experience, that graphite is superior to metal for internal anode tubes because of *unsurpassed thermal and non-warping properties*.

Heretofore, the enormous heat dissipating capacity of graphite anodes has been impeded by the use of free getters which deposited heavily on the bulb and tube elements.

The development of the *Isolated Getter Trap* by United has finally eliminated this long standing barrier to the full utilization of the superior features of graphite.

Gas content of these new United graphite anode tubes *average lower than that of any metal anode tubes of comparable size, and no gas can be liberated even on severe overloads*.

Available now with this new construction are types; HV-18, KU-23, 849, 838, 204A, 949A, 949H, V-70-D, 812H, and all of the diathermy types.

Order direct or from your *Electronic Parts Jobber*

UNITED ELECTRONICS CO.

NEWARK, 2  NEW JERSEY

Transmitting Tubes **EXCLUSIVELY** Since 1934

350,000 piece jig-saw puzzle . . .



callite kulgrid leads in the "eye" of the
*FARNSWORTH TELEVISION CAMERA

CALLITE DEVELOPED KULGRID to meet the need for a stranded wire that does not oxidize nor become brittle at the high temperatures necessary in beading, stem-making, sealing-in and exhaust. Kulgrid is a composite wire having an inner core of copper alloy bonded to a nickel sleeve. Kulgrid welds readily to itself and to nickel, copperclad, tungsten, molybdenum and other related metals. It has 70% of copper's conductivity, plus nickel's strength and resistance to oxidation.

We will be glad to discuss applications of Kulgrid and send samples. It will pay you to investigate our specialized abilities and complete facilities for all kinds of metallurgical components. Callite Tungsten Corporation, 544 Thirty-ninth St., Union City, New Jersey. Branch Offices: Chicago, Cleveland.



*Farnsworth's Television Camera dissects each picture it takes into as many as 350,000 separate pieces. Then it picks up the pieces one by one and sends them to the receiving set. There they are laid down so swiftly that your eyes see a complete picture all at once. The Farnsworth image-dissector tube, with its extraordinary step-up device called the electron multiplier, uses Callite Kulgrid Leads.

Hard glass leads, welds, tungsten and molybdenum wire, rod and sheet, formed parts and other components for electron tubes and incandescent lamps.

Kulgrid is covered by U.S. and foreign patents.

*For the
Laboratory*

BEAT FREQUENCY GENERATOR

TYPE 140-A

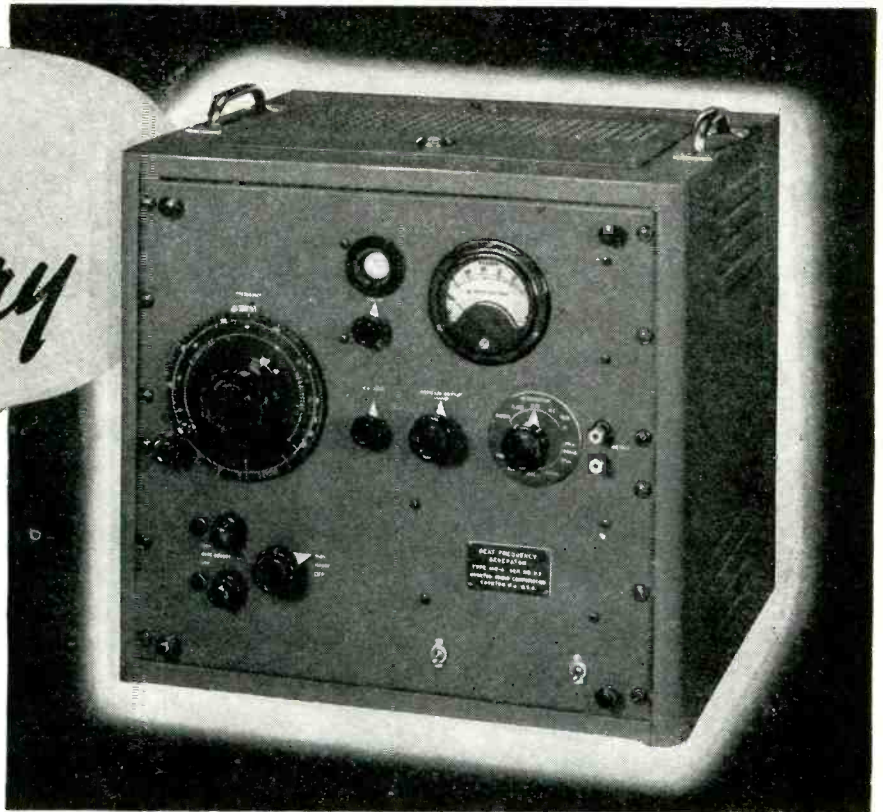

This instrument has found universal acceptance because of its wide frequency coverage from 20 cycles to 5 megacycles. A five step decade attenuator provides a means by which extremely small output voltages can be accurately set and a six position switch enables any one of a variety of output impedances to be quickly selected.

SPECIFICATIONS:

FREQUENCY RANGE: 20 cycles to 5 megacycles in two ranges.

Low range: 20 to 30,000 cycles.

High range: 30 kc to 5 megacycles.

FREQUENCY CALIBRATION: Accuracy ± 2 cycles up to 100 cycles, $\pm 2\%$ above 100 cycles.

STABILITY: About 5 cycles drift below 1000 cycles. On low range, drift becomes negligible percentage with increasing frequency. On high range, drift is 3% or less.

ADJUSTMENT: High and low ranges have individual zero beat adjustments. Low range may be checked against power line frequency with front panel 1 inch cathode ray tube.

OUTPUT POWER AND IMPEDANCES: Rated power output: One watt, available over the low frequency range from output impedances of 20, 50, 200, 500, 1000 ohms, and over both high and low frequency ranges from an output impedance of 1000 ohms.

DISTORTION: 5% or less at 1 watt output, 2% or less for $\frac{1}{2}$ voltage output.

VOLTMETER ACCURACY: $\pm 3\%$ of full scale reading.

For further details write for Catalog C

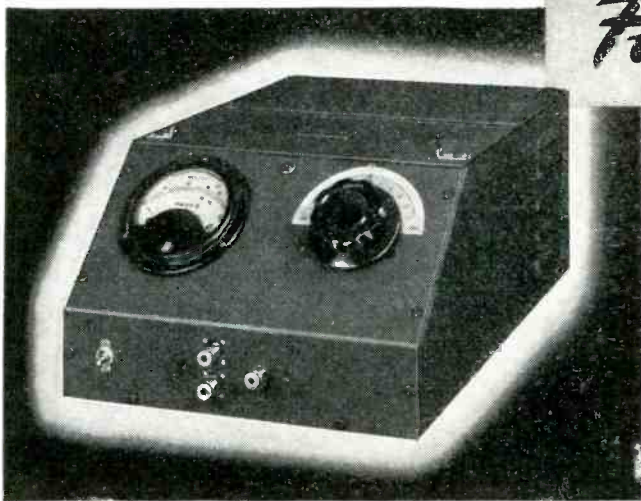

For the Production Line

QX-CHECKER TYPE 110-A

This production-test instrument is specifically designed to compare relative losses or Q simultaneously with inductance or capacitance in one operation and with a single setting. Built to laboratory precision standards, the QX-Checker is a sturdy, foolproof instrument for use in production work by any usual factory personnel.

SPECIFICATIONS:

FREQUENCY RANGE: 100 kc to 25 mc in 6 ranges using plug-in coils.

ACCURACY OF COIL CHECKS: May be checked against standard to within about 0.2% with coil values of 10 microhenries to 10 millihenries and Q of 100 or greater.

CAPACITANCE RANGE: Capacitance values ranging between approximately 2-1000 mmf may be checked against a standard to an accuracy of a few tenths of one mmf if the Q of the capacitor is high.

DESIGNERS AND MANUFACTURERS OF
THE "Q" METER . . . QX-CHECKER
FREQUENCY MODULATED SIGNAL GENERATOR
BEAT FREQUENCY GENERATOR
AND OTHER DIRECT READING TEST INSTRUMENTS



BOONTON RADIO

BOONTON-N.J.-U.S.A

Corporation



LITTLE COMPONENT*



HUGE SUCCESS

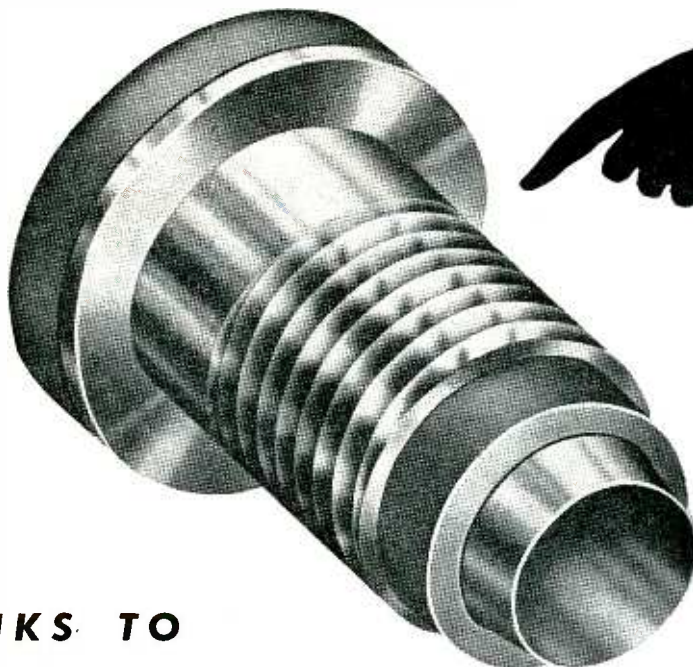

**... THANKS TO
MYCALEX**

THE "PERFECT" LOW LOSS INSULATION

The problem was to mold insulating material of exceptionally low loss factor and high dielectric strength into a closely integrated bond with a metal insert of high conductivity. The difficulty was acute, for both materials had to have virtually the same coefficient of expansion in order to insure an efficient electrical and mechanical seal. High resistance to arcing in the insulator was also imperative. It had to be moisture-proof and heat-resistant.

MYCALEX 410 (Molded Mycalex) proved to be the only solution after many other insulators had been tested and rejected . . . because MYCALEX has the ideal combination of electrical and mechanical

properties for today's high frequency applications.

Have you a problem involving the sealing of highest type insulation with metal? Are your specifications particularly exacting? More than 25 years of leadership in solving the toughest high frequency insulating problems make MYCALEX a "natural" to solve yours. Our engineers will be pleased to cooperate.

*PANEL JACK



MYCALEX CORPORATION OF AMERICA

"Owners of 'MYCALEX' Patents"

Plant and General Offices, CLIFTON, N. J.

Executive Offices, 30 ROCKEFELLER PLAZA, NEW YORK 20, N. Y.

You can't put the *squeeze* on "Sealdtite" Capacitors

Take a genuine "Sealdtite" capacitor and try to squeeze it. No "soft spots." Why? Because this Solar capacitor has its high purity paper-and-foil-winding ingeniously molded into a cylinder of solid wax.

No atmospheric moisture can penetrate this protective housing to attack the capacitor element. In genuine wax-molded "Sealdtite" capacitors, there just is no possibility of those twin omens of trouble — soggy cardboard tubes and moisture-filled hollows.

For real reliability, specify Solar "Sealdtites" for your new designs.



SOLAR MANUFACTURING CORPORATION

285 Madison Avenue • New York 17, N. Y.

Ⓢ 1009A



HOUSING CAN COST TOO MUCH

EVERYONE in the United States wants our people, and particularly our war veterans, well housed quickly. Almost everyone, we believe, likes the vigor and imagination with which Wilson W. Wyatt, the housing expediter, is going about the job of mobilizing our housing resources.

No one, however, wants the veterans, or anyone else, to get a lot of severe economic headaches along with the housing. As it stands, the emergency housing program runs unnecessary risks of having such results.

Here are the reasons:

1. The principal opportunity the program offers to the veteran is that of buying a high-cost house where a chance to rent would, more often than not, meet his needs much better.

2. At the worst possible time, the program adds substantially to the dangers of a runaway inflation of the sort that inevitably ends in a crash.

3. Little is done to try to reduce the arbitrarily high costs of building, such as those resulting from restrictions imposed by labor unions and antiquated building codes.

4. By giving overriding priorities to unattainable goals of home construction, the program endangers a volume of industrial construction necessary to sustain full employment.

Needs of Veterans

First on the needs of the veterans. What many, if not most, veterans need is a chance to rent a place at a reasonable rental while they are getting shaken down in their postwar careers which in many cases are inevitably unsettled at this time. Essentially, what the "Veterans Emergency Housing Program" gives them is a chance to buy, for about \$6,000, a house built along conventional lines and padded with much unnecessary labor and material cost.

But what are the alternatives? There are at least two. One is to put far more emphasis on more effective use of existing housing than the Wyatt program has thus far. The other is to see that the proportion of new rental units is much stepped up.

Incredible as it may seem, there are at present more than 2,000,000 vacant dwellings in the United States. Many of them should be demolished. But many permit of relatively satisfactory temporary use. Many more single dwellings can readily be converted into comfortable multiple dwellings. The emergency program assumes that only 350,000 dwelling units can be

provided this year by these expedients, but it does not seem unreasonable to assume that this figure might be doubled by a vigorous drive. The result would be a better balanced emergency housing program, because it would provide more rental housing immediately and save critical building materials.

Of the new housing units contemplated by the Wyatt program, it is estimated that only about 20 per cent will be for rent. Before the war more than half of the homes in the United States were rented. That means that unless the Wyatt program is to create little less than a revolution in the terms on which homes are occupied, it must be revised to include a much higher proportion of rental units.

To secure the result in the face of present high building costs special inducements will be required. They might be provided by allowing accelerated tax amortization of, say, half the construction cost over the next five years, together with rent ceilings high enough to make this form of investment attractive. This would, of course, call for higher rents, but the actual price to the veteran, in woe as well as money, might well be much less in the long run than if he bought an over-priced house now.

Too Easy To Pay Too Much

One of the mysteries of the Wyatt program is its general emphasis on measures to increase the supply of money with which to buy houses when the demand for houses is already at an all-time high. Some veterans may need special financial help, but the plan to give 90-95 per cent mortgages generally on new homes is not only unnecessary but positively dangerous. By providing up to \$3.5 billions of government-guaranteed credit for homes this year, and almost twice as much in 1947, the program will release an equivalent amount of individual savings to create further demand for goods and services. All that such generous mortgage terms will accomplish with certainty is a dangerous lengthening of the odds that we will not avoid a boom and bust cycle of inflation.

If building codes were brought up to date and arbitrary union working restrictions were eliminated, the way would be paved for reductions in the price of standard houses which, it has been estimated, might run as much as 20 per cent. This would both give the buyer of a new house a far better run for his money, and also reduce the inflationary pressure created by the super-generous credit arrangements involved.

Getting anything done along this line is difficult, particularly because the restrictions are imposed by tens of thousands of separate localities and organizations. Some headway is being made. The local emergency housing committees being set up under the Wyatt program provide a means of doing much more. Far more steam must be put behind this aspect of the program, however, if its greatest potentiality for permanently constructive accomplishment is to be realized.

Crippling Essential Industrial Production

The goals set for emergency housing construction—1,200,000 new homes started this year and 1,500,000 started in 1947—are higher than any qualified authority thinks can be met without crippling other essential construction. The reasons commonly assigned for such optimistic goals is that they are inspiring to those in the industry and soothing to those who want something tremendous done about housing.

Under normal circumstances, relatively little damage might be done by such excessive goals which are a common feature of most Washington programs trying to elbow their way to the center of the national stage. However, the emergency housing program carries with it top priorities for the materials to be used. Consequently, other essential construction will have to get along on whatever share of critical building materials will be left after all demands of home builders have been satisfied.

The Civilian Production Administration estimates that output of important materials will fall far short of needs. It forecasts a 15 per cent deficit in lumber, 18 per cent in bricks, and 52 per cent in cast iron radiators. Hence, unless building materials output can be stepped up far more rapidly than now seems possible, a prohibitive squeeze will be put on industrial building to provide the materials needed for the Wyatt program. This would complicate unbearably the problems of sustaining full employment and getting the flow of production so important in avoiding the boom and bust route.

Perspective on the Housing Shortage

What is needed is an aggressive drive to get full production of building materials as rapidly as possible. Such a drive should concentrate on measures aimed at helping the industry remove the obstacles to all-out production rather than on such measures as the subsidy plan which seems quite likely to succeed only in enmeshing the industry in more government controls. After making due allowance for the materials outlook and the needs for essential non-housing construction, housing goals should then be set as high as feasible. As matters stand, by setting construction goals before feasible material goals are determined, the cart is put before the horse.

There can be no doubt about the acuteness of the housing shortage and the necessity of a program

commensurate with the magnitude of the problem. It also remains true, however, that the housing shortage for the nation as a whole is not quite as desperate as those who want the country to drop everything and go to building houses would have us believe.

During the war 3½ to 4 million new dwelling units were built or created by remodelling in other than farm areas. The number of families living in such areas increased by less than 3½ million. Even though some of this housing was located in remote places as an adjunct of war production works, the wartime increase permitted a margin for more housing per family at this time. Indeed, it has been estimated that the rate of doubling up is only about one-third as great as in 1940. The margin did not begin to suffice, however, to meet the needs of those millions of people particularly in the lower income groups who, thanks to rapid increases in income, can afford to have and insist upon having better housing than they have ever had before.

A rising standard of income which makes possible a new standard of housing for many people is a fine thing. Above all, it is important to see the veterans get the best possible break in housing.

But Housing Can Cost Too Much

The Wyatt program has many good features. The emphasis on prefabrication, though perhaps over-optimistic, is hopefully modern. The emphasis on local collaboration in solving housing problems which are inevitably in large part local should lead to permanently valuable results. The vigorous mobilizing of 300,000 temporary dwellings to meet at high speed some of the most desperate shortage is all to the good.

The main trouble with the program is that it does not pay enough attention to the economic havoc which may be created in the process of trying to meet its excessive goals. As a nation, we should be and are willing to pay a high price to get adequate housing. But the price will be too high if we:

1. Give the veteran a bad bargain by selling him an over-priced house.
2. Cripple industrial production needed to create good jobs for veterans, and
3. Touch off a disastrous inflationary sequence in the process.

These pitfalls can be avoided. All of us, including the veterans, have a common interest in seeing that they are avoided.



President, McGraw-Hill Publishing Co., Inc.



THE COUNTERSIGN OF DEPENDABILITY IN ANY ELECTRONIC EQUIPMENT

Tests Prove 100% Longer Life in this New *Eimac* 3-750A2

made possible by:

- NEW COOLER OPERATING PLATE
- NEW NON-EMITTING GRID
- NEW FILAMENT STRUCTURE

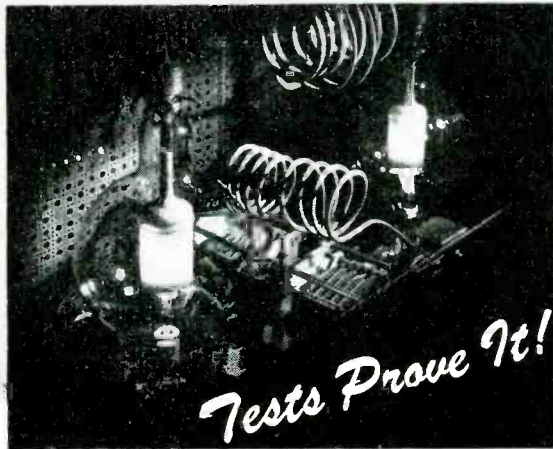

Tests Prove It!

Two Eimac 3-750A2 Tubes undergoing life tests in the Eimac testing laboratory

Repeated tests of the new Eimac 3-750A2 in the Eimac testing laboratory show 100% longer life than previous models operated under the same conditions.

This increase in life expectancy is a result of continuing research, culminating in this new version of the 750TL triode. Among its many new features are a new cooler operating plate, new non-emitting grid and a new filament structure.

The new 3-750A2 is a power triode, interchangeable with the previous model 750TL, and is but one example of the constant effort made at Eimac to furnish better tubes at lower cost. For further information and complete engineering data on Eimac tubes, write direct or contact your nearest Eimac representative.

Follow the leaders to



EITEL-McCULLOUGH, INC., 1102 E San Mateo Ave., San Bruno, California
Plant located at: San Bruno, California
Export Agents: Frazar and Hansen, 301 Clay St., San Francisco 11, California, U. S. A.

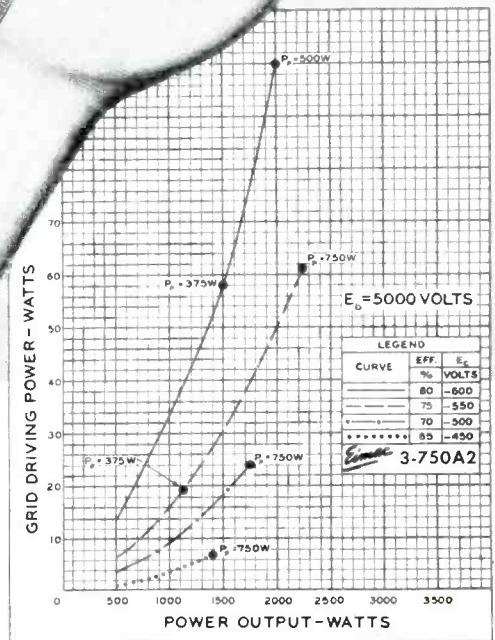
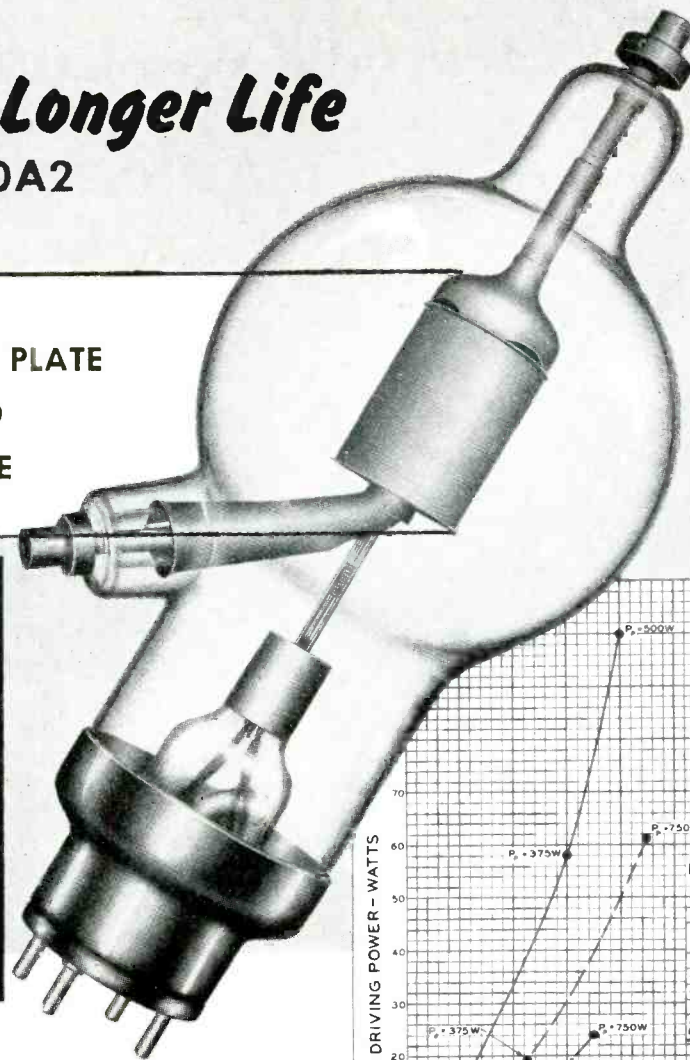

Typical of the outstanding performance of this new triode is its high power gain. With 5000 volts on the plate, the new Eimac 3-750A2 will deliver 2000 watts output with only 50 watts driving power, at a plate efficiency of 75%. (See above chart.)

ELECTRICAL CHARACTERISTICS

Filament: Thoriated tungsten	
Voltage	7.5 volts
Current	21.0 amperes
Amplification Factor (Average)	15
Direct Interelectrode Capacitances (Average)	
Grid-Plate	5.8 uuf
Grid-Filament	8.5 uuf
Plate-Filament	1.2 uuf
Transconductance ($I_b = 1.0$ amp., $E_b = 5000$, $e_c = -100$)	3500 umhos
Frequency for Maximum Ratings	40 mc

CALL IN AN EIMAC REPRESENTATIVE FOR INFORMATION

ROYAL J. HIGGINS (W9A10), 600 S. Michigan Ave., Room 818, Chicago 5, Illinois. Phone: Harrison 5948.
 VERNER O. JENSEN CO., 2612 Second Ave., Seattle 1, Washington. Phone: Elliott 6871.
 M. B. PATTERSON (W5CI), 1124 Irwin-Keasler Building, Dallas 1, Texas. Phone: Central 3764.

ADOLPH SCHWARTZ (W2CN), 220 Broadway, Room 2210, New York 7, New York. Phone: Courtland 7-0011.
 HERB BECKER (W6QD), 1406 S. Grand Ave., Los Angeles 15, California. Phone: Richmond 6191.
 TIM COAKLEY (W1KQP), 11 Beacon Street, Boston 8, Massachusetts. Phone: Capitol 0050.

"Preferred Type Contacts Save You Money"

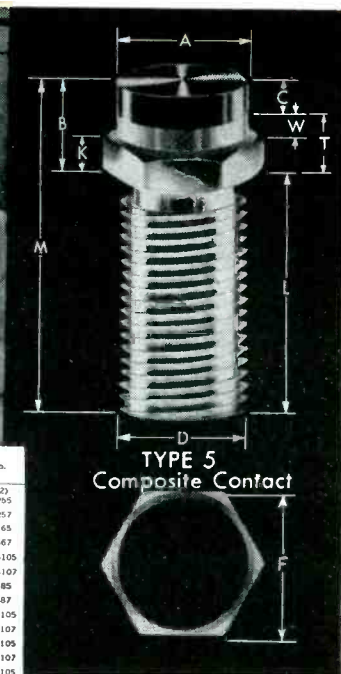
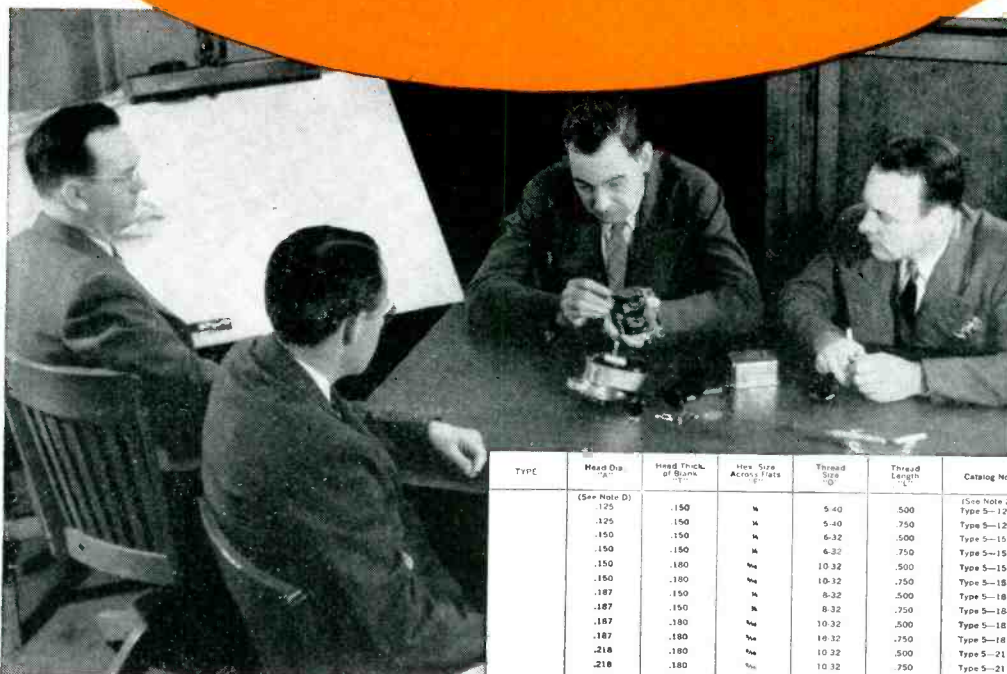

TYPE	Head Dia. "A"	Head Thick. of Blank "C"	Hex. Size Across Flats "F"	Thread Size "D"	Thread Length "L"	Catalog No.
	(See Note D)					(See Note E)
	.125	.150	1/8	5-40	.500	Type 5-1205
	.125	.150	1/8	5-40	.750	Type 5-1257
	.150	.150	1/8	6-32	.500	Type 5-1565
	.150	.150	1/8	6-32	.750	Type 5-1567
	.150	.180	1/8	10-32	.500	Type 5-15105
	.150	.180	1/8	10-32	.750	Type 5-18107
	.187	.150	1/8	8-32	.500	Type 5-1885
	.187	.150	1/8	8-32	.750	Type 5-1887
	.187	.180	1/8	10-32	.500	Type 5-18105
	.187	.180	1/8	10-32	.750	Type 5-18107
	.218	.180	1/8	10-32	.500	Type 5-21105
	.218	.180	1/8	10-32	.750	Type 5-21107
	.250	.180	1/8	10-32	.500	Type 5-25105
	.250	.180	1/8	10-32	.750	Type 5-25107
	.281	.180	1/8	10-32	.500	Type 5-28105
	.281	.180	1/8	10-32	.750	Type 5-28107

You can, of course, order *special* contacts if you need them for your new equipment. And you can depend on it that Mallory's experience in creating more than 5,000 special designs in the past twenty-five years will produce exactly what you want.

But why order "specials"? when the chances are nine out of ten that a Mallory Preferred Type Contact will do the job just as well — perhaps even better?

Mallory Preferred Contacts are eight basic types which

a quarter of a century has shown meet *most requirements*. They include the composite screw contact—Type 5—shown at the upper right, and available in a large variety of sizes. They can be ordered by catalog number . . . delivered without delay or the expense of special tooling.

So before you go too far with that post-war product, check the Mallory Contact Catalog first. A copy will be sent you without obligation. Engineers who write on company letterheads may also have a free copy of the Mallory Contact Data Book, *the new authoritative text* on contact fundamentals, designs, materials and applications.



MALLORY CONTACT CATALOG—Complete information about the Eight Basic Types of Preferred Contacts, including Range Charts as indicated above. Yours for the asking.

See "Mallory on Parade"
Booth 36
Chicago Radio Parts Show

P. R. MALLORY & CO., Inc.
MALLORY ELECTRICAL
CONTACTS & CONTACT ASSEMBLIES

P. R. MALLORY & CO., Inc. INDIANAPOLIS 6, INDIANA



CROSS TALK

► **TOUCHÉ** . . . The howl of anguish with which the broadcasters greeted the March 7 FCC 139-page report on the "Public Responsibility of Broadcast Licensees" indicates that blood has been drawn. If so, it is a blood letting in the interests of the broadcasters themselves and may relieve the pressure sufficiently to avoid more serious repercussions of the progressive degradation of the fine broadcast tradition.

From time to time this column has voiced one man's personal distaste for present-day trends in broadcasting. This opinion has gathered courage from the increasing number of dirty digs aimed at commercials by the cartoonists and by the criticism for the paucity of good programs and of the lack of originality on the air written by radio columnists whose very bread comes from broadcasting and whose only axe grinding is for better radio entertainment. The FCC report clinches the matter: the broadcasters must renew their earlier acquaintance with a sense of public responsibility. Otherwise a very nice golden goose may be seriously maimed if not completely knocked out.

The FCC report shows that station owners will promise practically anything and everything to get a license or a renewal; that having got their piece of paper they promptly say pfui to the commission and to the public by disregarding all their promises.

The report shows that the share of income devoted to technical or program expenses has gone down steadily; that the time devoted to sustaining programs, local talent, to public issues decreases right along. Paraphrasing one of the daily paper radio writers that Mr. So-and-So never allows a program to interfere with a plug, one might come to the conclusion that network affiliates will never permit a sustaining program

to go on the air if they can get a local advertiser to pay for a home-town commercial.

The report confirms the suspicion that soap operas, the form of "entertainment" that costs the station and advertiser least, get more and more of the daytime hours. In January 1940 92 percent of the weekly sponsored daytime programs were soap; in September 1945 NBC and CBS together devoted 9 hours a day Monday through Friday to soap thus completely upsetting good program balance. One either listens to drama (sic), tries to get something else, or (more than likely) turns off the radio and saves time, juice and tubes.

The report shows that the broadcasters' plea that the industry itself should set the rules of good service does not seem to work. The trade organizations have advisory functions only and no power to enforce good practices. Indeed, on reading the report one cannot help but believe that the members of the trade organization make suggestions for improving the service in the front office and then rush to the back room where they think up new devices for thumbing their noses at the public. Recordings by FCC indicate that "the NAB standards are honored as much in the breach as in the observance."

The FCC report shows a great deal more statistically and by station call letters. It is rather disgusting reading. Anyone who can take more of it without throwing up should spend some time with the thick volume recording the November-December 1943 hearings before the Senate Committee on Interstate Commerce on S. 814, a bill to amend the Communication Act of 1934. Here the station operators themselves say their pieces and quite a bit of it is not so hot.

PATENT

By COL. DONALD K. LIPPINCOTT

*U.S. Army Signal Corps
Washington, D. C.*

ABOUT THE AUTHOR

Colonel Lippincott was, before the war, a partner in the San Francisco firm of Lippincott & Metcalf, patent attorneys. During the war he successively held the positions of Patent and Inventions Counsel to the Signal Corps and, more recently, Chief of the Legal Division, a position just relinquished to return to civilian life

THE AFTERMATH OF WAR has presented the electronics industry with a first class puzzle all its own. It is a puzzle that must be solved if the industry is to prosper and advance in research, development and production. The puzzle: How shall the microwave patents be handled?

Wartime development resulted in the filing of some 6,000-odd applications for patent in the field of electronics. The inventions to which these applications are directed were largely classified, so that practically all of them were placed under patent office secrecy orders. As a result very few have issued, and no one knows who will control what. The normal adjustments that might have taken place gradually have been prevented. The individual inventor could not sell his rights, for he could not even talk about them. Companies with conflicting claims could not make compromises or cross-licensing agreements. Interferences between conflicting applications were not declared.

The government required speed in development, and encouraged companies which had never before done active development work to do so. Government employees made inventions under which they retain the commercial rights while the government holds a free license. Finally,

the government itself holds complete title to over 1,000 patent applications.

Situation Coming to Head

The issuance of these applications into patents will bring the problem to a head. Before the war a manufacturer of radio or other electronic equipment could reasonably insure himself against infringement suits by securing one or two general licenses, four at most if his manufacture covered practically the whole field. The prospect of dealing with ten or 20 corporate licensors, plus an indefinite number of individuals, is one that cannot be faced.

The solution might be simpler if the inventions were limited to radar, but they are not. Although many of them came from radar developments the same techniques are applicable to pulse communication, television, radio relay, f-m, and no one knows how many other branches of the art, old and new, and hence it is impossible for a few manufacturers of specialized equipment to get together and cross license. Everyone in the industry is involved.

Government Owned Patents Baffling

One possible solution would be for some one company to set out to corner the market in electronic patents. However, under our antitrust

laws it is probable that no company would dare attempt this. Nor could a number of companies make a concerted effort to divide the field, for that would be conspiracy. Moreover, neither of these solutions take into account the government-owned patents, which introduce a number of baffling problems of their own.

During the war the armed services acquired title to inventions, and filed applications for patent on them, for one primary purpose; to prevent others from patenting those inventions and demanding royalties thereon. If other inventors make improvements on government-owned inventions the patent defines their starting point, and prevents their claiming the basic invention instead of merely the improvement. Few have offered serious objections to the government taking out patents for this purely defensive purpose.

Two Schools of Thought

Two lines of thought, that government-owned patents pass automatically into the public domain, or, on the contrary, that they are an asset of the government, have ardent supporters. No court has passed on the question, and no act of Congress has clarified the issue.

Some 22 years ago the then attorney general rendered an opinion to the effect that the government could hold patents as any other proprietor could, and that the heads of executive departments could grant non-exclusive revocable licenses thereunder without express Congressional authority.

In the absence of statute law or

PUZZLE

Over 6,000 patent applications covering microwave apparatus were filed during the war. Few were issued, due to military classification, so removal of restrictions signals the beginning of a postwar game for high stakes. The industry, the government, and many individual engineers hold blue chips

judicial decision to the contrary, an opinion of the attorney general is binding on the executive departments. The opinion still stands and, no matter what legal theorists may think of that opinion, for the War and Navy Departments it represents the law and they must conduct themselves accordingly. But legislation now pending may reverse this, and dedicate government patents to the public, free for the use of everyone. For the present no one can forecast what the result may be.

Any solution of the patent puzzle must therefore take account of the thousand-odd patents which the government owns outright, and which its officers and agents are bound to administer for the best interests of the government, unless or until Congress says otherwise.

It is doubtful if anyone in either Army or Navy believes that the "best interests" in this case is a question of revenue. Both services consider the national security to be infinitely more important, and both believe that a healthy, aggressive electronics industry, free of all curbs on technical advance, is essential to such security.

One Suggested Solution

Though the government may be precluded for the moment from taking active steps toward solving the problems, industry is not. No matter what Congressional action may be, industry's problem will remain. Any satisfactory pooling plan must take account of all holders of patent rights. If a workable plan can be set up at all it should be possible

to set up a pool which could open to receive the government's patents and to give the government a voice in their administration. Directly or indirectly governmental influence is certain to have weight with a pool in any event, for it already holds a large number of free licenses under the patent applications of the potential corporate members, and, possibly more important, it can exercise a certain degree of control over the administration of its employees' rights.

Patent Pool Requirements

Any workable pooling plan for the electronics industry should meet some very severe conditions. Probably no two proponents would agree as to which of these conditions are absolutely prerequisite, which practically necessary, and which merely desirable. It is possible, however, to set down some on which there might be general agreement.

A workable pool must take full cognizance of and be compatible with the antitrust laws. Licenses under it must be available to all who need them. It must safeguard the interests of all, the great corporation no less than the hole-in-the-wall manufacturer, the "attic inventor" no less than the organized research laboratory.

A workable plan should preserve the incentive for research and invention. It should make effective research profitable, and its royalty rates must be high enough for this purpose but not high enough to put a burden on sales and reduce consumption by excessive prices. On the

other hand, it should not attempt to guarantee profits to all research, nor should it set a premium on securing mere numbers of patents.

A workable pool would have to be simple enough to be operable by a limited staff. That would mean acceptance, at the outset, of a system of rough justice, instead of exact accountancy in determining contribution to the art, distribution of royalty income by approximate formula rather than by exact extent of use. There is no doubt that such a system would result in some inequities, but those inequities would be minor compared to those met under present conditions. Any inequities should be in the formula and not its administration.

Other Solutions more Difficult

These do not exhaust the desiderata to be met, but they do include most of the major ones. To formulate such a structure will require the best efforts of the ablest brains in the industry, plus a concerted and wholehearted effort by all concerned to make it work. The requirements stated may seem idealistic, perhaps to some even Utopian. Yet they are not impossible of fulfillment, given the same degree of cooperative effort as was used by the industry in meeting its wartime problems.

If some such attempt is not made the alternative would seem to be chaos; delay in development and production, waste of money and energy in litigation, quite conceivably the breakdown of our entire patent system. If the task seems appalling, the other choices are worse.

Measurement of Ocean Waves Generated by Atomic Bombs

Bikini Atoll test plans include the use of radio-controlled switches, electronic echo-sounders, recording instruments of many kinds, and television. All of this equipment must operate despite blast, heat, and ionizing radiation

THE FORTHCOMING Bikini Atoll tests of the effects of the atomic bomb explosions on modern warships require a very large-scale program of instrumentation for the measurement of the many phenomena which will accompany the bursts. The difficulty of exactly calculating the effects of an atomic bomb explosion against ships at sea is such that only large-scale experiments can provide sufficiently useful information on what this country must do to protect its naval arm in the event of future atomic warfare.

Whether an atom bomb is exploded over barren land or over a complex system of islands and water, floating surface ships, and surfaced and submerged submarines, the measurement of the many effects of the burst is a difficult problem, particularly when using electronic equipment. The unique environment of great blast, heat, and ionizing radiation in which some of the instruments must operate poses problems not usually considered in electronic equipment design.

The instrumentation problems faced by the Technical Section of

By **NORMAN J. HOLTER**

*Senior Physicist
Joint Task Force 1, Oceanography Section
Navy Department
Washington, D. C.*

Joint Task Force One, the fleet created under the command of Vice Admiral Blandy for the determination of the vulnerability of modern navies to atom bomb attack, are being solved on a wide front and on a crash design basis, because of the limited time available before the tests. (Ed. Note: Scheduled to begin in July.) The experience of Army Manhattan District scientists in explosion measurements at New Mexico, Hiroshima, and Nagasaki has been combined with that of naval scientists with broad sea experience, to produce a cooperative and workable instrumentation plan under the overall technical direction of Dr. R. A. Sawyer, an outstanding Navy ordnance expert.

Of the effects to be measured, some are new, since atom bombs have never before been exploded at sea. One such effect is the production of surface water waves, particularly in the second test when a bomb will be exploded in the water. Fortunately,

the action of ocean waves and breakers was intensively studied during the war, so that instruments are already developed to the point where they can, with but little modification, be adapted to the study of waves produced by the explosions over and in the lagoon of Bikini Atoll. The instruments were first designed to measure the height, wavelength and other characteristics of wind waves in the open ocean, and to measure breakers on beaches. Data obtained enabled civilian laboratories, work-

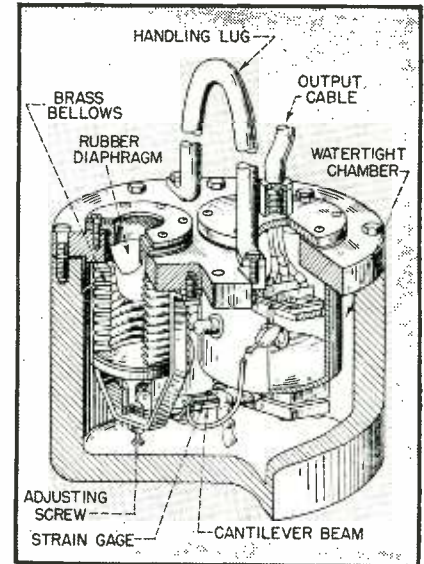

FIG. 2—Mechanical detail of strain-gage wave-recorder unit developed by the University of California. Water pressure acting via the diaphragm and bellows is recorded on shore through the three-wire cable. Wave heights are calculated from the resulting record of pressure on the sea bottom below the wave

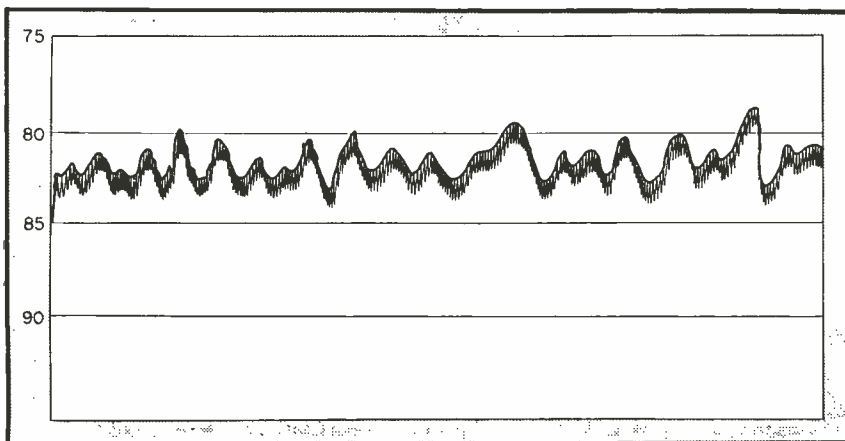

FIG. 1—Typical wave record from a recording echo-sounder installed on a ship at anchor in 82 feet of water. Waves are seen to be from 1 to 4 feet high

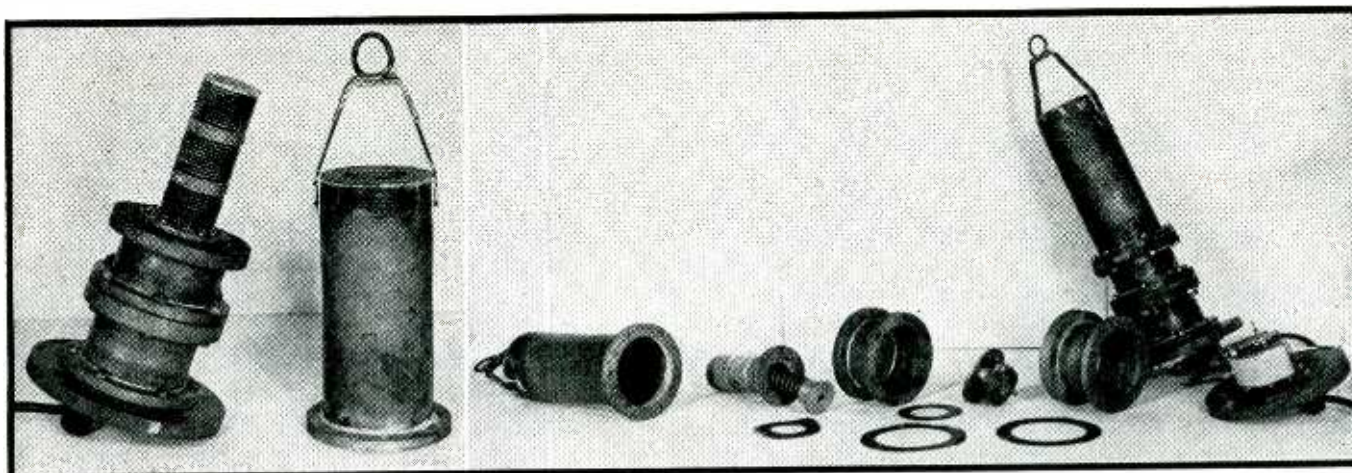

FIG. 3—Moving-coil type wave-pressure measuring unit developed by Woods Hole Oceanographic Institution, shown (left) with the cover removed, and disassembled, with the moving coil and magnet at the lower right

ing under contract to the Bureau of Ships and the Hydrographic Office of the Navy, to work out a method for predicting the height of surf on enemy-held beaches.

The program of the wave-measurements group is only a small part of the total instrumentation work of the Task Force, but will serve to illustrate the magnitude of the overall plans for comprehensive scientific documentation of the Bikini tests. Other groups will measure blast, heat, radioactivity, electromagnetic and many other effects.

The wave instruments planned for use in the tests are not all electronic but are included in this discussion for the sake of completeness. (Electronic niceties have, in fact, been intentionally sacrificed wherever possible in the interest of simplicity and ruggedness.) The waves at considerable distances from the burst are not expected to be unusually large and instruments which are used for measuring ordinary waves will be employed at such points. Near the explosion, where waves might vary from small values to a few hundred feet in height, the instruments will be capable of recording a greater range. No one type of instrument is being relied upon, because of many unpredictable factors. Approximately 100 separate instruments of about a dozen different types will be installed on the ocean bottom, on islands, on ships, and on airplanes, for the recording of the surface disturbances.

The following types of instruments are to be employed:

Portable recording echo-sounders, mounted on target ships

Standard ship-type recording echo-sounders, on target ships

Buoy-mounted recording echo-sounders

Bottom-mounted self-contained wave-pressure recorders

Bottom-mounted shore-connected wave-pressure recorders

Tower photography

Aerial photography

Recording television

Radio-link wave buoys

Maximum water-height recorders

Water-level recorders

Echo-sounder Wave Recorders

The echo-sounder is a familiar electronic instrument. Its principal component is an underwater transducer, usually a magnetostriction type, which is pulsed by a series of capacitor discharges. Each electric pulse to the underwater transducer provides a supersonic sound pulse which travels to the ocean bottom, is reflected, and returns to either the same or a separate receiving transducer. The echo signal picked up by the receiving transducer is amplified and recorded on a moving chart. The succession of pulses produces a record which is calibrated in terms of the time required for the sound pulse to travel to the bottom and return. The net result is a continuous record of the distance to the ocean floor. (180 feet in Bikini lagoon.)

On a moving ship such a record shows the hills and valleys in the bottom. On a stationary ship in quiet water, the record is essentially a straight line, indicating tidal range. But waves cause the ship to move up and down, so the varying distance

from the bottom is recorded and provides a record of wave height, as shown in Fig. 1. The wavelength of the water waves created by atom bombs is expected to be great enough so that a ship, which represents a body subject to an oscillatory force, will have essentially a 100 percent response to the applied periodic force of buoyancy. In other words, amplitude will equal wave amplitude.

Some echo-sounders are being mounted on special buoys because of the fact that some of the ships may have a tremendous roll and the sound beam may be tilted too much to give a satisfactory record. The buoys are designed for minimum roll, and are expected to rise nearly straight up and down under wave action.

Self-contained Wave-Pressure Recorders

Self-contained wave-pressure recorders are mechanical instruments which will be mounted on the bottom of the lagoon and spaced at various distances from the explosion point. Those closest to the explosion may be destroyed by blast pressure but most of them are expected to withstand the high underwater pressure from the explosion and immediately after the blast to record the low pressures produced by waves passing over the instruments. (The water pressure caused by an ocean wave decreases with distance below the wave, becoming negligible for most purposes at a depth equal to one half the length of the wave. Knowing the length of the waves, such pressure records can be corrected to provide wave heights.

These instruments consist of a shock-protected syphon bellows

which compresses with pressure and moves an arm which records on a clock-driven smoked chart. A heavy steel case houses the assembly and a mechanical frequency-filter protects the bellows from shock. Some of the instruments will have the clock started before the unit is lowered into position; others will contain a mechanism to start the clock when the underwater blast-wave arrives.

Shore-connected Wave-Pressure Recorders

Electrical types of wave-pressure units have obvious advantages over mechanical types for ordinary usage. They can be connected by cable, often several miles long, to recorders on shore where sea conditions can be observed continuously and without having to retrieve the unit. Recorders will be installed at Bikini in strategic locations some distance from the blast.

There are many types, embodying all of the usual means of translating motion into electrical current. Wave pressure can be used to compress a bellows whose motion can be transmitted to a coil in a magnetic field, to a simple variable potentiometer, to a strain gage, to a variable-reluctance element. The output may be presented in numerous ways; on a panel meter, ink-recording meter, or optical-photographic system. Two of the many possible types of pick-up units are illustrated in Figs. 2 and 3. Most such instruments incorporate a secondary pressure-chamber with a slow leak such that the pressure changes caused by slowly lowering to depth or by tides produce no net deflections of the sensitive element, whereas

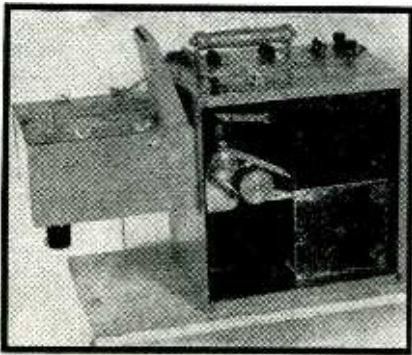

FIG. 4—Optical recorder for determining wave pressure, developed by Woods Hole Oceanographic Institution. The unit is self-contained and readily portable. It is used in connection with the moving-coil unit of Fig. 3

wave pressures cause a deflection since they have too high a frequency for the slow leak to have any effect. ELECTRONICS readers will note that high and low frequencies as applied to ocean waves are in an unfamiliar range, where one talks of a low frequency of 1/25th cycle per second and a high frequency of 1 cycle per second.

Figure 4 shows a recorder for use with a moving-coil pickup. The current from the sea unit is fed into a fluxmeter whose deflections are recorded photographically. Figure 5 shows the type of curves recorded.

Tower Photography

Towers on a number of islands in the Atoll will house cameras, both still and movie. Extremely rapid pictures will be taken by those groups studying bomb behavior and ship effects. For wave measurements, still pictures will be taken at approximately one-second intervals from each tower. All the cameras will be operated synchronously by radio pulses, and the results will enable stereoscopic calculations to be made for determination of wave characteristics.

Some of the cameras are to be quite distant, in order to help protect the film from radioactivity fogging, and will not provide much data unless the waves are quite high and the atmosphere is clear. Lead shielding will be used to protect the film in the interval during which it is unsafe for personnel to re-enter the atoll and retrieve the films. (If time was available, equipment would be built to automatically process the films before personnel could re-enter the area, thus decreasing the probability of radioactivity fogging of the film.)

Aerial Photography

Three planes, flying prescribed and timed courses, will take still photographs of the area. The cameras will be operated by the same radio pulses which operate the tower cameras mentioned above. Thus a wide variety of combinations of synchronous photographs will be available for stereoscopic examination.

Photoelectric cells with associated circuits will be paralleled with the radio circuits so that if the radio pulses which are scheduled to start just before the bomb explodes should

fail to operate, the brilliant flash of the explosion will trip all the cameras.

Recording Television

Waves are expected to arrive at the shore of some of the Bikini Atoll islands with sufficient height to produce breakers. Pressures could be recorded on the bottom below these breakers but would be of little value since the exact relation between breaker height and pressure below the breaker is not known. Breaker height can be readily measured by means of a sighting instrument developed during the wartime study of surf prediction but this requires the presence of an observer. As the en-

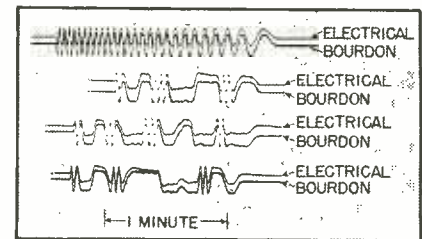

FIG. 5—Sample records of laboratory-generated waves, illustrating the ability of the electrical unit shown in Fig. 3 to reproduce complicated waveforms accurately by comparison with records obtained with a Bourdon gage and optical recording system

tire Atoll will be evacuated before the explosion this method cannot be used. Two towers will therefore be erected on one of the islands and used to house television cameras and video transmitters in the 200-mc band. These cameras will televise wave action at a range which is definitely unhealthy for humans but not so close but what the iconoscope will continue to function in the presence of ionizing radiation and the great actinic output of the bomb.

Television receivers are to be installed in two airplanes and their cathode-ray tube screens will be photographed by movie cameras. In addition, one receiver will be observed directly by a wave expert who will record his subjective qualitative impressions of what occurred. Selected press representatives and others will also view television receivers tuned to the tower transmitters.

Several buoys, such as the one shown in Fig. 6 and 7, will be planted in the lagoon at various points and will radio the desired data to a re-

ording unit in one of the photographic planes. These buoys will be anchored with a taut line so that they will not move up and down under wave action. The water level relative to the buoy will change as waves pass by. At the bottom of the buoy, a small echo-ranging transducer sends supersonic pulses upwards to the water surface. The travel time of these pulses is transmitted by a radio in the buoy and recorded. The record can be converted to wave heights.

This equipment, and television, have the advantage that data will be obtained very soon after the explosion without having to wait until it is safe to re-enter the lagoon.

Maximum Water-height Recorders

Simple maximum water-height recorders are expected to provide data with a minimum of design and manufacturing effort. Approximately ten sturdy pipes will be driven into the ocean bottom near the shore of one of the islands, as shown in Fig. 8. On each pipe will be mounted a series of electrical contactors which will be

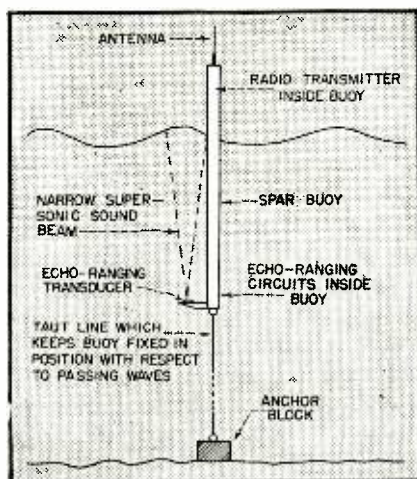

FIG. 6—Sketch illustrating principle of operation of a radio-equipped buoy which transmits wave data to a remote receiver-recorder. It was developed by the U. S. Navy Electronics Laboratory

shorted out by any sea water which rises to their level. Each shorted set of contactors will blow a fuse through a simple battery circuit contained in a compartment inside the pipe, and by counting the number of blown fuses after the explosion, the height of the water at that point will be known. In case the water goes over the top of the pipe, another pipe back of it and on higher ground will record the maximum water level.

Water-Level Recorders

As waves emanate outward from the explosion point they will decrease in height and increase in wavelength. At a safe distance from the burst, installations of simple laboratory-type float recorders will be made for obtaining data on these changes in the waves. Floats will ride up and down with the water and actuate an ink-writing pen mounted on a piling. The pen motion will be recorded on a clock-driven drum of chart paper to provide wave height and length data. Such data can be extrapolated back to points closer to the explosion for comparison with data obtained there by other instruments.

Instrument Timing and Programming

Nothing has been said so far about the procedure for actually putting each type of equipment into operation. All instrumentation groups face the difficulty of having some circuits or recording gear which cannot be started until just before the explosion. As all personnel must evacuate the area many hours before measurements actually start, clock or radio remote-switching methods must be used.

Several switches may have to be closed at different intervals for the same equipment. A large number of radio receivers with tuned relays in the output are being made available to the instrumentation groups by the Los Alamos Laboratory of the Manhattan District and a master transmitter will send coded signals at prearranged intervals before the explosion. Each receiver will close two circuits and any two of the standard signals can be chosen to suit the needs of the unit being turned on.

Other means available and satisfactory in certain cases for actuating electric circuits are the effects of the bomb itself, such as its light output or blast wave. The light will be utilized for turning on some of the wave cameras and the underwater blast will be used for starting the clocks of some of the wave-pressure recorders.

In all of the echo-sounder recorders, an accurate timing-signal is required in addition to starting and stopping signals. Timing signals are to be recorded at intervals of a few seconds on the wave-record chart to

enable accurate wave length and wave-speed data to be obtained. The fathometers will be turned on by a simple mechanical alarm-clock type of switch just long enough before the explosion to allow for circuit warm-up. Those equipments still functioning after the blast will be turned off by the same clock about 30 minutes after the last possible hour of the bomb drop.

All timing arrangements must take into account the fact that the bombing time may be postponed up to a few hours from the scheduled hour on D-day. The radio-controlled switches have a provision for recycling by a third signal, which opens all circuits, which are then ready to begin the program again. Also to be considered is the possibility of postponements of one day at a time in case of adverse weather for accurate bombing or winds adverse for carrying off the dangerous products of the explosion. These possibilities must be kept in mind in connection with power-supply requirements for various instruments. Power sources will include diesel generators of auxiliary ships, portable gasoline-driven generators, storage batteries, and dry cells. Some instruments will still be operative after delays of several days, whereas others will have to be revisited after the first evacuation to replace exhausted batteries or to replace generators. Not all types of equipment can be satisfactorily operated by remote switching and some

FIG. 7—Radio-buoy shown in Fig. 6 undergoing sea tests off San Diego. The receiver-recorder was in a plane several miles away

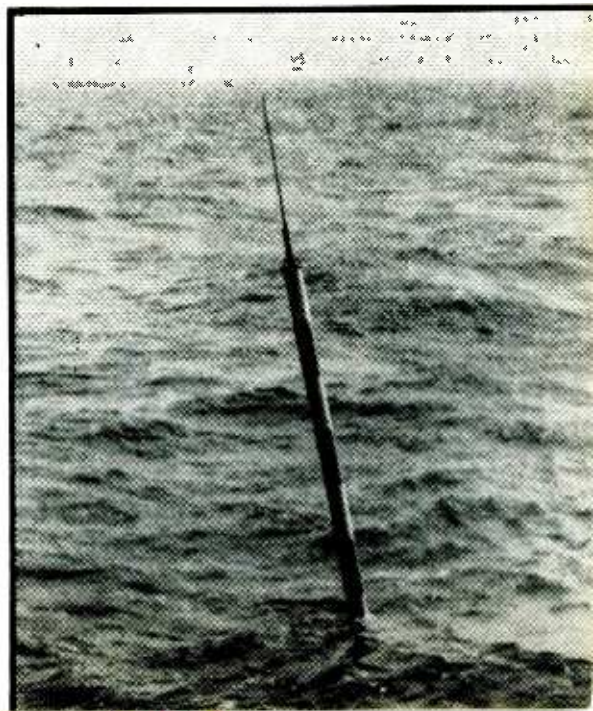

will have to be turned on and adjusted by the last to leave. It is these types of equipment (television, for example) which have a power-supply problem in case of bombing delays greater than a few hours.

Power Supplies

Present plans for powering the wave-measuring instruments are as follows: The portable-type echo-sounders will be powered by storage batteries both for the external ship mounts and the buoyed projectors; the standard ship echo-sounders will be powered by auxiliary ships supply. If the test is postponed by a day, ships will be boarded and the clocks reset for the following day. Batteries will not have to be replaced unless the test is delayed by two or more days.

The bottom-mounted pressure recorders contain clocks which will run for three days. Each clock will be started at the time the instruments are planted on D-1. If postponement is more than two days, each instrument will be retrieved and rewound. Some of the instruments will have the clock started by the underwater blast and will therefore require no servicing in case of delays.

The television transmitters will be turned on manually and adjusted through radioed instructions from the receiving planes. They will continue to televise the scene after evacuation and if still operative after the blast will continue to transmit until batteries are exhausted. Some provisions for trickle charging may be arranged for these transmitters but they will have to be readjusted in case of one or more days delay.

The tower and aerial wave photography will not be affected by delays.

For the shore-mounted maximum-water-height recorders, a special type of programming is necessary. If these instruments were operative over any more than the time required for the explosion waves to reach them, they would operate from wind waves or the tide. Since the waves may not be very high at these instruments, it would not be possible to distinguish wind waves or tide waves from waves caused by the atom bombs. This will be prevented by utilizing the standard 2-second radio signal to close a switch which will render the circuit operative. The circuit will be rendered inoperative about 30 min-

utes after the blast by the use of a separate mechanism. The 2-second signal will not be sent unless the bomb is to be dropped, so that no postponement problems arise.

The water-level recorders are clock driven and will be started by hand. If delay is more than two days the area will be entered to replace the chart paper.

The radio-repeating wave buoys will be started by hand and adjusted at a late hour before evacuating the region. The internal battery-supply will provide transmission over a period of several hours but not for a day. To facilitate battery replacement if it becomes necessary, an auxiliary float may be provided so that the entire buoy will not have to be raised.

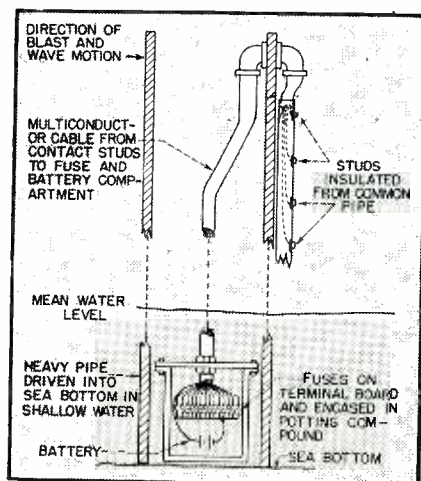

FIG. 8—Maximum water-height recorder which blows fuses corresponding to wave heights when water shorts the contacts. The blown fuses constitute a record which may be examined later, in the case of the Bikini Atoll atomic-bomb tests after danger of radioactivity subsides. A radio-controlled switch may be installed to place the recorder in operation when the tests are about to start

The cable-connected pressure recorders will be supplied with two radio signals, one to close the heater circuits and the later one to start a chart motor. These will be turned off by radio so that no delay in servicing will be necessary.

Advance Planning

A program such as the above would end in hopeless confusion if every step was not planned in advance and put into action on almost a military-discipline basis. A special staff of about 30 oceanographers, physicists, electronic engineers, and technicians

has been recruited from the U. S. Navy Electronics Laboratory, San Diego, the University of California Engineering Dept., Berkeley, Calif., and the Woods Hole Oceanographic Institute in Massachusetts, and is proceeding en masse to Bikini with all equipment. Officers in charge will be Comdr. Roger Revelle, Vice-Admiral Blandy's oceanographer. Lieut. Comdr. F. G. Morris, former destroyer skipper, has been made Project Officer. Technical coordination is by the author, Norman J. Holter. Among the others going to Bikini for wave work are Dean M. P. O'Brien, Head of the University of California Engineering Department, and Prof. Alexander Forbes, of the Harvard Medical School, a world authority on photogrammetry.

Several weeks are expected to provide time for installation of fixed equipment and planning for installation of gear which must be set up at the last minute. Personnel will be assigned to specific duties and the entire operation will be rehearsed, including the actual operation of instruments and taking of records. Starting about 48 hours in advance of the explosion, each man will know just where he should be, what he should be doing, how he is going to get there and back, etc., for each of his waking hours up to the time of the blast. Fifteen walkie-talkie SCR-300's will be available for coordinating the carefully timed movements of personnel and boats during this interval. Courses will have been laid out in advance and marked with buoys to indicate where each bottom recorder is to go on D-1.

The first atomic bomb exploding 300 to 600 feet in the air may not provide as much wave information as the second burst on the water surface. It will nevertheless be very valuable even if wave production is smaller than expected because it will be a real dress rehearsal for the second shot.

A special electronics repair ship is being outfitted to house the personnel and provide laboratory and repair facilities. As soon as it is found to be safe to reenter the lagoon, records will be retrieved, processed and studied to provide data on what modifications of programming or instrumentation are desirable for the water burst.

Engineering Approach to Wave Guides

Practical considerations in the choice and fabrication of wave guides are considered from the engineering viewpoint. The advantages of hollow, rectangular guides are described by comparison with coaxial cable characteristics at super high frequencies

By **THEODORE MORENO**

*Sperry Gyroscope Co., Inc.
Research Laboratories
Garden City, N. Y.*

UNTIL A FEW YEARS AGO, wave guides were a type of transmission line having considerable theoretical interest but little practical utility. The basic physical principles governing their operation were developed and published before the war,^{1, 2, 3, 4} but widespread use during the last few years has reduced their seemingly complex behavior to a set of engineering principles, sufficient for most microwave transmissions.

Choice of Conductor

When a transmission line is to be chosen for microwave frequencies, the choice must usually be made between rectangular wave guide and coaxial line. The coaxial line may be either rigid line or flexible cable, but both are operated with the principal mode (*TEM*) carrying energy, along with the first of the higher order modes ($TE_{1,1}$) that will be able to carry energy as the wavelength is reduced. The cutoff wavelength of this higher mode is given to a good approximation by $\lambda_c = 2\pi\sqrt{\epsilon}(b + a)/2$, where a is the outside diameter of the inner conductor and b the inside diameter of the outer conductor. A coaxial line is normally operated below cutoff for this higher mode. For a given operating frequency, a maximum limit is therefore set on the transverse dimensions of the line.

A practical wave guide is usually rectangular in cross section and is operated with the first of the higher order modes carrying energy. This is the $TE_{1,0}$ mode, also known as the dominant mode in rectangular wave

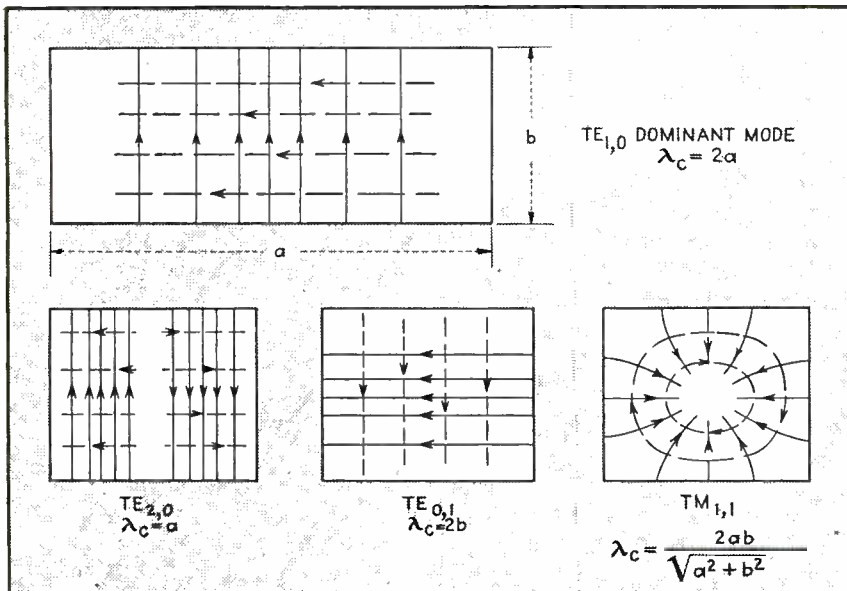

FIG. 1—The distribution of the transverse electric (solid) and transverse magnetic (dashed) waves in wave guides of various rectangular cross sections. The geometry of the guide is usually such that only the dominant mode ($TE_{1,0}$) is above cutoff. A few of the higher modes are shown

TABLE I—Comparison of Transmission Lines for 5,000 mc

Type of line	Rectangular wave guide	Rigid Coaxial line	Flexible cable
Army-Navy type no.	RG-49/U	RG-76/U	RG-9/U
outside dimensions	2 x 1 in.	5/8 in. diam	0.420 in. diam
conductor material	brass	brass	inner conductor 7/21 AWG silvered copper outer conductor double braid, inner silvered copper, outer copper
surface finish	silver	silver	silver
dielectric	air	air	polyethylene
weight lb per ft	1.40	0.292	0.150
attenuation db per ft	0.011	0.035	0.23
recommended power rating.	1.2 megawatts	0.3 megawatts	4,000 volts rms max 66 watts continuous

guide. It is illustrated in Fig. 1, along with some of the possible higher modes. To carry energy in the dominant mode, a rectangular wave guide must exceed certain minimum dimensions, but to avoid the higher modes, must not exceed certain maximum dimensions.

Circular wave guides are usually avoided because there is a very narrow frequency range over which any given size of guide is above cutoff for the dominant ($TE_{1,1}$) mode but will not carry energy in any of the other higher modes. Furthermore, any ellipticity or obstacle in the wave guide is likely to elliptically polarize the traveling wave, making it difficult to handle at the output.

Sometimes the $TM_{0,1}$ mode in circular wave guides is used because it combines circular symmetry with high power-carrying capacity, but care must be taken to avoid the lower modes, especially when the guide is long and resonances are likely to be encountered. Other odd shapes of wave guide offer possibilities of smaller size or greater bandwidth, but to the present time rectangular guides have been most widely used, and the subsequent discussion will be confined to guides of this type.

Low Attenuation In Guides

One of the principal advantages offered by rectangular wave guides

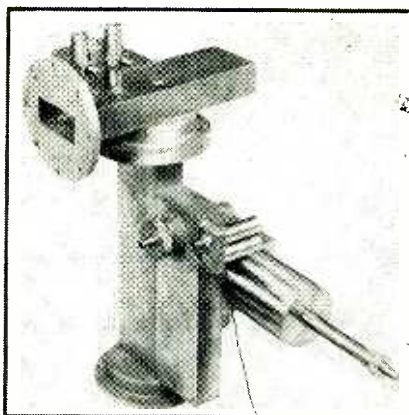

This wave-guide structure comprises a directional coupler, barretter mount, cavity wavemeter, magic tee, crystal mount, and tuning screws for impedance matching

is their low attenuation. The losses in a rigid, air-dielectric coaxial line will usually be at least half again as great as the losses in a wave guide, and the losses in standard coaxial lines are usually about three times as great as in standard wave guides operating at the same frequency. A flexible cable with polyethylene dielectric has even greater losses, usually about twenty times the loss in a wave guide.

High-Power Capacity

An additional advantage offered by wave guides is their high power-carrying capacity. The power-carrying capacity of a wave guide will be

from three to ten times as great as in a standard coaxial line, if the limit is set by the dielectric strength of the insulator. A large flexible cable will be able to handle peak powers that are comparable to those handled by an air-dielectric coaxial line, but the average power is greatly limited by the heating of the inner conductor, and will be several thousand times less than the capacity of a wave guide.

A still further advantage of wave guides is their mechanical simplicity. This arises chiefly from the fact that with a coaxial line it is necessary to support the center conductor. This can be a severe mechanical problem if the support must at the same time have good mechanical strength and not interfere with the electrical properties of the line.

The advantages that are offered by a wave guide may be offset by its size. For a given operating frequency, there is a minimum limit set on the dimensions of a wave guide, while no such restriction applies to coaxial lines. At frequencies much lower than 3,000 mc, the size and weight of wave guides become prohibitively large for all but certain limited applications. At higher frequencies wave guides lose their awkwardness, and above 10,000 mc, their size becomes an advantage. Methods of fabrication approaching

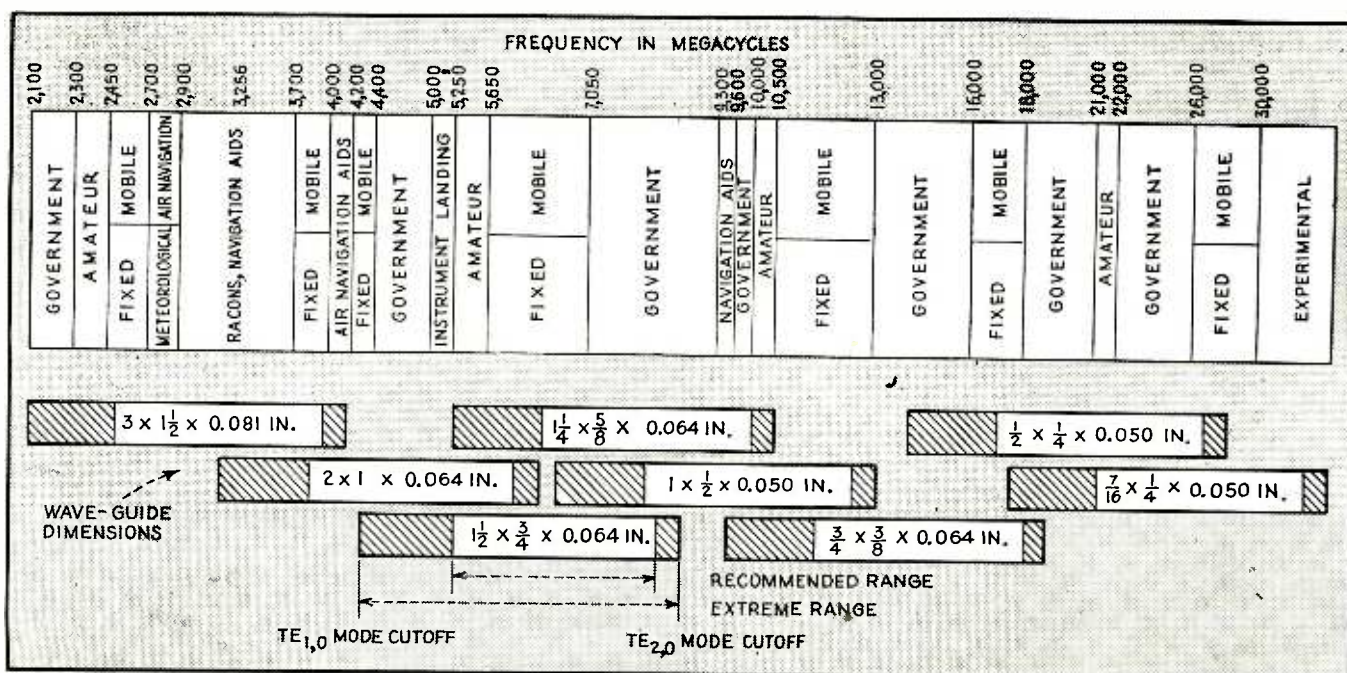

FIG. 2—Federal Communications Commission allocations in the microwave region and standard wave guides suitable for use at various frequencies. Dimensions on the wave guides indicate outside cross section and wall thickness

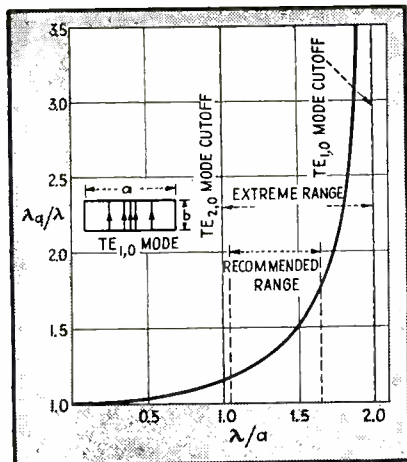

FIG. 3—Wavelength characteristics of a rectangular wave guide operating in the dominant mode. The ratio of wavelength in the guide to wavelength in space (ordinate) is plotted against the ratio of wavelength to the wider dimension (abscissa)

jewelers' techniques are needed for coaxial line structures operating under similar conditions.

Disadvantage of Limited Bandwidth

Another great disadvantage of wave guides is their restricted bandwidth. A given wave guide is limited by theoretical considerations to a 2:1 frequency range, if both cutoff and higher modes are to be avoided. The practical necessity of avoiding the high attenuation region near cutoff still further lowers this figure, and in practice it is necessary to limit a wave guide of fixed dimensions to about a 1.5:1 frequency range. A coaxial line, on the other hand, can be operated, in theory at least, at any frequency for which the higher modes are below cutoff. But this range is usually restricted because supports must be provided for the center conductor. A flexible cable, in which the center conductor is continuously supported by the flexible dielectric, does not encounter the same limitation, but when air dielectric is used, dielectric beads or stub lines must be used for support. A broad-band stub support is usually not operable over much greater than a 1.5:1 frequency band, and paired or multiple bead supports are even less satisfactory at microwave frequencies. Undercut dielectric beads have been designed which are satisfactory at all frequencies below several thousand megacycles, but they offer mechanical difficulties in long lines.

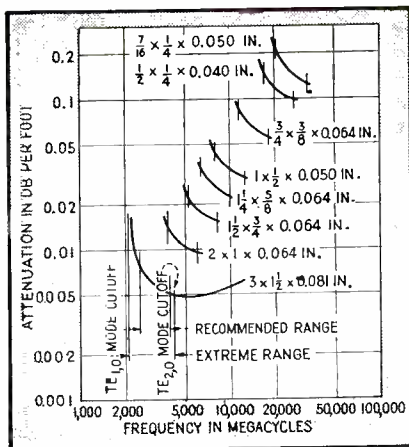

FIG. 4—Theoretical attenuation of copper wave guides over their operating frequency range for the dominant mode. Dimensions are outside measurements and wall thickness. Curves show the extreme ranges possible with each type of guide

Cables, by their flexibility, have advantages over wave guides, but to offset this, a variety of designs of wave guide have been developed which are usually flexible enough for most practical applications, and have attenuation that is not greatly in excess of the rigid guides.

For purposes of comparison, the properties of a typical rectangular wave guide, rigid coaxial line, and flexible coaxial line at a frequency

of 5,000 mc (6 cm wavelength) are summarized in Table I.

When a rectangular wave guide is chosen for a particular frequency or band of frequencies, the larger inside dimension of the guide must be greater than a half free-space wavelength for the lowest frequency signal to be passed, if the dominant mode of transmission ($TE_{1,0}$) is to be above cutoff. But that dimension must not exceed a full wavelength or one of the higher modes ($TE_{2,0}$) will also be above cutoff.

Dimensions vs Application

The smaller of the inside dimensions of the guide should be kept below a half wavelength or another mode of transmission ($TE_{0,1}$) will be above cutoff. There is no minimum limit on this dimension of the guide, for the cutoff wavelength of the $TE_{1,0}$ mode is independent of the smaller dimension of the guide. It is desirable, however, to make this dimension very nearly a half wavelength, as the attenuation will then be kept at a minimum and the power-carrying capacity maximized. Attenuation will be an inverse function of the height of the guide, and power-carrying capacity a direct function.

The wall thickness of the guide is

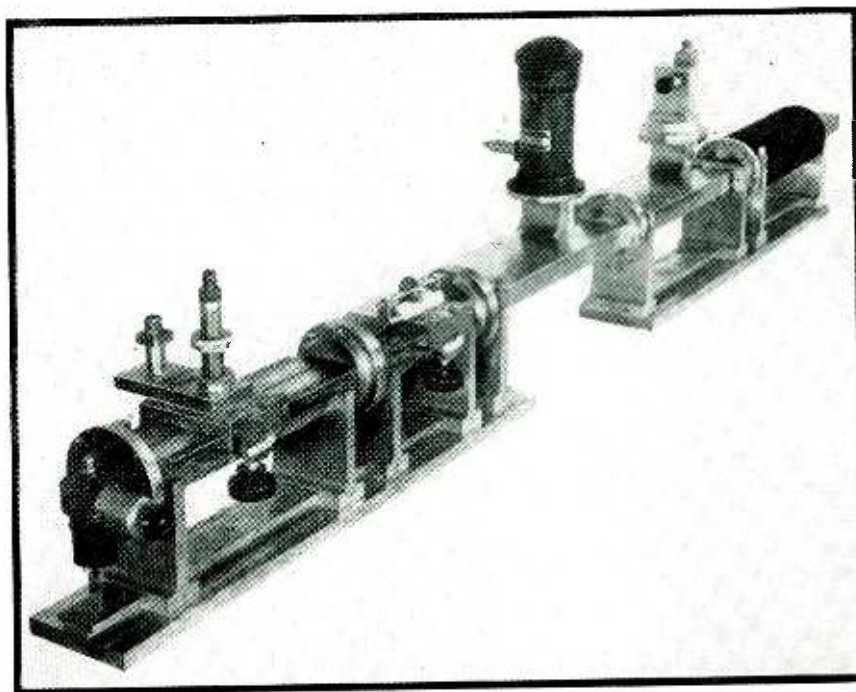

An assembly of wave-guide measuring instruments used to determine the effect of load impedance upon oscillator power and frequency. From left to right are: a reflex klystron, impedance meter, impedance transformer, directional coupler (with a cavity wavemeter this measures frequency) barretter mount for power measurement, and high-power matched load. All the rectangular guide shown is 2×1 inch.

determined solely by considerations of strength, weight, and ease of fabrication. Wall thicknesses in common use vary from 0.040 in. for the smallest guides to 0.081 in. for the largest.

Standard Sizes In Use

A number of sizes of wave guide have been picked as standard guides by the Army-Navy R-f Cable Coordinating Committee. The frequency ranges over which these guides can be used are shown in Fig. 2, along with the more recent allocations of the microwave spectrum by the Federal Communications Commission. Although the standard guide sizes overlap and cover the spectrum continuously, bands which have been allocated are not completely covered by any one size of guide. This is unfortunate in that more sizes of wave guide will have to be brought into widespread use.

Wave Guide Materials

The material most commonly used for wave guides is cold-drawn rectangular brass tubing. Different alloys have been used, but a red brass alloy of about 90 percent copper and 10 percent zinc is usually preferred for reasons of strength and corrosion resistance. Brass has been found suitable, for its mechanical strength is combined with good machineability and ease of fabrication, and its electrical properties, though generally satisfactory, can be readily improved by electroplating. The tubing is not free of stresses, and unless annealed may warp seriously when slotted.

Rectangular brass tubing is available in a wide variety of sizes and dimensions from a number of manufacturers. But most of this tubing has heretofore been used primarily for decorative purposes, and is held to no tolerances. The dimensions are likely to vary widely from sample to sample, and the tubing will be unsatisfactory for any applications that are at all critical. Most of the standard wave guides listed in Fig. 2 are generally available at manufacturing tolerances that are sufficiently close for most microwave applications. These close-tolerance guides are generally called radar tubing because they were first developed for radar applications. They are available for only slightly greater cost, and should

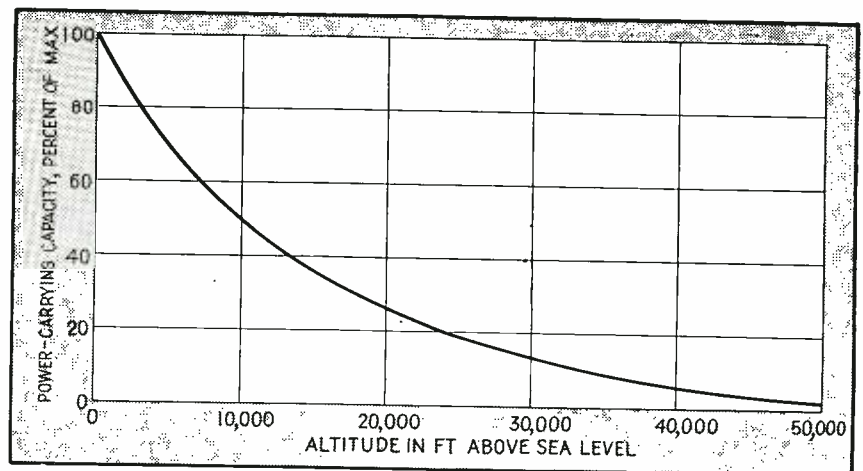

FIG. 5—Percentage decrease in the power-carrying capacity of a wave guide with increasing altitude (decreasing pressure)

be used for microwave work whenever possible. The tolerances vary with the particular dimensions and with the guide sizes, but the dimensions are generally held to within 0.005 in. or less.

Aluminum tubing has been rather widely used because its weight is less than a third that of the corresponding brass tubing. But this lightness is gained at a sacrifice in ease of fabrication. Methods of assembly such as dip brazing which assure a strong mechanical bond are carried out at such high temperatures that the wave guides will usually warp. Various methods of joining pieces at lower temperatures are also used. For example, an anodized aluminum guide may be copper plated and soft soldered. But these low-temperature techniques are in general more difficult and less satisfactory than the corresponding techniques for brass guide.

Solid silver guide has been used at very high frequencies for applications where low attenuation is important, but its cost is generally prohibitive. Other types of construction have been proposed, such as plated plastic tubing, but these have not been extensively used or tested.

Metal Finishes

The electrical properties of a brass or aluminum wave guide may be considerably improved by the type of finish applied which may also greatly improve the corrosion resistance of the guide. The skin depth in most metals is so small at microwave frequencies that if one metal is plated on another to a depth of less than a thousandth of an inch, essen-

tially all of the conduction current in the metal will flow in the plated surface. The guide losses will then depend upon the plated surface metal rather than the base metal. For this reason a silver plate is often used, because silver's exceptionally high conductivity is coupled with good resistance to corrosion. But both the electrical and mechanical properties depend to a considerable extent upon the type and quality of the silver plate, and the type of plate that gives the best electrical characteristics is not necessarily the most satisfactory from the standpoint of appearance and resistance to corrosion.

Plating Techniques

It has been found that the resistance to corrosion of a silver-plated surface is greatly improved and the electrical properties essentially unchanged if the silver is in turn coated with a flash plate of palladium or rhodium. These rare metals have poorer conductivity than silver, but when they are applied in an exceedingly thin plate, much less than the skin depth, essentially all of the conduction current flows in the silver underneath, and the losses are correspondingly low. The thin flash plate greatly improves the ability of the wave guide to withstand salt spray without corroding.

A gold plate has also been extensively used. Although gold has somewhat poorer conductivity than silver, the losses in gold surfaces are very little different from the losses in silver-plated surfaces, and the corrosion resistance of gold is very good, but its cost is relatively high.

TABLE II—Weights of Standard Brass Wave Guides

Outside dimensions × wall thickness in inches	Weight in pounds per foot
3 × 1 1/2 × 0.081.....	2.63
2 × 1 × 0.061.....	1.40
1 1/2 × 3/4 × 0.061.....	1.03
1 1/4 × 5/8 × 0.061.....	0.818
1 × 1/2 × 0.050.....	0.531
3/4 × 3/8 × 0.061.....	0.468
1/2 × 1/4 × 0.010.....	0.198
7/16 × 1/4 × 0.050.....	0.217

In general, the effective resistivity of a plated surface is somewhat higher than the low frequency resistivity of the metal, and the losses will therefore be somewhat greater than predicted by theory. This effective resistivity will vary greatly with the plating solution and rate of deposition, as well as with the type of base metal and its surface finish. The losses are also affected by ageing, tarnishing, and corrosion, and for these reasons, exceptions may be drawn to almost any general statement about losses in plated surfaces. But the following remarks are usually applicable.

Losses in Plated Surfaces

The difference between theoretical and measured losses will usually increase with increasing frequency. But at even the highest frequencies, the losses in a plated surface of high quality will usually be less than half again as great as predicted by theory, and will seldom exceed twice the theoretical value. If the plating is of poor quality or has corroded, the losses may be much greater. To get minimum losses in a plated surface, the thickness of plating should be many times the skin depth. For example, at 9,000 mc, 0.5 mils minimum thickness of silver plate is recommended—this is more than one hundred times the theoretical skin depth.

If the surface of a wave guide is coated with a thin, protective layer of insulating material, the conduction current in the surface will flow in the metal under this protective layer, and the attenuation will not be greatly affected. For example, if aluminum wave guide is anodized,

TABLE III—Relative Attenuation in Metals at High Frequencies

Metal	Attenuation relative to copper
Aluminum.....	1.28
Brass.....	2
Cadmium.....	2.09
Chromium.....	1.23
Gold.....	1.19
Lead.....	3.57
Magnesium.....	1.63
Manganin.....	5.05
Palladium.....	2.52
Phosphor-bronze.....	2.17
Platinum.....	2.11
Rhodium.....	1.71
Silver.....	0.97
Tin.....	2.58
Zinc.....	1.89

the losses will not be greatly changed, and may even be less than in the unanodized guide which has a very thin layer of nonconducting aluminum oxide on the surface. And the inner surface of any wave guide, brass or aluminum, can be coated with a protecting lacquer which will not affect the attenuation but will greatly improve the corrosion resistance.

The weights of the various standard wave guides of Fig. 2 are listed in Table II. The weights given are for brass guide, aluminum will weigh about 31 percent as much as brass.

Velocities in Wave Guides

Because a wave guide does not operate in the principal (*TEM*) mode of transmission, the wavelength in the guide λ_g will in general be greater than the wavelength in free space λ . The wavelength for any mode in any air-dielectric wave guide is given by $\lambda_g = \lambda / \sqrt{1 - (\lambda/\lambda_c)^2}$. For rectangular guide the cutoff wavelength of the dominant mode is $\lambda_c = 2a$, when a is the larger inside dimension. For this mode, the ratio λ_g/λ is plotted as a function of the ratio λ/a in Fig. 3.

The fact that the wavelength in the wave guide is greater than the wavelength in air may lead to the erroneous conclusion that the electromagnetic energy travels through the wave guide at a rate exceeding the speed of light. Actually, the phase velocity v_p is greater than the speed of light c by the factor λ_g/λ , but the energy travels through the guide at the group velocity, v_g , given by $v_g = c^2/v_p$.

The attenuation of the various standard wave guides of Fig. 2 is plotted as a function of frequency in Fig. 4. It is interesting to note that although the losses are greater in the higher frequency wave guides, the losses in any particular wave guide will actually decrease with increasing frequency over the normal frequency range. The values given in Fig. 4 are all theoretical values for copper wave guide, and represent minimum limits that are approached to a greater or lesser extent by actual guides. If the wave guide is constructed of, or plated with some metal other than copper, the losses in the guide will increase as the square root of the ratio of the resistivity of the metal to that of copper. The relative attenuation of the various metals compared to that of copper is given in Table III.

Power Limitations

The theoretical power-carrying capacity of a rectangular wave guide is $P = 3.85 ab(\lambda/\lambda_g)^{10}$ watts when the dimensions of the guide, a and b , are in inches. This equation assumes a breakdown potential of 30,000 volts per cm for the air dielectric, a value that has been experimentally checked, and also assumes that there are no standing waves in the wave guide. If there are standing waves present, the power-carrying capacity of the guide will be reduced by a factor representing the voltage standing wave ratio in the wave guide. The recommended maximum power to be carried in a wave guide is about one-fourth the theoretical maximum.

Breakdown at High Altitude

The breakdown potential in air will be lowered if the air pressure is decreased, and if a wave guide is operated at high altitude without pressurization, its power-carrying capacity will be greatly reduced. The reduction factor is given as a function of altitude in Fig. 5.

REFERENCES

- (1) Barrow, W. L., Transmission of Electromagnetic Waves in Hollow Tubes of Metal, *Proc. I.R.E.*, Oct. 1936, p. 1298.
- (2) Southworth, G. C., Hyper-frequency Wave Guides—General Considerations and Experimental Results, *B.S.T.J.*, April 1936, p. 284.
- (3) Carson, J. R., Mead, S. P., and Schelkunoff, S. A., Hyper-Frequency Wave Guides—Mathematical Theory, *B.S.T.J.*, April 1936, p. 310.
- (4) Chu, L. J., and Barrow, W. L., Electromagnetic Waves in Hollow Metal Tubes of Rectangular Cross-Section, *Proc. I.R.E.*, Dec. 1938, p. 1520.

Where COLOR

A point-by-point comparison of the color and black-and-white systems, equipments, and standards. Suggestions for needed research, intended to clarify the technical factors behind an important controversy

By DONALD G. FINK

Executive Editor

THE DEMONSTRATIONS of color television by the Columbia Broadcasting System reported recently in these columns¹ have brought into sharp focus a controversy regarding the future plans of television, a controversy which cannot be ignored.

Reduced to simple terms, the argument is this: Spokesmen for CBS state that in their opinion the present system of black-and-white television, exemplified by the standards of the Federal Communications Commission, is not adequate for public use. CBS argues that if color were added to the picture, its other aspects remaining substantially the same, the capabilities of the system would be so enhanced that public acceptance would be assured. The CBS demonstrations were intended to show that it is feasible to add color to the pictures, in the present state of the art, without undue additional expense to the public. Certain features of the system, particularly the direct pickup of high-fidelity color images from live subjects in the studio, have not yet been demonstrated, and other aspects of system performance, such as propagation of 500 to 1000-mc signals, have not yet been thoroughly explored. CBS argues that the remaining work can be accomplished in a few months. They ask the rest of the industry to assist in the program and urge that no further public participation in black-and-white telecasts be encouraged pending full availability of the color system.

The opposed point of view, held by a majority in the television industry, is this: Color added to the present picture will promote public acceptance to a very great degree, *other factors being equal*. But other factors are not equal at present and cannot be made so for a period of years, the range of opinion covering from two years to ten years. In some such period, it is agreed, present objections to the introduction of color may be removed by technical advances and field testing. In the meantime, it is held that black-and-white television should not be withheld from the public. It is stated that the present black-and-white picture has quality intermediate between 8-mm and 16-mm home movies and that this quality has already found favor in the home. The monochrome system has been thoroughly field tested. Finally, the black-and-white system proponents state that if television does not receive public support under the favorable economic conditions of the present its future progress, including the ultimate introduction of color, may be seriously retarded.

Time—The Important Dimension

The difference of opinion is one of time. Nearly all observers agree that if an adequately tested and economical system of color television could be offered to the public before the end of 1946 the black-and-white system should be abandoned. If the arrival of such a color system is going to be delayed for several years

the majority argues that best interest of the public and the industry will be served by proceeding with the present system.

But if the decision is taken to proceed with black-and-white and the color system becomes available as soon as its proponents predict, a considerable investment on the part of the public and the broadcasters may be jeopardized by obsolescence. Faced by the knotty question of how to proceed, the managements of the industry and the FCC must turn, first, to the engineer for technical opinion on the relative positions of the two systems. This technical information must be supplemented by consideration of economic factors and industry relationships of a non-technical nature.

System Similarities

Several items are readily disposed of as being essentially the same in the two systems.

The method of picture synchronization is the same (except for the omission of preparatory pulses in the color system, a minor difference); both systems can be expected to offer substantially the same synchronization performance for a given signal-to-noise ratio. The polarity of transmission is negative in both systems (upward modulation produces decreasing picture brightness), and the modulation percentages (25 per cent for sync, 75 per cent for picture information) are identical. The aspect ratio (four units wide by three units high) is the same, and

TELEVISION Standards

the polarization of the transmitted wave is horizontal in both cases. Finally, and perhaps most significant, the number of lines in the picture is the same, 525. This does not mean that the vertical resolutions of the two systems, as viewed by a subjective observer, are the same, because the presence of color offers an apparent (subjective) improvement in resolution.

System Differences

The most important difference in the systems as a whole is the element of color itself. The realism of reproduction is greatly enhanced and the subjective detail of the image is improved by adding color, all other aspects of the image remaining the same. The extent of the improvement must be evaluated by appeal to the viewer, on a statistical basis. The indicated avenue of research is a disinterested examination of what viewers prefer, comparing the presence of color with other qualities of the image such as contrast, flicker and definition.

The objective detail of the color image is the same as that of the black-and-white in the vertical dimension (since both are 525-line images) and somewhat superior in the horizontal dimension, assuming full use of the system bandwidth in both cases and terminal equipment capable of utilizing the bandwidth. The ratio of improvement in horizontal resolution is about 10-to-8 in favor of the color image. The subjective detail in both dimensions is enhanced by the color aspect, but the degree of improvement has not yet been definitely established.

The flicker of the two systems is difficult to compare because of the several repetition rates (120 fields per second, 60 frames per second, 40 color frames per second, and 20 color cycles per second) inherent in the CBS color system. The flicker in-

creases to a great degree as the brightness of the image increases. Other factors being equal, as we shall see later, the overall brightness of the color image is about one seventh that of the corresponding black-and-white image, due to light absorption in the optical filter segments. Thus if the same picture tube and accelerating voltage are used, flicker will be less evident in the color picture. But if the same peak brightness is demanded in the two pictures, solid colored areas in the color picture may display more flicker. Thus this question, which is one of the critical technical questions, cannot be settled until it is decided how bright the color picture must be to give satisfaction equal to that of a black-and-white picture when both are viewed in ambient illumination typical of home use. This is another avenue which should be explored on a quantitative basis.

Another system difference is the matter of interlacing. The two systems use the same method of interlace, two sets of interlaced lines. The difference is in the field repetition rate. This is 60 per second in the black-and-white system, versus 120 per second for color. The latter figure is not synchronous with the 60-cps power supply assumed as standard for domestic receivers. In fact, it has been found necessary to install 120-cps generators as the basic primary power source for the sync generator in the color television studio to assure rigid interlace. To avoid pairing of the interlace in home receivers, care must be taken to provide adequate filtering against hum in certain critical circuits.

A basic difference in the two systems is the bandwidth employed and its effect on the signal-to-noise ratio. The bandwidth is 4 mc, approximately, in the black-and-white system as against 10 mc in the color system. This implies a noise-to-

power ratio of 2.5-to-1, to the detriment of the color system, if only thermal and shot-effect noise sources are considered. Manmade interference of the impulse (ignition) type is also enhanced, provided that this type of noise is present in the same degree in the two systems. Actually, ignition noise is far less prominent in the uhf band (color) than in the vhf (black-and-white) band. Thus it may appear that in quiet, remote locations, where thermal noise determines the limit, the signal-to-noise ratio of the color picture, for a given received-signal amplitude, may be about 4 db worse than in the corresponding black-and-white picture. But the subjective effect of noise on the satisfaction derived from a color picture has not yet been established, so no definite conclusions can be drawn. Here, again, is an avenue of research worth pursuing.

The method of transmitting sound is another point of difference in the two systems. F-M on a separate carrier is used in the black-and-white system. Frequency-modulated pulses or bursts, sent during the blanking interval and imposed on the picture carrier, transmit the sound in the CBS color system. Here the differences are relative fidelity of reproduction, the relative effect of reflected signals, and the cost of equipment. The separate carrier used in the monochrome system can be modulated readily up to the limit of audibility; 15 kc is the FCC requirement. The f-m burst system can reproduce high-quality sound up to a frequency less than half the pulse repetition rate. Practical considerations (removal of images) limit the upper frequency value to about one third. Thus in the CBS color system, using 30,150 f-m bursts per second (equal to the number of blank vertical retraces in the picture), the upper limit of fidelity is about 10 kc. Whether this is suffi-

cient for high-quality sound reproduction is one of those moot questions. Certainly the separate carrier system has the potential advantage of a wider band, and the more faithful reproduction may be appreciated by many listeners. The effect of wave interference on sound transmission is another matter requiring study. Selective distribution has been observed on conventional f-m sound transmission when the direct and reflected waves are of comparable magnitude and when the path difference between them produces beats corresponding to the audio modulation. Similar effects are to be expected in the f-m burst system and their presence may be more serious because the intelligence is transmitted in a discontinuous fashion.

Studio Equipment

Studio equipment is, of course, more complicated in the color system than in the black-and-white system. The additional complication can be tolerated if it merely represents initial and maintenance costs, since such costs are usually a small part of the total expense of broadcasting. We are here interested rather in differences in studio equipment which impose limitations on the type of pickup or the fidelity of transmission. One item of great importance is the seven-times greater illumination required for the color system to overcome the absorption of light in the color wheel. In film pickup the necessary additional light can be obtained from arc sources, but direct color-pickup is not possible under illumination levels quite adequate for black-and-white transmission. The loss of light in the color wheel is fundamental to the trichromatic method of transmission, and while it may be reduced by the development of more efficient optical filters, the advantage will always remain with black-and-white transmission when the available illumination is marginal.

An important difficulty in the direct pickup of color images is the storage on the mosaic of the camera tube. Non-storage camera tubes are used for film pickup because plenty of illumination is available. But for direct pickup, the storage type of tube is essential. Here the difficulty appears. The entire mosaic plate is

exposed to the image through a given segment filter and so becomes charged through photoemission induced by light of the corresponding color. The cathode-ray beam in the camera tube scans the image in interlaced fashion and so removes the charge only from alternate lines. The remaining charge persists into the next exposure, which takes place through a filter segment of different color. The net charge remaining is thus produced by light of two colors, which dilutes the color purity of the reproduction resulting from the subsequent scanning. This trouble is purely one of apparatus. It can be solved by discharging the unscanned lines before the ensuing exposure. One method is to defocus the scanning beam to twice its normal size so that it passes over both of the adjacent lines in each pair, thus discharging them simultaneously. But this method reduces the detail of the image, in the horizontal dimension, by a factor of two. Another method is to employ a mosaic having a very thin mica plate as the dielectric, which will discharge rapidly. But the smaller capacitance thus employed has a corresponding effect in reducing the sensitivity of the camera. Until some satisfactory method of overcoming this stored-charge problem is developed, it appears that the color system will perform better on film, as to color quality and detail, than on direct pickup, even when the illumination problem is not considered.

The remaining differences in the studio equipment have to do with apparatus. The color system requires a considerably more complex sync-signal generator, as well as such auxiliaries as color mixers, gamma controls, and 120-cycle primary power. Aside from its cost, this additional equipment may impose some increase in the size and weight of portable pickup equipment.

Closely allied with the studio equipment are the video program lines and networks. Here the difference is one of bandwidth, in the ratio of 10 to 4. The wider band for color can be obtained only at the cost of lower gains per repeater stage and consequently, smaller spacings between repeater stations, other factors being equal. Since repeater input levels must not be permitted to fall

to the noise level, and since the noise power is greater by some 4 db over a 10-mc band than over a 4-mc band, the power levels of the repeater output must be higher. These requirements of increased gain and power level can be met, of course. The question is one of cost.

Transmitters and Radiators

The transmitters of the two systems differ in the modulator and the r-f amplifiers. The color modulator must provide the necessary modulating power over a 10-mc band with flat amplitude and time-delay characteristics. This requires a larger number of tubes, with heavier plate current drains and associated power supply than the corresponding black-and-white transmitter which modulates only to 4 mc. When the cost of the additional stages and power supply is accepted, there is no other fundamental difference. The r-f amplifiers differ, however, by a whole order of magnitude in frequency. The black-and-white system occupies 6-mc channels from 54 to 216 mc; the color system occupies 16-mc channels from 480 to 920 mc. Thus the color transmitter's final amplifier must be modulated over nearly three times as wide a band, at a carrier frequency from 5 to 10 times as great. The upshot of this requirement is that not as much peak r-f power may be developed from available tubes at any stage of the art in the color system as in the black-and-white system. The present ratio of generated peak power is about five to one in favor of the black-and-white system, considering transmitters at 60 mc and 490 mc, respectively. At the upper ends of the spectra, 216 and 920 mc, an even higher ratio may be expected, although no equipment has been built to demonstrate the facts.

This advantage of generated power in the monochrome system is more than counter-balanced by the fact that highly-directive radiators can be built conveniently on the uhf bands, with power gains in the vertical plane of the order of 10 or more. To obtain the same antenna gain at the vhf frequencies, for the black-and-white system, would require a structure some 5 to 10 times as large in vertical dimension, or about 100 to 200-feet high at 60 mc. Such a large radiator, supported on a

still higher tower, might be built for vhf use, but it would be vastly easier to build for uhf use. The net result is that the horizontally-radiated power is actually higher in the CBS uhf transmitter than in the majority of vhf television transmitters now operating.

Propagation Effects

The comparison of propagation on the vhf and uhf bands is difficult to make, for lack of comparative test data. Fundamental diffraction theory shows that the shadows cast by obstacles in the path of uhf waves are sharper than those of vhf waves. This indicates that the coverage should be more uniform over hilly country and large cities when the lower frequencies are used. But this is a theoretical deduction only. It has been supported by measurements only up to 100 mc. That this problem is a real one is shown by the difference in propagation reported between the old f-m band, 42 to 50 mc, and the new band, 88 to 108 mc. When the frequency is further extended to between 480 and 920 mc, marked reduction in the marginal coverage radius is to be expected. This is certainly the case if low-gain receiving antennas are used in the two cases. But, as in the case of the transmitting radiator, high-gain receiving antennas can be constructed within reasonable space in the uhf band, and the gain may readily make up for the propagation losses.

One factor in propagation is readily misunderstood. The field strength in microvolts-per-meter, produced by a given radiated power, increases directly with the frequency. But the effective height of a receiving antenna of given configuration decreases in the same proportion, so no net advantage is obtained at the high frequencies unless an antenna of higher gain is erected.

The propagation question is one which, above all others, cannot be resolved without thorough testing over a reasonable period of time and over many types of terrain.

Closely associated with propagation is the relative effect of ghost reflections. There is no theoretical reason to suspect that the energy reflected from a surface should change with the frequency of the wave, except when the extent of the

surface is of the order of a square wavelength. Since most reflecting objects (buildings, hills, etc.) are many wavelengths across even at the lowest frequencies, the reflected power should not be markedly different in the two cases. But the visible effect of reflections may be expected to be worse in the color system for a number of reasons. First, the speed of scanning across each line in the image is twice as great, so the displacement of the ghost image from the main image is twice as great. Ghost reflections which are not discernible as such in the black-and-white picture thus may become visible in the color picture. Secondly, the definition of the color picture is, as we have seen, superior to the black-and-white on two counts. Such improvement in quality, as in the case of sound systems, makes any aberration more noticeable. The ghost problem should be investigated in the propagation study previously recommended.

The final aspect of propagation is long-range propagation effects; ionospheric transmission, meteor bursts, and tropospheric transmission. The first two should be virtually absent in the uhf band, although they are present on the lower channels of the vhf band. Tropospheric transmission should be present in both cases, with a probability of higher incidence in the uhf case, since trapping layers of low height (capable of trapping high-frequency radiation) are more common than layers of higher altitude.

Receivers

The final element is the television receiver, the most important from the standpoint of economic factors, because a large public investment is involved.

The color receiver, having a wider acceptance band, has more noise at its input, and it may also have a lower noise figure (although radar receiver design has proved that the noise figure attainable at 1000 mc is only a few db worse than that at 200 mc. The receiver must have more stages of i-f amplification because at the wide bandwidth the gain-per-stage is lower.

The color-receiver scanning system must be very carefully filtered and shielded at critical points to

avoid pairing of the interlace and hum patterns on the image. This is a substantially more difficult problem than in the vhf black-and-white receiver, but fully capable of solution. The color wheel and synchronous drive, necessary in the color receiver, have no counterpart in the black-and-white receiver. A sevenfold loss of image brightness occurs in the color receiver. But the effect of ambient illumination is substantially reduced by its double passage through the filter disc. This latter effect also improves the apparent contrast of the color image, and requires less peak brightness to display a given range of tonal values.

The sound system of the color receiver is simpler in some respects and more complicated in others. No separate i-f amplifier for the sound is required, because the sound is transmitted on the picture carrier. This also eliminates the need for precise tuning of the r-f end of the receiver. But pulse-detection circuits and a low-pass filter must be provided in the color receiver. The relative costs of these components have not been announced, but it seems certain that the cost differential in the sound systems of the two receivers will be small compared to the cost of the color wheel and drive and the associated filtering and shielding.

Summary

It will appear from the foregoing that the color system requires a number of additional elements, of appreciable cost, and that there are several important uncertainties in system performance. The question remaining is the time required to assess the additional costs and resolve the system uncertainties. The editors of *ELECTRONICS* take no position in the matter except to point out that the costs can be assessed and the questions resolved by a straightforward engineering approach. Whatever the time required to do so, there is no point in delaying these engineering studies. The larger question of whether to wait until the studies are complete or to proceed with one system or the other at once, must be decided by the industry.

REFERENCE

- (1) Color Television on Ultra High Frequencies, *ELECTRONICS*, p 109, April 1946.

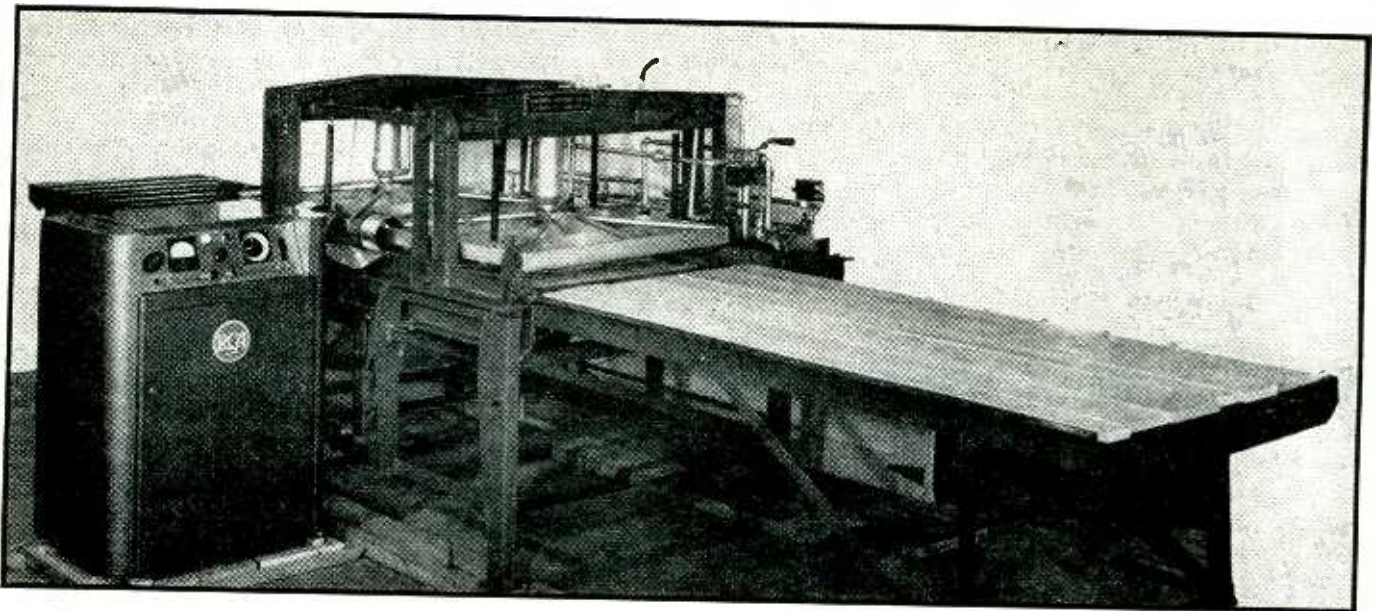

Edge-gluing press connected to 2-kw electronic generator for setting glue in core lumber to be used in veneered furniture

ELECTRONIC HEATING in the Furniture Industry

THE SUCCESSFUL APPLICATION of electronics to the heating problems of the furniture industry calls for a distinct appreciation of the economics of high-frequency heating as well as a general understanding of the available methods for generating the high-frequency power and applying it effectively to the work load. Before taking up specific applications in which dielectric heating can be used economically and successfully, it will be in order to review briefly the fundamental rules for generating the power, bringing it to the load, and shaping the electrodes to concentrate the heat where it is needed.

Generator Circuits

Three generator circuits commonly used for dielectric heating systems are shown in Fig. 1. Though Hartley circuits are indicated, both Hartley and Colpitts circuits are used with identical results. In Fig. 1A, the tank capacitance is that of the load itself and the frequency of the oscillator varies considerably in accordance with changing material properties as it heats. With this cir-

cuit, the maximum voltage obtainable on the load is approximately 70 percent of the d-c voltage used on the tube, or twice that voltage if a push-pull circuit is used.

In Fig. 1B, a fixed capacitance is used in the tank circuit to provide a relatively fixed frequency. A variable capacitance is used in series with the load to provide adjustable coupling, and a tapped inductor is used to resonate the load and incidentally to boost radio-frequency voltage beyond that possible with an untuned load. With this circuit, voltages on the load much in excess of the d-c voltage are practical.

In Fig. 1C, a fixed tank frequency is again used and coupling is adjusted by means of a variable inductance in series with the load. The absence of a series capacitor in the load circuit permits working into lower power-factor loads (materials otherwise difficult to heat). A thyatron-controlled motor operates the variable inductance automatically, and the thyratrons are controlled by plate current of the tube. This control provides approximately constant power output of the generator, re-

gardless of changing properties of the load material.

It is important that stray capacitances, other than that of the load itself, be minimized. The effect of unnecessarily large electrodes, or of too close proximity of the shielding, is shown in Fig. 1D. In order to provide the same voltage across the load material, it is apparent that additional current is required through the tuning inductance and the tank circuit in order to take care of the additional reactive current through the stray capacitance. While there is no actual power loss in the stray capacitance (this applies as well to air-gap electrodes), there is nevertheless unnecessary I^2R loss in the tuning inductance and in the tank circuit, which results in lowered efficiency.

Many occasions arise where electrodes are required at a position remote from the generator itself. Transmission-line technique used for this purpose is illustrated in Fig. 1E. Generally the load is either parallel-resonated (Fig. 1E) or series-resonated (Fig. 1F) to obtain a satisfactory impedance into which the transmission line may work.

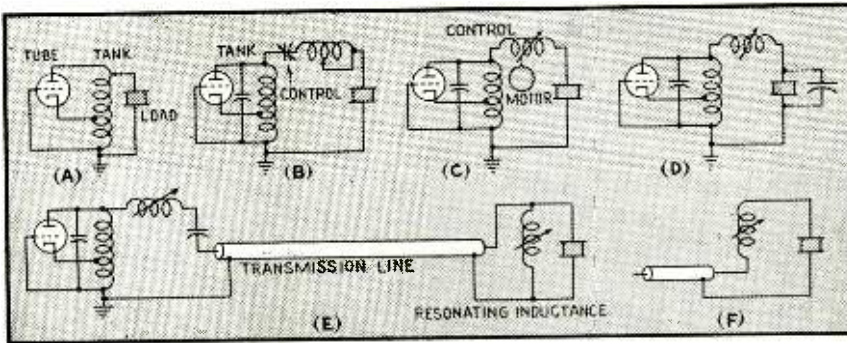
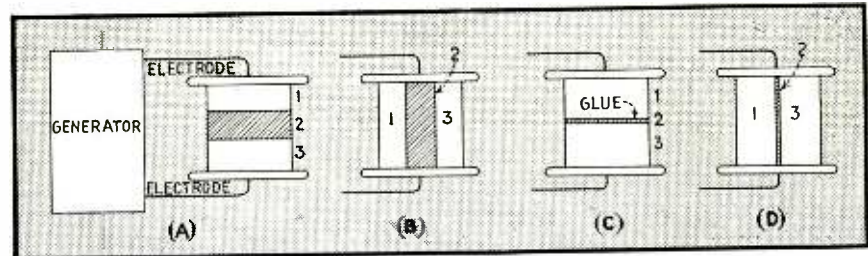

FIG. 1—Basic generator and coupling circuits employed in high-frequency heating

FIG. 2—Fundamental configurations involved in setting bonding glues



By E. S. WINLUND

Industrial Electronics Engineer
Radio Corporation of America
Los Angeles, California

Fundamentals of generating and applying high-frequency power to set bonding-glues employed in producing plywood, joining core-lumber for veneered furniture, and assembling joints of furniture, and discussion of economic aspects of woodworking industry applications

In general, it may be said that the lower the power-factor of the load, the more difficult it will be to get satisfactory performance at the end of long transmission lines. The effect of a transmission line is to add kva to the load circuit in proportion to its length. When this total kva becomes nearly equal to that in the tank circuit itself, generator operation becomes unstable. Installations are in operation with electrodes as far as 20 feet away at 27 mc and up to 40 feet away at 10 mc, with satisfactory operation. The maximum transmission line length, however, depends directly upon the properties of the material to be heated.

Obtaining Uniform Heating

When two materials are placed between electrodes in a dielectric heating application, their relative behavior depends entirely upon their placement. For example, in Fig. 2A the three materials are in series as far as current flow is concerned; in Fig. 2B they are all in parallel. If the center material is considered to be quite thin (for example, merely the thickness of the glue between two

pieces of wood, as in Fig. 2C and 2D), the identical principles apply. For materials in parallel, the rate of temperature rise depends upon the factor KPF/HD , where the numerator KPF is the well-known loss factor of the material, K being the dielectric constant and PF the power-factor. In the denominator, H is the specific heat and D the density of the material. For materials in series, it is seen that the loss factor does not enter as such into the relative heating picture and heating rate is proportional to PF/KHD .

For this reason a very moist glue line will heat very much faster than the wood when it is in parallel with the wood, but the wood will heat very much faster than the glue if they are placed in series. It is decidedly practical to take advantage of this fact in so-called edge gluing by bringing the glue line up to temperature very rapidly to set it within 5 to 125 seconds, without wasting power to heat much of the adjoining wood.

Incidentally, if pieces 1, 2, and 3 of Fig. 2A were all the same material, they would all heat at the same rate. There is no standing-wave effect be-

tween the electrodes. If the electrodes and their surroundings remain cooler than the material as it heats, there is some loss of heat from the surface of the material by thermal radiation and conduction. If fast heat cycles are used, so as to minimize the time for heat loss, or if the electrodes and their surroundings are kept at elevated temperatures, the heating can be decidedly uniform.

Means of obtaining uniform heating in materials of nonuniform cross-section are shown in Fig. 3. For example, in Fig. 3A the left side would heat faster than the right; in Fig. 3B the right would heat faster than the left; in Fig. 3C there is a position for the upper electrode at which uniform heating can be accomplished. Adaptations of the principle to aircraft and plastic lens manufacture are shown in Fig. 3D and 3E.

Minimum Heating Time

When it is desirable to heat a material dielectrically, but impractical to get at both sides of the material with electrodes, a grid can be used. Alternate bars of the grid are connected to each side of the generator

as in Fig. 4, and power flows from one bar to the next through the material itself.

For a given weight of various materials to be heated through the same temperature rise, Table I shows the minimum time in which they may be heated without flashover. This is comparatively simple to compute on an approximate basis. Any wood with a considerable percentage of water in it can be heated very rapidly—in fact, so fast that the wood explodes because of the vapor pressure behind the water trying to get out of it. Seasoned wood has a moisture content in the vicinity of 5 to 10 percent, and most of the species usually can be heated through a 200-degree F rise in ten seconds without flashover. Extremely good insulating materials, such as polystyrene, require so long a time to heat that the losses by radi-

at 27 mc could be heated in 10 seconds can, at 1/4-inch thickness, be heated through the same temperature rise in only four seconds without flashover.

As indicated previously, the moisture content of the wood has an important effect upon minimum heating time. In Table IV, note that for a given piece of wood containing 10 percent moisture, whose minimum heating time is 13 seconds, this time increases to 41 seconds if all the moisture is out of the wood. In other words, when entirely dry, the wood becomes a fairly good insulator.

Airgaps, that is, air spaces between the material and one or both electrodes, are rather commonly used in dielectric heating. However, for maximum speed and efficiency, they are always to be avoided if possible. Irregular shapes, or variations in thick-

to be heated, it is only necessary to place stubs every two feet along the electrodes. Similarly, at 10 mc, the stub spacing for 90-percent temperature uniformity would be about six feet. Electrically, a stub is merely an inductance placed across a portion or all of the load to resonate it. With proper design electrodes have no length limitations.

The data presented in Tables I to VI was computed on the basis of maximum voltage gradient experience, with a reasonable factor of safety. While individual minimum heating times are very approximate, their trends with respect to other variables are accurate.

Furniture Industry Applications

Thus far the principal interest in dielectric heating in the furniture industry has centered around edge glu-

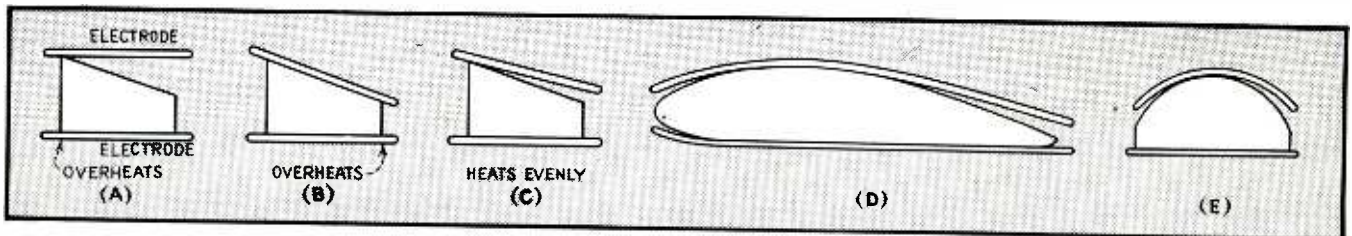

FIG. 3—Electrode contours for securing uniform heating of nonuniform thicknesses

ation and conduction practically prevent ever attaining a temperature rise by dielectric means.

The much-discussed generator frequency has a negligible effect upon the efficiency and power requirement to do a given job. In dielectric heating, the only significant effect of frequency is to set a minimum time in which a given material of given thickness can be heated without flashover. In the large majority of applications it is neither necessary nor desirable, as a practical matter, to work anywhere near the minimum heating time, so that frequency is seldom a critical matter.

Table II shows that seasoned wood can be heated at 27 mc in about 10 seconds without flashover. Raising the frequency by about seven times reduces the minimum time to about one-seventh, all other factors remaining the same.

If generator frequency and weight of the material are kept constant, the thickness of the material to be heated has an effect upon the minimum time without flashover. In Table III, note that a one-inch piece of wood which

ness or material properties, sometimes necessitate the use of an airgap as a practical matter.

Table V shows that a one-inch thick piece of wood can be heated in about 10 seconds with contact electrodes. As the airgap is increased from zero to one inch, the minimum time increases from 10 seconds to more than two minutes.

Electrode Length Limitations

Occasionally one hears the statement that with dielectric heating the length of electrodes is limited to approximately 1/16 of a wavelength. If connections are made merely between the generator and electrodes, without other tuning of the electrodes, there is indeed a limitation. But for longer electrodes, it is virtually always possible to add additional tuning stubs to provide essentially flat voltage distribution along the electrodes. For example, Table VI shows that at 27 mc, 90-percent temperature uniformity is produced by electrodes two feet long. In order to provide the same temperature uniformity for a longer set of electrodes and longer material

ing to make core lumber and solid stock. Core lumber is the name given to the solid wood placed between two pieces of veneer to make such large flat surfaces as desk tops, doors, chair seats, and table tops. In other words, the process of making core lumber is simply that of making big pieces out of little ones, and the wood, because it is to be covered with veneer, can be of a lower grade. The thickness usually runs from 1/2 inch to 1 1/2 inches and areas from one foot square to four by eight feet.

In Fig. 5, core lumber stock is shown lengthwise on the left and endwise on the right. The two electrodes are placed above and below the stock. The object is to set the glue which has been applied to the interface between adjacent pieces of stock. Because the glue line is in parallel with the wood as far as current is concerned, the glue line will heat a great deal faster than the wood alongside it. It is a common practice to apply power in the range of 5 to 125 seconds, which gives a glued board that will fail somewhere else than at the glue line even if stressed immediately

after being pulled out from the electrodes. This obviously makes for an extremely high-speed and efficient production process, readily adaptable to continuous production of core lumber.

It is not necessary to set up all of the glue area when in the high-frequency field. If, for example, 30 percent of the glue face area is set up in the machine, this will usually be sufficient to hold the pieces of stock together without further clamping, so that a number of hours later the remainder of the glue line will set up cold, and the finishing operation can follow.

The several electrode configurations in Fig. 5A to 5E provide various glue-set patterns and various percentages of glue line set. There are advantages and disadvantages, from a practical standpoint, to each of these, even though all accomplish approximately the same result. The same applies to the electrode arrangements for scarf joints, shown in Fig. 5F, 5G, and 5H.

In general, a 15-kilowatt generator has been found capable of handling in the vicinity of 3,750 board feet per hour on a continuous basis. A 2-kilowatt generator can handle about 500 board feet per hour, or 4,000 board feet per day, on a continuous basis. Where only one press is used per generator, duty cycles (to allow time for unload and reload) generally run about 75 percent, making production that fraction of the generator capability.

Jigs for Joints

Where production volume justifies the expense of setting up electrode fixtures and jigs for specific corners and joints in the article to be manufactured, high-frequency gluing can provide decided economies through increased production speed and consequent lower labor costs. Figure 6 shows several commonly encountered butt joint and corner configurations and the placement of electrodes to set the glue lines within a few seconds. Either contact electrodes or airgap can be used, but it is well to remember that contact electrodes always provide the highest speed and efficiency if it is practical to use them.

The application of dielectric heating to set glue in the rounded corners of furniture, shown in Fig. 6G,

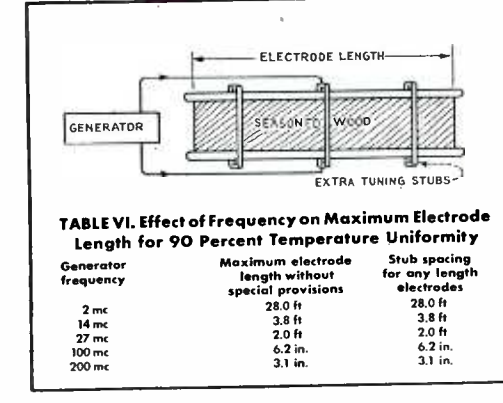
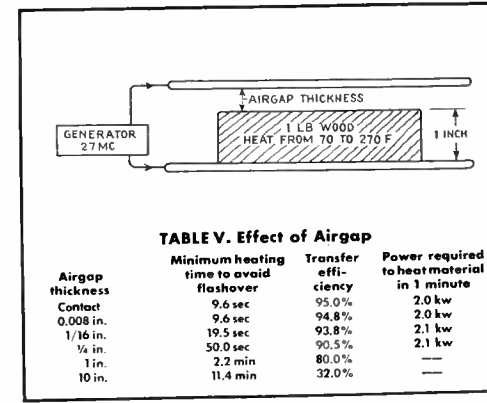
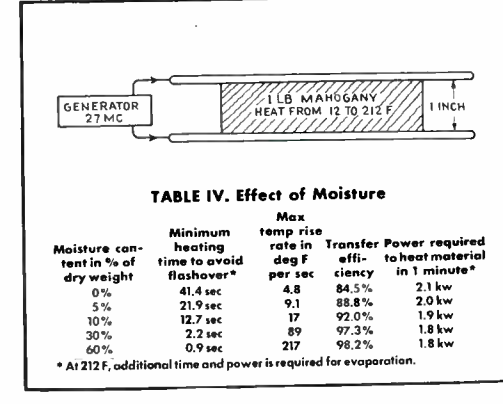
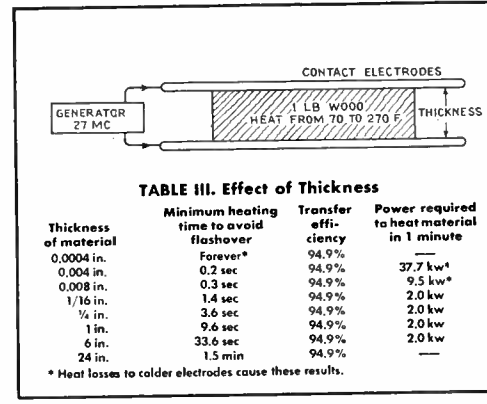
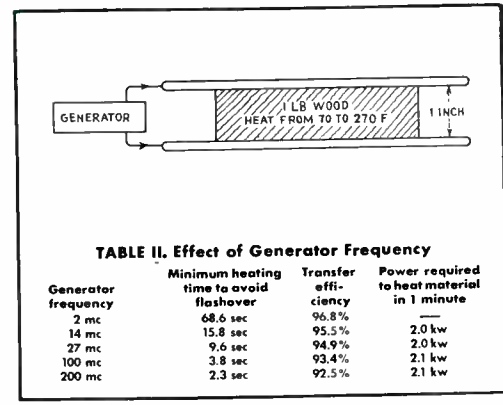
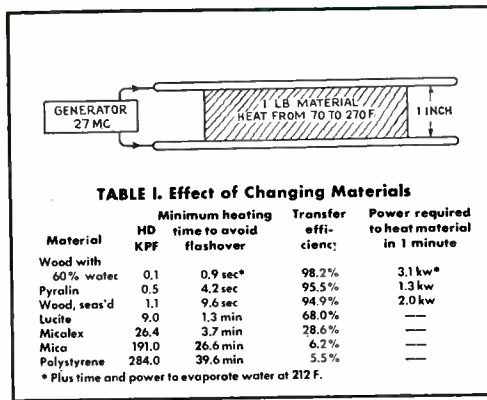

is considerably faster than conventional slotting and bending, and requires no block to be glued and clamped overnight. Several 15-kilowatt generators are now being used to set laminated chair and table frames in this manner, in about one minute.

Plywood and Veneer Heating

The use of high-frequency heating for setting the glue in molded plywood radio cabinets is beginning to come into its own. In Fig. 6H is shown a die arrangement for molding two cabinet sections simultaneously. The central steel die is used as the high-potential electrode, from which current passes through the two plywood forms to the two female dies which are used as ground electrodes. These are placed between the two platens of the press and no further insulation is necessary because it is

equivalent to a sandwich. The wood and glue line are brought up to temperature in about one minute, in comparison with 15 to 30 minutes if high-frequency heating were not used. Both the male and female dies are steam-heated to avoid heat conduction losses from the wood after it is brought up to temperature. The principles involved in Fig. 6 are of course applicable to all kinds of furniture.

In one application of high-frequency heating to the manufacture of bed foots and bureau tops, the net saving per day was found to be \$160 for materials and \$112 for labor, due solely to the change to high-frequency heating. These figures constitute a total saving of \$68,000 per year, confirming the statement often heard that high-frequency equipment, if properly applied, will easily pay for itself in a year.

Resin-impregnated and compressed

wood is known to the trade as compreg. If resin-impregnated only, it is called impreg. These woods have found a number of war applications, one of which has been the production of propeller blades for aircraft. Compreg propellers are reported to have strength per unit weight in excess of that of steel.

The manufacturers of compreg and impreg envision considerable use of the material, particularly in the form of veneer for such things as table tops and general furniture finishing, because it is extremely hard, almost impossible to nick, and comparatively impervious to alcohol and other stains.

House Construction Applications

While there has been comparatively little evident application for dielectric heating by individual contractors in the fabrication of a house,

the studs as well as the glue lines, but is by far the most flexible from the standpoint of variable stud spacing and panel size.

Dielectric heating is of course applicable to the various cabinets and bookcases which are being built into the newer homes. The above comments concerning furniture construction are also applicable in this field.

Prefabricated panel insulation, made chiefly from rock, glass, or fiber materials, is generally a very good insulator and difficult to heat with electronic equipment.

At regular intervals someone proposes dielectric heating of homes—or rather of the occupants of the home, without actually heating the house. The idea always gets immediate publicity, much to the embarrassment of the manufacturers of electronic equipment. For perhaps \$50,000 to \$100,000 it might be pos-

removal of most of the water without checking or otherwise harming the wood, the several days to several weeks of conventional drying time appears to indicate a natural application for dielectric heating. In general, lumber containing 25 to 75 percent moisture is placed in large ovens or kilns with controlled humidity and temperature, so that the water is driven out slowly from the inside of the wood and the surface of the wood is prevented from becoming too dry during the process. It is the humidity control that preserves the surface.

It is true that dielectric heating can bring the interior of a large piece of lumber up to the temperature of the boiling point of water in an extremely short time, compared to a kiln. After the wood reaches 212 F, however, dielectric heating appears to provide no advantage whatever over other forms of heat, because the process becomes a function of the time it takes the water to make its way slowly out of the pores of the wood without harming the wood. Also, dielectric heating has the distinct disadvantage of higher initial and operating cost than kiln heating, considering the practice of most mills of burning waste sawdust to provide fuel for kiln heat.

Thus, while there are a number of distinct exceptions to the above generality, we have yet to see a large-scale lumber drying application for dielectric heating which can be justified economically. The exceptions occur where the part to be dried is extremely small, as it would be in the case of seasoning such items as broom handles, knife handles, smoking pipe preforms, and the like.

Economics of Heating Plywood

On the other hand, one of the applications in the lumber industry that has begun to be successful is the use of dielectric heating for veneer patching. Figure 8A shows the three plies of conventional plywood, in which a knot-hole or other imperfection has been found in the top veneer. A piece is cut out of the top veneer surrounding the knot-hole. The piece is of exact shape to match an available pre-cut patch, which is then laid in place. The sketch shows the plywood with the new patch in place. A portable tool, upon which are mounted two round electrodes as shown, is held

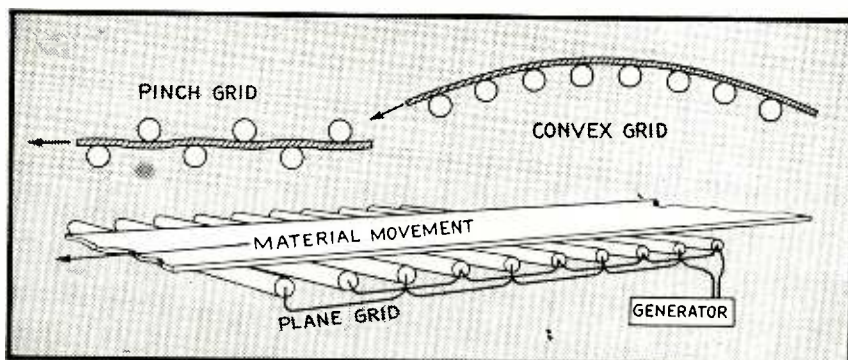

FIG. 4—Arrangement of grid electrodes for heating material from one side, and use of pinch grid for continuous heating of moving material

there has been a great deal of interest in the manufacture of pre-fabricated wall panels.

Such panels are normally made up of $\frac{1}{8}$ - to $\frac{3}{8}$ -inch plywood placed on each side of 1 x 3 or 1 x 4 studs, the space between being filled with insulating material. The panels are made in various shapes up to about a 4 x 8-foot rectangle, according to the contractor's or panel fabricator's scheme of fitting the panels together in the ultimate variety of houses.

Various means of applying electrodes to individual studs are shown in Fig. 7A. Because it is more convenient to put the thermal insulation in place before laying the top panel, it is ordinarily not very practical to use inside electrodes. Because of its high stray capacitance the arrangement of Fig. 7B is more difficult to couple and tune, and requires heating

sible to install a heating system for a five-room house. Of course the warmth imparted to the occupants of such a home would depend upon whether they were sitting or standing, had their arms outstretched or at their sides, and how many other people happened to be lined up in certain directions in the room. Dielectric heating of homes is not permanently out of the question, but the complexity and poor economy of the application certainly throws it out for many years to come.

Kiln Drying of Lumber

Among lumber mills and lumber associations, perhaps the most frequently considered application of dielectric heating is its use in kiln drying. To everyone who has knowledge of the problem of seasoning lumber, which might be defined as the re-

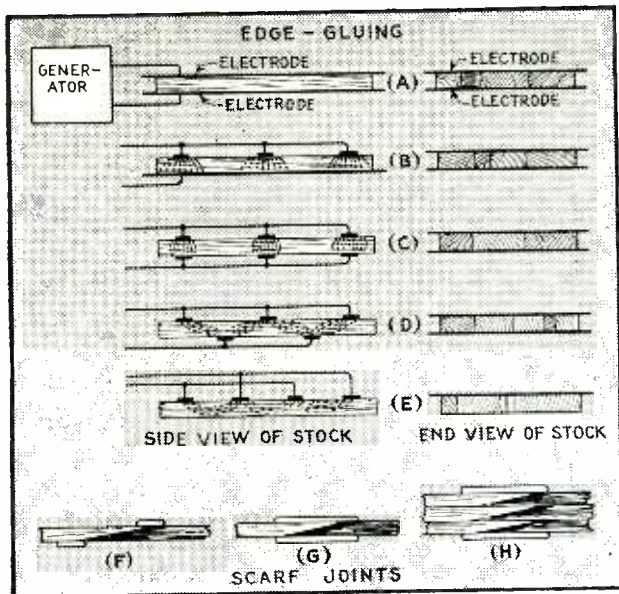

FIG. 5—Electrode arrangements for gluing core lumber

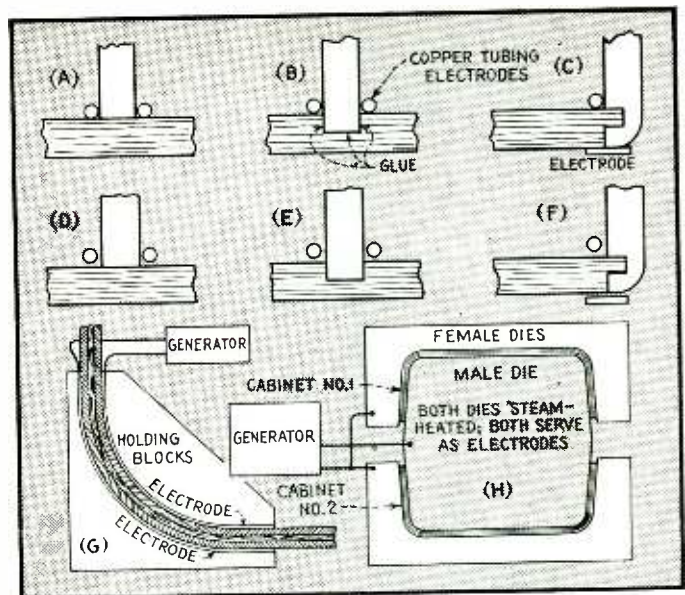

FIG. 6—Electrode arrangements for setting glue in joints

against the top veneer and the current, as in the case of edge gluing, flows through the glue line in a very short time. With only a few hundred watts of power, such patches can be set in five to fifteen seconds.

Veneer splicing as it can be accomplished with dielectric heating in two to ten seconds is illustrated in Fig. 8B. Here the problems are predominantly mechanical, most of which have been solved in conventional veneer splicing practice.

The manufacture of plywood in large batches has come in for considerable attention and at least one installation in the United States has been in operation for some time. Figure 8C shows the setup wherein two batches of 4 x 8-foot plywood, each batch one to two feet in height, are heated simultaneously, with rather high-power generating equipment. A sandwich is used so that both stacks are heated equally. Because the materials run in series in this configuration, the glue heats primarily by heat conduction from the wood. The wood in turn must receive most of the dielectric energy. Thus it is necessary to heat wood and glue alike up to full setting temperature, in contrast to edge gluing where only the glue need be heated.

In comparison with the use of multiple-platen presses, the dielectric heating method requires almost as much handling. The dielectric process is somewhat limited to the manufacture of medium-grade plywood, where a flat surface is not required.

As a general guide, it may be said that the dielectric heating of thinner materials offers less of an economic advantage than dielectric heating of thicker materials. The plywood application is rather critically affected by this generality and for thicker varieties of plywood the use of dielectric heating can be economical.

High-frequency heating has been used extensively in the manufacture of aircraft wing spars, PT boat girders and ribs, boat keels, and other comparatively large items. The sandwich method is used and electrodes and presses 20 feet long are entirely practical. Now that the war is over, extensive use of dielectric heating is expected in the manufacture of prefabricated laminated girders and arches for auditoriums, hangars, and stages.

Similar installations were used during the war to manufacture many sections of wooden airplanes and skis. High-frequency heating has also been employed to glue such products as balsa wood life rafts, lead pencils, and shuffle boards.

Conclusions

Perhaps most important of all is the necessity for close cooperation between the user of high-frequency heating and the industrial electronic engineers employed by the equipment manufacturers. To most of the users, electronic equipment is new and strange, and high-frequency current behavior seems to bear utterly no relation to that of 60-cycle current.

The degree of success or failure of most high-frequency installations depends largely upon skillful electronic application engineering. In fact, the competitive advantage enjoyed by a high-frequency user bears a direct relationship to the efficiency of his application as compared with that of his competitor.

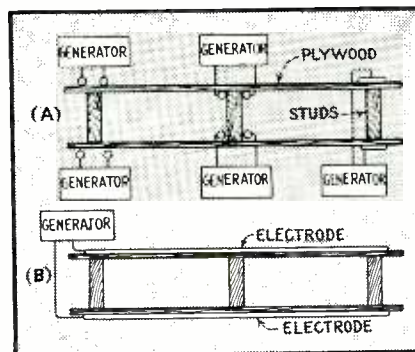

FIG. 7—Electrode arrangements for setting glue in production of prefabricated panels

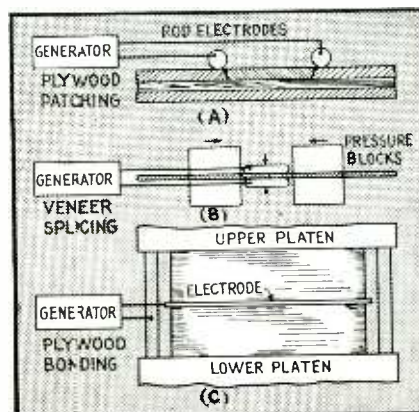

FIG. 8—Three successful applications of high-frequency heating to plywood and veneer pieces

JAPANESE

electronics WAR REPORT

instance comparable types were in existence in the United States before the war. Some modifications had been made for the sake of standardization or to fit Japanese production methods, but in general no new developments of importance were apparent in apparatus functioning outside of the microwave region. It was only in the field of microwave application and research that the Japanese engineers had gone in a somewhat different direction, even if somewhat behind our own.

Microwave Transmitting Types

During the few months immediately before the end of hostilities, the best efforts of vacuum-tube research groups in Japan were directed toward the improvement of magnetrons capable of generating centimeter waves. The earliest practical transmitting magnetron used in production radar equipments was the M-312 type, employed in a Navy search set. This tube was developed sufficiently early to permit the production of about 300 complete equipments before the end of the war. It has a four-cavity water-cooled anode and is completely enclosed in a glass envelope. Peak power rating was said to be 6 kw at 10 cm, but the complete equipment was rated at only

2.5 kw. The Nippon Musen Co., which had been sponsored by the government to specialize in the manufacture of magnetrons during the war, produced the tube.

Work in the 10-cm range was confined principally to developing a better transmitting magnetron of the air-cooled variety, known as the type M-314, which was said to be capable of delivering a peak power of 17 kw. Actually two types of 10-cm four-cavity magnetrons were developed; one was the M-314 with all of its elements totally enclosed in a glass envelope, and the other an experimental type of the so-called metal-enclosed construction having a central anode structure enclosed in a metal container and with filament and coupling leads brought out through glass stems sealed to the metal anode structure. Although this second type appears to be an attempted reproduction of our method of construction, any inference that the design might have been copied

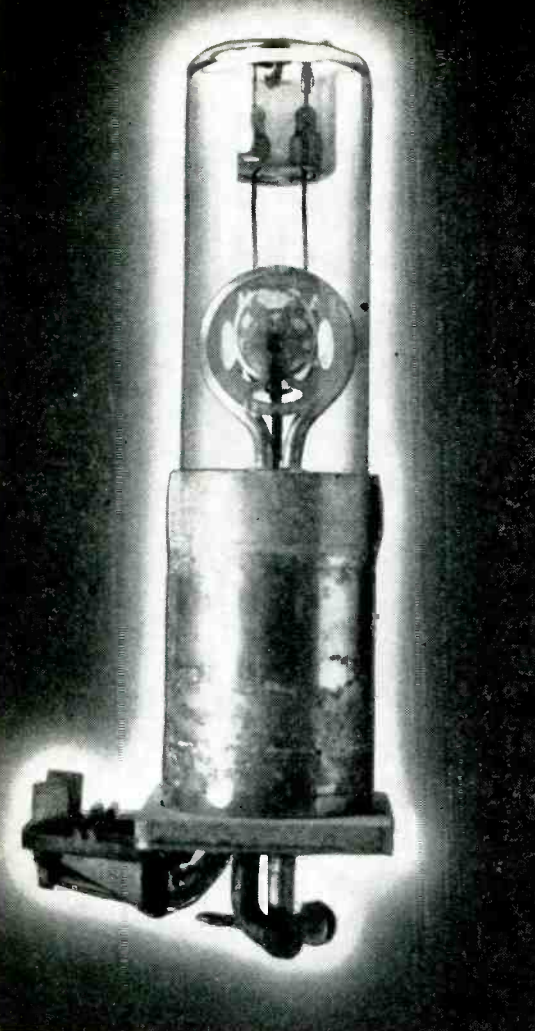

Type M-312 water-cooled 10-cm transmitting magnetron employed in Japanese naval search radar

By **MARVIN HOBBS**

Consulting Radio Engineer, Chicago, Ill., Formerly Operations Analyst, Far East Air Forces

By interrogating the technical and research personnel of the Japanese Army and Navy radar and communications laboratories as well as engineers employed by the three leading manufacturers of vacuum tubes in Japan, it was possible to determine recent design and research trends and the accomplished results.

Although Japanese Army and Navy engineers set forth the requirements for their apparatus and thus influenced tube design either directly or indirectly, the actual developments of new types was left to the more advanced tube designers employed by the three leading manufacturers, namely Sumitomo, Tokyo Shibaura, and Nippon Musen.

All of the tubes employed in the lower-frequency radio and radar equipment were of quite conventional design, and in almost every

Type M-60 low-power 10-cm receiving magnetron and its cast housing that serves both for shielding and protection. This tube was used in conjunction with the type M-312 for Japanese naval search radar equipment

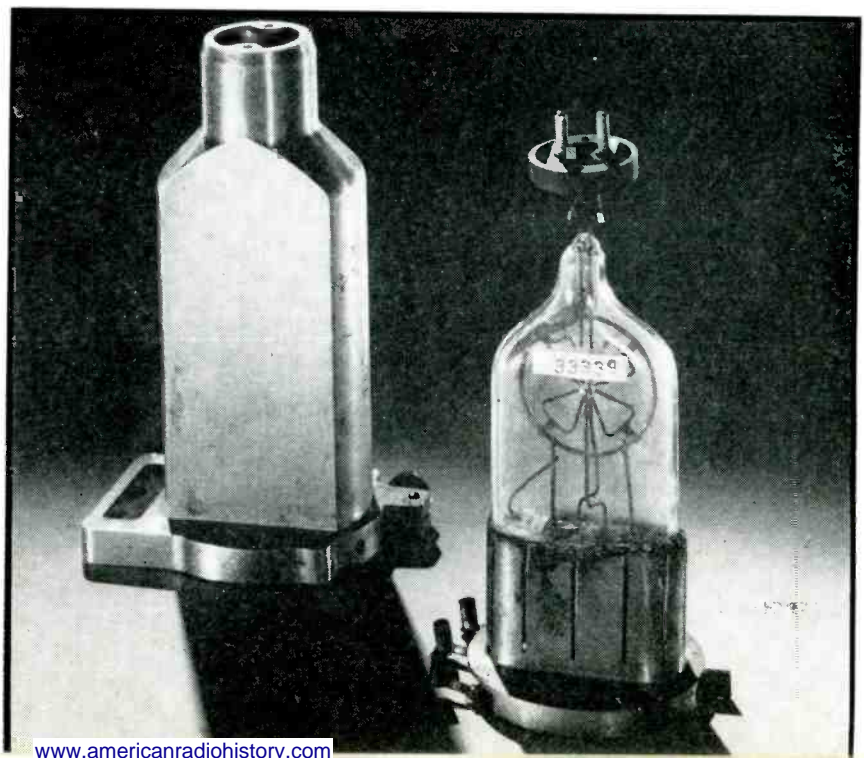

MAGNETRONS

Status of progress at war's end, with details of experimental tubes as well as those placed in production. Only magnetrons were used as local oscillators in radar receivers. One experimental 20-cavity tube oscillated at 0.7 cm with 2-kw peak power

was usually steadfastly denied.

Other magnetron developments by Nippon Musen included 5-cm (18-kw peak) and 3-cm (22-kw peak) types. Also, attempts were made to develop a 1-cm tube, with the result that one experimental unit oscillated at 0.7 cm with 2-kw peak power.

The 0.7-cm type was said to have had a 20-cavity anode. The research engineer who made the power measurements for this type said that he was not certain that the output was not higher, because he had not had available a suitable load for this frequency.

Magnetron anodes having as many as 12 cavities were seen in incomplete assemblies at the Sumitomo vacuum-tube research establishment. However, they did not appear to have progressed as far as Nippon Musen in obtaining higher peak power levels. Tokyo Shibaura had produced an experimental metal-enclosed 10-cm magnetron similar in appearance to one of the Nippon Musen types.

Microwave Receiving Types

As is well known, one of the main requisites of a microwave receiver is a satisfactory local oscillator. Toward this end the Japanese employed their type M-60 magnetron in the 10-cm range. Since peak power output is of minor importance in the receiver application the anode was made of thin plates rather than a copper core. The entire structure is enclosed in a glass envelope, which is sealed into a metal shield container for protection and to prevent radiation. A four-segment anode with a relatively low voltage is employed. Nippon Musen also made experimental models of a 3-cm unit known as the M-2643, which used an anode voltage about twice that of the M-60

The material in this paper is based on data contained in an unclassified Operations Analysis Report, "A Survey of Recent Japanese Vacuum Tube Developments", prepared by the author and issued by the Advance Echelon, Far East Air Forces, Tokyo, Japan.

and a magnetic field almost six times as great.

It is rather surprising that only magnetrons were developed and used as local oscillators. However, there is little evidence of any great progress with small klystrons except in the work of Sumitomo engineers. They developed experimental klystrons capable of oscillating in the 3- to 5-cm range. It was claimed that about one-half of the power available at the fundamental could be obtained at the second harmonic. This development was completed about three months before the end of the war. Another interesting Sumitomo development was a 10- to 20-cm r-f oscillator-amplifier of the parallel-plane type, similar to the American lighthouse tube construction but about three times as large. It was stated that this tube would provide a gain of 10 db as an r-f amplifier in the range of 600 mc and that it would deliver 1 kw of peak power as an oscillator at 3,000 mc. External cavities were associated with this unit to tune it to the required frequency.

Anode structure of type M-312 magnetron, with water-cooling tube attached. Perforated plates are placed on both sides of the anode to provide capacitive coupling to the antenna system

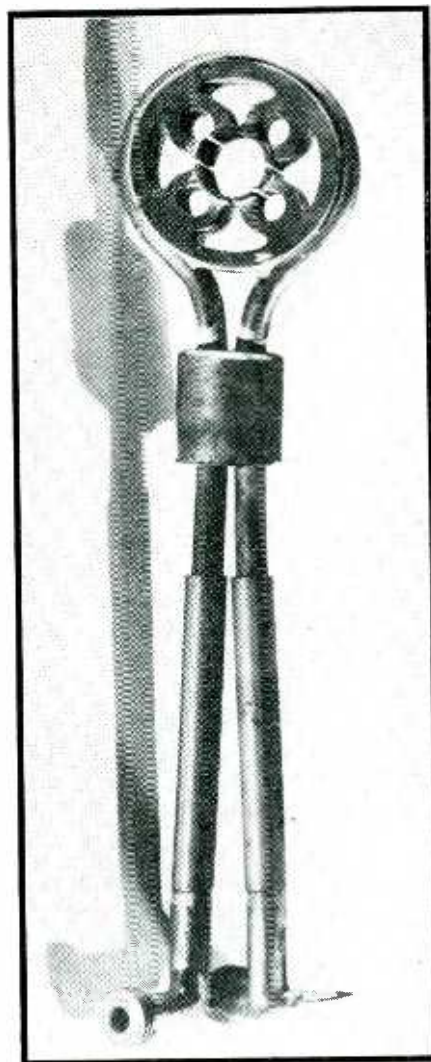

Table I—Characteristics of Japanese Magnetrons

Type	Transmitting Types				Receiving Types	
	M-312	M-314	S-60	S-51	M-60	M-2643
Plate voltage (volts).....	11,000	11,000	8,000	12,000	210	540
Plate current, peak.....	2 amp	5 amp	7 amp	6 amp	1.7 ma	1.5 ma
Filament voltage (volts)...	10	12	8
Filament current (amp)...	19.5	1.7
Input power, peak (kw)...	22	65	60	92
Output power, peak (kw*)	6.6	17	18	22
Allowable anode loss (w)...	2,000	50	30	30
Magnetic field (gauss)....	1,000	1,000	2,100	2,250	690	4,000
Wavelength (cm).....	9.875	9.875	5.2	3.15	9.83	3.0
No. of anode splits.....	4	4	10	10	4

*Pulse durations of approximately 1 microsecond were common in Japanese radar.

Recording CAA Traffic Control Instructions

Using automatic recording equipment, the Civil Aeronautics Administration records both sides of conversations between control center operators and aircraft pilots. Machine using flexible, plastic recording belts that can be stored in conventional filing cabinets is described

ELECTRONIC EQUIPMENT of many kinds plays an essential part in present-day control of air traffic. This article describes some of the methods used by the Civil Aeronautics Administration for air traffic control and, in particular, recording equipment.

The particular type of recording-reproducing equipment to be described was used to a great extent by the armed forces during the war. The machines are now used in government and commercial installations, in airport control towers, in radio communication stations, and with railroad train traffic control.

Air Traffic Control Centers

When pilots can see and be seen in time to avoid collision, little airway traffic control is required. On the

By K. M. MacLVAIN

*Executive Assistant
Dictaphone Corporation
New York, N. Y.*

other hand, if this condition does not exist, positive control by a ground agency is necessary. Ground control of airway traffic is exercised by offices (airway traffic control centers) each of which controls all air traffic within specified areas (airway traffic control areas).

Airway traffic control centers must have sufficient data pertaining to the movement of all air traffic within their control areas to provide a complete and accurate picture of traffic flow within the area at all times.

The center is the focal point for controlling air traffic. The tower is in radio contact with planes during take-offs and landings, and when

planes are within a few miles radius of the tower. Outside this radius, and until planes are within contact with the tower at their destination, radio communication stations are in contact with the planes.

Each commercial air line has its own radio communication station which relays instructions from the airway traffic control center to its pilots. The CAA also has radio communication stations to contact military, private, and other aircraft not under supervision of commercial companies.

Instructions Recorded

All flight instructions emanating from the airway traffic control center, as well as replies from pilots, are recorded. A recorder is associated with each airway traffic con-



FIG. 1—Dictaphone Belt Electricord recorder-reproducer records for one hour

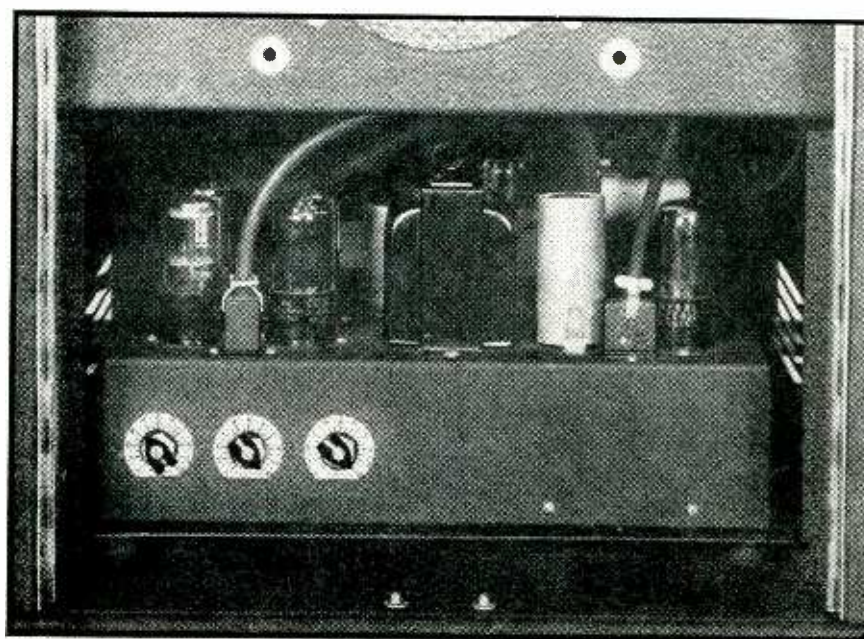
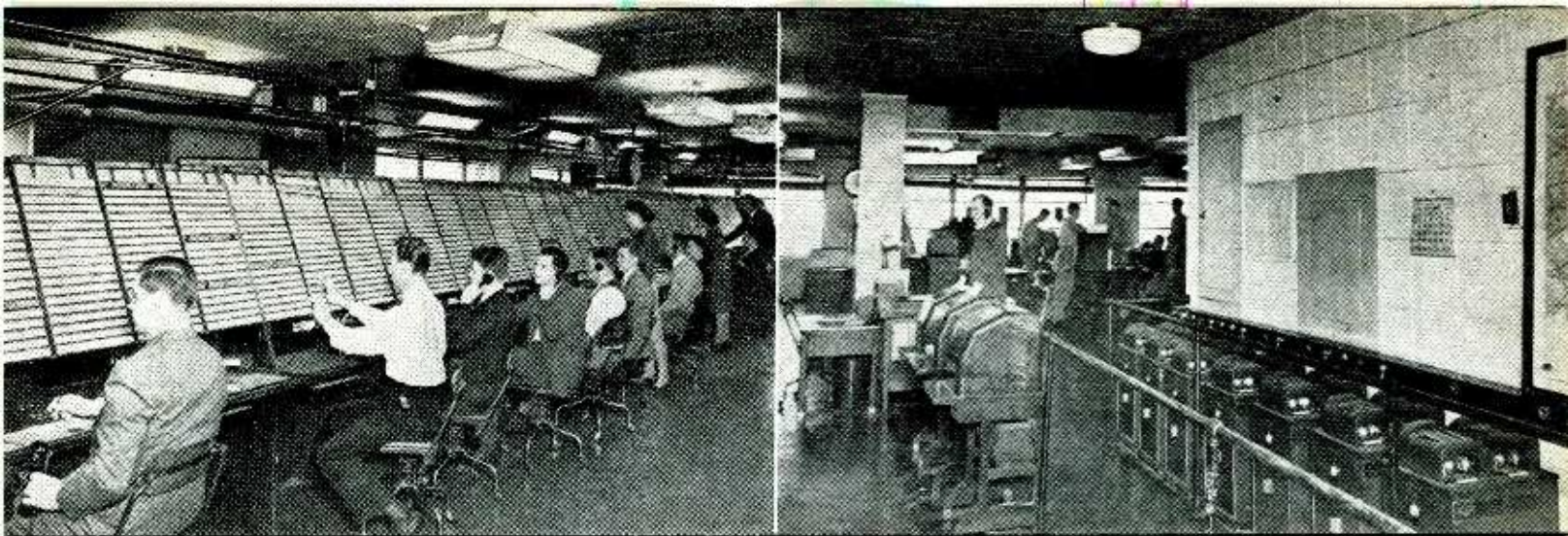

FIG. 2—Controls are set for desired recording characteristics when amplifier is installed. Plug connections facilitate servicing and replacement



At La Guardia airfield traffic control center in New York, operated by personnel of CAA, complete records of conversations between pilots and traffic control operators are made for filing, and for improving safety and operating procedure

troller's position. When the controller initiates a telephone call or answers an incoming call, he operates a switch which starts the recorder associated with his position. Both sides of the conversation are recorded. At the termination of the call the controller switches off the recording machine.

All of the records from a particular controller's position are placed in an envelope at the end of each day and filed in a standard file cabinet for future reference. Beyond this, because each record has the time it was removed from the machine marked on its inside, it is a simple matter to find any particular recording in this file of records.

The records are invaluable in case of accident or air traffic conflict, for establishing what was said and who said it. They are also used by chief controllers for making spot checks to promote operating efficiency. A batch of records are checked each day at random. When errors in operating procedure are observed, the chief controller notes the spot on the record and at a time convenient to himself and to the controller making the error reviews the record and suggests corrections in procedure.

Many of the recordings serve simply as a file copy of telephone conversations, but on occasion some recordings become vitally important because it is only through them that responsibility may be established and future safety enhanced.

Recording Equipment

The recording-reproducing machine described here is a complete unit designed for reference recording (logging purposes) and to afford continuous recording and simultaneous (or separate) reproduction, em-

ploying a permanent recording medium. This machine was designed to produce the greatest amount of recording in the smallest amount of space, with good intelligibility, and at a minimum cost for recording media.

Figure 1 is a photograph of this machine with the cabinet doors open. Two separate, identical recording and reproducing machine units, interlocked with an automatic electro-mechanical change-over mechanism to provide sequential operation, are mounted on top of the cabinet. Uninterrupted recording is provided because there is a 30-second overlap during the changeover period, the end of one record having the same recording as the beginning of the next.

The mounting plate for these two units, called the unit plate, is hinged at the rear edge and is secured by four holding screws, one at each corner. When these four screws are removed, the unit plate can be rotated up and back on its hinges, making recording motors and switches which provide automatic and safety controls accessible for servicing.

Amplifier Controls

Inside the cabinet, resting on the bottom as shown in Fig. 2, is the recording and reproducing amplifier with its associated power supply. In the middle of the front of the cabinet there is a combination loudspeaker and control panel. A meter, to show the recording level, is mounted at the top front of the machine cabinet, and a signal light above the meter indicates when 110-volt, 60-cycle power is applied to the machine.

Two controls on the loudspeaker panel are for switching the recording

machine motors on and off, and for adjusting the volume of reproduction. Two telephone jacks on this panel provide monitoring outputs for the recording and reproducing amplifiers.

Two recording tone controls are located at the left front of the amplifier chassis. One control modifies the high-frequency end of the amplifier characteristics; the other modifies the low-frequency end. The high-frequency tone control circuit consists of a 0.1 megohm variable resistor and a 0.005 microfarad capacitor. The reactance of the capacitor varies inversely with frequency; the higher the frequency, the lower the reactance. Thus, high frequencies are attenuated by this circuit, and the degree of attenuation depends on the amount of resistance in the circuit. The greater the value of the series resistance in the circuit, the lower the amount of high frequency attenuation.

The low frequency tone control circuit consists of a 1.0 megohm variable resistor and a 0.001 microfarad capacitor, as shown in Fig. 3. Bearing in mind the fact that the reactance of a capacitor is high for low frequencies and low for high frequencies, it is apparent that this capacitor will attenuate low frequencies and have very little effect on high frequencies in the input circuit of the output tube. The variable resistor paralleling this capacitor controls its effect. The higher the resistance in the circuit, the greater the effect of the capacitor.

Amplifier Circuits

The amplifier system is composed of a recording amplifier, a reproducing amplifier, and their common power supply, all mounted on one

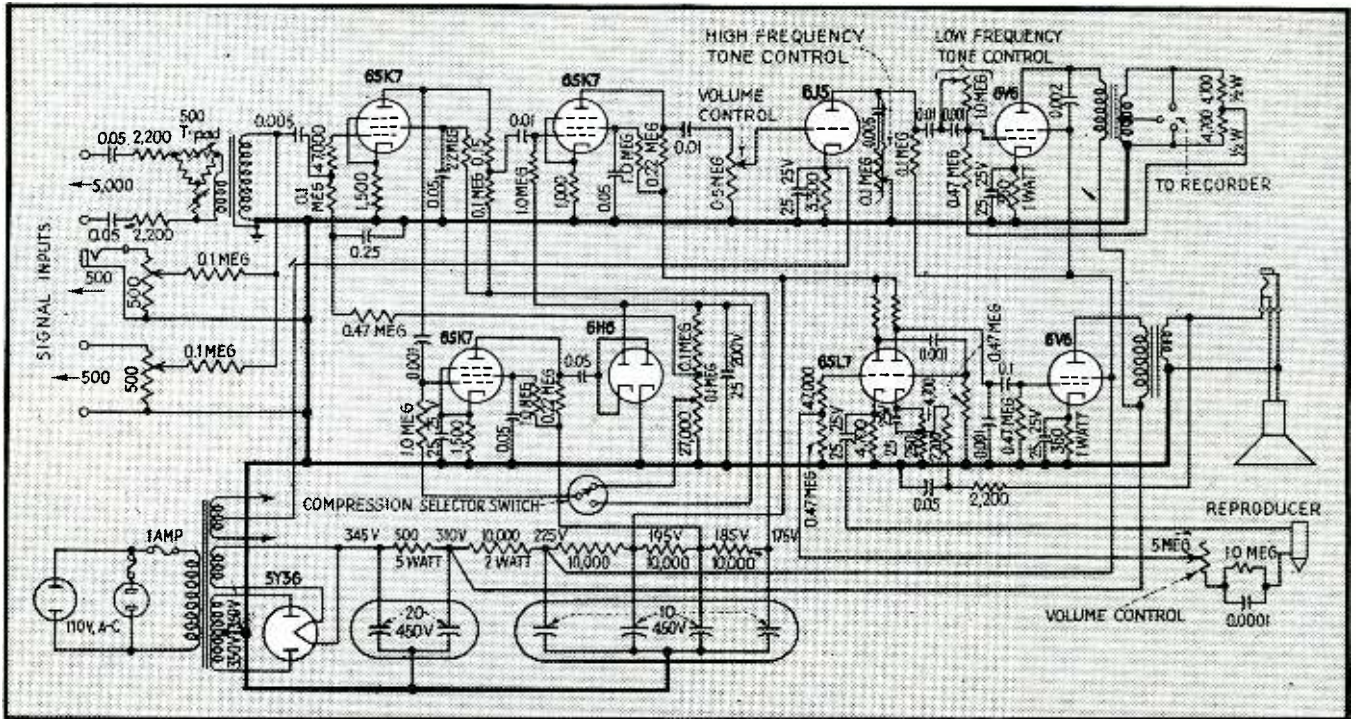

FIG. 3—Recording and reproducing amplifier circuit. Automatic volume compression, and high and low frequency compensation improve intelligibility of low velocity recordings

chassis. The recording amplifier is a four-stage compression amplifier. The reproducing amplifier is a standard three-stage linear amplifier.

The recording amplifier is designed to provide satisfactory recording at input levels of from minus 50 db to 0 db (where 0 db equals 6.0 mw). It is of the compression type to maintain volume level perspective, and at the same time to compress the signals supplied to the input of the machine to such a degree that they can be recorded within the volume range afforded by this type of equipment (dynamic range of the flexible, plastic recording belt used in the machine is about 35 db).

This amplifier also provides means for modifying the frequency characteristic of the applied signal to provide a recording that can be reproduced with the greatest intelligibility. In recording speech it is customary to accentuate the frequencies between 1,000 and 3,000 cycles to improve the sibilance.

There are three audio inputs to the machine, namely, a 500-ohm and a 5,000-ohm (bridging) screw-terminal input, and a 500-ohm telephone-jack input. There is a power supply input receptacle and a terminal board for connecting a remote signal light if desired. The foregoing comprise the external connections. There are

plug-in type internal connections to facilitate servicing and replacing the amplifier.

Recording Technique

The input level control on the rear of the machine, and the recording amplifier volume control at left-front of the amplifier chassis, are adjusted until normal indication is shown by the power level meter. The recording amplifier high and low tone controls are adjusted for satisfactory record-

ing and reproduction intelligibility.

Recording is done at constant-tone groove speed by swaging (embossing) a lateral tone groove in the recording medium. Two hundred tone grooves are recorded per inch, thus the tone groove pitch is 0.005 inch. Because the thin, flexible, plastic recording belt is 3½ inches wide and has an ¼-inch margin on either side, the recording area is 3¼ inches wide. Each record provides 30 minutes of continuous recording.

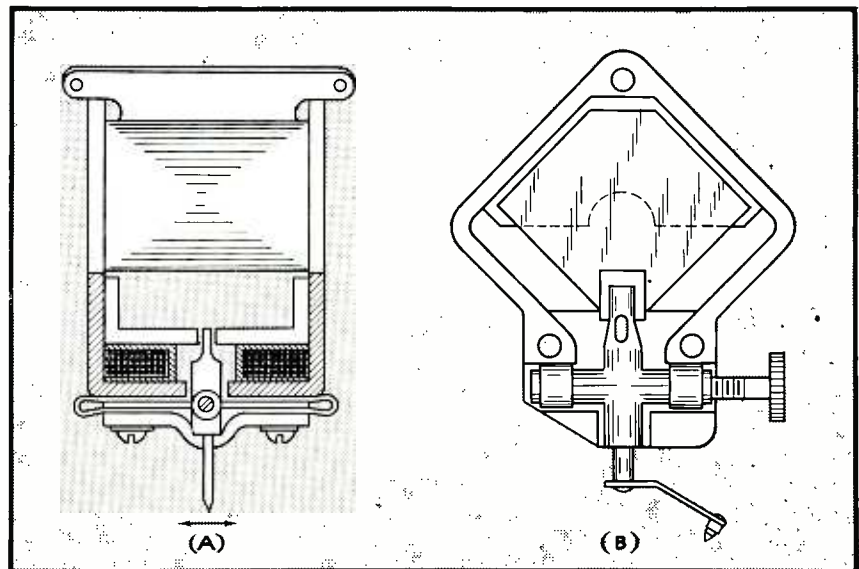

FIG. 4—Electromagnetic recorder head (A) and crystal reproducer (B) can be operating simultaneously on the flexible recording belt

The linear, tone-groove velocity is 21.66 feet per minute, which is 4.33 inches per second. This low linear velocity is used to provide maximum recording time in minimum recording space and subsequently provide minimum recording medium cost and minimum filing and storage space.

The lower the linear tone-groove velocity, the more difficult the problem of recorder stylus tip design, because the problem of faithfully recording the higher frequencies becomes more acute. For instance, even at a linear tone-groove velocity of 40 feet per minute, only eight inches of tone groove pass under the recorder stylus each second. Therefore, there is only 0.008 inch (8 mils) in which to trace one complete cycle of a 1,000 cps signal. In other words, there is 0.004 inch of tone groove in which to trace one alternation from zero to maximum amplitude in one direction and back to zero again.

From these numbers it is easy to see how small the recorder stylus tip must be to faithfully trace speech modulations. Beyond this, at a linear, tone-groove velocity of 20 feet per minute, four inches per second, the space for tracing each modulation of the tone groove, at any particular frequency, is cut in half. Thus at 20 feet per minute we would have 0.002 inch to trace one alternation of a 1,000 cps frequency. The foregoing explains how a reduction in linear tone-groove velocity reduces high frequency response for a given contour of recorder stylus tip. The

problem is solved in the case of this particular machine by a specially designed recorder stylus which makes it possible to obtain satisfactory high frequency response even at a very low linear tone groove velocity.

The minutes of recording per square inch of recording medium used is 0.77. The minutes of recording per square inch of total recording medium area (including waste space) is 0.71. Therefore, the efficiency of recording medium usage is 93 percent. There are about 2.77 seconds of recording per tone groove because each complete tone groove spiral is 12 inches in length and the tone groove velocity is 4.33 inches per second.

The recorder shown in Fig. 4A is of the magnetic type, consisting of a cylindrical permanent magnet, speech coils, stylus, and armature.

The reproducing head consists of a crystal element in its bracket assembly, as shown in Fig. 4B. The reproducer stylus consists of a conical pointed sapphire having a 0.0015-inch tip radius, mounted in a spring suspension which is attached to the end of the stylus shank. There is a flat ground on one side of the stylus shank to provide proper alignment of the reproducer stylus in the reproducer assembly. This type of stylus minimizes the effect upon reproduction of any vertical motion imparted to the stylus tip by the record. At the same time, it provides optimum reproduction of lateral modulation in the tone grooves.

There is a record-change switch associated with each of the dual units. This switch closes a signal light circuit to indicate that the record on the machine with which it is associated is fully recorded and should be changed. This switch is actuated when the recorder carriage reaches a point within a few seconds of the end of its right-hand limit of travel.

Mechanical Control

When both ready-switches associated with each of the dual recording units are operated, they close a series signal light circuit to indicate that the recorder carriage control levers on both units are in the operate position and the machine is ready for uninterrupted recording.

A reproducer safety switch associated with each dual unit is operated when the reproducer carriage reaches a point within 1/32 inch of its right-hand limit of travel. When this switch is operated, it opens the motor circuit of the machine with which it is associated, thereby protecting the feed on the reproducer carriage should the machine be left in the operate position.

To facilitate finding a particular conversation which has been recorded on the belt, a backspacer mechanism is provided. When the reproducer carriage control is moved from neutral to operate, the reproducer carriage moves back three tone grooves, equivalent to about eight seconds, before the stylus is lowered to the belt.

A control lever interlock prevents ejection of a recording belt when either carriage control is in the operate position, thus preventing damage to either stylus. This interlock also prevents operation of either carriage control if the ejector is in the ejected position, thus preventing lowering the recorder or reproducer stylus to the recording anvil or drive mandrel when there is no belt on the machine. Operating the ejector removes the recording belt from the machine. This mechanism also injects the flexible recording belt.

Because there are separate recording and reproducing heads and amplifiers, the two can be operating simultaneously. The reproducing head can come within about one second of the recording stylus.

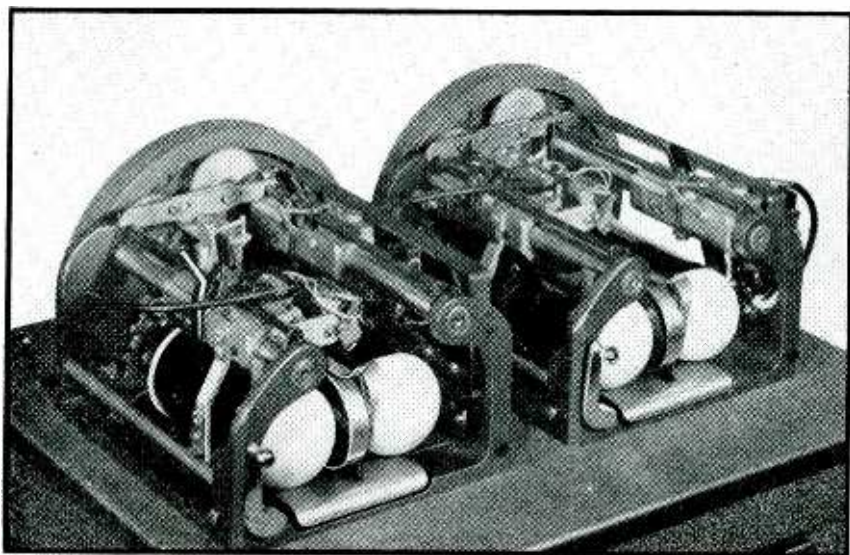

FIG. 5—Induction motors mounted underneath the unit plate drive the recording and reproducing carriages and the recording belt

RADIOSONDE Telemetering Systems

Technical details of modern meteorological radiosonde transmitters, which use ceramic temperature-responsive resistors, an electric hygrometer employing a lithium chloride film on polystyrene, and a new dry-pack perchloric acid battery. Both radar and radio d-f methods of radiosonde tracking for winds-aloft observations are described

By V. D. HAUCK, J. R. COSBY, and A. B. DEMBER

Friez Instrument Division, Bendix Aviation Corp., Towson, Md.

A radiosonde is the precision, low-cost balloon-carried measuring and transmitting end of a radio telemetering system used in the determination of temperature, humidity, pressure, cloud height, wind direction and speed, and other characteristics of the upper atmosphere.

Radiosondes are carried to heights of 15 miles or more by hydrogen or

helium-filled balloons. During flight, sensitive measuring elements react to variations of air pressure, temperature, humidity, etc, causing equivalent changes to occur in the modulation of the transmitter. On the ground, special equipment is provided to receive and record information from which accurate determinations of air temperature, relative humidity, wind speed and direction

at the various altitudes may be made.^{1, 2, 3, 4, 5}

Air-Borne Transmitting Equipment

Probably the most widely used radiosondes to date are the Army-Navy type AN/AMQ-1D and U. S. Weather Bureau type 506-WB, all representing improved models of the Diamond-Hinman audio-frequency modulation system originally developed by the National Bureau of Standards for use in the aerological branch of the U. S. Navy Department. These radiosondes consist of a ventilation chimney containing temperature and humidity-measuring elements, together with an aneroid switch, battery, and electronic unit assembled in a highly reflective, cellophane-surfaced, water-resistant, corrugated paperboard container approximately 4 x 8 x 9 inches in size and with a total weight of approximately 2.8 pounds. A suspension ring is fastened to the top of the container to provide an easy method of attachment to parachute and balloon. As the balloon ascends to the stratosphere, it continuously grows larger until it finally bursts, at which time the attached parachute opens, permitting usable measurements to be made on the descent and also preventing damage to life or property on landing.

Transmitter Circuit

A single type 3A5 miniature duotriode vacuum tube is used. Triode

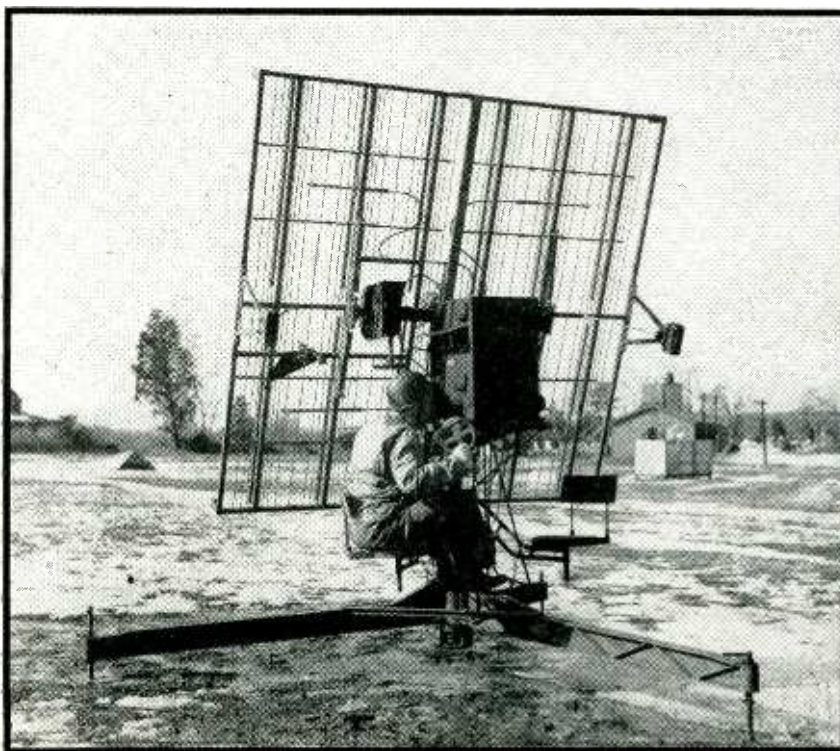

Radio set SCR-658, used for radiosonde tracking to determine wind speed and direction
(Signal Corps photo)

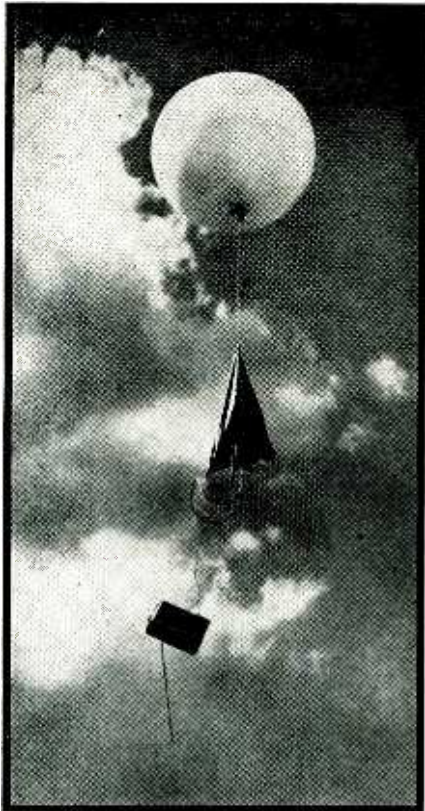

Radiosonde in flight

section VT_1 , is employed as a one-megacycle tuned-plate tuned-grid r-f oscillator having a variable relaxation frequency in the audio range, and triode section VT_2 serves as a 72-megacycle modulated r-f oscillator, as shown in Fig. 1. Advantage is taken of the mechanical movement of the aneroid pressure measuring unit to perform the various circuit switching functions in conjunction with the relay, in order that the temperature and humidity-sensitive resistors, reference resistors, etc. may be sequentially inserted into the grid circuit of VT_1 to give various relaxation (oscillator blocking or quenching) frequencies in the range from 10 to 200 cycles.

The frequency at which the 1-mc oscillation is interrupted is thus made alternately a function of the temperature, humidity, and reference resistors that are shunted across C_1 , and the sequence in which this switching is performed is used as the indication of air pressure at the time of switching. These data are obtained as a function of atmospheric pressure, accurate to 5 millibars, as the expanding aneroid cell of the barometric switch causes the contact arm to travel across the

commutator consisting of 80 contact segments.

Humidity measurements are made on all contacts except those noted below, with resistors R_5 , R_3 , R_2 , and humidity-sensitive element R_1 connected into the grid circuit by the 3-volt relay.

Whenever the contact arm is on an insulating segment, the relay drops out and the grid circuit is completed through R_5 , R_3 and temperature-sensitive element R_1 for temperature measurements.

At every 5th contact up to the 55th, except the 15th, 30th, and 45th, the grid circuit is completed through fixed resistors R_3 and R_2 in series (R_1 is now grounded at both ends and hence shorted out), resulting in a generation of a low reference frequency of 190 cycles which serves as a means of correcting for frequency drift in the entire transmitting and receiving system, as well as providing definite identification of specific contacts on the commutator.

Contacts 15, 30, 45, 60, 65, 70, 75, and 80 are termed high reference contacts, connecting only R_5 into the grid circuit and causing a frequency

5 cycles above low reference frequency to be generated, which further identifies the position of the contact arm during flight of the instrument.

Humidity measurements are not made above contact 59, as such data is not essential at high altitudes because of the extremely small amounts of water vapor present at the low temperatures encountered at these altitudes.

Measurements are not based on absolute frequencies, but on frequency ratios which are equivalent to resistance ratios, with the result that certain variable characteristics of the transmitting and recording equipment are largely eliminated from consideration.

Relaxation Oscillator Operation

In the one-tube radiosonde transmitter there is a period when the 72-mc r-f oscillator is operating and the audio relaxation oscillator is blocked, followed by a period during which the relaxation oscillator is functioning and the 72-mc oscillator is blocked. This transfer of the relaxation rate from the 1-mc oscil-

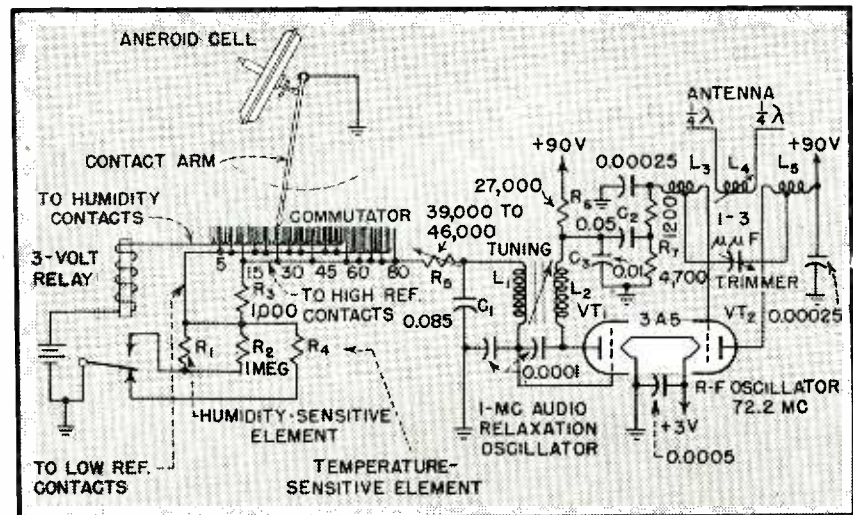
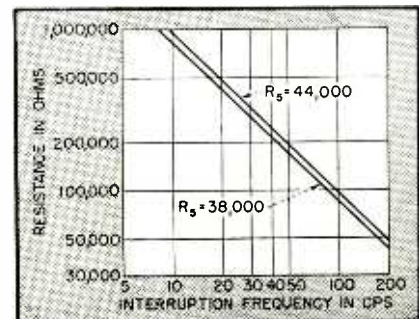

FIG. 1—Complete circuit (above) of radiosonde, including barometric switch. Interaction between the two triodes is such that when the 1-mc oscillator is on, the 72-mc oscillator is off, and vice-versa. The rate at which the 1-mc oscillator goes on and off is determined by the total resistance value shunted across C_1 .

FIG. 2—Variation of audio relaxation or self-blocking frequency with total resistance in grid circuit of 1-mc oscillator (right)



lator to the 72-mc oscillator results in a transmitted carrier having a pulsed or keyed characteristic, the frequency of which is determined by the resistance of the meteorological elements or reference resistors.

Referring to Fig. 1, during the period when the audio relaxation oscillator is blocked, the negative charge on C_1 leaks to ground through R_5 and R_6 and then either through humidity-sensitive resistor R_1 and shunt R_2 , through temperature-sensitive resistor R_4 , or through the contact arm of the barometric switch. As C_1 discharges and the grid voltage of VT_1 increases in a positive direction, a condition finally is obtained where VT_1 begins to conduct and oscillate at about one megacycle, causing a voltage drop across R_6 which is applied by means of C_2 to the grid of triode section VT_2 , stopping it from oscillating. Capacitor C_2 thereupon discharges through R_7 , causing the r-f oscillator section VT_2 to remain off. The current through R_7 does not become small enough to allow the transmitting oscillator to start oscillating again until the relaxation oscillator blocks itself by the accumulation of a negative charge on C_1 . At this time C_2 and C_3 charge toward +90 volts, reducing the current through R_7 and thus re-establishing conditions for oscillation of transmitting oscillator VT_2 . This brings the cycle back to its starting point.

The reference frequency is established by padding the value of C_1 . All transmitter frequency calibrations are based on a temperature-stabilized electronically-driven tuning-fork multi-frequency standard, which is checked daily against WWV.

The frequency-resistance relationship of the audio relaxation oscillator may be obtained from

$$f = \frac{1}{KC_1(R_3 + R_5 + R_x + R_y)} \quad (1)$$

where R_x is the resistance being measured while connected in series with reference resistors R_3 and R_5 by the barometric switch, R_y is the effective resistance introduced by the vacuum tube, L_1 and other constants, and K is a constant. In the frequency-resistance relationship shown in Fig. 2, the resistance plotted is the total resistance $R_3 + R_5 + R_x + R_y$. With C_1 fixed, the R_x -vs-frequency relationship depends on the values of

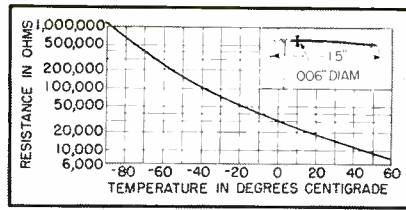

FIG. 3—Effect of temperature on ohmic value of temperature-responsive ceramic resistor used in radiosonde, and closeup view of unit

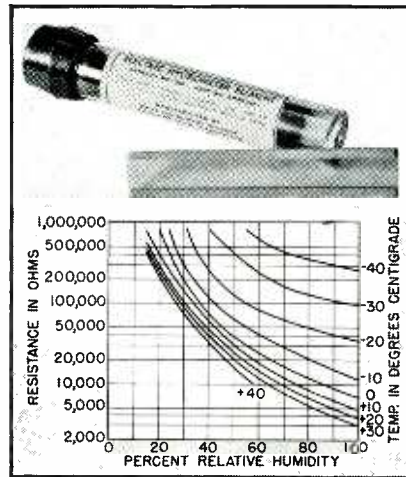

FIG. 4—Characteristics of electric hygrometer. The element is sealed in a glass vial for protection against dust, fumes, high humidity, and other deteriorating influences prior to use, and is removed from the vial and installed in the radiosonde at the time that the batteries are activated

reference resistors R_3 , R_5 , and R_y . Making R_x adjustable over a limited range permits compensating for tube and circuit variations affecting R_y .

The adjustment of grid current at the reference frequency is accomplished by positioning the iron slug of coils L_1 and L_2 (Fig. 1), thereby maintaining the proper audio-frequency resistance relationship. The carrier frequency may be adjusted from 70 to 74 mc by means of a trimmer. The coupling to the antenna and, therefore, the transmitter carrier output may be changed by adjusting L_1 .

In the past, radiosondes have been operated on various frequencies, the most widely used being 72.2 mc. Radiosondes are under development at the present time for use on frequencies of 400 mc and higher.

Ground Recording Equipment

In a ground station, the audio component of the carrier is used to actuate a recorder which utilizes a 10-inch wide continuous strip chart

having 100 equal divisions from left to right. The paper travels between a typewriter ribbon and a drum carrying a spiral ridge over which a taper bar is situated so that dots representing zero to full scale are printed on the chart, depending upon the position of the spiral ridge at the time the taper bar strikes the typewriter ribbon.

An electronic frequency meter converts the audio frequency to a value of direct current, proportional to frequency, which deflects a specially constructed meter, the pointer of which is synchronously scanned by a light beam and phototube. After the light beam has passed the meter pointer, the phototube is suddenly re-illuminated, causing a triggering of the circuit actuating the taper bar magnet. Thus, the left-to-right displacement of the recorder printing is a direct measurement of the position of the meter pointer and consequently of the received frequency. This record may be evaluated in definite terms of temperature, relative humidity and pressure by means of standard calibration data arranged in the form of slide rules and graphs.

Pressure and Temperature Elements

The barometrically operated switch is the only mechanically operated measuring unit in the radiosonde. The high order of accuracy (within 5 millibars over the entire range of pressure and temperature, 10 to 1,060 millibars and +60 to -90 C) is achieved by the use of a bimetallic temperature compensator, heat and cold-treated diecast frames, and heat-treated and specially aged beryllium-copper aneroid cells.

Until recently electrolytic temperature-responsive resistors were extensively used for radiosonde air temperature measurements. The ceramic resistor now used has higher speed of response, greater stability, freedom from polarization effects and high physical strength. These ceramic resistors have a negative temperature coefficient of approximately 2.5 percent per degree centigrade at 20 C and a resistance-temperature characteristic as in Fig. 3, permitting determination of temperature between +60 and -90 C with an accuracy of 1 degree over most of the range. New experimental

types with a resistance change as high as 4.5 percent per degree centigrade at 20 C have been developed and are usable up to +250 C.

Electric Hygrometers

The humidity-measuring elements in the most widely used radiosondes are essentially humidity-responsive resistors, highly developed and improved versions of electric hygrometers^{6, 7, 8} with faster response than hair hygrometers previously used. The modern hygrometer element consists of a polystyrene strip coated with a hygroscopic film containing lithium chloride as the active agent. Thin layers of tin deposited on both edges serve as electrodes. The resistance is a function of the amount of absorbed atmospheric moisture and of temperature, resulting in a relative humidity calibration like that in Fig. 4.

When subjected to direct current, the electric hygrometer exhibits a counter emf or polarization effect which depends to a degree on the current density, and causes the apparent resistance at fixed humidity and temperature to vary with time during the period of conduction. In order to minimize this effect and evaluate humidity with optimum accuracy, the a-c current with a d-c component in the radiosonde circuit is adjusted to approximately 250 microamperes at the reference frequency.

Perchloric Acid Battery

In order to combat difficulties in distribution and problems of storing dry cells at remote meteorological stations, the dry-pack acid battery shown in Fig. 5 was developed, based on experimental units first produced by the National Bureau of Standards. It consists essentially of a honeycomb polystyrene case having 49 B-section cells and two large rectangular cell cavities for the A section.

The battery is filled by an evacuation process whereby the acid is forced through capillary holes at the top of the battery case. When so prepared for use it will develop 15 milliamperes at 88 volts and 0.3 ampere at 3.6 volts, for approximately 3 hours, which is more than adequate for a complete radiosonde flight. The electrolyte is a solution

of perchloric acid, with electrodes consisting of lead and lead dioxide plated onto suitable conductive base materials. Since the electrolyte is injected into the battery at the time of use, no storage deterioration is experienced, and the batteries may be kept under severe conditions of temperature and humidity for years.

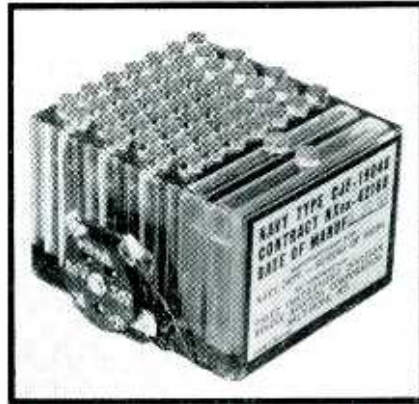
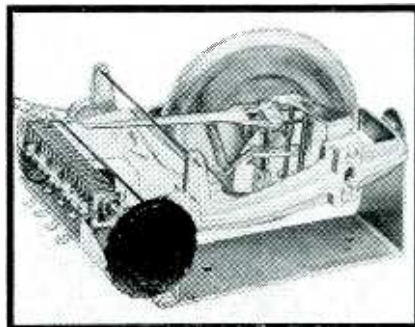
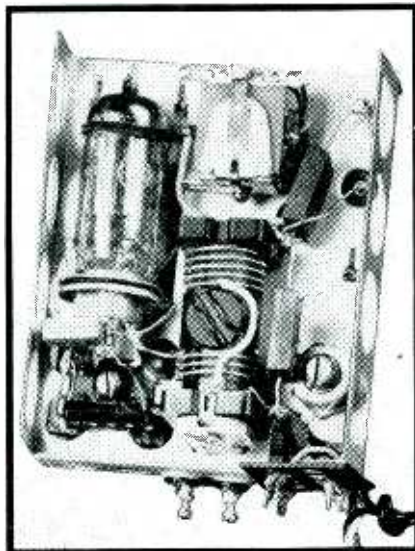

FIG. 5—Dry-pack acid battery used in radiosondes



Barometric switch used in radiosondes



Chassis of radiosonde transmitter, showing 3A5 tube and 3-volt relay (at top), adjusting screws, and antenna terminals (at bottom)

Winds-Aloft Observations

Several methods of radiosonde tracking have been used in order to determine the speed and direction of the wind at various altitudes. The systems employed or contemplated fall in two general categories: (1) radar methods for tracking free balloons with or without special reflective structures and thus without dependence on indications of the altitude measuring barometric switch; (2) determination of the position of the balloon-carried radiosondes by vertical and horizontal radio direction-finding methods, together with indications of the pressure switch, so that position may be determined by a knowledge of one side of the triangle (altitude), the opposite angle (angular elevation), and the azimuth.

Future Trends

The trend in design and development of future radiosonde equipment is toward the use of rapid sequence systems, in which a motor is used to select measuring elements of the system rapidly, to permit the use of faster ascension rates and to obtain a more detailed analysis of the atmosphere through which the equipment is to pass.

In general, the radiosonde of the future will operate at extremely high carrier frequencies, will be arranged to permit tracking by means of automatic recording ground equipment, and will encompass measuring systems of greater accuracy and lower cost than those heretofore available.

REFERENCES

- (1) Diamond, H., Hinman, W. S., Jr., and Dunmore, F. W., A Method for the Investigation of Upper-Air Phenomena and Its Application to Radio Meteorology, *Journal Research*, National Bureau of Standards, 20, p. 369-392, 1938; RP1082; *Proc. IRE*, 26, p. 1235-1265, 1938. See this article for complete bibliography on prior art.
- (2) Diamond, H., Hinman, W. S., Jr., Dunmore, F. W. and Lapham, E. G., An Improved Radiosonde and Its Performance, *Journal of Research*, 25, p. 327-367, 1940; RP1329.
- (3) Harmantas, C., Upper-Air Temperatures Obtained by use of Radiosonde, "Temperature, Its Measurement and Control", Reinhold Pub. Corp., p. 381-388, 1941.
- (4) Pear, C. B., Jr., Radio Sounding in the United States, *ELECTRONICS*, p. 82-85, Jan. 1943.
- (5) Orville, Howard T., Invasion Weather, *Fritz Weathervane*, June 1944 (Reprinted from *Collier's Magazine*).
- (6) Dunmore, F. W., An Electric Hygrometer and Its Application to Radio Meteorology, *Journal of Research*, 20, p. 723-744, 1938; RP1102; U. S. Patent No. 2,295,570, 1942.
- (7) Dunmore, F. W., An Improved Electric Hygrometer, *Journal of Research*, 23, p. 701-714, 1939; RP1265; U. S. Patent No. 2,285,421, 1942.
- (8) Fiene, M. E., Humidity Responsive Device, U. S. Patent No. 2,064,651, 1936.

Pulse-Modulated Radio Relay Equipment

Pulse-position-modulated, time-division-multiplex equipment provides eight voice channels between terminals. Links two hundred miles long can be constructed. Two similar equipments are described, one having 100-microsecond frame, the other a 125-microsecond frame



By JOHN J. KELLEHER

*Engineering and Technical Service
Office of the Chief Signal Officer
Washington, D. C.*

PULSE-MODULATION relay sets are the latest additions to the series of military radio equipment designed for use with or in place of single or multiple-channel wire telephone and telegraph circuits. This type of equipment was originally intended to satisfy a long-standing need for convenient means to bridge such obstacles as gorges, swamps, and rivers, and to span areas where installation of wire was impractical either because of rugged terrain or because the area was subject to enemy action.

Radio relaying has not only been

Microwave relay terminals are quickly erected as communication facilities are required. Enemy controlled or naturally impenetrable terrain is spanned by sharp beams which require little power and improve security

electronics
WAR REPORT

Components of radio set TRC-5 include—in addition to spare units and test oscilloscope—transmitter, multiplex unit, common frame, receiver, and power supply

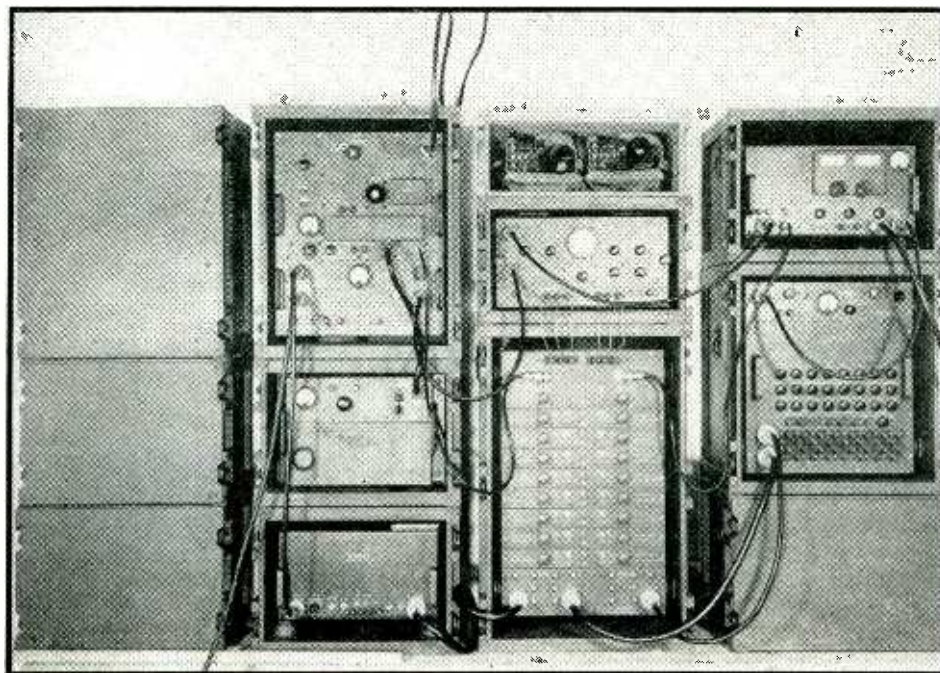

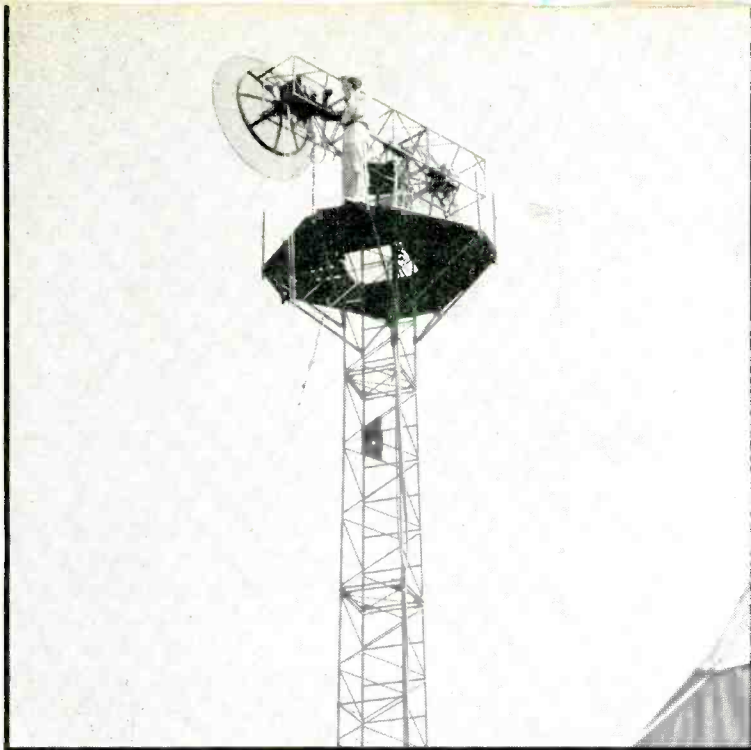

Transmitter and receiver of TRC-6 are mounted at antennas so that super high frequency circuits will be short

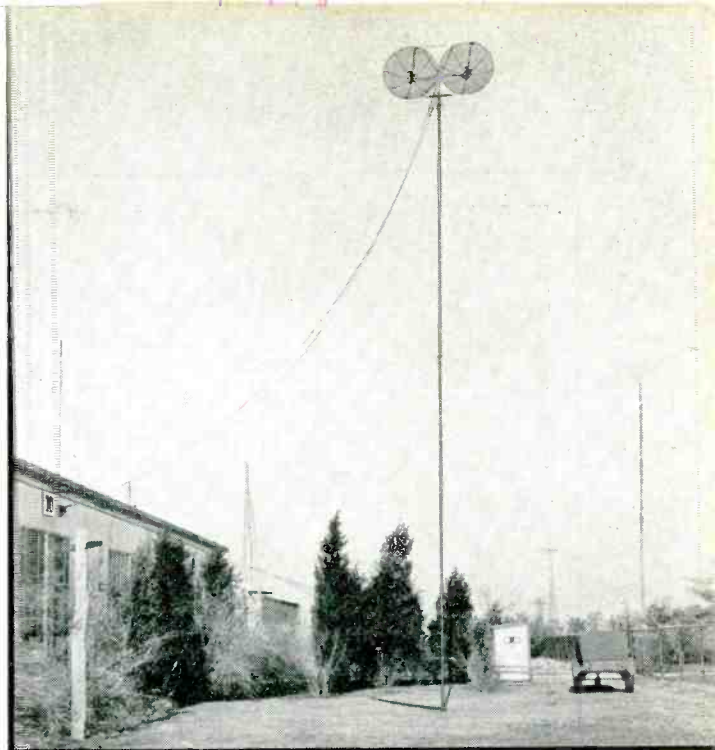

Antenna of the TRC-5 consists of two dipoles with parabolic reflectors atop a guyed fifty-foot pipe

employed with great success for these purposes, but has proved so dependable and versatile and has afforded such substantial savings in both men and materiel, that this equipment is now employed extensively as complete replacement for important wire circuits. Among its many advantages in this respect are the remarkable reduction in weight and bulk of equipment required per circuit mile, its rapidity of installation, the comparative ease with which circuits can be re-routed or completely re-sited to meet changing conditions, and the fact that faults

are localized at points where trained troubleshooters are instantly available. Moreover, the frequencies employed are little affected by natural phenomena such as magnetic storms, which at times render long wire circuits unusable.

Military Development of Radio Relay

When the war began, work was already under way toward adapting military and civilian radio sets for use with four-channel wire terminal equipment normally used with spiral-four cable. At the same time, Signal Corps engineers on duty with Allied

Force Headquarters in North Africa designed and installed what is probably the first radio relay system used in combat military operations. This system, which at one time extended from Algiers to Malta, was composed of revamped commercial, vhf frequency-modulation equipment of the type employed in many American police radio systems.

Attempts to convert existing equipment to radio relay were not generally satisfactory, however, and it was decided to design new equipment especially for this purpose. By February 1944, production lines were turning out the first of the series, radio terminal set AN/TRC-3 and radio relay set AN/TRC-4, f-m equipment operating on 70-100 mc. The TRC-3 is used at the terminals of the radio portion of a communication system and, because transmission at these frequencies is limited to line-of-sight distances, the TRC-4 is employed at intermediate points to receive and retransmit signals from adjacent stations. Average separation between stations is 35 to 50 miles. Such circuits can be extended several hundred miles, their length being limited mainly by distortion introduced at each additional relay station.

Many hundreds of these units

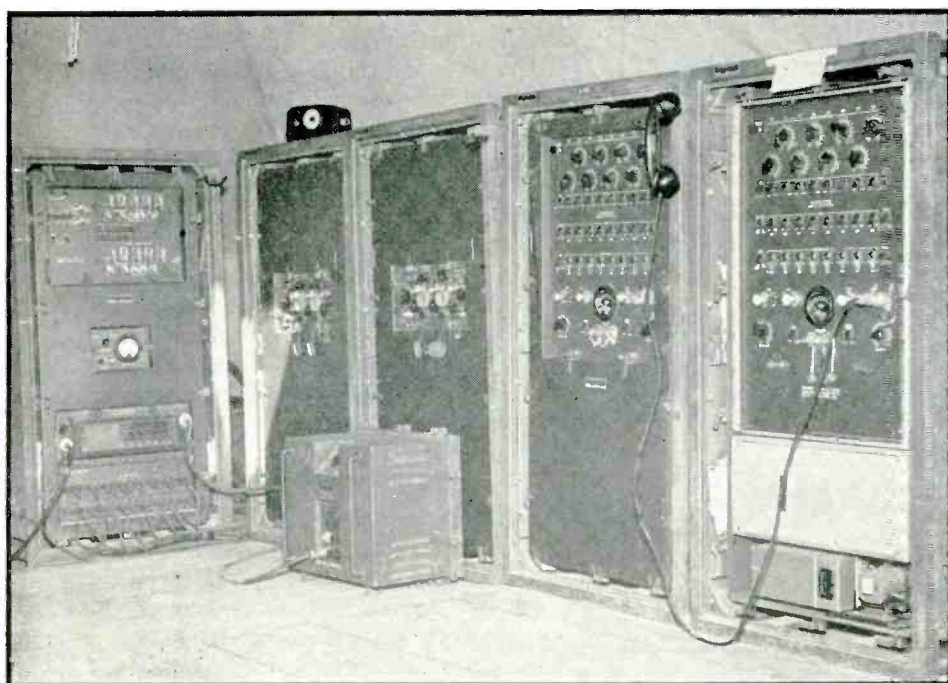

The TRC-6 consists, from left to right, of a common frame, spare radio, operating radio, multiplex frame, spare multiplex, and test oscilloscope

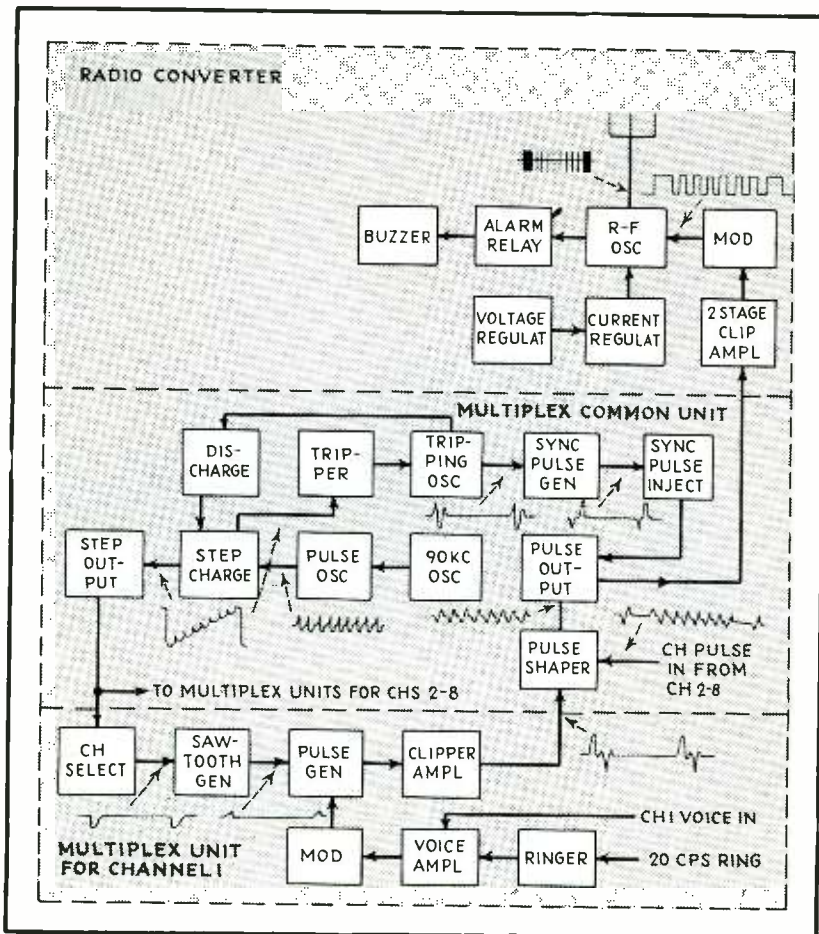

Transmitter functions of TRC-5

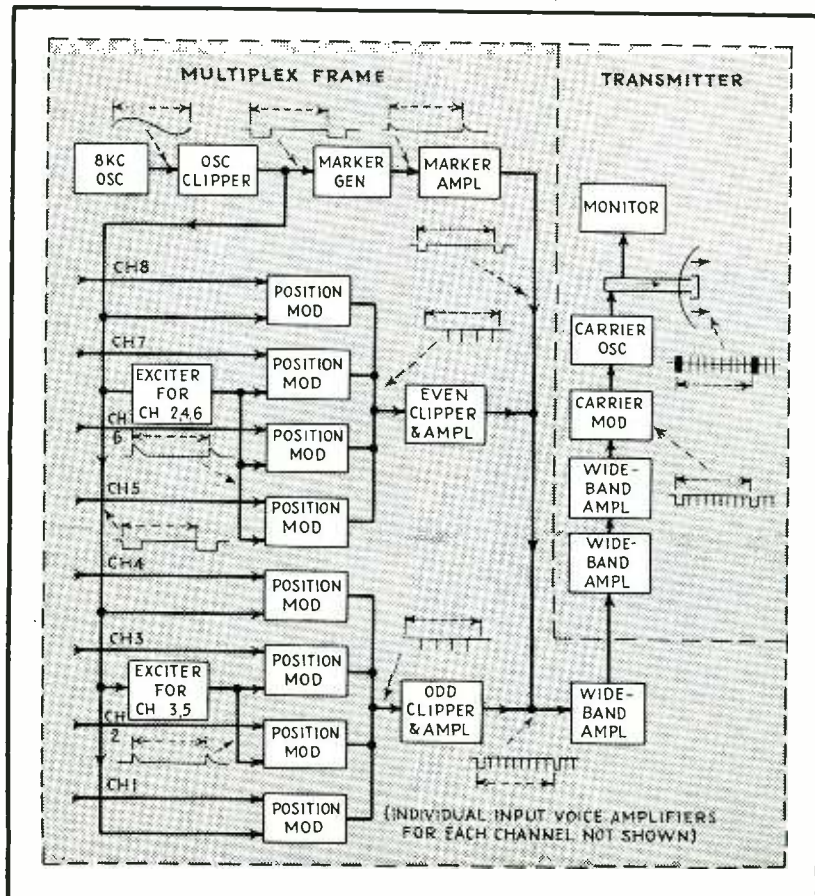

Transmitter components of TRC-6

were used in both European and Pacific Theaters with such outstanding results that General Bradley said, in September 1944, "Our rapid drive across France was dependent on a shoe string. That shoe string was radio link".

Meanwhile, communication engineers turned their attention to the microwave portion of the spectrum, as the lower frequencies were already overcrowded and there was urgent need for more radio communication channels. In September 1942, Signal Corps technicians, accompanied by engineers from the RCA and Bell Telephone Laboratories, visited England to examine a newly developed, microwave radio relay—employing pulse-modulation and time-division multiplex techniques—capable of transmitting and receiving eight conversations simultaneously. Their reaction was enthusiastic. It was decided to develop similar equipment in the United States without delay. In view of the paucity of information on propagation above 3,000 mc it was considered advisable to design equipments in both the uhf and shf ranges, one for operation at about 1,500 mc, the other for the vicinity of 4,500 mc.

In January 1943, Signal Corps Laboratories at Fort Monmouth completed development specifications and contracted with RCA Laboratories for preliminary models of the 1,500-mc set (now known as radio set AN/TRC-5) and with the Bell Telephone Laboratories for the 4,500-mc version (now identified as radio set AN/TRC-6). Models of both sets were delivered in the Spring of 1944, and by June of that year laboratory and field tests at Fort Monmouth had progressed to the point where it was decided to procure additional service test models of both types for further tests and personnel training. Rauland Corporation was chosen to manufacture radio set TRC-5, and Western Electric Company was awarded a contract for radio set TRC-6.

Time-Division Multiplex

Major components of both sets are shown in the photographs and block diagrams, except for the primary power source, a trailer-mounted, 5-kilowatt, a-c generator driven by a four-cylinder four-cycle gasoline en-

gine. As can be seen from these photographs, the antenna structures of the sets differ considerably; in the case of TRC-5, the transmitting and receiving antenna arrays are mounted atop a 50-foot tubular steel mast. Connections to transmitter and receiver are made with high-grade coaxial cable. In the case of the TRC-6, the transmitter and the receiver converter are located immediately behind the parabolic antenna reflectors at the top of the 50-foot tower. This arrangement was used because of technical problems, one of which was that the use of coaxial-cable feeders at 4,500 mc would entail prohibitively high losses. Coaxial cables carry the 60-mc, i-f output of the receiver converter and the wide-band input to the transmitter.

The most noteworthy departure from convention in both sets is the time-division-multiplex system used, which is radically different from frequency-division-multiplex techniques generally employed in wire terminal equipment. In frequency-division systems each channel to be transmitted is placed in a different portion of the audio-frequency spectrum by means of fixed-frequency carriers so chosen that, after filtering, the lower sidebands of each channel can be transmitted simultaneously. For example, if the bandwidth of each voice channel is 200 to 2,800 cycles and a 6,000-cycle carrier is employed, the lower sideband will lie between 3,200 and 5,800 cycles (the speech is, of course, inverted as a consequence of the modulation process). Similarly, lower sidebands of 6,200 to 8,800 cycles and 9,200 to 11,800 cycles result when 9 and 12 kilocycle carriers are utilized.

In time-division-multiplex, each channel to be transmitted is connected to the line in rapid succession, either electronically or by means of a rotating commutator, thus the multi-channel signal is composed of interlaced samples of the several channels being transmitted. A large number of these samples are transmitted per unit of time to permit reconstruction of the original signals at the receiving apparatus, where they are separated by another electronic or mechanical commutator synchronized with that at the transmitter. Time-division-multiplex systems have been in use commercially for many years

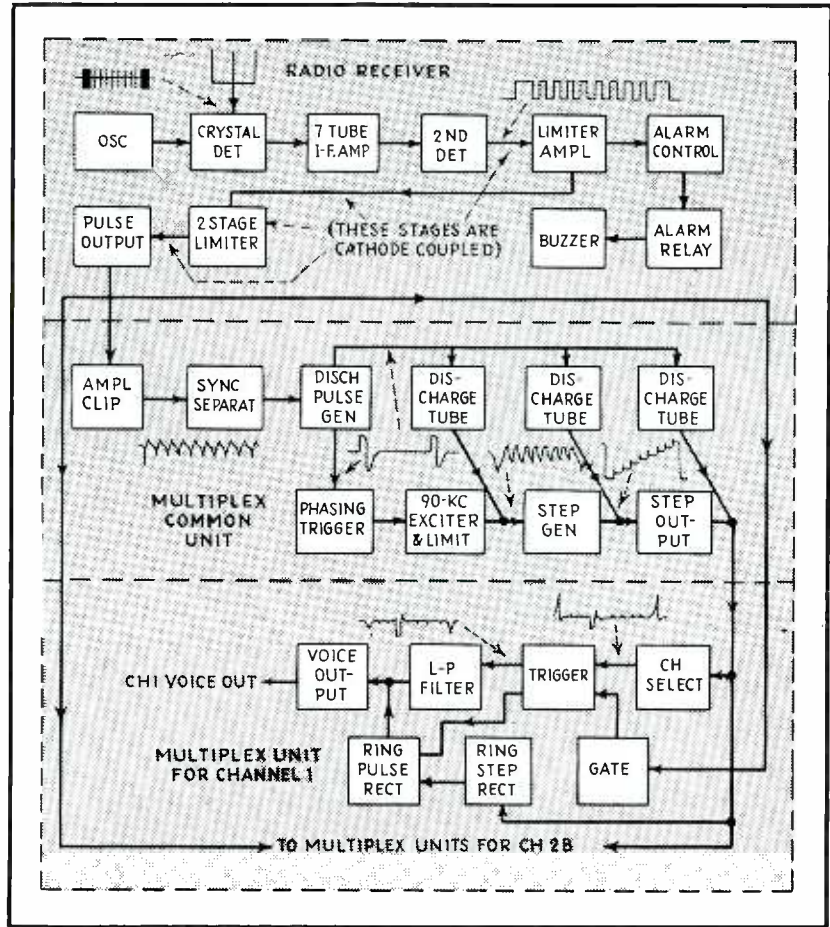

Functions of the TRC-5 receiver

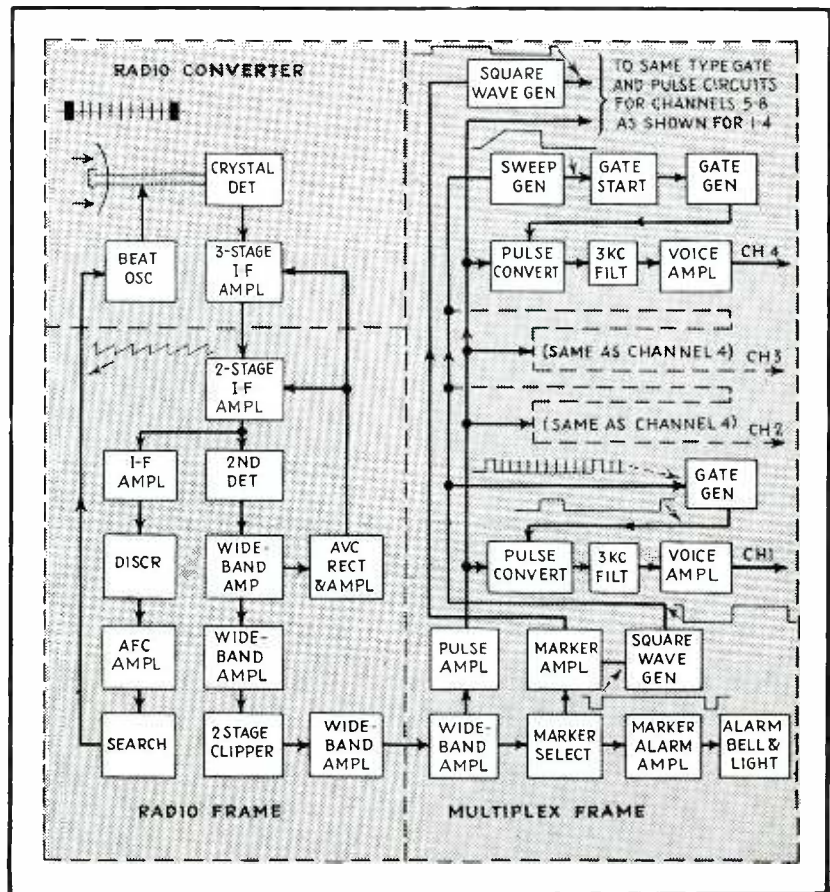

Components of the TRC-6 receiver

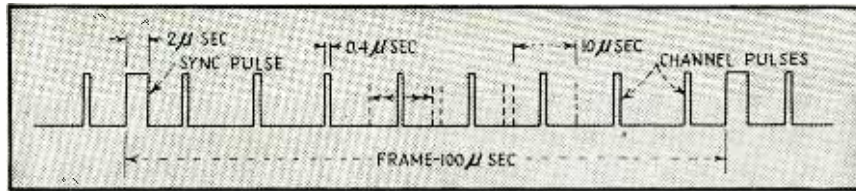

FIG. 1—Frame consists of a long synchronizing pulse followed by short channel pulses

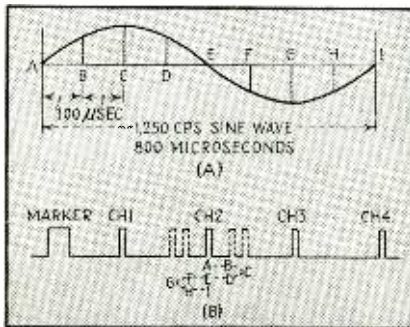

FIG. 2—(A) Signal is periodically sampled. (B) Instantaneous signal amplitude modulates pulses by displacing them about their normal position

to transmit several telegraph or teletype signals over a single circuit, but radio sets TRC-5 and TRC-6 represent the first practical application of these techniques in the transmission of several voice signals simultaneously. The specifications of these two sets are summarized in Table I.

Circuit Function

The following illustrates, in general, the manner in which radio set TRC-5 functions. When no modulation is present in any of the eight voice channels, the transmitted carrier is as shown in the solid lines of Fig. 1. A two-microsecond synchronizing pulse is followed by eight channel pulses, each of 0.4 microsecond duration, the first of which occurs about six microseconds after the synchronizing pulse with the remaining seven following at about 12 microsecond intervals. The synchronizing pulse recurs about six microseconds after the eighth channel pulse, and the cycle is repeated. Each group of nine pulses constitutes a frame, which has a duration of 100 microseconds; hence, 10,000 frames are transmitted in one second. Audio-frequency signals transmitted in this manner can be regenerated at the receiver without appreciable distortion if the sampling rate is approximately three times the highest audio-frequency to be transmitted; in this case, 3,000 cycles.

In the unmodulated condition, each of the eight channel pulses recurs in the exact center of a ten microsecond time interval allotted to that particular channel, as indicated by the dotted lines in Fig. 1. Modulation on any channel varies the time of occurrence of the channel pulse, with respect to its unmodulated position, a maximum of plus or minus about five microseconds, the extent of the deviation depending upon the instantaneous amplitude and polarity of the modulating signal. Because the channel period is only about ten microseconds, and the interval between adjacent channel pulses is approximately 12 microseconds, there exists a two-microsecond guard band between channels which greatly reduces the possibility of interchannel crosstalk caused by excursions of a pulse into an adjacent channel.

The relative positions of the nine pulses which occur for a given channel during one cycle of a 1,250-cycle sine wave are illustrated in Fig. 2.

Considering channel 2, in Fig. 2B, pulse A occurs at a time when the wave has neither amplitude nor polarity; hence, it is centered in the ten-microsecond channel. Pulse B, occurring approximately 100 microseconds later, is retarded 0.707×5 microseconds, corresponding to the amplitude of the wave at 45 electrical degrees. Pulse C samples the peak amplitude of the wave and is retarded five microseconds, and so on. Pulses F, G and H are advanced, rather than retarded, indicating the polarity reversal of the modulating signal.

At the receiver, the synchronizing pulse is separated from the channel pulses and is utilized to generate eight ten-microsecond gates, synchronized in time with the channel assignments at the transmitter. Each gate is connected to the input of a different channel demodulator, so that the channel is operative only during the expected time of arrival of a pulse for that channel.

After being separated in this manner, the position-modulated pulses for each channel are converted to width-modulated pulses, from which the original modulating signal can be recovered quite simply by means of appropriate lowpass filters. This conversion is accomplished by using the opening of the channel gate to trigger flip-flop multivibrator, which then conducts and continues to conduct

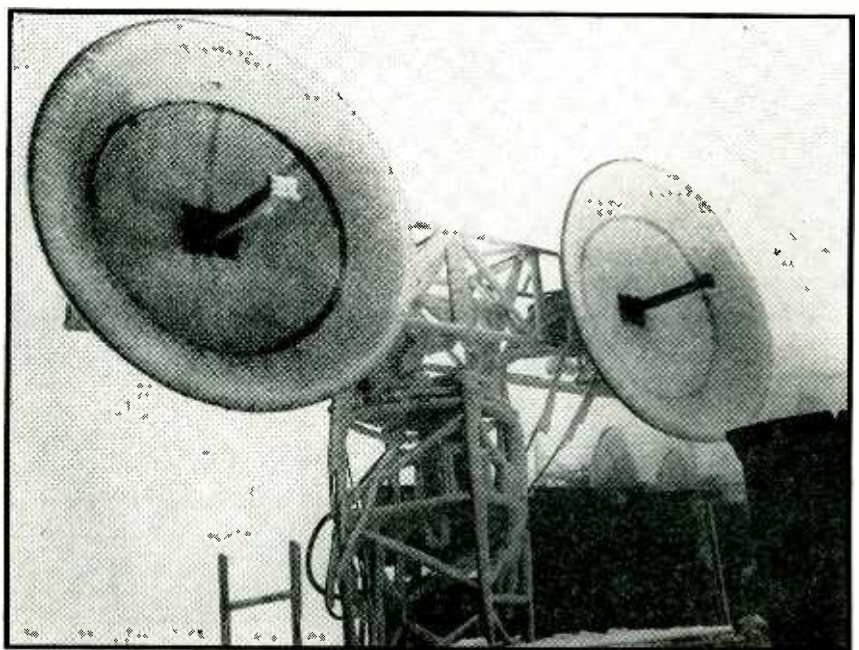

Weather has little effect on system performance

until the incoming pulse arrives. Because pulses may arrive at any time during the ten-microsecond interval that the gate is open, the pulses passed by the local circuit vary in length from ten microseconds when a pulse arrives five microseconds late to only one microsecond when the pulse occurs five microseconds early.

Although these sets have been in production in limited quantities since the Fall of 1944, they are still considered to be in the development stage, and extensive tests are now under way on the West Coast of the United States, under conditions approximately those encountered in actual military service. These tests, which are being conducted under the direction of the Chief Signal Officer, are being closely supervised by both engineers and tacticians with the objective of exploring to the fullest extent the capabilities and limitations of both sets from the military and technical points of view.

There are a number of advantages to be gained from the use of TRC-5 and TRC-6 equipment in radio-relay communication systems. Their traffic-handling capacity is twice that of the TRC-3 and TRC-4 combination. Use of microwavelengths permits design of high gain parabolic-mirror antennas of reasonable dimensions. Time-division multiplex affords very low interchannel crosstalk. Up to the extreme range of the set, signal-to-noise ratio in the individual voice channels is considerably better than the ratio of average signal and noise powers at the input of the receiver. Finally, the audio distortion is negligible with properly designed circuits, so that the practical length of a system is limited by the cumulative effects of individual equipment failures rather than by cumulative distortion.

Advantages afforded by pulse-modulation and time-division multiplex are outweighed to some extent by the required bandwidth, which is several times greater than that needed to transmit an equivalent amount of intelligence by an a-m or f-m continuous carrier. At present the minimum channel separation at these frequencies is determined more by oscillator stability, receiver selectivity, and calibration accuracy than by bandwidth. However, the

TABLE I. Specifications of Military Pulsed Radio Communication Sets

Characteristics	AN/TRC-5	AN/TRC-6
Emission.....	short pulses	
Modulation.....	pulse time	
Voice freq chnrl.....	8	
Multiplexing.....	time division	
Avg trans watts.....	20	0.2
Peak trans watts.....	100	2.0
Net duty factor.....	5.2%	9.6%
Antenna radiator.....	dipole	slotted waveguide
reflector.....		parabola
Net power concentration into beam, db....	14	27
Beam width at half power, deg.....	15	2.5
Antenna support height, ft.....	50	
Avg range of radio link, miles.....	25-50	
Power supply volts.....	115 or 230	
cps.....	50-60	
Nominal power drain, watts.....	1,500	
Generator, kw.....	5	
Carrier freq, mc.....	1,350-1,500	4,300-1,900
Receiver i-f, mc.....	16	60
Channel pulse-length, microsec.....	0.4	1.0
Synchronizing pulse, microsec.....	2.0	4.0
Frame repetition rate, kc.....	10	8
Voice freq. cps.....	300-3,000	
Voice line input impedance, ohms.....	600	
Voice line input connections.....	2 wire or 1 wire	
Ring input, cps.....	20 or 60	20
Ring output, cps.....	20	
Weight, with two trailer generators, lb....	8,200	10,100
Transportation.....	one 2.5 ton truck	two 2.5 ton trucks

day is not distant when increasing use of microwaves for nationwide telephone and telegraph trunks, broadcasting and television-relay systems, and aircraft navigation will require more economical use of this portion of the spectrum. This need will foster design improvements which will necessitate frequent review of the relative merits of pulsed carrier time-division and continuous-carrier frequency-division systems. Consequently, no one can now pre-

dict accurately whether or not pulse equipment will figure prominently in future military and civilian communication systems.

Regardless of the eventual destiny of pulse-modulation time-division systems it is an incontrovertible fact that timely action by Signal Corps Engineers in adapting already developed techniques and components provided practical microwave radio relay equipment far earlier than would otherwise have been the case.

Design Data for

By C. R. COX

Andrew Company
Chicago, Illinois

Symbols Used.

Z_0	= characteristic impedance measured at midpoint between adjacent insulators
b	= inside diameter of outer conductor in inches
a	= outside diameter of inner conductor in inches
k	= average dielectric constant
K	= dielectric constant of insulating material ($K = 6.0$ for steatite)
W	= effective width of insulating material in inches per foot of line
β	= $2\pi/\lambda$
Y_0	= $1/Z_0$ = characteristic admittance measured at midpoint between adjacent insulators
Y_c	= $1/138 \log_{10}(b/a)$ = characteristic admittance of line without beads
R	= conductor resistance (inner plus outer) in ohms per foot
G	= shunt conductance due to imperfect insulators, in mhos per foot
f	= frequency in mc
R_p	= $1/G$ = shunt resistance in one foot of line due to imperfect dielectric
R_s	= X^2/R_p = equivalent series resistance corresponding to R_p
C	= $7.35 \times 10^{-12}/\log_{10}(b/a)$ = capacitance per foot without beads
P_r	= power factor of dielectric material
X	= $1/2\pi f K C \times 0.0833W \times 10^6$ = reactance due to that portion of 1 foot of line which is occupied by insulation
L_f	= $K P_r$ = loss factor of insulation
σ	= heat emissivity in watts per square inch
L	= length of line in feet

A BEADED COAXIAL LINE is one in which the inner conductor is supported within the outer conductor by means of insulating beads, washers, or pegs inserted at regular intervals throughout the length of the line. Such lines are sometimes called air-dielectric lines, because most of the space between the two conductors is occupied by air or some other gas.

Beaded lines, utilizing conductors made of rigid or semiflexible copper tubing, have long been used in broadcast, police, and other transmitting installations, and now are being installed in hundreds of new f-m and television stations. During the war, beaded lines were extensively used in conjunction with high-power radar transmitters and in communication stations transmitting relatively high powers.

Compared to solid-dielectric cables, beaded lines offer the advantages of higher transmission efficiency, particularly at uhf and vhf, and higher

power-carrying capacity. Also, their superior resistance to heat makes them applicable to certain shipboard and aircraft installations. However, lack of flexibility and the inconvenience of having to maintain an internal gas pressure combine to make the beaded line undesirable in portable military equipment. For this reason, solid-dielectric lines have recently enjoyed a temporary advantage.

During the war years, approximately 215 million feet of Polyethylene-insulated r-f cables were produced, while production of beaded lines amounted probably to less than 10 percent of that figure. In the next few years, it seems likely that at least on a dollar basis the production of beaded cables will exceed that of solid-dielectric lines.

Characteristic Impedance of Beaded Lines

In a beaded line, the regularly spaced inner-conductor supports introduce reflections whose effects depend on insulator spacing and frequency, and on the size, shape, and electrical characteristics of the insulators. When the bead spacing is small compared to a wavelength, it is a simple matter to calculate an average capacitance per unit length and an average characteristic impedance and thus reduce the analysis to that of a uniform transmission line. As the bead spacing approaches a quarter wave, however, the recurrent discontinuities due to insulators cannot be averaged uniformly in respect to length, and a more involved analysis is necessary.

Characteristic impedance is normally defined as the impedance looking into an infinite length of line. In a beaded line, the characteristic impedance is defined only at the midpoints between insulators. At all other points, the characteristic impedance includes a reactive component. The impedance may be calcu-

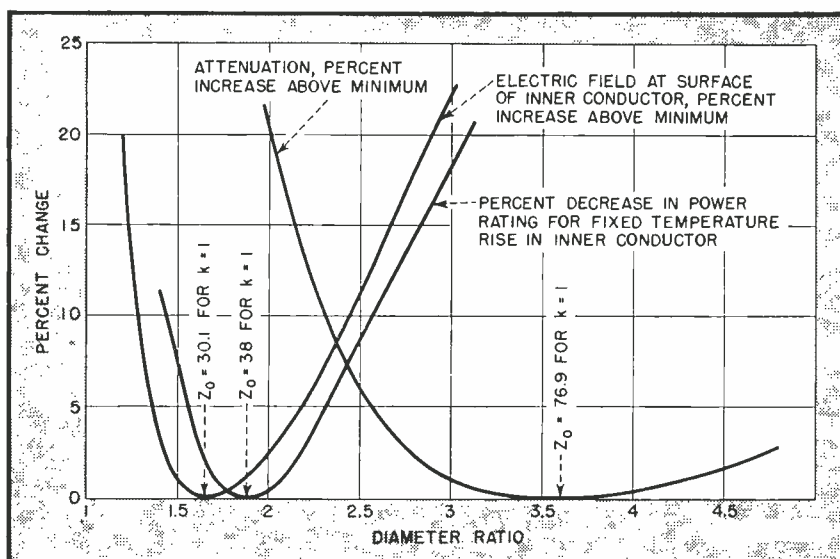

FIG. 1—Effect of diameter ratio b/a (which determines characteristic impedance as set forth in Eq. 1) on attenuation and on power-handling capacity as limited by flash-over and by temperature rise. (Temperature-rise curve calculated from data compiled by H. P. Thomas of the General Electric Co.)

Beaded Coaxial Lines

Determination of characteristic impedance, optimum insulator spacing, attenuation, and maximum power ratings. Choice of insulator materials and shapes for beads. Standard attenuation curves for 70-ohm broadcast lines and 51.5-ohm f-m and television lines

lated from Eq. 1 below, provided the proper interpretation is given to k , the average dielectric constant.

$$Z_0 = 138 k^{-1/2} \log_{10} (b/a) \quad (1)$$

When the bead spacing is less than 2 percent of a wavelength, the factor k may be determined from

$$k = [W (K-1) + 12]/12 \quad (2)$$

Optimum Impedance Values

Any choice of a standard characteristic impedance must be a compromise between mechanical convenience, attenuation, power-handling capacity (flashover), and temperature rise. The relation between these factors and the diameter ratio is shown in Fig. 1. The curves suggest the following optimum impedances: for maximum power-handling capacity as limited by flashover, 30 ohms; for maximum power-handling capacity as limited by temperature rise of inner conductor, 38 ohms; for maximum transmission efficiency, 77 ohms.

In practice it has become common to use 70-ohm cables in standard broadcasting and 51.5-ohm cables in f-m and television broadcasting. These two impedances are also standard for solid-dielectric lines, and hence it is possible to connect rigid and solid-dielectric lines together without matching sections.

Tolerances on characteristic impedance are not very important in standard a-m broadcasting, where the lines are short and standing waves are frequently ignored. In contrast, television requirements are severe, and a 10 percent standing wave is thought to be the maximum allowable for proper system performance. Since variations in antenna impedance over the television channel may account for most of the 10 percent, it is thought desirable to hold the characteristic impedance of the line to within plus or minus 2 percent.

The effect on characteristic im-

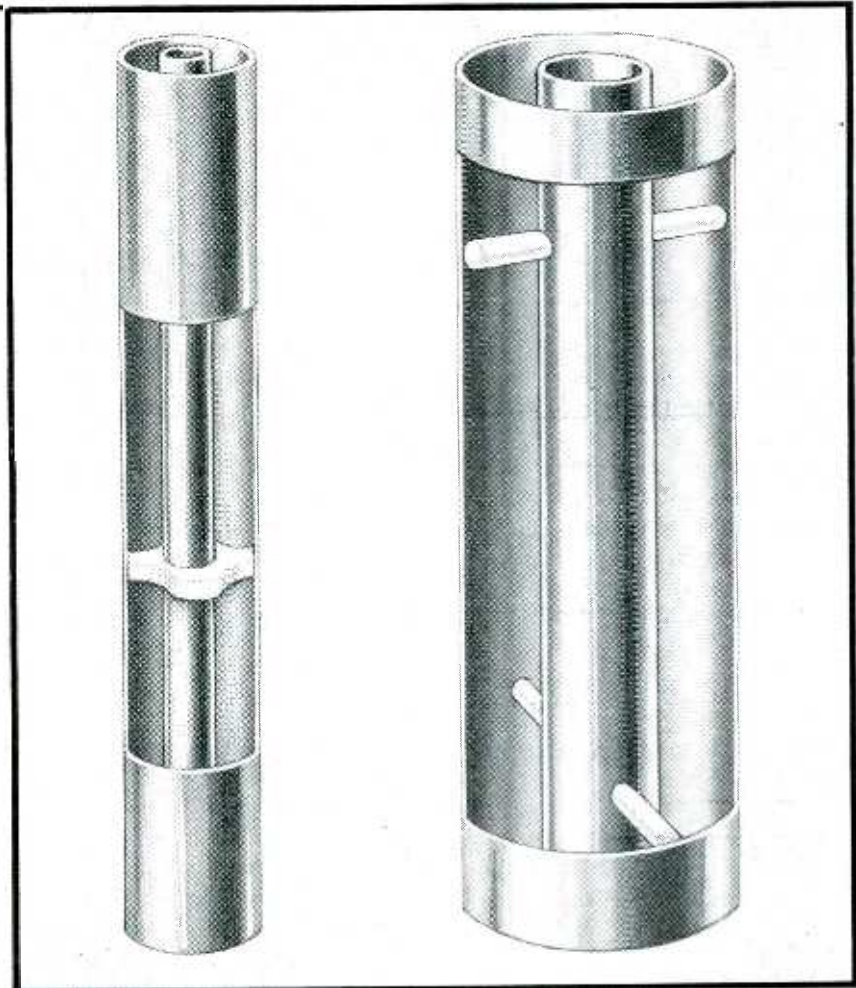

Cutaway views of coaxial cable with centering bead (left) and large-diameter line employing cross-pin construction

pedance of variations in conductor dimensions and dielectric constant of the insulating material may be determined by differentiating Eq. 1 and 2 above, treating the differentials as increments.

$$\Delta Z = \frac{60 \Delta b}{\sqrt{k} b} \quad (3)$$

$$\Delta Z = -\frac{60 \Delta a}{\sqrt{k} a} \quad (4)$$

$$\Delta Z = -\frac{W Z_0 \Delta K}{24 k} \quad (5)$$

Insulator Spacing

Two contradictory requirements influence the determination of insulator spacing. Close spacings are

desirable for constant impedance and to make the line as uniform as possible. Large spacings are desirable to minimize insulator loss. The practical solution to this dilemma has been to keep insulation loss down by making the insulators as small as possible consistent with mechanical strength. The spacing is then selected so that the impedance at the highest operating frequency differs from the low-frequency value by not more than 2 or 3 percent. This principle has led to spacings of 12 inches in lines used for f-m and television, at frequencies from 44 to 216 mc. At standard broadcast frequencies insulator spacing is not very impor-

Table I—Design Equations for Beaded Coaxial Line

$$Y_1 = Y_B + Y_c \left[\frac{Y_L \cos \frac{\pi d}{\lambda} + j Y_c \sin \frac{\pi d}{\lambda}}{Y_c \cos \frac{\pi d}{\lambda} + j Y_L \sin \frac{\pi d}{\lambda}} \right] \quad (7)$$

$$Y_P = Y_c \left[\frac{Y_1 \cos \frac{\pi d}{\lambda} + j Y_c \sin \frac{\pi d}{\lambda}}{Y_c \cos \frac{\pi d}{\lambda} + j Y_1 \sin \frac{\pi d}{\lambda}} \right] \quad (8)$$

$$Y_P = c \left\{ \frac{\left[Y_B + Y_c \left(\frac{Y_L \cos \frac{\pi d}{\lambda} + j Y_c \sin \frac{\pi d}{\lambda}}{Y_c \cos \frac{\pi d}{\lambda} + j Y_L \sin \frac{\pi d}{\lambda}} \right) \right] \cos \frac{\pi d}{\lambda} + j Y_c \sin \frac{\pi d}{\lambda}}{Y_c \cos \frac{\pi d}{\lambda} + j \left[Y_B + Y_c \left(\frac{Y_L \cos \frac{\pi d}{\lambda} + j Y_c \sin \frac{\pi d}{\lambda}}{Y_c \cos \frac{\pi d}{\lambda} + j Y_L \sin \frac{\pi d}{\lambda}} \right) \right] \sin \frac{\pi d}{\lambda}} \right\} \quad (9)$$

tant, and may be determined from mechanical considerations alone.

A mathematical expression for the impedance of a beaded line, in which insulators are spaced 2 percent or more of a wavelength apart, is easy to formulate but difficult to solve rigorously. To begin, it is convenient to write the familiar impedance transformation equation in terms of admittance

$$Y = Y_c \left[\frac{Y_L \cos \beta l + j Y_c \sin \beta l}{Y_c \cos \beta l + j Y_L \sin \beta l} \right] \quad (6)$$

In the above, Y_c is the characteristic admittance of the line without any bead effect. The problem is illustrated in Fig. 2, in which Y_L is an arbitrary load admittance. The characteristic admittance of the line with beads is, by definition, that value of Y_L which appears unmodified at point P after transformation by two sections of line of length $d/2$ with the capacitance due to a bead connected across their junction (at point B_1).

Graphical Solution

The admittance at B_1 is the admittance of the bead ($Y_B = j\omega C$) plus the admittance due to Y_L after trans-

formation by $d/2$, as in Eq. 7 (Table I). The admittance at point P is then given by Eq. 8, and the characteristic admittance Y_0 of the line with beads is obtained by inserting the value of Y_1 from Eq. 7 into Eq. 8 as is done in Eq. 9. Since Y_0 must be a pure conductance, the desired solution is that value of $Y_L = Y_0$ which causes the reactive term on the right-hand side of Eq. 9 to vanish. The characteristic impedance is then

$$Z_0 = 1/Y_0 \quad (10)$$

By using the Smith transmission line chart¹ a graphical solution of Eq. 9 is possible. Figure 3 shows a center section of the chart, on which have been drawn several lines corresponding to steps in the solution. The following example is illustrated:

Outer conductor 3.125 OD x 3.027 ID
 Inner conductor 1.200 OD x 1.130 ID
 Width of ceramic bead 0.375 inches

The characteristic impedance and admittance, omitting bead effect, are calculated from Eq. 1, using $k = 1$, $b = 3.027$, and $a = 1.2$, as $Z_c = 55.5$ ohms and $Y_c = 0.018$ mho. The added capacitance due to the addition of a bead of dielectric constant $K = 6.0$ is calculated from electrostatics to be

2.86 micromicrofarads. Bead susceptance Y_B corresponding to this capacitance is then calculated and normalized by dividing by $Y_c = 0.018$, giving the following susceptance and half-bead spacing ($d/2\lambda$) values for three frequencies

Freq	50 mc	100 mc	200 mc
Y_B	$j0.000898$	$j0.001796$	$j0.003592$
Y_B/Y_c	$j0.0499$	$j0.0998$	$j0.1996$
$d/2\lambda$	0.0254	0.0508	0.1016

Since any acceptable value of Y_L/Y_c must be a pure conductance, all possible values of this quantity lie on the vertical axis of the chart. Looking into the line at the first bead, however, the admittance values on the vertical axis appear to be rotated through an angle $d/2\lambda = 0.1016$ (at 200 mc), so that all possible solutions now lie on the line AA' . To all points on AA' we must now add the normalized susceptance Y_B/Y_c of the first bead, just as in Eq. 7. Line BB' represents the sum of these two admittances, and corresponds to Y_1 in Eq. 7. To transform the admittance Y_1 into the admittance Y_P at P , the ends of BB' are rotated through an angle $d/2\lambda = 0.1016$ forming a new line CC' . The intersection of CC' with the vertical axis at the point $Y_P/Y_c = 1.106$ corresponds to the value of Y_L which causes the reactive term in the right-hand side of Eq. 9 to vanish. Multiplying this solution by $Y_c = 0.018$ and inverting, we get an impedance of 50.2 ohms. Similar procedures give impedances of 51.4 ohms for 100 mc and 51.5 ohms for 50 mc.

It is also possible to determine characteristic impedance by assuming open and short-circuit conditions at the end of the line and calculating back to the midpoint between beads, using Eq. 6 a total of four times. This method is less tedious than solving Eq. 9, but is not as rapid as the graphical solution.

Insulator Materials

Steatite is commonly used for insulator beads because of its excellent electrical and mechanical properties. Various grades are available, the less expensive grades being entirely suitable for use at standard broadcast frequencies where insulation loss is an insignificant part of the total loss. Comparative efficiencies of 3½-inch

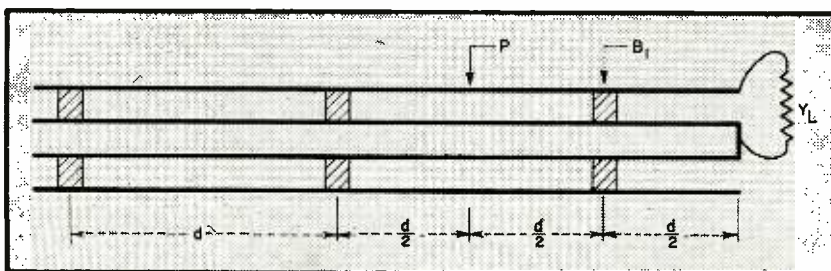

FIG. 2—Beaded coaxial transmission line terminated by an admittance

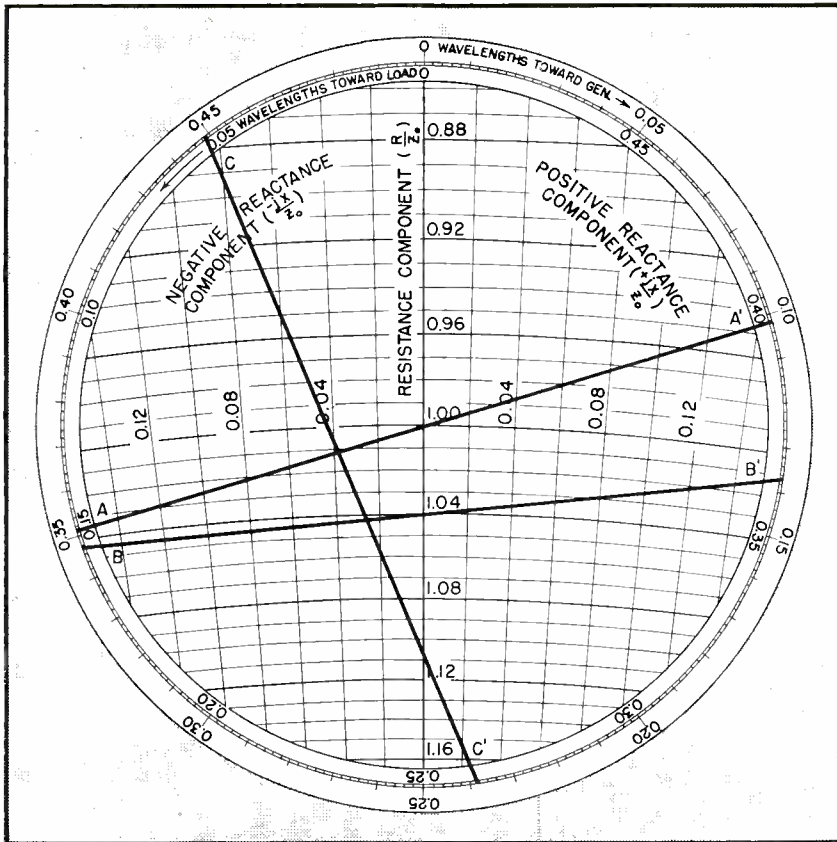

FIG. 3—Use of inner portion of Smith transmission line chart to obtain a graphical solution of Eq. 9, for determining the characteristic impedance and admittance of a beaded coaxial line at 200 mc for the example set forth in the text

diameter, 500-foot lines with bead spacing of 12 inches an $Z_0 = 51.5$ ohms are given below for two insulator materials (Alsimag 196 is the cheaper, and use of the more expensive Teflon is justifiable only at uhf)

Material	Loss factor	Eff at 1 mc	Eff at 200 mc
Alsimag 196	0.012	98.8%	67.8%
Teflon (Poly F-1114)	0.0004	98.8%	82.5%

Because creepage distances are small, steatite line insulators must be impregnated to prevent surface moisture films due to condensation. Waxes were used for this purpose until the recent appearance of water-

repellent low-volatility silicone fluids. Insulators treated with these solutions maintain a high surface resistivity even in a moist atmosphere, and the impregnant is not volatilized when heated (as in soldering). Surface glazing is occasionally used on large cable beads, but only because of the ease of cleaning which a glazed surface affords. Glazing is expensive, and offers no measurable improvement in surface resistivity.

A few thermoplastic materials have been successfully used for insulators in radar cables. Although some of these plastics, notably Polystyrene, Polyethylene, and Teflon,

display superior electrical properties, there are still mechanical difficulties to overcome.

Insulator Shapes

A few commonly used insulator shapes are illustrated in Fig. 4. For low-loss uhf operation (30-300 mc) it is desirable to minimize the discontinuities introduced by inner conductor supports so that insulators may be kept far apart. Discontinuities are minimized in the first four bead shapes by reducing the volume of dielectric material as much as possible. The scheme shown in Fig. 4A is good electrically because excess dielectric material has been removed from the region around the inner conductor where the electric field, and hence the capacitance per unit volume, is greatest. Temperature rise due to insulator loss is also greatest in this region; consequently, mechanical fracture due to large temperature gradients is less likely with the configuration of Fig. 4A.

The cross-pin construction in Fig. 4D is useful principally in large-diameter lines. In Fig. 4E the sides of the bead have been made concave to increase the flashover rating of the cable. This design is used at broadcast frequencies, and is just the opposite of what is needed for low-loss constant-impedance operation at ultrahigh frequencies.

Theoretical Attenuation

Attenuation is defined as the loss in decibels per hundred feet at a specified frequency and at a temperature of 25 degrees centigrade. Both conductor loss and insulation loss contribute to attenuation, and these terms may be computed separately and added together to obtain total attenuation. In terms of resistance R in ohms per foot and conductance G in mhos per foot, the attenuation is

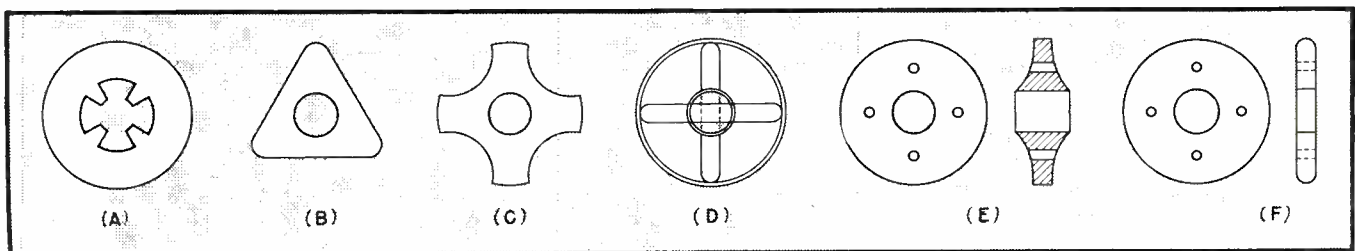

FIG. 4—Typical insulator shapes used in beaded coaxial transmission lines

$$\text{db per 100 ft} = 434 \frac{R}{Z_0} + G Z_0 \quad (11)$$

For radio frequencies Russell's expression² for resistance R may be used, so that the conductor loss only becomes

$$\text{db per 100 ft} = \frac{0.432 f^{1/2} (a + b)}{a b Z_0} \quad (12)$$

Equation 12 assumes that both inner and outer conductors are made of chemically pure copper, which although commercially available is quite expensive. Ordinary conductor copper has a conductivity of 95 percent. When this is used, Eq. 12 becomes

$$\text{db per 100 ft} = \frac{0.443 f^{1/2} (a + b)}{a b Z_0} \quad (13)$$

The principal problem in determining insulator loss is that of evaluating the shunt conductance G . This quantity is the reciprocal of the parallel resistance R_p due to the imperfect dielectric in one foot of line. If we let R_s be the corresponding equivalent series resistance due to dielectric losses in one foot of line, and X be the reactance due to that portion of a single foot of line which is occupied by insulation, then

$$R_p = \frac{X^2}{R_s} = \frac{X^2}{X P_r} = \frac{X}{P_r} \quad (14)$$

$$G = \frac{1}{R_p} = \frac{P_r}{X} = \frac{P_r 2 \pi f \times 10^6 K C W}{12} \quad (15)$$

The insulation loss is obtained by inserting Eq. 15 into the second term of Eq. 11, letting L_r (loss factor) equal the product of dielectric constant K and power factor P_r , and using Eq. 1 for the characteristic impedance

$$\text{db per 100 ft} = 0.231 k^{-1/2} L_r W f \quad (16)$$

By applying Eq. 2, Eq. 16 may be written in another form

$$\text{db per 100 ft} = \frac{2.77 P_r f K (k - 1)}{k^{1/2} (K - 1)} \quad (17)$$

For solid dielectric, $K = k$ and the insulation loss becomes $2.77 P_r f K^3$.

Analysis of Equations

Several approximations have been made in deriving Eq. 16 and 17. In practical cases, however, it happens that for frequencies less than 200 mc the conditions under which the approximations become poor ones are those for which the insulation loss is a relatively small part of the total,

Table II. Maximum Power Ratings of Coaxial Lines in Watts

Diam in inches	A-M	F-M			Television		
	0.5-50 mc	50 mc	100 mc	200 mc	50 mc	100 mc	200 mc
3/8	500
7/8	3,000	2,600	1,700	1,100	4,100	2,700	1,800
1 5/8	12,000	9,100	5,700	4,000	14,500	9,100	6,300
3 1/8	50,000	36,000	24,000	15,000	58,000	38,000	24,000
6 1/8	150,000	134,000	95,000	67,000	214,000	151,000	107,000

so that no substantial error in the total attenuation is produced.

The importance of having good insulation in lines used at ultrahigh frequencies can be seen by comparing Eq. 16 and 13. Since insulation loss increases directly with frequency, while conductor loss increases only with the square root of frequency, the former term may easily account for a substantial part of the total attenuation at 200 or 300 mc. At 200 mc, for instance, in 500 feet of 3 1/8-inch coaxial line, the difference between a steatite bead costing 10 cents and one costing 31 cents is the difference between an efficiency of 77 percent and one of 68 percent. Also, while conductor loss is roughly inversely proportional to diameter, insulator loss is independent of diameter, provided the relative volume and distribution of insulating material remains the same for all diameters. This fact has imposed a limiting factor on the development of vhf solid dielectric cables, because no matter how large a diameter is used no improvement in insulation loss can be obtained.

Measured Attenuation

In a complete transmission line system, containing connectors and other cable fittings, the measured attenuation is usually slightly greater than that predicted by Eq. 13 and 16. To allow for this discrepancy, standard attenuation ratings have been made 10 percent greater than the theoretical values. Standard attenuation curves for the nominal 70-ohm cables used in the broadcast band are given in Fig. 5, and curves applying to the 51.5-ohm cables used for f-m and television equipment are given in Fig. 6. The latter curves are based on the use of copper having 95-percent conductivity and insulators with a dielectric constant of 6.0 and a maximum loss

factor of 0.004 at 100 mc. A de-rating factor of 1.1 was applied to give the required 10-percent increase of attenuation above theoretical values. Efficiency may be obtained from attenuation by using the equation

$$\text{Eff} = \frac{100}{\text{antilog} \left(\frac{L \times \text{db per 100 ft}}{1,000} \right)} \quad (18)$$

Transmission line loss is increased by standing waves, due to improper termination, and by elevated temperature. An enclosed line, operating at f-m or television frequencies with restricted air circulation and carrying the maximum rated power, may suffer a temperature rise of almost 40 C. Under these conditions, the insulation loss is increased approximately 50 percent and the conductor loss is increased approximately 13 percent. At standard broadcast frequencies (500-1500 kc) coaxial lines develop only negligible amounts of heat, so the attenuation ratings are approximately the same for maximum power as for low power.

Coaxial transmission lines are occasionally connected in parallel, to form an unbalanced line of half the original impedance, or in series, to form a balanced line of twice the original impedance. No improvement in attenuation is obtained from these special arrangements, and it is easily shown that the overall efficiency in either case is the same as it would be if only one line of the same diameter were used.

Power-Handling Capacity

Maximum power ratings for coaxial lines used at frequencies above 50 mc have been calculated on a theoretical basis, using a temperature rise of 40 C in the outer conductor as a limiting factor. At lower frequencies, voltage breakdown becomes a limitation, and ratings must be based on experience because

breakdown usually occurs at lower voltages than theoretical considerations would indicate.

The following procedure is used to determine a power rating based on temperature rise:

(1) The efficiency of a length L (feet) is determined from attenuation figures in which copper loss has been increased 13 percent and insulation loss 50 percent.

(2) A power in watts which will produce a 40 C temperature rise in the outer conductor is calculated by multiplying the total surface area of the given length of conductor by the heat emissivity factor ρ and dividing the result by $1 - \text{efficiency}$.

(3) A maximum power rating for unity standing wave is obtained by dividing the result of step 2 by a factor of 2.

(4) A maximum power rating for any standing wave ratio other than unity is obtained by dividing the result of step 3 by the proposed ratio. For ordinary a-m broadcasting, the ratio may be 2.0, for television it may be 1.1, and for f-m broadcasting it may be 1.75.

Suggested maximum power ratings for various services and frequencies are given in Table II. These are maximum ratings, based on temperature rise or flashover. Except when lines are very short, they should not be operated at maximum power because of attenuation.

In step 2, it is assumed that after equilibrium is attained all of the heat generated inside the line is delivered to the outer conductor, where it is radiated into space (the process involves both radiation and convection). The factor ρ is the heat emissivity of the surface of a copper tube, in watts per square inch for a 40 C temperature rise. This factor, which depends somewhat on diameter, has been studied by power transmission engineers who frequently use copper tubes for busses. An average value is 0.25 watt per square inch.

In step 3, a safety factor of 2 has been applied because tubes enclosed in buildings or ducts or placed against walls suffer a loss of heat emissivity.

The inner conductor operates at a much higher temperature than the outer conductor, and a rise of 75 C may occur for a 40 C rise in the outer conductor. The difference between inner and outer conductor temperatures causes differential expansion, which must be accommodated in suitable expansion joints. The insulators also generate heat (4.5 watts per insulator in a 3½-inch line carrying 25,000 watts at 200 mc) and are further heated by thermal energy received from the inner conductor. Temperature gradients exist in the insulators, and can cause fracture if power ratings are exceeded.

Large-diameter lines are produced in hard-temper rigid lengths of 20

feet, which must be interconnected on the job by suitable couplings. Soft-temper coaxial cables of ¾-inch and 1-inch diameter are produced in continuous 100-foot coils which may be factory-spliced to any desired length and shipped under gas pressure with end terminals attached.

The method of attaching insulators to the inner conductor varies with diameter, but in general an attempt is made to perform the attachment without seriously degrading the flashover characteristic. Any small deformation of the inner conductor encourages concentration of charge, and sharp corners or edges on crimped or swaged inner conductors must be carefully avoided. In 1½-inch diameter and larger cables, in which the inner conductors are tubular, a good fastening may be made by inserting a spinning tool inside the inner conductor and spinning a ridge on both sides of the bead.

Coaxial lines must be pressurized with a dry gas to prevent condensation of moisture on insulator surfaces. Air and nitrogen are both used for this purpose. There is nothing critical about the amount of pressure, and anything from 1 to 30 pounds is satisfactory.

REFERENCES

- (1) Smith, P. H., *Transmission Line Calculator*, ELECTRONICS, p 130, Jan. 1944.
- (2) Russell, Alexander, *Effective Resistance and Inductance of Concentric Mains*, *Philosophical Magazine*, 6th series, 17, p. 524. Apr. 1909.

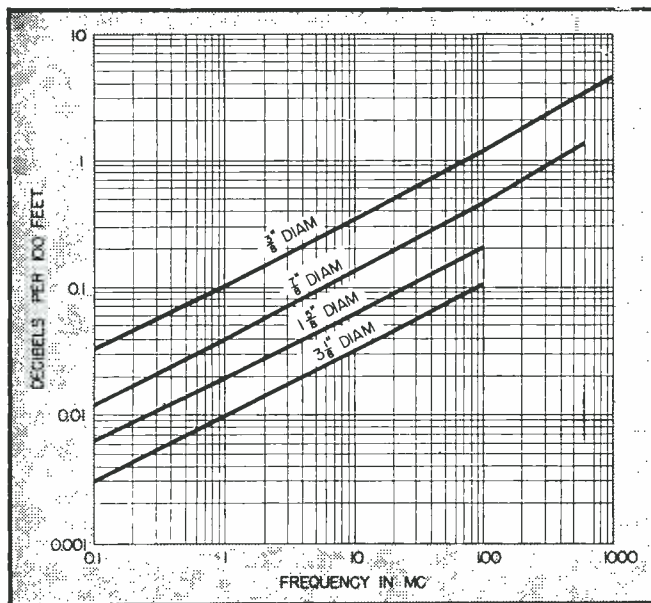

FIG. 5—Standard attenuation curves for nominal 70-ohm beaded coaxial cables used in broadcast-band work

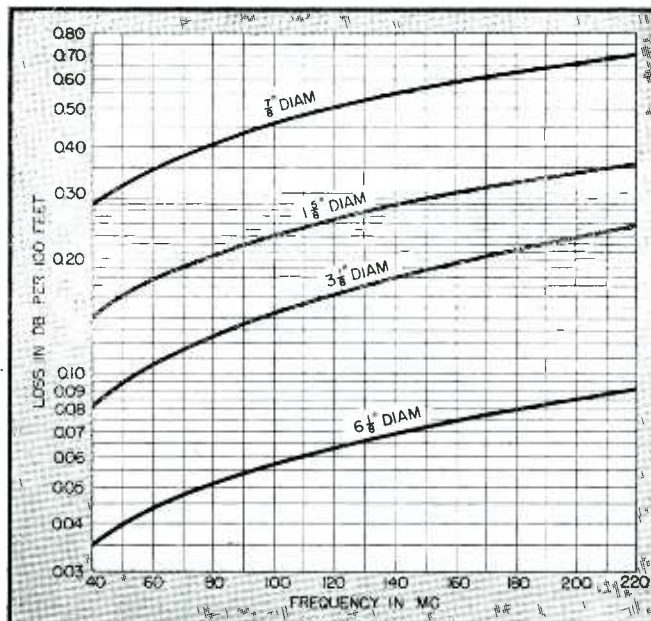

FIG. 6—Standard attenuation curves for 51.5-ohm beaded coaxial cables used with f-m and television equipment

TWO - TERMINAL

THE PHASE REVERSAL which exists between the input and output of a vacuum-tube amplifier operates as somewhat of an inconvenience in design of an oscillator circuit. The requirement of phase inversion which is required to produce the proper feedback for oscillation has been met in various ways. The most common is the use of a coupled circuit between the plate and grid which furnishes the phase reversal as well as the tuning elements.

Another means of setting up oscillations is by means of a negative transconductance tube, or circuit, which does not give the usual phase reversal between the input and output. The dynatron, transitron, and multistage amplifier are examples¹ of this type. These circuits have the advantage that they may be connected as oscillators by merely connecting a simple two-element tuned circuit between two points in the circuit.

The circuit to be described² is the multistage amplifier type in which two stages are connected in cascade amplification to eliminate the phase reversal effected by a single stage. The method of coupling between stages has many advantages over the prior types.

Basic Circuit

Figure 1 shows the fundamental circuit. A twin triode is connected with one triode acting as a cathode follower driving the cathode of the second triode through coupling

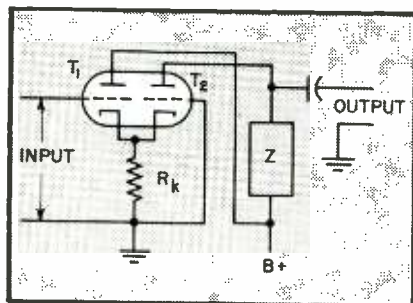

FIG. 1—Basic circuit of the oscillator. Tube T_1 operates as a cathode follower to drive T_2 .

By **MURRAY G. CROSBY**

*Paul Godley Company
Montclair, New Jersey*

effected by the common cathode resistor R_k .

A positive voltage applied to the grid of T_1 causes more current to flow in the plate circuit of T_1 and consequently more current through the common cathode resistor. The increased current through the cathode resistor raises the potential of the cathodes in the positive direction.

An increased positive potential on the cathode of T_2 is equivalent to an increased negative potential on the grid of T_2 . Thus a positive voltage applied to the grid of T_1 is converted, by the coupling system, to an equivalent negative potential on the grid of T_2 . This phase reversal, together with the phase reversal effected between the grid and plate of T_2 , forms a complete 360-degree phase rotation, so that the input is in phase with the output.

The transconductance between input and output is therefore negative, so that all that is required for oscillation is to place a tuned circuit in the output plate circuit and couple it back to the input grid circuit.

Characteristics

Figure 2 shows the plate-current-grid-voltage characteristics obtained between the grid of T_1 and the plate of the transconductance is negative, and that both positive and negative saturation are obtained in the nega-

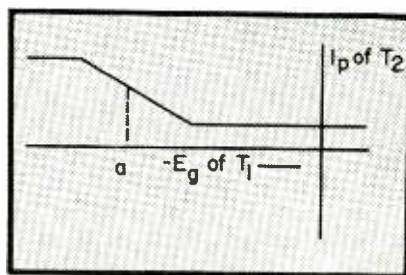

FIG. 2—Characteristics of the plate current of T_2 and the grid voltage of T_1 .

tive-grid region. In other words, the circuit operates as a class A limiter which does not draw grid current. For this type of operation, the grid of input triode T_1 is biased to point a on the characteristic.

The operation of a class A limiter³ is as follows: The negative half cycles of the input wave are limited by negative cutoff at the grid of T_1 . Positive half cycles on the grid of T_1 are converted to negative half cycles on the grid of T_2 by the phase inversion existing due to the cathode coupling. Hence, the positive half cycles are limited by negative cutoff on the grid of T_2 . The result is negative cutoff limiting of both half cycles of the input wave. This is accomplished without grid current as long as the input is made less than a peak voltage which draws current on the positive half cycles at the grid of T_1 . In the usual limiter arrangement, grid current is not drawn until the input is of the order of 50 volts rms.

Values of Components

Figure 3 shows how the feedback connection is made to form the oscillator circuit. Capacitor C_1 couples the output to the input and acts as a blocking capacitor to keep the plate voltage off the input grid. The value of C_1 is chosen to provide a reactance which is small in comparison to either R_g or the reactance of the input capacitance of T_1 . Resistor R_g is a grid-return resistor (0.5 megohm or less) and, for low frequencies, may consist of the output

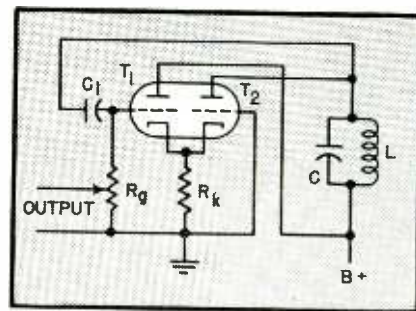

FIG. 3—Capacitor C_1 provides feedback to the grid of T_1 and also blocks the plate voltage

OSCILLATOR

Negative transconductance provided by a two-stage amplifier gives the phase reversal necessary for circuit oscillation. Only two points in the circuit are needed for connection of a simple tuned circuit to provide several oscillator arrangements

potentiometer. Cathode resistor R_k may be varied to control the amplitude of oscillation. Maximum output is usually obtained with an R_k of about 500 ohms with dual-triode receiving tubes.

The 6J6 miniature dual triode is perhaps the most ideally suited, especially for the higher frequencies, but tubes of the 6SN7GT, 6SL7GT, 6N7 and similar types may also be used. Frequencies as high as 130 megacycles have been obtained with the 6J6, but it is felt that frequencies much higher are possible.

Factors controlling the maximum oscillation frequency are the magnitude of impedance inserted in the output plate circuit, and the degree of shunting effect of the cathode-to-ground capacitance on the cathode resistor. The cathode-to-ground capacitance of the 6J6 is approximately seven micromicrofarads. When a 500-ohm cathode resistor is used with the 6J6, the cathode-to-ground capacitance does not become appreciable until frequencies above 50 megacycles are obtained.

As an audio oscillator, this circuit generates a waveform which has substantially less harmonic content than that obtained with conventional oscillator circuits. This is especially true for the higher values of common cathode resistor, R_k . Values of the order of 10,000 ohms may be used. These higher values also result in reduced output voltage.

Applications

The circuits of Fig. 4 are various arrangements taken from the author's U. S. Patent 2,269,417. Figure 4A is a multivibrator circuit in which resistance and capacitance take the place of the tuned circuit. This multivibrator circuit has the advantage that its output waveform is a true square wave, and does not

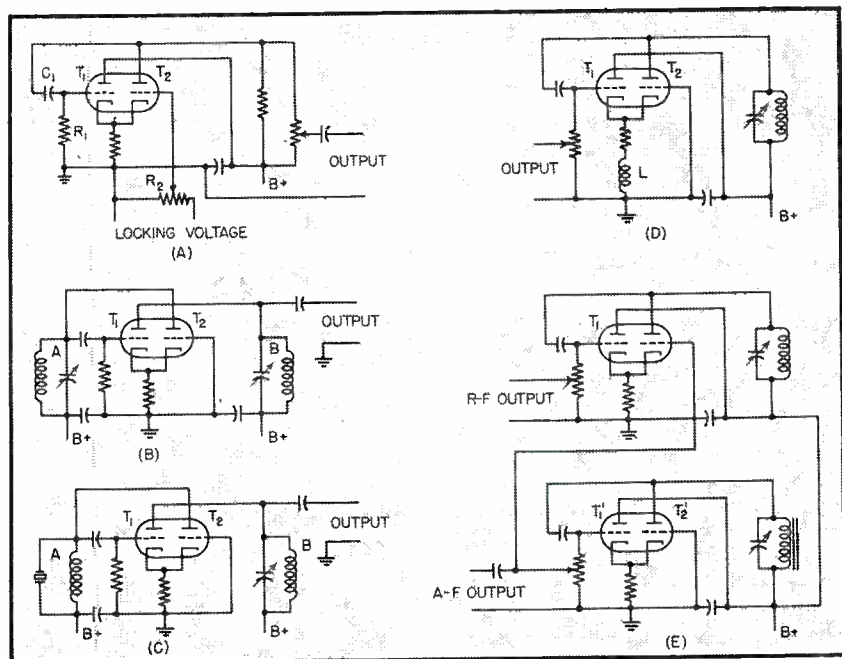

FIG. 4—Five useful circuit arrangements for the two-tube oscillator

have the exponential decay at the top of the square wave as is characteristic of the usual multivibrator circuit. Hence, it may be used for a square waveform generator. Frequency control may be obtained by varying resistor R_1 and capacitor C_1 . Locking voltage may be applied to potentiometer R_2 to hold the oscillations in step with an external oscillator. The percent mark or duty cycle, of the square-wave pulse may be controlled by feeding positive or negative voltage to potentiometer R_2 .

Figure 4B shows how fundamental frequency oscillation may take place in tuned circuit A, while harmonic output is obtained from tuned circuit B. The cathode-follower action of triode T_1 is not affected by tuned circuit B, because B is tuned to a harmonic.

Figure 4C shows how a crystal may be inserted as the fundamental oscillating element of the circuit of Fig. 4B. Such an arrangement has obvious advantages in crystal oscil-

lator operation where harmonics are usually desired.

Figure 4D shows the original oscillator circuit with an inductance L inserted in the common cathode circuit to form a peaking coil to extend the frequency range limited by the cathode-to-ground capacitance of the common cathode circuits.

Figure 4E shows r-f and a-f twin-triode oscillators arranged to provide either r-f output, a-f output, or modulated r-f output. Modulation applied as shown in the circuit diagram is quite linear up to the point where the overall gain is modulated below an amount sufficient for oscillation.

This circuit was developed while the author was in the employ of RCA Laboratories.

REFERENCES

- (1) Herold, E. W., Negative Resistance and Devices for Obtaining It, *Proc. IRE*, 23, p 1201, Oct. 1935.
- (2) Crosby, Murray G., Cathode-driven Oscillator, U. S. Patent 2,269,417, filed May 13, 1939, issued Jan. 6, 1942.
- (3) Crosby, Murray G., Limiting Amplifier, U. S. Patent 2,276,565, filed May 23, 1939, issued Mar. 17, 1942.

Radar for Blind Bombing

Part I

Technical details of H2X, the airborne microwave radar that enabled AAF bombers to knock out Wilhelmshaven through clouds in a single mission. Both the APQ-13 and APS-15 versions are covered in this two-part paper, with emphasis on new circuits employed

ON November 3, 1943, the largest force of bombers employed to that date by the United States Eighth Air Force took off to bomb a target in Wilhelmshaven, Germany. This was the eighth time that the same target had been their goal, but as yet

it had not been hit squarely enough to be destroyed. On this day, as wing after wing swept over the target, they found it completely obscured by clouds. Nevertheless, on a signal from the wing leader, each wing released its bombs. Reconnaissance

photographs taken several days later showed that the target had been virtually destroyed.

The device that made possible this successful raid on Wilhelmshaven was the H2X microwave radar. Designed primarily for the purpose of bombing through clouds, this radar proved an invaluable navigational aid and was used for sea search and patrol duties as well.

The British had been using a somewhat similar bombing radar, the H2S, for some time prior to the first United States radar mission described above, but the Eighth Air Force had experimented with H2S on only a very small scale. In June of 1943, however, it was realized that the European weather precluded continuous large-scale visual bombing. If this country were to carry out the large bombing program to which it was committed, some other type of bombsight had to be developed. The H2X radar bombing system was the first answer to the need for a bombsight that could operate when the target was obscured by smoke or clouds or darkness.

The accuracy that could be obtained with an H2X system was much discussed and investigated. Combat tests have shown that under equal conditions the circular error to be expected of the radar is at least five times greater than that expected of the visual bombsight. Thus the results achieved in the mission described above were due more to the size of the bomber force used than to the accuracy of the radar bombsight.

History of H2X

In July of 1943, Philco, Bell Telephone Laboratories, and the Radiation Laboratory, MIT, were asked by the Services to commence the devel-

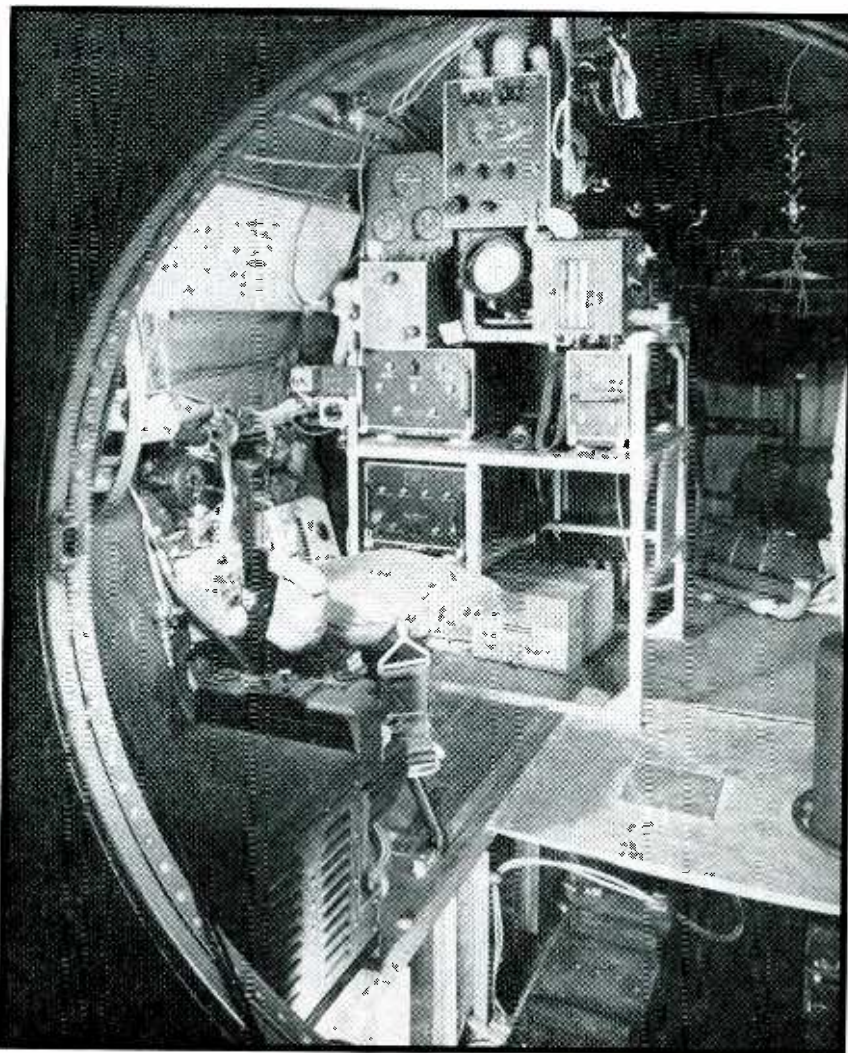

Radar operator's position at APQ-13 bombing radar installation in a B-29. Range unit is on lower deck of rack, while the synchronizer and a low-voltage power supply are on second deck. Antenna control-box is at left of c-r indicator and computer at right, with main control box directly above the c-r tube. Modulator is in lower left-hand corner of illustration, with an inverter unit visible below the floor

By J. V. HOLDAM,
S. McGRATH,
and A. D. COLE

*Cole, Holdam & McGrath
Boston, Mass.*

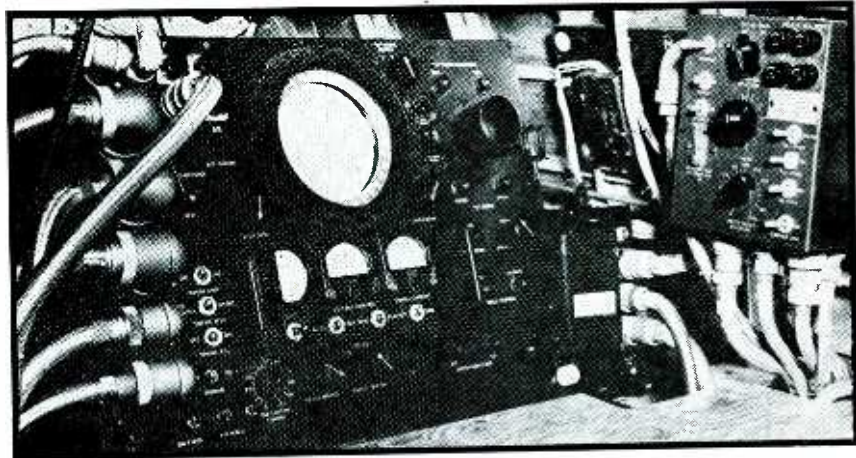

Operator's position at APS-15 installation in a B-17, with range unit and control box at the right of the receiver-indicator with its built-in ppi scope and a small A-scope

opment and design of the H2X bombing system for manufacture by Philco and Western Electric. Because of the urgency of the program, Bell Telephone Laboratories used as the basis of their design the SCR-717, a 10-cm airborne search system produced by Western Electric. Philco used the ASG, also a 10-cm airborne search system. The three organizations pooled their efforts and succeeded in producing systems in a remarkably short time. This pooling of design efforts resulted in two systems, the APQ-13 produced by Western Electric, and the APS-15 produced by Philco, which were very similar in design and performance.

To bridge the gap until production started, the Radiation Laboratory was requested to build enough systems to equip one squadron of bombers. Aircraft from this squadron led the raid on Wilhelmshaven in early November and continued to lead the Eighth Air Force on 80 percent of its missions until Philco production equipment started to arrive in England in February of 1944.

Before the end of the war in Europe, approximately 20 percent of the bombardment aircraft of the Eighth and Fifteenth Air Forces were H2X equipped. In the Pacific theaters of war, every B-29 was equipped with bombing radar, the great majority being equipped with the Western Electric H2X systems. The remainder were equipped with a system of considerably higher resolving power known as Eagle.

General Description

The H2X radar is a 3-cm system designed for use in aircraft to locate and make possible the identification of objects on land and sea, to bomb targets that cannot be seen visually, and to aid in the navigation of the airplane. It is equipped with an antenna employing a 29-inch diameter reflector shaped to give a beam three degrees wide in a horizontal plane

and fanned in the vertical to give coverage of the ground nearly under the plane when the plane is at high altitude. This antenna can be continuously rotated through 360 degrees and can be tilted to any angle between +20 degrees and -20 degrees.

The echoes received by the radar are presented to the operator on a ppi screen, with the north direction indicated by a vertical line from the center of the tube, regardless of the heading of the aircraft. The aircraft heading is displayed as a bright electronically produced radial line (termed the lubber line) originating at the center of the tube. This type of indication is known as an azimuth stabilized ppi.

A relatively crude bombing computer system suitable for bombing from altitudes greater than 15,000 feet is provided. An electronic computer provides a range mark indicating the range at which the bombs should be released. When the target and the release marker coincide, the bombs are released by a manual switch.

Radar Beacon Facilities

The H2X system is equipped for reception of radar beacons. These beacons, located on the ground, are equipped with antennas that radiate in all directions. When they receive

H2X Specifications

Wavelength.....	3.2 centimeters
Frequency.....	9,375 megacycles
Reflector.....	29 in., modified paraboloid
Pulse power.....	50 kw peak
Pulse width.....	1/2, 1, or 2 micro-seconds
Pulse rate.....	1,300, 650, or 325 pps
Receiver bandwidth.....	2 to 3 mc
Receiver noise.....	15 db above theoretical
Beam width.....	3 degrees
Scan rate.....	12 or 24 rpm
Azimuth range.....	360 degrees
Elevation range....	-20 to +20 degrees

a pulse of two to four microseconds duration in the airborne search radar frequency band, they respond with a set of pulses in the beacon band, at a different frequency. The spacing and number of these returned pulses provide a code to identify the beacon. By means of these beacons, a radar operator can determine from the ppi his position relative to a known point.

Radar beacons can be received at high altitude at distances up to 250 nautical miles. To receive beacons, provision must be made in the radar to switch from normal search conditions, where the pulse is shorter and the receiver is tuned to the transmitting magnetron's frequency, to beacon conditions, where the pulse is from two to four microseconds long and the receiver is tuned to the beacon frequency. The beacons are equipped with discriminators so that they respond only to pulses of the proper duration. This is to prevent the overloading of the beacons by

electronics
WAR REPORT

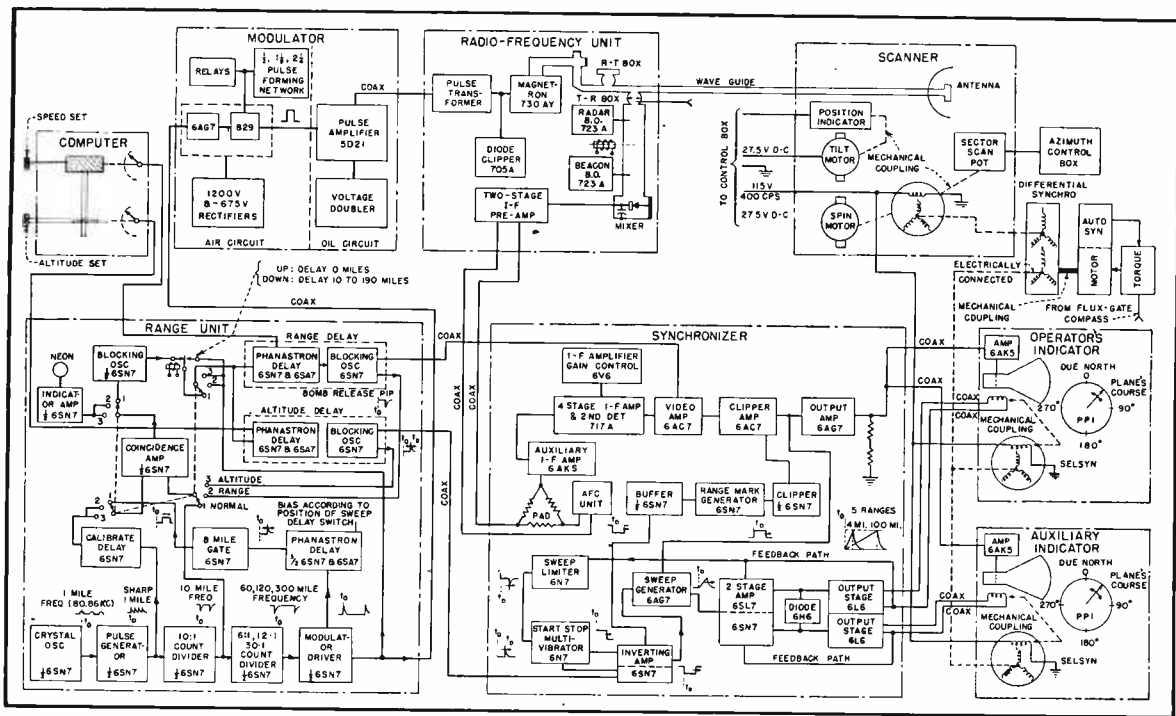

FIG. 1—Block diagram of Western Electric APQ-13 version of H2X bombing radar

planes that are engaged in normal search.

The H2X systems are capable of detecting from high altitude large cities and land masses at a range of 100 nautical miles, which is the longest-range sweep provided. Large ships may be seen at 70 miles, submarines at 30 miles, single fighter-type aircraft at 5 miles, and other ships and aircraft at intermediate ranges depending upon their size.

Operating Principles—Transmitting

The component parts of the two H2X systems are shown in Fig. 1 and 2. The sequence of operation starts in the range unit. By means of a crystal oscillator operating at 80.86 kc and two dividing stages whose ratio can be switched, modulator and indicator triggers are provided at about 1,300, 650, and 250 pulses per second (slightly different values are used in the two systems). A narrow trigger is fed to the modulator driver, which generates a square pulse with a width that can be switched to about $\frac{1}{2}$, 1, or 2 microseconds (slightly different in the two systems). The combinations of pulse repetition frequency and pulse length are chosen to maintain constant average power. The square pulse from the driver is amplified by the pulse amplifier and applied to the cathode of the magnetron oscillator. R-f

pulses of 50-kw peak power at a frequency of about 9,400 mc are produced. This r-f power passes down the wave-guide transmission line to the antenna, where it is radiated. On the way, the energy passes the r-t box and the t-r box, which are resonant cavities filled with a low-pressure gas and containing spark gaps which break down due to the high r-f field transmitted by the magnetron. The t-r box is used to prevent the high transmitted power from destroying the crystal mixer. The r-t box is used to switch impedances on transmitting and receiving so that the magnetron does not absorb a large amount of the received energy.

Operating Principles—Receiving

The reflected energy is received by the antenna and passes down the wave guide. The t-r and r-t boxes have ceased conducting by this time and have so switched impedances that the received energy passes into the crystal mixer. There it is mixed with power from the signal-beating oscillator for echo reception or with power from the beacon-beating oscillator for beacon reception. Thus it is converted to a 60-mc signal in the case of the APQ-13 and a 30-mc signal in the case of the APS-15, amplified, detected, amplified again as a video signal, then fed to the ppi grids

and, in the APS-15, to the vertical plates of an A-scope.

The indicating circuits are supplied with a trigger from the range unit. This trigger can be delayed to follow later than the r-f pulse. When an airplane flies at high altitude, the ground immediately below the plane, which is the first signal following the transmitted pulse, may be several miles removed. To avoid serious distortion of the map on the ppi the sweep is started at the instant the first signal (usually called the altitude signal) is received. Proper sweep delay is obtained by rotating an altitude dial on the computer to a position coincident with the altitude of the plane.

Another type of indicator trigger delay is produced to permit delaying the start of a fast sweep in accurate 10-mile steps from 10 to 190 miles. This is provided to permit accurate measurement of range to distant objects and de-coding of beacon signals.

The remaining function of the system is to provide a bomb-release marker. This marker is obtained by setting information on bomb type, air speed, ground speed, and altitude into the computer. The computer in conjunction with the range unit provides a pip which follows the transmitted pulse by the proper amount to indicate the slant range to the target at which the bomb should be released.

This pip from the range unit is mixed into the video to appear as a range circle on the ppi.

The Bombing Problem

In order to understand the purpose of the range unit, a brief discussion of the bombing problem is necessary. In dropping bombs, the resistance of the air will cause the bomb to lose velocity and strike the ground behind the aircraft by an amount known as the trail of the bomb. In the presence of wind, two other problems are introduced. The component of the wind parallel to the heading line of the aircraft will reduce or increase the speed at which the aircraft closes on the target, termed ground speed. The problem is illustrated in Fig. 3. The cross component of the wind will cause the plane to drift so that the plane must head at an angle, the drift angle, to the line of sight to the target in order to have its path along the ground, or ground track, pass through the target.

The solution of the bombing problem is now rather simple. The plane must be steered so its ground track passes through the target, and the bombs must be released when the ground range (horizontal component of the line of sight or slant range)

of the target equals $V_0 t_f - T$, where V_0 equals ground speed, t_f equals time of fall, and T equals trail. The trail and time of fall are found empirically for each type of bomb. They are dependent on the air speed and altitude of the plane. It is possible to plot curves of line-of-sight release range to the target versus altitude for various values of ground speed for a given type of bomb and fixed air speed.

Computer

The H2X computer employs a graph for solving the release problem, using a separate line on the graph for each ground speed in ten-knot steps. A separate sheet is used for each bomb type and air speed. These latter two factors are known before the start of a mission and the proper sheet may be selected. These sheets are wrapped around a drum so that altitudes as the ordinates of the graph are parallel to the axis of rotation of the drum. A cross hair is provided.

Moving the altitude-set knob on the computer moves this cross hair parallel to the axis of the drum to the proper altitude setting and at the same time rotates a linear potentiometer. The drum is then rotated by the

speed-set knob until the cross hair intersects the proper ground speed line. The curves are so plotted that the drum has thus been rotated an amount proportional to the slant range to the target at which the bomb should be released. Rotation of the drum moves a second linear potentiometer. The voltages from the two linear potentiometers go to the altitude and range delay circuits in the range unit and are there converted into short video pulses which are delayed the proper amount after the transmitted pulse to indicate the range to the ground and the release range.

Range Unit

The range unit provides the timing function for the system. The APS-15 version employs the circuit of Fig. 4 to provide a modulator trigger, an indicator trigger, and a bomb-release marker. The range units of the APQ-13 and the APS-15 are very nearly identical, so that a description of one will suffice for the other.

For accurate timing, a crystal oscillating at 80.86 kc is employed (at this frequency a pulse will make a round trip to an object 1 nautical mile distant in one cycle). This oscil-

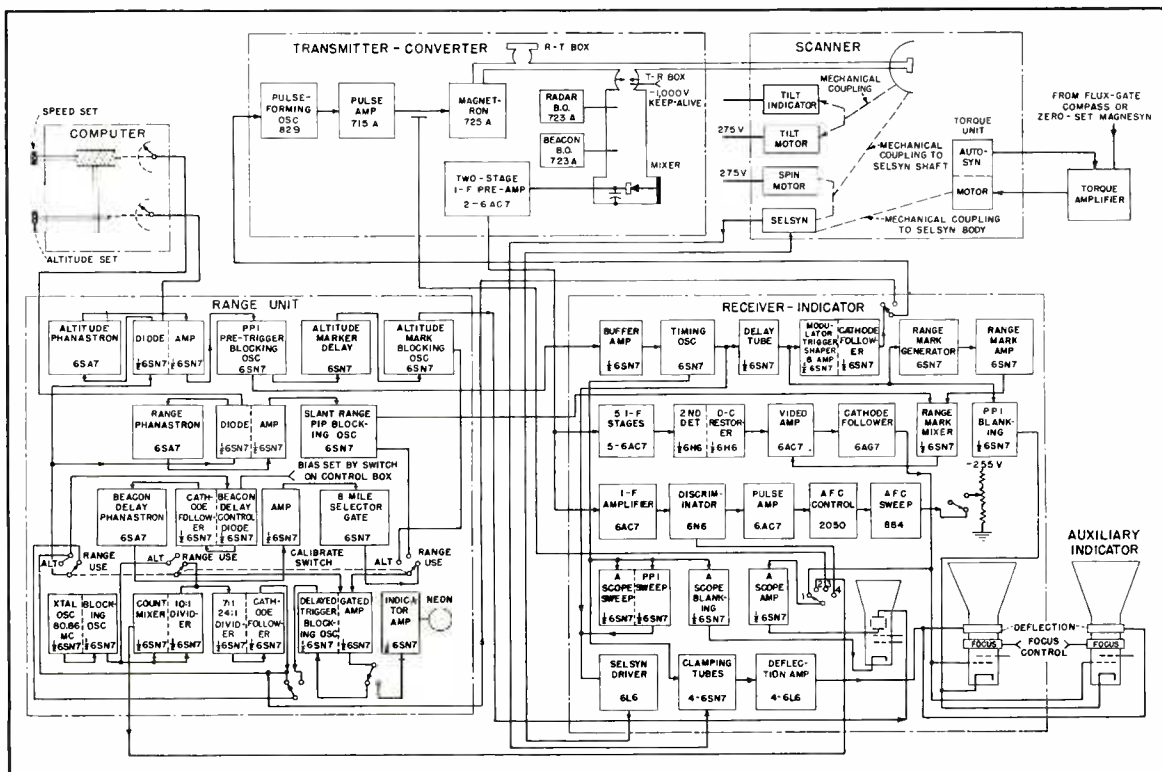

FIG. 2—Block diagram of Philco APS-15 version of H2X bombing radar

lator is operated highly class C so that plate current flows through a small angle. The pulses of plate current pass through one winding of a pulse transformer and are coupled to the grid of a blocking oscillator. The pulse transformer provides sufficient coupling between plate and grid of the oscillator tube so that plate current flow will drive the grid considerably below cutoff in less than one cycle. The grid will remain below cutoff a time dependent upon the RC value in the grid circuit. The blocking oscillator is capable of running free; however, if the time constant of the grid circuit is such that the free-running frequency is lower than that of the triggering pulse, the oscillator will synchronize with the trigger provided the trigger is of sufficient amplitude to raise the grid above cutoff.

The one-mile mark blocking oscillator is coupled to a second blocking oscillator which has a grid-circuit time constant long enough so that once the oscillator has fired, the grid does not begin to approach cutoff until ten one-mile marks have been produced. Thus every tenth mark triggers it off. In this manner a 10 to 1 division is obtained, giving pips with a ten-mile spacing.

Similarly the next blocking oscillator is employed to give 25 to 1 or 8 to 1 division. The time constant in the grid circuit is changed by means of a relay to change the dividing ratio. The output of this oscillator is fed through a cathode follower to the modulator. The cathode follower is employed to avoid affecting the blocking oscillator by changes in the length of cable going to the modulator and to isolate it from the pulse-

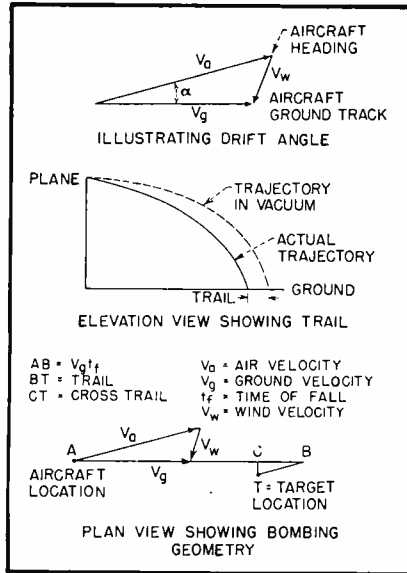

FIG. 3—Geometry of bombing problem

forming amplifier in the modulator.

The modulator trigger pulse also triggers the altitude, range, and trigger-delay phanastrons.

Phanatron Circuit Principles

The general characteristics of a phanatron time-delay circuit are well illustrated by the range phanatron circuit in Fig. 5. In the steady-state condition, the control grid of the phanatron is held near zero bias by grid current since it is tied through a high resistance to +250 volts. The screen grid is positive with respect to the cathode. Grid number 3 is negative with respect to the cathode since its voltage is set at about +20 volts by the voltage divider and the current flowing through the cathode resistor sets the cathode at about +40 volts. Since the number 3 grid is negative with respect to the cathode, it cuts off the current to the plate. The cathode cur-

rent is essentially all screen current. Since the plate resistor value is high, the plate voltage is held by conduction of the diode to a value equal to the voltage set on the diode cathode.

As a negative trigger pulse is fed to the cathode of the diode from the computer, a negative pulse will be developed in the plate circuit. This negative pulse is applied to the control grid of the 6SA7 through the capacitor connected between these two points. This will decrease cathode current and decrease the voltage drop across the cathode resistor. Thus, the number 3 grid becomes less negative with respect to the cathode and will allow plate current to flow. Plate current flow causes the plate voltage to drop, stopping the diode (left half of the 6SN7) from conducting and applying the drop at the plate to the control grid through the capacitor.

The above action takes place so rapidly that the capacitor does not have time to change its initial charge appreciably. Since the grid is connected to +250 volts, the capacitor starts to discharge, raising the control grid voltage. This increases the plate current, decreases the plate voltage, and tends to decrease the control-grid voltage. Since the two actions oppose each other, the result is a very slow decrease in plate voltage and increase in cathode voltage.

This effect continues until the plate and screen voltages are so low that further increase in control-grid voltage does not increase plate current. This occurs at a plate potential of about 40 volts. The control grid, and consequently the cathode voltage continues to rise for a short time, with the screen taking the increase

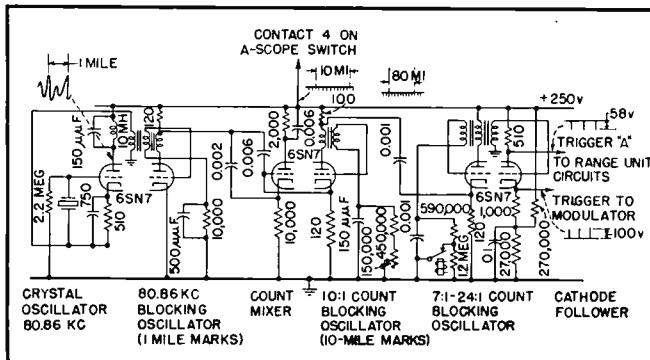

FIG. 4—Circuit of range unit that provides accurate timing pulses for the Philco APS-15 system

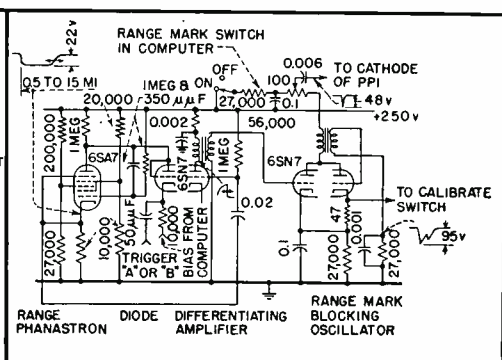

FIG. 5—Range phanatron circuit and succeeding stages in APS-15 system

in cathode current. At this point grid number 3 begins to cut the plate current off, with a consequent rise in plate voltage. This plate voltage rise is fed back to the control grid, increasing the effect, and bringing the circuit back to normal. It is this sudden rise at the end of the cycle that is amplified, differentiated, and used to trigger a blocking oscillator.

Thus, the time interval between the initiating pulse and the end of the cycle is the time for the plate voltage to drop from its steady-state value as set by the voltage applied to the diode cathode to the minimum value (about 40 volts). The greater the diode cathode voltage the greater the delay.

The phanastron circuit has the virtue of providing a delay that is closely linear with control voltage. It is relatively insensitive to changes in supply voltages. The altitude phanastron circuit in Fig. 6 and the trigger delay phanastron in Fig. 7 operate in essentially the same manner.

One-Shot Multivibrator

A second type of delay circuit, employed to give a fixed delay or a fixed-length square wave, is a triggered or one-shot multivibrator. The altitude mark delay stage in Fig. 6 uses a circuit of this type. The grid of the second section of the multivibrator is tied to +250 volts so this section is highly conducting. Since the cathode resistor is common to both sections, the voltage developed at the cathode cuts off the first section.

The incoming trigger is negative and causes the second section to be sharply cut off. With the removal of the cathode voltage, the first section conducts, dropping its plate potential and thus driving the grid of the second section highly negative through the capacitor. The circuit will remain in this condition until the capacitor discharges, permitting the second section to start conduction, when it will return very rapidly to its original condition. A square wave is produced with a duration dependent upon the time constant of the grid circuit of the second section.

With the trigger-delay phanastron stage of Fig. 7, a cathode follower is employed. This is necessary to get the extremely long delays with suffi-

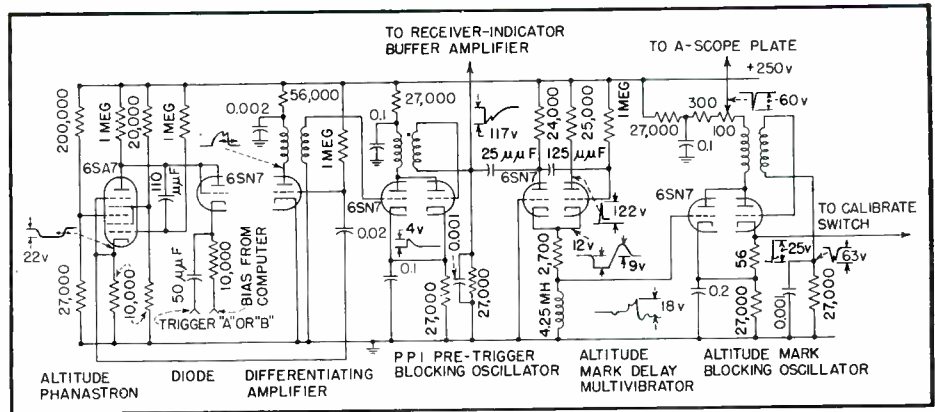

FIG. 6—Altitude phanastron circuit and succeeding stages in APS-15 system, including a one-shot multivibrator serving as altitude mark delay

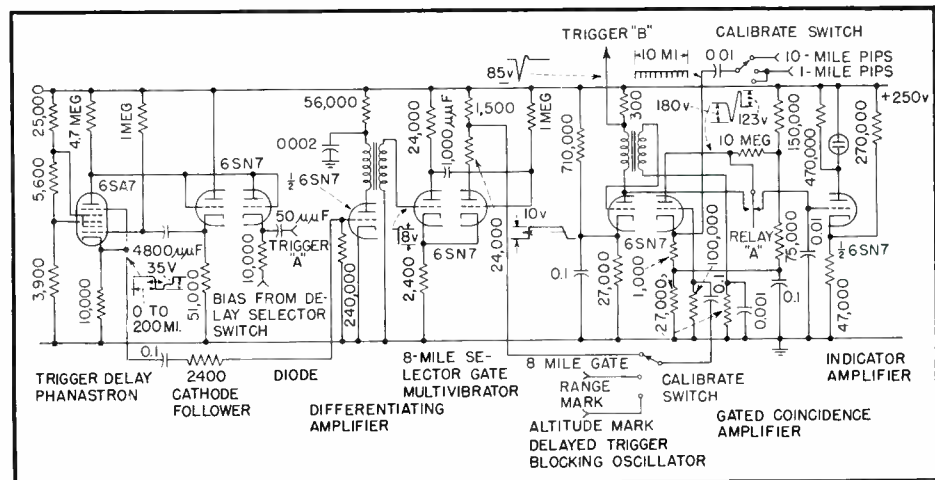

FIG. 7—Trigger-delay phanastron circuit and succeeding stages in APS-15 system, using a coincidence amplifier to increase the accuracy of long delays

cient linearity. The trigger-delay phanastron is employed to provide precise delays in the indicator trigger from 10 to 190 miles.

Since the phanastron cannot be depended upon for extremely accurate delays of such great length, a method of improving the accuracy is employed. The output of the phanastron is amplified, differentiated, and used to trigger a one-shot multivibrator which produces an 8-mile long gate. This gate is fed to the grid of the coincidence amplifier. The ten-mile marks are fed to the cathode. The coincidence amplifier is normally cut off by the control-grid bias. The square gate on the grid is almost enough to start it conducting. When a negative ten-mile mark appears on the cathode, at the same time as a positive 8-mile gate on the grid, the amplifier passes the 10-mile mark. The amplified mark then triggers a blocking oscillator. Thus, the phanastron need be only of sufficient accuracy to select the proper ten-mile mark which is accurately ob-

tained from the crystal oscillator.

The coincidence amplifier, in conjunction with the indicator amplifier, is also employed in calibration. By means of the calibrate switch, it may be connected to show coincidence between one-mile marks and the range or altitude mark. Coincidence of two marks causes a decrease in the average plate voltage of the coincidence tube, a decrease in grid voltage of the indicating amplifier, and a reduction in the brilliancy of the neon bulb.

The count mixer in Fig. 4 is employed to mix the one-mile and ten-mile marks so that they may be viewed together on an oscilloscope to assist in adjusting the ten-to-one divider for the proper count.

The second part of this paper, in an early issue, will complete the presentation of H2X circuits by taking up the modulators, scanners, r-f systems, receiver-indicator units, and synchronizers used in the two versions of this famous bombing radar.

GATE CIRCUIT

By **L. B. TOOLEY**

Southwestern Proving Ground
Hope, Arkansas

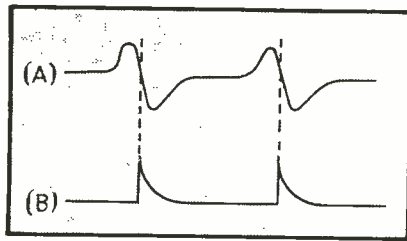

FIG. 1—(A) Pulses produced when a magnetized projectile passes through the two coils of a chronograph and (B) the same two pulses modified by wave-shaping networks

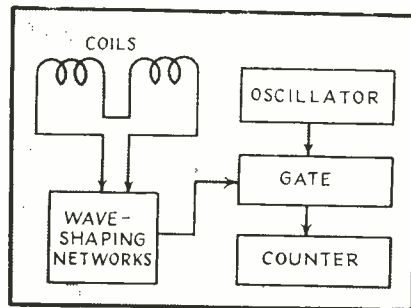

FIG. 2—Block diagram illustrating the basic elements of a chronograph

IT IS THE PURPOSE of this article to describe a simple switching circuit by means of which a succession of pulses derived from a given circuit may be used to cause sequential operation of another circuit.

During the writer's work, too much time-out-of-service had occurred on certain chronograph units. The particular circuits most frequently out of order were multivibrator switching units, together with thyatron lockouts and non-linear vacuum-tube relays. As much time was lost on account of these six-tube systems as on the circuits of the rest of the apparatus, involving from 30 to 100 tubes. The present switching circuit was devised to eliminate the troubles, and the effectiveness of the remedy is reflected in substantially zero out-of-service repair time over a period of five months.

In order to give the background of one application, the general layout of a chronograph system will first be discussed.

The Counter Chronograph

The counter chronograph is an electronic stop watch used for measuring time of flight of projectiles over a measured distance, from which data the velocity of the projectile is determined.

The chronograph system comprises

a pair of solenoids through which a magnetized projectile is fired. As the projectile goes through first one coil and then the second coil, a pair of pulses is generated. Such a pair of pulses is illustrated in Fig. 1A. By means of suitable wave-shaping networks, these pulses are reshaped as in Fig. 1B. The two pulses are impressed on tube grids in such a manner that two multivibrator tubes are successively tripped. When the first tube trips, an oscillator is caused to feed a counting circuit, and when the second tube trips, the oscillator is turned off. Thus the counting system counts up the oscillations, thereby giving an indication of the elapsed time between pulses and hence the time of flight. A crystal-controlled oscillator on 100 kilocycles is usually employed.

A block diagram, shown in Fig. 2, illustrates the principle by which the wave-shaping networks feed the pulses from the coils, suitably altered in shape, to a gate circuit which controls the oscillator which feeds the

counter during such time as the gate is open. The wave-shaping network ordinarily includes a series of amplifier stages, a clipping circuit, and a differentiating circuit.

The counter chronograph has not been widely discussed in the literature, but several pertinent articles have appeared.^{1, 2, 3, 4.}

The Gate Circuit

It is with the gate circuit, or switching unit, that the present discussion deals. Figure 3 shows one recommended arrangement. This figure shows in detail the circuit as set up and operated from the pulse shaper of a typical chronograph. The gate shown was simply substituted for the existing gate of the chronograph.

Values of applied voltage, or variations in voltage within the circuit, are indicated by numbers preceded by a plus or minus sign. Thus +300 indicates a d-c voltage of 300 volts to chassis or ground. Likewise, -150 indicates that the designated point

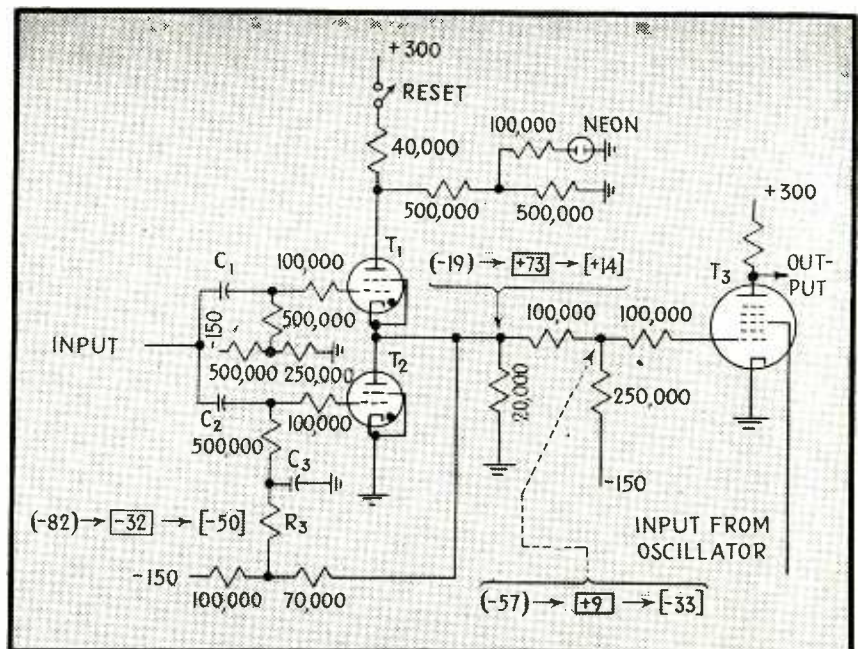

FIG. 3—The gate circuit discussed in the text, substituted for a more elaborate circuit originally employed in a typical chronograph

FOR CHRONOGRAPHS

Two thyratrons provide a simple switching system that permits amplification in a succeeding amplifier when the first pulse is received, blocks the amplifier when the second pulse is received. Readily substituted for more complicated gate circuits

in the circuit is 150 volts negative with respect to chassis or ground.

Operation is as follows: The first pulse from the shaper with a +30 volt positive crest ignites thyatron T_1 , the control grid of which is biased to -30 volts, but fails to ignite thyatron T_2 , whose grid potential is -82 volts. When T_1 fires, its cathode potential jumps to +73 volts, which after a time delay through R_3 and C_3 , biases the grid of T_2 to -32 volts so that the second pulse of +30 volts from the shaper can ignite the second tube.

The action can be followed by noting that the voltages at various points in the circuit before T_1 fires are indicated in parenthesis, the voltage at the same points after T_1 fires are indicated in boxes and after both tubes, T_1 and T_2 , have fired by brackets. Arrows between these numerical values indicate the ignition of one or the other thyatron.

Tubes T_1 and T_2 are gas thyratrons such as type 2050 or 2051 which, once fired, continue to glow until plate voltage is removed by opening the reset switch. The neon lamp may be a type 991 and is used to indicate the condition of the circuit. The lamp glows when the circuit is reset and is ready to function.

The conditions at the grid of vacuum tube T_3 are such that, before T_1 has ignited and after T_2 is ignited, the voltage is sufficiently negative to prevent amplification in T_3 . When T_1 has ignited but before T_2 has ignited, the grid voltage is sufficiently positive to permit amplification.

Circuit Details

Figure 4 shows a modification which has been applied to a chronograph of another type, in which the gate circuit output voltage is applied to the suppressor grid of a pentode tube. This circuit is basically the

same as that of Fig. 3, differing chiefly in that the level of the control voltage delivered is raised to approximately 130 volts during the gate-open part of the operating cycle.

In both Figs. 3 and 4, R_3 and C_3 should be designed to give the desired delay so that the control grid of T_2 will become armed or ready to be operated after the proper time interval. In the case of the chronographs used for measuring time of flight of projectiles, a preferred coil spacing is, say, 30 feet, so that a 3000-foot-per-second velocity will exhibit a time of flight of 0.01 second, or 1000 cycles of the 100-kc oscillator. The arming time under this condition should be about 0.001 second, so values of R_3 and C_3 should yield a time-constant product of $R_3C_3 = 1000$ microsecond. Thus suitable values are $R_3 = 100,000$ ohms and $C_3 = 10^{-6}$ farad or 0.01 microfarad. These are the values which were employed in the experimental model and later installed permanently in three chronograph instruments.

Capacitors C_1 and C_2 may be any suitable size, dependent upon the shape of the pulses from the control input line. In the chronographs to which these circuits were applied, $C_1 = C_2 = 0.00025$ microfarad.

While the accent has been placed upon application of this type of circuit to chronographs, there are obviously numerous other applications in which a device such as that described can be used.

The writer wishes to acknowledge the cooperation of Major P. W. Klipsch, under whose general supervision this work was done.

REFERENCES

- (1) Potter, John T., A Four-Tube Counter Decade, *ELECTRONICS*, p 110, June 1944.
- (2) Bradford, C. I., The Chronoscope, *ELECTRONICS*, p 28, Nov. 1940.
- (3) Bradford, C. I., The Chronoscope, *American Rifleman*, p 12, March 1941.
- (4) Bradford, C. I., A Radio-Frequency Device for Detecting the Passage of a Bullet, *Proc. of I.R.E.*, p 378, Nov. 1941.

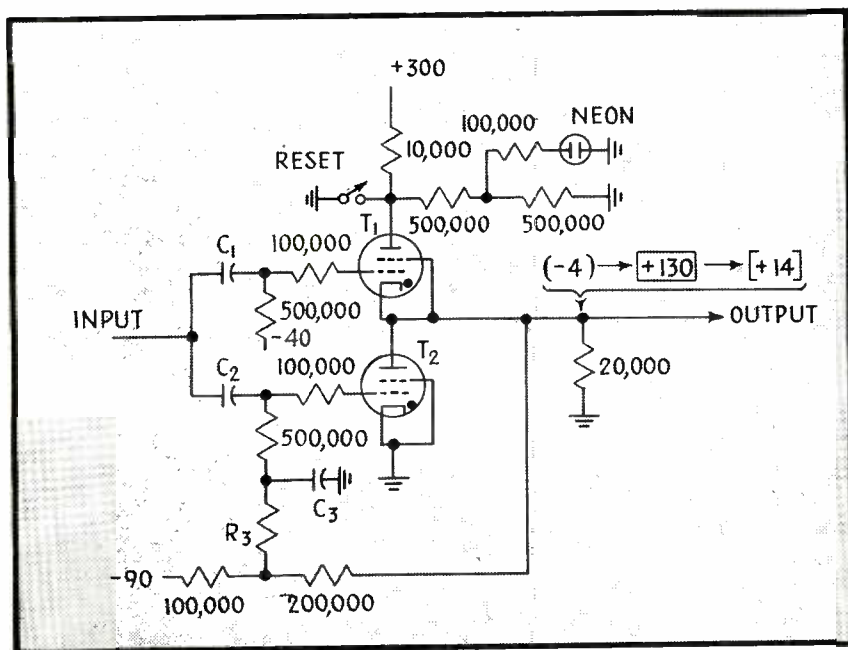

FIG. 4—Modification of the gate circuit, in which sufficient output voltage is developed to operate the suppressor grid of a pentode in another chronograph

2-Mc Sky-Wave

By J. A. PIERCE

Radiation Laboratory*
Massachusetts Institute of Technology
Cambridge, Mass.

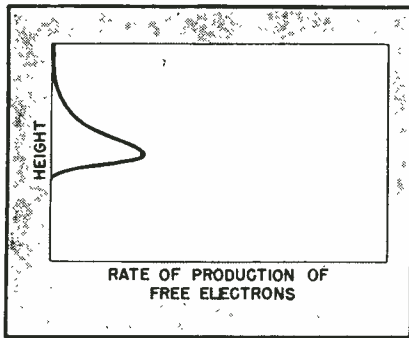

FIG. 1—Chapman curve showing vertical distribution of free electrons

THE ionosphere is usually defined as "that region of the earth's atmosphere which is ionized sufficiently to affect the propagation of radio waves." For practical purposes it may be thought of as all the atmosphere above the stratosphere, or, more specifically, the atmosphere between 30 and 300 miles above the surface of the earth.

The atmosphere at such heights consists primarily of the same constituents as at sea level, nitrogen and oxygen. Above 60 miles the oxygen presumably exists in atomic rather than molecular form because the ultraviolet light from the sun disassociates the atoms much faster than they recombine. Nitrogen may be disassociated at, say, 200 miles but the evidence for that is less clear.

There is little to indicate that the heavier elements settle out at the lower altitudes. Probably all the components of the atmosphere are quite well mixed, except for the change from molecular to atomic oxygen at 60 miles. It may be that hydrogen and helium escape into space; there is no strong evidence that they form much of the upper air.

The pressure at which these gases exist decreases exponentially with increasing height to very small values. At 60 miles it is about one millionth of the sea level pressure, while at 200 miles it is probably thousands of times again as small. The mean free path, at 60 miles height, may be taken as one centimeter while at 200 miles it may be as much as a mile or more. This mean free path is the distance a particle—molecule, atom, heavy ion or electron—will travel, on

the average, before it collides with another particle. It is a very important quantity.

The temperatures in the ionosphere are high. This does not mean that there is much heat in the upper air, because there are very few particles to contain heat, but it does mean that the particles travel rapidly. At sea-level temperatures the air molecules travel at about 0.5 kilometer per second, while at 200 miles altitude they move several times as fast. The temperature, after falling to about -70°F in the stratosphere, increases to nearly the sea-level value at about 30 miles. Then there is a sharp drop to about -140°F at 50 miles. Above that the temperature (velocity of particles) rises rapidly to somewhat more than 80°F at 60 miles and to perhaps $1,400^{\circ}\text{F}$ at 200 miles.

Production of Ionization

If a certain wavelength of solar ultraviolet light excites one of the electrons in an atom so that it breaks away from the atom and exists alone, the atom is ionized. The electron may be called a negative ion and the positively-charged remnant of the atom is called a heavy or positive ion. The electron is small and light. It will travel, independent of the heavy ion, at great speed until it finds another heavy ion with which it can unite or until it finds an atom or molecule to which it can stick temporarily.

Let us assume that ultraviolet light of some ionizing wavelength is falling upon the atmosphere. There will be, in general, enough energy at this wavelength to penetrate some distance into the air but not enough to reach the surface of the earth before it has all been expended in ionization. At several hundred miles above the surface very little ionization will be produced because there are very few atoms there to absorb the energy. The ionization will therefore increase as the height decreases

because there is more and more material which can be ionized. As the height decreases further, however, a substantial fraction of the original ultraviolet energy has been used up so that, although the number of atoms continues to increase very rapidly, the number of electrons set free does not increase so rapidly. At still lower heights the number of free electrons actually begins to diminish and, lower yet, decreases to zero when all of the suitable incoming energy has been used up.

This behavior can be calculated, under certain simplifying assumptions, and gives a curve of the shape of Fig. 1 which is known as the Chapman distribution. The height at which the free electrons are produced and the thickness of the layer of electrons depend upon the kind of ionizing energy, the kind of atoms which are ionized and the temperature of the air. The number of free electrons produced depends upon the same things but especially upon the total energy available in the ionizing ultraviolet light.

The true picture of the vertical distribution of free electrons is much more complicated. A separate distribution, of the form of Fig. 1, is produced for every combination of ionizing ultraviolet wavelength and atomic constituent in the atmosphere. Many of these distributions overlap

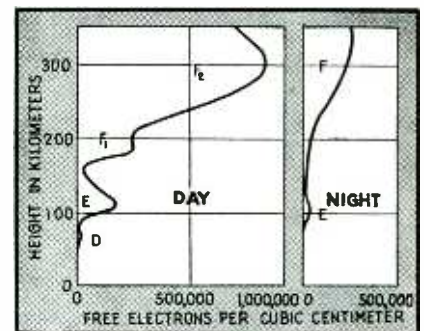

FIG. 2—Night and day distribution of free electrons showing disappearance of the D layer and combination of the F_1 and F_2 layers at night

*This paper is based on work done for the Office of Scientific Research and Development under Contract OEMsr-262 with the Radiation Laboratory, Massachusetts Institute of Technology

Transmission

A simplified review of present ionospheric knowledge and a critical survey of the information resulting from an empirical use of the night-time *E* layer. Its relative stability, as disclosed by loran operations, is little affected by ordinary disturbing phenomena

each other but some are quite well separated. Furthermore, these Chapman curves define the rate at which free electrons are produced. There is some diffusion from the heights at which they are produced and the electrons at lower levels recombine faster than those above. Both of these factors operate to cause the heights at which the density of ionization is maximum to be greater than the heights at which the electrons are set free most rapidly.

Formation of Layers

Figure 2 shows the approximate distribution of free electrons as they exist by day and by night. The maximum at about 250 km is called the *F* layer, or Appleton layer. The small bump on the lower side appears only in the day time in the summer, because it recombines quickly at night and is swamped in the body of the *F* layer in the winter. When it appears it is called the *F*₁ layer and the remainder of the *F* region is known as the *F*₂ layer. The *F* layer varies greatly in height, thickness, and density of ionization.

The *E*, or Kennelly-Heaviside layer at about 100 km, is much more stable. Its density of ionization follows the altitude of the sun quite closely, except that some ionization remains throughout the night when the sunlight does not fall on the layer. We shall be primarily concerned with the *E* layer.

The tail of the *E* layer, perhaps at about 70 km above the earth, sometimes shows a small maximum which is called the *D* layer. The density is low, so that only low frequency waves can be reflected from it. The *D* layer is primarily of importance because it absorbs energy from radio waves.

Reflection

If a radio wave penetrates obliquely into the ionosphere the phase velocity, which determines the

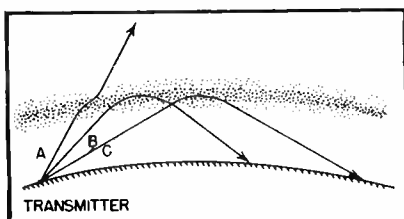

FIG. 3—A simplified representation of an ionospheric layer showing the effects of rays entering at different angles. Ray A has left the earth at too steep an angle to be turned back

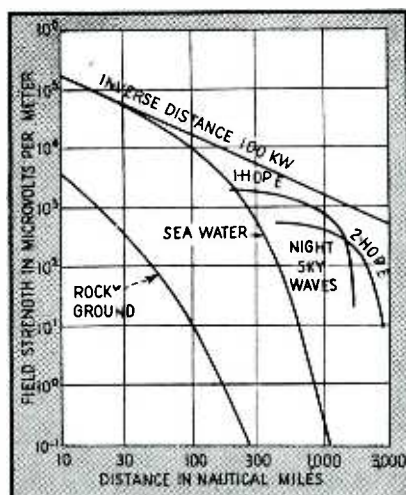

FIG. 4—Field strength as a function of distance from a 100-kw transmitter, over sea water and rocky ground. The 1-hop *E* sky waves can not be safely used beyond 1,400 miles because their strength falls rapidly below those of the 2-hop *E*

direction of the wave front, increases as the index of refraction decreases. At the same time the group velocity, which is the velocity with which the energy travels, decreases in the same ratio. Thus the upper part of the wave front travels faster as the wave penetrates into an ionized layer because the density of ionization is increasing. The wave is therefore refracted so that it curves back toward the earth, but it travels more slowly while being refracted.

In Fig. 3 we have postulated an ionospheric layer whose density (number of free electrons per cubic

centimeter) is roughly indicated by the density of dots. Three rays of radio frequency energy are shown entering the layer. If the frequency is such that reflection can occur at oblique incidence but not at vertical incidence on the layer the behavior will be as shown. A ray C departing at a small angle to the horizontal will only require a modest amount of refraction before it is turned parallel to the surface of the earth. It will therefore not need to penetrate far into the layer and will span a long range in a single hop. Another ray, B, departing more steeply from the earth will penetrate the layer more deeply because it must be turned through a greater angle. If the required bending cannot be achieved, because the frequency or departure angle is too high or the density of the layer is too low, the ray A will penetrate the layer, traveling on a path which is concave downward until the height of maximum ionization is reached and concave upward beyond that height. This ray, of course, leaves the earth completely unless it is turned back later by a higher layer. The effect of the penetration is to establish the well known skip distance within which sky-wave signals are not received. Outside a layer, rays travel straight lines.

Single-Hop Limit

There is a definite maximum range which can be spanned by single hop transmission. This is the distance covered by a ray departing horizontally (or as nearly horizontally as antenna radiation can be effective) and is about 1,500 miles in the case of *E*-layer transmission. At greater distances the signal is cut off by the earth itself. This shadow effect can be seen clearly in the sharp drop in the 1-hop sky-wave field-intensity curve of Fig. 4.

A rough diagram indicating the typical action of both *E* and *F* layers

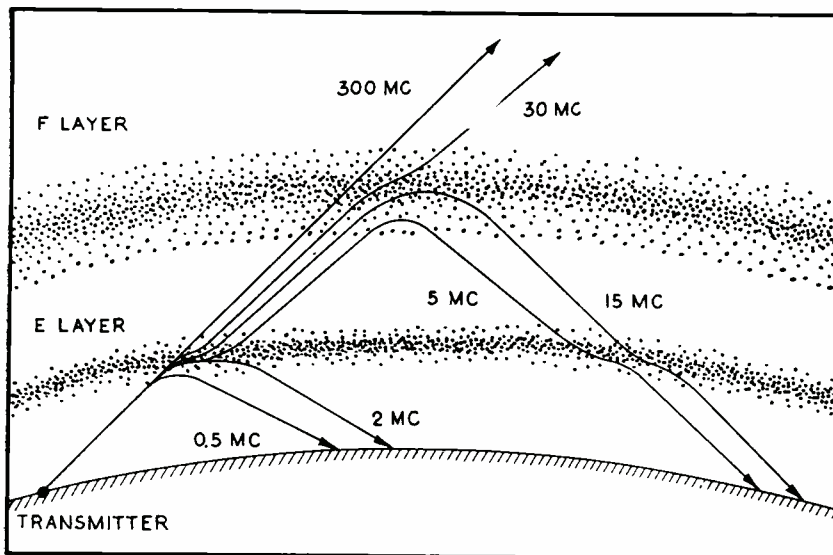

FIG. 5—Typical behavior of rays at various frequencies in the E and F layers. At the higher frequencies the rays are less affected by the ionosphere

is given in Fig. 5. Here we have assumed a number of rays at different radio frequencies, all departing from a transmitter along the same path. The medium frequencies shown, 500 kc and 2 mc, are both reflected by the E layer, but the 2-mc ray penetrates much more deeply and travels somewhat farther. At 5 mc, the ray is refracted strongly in the E layer but does penetrate it, and is easily reflected by the F layer. The 15-mc ray is less affected by the E layer and penetrates more deeply into the F layer, but the general behavior is much the same as at 5 mc. Thirty mc, however, is too high a frequency to be returned, under the conditions we have postulated. The ray passes the E layer with very little refraction, and is refracted strongly by the F layer but without being turned back toward the earth. The energy at this and all higher frequencies, such as 300 mc, escapes into space. As the frequency increases the deviation of the ray in the layers decreases until at microwave or optical frequencies the effect of the ionization is not at all perceptible.

The whole structure of Fig. 5 depends upon the density of ionization in the layers and upon the angle of departure of the original rays. At a lower angle the 5-mc ray might often be reflected from the E layer while the 30-mc ray would be returned from the F region.

The reflection of radio waves in the ionospheric layers is only half of the process of radio transmission

by sky waves. The absorption of energy from the waves is of at least the same importance.

Absorption

Some mention was made above of the mean free path of an electron (or other particle) in the upper atmosphere. This quantity, or more properly the inversely-varying collisional frequency, controls the energy lost by a radio wave. While there may be a million free electrons per cc in a highly ionized layer there are typically a million times as many neutral atoms or molecules with one of which an electron may collide at any instant. Suppose, for example, that on the average an electron can move freely only for a millionth of a second before bumping into a heavy atom. If the electron is being vibrated by a radio frequency field at 1 mc there is only about one chance in two that the electron can complete a cycle of oscillation before its motion is interfered with.

The collision is important for this reason. Some energy is abstracted from the radio wave to provide the kinetic energy contained in the moving electrons. This energy is, in effect, lost to the radio wave only for a half cycle because the moving electron, since it constitutes a moving charge, reradiates an electromagnetic field whose energy is equal to the energy absorbed by the electron. As the radio wave passes through the ionosphere the energy reradiated by all the electrons adds in phase to

constitute a wave traveling in the same direction as the original wave. If the electrons can move freely, tiny elements of the energy in the wave flow back and forth between electrostatic and kinetic states, but the total energy in the wave remains the same.

Energy Lost by Collision

If, however, an electron rebounds from an atom while temporarily carrying some of the energy two things happen. One is that the direction of motion of the electron is changed. The energy is then reradiated in a different orientation, so that the phase relation with the radiation from other electrons is damaged. Even more serious is a real loss of radio frequency energy because the atom is accelerated slightly and carries off part of the kinetic energy which had been loaned to the electron. This energy is completely lost to the radio wave and remains in the atmosphere in the form of increased kinetic energy, or heat.

If the probability of collision and loss of energy is high enough the radio wave will be completely attenuated in the ionized layer. The degree of absorption is less as the frequency is increased because the electrons are more likely to be able to complete their half cycles of oscillation before a collision occurs. In the F layer there is little collisional friction because the mean free paths are long and the collisional frequency is low. In the E layer collisions are frequent enough so that waves of frequency below 2 or 3 mc are completely absorbed in the daytime. At night the density of ionization in the E layer decreases to perhaps a tenth of the daytime value. The absorption goes down to low values because the chance of a collision between an electron and some other particle is similarly reduced.

We may summarize the situation thus: Ionization is needed to reflect radio waves but ionization at low heights in the atmosphere absorbs energy from the waves. The higher the frequency the stronger the ionization required for reflection and the less the absorption.

Little Ionization at Night

Since most ionization in the atmosphere is produced by the action of ultraviolet light from the sun there

is little new ionization created at night. The free electrons recombine, but slowly enough so that a substantial number of them remains throughout the night. Thus the maximum ionization occurs at or soon after noon and the minimum at sunrise. Similarly the ionization is more intense in summer than in winter because the sun shines more perpendicularly upon the atmosphere and the ionization increases as does the temperature.

Whether radio transmission is better by day or by night, in winter or in summer, is a question of frequency. At high frequencies, say 20 mc, the weak ionization may prevent sky-wave transmission completely in the winter or at night, while in summer or daytime the stronger ionization will support transmission when absorption is so small as to be unimportant. At broadcast frequencies, absorption is complete in the daytime so that only ground wave ranges are useful. At night, long distance transmission is possible, and the decreased absorption in the winter makes communication better than in the summer.

2-mc Sky-wave Loran Transmissions

During the war, much practical information was obtained from the use of *E*-layer transmissions which extended the night-time range of the loran navigational system. The balance of this paper describes some of the phenomena encountered.

Figure 6 shows typical variations of the critical frequencies (which are proportional to the square roots of the maximum densities of ionization) in the *E* and *F* regions throughout the day. Recombination is slow in

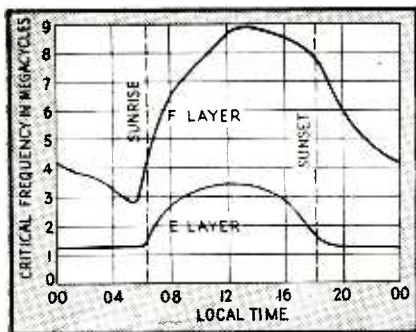

FIG. 6—Critical frequencies for the *E* and *F* layers at various times of the day. These plots are particularly important in showing that ionization in the *E* layer is not entirely dependent upon solar radiation

the *F* region that the maximum occurs well after noon although all of the ionizing energy appears to come directly from the sun. The smooth decrease throughout the night is another manifestation of the fact that some free electrons have lifetimes of many hours in the *F* layer.

The behavior of the *E* layer at night is not understood. At the height of the *E* layer complete recombination takes only a few minutes, so that the density of ionization adapts itself very quickly, in the daytime, to the amount of energy being received from the sun. The *E* layer curve of Fig. 6, between sunrise and sunset is nearly proportional to the fourth root of the cosine of the sun's distance from the zenith. This is so exactly true that without question the ionization would go almost to zero at night if ultraviolet

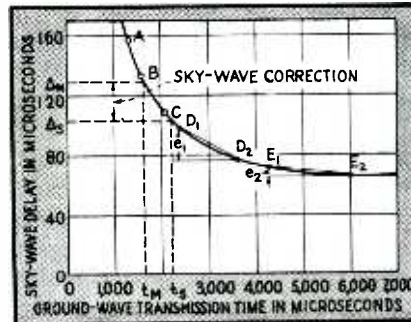

FIG. 7—Delay in reception of a sky wave after reception of a ground wave from the same transmitter is shown as a function of distance of the receiving point from the transmitter. The curve has been calculated to distances beyond ground-wave reception in terms of the travel time of radio waves

light from the sun were its only source.

The energy brought into the earth's atmosphere by meteoric bombardment may possibly be enough to sustain this night-time ionization.¹ In any case, meteoric effects are definitely perceptible and certainly cause many of the variations in the density and distribution of free electrons in the *E* layer even though they are probably not the major cause of the ionization. The random variations in the density of the *E* layer are of the first importance in the propagation of loran signals by sky waves, because they control the errors of the system.

Sky-wave Delay

The transmission time of a sky wave is greater than the transmis-

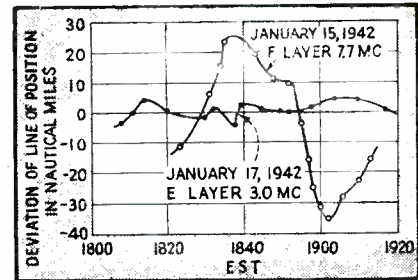

FIG. 8—Apparent deviation of a line of position with time using signals reflected from the *E* and *F* layers. As a result of this study, the *E* layer was chosen for loran work

sion time of the ground wave, primarily because of the greater distance traveled but also because the wave travels more slowly during the process of refraction. The difference between the two times is called the sky-wave delay. The delay observed at a point very near the transmitter (if penetration does not occur) is essentially equal to the transmission time of the sky wave. As the distance increases the transmission time of the sky wave increases but the transmission time of the ground wave increases more rapidly. The delay therefore decreases as the distance of transmission increases and, in fact, becomes very nearly constant at distances of a thousand miles or more. Figure 7 shows the standard delay curve for loran, which is drawn for reflection from the *E* layer. The curve is a mean for night conditions at a frequency just below 2 mc. It is never drawn back to zero distance because a 2-mc wave nearly always penetrates the night-time *E* layer at short distances and because the delay becomes more variable as the distance decreases. At distances less than 1,200 μ sec (about 200 nautical miles) the delay is completely unreliable. Fortunately for loran the ground-wave service of the system is ordinarily available at distances up to those at which the *E*-layer transmission becomes satisfactory.

The stability of the reflection becomes greater at longer distances partly because grazing reflection is better than reflection at a steep angle, but primarily because a change in the height of reflection does not greatly change the total distance traveled by the ray. At a distance of a thousand miles the length of the sky-wave path increases only 1.78 miles for a change in the height of

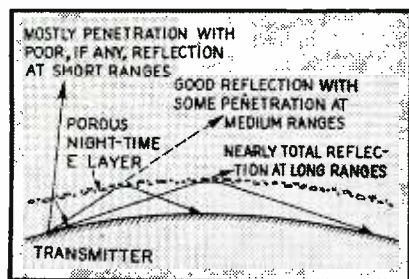

FIG. 9—The porous character of the night-time *E* layer is illustrated by the reflection at long ranges, the penetration at short distances

reflection of 5 miles. This is a change in the time of transmission of less than $10 \mu\text{sec}$ or about one-fifth of the corresponding change at a short distance.

Large-area Layer Variation

Variations of five miles in the height of reflection are rare but do occur at times. Their effect upon standard loran is not too large because such an extreme variation is likely to exist over a large area. It will therefore operate to increase (or decrease) the transmission times from both stations of a pair so that the time difference measured by the navigator does not vary as much as the individual delays.

The discussion in the last few paragraphs has been specifically applicable to the *E* layer. Only this layer is used in loran because the *F* layer is too variable to permit prediction of the times of transmission with the necessary accuracy. A comparison between the layers is given in Fig. 8 which shows the apparent variation of the line of position through a point in Bermuda. These observations were made as part of first experiments on loran. For obvious reasons work involving the *F* layer was discontinued after that time. The example shown is typical of the behavior of both layers although the time of day was not favorable to maximum stability of either. The average deviations of the line of position are 18 miles for the *F* layer and 2 miles for the *E* layer. The distance was 625 miles from the stations, so that the equivalent average errors in the bearing of Bermuda, as seen from near New York, were 1.7 deg for the *F*-layer experiment and 0.2 deg for the *E*-layer.

As will be seen from the notation

on Fig. 8, the layer can be selected by proper choice of frequency. At the time of these experiments 7.7 mc penetrated the *E* layer while 3.0 mc did not. The loran frequency is chosen as one which will be reflected by the *E* layer at all times at all distances which will not be adequately served by ground waves. It is possible that frequencies as high as 2.5 mc might satisfy this criterion, but both ground-wave range and sky-wave stability are improved by using lower frequencies. (The lower limit of frequency, incidentally, is that at which it becomes too difficult to generate and radiate a sufficiently short pulse for loran purposes. With the criteria adopted for standard loran, this frequency is probably about 1 mc).

Choice of Loran Frequency

It should be noted that the last paragraph did not state that signals at the loran frequency would not penetrate the *E* layer. They almost always do penetrate at short distances and part of the energy usually penetrates the layer at long distances. This seems to be because, in contradiction of what has been suggested above, the *E* layer is not really a smooth homogeneous layer at night, although it is in the daytime. At night the layer is porous, even gauzy. It seems to consist of many nuclei or clouds of ionization chiefly at about the same height—a little below the height of the daytime or nor-

mal *E* layer—with either spaces or patches of sparse ionization between them. The density of the ionization in the clouds is not very great so that 2-mc rays pass vertically through the layer partly because of penetration of the clouds and partly by passing between them. At more grazing angles the probability of passing through the spaces becomes smaller and usually goes nearly to zero for transmission over the longer distances. A diagram showing this effect is given in Fig. 9.

In general some energy will be reflected by the porous night-time *E* layer and some will pass through it and be reflected from the *F* layer. Multiple-hop transmission is possible in both cases so that the pattern of received pulses may be very complex. The structure of some of these components of the received pattern is shown in Fig. 10A. The way the corresponding signals look on a linear time base is indicated at B. This diagram is idealized.

The spotty character of the night-time *E* layer gives rise to pulses whose shape is not the same as that of the pulses when they leave the transmitter. Several of the small clouds of ionization in the neighborhood of the midpoint of the transmission path may reflect the pulse. While each reflection may be a complete and perfect reproduction of the transmitted pulse, the overlapping components arriving at the receiver may combine to give a very complex

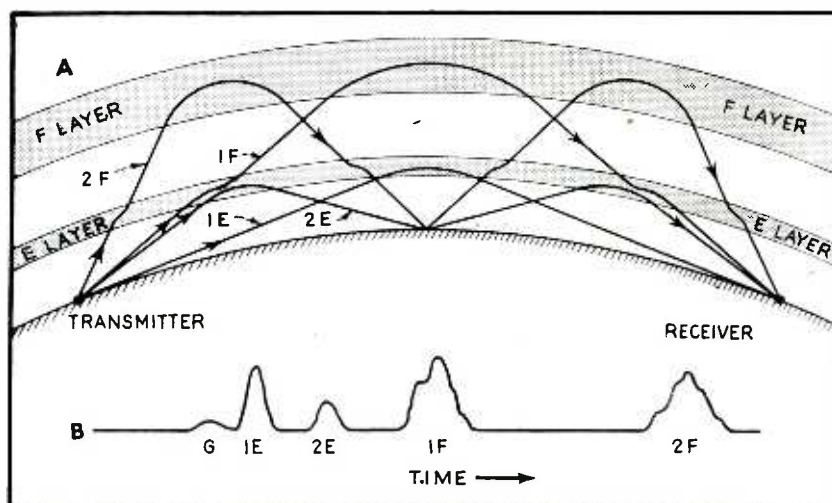

FIG. 10—Multiple-path transmissions occur in many combinations, only a few of which are shown. Their appearance on the loran indicator scope is suggested at B. Only the ground wave, G, and the 1-hop *E* will have any semblance of stability over a period of time

form indeed. This is particularly true at very short distances, say up to 100 miles, where often a family of ten or a dozen contiguous or overlapping pulses may be seen. As the range increases the weak multiple pulses move toward each other and coalesce into a single strong pulse which occasionally has a more or less serious distortion of its shape. Figure 11 shows some of the typical reflection patterns received between, say, 100 and 400 miles from a loran transmitter. The reason for not using sky waves at very short distances is clear.

The Delay Curve

The standard technique in loran is to measure to the first visible component of a pulse even though the pulse be complex. As seen in Fig. 11B this may be quite different from measuring to the dominant component. This decision was first made on theoretical grounds and was based on the belief that if a pulse should be simultaneously reflected from a number of clouds of ionization the part arriving first must travel by the simplest and most direct path and should therefore be the most reliable. This thesis has been amply confirmed by experiment, as measurements made on the first component exhibit smaller mean deviations than those made in any other way.

At the start of the loran program the night-time *E* layer was scarcely known to exist and its properties could not be predicted. It was necessary, therefore, in the interest of speed, to determine the necessary factors empirically. More than this has not yet been done. Fortunately the layer was found to be remarkably stable. That is, its characteristics change very little from one hour of the night to another. More surprisingly, the properties of the layer seem to be essentially the same at all latitudes, and to vary only simply and moderately between winter and summer. These auspicious discoveries greatly facilitated the use of sky waves for loran.

The delay curve already cited was determined by making loran observations on sky waves at accurately known points and comparing the observed readings with time differences calculated (for the locations where they could not be directly measured)

in terms of ground-wave transmission.

Charts and tables for Standard loran are computed in ground-wave time differences even though the distances are so great that ground waves cannot be received.

Sky-wave Corrections

A correction must be applied when sky waves are used. The correction can be read from the sky-wave delay curve if the distances to the two stations are known. Suppose that t_M in Fig. 7 represents the distance of the navigator from the master station while t_S is the distance from the slave. The first-hop *E* layer sky wave from the master will arrive Δ_M μ sec after the ground wave and the corresponding slave pulse will be Δ_S μ sec later than its ground wave. Since the navigator measures the time difference between the *M* and *S* pulses his sky-wave reading will differ from his ground-wave reading (if he has made one) by $(\Delta_M - \Delta_S)$ μ sec. This amount is the sky-wave correction. In this case (closer to the master station) the sky-wave reading is

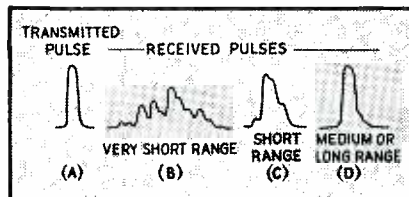

FIG. 11—Within 100 miles of a transmitter the pulses reflected from the *E* layer are complex and useless for accurate timing techniques. At 300-400 miles, the pulses have achieved sufficient stability

smaller than the ground-wave reading. The correction is therefore called positive, so that when it is added to the sky-wave reading the ground-wave time difference, which is shown on the charts, will be obtained.

The sky-wave corrections can, of course, be calculated easily at the time the charts are prepared. They are ordinarily exhibited on the charts as small numbers printed at the intersections of the whole degrees of latitude and longitude. The magnitude of the corrections is small so that interpolation by inspection is adequate. On the centerline of the pair and at long distances from both stations the corrections are zero be-

cause the master and slave delays cancel each other.

The delay curve was constructed through study of many thousands of loran sky-wave readings made at various distances from the stations. At short ranges both sky and ground waves could be received. Measurements of both against the ground wave of the other station of the pair gave two average readings whose difference was the delay at the distance of the station whose sky wave was used. Points derived in this way are shown at *A*, *B*, and *C* of Fig. 7. For longer ranges, where ground waves could not be used, an inverse process had to be employed. The sky-wave readings of a pair were averaged and compared with the calculated ground-wave reading at the monitor station. The discrepancy (e_1 or e_2 in the figure) was, of course, the sky-wave correction. Since the two distances were known, the correction gave the slope of a chord of the delay curve, as shown at $D_1 - D_2$ or $E_1 - E_2$. Many lines of this slope could be drawn in an effort to find the vertical position of the line which would fit its end points into a smooth curve with the end points of other similar lines at other distances. If enough observations are available, at enough distances, the curve can easily be constructed.

Empirical Formula for Delay

The curve which, after three years experience in various latitudes, seems to be the best average approximation to the true values has been shown in Fig. 7. This curve is described by the equation: delay in μ sec

$$= D + 0.3 \left(\frac{7,000 - t}{1,000} \right)^3 + 0.18 \times 10^{-6} \left(\frac{7,000 - t}{1,000} \right)^{11}$$

D is the minimum sky-wave delay which varies between 65 μ sec in the winter and 75 μ sec in the summer

t is the transmission time of the ground wave in μ sec

This formula applies for distances less than about 1,130 nautical miles (where $t = 7,000$). For greater distances the delay equals D . This equation has no mathematical justification.

As shown by the variation of the quantity D , the layer height is some-

what greater in the summer. However, the delay curve, for all practical purposes, simply moves upward so that the correction, which is always the difference between two delays, is not affected. There is an error introduced by this change in two cases; when the navigator may occasionally wish to measure the time difference between a sky wave and a ground wave, and in the case of the synchronization path in SS Loran^{2, 3} which will be discussed below.

The only significant latitude effect which has been isolated is that the

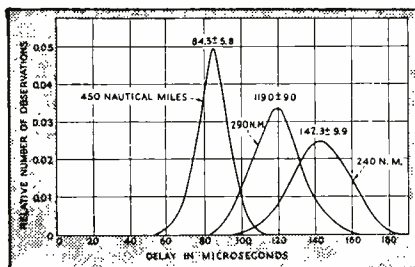

FIG. 12—As shown by the three sets of observations, the average sky-wave delay diminishes as distance from the transmitter increases and the spread of readings decreases proportionately

delay curve may be used at shorter distances at low latitudes. That is, near the equator fairly reliable operation may be had at as little as 150 nautical miles, while at 45 deg latitude about 250 miles is the minimum safe distance. The curve itself does not seem to vary appreciably over the range from 25 N to 63 N within which it has been carefully checked.

Variation in the Sky-Wave Delay

Since we propose to examine closely the averages and the mean deviations of the sky-wave delay and sky-wave corrections, it is necessary to test the accuracy with which transmitter synchronism can be maintained. An example, somewhat better than normal, is given by readings from a pair of stations in the Northwest Atlantic Chain observed at a monitor station where the computed reading was 3510.6 μ sec. The mean, as is usual, agrees with the computation within 0.2 or 0.3 μ sec, and the average deviation is of the order of 0.6 μ sec. A series of sky-wave readings usually shows an average deviation at least four or five times

as great. It is, therefore, nearly always satisfactory to assume that the synchronism of the transmitting stations is rigid and that any deviations observed are the result of variations in sky-wave propagation. Exceptions to this assumption are usually obvious.

Three distribution curves of observations of the sky-wave delay are given in Fig. 12. The curves are drawn to have the same area and exhibit clearly the two important facts of sky-wave transmission for loran. The average delay diminishes as the distance increases, as shown by the delay curve, and the spread of the readings also decreases in about the same proportion. The probable errors in this set of observations are: 9.9 μ sec at 240 nautical miles, 9.0 μ sec at 290 nautical miles, 5.8 μ sec at 450 nautical miles. The first two are somewhat below the normal scatter at these distances.

Layer Height Correlations

At long distances it is impossible to measure delay directly. Distribution curves of the sky-wave reading (not delay) compared with the computed reading at distances of 870 and 1,350 nautical miles show that the corresponding probable errors are 2.1 and 2.4 μ sec, although a smaller error would be expected at the greater distance. These are errors in the sky-wave correction. As remarked above, major changes in the height of reflection of a sky wave may be expected to affect both transmission paths in the same way and therefore to cancel to some extent. In other words, there should be a correlation between the two delay patterns, and the errors of a sky-wave measurement would be smaller than if the two reflection points behaved independently. For instance, the probable error of delay at a thousand miles averages about 3.9 μ sec. If every point in the reflecting layer varied independently, the probable error of a sky-wave reading would be about $\sqrt{2} \times 3.9$ μ sec, or 5.5 μ sec. Actually, for base-line lengths of about 250 or 300 miles, the probable error of a reading is usually between 1.5 and 2.0 μ sec for a thousand-mile range. This indicates a fair degree of correlation in the behavior of the layer at points separated by a hundred miles or more.

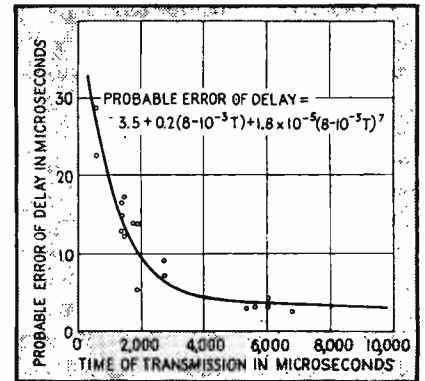

FIG. 13—Probable error of delay has been determined by actual observations at monitor stations of various pairs of transmitters

The probable error of delay is shown in Fig. 13 as determined from monitor station readings on many different pairs of stations. The points for ranges greater than could be served by ground waves were determined during the American trials of the SS Loran system.^{2, 3} The equation given on the diagram defines the smooth curve but has no other significance.

If no correlation existed between the layer heights at the two points of reflection, the probable error of a sky-wave reading would be found by taking the square root of the sum of the squares of the two values of probable error of delay for the two distances involved. Since there is a correlation, an estimate of the probable error of a reading can be made by multiplying the no-correlation value by a factor smaller than unity which can be obtained by experiment. This factor is given in Fig. 14 where it is plotted against the electrical length of the base line. The positive slope means simply that the greater the separation of the stations the less the variations in delay tend to cancel each other. The factor, "Probable error of synchronization", is given in the equation on the figure because sometimes, as in SS Loran, the absolute accuracy of synchronism cannot be assumed. In SS Loran, of course, the probable error of synchronization is equal to the probable error of delay at the distance separating the stations.

Sky-wave Accuracy Patterns

The accuracy (or average error) with which a sky-wave loran reading

can be made can be estimated by the method of the preceding section. This average timing error may or may not correspond to a significant number of miles depending upon the distance from the stations and their orientation with respect to the navigator.

Ordinary geometrical methods permit the calculation of the number of miles corresponding to a change in reading of one microsecond. These formulas may be combined with the methods of this article to yield the average error of a sky-wave reading in miles.

The probable error of a sky-wave line of position (in nautical miles) varies over the service area of a loran pair, whether standard or SS. It is of special interest to note that the errors increase very slowly with distance along the center line of the pair. This is because the timing errors are nearly inversely proportional to distance and almost cancel the increasing geometrical error. Beyond the 1,400 mile limit or within 250 miles of the stations it is not safe to use sky waves because of ambiguity in the first case and erratic behavior in the second.

The accuracy of SS Loran is greater than the sky wave accuracy of standard loran, because the long base lines greatly improve the geometrical accuracy, or miles per μsec of timing error. The timing error itself is not so good as in a standard loran, primarily because of sky-wave variations on the synchronizing path, but the timing error is not increased as much as the geometrical factors are improved. The total area served by an SS pair is not so great but the errors are smaller and more constant except along the base line extensions.

Sporadic E-Region Ionization

One of the outstanding anomalies in the *E* region is the existence of sporadic ionization. This takes the form of clouds of free electrons, at a very constant height, which are sporadic in both time and space. They may appear at any time, day or night, and last for a few minutes or for hours. Their size may be anything up to hundreds of miles across. They sometimes appear to move with very great velocities and at other times they seem nearly stationary. The density of ionization is often low

but occasionally is very great indeed—even greater than is ever observed in the *F* layer. On at least one occasion the density has been observed to be enough to reflect signals up to 110 mc over a thousand-mile path.

These clouds are probably caused by corpuscular bombardment of the atmosphere by particles shot off by the sun, in much the same way that northern lights are formed. While sporadic *E*-region ionization may appear at any time, it is most likely in the summer and at times of sunspot maximum. It is most probable at high latitudes and is very seldom if ever observed at the magnetic equator—again like the aurora.

In the early days of loran it was feared that signals from one station of a pair might be reflected from a cloud of sporadic *E* ionization while the other signals would be transmitted by the normal night-time *E* layer, thus leading to large and unpredictable errors. Fortunately this is not the case, apparently because the normal reflections occur at a height somewhat below that of the sporadic *E*, so that the signals never are propagated by the sporadic clouds.

At very short distances sporadic *E*-region ionization frequently does cause strong steady reflections. Since the height of reflection differs from the normal, this contributes to the unreliability of sky-wave transmission at short distances at 2 mc.

The best evidence to this effect is given in the table which exhibits the average value and probable error of sky-wave readings when sporadic *E* ionization is and is not present. These data were taken in Ottawa, Canada,

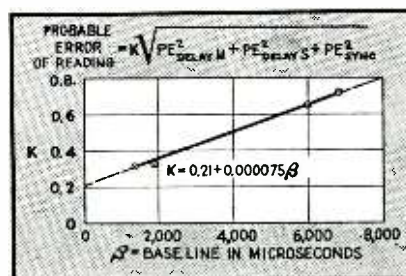

FIG. 14—The increasing value of the correlation factor, *K*, indicates that as the separation of transmitters increases, variations in delay tend to cancel less. This also shows that over great distances the ionosphere does not move uniformly

by the Canadian Navy, in May, June, and July, 1943, the season of maximum sporadic ionization. During this period the sporadic *E* layer appeared about one-third of the time at Ottawa. Of course there is no proof that sporadic ionization existed at the points of reflection at the same time they were observed at Ottawa, but it is more likely to have existed there then than when it was not observed at Ottawa. As the table shows, there was no significant change in the loran reading at times when sporadic *E*-region ionization was observed. The probable errors (or average errors) of the readings were actually smaller at those times, but the difference is not large enough to be significant except in the sense that it may be taken as proof that the errors were not larger in the presence of sporadic ionization.

Effect of Sporadic *E* on Loran Readings

Pair	Normal			Computed Reading
	No. of Observations	Mean Reading	Probable Error	
MF	561	2932.1	3.2	2932.4
MB	422	3816.3	4.4	
DB	368	1342.5	3.7	
	1351			
Pair	During Sporadic <i>E</i>			Computed Reading
	No. of Observations	Mean Reading	Probable Error	
MF	305	2932.6	2.9	2932.4
MB	256	3816.8	3.6	3814.7
DB	206	1341.8	3.1	1342.4
	767			

Magnetic Activity

The effect of sudden or large variations in the earth's magnetic field upon loran transmissions is known, but will not be discussed in this paper. It seems, however, that none of the ordinary phenomena which disturb radio transmissions have any appreciable effect upon the accuracy of loran sky-wave readings, although the reliability of the service may suffer in operating too near the magnetic pole.

REFERENCES

- (1) Pierce, J. A., Abnormal Ionization in the *E* Region of the Ionosphere, *Proc. IRE*, p 292, July, 1938.
- (2) Fink, D. G., The Loran System, *ELECTRONICS*, p 94, Nov. 1945.
- (3) McKenzie, A. A., Loran, *QST*, p. 12, Dec. 1945.

Circuits for SUB-MINIATURE TUBE

Electrical and mechanical characteristics of sub-miniature triode suit it for use in audio and radio-frequency stages of compact commercial equipment. Circuits are suggested and design data presented for very high frequency line oscillators.

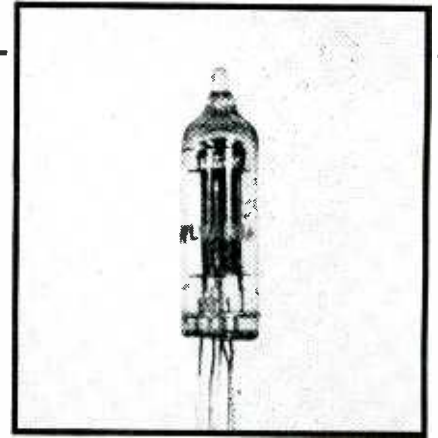

Actual-size photograph of 6K4 triode illustrates its small size

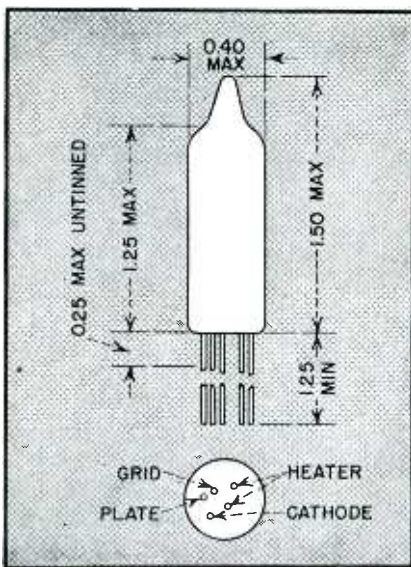

FIG. 1—Physical dimensions of small, baseless 6K4

IN applications where bulk, and weight of electronic equipment are limited, a physically small tube has the advantage of compactness over other tubes. The dimensions of one such midget tube, or midgetron, are shown in Fig. 1. In addition, the mechanical characteristics of the Sylvania 6K4 fit it for use in locations subject to vibration. Thus it is excellent for use in aircraft, railroad rolling stock, and factories.

The leads are brought straight through the button stem, thereby

simplifying tube assembly and contributing to its high frequency performance. The tube has the electrical characteristics listed in Table I, which enable it to be used in an oscillator at frequencies well into the hundreds of megacycles. The cathode provides the high plate current necessary for high mutual conductance.

Audio Amplifier

For operation at the lower frequencies, the 6K4 plate and transfer characteristics shown in Fig. 2 and 3 are average. From them circuits can be designed in the usual way and performance predicted. Table II gives typical circuit values for a conventional resistance-capacitance coupled amplifier.

Table I—Electrical Characteristics of the 6K4

Direct Interelectrode Capacitances (No Shield)		
Grid to Plate	2.2 μf	
Grid to Cathode	2.4 μf	
Plate to Cathode	0.85 μf	
Maximum Electrical Ratings (Open Air)		
Plate Potential	250 volts max	
Plate Dissipation	3.0 watts max	
Heater to Cathode Potential	100 volts max	
Cathode Current	20 ma max	

In a multivibrator circuit, the 6K4, because of its relatively low amplification factor and high plate current at zero grid bias, provides a large square-wave voltage and is not critical to loading. Thus the tube can be used in timing and counting circuits.

For connection, the tinned, flexible leads of the tube are soldered directly into the circuit. Although the tube is sufficiently strong mechanically to survive any normal dropping or vibration, it should be held in position by a grommet or mounting shield. A convenient mounting method is to wedge the top and bottom of the tube envelope into grommets that are not quite large enough to slip over the envelope. The grommets can be mounted on angle brackets or in the chassis. Another mounting method is to form a metal strap around the tube. The strap acts as both support and shield. In severely vibrating locations to reduce microphonics, the tube can be wrapped in rubber before being clamped by the strap. The tube leads themselves should not be relied upon for support, and should be slack enough to permit normal tube motion in its support.

Radio-Frequency Oscillator

The 6K4 was designed to have an amplification factor of the order of

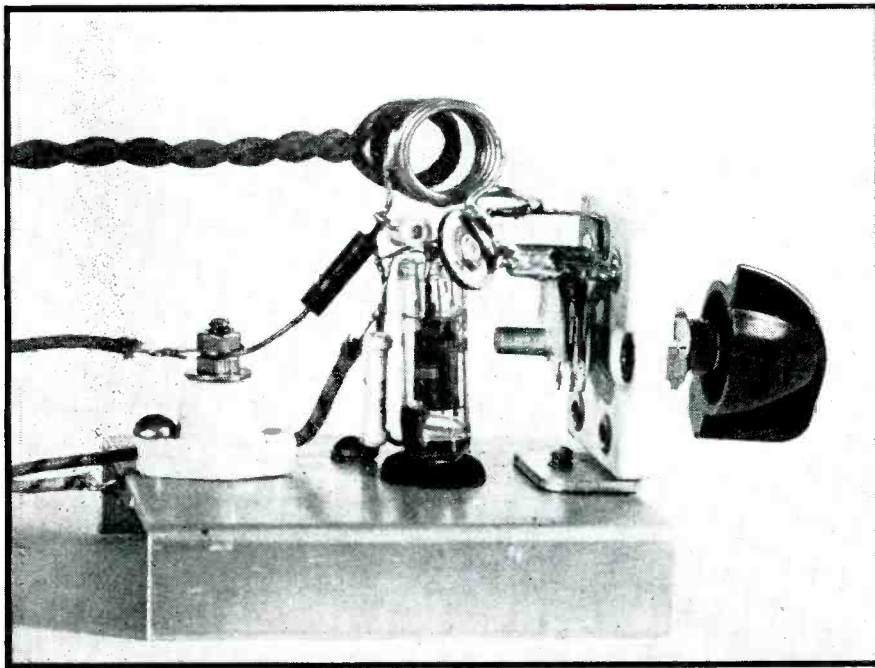

Full-size picture of the circuit diagrammed in Fig. 4 shows use of rubber grommet for shock mounting and compactness of circuit

cillations of nearly constant amplitude over the tunable range as illustrated by the graph. The grounded-cathode Hartley circuit proves more efficient than the cathode-tap Hartley because, although in it the tank capacitor is hot on both sides, it does not require radio-frequency chokes in the heater leads. If a superregenerative oscillator is required, a grid

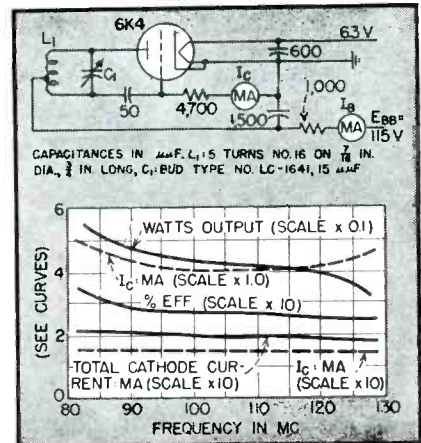

FIG. 4—The 6K4 oscillates stably at vhf in a Hartley circuit

twenty and relatively high mutual conductance with low input loading. These characteristics allow the tube to perform efficiently as an oscillator and have good output power at low plate voltages, of the order of 100 volts, without it being necessary to use excessively low grid resistances.

Because of the small size of the tube elements themselves, and the possibility of making short, direct connections to the circuit components, the 6K4 will oscillate in a

lumped-constant circuit in the two meter amateur band as well as in the frequency modulation and lower television bands. Because a tube will amplify at any frequency at which it will oscillate, the following discussion centers on the characteristics of the 6K4 as a power oscillator. It can be similarly operated as a radio-frequency amplifier.

Using the simple Hartley oscillator circuit shown in Fig. 4, tests have shown that one can obtain stable os-

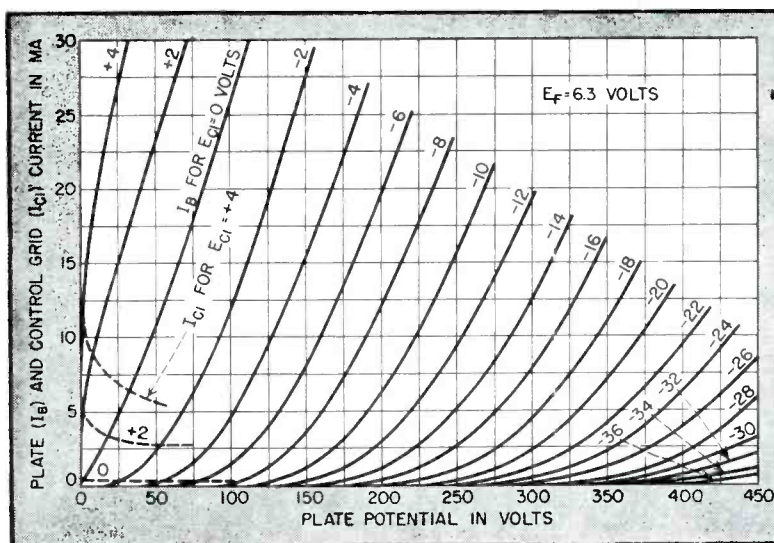

FIG. 2—Plate characteristics

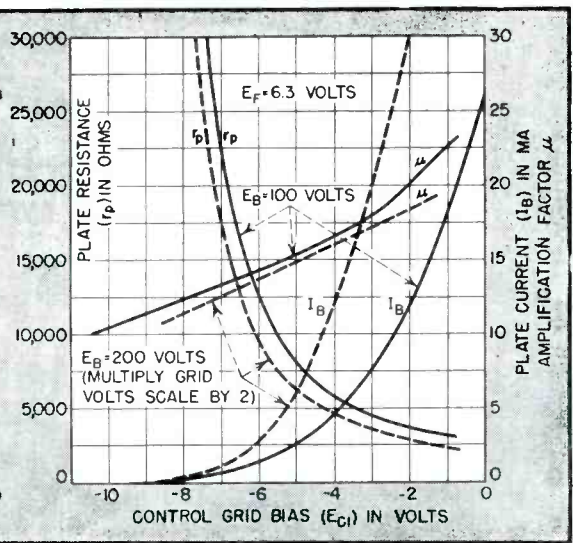
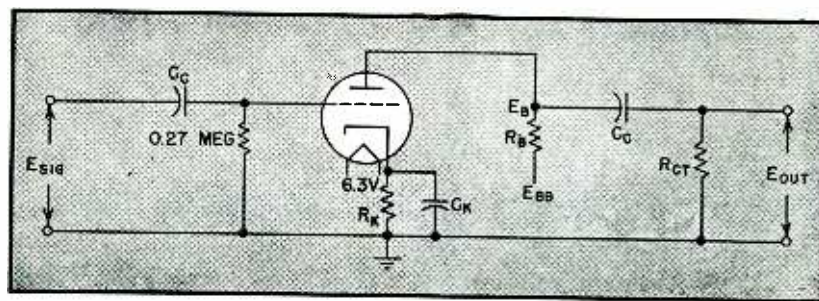

FIG. 3—Transfer characteristics

Table II—Resistance-Capacitance Coupled, Self-Biased Amplifier



R_B	$E_{BB} = 100$						$E_{BB} = 200$					
	0.047		0.10		0.27		0.047		0.10		0.27	
R_K	1200	1500	2200	3300	8200	10,000	680	820	1500	2200	5600	6800
I_B	1.38	1.28	0.715	0.64	0.26	0.244	3.10	2.96	1.53	1.41	0.56	0.535
E_C	-1.62	-1.92	-1.57	-2.11	-2.13	-2.44	-2.11	-2.43	-2.29	-3.10	-3.14	-3.64
E_B	36.5	39.8	28.5	36.0	29.8	34.1	54.2	61.0	47.0	59.5	49.0	55.8
R_{CT}	0.10	0.27	0.10	0.47	0.27	0.47	0.10	0.27	0.10	0.47	0.27	0.47
E_{SIG}	0.66	0.89	0.62	1.00	1.00	1.21	1.01	1.25	1.14	1.69	1.71	2.05
E_{OUT}	8.3	11.3	7.6	12.4	11.6	14.2	14.1	17.7	15.0	22.3	20.6	24.7
GAIN	12.6	12.7	12.2	12.4	11.6	11.7	14.0	14.2	13.2	13.2	12.1	12.1
% DIST.	4.8	4.7	4.3	4.5	5.0	5.0	4.5	4.8	4.8	4.7	4.8	4.7

R_B and R_{CT} in megohms; R_K in ohms; E_{BB} , E_B , and E_C in volts; E_{SIG} is maximum signal that can be applied, that is, the signal above which I_C exceeds $\frac{1}{2}$ microampere; I_B in milliamperes; E_{SIG} and E_{OUT} , in rms volts; C_K assumed large enough to neglect degeration, and C_C large enough to neglect voltage drop.

resistor considerably larger than the one shown here is used.

The graph of Fig. 4 gives measured characteristics of this particular oscillator. In taking these data, the tank tap and loading were adjusted for optimum output at 100 megacycles. The plate supply was adjusted to produce the maximum rated cathode current of 20 milliamperes. These adjustments were then fixed while the oscillator was tuned through its range.

A balanced circuit will provide a wider tuning range than a single-tube, unbalanced circuit. For example, the push-pull circuit of Fig. 5 can be continuously tuned from approximately 90 to 150 megacycles with a constant strength of oscillation similar to that shown for the single tube circuit. About 1.5 watts output can be relied upon over the entire range. At a fixed frequency, at which the circuit can be adjusted for optimum operation, 1.75 watts can be obtained. Voltages fed back to the grids from taps on the tank inductor counteract those voltages

fed back by interelectrode capacitances within the tube, thereby giving good high-frequency performance. Although neutralization is not usual for circuits of low power, it becomes necessary where the circuit

is to operate at the highest frequency of which the tube is capable.

For oscillation in the ultra high frequency range, transmission-line tanks should be used. Figure 6 shows the layout and circuit of such an oscillator. Under laboratory conditions, oscillations at 350 megacycles have been obtained with an output power of about 0.35 watt, sufficient for driving a radio-frequency amplifier. For mixer driving purposes the tube can be used at somewhat higher frequencies.—F. R.

FIG. 5—Push-pull circuit increases tunable frequency range and output power over that obtainable with circuit of Fig. 4

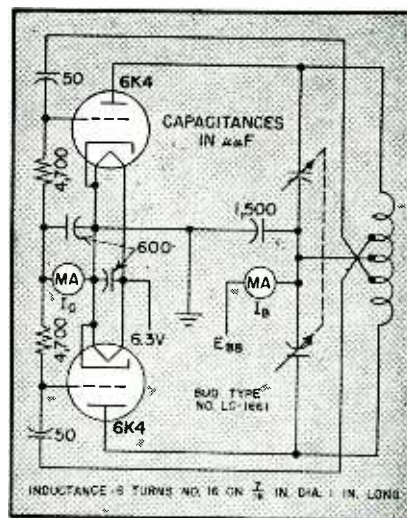
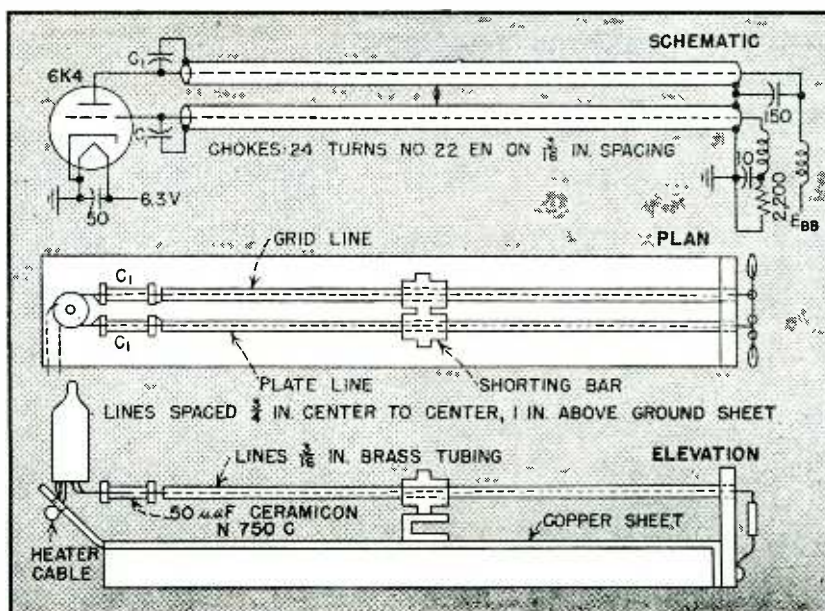

FIG. 6—Layout and circuit of line oscillator using small, baseless triode



Any way you look at it

... IT'S THE NEW
CINCH SUPER MINIATURE SOCKET

Extensive research on JAN Wartime Standards of miniature tubes and sockets and more recent commercial developments has shown the necessity for a miniature socket combining the best qualities of the wartime version and the old commercial type. The new Cinch super miniature socket is our answer. Write for sample and further details.

MINIATURE
SOCKET
No. 53C12136
(ACTUAL SIZE)

IT'S Cinch
KNOW HOW!

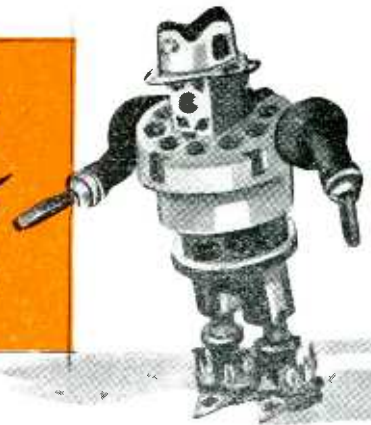

CINCH MANUFACTURING CORPORATION

2335 W. Van Buren Street, Chicago 12, Illinois
Subsidiary of United-Carr Fastener Corp., Cambridge 42, Mass.

Phase-Shifter NOMOGRAPH

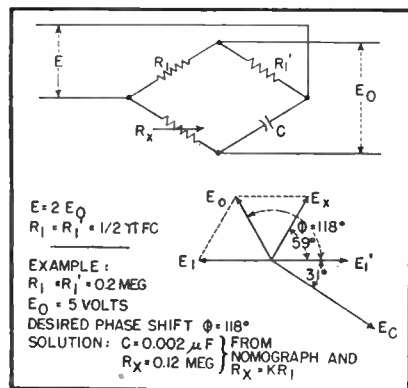

FIG. 1—Bridge-type phase-shifting network, and vector diagram for the example set forth

By **RAYMOND E. LAFFERTY**

Englewood, New Jersey

THE bridge-type network shown in Fig. 1 is useful for shifting the phase of the output voltage to any desired value between 0 and 180 degrees with respect to the input voltage. The amplitude of the output voltage remains constant at one-half the input voltage value for all degrees of phase shift.

In practice, a fixed value of C is employed and the value of R_x is varied between infinity and zero ohms. When R_x is infinity, the phase-shift angle ϕ is 0 degrees; when R_x is equal to R_1 , ϕ becomes 90 degrees; when R_x is zero, ϕ is 180 degrees.

The accompanying nomograph facilitates determining the value of R_x required to provide a desired phase shift angle with a particular set of values for R_1 , C , and frequency. A straight-edge is placed on the known values of f and R_1 , and the required value of capacitance for C is read on the C scale. This nomograph is based on the fact that the reactance of C must equal the resistance of R_1 , making C equal to $1/2\pi fR_1$. Next, on the ϕ - K column read the value of K corresponding to the desired value of

Bridge-type phase-shifting network covering the full range from zero to 180 degrees has many applications even though it requires ground isolation. The nomograph reduces design calculations to one reading with a straight-edge and a simple arithmetic calculation

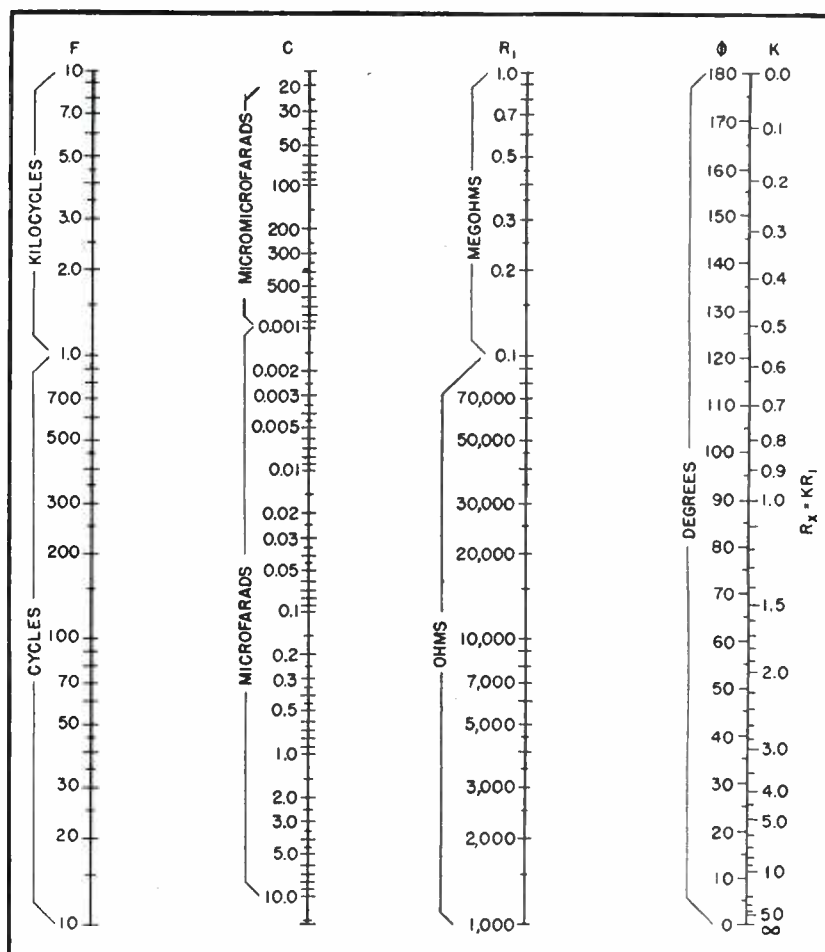

phase shift ϕ . Since $K = R_x/R_1$, the required value of R_x is readily computed as $R_x = KR_1$.

For the example set forth in Fig. 1, the nomograph gives the value of C directly as $0.002 \mu\text{f}$ and, for $\phi = 118$ degrees, gives $K = 0.6$. Multi-

plying this value of K by the 0.2-meg given value of R_1 gives 0.12 meg as the required value of R_x . The vector diagram in Fig. 1 illustrates the phase relations of the various voltages in the network for this particular example.

plastic case
resists moisture



plastic end cap
improves appearance



new
mounting bracket
simplifies installation

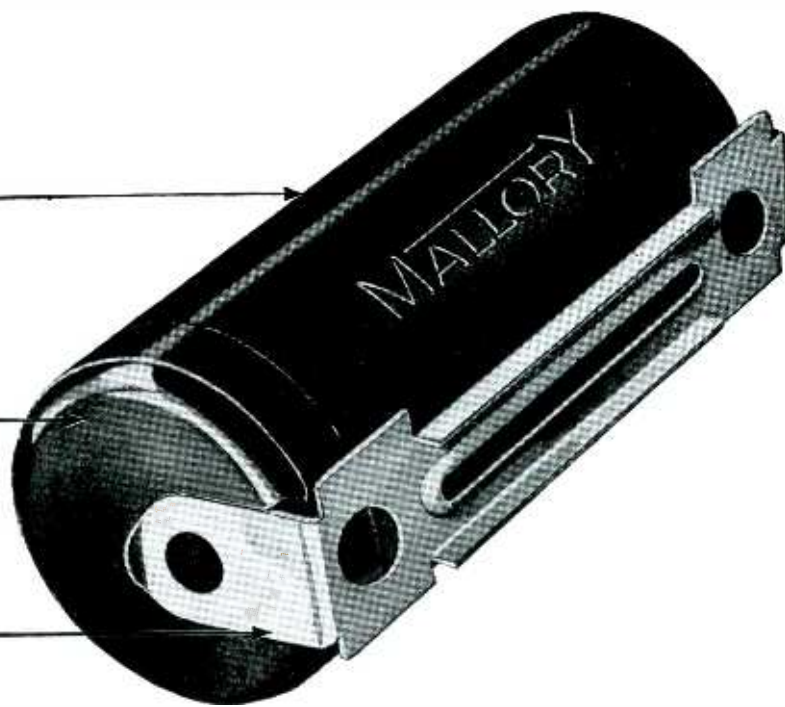

Three "PLUS" Features of the Type "P" Mallory Motor Starting Capacitor

BETTER than the standard cardboard insulated aluminum can capacitor? You bet! Better in at least three different ways:

1. The moisture-proof plastic case eliminates all insulation difficulties.
2. The plastic end cap improves appearance—makes it unnecessary to use padding to prevent rattling.
3. The handy new mounting bracket speeds up installation—rules out the need of insulating tubes, metal end caps, grommets and other extra parts. Two screws mount this capacitor to the motor frame—*quickly and permanently!*

Available in all popular ratings, Mallory Type P Motor Starting Capacitors are interchangeable with standard aluminum capacitors in old style mountings. We will be glad to send you further information—and our engineers, as always, are ready to help with special problems.

Send for It Today!

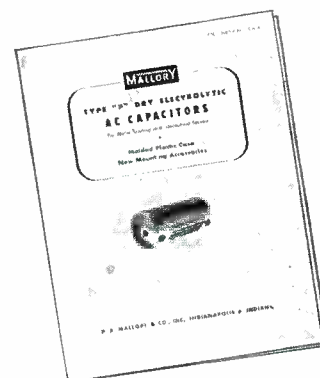

Everything you want to know about Mallory AC Capacitors. Pictures, drawings, electrical characteristics.

P. R. MALLORY & CO. Inc.
MALLORY CAPACITORS
(ELECTROLYTIC, FILM and PAPER)

P. R. MALLORY & CO., Inc., INDIANAPOLIS 6, INDIANA

See
"Mallory on Parade"
Booth 36
Chicago Radio
Parts Show

INDUSTRIAL CONTROL

Metal Detector for Conveyor Belts.....	160
GCA for Control of Commercial Aviation.....	160
Radiation from R-F Heating Generators.....	162
Thyratron Pulsar Tube for Industrial Microwaves.....	170
Rapid Moisture Testing of Granular Material.....	180
Automatic Flying with Electronic Equipment.....	186

Metal Detector for Conveyor Belts

FOR PROTECTION OF QUALITY and prevention of machinery damage and lost production time in industrial plants, an automatic metal detector employs a high-frequency field set up by induction coils embedded in plastic panels at top and bottom of an aperture. Metallic particles passing through the aperture produce impulses that are electronically amplified to light a warning lamp, ring a bell, stop a continuous process, mark the contaminated object, or deflect it into a special channel or receptacle for rejects. The material under test is passed through the inspection aperture on an endless conveyor belt or by means of a chute. The conveyor speed is about 600 feet per minute without impairment of inspection efficiency.

Developed by RCA Victor engineers, the unit will detect any kind of metal or alloy such as iron, copper, brass, lead, aluminum and stainless steel, and will react to minute as

well as larger pieces of metal. Its discrimination can be adjusted to fit conditions for each installation. Operation is independent of the depth to which the particle may be imbedded in the product being inspected.

The equipment is insensitive to nearby metal objects, electrical apparatus and operating personnel and is not affected by normal building and conveyor vibration. It is sealed against dirt, lint and dust and permits scrubbing and hosing where required by purity standards. It is unaffected by normal humidity and temperature changes, and an automatic voltage regulator assures freedom from effects of line voltage fluctuations.

There are no exposed electrical connections, and it is easily operated by regular factory employes. The operator need only check the adjustment of one simple control, and that is normally necessary only about once a day.

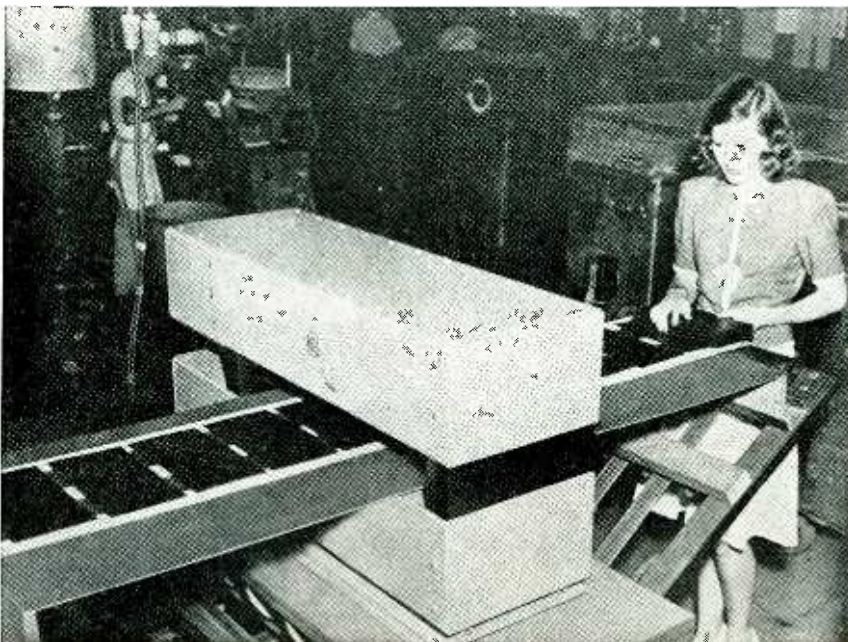

Plastic blanks are inspected for metal particles to prevent damage to dies used in pressing or molding. The blanks on the conveyor belt pass through an aperture where coils are embedded in surrounding panels

GCA for Control of Commercial Aviation

ONE WARTIME DEVELOPMENT that has peacetime importance is radar landing control. This device was hurriedly perfected to meet a desperate need in the days when we were trying to bomb Germany to her knees. American and British Air Forces Headquarters were greatly disturbed by the fact that our planes were incurring as many casualties on returning to base and attempting to land in darkness and bad weather as they had suffered over enemy targets due to flak and Nazi fighter planes.

Manufacturers were authorized to proceed with the development of a mobile radar device which came to be called Ground Controlled Approach (GCA). This military version of radar landing control (Ground Controlled Approach for Aircraft, *ELECTRONICS*, p 112, Nov. 1945) consisted of a search radar system and a precision radar system. Both of these features are retained in the commercial model.

The search system employed by Gilfillan Brothers, Los Angeles, uses a radar beam covering a radius of 30 miles in every direction, enabling the operator to actually see, upon a television-like indicator, every airplane, mountain, building, or other obstruction in the entire area. Through radio communication with the pilot, the operator directs the plane to a particular position about 10 miles from the airport. When the aircraft has been brought to this point, the operator turns to the precision radar scope. Two sharply defined radar beams present an expanded view of the approach area upon the precision scope, showing the aircraft's exact position in elevation, azimuth, and distance with respect to the prescribed runway.

By carefully watching the plane's progress upon the map-face of the precision indicator, the operator guides the approaching aircraft safely past obstacles, corrects the pilot as to course, elevation and speed, and "talks him down" to a safe landing upon the runway.

Of paramount importance to airline companies, pilots and passengers, and to private pilots as well, is the fact that the radar landing control requires no special equipment in



Something New

**HAS BEEN ADDED TO
IRC DISTRIBUTOR SERVICE...**

**NEW INDUSTRIAL SERVICE PLAN GIVES YOU
QUICK DELIVERIES ON STANDARD RESISTORS!**

Now, IRC Distributors are better prepared than ever before to give manufacturers quick, complete and intelligent service. The IRC Industrial Service Plan, developed by IRC in cooperation with its more than 300 distributors, gives you "just around the corner" sources of supply for the resistance units you need in experimental work, pre-production models, pilot runs, smaller production runs and for service and maintenance!

The IRC Catalog #50 lists standard IRC products stocked by distributors. By aiming toward standardization of your resistor requirements on these items, you will find that reasonable quantities can be delivered quickly by local distributors. In addition, the wider use of standardized items will eventually result in lower unit cost, it will provide better emergency service for your products when in use, and your customers will benefit by a more dependable piece of equipment.

FOR BETTER-THAN-STANDARD QUALITY ... *Standardize on IRC*

WRITE TO DEPT. 1-E FOR IRC CATALOG #50 AND NAMES OF LOCAL DISTRIBUTORS

INTERNATIONAL RESISTANCE CO.
401 N. BROAD ST., PHILADELPHIA 8, PA.
Canadian Licensee: International Resistance Co., Ltd., Toronto

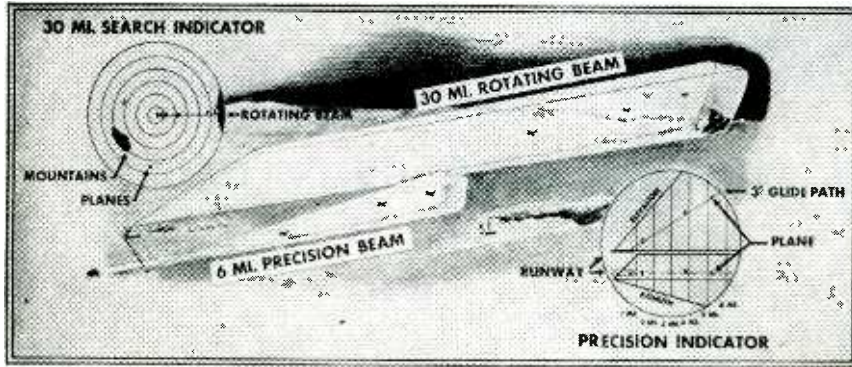

The scopes of the Gilfillan system are located in the airport control tower and show the exact location of the mountains, planes, power lines, buildings, and smokestacks in the area. The 30-mile beam sweeps in a 360-degree circle covering the entire 2,800-square-mile area once every ten seconds. The precision scope shows only that sector of the airport through which the plane approaches the runway, and is 6 miles in length. On the precision indicator, the elevation information is shown in the upper half and the azimuth dotted in the lower half.

the airplane except the usual two-way radio communication. Of equal importance is the fact that the pilot needs no prior training or periodical practice approaches to be successfully talked down to a safe landing. Finally, because the radar landing control operates in all types of weather and is accurate under all conditions, a pilot is able to land on split-second schedules with complete assurance and safety.

Radar landing control will help solve the ever-increasing problem of how to control traffic around congested airports in good weather as well as under conditions of zero-visibility. By enabling the control tower to direct planes to straight-in approaches in rapid sequence, it will also obviate the necessity of stacking planes. Recent tests with all types of planes established the record of landing them on dual runways at the

SAFETY CONTROL FOR TUBE-STEM PRESS

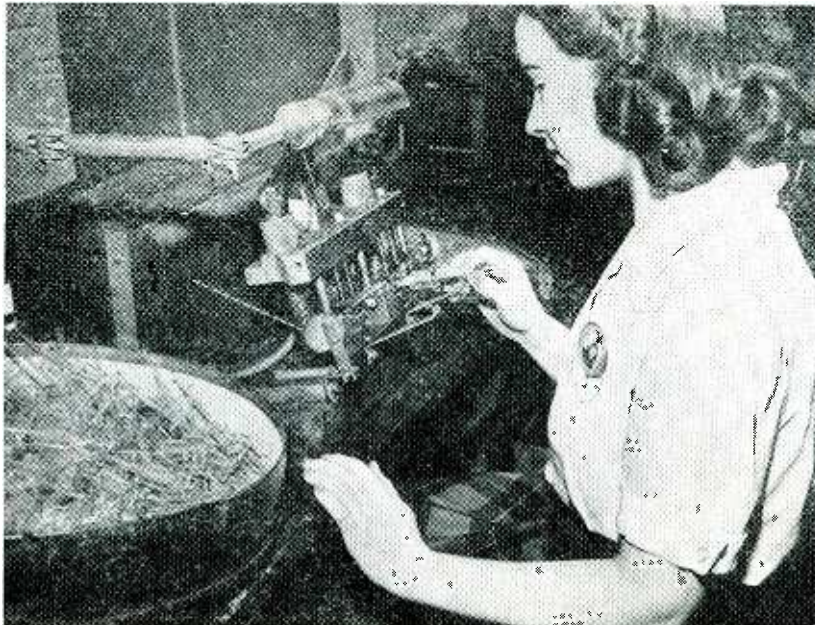

Workers that operate presses used for forming the leads of radio tube stems at RCA have their fingers safeguarded by photoelectric equipment. The amplifier is mounted behind the press so that the lightbeam, shown by the white dotted line, travels between mirrors at either side of the press before returning to strike the phototube. If the girl's fingers are dangerously close to the dies, the interruption of the lightbeam locks the press open. Failure of the light source or any component of the electronic amplifier also locks it

rate of one every thirty seconds—120 an hour. In making instrument landings, with ceiling at 500 feet, planes are normally landed—without radar—at the rate of four an hour, or one every 15 minutes.

Radiation from R-F Heating Generators

By ARTHUR G. SWAN

INDUSTRIAL USERS of electronic heating equipment that have encountered problems in minimizing the amount of radiation from the units can benefit by the work done in Hawaii for solving a similar problem.

During the war, the military governor of the Territory found it advisable to control the use of diathermy equipment by licensing for use only diathermy equipment whose radiated signals were sufficiently attenuated. Details of the control were passed to a board of Army officers, who, with the cooperation of the FCC, set up standards for maximum allowable radiation, and recommended a type of shielded room to limit this radiation.

Tests showed that a room consisting of two concentric shields, both floating above ground, and having an a-c service entrance filtered as in Fig. 1, gave satisfactory results. The filter box is grounded to the inside room-shield. Access to the room was by means of a door constructed with

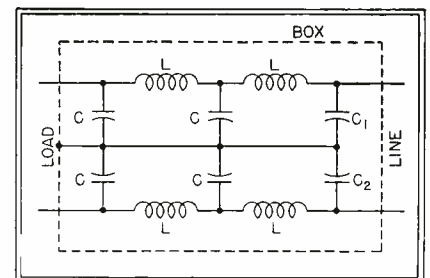

Capacitors C_1 and C_2 were not always necessary in the filter. All capacitor values were $0.1 \mu f$ but lower values were sometimes satisfactory. The inductors marked L consisted of 20 turns wound on a one-inch diameter form

shielding on both sides. When closed, there was no interruption in the continuity of the shields throughout the room.

Many such installations were constructed throughout the Islands, and

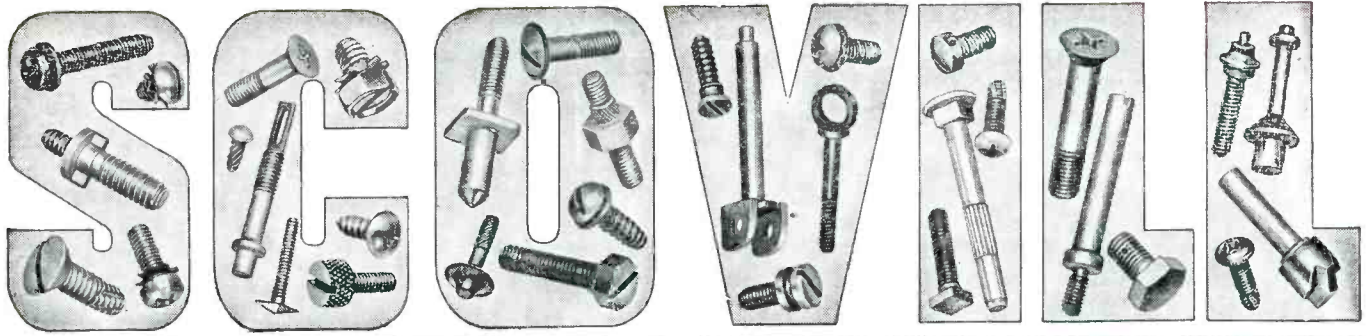

SCOVILL WASHER ASSEMBLED SCREWS MEAN SAVINGS FOR YOU

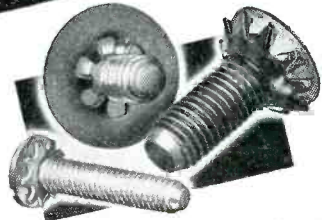

1 Standard "Sems" type internal or external multi-toothed washers.

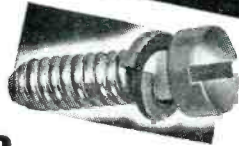

2 Standard split type lock washers.

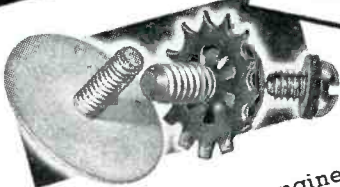

3 Special SCOVILL engineered adaptations of multi-toothed washers, and variations of fibre or metal, plain or spring, standard washers. Here SCOVILL ingenuity enables you to fit the right type of fastening to the exact requirements of your job.

These basic types of SCOVILL preassembled washers and screws will cut your production costs by meeting your fastenings requirements with faster and better work on any job where washers are used. Illustrated above are a few of the many screw head styles and screw and washer sizes.

These and every other type of SCOVILL washer assembled screws have three important advantages for you.

- 1** The washer is permanently fastened...yet free to rotate. No dropped or lost washers. No chance of the wrong washer on the right screw.
- 2** The extra cost of hand assembly on the job—plus the usually slower driving time of the hand assembled screw—are eliminated.
- 3** Ordering and stock control are simplified...inventories balanced.

Washer assembled screws are another of the many fastenings products with which SCOVILL can lower your fastenings costs. Talk over your needs with any one of the offices below.

SCOVILL MANUFACTURING COMPANY

WATERVILLE SCREW PRODUCTS DIVISION

WATERVILLE 48, CONN.



TEL. WATERBURY 3-3151

NEW YORK, Chrysler Building • DETROIT, 6460 Kercheval Avenue • CHICAGO, 135 South LaSalle Street • PITTSBURGH, 2882 W. Liberty Ave.
SYRACUSE, Syracuse-Kemper Insurance Building • LOS ANGELES, 2627 South Soto Street • SAN FRANCISCO, 434 Brannan Street

POWERSTAT TYPE "LC"

The annoyance of off-nominal line voltage in production testing, laboratory investigation and factory processes can be eliminated by use of POWER-STAT Variable Transformers type LC . . . LINE CORRECTORS . . .

This equipment consists of a POWERSTAT Variable Transformer in conjunction with a fixed ratio auxiliary transformer for bucking or boosting the line. With this equipment high current loads can be economically and smoothly controlled. By sim-

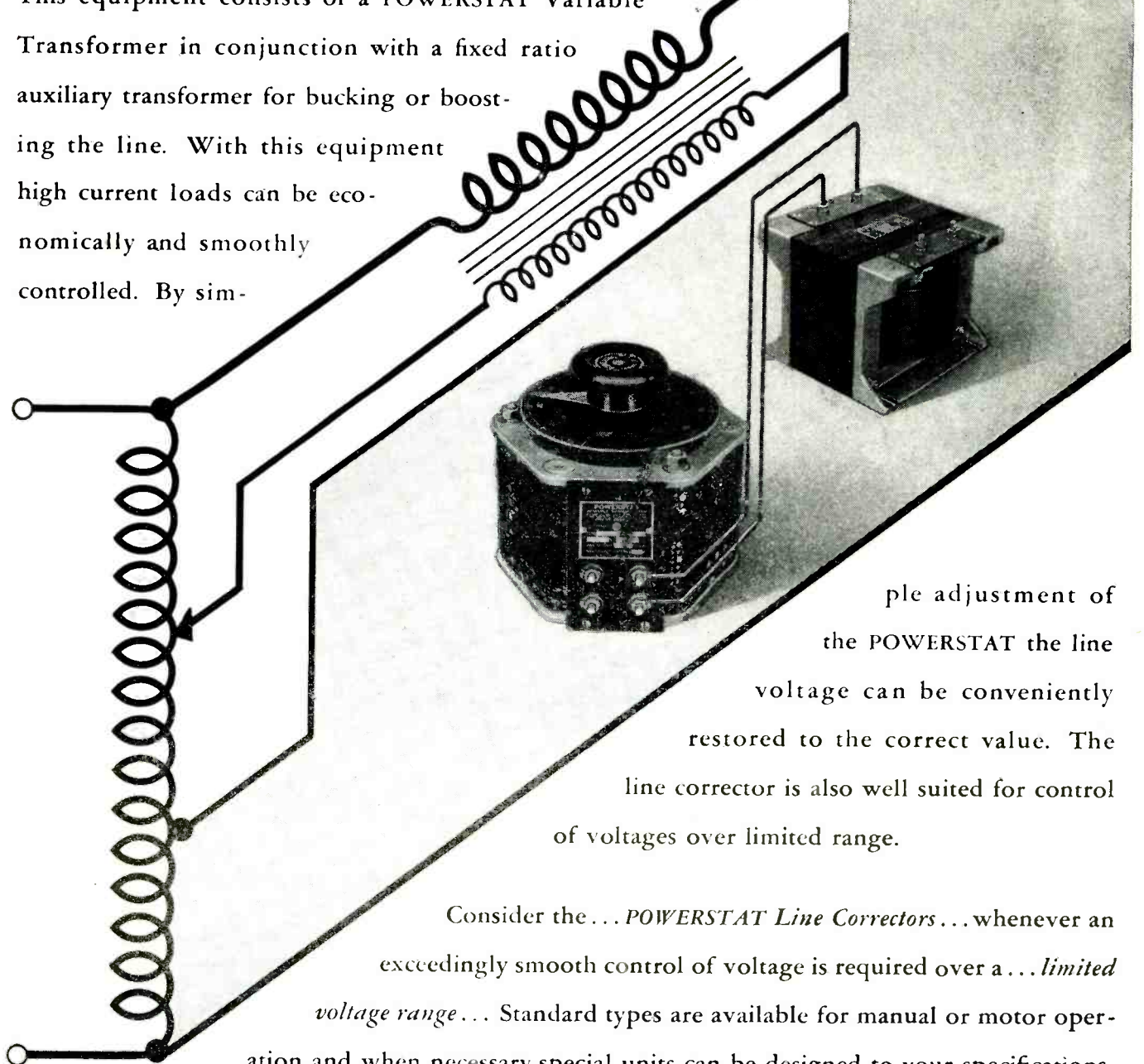

ple adjustment of the POWERSTAT the line voltage can be conveniently restored to the correct value. The line corrector is also well suited for control of voltages over limited range.

Consider the . . . *POWERSTAT Line Correctors* . . . whenever an exceedingly smooth control of voltage is required over a . . . *limited voltage range* . . . Standard types are available for manual or motor operation and when necessary special units can be designed to your specifications.

Send for Bulletins LE

SUPERIOR ELECTRIC COMPANY

705 LAUREL STREET,

BRISTOL, CONNECTICUT

Specify C-D MICABOND

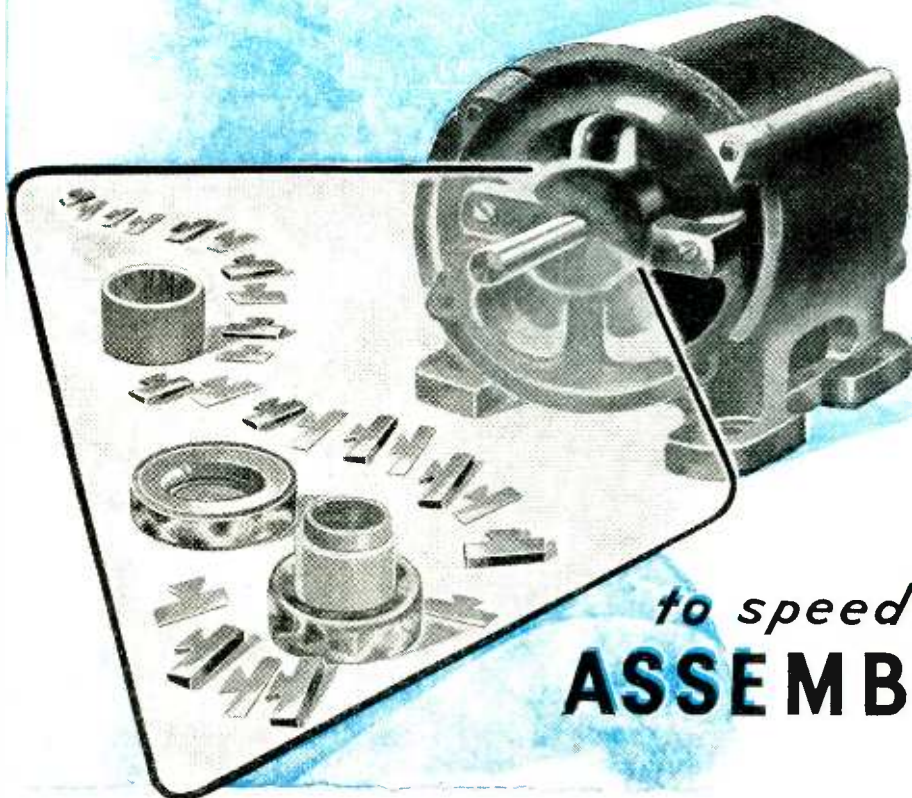

to speed-up
ASSEMBLY

ARMATURE assemblies fit when C-D MICABOND insulating rings and segments are used. They fit because C-D manufacturing standards assure close tolerance production of MICABOND materials and parts. The consistent quality and accuracy of C-D MICABOND products justify the confidence C-D MICABOND en-

joys from the many manufacturers of armatures who specify C-D MICABOND. When your electrical insulating problem dictates "mica insulation," C-D engineers will be glad to help you to design to use mica to the best possible advantage—and in its most usable form—C-D MICABOND.

C-D PRODUCTS

The Plastics

DILECTO—Thermosetting Laminates.

CELORON—A Molded Phenolic.

DILECTENE—A Pure Resin Plastic Especially Suited to U-H-F Insulation.

HAVEG—Plastic Chemical Equipment, Pipe, Valves and Fittings.

The NON-Metallics

DIAMOND Vulcanized FIBRE

VULCOID—Resin Impregnated Vulcanized Fibre.

MICABOND—Built-Up Mica Electrical Insulation.

Standard and Special Forms

Available in Standard Sheets, Rods and Tubes; and Parts Fabricated, Formed or Molded to Specifications.

Descriptive Literature

Bulletin GF gives Comprehensive Data on all C-D Products. Individual Catalogs are also Available.



KYC-46

BRANCH OFFICES

NEW YORK 17 • CLEVELAND 14 • CHICAGO 11 • SPARTANBURG, S. C. • SALES OFFICES IN PRINCIPAL CITIES

WEST COAST REPRESENTATIVES: MARWOOD LTD., SAN FRANCISCO 3

IN CANADA: DIAMOND STATE FIBRE CO. OF CANADA, LTD., TORONTO 8



Continental - Diamond FIBRE COMPANY

Established 1895.. Manufacturers of laminated Plastics since 1911—NEWARK 16 • DELAWARE

How Many Slices in a Loaf of Bread?



It's unimportant unless there aren't enough to go around. When the loaf isn't large enough to feed everyone who asks for a slice, the problem becomes involved. The size of each slice takes on significance.

We, at Stancor, are confronted with a parallel situation. A day never passes that we don't risk offending valued customers by keeping the slices as thin as feasible . . . that everyone may have his fair share.

We know how you feel about this. You need transformers, desperately perhaps, and it's been a long time since Stancor has been able to supply all you want. We're certain, however, that you would not condone a sacrifice of quality for quantity. In a sense, then, you dictate Stancor policy.

Because of our insistence on high standards of quality, production and delivery have never stayed apace with Stancor sales. Today there is a greater gap than ever. We feel you understand the reasons for this, since our current problems are also yours.

Soon, we hope to be able to meet your constantly increasing demands. Meanwhile, there can be no change in the Stancor policy of quality. We know you wouldn't want it any other way.

Jerome J. Kahn
PRESIDENT

STANDARD TRANSFORMER CORPORATION

1500 NORTH HALSTED STREET • CHICAGO 22, ILLINOIS

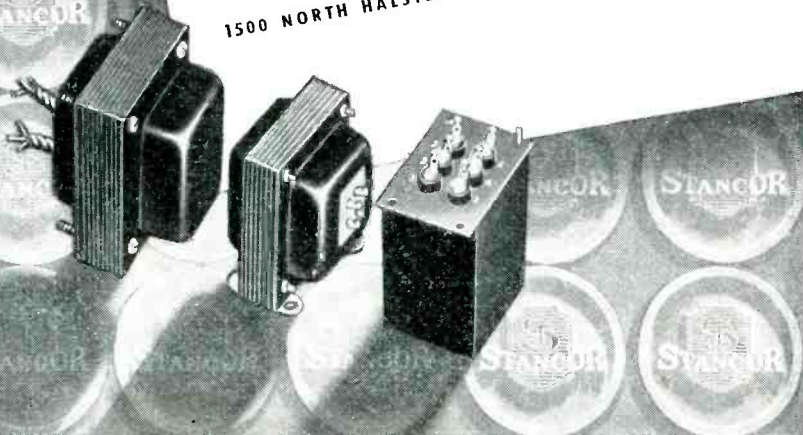

with proper attention to details and some experimental modifications to suit local conditions, all but a few proved very satisfactory.

Attenuation was estimated by listening to the diathermy signal on a Hallicrafters S-29 receiver carried out along radials from the diathermy equipment. In most cases, the signal was undetectable at distances greater than fifty yards from the offending unit.

Construction

The type of shielding material used was not critical. Copper fly screening was best, but was hard to obtain at that time. Ordinary steel fly screening, or hardware cloth up to half-inch mesh, worked satisfactorily. Wood spacers separated the inside from the outside shields by one or two inches and separated the outside shield from any possible external ground. In a few cases a ground on either the inside or outside shield helped, but in a large majority of cases attenuation was greatest with both shields ungrounded. No objection was found to running as much a-c wiring as was desired from the filter around the inside of the room, but there could be no exposed wire between the filter and the a-c entrance to the room. Radiation along the power line outside the room was sometimes troublesome, and in some cases could be followed nearly a mile along pole lines before proper shielding was accomplished.

A minimum number of doors should be built into the shielding. Best results were obtained where only one door opened into the room, and this, when closed, had to make good electrical contact on all four sides. The hinged side was provided with several flexible straps to connect the respective door shields to room shields.

Wood used as insulation between shields and between outside shield and ground had to be thoroughly dry. It was necessary to insulate between the outside ground and any plaster, concrete, linoleum, etc.

The filter was mounted flat against the inside shield directly over the spot at which the a-c line entered the room. The box was constructed of heavy gauge metal with all seams



Collins 26W-1 Limiting Amplifier

Collins Speech Equipment

provides better program transmission and stronger signals

THE COLLINS 26W-1 audio limiting amplifier is a product of the most advanced standards of broadcast engineering. It effectively raises the modulation level, yet prevents overmodulation of the r-f carrier. The resulting stronger signal assists materially in station area coverage.

Developed for high fidelity AM and FM applications, the 26W-1 has a frequency response flat from 30-15,000 cps, with a variation of less than 1.0 db. The compression ratio above the verge of compression is 20/1 in db. Harmonic and tone distortion are not more than 1.5% at any frequency, any setting of the input and output levels, and with any amount of compression up to 15 db. Hum and noise are 70 db below the operating level. Output range is -4 to +26 dbm.

Complete metering provides measuring facilities for individual tube currents, plate volt-

age, compression level, and output level. Inside-out chassis construction gives immediate access to all wiring and circuit components upon removal of the slip-on dust cover. Operate and release times are independently adjustable.

Dimensions, for standard rack mounting, 19" w, 14" h, 9" d. Weight, 45 pounds. Available in metallic gray or black wrinkle.

Collins speech equipment is thoroughly engineered for highest performance. Reliable in operation, accessible in maintenance, each unit meets rigid inspection and tests before it is approved for delivery. For your requirements, write today to the Collins Radio Company, Cedar Rapids, Iowa; 11 West 42nd Street, New York 18, N. Y.

FOR BROADCAST QUALITY, IT'S . . .



BEACH-RUSS High Vacuum PUMPS HELPED SPLIT THE ATOM



An Unsolicited Letter from the WAR DEPARTMENT Manhattan Engineer District

Beach-Russ Company
New York, N. Y.

Attention: Mr. C. A. Beach, President

Gentlemen:

It is desired to express the appreciation of this office for the outstanding development and production work accomplished by Beach-Russ Company for the Kellex portion of the Atomic Bomb Project performed under the supervision of the New York Area Office of the Manhattan District. When our design work indicated the need for large quantities of precision built high range vacuum pumps, we naturally turned to your company as a leader in the vacuum pump field. Your record of performance and the quality of your workmanship has proven that this was a wise decision.

Your vacuum pumps have operated very satisfactorily and were instrumental in the successful operation of one of the major Atomic Bomb plants.

This office is indeed appreciative of your cooperation and fine performance.

Very truly yours,

(signed) JAMES C. STOWERS
Lt. Col., Corps of Engineers
Area Engineer

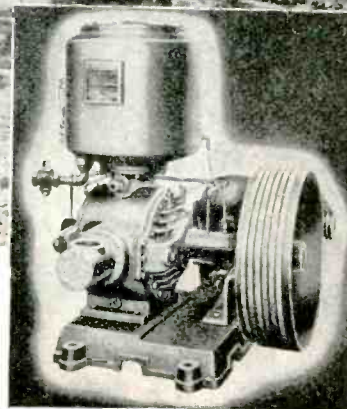

Our contribution to the success of the greatest undertaking in scientific history was further recognized when Beach-Russ Company was cited as one of the prime contractors honored at the award dinner of the Atomic Bomb Project at the Waldorf-Astoria Hotel, New York City, on February 26, 1946.

While the whole story of this production miracle cannot be revealed, the engineering and technical experience gained in meeting its extraordinary high vacuum requirements is available for improving chemical and allied processes today. To this can be added the work of Beach-Russ Standard Rotary Piston Pumps for high vacuum processes in the manufacture of chemicals, vitamins, penicillin, magnesium, etc., in vacuum packing and in vacuum testing of electronic and electrical devices and instruments.

For best performance in the field of high vacuum you can depend on Beach-Russ Pumps. Write for our complete catalog.

Beach-Russ Company

50 CHURCH STREET
NEW YORK 7, N. Y.

VACUUM PUMPS • AIR COMPRESSORS • GAS BOOSTERS • LIQUID PUMPS

MEET A POSTWAR CLEANER

it's new... it's plastic... **it's in color**

THE EUREKA VACUUM CLEANER is depending on materials teamwork to maintain its position as one of the country's leading household appliances. This new and improved home cleaner makes strategic use of both thermoplastic and thermosetting plastics as well as light metals and other materials. Thus the specific advantage of each material is utilized to the utmost.

Celanese plastics: LUMARITH CA and LUMARITH EC supply dent-proof toughness and surface permanence to the injection molded suction nozzles, hose connections, switch key, name plates, handle and cord clip.

Because of plastics, the Eureka makes its postwar debut in "technicolor" . . . The present model is a deep maroon—a color that adds quality and distinction to the workmanlike design.

Celanese is headquarters for cellulose— the most widely used plastics for consumer goods. The technical service staff can be depended upon for accurate and practical advice on product planning of this type. Celanese Plastics Corporation, a division of Celanese Corporation of America, 180 Madison Avenue, New York 16, New York.



Celanese* *Plastics*

FORTICEL† Cellulose Propionate LUMARITH* Cellulose Acetate
 †Trademark *Reg. U.S. Pat. Off. CELLULOID* Cellulose Nitrate VIMLITE* Plastic Glazing

TYPICAL!

The Shallcross Type 637 Bridge combines both the Kelvin and Wheatstone circuits in a single portable and durable instrument. Provides a resistance measurement range from .001 ohms to 11.10 megohms. List price \$100.



YOU DON'T HAVE TO CODDLE SHALLCROSS INSTRUMENTS

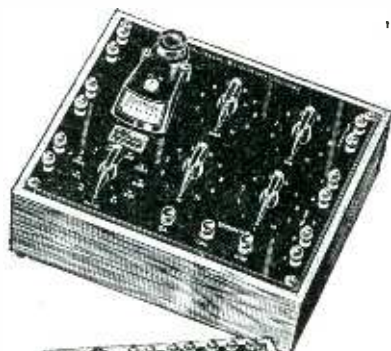

BRIDGES — RESISTANCE STANDARDS
 FAULT LOCATION BRIDGES
 DECADE POTENTIOMETERS
 HIGH-VOLTAGE TEST EQUIPMENT, etc.

LOW PRICED

RUGGED

ACCURATE

EASILY REPAIRED IN CASE OF MISUSE

Shallcross Test Instruments are built for hard, frequent use on any job — for production line, field, school or laboratory service. No need to worry about how or by whom they are used. They're rugged and dependable. In case of misuse, repairs are usually made locally.

These instruments are accurate for every commercial and most laboratory needs. Available in types, sizes and ranges for every testing need — at prices to make their regular use practical.

Write for engineering bulletins on any type.

SHALLCROSS MANUFACTURING COMPANY
 Dept. E-56 Jackson & Pusey Aves., Collingdale, Pa.

SHALLCROSS

Electrical Measuring Instruments • AKRA-OHM Resistors • Precision Switches • Electronic Engineering

soldered. Commercially built filters were not satisfactory.

Close proximity of the room to open house wiring had to be avoided and installations on ground floors or in basements worked best. Those in frame buildings were hardest to attenuate. The smaller the room, the easier it was to attain good attenuation. Care had to be exercised in construction to see that no nails or strands of wire shorted between shields. All seams in shielding had to make continuous electrical contact.

. . .

Thyratron Pulsar Tube for Industrial Microwaves

PULSED MICROWAVES for industrial applications such as new methods of heating, forming and bending of glass and plastics, high-speed welding and electroplating at increased speed and denser platings are controlled by the hydrogen thyratron developed during the war as a modulator or pulser tube for microwave radar systems.

The first type of modulator developed for this purpose was a high-vacuum tube that switched a charged capacitor across the oscillator and, after the required time of pulse, rapidly disconnected the capacitor. The capacitance stored from 50 to 100 times the charge that flowed through the load during a single pulse. The voltage developed across the load decreases exponentially in accordance with the time constant of the circuit but the pulse duration is so short that sharp rectangular pulses are rapidly obtained. Recharging takes place during the time interval between pulses. Voltage to control the keying tube grid is obtained by amplifying a pulse formed at low voltage levels.

Operation of Line Modulator

Need for higher power led to the development of the line modulator. If a charged open transmission line is discharged by a rapidly closing switch through a resistance equal in magnitude to the characteristic impedance of the line, a voltage pulse is impressed across the resistor. The duration of the pulse depends on the electrical length of the line and the voltage developed across the resistor

TELEVISION

Projection...

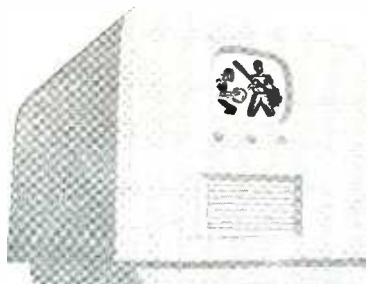
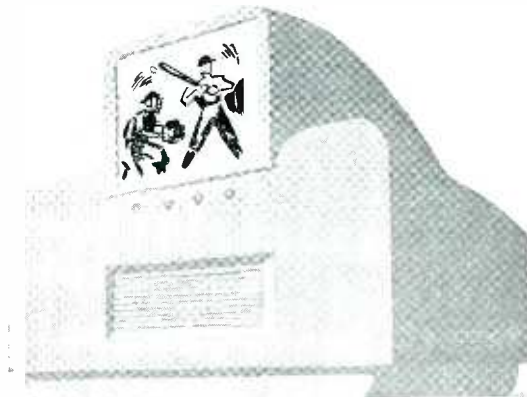

and Direct-Viewing

Whether your television plans embrace direct-viewing, projection, or both, you'll find RAULAND Cathode Ray Tubes adaptable to your needs. Research, continuing from television's early beginnings to development of theatre-size screen projection, has enabled RAULAND engineers to produce the finest direct-viewing and projection type tubes, using either reflective or refractive optics.

Consult with our engineers about your television problems with respect to Cathode Ray Tubes.

Be sure to visit Rauland Booth No. 83 while at Radio Parts and Electronic Show, Stevens Hotel, Chicago. May 13-16.

RADIO • RADAR • SOUND

Rauland

COMMUNICATIONS • TELEVISION

Electroneering is our business

THE RAULAND CORPORATION • CHICAGO 41, ILLINOIS

Are Your Postwar Developments Stymied?

...by lack of development staff?
 ...by inadequate research facilities?
 ...by need of hydraulic or other specialized experience?

You may find the answer in the services of

The Research Engineering Corporation*

We are an organization with a unique background of experience. Our staff of 20 engineers, technicians and draftsmen are skilled in the fields of hydraulic, mechanical and electrical engineering. For example, they have developed hydraulic equipment for many of the famous names in industry.

Bases of Working With You:

- * 1. **An engineering research fee** . . . a quoted-in-advance amount covering complete development of the engineering phase of your projects.
- * 2. **Royalty basis** . . . for those who prefer this arrangement, **The Research Engineering Corporation** will develop the job for your plant to manufacture, and put its services on a profit-sharing basis.
- * 3. **Cost plus** . . . reasonable per-hour and materials charges plus a modest percentage mark-up.
- * 4. **A complete manufacturing arrangement** . . . beyond engineering and putting the project on a production basis for you, we can manufacture it, if you wish us to, through a manufacturing affiliate.

The four alternatives offer you a much more attractive and complete range of choice than the inflexible charges of most engineering consultants. As you see, we are confident enough to risk our services against results.

Your inquiry is wanted. You will not be obligated and your inquiry will be confidential. Write *now* for help in speeding your ideas into production.

The Research Engineering Corp.

292 ELM STREET • NEW HAVEN, CONNECTICUT

is half of that to which the line is charged. The pulse time is determined by the time required for the voltage wave to travel to the far end of the line and return. In practice, an artificial line of relatively few sections is employed.

The pulses are formed at high levels and the line capacitance is completely discharged through the load at each pulse. The line, or pulse forming network, is recharged during the time interval between pulses. To produce a sharp leading edge of the pulse, the switch closes rapidly and, after the switch is closed, the pulse length is determined entirely by the network or line. The switch must also open rapidly so that the

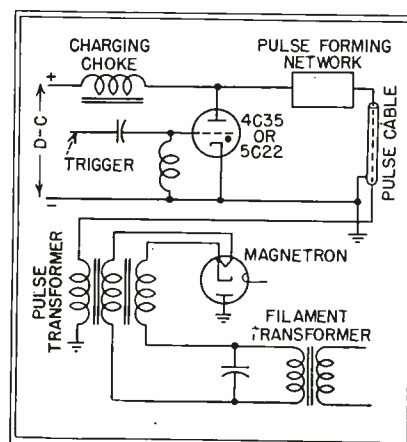

Circuit using a hydrogen thyratron in a line modulator arrangement for pulsing a magnetron

line can charge in the interval between pulses. The charging choke can be adjusted to resonate with the network capacitance and thus charge the network to approximately twice the voltage of the d-c power supply voltage.

Other Systems

The rotary spark gap was one of the first switches used in early radar systems. This had many undesirable features such as noise, weight, brush and bearing maintenance, electrode erosion, and was not capable of rapid shifts from one repetition frequency to another. In addition, the rotary gap produced considerable time jitter in which the time spacing between successive pulses varied erratically. This restricted it to self-synchronous systems, in which the modulator pulse started the sweep on the cathode-ray tube.

Another form of switch used in

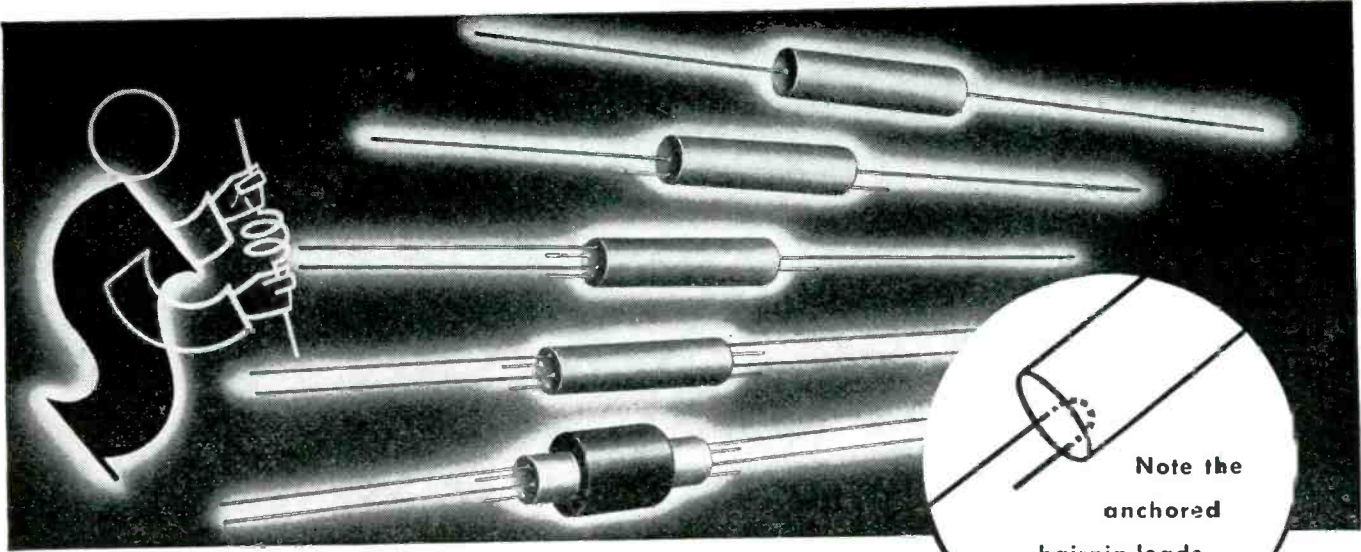

MOLDED COIL FORMS

THE MODERN ANSWER TO INEXPENSIVE MECHANICAL SUPPORTS FOR WINDINGS

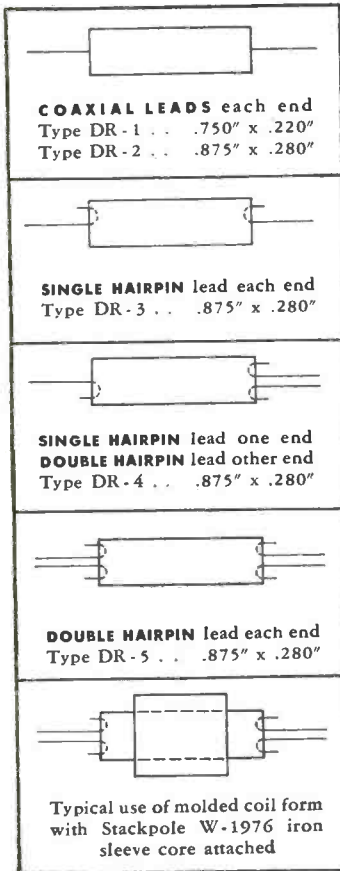

Reduced space factor . . . simplicity of assembly . . . point-to-point wiring . . . one third fewer soldered connections . . . extreme flexibility of application . . . absolute minimum cost

These proved advantages mean wide use for Stackpole molded bakelite coil forms in a variety of applications. Hairpin anchored leads mean that the soldered core wires are not disturbed or strained when leads are flexed or moved. The forms being smooth, coils may be wound on separate tubes and slipped over the forms—or windings may be wound directly on the forms. Where required, forms may be provided with Stackpole molded iron sleeve cores, thereby increasing Q materially, decreasing the amount of wire for a given inductance and reducing stray magnetic fields. Write for details or samples to meet your requirements.

STACKPOLE CARBON CO., ST. MARYS, PA.
Electronic Components Division

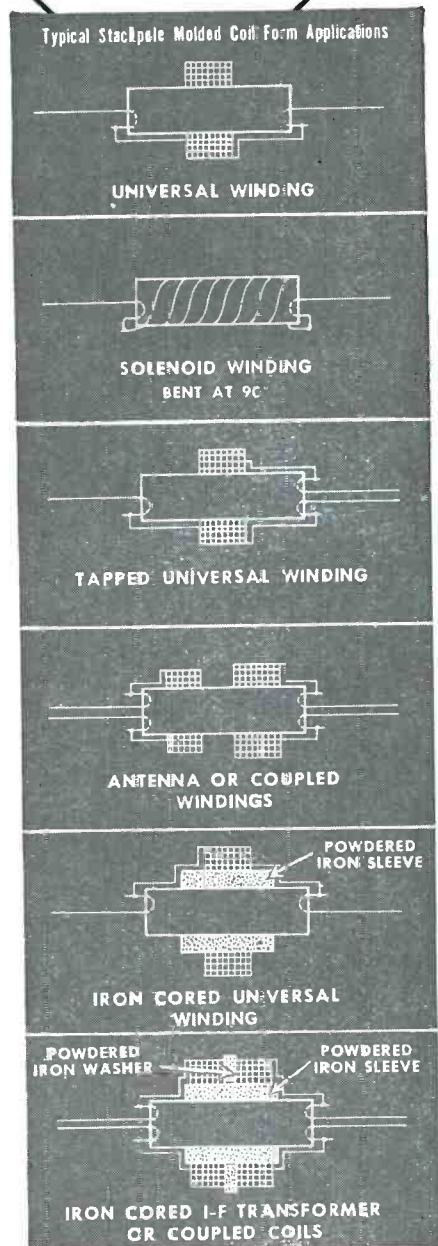

STACKPOLE

FIXED AND VARIABLE RESISTORS • IRON CORES • SWITCHES

Compact Heater Holder by Crystalab

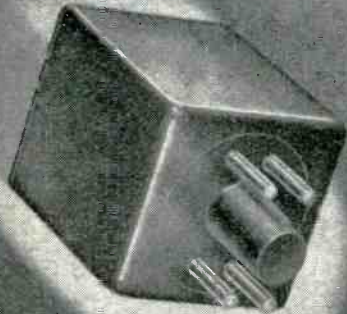

Especially suitable for applications for close frequency tolerance . . . VHF services — police, aircraft, railway communications, etc. . . . works on 6.3v at 1 amp. . . . temp control within $\pm 3^{\circ}\text{C}$ operates at 60°C frequency control of $\pm .005\%$. . . frequency range 3MC to 14MC . . . fits octal socket . . .

TYPICAL CRL — 30 FREQUENCY TEMPERATURE CURVE

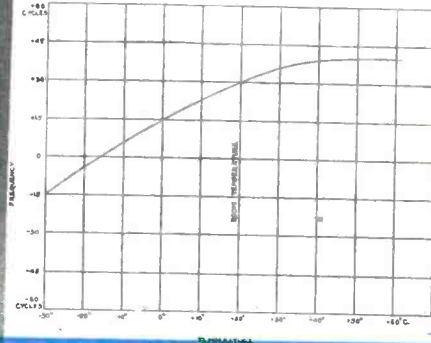

Specialists in Special Crystals



CRYSTAL RESEARCH LABORATORIES INC.

13 ALLYN ST., HARTFORD, 3, CONN., PHONE 7-3215

The FINEST MICROPHONES

for P.A. and RECORDING!

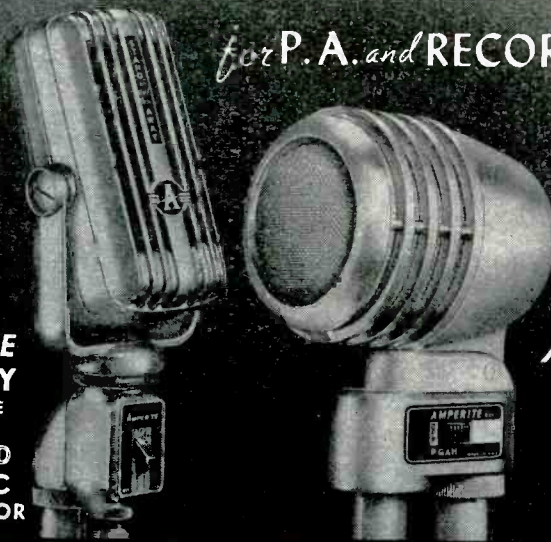

AMPERITE VELOCITY MICROPHONE WITH PATENTED ACOUSTIC COMPENSATOR

New P.G. DYNAMIC WITH NEW SUPERIOR ELIPSOID PICK UP PATTERN!

AMPERITE KONTAK MIKES IDEAL FOR AMPLIFYING STRINGED INSTRUMENTS USED WITH ANY AMPLIFIER AND WITH RADIO SETS.

ASK YOUR JOBBER . . . WRITE FOR FOLDER

AMPERITE

561 BROADWAY NEW YORK



line modulators consisted of fixed gaps enclosed in a glass tube filled with high gas pressures. Two or more were used in series, depending on the voltage requirements. Triggering or firing was accomplished by a highly damped oscillatory voltage applied across one of the gaps. When this gap fired, the applied voltage was sufficient to fire the string of gaps and discharge into the load. The series gaps were characterized by low efficiencies, excessive trigger requirements and a restricted voltage range.

Pulse Magnitude

In radar systems, peak network voltages ranged from 5 to 30 kilowatts; peak currents from several to 250 amperes; repetition frequencies from a few hundred to 4000 pulses per second; and pulse width from 0.1 to 6 microseconds. The switch tube must be capable of switching high peak voltages and currents. The peak powers involved reached power levels of 2 to 3 megawatts. Because of the short pulses, average power levels were of the order of one-thousandth of these peak power levels.

The use of thyratrons as a switch



R-F HEATS EIGHT AT ONCE

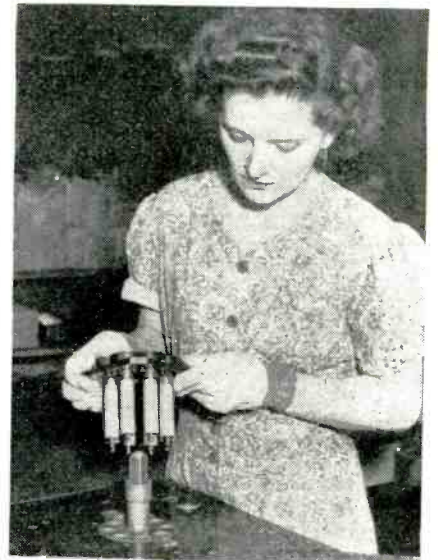

Eight elements for test equipment gear are assembled with a preformed ring of solder in position at the juncture to be sealed, then secured in a fixture. The operator lowers them through the holes into the field of an induction coil connected to a 15-kw RCA r-f generator used in the Camden plant of RCA Victor Division

There's always
something
cookin' at



FINE WIRE HEADQUARTERS

Yes sir, there's always something *new* cooking at North American Philips—Fine Wire Headquarters. And it's all because of our specialized experience in tackling a fine wire problem and coming up with a better solution.

Just for example, our engineers have added a few *new* fine wire items for specialized use.

There is the *new* insulating coating for fine wire which provides higher voltage insulation and the minimum number of pin holes on all fine resistance wires.

There is the *new* oxidized resistance wire with

a minimum voltage breakdown of 100 volts.

And there is copper wire in *any size* — uniformly coated with any thickness of silver.

Our experience is all wound up in fine wire —so, if you need fine wire information why not come to Fine Wire Headquarters? The welcome mat is out and the latch unlocked.

Among the products of North American Philips are: Quartz oscillator plates, cathode ray tubes, industrial and medical x-ray equipment, fine wire, diamond dies, tungsten and molybdenum products.

Norelco
Reg. U. S. Pat. Off.



ELECTRONIC PRODUCTS



NORTH AMERICAN PHILIPS COMPANY, INC.

DEPT. S-5, 100 EAST 42ND STREET
NEW YORK 17, N. Y.

**Here's How
MILFORD
"Know-How"
CUTS COSTS**

**on special, small metal
PARTS AND
FASTENERS**



Counterbored head, drilled secondary hole to 1/3 of way down through shank.

67% SAVING



Collared and drilled and delivered by the million.

72% SAVING



Two views—to show welding ring, vent hole, under cutting.

69% SAVING



5/8" deep tapped hole features this Milford special part.

37% SAVING

Wherever your product calls for a special, small metal part or fastener, it's a signal to call for Milford.

Milford will either design a part for you or manufacture one to your design. In either case, savings are usually impressive.

But, for savings not only in fastener costs but in assembly time as well, ask for users' experience with Milford semi-tubular rivets and Milford rivet-setting machines; ideal for speedy, low-cost, permanent fastening.

THE MILFORD RIVET & MACHINE CO.

859 Bridgeport Ave.
MILFORD, CONN.

1002 West River St.
ELYRIA, OHIO

Inquiries may also be addressed to our subsidiary:

THE PENN RIVET & MACHINE CO., PHILADELPHIA 33, PENNA.

Designers and Manufacturers of: SPECIAL COLD-HEADED PARTS; SPLIT, SEMI-TUBULAR AND DEEP-DRILLED RIVETS; RIVET-SETTING MACHINES; SPECIAL MACHINE SCREWS AND SCREW MACHINE PARTS.

tube was proposed early in the war by Dr. Germeshausen of MIT Radiation Laboratory. For these, hydrogen gas was selected because its high mobility decreases deionization time. Sylvania was one of several tube manufacturers who were called upon to help complete the development work to get a tube of satisfactory life into production. After a period of considerable development and testing, three hydrogen thyratrons were standardized by the services.

In the three tubes, a molybdenum disc anode is completely enclosed by and closely spaced from the grid structure. The control element of the grid structure is a perforated disc below the anode. A baffle mounted below the grid disc gives the tube its positive control characteristic and greatly reduces ion bombardment of the cathode. An equipotential cathode with radiation shields is used. A peep hole is provided in the tube structure to determine cathode temperatures with an optical pyrometer.

Applications

The thyratron is controlled by applying a trigger voltage of desired repetition rate to its grid. The pulses are transmitted over a pulse cable to an impedance-matching transformer with a magnetic load that passes the sharp pulses to the load without appreciable distortion and is usually designed to allow 4 to 5 times step up in voltage.

The pulse cable impedance is matched to that of the pulse-forming line and permits placing the magnetron in any position in the system, a feature of importance in the design of radar systems. The tubes can be operated in series to increase the voltage and in parallel to increase the current.

Ratings

Type 4C35 tube can pulse medium-power magnetrons and has a peak voltage rating of 8 kv and a peak current of 90 amp. This corresponds to a peak power of 360 kw, neglecting losses in the various circuit components. Type 5C22 handles peak voltages of 16 kv and a peak current of 324 amp, corresponding to peak power of 2600 kw at a maximum frequency of 560 pulses per second. The repetition frequency can be increased at lower powers. A typical operating

FAST KODAK PROCESS

TRANSFAX . . .

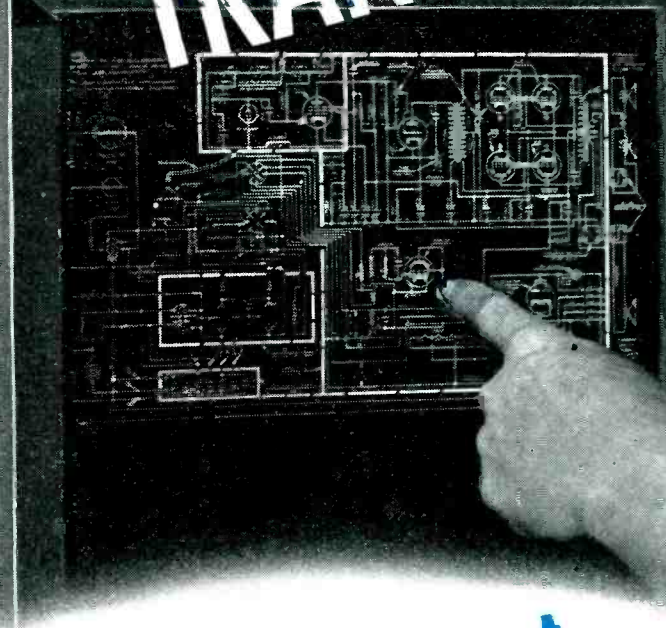

**for permanent
damage-proof
Wiring Instructions**

WHEREVER wiring diagrams and instructions are attached to electronic equipment—whether the units are few or many thousands—Transfax legends provide the answer. They end the trouble caused by legends that easily become lost or damaged . . . often leading to costly errors, to destruction of delicate circuit components.

Transfax puts a *permanent* legend on metal, plastics, rubber, and many other surfaces—at a material cost of 2¢ a square foot.

You simply spray on light-sensitive Kodak Transfax Spray, “print” your diagram—from a tracing—on the metal itself by exposure to arc, mercury, or Photoflood light. Wash off, lacquer, then bake at low temperature . . . and you have Transfax wiring

diagrams and instructions which you would practically have to *melt to erase*.

Highly adaptable, inexpensive, Transfax has many other industrial applications. For your customers’ sake, for your own sake, write today for the full story of the opportunities that Transfax offers.

Eastman Kodak Company, Rochester 4, N. Y.

Clip coupon for Free Folder

Eastman Kodak Company, Rochester 4, New York

Gentlemen: I want to know more about Transfax, its many applications and economics. Please send my copy of the FREE folder to:

Name _____

Street _____

City _____

State _____

TRANSFAX

Saves Time . . . Ends Error . . . Speeds Production

Kodak

These are the times you wish you were TWINS

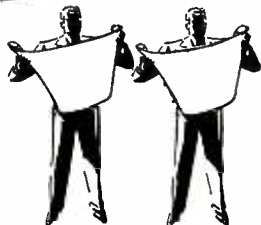

- When a new project must be launched, yet you can't sidetrack the job at hand
- When new production requires a "temporary" development department
- When direction of drafting, detailed engineering, and experimental production demands 36 hours of your day.



Of course YOU are the best man to run the job — it's YOUR business! But when you wish you were twins, our specialized experience in electronics and our model-shop facilities will let you "double up".

This is our method

First — you tell us what you want to accomplish

Second — we carry out the circuit refinement, mechanical design, and parts procurement for a first model

Third — we build — and performance-prove — the unit

Fourth — we deliver a prototype — ready for your immediate use, or in the case of production items, suitable for manufacturing specification.

Our specialized experience lies in the construction of quality-control apparatus and of pre-production models of measurements equipment, process control devices, and communications apparatus. In these branches of electronics, our services have aided other over-burdened engineers — and can probably help you.

Your request for specific information incurs no obligation. We will gladly give you details.

ELECTRONIC PROTOTYPES

285 Columbus Avenue
BOSTON 16, MASSACHUSETTS

condition is 100 kw of peak power at a repetition rate of 1500 pulses per second and a maximum average power of 1000 watts.

Both types of tubes require the same grid drive, a voltage pulse having a certain peak amplitude, rate of rise, pulse duration and source impedance. The tube drop of the 4C35 is approximately 75 volts and the drop of the 5C22 is about 110 volts. Tube losses are small for the power levels involved.

Since the hydrogen thyatron replaced the spark gap in line modulators, it may find use in the spark-gap type of induction heaters. A small 500-watt induction heater using a single thyatron is readily controlled by adjusting the drive frequency for economical induction heaters, diathermy, and electro-surgery equipments.

Because of its rapid deionization, high-speed sweep circuits are another application of the tube. Using a light modulator circuit, a hydrogen thyatron has been used to flash a gas discharge tube at frequencies between 5000 and 6000 times per second for high-speed photography as utilized with a uniform film motion for study of high-speed motion.

• • •

Rapid Moisture Testing of Granular Material

By JOHN H. JUPE

London Correspondent

IN THE FIELD of moisture determination, electronic instruments may soon constitute the regular industrial method when ease and speed are important, though it will always be necessary to calibrate them against one of the older methods such as boiling the test sample in xylene or toluene and distilling the resulting liquor.

A new instrument measures the moisture content of such things as cattle foods, seeds, dehydrated foods, straw, tobacco, malt, clays, and plastic powders and is remarkable for its accuracy and simplicity. Most readings are correct to within about 0.5 per cent moisture and different unskilled users can easily obtain results differing by less than 0.2 per cent.

In considering possible forms for the instrument, the method of meas-

EVERY DE MORNAY-BUDD WAVE GUIDE is Electrically Tested, Calibrated and Tagged



Crystal Mount DB-453



Rotating Joint DB-446



90° Elbow (H Plane) DB-433



Pressurizing Unit DB-452



Mitered Elbow (H Plane) DB-439

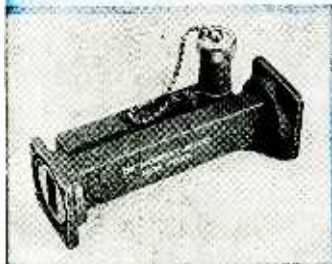

Uni-directional Broad Band Coupler DB-442

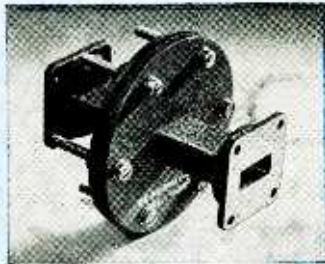

Bulkhead Flange DB-451



Uni-directional Narrow Band Coupler DB-440

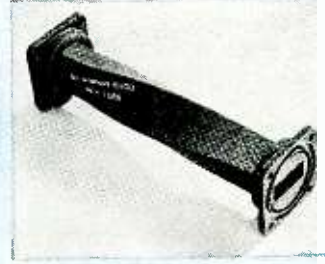

90° Twist DB-435

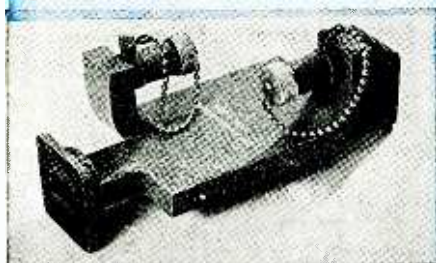

Bi-directional Narrow Band Coupler DB-441

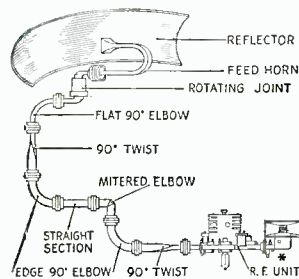

Typical plumbing arrangement illustrating use of De Mornay-Budd components available from standard stocks.

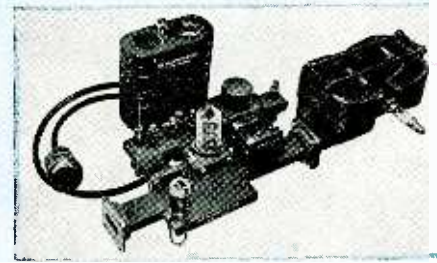

RF Radar Assembly DB-412

When you use any De Mornay-Budd plumbing arrangement, you know exactly how each component will function electrically. You avoid possible losses in operating efficiency through impedance mismatches, or breakdown and arcing caused by a high standing wave ratio. (See chart below.)

De Mornay-Budd wave guides are manufac-

tured from special precision tubing, and to the most stringent mechanical specifications. Rigid inspection and quality control insure optimum performance.

Complete laboratory service and consultations on micro-wave transmission line problems available.

The curve shows the manner in which the reflected power increases with an increase in the voltage standing wave ratio. The curve is calculated from the following equation:

$$\% \text{ Power Reflected} = \left(\frac{\left(\frac{V_{\max}}{V_{\min}} \right) - 1}{\left(\frac{V_{\max}}{V_{\min}} \right) + 1} \right)^2$$

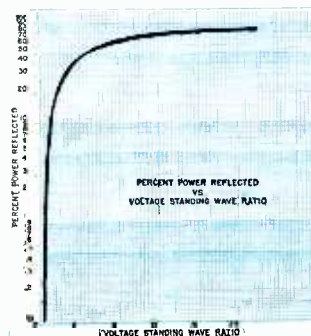

De Mornay-Budd, Inc., 475 Grand Concourse, New York 51, N. Y.

Be sure to visit the De Mornay-Budd display at Booth III, at the 1946 Radio Parts and Electronic Equipment Show, Hotel Stevens, Chicago, May 13-16th.

DO YOU MOUNT *Vertical or* HORIZONTAL?

**OPEN BLADE
Model S-I-P**

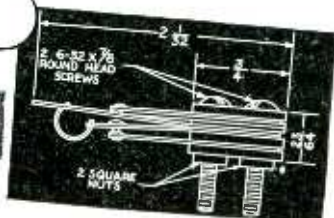

**OPEN BLADE
MODEL M**

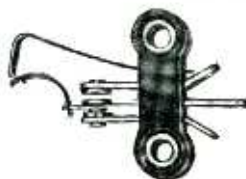
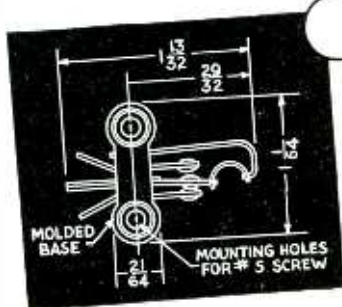

**FOR HORIZONTAL
MOUNTING**

ACRO *Open Blade* SWITCHES Simplify hundreds of problems

Whether you mount your switches vertically or horizontally you too should be able to improve product performance by adopting ACRO Snap-Action Switches. The flexibility of design and adaptation and the amazing performance records are keyed to ACRO's patented beryllium Rolling Spring construction. No other switch is made like it. No other switch performs like it. Yet the cost is low.

With better contact pressures, sturdy construction and positive fast action, ACRO Switches are virtually trouble-free. Many are built for millions of operations. Made in 1, 2 and 3 poles—single throw and double throw. Return types and set types with a wide range of operating pressures. Rated: 15 Amps. at 125 volts A.C. Illustrated above are but 2 of over 1500 models of open blade and inclosed type switches. Send your engineering details for a prompt answer.

ACRO ELECTRIC COMPANY

1316 Superior Avenue Cleveland 14, Ohio

uring d-c resistance was abandoned owing to inaccuracies produced by electrolytic polarization, endosmosis, cataphoresis, etc. Use of a-c methods was adopted because capacitance and a-c conductance are usually more stable than d-c conductance.

A-C Circuit

Capacitance is not always sensitive to changes in moisture so an instrument was designed which would respond to capacitance or a-c conductance changes or any combination of the two, the latter condition being very suitable for producing a linear scale of moisture. Another advantage is that a rise in temperature produces a decrease in dielectric constant and an increase in conductivity so a combined method of measurement enables overall temperature variations to be minimized.

The material to be examined is placed in a test cell and a constant alternating voltage applied. The resultant current is the vector sum of

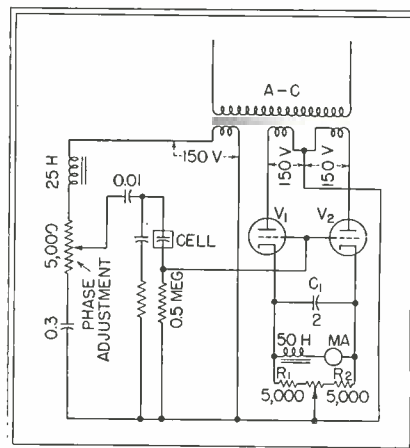

Fig. 1—Circuit for measuring small quantities of moisture in flaked and granular materials

the conduction current, which is in phase with the applied voltage, and the capacitance current which is in quadrature with it. This resultant current is passed through a fixed resistor and the potential difference at its terminals contains two components in quadrature which are proportional to the capacitance and conductance of the material being tested.

A voltmeter is connected to the terminals of the resistor so that it measures that component of the total voltage which bears a definite phase

AMPHENOL

Covers the Spectrum

**WITH CABLES
AND CONNECTORS
FOR EVERY FREQUENCY**

Amphenol serves the electrical and electronic industries with the most complete line of cables, connectors, plugs and fittings for every application. No matter what the need — from high-current, low-voltage cables and connectors such as are used in power lines, to high-voltage, high-frequency components required in the upper regions of the spectrum — there is an Amphenol product for the job. Amphenol cables and connectors are used in Radar, F.M., Television, Standard Broadcast, electronic controls and equipment... and in numerous industrial applications.

Amphenol connectors are engineered and constructed so as to afford the absolute minimum of loss of power, potential or waveform even at the highest frequencies. These components reflect the greatest advancement in all phases of electrically correct design and mechanically correct manufacture. Amphenol makes the most complete line of cables, connectors, plugs and fittings for the most efficient transmission of power at all frequencies.



AMERICAN PHENOLIC CORPORATION
CHICAGO 50, ILLINOIS
In Canada • Amphenol Limited • Toronto

COAXIAL CABLES AND CONNECTORS • INDUSTRIAL CONNECTORS, FITTINGS AND CONDUIT • ANTENNAS • RADIO COMPONENTS • PLASTICS FOR ELECTRONICS



A Ballantine ELECTRONIC VOLTMETER

For every requirement

ALL MODELS HAVE THE
SIMPLIFIED
LOGARITHMIC
SCALE

STANDARD
Model 300

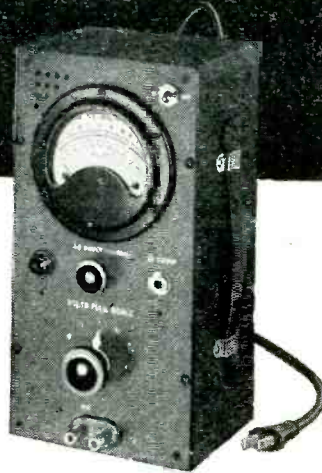

Ideal for the *Accurate* measurement of AC voltages in the Audio, Supersonic, Carrier Current and Television ranges.

Use of Logarithmic voltage scale assures uniform accuracy of reading over whole scale while permitting range switching in decade steps.

Each Voltmeter equipped with an output jack so that the instruments can be used as a high-gain stable amplifier.

SPECIFICATIONS

MODEL 300

RANGE—.001 to 100 volts.
FREQUENCY—10 to 150,000 cycles.
ACCURACY—2% at any point on scale.
AC OPERATION—110-120 volts.

MODEL 304

RANGE—.001 to 100 volts.
FREQUENCY—30 c.p.s. to 5.5 megacycles.
ACCURACY—0.5 DB.
AC OPERATION—110-120 volts.

MODEL 302

RANGE—.001 to 100 volts
FREQUENCY—5 to 150,000 cycles.
ACCURACY—2% at any point on scale.
DC OPERATION—self-contained batteries.

Send for Bulletin for further description



Model 304
R-F
VC-LTMETER

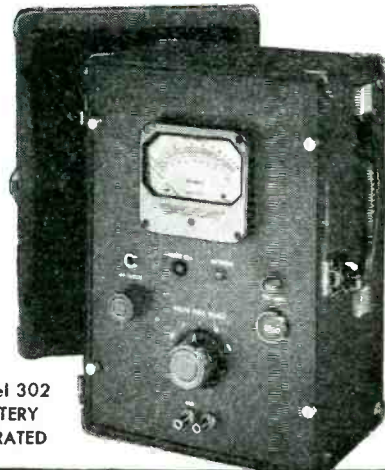

Model 302
BATTERY
OPERATED



BALLANTINE LABORATORIES, INC.

BOONTON, NEW JERSEY, U. S. A.

relationship to the main supply or some auxiliary voltage.

If there is a suitable phase relationship between the cell voltage and the reference voltage, the voltmeter can be arranged to indicate only that component of the resistor potential difference which is proportional to the capacitance of the cell or the component which is proportional to the conductance, the change from one to the other being made by moving the cell voltage through 90 degrees. Should the phase be intermediate to these points, the voltmeter will indicate a proportion of the capacitance and conductance voltages.

Circuit Arrangement

Figure 1 shows the schematic of the instrument. The two tubes receive equal anode voltage from the center-tapped transformer but with opposing phases. In series with the cathodes are resistors R_1 and R_2 , with a variable linking resistor. Both grids are joined and the voltage to be measured is applied to them so



Fig. 2—Unskilled workers differ in results by less than 0.2 percent when using the moisture meter

that the resultant voltage operative in the anode circuit of one tube is $\mu V + V$ while the other is $\mu V - V$, V being the anode voltage.

The indicating instrument is a d-c microammeter connected across the two cathode resistors. A 50-henry choke is connected in series with the indicator to prevent a-c from flowing through it and the combination is bypassed by capacitor C_1 . In opera-

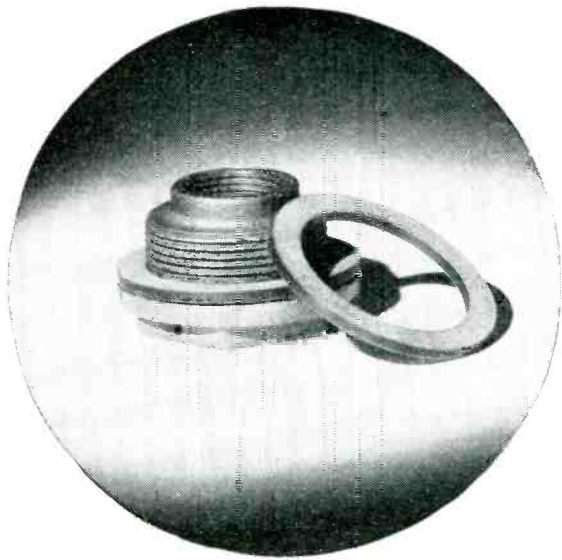

FLEXIBLE..

The flexibility of National Vulcanized Fibre, here illustrated as a barrel bung washer, is the property which makes it ideal for use where an airtight seal is required.

Resilient Lightweight

NATIONAL VULCANIZED FIBRE

takes the "kinks" out of tough production problems

If you need a strong, yet more flexible material to improve performance and efficiency of products or plant equipment—you're likely to get just the flexibility you want in National Vulcanized Fibre. All grades of National Vulcanized Fibre are not flexible—many are very hard, bone-like—but other grades are flexible and varying *degrees* of flexibility are available through a special treatment.

But it's the *unusual combination* of properties of National Vulcanized Fibre which may make it your answer to new, profitable products. Resilient and light in weight (about half that of aluminum), this versatile material is easily machined and formed. It has outstanding impact, tensile and dielectric strength . . . is extremely resistant to wear and abrasion . . . and is one of the strongest materials per unit weight known. Write for complete information.

NATIONAL VULCANIZED FIBRE CO.

Wilmington, Delaware



Offices in Principal Cities

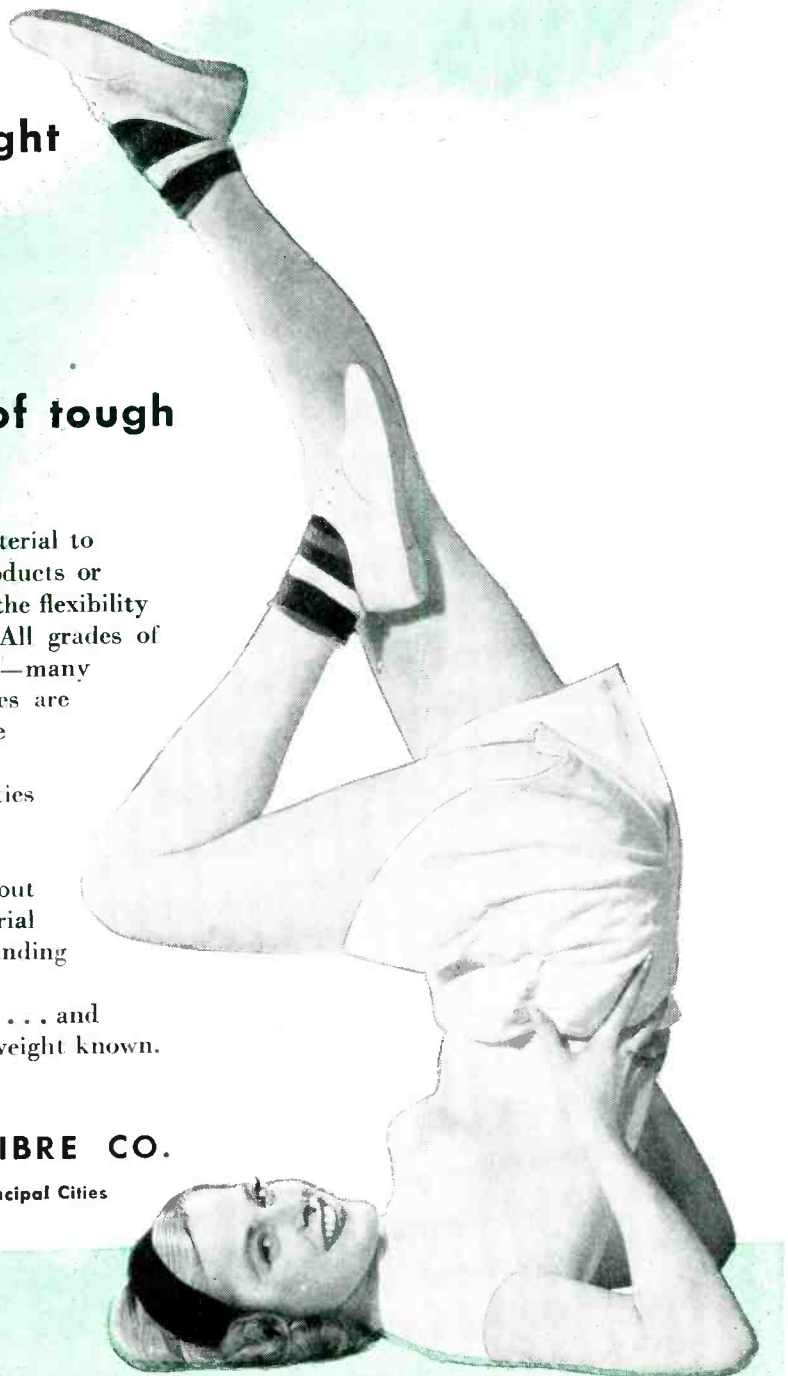

GUTHMAN precision COILS

Precision, a word basic to radio and electronics, has been made commonplace by over-use and often false by misuse . . . where it guides the purchase and production of materials, and sets the standards for engineering research as well as for the manufacture of the finished and inspected product, PRECISION becomes again a word of importance. It is so conceived and used by Guthman.

EDWIN I. GUTHMAN & CO., INC., 15 S. THROOP, CHICAGO 7, ILL.

- ★ I. F. Transformers
- ★ R. F. Coils & Chokes
- ★ Trimmer Condensers
- ★ Zinc Shield Cans
- ★ R. F. Assemblies
- ★ Textile Insulated
Litz & Magnet Wire

Visit Our Booth
No. 115
1946 Radio and Electronic Parts Show

Guthman
C H I C A G O

tion, the tubes pass pulsating current and the meter indicates the difference in the mean potential of the cathodes, which will be determined by the two anode voltages. To adjust the indicator to zero, the variable resistor joining the two cathode resistors is adjusted when the grid potential is zero, which takes place when the test cell is empty.

Automatic protection against overloads is obtained since resistors R_1 and R_2 determine the bias applied to the grids; if a large voltage is accidentally applied to the instrument, the grids automatically acquire a large bias. The instrument was developed in the National Physical Laboratory in Britain and is described by permission of the Director and its designer, Dr. Hartshorn.

• • •

Automatic Flying with Electronic Equipment

USE OF ELECTRONIC devices for the virtual elimination of weather as an obstacle to commercial airline operations is announced by United Air Lines.

United will equip its new fleet of four-engined Mainliner "230's" with Sperry electronic automatic pilots, incorporating automatic airport approach facilities. Coupled with auto-

• • •

BRAZING TUBE ASSEMBLY



Plate connectors are brazed to the caps on 833A transmitting tubes at the Dobbs Ferry plant of North American Philips. The plastic protective screen shields the operator from flying glass in the event the tube shatters



more efficient
...in miniature

To accommodate the reading matter we find between the covers of a small book would have required several dozen unwieldy, hand inscribed, parchment scrolls in Roman days. This is a striking example of greater efficiency in miniature but no more so than TUNG-SOL Miniature Electronic Tubes.

From everyone's viewpoint Miniatures are superior, especially for high frequency circuits. More compact equipment and less storage space are obvious advantages of Miniatures to both manufacturers and dealers. The engineer, however, sees their greater resistance to the effects of vibration

Visit our booth No. 61 at the
RADIO PARTS AND ELECTRONIC EQUIPMENT SHOW
STEVENS HOTEL, CHICAGO, MAY 13 to 16

and shock, lower lead inductance, lower inter-element capacities and higher mutual conductance.

Manufacturers of radio sets and other electronic devices are invited to work with TUNG-SOL engineers in the development of more compact and more efficient electronic equipment through the use of Miniature Tubes. Of course, consultation work of this nature is strictly confidential.



TUNG - SOL

vibration-tested

ELECTRONIC TUBES

TUNG-SOL LAMP WORKS, INC., NEWARK 4, NEW JERSEY
Sales Offices: Atlanta • Chicago • Dallas • Denver • Detroit • Los Angeles • New York
Also Manufacturers of Miniature Incandescent Lamps, All-Glass Sealed Beam Headlight Lamps and Current Intermittors

Seamless [PATENTED] RADIO PINS

DEVELOPED AND MANUFACTURED BY
THE AMERICAN BRASS COMPANY
WATERBURY BRASS GOODS BRANCH



Check the advantages...

These *seamless, patented* Radio Pins are uniform in size, with smooth surfaces for smooth operation. In staking, the ends roll over easily and without splitting. When molded into composition parts the closed end keeps out the molding compound.

If you use pins for vacuum tubes or adapters, fluorescent lights, plugs, or electrical equipment of any kind, the chances are you'll save time, money and rejections by using these seamless, patented Radio Pins. They are available in a wide variety of styles and sizes. Simply send a sketch, sample or description, with quantity, for quotation.

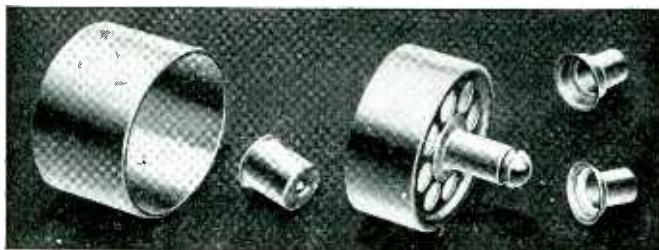

RADIO OR RADAR EQUIPMENT?

In addition to Radio Pins, we produce large quantities of top caps, base shells and adapter shells for vacuum tubes; also a wide variety of other metal products including deep drawn shells and cups, blanks and stampings, ferrules, grommets, washers, vents, fasteners—and the world's largest assortment of eyelets.

45406

THE AMERICAN BRASS COMPANY
WATERBURY BRASS GOODS BRANCH
WATERBURY 88, CONNECTICUT

matic landing controls, they will make possible the operation of airliners directly into airports under substantially lower weather minimum than are now observed.

Pilots approaching an airport will set the new equipment to receive localizer radio signals which will be fed from a special vhf airplane radio receiver into the electronic automatic pilot to lead the plane to the airport runway. At about five miles from the airport, signals from a glide path transmitter on the airport will lead the plane automatically down a precise beam sloping to a point exactly over the end of the airport runway. Such automatic descents will be at a normal rate of about 300 feet per minute.

At cruising altitudes, flight officers will use the electronic automatic pilot much as they have used the hydraulic automatic pilot in the past, setting its controls to maintain cruising elevation and direction. The same equipment which links the electronic pilot to localizer signals will be used to link the new electronic device with the radio directional range so that signals of the latter will keep the plane on course, without manual aid, in airport-to-airport flight.

Airport localizers and glide paths are being installed by the Civil Aeronautics Administration at cities along the nation's air routes.

• • •

CONTROL FOR ATOMIC TEST



Electronic equipment for the Fairchild radio-controlled cameras for photographing atomic bomb tests on Bikini Atoll

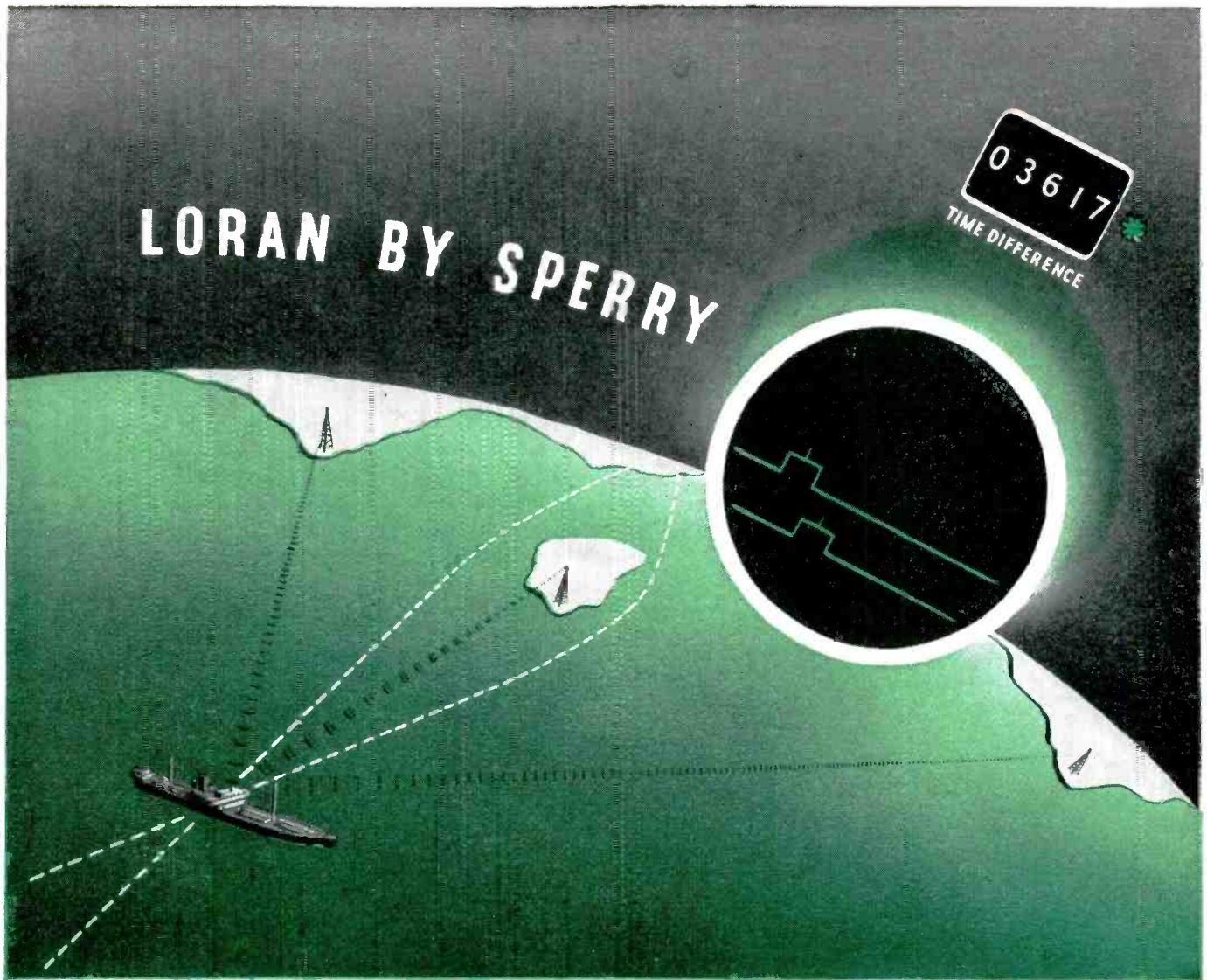

Accurate **LO**ng **RA**nge **N**avigation... anytime... in all weather

With Sperry Loran the navigator has at hand a quick and accurate means of determining a ship's position at any time, in all kinds of weather. This system involves the reception of accurately timed radio pulses from shore-based transmitting stations, usually 200 to 400 miles apart.

The *difference in time of arrival* of signals from a pair of transmitting stations is measured and the time difference is then used to determine, from special charts or tables, a line-of-position on the earth's surface. When two lines-of-position from two different pairs of Loran stations are

crossed, you have a "Loran fix." Fixes are obtainable at distances from shore stations up to 1400 miles at night, 700 miles in daytime.

In your consideration of Loran, note particularly that Sperry's equipment is easy to operate. A Time Difference Meter (see illustration above) greatly simplifies the operator's

work and prevents errors in readings.

Sperry Loran is backed by a worldwide service organization and meets the usual high standards of test and performance of all Sperry products. *Loran equipments in limited quantity are ready for immediate delivery.*

**The Time Difference Meter, giving position references directly, is a Sperry exclusive.*



Sperry Gyroscope Company, Inc.

EXECUTIVE OFFICES: GREAT NECK, NEW YORK • DIVISION OF THE SPERRY CORPORATION
 LOS ANGELES • SAN FRANCISCO • NEW ORLEANS • HONOLULU • CLEVELAND • SEATTLE
 GYROSCOPICS • ELECTRONICS • RADAR • AUTOMATIC COMPUTATION • SERVO-MECHANISMS

TUBES AT WORK

Crystal Mixer in F-M Converter.....	190
Grid and Plate Modulation in New System.....	192
Thermoelectric Generator.....	196
Recording the War Trials in Four Languages.....	202
Continuous Tuning for 44 to 216 Mc.....	204

Crystal Mixer in F-M Converter

ONE ALTERNATIVE to operating f-m transmitters on the old and the new frequencies simultaneously is to insure that all of the station listeners can receive the transmitter on the new frequencies. This solution was chosen by station engineers at WMLL, Evansville, Indiana, who have evolved a simple low-cost converter that can be supplied free to

listeners for the new frequency assignment on 94.7 megacycles.

It was planned to convert the ten-megacycle band between 90 and 100 megacycles using a fixed-tuned 50-megacycle heterodyning oscillator. The 40 to 50-megacycle output of the converter could then be received by a standard prewar f-m receiver by using the normal tuning controls.

A converter using the Sylvania type 1N34 crystal detector as a mixer and a 6J5 triode as oscillator was found to be far simpler than one using vacuum tubes exclusively, and performance exceeded that of the best tube converters tried. Power for the converter is obtained from an adapter under one of the audio output tubes in the receiver.

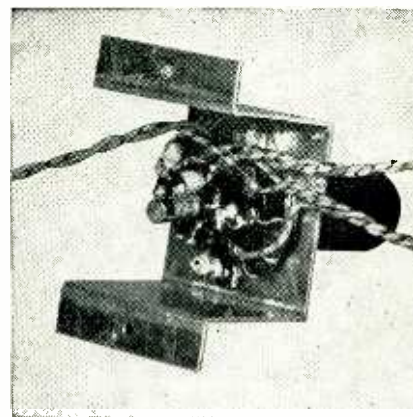
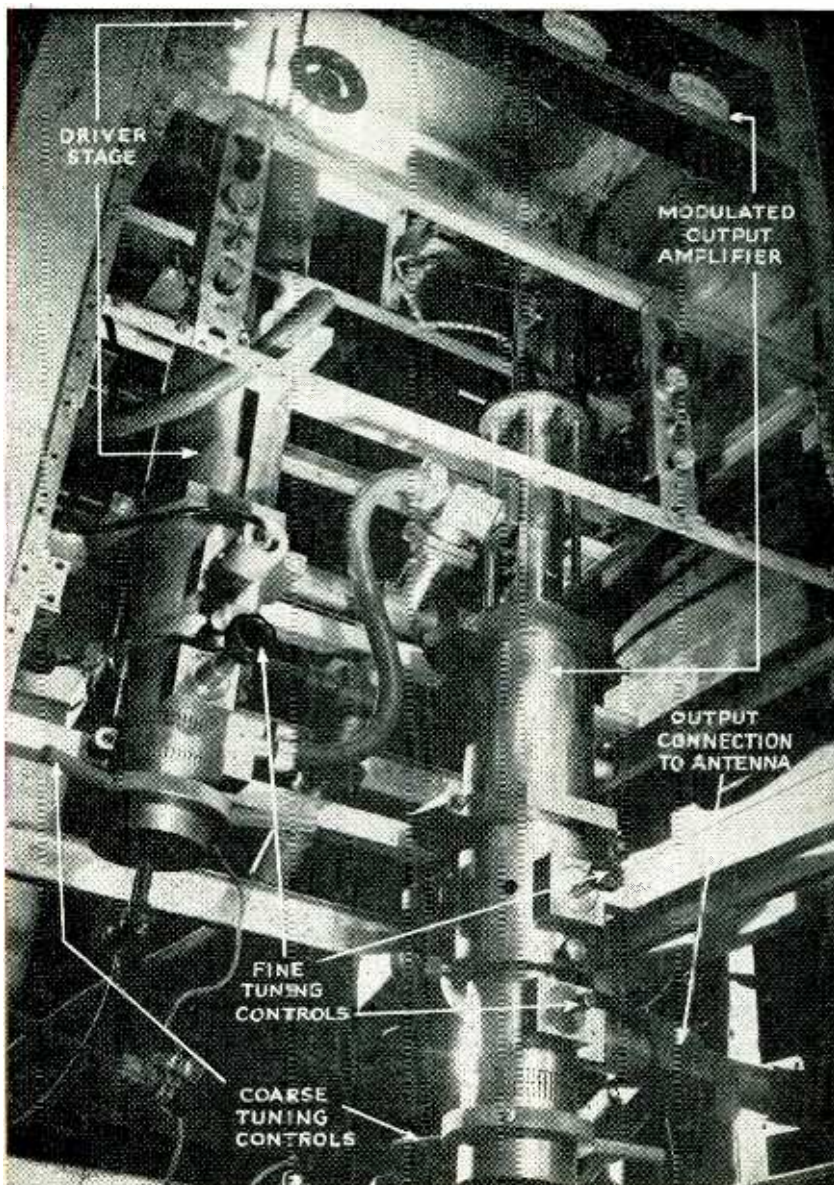

Laboratory model of the simple 100-mc converter made by Electronics Research, Inc. of Evansville, Indiana

The crystal detector is used as the nonlinear element in the mixing system. The 6J5 is connected as a Colpitts oscillator whose tank circuit consists of the tube interelectrode capacitances and the coil L_2 . Capacitor C_1 and coil L_1 function as a high-pass filter having a cutoff frequency between 65 and 85 megacycles, attenuating spurious responses resulting from low-frequency signals.

Oscillator coil L_2 is proportioned

• • •

FINAL OF THE FUTURE?

Arrows indicate the major components of the color-television driver and amplifier unit shown on the front cover of this issue

Switches

FOR DESIGNS OF TOMORROW
NOW

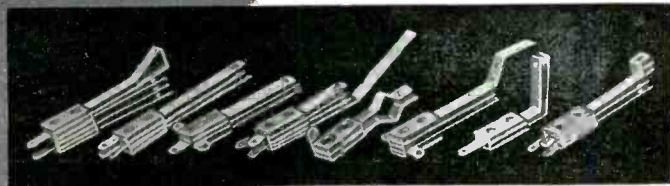
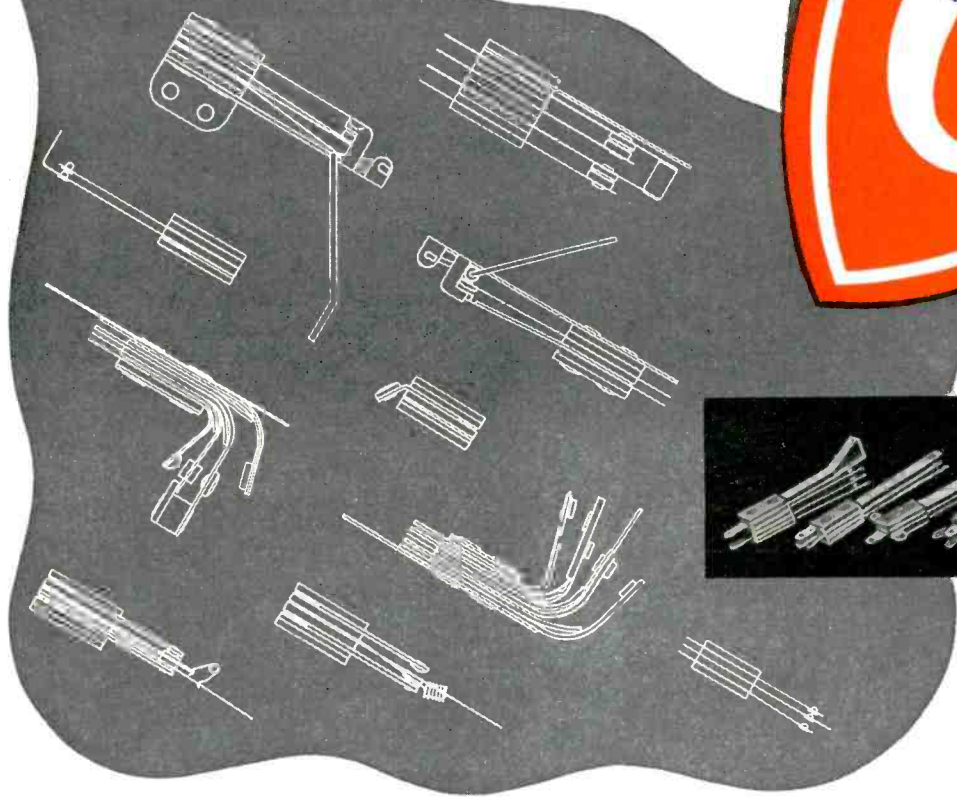

SWITCHES by GUARDIAN for every purpose

Scan the brief pictorial review of Guardian Contact Switch assemblies shown above and you will probably see a switch that is comparable to your needs. Each unit represents a switch so practical, so saving of assembly time, energy, materials and money, as to be worthy of your immediate consideration.

The Guardian Featherrub Switch is an example of such true efficiency. It is shown to the lower right of this page. An original Guardian creation, it is actuated mechanically and is adaptable to manual, roll-over or cam action. The Guardian Featherrub and all other units shown are standard items. There are hundreds of other types, all of the highest quality. Contact blades are obtainable in phosphor bronze tinned to withstand salt spray test, also in standard Guardian phosphor bronze. All switches are properly insulated. The switch you need is here singly or in combination . . . one or a million! Try Guardian Switches for performance, price and delivery. Write.

You are invited to visit Guardian's Booth, No. 51, Radio Parts and Electronic Equipment Trade Show, May 13-16, Stevens Hotel, Chicago

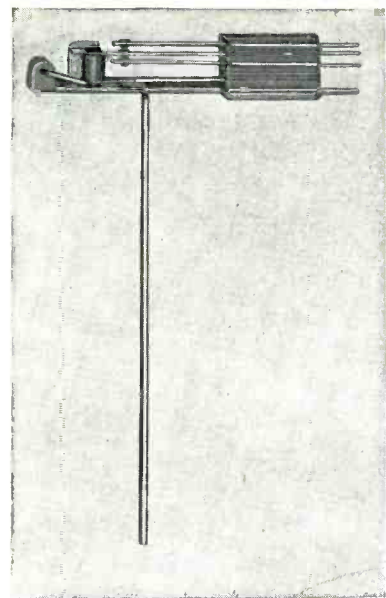

GUARDIAN
FEATHERUB
SWITCH

GUARDIAN  **ELECTRIC**
1625-F W. WALNUT STREET CHICAGO 12, ILLINOIS
A COMPLETE LINE OF RELAYS SERVING AMERICAN INDUSTRY

HEADQUARTERS FOR ALL TYPE MOISTURE & MILDEW PROOFING COMPOUNDS



Our wartime experience developing and producing moisture-mildew proofing compounds for all services has equipped INSL-X with the "know-how" to solve any problem in this field.



We have on hand at all times, the materials to render immediate service. Lacquer, wax or varnish with any fungicide alone or in combination with another. Any quantity—put up in any size containers.



When commercial or military requirements call for moisture-mildew proofing, check with INSL-X!

Literature on Request

INSL-X
MEANS MODERN
INSULATION

THE INSL-X COMPANY INC.
857 MEEKER AVE., BROOKLYN 22, N. Y.
CHICAGO • DETROIT • LOS ANGELES • PHILADELPHIA
CLEVELAND • ST. LOUIS

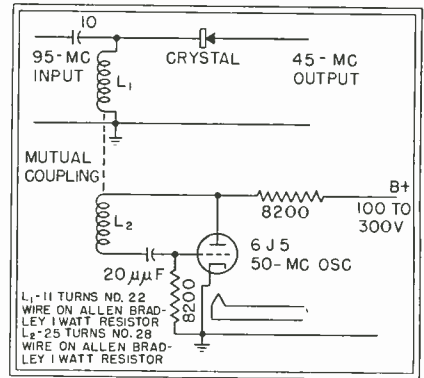

Circuit of a converter for f-m using a crystal detector as the mixer

to obtain an oscillator frequency of 50 megacycles, although deviations from this figure of plus or minus one megacycle are acceptable. Both coils are wound on Allen-Bradley type GB one-watt resistors having resistance values above 500,000 ohms.

• • •

Features of Grid and Plate Modulation in New System

A UNIQUE SYSTEM of modulation in which grid modulation is used on negative half cycles and an additional r-f amplifier tube operates as a side-band generator on positive half cycles is illustrated in the diagram. The system permits more power output for size in portable radio transmitters since high audio power is not needed and the modulation capabilities are said to be well in excess of 100 percent with less than usual distortion.

The input r-f voltage on the grids of both the power amplifier and side-band generator tubes is obtained from a tap on the plate tank coil of the buffer amplifier through blocking capacitors. The power amplifier is adjusted to operate class C at a plate efficiency from 60 to 70 percent while the side-band generator is biased to approximately three to four times class C. With no modulation, the side-band generator has practically no plate power input, and contributes very little to the transmitter output.

Without modulation, the power amplifier tube furnishes the carrier power and the side-band generator does not operate. With application of an a-f voltage, the negative half cycle of audio voltage from the modulation transformer causes the power

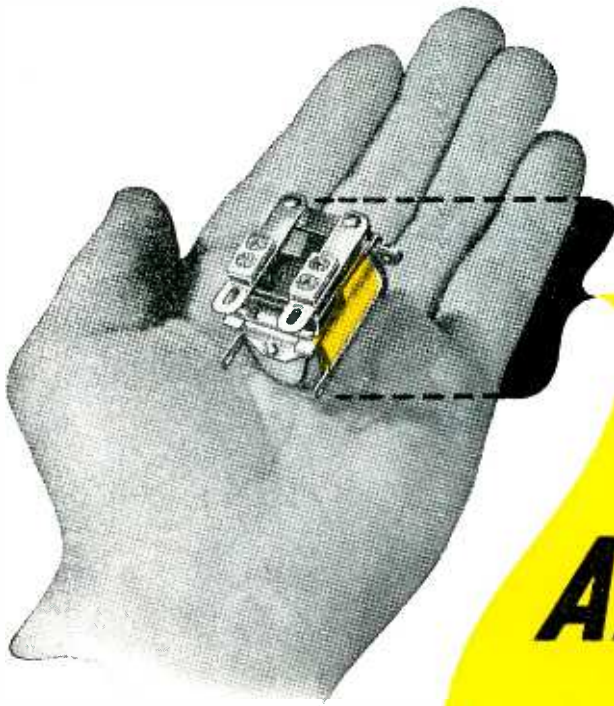

The "CR" relay illustrated is a single pole normally open double break arrangement. Standard insulation is molded bakelite. Contacts are silver, although alloy contacts can be supplied. Contact rating with $\frac{1}{4}$ " silver is 15 amperes at 24 volts D. C. or 110 volts A. C. Non-inductive. The arrangement shown is $1\frac{33}{64}$ " high; $1\frac{3}{32}$ " wide and $1\frac{25}{32}$ " long. Weight 3 ounces.

*Save Space
in your controls!*

use
Allied's "CR"
Relays

Remarkably small for a power relay the "CR" developed by Allied will enable you to materially reduce the size and weight of your electronic controls.

Having large contacts and heavy gram pressure the "CR" performs switching operations which usually require considerably larger relays. Highly adaptable the "CR" has two, three and four pole variations. Conveniently located contact and coil terminals permit speedy and simple assembly of the relay into your unit. For severe dust and dirt conditions the "CR" can be hermetically sealed with the handy plug-in base or with solder terminals.

The "CR" is but one of many types of relays produced by Allied to the high quality standards demanded by your product. Several modern, strategically located plants are available to furnish your immediate requirements. A check with Allied engineers will help you in the selection of the correct relay for your control. Write today.

ALLIED CONTROL COMPANY, INC.

GENERAL OFFICES: 2 East End Ave. (at 79th St.) New York 21, N. Y.
Factories: New York City (2 East End Ave.)—Plantsville, Conn. Chicago—4321 N. Knox Avenue, Chicago 41, Illinois. In California: Allied Control Co. of California, Inc., 1633 South Hope St., Los Angeles 15, Calif.



Allied Relay Types

Power, Sensitive, Telephone,
Differential and others.

Also—Solenoids and Electro-
magnetic devices.

AC-1

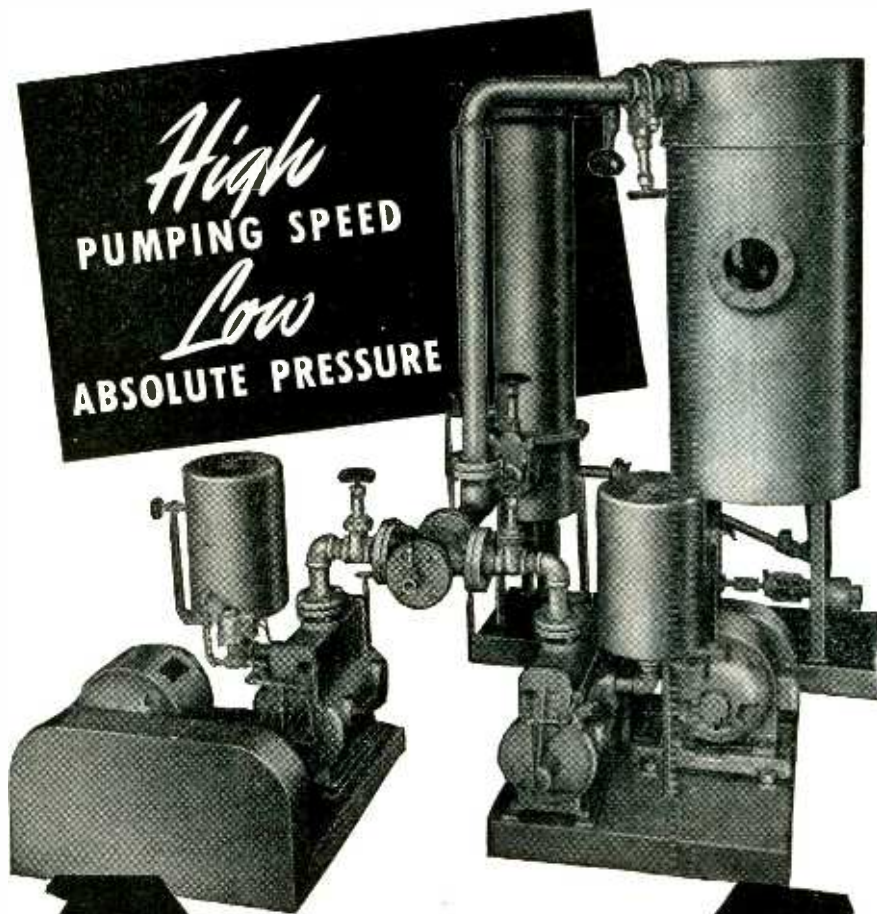

KINNEY

High Vacuum Pumps

Kinney High Vacuum Pumps provide the fast pumping speed and the extremely low pressures to meet production requirements in many of America's leading plants. The team of Kinney Pumps, shown above, work day after day, dehydrating and degassifying vacuum pump oil for the General Electric Co. Installed by Buckeye Laboratories of Cleveland, these units are typical of thousands of Kinney Pumps creating and maintaining the low absolute pressures required in making electronic products, in sintering alloy metals, coating lenses, producing penicillin and aiding countless other modern processes. Kinney Single Stage Pumps maintain low absolute pressures to 10 microns; Compound Pumps to 0.5 micron or better.

Send for Bulletin V45

KINNEY MANUFACTURING COMPANY

3565 WASHINGTON STREET, BOSTON 30, MASSACHUSETTS

NEW YORK • CHICAGO • PHILADELPHIA • LOS ANGELES • SAN FRANCISCO

We also manufacture Vacuum Tight Valves, Liquid Pumps, Clutches and Bituminous Distributors

amplifier tube to be grid modulated from the carrier level, downward. Upon completion of the negative half cycle of a-f voltage, the carrier level output is restored. With the application of the positive half cycle of a-f voltage, the plate current of the side-band generator tube is increased because the grid is swung in a positive direction.

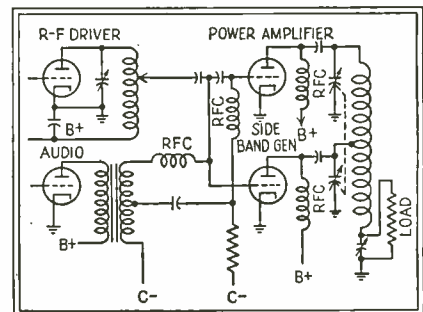

Basic circuit of modulation system for lightweight portable transmitters

The positive half cycle of audio applied to the side-band generator grid lowers its impedance to such an extent that more r-f excitation is required from the buffer amplifier. This reduces the excitation applied to the grid of the power amplifier tube and tends to cause a reduction in its plate current. This reduction is offset by the fact that positive audio-modulating voltage is applied to the grid at the same time.

With the completion of the positive half cycle of a-f from the modulation transformer, and the upward or positive peak of modulation, the plate current of the side-band generator tube is decreased to practically zero because of the high value of grid bias. The grid impedance is raised back to a high value, and maximum r-f drive is again applied to the power amplifier, thus restoring the circuit to carrier condition of no modulation. Therefore, the power amplifier tube may be considered to be supplying the carrier power and negative modulation peaks, while the side-band generator tube supplies the power required for upward peaks of modulation, above carrier level.

It may be considered that the power amplifier tube supplies the carrier power at all times, and is grid-modulated for the negative modulation peaks. The side-band amplifier is triggered by the positive



THE *Right* TOOL STEEL
FOR YOUR *Individual* REQUIREMENTS

Send for
THIS
BOOKLET



Complete shop data on the properties, uses, forms, sizes and methods of handling every member of the extensive Allegheny Ludlum family of Tool Steels—170 pages, handily pocket-sized and indexed for easy reference. Write for it today—on your company letterhead, please.

ADDRESS DEPT. . . . E-41

NO more using a tool steel that merely comes close to your actual requirements.

Now you can select the steel that fits each of your needs *exactly*—gives you better, faster performance or longer tool life. There's sharp emphasis on cost-reduction today—and in the broadly varied

line of Allegheny Ludlum Tool and Die Steels you'll find a type to fit each one of your machine operations like a hand in a glove—the *right* tool steel that can save money for you. ● It doesn't cost a thing to let our Service Engineers check your tooling set-ups with you—why not call us in?

ALLEGHENY LUDLUM

STEEL CORPORATION · General Offices, Brackenridge, Pa.

Specialloy Steels - EXCLUSIVELY

**NOW YOU
CAN SEE
THE TROUBLE**



ALTEC LANSING

Intermodulation Analyzer

What happens when a string bass and piccolo sound out together? Any distortion? Intermodulation? This intermodulation analyzer, designed by Altec Lansing for measuring the efficiency of their own amplifier and loudspeaker systems, will let you see the results at a glance. No calculations are necessary. A five-minute check on the Altec Lansing Intermodulation Analyzer gives you the information it takes hours to get by other methods. *Available for Prompt Delivery.*

ALTEC
LANSING CORPORATION
1161 NORTH VINE ST.
HOLLYWOOD 38, CALIF.

250 West 57th St.
New York 19, N. Y.

"KEEP ADVANCING WITH ALTEC LANSING"

audio voltages from the modulation transformer, and supplies the additional power required for positive or upward modulation. Both the power amplifier and side-band generator tubes are connected to the power amplifier output tank circuit, with the connection from the side-band generator tapped down at approximately two-thirds of the output tank inductance. Tuning of the output circuit is entirely conventional, since the side-band generator is inoperative with no modulation.

Portable transmitters using the system are in use by the military services and are made by Taylor-Western Transmitters, Los Angeles.

• • •

Thermoelectric Generator for Portable Equipment

By J. M. LEE

*Editors' Technical Associates
New York, N. Y.*

DURING THE WAR, an urgent need arose for a small, noiseless source of power for the charging of storage batteries and for the operation of small portable radio equipment. This power supply was to be used in isolated areas where conventional types, such as gasoline engine-driven generators, would not be readily available or the noise of operation would be objectionable.

The Signal Corps Engineering Laboratories were called upon to investigate the possibilities of a thermoelectric generator that would convert heat into electrical energy by

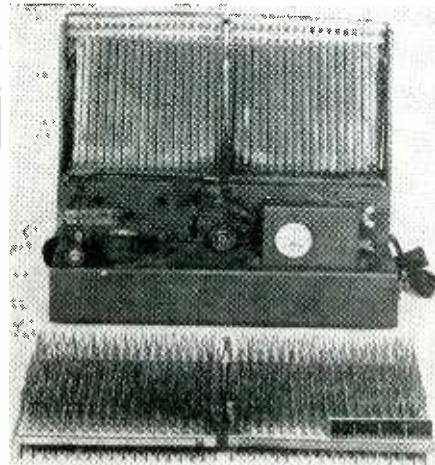

Twenty-watt thermoelectric generator with thermocouple unit removed to show assembly

**It Costs You Less
to Pay
a Little More
for
SILCOCKS-MILLER
PLASTIC DIALS**

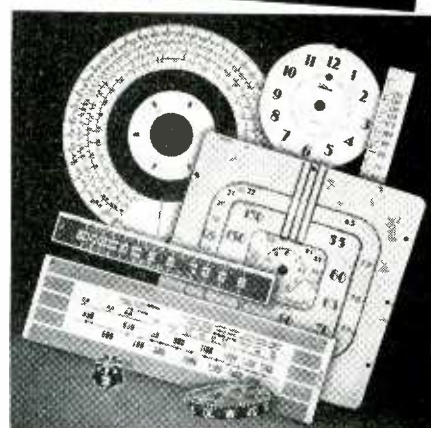

Quality, not quantity is the tradition at Silcocks-Miller.

Of course, we cannot make all the plastic dials industry requires, so we concentrate on producing only the best.

That's why design engineers who need plastic dials fabricated to close tolerances have come to depend on Silcocks-Miller craftsmanship through the years.

Our understanding of the problems, our ability to produce accurately and our thorough knowledge of all types of plastics enable us to supply your needs quickly and with a minimum of effort on your part.

That's why we can say "It costs you *less* to pay a little more for Silcocks-Miller quality."

Write for illustrated brochure today.

THE SILCOCKS-MILLER CO.
10 West Parker Avenue, Maplewood, N. J.
Mailing Address: South Orange, N. J.

SPECIALISTS IN HIGH QUALITY, PRECISION-MADE
PLASTICS FABRICATED FOR COMMERCIAL,
TECHNICAL AND INDUSTRIAL REQUIREMENTS.

WHEN THE INSULATION

GOES -



**BH SPECIAL TREATED
FIBERGLAS SLEEVING**
Tops in Electric Irons!

- Won't Fray When Cut
- Flexible and Strong
- Non-Burning to 1200°F!



YOUR TROUBLE STARTS!

WHAT does it mean to *you* when Mrs. Smith's electric iron goes *phht*? If electrical insulation is a part of *your* product, whether it's appliance, radio or electrical equipment, you, like the iron manufacturer, run this *risk*. The risk of insulation failure—of inconveniencing customers, jeopardizing good will, and possibly losing sales.

Since your product's performance may depend on a few cents worth of insulation, be sure to use the best. Assure trouble-free service with BH Fiberglas Sleeveing, the *original* non-fraying, non-stiffening, non-burning Fiberglas sleeveing.

An exclusive BH process combines *permanent* freedom from hardening, cracking or rotting with the many advantages of Fiberglas — including high dielectric and tensile strength, resistance to moisture, oil, grease and most chemicals.

Severest wartime uses prove beyond question the superior qualities of all three BH Fiberglas Sleeveings in electrical applications for home and industry. One of them may fit your needs to a "T"—*plus!* Write for free BH samples today and put them to the toughest tests your product can dish out!

3 GREAT BH FIBERGLAS SLEEVINGS—EACH 3 WAYS BETTER!



NON-STIFFENING*



NON-FRAYING*



NON-BURNING*



**BH EXTRA FLEXIBLE FIBERGLAS SLEEVING • BH SPECIAL TREATED FIBERGLAS SLEEVING
BEN-HAR COATED FIBERGLAS SLEEVING**

*Ask for sample folder giving degree above characteristics are combined in these three sleeveings.
All standard sizes and colors—available in standard 36-in. lengths and 500-ft. coils.



ALSO SLOW-BURNING IMPREGNATED MAGNETO TUBING • SLOW-BURNING FLEXIBLE
VARNISHED TUBING • SATURATED SLEEVING • A. S. T. M. SPECIFICATIONS

BENTLEY, HARRIS MANUFACTURING CO.

Dept. E Conshohocken, Penna.

Burlington

'DONUT' TRANSFORMERS



These transformers are designed for use with vane type ammeters which are used on frequencies from 25 to 133 cycles.

Maximum accuracy is obtained at 70% of full scale value and is dependent upon the number of primary turns used. Accuracy is directly proportional to the number of primary turns.

These transformers are designed for a capacity of two volt-amperes and the secondary windings are of such size as to allow in excess of 800 CM/ampere at maximum rating.

Insulation resistance is such that 4500 volts can be applied without breakdown.

Burlington Bulletin DT gives full information. Write for a copy today.

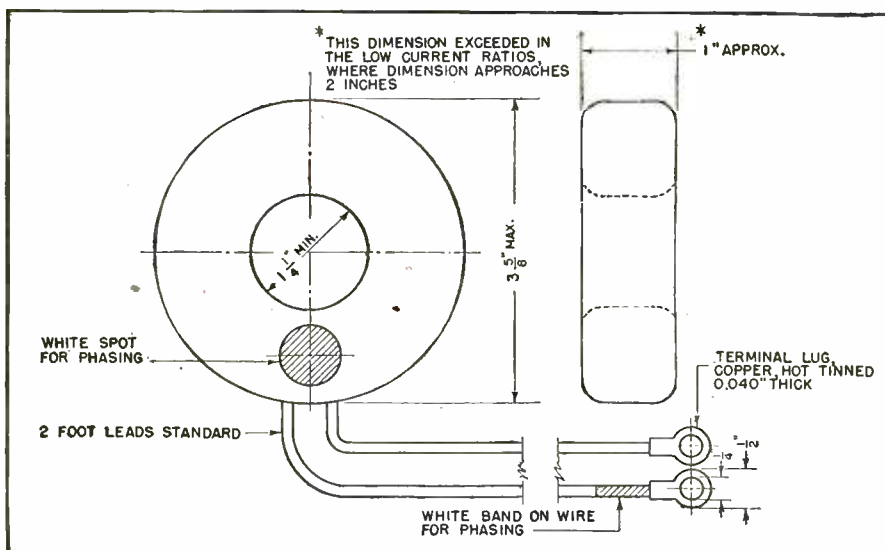

BURLINGTON INSTRUMENT COMPANY
109 Fourth Street **Burlington, Iowa**

applying heat to two dissimilar metals, setting up electro-chemical fluctuation between the two, and thereby generating an electrical potential. Since discovery of this theory by Seebeck in 1821, experimenters have attempted to produce a practical thermoelectric generator.

Early experimenters found that the combination of metals capable of delivering the highest thermoelectric power per degree F of temperature difference between junctions was an alloy of zinc and antimony against an alloy of copper and nickel. This type of thermocouple was found to be extremely brittle, had a low melting point, and was susceptible to oxidation at the junctions at elevated temperatures. This type would not be practical in a generator for military use, due to the rigid requirements

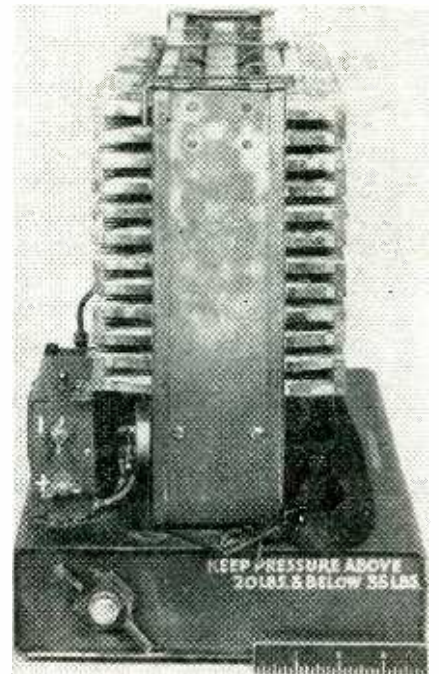

Side view of thermoelectric generator showing pressure-pump fuel cap and thermocouples in position

for ruggedness and possible rough handling during shipment and use in the field.

Alloy Combination

Investigation resulted in obtaining a thermocouple consisting of Chromel P against Constantan. This thermocouple could be readily arranged in banks by imbedding the units in a ceramic heat-resisting ma-



Quality is pure but not simple!

Pure because every step in the manufacture of this paper is controlled by science. Not simple because it requires unique technical skill to meet the specifications to which our papers are manufactured. Specify Schweitzer thin gauge paper for paper or electrolytic capacitors, coils, transformers or other applications using insulating papers in any thickness ranging from .00025" to .004".

SCHWEITZER PAPER CO.

182 CORNELISON AVENUE, Jersey City, N. J.
Plants: Jersey City, Mt. Holly Springs, Pa.
Research Laboratories:
Chrysler Bldg., New York, N. Y.

SPECIALISTS IN THIN GAUGE PAPERS

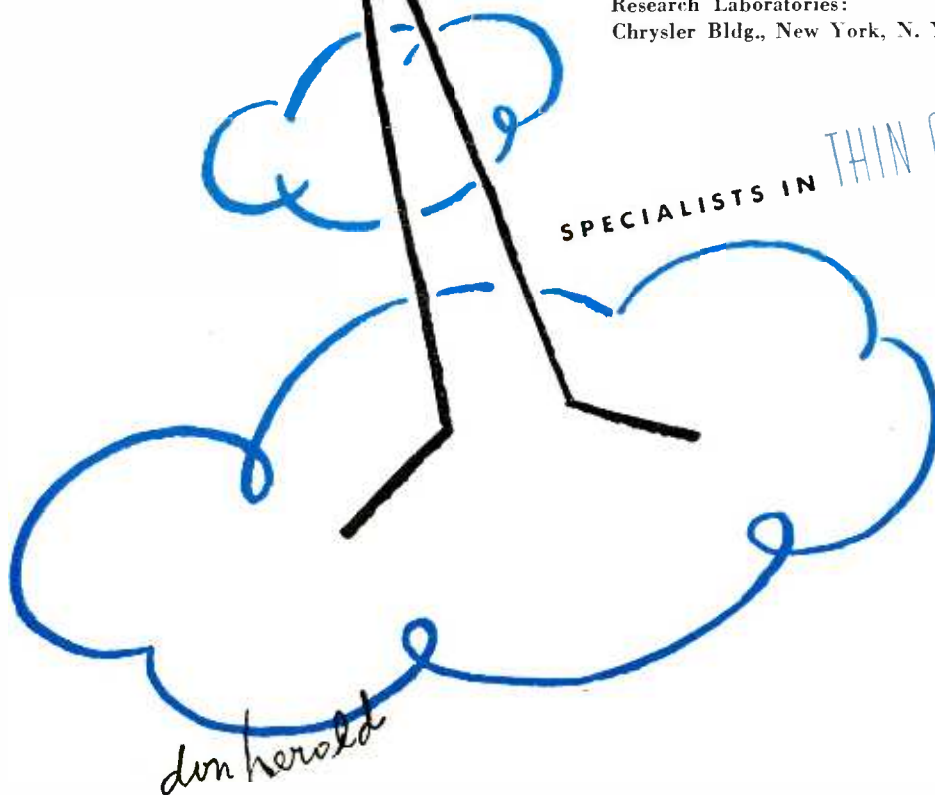

don herold

For FM and TV

NEW ANDREW COAXIAL CABLE WITH
51.5 OHMS IMPEDANCE!

Meets Rigid FM-TV Standards

A new coaxial cable, especially designed for FM and TV use, is now a reality at the Andrew Co. Scheduled for mid-June delivery to the first orders received, these new cables, in 4 sizes, introduce the following important engineering features:

1. Characteristic impedance of 51.5 ohms. (The regular Andrew cables for AM applications have a nominal impedance of 70 ohms.)
2. Connectors and associated fittings have been engineered with special care to avoid reflections and discontinuities. Being completely solderless, these fittings simplify installation and eliminate problems of flux corrosion and pressure leaks.
3. Insulators are spaced 12 inches apart in the 3 large size cables, and 6 inches in the $\frac{7}{8}$ -inch cable.
4. Improved low loss insulation material is used, having a dielectric constant of 6.0 and a maximum loss factor of .004 at 100 mc.
5. Close tolerances have been established on conductor and insulator dimensions, in order to maintain a constant characteristic impedance.
6. Inner and outer conductors are made of copper having a minimum conductivity of 95% IACS at 25° centigrade.

Your order now is the best assurance of early delivery on this new coaxial cable for your FM or TV installation.

Write or wire the Andrew Co., 363 East 75th Street, Chicago 19, Illinois, for complete information or engineering advice on your particular application.

ATTENUATION CURVE

Attenuation is calculated to provide for conductor and insulator loss, including a 10% derating factor to allow for resistance of fittings and for deterioration with time.

- The new 51.5 ohm air insulated coaxial cable for FM and TV comes in 4 sizes, priced tentatively as follows: $\frac{7}{8}$ " , 42c per ft.; 1 $\frac{1}{8}$ " , 90c per ft.; 3 $\frac{1}{8}$ " , \$2.15 per ft.; 6 $\frac{1}{8}$ " , \$5.20 per ft. Andrew Co. also manufactures a complete line of accessories for coaxial cables.

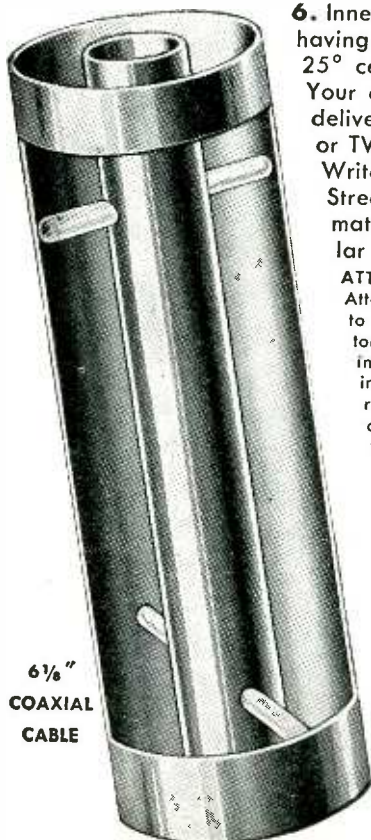
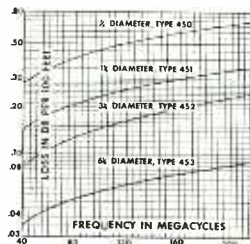

6 $\frac{1}{8}$ "
COAXIAL
CABLE



3 $\frac{1}{8}$ "
COAXIAL
CABLE

THERMOELECTRIC GENERATOR (continued)

terial. A silent gasoline-burning heater, capable of using 80 or 100 octane gasoline as a fuel, was then developed for placing a flame at the hot junction of each thermocouple.

Three types of generators were developed of 5, 10 and 20 watts capacity at output voltages of 2, 6 and 12 volts, respectively. The 20-watt generator is capable of supplying the power required to operate a 14-tube f-m radio transmitter and receiver.

The 5-watt thermoelectric generator is capable of delivering an output of 2½ volts at 2 amperes d-c, and can operate eight hours continuously on one gallon of fuel. This generator is used to charge the newly developed 2-volt portable lead-acid storage batteries, and portable radio equipment operating from a vibrator-type power supply. Two banks of thermocouples are used, each bank consisting of 84 thermocouples connected in series. The outputs of the banks can be switched either in series or parallel to deliver 2 volts at 2½ amperes or 2½ volts at 2 amperes, depending upon the load.

Temperature Gradient

The internal resistance of the 5-watt generator is approximately 1.75 ohms, and maximum power output is obtained when the resistance of the external load equals that of the generator. The hot junctions of the thermocouples are maintained at 1350 F and the cold junctions average 200 F, with a resultant temperature gradient of 1100 F between junctions of the thermocouples. The power developed by each thermocouple at this temperature gradient is approximately 0.012 volts at 2½ amperes. Connecting 168 of these thermocouples in series results in an output of 2 volts at 2½ amperes.

Controls for operation consist of a combination air pump and fuel tank cap, combination fuel level and air pressure gage, priming cup, air mixing chamber, fuel shut-off valve and needle valve for feeding vaporized gasoline to the burner.

The generators are designed for a weight of 2½ pounds per watt of energy output and their overall efficiency is 0.2 percent. In spite of the low electrical efficiency, the generator has such desirable features as no moving parts, extremely quiet operation, and up to two thousand



Why clinch, stake or weld ?

Just snap in a latching **SPEED NUT**



A SPEED NUT CASE HISTORY

A motor truck manufacturer used a battery of machines to clinch nuts in place for assembly of dash to cowl and attachment of instruments and equipment to dash. Two men were required to operate each machine . . . to handle the large stampings and position them for attachment of the fasteners. This extra handling meant frequent damage to stampings, and then after painting, nut threads had to be re-tapped.

30 self-retaining Speed Nuts are now snapped in place by hand on each stamping as it moves from the press department on conveyers. The entire assembly is completed in much less time, machines eliminated and costs substantially reduced.

In Canada: Wallace Barnes Co., Ltd., Hamilton, Ontario
 In England: Simmonds Aerocessories, Ltd., London
 In France: Aerocessoires Simmonds, S.A., Paris
 In Australia: Simmonds Aerocessories, Pty. Ltd., Melbourne

Sure, there are a lot of ways to attach nuts to mid-sections panels for blind location assembly, *but* they require expensive equipment, valuable floor space and skilled operators. Panels must be taken off conveyer, carried to press or welder and carefully positioned to attach the fasteners.

Now with Latching type Speed Nuts, panels stay right on the conveyer, and the assembler merely snaps the Speed Nuts in place by hand. These Speed Nuts are *self-retaining*, holding themselves firmly in place until the screw is driven from opposite side. Moreover, Speed Nuts provide a spring tension lock that holds tight under the most severe vibration.

We've developed many types of self-retaining Speed Nuts to simplify and reduce the cost of blind location fastening. We'll be glad to show you how they can improve the assembly of your product. Send in your details today!

TINNERMAN PRODUCTS, INC.

2106 FULTON ROAD • CLEVELAND 13, OHIO

Speed

MORE THAN 3000



Nuts

PATENTED
SHAPES AND SIZES

* Trade Mark Reg. U. S. Pat. Off.

F A S T E S T T H I N G

I N F A S T E N I N G S

For Output Measurement
VHF-UHF

**MODEL 63-A
 WATTMETER AND
 WIDE BAND LINE
 TERMINATION**



Guesswork in power measurement at ultra high frequencies is no longer necessary. Model 63-A Wattmeter effectively solves this problem while acting as an artificial antenna to dissipate power. For either general laboratory or production line testing, this instrument gives reliable power data and is consistent, delivering the same answers "day after day." Especially suited to 50 ohm circuits, Model 63-A, a war time development, is daily proving itself as valuable commercially as it was "in uniform."

We'd like to tell you more about this innovation in power measuring technique. Data sheets are available. Write Bird Electronic Corporation, 1800 East 38th St., Cleveland 14, Ohio, for your copy today.



BIRD ELECTRONIC

*Instrumentation for
 Coaxial Transmission*

hours of operation before replacement of the thermocouple banks is necessary. All parts may be replaced easily, and practically all the maintenance required is keeping the unit clean and making minor adjustments on the burner controls. It is capable of operating in a very wide range of ambient temperatures, or even in a heavy downpour of rain, without any noticeable effect on the output.

Although these particular units were not used to be great extent during the war, variations of the design were used throughout the world for specific applications. In some instances the generators served not only to supply electrical power for charging batteries or for operating radio sets, but also as a stove to cook food or keep personnel warm.



**Recording the War Trials
 in Four Languages**

AT THE NUERNBERG trials, every word in four languages is preserved by Signal Corps electronic film recorders for the official American records and historical reference. Each step in the legal proceedings of the International Military Tribunal is conducted in French, English, Russian and German.

Each person in the Nuernberg courtroom received a set of headphones and a small disk similar to a dial telephone with numerals from 1 to 6. Dialing No. 1 enables the listener to hear the verbatim courtroom proceedings. Contact No. 2 connects him with an English interpreter who translates the trial into a microphone as it progresses. Likewise, No. 3 has the Russian translation, No. 4 the French, No. 5 the German. No. 6 is a reserve channel. Each channel is connected to a Recordograph unit which records the testimony permanently on special 35-mm film.

Separate microphones are provided for the presiding judge, members of the prosecution, the defense and each of twelve interpreters.

Each interpreter has a monitor with buttons controlling yellow and red lights on a desk before the judge's bench. Should the speaker be talking too fast for an interpreter, the interpreter flashes a yellow light for him to slow down. Should the in-

DESIGNED AND ENGINEERED AT NO. 1 PLASTICS AVENUE

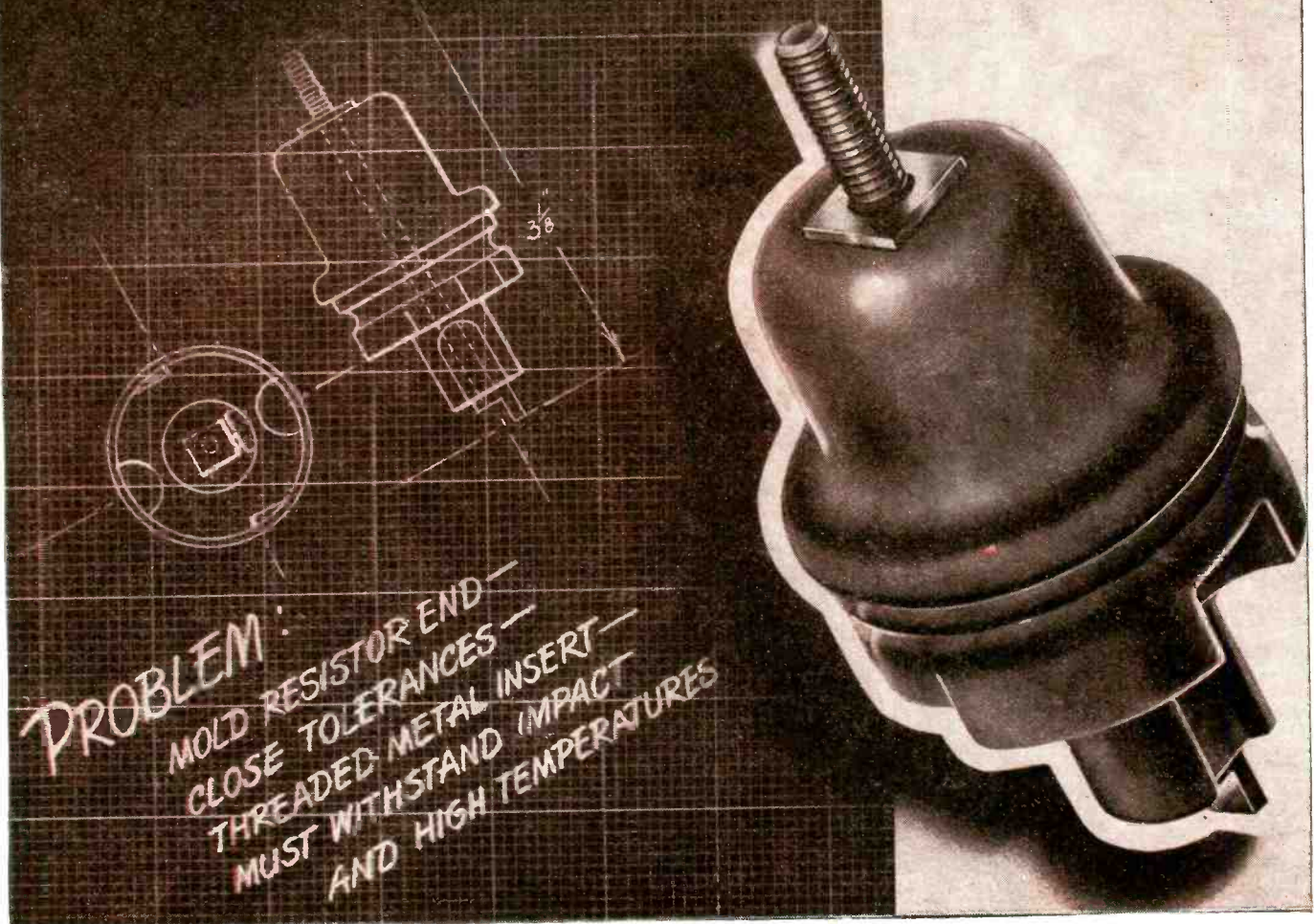

PROBLEM:
 MOLD RESISTOR END—
 CLOSE TOLERANCES—
 THREADED METAL INSERT—
 MUST WITHSTAND IMPACT—
 AND HIGH TEMPERATURES

G-E Mycalex — for safe-conduct through shock and heat

● Here is the end of a sealed tubular resistor unit that operates at extremely high temperatures. It forms the outside electrical connection of the unit.

Heat-resistant material designed to withstand impact had to be molded over a long threaded metal insert . . . to intricate dimensions so that a metal shell could be spun over it and held tightly in place. These exacting specifications were met by injection-molding G-E mycalex—compound of glass and powdered mica with a unique combination of properties.

Why not investigate the possibility of specifying

G-E mycalex for your own electrical components? This material is available to you in standard rods and sheets or molded to your design.

SEND FOR YOUR OWN COPY. A new bulletin on G-E mycalex is just off the press. A helpful design handbook, it contains complete and up-to-date information for solving your high-frequency insulation problems with G-E mycalex—a hard gray-colored, stonelike material with a unique combination of properties. Find out about new grades of G-E mycalex and new G-E mycalex molding techniques which make wider and more economical applications now possible. Fill in the coupon and mail it today.

GENERAL  ELECTRIC
GD46-M4



PLASTICS DIVISIONS (S-4), GENERAL ELECTRIC COMPANY
 1 Plastics Avenue, Pittsfield, Mass.

Please send me the new G-E mycalex Bulletin.

Name _____

Firm _____

Address _____

City _____ State _____

**THIS IS THE
TRANSFORMER
DESIGN...**

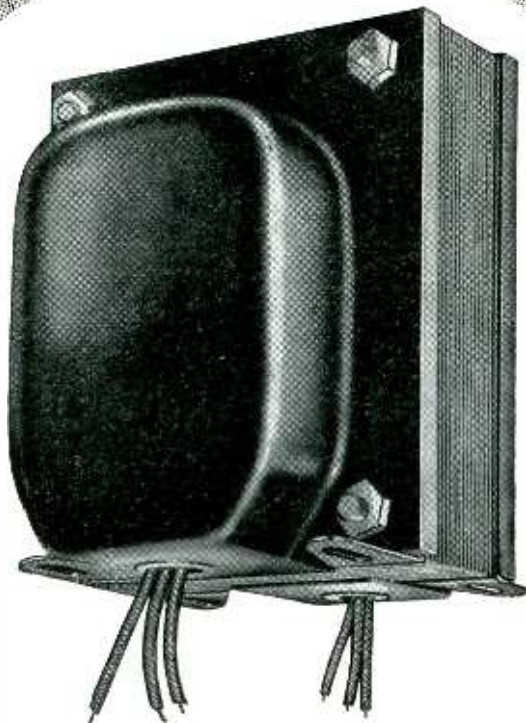

... THAT GUARANTEES FINEST PERFORMANCE

This is one of the basic Acme Electric transformer designs that has the mechanical features and basic physical appearance to provide for better than average performance. End bells protect coils from accidental damage. Leads may be brought out through bottom, front, sides or top to meet the requirements of the installation. Available in ratings from 35 VA to 500 VA. Send specifications to Acme Electric transformer engineers and enjoy the cooperation that has enabled manufacturers of electronic and radio products to improve performance through better transformer design. Bulletin 168 gives all details.

THE ACME ELECTRIC & MFG. CO.

TRANSFORMER ENGINEERS

31 Water St.

CUBA, N. Y.

Acme  **Electric**

RECORDING WAR TRIALS

(continued)

terpreter fall too far behind he flashes the red light for the speaker to stop until he has caught up.

The sound grooves are pressed or embossed by the recording needle in parallel lines on a 50-foot film of non-combustible cellulose acetate. It can be played back immediately after it is recorded, or filed away and re-played as required.



American electronic equipment at the Nuremberg war crimes trials includes an IBM switchboard at center, Western Electric control board in foreground, and a Frederick Hart recorder at right

The film records a total of 115 parallel sound tracks the full length of the fifty-foot strip which is spliced to form one continuous loop. As manufactured by Frederick Hart Co., a voice-actuated relay automatically starts and stops the machine.

The recording and playback needles on the machine automatically move across the film upon completion of each sound track. As the track is completed, the tracking indicator moves ahead one number, indexing the track. This index makes it possible to locate instantly any of the 115 sound tracks on the film should it be desired to play back any particular portion.

• • •

**Continuous Tuning for 44
to 216 Mc**

VARIABLE tuning without switching over the frequency range from 44 to 216 megacycles is continuously pro-

9 FACTORS in efficient, dependable, long-life RECTIFIER PERFORMANCE

CHATHAM engineers are specialists in rectifier design and production. Their concentration of effort in this field—the large scale production of rectifiers for industry and communication—has naturally culminated in exclusive design advancements and lowered costs. The CHATHAM rectifiers illustrated are but a few of the many types avail-

able. Although production is centered around standard types for complete interchangeability and to comply with industry wide standardization, each CHATHAM type incorporates proven advantages—mechanical and electrical—that improve performance and minimize replacements. Inquiries are invited; no obligation is incurred.



17 Grid Controlled Mercury Vapor Rectifier
 Peak inverse voltage 5,000 volts
 Peak plate current 2.0 amps
 Average plate current .5 amps
 Filament voltage 2.5 volts
 Filament current 5.0 amps
 Condensed mercury temperature 40° C to 80° C



3B28 Half Wave Xenon Rectifier
 Peak inverse voltage 10,000 volts
 Peak plate current 1.0 amp
 Average plate current .250 amps
 Filament voltage 2.5 volts
 Filament current 5.0 amp
 Ambient temperature range -75° C to +90° C



866A Half Wave Mercury Vapor Rectifier
 Peak inverse voltage 10,000 volts
 Peak plate current 1.0 amp
 Average plate current .25 amps
 Filament voltage 2.5 volts
 Filament current 5.0 amp
 Condensed mercury temperature 25° C to 60° C



394A Grid Controlled Argon-Mercury Vapor Rectifier
 Peak inverse voltage 1,250 volts
 Peak plate current 2.5 amps
 Average plate current .64 amps
 Filament voltage 2.5 volts
 Filament current 3.2 amp
 Condensed mercury temperature -40° C to +80° C



4832 Half Wave Xenon Rectifier
 Peak inverse voltage 10,000 volts
 Peak plate current 5.0 amp
 Average plate current 1.25 amp
 Filament voltage 5.0 volts
 Filament current 7.5 amp
 Ambient temperature range -75° C to +90° C



872A Half Wave Mercury Vapor Rectifier
 Peak inverse voltage 10,000 volts
 Peak plate current 5.0 amp
 Average plate current 1.25 amp
 Filament voltage 5.0 volts
 Filament current 7.5 amp
 Condensed mercury temperature 20° C to 60° C



884 Grid Controlled Argon Rectifier and Oscillator
 Peak inverse and peak forward voltage 300 volts
 Peak plate current 300 Ma
 Average plate current 75 Ma
 Average plate current (oscillator) 2 Ma
 Filament voltage 6.3 volts

WRITE FOR CATALOG DESCRIBING

CHATHAM RECTIFIERS

This informative catalog is now available without obligation. Address inquiries on company letterhead.



2050 Grid Controlled Xenon Rectifier
 Peak inverse voltage 1,300 volts
 Peak plate current 500 Ma
 Average plate current 100 Ma
 Filament voltage 6.3 volts
 Filament current .6 amps



CHATHAM ELECTRONICS

475 WASHINGTON STREET, NEWARK 2, NEW JERSEY

ARE YOU PLANNING TO GIVE MORE LISTENERS BETTER RECEPTION?

If you're planning to add load to your output, you can take a load off your shoulders by turning your antenna problem over to Blaw-Knox.

Unequalled experience in this field—backed by thousands of successful installations ranging in size up to 1000 feet—means that you can rely on Blaw-Knox for full responsibility in the fabrication of FM and Television Towers.

BLAW-KNOX DIVISION
of Blaw-Knox Company
2077 FARMERS BANK BUILDING
PITTSBURGH, PENNSYLVANIA

BLAW-KNOX

VERTICAL RADIATORS
FM and TELEVISION TOWERS

vided by an inductive tuning system that maintains a constant absolute bandwidth over its tuning range. It was developed by Paul Ware who described it at a joint meeting of IRE and the Radio Club of America in New York.

Variable Inductor

The tuner consists of a variable inductor in series with a fixed inductor of high Q. As the variable inductor is rotated on its ceramic form, it drives a sliding self-lubricating silver alloy contact. Motion of the contact changes the amount of inductance that is in the circuit. The tuner, assembled in its dust-tight box and used in airborne equipment, has been found to have less microphonics than a capacitance tuner as well as negligible noise, and long life.

The Inductuner will be standard equipment in all DuMont television sets so that no adjustment will be needed for station reception in any part of the country, or should FCC at any time decide to rearrange allocations within the limits of 44 to 216 megacycles.

• • •

CHTA, SACKVILLE, CANADA



Two engineers install one of the 100-kw water-cooled transmitting tubes at the Government-owned short-wave station in Canada. A special beam antenna gives a total effective power of 10 million watts to the station

MAILED FREE on request!

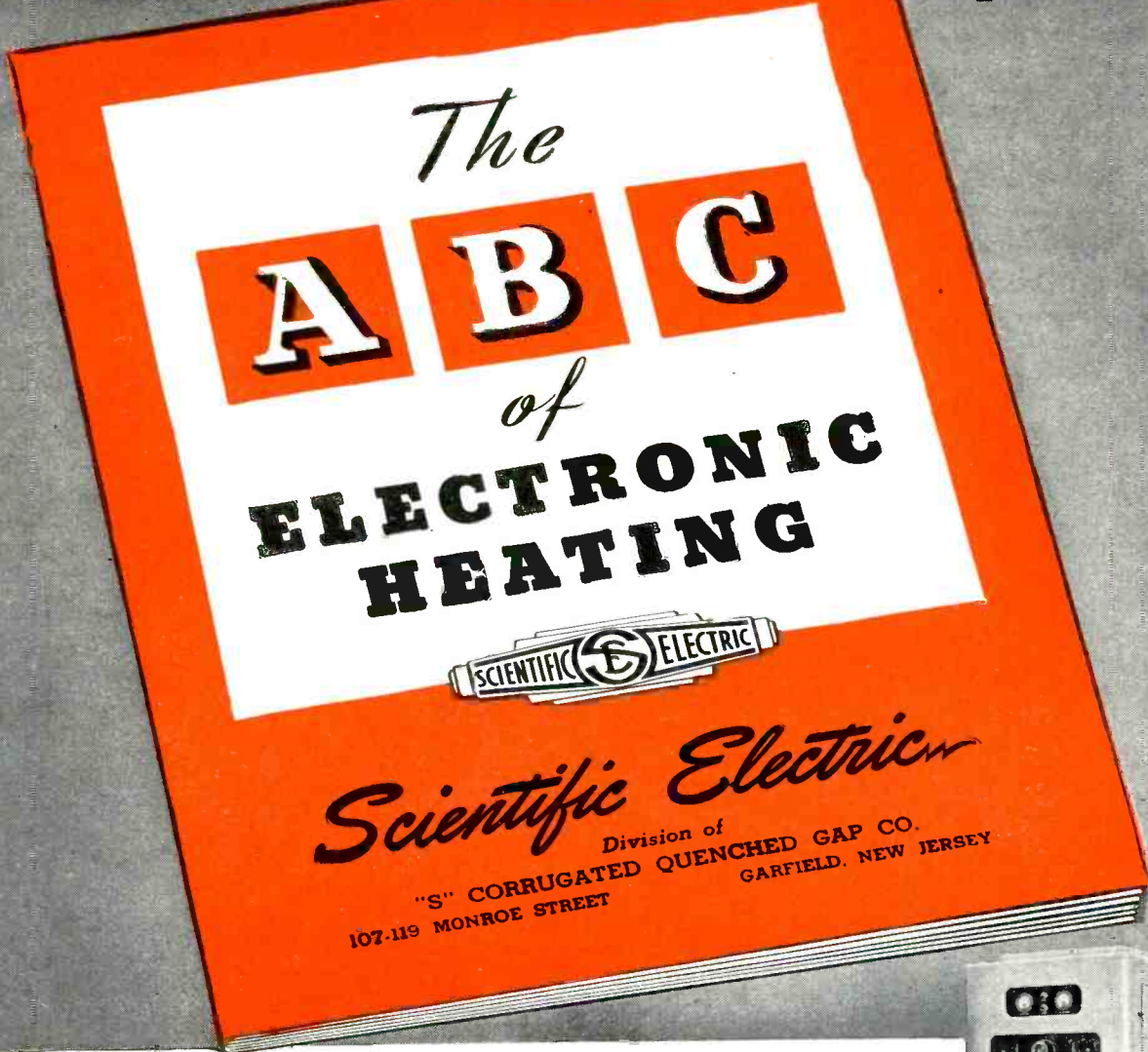

At last! Industries' *new and revolutionary heating process* explained in a language understandable to everyone. In fifteen minutes reading time, you will gain a complete basic knowledge of Electronic Heating. This important handbook discusses all the essential facts you have to know in considering the application of Electronic Heating to your own manufacturing methods.

It contains a brief record of the historical background and development of the process — explains the principle of its operation — describes the two chief methods and fields of application and lists many proved present-day uses.

Let us send you a complimentary copy at once. Fill in the coupon or write on your company letterhead.



Manufacturers of Vacuum Tube and Spark Gap Converters since 1921

Scientific Electric

DIVISION OF "S" CORRUGATED QUENCHED GAP COMPANY

107 Monroe Street

Garfield, New Jersey

USE THIS COUPON FOR CONVENIENCE

SCIENTIFIC ELECTRIC
107 Monroe Street, Garfield, N. J.

Please rush my complimentary copy of *The ABC of Electronic Heating* today to:

Name..... Title.....

Company Address.....

City..... State.....

THE ELECTRON ART

Frequency-Modulation Techniques	208
High-Level Detector	212
Sound-Pressure Measurement Standard.....	218
Patents	228

Frequency-Modulation Technique

GENERATION AND STABILIZATION of frequency-modulated carriers can be done by using pulses. Two such circuits are the frequency modulator using a nonlinear inductance described in the March *Bell Laboratories Record*¹ and the frequency control circuit developed by Westinghouse Electric Corp.² Both of these circuits are indicative of trends in design of electronic circuits. The inductance modulator is typical of the substitution of nonlinear circuit elements for vacuum tubes, a practice which has become necessary in circuits using so many tubes that the chances of a tube failing are high.

The frequency control circuit is representative of techniques depending, not on the amplification of vacuum tubes, but upon their rapid switching action. Using tubes in this manner circumvents complications arising from their nonlinearity. Both of these circuits depend for their operation on pulses.

Frequency Modulator

By taking advantage of the nonlinear characteristic of inductors having magnetic cores, a carrier can be frequency modulated. The quarter-inch diameter inductor consists of permalloy tape wound on a soap-

stone mandrel which is then wrapped with copper wire. This assembly is mounted in a shield that is filled with oil.

Because the terminal voltage of a saturable core inductor is proportional to the rate of change of flux in its core, that voltage will be higher during operation in the unsaturated region than in the saturated region, provided the exciting current changes at a uniform rate. This action is used in the circuit of Fig. 1A to develop pulses modulated in position.

The crystal-controlled carrier-oscillator sends a large current through the series resonant circuit C_2, L_2, L thereby developing a series of voltages pulses, shown by solid lines in Fig. 1B, across the nonlinear inductor L . The signal current also passes through the nonlinear inductor. Superposition of the signal current on the carrier current, shown in Fig. 1C, changes the time at which the current in the nonlinear inductor passes through the unsaturated region. The pulses are thus shifted in position as indicated by the dotted pulses in Fig. 1B. Only the negative

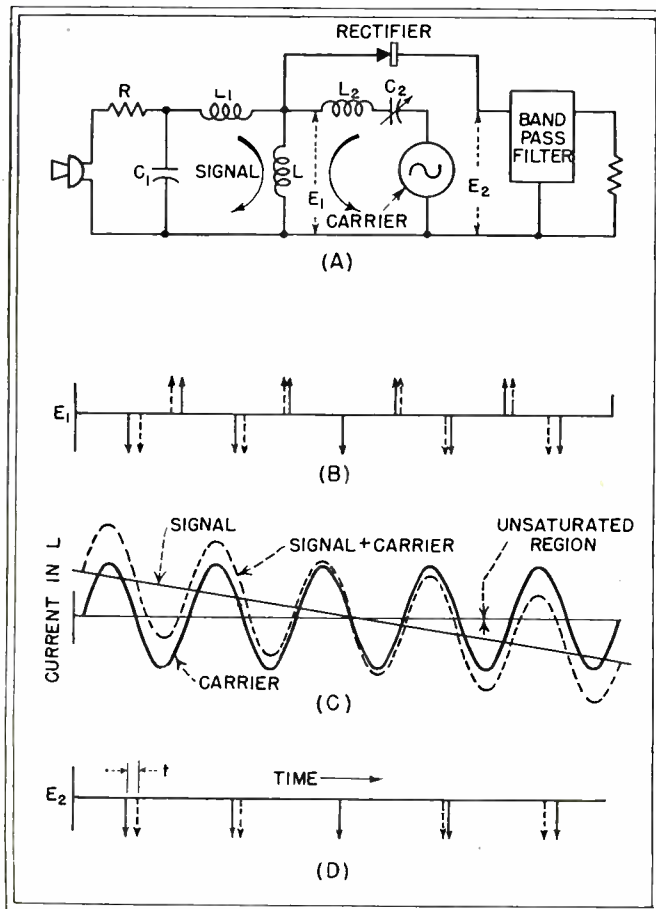

FIG. 1—Nonlinear inductor produces frequency modulation

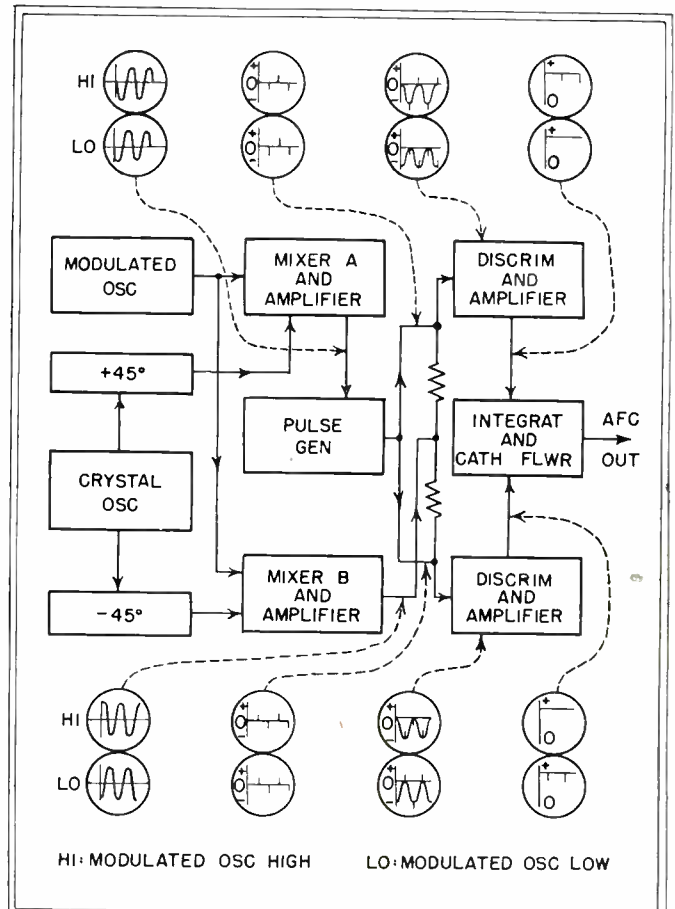

FIG. 2—Pulse counter stabilizes f-m oscillator

OHMITE

OFFERS THE WIDEST, MOST COMPLETE
RANGE OF TYPES AND SIZES IN

CLOSE CONTROL Rheostats

10 Wattage Sizes from 25 to 1000 watts,
from 1-9/16" to 12" Diameter, with Standard or
Special Features, with Uniform or Tapered
Windings, in Stock or Special Resistances,
in Single, Tandem or Concentric Units.

Only Ohmite provides such a wide range of types
and sizes . . . to give you a quick and correct answer
to your Rheostat needs. Stock models in 25, 50,
100, 150, 300, and 500 watt sizes in a wide range
of resistance values.

All models have the time-proved features of Ohmite
design—the pioneer design that revolutionized
rheostat construction. Every Ohmite unit assures
permanently smooth close control . . . under every
operating condition.

Get the benefit of Ohmite experience in countless
applications. Let Ohmite engineers cooperate in
solving your rheostat control problems.

OHMITE MANUFACTURING COMPANY
4817 FLOURNOY STREET, CHICAGO 44, U.S.A.

★ ★ ★

VISIT BOOTH NO. 72 AT THE RADIO PARTS AND
ELECTRONIC EQUIPMENT CONFERENCE AND SHOW
HOTEL STEVENS, CHICAGO, MAY 13-16

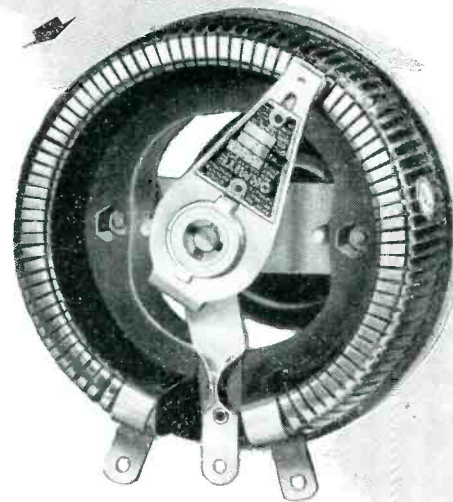
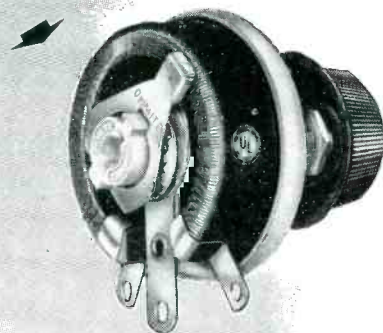

Send for Catalog and
Engineering Manual No. 40

Write on company letter-
head for this valuable
helpful guide in the selec-
tion and application of
rheostats, resistors, tap
switches, chokes and
attenuators.



Be Right with **OHMITE**
RHEOSTATS • RESISTORS • TAP SWITCHES

REGULATED D. C. UP TO 1000 VOLTS AT 500 M. A.

*Featuring continuously variable
output voltage Without Switching*

Listed below are four power supplies especially designed to cover a wide range of applications in development and production. These instruments feature continuously variable output voltage, good regulation, low hum level, good stability and overload protection. Models 200-B, 204-A 205-A and 207-B will operate from line input of 105 to 125 volts A.C. 50-60 cycles and provide rated regulation within this change. Examine the specifications carefully and you may find that one or more of these units has an application in your research or production program.



MODEL 204-A 0-500v D. C. at 300 MA.

Output Voltage:
0-500v D.C. at 300 Ma. regulated
6.3v A.C. at 6 Amps. unregulated
Regulation: Within 1% from 30-500 v
Hum: Within 10 millivolts at full load
Meters: 0-500v D.C.
0-300 Ma. D.C.
Negative or positive side of high
voltage output may be grounded.

MODEL 207-B 200-1000v D. C. at 500 MA.

Output Voltage
200-1000v D.C. at 500 Ma. regulated
Regulation: Within 1% from 200-1000 Volts
Hum: Within 20 millivolts at full load
Meters: 0-1000v D.C.
0-500 Ma. D.C.
Negative side of high voltage grounded.

MODEL 205-A 100-325v D. C. at 150 MA.

Output Voltage:
100-325v D.C. at 150 Ma. regulated
0-150v D.C. at 5 Ma. regulated by VR tube
6.3v A.C. at 6 Amps. unregulated
Regulation: Within 1% from 100-325v D.C.
Hum: Within 10 millivolts at full load
Meters: None
Negative or positive side of high voltage
output may be grounded.

MODEL 200-B 0-325v D. C. at 125 MA.

Output Voltage:
0-325v D.C. at 125 Ma. regulated
6.3v A.C. at 6 Amps. unregulated
Regulation: Within 1% from 20-325 V
Hum: Within 10 millivolts at full load
Meters: 0-500v D.C.
0-150 Ma. D.C.
Negative side of high voltage
grounded.



Detailed information on any or all of the instruments above will be sent upon request. Price and delivery information will also be forwarded at the time of your request.

ELECTRONIC MEASUREMENTS COMPANY

Red Bank



New Jersey

Regulated Power Supplies — Vacuum Tube Voltmeters — Signal Generators

pulses are passed by the rectifier to the band-pass filter, as shown in Fig. 1D.

The carrier current through the inductor is so large (as is necessary for linear signal-displacement of the pulse) and the unsaturated core region so narrow that the pulse harmonics are substantially equal in amplitude. As each harmonic is shifted by the same time, the high harmonics are shifted by a large phase angle. The band-pass filter passes one of the high harmonics, which, for a single sine-wave signal, is frequency modulated. Using a harmonic of the pulse is equivalent to usual frequency multiplication of phase-modulated signals to obtain wide-band frequency-modulated signals. The degree of modulation can be further increased by frequency multiplication after the filter.

To obtain frequency-modulation from complex waves, the resistance-capacitance network R, C_1 is inserted in the voice channel. Inductor L_1 blocks the carrier current from the voice circuit. Capacitor C_2 blocks the voice current from the carrier circuit.

Center Frequency Control

To keep the sidebands of a frequency-modulated carrier within the assigned channel requires stabilizing the central frequency against drift. In one type of control, the output of the frequency-modulated oscillator is mixed in a nonlinear impedance with the output of a crystal oscillator operating at the assigned carrier frequency. The number of cycles of the varying-pitch beat-note produced by this heterodyning while the carrier is on one side of its central frequency is proportional to the area under that part of the frequency excursion curve. Each cycle of the beat produces a pulse. The pulses produced while the frequency-modulated carrier is above its central frequency are passed to one circuit, those produced while it was below its central frequency are passed to another circuit. The difference between the number of these two sets of pulses controls the modulator to correct the central frequency of the carrier.

Figure 2 shows the sequence of these operations. The phase shifters are resistance-capacitance series cir-

Sometimes they are SIMPLER THAN THEY SEEM



EXTRUDED

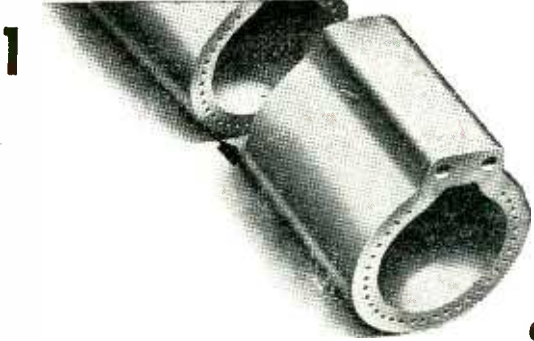

CUT



COUNTER-SUNK

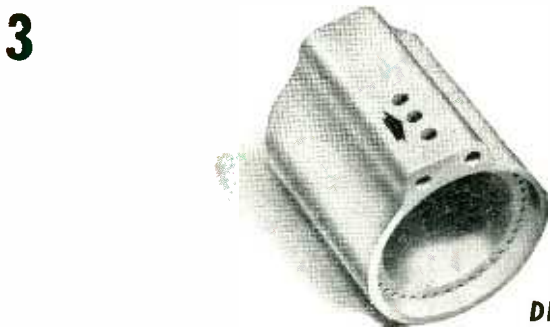

DRILLED

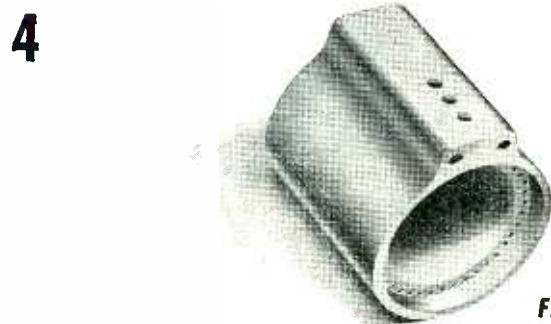

FIRED

SOME intricate ceramic designs machined from steatite seem unbelievably complicated. Actually they are simpler than they seem. By incorporating complex design details in extruded, pressed or cast basic shapes, American Lava Corporation frequently has been able to minimize the relatively slow and costly machining process. Production study may show desirable design alternatives which permit faster deliveries, lower cost.

Here in one organization you will find engineering vision and practical knowledge of AlSiMag technical ceramics, backed by highly versatile equipment of our own design. Send us your unusual, intricate, or complicated designs. Perhaps we can suggest practical design simplifications and streamline manufacture by a combination of production facilities and experience available from no other source. *We like tough jobs.*



Original Award July 27, 1942
Second Award February 13, 1943
Third Award September 25, 1943
Fourth Award May 27, 1944
Fifth Award December 2, 1944

AMERICAN LAVA CORPORATION
CHATTANOOGA 5, TENNESSEE

ALSiMAG

43RD YEAR OF CERAMIC LEADERSHIP

Case Histories from the RICHARDSON files

MOLDED PARTS

Problem: Produce a case for vital electrical indicating instruments. Must be lightweight, durable, high in dielectric strength and have a permanent finish.

Solution: Richardson Plastics used Molded INSUROK, Grade 1, finding in this specific grade and type a material ideally suited to the requirement. The result was a meter case having the precise characteristics desired.

Richardson Plastics are well equipped to help you solve your plastic problems—whatever they may be. For in the large family of INSUROK Precision Plastics, there is a type and grade to meet practically any requirement. Next time let us mold or laminate the kind of INSUROK you should have for better efficiency on your job.

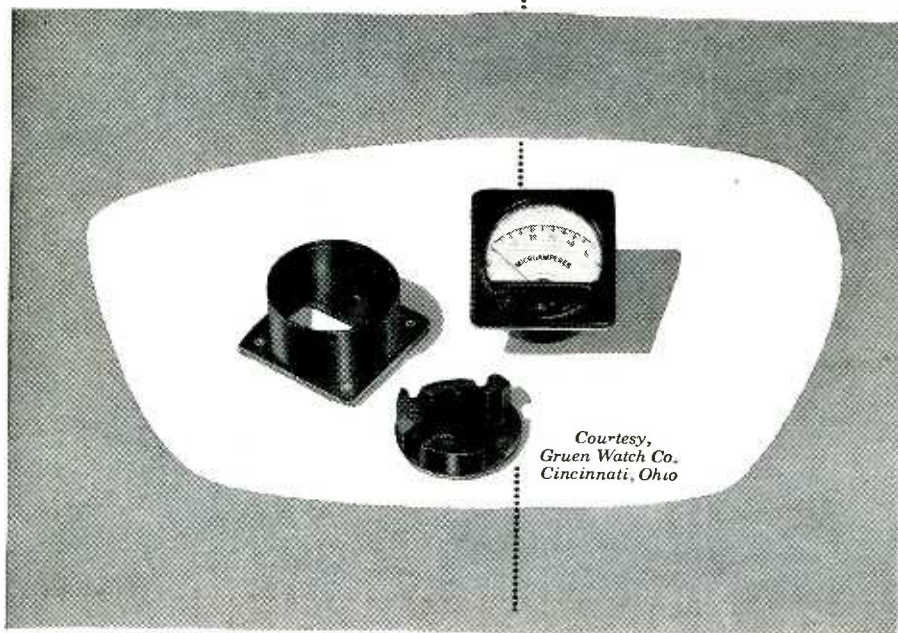

Courtesy,
Gruen Watch Co.
Cincinnati, Ohio

INSUROK Precision Plastics

The RICHARDSON COMPANY

LOCKLAND, CINCINNATI 15, OHIO FOUNDED 1858 Sales Headquarters: MELROSE PARK, ILL.

Sales Offices: NEW YORK 6 • CLEVELAND 15 • DETROIT 2

Factories: MELROSE PARK, ILL. NEW BRUNSWICK, N. J. INDIANAPOLIS, IND.

cuits. The pulse generator is a directly coupled multivibrator which converts the incoming sine wave into a square wave. The voltages at each of the plates of the multivibrator are differentiated giving two outputs, one a series of positive pulses, the other a series of negative pulses. Each of these series of pulses is superimposed on the output of mixer B and feed to their respective discriminators which consist of diodes biased just above the peak output of mixer B. When the pulses at one discriminator add to the mixer output, that discriminator conducts.

Because of the previously introduced phase shift of the reference oscillator output, the upper discriminator passes pulses when the modulated oscillator is above its central frequency, and the lower discriminator passes pulses when it is below. Conduction of one discriminator passes a definite charge from a point of fixed potential to a storage capacitor; conduction of the other discriminator removes an equal charge from the storage capacitor to a point of fixed potential. The charge of the storage capacitor is coupled through a cathode follower to the modulator tube to correct the central frequency of the modulated oscillator.

REFERENCES

- (1) Wrathall, L. R. Frequency-Modulation by Non-Linear Coils, *Bell Laboratories Record*, March 1946, p. 102.
- (2) Boykin, J. R., New FM Frequency Control Circuit, paper read at the fall meeting of the Detroit Section of I.R.E.

• • •

High-Level Detector

By J. C. RANKIN

*Australian Air Mission
Washington, D. C.*

METALLIC-OXIDE RECTIFIERS have been experimentally used for years in radio receivers, however, their use has been restricted to high-impedance circuits that are followed by audio frequency amplifiers. These amplifiers, unless carefully designed, introduce harmonic distortion. Coupling networks, especially the loudspeaker transformer, introduce frequency distortion.

High Level Detection

To avoid these sources of distortion a low-impedance high-level detector system, the basic circuit of



ROSEMARY TIERNEY
Personnel Mgr.



H. R. MENEFEE
Vice President
and Sales Manager

H. G. HAMILTON
President



L. C. PRATT
Chief Engineer



A. SKROBISCH
Chief Research
Engineer



WM. REARDON
Sales Engineer



C. RINDERLE
Asst. to President
and Comptroller



H. C. SCHLICKEK
In Charge of
Mech. Design



M. VOLSKI
Electrical
Engineer

The HEADWORK that makes motors go

EVERY manufacturing company is no more than a group of individuals working on various phases of the same job. A company is as capable, as ingenious, as easy to work with as the individuals who make it up—no more—no less. With this in mind, we present Our Company:

These are the men who pioneered—variable frequency motors . . . replaceable "capsule" bearings . . . snap ring construction for easy disassembly . . . who design and build our automatic winding and special purpose production equipment . . . who operate our factory on an up-to-date and progressive basis with "improve" constantly in mind.

When you buy an Eastern Air Devices product, this is the organization behind your job.



EASTERN AIR DEVICES INC.

585 DEAN STREET • BROOKLYN 17, N. Y.
Fractional Horsepower Motors and Blowers



C. KANTZ
Foreman,
Winding Dept.



A. T. GHEGAN
Foreman,
Assembly Dept.



S. WIMPIE
Electrical
Engineer



S. M. IGAUYE
Special Order
Engineer



P. YOUNG
Foreman,
Tool Room



W. F. SCHADEWALD
Foreman,
Press Room



L. BECKER
Factory
Engineer



G. BENNETT
Factory
Engineer



A. L. HANSEE
Purchasing
Agent



WM. KASINDORF
Foreman,
Machine Dept.



J. F. FERENCIK
Chief
Inspector



G. K. YOUNG
Factory
Manager



M. E. RUFF
Plant
Engineer



B. TICHY
Prod. Control
Manager



L. C. BENNETT
Supt., Methods
and Standards



S. A. BUEMI
Methods
Engineer



H. H. MOORE
Tool Design



R. VOLKMER
Auto. Machine
Design



P. J. LUSARDI
Time Study
and Standards

LARGE or small WE BUILD THEM ALL!



**MADE
ON
ALUMINUM**

Seletron

SELENIUM RECTIFIERS

When preparing details for circuits that require rectifiers of minimum weight and size plus continuous, trouble-free service . . . write SELETRON into your specifications right at the start!

These advanced-type selenium rectifiers built on aluminum are specially engineered for long life span, minimum weight; compactness, and maximum heat-dissipating value. No load is too big or too small for Seletron. Seven standard sizes of discs provide outputs ranging from 25 milliamperes to thousands of amperes. Arrangement of discs in an infinite number of series and parallel combinations makes possible stacks to meet your individual needs.

There are no fragile or moving parts in Seletron rectifiers, assuring less trouble in production and less trouble-shooting in the field. Write NOW for Seletron application data sheet! Seletron literature is free for the asking, as are recommendations of Seletron applications.



RADIO RECEPTOR CO., Inc.

Since 1922 in Radio and Electronics

251 WEST 19th STREET

NEW YORK 11, N. Y.

HIGH-LEVEL DETECTOR

(continued)

which is shown in Fig. 1, is suggested. It will be observed that all audio frequency amplification has been eliminated and that the only source of distortion is the detector.

This detector can be any single element metallic rectifier, such as used for battery chargers or toy trains. The output transformer operates at radio frequency and is constructed

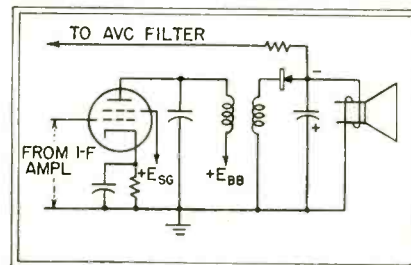

FIG. 1—Metallic-oxide rectifier simplifies audio output circuit

so that the tuned primary winding, in conjunction with the reflected impedance of the voice coil, substantially matches the plate resistance of the output tube. The radio-frequency impedance of the secondary winding is equal to the audio-frequency impedance of the loudspeaker voice coil.

The capacitance of the metallic oxide rectifier plates, which is detrimental in high impedance circuits, has little effect on this circuit. This capacitance may be in the order of 500 micromicrofarads but because it is in series with an impedance of approximately six ohms, it causes little loss.

The shunting capacitor C_1 can be $0.5 \mu\text{f}$ without affecting the audio frequencies; at 455 kc a $0.5 \mu\text{f}$ capacitor has a capacitive reactance of approximately 0.6 ohms and will bypass any radio frequency voltage which may be fed through the capacitance of the rectifier plates.

The voltage applied to the loudspeaker voice coil can also be used as a source of voltage for automatic volume control. As the detector operates into a low impedance load, the avc can be applied to the cathodes of the i-f amplifier tubes instead of their grids.

Circuit Modifications

The circuit, shown at Fig. 1, operates as a half-wave detector but greater output can be obtained by using a fullwave bridge rectifier, as shown in Fig. 2.

The metallic oxide rectifiers oper-

NEW EBY SOCKETS

Lock-In, Octal, and Non-Microphonic

LOCK-IN (Low Loss Ceramic)

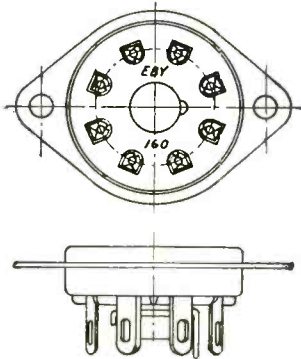

Chassis Hole— $1\frac{1}{16}$ " dia.
Mounting Centers— $1\frac{1}{16}$ "
Mounting—Top or Bottom

LOCK-IN

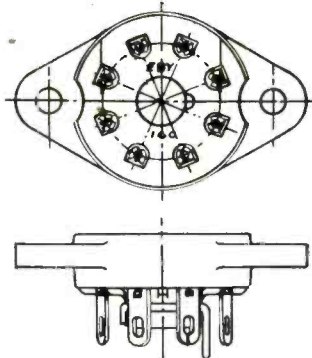

Chassis Hole— $1\frac{1}{16}$ " dia.
Mounting Centers— $1\frac{1}{16}$ "
Mounting—Top or Bottom

LOCK-IN

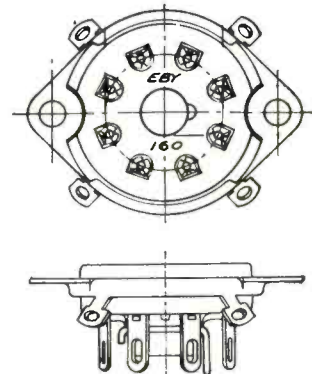

Chassis Hole— $1\frac{1}{16}$ " dia.
Mounting Centers— $1\frac{1}{16}$ "
Mounting—Top or Bottom
With or without Grounding Lugs

OCTAL

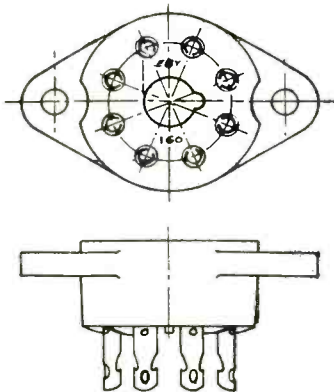

Chassis Hole— $1\frac{1}{16}$ " dia.
Mounting Centers— $1\frac{1}{16}$ "
Mounting—Top or Bottom

OCTAL

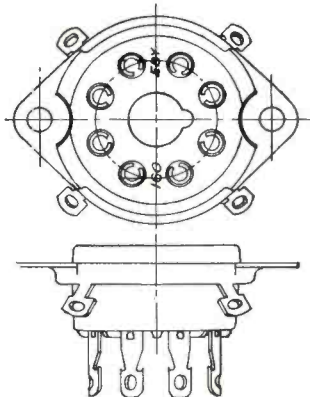

Chassis Hole—1" dia.
Mounting Centers— $1\frac{1}{16}$ "
Mounting—Top or Bottom
With or without Grounding Lugs

NON-MICROPHONIC (Miniature)

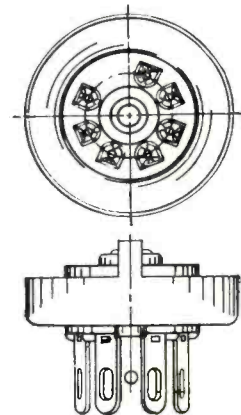

Chassis Hole— $\frac{11}{16}$ " dia.
Mounting Centers— $\frac{7}{8}$ "
Mounting—Top or Bottom

Write today for
complete details . . .

**HUGH H.
EBY**
INCORPORATED
18 W. CHELTEN BLDG.
PHILA., PENNA.

RIVET

with

ONE HAND ONLY

Rivet in glass, plastic, rubber, plywood, enameled surfaces—any kind of metal, wood or fabric. Real "BLIND" Riveting from one side of work. Here is a GENUINE CHERRY RIVET OUTFIT, gun and rivets complete—ready to go to work for you—operating on the famous "pull rivet" principle. It is exactly the same principle used on the billions of rivets on aircraft and other construction during the war when Cherry equipment could be obtained only on high priority. Fill out and mail the FREE TRIAL coupon below with a GUARANTEE of your complete satisfaction, backed by this big, well-established manufacturer.



Now you can rivet almost anything anywhere—make a neat, tight joint with rivets that don't work loose like screws or bolts. Rivet in tubes or completely enclosed assemblies or the hundreds of other places where you can reach one side of the job only.

Rivet materials that previously could not be fastened this way—brittle materials without danger of cracking or shattering—soft materials without buckling the rivet. Action is gentle but firm. No hammering or pounding. No hucking or backing up of any kind. It's all done with a steady, controlled PULL.



Send no money!

Kit, gun, or replacement rivets can be secured from your dealer. Or, just fill out and mail the coupon below. You can paste it on a penny postcard if you wish. Pay postman only \$2.48 plus slight C.O.D. charge and postage. Your Cherry Rivet Kit will be delivered complete with a generous supply of Cherry Rivets and instructions for their use. Try it out on almost anything that needs fastening—use Cherry Rivets instead of nails, screws, bolts and nuts. Do difficult, seemingly impossible jobs with it. Satisfy yourself it does all we claim for it. Then, if for any reason at all, you are not completely pleased with results, send the outfit back within ten days and every penny you spent for it will be returned.

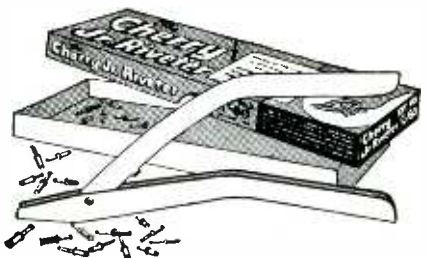

YOU GET THIS COMPLETE OUTFIT

This Cherry Jr. Riveter is a real Cherry Rivet kit—not a toy or sample. It is designed for the thousand and one casual jobs around the shop, office or home. EASY TO USE. It takes no special experience. Anyone can follow the simple directions with COMPLETE SUCCESS the first time. It's something you will be proud to have among your tools. Uses standard pull-through Cherry Rivets 3/32" in diameter.

PASTE THIS COUPON ON A POSTCARD

Cherry Rivet Company

Dept. A-120
231 Winston Street, Los Angeles 13, California

Send me one complete Cherry Jr. Riveter outfit, including a generous supply of rivets at \$2.48 plus postage and C.O.D. charges. I agree to pay postman on delivery. I understand I am to be completely satisfied or my money will be refunded on application within ten days.

Name _____
PLEASE PRINT

Address _____

City _____ Zone _____ State _____

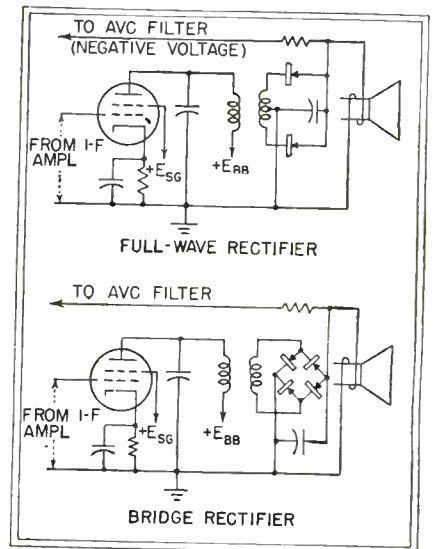

FIG. 2—Best results are obtained with a full-wave rectifier

ate fairly efficiently at 455 kc but greater overall stability and gain can be obtained by using a second converter in the receiver to produce approximately 50 kc on the grid of the power tube.

A volume control of the wire wound type can be inserted between loudspeaker voice coil and secondary winding of the output transformer. This control may be either a variable series resistance or a pad type attenuator. If a variable series resistance is used, when the volume is decreased the output transformer secondary no longer looks into a six-ohm load and the voltage across the secondary coil increases, consequently the avc voltage increases simultaneously with a decrease in volume at the loudspeaker. However, this feature cannot be utilized beyond a certain limit as it is necessary to maintain a load on the primary winding of the output transformer to prevent radiation and coupling between various stages of the receiver.

It will be noted that besides improving the fidelity, the use of a low-impedance high-level detector allows all tubes to contribute to the selectivity of the receiver.

Experimental Circuit

One experimental circuit used by the author was similar to that of Fig. 1; the output tube was a 6V6. This tube was fed from the final 455 kc i-f transformer of a small receiver. The primary winding feeding the 6V6

Special formulations
FOR SPECIFIC NEEDS!



Fibron

PLASTIC EXTRUSIONS AND TAPES

Users of flexible plastic extrusions or plastic tape secure a large increment of efficiency and economy when they specify "Fibron by Irvington." For the product they receive has been especially formulated for their own specific need. Should the *major* requirement be operation at elevated temperatures, a Fibron formulation for exactly that job can be supplied. Likewise for temperatures as low as -70°F ; or for services requiring resistance to acids, alkalis, corrosive fumes, and abrasion. In each case the correct Fibron formulation is supplied.

It is this Irvington policy of "*engineering and formulating* for specific applications," that accounts for the long service which Fibron plastic products provide . . . under many varied and difficult conditions.

Fibron flexible plastic extrusions can be manufactured to meet your requirements for shape, size and color; Fibron plastic tapes in a wide variety of colors, thicknesses and widths. An outline of your special requirements will receive immediate attention. Write Dept. 106.



IRVINGTON
VARNISH & INSULATOR CO.
Irvington 11, New Jersey, U. S. A.

"LOOK TO IRVINGTON FOR CONTINUED LEADERSHIP IN INSULATION"

The Difference Between "We Think So" and "We KNOW So"

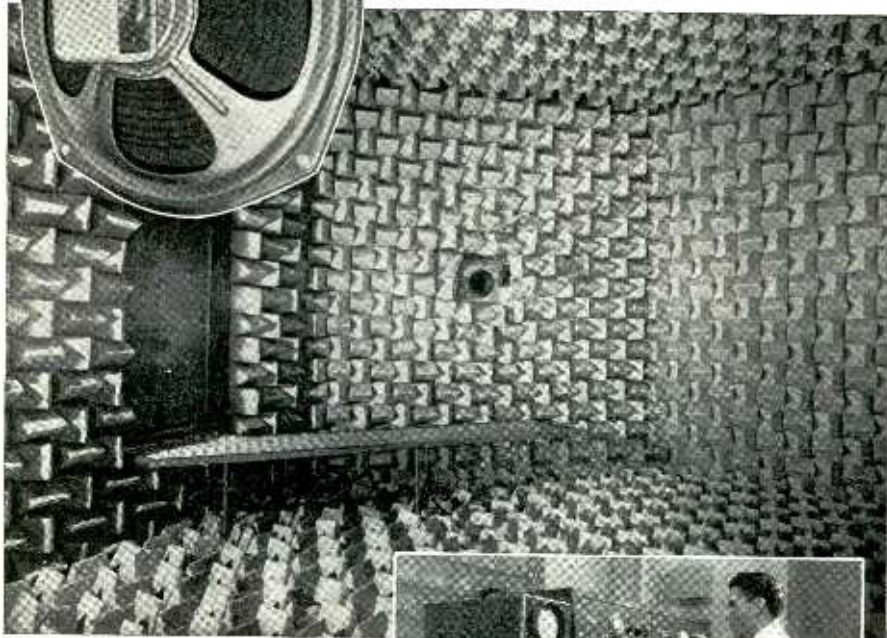

*Permoflux
Speakers*



**...are Engineered for Application in
this Stalactite Acoustical Chamber**

In this completely soundproof room, asymmetrical walls and carefully designed mass-interval baffles effectively reduce troublesome resonant harmonics and reflected sound to an insignificant value. Response curves are plotted which represent true performances so that Permoflux engineers can say "We Know So." Its use at Permoflux is characteristic of the many factors which make it possible to substantiate the fact that Permoflux Speakers provide the finest possible sound reproduction.

SEE US AT THE CHICAGO TRADE SHOW—BOOTH 32

TRADE MARK
PERMOFLUX
PERMOFLUX CORPORATION
4900 WEST GRAND AVE., CHICAGO 39, ILL.



PIONEER MANUFACTURERS OF PERMANENT MAGNET DYNAMIC TRANSDUCERS

HIGH-LEVEL DETECTOR

(continued)

was a broadcast antenna coil approximately $\frac{3}{4}$ inch in diameter, with the antenna winding removed. A variable capacitor in series with a fixed one tuned this primary winding. The secondary winding consisted of 15 turns of 20-gauge enamel covered wire wound over the bottom end of the primary; the position of this winding was made adjustable as the coupling position is critical.

It was found that the loudspeaker winding presented an inductive load which was reflected across the transformer primary and because of this fact more tuning capacitance than is normally required was needed to retune the loaded circuit to 455 kc.

When the correct coupling position is obtained, only a small amount of shielding is required and it was found that radiation from the power stage did not affect another receiver placed three feet away.

The rectifier is a single copper plate that is oxidized over an area $1\frac{1}{4}$ -inches square and pressed against a steel plate. Using the full-wave circuit, about two-watts output was developed from a 6V6. Listening tests indicated that fidelity was comparable to a console receiver.

The low-impedance high-level detector can be applied to phonograph amplifiers by modulating an oscillator with the pickup voltage, and amplifying and detecting as described above.

• • •

Sound-Pressure Measurement Standard

By FRANK MASSA
Massa Laboratories, Inc.
Cleveland, Ohio

BASIC REQUIREMENT of a good sound-pressure measurement standard is that it give an exact reproduction of the sound pressure wave as it existed at a point before the microphone was introduced. The instrument to be described satisfies this requirement over a wider frequency range and a greater dynamic range than other microphones generally available for making absolute sound pressure measurements. In addition the new standard shown in Fig. 1 is extremely rugged, simple to use, and permits measurement of sound pres-

New! L-A-R-G-E-R Size Sheets of



Make Possible Many
Additional Uses for this
Superior Insulation

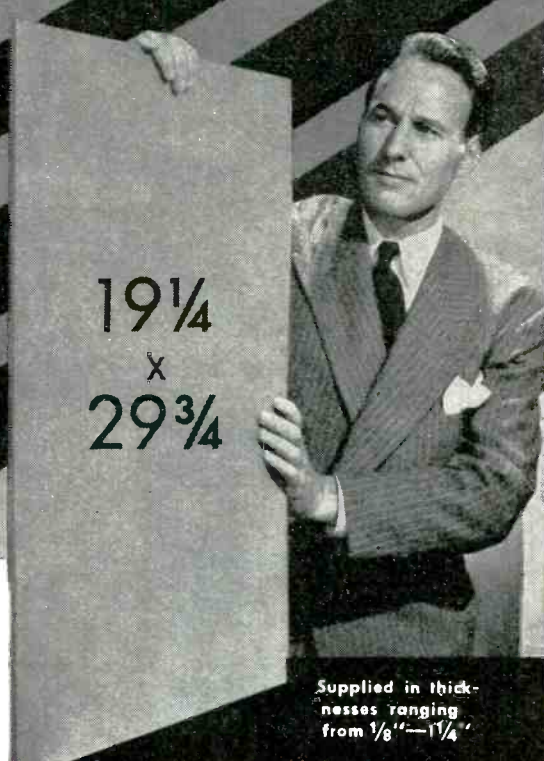

Supplied in thick-
nesses ranging
from 1/8" - 1/4"

Now You Can Use MYKROY For:

- Large Terminal Boards
- Switch Board Panels
- Large Inductance Bars and Strain Insulators up to 29 inches long
- Switch Connecting Rods
- Transformer Covers
- Large Meter Panels
- Bases for Radio Frequency and Electrical Equipment assemblies requiring large one-piece sheets

HERETOFORE the largest sheet of glass-bonded mica insulation available measured 14 1/2" x 19 1/4". By doubling the size, Electronic Mechanics, exclusive manufacturers of Mykroy, now afford Design and Production Engineers many important, new application and fabricating advantages.

Lower Cost per square inch affects savings as high as 33% depending upon work piece size, greatly reducing the cost per fabricated part. Better Cutting efficiency lowers cost still further extending the use of Mykroy to a longer list of electronic applications where formerly cost prohibited its use.

Get the full facts about this versatile dielectric now. Ask for a copy of the new MYKROY BULLETIN 102 which describes the new, larger 19 1/4" x 29 3/4" sheets.



MADE EXCLUSIVELY BY

ELECTRONIC MECHANICS
INC.

70 CLIFTON BLVD., CLIFTON, N. J.
CHICAGO 47; 1917 W. Springfield Ave., Tel. Albany 4310
EXPORT OFFICE: 89 Broad Street, New York 4, New York

MYKROY IS SUPPLIED IN SHEETS AND RODS — MACHINED OR MOLDED TO SPECIFICATIONS

MECHANICAL PROPERTIES*

MODULUS OF RUPTURE.....	18000-21000 psi
HARDNESS	Mohs Scale 3-4 BHN, BHN 500 K9 Load. 63-74
IMPACT STRENGTH.....	ASTM Charpy .34-.41 ft. bs.
COMPRESSION STRENGTH.....	42000 psi
SPECIFIC GRAVITY.....	2.75-3.8
THERMAL EXPANSION.....	.000006 per Degree Fchr.
APPEARANCE.....	Brownish Grey to Light Tan

ELECTRICAL PROPERTIES*

DIELECTRIC CONSTANT.....	6.5-7
DIELECTRIC STRENGTH (1/8").....	630 Volts per Mil
POWER FACTOR.....	.001-.002 (Meets AWS L-4)

***THESE VALUES COVER THE VARIOUS GRADES OF MYKROY**

- GRADE 8 Best for low loss requirements.
 - GRADE 38. Best for low loss combined with high mechanical strength.
 - GRADE 51 Best for molding applications.
- Special formulas compounded for special requirements.

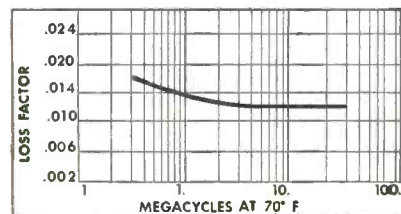

Based on Power Factor Measurements made by Boonton Radio Corp. on standard Mykroy stock.

THE ART OF ACCURACY

THE

QUAKER CITY CRAFTSMEN, USING THE MOST

MODERN MACHINES PRODUCE PRECISION GROUND

FORM WORMS ... OUR RIGID STANDARDS ARE NOW

MEETING EXACTING DEMANDS OF THE ELECTRONICS

INDUSTRY ... YOUR INQUIRY WILL BE APPRECIATED

AND WILL BE GIVEN PROMPT ATTENTION.



QUAKER CITY GEAR WORKS, INC.

**1918 NORTH FRONT ST.
PHILADELPHIA 22, PENNA.**

SOUND MEASUREMENT

(continued)

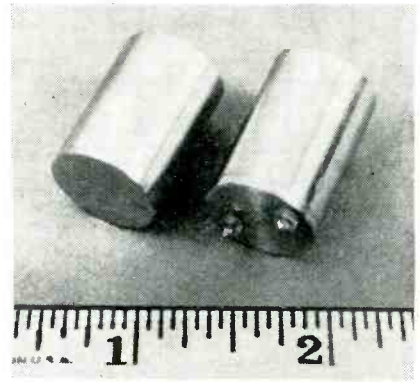

FIG. 1—Acoustic measurement standard

sure on an absolute basis with no more effort than is usually employed in obtaining relative measurements.

Requirements of Standard

Uniform response over the audio-frequency range, although unnecessary for some measurements, is desirable. For example, if distortion characteristics of sound generators are to be measured, the apparent harmonic content depends on the variation in the response characteristic of the measurement microphone. Attempts to compensate for irregularities in the response by electrical networks, in addition to being involved, may introduce electrical phase shifts in the system that, in themselves, cause further errors in the measurement.

A wide dynamic range is necessary for accurate measurement of intense sound pressures such as exist near the throat of a high-powered horn loudspeaker, or inside sound filters or conduits. For a microphone to possess a wide dynamic range, it is essential that the electro-mechanical constants of the vibrating system be inherently linear for large variations in applied pressure.

The importance of high acoustic impedance throughout the audible range compared to the environment is not generally appreciated. If this condition is not fulfilled, insertion of the microphone at the point where the sound pressure measurement is to be made can completely disturb the sound pressure field which existed at the point before the microphone was introduced, and the measurement obtained might be in very considerable error.

To measure true pressure at a point, physical dimensions of the

**HERE'S A NON-HYGROSCOPIC,
NON-CORROSIVE WRAP FOR
Small ELECTRICAL COILS**

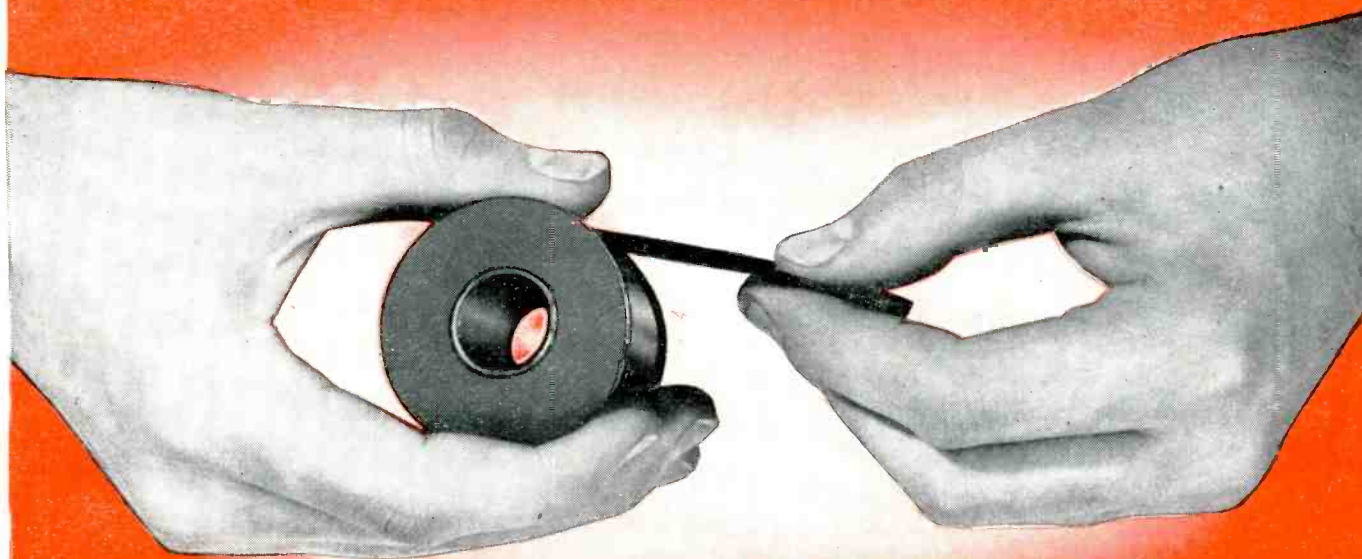

SCOTCH CELLULOSE ACETATE CLOTH ELECTRICAL TAPE

It comes in rolls of exactly the right width to fit small coils—
is non-hygrosopic and non-corrosive. Contains no animal
glue or ionizable material.

Coils sealed with "SCOTCH" Acetate Cloth Electrical Tape will
not open up under the most severe atmospheric conditions.

Send for a sample roll of "SCOTCH" Acetate Cloth Electrical
Tape No. 10 (white) or No. 11 (black). Address Dept. E5,
Minnesota Mining & Mfg., Company, St. Paul 6, Minnesota.

SCOTCH *Electrical* **TAPES**
BRAND

Made in U. S. A. by **MINNESOTA MINING & MFG. CO.**, Saint Paul 6, Minn.

THE **3M** COMPANY

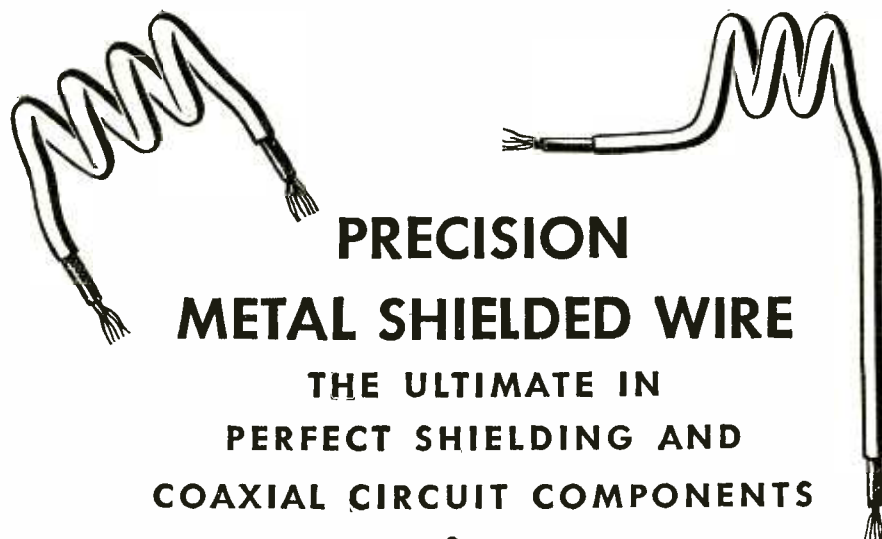

PRECISION METAL SHIELDED WIRE

THE ULTIMATE IN PERFECT SHIELDING AND COAXIAL CIRCUIT COMPONENTS

***Better because it is Shielded with
Seamless Metal Tubing***

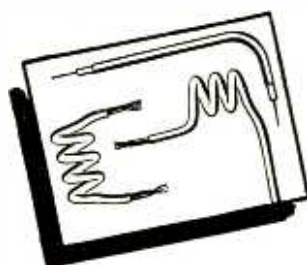

QUALITY, PERFORMANCE

Precision metal shielded wire is especially suited for closely coupled air core transformers, shielded grid, filament, and antenna leads, and wherever low-loss transmission is required.

VARIETY

A single inner conductor or number of conductors can be shielded with seamless copper, brass, aluminum, or nickel tubing, plated if desired, in random or cut lengths, or formed to customers' specifications. Outside diameters range from 0.018" to 0.375", with any desired wall thickness.

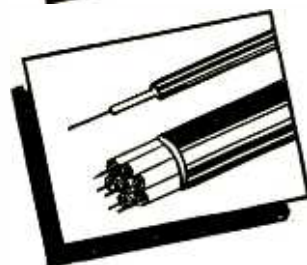

STABILITY

Formed parts are self-supporting. This simplifies assembly and enhances appearance. Rapid changes in barometric pressure, temperature, and humidity do not cause injurious moisture condensation. Dirt is excluded. Since tube is seamless and dielectric is continuous, conductor and shield remain coaxial even when formed into coils or other intricate components.

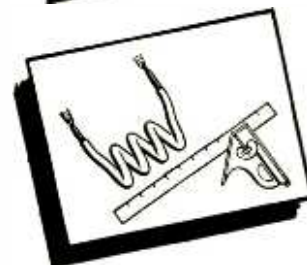

EASY TO HANDLE

Tubing is easily stripped and formed right on the job, or can be furnished cut to exact length, stripped and formed, ready for instant application.

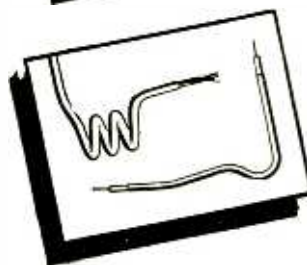

PRECISION METAL SHIELDED WIRE offers many advantages. It is an absolute method of shielding insulated wire or wires with seamless aluminum, copper, brass, or nickel tubing to provide the most perfect shielding yet devised against electrical interference, noise, moisture, or mechanical damage. As a coaxial line, it provides low loss over a range of frequencies and uniform capacity. Unlimited combinations of desirable electrical characteristics are available to meet your most exacting requirements.

We will be glad to cooperate on engineering problems. Write for further information.

PRECISION TUBE COMPANY

3826 Terrace Street, Philadelphia 28, Pa.

measurement standard must be small compared with the shortest wavelength of the sound. If the structure is large enough to cause appreciable diffraction, the microphone will show sensitivity variations with angle. Knowledge of the direction along which the sound wave is travelling will then be required before the microphone can be used intelligently. In some cases, even for work in the lower frequency range, it is necessary to have a microphone as physically small as possible. A typical example is one in which sound pressure measurements are made inside relatively small chambers in which insertion of the microphone must not appreciably upset physical dimensions of the enclosure, nor must its presence reduce the acoustic impedance of the system.

In addition to having uniform response characteristic, a good measurement standard should have an electrical impedance characteristic that can be easily used with conventional electronic circuits. An undesirable impedance characteristic is one in which large variations in magnitude occur over relatively small ranges of frequencies, whereas a satisfactory impedance is one presented by a single circuit element over the entire audible frequency range. A microphone with a smooth electrical impedance characteristic can readily be adapted to modified input circuits when special measurements are to be made.

Design Details

One means for realizing these ideal requirements is to employ a stiffness-controlled vibrating system. (W. M. Hall, *J. Acous. Soc. Am.*, July, 1932, and Harrison and Flanders, *J. Acous. Soc. Am. Supplement* to July, 1932.) The inherent limitations of the strength of materials, however, makes it impossible to stretch a diaphragm sufficiently to satisfy the basic requirement of high acoustic impedance at the higher audio frequencies. In fact, the natural resonance of a small stretched diaphragm generally cannot be extended beyond 10 to 15 kilocycles, so that severe variations in the acoustic impedance, which can greatly upset a high-frequency sound field, are certain to occur above this limit.

To avoid inherent limitations of a

Receiving Diversity Tone Keyer

Designed, Engineered

and Built to Work

for the World's Most

Critical Employer . . .

The International Press

MODEL R-626

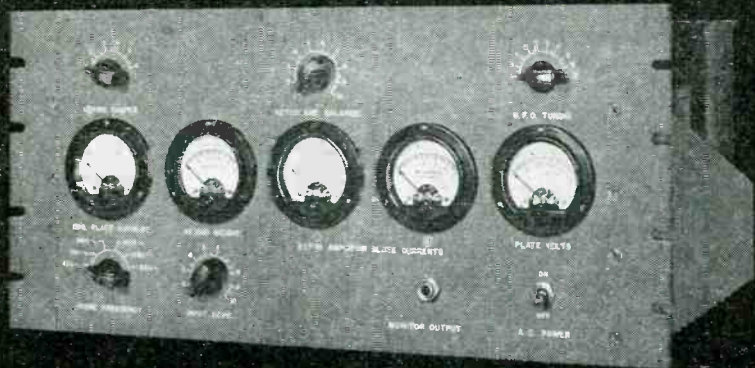

It's to the credit of Press Wireless that its international communications systems and their components have for a decade and a half stood up to the task of delivering the tens-of-thousands of words of vital, high speed radio communications traffic daily demanded by the press of the world.

The R-626 Tone Keyer, like all other Press Wireless developed equipment, has been carefully designed by experienced engineers; the men who for years have been charged with the responsibility of planning, installing and operating the vast array of equipment which makes up the Press Wireless international radio press circuits.

**R-626 RECEIVING
DIVERSITY TONE KEYS
CHARACTERISTICS**

- Connections for diversity receiver operation
- Multiple fixed-frequency receiving feature
- High keying speeds better than 1000 w p m
- Constant amplitude keyed audio output to + 20 vu
- Input requires minimum of only 1 volt from 2nd detector of one or more receivers.
- Output selectable for anyone of 6 standard filter tones
- Reduced keying bias with front panel "shaper" control
- I-F Monitor circuit for precise receiver i-f adjustment
- Built-in, 110 volt, 50/60 cycle power supply
- Standard 19-inch rack mounting



PRESS WIRELESS MANUFACTURING

C O R P O R A T I O N

Executive Offices: 38-01 35th AVENUE, LONG ISLAND CITY 1, NEW YORK

FRANKLIN LAMITEX

(LAMINATED BAKELITE)

is so versatile!

Pictured below just a few of the many thousand various parts we at FRANKLIN FIBRE-LAMITEX have furnished completely machined to exacting specifications for countless uses.

SHEETS, RODS and TUBES FABRICATED OR MOLDED PARTS

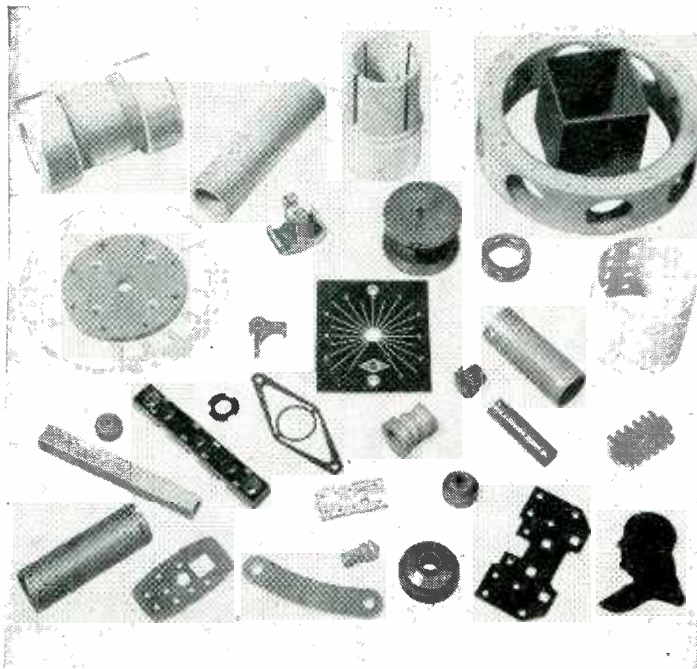

FRANKLIN LAMITEX and VULCANIZED FIBRE are highly machinable. We will machine parts if you lack facilities—or furnish sheets, rods, and tubes. Both LAMITEX and FRANKLIN FIBRE can be drilled, tapped, turned, threaded, punched, shaved, bored, reamed, sawed, milled or completely fabricated into automatic screw machine parts.

Check these FRANKLIN LAMITEX characteristics

- High dielectric strength
- Low power factor
- Low moisture absorption
- Remarkable dimensional stability
- High mechanical strength
- Low co-efficient of thermal expansion
- Low in weight (about half that of aluminum)
- Unaffected by solvents and oils
- Unaffected by most organic acids, dilute mineral acids or salt solutions

SEND FOR CATALOG CONTAINING COMPLETE DATA.

FRANKLIN FIBRE-LAMITEX CORP.
WILMINGTON, DEL. — 187 LAFAYETTE ST., NEW YORK 13, N. Y.

stretched diaphragm, we have developed a rigidly housed precision assembly of a number of piezoelectric crystal plates within a metallic cylinder as illustrated in Fig. 2. The mechanical structure was designed to keep the system stiffness-controlled to well beyond 30 kc, and both the electrical and mechanical constants are unaffected by temperature changes up to 160 F and are truly represented by single circuit elements over the audible frequency range.

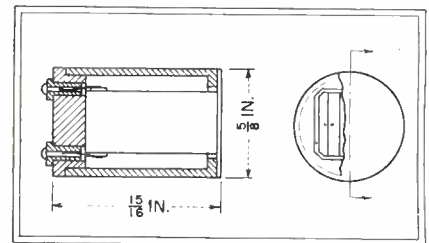

FIG. 2—Microphone consists of a pile of crystal plates within a rigid housing

An indication of the amount of deviation from stiffness-control of a vibrating system may be learned from the change in phase angle of the impedance of the mechanical system with frequency. An ideal system would show a phase shift in the mechanical impedance equal to minus 90 degrees over the entire audible range. The phase shift of this microphone does not deviate from the ideal until about 35 kc, indicating stiffness control throughout the audio range.

Acoustic impedance of the measurement standard is only slightly greater than the acoustic impedance of 0.001 cubic centimeters of air. Thus this microphone will offer negligible disturbance to a sound pressure field even when such measurements are made under unusual conditions, such as in artificial ear cavities. The electrical impedance of the microphone is equivalent to a 100 micromicrofarad capacitor throughout the entire audible range. This high capacitance is obtained by the multiplicity of crystal plates previously mentioned.

Applications

A stretched-diaphragm type of microphone is limited in its ability to accurately measure intense sound pressure because of the relatively small permissible deflection of the

High Frequency Relays...

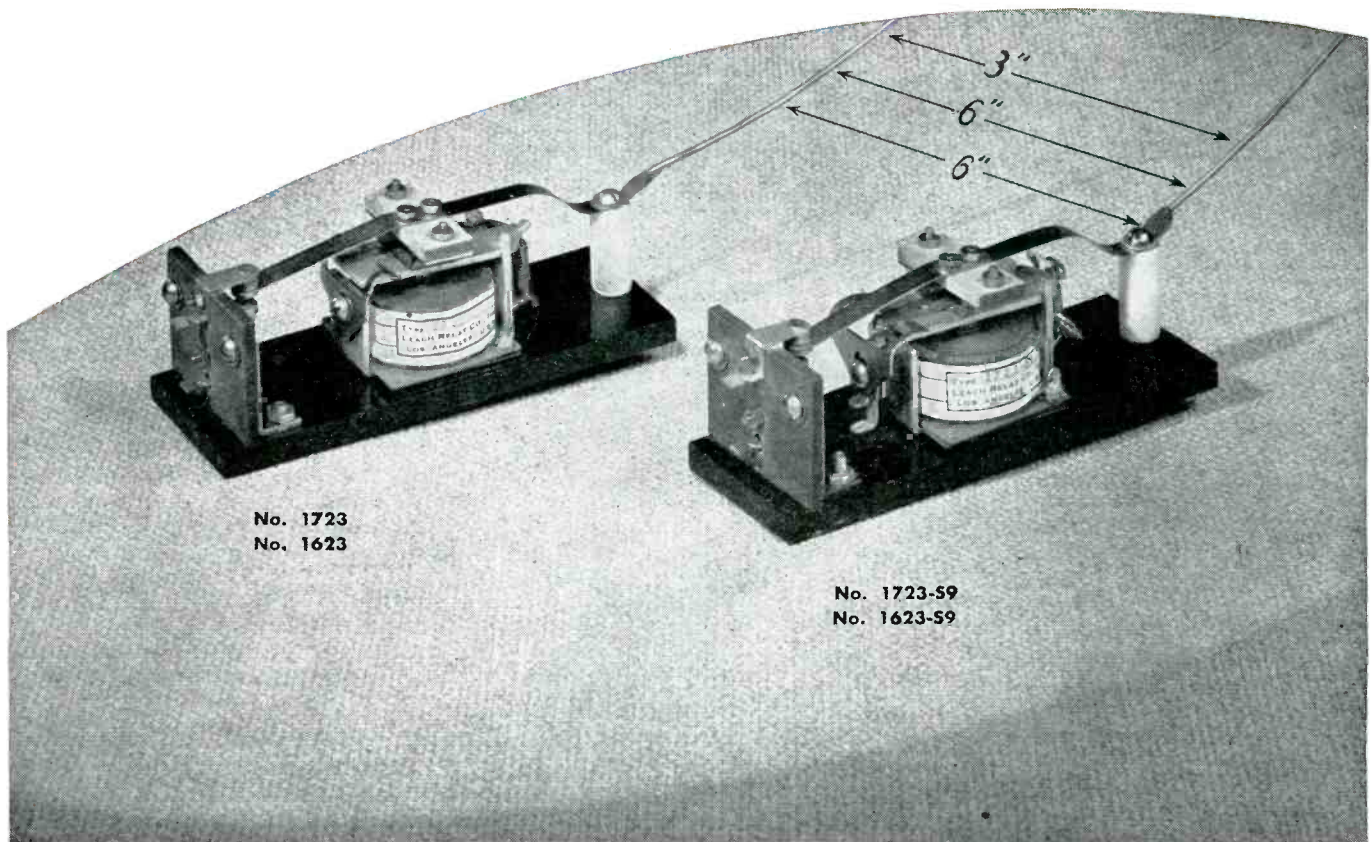

No. 1723
No. 1623

No. 1723-S9
No. 1623-S9



ANOTHER **LEACH** FIRST

Mounted tandem to fit line or outlet spacing, these new high frequency or high voltage relays are capable of withstanding over 4000 volts R.M.S., 60-cycles in high-pot tests between contacts and between contacts and frame or ground. Light weight and low priced, these relays can be used for a wide variety of control purposes in high-frequency heating and communications equipment. Paired, they are especially useful for antenna switchover work. Practically any contact combination from DPDT up can be obtained by connecting the required number of relays in either series or parallel.

Both relay types are arranged SPDT, with the S-9 designating a 1/8" auxiliary SPST normally open contact, insulated for 125 volts. They are available with either alternating or direct current coils. The auxiliary contact can be used for grounding or controlling light power circuits or closing a power relay when the relays are used for antenna switchover. WRITE TODAY FOR DETAILED ENGINEERING SPECIFICATIONS

SPECIFICATIONS

RF INSULATION: Contacts and terminals mounted on Mycalex and Isolantite
 MAIN CONTACTS: SPDT—1/4" silver
 COILS: AC—6 V/A, 6 to 220 volts, 50-60 cycles. DC—3.5 watts, 2 to 120 volts
 DIMENSIONS: 1 1/2" x 4 5/8" x 1 3/4" high
 WEIGHT: 6 1/4 oz. each
 DC AC
 1623 1723 SPDT
 1623-S9 1723-S9 SPDT
 Aux. Cont.—SPST-N.O.



LEACH RELAY CO.

5915 AVALON BOULEVARD, LOS ANGELES 3, CALIF.

THE *Individual* TOUCH

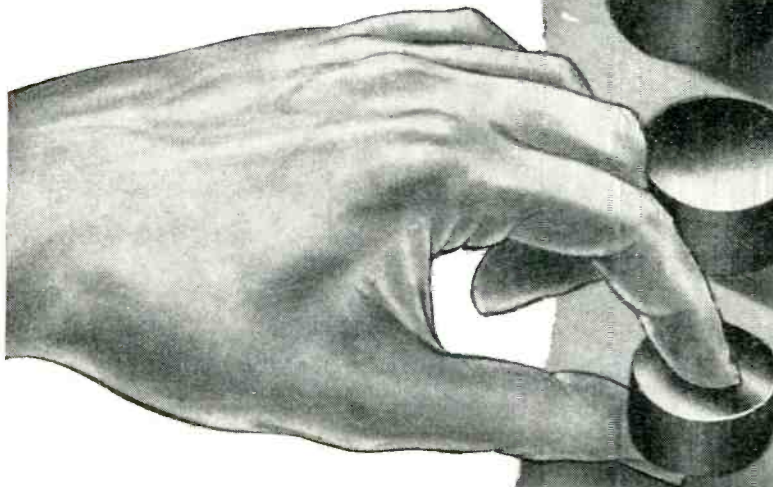

• Every magnet individually tested in loud speaker structure before shipping . . .

• Every magnet meets R. M. A. proposed standards . . .

• Every magnet meets Arnold's minimum passing standards of 4,500,000 BHmax.

Here's what the individual touch means. Thousands of the nine different sizes of speaker magnets shown at right are now being turned out daily. Each one is individually tested in a loud speaker structure before shipping. Each magnet is made to meet R. M. A. proposed standard for the industry. Each magnet must meet Arnold's own minimum passing standard of 4,500,000 BHmax for Alnico V material. Thus by careful attention to the important "individual touch" in volume production can Arnold promise you top quality in each individual magnet you select.

THE ARNOLD ENGINEERING COMPANY

147 EAST ONTARIO STREET, CHICAGO 11, ILLINOIS
Specialists in the Manufacture of ALNICO PERMANENT MAGNETS

diaphragm before nonlinearity is apparent. In the standard being described, the limitation is associated with the linearity of the compliance of the piezoelectric crystals. Because these crystals obey Hooke's law to pressures of the order of thousands of pounds per square inch, the microphone can be safely used in measuring sound pressures of many million dynes per square centimeter.

The minimum sound pressure that can be measured by the new standard will be limited by the thermal noise generated by the input grid resistor of its associated amplifier. The threshold level of the microphone can be defined as the sound pressure per one-cycle bandwidth which generates the same voltage as is being produced by thermal agitation in the grid resistor. For a resistance value of 100 megohms, the measurement standard has a threshold level as indicated by the solid line in Fig. 3. The dotted curve in the

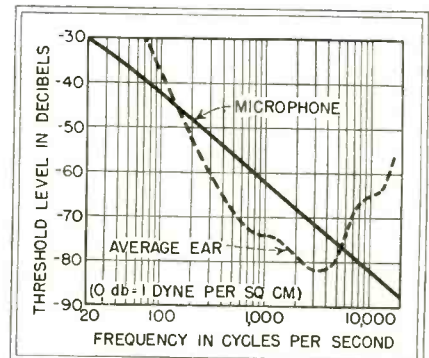

FIG. 3—Comparison of operating thresholds of microphone and of average ear

figure shows the minimum threshold of the average human ear plotted on the same scale. (The data for the ear characteristics were obtained from Fletcher and Munson, *J Acous. Soc. Am.*, Oct., 1933.) Shunting capacitances, such as those of the connecting cable will lower the obtainable output. The circuit of Fig. 4 is recommended. The cable should be mechanically stable and as short as possible. Nominal sensitivity is 23 microvolts per dyne per square centimeter regardless of the value of load resistance.

Because of its dynamic range, the standard is usable for pressure measurements such as occur in the experimental investigation of gun blast

LARGE HEAT SENSITIVE AREA SMALL HEAT STORAGE*



How much sensitivity do you demand from your thermostat? The high degree of sensitivity of the Fenwal Thermostat is due to its large heat sensitive area. This insures fast heat interchange between the medium controlled and the Thermostat. Its small heat storage means a minimum of heat is required to raise its temperature a given amount.

Chart shows the area of the sensitive element of the Fenwal Thermostat compared to Type 1 and Type 2 thermostats. Note the much larger sensitive area of the Thermostat.

AREA OF SENSITIVE ELEMENT

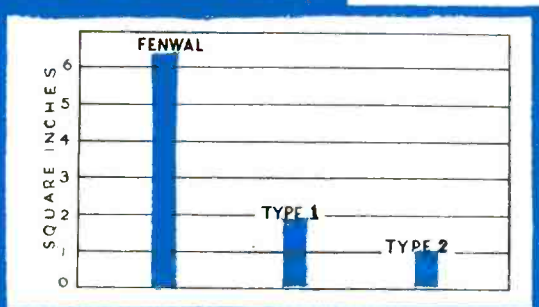

Fenwal Thermostats... are readily adaptable for all applications... are easily installed even where space is extremely limited... are inexpensive and offer a light-weight, compact, vibration-proof, highly sensitive, yet rugged regulatory unit.

The Fenwal Thermostat embodies many desirable features that are not found in other types of thermostats.

When deciding on a heat control unit for your needs, investigate Fenwal Thermostats. Send for the Thermotechnics booklet including "Fourteen Facts in Fenwal's Favor."



BLOCK HEAT THERMOSTAT

FOURTEEN FACTS IN FENWAL'S FAVOR

- 1.—Fast reaction time
- 2.—Large heat sensitive area, small heat storage
- 3.—Short heat transfer path
- 4.—Small temperature differential
- 5.—Built-in temperature anticipation
- 6.—Enclosed assembly
- 7.—Minimal vibration effects
- 8.—Tamper-proof and sealed
- 9.—Rugged construction
- 10.—Adjustable over wide temperature range
- 11.—Minimum size
- 12.—Directly responsive to radiant heat
- 13.—Uniform sensitivity over adjustable temperature range
- 14.—Readily installed

* #2 of the "Fourteen Facts in Fenwal's Favor".



FENWAL INCORPORATED

43 PLEASANT STREET
ASHLAND MASSACHUSETTS

THERMOTECNICS FOR COMPLETE TEMPERATURE REGULATION

Specialized SWITCHING APPARATUS FOR ELECTRONIC EQUIPMENT

A few of many specialized types of switching apparatus we design and manufacture for electronic applications.

HIGH VOLTAGE D. C. HOT BREAK CONTACTORS ...

for energizing high voltage vacuum tube circuits, break circuits carrying up to 1.5 amps at 3 to 5 thousand volts. Vacuum switch eliminates external moving parts.

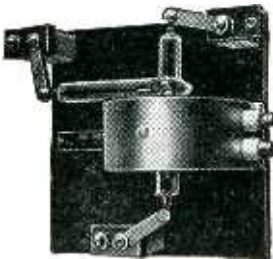

CONTACTOR TIMERS ...

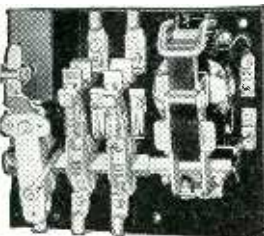

used as main power or filament contactors with auxiliary delayed time circuit or circuits. Contactor and timer joined physically, electrically, — saving space, assuring certain operation.

HIGH VOLTAGE-HIGH FREQUENCY CONTACTORS ...

designed primarily for high frequency switching from remote control point. Use with any high voltage cold break application.—A. C. or D. C. Low loss insulation, steatite or glass bonded mica. Contactors range from 15 amps at 3000 volt to 35 amps at 25,000 volt maximum.

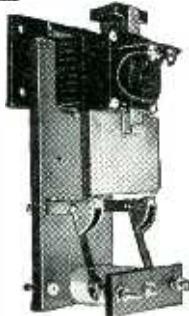

HIGH FREQUENCY-HIGH VOLTAGE TRANSFER SWITCHES ...



for radio or industrial load transfer. Magnetically operated from remote point. Mechanically held in either position. Accommodates currents up to 75 amps high frequency. Low loss insulation, steatite or glass bonded mica. Cold break only.

COMBINATION POWER & SIMULTANEOUS CONDENSER DISCHARGE CONTACTOR ...

is a striking example of our ability to create specialized switching apparatus in accordance with unusual customer specifications.

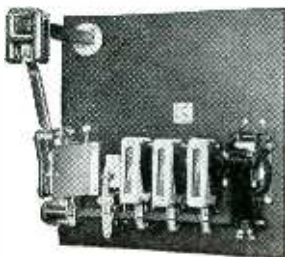

Consult us—we specialize in the unusual!

The Monitor Controller Company
BALTIMORE 2, MARYLAND

Monitor

CANADIAN AFFILIATE - CANADIAN CONTROLLERS, LTD.
TORONTO, ONTARIO, CANADA

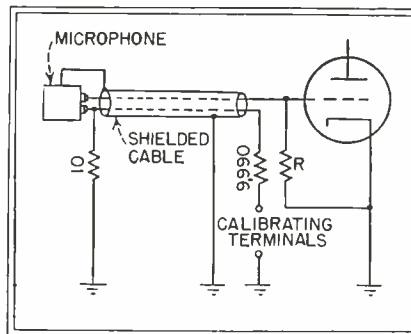

FIG. 4—For frequencies down to 50 cps. R should be 50 meg

pressure waves as well as in the absolute measurement of low-intensity sound pressures as occur in conventional acoustic laboratory practice.

• • •

Patents

CURRENT DISCUSSION on patents centers around revamping federal laws to increase protection of small business through the patent system. Instead of reviewing an outstanding electronic patent, as has recently become our habit, we comment this month on the status of patent proposals of specific interest in the field of electronics. It is a particularly appropriate time to discuss patents because 300 years ago this month the first American patent was issued to Joseph Jenkes for a water powered saw mill.

Recent Patent News

In April 1945 N. V. Phillips Gloelampenfabrieken, Holland, Europe's largest manufacturer of radio equipment and owner of such basic electronic patents as the pentode, announced that, beginning in July 1945, it would handle directly its licensing in this country instead of through the Radio Corp. of America as in the past. This action places RCA and Phillips as parallel licensing bodies in America, and has the effect of giving RCA as free a band in Europe and South America as Phillips now has in this country.

By May 1945 the National Patent Planning Commission's recommendations had taken the form of three Congressional bills: HR-2630 providing for public registration of patents available for licensing, HR-2631 proposing that patents terminate not more than twenty years from date of filing (instead of 17

NOW
RESISTANCE WIRE
AS
Fine
AS
.0006" DIA.

Drawn entirely in the
JELLIFF MILL

WIRE PRODUCTS
Jelliff
SINCE 1880

The finest name for the finest wire

THE C. O. JELLIFF MFG. CORP.
SOUTHPORT - CONN.
SPECIALISTS IN
FINE WIRES

NEW!

- *manufacturers*
- *designers*
- *purchasing agents*

send for this
slide-rule on product identification



INVESTIGATE THE
NEW DEVELOPMENTS IN

MEYERCORD DECAL NAMEPLATES

Don't let unusual surfaces deprive your product of the smarter effect and lower cost of Decal nameplate identifications. Send for Meyercord's new Nameplate Selector and see how scientifically produced Decal nameplates can take the toughest surfaces in their stride. There's a Meyercord Decal for every surface, from standard Kwik-Ways to highly specialized types resistant to acid, abrasion, temperature extremes, moisture—for appli-

cation on any shape or kind of commercial surface. No rivets, bolts or screws required. They can be produced in any size, design or number of colors. And they last.

Let the new Meyercord Decal Selector help you specify the right Decal for product trademarks, instructions, patent data or diagrams. It's another Meyercord service that is yours on request. Write for one today. The supply is limited. Address Dept. 9-5.

Bring the Boys Home... with Victory Bonds!

THE MEYERCORD CO.

World's Largest Decalcomania Manufacturers

3323 WEST LAKE STREET • • • CHICAGO 44, ILLINOIS



MOLDITE IRON CORES



SPECIALIZATION

Moldite iron cores are produced by specialists engaged exclusively in the manufacturing of iron cores. A complete line of magnetic iron cores. For use at all frequencies including television and FM is now available.

ENGINEERING

It is a simple matter for Moldite engineers to fit the right core to your particular coil for the best results. Moldite engineers are thoroughly familiar with every iron core application and will be glad to assist you in determining which of these components can best satisfy your requirements.

PRODUCTION

With our vastly expanded production facilities, we are in the position to meet your urgent iron core requirements. Quality, economy and dependability are assured.

SAMPLES

Moldite sample iron cores will be submitted for design, test and pre-production purposes upon receipt of your request. Use Moldite material grade designations to insure prompt and exact duplication of the required cores. Specify "MOLDITE" for "QUALITY."

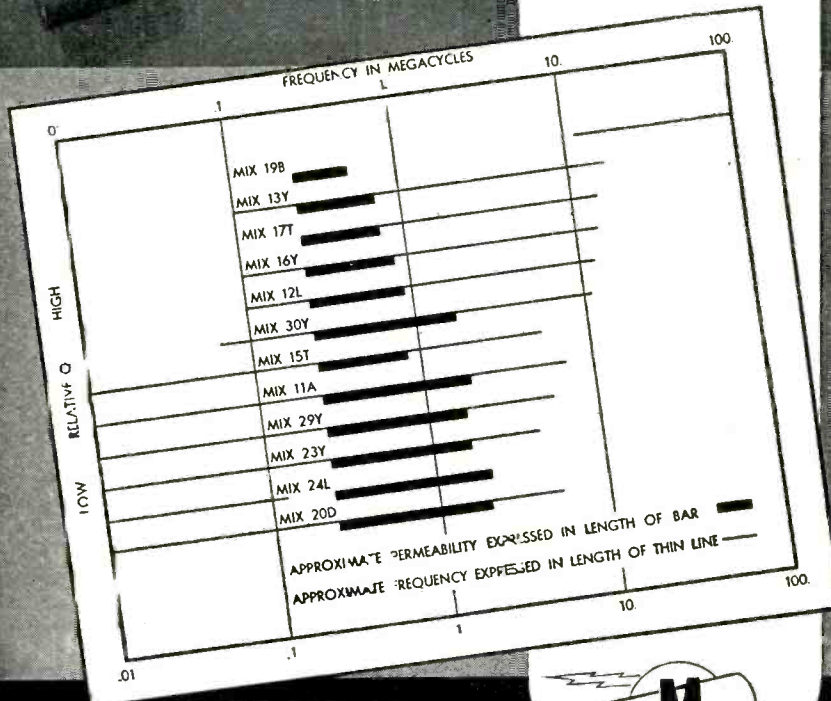

NATIONAL MOLDITE COMPANY

25 MONTGOMERY STREET • HILLSIDE 5, NEW JERSEY

SALES REPRESENTATIVES

MID-ATLANTIC STATES:
Robert A. Sylvestor - L. D. Lowery Corp.
407 N. Broad St. Philadelphia, Pa.

MID-WESTERN STATES:
Harold Kadell
20 N. Wacker Drive Chicago, Illinois

WESTERN STATES: J. J. Perlmuth Associates, 942 Maple Avenue, Los Angeles 15, California

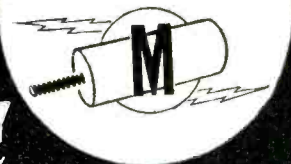

PATENTS

(continued)

years from date of issue), and HR-2633 requiring recording of patent agreements.

Responding to recommendations in HR-2630, the patent office began listing patents registered as being available for licensing in the Official Gazette of the Patent Office (published weekly under direction of Superintendent of Documents, Government Printing Office, Washington, D. C.; single copies \$0.35, subscriptions including annual index \$18.75 per year—contains title, number, patentee, assignor, a diagram, and a significant claim of each patent issued that week). It was hoped that, by attracting industrialists to available patents, industry and consequently employment would be eased through reconversion.

In the middle of December, the Justice Department filed civil action against several motion picture companies and individuals, in particular the Scophony Corp. of America for monopolizing Scophony's supersonic and skiatron techniques for projection television. These techniques are held to the most satisfactory methods of large image television projection, as would be used in movie theaters.

In the Patent Office Gazette for January 8, 1946, notice was given the public that RCA had entered its patents on the Register of Patents Available for Licensing, under the plan mentioned above, thus making RCA owned and controlled patents generally available.

These few incidents are typical of current trends. Cartel practices in Europe are pressing American industry. At the same time, our patent legislation is being strengthened to prevent monopolies. The problem confronting American industry is whether or not free, competitive, small scale business can progress in a world of nationally subsidized cartels.

Business Success

One recent survey shows that during the decade from 1923 to 1933 an average of about 40 percent of the existing radio manufacturers went out of business each year. Businesses were not included in this survey unless they had reached a size justifying national advertising. Another study indicates that the birth rate of



Long Term
Dependability...

... for the equipment you build!

There's no more certain way to insure the efficient performance in your customers' hands of the machines or devices you build, than to equip their panels or controls with *trustworthy* instruments. And for that very reason, the name WESTON on a panel instrument helps build buyer acceptance and goodwill for the products on which they are installed.

WESTON instruments are available in all the types, sizes and ranges essential for panel or built-in requirements. Complete information, or engineering cooperation, is available on request. Weston Electrical Instrument Corporation, 618 Frelinghuysen Avenue, Newark 5, New Jersey.

Weston *Instruments*

Albany • Atlanta • Boston • Buffalo • Chicago • Cincinnati • Cleveland • Dallas • Denver • Detroit • Jacksonville • Knoxville • Los Angeles • Meriden • Minneapolis • Newark • New Orleans • New York • Philadelphia • Phoenix • Pittsburgh • Rochester • San Francisco • Seattle • St. Louis • Syracuse • In Canada, Northern Electric Co., Ltd., Powerlite Devices, Ltd.

A Remote Control COMPONENT FOR AIRBORNE RADAR COMPUTER UNIT
MADE POSSIBLE BY A. W. HAYDON FOR FARNSWORTH
 Television & Radio Corporation

During the war, Farnsworth needed a special, remote control, differential gear reduction drive for their airborne radar computer unit. It had to meet rigid performance requirements . . . be of minimum size and weight . . . stand vibration, salt-spray, humidity, temperature changes.

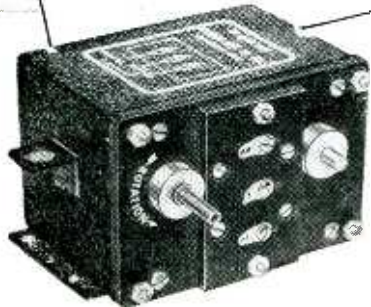

Remote control differential drive for airborne radar computer unit.

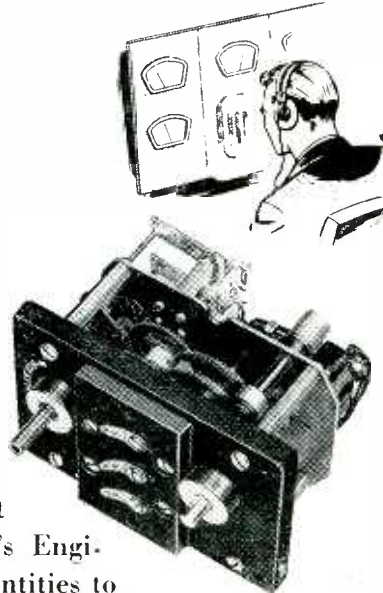

A. W. Haydon designed this unit in conjunction with Farnsworth's Engineers and it was delivered in quantities to meet high priority schedules.

Seventeen years of experience in the design and manufacture of electrical devices can solve similar problems for you. Write to:



The **A. W. HAYDON**
COMPANY

WATERBURY 32, CONNECTICUT
 Custom Design and Manufacture of Electrical Devices

businesses had steadily fallen between the two world wars. Today the radio industry has four times its prewar productive capacity, at least a part of which will be disbanded.

To counteract such failure of industries, the Fulbright bill (S-1248), proposing wider dissemination of technical information, has been presented. It would establish a Bureau of Scientific Research within the Department of Commerce. This bureau would coordinate and distribute on a non-exclusive basis to all industries and individuals, patents and techniques at the level of applied science that were judged to be commercially valuable. The bureau would conduct developmental research and coordinate work done in university laboratories. In addition, there are three other bills: the Magnuson (S-1285), the Kilgore (S-1297), and a recent bill (S-1777) that attempts to avoid the objections of scientists and industrialists to the two previously mentioned bills. These three bills provide for socialized research in basic science. Their recommendations have been combined in the compromise Kilgore-Magnuson bill (S-1850) to establish a National Science Foundation for coordinating and supporting scientific research in university, industrial and governmental laboratories.

Whatever the outcome of these bills, scientific research by the government will expand. Patent legislation and court action is tending toward wider licensing of patents. Technical information is becoming more available. Already the Department of Commerce has launched a program of giving technical and operational advice to industries upon request.

Patent Problems

The basis upon which these pending patent and research proposals can be evaluated is:

The first purpose of this legislation is to develop healthy small businesses, just as the program of the Department of Agriculture has been to aid the small farmers. In themselves, these bills would help accomplish this result; however, two points should be considered in connection with them. Court action to force licensing of patents, such as that in the case of Scophony, can lead to

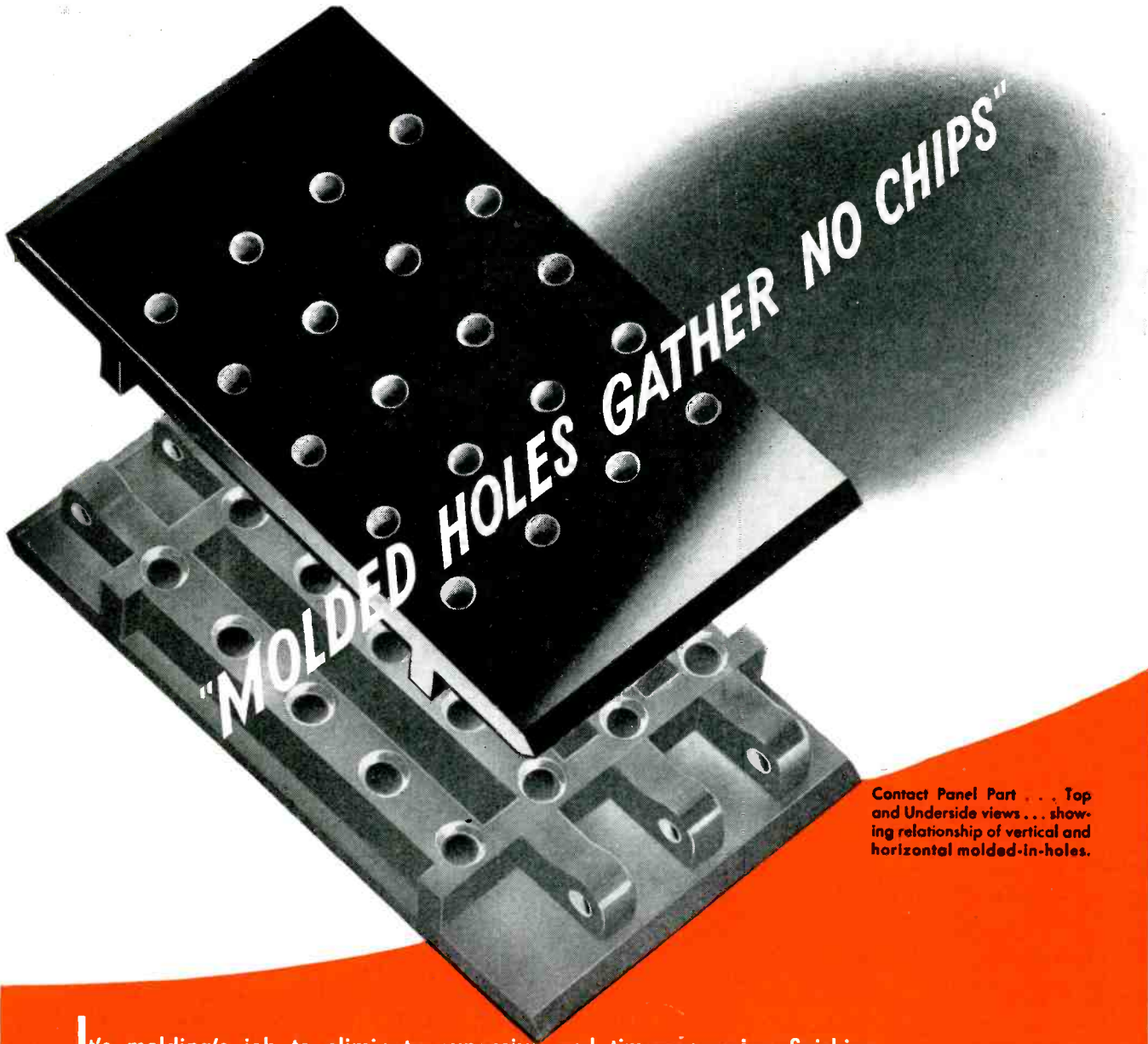

Contact Panel Part . . . Top and Underside views . . . showing relationship of vertical and horizontal molded-in-holes.

It's molding's job to eliminate expensive and time-consuming finishing operations, as for example: the holes in the above panel piece. These could have been drilled in place after the part had been molded — but this would have meant additional cost . . . a possibility of chipping . . . and with both, the certainty of rejects and regrets.

Because of the ingenuity of Consolidated engineers, provisions for the part's 20 vertical holes (top side) and 6 horizontal holes (under side) were made when the mold was being designed and constructed. The processed result: as you see it pictured — a completely finished piece . . . ready to step from the mold to end-use assembly.

Through its years of experience . . . continuously carrying forward a development program . . . always improving techniques . . . Consolidated is qualified to tackle and solve plastics' requirements. When you are faced with a product problem, call upon Consolidated! Our complete facilities are at your disposal. Inquiries Invited!

INJECTION
molding

TRANSFER
molding

COMPRESSION
molding



Consolidated **MOLDED PRODUCTS Corporation**
309 CHERRY STREET, SCRANTON 2, PA

Branches: NEW YORK • CHICAGO • DETROIT BRIDGEPORT • CLEVELAND

Durability is a Feature of **WELCH** **DUO-SEAL VACUUM PUMPS**

Welch Rotary Oil-Sealed Vacuum Pumps

are precisely machined to insure smooth, efficient operation. Before being placed in stock, every pump undergoes a long, continuous "run-in" period, so that each moving part will fit perfectly into the other. Surfaces of rotor and stator are ground to within 1/10,000 inch.

HIGH VACUUM—.05 Micron (.00005 mm. Hg.) GUARANTEED
 Double-Seal prevents diffusion of exhaust gases back into intake side, increasing vacuum.

FREE AIR CAPACITY — 33.4 Liters Per Minute
 Double-vane system evacuates crescent-shaped air spaces in the two rotor units twice each revolution at comparatively low speed of 300 R.P.M.

OIL REQUIRED 650 ml. Duo-Seal Oil

Only a small fraction of the oil circulates in the pump—a distinct advantage in out-gassing the oil. Positive oil seal prevents oil from backing up into the exhaust line.



No. 1405-H

DUO-SEAL VACUUM PUMP, Motor Driven. Vacuum .05 micron—free air capacity of 33.4 liters per minute\$140.00

With larger motor giving 57 liters free air capacity per minute and vacuum of 0.1 micron\$155.00

Write for **FREE 32 page booklet** on Welch Duo-Seal Pumps and Vacuum Techniques.



W. M. Welch Scientific Company

1515 Sedgwick St., Dept. H. Established 1880 Chicago 10, Illinois, U.S.A.

universal patent licensing, in which event the advantage of exclusive use of a patented idea upon which small industries have depended to obtain a foothold would be lost. In addition, despite the increased availability of knowledge through socialized research and greater licensing of patents, "know-how" will still play a major part in industrial success or failure.

From the viewpoint of research and patents, one must bear in mind the uncertain expense involved in research and the extensive promotion necessary to win public acceptance of new products. Of the twenty greatest American patents, as poled at the sesqui-centennial of the Patent Act held in 1940, the four in the electronic industry, the telegraph (S. F. B. Morse), the telephone (A. G. Bell), the phonograph (T. A. Edison), and the triode (L. deForest), have required years of additional research, development, and promotion to rise to their present commercial and social importance. Whether society is willing to advance the funds for research that must extend so far ahead before its benefits will be realized, and whether the necessary promotion of the developments would be made are matters of conjecture.

In any case, what we are witnessing in the patent and research fields is the gradual transition of the functions of government from protection of persons, property, and rights, to participation in the activities it has protected. From licensing of banks, the government has advanced to banking; from licensing of public utilities and insurance companies, the government is advancing into operation of public utilities and "social security"; from issuance of patents for inventions, government will advance into administration of patents and creation of inventions.

RADAR SCREEN at Winnipeg indicates not only aircraft flying in the vicinity, but also geese and ducks. For a long time radar operators at Trans-Canada Air Lines could not identify some dots appearing on their screen. Too small for training craft, they were finally found to be birds migrating at 2,000 feet.

Presenting

**MERCURY RELAYS
AND
MERCURY SWITCHES**

BY

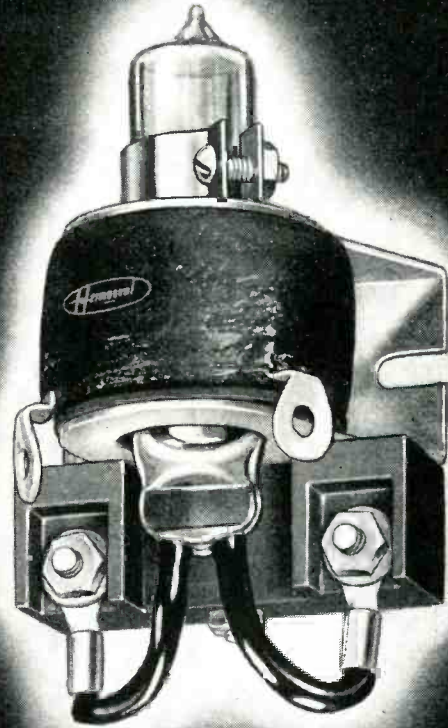

Engineered and manufactured by pioneers in the field of mercury switch design and craftsmen in the art of glass to metal sealing, HERMASEAL Relays have the following advantages:

Superior in design, performance, and appearance . . . High capacity mercury to mercury contact . . . Filled with an inert gas and hermetically sealed against dirt, dust, moisture, and explosive vapors . . . Compact design, flexibility of mounting . . . Sturdy one-piece iron circuit . . . Positive coil locking arrangement . . . Heavy moulded plastic terminal block . . . Designed for long life and trouble-free operation . . . Standard model rated at 1½ H. P. at 110 or 220 Volts A.C.

Write, wire or phone for bulletins and descriptive literature.

HERMASEAL manufactures mercury plunger type relays, tilt type mercury switches, hermetically sealed terminals and power plugs. Consult us regarding your special applications—We design and manufacture to suit your requirements. Your inquiry involves no obligation to you.

Sales Representatives:
E. C. Winkenwerder, 203 W. Wacker Dr., Chicago, Illinois
Law Instrument Co., Angola, Indiana
European Representative:
U. C. Hedin, Kopparberg, Sweden

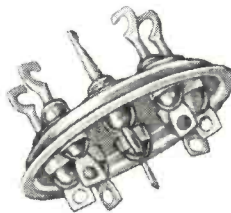

THE HERMASEAL COMPANY, INC., RIVERSIDE DRIVE, ELKHART, INDIANA

NEW PRODUCTS

Latest developments in new apparatus, components, materials. New literature

1

Generator and Analyzer

ALTEC LANSING CORP., 1161 North Vine St., Hollywood, Calif. Intermodulation test equipment consisting of a signal generator and separate intermodulation analyzer is available for single-measurement testing of audio facilities. The sig-

nal generator unit consists of two oscillators supplying 40, 60 or 100 cps and 1,000, 7,000, or 12,000 cps. The analyzer contains the components necessary to read distortion from 0.1 to 100 percent. The equipment is easily operated.



2

Registration Control

FISHER-PIERCE CO., 65 Ceylon St., Boston 21, Mass. A new high-speed control for use on either intermittent or continuous-flow wrapping ma-

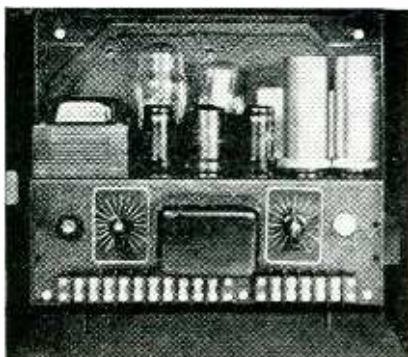

chines operates when a registration mark on the wrapping paper enters the field of view of the photoelectric scanner. A change in light intensity of as little as one footcandle with a duration between 0.001 second and 0.5 second is sufficient to initiate the control. The equipment is contained on a chassis designed to plug into a wrapping machine and may be quickly removed for servicing.

Automatic Sorter

POLLAK MFG. CO., Arlington, N. J. The Limitron is a new kind of limit-type electronic comparator which automatically inspects, sorts and



places each piece in the proper bin. The range of measurement possible is between 0.0001 and 0.03 inch. Contact spindle pressure is adjustable from 4 ounces to 1 pound.

3

Transcription Table

THE FAIRCHILD CAMERA & INSTRUMENT CORP., Jamaica, N. Y. The unit employs a synchronous motor and worm-gear drive to obtain 33 $\frac{1}{3}$



rpm speed. The 78-rpm speed is secured through a ball-race mechanism. A clutch is included to aid in smooth starting and stopping as well as in cueing the record.

4

Sound Pressure Standard

MASSA LABORATORIES, INC., Cleveland, Ohio. The model M101 sound pressure measurement standard is a precision acoustic instrument for making absolute sound-pressure measurements throughout the audible frequency range without ap-

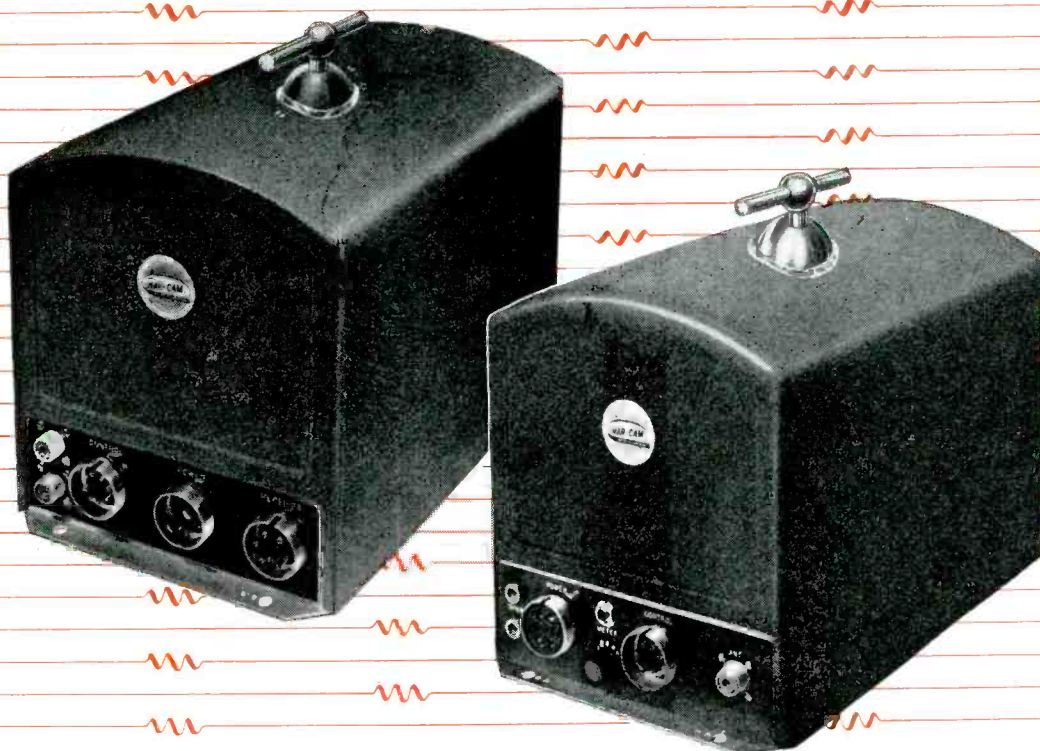

In Any Emergency, You Can Count on HAR-CAM Emergency Communications Equipment

HARVEY OF CAMBRIDGE Transmitters and Receivers team up to provide the most dependable and efficient two-way radio combination you can get. Here's why:

HARVEY OF CAMBRIDGE is one of the oldest manufacturers of two-way radio. Many of HARVEY'S initial installations are still considered stand-

ards of quality and performance. During the war, HARVEY OF CAMBRIDGE specialized in the development and manufacture of communications equipment — units that for obvious reasons had to be the last word in dependability and efficiency.

This combination of sound basic design and construction supplemented

by the many important new and better communications developments mean HAR-CAM Transmitters and Receivers are now better than ever.

For complete information and specifications that will prove it beyond question, write for HARVEY Emergency Communications Equipment Bulletins No. 35 and No. 36.

HARVEY RADIO LABORATORIES, INC.

439 CONCORD AVENUE • CAMBRIDGE 38, MASSACHUSETTS

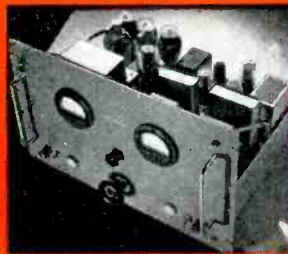
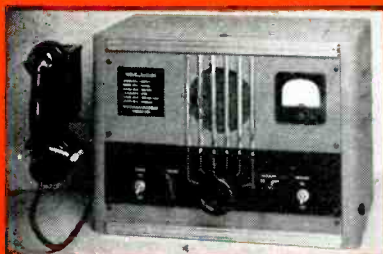

Typical HARVEY products: Above left: The HARVEY Marine Radio Telephone Model M-25; center: The HAR-CAM Visual Alignment Signal Generator Model 205 TS; right: The HARVEY Regulated Power Supply 206 PA. Write for Bulletins.

preciably disturbing the sound field. Owing to its small physical size, the structure behaves as a point source up to 5,000 cycles per second. It is a device of great versatility, useful in determining wave front along horns and other sound-propagating apparatus or in blast-wave analysis from explosions and gun fire.

5

Dielectric Heater

ALLIS-CHALMERS MFG. Co., Milwaukee, Wis., is now manufacturing a new 2-kw dielectric heater which operates on a frequency of 27 mc. Adjustable electrodes are mounted in



an oven which is shielded to prevent r-f radiation. There is front panel control of frequency and an automatic timer to control the heat sequence from 2 seconds to 20 minutes as selected.

6

Audio Amplifiers

NEWCOMB AUDIO PRODUCTS Co., Los Angeles, Calif., has two lines of amplifying equipment available, the less expensive designated as H and the deluxe models, KX. Typical speci-

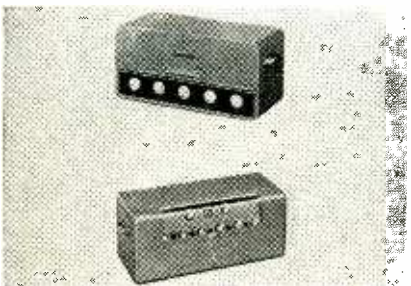

cations for the H-30 amplifier include a power output of 30 watts at less than 5 percent distortion, frequency response within 2 db from 30 to 15,000 cps, and a line power consumption of 144 watts at 105 to 129 volts, 50 to 60 cps. The KX-30 amplifier gives the same power output with a frequency response 20 to 20,000 cps within ± 1 db. Power consumption for this model is 136 watts.

7

Vacuum Capacitors

INDUSTRIAL & COMMERCIAL ELECTRONICS, Belmont, Calif., is now manufacturing vacuum capacitors, Series 25, 55, 75, in values ranging from 7 to 75 micromicrofarads. They are designed to withstand peak test voltages as high as 20,000 and have an rms current rating of 15 amperes. The units are 2½ in. in diameter and 6½ in. long.

8

Range Receiver

BENDIX RADIO, Baltimore, Md. The type PAR-70A range and broadcast receiver for personal planes is now available. Reception of control towers is on 200 to 400 kc and broadcast stations are received in the 550 to 1,500 kc band. When these stations are received with the PMN-1A loop, navigation is possible. The

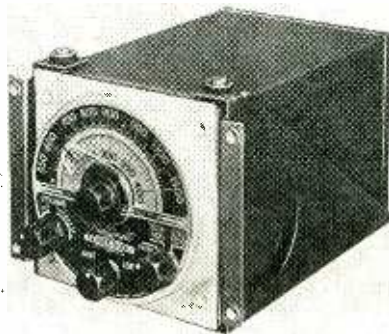

PAR-70A requires 2.5 amperes at 12 volts. The -70B type equipment requires 1.25 amperes at 24 volts. Overall size is 4½ x 5½ x 7 inches. The weight is 5 pounds, including a vibrator power supply. The loop antenna is 11 inches high, 9 inches in diameter and weighs 1.4 pounds including azimuth indicator and 6-foot transmission line.

9

Street Lighting Control

THE RIPLEY Co., Torrington, Conn. A new electronic switch makes possible street lighting service regardless of fluctuations in cloudiness or time of



nightfall. The unit consists of conventional electron tubes, a photoelectric cell and relay. Overall dimensions are 9¼ x 4½ in. diameter. The weight is 4½ pounds.

10

Cathode-ray Tube Connector

ALDEN PRODUCTS Co., 117 No. Main St., Brockton 64, Mass., now has available tube connectors with or without leads. The 211FC straight connector takes a minimum of space. Clearance of ½ in. in back of the connector will allow for leads. Clearance of 1¼ in. will allow removal of tubes. Other types are equipped with back cover or mounting plate.

11

Sweep Oscillator

KAY ELECTRIC Co., 47 North Grove Street, East Orange, N. J. The frequency output of the Mega-Sweep oscillator can be varied from 50 kc to 500 mc. Within this spectrum

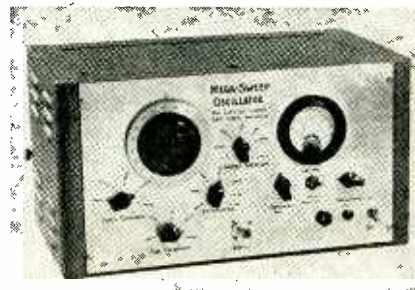

Now

**INSTANT SEPARATION
for
MULTIPLE CONTACT CONNECTORS**

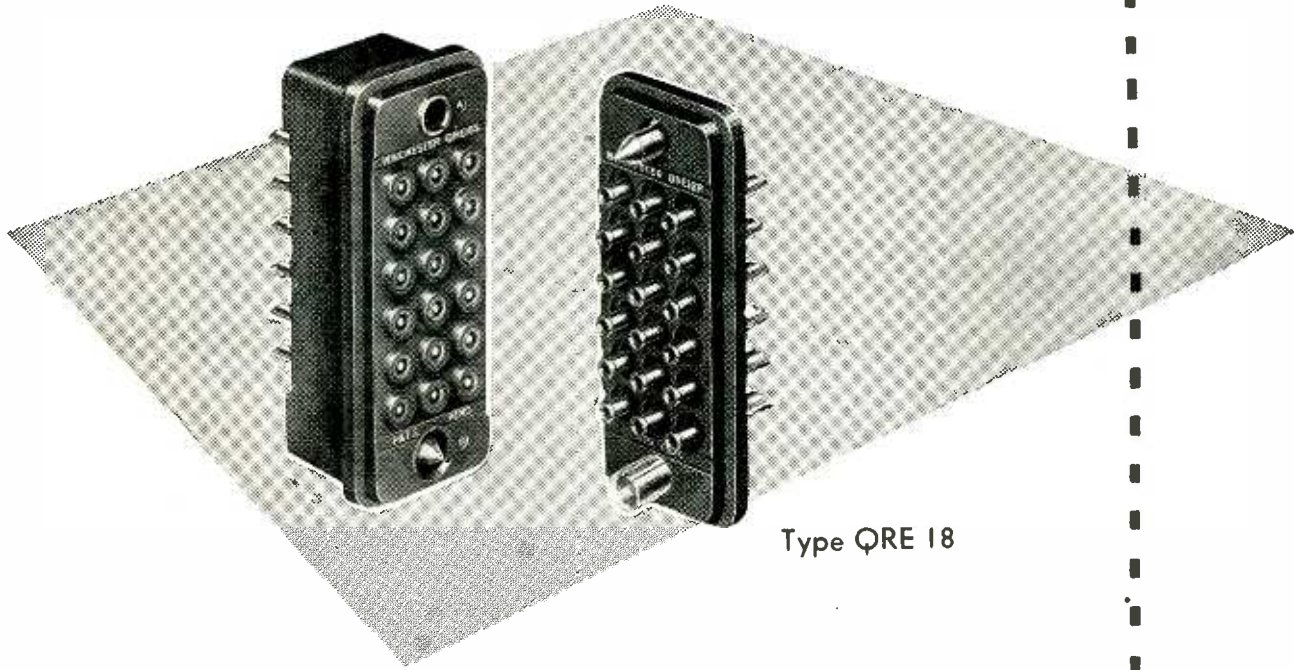

Type QRE 18

Winchester SELF-SEPARATING CONNECTOR

Winchester offers a new and long-needed development—QRE banishes the prying and pulling usually required in separating multiple contact connectors. Separation is easy and instantaneous . . . without damage to contacts.

QRE's spring construction does the job!

- Monoblock construction
- Ideal for rack and panel rear mounting
- Suitable for chassis or cable mounting
- Contacts provide wiping action—
- Polarized centering pins—
- Self-aligning—
- Surface creepage of 1/4 inch minimum between all contacts (#16 AWG wire, size)—

Available now in 12 and 18 conductor sizes—

Type QRE 12—12 contacts
Type QRE 18—18 contacts

WRITE FOR BULLETIN 134-J

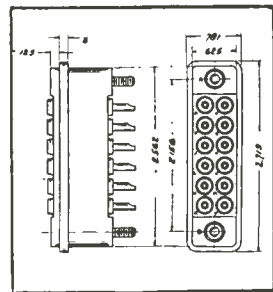

QRE 12S

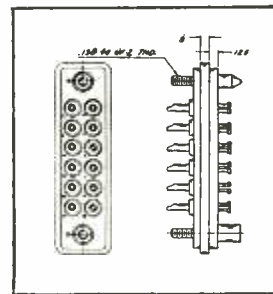

QRE 12P

The Winchester Company
6 EAST 46th STREET • NEW YORK 17, N. Y. U. S. A.

excursions up to 30 mc are possible. Other features of the equipment include a regulated power supply, variable attenuator, and built-in wavemeter for the 50 to 500 megacycle range. It can be operated from 117-volt, 60-cps lines. The size is 10 x 14 x 8 inches and weight is 30 pounds. Price is \$350, f.o.b.

12

Liquid Insulation

U. S. INDUSTRIAL CHEMICALS, INC., 60 East 42nd St., New York, N. Y. A new war-tested liquid insulation product, PiB, is now available for civilian use. Primarily designed for



water-proofing the ignition systems and preventing corrosion of batteries in motor vehicles, the new material should find use in electronic equipment where moisture conditions and corrosion can bring about short circuits. It is a penetrant which is absorbed into the material treated, rather than a coating, and is readily applied with a brush.

13

Frequency Meter

BROWNING LABORATORIES, INC., 742 Main St., Winchester, Mass. The Model S-4 frequency meter consists of a stable electron-coupled oscillator operating in the region of desired frequencies between 1.5 to 100 mc. A 100-kc crystal oscillator serves as a secondary standard which in turn can be checked against the standard frequency transmissions from WWV. The meter can be used to measure the carrier frequency of a-m

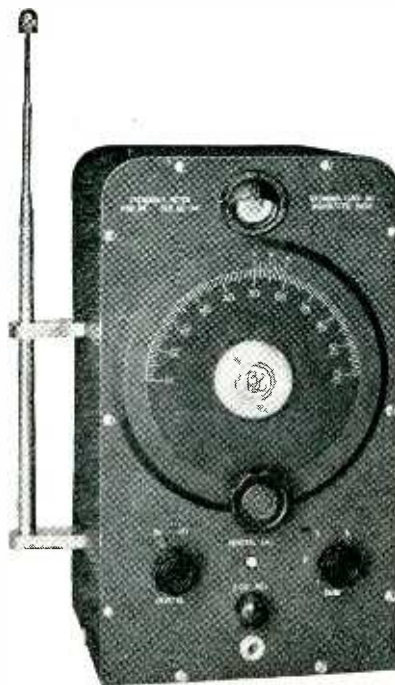

or f-m transmitters to an accuracy of 0.0025 percent. A telescoping antenna is employed to pick up radiated energy from the transmitter being checked. The unit measures 13 3/4 x 7 7/8 x 6 1/2 inches and weighs 15 pounds.

14

Latching Connector

CANNON ELECTRIC DEVELOPMENT CO., 3209 Humboldt St., Los Angeles 31, Calif. The new XL Series of microphone connectors accommodates three No. 14 wires and will carry up to 15 amperes. Under ideal conditions, the minimum flashover voltage to the shell is 1,200 volts. Chief feature of the new connector is the latch-locking device which makes instant connection or disconnection possible by means of thumb pressure on the latch.

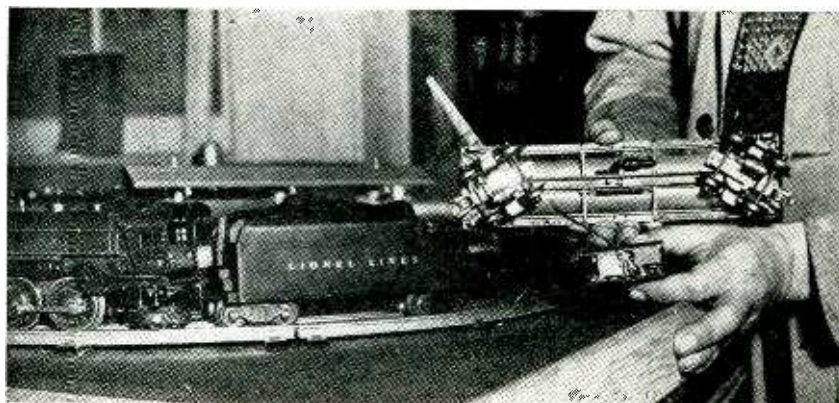

15

Reset Timer

HAYDON MANUFACTURING CO., Forestville, Conn., announces a new, inexpensive reset timer in models giving a range of delay from 1 second to ten minutes. The timer operates on the principle of a magnetic clutch which engages a gear train. When the

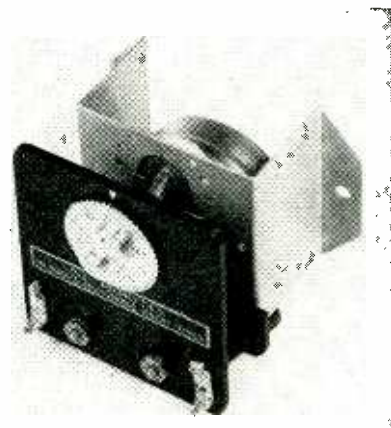

clutch is disengaged, a spring returns the drive shaft to its starting position. The switch will break 10 amperes and is insulated for use at 125 volts. Overall size is 3 3/8 x 2 1/4 x 2 1/4 inches.

16

Electronic Train Control

LIONEL CORP., 15 East 26 St., New York, N. Y., has developed an electronic method of controlling at will various toy train functions which were formerly performed only at set positions along the track. A low-

Franklin AIRLOOPS

have left the stage of
experiment and investigation!

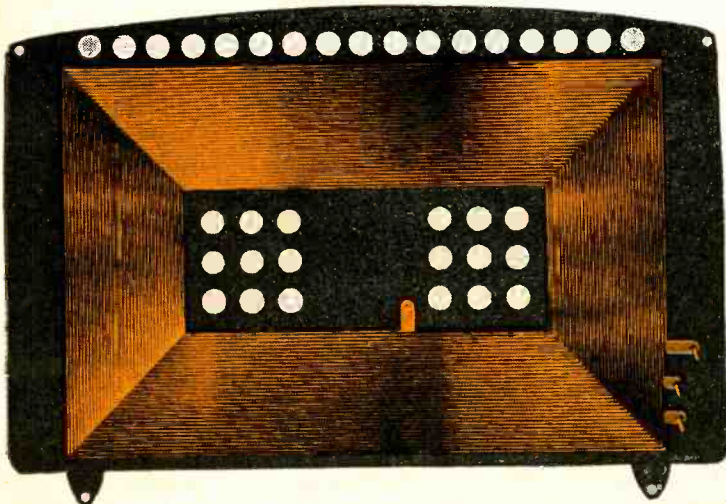
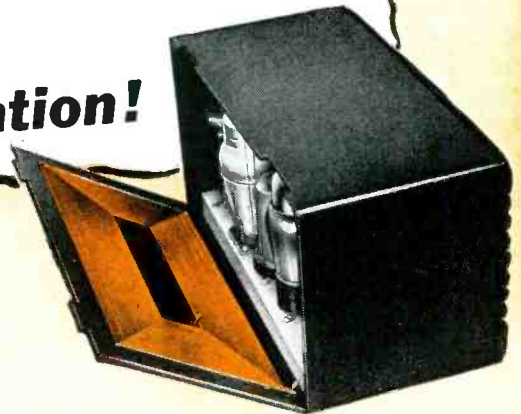

**HUNDREDS OF THOUSANDS
ARE NOW BEING PRODUCED
FOR SOME OF THE LARGEST
MANUFACTURERS OF
RADIO RECEIVERS.**

IF loops are bottlenecking your assembly lines?
you want the best loop for your set?
you are cost conscious?

consult *Franklin*
for large scale delivery of
AIRLOOPS

A radio engineer's dream come true! The greatest development in loop antenna design and manufacture since 1920! Flat sheets of copper die-stamped into perfect supersensitive loops . . . air dielectric throughout their entire length . . . being rectangular they have 27% more effective area . . . better performance at lower cost . . . no set builder can afford to overlook the significance of the AIRLOOP.

Compare these AIRLOOP values with conventional loop values and you too will SPECIFY AIRLOOPS.

- Optimum sensitivity
- High uniform "Q" over entire band
- Inductance to close tolerance without adjustable turn
- Low distributed capacity
- 27% greater effective loop area
- Electrical and mechanical stability
- Backboard and loop in one
- Lower cost
- Elimination of individual loop adjustment on assembly line
- Maximum space utilization
- No haywire

Franklin **AIRLOOP**
175 VARICK ST., NEW YORK 14, N. Y. *corp.*



SELF SYNCHRONIZING

finch facsimile

World's Fastest and Most Accurate Communications Equipment

POINT TO POINT (Mobile or Stationary)

TELEFAX

the "Instant Courier"

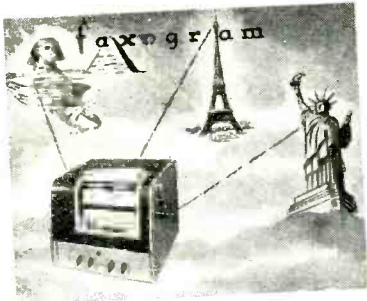

With Finch Facsimile equipment ("Telefax"), illustrated and written messages called Faxograms can be sent at great speed between any two points that can be connected by radio or wire. These points may be stationary (as between factory and office) or mobile (as between ship to airplane or station to patrol car). Anything or everything that can be printed, drawn or written on a sheet 8½" x 11" can be transmitted and received by radio in two minutes or by wire at slightly slower speeds depending upon type of circuit used.

For Full Information
write to:

FINCH TELECOMMUNICATIONS, Inc.

Passaic, N. J., U.S.A. • 10 East 40th St., New York, 16

BROADCAST

Pictures and
printing broadcast
to homes

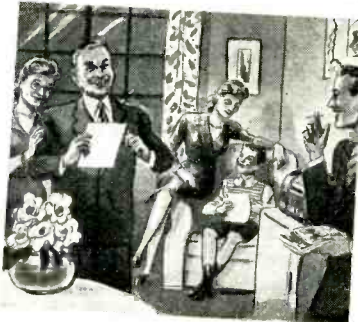

With Finch Facsimile equipment, illustrated printed matter such as newspapers or magazines can be sent by radio to homes. Stations are now being licensed to render this service. Home recorders and recording paper will be moderately priced. Broadcasts will include all news and features such as cartoons, market reports, photographs, and maps besides illustrated and printed advertisements. In one hour, the equivalent of more than twenty pages of tabloid size can be transmitted and received. This is the *Air Press* of the future.

power oscillator sends medium-frequency carrier impulses through the track and miniature receivers attached to the cars actuate the desired mechanisms. • Ten different frequencies are available for as many different operations.

17

Crystal Signal Generator

MONITOR PRODUCTS, 815 Fremont Ave., South Pasadena, Calif. The Crystaliner supplies 10 preselected crystal-controlled frequencies, which can be modulated at 400 cps if desired. Output is approximately 10 volts. At higher frequencies, harmonics appear which can be used as calibration points. The units lists at \$57.50.

18

Coaxial Antenna

SERDEX, INC., 91 Cambridge St., Boston, Mass. The Model A-144 coaxial antenna has been designed principally for amateur use on the 144-148 mc band, but embodies the same fea-



tures used in forthcoming models for commercial use at other frequencies. The model pictured is 5 feet high and employs a tubular mast that is both support and feed line. A mounting flange is included.

19

Microphone Connector

KINGS ELECTRONICS Co., 372 Classon Ave., Brooklyn 5, N. Y. A new microphone jack (M-161) and plug (M-151) combination has been de-

For Economical Precious Metal Performance

Overlay, precious metals,
one side or both sides,
any thickness.

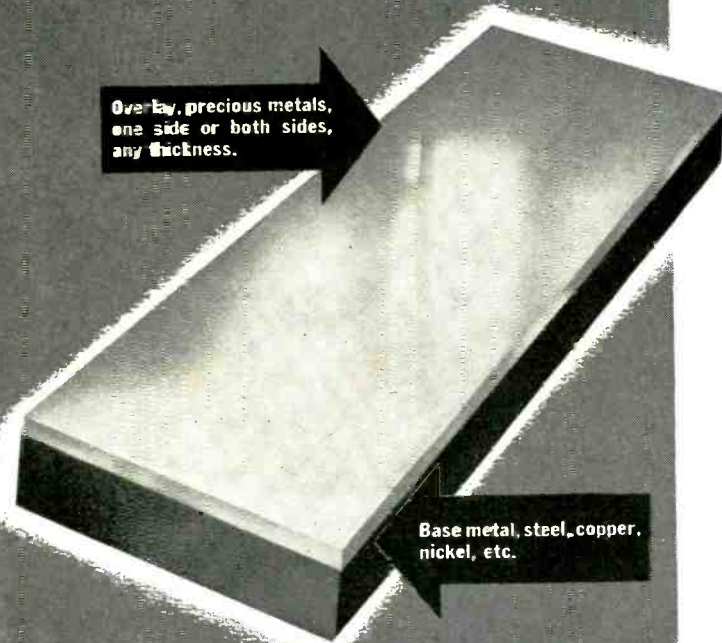

Base metal, steel, copper,
nickel, etc.

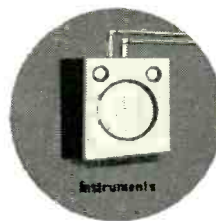

Instruments

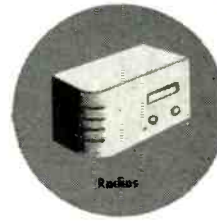

Radios

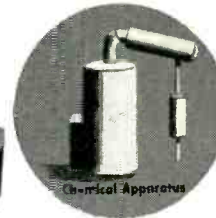

Chemical Apparatus

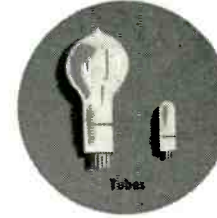

Tubes



Auto Equipment

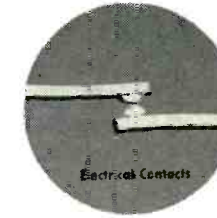

Electrical Contacts

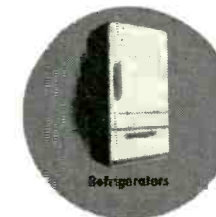

Refrigerators



Appliances

... USE **GENERAL PLATE Laminated Metals**

You simply can't beat General Plate Laminated Metals for solid precious metal performance at low cost.

Combinations of thin layers of precious metal permanently bonded to heavier base metals, they give you all the performance characteristics of solid precious metals yet you only pay for the thin layer of gold, silver, etc., plus the low cost of the base metal backing.

Typical application for General Plate Laminated Metals are electrical equipment, chemical apparatus, instruments, mobile equipment, aircraft, signal apparatus and electronic devices. Their advantages include economy, better electrical performance, high corrosion resistance, ease of

fabrication, workability and long wearing life.

Base to base metal combinations are also available for those applications where single base metals do not provide structural, mechanical or performance requirements desired.

Find out about General Plate Laminated Metals, today. They are available in sheet, wire and tube form or as fabricated assemblies. Write.

GENERAL PLATE DIVISION

of Metals and Controls Corporation

50 Church St., New York, N. Y.; 205 W. Wacker Drive, Chicago, Ill.; 2635 Page Drive, Altadena, California; Grant Bldg., Pittsburgh, Pa.

ATTLEBORO, MASSACHUSETTS

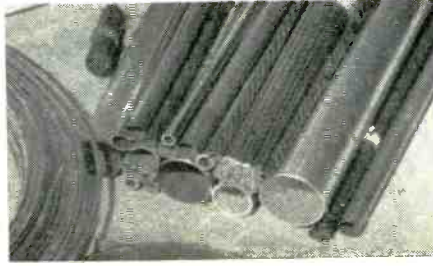

CARDWELL ANNOUNCES A NEW ADVANCED HIGH FIDELITY AUDIO AMPLIFIER



MODEL CE-25

- 25 watts undistorted output.
- Three High Impedance Inputs—Two for microphone and one for phonograph.
- Individual bass and treble boosting controls.
- Dynamic audio compensation circuit on phonograph channel.
- Ultra-modern cabinet styling with recessed control panel edge lighted.
- All aluminum construction combines durability with light weight.
- New vane type construction assures good ventilation and low operating temperature.
- Concealed hand holds for easy portability.

SPECIFICATIONS

POWER OUTPUT: 25 watts undistorted.

GAIN: Microphone 135 db
Phonograph 86 db.

FREQUENCY RESPONSE: Response at 50 cycles controllable from -15 to +17 db. Response at 10,000 cycles controllable from -15 to +22 db. In addition, Audio Compensation is used on the phonographic input which boosts bass as the volume level is reduced. This compensation is effective over a 40 db range in volume level and results in exceptional tone balance.

POWER REQUIRED: 115 watts at 105-125 volts 60 cycles AC.

DIMENSIONS: Length 15½ in.,
Depth 10¼ in., Height 8½ in.

CONTROLS: Two microphone volume controls and one phonograph volume control. One bass boost and one treble boost control.

TUBES: (2)—6SJ7, (3)—6SL7GT, (2)—6L6G, (1)—5U4G.

OUTPUT IMPEDANCES: 2, 4, 8, 16, 250, and 500 ohms.

INPUT IMPEDANCES: Microphone channels—10 megohms,
Phonograph channel—500,000 ohms.

WEIGHT: 26 lbs. All aluminum case.

SEE US AT BOOTH No. 97 AT
THE 1946 RADIO PARTS AND ELECTRONIC
EQUIPMENT CONFERENCE AND SHOW

May 13th to 16th Inclusive

HOTEL STEVENS, CHICAGO, ILL.



**THE ALLEN D. CARDWELL
MANUFACTURING CORP.**

MAIN OFFICE: 81 PROSPECT ST., BROOKLYN 1, N. Y.

FACTORIES: PLAINVILLE, CONN.—BROOKLYN, N. Y.

signed which is sufficiently massive to carry appreciable current. Points of contact are silver plated and connecting wires are soldered to the far ends of the heavy brass contact pins. The outer shield is intended to be grounded and secure contact is made by tightening the close-threaded coupling nut. The chassis half of the connector is mounted in a 1/8 inch hole stamped with a flat to prevent twisting.

20

Reflex Klystron

SYLVANIA ELECTRIC PRODUCTS, INC., 500 Fifth Avenue, New York 18, N. Y. The new reflex klystron has been designed for operation at wavelengths between 6 and 7 centimeters with power output between 65 and 70 milliwatts. The beam current is 32

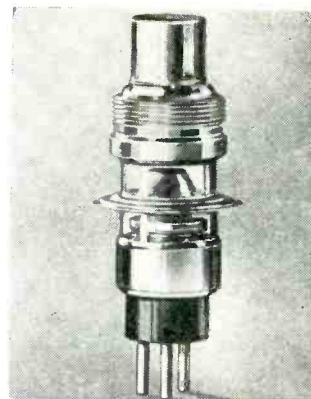

milliamperes, cavity voltage 325 volts and heater voltage 6.3 volts. Heater current is 1.1 amperes. The type SD-835F klystron has an overall length of 3 inches; bulb diameter 0.75 inches; and diameter of grid disc 1.125 inches.

21

Lead-in Insulator

THE WORKSHOP ASSOCIATES, 66 Needham Street, Newton Highlands 61, Mass., have developed a new standoff insulator for the new 300-



May 1946 — ELECTRONICS

electronics READER SERVICE . . .

TO BRING YOUR LIBRARY UP TO DATE ON LITERATURE AND NEW PRODUCTS

Manufacturers' Literature as well as further information on New Products described in this issue are important "working tools" for design and production departments. To make it easy to keep up to date, ELECTRONICS will request manufacturers to send readers the literature in which they are interested. Just fill out card—we do the rest.

HOW TO ORDER: Fill out completely (name, address, etc.) for each piece of literature or new product information you desire. This service only applies to the above and not to advertisements. Write directly to company for information on their advertisements. Each circle must contain the number that appears in this issue over the article on which you desire further information. This gives your request authority and allows the manufacturer to whom we send your original request, to address your copy correctly.

PLEASE NOTE . . .

In the event this copy of ELECTRONICS is passed along to other members of your company, please leave this sheet in for their convenience. This assures everyone in your plant the opportunity to fill in their requests. When the round is completed, cards can then be detached along perforated lines and dropped in the mail. Each individual request will be mailed by us to the company offering the information.

Write in circle number of item describing one catalog wanted →

Your Company Name *Jones Mfg. Co*
Address *3217 Lewis Ave.*
Chicago, Illinois
Your Name *John Smith*
Your Title *Chief Engineer*
ELECTRONICS, 330 W. 42nd St., New York 18

**CARDS NOT GOOD
AFTER JULY 1, 1946**

ELECTRONICS—May, 1946

Write in circle number of item describing one item wanted →

Your Company Name.....
Address.....

Your Name.....
Your Title.....
ELECTRONICS, 330 W. 42nd St., New York 18, N. Y.

Write in circle number of item describing one item wanted →

Your Company Name.....
Address.....

Your Name.....
Your Title.....
ELECTRONICS, 330 W. 42nd St., New York 18, N. Y.

Write in circle number of item describing one item wanted →

Your Company Name.....
Address.....

Your Name.....
Your Title.....
ELECTRONICS, 330 W. 42nd St., New York 18, N. Y.

Write in circle number of item describing one item wanted →

Your Company Name.....
Address.....

Your Name.....
Your Title.....
ELECTRONICS, 330 W. 42nd St., New York 18, N. Y.

Write in circle number of item describing one item wanted →

Your Company Name.....
Address.....

Your Name.....
Your Title.....
ELECTRONICS, 330 W. 42nd St., New York 18, N. Y.

Write in circle number of item describing one item wanted →

Your Company Name.....
Address.....

Your Name.....
Your Title.....
ELECTRONICS, 330 W. 42nd St., New York 18, N. Y.

Write in circle number of item describing one item wanted →

Your Company Name.....
Address.....

Your Name.....
Your Title.....
ELECTRONICS, 330 W. 42nd St., New York 18, N. Y.

Write in circle number of item describing one item wanted →

Your Company Name.....
Address.....

Your Name.....
Your Title.....
ELECTRONICS, 330 W. 42nd St., New York 18, N. Y.

Write in circle number of item describing one item wanted →

Your Company Name.....
Address.....

Your Name.....
Your Title.....
ELECTRONICS, 330 W. 42nd St., New York 18, N. Y.

Write in circle number of item describing one item wanted →

Your Company Name.....
Address.....

Your Name.....
Your Title.....
ELECTRONICS, 330 W. 42nd St., New York 18, N. Y.

Write in circle number of item describing one item wanted →

Your Company Name.....
Address.....

Your Name.....
Your Title.....
ELECTRONICS, 330 W. 42nd St., New York 18, N. Y.

Write in circle number of item describing one item wanted →

Your Company Name.....
Address.....

Your Name.....
Your Title.....
ELECTRONICS, 330 W. 42nd St., New York 18, N. Y.

An electronics service designed for READERS and MANUFACTURERS

For the Reader...

ELECTRONICS' fundamental policy has always been to supply its readers with all the pertinent and timely industry news. The ELECTRONICS' Reader Service supplements this policy by offering the reader an easy and effective means of obtaining complete, up to the minute data on new products and of maintaining at his fingertips comprehensive, practicable information on "who's doing what" in the industry.

There's complete coverage in every issue of ELECTRONICS of the month by month development by manufacturers of new materials, components and equipment, as well as brief mention of all the important, new, manufacturers' technical pamphlets and catalogs. Some of these items will be of particular interest to specific design and plant engineers, buyers, executives and others of our readers. They will want to make further inquiry concerning the new products described, or they will want to read and make a permanent part of their industrial library some of the manufacturers' literature and catalogs. ELECTRONICS' Reader Service makes it easy for them to obtain in readily accessible and usable form the information they desire.

For the Manufacturer...

ELECTRONICS' Reader Service will also be welcomed by manufacturers who are desirous of placing the complete news of their product developments as well as their technical bulletins and catalogs in the hand of those members of the electronic industry... including design, electrical, and production engineers, researchers, physicists, executives, and buyers — who have a particular interest in, or represent a potential buying power, for their products.

SUGGESTIONS FOR THE IMPROVEMENT OF OUR READERS' SERVICE ARE INVITED

ELECTRONICS is constantly seeking new and improved ways of providing its readers with the news and information they want and need, and of assisting the manufacturer in effectively delivering his message to electronic markets. If you have any ideas for us, send them along. They'll receive prompt and grateful consideration.

May, 1946—ELECTRONICS

FIRST CLASS
PERMIT No. 64
(Sec. 510 P.L.&R.)
NEW YORK, N. Y.

BUSINESS REPLY CARD

NO POSTAGE STAMP REQUIRED IF MAILED IN THE UNITED STATES

4c. - POSTAGE WILL BE PAID BY —

ELECTRONICS

330 WEST 42nd STREET

NEW YORK 18, N. Y.

FIRST CLASS
PERMIT No. 64
(Sec. 510 P.L.&R.)
NEW YORK, N. Y.

BUSINESS REPLY CARD

NO POSTAGE STAMP REQUIRED IF MAILED IN THE UNITED STATES

4c. - POSTAGE WILL BE PAID BY —

ELECTRONICS

330 WEST 42nd STREET

NEW YORK 18, N. Y.

FIRST CLASS
PERMIT No. 64
(Sec. 510 P.L.&R.)
NEW YORK, N. Y.

BUSINESS REPLY CARD

NO POSTAGE STAMP REQUIRED IF MAILED IN THE UNITED STATES

4c. - POSTAGE WILL BE PAID BY —

ELECTRONICS

330 WEST 42nd STREET

NEW YORK 18, N. Y.

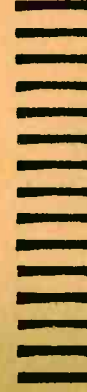
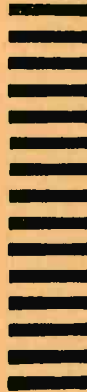
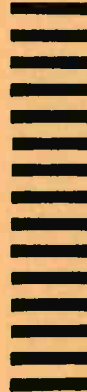

5-1-46

5-1-46

5-1-46

WALDES

TRUARC RETAINING RINGS SPECIFIED FOR LEAR'S SERVO ACTUATORS



The Lear Triple Servo — designed for application with the Lear Automatic Pilot.

DESIGNED FOR THE **AUTOMATIC PILOT** WITH SUPERHUMAN SENSITIVITY

LEAR, Inc.
"To eliminate excess weight in our Triple Servo Unit, and make every possible saving of space without loss of power, our design engineers specified Waldes TRUARC Retaining Rings. Retention by any other means was not even attempted. Our experience with Truarc, in other Lear units used in famous aircraft, precluded experimenting with other types of retainers. Truarc has made possible the lightest, most compact unit without sacrificing efficiency. Weight of the entire assembly is only 11.5 pounds."

NOW YOUR MACHINES CAN HAVE THE DESIGN ECONOMY of retaining rings regardless of load, stress or accuracy involved. Waldes TRUARC high precision retaining rings do the job of nuts, shoulders, collars and pins. Yet they allow lighter, more compact units—make assembly and disassembly quicker, easier. TRUARC rings give *better, more dependable* retention because their mathematically precise construction means perfect circularity—insures a never-failing grip. There's a Truarc ring for every mechanical product.

FREE! See how TRUARC can improve your product—cut production and maintenance costs. Write today for Truarc Booklet 18B showing industrial applications and design sketches.

U. S. PAT. RE. 28,144

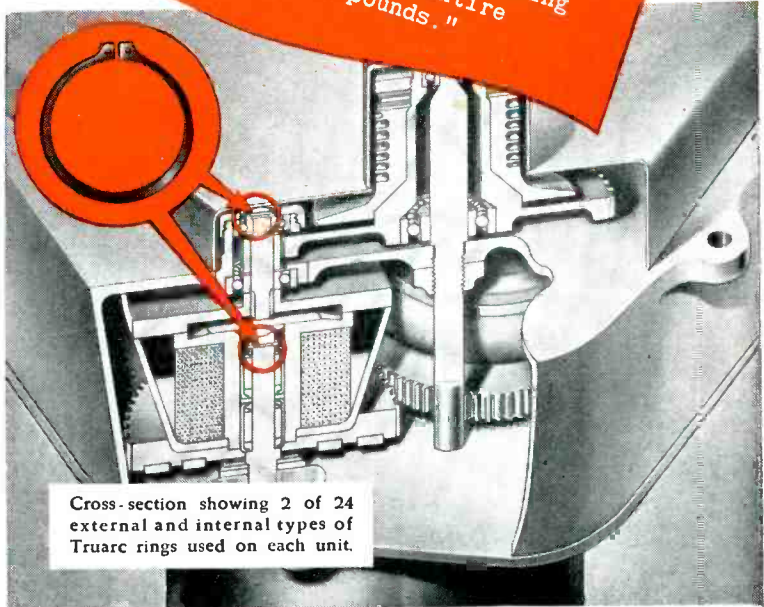

Cross-section showing 2 of 24 external and internal types of Truarc rings used on each unit.

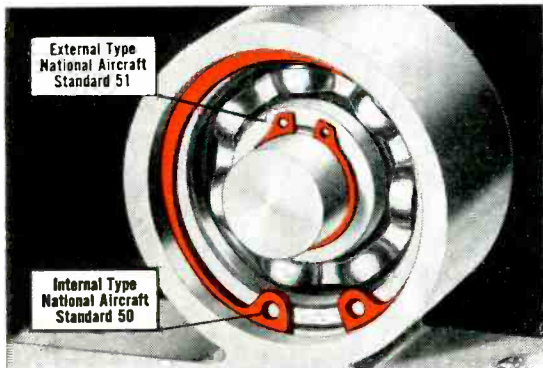

WALDES
TRUARC RETAINING RINGS
WALDES KOHINOOR INC., LONG ISLAND CITY 1, N. Y.
CANADIAN REPRESENTATIVE: PRENCO PROGRESS AND ENGINEERING CORPORATION, LTD., 72-74 STAFFORD STREET, TORONTO





there
is

NO SUBSTITUTE

for good, honest WIRE, unwinding itself
cross-country, through mighty public buildings and
humble cottages, in and out of America's radio sets and
legion other communications units. You are getting some
CORWICO Wire now . . . and more is on the way . . .

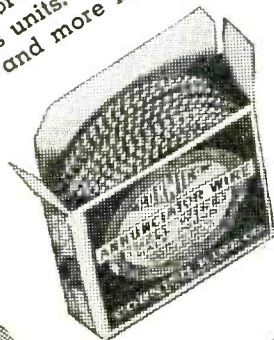

cornish

WIRE COMPANY, INC.

15 Park Row, New York 7, N. Y.

"Made by Engineers for Engineers"

ohm parallel line. The advantages of this transmission line are lost if the line becomes unbalanced owing to proximity to roof, downspout or other large metal object. The insulator, molded of weatherproof plastic material, is attached with a single wood screw.

22

Miniature Thyatron

SYLVANIA ELECTRIC PRODUCTS, INC., 500 Fifth Avenue, New York. The Type 6D4 miniature thyatron measures 2½ inches overall and is mounted in a T-5½ bulb. Heater voltage is 6.3 volts, a-c or d-c; heater current, 250



milliamperes; heating time, 30 seconds. The maximum voltage between elements is 450 volts. The maximum peak anode current is 100 milliamperes, maximum heater-to-cathode voltage ranges between +25 volts and -100 volts.

23

Waterways Radiophone

RADIOMARINE CORP. OF AMERICA, 75 Varick Street, New York 13, N. Y. The model ET-8031 radio telephone unit operates from a shipboard 150-volt d-c supply and has been designed

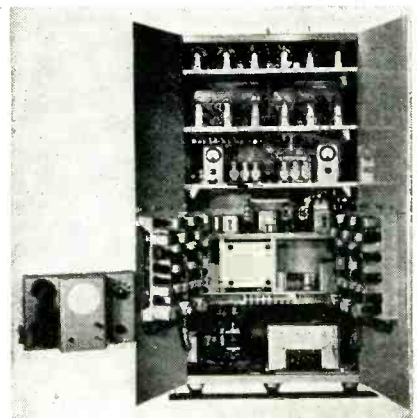



LABORATORY INSTRUMENTS FOR SPEED AND ACCURACY

A New Versatile -hp- Power Supply Unit

- Portable
- Compact
- Light Weight
- 1% Regulation
- Low Cost:

\$75.00

New -hp- Model 710A

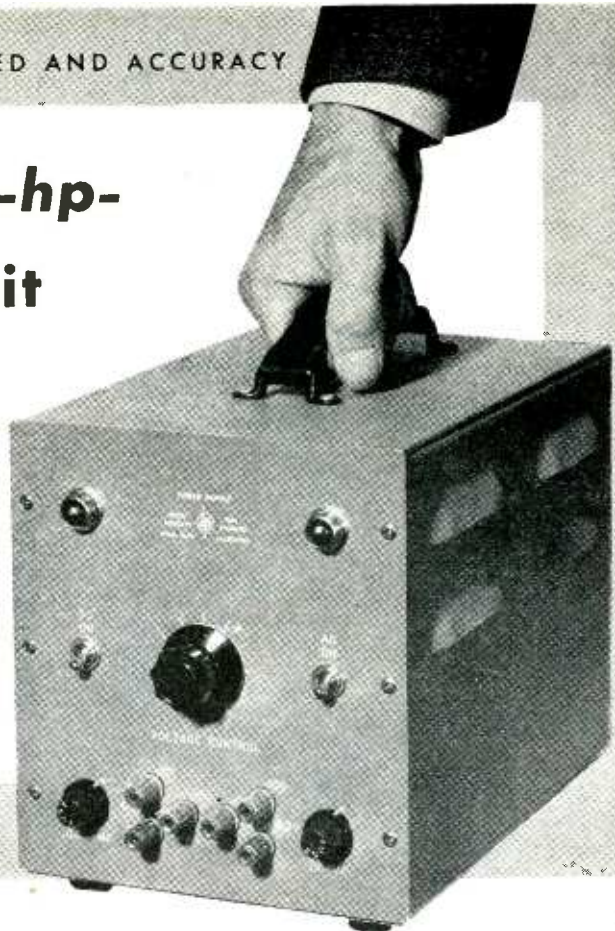

With good regulation, light weight and small physical size, the new -hp- Model 710A Power Supply is now available at the exceptionally low price of \$75.00. Every laboratory and production department will find hundreds of uses for this versatile power source. The low cost makes it practical and economical to utilize several of them.

RANGE 180—360 VOLTS

The -hp- Model 710A Power Supply will deliver any required voltage between 180 and 360 volts, with less than 1% variation for output currents of from 0 to 75 ma. (Maximum current is 100 ma).

6.3 FILAMENT VOLTS

Either positive or negative terminal may be grounded to provide maximum flexibility. To increase its usefulness even more, the -hp- Model 710A supplies up to 5 amps at 6.3 volts AC for heating fila-

ments. Either terminals or center-tap may be grounded.

These features, combined with its compact portability, make the -hp- Model 710A the ideal power supply for general use. It can simplify your equipment problem tremendously. Get your order in early for immediate delivery.

SPECIFICATIONS

Supplies any DC voltage between 180 and 360

Either positive or negative terminal may be grounded

Small size, consumes a minimum of bench space

Holds DC voltage constant from 0 to 75 ma load

Holds DC voltage constant with $\pm 10\%$ change in line voltage

Low AC ripple output

Low cost . . . **\$75.00**

HEWLETT-PACKARD COMPANY

BOX 1198 A • STATION A • PALO ALTO, CALIFORNIA

Audia Frequency Oscillators

Signal Generators

Vacuum Tube Voltmeters

Noise and Distortion Analyzers

Wave Analyzers

Frequency Meters

Square Wave Generators

Frequency Standards

Attenuators

Electronic Tachometers

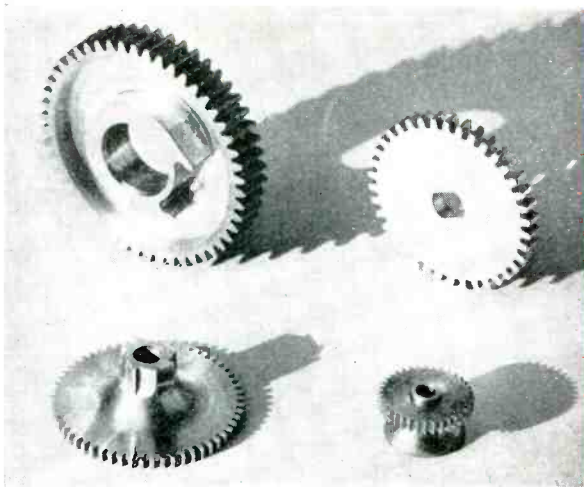

GEARS WITH SHAPES

Special Shapes and Features? . . . Tolerances within .0005" . . . Let our experience in supplying precision small and medium sized gears with such features solve these production problems for you . . . Ask for quotation on your job specifications. Circular on Request.

- SPUR
- WORM
- SPLINE
- HELICAL
- SPROCKET
- STRAIGHT BEVEL
- GROUND THREADS



Beaver Gear Works Inc.

1021 PARMELE STREET, ROCKFORD, ILLINOIS

UP
TO 3.2
K.V.A.

D.C. to A.C. CONVERTERS

An Inverted Rotary Converter is a rotating electrical machine for converting direct to alternating current.

Janette was one of the first manufacturers to design, build and develop rotary converters for use with numerous A.C. devices; especially those using electronic tubes. Since their inception they have established a world wide record for reliable, efficient, quiet, trouble-free operation under the most adverse conditions. **Two types are built:** one for standard and special commercial uses; the other for marine service.

Ask for **Bulletin 13-25** for **COMMERCIAL** Type Converters or **Bulletin 13-27** for the **MARINE** Type

Janette

Janette Manufacturing Co. 556 W. Monroe St. Chicago 6, Ill.

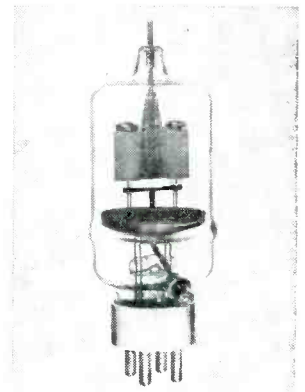

typical voltages include d-c plate voltage, 3,000; d-c plate current, 250 milliamperes; plate power output, 600 watts with an approximate driving power of 27 watts. The filament operates on 5 or 10 volts at currents of 12.5 or 6.25 amperes. Overall length of the tube is 7.625 in.; diameter, 2.563 in. Net weight 7 oz.

for use on inland waterways such as the Mississippi River or the Great Lakes. Receivers operating at several different frequencies continuously provide for sure reception of incoming calls. The remote control unit pictured at the left measures 10½ x 16 x 14½ inches and weighs 20 pounds. The 75-watt amplitude-modulated transmitter is contained in a weatherproof aluminum cabinet 60 x 32½ x 14½ inches. This cabinet contains the six-channel radio transmitter and up to six receivers.

24

Multi-Element Triode

EITEL-MCCULLOUGH, INC., San Bruno, Calif. The new type 3-150A multielement triode is suitable for many applications including television and industrial heating. The tube operates at maximum power up to 40 megacycles and for a single tube in class C telegraphy operation

25

Equation Computer

CONSOLIDATED ENGINEERING CORP., 620 North Lake Ave., Pasadena 4, Calif. Originally developed for computation of mass spectrometer data, a new computer is now available for the solution of linear simultaneous equations encountered in the study of electrical circuits, aircraft flutter analysis and statistics. Based on the

Only **FEDERAL** gives you
2 plus values in . . .

FM and TELEVISION LEAD-IN WIRE!

1. Produced by world's largest manufacturer of high frequency cable!
2. Engineered in the same laboratories that have put Federal in the forefront in FM and Television research!

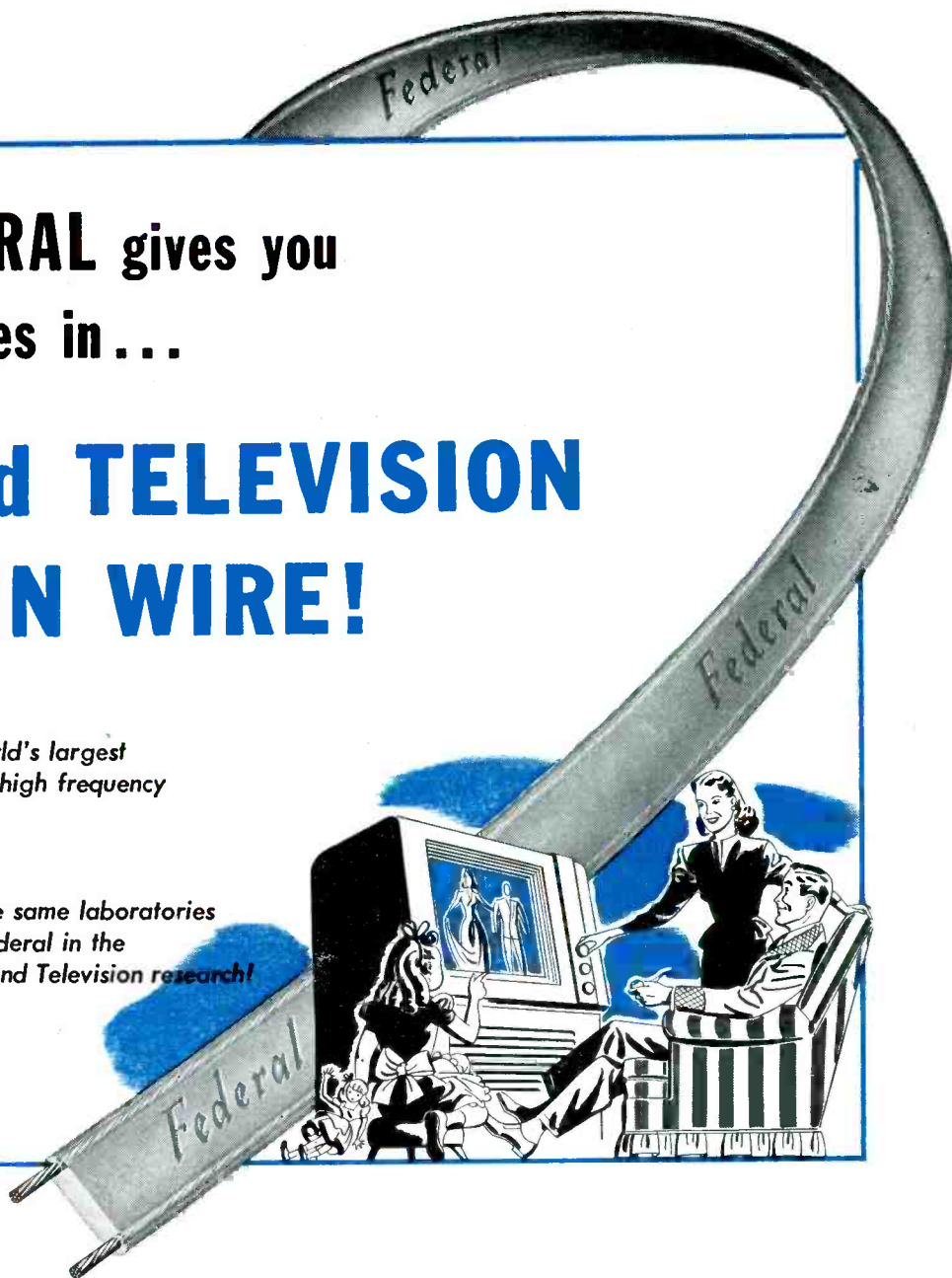

FEDERAL's high frequency cable is *really engineered* for low-loss signal transmission from antenna to receiver . . . the product of years of experience in FM and Television.

It's a solid, polyethylene insulated type . . . resisting water, acids, alkalis, oils . . . won't embrittle or age in sunlight. It retains flexibility in sub-zero temperatures; and dimensional precision even in hot weather. Elliptical cross section enables it to withstand twisting and abrasion—eliminates any moisture conduction path.

Federal's lead-in cable is available to you now, in various sizes. Write for complete details.

Federal lead-ins have dual, stranded conductors. Characteristic impedance for commercial telecasts is 300 ohms—capacity per foot is 5 mmf.

Other types produced for special applications and experimental work have characteristic impedances of 200 and 100 ohms.



Federal Telephone and Radio Corporation

Export Distributor
International Standard Electric Corporation

Newark 1, New Jersey



How to assure PERFECTION IN PRODUCTION

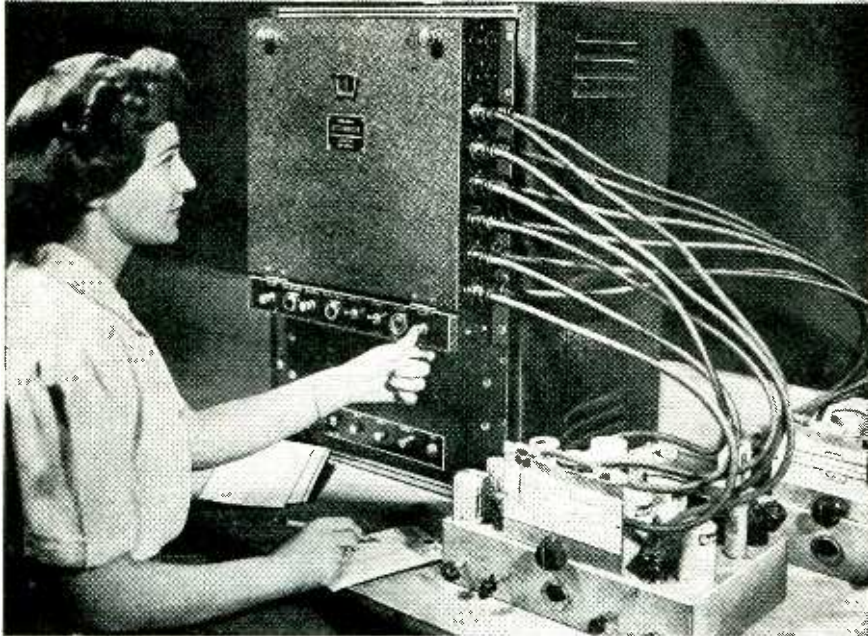

classical iterative method, the new device is advantageous in that it reduces computation time to a fifth that required by mechanical calculators and requires a short operator training period. The power supply operates on 100 watts, from a 115-volt, 50 or 60-cps lighting circuit. measures 17 x 8 x 8 inches and weighs 35 pounds. The computer itself measures 35 x 23 x 19 inches and weighs 200 pounds. As an example of the performance of this computer, the expression $E_{\text{ουσυείδητος}}$ can be solved for E in less than 5 seconds.

26

Midget Dry Cell

P. R. MALLORY & Co., INC., 3029 East Washington Street, Indianapolis 6, Ind. The Tropical Dry Battery is a war-time development featuring a high capacity-to-volume ratio, long cell life, and a substantially flat dis-



charge characteristic. No rest periods are required owing to a new method of minimizing polarization effects. Within rated limits each cell has an ampere-hour capacity independent of drain. Each cell measures 1 inch in diameter and is $\frac{3}{8}$ inch high. The cell case does not corrode, being made of steel, nor does it take part in the electrolytic action of the

ROTOBRIDGE

Checks a Circuit a Second

Use the Rotobridge as insurance against returns, rejects and troublesome service calls.

This automatic instrument checks wiring errors, resistance and reactance values—right on the assembly line!

Designed for continuous 24-hour duty, the Rotobridge serves you where and as you direct. A 10% resistance tolerance at one point? A 25% capacity tolerance at another spot? Trust the Rotobridge to do the job with unfailing accuracy—and completely automatically!

Versatile, the Rotobridge is adaptable either to several small-sub-assemblies, or a complete set comprising as many as 120 circuits. Two or three Rotobridge units, working simultaneously, will inspect a 30 or 40 tube set up . . . in five minutes!

Write for Bulletin and Prices

Communication Measurements Laboratory
120 GREENWICH STREET, NEW YORK 6

SEALED

**to stop air, oil, water
and current leaks
in h-f circuits**

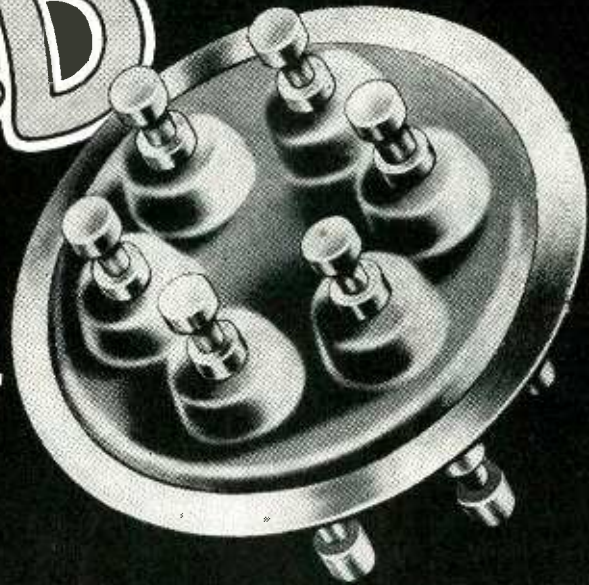

In high-frequency, high-voltage circuits, current arcs right through ordinary insulation or seeps away in high losses.

Specially-developed dielectrics are needed. One of these is Mycalex, a glass-bonded mica product made by the Mycalex Corporation of America, Clifton, N. J., and widely used for more than twenty-five years.

But even with Mycalex there still remains a difficulty when building units in which the insulation must be combined with metal conducting elements—as, for example, lead-ins or terminals.

For such units you need a current-carrying metal that will match the thermal expansion characteristics of Mycalex. Otherwise, unequal expansion and contraction rates will separate the metal inserts from the insulating material, letting oil, air and

moisture into the electrical system.

The metal also must offer adequate electrical conductivity... must suffer no corrosion that would reduce surface conductivity... must be workable into the small sizes and intricate shapes needed.

To get all these properties, Mycalex engineers always recommend Monel—one of the versatile INCO Nickel Alloys—to ensure the dependable hermetic seals they need.

MORE AND MORE ENGINEERS ARE "DISCOVERING" THE INCO NICKEL ALLOYS

Investigate the INCO Nickel Alloys whenever you have a tricky metal problem. Strong, tough, and corrosion-resisting as a group, each also offers the individual properties so frequently needed in electric and electronic applications.

★ ★ ★

Write for your copy of "INCO NICKEL ALLOYS for ELECTRONIC USES"—a summary of properties and recommended applications.



"EXTREMELY SATISFACTORY"

Six Monel terminals are molded into this Mycalex assembly for a transformer. After testing it for leakage, United Transformer Corporation reported it to be "extremely satisfactory for hermetic sealing purpose."

Because the coefficients of thermal expansion of Monel and Mycalex are so compatible, and because the surface conductivity of Monel cannot be reduced by corrosion, Mycalex engineers recommend Monel above all other metals for use with Mycalex.

THE INTERNATIONAL NICKEL COMPANY, INC., 67 Wall St., New York 5, N. Y.

NICKEL  ALLOYS

MONEL • "K" MONEL • "S" MONEL • "R" MONEL • "KR" MONEL • INCONEL • NICKEL • "L" NICKEL • "Z" NICKEL
*Reg. U. S. Pat. Off.



MR. RADIOMAN: Here's How Capitol Radio Can Prepare You Now for a Better Job and a Secure Career in Radio-Electronics . . . !

Add CREI Technical Training to Your Present Experience—Then Get that Better Radio Job You Want—More Money, Security!



CREI home study training in Practical Radio-Electronics Engineering equips you with the ability to go after—and get—a better job in radio-engineering that offers security, advancement and importance.

We are now entering a period where employers can once again afford to be "choosey" in selecting the best-qualified men for the important jobs to be filled.

In our proved course of home study training, you learn not only how . . . but why! Your ability to solve tough problems on paper, and then follow with the necessary mechanical operation, is a true indication that you have the confidence born of knowledge . . . confidence in your ability to get and to hold the type of radio job you want.

CREI courses have been studied by more than 10,000 professional radiomen—so don't say YOU haven't the time. CREI courses are designed to be studied in the most crowded schedules—without interfering with your present work, yet helping you as you progress lesson by lesson.

Now you can read what these typical CREI students have to say. They are men who had the initiative to get started on their own betterment program toward better jobs and more money. You have the same opportunity. It costs you nothing but a moment's time to send for complete details in free book.

"I give CREI full credit for my securing the position as Asst. Chief Engineer . . ."—W. H. Meiners, 420507

"In the past 7 months I have received 3 increases in salary and a promotion that can be partly credited to CREI . . ."—C. B. McKnight, 401101

"There are many times when what I am studying in the course works right in with the immediate problems of my job . . ."—C. I. Carpenter, 411024

CREI Training for Veterans is Approved Under the "G. I." Bill.

CAPITOL RADIO ENGINEERING INSTITUTE

E. H. Rietzke, President

Dept. E-5, 3224-16th Street, N. W., Washington 10, D. C.

Member: NATIONAL HOME STUDY COUNCIL • NATIONAL COUNCIL OF TECHNICAL SCHOOLS

cell. Chemicals used are zinc and mercuric oxide rather than the zinc and carbon employed in most commercial dry cells. These cells are expected to be available within the next few weeks.

27

Miniature Welder

RAYTHEON MANUFACTURING COMPANY, INC., 60 East 42nd Street, New York 17, N. Y. The new electronic Weldpower unit produces 60 to 120 welds a minute on non-ferrous met-

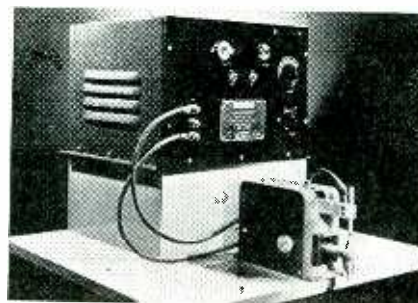

als. The unit measures 9½ x 13½ x 13½ inches and can be used successfully in the manufacture of small electrical equipment and radio parts. Average current drain is about 3 amperes at 110-125 volts, 60 cps.

28

Impedance Calculator

OPERADIO MFG. Co., St. Charles, Ill. The calculator is designed to aid in quickly matching loudspeaker lines to an amplifier for any sound system using loudspeakers with impedances between 500 and 16,000 ohms. It consists of a 5 in. diameter heavily varnished card disc with two rotating scales. The price is 25 cents.

29

Volt-Ohm-Milliammeter

RADIO CITY PRODUCTS, 127 West 26th Street, New York 1, N. Y. The Model 424 Volt-Ohm-Milliammeter employs a meter with a sensitivity of 2,500 ohms per volt and a movement of 400 microamperes. Uniform a-c and d-c voltmeter sensitivity of a thousand ohms per volt at an accuracy of 1 percent is available up to 1,000 volts. Direct current in the range from 0 to 1,000 milliamperes can be measured. As an ohmmeter the instrument reads between 0 and 10 meg-

JUST OFF THE PRESS!



WRITE FOR FREE 36-PAGE BOOKLET

"Your Opportunity in the New World of Electronics"

If you have had professional or amateur radio experience and want to make more money, let us prove to you we have something you need to qualify for a better radio job. To help us intelligently answer your inquiry — PLEASE STATE BRIEFLY YOUR BACKGROUND OF EXPERIENCE, EDUCATION AND PRESENT POSITION.

R.C.P.

first in world sales* ...

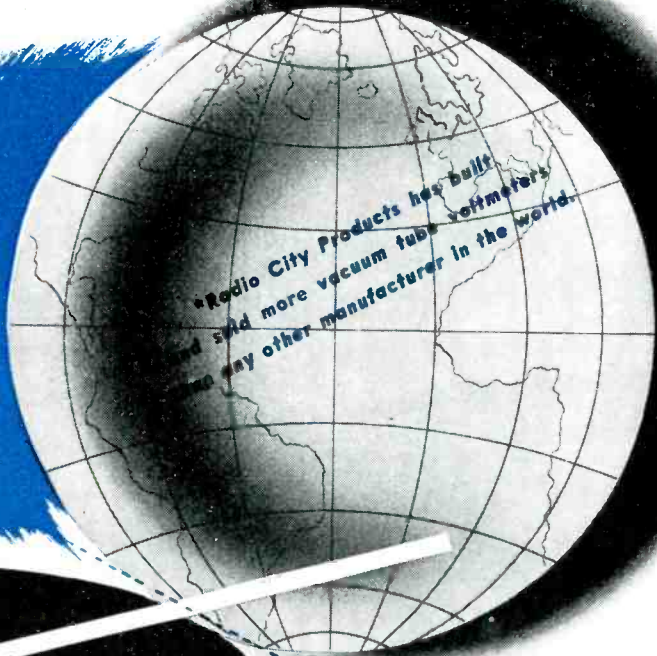

*Radio City Products has built and sold more vacuum tube voltmeters than any other manufacturer in the world.



MODEL 668 VACUUM TUBE VOLT, OHM, CAPACITY METER

VACUUM TUBE AC AND VACUUM TUBE DC voltmeters provided in this quality test unit. A highly accurate instrument, sensitive and flexible, designed to speed production and laboratory test work.

★ **DC VACUUM-TUBE VOLTMETER**—Direct Reading Sensitivity: 160 to 16 megohms. Six ranges: 0-6-30-150-600-1500-6000 Volts. Voltmeter readings can be taken without affecting circuit contents.

★ **AC VACUUM-TUBE VOLTMETER**—Direct Reading. Input capacity 0.00005 mfd. at terminals of instrument. Input resistance: 160 to 16 megohms. Seven ranges 0-3-6-30-150-600-1500-6000 volts. Measures signal and output voltages from 10 cps to 10,000 cps.

★ **VACUUM TUBE OHMMETER**—Direct reading. From 0.1 ohm to 1,000 megohms. Seven ranges: 0-1,000-10,000-100,000 ohms; 1-10-100-1,000 megohms.

★ **CAPACITY METER**—Accurate measurements from 0.00005 to 2,000 mfd. Seven ranges: 0-0.002-0.02-0.2-2-20-200-2,000 mfd.

MODEL 668. Size 9 $\frac{3}{4}$ " x 9 $\frac{1}{4}$ " x 7 $\frac{3}{8}$ ". Weight 7 $\frac{3}{4}$ lbs. Available for 110 volt, 60 cycles a.c.; 210-270 volt, 50-60 cycles.

ACCURACY —Adjustable line voltage compensator assures complete accuracy on all capacity readings. Constant accuracy of low resistance ohmmeter ranges assured by test of ohmmeter battery under load to determine need for battery replacement. Accurate capacitymeter reads direct in microfarads —40,000,000 to 1 measurement ratio.

SAFETY —Meter cannot be damaged by using low range on high voltage reading. No danger of shock on high resistance or low capacity measurements. Entire instrument is thoroughly shielded. Easy replacement of line fuse at front panel.

VISIT WITH US AT THE 1946 RADIO PARTS & ELECTRONIC EQUIPMENT SHOW. BOOTH 62 AT THE STEVENS HOTEL

RADIO CITY PRODUCTS COMPANY, INC.

127 WEST 26th STREET

NEW YORK CITY 1, N.Y.

MANUFACTURERS OF PRECISION ELECTRONIC
OHM-MILLIAMMETERS, SIGNAL GENERATORS,



LIMIT BRIDGES, VACUUM TUBE VOLTMETERS, VOLT-
ANALYZER UNITS, TUBE TESTERS, MULTI-TESTERS.

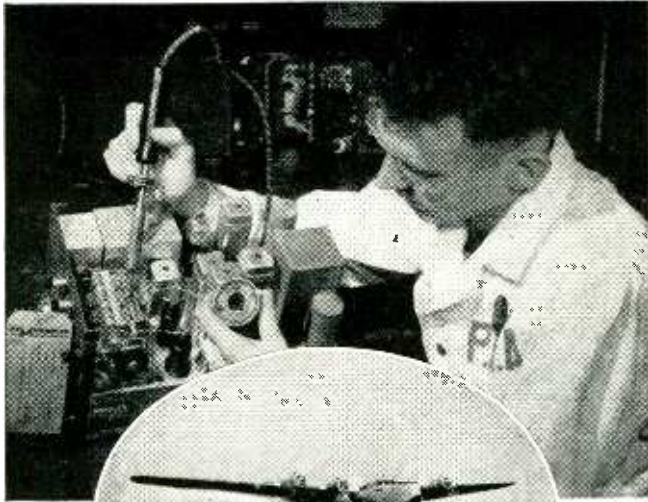

Photo courtesy Pan-American World Airways

STAYING POWER
Anywhere

with KESTER Cored Solders for Long-Range Performance

- In the field of electronics, as in scores of applications on the Pan American's globe-circling Flying Clippers, Kester Cored Solders have demonstrated the rugged dependability and staying powers which has made them No. 1 choice throughout industry.

- Tested, time and again, under all possible operating conditions, Kester solder-bonds hold tight—permanently—against shock, vibration, bending, and the contraction and expansion of temperature extremes.

- Kester Cored Solders are virtually mistake-proof and trouble-free as well, for the flux-filled cores are scientifically balanced with superior alloys—ready to apply in one simple operation.

- Kester Rosin-Core Solder, for electrical connections, will not cause corrosion nor harm insulation. Kester Acid-Core Solder, for general work, is an ideal all-purpose solder.

- Kester engineers, backed by 47 years of practical experience and laboratory research, are at your service any time. They will gladly work out any solder problems you may have—and at no obligation.

KESTER SOLDER COMPANY

4204 Wrightwood Ave., Chicago 39, Illinois
Eastern Plant: Newark, N. J. Canadian Plant: Brantford, Ont.



KESTER
Cored Solders
STANDARD FOR INDUSTRY



ohms. It can also be read directly as a decibel meter across a 500-ohm line. The instrument measures $7\frac{1}{2} \times 5\frac{1}{4} \times 3\frac{3}{4}$ inches and weighs 2 pounds. A portable type, Model 424P, is somewhat larger and heavier. Both models have self-contained batteries.

30

Tube Adapter

J. F. D. MANUFACTURING COMPANY, 4117 Fort Hamilton Parkway, Brooklyn, N. Y. has designed some thirty-five adapters which will permit the substitution of available miniature tubes for octal-base tubes like the 50L6 and 35Z5.

31

Cloverleaf Antenna

WESTERN ELECTRIC Co., INC., 195 Broadway, New York 7, N. Y. The new Cloverleaf antenna has been designed for use by frequency-modulation broadcast stations operating on new frequencies between 88 and 108 megacycles at power levels up to 50

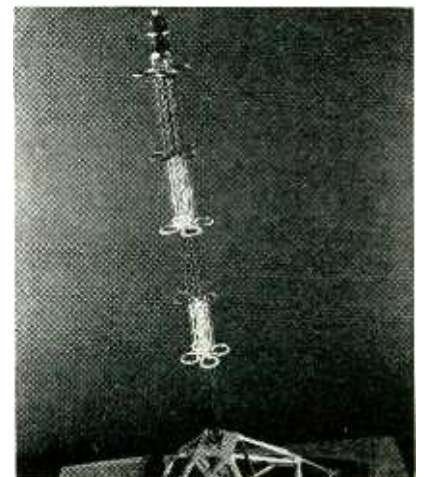

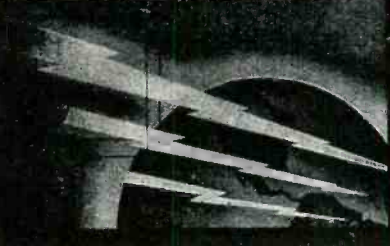

- PRECISION WIRE WOUND RESISTORS
- WHEATSTONE BRIDGES
- RADIO & ELECTRONIC TEST EQUIPMENT
- RADAR ASSEMBLIES

Eastern Electronics Corp.

PHONOGRAPH TURNTABLE UNIT The need at this time for large quantities of phonograph turntable assemblies has prompted us to quickly design and tool up for the immediate production of this item. Engineers will find this compact turntable meeting all of their requirements for performance.

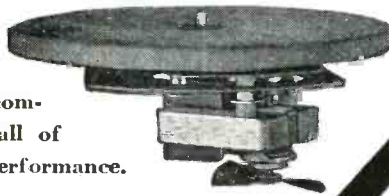

PERFORMANCE:— Correct and uniform speed is secured through the use of a motor of ample capacity, preloaded to operate on the flattest portion of the torque-speed characteristic.

QUIETNESS:— Is assured by full-floating rubber motor mountings and rubber cushioned drive. Permanent freedom from turntable wobble is guaranteed by an extra rigid turntable, an extra long bearing and precision machining of these parts.

RELIABILITY:— The motor is fan-cooled and will operate continuously with an exceptionally low temperature rise. All bearings are of ample size and are provided with self-lubricating features.

We will make special resistors to any value or tolerance.

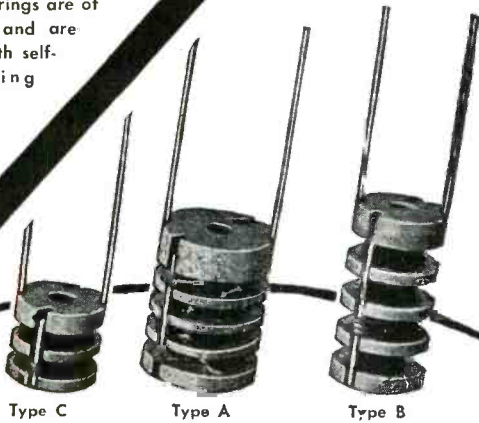

Type C

Type A

Type B

Type C
Maximum resistance 500,000 ohms.

Type A
Maximum resistance 1,000,000 ohms.

Type B
Maximum resistance 1,000,000 ohms.



Type XM
Instrument resistance shunt .1 ohms or lower, 25 watts.



ROTARY SELECTOR SWITCH

Designed for use where low contact resistance and mechanical sturdiness is required. Its construction insures long wear with low contact resistance of less than .001 ohm. May be arranged to have several sections to obtain multi-polar switching.

Well suited for precision test instruments; shunt ammeters, thermo-couple types, Wheatstone Bridges, and similar devices.

Eastern Electronics Corp.

41 CHESTNUT STREET, NEW HAVEN, CONN.

New York Sales Office
Turney & Beale
215-05 27th Ave.
Bayside, Long Island, N.Y.
Tel. BA 9-8958

Chicago Sales Office
Bauman & Bluzat
2753 West North Ave.
Tel. Humboldt 6809

Boston Sales Office
11 Pemberton Square
Tel. Capitol 2425

J. E. Oliphant and Company
505 Uhler Building
Marion, Ohio

Toronto Sales Office
C-M Engineering Co.
137 Wellington St. West
Toronto, Canada
Tel. Adelaide 5366

Announcing The KEYNOTE DINNER

The first Post-war get-together. . . The initial recon-
version gathering of manufacturers and distributors
. . . opening with an industry-wide business meeting!

YOU ARE CORDIALLY
INVITED TO ATTEND

THE KEYNOTE DINNER

OF THE

1946 RADIO PARTS AND ELECTRONIC EQUIPMENT SHOW

Monday, May 13, 1946

7:00 P. M.

GRAND BALLROOM

STEVENS HOTEL

CHICAGO, ILL.

Make Your Reservations NOW! Space limitations will permit the acceptance of only the first 1500 requests. Fill out the attached form and send it with your check for \$5.00 per plate or \$50.00 per table of ten.

P. S. A renowned business man . . . The speaker of the evening . . . will discuss current business practices as they affect YOUR problems.

TEAR OFF HERE AND MAIL NOW!

PLEASE RESERVE . . . plates for the KEYNOTE DINNER of the 1946 RADIO PARTS and ELECTRONIC EQUIPMENT CONFERENCE and SHOW. The following persons connected with this company will attend:

Name

Title or Position

Name

Title or Position

Name

Title or Position

Check for \$5.00 per plate is enclosed herewith. Please send our Keynote Dinner tickets by return mail to:

Name of Company

Signature

Address

Send check to RADIO PARTS AND ELECTRONIC EQUIPMENT SHOWS,
SUITE 2214 221 NORTH LASALLE STREET CHICAGO 1, ILLINOIS

kilowatts. Preliminary measurements on accurately scaled models show that the distribution of energy in azimuth is circular and the computed beam width is realized to plus or minus one degree. The new antenna structure illustrated can be supplied in from two to eight-section units, depending upon the operating frequency. The computed power gain for an eight-section tower is 4.7.

32

Coil Winder

CONNECTICUT SPECIALTIES COMPANY, Box 501, Stamford, Conn. The new 1-20 tension multiple winding machine has a capacity of 2,000 coils per day in wire sizes ranging from

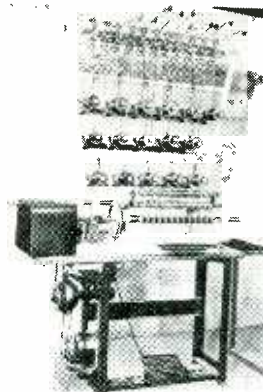

20 to 44. The machine handles coils up to 6 inches in diameter, and is driven by a 1/3 horsepower motor at speeds between 800 and 2,500 rpm.

33

Electrical Connector

AIRESEARCH MANUFACTURING COMPANY, 9851 Sepulveda Blvd., Los Angeles 43, Calif. The new Williams-Grip electrical connector develops a

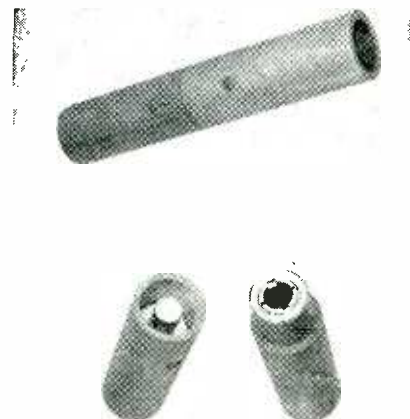

skilled springmakers . .
AND practical,
experienced engineers,
SPECIALISTS
in spring design
and manufacture

At Accurate



It takes people to make springs. Ours are specialized, highly trained, long-experienced people—well qualified to give you the finest in spring craftsmanship.

Q Our engineers too, are an important reason why you'll like Accurate Spring Service. They're old hands at spring-making . . . they've developed manufacturing systems and procedures that enable us to handle your jobs with the greatest speed and efficiency. These Accurate engineers are at your service on spring design problems. You will benefit from their practical assistance in designing exactly the right spring for your application.

Q Why not try Accurate on your next job.

Send for your copy of the new Accurate Spring Handbook. It's full of data and formulae which you will find useful. No obligation of course.

ACCURATE SPRING MFG. CO.

3830 W. Lake Street

Chicago 24, Illinois

Accurate

Springs

SPRINGS • WIREFORMS • STAMPINGS

Electricity



FOR RADIO AND ELECTRONIC APPLICATIONS

ONAN ELECTRIC GENERATING PLANTS supply reliable, economical electrical service for electronics and television applications as well as for scores of general uses.

Driven by Onan 4-cycle gasoline engines, these power units are of single-unit, compact design and sturdy construction. Suitable for mobile, stationary or emergency service.

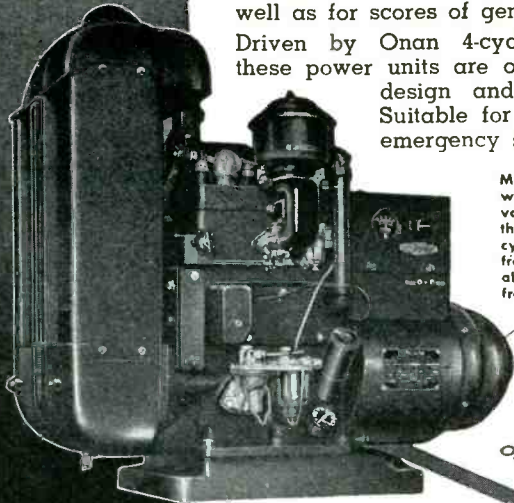

Models range from 350 to 35,000 watts. A. C. types from 115 to 660 volts, 50, 60, 180 cycles, single or three-phase and 400, 500 and 800 cycles, single phase. D. C. types from 6 to 4000 volts. Also available in dual voltage and special frequency types.

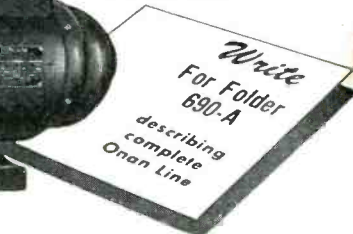

Model shown is from W2C series: 2000 to 3500 watts; powered by Onan two-cylinder, water-cooled engine.

D. W. ONAN & SONS

3551 Royalston Ave.

Minneapolis 5, Minn.



FOR SAFETY'S SAKE

Safety first for personnel is of the utmost importance. This protection can be guaranteed through the use of G-E Interlock Switches on radio transmitters, X-ray and therapeutic machines, burglar alarms, and signal controls for fire doors.

Safety first for equipment is important, too. G-E Indicator Lamps give visual evidence of what is going on inside equipment, and circuit troubles can be corrected before they become serious. Write: *Electronics Department, General Electric Company, Syracuse, New York.*

GENERAL ELECTRIC

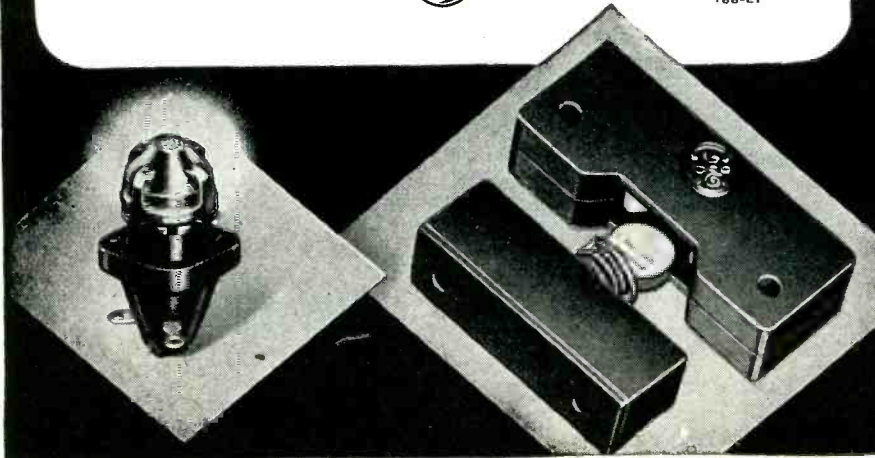

positive contact by means of a special thread-actuated thrust, such that when the connector is carrying 100 amperes it has a maximum drop of only 1.9 millivolts. It is particularly applicable for aircraft wiring carrying heavy current.

34

Amateur Antenna

ANDREW COMPANY, 363 E. 75th Street, Chicago 19, Ill. The Type 702 ground-plane antenna clamps to metal or wood poles and is provided with a universal-type joint to maintain proper orientation. It is factory

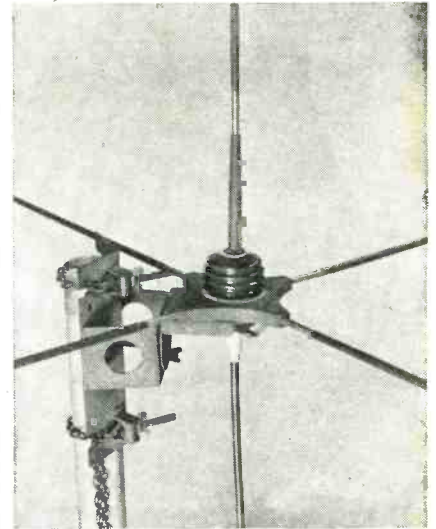

cut to a specified frequency in the range 28 to 152 megacycles. Complete with 50 feet of RG 8/U solid dielectric cable it sells for \$33.50, f.o.b. The Type 703 50-foot cable extension complete with connectors is priced at \$12.75.

35

Broadcast Transmitter

WESTINGHOUSE ELECTRIC CORPORATION, Pittsburgh 30, Pa., announce a new 5 to 10 kilowatt a-m transmitter. The equipment is contained in three

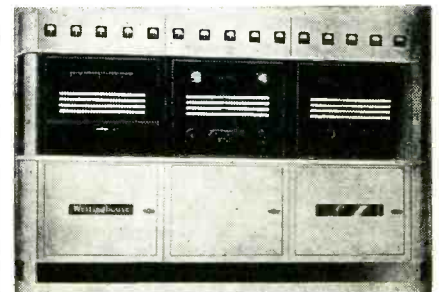



Covers resistance range of 1 ohm to 999,999 ohms.



Each decade dissipates up to 225 watts. Greenohms (wire-wound cement-coated power resistors) used throughout. Glass-insulated wiring.



Six decade switches on sloping panel. Direct-reading in ohms.



Maximum current per decade: 5, 1.5, .5, .15, .05 and .005 amp.



Attractive frosted-gray metal case. Etched black-and-aluminum panel. Dual binding post terminals for left and right-hand duty.



Grille at bottom and louvers at side for adequate ventilation. Baffle plate protects switch mechanism against internal heat.



13" long; 8½" deep, 5¼" high. Weight, 11 lbs.



Moderately priced for general use. Many of these instruments in daily use today. Prompt delivery.



★ **Literature**

on request . . .

Let **CLAROSTAT**

Solve
your
RESISTANCE PROBLEMS

★ With this unique Power Resistor Decade Box, Clarostat solves your resistance problems *under actual working conditions*.

No calculations required. No guesswork. No extensive experimentation. Here's a *power resistor* decade box. It can be introduced in any circuit or for any application. It provides the correct resistance value *under actual working conditions*, at the mere twist of the knobs. The resistance value that works best is then *read directly off the dials*.

Simple. Practical. Time-saving. Yet moderately priced. This instrument soon pays for itself—and continues to pay handsome dividends year after year. Typically a Clarostat solution of your resistance problems.



Controls and Resistors

CLAROSTAT MFG. CO., INC., 285-7 N. 6TH ST., BROOKLYN, N. Y.

Export Division: 25 WARREN STREET, NEW YORK 7, N. Y.

Cable Address: SIMONTRICE, NEW YORK

Designed for



Application

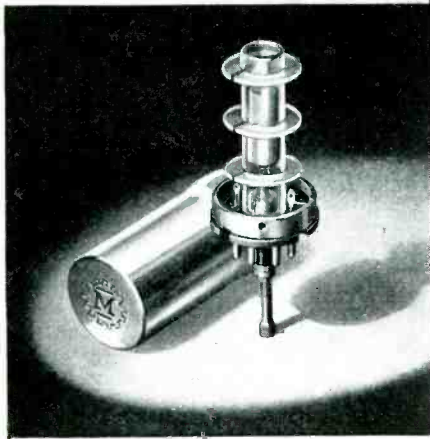

The No. 74001 Tunable Coil Form

Another new Millen "Designed for Application" product is the No. 74001 permeability tuned, shielded plug-in coil form. Standard octal base of low loss mica-filled Bakelite, polystyrene 1/2" diameter coil form, heavy aluminum shield, iron tuning slug of high frequency type, suitable for use up to 35 mc. Adjusting screw protrudes through center hole of standard octal socket. Special extension terminals facilitate connection to base pins.

**JAMES MILLEN
MFG. CO., INC.**

MAIN OFFICE AND FACTORY
**MALDEN
MASSACHUSETTS**



cubicles, one each for exciter, power amplifier, and modulator. These are installed as a complete self-contained unit. The equipment operates in the frequency range 540 to 1,600 kilocycles. Power input is 3 phase, 220 volts, 60 cycles. The 5-kilowatt transmitter illustrated requires some additional space for modulation and main power transformer, audio reactor and power frame.

36

Program Time Switch

ZENITH ELECTRIC COMPANY, 152 West Walton Street, Chicago 10, Ill. The type PR-24 time switch operates automatically in periods as close

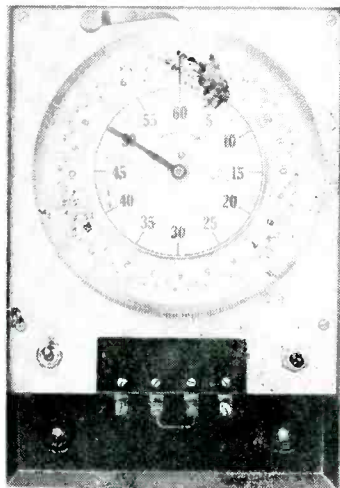

as five minutes throughout 24 hours, repeating daily. The unit is accurate within two seconds. It is inclosed in a sealed case measuring 4 x 8 x 12 inches.

37

Sealed Rectifier

WESTINGHOUSE ELECTRIC CORP., Pittsburgh 30, Pa. announces the development of a new hermetically sealed plate-type rectifier consisting of a selenium element suspended in oil. With a life in excess of 1,000 hours, the new rectifier is said to operate satisfactorily at the boiling point or the freezing point of water.

38

Automobile Antenna

GENERAL ELECTRIC COMPANY, Syracuse, N. Y. A new line of radio antennas for all types of motor vehicles is now available in lengths ranging from 56 to 100 inches. They are made of brass, chrome plated, and

CUSTOM MADE COAXIAL CABLE and TUBING

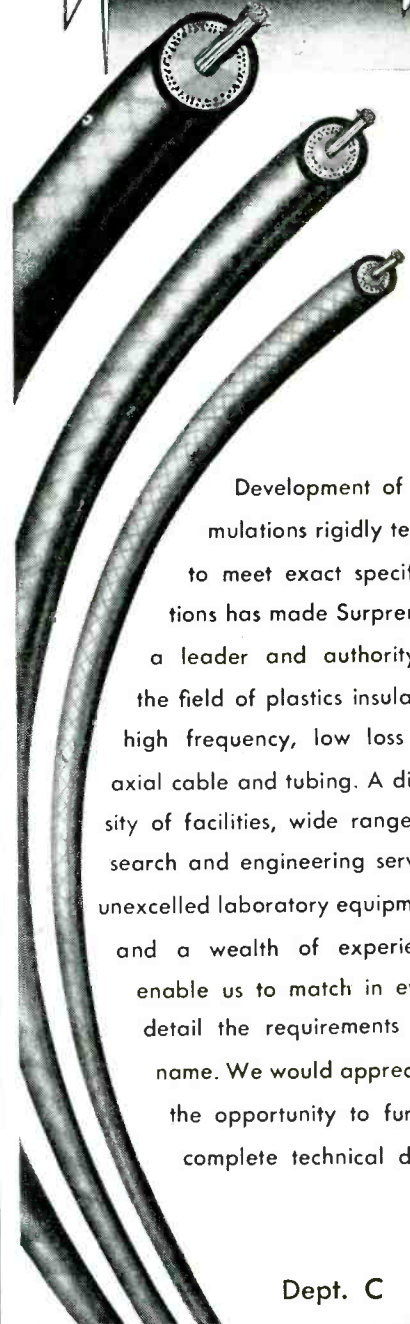

Development of formulations rigidly tested to meet exact specifications has made Surprenant a leader and authority in the field of plastics insulated, high frequency, low loss coaxial cable and tubing. A diversity of facilities, wide range research and engineering service, unexcelled laboratory equipment, and a wealth of experience enable us to match in every detail the requirements you name. We would appreciate the opportunity to furnish complete technical data.

Dept. C

Surprenant
ELECTRICAL INSULATION CO.
84 Purchase St., Boston 10, Mass.

May 1946 — ELECTRONICS

Radio Serviceman:

here's a valuable
tool for your shop!



**RADIO
MAINTENANCE**

MAGAZINE serves the Radio Service man with original articles on servicing techniques, educational articles on how to use all kind of test equipment, and "know-how" that will speed your servicing.

For example, each month we carry a special feature entitled, "The Radio Service Bench." Prepared by **Radio Maintenance** staff and readers, this department completely discusses the various problems of a radio shop such as tools, work bench, hints and kinks, and so on. Here we tell you not only what is needed but how, through your own ingenuity, your service jobs will go faster with more profit for you.

Of course, we go beyond the service bench. Each month, **Radio Maintenance Magazine** focuses attention upon all services which come under your jurisdiction. Trouble-shooting Procedures in AM-FM-Television; Public Address Systems; Alignment Problems—all are dealt with by well known men in the radio industry.

Radio Maintenance Magazine is a trade publication. You can't buy it on the newsstands. A one year subscription—twelve full months—costs only \$2.50.* If you double up on two years, the cost is only \$4.00. Either way, you win in the long run.

Don't miss this valuable tool for your shop—this magazine that is published especially for you! Clip the coupon below and send it with your check to **Radio Maintenance**.

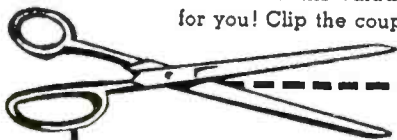

RADIO MAINTENANCE MAGAZINE
460 Bloomfield Avenue
Montclair, New Jersey

Gentlemen:
Please send me (one year's
(two years') subscription to
Radio Maintenance Magazine.

I enclose \$2.50 \$4.00 to cover same.

Bill me later.

NAME _____

ADDRESS _____

CITY _____ ZONE _____ STATE _____

*If you send payment
now, thus eliminating
billing expense, we
will add one issue
free!

RADIO

MAINTENANCE

460 BLOOMFIELD AVENUE • MONTCLAIR, N. J.

BOLAND AND BOYCE, INC. - PUBLISHERS

for U.H.F.

JOHNSON 122-101 SOCKET



FOR TOP
PERFORMANCE
FROM
826-829
832
TRANSMITTING
TUBES

Latest addition to the famous line of JOHNSON Tube Sockets is the 122-101. A ceramic wafer socket with aluminum base shield and JOHNSON superior contacts—the 122-101 is designed to really "take it"!

Socket is designed so that by-pass capacitors may be mounted directly on the tube socket base. Button mica capacitors are available in a range of capacitances enabling the tube to be used at its highest frequency.

Grid terminals are designed so that connecting wires may be isolated from other circuits.

Grid terminals are specially constructed to permit small grid coils to be mounted directly on the terminal ends, thus eliminating connecting leads.

Holes are provided for adequate ventilation of the tube.

Built-in retainer springs hold tube securely in place under conditions of heavy vibration and shock.

Write for Data Sheet 3S describing the 122-101 or see this socket at your JOHNSON Distributor.



Shown at left are JOHNSON 228 and 275 tube sockets. The 228 socket is ideal for many tubes including the "Tuf-20" and the 275 socket is designed for tubes including the 4-125-A, RK28, 125M, 803 and X404.



JOHNSON Tube Sockets are outstanding and are found widely used in commercial communication and industrial equipment. Write for specific information about sockets to meet your requirements. JOHNSON Tube Sockets, Condensers, Inductors, Insulators, Connectors, etc., for highest quality, adaptability, low cost and rapid delivery.

Write for catalog 968.

JOHNSON

a famous name in Radio



E. F. Johnson Co. Waseca, Minn.

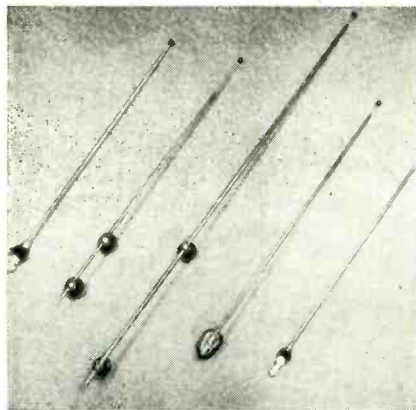

provided with silver contacts to a shielded transmission line which prevents electrical interference. Of the several types available, all telescope into a moderate length.

39

Small Industrial Relays

WARD LEONARD ELECTRIC COMPANY, Mount Vernon, N. Y. The new Bulletin 130 relays are designed for industrial and electronic application, such as light contactor duty and control of single-phase motors. Various standard contact arrangements are available. The d-c relays operate on

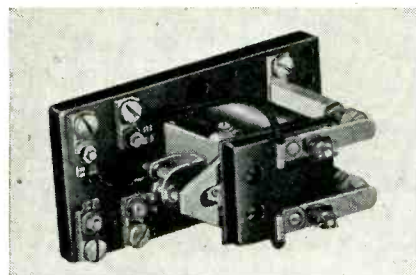

6 to 230 volts, and the a-c types, on 6 to 440 volts. Contacts will carry 25 amperes d-c up to 24 volts, or one ampere at 230 volts. In operation on 60 cycle a-c circuits, contacts will carry 25 amperes up to 250 volts or 50 amperes up to 440 volts. All relays employ silver-to-silver contacts.

40

H-f Beam Tetrode

LEWIS ELECTRONICS, INC., Los Gatos, Calif. The AT-340 150-watt beam tetrode operates at full power to 120 megacycles. A circuit diagram is available showing two of these tubes

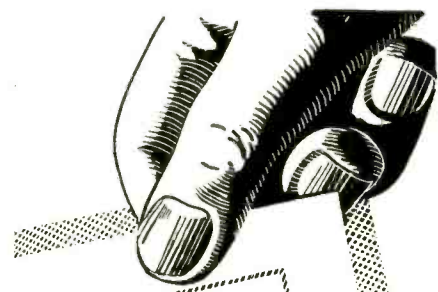

From out of
the west...
America's
finest
transformers

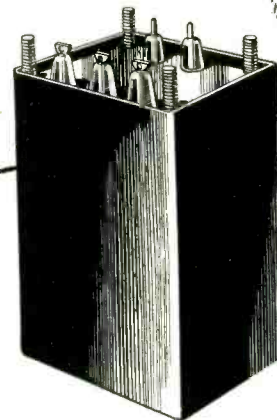

Thermador is a name remembered when the utmost in transformer quality is desired, and when exceptional engineering skill is required.



"Seven Leagues Ahead"

THERMADOR

THERMADOR ELECTRICAL MFG. CO.
5119 District Blvd., Los Angeles 22, California

BENDIX HOME APPLIANCES, INC.

enlists **3** advantages
of Phillips Screws
to make
**BIG ASSEMBLY
SAVINGS**



"THEY'RE MUCH, MUCH FASTER by every driving test," Harry L. Spencer, Bendix V. P. in charge of manufacturing, told the investigator. "Since we'll use well over 19,000,000 Phillips Screws this year on washer production alone, that means an important saving.

"EVERY DRIVER SKID WE AVOID (and we'd have plenty with slotted screws) saves us 50c to \$5.00, according to the extent of the damage, for disassembly, refinishing, and re-assembly. That's another reason why we are sold on Phillips."

This investigator from James O. Peck Co., industrial research authorities, is visiting representative plants to get unbiased facts on assembly savings. Get his fact-filled reports!

"UNSIGHTLY SLOTS with burrs to snag clothes just couldn't be tolerated on a washer. We get no burrs with the Phillips Head - and it looks well, wherever it shows."

These highlights from the complete report on Bendix assembly savings point up economies you can't afford to ignore with today's squeeze on profits. This report, together with others now ready, and more to come, make up a practical manual of successful assembly practice inside facts you can get now, FREE.

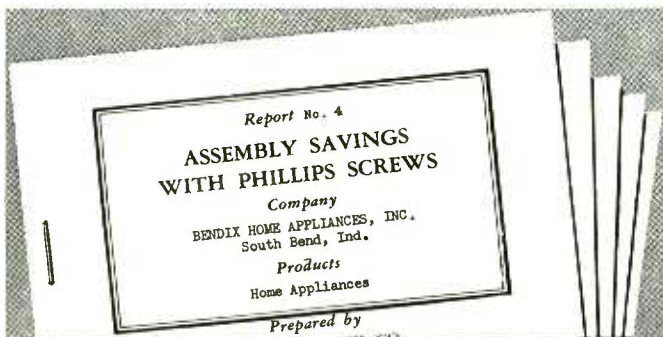

WHATEVER YOU MAKE, THERE ARE SAVINGS SUGGESTIONS FOR YOU IN THESE REPORTS!

Studies cover products of metal, plastic, wood. Get these reports! Mail the coupon TODAY.



PHILLIPS Recessed Head SCREWS

Wood Screws • Machine Screws • Self-tapping Screws • Stove Bolts

American Screw Co.
Atlantic Screw Works
Atlas Bolt & Screw Co.
Central Screw Co.
Chandler Products Corp.
Continental Screw Co.
Corbin Screw Div. of
American Hdwe. Corp.
The H. M. Harper Co.
International Screw Co.
Lamson & Sessions Co.

26 SOURCES

Manufacturers Screw Products
Milford Rivet and Machine Co.
National Lock Co.
National Screw & Mfg. Co.
New England Screw Co.
Parker-Kalon Corp.

Pawtucket Screw Co.
Pheoff Manufacturing Co.
Reading Screw Co.
Russell Burdall & Ward
Bolt & Nut Co.
Scovill Manufacturing Co.
Shakeproof Inc.
The Southington Hardware Mfg. Co.
The Steel Company of Canada, Ltd.
Sterling Bolt Co.
Wolverine Bolt Co.

PHILLIPS SCREW MFRS.,
c/o Horton-Noyes
2300 Industrial Trust Bldg., Providence, R. I.

Please send me the reports on Assembly Savings with Phillips Screws

Name

Company

Address



It's a question of experience

GOTHARD INDICATOR LIGHT ASSEMBLIES

See them in Booth 150

If you don't attend
THE RADIO PARTS &
ELECTRONIC EQUIPMENT SHOW
HOTEL STEVENS—CHICAGO
MAY 13-16

Write for your copy of the new Catalog
just off the press.

Gothard MANUFACTURING
COMPANY
2114 CLEAR LAKE AVENUE, SPRINGFIELD, ILLINOIS

EXPORT DIVISION: 25 WARREN STREET • NEW YORK 7, N. Y.

HOPP
Plastic
RADIO DIALS
DIAL WINDOWS, NAME PLATES, SCALES, GAUGES, CHARTS, CALCULATORS, ETC.

PLASTIC RADIO DIALS combine the beauty of radiant color with the utility of perfect light transmission.

The possibilities of design, size, shape and color combination are limitless.

Whether your problem is dials, or any of hundreds of allied applications, let Hopp artists and engineers "sit in" on your designing problem.

Send us your blueprints or samples for quotation.

THE HOPP PRESS, INC.
460 WEST 34th STREET, NEW YORK 1, N. Y.
ESTABLISHED 1893

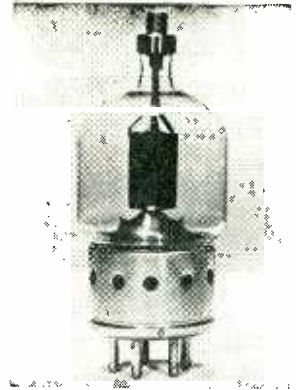

used as a 1,000-watt input final amplifier driven by a single 6L6 crystal oscillator. Low interelectrode capacitances make this tube useful at high frequencies. The grid-to-plate capacitance is 0.19 $\mu\mu\text{f}$; grid-to-filament 9.04 $\mu\mu\text{f}$; plate-to-filament 4.16 $\mu\mu\text{f}$. Overall length of the tube is approximately 6 $\frac{1}{2}$ inches, diameter, 2 $\frac{1}{2}$ inches.

41

Linear Potentiometers

FAIRCHILD CAMERA AND INSTRUMENT CORP., Jamaica, N. Y. A new line of wire-wound linear potentiometers is now available in three models. Accuracies of 0.05 percent are claimed for the 5-inch diameter size and 0.15 percent for the 2-inch size. The electrical angle of rotation is from 352 to 357 degrees depending upon the size of the unit. Torque is less than one inch-ounce.

42

Power Tubes

ELECTRONIC PRODUCTS Co., 111 East Third St., Mt. Vernon, N. Y., announces manufacture of types 207m, 891m, and 892m power tubes suitable for electronic heating, radio frequency amplification or class B mod-





**SPECIFICATIONS
TYPE 566-A WAVEMETER**

FREQUENCY RANGE: 0.5 to 150 Mc

COILS: Five plug-in coils furnished

DIAL: Direct reading in frequency to 2% or better

ACCURACY: 2% for 0.5 to 16 Mc; 3% for 16 to 150 Mc

RESONANCE: Indicator is small incandescent lamp. Two spares supplied

DIMENSIONS: 4¾ x 5½ x 5¾ inches, overall

NET WEIGHT: 3 pounds

PRICE: \$60.00

A WAVEMETER with very useful range

Now available (at the moment from stock) the popular Type 566-A Wavemeter leaves the war effort to return to the civilian laboratory. This meter with its very wide range of 0.5 to 150 Mc (600 to 2 meters) is an extremely handy gadget in any laboratory. Its accuracy is sufficient for a large number of measurements such as determination of coil ranges, oscillator spans, lining up oscillators and transmitters, locating and naming harmonics in either the receiver or the transmitter, and for general experimental work.

All five plug-in coils are stored in a rack on the side of the cabinet. It weighs only three pounds and can be held in the palm of one hand.

Despite its modest price, this wavemeter is built with the same care and is calibrated with the same thoroughness as the most expensive piece of G-R measuring gear.

ORDER NOW. Shipment probably can be made from stock.



GENERAL RADIO COMPANY

Cambridge 39,
Massachusetts

90 West St., New York 6 920 S. Michigan Ave., Chicago 5 1000 N. Seward St., Los Angeles 38

Available at **HARVEY!**

Limited quantity of
WESTERN ELECTRIC
13A (SPL)
TRANSMISSION
MEASURING SET
DI65655

REGULAR PRICE, APPROXIMATELY \$280

HARVEY SPECIAL
\$95



HARVEY has procured a limited quantity of the still-scarce Western Electric 13A (SPL) Transmission Measuring Set. Of highest quality, this standard telephone line measuring unit for recording studios and broadcasting stations is available for immediate delivery . . . at a special low price. It is ideal for measuring transmission losses in studio lines or remote pickups. Act now to obtain yours! A wire, call or letter to HARVEY, Dep't R, will bring you prompt service.

Range: +5 to -40 db in 5 db steps. Meter calibrated: 0-5 db and 5-0 db (two scales).

For use on 110 volt DC or 50-60 cycle AC lines.

Tube line-up: two 6J7, one 25L6, one 25Z6.

Remember: HARVEY has a complete stock of famous name radio and electronic parts and equipment. HARVEY is known for fast, efficient service!

Telephone  Longacre 3-1800

HARVEY
RADIO COMPANY

103 West 43rd St., New York 18, N. Y.

ulation. Overall, the tubes measure 14 $\frac{3}{8}$ inches long and have a maximum diameter of 3 $\frac{1}{8}$ inches. They can be either water cooled, requiring a flow of 3 to 8 gallons of water per minute, or air cooled with 450 cubic feet of air per minute. Filaments operate at 22 volts and 60 amperes (except the 207m at 51 amperes). The average plate voltage is 10,000 volts, with currents between 750 and 930 milliamperes. Amplification factors vary from 8 to 50 for the various types. At maximum power the highest frequency for operation is 1,500 kc.

43

Dust Precipitator

RAYTHEON MANUFACTURING Co., INC., 60 East 42nd St., New York 17, N. Y. The new electrostatic dust, smoke, pollen and oil mist collector consists of two main units, the power supply and the ionizer and collector



(illustrated). Although the equipment is used most advantageously when placed in the incoming air duct supplying a space, room-type units are also being manufactured which by recirculation withdraw most of the impurities from the air.

44

Mobile Radio System

GALVIN MFG. CORP., 4545 Augusta Boulevard, Chicago 51, Ill., has produced an f-m mobile radio system with selective calling which provides for 4,000 individual calls. The fixed transmitter with 15 watts output on about 162 mc has a range of 17 to 20 miles, using a triple-skirt broad-band coaxial antenna 145 feet high. The receivers, with a band-

BRADLEY

PHOTO ELECTRIC CELLS



Many Standard Mountings

In addition to the pigtail contact model shown here, Bradley also offers cells with plug-in and nut-and-bolt mountings.

The shapes of Luxtron photocells vary from circles to squares, with every in-between shape desired. Their sizes range from very small to the largest required.

For direct conversion of light into electric energy, specify Bradley's photocells. They are rugged, lightweight and true-to-rating.

Illustrated literature available on request, shows more models of Bradley photocells, plus a line of copper oxide and selenium rectifiers. Write for "The Bradley Line."

BRADLEY
LABORATORIES, INC.

82 Meadow St. New Haven 10, Conn.

SOUND EQUIPMENT—precisionized—mechanically and electronically—for finer performance



Recorded Broadcasts become
"ALIVE"



Unit 524
Transcription
Turntable

From now on your station announcement must be relied upon to *convince* your listeners that your program is recorded—not alive.

Why? Because there will be no tell-tale rumble, noise or 'wows' from the turntable. Rumble-free performance is assured through the unique method of mounting the famed Fairchild drive. This drive with its synchronous motor is mounted in a heavy casting in the base of the cabinet. It is connected to the turntable by means of a hollow shaft equipped with mechanical filters.

Vertical vibration is eliminated by mounting the turntable in a heavy cast aluminum panel on the top of the solidly constructed cabinet.

'WOW' is reduced to a minimum at either 33.3 or 78 rpm by the patented Fairchild direct-from-the-center, two-speed drive. Evenness of speed is assured by a carefully calculated loading of the drive mechanism that keeps the motor pulling constantly, by precision control of all alignments that might cause intermittent grab and release.

In addition, all of the natural beauty

of recorded music or speech can be reproduced *with full naturalness* on the new Unit 524 Fairchild Transcription Turntable when equipped with the Fairchild Unit 542 Dynamic Pickup described below. The 'floating' pickup arm practically eliminates record wear to add long life to your library of fine recordings.

Arrange to see the new desk-high Unit 524 Fairchild Transcription Turntable. Examine it closely. Listen to it critically. Address: 88-06 Van Wyck Boulevard, Jamaica 1, New York.



Fairchild CAMERA
AND INSTRUMENT CORPORATION

**SOUND
EQUIPMENT**



**FOR IMPROVED
PERFORMANCE**



UNIT 542
LATERAL DYNAMIC PICKUP

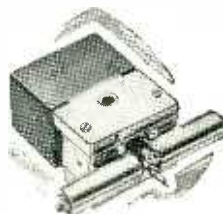

UNIT 541
MAGNETIC CUTTERHEAD

Earlier FAIRCHILD portable models and many other types of recorder-playbacks will give vastly improved performance if equipped with an adapter and an improved Fairchild Pickup and Cutterhead.

Write for complete information.



Instant Power for
Your MOBILE TRANSMITTER

Send today for latest free catalog of CARTER Rotary Products.

1606 MILWAUKEE Avenue

Carter Motor Co. Cable Genemotor

Only CARTER gives you instant power when you press your transmitter microphone switch. 600 volt plate power in less than 350 milliseconds!! Actual laboratory tests prove this unequalled starting performance, so important for instant communications. Remember, only the CARTER ORIGINAL GENEMOTOR gives you truly instant power.

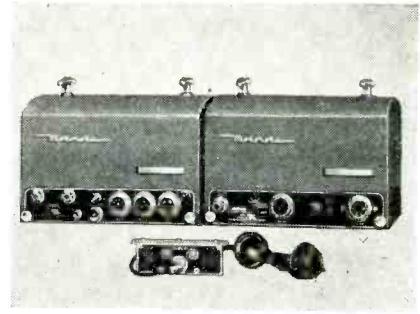

width of 60 kc at 6 db down, received signals in a field test with a 25 to 30 db signal-to-noise ratio. Mobile transmitters are similar to the fixed station but operate from a 6-volt vibrator power supply.

45

Midget Capacitors

STACKPOLE CARBON COMPANY, St. Marys, Pa. The type GA midget capacitors have been designed to replace makeshift devices for introducing small amounts of capacitance. Molded with securely anchored leads

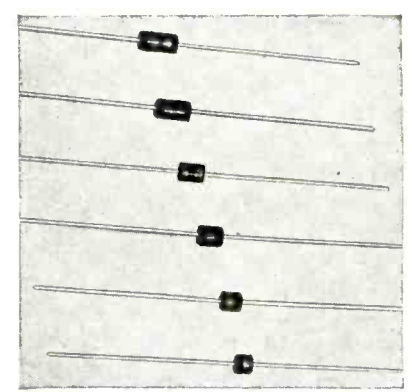

they eliminate the undesirable inductive characteristics common to twisted wires. Standard capacitance values include 0.68 to 4.7 micromicrofarads. The standard tolerance is plus or minus 20 percent.

46

Intermodulation Tester

PICKERING AND CROWE have designed the Models 501 and 502 intermodulation distortion meters used in determining the linearity of any audio transmission system by means of a single measurement. The Model 502 has a somewhat greater flexibility of operation and greater accuracy. Both instruments operate from 110-

BOOKS *designed for the* **ENGINEER**

UNDERSTANDING MICROWAVES
by VICTOR J. YOUNG

For those who have not previously considered radio waves shorter than 10 centimeters. Provides foundation for understanding various microwave developments of past five years. To simplify explanations, mathematics are placed in footnotes wherever possible.

CHAPTER HEADS

The Ultra High Frequency Concept • Stationary Charge and its Field • Magnetostatics Alternating Current and Lumped Constants • Transmission Lines • Poynting's Vector and Maxwell's Equations • Wave-

guides • Resonant Cavities • Antennas Microwave Oscillators • Radar and Communication • Section Two is devoted to descriptions of Microwave Terms, Ideas and Theorems. Index.

SPEED AND SIMPLICITY
A-C CALCULATION CHARTS

Student engineers will find that this book is invaluable. It simplifies and speeds any work involving AC calculations. The book contains 146 charts. Covers all AC calculations from 10 cycles to 1000 megacycles.

160 PAGES—PRICE \$7.50

OUT IN MAY—OVER 400 PAGES—PRICE \$6.00

ORDER TODAY

JOHN F. RIDER PUBLISHER, INC.
404 FOURTH AVENUE, NEW YORK 16, N.Y.
Export Division: Rocke-International Electric Corp., 13 E. 40th Street, New York 16, N.Y.

POLISHED POLYSTYRENE ROD AVAILABLE NOW



Plax polystyrene rod is now available in a new form: with a highly polished surface lustre. Thus designers may now readily work with crystal-clear rods of this unique material.

In this form, Plax polystyrene rod requires very little fabricating and it is easily polished after fabrication. A cutting-down wheel, using a compound held by a non-petroleum grease, will remove any surface imperfections caused by machining — and the final high lustre is restored by a soft cotton buff, free of compound.

The availability of crystal-clear polystyrene rod will suggest many new uses for this versatile material, which is light, hard, inexpensive, and easily fabricated. A few of the applications which immediately come to mind are push bars and racks, display and decorative fixtures, edge lighting effects, novelties, etc.

Plax polished polystyrene rod is available in standard 4' lengths in all diameters up to 2". Special lengths and colors are available on minimum order. Samples are available for testing purposes.

POLYSTYRENE LITERATURE AVAILABLE:

Bulletins on how to machine, polish and cement polystyrene; on what to tell machinists about polystyrene; and on how to use coolants with polystyrene are available on your request.

While Plax has been the leader in development of uses for polystyrene, we also offer several other plastic materials in unique forms and shapes.

In fact, between the resources of Plax and the Shaw Insulator Company, Irvington 11, N. J., you can obtain help and counsel in the use of most plastic materials and processes. For the literature mentioned above . . . write Plax.



133 WALNUT STREET ★ HARTFORD 5, CONNECTICUT

Actual



Size

To utilize the possibilities of new circuits for finer instrumentation.

The VX Series of sub-miniature vacuum tubes.

Measured characteristics of the VX-41 Tetrodes.

Filament current	10 M. A.
Filament voltage	1.25V
Grid current	10 ⁻¹⁴ amp.
Grid resistance	10 ¹⁶ ohms
Plate current	250 microamps.

If these characteristics suggest a solution to a circuit or instrument problem, consult us. A technical bulletin showing circuit applications is yours for the asking.

Available as Pentodes, Triodes, Tetrodes, Diodes.

THE VICTOREEN

3800 PERKINS
CLEVELAND

INSTRUMENT CO.

AVENUE
14, OHIO

The Victoreen Hi-Meg vacuum Sealed Resistor offers a new standard of precision and stability for resistance values in a range of 100 to 10,000,000 megohms. Especially needed where low operating currents require extremely high resistances. The only resistor that covers this range of values with relatively low temperature and voltage coefficients.

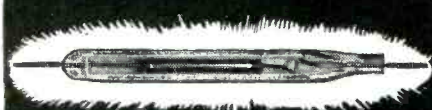

Write for technical data on
VX Tubes and Resistors.



120 volts, 50-60 cps at approximately 100 watts. They are available through F. Sumner Hall, 253 55th St., New York 19, N. Y., priced at \$375 and \$485 respectively, f.o.b. New York.

47

Printed Circuits

METAPLAST Co., 205 W. 19th St., New York 11, N. Y. A new paint which dries out to form a silver conductor can be used to print low-current electrical circuits or circuit elements, such as inductors. The Metapaint can also be sprayed on nonconducting compartments to form shields. It is available in quantities of 1 oz. or more.

48

Test Meter

REINER ELECTRONICS Co., 152 West 25th St., New York, N. Y. The Model 456 master tester serves as insulation tester, capacitance meter, impedance-inductance meter as well

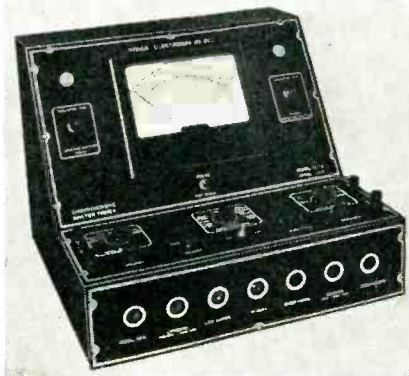

as voltmeter and ammeter. It has the following ranges: 6-30,000 a-c ma; 6-30,000 d-c ma; 3-6,000 v a-c; 6-6,000 v d-c; 0-1,000 megohms.

49

Plane Radiophone

RAYTHEON MANUFACTURING Co., Belmont Div., Chicago, Ill. is now producing a two-way personal plane

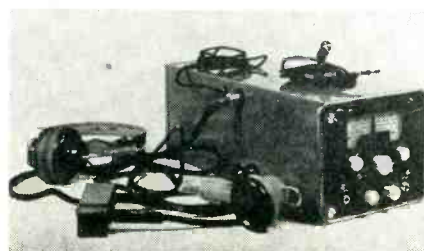

Quiet • POWERFUL
SM Fractional
H. P. Motor

The Home Power Servant
also handles many other
jobs efficiently, dependably



For quiet operation, dependable performance, long life, maximum

power per ounce of weight and per inch of space, use SM Fractional H.P. Motors. Models from 1/10th to 1/200th H.P. Speeds of 3,000 to 20,000 R.P.M. Voltage from 6 to 220 AC-DC Large volume production to your exact specifications.

Small Motors, Inc.

DEPT. 50
1308 ELSTON AVE. • CHICAGO 22

Manufacturers of special small universal, fractional H. P. motors, dynamotors, shaded pole motors, heater motors, generators.

Design, Engineering, Production

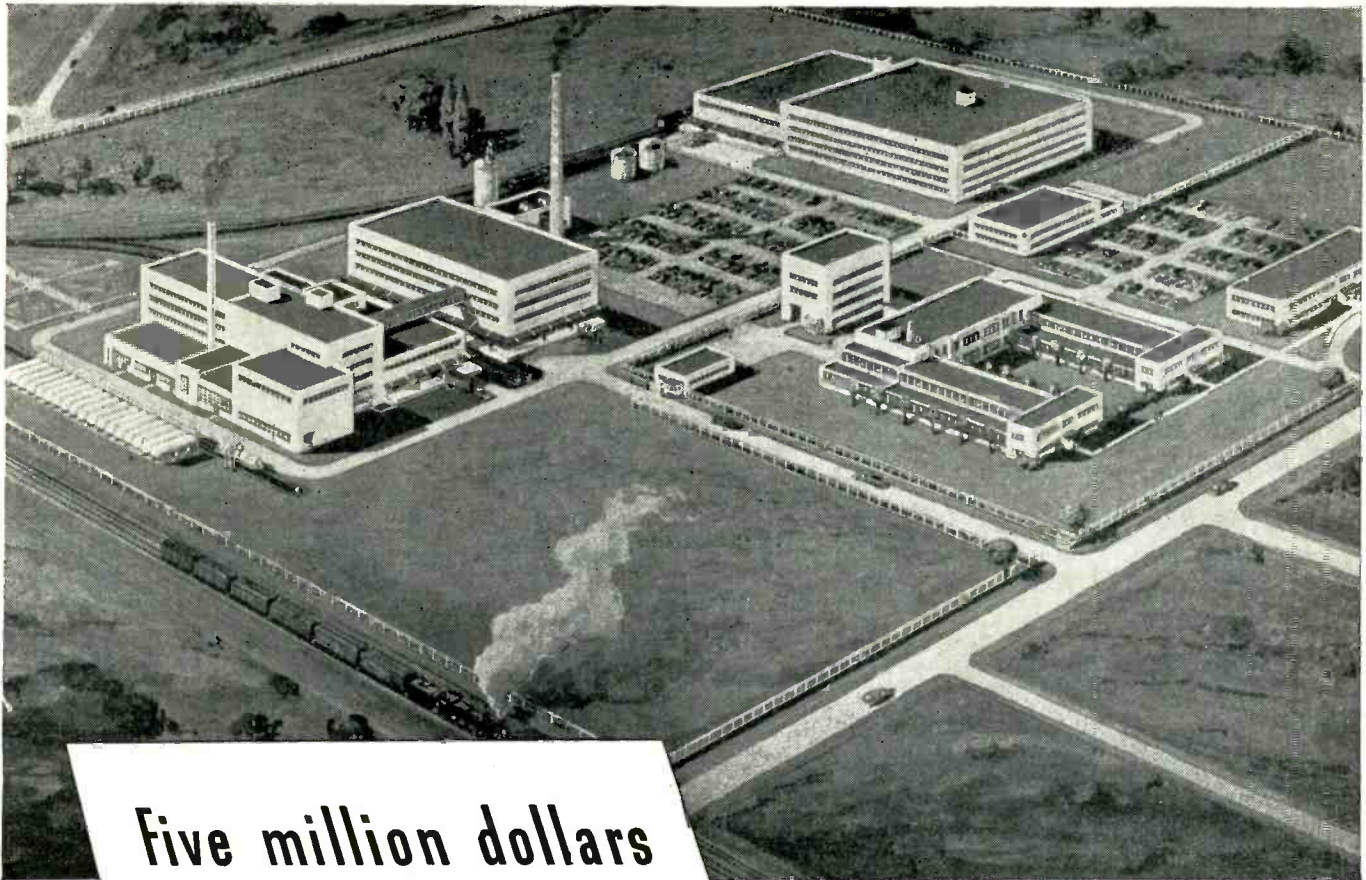

Five million dollars
for Plaskon plant expansion

● In 1930, a small brick building in Toledo housed the beginning of the first Plaskon product. Today, on a 40 acre tract in that city, a great new five million dollar plant is being erected to meet world demands for the wide range of versatile Plaskon materials.

Modern equipment based on 15 years' experience by Plaskon chemists and engineers has been especially designed for the new Plaskon structures. These facilities will be controlled by efficient processes for the mass production of Plaskon molding powders, coating resins, glues and industrial resins.

The new Plaskon five million dollar plant will stimulate greater research, experiment and development in the synthetic resin field; will permit vast expansion in the production of Plaskon molding compounds, coating resins, resin glues and special industrial resins; and will open greater opportunities

for Plaskon service to the molder, fabricator and industry in general.

Plaskon Materials today include urea-formaldehyde and melamine-formaldehyde plastics for molding a wide variety of useful products; resin glues and laminating resins for bonding, veneering or laminating wood, paper, fabrics, glass fibers and other materials; coating resins for the paint and varnish industry; and specialty resins for new and unusual uses.

For years, Plaskon research chemists and engineers have kept a finger on the pulse of industry. They have studied trends. They have formed the habit of looking ahead. Their efforts bring you Plaskon's five million dollar contribution to the plastics and resins field . . . and will continue to serve and grow with the industry's fast-expanding needs for these vital materials.

PLASKON DIVISION, LIBBEY • OWENS • FORD GLASS COMPANY
2136 Sylvan Avenue, Toledo 6, Ohio
Canadian Agent: Canadian Industries, Ltd., Montreal, P. Q.

PLASKON

TRADE MARK REGISTERED

★ **MATERIALS** ★

DEPENDABLE!

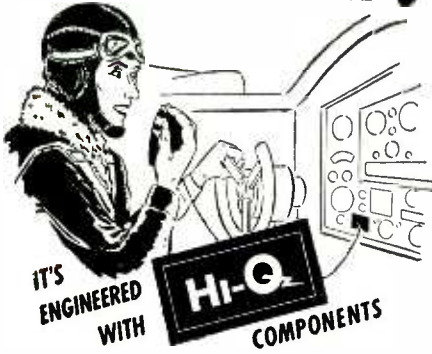

Made right . . . to work right . . . and stay right. Whether in stock ratings or to your own specifications you will find Hi-Q components precise, dependable and long lived. Send for samples and complete information.



Hi-Q Ceramic Capacitors are of titanium dioxide (for temperature compensating types) and are tested for physical dimensions, temperature co-efficient, power factor and dielectric strength. CI type with axial leads; CN type with parallel leads.



Hi-Q Wire Wound Resistors can be produced promptly and in quantity — with quality physical specifications and high performance electric specifications.

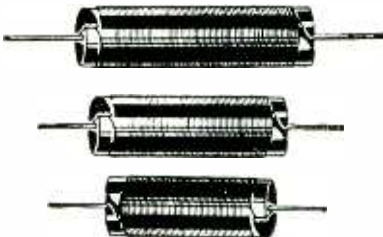

Hi-Q Choke Coils are uniform in their high quality performance. Ruggedly constructed for long service.

ELECTRICAL REACTANCE CORPORATION
FRANKLINVILLE, N. Y.

radio which operates on both low and vhf airways facilities. Frequency ranges covered are 75 mc, 195-410 kc and 540-1,600 kc. Transmitter operation is at 3,105 kc. Total weight of the equipment is 14 pounds and it requires only 5 x 5½ x 14¼ inches of space. Models are available for operation on 6, 12, or 24 volts d-c.

50

Amateur Tube

UNITED ELECTRONICS Co., 42 Spring St., Newark 2, N. J. The type V-70-D and 812-H graphite anode tubes have a plate dissipation of 85 watts and are designed for an input of 300



watts. The type 812-H illustrated has a 6.3 v filament which draws 4.0 amp. The tubes are constructed with a ceramic base insert and hard glass bulb. Price is \$5.90.

51

Phonograph Pickup

MAGNETOSTRICTION DEVICES, INC., Boston, Mass., has developed a unique phonograph pickup having a substantially uniform response over the frequency range 30 to 10,000 cps. The Type TM device has a small moving mass and is correspondingly small in size. It operates on the basis of torsional strain in a magnetostrictive wire. The output level is about -49 db at high amplitude.

52

Dry Air Compressor

ANDREW COMPANY, 363 East 75th Street, Chicago 19, Ill. The type 1800 automatic dehydrator supplies dry air for coaxial cable and automat-

TRACING CLOTH

for

HARD PENCILS

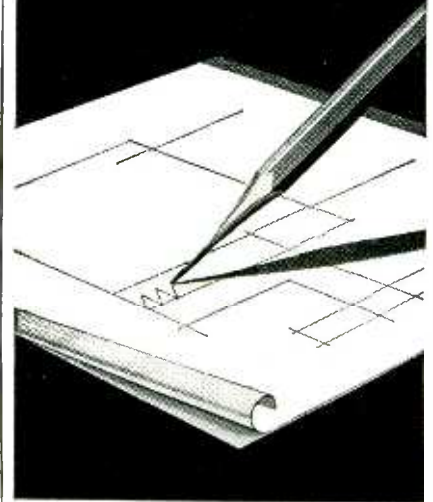

● Imperial Pencil Tracing Cloth has the same superbly uniform cloth foundation and transparency as the world famous Imperial Tracing Cloth. But it is distinguished by its special dull drawing surface, on which hard pencils can be used, giving clean, sharp, opaque, non-smudging lines.

Erasures are made easily, without damage. It gives sharp, contrasting prints of the finest lines. It resists the effects of time and wear, and does not become brittle or opaque.

Imperial Pencil Tracing Cloth is right for ink drawings as well.



IMPERIAL PENCIL TRACING CLOTH



SOLD BY LEADING STATIONERY AND DRAWING MATERIAL DEALERS EVERYWHERE.

PUT CONTROLS WHERE YOU WANT THEM

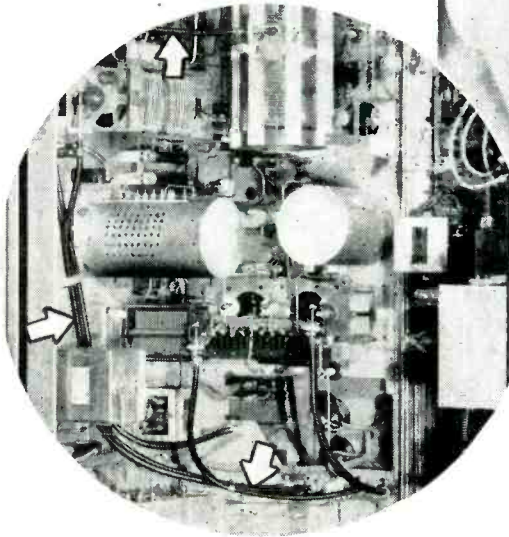

← **HERE'S HOW TO DO IT** *with*
S.S. WHITE FLEXIBLE SHAFTS

Simply use these easily applied elements as couplings between your variable units and their control knobs or dials. That's how it was done in the broadcast transmitter shown above. What makes this practical is the specially designed construction of S.S. White Remote Control flexible shafts. When properly applied, they provide control that is as smooth and sensitive as a direct connection. For full details, send for . . .

FREE FLEXIBLE SHAFT HANDBOOK

It has complete descriptions of flexible shafts and their applications. Request it on your business letterhead. Be sure to mention your position.



S.S. WHITE INDUSTRIAL DIVISION
 THE S. S. WHITE DENTAL MFG. CO. DEPT. E, 10 EAST 40th ST., NEW YORK 16, N. Y.



FLEXIBLE SHAFTS • FLEXIBLE SHAFT TOOLS • AIRCRAFT ACCESSORIES
 SMALL CUTTING AND GRINDING TOOLS • SPECIAL FORMULA RUBBER
 MOLDED RESISTORS • PLASTIC SPECIALTIES • CONTRACT PLASTICS MOLDING

One of America's AAAA Industrial Enterprises

Are Radio Parts Getting Bigger?



IMMEDIATE DELIVERY

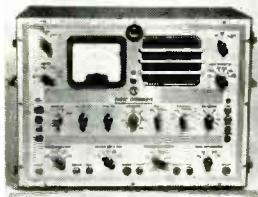

RCA 170-A Audio Chanalyst

Test any sound system for failure to operate, interrupted operation, and weak, distorted, or noisy output. Check presence, absence, or character of a signal from source to load. Narrow down poor performance to its cause, and locate the defective part in an amazingly short time. Check gains or losses, measure component values, and test voltages of any item supporting or controlling the signal.

Net. \$345.00

FREE OFFER

Condensed chart of Graphical Symbols for Electronic Diagrams as standardized by the RMA (includes those unit recently kept secret) Just ask for it. Address Dept. RCE

You'd think so by the way Sun Radio's shelves are bulging. But it's only that we have more parts, not bigger ones — more components than ever before, because we have more room than ever before (at Sun's one and only address, 122-124 Duane Street, N. Y. C.).

It makes for simplicity in purchasing, and although we can't guarantee you the afternoon off for a round of golf, you will save time by calling Sun and getting exactly what you want — the FIRST time.

Call Sun first — it's Simpler.

Note our ONE and ONLY address.

SUN RADIO & ELECTRONICS CO., INC.

122-124 DUANE ST.

NEW YORK 7, N. Y.
BARCLAY 7-1840

eight years ago

.....PyroFerric PIONEERED the manufacture of SCREW-TYPE POWDERED IRON CORES

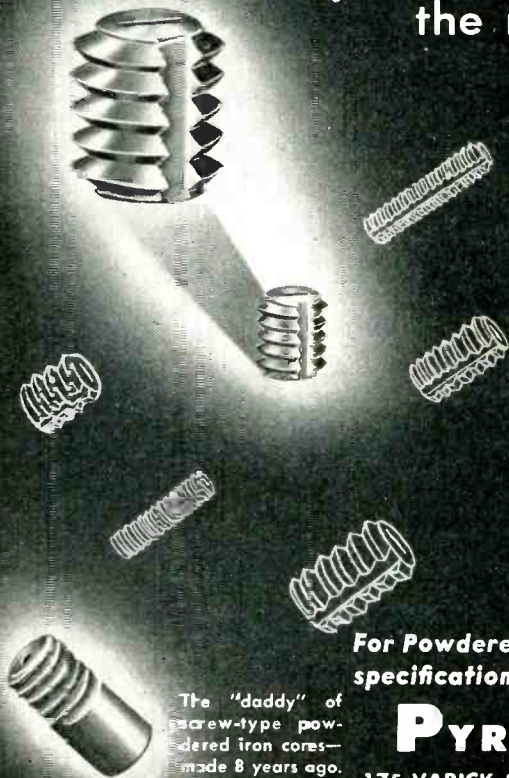

... today PyroFerric is manufacturing a full line of standard sized Powdered Iron Screw-type Cores of varying lengths, with standard threads, as well as its complete line of powdered iron cores, with and without inserts.

For Powdered Iron Cores to meet your specification address your inquiry to

PYROFERRIC Co.

175 VARICK ST. NEW YORK 14, N. Y.

The "daddy" of screw-type powdered iron cores—made 8 years ago.

ically maintains a constant pressure. Two cylinders containing a drying agent are available and while one is in use the other is heated electrically to dry out the agent. The unit measures 14 x 14 x 11 inches and weighs 40 pounds. Power consumption is 210 watts during normal operation and 320 watts during reactivation. Without cabinet the price of the unit is \$205, f.o.b.

53

Signal Tracer

SPECIAL PRODUCTS Co., Silver Springs, Md. The signal tracer probe pictured serves as a detector, radio-frequency and audio-frequency amplifier with a low-capacitance input

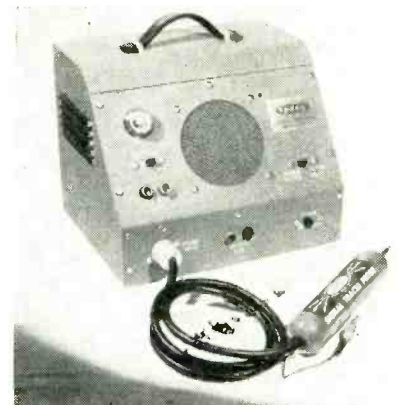

and variable gain control; used with the amplifier from which it obtains power it gives visual or audible signals at various points in the receiver circuit when the input to the receiver is energized by a signal generator.

Literature

54

Components and Receivers. National Co, Inc., 61 Sherman St., Malden, Mass. Catalog No. 600 is a 20-page bulletin describing products currently available in the way of transmitting and receiving parts, complete receivers, and small cathode-ray oscilloscopes. It is of greatest interest to communications people and amateurs.

55

New Publication. Weston Electrical Instrument Corp., 614 Frelinghuysen Ave., Newark 5, N. J. The first number of Weston Engineering Notes features an article on Wheat-

SEE US AT THE PARTS SHOW—BOOTH #30 IN CHICAGO

AT STEVENS HOTEL

MAY 13 TO 16

New

PRICE RELAYS

An outstanding group of new "Price" relays designed to provide superior performance in the Electronic, Industrial, Signal and Transportation fields. **GENERAL PURPOSE, A.C. or D.C. RELAY.** Excellent for use where non-inductive load does not exceed 10 Amperes at 115 Volts A.C.

CO-AXIAL, A.C. or D.C. RELAY. For use in television, police radio, aircraft radio, railroad communication, photo cell and other mobile or stationary applications. **TIME DELAY, A.C. RELAY.** Provides a predetermined time delay of from one to ten minutes between actuation of relay coil and operation of relay contacts.

LATCHING, A.C. or D.C., MEDIUM DUTY RELAY. Contacts operate when operating coil is momentarily energized and are mechanically held in operated position until reset coil is momentarily energized. Small size recommends it for use where space is limited.

POLARIZED D.C. RELAY. A single coil relay, responsive to the amount and direction of the current in the control circuit. Provides 3 position action.

AUTOMATIC STEPPING SELECTOR D.C. RELAY. Automatically selects any one of 12 drive shaft positions, or wafer settings, when actuated from a 12 point locking type push button plate or dial set switch.

MULTIPOLE A.C. RELAY. Provides contact combinations from 3 pole single throw to five pole double throw. **TELEPHONE-MIDGET D.C. RELAY.** "Stacked-blade" type, available in a number of contact combinations.

SENSITIVE D.C. RELAY. For use in temperature control units, electronic timers, emergency lighting control units, protection of delicate instrument contacts, and many other applications. Contact gap .006". Current required .012 Amps. D.C.

SNAP ACTION RELAY for D.C. ONLY. Combines one or two snap action units with any combination of telephone stacked blade contacts up to 4 pole, double throw.

SNAP ACTION RELAY A.C. or D.C. Of medium sensitive design having fully enclosed "quick make and quick break" contacts for general use. Provides up to 2 P.D.T. contacts when A.C. operated, and up to 4 P.D.T. when D.C. operated.

For complete details of these relays and the many others in the Price line, send for free catalog.

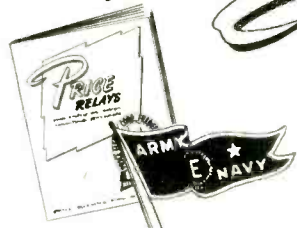

PRICE RELAYS

PRICE ELECTRIC CORPORATION

(Formerly Price Bros. Co.)

AND OTHER DEVICES FOR ELECTRONIC AND INDUSTRIAL APPLICATIONS
FREDERICK, MARYLAND

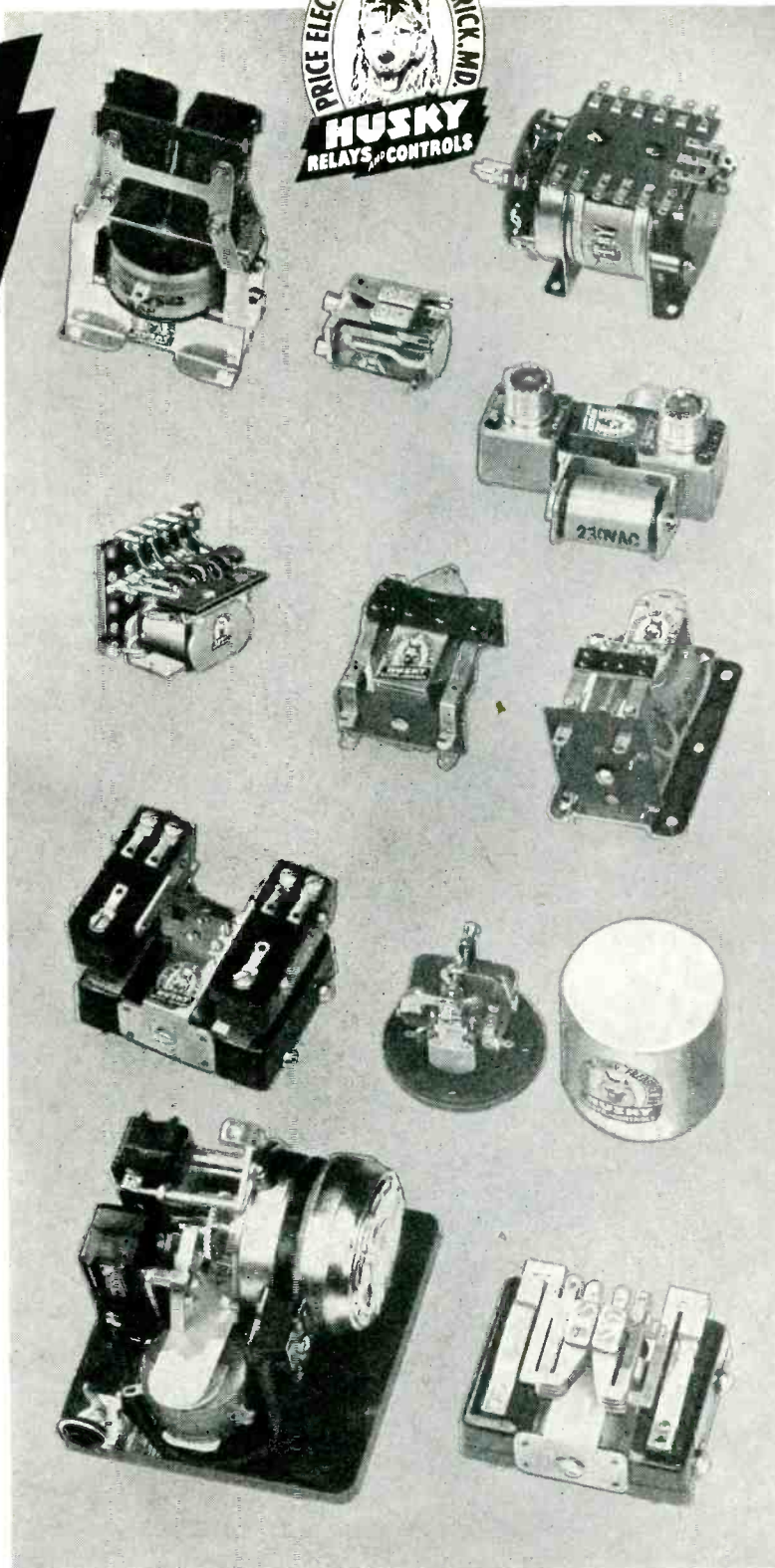

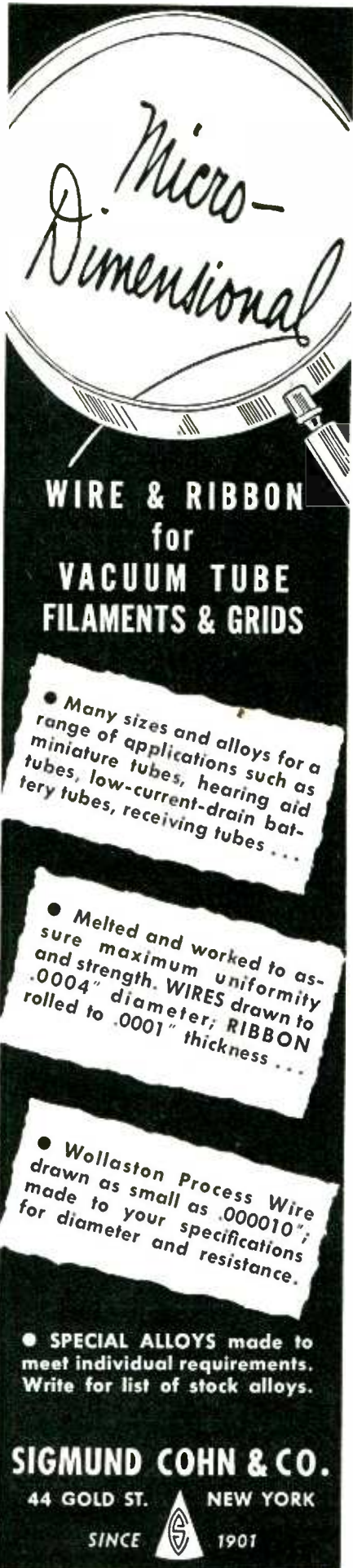

Micro-Dimensional

**WIRE & RIBBON
for
VACUUM TUBE
FILAMENTS & GRIDS**

- Many sizes and alloys for a range of applications such as miniature tubes, hearing aid tubes, low-current-drain battery tubes, receiving tubes...
- Melted and worked to assure maximum uniformity and strength. WIRES drawn to .0004" diameter; RIBBON rolled to .0001" thickness...
- Wollaston Process Wire drawn as small as .000010"; made to your specifications for diameter and resistance.
- SPECIAL ALLOYS made to meet individual requirements. Write for list of stock alloys.

SIGMUND COHN & CO.
44 GOLD ST. NEW YORK
SINCE  1901

stone Bridge equations and includes data on instrument rectifiers. This 8-page bulletin should find a receptive audience.

56

Meters. Marion Electrical Instrument Co., Manchester, N. H. has issued a 28-page catalog describing a line of hermetically sealed meters and the materials and parts from which they are made.

57

Quartz Crystals. Monitor Products Co., 815 Fremont Ave., South Pasadena, Calif. "The Story of Monitor Crystals" is non-technical and well illustrated. The history and uses of quartz are described in 28 pages.

58

George Westinghouse. Westinghouse Electric Corp., 306 Fourth Ave., Pittsburgh, Pa. A 36-page booklet of general interest to engineers.

59

Personal Plane Radio. General Electric Co., Syracuse, N. Y. Publication EBA-2 describes the AS-1B airborne transmitter and receiver in detail.

60

Communication Equipment. Taylor-Western Transmitters, 6127 So. Western Ave., Los Angeles 44, Calif. Small transmitters, studio and remote amplifiers, and transcription equipment are pictured in a 22-page booklet which also gives some details of the modulation system employed in the transmitting equipment.

61

Audio Test Equipment. Hewlett-Packard Co., Box 1188, Station A, Palo Alto, Calif., has an 8-page brochure describing the new Model 201B a-f oscillator, and Model 330B Distortion Analyzer. Included is a brief summary of technical data on all instruments manufactured by the company.

62

Studio and Transmitter Equipment. Sherron Electronics Co., 1201 Flushing Ave., Brooklyn 6, N. Y., show



**Bogen
SOUND and
COMMUNO-
PHONE
Equipment**

Look for us at the
**RADIO PARTS AND ELECTRONICS
EQUIPMENT SHOW BOOTH NO. 40**

**NATIONALLY ADVERTISED,
READILY ACCEPTED!**

Backed by a nation-wide advertising and sales promotion campaign, the BOGEN line of inter-communication and paging systems is finding enthusiastic acceptance in industrial and consumer applications. With its reputation for quality earned over the years, and more recently its importance in war—from engineering, efficiency and dependability standpoints—specification of BOGEN products by name is understandable. For new developments, sales possibilities and substantial profit potential in inter-communication and paging systems, investigate BOGEN.

Address Inquiries to Department D

BOGEN EX 35 DELUXE AMPLIFIER

Delivers 35 watts undistorted power. 4 input channels with simultaneous mixing. Electronic tone corrected for perfect tone control.

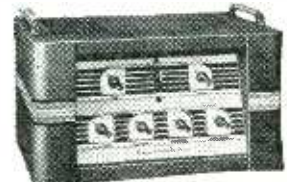

David Bogen CO. INC.

663 BROADWAY, NEW YORK 12, N. Y.

BOGEN SOUND SYSTEMS - AMPLIFIERS
COMMUNO-PHONES - ELECTRONIC EQUIPMENT

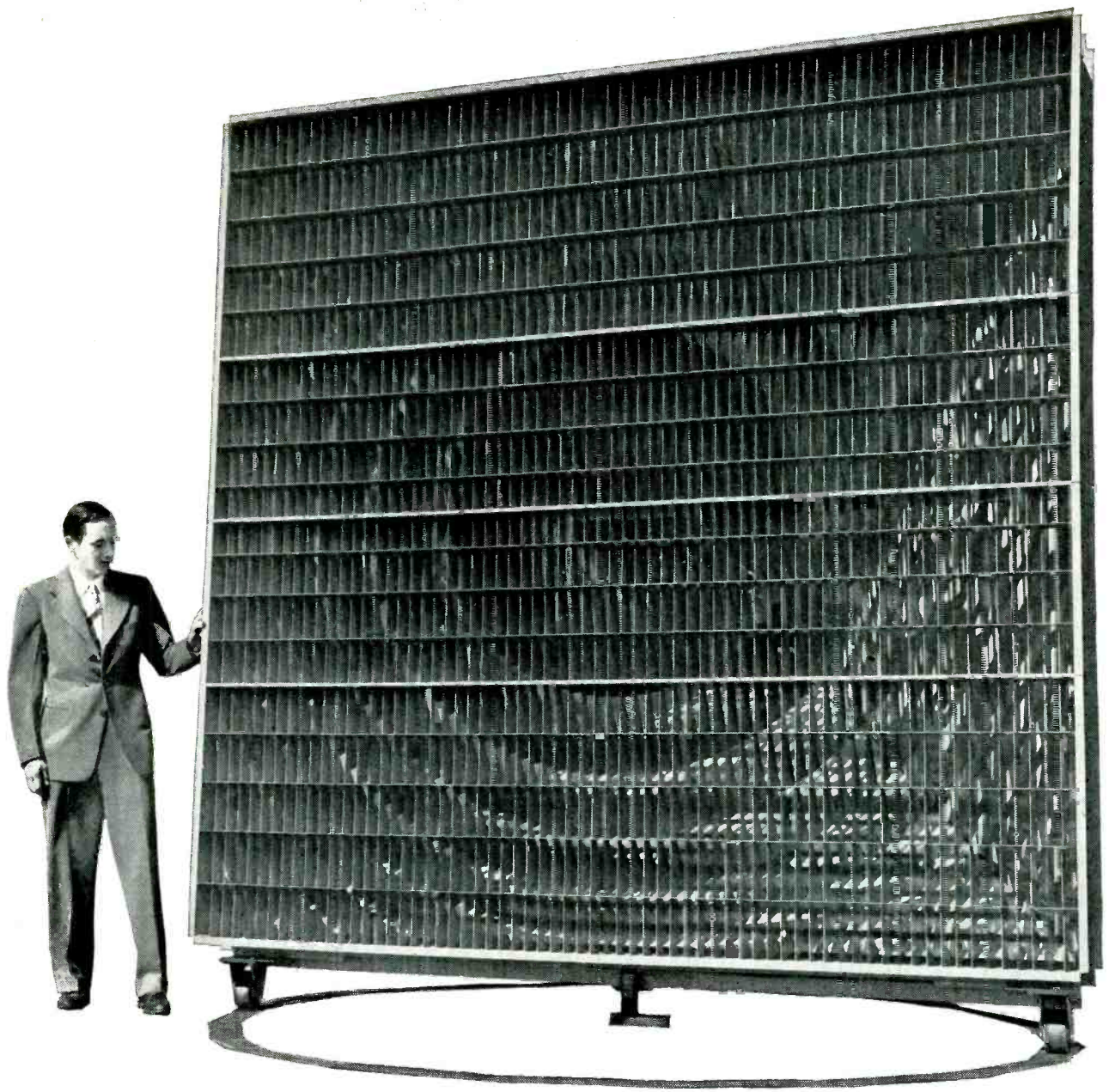

A "SEARCHLIGHT" TO FOCUS RADIO WAVES

In the new microwave radio relay system between New York and Boston, which Bell Laboratories are developing for the Bell System, giant lenses will shape and aim the wave energy as a searchlight aims a light beam.

This unique lens—an array of metal plates—receives divergent waves through a waveguide in the rear. As they pass between the metal plates their direction of motion is bent in-

ward so that the energy travels out as a nearly parallel beam. At the next relay point a similar combination of lens and waveguide, working in reverse, funnels the energy back into a repeater for amplification and re-transmission.

A product of fundamental research on waveguides, metallic lenses were first developed by the Laboratories during the war to produce precise radio beams.

This "searchlight" is a milestone in many months of inquiry through the realms of physics, mathematics and electronics. But how to focus waves is only one of many problems that Bell Telephone Laboratories are working on to speed microwave transmission. The goal of this and all Bell Laboratories research is the same—to keep on making American telephone service better and better.



BELL TELEPHONE LABORATORIES

EXPLORING AND INVENTING, DEVISING AND PERFECTING FOR CONTINUED IMPROVEMENTS AND ECONOMIES IN TELEPHONE SERVICE

To test
over-all
performance



SQUARE-WAVE GENERATOR

● This unit, generating its own frequency or synchronized from an external source, will be found invaluable in many fields. FM, AM and Television Broadcasting—Telephone and Telegraph Communications—Manufacture of Transmitting and Receiving Equipment and Parts.

● Many additional functions will recommend it for use in school and college research projects and in scientific laboratories.

For additional information write: *Electronics Department, General Electric Company, Syracuse, New York.*

Electronic Measuring Instruments

GENERAL  ELECTRIC
164-E1

layouts of control boards and transmitting equipment with particular emphasis on television equipment in a couple of brochures issued recently.

63

Relays. Cook Electric Co., Chicago 14, Ill. Catalog AR-145 lists the various types of relays, spring combinations, and time-delay features available in the "Aerotrol" line. A special application is the 52-point consecutive operation rotary relay.

64

Loran Receiver. Sperry Gyroscope Co., Inc., Great Neck, N. Y. A brief painless lecture on the basic concepts underlying the long-range navigation system known as loran has been published by the manufacturers of the first commercially available equipment for shipboard use. Ten pages of clear exposition and illustrations.

65

Electronics Digest, Westinghouse Electric Corp., Box 868, Pittsburgh 30, Pa., contains a number of interesting articles in the second issue, including a somewhat more elaborate explanation of Statovision than has appeared in most of the public prints.

66

Lateral Pickup. Pickering and Crowe, Oceanside, N. Y. are now marketing a magnetic-type pickup engineered for lateral records and transcriptions, completely described in an 8-page bulletin.

67

Conductivity Apparatus. Industrial Instruments, Inc., 17 Pollock Ave., Jersey City 5, N. J. Bulletins A-2 and RD-104A describe the Solu-Bridge and conductivity cells used with it, both applicable wherever the conductivity of liquids is a factor of importance.

68

Wire and Cable. General Cable Corp., 420 Lexington Ave., New York, N. Y. Catalog 37 has been broken into separate sections describing the company's specialized products, such as telephone wire and cable, radio wires (cables and

Engineered
TRANSFORMERS

To make a transformer that will successfully meet your most exacting requirements, call for engineering of the highest order.
Engineering transformers for every kind of application, ordinary or unique, is the day to day business of Electronic Engineering Company. The finest engineering talent and most complete electronic laboratories are ready today to consult with and help you.

"SPECIALIZED *Transformer* ENGINEERS"

ELECTRONIC
Engineering
COMPANY
INC.

3223 WEST ARMITAGE AVENUE CHICAGO 47, ILL.

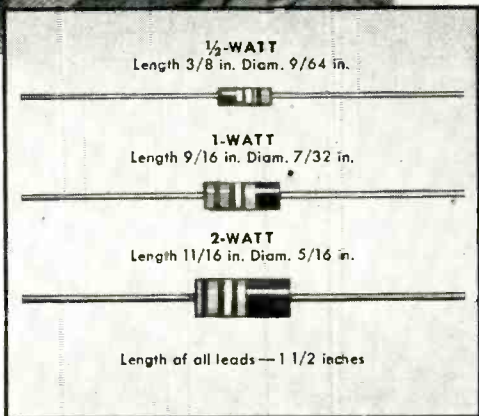
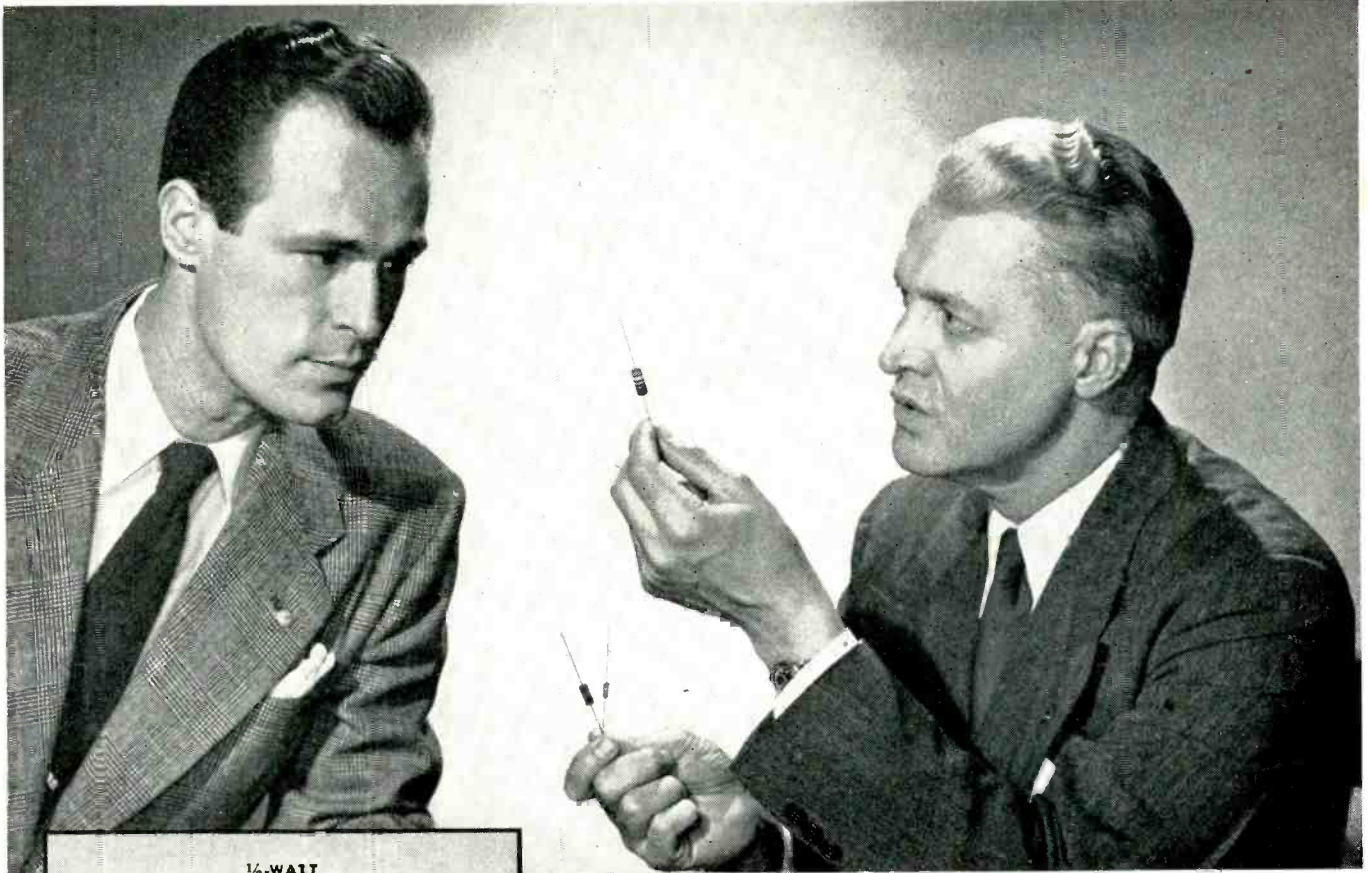

“These fixed resistors pack the greatest wattage capacity for their size”

Bradleyunit solid-molded, fixed resistors are not rated on the basis of the conventional 40 C ambient temperature . . . instead they are rated at 70 C ambient temperature.

Bradleyunits . . . in 1/2-watt, 1-watt, and 2-watt ratings . . . will operate at full rating for 1000 hours in an ambient temperature of 70 C, with a resistance change of less than 5 per cent. They pass salt water immersion tests without wax impregnation. All three sizes are available in standard R.M.A. values from 10 ohms to 22.0 megohms, inclusive.

Such “extra” performance improves the dependability of your electronic equipment. Specify Bradleyunit resistors . . . and you add “extra” quality to your products.

Allen-Bradley Company, 110 W. Greenfield Ave., Milwaukee 4, Wisconsin.



Type J Bradleyometers are the only continuously adjustable, solid-molded resistors having a 2-watt rating with a generous safety factor. Any resistance-rotation curve is available.

ALLEN-BRADLEY
FIXED & ADJUSTABLE RADIO RESISTORS
 QUALITY

It's SOUND ADVICE to Consult **MURDOCK**



Headphones Engineered to YOUR Requirements

Hearing efficiency is increased when MURDOCK Headphones are on the job. Their "hear-ability" has been demonstrated through two wars.

The widespread preference for them is a tribute to MURDOCK'S 42 years' insistence on highest quality standards . . . the same quality "yardstick" that William Murdock applied to his first radio phones which he patiently put together by hand way back in 1904.

On special or difficult assignments MURDOCK engineers can create Headphones to meet your particular needs. For finest listening performance, be sure to consult MURDOCK!

Write for Catalog

JOBBERS!

MURDOCK Headphones are again available in greater quantities. Write us today for full details.

WM. J. MURDOCK CO.
220 Carter St., Chelsea 50, Mass.

assemblies), magnet wire, paper insulated power cables, and others, each with its own cover and specific designation.

69

Photoelectric Devices. Photovolt Corp., 95 Madison Ave., New York 16, N. Y., has issued a 4-page leaflet listing its available apparatus for electronic determination of smoke density, specular gloss of surfaces, and color of liquids, each of which is described in greater detail in a separate bulletin.

70

Sensitive Films. Eastman Kodak Co., Rochester 4, N. Y. Two bulletins, titled "The Photography of Cathode-Ray Tubes" and "Materials for Spectrum Analysis" will be useful to engineers faced with the problem of making permanent records of transient phenomena. Besides the general discussion of the problems involved, there are many practical details helpful to the technician.

71

AP Connectors. Cannon Electric Development Co., 3209 Humboldt St., Los Angeles 31, Calif., Exploded views, dimensions, and general information on AP type plugs and jacks are given in a 12-page booklet.

72

F-M Transmitters. Westinghouse Electric Corp., 306 Fourth Ave., Pittsburgh, Pa., has a booklet available on the new 1 and 3-kw f-m transmitters now being manufactured. Complete electrical specifications are given in a form suitable for filing an FCC construction permit application.

73

High Vacuum Engineering. National Research Corp., 100 Brookline Ave., Boston, Mass. Low pressures formerly obtainable in the laboratory are now commercially feasible. Equipment for obtaining vacuums is described in a well-illustrated booklet recently published.

74

High Frequency Cables. Simplex Wire and Cable Co., 79 Sidney St., Cambridge 39, Mass., has published

**A major
advancement
in the
recording blank
field . . .**

10 Year

GUARANTEE

GOULD-MOODY

"Black Seal"

**ALUMINUM
RECORDING BLANKS**

**. . . at no increase
in price!**

After prolonged research and experimentation, we have introduced technological improvements into "Black Seal" blanks that not only increase life span, but materially enhance the other finer characteristics of these blanks. And so positive are we of the worth of these perfected "Black Seals" that we're offering them to you on an unconditional ten-year guarantee basis.

**You can't afford to be a
recording isolationist . . .**

"Black Seal" blanks will not rip up, disintegrate or powder after the first playing if kept in storage for any long period of time. You are in no danger of losing valuable recordings in what, up until now, you have considered your safe library of recording blanks. No matter how well you may be satisfied with your present blanks, you can't afford to be a recording isolationist. Try "Black Seals"—if, for any reason whatsoever, you aren't satisfied, return them at our expense.



THE GOULD-MOODY CO.

Recording Blank Division
395 BROADWAY NEW YORK 13, N. Y.

ACCURACY IN 1-INCH AND 1½-INCH INSTRUMENTS!

±2% OF FULL SCALE
AT EVERY POINT

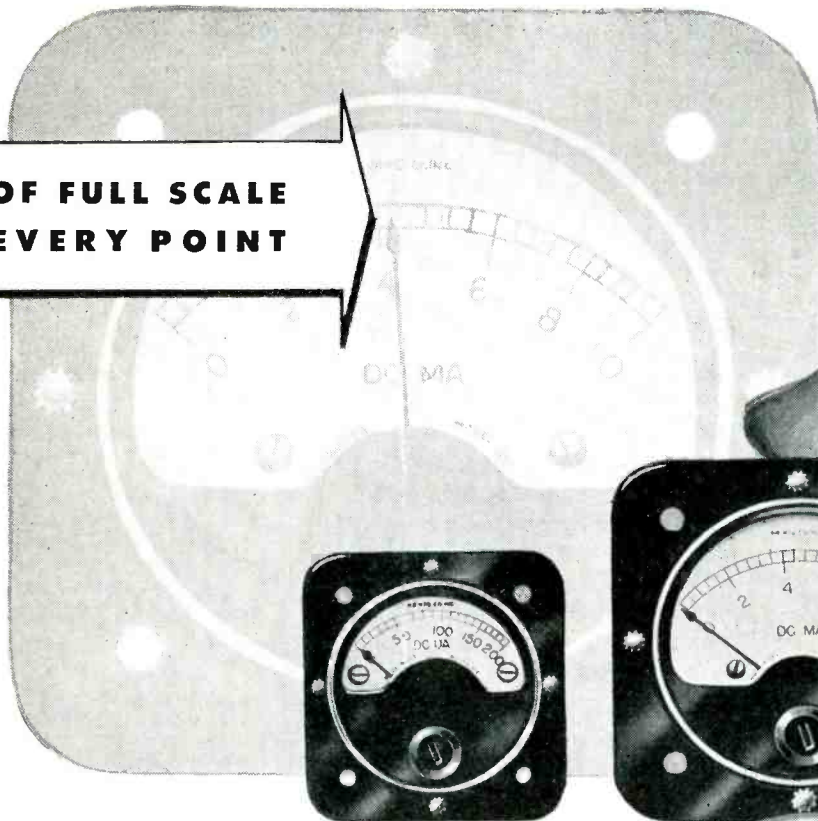

... IS STANDARD WITH MB MINIATURES

ACCURACY is the prime requisite of any fine instrument. For readings are useful only if thoroughly reliable. And so MB meters, though miniature in size, are designed to give you the kind of performance you would expect only from larger instruments.

This is assured first by the expertly engineered *design* of the MB moving coil element, with its Alnico No. 5 magnet and finely machined soft iron pole pieces . . . and then by skillful construction with modern materials of the highest quality obtainable.

Every step in manufacture is carefully controlled. Each MB meter is individually calibrated, and rigidly tested before shipment; you get a responsive instrument of hairline accuracy . . . one that stands up in long service, too.

Plan on MB instruments in all your portable products. From pocket-size testing devices to panels of exacting industrial and communication equipment, there's a compact MB meter to do the job . . . *accurately!* Write for particulars on ranges, types and prices.

THE
MB MANUFACTURING COMPANY, INC.
331 East Street, New Haven 11, Conn.



MINIATURE ELECTRICAL INSTRUMENTS FOR ANY PURPOSE

PRECISION PARTS

**A FREE FIT . . .
BUT NOT LOOSE**

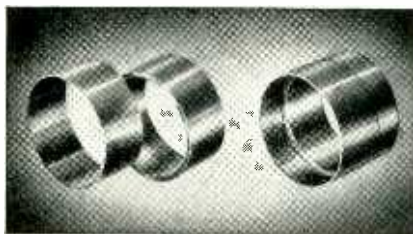

Laboratories that in peace as in war are pacing the advance of American industry demand accuracy above everything else. It is no wonder, then, that one of the largest laboratories in America came to Ace for these pressure support rings.

Here is a job that calls for exceptionally fine tolerances. The thin-walled ring had to fit snugly over the thick-walled ring—a free fit . . . but not loose. Not only was it necessary to hold close tolerances for size, but also for accurate concentricity. From the selection of special steel bar stock, through the machining, heat treating, grinding, and inspection operations, this was a typical Ace precision job.

Such jobs are merely a part of the daily grind at Ace, where accuracy applied to mass production was pioneered. Management skill and modern equipment are turning out tolerances as close as .0002" (which makes paper seem mattress-thick) and finishes which a speck of dust or a warm hand distorts.

If you are looking for a source of supply for small parts or assemblies from the tool and die stage—on through stamping, machining, heat treating and grinding, it will pay you to consult Ace. Ace will make you high-man in the coming competitive market. Send us a sketch, blueprint, or sample for quotation.



... send for this Ace story ...



ACE MANUFACTURING CORPORATION
for Precision Parts

1255 E. ERIE AVE., PHILADELPHIA 24, PA

282

a 4-page leaflet which sums up the Army-Navy RG types of r-f cables, listing wire sizes, dielectric uses, outer covering, voltage capacity and attenuation. Included is a table giving the most recent nomenclature applied to various bands of radio frequencies. Write for Data Sheet 113.

75

Magazine Reborn. Western Electric Co., 195 Broadway, New York 7, N. Y., is now putting out an interesting publication called the "Oscillator" which succeeds the prewar "Pick-Ups". It is well illustrated and of general appeal.

76

Emergency Communications System. Federal Telephone and Radio Corp., Newark 1, N. J., manufactures complete communications systems for police and other mobile operation. Included in the system described in a 4-page brochure is a selective calling device used to open the receiver of the desired mobile unit.

77

Magnet Wire. Electric Auto-Lite Co., Port Huron, Mich., has prepared an 88-page catalog describing its available forms of magnet wire insulated in various ways. There are tables included which give resistance, turns per inch, and other useful information for day-to-day work with wire.

RADAR PUZZLE



Installed on the ferry Kalakala, a radar control panel and scope for night operation and foggy weather intrigues Capt. Van Bogaert, commodore of the Black Ball ferry lines in Seattle, Washington

Maximum Dependability Minimum Size

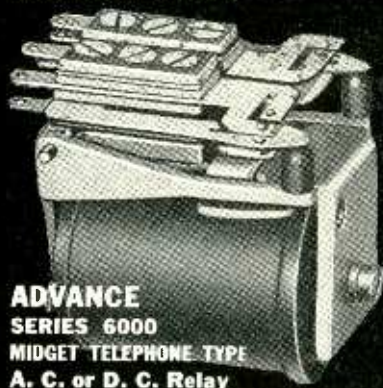

Used in AIRCRAFT REMOTE CONTROL, RADIO and RADAR for maximum dependability and minimum size with these special features:

- HIGH VIBRATION RESISTANCE to 12G at 100 milliwatts D.C. in coil.
 - DOUBLE CONTACTS on each blade, which gives double the assurance of good contact. Platinum silver alloy contact material, rating 1.5 amperes at 115 volts A.C.
 - LOW OPERATING POWER of 60 milliwatts on D.C. or approx. 1/3 watts A.C. Coil resistance 1 to 10,000 ohms.
 - MIDGET SIZE, 1" x 1/4" x 1/4", 2 1/2 oz. (Type 6004, D.P.D.T.)
 - MOISTURE PROTECTION of coil by cellulose acetate insulation, varnish vacuum impregnation, second varnish dip and baking.
- You Need an Advance Telephone Type Relay for —
- HIGH UNIT PRESSURE of small, hemispherical contacts, no waste contact area.
 - POSITIVE MECHANICAL ALIGNMENT of armature to core, of contact to contact.
 - PIVOT BEARING HINGE between armature and frame assures minimum of friction—maximum life.
 - SWITCHING CAPACITY from single pole single throw to 4 pole double throw.
 - OPERATING POWER moderately low.
 - TRUE ECONOMY OF DESIGN, correct materials used where needed, excess eliminated, no waste space.

See our display booth #140, RADIO PARTS AND ELECTRONIC EQUIPMENT CONFERENCE AND SHOW, Chicago, Illinois, MAY 1946.

Catalog with complete description and prices will be sent by return Air Mail by —

Advance Relays

**ADVANCE
ELECTRIC & RELAY CO.**
1260 West 2nd Street
Los Angeles 26, Calif., U. S. A.
Phone Michigan 9331

May 1946 — ELECTRONICS

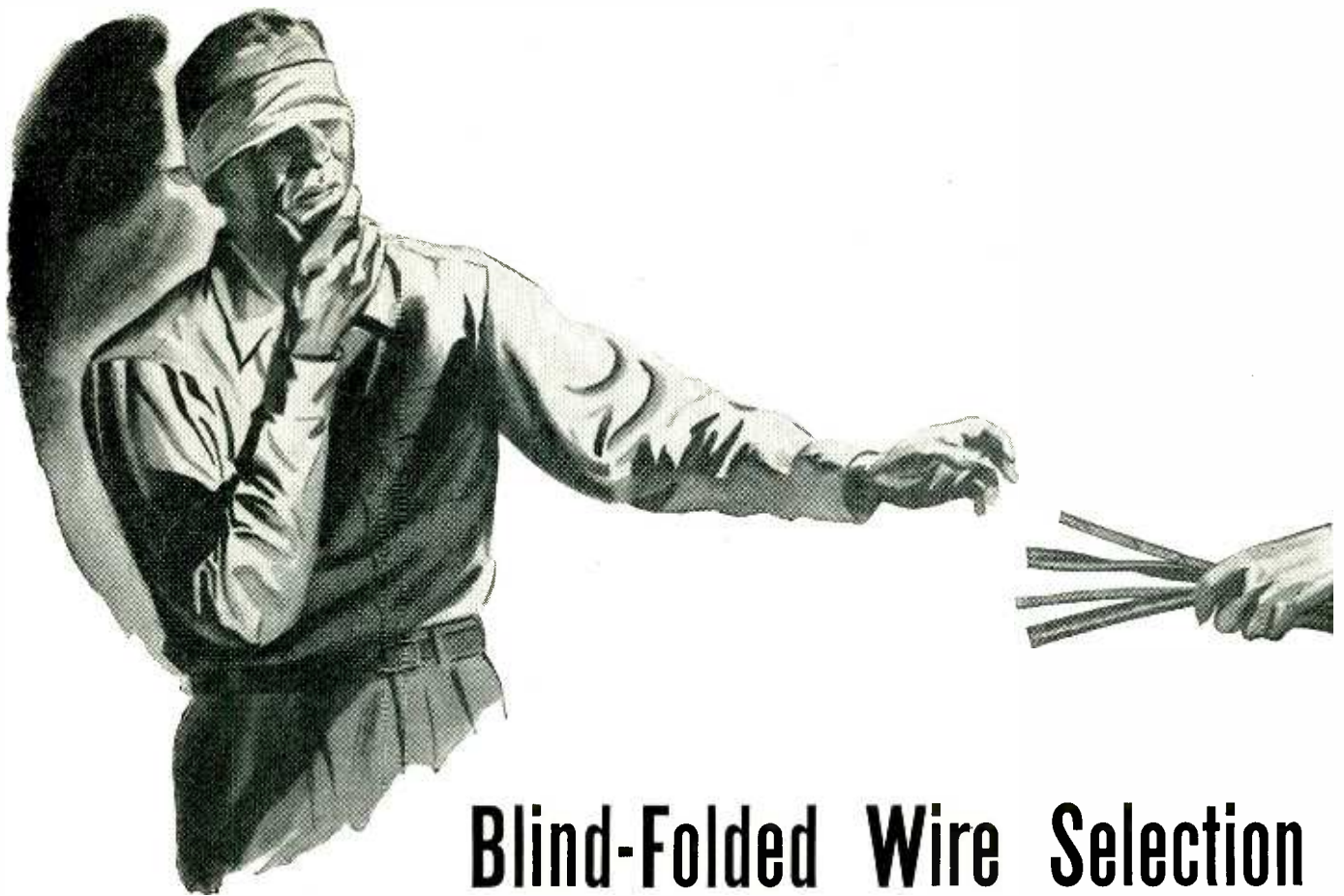

Blind-Folded Wire Selection IS POOR ECONOMY

ROCKBESTOS FIREWALL RADIO HOOKUP WIRE

This heat, flame and moisture resistant wire, insulated with high-dielectric synthetic tapes and impregnated felted asbestos covered with color-coded lacquered glass braid, may be run *continuously* at its maximum operating temperature of 125°C without baking out. It is widely used in airborne, ground, marine and mobile communications systems, electronic devices and compact apparatus in which dependable performance is essential. Also ideal for small motor, coil, transformer and dynamotor leads. Sizes No. 22 to 4 AWG in 1000 volt rating and 12, 14 and 16 AWG in 3000 volt—also in twisted pair, tripled, shielded and multi-conductor constructions.

The failure-resisting characteristics of this wire are typical of 125 permanently insulated constructions developed by Rockbestos to give longer and more dependable service under any and all operating conditions. They include high temperature wires, tiny multi-conductor cables smaller than a No. 14 hook-up wire, and everything up to power cables from which to select your requirements.



It may be the right size, correct voltage rating, and look okay—but don't waste time and money designing or building a product around a wire that doesn't give it a good safe margin of *performance-protection* against the use and abuse it may get in service.

A little wire-planning *in advance* can save you a lot of trouble and dollars later by preventing the wire-failures that pile up repairs and replacements, costly service calls, dissatisfied customers and loss of sales.

Check your wire requirements against the *worst conditions* your product may have to work under. Will internal heat dry out and crack the insulation or cause it to flow? Will high ambient temperatures cause similar failure-creating possibilities? How about rotting, destructive fumes, oil and grease? And wouldn't the elimination of wire-fire hazards be advisable?

The wire illustrated and 124 other *permanently insulated* Rockbestos wires, cables and cords were designed to give lasting *dependable* service under just such conditions as are mentioned above—and Rockbestos Research will be glad to make up specials if your job requires them. Write for information and recommendations.

ROCKBESTOS PRODUCTS CORPORATION
435 Nicoll St., New Haven 4, Conn.



ROCKBESTOS RESEARCH

Solves Difficult Wiring Problems

NEW YORK BUFFALO CLEVELAND CHICAGO PITTSBURGH
ST. LOUIS LOS ANGELES SAN FRANCISCO SEATTLE PORTLAND, ORE.

NEWS OF THE INDUSTRY

Sonar; Crossroads; moon radar; Ring and Bloc airborne television; Chicago Electronic Conference; capacitors without foil; personnel changes

Final Wartime Electronic Production Figures

IN 1939 THE RADIO, electronics, and communication industry had an output valued at \$467,000,000, produced in 451 establishments employing about 101,000 persons. By the last quarter of 1944, the rate of production had increased eightfold over the quarterly average for 1939.

Based upon reports of the Bureau of the Census and the War Production Board, it is estimated that during the period from the beginning of 1941 through VJ-day, the total value of shipments of radio, electronic, and communication equipment was about \$10,700,000,000. This represented

virtually the entire output of the industry. The relative amounts produced by each of the services were: Army—\$4,400,000,000; Navy—\$3,200,000,000; Air Force—\$3,100,000,000. The nature of this procurement, as obtained from WPB data for Jan. 1, 1941 to July 31, 1945, was as follows:

Airborne radio	\$1,827,000,000
Ship (and ship-shore) radio..	591,000,000
Ground radio	2,017,000,000
Airborne radar	1,934,000,000
Ship (and ship-shore) radar.	936,000,000
Ground radar	899,000,000
Spare tubes, crystals, capacitors	299,000,000
Underwater sound equipment	241,000,000
Wire communications and misc.	1,965,000,000
Total value	\$10,709,000,000

Navy Releases Sonar Story

THE FOLLOWING EXCERPTS are taken from a Navy Department release dated April 6, 1946, tracing the history of underwater sound devices, summarizing the role of modern sonar in winning the U-boat war, and giving technical details of early types of supersonic echo ranging sonar.

Sonar, the only effective method of detecting completely submerged submarines, was a major factor in the defeat of the U-boat and the winning of the Battle of the Atlantic. A majority of the 996 enemy submarines sunk during the war were detected and located by sonar.

The word sonar was coined from abbreviations for sound, navigation and ranging, and includes various types of underwater sound devices used in detecting submarines and other submerged objects and in obtaining water depths. Its secret has been maintained by the Navy since World War I, and its development has been an unspectacular, long, steady conquest over physical elements of the sea which have resisted penetration by radio waves, radar and other types of radiation.

The underlying principle of rang-

ing sonar is the principle of the echo. Sound waves are sent through the water, and are echoed back to the sender when they strike an underwater object. Between that simple principle and the development of equipment capable of detecting and tracking moving submerged submarines, however, lie years of scientific research and experimentation that spanned two wars.

History of Sonar

The first popular use of underwater sound was confined to navigational purposes with apparatus produced by the Submarine Signal Company of Boston, Massachusetts, about 1902. A clapper-type pneumatic bell, installed on light-ship vessels, transmitted sound waves which were received by ships having a microphone on each bow. A rough estimate of the sound's direction was obtained by shifting headphones alternately to port and starboard microphones. Because the bell's low frequency could barely be distinguished from various ship noises, the company replaced it in 1907 with the 540-cycle Fessenden oscillator, which was essentially an electromag-

netic loudspeaker which vibrated against the water.

These equipments were useless in detecting any of the U-boats at sea during the first half of World War I. By 1916, the United States Navy had developed and installed an acoustical listening device designated as SC, which consisted of two three-inch diameter rubber nipples mounted five feet apart on a T-shaped hollow pipe which terminated in a stethoscope. The T's were hung over the side or protruded through the bottom of Submarine Chasers, which searched

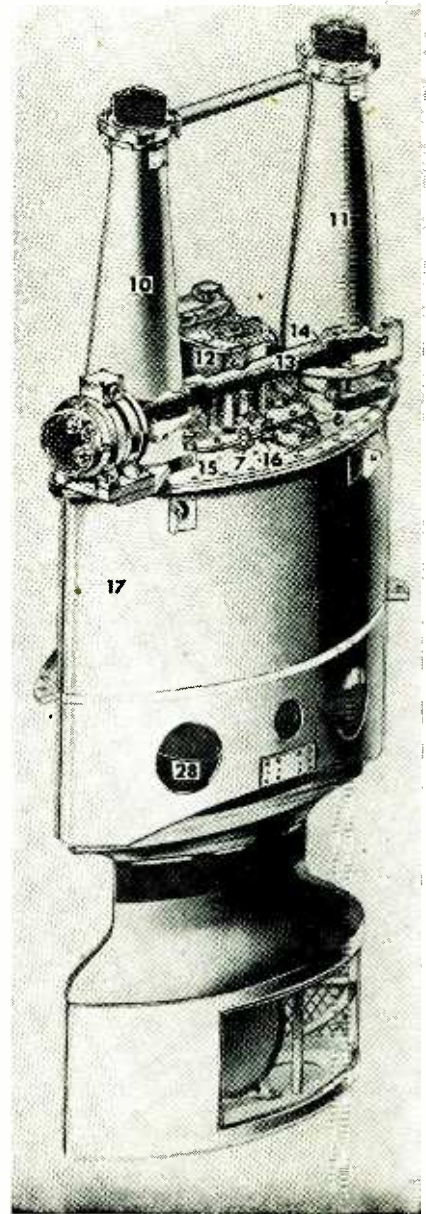

Sonar transducer mechanism in retracted position, showing 20-inch diameter disc that rotates in its streamlined dome. Motor turns gears which rotate lifting screws inside pillars 10 and 11 to raise or lower dome

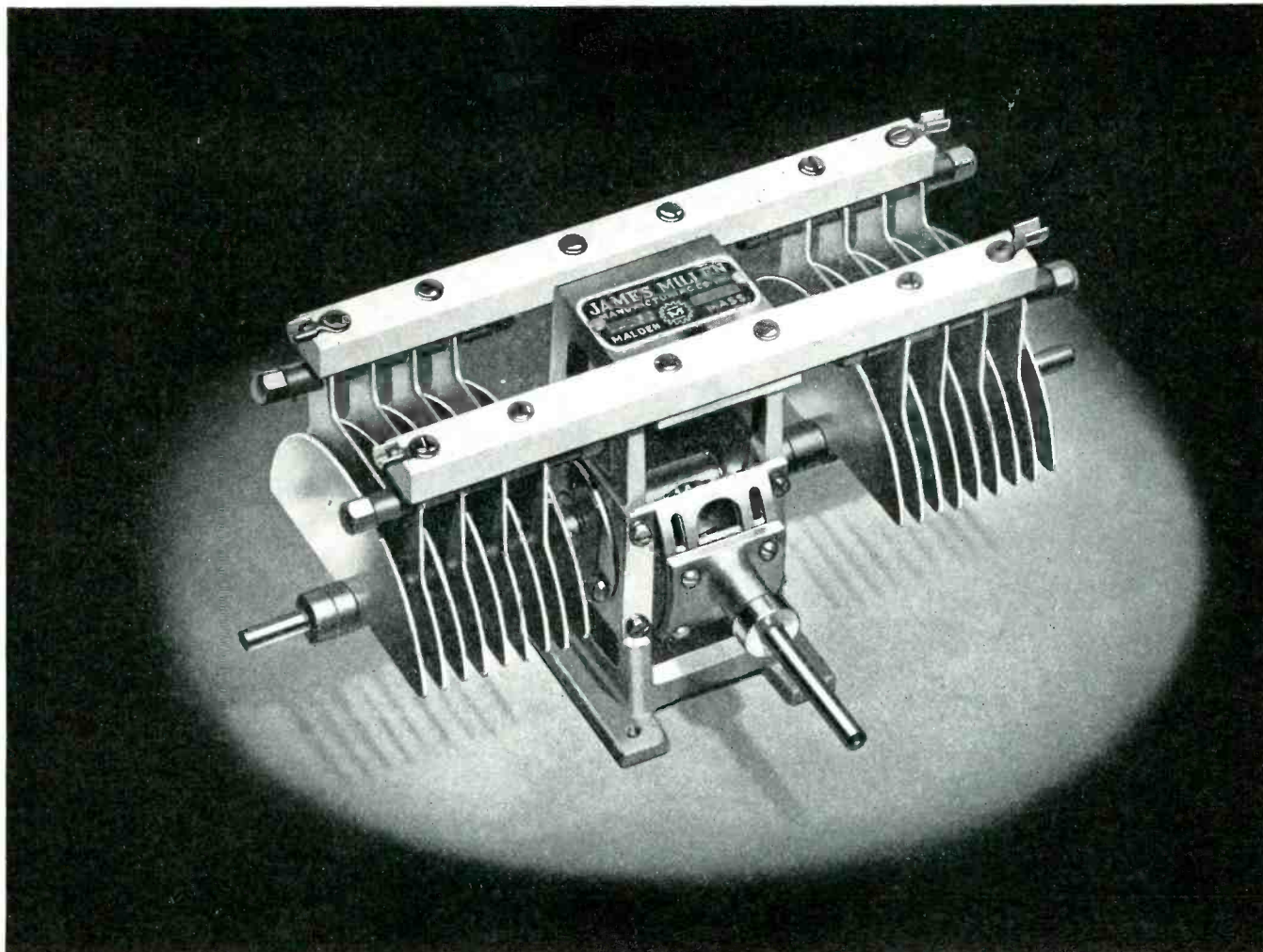

"Designed for Application"

THE 04000 VARIABLE TRANSMITTING CONDENSER

Another Millen exclusive "Designed for Application" product is the No. 04000 series of variable air transmitting capacitors. Permits more efficient use of newer tubes—more compact and symmetrical circuit arrangements and consequent better neutralization. Center fed rotors for better high frequency current distribution. Constant impedance, heavy current, multiple finger rotor contactor of new design. Extruded steatite insulation. Ter-

minals in convenient places. Sturdy cast aluminum frame with right angle 1/1 drive. Adjustable drive shaft angle for either vertical or sloping panels. Heavy gauge rounded and polished aluminum rotor and stator plates. Rotor plate radius, 1 1/2". Available in peak voltage ratings of 3000, 6000 and 9000. Ideal for heavy duty industrial electronic heating applications.

JAMES MILLEN

MAIN OFFICE



MFG. CO., INC.

AND FACTORY

MALDEN, MASSACHUSETTS, U. S. A.

ANOTHER SPECIAL BY PROGRESSIVE

QUALITY PROMCO BRAND

ACTUAL SIZE

ENLARGED FOR DETAIL

BLUE PRINT

CATALOG SHOWS DOZENS MORE

Special heads, threads and finishes on any metal or alloy adapted to cold upset. Weekly output: 25,000,000 pieces. Many specials, suggesting production savings for you, illustrated in latest catalog. Includes weights per 1M standard pieces, dec. equivs. of fractions, other purchasing and engineering helps. Write for Catalog 18.

The PROGRESSIVE MFG. CO.
50 NORWOOD ST. TORRINGTON, CONN.

by stopping to listen, proceeding a few hundred yards, then stopping and listening again. Only a rough estimate of the target's location could be obtained. Teamwork and triangulation by several anti-submarine vessels, however, provided the location for depth-charge attacks. The charges were dropped over large areas with small hope of scoring a kill, or forcing the U-boat below periscope depth to prevent its aiming torpedoes or tracking ships. United States submarines also had the SC. The German U-boat listening device was effectively identical, and the British detectors were similar.

ASDIC, SC, and MV

In the closing months of World War I the Allied Submarine Devices Investigation Committee (ASDIC) was formed to obtain more effective underwater detection equipment from science and technology. United States activity was headed by the National Research Council. A French representative, P. Langevin, described his experiments in producing intense underwater sounds by employing a technique invented by Pierre Curie, the discoverer of radium. The technique involved passing an alternating current of about 15,000 cps through a crystal of quartz, which made the quartz vibrate and produce a series of compressions and rarefactions in the surrounding medium, thereby propagating sound waves. Langevin had sandwiched slabs of quartz between the steel plates of his underwater transmitter, which produced sound that traveled a path similar to the beam of a searchlight.

Throughout World War I the Navy's major investigations were made at its experimental station at New London, Connecticut, where important techniques were developed too late to enter the war. The SC acoustical air tube was expanded to contain six or more nipples on each bow, and an electrical sonic system designated MV was developed. The MV consisted of a blister on each bow which contained 12 microphones of the carbon-button type that fed the sounds through electrical phase lines to a compensator which featured direction finding to within a few degrees. The MV and SC became Navy standard installations. In September, 1918, experiments were conducted with quartz-steel

A Buy-word for Excellence

40 YEARS

PUR-A-TONE
Reg. Trade Mark

ANTENNAS

DEPENDABILITY

BRACH
1906
1946

ALL TYPES FOR

- AUTOS
- HOMES
- MARINE

A.M. — F.M. — TELEVISION

Make pleased customers and bigger profits . . . ask your distributor for BRACH Puratone ANTENNAS.

Special-purpose transmitting antennas designed for volume production to your own specifications. Collapsible — sectional — direction finding — radar and coaxial type. All sizes, lengths and materials. Consult us on your needs.

L. S. BRACH MFG. CORP.
200 CENTRAL AVENUE NEWARK, N. J.

WORLD'S OLDEST AND LARGEST MANUFACTURERS OF RADIO ANTENNAS AND ACCESSORIES.

Announcing TWO TUBES IN A New FAMILY OF VHF TRIODES

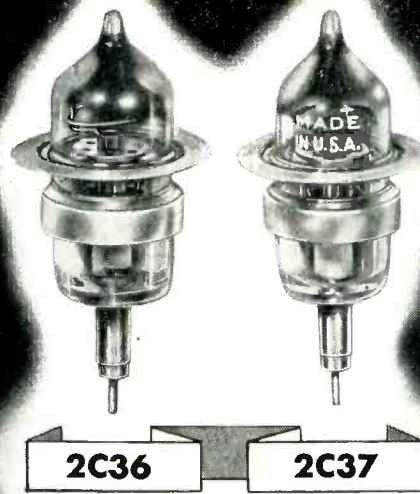

2C36

2C37

PHOTOGRAPHS ACTUAL SIZE

- ### FEATURES
1. Streamlined cathode assembly—higher efficiency.
 2. Planar grid.
 3. Minimum interelectrode capacitances.
 4. Minimum transit time effect.
 5. Efficient operation up to 3000 mc.
 6. Maximum power output with minimum input power.
 7. Low heater drain.

An entirely new type of construction characterizes a family of tubes developed by Sylvania research. First of the family to become available are the 2C36 VHF triode oscillator (utilizing internal feedback) and the 2C37 VHF triode general purpose tubes.

PHYSICAL SPECIFICATIONS

Max. length	2.338"
Max. diameter	1.0" ± .005"
Cathode	Coated Unipotential
Base	None required
Mounting Position	Any

ELECTRICAL CONNECTIONS

Inner Conductor	Heater
Outer Conductor	Heater and Cathode
Straight Disc	Plate
Cupped Disc	Grid

RATINGS and CHARACTERISTICS

	2C36	2C37
Heater Voltage ± 10% (a-c or d-c)	6.3 v	6.3 v
Heater Current	0.4 amp	0.4 amp
Maximum Plate Voltage	350 v d-c	350 v d-c
Maximum Plate Dissipation	5.0 w	5.0 w
Maximum Efficient Operating Frequency	1200 mc	3000 mc
Maximum Plate Voltage (pulsed)	1500 v	—
DIRECT INTERELECTRODE CAPACITANCES*		
Grid-Plate	2.4 μmf	1.85 μmf
Input	1.4 μmf	1.40 μmf
Output	0.36 μmf	0.020 μmf

* Measured in shielded adapter of approximately 1.5" inside diameter with polystyrene insulation.

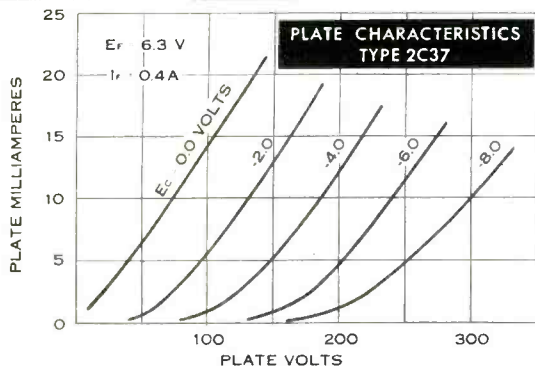

TYPICAL OPERATING CONDITIONS and CHARACTERISTICS

2C36 and 2C37 as Class A₁ Amplifiers

	2C36	2C37
Heater Voltage (a-c or d-c)	6.3 v	6.3 v
Heater Current	0.4 amp	0.4 amp
Plate Voltage	180 v d-c	180 v d-c
Cathode Bias Resistor	400 ohms	400 ohms
Plate Current	11.5 ma d-c	11.5 ma d-c
Transconductance	4500 μmhos	4500 μmhos
Amplification Factor	25	25
Grid Voltage for I _b = 10 μa d-c	-13.0 v d-c	-13.5 v d-c

2C36 as VHF Oscillator—Plate Modulated

Peak Plate Voltage	1000 v
Peak Plate Current	0.9 amp
Grid Voltage	0 v d-c
Pulse Repetition Rate	1300 pps
Pulse Width	2 μsec
Frequency of Operation	1000 mc
Peak Power Output	200 w

2C37 as VHF Oscillator—Continuous Wave**

Plate Voltage	150 v d-c
Plate Current	15 ma d-c
Grid Resistor	3000 ohms
Grid Bias Developed (approx.)	-11.5 v d-c
Frequency of Operation	1000 mc
Power Oscillation	0.5 w

** Measured in tunable concentric line circuit with external feedback.

Inquiries are invited

Visit us at the Chicago Radio Show — Booth 86

SYLVANIA ELECTRIC

Electronics Division . . . 500 Fifth Avenue, New York 18, N. Y.

MAKERS OF ELECTRONIC DEVICES; RADIO TUBES; CATHODE RAY TUBES; FLUORESCENT LAMPS, FIXTURES, WIRING DEVICES; ELECTRIC LIGHT BULBS

A CORDIAL INVITATION

TO ALL

- **Representatives**
- **Manufacturers**
- **Servicemen**
- **Distributors**

WELCOME TO

BOOTH 101

RMA NATIONAL PARTS SHOW

STEVENS HOTEL
CHICAGO—MAY 13-14-15

See **SUPREME'S**
NEW LINE OF POST-WAR
RADIO, TELEVISION and
ELECTRONIC TEST EQUIPMENT

Supreme Engineers,
Technicians and Sales-
men will be on hand to
show the line and answer
all questions.



SUPREME INSTRUMENTS CORP.
GREENWOOD, MISS.
U. S. A.

Export Department:
THE AMERICAN STEEL EXPORT CO., Inc
374 Madison Ave., New York 17, N. Y.

echo ranging techniques (Langevin's principles), and resulted in equipment which produced underwater sounds that were reflected from a moving target several hundred feet distant.

Between-Wars Research

In 1919, sonar problems were transferred to the Naval Engineering Experiment Station, Annapolis, Maryland. One important development which had its beginning there was the Hayes Sonic Depth Finder. It contained an electromagnet which sent sound waves to the ocean floor, received the reflection, and indicated the water depth by a timing device basically calibrated at 4,800 feet per second, the speed of sound through water.

Sonar projects were transferred in 1923 to the newly established Naval Research Laboratory at Bellevue, Washington, D. C. The greatest emphasis was then placed on echo ranging experiments at supersonic frequencies (above the 16 to 15,000 cps band designated as sonic). The advantages of supersonic echo ranging are many. The signal is amplified electronically, and the employment of supersonic frequencies narrows the reception range to a selective band which eliminates much of the ocean's inherent sonic noises. The directivity of reception also is confined to selective, narrow pie-shaped sections. The ping-echo features were added to these improved listening techniques.

Sonar in Pearl Harbor Days

At the beginning of World War II, we had ships equipped with sonar systems capable of detecting U-boats that were surfaced, submerged, underway or lying still. We also could tell their bearing, distance, and almost exact location. The British had fitted their asdic (British word for sonar) on 165 destroyers, 34 small patrol craft and 20 trawlers, and the United States had about 60 destroyers fitted with echo ranging sonar. British asdic transducers contained quartz-steel, while U. S. sonar transducers had magnetostriction tubes; the British asdic dome was streamlined, while ours was a sphere; British asdic ranges were permanently recorded on a range recorder, while U. S. sonar ranges were indicated on a dial.

Range recorders are a valuable

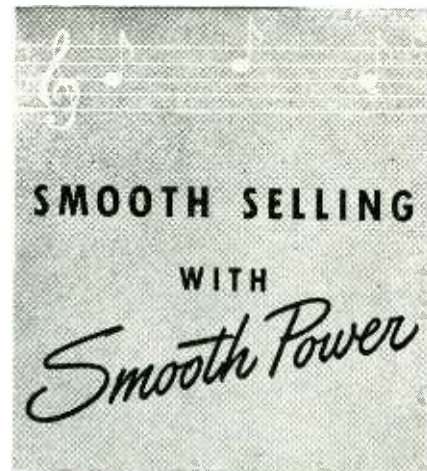

• The fine performance of General Industries *Smooth Power* motors will bring smooth selling for your new designs of phonographs, recorders and record-changers. Any motor you select from the comprehensive GI line will make quick and permanent friends with its smooth-as-velvet operation, quietness and uniform speed. So, for smooth selling and smooth performance, standardize on *Smooth Power*.



The General Industries Company
DEPT. M • ELYRIA, OHIO

Practical Research
DEDICATED TO
Superior
Electronic Tubing

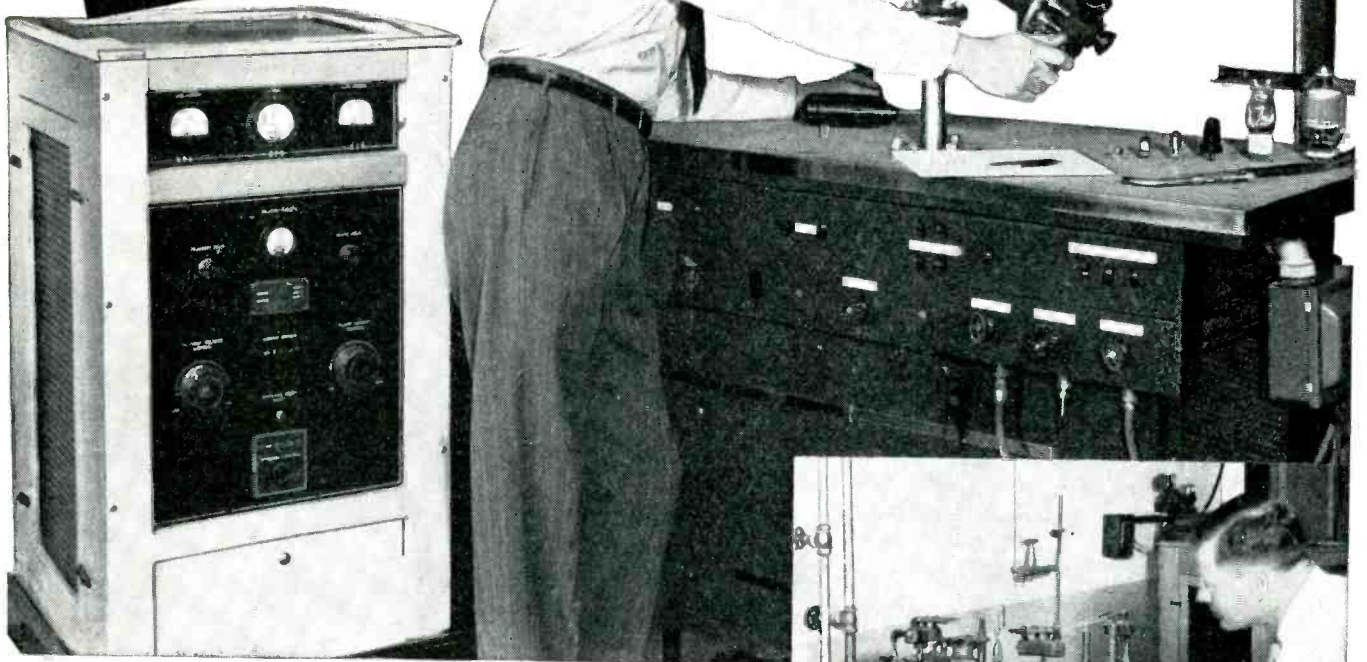

Superior's Electronic Laboratory opens the doors to far reaching research and development of electronic tubing, through the study of materials, processes and controls.

The Emission Microscope, shown above, makes it possible to test the material in electronic tubes, under actual operating conditions, for emissive qualities. Material control standards, otherwise unattainable, are now realities. The way is open to important development of new tubing materials and uses.

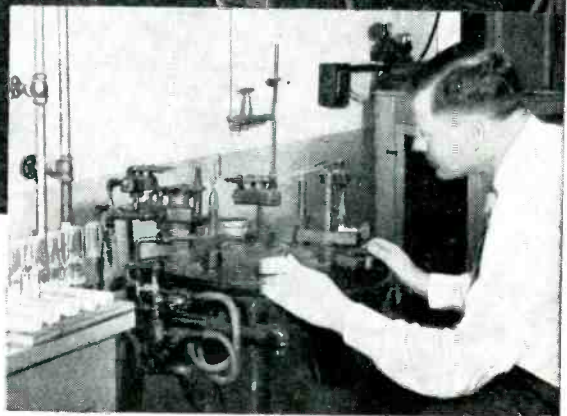

Sealing-in Machine in the process of sealing experimental electronic tubes preparatory to emission testing.

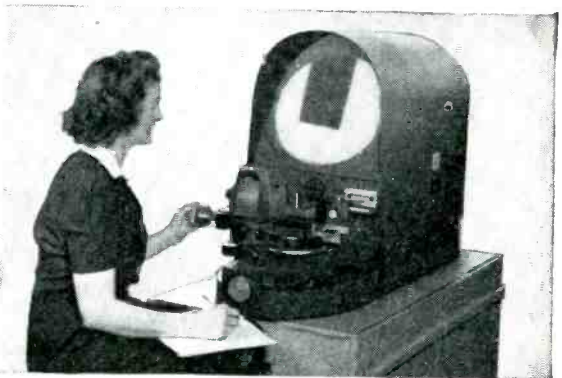

Comparator measuring dimensions to 10 thousandths of an inch, for inspecting the quality of work going into electronic tube cathodes and parts. This is just one of many tests conducted by the "Quality Control Group" of the Superior Laboratories.

THE BIGGER NAME IN SMALL TUBING
Superior



SUPERIOR TUBE COMPANY
NORRISTOWN • PENNSYLVANIA

SPECIAL UNITS...

We have had such success in cooperating with engineers of our customers that we do not hesitate to offer you this special service in development of sample units.

You may have an unusual problem for reconversion, one in which greater efficiency for a tough job will save money and give better service.

Let our engineers consult with yours. We are well equipped for this type of cooperation.

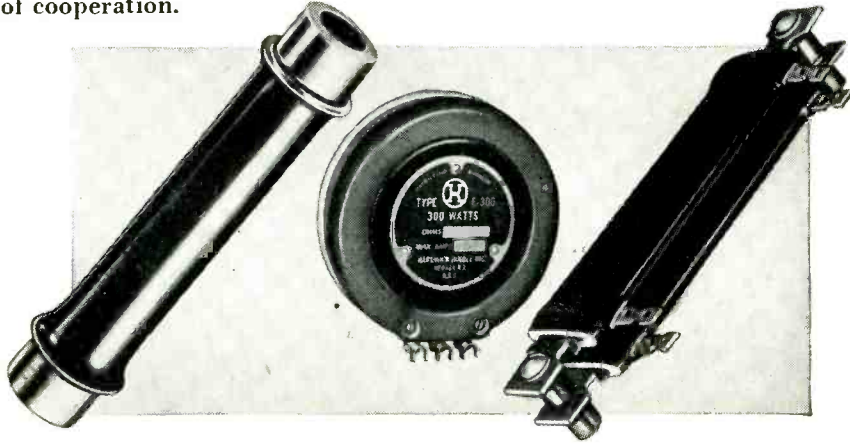

HARDWICK, HINDLE, INC.
RHEOSTATS and RESISTORS
 Subsidiary of THE NATIONAL LOCK WASHER COMPANY
 NEWARK 5, N. J. ESTABLISHED 1886 U. S. A.



NEW and Ready for you!

**Allied's 1946
 CATALOG**
*of Radio and
 Electronic Supplies*

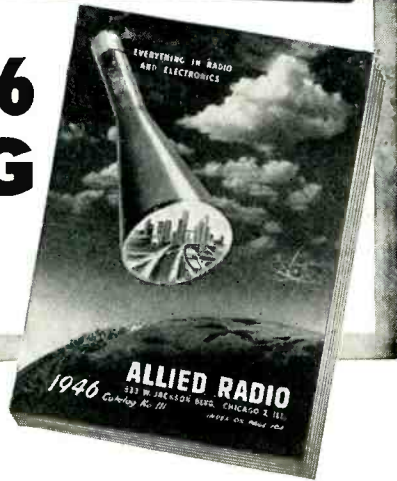

**LARGEST AND MOST COMPLETE
 STOCKS... Under One Roof**

You'll find this new Buying Guide extremely helpful and valuable today! Places over 10,000 items at your finger tips—for research, maintenance and production. Includes parts, tubes, tools, books, test instruments, public address and communications equipment. Concentrates all leading

makes here in one large central stock to give you faster, more efficient, more complete service—saves you time, work and money. Whatever you need... it pays to check with Allied. Write, wire or 'phone Haymarket 6800.

Everything in Radio and Electronics
ALLIED RADIO CORP.
 833 W. Jackson Blvd., Dept. 24-E-6, Chicago 7, Illinois

FREE
Send for it
NOW

aid in conducting attacks. Sample recorders were obtained from Britain, and the Sangamo Electrical Company of Springfield, Illinois, started producing our own types. The streamlined dome increased from 10 to 15 knots the speed that ship's sonar could be effectively operated.

Intimations of Electronic Sonar

The engineering groups enlisted the aid of additional manufacturers and furnished a gyro-controlled device to keep the sonar beam directed on the U-boat during an escort's maneuvers or turns, an electronic scope to indicate visually whether the sonar beam tended to lose contact due to the operator moving the beam either to the right or left of the U-boat, and a control device which reduced the heavy reverberations resulting from sudden sonar

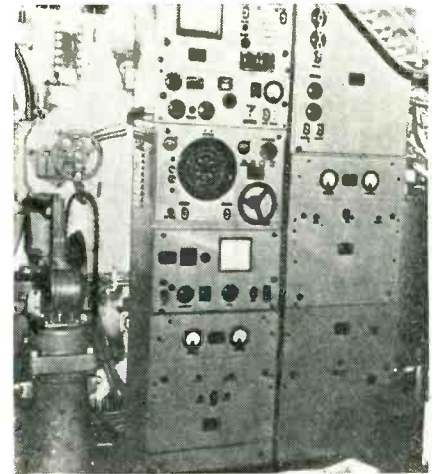

Modern echo-ranging sonar installation in a U. S. submarine. Right-hand rack generates supersonic voltages that energize the transducer which is lowered through keel of submarine by hoist mechanism at extreme left. Left-hand rack contains echo amplifier, target range and bearing indicators, and training control wheel

pings which cause the surrounding water to act like an empty hall with bad acoustics. The control device also reduced undesirable interfering echoes from seaweed, shallow water bottoms, tidal currents and wakes.

The effectiveness of the improved Allied anti-submarine measures was demonstrated when history's greatest invasion armada of about 1,065 vessels made passage in November, 1942 from United States and United Kingdom ports for the coast of North Africa. Although some 40 U-boats were lying in wait, they sank only 23 ships during November.

By April 1944 the Navy's sub-

HEADLINES and HEADLINERS

No. 18 in a series

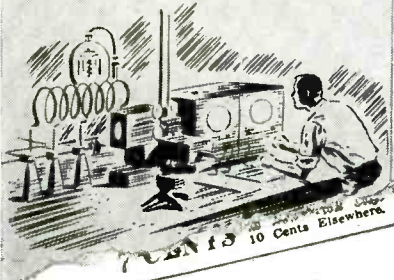

*** Midget Battery**
Cell, 5/8 Inch High, Used
In Walkie Talkies, Has
Bright Civilian Future

Now Going Into Hearing
Aids, Probably Pocket Ra-
dios Later; Life Is 40 Hours

Steel Case Bars Corrosion

Price

harvest private at esti- milled million e proce- cked. 7 prep- ats of a men fewer

15 10 Cents Elsewhere.



DON G. MITCHELL, Executive Vice President, Sylvania Electric Products Inc.

"THE vital field of electronics is becoming more and more a force of influence in the nation's business and industry. To keep ourselves constantly abreast of the developments in this field and allied industries, I, and many of my asso-

ciates, have found The Wall Street Journal the publication that serves our interests to the best advantage. We look to the Journal to keep us completely informed daily of the changes affecting the business world."



*Like most important business news, this story appeared first in The Wall Street Journal. That's why this national daily is "must" reading for business men who need to be fully, accurately and quickly informed. And that's what provides such an unusually responsive audience for advertisers.

The ONLY National Business Daily
Published simultaneously on both coasts

BRADLEY COPPER OXIDE RECTIFIERS

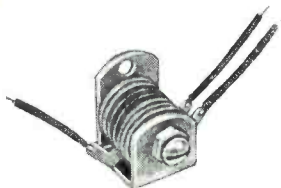

Coprox Model CO12D4F

Designed for control applications. Conservatively rated at 6 volts A.C., 4½ volts D.C., 35 milliamperes D.C. Completely sealed with special plastic compound.

Bradley's experienced engineering staff will gladly specify the proper copper oxide rectifier for you, or design and produce a special model tailored to your requirements.

Illustrated literature, available on request, shows more models of copper oxide rectifiers, plus a line of selenium rectifiers and photocells. Write for "The Bradley Line."

BRADLEY LABORATORIES, INC.

82 Meadow St. New Haven 10, Conn.

marine echo-ranging sonar had been augmented by: (1) a topside listening hydrophone consisting of a three-foot long two-inch diameter magnetostriction tube having excellent directional accuracy on sounds up to about 10 miles distance in average water conditions (JP sonar, described in *ELECTRONICS*, April 1946, p 99); (2) a shipboard listening trainer attached to the sonar to provide practice in estimating speeds of various ships by their propeller rhythm; (3) other sonar equipment which facilitated submerged excursions into Japanese held waters including Tokyo Bay.

Sonar on Normandy D-day

When the Allies invaded the Normandy beaches on June 6, 1944, the invasion waves were led by small naval scout craft equipped with an echo-ranging asdic whose recorder traced the outlines of the beaches. Mines, fencing and other obstacles were detected and blasted from the path of landing craft. The invasion forces were blanketed by heavy air coverage and a sonar screen so tight that no ships were lost to submarines until the end of June, when the seven ships they sank cost them 21 U-boats.

U-boat tactics were revolutionized in the summer of 1944 when they were equipped with the Schnorchel extension stack, which expelled diesel exhaust and drew in fresh air. The U-boats took up stalking positions at focal points of convoy routes, from

TO LONDON VIA THE MOON

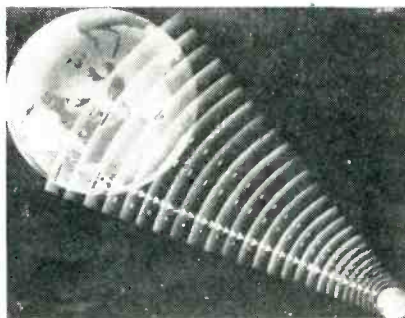

Hemisphere radio broadcasting as envisaged by engineers of Federal Telephone and Radio Corp. Reception would be possible from any place on the earth where the moon is visible at the time of the broadcast. Many technical problems must be overcome, however, before commercial broadcasting via the moon becomes economically feasible

Why leaders
in every field
use **PALNUTS**



ALWAYS HOLD TIGHT

**EASY AND FAST
TO ASSEMBLE**

LOW IN COST

**WITHSTAND
HIGH TEMPERATURE**

**DO NOT DAMAGE
NUT OR NUT SEAT**



Used as
locknut on heavier
assemblies.

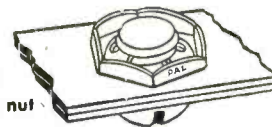

Used alone
as self-locking nut
on lighter assemblies.

● Send details of your application for recommendation and free samples. Ask for literature describing Palnut double-locking principle, advantages, types, etc.

THE PALNUT COMPANY

77 Cordier St.,
Irvington 11,
N. J.



**DOUBLE-
LOCKING**

PALNUTS

THE ANSWER TO YOUR TUNER PROBLEMS

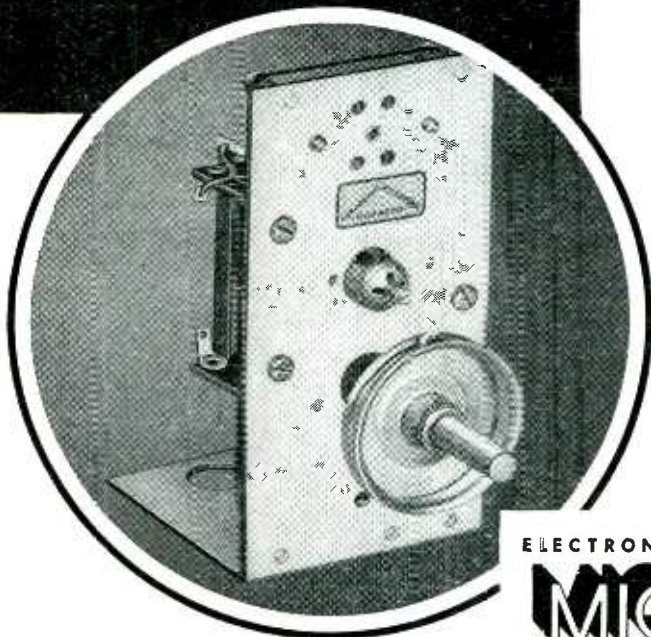
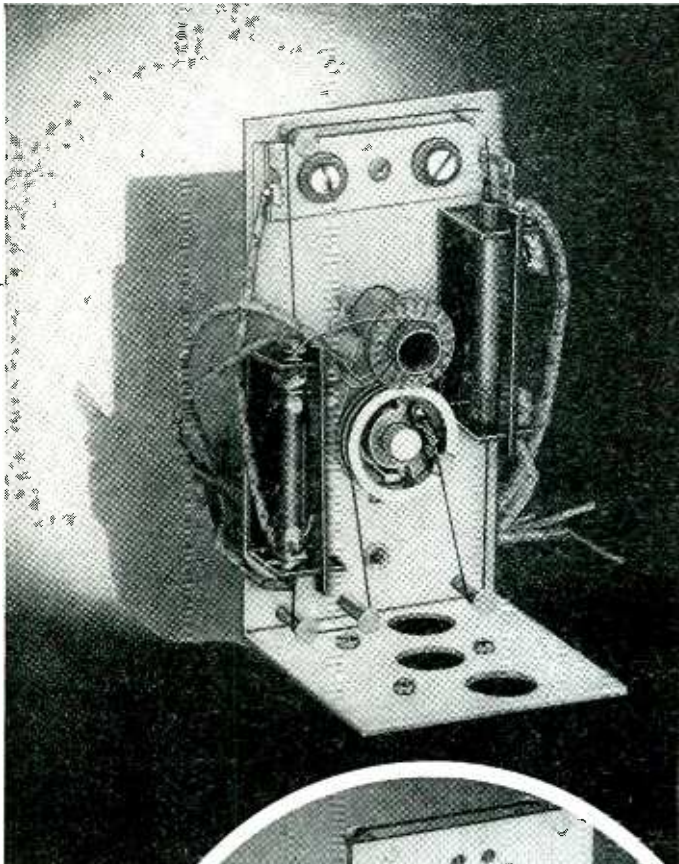

• Here in these newly designed Radacor Tuners is Micro-Ferrocart's answer to present-day problems of procurement and engineering... as well as a typical example of Micro-Ferrocart production "know-how." By combining the manufacture of tuner and core in the production of this new-type component our engineering department has evolved a better product at lower cost.

• These Tuners are available for use with any type aerial, including built-in loops.

• If you are interested in these Radacor Tuners or if you have a manufacturing problem that can be solved by electronic or mechanical powder metallurgy, why not get in touch with us today. Our engineering department and complete laboratory facilities are at your disposal.

ELECTRONIC & MECHANICAL POWDER METALLURGY
MICRO-FERROCART
PRODUCTS DIVISION

MAGUIRE INDUSTRIES., INC., 375 FAIRFIELD AVENUE, STAMFORD, CONNECTICUT

EASTERN PUMPS

COVER A WIDE RANGE OF PERFORMANCE

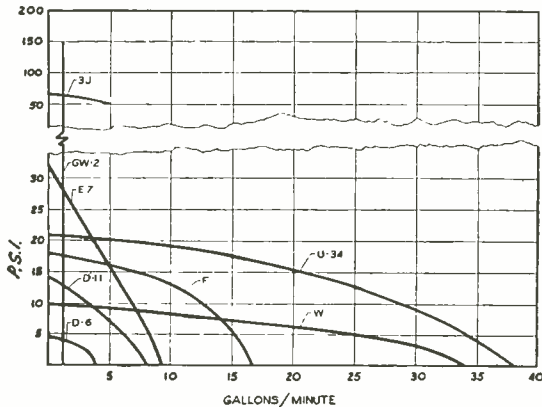

The performance chart shown above typifies the wide range of performance available through the selection of Eastern Midget Pumps. These pumps can provide the right equipment for your needs where small size and light weight, combined with high performance and economy of operation are factors. They may be equipped with the easily adjustable stuffing boxes or rotary seals and will not leak at several times the maximum working pressures. Weights are from 2¼ to 100 lbs., capacity from ½ to 70 G.P.M. and pressures range up to 250 P.S.I. Standard models of many pumps are available in Monel Metal, Stainless Steel, Hastelloy "C", Cast Iron, Bronze and other metals and alloys. Models are motor driven, including Underwriters' approved explosion-proof motors, air driven or belt driven. Write for NEW CATALOG describing entire line of pumps.



EASTERN ENGINEERING CO.
84 Fox Street, New Haven 6, Conn.

PLASTIC FABRICATING ... O.K!

BAKELITE SHEETS, RODS, TUBES
FABRICATED PARTS



Twenty Years of Experience

ELECTRICAL INSULATION CO., INC.

12 VESTRY ST., NEW YORK 13, N. Y.

where they attacked by blindly firing acoustic and looping torpedoes into passing convoys. Periodically they came to Schnorchel depth to replenish air and recharge batteries.

The top of the Schnorchel stack was covered with anti-radar material, visual detection range on the Schnorchel was only about a mile or two in daytime and practically nil at night, and radio silence was maintained, thereby neutralizing our anti-submarine air offensive and surface detection. But—whether Schnorchelling, submerged or bottomed—the asdic-sonar teams continued to detect and locate the U-boats.

Chicago Electronic Conference

THE SECOND NATIONAL Electronic Conference, sponsored by the Illinois Institute of Technology, Northwestern University, and the Chicago sections of AIEE and IRE with the cooperation of the Chicago Technical Societies Council and the University of Illinois, will be held at the Edgewater Beach Hotel in Chicago from October 3rd to 5th inclusive. Technical papers will be presented in morning, afternoon, and evening sessions scheduled for each of the three days. Panel discussions will be arranged on an industry basis so that delegates may concentrate on their special fields of interest.

AAF Plans for Crossroads

EMPLOYMENT OF RADIO-CONTROLLED B-17's during the atom-bomb test at Bikini is expected to aid immeasurably in the collection of scientific data which might otherwise be unobtainable. It is planned to employ television sets to transmit a picture of the terrain beneath the plane wherever it may be, as well as a picture of the instrument panel, so that the behavior of the drone will be known even when it flies through the atom cloud.

The AAF Wright Field Test Laboratory will gather vital knowledge from its recording equipment aboard the planes. Torque noses are installed on the planes to record engine power changes. Accelerometers will measure the G stresses. Specially constructed bags will open to gather particles from the cloud and

Model 2405 Volt • Ohm • Milliammeter

25,000 Ohms
per volt D.C.

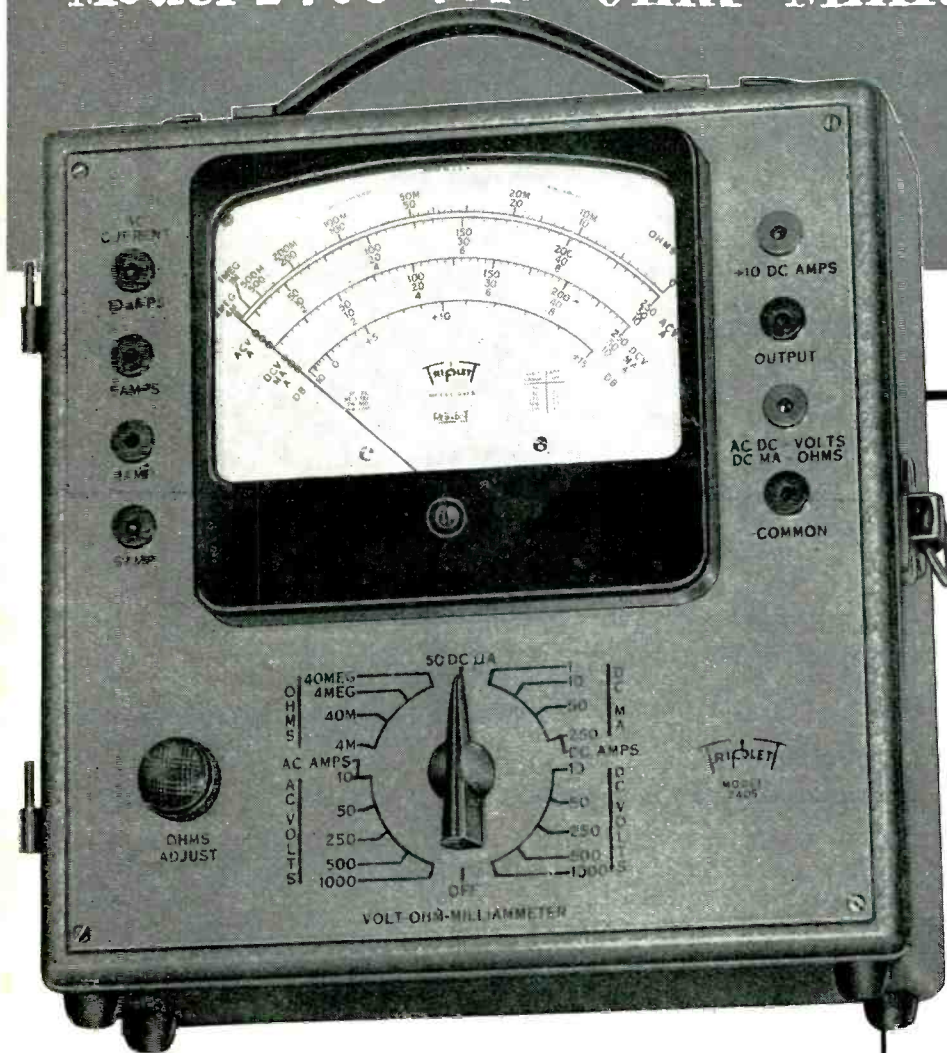

Specifications

NEW "SQUARE LINE" metal case, attractive tan "hammered" baked-on enamel, brown trim.

✓ PLUG-IN RECTIFIER

Replacement in case of overloading is as simple as changing radio tube.

✓ READABILITY

The most readable of all Volt-Ohm-Milliammeter scales—5.6 inches long at top arc.

✓ RED • DOT LIFE-TIME GUARANTEE

on 6" instrument protects against defects in workmanship and material.

New ENGINEERING • New DESIGN

• New RANGES • (50 RANGES)

Voltage: 5 D.C. 0-10-50-250-500-1000 at 25000 ohms per volt.
5 A.C. 0-10-50-250-500-1000 at 1000 ohms per volt.

Current: 4 A.C. 0-.5-1-5-10 amp.
6 D.C. 0-50 microamperes—0-1-10-50-250 milliamperes—0-10 amperes

Resistance 0-4000-40,000 ohms—4-40 megohms.

6 Decibel —10 to +15, +29, +43, +49, +55.

Output Condenser in series with A.C. volt ranges.

Model 2400 is similar but has D.C. volts

Ranges at 5000 ohms per volt.

WRITE FOR COMPLETE DESCRIPTION.



Triplet

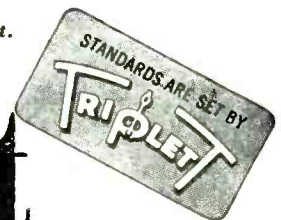

ELECTRICAL INSTRUMENT CO. BLUFFTON, OHIO

EASY-FLO BRAZING...



Photo courtesy of Edwin L. Wiegand Co., Pittsburgh, Pa.

..the fast, low-cost way to make **WATER-TIGHT metal joints**



RINGS OF EASY-FLO WIRE PREPLACED HERE



Water-tight joints by the thousands are being made today with EASY-FLO. One typical example is the brazing of electric Immersion Heaters by the Edwin L. Wiegand Co., of Pittsburgh. Wiegand engineers worked out the simple procedure illustrated for joining the formed copper tubes to the copper-clad steel flanges. Operator slips EASY-FLO wire rings on tube ends, inserts ends in flange, places assembly in fixture, applies Handy Flux. Meanwhile another assembly in the induction coil (center) is brazed

and a third, in fixture at left, is cooling. This simple process turns out a steady stream of 100% water-tight heaters.

GET FULL EASY-FLO FACTS IN BULLETIN 12-A

It tells exactly what this alloy does and why—also where and how you can profitably use EASY-FLO on your own metal joining. Write for a copy—today.



HANDY & HARMAN
82 FULTON ST., NEW YORK 7, N. Y.
Bridgport, Conn. - Chicago, Ill. - Los Angeles, Cal.
- Pasadena, B. C. - Toronto, Canada
Agents in Principal Cities

will automatically seal closed after the plane has completed its trip through the radioactive area.

The AAF is providing Boeing B-29 Superfortress photo planes (F-13's) and specially trained crews who will fly their aircraft near enough to the explosion to obtain accurate photographic records of the occurrence. Each aircraft is equipped with 24 cameras of different types, which will take thousands of pictures of the explosion.

AAF participation in Crossroads is divided into four phases: (1) The bomb dropping, to be accomplished by one B-29; (2) The placing of certain parachute-suspended pressure recording instruments and blast gages which will be dropped from higher altitudes by two B-29's, simultaneously with the actual bomb release; (3) Detailed photography of every phase; (4) The air instrumentation phase, to be accomplished by radio controlled B-17's which will be flown into untenable areas at various times after the bomb burst.

Moon Radar To Be Tried Against German V-2 Bombs

GERMAN V-2 LONG-RANGE rockets will be sent streaming 90 miles into the stratosphere this summer by Army Ordnance to serve as targets for every known means of radar detection and tracking equipment, including the super-power moon radar setup. The AAF, in cooperation with the Signal Corps, will attempt to plot the courses of these 3,000-mph missiles as they arch across the sky.

Whatever the conclusions reached as a result of the summer tests at White Sands proving ground in New Mexico, the AAF plans to go on with its research until a way is found to stop such missiles, either by interception with radar-guided counter-attack rockets or by other as yet undeveloped or undisclosed means.

Airborne Television Demonstrated

TWO TYPES OF AIRBORNE television equipment developed for military use and known under the security pseudonyms of Ring and Bloc were publicly demonstrated for the first time recently at Anacostia Naval Air Station, Washington, D. C.

Ring television is the more power-



ACTUAL SIZE

Now

Commercial Crystals to 35 Megacycles

35 megacycle crystals now mean fewer doublers, less weight, space and cost in your VHF equipment. Immediate delivery of specified frequency crystals.

- Low Temp. Co-efficient
- .01% Tolerance
- 60 ma. Current Capacity
- Nominal Cost

Territory Open for Factory Representation

RADIO SPECIALTY MFG. CO.
PORTLAND, OREGON

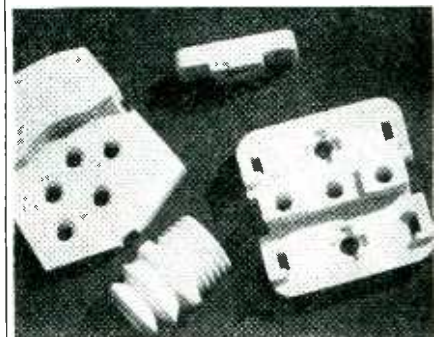

Lavite STEATITE CERAMIC

Properties and Characteristics of Our LAVITE 51-5 Steatite Ceramic Body

Compressive Strength	96,000 lbs. per square inch
Tensile Strength	7,200 lbs. per square inch
Flexural Strength	10,500 lbs. per square inch
Modulus of Rupture	20,000 lbs. per square inch
Dielectric Strength	235 volts per mil
Dielectric Constant	6.42
Power Factor	2.90
	.446 } 1 megacycle
Bulk Specific Gravity	2.664%
Density (from above gravity)	0.096 lbs. per cubic inch
Hardness (Mohr scale)	7.0
Softening temperature	2,350° F.
Linear Coefficient of Expansion	8.13x10 ⁻⁶
Moisture Absorption (ASTM D-116-42-A)	0.009%

Design engineers and manufacturers in the radio, electrical and electronic fields are finding in LAVITE the precise qualities called for in their specifications . . . high compressive and dielectric strength, low moisture absorption and resistance to rot, fumes, acids, and high heat. The exceedingly low loss-factor of LAVITE plus its excellent workability makes it ideal for all high frequency applications.

We will gladly supply samples for testing.

D. M. STEWARD MFG. COMPANY
Main Office & Works: Chattanooga, Tenn.
Needham, Mass. Chicago Los Angeles

You Save *3 Ways* with Essex "Packaged" Wiring Harness

*1 First Cost
 2 Installation
 3 Engineering*

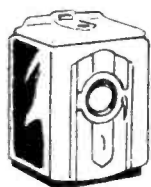
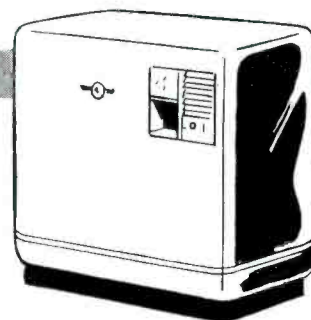
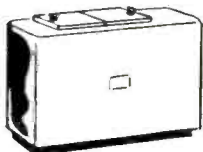
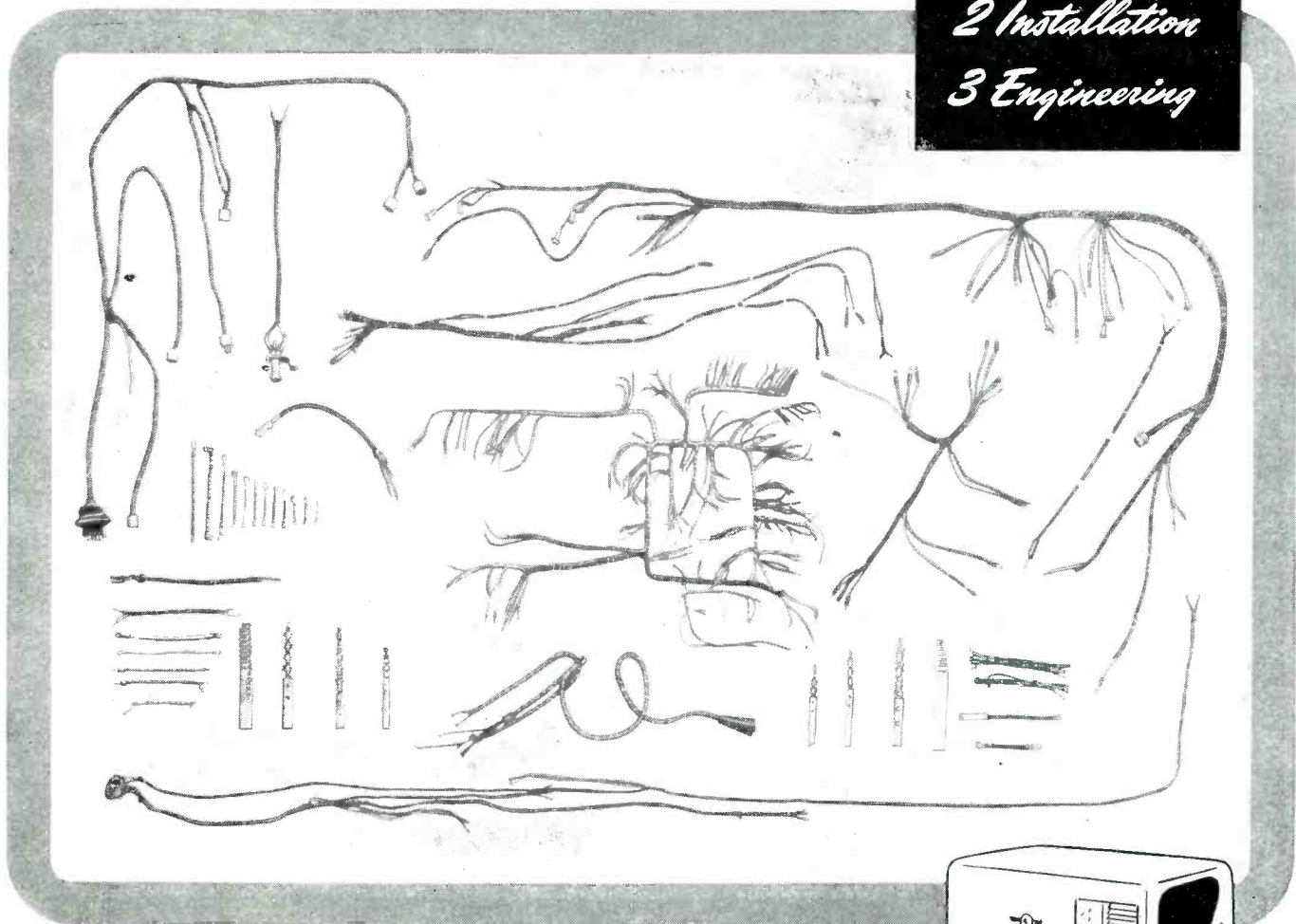

HARNESS assemblies shown here are typical of what Essex can produce for you, *custom-built* to your exact requirements—*at a saving*. Essex *One-Source* service delivers to you *complete* with all manual and electrical control devices, ready for quick, efficient installation. You are relieved of all details. Through intense specialization in wiring har-

ness assemblies, Essex has developed line production methods of manufacturing, assembly and inspection, making economical production of high grade, individually tested, specially engineered assemblies possible. Whatever your wiring problem, it will pay you to investigate Essex *One-Source* service for *complete* assemblies today.

ESSEX WIRE CORPORATION FORT WAYNE 6, INDIANA

Plants: Fort Wayne, Ind.; Detroit, Mich.; Anaheim, Calif.

Warehouses* and Sales Offices: *Atlanta, Ga.; *Boston, Mass.; *Chicago, Ill.; Cleveland, Ohio; Dayton, Ohio; *Detroit, Mich.; Kansas City, Mo.; Milwaukee, Wis.; *Minneapolis, Minn.; *Newark, N. J.; Philadelphia, Pa.; San Francisco, Calif.; *St. Louis, Mo.; *Los Angeles, Calif.



New... "DIALCO" PLN-849 Pilot Light

features the
New Neon NE-51 Bulb
with

BUILT-IN RESISTOR

For 110 Volts (and higher)

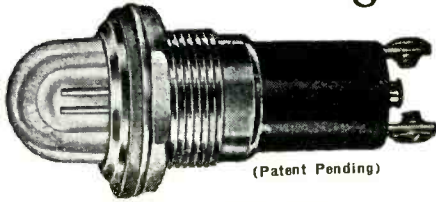

(Patent Pending)

A RUGGED UNIT. Consumes a small amount of current (under one milliampere) and has dependable long life.

Note these important features of the PLN-849 Pilot Light:

(1) RESISTOR INTEGRAL with socket assembly. Value to suit supply voltage. (2) Moulded Bakelite Socket. (3) Full-view Jewel Plastic Cap for visibility at all angles. (4) Rugged terminals, binding screw or permanent soldering type.

(5) High resistance to vibration or shock. (6) Supplied complete with General Electric Neon NE-51 Bulbs. May also be adapted to accommodate General Electric Radio Panel Bulbs such as 47, 44, etc., for low voltage circuits. Bulbs removable from front of panel.



Write today for samples and prices.
See us in Booth #60 at the "SHOW"

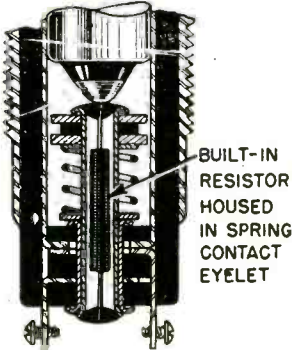

BUILT-IN RESISTOR HOUSED IN SPRING CONTACT EYELET

WRITE FOR NEW ILLUSTRATED BROCHURE

DIAL LIGHT CO. of America, Inc.

900 BROADWAY • NEW YORK 3, N. Y.

Telephone: ALgonquin 4-5180-1-2-3

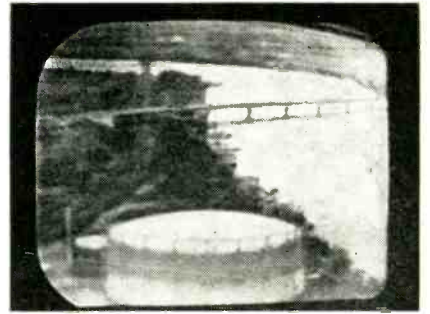

Bridge across Potomac river as picked up by Ring television system and viewed on receiver screen many miles away

ful of the two, having a range of over 200 miles when broadcasting at an altitude of 15,000 feet. The standard installation in a Martin JM-1 airplane employs two cameras, one in the nose bombardier nacelle and one in the waist of the fuselage. Interlaced scanning with a field frequency of 40 and a frame frequency of 20 gives a 567-line picture with high resolution. The transmitter has a peak output of 1.4 kw at 90 or 102 mc. Under poor lighting conditions such as are encountered during dawn or dusk flights, the new image orthicon pickup tube is used in the cameras, while under good lighting conditions a modified orthicon tube with its higher resolving power is employed.

Bloc television produces 40 frames

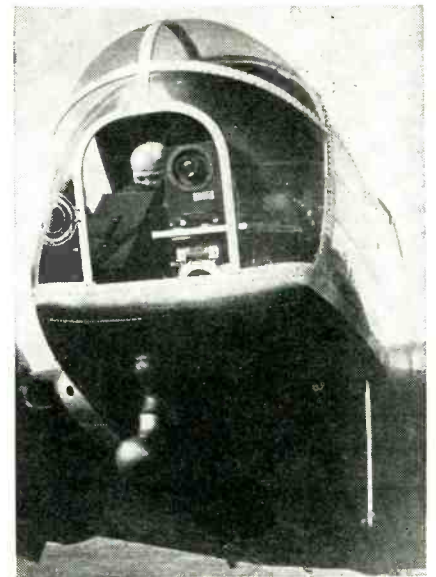

Camera unit of RCA's Bloc airborne television system, mounted in nose of plane for first public demonstration of this military television application. Many thousands of these units were built by RCA Victor for the armed forces, including special adaptations for pilotless bombers, gliders, rocket projectiles, aerial bombs, and explosive-crammed crash boats

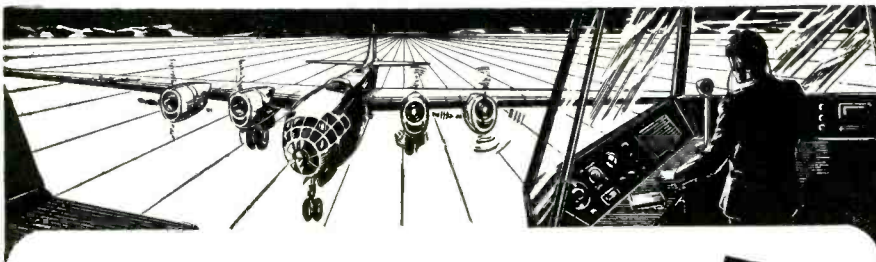

An Invitation to All Electrical Designers to TRY SILVER GRAPHALLOY

FOR BRUSHES

High current density, low contact drop, low electrical noise, and self-lubrication are characteristics of this silver-impregnated molded graphite that may be the answer to your electrical brush problems.

SAMPLES of Silver Graphalloy will be gladly furnished for test on your applications. Silver Graphalloy is usually silver plated to permit easy soldering to leaf springs or holders. Why not WRITE NOW for your test samples?

FOR CONTACTS

Low contact resistance and non-welding when breaking surge currents are inherent properties of this unique combination of conductive silver and self-lubricating graphite.



GRAPHITE METALLIZING CORPORATION

1055 NEPPERHAN AVE • YONKERS, NEW YORK

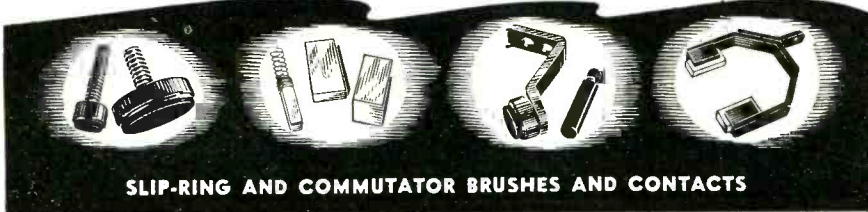

SLIP-RING AND COMMUTATOR BRUSHES AND CONTACTS

... it's New!



**FOR
TELEVISION
RADAR AND
FAC-SIMILE**

Wide Band **VIDEO AMPLIFIER**

Designed primarily for use in amplifying complex waves to be viewed on an oscilloscope, this instrument is also extremely useful in laboratory work as an audio amplifier for tracing and measuring small R. F. Voltages, (as in the early stages of radio receivers,) and many similar applications.

Specifications

BAND WIDTH: Frequency response is flat within 1.5 DB of the 10 KC response from 15 cycles, to 4 megacycles and 3 DB from 10 cycles to 4.5 megacycles. Phase shift is controlled to provide satisfactory reproduction of pulses on the order of one micro-second, and square waves at repetition rates as low as 100 per second.

GAIN: The gain is approximately 1000 when direct input is used. Use of probe input introduces an attenuation of approximately 10:1.

INPUT is normally through a probe (furnished with the equipment), which has an input circuit consisting of a 1.1 megohm resistance in parallel with approximately 18 mmfd. The amplifier direct input (without probe) is approximately 2.2 megohms of resistance in parallel with 40 mmfd.

OUTPUT voltage can be adjusted from zero to 50 volts R.M.S. with a sine wave signal.

LOAD IMPEDANCE: Designed to work into a load of not more than 22 mmfd.

RIPPLE OUTPUT is less than 0.5 volt for all operating conditions and all positions of gain control.

CIRCUIT FEATURES: A cathode follower input stage provides circuit isolation and is equipped with a 3-position attenuator.

Attenuator ratios are 1:1, 10:1 and 100:1 (This is in addition to probe attenuation). A gain control conveniently varies the video output. A "Signal Polarity" switch is provided which carries the cathode bias on the output stage in such a manner that the amplifier may be adjusted for optimum performance, regardless of the polarity of the input signal.

OPERATING VOLTAGE: 110 to 120 volts, 60 cycles.

POWER CONSUMPTION: 100 watts.

WEIGHT: 35 pounds (Complete with tubes and probe).

WIDTH: 7 $\frac{1}{4}$ " **HEIGHT:** 9" **LENGTH:** 20 $\frac{3}{4}$ "

INQUIRE EARLY TO INSURE PROMPT DELIVERY

UNITED CINEPHONE CORPORATION

Designers, Engineers and Manufacturers of Electronic Products

13 NEW LITCHFIELD STREET

TORRINGTON, CONNECTICUT

CHECKS — GRADES RESISTORS

100 Ohms to 100 Megohms At a GLANCE



Clippard

AUTOMATIC RESISTANCE COMPARATOR



The quality inspection instrument every radio, electrical, electronics, resistor manufacturer and large parts jobber has long been looking for. Makes precision checking of incoming shipments of resistors, factory output, matching or grading to close tolerance limits, a simple production routine!

Easy to Operate

Instrument is readied for operation by snapping power switch, warming up, adjusting zero and connecting standard resistor at left. Operator places resistances to be checked across "unknown" terminals in center. Accuracy can be checked periodically by a simple turn of knob at left. To change from one value resistor test to another, merely plug in proper standard. No other adjustment necessary!

Reads Percent Deviation

Face of large, easily-read meter in center illuminates when unknown is inserted, showing percent of variation from standard within limits of -25% to $+30\%$. NO OTHER OPERATION IS REQUIRED, reducing inspection time to ABSOLUTE MINIMUM!

Laboratory Quality

Rugged laboratory construction and careful calibration assure accuracy of better than $\pm 1\%$ throughout entire range of 100 ohms to 100 megohms. Line variations, 105-125 volts A.C., automatically compensated for by special newly-developed electronic bridge circuit. An instrument that pays for itself quickly and saves you time and labor costs for years thereafter. Write for complete details and specifications, today!

SPECIAL INSTRUMENTS FOR ELECTRICAL AND ELECTRONIC TESTING

ELECTRO MAGNETIC WINDINGS

R. F. COILS

SUB-ASSEMBLIES



a second in sequential scanning, giving a 350-line image. The transmitter has a peak power output of 60 watts at 264 to 372 mc, with special antennas being available for each of its ten workable channels. The corresponding receiver has two broad-band antennas and uses a special 7-inch diameter kinescope for viewing. Some adaptations of the Bloc system employ the new supersensitive image orthicon in the camera for use in adverse light conditions. Bloc television is basically a lighter short-range type of equipment. In the Beechcraft JRB it is fixed in the nose of the airplane and aimed by maneuvering the entire airplane. Range is about 20 miles.

Highway Radiotelephone Plans

SERVICE TRIALS of mobile radiotelephone service along three intercity highway routes totalling nearly 1,000 miles are now being planned by the Bell System. The routes are between Chicago and St. Louis, between New York, Albany and Buffalo, and between New York and Boston. Applications for authorization to establish the Chicago-St. Louis route have already been filed with the FCC.

When these services are established it will be possible for any suitably-equipped vehicle on the highways along these routes or any boat on adjacent waterways to make

WORLD'S GREATEST TUBE



This resonator, developed by the Westinghouse Research Laboratories and made in their Sharon, Pa. plant, is being modified for television and communications applications. Weighing 500 lb. it served during the European campaign to jam German night-fighter radar sets by generating a powerful barrage of static in a continuous wave that blanketed large areas

CERAMIC PORCELAIN & STEATITE INSULATORS

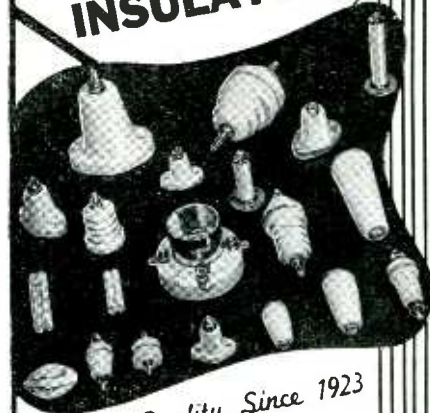

Quality Since 1923

MANUFACTURERS OF RADIO
HARDWARE and ANTENNAS

Also Carrying a
COMPLETE LINE of
WIRES CABLES
and HOOK-UP
WIRES

Inquiries
Invited!



BIRNBACH RADIO CO., Inc.
145 HUDSON ST. NEW YORK, 13, N. Y.

Here's the answer



NEW

CATALOG Just Published
ROBINSON VIBRASHOCK* UNIT MOUNTS
NO OTHER UNIT TYPE SHOCK MOUNT
HAS THESE OUTSTANDING FEATURES

1. Stainless steel springs with three-way vibration absorption...
2. Built-in damping mechanism...
3. Built-in three-way shock assembly

Vibrashock is amazingly effective and surprisingly inexpensive. Send for new catalog shown here.

ROBINSON AVIATION, INC.

Teterboro Air Terminal, Dept. E2

*trade mark Teterboro, New Jersey

3757 WILSHIRE BLVD., LOS ANGELES 5, CALIFORNIA

THE RIGHT *Combination*

FOR EFFICIENT PRODUCTION

of drawn shells, coil shields, housings,
radio chassis and complete or sub-assemblies

Paul and Beekman has the men, the machines and the experience to produce component parts economically for you. Many of the items shown here were made in lots of from 100,000 to millions. All of them were made to exacting specifications . . . finished carefully . . . and completed on schedule.

Find out about the advantages of letting Paul and Beekman act as your Parts Division. Our engineers are always available for preliminary consultation . . . with no obligation to you. Write us.

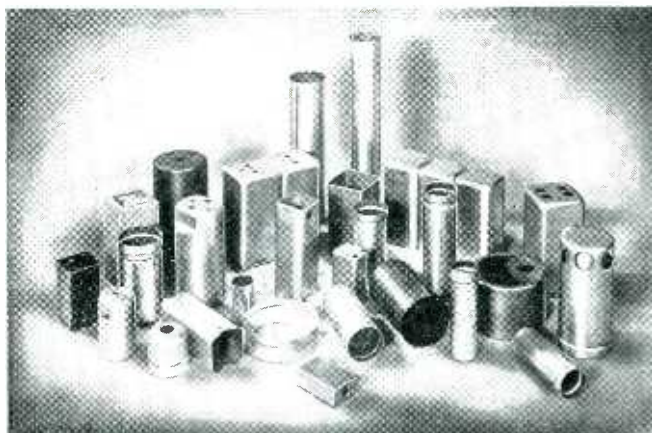

Drawn cans and housings from aluminum, steel and copper.

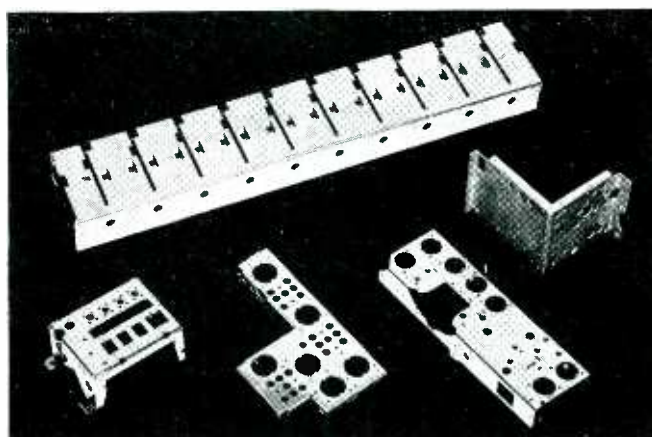

Chassis and sub-assemblies for the radio and electronic industries.

Below: Paul & Beekman plant, largest producer in the East of cans for the radio industry.



PAUL and BEEKMAN *Division* 1805 COURTLAND ST., PHILADELPHIA 40, PA.

PORTABLE
MANUFACTURERS OF:

PRODUCTS CORPORATION
LAWN MOWERS • ELECTRICAL APPLIANCES • PRECISION STAMPINGS
INDUSTRIAL INSTRUMENTS • RADIOS • SAFETY EQUIPMENT

Write for
illustrated
catalog
sheets.



New ATLAS
"Hi-Conversion"
Re-entrant Speakers

Portrait of Progress



Advancement on Sound Equipment has kept pace with Allied Fields. That means Progress has been greatly accelerated during the past few years. New models incorporate such a vast number of improvements that preceding models are almost entirely antiquated. Get acquainted with the newly completed, redesigned and restyled Atlas Sound Equipment—and know the perfection of modern, up-to-the-minute performance! Visit our display at Booth 80 of the 1946 Radio Parts & Electronic Equipment Show, Hotel Stevens, May 13th to 16th.

ATLAS SOUND

CORPORATION

1449 39th Street

Brooklyn 18, New York

And **NOW!** a "Pocket-Size" OSCILLOSCOPE

The POCKETSCOPE

- So **SMALL** in size (4" x 5 1/2" x 10")
- So **LIGHT** in weight (5 1/2 lbs.)
- So **COMPLETE** in performance
- So **INEXPENSIVE** in price (\$55 net)
- Plus **WIDE-ANGLE VISION**: on shelf, on floor, on bench
- Plus **RETRACTABLE LIGHT SHIELD**: for increased visibility

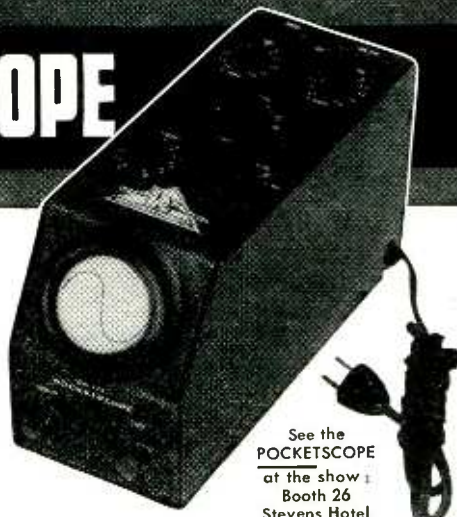

See the
POCKETSCOPE
at the show
Booth 26
Stevens Hotel
May 13-16

WATERMAN PRODUCTS CO.
INCORPORATED
Phila. 25, Pa.

FOR DELIVERY :

Contact your nearest jobber. If he doesn't have the **POCKETSCOPE** available, contact us direct.

WATERMAN PRODUCTS

TERMINALS for ELECTRIC WIRES

Condenser Plates
Small Metal Stampings

• in accordance with
Customer's Prints

- **ACCURACY**
- **PRECISION**
- **REASONABLE
DIE CHARGES**

Modern Equipment and Factory
No Screw Machine Parts

**PATTON - MacGUYER
COMPANY**

17 VIRGINIA AVENUE
PROVIDENCE, R. I.

ARGON HELIUM KRYPTON
NEON XENON MIXTURES

Linde

RARE GASES
AND MIXTURES

... Spectroscopically Pure
... Easily removed from bulb
without contamination

Scientific uses for LINDE rare gases include—

1. The study of electrical discharges.
 2. Work with rectifying and stroboscopic devices.
 3. Metallurgical research.
 4. Work with inert atmospheres, where heat conduction must be increased or decreased.
- Many standard mixtures are available. Special mixtures for experimental purposes can be supplied upon request.

The word "Linde" is a trade-mark of

THE LINDE AIR PRODUCTS COMPANY
Unit of Union Carbide and Carbon Corporation
30 E. 42nd St., New York 17, N.Y. Offices in Principal Cities
In Canada, Dominion Oxygen Company, Ltd., Toronto

and receive calls to or from any telephone connected to lines of the Bell System.

Calls will be handled by mobile service telephone operators. If a caller in Chicago wants to talk to the occupant of a certain automobile somewhere between Chicago and St. Louis, he will first ask Long Distance for the mobile service operator, and give her the call number of the vehicle. She will route the call over telephone wires to one of the transmitting-receiving stations along the highway, which sends the signal on to the vehicle by radio. The car occupant will receive an audible and visual signal indicating that he is wanted. On his telephone handset is a push-to-talk button that permits him to switch from listening to talking.

To make a call, the occupant of a mobile unit merely pushes the talk button and gives the desired number to the mobile service operator.

It is planned to make the trials under actual operating conditions. A number of companies have indicated a desire to participate in the test and it is expected that several hundred vehicles will be equipped initially to send and receive messages on the three routes.

Capacitors Without Foil

OVER FIFTY MILLION fixed paper capacitors without metal foil plates, employing instead a very thin vaporized zinc coating applied directly onto the paper dielectric, were made by the Robert Bosch Co. of Stuttgart, Germany during the war. It is claimed that with this new manufacturing process the capacitors heal automatically after an electrical breakdown, so that numerous breakdowns may occur before the usefulness of the unit is ended. Metallized paper capacitors are about 40 percent smaller than equivalent foil types, and a War Department release intimates that production costs will be about 20 percent less.

The metallizing process is covered by U. S. Patent 2,244,090, in the custody of the Alien Property Custodian and therefore available to American manufacturers under the regulations of that office. Patent information alone is insufficient to enable a manufacturer to adopt the process, but a mimeographed technical report (PB



An Announcement To Those Who Require The Best

THIS advertisement is addressed to the manufacturers of electronic equipment whose product demands the best in component parts—who will want the best in transformers, if “the best” is offered at a price that will fit the cost specifications of their finished product.

By adapting to peace-time use the major features of the Hermetically-Sealed transformer construction that won war-time leadership, Chicago Transformer is prepared to provide the best in transformers to those who require them. Fully developed basic mounting parts, when utilized on a mass production basis, will provide the element of economy in manufacture.

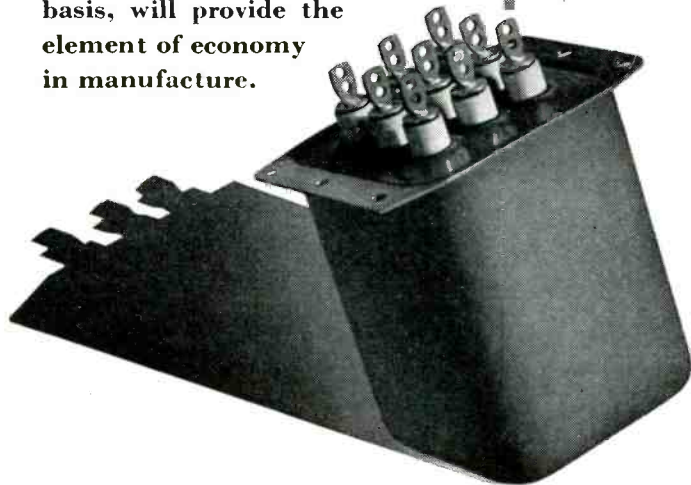

CHICAGO TRANSFORMER

DIVISION OF ESSEX WIRE CORPORATION

3501 WEST ADDISON STREET

CHICAGO, 18



TRADE MARK REG.



**DEPENDABLE PORTABLE ELECTRIC
POWER**

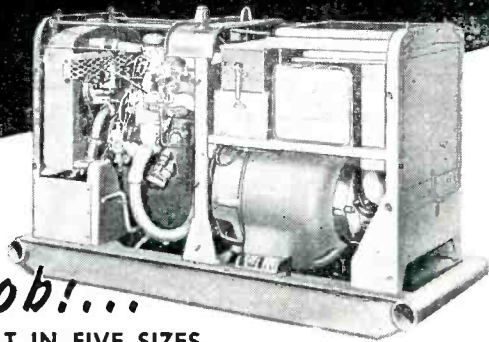

For Your Job!...

... BUILT IN FIVE SIZES, ranging from 3 K. W. to 15 K. W., these portable electric power plants are manufactured to give dependable service under the most rugged conditions. Write today for specifications.

Models Range from 3000 to 15000 Watts, A.C. 120 to 440 Volts, 50 and 60 Cycles, Single or Three Phase.

DEALERS WANTED! Some profitable franchises still available. Write or wire

PIONEER ELECTRIC CO. 3700 East Olympic Boulevard
Los Angeles 23, California

Find Out Now About
**★ STAR ★
CERAMICS**

There are many kinds for special uses, such as applications calling for resistance to electricity, heat, moisture, chemicals or weathering agents. There are more than a score of formulas in actual production at one time in our factory.

Send for "A Brief Survey of Technical Characteristics of Molded Ceramic Products." It is right to the point.

★
**The STAR
PORCELAIN CO.**
Electronics Dept.
Trenton 9, N. J.

For COMMUNICATIONS and INDUSTRIAL Jobs

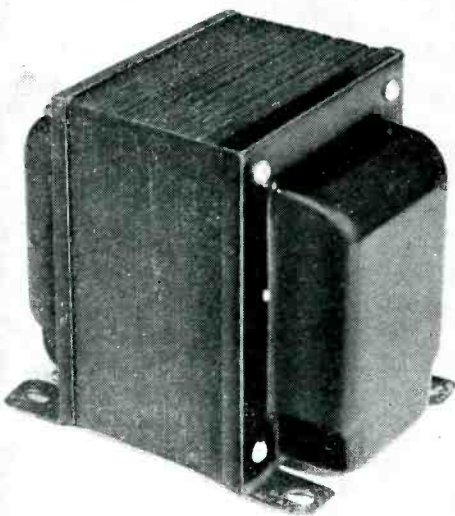

Power Transformers
(Up to 1 kw.)

Audio Transformers

High-Voltage Transformers

Filter Chokes

Coils

DINION COIL COMPANY, Inc.
CALEDONIA, N. Y.

Specialists in Difficult Designs

*Radio-Electronic
Materials*

• Try us for those items you need in a hurry. Our stocks are big—our service, extra-fast!

We've been at it since 1925—and we know how!

Just Try Us

H. L. DALIS, Inc.

Wholesale Distributors
RADIO-ELECTRONIC SUPPLIES & PARTS
17 Union Square
NEW YORK 3, N. Y.

Phones: ALgonquin 4-8112-3-4-5-6-7

421, 6 pages, 10 cents) is available from the Office of the Publication Board, Department of Commerce, Washington, D. C., and one of the machines has been brought over from Germany for inspection by those interested in its production possibilities.

Police Like Higher Frequency

A COMPARATIVE TEST of hilly-country f-m performance on three mobile bands available for police use was conducted by the Indiana Chapter of the Associated Police Communication Officers, Inc., in cooperation with Motorola's Communication Division. Recorded results indicated that when a deep valley and an intervening hill stopped signals from the 161-mc car, the signals from the 73-mc and 37-mc cars were also stopped. There was no significant reduction in coverage with the higher frequencies, even in rough areas, and the 161-mc car with its 30-watt transmitter talked back to Central consistently at twice line-of-sight distance. Indiana police have decided to use the new 152-162 mc mobile band for their county and city systems.

Status of British Television

ONLY ONE STATION in Great Britain is transmitting television programs at present, this being the Alexandra Palace station using 41.5 mc for sound and 45 mc for video. Picture

• • •

FLASHING SURGERY

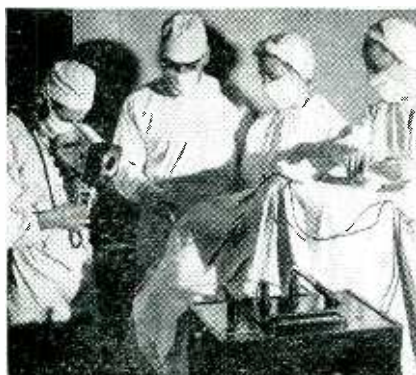

Demonstration of new surgiscope, a combination 35-mm camera and microflash unit for taking color or monochrome pictures of surgical operations at Cushing General Hospital, Framingham, Mass. Built-in discharge tube energized by electronic unit in foreground provides a 1/25,000th second flash at each exposure

Now... a compact audio signal source for laboratory and production test applications

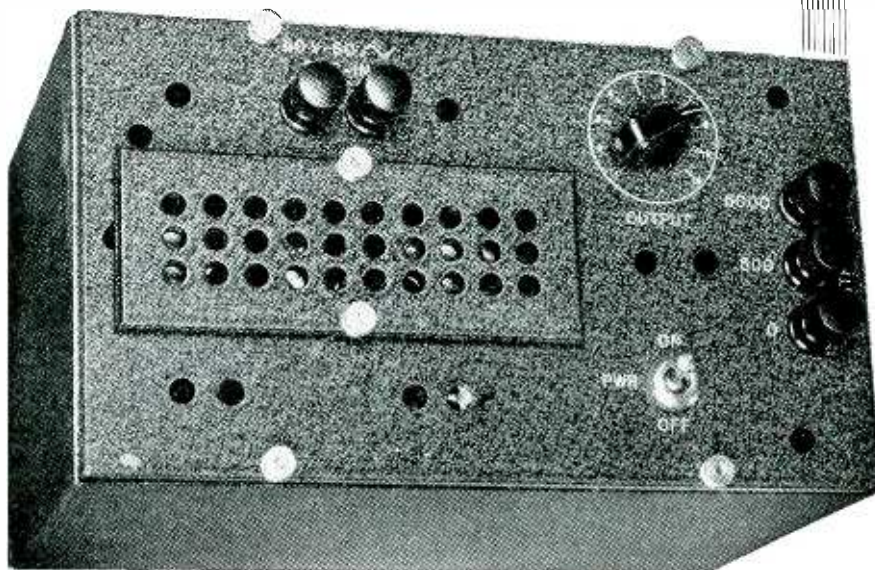

The Type MR-1000 is a compact source of audio frequency power producing up to 35 MW of signal energy at output impedances of 500 or 5000 ohms.

The distortion at maximum output is less than 2% over all. The built-in attenuator features an arbitrary scale of 1 to 10 units.

The Type MR-1000 operates from a standard source of 110 volts, 60 cycles.

The case, panel and subchassis are 1/4" aluminum. A removable ventilator panel at the top permits easy tube replacement.

Using a new type of oscillating amplifier circuit, this unit maintains an output frequency of 1000 cycles at plus or minus 1 cps over 24 hours and will operate continuously for 720 hours with a variation of less than 4 cps.

OPERATION:—The MR-1000 serves to replace tuning forks and offers a source of audio test energy for bridges etc. and can be substituted in existing test positions without wiring changes. The MR-1000 can be furnished at frequencies other than 1000 cps at slight additional cost.

SIZE:—6 1/4" deep x 5 3/4" high x 9 1/4" long.

WEIGHT:—13 1/2 lbs. . . . Guaranteed 2 years.

Write for literature on this and other Televiso products.

TELEVISO PRODUCTS CO.
7466 IRVING PARK ROAD CHICAGO 34, ILL.



Cameras Binoculars Telescopes

Lined with
Cellusuede Flock

When used as an interior lining, black Cellusuede flock does an efficient job of "blackening out" the insides of cameras, binoculars, and telescopes, because the flock does not reflect light rays... it absorbs them. A trial application will convince you that Cellusuede is inexpensive and easy to apply. Available for immediate shipment.

Cellusuede
FLOCK

Write for Color Card.
Prices, Samples and Booklet explaining Uses and Methods of Application.

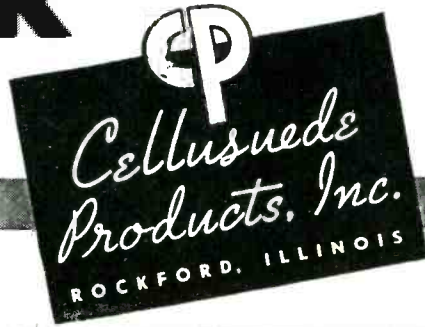

Performance

of most carefully built electrical equipment needs support of Washers made for the job.

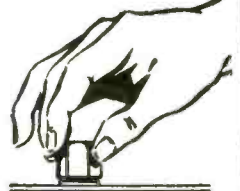

Positive locking action... compensation for expansion and contraction... full gripping area... these and other factors are engineered in Quadriga for electrical manufacture.

QUADRIGA
Quality

WASHERS



Exactly to your specifications. Any washer material. Flat, Special Dimensions, Irregular, Contour, Finishing, Tension, Cupped and Drawn, Friction, etc. Also wire terminals.

SMALL METAL STAMPINGS
Any Design

Put your problems in Washers and Stampings up to Quadriga. Immediate attention, prompt delivery of any quantity, small or large.

QUADRIGA BOOKLET FREE
Shows many types from photographs, with valuable information. Should be in your file. Write

THE QUADRIGA MANUFACTURING CO.
221 A West Grand Ave., Chicago 10, Illinois



MANUFACTURERS OF RADIO, ELECTRICAL
AND ELECTRONIC COMPONENTS

VOKAR Corporation

7300 HURON RIVER DRIVE · DEXTER, MICHIGAN

flexible shafts

Flexible Shafts

that carry power around any corner have many new uses in peacetime developments.

Faithful, dependable power drives or remote control in airplane, automobiles, radio, and many other commercial products.

Shafts made to your specifications. Our engineering department will work out your particular power problem without obligation.

Write today for Manual D

F. W. STEWART MFG. CORP.
4311-13 RAVENSWOOD AVE.
CHICAGO 13, ILL.
WEST COAST BRANCH:
431 Venice Blvd., Los Angeles 15, Cal.

transmission standards are still 405 lines, 50 frames interlaced, giving 25 complete frames per second, with no changes contemplated in the near future. Present programming involves about one hour in the afternoon and one hour in the evening, with fixed signals sent out for checking at certain other times of the day.

The estimated peak prewar number of television sets in use was 20,000, with no data available on how many are still functioning. When manufacture of new television sets is resumed (after the greater part of the demand for home radio receivers is met), prewar standards will be followed by order of the responsible Committee.

The BBC have no immediate plans for f-m.

Radio Speeds Telegram Delivery

AUTHORITY TO CONSTRUCT an experimental land station at Baltimore and a portable mobile unit to operate in the proposed urban mobile service has been granted to the Western Union Telegraph Co. by the FCC.

The fixed station, in a cable hut at the south side of a given delivery area for telegrams, will be remotely controlled from the main office for transmission of messages by voice to the mobile station placed in a truck or sedan. The mobile station can in turn transmit back to the main office, via the fixed station, any replies or outgoing messages that it picks up. The truck will be in motion to its next delivery point while transmitting or receiving messages, thereby reducing message delivery time.

MEETINGS TO COME

APRIL 29-30; RMA SPRING MEETING; Hotel Penn-Harris, Harrisburg, Pa.; chairman V. M. Graham, P. O. Box 750, Williamsport, Pa.; eight technical papers to be presented.

MAY 6-10; SMPE TECHNICAL CONFERENCE; Hotel Pennsylvania, New York City, N. Y.

MAY 13-16; RADIO PARTS AND ELECTRONIC EQUIPMENT TRADE SHOW; Stevens Hotel, Chicago; inquiries to 221 N. LaSalle St., Chicago; special train for radio industry personnel leaves Grand Central Station, New

Our 24th year of dependable service to American industries



Use a solder that contributes to the excellence of your product

No matter what you manufacture, the all-around excellence of your product depends on the quality of the materials you put into it.

Because solder is so extensively used in the manufacture of radio sets, instruments for radar, relays, tubes, transformers, etc., it is important to select a brand of known quality and proven dependability.

In every department of the Electronic and Radio fields, GLASER PLASTIC ROSIN CORE SOLDER has given conclusive proof of its outstanding quality—during war and peacetime years.

More and more of the leading manufacturers throughout the country have adopted Glaser Solders as standard. Make Glaser Plastic Rosin Core Solder a contributing factor to the built-in perfection of your product.

Specify "GLASER", the name that means everything you can ask for in Solders and Fluxes.

Glaser Plastic Rosin Core solders exceed Government specifications in purity and are guaranteed to conform with A.S.T.M. Class A specifications.

OTHER GLASER PRODUCTS

Silver Brazing Solder and Flux
Fluxes for every purpose
Lead Products of every description
Lead Lining of acid and plating tanks

Consult our Engineering Department on your Soldering and Flux problems.

GLASER LEAD CO., INC.

31 Wyckoff Avenue

Brooklyn 27, N. Y.



Glaser
SOLDER
PRODUCTS

"DIE-LESS" DUPLICATING

SAVES MAN HOURS AND DELAYS

DIE ACCURACY WITHOUT DIES

Send for CATALOG

BENDER

SHEAR

BRAKE
DI-ACRO is Pronounced "DIE-ACK-RO"

"DIE-LESS" DUPLICATING
The DI-ACRO System of METAL DUPLICATING Without Dies
DI-ACRO
PRECISION MACHINES
DIE-LESS DUPLICATING

O'NEIL-IRWIN MFG. CO.
321 EIGHTH AVENUE SO. • MINNEAPOLIS 15, MINN.

York City at 4:15 p.m. May 12—make reservations with Perry Saftler, 53 Park Place, New York.

MAY 15-17; NEW ENGLAND ELECTRICAL TRADE SHOW; Exhibition Hall, Boston, Mass.

MAY 20-25; NATIONAL MARITIME EXPOSITION; Grand Central Palace, New York City; inquiries to headquarters at 17 Battery Place.

JUNE 20-23; SOCIETY FOR THE PROMOTION OF ENGINEERING EDUCATION; annual meeting, Jefferson Hotel, St. Louis, Mo.

JUNE 24-28; ASTM ANNUAL MEETING AND EXHIBIT; Statler Hotel, Buffalo, N. Y.

BUSINESS NEWS

RADAR ENGINEERS, 1319 Second Ave., Seattle, Wash., has been established by W. L. Flock, W. T. Harrold, and W. D. Hayes, all former members of Radiation Laboratory, MIT, to provide consulting and manufacturing services in the field of microwave electronics.

CORNELL-DUBILIER ELECTRIC CORP. adds 26,000 sq ft of manufacturing space for capacitors by leasing two floors of a plant in Providence, R. I.

ELECTRONIC WINDING Co., Chicago, has been purchased by Hallicrafters Co., Chicago, in order to expand Hallicrafters facilities for the manufacture of component parts.

PHILCO CORPORATION and KELLOGG SWITCHBOARD AND SUPPLY Co. announce an agreement whereby the former will manufacture f-m mobile radiotelephone facilities for installation by the latter firm in the independent telephone field.

RADIO MANUFACTURERS ASSOCIATION has formed a new Amateur Radio Section, with William J. Halligan as chairman.

POLYTECHNIC RESEARCH AND DEVELOPMENT Co., INC., Brooklyn, N. Y. has opened its consulting engineering laboratory for development of microwave measuring equipment and industrial instruments and controls. The corporation is headed by Dr. H. S. Rogers, president of the Polytechnic Institute of Brooklyn, and under the technical direction of F. J.

IN-RES-CO RESISTORS

For dependable service in communications.....

IN-RES-CO resistors are conservatively rated, compact, convenient to mount. They are available for quick delivery on short notice. Standard tolerances are 1 or 2%; closer tolerances are supplied on order. Most units are wire wound for permanent, exact resistance value. Inductive and non-inductive types included. Every component engineered for maximum stability, long life and noise-free operation. Write today for the informative IN-RES-CO catalogue — no obligation.

TYPES SB AND RB compact, accurate resistors.
SB: 1 1/16" long, max. res. 1 Meg. RB: 9/16" long, max. res. 0.5 Meg. Both 9/16" diam. Standard tolerance 0.5%.

INSTRUMENT RESISTORS CO.
25 AMITY STREET, LITTLE FALLS, NEW JERSEY

**TAKE ADVANTAGE
of RUBYFLUID'S
Trial Offer
PASTE and LIQUID
SOLDERING FLUX**

See for yourself how freely Rubyfluid Flux wets out and properly prepares metal for strong neat unions. Notice it is free from harmful and objectionable fumes. Test it for economy and ease of application—for good results every time. Send 25c in coin or stamps for a generous trial supply.

THE RUBY CHEMICAL CO.

59 McDowell St.
Columbus 8, Ohio



Rubyfluid

**The Most Indispensable Reference in Radio-Electronics
Electronic Engineering Master Index**

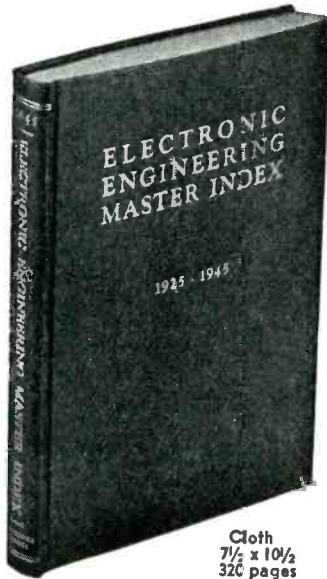

Cloth
7 1/2 x 10 1/2
326 pages

A master compilation of over 15,000 titles, articles and texts selected for their value to the research engineer, this INDEX covers the years 1925-1945 and enables you to survey twenty years of research literature on any subject in a matter of minutes!

Vitally Needed in Every Laboratory and Library
COMPLETE IN ONE VOLUME

PART I

January 1925 to
December 1934

PART II

January 1935 to
June 1945



PARTIAL LIST OF PERIODICALS INDEXED:

- | | |
|-------------------------------|--------------------------|
| Bell Laboratories Record | Journal of I.E.E. |
| Bell System Technical Journal | General Electric Review |
| Communications | Physical Review |
| Electrical Communication | Proceedings I.R.E. |
| Electrical Engineering | Transactions of A.I.E.E. |
| Engineering | Transactions of A.S.M.E. |
| Electronics | Radio News |
| Electronic Industries | R.C.A. Review |
| Jour. of Applied Physics | Wireless Engineer |

A \$500 Reference Library in One Volume for \$17.50

Descriptive circular on request.

ELECTRONICS RESEARCH PUBLISHING COMPANY

2 West 46th Street

New York 19, N. Y.

HARRIS

DUFLEX SHOCK MOUNTS



TUBULAR MOUNTS
Bonded or Torflex Type



TORFLEX BEARINGS

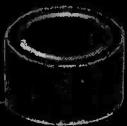

**CONTROL VIBRATION
ELIMINATE SHOCK & NOISE**

**HARRIS PRODUCTS
COMPANY**

5106 Cowan Ave. • Cleveland 4, Ohio

Shock proof

INSULATION BREAKDOWN

Testers



MODEL ITC-630

The new Industrial AC Breakdown Test Sets afford a convenient, compact and accurate means of testing for insulation breakdowns.

FEATURES

- Smooth variable voltages from 0 to 3000 or 0 to 6000 Volts A.C.
- Instantaneous trip Circuit Breaker indicates breakdown
- Heavy bakelite shockproof Test Handles with disappearing points
- Voltmeter indicates output voltages 0-3000 or 0-6000 volts.
- Input 115 Volts 60 Cycle—Rating 1 KVA

MODEL ITC-25

- Designed for accurate testing for apparatus at fixed voltages.
- High Reactance Power Transformer is burn-out proof.
- Neon Lamp permits accurate indication of material under test.
- Heavy bakelite Shock-proof Test Handles with disappearing points.
- Eight point switch varies the secondary voltage.
- Input 115 Volts 60 Cycles, Rating 500 VA.

INDUSTRIAL TRANSFORMER CORP.

(ELECTRONICS DIVISION)

2540 BELMONT AVENUE, NEW YORK 58, N. Y.

LOOK!

BEAM POWER TUBES

829-B push-pull R-F beam power amplifiers. Exceptionally efficient, with full input at frequencies up to 200 Mc. Max. ratings are: 750 plate volts, 60 watts plate dissipation. While they last...
\$4.95 Stock Number WPS416

R. W. T. BARGAINS of the MONTH

LOOK!

ACORN TUBES

Government Released, Sensational offer. Normally \$2.85-\$5!
 Stock No. WPS 422: Type 954
 Stock No. WPS 423: Type 955
 Stock No. WPS 424: Type 956
 Stock No. WPS 425: Type 955A
 Socket for above: W8464, price 49c
69¢

FREE! Latest Bargain Flyer includes test instruments, record changers, communication receivers, ham transmitting tubes and many other electronic items you need today. Big new catalog coming! Get your name on our list!

Radio Wire Television Inc.
 NEW YORK 13 BOSTON 10 NEWARK 2

Originators and Marketers of the Famous **Lafayette Radio**

Cut out coupon, paste on penny post card, mail today.

R. W. T. Dept. EE6
 100 AVENUE OF THE AMERICAS, NEW YORK 13

Gentlemen: Send me FREE copy of your Latest Bargain Flyer and put my name on list for your Big New Catalog

NAME _____
 ADDRESS _____
 CITY _____ ZONE _____ STATE _____

Gaffney, formerly at Radiation Laboratory, MIT.

SYLVANIA ELECTRIC PRODUCTS INC. has started work on a new plant at Riverside, to be used by their wholly owned subsidiary, Colonial Radio Corp., in the assembly of home radio receivers from parts made in Colonial's Buffalo, N. Y. plant.

HYTRON RADIO & ELECTRONICS CORP. has acquired all outstanding capital stock of Air King Products Co., Inc. of Brooklyn, N. Y., for integration of the latter's manufacturing facilities for 5,000 radio sets daily with Hytron's daily output capacity of 100,000 radio tubes.

ELECTRONIC VALVES, LIMITED, newly formed in Great Britain by the Cos-sor interests, will manufacture Sylvania type radio tubes for British markets.

SPECIAL DEVICES DIVISION, OSRD, has moved from Washington, D. C. to the former quarters of the Institute of Aeronautical Science at Sands Point, Long Island, N. Y.

FEDERAL TELECOMMUNICATION LABORATORIES, Nutley, N. J. has broken ground for its 300-foot microwave tower, intended for experimental purposes in connection with antenna research, development of the Navar method of air traffic control, and other electronic projects.

LOCKE INSULATOR CORP., Baltimore, Md. had added 30,000 sq ft of working space to its plant, to house a complete pilot plant and laboratory for ceramic research and provide additional manufacturing facilities for apparatus porcelain.

PERSONNEL

RUSSELL E. KRAFT has joined Radio Frequency Laboratories, Inc., Boonton, N. J. as senior electrical engineer after five years service in the Navy. Prior to that he was a communications engineer with AT&T.

GEORGE SOMMERMAN, who formerly conducted radio research for the Navy under OSRD, was appointed associate professor of electrical engineering at the Technological Institute of Northwestern University.

ALEXANDER WING, JR., formerly on the staffs of the preradar school and radio research lab at Harvard Uni-

High PERFORMANCE RELAY AT A Low PRICE

THE NEW SIGMA SERIES 41 RELAY

is streamlined for high volume applications and yet offers the standard of quality inherent in all Sigma Relays.

Construction Features:

- Beryllium copper armature and contact springs.
- Spring reed-type, armature hinge with low reluctance gap.
- High permeability, low-residual iron parts



41 R(dc), RZ(ac) 41 FZ(ac), F(dc)
 Size:
 Unenclosed types: 1" x 1 7/32" x 2 3/16"*
 Plug-in types: 1 1/2" x 1 1/2" x 1 7/8" high.

* (Long dimension includes full length of mounting bracket).

Minimum Input Requirements:
 20 milliwatts for D.C. types.
 0.1 volt-amperes for A.C. types.

Contacts:
 S.P.D.T.

Ratings up to 15 amperes with low voltage D.C. or up to 1 K.W. incandescent lamp load at 115 volts A.C., with sufficient input power.

For critical performance requirements at minimum cost, specify the Sigma Series 41 Relay.

SIGMA
Sigma Instruments, Inc.
Sensitive RELAYS
 62 Ceylon St., Boston 21, Mass.

Alnico permanent magnets

Specializing in the production of highest quality Alnico Magnets in all grades including new triple strength No. 5.

Production material checked to assure highest uniform quality of product.

Castings made to customer's special order on the basis of sketches or blue prints furnished.

Information and suggestions furnished on request.

GENERAL

MANUFACTURERS OF HIGH COERCIVE MAGNETIC ALLOYS



MAGNETIC CORPORATION

2126 E. FORT STREET
DETROIT 7, MICHIGAN

Toroids..

by

DX

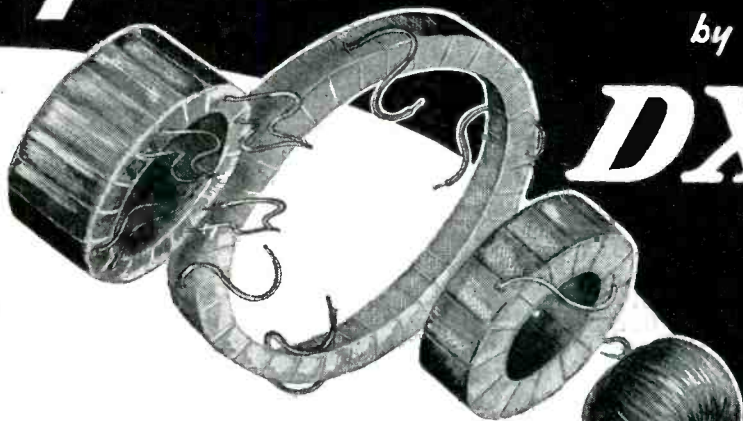

Doughnut Coils for electronic and telephone purposes. High Permeability Cores are hydrogen annealed and heat treated by a special process developed by DX engineers. Send us your "specs" today—ample production facilities for immediate delivery.

DX RADIO PRODUCTS CO.

GENERAL OFFICES 1200 N. CLAREMONT AVE., CHICAGO 22, ILL., U.S.A.

DX
COILS

"the heart of a good receiver"

NEW MODELS

Available Now!

of **ATR**

QUALITY PRODUCTS

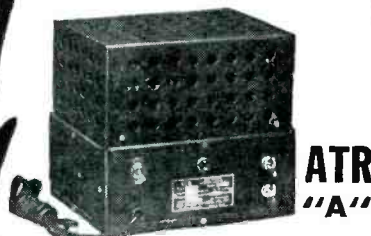

ATR
"A"

BATTERY ELIMINATORS

FOR CONVERTING A.C. TO D.C.
New Models... designed for testing D.C. electrical apparatus on regular A.C. lines. Equipped with full-wave dry disc type rectifier, assuring noiseless, interference-free operation and extreme long life and reliability.

- Eliminates Storage Batteries and Battery Chargers.
- Operates the Equipment at Maximum Efficiency at All Times.
- Fully Automatic and Fool-Proof.

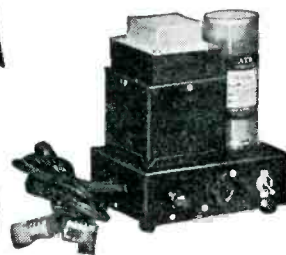

ATR

LOW POWER INVERTERS

FOR INVERTING D.C. TO A.C.
Another New ATR Model... designed for operating small A.C. motors, electric razors, and a host of other small A.C. devices from D.C. voltage sources.

ATR



STANDARD AND HEAVY DUTY INVERTERS

FOR INVERTING D.C. TO A.C.
Specially designed for operating A.C. radios, television sets, amplifiers, address systems, and radio test equipment from D.C. voltages in vehicles, ships, trains, planes, and in D.C. districts.

WRITE FOR NEW CATALOG—
JUST OFF THE PRESS!

AMERICAN TELEVISION & RADIO CO.

Quality Products Since 1931

ST. PAUL 1, MINN.

U. S. A.

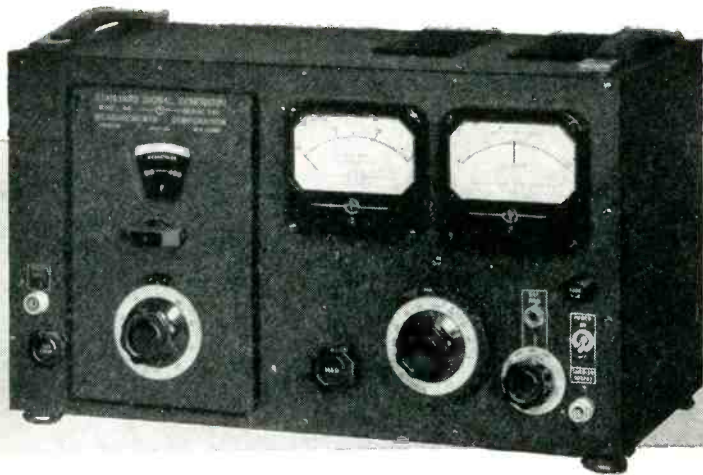

STANDARD SIGNAL GENERATOR Model 80

SPECIFICATIONS:

CARRIER FREQUENCY RANGE: 2 to 400 megacycles.

OUTPUT: 0.1 to 100,000 microvolts. 50 ohms output impedance.

MODULATION: A M 0 to 30% at 400 or 1000 cycles internal. Jack for external audio modulation.

Video modulation jack for connection of external pulse generator.

POWER SUPPLY: 117 volts, 50-60 cycles.

DIMENSIONS: Width 19", Height 10 3/4", Depth 9 1/2".

WEIGHT: Approximately 35 lbs.

PRICE—\$465.00 f.o.b. Boonton.

Suitable connection cables and matching pads can be supplied on order.

MEASUREMENTS CORPORATION
BOONTON  **NEW JERSEY**

CHASSIS • CABINETS • PANELS • RACKS

Skill in **METAL**

PAR-METAL . . . a specialized manufacturing plant employing modern high-speed methods. Nevertheless, Par-Metal products have a definite quality of Craftsmanship—a "handmade" quality born of genuine skill and long experience. *Write for Catalogue.*

PAR-METAL PRODUCTS CORPORATION

Export Dept.



Serving the
Electronics
Field
Exclusively

32-62—49th STREET . . . LONG ISLAND CITY, N. Y. 13 E. 40th St., N. Y. 16, N. Y.

versity, is now associate professor of electrical engineering at the Technological Institute of Northwestern University.

ROBERT R. BUSS, formerly with Harvard radio laboratory, becomes assistant professor of electrical engineering at the Technological Institute of Northwestern University.

ROBERT B. JACOBS will direct the work of the physics laboratory at Distillation Products, Inc., Rochester, N. Y. He was previously engineer in charge of high vacuum development and research for Kellex Corp.

ADELBERT R. MORTON is now chief engineer of the Electronics Division of Insuline Corporation of America, Long Island City, N. Y., in charge of new product development.

ALLEN A. SYLVANE has been appointed chief engineer of Continental Electronics, Ltd., New York City, and will design and engineer their line of portable radio receivers and record players.



A. A. Sylvane



G. Mountjoy

GARRARD MOUNTJOY has assumed his new duties as vice-president in charge of engineering at Electronic Corporation of America, New York City.

RAYMOND A. LEWTHWAITE, who recently worked on radar equipment at Federal Telephone and Radio Corp., has been made chief of design and drafting for the Instrument Division of Thomas A. Edison, Inc., West Orange, N. J.

M. J. GROSS is now manager of engineering for General Electric X-ray Corp., Chicago.

DAVID C. PRINCE, vice-president, General Engineering and Consulting Laboratory, General Electric Co., Schenectady, has been awarded the 1945 Lamme Medal of the AIEE for

KURMAN RELAYS

SERIES 13, SENSITIVE D.G. MIDGET

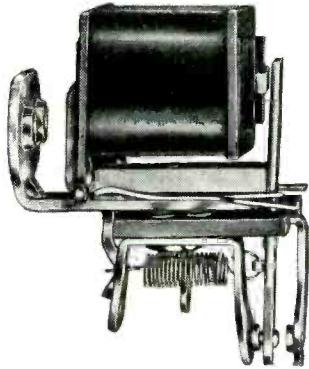

NOTE THESE FIVE IMPORTANT FEATURES:

(1) Small and light, weighs less than 2 ounces. (2) Balanced armature assures stability at high speed operation. (3) .035 watt operation, ideal for low-power circuits. (4) Coil will safely stand 1 watt continuous duty without overheating. (5) Coil impregnated against moisture and temperature attacks. Contacts are single pole, double throw, rated at 1/4 amp., 110V A.C. non-inductive load. Write for details on KURMAN LINE OF RELAYS and KURMAN MICROPHONE HUMMERS

For complete details, ask for Bulletin 1346

KURMAN ELECTRIC CO.
35-18 37TH ST.
LONG ISLAND CITY 1, N. Y.

WALKER-TURNER FLEXIBLE SHAFTING

—designed for Long Life

● In design, selection of materials and construction, the primary objective of Walker-Turner Flexible Shafting is long and trouble-free service. The photograph illustrates an important W-T development in this direction—our special phosphor bronze bearing liner. This bearing liner fits over the flexible shaft, minimizing vibration, distributing lubrication and keeping shaft cool while operating at high speeds.

WALKER-TURNER COMPANY, INC.
PLAINFIELD, NEW JERSEY



FLEXIBLE SHAFTING

FOR REMOTE CONTROL AND POWER TRANSMISSION

CUSTOM MOLDED PLASTICS PARTS
FOR THE ELECTRONICS INDUSTRY

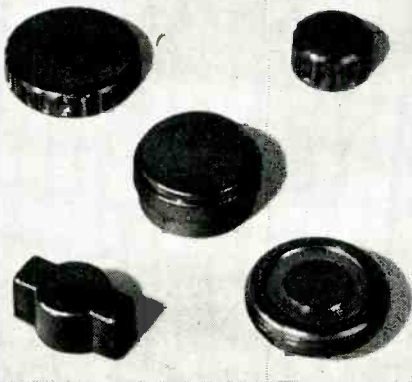

Compression Molded... to meet specific requirements... by an experienced organization... tooled for the production of plastics parts for electrical or general applications. Inquiries acknowledged promptly.

Midwest Molding and Manufacturing Co.

335 NORTH WHIPPLE ST. • CHICAGO 12, ILL.

PERMOPIVOTS

Yes, Extra Value!
Long after the ordinary pivot has worn out you'll find PERMOPIVOTS in the prime of life—faithfully keeping precision instruments precise! It's all due to the special PERMOMETAL tip—the ideal osmium alloy... Made to your specifications. Write for information!

PERMO INCORPORATED

6427 RAVENSWOOD AVE., CHICAGO 26
MANUFACTURING METALLURGISTS

Attention GI JOE!

Here's Your Opportunity to be First to
**Start Your Own
RADIO SERVICE
SHOP**

Complete Starting-in-Business
Package Stocks of

**TEST EQUIPMENT
TUBES, PARTS, TOOLS** **\$350 up**

Act quickly! Meet the pent up demand for radio service. Turn your special service training into a profitable business of your own. No fuss. No worry. Here's everything you need—\$350 up. Details upon request! Write, wire or phone

RCP 448

"POCKET" VOM
A.C.-D.C. Volts
0-5-50-250-1000
D.C. Mills
0-5-10-100-1000
Ohms
0-2,000-20,000-200,000-
2 Meg.
Size 3" x 5 1/4" x 2 1/2"



\$24.50 net

RECORD CHANGERS

UTAH-DETROLA #550C \$18.27
WEBSTER-CHICAGO #56 27.20

HALLICRAFTERS SX-28A

\$223



SUPER DEFIANT SX25 **\$94.50**
SKY CHAMPION S20R **60.00**
SKYRIDER MARINE S22R **74.50**
S40 NEW MODEL Approximately **79.50**
SKYRIDER JR. S41 **33.50**

HAMMARLUND HQ-129-X \$129

TRIPLETT 625-N

20000 ohms per volt D.C.
10000 ohms per volt A.C.
5" Scale-TOPMOST QUALITY
(12) D.C. Volt Ranges to 5000
(6) A.C. Volt Ranges to 5000
(3) OHM Ranges 0-400-50000-
10 Meg.
(5) D.C. Current Ranges 1 Ma.
to 10 Amp.
PLUS OUTPUT and DB.
RANGES



\$45.00 with test leads.

PHILCO BEAM OF LIGHT

Selenium Cell only, no holder **1.80**

20% deposit required on all C.O.D. orders. -2% transportation allowance on orders of \$25.00 or more accompanied by payment in full.

RADIO SUPPLY & ENGINEERING CO., Inc.
127 SELDEN AVE. DETROIT 1, MICH.

Write for
FREE CATALOG

his distinguished work in the development of high-voltage switching equipment and electronic converters.

J. O. ASHTON, pioneer radio engineering consultant, has joined the engineering staff of National Electrical Manufacturers Association, New York City.

HARRY E. RICE is now assistant chief engineer of the Radio Division at Lear, Inc., Grand Rapids, Mich., and will be in complete charge of production for home radio, aircraft radio, and television equipment.

A. V. LOUGHREN has been made chief engineer of Hazeltine Electronics Corp., New York City. Since joining Hazeltine in 1936 he has concentrated on television research.



A. V. Loughren



D. G. Haines

DONALD G. HAINES, Chicago consulting engineer, has been selected to fill out the unexpired term of Section Secretary for the IRE Chicago Section.

NOEL C. JAMISON has joined North American Philips Co., Inc. as division chief in charge of electro-acoustics at their Irvington, N. Y. research center.

EDWARD J. GIRARD, assistant vice-president of Federal Telephone and Radio Corp., was presented a scroll of appreciation by the Veteran Wireless Operators Association for his work on marine radio units used on Victory and Liberty ships during the war.

NELSON P. CASE, who recently joined Hallicrafters Co., Chicago, has been promoted to chief engineer for the entire organization.

F. B. LLWELLYN, IRE president and member of the technical staff of Bell Telephone Laboratories, addressed a special radar convention of the British Institution of Electrical Engineers in England March 26-28, and

NEW RAWSON D.C. MULTI-VOLTMETERS



Type 501F

- 1) All the voltage ranges you need in one instrument.
Ranges: .01-.03-1-3-1-3-10-100-300-1000 fullscale
- 2) Guaranteed accuracy 1/2 of 1%
- 3) 10,000 ohms per volt on all ranges
- 4) All resistors WIRE WOUND for permanent accuracy.

Type 501G

Same as above except 100,000 ohms per volt. Ranges .1-3-1-3-10-30-100 volts full scale.

Write for bulletin

WE ALSO SUPPLY
REGULAR DC METERS
THERMOCOUPLE AC METERS
MULTIMETERS FLUXMETERS
ELECTROSTATIC VOLTMETERS
Special apparatus built to order

**RAWSON ELECTRICAL
INSTRUMENT COMPANY**

111 POTTER ST. CAMBRIDGE, MASS.
Representatives
Chicago - New York City - Los Angeles

DIALS PANELS and PLATES

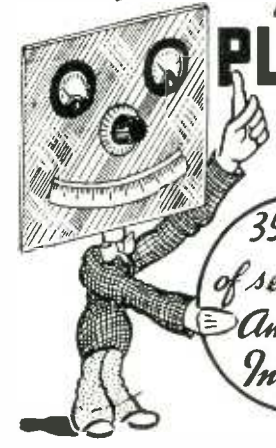

35 years
of service to
American
Industry

DIALS · PANELS · PLATES

made to your precise engineering specifications in etched metals and finishes.

**PREMIER
METAL ETCHING CO.**
21-03 44th AVE.
LONG ISLAND CITY, NEW YORK

Optical Glass Specialties



Television Reflectors

Precision-polished optical
face plates for cathode ray
tubes

Optical lenses, prisms
and flats

FS Precision-Bore Glass Tubes
with bore exact within .0002"

Contact us for
such requirements

FISH-SCHURMAN CORPORATION
230 East 45th St., New York 17, N. Y.

Fish-Schurman

PURCHASING AGENT

Excellent opportunity
for purchasing agent
with a substantial ex-
perience in purchas-
ing all types of ma-
terial required for
manufacturing a
high quality line of
radio - phonograph
combinations. In re-
sponding, indicate in
detail experience, ed-
ucation and salary
expected.

FREED RADIO CORPORATION
200 HUDSON STREET
NEW YORK 13, N. Y.

ATTENUATORS

by
TECH LABS



STANDARD
TYPE
700



MIDGET
TYPE
600

"Midget" model is especially designed for crowded apparatus or portable equipment.

- Solid silver contacts and stainless silver alloy wiper arms.
- Rotor hub pinned to shaft prevents unauthorized tampering and keeps wiper arms in perfect adjustment.
- Can be furnished in any practical impedance and db. loss per step upon request.
- TECH LABS can furnish a unit for every purpose.
- Write for bulletin No. 431.

TECH
LABORATORIES

Manufacturers of Precision Electrical Resistance Instruments
337 CENTRAL AVE. • JERSEY CITY 7, N. J.

STANDARD CRYSTALS

Send for New Catalog

STANDARD PIEZO COMPANY

Established 1936

Quartz Crystals and Frequency Control Equipment

Office and Development Laboratory

SCRANTON, PA.

CARLISLE, PA., P. O. BOX 164

CARLISLE, PA.

Representatives

COOPER-DIBLASI

259 WEST 14th STREET, NEW YORK 11, N. Y.

HAL F. CORRY

3522 GILLON AVENUE, DALLAS 5, TEXAS

THE FOSTER COMPANY

409 LUMBER BLDG., MINNEAPOLIS, MINN.

GERBER SALES COMPANY

94 PORTLAND STREET, BOSTON 14, MASS.

A. SIDNEY HARDY

450 BOULEVARD N. E., ATLANTA, GA.

HARRY A. LASURE

2216 WEST 11th STREET, LOS ANGELES 6, CALIF.

L. D. LOWERY

1343 ARCH STREET, PHILADELPHIA, PA.

MANUFACTURERS SALES TERMINAL, Inc.

222 COLUMBIA BLDG., SPOKANE, WASHINGTON

HARRY B. SEGAR & COMPANY

ELLCOTT SQUARE BLDG., BUFFALO, N. Y.

E. J. WALL

1834 EUCLID AVENUE, CLEVELAND 15, OHIO

PHENOL AND VULCANIZED FIBRE FABRICATIONS

by

BAER

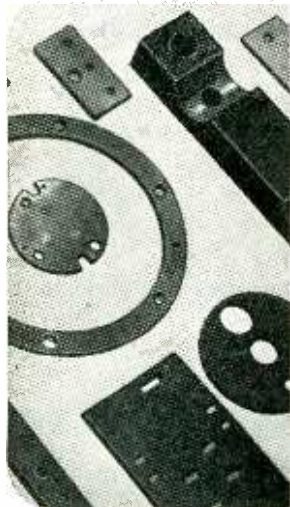

**Available now
to your exact
specifications!**



**PUNCHED, STAMPED, SHAVED, SAWED,
DRILLED, MILLED, TAPPED, THREADED**

If you have stiff production schedules investigate BAER facilities for volume production and accuracy. Orders for any quantities, shapes and sizes to your specifications. For details, write today for descriptive Bulletin 120.

N. S. BAER COMPANY

Craftsmen in Fibre Fabrication

7-11 MONTGOMERY ST. • HILLSIDE N. J.

University Speakers



**...for railroad and
marine applications**

Indoors or outdoors, on ships and docks, in railroad yards or locomotive cabs, mines or mills, wherever there is dirt, salt spray, excessive humidity, explosive dusts, gases or live steam, UNIVERSITY series MM speakers will function efficiently. Especially designed for ready maintenance, these speakers are available for every type of installation. UNIVERSITY speakers are unconditionally guaranteed for one year.

Write for details

**UNIVERSITY
LOUDSPEAKERS • INC**

225 VARICK STREET, NEW YORK 14, N. Y.



visited various research laboratories in that country.

ESTERLY C. PAGE, a pioneer in radio engineering and the 39th person to receive a radio operator's license in this country, has been made vice-president in charge of engineering for Mutual Broadcasting System.

G. F. LEYDORF, until recently with Crosley Corp., is in charge of all engineering at station WJR, Detroit, Mich.

JOHN D. KRAUS, formerly at RRL, Harvard, is now Associate Professor of Electrical Engineering at Ohio State University.

GEORGE C. SOUTHWORTH of the Bell Telephone Laboratories, New York City, was 1946 winner of the Levy Medal of The Franklin Institute, for his paper, "Microwave Radiation from the Sun", published in the April 1945 issue of Journal of the Franklin Institute.

REINHOLD RUDENBERG, professor of electrical engineering at Harvard University, received an Honor Award Medallion of Stevens Institute of Technology as the inventor of the electron microscope, for which he was granted U. S. patents in 1936 and 1937.

AWARDS

W. G. H. FINCH, president of Finch Telecommunications, Inc., was awarded The Legion of Merit for outstanding service as head of the



W. G. H. Finch

Countermeasures Design Section, Electronics Division, Bureau of Ships from Dec. 1, 1941 to Sept. 1, 1945.

ACHESON COLLOIDS CORP., Port Huron, Michigan, received the U. S. Navy's Certificate of Achievement in recognition of development work and production accomplishments in the fields of special lubrication, involv-

2 VITAL AIDS

TO THE MANUFACTURER OF
Miniature Tube Radios

★ **STAR**



DOUBLE-CHECK SYSTEM

#JE-10—Miniature socket wiring plug for accurate alignment of miniature socket contacts during wiring. Precision cast of zinc base alloy—Pins of stainless steel.

#JE-12 — (Hardened tool steel insert) or JE-13 (Stainless steel insert) Miniature tube pin straightener to obtain a perfect fit when the tube is placed in the set.



For complete information and prices—write

RADIO ACCESSORY DIVISION

STAR EXPANSION PRODUCTS CO.
147 Cedar St., New York 6, N. Y.

CAPACITORS -

OIL, PAPER and
ELECTROLYTIC



Illinois
CONDENSER COMPANY

1616 N. Throop St. • Chicago 22, Ill.

When You Want TERMINAL LUGS...

TURRET



SPLIT



DOUBLE END



say **C.T.C.**

These heavily silver plated C.T.C. Terminal Lugs simply swage to the terminal board, provide strong, well-anchored, swift-soldering terminal posts in a jiffy.

C. T. C. Turret Terminal Lugs have two soldering spaces. Lugs heat quickly, make wiring firm and neat. Made to fit $\frac{1}{32}$ ", $\frac{1}{16}$ ", $\frac{3}{32}$ ", $\frac{1}{8}$ ", $\frac{3}{16}$ " and $\frac{1}{4}$ " terminal board thicknesses. Also available with single soldering space and in Midget size.

C.T.C. Split Terminal Lugs have a .050" hole through them, permit wiring from top or bottom side of board without drilling. Stocked to fit $\frac{3}{32}$ " boards. Ideal for transformers and other potted units.

C. T. C. Double End Terminal Lugs provide two terminal posts in one swaging operation. May be wired from top or bottom. Electrical connection perfect. Stocked to fit $\frac{3}{32}$ " boards. Also available in Midget size.

Write for C.T.C. Catalog 100 today.



CAMBRIDGE THERMIONIC CORPORATION

439 Concord Avenue

• Cambridge 38, Mass.

EISLER EQUIPMENT

..complete and diversified for every phase
of electronic* manufacture!

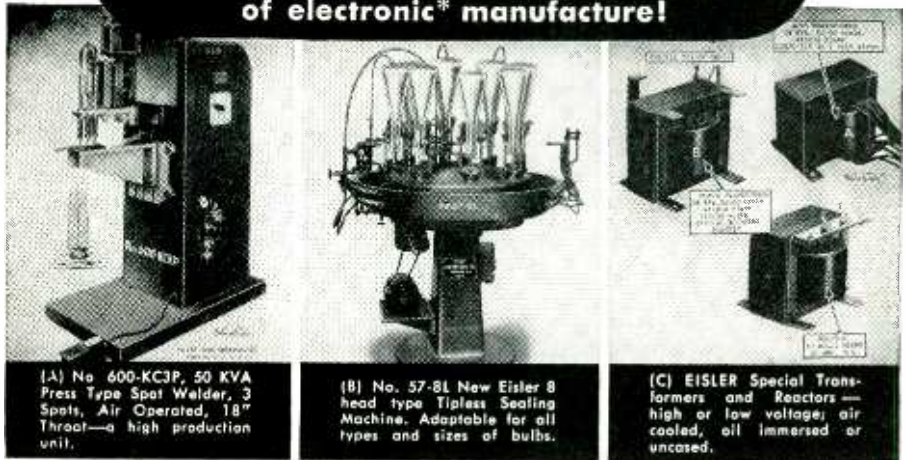

(A) No. 600-KC3P, 50 KVA Press Type Spot Welder, 3 Spots, Air Operated, 18" Throat—a high production unit.

(B) No. 57-8L New Eisler 8 head type Tipless Sealing Machine. Adaptable for all types and sizes of bulbs.

(C) EISLER Special Transformers and Reactors—high or low voltage; air cooled, oil immersed or uncased.

The CHAS. EISLER line of specialized electronic tools, machines and devices is complete and diversified. Included are innumerable types of welders—spot, seam, butt, rocker, arm, pneumatic and special types. Also included are hundreds

of devices for vacuum tube manufacture—glass tube cutters, slicers, stem and sealing machines as well as an all-inclusive line of transformers for every industrial and general need.

* EISLER serves 99% of American vacuum tube producers today. Write for completely illustrated catalog.

CHAS. EISLER
EISLER ENGINEERING CO.

75 HUDSON STREET (Near Avon Ave.) NEWARK, NEW JERSEY



**WORKS LIKE A
SCREW DRIVER
Speeds Production!**

Standard
Sizes, Hex,
Square or Knurled,
Chuck Type with many
Tools for many uses
Radio and Electrical Shops
Need them

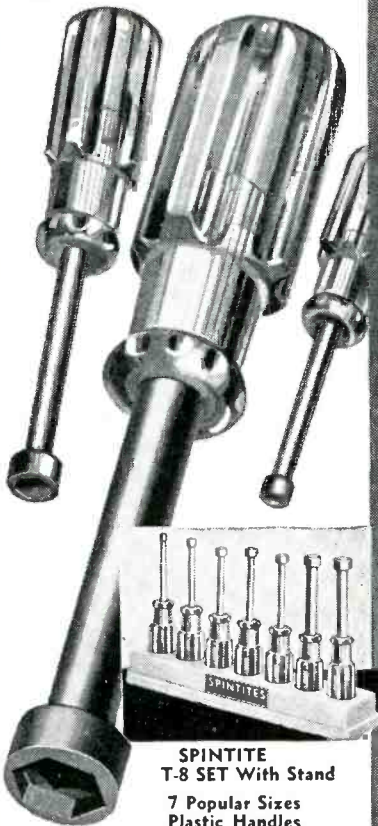

**SPINTITE
T-8 SET With Stand
7 Popular Sizes
Plastic Handles**

Send for Catalog No.
141 picturing a full line
of Automobile, Aircraft
and Radio Tools.

**WALDEN
WORCESTER
WRENCHES**

STEVENS WALDEN, INC.
468 SHREWSBURY STREET
WORCESTER, MASSACHUSETTS

ing special dispersions of "Dag" colloidal graphite. The award is a post-war recognition of an accomplished contribution to the war effort.

CORNELL-DUBILIER ELECTRIC CORP. has been awarded the Navy's Certificate of Achievement in recognition of its important contribution in supplying vast quantities of tiny capacitors used in proximity fuses.



Major General H. C. Ingles, Chief Signal officer (left) presents the Medal for Merit to Brig. General David Sarnoff, president of RCA

DAVID SARNOFF received the Medal for Merit for "performance of outstanding services to the United States as president of Radio Corporation of America October 1942 to March 1944".

• • •

R-F ON HOT DOG

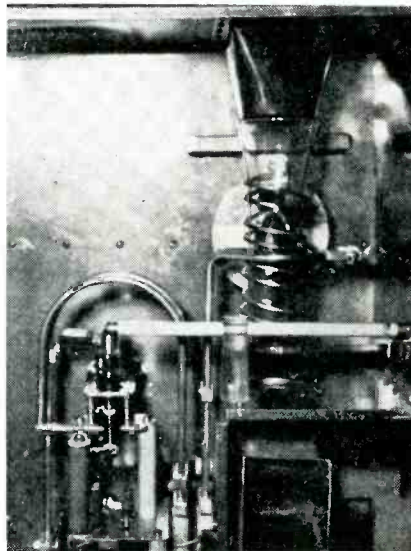

Tank circuit assembly of the Aireon r-f heating generator for a slot machine. A cellophane-wrapped frankfurter and roll slides down the chute to the coil where it is electrically heated in 20 seconds and then delivered to the customer for ten cents

\$\$\$\$\$\$\$\$\$\$\$\$\$\$\$\$

TIME = \$\$\$

**Save BOTH
by calling on
HARRISON
for all your
ELECTRONIC PARTS
AND EQUIPMENT**

**Complete Stocks
Prompt Delivery**

How you may obtain a copy of
"ELECTRONIC PARTS AND EQUIPMENT"
(our BUYER'S GUIDE)
sent upon request.

Since 1925—Distributors of all top brands

HARRISON
RADIO CORPORATION
12 WEST BROADWAY • NEW YORK CITY 7
BARCLAY 7-9854
JAMAICA BRANCH — 172-31 Hillside Ave. — REpublic 9-4102

**JONES 300 SERIES
PLUGS and SOCKETS**



P-306-CCT

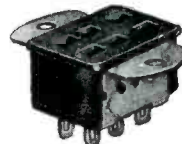

S-306-AB

A high quality line of small Plugs and Sockets adaptable to a thousand uses. All Plugs and Sockets are Polarized. "Knife-switch" Socket contacts are of phosphor bronze, cadmium plated. Bar type Plug contacts are of brass, silver plated.

Insulation is of BM 120 molded Bakelite. Caps are of metal with formed fibre linings. Made in 2 to 33 contacts. Although designed for 45 volts at 5 amperes, these Plugs and Sockets can be used at higher ratings where circuit characteristics permit. 2 contact round, others rectangular. For additional information write today for catalog No. 14 showing complete line of Electrical Connecting Devices.

HOWARD B. JONES COMPANY
2460 W. GEORGE ST. CHICAGO 18

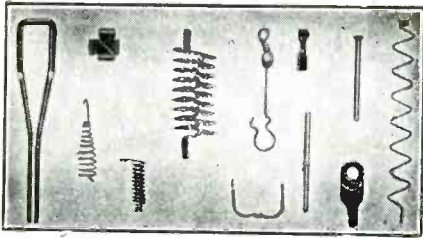

SMALL PARTS

Filaments, anodes, supports, springs, etc. for electronic tubes. Small wire and flat metal formed parts to your prints for your assemblies. LUXON fishing tackle accessories, double pointed pins, fine size wire straightened. Inquiries will receive prompt attention.

ART WIRE AND STAMPING CO.

227 High St.

Newark 2, N. J.

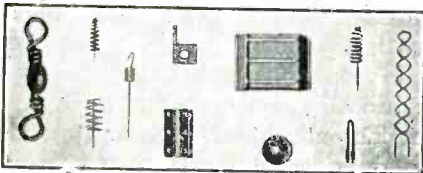

CHICAGO

Radio Show

Meet us in Person
at Booth 162
Chicago Radio Show
Stevens Hotel
to see the
new improved
Shur Interceptor
& Antenna Mount

Shur - Antenna - Mount, Inc.

Eastern Division
266 SEA CLIFF AVENUE
SEA CLIFF, N. Y.

Western Division
PORTER BUILDING
KANSAS CITY, MO.

WANT HIGH-SPEED SOLDERING?

SEE THE NEW LINE OF
G-E SOLDERING IRONS

STURDILY BUILT
EASILY REPAIRED
MODERATELY PRICED

A NEW AND IMPROVED LINE
of G-E Soldering Irons
for INDUSTRIAL USE

THEY GIVE YOU
THESE IMPORTANT
ADVANTAGES:

- HIGH SPEED SOLDERING
- UNIFORM PERFORMANCE
- LONG LIFE AND LOW MAINTENANCE
- CONVENIENT AND LOW-COST RENEWAL

Write today for Bulletin
GEA-4519. Address
Section A675-127,
Apparatus Dept.,
General Electric
Company, Schenectady 5, N. Y.

FREE BOOKLET

GENERAL ELECTRIC

675-127-8709

GASES

HYDROGEN
NITROGEN · OXYGEN

ARGON · NEON
HELIUM · KRYPTON
XENON

COMPLETE
GAS PRODUCTION
PLANTS INSTALLED
FOR LOWEST COST
OPERATION

FORMING MIXTURES
CARBON DIOXIDE
ACETYLENE

HIGHEST QUALITIES · ANY QUANTITY
DELIVERED ANYWHERE

AMERICAN GAS & CHEMICAL CO.

HARRISON, NEW JERSEY · Contracted Complete Service on All Gases

PERMANENT MAGNETS

Alloys: COBALT · CHROME · ALNICO

The making of permanent magnets is an alloy, too . . . of experience, engineering, facilities. We'll be glad to tell you more. Write for bulletin.

THOMAS & SKINNER

THOMAS & SKINNER STEEL PRODUCTS CO.
1116 E. 23rd St., Indianapolis 5, Ind.

Thomas & Skinner

FULL SOLDERING HEAT

in 5 Seconds



SPEED IRON* TIME SAVERS

STAYS TINNED—
NO TIP BURNING



SEE WHAT
YOU SOLDER



SOLDER AROUND
CORNERS

Ask for SPEED IRON at
your RADIO PARTS DISTRIBUTOR

FAST heating speeds your work. A new transformer principle is applied to soldering for producing high current at low voltage, generating heat in tip almost instantly. SPEED IRON is always ready for use.

- 100 WATTS—115 VOLTS—60 CYCLES
- INTERMITTENT OPERATION THROUGH TRIGGER SWITCH
- NOTHING TO GET OUT OF ADJUSTMENT
- TIP COOLS AS FAST AS IT HEATS
- HANDLE STAYS COOL
- CAN'T OVERHEAT OR BURN OUT

WELLER MFG. CO.

515 NORTHAMPTON ST. • EASTON, PA.

*TRADE MARK REG. U. S. PAT. OFF.

SEE US AT THE RADIO SHOW—BOOTH 47

NEW BOOKS

Television, The Eyes of Tomorrow

By WILLIAM C. EDDY. *Prentice-Hall, Inc., New York, 1945, 330 pages, \$3.75.*

THE PREFACE describes this work as "originally designed to summarize the problems and potentialities of all the functions that go into a television production." The promise is faithfully kept, covering such subjects as television history, development, equipment, studio design, color in television, visual effects and miniatures, film in television, commercials, acting, and production.

The sections describing television broadcasting and receiving and associated circuits are unusually lucid without sacrificing a technical vocabulary or descending to popular explanations. More material on visual effects and miniatures, to which field Captain Eddy has made masterly contributions, would be very welcome.

In outlining the staging of a production only the most elaborate system is given. Others, more simple, have been used with equal success. In view of the great cost of television productions, some evaluation of the various set-ups should have been included.

Television program producers believe the new image orthicon camera with its increased sensitivity will greatly change programming. Speculation along these lines by the author would have added to the timeliness of this book. As it stands, it is an excellent review of general opinions of prewar television, useful both to the specialist who wishes to know more about related contributions, and to the newcomer as an initial survey.—V. M. BRADLEY

• • •

Elementary Engineering Electronics

By ANDREW W. KRAMER, *Managing Editor, Power Plant Engineering. Instruments Publishing Co., Inc., Pittsburgh, 1945, 340 pages, \$2.00.*

THE MATERIAL in this little book (format 4½ x 8 inches) was originally published in the author's publication and, after revision, in *Instruments*. The text matter, now brought up to date, deals with the fundamentals of electronics and requires only a

SAFE • SURE • SIMPLE

• • PROTECTION FOR
COSTLY TUBES

Cramer PRECISION MODEL C TIME DELAY RELAY

Here is a simple, dependably accurate and rugged control which has been specified by many radio engineers because it has been especially designed for tube protection. Providing a fixed time delay (with adjustable feature), its flexibility of design permits special combinations and circuit arrangements which our Engineering Department can adapt to your requirements. Get the long run economy of accurate, highly dependable and ruggedly designed Cramer Time Controls at comparable initial cost. Write us today for engineering bulletins.

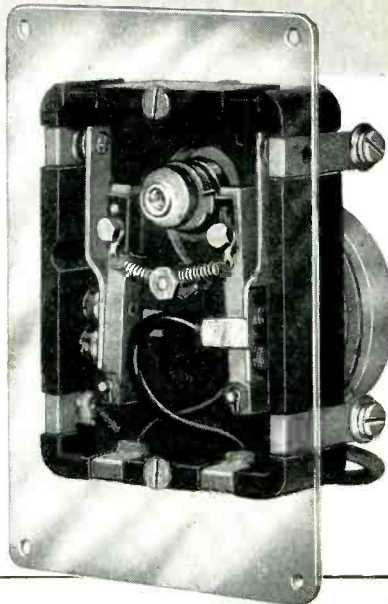

THE R. W. CRAMER COMPANY, Inc.
Box No. 3 Centerbrook, Conn.

SPECIALISTS IN
TIME
AS A FACTOR OF
CONTROL

Cramer

INTERVAL • DELAY • CYCLE • IMPULSE • PERCENTAGE

Find the help you need

in
these
3



McGRAW-HILL BOOKS

10 days examination
on approval

INTRODUCTION TO MICROWAVES

By Dr. Simon Ramo, General Electric Company; Union College, Schenectady, N. Y. 135 pages, 5 1/4 x 8 1/4, \$1.75.

Here is a complete non-mathematical description of the physical basis for all microwave phenomena, for engineers and industrial men who desire an understanding of microwaves and their application. The book covers transit-time electronics, velocity modulation, radiation, transmission lines, resonant cavities and wave-guides and correlates microwaves with lower frequency electricity in simple language and with a large number of explanatory diagrams. Presents for the first time the basic concepts of microwaves and their relation to the lower electricity range in such a manner that in a few hours time, any one may understand the principles involved and their application.

ELECTRONICS FOR ENGINEERS

Edited by John Markus and Vin Zeluff, Associate Editors, Electronics. 390 pages, 488 figures, \$6.00.

This handy reference book brings to designers, builders and users of electronic equipment and parts a host of valuable aids—material which has been condensed into graphs, charts, and concise articles, to supply you with a short cut to more and better reference data in your field. It contains a multitude of engineering aids related to the design of circuits, equipment and individual parts for radio, electronic, television, facsimile, radar, sound, and related vacuum-tube apparatus—including topics brought into prominence by acceleration of wartime, electronic research.

INDUSTRIAL ELECTRONIC CONTROL

A Guide to the Understanding of Electronic Control Circuits for Industrial Use.

By W. D. Cockrell, Industrial Engineering Divisions, General Electric Co. 247 pages, 175 illustrations, charts, and tables, \$2.50.

The first book written especially for the practical electrical man in industry who desires a basic working knowledge of electronic control. In a direct, non-mathematical treatment, it gives you fundamental facts of electron tube operation and practical applications of tubes in basic circuits of industrial electronic control apparatus. Here is the information needed by the engineer for quick understanding of the special aspects of this new and rapidly growing field.

Send this McGRAW-HILL coupon

McGraw-Hill Book Co., 330 W. 42 St. N. Y. C. 18

Send me the books checked below for 10 days' examination on approval. In 10 days I will pay for books, plus few cents postage, or return them postpaid. (Postage paid on cash orders.)

- Ramo—Introduction to Microwaves, \$1.75.
- Markus and Zeluff—Electronics for Engineers, \$6.00.
- Cockrell—Industrial Electronic Control, \$2.50.

Name

Address

City and State

Company

PositionL. 5-46

(For Canadian prices, write: Embassy Book Co., 12 Richmond St. E., Toronto 1.)

PLASTICON* CAPACITORS

Can you use a 10,000 VOLT PLASTICON
1/8 the size of a corresponding paper capacitor?

Because of the 4400 volt per mil breakdown voltage of the Plasticon film dielectric, high voltage Plasticons are smaller, lighter and more economical than paper capacitors.

*Plasticons—plastic film dielectric capacitors

Condenser Products Company
1375 NORTH BRANCH STREET
CHICAGO 22, ILLINOIS

THE FEATHEROAK?

THERE'S NO SUCH THING... BUT

Skydyne
SANDWICH CONSTRUCTION

IS
**LIGHT AS A FEATHER...
STRONG AS AN OAK...**

... a long-sought combination correctly engineered into "SKYPLY"—the miracle material now available for your electronics cabinet needs.

Rigidly tested on fighting fronts throughout the world, where "SKYPLY" radar and radio cabinets proved their resistance to heat, cold, moisture, vibration and sound—this modern Skydyne Sandwich Construction is the perfect

answer to your product housing requirements.

Results of the "Drop Test" show that "SKYPLY" is twice as strong with half the weight, thereby reducing dead weight and lowering shipping costs.

Adaptable to all types of designs because "SKYPLY" is form-moulded, this Skydyne Sandwich Construction offers a beautiful, smooth surface, with curvatures easily attained.

Get the full story of this and many other "SKYPLY" uses.

WRITE TODAY FOR OUR FREE BROCHURE

Skydyne Inc

PORT JERVIS, NEW YORK

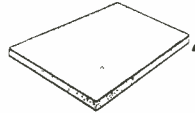

"SKYPLY"



limit the qualities OF YOUR SPEAKERS?

The NEW BUD wall type speaker case is the result of research into the field of speaker case design. The need for a durable, crack-proof, high tonal quality housing is answered by this complete line. The Bud qualities of **Beauty, Utility and Dependability** are fully expressed.

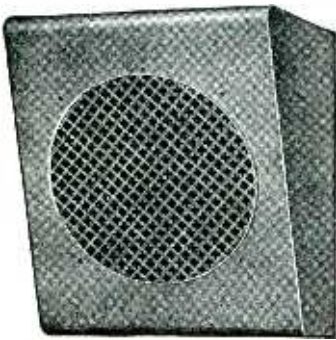

Catalog Number	Hole Size	Speaker Size	Height	Width	Depth
CS-1939	4"	4" & 5"	7 1/2"	6 1/2"	4 1/4"
CS-1940	4 3/4"	6"	9 1/2"	8"	5 5/8"
CS-1941	6 1/2"	8"	11 1/2"	9 1/2"	7"
CS-1942	8 1/2"	10"	13 1/2"	11 1/2"	8 3/4"
CS-1943	10 1/2"	12"	15 1/2"	13 1/2"	9 3/4"

Keyway holes are provided for wall mounting and four embossed feet are on the bottom to prevent damaging of table surfaces. The cases are finished in an attractive brown enamel color.

BUD Can Supply All Your Needs! . . .

. . . with the latest types of equipment including: condensers—chokes — coils — insulators — plugs — jacks — switches — dials — test leads — jewel lights and a complete line of ultra-modern cabinets and chassis.

Visit Bud at Booth No. 54
Radio Parts and Electronic Equipment Show
Stevens Hotel, Chicago
May 13th-16th



knowledge of electricity to be understood. Much use is made of mechanical and hydraulic analogies for the benefit of the reader familiar with nonelectronic apparatus.

The author sets out to accomplish a difficult task—to make electronics simple when it is essentially complex—but quite probably succeeds better than a pure electronic engineer could do. Certainly there is no royal road to this subject; it requires study and much mental application no matter how simply it is written.

The book follows a fairly conventional plan, dealing first with the basic phenomena and then with applications of gas and vacuum tubes, relays, phototubes, and all the other intricacies that make electronics what it is.—K.H.

. . . .

Basic Electrical Engineering

By A. E. FITZGERALD, *Massachusetts Institute of Technology*. McGraw-Hill Book Co., Inc., New York 18, N. Y. 1945, 443 pages, \$3.75.

THIS BOOK is intended for engineering and science students not majoring in electrical engineering. As stated in the preface, "Among its principal objectives are reasonable thoroughness in covering basic principles, forming a foundation upon which specialized techniques can be developed later in the student's professional life; a treatment of the fields of electronics, measurements, and control which is commensurate with their present-day industrial and scientific importance; and emphasis on the engineering applications and economic implications of the material being considered, particularly in problems and examples."

The author assumes a background in basic college physics, acquaintance with the general nature of the electric-circuit parameters, and some experience in using simple d-c circuit theory. The last two items are, however, briefly reviewed in the first chapter.

Of the twenty chapters in the book, the first seven are devoted to circuit theory; six chapters treat rotating machines, including selsyns; five chapters cover electronics, while the two concluding chapters treat instrumentation and electrical control of motors.

The section on electronics begins with a chapter introducing the vari-

KINGS Electronics

NEW IMPROVED MICROPHONE PLUGS and JACKS ELIMINATES NOISE • SHORTS • LEAKAGE



MODEL M-151
Female connector, solid silver plated contact, coupling can be removed completely for soldering.



MODEL M-161
Chassis mounting, solid silver plated contact. Milled flat, prevents turning in chassis.



MODEL M-180
Phono plug, mates M-150 or M-151 for insertion in standard phono Jack.



MODEL M-192
Solid silver plated contacts double female with coupling nuts.



MODEL M-190
Solid silver plated contacts Double male, mates M-151 or M-150.

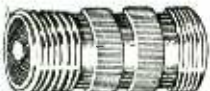

MODEL M-170
Standard solder contact mates with models M-170, M-161, M-160.

STANDARD MICROPHONE JACKS AND PLUGS



MODEL M-170
Mates with Model M-151 and M-150 Standard solder contacts



MODEL M-160
Chassis mounting — standard solder contact.



MODEL M-191
Double female coupling mates M-170, M-160-161.



MODEL M-150
Standard solder contact mates with models M-170, M-161, M-160.

FOR FURTHER DETAILS CONTACT ROBBY



KINGS ELECTRONICS CO.
372 CLANSON AVE., BROOKLYN 5, NEW YORK

MANUFACTURING FACILITIES

Now Available ★

We're ready to help you with your postwar plans. With a 5-Star Army-Navy "E" Award, the Air-Track Manufacturing Co., has a modern, well-equipped plant in Maryland to assist you.

- Complete production facilities, including production engineering to manufacture and assemble quality radio, radar, electronic or electro-mechanical devices.
- Complete facilities to machine and fabricate mechanical parts.
- Complete facilities to construct electrical assemblies requiring complicated wiring layouts, perform required mechanical and electrical tests.
- Complete facilities to sub-contract work within these limits.

Air-Track Manufacturing Co.
A Division of The Aerodynamic Research Corp.
5009 Calvert Road WARfield 9200
College Park, Maryland

NEW PRODUCTS

We have a twenty year corporate record of accomplishment in the highly specialized field of **PATENT ENGINEERING**. A solution of your new-product problem requires: (a) Engineering analysis of patents of others. (b) Development of non-infringing devices. (c) Creation of a *really protective* situation about products developed.

Correspondence invited.

H. R. Van Deventer, Inc.
342 Madison Avenue
New York 17, N. Y.

SOLDER USERS



Write Today

**For This
TRI-CORE
TEST SAMPLE**

- **FASTER FLUXING!**
- **FASTER BONDING!**
- **MORE JOINTS PER HOUR**

TRI-CORE'S unique arrangement of three separate cores places flux closer to the surface. Application of heat quickly frees flux, resulting in better connections, faster.

TRI-CORE means more soldered joints—with less tin.

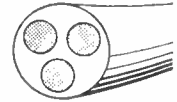

ALPHA METALS, INC.

Single Core, Rosin and Acid Filled, Special Core Solder, Wire, Bar, Sheet, Preforms. Lead and Tin Products.

371 HUDSON AVENUE

BROOKLYN 1, N. Y.

at your service . . . A DIRECTORY THAT TALKS!

Firms needing radio and electronic components quickly and on time have found the Henry P. Segel Company, Manufacturers' Representatives and Field Engineers, a veritable directory of excellent sources of supply.

If you, too, are looking for finest quality components that will be delivered as promised, the Henry P. Segel organization is equipped to talk *facts* with you — save you time and effort — give you dependable information promptly and courteously.

Take advantage of this service by a company that represents leading manufacturers in the radio-electronic field. Our business is to help you do business.

Henry P. Segel Co.
Manufacturers' Representatives Field Engineers
143 NEWBURY ST. BOSTON 16, MASS.
Tels.: KENmore 3012-6333-9755
Branch Office in Hartford, Connecticut

S.S. White MOLDED RESISTORS

The "All-Weather" Resistors

TYPE 65X
Actual Size
Other types available
in the lower values

**RESISTOR BULLETIN 4505
GIVES FULL DETAILS . . .**
It shows illustrations of the different
types of S. S. White Molded Resistors
and gives details about construction,
dimensions, etc. A copy, with Price
List will be mailed on request. Write
for it—today.

- Noiseless in operation
- Strong and durable
- Good performance in all climates

STANDARD RANGE

1000 ohms to 10 megohms

- NOISE TESTED •

At slight additional cost, resistors in the Standard Range are supplied with each resistor noise tested to the following standard: "For the complete audio frequency range, resistor shall have less noise than corresponds to a change of resistance of 1 part in 1,000,000."

HIGH VALUES

15 to 1,000,000 megohms

S.S. WHITE INDUSTRIAL DIVISION

THE S. S. WHITE DENTAL MFG. CO. DEPT. R, 10 EAST 40TH ST., NEW YORK 16, N. Y.



FLEXIBLE SHAFTS • FLEXIBLE SHAFT TOOLS • AIRCRAFT ACCESSORIES
SMALL CUTTING AND GRINDING TOOLS • SPECIAL FORMULA RUBBERS
MOLDED RESISTORS • PLASTIC SPECIALTIES • CONTRACT PLASTICS MOLDING

One of America's AAAA Industrial Enterprises

"Here's better welding control at lower cost!"

COMPLETE ELECTRONIC
TIMING AND SWITCHING
IN ONE PACKAGE . . .
FULL-WAVE SYNCHRO-
NOUS OPERATION . . .
APPLICABLE TO ANY
NEW OR OLD RESISTANCE
WELDER UP TO 15 KVA

★
E-1 Electronic Timer
controlling weld cycle
on 5 KVA Eisher press
type welder

NEW E-1 ELECTRONIC WELDING TIMER

SYNCHRONOUS • FULL-WAVE

No special skill is required to operate an E-1 timer. Single knob control gives precision timing from 1/2 and 1 cycle to 20 cycles in single cycle steps. Circuit incorporates automatic splash quench if electrodes are opened prematurely. E-1 control eliminates mechanical contactors and their troubles . . . gas tubes handle all current. Unit is housed in sturdy steel case

ELECTRICAL INDUSTRIES INCORPORATED

42 SUMMER AVENUE NEWARK 4, NEW JERSEY

ous types of high-vacuum tubes and surveying their application as amplifiers, oscillators, modulators, and detectors. Succeeding chapters discuss vacuum-tube amplifiers and oscillators in greater detail. A brief analysis of half and full-wave rectifiers is included in the chapter on gas tubes and phototubes.

The chapter on instrumentation discusses electrical measuring instruments, potentiometers, oscillographs, impedance bridges, and some special instruments.

On the whole, the book is clearly and pleasantly written. The illustrations are carefully chosen, the diagrams carefully drawn. A host of illustrative examples and well-chosen problems should be of material aid to those who attempt to study the subject on their own.—RALPH J. SCHWARZ

Metallizing Non-Conductors

By SAMUEL WEIN. *Metal Industry Publishing Co., New York 18, N. Y., 62 pages, paper-covered, \$2.00.*

A SURVEY OF commercial methods of forming metallic films on almost any type of surface, including chemical formulas and detailed procedures. The two pages devoted to cathode sputtering are merely descriptive, however, but references are made to patents and other sources of technical data on this electronic method. The six chapters are: Historical Survey; Mechanical Films; Chemical Reduction Films; Cathode Sputtering and Metal Spraying; Metallic Paints; Plating.—J. M.

The Electronic Engineering Master Index

A subject index to electronic engineering periodicals, January 1925 to June 1945, edited by FRANK A. PETRAGLIA. *Electronics Research Publishing Co., New York, 1945, 317 pages, \$17.50.*

PURPORTING to be a complete index to electronic articles from numerous periodicals, including ELECTRONICS, this compendium falls far short of its mark. Neither is the index complete for the period and periodicals which it covers nor are the indexed articles logically classified.

An index should serve two purposes: it should enable one to locate a work whose title or author is

- SOFT SOLDER RINGS AND PREFORMS
- SILVER SOLDER RINGS
- COPPER BRAZING RINGS

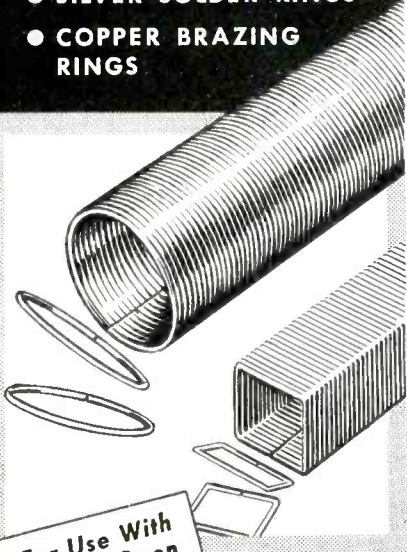

For Use With
Flame, Oven
or Induction
Heating

Large range of wire sizes carried in stock for immediate fabrication into Rings and Preforms.

ELECTRONIC SPECIALTIES MANUFACTURING COMPANY
127 North Main Street, Elkhart, Indiana



UTILIZED by the
BUSIEST
PURCHASING AGENTS

MacRae's
Blue Book

A DIRECTORY OF AMERICAN INDUSTRY... FOR ADVERTISING AND BOOK RATES, CALL YOUR AGENCY OR WRITE... 29 E. HURON ST., CHICAGO 11, ILL.

**INSTRUMENT HOUSINGS
PANELS • CHASSIS**

Manufactured to
your Requirements



For RADIO,
ELECTRONIC,
& ELECTRICAL
PRODUCTS

STAMPINGS,
ALL METALS

Also Stamped
Automotive
Products

A complete manufacturing service: Fabricating, Stamping, Screw Machine Work, Assembling. Precision work, experienced fabrication, dependable service... Send Specifications for Estimates.

STAMFORD METAL SPECIALTY COMPANY
Metal Work of Every Description
427-29 West Broadway, New York 12

For Originality

LOOK TO



XCELITE Tools make news! Originated and built by expert craftsmen, Xcelite Screwdrivers along with other Xcelite quality-built tools have created a demand which we have not been able to meet. But production is on the up-swing. Watch Xcelite! See our exhibit at Radio & Electronic Parts Show Chicago, May 13-16, Booth 128.

PARK METALWARE CO., INC.
Dept. C Orchard Park, New York

Quality Tools **PREFERRED BY EXPERTS**

PLATINUM

WIRE - RIBBON
FOIL
SEAMLESS
TUBING



for

SILVER

WIRE - SHEET
TUBING
SILVER BRAZING
ALLOYS & FLUXES

ELECTRONIC USE

FOR YEARS A LEADING SUPPLIER OF PRECIOUS METALS TO THE ELECTRIC AND ELECTRONICS INDUSTRIES.

THE AMERICAN PLATINUM WORKS

N. J. R. AVE. AT OLIVER ST.
NEWARK 5, N. J.

PRECIOUS METALS SINCE 1875

FOR THE MOST EXACTING APPLICATIONS

Where dependability and economy are vital, leading manufacturers specify Westfield nuts of special design.

Send us your drawings and specifications for recommendations and prices.

WMP
WESTFIELD METAL PRODUCTS CO. Inc.
 WESTFIELD, MASS.
 Custom Made Nuts in Brass, Steel and Various Alloys

IMMEDIATE DELIVERY!

For The First Time

HIGH FREQUENCY PROBE

with INPUT CAPACITY of 1/2 to 1 MMF
 Extends Measurement Range 10 Times
 —50 to 500 Megacycles!

★
 Write for
**BULLETIN
 AND PRICES**

Measurements once impractical are now made simple and routine. Model 29 High Frequency Probe bridges the gap in measuring voltages in the range from 50 to 500 megacycles. Designed specifically to replace the standard probe of the Model VM-27 Vacuum Tube Voltmeter, this new High Frequency Probe is adjusted accurately to one-tenth the sensitivity of the standard probe. As a result, voltage readings are exactly ten times the indicated values. Thus with the High Frequency Probe, the Model VM-27 has full scale ranges of 10, 30, 100, 300 and 1000 volts. No multiplier is required to measure voltages up to 1000 volts. Frequency range 0.5 to 500 megacycles.

ALFRED W. BARBER LABORATORIES
 34-06 FRANCIS LEWIS BLVD. FLUSHING, N. Y.



known, to find where and when it was published; and it should enable one to find material on a given subject. To provide the first mentioned service alphabetical title and author catalogs are necessary. The index under review lacks both of these and is therefore inadequate for locating more accurately articles for which one remembers only the title or author.

The index is exclusively a subject index; that is, the articles are grouped and cross-indexed under a series of topical headings. The editor has used headings which limit the utility of the index and has classified articles, not properly by major material content and written intention, but for incidental or related material of particular interest to the editor perhaps, but not of general concern.—F.R.

• • •

Going Into Business for Yourself

By O. FRED. ROST, *Editor, Wholesaler's Salesman. McGraw-Hill Book Co., Inc., New York 18, N. Y. 1945, 334 pages, \$3.00.*

DISCUSSION OF PROBLEMS, basic factors, and chances for success that should be considered before the plunge is taken, with analyses of mistakes and pitfalls that can lead to failure. Constructively, the book emphasizes three fundamental requirements for success—personal experience in the particular line of business being considered, business acumen and managerial ability, and knowledge of legal, financial, and other factors that must receive consideration at the start. Guides and tips to success in specific fields occupy about a hundred pages, and give such vital information as the odds on success, typical budget percentages, location-choosing advice, merchandise-displaying techniques, floor plans, etc. Electric appliance and radio stores are among those covered.—J. M.

• • •

Dr. W. C. Röntgen

By OTTO GLASSER, *Cleveland Clinic Foundation. CHARLES C. THOMAS, Publisher, Springfield, Ill., 1945, 169 pages, \$4.50.*

THIS BOOK COMMEMORATES the 50th anniversary of the discovery of x-rays. It is a biography—brief but

interesting—of the man who made this discovery.

Röntgen was one of those exceptional geniuses who could admit that his great discovery was an accident. He was looking for something else but he discovered x-rays. He lived to enjoy the significance of his discovery but to abhor the consequences of fame.

For the scientific-minded person this book is an inspiration to give much attention to detail and accuracy, being careful to notice any slight deviation from the expected results of an investigation. To anyone interested in electronics it should be valuable as an indication of how far this science has progressed in an extremely short time.

Röntgen wrote three papers about his discovery. These are reproduced in the book in new translations, along with a list of his scientific papers, a chronology of his life, and a bibliography of source material used in preparing this biography.—K.P.

• • •

Uranium and Atomic Power

By JACK DEMENT and H. C. DAKE.
Chemical Publishing Co., Inc., Brooklyn, N. Y., 343 pages, \$4.00.

A DIGNIFIED AND SERIOUS scientific work on the chemistry of uranium, unfortunately misnamed in an apparent attempt to take advantage of current interest in atomic power. This publishing practice tends to place the book in the same class with the flood of recent atomic power "quickies", whereas preparation of the material was undertaken early in 1939.

Only the introduction and an appendix chapter, apparently written recently to justify the second edition, deal with the glamors of the predicted forthcoming atomic age. The real meat of the book is contained in six chapters, headed The Uranium Minerals, Prospecting for Uranium Minerals, The Physics of Uranium, Chemistry of Uranium, Specific Methods in Uranometry, and Special Methods in Uranometry. Equally valuable for content and reference use is the appendix, which includes a table of natural stable isotopes of elements and a table of isotopic masses.—J. M.

VANATTA



Kwikheat
THERMOSTATIC SOLDERING IRON
A Division of
Sound Equipment Corp. of Calif. • 3903 San Fernando Rd., Glendale 4, Calif.

**America's Only Soldering Iron
WITH BUILT-IN
THERMOSTAT**

225 WATTS POWER in a Mere 14 ozs.

HOT IN 90 SECONDS

Ready for use 90 seconds after plugging in! The Kwikheat Soldering Iron cannot over-heat... adds to life of tips... requires less retinning time, because Kwikheat's built-in patented thermostat maintains proper, even heat for most efficient, economical operation. Powerful—225 watts—yet light weight (14 ozs.). Well balanced with cool, protecting handle. Six interchangeable tip designs adapt the Kwikheat Iron to most any soldering job. Iron with choice of any one tip, \$11.00

6 Interchangeable tip styles are available.



6 TIP STYLES—QUICK-HEATING ELEMENT—BUILT-IN THERMOSTAT—WELL-BALANCED—LIGHT-WEIGHT—COOL, PROTECTING HANDLE

**Order Now
For 1946-1947**

**First Come...
First Served!**

Orders for transformers are pouring in so fast that we will soon be booked to capacity for several months to come. If your product requires heavy duty filter reactors, swinging reactors, or plate transformers, anticipate your requirements and place your order NOW!

DONGAN ELECTRIC MFG. CO.
2977 Franklin Detroit 7, Mich.

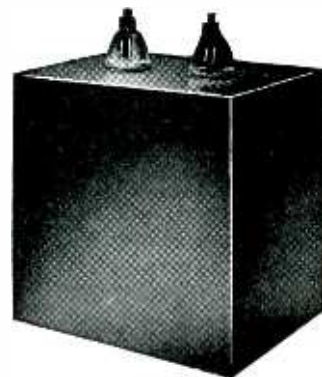

DONGAN

TRANSFORMERS

The Dongan Line Since Nineteen-Nine

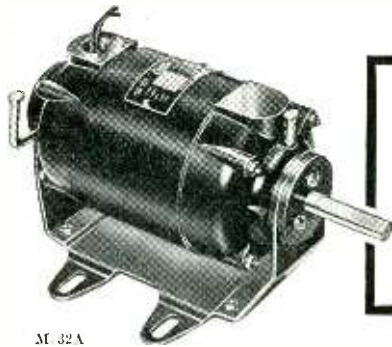

M 32A

Specifications

- Motor Type KS-837
- Model I-S 225S
- Approx. 1/20 H.P.
- Speed 1140 R.P.M.
- 115 V. A.C. 60 cycles
- Split phase induction
- Continuous duty

Where quiet, vibrationless operation and long life are essential, we recommend this special *Ostermotor*

for your continuous-duty fan and blower applications, such as oil, gas, or steam unit heaters—oil burners — air-conditioning units — etc.

Construction features: Motor is totally enclosed. Tubular steel stator housings are rabbeted to fit die cast end bells, providing perfect alignment. Bronze sleeve bearings are grooved for best oil distribution. Oversize felt oil retainers feed oil to shaft through two spring tension wicks at each bearing.

John Oster Mfg. Co., 4 Main St., Racine, Wis.

Resilient neoprene motor mountings absorb vibration — are not affected by oil and grease. Can be furnished with standard motor mounting dimensions. Finished in black, baked enamel. Length over bearings, $8\frac{3}{8}$ ". Housing diameter 4-27/64". Weight 15 lbs.

Orders for this motor are now in production. If you need special motors for your products, write for information.

Specialists in special motors — series, split phase, capacitor, synchronous, and shaded pole in fractional h.p. ratings.

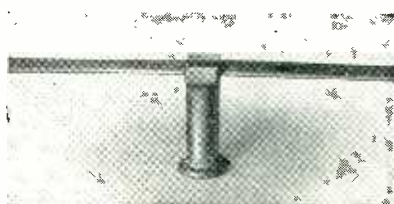

New STAND-OFF INSULATOR

The Workshop has recently developed a new stand-off insulator for the new 300 ohm parallel line, designed to keep both conductors parallel and at a fixed distance from any surface. If the line becomes unbalanced, antenna efficiency drops off sharply and proximity effects cause the characteristic impedance of the line to vary. This rigid insulator corrects these conditions. The insulator is attached with a single wood screw, and the line is easily snapped securely in place. Molded of strong, weatherproof plastic material (PATENT APPLIED FOR).

THE WORKSHOP ASSOCIATES INCORPORATED

Specialists in High-Frequency Antennas
66 Needham St., Newton Highlands 61, Mass.

**VISIT OUR BOOTH (No. 142)
at the RADIO PARTS SHOW**

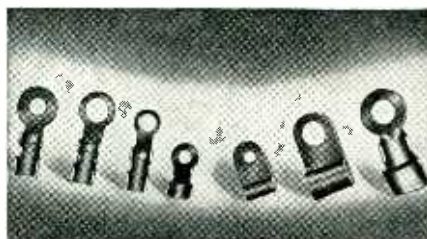

HEYCO SOLDERING LUGS

Available in various sizes and shapes. These copper lugs are easy to apply. Samples free.

HEYCO STRAIN RELIEFS

Three low-cost types. Prolong appliance life... Improve product performance... Act as grommet. Samples and literature.

HEYMAN MANUFACTURING CO.
510 Michigan Ave. Kenilworth, N. J.



Backtalk

This department is operated as an open forum where our readers may discuss problems of the electronics industry or comment upon articles which **ELECTRONICS** has published.

Ideal Loran System

Dear Sir:

THE FIRST INSTALLMENT of the series of articles describing loran, recalls sad memories of my beautiful—but alas—I am told by high authorities—impracticable system of world-wide radio navigation which, I think, will prove to be of interest to some of your more imaginative American readers.

It is that special case of loran which arises if four synchronized pulse-modulated transmitters are arranged to work in opposite pairs at four mutually perpendicular points on the earth's surface. This would provide one pair of transmitters at the North and South geographical poles and the other at a pair of diametrically opposite points on the equator.

If the transmitters had world-wide coverage and were equipped with omni-directional aerials, the position of a receiving station at any point on the earth's surface would bear a very simple and direct relationship to the time difference in arrival of the simultaneously broadcast pulses from the master transmitters.

At any point on the equator, signals from each polar transmitter would have the same distance to travel and would arrive simultaneously, the time difference being zero.

At the poles, the pulse from the adjacent transmitter would arrive almost instantaneously and that from the opposite polar transmitter would arrive approximately 1/15th second later.

Thus the latitude of the receiving station could be determined by reference to the polar pulses which may be separated by an interval of time ranging between 0 and $70 \times 10^3 \mu\text{sec}$, depending upon position, and there aren't any hyperbolae, degenerate or

PROFESSIONAL SERVICES

Consulting — Patents — Design — Development — Measurements

in

Radio, Audio, Industrial Electronic Applications

ASSOCIATED ELECTRONICS COMPANY

INDUSTRIAL ENGINEERING SPECIALISTS
Engineering Research & Development
Product Design Market Research
Sales Brochures Technical Manuals
Field Surveys Laboratory Analysis
Complete Engineering Service For All Industries
132 Nassau Street, New York 7, N. Y.

ELM LABORATORIES

Research and Design
RADIO TRANSMITTERS AND RECEIVERS
Designs for Home Radios, Electro-Mechanical Devices and Components.
20 South Broadway Dobbs Ferry, New York
Phone—Dobbs Ferry 4058

NATIONAL DESIGN SERVICE

Designers and Developers of
FACTORY TEST EQUIPMENT
TELEVISION R.F. SWEEP GENERATORS
F.M. SIGNAL GENERATORS
COMPLETE CENTRALIZED MODULATED SYSTEMS
96 Liberty St. New York 6, N. Y.

MICHAEL BOZOIAN

Consulting Service In Electronics
Instrumentation & Controls Design—Development—Models Literature & Patent Survey Recommendations For New Laboratories.
Telephone 8521
702 Fifth Street Ann Arbor, Mich.

F. T. FISHER'S SONS LIMITED

Consulting Engineers
Broadcast Transmitters, Antenna Systems, Studio Equipment, Mobile and Fixed Communication Systems.
1425 Dorchester St. West, Montreal

ALBERT PREISMAN

Consulting Engineer
Specializing in Television and Pulse Techniques, Video Amplifiers, Industrial Applications.
616 St. Andrews Lane, Silver Spring, Md.

H. RUSSELL BROWNELL

Consulting Engineer
Specializing in Measurements & Testing Instruments & Techniques - Electrical - Electronic - Magnetic.
188 West 4th St. New York 14, N. Y.

PAUL E. GERST & CO.

CONSULTING ENGINEERS
Specialists in Electrical Product Design
El. Machinery, Apparatus & Applications
El. Appliances, Hi-Frequency Apparatus
Electronics, Radio Communication
205 W. Wacker Dr. Chicago 6, Ill.

JOSEPH RAZEK, Ph.D.

Consulting Physicist
Electrical and Mechanical Engineering Problems Instruments and Control Devices Electronics Specialists in Colorimetry, Spectrophotometry and Industrial Color Control
Laboratory and Shop Facilities
202 Darby Road Llanerch, Pa.
Phone Hilltop 6910

E. STUART DAVIS

Consulting Engineer
Research—Design—Development
Radio - Carrier Current - Supersonics - Radiant Energy - Control and Measurement - Methods and Devices, Communication - Transportation & Industrial applications.
Marine Laboratory facilities aboard the yacht "ELECTRON"
422 N. E. River Drive Ft. Lauderdale, Florida

C. M. HATHAWAY

Consulting Engineer
Product Development
Project Engineering Production Designs
Planning Tool and Method Engineering
ELECTRICAL MECHANICAL ELECTRONIC
1315 S. Clarkson Street • Denver 10, Colorado

G. W. RHEIN

Engineering Consultant
Radio Communication Electronics
Complete Development and design for manufacture with engineering models.
St. Paris Pike Springfield, Ohio

STANLEY D. EILENBERGER

Consulting Engineer
INDUSTRIAL ELECTRONICS
Design—Development—Models
Complete Laboratory and Shop Facilities
6309-13—27th Ave.
Kenosha, Wis. Telephone 2-4213

HODGSON & ASSOCIATES

Physics, Mathematics, Research, Development & Patent Consultants.
Satisfaction guaranteed. Submit your problem for a preliminary survey without cost.
Sherman Oaks, California

PAUL D. ZOTTU

Consulting Engineer
INDUSTRIAL ELECTRONICS
High Frequency Dielectric and Induction Heating Applications, Equipment Selection, Equipment and Component Design, Development, Models.
314 Washington St. Newton, Mass.
BIG-9240

ELECTRONIC RESEARCH ASSOCIATES

ERA will apply progressive, war-proven development in electronic research . . . counting . . . timing . . . measuring . . . industrial controls . . . to your manufacturing advantage.
Box 333, 305 Linden Av., San Francisco, Cal.

J. L. A. McLAUGHLIN

Designer of
Communications Receivers
Specializing in the elimination of heterodyne interference.
P. O. Box 529, La Jolla, Calif.

RAYMOND M. WILMOTTE INC.

A Complete Engineering Service for the
Application of Electronics to Industry
Consultation Design Construction
236 W. 55 St. 1469 Church St. N.W.
New York 19, N. Y. Washington 5, D. C.

THE
CONSULTING
ENGINEER

"By reason of special training, wide experience and tested ability, coupled with professional integrity, the consulting engineer brings to his client detached engineering and economic advice that rises above local limitations and encompasses the availability of all modern developments in the fields where he practices as an expert. His services, which do not replace but supplement and broaden those of regularly employed personnel, are justified on the ground that he saves his client more than he costs him."

New! PRESSUREGRAPH

LINEAR PRESSURE — TIME — CURVE INDICATOR

Indicates in linear response, on screen of cathode ray oscillograph, the pressure - time - curve of any internal combustion engine, pump, airline, or other pressure system where pressure measurements are desired. Covers wide range of engine speeds and pressures up to 10,000 p.s.i. Screws into cylinder and can be calibrated using static pressures. Vibration-proof. Accurate, dependable for frequent engine tuning. Simple operation—only one control.

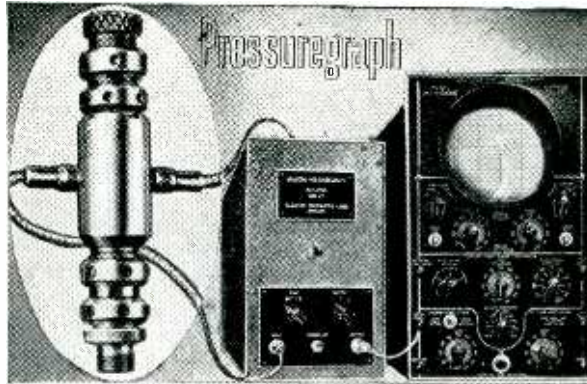

Also Pioneer Manufacturers of

THE FAMOUS **ELECTRO** BATTERY ELIMINATORS

A complete line—Models for use anywhere beyond high line connections (operate from 6 volt battery)—Others for operation from 110 volt AC. Improve radio reception. Greatly reduce battery drain. See our Exhibit at 1946 Radio Parts Show—Booth 127 Stevens Hotel—Chicago—May 13th-16th.

For complete information write

ELECTRO PRODUCTS LABORATORIES
549 W. Randolph St., Chicago 6, Ill. Phone STate 7444

otherwise to work out, but just plain, round simple circles.

In a similar manner, longitude may be found by reference to the pulses from the equatorial transmitters.

If the interval could be measured to an accuracy of $\pm 10 \mu\text{sec}$, the observed position would be correct to within ± 1 mile at any point on the earth's surface.

Neglecting problems due to reception of echoes from the ionosphere, and borrowing timing and synchronizing techniques from radar and loran, the insurmountable difficulty, I am told, is the impossibility of ensuring world-wide coverage from the four master transmitters even if they each used a diversity of carrier frequencies and were of extremely high peak power.

You must admit it works nicely on paper.

WM. A. GOLD
London, England



More on Pickup Design

Dear Sir:

IT HAS BEEN CALLED to my attention that the letter I wrote you sometime ago pertaining to the article, "Moving Coil Pickup Design" was published, together with an answer to it, in your Backtalk section.

It is obvious from Mr. Lindenberg's answer that he is not clear as to the magnetic forces in this Fairchild pickup. The fact is that, if the mounting is as he says it is, then the magnetoinductive action is at its highest and does not cancel out as Mr. Lindenberg claims. If he will make the test, he will find that the greater part of the emf in the coil is induced by the moving steel tube. He will also find phase distortion due to the dual emf potentials.

It would probably be of assistance to Mr. Lindenberg if he refer to the magnetic circuit of the well-known Baldwin phone, whose highly efficient operation depends on that very principle.

N. PAYNE
New York, N. Y.



WIRE ONLY A THIRD as thick as human hair, is used in instruments that measure electronic circuits. A pound of the wire stretches 62 miles.

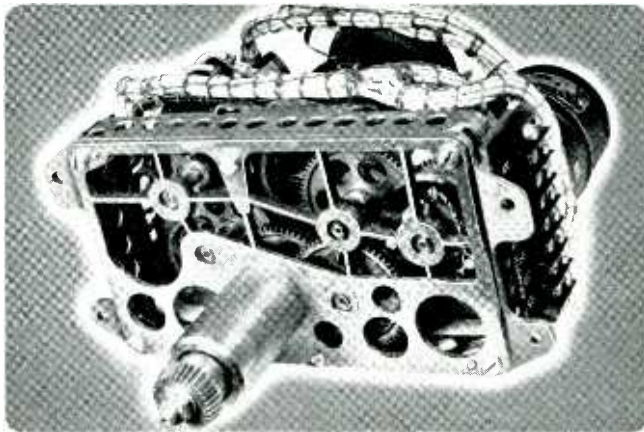

Specialists in intricate electrical mechanical assemblies

Illustrated above is an example of the type of work Gray knows how to do—and do well. We're open now for contracts and sub-contracts in this highly specialized field. Write to Laurence McCulloch, address below.



RAY MANUFACTURING CO.

W. E. DITMARS, President

230 Park Ave., N. Y. 17, N. Y. • 16 Arbor St., Hartford 6, Conn.

CONTACTS

FOR THE FIELD OF ELECTRONICS

Electron Tube Machinery

of every type, — standard, and special design

Specialists in Equipment for the manufacture of Radio Tubes, Cathode Ray Tubes, Fluorescent Lamps, Incandescent Lamps, Neon Tubes, Photo Cells, X-ray Tubes and other glass or electronic products, on production or laboratory basis.

Kable

ENGINEERING COMPANY

1307-1309 Seventh St., North Bergen, N. J.

Strip Insulated Wires

QUICKER... BETTER

with "Speedex"
AUTOMATIC WIRE STRIPPER
 ... Speeds Production
 Strips insulation from all types of wire — instantly, easily, perfectly. Just press the handles and the job is done. Cuts wire too. Strips 800 to 1000 wires per hour. Available for all size solid or stranded wires — No. 8 to No. 30. List Price \$6.00.
 Write Dept. E for Full Particulars



GENERAL CEMENT MFG. CO.
 Rockford, Illinois, U.S.A.

FINE RIBBONS OF TUNGSTEN and MOLYBDENUM
 Quality and accuracy in our fabrication of Tungsten & Molybdenum Ribbons have characterized our service to the Electronic industry.
 A development of
H. CROSS Co.
 15 Beekman St., New York 7, N.Y.



We manufacture a complete line of equipment

SPOT WELDERS, electric from 1/4 to 50 KVA
 TRANSFORMERS, special and standard types
 INCANDESCENT LAMP manufacturing equipment
 FLUORESCENT TUBE MAKING EQUIPMENT
 ELECTRONIC EQUIPMENT, vacuum pumps, etc.
 WET GLASS SLICING and cutting machines for laboratory use
 GENERAL GLASS working machines and burners
 COLLEGE GLASS working units for students and laboratory
 EISLER ENGINEERING CO. Newark, New Jersey



MORE RF KILOWATT HOURS PER DOLLAR WITH

F & O TRANSMITTING TUBES

Inquiries Invited—Let us explain how Savings are effected and the F & O greater guarantee.

FREELAND & OLSCHNER PRODUCTS Inc.
 611 Baronne St., New Orleans 13, La.
 Raymond 4756

High Power Tube Specialists Exclusively
 (5 KW to 100 KW)

HETERODYNE ELIMINATORS

If you are troubled by heterodyne interference consult

J. L. A. McLaughlin
 P. O. Box 529, La Jolla, Calif.

MICROMETER FREQUENCY METER

for checking Transmitters from 1.5 to 56 mc., within 0.01 per cent

LAMPKIN LABORATORIES
 Bradenton, Fla., U. S. A.

REPAIR YOUR ELECTRIC APPLIANCES WITH NEW AMAZING NICHROCITE



Burned or Broken Electric Heating Elements Repaired Instantly . . .

Handy for Home or Industrial Use

Simply overlap ends, apply Nichrocite paste and turn on the current — a perfect

weld results. Used by big utility companies and repair shops. Just the thing for that broken or burned out heating element in your electric iron, stove, toaster or heater. Does the job in a jiffy. Trial order, \$1; 4 ozs. \$2.50; 1 lb. \$8.00.

Armstrong Electric Co., Box 861-EG, Minneapolis

MINIATURE PRECISION BALL BEARINGS

(WORLD'S SMALLEST BALL BEARING)

For precision instruments, laboratory equipment, electronic devices, to minimize friction, space, weight; overcome starting torque.

ENLARGED SIX DIAM.



Radial Series (5 Sizes) 1/8" to 5/16" O. D.
 Pivot Series (6 Sizes) 2 mm to 10 mm O. D.

Write for data sheet EL

MINIATURE Precision BEARINGS
 KEENE, NEW HAMPSHIRE, U.S.A.

This CONTACTS Section

supplements other advertising in this issue with these additional announcements of products essential to efficient and economical operation and maintenance. Make a habit of checking this page, each issue.

Departmental Staff
ELECTRONICS

18 YEARS IN RADIO

GET THIS New CATALOG By This Old Firm



Latest developments in radio and electronic parts and devices, newest ham gear, gadgets for experimenters, bargains in war surplus items.

FREE TO YOU

Mail the coupon below and get this new catalog FREE.

BURSTEIN-APPLEBEE CO.,
 1012 McGee, Kansas City 6, Mo.

Send me FREE catalog advertised in Electronics.

I AM _____

STATE CONNECTION IN INDUSTRY

NAME _____

ADDRESS _____

TOWN _____ STATE _____

SEARCHLIGHT SECTION

EMPLOYMENT • BUSINESS • OPPORTUNITIES • EQUIPMENT—USED or RESALE

UNDISPLAYED RATE:

15 cents a word, minimum charge \$3.00.
(See ¶ on Box Numbers.)

POSITIONS WANTED (full or part-time salaried individual employment only), 1/2 above rates.

PROPOSALS 75 cents a line an insertion.

INFORMATION:

BOX NUMBERS in care of any of our New York, Chicago or San Francisco offices count 10 words additional in undisplayed ads.

DISCOUNT of 10% if full payment is made in advance for four consecutive insertions of undisplayed ads (not including proposals).

DISPLAYED—RATE PER INCH:

The advertising rate is \$7.50 per inch for all advertising appearing on other than a contract basis. Contract rates quoted on request.

AN ADVERTISING INCH is measured 7/8 inch vertically on one column, 3 columns—30 inches—to a page. E.

NEW ADVERTISEMENTS received by 10 A. M. May 7th will appear in the June issue, subject to limitation of space available.

WANTED LOUDSPEAKER DESIGN ENGINEER

Large electronic equipment manufacturer located in the East with extensive research development and design facilities has opening for an experienced Loudspeaker Design Engineer capable of designing quality equipment. Permanent position with opportunities for advancement. Salary commensurate with past experience and ability.

P-153, Electronics
330 West 42nd Street, New York 18, N. Y.

ELECTRICAL DESIGNER

fully capable of developing automatic watch gear equipment. Practical experience on electric coin machine, music machine, automatic telephone, step switches, etc., very essential.

If you can qualify, this opportunity will offer future with permanent employment and good salary. When applying for position, please state fully past experience, qualifications, salary expected, and availability.

P-117, Electronics
520 North Michigan Ave., Chicago 11, Ill.

PRODUCT ENGINEER WANTED

Mechanical engineer with electrical experience. Large manufacturer in electronics field has permanent opening for a graduate engineer of several years' experience, preferably in the manufacturing field. Background should be in manufacture of small precision apparatus such as relays, switches or meters. Right man will be made chief engineer of a division manufacturing a new product with a strong, steady demand, and will be given appropriate responsibility and salary. Reply by letter giving background, to

P-157, Electronics
330 West 42nd Street, New York 18, N. Y.

YOUNG ELECTRICAL ENGINEER

Electrical engineer—young graduate wanted by a large manufacturer in electronics field. Manufacturing experience not necessary as applicant will be taught on the job. This is a permanent position in product design and test, with increasing responsibilities and pay. Reply by letter, giving background, to

P-156, Electronics
330 West 42nd St., New York 18, N. Y.

WANTED ELECTRONIC ENGINEER

Leading manufacturer of electronic and therapeutic equipment located in the Northern New Jersey area requires the services of an engineer with several years experience in electronics—Mercury vapor lamps, fluorescent lamps, and vacuum tubes. In reply, give education, experience, and salary expected.

P-152, Electronics
330 West 42nd Street, New York 18, N. Y.

WANTED TRANSFORMER ENGINEER

Leading manufacturer of electronic and therapeutic equipment located in the Northern New Jersey area requires the services of an engineer with several years experience in the design and production of small and medium transformers. In reply, give education, experience, and salary expected.

P-151, Electronics
330 West 42nd Street, New York 18, N. Y.

POSITION VACANT

RADIO INSTRUCTORS. Receiver servicing experience. College degree preferred. \$3600 a year to start. \$4200 after four months. Work in the heart of the Radio Industry. Write Raleigh G. Dougherty, 158 Market Street, Newark 2, New Jersey, c/o New York Technical Institute of New Jersey.

EMPLOYMENT SERVICE

SALARIED POSITIONS \$2,500-\$25,000. This thoroughly organized confidential service of 36 years' recognized standing and reputation carries on preliminary negotiations for supervisory, technical and executive positions of the calibre indicated, through a procedure individualized to each client's requirements. Retaining fee protected by refund provision. Identity covered and present position protected. Send only name and address for details. R. W. Bixby, Inc., 278 Dun Bldg., Buffalo 2, N. Y.

POSITIONS WANTED

EX-NAVY CHIEF radio technician wishes to contact a company who wants a man with 16 or more years radio experience as, a mature, service man, and radio navy. Experienced with low and high frequencies, A.M. & F.M. and radar. Graduate of the school of Hard Knocks, but can use math up to and including some calculus, and apply same. Hold first class radio telephone license. Progressive, age 37, height 5-7, weight 195, presentable, available now. PW-161, Electronics, 520 N. Michigan Ave., Chicago 11, Ill.

DESIRE POSITION as electrical maintenance foreman or approximate capacity. Age thirty-one. Eleven years experience rewinding and complete repair and maintenance of electrical rotating machinery, including amplifiers and selsyn units. Also high school graduate, plus college courses in industrial management, industrial electronics, radio technology. Augmented by extensive home study. Employed at present. PW-158, Electronics, 330 W. 42nd St., New York 18, N. Y.

ENGINEER EE graduate 35 desires technical sales or contact position. Experience radio broadcasting, sound pictures, general manager small electronic and optical manufacturing plant, sales contact. PW-160, Electronics, 520 N. Michigan Ave., Chicago 11, Ill.

COMMUNICATIONS AND Electronics engineer, graduate E.E. Eleven years telephone plant experience; civilian engineer testing radar equipment and instructing armed forces in its operation. Qualified for work in connection with power carriers and control equipment, broadcast station, telephone equipment, or other electronic applications. Age 36. Teaching position considered. PW-159, Electronics, 520 N. Michigan Ave., Chicago 11, Ill.

EXECUTIVE—ENGINEER—ELECTRONIC

Age 33—42 yrs. Industrial experience including research lab, directorship and radar development design. Have worked with the following types of problems: Vibration control, radio-telephonic and inter-commun. design, transformer design, relay design, instrument design, etc. Desires permanent connection leading to exec. responsibility. Salary desired—\$5,500 p.a. In exec. cap.—willing to accept interest in firm as partial remuneration.

PW-154, Electronics
621 So. Hope St., Los Angeles 14, Calif.

POSITIONS WANTED

RADIO ENGINEER, experienced in: design, development, construction and testing of (100Mc) transmitters and all test equipment, instructor in FM & AM receivers and transmitters, 16 mm sound on film equipment, good machinist. Studied: aircraft instrument landing, radio range, DF, microwave, television, radar, electronic musical instruments. Location optional, ambitious, creative. Desire position as research, testing or project engineer. PW-162, Electronics, 520 N. Michigan Ave., Chicago 11, Ill.

EXECUTIVE'S ASSISTANT, M.S., secretary-stenographer, 28; 4 years electronic experience. Will work in N.Y.C. or environs. PW-163, Electronics, 330 W. 42nd St. New York 18, N. Y.

PART TIME WORK WANTED

ELECTROMECHANICAL ENGINEER desires part time work. Experienced mechanical design development radar, electronic and acoustic equipment. PTWW-164, Electronics, 330 W. 42nd St., New York 18, N. Y.

WANTED

ANYTHING within reason that is wanted in the field served by Electronics can be quickly located through bringing it to the attention of thousands of men whose interest is assured because this is the business paper they read.

Now Available

Over five years Chief Engineer of Transmitter and Government Radio Engineering Department designing radar and communication equipment the total production of which totaled about one hundred million dollars. Seven years designing commercial, aviation and broadcasting transmitters from 5 Watts to 50 KW. Five years research and design of electronic heating equipment, seismic instruments and high power high frequency vacuum tubes. Would prefer although not limited to Engineering or Sales Engineering work in the middle West.

PW-150, Electronics
520 North Michigan Ave., Chicago 11, Ill.

NAVAL ELECTRONICS OFFICER

Wants Position—Available Now

Eighteen years radio experience. Two years Electrical Engineering. Two years Naval Electronics Schools. Degree in Business Administration. Majoring in Marketing. Have supervised 300 technicians in installation and maintenance of groups of 200 bombers. Supervised ground radar installations of 100 kilowatts input power. Desire position selling or installing communication, F.M. television, radar, or microwave equipment. Extensive travel experience. Will consider foreign assignments.

PW-155, Electronics
520 North Michigan Ave., Chicago 11, Ill.

Selling opportunity
advertising
on opposite page

Additional Position Vacant Ad on Page 315



Representatives Wanted For New Microphone Line

Unlimited selling opportunity with a complete line of Microphones designed for SPECIFIC APPLICATIONS. The Last Word in Precision, Performance and Design. Contact:

ST. LOUIS MICROPHONE CO.
BOX 3440 MAPLEWOOD 17, MO.

CALIFORNIA REPRESENTATION OFFERED

To radio and electronic manufacturers now looking for firmly established and thoroughly experienced sales agency. Correspondence invited.

"IN RADIO SINCE 1911"

RA-133, Electronics
330 West 42nd St., New York 18, N. Y.

NATIONAL DISTRIBUTION AVAILABLE

For Manufacturers who make products suitable for sale to radio and electronic jobbers. We have a complete sales staff for national and export distribution. Reply with samples or description of products.

RA-870, Electronics
330 West 42nd St., New York 18, N. Y.

WRITE FOR 24 P. CATALOG OF

METERS

AND INSTRUMENTS

VOLTMETERS	BRIDGES (Wheatstone)
AMMETERS	MEGOhmmeters
MICRO	RHEOSTATS
AMMETERS	VARIABLE
Ohmmeters	TRANSFORMERS
FREQ. METERS	RELAYS

ELECTRO-TECH Equipment Co.
329 CANAL ST., N. Y. 13, N. Y.

Sales Engineers

Well established firm in the East desires Sales Engineers in the field of Industrial Electronics as well as sales of other Electronic products. To work out of factory. State fully education, age, and experience.

SW-116, Electronics
330 West 42nd St., New York 18, N. Y.

SALES REPRESENTATIVE WANTS LINES

Chicago and Vicinity
Prime materials or parts for Mechanical, Electrical, Radio and Radio Parts Manufacturing Trade.

RA-149, Electronics
520 North Michigan Ave., Chicago 11, Ill.

"Public Domain" gives you PATENTS for PENNIES!

Over 1000 expiring patents with drawings and typical claims in each weekly 250 page issue—use any of them free for new items! Improve your present product, machinery, etc. Sample copy \$1.50; yearly subscription, \$45.00; trial subscription, 10 weeks for \$10.00.

Scientific Development Corporation • Dep't 14
614 W. 49 St., N. Y. 19, N. Y.

Let This Leading Distributor Sell Your Products Through Music Stores—Coast-to-Coast

Let's assume that your product is one that can be sold through music stores—that it has merit—and that it is priced in accordance with its quality. Whether or not you are now selling in the music field makes no difference.

Here's what we can do for your product:

—within five days after receiving delivery promises and your approval, we can present your product to virtually every music store in the United States.

—we can assure you of continuous product promotion to dealers—promotion of a calibre that will sell long after the buyers' rush is over.

—providing you deliver to us, dealers' orders for your product will be shipped within 24 hours after receipt.

—you can sell to us in quantity—get your cash immediately if desired—get firm commitments in advance and serve one large account instead of many small ones.

—your credit problems are eliminated—handling in your plant is simplified—correspondence is reduced—you can concentrate on manufacturing.

—you can profit from the good will of our name, which may be better known in the music field than yours.

DO THIS TODAY!

Drop a line to us at the address below. We'll do the rest. We'll place a responsible executive of our firm in touch with you to discuss the matter—lay our cards on the table—and let you decide the advantages of doing business through us. Negotiations will be on a confidential basis if you say so and we'll supply first class credit references.

Furthermore, if you do not care to open up correspondence with a "blind" address, just get in touch with the editor of this magazine, tell him you are interested in selling us, and he will tell you who we are.

"DISTRIBUTOR"

RA148 ELECTRONICS

520 North Michigan Ave., Chicago 11, Ill.

SOME OF THE LINES IN WHICH WE ARE INTERESTED

Plastic Musical Specialties, Musical Toys, Musical Supplies, Musical Instrument Accessories, Phonographs and Accessories, Radios, Amplifiers, Music Boxes, Band Instruments, Electronic Musical Instruments—anything that can be sold through music stores except publications.

WANTED

WANTED

Your Business

"ANYTHING containing IRON or STEEL"

**MORE FOR YOUR DOLLAR
IRON & STEEL PRODUCTS, INC.**

40 years' experience
13422-A S. Brainard Ave., Chicago 33, Ill.

At Your Service . . .

The Searchlight Section is at your service for bringing business needs or "opportunities" to the attention of men associated in executive, management, sales and responsible technical, engineering and operating capacities with the industries served by McGraw-Hill publications.

TAB

That's A Buy

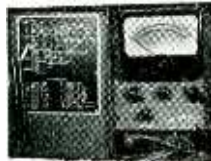

ELECTRONIC VOLT-OHMMETER BRAND NEW U. S. ARMY TYPE 1-107-F PRECISION UNIT. Rugged design housed steel case 6"x9 1/4"x4 1/4" leather carrying handle. Contains Simpson 4" highly damped 400 microamp Alnico meter. Clear visible scale large numerals easily readable at all points. All voltage ranges ten megohms sensitivity; reads 0-3 volts in .05 v steps; 0-10 volts in .2 v steps; 0-30 volts in .5 v steps; 0-100 volts in .2 v steps; 0-300 volts in 5 v steps—OHMS Rx1 from .02 to 1000 ohms; Rx10 from 2 to 10000 \pm ; Rx100 from 20 to 100000 \pm ; Rx100 from 200 to 1 meg \pm ; Rx10000 from 2000 to 10 meg \pm (center scale is 10) Unit complete with 3 test leads; batteries and instructions. Cost gov't \$65. "TAB" special \$29.70. Additional V.T.V.M. Loctal tube 1 LE 3/SP Sig C \$1.15.

COMPLETE NEW W. E. OSCILLOSCOPE 5 inch made by Western Electric for U. S. Army type BC412 Cost gov't over \$2000. Contains power supplies 115 v 60 cy; amplifiers and controls for Vertical and Horizontal position. Focus intensity, Sensitivity, Spread, Sweep (fixed freq.) with new Tubes 5BP4, 6T9, 5T4, Six 6L6, Two 6S17, 6AO7, 6H6. Easily adapted to laboratory Radio service work or television. Completely housed heavy steel case. Exceptional "TAB" price \$65. Ship. wt. cased 200 lbs. Tested, guaranteed new. \$1 Min. orders FOB, N.Y.C. Add Postage all orders and 25% deposit. Whitehall 3-3557. Send for catalog 300. Don't wait, rush orders as quantities are limited.

"TAB", Dept. E5
Six Church Street, New York 6, N. Y.
Our Central Location

GOV'T SURPLUS ELECTRONIC EQUIPMENT

CONDENSERS

.25 mfd 400 vdc can Sprague.....	.45
.25 mfd 600 vdc can Solar.....	.60
1. mfd 500 vdc (pyr G.E. 23f303).....	1.00
.85 mfd 600 vdc rd can Aero 55850 1/2 x 1 3/4.....	.30
.5-5 mfd 400 vdc th rect can.....	.60
4. mfd 600 vdc C.—D.....	1.50
8. mfd 600 vdc C.—D.....	2.88

TEMP COMPENSATED COND.

.25 mfd 200 vdc WE oil 0 to +55 C.....	.50
.535 mfd 200 vdc WE oil 0 to +55 C.....	.50
1. mfd 200 vdc WE oil —40 to +65 C.....	1.00
2.16 mfd 400 vdc WE oil 0 to 55 C.....	1.00
.4 mfd 1500 vdc, WE oil —50 to +85 C.....	.70
.05 mfd 1000 vdc inv mtg GE pyr 1 1/4 x 1 1/4 x 3/4.....	.70
.25 mfd 1000 vdc inv, mtg G E pyr 1 1/2 x 1 1/2 x 3/4.....	.80
4 mfd 1500 vdc WE oil.....	.50
1.—1 mfd 7000 vdc G. E. Pyr.....	7.50
.25 mfd 20,000 vdc C.—D.....	15.00

SPECIAL

2 mfd 220 Vac C.—D.....	1.25
500 mfd 200 vdc rd 2x4 1/2 bakel, ease.....	2.95

TRANSFORMERS



H.V. PLATE XFMR'S
115 v/860 vct 510
Ma./oil 7.50
115 v/2750 v
750 Ma./oil 45.00
USN spec.....
115 v/750 vct 110
Ma./6.3N —
5A/5V—3A .. 6.95
KENYON FIL
115 V/5
V—115 A ... 8.95

Pwr Transf 400 2400 cps	
116/620 vct—4A/6.3V—6A/6.3—V—9A/	
5V—6 A.....	5.00
118 8v/3600 V—5 M. A./2.5—1.75A.....	7.00

AUDIO TRANSFORMERS

UTC 3—1 SCC-61.....	.75
UTC 0—1 HI-FI XFMR 7/8 x 1 3/16 40—	
15,000 CPS.....	1.50
UTC 0—14 HI-FI XFMR 7/8 x 1 3/16 40—	
15,000 CPS.....	1.50
Cardwell Audio Interstage 1/2 x 2 PRI. 10	
Mohms SEC. 400 Mohms.....	1.00
GE ICW Tone OSC. XFMR 2 x 3.....	2.00
GE Driver 6v6 to Pair 811's 2 x 3.....	3.00
GE Modulation Pair 811's to 813 3 x 4.....	5.00
CHI XFMR P.P. Mod. & DR. 6 Lbs. per Pair	3.30
IF XFMR—900 to 2000 KC 3/4 x 2.....	.72
IF XFMR—SOKC & 150 KC in One Unit	
1 1/2 x 1 1/2 x 2 1/2.....	.72
IF XFMR—2.65 MC. 2 x 1 1/2 x 4.....	.72
RF XFMR—20—27 MC 2 x 1 1/2 x 4.....	.72

KITS

RADIO HARDWARE KIT—1,000 PIECES, AS-SORTED SCREWS—6-32, 8-32, in various lengths. NUTS brass nickel plated, brackets look, round & Insul. washers, grom-mets—everything for the experimenter & the ex-serviceman. **\$2.49**

50 MICA COND.
KIT. Assorted 400
& 600 V. .0005-
0 0 8 - \$
.001 - .01 **\$4.65**
etc.

200 RESISTORS
Assorted Kit in 1/4-
1/2 & 1 W. Ranging
from 50
ohms to **\$5.95**
1 meg.

MISCELLANEOUS

Phono Ejector SW. DPDT.....	.24
Phone Plugs PL-55.....	.25
Phone Jacks.....	.25
866 Sockets.....	.75
Terminal Strips, Jones, from 2 to 17 Term, at	
4 Cents a Terminal.....	
Terminal Strips, Burke, Heavy Duty—12	
Term.....	1.00
Coil Ass. Pri, 700 Ohms SEC 3000 Ohms #40	
Wire Approx. 3/4 x 2 with 5/16 Core Hole... 20	
Aeroplane Jack Box APX 3 x 4.....	1.00
Radio Remote Control Box W.E. 190—550KC	
BC-473B.....	3.00
Potentiometer 750 Ohms Clar. WW 2 Watt	.14
Tuning Forks.....	3.00
Chokes 1HY 800 M.A. 15 Kv Test 7.5 Ohms	.1200

SEND FOR FLYER

All merchandise guaranteed. Mail orders promptly filled. All prices F.O.B. New York City. Send Money Order or Check. Crating and shipping charges sent C.O.D.

COMMUNICATIONS EQUIPMENT CO.

131 Liberty St., N. Y. C., 7, N. Y.
Telephone WH 4-7658

FOR SALE NEW and USED ELECTRONIC EQUIPMENT GOOD CONDITION

Part Name	Voltage	Frequency	Serial No.	Form or Type	Made By
1 Hickok Oscillograph Inductance Bridge	110 V.A.C.	60	4-2230		Hickok Elec. Company
Cathode Ray Oscilloscope	110-220 V	50/60	434	667-A 715-A	General Radio Company R. C. A.
Cathode Ray Oscilloscope	110-220 V	50/60		715-A	R. C. A.
Amplifier P. A. 6 watt	110 V	60	10665	MI-12238	R. C. A.
Amplifier P. A. 6 watt	110 V	60	10370	MI-12238	R. C. A.
Commercial Receiver	110 V	60			Hallicrafter
Dynamic Speaker	110 V				Hallicrafter
Regulated Power Supply	110 V.A.C.—300 VDC				Radio Technical
Standard Self Inductance	1000 C.P.S.	100 Millihenry			Leeds & Northrup
Voltohmyst	110 V.A.C.	60	18778	143	R. C. A.
Voltohmyst	110 V.A.C.	60	19188	143	R. C. A.
Voltohmyst	110 V.A.C.	60	18798	143	R. C. A.
DC Voltmeter 16" Face Micromax	Calibrated 0-15 Volts DC				Leeds & Northrup Co.
Fahrenheit Thermometer 16" Face Micromax	Calibrated 50-150°F—Recording 30601				Leeds & Northrup Co.

THE WEBBER DENTAL MANUFACTURING CO. CANTON 5, OHIO

Remler Appointed Agent for WAR ASSETS CORPORATION

(Under Contract No. 59A-3-48)

... to handle and sell a wide variety of **ELECTRONIC EQUIPMENT**

released for civilian use

Write for Bulletin 27-E

Remler Company Ltd.

2101 Bryant St.

San Francisco 10, Calif.

REMLER

Since 1918

Radio • Communications • Electronics

PAN-OSCILLO RECEIVER

new, surplus units

Latest design, 3" Oscilloscope, Panoramic Adapter, Synchroscope, Receiver (when used with converter). Push-pull vertical and horizontal amplifiers. Ideal for laboratory, television, and general use. 60 cycle transformer provided (if wanted installed and tested add \$8.00 extra.)

Originally \$2,000—your cost with 21 tubes \$97.50.

Write for picture flyer or send 50c for eighty-page technical manual.

WESTCHESTER ELECTRONIC PRODUCTS
29 Milburn St., Bronxville., N. Y.

SURPLUS PARTS and EQUIPMENT

Engineers are invited to inspect our display of surplus Government-owned electronic parts and equipment, 55,000 sq. ft. teeming with worthwhile items! All material inspected and tested; backed by usual 90-day manufacturers' guarantee.

Sorry, no retail sales; all purchases against company orders only.

COMMUNICATION MEASUREMENTS LABORATORY

Central Agent for War Assets Corp.

Display Room: 350 W 40th Street

Main office: 20 Greenwich St., New York 6

BEST QUALITY, USED

ELECTRON TUBE MACHINERY

Equipment for the manufacture of all kinds of electron tubes, radio tubes, incandescent lamps, neon tubes, photo electric cells, X-ray tubes, etc.

AMERICAN ELECTRICAL SALES CO., Inc.
65-67 East 8th St. New York, N. Y.

HAZELTON INSTRUMENT CO.

Electric Meter Laboratory

Electrical Instruments, Tube Checkers and Analyzers repaired.

War surplus meters converted for civilian use.
140 Liberty St., New York, N. Y.
Tel. BArcley 7-4239

FOR EVERY
BUSINESS WANT

"Think Searchlight First"

Surplus ELECTRONIC TEST SETS

SIGNAL CORP TYPE I-56-A

Manufactured in 1940 by Weston Electrical Instrument Corp.



volt-ohm-millimeter 0-1-2½-5-10-25-50-100-250-500-1000 volts AC & DC at 1000 ohm per volt. Also has the same ranges in DC milliamperes. Has four ohm meter ranges $R \times 1 = 0-1000$ ohms, $R \times 10$, $R \times 100$, $R \times 1000$.

564-3C volt ohmmeter, 0-3-30-300-600 volts D.C. at 1000 ohms per volt. Has four ohmmeter ranges, $R \times 1 = 0-1000$ ohms, $R \times 10$, $R \times 100$, $R \times 1000$.

571-3A, out put meter, 0-1½-6-15-60-150 volts A.C., all ranges have a constant impedance of 4000 ohms. Their four ranges can be switched without changing load on circuit. A built in condenser is also provided to block D.C. when checking output right at the plate terminals. This instrument is very useful when using a signal generator to align a set.



685-2 Tube Checker, check many tubes but not above a 25 volt filament comes complete with Loktal and Octal adapters. It can easily be converted by adding a new transformer for the higher filament voltages. Without conversion it will check over 250 standard radio tubes.

These four units come complete in a carrying case, with extra adapters and socket selector as illustrated in first picture. The units are completely reconditioned, guaranteed to be in perfect working condition. Comes complete with new ohmmeter batteries, instruction books and an unconditional 30 day guarantee. List price approximately \$250 dollars. Your cost FOB, N. Y. C. well packed in a wooden shipping case

Only \$49.50.

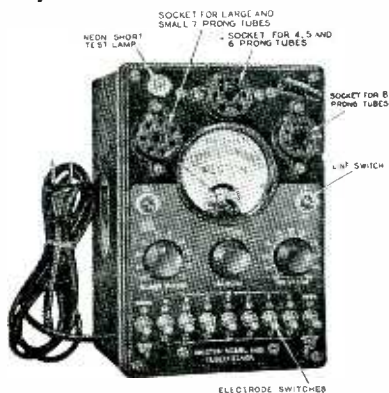

OSCILLOSCOPE

Western Electric (USED) Signal Corps 5" oscilloscope made for SCR 268 Radar set. Contains power supplies 115 volt, 60 cycle; amplifiers and controls for vertical and horizontal positions, sensitivity, spread, focus intensity, and fixed frequency sweep. Contains 13 tubes. Comes complete with diagram showing how to add a sweep circuit. Excellent for radio servicing and laboratory experimenting. Model BC 412 A and B. Shipping weight 200 lbs. **Only \$32.50.** all complete.

We have a few new BC 412 B oscilloscopes with the same characteristics as above complete in original shipping boxes for **only \$49.50.**

SIGNAL CORPS TYPE I-56 C & D

Manufactured in 1943 by Triplett & Espey

COMBINATION TESTER



Combination tester is used for testing tubes and making measurements of AC output, AC and DC voltages direct current, resistance, and capacity. It can also be used as a free-point tester to make voltage and current measurements at tube socket terminals of radio equipment while the power supply of the equipment is turned on. Basically, the combination tester consists of a highly accurate 100 microampere meter which is connected into the correct test circuits by switches and jacks on the panel. The combination tester operates on 105 to 130 volt, 60 cycle

alternating current. When combination tester is used as a tube checker it will check

ALL RECEIVER TUBES USED TODAY

COMBINATION TESTER AS A TUBE CHECKER

The combination tester uses a standard RMA-approved emission type tube checking circuit. Individual emission tests can be made for each plate in rectifier tubes and multiple function tubes.

a. Sockets on the tester panel serve for both Signal Corps and commercial vacuum tubes. The tester provides sockets for 4-prong, 5-prong, 6-prong, combination large and small 7-prong, 8-prong octal, 8-prong loctal, 5-prong Bantam Jr., 7-prong miniature and 7-prong midget tubes. Pilot lamps can be tested in a special socket located in the center of the 7-prong socket. A special BN adapter for tests of acorn tubes and a lead for testing tubes with top caps are provided in the test lead compartment.

b. A loose leaf card-type tube chart, mounted on the upper right corner of the tester panel, lists the switch settings for Signal Corps and commercial tubes. Index tabs aid in locating the correct card.

COMBINATION TESTER AS A VOLT-OHM-MILLIAMETER

a. The five D.C. voltage ranges are, 10 V, 50 V, 250 V, 500 V, and 1000. Each range has a sensitivity of 10,000 ohms per volt.

b. The five A.C. voltage ranges, the same as the D.C. ranges have a sensitivity of 2000 ohms per volt.

c. The four D.C. Milliammeter ranges are: 1MA, 10MA, 50MA and 250MA.

d. The Four ohmmeter ranges are 0-500 ohms, 0-150,000 ohms, 0-1.5 megohms, and 0.15 megohms.

COMBINATION TESTER AS A FREE-POINT TESTER SOCKET ANALYZER

A free-point tester makes circuits in radio equipment accessible through the tube sockets, and eliminates the need of under-chassis socket-voltage and resistance measurements. Current measurements may also be taken without physically opening a circuit.

b. The free-point testing jacks are numbered according to the standard RMA system for tubes. A connection to a particular tube socket terminal can be made instantly by plugging a test probe into the jack with the corresponding number.

COMBINATION TESTER AS USED FOR CAPACITANCE

Capacitance values of paper and mica capacitors ranging in size from 0.001 mf to 10 mf can be measured.

30 DAY UNCONDITIONAL GUARANTEE

VOLT-OHM TESTER

a. Five D.C. voltage ranges, 3V, 30V, 300V, 600V, and 1800V, having a sensitivity of 1000 ohms per volt, are provided.

b. There are four ohmmeter which are: 0-1000 ohms, 0-10,000 ohms, 0-100,000 ohms, and 0-1 meg.



OUTPUT METER

The output meter, 0-1.5-6-15-60-150 V. AC, all ranges have a constant impedance of 4000 ohms, therefore ranges can be switched without changing load on circuit. A built-in condenser is also provided to block D.C. when checking output right at the plate terminals. This instrument is very useful when using a signal generator to align a set.



MARITIME SWITCHBOARD

WOrth 4-8217

• 336 CANAL STREET NEW YORK 13, N. Y.

**PRECISION
CRYSTALS**

S
I
N
C
E



1
9
3
4

TYPE Z-1

**THE NEW STANDARD CRYSTAL UNIT
FOR ALL HIGH FREQUENCY SERVICE**

FREQUENCY 1.5 TO 10.5 MC.

**TEMPERATURE COEFFICIENT LESS THAN 2 CYCLES
PER MC. PER DEGREE CENTIGRADE**

**CALIBRATION ACCURATE TO WITHIN .005%
OF SPECIFIED FREQUENCY**

**MADE BY
PETERSEN RADIO COMPANY
COUNCIL BLUFFS, IOWA**



**HOW
TO
BUILD**

LAMP ANNUNCIATORS

Kirkland Bulls-I-Units are ideal for this purpose. Just provide the proper size holes in the panel, then insert the Kirkland units and lock into place. Many different units to choose from. Assembly is then ready for installation. Connect incoming wires and place in service. Typical unit illustrated above made with T2 units.

KIRKLAND Pioneer
INDICATING LAMPS

TYPE T2 UNIT



Small and modern, molded of bakelite. For use with slide-base switchboard bulb (24 volts, 0.038 Max. Amp) with resistor on 120-220-440 volts. Overall dia. Lens-Cap 3/4".

LIST PRICE (less bulb) 70c.

Write Today for Catalogue

The H. R. KIRKLAND-CO., Morristown, N. J.

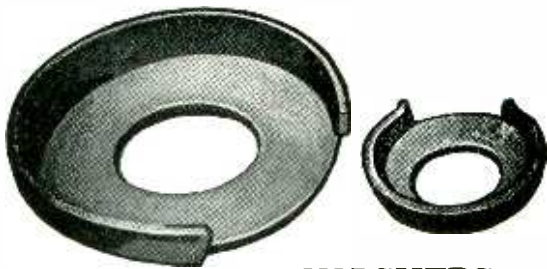

CUP WASHERS
for Binding Screws

Preferred

as a source of precision-made WASHERS and STAMPINGS manufactured to your specifications

WHITEHEAD STAMPING CO.

1691 W. Lafayette Blvd.

Detroit 16, Michigan



for Results



**If You Are Having Difficulty
Maintaining Your Mailing Lists...**

Probably no other organization is as well equipped as McGraw-Hill to solve the complicated problem of list maintenance during this period of unparalleled change in industrial personnel.

McGraw-Hill Mailing Lists cover most major industries. They are compiled from exclusive sources, and are based on hundreds of thousands of mail questionnaires and the reports of a nation-wide field staff. All names are guaranteed accurate within 2%.

When planning your direct mail advertising and sales promotion, consider this unique and economical service in relation to your product. Details on request.

McGraw-Hill Publishing Co., Inc.
DIRECT MAIL DIVISION

330 West 42nd Street

New York, 18, New York

Coming Next Month

free to every **ELECTRONICS** subscriber—an additional issue... the

**1946-47 ELECTRONICS
BUYERS' GUIDE ISSUE**

A complete and authentic directory of products and manufacturers for year-round buying reference—In an entirely new form with a new method of indexing to make for quick and easy use plus new product and literature information, reference material of the type the electronic engineer needs every day, and informative, catalog-type advertisements by the leading manufacturers in the electronic field.

INDEX TO ADVERTISERS

	Page
Accurate Spring Mfg. Co.	257
Ace Manufacturing Corporation	282
Acheson Colloids Corporation	43
Acme Electric & Mfg. Co.	204
Acro Electric Co.	182
Adams & Westlake Company	76
Advance Electric & Relay Co.	282
Aerovox Corporation	34
Aireon Manufacturing Corporation	18, 19
Air-Track Manufacturing Co.	323
Aladdin Radio Industries, Inc.	51
Allegheny Ludlum Steel Corp.	195
Allen-Bradley Co.	279
Alliance Manufacturing Company	49
Allied Control Co., Inc.	193
Allied Radio Corp.	290
Allis-Chalmers Mfg. Co.	4, 5
Alpha Metals, Inc.	323
Altec-Lansing Corporation	196
American Brass Co.	188
American Gas & Chemical Co.	319
American Lava Corporation	211
American Phenolic Corp.	183
American Platinum Works	325
American Screw Co.	62
American Television & Radio Co.	311
American Transformer Co.	78
Amperite Co.	176
Andrew Co.	200
Armstrong Electric Co.	331
Arnold Engineering Co.	226
Art Wire & Stamping Co.	319
Astatic Corporation	25
Atlas Sound Corporation	302
Atlas Tool & Designing Co.	40
Audak Co.	339
Audio Devices, Inc.	68
Automatic Electric Sales Corporation	46
Automatic Mfg. Corporation	38
Baer Company, N. S.	316
Ballantine Laboratories, Inc.	184
Barber Laboratories, Alfred W.	326
Beach-Russ Company	168
Beaver Gear Works, Inc.	248
Bell Telephone Laboratories	277
Bentley, Harris Mfg. Co.	197
Bird Electronic Corporation	202
Birnbach Radio Co., Inc.	300
Blaw-Knox Company	206
Bogen Co., Inc., David	276
Boland and Boyce, Inc.	261
Bone Engineering Corp.	29
Boonton Radio Corp.	86
Brach Mfg. Corp., L. S.	286
Bradley Laboratories, Inc.	266, 292
Brand & Co., William	65
Bud Radio, Inc.	322
Burlington Instrument Co.	198
Burstein-Applebee Co.	311
Callite Tungsten Corp.	85
Cambridge Thermionic Corporation	317
Capitol Radio Engineering Institute	252
Cardwell Mfg. Corp., Allen D.	244
Carter Motor Co.	268
Celanese Corporation of America	169
Cellusuede Products, Inc.	306
Centralab, Div. of Globe-Union, Inc.	20
Chatham Electronics	205
Cherry Rivet Company	216
Chicago Transformer Corp.	303
Cinaudagraph Speakers, Inc.	18, 19
Cinch Mfg. Corp.	157
Clare & Co., C. P.	41
Clarostat Mfg. Co., Inc.	259
Clippard Instrument Laboratory, Inc.	300
Cohn & Co., Sigmund	276
Collins Radio Co.	167
Communication Measurements Laboratory	250
Concord Radio Corporation	13
Condenser Products Company	321
Consolidated Molded Products Corp.	233
Continental-Diamond Fibre Co.	165
Cornell-Dubilier Electric Corp.	21
Corning Glass Works	56, 57
Cornish Wire Company, Inc.	246
Cossor, Ltd., A. C.	172
Cramer Co., Inc., R. W.	320
Cross, H.	331
Crystal Research Laboratories, Inc.	176
Dalis, Inc., H. L.	304
Daven Company	Inside Back Cover
De Mornay Budd, Inc.	181
Deutschmann Corp., Tobe	2
Dial Light Co. of America, Inc.	298
Dinion Coil Co., Inc.	304
Dixon's Typhonite ELDORADO Pencils	40a

	Page
Dongan Electric Mfg. Co.	327
Driver-Harris Co.	81
Dumont Electric Corp.	8
DuMont Laboratories, Inc., Allen B.	37, 54
du Pont de Nemours & Co. (Inc.), E. I.	17
Durez Plastics & Chemicals, Inc.	173
DX Radio Products Co.	311
Eastern Air Devices, Inc.	213
Eastern Electronics Corp.	255
Eastern Engineering Co.	294
Eastman Kodak Company	179
Eby, Inc., Hugh H.	215
Eisler Engineering Co.	317, 331
Eitel-McCullough, Inc.	89
Electrical Industries, Inc.	324
Electrical Insulation Co., Inc.	294
Electrical Reactance Corp.	272
Electro Motive Mfg. Co.	67
Electro Products Laboratories	330
Electronic Engineering Co., Inc.	278
Electronic Laboratories, Inc.	52
Electronic Measurements Co.	210
Electronic Mechanics, Inc.	219
Electronic Prototypes	180
Electronic Specialties Mfg. Co.	325
Electronics Research Publishing Co.	309
Electrons, Inc.	32
Erie Resistor Corp.	10
Essex Electronics	337
Essex Wire Corporation	297
Fairchild Camera & Instrument Corp.	267
Federal Tel. & Radio Corp.	47, 249
Fenwal, Inc.	22
Ferranti Electric, Inc.	42
Finch Telecommunications, Inc.	242
Fish-Schurman Corporation	315
Franklin Airloop Corp.	241
Franklin Fibre-Lamitex Corp.	224
Freed Radio Corporation	315
Freeland & Olschner Products, Inc.	331
Garrett Co., Inc., George K.	11
Gear Specialties	53
General Aniline & Film Corporation	82, 83
General Cable Corporation	58, 59
General Cement Mfg. Co.	331
General Electric Co.	14, 15, 39, 203, 258, 278, 319
General Industries Co.	288
General Magnetic Corp.	311
General Plate Div. of Metals & Controls Corp.	243
General Radio Company	265
Glaser Lead Co., Inc.	307
Goodrich Chemical Co.	340
Gothard Manufacturing Company	264
Gould-Moody Co.	280
Graphite Metallizing Corp.	298
Gray Manufacturing Co.	330
Guardian Electric Mfg. Co.	191
Guthman & Co., Inc., Edwin I.	186
Hammarlund Mfg. Co., Inc.	6
Handy & Harman	296
Hardwick, Hindle, Inc.	290
Harris Products Co.	309
Harrison Radio Corporation	318
Harvey Radio Company	266
Harvey Radio Laboratories, Inc.	237
Haydon Company, A. W.	232
Hermaseal Company, Inc.	235
Hewlett-Packard Company	247
Heyman Manufacturing Co.	328
Hopp Press, Inc.	264
Hytron Radio & Electronics Corp.	73
Illinois Condenser Co.	317
Imperial Tracing Cloth	272
Indiana Steel Products Co.	66
Industrial Transformer Corporation	309
Insl-X Co., Inc.	192
Instrument Resistors Company	308
International Nickel Co., Inc.	251
International Resistance Company	161
Irrington Varnish & Insulator Co.	217
Jack & Heintz Precision Industries, Inc.	70, 71
Janette Mfg. Co.	248
Jelliff Mfg. Corp., C. O.	228
Jensen Radio Manufacturing Co.	33



MIDGET
I.F.
TRANSFORMER

for
PERSONAL RADIOS

Specifications:

- INPUT and OUTPUT
- IRON CORE
- 456 KC.
- 3/4" x 3/4" x 2" high

Orders accepted for
PROMPT DELIVERY

Precision manufacturers of all
types of IF and RF coils,
chokes, and transformers.

ESSEX
ELECTRONICS

1060 Broad St., Newark, N. J.

NOW
Specially Designed Heat Control
added to
LECTROHM SOLDER POTS

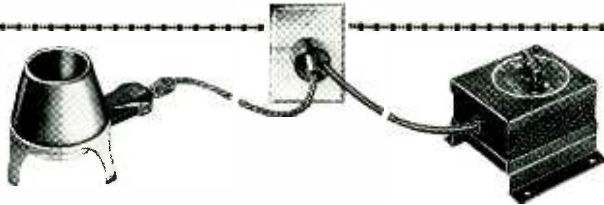

Lectrohm 1 1/4 lb. and 2 lb. capacity Solder Pots, widely used for individual operator production-tinning of small wires, leads, etc., may now be controlled by a further reduction of their original low wattage. Life of element is greatly increased. Control permits accurate maintenance of soldering temperatures for various types of solders and reduces oxidation of soldering iron tips. Solder Pots and controls may be had separately. This new control is ideal for use with other heating appliances such as glue or wax pots, etc., not exceeding rating of 250 watts. Ask for complete information.

See these and Lectrohms Resistors Booth 63—Radio Parts Show—Chicago



5127 West 25th Street, Cicero 50, Illinois
 Division of the National Lock Washer Co., Newark, N. J.



for Radio Components....

call NORMAN H. LAWTON

ENGINEERING • SALES • SERVICE

NEW YORK: 1775 Broadway, 19 INDIANAPOLIS: 635 Pennsylvania St., 4
 DIRECT FACTORY REPRESENTATIVE

- A. W. FRANKLIN MFG. CORPORATION—Sockets . . . Terminal Strips . . . Plugs . . . Assemblies.
- ELECTRO-MOTIVE MFG. CORPORATION—Moulded Mica Capacitors . . . Mica Trimmer Capacitors Fused Plugs . . . etc.
- F. W. SICKLES COMPANY (Eastern Representative)—I. F. Transformers . . . Antenna Loops . . . Trimmer . . . Condensers (mica and air dielectric) . . . Tuning Units
- QUAKER CITY GEAR WORKS—Precision Gears for Industry.
- UNITED TRANSFORMER COMPANY—Transformers
- MICA PRODUCTS COMPANY—Mica Sheets and Fabricated Parts

	Page
Johnson Co., E. F.	262
Jones Co., Howard B.	318
Kable Engineering Co.	331
Karp Metal Products Co., Inc.	63
Kester Solder Co.	254
Keuffel & Esser Co.	3
Kings Electronics Co.	322
Kinney Manufacturing Company.	194
Kirkland Co., H. R.	336
Kurman Electric Co.	313
Kwikheat Division, Sound Equipment Corp.	327

Lampkin Laboratories	331
Lapp Insulator Co., Inc.	35
Lawton, Norman H.	338
Leach Relay Company.	225
Lectrohm, Inc.	338
Lewis Electronics	18, 19
Linde Air Products Co.	80, 302
Lord Manufacturing Co.	44

MacRae's Blue Book.	325
Maguire Industries, Inc.	26, 27
Makepeace Company, D. E.	36
Mallory & Co., Inc., P. R.	90, 159
MB Manufacturing Co., Inc.	9, 281
McGraw-Hill Book Co.	321
McLaughlin, J. L. A.	331
Measurements Corporation	312
Meyercord Company	229
Micro-Ferrocarr Products, Div. of Maguire Industries, Inc.	293
Midwest Molding & Mfg. Co.	313
Milford Rivet & Machine Co.	178
Millen Mfg. Co., Inc., James.	260, 285
Miller Transformer Co., Inc., B. F.	12
Miniature Precision Bearings.	331
Minnesota Mining & Mfg. Co.	221
Mitchell-Rand Insulation Co., Inc.	77
Monitor Controller Co.	228
Murdock Co., William J.	280
Mycalex Corporation of America.	87

National Moldite Company.	230
National Varnished Products Corporation.	40b
National Vulcanized Fibre Company.	185
North American Philips Co., Inc.	177

Ohmite Mfg. Company.	209
Onan & Sons, D. W.	258
O'Neil-Irwin Mfg. Co.	308
Oster Manufacturing Co., John.	328
Owens-Corning Fiberglas Corporation.	74, 75

Palnut Company, The.	292
Park Metalware Co., Inc.	325
Parker-Kalon Corp.	16
Par-Metal Products Corporation.	312
Patton-MacGuyer Co.	302
Permo, Inc.	313
Permoflux Corporation	218
Petersen Radio Co.	336
Phillips Screw Manufacturers.	263
Pioneer Electric Co.	304
Plaskon Div., Libbey, Owens, Ford Glass Co.	271
Plax Corporation	269
Portable Products Corporation, Paul & Beekman Div.	301
Precision Tube Co.	222
Premier Metal Etching Co.	314
Press Wireless Mfg. Corp.	223
Presto Recording Corp.	79
Price Electric Corporation.	275
Progressive Mfg. Co.	286
Pyroferic Co.	274

Quadrige Manufacturing Co.	306
Quaker City Gear Works, Inc.	220

Radio City Products Co., Inc.	253
Radio Condenser Co.	61
Radio Corp. of America, Victor Div. Back Cover	261
Radio Maintenance Magazine.	214
Radio Receptor Co., Inc.	296
Radio Specialty Mfg. Co.	314
Radio Supply & Engineering Co., Inc.	310
Radio Wire Television, Inc.	171
Rauland Corporation	314
Rawson Electrical Instrument Co.	174
Research Engineering Corp.	22
Revere Copper & Brass, Inc.	212
Richardson Company	268
Rider Publisher, Inc., John F.	500
Robinson Aviation, Inc.	283
Rockbestos Products Corp.	309
Ruby Chemical Company.	309

	Page
Schweitzer Paper Co.	199
Scientific Electric Div. of "S" Corrugated Quenched Gap Co.	207
Scovill Mfg. Co., Waterville Screw Prod- ucts Div.	163
Segel Co., Henry P.	323
Shallcross Manufacturing Co.	170
Shur-Antenna-Mount, Inc.	319
Sigma Instruments, Inc.	310
Sillcocks-Miller Co.	196
Simpson Electric Co.	30, 31
Skydyne, Inc.	321
Small Motors, Inc.	270
Sola Electric Co.	45
Solar Manufacturing Corp.	88
Sperry Gyroscope Co., Inc.	189
Sprague Electric Co.	28
Stackpole Carbon Co.	175
Stamford Metal Specialty Company	325
Standard Piezo Company	315
Standard Pressed Steel Co.	64
Standard Transformer Corp.	166
Star Expansion Products Co.	317
Star Porcelain Co.	304
Stevens-Walden, Inc.	318
Steward Mfg. Co., D. M.	296
Stewart Mfg. Corp., F. W.	306
Struthers-Dunn, Inc.	60
Stupakoff Ceramic & Mfg. Co.	50
Sun Radio & Electronics Co.	274
Superior Electric Co.	164
Superior Tube Co.	289
Supreme Instruments Corp.	288
Surprenant Electrical Insulation Co.	260
Sylvania Electric Products, Inc.	23, 287
Synthane Corporation	32a, 32b

Taylor Fibre Co.	69
Tech Laboratories	315
Teleso Products Co.	305
Thermador Electrical Mfg. Co.	262
Thomas & Skinner Steel Products Co.	319
Tinnerman Products, Inc.	201
Triplet Electrical Instrument Co.	295
Tung-Sol Lamp Works, Inc.	187
Turner Company, The	55

Ucinite Company	72
Union Carbide & Carbon Corp.	80, 302
United Cinephone Corporation	299
United Electronics Co.	84
United Transformer Corp.	Inside Front Cover
University Loudspeakers, Inc.	316

Van Deventer, Inc., H. R.	323
Victoreen Instrument Co.	270
Vokar Corporation	306

Waldes Kohinoor, Inc.	245
Walker-Turner Co., Inc.	313
Wall Street Journal	291
Ward Leonard Electric Co.	24
Waterman Products Co.	302
Welch Scientific Co., W. M.	234
Weller Mfg. Co.	320
Western Electric Co.	48
Westfield Metal Products Co., Inc.	326
Weston Electrical Instrument Corp.	231
Whistler & Sons, Inc., S. B.	7
White Dental Mfg. Co., S. S.	273, 324
Whitehead Stamping Co.	336
Winchester Company, The	239
Workshop Associates, Inc.	328

PROFESSIONAL SERVICES 329

SEARCHLIGHT SECTION
(Classified Advertising)

EMPLOYMENT	332-333
SPECIAL SERVICES	333
USED EQUIPMENT	333-335
American Electric Sales Co., Inc.	334
Communications Equipment Co.	334
Communication Measurements Laboratory	334
Electro-Tech. Equipment Co.	333
Hazleton Instrument Co.	334
Iron & Steel Products Inc.	333
Maritime Switchboard	335
Remler Co. Ltd.	334
Tab	333
Webber Dental Mfg. Co.	334
Westchester Electronic Products	334

5 letter-word for PICK-UP PERFORMANCE

Audax



... the substantially unani-
mous verdict of experts and
music lovers who have put the

RELAYED-FLUX
Microdyne

to the only test that really
matters ... the **EAR TEST**

*"The Standard
by Which
Others
Are Judged
and
Valued"*

SPECIALIZATION

has made AUDAX a leader in its field. World-wide recognition such as ours could never "just happen". Rather it is the product of KNOW-HOW that comes only through years of specialization.

For twenty years—since pick-ups first became important commercially—the distinguished products of AUDAX have been SELECTED wherever the requirements were exacting.

The leadership which we have won the hard way will never be jeopardized by making pick-ups a side line. Of future MICRODYNE improvements—and of course we are planning them now—we can tell you one thing NOW:—They will uphold and carry forward the AUDAX quality tradition of *fac-simile* performance, regardless of external conditions.

Send for complimentary copy of
"PICK-UP FACTS"

AUDAX COMPANY

500 Fifth Avenue,

New York 18

"Creators of Fine Electronic-Acoustical Apparatus since 1915"

It's so-o-o small ➡

It's so-o-o big ➡

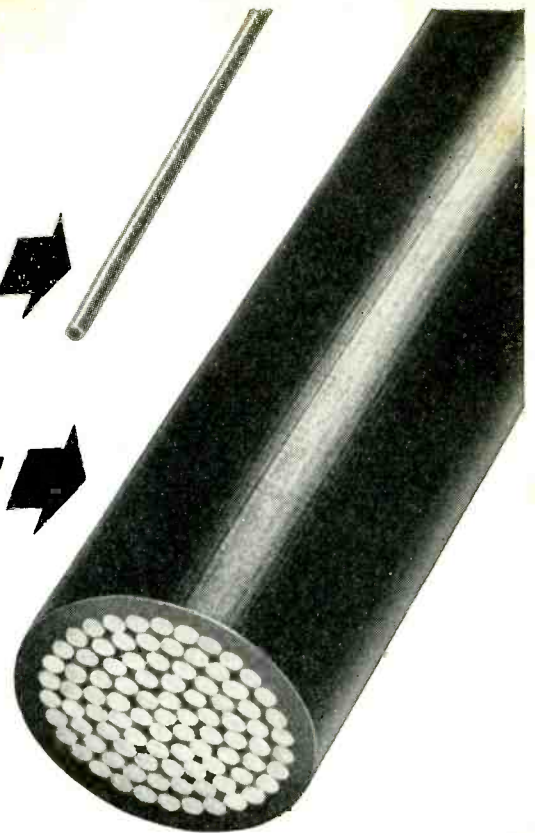

Insulation and jacketing made from **Geon**

SLIP-ON spaghetti for radio hookup wire on the left—insulated 2,000,000 circular mil cable on the right—show the broad range of applications for insulation made from GEON.

This versatility is possible because of GEON's many unusual and valuable properties. Excellent electrical properties lead the list, of course. And that permits a thinner coating of insulation. That, in turn, means more conductors per conduit or smaller holes to be bored. In instrument wiring it means easier handling, faster work. Insulation made from GEON resists most

normally destructive factors—oil and grease, acids and most other chemicals, ozone, sunlight, aging, abrasion, flexing, heat, cold, water, and many others. And it can be brilliantly—and permanently—colored in the entire NEMA range.

Wire insulated with GEON is now being made by leading wire and cable manufacturers. The next time you order wire—for instrument, industrial, domestic, or utilities wiring, be sure to specify *wire insulated with GEON*. For more in-

formation please write Department F-5, B. F. Goodrich Chemical Company, Rose Bldg., Cleveland 15, Ohio
In Canada: Kitchener, Ontario.



B. F. Goodrich Chemical Company

A DIVISION OF
THE B. F. GOODRICH COMPANY

DAVEN

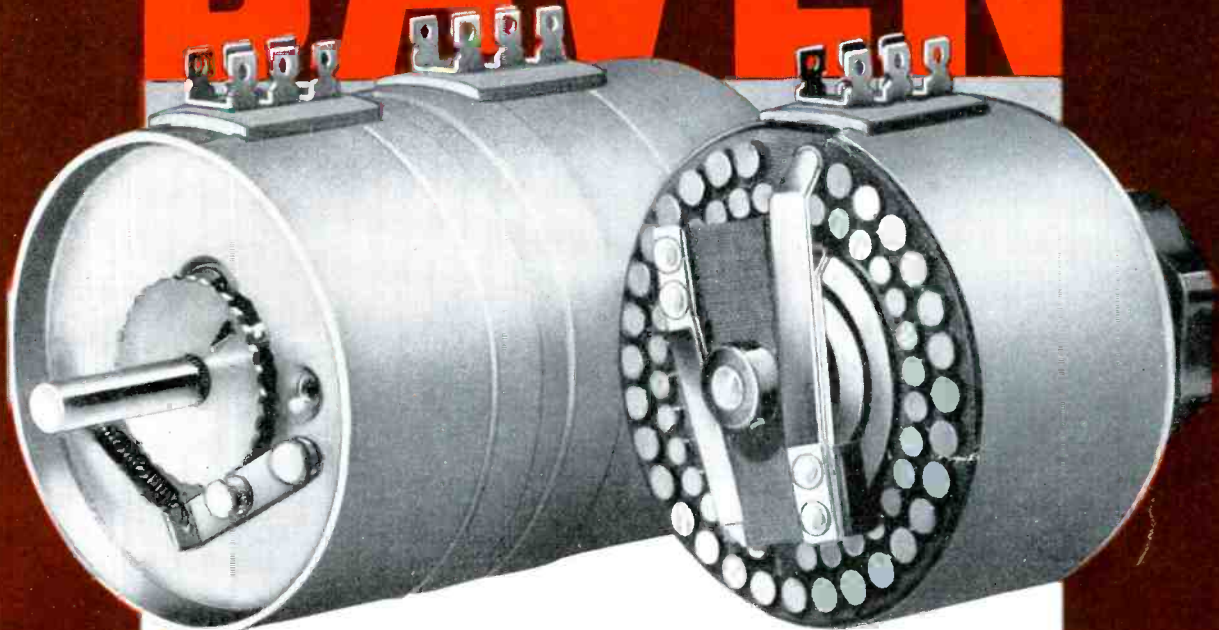

PRESENT DELIVERY SCHEDULES ON DAVEN ATTENUATORS

Despite the current supply situation, we are pleased to announce that our present production schedules assure rapid deliveries of many types of Daven Attenuators. For example, some of our stock items are available for immediate delivery. Reasonably prompt shipments are provided on standard units. Consult us on deliveries of special units. We will do our best to fill your needs as quickly as possible.

THE **DAVEN** CO.

191 CENTRAL AVENUE
NEWARK 4, NEW JERSEY

FEATURES OF DAVEN ATTENUATORS

DETENT GEAR: Large gear and roller mounted in recessed front end of cover, separate from resistive network, gives accurate indexing.

CERTAIN STOP: Extrusions of detent gear and steel attenuator cover form sturdy stop to rotation, eliminating rotor-hub strain of previous method.

IMPROVED SHIELDING: Sturdy, snug-fitting steel cover affords superb electrical and dust shielding and greater all-around ruggedness.

CAPTIVE TERMINAL BOARD: Bakelite board held securely in position, readily released; new, heavy duty solder lugs.

ANTI-FUNGUS TREATED: On request.

SILVER ALLOY CONTACTS: Switch arm contacts and returns made of special silver alloy lowers internal resistance. Other metals optional.

SEPARABLE COUPLINGS: (Feature of dual and multiple unit models) units easily separated for quick access to switch assemblies; simple, durable, foolproof.

WRITE FOR THE COMPLETE DAVEN CATALOG ON YOUR COMPANY STATIONERY

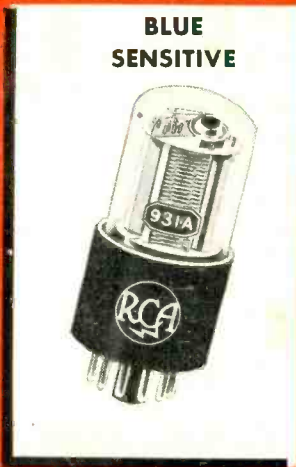

BLUE SENSITIVE

RCA-931-A. Current amplification is 1,000,000. Has S-4 spectral response. Maximum response at 4200 Angstroms. Range, approximately 3000 to 7000 Angstroms.

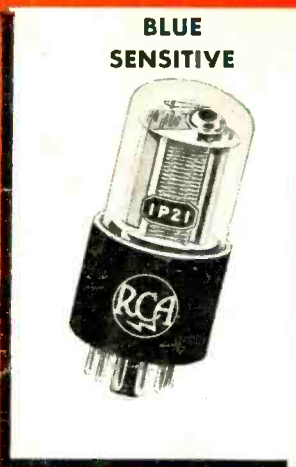

BLUE SENSITIVE

RCA-1P21. Current amplification is 2,000,000. Has S-4 spectral response. Maximum response at 4200 Angstroms. The tube has extremely low dark current.



BLUE-GREEN-RED SENSITIVE

RCA-1P22. Current amplification is 200,000. Has S-8 spectral response. Maximum response at 4200 Angstroms. Range, approximately 3000 to 7500 Angstroms.



ULTRAVIOLET SENSITIVE

RCA-1P28. Current amplification is 200,000. Has S-5 spectral response. Maximum response at 2537 Angstroms. The tube has extremely low dark current.

RCA Multiplier Phototubes

For Measurement and Detection at Low Light Levels

THE extraordinarily high values of amplification obtainable from RCA Multiplier Phototubes make them particularly applicable to the measurement and detection of weak illumination in the fields of science and industry. Because of the high gain, amplifier stages are not required, resulting in an improved signal-to-noise ratio at very low light levels.

Because the photocurrent produced at the light-sensitive cathode is multiplied many times by secondary emission occurring at successive dynodes, multiplier phototubes are capable of multiplying feeble currents produced under weak illumination *hundreds of thousands of times*. The resultant output current is a *linear function* of the exciting illumination under normal operating conditions. Since secondary emission occurs almost instantaneously, *frequency response is flat* up to frequencies at which capacitance effects become the limiting factor.

The characteristics of the RCA-931-A Multiplier Phototube make it particularly suitable to light-operated

relay circuits, sound reproduction from films, facsimile transmission and scientific research. The extreme sensitivity of the RCA-1P21 suggests its use in scientific research involving exceedingly weak light radiation. The RCA-1P22 is especially useful in colorimetry and spectroscopy, sound-on-film applications and light-operated relay circuits. The RCA-1P28 is intended for specialized industrial and scientific applications involving weak ultraviolet radiation.

RCA tube application engineers are ready to assist you in the adaptation of these or any other RCA tube types to commercial, scientific, or industrial electronic equipment. Technical data sheets on the phototubes illustrated are available and may be obtained upon request. Address your inquiries to RCA, Commercial Engineering Department, Section D-6E, Harrison, N. J.

TWO NEW PHOTOTUBES WITH LOW-LOSS BASES

The RCA 1P39 and 1P40 phototubes are provided with non-hygroscopic bases which insure a value of resistance between anode and cathode pins about 10 times higher than conventional bases under adverse operating conditions of high humidity. As a result, more output for a given light input is obtainable under high-humidity conditions.

RCA-1P39 is a high-vacuum phototube similar to the 929. It has very high sensitivity to light sources predominating in blue-radiation, and has negligible sensitivity to infrared radiation. It is particularly adaptable to light-operated relay circuits, measurement, and color-control applications.



RCA-1P40 is a gas phototube similar to the 930. It has high response to red and near infrared radiation. Because of its high sensitivity, it is recommended for use in sound-on-film equipment, light-operated relays, and light-measurement devices employing an incandescent light source.



The Fountainhead of Modern Tube Development is RCA



TUBE DEPARTMENT

RADIO CORPORATION of AMERICA

HARRISON, N. J.