

CROSS TALK

AR . . . On May 18 FCC required possessors of diathermy apparatus, including equipment in stock, to register the apparatus with the commission. There are an estimated 100,000 units capable of dangerous communication, although performing meritorous service in other capacities, were brought under the regulatory powers of the government communications agency. War had accomplished something that peace had not. Several industry-wide meetings of communications and medical people had been held in past years seeking to find a way by which the troublesome emission of the medical apparatus could be prevented from creating havoc on communication channels. There is every belief now that some definite policy can be effected regarding these important electronic devices. Actual registry was required to be completed by June 8, but extended to June 22.

Louisiana a doctor was ordered to stop operating an x-ray machine that interfered with aircraft communication. This may be a precedent which will lead to start a cleanup of many ether users which have bothered communications people no end. For years your club has suffered a distinct blank space of many megacycles in his region where the interference from radio eliminators on nearby printing presses created an uproar. These devices operate at high voltage and produce sparks which could easily be keyed if the old spark transmitters could be keyed.

Utilities and industrial concerns have been advised to exercise caution about purchasing or installing blackout mask- ing warning devices until the several governing bodies have settled the basic requirements. The warning has been issued on the basis that it is futile to install equipment which may not satisfy the and regulations soon to be issued. This will apply, presumably, to the electronic types of devices offered on the

market, either speculatively (we'll build it if you order it) or from actual stock.

On June 9, the FCC ordered that everyone owning a radio transmitter who does not hold a station license for it to register the machine with the FCC. Our own rig (W2GY, W2EJ et al) of past days long ago fell apart in the garage under the joint action of the weather and ants which, somehow, got into the wooden base and pried the components apart. Rust took care of the metal parts. We hope no license is required.

On May 19, OPA excluded from the General Maximum Price Regulation sales of Brazilian rock quartz crystals. This meant that the Government or its agencies can buy quartz crystal at prices higher than established maximum levels. On the previous day WPB had placed the sale of quartz crystals under such control that they could be used only for products for use as implements of war for the Army, Navy, Government agencies or Lend-lease, as oscillators and filters for use in radio systems operated by Federal agencies or commercial airlines and as telephone resonators.

► JINX . . . There is, around every editorial office, a jinx. Sometimes he parks in someone's memory; sometimes he goes to see the printer; there are always plenty of places between writing copy, editing it, setting it in type, proof reading it once or twice, printing it in cold type where the jinx can get in his licks.

As a useful addition to Mr. Sasso's article in July on "Plastics as Dielectrics" the editors prepared a list of manufacturers and suppliers of plastics. On the copy to the printer was the name of Plax Corporation of Hartford, makers of polystyrene high frequency communication components. Either the typesetter did not set this material, or

the jinx threw the type away or something; anyhow it did not appear on page 67 under G where it belonged.

Usually jinx picks on our best friends; this time he worked on a new friend who, we hope, will not think we treat all new friends in this apparently cavalier manner.

► PERSONNEL . . . A wartime manpower board, WMC, soon will step into the situation regarding scarcity of skilled manpower. It is not certain, yet, how far this commission will go toward controlling movements of men from place to place, toward killing the raiding that goes on, toward getting good employers and good employees together, but something is urgently needed. Much time is spent by ELECTRONICS staff, willingly but not always efficiently, in trying to find skilled men for various government and government-sponsored privately-controlled jobs. A further expenditure of time and effort goes trying to find places for men who wish to serve their country as civilians or in uniform but who do not know where to turn. Most of these men are highly trained and in great demand, and it is only natural that each man wants to know where his talents will best serve. If he gets into the wrong place he is more or less stuck and someone else, needing him badly, cannot get him. Some agency to coordinate all this sort of thing would help tremendously.

► A-1-A . . . ELECTRONICS is the proud possessor of an order of this high rating for reprints of its UHF Technique articles as published in the April issue. With the same solemnity and the same number of signatures of civilians and army officers that would purchase an antitank gun, a batch of reprints was ordered.

Tobruk fell yesterday.

Broadcasting Under War Conditions

Technical operation of broadcast stations adversely affected by wartime shortages of equipment and engineering personnel. Pooling arrangement and strict maintenance urged to conserve existing reserves. Replacement of equipment is critical problem.

THE effects of war conditions on the broadcast industry are demanding the most careful consideration of both operating and regulatory bodies at the present time. From the standpoint of technical operations these problems are primarily twofold, although additional factors sometimes enter to affect the operation of broadcast stations adversely. The main problems are: (1) difficulty in obtaining replacement tubes and repair parts due to the high priorities required, and (2) shortage of technical operators and engineers. Unless some way is devised to care for their future needs, broadcast stations may face eventual shutdown in cases of equipment failures.

The equipment and tube shortage is brought on because all manufacturers of transmitting equipment and tubes are extraordinarily affected by the war. All are carrying a heavy defense load, with the result that the A-10 priority rating formerly assigned to broadcasting for maintenance and repair became practically worthless for obtaining tubes and other equipment. Recognizing this condition, WPB issued its order P-129 on April 23, 1942, assigning an A-3 rating for critical materials needed for maintenance and repair. However, because of the increasing scarcity of critical materials, it appears that the A-3 rating is little better than the former A-10 rating when it comes to the purchase of transmitting tubes. This is borne out by the following extract from a form letter received from one tube manufacturer immediately after the P-129 order became effective:

"The critical nature of many essential materials required in the manufacture of transmitting tubes is such as to make it impossible for us to replenish our stock under the A-3 rating. Under these circumstances we shall continue to supply tubes wherever possible against your or-

By **J. B. EPPERSON,**

*Chief Engineer
Scripps-Howard Radio, Inc.*

and **BEVERLY DUDLEY**

*Acting Managing Editor,
Electronics*

ders when covered by the A-3 rating. We feel that you should be advised, however, that for reasons aforementioned, we can fill such orders only provided we have the materials available and we do not have any other unfilled orders bearing higher ratings. It will also be impossible for us to commit ourselves to definite delivery unless the preference rating be sufficiently high to enable us to use it in the purchase of additional materials."

With few exceptions, broadcast stations have managed to keep their equipment in a satisfactory operating condition, but this has been accomplished largely at the expense of reserve stocks of materials. There can be no doubt that the demands on equipment manufacturers have not yet reached their maximum and that it will be necessary to devise some way by which it will be possible to care for future demands of the industry.

Pooling Arrangement as Conservation Aid

To alleviate the shortage of equipment (especially tubes) and to assure that broadcast service will be maintained to the fullest, a "share the spare parts" program has been recommended by the Defense Communication Board (now the Board of War Communications). In brief, this proposal, released on May 24, calls for: (1) inventory of equipment of all stations, together with establishment of requirements of minimum equipment necessary to maintain operations, (2) establishment of conservation districts, each district to con-

tain enough stations so that a representative stock of parts is available in each and to be presided over by a civilian administrator and two assistants, (3) the district administrator and his assistants will be charged with the checking and control of the inventory stock in his district and the redistribution, on sales basis, of surplus equipment from one station to another.

Such a plan could operate only with the full co-operation of the broadcasters and this co-operation is assured by the fact that it originates with the broadcasters themselves and was prepared and submitted to the BWC by the Domestic Broadcasting Committee of the Board. It is believed that the operation should go a long way to relieve the priorities problem now confronting the 900-odd broadcasting stations in repair and maintenance materials.

It would appear that such a provision for conservation is not only ticklish in its administration, but is at best, only a temporary stop-gap. There is evidence that not all station operators are fully behind this plan since, it is pointed out, the "share the spare parts" program penalizes the well managed, conservatively operated stations for the benefit of the less efficient stations. Another difficulty with this program as initially outlined is that it makes no provision for the replacement of parts which may be used up in normal operation. Under a system of this sort, it is conceivable that all the broadcasting services of the country could disintegrate simultaneously, like the "One Horse Shay."

The lack of parts is of little concern for many recently modernized stations, or those near metropolitan centers of supply, but it is an increasingly difficult problem for the stations in areas remote from production facilities. A number of stations are unable to obtain such spare parts as condensers, resistors, sock-

transformers or repair parts for their transmitters. Extension of radio line facilities is hampered, and portable and remote amplifying equipment once damaged will probably not be replaced. This situation is being faced as a matter-of-fact problem whose solution must, somehow, be obtained.

Many stations have instituted a complete house cleaning program in which broken and obsolete parts from used equipment have been repaired or reclaimed for future use, even under restricted conditions. More rigid schedules of repair and maintenance are being enforced, and systematic maintenance is aided by assigning regular duties on a well planned time schedule. Most stations have reduced the filament voltage of tubes to obtain longer life, the amount of reduction being determined by limitations of audio distortion or power output. One station engineer reports that the life of tubes in his station has been increased from 4½ to 7 months through a procedure.

With regard to tubes, many broadcast operators are caught between the sharp points of a two-horned dilemma. On the one hand they are required by the standards of good engineering practice to maintain an adequate supply of replacement tubes. On the other hand, the heavy demand on tube production for military services makes it difficult or impossible to conform to these regulations. To alleviate the situation somewhat, some stations are reclaiming old tubes previously regarded as unsuitable for operation, but which can be pressed into service under a program of restricted materials. Other stations have experimented with the repair of old tubes. Some engineers feel that too little attention is being given to the rebuilding of transmitting vacuum tubes as a conservation measure. According to the statement of one company which has rebuilt several tubes, approximately 90 per cent of the defective transmitting tubes above 250 volts in size can be satisfactorily rebuilt. The cost of rebuilding a transmitting tube is ordinarily one-third that of a new tube of the same type. A rebuilt tube might even be better than a new one, providing the tube was originally built before substandard materials were employed.

Even more important than the shortages of tubes and other physical equipment is the shortage of technically qualified personnel for station operation. Through the exercise of additional maintenance and repair work, a station in normally good operating condition can be kept in satisfactory operation for a considerable length of time, with capable technical administration. But the technically trained operating and engineering personnel are vital to its operation and cannot be so easily replaced. Many stations are having difficulty in obtaining experienced technicians since so many have been absorbed by the various government services. The main difficulty arises from the necessity of placing inexperienced men in important positions, and the inability to find individuals with a background sufficiently adequate to become thoroughly trained in a short time.

Personnel Shortages, too!

There is no blanket deferment from military service of men engaged in station operation. Indeed, the broadcast industry has contributed many of its best technical personnel to the Army, or Navy, to various government administrative agencies, or to technical teaching and research jobs, all of which further the country's war effort. Certainly no one makes such a change without the fullest desire to be of maximum assistance, while those left to carry on are performing equally valuable (if less publicized) work in the additional duties imposed upon them. But several stations have lost heavily of their technical personnel, and are unable to replace licensed operators. The loss of technical personnel does create a serious question as to how the normal services are to be maintained or even extended with an ever-decreasing technical staff.

There are several partial solutions to the problem of personnel; none are completely satisfactory. Control room operators having operator's licenses but no transmitter experience, have been transferred to the operation of the transmitter, and have, in turn, been replaced by persons less experienced. Qualified individuals who, for one reason or another, are not likely to be called into military service, have been used wherever

possible. The shortage of personnel has, in some instances, led to out-bidding by various stations for the services of those still available. However, a more frequent and self-reliant approach seems to be that of training personnel for broadcast jobs by the NYA or other agencies. In several cases women have been trained as control room operators. It is too early to draw definite conclusions from the few cases in which women have actually been engaged in control room work, although there are indications that qualified women operators are entirely capable of discharging control room duties properly.

Concern has been expressed by some station managers that the necessity for employing less experienced personnel may force a relaxation of standards of operation which could become permanent. Under such conditions, those technically trained men now leaving the broadcast industry might be expected to find other careers for themselves after "the duration." Nevertheless, the opinion is frequently expressed that relaxation of certain standards of good engineering practice, especially with regard to requirements as to distortion tolerances and time off the air, will help materially in easing the present problems.

Several stations, especially the smaller ones, complain of loss of revenue at a time when prices are rising and additional services are required of their operating personnel. The monitoring of key stations for blackout warnings is a problem for some stations who have already lost heavily of their operators and find themselves operating with shoestring personnel. Protection of the station against possible invasion or bombing attacks, fire, lightning, or acts of sabotage requires additional vigilance, especially of stations near the territorial limits of the United States. The need for emergency service equipment, in the event of failure of regular equipment, is recognized by foresighted operators, but again difficulty is encountered in obtaining the necessary priority ratings for engine-driven generators and similar equipment.

Broadcasting forms an integral and important part in the lives of all in the United States. It is a powerful and important factor in knitting

(Continued on page 56)

Electronic WELDING

An introductory discussion of the design problems involved. Basic power circuits. Selection of tubes to fit the work. Phase shift current control. Timing methods. A commercial synchronous spot welding machine control

RESISTANCE WELDING is a broad term which can be subdivided into spot, seam, pulsation spot, projection, butt, and flash welding. As a procedure, it is well known but it did not come into general prominence until after the development of electronic control. Soon after electronic control was made available it became evident that existing jobs could be run faster and that many combinations and materials that previously could only be welded in the laboratory could be welded in production.

Why is electronic welding control so important? To answer this question, a few facts regarding welding machines must be given. To make a resistance weld, the two pieces to be welded must be held in close contact and under pressure. The weld is made by passing a definite amount of current through this joint for a definite period of time, causing the metal at the joint to soften and the

grains to interlock. The result is like a rivet in mechanical properties.

General Considerations

Current through the work will seldom be less than 1000 amperes and may be as high as several hundred thousand amperes. The metal sections in the current path are usually large, therefore the resistance is quite low. The mechanics of getting the pressure where it is needed usually call for a fairly long and large loop of conductor connected to the secondary of the welding transformer. This, together with the low resistance factor, means a highly inductive, low power-factor load. The power-factor range is from as low as 0.1 to as high as 0.9, with the average about 0.5. This brings out one very significant fact—the control must work satisfactorily over a wide range of power factor.

To generate the required heat at the joint, the time of application of the current must be precisely controlled. The increment of time when working with alternating-current is the cycle, therefore the timing is in terms of cycles of the supply frequency. This doesn't mean that the elapsed time is the equivalent of so many cycles. It means that time starts at a predetermined point on the supply voltage wave and ends at the corresponding current zero point so many cycles later.

Weld timers must operate differently for the different types of resistance welding. Spot and projection welding require a single impulse of power, adjustable from 1 cycle to 30 cycles, or $\frac{1}{2}$ second on a 60-cps power supply. Seam welding requires a series of power impulses spaced by a definite "off" time. Both

the "on" and the "off" time may be adjustable over a range of 1 to 30 cycles. Pulsation spot welding timers are similar to seam welding timers except that only a definite number of "on" times are permitted to pass and then the control is locked out and cannot start a new series of impulses until the spot initiating switch is operated. Such "counting control" is usually designed for operation over a range of from 1 to 10 power impulses.

The fact that the power factor is low, that the time is short and that the energy must be the same for each power application, dictates that for best performance welding power must be applied without transient. This feature is called synchronous starting and is a valuable contribution made by electronic control.

Tube Data

Welding controls must be designed to handle from a few hundred volt-amperes, for welding small parts, to 1000 or more kva, for welding heavy parts and structures. Ignitron tubes are commonly used to control large powers. These are mercury pool tubes with immersed starting electrodes. They are artificially cooled, usually by water. For the smaller welding jobs, hot cathode thyratrons are available. Both thyratrons and ignitrons are half-wave rectifiers, therefore two tubes must be used in an inverse parallel fashion to conduct both halves of the a-c wave. Figs. 1A and 1B each show two ignitrons connected in series with the primary of a welding transformer. Two such tubes make the equivalent of a single-pole, single-throw switch.

Ignitrons are rated for two conditions; first, the maximum current

SCHEDULED

Part 2

Electronic Controls for Seam, Pulsation and Special Welding Machines

Part 3

Magnetic and Electrostatic Energy-Storage Welding Machine Controls

Part 4

Checking Resistance Welding Controls With a Cathode-Ray Oscilloscope

CONTROL... Part 1

By H. L. PALMER

Electronics Section
Industrial Control Eng. Dept.
General Electric Co.
Schenectady

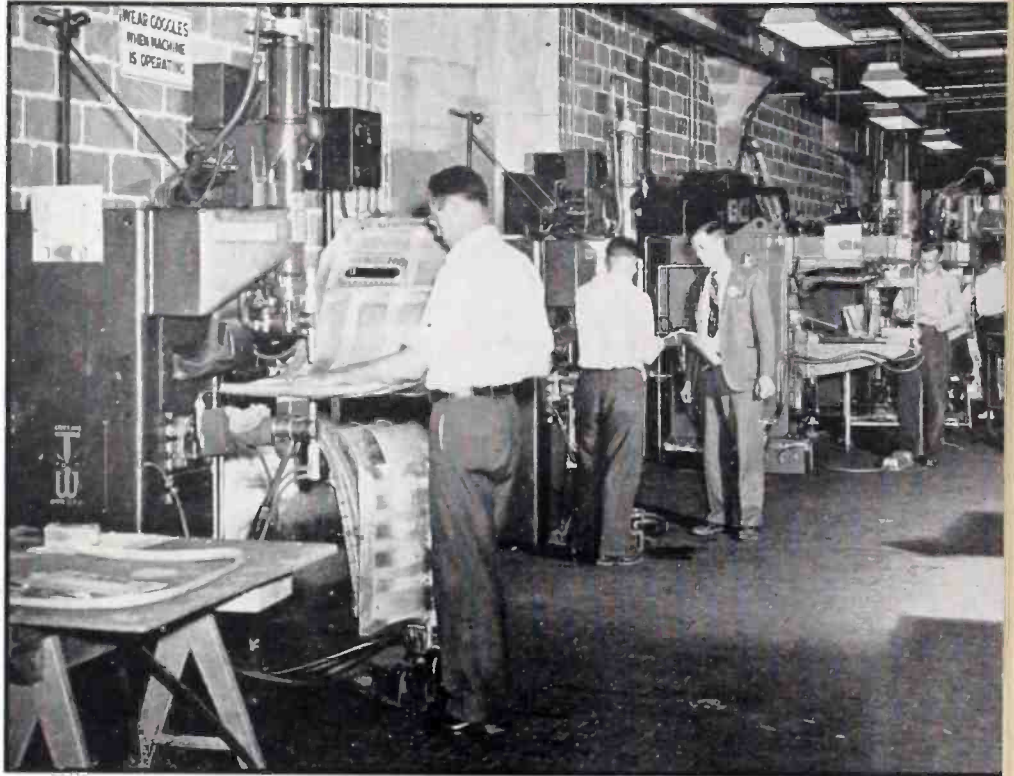

A-c type spot welding machines with synchronous welding control fabricate aluminum alloy parts in an eastern aircraft plant

It can be controlled regardless of the conditions of operation; second, the average current, or the equivalent continuous current, that can be controlled. These two limiting ratings are related to one another and can best be expressed by curves. A third condition, the voltage of the supply, also affects the other two, therefore a series of curves are required for different voltages. Ratings are usually expressed in terms of rms demand current against duty cycle. By duty cycle is meant the percentage of the total time current is passed by the tubes. The 200-300 volt and the 400-500 volt rating

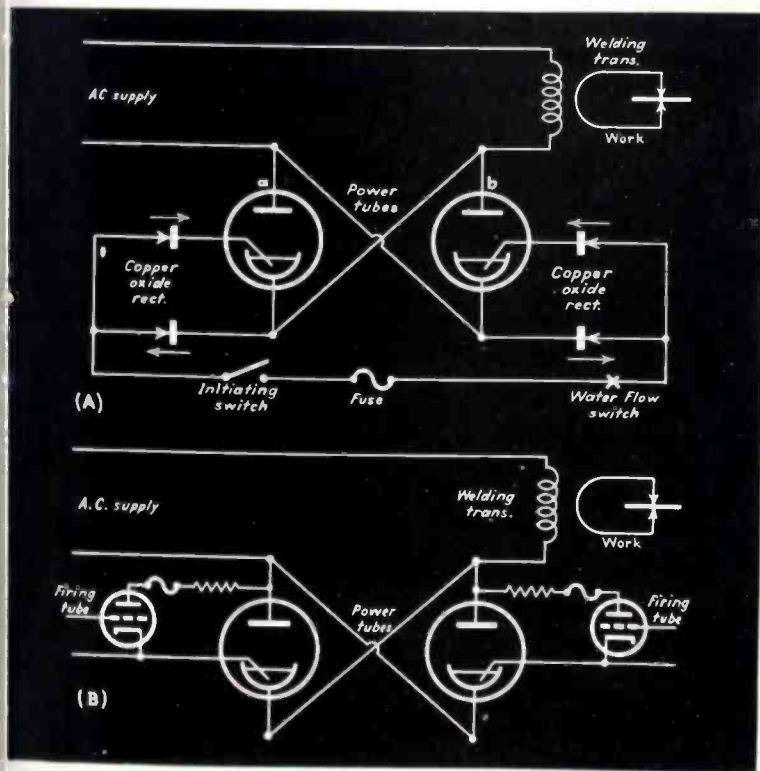

FIG. 1—(A) An electronic welding contactor without phase control or timing. (B) A power circuit used in many synchronously controlled systems, particularly where high voltage supplies are employed

curves for typical ignitrons available for welding control are given in Fig. 2. It should be noticed that on the curve for each size tube is given an averaging time, which is a measure of the thermal capacity of the tube as applied to its rating. This is the maximum time over which the duty cycle can be calculated. The maximum length of spot that can be allowed under the rating for any given value of welding current is the duty cycle for that particular value of current times the averaging time. This is the maximum allowable length of spot, regardless of how long the tube is off between spots. For example, consider the size C tube on 500 volts with a during-weld current of 1500 amps. The tube can operate with a spot length or "on" time of $0.15 \times 7.1 \text{ sec.} = 1.06 \text{ sec.}$, providing the tubes are allowed to remain idle 6.04 sec. It must also be remembered that any one spot must not be over 1.06 sec. even though the tube is off for an hour between spots. The 1.06-sec. "on" period does not have to occur

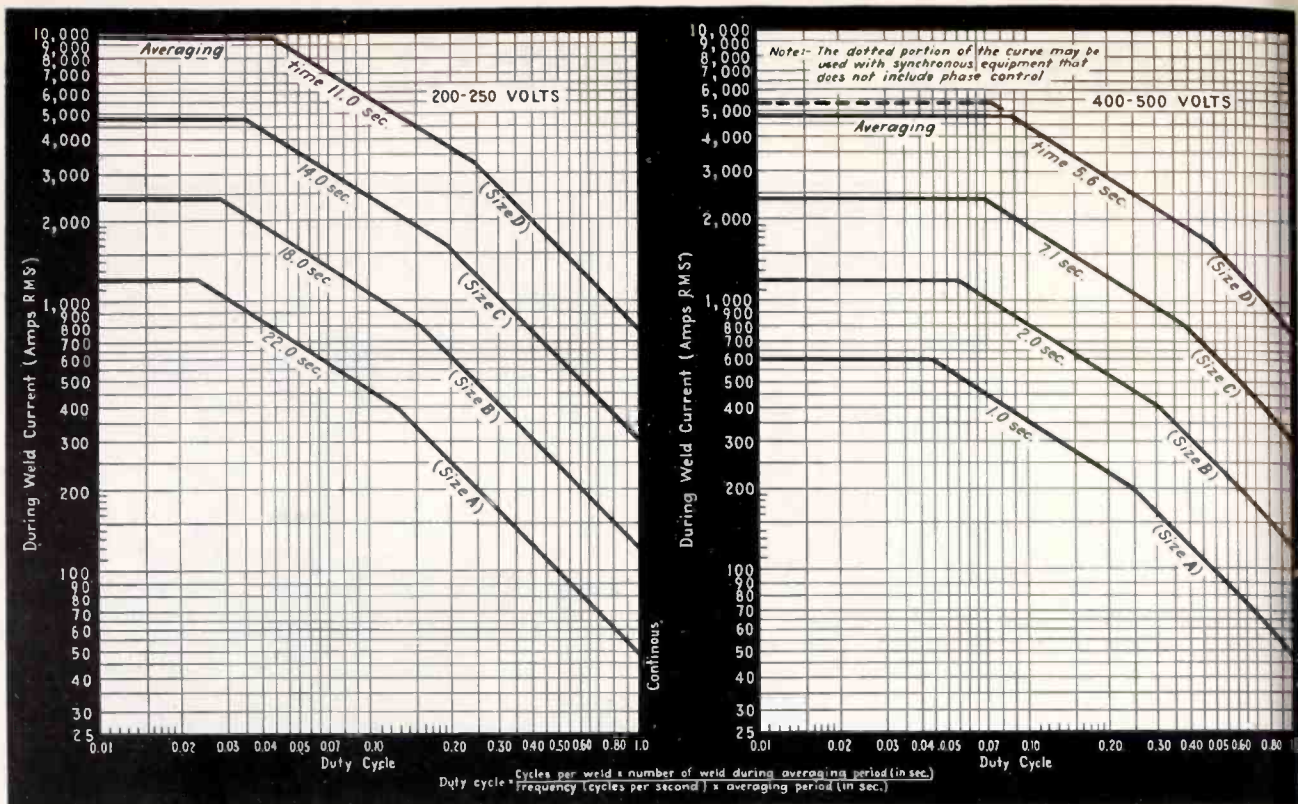

FIG. 2—Rating curves for four typical ignitron tubes used in welding control equipment. Data at the left is for 220 while that at the right is for 440-volt supplies

in one continuous spot. It can be the total conducting time during any 7.1-sec. interval.

Ignitrons tend to have a constant kva rating and therefore the allowable currents for 220 volt operation are somewhat higher for the same duty cycle than for 440 volts. (Hot-cathode thyatron ratings for welding are somewhat simpler in that the ratio of peak to average is lower and the current rating is more nearly independent of line voltage.)

Power Circuits

Certain types of welding do not require full electronic control but speed of operation and maintenance problems make an electronic contactor desirable. The simple circuit shown in Fig. 1A, involving two ignitrons and four copper oxide rectifiers, has been developed to meet this need. With this circuit the power tubes will conduct when the initiating switch is closed and cease to conduct when the switch is opened. No synchronizing feature or timing is included in such a control.

The copper oxide rectifiers are required to prevent damaging reverse current flow from pool to ignitors. When anode *a* is positive and the initiating switch is closed, current

will flow from point *a* through the lower right rectifier, through the flow switch contacts, fuse, initiating switch and the upper left rectifier into the ignitor of the first tube and back to the other side of the line through the welding transformer. When this current flows from the ignitor to the pool a cathode spot is formed and the ignitron carries reverse current for the half cycle.

In tracing this current two alternate paths were available at two places in the circuit. First, at the cathode of the second tube an alternate path is shown, through the ignitor and its copper oxide rectifier. Notice that this copper oxide rectifier is connected to oppose current flow from the pool, while the lower right rectifier allows an easy flow of current. Thus the ignitor rectifier prevents any appreciable amount of reverse current flowing through the ignitor of the second tube. The other choice occurs at the second group of rectifiers, affiliated with the first tube. Here it should be noticed that the ignitor series rectifier is connected to allow current to flow to the ignitor into the pool while the other rectifier blocks the flow directly to the pool. When anode *b* is positive the current path is reversed and the

second ignitron will be fired, causing both half cycles to flow to the welding transformer. This action will continue as long as the initiating switch is closed and will cease when it is opened.

A conventional power circuit when synchronous starting is required is shown in Fig. 1B. In this arrangement, thyatrons are used to fire the ignitrons by connecting the ignitor ignitors to the ignitron anode through the thyatrons so that load current will flow to the ignitors until the ignitrons are fired. When an ignitron starts to conduct, the voltage across the associated thyatron is reduced to arc drop or about 1 volt, which stops its conduction and therefore, the current through the ignitor. The grid in the thyatron provides a flexible means of control.

These two basic power circuits will meet the requirements of a complete line of welding controls. The choice of one or the other is determined by the control functions required and the operating conditions encountered. The application of the tube rating curves is the same in either case. The circuit of Fig. 1B has certain technical and economic advantages where the supply exceeds 600 volts. Two functions of control can be

performed—the amount of welding current or “heat” can be varied by means of phase control, and the application of power can be timed to meet the requirements of the welding operation. Both phase control and timing can be applied independently or together.

Control Circuits

Phase shift control may be added to the Fig. 1A circuit by putting in series with the contacts of the initiating switch a pair of inversely connected thyratrons as shown in Fig. 3. Control is applied to the grids of these two thyratrons so as to delay their firing during each half cycle. Thus each ignitron is delayed in firing until the associated thyatron starts to conduct. Two methods of controlling the thyatron grids suggest themselves. The simplest is to apply an alternating voltage to the grids of the thyratrons and vary its phase by means of a conventional phase-shift network. When grid vol-

tage is negative it holds the thyratrons nonconducting, allowing the tubes to conduct as the grid goes positive on the next half cycle. By shifting the crossover point the angle of firing can be shifted. Figure 3B shows the phase relation of the anode or line voltage, grid voltage, and line current.

A second method of phase controlling is shown in Fig. 4A. In this case a separate thyatron bias voltage is used and control of the thyratrons is effected by a peak voltage superimposed on the bias voltage. The peak voltage is shifted by the phase shift network to vary the firing point. On and off control of this combination can be obtained by means of a series contact, as in Fig. 3, or it can be controlled by changing the a-c bias with a bucking transformer as shown in Fig. 4A. The phase relations of the on and off conditions are shown in Fig. 4B. The phase shift system using a peaking transformer has the advantage of avoiding completely the transients that can exist on the first half cycle when the Fig. 3 circuit is used because the tubes can only fire when a peak is present. Thus, if the initiating switch is closed just after a peak the tube will not fire but will wait until the peak on the next half cycle. Timing may be off by a half cycle but no transients will be generated.

Phase shift heat control is added to power circuit 1B by putting a phase shift control on the grids of the two thyatron firing tubes. This is done by adding an a-c bias 180 deg. out of phase with the anodes, then superimposing a peak voltage that is not high enough to break through and drive the grids positive. When the power tubes are supposed to conduct, the thyatron bias voltage is reduced by a bucking voltage just great enough to let the peak voltage drive the grids positive. In this way the firing point can be changed by shifting the phase of the peak voltage. Such a circuit is shown in Fig. 5A. Figure 5B gives the phase relations with the power tubes nonconducting and Fig. 5C shows the voltage conditions when the power tubes are conducting.

It will be noticed that whenever an alternating voltage is used to hold a thyatron nonconducting, as in Figs. 4A and 5A, a capacitor is connected around the current-limiting grid resistor. This gives a d-c

component of negative grid voltage due to grid rectification, which avoids difficulty due to false firing by transient voltages that might occur as the alternating bias voltage is building up negative.

Timing Circuits

The timing function can be added to either of the power circuits shown in Figs. 1A and 1B, or it can be added to the power tube phase control combinations shown in Figs. 4A and 5A. To turn any of these circuits on, it is necessary to switch an alternating voltage, which means the two control tubes must be connected in inverse parallel to control both halves of the a-c wave. In such a circuit the cathodes of the two control tubes are not at the same potential, which prevents their connection to the same timing control voltage. This is overcome by the use of a trailing control circuit as shown in Fig. 6. The two control tubes *A* and *B* are connected in such a way as to energize the control or grid transformer when they conduct. The grid circuit of tube *B* is made up of three elements with the polarities as shown. The bias voltage is 180 deg. out of phase with the anode and therefore keeps tube *B* nonconducting, with the aid of the grid resistor and capacitor combination, as long as the feedback transformer is de-energized.

As long as tube *A* is held off by the timing circuit, the feedback transformer will not be energized and the control or grid transformer will have zero secondary voltage. Now assume that the timing voltage puts the grid of tube *A* positive when its anode is positive, causing tube *A* to conduct for a half cycle. This energizes the feedback transformer and, due to the inductance in the circuit, the current in the primary of the control or grid transformer will continue past the zero of the voltage wave as in any lagging circuit. This means that as the current in tube *A* goes to zero there will be a positive voltage on the plate of tube *B* and the feedback transformer will put a positive voltage on the grid that makes tube *B* conduct for a half cycle.

As long as the grid of tube *A* conducts, tube *B* will follow the next half cycle. This is only true when the load has a lagging power factor. If the current through tube *A* went to zero at the voltage zero there wouldn't be any voltage to fire tube

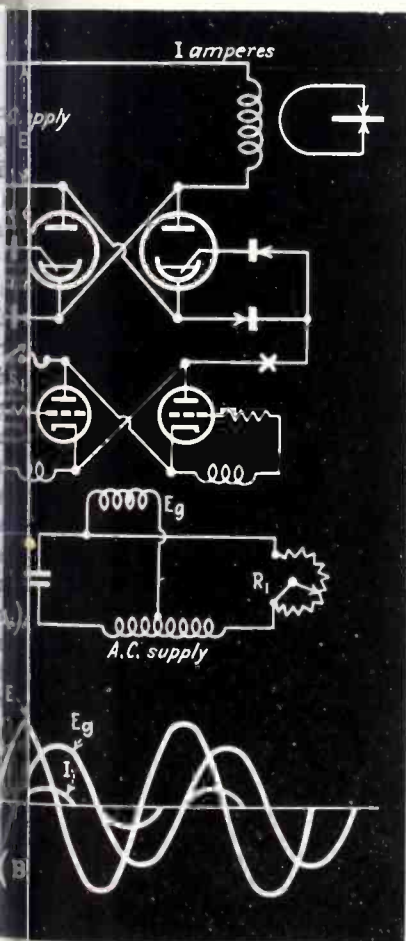

FIG. 3—(A) Contactor with simple phase control added. The amount of current passed to the welding machine depends upon the position of R_1 . (B) Phase relations of line voltage E , grid voltage E_g , and line current I for one position of R_1 .

B. However, practically speaking, there is usually enough leakage reactance in the feedback transformer to cause the current to lag enough to make tube B trail. When the grid of tube A goes negative, the feedback transformer will be de-energized when tube B stops, and when tube A does not fire there is nothing to fire tube B and the control or grid transformer is de-energized.

A trailing tube circuit has a number of important features as applied to resistance welding control. This circuit provides a means of controlling two tubes whose cathodes are at different potentials from one timing source. The suggested solution also uses only one tube in the timing circuit, so that there is no problem of matching tube characteristics. With a trailing tube circuit there is no possibility of getting an odd number of half cycles. This insures against a d-c component and possible saturation of the welding transformer, which is of extreme importance when designing seam weld-

ing controls where the "on" and "off" times are comparatively short and occur with the secondary shorted continuously by the electrodes.

The basic scheme of Fig. 6 is added to Fig. 1A by connecting the two thyratrons A and B in place of the initiating switch and connecting the primary of the feedback transformer across the welding transformer. The application to Fig. 1B is to add the bias and feedback voltage to the grid of one of the thyratrons, with the primary of the feedback transformer across the welder. When added to Figs. 4A and 5A, Fig. 6 is added complete. The control or grid transformer is used in place of the transformer controlled by switch S_1 .

The timing circuit itself is that part of a welding control which gives the control its name, as the power and control circuits in one or the other of the forms just described are used in all types of welding. It is the timing circuit that makes a control a spot welder control, a seam welder control, a pulsation spot weld-

ing control, or all three.

A commercial spot welding control, without phase control and using the power circuit of Fig. 1B, shown in elementary form in Fig.

The control is made up of a rectifier furnishing d. c. for timing and control circuits, a keying tube to insure starting at the desired point in the voltage wave after closing the switch, the timing and leading tube and trailing and power tubes.

Complete Circuit

The rectifier is of the conventional type with a filter reactor, X , and filter capacitor C_1 . A voltage divider made up of two components, R_1 and R_2 , is connected across the filter rectifier output. The major part of the voltage appears across R_1 and charges the timing capacitor. The small voltage across R_2 is used as d-c bias on the keying tube, T_1 . Connected across a part of R_1 is the filter combination R_3 and C_3 , which makes the timing practically independent of the load.

(Continued on page 117)

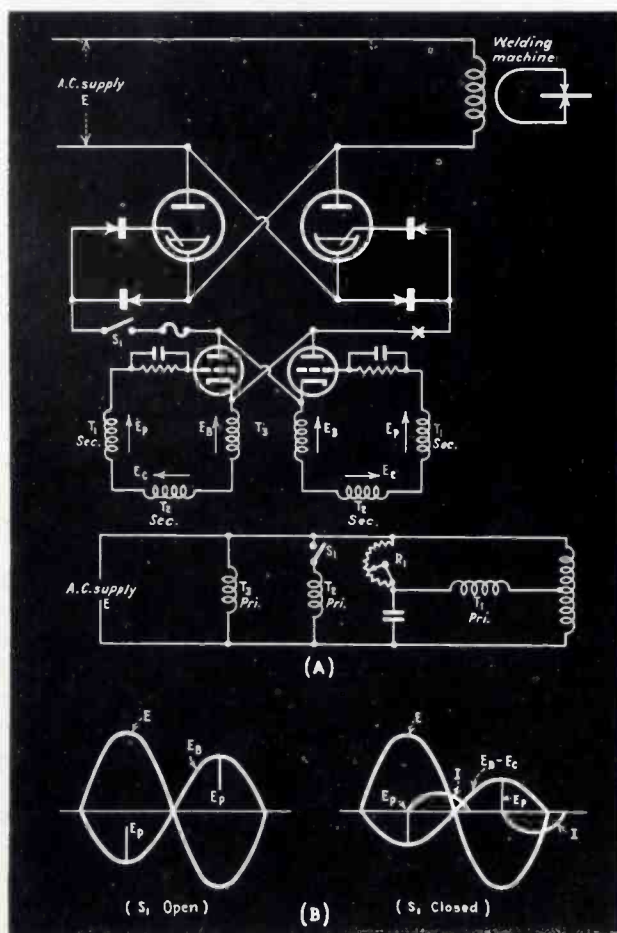

FIG. 4—(A) Another form of phase control, added to an electronic contactor. The amount of current that will flow to the welder is determined by the position of R_1 (B) Voltage and phase relationships, as explained in the text

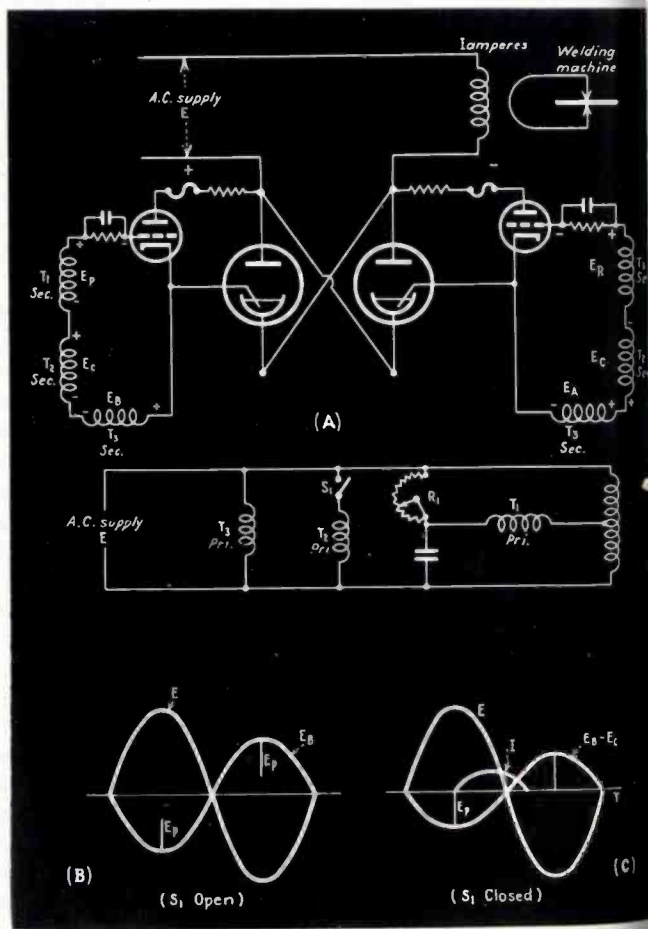

FIG. 5—(A) Phase control added to Fig. 1B. The amount of current that will flow to the welder depends upon the adjustment of R_1 . (B) Voltage and phase relations with S_1 open. (C) Voltage and phase relations with S_1 closed and the tubes passing current

Unsymmetrical Attenuators

This article presents a graphical method of designing T or π resistance attenuators and simplified means of converting to a dissymmetrical network where impedances of different magnitudes must be matched

By P. M. HONNELL

Southern Methodist University

WHEN the need arises for an attenuator with a given loss which will match terminal apparatus of lines of unequal impedances, it will be found necessary to compute the values of the branch resistances of the required pad since such data cannot ordinarily be found in curves or tables. For a T or π network of constant impedance level, however, such information is usually available. Now by utilizing a symmetrical pad which matches one of the two impedances and a transformer of proper ratio to match the other impedance, the required network can always be realized. But it is not always convenient, and certainly not economic, to utilize this combination, especially as it is possible in most instances to replace both the constant impedance pad and the transformer by a dissymmetrical pad.

The purpose of this note is to summarize the results of the matrix transformation* which may be used

to obtain the branch resistances of the dissymmetrical pad which will fit the required terminal impedances, from design data for the resistance of the branches of a symmetrical T or π pad of the desired attenuation. This follows in Sections I and II. If exact branch resistance values for symmetrical T or π pads (of any impedance level) are not available, they may be obtained from the curves in Section III with fair accuracy.

Section I—T Pad

It should be understood at the outset that the values of branch resistances of a symmetrical T or π pad of given impedance level (say 600 ohms) may be changed to any other impedance level (say 500 ohms) by

multiplying all the branch resistances by the ratio of the required to given impedance levels (namely 500/600 or 5/6 in this example). Thus it is always possible to adjust available data for a pad of the desired loss to fit one of the two impedance levels.

In Fig. 1A, for example, the symmetrical pad giving the desired attenuation, and having branch resistances r_a , $r_b = r_a$, and r_c has been chosen to match the input impedance Z_1 . Since the pad is of constant impedance level, the output impedance Z_2 can be matched only by means of the (ideal) transformer of impedance ratio $1:a^2$.

The branch resistances r_a' , r_b' , and r_c' of the dissymmetrical pad (Fig. 1B) which will replace both the symmetrical pad and the transformer (Fig. 1A), are obtainable from the following equations:

$$\left. \begin{aligned} r_a' &= r_a + (1-a)r_c \\ r_b' &= a^2(r_a + r_c) - ar_c \\ r_c' &= ar_c \end{aligned} \right\} \quad (1)$$

* E. A. Guillemin, "Communication Networks," John Wiley (1935), Vol. II, Chapter VI, Section 5.

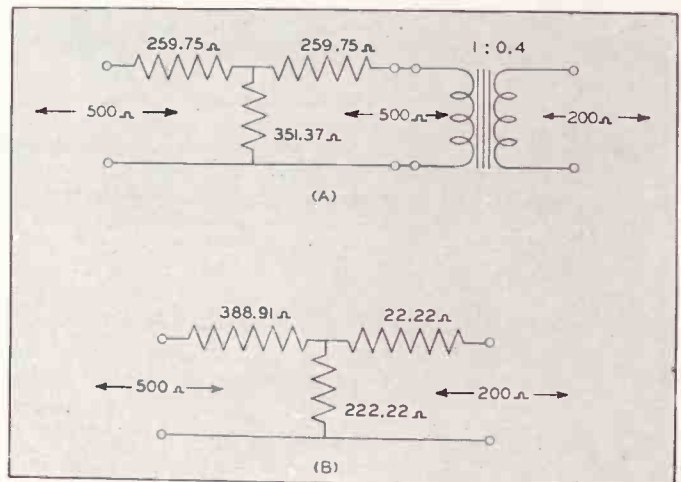
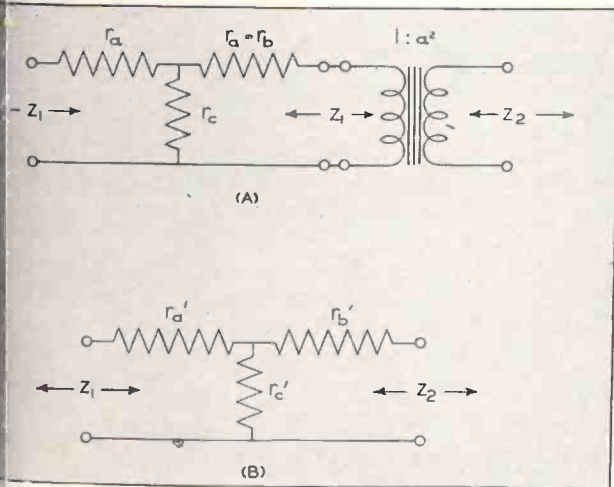

Fig. 1—Symmetrical T pad and ideal transformer (A) and the electrically equivalent dissymmetrical T pad (B), both having the same loss

Fig. 2—Examples of dissymmetrical T network (B) equivalent to symmetrical T network and ideal transformer (A), both with 10 db loss

where impedance ratio is given by

$$a^2 = Z_2/Z_1, \quad (2)$$

the ratio of output to input impedance levels. The equations maintain the loss from input to output terminals of the network invariant.

Without going into an exhaustive analysis, it may be evident that for a given ratio of impedance levels, or a' , negative elements for r_a' or r_b' may occur. In such an event, the only alternative is to choose a network with more attenuation, which will then result in realizable resistances. Of course, either r_a' or r_b' may actually be zero in the limiting case. This result may answer a question that has undoubtedly arisen in the reader's mind: "Wherein does a symmetrical network and (ideal) transformer differ physically from a dissymmetrical network?" The answer lies in the fact that for a given terminal impedance ratio the former can be approximated physically for any attenuation, whereas the latter network has a definite minimum attenuation below which some of its elements become physically unrealizable.

Numerical Example

As a concrete numerical example of the application of these equations, consider a 10 db pad, required to match impedances $Z_1 = 500$ ohms and $Z_2 = 200$ ohms. From tables (or Section III), the following resistances for the branches of a symmetrical, 10 db, 500-ohm level pad are obtained:

$$\begin{aligned} r_a &= 259.75 && \text{ohms} \\ r_b = r_c &= 351.37 && \text{ohms} \end{aligned}$$

From Eq. (2) we obtain for the ratio of output to input impedances,

$$\begin{aligned} a^2 &= 200/500 = 0.4, \\ a &= 0.63246. \end{aligned}$$

Substituting these values into Eq. (1), we obtain for the branch resistances of the dissymmetrical pad:

$$\begin{aligned} r_a' &= 259.75 + (1 - 0.63246) 351.37 \\ &= 388.91 && \text{ohms} \\ r_b' &= 0.4(259.75 + 351.37) \\ &\quad - 0.63246(351.37) = 22.22 && \text{ohms} \\ r_c' &= 0.63246(351.37) = 222.22 && \text{ohms} \end{aligned}$$

The resulting dissymmetrical network equivalent to the symmetrical pad and (ideal) transformer is shown in Fig. 2B.

Section II—Dissymmetrical π

In order to simplify the mathematical expressions, it is desirable when dealing with π networks to express all quantities as admittances. Since resistors of commercial manufacture, and measuring equipment in general, are calibrated in terms of impedances, computed circuit admittances must be converted into impedances before the final circuit elements are obtained physically. But this is a mere matter of reciprocation of the branch admittance of the network, and should cause no confusion, if the inverted omega is recognized as the conductance symbol in mhos.

Thus, the equations which relate the symmetrical π pad and (ideal) transformer to the equivalent dissymmetrical π , working between unequal terminal admittances, are as follows:

$$\left. \begin{aligned} g_a' &= g_a + (1 - 1/a) g_c \\ g_b' &= (1/a^2)(g_b + g_c) - (1/a) g_c \\ g_c' &= (1/a) g_c \end{aligned} \right\}, \quad (3)$$

where

$$1/a^2 = Y_2/Y_1 \quad (4)$$

is the ratio of output admittance Y to input admittance Y_1 , of the terminal equipment.

As shown in Fig. 3A, g_a , $g_b = g_c$, and g_c are the branch conductances of the symmetrical π , with the dissymmetrical π branch conductances, g_a' , g_b' , and g_c' given by Eq. (3) shown in Fig. 3B.

Numerical Example

As a numerical example, we consider again a pad with 10 db loss, this time a π , working from 200 ohms into 500 ohms (Fig. 4A). For the ratio of admittances ($1/a^2$) we have converting the terminal impedances to admittances,

$$1/a^2 = Y_2/Y_1 = \frac{1/500}{1/200} = 0.400,$$

which gives

$$1/a = 0.63246.$$

Reference to tables or the curves of Section III gives the following values for the branch conductances of a symmetrical π pad of 10 db loss, and $1/200$ mho admittance level:

$$\begin{aligned} g_a &= 2.5975 \times 10^{-3} && \text{mho} \\ g_b = g_c &= 2.5975 \times 10^{-3} && \text{mho} \\ g_c &= 3.5136 \times 10^{-3} && \text{mho} \end{aligned}$$

The symmetrical 10 db π , therefore, and the required 0.4 admittance ratio (ideal) transformer are shown in Fig. 4A.

To obtain the equivalent dissymmetrical π , substitute these values into the Eq. (3), giving:

$$\begin{aligned} g_a' &= 2.5975 \times 10^{-3} + (1 - 0.63246) \\ &\quad 3.5136 \times 10^{-3} = 3.8902 \times 10^{-3} \text{ mho} \\ g_b' &= 0.4(2.5975 + 3.5136) \times 10^{-3} - \\ &\quad 0.63246(3.5136 \times 10^{-3}) = 0.22243 \times 10^{-3} \\ &\quad \text{mho} \\ g_c' &= 0.63246(3.5136 \times 10^{-3}) = 2.2220 \\ &\quad \times 10^{-3} \text{ mho} \end{aligned}$$

The desired dissymmetrical π is shown in Fig. 4B, together with the

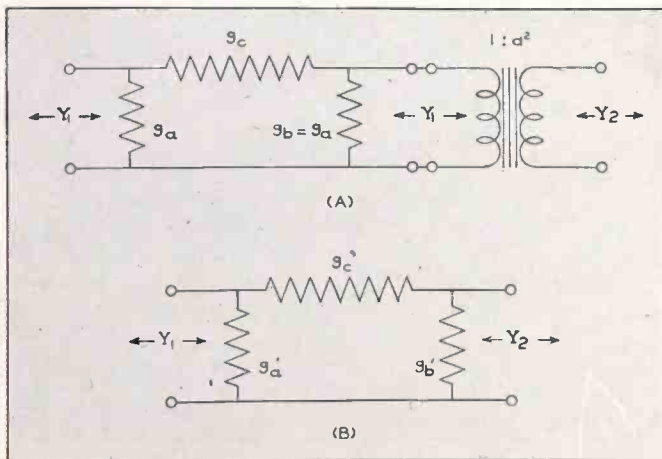

Fig. 3—Symmetrical attenuator and ideal transformer (A) and equivalent dissymmetrical attenuator, (B), with the same loss

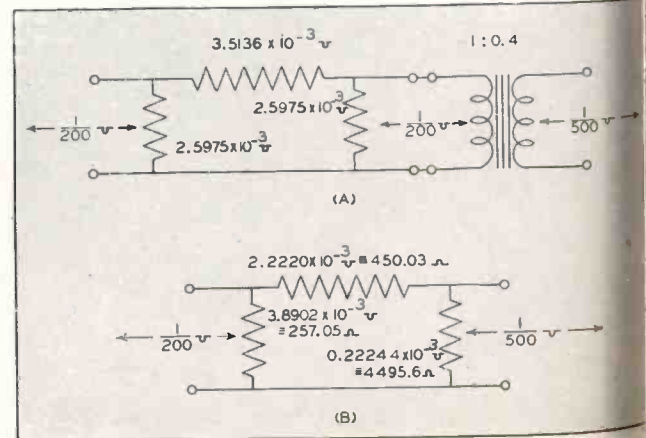

Fig. 4—Dissymmetrical pad of 10 db loss (B) equivalent to symmetrical and ideal transformer (A) both having the same loss

branch element resistances as well as conductances, obtained, of course, by taking the reciprocals of g_a , g_b and g_c .

Section III—Design of Symmetrical T or π Attenuators

There would be no point in repeating here the design equations for symmetrical attenuators, since such information is readily available. However, for those who do not wish to calculate the numerical values of branch resistance or conductance for symmetrical attenuators, the graphs in Fig. 5 are presented for convenience.

The two curves in the figure provide the basic design constants of T or π pads of any constant impedance level, and of 0.1 to 100 db loss. The ordinate of the graph gives the branch impedance of T pads, and the branch admittance of π pads on a normalized basis, that is, on a 1 ohm or 1 mho level. For any desired impedance or admittance level, multiply all the values from the curves by the particular attenuator by the desired impedance or admittance level. The abscissa of the graph is the desired attenuator loss, for which the branch values are to be determined. Although the graph is self-explanatory, it may best be demonstrated by a numerical example.

Numerical Example—T Pad

Required: A 10 db T pad, 500 ohm impedance level. From curve 1, Fig. 5, we find, at 10 db on the abscissa, the

$$r_{a1} = r_{b1} = 0.52,$$

and from curve 2, still at 10 db on the abscissa, we find that

$$r_{c1} = 0.70.$$

These values are on a 1 ohm basis (that is the reason for the subscript 1).

To obtain the branch resistances for the 500-ohm level pad, multiply each factor by 500, giving:

$$r_a = r_b = 0.52 \times 500 = 260 \text{ ohms}$$

$$r_c = 0.70 \times 500 = 350 \text{ ohms.}$$

These values compare with $r_a = 259.75$ and $r_c = 351.37$, obtained from exact equations, as given in the example in Section I.

π Pad

Required: A π pad of 10 db loss, 200 ohm impedance level. We first recall that, on an admittance basis, this would be a 10 db pad of 1/200 mho admittance level. From curve 1 of

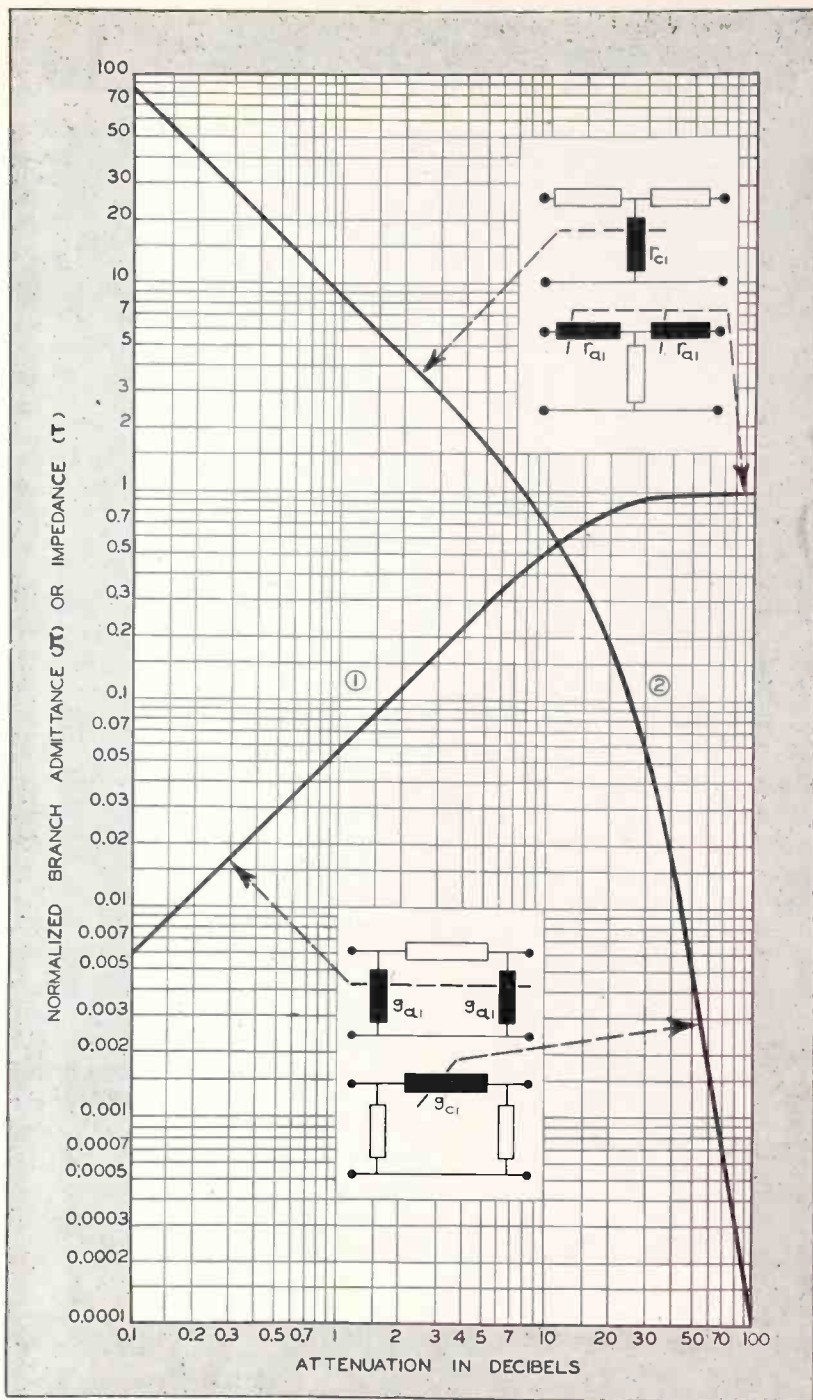

Fig. 5—Graph showing the normalized impedance or admittance for the series and shunt arms of T and π networks. Curve 1 applies to shunt elements of π network or series elements of T network, while curve 2 refers to shunt elements of T network or series elements of π network. The values obtained from this graph must be multiplied by the impedance level for which the symmetrical attenuator is designed

Fig. 5, we obtain at 10 db on the abscissa:

$$g_{a1} = g_{b1} = 0.52,$$

and similarly from curve 2,

$$g_{c1} = 0.70.$$

These values are on a 1 mho basis. To obtain the branch admittances on the required 1/200 mho admittance level, multiply each factor by 1/200,

giving the branch conductances as:

$$g_a = g_b = 0.52 \times (1/200) = 2.6 \times 10^{-3} \text{ mho}$$

$$g_c = 0.70 \times (1/200) = 3.5 \times 10^{-3} \text{ mho}$$

These values compare with $g_a = g_b = 2.5975 \times 10^{-3}$ mho, and $g_c = 3.5136 \times 10^{-3}$ mho, obtained from exact computations, given in the numerical example in Section II.

ELECTRONIC Switching Simplifies

In carrier current communication systems, electron tubes are used to effect voice stimulation sequence operations to provide rapid and automatic conversations without feedback. The article gives the outlines of one highly successful design

TODAY, many high voltage power transmission lines are being used for telephonic communication by radio. In power-line-carrier-communication, the high frequency currents travel along the power line and are not radiated into space. At each power station a complete high frequency transmitter and receiver are used. Because of electronic switching, the system is ready to transmit or receive signals almost instantly when a person speaks into any one of several microphones.

Since it is desirable to utilize only one carrier frequency for each communication channel, all of the transmitters and receivers are tuned to the same frequency. At each station, the transmitter output is connected in parallel with the receiver input and coupled through suitable insulating capacitors to the high voltage transmission line. Because of this parallel connection, when the system is transmitting, the local receiver must be shut off; and when receiving, the local transmitter must be inactive. In many space radio communication systems, the user is required to push a button to accomplish the transfer from receive to transmit. A newly developed voice controlled transfer scheme, working on electronic principles, has now eliminated the necessity of pushing a transfer button.

The transfer is accomplished by means of electron tubes, without any moving parts. The basic operation is indicated in Fig. 1. Two transmitter-receivers (the minimum quantity necessary for a channel) are shown with each divided into four parts:

(A) transmitter input (audio system), (B) transmitter output (carrier system), (C) receiver input (carrier system) and (D) receiver output (audio system).

In the standby condition, i.e. no

By **J. D. BOOTH**

Westinghouse Electric and Manufacturing Co., Baltimore, Md.

user talking, the input circuits A and C must be active and the output circuits B and D must be inactive. The reason for this is obvious when it is noted that the output terminals of B are directly connected to the input terminals of C and the output terminals of D are directly connected to the input terminals of A. For the "transmit" condition, A₁ and B₁ must operate, and C₁ and D₁ must be blocked. For the receive condition C₂ and D₂ must operate and A₂ and B₂ must be blocked. This requires four transfer functions which must be performed in the following order: (1) block local receiver carrier system (C₁), (2) actuate local transmitter carrier system (B₁), (3) block remote transmitter audio system (A₂), and (4) actuate remote receiver audio system (D₂).

These functions are initiated by speaking into the microphone of an ordinary telephone handset. They are accomplished in a very short time to permit the person at the remote end of the channel to hear and understand the first syllable spoken. When the speaker stops talking, the system must return to the standby condition as quickly as possible. The sequence for releasing the four transfer functions is 2-1-4-3, 2-4-1-3, or 2-4-3-1.

Unfortunately, the difference between speech and noise is sometimes only a matter of opinion. The electronic transfer circuits are unable to select and respond exclusively to the proper sounds. In fact, the only feasible method of accomplishing this choice is for the speaker to talk louder than the noise level at his microphone. In some cases this is very simple. However, the energy content of some syllables is extremely small. Also, the peak sound energy from some common source of noise, such as typewriters, is quite

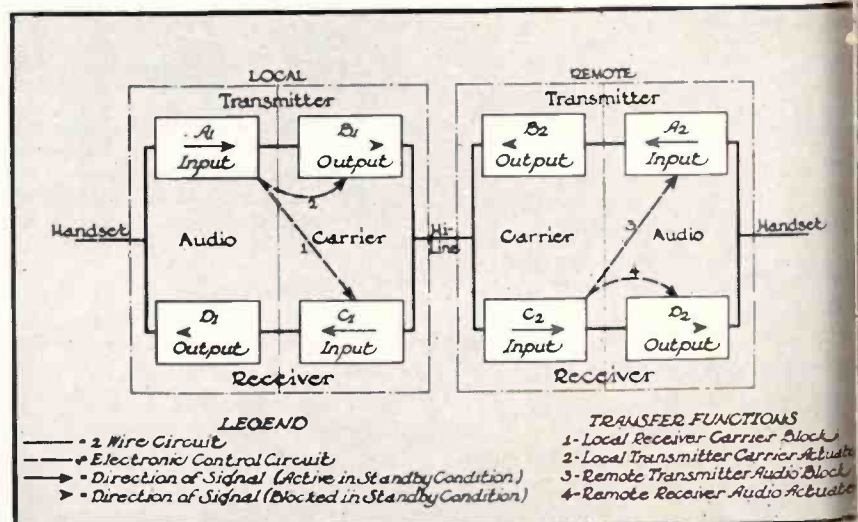

Fig. 1—Functional diagram, in block form, of power line carrier frequency channel with electronic switching control

POWER-LINE COMMUNICATIONS

gh. To guard against the undesirable transmission of such noises, the circuits may be so arranged that sounds of short duration even if rather high in amplitude will not cause transmissions.

It is not so easy to take care of the wide variations between syllables and between different speakers. The most practical solution seems to be to provide a slight time delay in releasing function 2. This insures the transmission of weak syllables following relatively louder ones and greatly improves the intelligibility. To take care of weak syllables preceding much louder ones, a quick-acting automatic gain control in the speech amplifier of the transmitter is used. To assure the proper sequence of transfer functions under all conditions, the circuits are so arranged that a gradual increase in the intensity of sound at the microphone makes them operate in the same order as if the initial sound were very loud.

To understand how these various functions are performed, it is necessary to delve more deeply into the circuit details. (See Fig. 2.) For function 1, speech is amplified by the variable gain and isolation amplifiers. It is then rectified and is applied as a positive voltage to the grid of the receiver blocker tube to overcome the high negative bias which holds the tube well beyond cutoff for the

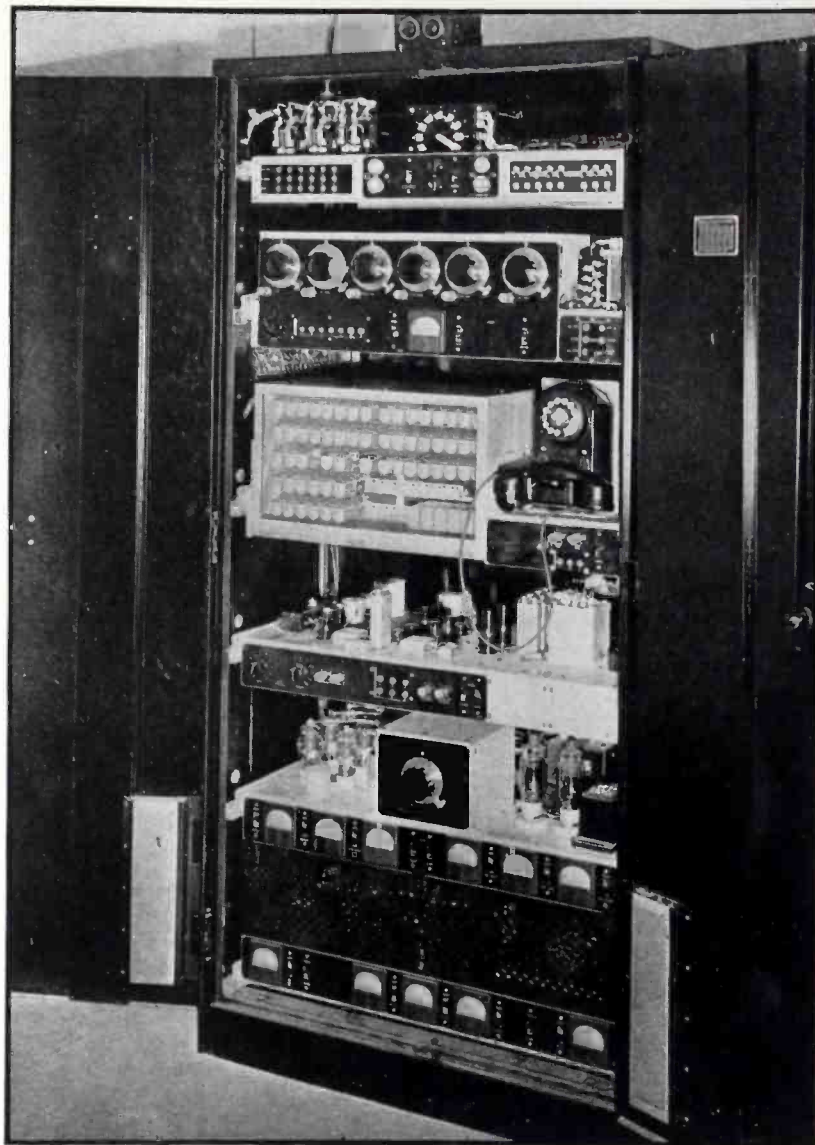

General view of power line carrier frequency communication system in steel protective cabinet

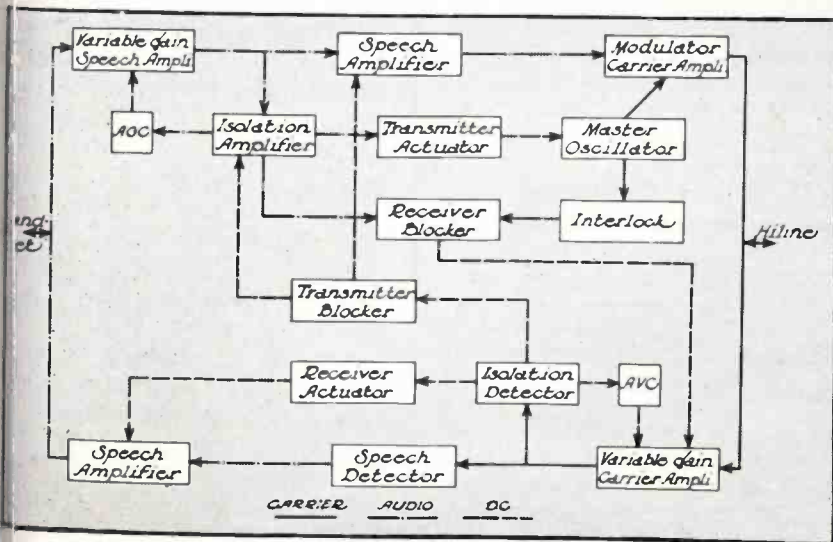

Fig. 2—Functional diagram of transmitter and receiver for the power line carrier frequency system

standby condition. The plate current of the receiver blocker tube passes through a resistor in the receiver carrier amplifier grid circuit. A very high bias is thus applied to cut off the receiver. For function 2, a portion of the output of the isolation amplifier is rectified. Negative voltage is applied to the grid of the transmitter actuator tube. The blocking of this actuator tube starts the transmission of carrier because the plate current of this tube passes through a resistor in the master oscillator screen circuit and holds the screen negative for the standby

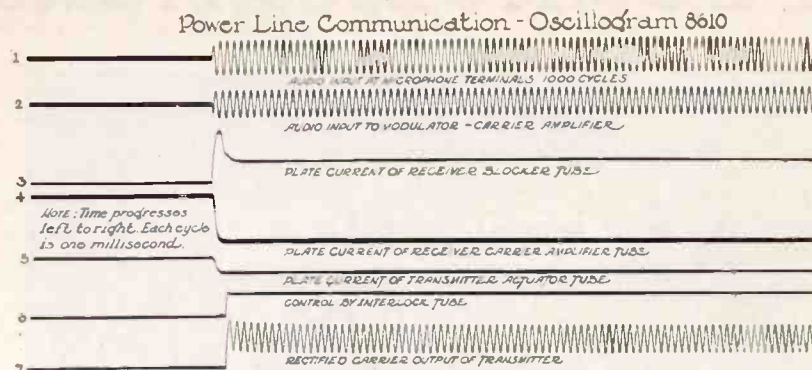

Fig. 3A—Oscillograms illustrating application of input tone

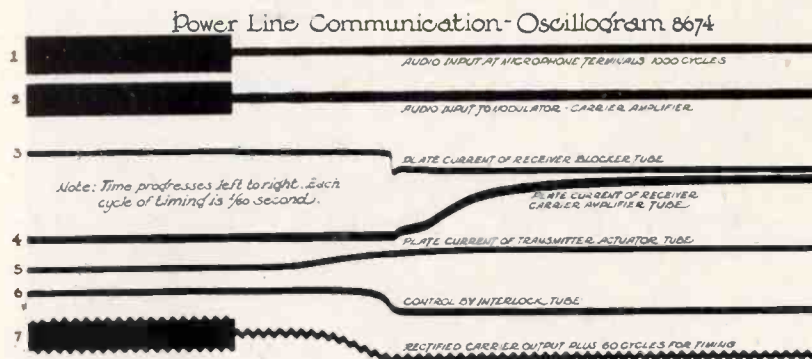

Fig. 3B—Oscillogram showing stopping of input tone

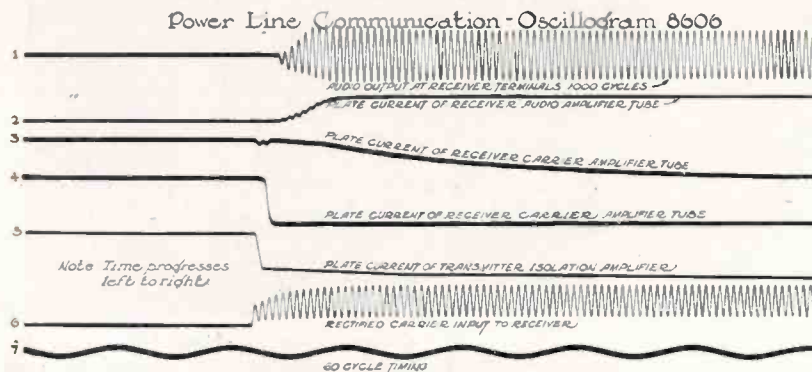

Fig. 3C—Oscillograms illustrating operation of carrier system showing that transmitter speech and isolation amplifier are cut off immediately when audio input is applied

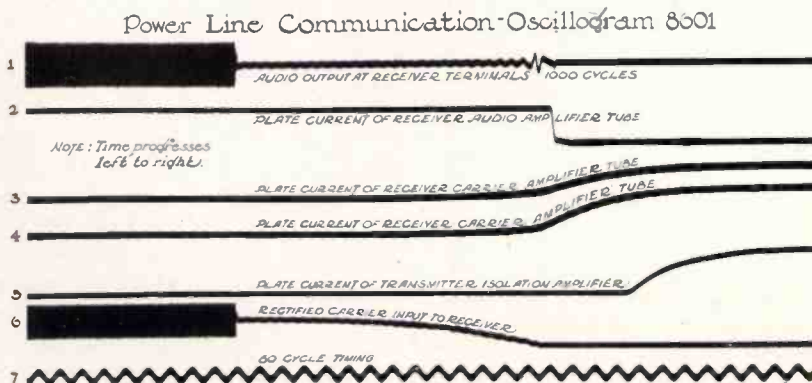

Fig. 3D—Oscillogram illustrating return of carrier system to normal or standby operation

condition required at this time. For function 3, the received carrier is amplified and rectified. Positive voltage is applied to the grid of the transmitter blocker tube which is held considerably negative for the standby condition. The plate current of this tube passes through a resistor in the grid circuits of the speech and isolation amplifiers in the transmitter circuit. This provides blocking bias for the transmitter audio system. For function 4, a negative voltage is applied to the grid of the receiver actuator tube. The plate current of the receiver actuator tube controls the bias of the speech amplifier tubes in the receiver which are cut off for the standby condition. Thus, the receiver audio system is made active.

To produce the proper release sequence, an interlock circuit as shown in Fig. 2 is provided which holds the receiver blocked after speech starts as long as the transmitter master oscillator is operating. The AGC and AVC circuits shown in Fig. 2 are conventional except that they operate almost instantaneously.

The control tubes (type 6SJ7) are standard high vacuum, high- μ , sharp cut-off pentodes. The trigger action is due to the circuits used and particularly to the use of high control voltages and high biases. The use of high vacuum tubes practically eliminates the effects of ambient temperature which are rather serious in the case of certain types of gas filled tubes. Furthermore, the necessity of interrupting the plate voltage to stop ionization is, of course, eliminated. The use of standard receiver tubes in the preferred series not only minimizes the upkeep cost but facilitates obtaining replacements when necessary. All tubes in the design may be had in the open market.

The tests shown in Fig. 3 were made at the factory using a dummy transmission line in place of the high voltage power line. The top line of oscillogram 8610 shows the application of a 1000 cps tone as a substitute for speech. With this substitute, the functioning of the system is the same as when an operator speaks into the microphone. The second line shows that modulation is instantly applied to the modulator carrier amplifier. The third line shows the pulse delivered by the receiver blocker to the receiver carrier amplifier grids. The fourth line

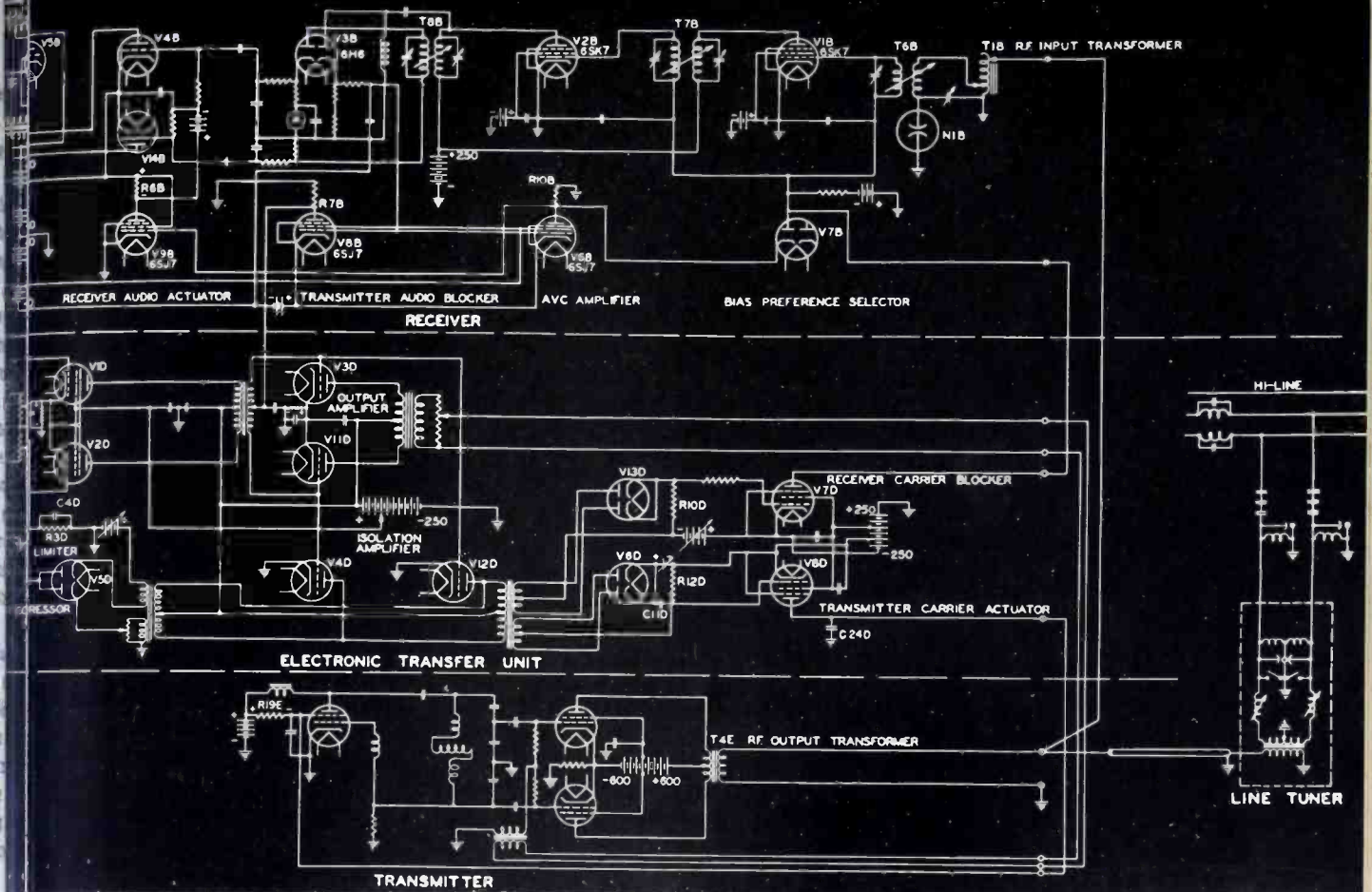

Expansion of Fig. 2 into a simple practical diagram. Microphone output goes to V1D, V2D, V4D and V12D. For transfer function 1 (local receiver carrier block) output of V12D is rectified by V13D and amplified by V7D to appear across a resistor in the receiver carrier amplifier grid circuit to block the plate current of V1B and V2B. For transfer function 2 (local transmitter carrier actuate) amplified a-f from V4D and V12D is rectified by V6D to block plate current of V8D. At the receiving station, modulated carrier passes from hiline through coupling capacitors, line coupling tuner, coaxial cable to V1B and is amplified by V1B, T7B, and V2B. V3B acts as a detector for transfer function 3 (remote transmitter audio block)

and its filtered d-c output is amplified by V8D to block V3D, V11D, V4D and V12D preventing transmission from the local station until the distant station speaker ceases (alking and releases the channel. Transfer function 4 (remote receiver audio actuate) is accomplished by operating the grids of V6B and V8B in parallel. V6B controls gain of the receiver carrier amplifiers, and blocks V9B when a carrier of usable magnitude is received. Plate current of V9B flows through R6B and normally blocks a-f amplifiers V4B and V14B, by the drop across R6B. Thus there is no audio output from the receiver until a sufficient carrier has been received to block the transmitter audio amplifier

shows that the plate current of the receiver carrier amplifier is cut off completely in less than 2 milliseconds. The fifth line shows that the transmitter actuator plate current is cut off in less than 2 milliseconds. The seventh line shows modulated carrier slightly delayed by a capacitor discharge circuit to provide the proper starting sequence. The sixth line shows the interlocking control instantly when carrier becomes available. Oscillogram 8674 shows the results of dropping the input tone. Note that the transmitter actuator, line 5, does not block the oscillator abruptly since this might cause objectionable transients (clicks). A 60-cycle timing current was added to line 7. This shows that the carrier persisted almost 250 milliseconds after the input tone stopped. Oscillogram 8606 illustrates func-

tions C and D. The sixth line shows the application of a modulated carrier to the input terminals of the receiver. The fifth line shows that the transmitter speech and isolation amplifiers were cut off almost immediately. Lines 3 and 4 show that the plate currents of the first and second stages of the receiver carrier frequency amplifier are reduced by the automatic volume control. One of these stages is controlled very quickly and overshoots somewhat. The other stage is controlled much more gradually to maintain a more nearly uniform output. Line 2 shows that the receiver speech amplifier becomes gradually active in the proper sequence. Line 1 shows the receiver speech output to the listener. The gradual build-up is coordinated with the automatic sensitivity control characteristics of the human ear so as to provide better intelligibility

than would result from an instantaneous start at or above the final level. Oscillogram 8601 shows the return of the receiver to standby conditions after the cessation of speech. These oscillograms clearly indicate that both the transmitter and the receiver are made active from the standby condition very quickly. In fact, the transfer takes place so rapidly that the delay is not noticeable. The users of this communication system seldom realize that they are unable to talk in both directions at the same time until the listener tries to interrupt the speaker. Then, the listener is reminded that he must be polite and wait until the speaker stops to take a breath. Fortunately, most speakers breathe quite frequently and, in so doing, allow the circuits to return to the standby condition.

Wave Form Circuits for CATHODE

Mr. Lewis concludes his summary of circuit arrangements for providing timing axes and waveform control in cathode-ray tube oscillography by dealing with amplitude and impedance methods of changing wave shape

By **H. M. LEWIS**
Consulting Engineer

THE first part of this article, published in the July 1942 issue of *ELECTRONICS*, dealt with the fundamentals of cathode-ray oscilloscopes and some fundamental forms of *RC* and *R/L* generators used as timing axes. The second and concluding part continues with a discussion of additional means of providing waveform circuits.

The circuit arrangement of Fig. 13 is one which is frequently employed to produce saw-tooth current in an inductance for magnetic scanning in television. This circuit illustrates, in the broadest way, the impedance control of waveform.

As an initial source we have the low voltage impulse wave, e_0 , of the group of waves labelled *A*. The output circuit of V_1 , termed a shaping circuit, is comprised of R, C, L_1 in series and the voltage across this load impedance is of the complex form, e_1 . The output circuit of V_2 is the impedance comprised of the scanning inductance, L_2 , with inherent shunt capacitance C_2 and resistance, R_2 . With a proper choice of circuit constants in the shaping circuit, the output voltage, e_2 is a large

amplitude impulse of the same form as e_0 . The relations required for reproducing the original waveform are:

$$\begin{aligned} L_1 C_1 &= L_2 C_2 & (2) \\ L_1/R_1 &= C_2 R_2 & (3) \\ C_1 R_1 &= L_2/R_2 & (4) \end{aligned}$$

In other words the series circuit is tuned to the same resonant frequency as the parallel circuit and the *RC* time constants of one circuit equal the *L/R* time constants of the other.

To understand the circuit operation clearly we must refer to the saw-tooth derivative series shown in Fig. 14. This series of related waveforms is such that each waveform is the mathematical derivative of the form immediately below it. Thus the double impulse *A* is the derivative with respect to time of the impulse wave *B*, which is the derivative of the saw-tooth wave *C*, which is the derivative of the parabolic impulse wave *D*. The series may be extended in either direction. Conversely we may say that *B* is the integral of *A*; *C* is the integral of *B* and so forth.

These four forms are commonly encountered in reactive circuits since the current through a condenser is the time derivative of the voltage across the condenser; the voltage across an inductance is the time derivative of the current through the inductance. i.e.,

$$e = L \frac{di}{dt} \quad (5)$$

$$i = C \frac{de}{dt} \quad (6)$$

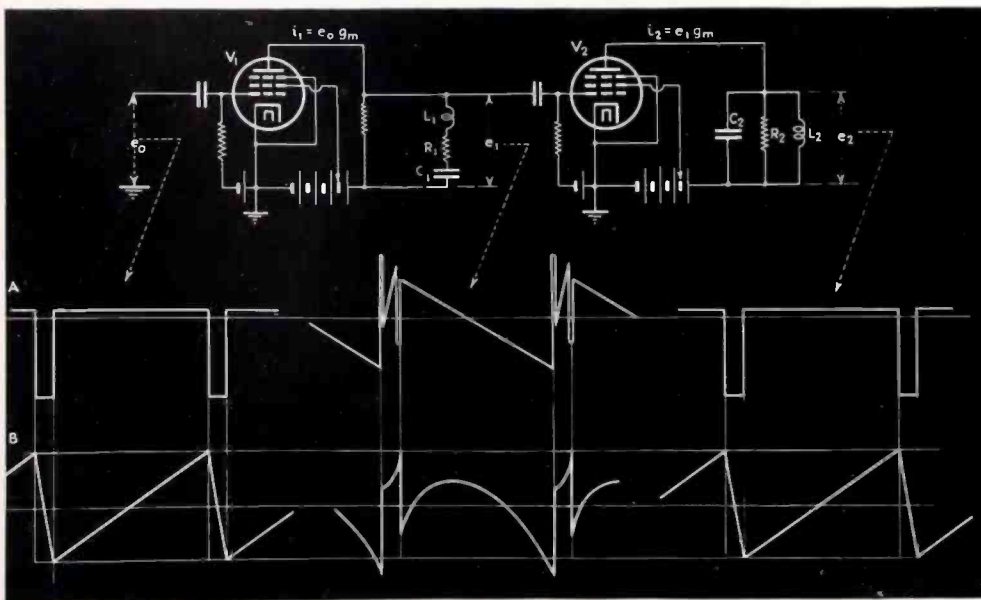

Fig. 13—A two-stage amplifier with series circuit in output of first stage and parallel circuit in output of second stage. If the values of these output circuit constants are properly selected, the output waveform is a replica of the input

RAY TUBES—Part II.

Another way of saying it, is that each waveform represents the rate of change of the waveform immediately below it. For example each trace and trace of the saw-tooth *C* is shown as a straight line of constant slope. Hence the retrace interval of the pulse wave *B* is at a constant height proportional to the steepness of the saw-tooth retrace and in the positive direction since the saw-tooth trace has a positive slope. The retrace interval of *B* is negative and constant at a value corresponding to the lesser negative slope of the saw-tooth trace.

The double impulse *A* would be comprised of points at plus and minus infinity if the sides of the pulse *B* were infinitely steep as down. In practice this cannot be done and finite double impulse forms are readily obtained usually with exponential sides due to distributed capacities. The waveform *D* is a parabola during the trace interval followed by an opposite small parabola during the retrace interval.

The waves are all shown with an a-c axis since in coupling through transformers and capacities a d-c component will not be translated. All it is to be observed that, since the average value of an a-c wave over a complete cycle is zero, the areas above and below the axis are equal.

Recurrent waveforms may be resolved into harmonic series of sine and cosine components by means of Fourier series analysis. This has been done*, for the saw-tooth waveform *C* and the corresponding series for *B* and *D* then obtained by differentiation and integration respectively. In summation-form these series are:—

$$\text{Saw-tooth wave } \left\{ i = \sum_{m=1}^{m=\infty} \left(\frac{2I}{\pi^2 \omega} \right) \right.$$

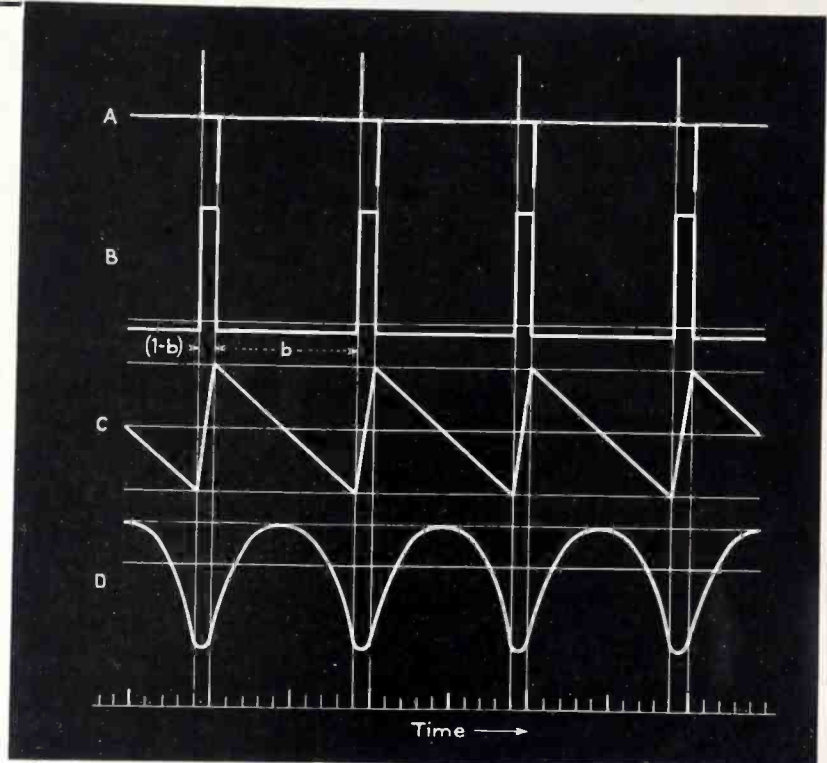

Fig. 14—Derivative and integral waveforms frequently encountered. Any one waveform is the derivative of the waveform immediately below it; conversely it is the integral of the waveform immediately above it

$$\left(\frac{\sin m b \pi}{b(1-b)} \cdot \frac{1}{m^3} \right) \cos m \omega t \quad (7)$$

$$\text{Saw-tooth wave } \left\{ i' = - \sum_{m=1}^{m=\infty} \left(\frac{2I}{\pi^2} \right) \right.$$

$$\left(\frac{\sin m b \pi}{b(1-b)} \cdot \frac{1}{m^2} \right) \sin m \omega t \quad (8)$$

$$\text{Impulse wave } \left\{ i'' = - \sum_{m=1}^{m=\infty} \left(\frac{2I}{\pi^2} \omega \right) \right.$$

$$\left(\frac{\sin m b \pi}{b(1-b)} \cdot \frac{1}{m} \right) \cos m \omega t \quad (9)$$

where $\omega = 2 \pi f$
 m is the order of harmonic
 b is the fraction of cycle during which trace occurs.

Returning now to Fig. 13 it will be evident that, since pentodes are employed, the current i_1 through the series circuit is of the same wave-

form as the grid voltage e_0 . For the applied pulse *A* we have then a pulse voltage across R_1 , a saw-tooth voltage across C_1 , and a double impulse voltage across L_1 . The addition of these three waveforms is the complex voltage e_1 , as inspection will reveal.

The output current i_2 from tube V_2 will therefore be of this waveform. In order that e_2 shall be of impulse waveform the double impulse current component must flow through C_2 , the impulse component through R_2 , and the saw-tooth component through L_2 since this condition is required by the derivative series. The choice of the impedance elements with the relations previously given will produce this division of the complex current components through the several parallel elements.

*By Madison Cawein, Unpublished Report—April 1933.

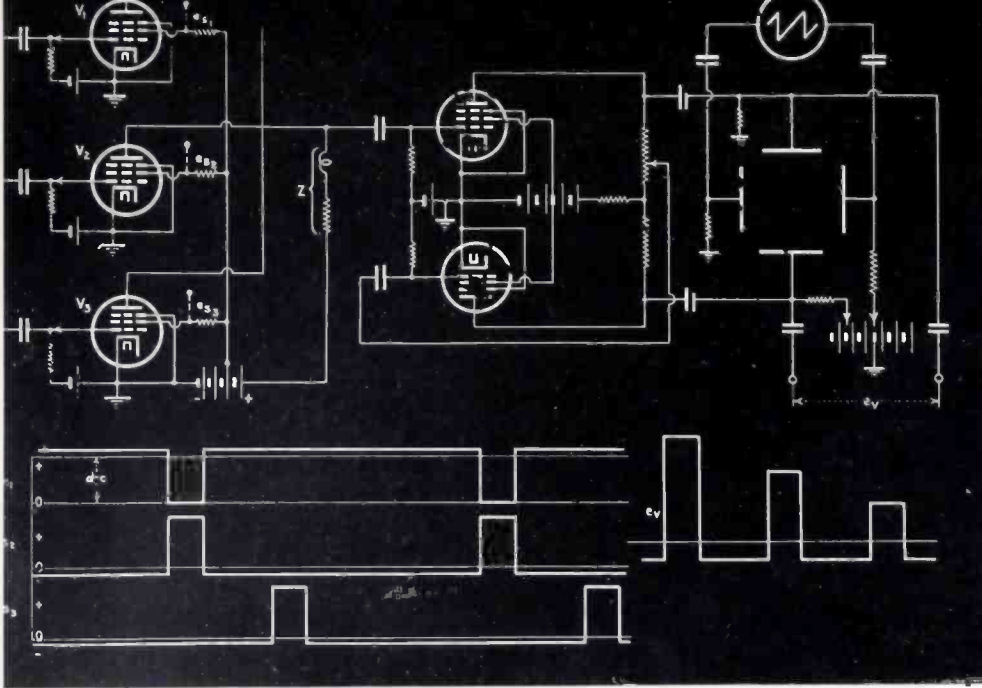

Fig. 15—By applying various input voltages to the grids of the amplifier tubes V_1 , V_2 , and V_3 , these voltages may be combined and the resultant effect viewed on the screen of the cathode-ray tube

For electrostatic deflection, the circuit of Fig. 13 is also employed to develop saw-tooth voltage across the inductance, L_2 , or across a secondary winding coupled to L_2 . This is illustrated in the series of waveforms labelled B , where the initial source of voltage, e_s , is of saw-tooth form. The voltage across the shaping circuit is the complex form, e_1 , and is comprised of a saw-tooth component across R_1 , a parabolic component across C_1 , and an impulse component across L_1 . The output voltage is of the required saw-tooth form. The

current through L_2 is of parabolic form while currents through the shunt elements, R_2 and C_2 are of saw-tooth and impulse form, respectively.

Since all periodic waveforms are comprised of a fundamental plus a large number of harmonic frequencies the waveforms are readily modified by frequency discrimination. Hence care must be taken in translating waveforms to provide circuits of suitable bandwidth and linear phase characteristics. The characteristics of filter and other networks are now commonly studied by observ-

ing the waveform at the filter output as compared with that applied at the input. The square wave, pulse having equal trace and retrace intervals, is frequently employed for this purpose since the changes due to frequency and phase distortion are easily recognized. A number of articles on this form of testing have recently appeared in the literature

Amplitude Control of Wave Form

The complex waveform e_1 of curve A Fig. 13 could of course be made up by combining components of pulse saw-tooth, and double pulse derived from separate sources in chosen amplitude. Many complex forms in television practice are made up by such addition and subtraction.

A general circuit arrangement for combining waveforms and viewing them on an oscilloscope is shown in Fig. 15. The several waveforms will be applied to the grids of the three pentode amplifiers having a common impedance load Z . The combined voltage is thereby developed at the input of the balanced amplifier and so applied to the vertical deflection plates of the oscilloscope. Some complex waveforms, for example those of the standard television synchronizing signal, are made up of sections of one type of pulse which is abruptly changed during intervals to another type. This is accomplished by "keying." Thus a group of keying signals are developed by relaxation oscillators such as the pulse

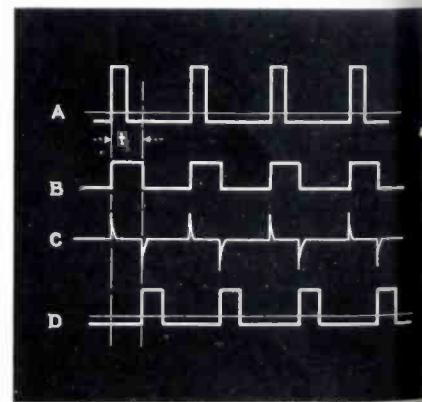
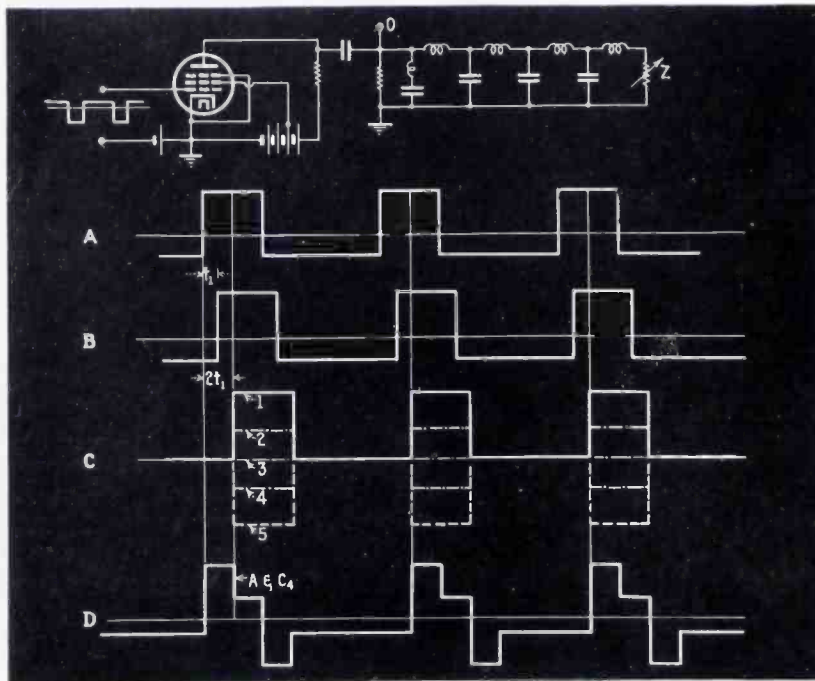
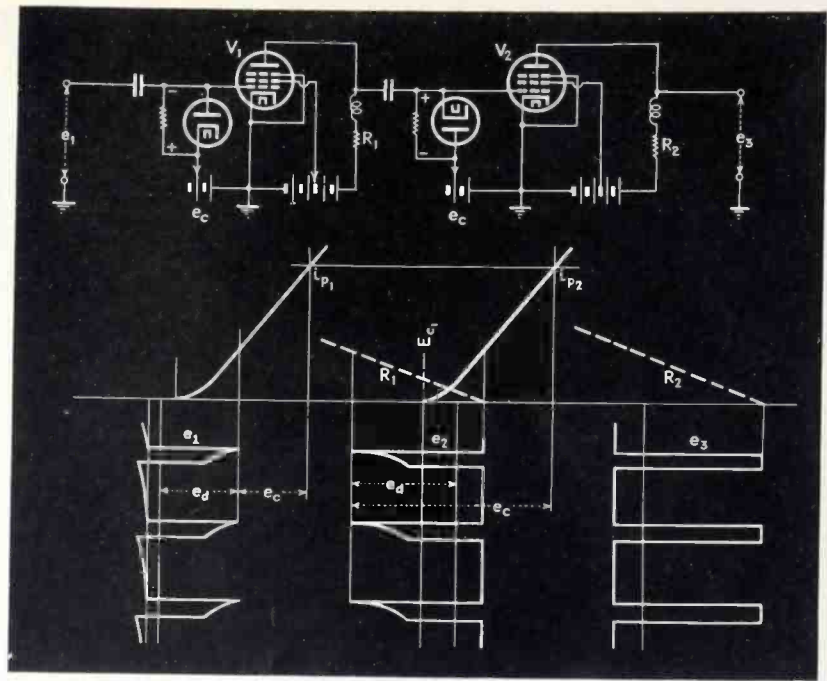

Fig. 17—A square-wave generator rather than the transmission line may be used to provide suitable time delays

Fig. 16—An artificial line provides time delay of input pulses, which may then be combined with other voltages to form new wave shapes

Fig. 19—Circuit for providing successively, amplification and clipping of signal, to produce wave pulses with steep sides



waves e_{s1} , e_{s2} and e_{s3} . Each screen grid d-c voltage connection is suitably chosen and the pulse voltages are applied at the respective screen grid connections as indicated. It is evident that e_{s1} is the same as e_{s2} but oppositely poled and augmented by a d-c potential. Hence the major part of the time the component from V_1 is alone transmitted. When the pulse occurs V_1 is keyed out and V_2 is keyed in to change the waveform during the pulse interval. When the pulse of V_2 occurs the signal from V_2 is added to that of V_1 for the duration of the pulse interval.

It is often desirable to view certain sections of a long cycle of complex waveforms. This may be accomplished by keying the position of the time axis on the oscillograph screen. For example a composite wave of pulses of different height such as e_s may be made up from the pulse sources by means of a combining amplifier. This will be applied as indicated to the vertical plates to change the position of the vertical axis. The frequency of the horizontal saw tooth deflection will be increased so that a single horizontal time axis trace occurs during each pulse interval. Thus we may view three sections of the complete cycle simultaneously and compare the waveforms of these sections. An example of this type of

waveform viewing is shown on the cover of ELECTRONICS for April 1939 where sections of the "odd" and "even" portions of a complete cycle of television synchronizing signal are shown as separate and directly comparable intervals. Keying pulses are often applied to the grid of the oscillograph tube to blank (black-out) the screen except during predetermined intervals which are to be observed.

Frequently a desired waveform may be built by the addition or subtraction of available forms and by delaying and then combining these forms. A long artificial line is frequently employed to provide short delays. Thus in Fig. 16 if the artificial line is designed to pass the essential frequency band of a pulse voltage such as A applied to the input, then the voltage wave at the far end is of the same form delayed by the time interval t_1 as shown at B . If the far end is terminated by a resistance Z equal to the surge impedance of the line no reflection occurs. If however we vary Z and if the generator end is also terminated to avoid a second reflection then the wave reflected back to the generator end will be delayed by the interval $2t_1$ as shown at curve C . However the amplitude and polarity of the reflected wave will depend on the far end termination, Z .

If Z is infinite (open circuit) the reflected wave is shown by the solid

line waveform (1). If Z is somewhat greater than the surge impedance the reflected wave is decreased in amplitude as at (2). No reflection is indicated at (3) when Z equals the surge impedance. Reflection with reverse polarity indicated at (4) occurs with Z less than the surge impedance and full amplitude with reverse polarity as shown at (5) occurs when the far end is short circuited.

The output waveform viewed at O may therefore be varied in form by varying Z . The waveform shown at (D) is an example of the form due to the original wave (A) and the reflected wave (C). The waveform viewed at various points along the line will differ due to the difference in delays between the transmitted and reflected waves. If only the delayed wave is wanted it may be obtained with the total delay $2t_1$ by applying the voltage O , and the grid voltage of the tube, to inputs of a combining amplifier whereby the component form A is neutralized and reflected wave C is developed.

Because of the long lines required and the care required in building them, electronic methods are generally more serviceable in obtaining long delays of impulse waveforms. In Fig. 17 we have a pulse waveform A and our problem is to obtain a related form D which is delayed by the interval t_1 and has the pulse intervals as shown. Our procedure

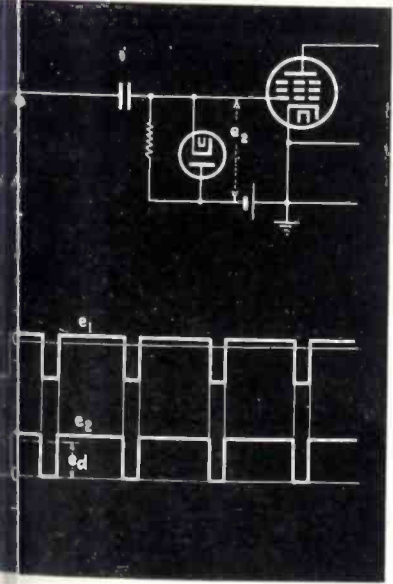

Fig. 18—Circuit for operating pulse waveforms from a fixed level

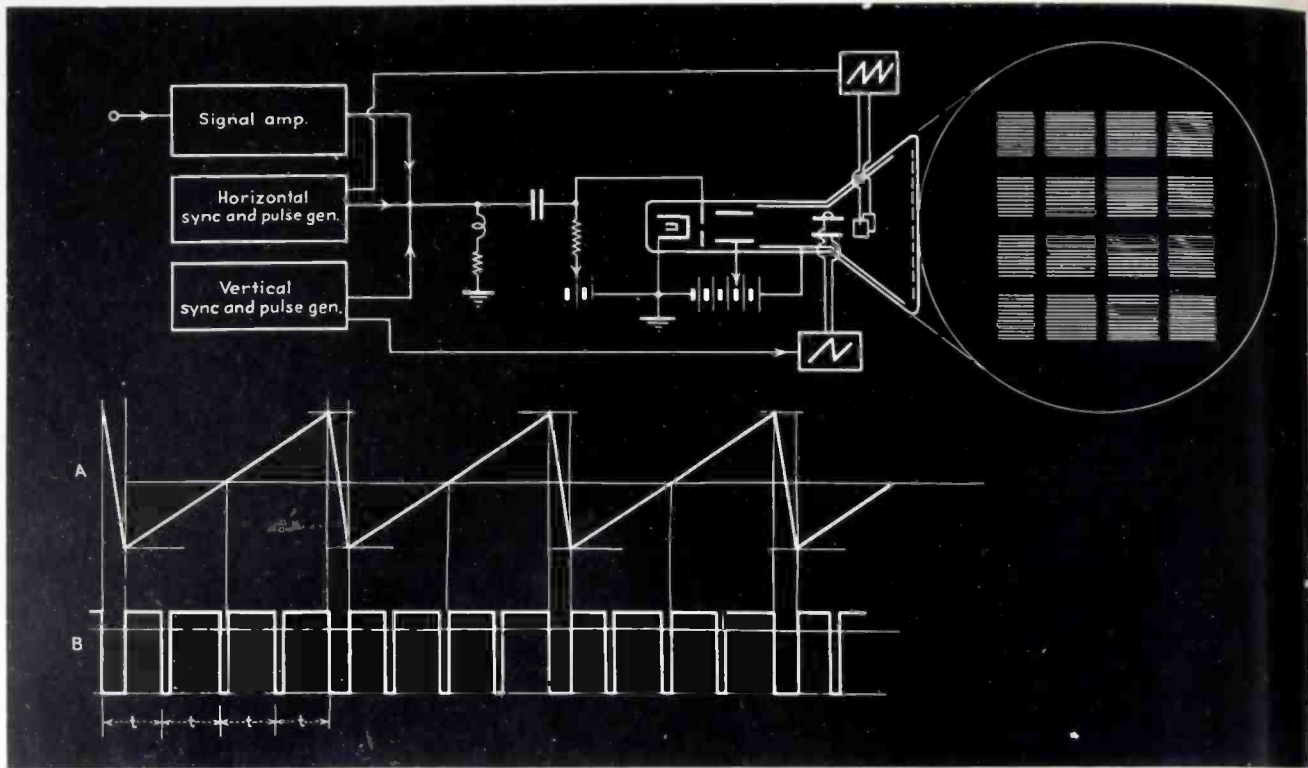

Fig. 20—Functional diagram illustrating method of obtaining two-dimensional saw-tooth deflection on screen of cathode-ray tube with vertical and horizontal scanning

is to use wave *A* to synchronize a relaxation oscillator at the same periodicity and to adjust the circuit constants of the oscillator so that the pulse intervals correspond to the delay interval t . In any circuit path of the oscillator which carries current of the form *B* we insert a small inductance or transformer so that double pulse voltage of the differentiated waveform *C* is developed across a winding. This voltage is applied to a second relaxation oscillator in polarity such that synchronization is effected by the second pulse of the pair. This gives us a source of pulses suitably delayed and by adjusting the circuit constants of this second oscillator to give the desired pulse intervals we achieve the required waveform *D*.

It will be noted that the waveforms have been shown relative to an a-c axis which divides the area equally above and below the axis. The amplitude of a pulse relative to the axis will thus depend automatically upon the ratio of trace to retrace time. Referring back to the waves of the derivative series (Fig. 14) it will be seen that the saw-tooth *C* has a value of $b = 0.9$. The corresponding pulse wave *B* therefore has the positive amplitude 9 times that of the negative amplitude.

It is frequently necessary to operate pulse waveforms from a fixed level irrespective of its interval ratios. This is termed stabilization and is generally effected by employing a diode to develop a d-c component equal to the peak value of the wave. Thus in Fig. 18 the a-c impulse wave coupled to the vacuum tube grid is that shown as e_1 . The diode converts this wave to the form shown as e_2 . This is because the diode, poled as shown, draws a small amount of current at each pulse peak to develop and maintain the positive d-c component e_d . If e_1 is of opposite polarity it is preferable to reverse the diode to develop a negative peak value of d-c stabilizing potential. Frequently the control grid of the vacuum tube may then be used in place of a diode to stabilize the wave by drawing a small amount of grid current as each positive peak occurs.

In the best of the circuits we have been discussing the precise pulse waveforms are not generally available. They generally occur in the exponential form first mentioned and are thereafter shaped by limiting or clipping. This is generally done by applying the pulse wave in large amplitude to a vacuum tube stage or stages as shown in Fig. 19. Stabilization as also illustrated in this

circuit will generally be employed. The diagrams show that the waveform e_1 is set partially beyond cutoff of the characteristic i_{p1} of tube V_1 due to the battery bias e_c and stabilizing diode bias e_d . The output voltage developed across R_1 is the amplified form e_2 having flat trace intervals. The wave e_2 is set with the peaks beyond cut-off of the characteristic i_{p2} of V_2 by battery bias e_c and diode bias e_d so that the output voltage developed across R_2 is the desired pulse e_3 . By this successive process of amplification and limiting we may produce pulses with sides as steep as our circuits permit.

Expanded Time Bases

Two dimensional saw-tooth deflection is common in television wherein the horizontal traces are spread vertically by a second lower frequency vertical saw-tooth deflection voltage to form a grid of lines or picture area. This process is shown in Fig. 20. The pulse generators indicated in block diagram each include sub-multiple pulse generators so that a waveform such as *B* related to the scanning waveform *A* is developed in each unit. The waves of form *B* from each unit are applied to the control grid as shown to blank the retrace and establish

dark lines corresponding to the pulse
 peaks which divide the screen area
 into time intervals. A standard
 reference of frequency may be employed
 to synchronize the horizontal and
 vertical pulse generators so that pre-
 cise time intervals of known value
 are established. Signals whose time
 variations are to be determined are
 then added to the grid voltage by
 the amplifier shown. Their effect of
 brightening or darkening of the
 screen marks their position on this
 two-dimensional time scale. Systems
 for depicting various network char-
 acteristics have been developed using
 this type of expanded time scale.
 Another two-dimensional time
 scale is the circular trace of Fig. 21.
 A phase splitting network serves to
 provide time quadrature sinusoidal
 deflection voltages to the deflection
 plates which are in space quadrature.
 An elliptical trace results which be-
 comes circular when the two deflec-
 tion fields are of equal amplitude.
 This is a case of rotating electro-
 static field.

Thus

$$x = K_1 e_x = K_1 E_1 \cos \omega t \quad (10)$$

where e_x is horizontal deflection volt-
 age

$$y = K_2 e_y = K_2 E_2 \sin \omega t \quad (11)$$

where e_y is vertical deflection voltage

$$x^2 + y^2 = \rho^2 \quad (12)$$

From Eq. (10) and (11) above we
 may write

$$\frac{x^2}{(K_1 E_1)^2} + \frac{y^2}{(K_2 E_2)^2} = \sin^2 \omega t + \cos^2 \omega t = 1 \quad (13)$$

which is the equation of an ellipse,

If $K_1 E_1 = K_2 E_2$ then, with (12) above

$$x^2 + y^2 = (K_1 E_1)^2 = \rho^2 \quad (14)$$

which is the equation of a circle.

Also we note that

$$\theta = \tan^{-1} \frac{y}{x} = \omega t$$

when the trace is a circle.

Ordinarily the deflection sensitiv-
 ities K_1 and K_2 of the two pairs of
 plates are sufficiently equal so that
 we need simply make the deflection
 voltages equal to obtain a circular
 trace. The radius of the circle,
 which the spot traces at angular
 velocity ωt is then directly propor-

tional to the voltage E as Eq. (14)
 shows. A signal e_s applied to V_1 is
 effective therefore to change the ra-
 dius of the circle, as indicated on the
 diagram. If the signal e_s is periodic
 at the frequency $f = \omega/2\pi$ then the
 ripple it produces on the circular
 trace is stationary. If e_s differs in
 frequency from f it will move around
 the circle.

If a saw-tooth voltage is applied
 to the tube V_2 as shown, then it will
 be evident that the radius of the
 circular trace will change linearly
 with time. If the periodicity of this
 saw-tooth voltage is f_s and lower
 than f , then the trace becomes a
 spiral which is stationary if f_s is a
 submultiple of f . Otherwise the
 spiral will rotate. If f_s is much
 higher than f then the diagram be-
 comes radial; like a series of spokes
 radiating from a central hub. Sig-
 nals applied to the oscillograph grid
 or to the tube V_1 will register on
 these expanded time scales and a
 variety of useful arrangements are
 possible.

Fig. 21—Phase splitting circuits are employed to produce two-dimensional deflections in polar coordinates

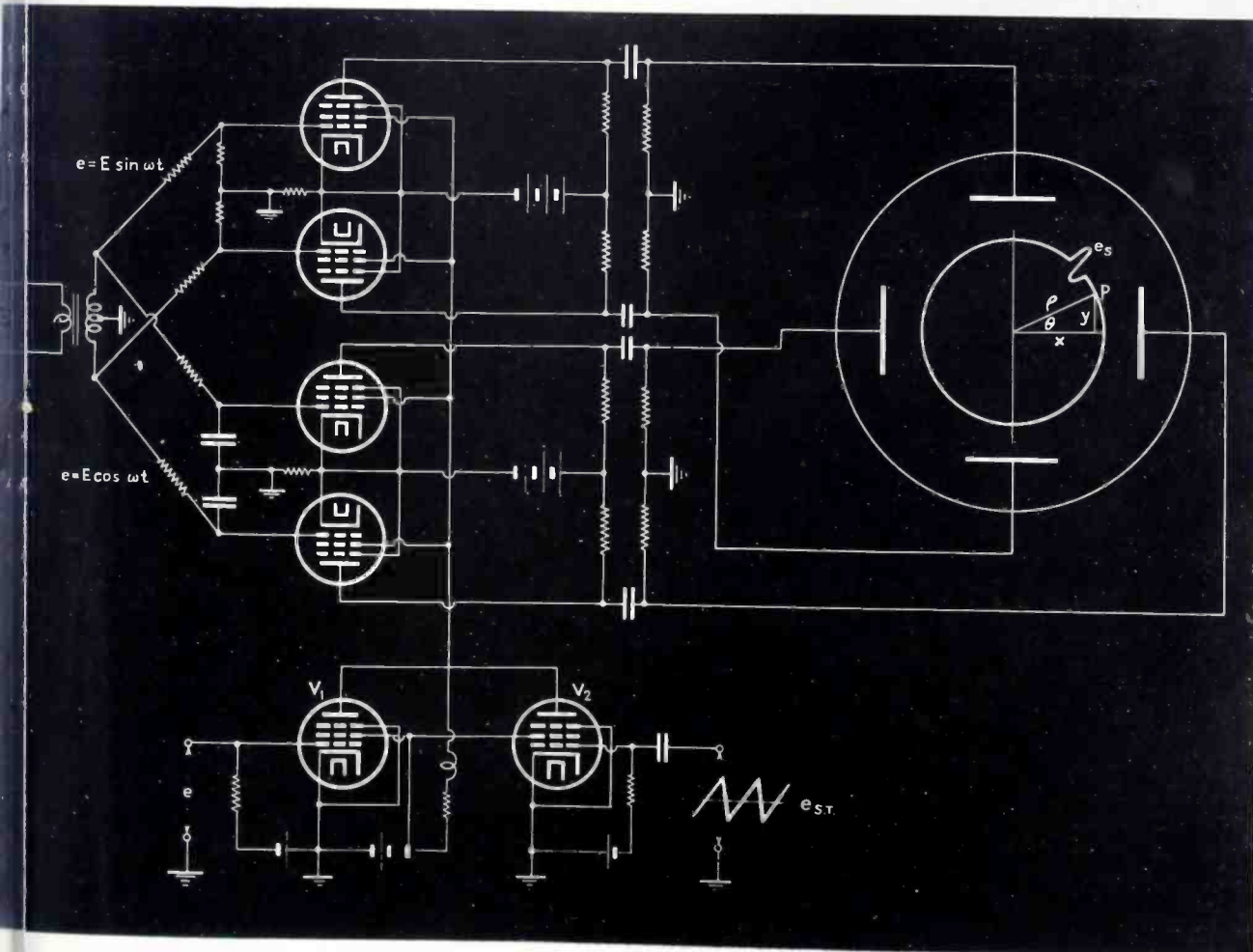

Notes on Band Pass

By H. HOLUBOW

Engineering Department, Thordarson Electric Manufacturing Co., Chicago

THE following notes represent simplifications in methods of calculating the performance of band pass and band elimination filters, especially when it is necessary to allow for the dissipation in the coils. The usual notation holds, i.e., F_1 and F_2 are the critical frequencies (cut-off), F_m is the median frequency in the critical band, R is the terminating resistance.

Band Pass Filters

Although there are a number of networks which may be used as band pass filters, the constant K type, shown in Fig. 1, is most commonly employed. In this structure, the product of the series and shunt element impedances, Z_1 and Z_2 respectively, is a constant equal to K^2 . The expected performance of the band pass filter is usually obtained graphically from the values of $Z_1/4Z_2$. These values are usually given in texts and handbooks in terms of the cut-off frequencies. The calculation of $Z_1/4Z_2$ becomes quite cumbersome when dissipation must be taken into account, but the simplifications that follow are useful in that they do not entail much sacrifice in accuracy.

The impedance of the series arm Z_1 at any frequency F_{11} may be expressed as follows:

$$Z_1 = j 2\pi F_{11} L_1 - j \frac{1}{2\pi F_{11} C} = j \left[\frac{2\pi R F_{11}}{\pi (F_2 - F_1)} - \frac{4\pi F_2 F_1 R}{2\pi F_{11} (F_2 - F_1)} \right]$$

Simplifying,

$$Z_1 = j 2R \frac{F_{11}^2 - F_2 F_1}{F_{11} (F_2 - F_1)}$$

The impedance of the shunt arm

$$Z_2 = \frac{1}{j 2\pi F_{11} L_2 + j 2\pi F_{11} C_2} = \frac{j}{1 - 4\pi^2 F_{11}^2 L_2 C_2}$$

Substituting for L_2 and C_2 their values from Fig. 1,

$$Z_2 = j \frac{R F_{11} (F_2 - F_1)}{2 (F_2 F_1 - F_{11}^2)}$$

whence

$$\frac{Z_1}{2 Z_2} = \frac{2 (F_{11}^2 - F_2 F_1) (F_2 F_1 - F_{11}^2)}{F_{11}^2 (F_2 - F_1)^2} \quad (1)$$

The attenuation of the band pass filter at any point may now be calculated from the relation

$$\cosh \alpha = 1 + \frac{Z_1}{2 Z_2}$$

or graphically from

$$\frac{Z_1}{4 Z_2}$$

This equation, however, is cumbersome to use, but the following simplification can be made:

For any point on the filter curve corresponding to F_{11} , there is another point F_{22} such that $F_{11} F_{22} = F_1 F_2 = F_m^2$. Substituting F_{11} , F_{22} for F_1 , F_2 in

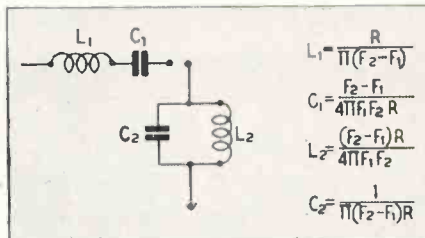

Fig. 1—Constant K band pass filter circuit

Eq. (1), the following is obtained:

$$\frac{Z_1}{2 Z_2} = \frac{2 (F_{11}^2 - F_{11} F_{22}) (F_{22} F_{11} - F_{11}^2)}{F_{11}^2 (F_2 - F_1)^2} = \frac{2 (F_{11} - F_{22}) (F_{22} - F_{11})}{(F_2 - F_1)^2} = -2 \frac{(F_{22} - F_{11})^2}{(F_2 - F_1)^2} \quad (2)$$

This may now be written as

$$\frac{Z_1}{2 Z_2} = -2 \left(\frac{F_{\Delta 1}}{F_{\Delta}} \right)^2 \quad (2a)$$

where $F_{\Delta 1}$ is the band spread at the points of determination (F_{22} , F_{11}), while F_{Δ} is the band spread of the filter between points $F_2 - F_1$. A curve (Fig. 2) may now be made that will give the theoretical determination of the attenuation at any point of any constant K band pass filter.

Attenuation in Filters with Dissipation

The attenuation of a band pass filter obtained by means of curve in

Fig. 2 assumes no dissipation either in the reactors or condensers. The dissipation in condensers is usually small and can be neglected; the dissipation present in the coils, however, is considerable, especially at the audio frequencies. In the ideal filter there is no attenuation within the pass band, while in an actual filter the attenuation within the pass band may be considerable, especially in the narrow band pass filters. However, if the attenuations at the mid-frequency $F_m = F_1 F_2$, and at F_1 , F_2 are known, the response of the filter may easily be determined.

In the constant K band pass filter at the frequency F_m , $X_{L1} = X_{C1}$ and $Z_1 = 2\pi F_m L_1 d$, or $Z_1 = \frac{2\pi F_m L_1}{Q}$, where

$$d \text{ is } \frac{r}{2\pi F L} \text{ or } Q = \frac{2\pi F L}{r} \quad (r \text{ is the}$$

equivalent series resistance of the reactor) and L_1 is the series arm inductance. In terms of the cut-off frequencies (Fig. 1).

$$Z_1 = \frac{2\pi F_m R}{Q\pi (F_2 - F_1)} = \frac{2 F_m R}{Q (F_2 - F_1)}$$

In the shunt arm, $X_{L2} = X_{C2}$, and assuming dissipation present in the inductances only,

$$Z_2 = \frac{X_{L2} X_{C2} - jr X_{C2}}{r + j (X_{L2} - X_{C2})} = \frac{X_{L2} X_{C2}}{r} - j X_{C2}$$

or

$$Z_2 = Q X_{L2} - j X_{L2}$$

Inasmuch as the Q of a filter choke is seldom smaller than 20, the reactive component $j X_2$ may be neglected and, from Fig. 1,

$$Z_2 = Q X_{L2} = 2\pi Q \frac{F_m (F_2 - F_1) R}{4\pi F_1 F_2} = \frac{Q (F_2 - F_1) R}{2 F_m}$$

and

$$\frac{Z_1}{Z_2} = \frac{4 F_m^2}{Q^2 (F_2 - F_1)^2}$$

and

$$\frac{Z_1}{2 Z_2} = \frac{2}{Q^2} \left(\frac{F_m}{F_2 - F_1} \right)^2$$

at

$$F_{11} = F_m$$

and Band Rejection Filters

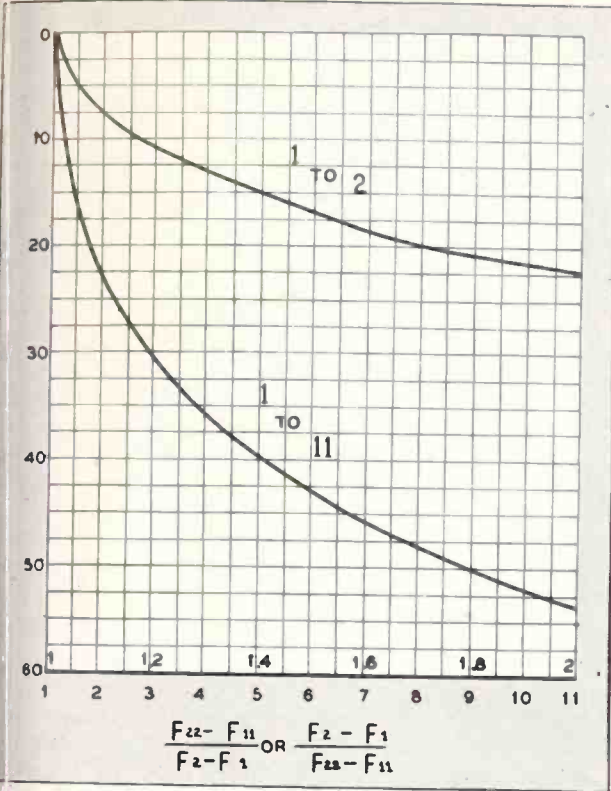

Fig. 2—Curve showing attenuation of band pass filter, without taking into account resistance in coils or condensers

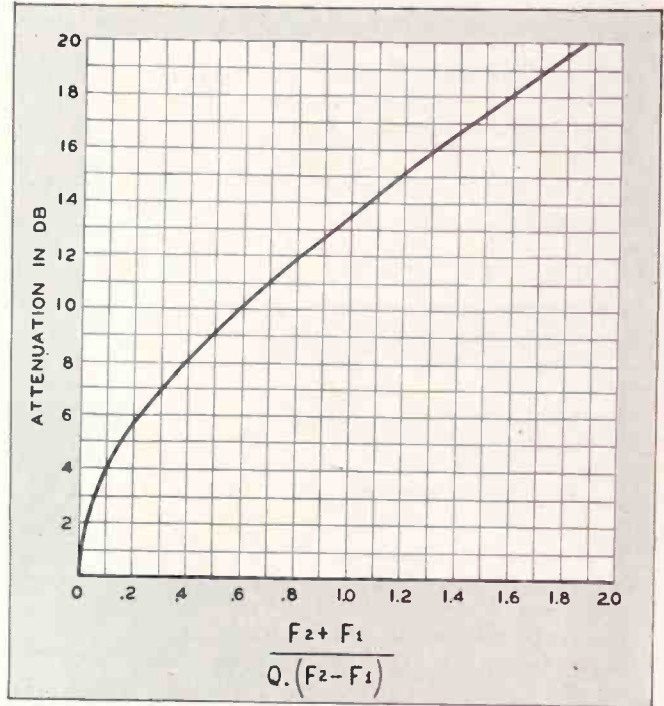

Fig. 3—Attenuation of band pass filter at the critical frequencies F_1 and F_2 when the coils have dissipation

Attenuation at f_m

The attenuation at the midband frequency may be found from tables of hyperbolic functions where

$$\cosh \alpha = 1 + \frac{Z_1}{2Z_2}$$

When α is attenuation in nepers. However, inasmuch as α at the midband frequency is less than one neper, the following approximation may be used:

$$\cosh \alpha = 1 + \frac{\alpha^2}{2!} + \frac{\alpha^4}{4!}$$

Using the first two terms

$$1 + \frac{\alpha^2}{2!} = 1 + \frac{Z_1}{2Z_2}$$

$$\alpha = \sqrt{\frac{Z_1}{Z_2}} = \frac{2}{Q} \times \frac{F_m}{F_2 - F_1} \text{ nepers, (3)}$$

$$\alpha = \frac{17.3}{Q} \times \frac{F_m}{F_2 - F_1} \text{ decibels (3a)}$$

The error from using this expression is less than 4 percent for α less than 8 db.

Attenuation at a Cut-off Frequency, F_1

In the same manner it may be shown that at F_1

$$\frac{Z_1}{2Z_2} = 2 \frac{d \frac{F_1}{F_m} + j \frac{F_2 - F_1}{F_m}}{(1 - jd) \left[\frac{F_2 - F_1}{F_m} \right]^2}$$

where d is the dissipation factor of the filter components. Performing the indicated operations

$$\frac{Z_1}{2Z_2} = 2 \times \frac{d^2 \left(\frac{F_1}{F_m} \right)^2 + j2d \frac{F_1}{F_m} \left(\frac{F_2 - F_1}{F_m} \right) - \left(\frac{F_2 - F_1}{F_m} \right)^2}{\left(\frac{F_2 - F_1}{F_m} \right)^2 - jd \left(\frac{F_2 - F_1}{F_m} \right)}$$

Inasmuch as d is usually small, all terms containing d^2 or d^3 can be neglected.

$$\begin{aligned} \frac{Z_1}{2Z_2} &= 2 \left[-1 + j2d \frac{F_1}{F_2 - F_1} + jd \right] \\ &= -2 + j2d \frac{F_2 + F_1}{F_2 - F_1} \\ &= -2 + j \frac{2}{Q} \frac{F_2 + F_1}{F_2 - F_1} \end{aligned}$$

The attenuation at F_1 or F_2 may be

obtained from the curve in Fig. 3 where the abscissas are in terms of

$$\frac{F_2 + F_1}{Q(F_2 - F_1)}$$

or

$$d \frac{F_2 + F_1}{F_2 - F_1}$$

To illustrate the procedure in the design, let us assume that it is required to obtain the expected performance curve for a band pass filter when $F_1 = 3000$ cps, $F_2 = 4000$ cps, and the dissipation factor of the coils is 0.04 ($Q = 25$), and in which $F_m = \sqrt{4000 \times 3000} = 3450$. The theoretical performance of the filter may be calculated as shown.

F_{11}	F_{22}	$\frac{F_{\Delta 1}}{F_{\Delta}}$	Attenuation in db
2800	4300	1.5	17
2600	4620	2.02	22.5
2400	5000	2.6	28.0
2000	6000	4.0	36.0
1500	8000	6.5	44.5
1200	10000	8.8	50

In this table either F_{11} or F_{22} is

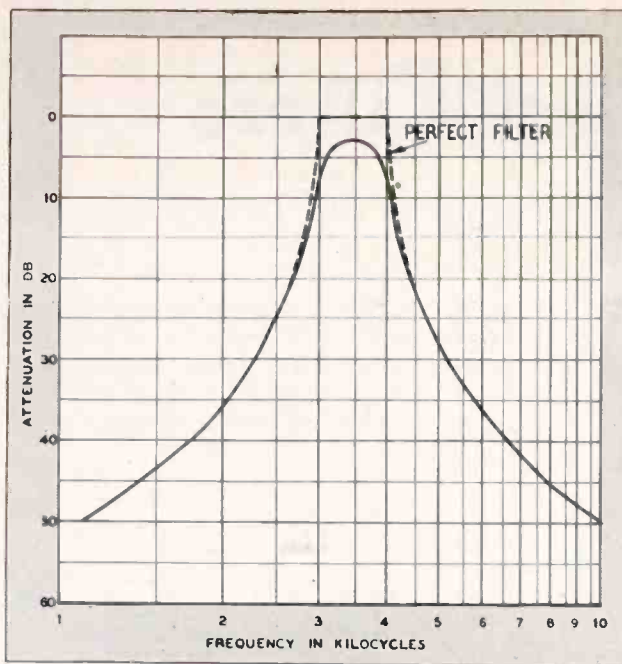

Fig. 4—(Left) Performance curve of band pass filter as calculated by the methods outlined in this article

assumed and the other frequency is calculated from

$$\frac{F_1 F_2}{F_{11}} \text{ or from } \frac{F_1 F_2}{F_{22}}$$

and

$$\frac{F_{\Delta 1}}{F_{\Delta}} = \frac{F_{22} - F_{11}}{F_2 - F_1}$$

The attenuation in decibels is obtained from Fig. 2. The insertion loss at F_m is obtained from Eq. (3a) and is

$$\frac{17.3}{25} \times \frac{3450}{1000} = 2.4 \text{ db}$$

The insertion loss at F_2 and F_1 is 7.6 db, (obtained from Fig. 3). The expected performance curve of the filter is as shown in the heavy line on Fig. 4.

Band Rejection Filters

The band rejection filter does not find as wide an application as the band pass filter. Nevertheless, it is desirable to be able to predetermine

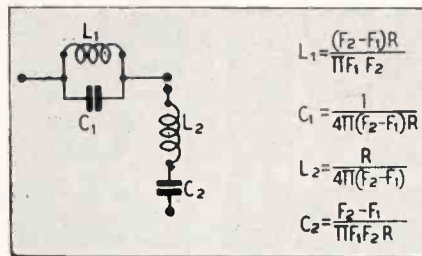

Fig. 5—(Below) Band elimination filter of the constant K type in which the series and shunt reactances are as shown, in terms of the terminal resistance R

the performance of this type of filter. There is only one type constant K structure that is commonly used, as shown in Fig. 5.

Using the same method of analysis as in the case of the band pass filter, it is found that

$$\frac{Z_1}{2Z_2} = -2 \frac{F_2 - F_1}{F_{22} - F_{11}} = -2 \frac{F_{\Delta}}{F_{\Delta 1}}$$

This relation is similar to that obtained for the band pass filter except $F_2 - F_1$ and $F_{22} - F_{11}$ are interchanged. The theoretical performance of a band rejection filter may be then obtained from curve in Fig.

2 using $\frac{F_{\Delta}}{F_{\Delta 1}}$ for the abscissas.

At midband frequency $2\pi FL = \frac{1}{2\pi FC}$ for both the series and the shunt arm. At F_m ,

$$Z_1 = 2\pi F_m L_1 Q = \frac{2F_m(F_2 - F_1)RQ}{F_1 F_2}$$

$$Z_2 = \frac{2\pi F_m L_2}{Q} = \frac{F_m R}{2(F_2 - F_1)Q}$$

$$\frac{Z_1}{2Z_2} = 2 \frac{(F_2 - F_1)^2 Q^2}{F_1 F_2} = 2 \left(\frac{F_2 - F_1}{F_m} \right)^2 Q^2$$

Attenuation α at midband may be obtained from the relationship

$$\cosh \alpha = 1 + \frac{Z_1}{2Z_2}$$

where

$$\cosh \alpha = \frac{e^{\alpha}}{2} + \frac{e^{-\alpha}}{2}$$

Inasmuch as the attenuation is usually large,

$$\frac{e^{\alpha}}{2} = \frac{Z_1}{2Z_2} = 2 \frac{(F_2 - F_1)^2 Q^2}{F_m^2}$$

or

$$e^{\alpha} = \left[2 \frac{F_2 - F_1}{F_m} Q \right]^2$$

The attenuation

$$\alpha = 2 \log_e 2 \frac{F_2 - F_1}{F_m} Q \text{ nepers,}$$

or

$$\alpha = 40 \log_{10} 2 \frac{F_2 - F_1}{F_m} Q \text{ decibels}$$

At the cut-off frequencies F_2 and F_1

$$\frac{Z_1}{2Z_2} = -2 \frac{\frac{F_2 - F_1}{F_m} - jd \left(\frac{F_2 - F_1}{F_m} \right)^2}{\left(\frac{F_2 - F_1}{F_m} \right)^2 - j2d \frac{F_1}{F_m} \left(\frac{F_2 - F_1}{F_m} \right)}$$

Simplifying and discarding terms containing d^2 and d^3 , we obtain

$$\frac{Z_1}{2Z_2} = -2 - j2d \frac{F_2 + F_1}{F_2 - F_1} = -2 - j2 \frac{F_2 + F_1}{Q(F_2 - F_1)}$$

The attenuation at points F_2 and F_1 for band rejection filter is obtained in the same manner as for band pass filter from Fig. 3.

Broadcasting Under War Conditions

(Continued from page 35)

together the nation as a unified whole. It is perhaps the most effective single method of disseminating propaganda, in the dictionary sense of "tending to persuade by just discussion and argument." One has only to listen to an hour's radio program to be convinced of the importance broadcasting is playing in the building up of national solidarity, for each and every program makes its appeal for some cause or another which is in-

tended to further our war effort. Only one important speech from Washington or London need be marred, through failure of strategically critical equipment or of inexperienced personnel to bring us forcefully to the realization that broadcasting must be maintained because it is so vital a cog in our vast war effort.

There is no use taking an alarmist's point of view with regard to

the present situation, for those factors which are being recognized as potentially dangerous can be rectified in time to alleviate any serious disruption of service. Nevertheless, the problems confronting the broadcasting industry must be squarely faced immediately, so that steps may be taken to assure the industry that it will receive the personnel and equipment it requires to maintain its services.

PROPAGATION CONSTANT AND CHARACTERISTIC IMPEDANCE

of High Loss Transmission Lines

Graphical and analytical methods for determining the characteristic impedance and propagation constant of transmission lines having high losses resulting from series resistance are presented in this Reference Sheet

MANY transmission lines have a negligible leakage conductance but have a relatively high series resistance. This is particularly true of lines operated at radio frequencies. For such lines the usual formulas for low loss lines are in serious error.

There are many applications of lines especially designed to have a high loss besides those high loss problems normally encountered. Such applications include power dissipating engines in which a short section of a transmission line which has a high resistance is used.¹ Other applications include attenuating sections in which a section of a high resistance line is used to reduce a voltage.

The accompanying charts are shown universal characteristics of such lines. These curves show simultaneously the components of the line characteristic impedance and of the propagation constant.

Characteristic Impedance

A line with a negligible leakage conductance has a series impedance of

$$Z = R_s + j\omega L \quad (1)$$

and a shunting admittance per unit length of

$$Y = j\omega C \quad (2)$$

where R_s represents the series resistance of the line per unit length,

L represents the series inductance of the line per unit length, and

C represents the shunting capacitance of the line per unit length.

By **KARL SPANGENBERG**

Stanford University

Such a line has its characteristic impedance given by

$$Z_0 = R_0 \sqrt{1 - \frac{jR_s \lambda}{2\pi R_0}} \quad (3)$$

where $R_0 = \sqrt{L/C}$, is characteristic impedance for R_s equal to zero, i.e. no loss, and

λ represents the free space wavelength.

It is convenient to express components of the characteristic impedance in units of R_0 , thus

$$\frac{Z_0}{R_0} = \frac{R}{R_0} - \frac{jX}{R_0} = r - jx \quad (4)$$

where r represents the real part of Eq. (3), or the resistive component of the characteristic impedance, in units of R_0 and x represents the imaginary part of Eq. (3), or the reactive component of the characteristic impedance, in units of R_0 . It will be seen in the above that the factor $R_s \lambda / R_0$ is the series resistance per free space wavelength in R_0 units.

Some approximations for limiting cases are useful. For small R_s , (less than R_0 / λ),

$$x = R_s \lambda / 4\pi R_0 \quad (5)$$

$$r = 1 + (x^2 / 2) \quad (6)$$

For R_s , greater than $30R_0 / \lambda$,

$$r = \sqrt{R_s \lambda / 4\pi R_0} \left(1 + \frac{\pi R_0}{R_s \lambda} \right) \quad (7)$$

$$x = \sqrt{\lambda R_s / 4\pi R_0} \left(1 - \frac{\pi R_0}{R_s \lambda} \right) \quad (8)$$

Propagation Constant

The propagation constant of the line per unit length is given by

$$\gamma = \frac{2\pi}{\lambda} \sqrt{-1 + \frac{jR_s \lambda}{2\pi R_0}} \quad (9)$$

It is convenient to express the components of the propagation constant in terms of the values per free space wavelength, thus

$$\gamma = \alpha + j\beta \quad (10)$$

where α represents the attenuation constant per free space wavelength

β represents the phase shift constant per free space wavelength

It is seen that the attenuation constant is zero for zero series resistance and increases without limit as the series resistance increases. The phase shift per free space wavelength is 2π radians for zero series resistance and increases without limit as the series resistance increases. For R_s , less than R_0 / λ

$$\alpha = R_s \lambda / 2R_0 \text{ nepers per free space wavelength} \quad (11)$$

$$\alpha = 4.34 R_s \lambda / R_0 \text{ db per free space wavelength} \quad (12)$$

$$\beta = 2\pi \left[1 + \left(\frac{R_s \lambda}{R_0} \right)^2 \frac{1}{8} \right] \text{ radians per free space wavelength} \quad (13)$$

$$\beta = 360 \left[1 + \left(\frac{R_s \lambda}{R_0} \right)^2 \frac{1}{8} \right] \text{ degrees per free space wavelength} \quad (14)$$

For large R_s , (greater than $30 R_0 / \lambda$)

$$\alpha = \sqrt{\pi R_s \lambda / R_0} \left(1 - \frac{\pi R_0}{R_s \lambda} \right) \text{ nepers per free space wavelength} \quad (15)$$

$$\alpha = 27.35 \sqrt{R_s \lambda / R_0} \left(1 - \frac{\pi R_0}{R_s \lambda} \right) \text{ db per free space wavelength} \quad (16)$$

$$\beta = \sqrt{\pi R_s \lambda / R_0} \left(1 + \frac{\pi R_0}{R_s \lambda} \right) \text{ radians per free space wavelength} \quad (17)$$

$$\beta = 180 \sqrt{R_s \lambda / R_0} \left(1 + \frac{\pi R_0}{R_s \lambda} \right) \text{ degrees per free space wavelength} \quad (18)$$

¹G. I. Brown and J. W. Conklin, Water-cooled Resistors for Ultrahigh Frequencies, *Electronics*, Vol. 14, No. 4, April 1941, pp. 28.

The graph is plotted to show the reactive component of the characteristic impedance plotted against the real component, both components of which are measured in terms of units of R_0 . The curves also show the attenuation in 2π nepers, plotted against the phase shift in 2π radians. For convenience in using small values, the graph is divided into two portions, the portion in the insert showing the region near the origin on an enlarged scale.

The use of the graphs is illustrated in the following examples.

Example 1: A rhombic antenna is fed with 1 kw of power at 10 meters or 30 Mc. The antenna radiates 60 percent of the input power and puts 40 percent or 400 watts into the

terminal impedance. It is desired to dissipate most of this power in a transmission line made of No. 10 iron wire so that only 40 watts reaches a resistor at the end of this line. The terminal impedance should be nearly 600 ohms.

The No. 10 iron wire has a diameter of 0.1019 in. At 30 Mc the skin depth is of the order of 0.0001 in. so that the ordinary skin depth formulas for resistance can be applied. The resistance of the wire is about 1156 ohms per wavelength.

Let $R_0 = 600$ ohms. Then $R\lambda/R_0 = 1156/600 = 1.927$. From the charts, $R/R_0 = 1.0116$. Therefore $R = 606.96$ ohms. Also, $-X/R_0 = 0.0553$, so that $-X = 33.18$ ohms. Hence, $Z_0 = 607 - j 33.2$ ohms.

Reactive and resistive components of characteristic impedance, and attenuation and phase shift of transmission lines with high losses. The insert, upper right corner, is an enlarged scale drawing for small values of the graph

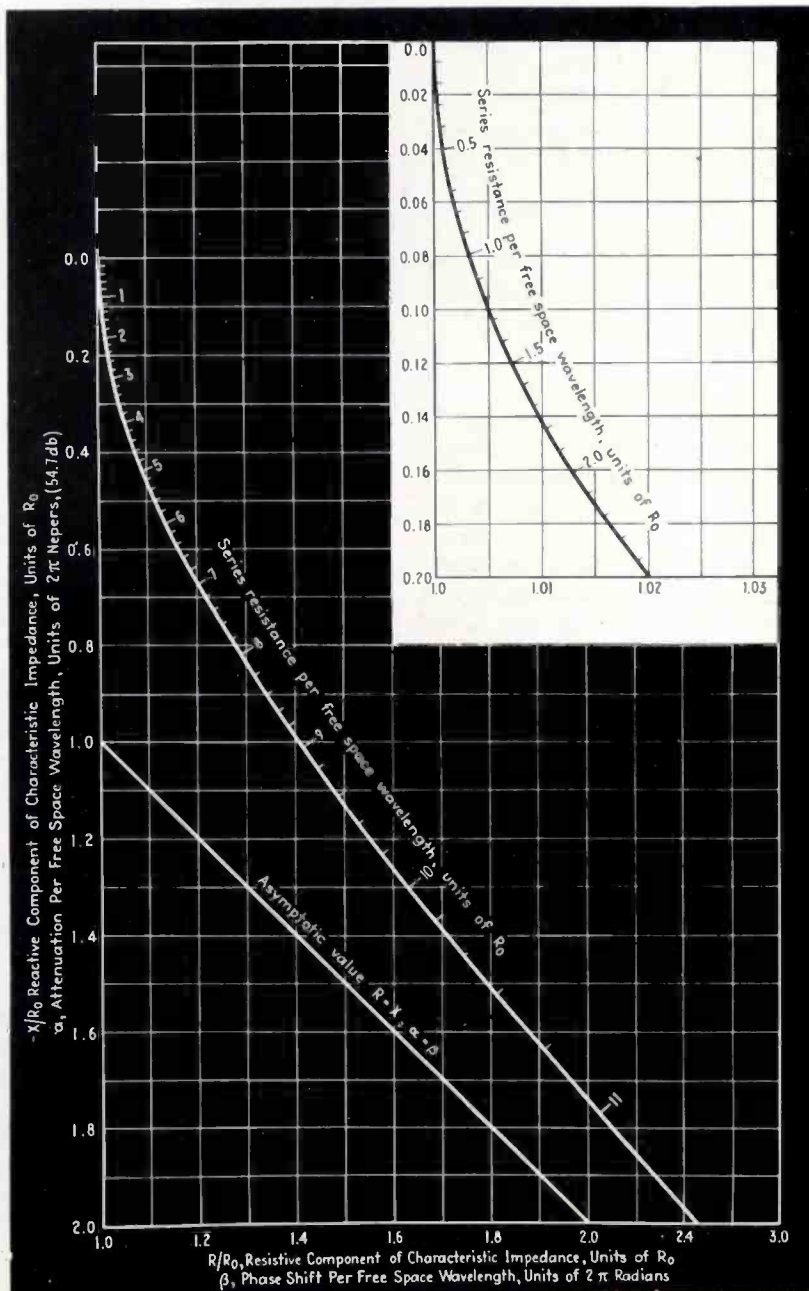

The attenuation is $0.0553 \times 54.7 = 3.03$ db per wavelength. For power to be reduced to 1/10 of initial value or 10 db, the length of the line must be $10/3.03 = 3.3$ wavelengths = 33 meters. This length of wire will dissipate 360 of the 400 watts fed into it. The other 40 watts must be taken up by a terminal resistor. A 1.5 inch spacing of wires is needed to give the impedance characteristics indicated above.

Example 2: It is desired to make an attenuator, for use at 51.5 cm, Mc, in the form of a section of a concentric line. The line is to have a section of its center conductor made of a metallized resistor. Use a 1 ohm resistor, 1 inch in length, $\frac{1}{8}$ inch in diameter. At this frequency the resistance will be assumed not to be affected by the frequency.

At 51.5 cm, one wavelength is 194 inches long. The high resistance section of the line has a resistance of 1000 ohms per inch. Let the characteristic resistance of the line be about 75 ohms which is given by using an outer cylinder with an inner diameter of $\frac{7}{8}$ inch. Therefore $R_0 = 1000 \times 20/75 = 267$. Using high resistance approximation

attenuation = $27.35 \sqrt{267} \left(1 - \frac{\pi}{267}\right) = 439$ db per wavelength = 21.95 db per inch. The resistive component of the characteristic impedance is

$$r = R/R_0 = \sqrt{\frac{267}{4\pi}} \left(1 + \frac{\pi}{267}\right) = 4.69$$

Therefore $R = 4.69 \times 75 = 352$ ohms and the reactive component of characteristic impedance is

$$-x = -X/R_0 = \sqrt{\frac{267}{4\pi}} \left(1 - \frac{\pi}{267}\right) = 4.52$$

Therefore $-X = 4.52 \times 75 = 339$ ohms, so that $Z_0 = 352 - j 339$ ohms.

From the phase shift formula for the 1 inch or 1/20 wavelength section the phase shift is calculated to be

$$\text{phase shift} = \frac{180}{20} \sqrt{267} \left(1 + \frac{\pi}{267}\right) = 149.5^\circ$$

It will be observed that the phase shift and the characteristic impedance differ tremendously from the corresponding low loss values.

The high resistance 1 inch section of line must be matched to the 75 + j0 ohm non-resistive portion of the line in both directions. When this is done the attenuation of the section is approximately 22 db and the phase shift 149.5°.

OCD Carrier Current Tests

INVESTIGATING the practicability of using existing electric power distribution lines for disseminating preliminary air-raid warning signals and general information to civilian defense personnel, the Office of Civilian Defense has conducted a series of tests in an eastern city and suburban environs, using existing broadcast receivers without alteration for picking up carrier-current or "wired radio" signals fed to the lines on 720 kc.

For requirements were laid down in advance. These were:

1. Radiation from the lines shall be of a directive value to enemy raiders.
2. The signal at all desired terminal points must be dependable, adequate and must not be affected unduly by varying nodes, power loads, or other characteristics.
3. The substation equipment for generating and superimposing the carrier must be of reasonable power rating, and must entail a minimum of critical materials.
4. The signal must be capable of central point control and must not be unduly subject to sabotage or jamming or false signals.

Line Data

The types of power distribution lines were available in the area selected for the tests:

TYPE "A"—In the heavily loaded downtown area all low voltage secondaries are connected in multiple or parallel (grid type) network. Service is fed to the system at various points, depending upon load requirements. Feeder lines are interconnected to several power sources. All distribution is essentially underground, with various transformer vaults strategically located throughout the area.

TYPE "B"—In outlying areas underground 4,000-v feeder line distribution is employed. Underground pole and subway type transformers are fed from centrally located substations which in turn are fed from three-phase 13,000-v lines. Low voltage secondaries of underground pole or subway type transformers distribute power to service centers over an area of approximately one square block in residential sections and approximately one square block in neighborhood commercial areas. Feeder lines from the substation is by three-phase, 4,000-v "Y"-type distribution with the center-tap or neutral grounded at the substation as well as at various points throughout the system.

TYPE "C"—In suburban areas the overhead power line distribution system is used. Various substations are interconnected by both 13,000-v and 4,000-v three-phase feeders. The three-phase, 4,000-v feeders emanating from

these various substations distribute power to subscribers in the various residential and commercial areas. The primaries are shunted at convenient points by the usual pole type transformer. Low voltage secondaries which distribute power to subscribers generally run parallel to the primary feeders for a distance of one-quarter wavelength or more.

Equipment Used

Equipment used for the tests consisted of two relatively low power radio transmitters, one consisting of a composite electron-coupled oscillator-buffer stage and a 6L6G power amplifier, high level modulated by means of a three-stage audio amplifier and the other consisting of a 25-watt amateur transmitter modified for broadcast band operation. The latter unit used a type 807 tube in the final r-f amplifier. Both units were equipped with the usual microphones and audio oscillators capable of turning out a 1,000 cps tone. They were capacitively coupled to distribution lines.

Broadcast receivers used for the tests included battery portables, auto-radio and standard line-operated types. Reports were also solicited from listeners located in the areas selected for the tests.

Test Results

Testing results on *Type "A"* lines, a transmitter was coupled into power service lines at a fuse box located on the seventh floor of a downtown office building. Various nearby locations were checked to determine the area covered. The signal was received satisfactorily in other offices on the same floor and, in some instances, on other floors but in no instance was there any indication that the signal followed electric power distribution lines outside the building. By using a portable battery operated receiver a strong signal was detected three-quarters of a block from the building. Tests even at this distance, however, indicated that noise level caused by elevators, motors, diathermy and other electrical equipment precluded satisfactory results in accordance with requirements 2 and 3. The result was not unexpected inasmuch as heavily loaded neutral-grounded grid networks carry several times the power load experienced under average urban conditions. (The problem of civilian defense communications and signalling is not considered serious in central business areas due to the usually ample telephone and alternate wire facilities available.)

Testing on *Type "B"* lines, a transmitter was connected at a substation. Dummy load against earth ground was used for preliminary tuning of the

resonant *L/C* coupler. When connected to the 4,000-v primary very little retuning was required, indicating that the distribution line was being fed under almost short-circuit conditions. The neutral of the three-phase 4,000-v system was well grounded at almost the same point. An estimated five watts of power went into the distribution system. A tour of the area supplied by the particular line bus "disconnects" which were energized indicated good coverage and proved that the signal was following the 4,000-v feeder lines. Although but one phase of the three-phase 4,000 v-primaries were energized directly it was apparent that the other two phases were receiving equal energy as transformers connected to these phases appeared to radiate the same signal strength. Strong signals were detected at manhole locations by means of a portable battery operated receiver for approximately two miles distance from the substation. Where transformers were of the subway type, fully shielded, no signal was received. Tests conducted with various receiver coupling methods to determine to what extent the signal was being induced into low voltage house secondaries were generally unsuccessful. No attempt was made to bridge primaries to secondaries of subway transformers, inasmuch as the equipment needed to do so on the scale which would be required was considered unjustifiable. It was concluded that although requirements 1, 3 and 4 were accomplished satisfactorily terminal locations desired in requirement 2 were limited to the comparatively few points where access to the 4,000-v primary

(Continued on page 130)

How The Wind Blows

THE OFFICE OF CIVILIAN DEFENSE, investigating every possible means of keeping civilian air-raid wardens and other officials in constant touch with headquarters, has already set up a War Emergency Radio Service plan in cooperation with the FCC

NOW THE OCD is hard at work investigating alternate signaling facilities. Here are some pertinent notes concerning one phase of the busy organization's carrier-current investigations.

G-E IGNITRON



The ignitron is a mercury-arc rectifier having a special control electrode or ignitor for starting the arc. Of the three G-E ignitrons shown, the two farthest left are welding-control types; the one above, a power-rectifier type.

Cutaway view of a typical welding-control type ignitron. For power-rectifier service, G-E ignitrons, in addition to the features shown below, include a deionization baffle, a splash-hood baffle, and an auxiliary anode.

Anode lead—connects tube in series with line.

Hose connection for cooling water.

Stainless-steel tube wall surrounded by water jacket.

Ignitor—with tip immersed in mercury pool. Connected in series with timer to control tube operation.

Ignitor lead.

Strong glass seal to insulate anode

Anode—made of treated carbon

Mercury pool (cathode),

Cathode terminal for support of tube and for connection in series with line.

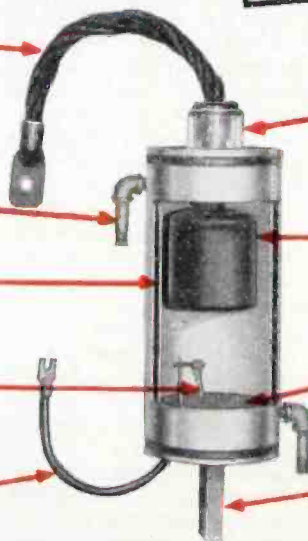

Today's Electronic Answer

Myriad New Applications Lie Ahead for the Electronic Engineer

THE use of ignitrons in industry has grown steadily in the welding-control and power-conversion fields. The advantages of their use over ordinary mechanical devices are many: (1) There are no moving parts, hence little or no attention is required—one reason for the low maintenance expense of electronic equipment. (2) G-E ignitrons are sturdy and do not require extreme care in handling. (3) Because they are replaceable units, tube failure results in only the few minutes' shutdown necessary for making a replacement.

FAST, ACCURATE, RESISTANCE-WELDING CONTROL

In this field, G-E engineers have developed electronic-control equipment using ignitrons which now makes it possible to weld steels and alloys once difficult or impossible to weld. Ignitrons were immediately accepted for this job because of (1) their ability to pass the very high currents needed to develop the necessary heat and (2) their quick response. The flexible and accurate electronic control of current with ignitrons is evidenced by smoother, neater, and faster welds and a reduction of rejects.

The sale of these tubes conveys no license, either expressed or implied, under patents of the General Electric Company other than those covering the tubes themselves.



RESISTANCE WELDING IS A HIGH-SPEED, PRECISION PROCESS when ignitrons are used to control the high-current surges necessary for this work. There are practically no resistance-welding machines in use today that require currents higher than G-E ignitrons are able to control.

The long life of G-E ignitrons and the ease of replacement are also important. Another consideration is their comparatively small size. Since they require only a small amount of auxiliary apparatus, valuable space can be saved in high-production shops.

SIMPLIFIED, QUIET, HIGH-POWER CONVERSION

Power rectifier service is a new field of application for ignitrons in which G-E engineers are also contributing. Electronic rectifiers show how these tubes can replace hard-to-get rotating equipment, and often do a better job, with fewer auxiliaries, lower installation cost, less maintenance, higher efficiency, simpler control, and with no noise or vibration.

One application suggests another. Think of G-E ignitrons when accurately controlled high-current surges are necessary for a job.

Electronic control is fast making yesterday's impossible jobs a regular part of today's production. General Electric has a complete line of electronic tubes—for work that must be done better and faster. General Electric Co., Radio, Television, and Electronics Department, Schenectady, N. Y.

Welding control Types*	Price	Kva Demand	MAXIMUM RATINGS			Cooling	Shipping Weight in Lb	Ask for This Bulletin
			Corresponding Average Anode Current Amperes	Maximum Average Anode Current Amperes	Corresponding Kva Demand			
GL-415	\$33.00	300	12.1	22.4	100	Water	6	GET-968
FG-271	55.00	600	30.2	56.0	200	Water	12	GET-967
FG-235-A	110.00	1200	75.6	140	400	Water	16	GET-967
FG-258-A	250.00	2400	192.0	355	800	Water	45	GET-967

Power-rectifier Types†	Price	D-c Volts	MAXIMUM CURRENT			Cooling	Shipping Weight in Lb	Ask for This Bulletin
			Peak Amp	Average Amp	Average Amp 1 Minute			
GL-427	\$55.00	125	30	5	—	—	3	—
FG-238-B	355.00	300	1800	300	400	Water	35	GEA-3565
		600	1200	225	300			
FG-259-B	200.00	300	900	150	200	Water	22	GEA-3565
		600	600	100	133			

* Ratings are for voltages of 600 volts rms and below. Ignitor requirements for all welding-control types are 200 volts and 40 amperes.
 † Typical ignitor requirements for power-rectifier ignitrons are 75-125 volts, 15-20 amperes. Maximum requirements are 150 volts, 40 amperes.

POWER-RECTIFIER SERVICE MADE EASY in E. D. mine at Blanche, Ky. A portable d-c substation, 200 kw, 75 volts, including a sealed-off ignitron-type rectifier. View General Electric FG-238-B ignitrons and the FG-172 thyristor used for firing.

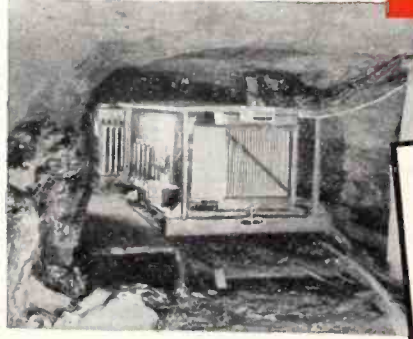

There's a G-E Electronic Tube for Every Electronic Device

Free — Quick-selection Chart of G-E Electronic Tubes for Industrial Use

General Electric, Section 162-3
Schenectady, N. Y.

Please send me.....copies of your quick-selection chart containing condensed technical data and prices on your complete line of industrial electronic tubes.

Name.....
 Company.....
 Address..... State.....
 162-3



THE ELECTRON ART

Engineers at I.R.E. convention discuss engineering activities under war conditions, application of f-m to home recording, and award Morris Liebmann prize to Dr. S. A. Schelkunoff for contributions to the theory of electromagnetic wave radiation

Summer Convention of the Institute of Radio Engineers

SMALLER THAN ANY CONVENTION within recent years was the Cleveland Summer Convention of the Institute of Radio Engineers, held at the Statler Hotel, June 29, 30, and July 1. A total registration of approximately 250 persons was indicated with an attendance at each of the meetings of about 180. This low attendance and the lack of papers on new developments reflected war-time activities of the radio engineers.

Highlights of the convention were the luncheon on Tuesday afternoon, at which Frazier Hunt, General Electric News Commentator analyzed world affairs and evaluated them in terms of recent developments in the Mediterranean, the banquet on Tuesday night which included a talk by George C. A. Hantelman on his collection of 14,000 recording discs, and the trip on Wednesday evening to Nela Park, and the Warner-Swasey Observatory to view the large Schmidt telescope.

At the banquet on Tuesday Evening, the Morris Liebmann Memorial Prize for 1942 was awarded to Dr. S. A. Schelkunoff of the Bell Telephone Laboratories "for his contribution to the theory of electromagnetic field in wave transmission and radiation."

In opening the convention on Monday morning, addresses of welcome were given by A. F. Van Dyck, president of the IRE, P. L. Hoover, chairman of the Cleveland Section, and Carl E. Smith, chairman of the Convention Committee. In his address, Mr. Van Dyck emphasized the position of the radio engineer in the country's present war effort, and pointed out that while a certain amount of secrecy may be necessary to prevent the enemy from knowing what is being developed in this country, this policy may become harmful if it prevents our own research workers or engineers from becoming familiar with the developments taking place at the present time. A free interchange of technical ideas is necessary if we are not to limit the present activities of research workers. Ways and means must be found to determine the results of research activities now under way. It was also pointed out that the Institute is engaged in an active program of standardization of

radio components which, it is believed, will prove beneficial after the war. As a result of the recent urging by the War Production Board to minimize travel, it was indicated that the Cleveland Convention may be the last for the duration of the war.

The first technical paper of the Convention was "Recording Standards" by I. P. Rodman, Columbia Recording Corporation, New York, whose paper was largely a recital of the preparation and establishment of standards for recording and associated equipment used for

broadcasting, under the sponsorship of committees organized in June, 1940, by the National Association of Broadcasters. The reports which have already been prepared, have been forwarded to all broadcasting stations. The standards covered such items as the mechanical dimension of records, direction and speed of rotation, the electrical characteristics, recording level, signal-to-noise ratio and wow factor measurements. The most desirable frequency characteristics for transcription records was the point of most concern in the committee meeting establishing the standards. The standard finally adopted for lateral transcriptions was a rising characteristic, almost linear from -14 db at 100 cps, to +16 db at 10,000 cps. For vertical transcriptions the standard rises almost linearly from -14 db at 50 cps to 0 db at 400 cps, is flat at 0 db between 400 and 1500 cps and then rises to +5, +10, and +18 db at 4200, 6900 and 10,000 cps, when the frequency scale is logarithmic, in both standards.

The second paper of the morning, and forming one of four papers on a symposium on sound recording and distortion was delivered by G. L. Beers and C. M. Sinnett, of the RCA Manufacturing Company, under the title "Recent Developments in Record Reproducing

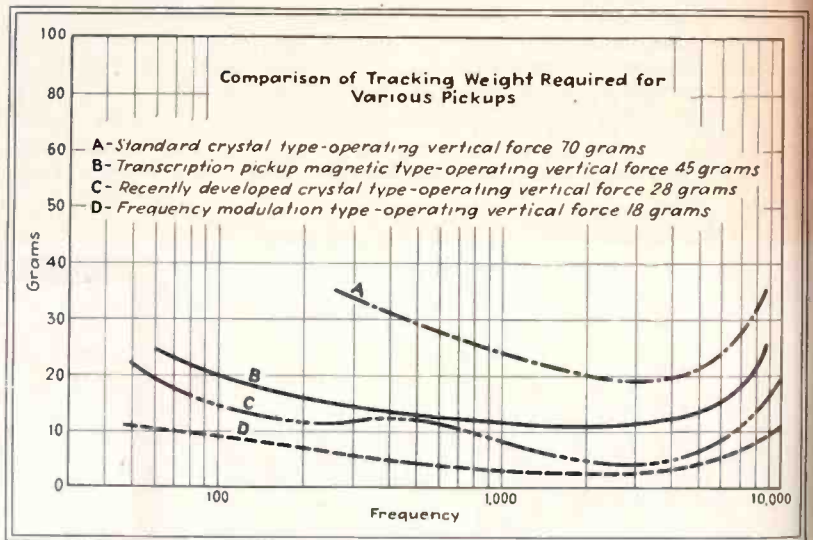

Fig. 1—Graph illustrating the tracking weights required for pick-ups of various construction and illustrating the advantage of the f-m type of pick-up (curve D)

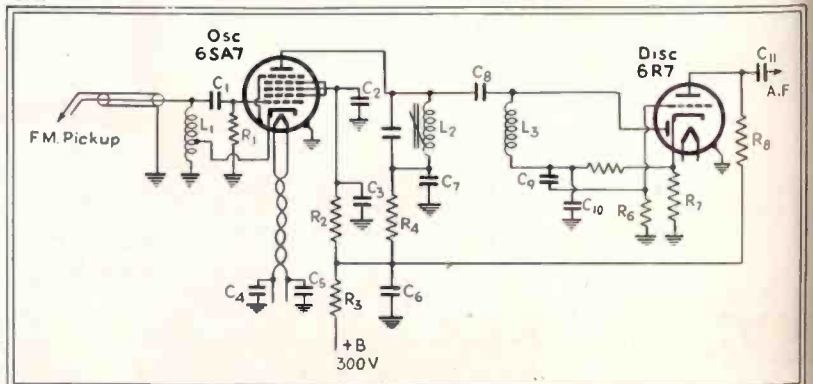

Fig. 2—Schematic wiring diagram of oscillator and discriminator of f-m phonograph pick-up recording system

A special message to industries converting to war production



If You Have Any Magnet Wire and Coil Problems, or need Increased Production on These Items . . .

Anaconda Can Help!...

Anaconda's Central West plants still have unfilled capacity on magnet wire and coil production... *for war work*. In addition to these facilities, they have experienced personnel to help solve problems you might have with this phase of manufacture.

Here is an opportunity to release your time so that it can be devoted to other important problems. Our sales offices, located in all principal cities, are near you. Call today. A representative will be glad to discuss your problem.

GENERAL OFFICES: 25 Broadway, New York City
 CHICAGO OFFICE: 20 North Wacker Drive
 Subsidiary of Anaconda Copper Mining Company
 Sales Offices in Principal Cities

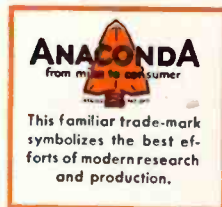

These Improved Insulations Are Now Available Nylon—Vitrotex—and Formvar

The commercial development of Nylon and Vitrotex insulations is in part the result of Anaconda research . . . research that continues with redoubled effort producing new products for war work. Of course, when peace comes, the benefits of this research will be ready for industry everywhere.

42262

 Magnet wire and coils

ANACONDA WIRE & CABLE COMPANY

Systems." The research underlying this paper (as well as that for other papers, for that matter) was concluded before the United States entered the War. Investigations were conducted during the past two years to determine the prospect of materially improving the overall performance of record-reproducing systems. Considerable attention was directed toward the possibility of reproducing frequencies up to 10,000 or 12,000 cps from standard shellacked records without the introduction of objectionable surface noise. The possibility of producing a frequency-modulated signal by means of a special pick-up and associated circuits was studied and such a method was found to lend itself to a realization of many requirements considered essential to a satisfactory reproducing system. A new pick-up, consisting of a metal frame or mounting block serving as a support for an insulated plate which holds a thin ribbon and stylus, was developed as the first essential unit in the frequency-modulated system. The lateral displacement of the stylus in this pick-up results in a change in the position of the ribbon with respect to the fixed mounting block, and thus produces a change in capacitance. In the frequency modulation pick-up it is essential that the change in capacitance with displacement of the stylus be such as to produce a linear relationship between frequency change and motion of the stylus. This condition is fulfilled, to a practical extent, in the type of pick-up already mentioned.

The pick-up producing capacity variations may be connected directly across the tuned circuit of the oscillator. This arrangement is not particularly desirable because the tone arm is made unduly large and the heat from the oscillator tube causes the end of the tone arm, which is handled by the user, to become uncomfortably hot. The same result can be accomplished by mounting the oscillator tube in the main instrument chassis and connecting it to the pick-up through a resonant transmission line which is used as the oscillator tuned circuit.

A simple resonant circuit is utilized as the means for converting the oscillator frequency variations into changes in the amplitude of the signal applied to the diode portion of the 6R7 tube.

The schematic diagram of the circuit used in the f-m recording system is shown in Fig. 2. Considerable attention must be paid to an arrangement of circuit and components which are free from temperature changes, and at the same time enable the pick-up capacity variation to produce the desired frequency changes, as a result of modulation.

A considerable portion of the Beers-Sinnett paper was devoted to a discussion of the experimental and mathematical analyses carried out to determine the characteristics of:

- (a) Lateral mechanical impedance,
- (b) Lateral force acting upon stylus,
- (c) Response characteristic of pick-up and tone.

Fig. 3—Simplified wiring diagram of reactance tube circuit which acts as an adjustable inductance in the distortion meter described by J. E. Hayes. This type of circuit replaced the inductances in a bridged-T frequency discriminating circuit

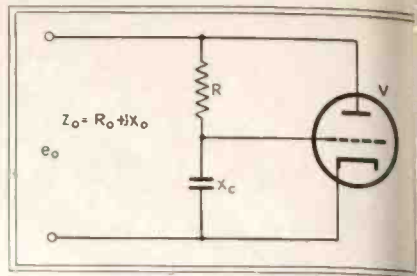
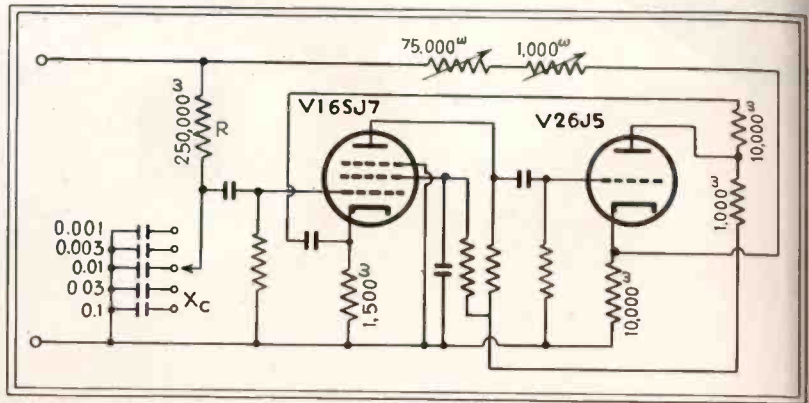

Fig. 4—Simplified schematic wiring diagram of the distortion meter. Gain is provided by the pentode, while proper phase relations are maintained by the triode cathode follower



- (d) Tracking weight required to overcome vertical force due to lateral velocity,
- (c) Tracking weight and relative output to be obtained with different radius of stylus.

An experimental frequency modulation record reproducing system, of the type described has been in use for some time. All of the evidence to date indicates that the system is a practical one and not adversely affected by changes in temperature, humidity and line-voltage.

The experimental frequency modulation pick-up meets the requirements of a satisfactory pick-up to a degree which has not previously been obtained in a relatively inexpensive device. The general performance characteristics in a pick-up of this device can be calculated within reasonable limits.

From the listener's standpoint, the experimental frequency modulation phonograph system which has been de-

scribed, makes it possible when using conventional shellacked records, to extend the frequency range of a record reproducing system to 10,000 or 12,000 cps with a surprising freedom from surface noise, mechanical noise, and distortion. A further reduction in surface noise can be obtained with shellacked records if they are recorded with a high frequency accentuation characteristic which is comparable to that used in transcription. Experimental records of this type have been made. The surface noise obtained from these records with the frequency modulation reproducing system was reduced to a point where it was not objectionable to the most critical listeners.

Although the calculations and measurements which have been given are confined primarily to 78 rpm, records of the same performance advantages are retained in a frequency modulation reproducing system designed for transcription.

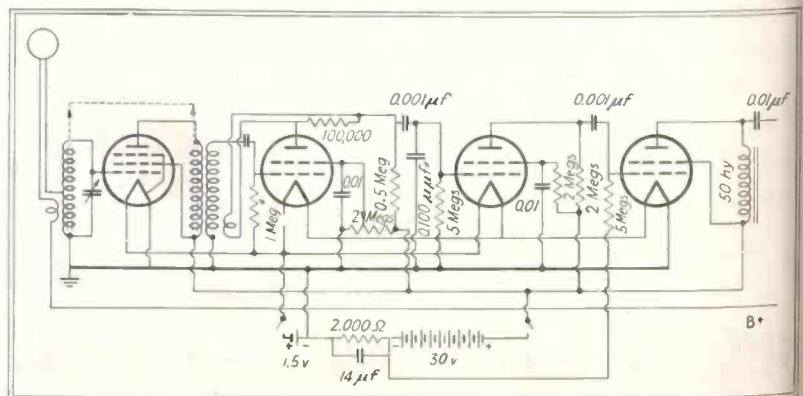
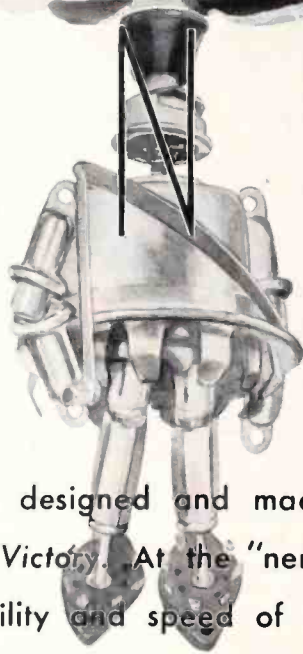

Fig. 5—Circuit of four-tube portable radio receiver which fits into breast pocket of man's suit, as described by W. J. Brown

SMALL PARTS DOING THEIR DUTY....



C I N C H



CINCH small parts are designed and made with one thought in mind, to give their utmost for Victory. At the "nerve center" where "everything" depends upon the reliability and speed of the communicated signal—on the land, in the air, and at sea...the tank, the motorized service—in the bomber, the fighter, the interceptor...the entire fleet, everywhere down to the smallest contact unit, CINCH parts are in it, doing their duty.

CINCH MANUFACTURING CORPORATION

2335 West Van Buren Street, Chicago

SUBSIDIARY: UNITED-CARR FASTENER CORP., CAMBRIDGE, MASS.

A paper by H. E. Roys, RCA Manufacturing Co., Indianapolis, on "Measuring Transcription Turntable Speed Variations" was the third paper on the recording symposium of Monday morning. Because of the extensive use of discs of the transcription and home phonograph type in the radio broadcasting field, it is becoming more important to maintain high standards of record reproduction. One of the essential requirements is that of speed constancy or freedom from wows of the reproducing turntable. The term wow is now generally used to denote such speed variation.

The effect of speed variations as perceived by the ear occur as direct pitch variations at low rates, increasing to flutter at higher rates, and finally indiscernible as pitch changes but recognized as distortion due to the production of side bands because of frequency modulation.

Early wow equipment developed for measuring turntable speeds with the aid of a constant note record and a frequency modulation detector consisted of a tuned circuit where operation was on one side of the resonance curve. The present laboratory equipment which operates on the same principle has been improved and uses two tuned circuits in push-pull to balance out changes of input voltage. A magnetic tone wheel is used instead of records and two balanced pick-ups help to minimize errors due to misalignment and vibration.

Simplified equipment such as used by the RCA Service Department in which a bridge circuit with three resistance branches and one tuned circuit branch was described. With this type of circuit a band-pass filter is used in the input circuit and the tuned circuit of the bridge is tuned to the carrier signal. Any change in speed-frequency unbalances the bridge and is registered on the detector meter. The reading of the meter is then the wow of the turntable.

Due to operating directly at the resonance point of the tuned circuit a speed deviation in either direction gives the same voltage increase across the detector and doubles the frequency applied to the meter. The frequencies applied to the meter are low, however, when wow rates of frequencies corresponding to one revolution at 33½ and 78 rpm are encountered so that the ballistic constants of the meter are important. Tests made with different meters showed the difficulty of reading the meter accurately and to overcome this a special meter with a lower frequency resonance and increased damping was obtained. An improvement in accuracy of reading resulted.

The method of expressing the wow content as a single figure was discussed and preference given to the r-m-s method over the present peak to peak (maximum to minimum speed deviation expressed as a percentage of the average value) method.

A 16 mm film showing the swinging of the meters at low wow rates was shown at the convention.

"A New Type of Practical Distortion

Meter" was described by J. E. Hayes, Canadian Broadcasting Corporation, Montreal. The distortion measuring instrument was developed since commercially available instruments were usually either rather critical in adjustment, or else could be used only on certain predetermined frequencies, and furthermore could be obtained only on orders having high priority rating.

A simple method of making distortion measurements may be based on the frequency selective characteristics of the bridged-T network. The difficulty with such a network made of the usual circuit elements is the lack of flexibility because of the large variable inductances required. This has been overcome in the design developed by Mr. Hayes by replacing actual inductances by their electrical equivalent inductances provided by a reactance tube circuit. The inductance is altered by varying the voltage.

A simplified reactance tube circuit is shown in Fig. 3 in which the voltage applied to the grid of the vacuum tube is retarded almost 90 deg. with respect to e_0 by making R large with respect to X_c . The plate current also lags e_0 by almost 90 deg., producing an effective inductance at the input terminal.

A practical embodiment of this circuit is shown in Fig. 4 where two tubes are required to obtain the desired results. A pentode tube provides the necessary gain, while a triode used as a cathode follower maintains the proper phase relationship and gives the low output impedance necessary for low

values of reactance. Smooth control of the reactance is obtained by a 76,000 ohm resistor, which changes the effective output impedance R_p of the tube. This circuit is used as the electron inductance in the frequency discriminating circuit. The distortion meter consists essentially of a bridge T audio frequency bridge circuit in which the inductance element is replaced by a reactance tube circuit. Because of the flexibility obtainable in vacuum tube circuits, it is a relatively simple matter to vary the effective inductance continuously over a fairly wide range, and thus allow the distortion meter to be used at any frequency in the audio range.

Certain precautions must be taken in a circuit of this type in order to avoid difficulties due to non-linear action of the reactance tube circuit. Application of negative feedback effectively reduces the non-linearity, increases stability and at the same time keeps tube noise and hum at a minimum level. Certain limitations inherent in a reactance tube circuit of this type are:

1. It can be used only in relatively low-voltage circuits.
2. The Q of the circuits drops off on either side of some optimum frequency, and
3. Care must be taken in the design of the amplifier portion so that phase shifts introduced by it do not cause the circuit to break into oscillation.

The final paper on the Monday morning session was "Frequency Modulation Distortion in Loud Speakers" by

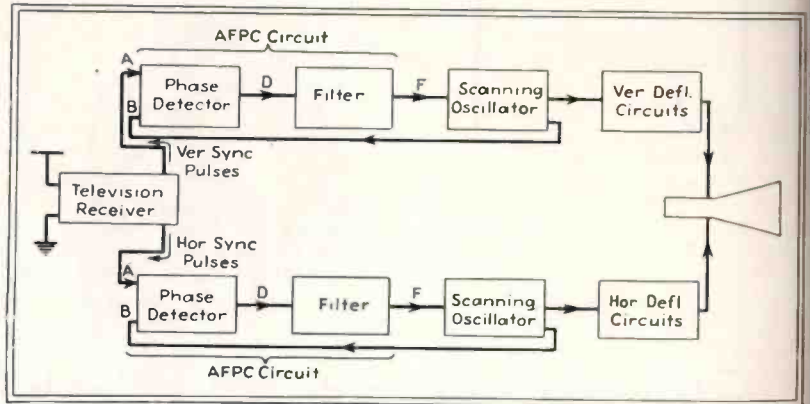

Fig. 6—Block diagram of the elements required in the automatic frequency and phase control synchronizing circuit described by Wendi and Fredenhall

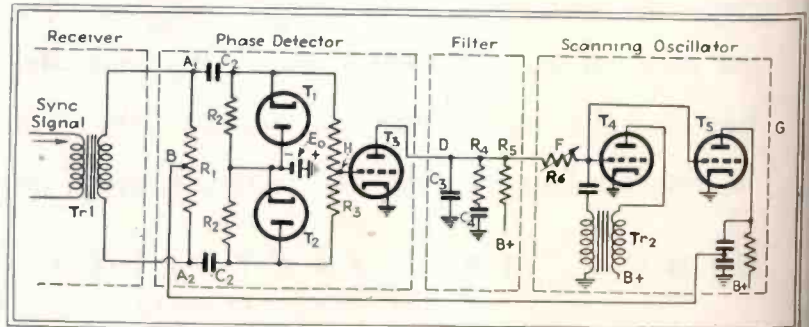
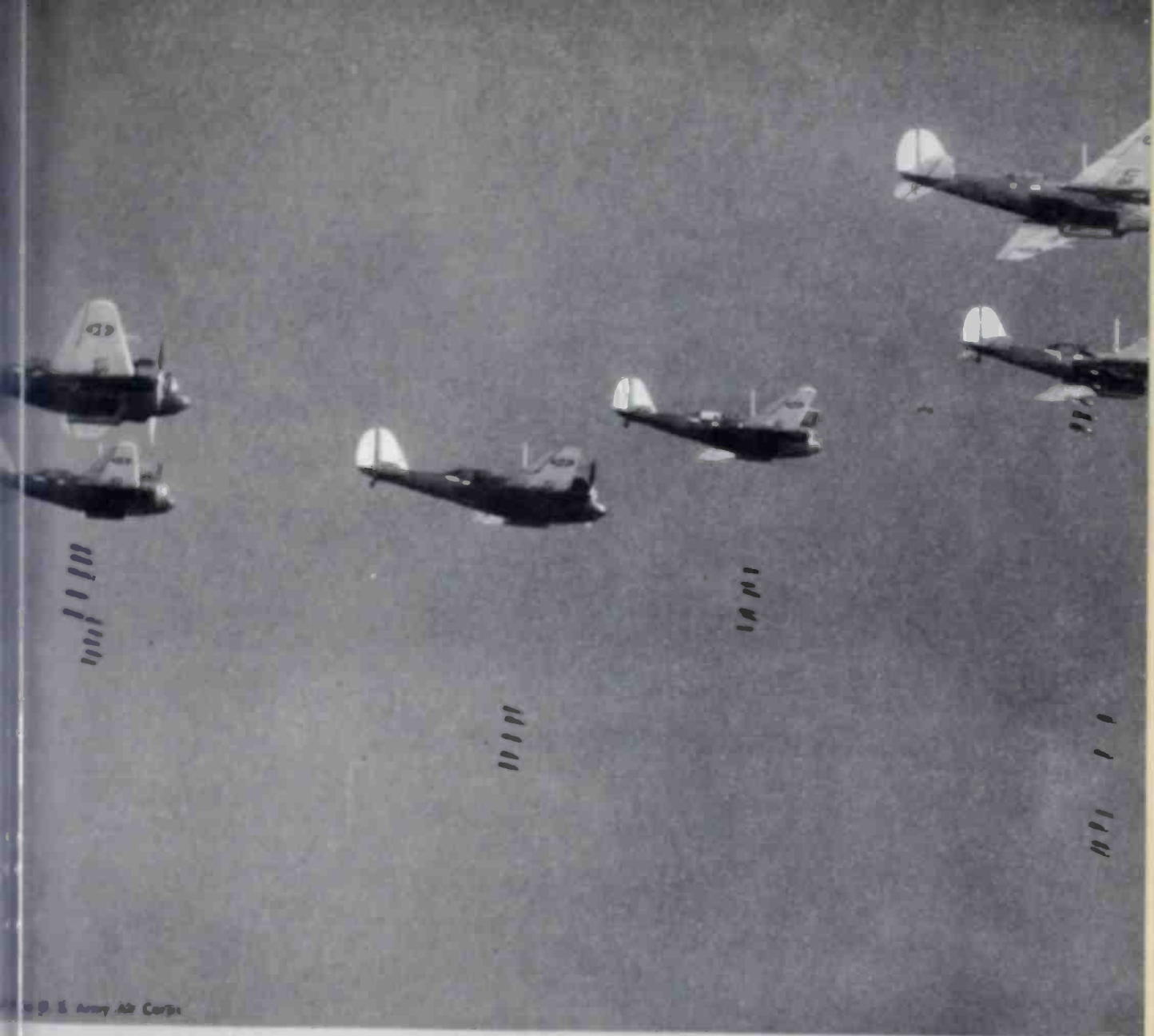

Fig. 7—Schematic diagram of connections of the phase detector and scanning oscillator of the AFPC television circuit



U.S. Army Air Corps

Tokio, Nagoya, Osaka, and Points East

WHIRE did those planes come from? Where did they go? We don't know. All we do know is that they got there—and that mighty armadas will follow them.

Synthane, because of its combination of properties, is valued in wartime production. These properties include excellent electrical insulating characteristics, light weight (half the weight of aluminum), structural strength, ease of machining, and resistance to corrosion from solvents, petroleum products, water, many acids and salts.

If you are producing to win this war, and are not as familiar with laminated plastics as you'd like to be, let us help. We have a number of folders—ready now—on: 1. Synthane Sheets, 2. Synthane Tubing, 3. Technical Plastics for Industry, 4. Synthane Gear Material, 5. Corrosion-Resisting Synthane, 6. Practical Methods for Machining Bakelite-laminated Plastics, 7. The Synthane Sample Book, containing Synthane grades.

SYNTHANE CORPORATION, OAKS, PENNA.

Plan your present and future with plastics

SYNTHANE TECHNICAL PLASTICS

SHEETS • RODS • TUBES • FABRICATED PARTS



SILENT STABILIZED GEAR MATERIAL



Turner Case, turned, threaded, bored, drilled, tapped and counter-bored.
 Insulated and drilled insulators.
 Flyer bracket, sawed, milled and drilled.

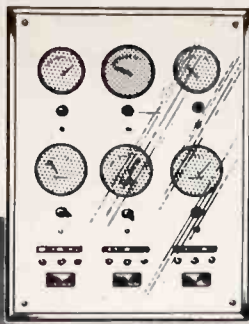

NEW RESERVES GO INTO ACTION...

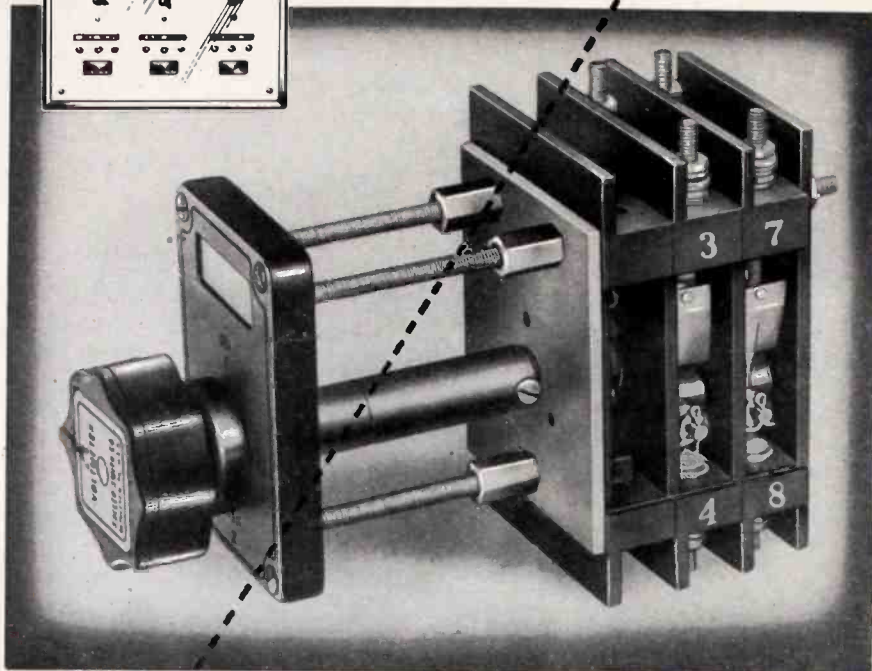

when Roller-Smith and Callite "take over"

One instrument often does the work of two or three when Roller-Smith Instrument Switches "take over" a panel. Hard-to-get meters now in service can be released for new installations by replacing one or more of a group with Roller-Smith Instrument Switches.

This important aid to America's hard-pressed industry depends heavily on the quality of component parts. Callite silver contacts, chosen by Roller-Smith for their low resistance and longer life, have set new performance records in this important application. In countless other fields, Callite contacts are the standout choice where operations depend on uni-

form high quality, stamina and all-around dependability.

There is a large group of Callite Tungsten products, each designed to do a particular job better. Callite research and resourcefulness have contributed to countless technical and scientific developments. If you have a special problem, why not consult Callite's engineering department today?

Specialists in the manufacture of electrical contacts of refractory and precious metals, bi-metals, lead-in wires, filaments and grids—formed parts and raw materials for all electronic applications.

CALLITE TUNGSTEN CORPORATION

544 39th STREET



UNION CITY, N. J.

CABLE: "CALLITES" • BRANCH OFFICES: CHICAGO • CLEVELAND

G. L. Beers, and H. Belar, RCA Manufacturing Company. It was shown that as the frequency response range of sound reproducing system is extended, the necessity for minimizing all forms of distortion is correspondingly increased. Although distortions contributed by a loud speaker have been frequently analyzed, a type of loud speaker distortion which has not received general consideration was described. This distortion is the result of the Doppler effect, and produces a frequency modulation of loud speakers reproducing complex tones. It was shown by mathematical derivation, supported by laboratory measurements, that this type of distortion may be minimized by reducing the diameter of the cone of the speaker and using separate speakers for both the low and the high-frequency components.

The first paper of the Monday afternoon technical session was "Radio Frequency Oscillator Apparatus and Its Application to Industrial Process Control Equipment" by T. A. Cohen, Wheelco Instruments Co., Chicago. This paper described an electronic relay mechanism which avoids many detrimental features incidental to photoelectric equipment when applied to industrial control. The apparatus described is Fig. 8, a type of tuned-grid-tuned-plate oscillator which takes advantage of the large steady current changes which may be made to take

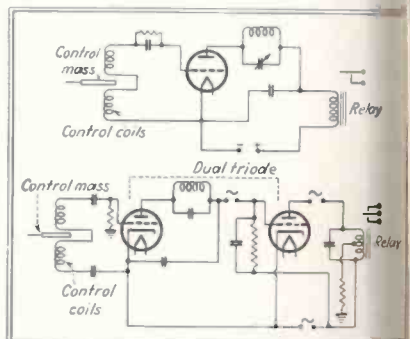

Fig. 8—Fundamentals of tuned-grid-tuned-plate oscillator used as a relay. The control mass alters the plate current which in turn actuates a relay

place in some varieties of self-excited radio frequency oscillators, with small changes in coupling or excitation.

In most instances the direct current component present in the plate circuit of such oscillators is allowed to flow through an electromagnetic relay of suitable characteristic which is maintained in a pre-chosen contacting position by suitable adjustment of the oscillator. Upon being tuned or de-tuned by the approach of a mass of metallic, in other cases, non-metallic material, to a suitable portion of the oscillator circuit, the oscillator causes a change in contacting position of the relay through the change in steady plate current value.

One form of the oscillator type relay mechanism has been applied widely to the problem of producing an electrical contact function by the motion of the pointer of a sensitive and delicate measuring mechanism without disturbing

4 Things Resistor Users Can Do

TO SPEED DELIVERIES... CONSERVE CRITICAL MATERIALS

USE WIDER TOLERANCES WHEREVER POSSIBLE

Wherever possible specify $\pm 20\%$ or $\pm 10\%$ tolerance resistors instead of $\pm 5\%$ tolerance. Stocks of 10% in some ranges, and 20% in almost all ranges, are available whereas 5% resistors must be manufactured. In many types of resistors yield is based on tolerance, therefore the wider the tolerance the greater the yield. Specify wider tolerances to save material, time in delivery, delays in production.

USE STANDARD RESISTORS



Special resistors require special engineering, tooling, materials, and specially trained operators plus special Army and Navy stocks of spares which greatly complicate the problems of fast production and replacement in the field.

Resistor users are urged to use standard types and sizes wherever possible—standards of the industry, and the standards included in existing specifications for large percentage of Army and Navy equipment.

Whatever your war equipment resistor need, whatever your tolerance specifications or delivery dates, IRC will cooperate to the full limit of its greatly expanded facilities in meeting them. We realize there are many cases

SPECIFY NON-FERROUS METALS FOR NON-CONDUCTING PARTS

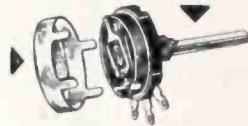

In many instances, specifications can safely be revised to eliminate hard-to-get ferrous metals in favor of non-ferrous metals. This is especially true of non-conducting, non-functioning parts such as covers, shafts, etc. for controls and rheostats. Not only does this mean conservation of critical materials, but it serves as an aid in obtaining materials promptly.

SPECIFY DELIVERIES TO MEET ACTUAL PRODUCTION SCHEDULES

The problem of specified delivery dates versus actual production-use dates is a difficult one for both buyer and supplier. With IRC Resistors so generally specified for war work, however, and with IRC production devoted 100% to meeting these demands, our manufacturing problem is simplified when *production-use* dates are specified. On this basis, deliveries can often be staggered over an entire production period, rather than being demanded far in advance of actual use dates, thus taking a long step toward "on time" deliveries for all.

where none of the foregoing suggestions may prove applicable. Wherever they can be applied, however, they will play a part—small, but none the less important—in speeding up the war effort and increasing its efficiency.



INTERNATIONAL RESISTANCE COMPANY
401 NORTH BROAD STREET • PHILADELPHIA • PENNSYLVANIA

Simplicity is the keynote

To obtain utmost speed of operation without sacrifice of accuracy, all -hp- instruments are designed to operate with a minimum of adjustments. Most -hp- instruments are complete in one cabinet.

-hp- INSTRUMENTS ARE AS REVOLUTIONARY AS THE ONE DIAL RADIO

Illustrated is the model 300A Wave Analyzer which is extremely easy to operate. The large single dial is logarithmically calibrated.* Selectivity is variable by means of a unique selective amplifier developed especially for this instrument. Harmonics of frequencies as low as 30 cycles can be measured and higher frequencies can also be measured with great speed yet with no sacrifice of accuracy.



* Variable condenser is controlled by this unusual cantilever action which graduates the speed of the rotor section in relation to the dial movement to give a logarithmic frequency coverage. The action is positive with no lost motion.



For detailed information on this and other -hp- instruments, write direct to the factory. There is no obligation, of course.

LABORATORY  INSTRUMENTS

Chicago Office
ALFRED CROSSLEY
549 West Randolph Street
Chicago, Illinois

Hollywood Office
N. B. NEELY
5334 Hollywood Boulevard
Hollywood, California

New York Office
BRUCE O. BURLINGAME
ASSOCIATES
69 Murray St., New York City, N. Y.

HEWLETT-PACKARD COMPANY
BOX 135E STATION A • PALO ALTO, CALIFORNIA

the measuring accuracy of the mechanism. Other forms of the apparatus where described as applied to forms of industrial control in which no mechanical measuring mechanism is involved but in which the motion of fluids such as in manometer columns and flow meters, or moving masses of metallic non-metallic, solid or liquid materials were considered. The control functions described are primarily concerned with contacting action in which the contact determines the presence or absence of the controlled medium such as the electric power flow to a furnace.

The paper dealt finally with more specialized forms of control function, in which the controlled medium must be throttled so that only sufficient controlled medium is made available to supply the demands of the process, consistent with maintaining a steady state of balance in the process.

A comparatively new type of electronic development, "The Scanning Microscope", was described by V. K. Zworykin in a paper of which J. Hillier and R. Snyder were co-authors. The new electron microscope of the scanning type has been developed to examine the surfaces of all material with the high resolving power afforded by the use of the electron beam. The new scanning microscope is suitable for the examination of opaque objects, whereas the usual type of electron microscope thus far in use has been limited to an examination of "transparent" subjects by passing the electron beam through the material under examination. In the scanning microscope the specimen is moved mechanically in such a way that each point of its surface is scanned in a systematic fashion by the electron probe in much the same manner as television scanning. The secondary electrons which are emitted from the point of the specimen bombarded by the electrons of the probe, are accelerated and projected on a fluorescent screen. The intensity of the light emitted by the fluorescent screen varies in accordance with the secondary emission properties of successive points of the specimen. This modulated light signal is converted into an electrical signal by means of a multiplier phototube and is then synthesized in a printed picture by an amplifier and facsimile printer system. The use of the electronic-light-electronic transformation of the image signal improves the signal-to-noise ratio by at least an order of magnitude over that found in conventional method of collection and voltage amplification.

In outlining this paper, Dr. Zworykin traced the difficulties in the development of this scanning microscope and showed how various methods of approach proved most promising at one time or another, depending upon the status of the television development of the time.

An experimental model of the scanning microscope has been constructed and has been successful in producing images of etched metal surfaces at magnifications as high as 10,000 diameters with a resolving power considerably better than 50 millimicrons.



PHOTO COURTESY OF PAN AMERICAN AIRWAYS

In PEACE . . . as in WAR

Two-way radio communication is a vital factor whose importance is magnified by today's events around the globe. Not only do our far-reaching fighting forces coordinate their operations through the maintenance of radio communication—but we, at home, are supplied with constant information concerning their activities.

Tomorrow, when the nations will again be at peace, giant transports will link the peoples of the world closer and closer . . . and two-way radio communication will cement new ties with all peoples, everywhere.

JEFFERSON-TRAVIS RADIO MFG. CORP.
Manufacturers of Aircraft, Marine and Mobile Radio Communication Equipment

NEW YORK, N. Y.



WASHINGTON, D. C.

BUY WAR BONDS AND STAMPS

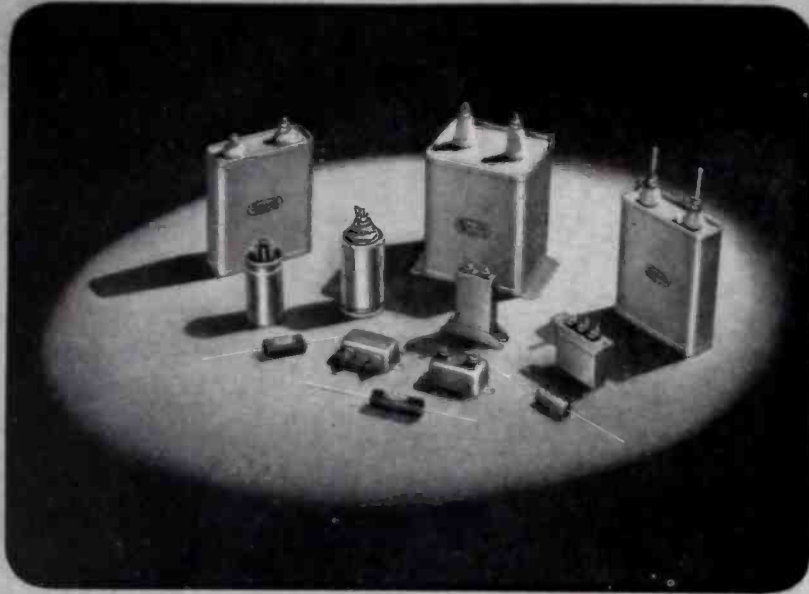

PAPER CAPACITORS - *at their best!*

Solar experience plays a vital part in the production
of completely dependable paper capacitors for the
Armed Service Branches of our Government.

*Consult Solar for prompt solution
of your paper capacitor problems*

SOLAR MFG. CORP. . . . BAYONNE, N. J.



"QUALITY ABOVE ALL" CAPACITORS



Dr. S. A. Schelkunoff, of the Bell Telephone Laboratories who received the Morris L. Lippmann memorial award for his theoretical studies of the transmission and radiation of electromagnetic waves

"Spectroscopic Analysis in the Manufacture of Radio Tubes" was the title of a paper delivered by S. L. Parsons of the Hygrade Sylvania Corporation. The paper was devoted to a description of the use of spectrographic methods in attacking some of the problems encountered in the manufacture of tubes.

The spectrographic equipment installed at the Hygrade Sylvania plant was intended as a tool in attacking chemical, metallurgical, fluorescent and ceramic problems of tube manufacture. The spectroscope and densitometer used in making and analyzing the measurements, as well as the arc light sources were described in detail. The various applications of this equipment to the quantitative and qualitative analyses of materials going into the manufacture of radio tubes were discussed, and it was shown how the spectroscopic laboratory was able to improve the quality of tubes, minimize difficulties of manufacture through accurate and appropriate analyses.

A rather mathematical paper on "Minimizing Aberrations of Electron Lenses" was given by H. Poritsky of the General Electric Company in Schenectady. The primary object of the paper was the determination of minimum spherical aberration through the investigation of several possible ways of obtaining sharp focusing.

C. H. Gleason presented the paper "Half-Wave Voltage-Doubling Rectifier Circuit" of which W. D. Waidelich is co-author. Both men are with the University of Missouri. It was shown that the half-wave voltage-doubler is useful as a power supply and has several advantages over other circuits employing input transformers. It offers economy in cost, size, and weight and hence is used in transformerless receivers. For use in radio-receiver power supplies, it has the important advantages of having a common input and output terminal. Although no analysis of this half-

Isolated from Vibration

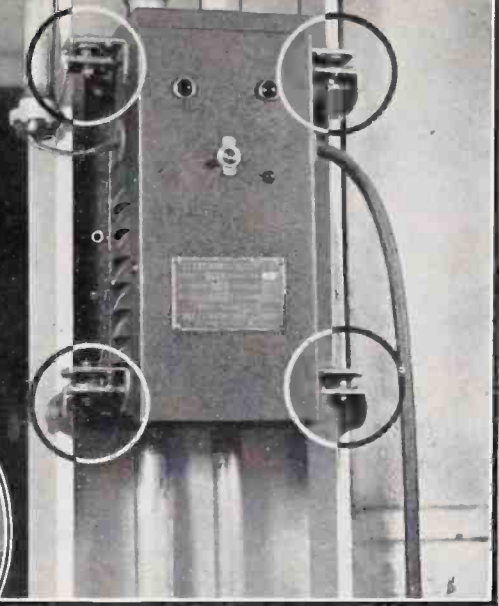

When flexibly suspended on **LORD** Mountings,
BONDED RUBBER
electronic equipment requires fewer tube replacements
and retains its designed accuracy in any installation

VIBRATION from overhead cranes and production equipment can easily affect the accuracy and normal operating life of electronic control equipment. Manufacturers who want to be certain that their electronic equipment will function as well in a steel mill, for example, as in a quiet laboratory, are using Lord Mountings to isolate destructive vibration. Standard Plate Form Mountings are manufactured for supporting loads from 1/2 lb. up to 300 lbs. each. For heavier loads, Lord Tube Form Mountings are made in sizes from 20 lbs. up to 1500 lbs. each.

A typical installation is shown in the above photographs of an electronic rectifier. This instrument is flexibly attached to a steel column at four points by Lord Plate Form Mountings in series. Lord Mountings, when properly installed operate freely in shear, and

the vibrations are dissipated by a slight movement of the equipment on the mountings, rather than being absorbed in the instrument. The use of two Lord Mountings in series, doubles the axial softness, and increases the sensitivity and isolation efficiency of the mounting assembly. Double mountings are also recommended for applications when the vibrations are of a lateral nature in addition to vertical disturbances.

The services of Lord Engineers, who have had considerable experience in solving vibration problems in the electronic field, is yours for the asking. They will be glad to show you how proper vibration control can lengthen tube life, and eliminate other operating failures in existing and contemplated electronic equipment.

LORD MANUFACTURING COMPANY ... ERIE, PA.

100 E. OLIVE AVE., BURBANK, CAL.

280 MADISON AVE., NEW YORK

520 N. MICHIGAN AVE., CHICAGO



PLATE FORM MOUNTINGS



TUBE FORM MOUNTINGS



FRACTIONAL H. P. FLEXIBLE COUPLINGS

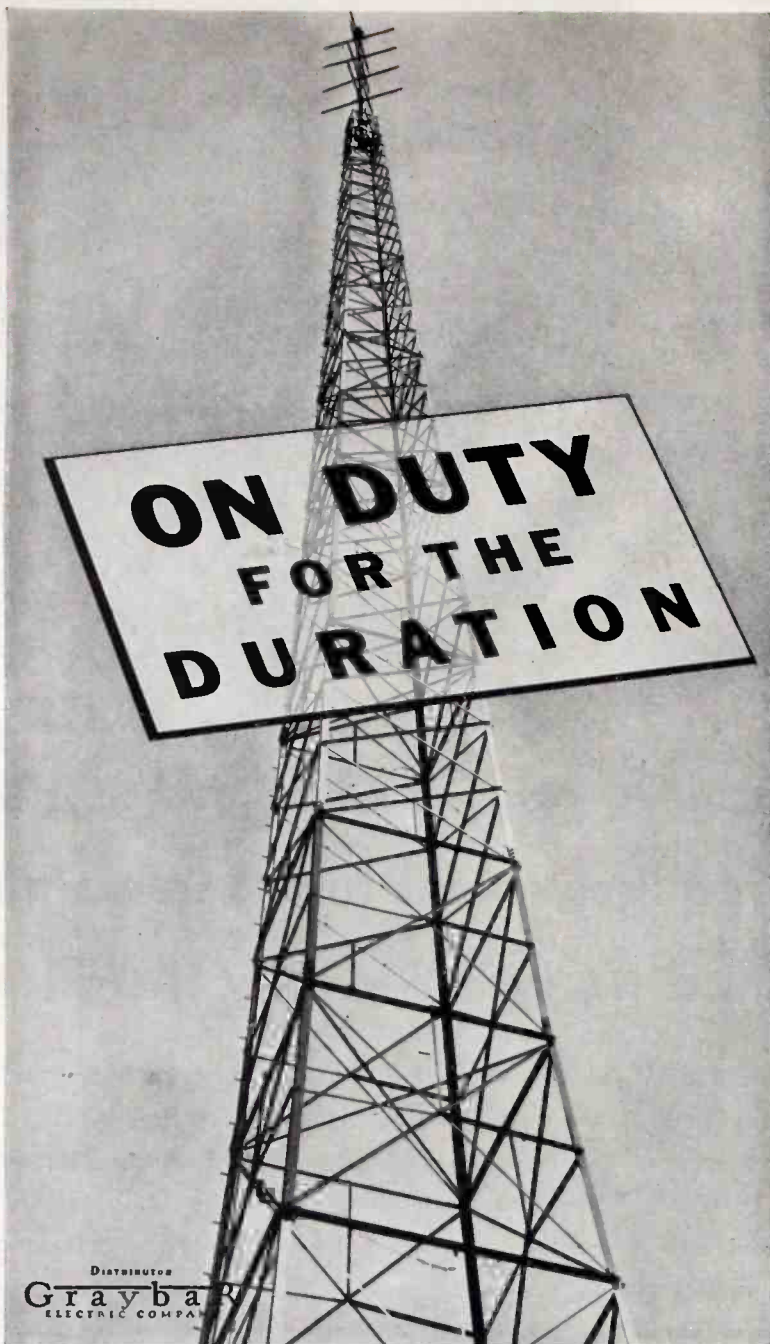

Extra dependability to assure broad, consistent coverage. That's just one of the many things war demands of America's great broadcasting industry. Blaw-Knox is proud that it is helping to answer this challenge — proud that more than 70% of all the radio towers in the nation were built by Blaw-Knox.

BLAW-KNOX DIVISION of Blaw-Knox Co.
2077 Farmers Bank Bldg. Pittsburgh, Pa.

BLAW-KNOX
VERTICAL
RADIATORS
FM AND TELEVISION TOWERS

wave doubler seems to have been made, several references to its operation and applications may be found. The purposes of this paper were to present the results of the analysis by means of curves suitable for use in design, to compare some of the theoretical results with experimental results.

A comparison of the operating characteristics of the half-wave and full-wave voltage doublers shows that throughout the normal operating range (ωCR greater than 10) the full-wave doubler offers a higher input power factor, lower maximum tube currents, slightly less ripple (and of higher frequency) in the input voltage, and slightly better voltage regulation; while the half-wave doubler offers lower peak inverse tube voltages, lower effective input currents, and a common input and output terminal allowing both the load and input source to be grounded if necessary.

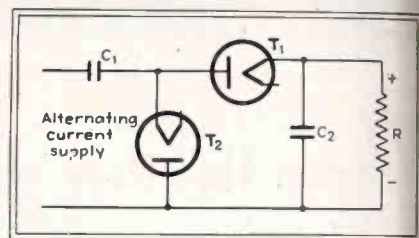
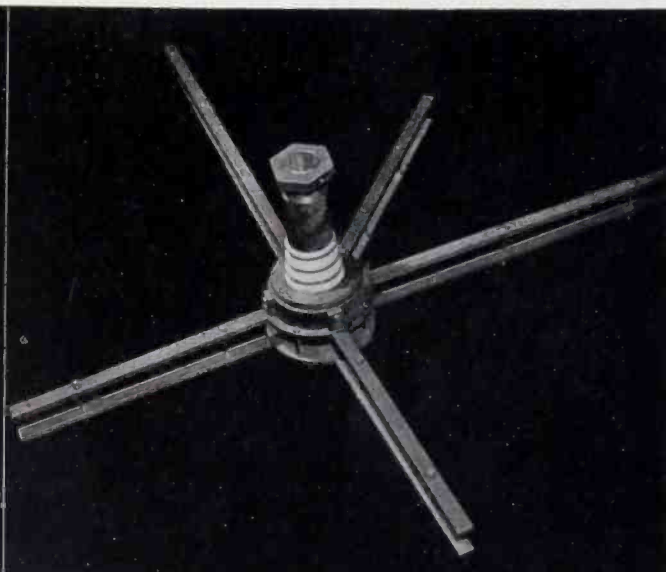
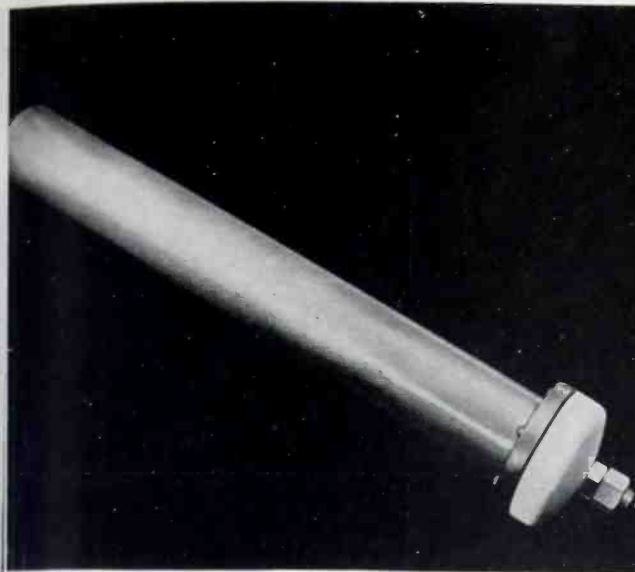

Fig. 9—Diagram of circuit of single wave voltage doubling rectifier

The performance of a half-wave doubler, Fig. 9, may be predicted if the capacitance of the two equal condensers, C_1 and C_2 and the load resistance R are known. Upon evaluation of the parameter (ωCR), the curves of Fig. 10 may be used to determine the operating characteristics of the circuit.

These curves may also be used to design a half-wave doubler to meet certain prescribed operating conditions. Often the input voltage and frequency, the output d-c voltage, and the output d-c current are specified. In addition, the application may restrict the percent ripple allowable in the output voltage. Hence E_m , E_{dc} , and I_{dc} are specified together with a restriction on the percent ripple r . From the curve of Fig. 10 the value of (ωCR) is fixed by the ratio (E_{dc}/E_m). The capacitance of the condensers may be found from ωCR , the load resistance, ($R = E_{dc}/I_{dc}$), and the supply frequency $\omega/2\pi$. The curves of Fig. 10 may be used to determine the peak inverse tube voltage and the maximum tube current, thus enabling the selection of rectifier tubes of proper inverse voltage and maximum current ratings, and percent ripple in the output voltage. If this value is greater than the percent ripple allowable, the output voltage may be filtered, or some compromise in the specified current and voltages may be made so as to increase the value of (ωCR). The percent ripple in the output can be materially reduced by placing a filter circuit between the output condenser and the load resistance. Insertion of a



SUBASSEMBLIES FURNISHED BY ISOLANTITE

release production facilities and
personnel for major assembly jobs

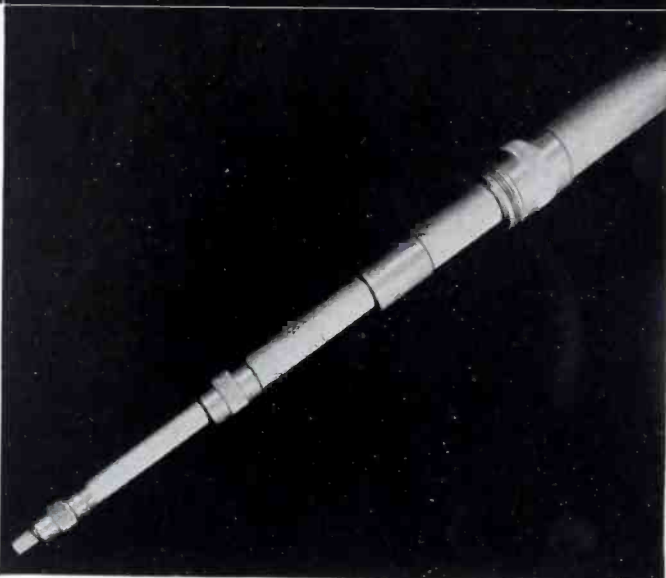

IT IS the countless minor assembly operations that add to the cost and delay the production of war equipment. By turning over to Isolantite Inc., for subassembly, the parts in which steatite is combined with metal in various forms, you release needed production facilities and skilled hands for major assembly tasks. Isolantite's ability to furnish subassemblies that meet the most exacting demands is a matter of record.

In addition to speeding war production, this "subassembling" gives you all the advantages of Isolantite.* Among these are the extremely close dimensional tolerances Isolantite's manufacturing processes permit... its adaptability to the production of intricate shapes... and a uniformity of product, high mechanical strength, electrical efficiency and non-absorption

of moisture which contribute greatly to dependable insulation performance.

If you have a problem in production that is vital to Victory, Isolantite-furnished subassemblies might help solve it. War equipment manufacturers taking advantage of this unique service enjoy the benefits of Isolantite high-grade insulation at the same time that they ease the burden of war production.

ISOLANTITE

CERAMIC INSULATORS

ISOLANTITE INC., BELLEVILLE, NEW JERSEY

*Registered trade-name for the products of Isolantite Inc.

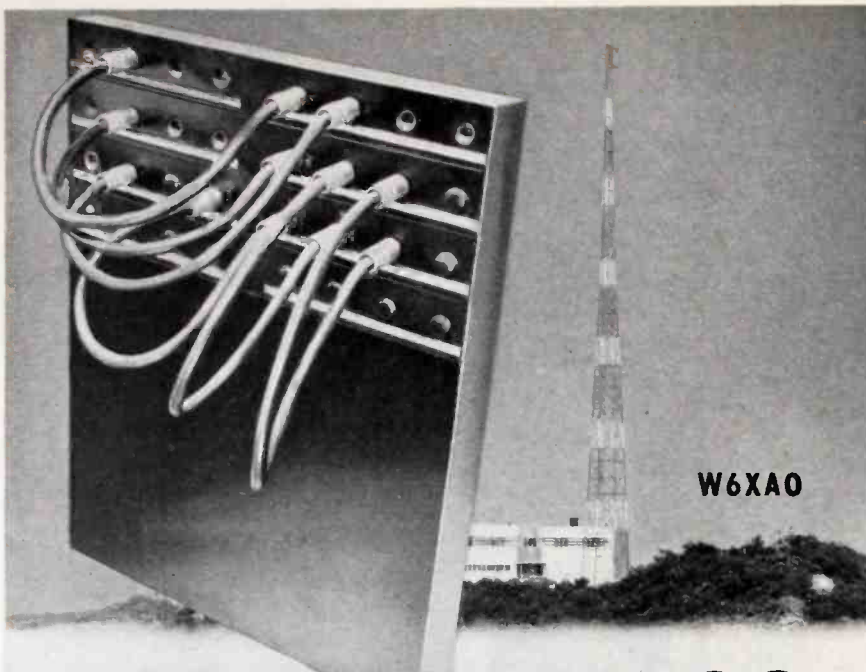

CANNON PLUGS for a *picture* switchboard

An important link in the television "picture" switchboard, through which electrical waveforms are patched from one studio to another, is the Cannon Coaxial Connector. The problem of conveying frequencies of 0 to 5 million cycles was solved by coaxial cables and the accompanying plugs and jacks, which are a special Cannon application.



Voices, music and television pictures must pass through plugs without loss or distortion at the Don Lee Television Station atop Mt. Lee, Hollywood, Calif. These coaxial fittings provide continuous shielding with constant impedance. Wiring and shielding are shell protected and Isolantite washers are used for further insulation.

This is just one use of the many highly specialized Cannon Connectors for making electrical connections quickly and with absolute certainty—in tanks, planes, motion picture studios and hundreds of other civilian and military uses.



CANNON ELECTRIC

DEVELOPMENT COMPANY

LOS ANGELES, CALIFORNIA

filter will cause some alteration in the operation of the doubler circuit as predicted from this analysis; however, the analysis will still afford a rather good approximation of the other operating characteristics of the doubler.

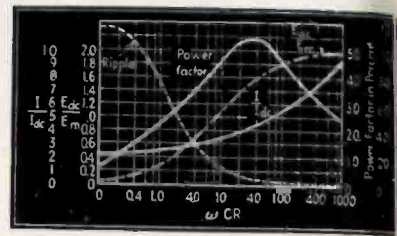

Fig. 10—Performance characteristics of the circuit of Fig. 9

On the basis of the experimental verifications obtained, the mathematical analysis is representative of actual operation of the doubler circuit and therefore, prediction of the performance of the doubler by the analysis seems justifiable. The assumption of tube drop while conducting seems to have introduced little error, but large tube drops an extension of the analysis would have to be used.

It has been shown that the design of this circuit and the predetermination of its performance is facilitated by the use of the results of this analysis.

In opening the Tuesday morning technical session, J. A. Ouimet of the Canadian Broadcasting Corp., gave a very timely paper on "Maintenance of Broadcasting Operations During Wartime." A rather complete analysis of the current wartime problems facing operators and engineers in broadcasting stations was made. The important factors which must be taken into account include: (1) protection against sabotage, by the erection of fences and barricades, by the provision of flood lighting, and armed guards; (2) protection of plants by fire instruction and precautions; (3) conservation of equipment by efficient utilization, by good maintenance and operation practices, by the rehabilitation of obsolete units, by the elimination of unnecessary operations, and by the reduction of the power of transmitters; (4) protection of transmitter operation by emergency antennas for operation out of the driver stage by standby generators, and by standby transmitters of low power; (5) protection of studio operation by dispersion of facilities, by the setting up of emergency control points and by the use of portable equipment and mobile units.

It was pointed out that in all of these measures and others which may be taken, the engineering difficulties are minor ones and yet progress in overcoming them is frequently most difficult. The real problem of the broadcast engineer is first to bring about a full and general realization of the seriousness of the situation and secondly, to take immediate and effective measures to meet that situation irrespective of the effort, inconvenience and constant self-

**SPEEDS PRODUCTION
LOWERS COSTS**



**SPRAGUE
KOOLOHM
RESISTORS
Free You From
MOUNTING
Limitations**

The unique construction of Koolohm resistors allows them to be mounted directly to (and flat against) metal or grounded parts with complete resistor circuit insulation. This offers a flexibility in designing and manufacturing that is invaluable under today's changed — and changing — conditions.

Koolohms are doubly protected. The wire itself is insulated before being wound AND—all types are sealed in sturdy, chip-proof, ceramic or tempered shock-proof glass casings.

Therefore, they operate safely and dependably even when mounted directly to grounded parts with the simple attachments illustrated above. All of these methods of mounting are today being used by prime- and sub-contractors who are meeting exacting specifications with Koolohms.

Meter multipliers — high resistance, high-power units, truly non-inductive resistors — ferrule type resistors that withstand the most severe salt water immersion test and other features are found in Koolohms—the answer to practically all your resistor problems.

Write for further particulars, samples and catalog

SPRAGUE SPECIALTIES COMPANY
(Resistor Division) North Adams, Mass.

THE ONLY RESISTORS WOUND WITH CERAMIC-INSULATED WIRE



Thordarson Wave Filters

Low pass, high pass, band pass or band rejection types of the size, weight and characteristics to serve your purpose. Discuss your filter problem with experienced Thordarson engineers.

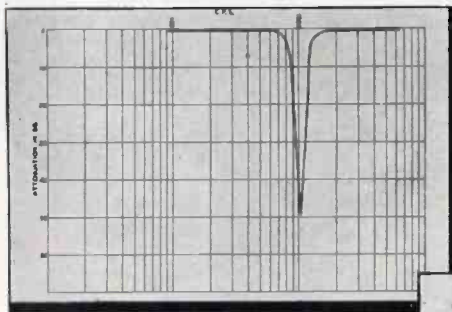

☆ ABOVE Band rejection filter

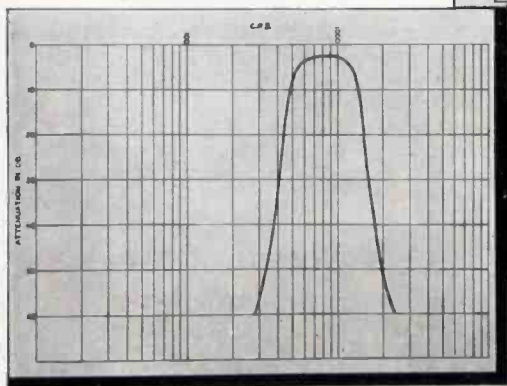

☆ ABOVE Low pass filter

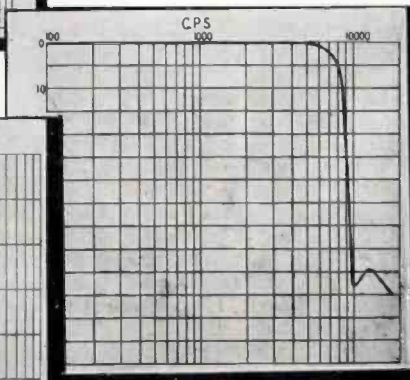

☆ LEFT Band pass filter

THORDARSON

ELECTRIC MFG. COMPANY
500 WEST HURON STREET CHICAGO ILL

Transformer

Specialists Since 1895

discipline which these may entail. In the face of an emergency which may strike at any time in any location, preparedness is the first and most important duty.

H. B. Fancher, General Electric Company, described a "High Power Television Transmitter", station WRGB, whose erection was started in 1938. The transmitter is at Helderberg Mountain, 12 miles from Albany, and serves the Albany-Schenectady area. The station includes a 40 kw visual transmitter and a 20 kw aural transmitter. That part of the visual transmitter located at the main station consists of a high frequency receiver, a converter and a chain of linear Class B push pull amplifiers. A standard modulated vestigial side band signal is received from the Schenectady studio or from the New York relay stations, over a high frequency radio link. These signals are then retransmitted from WRGB for television enthusiasts in the Albany-Schenectady area. The principal task at the transmitter was the design of the high-gain, multi-stage wide-band amplifier stages. The final stages each consists of a pair of water-cooled triodes especially designed for television service.

The aural transmitter consists of a 50 watt exciter unit containing an oscillator, modulator, and frequency control unit, a 2 kw amplifier consisting of air cooled triodes, and a 20 kw amplifier using a pair of tubes similar to those in the visual power amplifier.

H. W. Wells, Carnegie Institution, Washington, spoke on "Effect of Solar Activity on Radio Communication." It was shown that the radio disturbances which are most severe are coincident with intense magnetic storms which are usually associated with active sunspot areas. Severe magnetic storms can disrupt normal radio communication for several days and various occasions of interruption to land wire circuits have also been reported. It is felt, however, that the progress which is being made in the observation of ionosphere phenomena will make it possible to predict quite accurately the time and frequency at which radio interference will be maximum as well as a minimum.

W. J. Brown, of the Brush Development Company, described "The Development of a Pocket Radio Receiver" such dimensions as to fit conveniently into the breast pocket of an ordinary suit of clothes, and containing a specially developed hearing aid unit which fits into the recess of the normal ear.

Unusual features of this circuit which is shown in the diagram of Figure 1 are the use of a four tube receiver employing permeability tuning, the use of the cord connecting the hearing unit with the radio receiver as an antenna and the very small physical dimensions of the complete receiver. To all external appearances the portable receiver greatly resembles the present-day hearing aid except that the batteries were incorporated as a part of the radio receiver rather than being a separate unit as is usually the case with hearing aid devices.

OHMITE Rheostats!

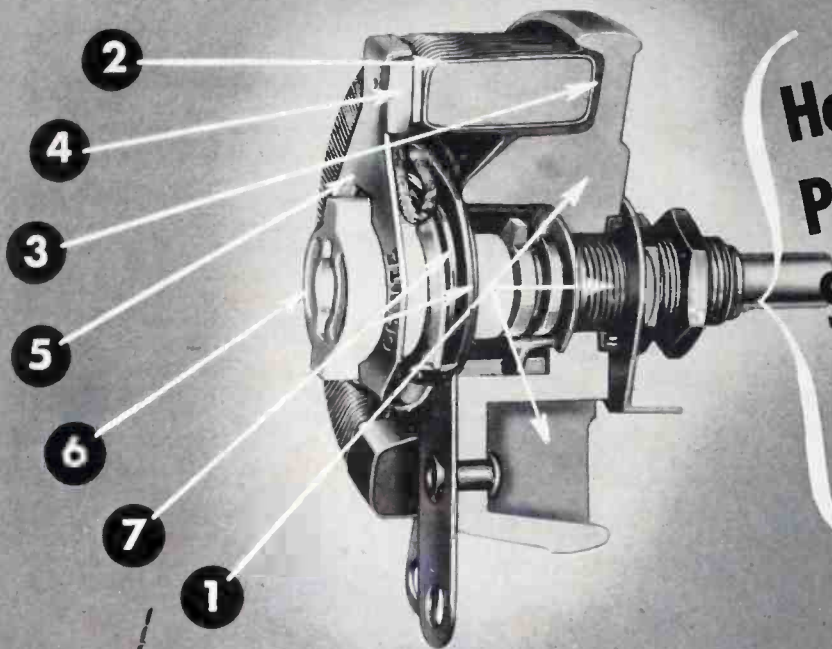

**How
Permanently
Smooth,
Close-Control
Is Built-in**

The cut-away view shows a number of the important features which make Ohmite Rheostats especially suitable for today's exacting requirements in industry, and in planes, tanks, ships.

1. Compact all ceramic and metal construction. Nothing to shrink, shift or deteriorate.
2. Wire is wound on a solid porcelain core. Each turn is a separate resistance step, locked in place and insulated by Ohmite vitreous enamel.
3. Core and base are bonded together into one integral unit by vitreous enamel.
4. Self-lubricating metal-graphite contact brush with universal mounting, rides on a large, flat surface. Insures perfect contact, prevents wear on the wire.
5. Tempered steel contact arm assures uniform contact pressure at all times. Pressure at the contact and at the center lead are independent.
6. High strength ceramic hub insulates shaft and bushing.

7. Compression spring maintains uniform pressure and electrical contact between slipping and center lead. Large slip-ring minimizes mechanical wear.

There are many other features which add to the dependability of Ohmite Rheostats—all proved on the Ohmite Life Tester illustrated below, and in actual service as well. They are built to withstand shock, vibration, heat and humidity.

Ten wattage sizes, from 25 to 1000 watts, from 1 9/16" to 12" diameter, in stock or special units to meet each control need. Approved types for all Army and Navy specifications.

Send for Catalog and Engineering Manual No. 40 Write on company letterhead for complete, helpful 96-page guide in the selection and application of Rheostats, Resistors, Tap Switches, Chokes and Attenuators.



OHMITE MANUFACTURING CO., 4817 Flournoy St., Chicago, U.S.A.
Foremost Manufacturer of Power Rheostats, Resistors, Tap Switches

**BE RIGHT WITH
OHMITE
Rheostats-Resistors
Tap Switches**

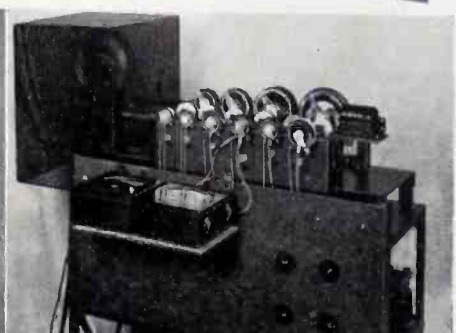
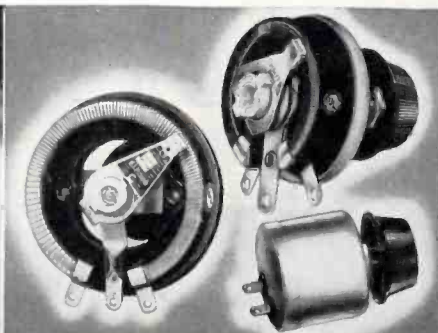

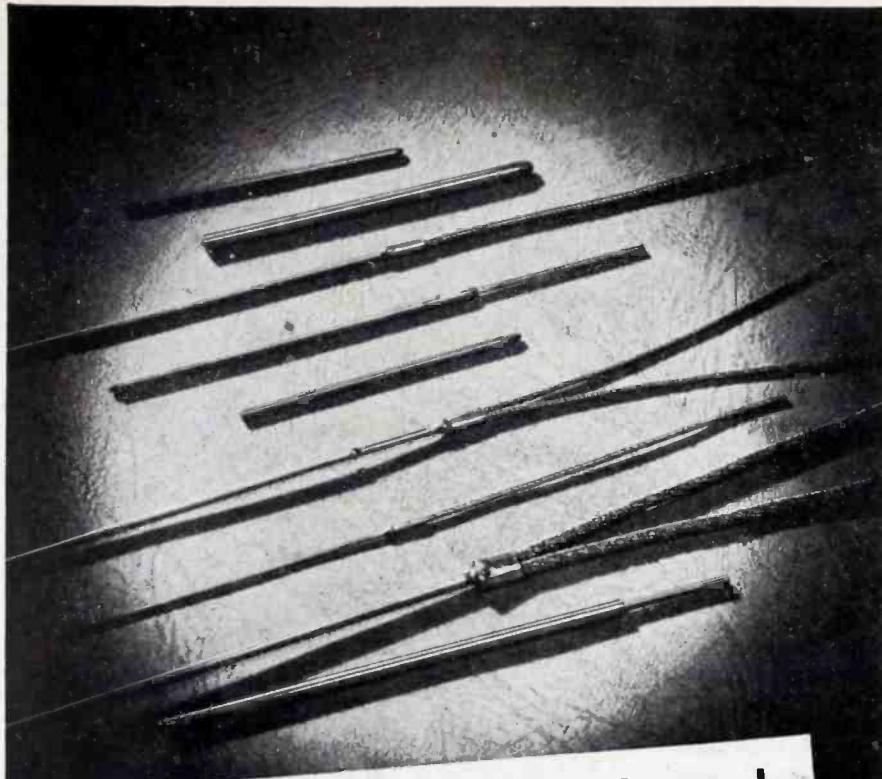

For your present electronic needs TUNGSTEN LEAD-IN WIRES

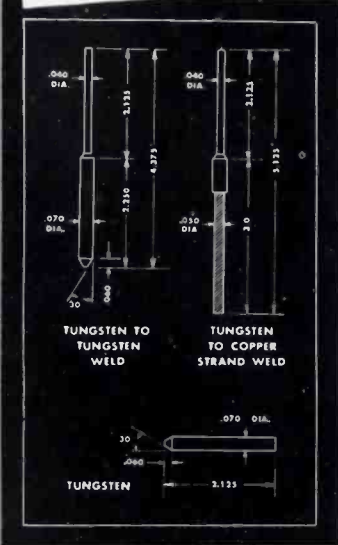

METROLOY for performance

● METROLOY tungsten lead-in wires are available to meet the requirements of tube manufacturers. Built to your specifications by men thoroughly familiar with the design and manufacture of tungsten products. Your requirements will receive our immediate attention. A METROLOY engineer is available for collaboration on your tungsten wire problems; a consultation obligates you in no way; write today. Metroloy Company, Inc., 60 East Alpine Street, Newark, N. J.

METROLOY CONTACTS
Metroloy tungsten contacts, purposely designed to reduce pitting and cracking, are available for all applications.

METROLOY TUNGSTEN PRODUCTS



TUNGSTEN LEAD-IN WIRES • TUNGSTEN WELDS • TUNGSTEN & MOLYBDENUM SUPPORTS
FOR ELECTRONIC APPLICATIONS • TUNGSTEN CONTACTS FOR ELECTRICAL APPLICATIONS

On Tuesday afternoon a symposium was held on the subject "What Radio Means in the War Effort." Discussing leaders in this symposium were A. Van Dyck, Paul Galvin, president of the Radio Manufacturers Association; K. Jett, chief engineer, Federal Communications Commission; Neville Miller, president of the National Association of Broadcasters, and Capt. E. M. Webster of the U. S. Coast Guard.

Mr. Van Dyck pointed out that radio has had to go 100 percent to war since that whereas the vacuum tube and telephony were beginning to be made use effectively in the last war, the techniques of ultrahigh frequency and television are important contributions in the present war. It was also shown that as a result of present organized research, the rate of change of things in the present time is exceedingly fast. The social and cultural aspects of the developments were also considered with Mr. Van Dyck pointing out that technical developments are proceeding at such a pace and technical achievements are so powerful that administration must be made aware of their social and economic implications if they are to perform their administrative and executive duties properly. This imposes additional responsibility on the engineers and technicians who must learn how to "sell" these technical devices to people who will use them and administer their use. As a corollary of this argument it was shown that technicians must find out how to have more influence in places of decision.

E. K. Jett outlined some of the more recent developments of the Defense Communications Board (now known as the Board of War Communications). His talk was largely a survey of recent governmental activities which are adequately recorded in FOC orders and elsewhere.

The manufacturer's point of view was stressed by Paul V. Galvin who traced the conversion of the broadcast industry from a peacetime to a wartime industry in a remarkable short period of time. In the summer of 1940 some half a dozen companies were making a few million dollars worth of radio apparatus for the Army and Navy. During the latter part of 1940, throughout 1941 and up to the present time, these firms have converted their entire production to a war basis without disruption of service. The magnitude of the job emphasized by the projection of a radio apparatus program in excess of one billion dollars.

The part which the broadcast stations are playing in the present war effort was ably outlined by Neville Miller, president of the National Association of Broadcasters, who again pointed out the need for social development keeping pace with technical developments.

A. O. Austin, president of A. O. Austin, Inc., Barberton, Ohio, opened the Wednesday morning technical session with two papers entitled, respectively, "Radio Strain Insulators for High Voltage and Low Capacitance," and "Improved Insulators for Self-Supporting

BUILT TO ENDURE!

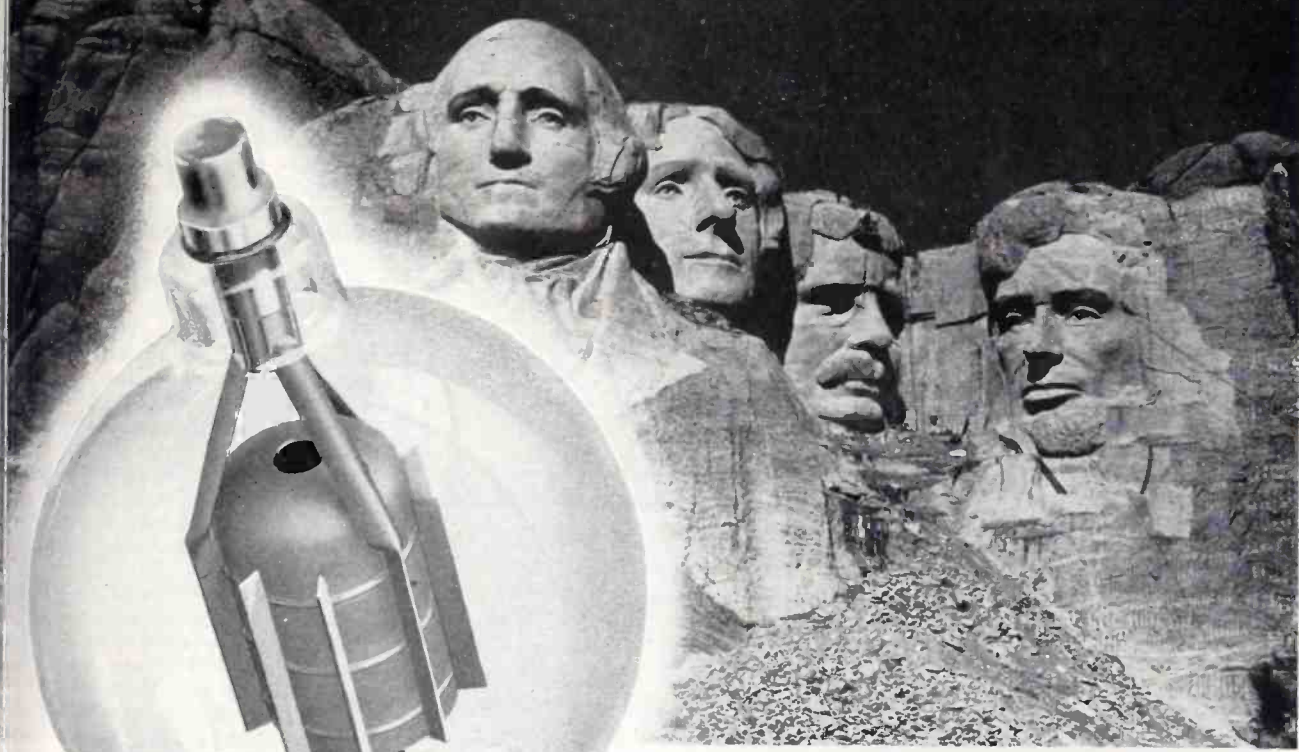

HK 854

4 Watt Plate diss.
output 1800
Watts



MAIL THIS COUPON TODAY
FOR NEW FREE BULLETIN
(Attach coupon to your letterhead)

Gentlemen:
Please send me your new free bulletin,
"THIRTEEN WAYS TO PROLONG TUBE LIFE."

The four colossal heads carved in granite on the rugged heights of Mount Rushmore will weather the storm and fury of ages to come.

Like this mightiest sculpture of man, GAMMATRON tubes are built to endure terrific punishment. Tantalum plate and grid construction, elimination of all internal insulators, and a special exhaust process positively prohibit the release of gas even at tremendous overloads.

GAMMATRON low voltage type filaments have a large reserve emission supply. They are conservatively rated, have an ample safety factor, and are operated at a point which provides the largest number of watt hours per dollar.

In these days the extra stamina of long-lasting GAMMATRONS is of greater-than-ever importance.



GAMMATRONS OF COURSE!

MR. MANUFACTURER:

Here are 3 good reasons why you should

**SPECIFY
STACKPOLE**



→ *Guaranteed to Meet Your Demands for Speedier Production, More Efficient Operation*

Precision-Tested SWITCHES



Longer life and better service are designed into every Stackpole Switch. Each unit is pre-tested under actual operating conditions to insure dependable operation for every small circuit use. They are available in slide, rotary and toggle operated models—in a full range of sizes from single pole, single throw to four pole, double throw—and any combination between these extremes.

Laboratory Controlled RESISTORS



Stackpole offers you a complete line of Variable and Fixed Resistors for every type of electronic or communication application. All Stackpole Resistors, both Variable and Fixed, are completely laboratory controlled from raw material to finished state. Stackpole Variable and Fixed Resistors are tested 100% for all characteristics necessary for the proper functioning of the unit in the circuit.

Uniformly Constructed IRON CORES

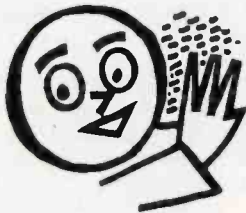

Dependable service over a long period of years, under all conditions in every part of the world . . . is the achievement and experience behind Stackpole Iron Cores. Available in a variety of grades and sizes for fixed inductance, variable inductance and station tuning . . . in any frequency up to 100 meg. Obtainable also with "cup type" cores, with and without adjustable centers.

STACKPOLE PRODUCTS SOLD TO MANUFACTURERS ONLY
Write at once for samples and prices

S **STACKPOLE CARBON CO.**
ST. MARYS, PENNA. U. S. A.

or Sectionalized Towers." Both papers were on the same general topic and may be reviewed, therefore, together. In the first paper the high voltage requirements of radio insulators for withstanding radio frequency loads were given. The effect of surface conditions in maintaining the quality of the insulator tended to support the motto "Save the surface and you save all," of the paper manufacturers. Some of the defects of past insulator designs were pointed out. In many cases the insulator suffered from high capacitance between terminals. In other cases, the path of surface leakage was small whereas still other cases an insulator would be quite serviceable for loads in tension but would be subject to failure from small transverse shocks or impact. A type of insulator designed to overcome these defects was described. Essentially it consisted of an insulating belt impregnated with resin or bakelite materials, contained in an outer protective tube of porcelain or similar material. Appropriate corona sheaths were provided as required. Insulators of this design are affected to a very slight extent by transverse impact loads, and may be used either in tension or compression. Thus, this design is suitable for use as a strain or a compression type insulator.

A "Brief Discussion of the Design of a 900-ft. Uniform Cross Section Guided Radio Tower" was given by A. E. Wahlen of the Truscon Steel Co., Youngstown, Ohio. In contrast to the majority of papers usually presented before the meetings of the I.R.E., this one was primarily a discussion of mechanical design factors with consideration given to such matters as wind resistance, effect of anticipated wind velocity in terms of actual pressures on a complex tower form used in tower construction, correct balance of anticipated external load, complete analysis of the stress diagram under anticipated operating conditions, effect of ice and other loads, and so on. In the working out of this problem a considerable amount of work was done with various types of sections which were tested after sample models had been constructed.



The circular antenna, described by M. Scheldorf, has unusual applications for use on vehicles, because of its ruggedness and small size

INJECTION MOLDED

MYCALEX

Unique Among Insulators

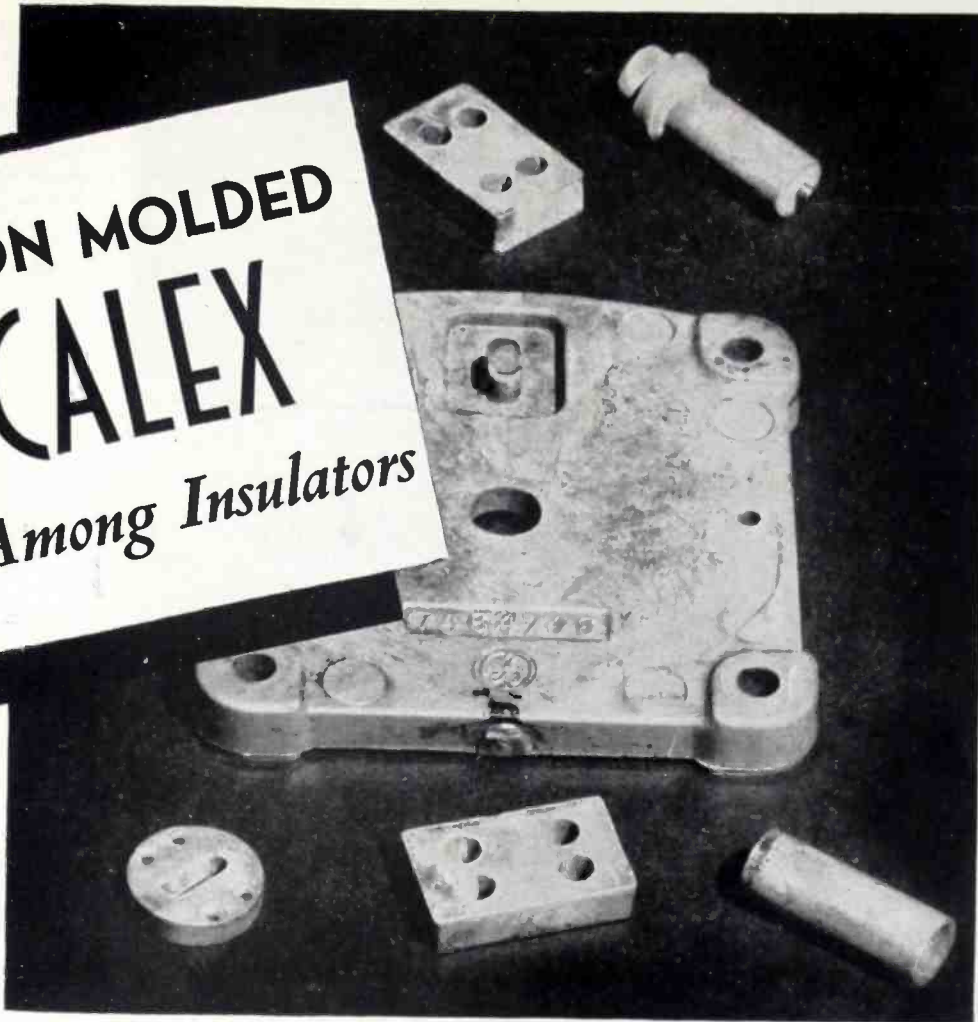

MYCALEX is a material possessing a combination of desirable properties and characteristics not found to a degree in any other insulator. G-E Mycalex has better over-all electrical properties and mechanical strength than porcelain; it has refractory qualities superior to phenolic resins, gums, pitches, shellacs and other organic materials; and it may incorporate metal parts and inserts in molded parts, a feature not readily practicable with ceramic products.

The G-E Plastics Department recently announced the development of a method of injection molding for mycalex which greatly extends the scope of application for this remarkable material.

INJECTION MOLDED G-E MYCALEX PARTS HAVE SEVERAL DISTINCTIVE FEATURES:

- 1. More intricate shapes may be obtained.
- 2. Finishing and machining operations are reduced or eliminated.
- 3. Holes may be molded in part.
- 4. Tolerances may be held closer than in other types of injection molded insulation.

IN ADDITION, G-E MYCALEX HAS THE FOLLOWING PROPERTIES:

1. High dielectric strength.
2. Low power factor.
3. Prolonged resistance to electric arcs.
4. Chemical stability; no deterioration with age.
5. Dimensional stability; freedom from warpage, shrinkage, etc.
6. Imperviousness to water, oil, and gas.
7. Resistance to sudden temperature changes.
8. Low coefficient of thermal expansion.

Two types of G-E mycalex for injection molding are available,— general purpose, and radio grade,—both suited for many uses as insulators in the electrical industry. A booklet describing properties and applications may be obtained by writing Section H-7,

**ONE PLASTICS AVENUE,
PITTSFIELD, MASS.**

PLASTICS
GENERAL



DEPARTMENT
ELECTRIC

PD-51



Official U. S. Navy Photograph

Seeing Action!

For more than a quarter century our organization has been supplying specialized equipment and components to our military services.

With the same engineering skill that pioneered metal end plate condensers . . . universally adopted as commercial standards . . . we are concentrating our efforts on the design and construction of equipment for our Army and Navy.

In this war, again, better-than-ever CARDWELLS are seeing front-line action.

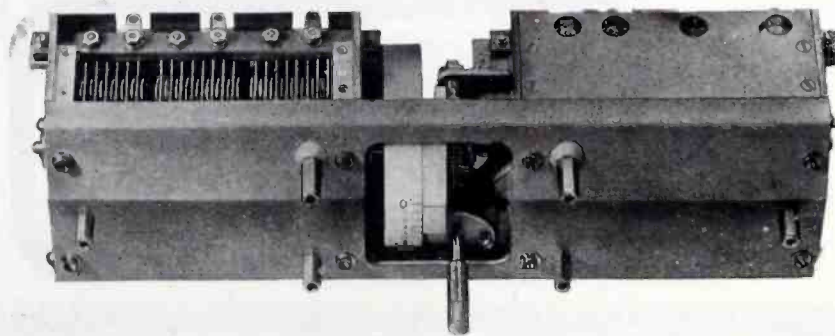

CARDWELL  CONDENSERS

THE ALLEN D. CARDWELL MANUFACTURING CORPORATION

BROOKLYN, NEW YORK

A "Circular Antenna" was described by M. W. Scheldorf of the General Electric Company. This is a new horizontally polarized antenna whose outstanding feature is the radiation of substantially uniform energy in all directions about the antenna without resorting to a complex structure or network to secure this pattern. Essentially it is derived from a half-wave antenna with capacitive loading by bending the elements around a circular shape as shown in Fig. 11. Its low vertical radiation gives a twofold improvement over a single doubler and several units may be used to improve this gain. In multiple unit antennas the coupling between bays in such an arrangement has been reduced to such an extent that adjustments are simplified. The antenna has a pleasing physical appearance and is relatively small in size while it has the further advantage of being mechanically very rugged.

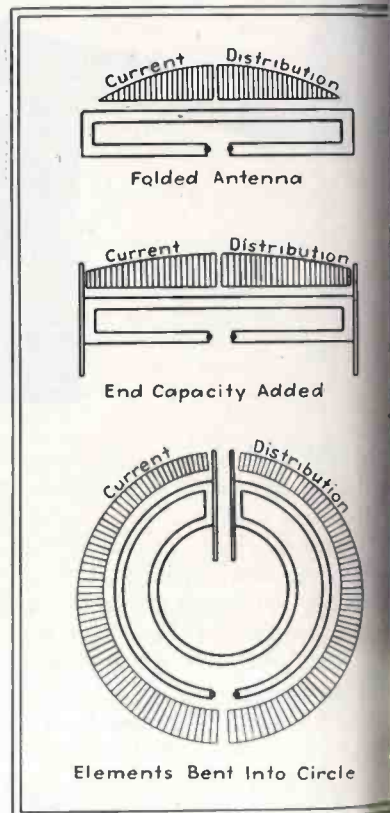
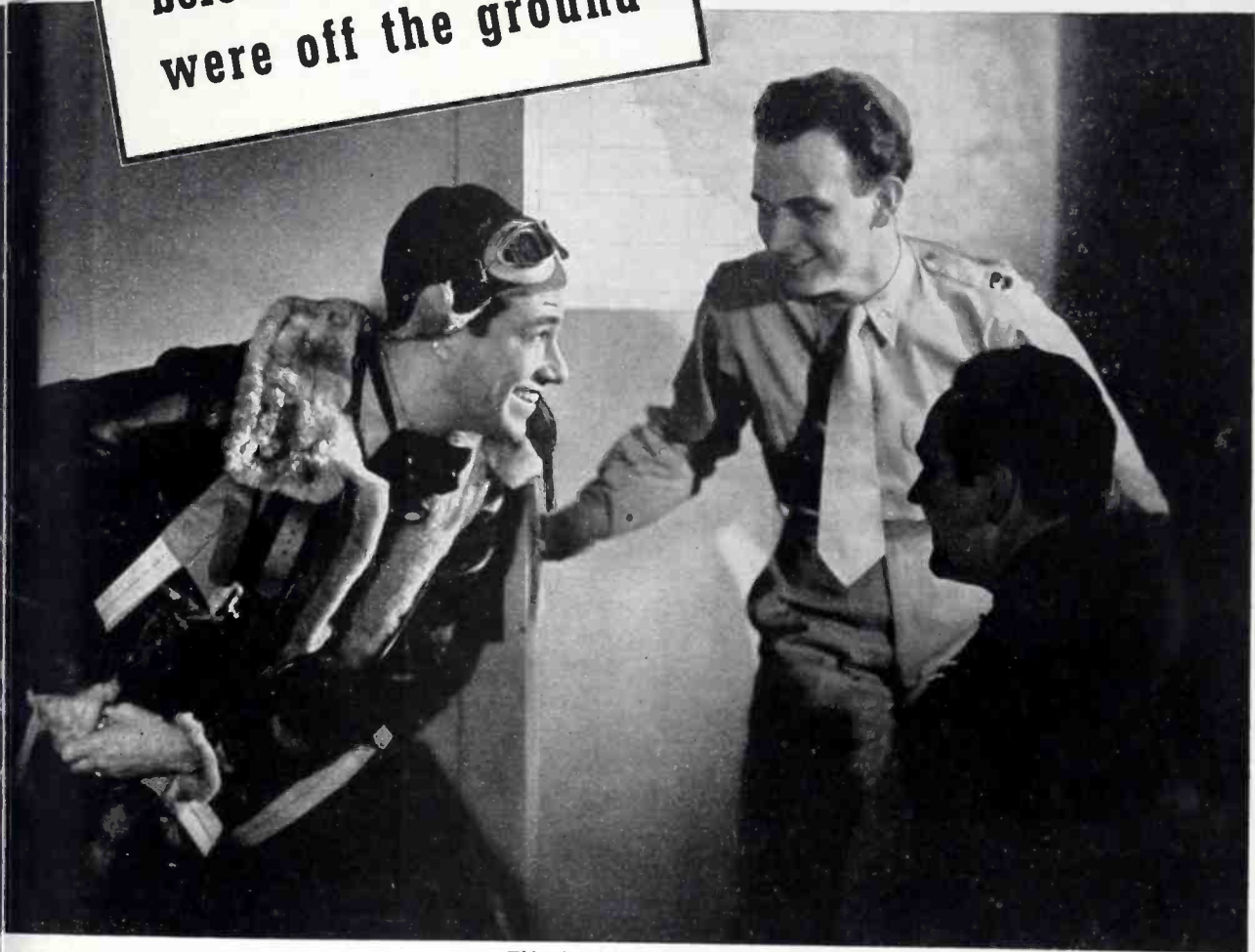

Fig. 11—Diagrams illustrating the development of the circular antenna from a folded doublet, at top

The features of the new antenna are as follows: (1) A simple horizontal polarized antenna with only two terminals, yet essentially uniform in its horizontal radiating properties; (2) low mutual inductance between vertical bays with greatly improved adjustment of multi-bay installations; (3) ability to cover a wide frequency range with one physical structure, through the use of simple means; (4) a system that is easily mounted to a pole of any diameter and grounded to that pole so that there is lightning protection; (5) a system that may be applied to metallic covered vehicles to an advantage.

**"We were on their tails
before they knew we
were off the ground"**



This advertisement has been reviewed and approved for publication by the War Department.

It takes top notch men, planes and communications to get the jump on the enemy in the air. We Americans have all of these. Help the Signal Corps to get the jump on communications has long been part of our jobs. Even before our country entered World War I, Connecticut was pioneering the

production of two-way military aircraft radio, and throughout the war continued to be a leading supplier of aircraft communications equipment for the Allies.

Today the skill of "Connecticut's" engineers and craftsmen is again fully mobilized in the service of Uncle Sam. And just as radio played

a vital role in making air travel safer and surer after the last war, so today's military developments will blaze new peacetime trails when final victory is won.

**Research, Engineering,
Precision Manufacturing**



CONNECTICUT TELEPHONE & ELECTRIC CORPORATION

MERIDEN, CONNECTICUT

• UTAH-CARTER PARTS •



DEPENDABILITY

is awake at the switch

• Here at the switch, where the human element and mechanical perfection must combine to assure top performance—Utah engineering and manufacture can be depended upon. Utah dependability is proving itself in hundreds of industrial electrical applications.

Utah Imp Push-Button Switches combine compact size, highest quality and economical price. Have finest nickel silver or phosphor bronze springs with integral contacts. Springs are fully insulated from the mounting, bushing and shaft—have high grade phenolic insulation. They are made in three circuit arrangements: “single make”—“single break”—one “break—make.”

Utah-Carter Rotary and Push-Button Jack Switches are made in long and short types. Small and compact they are designed to take minimum panel size. All electrical parts are fully insulated from the frame. Write today for full details.

UTAH RESISTORS have a minimum of two separately fired coats of vitreous enamel, forming a hard, glassy surface. Resistors 5-200 watts are available, either as Fixed, Tapped or Adjustable.



UTAH JACKS . . . The popularity of the “Imp” Jack is due to its compact size, highest quality and economical price. Its unique and patented design makes it the smallest jack to fit standard phone plugs. They are being used in connection with many war products.



UTAH PHONE PLUGS (2- and 3-Conductor Types)
They are designed to meet your needs—whether it's the application, size or shape.



WRITE FOR FULL DETAILS

UTAH RADIO PRODUCTS COMPANY

General Offices and Factory
837 ORLEANS STREET • CHICAGO, ILLINOIS

tage; (6) improvements in gains per bay over existing units in the field; (7) a design which readily permits sleeve melting if desired; (8) a design which is pleasing in appearance.

A paper by H. A. Brown and W. J. Trijitsky on “Stub Feeder Calculation” was not delivered.

An interesting analysis of the redesign of the antenna system for KDYL was given by G. H. Brown of the RCA Mfg. Company. The paper delivered was entitled “A Solution of the Problem of Adjusting Broadcast Directional Rays with Towers of Unequal Height” by J. M. Baldwin of KDYL and G. H. Brown. The original antenna at KDYL was a half-wave vertical tower radiator whose radiation pattern was to be modified to minimize interference in certain directions and reach the radio audience in other directions more effectively. The method of modifying this radiation pattern consisted in erecting a quarter wave vertical tower as a reflector. Three means of determining the radiation pattern were employed and all were found to work quite well. One of these was based on measurements in the field using the original tower and its reflector. The results obtained by this method were checked by an experimental model built in the laboratory and both of these preliminary checks agreed quite well with the final pattern ultimately obtained.

A complete studio-transmitter (S-T) system for high fidelity program relaying studio and main transmitter was described by J. D. Keister of the General Electric Company who presented a paper “Television Video Relay System.”

The entire equipment was designed for simplicity and reliability and of course uses the frequency modulation method of varying the carrier.

The 25 watt transmitter incorporates several novel features which account for the excellent performance obtained. Among these new tube designs especially suited for ultrahigh frequency operation are of most importance. A crystal control, double conversion superheterodyne receiver, employs such features as cascade limiting, carrier-off noise-suppression, and vertical chassis construction. Harmonics from the same crystal oscillator are used in performing both frequency conversions, resulting in an extremely stable unit. Both transmitter and receiver may be remotely controlled when proper compliance is made with the regulations of the Federal Communications Commission.

A high gain studio-transmitter antenna which meets all F.C.C. requirements is totally inclosed against the weather to avoid ice melting problems. An f-m station monitor, for FCC application, indicates center frequency continuously, as well as percent modulation interior level. All monitoring is also obtained from the same unit.

H. A. Breeding of the General Electric Co. presented a paper on “Mercury Lighting for Television Studios.” Experiments with water-cooled mercury vapor



LITTLE THINGS

that a Battleship's Life Depends On
★ ★ ★ Require the Most in Precision

Absolute dependability at all times and under the most severe conditions is required of all parts that go into the making of a battleship — the most important single unit of our first line of defense.

All important to a battleship is its nervous system, a complex masterpiece of electrical communications and controls upon which the safety of thousands of lives and the efficiency of millions of dollars worth of fighting equipment depend.

The Chicago Transformer Corporation is proud of its ability to furnish parts in keeping with the tradition of excellence and precision required of units that make up the world's mightiest fighting machine—The American Battleship.



CHICAGO TRANSFORMER
CORPORATION
3501 WEST ADDISON STREET • CHICAGO



this war can't be won without
RELAYS

★ You need Relays and Solenoids for timing, fusing and releasing bombs . . . Solenoids to fire the guns . . . Relays to control the radio—floodlights—landing gears —navigation aids—turrets.

Used in practically every type warplane . . . government specified Relays by Guardian are the finest electrical controls we've ever designed . . . more control in less space . . . more room for guns and bombs . . . all done with a "know how" that's unmistakably—Guardian Electric!

- ★ GUN SWITCH HANDLES
- ★ TURRET CONTROLS
- ★ NAVIGATION CONTROLS
- ★ BOMB RELEASES
- ★ REMOTE FIRING EQUIPMENT
- ★ RADIO CONTROLS
- ★ AIRCRAFT CONTROLS
- ★ SOLENOID CONTACTORS

P. S. Samples only available now for that "after it's over" product.

GUARDIAN ELECTRIC
 1625 WEST WALNUT STREET CHICAGO, ILLINOIS
 LARGEST LINE OF RELAYS SERVING AMERICAN WAR INDUSTRY

lamps for television studio lighting were carried out by the General Electric Co. at the New York World's Fair in 1939 and finally culminated in a complete installation in the new modern studios of WRGB at Schenectady in the fall of 1941. Studio lighting in the television studio WRGB is provided by a series of ceiling lights which may be controlled from an appropriate wall panel so that the horizontal and vertical directions of maximum intensity may be varied by operators in the studio. Each of these units contains three water-cooled H-lamps in their appropriate containers with metallic reflectors. The front surface of each of the ceiling lamps is provided with an irregularly shaped sheet of glass to prevent excess uneven distribution of light. Each ceiling installation is on rows 9½ ft. apart across the building and 6½ ft. apart along the building. The average space per unit is therefore approximately 120 sq ft. and these units are mounted approximately 14 ft. above the floor. Ultimately there will be 19 luminaires of which 12 are installed and in operation at the present time. The average footcandles with all of the floodlights pointed downward and oriented with the long axis of the reflector across the room was found by measurement to be 315 footcandles. It is possible to build up the intensity over a 10x15x10-ft. high scene to 650 or more footcandles of general lighting, with the upper portion of the scene reaching 1000 footcandles. By supplementing this lighting with floor lamps, good pictures are produced with little or no discomfort to the performers. This "no discomfort" feature has been found to give excellent results.

Again performing for RCA, G. L. Beers presented a paper "The Focusing View Finder Problem in Television Cameras". It was shown that the technical excellence of the television program frequently depends upon the char-

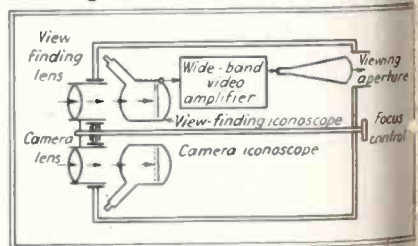

Fig. 12—Electronic view finder using two image forming tubes meets most requirements for view finder for television cameras.

acteristics of the view finder used in the television camera. Conditions peculiar to television make it desirable that the television camera view finder be of the focusing type in order that the image as seen by the television enthusiast may be properly focused. The requirements of an ideal view finder of this type are discussed not only from the angle of technical performance required but also from the angle of convenience of operation and speed of manipulation. The characteristics of various types of or-

ary camera view finders were discussed but it was found that none of these is ideally suited to television cameras. The most suitable type of view finder which has been developed at the present time is illustrated diagrammatically in the illustration of Fig. 1. Essentially it consists of a view finder lens and a camera lens of the same general optical design, a viewing iconoscope and a view finding iconoscope, the latter of which features a wide band video amplifier and ultimately makes the picture available in an iconoscope. The view finding equipment is a miniature reproduction of the complete television monitoring system. K. R. Wendt and G. L. Fredenall of RCA Manufacturing Co. presented a paper "Automatic Frequency and Phase Control of Synchronization in Television Receivers" as their solution to one of the problems in the reception of television images in providing satisfactory synchronization in the presence of noise. The system of synchronization which has given satisfactory results up to the present time has depended for its operation on the reception and separation of individual pulses. Satisfactory synchronization can be obtained from these signals which will in all other respects provide an entirely acceptable picture with this method of synchronization. Nevertheless, for limiting conditions of service, particularly where the signal strength may be low, an improvement in synchronization will be effective and desirable provided that it does not involve other complications or disadvantages. The new method of synchronization which was described by Mr. Fredenall makes use of automatic frequency and phase control of the sawtooth scanning voltages. In this system, the synchronization depends not on the individual pulses but rather on the average of many regular recurring synchronizing pulses so that the overall effect is an increased synchronization. Noise is relatively ineffective since it occurs at a random distribution rather than at regularly recurring intervals. Noise cannot affect the horizontal resolution of interlacing.

Experimental receivers in which the automatic frequency control of the scanning oscillator has been incorporated have operated well with a high immunity to noise.

Consideration of this new development indicates that its use would result in several improvements in television service. The system is particularly useful when severe noise conditions occur since superior performance is realized within the service area by the new method. Under excess noise conditions the useful service area is extended with the new frequency and phase control system. The maximum resolution permitted by a television channel is attained with the new system whereas it may not be attained in the old system especially where noise is important. It is expected that the cost of television receivers will not be increased by the use of the automatic frequency and phase control circuit, Fig. 6 and Fig. 7.



Creators and Makers of
**ACCURATE RESISTORS—SWITCHES—SPECIAL EQUIPMENT AND
 SPECIAL MEASURING APPARATUS FOR PRODUCTION AND
 ROUTINE TESTING OF ELECTRICAL EQUIPMENT ON MILITARY AIR-
 CRAFT... SHIPS... VEHICLES... ARMAMENT... AND WEAPONS**

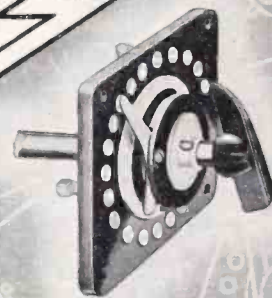

True . . . our present activities are mostly high priority War-Time Work . . . yet, we have recently greatly enlarged our Manufacturing facilities . . . and perhaps we could take care of your needs. Why not submit your problems to us NOW . . . and we will do our best to give you an answer. Please address Dept. No. 3.



HALLCROSS MFG. CO.
COLLINGDALE, PENNA.

WAR

is engineered scrap

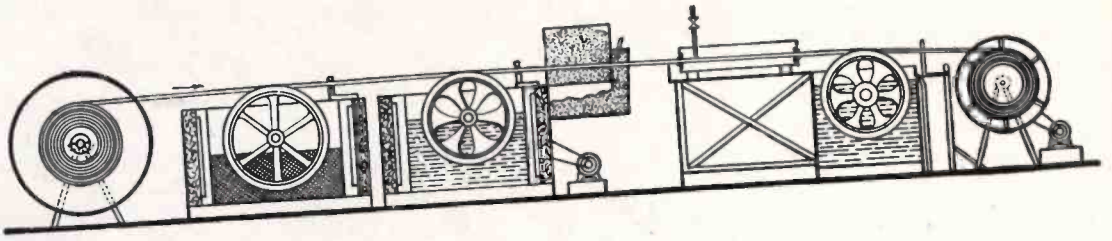

This war machine was built from an old pulley, the rear wheels of a truck and odds and ends of sheet steel.

It will never fire a projectile nor drop a bomb. But if our enemies really understood America it would frighten them.

The function of this scrappy gadget is to renew the weather-proofing on electric power wire . . . wire that would otherwise have to be junked.

▶ But war teaches us to look beyond machines to the hearts and minds of the men who make them.

In such perspective the device shown above takes on deep significance. It becomes a mechanical parable on the ingenuity of men whose job it is to keep electric power flowing to the vital war industries, regardless of shortages of copper, steel, rubber, aluminum.

▶ There are hundreds of such parables in every war-converted industry. Here are just a few from our great electric power plants:

. . . tons of bolts are being saved by a new method of rigging crossarms on electric poles.

. . . a southern generating station found its dam weakening. To keep the power flowing, holes were bored through the concrete and the dam bolted to bedrock!

. . . to avoid a shutdown, a middle-Atlantic utility worked out a method of stopping leaks around the giant valves controlling its water supply by mixing sawdust with the water. It worked.

. . . a western company bought old suspension cables from the wrecked Tacoma Bridge, untwisted them and used the metal as concrete reinforcement.

So goes the saga of electric power, as the industry does its share in the common task . . . With much of its trained man-power in the services, with priorities available only in the most urgent cases, the American utilities are showing the stuff American management and labor are made of.

But where are the stories of plants rushed into being almost overnight to supply electric energy?

As an American, you can thank your lucky stars such stories are few. Generating plants and power lines take years to build. For instance, our country's power equipment at the start of the war represented an investment of more than the present combined cost of the two-ocean navy and lend-lease expenditures.

War conversion for this vigorous industry was almost as simple as pushing the light switch on your reading lamp. The power was there because energetic managements had created it in the normal course of American life.

Some rush construction was necessary, but the electric power industry was first in war because it had been first in peace.

▶ The story goes back to the depression years. The utilities were the first to shake off the doldrums. In 1935, they had already passed 1929 levels.

. . . By the time the war broke out in Europe, America's giant electrical capacity surpassed that of a combination of potential enemies.

. . . It has grown since then, with 3½ million kilowatts capacity scheduled to be added in 1942. This year the industry also will spend 150 million dollars on maintenance alone.

▶ Because of these private expenditures, because the electrical companies started years ago to cater to women on the convenience of electrical home appliances . . . and because the industry has always been in advance of demand, it was ready for either peace or war, with the world's greatest system of power production and distribution.

* * *

In recognition of the miracle of war production—accomplished through the cooperation of American management and labor with the W. P. B. . . . this advertisement is published by the McGraw-Hill Network of Industrial Communication.

McGraw-Hill PUBLISHING COMPANY, Inc.

WEST 42nd STREET

NEW YORK



WITH A POSTSCRIPT FOR BUSINESS EXECUTIVES

PERHAPS you saw the advertisement on the opposite page, in the newspapers.

Did you notice those five examples of the way in which maintenance men are meeting the problem of war operation?

That's what this page is about.

If one public utility maintenance man works out a new way of reconditioning wire, his idea becomes really valuable to the country when all maintenance men with a similar problem find out how he did it.

If one man experiments with silver and bismuth as a substitute for tin solder, that becomes great news for a man who needs tin solder and can't get it.

That's why industry after industry has been able to meet the war production challenge . . . by swapping ideas.

► In industry, this idea swapping is done mostly through the editorial and advertising pages of the industrial press.

McGraw-Hill, for instance, keeps 153 editors and 725 engineer-correspondents busy digging up new methods of doing things.

Industrial advertisers, too, often send men

into the field to discover new ways of making their products do more work, or last longer.

When such practical editorial and advertising information is distributed to the readers of the 23 McGraw-Hill publications, the value of each idea is multiplied by thousands.

So valuable is this interchange of technical information that many companies are surveying their organizations to make sure that the supply of Industrial Magazines is adequate.

► If you would like suggestions as to how to conduct such a survey, just write to Reading Counselor Department, McGraw-Hill Publishing Company, Inc., 330 West 42nd Street, New York.

★ ★ ★

THE McGRAW-HILL NETWORK

More than 1,000,000 of the executives, designers and production men, who give America her world supremacy in technical "know-how", use the editorial and advertising content of the 23 McGraw-Hill publications as a means of exchanging ideas.

THE McGRAW-HILL BOOKS

Technical, engineering and business books for colleges, schools, and for business and industrial use.

McGRAW-HILL PUBLISHING COMPANY, INC.

330 WEST 42nd STREET • NEW YORK

THE McGRAW-HILL NETWORK OF INDUSTRIAL PUBLICATIONS

American Machinist
Edition

Transportation

Business Week

Chemical & Metallurgical

Engineering

Coal Age

Construction Methods

Electrical Contracting

Electrical Merchandising

Electrical West

Electrical World

Electronics

Engineering & Mining Journal

E. & M. J. Metal and Mineral Markets

Engineering News-Record

Factory Management & Maintenance

Food Industries

Mill Supplies

Power

Product Engineering

Textile World

Transit Journal

Wholesaler's Salesman

TUBES AT WORK

Continuous Balance Potentiometer Pyrometer.....	92
Transmitter Modulation Production Test.....	94
An Electronic Profilometer.....	94
Iron-to-Glass Seals.....	97
Moisture Determination In Non-Polar Compounds..	98
Hydrogen Moisture Content Check Method.....	100

Continuous Balance Potentiometer Pyrometer

By ROBERT D. TOWNE and D. M. CONSIDINE

A COMPACT ELECTRONIC balancing unit has replaced a galvanometer and complex system of cams and levers in the new continuous balance potentiometer pyrometer designed by The Brown Instrument Company.

Galvanometer balancing mechanisms previously used were cyclic in operation, with continuous mechanical motion providing intermittent periods during which the galvanometer was freed to assume its proper deflection unhampered by an engaging mechanism. In the new electronic system, unbalanced d.c. in the pyrometer measuring circuit is converted to a.c., amplified, and used to drive a motor in the proper direction to balance the measuring circuit and maintain correct instrument reading.

Use of the electronic unit eliminates galvanometer inertia, pivot friction, effects of vibration and changes in posi-

tion. When a balanced condition has been established, there is no unbalanced voltage to be amplified and no driving power to be fed into the motor. No further motion takes place until a change in the measured condition requires further rebalancing.

Measuring Circuit

The measuring circuit of the balancing system shown schematically in Fig. 1 consists of a thermocouple and a slide wire through which a known current is passed. Position of the slide wire contactor is adjusted mechanically to balance the voltage from the thermocouple. When the temperature changes, unbalanced d.c. appears across AA. This unbalanced voltage is changed into a.c. by the converter, which is a single-pole, double-throw switch actuated by an a.c. energizing coil so that it vibrates in synchronism with the 60-cycle line voltage. Contacts mounted on the vibrating reed feed the unbalanced voltage into alternate ends of the primary of a specially designed transformer, creating a 60-cycle control voltage which is either in phase or 180 deg. out of phase with the line a.c., depending upon the polarity of the unbalanced voltage of the measuring circuit.

Voltage and Power Amplifier

The a-c control voltage passes into a conventional voltage amplifier employing a three-stage resistance-capacitance coupled circuit. Each stage has an amplification factor of 50, providing total voltage amplification of 125,000. Tubes are high- μ twin triodes. A section of the second twin triode tube is used as a half-wave rectifier to supply plate voltage. The grid of this section is connected to the cathode so that this section functions as a diode.

The power amplifier consists of two identical twin triode tubes having their input circuits connected in parallel and their output circuits in push-pull. Since the twin-triode tubes perform duplicate functions, one of them will be disregarded in the following explanation, and the two sections of the twin triode tube under discussion will be designated tube 1 and tube 2. Referring to the schematic diagram in Fig. 2, in which polarity signs are arbitrarily assumed, tube 1 can conduct plate current only during the odd half-cycles of the control voltage from the voltage amplifiers, and tube 2 can conduct plate current only during the even half-cycles. Thus, a definite phase relation-

ship exists between the control voltage from the thermocouple circuit and the power amplifier output.

Half-wave pulses of current will pass through motor winding A and condenser C_1 during the odd half-cycles of the control voltage. During the even half-cycles, the tubes will pass no current, but condenser C_1 will discharge the motor winding A. Thus, with an

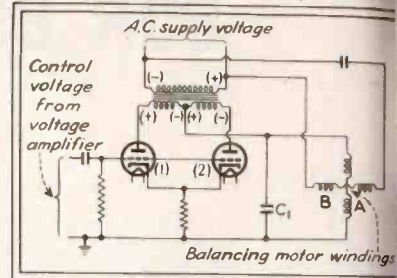

Fig. 2—Simplified schematic of the power amplifier

phase signal on the grid of the power tubes, a sine wave alternating voltage in phase with the supply voltage will be developed across the motor winding A. Conversely, when the control voltage is 180 deg. out of phase with the line voltage, a sine wave a-c voltage 180 deg. out of phase with the supply voltage will be developed across winding

Balancing Motor

The balancing motor is a reversible two-phase induction type. The power winding is energized continuously by the line voltage; the control winding is energized, as explained above, by the power amplifier. Thus, when the thermocouple circuit is unbalanced, the phase relationship between the two windings is determined by the direction of unbalance. Hence the motor which is connected through gears and levers to the slide wire contactor and to the instrument pointer, always rotates in the proper direction to balance the thermocouple circuit, at the same time correcting the position of the instrument pointer.

When the measuring circuit is balanced and the control voltage to the grids of the power amplifier is zero, the power tubes act as full wave rectifiers applying pulsating d.c. to motor control winding A. This brakes the motor at the position of true balance and prevents overtravel.

Sensitivity of the electronic continuous balance unit is such that maximum driving power of the balancing motor is

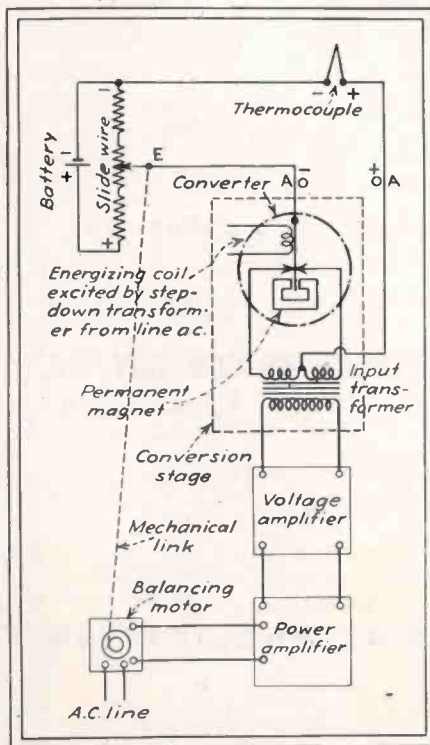
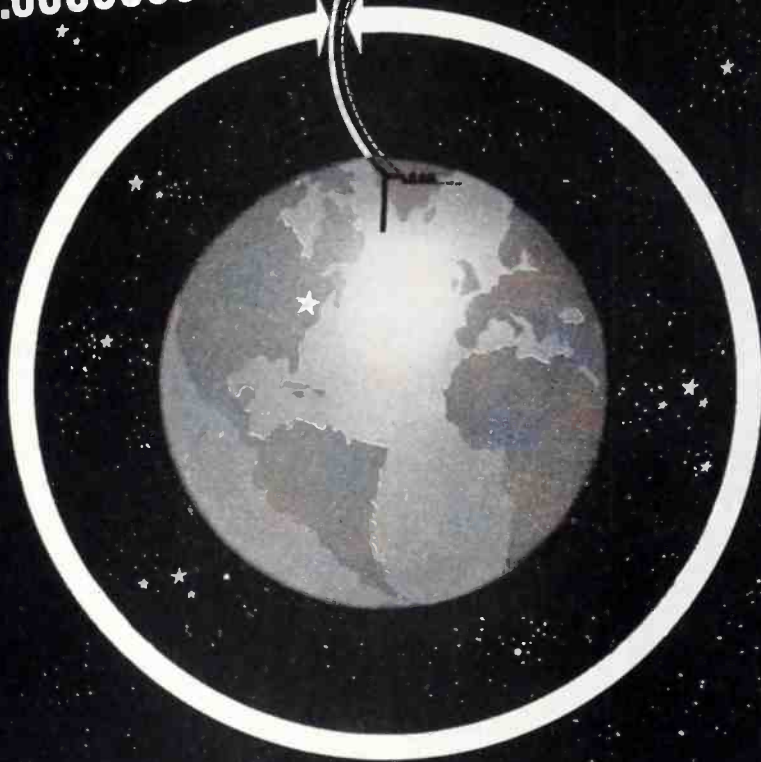

Fig. 1—Diagram of the complete continuous balance potentiometer pyrometer system



Fig. 3—Photograph of the electronic portion of the equipment

A motion .0000006" sends a Voice around the world



Microphone Diaphragm Design is a Difficult and Fascinating Art

THE Diaphragm is the heart of the Microphone. It responds to sound wave vibrations and actuates the translating element carbon, piezoelectric crystal, moving armature or moving coil. A Diaphragm must be extremely light—present a correct driving impedance to the sound wave and to the translating system—vibrate with uniform displacement or velocity at all frequencies. It must withstand atmospheric changes, extreme temperatures and hard service conditions of vibration, shock, gunblast. Whether designed for the studio or the battlefield, it must function.

The Diaphragm in the "556" Shure SuperCardioid Microphone is .0010" thick and weighs only 1/470th of an ounce. It drives a coil of wire in a magnetic field through .0000006 (six ten-millionths) inch, for average speech at 1 foot from the Microphone. This Diaphragm is designed so that it vibrates equally well at all frequencies from 40 to 10,000 cycles per second, yet is rugged enough to withstand the abuse encountered in daily service.

The Shure Engineering Staff are specialists in Microphone Diaphragm design. At Radio Station WRUL, America's Powerful Short-Wave Station, Diaphragms in Shure SuperCardioid Microphones are moving this .0000006 (six ten-millionths) inch to send the Voice of Freedom around the world!

Send for Booklet 172M

This booklet describes the theory of the SuperCardioid and the Shure SuperCardioid Microphone.

SHURE BROTHERS

Designers and Manufacturers of Microphones and Acoustic Devices
225 West Huron Street, Chicago, U. S. A.

SHURE



NOW 100% WAR PRODUCTION



WARD

*Now
Specializing
in*

TELESCOPING
and
SECTIONAL ANTENNAE
for
MOBILE PORTABLE
and
FIXED UNITS
for our
ARMED FORCES

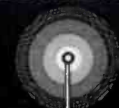

*Ward can help you with
your antenna problem*

WARD PRODUCTS CORPORATION
1523 East 45th Street
CLEVELAND, OHIO

obtained with an unbalance of less than 0.06 percent of the scale span, which represents one convolution of the slide wire. This is equivalent to a 0.00005 volt unbalance in the thermocouple circuit.

Fig. 3 is a photograph of the electronic portion of the system.

• • •

Transmitter Production Test

SPEECH AMPLIFIER and modulator performance of transmitters coming off the assembly line is rapidly compared with pre-determined standards by means of a simple yet commercially effective test setup devised by the engineering department of the Jefferson-Travis Radio Mfg. Corp.

A 1000 cps signal generated by a beat frequency oscillator delivering between 5 and 10 mw of power is fed to the microphone input terminals of the transmitter under test through a "dummy microphone" circuit consisting of an inverted microphone transformer having a variable resistor and a milliammeter in series with one leg and a 2000-ohms-per-volt a-c voltmeter of the copper-oxide rectifier type across the line. An electrolytic capacitor bridging the resistor and the milliammeter provides a low impedance a-f path while a paper dielectric capacitor connected as shown keeps d.c. out of the voltmeter.

When testing one particular transmitter series the variable resistor is adjusted so that 20 ma flows through the milliammeter, establishing an input impedance condition comparable with that which obtains when a single-button carbon microphone furnished with the transmitter is connected in the circuit. The output of the bfo is then adjusted until the voltmeter reads 1.8 volts. Tests with transmitters known to be up to standard indicate that this input volt-

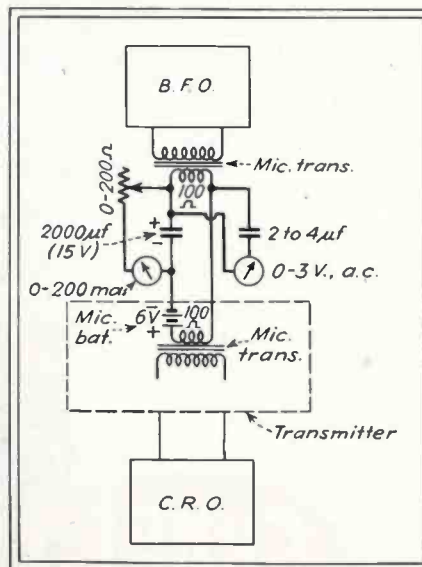

Simple "dummy microphone" setup for testing transmitter speech amplifier and modulator performance in production

age should be sufficient to modulate the transmitter 100 percent, indicated by cathode-ray oscilloscope connected the transmitter output circuit in a conventional manner.

Where transmitters must be tested over a definite audio frequency range as in the case of a series in current production on which specifications require that modulator output be flat within plus or minus 3 db between 20 and 3000 cps and at least 10 db down at 60 and 5000 cps, production checks are accomplished with the same test device by holding a-f input voltage constant while tuning the bfo over the necessary range and noting the modulation percentage indicated on the calibrated cro screen.

• • •

An Electronic Profilometer

ROUGHNESS ON THE SURFACE of materials finished by abrasives, by milling, turning, plating, grinding and other similar operations, may be measured by means of an electronic profilometer designed by the Physicists Research Company of Ann Arbor, Michigan. Surface irregularities from 0

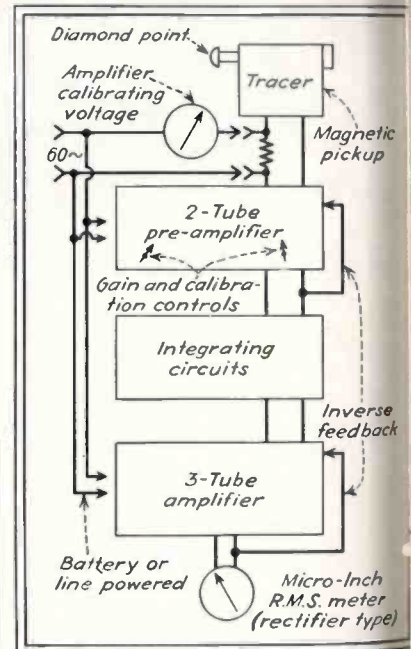

Fig. 1—Block diagram of the electronic profilometer, showing diamond-point pickup tracer head, amplifier with inverse feedback, velocity compensating integrating circuit, rms microinch meter and provision for calibration check

to 1000 microinch above or below an average centerline or reference point are easily read on the scale of a calibrated rms meter. An instrument with a special scale permits readings between 0.1 and 1 microinch.

Fig. 1 shows the circuit of the instrument in elemental form. Basically, the principle of operation involves generation of voltage in the coil of a p.m.



New Target for Industry:
**More Dollars Per Man Per Month in the
PAY-ROLL WAR SAVINGS PLAN**



TO WIN THIS WAR, more and more billions are needed and needed fast—**AT LEAST A BILLION DOLLARS A MONTH IN WAR BOND SALES ALONE!**

This means a *minimum* of 10 percent of the gross pay roll invested in War Bonds in every plant, office, firm, and factory in the land.

Best and quickest way to raise this money—and at the same time to “brake” inflation—is by stepping up the Pay-Roll War Savings Plan, having every company offer every worker the chance to buy **MORE BONDS**.

Truly, in this War of Survival, **VICTORY BEGINS AT THE PAY WINDOW.**

If your firm has already installed the

Pay-Roll War Savings Plan, *now is the time—*

1. To secure wider employee participation.
2. To encourage employees to increase the amount of their allotments for Bonds, to an average of at least 10 percent of earnings—because “token” payments will not win this war any more than “token” resistance will keep the enemy from our shores, our homes.

If your firm has not already installed the Pay-Roll War Savings Plan, *now is the time to do so.* For full details, plus samples of result-getting literature and promotional helps, write, wire, or phone: War Savings Staff, Section E, Treasury Department, 709 Twelfth Street NW., Washington, D. C.



U. S. War Savings Bonds

This space is a contribution to America's all-out war program by
ELECTRONICS

For Distinguished

Service

In



- ★ POLICE WORK
- ★ AIRLINES
- ★ SIGNAL CORPS
- ★ COMMERCIAL BROADCAST

WINCHARGER VERTICAL RADIATORS and ANTENNA TOWERS

It is easy to see why an ever increasing number of Wincharger Towers are being used in every type of broadcasting. That is . . . it's easy when you add up all these advantages:

- ★ LOW INITIAL COST
- ★ STRONG EFFICIENT COVERAGE
- ★ ATTRACTIVE APPEARANCE
- ★ LOWER MAINTENANCE COST
- ★ DESIGNED FOR 100-MILE WINDS

Experienced contractors are available for complete erection service, including lighting, anchors, base and ground systems.

Write or wire for complete information

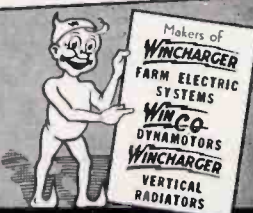

WINCHARGER VERTICAL RADIATOR
WINCHARGER CORPORATION SIOUX CITY, IOWA

pickup as a diamond-point stylus is moved over the surface to be examined, an amplifier and a rectifier-type output meter calibrated in rms micro-inches. Provision is made for calibrating the amplifier by means of voltage obtained from the power lines.

The Tracer

One tracer head available for use with the instrument, shown in Fig. 2, is about the size of a pack of cigarettes and so shaped that it may be conveniently held in the hand and moved over the surface to be examined. (It may also be bolted to any mechanical device, such as a motor supplied by the designers, suitable for effecting its motion.)

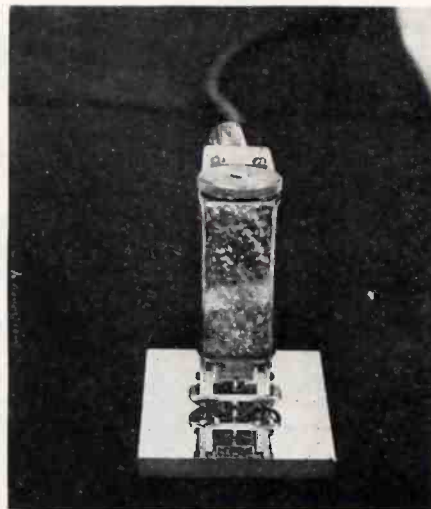

Fig. 2—Typical tracer unit. Note yoke supporting weight and establishing a reference level for the diamond point at the bottom, surface pressure adjustment knob at the top

A diamond is mounted on the end of a duralumin rod which is, in turn, screwed into a tube mounted on parallel springs. The parallel springs serve to restrict the motion so that it is essentially perpendicular to the surface. The upper end of the tube terminates in a coil form upon which is wound about 40 turns of wire two-thousandths of an inch in diameter. The coil is located in the field of a permanent magnet. When the tracer unit is drawn over the surface of the finish to be investigated the diamond transmits vertical motion to the coil. The output of the coil is proportional to the motion and is about 2 μ v per microinch at a 60 cps reference frequency.

The diamond point is positioned midway between two cemented carbide "skids," mounted upon an inverted U-shaped "yoke." Skids may be moved up and down by adjusting a knurled control knob on the top of the tracer unit, so that the tension of the diamond point against the surface to be examined may be delicately controlled to suit the material whose surface is being measured.

The instrument's amplifier consists of a five-tube resistance-coupled circuit using transformer input and trans-

former output. Two inverse feedback circuits contribute to stability and improve frequency response, permitting circuit constants to be altered by a factor of two-to-one without appreciably affecting the gain of the amplifier. The input transformer is provided with a "six-ply" shield to avoid sensitivity to extraneous a-c fields.

The Amplifier

Because the profilometer tracer unit produces voltage through the motion of a coil in a magnetic field, voltage is proportional to the velocity at which the turns of the coil cut the magnetic lines of force. Consequently, the voltage produced by the tracer is proportional to the speed at which the tracer is moved over the surface. This velocity effect is compensated for by special integrating circuits, designed to operate over a frequency range of from 20 to 10,000 cps, within plus or minus one percent.

Calibration

The tracer head calibration is effected during manufacture by placing the point of the tracer in contact with a brass block vibrating vertically at the end of a brass reed. The up and down excursions of the reed are then transmitted to the diamond point, which produces a reading on the profilometer rectifier-type meter. A microscope with a calibrated eyepiece measures the up and down excursions of the point. The meter of the profilometer is then adjusted to read the value determined by the microscope measurement. After during manufacture, amplifier gain is measured by introducing a known input voltage. The gain of the amplifier is thus expressed in terms of micro-inches and becomes the calibration number of the tracer. This calibration number is stamped on the back of the tracer and enables any tracer head to be used with any profilometer by performing an amplifier adjustment in the field.

To adjust the instrument so that it reads true microinch units in the field the thermocouple meter shown in the upper left corner of Fig. 3 is employed. Alternating current from any 60 cps power line is fed through this meter and through standardized resistances to produce a known standard voltage drop. This drop, produced at power line frequency, is 100 μ v. It is

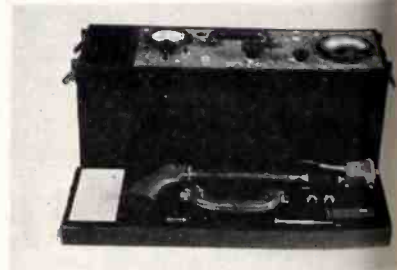

Fig. 3—The complete instrument, with cover removed. Tracer head, extra "yokes" and accessories may be seen in the foreground

inserted in series with the tracer unit
 thus effects an open circuit calibra-
 tion. With such a test voltage exciting
 the instrument amplifier, the output
 meter is adjusted to read the number
 of microinches stamped on the back of
 the tracer unit by means of a T-pad
 controlled by a knob on the panel.

• • •

Iron-To-Glass Seals

TIGHT SEALS BETWEEN iron and glass,
 emanating the need for the critical
 materials nickel and cobalt, are now being
 effected in the construction of vacuum
 tubes by means suggested by General
 Electric's Dr. Albert W. Hull and Dr.
 Luis Navias. Such seals involve the
 use of special glass compositions. One
 consists of 45 percent silicon dioxide, 14
 percent potassium oxide, six percent
 sodium oxide, 30 percent lead oxide and
 five percent calcium fluoride. The rate
 of expansion is very close to that of
 iron.

When a glass containing lead is sealed
 in contact with iron some of the lead
 atoms migrate from the glass into the
 iron. Weakening of the resulting joint
 is avoided by placing a thin layer of
 lead-free glass directly over the iron,
 thus sealing the lead-containing glass
 to the lead-free glass. The thin lead-
 free glass layer prevents lead from
 reaching the iron yet is not thick
 enough to crack and let air into the
 tube.

• • •

POWDER PARTICLES

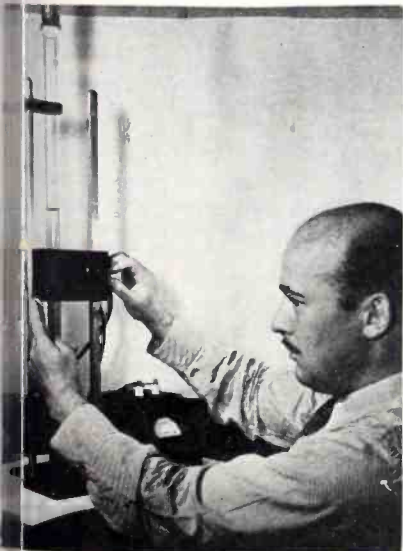

A. A. Bates of Westinghouse demon-
 strates P. R. Kalischer's device that quickly
 determines grain size of metallic powders
 having particles as small as 1/25,000 inch.
 Fed with a liquid in a long glass tube,
 the particles intercept a light beam directed
 into a phototube as they settle. The rate
 at which the solution clears up, indicated
 by anode current change through a millia-
 meter, gives comparative data

For Finer Co-ordination... remember

ONLY

WINCO GIVES YOU

ALTI-TEMP

The dynamotor specially designed to
 insure maximum efficiency at all operating
 altitudes and temperatures.



Quality Built WINCO DYNAMOTORS Insure

- ★ COMPLETE DEPENDABILITY
- ★ PERFECT BALANCE
- ★ MINIMUM A. C. RIPPLE
- ★ LOW VOLTAGE REGULATION
- ★ COMPACTNESS and LIGHT WEIGHT

... And, whatever your power problem,
 Winco Engineers will be glad to help you
 solve it. This service is free and without obliga-
 tion. Why not consult us?



WINCO DYNAMOTORS
 WINCHARGER CORPORATION - SIOUX CITY, IOWA

Meeting a pressing need

- for defense communications improvement
- demanding extension of services, development of refinements, more specially-trained engineers

Prepare for specialization in this important field

with the aid of these books



THIS LIBRARY was selected by radio engineering specialists of the McGraw-Hill publications to give a well-rounded view of communications engineering theory, applications, and special techniques. From important tube and radio fundamentals to special emphasis on high-frequency prob-

lems, the essentials of this field and its complete modern background are grouped here, for the aid of those who wish to prepare quickly for design and research work in the vitally important and expanding field of defense communications engineering.

The newly-assembled . . .

DEFENSE COMMUNICATIONS LIBRARY

6 volumes, 3662 pages, 6 x 9, 2111 illustrations, many tables and charts

These books give the basis for comprehensive practical working knowledge of ultra-high frequencies

1. Hund's PHENOMENA IN HIGH FREQUENCY SYSTEMS

A complete survey of theories, practices, and equipment the high frequency communications engineer requires in design and development of ultra-high frequency systems. Chapters on High Frequency Generators, Electromagnetic Theory, Theory of the Ionized Layer, Lines of Long and Short Electrical Length, and on Directive Systems have particular application in the present emergency.

2. Hund's HIGH-FREQUENCY MEASUREMENTS

An authoritative treatise on measurements of voltage, current, power frequency, L, C, R, tube constants and characteristics, radiation, and other high frequency electrical quantities. Of special timeliness is the material on measurements of frequency and phase modulation, the discussion of the use of cathode ray tubes in high-frequency measurements, and the determination of radiation, directivity and other transmission phenomena.

3. Stratton's ELECTROMAGNETIC THEORY

An advanced text on electromagnetic theory, treated mathematically through the extensive application of vector analysis. The first chapters deal with electrostatic and electromagnetic fields, which are followed by chapters on plane, cylindrical and spherical waves. Of particular interest to the engineer en-

gaged in ultra-high frequency phenomena, is the material on radiation from antennas of various types, effect of the earth on the propagation of radio waves, and the refraction and reflection of waves. A "must" for advanced workers engaged in wave propagation phenomena.

4. Reich's THEORY AND APPLICATION OF ELECTRON TUBES

A standard and authoritative text on electron tubes, the heart of modern communication system, giving thorough, coordinated groundwork in tube and circuit theory, with emphasis on fundamental principles and their use in many applications in electronics, communications, power, and measurements.

5. Everitt's COMMUNICATION ENGINEERING

A standard and well-known text covering communication practice at all usual frequencies, emphasis is on theorems which apply fundamental similarities of simple networks to new complicated structures.

6. Glasgow's PRINCIPLES OF RADIO ENGINEERING

A well-known text, relating theory of the thermionic vacuum tube and its associated circuits to communications without slighting necessary mathematical explanations. Used in Government-sponsored defense communications courses.

10 DAYS' FREE EXAMINATION

Special low price Easy terms

Bought singly, these 6 books would cost you \$31.00. Under this offer you save \$2.50 and in addition have the privilege of paying in easy installments beginning with \$3.50 ten days after receipt of the books, and continuing at \$5.00 monthly for 5 months.

No installment charge

These books assemble for your convenience facts, standards, practice, data, for the whole field of communications engineering, with emphasis on training in ultra-high frequencies. Add them to your library now, under this advantageous offer.

EXAMINATION COUPON

Send me Defense Communications Library for 10 days' examination on approval. In 10 days I will send you \$3.50, plus few cents postage, and \$5.00 monthly till \$28.50 is paid, or return books postpaid. (We pay postage if you send first installment with order.)

Name

Address

City and State

Position

Company L. 8-42

Moisture Determination in Non-Polar Compounds

By H. LOUGHNANE

IN NON-POLAR COMPOUNDS such as naphtha, recovered by a system using steam moisture remains in the solvent in both the condensed and vaporous state. The following method isolates the moisture and permits measurement of very small quantities:

A chamber of known volume is purged with dry air and then a measured quantity of solvent or solution is added. The dry air above the solution is circulated through the solution until it no longer takes up moisture. The dew point of the air is taken to determine the number of grains of water present in the air and this is compared with the number of grains of solution responsible for the rise in humidity. (In practice, absolutely dry air is not required. Humidity may be read before and after the air has been in contact with the solvent. The air is never allowed to go to 100 percent saturation. If samples are so laden with moisture they are diluted with dry solvent and the necessary correction made for volume change. In a converse manner small amounts of moisture may be more readily measured by using a comparatively large amount of solvent with respect to the volume of air in the chamber.)

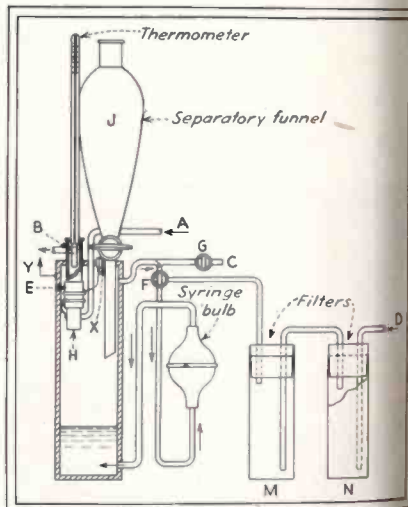

Fig. 1—Setup for moisture determination in non-polar compounds such as naphtha

Fig. 1 shows the chamber, the valve arrangements, a small copper tank H and the drying filters M and N. The volume of this chamber and of the syringe bulb and the tubing is determined by filling up every air space with a dry solvent and measuring the volume of the solvent. With the aid of the bulb, dry air may be drawn through the drying filters to purge the chamber and, by changing the valves, this dry air may be re-circulated in the chamber to bubble through the solution. The tank H is fitted with small copper tubes in such a manner as to allow a brine solution to enter the tank

A, flow about the thermometer bulb and leave through B. The flow of the brine is controlled in order to permit a slow drop of temperature at the glass jacket E.

Electronic Measurement

The Pyrex jacket E contains two number 18 tinned copper wires 1/64-inch apart. One wire is grounded to tank H and the other is brought out through the polystyrene bushing terminating at X.

Fig. 2 shows the amplifier. This amplifier has an input resistance of 1110⁶ ohms and is capable of reading the resistance of the microscopic film of moisture that forms on the glass jacket E without causing decomposition of the film through electrolysis. A 11 tube has one control grid tied to ground and in its plate circuit, bridge fashion, is a 0.5-0-0.5 milliammeter. R_i is used to balance the meter to zero when the remaining control grid is short-circuited. In series with the open grid and the conductors on the jacket E there is a potential of 67.5 volts, positive side to ground. The connection from the polystyrene bushing X is well shielded.

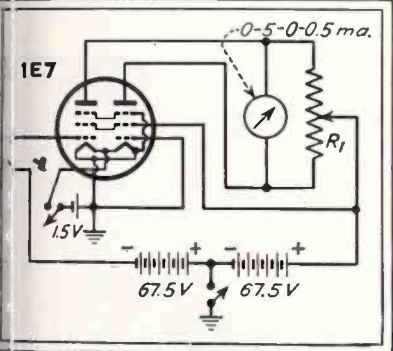

Fig. 2—Circuit for measuring resistance of moisture film condensed on inside of glass jacket

operation of the instrument is as follows: A measured quantity of solvent solution is placed in the separatory funnel J. Valves are set to bring dry air into the chamber from D through M and N and to exhaust through C. When the brine is at a temperature of about 26 deg. F., the jacket is cooled until a meter indication shows that there is condensation on the glass jacket. The temperature of the jacket is taken at the start of the meter movement. This is the dew point of the air from the dryers. The brine flow is then stopped and the chamber allowed to warm up above the wet bulb temperature. Further purging with dry air will evaporate moisture from the jacket and the meter will return to zero. The solution is now introduced into the chamber. Air is allowed to escape at F. This release of air should be used to control the flow of solution into the chamber. A low mark on the funnel used to keep a liquid seal over the chamber is suggested. With the solution in the chamber, valve G is closed and F is turned to permit the

**THE ONLY GUARANTEE OF ITS KIND
IN THE ENTIRE INDUSTRY!**

Try them at our expense!

Send for a trial order of the new Gould-Moody "Black Seal" Glass Base Instantaneous Recording Blanks. Give them every critical test you can think of. If you're not completely satisfied that they are as good as, if not superior to, any blank you've ever used—return the unused blanks, and keep the used ones with our compliments. We'll pay the freight both ways! You've got nothing to lose.



**GOULD-MOODY
"BLACK SEAL"
GLASS BASE
INSTANTANEOUS
RECORDING BLANKS**

**"No better blanks
were ever made"
- say major studio
engineers from
coast-to-coast**

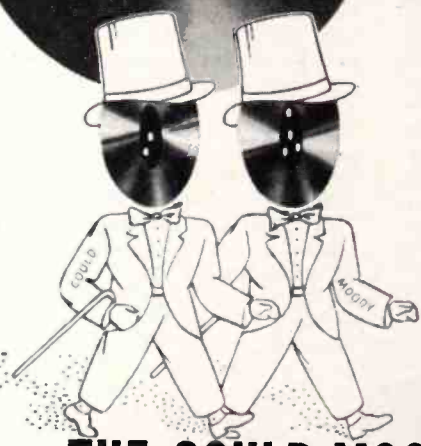

- A thin, flexible glass base disc
- A medium weight glass base disc
- Both with two or four holes
- All glass throughout . . . no fibre or foreign material inserts
- No metal gromets to "wow" or rumble
- Holes precision machined in the glass
- Priced at less than other fine brands
- Immediate delivery anywhere in U.S.A.
- Old aluminum blanks can be re-coated with "Black Seal" formula in 24 hours—same "no satisfy-no pay" guarantee

All accounts serviced with styli and shipping cartons at actual cost. 10", 12" and 16" sizes, with 2 or 4 holes. For transcriptions, professional recordings and libraries, Gould-Moody "Black Seal" Glass Base Instantaneous Recording Blanks "Speak for themselves".

THE GOULD-MOODY COMPANY

RECORDING BLANK DIVISION • 395 BROADWAY • NEW YORK, N. Y.

APPLICATION-DESIGNED RESISTORS for electronic requirements

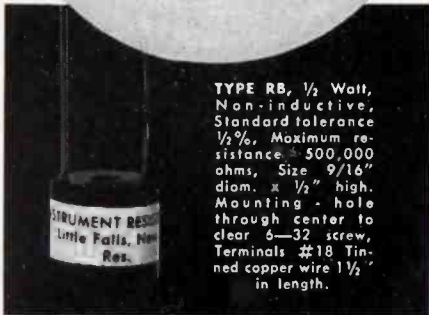

TYPE RB, 1/2 Watt, Non-inductive, Standard tolerance 1/2%, Maximum resistance 500,000 ohms, Size 9/16" diam. x 1/2" high. Mounting hole through center to clear #32 screw. Terminals #18 Tinned copper wire 1 1/2" in length.

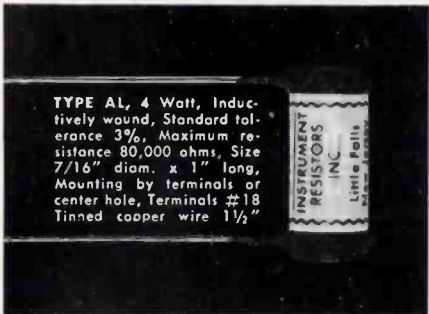

TYPE AL, 4 Watt, Inductively wound, Standard tolerance 3%, Maximum resistance 80,000 ohms, Size 7/16" diam. x 1" long. Mounting by terminals at center hole. Terminals #18 Tinned copper wire 1 1/2"

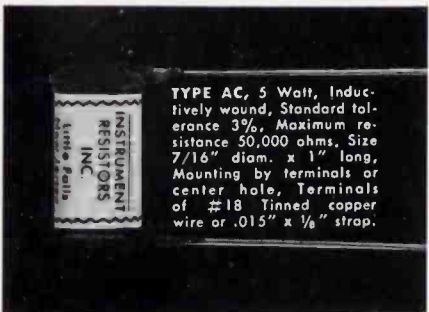

TYPE AC, 5 Watt, Inductively wound, Standard tolerance 3%, Maximum resistance 50,000 ohms, Size 7/16" diam. x 1" long. Mounting by terminals at center hole. Terminals of #18 Tinned copper wire or .015" x 1/8" strap.

★ When available mounting space is extremely limited, and ventilation and other operating factors require serious consideration, Instrument Resistors solve troublesome problems. These precision wire wound products will withstand atmospheric and temperature changes without impairment of their operating accuracy.

Check on Instrument Resistors today—they're application-designed to meet strict requirements. Send blueprints and data today for recommendations; inquiries treated in strict confidence.



INSTRUMENT RESISTORS COMPANY

25 AMITY STREET, LITTLE FALLS, N. J.

circulation of air above the solution in such a manner that it bubbles through the solution. The temperature of the jacket is then slowly lowered while operating the syringe bulb. As we now have a closed system, the circulation will depend upon unequal pressures on either side of the syringe bulb, hence high pressures will be built up in the chamber on the compression cycles. This pressure will cause a premature reading of dew point but, on release of the pressure, the meter will start to fall, indicating that the temperature is in the wet bulb range.

When this point is reached the brine flow is adjusted to give a constant reading and the syringe bulb operated until the meter swings, occurring on compression, have reached the maximum. This will indicate that the volume of moisture on the jacket has also reached a maximum and that there is no more moisture available from the solvent. The chamber is then allowed to warm up past the wet bulb reading, or until the meter reads zero. Without any further operation of the syringe, the temperature is again allowed to fall in the jacket *E* until condensation takes place at normal pressures. This will be the actual dew point of the known volume of air.

The water content is then calculated from a psychrometric chart. Subtracting the water content that was first found, before the introduction of the solvent, the grains of moisture that actually came from the solvent may be readily compared with the weight of the solvent.

. . .

Hydrogen Moisture Check By Direct Electronic Method

THE QUALITY OF CERTAIN steels treated in atmosphere furnaces is largely dependent upon the purity of hydrogen gas flowing over the metal during manufacture. In bright annealing, for example, the hydrogen must be virtually free of moisture containing oxygen. Ordinarily, to measure the moisture content of hydrogen where dew points are less than 0 deg. C. a cooled and polished metal plate is inserted in the gas stream and the temperature at which condensation first occurs on this plate is noted. Below -40 deg. C. this method depends largely upon niceties of judgment on the part of the operator and is, therefore, subject to human error.

A direct electronic method of continuously monitoring the moisture content of hydrogen is illustrated in Fig. 1. Hydrogen of known moisture content is pumped through a special Westinghouse half-wave rectifier tube with intake and exhaust ports at a constant rate until the interior of the glass envelope is thoroughly purged. Regulated filament and anode potentials are then applied to the tube and adjusted to give a full-scale reading on the anode circuit milliammeter. Hydrogen to be used in the steel-making process is then substituted for the calibrating hydrogen

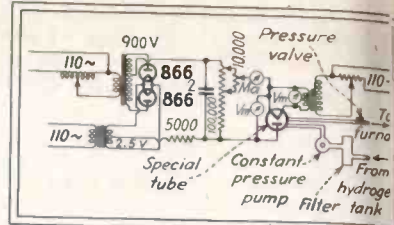

Fig. 1—Circuit of electronic device for continuous monitoring of hydrogen gas moisture content

and, with gas pressure and tube voltages maintained at the pre-determined values, any milliammeter reading change indicates a change in the moisture content of the gas. Presence of moisture, or oxygen, in the hydrogen flow through the tube in amounts greater than that in the gas used for calibration collects more negative ions in the tube electron stream, increasing internal impedance and reducing anode current.

The special tube pictured in Fig. 2 employs a tungsten filament and tungsten anode, this metal being satisfactorily impervious to hydrogen. Moisture determination by this process in connection with certain other gases would, undoubtedly, require the use of other tube metals impervious to such gases.



Fig. 2—The heart of the system, a special half-wave rectifier tube with gas intake and exhaust ports

Variations in tube anode current with changes in gas moisture content could, obviously, be used to control the operation of dehydrating equipment, thus rendering the entire process fully automatic.

. . .

Vacuum Tube Voltmeters The Meter at Work

THESE TWO VOLUMES were reviewed in June *ELECTRONICS* and it has just come to our attention that the prices given are not correct. The book "Vacuum Tube Voltmeters" actually sells for \$2.00, and "The Meter at Work" volume can be had for \$1.50. Both are published by John F. Rider, New York.

NEWS OF THE INDUSTRY

First-quarter receiver production figures. Defense communication equipment and personnel survey. Wartime tube packaging. Notes about men and materials

People

D. C. B. JOLLIFFE, chief engineer RCA Laboratories and communications chairman of NDRC, was awarded honorary LL.D. degree by the University of Virginia, his alma mater at the school's 75 annual commencement.

Alph S. Merkle, commercial engineer Hygrade Sylvania, has been commissioned First Lieutenant in the Communication Branch, U. S. Signal Corps.

Clivid Grimes has been made vice president in charge of engineering, **Joseph H. Gillies**, vice president in charge of radio production, and **Robert F. Ferr**, vice president in charge of service, all of Philco Corporation.

Nets

AVOX CORPORATION celebrated its 25th anniversary recently with presentation of tokens of esteem to S. I. Cole, president and other officials and old-timers in the company.

Calin Corporation of America, manufacturers of cast and liquid resins and plastics, has completely reorganized manufacturing facilities at its plant in Gladstone, N. J., has embarked on the construction of a new building for the production of polystyrene molding compounds, and the purchase of land, building and equipment of the former U. S. Products Co., Inc., at Matawan, N. J.

Eastone Carbon Co., St. Mary's, Pa., manufacturers of precision electrical products is completing a large program of expansion of plant and manufacturing facilities.

President Roosevelt requested Congress on June 8 for an appropriation of \$2,505,730,000 for the Signal Corps.

Seven official television listening posts have been established in Schenectady County, N. Y. where air raid wardens have been getting instructions originating in New York City relayed to them by the G-E television station.

More About Civilian Defense Communications

RULES GOVERNING THE operation of civilian defense radio stations (ELECTRONICS, July 1942, p. 103) released in June by the Federal Communications Commission specified that licenses would be issued to amateurs and others having the necessary technical training and equipment only through groups affiliated with the Office of Civilian Defense. The OCD simultaneously announced that it was preparing a manual explaining the procedure to be followed by properly accredited defense groups wishing to set up War Emergency Radio Service networks.

The manual referred to by the OCD is still in process of preparation as this issue goes to press but, in the interim, regional directors of the OCD have received a memoranda from director James M. Landis outlining suggested preliminary organizational steps which should be taken. Among the suggestions are the following: It is recommended that surveys be undertaken to determine to what extent equipment, licensed operator personnel and technical skill are available in each control



★ A decade ago the cathode-ray oscillograph was a scientific curiosity. A few such costly instruments were in use, in leading laboratories, entrusted to skilled technicians.

Then came the first DuMont cathode-ray oscillograph. Simplicity, practicability, economy—those were the cardinal features. And those very features soon attracted universal attention. Thus the DuMont cathode-ray oscillograph became indispensable equipment not only in laboratories but also in factories and out in the field.

Today the DuMont name is synonymous with cathode-ray oscillography. That name is your assurance of the latest refinements in this firmly-established technique.

★ Write for literature . . .

DUMONT

ALLEN B. DU MONT LABORATORIES, INC.
Passaic, New Jersey

Cable Address: Wespelin, New York

Radio Receiver Production-January to March 31*

	1942 Units	1941 Units	1942 Dollars	1941 Dollars
Cast Receivers				
Table sets.....	1,120,296	1,261,997	\$14,379,700	\$10,713,000
Coole's sets.....	141,883	124,976	5,710,900	3,857,600
Table sets.....	374,307	196,824	5,810,000	2,228,500
Television (no sound)....	139	4	7,500	200
Auto sets.....	216,910	650,035	3,671,200	10,405,800
Auto battery sets.....	195,854	157,077	2,761,900	1,845,800
Adapters.....	4,798	884	120,500	20,100
Table phonographs.....	64,563	43,754	932,800	494,600
Communication Apparatus				
Table combinations.....	227,120	112,684	5,761,100	2,034,600
Table sets.....	223,791	106,119	16,345,500	6,498,700
Table, phono., and recorder	24,488	15,047	2,232,000	742,700
Television.....	92	23	17,300	3,100
Apparatus sans cabinets..	127,608	93,641	2,323,600	1,237,900
Control apparatus.....	780	834	10,600	7,200
Total.....	2,722,629	2,763,899	\$60,084,600	\$40,089,800

*Compiled by the Radio Corporation of America from reports from its licensees.

APPROVED by U. S. SIGNAL CORPS BRANDING by ROGAN on PLASTICS!

"Tested and found to comply as an "or equal" to engraving now called for in specifications . . ."

★ Above excerpt from the U. S. Signal Corps Approval offers convincing evidence that Rogan "deep relief" branding on phenolic or other plastic parts achieves results equal to engraved markings. Of greater importance, Branding by Rogan permits the use of simple, fewer cavity, less costly molds.



Heat Control Unit Branded by Rogan

Branding on Plastics Will Speed Your War Production!

Fewer molds are required where parts are interchangeable, save for different markings for specific uses. Eliminates costly new molds and time-consuming mold-making operations. Permits use of blank stock parts.

See accompanying illustrations showing "deep-relief" markings branded on curved surfaces and hard-to-get-at places. Try this faster, big money-saving process now.



Plastic Shut - Off Branded by Rogan



Calculating Device Part Branded by Rogan

Get New Fully Descriptive Circular. No Obligation. Write

ROGAN BROTHERS 2003 S. Michigan Ave., Chicago, Illinois
EASTERN PLANT: 154 Lawrence St., Brooklyn, N. Y.

HIGHER *Q* WITH
Meissner-LITZ
MEISSNER MANUFACTURING CO., MT. CARMEL, ILLINOIS

area. (The OCD does not encourage manufacture of new equipment, believing that there is a sufficient supply of parts and materials for purposes construction already in the hands amateurs or on the shelves of dealers and distributors, and will not endorse requests to the War Production Board for preferential treatment). Region directors are urged to study the FCC regulations governing the War Emergency Radio Service and are also urged to inform prospective station operators of the contents of OCD publication "Staff Manual" and "The Control System of the Citizen's Defense Corps" that such operators will be familiar with the organizational rules which they will be expected to comply in the event that their equipment a service is enlisted.

Within the OCD memoranda, it is interesting to note, is a statement to effect that War Emergency Radio Service nets will be required to show proof that all transmitters within such nets can be instantly silenced upon receipt of a single order at the District Waring Center.

Music While You Work

THE ROLL CALL OF FACTORIES using sound system to furnish music to employees while they work is most impressive. Music of the proper kind, length and frequency relieves nervous fatigue and increases morale. Of course the sound systems can be used for announcements, etc.

A new sound system division, created to handle the sound problems of government requirements and of war industries, has been established by Stromberg-Carlson Tel. Mfg. Company and has taken over a large share of space in one of the company's plants. A. C. Schifino will head up the new divisions, with A. R. Royle as sales manager.



A. C. Schifino, head (left) and A. G. Royle, sales manager

Coming events cast their shadows...

Victory often hides behind the appearance of defeat! Things looked gloomy at Valley Forge and when the Huns were within 23 miles of Paris 1914! But we've always won.

Today American draftsmen in war work call upon Typhonite ELDORADO pencils to help maintain the speed necessary for Victory! Pencil Sales Dept. 59-J8, Joseph Dixon Crucible Co., Jersey City, N. J.

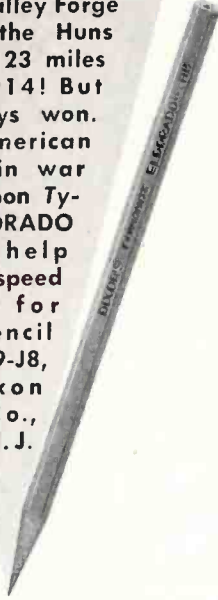

ELDORADO

**PERFORMANCE
COUNTS MOST
AND COSTS LESS
WITH LINGO**

Into Lingo designing has gone the finest engineering skill and modern antenna engineering. The result—"plus" performance combined with low installation and maintenance costs.

199 ft. (above roof)
Radiator at WIBM,
Jackson, Mich. Another
example of
Lingo versatility to
meet every station
need.

LINGO

**VERTICAL
TUBULAR STEEL
RADIATORS**

JOHN E. LINGO & SON, INC., CAMDEN, N. J.

Included in the new sound division's quarters will be a new development laboratory to handle specific sound system problems, and to conduct a continuous study of sound system equipment and correlate its studies with sound system research.

Within recent months, Stromberg-Carlson sound system engineers have installed sound systems in the ship repair station of Maryland Drydock Company, Camp Lee, Virginia, Bartlett-Hayward Co. of Baltimore, a division of the Koppers Coke Company, and many others.

A testing ground for the new sound division has been established within the Stromberg-Carlson plant in the form of a model sound system.

The new sound system will not only include a straight paging and voice system suitable for general and emergency announcements, but it will be able to carry musical programs to workers to speed production, pick up radio broadcasts, and through central control permit two way communications from guardhouse to guardhouse, or from guardhouse to all of the plant, or any section of the plant. A disaster provision has been built in, enabling each section of the plant to be segregated, in case of demolition, fire, etc., or enabling that section to summon help from either control station, or special department. The system is geared to serve sections with such varying noise levels as machine shops, or offices, serving each with a suitable but not disproportionate level of sound.

War work has been set to music recently in the Westinghouse Lamp Division, Bloomfield, N. J.

Loudspeakers stationed in main manufacturing areas now play marches, tangos and swing for five and a half hours a day while men and women turn out communications equipment for the nation's armed forces. Recorded music is also played in the Company's recreation rooms and cafeteria.

Band music, greets the first shift workers at 7 a.m. and continues for 15 minutes. Five other half-hour periods of music are scheduled during the eight-hour shift, one at lunch time and the rest timed to coincide with periods of "let-down" or fatigue among the workers. Music during the fatigue periods acts as a stimulant to the employees, reports show. Band selections are played at the end of the first shift and as new workers arrive for the second shift.

Service

TWO WELL KNOWN RADIO engineers have recently been given leaves of absence from their civilian posts to add their abilities to the war effort.

Robert M. Morris has been named a Chief Radio Engineer, U. S. Army Signal Corps, and assumed his duties in the office of the Chief Signal Officer, Washington, June 22. A pioneer in radio, Morris has been given a leave of absence from the National Broadcast-

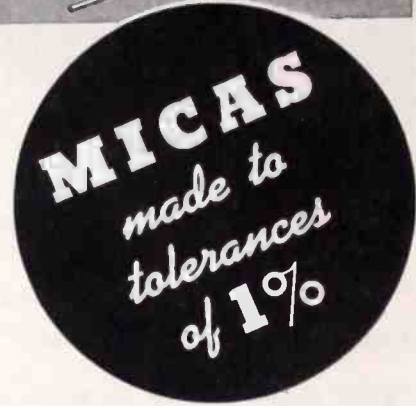
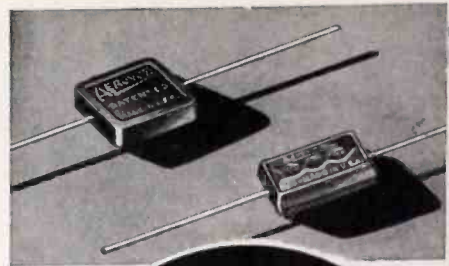

- For applications requiring precise capacity values, Aerovox offers two precision-type mica capacitors:

SILVER MICAS . . .

Molded in low-loss red (for identification) bakelite. "Postage-stamp" design and dimensions. Thoroughly wax-impregnated internally and externally. Heat-treated for stability. Average temperature coefficient of only .004% per degree C. excellent retrace characteristics. Practically no capacity drift with time. Q as high as 3000 to 5000 in higher capacities. Tolerances to 1%. .00001 to .0025 mfd. 1000 v. D.C.T., and .003, .004 and .005 mfd. 600 v.

MICA PADDERS . . .

Screwdriver-adjusted mica capacitors set to 1% of given capacity. Can be re-adjusted to compensate for slightest variations in coils and circuit conditions as required. Heat-treated. Wax-impregnated. Four mounting types. .000075 to .01, 600 v. D.C.T.

● Write for DATA . . .

Engineering data on these precision mica capacitors, sent on request. Let us quote on your requirements.

AEROVOX

CORPORATION

NEW BEDFORD, MASS., U. S. A.

In Canada: AEROVOX CANADA LTD., Hamilton, Ont.

EXPORT: 100 Varick St., N. Y., Cable 'ARLAB'

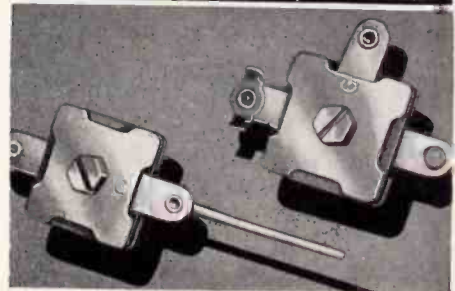



"..information of aid and comfort to the enemy"

THE censor's stamp is, today, a badge of honor. The necessity of withholding information concerning a product implies its importance to the war effort.

How and where this censored new product is going to be used would be of interest to Axis engineers. It and many other parts were created by *Richardson Plastics* to help increase and speed up production of better equipment.

INSUROK Precision Plastics and the suggestions of *Richardson Plastics* have helped many war products producers save time and increase output. If molded or laminated plastics might solve one of your problems, write us.

INSUROK and the experience of *Richardson Plastics* are helping war products producers by:

1. Increasing output per machine-hour.
2. Shortening time from blueprint to production.
3. Facilitating sub-contracting.
4. Saving other critical materials for other important jobs.
5. Providing greater latitude for designers.
6. Doing things that "can't be done."
7. Aiding in improved machine and product performance.

The Richardson Company, Melrose Park, Ill.; Lockland, Ohio; New Brunswick, N. J.; Indianapolis, Ind. Sales Offices: 75 West St., New York City; G. M. Building, Detroit.

INSUROK

ing Company for the duration of the war. Morris started his radio career as engineer for the A.T. & T. when WEAJ was established. When NBC was formed in 1927 Morris was named Chief Development Engineer. In 1935 Morris developed the Orthacoustic method of making lateral electrical transcriptions. He continued as Chief Development Engineer until March, 1941, when he was named Business Manager of the NBC Radio-Recording Division, from which post he has been given leave to assume his new duties.



Robert M. Morris



P. C. Sandretto

P. C. Sandretto, superintendent of United Air Lines' communications laboratory in Chicago and a leading aeronautical radio engineer, has been given leave of absence by United to become a major in the Communications Directorate of the Army Air Forces at Washington.

As head of United's laboratory, Sandretto participated in many aircraft radio developments which have become standard on the nation's air-

lines. A graduate of Purdue University in electrical engineering, he was on the technical staff of the Bell Telephone Laboratories in New York before joining United Air Lines 10 years ago.

While still in college, Sandretto designed and built one of the first crystal control broadcasting stations in the United States and, after his graduation, worked on television research at Purdue's engineering experiment station. His work with United Air Lines in perfecting plane-ground radio communication and in ground radio direction finding of planes in flight has attracted particular attention.

Sandretto is the author of "Principles of Aeronautical Radio Engineering" which will be published early this Fall by the McGraw-Hill Book Co.

New Cartons for Tubes

A NEW PRINCIPLE of packing radio tubes which will result in major contributions to the war effort in shipping space, material, handling and warehousing savings, has been developed by RCA.

By the new method, RCA is saving some 120 tons of packing material each year, and is able to ship approximately twice as many tubes in a boxcar or truck, thus halving the need for critical shipping space. The new method supplants packing, handling, storing and shipping practices which have been common for many years.

To extend the value of the new packing principle more quickly, RCA has granted patent rights to the new type cartons to other tube manufacturers. In addition, other tube manufacturers have been shown factory routines that have been developed to make the most efficient use of the new process.

The new packing ideas were developed by Charles I. Elliott, a 27-year-old packing engineer who was employed by the RCA tube division to study the company's methods of handling tubes during the manufacturing process, and preparing them for warehousing and shipping.

Old Systems Scrapped From Start

Mr. Elliott attacked the problem by consigning all existing packing containers to the scrapheap. Then he set about designing new type containers which would use the least possible amount of cardboard and that would make possible more efficient factory handling. He found that existing packing methods required the use of 210 separate pieces of packing material per 1,000 tubes. Improvised handling methods were used in the factory where tubes travel from one assembly operation to another. A packing box of 22 parts, some of them no longer obtainable, was used to store and ship glass tubes.

When he had finished re-designing

packing cases, Mr. Elliott found that he had reduced the 210 pieces of packing for 1,000 tubes to 24 pieces. He discovered that a single one-piece, tray-like container, planned to hold the tubes close within shipping cases, could also be used to save time in the manufacturing processes.

Standardization Important in Wartime

Standardization of tube packages is vitally important in wartime for many reasons. Spare radio tubes can be made to fit into spaces designed for them by the builders of planes, tanks, mobile units, ships and other fighting equipment. And the tube packages will fit the spaces, no matter from which factory they originated.

In handling receiving tubes alone, savings of 30 percent in material were achieved. Factory handling efficiency has been stepped up 20 percent, loss by package has been materially reduced, and the need for storage space. It is now possible to pack 647,500 tubes of a given type into a single boxcar, an increase of nearly 100 percent in capacity.

For further improvement in the handling of the smaller types of receiving tubes has been made in the form of a "clip" of cardboard which holds 10 tubes. During testing, warehousing and handling operations, the "clip" of 10 tubes is handled as a unit. However, when the time comes for the tubes to be packed into individual cartons for shipment, the "clip" is torn into 10 pieces along perforated lines, to become the inner support for each tube in its individual carton. Further, the old 31-piece glass tube carton had resolved itself into a smaller, eleven-piece box. In the case of a certain type power tube a wooden box used to transfer large quantities about the factory and to the warehouse has given way to a compact cardboard box in which the tubes are transported with greater protection from breakage.

A universal box has been designed for packing all types of power tubes of the same size, supplanting a large number of various sized special boxes. Ingeniously designed inner supports dovetail with the layers of wadding once packed while the application of simple laws of physics provides greater safety for the tubes when the box is subjected to unusual stress.

In the case of cathode-ray tubes, the fragile glass bulbs are now received at the factory from the glass works in the shipping cases in which they are supported throughout the manufacturing processes, testing, warehousing and shipping processes. So much has been saved in the cost of the packing cases that the company has agreed to furnish them to RCA without cost.

Mr. Elliott's work has been carried out under the direction of L. E. Mitchell, manager of the Industrial Engineering Department devoted to the development of better methods through work simplification.

The overall savings under the new methods are tremendous, when consid-

KENYON TRANSFORMERS

WHEN SPECIFICATIONS ARE Tough



KENYON TRANSFORMER CO., INC.
840 BARRY STREET NEW YORK, N. Y.

"TEST TO DESTRUCTION"



Standard Electro-Voice engineering practice includes orders for "Test to Destruction" during manufacture and assembly. At frequent intervals, microphones are taken from our production lines and abused until they are completely demolished.

Throughout the procedure, Electro-Voice engineers carefully examine and analyze the resulting changes in level and response. This is but one of a series of tests that are perfecting a line of rugged microphones for dependable service under the strains and shocks of military service.

ELECTRO-VOICE MFG. CO., Inc.
1239 SOUTH BEND AVENUE SOUTH BEND, INDIANA
Export Office: 100 VARICK STREET, NEW YORK, N. Y.

SERVING  AMERICA!



DeJUR

POTENTIOMETERS RHEOSTATS

1 to 200,000 ohms in
single or dual units.
Custom-crafted in the
tradition which has
earned world-respect.
Special attention to in-
dividual needs.

*Write, wire or phone for new
Catalog 1-61, Dept. B*



DeJUR-AMSCO CORPORATION

SHELTON, CONNECTICUT

S. S. White

MOLDED RESISTORS

The "All-Weather" Resistors

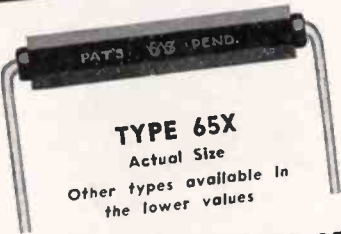

TYPE 65X
Actual Size
Other types available in
the lower values

RESISTOR BULLETIN 37
GIVES FULL DETAILS...

It shows illustrations of the different types of S. S. White Molded Resistors and gives details about construction, dimensions, etc. A copy, with Price List, will be mailed on request. Write for it—today.

THESE widely used Resistors are favored because of their noiseless operation and durability and because they retain their values and characteristics under extremes of temperature, humidity and climatic changes.

STANDARD RANGE

1000 ohms to 10 megohms.

NOISE TESTED

At slight additional cost, resistors in the Standard Range are supplied with each resistor noise tested to the following standard: "For the complete audio frequency range, resistors shall have less noise than corresponds to a change of resistance of 1 part in 1,000,000."

HIGH VALUES

15 megohms to 1,000,000 megohms.

S. S. WHITE

The S. S. White Dental Mfg. Co.
INDUSTRIAL DIVISION
Department R, 10 East 48th St., New York, N. Y.

ered in the light of the national emergency," Mr. Mitchell said. "In 1941 we used 400 tons of packing material. In 1942, for the same quantity of tubes, we will need only 280 tons, a saving of 120 tons.

Not only does the new method packing and handling tubes save on materials but it speeds up the tube testing by 30 percent enabling 30,000 hours of labor at the RCA plant to be devoted to making more tubes. The fire hazard has been reduced since there is no shredded paper in packing cases and no loose partitions, the containers can be laid out flat and so require less storage space.

Radar

CHARLES F. KETTERING, President of the General Motors Research Corporation and Vice President of the General Motors Corporation has been appointed as consultant to the Radio and Radar Branch of WPB.

In announcing the appointment, Donald M. Nelson, WPB chairman, made public a portion of a letter to Mr. Kettering, as follows:

"Our Radio and Radar program has assumed such tremendous proportions that I feel it is now vitally important to have someone of your outstanding capacity and accomplishments in the scientific world, to whom we can turn from time to time in the difficult task of meeting the requirements of the program. Your acceptance of the position of consultant to us in these matters makes me increasingly confident that the job will be well done and I wish to take this opportunity of telling you how pleased I am about the arrangement.

The Radio and Radar Branch is concerned with providing facilities for the production of radio communications, aircraft detector, signalling and fire control equipment. Ray Ellis is chief of the Branch, which reports to Harold Talbott, Deputy Director of the Production Division.

Late News

WPB PROHIBITION on use of copper and brass in radio manufacture has been lifted to permit manufacture of replacement vacuum tubes and various types special types of radio apparatus under certain circumstances.

Because of critical shortage of scientific equipment, university and other private laboratories engaged in research work unrelated to the production of materials or in other research not directly connected with the war effort will be unable to secure new laboratory equipment unless the particular use is approved by the Director of Industrial Operations. Repair parts may be obtained, however.

FCC has ordered all amateur transmitters to be registered with the Commission by August 25. Thus the FCC will have a record of what equipment is available, where it is, etc.

JONES BARRIER STRIPS

SOLVE MOST TERMINAL
PROBLEMS



to, 151

A compact, sturdy terminal strip with Bakelite Barriers that provide maximum metal to metal spacing and prevent direct shorts from frayed wires at terminals.

6 SIZES

cover every requirement. From 3/4" wide and 13/32" high with 5-40 screws to 2 1/2" wide and 1 1/8" high with 1/4"-28 screws.

Jones Barrier Strips will improve as well as simplify your electrical intra-connecting problems. Write today for catalog and prices.

HOWARD B. JONES
2300 WABANSIA AVENUE,
CHICAGO ILLINOIS

For Everything in Electronics & Radio



**OUR ONE DEPENDABLE
SOURCE OF SUPPLY . . .
Your ALLIED Catalog!**

Your ALLIED Catalog has Everything in Electronic and Radio Equipment for engineering communications, laboratory and industrial applications, etc. All the leading lines: Test Equipment, Amplifiers, Publishing Address, Electronic Tubes, Xmitting Gear, Photo Cells, Receivers, 15,000 Parts, etc. Complete stocks; quick delivery; everything you need from one dependable source. You'll want your ALLIED Catalog handy. For your FREE Copy, write Dept. 24-H-2.

ALLIED RADIO
833 W. JACKSON • CHICAGO

Colin B. Kennedy

IN ANNOUNCING the death of Colin B. Kennedy, one of the radio industry's pioneering spirits, we can do no better than to quote from a letter from E. F. McDonald, Jr. President of Zenith Radio Corporation.

"When, back in 1921, I became associated with Chicago Radio Laboratory, which two years later became Zenith Radio Corporation, to me the two great names in radio were Grebe and Kennedy, both of whom now have passed on.

"Colin Kennedy, back in those days, headed the radio company bearing his name with St. Louis as its headquarters. He was an engineer radio pioneer, a quiet, modest man, who sought no glory but contributed much to the early days of radio. He was one of the first holders of a license to manufacture home radio under Armstrong patents.

"Colin Kennedy, when he died, was doing his stint for his country as an OPM engineer assigned as civilian advisor to the Army Signal Corps."

Alien Patents

ALIEN PROPERTY CUSTODIAN has taken over approximately 3,000 patents and by end of September 40,000 may be in the same category. In one of the first groups of 600 taken over, 50 were Italian, 10 Hungarian, 100 Japanese and the remainder were German.

Furthermore, the Custodian requires everyone claiming any interest in patents or patent applications now or formerly owned by nationals of certain designated countries to report their interest on Form APC-2 by August 15, 1942.

• • •

REGISTER CONTROL



A G-E photoelectric color register control installed on a press in the plant of New York's Neo Gravure Printing Company is checked for synchronization by means of a cathode-ray oscilloscope

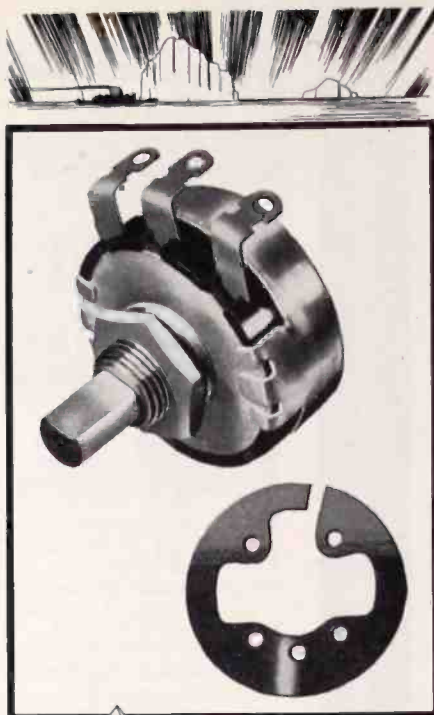

with the new

STABILIZED Element

★ Quietly, modestly, quite unannounced, Clarostat Series 37 controls have, for many months past, been coming through with the new *Stabilized Element*. We wanted this outstanding development to prove its worth out in the field, by users, corroborating our own critical tests.

Results have spoken for themselves. Users have promptly spotted something radically different in non-wire potentiometers and rheostats. Remarkably accurate resistance values first and last; extreme immunity to humidity, temperature and other climatic conditions; minimized wear; noiseless operation; smooth rotation—these features have marked the introduction of the new Clarostat Stabilized Element—stabilized by heat-treatment, chemical-treatment, lubrication-treatment, for truly outstanding performance.

Try a Clarostat Series 37. Sample on request to responsible parties. Judge it by your own tests. Let us quote.



Clarostat Mfg. Co., Inc.
285-7 N. 6th St. • Brooklyn, N. Y.

Globar
REG. U. S. PAT. OFF.

CERAMIC RESISTORS

● Finding the right resistor for a specific application is likely to be no easy problem. Because the solution so often is found in Globar Brand Ceramic Resistors we urge you to acquaint yourself with the distinctive qualities of these versatile resistors. The handy chart below shows types available, together with their characteristics.

TYPE	A	B	CX
DIAMETER			
MIN.	1/16"	1/16"	1/16"
MAX.	1"	1"	1"
LENGTH			
MIN.	1/4"	1/4"	1/4"
MAX.	18"	18"	18"
WATT RATING*			
MIN.	1/4w.	1/4w.	1/4w.
MAX.	54w.	54w.	150w.
RESISTANCE per in. of length			
MIN.	25 ohms	5 ohms	1 ohm
MAX.	15 meg.	15 meg.	1000 ohms
NORMAL RATING w./sq. in. of radiating surf.	1	1	2-1/2

*By artificial cooling these ratings may be increased substantially.

Characteristic Coefficient:

Type A: Commercial straight line Voltage and Temperature

Type B: Negative Voltage Negative Temperature

Type CX: Commercial straight line Voltage and Temperature

Terminols: All types: Metallized ends with or without wire leads

In addition to these standard items, special resistors can be made to meet definite specifications both as to shape and characteristics. Ask for Bulletin R and give us details of your requirements.

Globar Division
THE CARBORUNDUM CO.

REG. U. S. PAT. OFF.

NIAGARA FALLS, N. Y.

Carborundum and Globar are registered trade-marks of and indicate manufacture by The Carborundum Company.

NEW PRODUCTS

Month after month, manufacturers develop new materials, new components, new measuring equipment; issue new technical bulletins, new catalogs. Each month descriptions of these new items will be found here

Explosion-Proof Timers

EXPLOSION-PROOF TIMERS suitable for operations in atmosphere containing gasoline, naphtha, petroleum, benzol, acetone, lacquer solvent, natural gas, etc., can now be had.

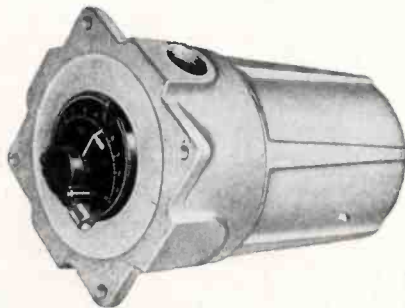

The illustration shows a Type TD1C explosion-proof time delay relay which is laid out for panel board mounting with the setting knob and dial projecting. Within this housing it is possible to mount either Type TD1C or TD1 with a small relay. The latter construction would be used where it is desired to control the timer from remote located momentary start button.

The R. W. Cramer Co., Inc., Centerbrook, Conn.

Printing and Coloring Acetate

WIRING DIAGRAMS, CHARTS, indicators and dials can be printed on plastic by a new process called "Print-Cote." Coloring plastics such as cellulose acetate is done by a process called "Print-color." The "Print-Cote" method used for protecting cellulosic sheet plastic is to apply to the printed sheet a liquid film of cellulose acetate, coupled with a suitable solvent and plasticizer. The process is not a lengthy one and the coating will not peel off. The finished product is unaffected by oils, dirt or atmospheric conditions. These printed acetate plates can also be bent to conform to the shape of curved surfaces where necessary.

"Printcolor" plastics may be used for sheet stock, molded items and extruded shapes. In some cases, extruded shapes can be dyed in complete coils. Crystal clear transparent materials become transparent colors by this dyeing process, and translucent or opaque materials in white or light shades may

be given a wide variety of colors. The dye penetrates the surface of the plastic, and the color is almost indestructible. The piece can be buffed without removing the color. Since the object to be dyed is not subjected to the action of solvent chemicals, its original finish is not altered, and it needs no subsequent polishing or processing.

Printloid, Inc., 93 Mercer Street, New York, N. Y.

Rheostat, Potentiometer

THESE RHEOSTATS, POTENTIOMETERS, designated as Types 260 and 275 are rugged and durable and were designed to withstand vibration, tropical heat, and moisture. They may also be used in high impedance vacuum-tube circuits where high values of resistance and low noise level are required.

Specially developed machines space wind the fine resistance wire on a strip of fabric base bakelite. These strips are then coated with a binding agent which cements the wire to the strip. A protective bakelite band is then placed externally over the fine wire strip protecting the wire from mechanical damage or derangement. This strip is then bent around and securely fastened to the bakelite supporting form. Constant contact resistance and low noise level is maintained for any position of the knob through the use of five separate wiping fingers which are

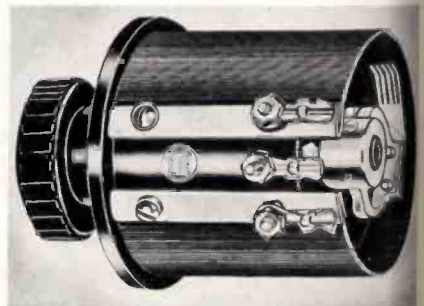

self-aligning. The type 260 and 275 have the same mechanical characteristics with the exception of physical depth dimensions and wattage rating. These units are usually furnished for panel mounting and can be converted for top of table mounting by simply reversing the shaft. Either unit can be mounted

rectly on metal panels without short circuiting the variable arm. Specifications of Type 260 are maximum rating, 2 to 100,000 ohms; power rating, 6 watts; net weight, 6 ounces. Type 275 specifications are maximum resistance, 50 to 200,000 ohms; power rating, 11 watts; net weight, 8 ounces. Both of these models have a rotation angle of approximately 327°, a standard 3-hole mounting, and a 3/8 inch diameter Bakelite shaft. DeJur-Amsco Corp., Shelton, Conn.

Vacuum Tube Voltmeter

ACCURATE MEASUREMENTS throughout the entire audio frequency range are simplified by Model No. 666, a vacuum tube voltmeter specifically designed for that purpose. Essentially a peak type voltmeter, this instrument has a constant input impedance resistance of 1 megohms. Although designed for 1-130 volt, 60 cps operation, provision has been made for external battery



operation through appropriate terminal connections and a throw-over supply switch. Readings are made quickly and easily. The instrument is equipped with a 4 1/2-inch rectangular meter having a movement of 0-200 microamps. Ranges are 0-3-6-30-150 volts. Tubes used are type 6K6GT, 6X5GT, 6H6 and 6BD5-30. The latter is a voltage regulator, eliminating errors due to line voltage fluctuations. Radio City Products Co., 127 West 26th Street, New York, N. Y.

Self-Locking Nuts

A NEW ACORN TYPE, self-locking nut is available in three popular bolt sizes, No. 10-32, 10-24, and 1/2 inch-20. They are made of spring steel, heat treated and hardened, and have spring-steel jaws that compress in and grip the bolt thread when the nut is tightened. They are light in weight, low in cost, and are relatively long life, and can be used to replace regular acorn nuts or nuts with lock washers. T. Palnut Co., 61 Cordier Street, New York, N. J.

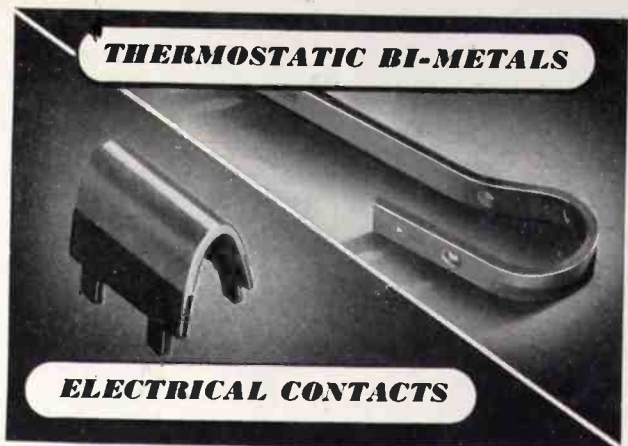

THERMOSTATIC BI-METALS

ELECTRICAL CONTACTS

Percolators or Pursuit Planes

★ Almost overnight, whole industries have changed over from peacetime to war production. ★ Yet, whether it's brooders or bombers, transformers or transports, percolators or pursuit planes, the need for Wilco specialized thermostatic bi-metals and electrical contacts remains unchanged. Resistance bi-metals (from 24 to 440 ohms, per sq. mil, ft.) and high and low temperature thermostatic bi-metals are available in wide variety. ★ Also Wilco electrical contact alloys (in Silver, Platinum, Gold, Tungsten, Metal Powder Groups).

WILCO The **H. A. WILSON CO.**
 105 CHESTNUT ST., NEWARK, N. J.
 Branches: Chicago and Detroit

Suppliers to Foremost Manufacturers of **ELECTRONIC Devices** demanding HIGHEST QUALITY!

NYC **NEW YORK TRANSFORMER CO.**
 26 WAVERLY PLACE, NEW YORK, N. Y.



Panoramic RECEPTION!

THE VISIBLE SPECTRUM OF RADIO FREQUENCIES

Research and development engineering in the Hallicrafter laboratories goes constantly forward . . . keeping ahead of the fast moving pace of today's defense requirements for communications equipment.

Panoramic reception is only one of the many new developments Hallicrafters will be the first to introduce when short wave equipment is again available for civilian use.

the hallicrafters co.
CHICAGO, U. S. A.

Keep Communications Open!



Densitometer

THE BASIS OF THE ANSCO Sweet densitometer (a photographic density measuring device) is its use of a photo-sensitive tube which, when placed in the path of a beam of light, varies the flow of an electric current in proportion to the intensity of the light. This current, after amplification, actuates a meter which is calibrated directly in terms of density. The electronic circuit remains stable over long periods of time and permits uniform calibration of the meter scale in terms of density. The densitometer is easily operated with a minimum of visual fatigue. Agfa AnSCO, Binghamton, N. Y.

Switch Actuator

DESIGNED FOR USE in the throttle mechanism of aircraft and other applications, Type "T" Switch Actuator provides a light-weight, compact mechanism for performing a widely useful three-step operation. Steps in the cycle of operation are: closing a circuit by depression of an actuating arm; opening the circuit by mechanical release of the normally open switch while the actuating arm is held in the depressed position; and, return of the actuating arm to normal position. As used in aircraft, the unit employs the

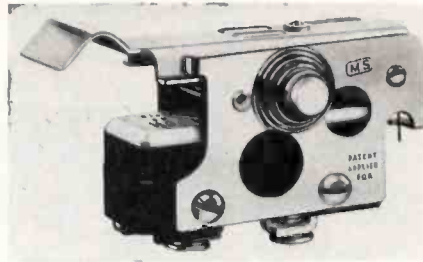

Micro Type R31 switch, Army Air Corps approved, and replaceable in the field. The Actuator is considered part of the aircraft, and no deviation permit is required. The "T" Actuator is supplied as a single unit, or in gang assemblies of 2, 3, or 4 units, left or right hand, spaced to meet customers' requirements. Other variations, such as pull instead of push button release, can be supplied, and the Actuator may be used with basic units other than the Type R31.

Micro Switch Corp., Freeport, Ill.

Electronic Photometer

THE PHOTOMETER is designed to measure very weak light, as well as thin light beams. It comprises a phototube, an electronic d-c amplifier and an indicating instrument. The unit operates from a power line without the use of batteries, and the amplifier circuit is stabilized so as not to be affected by line voltage variations. The instrument is self-contained and built into a port-



"KNOW HOW"

Years of actual experience in producing aircraft dynamotors and similar equipment develops a "know how" unattainable in any other way. The most convincing proof of such skill is found in Eicor dynamotors or DC motors for the communications apparatus you are now building.



EICOR

EICOR, Inc., 1050 W. Adams St., Chicago, U.S.A.
Export: Ad Aurlema, 89 Broad St., New York

HERE'S HANDY HELP

for solving technical
and business problems

When you want information fast—for dealing with difficult production problems, for settling special managerial questions, or for handling the "1001" situations that arise in every shop, office, laboratory and field—

get the facts—experience—data
you need to solve your particular
problems from



McGRAW-HILL BOOKS

**NEW 302-PAGE 1942 CATALOGUE
NOW READY!**

Here is your free guide to practical, expert information on scores of subjects—from Accounting to Zoology. It contains clear, concise descriptions of more than 2000 authoritative, formative books written by leaders in industry, business, engineering and the sciences. Fill in your copy fill in and mail coupon. (Also fill in on it subjects of special interest on which you desire detailed information.)

MAIL THIS COUPON

McGraw-Hill Book Co., Inc., 330 W. 42 St., N. Y.
Send me a free copy of the New 1942 Catalogue of
McGraw-Hill Books. I want to know more about:

Name

Address

City..... State..... FL 8-12

August 1942 — ELECTRONIC

le case. The phototube is mounted in "search unit" connected to the instrument by a flexible cable. The current output of the amplifier is about 10,000 times higher than the input. Three types of phototube will be suggested, depending upon the spectral characteristics of the light to be measured. The photometer when exposed to incandescent light of approximately 55°K shows full scale deflection at 125 foot candle. The instrument has



any applications in photography, and can be used to measure the density of spectrographs, brightness of paints, measurement of low turbidities and size, etc.

Model 505 is especially adapted for the densitometry of spectrographs, and Model 510 (battery operated), has a mirror galvanometer which provides increased sensitivity.

Photovolt Corp., 95 Madison Ave., New York, N. Y.

Ridget Switch

EXTREMELY LIGHT and small switch using a rolling spring which snaps the blade from one position to another has the following specifications:—size, 1 1/2 x 1/2 x 1/8 inches; weight, 7 1/2 grams; thickness, 0.040 inch; actuating pressure, 2 ounces or less; and ratings, 250 volt, 5 amp a.c., and 115 volt, 10 amp, a.c. The Acro Electric Co., 3159 Fulton Road, Cleveland, Ohio.

High Impact Plastic

INCREASING DEMANDS FOR heavier duty molding compounds to replace other material have led to the development of Durez 11934. It has a macerated fabric filler and consequently is not readily preformed. It has an impact strength of 2.0 and a specific gravity of 1.44. The plastic is available in black or brown color. Durez Plastics & Chemicals, Inc., North Tonawanda, N. Y.

CONSTANT VOLTAGE

is the answer to the precision demands of
SCIENCE and INDUSTRY for DEFENSE

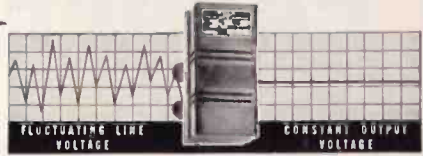

Every COMMUNICATIONS system—every electrical INSTRUMENT employed in the production of materials of war needs CONSTANT VOLTAGE protection against line surges and fluctuating voltage levels caused by overloaded power lines. Sola CONSTANT VOLTAGE TRANSFORMERS will deliver a perfectly stabilized output voltage, even though line voltages vary as much as 30%. No moving parts. Instantaneous in action. Self-protecting against overload or short circuit.

Ask for Bulletin DCV-74

SOLA ELECTRIC COMPANY



Constant Voltage **TRANSFORMERS**

2525 CLYBOURN AVE., CHICAGO, ILL.

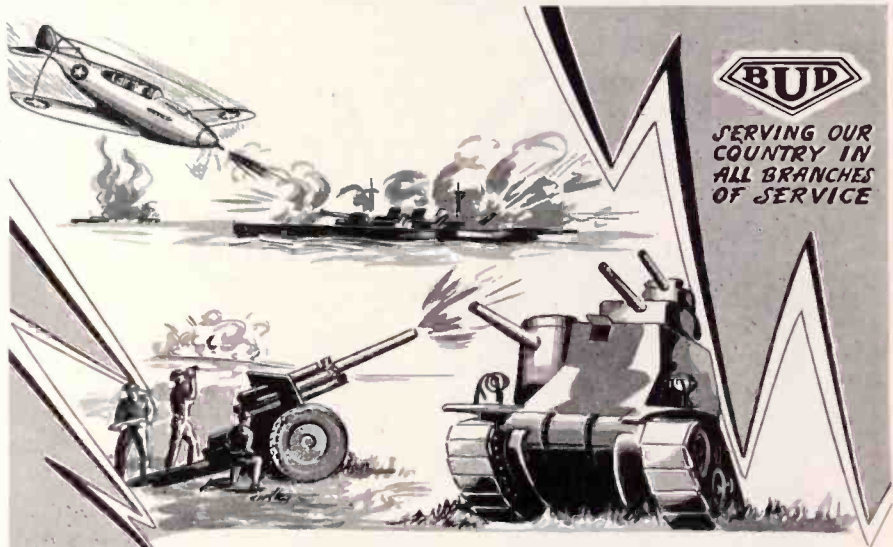

BUD Is in the Service

• In modern warfare, radio communications are a vital factor in knitting our many combat units into one powerful striking force. As component parts of essential communications units, BUD products are on the firing line, doing their part to assure victory for America.

BUD RADIO, Inc.

CLEVELAND • OHIO

HIGH MELTING POINT, FULLY REFINED PARAFFIN WAX

ARISTOWAX 145° F. AMP. (Crystalline)
 ARISTOWAX . . . 160/165° F. AMP. (small crystalline)
 FILTRAWAX 150° F. AMP. (amorphous, tacky)

Inquiries invited from engineering departments and manufacturers of radio, communication, electrical, aircraft and electronic components or equipment.



PETROLEUM SPECIALTIES, INC.

570 Lexington Avenue, New York, N. Y.
 Plaza 8-2644

DESIGNED FOR DISCRIMINATING MANUFACTURERS

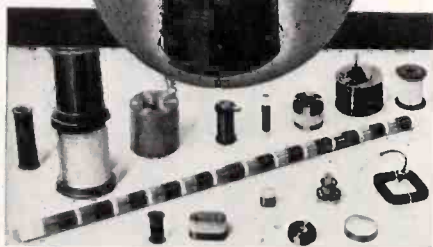

QUALITY
 UNIFORMITY
 SERVICE

Also manufacturers of high grade cotton and silk covered wires, cotton and silk coverings over enamel coated wires, and all constructions of Litz wires. A variety of coverings made to customers' specifications, or to requirements determined by our engineers. Complete design and engineering facilities are at your disposal; details and quotations on request.

Leakproof

ENAMELED MAGNET WIRE

A product, resulting from many years of research in the field of fine wire manufacture, that meets the most rigid requirements of radio and ignition coils. A new coating method gives a smooth, permanently-adherent enameling, and mercury-process tests guarantee perfect uniformity. Great flexibility and tensile strength assure perfect laying, even at high winding speeds. If you want reduction in coil dimensions without sacrificing electrical values, or seek a uniform, leakproof wire that will deliver extra years of service, this Hudson Wire product is the answer.

Winsted
HUDSON WIRE CO.
Division
 WINSTED • CONNECTICUT

Shipping Packing Material

A NEW TYPE OF SHIPPING packing material, known as Research Shipping Pack, is a resilient material made kraft stock, expanded into a honeycomb pattern. The expansion process creates a third dimension having an unusual cushioning property. The Pa



conforms to double curvature surface and because of its lacy openness, partially reveals the article packed. It is light, uniform, easy to handle, and is economical. Potential users may obtain a sample roll for one dollar from the manufacturer, Research Product Corp., Madison, Wis.

Air-Raid Alarm

MODEL AR-101 AIR-RAID alarm is designed to work on any automatic volume control type of radio set, table model or console, a.c. or d.c. or battery operated. The alarm is set off by the user's local "alert" broadcast station

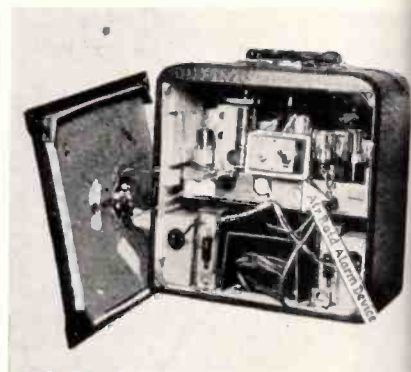

When the radio station goes off the air, the alarm automatically goes on, creating a loud, penetrating signal in the radio, warning one that an air-raid alarm is in order. The unit is supplied complete, in a compact case.

National Union Radio Corp., Newark, N. J.

Socket Screw Dimension Finder

A SOCKET SCREW DIMENSION finder that helps speed up work is being offered free of charge to designers, engineers, drafting and production men in key

LETTERING • SCALES AND OTHER MARKINGS ON METAL OR PLASTICS

FOR RADIO • COMMUNICATION
ELECTRICAL • AIRCRAFT
AND
ELECTRICAL INSTRUMENTS AND
EQUIPMENT

Machine Engraving

Scale and other markings made in plastics, steel, brass, aluminum and other metals.

Milling

Light vertical milling.

Etching

On brass, steel, or copper. Our etching department, in operation by us over 30 years, is capable of remarkably accurate, unusual results. In many cases, from specially made negatives, can replace quantity machine engraving on flat surfaces of dials, scales, etc. Delicately contoured pieces may be etched completely through thin (.004 to .015) metal, to produce pieces not possible by stamping or other methods.

Nameplates, Panels, Labels, etc.

In metals and plastics.

Inquiries promptly answered.

★ A small shop with skilled personnel.

BEGKER BROTHERS ENGRAVING COMPANY

103 LAFAYETTE ST., NEW YORK CITY
CANAL 6-7282

PATENTED!

Pat. No. 2,283,797
Applied to Audio covers
and recording body
comprising a fractureable
carrying films of sound
receiving material and a
punchable center insert.
Inquiries considered. In-
quiries will be acted upon promptly.

GLASS-BASE

audi discs

are now covered by a patent of vital importance to the recording industry. Audio's protection on this—the most significant blank-disc achievement in years—is likewise your protection.

Audi discs' established leadership in sales to broadcasting stations, motion picture and sound recording studios is immeasurably strengthened by this outstanding patented development. Save time, increase your recording and playback efficiency with superior-quality Audi discs—the original four-hole, glass-base recording blanks.

RED LABEL ★ YELLOW LABEL ★ MASTER REFERENCE RECORDING AUDI DISCS

Call your jobber — or wire us for complete information today.

AUDIO DEVICES

INCORPORATED
1600 BROADWAY NEW YORK CITY

positions who write for it on their company letterhead, mentioning their title and the make of socket screw they use. At a glance, this finder gives all of the important dimensions of the standard sizes of socket head cap screws, stripper bolts and set screws. The finder is 10 inches in diameter and is printed in two colors on heavy card stock.

Parker-Kalon Corp., 200 Varick Street, New York, N. Y.

Literature

Insulating Varnishes and Compounds.

The different characteristics of baking, air drying, finishing, and miscellaneous varnishes are described. Also a description of red oilproof enamels, machinery enamel, special lacquers, shellac, cable lacquers, synthite varnishes and insulating compounds. The booklet includes conversion tables and tank capacity charts. This may be secured from the John C. Dolph Co., 168 Emmett St., Newark, N. J.

Circuit Control Switches. A pamphlet describing circuit control switches for use in signalling equipment, communication apparatus, instrument panel boards, utility lighting systems, specialized lighting equipment, aircraft circuit control systems and many other industrial applications may be had from General Electric Co., Accessory Equipment Sales, Bridgeport, Conn.

Soldering Iron. A circular which describes and illustrates the uses of "Hexacon" screw tip and plug tip soldering irons. The new "Hatchet" iron described has the handle offset to give better balance and reduce fatigue so that better soldered joints may be perfected. Hexacon Electric Co., 161 W. Clay Ave., Roselle Park, N. J.

Metal Shielded Wire. This recent booklet tells about the method of shielding insulated wire with seamless aluminum or copper tubing against electrical interference, noise, moisture and mechanical damage. Bulletin 201 contains mechanical and electrical specifications of approved aircraft wire manufactured to specifications No. AN-J-C48 and No. 95-27074 by General Motors Corp. Both booklets obtainable from Precision Tube Co., 3824-26-28 Terrace St., Philadelphia, Pa.



BROTHER,
THIS IS **WAR!**

War jobs demand
speed with accuracy

... Arkwright
gives you both!

Those blueprints whirling through the machine must be sharp and clear — or else! Mistakes on war jobs can be as bad as sabotage — why risk them by using inferior tracing cloths? Arkwright's superb, uniform, closely-woven finish is your best protection. It assures perfect jobs — now and for years to come. Give your men this inexpensive aid to better work. Arkwright Finishing Company, Providence, R. I.



Arkwright
**TRACING
CLOTH**

AMERICA'S STANDARD
FOR OVER 20 YEARS

There is every advantage in assembling with

UNBRAKO

Self-Locking
SET SCREWS

with the
Knurled Points



U. S. & Foreign
Pats.
Pending

Self-Locking
Hollow Set
Screw with
Knurled
points

When tightened, the knurled points "dig in" and prevent any loosening or "backing out" due to the friction of use or vibration of motion.



Pat'd
and
Pats. Pending
Square Head
Self-Locking
set screw with
Knurled points.

"Unbrako" Set Screws with Knurled Points are strong, accurate, self-locking. Come in complete range of sizes from No. 4 up—and deliveries are better than average. Let us know your requirements.

**STANDARD
PRESSED STEEL CO.**
BOX 596 JENKINTOWN, PENNA.

Knurling of socket screws originated with "Unbrako" years ago.

Condensers. This catalog lists the essential condensers, resistors and test instruments in demand and which are still produced. Also included are motor starting replacement capacitor listings. Aerovox Corp., New Bedford, Mass.

Interchangeability Chart. A transmitting tube interchangeability chart has just been released by the General Electric Co., Radio & Television Dept., Schenectady, N. Y.

TIN Research Report. This report (publication No. 109) summarizes recent researches and developments in the uses of tin in industry. It discusses quite thoroughly tinplate and hot-tinning, electro-deposition of tin and tin alloys, bearing metals, foil, bronzes and chemical compounds of tin. Publication No. 109 available from Battelle Memorial Inst., 505 King Ave., Columbus, Ohio.

Flexible Shafting. An illustrated book showing the many uses for flexible shafting in power drive and remote control. Reproductions show the applications of flexible shafting in airplanes, automobiles and radio. Circle Ess shaftings are graphically illustrated along with illustrations of shaft end and casing end fittings. Manual D from F. W. Stewart Mfg. Corp., 4311 Ravenswood Ave., Chicago, Ill.

Antenna Measurements. In the June 1942 issue of *Experimenter* "Antenna Measurements with the Radio-Frequency Bridge" is discussed. This article outlines the means for measuring antenna systems, gives a convenient procedure and points out the precautions if satisfactory results are to be obtained by present owners of the popular Type 516-C radio-frequency bridge (recently discontinued). Also just released is an up-to-date price list for Catalog K and a list of the new instruments announced since the publication of Catalog K. Both available from General Radio Co., 30 State St., Cambridge A, Mass.

Electronic Devices. This is the third and final discussion on "Industrial Applications of Electronic Devices". This covers inverters and features the following; "direct current" transformer, thyatron temperature control circuits, thyatron ignitron are light timer, electronic welder control and radio interference. Prepared by the Engineering Dept., Aerovox Corp., New Bedford, Mass.

MEMO

*Get in touch
with Meissner
for Coils!*

*(Meissner already
makes our U.H.F.
Coils.)*

Meissner
MT. CARMEL, ILLINOIS
PRECISION-BUILT PRODUCTS

Write for
NEW 1942 CATALOG
Address—Dept. E-8

JACKSON
Resistance-Capacity Tuning
★ AUDIO OSCILLATOR



★ Model
★ Here is a tried, proven and accepted Audio Oscillator whose brilliant performance sets it apart from other models. Audio Frequency voltage is developed by its Fundamental Frequency—by the Resistance-Capacity Tuned Principle. This is not a "beat frequency" oscillator and contains no R.F. circuits. Operation is vastly simplified. Characteristic faults of old style methods are eliminated. The enclosed direct reading dial is accurate within 3% or one cycle. Many other outstanding features. Price \$89.50.

★ Write for descriptive literature
★ **THE JACKSON ELECTRICAL
INSTRUMENT COMPANY**
★ 123 Wayne Avenue Dayton, OH

Microphones. This booklet "Long Live Your Microphone" gives many helpful hints on the use and care of crystal, dynamic and carbon microphones. Also practical pointers on feedback, cable, plugs, output, response and other information. Bulletin 173G from Shure Bros., 215 W. Huron St., Chicago, Ill.

Iron Powders. The characteristics, and applications of carbonyl iron powders are given in this twenty-three page booklet. The three different grades of G.A.W. carbonyl iron powders, designated as "E", "TH" and "C", are discussed and their special applications are pointed out. Also included are graphs of relative Q-values vs frequency of G.A.W. carbonyl iron powders "E" and "C". Available from Advance Invents & Chemical Corp., 245 Fifth Ave., New York City.

Colloidal Graphite. A revised technical bulletin No. 230.8 includes applications for the use of Colloidal graphite dispersions such as "Aquadag" (in water), "Glydag" (in petroleum oil), "Castordag" (in castor oil), "Glydag" (in glycerine) and "dag" dispersions used in the more volatile liquids. Also covered are "Prodag" a concentrated graphite for parting compounds, coarse wire drawing and forging lubricants and a new type 1175 designed for heavy duty work such as shell forging work. Available from Acheson Colloids Corp., Port Huron, Michigan or from Denham & Co., 812 Book Bldg., Detroit, Michigan.

Copper Springs. Bulletin No. 4 gives in detail the functions and uses of beryllium copper coil or flat springs. It discusses the Carson Electronic Micro-meter which measures wire diameter, etc. Available from Instrument Specialties Co., Inc., Little Falls, N. J.

Microphones and Acoustic Devices. A catalog for help in the selection of microphones for various war and civilian applications. Technical data is given on dynamic, crystal, and carbon microphones for use in ordnance plants, army camps, air terminals, broadcast stations, police mobile and station transmitting equipment, industrial war factories, OCD control centers, etc. Also included is a story telling how microphones are measured. Catalog No. 154, Shure Bros., 225 W. Huron St., Chicago, Ill.

Self-Locking Nuts. The design, advantages, assemblies, types, and application of various types of Palnuts are discussed in this booklet. Suggestions for use on war products are included. Available from The Palnut Co., Inc., Cordier St., Irvington, N. J.

EXTRA FACILITIES

We have additional facilities for the production of Transmitter- Receivers to YOUR own specifications. Write . . .



ABBOTT
INSTRUMENT, INC.
8 WEST 18 STREET • NEW YORK, N. Y.

ILLUSTRATED
Our TR-4, a 2 1/2 meter UHF Transmitter - Receiver only 8" x 9" x 4 1/2" in size.



TWO IRONS in the fire

While endeavoring, first, to be of all possible service in the wartime production emergency, The Astatic Corporation at the same time is making an earnest effort to supply users, through authorized jobbers, with Astatic Microphones, Pickups and Cartridges as replacement parts for existing radio, phonograph and sound equipment.

Due to a shortage of certain materials used in the manufacture of pickup and microphone cartridges, all such purchases must be accompanied by old cartridges of a similar type.

See Your Radio Parts Jobber.

ASTATIC

THE ASTATIC CORPORATION

YOUNGSTOWN, OHIO

Licensed Under Brush Development Co. Patents

In Canada: Canadian Astatic Ltd. Toronto Ontario

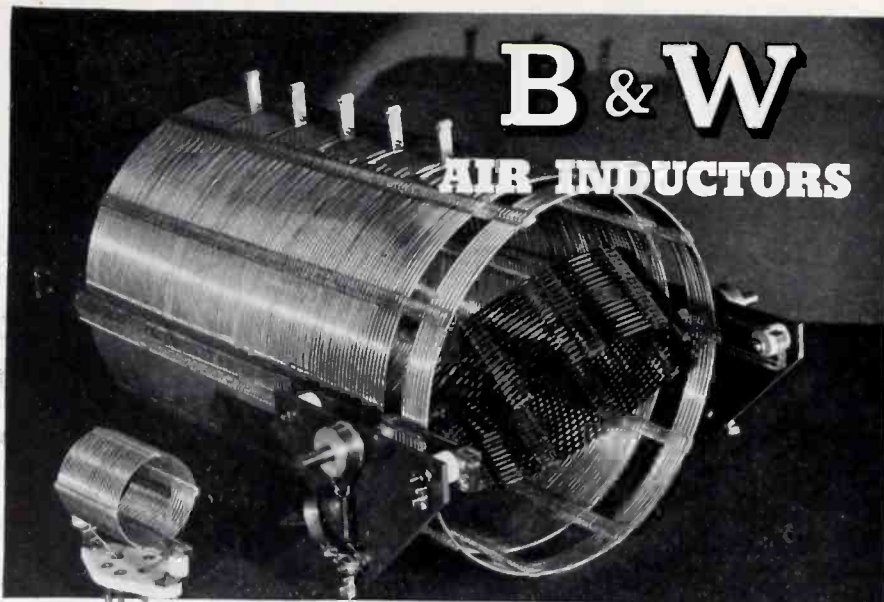

STANDARD or SPECIAL... Large or Small

Built like a fine watch—sturdily constructed for real dependability—produced by engineers responsible for Radio's outstanding coil developments—B & W Air Inductors are available in standard or custom-built sizes and types for almost any application. Write for information and literature.

Shown above is a giant low-frequency



variometer-type inductor, "tailor-made" for a war equipment application, compared in size to the famous B & W 75-watt Junior Inductor.

VARIABLE AIR CONDENSERS, TOO!
Both physically and electrically, B & W Variable Condensers set new standards of performance. Write for details.

PRECISION BUILT

BARKER & WILLIAMSON, Radio Manufacturing Engineers
235 Fairfield Avenue, Upper Darby, Pa.

Bliley

Accuracy and dependability are built into every Bliley Crystal Unit. Specify **BLILEY** for assured performance.

BLILEY ELECTRIC CO.
TYPE MOS OVEN
VOLTS 6.3 AMPS 1.9
MADE IN U.S.A. ERIE, PA.

QUARTZ CRYSTALS

BLILEY ELECTRIC COMPANY
UNION STATION BUILDING ERIE, PA.

Sectional Resistors. An 8 page catalog on sectional resistors for a-c and d-c circuits, non-inductive, wire wound and hermetically sealed. The booklet outlines their construction, flexibility and interchangeability. Contains illustrations of various parts and the latter part of the book contains tables giving size, voltage, resistance and price. Catalog 43-820 is available from Dept. 7-N-20, Westinghouse Elec. & Mfg. Co., East Pittsburgh, Pa.

Measuring and Control Instruments. This 16-page bulletin describes a variety of measuring and control instruments. It illustrates unit construction of temperature controllers. Remote controlled combustion safeguard equipment and other instruments are covered. Prices and list numbers of catalog sections are also included. Bulletin Z6000 from Wheelco Instruments Co., Harrison Peoria Sts., Chicago, Ill.

Filters and Coils. This forty-six page catalog gives a complete listing of radio interference filters and coils for mobile equipment. It is very complete in detail and specifications. Catalog No. 4 maybe obtained from the J. W. Mille Co., 5917 S. Main St., Los Angeles Calif.

Indicating Instruments. D-c and a-c indicating instruments for mounting on switchboards are described in this 12 page catalog. The instruments included are ammeters, voltmeters, wattmeters, frequency and power factor meters, synchrosopes, rectangular triplex ammeters and horizontal edgewise triplex ammeters. The dimensions, weights and list prices on all instruments are included. Catalog 4220, Roller-Smith Co., Bethlehem, Pa.

RCA Questions and Answers. A brochure designed to answer many questions that are asked about the multitudinous activities of RCA. The history of the company, its board of directors and officers, its record of earnings and other financial data, photographs of its laboratories and plants—all this and more is in this book. R.C.A. Bldg., 30 Rockefeller Plaza, New York City.

Guide Book. Two booklets from Mitchell-Rand Insulation Co., Inc., 51 Murray St., New York City, a Guide Book to tape, cloth, sleeving, tubing, papers; and Compounds on waxes, asphalt and similar hydrocarbons, Rubberseal cloth, and copper; both giving considerable useful information on the characteristics of insulating materials of the company. Also a convenient wall map giving dimensions of materials, etc.

Electronic Welding Control

(Continued from page 40)

pendent of line voltage regulation because point A will be held reasonably constant by the energy stored in capacitor C_2 . The slider on R_1 determines the actual potential of point A when C_2 becomes charged through

The keying tube T_1 has the voltage across R_2 applied to its grid as negative d-c bias that would normally hold the tube non-conducting. Connected in series with this d-c bias is the secondary of a peaked wave or impulse transformer that makes the grid positive so that the tube can conduct once every cycle, at a time dependent upon the position of the peak. The position of this peak is determined by adjusting the value of R_1 in series with the primary. It

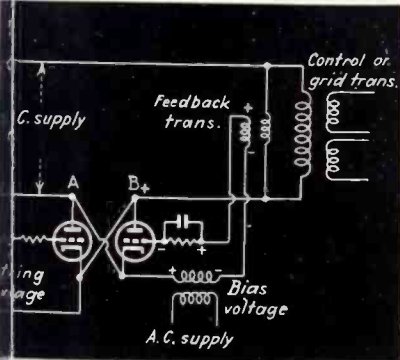

Fig. 6—A "trailing" tube control circuit

It will be noticed that the normal position, 1, of the initiating switch S_1 keeps the plate circuit of T_1 open so that it cannot pass current even though the grid goes positive once every cycle.

With initiating switch S_1 in the number 2 position, the plate circuit to T_1 is closed and the next positive peak will cause it to pass current through R_2 . This current will continue to flow as long as S_1 is closed, regardless of voltage applied to the grid of T_1 because of the characteristics of a thyratron on

DOUBLE POWER

with **PINCOR Products**

- ★ DYNAMOTORS
- ★ CONVERTORS
- ★ GENERATORS
- ★ D. C. MOTORS
- ★ POWER PLANTS
- ★ GEN-E-MOTORS

PIONEER GEN-E-MOTOR
CHICAGO, ILLINOIS

Export Address: 29 Warren Street, N. Y., N. Y.
Cable: SIMONTRICE, New York

PERMANENT MAGNETS

ALL SHAPES — ALL SIZES
FOR ALL PURPOSES

Stamped, Formed, and Cast; Chrome, Tungsten Cobalt and ALNICO** (cast or sintered) under G. E. license.

THOMAS & SKINNER
STEEL PRODUCTS COMPANY
1116 E. 23rd STREET INDIANAPOLIS, INDIANA

Laminations for Radio Transformers — Tools
Dies — Heat Treating — Stampings

40 YEARS EXPERIENCE

TAYLOR
LAMINATED PLASTICS
Vulcanized Fibre • Phenol Fibre

SHEETS, RODS, TUBES, FABRICATED PARTS

TAYLOR FIBRE COMPANY
NORRISTOWN, PA.

Pacific Coast Headquarters: 544 S. San Pedro St., Los Angeles, Cal.

New

DECADE AMPLIFIER MODEL 220



A highly stable amplifier giving gains of exactly 10 and 100 times. Operated by self-contained batteries. Through the use of special circuits the gain is independent of battery voltage, circuit constants and tubes within 2% from 10 to 100,000 cycles. Particularly useful with our Model 300 Electronic Voltmeter to increase its sensitivity, permitting voltage measurements down to 30 microvolts. Send for Bulletin 7.

SENSITIVE ELECTRONIC AC VOLTMETER

MODEL 300



10 to 150,000 cycles.
1 millivolt to 100 volts in five ranges (to 1,000 and 10,000 volts with multipliers).
Logarithmic voltage scale.
AC operation, 115 volts, 60 cycles.
Accurate and stable calibration.

Ballantine Laboratories, Inc.

BOONTON

NEW JERSEY

direct current. The voltage across R_6 will be the same as that across R_1 , minus the arc drop of T_1 . This same voltage is applied to the resistor R_6 and capacitor C_2 network. The time required to charge capacitor C_2 up to a given voltage will depend on the value of R_6 .

Assume that the initiating switch S_1 is in the number 1 position. Point B , which is the cathode of the leading firing tube, is at the same potential as point C because no current is flowing in resistor R_6 and the C_2R_6 combination is completely de-energized. The grid of T_2 is connected to point A through current limiting resistor R_7 , which is definitely negative with respect to point C , therefore T_2 is held non-conducting. When switch S_1 is thrown to the number 2 position, R_6 is energized and for the first instant before C_2 starts to charge, R_6 will have the full voltage of R_6 across it and point B will be at the same potential as point D minus the drop in T_1 . Under this condition the grid of T_2 is positive with respect to the cathode point B and the tube conducts. Immediately, C_2 starts to charge and at a certain time later, point B will be at the same potential as point A . At approximately this time T_2 will cease to conduct, as its grid goes negative with respect to its cathode.

The time required for point B to reach the potential of point A depends on the value of R_6 . Therefore, by adjusting R_6 the time can be changed from a short time ($\frac{1}{2}$ cycle)

to a long time ($\frac{1}{2}$ second). By making R_6 a series of fixed resistors controlled by a tap switch, the time can be adjusted in one-cycle steps. The slider on R_1 allows the designer to compensate manufacturing tolerances of resistors and capacitors.

Tube T_2 serves the dual purpose of being the timing tube and the leading firing tube for one ignitron power tube. Tube T_3 is the firing tube for the other power tube and is controlled by a feedback transformer connected across the welding transformer. The details of operation are the same as for Fig. 6. The use of this type of circuit insures full cycle of power applied to the welder, which avoids saturation of the welding transformer even though the calibration should shift. For this same reason, the calibration is much less likely to shift because the timing would have to shift a whole cycle to make any change in the time.

To add phase control to this synchronously timed spot welding control it is necessary to connect the grid of tube A in Fig. 6 in place of the grid of tube T_2 in Fig. 7. This combination produces synchronously timed voltage on the primary of the control or grid transformer of Fig. 6. Now, if this control and grid transformer are put in place of T_2 in Fig. 5A the combination will be a synchronously timed spot welding control with phase control, using the power and firing tubes of Fig. 5A, the control tubes of Fig. 6, and the timing circuit of Fig. 7.

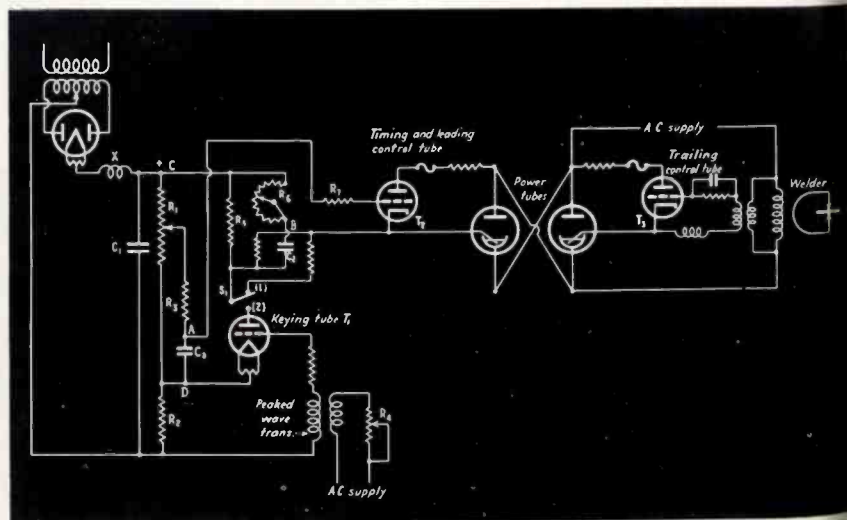

Fig. 7—Elementary circuit of a spot welder control without phase control

RECENT U.S. PATENTS

Each week the United States Patent Office issues grants to many hundreds of inventions that pass the acid test of that office. A few of those relating to electronics are reviewed here

Antennas

Phase Measurement. Voltmeter connected $\frac{1}{4}$ wavelength from each of two antennas by means of a 2-wire transmission line. A. G. Kandoian, IT&T. Dec. 1, 1939. No. 2,283,676. See also No. 2,283,677 to Kandoian on a localizer beacon composed of a central and several side radiators which are fed energy in proper phase and amplitude with respect to central radiator.

Direction and Position Finder. At regular intervals a receiver is tuned to several known marker frequencies, light sources illuminated alternately under control of the receiver, light shutter rotated with a tunable loop in synchronism at a rate within the persistency of vision. Philip Bernstein, Press Wire-tele, Inc. Dec. 11, 1940. No. 2,282,541.

Guiding System. Finding the direction of an electromagnetic wave transmission comprising two sets of three antennas, one made up of loops in mutually perpendicular planes, another of doublets perpendicularly arranged, cathode-ray oscillograph etc. H. G. Bignies, IT&T. Sept. 1, 1938. No. 2,12,030.

Non-communication Applications

Contour Device. Means for outlining contours at various elevations from stereoscopic photographs comprising resonant circuits, phototube apparatus, relays etc. Harry B. Porter, March 19, 1941. No. 2,283,226.

Wave Analysis. In using an oscillograph for wave analysis, a ray is deflected in one direction by a generator of predetermined wave form and deflected in another direction in accordance with an oscillatory wave of a second frequency and of an unknown wave form to be analyzed. Means are provided for varying the intensity of the ray intermittently and periodically at a third frequency differing from the second frequency by a fourth frequency which is normally related to the first frequency in an integral ratio. D. E. Morgaard, G.E. Co., Nov. 1, 1940. No. 2,280,531.

Density Measurement. Resonator with electromagnetic transmitting and receiving apparatus at the free ends of the resonator, amplifier free to oscillate at a frequency determined by the den-

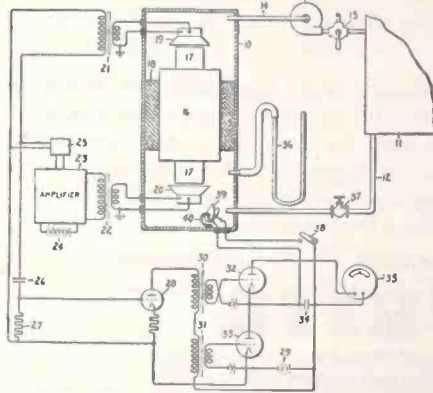

sity of the gas admitted to the resonator and means to compensate frequency for temperature variations in gas. W. Mikelson, GE. Jan. 16, 1940. No. 2,283,750.

Spark Coil Tester. Charging a condenser from a rectifier circuit and alternatively connecting a spark gap to the condenser and to the spark coil. S. S. Verney, Auto Electric Supply Co., San Francisco. Oct. 19, 1940. No. 2,283,399.

Synchronizing Apparatus. Method of synchronizing a rotating body with that of a rotating standard comprising pho-

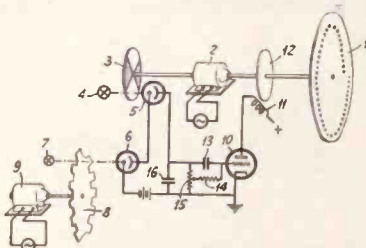

totube apparatus and a braking system. Herre Rinia, RCA. Sept. 26, 1939. No. 2,281,954.

Generator. Circuit to produce triangular waveforms with sides of equal slope using gas and vacuum tubes. B. M. Hadfield, Associated Electrical Labs. May 13, 1940. No. 2,282,130.

STANCOR

PROFESSIONAL SERIES COMPONENTS



UNIQUE and conservatively designed, yet ruggedly constructed to serve many needs. May be mounted with terminals either above or below mounting surface. When sub-panel mounting is used, cabled wiring is easy, providing quick assembly, wiring and testing. All are tropic impregnated, then potted in moisture-resistant compound for trouble-free service.

The extreme flexibility of these STANCOR PROFESSIONAL SERIES TRANSFORMERS make them highly desirable for use in production runs of communication equipment, amplifiers and many other electronic devices.

Special types manufactured to comply with government specifications. Send in full data on your transformer problems for prompt quotations.

STANCOR STANDARD TRANSFORMER CORPORATION
1500 NORTH HALSTED STREET... CHICAGO



S. S. White

for

FLEXIBLE SHAFTS

ENGINEERS will find these two free bulletins helpful

In view of the many and growing applications of S. S. WHITE Power Drive and Remote Control Flexible Shafts in planes, tanks, ordnance, naval, signal corps and other war equipment, many engineers will want the information and data contained in the following bulletins:

BULLETIN 641 "How to Make the Most of Flexible Shafts." Written by our Chief Engineer, this bulletin explains the difference between power drive and remote control shafting, gives engineering data about both types and discusses their application to a wide range of operating conditions.

BULLETIN 741 "Choice and Application of Flexible Shafts in Aircraft." This bulletin illustrates and describes the use of flexible shafts for driving tachometers and tachometer generators, fuel pumps, cowl flap mechanisms etc. and for remote control of radio transmitters, receivers, direction finding and other aircraft equipment.

CONSULT S. S. WHITE

when you need flexible shafts for war jobs. Also for engineering assistance in selecting and applying flexible shafts for any power drive or remote control purpose.

COPIES MAILED TO YOU ON REQUEST

S. S. WHITE

The S. S. White Dental Mfg. Co.

INDUSTRIAL DIVISION

Department E, 10 East 40th St., New York, N. Y.

Solve Voltage Variation
PROBLEMS IN AIRCRAFT, TANKS, ETC.

WITH

AMPERITE
BATTERY CURRENT & VOLTAGE REGULATORS

Features:—

1. Amperites cut battery voltage fluctuation from approx. 50% to 2%.
2. Hermetically sealed — not affected by altitude, ambient temperature, or humidity.
3. Compact, light, and inexpensive.

Now used by U. S. Army, Navy, and Air Corps.

Send us your problem.

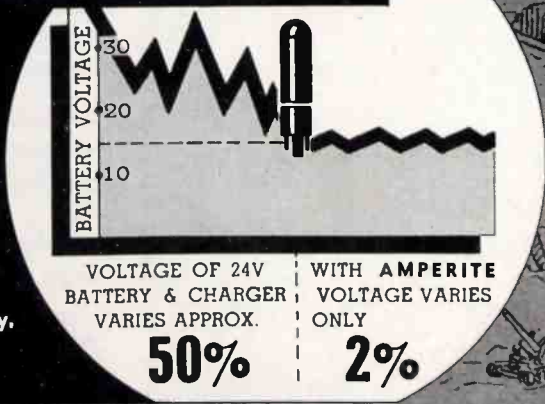

AMPERITE COMPANY • 561 Broadway, New York, N. Y.
 In Canada: Allas Radio Corp., Ltd., 560 King St. W., Toronto

Cable: Alkem. New York

Burner Control. Application of phototube to burner in a furnace. D. W. Fehrbach, M Kansas City Journal-Post C July 31, 1939. No. 2,283,496. See also No. 2,282,551 to R. E. Yates, Dryin Systems, Inc., Chicago and No. 2,281,619 to C. R. Roberts, Brighton, Mich.

Hysteresoscope. Application of cathode-ray tube to measuring core materials. S. C. Leonard, GE. March 2 1940. No. 2,283,742.

Frequency Measurement. Measuring an unknown frequency by arithmetically combining the unknown to an interpolating frequency and adjusting the latter until it differs from the standard frequency by an integral multiple of the same amount as the unknown differs from another integral multiple of the unknown whereby the unknown is calculated from the difference and the known integral multiple frequencies. T. Sloczewski and F. R. Stansel, BTL, Inc. Aug. 3, 1940. No. 2,283,616.

Follow-up System. Light responsive device, source of light, follow-up system for repositioning the light responsive device, and means for anticipating the effect of the follow-up system comprising means for varying the emanation of light prior to the operation of the follow-up device. Mathias Michalski, Allis-Chalmers. July 31, 1940. No. 2,283,121.

Telemetering. No. 2,281,710 to C. Oman, WE&M Co. on a system for transmitting pulses at a rate proportional to a measured quantity; and No. 2,283,000 to Ward Leathers, IBM, on a method of measuring resistances over a wire line.

Waveform Selection. Use of a linear and a square law detector and a polarized relay for distinguishing between currents having a waveform with high peak factor from currents having a waveform of low peak factor. D. Gannett, BTL, Inc. Oct. 25, 1940. No. 2,282,719.

Measurement Apparatus. Determining a magnitude having a related photoelectric effect measurable potentiometrically. A. E. Parker, ETL. June 1 1938. No. 2,282,741.

Measurement. Two patents, No. 2,128,480 and 2,282,726, E. A. Keeler and H. S. Jones, Brown Instrument Co. on measurement and control apparatus.

Time Delay. Circuit using a cathode gas tube of the OA4G type. Otto Weitmann, IBM. Nov. 20, 1940. No. 2,282,108.

Differential Analyzer. Phototube amplifier circuits for comparing optical properties. S. J. Murcek, WE&M Co. July 13, 1939. No. 2,282,198.

Piezoelectric Apparatus. Patent Nos. 2,31,778 and 2,282,369 to W. P. Mason, BL Inc. The following description is from Claim 1 of No. 2,281,778. A piezoelectric quartz crystal vibratory body having its opposite rectangular major faces parallel to an X axis and inclined at an angle of +49°30' with respect to the Z axis as measured in a plane perpendicular to said major faces, the major axis over-all length dimension and the width dimension of said major faces being inclined 45 degrees with respect to said X axis, said over-all length dimension being in effect divided into a plurality of equal length elemental lengths corresponding to the numerical order of a desired harmonic frequency, said width having a dimensional ratio of less than 0.8 with respect to said over-all length dimension, the thickness dimension between said major faces being one of the values midway between the nearest values given by the relations:

$$\frac{L}{T} = \frac{m^2}{10.88n}$$

$$\frac{W^2}{LT} = \frac{m^2}{10.88n}$$

where L, T and W are respectively said over-all length, thickness, and width dimensions expressed in the same units, n is the numerical order of said harmonic frequency, and m is equal to $\pi(i + \frac{1}{2})$ where i is an even order integer that is one of the integers, 2, 4, 6, 8, 10, 12, 14, 16 and 18.

Accelerometer. Apparatus for determining maximum and minimum of attenuated acceleration comprising inertia-actuated elements, with means so that acceleration may be classified according to the pitch of an audible signal. James A. Buchanan, U. S. Navy. Jan. 2, 1941. No. 2,283,180.

Phase Comparison. Method of comparing phase displacement between two voltages, comprising two amplifiers connected to the voltages, rectifiers connected to the amplifiers and actuated by the vector sum and difference of the applied voltages, a work circuit responsive to the differential effect of the rectified currents, and means controlling the gain of the amplifiers in accordance with the total amount of the rectified current whereby the operation becomes independent of the amplitude of the applied voltages. E. S. Purington, R. A. April 27, 1939. No. 2,281,995. See No. 2,282,951 to G. B. Englehardt, E. I. Inc. on a method of measuring phase shift.

Oscillators

Relaxation Oscillators. Gas tube and vacuum tube in series across d-c line; positive line to anode of gas tube; condenser from positive terminal to anode of vacuum tube; cathode of vacuum tube

TIME-TESTED *veteran* IN

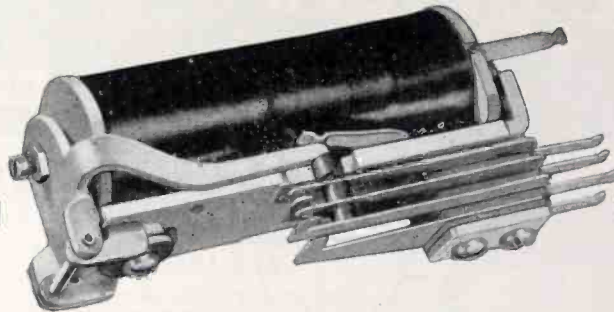

ELECTRICAL REMOTE CONTROL APPLICATIONS

Designed and made by the originators of the dial telephone system, the Automatic Electric's Class A "telephone type" relay has been used as standard in that service for a generation. And because the Class A relay has proved so dependable and durable, it is now providing these advantages in hundreds of industrial products important to the war program.

Only one of the scores of electrical control devices offered by Automatic Electric, the Class A relay can be supplied in a limitless variety of contact and coil combinations— for d-c or a-c operation, slow acting or quick acting, and with almost any desired contact load capacity. If you are engaged in war production, write for a copy of our new catalog 4071-C.

AMERICAN AUTOMATIC ELECTRIC SALES COMPANY
1033 W. Van Buren Street, Chicago, Ill.

AUTOMATIC ELECTRIC
RELAY MAKERS SINCE 1898

REMLER *Plugs and Connectors*



ARMY SIGNAL CORPS SPECIFICATIONS

- Also PL—PLP—PLQ and PLS Plugs
- M Type Connectors
- M Type Caps
- FT Type Fittings

Quantity Prices Quoted
on receipt of Delivery
Schedules

*Manufacturers of Communication Equipment
SINCE 1918*

REMLER COMPANY, Ltd. • 2101 Bryant St. • San Francisco, Calif.

Faster

THAN A SLIDE RULE

A-C CALCULATION CHARTS

by R. LORENZEN

This new Rider Book greatly reduces the time required for alternating current engineering calculations—speeds up the design of apparatus and the progress of engineering students. Two to five times as fast as using a slide rule!

A-C CALCULATION CHARTS are designed for use by civilian engineers and engineers of the armed forces who operate in the electrical—communication—power—radio—vacuum tube—telephone—and, in general, the electronic field. Invaluable for instructors as well as students, and also administrative officers who check engineering calculations.

RANGE OF THE 146 2-COLOR CHARTS

Frequency	10 cycles to 1000 megacycles	Reactance	0.01 ohm to 10 meg-ohms
Inductance	10 micromicrohenrys to 100,000 henrys	Susceptance	0.1 micromho to 100 mhos
Capacitance	0.0001 micromicrofarad to 1 farad	Impedance	0.01 ohm to 10 meg-ohms
Resistance	0.01 ohm to 10 meg-ohms	Admittance	0.1 micromho to 100 mhos
Conductance	0.1 micromho to 100 mhos	"Q"	0.1 to 1000
		Phase Angle	6° to 89.94°

\$7.50
160 Pages
9 1/2 x 12
Inches

**JUST OUT—
ORDER TODAY!**

JOHN F. RIDER PUBLISHER, Inc.

404 FOURTH AVENUE, NEW YORK CITY

Export Division: Rocke-International Elec. Corp., 100 Varick St., N. Y. C. Cable: ARLAB

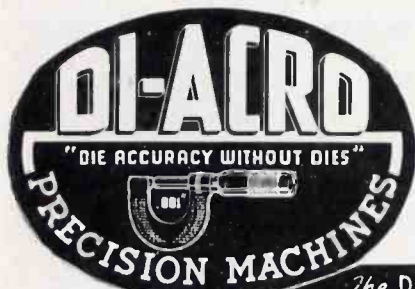

The DI-ACRO SYSTEM of

METAL DUPLICATING
—without Dies!

For 1 piece—500—5,000 or 50,000—here is fast die-less duplicating accurate to .001". Time has an A-1-A priority these days.

Write for Catalog

O'NEIL-IRWIN MANUFACTURING CO., 321 8th Ave. S., Minneapolis, Minn.

WAXES • COMPOUNDS for ELECTRICAL INSULATION

Zophar offers prompt service on Insulating Compounds for a wide variety of electrical applications, including:

... Insulation for CONDENSERS, TRANSFORMERS, COILS, power packs, pot heads, sockets, wiring devices, wet and dry batteries, etc. Also WAX SATURATORS for braided wire and tape. WAXES for radio parts.

Special compounds made to your order.

ZOPHAR MILLS INC.

130-26th St.

Brooklyn, N. Y.

FOUNDED 1846

to negative terminal; grid of gas tube to negative terminal through an impedance; and means for controlling potential of grid of vacuum tube in accordance with potential across the above

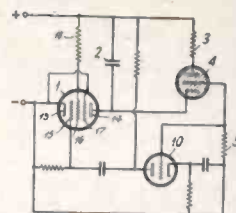

mentioned impedance. H. Pieplow, GE. June 10, 1939. No. 2,282,340. See also No. 2,282,895 to F. H. Shepard, Jr., RCA, on a relaxation oscillator producing saw-tooth waves. Two tubes and an electron storage device between anode of each tube and grid of the other tube and rectifiers for maintaining grids positive with respect to cathodes.

Ultrahigh Frequencies

Waveguides. Nos. 2,281,551 and 2,281,552 to W. L. Barrow, Research Corp., New York. Sept. 10, 1937 and Oct. 31, 1938.

Oscillator. Nos. 2,283,894 and 2,283,895 to I. E. Mouremtseff and G. L. Dinnick, WE&M Co. Resonator type devices.

Bias system. Sources of uhf and dc connected serially in cathode-anode circuit of a tube, the dc being poled and proportioned so that this tube is biased beyond the upper knee of the saturation curve so that current occurs in pulses only during a half cycle of the uhf. R. S. Ohl, BTL, Inc. June 18, 1940. No. 2,283,568.

Magnetron. Tube contained within a coaxial cable with cathode perpendicular to axis of cable, inner conductor of cable being short relative to cable and

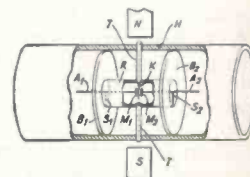

having extension which constitutes antenna for exciting the cable. W. Engbert, Telefunken. April 7, 1941, No. 2,282,856.

Modulation. Method of modulating a long-line controlled oscillator by placing modulating input in series with a d-c biasing potential. C. W. Hansell, RCA. Nov. 16, 1938. No. 2,282,295.

RACKS · CHASSIS · CABINETS



PAR-METAL

METAL

for
ELECTRONIC APPARATUS

ENGINEERS, CONTRACTORS: Send specifications for estimates, or request Catalogue No. 41

PAR-METAL PRODUCTS CORP.
32-62 49th ST., LONG ISLAND CITY, N. Y.
Export Dept.: 100 Varich St., New York, N. Y.

The Challenge of CHANGE...

✓ Change, with all its problems, offers Opportunities, as well.

Men in every branch of Radio face changes so rapid and drastic that last year's outlook is this year's history.

Through the years our policy has been directed toward helping men IN radio become *better* radiomen in *better* jobs . . . with modern advanced technical training. The fact that men in over 350 broadcasting stations are CREI students or graduates is evidence that our training is bringing results.

Your own radio experience backed by CREI advanced technical training will prepare you to step into the better salaried positions that await trained men. CREI home-study courses in practical radio engineering are prepared for *experienced* radiomen who realize the value and necessity of TRAINING FOR and not merely *hoping* for a better job!

WRITE FOR FACTS TODAY

Send for free booklet and personal recommendations. In your inquiry, please state briefly your experience, present position and education.



CAPITOL RADIO ENGINEERING INSTITUTE

E. H. RIETZKE, President

Home Study Courses in Practical Radio Engineering for Professional Self-Improvement

Dept. E-8, 3224 — 16th Street, N.W. WASHINGTON, D. C.

High-frequency Amplifier. At frequencies sufficiently high that the input conductance of a conventional amplifier tube is so positive that it is difficult to develop voltage between cathode and grid, a tube having a cathode, a positive grid-like structure, a control electrode, and an output electrode; potential on electrodes so arranged that a variation in output electrode current is produced which, in relation to input potential, in the vicinity of the applied grid potential is definable by the equation $i = ke^n$ where n is less than $3/2$ and the operating potential of the control grid is negative, i is plate current, e is grid voltage and k is a constant. Horst Rothe, Telefunken. Dec. 21, 1937. No. 2,282,886.

Television Circuits

Discharge Device. An electronic device suitable for use in television comprising an evacuated envelope containing an electron permeable light responsive structure upon which a light image is projected and constructed to develop and retain an electrostatic charge image; a source of electrons for producing a focused electron beam of constant current intensity for scanning one side of the electron permeable structure to project electrons through the structure, the electrons being modulated in intensity in passing through the structure during the scanning by reason of the electrostatic charge image developed on the structure. H. G. Lubszynski, E&MI, Ltd., Jan. 15, 1937. No. 2,280,922.

Synchronizing System. Means for transmitting synchronizing signals to a remote scanning system and means for returning the synchronizing signals from the scanner to the original apparatus. By means of a phase comparator a regulating voltage in accordance with the phase difference between the returning synchronizing signal and the master signal is secured for controlling the synchronizing signals. Ulrich Knick, Fernsch Akt. June 14, 1939. No. 2,278,788.

Receiving System. Method for receiving television signals where a common modulated carrier is used for both synchronizing and picture signals comprising band pass circuit to separate the signals. D. L. Plaistowe, RCA. July 16, 1938. No. 2,268,671.

Amplification

Feedback amplifiers. No. 2,282,870 to E. S. Lundie, RCA; No. 2,282, 605 to D. G. Lindsay, Amalgamated Wireless; No. 2,281,618 to J. M. Riddle, Jr. RCA; No. 2,281,644 to Paul Weathers, RCA.

"The new edition is 'first-rate . . .'"

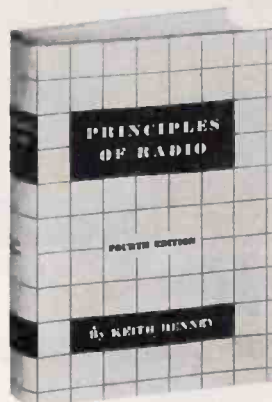

PRINCIPLES OF RADIO

FOURTH EDITION

By KEITH HENNEY

With or without the aid of a teacher, with or without technical training, "Henney" is on hand in a new edition ready to guide you in easy stages to a working knowledge of radio. The fourth edition contains the latest on detection, ultra-high frequencies, television, radio-frequency amplifiers, vacuum tube detectors, antennas, etc. Considers the applications of radio which are important now.

"Principles of Radio" is the recommended textbook for the course for radio technicians designed for the U. S. Signal Corps and sponsored by the U. S. Office of Education.

549 pages 316 illustrations
5 1/4 by 7 7/8 \$3.50

ON APPROVAL COUPON

JOHN WILEY & SONS, Inc.
440 4th Avenue, New York, N. Y.

Kindly send me a copy of Henney's "Principles of Radio," on ten days approval. If I decide to keep the book I will remit \$3.50; otherwise, I will return the book postpaid.

Name

Address

City and State

Employed By E-8-42

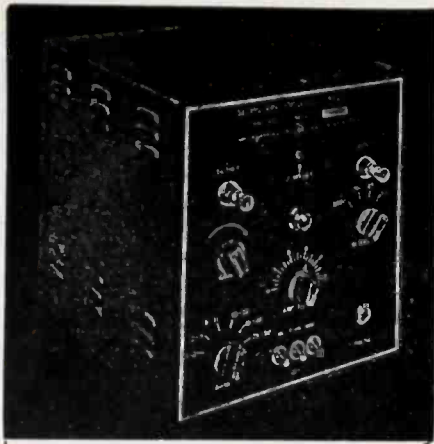

A Precision Crystal

Secondary

FREQUENCY STANDARD

THAT HAS BEEN

"Designed for Application"

A precision frequency standard capable of being adjusted to WWV or some other primary standard and putting out uniformly accurate calibrating signals with 10, 25, 100, 1000 KC intervals. Uses the new GENERAL ELECTRIC No. 15A 1000 KC crystal having a frequency temperature coefficient of less than one cycle /M°C. The crystal is sealed in Helium in a standard metal tube envelope.

The self-contained AC power supply has VR150-30 voltage regulator tube.

In addition to oscillator, multivibrators, and harmonic amplifier, a built-in mixer with phone jack and gain control on panel is incorporated.

JAMES MILLEN
150 EXCHANGE ST.



MFG. CO. INC.
MALDEN, MASS.

New Carter AIRCRAFT TYPE GENEMOTORS

● **SENSATIONAL!!** That's the word for the new Carter Multi-Output Dynamotor. Since its introduction a year ago, Police Departments, Government Agencies, and manufacturers of Tank Radio Equipment have found it has no equal for small size, high efficiency, and extra light weight. It's the coming thing for all Transmitter and Receiver installations



● Write today for descriptive literature on Carter Dynamotors—D.C. to A.C. Converters—Magmotors—Heavy Duty Permanent Magnet Hand Generators—Special Motors—High Frequency Converters—Extra Small A.C. Generators—Permanent Magnet Dynamotors and Generators.



1606 Milwaukee Ave. Cable: Genemotor
Carter, a well known name in radio since 1922

Backtalk

This department is operated as an open forum where our readers may discuss problems of the electronic industry or comment on articles which **ELECTRONICS** has published

Patents

IN THE CROSSTALK column of **ELECTRONICS**, July 1942, the editor complains about the lack of a description of inventions patented in the U.S. in "full, clear, concise, and exact terms." In particular the editor complains that the single claim of each granted patent published in the *U.S. Patent Office Gazette* is inadequate as a full description of the invention claimed and that, therefore, reading of the *Gazette* is of no value to the engineer. Finally, the editor finds the claims of U.S. patents ambiguous, excessively broad, and lacking a full disclosure of the invention.

As a communications engineer and registered patent agent I would like to

attempt to clarify some of the questions raised in *Crosstalk* and often raised by engineers.

Crosstalk quotes from a court decision as follows: "... it is a precedent to the obtaining of a patent that the applicant shall, in his written application, describe his claimed invention or discovery in 'such full, clear, concise, and exact terms as to enable a person skilled in the art ... to make, construct, compound, and use the same.'"

This quotation refers to a requirement contained in the U.S. Patent Laws, which applies to the so called patent specification or the detailed description of the invention and the drawings, which are part of the application and which constitute the disclosure of the invention. It is, however, not to be applied in this general manner to the claims as attempted in *Crosstalk*, since it is not the purpose of claims to give a detailed description of the invention.

It should be kept in mind that a patent is primarily a legal instrument granting to the patentee a monopoly, the extent and boundaries of which are defined in the claims. The basis for the monopoly granted and defined in the claims is the disclosure of the invention which is found in the patent specification and drawings, which are required fully to describe the invention. Therefore, the engineer who wishes to find a disclosure of the nature and aims of the invention should consult the specifica-

GLARE OUT OF GLASS

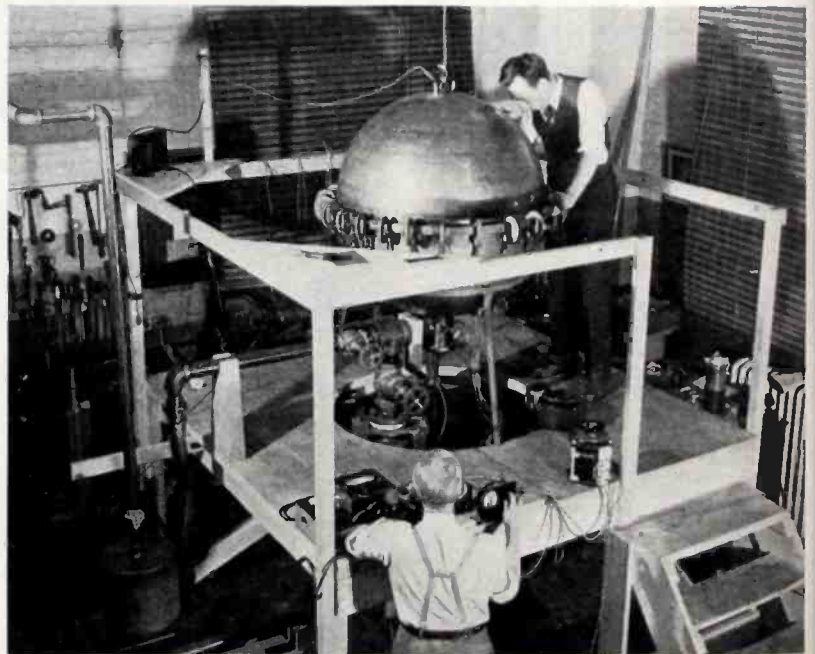

Glass surfaces to be treated are placed in a large metal globe, as much air as possible is removed by a vacuum pump, then a tiny bit of magnesium fluoride is electrically evaporated, coating each surface with a film about 1/300,000th of an inch thick. Surfaces treated in the metal globe can be handled without damaging the non-glare surface. Glass to be treated is placed in metallic frames and then stuck to the inside of the globe by alnico magnets. Dr. Hewlett is peering into the sphere and C. W. Moore, his assistant, is at the controls

tic and drawings for this purpose and no the claims. If it were the function of the claims to set forth a detailed description of the invention, the specification would be superfluous.

My own experience has been that the Gottie, which usually publishes only a single claim and figure of the drawing of each granted patent, is valuable in selecting patents of interest. However, a full disclosure can be obtained from the specification, which is part of the patent, copies of which are available at some libraries or from the Patent Office at the price of 10 cents per patent.

Crosstalk complains that "most of the claims of most of the patents published are completely non-understandable without a great deal of study." To spend much time trying to deduct the details of an invention from the single claim published in the *Gazette* seems an inefficient way of operating, since the full disclosure can be had for 10 cents. The determination of the scope of a claim with reasonable accuracy requires study of the complete patent, because claims are always to be interpreted in connection with the disclosure, and this often does require a great deal of study.

No patent claims are cited in Crosstalk the first of which relates to a method of manufacturing electrical devices "of the general character indicated." These last words quoted directly from the claim are further evidence of the fact that the specification may be used to interpret claims. The claim enumerates a series of methods. The editor questions whether the invention resides in the individual steps or the summation thereof. A claim may always be considered in its entirety and, therefore, the invention obviously resides in the summation or combination of the steps. The recitation of the claim of each additional step represents an added limitation of the monopoly granted and it is not feasible to require any one of the steps enumerated in the claim. Therefore, this claim is intended to protect the invention residing in the particular combination of method steps and does not cover any individual step per se, each of which is common knowledge in the art.

The second claim cited in Crosstalk relates to a welding system comprising a combination of elements. Again it is a particular combination of the enumerated elements which is patented and not any one element per se. The patent invention does not reside in the "control device" listed as an element of the combination, since it is not possible to use such a broad term without a description of the structure of the element, if the invention resided in that particular element. Several decisions of the Patent Office and the author deal particularly with this matter, and I am quite certain that the recitation of the patent from which the claim is taken, contains a description of the "control device," which in all probability does not constitute a patentable invention.

ALLIED PRECISION BUILT LATCHING RELAYS

ALLIED presents a new line of mechanical lock, electrical release relays. They are designed for operation on any nominal voltage under 125 A. C. or 50 D. C. Current types are available in single pole double throw and double pole double throw.

This new line of relays has important features such as compactness, light weight, and minimum base mounting area. They are designed to meet Aircraft vibration tests and Army and Navy temperature and humidity requirements.

Allied Control Company, Inc. has specialized in the development of relays to meet critical test specifications. Special adaptations of standard relays to meet your specific requirements are solicited.

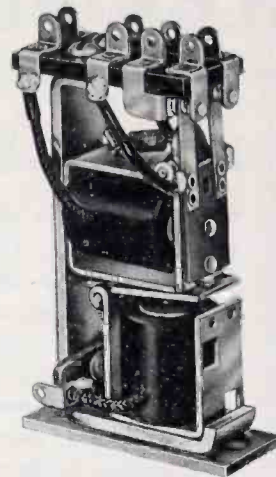

Type BJL
D.P.D.T.

Inquiries from aircraft and other designing engineers will receive prompt attention.

ALLIED CONTROL COMPANY, INC.
227 FULTON STREET
NEW YORK CITY

TRANSMITTING

AND SPECIAL PURPOSE TUBES

including

THE LATEST TYPE OF HIGH FREQUENCY TUBES

such as:

832 • 829 • 615 • 114B • 813 • 1201 • 1203A

A COMPLETE LINE OF TRANSMITTING TUBES IN ALL IMPORTANT SIZES UP TO 200 WATTS

for your ELECTRONIC tubes • parts • supplies

SEE YOUR LOCAL NATIONAL UNION DISTRIBUTOR

EVERY research department today is working with electronic principles. NATIONAL UNION DISTRIBUTORS handle National Union Radio tubes and allied products. They specialize in radio and electronic items and you will find their stocks very complete. Call or write your N.U. distributor for his industrial catalogue. If you do not know his address send your letter to us and we will forward it.

NATIONAL UNION RADIO CORP.

57 STATE STREET, NEWARK, NEW JERSEY

Transmitting tubes, panel lamps, dry batteries

cathode ray tubes, exciter lamps, sound equipment

flash light tubes

photo electric cells, condensers



ARGON HELIUM KRYPTON
NEON XENON MIXTURES

Linde

RARE GASES AND MIXTURES

... Spectroscopically Pure
... Easily removed from bulb
without contamination

Scientific uses for Linde rare gases include—

1. The study of electrical discharges.
 2. Work with rectifying and stroboscopic devices.
 3. Metallurgical research.
 4. Work with inert atmospheres, where heat conduction must be increased or decreased.
- Many standard mixtures are available. Special mixtures for experimental purposes can be supplied upon request.

The word "Linde" is a trade-mark of

THE LINDE AIR PRODUCTS COMPANY
Unit of Union Carbide and Carbon Corporation
30 E. 42d St., New York **UCC** Offices in Principal Cities
In Canada: Dominion Oxygen Company, Ltd., Toronto

quoted. He would not infringe the claim unless he carried on every step in the particular combination and for the particular purpose.

It would not be necessary for him to dope out a control device, as no doubt one is fully disclosed in the specification of the patent.

Your statement that the claims are written by lawyers and not by engineers is in error. A large majority of patent lawyers handling technical patent prosecution are engineers first and lawyers second. Most of them received engineering degrees before they studied patents or law.

I may say that I have no knowledge of the inventors or owners of these patents, nor as to their numbers.

At a time when there is so much wholly unjust criticism of the patent system, your magazine, which is the spokesman of an art so greatly dependent on patents for its development, should be extremely careful of any statements made.

You are careful as to the technical content of your magazine and would not publish an article on an electronic subject unless it were carefully checked or its author were a recognized expert. You should deal similarly with a subject such as patents and patent law.

There are many able patent counsels in New York who would no doubt be very glad to give you any information or advice necessary to discuss the matter properly and correctly.

HOWARD W. HODGKINS

Harmonic Filter

I HAVE READ with interest Mr. R. Snoddy's article in the May 1942 issue of *ELECTRONICS*. In this article he has shown that the characteristic impedance of the line differed from the manufacturer's value of inductance given as 4.5×10^{-10} henries per 60 ft. which was to determine the capacity for the same 60 ft. section. This is shown to be 954×10^{-12} farads per 60 ft. Then, through a process of working out the equations containing (R, L) and (G, C) in their pole form, the phase shift factor is computed by the equation of the propagation constant, namely:

$$\gamma = \sqrt{ZY}$$

Granting the characteristic impedance of the manufacturer to be wrong, let us use the computed values of Z the characteristic impedance, 68.2 ohm and C , the capacity per 60 ft., 954×10^{-12} farads and see if there is not a simple way to arrive at the same result, namely, that the velocity of propagation on the line is 93.6 percent, the velocity of light in free space.

My approach is as follows: $\frac{V}{c} =$

Where V = velocity of the wave in the line
 c = velocity of the wave in free space
 $= 3 \times 10^{10} \text{ cm/sec}$
 θ = angular velocity in free space
 β = angular velocity in the line.

$$V = \frac{1}{\sqrt{L \cdot C}}$$

NEEDED AT ONCE ELECTRICAL OR RADIO ENGINEER,

familiar with Quartz Crystal work, X-Ray technique in connection with same, etc.

CRYSTALLOGRAPHER,

familiar with orientation by various methods and slabbing of Quartz Crystal and grinding.

LAPPING OPERATOR,

familiar with mechanical and hand lapping of crystal blanks.

Men who are available for these jobs and have the necessary knowledge, can count on substantial remuneration and on advancement.

Box P 341 Electronics

330 W 42 St., New York City

NOTICE

OLD TRANSMITTING TUBES ARE VALUABLE

Let us help solve your tube problem. We can rebuild most any tube from 250 watts to 20 K.W.

Freeland & Olschaer

922 Howard Ave. New Orleans, La.

SEARCHLIGHT SECTION

(Classified Advertising)

EMPLOYMENT: "OPPORTUNITIES" : EQUIPMENT
BUSINESS: : USED OR RESALE

UNDISPLAYED — RATES — DISPLAYED

10 CENTS A WORD. MINIMUM CHARGE \$2.00

Positions Wanted (full or part time salaried employment only) $\frac{1}{2}$ the above rates payable in advance.

Box Numbers—Care of publication New York, Chicago or San Francisco offices count as 10 words.

Discount of 10% if full payment is made in advance for 4 consecutive insertions.

Individual Spaces with border rules for prominent display of advertisements.

The advertising rate is \$6.50 per inch for all advertising appearing on other than a contract basis. Contract rates quoted on request.

An advertising inch is measured $\frac{1}{8}$ " vertically on a column—3 columns—30 inches to a page.

Permanent Employment

ELECTRONIC DEVELOPMENT ENGINEERS

Well-established Eastern Massachusetts concern desires graduate electronic engineers with flair for research and eye to future. Permanent position concerned at present with important development work for government, with increased opportunities after the war. Unusual openings for men with capacity and initiative. Must be U. S. Citizens.

P-342, Electronics

330 West 42nd St., New York City

BEST QUALITY, USED

ELECTRON TUBE MACHINERY

Equipment for the manufacture of all kinds of electron tubes, radio tubes, incandescent lamps, neon tubes, photo electric cells, X-ray tubes, etc.

AMERICAN ELECTRICAL SALES CO., INC.

65-67 East 8th St. New York, N. Y.

POSITION WANTED

ELECTRICAL ENGINEER, Radio Engineer, Physicist. Desires executive or Supervisory position in charge of research or development. Eight successful years developmental engineering experience with electro-magnetic, acoustic, high voltage, electronic, transformer, and radio equipment. Age 33, married. PW-40, Electronics, 520 N. Michigan Ave., Chicago, Ill.

WANTED

REWARD FOR INFRINGEMENT PROOF
Patent 2,107,135 covering "Distortion Neutralization" being infringed. 50% reward on net back royalties, plus 10% on future collections thereon. Reply guaranteed confidential. Attention: Walter Steffa, Attorney, c/o Wilson Electrical Development Co., 154 W. Erie St., Chicago.

WANTED—Volumes and copies of *Electronics* and other scientific periodicals. B. Logan & Son, Inc., 29 E. 21st St., New York.

At Your Service . . .

The Searchlight Section is at your service for bringing business needs or "opportunities" to the attention of men associated in executive, management, sales and responsible technical, engineering and operating capacities with the industries served by McGraw-Hill publications.



MEASURE SPEED Simply by Touch

Consider the advantages of a Portable Hand Tachometer that does not even "see" the rotating shaft, that has no wearing parts or pots, that requires no belts, gears or electrical connections and that cannot lose its calibration through lack of oil or over-speeding.

Write for Bulletin 1590-E on Frahm Tachometers for speeds and rates of vibration between 900 and 30,000 r. m. and v. p. m.

JAMES G. BIDDLE CO.
ELECTRICAL AND
SCIENTIFIC INSTRUMENTS
11-13 ARCH ST. PHILADELPHIA, PA.

Speed Up PANEL ASSEMBLY JOBS!



• One of the handiest tools ever designed for electrical and radio work—especially panel assembly jobs. The nut is readily tightened or loosened without damage to the panel. On telephone or power switchboard, the hollow shaft readily slips over the long protruding bolts or studs and the socket firmly engages the nut. Shock-proof handle; precision machined shafts and sockets. Five sizes, from 5/16" to 5/8" (nut sizes). Full details on request.

PARK METALWARE CO.
Orchard Park New York

XCELITE

**Hollow Shaft
NUT DRIVER**

where L , and C , are the unit inductance and capacity per cm length.

We now have upon substitution:

$$\frac{1}{\sqrt{L_1 C_1}} \sim \frac{\beta}{\theta}; \frac{\beta}{\theta} \sim \frac{1}{\sqrt{L_2 C_2}}$$

$$\frac{\beta}{\theta} \sim \frac{1}{1.07} = 0.936 \times 100\% = 93.6\% = \frac{V}{C}$$

This would mean λ_0 in free space = 664 ft. at 1480 kc and λ_1 (wave-length in the line) = 664' \times 93.6 = 622' or

$$\frac{\lambda_1}{2} = 311'$$

Thus we see we can arrive at the same result by what seems to me a much shorter method.

ROBERT F. LEWIS
New York City

Tropical Radio Receiver Trouble

I WAS NATURALLY very interested in Mr. H. C. Schwalm's comment in the March, 1942 "Backtalk" column on my article of a year earlier concerning tropical radio receiver troubles.

His comment is similar to that of many men who have struggled with this problem, and I quite agree with him when he states that the corrosion of the high potential windings in receivers is due to electrolysis.

He suggests in the case of an audio transformer that a choke in inductance-capacity coupling be used to take the high potential from the transformer winding; and in the case of a speaker field the speaker frame be placed at a higher positive potential than the field winding to prevent electrolysis. The same procedure, he says, might be applied to other parts of the set. He mentions some applications that have been tried, and I have also seen such schemes used with some success.

I can imagine the alarm caused in some engineers' minds by the idea of placing the chassis or speaker frame at high potentials. I can also imagine Mr. Schwalm's retort that you don't dare touch the frame or chassis of most North American receivers after they have been in the tropics a few weeks anyhow. The leakage currents automatically raise their potential to high values while operating, unless they are definitely tied to ground.

However, I do not feel that the solutions offered by Mr. Schwalm are the best answers. In the case of the inductance-capacity coupling the high potential has simply been transferred to the winding of the choke. If it is made of the same materials as the transformer the problem still exists, but in the choke instead of the transformer.

The presence of leakage currents in the various parts of a receiver detunes the r.f. and i.f. transformers, changes the grid bias on tubes, upsets AVC action, and in various ways greatly reduces performance. The electrolysis is only the most annoying feature because it eventually stops operation completely, and requires costly repairs.

IMMEDIATE DELIVERY ON ELECTRICAL COIL WINDINGS

... Vacuum Impregnated ...
... Bobbin and Form Wound ...

★ This is your dependable source of supply for all types of Magnet and Solenoid Coils for all purposes.

We have a fully equipped plant with facilities to serve you for special requirements.

Let us help you—

Write—Wire—Phone

We will gladly send our Facilities Record—ask for it!

We also do coil winding to Government Specifications.

ELECTRO UNITS SUPPLY CO.

4203 W. Fullerton Avenue

CHICAGO

ILLINOIS

Phone Albany 6680



On the alert . . .

In perfecting and offering "BERALLOY 25" and other ternary BERYLLIUM-COPPER alloys, Wilbur B. Driver Company again evidences that it is "on the alert" to serve its country by furnishing special alloys* for vital war applications.

We have the facilities, personnel and experience to meet the most exacting specifications.

*Available in rod, wire, ribbon and strip both hot and cold rolled.

WILBUR B. DRIVER CO.
NEWARK, NEW JERSEY

Professional Services

STANLEY D. EILENBERGER Consulting Engineer

Complete Laboratory and Shop Facilities
General Electronics Communications Electro Biology Patent Development
6309 27th Ave. Kenosha, Wis.
Telephone 2-4213

HAROLD J. McCREARY Mem. A.I.E.E. & W.S.E. Consulting Engineer

Laboratory Facilities
Research Development Design Factory Practice Patent Studies
Electronics Television Radio Railroad Signaling Telephony
105 W. Adams St. Phone STAtE 4003 Chicago, Ill.

JOSEPH RAZEK, PH.D. Consulting Physicist

Electrical and Mechanical Engineering Problems Instruments and Control Devices Electronics Specialist in Colorimetry, Spectrophotometry and Industrial Color Control
Laboratory and Shop Facilities
430 Greenview Lane Elmerch, Pa.

J. ALBERT STOBBE

Consultant
Electronics and Communications
63 Wall Street New York City

HELP . . .

with your design and construction problems . . .

ELECTRONICS,

is the quickest, most direct method of contacting

CONSULTANTS

who may be available NOW . . .

It would seem to be much more desirable to use better insulations and better designed insulators so that the leakage currents do not exist, even under extremely humid conditions.

At the same time that I was observing these faults in commercial equipment in the tropics I was working with U. S. Army Signal Corps equipment that was operating under the same weather conditions. However, the Signal Corps equipment had been built to meet rigid specifications with regard to humidity and temperature. From my observations I am sure that receivers can be built with conventional circuits that perform as well in humid climates as in the more temperate ones.

Nearly every radio design engineer in North America is now working on equipment for our armed forces which must meet those rigid humidity tests. If the lessons they learn there will only be carried over to commercial products they can certainly make friends in tropical America.

W. E. STEWART
Formerly Ass't Radio Eng.,
Panama Air Depot

UHF Nomenclature

SEVERAL LETTERS have been published in this column and in Crosstalk dealing with the terms to be decided upon for the very high frequencies, or very short wavelengths, which are now coming into use. Readers interested in the background for the following letters should see ELECTRONICS.

Mr. William A. Stirrat of Schenectady suggests that since engineers like to reduce matters to logarithmic terms, the higher frequencies could be designated as log cycles. Thus a frequency of 1 megacycle would be represented by 6 lcs. A 10 megacycle frequency would be in the 7 lcs range. He also suggests the ranges from 0 to 1, 1 to 10, 10 to 100 etc., be given spectra letters A, B, C, etc. In his system a frequency of 7500 Mc would be designated as 9.875 lcs or $K_{.875}$.

Two other proposals are cited in full since they are simpler and have a better chance of being worked upon by other engineers.

"Since reading that portion of Crosstalk for May, 1942, dealing with proposed names for 10^9 and 10^{12} cycles per second, I have been looking around for established precedence, both of the prefixes which others have recommended and the one which we have been using in connection with 10^9 cycles per second. To date, however, my quest has been fruitless.

"For a period of over a year now, this laboratory has employed the name begacycles for frequencies expressible in units of 10^9 cycles per second. We believe that our choice has a basis in logic because of its resemblance to megacycles. The Greek prefixes deci, centi, and milli, resemble closely the prefixes billi and trilli, which others mentioned, yet unlike the Greek prefixes, they do not designate units which are submultiples of unity.

"We should like to propose, therefore,

that the prefixes bega and trega adopted for factors of 10^9 and 10^{12} respectively."

R. M. BOW
Director of Research
Hygrade Sylvania Corporation

"I have been interested in the Crosstalk items in ELECTRONICS relative to UHF. I think Mr. Pickard's suggestion of billicycles and trillicycles is most excellent one. I have only one additional comment and that is that this gives only four divisions for the whole range and also, for many workers in the higher frequencies, the use of wavelengths has certain advantages.

"These two points could be taken care of by speaking of the millimeter band or millimeter waves and dekameter waves. In other words, the following ordinary metric table could be used:

Millimeter	0.001 meter
Centimeter	0.01 meter
Decimeter	0.1 meter
Meter	1 meter
Dekameter (or decameter)	10 meter
Hectometer	100 meter
Kilometer	1000 meter
Myriameter	10,000 meter

We would, therefore, speak of broadcasting using the hectometer band of range.

"So far as I can find out, there is no common expression for a unit of length that corresponds to 1/10 millimeter. However, the term "micrometer" is well known and, of course, is equivalent to 0.001 millimeter. Even at the way progress has been made the past few years in expanding the spectrum on the high-frequency side, it may be a little time before we are using micrometer waves and, even then, the mechanical engineer may claim them as a part of his sphere of thermodynamics."

W. C. WHITE,
Engineer
Electronics Laboratory
General Electric Company

OCD Tests

(Continued from page 59)

might be available and convenient for civilian defense use.

Testing on Type "C" lines, a transmitter was coupled to the overhead lines at a substation whose 4,000-v primary feeders are extended to and interconnected with other substations serving a dozen or more small towns throughout the county. A 75-mile tour was made and it was found that in a majority of these small towns there was a well-distributed pattern or radiation which fulfilled requirements 1, 2, 3 and 4 satisfactorily. It was the general consensus that local distribution in these various areas could usually be accomplished by extremely low powered "phonograph oscillators" operated as remote-controlled carrier-current transmitters and turned on or excited by a carrier radiated along the 4,000-v primary feeders.—W. MACD.