

MARCH • 1942

electronics

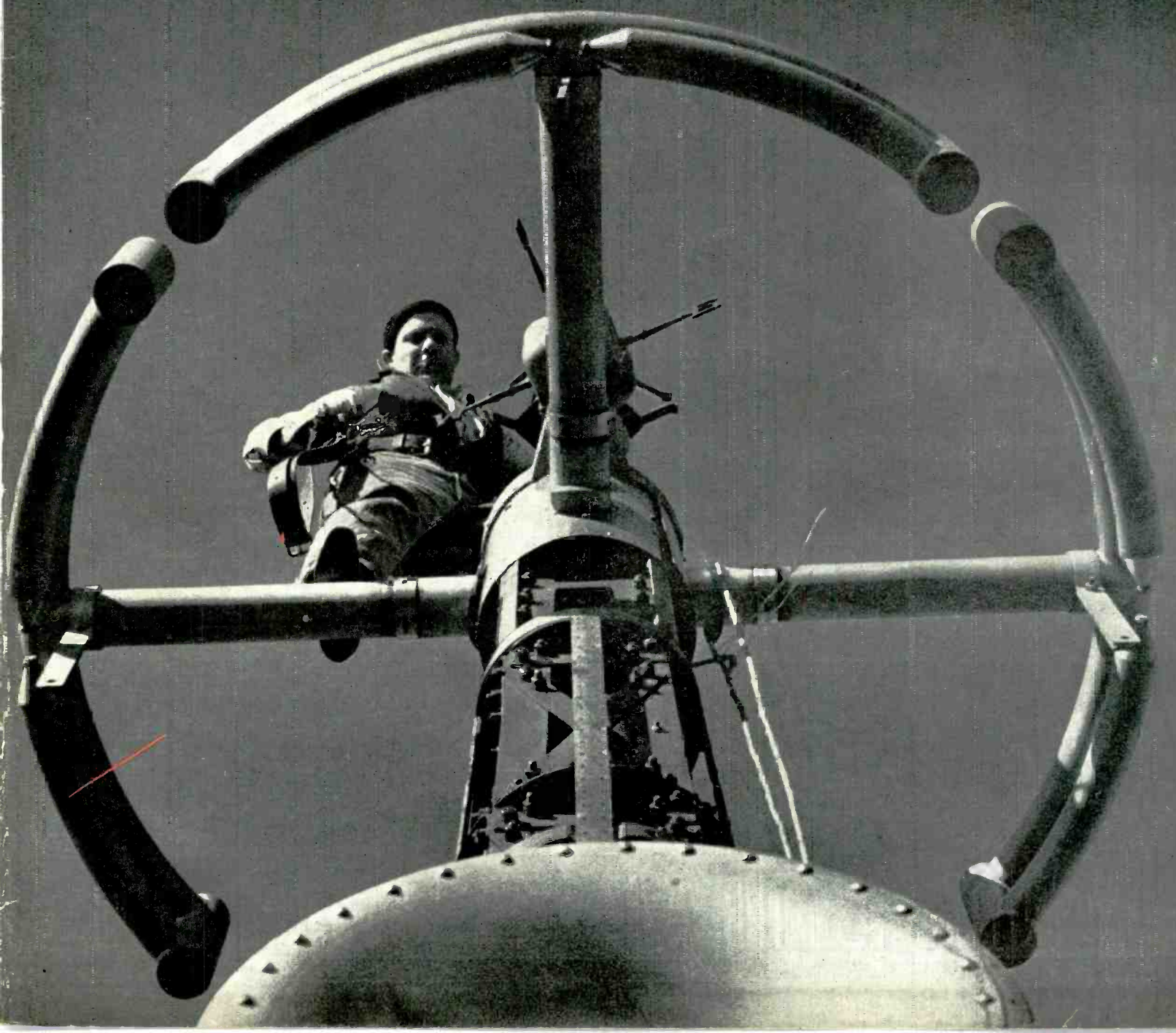



We're "nuts" about our
UTC SUBMERSION
 TYPE COMPONENTS

Yes . . . we are proud of our submersion type units. They are now available in a wide range of sizes to cover practically every requirement in defense and non-defense applications.

These units are designed to take the most extreme of Navy tests, which consist of five complete submersion cycles under salt water over a very wide range of temperatures.

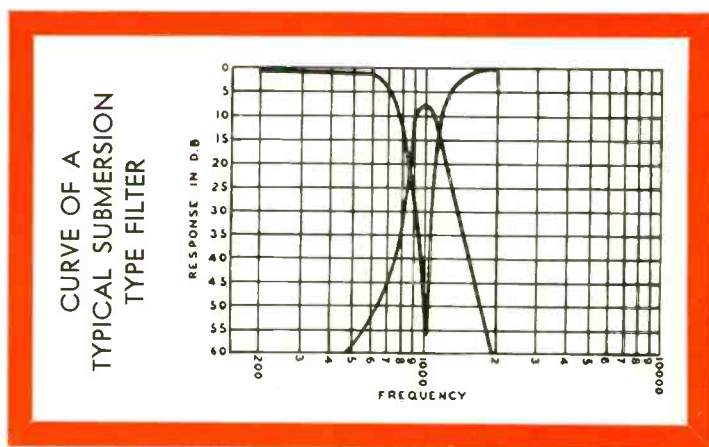

The same engineering development which perfected these units can be applied to the solution of your transformer problem.

**MAY WE HAVE AN OPPORTUNITY
 TO COOPERATE?**

UNITED TRANSFORMER CO.

150 VARICK STREET



NEW YORK, N. Y.

EXPORT DIVISION: 100 VARICK STREET NEW YORK, N. Y. CABLES: "ARLAB"



electronics

CONTENTS—MARCH, 1942

COVER

The WNBTV television antenna atop the Empire State building. The antenna for the audio channel is shown nearly completed. Photo by V. S. Barker

TELEVISION—An Agency for Preparedness, by Noran E. Kersta . . . 26

A summary of the first six months of commercial television, with special emphasis on the use of television in training civilian defense personnel

EMBOSSED GROOVE RECORDING, by Lincoln Thompson 30

Recording by the embossed groove and cut groove methods are compared. Many of the problems of embossing and their relation to a practical office dictating machine are discussed

NEW NBC STUDIOS 34

Two new studios have been built by the National Broadcasting Co. at Radio City in New York. The salient features of the acoustical design in diagrams and photographs

ENGINEERS TRAIN FOR VICTORY, by Beverly Dudley 36

Technically trained personnel, to design, manufacture, and operate war equipment, are given special training under the E.S.M.D.T. program

AUTOMATIC MONITOR CIRCUIT, by Frank Marx 39

An electronic device for automatically monitoring key stations for air raid warning signals. A "dead man control" to guard against failure is incorporated in the circuit

A MODERN 10-kw FREQUENCY-MODULATION TRANSMITTER, by E. S. Winlund and C. S. Perry 40

Description of a new RCA transmitter having low distortion characteristics and typical of modern design

THE ELECTROPLANE CAMERA 44

A unique lens system designed to permit alteration of focal length without change in image size is oscillated electronically. The result is greater depth of field than that obtainable by optical means alone

L-TYPE IMPEDANCE TRANSFORMING CIRCUITS, by Phillip H. Smith 48

A discussion, with design charts, of a simple and yet effective series of impedance transforming networks useful in radio frequency circuits

DEPARTMENTS

CROSSTALK	25	TUBES	98
BOOK REVIEWS	56 & 90	NEWS OF THE INDUSTRY	104
TUBES AT WORK	65	NEW PRODUCTS	106
ELECTRON ART	80	BACKTALK	126

INDEX TO ADVERTISERS 130

KEITH HENNEY
Editor

Donald G. Fink Beverly Dudley
Managing Editor Acting
(on leave) Managing Editor

W. W. MacDonald Craig Walsh
Associate Editor Associate Editor

M. L. Matthey J. M. Heron
Assistant Editor Assistant Editor

Harry Phillips
Art Director

H. W. MATEER
Publisher

Wallace B. Blood
Sales Manager

J. E. Blackburn, Jr.
Director of Circulation

Contents Copyright, 1942, by
McGraw-Hill Publishing Company, Inc.

**McGRAW-HILL
PUBLISHING COMPANY, INC.**

JAMES H. MCGRAW
Founder and Honorary Chairman

Publication Office
99-129 North Broadway, Albany, N. Y.
U. S. A.

Editorial and Executive Offices
330 West 42nd St., New York, N. Y., U.S.A.

James H. McGraw, Jr., President
Howard Ehrlich, Executive Vice President
Mason Britton, Vice President
B. R. Putnam, Treasurer
D. C. McGraw, Secretary

Cable Address:
MCGRAWHILL, New York
Member A. B. P. Member A. B. C.

ELECTRONICS, March, 1942, Vol. 15; No. 3. Published monthly, price 50c a copy. Allow at least ten days for change of address. All communications about subscriptions should be addressed to the Director of Circulation, 330 West 42nd Street, New York, N. Y.
Subscription rates—United States and possessions, Mexico, Central and South American countries, \$5.00 a year, \$8.00 for two years, \$10.00 for three years. Canada (Canadian funds accepted), \$5.50 a year, \$9.00 for two years, \$11.00 for three years. Great Britain and British possessions 36 shillings for one year, 72 shillings for three years. All other countries, \$6.00 for one year, \$12.00 for three years. Entered as Second Class matter, August 29, 1936, at Post Office, Albany, New York, under the Act of March 3, 1879. BRANCH OFFICES: 520 North Michigan Avenue, Chicago; 68 Post Street, San Francisco; Aldwych House, Aldwych, London, W.C. 2; Washington; Philadelphia; Cleveland; Detroit; St. Louis; Boston; Atlanta, Ga.

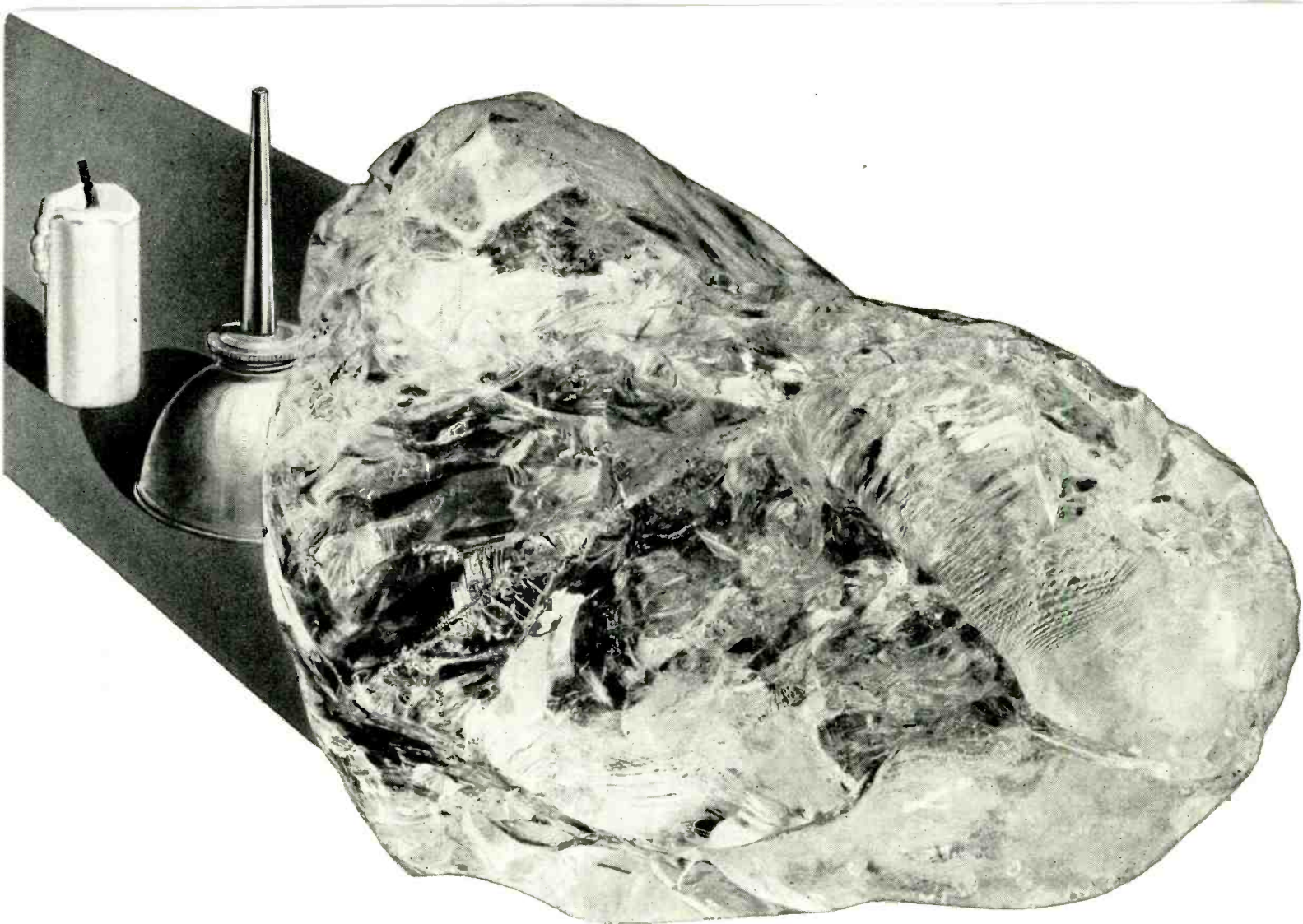

This *permanent* tracing paper is transparentized with *Albanite*

No oil, no wax—but a remarkable new transparentizing agent developed in the K&E laboratories—produces this truly permanent tracing paper! ALBANENE is made of 100% long fiber pure white rags—treated with *Albanite*—a new crystal clear synthetic solid, physically and chemically inert. ALBANENE will not oxidize, become brittle or lose transparency with age.

Equally important, ALBANENE has a fine hard "tooth" that takes ink or pencil beautifully and erases with ease . . . a high degree of transparency that makes tracing simple and produces strong sharp blueprints . . .

extra strength to stand up under constant corrections, filing and rough handling. ALBANENE has *all* the working qualities you've always wanted—and *it will retain all these characteristics indefinitely.*

Make ALBANENE "prove it" on your own drawing board. Ask your K&E dealer or write us for an illustrated brochure and generous working sample.

EST. 1867

KEUFFEL & ESSER CO.

NEW YORK—HOBOKEN, N. J.

CHICAGO · ST. LOUIS · SAN FRANCISCO · LOS ANGELES · DETROIT · MONTREAL



MINERAL OIL. Most tracing papers are treated with some kind of oil. Mineral oil is physically unstable, tends to "drift", never dries completely. Papers treated with mineral oil pick up dust, lose transparency with age.



VEGETABLE OIL, chemically unstable, oxidizes easily. Papers treated with vegetable oil become rancid and brittle, turn yellow and opaque with age.



ALBANITE is a crystal-clear synthetic solid, free from oil and wax, physically and chemically inert. Because of this new stabilized transparentizing agent Albanene is unaffected by harsh climates—will not oxidize with age, become brittle or lose transparency.

K&E

Albanene

REG. U. S. PAT. OFF.
THE STABILIZED TRACING PAPER

Centralab Ceramic Tubular Fixed Capacitors with Controlled Temperature Sensitive Characteristics

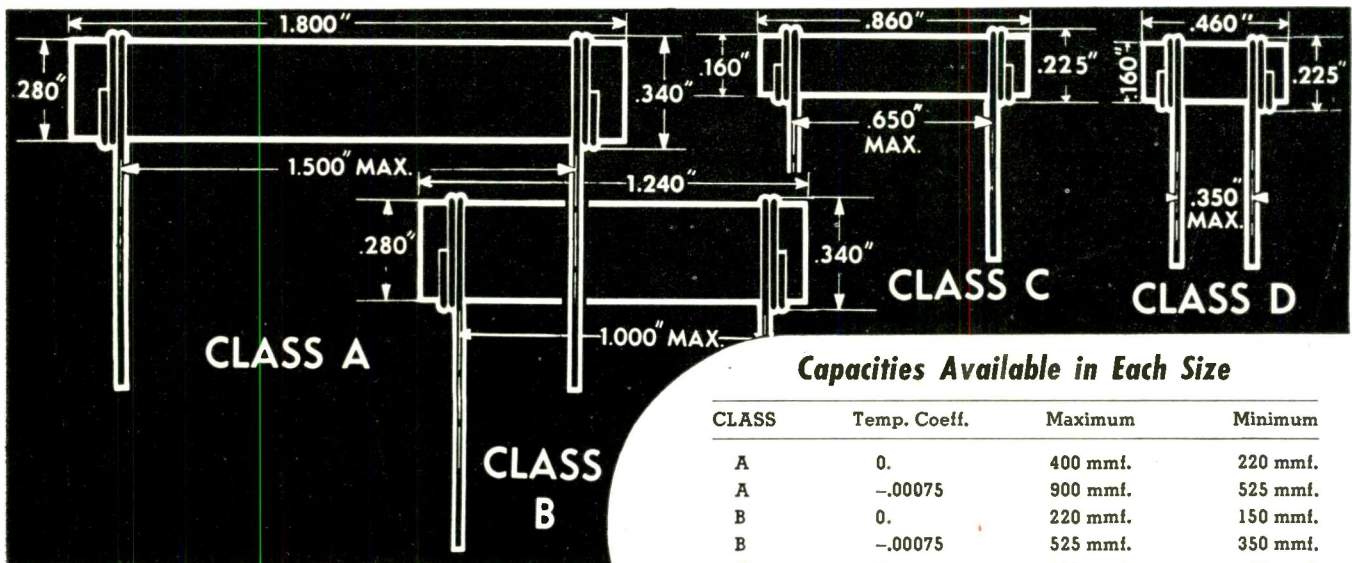

Capacities Available in Each Size

CLASS	Temp. Coeff.	Maximum	Minimum
A	0.	400 mmf.	220 mmf.
A	-.00075	900 mmf.	525 mmf.
B	0.	220 mmf.	150 mmf.
B	-.00075	525 mmf.	350 mmf.
C	0.	160 mmf.	50 mmf.
C	-.00075	375 mmf.	120 mmf.
D	0.	50 mmf.	1 mmf.
D	-.00075	120 mmf.	2 mmf.

STABILITY:

Ageing and humidity cause no measurable change in capacitance. There is no air film or possible mechanical movement between the plates.

RETRACKING:

Small mass and open tubular construction insure rapid and uniform changes with temperature. No measurable change in the coefficient after cycling.

POWER FACTOR:

Less than .08%. After 100 hrs. at 90% humidity . . . less than 0.2%.

VOLTAGE RATING:

500 volts D.C. Tested at 1000 volts RMS 60 cycles. Special small capacity high voltage units available on special order.

Write for special Bulletin 597

CENTRALAB Ceramic fixed Capacitors are furnished with zero temperature coefficient where absolute stability is desired, and with any desired negative temperature coefficient to a maximum of $-.00075$ mmf/mm 2 /C $^{\circ}$.

The temperature coefficient is determined by the ingredients of the ceramic dielectric and is accurately controlled. The dielectric constant of the material increases with the amount of negative coefficient which makes possible highest capacitance per unit size in the maximum negative coefficient. (See chart).

Centralab

Division of GLOBE-UNION INC., Milwaukee, Wisconsin

the instrument pivot that



NO BLU TING



Made like this Stays like this Never like this

takes the shocks!

Pivots that blunt easily destroy instrument accuracy. Tough, hard pivots developed by Westinghouse protect it. Even despite repeated shocks and continuous vibration these Westinghouse instruments retain their fine initial accuracy. Today, when full effectiveness of so many intricate machines and weapons of war depends on sustained instrument accuracy under all conditions, this is a development of vital importance.

Any pivot can be made sharp when new—but it's permanent sharpness that makes the instrument stay accurate. That's why our process includes precision regulations of honing pressure, a 500-to-1 enlargement of contour for inspection, tumbling to relieve stresses and set grain structure, photomicroscopic studies, and Rockwell hardness tests to assure uniformity.

To test sustained accuracy we have rigidly packed groups of instruments and shipped them all over the United States. Those with Westinghouse pivots came back with pivots unblunted, accuracy unimpaired.

What we do for pivots is typical of the whole quality procedure. It is an example of what we do to dials, springs, pointers, and magnets to give these instruments the non-aging quality that is so essential for today's production demands and power conservation requirements.

Our Bulletin 3013 makes instrument selection simpler and easier than ever before. Address Westinghouse Electric & Manufacturing Co., East Pittsburgh, Pa., Dept. 7-N.

J-40331

industry's most complete
line of electrical quality
instruments

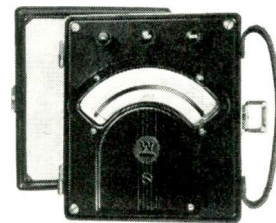

P-5 portables with $\frac{1}{2}\%$ accuracy have 5-inch scale with mirror strip for easy reading.



P-14 portables, with 1% accuracy, are ideal for schools, servicemen, etc.

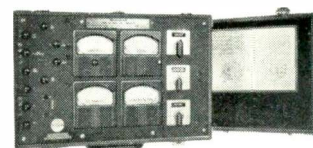

TA Industrial Analyzer—in one case all instruments for a-c data in any industrial plant.

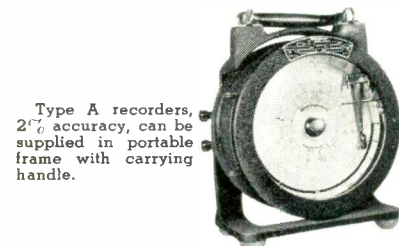

Type A recorders, 2% accuracy, can be supplied in portable frame with carrying handle.



AX voltmeters with 2% accuracy for aircraft service in accordance with government specifications.

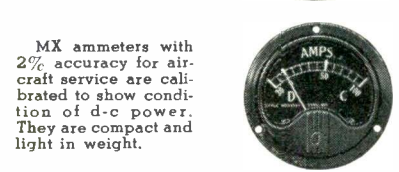

MX ammeters with 2% accuracy for aircraft service are calibrated to show condition of d-c power. They are compact and light in weight.

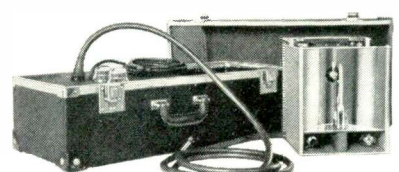

Portable Stroboglow, Type PSE-2, can analyze recurring motions up to a frequency of 30,000 per minute.

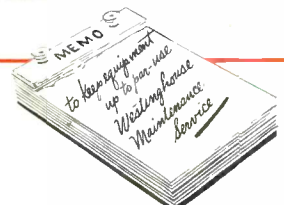
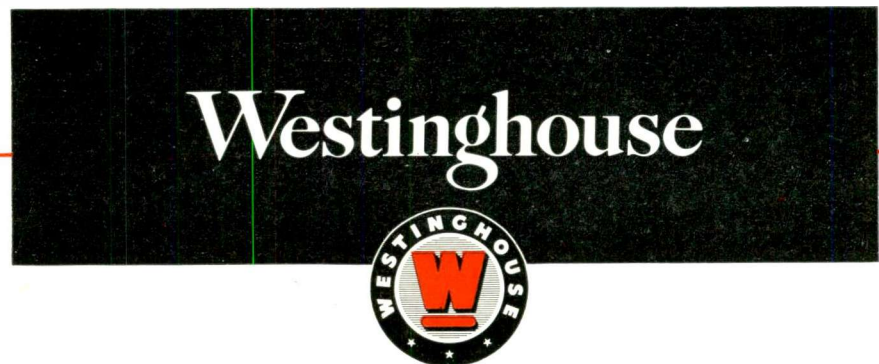

THE INTRICATE INNARDS OF A BRUTE

SYLVANIA
LOCK-IN
TUBE

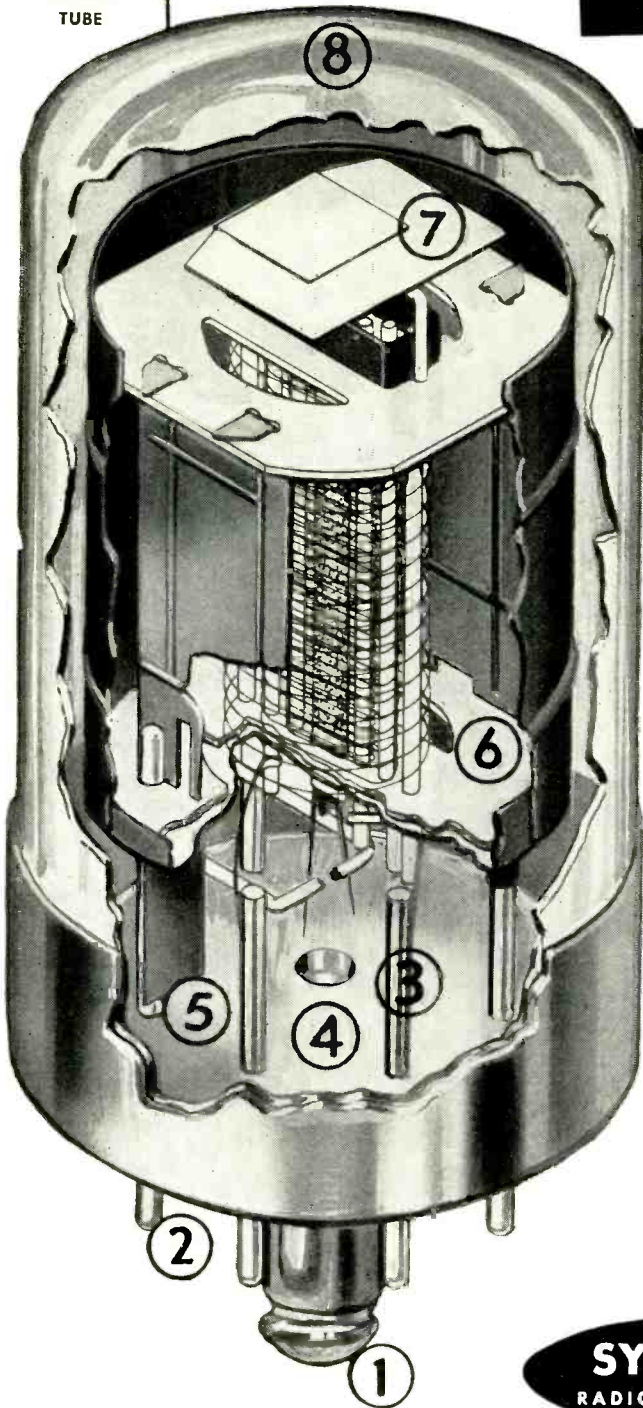

HERE you see the inside story of the Sylvania Lock-In, a tube so powerfully constructed, so ruggedly fortified against impact and concussion — it satisfies the most exacting demands of wartime radio use.

Note the exclusive features in the accompanying diagram, each contributing to the solid, durable worth of this outstanding tube.

Together, they add up to another triumph of Sylvania engineering skill—a triumph that will help American armed forces utilize to the full the vital implement of radio.

A CHAMP ON EVERY COUNT

1. "LOCK-IN" LOCATING LUG . . . also acts as shield between pins.
2. NO SOLDERED CONNECTIONS . . . all welded for greater durability.
3. SHORT, DIRECT CONNECTIONS . . . fewer welded joints—less loss.
4. ALL-GLASS HEADER . . . low loss and better spacing of lead wires.
5. NO GLASS FLARE . . . unobstructed space for internal shielding.
6. IMPROVED MOUNT SUPPORT . . . ruggedly mounted on all sides.
7. GETTER LOCATED ON TOP . . . shorts eliminated by separation of getter material from leads.
8. NO TOP CAP CONNECTION . . . overhead wires eliminated.
9. REDUCED OVERALL HEIGHT . . . space-saving.

SYLVANIA
RADIO TUBE DIVISION

HYGRADE SYLVANIA CORPORATION

New York City EMPORIUM, PA. Salem, Mass.

Also makers of HYGRADE Incandescent Lamps, Fluorescent Lamps and Fixtures.

**"... FOR THE LOVE OF
GOD... LET US HAVE
... SOME GREAT SHOT
SENT US..."**

LORD HOWARD—BATTLE OF SPANISH ARMADA

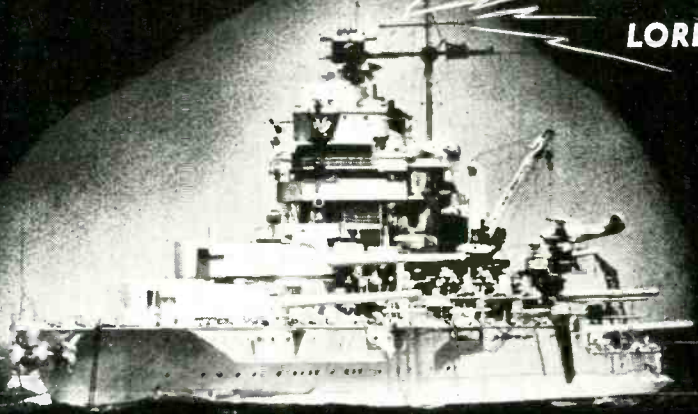

TODAY three quarters of the world is crying, "For the love of God let us have, and with great haste, more tanks, guns, planes, ammunition, trucks, etc." There can be no doubt in the hearts and minds of all Americans that these demands must and shall be met with all possible haste.

Of equal importance is the reliability of this armament and the permanency of its associated equipment. Greater than we realize is the part radio communication is playing—vital in its necessity, absolute in its dependability. The foundation of all radio equipment is transformers.

We at Kenyon take justifiable pride in knowing that whatever small part has been ours to contribute, then that part carries the character of our company. It is significant that wherever you see the Kenyon "mark of excellence", you will know that the men around it have seen fit to place their lives and their destiny on, "There can be no failure".

To these three-quarters of the world, we are at your service and, "For the love of God we will give you more shot and with greater speed".



**THE MARK OF
EXCELLENCE**

KENYON TRANSFORMER CO., INC.
840 BARRY ST., NEW YORK, U. S. A.

Erie Ceramicon UNIFORMITY

REG. U. S. PAT. OFF.



Controlled by precision electronic equipment

Capacity Tolerance

Standard minimum tolerance is ± 0.5 MMF. or $\pm 1\%$, whichever is greater. Closer tolerances can be supplied on special order.

Temperature Coefficient Tolerance

Ordinary tolerance on temperature coefficient is $\pm 60 \times 10^{-6}/^{\circ}\text{C}$ or $\pm 15\%$, whichever is the larger. When necessary, $\pm 30 \times 10^{-6}/^{\circ}\text{C}$ or $\pm 15\%$ —and on special order, even closer tolerances—can be supplied.

THE effectiveness of Erie Ceramicons in compensating for oscillator frequency drift lies in their uniform stability with respect to temperature change. This uniformity is essential for dependable compensation in Naval and Military high frequency communications equipment.

To meet the stringent present-day standards of performance, several different types of electronic test equipment have been designed and built by Erie Resistor engineers. Such precision instruments provide an accurate means of checking the performance of these small, silver-ceramic condensers at various stages of production. Pictured above is a testing line that measures the capacity of Ceramicons to an accuracy of ± 0.5 MMF.

Erie Ceramicons are made in 9 standard temperature coefficients from $+0.0012/^{\circ}\text{C}$ to $-0.00075/^{\circ}\text{C}$. Insulated Ceramicons are available, in maximum negative coefficient, in capacities from 1 mmf. to 375 mmf.; non-insulated units from 376 mmf. to 1100 mmf. A data sheet giving the characteristics of Erie Ceramicons will be sent on request.

ERIE RESISTOR CORP., ERIE, PA. LONDON, ENGLAND · TORONTO, CANADA.

POWER CONSERVATION AND BREAK-DOWN ELIMINATION

dictate and demand supreme insulation . . .

TURBO INSULATION

IN THREE TYPES

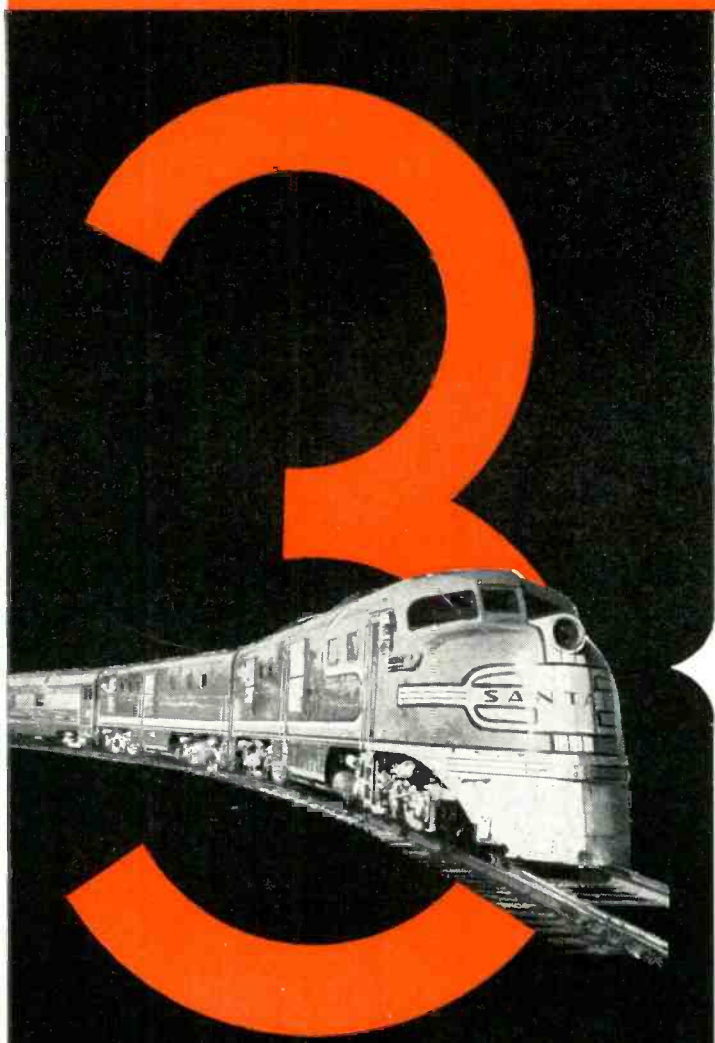

Turbo

WILLIAM BRAND & CO.

276 FOURTH AVENUE, NEW YORK, N. Y. • 325 W. HURON STREET, CHICAGO, ILL.

FLEXIBLE VARNISHED OIL TUBING, SATURATED SLEEVING — meeting the all-purpose requirements of a sleeve insulation to stand guard against break-down, moisture absorption —all commonly encountered acid and oil influences.

VARNISHED GLASS TUBING for those applications where extremely high-heat resistance becomes the above-all consideration.

EXTRUDED TUBING where extreme sub-zero temperature resistance to embrittlement becomes a prerequisite.

Each supreme in their respective and specialized field of application.

For proof ask for samples of each; also for new specimen board and list of standard sizes. There is no obligation.



NOW IT'S WAR

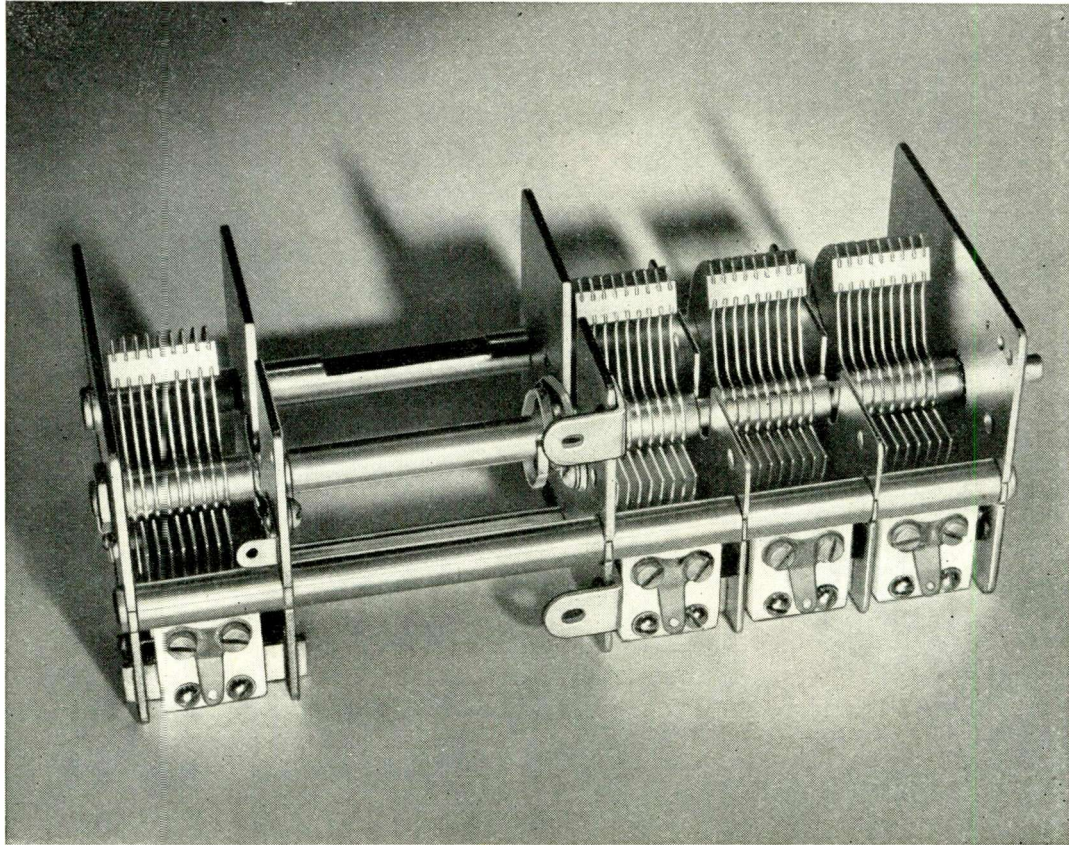

B. C. Condenser Redesigned for Military Use

MANY formerly "peaceful" broadcast receiver condenser designs have been modified to go into implements of modern warfare. The one illustrated is a typical example—it is now made of invar, 100% soldered and silver plated.

THE HAMMARLUND MANUFACTURING CO., INC.
424-438 West 33rd Street, New York, N. Y.

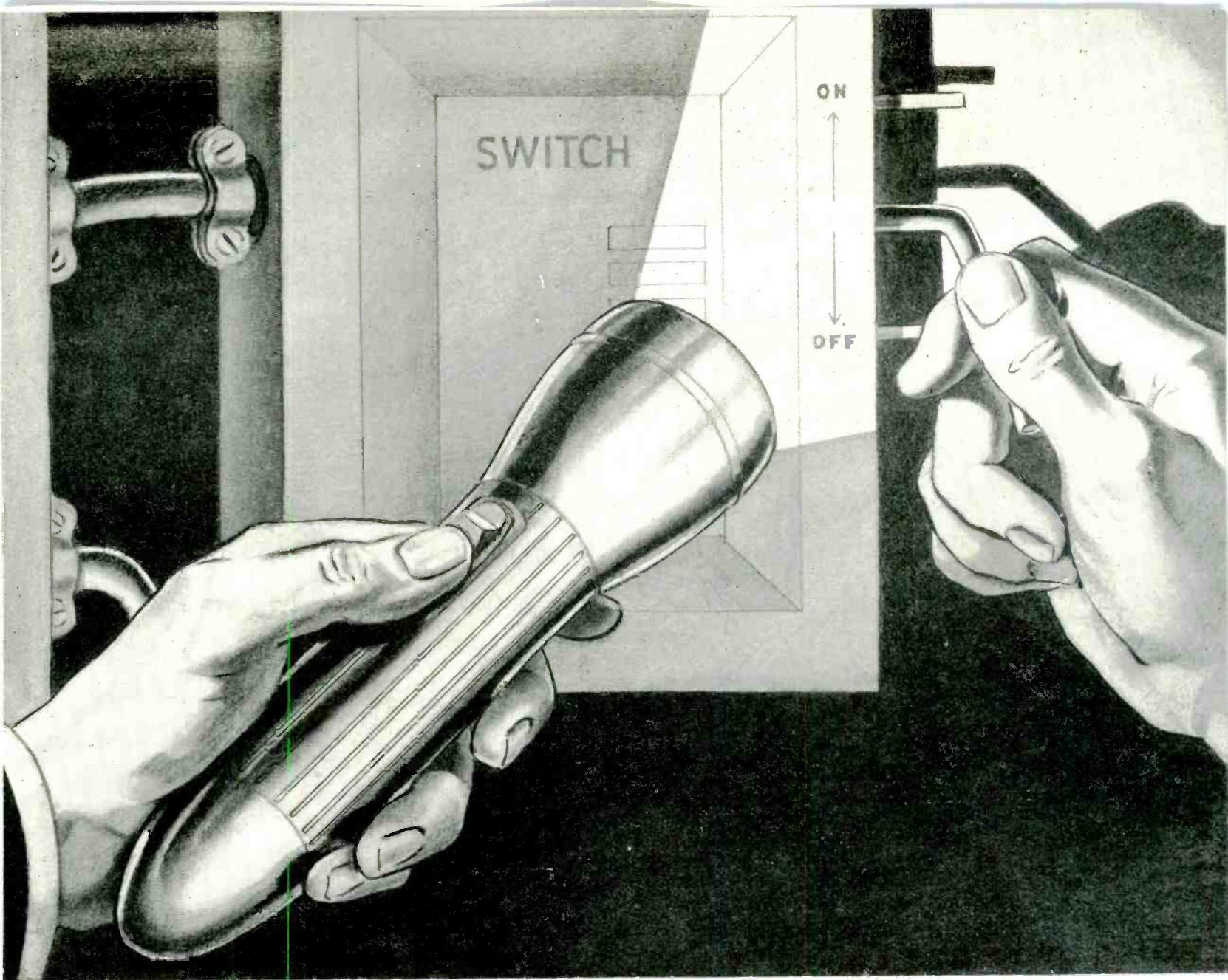

A Vital Ray of Light WHEN THE "ALL CLEAR" SIGNAL SOUNDS

**The Changeover to
NATIONAL VULCANIZED FIBRE
Releases Essential Plastics for Defense
Keeps production of Flashlights mov-
ing for the Home Front**

★ ★ ★

A WELL-KNOWN manufacturer of flashlights was confronted with shortages of certain plastics which were used as insulating parts. The problem

was to find a replacement material which would do the job just as well. The answer was found in National Vulcanized Fibre because of its excellent electrical insulating qualities and its ready fabrication into many forms and shapes.

Today, National Vulcanized Fibre is finding more and more uses in industry as a practical replacement material for hard-to-get metals and plastics. Our engineering and research facilities are available to you on any problem. Wire, phone or write us.

NATIONAL VULCANIZED FIBRE COMPANY

WILMINGTON  DELAWARE

Offices in Principal Cities

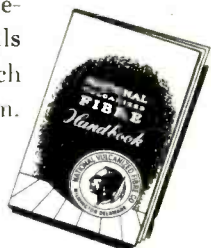

You can use this Handbook profitably. Write for free copy today.

★★★ *Broadening American Enterprise through Dependable Plastics* ★★★

5 *plus* FEATURES

YOU GET WITH G-E SIMPLIFIED FM

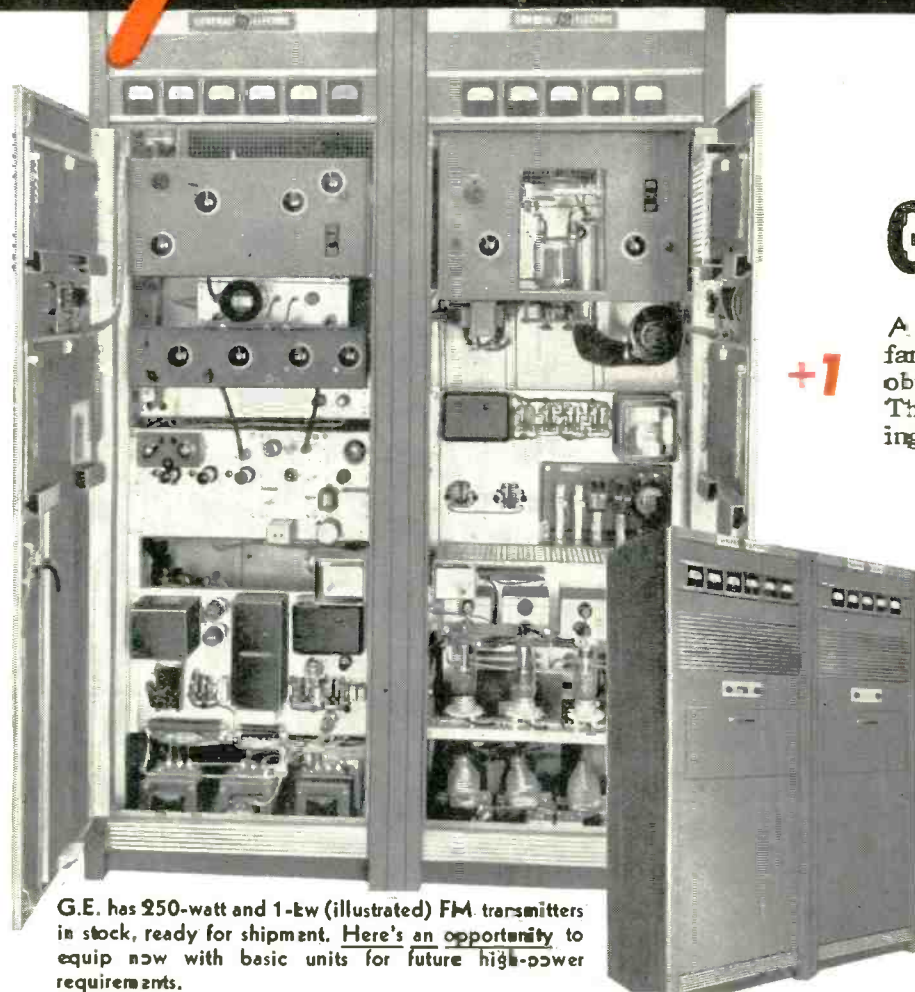

G.E. has 250-watt and 1-kw (illustrated) FM transmitters in stock, ready for shipment. Here's an opportunity to equip now with basic units for future high-power requirements.

+1

A new method of controlling crystal temperature, which far surpasses older methods in the frequency stability obtained, is utilized in the hermetically sealed G-31 Thermocell crystal unit. Provision is made for switching to a spare during operation.

+2

An automatic recloser circuit makes the interruption of service caused by momentary overloads (removed by overcurrent relays) almost imperceptible to the listener.

+3

Telechron motor time-delay relays protect the rectifier tubes against premature application of plate voltage.

+4

Vertical-chassis construction makes every tube and soldered joint completely accessible. There is no need of removing entire units from the transmitter for detailed inspection.

+5

Safety to operating personnel is assured by interlocks and high-voltage grounding switches on the main-access doors.

Details, yes, but important. Extras like these, standard for all G-E FM transmitters, contribute substantially in assuring you unusually excellent performance. For long dependable operation at low cost make your FM installation completely General Electric.

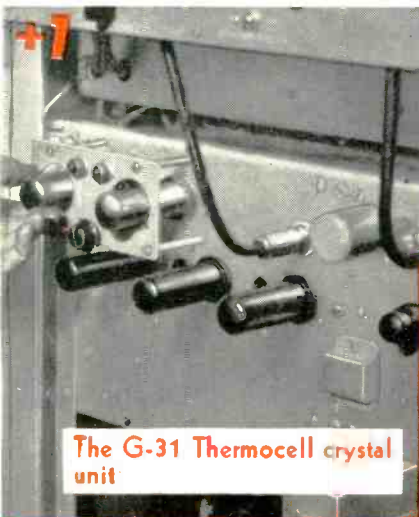

The G-31 Thermocell crystal unit

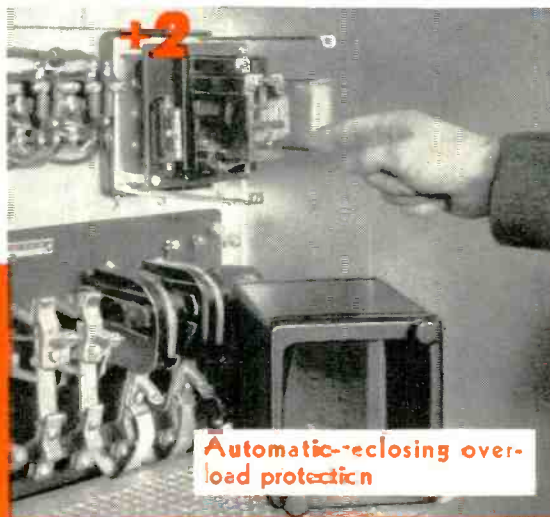

Automatic-reclosing overload protection

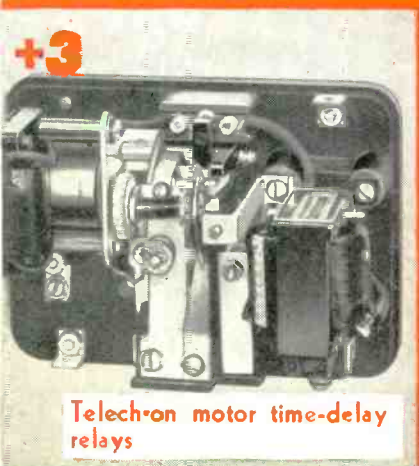

Telechron motor time-delay relays



Complete accessibility without disassembly

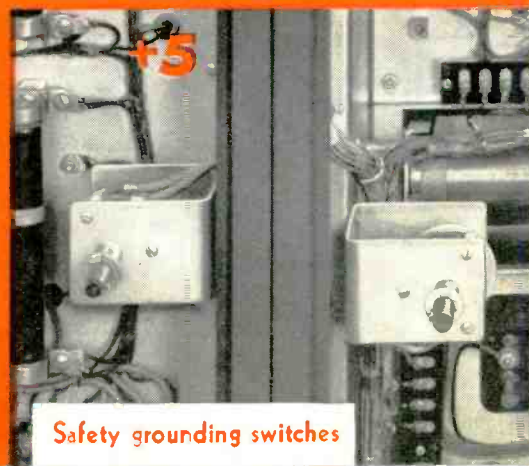

Safety grounding switches



General Electric and its employees are proud of the Navy award of Excellence made to its Erie Works for the manufacture of naval ordnance.

...and here are
THREE TUBES FOR HIGH EFFICIENCY
 at the U.H.F.'s

Hardly a handful,
 but the GL-
 8002R's output is
 1800 watts up to
 100 mc



Zenith's FM sta-
 tion W51C packs
 a 50-kw wallop
 with a pair of
 GL-880's

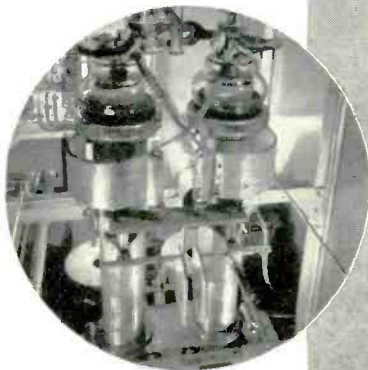

Twenty kilowatts
 of FM from these
 GL-889's at
 W47NV*

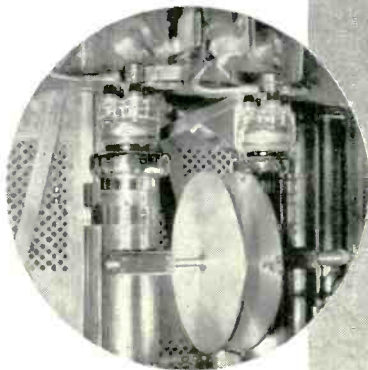

"EXCELLENT stability," "Easy to drive," "Easy to neutral-
 ize," "No cooling problems."—that's what users are saying
 about these three tubes. Although built by General Electric prima-
 rily to speed the conquest of the ultra-highs, the GL-8002R, GL-889
 (also available with radiator for forced-air cooling) and GL-880
 provide superior performance for all present-day broadcasting.

Have you investigated our complete line of transmitting tubes for
 standard broadcasting, FM, television, and international service?
 Bulletin GEA-3315C will bring you the story. Get a copy from
 your nearby representative or dealer. Ask also for information about
 any of the FM equipment listed below. General Electric Company,
 Schenectady, N. Y.

**Operated by the National Life and Accident Insurance Co., Nashville, Tenn.*



FM Broadcast Transmitters
 250 to 50,000 Watts

FOR



S-T Transmitters

ALL



Measuring & Testing
 Equipment

YOUR



Receivers for Home
 and S-T Service

FM



FM Police and Emergency
 Transmitters and Receivers

NEEDS



Tubes

GENERAL  **ELECTRIC**

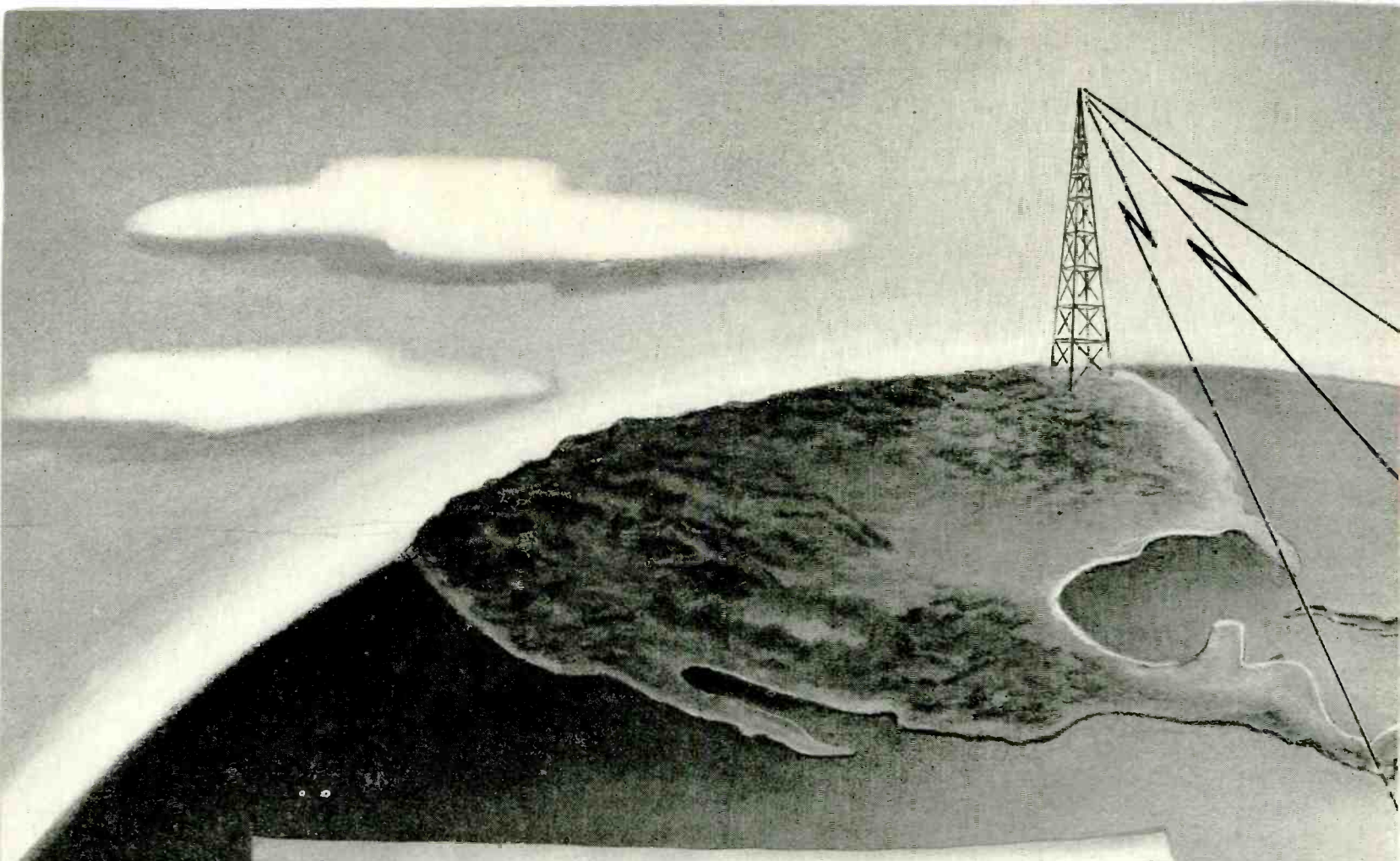

*America's Most Modern Short-Wave Station. Designed and Manufactured
for Columbia Broadcasting System by I. T. & T. Associate Companies*

Just as radio helped make America one big family, so short-wave radio is making the Americas one big neighborhood. The President speaks — and the ears of Central and South America listen . . . The Philharmonic plays — and below the Rio Grande hearts are warmed . . . Olga Coeltz sings — and her continent welcomes back a favorite artist.

Helping set the Good Neighbor philosophy to words and music are America's most modern short-wave stations — WCBX and WCRC — at Brentwood, Long Island. New voice of the Columbia Broadcasting System, the great directional antennas were designed and erected by I. T. & T.'s associate company, Mackay Radio. This company also installed the 50,000 watt transmitters which were designed and manufactured by another I. T. & T. associate, The Federal Telegraph Company.

INTERNATIONAL TELEPHONE AND TELEGRAPH CORPORATION
67 Broad Street, New York, N. Y.

A New Voice to Our
Good Neighbors . . .

by **IT&T**

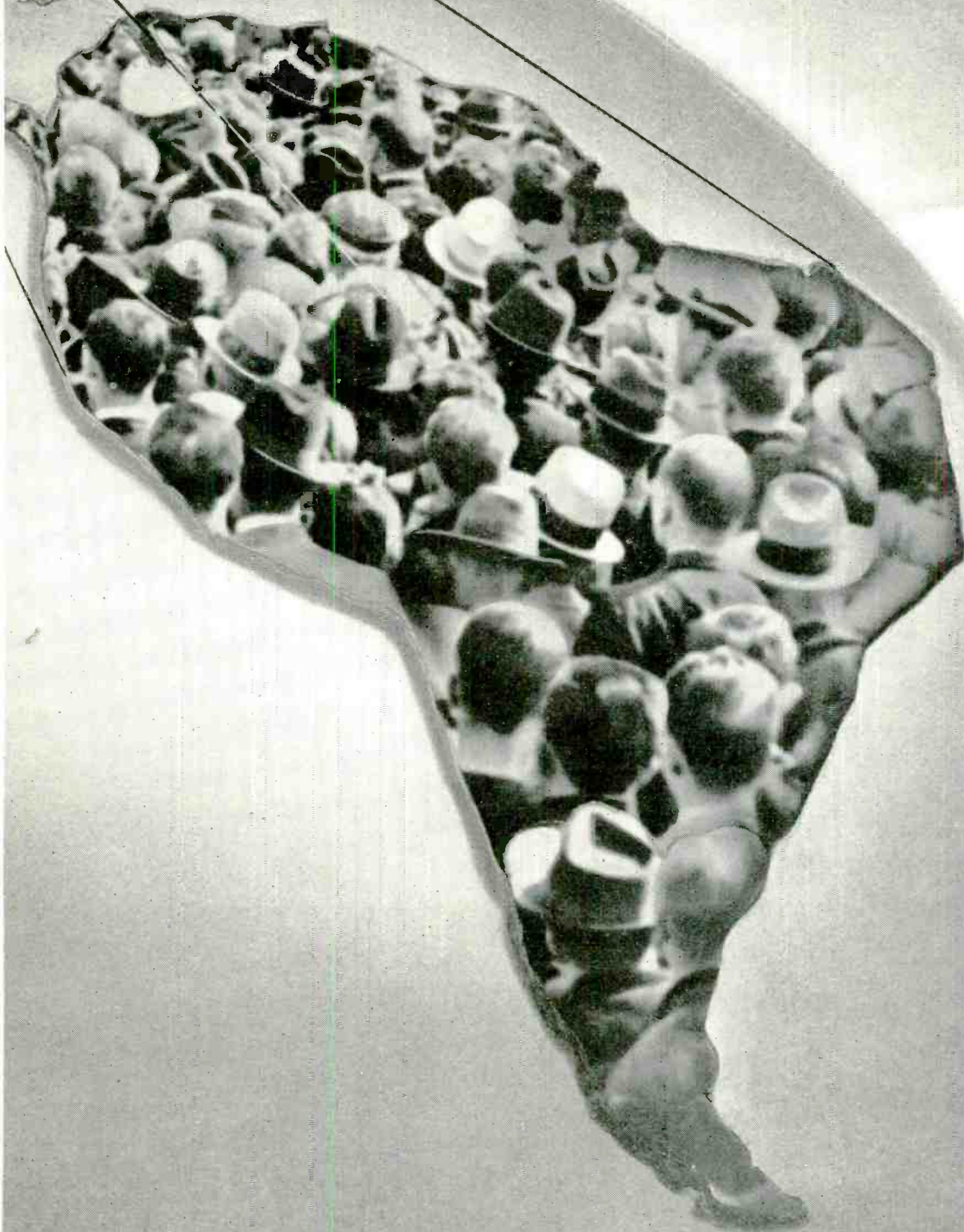

What Can You Expect?

KNOWING about small tubing, and who can make it for you is often not enough. Two additional factors enter in — *uniform quality as a standard*, and production of tubing for *new and unique uses required by the war effort*. The Superior

Plant is set for the long pull. You can expect continuing high quality, resourcefulness in production, and the use of our niche of knowledge which is the result of intensive specialization. **SMALL TUBING IS OUR ONLY BUSINESS AND WE KNOW IT.**



SUPERIOR

SUPERIOR TUBE COMPANY, NORRISTOWN, PENNSYLVANIA





THE BIG NAME IN
**SMALL
TUBING**

The *FACTS* about *SUPERIOR BRIGHT FINISH*...

BRIGHT finish means clean surfaces, nothing hidden by scale. Annealing in carefully controlled atmospheres is the modern way of maintaining that bright surface. Superior has found that anneal-

ing in atmospheres precludes the possibility of loss of inherent physical characteristics of the tubing. Our processing is built around this principle. *Specify SUPERIOR—THE BRIGHT TUBING.*

Tubing from 5/8" OD down...SUPERIOR  Seamless in various analyses. WELDRAWN  Welded and drawn Stainless. BRAWN  Welded and drawn "Monel" and "Inconel". SEAMLESS and Patented LOCKSEAM Cathode Sleeves.

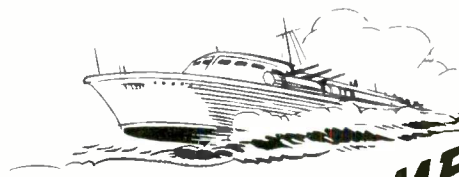

Saves LIGHT METALS!
Saves SPACE!
Increases EFFICIENCY
OF CONTROL APPARATUS!

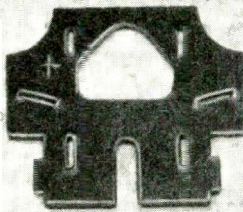
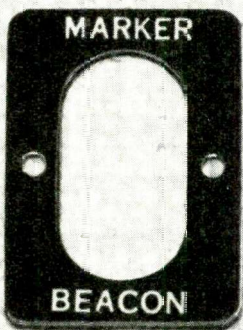
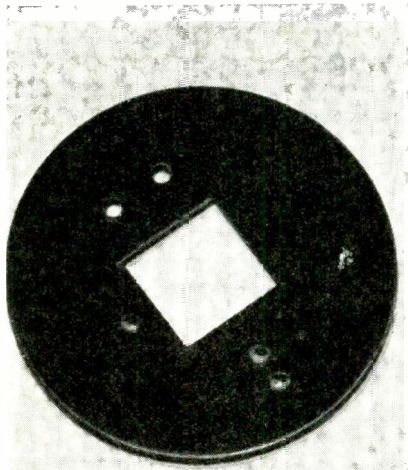

No
CORROSION
FROM
SALT AIR

HIGH
DIELECTRIC
STRENGTH -
LOW POWER
FACTOR

IN the design of merchant and naval shipping there has been a steady increase for years in the amount of Formica used in control apparatus for the numerous electrical circuits. Originally the material was selected because of its qualities as an electrical insulator, but more recently it has been used for structural parts replacing scarce light metals and making possible more compact, lighter and more effective construction.

It serves effectively in all climates, and under the widest range of weather conditions because it is chemically inert, and non-porous. It does not corrode and is stable in dimensions.

The Formica data book provides engineering test data, and suggests methods of application. Send for it.

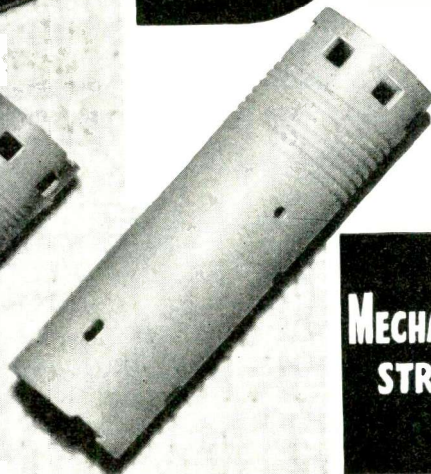
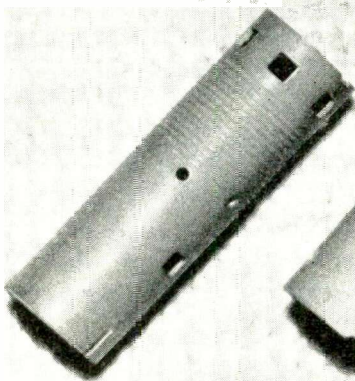

MECHANICALLY
STRONG -

HALF
THE WEIGHT
OF
ALUMINUM

THE FORMICA INSULATION COMPANY
 4661 Spring Grove Avenue, Cincinnati, Ohio

FORMICA

Formica In DEFENSE

- ★ Formica serves not only in ships but in airplanes
- ★ where it is used for control pulleys, mechanical parts,
- ★ instrument panels; for ignition parts in tanks, and in-
- ★ sulating parts in communications apparatus.

★ ★ ★ ★ ★ ★ ★



GRAPHITE ANODES Make Power and Transmission Tubes

Last Longer

Stay Stronger



Many of the Nation's leading tube manufacturers use SPEER Graphite Anodes. Write for list and for SPEER Anode Booklet.

Heat, arch enemy of power and transmission tubes, cannot fuse—cannot even soften or warp—SPEER Graphite Anodes. No anodes made of material other than graphite can compare with SPEER Graphite Anodes in that respect. Note the figures in the following table.

The amount of power a tube can handle depends largely on the ability of the Anode to dissipate the heat of the operation.

Relative Heat Dissipating Value at 510° C.

Graphite	1.00	Tantalum	0.22
Tungsten	0.30	Nickel No. 1	0.025
Molybdenum	0.24	Nickel No. 2	0.01

Tubes with SPEER Graphite Anodes give you many other advantages too. The anodes help keep the tubes gas-free, absorb gasses given off by other elements.

SPEER CARBON CO.

ST. MARYS, PA.

CHICAGO

CLEVELAND

DETROIT

MILWAUKEE

NEW YORK

PITTSBURGH



⊕ 2093

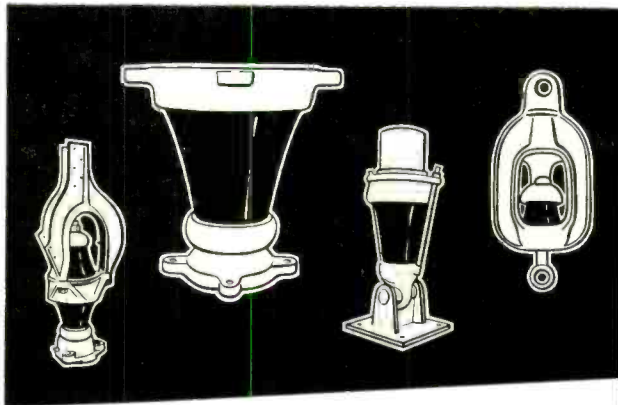

The largest and smallest. Lapp curved-side cones—for a low power pipe mast, and for the world's largest vertical radiator—1050 feet.

LAPP HAS MADE 142 DESIGNS

**IN ANTENNA
STRUCTURE INSULATORS**

**.. ALL ARE BASED ON THE
LAPP *CURVED-SIDE*
COMPRESSION CONE**

Each of the 142 Lapp units—for self-supporting towers, guyed masts and mast guys—is designed around the Lapp curved-side compression cone of electrical porcelain. More than 20 years of service records prove that this Lapp design meets every operating requirement. It affords double the strength of an ordinary straight-side cone, assuring the maximum in security and permanence. Finally, each insulator, before shipment, is tested by loading to 50% more than maximum design load. Most radio engineers know they've covered the insulator question adequately when they say to their tower manufacturer, "Use Lapp Insulators." Lapp Insulator Co., Inc., LeRoy, N. Y.



Specify

LAPP

FOR SECURITY IN ANTENNA STRUCTURE INSULATORS

HARDWICK, HINDLE PRODUCTS ARE SUBJECT TO HIGH PRIORITY RATINGS



Like many other fine products, they are subject also to first call by Uncle Sam.

We are proud of the service they are performing in so many defense jobs.



HARDWICK, HINDLE, Inc.

Newark, N. J., U. S. A.

RHEOSTATS AND RESISTORS





EXTRA PROTECTION

The Army tank shown above is provided with **extra protection** against almost any War hazard. In the same manner, every GAMMATRON tube is designed and built to give **extra protection** against circuit hazards which would cause ordinary tubes to fail. Full tantalum construction, improved GAMMATRON pumping methods make failure due to internal release of gas impossible. Sturdy mechanical construction prevents handling breakage and provides low internal inductance for better UHF performance. Get in touch with your nearest GAMMATRON sales representative for further details.



TYPE
HK1054

MAX. POWER
OUTPUT
3000 WATTS

GAMMATRON SALES REPRESENTATIVES

Wash., Ore., Idaho, Mont.
MARSH AGENCIES
104 Battery Street
Seattle, Washington
Mo., Kansas, Nebraska
H. A. ROES
2017 Grand Avenue
Kansas City, Missouri
Ind., Ohio, Kentucky
W. E. McFADDEN
915 Montrose Ave., Bexley
Columbus, Ohio
Michigan—W. B. SWANK
610 Blaine Avenue
Detroit, Michigan

New York State
W. F. SEEMAN
523 Ellicott Square
Buffalo, New York
Pa., Va., W. Va., Md.
Wash., D. C., Del., N. J.
S. K. MACDONALD
1334 Arch Street
Philadelphia, Pennsylvania
Maine, N. H., Vr., Mass.
Conn., R. I.
TRADE CONTACT
CORPORATION
25 Huntington Avenue
Boston, Massachusetts

Minn., N. D., S. D., Wis.
KENNEDY SALES CO.
2362 University Ave.
St. Paul, Minnesota
Illinois, Wisconsin
RALPH M. HILL
GORDEN GREY
1 North Crawford Ave.
Chicago, Illinois
Tenn., N. C., S. C., Ala.
Ga., Fla.
HOLLINGSWORTH
& STILL
Norris Bldg., Atlanta, Ga.

Calif., Nevada, Arizona
E. P. DEMAREST
1630 South Flower Street
Los Angeles, California
Texas, Okla., Ark., La.
M. B. PATTERSON & CO.
434 Allen Building
Dallas, Texas
New York City, New Jersey
D. R. BITTAN SALES
CO., INC.
53 Park Place
New York City, N. Y.

HEINTZ... KAUFMAN
SOUTH SAN FRANCISCO LTD., CALIFORNIA U.S.A.

GAMMATRONS of course!

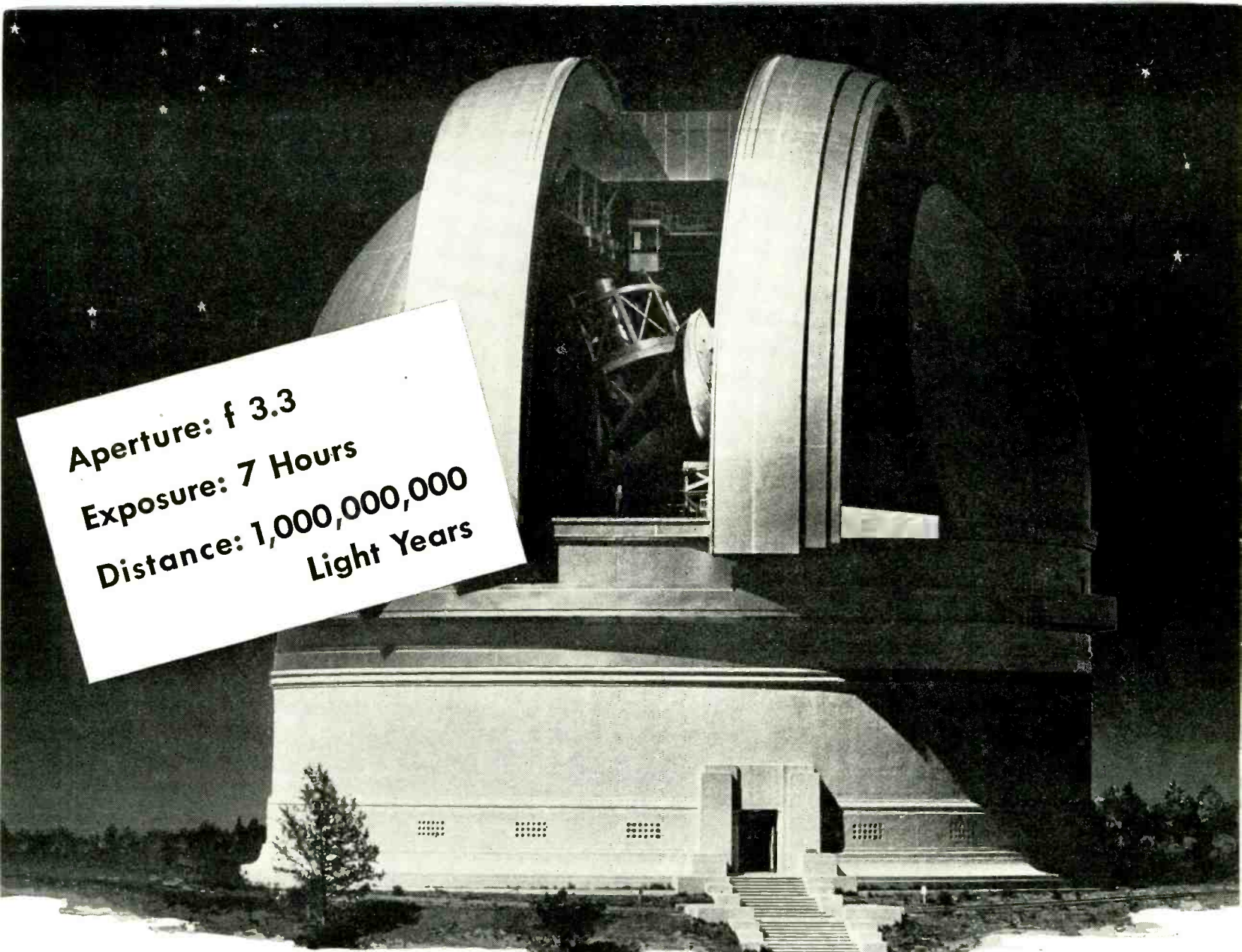

Aperture: $f\ 3.3$
Exposure: 7 Hours
Distance: 1,000,000,000
Light Years



● **New outposts of the universe** will be photographed for science, for the first time, when the 200-inch telescope of Mt. Palomar Observatory is completed. A development of California Institute of Technology, Mt. Palomar will have an optical range of approximately *one billion light years*. Objects far too distant for visual observation will be permanently recorded on long-exposure photographic plates.

● **A specially-designed Electronic Power Supply**, incorporating frequency synchronization, will serve an accurately controlled mechanism to keep the telescope trained on its object

throughout the long period of photographic exposure. Electronic specializes in vibrator-type power supplies, designed to convert DC to AC or to higher voltage DC. An outstanding Electronic development has been constant frequency or controlled variable frequency converters for synchronizing two or more electrical units.

The Mt. Palomar installation is but one example of the resourceful engineering, precision manufacture, and outstanding performance which have won Electronic leadership in many diversified fields. To mention a few: Aviation, Marine, Communications. Electronic engineers will be glad to help you with *your* power supply and frequency control problems. Just address:



ELECTRONIC LABORATORIES, INC.
INDIANAPOLIS, INDIANA



INDUSTRY CAN COUNT ON MORE HOURS OF CAPACITOR USE PER DOLLAR

SOMEDAY, they'll ride serenely at anchor in our own ports in a world at peace — these mighty battleships of the United States Fleet. And when they come home, what stories their crews will tell — of the courage of American sailormen, and the endurance of navy equipment.

Nowhere is dependability more vital than in the communications equipment of our Armed Forces, and in this Cornell-Dubilier plays an important part. C-D capacitors, long recognized for their *extra*

dependability, today are setting new performance records in the service of Uncle Sam. From the experience of Cornell-Dubilier engineers, gained through more than thirty-two years of capacitor specialization, including all-out production during two world wars, American Industry stands to benefit — when peace comes — with more hours of capacitor use per dollar than ever before.

Cornell-Dubilier Electric Corporation, South Plainfield, New Jersey. New England Division; New Bedford, Mass.



DYKANOL TRANSMITTING CAPACITORS
Copied, imitated...but never duplicated.

Type TK Dykanol Capacitors are universally accepted as the finest quality capacitors ever offered in larger capacity and higher voltages for filter service. Hermetically sealed, these Dykanol capacitors are non-inflammable and non-explosive. Standard types available in capacities from .25 mfd. to 10 mfd. at voltages from 6,000 to 25,000 V.D.C. working.



Cornell Dubilier Capacitors

MICA • PAPER • DYKANOL • WET & DRY ELECTROLYTIC CAPACITORS

MORE IN USE TODAY THAN ANY OTHER MAKE

IN WHAT TYPE OF CIRCUIT IS THE EQUIPMENT USED... LIGHTING CIRCUIT, MOTOR, GENERATOR CIRCUIT OF SOME OTHER ?

WHAT ARE NORMAL VALUES OF CURRENT AND VOLTAGE THAT MAKE AND BREAK ?

WHAT IS THE FREQUENCY OF ELECTRICAL INTERRUPTIONS ?

WHAT IS THE NORMAL CURRENT CARRIED BY CONTACTS IN THE CLOSED POSITION ?

WHAT OVERLOAD CONDITIONS MUST BE SUSTAINED ?

WHAT OPERATING LIFE IS EXPECTED ?

*See
Mallory
for
Contact-
Assemblies*

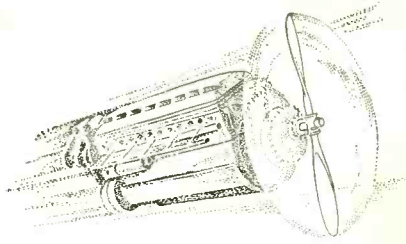

New Aviation Products on Your Schedule?

Write Mallory Complete Contact Assemblies into Your Blueprints

Recently, a company that had used a Mallory-developed alloy, Elkonite, as the contact material for a Diesel engine starting relay . . . carrying a high initial current . . . came to Mallory with a new problem. "We're going into production on aircraft relays—what about some help with contacts and contact assemblies?"

This request was right up our alley. Mallory engineers have been doing research on aviation and other industrial contact problems for many years. And Mallory is delighted to get in on planning when designs are still on the drafting board . . . it usually saves time, money and effort for all concerned.

By working closely with the relay manufacturer, Mallory engineers were able to suggest silver Elkonite for the main contact and Mallosil . . . our special dense, hard silver surfacing . . . for several points in the relay. *Result:* A relay with lower contact resistance and better performance than anyone expected.

Mallory isn't satisfied with just suggesting the right electrical contact. Our engineers know that the contact member may be equally important. So a Mallory Complete Contact Assembly is often the complete answer for highest functional efficiency, electrical *and* mechanical . . . and faster production.

Why not call us in . . . to blend Mallory experience with your blueprints? Your Mallory representative will gladly supply you with full details.



Delivered to Your Desk! Mallory Contact Catalog.

Complete information on every phase of electrical contact selection, design and service. You need it for your technical library. Write today. No obligation.

P. R. MALLORY & CO., Inc., INDIANAPOLIS, INDIANA • Cable Address — PELMALLO

P. R. MALLORY & CO. Inc.
MALLORY

**ELECTRICAL CONTACTS AND CONTACT ASSEMBLIES
NON FERROUS ALLOYS, POWDERED METAL ALLOYS**

"Ten Silver Months . . ."

"EVERY WEAPON we make today is worth ten that we might produce next year; for this year — 1942 — is the critical year in the existence of the United States."

This grim challenge was thrown at American industry by Donald Nelson in his first speech as chief of the War Production Board. He was speaking to a group of business paper editors, called together to receive at first hand Mr. Nelson's urgent message to the industries they serve.

"We've wasted the golden months", he declared, "the months in which we could have expanded our steel industry, our chemical industry, our copper industry, and all the others, so that we would have plenty of everything. But we still have ten silver months—the months that remain in 1942—and in them we can do things that we never thought possible."

To that objective Mr. Nelson has dedicated his high talents and boundless energy. And to that task he asks American industry to apply the full measure of its resources and skill.

That challenge should be all that it takes to exact from industry the last ounce of its energies. For by now we all can see that in this war the American way of life is at stake. American industry is the essence of the American way of life. Neither can survive without the other. So, even if it had no better reason, industry must go all out to win this war as a measure of self-preservation. Here self-interest and patriotic duty are synonymous. American industry cannot afford to let America lose this war.

The 1942 job is crucial. If it is well done we have a chance to win. If it is badly done we cannot possibly win. There is the measure of the responsibility that now rests upon the shoulders of industrial management.

It is not just Donald Nelson who asks this of industry. He speaks for the millions of fighting men — on land, at sea, in the air — the world over, whose eyes turn so desperately to the workshops of America. There and there alone can they see the hope of victory.

The people of America are not going to let those men down. They demand of industry every effort and every sacrifice that may be necessary to back them up. On that score, American industry stands, of necessity, on trial before our people. It must come through — or else!

* * *

As industry goes all out to meet this demand, its management asks of those who set its tasks and supervise its performance the utmost possible cooperation. It asks of them specifically an understanding of its problems and a chance to work them out without unnecessary interference. It asks for protection against attack from the rear while it concentrates its energies against the common foe. It asks a truce on economic reforms and social experiments that have nothing to do with winning the war and that are bound to arouse misgiving and mistrust amongst the proprietors of industry. Above all, it asks that it be not made a political scapegoat for every deficiency that is sure to develop in the confusion of a war effort.

This does not mean that industry resents honest criticism or constructive direction. Neither does it mean that it is unwilling to do its best unless it can have its own way in all things. The managers of industry are practical men. They

know better than anyone else that unprecedented conditions call for new methods, that they must be open-minded to every criticism sincerely directed toward winning the victory. They know that no one can afford to be smug in the face of a national crisis.

There would be no point to my rehearsing here the pros and cons of such criticisms. Time is too short for that. Only in its performance can industry write a convincing answer to its critics. But as a help toward the achievement of that performance, I should like to clear up, if I can, one prolific source of misunderstanding and mistrust.

I refer to the solicitude of industrial managers as to where their companies may find themselves after the war. *This concern for the future sometimes is misinterpreted to mean that management is blind to the urgency of the present. But it does not mean that. It is a perfectly natural anxiety that must be felt by any responsible management operating under the American enterprise system — which is one of the things we are fighting to preserve.*

Under our system, the managers of industry cannot but feel a sense of responsibility to its owners, not merely for current dividends on their investments but also for the conservation of their properties. That means they must feel some concern over what may happen after the war to a business that now must go all out to help win the war. And their concern is but part of a general concern over what may be the effect of the war on the whole American way of life, preservation of which is our reason for being at war.

To give practical effect to that concern under present conditions is one of the problems of management. It is not an insuperable problem. Competent management will be able to surmount it, I am sure. But the right kind of help from those in authority can make the job a lot easier. And let us note in passing that the problem cannot be written off, as some critics of business seem to think, merely by setting off against it the profits that business can make on war contracts. That misses the whole point.

For a business enterprise is not, as many seem to think, just a "profit-machine." It is not set up and operated by its owners and managers for the sake of this month's or this year's profits, without regard to any other consideration.

The fact is that any worth-while business must operate as a going concern. It consists not only of stockholders and managers, but also of employees, markets, distributors, and dealers. Mostly, I might say, of markets, distributors, and dealers. They are the "reason for being" of any business, the source of its payrolls and its profits.

No competent management wants to scrap such essential elements of its business just for the sake of war-bred profits, however large they might look . . . at the moment. Most of the original reluctance to get into arms production, for which industry has been criticized, was not due to a "greed for profits", as has been charged. Rather did it arise from management's mistrust of "war profits" that can be made only by sacrificing the essential elements of a healthy business.

* * *

But now industry faces a dire national emergency. The survival of our country and all its institutions — including American business — is at stake. So management must shape its course to meet without stint every need of the war

TELEVISION . . .

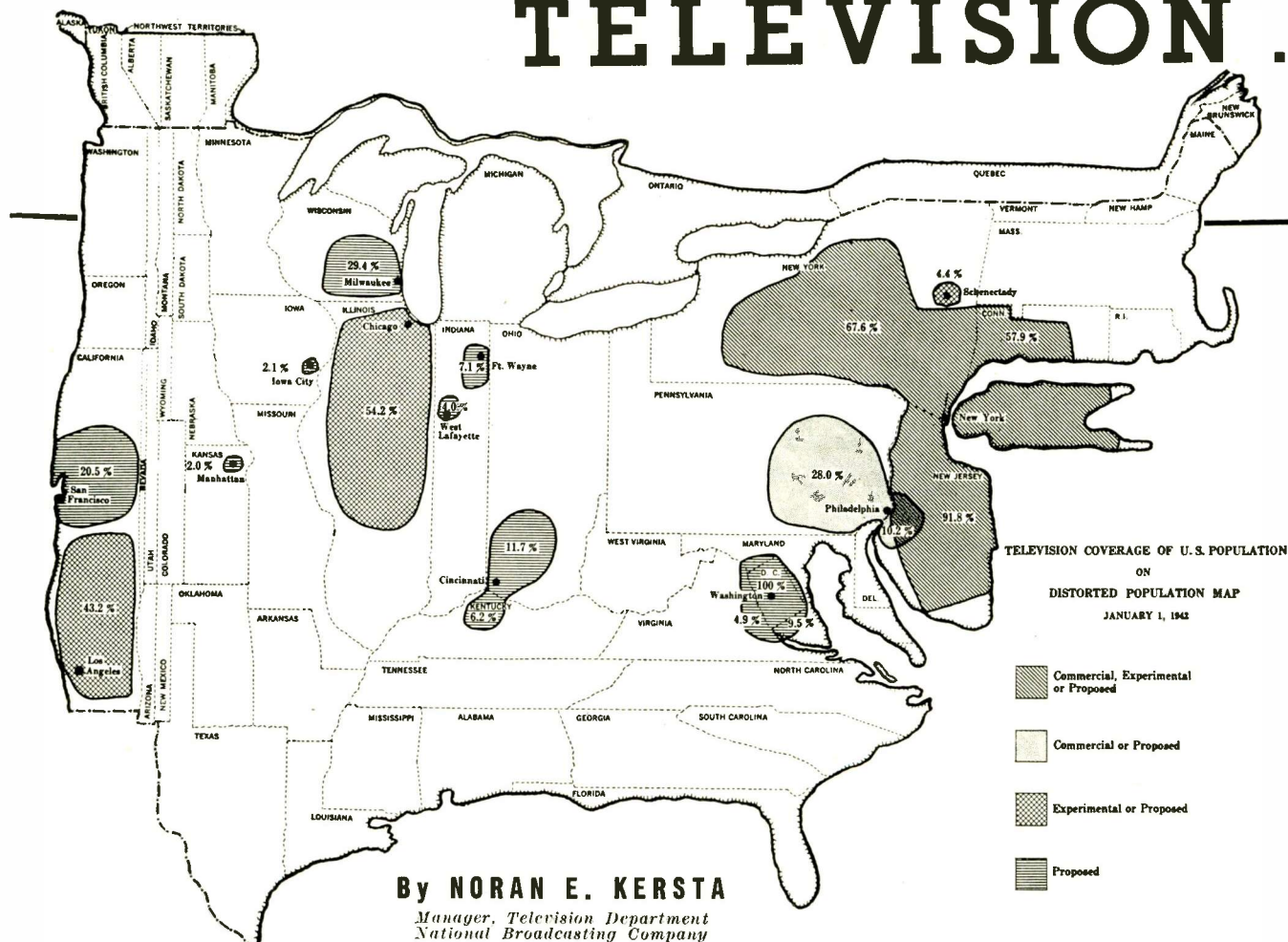

THE keynote of television today is the role it is playing in national defense. Television, the ultimate of all communication media, combines the virtues of sound radio and motion pictures and has additional advantages of its own.

In New York City it is now used as the chief method of training air raid wardens. At present the first group of 54,000 prospective wardens are obtaining their training in the five boroughs of New York City alone where receivers are installed in all police station classrooms. At the same time the 60-mile coverage of WNBT, the NBC television station, enables thousands of additional organized civilian defense groups to obtain uniform and authentic training. Through radio relays this official training program is rebroadcast in the Philadelphia area by Philco station WPTZ and in the Albany-Troy-Schenectady area by the G-E station WRGB.

On July 1, 1941, the FCC proclaimed that television had proven itself technically ready for commercial operation.

By commercial operation is meant the selling of "time on-the-air" as is done in sound broadcasting. Thus were ushered in new opportunities for the radio industry to serve the government and the public.

Television in National Defense

From the very beginning of NBC's experimentation with a public television program service right on through the beginning of commercialization and to the present date, constant attention has been paid to the role of television as a broadcasting service during the emergency.

Five years ago the first large scale special demonstration was made for Army and Navy officers during which various types of civilian instruction and defense measures were shown. Many other demonstrations followed. During the past months, more critical efforts and programs were devoted to the actual instruction of civilians in the use of gas masks, air raid warden instruction, and instruction in fire control. Many

appeals for the USO, Defense bond drive, Red Cross blood donors, and other worthy causes were likewise telecast.

On January 5, 1942, upon the request of the New York City Police Department, television was used to disseminate the first official OCD film to organized air raid warden groups throughout the five boroughs of the city. Television receivers, in radio dealers' stores, and in some homes, were used as meeting places for air raid wardens. From one to forty sets were located in most of the the one hundred-odd air raid zones in the five boroughs.

In addition to the film shown, a lieutenant from the Police Academy lectured for forty minutes with the use of additional film and actual air raid warden tools and demonstrations in the studio.

The reports turned in by police captains and air raid wardens ranked this type of instruction above all others received by them to date. It was brought out that television had the unique flexibility of reaching the

... An Agency for Preparedness

with a summary of six months of commercial operation

air raid wardens almost at the posts where they must be in case of air raid. Through the technique of television certain types of information can be relayed much more effectively than by the usual type of lecture and demonstration given on the spot.

Further, it is difficult to train a sufficient number of qualified instructors to do the job in such a large number of locations. There is always a best lecturer for any subject. It is this best lecturer that can authentically instruct all parties instantaneously and uniformly through television. Standardization of training is thus introduced into the defense plan and considerable economies are effected in the time of the government's instructors.

New York City police officials have expressed the conviction that without television the task of training the tens of thousands of air raid wardens would be most difficult and expensive.

In addition to instruction in the five boroughs this same lecture was transmitted to the entire 60-mile area around New York City where many police centers had been notified to look in. Beyond this 60-mile area, Poughkeepsie, Middletown, and Newburgh received the same instruction via television. By use of the G-E relay station in the Albany-Troy-Schenectady area, officials and air raid wardens in those cities were also in the class. In the Philadelphia and the Camden area, police, fire, and air raid warden officials were also present at their sets.

The telegrams and mail which followed this demonstration were very heartening. The comments demanded more of this type of effective and official instruction. Practically all of them stated this instruction surpassed any that had previously been given.

So successful and forceful were the results of this test that, through the New York City Police Department,

steps were taken to install television receivers in each of the police station classrooms in every air raid warden zone of the five boroughs. Through the cooperation of the DuMont Laboratories, the General Electric Company and the RCA Manufacturing Company a 100 percent coverage plan for the organized training of various civilian groups such as air raid wardens, Red Cross workers, et al, has been mapped out.

Following this preliminary test lecture an extensive lecture course was put into operation. It started with a series of thirty-minute periods of instruction given once a week for a month in the basic features of the city's defense plans. Although the course is intended primarily for air raid wardens and other defense workers, the general public is invited to look in. Representative queries, selected from thousands addressed to the Police Department, are answered.

The basic course comprised four successive Monday evening televi-

sion broadcasts. At the end of this period, more specialized instruction was undertaken for all groups embraced in the plan for protecting the city against enemy bomber action. Instruction is given six times daily, in the morning, the afternoon and the evening, three days a week. Attendance is accredited to each warden, and the credits are used in conjunction with the passing of an examination for final qualifications of an air raid warden.

The New York City television training setup can instruct 54,000 wardens in the group training schedule handling 18,000 a day, three days a week. Little investment in ef-

Network for training air raid wardens and others for the Office of Civilian Defense showing location in New York City of television receivers

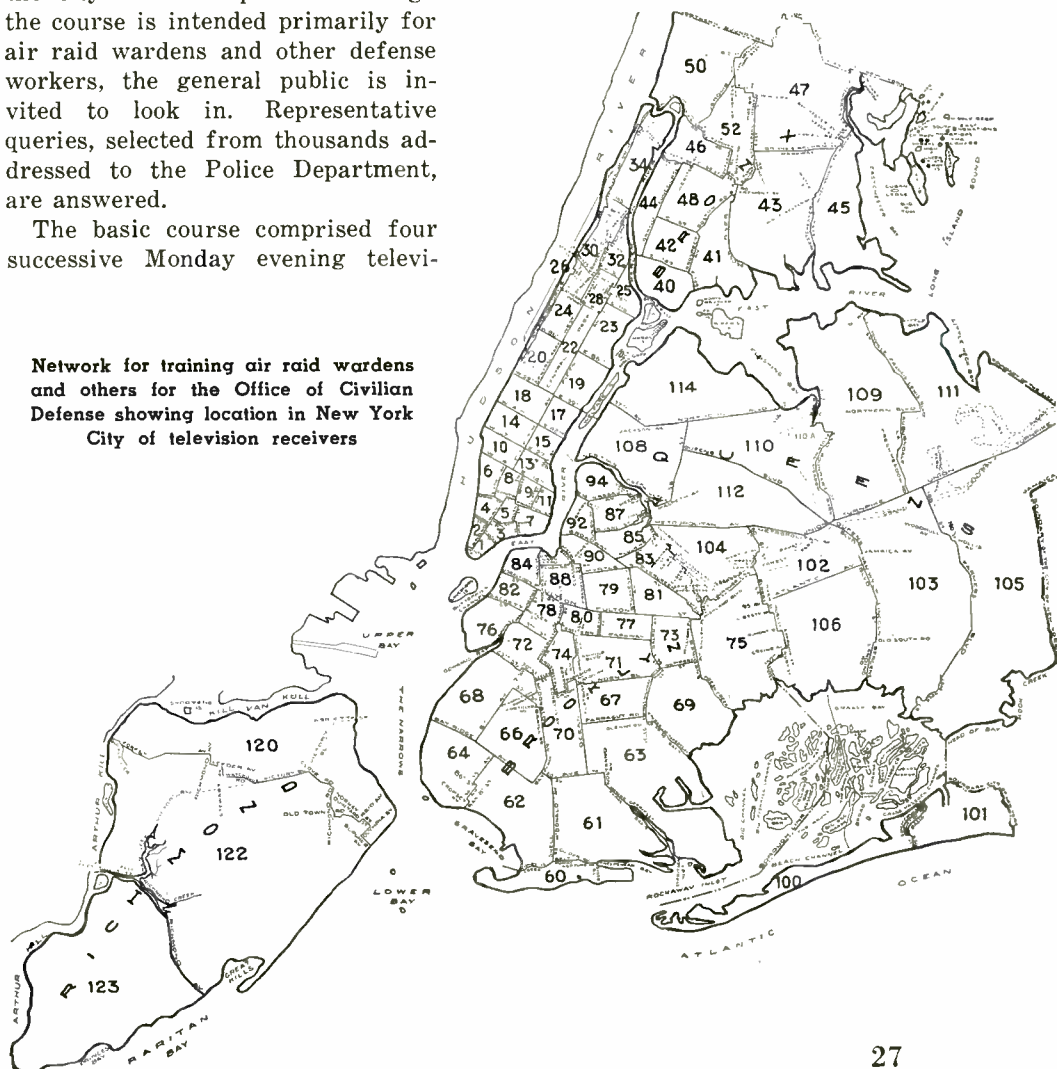

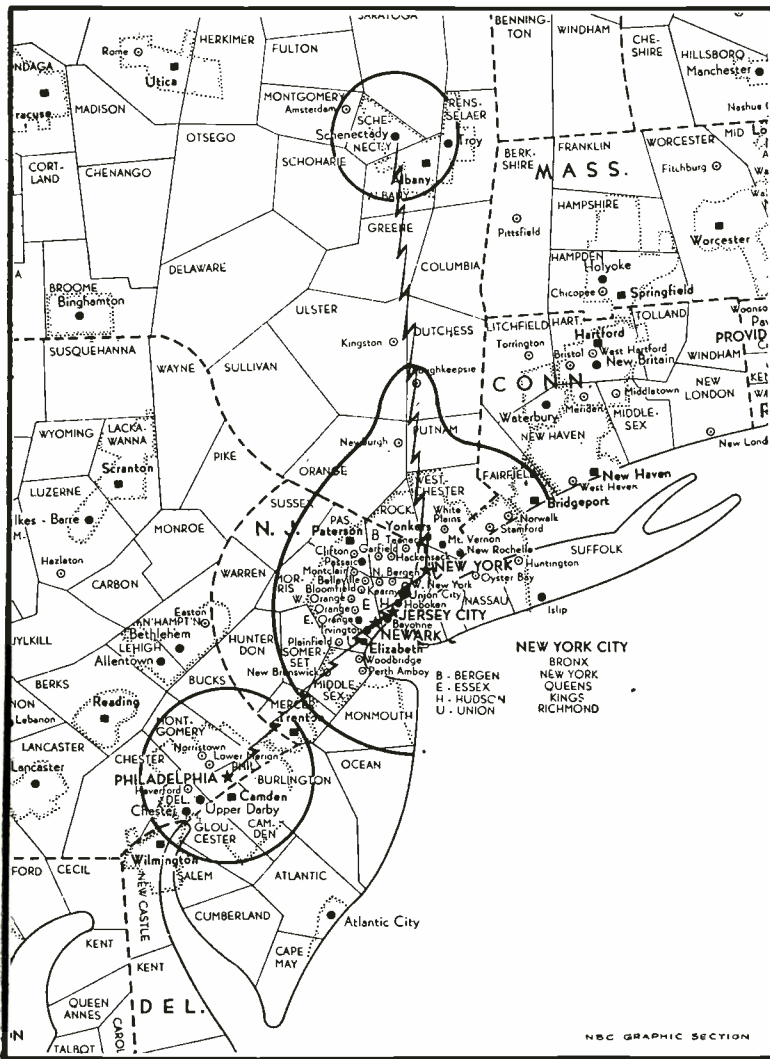

Relay set-up for transmitting programs to Philadelphia, 90 miles away, and to Schenectady-Albany-Troy area, 132 miles from New York City

fort and material can extend the network beyond Philadelphia to Washington where it can be linked to a television station in that city.

Through the cooperation of sound radio stations, air raid wardens can be assembled before their television viewing posts in a matter of minutes for the very latest information that the various intelligence departments of our armed forces are acquiring from day to day concerning enemy activities and methods.

In addition to this direct training work practically all of NBC's entertainment programs are dedicated to some department of the government, such as the Greater New York Office of Civilian Volunteers; the Red Cross, Army and Navy Recruiting and the Defense Bond Drive.

Television as a communication medium can surpass in speed, accuracy, and security any other com-

munication medium in existence today. For years complete pages of material and scenes sent by television have been photographed with simple equipment in fractions of a second. Using these extended television network facilities for an auxiliary communications link, with the extension of these network facilities to Washington, there should be no problem to duplicate for record all kinds of visual material between the east coast cities in fractions of a second with maximum security.

Six Months of Commercial Television

All of the time this defense work has been growing, television has been "commercial" and much has been learned in the first six months of commercial operation.

There are three main channels in which the commercial progress of television can be measured:

(1) The growth of broadcasting and receiving facilities.

(2) The service rendered to the public in the form of program entertainment, public service, and education.

(3) The headway made toward becoming a self-supporting industry.

Broadcasting Facilities

According to a report of November 19, 1941, there were two commercial television stations in the United States, plus six experimental stations transmitting some kind of program service.

The commercial stations were:

New York

WNBT National Broadcasting Company

Philadelphia

WPTZ Philco Radio & Television Corporation

The experimental stations were:

Chicago

WTZR Zenith Radio Corporation
W9XBK Balaban & Katz Corporation

Los Angeles

KTSL Don Lee Broadcasting

New York

WCBW Columbia Broadcasting System
W2XWV Allen B. Dumont Laboratories, Inc.

Schenectady

WRGB General Electric Company

In addition to these experimental and commercial stations actually transmitting programs, there were 22 stations in various stages of planning and construction in the following cities:

New York

W2XBB Bamberger Broadcasting Service, Inc.
W2XVT Allen B. Dumont Laboratories, Inc.
W2XMT Metropolitan Television, Inc.

Philadelphia

W3XAU WCAU Broadcasting Company
W3XPP National Broadcasting Company
W3XEP RCA Manufacturing Company, Camden, N. J.

Washington

W3XWT Allen B. Dumont Laboratories, Inc.
W3XNB National Broadcasting Company

Los Angeles

W6XHH Hughes Production, Division of Hughes Tool Company

W6XYZ Television Productions, Inc.
 W6XCB Columbia Broadcasting System
 KSEE Earl C. Anthony, Inc.

San Francisco

W6XDL Don Lee Broadcasting System
 W6XHT Hughes Productions, Division of Hughes Tool Company

Chicago

W9XCE Columbia Broadcasting System

Cincinnati

W8XCT Crosley Corporation

Schenectady

W3XD General Electric Company

Milwaukee

WMJT The Journal Company

West Lafayette, Ind.

W9XG Purdue University

Ft. Wayne, Ind.

W9XFT Farnsworth Television & Radio Corp.

Iowa City, Iowa

W9XUI State University of Iowa

Manhattan, Kans.

W9XAK Kansas State College of Agriculture and Applied Science

The accompanying map is population-distorted to show areas in the country now served with various types of service. The population coverage of each station is an estimate from the best information at hand

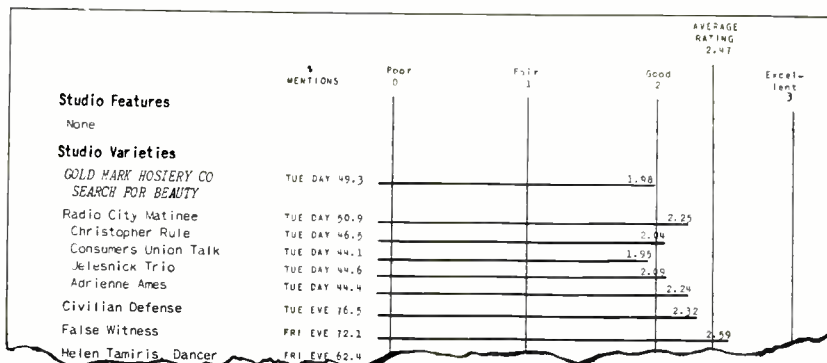

Typical report on audience ratings of WNBT television programs used by all television personnel as aid in improving program quality

put forward by the television broadcasters based on their observations and experience. Twelve and seventenths percent of the nation's population is within range of commercial service. An additional 6 percent is within range of experimental service. Thus, at the end of the year 1941, approximately 18.7 percent of the nation's population was within range of actual television program service. Another 3.6 percent was within range of authorized stations planning to go on the air. This means that within range of all stations actually programming and planning to program is 22.3 percent of the nation's population.

The first steps have been taken to

extend local broadcasts into a network service. From New York City the link branches by a radio path from the NBC-WNBT Empire State transmitter 129 miles to the G-E relay station atop Helderberg Mountain. From there the signal gets its one and only boost for three miles to the main WRGB transmitter for re-broadcast to the Albany-Troy-Schenectady area. This link to Albany underwent a series of tests last year, and arrangements to resume relay service were established in December, 1941.

To the South, there are two network links. One is the AT&T coaxial cable. The second is a radio relay link established by Philco. The coaxial cable got its first real program service test a year and a half ago during the Republican National Convention. At that time the entire convention proceedings were sent to New York through this cable for re-broadcast. It is of interest to note that during the broadcasts from June 24 to 28, 1940, three major markets were receiving the same television program simultaneously; Philadelphia, New York, and the Albany-Troy-Schenectady area.

Since October 15, 1941, Philco has been rebroadcasting a number of NBC's WNBT programs to the Philadelphia audience. This is done through the use of W3XP, a relay station at Wyndmoor, Pa., which is 82 miles from WNBT in New York, and 8 miles from WPTZ in North Philadelphia.

To study the technical progress of the Philadelphia link, two surveys have been conducted among approximately 300 receiver owners in the Philadelphia area. A chart shown

(Continued on page 116)

Relative proportions of time devoted to programs originating in studio and from film and mobile sources and broadcast over WNBT, July to December 1941

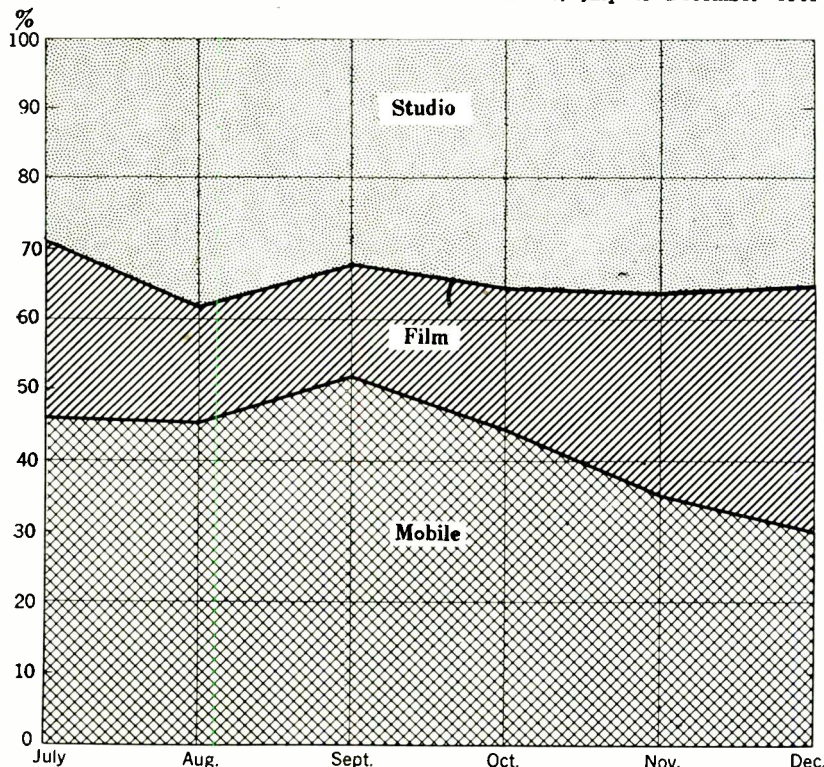
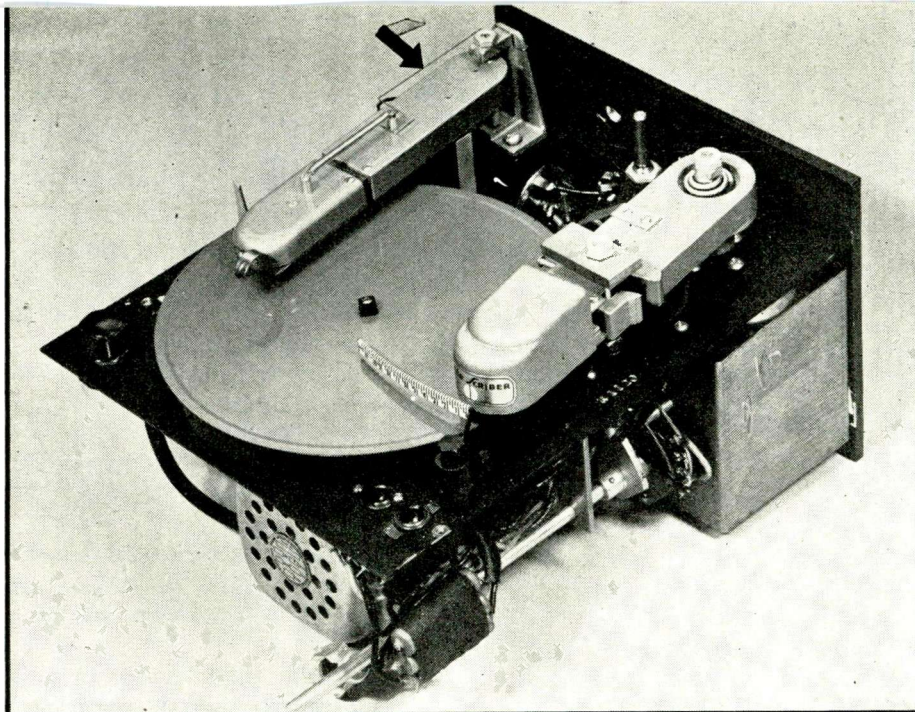

FIG. 1—The SoundScriber office recording machine showing the magnetic recording head at the right and the moving-coil reproducing head at the left. The arrow indicates the spring which neutralizes the tangential forces of the pickup arm



By LINCOLN THOMPSON

SoundScriber Corp., New Haven, Conn.

Embossed Groove Recording

Recording by the embossed groove method offers much in that the equipment requires little attention for reliable operation and that it uses inexpensive records which may be filed or mailed. It is particularly adaptable for office dictating machines and for recording radio programs and conversations

EMBOSSED groove recording as a method of impressing voice on discs is just now assuming a significant place in the industry. For certain purposes it has definite advantages over the more conventional cutting methods. For one thing, there is no chip to be removed and for another, a very thin disc may be used. Embossing is highly adaptable to use where the recording machine must operate either unattended or with a minimum of attention from an indifferent operator. Office dictating machines using embossed groove recording have been very successful where such recording is very important to the business at hand and therefore must be very reliable in operation. It is the purpose of this article to point out some of the problems to be solved in the design of a compact recording machine using the embossing method.

The cutting process requires a sharp edged tool, usually made from sapphire, while in the embossing process a diamond tool, in the shape

of a cone with its tip blunted to a small radius, is usually used. The cutting tool presents a keen, sharp edge to the side wall of the groove, and is usually mounted so as to engage the recording medium at a 90-degree angle. The embossing tool usually is used at an angle of 60 degrees to 75 degrees with the recording material and presents a broad round surface to the groove walls. The embossing tool does not remove any material from the record surface, but merely throws the material up in furrows on each side of the sound groove. The cutting tool removes a continuous chip from the recording surface. The keen edge of the cutting stylus does not give rise to nearly as high losses of high frequency registration as the relatively blunt edge. The difference is much like that between a broad and a narrow slit in photographic recording. Furthermore, the embossing stylus demands considerable power from the recording head mechanism in order to displace the material of the

sound grooves from side to side. This power requirement is much higher than in the cutting process.

However, the embossing process has great advantages in simplicity of operation and permits unattended recording except for record change. It eliminates the problems inherent in the disposal of a chip and a change of recording stylus. This is due to the fact that the stylus can be made of diamond because of its simple conical construction. Because there are no sharp edges to wear and because of the extreme hardness of the diamond, the embossing stylus is permanent. Also the embossing stylus indents its groove in the recording material by vertical pressures of the order of 4 to 10 ounces, and this eliminates the very accurate counter balancing which must be employed in the cutting process. The embossing stylus pressure is supported by a broad surface and is not critical. However, under comparative conditions, the embossing process has poorer fidelity due to inher-

ent loss of the higher frequencies and has less volume range because the amplitude of modulation for a given groove spacing is decreased by the ridges thrown up on the sides of the groove and the resultant loss of effective "land" between the grooves.

Application Requirements of Embossed Recording

It is obvious that many problems are to be found in embossed recording, particularly if the requirements of economical recording and long playing must be met at the same time. Since the major fields of embossed recording are those of office dictation, conference recording and communications recording, where recording costs must be kept low, these problems are still further magnified.

To keep the recording cost of a dictation system or reference recording system within the definite low limits

of a constant angular velocity recording is selected for the constant linear speed, there is no gain in playing time and the gain would be better quality on the inside of the record and poorer quality at the outside. If a lower standard than the average is used, gains of playing time can be realized but at the expense of mechanical complexity.

Although the fidelity does not need to be equal to high fidelity phonographic reproduction to meet dictation and many other needs, the better the fidelity, the more uses to which the machine can be put and the easier will be the transcription of the record by the typist due to increased intelligibility. The criteria of excellence of any recording process are always: 1. Frequency response. 2. Waveform distortion. 3. Volume range. 4. Extraneous noise. 5. Wows.

While frequency response can be reasonably limited, it is quite obvious that extension into the range of the S sounds and other consonant sounds is an important advantage to the typist in transcribing. Waveform distortion must be at a minimum or the result becomes very unpleasant to listen to for long periods of time. The volume range must be such as to permit the dictator (or any other source of recording signal) to have reasonable flexibility and still produce recordings which, on the one hand, are not overloaded and on the other hand are relatively free from scratch or surface noise. The extraneous noises present are those of surface noise (mostly in the high frequency band), motor rumble and other forms of extraneous vibration or modulation. While it is generally considered that speed variations are not very important in speech, it is

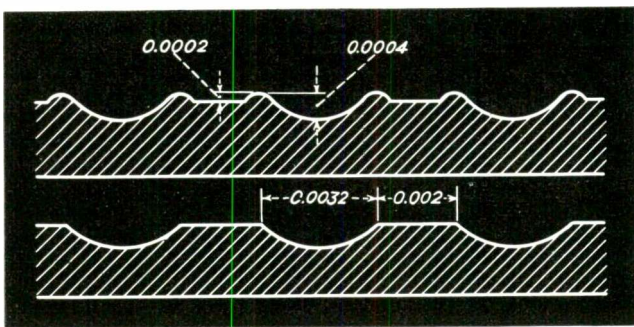

FIG. 2—Embossed groove (top) and cut groove (bottom) showing how the record material is pushed aside in embossing and removed in cutting

required, a combination of several factors must be employed if the record is to be discarded or filed after use. First, the playing time must be relatively long in order that the consumption of material per unit of time can be kept low. Second, the recording disc must be thin so as not to contain an excessive amount of material. To get long playing time, the groove speed must be kept low and the groove spacing must be decreased. The SoundScriber recorder utilizes 7-inch discs operating at a constant angular speed of 32 rpm with a little over 200 grooves per inch, giving 15 minutes of playing time on each side of the disc. The disc is of plastic 0.010 inch thick. The use of constant linear velocity gains little for small diameter records and introduces mechanical complexity and difficulties due to the need for constant smooth change of angular speed for varying diameters in recording. If the average quality

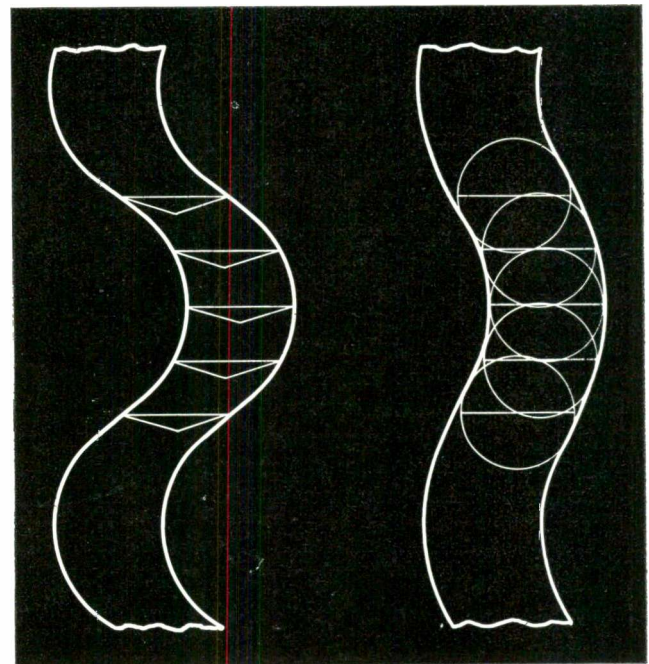

FIG. 3—Top view of embossed (right) and cut (left) grooves showing the pinch effect when a keen shallow stylus is used for cutting the groove

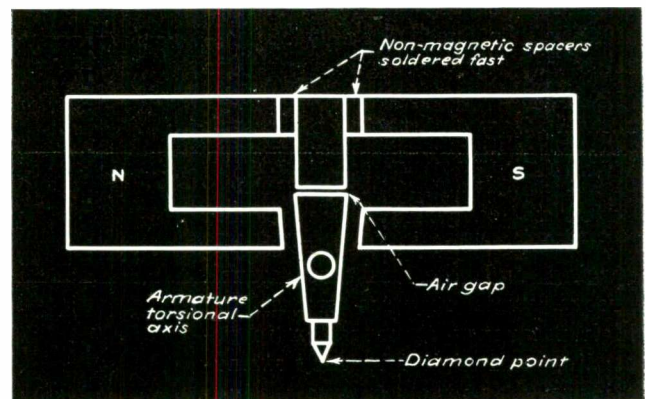

FIG. 4—Cross-section of the magnetic cutting head. Only the lower portion of the armature moves to provide a very low inertia vibrating element

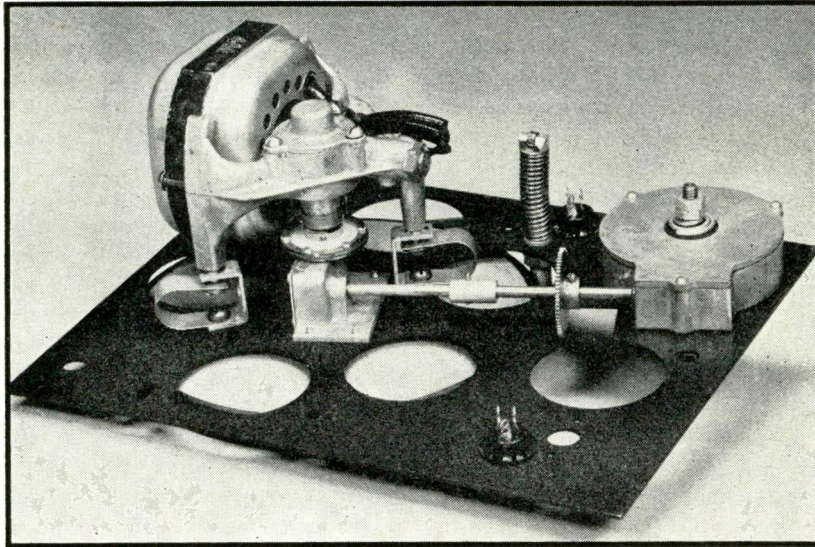

FIG. 5—Bottom of the chassis with the bottom side up. Note the motor mounting and the cutting-head arm drive shaft. Accurately spaced grooves are produced 200 to the inch

undoubtedly a fact that in transcribing over long periods, the speed variations do produce some loss in intelligibility. Furthermore, freedom from wows makes recording equipment of this type usable for many purposes other than those concerning ordinary speech.

To use a thin disc, it is essential that the disc should remain reasonably flat even after recording. The blank disc must be flat enough to provide recording without scraping on parts of the mechanism. The method of embossing the groove by using a hard surface under the disc provides an important step in reducing the tendency to warp after recording on one side. The disc material has to be thick enough to handle without tearing when transferred from the recorder to the transcriber and after any normal number of changes.

Overcoming High Frequency Losses

To get satisfactory quality, accentuation of the high frequencies must be introduced not only to overcome losses caused by slow groove speed, but also to compensate the normal losses due to the embossing process. A still further accentuation of the high frequency range must be added to compensate the limited volume range due to the close groove spacing and the embossed sound groove. This requires tremendous high frequency accentuation in recording, and high frequency attenuation in the reproduction to produce

an overall result which has reasonably good response and reasonably low level of surface noise.

An important fact in this tremendous accentuation of the higher frequencies is that the embossed sound groove is produced by a round-ended tool and therefore does not give rise to the "pinch" effect produced by the cutting stylus when steep amplitudes are produced as shown in Fig. 3. This permits a far greater high frequency accentuation than is practical with the cutting process and is a very important factor in embossed groove recording. By keeping this high frequency accentuation to a maximum, surface noise can be kept down by reproducing with attenuated high frequencies and a reasonable volume range can be produced, particularly if the motor rumble and other extraneous noises are kept low.

However, to reproduce with a decided accentuation of the lower frequencies, motor rumble and other vibrations must be kept at extremely low levels since their disturbances are in the low frequency range. Since the recording speed is to be low, spe-

cial attention must be given to all factors which would cause wows.

The high frequency accentuation is attained in the inverse feedback loop of the amplifier. Feedback provides definite advantages in recording because of the wide variations in recording head impedance with frequency. A recording accentuation of 18 db at 4,000 cps over that of 400 cps is used in a small amplifier with an output of about three watts. Severe overloading of the amplifier at high frequencies on mixed frequency signals demands that the power sensitivity of the recording head produce adequate modulation with low power.

Recording Head

The recording head requirement is an extremely severe one since it must respond to this accentuated high frequency response and generate the necessary power at the recording stylus point to produce this high modulation at high frequencies. The type of recording head used is a magnetic head and its construction is shown in Fig. 4. It will be noted that there is an air gap in the armature which permits the movement of only the lower portion of the armature, thus providing an extremely low inertia vibrating element. Naturally, the air gap introduces a loss in sensitivity which must be kept at a minimum by making this space extremely small. That is compensated by the fact that a large coil can be used plus the fact that the magnetic structure can be large in cross section. This large cross section structure means that a minimum of magnetic saturation will result and it permits high sensitivity by large area air gaps with low inertia moving elements.

The cutting head armature vibrates about its torsional axis which is very stiff. This produces a high natural period and permits a response with a rising characteristic

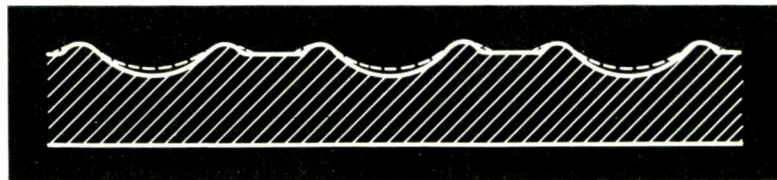

FIG. 6—Comparison of embossed grooves in aluminum and plastic records. The dotted line indicates the groove in the plastic made under identical conditions as the aluminum groove

to 4,000 cps. This stiff structure gives excellent mechanical strength and complete freedom from any adjustment during life of the machine.

Pickup Characteristics

To play these very shallow sound tracks with proper tracking and without excessive wear, a moving coil pickup is employed. A very light coil is mounted on a Lucite frame mounted in Neoprene and moving in very heavy oil. This results in a very flexible pickup mounting with extremely low inertia and extremely low wear on records together with excellent tracking even at pressure considerably less than one ounce. These low pressures permit the user to skid the reproducing stylus across the record grooves without damage and to conveniently position the pickup.

The pickup head is on the end of a short arm on a hinge to provide a low inertia mounting to give rapid "following" of the pickup with vertical eccentricities of the record or turntable. This is important if good tracking is to be obtained.

Motor Mounting and Vibration Filtering

The motor is supported on springs and its shaft drives the turntable spindle through a flexible membrane coupling. By means of this structure the motor is supported very flexibly to the chassis and direct vibrations through the springs are eliminated. The fabric coupling gives high stiffness in the rotational direction with a very slight viscous-like yielding, but allows flexibility in the vertical direction. Thus, vibration from the motor shaft is eliminated. The turntable weighs four pounds and even though it is only seven inches in diameter, it gives effective stability and freedom from wows by virtue of its inertia and the filtering action of the coupling. On the top of this turntable is a cork ring supporting a thin Bakelite shell which provides the hard recording surface. This cork ring provides additional vibration filtering. This construction also permits the transcriber to start and stop transcription instantaneously by merely stopping the light outside shell with a magnetic brake independent of the continuous rotation of the inside turntable.

Since the spacing of the grooves

on the disc is 200 per inch, it is essential that extreme accuracy of spacing be maintained or the volume range will be limited to the minimum land between tracks. Assuming a ratio of land between grooves to the groove width of 1 to 2, the land is only 0.0017 inch. The order of accuracy is very high and an error of 0.001 inch would consume 60 percent of the land. Compactness and the limited weight of the device necessitate that this precision be produced with a simple compact construction. The feed mechanism employs a worm gear in contact with a worm on the center spindle which drives a shaft connected to the worm of a gear box at the axis of the cutting arm. The feature largely responsible for the precision groove spacing is a powerful friction termination against the final gear in the train which takes up all backlash by exerting a constant load on the gear train. In addition to this three teeth of the worm gear are always engaged by the worm, thus integrating out any possible errors in any one of these teeth.

Aluminum and Plastics Compared as Recording Media

The recording medium first used, was aluminum of a special finish and 0.006 inch thick. This provided an excellent embossing medium although the inherent ground noise of the aluminum was fairly high. However, by high frequency accentuation in recording and attenuation in reproducing, reasonably low level surface noise conditions were produced. Due to the defense program, however, it was essential that a change be made to another material. Various plastics were experimented with and new problems presented themselves. Some very interesting factors were found, among them the fact that many of the plastics had the property of springing back after the sound groove was formed. Figure 6 shows the sound groove tracing of the cross section of a groove produced on aluminum and, with a dotted line, the groove produced on one of the best plastics with an identical stylus and identical conditions. It will be noted that the plastic groove, even though produced under identical conditions, has

sprung back and gives a groove which is shallower than aluminum even though it has the same groove width. This factor produces a loss in quality because the higher frequencies of the recording also spring back and the quality suffers. With many of the plastic materials, this springing back goes on over a period of time and the record gradually loses its recording level. With some vinyls and styrenes this springing back is small and does not continue with age. Records of these materials seem to have good life. Furthermore, some other plastic materials give rise to definite high frequency losses due to the very softness of the groove walls and the inability to properly drive the reproducing stylus. It is a strange fact that the materials which when shaken give a metallic-like ring are the best materials. This

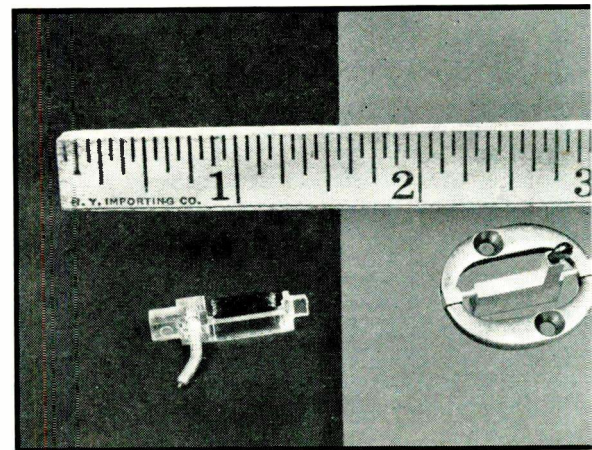
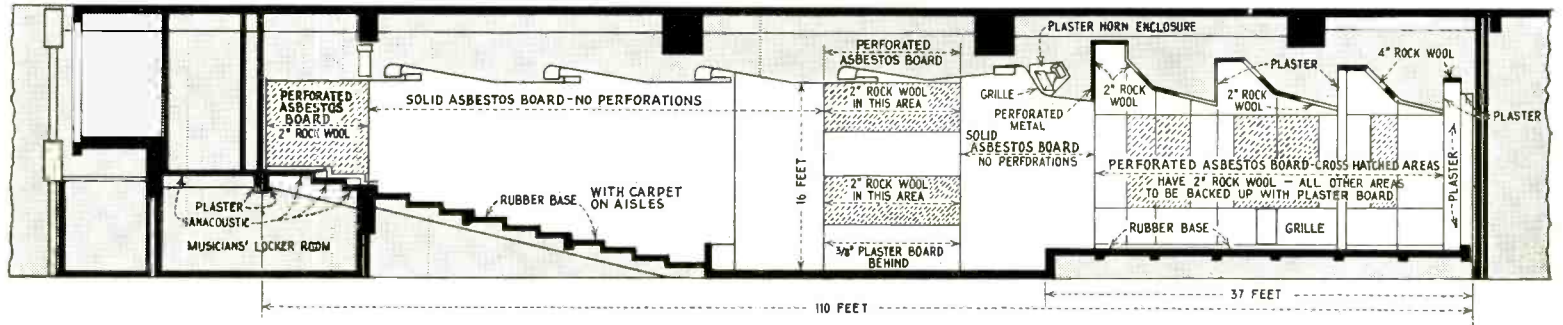

FIG. 7—Pickup unit and coil mounted in a Lucite frame (left) and the cutting head armature (right) mounted in a non-magnetic frame

ring indicates a rigidity of the material which will give a sound groove wall of high stiffness and strength.

To produce satisfactory tracking, it is essential that the disc be reasonably flat both before and after recording. Even though means can be used to hold it flat while reproducing, this means cannot press hard enough to iron out small abrupt irregularities in the material without harm to the record. These irregularities give rise to distortion and groove jumping, particularly if the plastic material is one which dries out and stiffens in time. Therefore, it is important that the plastic be of a material such as the vinyls or styrenes, (Continued on page 76)

Advances in Acoustical



Cross-section of the new studio showing the method of applying acoustical materials to the walls and ceiling as well as the

arrangement of the stage and the audience seats on the level and sloped portions of the floor as is customary in theaters

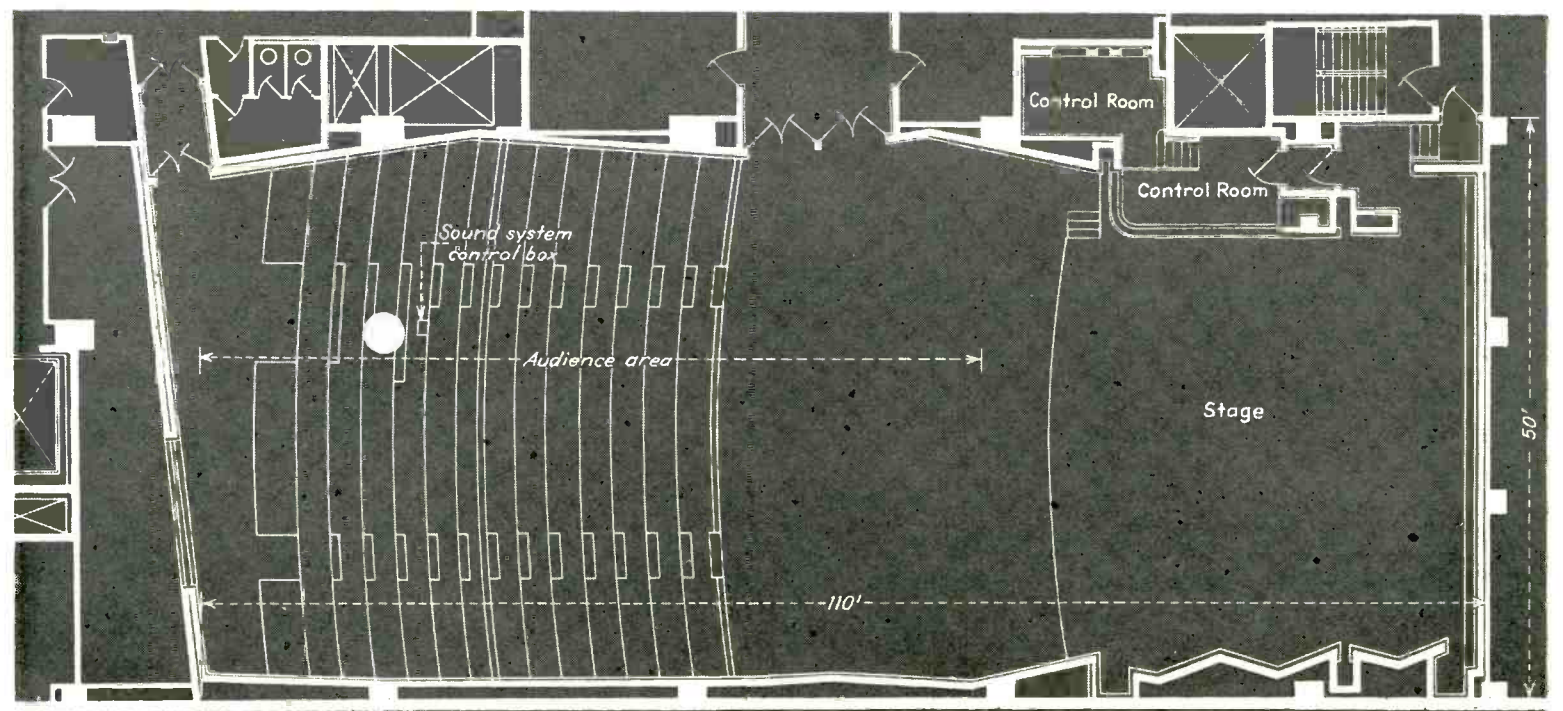

(Below) A corner of the stage showing details of the perforated asbestos board and the hard, rounded surface at the rear of the stage used to disperse the sound waves rather than to absorb them or to reflect them to some point in the studio space where they might upset the acoustic balance or be otherwise annoying

(Above) Floor plan showing the non-parallelism of the walls. A sound reinforcing system is used to permit the studio audience to hear the program just as it is broadcast. A control box for the sound reinforcing system is located in the audience area to provide the best possible listening conditions for the studio audience



The newly built NBC studios described on these pages embody ideas which are considered the most desirable by acoustical engineers on the basis of experience with older studios. A sound dispersing wall on the rear of the stage is one of the significant improvements

Treatment at New NBC Studios

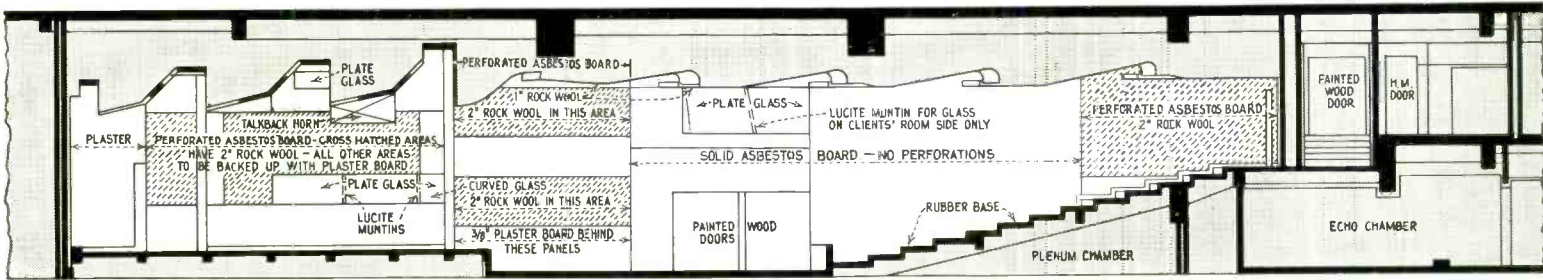

The two side walls are treated in slightly different manners. No two walls are parallel to each other and various areas are treated

differently to prevent the formation of standing waves in any portion of the studio. The seating capacity is 450 persons

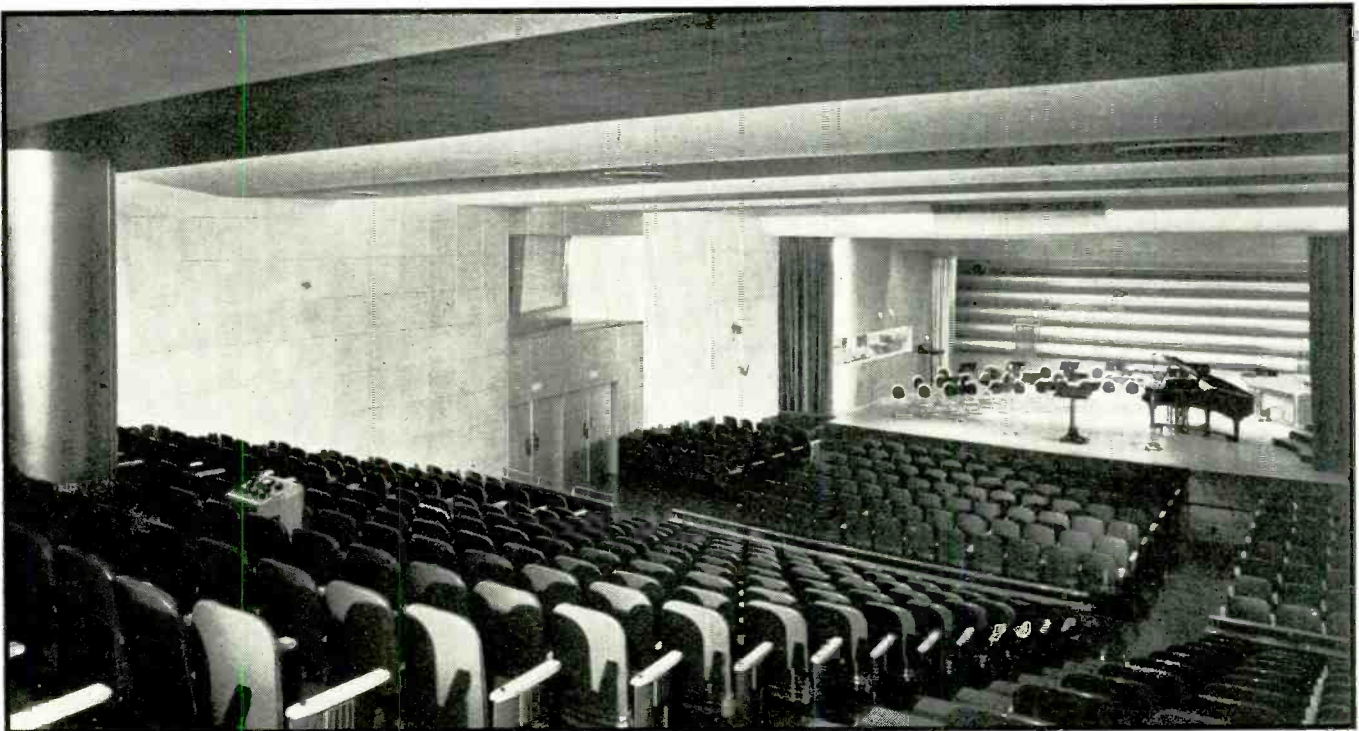

(Above) An overall view of one of the two new studios showing the sound dispersal wall at the rear of the stage and the seating arrangements. Seats of sound absorbent material are used to reduce as much as possible the differences in sound characteristics with the studio empty or with an audience present for a broadcast

Drapes are used to change the effect of the sound dispersal wall as may be desired by the program director. The window of the control room has a curved and sloping surface to avoid disturbing light and sound reflections and to give the control operator full visibility of the studio

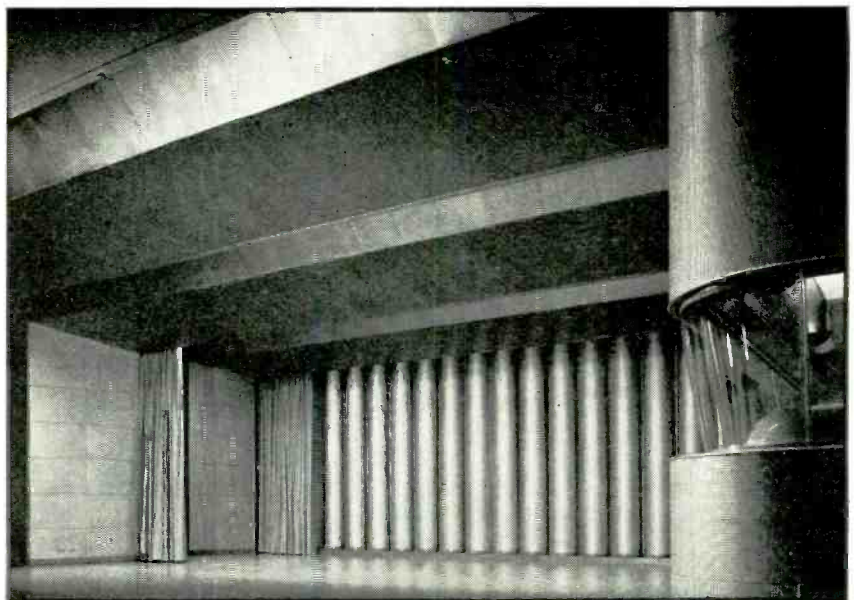

Engineers Train For Victory

ESMDT courses in electronics, radio communication, and ultrahigh-frequency technique are important factors in the training of engineers to assume greater responsibilities in design, production and use of electronic equipment for war purposes. National Association of Broadcasters advocates the training of thousands of radio technicians

By **BEVERLY DUDLEY** *Acting Managing Editor, Electronics*

VICTORY and vacillation are not companionable, and with country at war, vacillation should be an outmoded word. But science and victory are closely linked to each other, for in modern times science is forced to become the torchbearer for victory.

When Congress established the Engineering, Science, and Management Defense Training (ESMDT) courses* of collegiate calibre and provided the necessary appropriations for their proper execution, every intelligent man and woman with foresight welcomed the opportunity thus provided to become better trained and more effective in this nation's war effort. The need for

technical personnel, adequately qualified to carry out the necessary manufacturing and operating functions of our highly mechanized armed services and civilian needs had been realized. It is even more thoroughly realized since Pearl Harbor and Singapore have become the focus of world attention. The various courses of instruction, originally established as a defense measure as the name indicates, now take on new meaning. The administration of these courses, which is lodged with John W. Studebaker, U. S. Commissioner of Education, and assisted by Dean R. A. Seaton as Director of the ESMDT program, assumes increased importance as a result of the entry of the

United States into the war. It is realized that training technically qualified personnel to provide material assistance in equipping the armed forces with tanks, planes, direction finders, radio communication apparatus, and similar equipment is but a part of the job to be performed. At the same time large numbers of men will be needed to service this apparatus so that it is in good working condition at all times.

With a change in industrial activity from civilian to war production, existing technical personnel has been severely overworked, and it is urgent that this important group be amply augmented if we are to avoid the bottlenecks in the production of war items "on order." Equipment on order becomes effective only when it is available in sufficient amounts at the proper time and place, and when it is properly operated by skilled personnel. It can be produced only when there are adequate production facilities and manpower of sufficient capability to see the job through, from the original conception to the delivery of the finished product. Its satisfactory operation at the proper location is equally important. Since the supply of personnel trained in the usual manner would be totally inadequate for the purpose, new means must be provided for readjusting our available manpower to make it most effective. This is the function of the ESMDT courses, the primary purpose of which is to offer short, intensive training courses to meet shortages of engineers, chemists, and production

HIGHLIGHTS IN TECHNICAL DEFENSE TRAINING

The first program of Engineering Defense Training was authorized by Congress on October 9, 1940, and the first class was organized on December 9, 1940. Under this first program, the enrollment in electrical engineering subjects was

COMMUNICATIONS COURSES 2,018 students
ELECTRONICS COURSES 1,158 students

The second program, establishing the Engineering, Science, and Management Defense Training courses, was authorized on July 1, 1941, and is still in operation. Under this program, 29 colleges and universities are offering training in physics and electricity, 39 in electrical engineering subjects, 27 in tubes and electronics, 37 in ultra-high-frequency technique, and 58 institutions offer college courses in electrical communication including radio. These figures do not include data for the radio operator's courses sponsored by the N. A. B.

As of the first of this year, enrollment in electrical engineering and related courses was as follows

SUBJECT	ACTUAL ENROLLMENT		TOTAL
	REPORTED	ADDITIONALLY AUTHORIZED	
Electrical Engineering and Communications	3,178	19,092	22,270
Electronics	1,078	2,761	3,839
Physics, Electricity, and Magnetism	262	979	1,241

* Originally these were known as the Engineering Defense Training Courses.

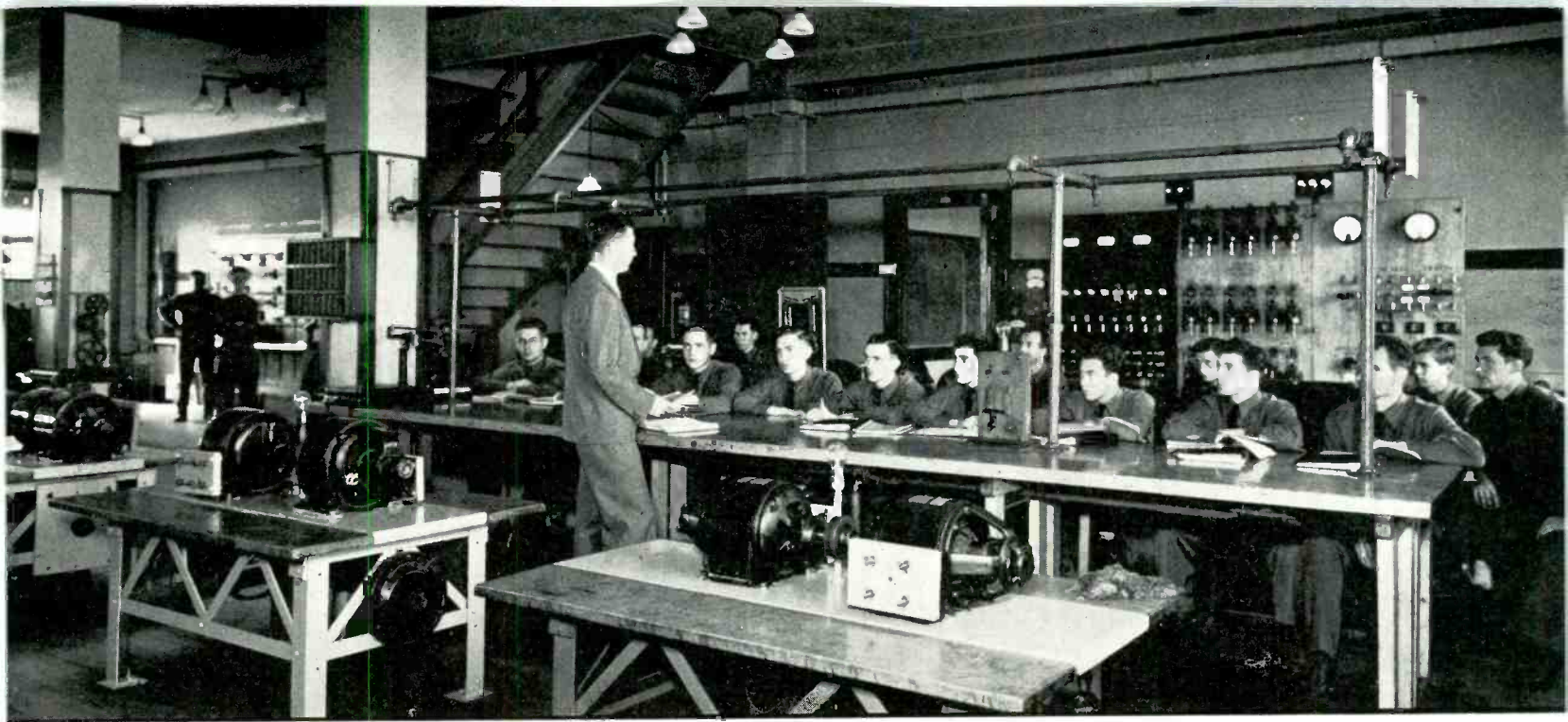

Technical training is of utmost importance in the successful conduct training engineers to take on increased responsibilities under the of modern warfare. Courses in colleges throughout the country are program of Engineering, Science, and Management Defense Training.

supervisors for the design, manufacture, inspection, and maintenance of those mechanized devices required for the proper conduct of our war effort and the safeguarding of our home front.

For more than a year, ESMDT courses in general engineering and production management have been in operation in various educational centers throughout the country. Of late there has been a noted change in emphasis on subject matter which the ESMDT program has made available to students. By the Fall of 1941 it was evident that the need for men who were familiar with the fundamentals of electronics and radio communication systems would be far in excess of those currently available under normal conditions. Events at Pearl Harbor spurred on the realization that all the engineers which the radio industry could produce would not be sufficient to meet the demands of our war industry. The Army alone estimates that it requires 6,000 officers and 100,000 men with radio training to carry out its program effectively, but there are not more than 20,000 radio and electronics engineers in the country to serve as a nucleus. As a result of this need for a vast army of radio and electronic technicians, the Office of Education encouraged the establishment of courses in electronics, radio communication, and ultra-high-frequency techniques in qualified colleges and universities. These courses

are now being given in those institutions listed in the accompanying table; other courses, primarily for technicians and maintenance men rather than for engineers are now being organized and are getting under way.

Organization of ESMDT Courses

Rapid progress has been made in radio instruction under the ESMDT program. Existing educational facilities in each locality are employed to the fullest in meeting the industrial and technical needs of the community. Under such a program of operation, qualified institutions (and this means in practically all cases, institutions of college level awarding degrees in engineering or science at the end of a four year period of study) may undertake a program of defense training. To expedite defense training and still retain the flexibility required in adapting existing facilities to the needs of the community, each institution undertaking ESMDT instruction must determine the technical educational needs of its community or industrial area. It must then determine whether it has the personnel, equipment, and other facilities for initiating and maintaining a course of instruction which will meet local requirements. If the decision is in the affirmative, the institution may submit an outline of intended instruction to the Office of Education or one of its regional advisors. Upon

approval by the Office of Education, the institution may begin its course of instruction and may obtain funds for salaries of teaching or administrative personnel. It may, in some cases, obtain appropriations for laboratory instruments or other equipment if the college can demonstrate a need for, and proper use of, such equipment.

The institutions operating under the ESMDT program are responsible for the quality of instruction offered, and for selecting the most suitable and best qualified personnel for defense training instruction. In many cases the response to ESMDT instruction is greater than the institution can handle efficiently, and in such cases the institution may either limit enrollment to the best qualified students or it may sponsor and direct additional courses of instruction in institutions which would not otherwise qualify for ESMDT courses. Upon satisfactory completion of these defense training courses, the student is awarded a certificate of proficiency, which may be used in industry or in the armed services, as proof of proficiency in the selected subject. The ESMDT defense courses do not, ordinarily carry college credit, and certificates are no guarantee that satisfactory employment in the particular field in which the course was given will come to the student. Many students completing such courses of instruction are expected to obtain useful employment

in defense industries or to be available for research and engineering work which is going on under the direction of the N.D.R.C. and similar agencies. But in highly industrialized areas, such as those around Boston, New York, and Philadelphia, many of the students may already be employed in vital defense work, and are taking these courses to fit themselves for more highly specialized or more responsible positions. Indeed, in such communities, those taking such courses may be authorities in their own name in certain phases of the subject of instruction.

Under such a system of operation, it might be expected that there is considerable deviation between the approximately equivalent instruction offered by institutions in various parts of the country. While this is true, to a large extent, the outline of courses already submitted to the Office of Education appears to indicate that these are well planned for the needs of the community which the institution serves.

So far as instruction in electronics, radio communication, and ultrahigh-frequency techniques is concerned, indications are that the deviations in subject matter and methods of treatment are less than one might expect when several scores of institutions are giving these subjects throughout the country. A considerable impetus to a unified treatment of ultrahigh-frequency technique, for example, was given last October and November when the Massachusetts Institute of Technology established a three-week, full-time training course for qualified representatives of colleges undertaking ESMDT instruction.

M.I.T. Offers Courses for Instructors

Under the direction of Dr. W. L. Barrow, a group of professors and instructors were given an intensive course in the theory and technique of ultrahigh-frequency communication, could be adapted to the needs outlined which, with minor modification could be adapted to the needs of the institutions sending representatives. M.I.T. assisted in expediting delivery of laboratory equipment to the institutions represented at the conference and conducting u-h-f courses, through consolidation of purchases of the various indi-

vidual institutions.

The courses based upon the instructors' course given at M.I.T. covered such subjects as the following: (1) Generation of u-h-f waves and an examination of the operation of triodes, magnetrons, and velocity modulated tubes, (2) transmission of u-h-f waves, based on Maxwell's equations and with emphasis on conventional transmission lines, waveguiding pipe lines, closed cavity resonators, and line transformers and impedance matching devices, (3) radiation of u-h-f waves with particular emphasis on directional radiation systems employing antenna arrays, electromagnetic horns, and parabolic reflectors, (4) propagation through free space at different regions of the ultrahigh-frequency spectrum, (5) the detection of u-h-f waves through the use of crystal detectors, diodes, triodes, and similar electronic devices, and a discussion of intermediate frequency and ultrahigh-frequency circuits and amplifiers, and (6) measurements of impedance, voltage, power, and similar quantities at ultrahigh-frequencies, primarily through the use of transmission line principles, with particular emphasis on various types of measurements with cathode ray oscilloscopes.

Courses in U-H-F Technique

Courses of instruction of the ultrahigh-frequency techniques have, accordingly, been recently established in forty institutions of college grade throughout the country and are in progress at the present time. The course in ultrahigh-frequency technique is considered of sufficient importance that a number of institutions are making such courses available to senior and graduate students either as an elective course or as a substitution for courses normally otherwise required. In some cases under the appropriate circumstances these courses may be accepted for college credit although in general this is contrary to ESMDT practice. Those taking the u-h-f courses are either senior students in electrical communication physics courses, or may be practicing engineers already in industry, the majority of whom have degrees or the equivalent training and professional experience.

However, not all of the ESMDT

courses are devoted to ultrahigh-frequency technique. A considerable number are being devoted to courses in industrial physics, in electricity, in various phases of electrical engineering, especially with emphasis on the need in the aircraft and ship-building industry. Finally, there is a considerable and growing interest in instruction in radio communication for groups of practically all educational levels. As a part of the ESMDT courses initiated by the individual colleges serving their own communities, the courses in radio communication are similar to those normally offered by these colleges and forming a part of their curriculum in electrical engineering. The primary purpose of such courses is to train engineers and technicians who will be engaged, primarily in the engineering and manufacturing aspects of the production of communication equipment.

NAB Sponsors Courses for Operators

A still further type of course has recently been inaugurated and is being promoted by the National Association of Broadcasters, although these like the other ESMDT courses, are subject to the approval of the Office of Education and are paid for by Congressional appropriations administered by the Office of Education.

The purpose of the courses of instruction for which the National Association of Broadcasters is interested, is primarily to train operators and service technicians who will be in charge of the operations and maintenance of detecting and locating equipment or other communication equipment employed either in the armed services or for civilian needs. Through the many broadcasting stations throughout the country, the National Association of Broadcasters has made it possible to give wide publicity to the availability of these courses as they are established in various educational institutions throughout the country. Furthermore, for some of the laboratory work which may be required in these courses, it is expected that the local broadcasting stations may be able to make valuable contributions of their own test and measurement equipment through the dura-

(Continued on page 103)

Automatic Monitoring Circuit

By FRANK MARX

Knickerbocker Broadcasting Co.

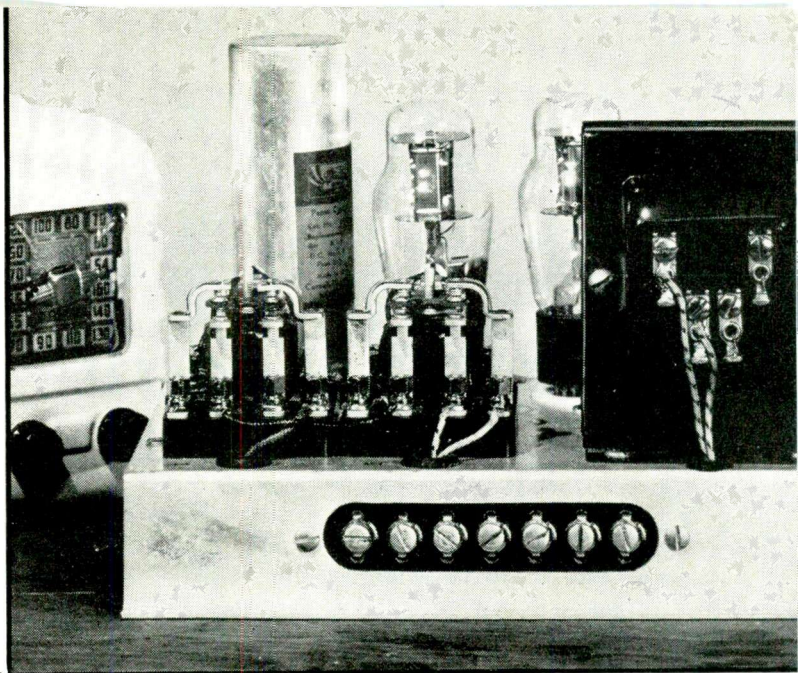

The automatic monitor is contained on the small chassis shown here and may be attached to any set

An electronic device to relieve broadcast station operators of the strain of monitoring another station's programs to intercept air raid warnings. The circuit is very simple and can be applied to many other uses

WAR time conditions have imposed an extra duty upon broadcast station operators in that they must monitor, in addition to their own programs, the programs of another station which is designated by the Interceptor Command of the Army as the key station in its area to inform all other stations within that area of an enemy air raid alarm. When the alarm is given all stations must go off the air and it is therefore of extreme importance that the key station be monitored for the warning signal. Monitoring of two programs simultaneously has a fatiguing effect on the operator and the quality of his own station may suffer because of lack of attention. Therefore it is desirable to provide an automatic means of monitoring the key station which would indicate in no uncertain terms when the air raid warning is broadcast by the key station. The standard warning is a 1000-cps note modulating the carrier at 100 percent for a period of 30 seconds. An automatic monitoring device was developed to meet these conditions with the standard warning signal. In addition it can be adjusted to operate on signals of other frequencies for other purposes, or with multiple units to operate on any one of several signals modulating the same carrier.

Any type of receiver with automatic volume control will operate the device. The system consists essentially of two electronic controls, one operating from the a-v-c voltage developed in the receiver, and the other from the audio voltage developed when a single tone of predetermined frequency is transmitted.

The a-v-c voltage of the receiver is fed to the grid of the "receiver

failure" control tube. This voltage is used to bias the tube to plate current cutoff. Any break in this voltage will cause the tube to draw current, and to close a relay to control any external circuit or operate an alarm. The recommended tube for this use is a grid controlled gas tetrode similar to the type 2050. Because of the control feature of the shield grid, the tube will operate with variations in the control grid potential. This portion of the device gives complete protection against transmitter failure, receiver tube failure,
(Continued on page 96)

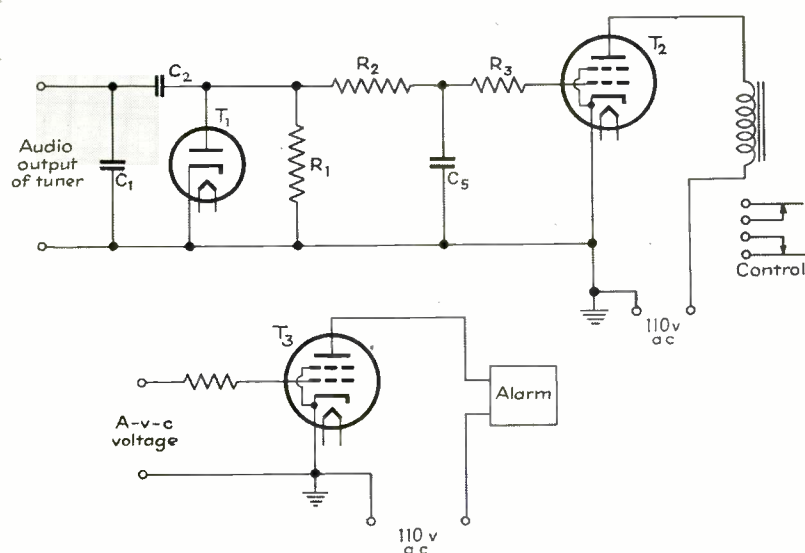

Circuit diagram of the automatic monitor. The upper portion indicates the presence of the standard 1000-cps warning signal and the relay increases the gain of the monitor amplifier so that instructions may be heard. The lower portion is the "dead man control" which gives an alarm when the carrier of the key station goes off the air or if any of the monitoring equipment fails

A Modern 10-kw Frequency-Modulation

INTEREST in f-m transmitting equipment is evidenced by the great number of applications for construction permits on file at the office of the FCC. This article will describe a ten-kilowatt transmitter capable of less than 1½ percent overall distortion between 30 and 15,000 cycles at 100 kc deviation, installed at W69PH (WCAU) Philadelphia.

The 10-kw amplifier employs a pair of 889-R tubes and is excited by the well-known FM-1B 1-kw unit¹ several of which are in operation in the United States. Exhaustive tests on this 10-kw transmitter have shown that it more than meets the FCC requirements. Realizing the high fidelity possibilities of frequency modulation transmission, the measured distortion between 30 and 15,000 cycles at 100 kc deviation is actually less than 1

By **E. S. WINLUND**
and
C. S. PERRY

*RCA Manufacturing Co.,
Camden, N. J.*

percent, and response is well within the ± 1 db limit. Using the "flat response" input connection, the response is actually flat to 25,000 cycles, allowing use of the equipment for facsimile. The f-m noise level is more than 70 db down, and the a-m hum measured ± 55 db on a typical unit. The automatic frequency control action shows a frequency drift maximum of 750 cycles at the carrier frequency, or ± 375 cycles for normal room temperature variations. Twenty-two meters make possible the metering of thirty-seven circuits providing ample and rapid checking facilities. The transmitter is air-cooled throughout, avoiding

the complication and expense of water-cooled tubes and tank circuits.

After preliminary coarse tuning of shorting bars, etc., is made, according to the station's approximate frequency, all further PA tuning is accomplished by tuning motors. A motor-control on-off switch disconnects all motor power so that accidental touching of the key switches will not detune the equipment.

The 1-kw Exciter

Within the central portion is housed a complete 1-kw transmitter—in this case the exciter unit for the 10-kw power amplifier. By careful positioning of the circuit elements, it was found convenient to use conventional lumped constants and circuits over the entire frequency range of 26 to 108 Mc for which an output of 1 kw is obtained.

Rear view of the 10-kw modulator-rectifier compartment

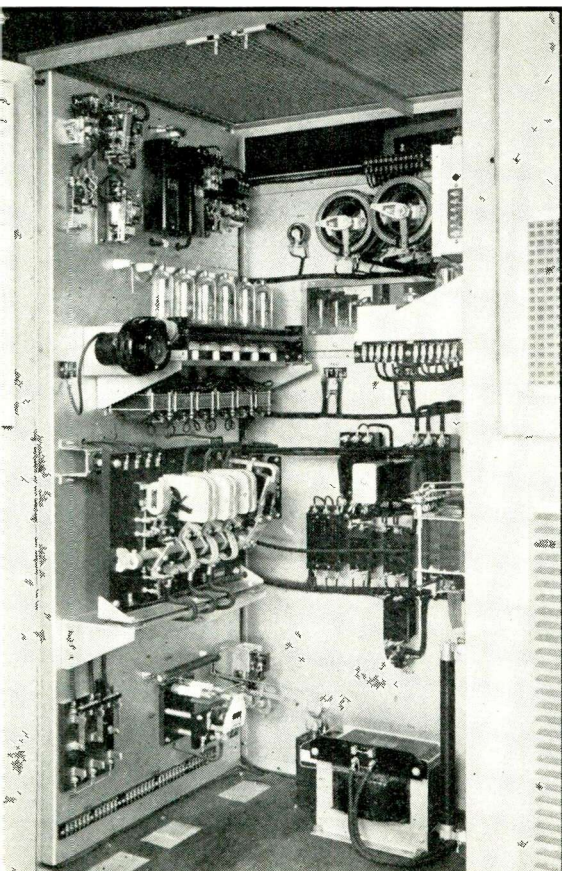

Front view into the power amplifier cubicle. The 140-ohm transmission line from the 1-kw driver enters the cubicle at the upper right hand corner, where it is tapped on to the bottom of a ¼-wavelength grid tuning line at an impedance matching point

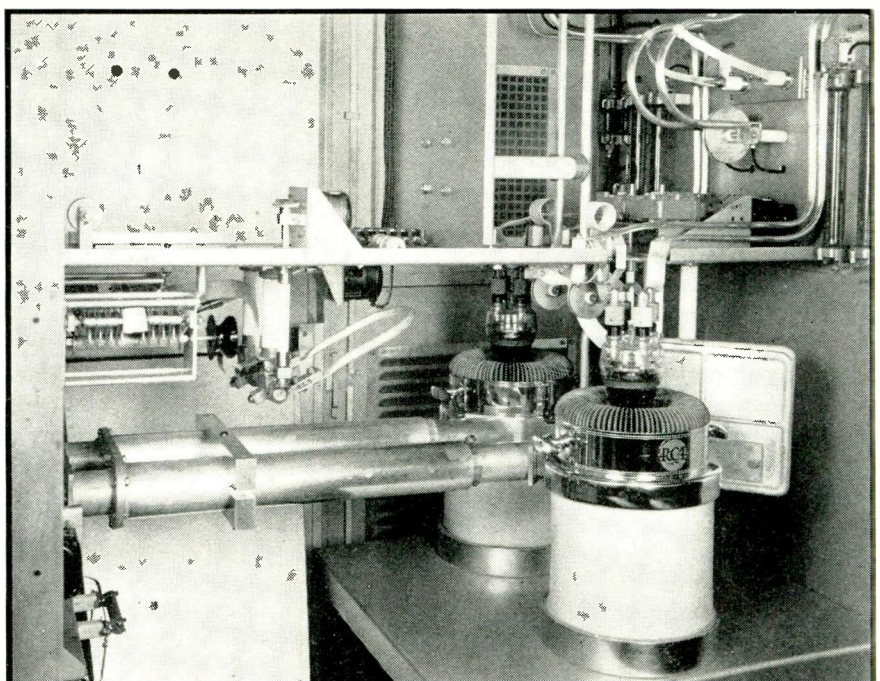

Transmitter

Plate tank tuning of the amplifier is accomplished from the front panel by varying the capacitance between the metal shells into which the tube anodes are mounted. The 10-kw power amplifier input feed is co-axial line, link-coupled to the second IPA tank circuit through variable capacitors for neutralization of the link inductance.

The Modulator-Rectifier Cubicle

Wiring is out of the way of routine cleaning, yet accessible by removal of the outside cover. To avoid high surge currents when plate voltage is first applied, the filter condensers for the 7000-volt rectifier are charged through a series resistor of such value as to provide a charging time of about one second. In case of rectifier arc-back, the plate voltage will automatically remain off for one second and then come on again. At the third such interruption the plate voltage will stay off until manually reset by means of the front-of-panel push-button.

When initially starting the transmitter, there is an automatic 30-second rectifier filament time delay, and separate provision for warm-up of the Crosby exciter.

If power returns within 4 seconds after a complete power failure the full plate voltage will return. After a failure of more than 4 seconds, the rectifier time delay permits plate voltage to return only after 30 seconds following restoration of power. A blower failure removes all plate and filament voltages.

The Power Amplifier

The grid tank resonance tuning is accomplished with a motor driven capacitor shunting the line. The lines are connected to the tube grids through special grid lead inductance neutralizing circuits. Reduction gear boxes controlling the neutralizing plates are located just back of the

foremost 889R tube. To insure non-critical tuning, the shafts from the gear boxes rotate one revolution in 20 minutes; adjustment of only 15 degrees of arc, however, is required. The neutralizing motor-control keys are located side by side on the front panel.

The plate tank is a single turn, resonated by plate circuit capacitance. For fine adjustment the motor control slides the outer or telescoping tubing along the inner fixed tubing, positive contact being maintained by spring fingers near the low current end of the line.

The load coupling link is located just above the tank inductance of the power amplifier and its motor control equipment is easily discernible. A pickup coil, used to feed the line current indicating meter, is coupled to the transmission line through a small aperture in the shield. Capacity

coupling is provided to feed the "carrier-off" and feedback amplifier rectifier.

Coupling is also provided at this point to the Conrad-Korman discriminator used for aural monitoring of the station. This f-m detector may also be used to obtain overall frequency response measurements.

The Circuit

The FM-10A may be considered in three parts; the Crosby exciter, the FM-1B amplifier, and the FM-10A amplifier. The exciter unit used in all of the RCA f-m transmitters employs a highly developed form of the stabilizing circuit invented by M. G. Crosby. This circuit^{2,3,4} has the outstanding advantages of simplicity, a small amount of frequency multiplication, high stability and a high degree of performance.

Referring to the simplified sche-

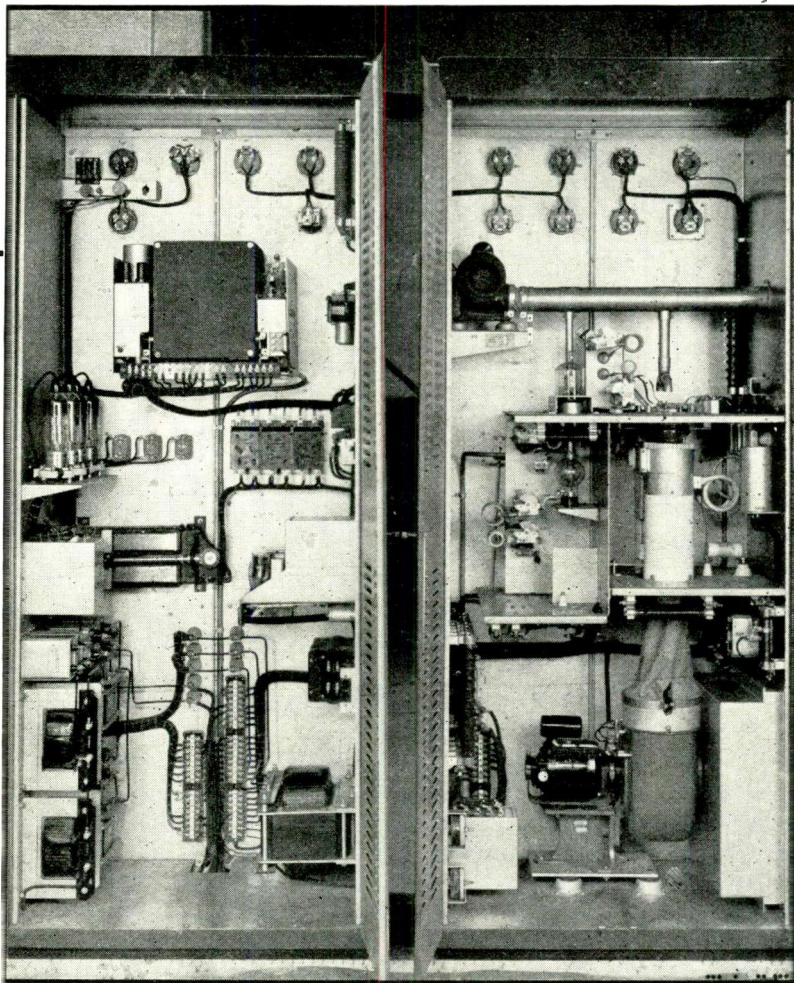

Interior views of the 1-kw exciter. The left-hand cabinet houses the Crosby exciter and the rectifier for the FM-1B. The right-hand cabinet contains all IPA stages from the 814 to the 827-R tubes. Blower at top furnishes air for cooling grid seals

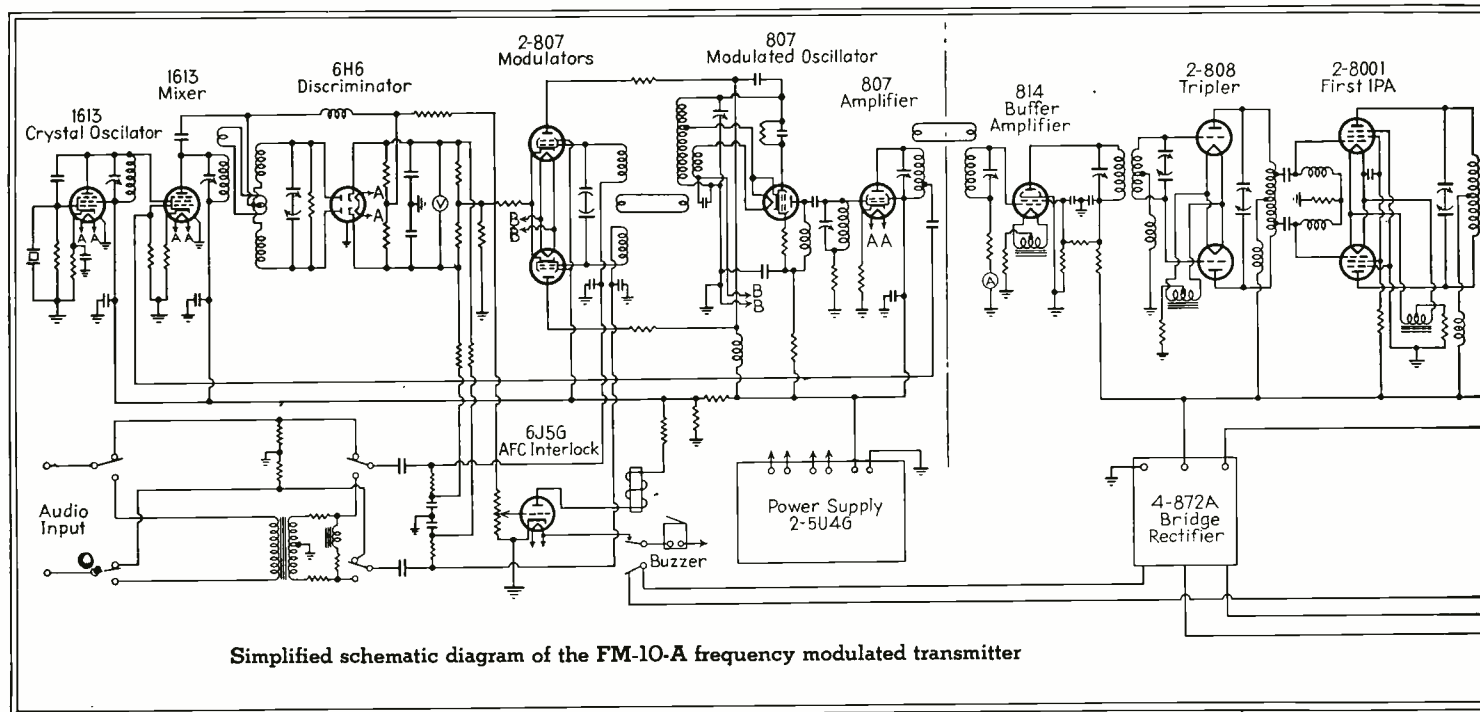

Simplified schematic diagram of the FM-10-A frequency modulated transmitter

matic diagram of the complete transmitter it will be noted that an 807 tube is used as the electron-coupled oscillator. This oscillator is modulated by two 807 reactance tubes to provide the frequency modulation. These modulator tubes have their plates connected in parallel across the oscillator tank while their grids are supplied inductively with push-pull excitation from, but 90 deg. out of phase with, the oscillator tank circuit.

The audio frequency modulating voltage is also introduced into the grid circuits in push-pull so that under quiescent conditions the modulator tubes draw equal and oppositely phased currents from the tank circuit. An audio signal disturbs this balance causing one tube to draw more current and the other to draw less to produce an effective positive or negative reactance across the oscillator tank circuit, thereby modulating the frequency in accordance with the amplitude of the audio frequency voltage impressed on the modulator grid.

To maintain the high degree of frequency stability required by the regulations of the FCC, the Crosby a-f-c circuit is provided to hold the average carrier frequency within very close limits. A separate quartz crystal-controlled oscillator is arranged so that its output excites one

grid of a 1613 mixer tube. The other grid of this tube is supplied with energy from the 807 amplifier stage following the oscillator. The plate circuit of the mixer is tuned to the difference in frequency between these two signals, or 1 Mc. The output of the mixer is coupled to a 6H6 rectifier tube through a discriminator circuit and the d-c output of the rectifier is in turn connected into the grid circuit of the modulator tubes to provide differential correction bias.

The discriminator circuit is so set up and tuned that no control voltage² is obtained on the grids of the modulating tubes as long as the mixer output frequency is 1 Mc. If the oscillator frequency varies, the beat frequency fed to the discriminator will vary in the same way, thus setting up a differential voltage on the grids of the modulator tubes which tends to counteract this frequency change. The control ratio is such that the net frequency change is a very small fraction of the change which would have resulted had the oscillator been uncorrected.

A 6J5 is used in an interlock circuit so arranged that failure of any component in the a-f-c circuit actuates a relay which is used to sound an alarm and/or take the transmitter off the air.

Provision is also made in the

move the unmodulated carrier from side to side by full deviation capability to aid in aligning succeeding amplifier stages for proper bandwidth.

Two a-c input circuits are provided, one following the standard 100 microsecond RMA pre-emphasis curve from 30 to 15,000 cycles for high fidelity audio transmission and other flat from 30 to 25,000 cycles to provide for multiplexed transmission of facsimile on a subcarrier frequency as well. Filter circuits are provided in the a-f-c circuit to give sufficient time lag so that fidelity will not be affected by the feedback modulation, nor will afc be affected by the modulating signal.

Since no audio amplifier tubes are used in the transmitter between the audio input terminals and the modulator grids, distortion is extremely low and substantially independent of the modulating frequency.

The discriminator and modulated-oscillator tank circuits are equipped with negative temperature coefficient compensators and all frequency affecting circuits in the exciter are enclosed within a dual heat oven to further insure the utmost in frequency stability. The oven heater winding operates on a separate 115-volt a-c input, in series with two thermostats. One of these is for normal regulation of the oven temperature and the

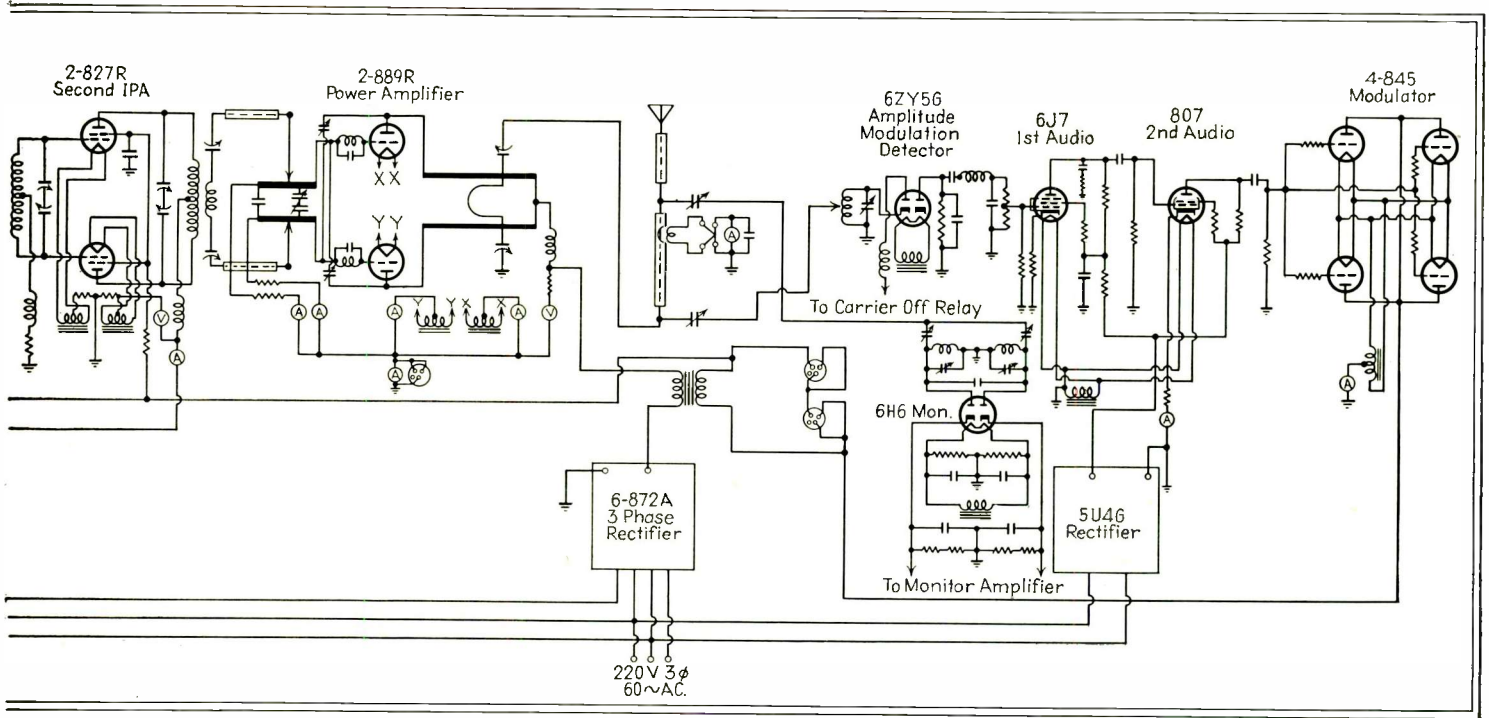

other for emergency cut-off in case of failure of the first.

The use of two tubes as a differential or push-push modulator gives the circuit a compensating effect which tends to balance out circuit disturbances or irregularities which exist simultaneously in both modulator tubes.

The output of the Crosby exciter 807 amplifier tube feeds an 814 buffer which in turn drives the push-pull 808 tripler stage. This feeds the 8001 IPA push-pull stage which in turn drives the 827-R push-pull IPA.

The FM-10A amplifier, when used with the FM-1B frequency modulated transmitter, constitutes a complete 10-kw transmitter. The FM-1B amplifier output from the 827-R tube drives two 889R tubes connected in push-pull to generate the 10-kw carrier. Four 845 amplitude-modulator tubes are used in conjunction with the 5U4G rectifier and 6J7 and 807 audio feedback amplifiers to reduce amplitude modulation due to hum to better than 50 db below 100 per cent amplitude modulation. The four 845's modulate the plate supply to the power amplifiers. All tubes are aircooled.

The a-m modulation transformer is so designed that the same number of d-c ampere-turns exists in primary and secondary, thus bucking out core saturation effects. It is protected

from power amplifier surges by special gas-filled surge gaps.

Performance

The following figures are characteristic of operation into a 70-ohm dummy antenna at 4518 Mc. They illustrate the correctness of PA tank design for minimum phase distortion:⁵

10 to 15 KC Audio Distortion Maxima

Deviation	3 Kw	10 Kw
± 100 KC	0.9%	0.8%
± 75 KC	0.7	0.8
± 19 KC	0.7	0.8

Likewise the freedom of reactance-modulators from low-frequency angle-tangent distortion is shown by these figures:

30 to 50 cycles Audio Distortion Maxima

Deviation	3 Kw	10 Kw
± 100 KC	0.9%	0.8%
± 75 KC	0.7	0.7
± 19 KC	0.5	0.5

The fidelity of the great bulk of the program material is indicated by the middle-range figures:

1000 cycle Audio Distortion

Deviation	3 Kw	10 Kw
± 100 KC	0.5%	0.7%

± 75 KC	0.4	0.4
± 19 KC	0.4	0.4

It must be emphasized that although f-m transmitter tank circuits may be tuned by watching a distortion meter, the above figures are obtained after tuning the equipment solely by watching the meters provided, for conventional grid-maximum and plate-minimum readings. As is now well known, f-m circuits require far more accurate tuning than a-m circuits to insure minimum distortion. For the same reason ruggedness is important; for example, unless properly engineered construction is used vibration can cause low frequency phase modulation. All components therefore, must be rigidly supported.

REFERENCES

¹J. E. Young and A. K. Wing, A Transmitter for Frequency Modulated Broadcast service using a New Ultra-High Frequency Tetrode, *RCA Review* Vol. 5, No. 3, pages 327 to 336, January 1941.

²M. G. Crosby, Reactance Tube Frequency Modulator, *RCA Review*, Vol. 5, pp. 89-96, July 1940.

³E. S. Winlund, Drift Analysis of the Crosby Frequency Modulated Transmitter Circuit, *Proc. IRE*, Vol. 29, No. 7, pp. 390-398, July, 1941.

⁴E. S. Winlund, FM Engineering Considerations, Part 2, *FM Magazine*, Vol. 1, Nos. 9, 10, July, Aug. 1941.

⁵N. I. Korman, Distortion in FM Systems, presented at Summer Convention of Institute of Radio Engineers, Detroit, Michigan.

The Electroplane Camera

One element of a unique lens system designed to permit alteration of focal length without change in image size is oscillated electronically. The result is greater depth of field than that obtainable by optical means alone. Electronic remote control of focus is also provided

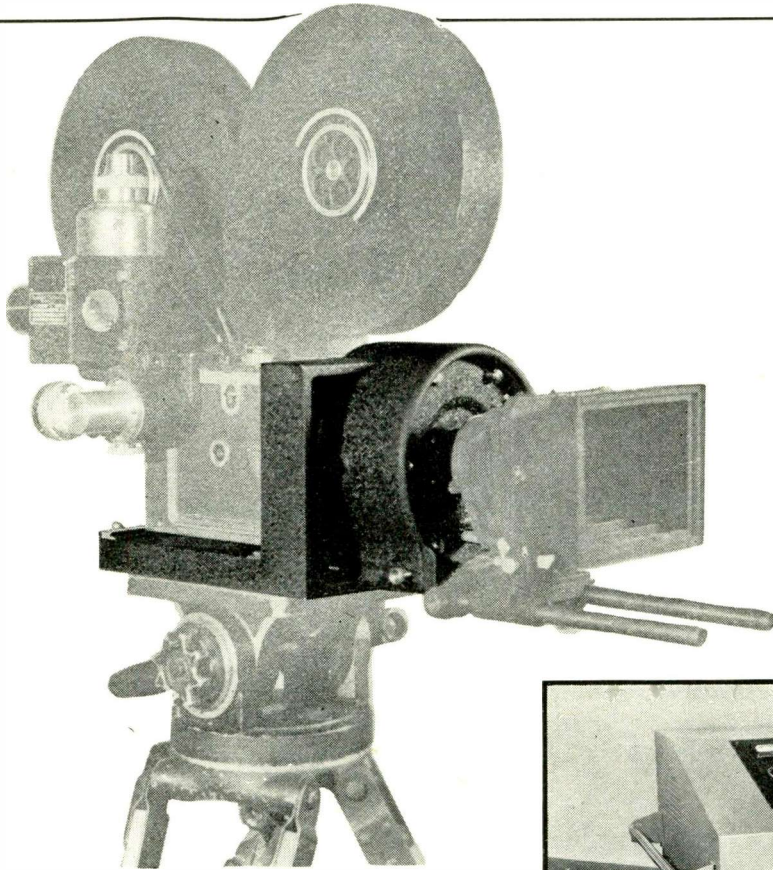

The "lens-motor," substituted for the original lens-turret of a standard motion-picture camera. It contains a 50-mm lens system providing uniform focus from four feet to infinity at full $f/3.2$ aperture when one element is oscillated. By removing seven screws from the face of the cylindrical part of the casting other objectives may be inserted

The "power-unit," operated from 110-volts a-c and cabled to the lens-motor, permits complete electronic remote control of depth of field

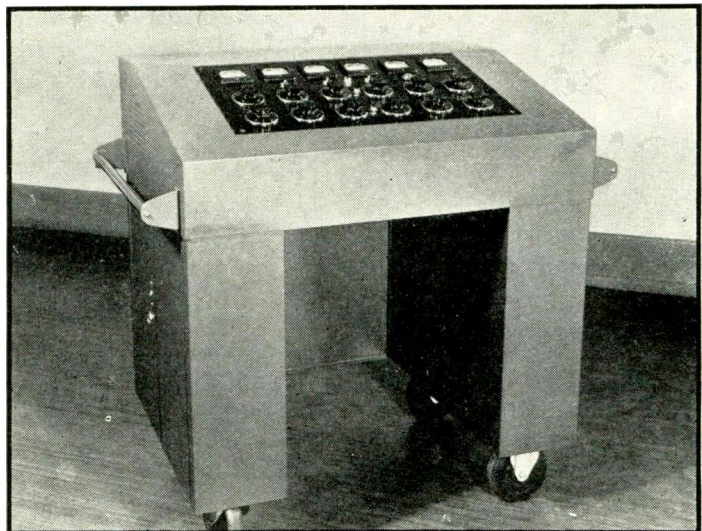

travel through successively distant planes as it does when looking at an actual scene. It sees clearly in a projected picture only those planes that are in sharp focus upon the flat surface. Thus in order to produce a picture which is realistically competitive with an actual scene, photographers must include in it sufficient depth of field to foster an illusion that the eye can see clearly everything within the full range of vision.

Extreme realism, requiring great depth of field, is not always necessary in photographic practice. It is frequently desirable to concentrate attention upon foreground subject-

THE HUMAN EYE possesses unique ability to adjust itself automatically to objects at different distances. Normally, it first focusses upon a plane in which subject-matter of primary interest appears, objects at other distances being at that instant less sharply defined. Then, where the eye desires to scan an entire scene in greater detail, it travels

to foreground and background material. Automatic adjustment of the lens system, or cornea, to planes at different distances creates an illusion that all objects within the range of vision have been continuously in focus.

When viewing a picture projected upon a two-dimensional screen lacking depth, the eye obviously cannot

matter by deliberately allowing backgrounds to photograph "fuzzy" or out of focus. There are, however, many scenes in which pictorial realism obtainable only by utilizing maximum obtainable depth of field is wanted. Modern lens systems have considerable latitude in this respect, particularly where objectives of short focal length are employed and

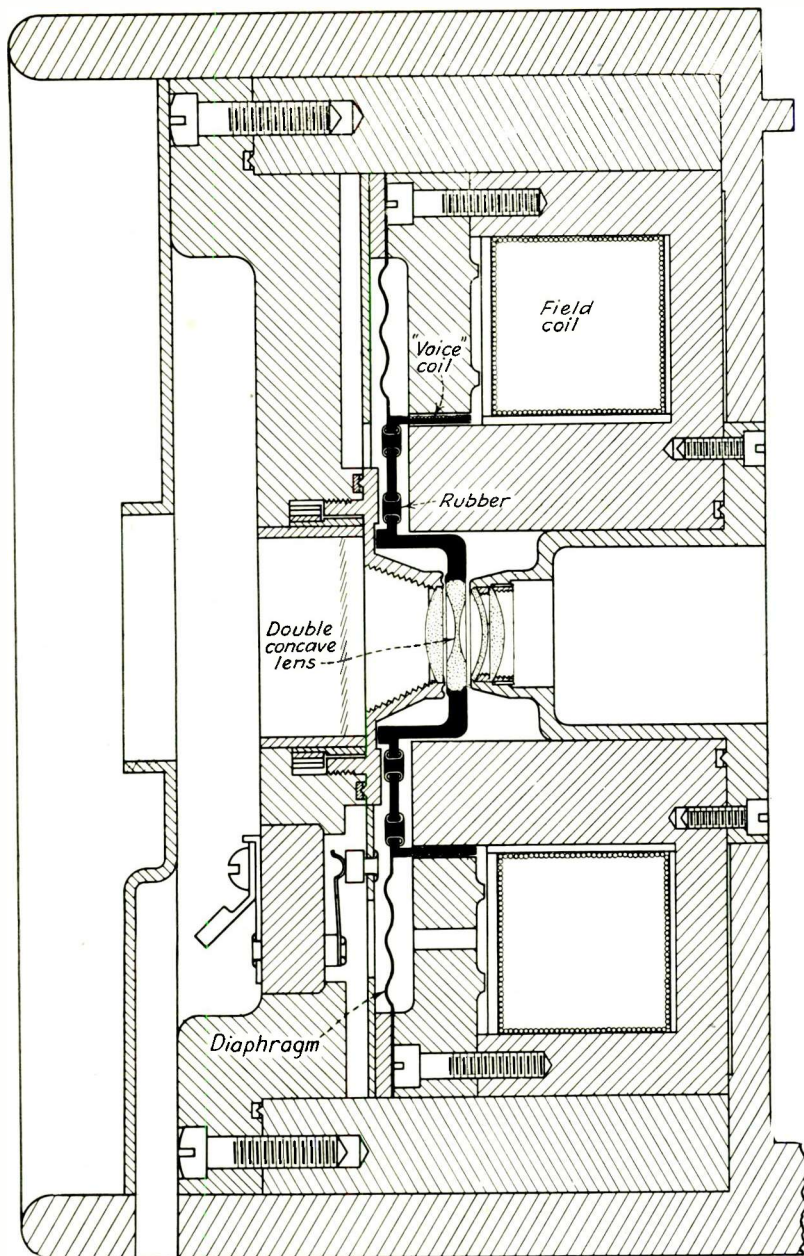
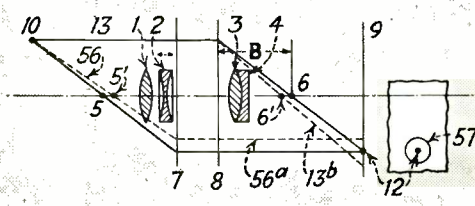

FIG. 2—Lens-motor, shown in cross-section, resembles an electro-dynamic loud-speaker with an optical element substituted for the usual cone load. The entire casting illustrated is approximately eight inches high. The maximum movement of the lens is limited to 0.3 mm

FIG. 1—Optical diagram of the "Detrar" objective, showing design proposed to maintain image size despite change in focal length, as detailed in the text



9. The second principal focal point 6 is thus moved to position 6', toward the optical center of the lens system. A commensurate shifting of the first principal focal point 5 takes place, to position 5'. No shifting in principal plane 7 takes place. Light rays 13, (illustrated passing outside the lenses to simplify analysis) after this shift in the lens 2, strike the principal plane 8 and are bent as shown at 13^b, passing through the new focal point 6'. The first principal focal point having, however, moved from point 5 to point 5', light rays 56 from point object 10 pass through the focal point 5', strike the principal plane 7 and are bent as at 56^a to pass parallel to the optical axis. Similar rays, intersecting as shown by the broken lines, produce a circle of confusion 57 whose center is spaced from the optical axis by exactly the same distance as the spacing of point image 12 from the optical axis. Point image 12 and circle of confusion 57 are concentric. No change of the image size results from change of focus because of this concentric relation."

Shifting of the movable optical element of early "Detrar" lens systems during an exposure was accomplished mechanically. A cam attached to the balance wheel of a motion picture camera's film-driving mechanism transmitted oscillatory motion through a series of levers and shafts to a sleeve in which the mov-

stopped-down to small apertures. The extent to which lens systems can be so stopped-down is, unfortunately, limited by the amount of illumination available for satisfactory exposure and the speed at which subjects to be photographed are moving so the search for fast systems having still greater depth of field continues.

The "Detrar" Objective

In 1933 Dr. L. M. Dieterich described a method of expanding depth of field by rapidly moving one optical element of a lens system back and forth on its axis during a single photographic exposure. It is evident that depth of field may be theoretically increased in this manner, which involves superimposing several individually sharp image planes upon a negative so that the composite result creates an illusion of satisfactory focus in several widely separated

planes. But if one tries this with a conventional lens system it is soon discovered that image sizes change as focus is altered and serious "ghost" or halo effects appear in the finished picture. The several impressions of a given object upon the film during a single exposure appear to be "out of register."

Dieterich, however, simultaneously proposed¹ a lens system in which change of focus may be effected without change in image size, outlining the principle of operation as follows: "Referring to Fig. 1, assume that the optical system is sharply focussed upon point object 10, producing a point image 12 on film 9. Now assume that the movable lens 2 is shifted to the left. The focal length *B* is permitted to change but without changing the position of the principal plane 8 relative to the lenses 1, 3 and 4 and relative to the film plane



A sample of the Electroplane camera's work at full $f/3:2$ aperture. The girl walking in the foreground is four feet away, her companion moving in the middle-distance eight and the rear wall 25 feet away

able lens was mounted. Experimental results proved promising as objects in each plane within a scene appeared to the eye to be in focus despite superimposing of sharp images over "fuzzy" images. The individual photographic impressions within a single exposure were in good "register" insofar as size was concerned and good registry apparently permitted sharp impressions to "mask" fuzzy impressions to a satisfactory extent. But the driving mechanism was cumbersome and considerable mechanical difficulty was experienced in securing a desirable number of lens oscillations where variable-speed shutter adjustments were involved.

Method of Oscillation

Shortly after Dr. Dieterich's death, P. Stanley Smith² devised an electronic method of oscillating the movable optical element of the Detrar lens system in the required manner. The lens was placed in a motor unit resembling an electro-dynamic loudspeaker, constituting the "voice"-coil load in place of the usual cone. Application of direct current to the field or exciter winding of this motor

unit and audio-frequency power to what might be termed its lens-coil permitted electro-dynamic actuation of the lens by a driving-power source completely independent of mechanisms motivating the camera itself.

Figure 2 shows in cross section a recently completed lens-motor, the emphasized portion of the drawing illustrating the moving part. In this particular motor the double-concave lens weighs 14 grams and the entire moving structure weighs 28 grams including the lens. Maximum lateral movement of the oscillated optical element, mounted axially with respect to three others rigidly fixed in position within the unit, is limited to 0.3 millimeter. The corrugated duralumin diaphragm provides suitable suspension and a degree of air damping which is supplemented by rubber sleeving. The chief design problem was suppression of mechanical resonant peaks.

Motor field and lens-coil power is obtained from a separate power unit, pictured in these pages and diagrammed in Fig. 3. The several

stepdown transformer, fullwave rectifier, choke-input filter feeds low voltage dc, continuously variable up to 1.5 amperes, to the exciter field winding. A third circuit, similar electrically to the second, is particularly interesting in that it delivers direct current to the lens-coil in shunt with a-f power furnished by the audio oscillator-amplifier described above. D-c lens-coil "bias" may be varied in steps up to 2 amperes by manipulating switches controlling relays connected to transformer primary taps in this circuit, with finer control available by varying an output circuit rheostat. It will be noted that a reversing relay is also included in the output circuit of this d-c bias supply so that the polarity of applied voltage may be changed.

By adjusting lens-coil dc bias or exciter field winding current or both, the movable optical element of the lens system may be held "at rest" at any point between the fixed lenses and then oscillated about this point by the simultaneous application of

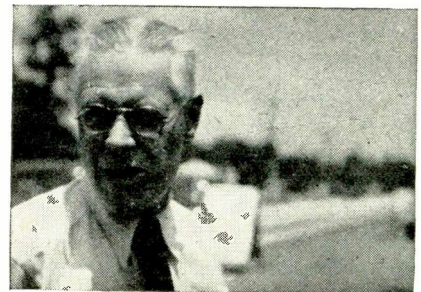
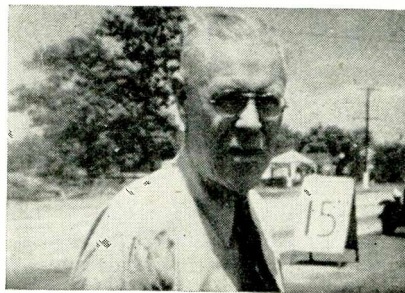

A depth of field comparison. The man is four feet away. Both frames were taken from motion-picture films exposed at $f/9$, one with the lens system oscillating and the other with the camera used as a conventional limited-focus device and focussed on the man

functions of this unit are readily grasped despite apparent circuit complication if it is noted that the only connections between it and the lens-motor are four leads seen at the lower right of the diagram, two of them going to the motor lens-coil and two to the exciter field winding.

Three separate functions are performed by the power unit. An a-c operated a-f oscillator tunable in coarse or fine steps between 51 and 286 cps drives a push-pull amplifier delivering up to three volts of audio to the lens coil through switch-selected attenuation networks providing amplitude control. A conventional

a-f power. This facilitates accurate electrical orientation of the movable lens with respect to the fixed lenses where maximum lens motion is to be employed for fullest depth of field. It also permits the movable lens to be initially located at other points between the fixed lenses so that critical focus is obtained in some particularly important photographic plane, and then oscillated to a lesser degree to give partial out of focus effects in all but, say, a middle range. At least equally important is the fact that a-f power may be entirely removed from the lens-coil and direct current alone applied. This allows the cam-

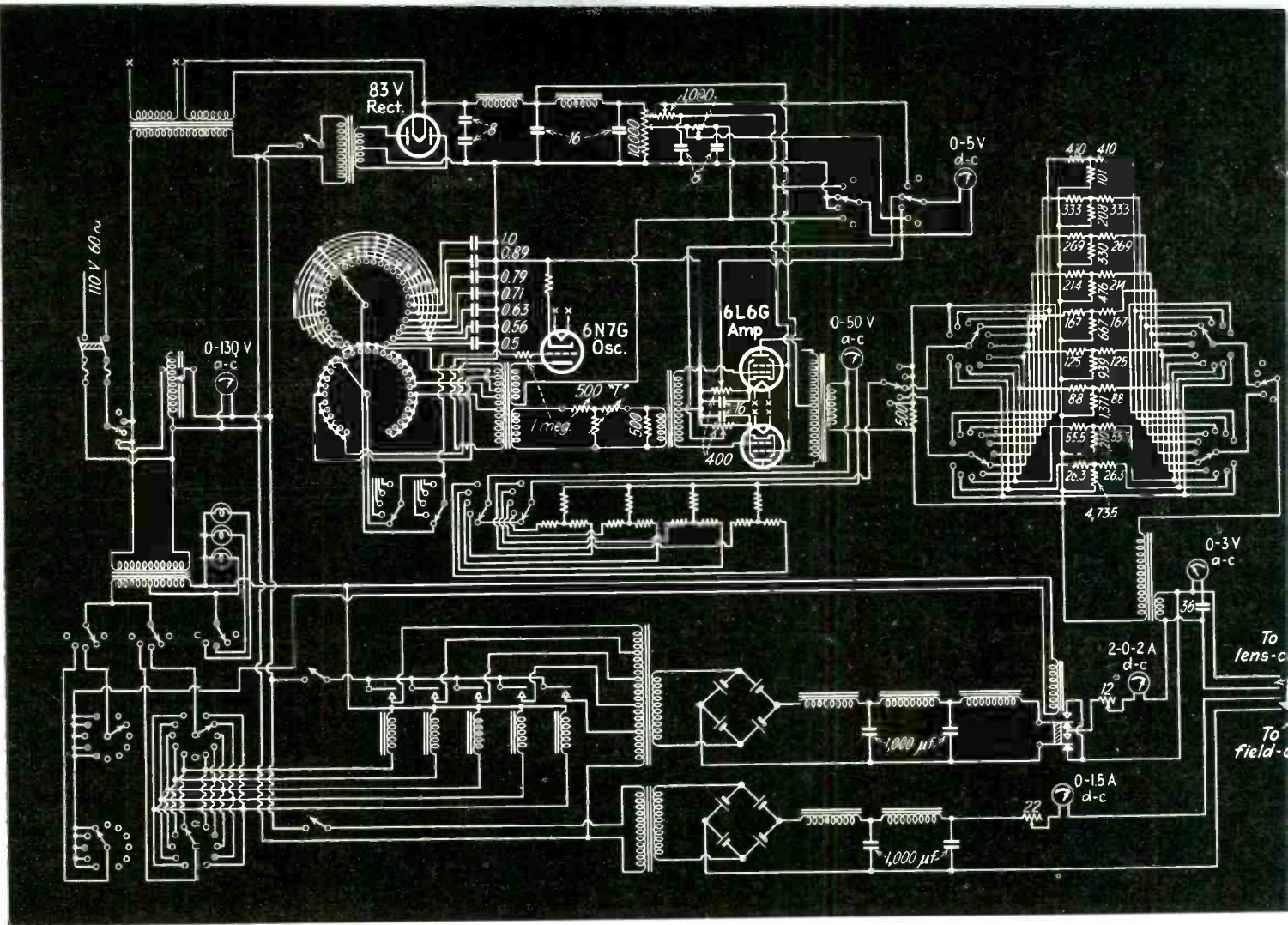

FIG. 3—Circuit diagram of the Electroplane camera power-unit. This unit supplies d-c "bias" as well as a-f power to the "voice"

or lens-coil of the motor unit, plus direct current for the motor's exciter field winding. Four output leads appear at the lower right

era to be used as a standard limited-focus device but with the particular advantage that focussing may be accomplished electronically by remote control.

Superficial examination of the circuit will make the functions of the various meters obvious without detailed discussion here. Understanding of the basic functions of the circuit, similarly, does not require identification of the many switches diagrammed and it suffices to say that most of them are included to permit initial adjustment of the system or to facilitate rapid shifting of focal characteristics where such changes are required during the filming of a scene. Two independent banks of controls are incorporated on the power-unit panel so that one bank may be pre-set to meet an anticipated change in focal requirements while the other bank is in use. A single master switch is thrown to effect a quick transfer. The camera need not be stopped during focussing adjustments.

The camera pictured in these pages is equipped with a lens system ground

to Dieterich specifications¹. Focal length is 50 mm and effective speed $f/3:2$ (obtained by coating an $f/3:75$ design). Used at full aperture and with the movable optical element oscillating, sufficient depth of field is obtained to keep in uniform focus all subjects from four feet to infinity. This depth of field is considerably greater than the lens system is capable of encompassing when operated as a conventional limited-focus device, particularly where subjects of primary photographic interest within eight feet of the camera must be kept sharp. Focus is considered slightly "softer" throughout the entire range than that obtainable with lens systems of fixed focal length.

Photographic Results

Focussing of the lens system is facilitated by the fact that main electronic controls are pre-calibrated. Powering of the lens-motor by a supply source completely independent of the camera itself simplifies adjustment of lens oscillation frequency to suit various camera shutter speeds. Lens oscillation frequency

does not appear to be particularly critical so long as the movable lens passes through at least one complete cycle of oscillation during the exposure of each film frame, which amounts to two "impressions" or registrations of objects in all planes within the photographic field per frame. In the case of the model illustrated practical experiment indicated that four complete impressions in each plane per frame were desirable. Film moving at the normal rate of 90 feet per minute is framed at the rate of 24 frames per second and exposed $1/51$ second in this modified camera² having a maximum 170-degree open segment in its rotating shutter-disc or "light-gate". A lens oscillation frequency of 110 cps approximates the desired condition.

The lens continues to oscillate, of course, while the film is in eclipse between exposures—W.MACD.

¹ U. S. Patent No. 1,927,925.

² Smith-Dieterich Corp., New York, N. Y.

³ By Bausch & Lomb Optical Co., Rochester, N. Y.

⁴ Mitchell.

L-type Impedance

One of the simplest and most effective impedance transforming networks for radio frequency applications is the half-section L-type circuit employing two essentially pure reactances. A discussion of these networks, with practical examples of their use is presented

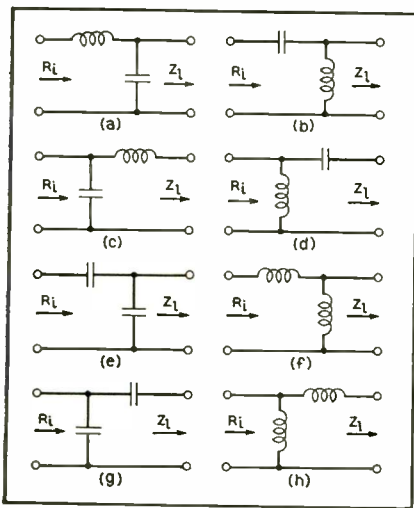

FIG. 1—L-type impedance matching circuits for transforming a complex load impedance, Z_L , to a pure resistance, R_i . There are eight possible circuit combinations of reactances as shown above

IN nearly all radio transmitting and receiving systems and in the circuits which connect them with their associated antenna systems there are points where impedance transformations are required if the apparatus as a whole is to operate efficiently. It is usually necessary, for example, to transform the input impedance of the antenna to a value which will "match" the characteristic impedance of the transmission line which supplies radio frequency power to it. If the transmission line branches or divides to two or more antennas, as in many directional antenna systems, other impedance transformations are generally required at each of the junction points. Impedance transformations, particularly at the higher radio frequencies, may also be required in the transmission line itself to overcome serious reflections caused by sharp bends, supporting insulators,

switches, etc., and they will usually be required where transmission lines of different characteristic impedances are joined together. Again, at the input end of the radio frequency transmission line an impedance transforming circuit is ordinarily required to match the impedance of the transmitter or receiver to the characteristic impedance of the line. Impedance transforming networks are also useful for controlling, without the introduction of appreciable loss, the voltage applied to radio frequency monitoring and measuring equipment, which is often closely associated with the antenna system.

One of the most commonly used and generally satisfactory impedance transforming networks for radio frequency applications is the half-section L-type circuit employing two essentially pure reactance elements. At a single frequency and, for most practical purposes, embracing at least the sideband frequencies of a radio telephone transmitter, the simple L circuit may be used effectively to transform any load impedance to any desired pure input resistance value. Conversely, the L circuit may be employed to accomplish the reverse transformation, that is, to transform any load resis-

CONSTRUCTION DATA FOR THE CIRCUIT DESIGN CURVES						
FIG.	FAMILY OF CIRCULAR LINES LABELED:	POSITION OF CENTER OF EACH CIRCULAR LINE (COORDINATES):		RADIUS OF EACH CIRCULAR LINE	Family of Straight Vertical Lines Labeled:	POSITION OF EACH STRAIGHT VERTICAL LINE ALONG R _i AXIS
		$R_1/R_i =$	$X_1/R_i =$			
3A	X_c/R_i	$\frac{1}{2}(X_c/R_i)^2$	$-X_c/R_i$	$\frac{1}{2}(X_c/R_i)^2 R_i$	—	—
3B	X_L/R_i	$\frac{(X_L/R_i)^2 + 1}{2}$	0	$\frac{(X_L/R_i)^2 + 1}{2} R_i$	—	—
4A	X_L/R_i	$\frac{1}{2}(X_L/R_i)^2$	$-X_L/R_i$	$\frac{1}{2}(X_L/R_i)^2 R_i$	—	—
4B	X_c/R_i	$\frac{(X_c/R_i)^2 + 1}{2}$	0	$\frac{(X_c/R_i)^2 + 1}{2} R_i$	—	—
5	—	—	—	—	X_c/R_i	$\frac{(X_c/R_i)^2}{1 + (X_c/R_i)^2}$
5	X_L/R_i	.5	$-X_L/R_i$	$.5R_i$	—	—
6	—	—	—	—	X_L/R_i	$\frac{(X_L/R_i)^2}{1 + (X_L/R_i)^2}$
6	X_c/R_i	.5	$-X_c/R_i$	$.5R_i$	—	—
7	X_{c1}/R_i	0	$-\frac{1}{2}(X_{c1}/R_i)$	$-\frac{1}{2}(X_{c1}/R_i)R_i$	—	—
7	X_{c2}/R_i	$\frac{(X_{c2}/R_i)^2 + 1}{2}$	0	$\frac{(X_{c2}/R_i)^2 + 1}{2} R_i$	—	—
8	X_{L1}/R_i	0	$-\frac{1}{2}(X_{L1}/R_i)$	$\frac{1}{2}(X_{L1}/R_i)R_i$	—	—
8	X_{L2}/R_i	$\frac{(X_{L2}/R_i)^2 + 1}{2}$	0	$\frac{(X_{L2}/R_i)^2 + 1}{2} R_i$	—	—
9	—	—	—	—	X_{c1}/R_i	$\frac{(X_{c1}/R_i)^2}{1 + (X_{c1}/R_i)^2}$
9	X_{c2}/R_i	.5	$-X_{c2}/R_i$	$.5R_i$	—	—
10	—	—	—	—	X_{L1}/R_i	$\frac{(X_{L1}/R_i)^2}{1 + (X_{L1}/R_i)^2}$
10	X_{L2}/R_i	.5	$-X_{L2}/R_i$	$.5R_i$	—	—

NOTE: For X_c , X_{c1} , or X_{c2} use a minus (-) sign, and for X_L , X_{L1} , or X_{L2} use a plus (+) sign ahead of its numerical value

Transforming Circuits

By PHILLIP H. SMITH

Radio Development Department
Bell Telephone Laboratories, Inc.

tance to any desired complex input impedance value. It is necessary to consider only the former type of transformation, however, if one bears in mind that the circuit can always be reversed to make the transformation in the opposite direction. This simplifies the presentation of design information.

It will be seen by referring to Fig. 1 that there are a total of eight possible combinations of reactance types (i.e. inductive and capacitive) in an L circuit. Each of these eight circuits is capable of transforming a restricted range of complex load impedance values to a given pure resistance value. The transformable impedance values associated with each circuit can conveniently be represented as an area on an impedance vector diagram. A set of eight such impedance vector diagrams will therefore completely outline the capability and limitations of the eight possible reactance combinations, and will furnish a comprehensive outline of the impedance transforming capability of each reactance combination.

For radio frequency applications, the losses in an L circuit will usually be small in comparison to the power which is being conducted through the circuit. The circuit losses will generally not limit to any serious extent the range of load impedance values which can be transformed successfully to a desired resistance, nor will they ordinarily have a major effect upon the reactance values for the circuit elements which are theoretically required on the assumption that they are "lossless." The design charts to be described are, therefore, plotted for the idealized case of lossless circuits. Having selected a suitable lossless circuit and having obtained the reactance values required in such a circuit from the charts, one

is in a better position to determine the probable resistance of the circuit elements which he must use and what the losses will be, if he is interested. In some cases there will be a choice available between two or more L circuit configurations and in these cases one may select the circuit more suitable to his needs either because it may introduce the lesser loss or because, for example, the circuit components may be more readily available.

Choice of Reactance Combinations

The eight vector diagrams, shown in Fig. 2, provide a convenient method of selecting a suitable L circuit for any particular impedance transformation. To understand these

diagrams, however, it may be well to discuss briefly certain factors relating to the manner in which they are plotted.

Each of the eight diagrams in Fig. 2 is plotted on rectangular coordinates and, according to the usual procedure, the series resistance component of the load impedances is indicated along the horizontal coordinates marked R_L , and the series reactance component, X_L , is indicated along the vertical coordinate, either up or down from the R_L -axis, depending upon whether it is an inductive or a capacitive reactance component, respectively. Both coordinates of these diagrams are measured in the same units, namely, ohms, but are labeled as a function

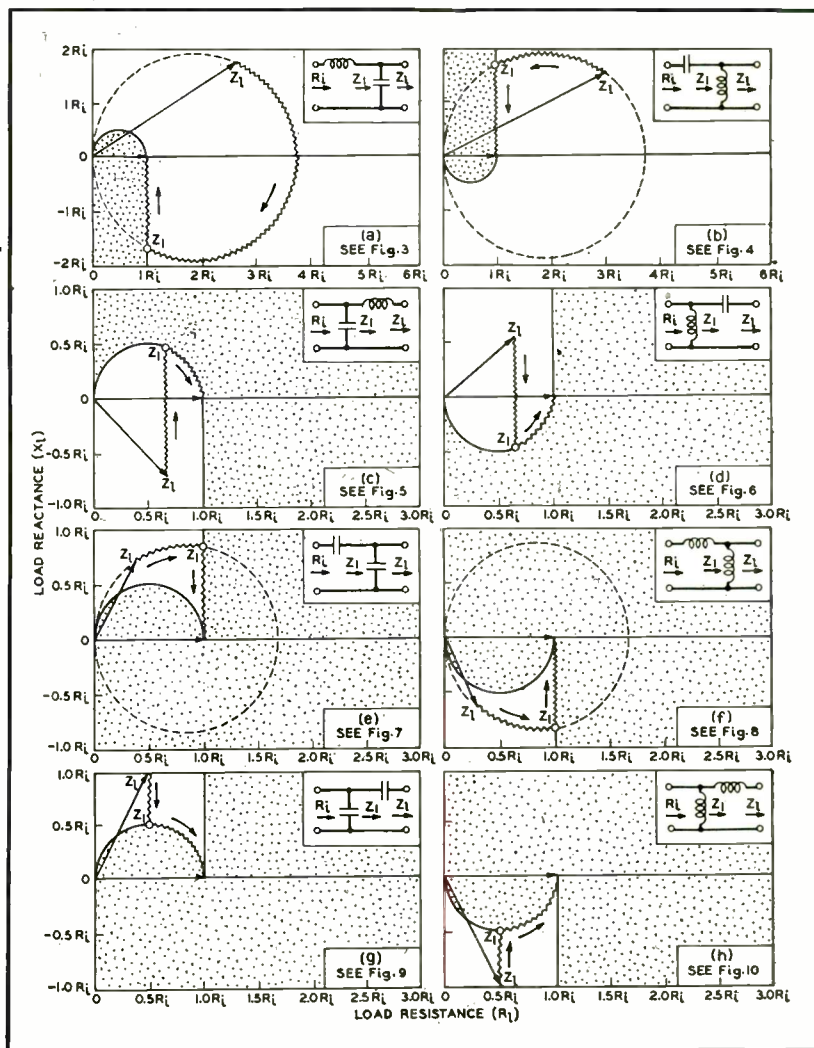

FIG. 2—Any impedance, Z_L , whose vector terminates within an unshaded area on the above diagrams is transformable to a pure resistance, R_L , by means of the circuit to which the diagram applies

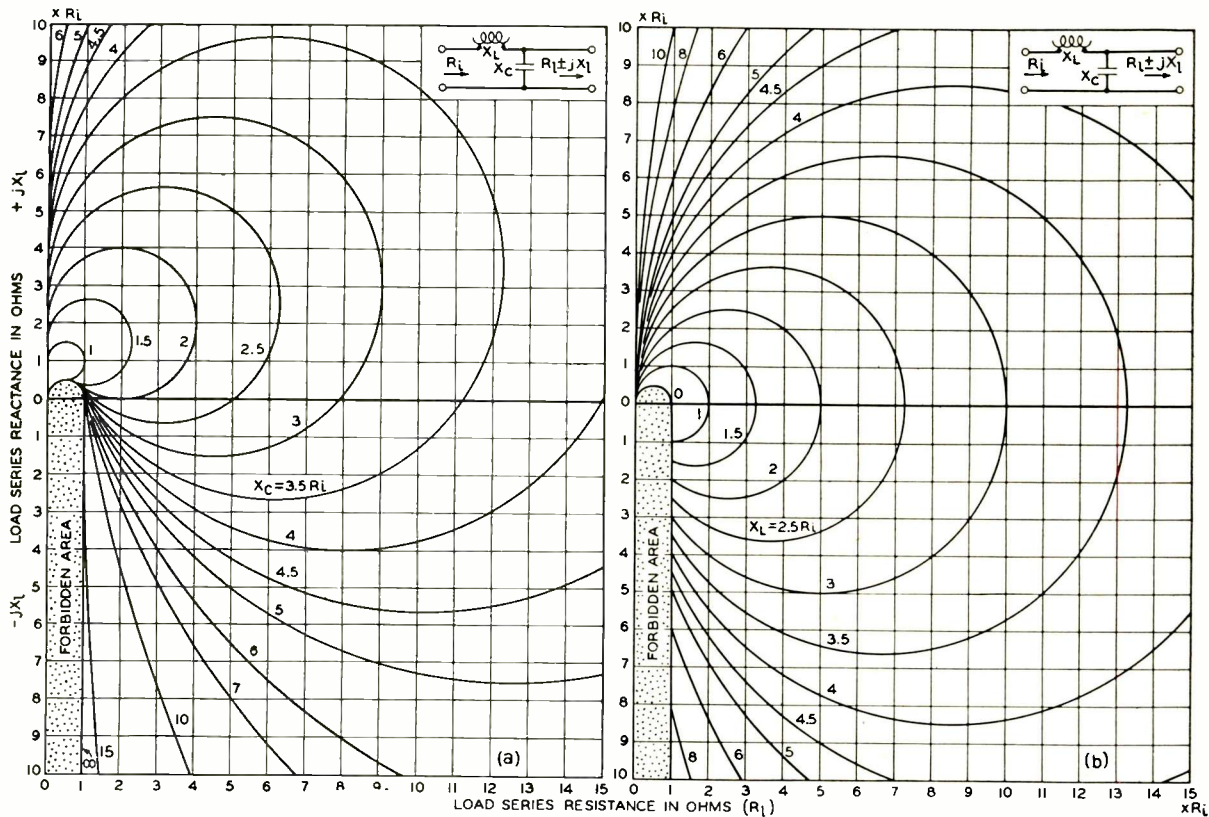

FIG. 3—Shunt reactance, X_c , (left) and series reactance, X_L , (right) required to transform load impedance, $R_i \pm jX_i$, to a pure resistance, R_i .

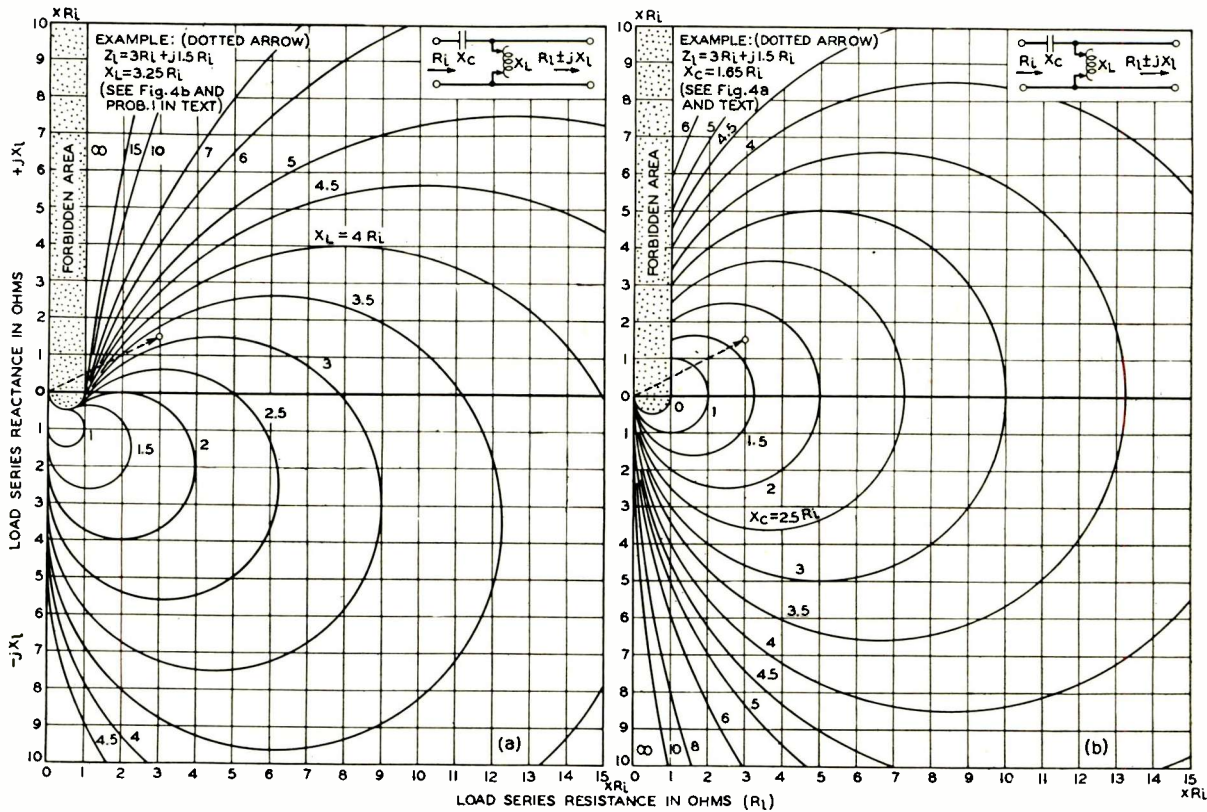

FIG. 4—Shunt reactance, X_c , (left) and series reactance, X_L , (right) required to transform load impedance, $R_i \pm jX_i$, to pure resistance, R_i .

of the desired input resistance value, R_i , as $1R_i$, $2R_i$, $3R_i$, etc. rather than directly in ohms, to make the diagrams of more general application. Thus, for example, the desired input resistance R_i may be 100 ohms. In this event the scale intervals along

the coordinates as $1R_i$, $2R_i$, $3R_i$, etc., would simply be 100, 200, 300, etc., ohms, respectively. If the desired input resistance R_i were, for example, 60 ohms the scale intervals designated as $1R_i$, $2R_i$, $3R_i$, etc., would be 60, 120, 180, etc., ohms, respec-

tively. The desired input resistance may have any chosen value, but for a given problem the value will be known, and will be a fixed constant throughout the problem, thus establishing numerically the scale intervals, in ohms, along the coordinates

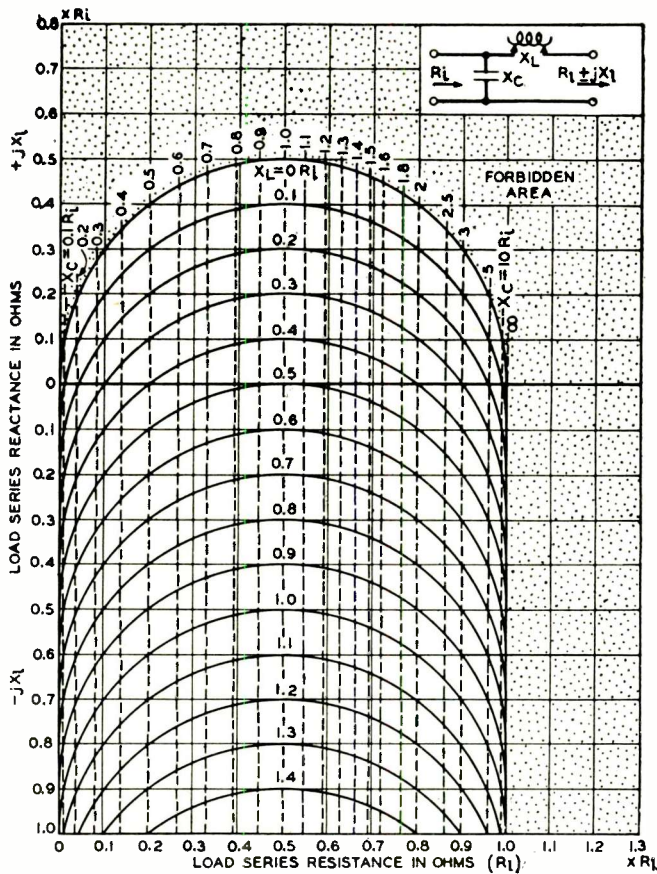

FIG. 5—Series reactance, X_L , and shunt reactance, X_C , required to transform load impedance, $R_L \pm jX_L$, to pure resistance, R_L .

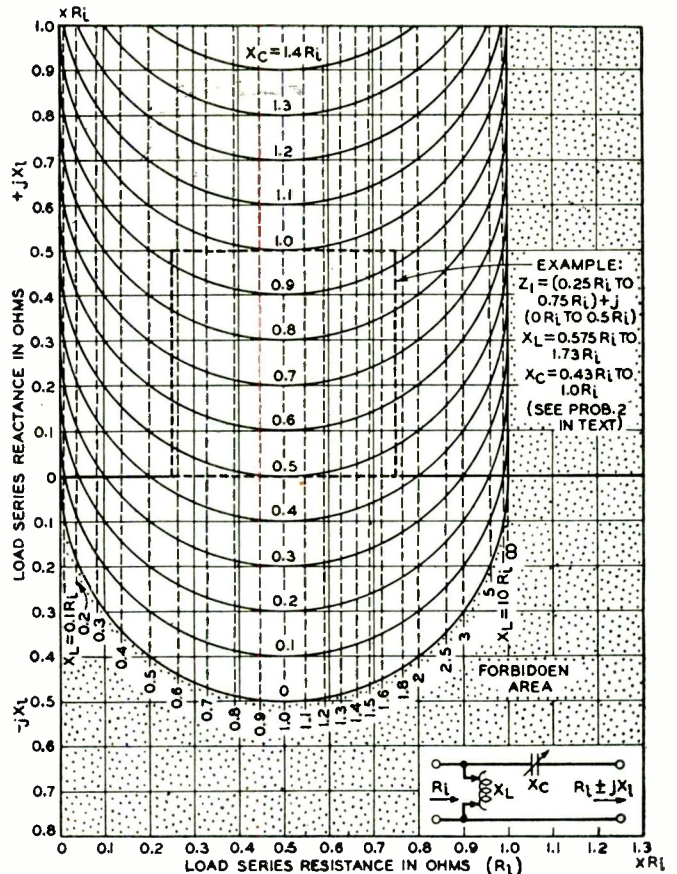

FIG. 6—Shunt reactance, X_L , and series reactance, X_C , required to transform load, $R_L \pm jX_L$, to pure resistance, R_L .

of the vector diagrams on Fig. 2. This is further discussed in connection with an example for the use of the charts.

It will be noted that a shaded area is shown on each of the eight diagrams on Fig. 2. This is to indicate that any load impedance vector whose extremity falls anywhere within this "forbidden" region cannot be transformed to R_L , the desired input resistance value, with the specific L circuit to which the diagram applies, and in this case one of the other seven L circuits must be selected. If the extremity of the load impedance vector falls anywhere inside of the unshaded area the circuit is capable of performing the desired impedance transformation. Where either the unshaded (transformable) or the shaded (forbidden) area exists at the outer limits of the diagram it may be regarded as continuing, if the diagram were sufficiently large, to infinity.

In cases where the impedance transforming capability of two or more L type circuits overlap, the

particular circuit which results in the more practical circuit constants should, of course, be chosen. It is of interest to note that the circuits shown on diagram e and diagram g (Fig. 2) are each capable of transforming the same range of load impedances although each accomplishes a given transformation with different reactance values. The circuits on diagram f and diagram h are also both capable of making the same impedance transformations. Note also that either of these circuits is capable of transforming only a small portion of the range of impedance values which may be transformed by the circuit of diagram a or b.

Graphical Concept of Impedance Transformation

On each of the eight impedance vector diagrams, shown on Fig. 2, an example of the function of each element of the circuit is illustrated using an assumed load impedance vector, Z_L . The influence of each of the circuit elements upon the load impedance vector, Z_L , may be re-

garded as forcing the latter to move along an "impedance path" from its initial position to a position along the R -axis, with its extremity at position $1R_L$. This impedance path followed by a single vector is illustrated on each of the eight diagrams of Fig. 2 by a zig-zag line (and arrows to show its direction of movement). More specifically, for example, refer to diagram a of Fig. 2. Here, any load impedance, as Z_L , may be selected whose extremity falls in the unshaded area, which it is desired to transform, with an L circuit of the type indicated on this diagram, to a chosen value of pure resistance, $1R_L$. In this case it will be noted that the effect on the impedance vector Z_L of the shunt capacitive reactance is to rotate its extremity clockwise around a circular zig-zag path leading to the point Z_L . This path is always along a circle tangent to the X -axis and centered on the R -axis. Z_L represents the extremity of a second impedance vector, the resistance component of which is equal to $1R_L$. (To simplify

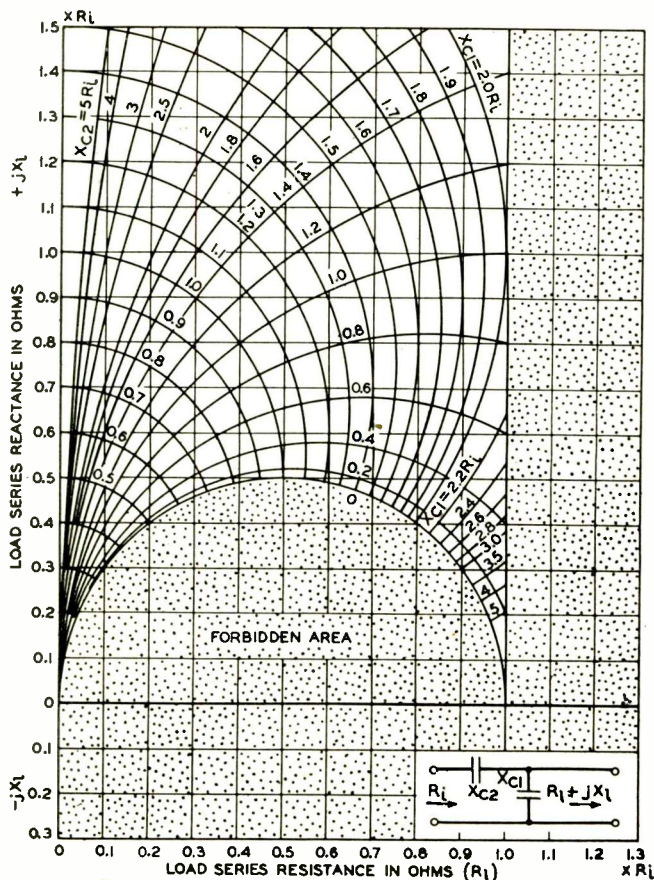

FIG. 7—Shunt and series capacitive reactances required to transform load impedance, $R_i + jX_i$, to pure resistance, R_i .

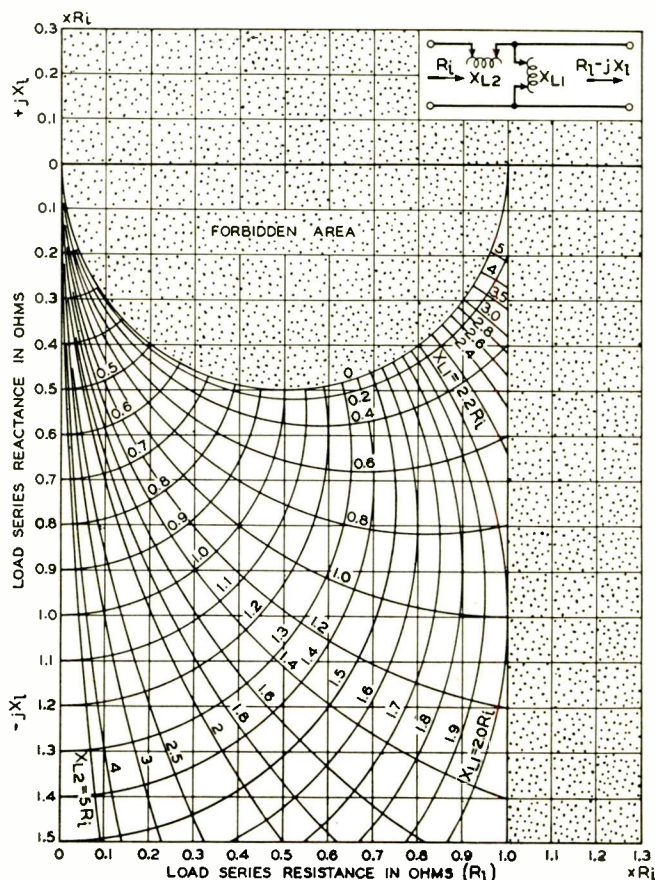

FIG. 8—Series and shunt inductive reactances required to transform load impedance, $R_i - jX_i$, to pure resistance, R_i .

the diagrams, only the extremity of the vector Z_i is indicated.) The capacitive reactance component of the impedance vector Z_i is then cancelled by the reactance of the series inductance element of the L circuit which moves the vector vertically along the zig-zag path to position $1R_i$, thus completing the transformation.

Z_i is, of course, the parallel resultant of the complex load impedance, Z_i , chosen and a definite value of shunt capacitive reactance, and impedance vectors whose extremities lie at intermediate points along the indicated circular "path" would, of course, have been obtained only if an intermediate shunting reactance value (between infinity and the value which is required to move the vector Z_i to the position Z_i) had been selected.

If, in the limit, the shunting reactance were of infinite capacity (0 reactance) the circular path which Z_i follows would, of course, continue along this same circular path all the way to the origin. A specific capaci-

tive load shunting reactance is therefore required to stop the rotation of the vector at the desired point Z_i . Similarly, a specific inductive series reactance is required to continue the path of the vector from Z_i , exactly to position $1R_i$. The required reactances of the condenser and coil are not shown on this "key" diagram (Fig. 2) which, as explained, is intended only to outline the capabilities of the particular circuit to which the diagram refers.

Determination of L Circuit Constants

After having selected an L circuit for a given impedance transformation with the aid of Fig. 2 it will next be required to determine the reactance values in the circuit. To obtain the proper value of the inductive and capacitive reactances required in a given L circuit arrangement to transform a given complex load impedance ($R_i \pm jX_i$) to a given pure resistance, $1R_i$, select the family of design curves which have been plotted for the particular circuit chosen. These are plotted on Fig. 3

to Fig. 10, for each reactance element of each of the eight possible circuits. The appropriate design curves from which the circuit constants can be obtained may be identified by referring to the small schematic circuit diagram associated with each family of design curves or by the notation given in connection with each diagram of Fig. 2.

The load impedance point (extremity of the load impedance vector) should be spotted on the appropriate design chart. The proper circuit reactance value is then determined by interpolating between the nearest reactance curves plotted. If, for example, the load impedance point is midway between a curve labeled $X_L = 3R_i$ and a curve labeled $X_L = 3.5R_i$, the correct reactance value for X_L would be $3.25R_i$, and so on. Problem 1 which follows further illustrates the use of the charts.

PROBLEM 1.

- a. Select an L-type circuit which will transform a load impedance of $150 + j75$ ohms to a

CINCH
KEEPS 'EM COMING

**...STAMPED..
ELIMINATES SCREW
MACHINE PARTS**

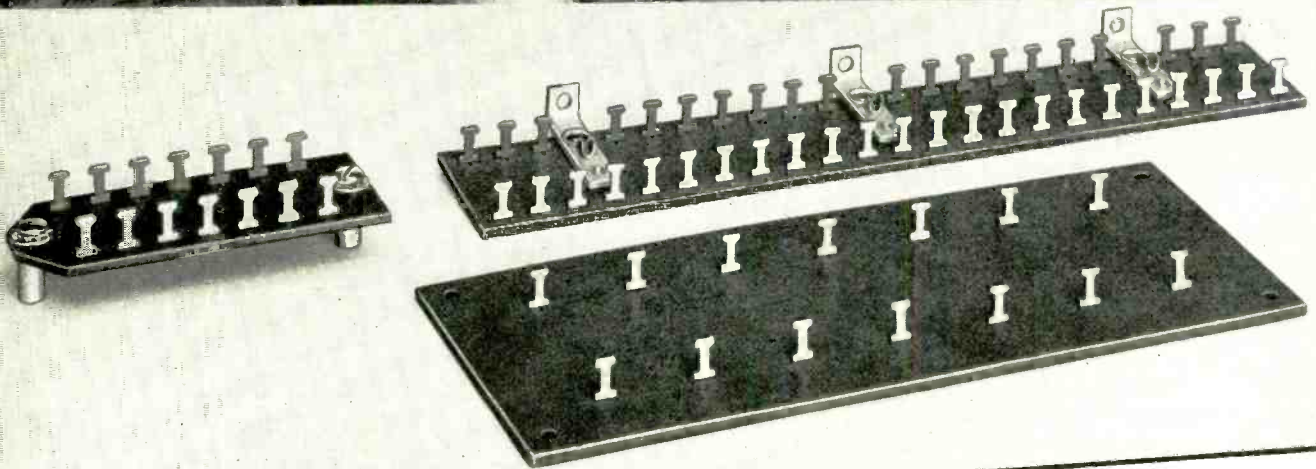

A SIGNAL contribution to the defense program . . . these sturdy CINCH Terminal Boards with the lugs *stamped* from copper. Substantial, for heavy duty, these terminal boards are made of fabricated *Ucinite*, CINCH's own laminated material. And so designed and constructed that wires can be soldered and removed several times. The specially treated 1/16 and 3/32 canvas base *Ucinite* is impervious to moisture. The copper lugs with serrated edges firmly hold wires in place . . . all hot tin dipped for quick and easy soldering. Many different types of these terminal boards . . . and similarly assembled parts . . . are available for your defense program requirements.

Parts shown approx. 1/4 size.

CINCH MANUFACTURING CORPORATION • 2335 WEST VAN BUREN STREET • CHICAGO, ILLINOIS
SUBSIDIARY: UNITED-CARR FASTENER CORP. • CAMBRIDGE, MASS.

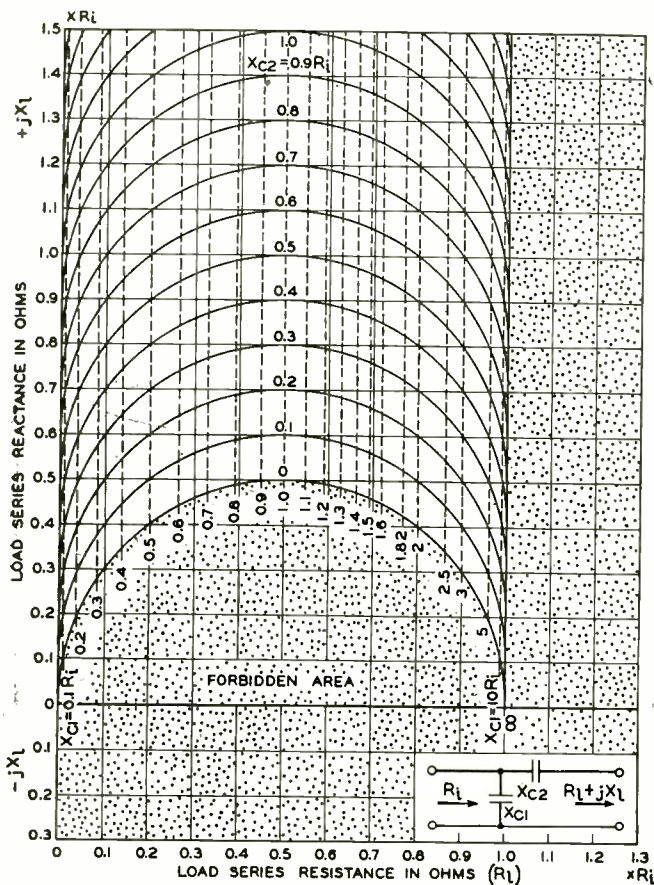

FIG. 9—Shunt and series capacitive reactances required to transform load impedance, $R_L + jX_L$, to pure resistance, R_L .

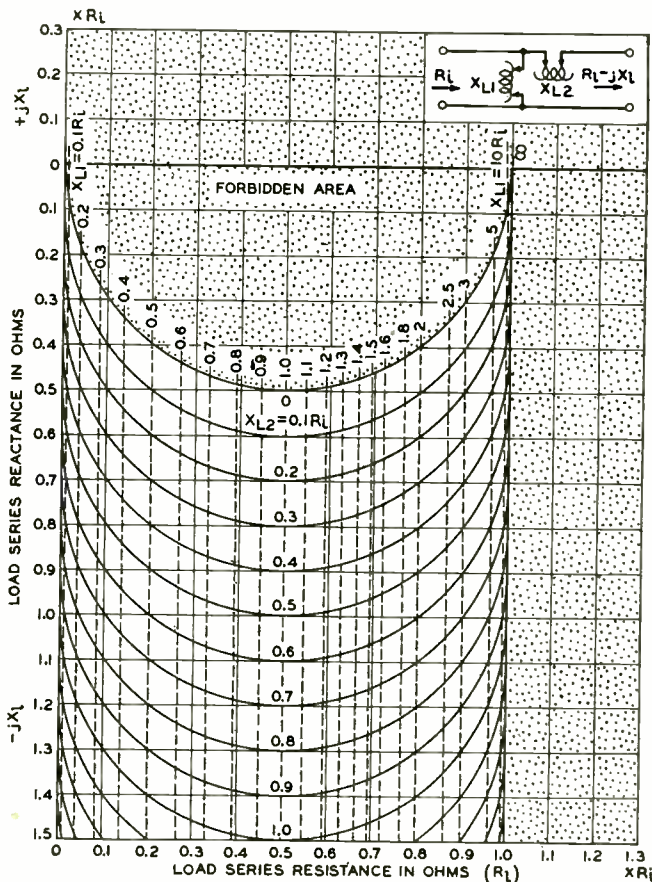

FIG. 10 Shunt and series inductive reactances required to transform load impedance, $R_L - jX_L$, to pure resistance, R_L .

- pure resistance of 50 ohms.
- Determine the reactance value for each branch of the circuit selected.

SOLUTION:

- From the above problem
 $R_L = 50$
 $Z_L = 150 + j75 = 3R_L + j1.5R_L$

Refer to key diagram Fig. 2, and observe that the extremity of the above load impedance vector ($3R_L + j1.5R_L$) falls within the unshaded (transformable) area of diagrams a and b, and within the shaded or "forbidden" area of diagrams c to h inclusive. A choice of two circuits is therefore available for this transformation. Select one—say that of diagram b.

- Refer to Fig. 4A (as directed on diagram b) and determine the correct reactance value for X_L by noting that the extremity of the load impedance vector ($3R_L + j1.5R_L$) will fall at

a point approximately midway between the curves labeled $X_L = 3.5R_L$ and $X_L = 3.0R_L$, therefore X_L is approximately $3.25R_L$, that is, $X_L = 3.25 \times 50 = 162.5$ ohms. From Fig. 4B observe in a similar manner that $X_C = 1.65R_L$, that is, $X_C = 1.65 \times 50 = 82.5$ ohms.

If a complex load impedance is not known exactly but can be estimated within certain limits, these limits may be blocked out directly on the design charts and the range of circuit reactances required can thus be bracketed at a glance. This feature will be most appreciated when an L circuit must be designed to accommodate any one of a range of possible load impedance values. The design of a circuit to match the base impedance of a radio antenna, which is usually not definitely known, to the characteristic impedance of a concentric transmission line is readily accomplished with this type of diagram. In such cases, it will be found of great value to be able to visualize the limitations of a given circuit and

thereby establish limiting requirements for the circuit elements. Problem 2, which follows, illustrates this case.

PROBLEM 2.

- Select an L circuit which can be adjusted to match any load impedance falling within the range 25 to 75 ohms resistance and 0 to 50 ohms positive reactance to a pure resistance of 100 ohms.
- Give the limiting reactance values of each of the two circuit elements.

SOLUTION:

- From the above problem
 $R_L = 100$
 $Z_L = (25 \text{ to } 75) + j(0 \text{ to } 50)$ ohms = $(0.25R_L \text{ to } 0.75R_L) + j(0R_L \text{ to } 0.5R_L)$ ohms

From Fig. 2 select a diagram upon which the above "block" of impedance values all fall within an unshaded (trans-

(Continued on page 125)

Filament Emission

Makes the Modern World Go Around

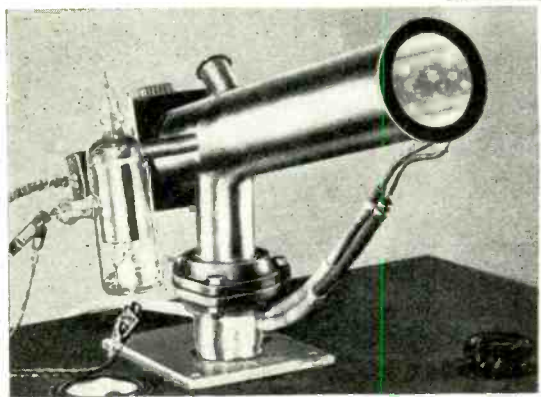

Close observation of the flow of electrons from a heated filament is made possible with this Electron Microscope. This instrument, designed and constructed in the Eimac laboratories, virtually gives a motion picture projection of the electron movement.

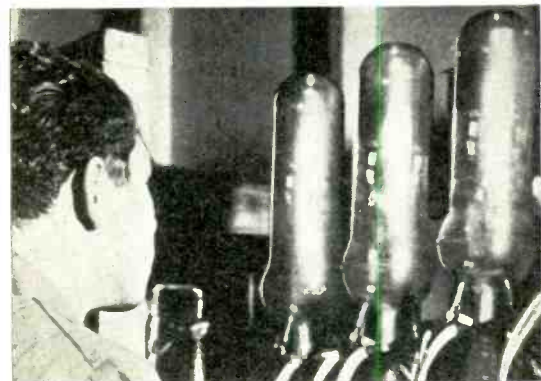

Before filaments are sealed into the triode they are placed in a temporary vacuum where they undergo their first emission test. Thus faulty filaments may be weeded out without further processing.

T

HE life of radio communications hangs by a tiny thread of filament wire. If the steady flow of electrons from the vacuum tube filaments ceases, the transmitter is off the air no matter how excellent the other components may be performing. To assure peak emission under the most severe operation conditions, many exacting tests are conducted during the process of manufacture.

Above is an Eimac technician checking an Eimac tube on the Peak Emission Tester. This device, designed and constructed in the Eimac laboratories, measures the flow of electrons emitted from the completed tube. Of a long series of filament tests conducted at various stages of manufacture, this test is the final. Other important controls are illustrated at left.

From beginning to end, Eimac tubes are designed and constructed to give vastly superior performance. The proof that they do is made clear by the fact that Eimac tubes enjoy first choice in the minds of leading radio engineers throughout the world.

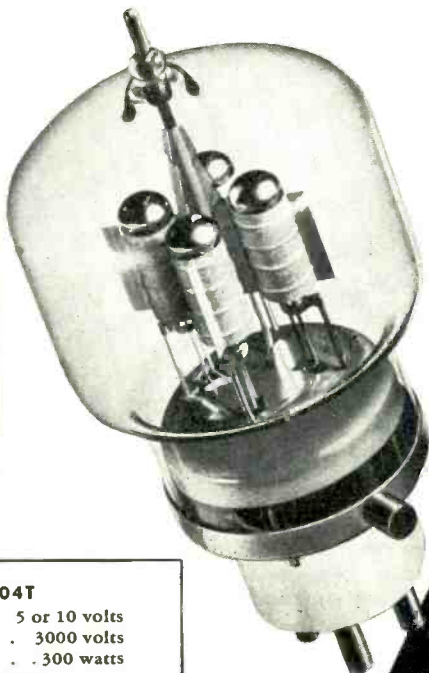

EIMAC 304T

Filament Voltage . . . 5 or 10 volts
Plate Voltage (D.C.) . . . 3000 volts
Plate Dissipation300 watts
Power Output 3000 volts
at 75% eff. 900 watts

Follow the leaders to . . .

Eimac

TUBES

Eitel-McCullough, Inc. San Bruno, California

New Books

Fun With A Recorder How to Make Good Recordings

Published by Audio Devices, New York City, 1941

THERE IS A STRIKING SIMILARITY between the making of amateur movies and the making of amateur recordings. Most of us remember our first amateur movies. We pushed our relatives in front of the camera. Most of them stared or waved their hands and felt rather silly. Everybody whooped when they saw the film, but there was no point in making many films like that, so our movies from then on had to mean something. So it is with amateur recordings. When somebody first produces a recorder at a party and thrusts a microphone in front of unwilling victims, they get panicky, ask what to do, what to say, or else indulge in ancient wise cracks, such as "unaccustomed as I am, etc., etc." Here again, the playback brings the house down, and here again, subsequent recordings must have something to them. What amateur movie scenarios do for the movie bug, so does "Fun with a Recorder" do for his acoustic counterpart.

"Fun with a Recorder" is a collection of 30 most intriguing "audio-scripts" or scenarios. They require little else than several peoples' voices and a few rather simple sound effects. They should be most interesting to carry out and amusing to listen to. Part Two of "Fun with a Recorder" tells how to put an "audio-script" show over, and includes, among other things, "Recording at Parties," "Live' Microphone Areas," "Speech Recording," "Recording Sound-Effects," "Recording Children," and "Making Copies."

Altogether, this is a most helpful little booklet for putting fun into recordings. For the more serious devotees of sound recording who are interested in all the principles and procedures and, most of all, in finest acoustical reproduction, "How to Make Good Recordings" will have a great appeal. It is a very readable book, very well illustrated with diagrams. The "Principle of Direct Recording" includes "Cutting Heads," "Feed Mechanisms," "Drives," etc. A few of the titles are "Adjusting the Turntable Drive," "Setting the Cutting Angle," "Adjusting the Depth of Cut," "Determining the Correct Recording Volume," "Controlling the Thread," "Making Radio Recordings," "Microphone Technique," "Speech Recording," "Microphone Placements," etc. The dubbing of records is included. Some

space is devoted to planning of records and the approach, including such things as "Ad-libbing," "The Candid Approach," "The Use of Sound Effects," "Master of Ceremonies Technique," "Recording for Home Movies." There is a "flop" section on common recording defects, and a glossary.—J.W.M.

Acoustics, A Handbook for Architects and Engineers

PERCY L. MARKS. *Chemical Publishing Co., New York. 143 pages. Price \$3.00.*

THIS BOOK HAS TWO main parts and an extensive appendix. It might more properly be called an annotated scrap book since it consists largely of quotations from many authoritative sources. Unfortunately the authority of the reference is vitiated by the manner in which the quotations have been divorced from the original and by the author's comments and inter-

polations. The author has set himself the difficult task of writing an elementary book on a technical subject and this has been further complicated by his failure to understand the fundamental principles involved and the definitions and connotations for the technical words employed. For example, the author confuses such very different terms as "loudness and noise". Although the book discussed the architectural branch of acoustics exclusively it disposes of the fundamental problems of normal modes of vibration in a room with a single inaccurate sentence.

The second part of the book consists of excerpts from the literature of firms producing acoustic materials. This portion of the book is of interest to those who wish data on materials marketed in Great Britain. Many of the products listed are not generally available in this country and identification of others is complicated by the differences in designation used here and abroad. The appendix contains an extended quotation from "Acoustics of Buildings" by F. R. Watson and other interesting material. One has the feeling that the book might well have contained more appendix and no theoretical section.

While some of the tabular material is undoubtedly of interest to the "architect and engineer", the section on theory is very apt to lead to confusion and furthermore fails to even touch a modern viewpoint in architectural acoustics.—H.S.K.

RADIO CODE SCHOOL FOR THE ARMY

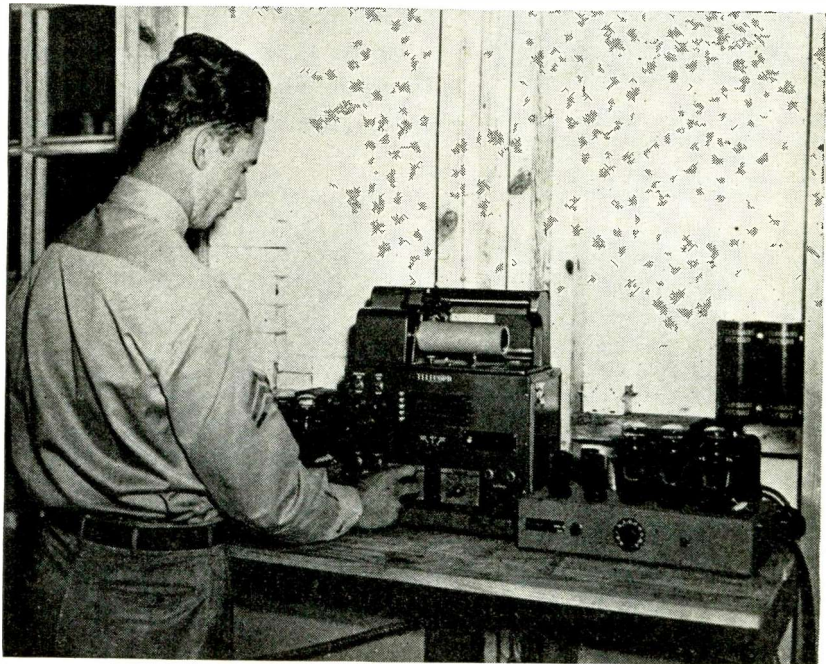

The machine shown here plays records which test the soldier's hearing to see whether or not he will make a good operator. This is part of an aptitude test soldiers must take before becoming a student in the Second Armored Division's new radio code school. The school is under the supervision of 1st Lt. Eric R. Osborne and is being built by personnel of the 142nd Signal Armored Company at Ft. Benning, Ga.

TUBES AT WORK

Delayed Single Sweep Circuit for CRO's.....	65
Electronic Control for Carbon Arcs.....	65
Photoelectric Scanning Device	70
Phototube Controlled Revolving Door.....	72
An Anti-Electrolysis Relay	72
Photoelectric Intrusion Detector.....	73

CRO Delayed Single Sweep Circuit

By W. E. GILSON

*Physiology Dept.
University of Wisconsin Medical School
Madison, Wis.*

THE CIRCUIT TO BE DESCRIBED was designed to be used in conjunction with any cathode-ray oscilloscope incorporating a single sweep which may be initiated by a positive impulse.¹ Its purpose is to delay the sweep any desired time after the peak of a repeating transient so that the sweep may be adjusted to cover any time interval desired with respect to the peak.

For example, it may be desired to photograph the QRS complex in the turtle. This is a diphasic electrical pattern produced at the beginning of each contraction of the heart, lasting less than one-fifth second and recurring every 4 seconds with a rate of 15 per minute.

If an ordinary single sweep is used, set off by the signal peak producing an upward deflection of the spot, a record showing the electrical events following the peak is obtained. Figure 1 was made with a slow sweep, Fig. 2 with a faster sweep.

It is obvious that a device which will respond to a positive impulse and produce a second positive impulse after any desired interval will enable the operator to delay the sweep from the peak

of the transient until just before the transient next occurs, the photograph of the sweep showing the transient in its entirety or any part of it desired. Thus Fig. 3 shows the entire QRS complex.

Any event related to the peak may be photographed. Figure 4 shows the T wave, which occurs about half way between the QRS complexes. This was photographed by shortening the period of delay.

Circuit Operation

The circuit operation is as follows: Referring to Fig. 5, switch S2 permits putting the signal directly into the single sweep circuit or into the delay circuit. In the latter case the impulse passes through the unity amplifier T1, which isolates the signal source (the last stage of a push-pull, direct-coupled amplifier) from the thyatron circuit.

T2, the 2A4G, is a relaxation oscillator so biased that it will break down only when a positive impulse is applied to its grid. T3 is another isolating amplifier. T4, the 884, is ordinarily broken down but because of the high resistance in its plate circuit, conduction may be stopped by throwing the grid sharply negative. This occurs when the transient peak causes T2 to break down. When T4 opens up, its plate becomes suddenly more positive. This is changed to a negative pulse by

passing through T5. The negative pulse is passed on to the single sweep circuit but produces no effect.

The grid of the 884 becomes less negative at the 3 μ f condenser in the T2 relaxation oscillator circuit charges through the 3 megohm variable resistor. When the breakdown voltage is reached the 884 fires, its plate becomes suddenly less positive, and this negative pulse is changed to a positive pulse by T5. The positive pulse is applied to the single sweep circuit and initiates the sweep. The length of the delay is controlled by varying the 3 megohm resistor.

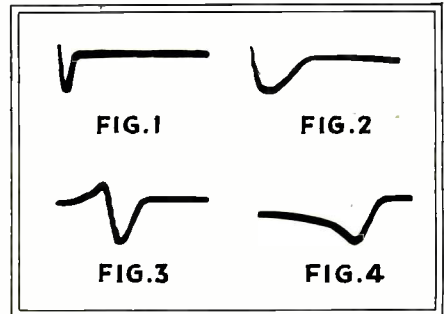

Oscillographs of the QRS complex of a turtle, taken with slow sweep, fast sweep, long and short delays

In many cases it is desirable that the circuit throw itself out of action after one sweep. This is accomplished by closing switch S3 in the plate circuit of T6, a 2A4G which is caused to conduct by the same positive impulse which initiated the single sweep. This reduces the plate voltage on T3 so that any further synchronizing impulses do not affect T4. The circuit is made ready for another operation by opening S3.

The use of this circuit is, of course, not limited to cardiac research but is applicable to the study of repeating transients of various types. It should be of value in a modified form in other timing applications.

(1) Gilson, W. E., A Versatile Oscilloscope, ELECTRONICS, December, 1941.

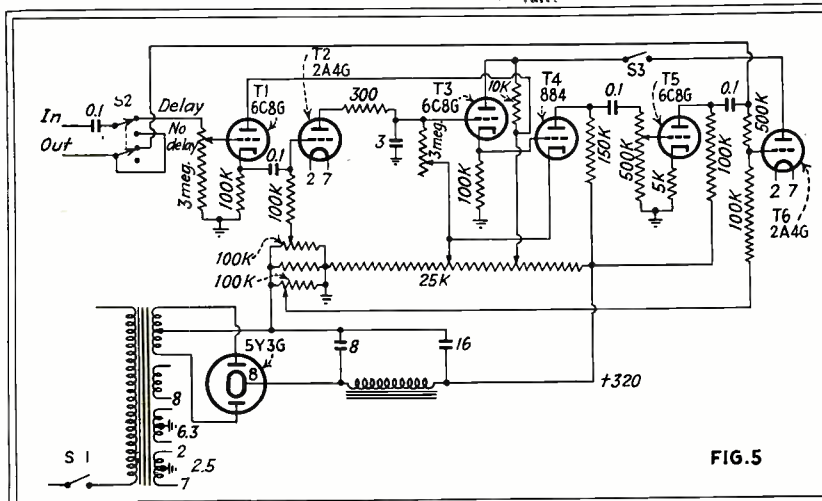

Circuit diagram of the delayed single sweep circuit, which may be used in conjunction with any cathode ray oscilloscope incorporating a single sweep that may be initiated by a positive impulse

Electronic Control for Carbon Arcs

By WILBUR FLAHERTY

Strand Theatre, Fort Dodge, Iowa

RECENT RESEARCH on the behavior of carbon arcs used in motion picture theater projection service has brought out several interesting facts. Such arcs are more critical with respect to current density than to voltage across their electrodes. The length of the gap has a major bearing upon illumination intensity and steadiness, formation of craters at the positive electrode and the rate at which carbons are consumed.

Direct current for such arcs is sometimes obtainable from central station lines. Where only a-c lines are available local motor-generators are occa-

NEW PROBES FOR THE UNKNOWN

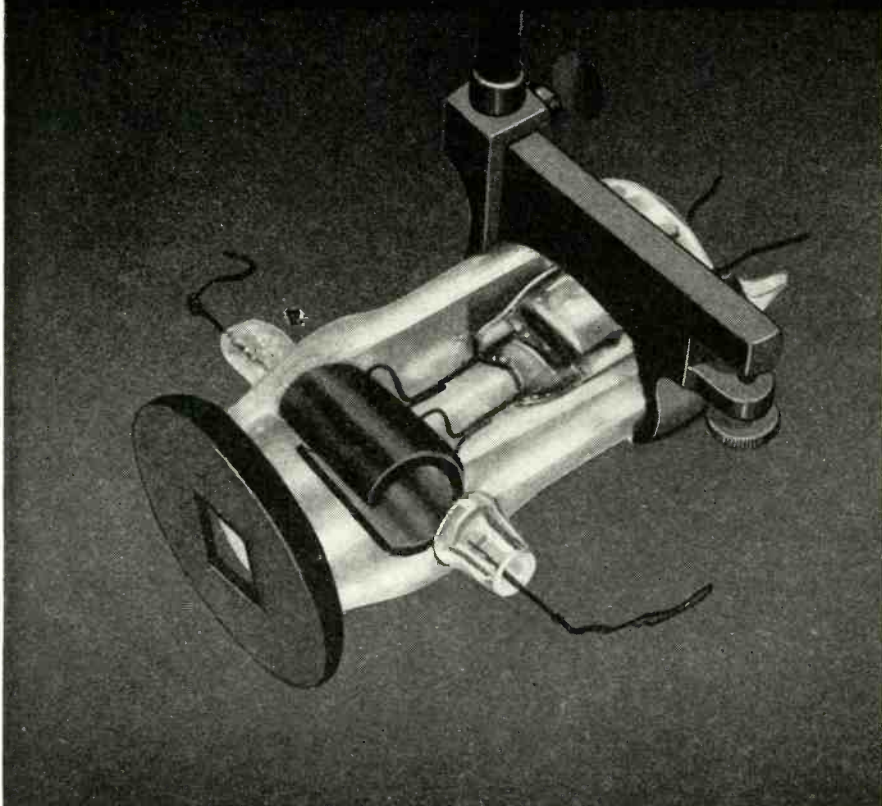

a development of **BARTOL RESEARCH FOUNDATION**
to which **CALLITE** contributed

WHEN BARTOL RESEARCH FOUNDATION scientists pioneered momentous improvements in the Geiger Mueller Tube, they opened new uncharted fields of research in the laboratories of chemistry, biology, medicine and industry. Its amplifying powers and high degree of sensitivity make possible the detection—and often the measurement—of radiations emitted by radioactive substances, nuclear particles, x-rays, ultraviolet and cosmic rays.

It is logical that Callite tungsten rod and wire were chosen for this important development work. Logical because of Callite's uniform dependability in so many electronic applications where failure cannot be tolerated. Proven through long experience and painstaking research, this resourcefulness is yours to command today. Call in Callite engineers on your metallurgic problems now.

Specialists in the manufacture of electrical contacts of refractory and precious metals, bi-metals, lead-in wires, filaments and grids—formed parts and raw materials for all electronic applications.

CALLITE TUNGSTEN CORPORATION

544-39th STREET UNION CITY, N. J.

Cable: "CALLITES" Branches:  Chicago, Ill. • Cleveland, O.

sionally used. Direct current is more often supplied by half-wave Tungar bulb rectifiers without filters and carbon-feed is something of a problem because the ordinary arc control does not function very well where current is pulsating.

Simple and Inexpensive

Pictured in Fig. 1 is a simple, sensitive and inexpensive electronic carbon arc control which adjusts arc length as a function of arc current. It is diagrammed in Fig. 2.

A heavy shunt having a value sufficient to produce about 10 millivolts drop across the primary winding of transformer *T* is connected in series with the power supply feeding the arc. (No-load output of rectifier units used

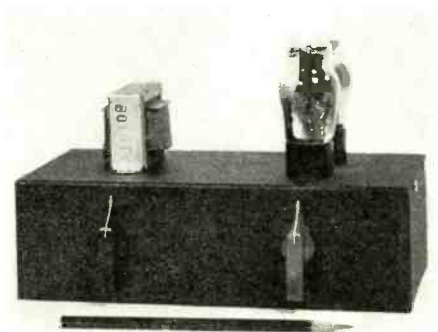
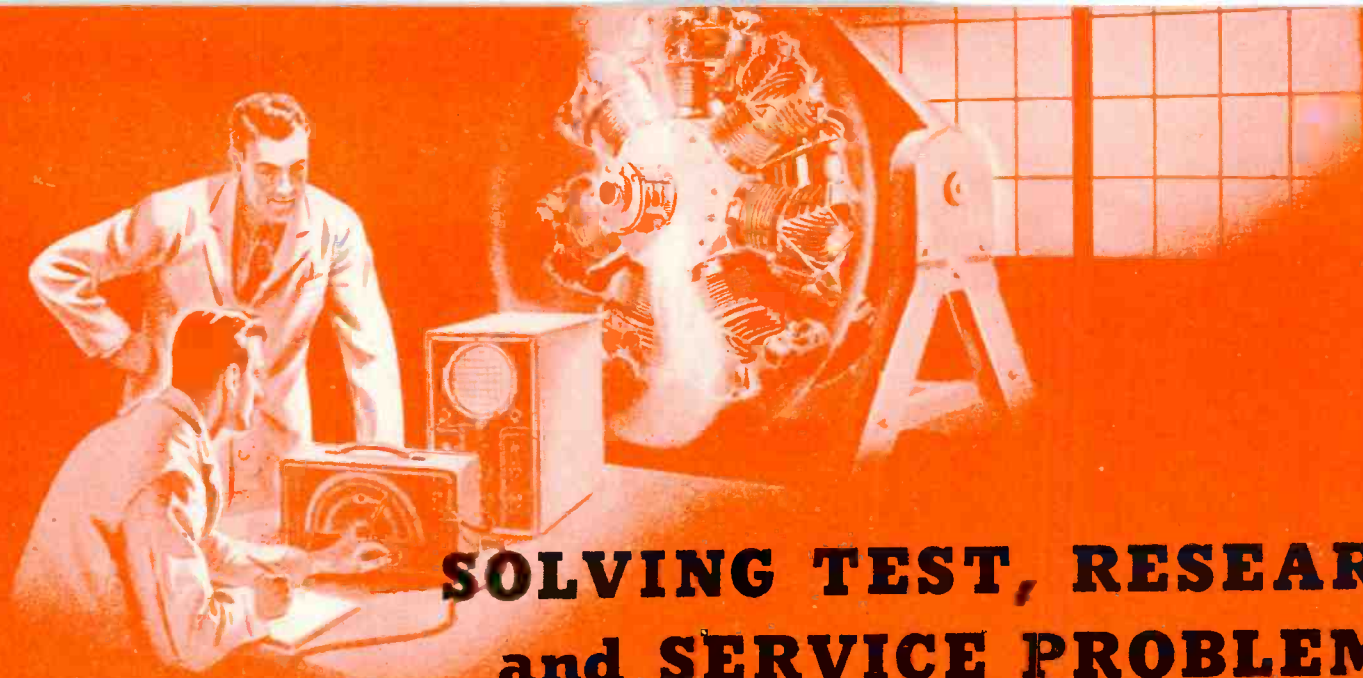

Fig. 1—Completed carbon arc control unit. Pencil in foreground indicates size

with most commonly encountered carbon combinations is 70 volts, falling to approximately 54 volts under load. Shunt unit values for supplies having other characteristics are readily calculated.) The secondary winding of *T* delivers about 25 volts to the type 27 tube, used as a half-wave diode rectifier. D-c voltage developed by the diode is applied as negative bias to the grid of the 2A4G thyatron. Thyatron fixed bias may be adjusted by varying *R*₁. Rheostat *R*₂ shunts the 2A4G so that this tube need not pass the entire arc-adjusting motor current. *C* shunts the motor to keep the thyatron anode in phase with its grid, so that the tube may continue to exert control after the motor starts. (Relay coils originally furnished with the motor are removed to avoid impairment of circuit operation due to their self-induction.)

When the control unit is placed in operation the arm of *R*₁ is rotated to the most negative point of this potentiometer, i.e., the cathode center tap of the thyatron. With the arc burning, *R*₂ is adjusted until the arc-feed motor is just barely turning over. *R*₁ is then varied until the arc assumes its most efficient length and held at this position until the carbon crater has formed. After the crater has formed *R*₁ is re-adjusted for optimum arc-length and remains set, needing no further adjustment until carbons have burned down to short stubs and re-



SOLVING TEST, RESEARCH and SERVICE PROBLEMS on a Thousand Fronts

It Pays Many Ways!

RCA Test Equipment is noted for its long, dependable performance. It is designed for minimized obsolescence. Standard parts are used in its construction. Complete operating and service data is available for every instrument.

Now, at a time when most servicemen are busier than they have been for years, and when new equipment is difficult to obtain, these factors loom more important than ever before. They spell increased value to RCA Test Equipment owners!

Although designed primarily for Radio needs, RCA Test Equipment has proved its ability to serve industry in general along lines far removed from radio uses. It is doing many jobs better, more accurately than they have ever been done before. It has opened new horizons in engineering, testing and servicing on a vast industrial front.

These factors help explain why practically the entire production of RCA Test Equipment is today being supplied on Defense orders for War needs and War material manufacture. Tomorrow's users, however, will benefit, not only through RCA's increased facilities for production but, even more so, through the far-reaching experience gained in the application of this Equipment along almost unlimited lines.



TEST EQUIPMENT

Modern Devices for Modern Methods

RCA MANUFACTURING CO., INC., CAMDEN, N. J.
A SERVICE OF THE RADIO CORPORATION OF AMERICA

IN CANADA: RCA VICTOR COMPANY, LIMITED, MONTREAL

FOR VITAL MILITARY AND

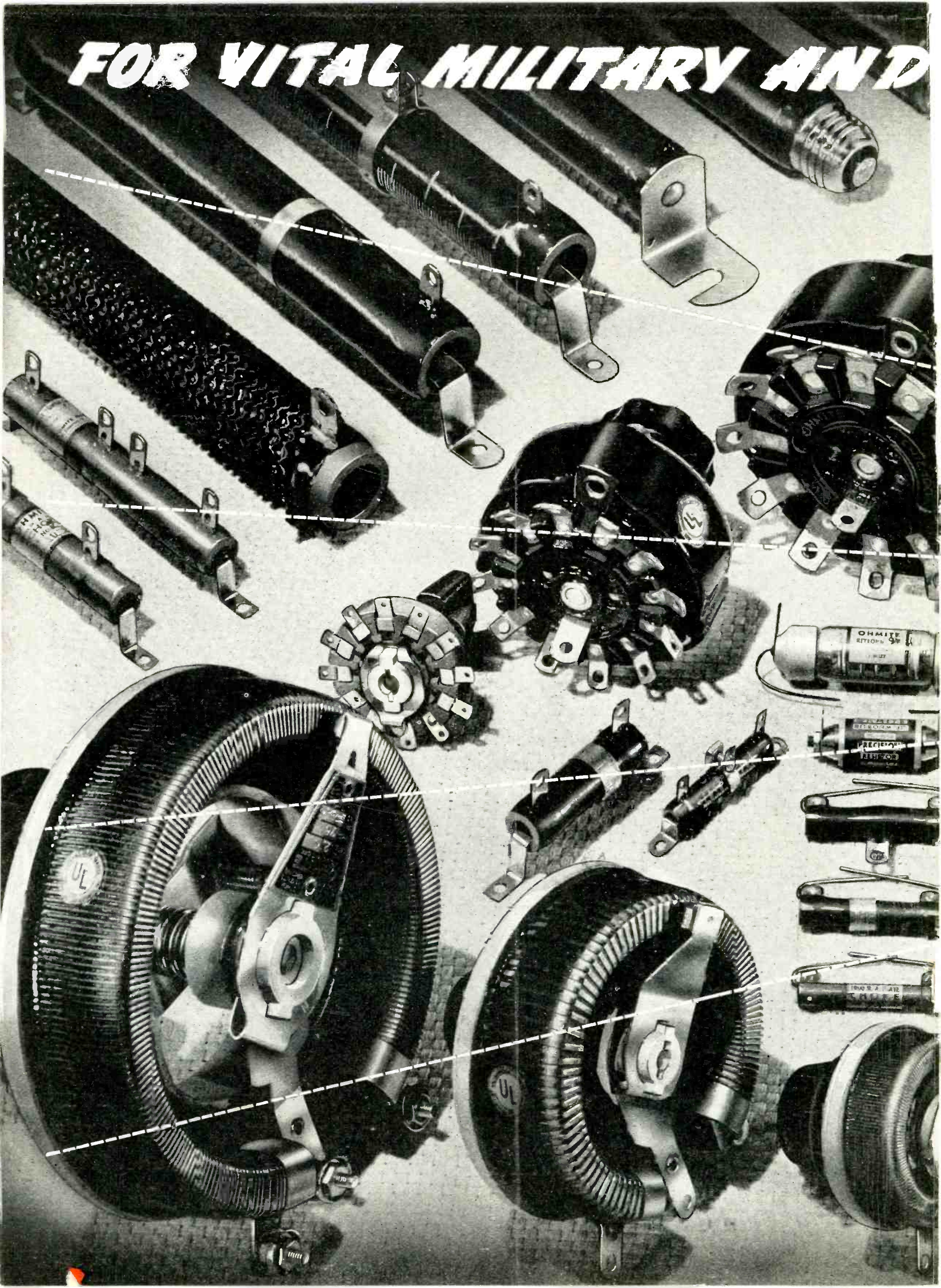

INDUSTRIAL APPLICATIONS

OHMITE Rheostats, Resistors, Tap Switches MEET THE TEST!

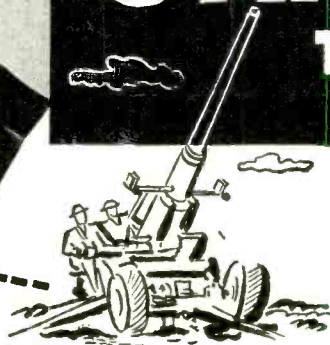

Today's critical requirements find Ohmite Products well qualified for any service. Ohmite Rheostats were the first to be used in aircraft—and have been first ever since. Today, more Ohmite Rheostats are used in military and commercial airplanes than any other make. Approved types for all Army and Navy specifications.

Like the Rheostats, Ohmite Resistors and Tap Switches are used in endless variety and number in many other military, industrial and electronic applications. They have proved their ability to meet the test of service on land, sea and in the air, in every climate.

Widest range of types and sizes make it easier to provide the right units for each need. Many stock items. Units produced to Governmental specifications. Special units engineered for you.



Send for Catalog and Manual No. 40

96 pages of helpful information and engineering data on resistance problems. Write for your copy on company letterhead to Ohmite Manufacturing Co., 4818 Flournoy St., Chicago, Ill.



Vitreous Enameled Resistors

The resistance wire is evenly wound on porcelain core, rigidly held in place, insulated and protected by Ohmite vitreous enamel. Dissipates heat rapidly—prevents hot spots and failures. Core sizes range from 2 1/2" diameter by 20" long to 5/16" diameter by 1" long.



Close Control Rheostats

Smooth, gradual, close control is permanently built in. The wire is wound on a solid porcelain core, locked in place and insulated by Ohmite vitreous enamel. Nothing to shrink, shift or deteriorate. Self-lubricating metal graphite contact prevents wear on the wire.



High Current Tap Switches

Load-break, single-pole, multi-point rotary selectors. Compact, all-enclosed ceramic construction. Unique slow-break action. Large self-cleaning silver-to-silver contacts. Low contact resistance. Back of panel mounting. Non-shorting type. Five sizes from 10 to 100 amperes, A. C.

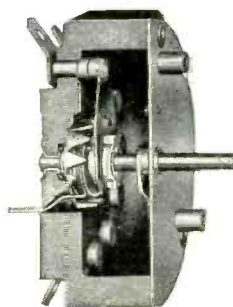
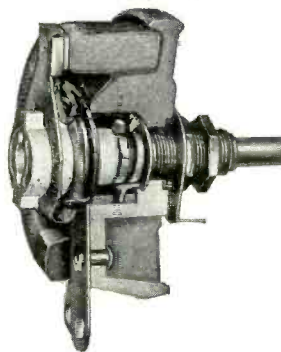

OHMITE MANUFACTURING COMPANY

Foremost Manufacturers of Power Rheostats, Resistors and Tap Switches



Super-Cardioid Simplifies Sound Pickup Problems in Studio and Remote Broadcasting



Model 556A for 35-50 ohms, Model 556B for 200-250 ohms, Model 556C high impedance—at only \$75.00 list.

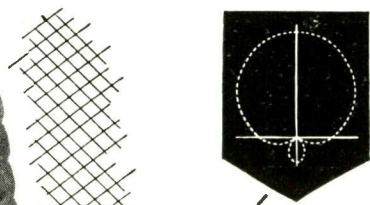

FEATURES

- ★ More unidirectional than the cardioid—yet has wide-angle front pick-up.
- ★ Decreases pick-up of reverberation energy and random noise 73%.
- ★ Improved wide-range frequency response—from 40 to 10,000 cycles.
- ★ Symmetrical axial polar pattern at all frequencies.
- ★ Highly immune to mechanical vibration and wind noises.



Tests prove it gives optimum directional performance under the great majority of acoustical conditions. This, together with other advantages of the Shure Uniphase single-unit moving-coil construction, offers a simpler solution to sound pick-up problems in studio and remote locations. The *Super-Cardioid* eliminates undesired noises more easily—simplifies microphone placement—insures better performance outdoors as well as indoors.

30-Day Free Trial. Broadcast Engineers: Try the *Super-Cardioid* for 30 days in your station without obligation. Prove it yourself. Write us today.



SHURE BROTHERS
Designers and Manufacturers of Microphones and Acoustic Devices
225 West Huron Street, Chicago, Illinois

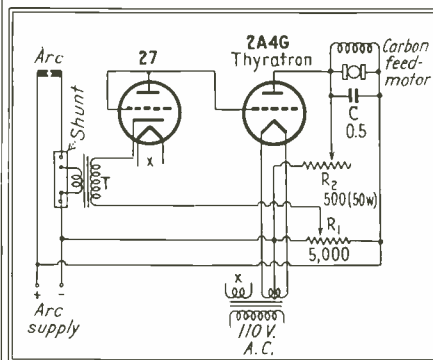

Fig. 2—Carbon arc control circuit

quire replacement. When these adjustments have been made any increase in arc-current (carbons too close together) develops a higher negative bias on the grid of the thyatron, cutting this tube off and slowing down the motor which is geared to drive carbons closer together. Any decrease in arc-current (carbons too far apart) causes the carbon-feed motor to speed up.



Photoelectric Scanner

A PHOTOELECTRIC SCANNER consisting of a light source, converging lens system and two phototubes in a single, compact housing (Fig. 1) has been designed by United Cinephone Corporation of Torrington, Connecticut. It is useful wherever light reflected from a surface two inches or less distant from the unit may be employed to control an industrial process.

In operation (Fig. 2) light from a lamp mounted in metal housing A passes through the double-converging lens system in lens-barrel B, then

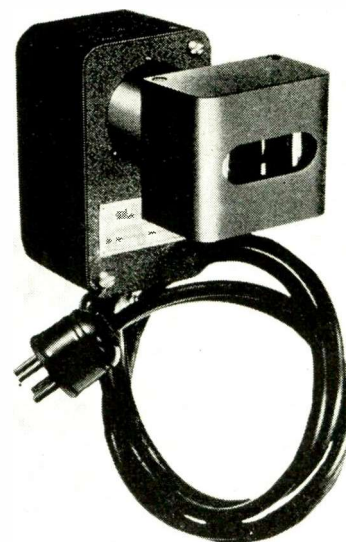
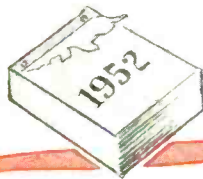
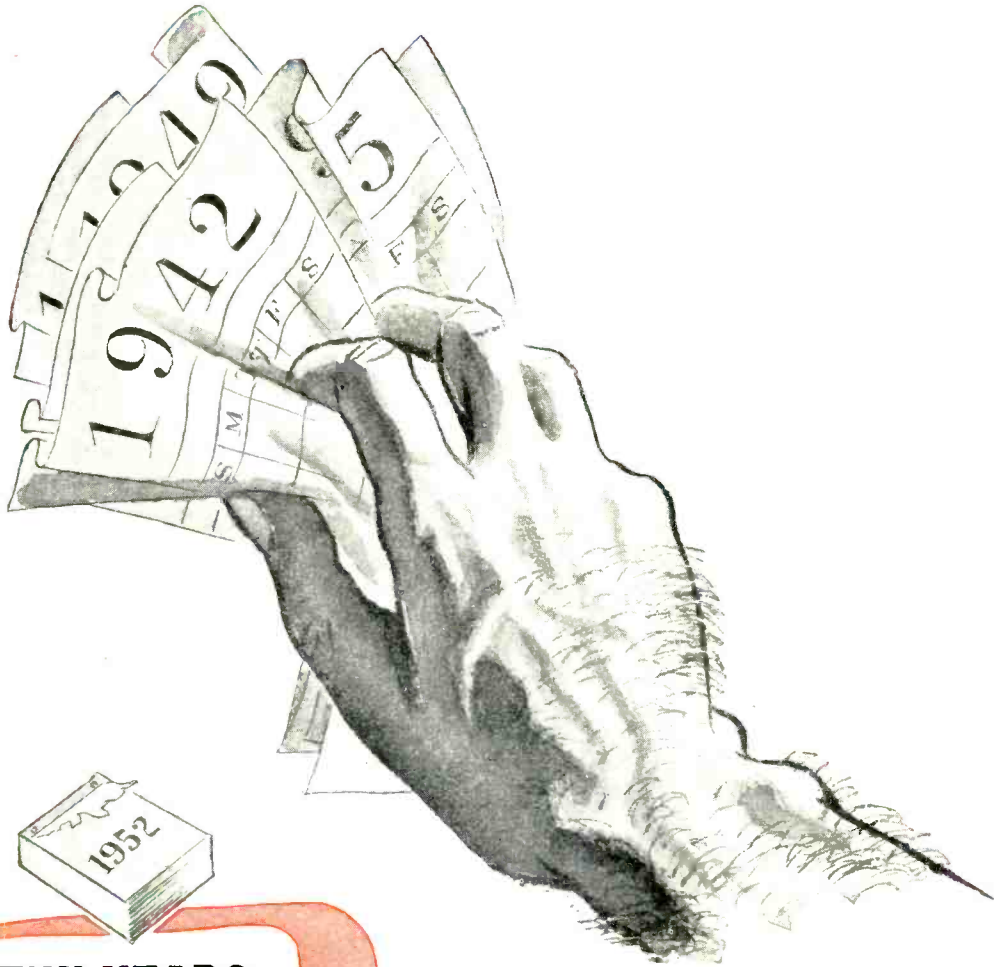

Fig. 1—Photoelectric scanner, combining light source, converging lens system and two phototubes in one housing



**TEN YEARS
PRACTICAL
PROGRESS**

IN ONE YEAR

The impetus of all-out war production will result in more progress this year than would occur in many years of normal activities. A large part of that progress will be due to prompt and correct solutions to practical problems worked out by the research laboratories of America.

Two years ago, the Research Staff of American Lava Corporation was faced with the full flood of war problems. Their solutions and the resulting production brought a wealth of practical experience. Production has been increased many times over peace time requirements and this progress is continuing at an unprecedented pace.

It is with pride that we offer the services of this outstanding organization on any problem involving custom-made technical ceramic compositions. We sincerely believe that nowhere can you find better mental or physical equipment for problems of this type. On war problems, this technical help is offered without cost or reservation. What can we do for you?

ALSiMAG FROM CERAMIC HEADQUARTERS
Trade Mark Reg. U. S. Pat. Off.
AMERICAN LAVA CORPORATION • CHATTANOOGA • TENNESSEE

CHICAGO - CLEVELAND - NEW YORK - ST. LOUIS - LOS ANGELES - SAN FRANCISCO - BOSTON - PHILADELPHIA - WASHINGTON, D. C.

through aperture *F* in protective hood *G*. A highly concentrated spot of light *E* strikes the surface being scanned *H* and is reflected back into phototubes *D* and *D'*, its intensity being dependent upon the reflective quality of the scanned material. The response of the phototubes to a change in reflected light intensity is transmitted through coaxial cable to any suitable remote amplifier (such as this firm's model 66S), making possible the control of auxiliary electrical devices.

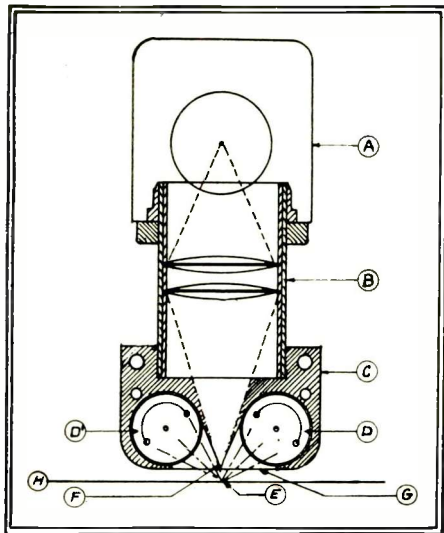

Fig. 2—Optical diagram of photoelectric scanner

Typical applications of the scanner include: Registration control from marks imprinted on materials such as Cellophane, light or heavy opaque papers, cloth or metals; sensitive cutoff from contrasting colors on similar materials; operation, through glass, from a meter-pointer for underload or overload alarm; operation from a scale-pointer for automatic batch weighing; counting watt-hour meter revolutions; tape reading or repeating on automatic tape machines; control according to perforations punched or marked on automatic business machine cards; detecting absence or misplacement of labels on tin cans; in conjunction with mirror galvanometers and mirror compasses; for paper-cutting or folding.

Casing *A* measures 3½ by 2¼ by 2¼ inches, casing *B* 2½ by 2½ by 1½ inches.

Phototube-Controlled Revolving Door

A MOTOR-DRIVEN revolving door made by the International Steel Company of Evansville, Indiana, incorporates photoelectric control limiting rotation to periods when there is traffic flow.

The drive-shaft of a ¼-hp a-c electric motor concealed above the ceiling of the door enclosure is geared down, generally to 8.7 rpm. Gears rotate the central "axle" of the door through a cone-

type clutch designed to reduce applied power to a negligible minimum should dawdlers move slower than the "wings" of the door and also to permit people in a hurry to push through faster than normal rotation speed.

A-c supply to the motor is applied through a relay operated by a General Electric control unit utilizing a gaseous phototube and single-stage triode d-c amplifier. Two such light-beam operated control units are used, one for operation by persons entering the building and another for those leaving. Delay is provided electronically by an auxiliary single-tube unit common to both phototube switching circuits and is adjusted to keep the door revolving somewhere between 5½ and 15 seconds after either beam is interrupted, exact adjustment depending upon the average time required for walkers to go through and exit from the door after interrupting a beam. Delay is not cumulative but cuts off motor power a few seconds after the last beam interruption by traffic.

Lightsources actuating the phototubes are 6-v automobile headlamps with double filaments, permitting reversal in sockets should the filament first placed in service burn out. Light-source power is obtained from a-c step-down transformers with secondary taps, permitting brilliancy to be adjusted to specific jobs. Filters behind projector lenses confine light to the nearly invisible red end of the spectrum.

Motor-drive and phototube control may be applied to revolving doors of other manufacture, provided an 18-inch clearance is available above the ceiling of the door enclosure. The motor is equipped with a power-adjustment screw which permits it to be adapted to heavier or lighter door loads.

CORELATOR, NEW MUSIC TEACHER

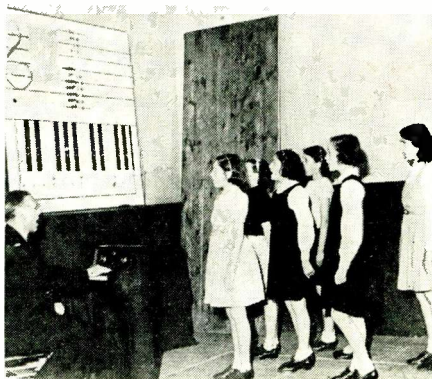

William Willmott, headmaster of an English school has devised a new method for teaching music to school children. The Corelator consists of the synchronization of a series of electric lights on a board connected with a miniature piano. Pupils are trained in sight singing, theory of music, and the relationship of keys

An Anti-Electrolysis Relay

By C. R. DAVIS and R. M. WAINWRIGHT
The Montana Power Co., Butte, Mont.

WHEN A GAS MAIN is located close to an electric railway, stray currents from the railway frequently damage the main by producing electrolytic action. Damage is done when the main is at positive potential with respect to the rails, causing a current flow from rails to main. It can be avoided by keeping the main neutral, or negative, with respect to the rails so that current may flow from main to rails but not in a reverse direction. This may be accomplished by connecting the directional thyatron tube relay diagrammed (five-mile protective unit) in series with a

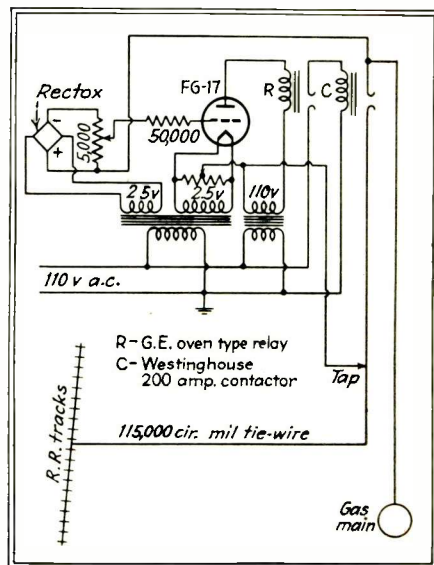

Schematic of anti-electrolysis relay designed to prevent damage of a gas main by stray currents from a nearby electrified railway line

tie-wire joining rails and main as shown.

Grid bias is adjusted by setting the arm of the 5,000-ohm potentiometer and the tie-wire tap so that when the rails are positive with respect to the main this external voltage bucks direct-current bias supplied by the Rectox unit, making the grid of the FG-17 more positive with respect to its cathode and causing the tube to fire. Anode circuit relay *R* closes, simultaneously closing contactor *C* and permitting current to flow through the contacts of *C* from main to rails. Reversal of external voltage polarity produces an increase in negative grid bias, causes the tube to cease conducting, opens relay *R*, contactor *C* and the tie-wire circuit.

Up to 200 amperes may flow from main to rails through the contacts of *C* but the contacts need not break currents of this order. Proper adjustment of the relay's trigger point causes it to function when the voltage differential between rails and main is nearing zero.

Photoelectric Intrusion Detection System

MODULATED LIGHT BEAM¹ photoelectric intrusion detection system units built by the Electronic Control Corporation of Detroit for the protection of industrial plants against sabotage incorporate several interesting mechanical as well as electronic design innovations.

The outdoor projector illustrated in Fig. 1, transmitting virtually invisible light optically confined to the spectrum range between 7,500 and 7,800 Angstrom units, uses standard cast pipe as its housing, with a lighter metal "snout" on the business-end protecting the lens system from snow and ice. This unit is ordinarily bolted down to a concrete base 12 to 24 inches in diameter and from two to five feet in the ground to prevent movement and misalignment of the beam. Trench-laid cable is commonly used to supply power.

The receiver unit, shown without its protective case in Fig. 2, contains phototube and pre-amplifier. It is used in the upright position illustrated to conserve floorspace and to permit the use of a long internal optical path. Entering light passes from the adjustable



Fig. 1—Outdoor modulated light beam projector

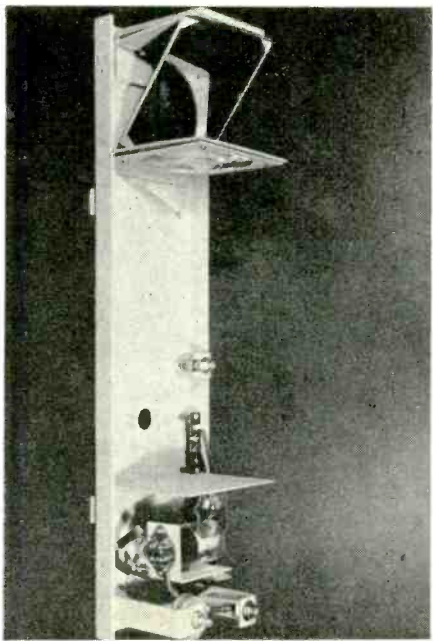
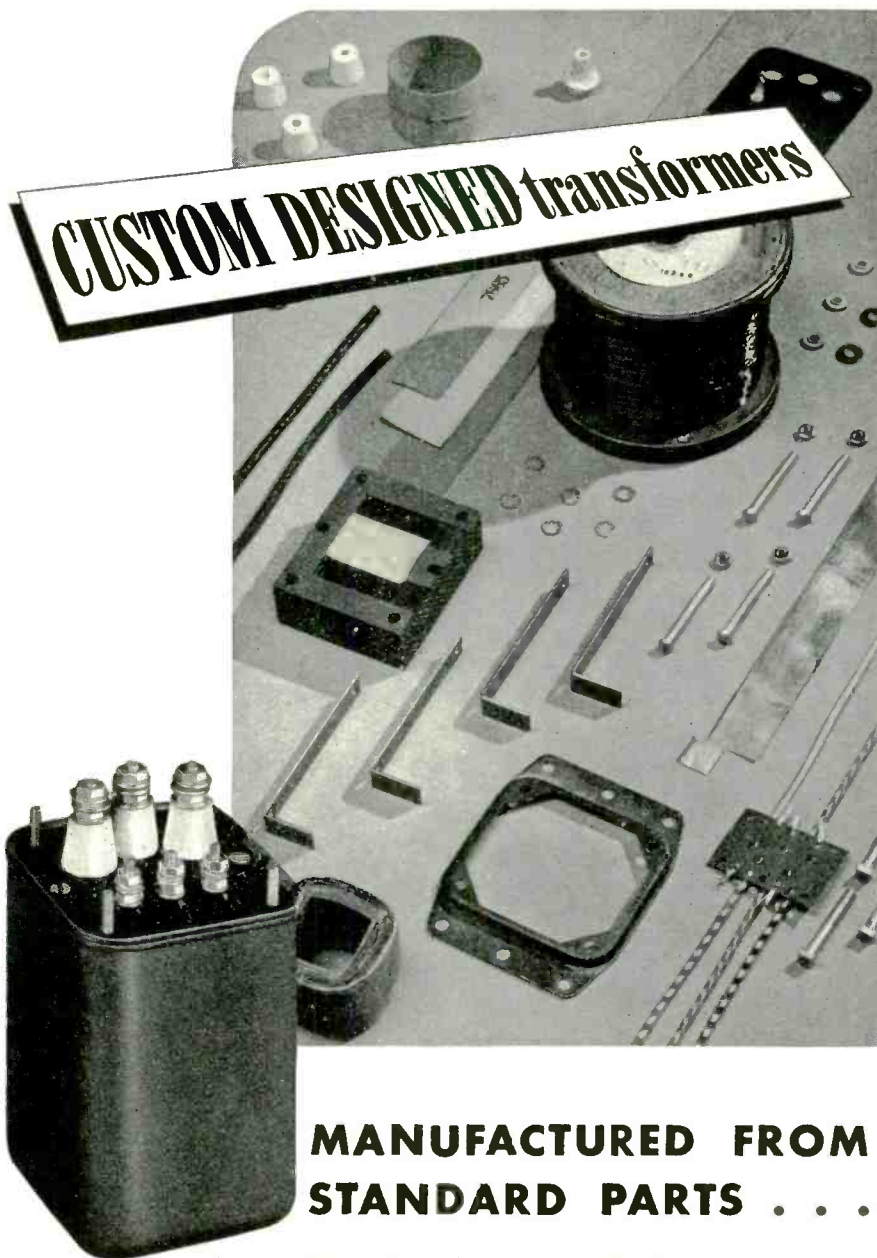

Fig. 2—Receiver unit, containing phototube and pre-amplifier



MANUFACTURED FROM STANDARD PARTS . . .

Custom designed transformers can often be assembled from standard parts found in the large variety of types and sizes available to Chicago Transformer's customers.

Where entirely different designs are necessary, it's modern and complete plant and laboratory facilities are equipped to handle the most unusual assignments.

Given the application, description and the electrical results desired, the Chicago Transformer organization should best be able to solve your new and difficult transformer problems.



Manufacturers of all types of Transformers up to 10 KVA

CHICAGO TRANSFORMER CORPORATION

3505 WEST ADDISON STREET • CHICAGO



AMERICA DEPENDS ON RELAYS by GUARDIAN

The controls of tomorrow—today! This "G" in the shield stands for MORE THAN A TWO-YEAR START on the sustained development of government approved controls by Guardian.

Result . . . Guardian paces production for war industries with immediate deliveries of samples of approved controls for armaments, implements or instruments used on planes, guns, tanks, ships. If it's an approved control for the U. S. Army, Army Air Corps, Navy, Naval Air Corps, Marine Corps, Signal Corps, Ordnance . . . write—wire—phone.

SAMPLES OF APPROVED CONTROLS
AVAILABLE ON SHORT NOTICE

- GUN SWITCH HANDLES
- REMOTE FIRING EQUIPMENT
- TURRET CONTROLS
- RADIO CONTROLS
- NAVIGATION CONTROLS
- AIRCRAFT CONTROLS
- BOMB RELEASES

P. S. Want to take advantage of some of our recent developments for that "after it's over" product you have in mind? Samples only available now!

GUARDIAN  ELECTRIC
 1625 WEST WALNUT STREET CHICAGO, ILLINOIS
 LARGEST LINE OF RELAYS SERVING AMERICAN INDUSTRY

mirror seen at the top through the culminating lens directly beneath this mirror and then through a pinhole aperture in the baffle plate down near the bottom of the unit to the phototube. A jack is provided at the lower right for checking pre-amplifier plate current and manipulation of the control at the lower left adjusts sensitivity. Note the tamper contact or switch at right center, wired to transmit an alarm if the unit is opened.

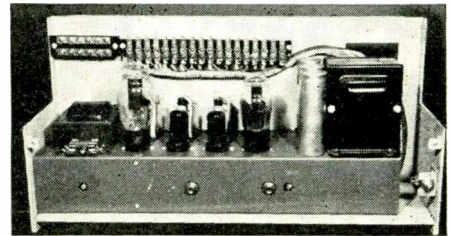

Fig. 3—Amplifier and a-f filter chassis

The amplifier unit illustrated in Fig. 3, equipped with an a-f filter tuned to the modulation frequency, contains a rectifier for its own power supply and an additional rectifier-filter circuit feeding the remote pre-amplifier through a three-conductor connecting cable. Terminals permit the amplifier to handle several receiver units. Note screwdriver adjustment control at lower left, test jacks in center and tamper switch at extreme right.

(1) "Electronic Intrusion Detection Systems", *ELECTRONICS*, February 1942.

NEW ORGAN FOR PATIENTS



Rev. E. E. Haring, Dr. Thobus Berman, and Dr. Edward Kupka at the organ. Student nurses look on while tuberculosis specialist Kupka plays the organ for the benefit of the hospital patients. Under the chairmanship of Dr. E. E. Haring, work is being laid out for experiments with the width and possible application of controlled "musical treatment," for certain types of patients. Dr. E. S. Bennett, superintendent of the hospital, has made plans for the installation of a complete sound distributing system

Vital for Victory!

WINCO DYNAMOTORS help to "Keep 'Em Flying"

Today when "Keep 'em Flying" is a mandate for liberty—we stand more than ready to pledge our all to the Herculean tasks that lie ahead.

As a matter of fact—we've already started working—tremendous manufacturing expansion on Winco Dynamotors gives us facilities not only to meet current delivery schedules—but also future orders.

Quality built in every detail, the sturdy, tough Winco Dynamotors supply efficient, dependable current for all types of communication systems. Special design, finest materials and skilled workmanship insure years of uninterrupted service in conditions ranging from -40° to $+65^{\circ}$ centigrade. More than 50 separate electrical and mechanical assembly tests guard the outstanding quality of Winco Dynamotors.

Winco Dynamotors are regularly available in standard outputs and sizes. . . . Special Winco Dynamotors can be quickly and easily designed to meet your exact needs. Why not take advantage of our complete free Advisory Engineering Service. Write or wire today!

ONLY **WINCO** GIVES YOU

ALTI-TEMP

The Dynamotor designed to insure maximum efficiency—at all operating altitudes and temperatures.

WINCO DYNAMOTORS

WINCHARGER CORPORATION

SIoux CITY, IOWA

which is switch?

**STACKPOLE
HAS THE SWITCH YOU NEED**

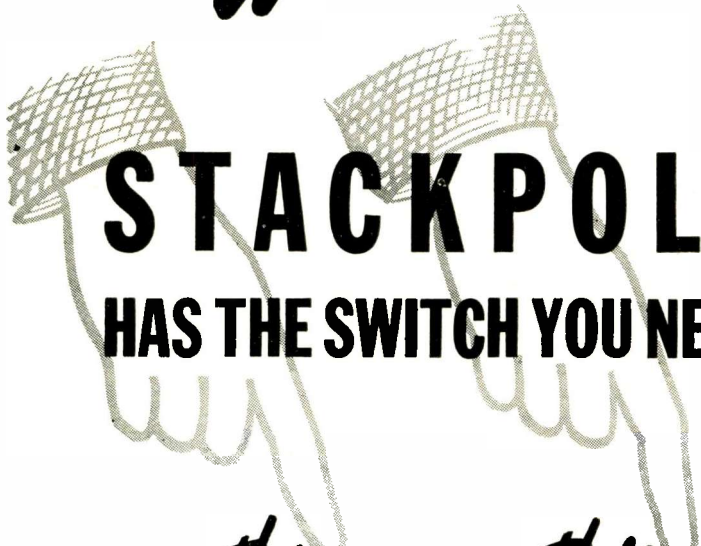

from this - to this

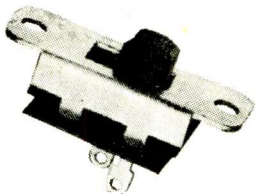

● SINGLE POLE -- SINGLE THROW

(Model SS-1) Slide action switch suitable for two-position tone control, sensitivity control, line switch for small sets, small motor control, tap switch for power transformers and many other uses. Carries Underwriters' Approval for .75 amp., 125 volts.

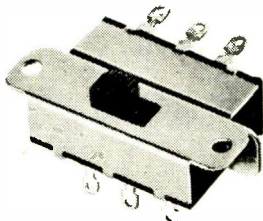

● FOUR POLE -- DOUBLE THROW

(Model SS-12) Slide action switch for circuit changing and a wide variety of applications to all types of electrical equipment. Underwriters' Approval with a 15 amp., 125 volt rating. Terminals in two planes, extremely accessible for wiring. Mechanically rugged; fully enclosed.

STACKPOLE SWITCHES meet every requirement for small circuit operation with a complete size range from the single pole-single throw model to the four pole-double throw switch, including any combination between these extremes. Each is designed to do a particular job—do it better, longer and *most effectively!* Right now, we can fulfill your need for small circuit switches—when you order Stackpole Switches you will be getting a combination of strength and compactness, plus trouble-free performance.

Samples and Prices Sent on Request!

(Stackpole Products Sold to Manufacturers!)

S **STACKPOLE CARBON CO.**
ST. MARYS, PENNA. U. S. A.

Embossed Groove Recording

(Continued from page 33)

relatively free from volatile plasticizers. Otherwise, as time goes on, the disc may become less flexible and may develop irregularities and warp-
age. For reasons of economy, the disc must be kept quite thin and therefore initial rigidity sufficient to keep it flat cannot be used. The thickness and strength of the material must be such as to permit normal rough handling.

For simplicity of design, the reproducing pickup is self-feeding from the sound grooves. While it would seem that a feed on the reproducer would aid tracking greatly, this is not the case. This is due mainly to small eccentricities in the record, which develop from the fact that the center hole might be out of true when put on another machine than the one on which it was made. This eccentricity demands, therefore, that the reproducing head shall have a certain amount of play if attached to a feed mechanism. The result is that a skip within the limits of this play can be produced with ease equal to that of a pickup which is self-feeding. However, this demands that the pickup which is self-feeding shall

• • •

SCHOOL MONITOR



A radio set, tuned to WNYC at all times, which will broadcast an impending air raid alarm. While classes are in session a student is stationed here to inform the principal of any alarms

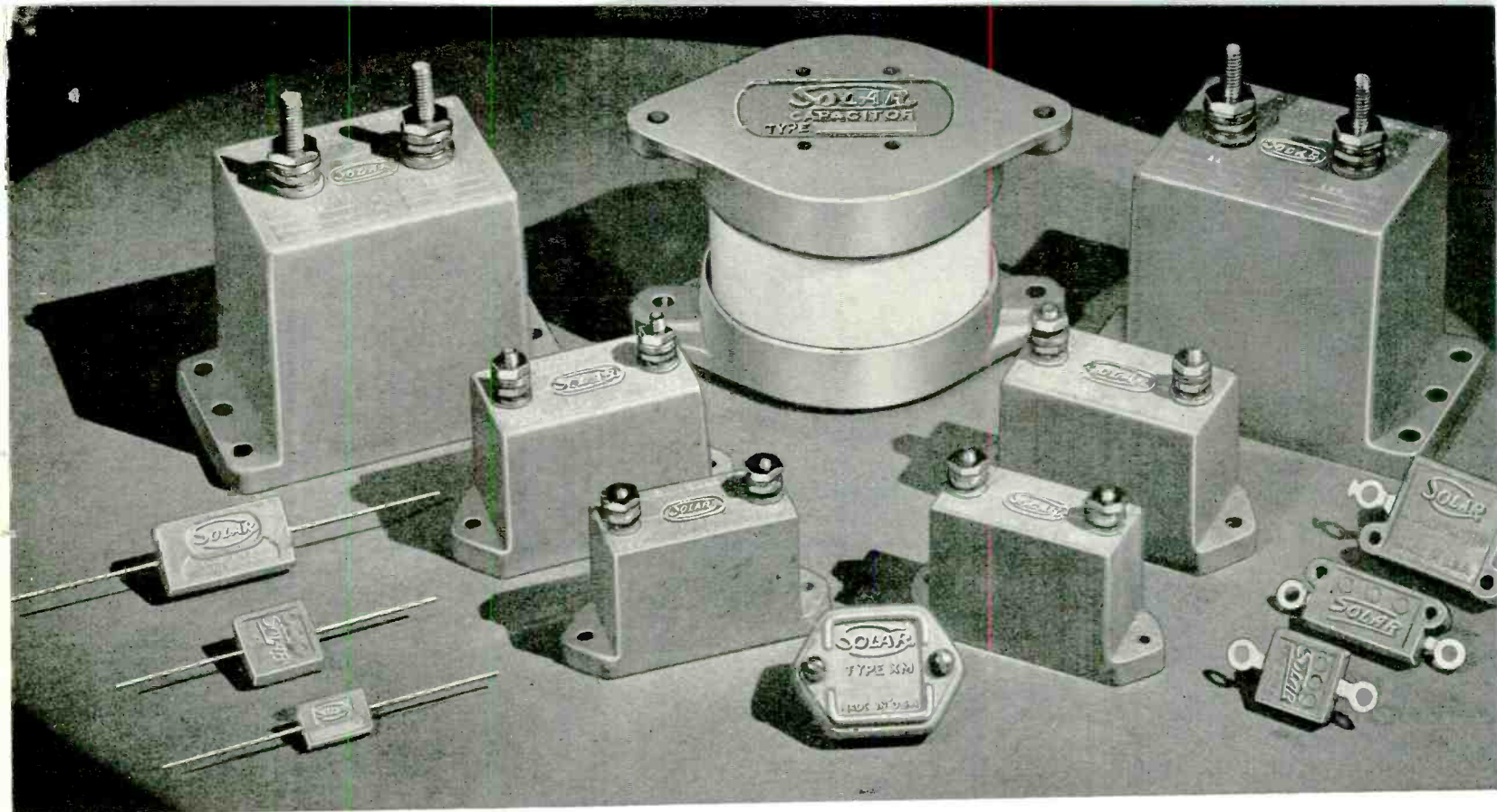

MICA CAPACITORS

Solar Mica Capacitors add vital dependability to radio and communications equipment for the Armed Service Branches of the Government.

The "Quality Above All" incorporated in these units is evolved from a wealth of experience.

If Mica Capacitors are part of your present problems, consult Solar for a ready solution.

Catalog 12-E available on letterhead request

SOLAR MFG. CORP., BAYONNE, N. J.

Do you need **SPECIAL SERVICE**



ON
SAMPLE TRANSFORMERS

OUR engineering department is equipped to turn out sample audio or power transformers, chokes, reactors or filters, of broadcast quality . . . with speed and precision. These special units are designed to meet exacting requirements under adverse conditions and, because of our increased manufacturing facilities to meet war-time demands, can be delivered in a few days.

Wide experience with a variety of designs enables us to meet the most exact specifications for audio and power equipment. Our engineers will be glad to help you solve your particular problems. Write today for complete descriptive literature.

The NYT DECADE INDUCTANCE

This precision laboratory unit is very useful in setting up experimental filters, equalizers, tuned amplifiers, phasing networks, etc.

SPECIFICATIONS

1. Available decades from .001 henry per step to 10 henries.
2. Q approximately 25
3. Useful range 50 to 20,000 cycles per second.
4. Accuracy \pm 5%.
5. Operating level up to 30 db.

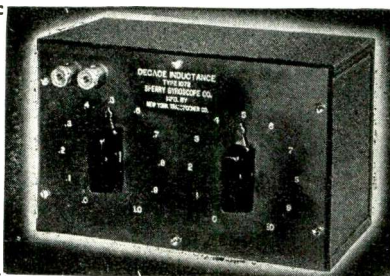

Suppliers to Manufacturers Demanding Highest Quality



NEW YORK TRANSFORMER CO.
51 WEST 3rd ST., NEW YORK, N. Y.

not have any tangential or other forces on it which are not present in the pickup mounted on a feed mechanism. With the SoundScriber pickup, a neutralizing spring is employed which neutralizes the tangential forces inherent in any pickup which travels in the arc of a circle. The elimination of these tangential forces by such neutralizing results in better stability than that of the pickup on a feed and tracking is produced with much simpler apparatus. It will be noted in Fig. 1 that the pickup is mounted on the left-hand side of the turntable with the reproducing stylus apparently backwards from the conventional method. In the transcriber the reproducer is mounted conventionally and the tangential forces are the conventional ones. Here, however, an auxiliary stylus is mounted in close proximity to the regular recording stylus and has the function of aiding the tracking. This auxiliary stylus is mounted in a soft rubber ring and is extremely short and therefore has extremely low inertia. It is also extremely flexible and, of course, is not for reproducing purposes. It is mounted a slight distance ahead of the standard reproducing stylus to pull the reproducing stylus over any small blanks between grooves in the record. The recorded groove on aluminum was such as to permit satisfactory tracking without this device, but with the plastic it was essential to aid the stylus in following the groove.

• • •

COMMUNICATIONS ROOM

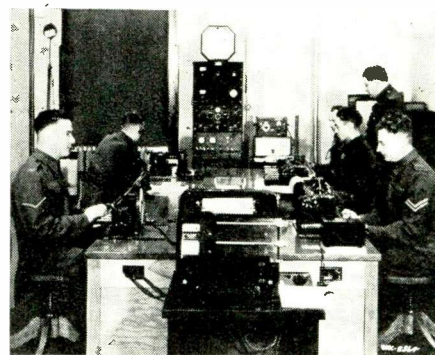

From this battery of machines, thousands of words are transmitted each day to Canadian Army key points both abroad and in Canada. These wireless operators are shown at work in the communications room in Ottawa

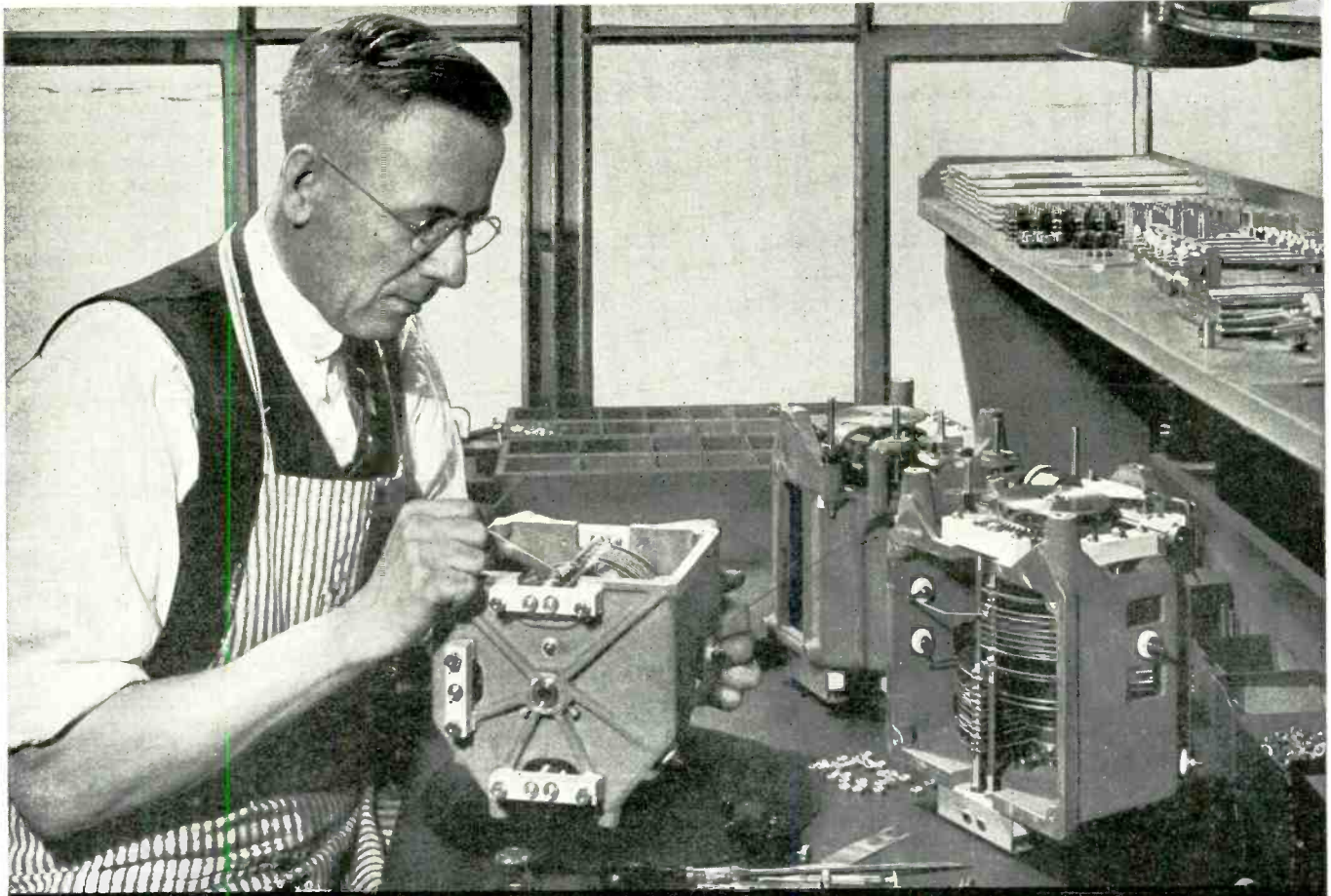

CRAFTSMEN ... 1942 STYLE

BELIEVING the popular conception of a craftsman . . . a long-bearded gent whose great-grandfather also made fine watches . . . is the modern shop worker whose mechanical skill equals, and often exceeds, that of the Old World mechanic. Even in this modern age of mass production there is more fine craftsmanship shown than the Old World ever dreamed possible.

General Radio, in the manufacture of precision electrical measuring apparatus, has its share of craftsmen whose fine mechanical skill is of the highest order. Take P. A. Sharpe, for example. He came to General Radio in 1924 to assemble intermediate-frequency transformers. Then in 1926 he graduated to the assembly of broadcast-receiver variable condensers. After a brief session with hot-wire meters, thermo-couples and string oscillographs . . . all with enough delicate parts to try the patience of a saint . . . Sharpe returned to condenser manufacture.

Since 1930 Sharpe has devoted his entire time to the manufacture of precision condensers, both the stock laboratory type and the even more precise "bath-tub" models used in commercial and governmental frequency meters and similar precision equipment.

If there is doubt that true craftsmanship is required to assemble one of these precision condensers, you should drop in on Sharpe late some afternoon and watch him struggle with a row of condensers in the making, particularly on one of those days when nothing will seem to go together properly. The mechanical tolerances allowed for the numerous parts of a G-R precision condenser are so small that many times it is a feat to assemble a group of these condensers!

Percy Sharpe is typical of the large majority of General Radio men, most of whom have been working for some years on only a few instruments. In the interest of quality G-R has limited its production to small lots so that each man will concentrate on one or two instruments at a time. As a result G-R workmen know how to assemble G-R equipment rapidly and accurately no matter how complex the job is. In the assembly department G-R has never employed inexperienced and unskilled workmen.

All G-R apparatus is put together by men like Percy Sharpe, men who have been with the company for years and who will continue to show expert craftsmanship on G-R equipment for years to come.

GENERAL RADIO COMPANY
CAMBRIDGE, MASSACHUSETTS
 Branches in New York and Los Angeles

THE ELECTRON ART

Amplifier Transient Characteristic.....	80
1941 Radio Audience Statistics.....	84
A Frequency-Modulated Reproducing Control for Sound Films.....	88

Amplifier Transient Characteristic

THE AMPLITUDE CHARACTERISTIC of an amplifier, which represents the amplitude of a signal as a function of the frequency is often unsuitable as a means of judging the properties of an amplifier. For a complete characterization the phase characteristic as well as the amplitude characteristic must be shown. A method of determining the behavior of an amplifier by means of a transient characteristic which indicates the output signal for a discontinuous change of the input signal is discussed in the July 1941 issue of *Philips Technical Review*. The article is called "Judging an Amplifier by Means of the Transient Characteristic" and is written by J. Haantjes.

Since linear distortion originates mainly in the networks coupling successive tubes together, the author limits his consideration to such networks. The method consists of deriving an equation for the transient characteristic of a particular network and comparing its plot with the transient characteristics

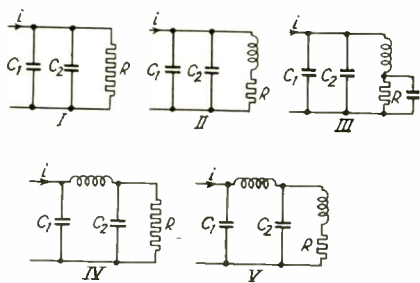

Fig. 1—Various circuits whose transient characteristics are investigated

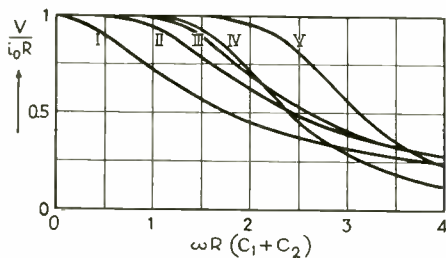

Fig. 2—Amplitude characteristics of networks of Fig. 1

of other networks. Several coupling networks whose amplitude characteristics remain flat to high frequencies are shown in Fig. 1. Their amplitude characteristics are shown in Fig. 2. On the basis of these curves one is led to believe that the accuracy of amplification at high frequencies is very much improved by elaboration of the coupling network. For example, if a decrease in amplitude to 90 percent of the maximum value is permissible, then the upper frequency limit of network II is more than twice that of network I. The improvement in network V amounts to more than a factor of four.

However, referring to the curves in Fig. 3 which are the transient characteristics of the networks in Fig. 1 shows that the improvement is only apparent and not real in each case. In

all cases except that of the ordinary resistance coupling (curve I) there is a certain amount of overshooting of the maximum voltage. When transient characteristics of successive networks II, III, IV, V, are compared, it is seen that the maximum slope in the rising part becomes steadily steeper. At the same time, the degree of overshoot increases also. This overshoot indicates the presence of weak damped resonances which will lead to a local steep slope in the amplitude characteristic. An extension of the flat part of the amplitude characteristic to higher fre-

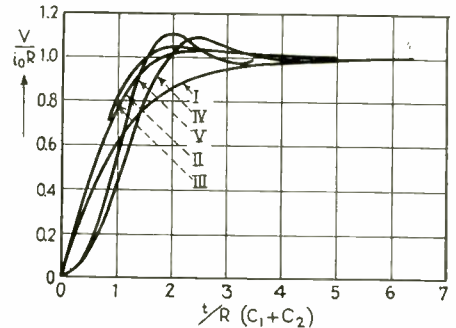
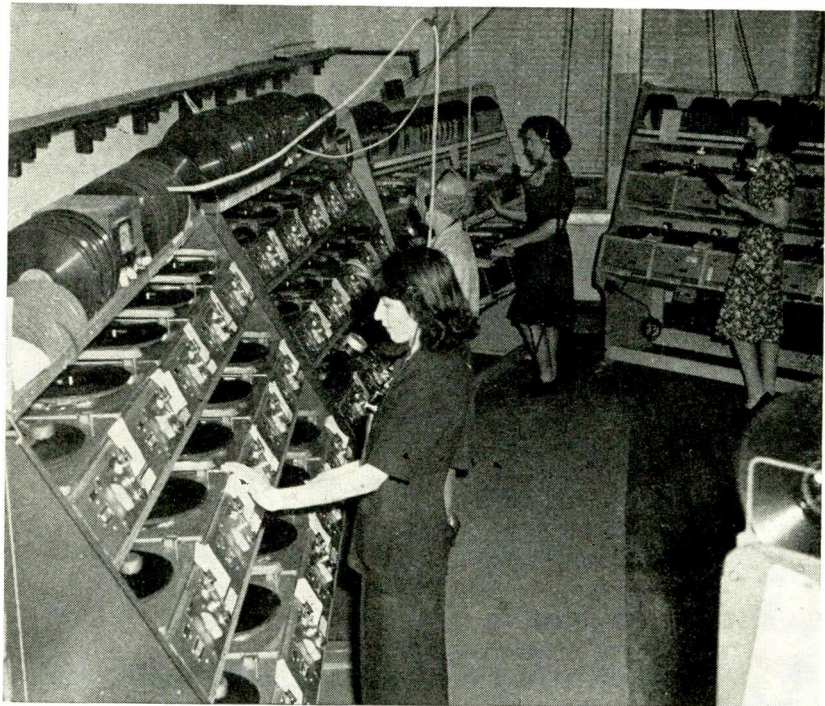

Fig. 3—Transient characteristics of networks of Fig. 1

quencies will therefore involve no improvement when it is accompanied by the appearance of resonance peaks or by a large increase on the slope of the descending part of the characteristic.

JUKE SYSTEM AIDS RAID ALARM SYSTEM



Largest of the phone-juke box services is aiding the San Francisco emergency warning system by permitting the use of their lines in more than 500 bars and cafes throughout the city. Air raid alarms, all clear signals, and announcements will be relayed by defense authorities over these lines. Photo shows central office of Maestro Music Co.

**FIRST OPM POWER
RATIONING ORDER
COVERS 7 STATES**

**regardless of overloaded
power lines, defense production
*MUST GO ON!***

**Signs and Show Windows
to Be Blacked Out.**

Washington, D.C., Oct. 30 (AP).—The
Office of Production Management today
ordered emergency power rationing
in seven southeastern states effective
immediately.

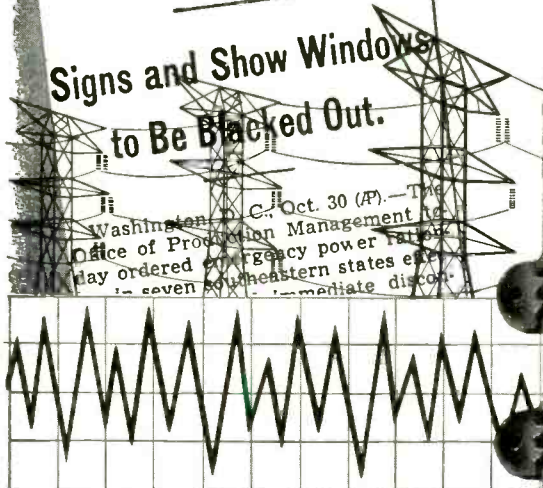

**FLUCTUATING LINE VOLTAGE
CAUSED BY OVERLOADED
ELECTRIC POWER SUPPLY LINES**

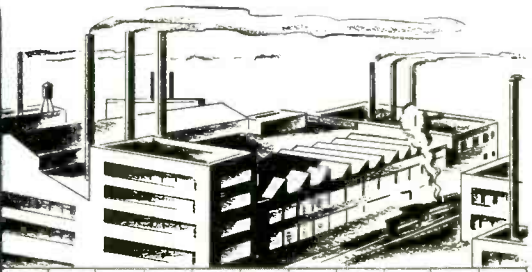
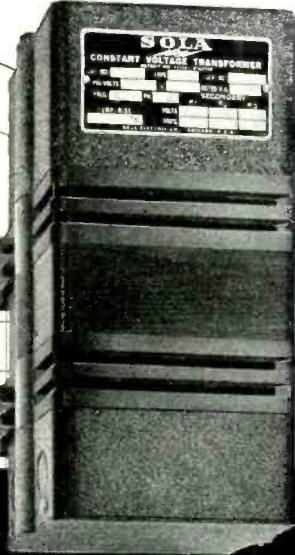

**CONSTANT OUTPUT VOLTAGE SUPPLIED
TO VITAL DEFENSE INDUSTRIES BY
SOLA CONSTANT VOLTAGE TRANSFORMERS**

SOLA constant voltage TRANSFORMERS

The enormous demands placed on power stations by the arms production program are already making the maintenance of stable line voltages an overwhelming problem. This situation threatens to become even more acute with the acceleration of our national facilities to full wartime production.

Every COMMUNICATIONS system, every electrically operated machine, designed for production of the materials of war, needs the protection of constant voltage to—

- 1—insure dependable operation under emergency conditions.
- 2—protect vital equipment against damage by line surges.
- 3—eliminate the necessity of constant supervision.

Manufacturers of communications equipment can provide protection against the contingencies of line surges or abnormal voltage levels by building CONSTANT VOLTAGE into their products. Sola CONSTANT VOLTAGE TRANSFORMERS will deliver a perfectly stabilized output voltage, even though line voltages vary as much as 30%. No moving parts. Instantaneous in action. Self-protecting against overload or short circuit.



SOLA ELECTRIC CO.
2525 CLYBOURN AVE.
CHICAGO, ILLINOIS

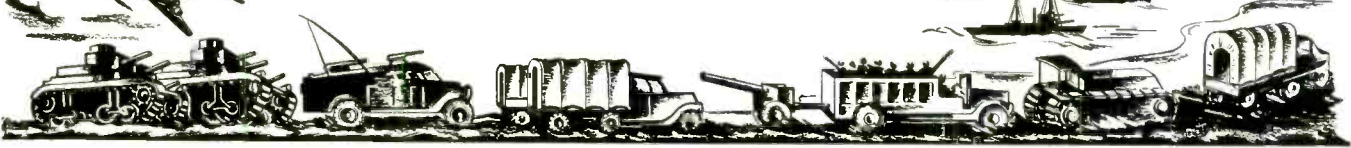
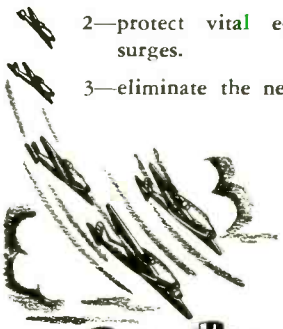

TWO VALUABLE NEW FEATURES HAVE BEEN ADDED TO THIS PRESTO RECORDER!

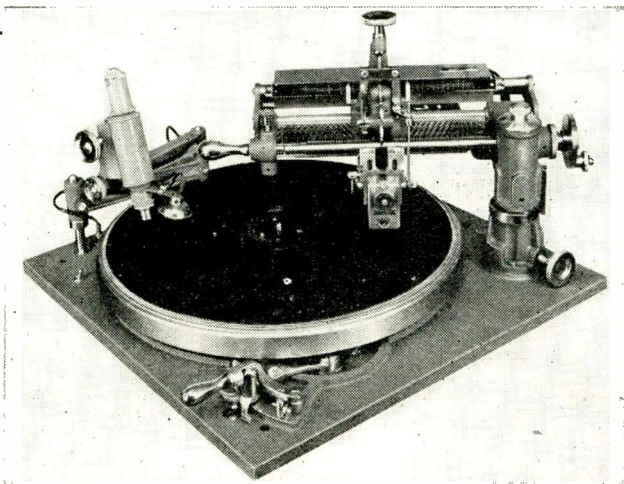

Here is a more versatile recording turntable, a recorder with variable cutting pitch, one that can be quickly adjusted for discs of varying thickness, a machine that will operate "faster" in busy control rooms. It's the new Presto 8-C recorder with . . .

INDEPENDENT OVERHEAD CUTTING MECHANISM: The cutting mechanism of the 8-C is rigidly supported at one end by a heavy mounting post $2\frac{1}{4}$ " in diameter. The other end is free of the table so that the alignment is independent of the disc thickness. A thumbscrew above the cutting head carriage adjusts the angle of the cutting needle *while cutting* for any direct playback or master disc from .030" to $\frac{1}{4}$ " in thickness. The cutting mechanism swings clear of the table for quick change of discs.

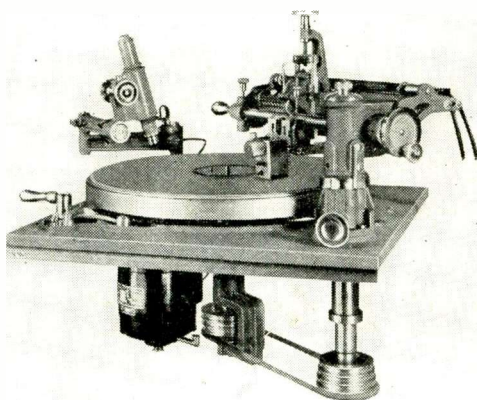

VARIABLE CUTTING PITCH: The buttress thread feed screw is driven by a belt and two step pulleys beneath the table giving accurate cutting pitch adjustments of 96, 112, 120, 128 or 136 lines an inch. Changing the cutting pitch is a matter of seconds. A hand crank and ratchet on the feed screw spirals starting and runout grooves up to $\frac{1}{4}$ " apart.

Other specifications are identical with the well-known Presto 8-N recording turntable described in our complete catalog. Copy on request. Cabinets are available for mounting single or dual turntable installations. If you are planning to improve your recording facilities write today for price quotations and detailed specifications.

PRESTO
RECORDING CORP.
• 242 WEST 55th ST. N. Y.

In Other Cities, Phone . . . ATLANTA, Jack. 4372 • BOSTON, Bel. 4510
CHICAGO, Har. 4240 • CLEVELAND, Me. 1565 • DALLAS, 37093 • DENVER,
Ch. 4277 • DETROIT, Univ. 1-0180 • HOLLYWOOD, Hil. 9133 • KANSAS
CITY, Vic. 4631 • MINNEAPOLIS, Atlantic 4216 • MONTREAL, Wel. 4218
PHILADELPHIA, Penny. 0542 • ROCHESTER, Col. 3548 • SAN FRANCISCO,
Yu. 0231 • SEATTLE, Sen. 2560 • WASHINGTON, D. C., Shep. 4003

World's Largest Manufacturers of Instantaneous Sound Recording Equipment and Discs

This is why network IV will behave less favorably than network III as far as the transient characteristic is concerned. The flat part of the amplitude characteristic is but little extended upon transition from III to IV, while the slope of the descending part has increased considerably. On the other hand, the transition from network I to II shows an appreciable improvement. The flat part of the amplitude characteristic is considerably extended without the slope of the descending part having become greater.

An example of the calculation method is cited for the case of network II. In order to obtain the amplitude characteristic in Fig. 2 (curve II), L must be equal to $0.414 R^2 (C_1 + C_2)$. Furthermore, $C_1 + C_2$ is made equal to C . The voltages and currents in the network satisfy the following equations:

$$V = L \frac{di_L}{dt} + Ri_L$$

$$i_o = i_c + i_L$$

$$LC \frac{d^2 V}{dt^2} + RC \frac{dV}{dt} + V - Ri_o = 0$$

If $V - Ri_o = v$, then:

$$LC \frac{d^2 v}{dt^2} + RC \frac{dv}{dt} + v = 0$$

Letting $v = Ae^{at}$ the so-called characteristic equation is found:

$$a^2 + \frac{R}{L} a + \frac{1}{LC} = 0$$

which gives:

$$a = -\frac{R}{2L} \pm \sqrt{\frac{R^2}{4L^2} + \frac{1}{LC}}$$

Substituting $L = 0.414 R^2 C$ we have:

$$a = -\frac{1.209}{RC} \pm j \frac{0.980}{RC}$$

The general solution is therefore:

$$v = Ae^{-1.209t/RC} \cos(0.980t/RC + \Phi)$$

or

$$V = i_o R + Ae^{-1.209t/RC} \cos(0.980t/RC + \Phi)$$

The initial conditions are such that:

$$V(t)_{(t=0)} = 0$$

$$i_L(t)_{(t=0)} = 0$$

It follows that

$$i_c(t)_{(t=0)} = i_o$$

and since

$$i_c = C \frac{dV}{dt} \quad \text{then} \quad \left(\frac{dV}{dt} \right)_{(t=0)} = \frac{i_o}{C}$$

For A and Φ the following equations then result:

$$i_o R + A \cos \Phi = 0$$

$$1.209 \cos \Phi + 0.980 \sin \Phi + \frac{i_o R}{A} = 0$$

These give:

$$A = -1.022 i_o R$$

$$\Phi = -0.209$$

The complete formula for the transient characteristic is thus:

$$V = i_o R [1 - 1.022 e^{-1.209t/RC} \cos(0.980t/RC - 0.209)]$$

This function is plotted in Fig. 3 and appears as curve II.

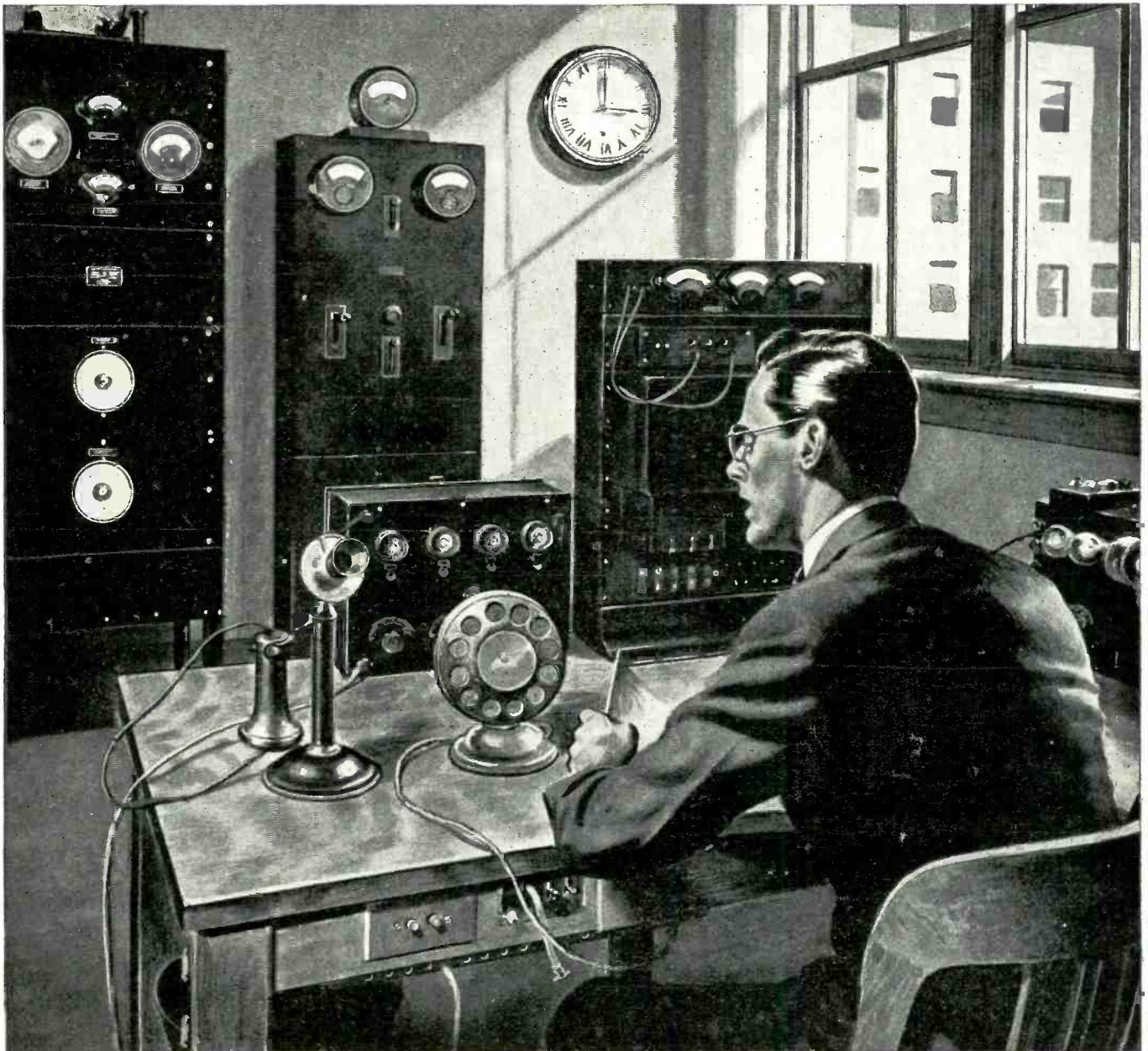

The world's finest transmitter . . .

Just 22 years ago this Western Electric transmitter was the finest in the world. And it might still hold that title today if there hadn't been a constant urge for Better Broadcasting.

It was this urge, this never ceasing effort, that made the remarkable Western Electric transmitter of 1920 but a single step in the development of Commercial Broadcasting. Improvements such as water-cooled tubes, crystal control, stabilized feedback, the Doherty circuit and many others—each was a step forward toward today's equipment.

By paralleling this record with microphones, speech input and antenna equipment, Western Electric has earned the dominant position it now holds in the broadcasting industry.

Today Western Electric is engaged in the great drive for Victory. Speeded-up research is resulting in huge strides in the art of radio communication. And, after the emergency, you can feel sure that many of these new developments will be available to you in Western Electric equipment for Better Broadcasting.

Western Electric
EQUIPPED FOR
BETTER BROADCASTING

DISTRIBUTORS: In U.S.A.: Graybar Electric Co., New York, N.Y. In Canada and Newfoundland: Northern Electric Co., Ltd. In other countries: International Standard Electric Corporation.

COVERAGE

MEANS

MORE

NOW

ADD to your audience whenever America speaks on emergency topics or talks to its citizens on other subjects of national import. Coverage is more important now than it ever was before.

**INSTALL BLAW-KNOX
RADIATORS FOR MAXIMUM
COVERAGE**

BLAW-KNOX
VERTICAL
RADIATORS
FM AND TELEVISION TOWERS

DISTRIBUTORS
Graybar
ELECTRIC COMPANY

BLAW-KNOX DIVISION of Blaw-Knox Company
Farmers Bank Building • Pittsburgh, Pa.

1941 Radio Audience Statistics

SOME INTERESTING FIGURES on the listening habits of American radio audiences during 1941 are revealed in the January 26, 1942 issue of *Broadcasting*. These statistics were compiled by Co-operative Analysis of Broadcasting (CAB), and appear in an article called "1941 Audience Far Ahead of Past Years," by A. W. Lehman.

The CAB is the official organization for rating radio programs. It is a mutual, non-profit group with a governing committee of six, three appointed by the Association of National Advertisers, and three appointed by the American Association of Advertising Agencies. Crossley Inc. is employed to do the field and technical work. Fifty-two investigators, making calls at eight stated times each day, working simultaneously in 33 major cities from coast to coast 168 days of the year, completed 690,000 interviews based on more than 1,100,000 telephone calls. If, out of every 100 set owners who are interviewed in the area covered by a given program, 20 report that they heard it, then the program receives a rating of 20. This is the system used to rate the various radio programs.

In the latter part of 1941 it was demonstrated at least on the basis of past ratings, that the leading commercial programs were no longer the yardstick of maximum audience size. The addresses of President Roosevelt and Prime Minister Winston Churchill created audiences of such vast dimensions that the highest ratings of years gone by were not only outstripped, but were doubled or more. On December 8, the President's appeal for declaration of war against Japan attained a rating of 65.7 percent. The next evening, his speech at 10 p.m. shattered all nighttime listening levels with a rating of 83 percent. Up to that time the highest CAB rating for a speech of any

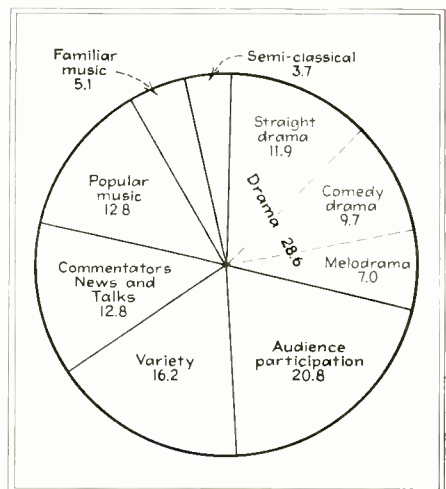

Comparison of time spent in listening to the more popular types of evening programs, May to September 1941

Gateway to the ^{New} "Radio Age"!

CONFIDENT that the future of radio will be greater even than its past, the Radio Corporation of America has laid the cornerstone for the world's foremost center of radio research and pioneering—RCA Laboratories at Princeton, N. J.

The main section of the Laboratories will open in 1942, dedicated to the service of mankind through increased usefulness of radio and electronics to the nation, to the public and to industry.

Radio has marched hand in hand with progress in electronics. The magic which created electronics—infinitesimal particles of electricity—lifted radio out of its mechanical era...took wireless out of the spark gap and sealed it inside the vacuum tube...took television off the me-

chanical scanning disc and put it in the Iconoscope.

In this hour of history RCA Laboratories fittingly symbolize our faith in the future—that science will blaze new trails in the unexplored wilderness of the electronic sciences through radio research.



RCA LABORATORIES

A Service of the Radio Corporation of America, Radio City, N. Y.

Other RCA Services: RCA Manufacturing Company, Inc.
Radiomarine Corporation of America R.C.A. Communications, Inc.
National Broadcasting Company, Inc. RCA Institutes, Inc.

Blue Network Company, Inc.

Main section of the new RCA Laboratories under construction at Princeton, N. J. This section will open in 1942. Inset shows the Laboratories as they will look when completed.

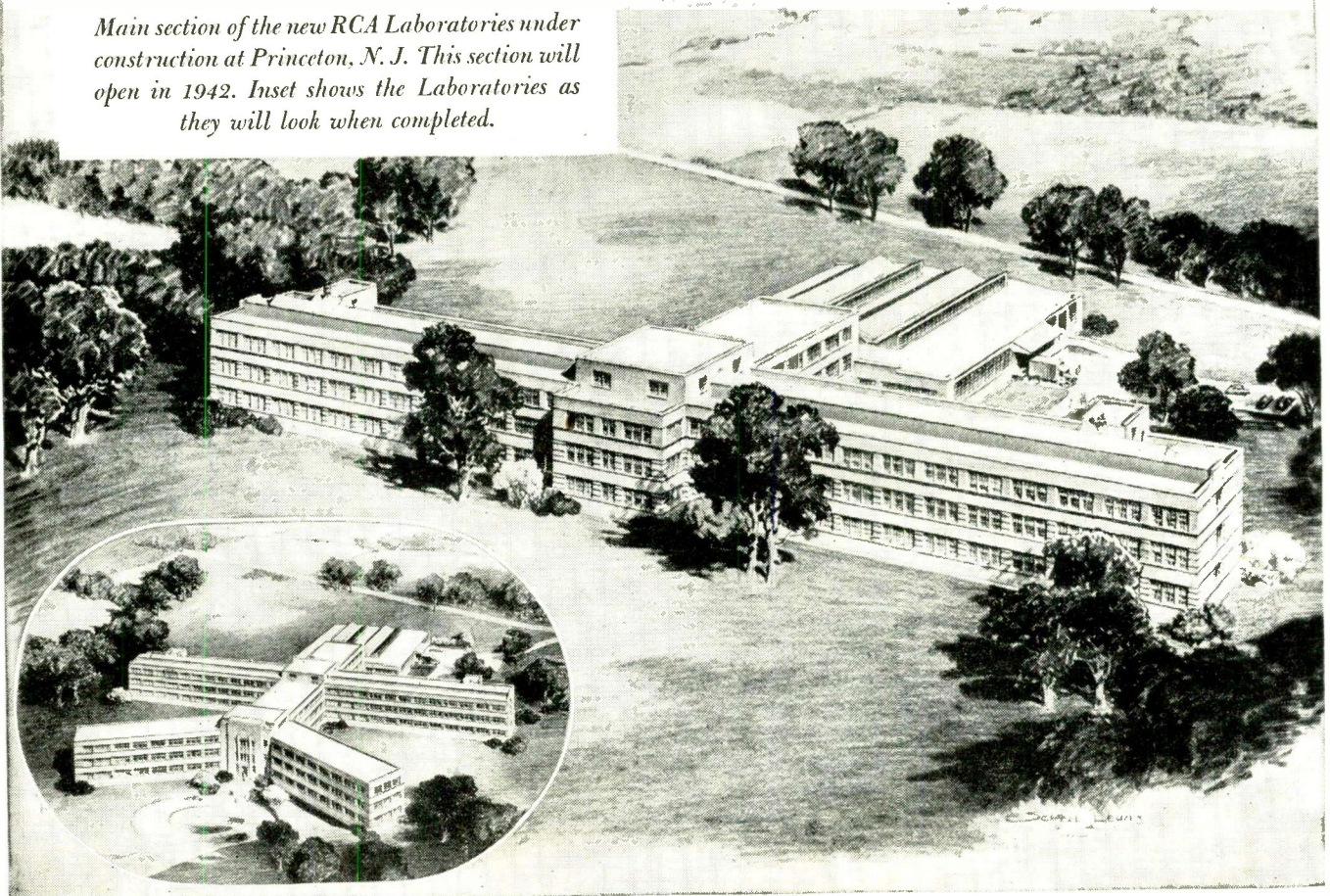

Now *-hp-* offers an outstanding new
VACUUM TUBE VOLTMETER

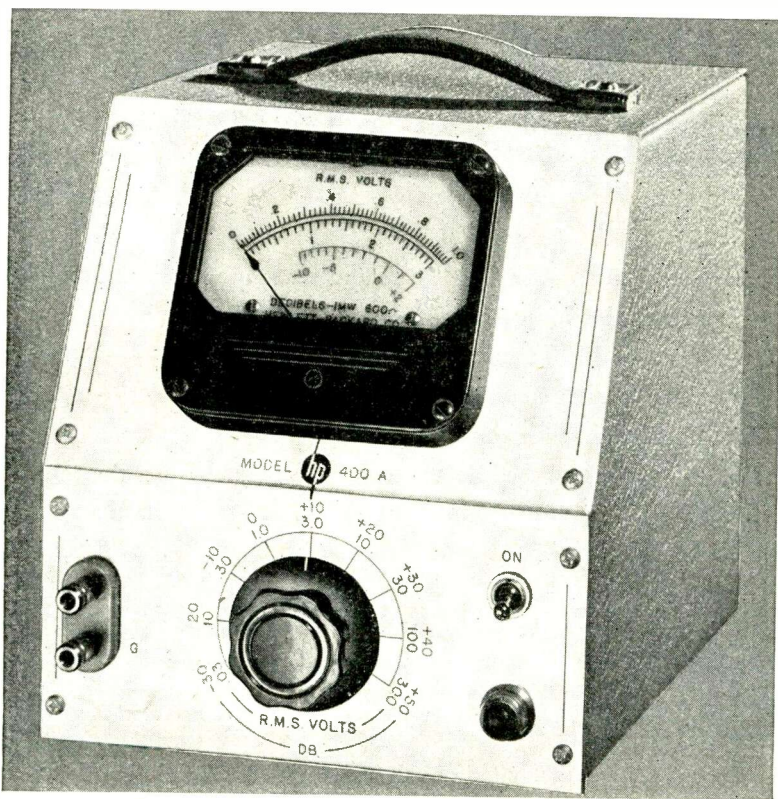

**Ideal for use in audio frequency, carrier current,
 super-sonic, television and broadcast fields**

Here's the most recent development from Hewlett-Packard Laboratories... a Vacuum Tube Voltmeter designed to cover the frequency range from 10 cps to 1 megacycle. Measurements with this new instrument are extremely accurate because the indication is proportional to the average value of the wave... thus, waveform errors are reduced.

Measurements up to 1 megacycle with this Voltmeter are as simple as measurements with the usual multi-range meter at d-c! Generally, no precautions are necessary... no adjustments to make during operation... no damage from large overloads... and, input impedance is high enough so that it won't affect the circuit being measured.

The very excellence of this Voltmeter makes it particularly valuable for laboratory work in measuring amplifier gain, network response, and output level. In many cases, its sensitivity is sufficient to measure the hum level directly. The high voltage ranges are very useful for measuring both power circuit voltages and high frequency voltages in transmitting equipment. This new Voltmeter also provides a decibel scale to facilitate readings where a decibel base is desired.

All in all, the simplicity of operation of Model 400A saves valuable time in production testing... no time lost in adjusting zero position or other adjustments... wide frequency range is another asset... just one more link in a long chain of evidence that *for speed and accuracy in laboratory instruments, Hewlett-Packard is unsurpassed!*

Get the facts on the 400A Voltmeter today! Write for complete details and specifications. Request a data sheet on your letterhead.

HEWLETT  PACKARD
 481 PAGE MILL ROAD PALO ALTO, CALIFORNIA

kind was 45.5 percent. This was for the President's speech of June 10, 1940 denouncing Italy's entrance into the war. On four separate occasions Prime Minister Winston Churchill's speeches were rated by the CAB. The ratings ranged from 16.5 percent to 44.7 percent.

The 20 leading evening programs listed in the order of their ratings as of December, 1941 are: (1) Chase and Sanborn Program, (2) Jack Benny, (3) Fibber McGee and Molly, (4) Lux Radio Theater, (5) The Aldrich Family, (6) Pepsodent Program—Bob Hope, (7) Maxwell House Coffee Time, (8) Walter Winchell, (9) Kate Smith Hour, (10) Kraft Music Hall, (11) Fitch Bandwagon, (12) One Man's Family, (13) Major Bowes' Amateur Hour, (14) Time To Smile—Eddie Cantor, (15) Kay Kyser, (16) Lowell Thomas, (17) Texaco Star Theater—Fred Allen, (18) Mr. District Attorney, (19) Burns & Allen, and (20) Red Skelton.

The daytime network leaders in the order of their ratings as of December 1941 are: (1) Life Can Be Beautiful, (2) Kate Smith Speaks, (3) The Woman in White, (4) Right to Happiness, (5) Romance of Helen Trent, (6) Our Gal Sunday, (7) The Guiding Light, (8) Ma Perkins, (9) Road of Life, (10) Mary Marlin, and (11) Vic & Sade.

The chart shows a comparison by program types, of ratings for the period from May to September, 1941. Other ratings for sports programs and special events are also covered in the article.

• • •

**VICAR'S CAR IS MOBILE
 CHURCH**



The Rev. Frank Mooer, vicar at Well-ing, Kent, found that the war so diminished his congregation that he feared his church would become a museum piece. Consequently he decided to take the church to the people. With an amplifier and microphone in his car and a schedule for his services, he sets out to take the services to the people as they sit in their own homes



"REMEMBER...!"

**REA
MAGNET WIRE**

AMERICA'S fighting men fly into action . . . and REA Magnet Wire goes with them.

Millions of miles of wire are built into the electrical components of energizing, controlling and signaling equipment for the Army, Navy, and the Air Forces. These fine, precision wires are the control-nerve of our lightning-fast Fighters and our giant Bombers. A quarter century of experience goes into every inch of REA Magnet Wire produced for these purposes.

And because America's war production must zoom upward, the REA organization has been keyed to high-speed action. To help speed up production of vital war equipment, REA offers longer continuous lengths, better spooling, and maximum uniformity both before and after enameling. *If you have a problem in procurement, engineering, or production involving magnet wire . . . REA will be on the jump to help you!*

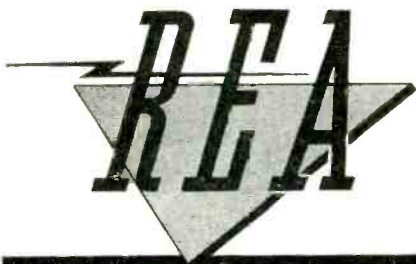

REA MAGNET WIRE COMPANY, INC.

FORT WAYNE, INDIANA, U.S.A.

Remember . . . American Industry has a big job ahead — let's get at it NOW!

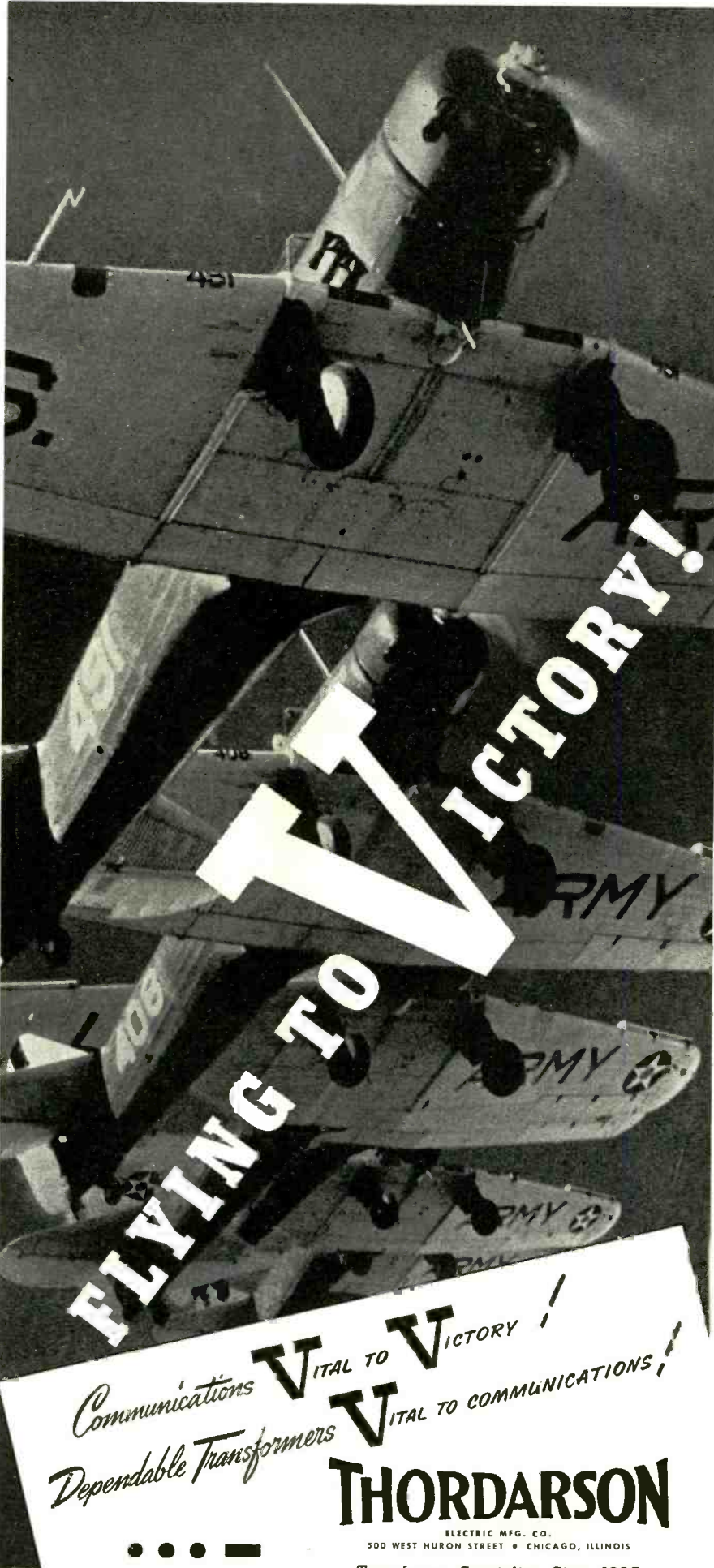

A Frequency-Modulated Reproduction Control for Sound Films

IN SPITE OF THE RECENT improvements in sound picture recording, the volume range available is still far short of meeting the volume range requirements of modern sound pictures. An ingenious method of accomplishing volume expansion at the desired points by means of a 5-mil frequency-modulated control track is described in the February 1942 issue of the *Journal of the Society of Motion Picture Engineers* by J. G. Frayne and F. P. Herrfeld in an article "A Frequency-Modulated Control Track for Movietone Prints".

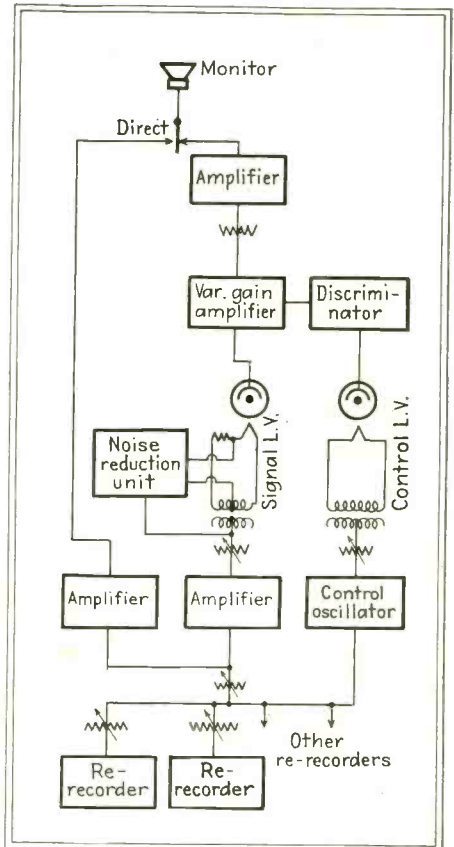

Fig. 1—Re-recording and monitoring system

The system operates as follows: The output of various recording machines are mixed and fed into a single channel, amplified, and then applied to one pair of ribbons in the RA-1061 tube in the customary manner. Simultaneously, the control frequency generated by a variable-frequency oscillator is applied to the second pair of ribbons of the light valve. The desired volume which is heard over the expanded monitoring system is controlled by varying the frequency of the oscillator. The signal appears as a standard 76-mil sound track on the film. The frequency variations which control the desired volume range appear as a 5-mil fre-

(Continued on page 92)



Odyssey of a Transmitter

Like Ulysses, Collins transmitters are subjected to great hardship and long journeys; like Ulysses they meet and pass each test, and then go on to the next. ¶Tutelary engineers accompany the transmitter through the final test department. They submit a Collins transmitter to every variety of climate, arctic cold, tropic heat, dryness of the desert, and the humid salt spray of the ocean. ¶They verify its mechanical structure through the ordeal of gruelling vibration and shock. They watch it through its electrical trials

for distortion, noise level, carrier shift and frequency stability. ¶As Ulysses was compelled to face each adversity, so is a Collins transmitter taken on its journey in the final test department where it must meet specifications. Actual use of the equipment is anticipated and under simulated conditions the transmitter is put to the proof. After it has successfully passed each test, then, and then only, is your Collins transmitter shipped.

COLLINS RADIO COMPANY
CEDAR RAPIDS, IOWA NEW YORK, NY: 11 WEST 42 ST.

New Books

Fundamentals of Electricity and Electromagnetism

By V. A. SUYDAM, *Professor of Physics, Beloit College.* (690 pages. Illustrated. Price, \$4.75. 1940, D. Van Nostrand Co., New York.)

THIS VOLUME, developed for instruction in physics, will be a useful addition to the electrical engineer's library since the general scope and point of view do not appear to be so completely detached from practical reality as has appeared to be the case for physics texts, in the past. Throughout, the emphasis is on the fundamental principles involved and the use of necessary mathematics is not spared when this contributes to a better understanding of the problem at hand. But mathematics is not flouted merely for its own sake; instead it is used to obtain a needed result in quantitative language. Moreover, the principles of electricity are brought forth not only by discussing electrostatics, magnetostatics, steady and varying currents and other physical effects, but by examination of the mechanism of operation of electrolytic rectifiers, a-c bridges, vacuum tubes, and other apparatus which the student can use in laboratory work.

The various chapters deal with such topics as electrostatics, capacitance, dielectric theory, magnetostatics, terrestrial magnetism, direct and alternating currents, metallic and electrolytic conduction, vectors and complex quantities, a-c bridges, thermionic electron tubes, oscillations on transmission lines, and the electromagnetic field. The chapter on electron tubes is rather too brief and elementary to appeal much to readers of *ELECTRONICS*, but then the chapter is not intended for the specialist.

Throughout an effort has been made, quite successfully this reviewer feels, to present a clear, concise physical interpretation and understanding of electricity and electromagnetism. The student coming to the subject for the first time should have less difficulty with Prof. Suydam's treatments than with other reasonably comparable volumes which have recently appeared. The practicing physicist or engineer will find the volume a good addition to his library for that occasional "brushing up" which may be necessary.—B.D.

Rhombic Antenna Design

By A. E. HARPER, *Bell Telephone Laboratories.* D. Van Nostrand Co., Inc., New York, 1941, 112 pages, plus charts, fold-out construction drawings, etc. Price \$4.00.

A FOREWORD BY RALPH BOWN explains the importance of the rhombic of Bruce, states that this book was compiled by Mr. Harper from published and unpublished data of the Bell Laboratories, stating that the prospect of libraries, students and other engineers being able to use the information prompted the formal publication of the data.

The book itself is made up of off-set

RECORDING FOREIGN BROADCASTS



James A. Homsy, assistant supervisor of the South Pacific Monitor Area, with recording and play back equipment at the Santa Ana monitoring station. The cream colored 16-inch disks record a full hour of suspicious broadcasting. Upon completion of the recording, the disk is mailed to the chief of the National Defense Operations Section of the Federal Communications Commission in Washington, D. C., where it is further examined.

typewritten text in a large format (page size 9x11) which makes the line drawings easy to read and use. The book is attractively bound and, in our opinion, may mark a new trend in technical publishing, avoiding the expense of typesetting and cut marking.

Chapter headings indicate the contents of the book—general discussion of directional antennas, antenna gain and location, angles of arrival and departure, properties of rhombic antennas, effect of ground plane, directional characteristics, measurement and computation of antenna gain, transmitting and receiving antennas, maintenance, lightning protection, construction data. The constructional drawings are large folded sheets and give extended information on dimensions, angles, etc.—K.H.

• • •

Acoustics

BY ALEXANDER WOOD. *Interscience Publishers, New York.* 1941, 575 pages. Price \$6.00.

THE AUTHOR OF THIS work (not to be confused with A. B. Wood, author of the "Textbook of Sound") is a fellow and tutor of Emmanuel College of Cambridge and University Lecturer in Experimental Physics. This background has undoubtedly contributed to the well-balanced objective viewpoint the author has preserved in writing this comprehensive survey of the field. The book is a valuable contribution because of its broad view; something which most recent works, however valuable in presenting specialized aspects, have lacked.

The dynamics of sound and vibrating systems is well treated. Interesting material on the subjective aspect of sound, speech and hearing, architectural acoustics, supersonics, underwater signaling, subaqueous and aerial sound ranging, architectural acoustics and electroacoustics is also included. While the chapter on electroacoustics may seem somewhat brief to many of the readers of this periodical who have special interest in this field, additional material would have upset the nice balance which has been achieved.

Historical aspects of acoustics have been interwoven with classical text-like treatment of theory and experiment in a very interesting narrative style. Selected references are freely given where required and are singularly free of personal, commercial and nationalistic taint. The book should serve as an excellent text for a general or survey course on acoustics on either the intermediate or advanced level. It is also a very worth while general reference book in the field.—H.S.K.

Additional Book Reviews will be found on page 56 of this issue.

Contact springs employing any of these forms can be furnished.

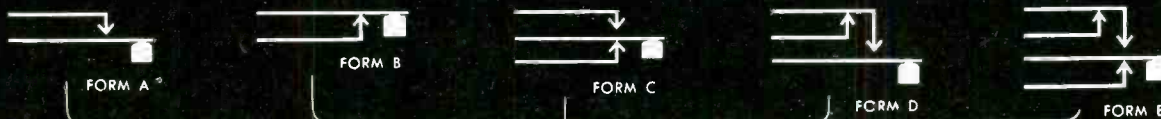

Contacts of rare metals and special alloys, "over-all" welded to nickel silver springs.

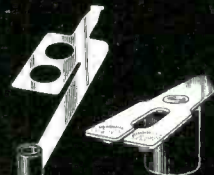

Spring bushing insulators made by a patented process from Bakelite rod. Illustration also shows twin contacts.

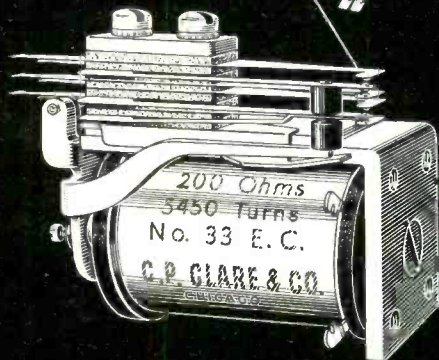

Clare Type "G" Short Coil Relay

Features of the Clare Type G

- 1 Standard spring assemblies may embody any combination of the five forms illustrated. It may be equipped with as many as 16 springs total.
- 2 It can be provided with twelve different standard—or special—types and sizes of contacts which are welded to the nickel silver springs by a special process. The contacts are made from precious metals and alloys, such as silver, palladium, palladium-iridium, tungsten and elkonium. They can be furnished in sizes from .062" silver, rated at 1 ampere, 50 watts to .1875" tungsten, rated at 4 amperes, 500 watts. Various types may be incorporated in one relay. Also furnished with Micro or other snap action switches which carry a higher rating.
- 3 Special anti-vibration springs guard against accidental or vibration-induced operation of the relay.
- 4 All exposed metal of the Type "G" is cadmium plated to withstand a 200-hour salt spray test.
- 5 Standard insulators are made of special heat treated Bakelite that permits punching without cracks or checks and possesses minimum cold flow and low moisture absorption properties.
- 6 The patented spring bushing insulators are made of Bakelite rod. These strong, hard, long wearing bushings are essential where heavy contact pressures are employed, where vibration exists, or heavy duty service is desired.
- 7 The armature assembly consists of drawn phosphor bronze rod operating in a hard brass yoke. The heelpiece, coil core, and armature assembly of this relay are of magnetic metal carefully annealed in precision ovens.
- 8 Coils are carefully wound to exact turns on precision machines. Lead-out wires are securely soldered. Coils impregnated with a special varnish are available. Data regarding resistance, number of turns, type of wire appear on the coil as illustrated. The coil is protected with a transparent acetate covering.
- 9 The Type "G" is particularly adaptable for plug-in mounting, permitting easy service and replacement.

"Custom Built" for Walkie-Talkies . . .

Because it is compact, rugged, and dependable, the Clare Type G relay is well adapted to use in the Army's Walkie-Talkie. These same qualities have led to the selection of the Type G for use in radio transmitters in ships and aircraft, in aircraft signalling devices, height indicators, fan markers, radio compasses, radio aircraft compasses, and propeller feathering controls.

The Type G is a short coil relay designed specifically for locations where space is limited and where allowance must be made for shock, vibration, and exposure. The features that give the Type G its favorable characteristics for this kind of service are listed at right.

Notable feature of every Clare relay is the care with which they are manufactured and the quality of the materials of which they are made. Notable feature of the C. P. Clare & Co. organization is its eagerness and ability to produce relays "custom built" to the requirements of each customer. Whether this can be done by experienced selection among the constructions and materials we consider standard, or by design that is special all the way through, we are ready to serve you promptly, confidentially, expertly.

Write for catalog and data book. C. P. Clare & Co., 4719 W. Sunnyside Avenue, Chicago, Ill. Sales engineers in all principal cities. Cable address: CLARELAY.

CLARE RELAYS

"Custom-built" Multiple Contact Relays for Electrical, Electronic and Industrial Use

New DECADE AMPLIFIER

MODEL 220

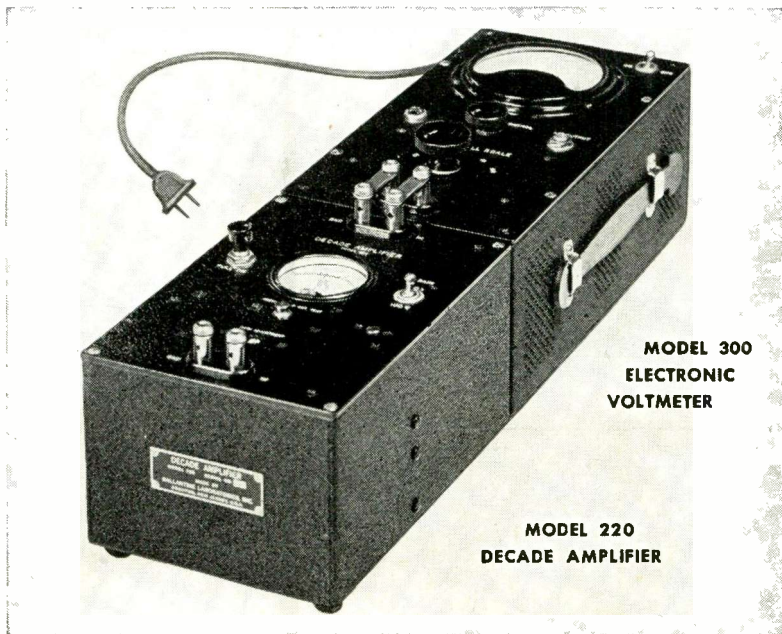

NEW ACCESSORY FOR MODEL 300 VOLTMETER FOR MEASUREMENT OF VERY LOW A-C VOLTAGES

Decade Amplifier: This is a highly stable amplifier giving accurately standardized gains of 10x or 100x over a frequency range of 10 to 100,000 cycles. Operated by self-contained batteries having a life of over 150 hours. Used with our Model 300 Electronic Voltmeter (as shown in cut) A-C voltages down to 0.00003 volt (30 microvolts) can be measured. By means of special circuits the gain is independent within 2% of circuit constants, battery voltages and tubes. Fully described in Bulletin 7.

Electronic Voltmeter: A popular instrument for the measurement of A-C voltages, 10 to 150,000 cycles, 1 millivolt to 100 volts (up to 1000 and 10,000 volts with Model 402 Multipliers). Logarithmic voltage scale and auxiliary uniform decibel scale. A-C operated. By means of special circuits indications are independent of line-voltage, tubes and circuit constants within 3% over entire frequency range. Several accessories, such as an artificial ear, vibration pickup and multipliers are available. Fully described in Bulletin 6.

MADE BY

Ballantine Laboratories, Inc.

BOONTON, NEW JERSEY

ELECTRICAL AND ACOUSTICAL INSTRUMENTS

(Continued from page 88)

quency modulated track, located between the sound and the picture areas. The re-recording and monitoring system is shown in Fig. 1, and the position of the control track can be seen in Fig. 2. Simple controls vary the output of the oscillator from 2000 to 4000 cps. The relationship between frequency and control resistance of the oscillator is shown in Fig. 3. The circuits used for monitoring the expanded volume range in the re-recording operation are identical with those intended for reproducing the control-track film in the theater.

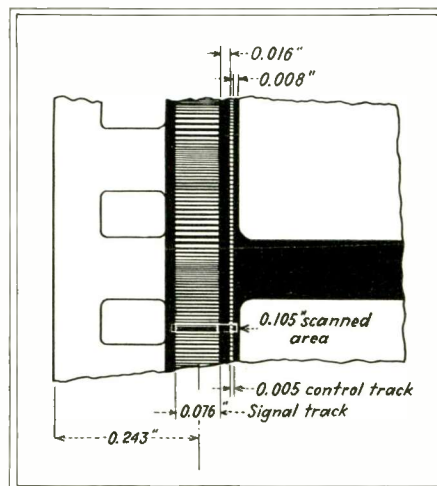

Fig. 2—The control-track

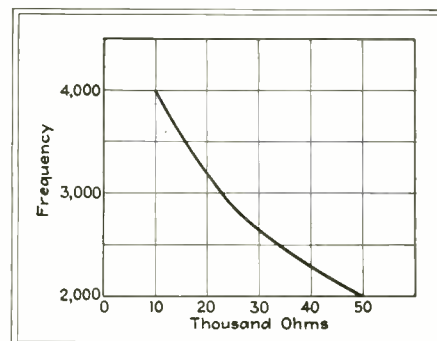

Fig. 3—Oscillator control curve

The sections making up the discriminator unit are shown in Fig. 4. The output of the control-track is amplified and then passes through a high pass filter which cuts out frequencies below 2000 cps which might affect the operation of the frequency discriminating circuit. A limiter keeps the voltage input to the frequency bridge constant and independent of frequency. The bridge is balanced at 4000 cps, and converts the frequency variations to voltage variations. These are amplified, rectified, and then pass on to a combination low-pass and R-C filter which prevents noise and extraneous frequencies above the balance point from being transmitted to the signal channel. The voltage variations are fed into the variable-gain amplifier of the signal channel where they vary the bias of

... a high priority means that the need is sufficiently vital to require instruments of proved dependability

the instruments of proved
DEPENDABILITY



WESTON

Laboratory Standards . . . Precision DC and AC Portables . . . Instrument Transformers . . . Sensitive Relays . . . DC, AC, and Thermo Switchboard and Panel Instruments . . . Specialized Test Equipment . . . Aircraft Instruments . . . Light Measurement and Control Devices . . . Exposure Meters . . . Electric Tachometers . . . Dial Thermometers. Weston Electrical Instrument Corporation, 618 Frelinghuysen Avenue, Newark, New Jersey.

FOR OVER 53 YEARS LEADERS IN ELECTRICAL MEASURING INSTRUMENTS

HERE'S YOUR NEW GUIDE

TO BETTER USE OF ELECTRICAL CONTROL

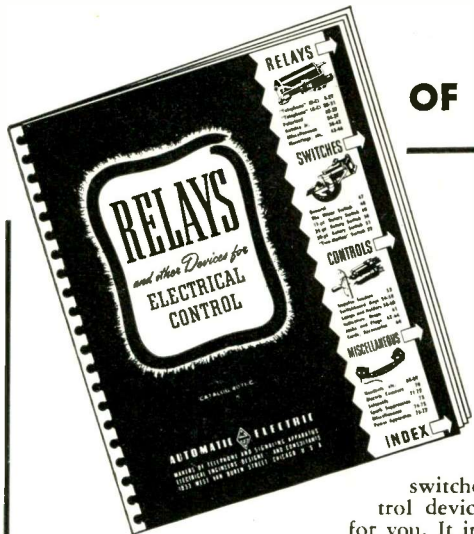

... COMPLETE CATALOG OF RELAYS AND ELECTRICAL CONTROL APPARATUS

If the products you are building for the war effort call for the use of relays, stepping switches, keys or other electrical control devices, this book is a "must" item for you. It includes more helpful data and a greater variety of products than you will find anywhere else under a single cover.

More important still, it lists the products of the pioneer organization in the electrical control field; the company which originated the automatic telephone and has adapted electrical control units and principles to every conceivable type of business.

Write for your copy of this new book today. It will not only save you time and money, but will also help you improve your products.

AMERICAN AUTOMATIC ELECTRIC SALES COMPANY
1033 W. Van Buren St., Chicago, Ill.

AUTOMATIC ELECTRIC
RELAY MAKERS SINCE 1898

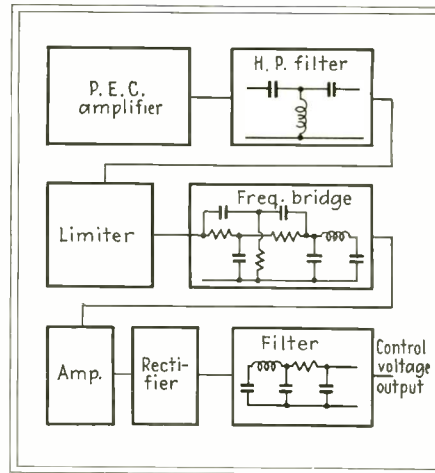

Fig. 4—The discriminator unit

variable-mu tubes thus giving the desired gain. A variation of about one octave in the control frequency can be made to give a 30-db. change in volume range. The control-track may be recorded in such a manner that part of the gain change, the upper 20-db. for example, may be used to increase the volume of the louder sounds while the lower 10-db. may be used to reduce the gain during the quieter passages, thus adding effectively to the noise reduction during these passages.

In the theater, the frequency variations which had controlled the gain of the amplifier in the monitor appear on the 5-mil control-track and are scanned by a phototube. The resulting frequency variations of the light are fed into a discriminator circuit, changed into voltage variations, and are used to control the gain of a variable gain amplifier which in turn feeds the loudspeakers.

• • •

Corrections

TWO CORRECTIONS should be made in "Super-Cardioid Directional Microphone" by B. B. Bauer which appeared in the January 1942 issue of *ELECTRONICS*. On page 33, first column, fourth line from the bottom "90-degree incidence" should replace "90 percent incidence" and in Fig. 7 on the same page the pressure ratio E_c/E_s curve should be lowered to coincide with the zero db line.

Also the following errors occurred in J. R. Whinnery's article on "Skin Effect" appearing in February 1942 *ELECTRONICS*.

In Fig. 1, right margin read "multiply by 10^2 if frequency in cps" and not 10^{-2} ; similarly on left margin "multiply by 10^{-2} " instead of 10^{-1} . Fifth line following Eq. 2, read "at infinite frequency" instead of "at any frequency." In Fig. 9, steepest curve, read $\omega L_1/R_s$ instead of $\omega L_1/R_s$. In third line preceding Eq. 23 read "impedance" instead of "reactance".

JAGABI
"Lubri-tact" Rheostats

For Fine Adjustment and Control
of Electric Current
Lubricated Sliding Contact
Four Sizes
Seventy-Six Ratings
BULLETIN 1620-E

JAMES G. BIDDLE CO.

1211-13 ARCH STREET *Electrical and Scientific Instruments* PHILADELPHIA, PA.

INJECTION MOLDED MYCALEX

TYPICAL APPLICATIONS

Recent developments in molding technique have made possible the injection molding of G-E Mycalex—a mixture of ground mica and a specially prepared glass. Superior for many types of insulation, G-E Mycalex is admirably adapted to use in radio frequency insulation and in any parts requiring close tolerances on moderately intricate shapes.

TERMINAL INSULATOR FOR CALROD HEATING UNIT ▶

G-E Mycalex terminal seals for Calrods combine 1500-2500 v high potential and 325° C heat resistance in a watertight assembly. Sudden stresses from thermal shock are easily withstood because of a coefficient of expansion of 10^{-6} per degree C. The G-E Mycalex part can resist a torsion strain of 15 ft-lb from the terminal nuts. Ready anchorage of the metallic insert in the material during the molding operation ensures permanency of the finished unit.

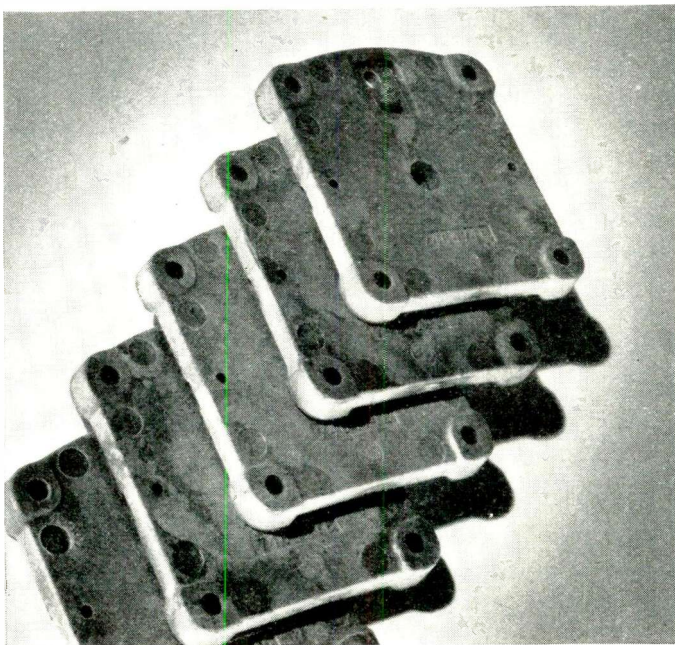
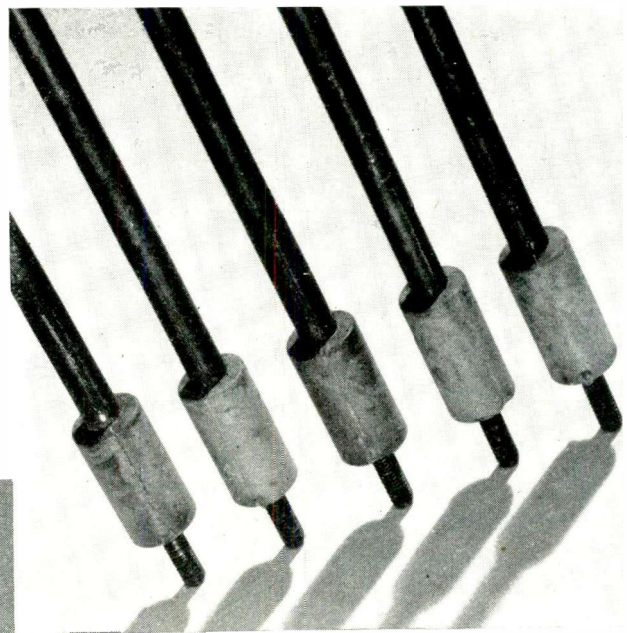

◀ TUNING COIL END PLATE FOR RADIO TRANSMITTER

Dielectric strength of 360 v/mil per .2" thickness at 25° C, power factor of .0018, and negligible water absorption make this injection molded G-E Mycalex part ideal for radio frequency insulation. With an impact strength 50% higher than that of the part which it replaces, this moderately intricate structural part is molded to exact tolerances and eliminates a formerly used machining operation for flatness.

Write Sec. H-3 for booklet.

P L A S T I C S D E P A R T M E N T

GENERAL  **ELECTRIC**

PD-49

Here's the
time delay
relay that
offers many
timing effects

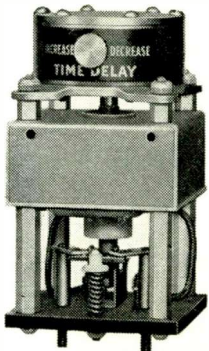

Flexibility — that's what the AGASTAT offers! This instantaneous recycling unit introduces a

delay when the control circuit is either opened or closed. Multiple timing effects are possible with circuit combinations. Ruggedly built for severe service requirements, the AGASTAT permits a delay ranging from a fraction of a second to several minutes— all by the simple thumb screw adjustment. Electrical Division, American Gas Accumulator Company, Elizabeth, New Jersey.

Write for Illustrated Literature 4N-4

CHECK THESE AGASTAT ADVANTAGES

- Unaffected by dust, dirt or temperature
- Thumb screw adjustment for delay increase
- For use with either AC or DC
- Diversity of timing effects possible
- Positive snap-action type contacts

AGASTAT
★
**FOR DIVERSITY
IN TIME DELAY**

Automatic Monitor Circuit

(Continued from page 39)

or equipment failure. Long life can be expected from this control tube, since it draws no current except when in the alarm position.

A single tone of predetermined frequency actuates the "alarm signal" unit. The operation is as follows: A tone is transmitted at 100 percent modulation for a definite time period. This tone is received, rectified, and converted to an audio voltage. This voltage is converted to direct current by a frequency discriminating rectifier and fed to an R-C delay circuit. The grid of the second control tube is energized by the voltage developed across this R-C circuit. Care must be taken to have the time constant large enough so that ordinary program material of a broadcast station will not trip the control tube. It is again recommended that a type 2050 or similar tube be used, although other types of tubes will operate satisfactorily. It will be noted that the alarm signal tube draws plate current on the "no signal" position. This insures protection in case of failure of either tube or the circuit. When a tone is received and rectified, the resulting direct voltage is impressed on the R-C circuit. The condenser begins to charge and when the charging voltage across the condenser reaches the proper value to cause plate current cutoff, the control relay drops out.

Details of the Monitor Receiver

This device has been adapted to a Stromberg-Carlson No. 44 radio tuner, and is being used as an air alert alarm receiver. The receiver is a six-tube superheterodyne with a type 85 tube used as the first audio and a-v-c tube. One of the diodes of this tube was disconnected and was fed audio voltage from the plate circuit through condenser C_2 . Tube T_1 of the accompanying circuit diagram refers to this diode. Condensers C_1 and C_2 make up the frequency discriminating circuit, C_1 attenuating the high frequencies, and C_2 attenuating the low frequencies, so that the maximum response of T_1 is 1000 cps,

the frequency of the alarm signal.

The rectified voltage is developed across the load resistance R_1 . Resistor R_2 and condenser C_3 make up the time constant circuit, and this time is adjustable by varying the audio volume control of the receiver. Resistor R_3 is an isolating resistor required in the grid circuit of T_2 , a type 2050. When this tube is drawing current, the grid cathode resistance assumes a very low value and it is therefore necessary to isolate the R-C circuit from the grid through R_3 .

The time delay of this circuit is adjusted for approximately 15 seconds, so that when the air alert transmitter being monitored sends out a 1000-cps tone, this tone will operate the device at the end of this period. The relay in the plate circuit of T_2 has two sets of contacts. One set opens the plate supply to this tube so that when the alert is received, the tube is kept in the "off" position, and must be reset manually. The second set of contacts controls the gain of a separate amplifier used for monitoring the alert station. For normal operation the loudspeaker is kept at low volume, and upon receipt of an alarm, T_2 is operated by the R-C circuit and the level of the loudspeaker is increased to the point that it overrides the regular monitor loudspeaker in the control room. In case of carrier failure of the station monitored, or a breakdown of the receiver, tube T_3 operates to close the relay in its plate circuit, and sound an alarm buzzer.

Only one of the many applications to which this device is adaptable, has been described. It can be used wherever an alarm system or a repeating cycle of on or off operation is necessary. The electronic control circuit for any type of operation remains the same, regardless of the type of control necessary. The number and connections of the relay contacts will allow for a wide variety of circuit combinations. The manufacturing rights to this automatic monitoring device have been granted to the Washington (D.C.) Institute of Technology.

WHEREVER THERE IS RADIO THERE ARE SPRAGUE CONDENSERS

Sprague Condensers are made to the highest quality standards in a complete line meeting practically every electronic, electrical and industrial need. It is natural then, that today's production is largely devoted to a complete, fully approved assortment for Army and Navy uses. Our engineers will gladly cooperate in solving your capacitor problems.

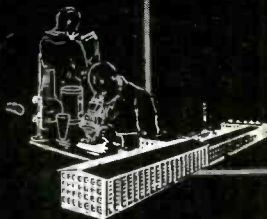
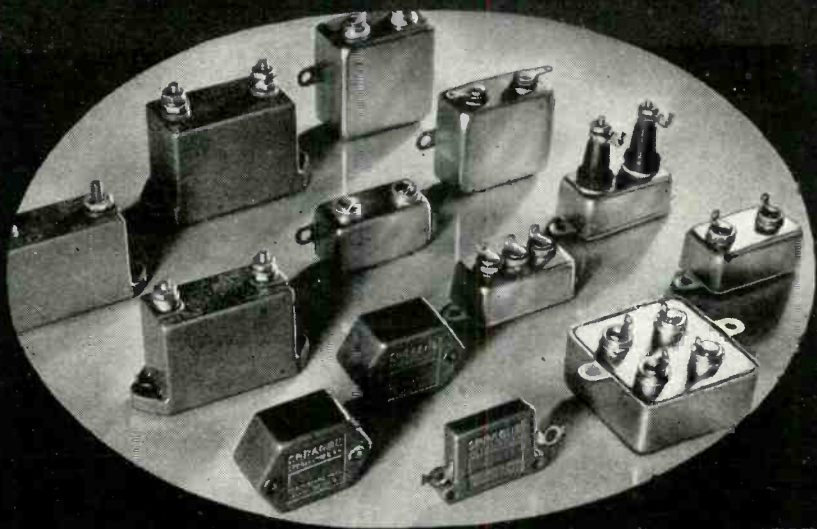

SPRAGUE

CONDENSERS—KOOLOHM RESISTORS

Quality Components • Expertly Engineered • Competently Produced

SPRAGUE SPECIALTIES COMPANY, NORTH ADAMS, MASS.

ACME

has the
FACILITIES
to work for you
BETTER

Transformer building is a specialist's job, and Acme is an organization of transformer specialists with all the facilities to relieve you of voltage control problems. Three specially equipped plants, men and machinery are ready to work for you better and economically. For example: Acme has on hand complete dies, tools and fixtures for manufacturing transformers in a variety of designs and mountings and a range of ratings. If your needs can be adapted to the mechanical requirements of this material—then there are many advantages that you can expect. Write today for Specification Transformer Bulletin 155. Send outline of your transformer application and let Acme engineers work with you.



CAN THE ACME INSULATION BREAKDOWN TESTER HELP IN YOUR WORK?



Here's a testing device of many uses. A 500 V.A. capacity unit that plugs into any 110 volt 60 cycle line. Provides secondary voltage, (manually controlled) of 500, 1000, 1250, 1500, 1750, 2000 or 2500 volts. Provides practical test to Underwriters specifications of double the rated voltage plus 1000. 100% leakage type transformer limits current under short-circuit conditions thus preventing needless destruction to materials at point of breakdown on apparatus under test. Get full details on this unit. Write for Acme Breakdown Tester Bulletin 140.

The Acme Electric & Mfg. Co.
31 WATER ST. CUBA, N. Y.

Acme Electric
TRANSFORMERS

TUBES

Characteristics of cathode-ray and television picture tubes are presented this month in addition to the new receiving tube types registered by the RMA Data Bureau during January 1942

Tube Registry

New tube types registered by the RMA Data Bureau during January 1942

Type 6AH5G

BEAM power amplifier, heater type, ST-16 glass envelope, seated height $4\frac{3}{4}$ inches, (max), 6-pin octal base.

RATINGS
 $E_f = 6.3$ v
 $I_f = 0.9$ amp
 $E_b = 350$ v (max)
 $E_{c1} = 250$ v (max)
 Plate Dissipation = 18.5 watts (max)
 Screen Dissipation = 2.7 watt (max)

TYPICAL OPERATION
 $E_b = 350$ v
 $E_{c1} = 250$ v
 $E_{c2} = -18$ v
 $r_m = 5200$ μ hos
 $r_p = 33,000$ ohms
 $R_i = 4200$ ohms
 $P_o = 10.8$ watts (15%)
 Basing 6AP-0-0

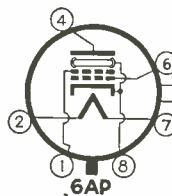

Type 6SC7GT

TWIN triode, heater type, T-9 glass envelope, seated height $2\frac{3}{4}$ inches (max), 8-pin octal base.

RATINGS
 $E_f = 6.3$ v
 $I_f = 0.3$ amp
 $E_b = 250$ v (max)

TYPICAL OPERATION
 $E_f = 6.3$ v
 $I_f = 0.3$ amp
 $E_b = 250$ v
 $E_c = -2$ v
 $I_b = 2.0$ ma
 $\mu = 70$
 $r_m = 1325$ μ hos
 $r_p = 53,000$ ohms
 Basing 8S-0-0

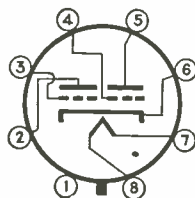

Type 6Y3G

HALF-WAVE rectifier, heater type, ST-12 glass envelope, seated height 3-29/32 inches (max), 6-pin octal base.

$E_f = 6.3$ v
 $I_f = 0.7$ amp
 $E_{in} = 14,000$ v
 I_p (peak) = 100 ma (max)
 $E_p = 5000$ v rms (max)
 $I_b = 7.5$ ma (max)
 Where filter input is capacitative, value of capacitance should not exceed 0.5 μ f.
 Basing 4AC-0-0

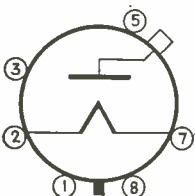

Cathode-Ray Tubes

Type 2514A9

DuMont

CATHODE-RAY tube; medium-persistence, green fluorescent screen; electrostatic focus and deflection; usual application—oscillographic, high voltage and television; diameter 9 inches; 11-pin mag-nal base.

$E_f = 6.3$ v
 $I_f = 0.8$ amp
 E (anode 1) = 2000 v (max)
 E (anode 2) = 5000 v (max)
 E (grid) for cutoff = -75 v
 E (intensifier) = 10,000 v
 Deflection Factor
 $D_1 - D_2 = 21$ v (d.c.)/kilo-volt-inch
 $D_3 - D_4 = 20$ v (d.c.)/kilo-volt-inch

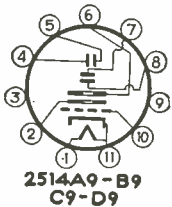

Type 2514B9

DuMont

CATHODE-RAY tube; long-persistence, green fluorescent screen; electrostatic focus and deflection; usual application—oscillographic, high voltage and television; diameter 9 inches; 11-pin mag-nal base.

$E_f = 6.3$ v
 $I_f = 0.8$ amp
 E (anode 1) = 2000 v (max)
 E (anode 2) = 5000 v (max)
 E (grid) for cutoff = -75 v
 E (intensifier) = 10,000 v
 Deflection Factor
 $D_1 - D_2 = 21$ v (d.c.)/kilo-volt-inch
 $D_3 - D_4 = 20$ v (d.c.)/kilo-volt-inch

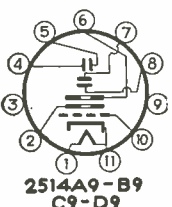

Type 2514C9

DuMont

CATHODE-RAY tube; short-persistence, blue fluorescent screen; electrostatic focus and deflection; usual application—oscillographic, high voltage and television; diameter 9 inches; 11-pin mag-nal base.

$E_f = 6.3$ v
 $I_f = 0.8$ amp
 E (anode 1) = 2000 v (max)
 E (anode 2) = 5000 v (max)
 E (grid) for cutoff = -75 v
 E (intensifier) = 10,000 v
 Deflection Factor
 $D_1 - D_2 = 21$ v (d.c.)/kilo-volt-inch
 $D_3 - D_4 = 20$ v (d.c.)/kilo-volt-inch

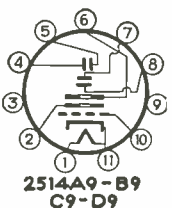

WARD LEONARD CONTROLS

We are proud that Ward Leonard Controls developed during the past fifty years, now contribute their part in increasing safety, comfort and efficiency of our men in the service.



**CONTROLS
ON "MESS DUTY"**

Yes, Ward Leonard is even doing its part in peeling "spuds". Many of the potato peeling machines used by both Army and Navy are equipped with Ward Leonard Motor Starters. This is about the simplest of the many controls that Ward Leonard is now supplying for the service. Our long experience in designing and building electric controls, through the intensive electrification period of industry, admirably fits us for the present emergency. We know how to meet special control requirements and how to produce in quantity to government standards.

WARD LEONARD
RELAYS • RESISTORS • RHEOSTATS

Electric control  devices since 1892.

WARD LEONARD ELECTRIC COMPANY, 32 SOUTH STREET, MOUNT VERNON, NEW YORK

PANORAMIC ADAPTOR

lets you SEE the SIGNALS in 100 KC band width.

This instrument may be attached to any conventional superheterodyne with an IF of 450 to 480 K.C., and permits continuous observation of ALL signals present within 50 KC above and below the frequency to which receiver is tuned.

IMPORTANT APPLICATIONS:

- **COMMUNICATIONS:** More effective band supervision, less operator concentration and nerve fatigue. Intermittent signals indicated. Open channels instantly visible. Indicates reception interference. Monitoring of FM transmitter.
- **LABORATORY:** Study of UHF and ALL other oscillators, IF transformers, RF stages, etc.
- **PRODUCTION** matching or classifying inductances, capacitors, resistors, tracking RF and IF stages, and comparing with standards.

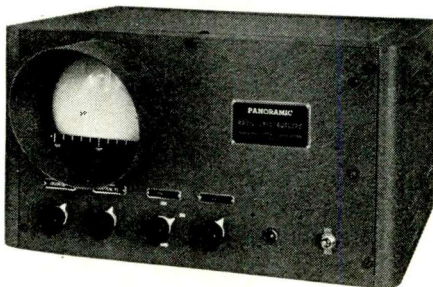

Send for complete information today

WHAT THE PANORAMIC SCREEN SHOWS

The signal deflections on the Panoramc screen are indicative of frequency, amplitude, and modulation characteristics.

Sensitivity is greater than the receiver itself. It provides an overall picture of a constant band of 100 KC which shifts as the receiver is tuned.

The audible signal is always visible in the center of the PANORAMIC SCREEN.

Canadian Repres: Canadian Marconi Co. Ltd., Montreal, Canada

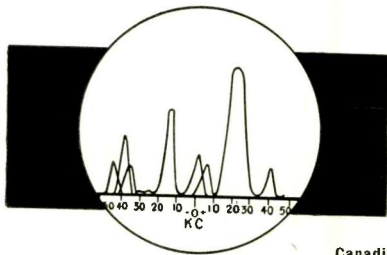

PANORAMIC RADIO CORP.

242-250 West 55th Street, New York City

Phone: Circle 6-9440

Cable: Panoramc, New York

Here's Instant Action in CIRCUIT PROTECTION

Short Circuit and Overload
Protection for this Quick
Battery Charger provided by

HEINEMANN "Re-Cirk-it"

Fully Electro-Magnetic AUXILIARY BREAKER

Hunter-Hartman Corp., manufacturers of this charger, tells us—and you, "Your circuit breaker has performed most efficiently in preventing the possibility of an overload damaging the rectifier or the battery being charged. Its efficient performance has been constant." Heinemann Auxiliary Breakers, made in any rating from 250 milliamperes to 50 amperes, open instantly on short circuits and dangerous overloads but permit harmless overloads of short duration.

Send for Catalog showing full line of Circuit Protective Devices.

HEINEMANN CIRCUIT BREAKER CO.

97 PLUM ST. - - - TRENTON, N. J.

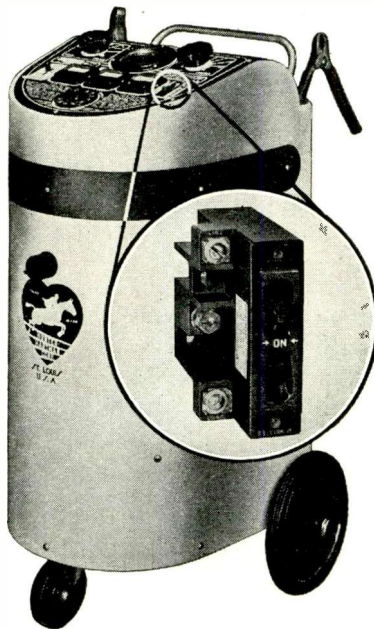

Type 2519C14

DuMont

CATHODE-RAY tube; short-persistence, blue fluorescent screen; electrostatic focus and deflection; usual application—television; diameter 14 inches; 12-contact peripheral base.

$E_f = 2.5$ v
 $I_f = 2.1$ amps
 E (anode 1) = 2000 v (max)
 E (anode 2) = 6000 v (max)
 E (grid) for cutoff = -75 v
 E (intensifier) = 12,000 v
 Deflection Factor
 $D_1 - D_2 = 17$ v (d.c.)/kilo-volt-inch
 $D_3 - D_4 = 15$ v (d.c.)/kilo-volt-inch



Intensifier
2519A14-B14
C14-D14

Type 2520A20

DuMont

CATHODE-RAY tube; medium-persistence, green fluorescent screen; electrostatic focus and deflection; usual application—television; diameter 20 inches; 12-contact peripheral base.

$E_f = 2.5$ v
 $I_f = 2.1$ amps
 E (anode 1) = 2000 v (max)
 E (anode 2) = 6000 v (max)
 E (grid) for cutoff = -75 v
 E (intensifier) = 12,000 v
 Deflection Factor
 $D_1 - D_2 = 15$ v (d.c.)/kilo-volt-inch
 $D_3 - D_4 = 14$ v (d.c.)/kilo-volt-inch

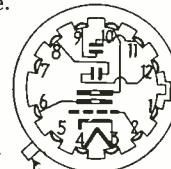

Intensifier
2520A20-B20
C20-D20

X-RAY REVEALS FLAWS IN METAL



Dr. S. S. Sidhu, head of the x-ray labs at the University of Pittsburgh, holds a metal casting under a Westinghouse 220,000-volt x-ray machine. This machine reveals metal defect spots and records them on photographic film placed under the casting. Defense workers are being trained to use this machine at this university and Pennsylvania State College

(Below) MINIATURE TERMINAL BUSHINGS offer a convenient, economical means of terminating low-potential leads in condensers, transformers, and similar equipment. In addition, they may be used as small stand-off insulators for anchoring condensers and resistors in radio equipment. Bushings are supplied complete with hard tinned copper terminals and nickel-plated copper flanges. Insulator bodies are of glazed Isolantite*. Bushings are supplied in two terminal lengths and two insulator lengths, making a total of four combinations, as shown in upper photograph. Lower photo shows a typical application of the bushings on transformers. Detailed information on these bushings is contained in Bulletin 104-A, which is available on request.

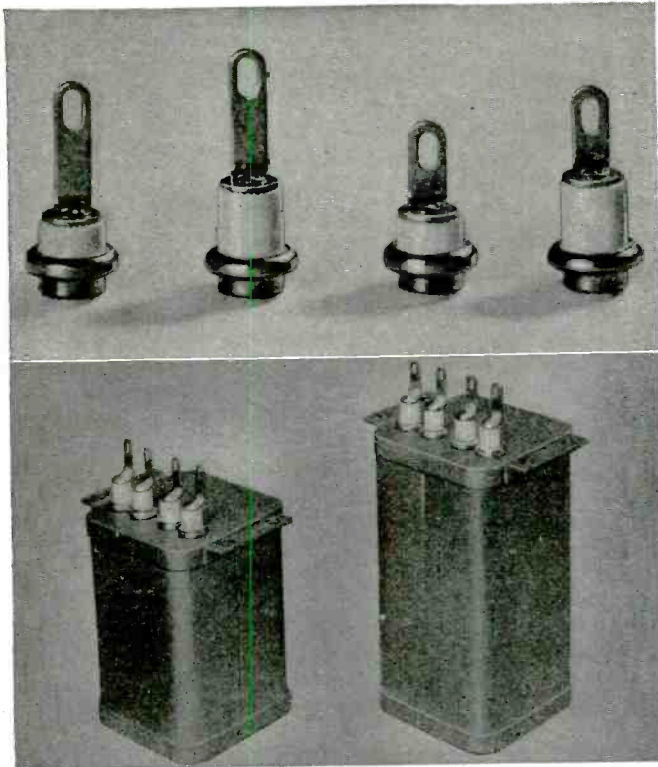

(Below) ACCURACY IN MANUFACTURE is an important advantage in many applications of Isolantite. In this high-voltage neutralizing condenser, for example, the eight faces of the upright supports are specially fabricated after firing to obtain accurate relationship of plane surfaces. This provides correct alignment of metal parts, and aids in producing desired electrical characteristics in the condenser.

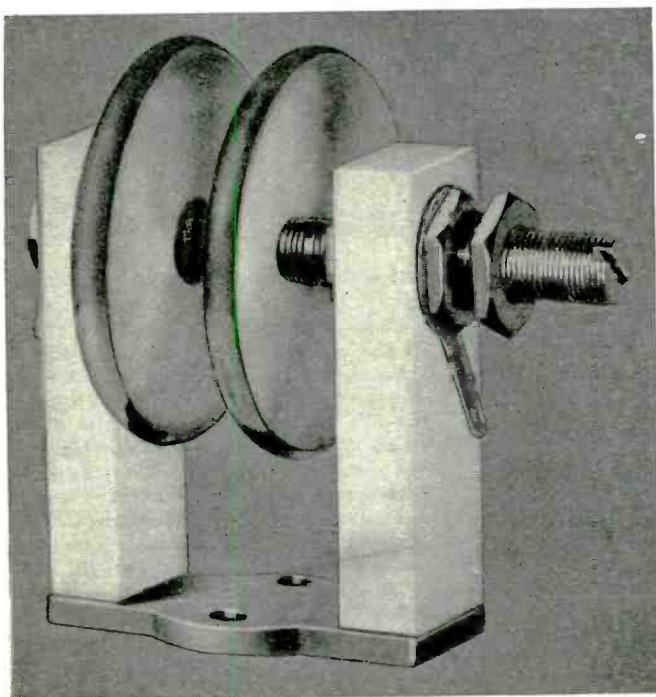

INSULATION HIGHLIGHTS

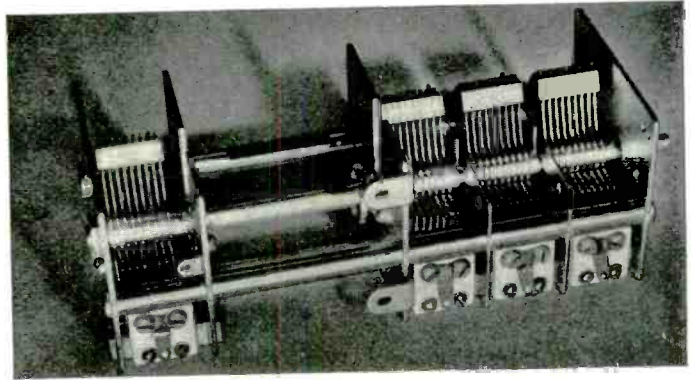

(Above) IN HIGH-FREQUENCY SERVICE of every type, Isolantite is the choice of leading manufacturers, because of its unique combination of high dimensional precision, low power factor, and high strength. These are among the reasons why Isolantite insulation was selected for use in this new condenser design.

(Below) NEW AUTOMATIC PRESS is unloaded as Isolantite's expansion program is rapidly pushed toward completion. The new press will facilitate production by permitting the automatic molding of shapes which formerly required special machining operations or partial molding on hydraulic equipment.

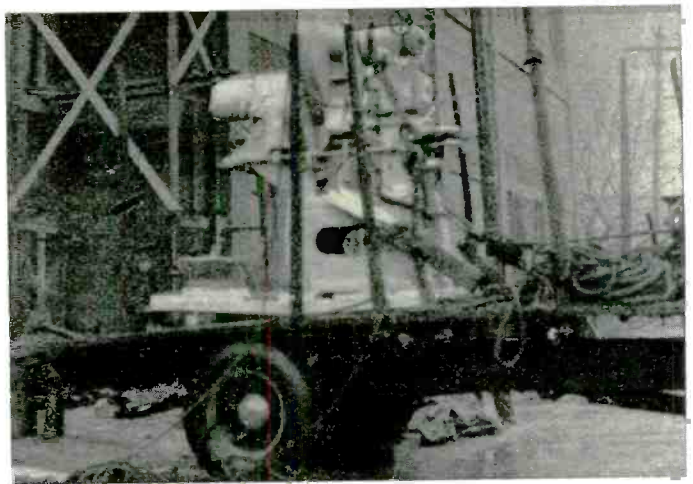

ISOLANTITE

CERAMIC INSULATORS

ISOLANTITE INC., 233 BROADWAY, NEW YORK, N. Y.

*Registered trade-name for the products of Isolantite Inc.

get this new, free booklet

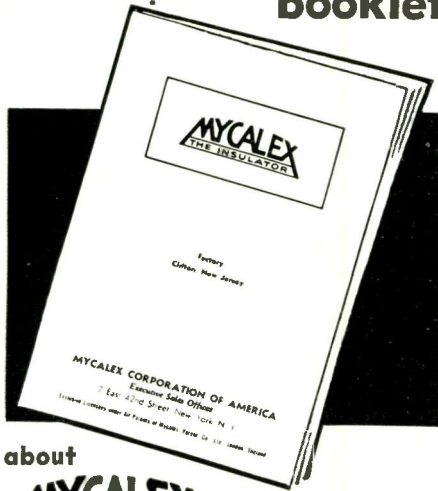

about



the low-loss insulator that can be machined!

TRADE MARK REG. U. S. PAT. OFF.

MATERIAL NOW SUPPLIED from the NEW, LARGE PLANT of the EXCLUSIVE AMERICAN LICENSEES under all British patents*

MYCALEX CORPORATION OF AMERICA
Sales: 7 E. 42 St., N. Y. Plant: Clifton, N. J.

*THERE IS A DIFFERENCE: MYCALEX insulating material IS LEADLESS. It offers improved insulating properties, and can be machined more easily and more quickly to accurate measurements. Mark your specifications: "LEADLESS" MYCALEX insulating material."

Send today for new, informative 12-pg. booklet, generously illustrated with factual photographs of sockets, coils, spacers, many other parts made of, or in conjunction with, MYCALEX insulating material. Contains helpful engineering data, description of properties, advice on machining, suggestions for new uses in your business. MYCALEX insulating material rates high among the world's leading electrical engineers, because of its great mechanical strength, its high dielectric strength and the comparative ease of its machining. To get full facts, mail coupon.

Examples of machined MYCALEX insulating material

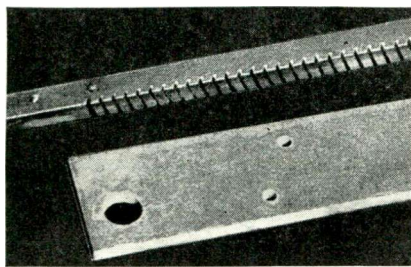

Shows MYCALEX insulating material grooved for insulation and support of radio transmitter tank coils. Its extremely low loss at even ultra high frequencies makes it possible to use MYCALEX insulating material wherever needed for mechanical strength, regardless of position or bulk, in R. F. Aids. Many users machine MYCALEX insulating material in their own shops; our own new, large machine shop at our Clifton, (N. J.) plant is well-equipped to cut, drill, tap, machine, grind and polish MYCALEX insulating material to your exact specifications.

TEAR OFF COUPON NOW—before you forget.

Mycalex Corporation of America Dept. 20
7 E. 42nd St., New York, N. Y.
Please send illustrated booklet.
Name
Street
City State

Type 2520B20

DuMont

CATHODE-RAY tube; long-persistence, green fluorescent screen; electrostatic focus and deflection; usual application—television; diameter 20 inches, 12-contact peripheral base.

$E_f = 2.5$ v
 $I_f = 2.1$ amps
 E (anode 1) = 2000 v (max)
 E (anode 2) = 6000 v (max)
 E (grid) for cutoff = -75 v
 E (intensifier) = 12,000 v
Deflection Factor
 $D_1 - D_2 = 15$ v (d.c.)/kilo-volt-inch
 $D_3 - D_4 = 14$ v (d.c.)/kilo-volt-inch



2520A20-B20 C20-D20

Type 2520D20

DuMont

CATHODE-RAY tube; medium-persistence, white fluorescent screen; electrostatic focus and deflection; usual application—television; diameter 20 inches, 12-contact peripheral base.

$E_f = 2.5$ v
 $I_f = 2.1$ amps
 E (anode 1) = 2000 v (max)
 E (anode 2) = 6000 v (max)
 E (grid) for cutoff = -75 v
 E (intensifier) = 12,000 v
Deflection Factor
 $D_1 - D_2 = 15$ v (d.c.)/kilo-volt-inch
 $D_3 - D_4 = 14$ v (d.c.)/kilo-volt-inch



2520A20-B20 C20-D20

Type 2532C20

DuMont

CATHODE-RAY tube; short-persistence, blue fluorescent screen; electrostatic focus and deflection; usual application—television, diameter 20 inches, 12-contact peripheral base.

$E_f = 2.5$ v
 $I_f = 2.1$ amps
 E (anode 1) = 2000 v (max)
 E (anode 2) = 6000 v (max)
 E (grid) for cutoff = -75 v
 E (intensifier) = 12,000 v
Deflection Factor
 $D_1 - D_2 = 15$ v (d.c.)/kilo-volt-inch
 $D_3 - D_4 = 15$ v (d.c.)/kilo-volt-inch



2532A20-B20 C20-D20

Type 2532D20

DuMont

CATHODE-RAY tube; medium-persistence, white fluorescent screen; electrostatic focus and deflection; usual application—television; diameter 20 inches, 12-contact peripheral base.

$E_f = 2.5$ v
 $I_f = 2.1$ amps
 E (anode 1) = 2000 v (max)
 E (anode 2) = 6000 v (max)
 E (grid) for cutoff = -75 v
 E (intensifier) = 12,000 v
Deflection Factor
 $D_1 - D_2 = 15$ v (d.c.)/kilo-volt-inch
 $D_3 - D_4 = 14$ v (d.c.)/kilo-volt-inch



2532A20-B20 C20-D20

Type 2532A20

DuMont

CATHODE-RAY tube; medium-persistence, green fluorescent screen; electrostatic focus and deflection; usual application—television; diameter 20 inches, 12-contact peripheral base.

$E_f = 2.5$ v
 $I_f = 2.1$ amps
 E (anode 1) = 2000 v (max)
 E (anode 2) = 6000 v (max)
 E (grid) for cutoff = -75 v
 E (intensifier) = 12,000 v
Deflection Factor
 $D_1 - D_2 = 15$ v (d.c.)/kilo-volt-inch
 $D_3 - D_4 = 14$ v (d.c.)/kilo-volt-inch



2532A20-B20 C20-D20

Type 2532B20

DuMont

CATHODE-RAY tube; long-persistence, green fluorescent screen; electrostatic focus and deflection; usual application—television; diameter 20 inches, 12-contact peripheral base.

$E_f = 2.5$ v
 $I_f = 2.1$ amps
 E (anode 1) = 2000 v (max)
 E (anode 2) = 6000 v (max)
 E (grid) for cutoff = -75 v
 E (intensifier) = 12,000 v
Deflection Factor
 $D_1 - D_2 = 15$ v (d.c.)/kilo-volt-inch
 $D_3 - D_4 = 14$ v (d.c.)/kilo-volt-inch



2532A20-B20 C20-D20

AIRCRAFT IN TELEVISION

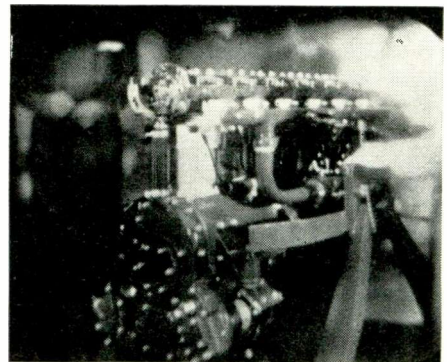

An airplane engine made its television debut in New York City recently when thousands of unseen spectators who make up the television public saw this engine on the screens of their receivers as mechanics of the Ranger Engine Division of the Fairchild Engine & Airplane Corp. assembled it before the camera. The mechanics worked at regular factory tempo during the 45 minute "national defense" program while engineers and company executives discussed the problem of high speed airplane engine construction. The photograph shows the image of the finished engine as it appeared on the screen of a television set during the telecast

Engineers Train for Defense

(Continued from page 38)

tion of the courses. Finally, it is anticipated that each broadcasting station has at least one technically qualified person who could act as instructor for the course in radio communication.

The course in radio fundamentals promoted by NAB does not require such advanced academic training as that usually required for the majority of ESMDT courses. The courses in radio operation are open to graduates of technical high schools. In certain cases those without a complete high school education may be accepted provided they have the necessary high school physics and mathematics as prerequisites, or have the equivalent in practical experience.

An important consideration in the NAB courses is the number of persons to whom instruction is to be given. The training of a group of several thousand radio technicians within the span of the next several months is a task of considerable magnitude and indicates the importance with which the radio technician is regarded in this war.

But, important as is adequate training, this is of little avail without adequate planning and preparation for victory. The technical and scientific manpower of this country is more than anxious to fulfill its obligation in the development of communication and protective services and equipment for the welfare of the United States. The technical achievements being made at the present time are greater than have ever been made before. Many of the contributions arising from the war will be carried over in peace time.

Everyone recognizes that the job, right now, is to produce materials needed for ultimate victory in the vast contest in which the country is engaged, and to get the materials so produced to the places where they are needed. It is also recognized that properly trained men must be found to operate this equipment; and these several aspects of a vast educational program are steps in this direction.

The war-time value of these men is known; but it is not possible to assay their post war value.

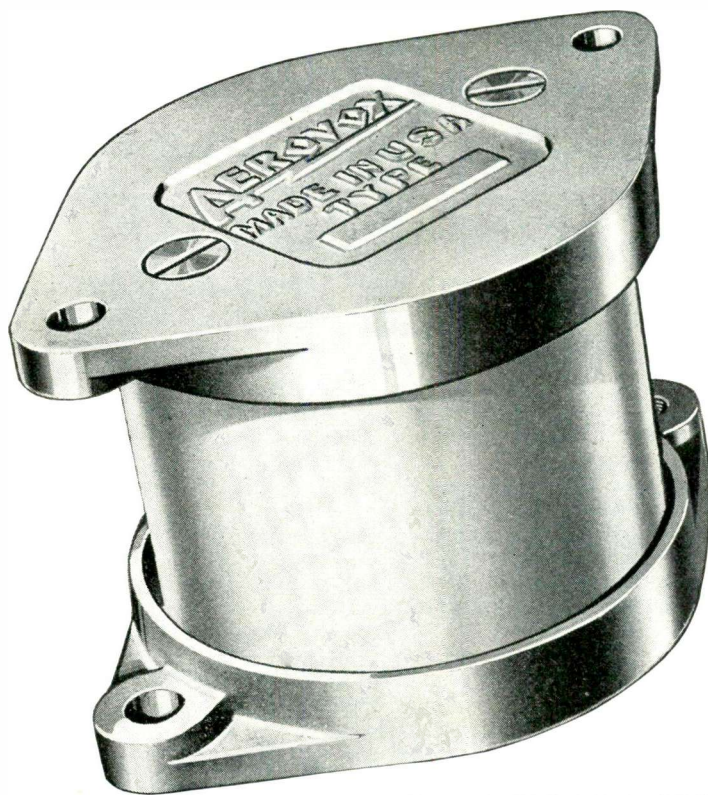

Yesterday, "SPECIAL"

today, "STANDARD"

● Until recently the mica stack-mounting type and other extra-heavy-duty transmitting capacitors in mica, oil-filled, electrolytic and paper plug-ins and other types, were definitely "special" or made to order. Previous prices reflected the custom-built angle.

Aerovox, however, has made these extra-heavy-duty transmitting capacitors *standard* items in regular production as listed in the Aerovox Transmitting Capacitor Catalog. Such capacitors are now available to you at new and reasonable prices for your initial equipment, alterations or maintenance. Therefore, before placing your next order, be sure to check AEROVOX *standard* types and prices!

Ask for DATA...

- If you are engaged in designing, building or maintaining radio or electronic equipment using extra-heavy-duty capacitors, write on business letterhead for your copy of the Aerovox Transmitting Capacitor Catalog. Submit that capacitance problem for engineering collaboration, recommendations, specifications, quotations.

NEW BEDFORD, MASS.,
U. S. A.
Sales Offices in All
Principal Cities

AEROVOX
CORPORATION



In Canada
AEROVOX CANADA LTD.
Hamilton, Ont.
EXPORT: 100 Varick St., N. Y.
Cable 'ARLAB'

NEWS OF THE INDUSTRY

Radio receiver production tapers off toward end of year. General Electric starts broadcasts to make public conscious of electronics. Television helps train air raid wardens.

Persomel News

DR. CLEDO BRUNETTI, assistant professor of electrical engineering at Lehigh University was Eta Kappa Nu's selection for 1941 outstanding young electrical engineer. Honorable Mention awards were presented to George F. Leydorf, staff engineer, Crosley Corporation, and Simon Ramo, engineer, General Electric Company.

Walter L. Krahl has been made assistant chief engineer of the Hygrade Sylvania Corp., radio tube division. Two promotions have been made in the staff of the International Resistance Co. Harold G. Beebe, formerly assistant manager of the IRC industrial division, becomes manager of that division; Harry A. Ehle, formerly manager of the industrial division and assistant to the president, now becomes a vice-president.

Noran E. Kersta has been appointed manager of the television department of NBC succeeding to the duties of Alfred H. Morton, vice-president to whom Kersta was assistant for two years.

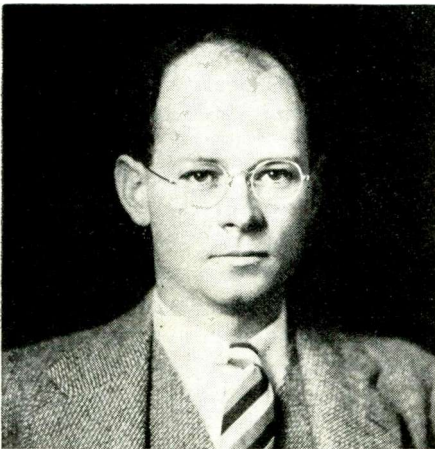

Harry A. Ehle, new vice-president, International Resistance Company

Television Aids Defense

THE AIR RAID WARDENS' courses on the air during early months of this year culminated in a concentrated effort the week of February 23 when WNBT put programs on the air, aimed at air raid wardens at intervals throughout the day. Watchers in private homes and in

police stations and stores participated.

Station W2XWV, DuMont New York Television televised the burning of the Normandie at her piers in the Hudson River. From the roof of the building in which the transmitter is housed at 515 Madison Ave., and by means of telephoto lenses the tragic event was sent through the ether to those equipped with receivers. This station is now on the air every Thursday evening from 7:30 to 9:30 usually with film programs. Although present output is 2 kw, higher power will be available soon.

Saving Tungsten and Copper by Using Silver

TUNGSTEN BEING on the critical list, is scarce. Silver is more plentiful, and can be used as a substitute for the scarcer material in several ways, according to an American Silver Producers' research project under Handy and Harmon direction. There is no need, for example, to make high-speed-steel tools entirely of high-speed steel. Only a small tip need have the tungsten-bearing alloy. Practically all the rest can be of carbon steel—thanks to the use of silver brazing alloys for making a secure joint between the two other metals. A joint less than 0.003 inch thick turns the trick, hence mighty little silver is needed and the cost is slight. The same is true in millions of joints brazed with silver alloys or made with silver solders. Such joints stay put.

Another place where silver may serve as a substitute is in the form of

fine wire which replaces fine copper wire for small coils used in thousands of electrical applications. This is partly because silver is plentiful, whereas there is a great shortage of copper and its use is now being largely restricted to defense needs. In addition, however, silver has the highest electrical conductivity of any metal.

Naturally, silver costs much more than copper per pound, but the difference in metal cost for enough fine wire for small coils is small, especially in relation to total cost. The latter is only slightly altered, since labor and other factors involved in total cost are large as against material cost. Silver's high resistance to corrosion is also a factor in electrical applications and accounts for a growing use of silver in electrical equipment.

Electronics on the Air

BEGINNING MARCH 3, electronics will be the theme of 15-minute news broadcasts every Tuesday, Thursday and Saturday over 48 Columbia stations and several f-m stations with Frazier Hunt as news commentator, and the radio and television department of General Electric Company as sponsor. The CBS broadcasts will be from 6:00 to 6:15 p.m. EWT, and there will be a re-broadcast at 10:45 EWT for central, mountain and Pacific time zones.

"We are on the threshold of the electronic age", according to Dr. W. R. G. Baker, vice president in charge of the radio and television department. "Electronic devices help us build better bombers, tanks, ships and guns. During the past decade, our progress in the use of tubes has helped us to do thousands of jobs better. The advancement made in electronics during this war will help us reconstruct a better world when victory is won."

Frazier (Spike) Hunt is a globe trotting reporter. His broadcasts will be about the news of the day; and will use news items as means of telling stories of developments made possible by electronics.

Radio Receiver Production

	Units		Dollars		
	Oct.	Nov.	Oct.	Nov.	
Table sets	530,595	478,844	6,434,100	6,029,400	
Console sets	72,571	87,540	3,067,300	3,646,700	
Portable sets	119,667	90,231	1,674,200	1,322,800	
Auto sets	205,270	190,405	3,600,900	3,458,700	
Farm battery sets.....	80,081	69,316	1,046,500	996,900	
F-m adapters	534	728	11,400	16,500	
Electric phonographs	18,072	25,955	254,800	333,000	
Table combinations	57,145	67,315	1,357,000	1,672,100	
Console combinations	106,313	107,569	7,918,700	7,951,100	
Radio, recorder and phonographs...	9,781	6,275	729,400	622,500	
Television sets	67	84	15,700	18,800	
Apparatus without cabinets.....	51,854	47,879	937,200	1,094,400	
External control devices.....	288	61	3,500	800	
	1941 units..	1,252,238	1,172,118	27,050,600	27,164,400
	1940 units..	1,315,229	1,329,364	20,957,200	19,929,500

AS THE ARCHITECT PLANS...

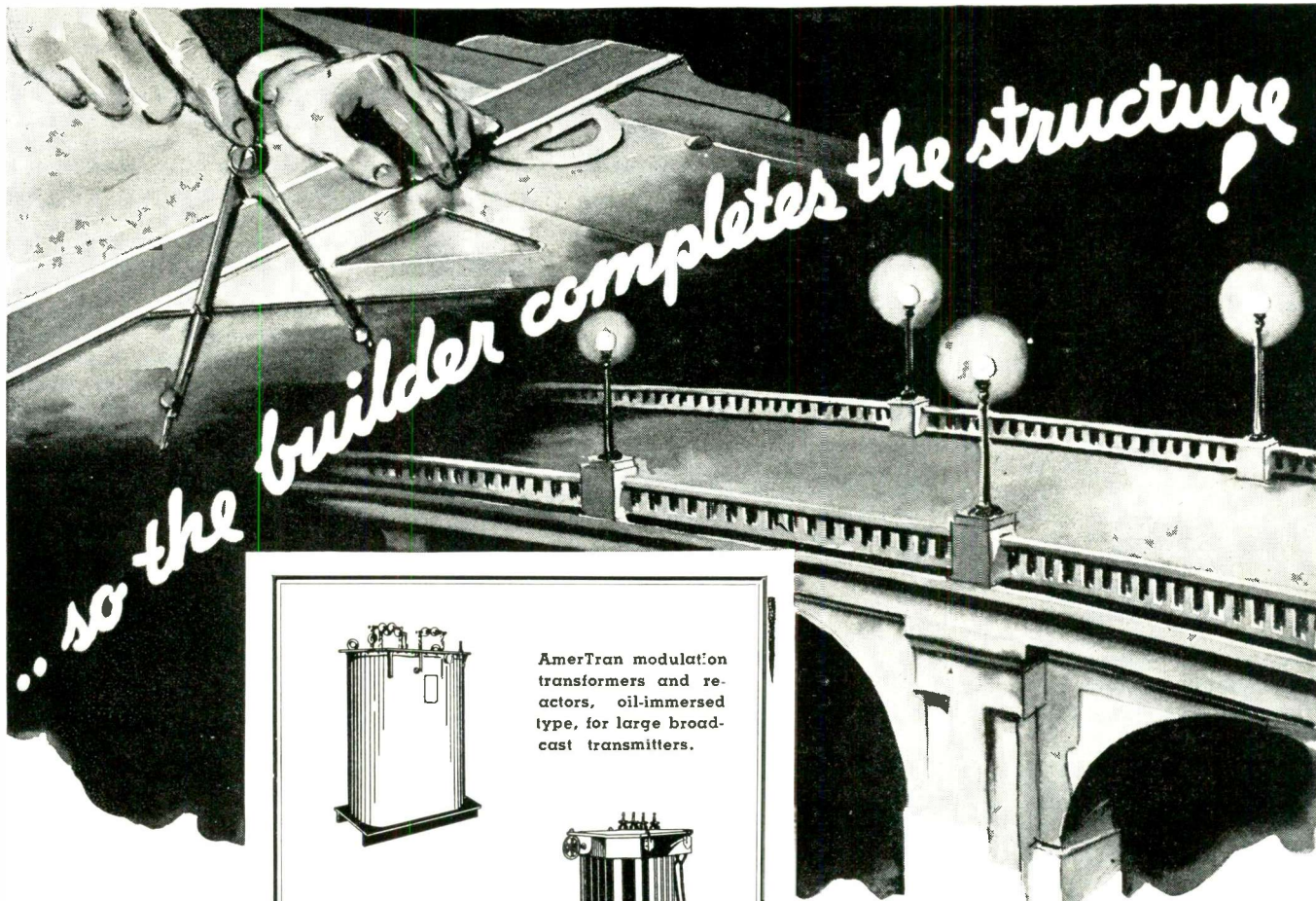

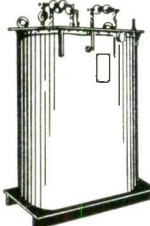

AmerTran modulation transformers and reactors, oil-immersed type, for large broadcast transmitters.



AmerTran RS plate transformers and reactors, oil-immersed type, for all large installations.

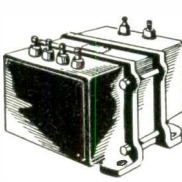

AmerTran W plate transformers and reactors for all small and medium installations.

PLANNED, designed and constructed to withstand safely every stress and load of a specified service . . . this is how modern steel structures (bridges, for example) are created, and likewise this typifies the manner in which AmerTran Transformers are produced. Our transformers are not all of one basic type which is modified to meet varying requirements of voltage and capacity. Instead we have developed what is probably the most diversified line of transformers offered by any single manufacturer, including

many distinctly different types, each for a specified type of service and each available in a wide range of ratings. An important branch of our business for more than 40 years has been supplying all manner of transformers required by the communication industry with the result that today AmerTran transformers for Electronic circuit applications are considered "The Standard of Excellence." May we recommend equipment for your requirements?

AMERICAN TRANSFORMER CO., 178 Emmet St., Newark, N. J.

Manufactured Since 1901 at Newark, N. J.



AMERTRAN

Built to your Specifications

NEW PRODUCTS

Month after month, manufacturers develop new materials, new components, new measuring equipment; issue new technical bulletins, new catalogs. Each month descriptions of these new items will be found here

Aircraft Communication System

A NEW LIGHTWEIGHT (25 LBS) communication system, known as Model 3801, has been announced. It is for use in large patrol airplanes as an auxiliary to existing equipment. The manufacturer states that it is capable of maintaining constant two-way communications on flights up to 2500 miles.

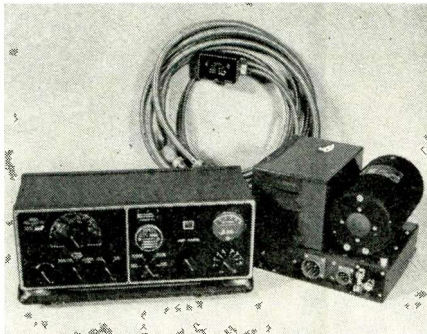

Model 3801 communication system

The system comprises two major units with connecting cables and jack boxes. The transmitter-receiver unit is designed for front panel operation so that it may be installed in any readily accessible location. The power unit may be located anywhere in the plane. Jack boxes are located at each unit to provide handy connection of microphones, headphones and telegraph key. The receiver is a six tube superheterodyne with a stage of tuned radio frequency. Tuning is accomplished with one knob. The receiver has one band for flying the radio beacons and another band for contact with ground stations or other aircraft. The volume of the receiver is controlled in all headphones by a control located on the receiver control panel. An antenna changeover relay in the unit permits transmitting and receiving on the same antenna.

The i-f and a-f amplifiers for the receiver are located in the power supply unit to keep the receiver dimensions to a minimum. By front panel switching, the audio amplifier provides an interphone system for the plane. The

audio amplifier is also used to modulate the transmitter on phone and to produce the tone for modulated CW transmission.

The transmitter which is in a common unit with the receiver is equipped with a switch which permits selection of interphone, radiotelephone modulated CW and CW.

The transmitter is crystal controlled and coupled to the antenna through the use of a continuously variable inductor. Any one of three crystals may be selected by a switch. Each crystal will operate on both the fundamental and second harmonic, providing each falls within the tuning range of the transmitter. Therefore, six frequencies are available without changing the crystal assemblies.

The system is available for both 12-volt operation, drawing a maximum of 13 amps, and for 24-volt operation, drawing a maximum of 6 amps. Dimensions of the transmitter-receiver unit are 13 $\frac{3}{8}$ inches long x 5 $\frac{1}{2}$ inches deep x 5 $\frac{1}{2}$ inches high. The power supply measures 9 inches long x 8 inches deep x 6 $\frac{1}{2}$ inches high.

Bendix Aviation, Ltd., North Hollywood, Calif.

Relays

TWO NEW TYPES OF RELAYS have been announced. One of these is a "snap-action relay" designated as Type 17 and is a small (2 $\frac{1}{4}$ x2 $\frac{1}{4}$ x2 $\frac{1}{2}$ inch) and lightweight relay for d-c control of a-c circuits, for aircraft service, or for

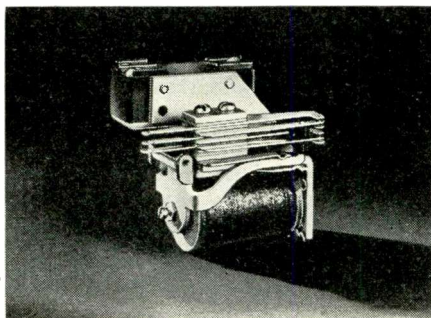

Type 17 snap-action relay

applications involving extreme humidity or vibration. This relay utilizes snap-action contacts (single-pole, arranged to open, close, or switch circuits when the relay is in operation). It will "make" 1150 watts, "break" 690 watts, at 115 volts, alternating current. The coils are impregnated with insulating varnish and are constructed to withstand approximately 95% humidity, as well as prevent movement of windings under vibration. Either one or two snap-action contacts are available. Type 17 relays can be supplied with one snap-action contact, and one contact spring assembly—up to ten springs. Contact springs are available with a wide choice of contacts.

For remote-controlled starting and stopping of radio transmitters and receivers, or other apparatus, a new "start-stop" relay has been developed.

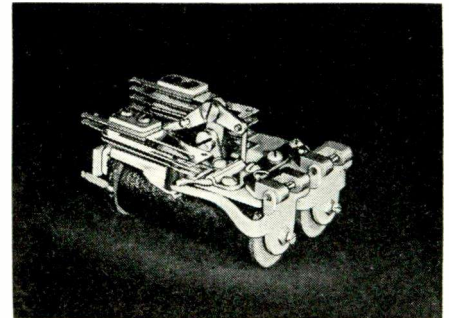

Type 19 start-stop relay

This relay is designated as Type 19. It operates and releases over two wires with a common return. An electro-mechanical locking arrangement makes it possible to hold contacts operated for long periods of time, without drawing coil current for the entire period. When the "operate" circuit is closed, the "lock-up" relay operates all of its springs, locks up, and then opens the "operate" circuit. When the "release" circuit is closed, the "release" relay unlocks the locked-up springs, which also opens the "release" circuit.

The manufacturer states that the operation is unaffected by any normal temperature changes and that laboratory tests indicate dependable operation over the range of temperatures from -30 to +55°C (-22 to +131°F).

Automatic Electric Co., 1033 Van Buren St., Chicago, Ill.

Compact Voltage Regulator

A VOLTAGE REGULATOR the size of an ordinary box camera is being used to supply current to radios and instruments of airplanes. This regulator operates at temperatures as low as 40° below zero, and from sea level to more than 35,000 feet in altitude. It weighs less than 2 lbs. and handles three times

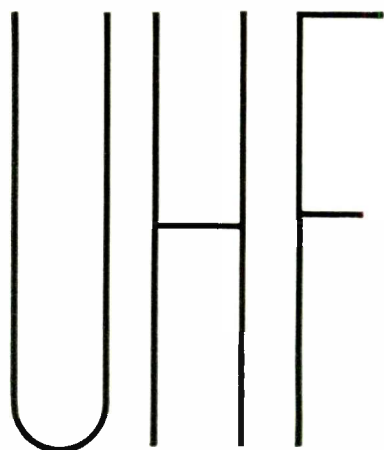

WHAT IT IS and WHAT IT DOES

In April **ELECTRONICS**—By Demand

A special section will be presented on this pertinent subject—each division written by a prime authority

To help meet the country's need for technically trained personnel in radio communication, the April issue of **ELECTRONICS** will include a special section dealing with ultra-high-frequency technique. The basic idea of this insert is to describe, simply, concisely and compactly, the fundamental differences between radio com-

munication at ultra-high frequencies and that at lower frequencies. The articles in the section should enable the reader to obtain a basic understanding of the practical aspects of u-h-f phenomena, and a sense of values of u-h-f phenomena. The subject will be covered in five divisions, each written by a specialist, as follows:

1. Radiating Systems and Wave Propagation
2. Electronics and Electron Tubes at Ultra-High Frequencies
3. Generation and Transmission of Ultra-High Frequencies
4. Ultra-High Frequency Reception and Receivers
5. Measurements at Ultra-High Frequencies

OF SPECIAL INTEREST TO ADVERTISERS—Ultra-High Frequency is undoubtedly the hottest subject now under discussion in the electronic field. Special interest in the issue means special interest in the advertising. It's a great spot to tell of your products and your abilities.



A McGRAW-HILL PUBLICATION

ABC ABP

330 West 42nd Street, New York, N. Y.

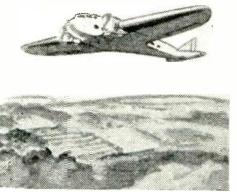
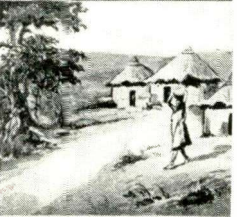
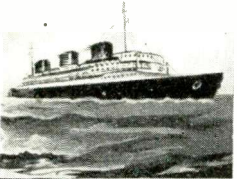

MOLDED

S.S. White RESISTORS

The "All-Weather" Resistors

1000 OHMS TO 1,000,000 MEGOHMS

PREFERRED for Aircraft and Marine Radio—

The materials and construction of these resistors is such that their performance is unaffected by extremes of temperature, humidity and rapid climatic changes. This plus their noiseless operation and durability, makes them ideal for radio equipment used aboard military and commercial aircraft and ships. Representative users include Air-Track Mfg. Corp., Arma Corp., Pan American Airways, RCA, U. S. Army and Navy, Westinghouse and many others.

SEND FOR RESISTOR BULLETIN 37

It contains illustrations of the various types and gives details as to construction, capacities, dimensions, etc. A copy, with Price List, mailed on request. Write for it today.

S. S. WHITE

The S. S. White Dental Mfg. Co.

INDUSTRIAL DIVISION

Department R, 10 East 40th St., New York, N. Y.

more current than its predecessors. The regulator may be quickly mounted and easily repaired, and can be conveniently installed in the fuselage of aircraft.

Westinghouse Electric & Mfg. Co., East Pittsburgh, Pa.

Rochelle Salt Speaker

WITH STEEL AND COPPER being assigned in greater and greater quantities to defense jobs, substitutes must be developed to meet civilian needs. This small Rochelle salt speaker uses a minimum of strategic materials. When used with a folded horn, which may form part of the cabinet, it is capable

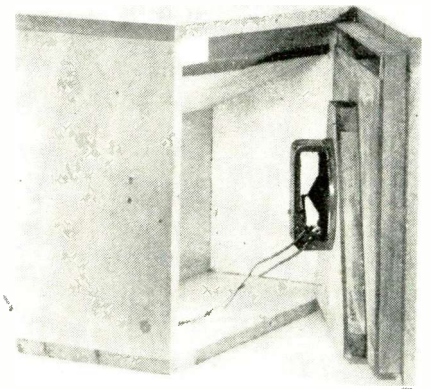

of producing sound of such quantity and quality as to compete on a performance basis with more conventional speakers. The speaker was developed for use in battery portable receivers. When operated from a 3Q5GT tube, the performance of this 2 3/4-inch unit is comparable to that of a 5-inch dynamic speaker.

Brush Development Co., 3311 Perkins Ave., Cleveland, Ohio.

Power Plants

A COMPLETE LINE OF ELECTRIC plants powered by International Harvester Diesel engines, has been announced. They are available for both alternating and direct current output and are designed around four different sizes of engines operating at speeds of either 900 or 1200 rpm. Eight models are available to cover the range between 12 1/2 and 50 kw. Designated as "Ready-Power-International" electric plants, they are designed primarily for those whose power bills run from one-hundred to five hundred dollars per month and whose current cost averages more than two cents per kw hour; where power lines are not available; where power service is not completely dependable; or where reserve or stand-by capacity is needed.

The Ready-Power Co., 3826 Grand River Ave., Detroit, Mich.

BUD Condensers
for every application

BUD precision-built condensers are made in many types and capacities for a variety of commercial electronic applications. We will submit prompt quotations on receipt of your prints or specifications.



BUD RADIO, INC.

CLEVELAND, OHIO

New Carter AIRCRAFT TYPE GENEMOTORS

● **SENSATIONAL!!** That's the word for the new Carter Multi-Output Dynamotor. Since its introduction a year ago, Police Departments, Government Agencies, and manufacturers of Tank Radio Equipment have found it has no equal for small size, high efficiency, and extra light weight. It's the coming thing for all Transmitter and Receiver installations



● Write today for descriptive literature on Carter Dynamotors—D.C. to A.C. Converters—Magmotors—Heavy Duty Permanent Magnet Hand Generators—Special Motors—High Frequency Converters—Extra Small A.C. Generators—Permanent Magnet Dynamotors and Generators.



1606 Milwaukee Ave. Cable: Genemotor
Carter, a well known name in radio since 1922



INSTANTLY AND AUTOMATICALLY
INSURED BY

LITTELFUSE
Midget Mercury Switch

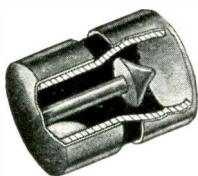

Cut-away shows anti-splash baffle.

Has wide and increasing range of use: For auto glove and trunk compartments, thermostat circuits, refrigerators, radio door lights, sliding panel light, indicator circuits, safes, etc.

Baffle on end of electrode prevents light flickering (as when car is on rough road). Central position of electrode makes it operative in any position.

For circuits to 25 volts AC or DC, non-inductive, and currents up to 6 amps, at 6 volts, and 1½ amps, at 25 volts. Whatever your application write us. Can be designed in several different types. Let us show you how it fits.

No. 1303 High Voltage
Fuse Mounting



For 1000 volt fuses, 1" wide, 3¾" long, ¾" thick. Overall height 1 3/16. Dependable. Send for catalog.

LITTELFUSE INC.
4755 RAVENSWOOD AVE. CHICAGO, ILL.

Insulation Resistance Tester

THE NEW WESTON MODEL 792 insulation and cable covering resistance tester is a compact device designed to adapt the Weston Model 785 industrial circuit tester or the Model 772 test analyzer for the measurement of insulation resistance up to 900 megohms. The new device fits into the compartment of the Model 785 circuit tester, and operates from a 100-130 volt a-c 50-60 cys supply line. It is connected into the ohmmeter circuit of the Models 785 or 772 by means of a pair of leads, and the insulation resistance measurement read on the ohmmeter scale.



Measurements up to a value of 900 megohms are made at a test potential of 500 volts as recommended by the AIEE, making it possible to quickly determine whether insulation properties are above the safe working minimums.

The Model 792 insulation tester is offered as optional equipment with both the Model 785 and 772 test units, and is also offered singly for use with Weston test units now in service and not equipped for insulation testing.

Weston Electrical Instrument Corp., Newark, N. J.

• • •

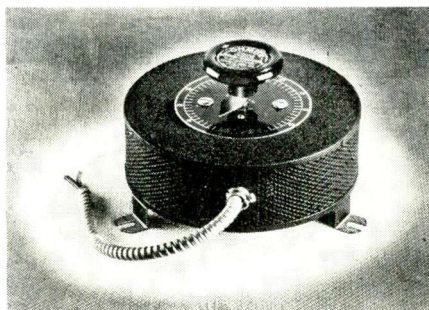

Variety of rheostat cages developed by Ohmite Mfg. Co., Chicago, for use with Ohmite rheostats. Convenient form of table-top or surface mounting

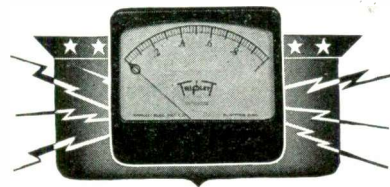

FOR TRIPLETT CUSTOMERS ONLY

Long before the state of emergency was proclaimed, the Triplet Company was getting ready to do its part in building our national security. We knew that we must meet important new responsibilities. At the same time, we felt keenly our continuing obligations to our customers—old friends with whom we have had happy business relations through many years.

We doubled—then tripled—our output to fill the needs of our old accounts. We added to our production facilities . . . hired many more men . . . are working extra shifts at time-and-a-half.

All this has not been enough. We have been called on to produce more and more for national defense. We are proud of the job we are doing to help meet the emergency, but it is difficult not to be able to serve our old friends equally as well. In the face of these conditions, the Triplet Company has adopted these policies "for the duration."

First: We will continue to serve you by our service to our mutual responsibility — the national emergency.

Second: We will continue to do everything we can to fill orders from our regular customers, even though some deliveries may be temporarily delayed. No business from new accounts has been nor will be accepted until after our old friends have been served, except where priorities make it impossible to do so.

Third: Our engineering and research departments will continue to work on the development of superior equipment and improved methods to serve you still better when we can resume normal operations.

The present emergency is incidental and as we work towards the future, we will do our best to continue to merit your confidence and loyalty.

C. L. Triplett
President

The Triplet Electrical Instrument Company
Manufacturers of
Precision Electrical Instruments

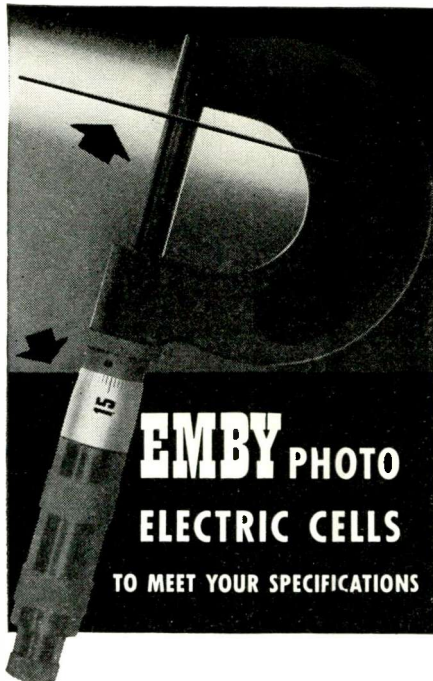

EMBY PHOTO ELECTRIC CELLS

TO MEET YOUR SPECIFICATIONS

The Photo-Electric Cell illustrated (.016" x 2" active surface) was developed to a client's specification for special application in the field of experimental physics. Its generation was over 100 microamperes at high levels of illumination.

• The development of a new and thoroughly proved technique in Photo-Electric Cell manufacturing is combined with the most modern equipment for vacuum work. This enables EMBY to supply barrier layer type cells with output, resistance, spectral response, etc. according to clients' specifications regardless of shapes and quantities involved.

EMBY standard size Photo-Electric Cells have a current sensitivity in excess of 400 microamperes per lumen. For complete technical data on EMBY Photo-Electric Cells, write to EMBY PRODUCTS COMPANY, 1800 W. Pico Boulevard, Los Angeles, California.

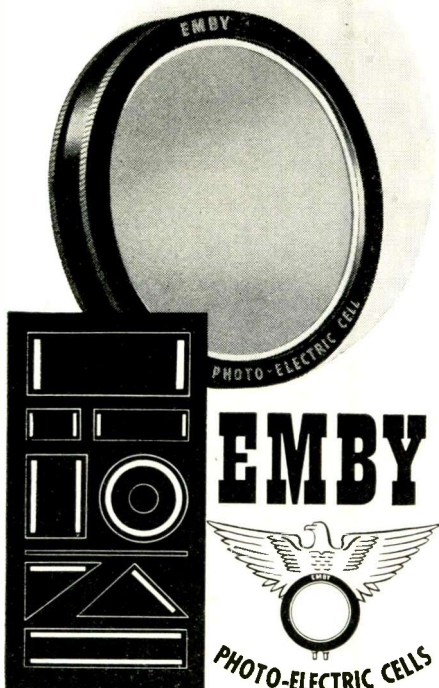

• Our engineering department will cooperate with you in developing colorimetric equipment and any other apparatus requiring Photocell applications. Standard types of colorimeters can be shipped promptly.

Tubing

A NEW TYPE OF ELECTRICAL insulation, known as "Fibronized Koroseal Tubing," has been announced. This new insulation was developed by the manufacturer from "Koroseal," a product of B. F. Goodrich Co. Characteristics of the tubing include inside and outside smoothness, elasticity and close manufacturing tolerances. It has good resistance to acids, alkalis, solvents and heat, and is fireproof. The insulation resistance is rated at infinity after sixteen hours at 90% relative humidity at 105° F.

Other characteristics are: It has a tensile strength of 2,845 lbs. per square inch, a dry dielectric strength (0.022 inch wall thickness) of 1050 V.P.M., a wet dielectric strength (0.022 inch wall thickness) of 817 V.P.M. after twenty-four hours of immersion. The tubing meets all ASTM specifications and comes in ASTM sizes. This tubing is available in various colors as well as transparent.

Irvington Varnish & Insulator Co.,
24 Argyle Terrace, Irvington, N. J.

Sensitive D-C Relays

CS SERIES SENSITIVE d-c relays are for use in such applications as vacuum tube plate circuit control, electronic devices, sensitive temperature and pressure control, and mobile applications such as aircraft radio and marine services. They were designed to provide immunity to vibration, dust, moisture and physical damage.

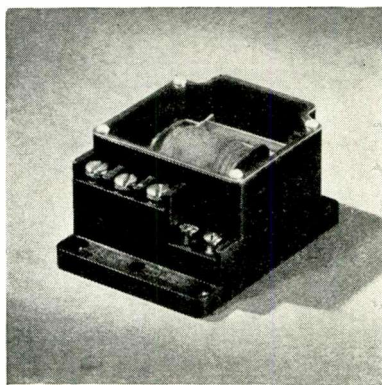

The relays are mounted within a molded phenolic enclosure, and are covered with a removable transparent window. Other features are stability of adjustment (fixed contact spacing, adjustable gap); increased contact pressure; freedom from sticking; light weight (6½ ounces); moisture-proof coils; and low input wattage.

Available in many combinations of coil and contact ratings from General Controls Co., 801 Allen Ave., Glendale, Cal.

All-metal Rheostats

A NEW TYPE OF ALL-METAL rheostat for aircraft and ordnance use where it is necessary to withstand bomb and gunfire concussions, as well as to meet conditions of high humidity and temperature extremes has been announced. These units utilize Bakelite insulation instead of the usual ceramic insula-



tion. They are light in weight, and have a 50% lower temperature rise than conventional types of rheostats of equal size. Sizes available are 25 and 50 watts.

International Resistance Co., 401 North Broad St., Philadelphia, Pa., are the manufacturers.

Radio Spectroscope

A RADIO-SPECTROSCOPE designed to make studies and operations in laboratory or a field much more rapid is available in different models having various screen sizes and various bandwidths, and for use with any type of superheterodyne receiver. These instruments operate from their own power supply, and in conjunction with a superheterodyne receiver having an intermediate frequency between 450 and 480 kc. Upon connecting the spectroscope to such a receiver the operator will be able to observe the characteristics of all signals present over a wide band of the frequency spectrum.

The observation of a 100 k-c band is made visually on the screen of a cathode-ray tube, without disturbing the normal aural reception of the receiver. The weakest audible signal is visible. As the receiver is manually tuned through its tuning range, a constant bandwidth of 100 kc passes in view of the operator, and all signals contained therein, appear simultaneously on the cathode-ray screen, as deflections indicative of the frequency and amplitude of each signal encountered. Signals less than 3 kc apart can be resolved. The operator listening to the aural output of the receiver can hear that signal which is visible in the center of the screen, and can see all signals 50 kc above and below that signal.

Panoramic Radio Corp., 242 West 55th St., New York, N. Y.

Electronic Multitester

JUST PUT ON THE MARKET IS Model 662 multitester which was designed to provide a total of twenty-seven measurement ranges to take care of both a-c and d-c voltages, up to 6,000 volts; resistance to 1,000 megohms; capacities to 2,000 μ f. The low ranges for each of these type of measurements have values as low as 0.1 volt, direct current, 1.0 volt alternate current, 0.2 ohms and 30 μ f which can be read directly from the meter scale without interpolation or estimating fractional scale divisions. Any one of the 27 ranges is selected by means of two rotary switches, one of which selects the type of measurement desired, the other the numerical range.

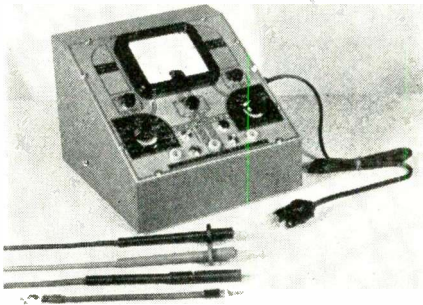

The indicating instrument, set into the face of the all-metal cabinet, is a 4½ inch square type D'Arsonval microammeter guaranteed accurate within 2% of full scale. Its direct-reading scales are laid out on a 100° arc. Protection is provided against burn-out or other damage to this instrument through improper range selection or attempting measurement of live resistors, etc. The vacuum-tube and power supply circuits are built-in and operating power is drawn from any 105-130 volt line. Applied voltages are held constant by means of a built-in electronic voltage regulator.

The entire instrument is self-contained in a metal cabinet 9½ inches wide, 9½ inches deep and 7½ inches in overall height. The sloping control panel gives maximum visibility and operating convenience.

The instrument is priced at \$47.50 complete and is available from Radio City Products, 88 Park Place, New York, N. Y.

Power Supplies

TYPE 759-P50 POWER supply unit was developed for use with the manufacturer's sound level meters of the 759 Series, but particularly for use with sound level meters Types 759-A and 759-B. Type 759-B was described in this column in June 1910 *Electronics*. These power supply units are small, light and compact and fit directly in the battery component of the sound level meter in

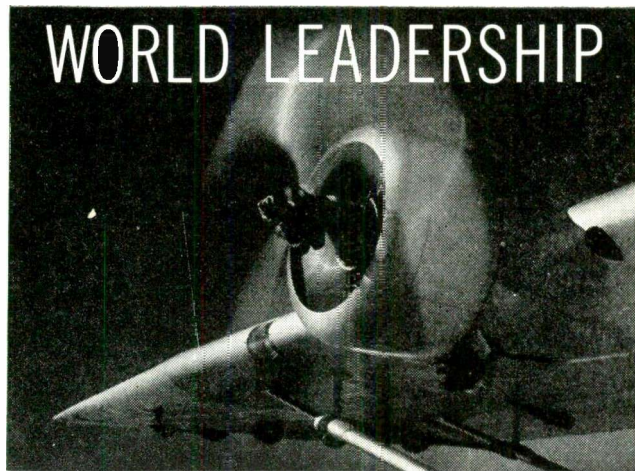

Wilco Electrical Contacts and Thermostatic Bi-Metals

Just as Wilco precision materials were outstanding in use in peace-time industrial devices, so now Wilco Electrical Contacts are outstanding performers in aircraft, tank, gun and ship applications. And Wilco Thermostats (thermostatic bi-metals) are used in various instruments for the

Army and Navy. Send us your problems for analysis or write for a copy of the Wilco Blue Book of Thermometals and Electrical Contacts.

The H. A. WILSON CO.

105 Chestnut Street
Newark, N. J.



Branches: — Chicago • Detroit

Bliley

Catalog G-12 describes Bliley Crystal Units for frequencies from 20 kc. to 30 mc. Write for your copy.

QUARTZ CRYSTALS

FOR GENERAL COMMUNICATION FREQUENCIES

BLILEY ELECTRIC COMPANY

UNION STATION BUILDING

ERIE, PA.

A
C
C
U
R
A
T
E

D
E
P
E
N
D
A
B
L
E

ACCURATE to $\frac{1}{1,000,000}$

TABLE-TOP
Frequency Standard
 proved through two years use
now
available to you!

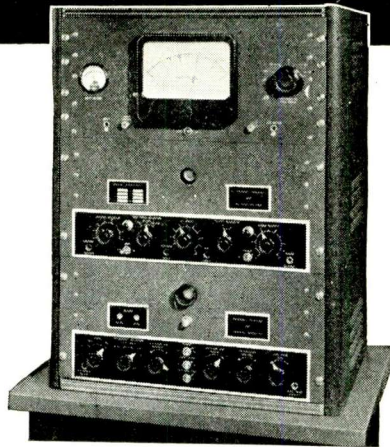

Developed by Western Electric for its own use in testing oscillators, signal generators, etc., this frequency standard has many exclusive advantages. *Look at these features:*

1. FREQUENCY STANDARD AND HARMONIC GENERATOR (lower panel) gives stable signals—harmonically rich or sinusoidal. Fundamental output frequencies of 100, 50, 20 and 10 kc. Harmonic output usable to 1000th harmonic. Accurate to better than 1 part per million without temperature control.
2. REFERENCE FREQUENCY AND HETERODYNE UNIT (center panel)—crystal controlled

oscillator circuit; modulator and amplifiers. Eight crystals give fundamental frequencies from 2 to 10 megacycles.

3. FREQUENCY INDICATOR UNIT (upper panel) gives direct frequency reading of input signal from 0 to 100,000 c.p.s.

Send for complete details. Write to:

Electrical Research Products Division
 of
Western Electric Company
INCORPORATED
 76 VARICK STREET, NEW YORK, N. Y.



*Ready
 for Action!*



NEW Super-Power ABBOTT WT-5

PORTABLE, SELF-CONTAINED, BATTERY OPERATED

2 1/2 METER TRANSMITTER-RECEIVER

- Input up to 5 Watts, 3 or 4 times the power of ordinary "walkie-talkie" equipment
- Receiver radiation at a minimum
- Transmitter and Receiver sections are completely separated
- Frequency: 112-116 MC
- Size: 14 3/8" long, 12 1/2" high and 5 3/4" deep
- Weighs only 37 pounds, complete with batteries
- Single inter-connected switch throws antenna from transmitter to receiver
- All advanced operating conveniences associated with fixed station units are incorporated in this ABBOTT WT-5
- Details and prices available on request.

ABBOTT
INSTRUMENT, INC.
 8 WEST 18 STREET • NEW YORK, N. Y.

place of the batteries. Specifications are: Output—1.5-volt and 3-volt filament supplies; 90-volt plate supply. Input—105 to 125 volts, 40 to 60 cps. The power input is less than 8 watts at 115 volts, 60 cps. Hum and noise level is sufficiently low to assure satisfactory operation over the entire range of the Type 759-B sound level meter when the supply-line frequency is 60 cps. On the Type 759-A meter, satisfactory operation is obtained on all ranges except at the 60 db attenuator setting, provided the a-c line frequency is 60 cps. Rectifier tube is a type 6H6. Dimensions are 10x2 1/4x5 inches overall.

General Radio Co., Cambridge, Mass.

Photoelectric Colorimeter

A NEW PHOTOELECTRIC colorimeter recently announced is "Lumetron" Model 400. The instrument is portable, easy to handle and low priced. It works from any 110-volt a-c or d-c outlet and was designed to meet the requirements of practical colorimetry. One advan-

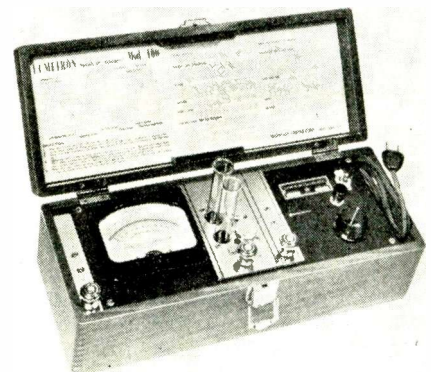

tage of this new instrument over visual colorimeters is that the readings are definite and independent of the judgment of the operator. No standard solutions are required at any time in routine work.

Photovolt Corp., 95 Madison Ave., New York, N. Y.

Capacitors

TYPE XP MICA TRANSMITTING capacitors are housed in ceramic shells with cast aluminum end bell terminals. These capacitors are designed for heavy-duty service involving high voltage and high current requirements for high-power transmitting equipment. The design takes into account the necessary terminal separation for high voltage ratings. The area of the terminals provides a low resistance positive contact where multiple stack assemblies are required. The capacitor stack assembly consists of a number of series sections which are pre-tested before assembly to provide an ample margin of safety to assure good service.

The four types, XPN, XPV, XPX

JONES BARRIER STRIPS SOLVE MOST TERMINAL PROBLEMS

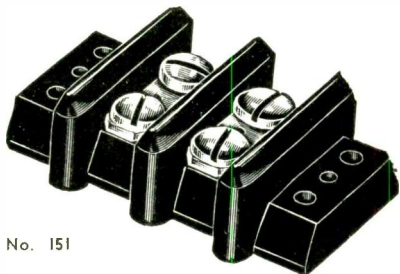

No. 151

A compact, sturdy terminal strip with Bakelite Barriers that provide maximum metal to metal spacing and prevent direct shorts from frayed wires at terminals.

6 SIZES

cover every requirement. From $\frac{3}{4}$ " wide and $\frac{13}{32}$ " high with 5-40 screws to $\frac{1}{4}$ " wide and $\frac{1}{8}$ " high with $\frac{1}{4}$ "-28 screws.

Jones Barrier Strips will improve as well as simplify your electrical intra-connecting problems. Write today for catalog and prices.

HOWARD B. JONES
2300 WABANSIA AVENUE,
CHICAGO ILLINOIS

MATHEMATICS FOR RADIO AND COMMUNICATION

by **GEORGE F. MAEDEL, A.B., E.E.**

Chief Instructor, N. Y. School, RCA Institutes

To master the technicalities of radio—to read engineering literature intelligently—you must have the mathematical groundwork covered by these absorbing books prepared for home study. Book I (314 pp.) covers the algebra, arithmetic, and geometry; Book II (329 pp.) covers the advanced algebra, trigonometry, and complex numbers necessary to read technical books and articles on radio.

MAEDEL PUBLISHING HOUSE Room 108
593 East 38 Street, Brooklyn, New York

Send me Mathematics for Radio and Communication as checked below. I enclose payment therefor with the understanding that I may return the book(s) within 5 days in good condition and my money will be refunded.

Name

Address

- Book I at \$3.75 plus 3c postage
 Book II at \$4.00 plus 3c postage
 Books I and II at \$7.75 postage prepaid

and XPY, are all of the same general construction, but differ in size, depending upon voltage (6,000, 10,000, 20,000

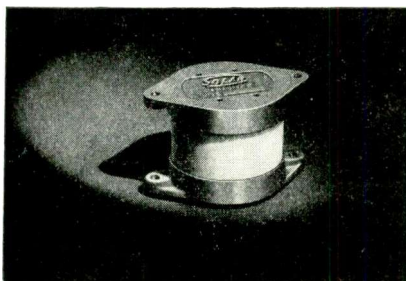

and 30,000) and ranging in current specifications. In each series are capacitors ranging in capacity from 100 to 20,000 $\mu\mu\text{f}$. The standard capacity tolerance is $\pm 5\%$.

Other new capacitors available are Types ML and MK which are designed for standard radio receivers and other low voltage applications. Also types MWS, MOS, MKS, and MLS which are standard silver-mica capacitors, supplied only in low-loss Bakelite. These are more thoroughly described in literature available from the manufacturer, Solar Mfg. Corp., Bayonne, N. J.

Self-Generating Photoelectric Cells

A PROCESS FOR THE MANUFACTURE of self-generating photoelectric cells has been announced. The process enables the manufacturer to produce cells of different shapes, sensitivity and spectral response, according to specifications, regardless of quantity. A standard cell has a sensitivity of 400 microamps per lumen and a spectral response extending from ultra-violet to near infra-red. Necessity of quartz enclosure for measurement in ultra-violet is eliminated. The cells are ruggedly constructed and are protected by special surface coating. These cells may be used at temperatures up to 120° F. The standard cells are available in five sizes.

Emby Products Co., 1804 West Pico Boulevard, Los Angeles, Cal. are the manufacturers.

Literature

Fastening Guide. This is a guide for purchasing and specifying non-ferrous and stainless steel bolts, nuts, screws, rivets, washers and accessories. It contains tables and weights, chemical and mechanical properties and standard dimensions. This 80-page book lists and describes some 4320 items carried in stock by The H. M. Harper Co., 2620 Fletcher St., Chicago.

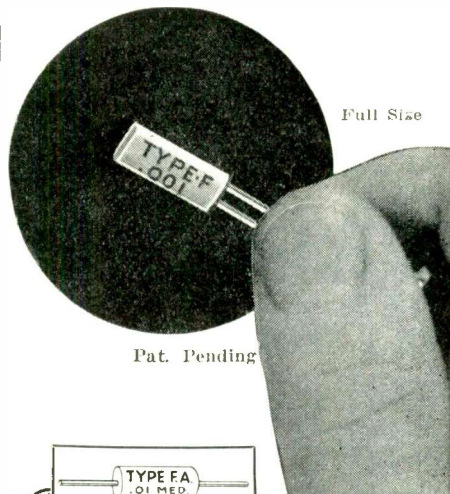

Full Size

Pat. Pending

TYPE FA
.01 MED

HAVE YOU A SPACE PROBLEM?

DUMONT

OFFERS A NEW
PERFECTED

Super Small CAPACITATORS

Specially designed to fit your space problems. The wee little fellow that does a big man's job.

Featuring

1. Non-inductive and inductive types. Round or flat shaped.
2. Soldered leads to foil for low resistance contacts.
3. Terminals solidly anchored for mechanical strength.
4. Wax and varnish covered for high heat and moisture proof operation.
5. Voltages from .00005 to 5000 mfd. D.C.
6. Capacity from 0001 to .5 on F D.

Send for free literature
and samples.

DUMONT ELECTRIC CO.

34 TO 54 HUBERT STREET
NEW YORK, N. Y.

★ ★ ★ ★

3
ELECTRO-MAGNETIC
Relays

PRODUCED for DEFENSE

**PRACTICAL FOR
A MULTITUDE OF USES**

Here are three G-M relays designed and built to meet defense standards, and available for your defense requirements. Type 'C' is a small, 1, 2, 3 or 4 pole, single or double throw relay with self-cleaning wiping contacts available in a variety of materials for different load requirements. Type 'J' relay is a low weight, small size, ruggedly constructed relay, built to withstand high acceleration and aircraft vibration. Suitable for high altitude and high humidity operation. Type 'F' relay measures 2 1/4" high, 2 1/2" long and 1 1/8" wide, and is available in 1, 2, 3 or 4 pole, single or double throw, for either A.C. or D.C. with self cleaning heavy pressure contacts.

For full data on any one or all of these relays, write or wire for completely descriptive bulletins.

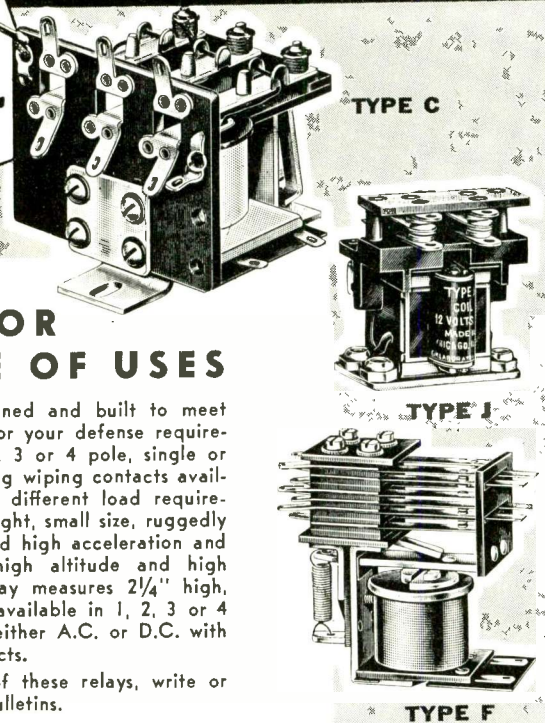

G-M LABORATORIES INC.
4313 NORTH KNOX AVE. CHICAGO, U. S. A.

**STABILIZED A. C. VOLTAGE
UP TO 25 KVA**

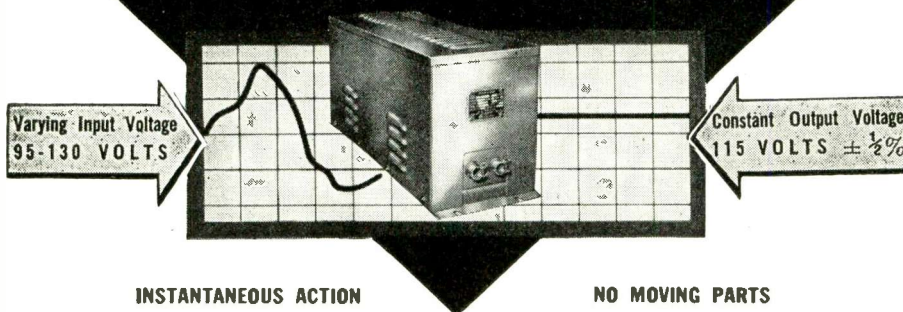

When a precision electrical device or a critical process is powered from an AC line, a Raytheon Voltage Stabilizer will permanently eliminate all of the detrimental effects caused by AC line voltage fluctuations. Made for all commercial voltages and frequencies, single or three phase.

Raytheon's twelve years of experience in successfully applying the Stabilizer to hundreds of perplexing voltage fluctuation problems is at your service. It will pay you to take advantage of our engineering skill.

Write for Bulletin DL48-71 JE describing Raytheon Stabilizers.

RAYTHEON MANUFACTURING CO.
100 Willow Street, WALTHAM, Massachusetts

Capacitor Manual. This 50-page manual takes the form of a supplement with provision for attaching directly to the cover of the 1941 manual. It contains complete capacitor replacement data on all receivers up to and including current models. This replacement catalog is issued by Cornell-Dubilier Electric Corp., South Plainfield, N. J.

Laboratory Rheostats. This bulletin describes Jagabi "Lubritact" laboratory rheostats which have a graphite lubricated contact. Bulletin 1705 is being issued by the James G. Biddle Co., 1211-13 Arch St., Philadelphia, Pa.

Aircraft Accessory Motors. A complete line of motors for all types of mechanized flight accessories is shown and described in a recent booklet released by General Electric Co., Schenectady, New York.

Insulators. A twelve page booklet describing how Mycalex is made, its mechanical and electrical properties, and how to work it. This booklet is obtainable from the Mycalex Corporation of America, 7 East 42nd St., New York City.

Tube Characteristics Sheet. This twelve page booklet contains average receiving tube characteristics, panel lamp characteristics and tube and base diagrams. Each tube type is horizontally ruled off, making readability simpler. This may be obtained from Hygrade Sylvania Corp., Emporium, Pa.

Measurement Instruments. A catalog with information on various Q Meters, production line checkers, signal generators, accessories and parts. It also contains a price sheet and a partial list of Q meter owners. Catalog B may be obtained from Boonton Radio Corp., Boonton, New Jersey.

Components. Bulletin No. PS-405 contains information on transformers for broadcast, amateur, laboratory and replacement purposes. Bulletin No 1B-1 has information on industrial components. Both bulletins are from United Transformer Corp., 150 Varick St., New York City.

Stock List. Many products, some of which include dial light sockets, wire braiding, punched parts, etc., are listed in a bulletin entitled "Stock List and Can Make List" published by the manufacturers, Alden Products Co., 117 North Main Street, Brockton, Mass.

General Catalog. Catalog No. 65, 1942 edition, is devoted to descriptions and illustrations of adapters, co-axial cable, coil forms, connectors, hardware, insulators, plugs and rod-sheet-tube available from American Phenolic Corporation, 1250 Van Buren Street, Chicago.

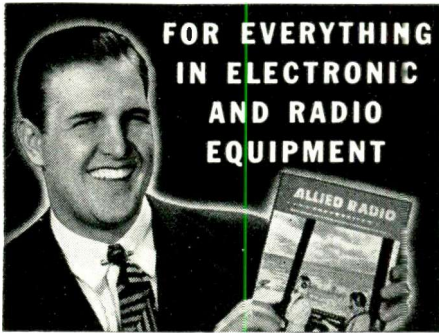

**FOR EVERYTHING
IN ELECTRONIC
AND RADIO
EQUIPMENT**

You Can Depend on ALLIED

- FOR:
- Electronic Tubes
 - Test Equipment
 - Public Address
 - Xmitting Gear
 - Photo Cells
 - Receivers
 - 15,000 Parts, etc.

VAST COMPLETE STOCKS

IMMEDIATE DELIVERY

ONE DEPENDABLE SOURCE

GET YOUR 208 PAGE BOOK

★
All the leading lines:
RCA, National, Ham-
marlund, Mallory,
Raytheon, Hallicraft-
ers, Triplett, Thordar-
son, Bliley, etc.

★
Here's everything in Radio and
Electronic equipment for engi-
neering communications, labora-
tory and industrial application.
You'll want the 208 Page ALLIED
Buying Guide handy. For your
FREE copy, write Dept. 24-C-2.



ALLIED RADIO
833 W. JACKSON • CHICAGO

JACKSON
Resistance-Capacity Tuned
★ **AUDIO OSCILLATOR**



Model 652

★ Here is a tried, proven and accepted
Audio Oscillator whose brilliant perfor-
mance sets it apart from other makes.
★ Audio Frequency voltage is developed at
its Fundamental Frequency—by the Re-
sistance-Capacity Tuned Principle. This is
not a "beat frequency" oscillator and
contains no R.F. circuits. Operation is
★ vastly simplified. Characteristic faults of
old style methods are eliminated. Glass
enclosed direct reading dial is accurate to
within 3% or one cycle. Many other out-
standing features. Price \$88.50.

Write for descriptive literature

**THE JACKSON ELECTRICAL
INSTRUMENT COMPANY**

123 Wayne Avenue Dayton, Ohio

Tubing Shielded Wire. Bulletin 201, pub-
lished by the Precision Tube Company of
3824-28 Terrace St., Philadelphia, con-
tains interesting electronic as well as
electrical and mechanical data con-
cerning single conductor aircraft wire
made to government specifications
AN-J-C48 and 95-27074 and then
shielded with thin wall seamless copper,
aluminum and lead tubing. Tubing was
drawn over stranded conductors equiva-
lent to gauges from 2 to 20, insulated
with flame-proof glass, cotton and
other materials suitable for lighting
and instrument wiring. Capacitance
between inner conductor and outer
shield was measured and is stated in
 $\mu\mu\text{f}$ per foot. In addition to this in-
formation, which will be of particular
interest to electronic engineers, the
bulletin lists the power factor of vari-
ous tubing-shielded wires, notes the
inner conductor resistance in ohms-per-
foot, states the outer diameter of vari-
ous types of tubing together with the
wall thickness.

Rotary Switch. Catalog 7140 lists ro-
tary type instrument, control, trans-
fer, and auxiliary switches. It may be
obtained from Roller-Smith Co., Beth-
lehem, Pa.

Transformers. Control, signaling and
power circuit transformers are de-
scribed in bulletin 411CT. It is section-
alized and complete electrical and di-
mensional data is included. Available
from Jefferson Electric Co., Bellwood,
Illinois.

Relays and Light Sources. Photoelectric
relays, light sources and phototube
housing are described in bulletin
18-310. The three most widely used
light sources are described and illus-
trated. This may be obtained from
Westinghouse Electric and Mfg. Co.,
East Pittsburgh, Pa., Dept. 7-N-20.

Fastening Data Book. A 140-page
book describes lock washers, thread-cut-
ting screws, SEMS fastener units,
spring washers, locking and plain ter-
minals, locking screws and intricate
precision stampings. It includes a spe-
cial section for government specifica-
tions and approvals. Copies may be ob-
tained by writing, on company station-
ary, to Shakeproof Inc., 2501 N. Keeler
Ave., Chicago.

Steel Cabinets. Catalog No. 22 de-
scribes such electrical housings as
cover-pull, breaker and Safe-T-Cir-
kits boxes; as well as cabinets which
include the following types: surface,
weatherproof, slant-roof, flush, gut-
tered-type, panelboard, conduit fittings.
Available from Columbia Metal Box
Co., 260 East 143rd St., New York,
N. Y.

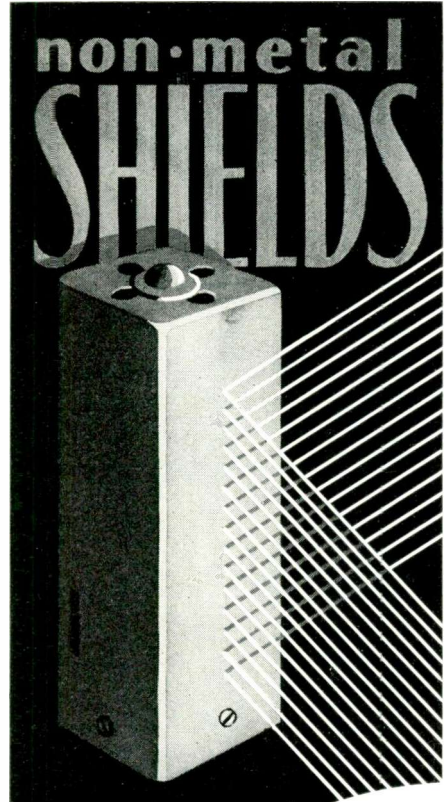

for
**ELECTRONIC
DEVICES**

Electrostatic shields can be formed
conveniently on non-conductors by
means of "dag" colloidal graphite
dispersions . . . Graphite films
so produced are tenacious and
homogeneous and possess con-
ductivity. . . Write for bulletin

No. 31 for complete details.

"dag" is a registered trade-mark of Acheson
Colloids Corporation.

**ACHESON COLLOIDS
CORPORATION**
PORT HURON, MICH.



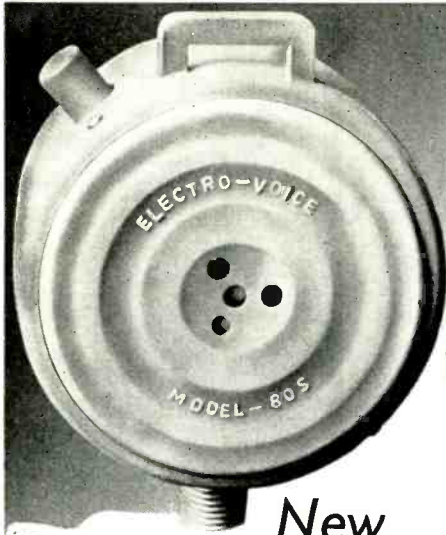

**New
Lightweight CARBON
MICROPHONE**

Size: 2 1/16" diameter, 1 1/16" thick. Weighs only 2 ounces. Molded, non-breakable plastic case. Supplied with 42" cable.

MODERATELY PRICED. Designed for mobile communication, aircraft training, innerphone, aircraft transmission, etc. . . . Produced with non-restricted materials. Samples, complete specifications and prices are available on request.

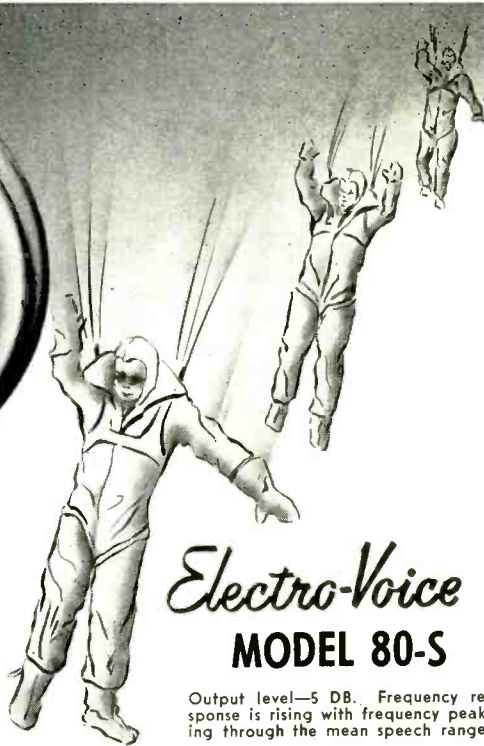

**Electro-Voice
MODEL 80-S**

Output level—5 DB. Frequency response is rising with frequency peaking through the mean speech range.

ELECTRO-VOICE MFG. CO., Inc.
1239 SOUTH BEND AVENUE, SOUTH BEND, INDIANA
Export Division: 100 Varick St., New York, N. Y.—Cables: "Arlab"

The VIBROTEST

TODAY'S MODERN INSTRUMENT
FOR INSULATION TESTING

OUTSTANDING VALUE
REVOLUTIONARY DESIGN
ACCURATE . . . SIMPLE

The VIBROTEST makes insulation testing very simple. Readings shown in Ohms and Megohms with constant potential of 500 volts. TWO binding posts for all ranges eliminates connection errors and makes for extreme simplicity and ease of operation. An additional exclusive function is accurate readings as a Voltmeter—3 A. C. and D. C. ranges. Versatile, self contained, compact, and portable—tests any type of equipment whose insulation resistance value is desired.

Bulletin No. 201-C contains interesting facts, descriptions, and prices—send for it.
Made in U.S.A. of Domestic Materials



ASSOCIATED RESEARCH, INC.

MFRS. KEELER POLYGRAPH—THE "LIE DETECTOR"
431 SOUTH DEARBORN STREET • CHICAGO

PERMANENT MAGNETS

ALL SHAPES — ALL SIZES
FOR ALL PURPOSES

Stamped, Formed, and Cast; Chrome, Tungsten Cobalt and ALNICO** (cast or sintered) under G. E. license.

**THOMAS & SKINNER
STEEL PRODUCTS COMPANY**
1116 E. 23rd STREET INDIANAPOLIS, INDIANA

Laminations for Radio Transformers — Tools
Dies — Heat Treating — Stampings

40 YEARS EXPERIENCE

Television

(Continued from page 29)

here compares the results of the two surveys, one conducted during the week of October 17-26, 1941, and one during the week of November 24-30, 1941, one month later. A third survey was conducted in January, 1942 and the results will be available shortly.

Already there have been requests by advertisers for network television. It is very likely that the next time this network service is heard of, one of television's clients will have considered the technical results sufficiently good to justify his participation in the work and thereby encourage its progress.

Receiving Facilities

So far, only transmitting facilities have been discussed. Now to the other end of the circuit—the television receiver situation. Roughly, here are some estimates of distribution of the receivers in various markets:

New York	5,000
Philadelphia	400
Los Angeles	450
Chicago	200
Albany	75

In its files NBC keeps as much information as possible on the type and location of all receivers in the New York area. The files are approximately 75 percent to 80 percent complete and the facts which follow are based thereon.

During the six months of commercial operation, additional receiver owners have been added to the file at an average of about 100 per month. The main drawbacks to this growth were: (1) the time required (July 1 to October 15, 1941) to convert the receivers which were already in the field on July 1st to the new FCC commercial broadcasting standards, and (2) the lack of any receiving set promotion on the part of television receiver manufacturers.

The approximate distribution of ownership of television receivers (based on NBC's circulation file) by type of owner, is as follows:

Private Homes	78.3 percent
Public Places	12.5 percent
Radio Dealers	9.2 percent

**"what do you
require of a
DYNAMOTOR —**

**Specialized
Engineering?**

All the engineering behind Eicor Dynamotors is aimed at just one thing—to develop the ideal power supply unit for the communications industry. Comparative tests show that this has been accomplished by our engineers—without stint of time or effort. Every detail, from initial design to finished product has been analyzed, tested, proved in a plant devoted to dynamotors by men who have a background of years of experience in this highly specialized field. Q.E.D. — *Eicor Dynamotors are in daily use throughout the world in the most critical applications.*

EICOR

EICOR, Inc., 1050 W. Adams St., Chicago, U.S.A.
Export: Ad Aurlima, 89 Broad St., New York

**.. AND THE H-B
RELAY IS NOW
AVAILABLE
FROM STOCK**

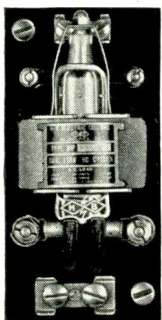

**ONLY ONE MOVING
PART DUST PROOF—
OPERATES IN ANY PO-
SITION WITHIN 45 DE-
GREES—NO EXPOSED
ARC.**

Full description of this one moving part mercury to mercury break relay is contained in bulletin B. Write for your copy

H-B ELECTRIC CO., Inc.

Manufacturers of **H B** Electrical Devices

2500 NO. BROAD ST., PHILADELPHIA, PA.

One way of increasing the number of television viewers is to increase the number of receivers in the field. Another way is to increase the number of people viewing each receiver.

It is logical that the increase in the number of receivers in the field is related to the number of persons which can be induced to make their first acquaintance with television at someone else's receiver. Hence, the first step in promoting a larger television audience is to increase the turnover of the number of viewers per receiver. This is difficult in home installations. However, in public places, where the main object of having a receiver is to make use of the drawing power of television, direct methods may be used. Public-place receiver installations, in taverns, restaurants, and theaters, for instance, are a vital factor in increasing receiver sales.

The Crossways Restaurant in Fleetwood, Mount Vernon, New York, was chosen as a test location to see what results could be obtained (using simple methods) in attracting new customers to a public place equipped with television. Monday evening was chosen for the test. The program was the regular amateur boxing pickup from the Jamaica Arena. The simple promotion used consisted of two signs in the restaurant window reading "Fights by Television Here Monday Night". They were installed on the previous Saturday. Over the weekend small cards were distributed at the bar and tables. Handbills were distributed to residents in the neighborhood on Saturday. Boys distributed cards to commuters as they left trains at the Fleetwood station on Monday evening. This was considered a minimum to be used by any tavern owner or television advertiser interested in promoting a television audience.

The normal attendance at this restaurant on an average Monday evening, which is the low evening of the week, had been approximately 15 to 20 persons. On this test night, the first television guests began to arrive at 8:30. At 9 o'clock, the starting time of the broadcast, there were 37 people in the restaurant. By 11 o'clock, the end of the broadcast, there were 163 patrons present. A check of other taverns in the area showed that this attendance was better than all others combined. The

COMPONENTS TO ARMY — NAVY — AIRCORPS SPECIFICATIONS

TELEPHONE PLUGS TELEGRAPH KEYS, and CONNECTORS to Signal Corps Specifications. Continuous production on PL-54, PL-55 Telephone Plugs, J-37, J-44, J-45, and J-47 Telegraph Keys, as well as PL-114, SO-104. PL-Q103 and PL-P103 Connectors and others.

CATHODE RAY CONNECTORS—a magal type socket assembly with leads prepared to your specifications. Assembly approved for use at high altitudes and over a high temperature range.

INSULATED TUBE CAPS—A complete line for all types of Rectifier and Power transmitting tubes.



**POWER OUTLETS ADAPTERS
DIAL LIGHTS TEST EQUIPMENT
PILOT LIGHTS TELEPHONE PLUGS
SOCKETS TELEGRAPH KEYS**

ALDENITE WIRE—the NEW wire without rubber. Underwriters approved for numerous Radio applications.

CABLE ASSEMBLIES—particular attention given to special, shielded and complicated types.

PHENOLIC and ACETATE MOLDINGS—Special magazine method of phenolic molding for both large and small quantities. A single mold starts your order, additional molds step up production to any daily requirement. This method also permits any required changes, and is particularly well-suited for government requirements.

MULTI-WIRE CONNECTORS—of all kinds, with particular attention to compactness and complete insulation around each lead. Both government and commercial types.

COMPLETE MACHINE ASSEMBLIES ENGINEERED—Facsimile Recorders, Aircraft Tuning Controls, etc. (Write for complete information.)

ALDEN PRODUCTS

ALDEN PRODUCTS CO. INC.

117 N. Main St., Brockton, Mass.

Catalog sent upon request.

why do
you
demand
audiodiscs?



BECAUSE AUDIODISCS' brilliant exclusive glass-base features make possible new advances in professional high fidelity sound recording.

BECAUSE AUDIODISCS, thanks to higher strength-to-weight ratio of the flexible glass base, are safely handled and shipped.

EXCLUSIVE FEATURES

- ★ *New, crisper tone quality.*
- ★ *All three drive pin holes.*
- ★ *Interchangeable with aluminum-base discs, without fussy readjustments or gadgets.*
- ★ *Absence of surface imperfections.*

For Red Label, Master, and Reference Recording Audiodiscs (and special Safety Cartons for reshipping 1 to 3 Audiodiscs)

CALL YOUR JOBBER, OR WIRE FOR COMPLETE INFORMATION TODAY



AUDIO DEVICES
INCORPORATED
1600 BROADWAY NEW YORK CITY

METAL DUPLICATING **DI-ACRO** **WITHOUT DIES!**

You can make many metal parts to die accuracy and save time and die costs with "DI-ACRO" Precision Machines—Bender, Shear, Brake.

DI-ACRO BRAKE NO. 2

Creates non-stock sized angles, channels, "Vees", etc. Folding width 12". Right or left-hand operation. DI-ACRO BRAKE No. 1 smaller size, folding width 6".



DI-ACRO
BRAKE NO. 2



DI-ACRO SHEAR NO. 1

Trims duplicated stampings, shears stock sheets, cuts strips, squares up stampings, makes slits or notches. Shearing width 6". ALL DI-ACRO machines accurate to .001".

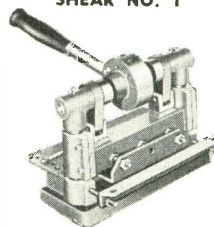

DI-ACRO
SHEAR NO. 1

Send for Catalog
"METAL DUPLICATING WITHOUT DIES"

O'NEIL-IRWIN MFG. CO. 321 8th Ave. S. Minneapolis, Minn.



TAYLOR
LAMINATED PLASTICS
Vulcanized Fibre • Phenol Fibre
SHEETS, RODS, TUBES, FABRICATED PARTS
TAYLOR FIBRE COMPANY
Norristown, Pennsylvania

Crossways Restaurant owner reported that, for this Monday night, his attendance was more than 900 percent larger and his receipts were many times that of his normal business. They compared favorably with Saturday night, his best night of the week. Paralleling these findings a survey on television program preference, made by the *Beverage Retailer Weekly*, trade paper of the bar and restaurant field, showed that of the tavern owners who have television receivers, 94 percent reported that such installations had improved their business.

During the course of the broadcast, a questionnaire was distributed to the patrons in the restaurant. In answer to one of the questions "Did you enjoy this television program?" 90 percent acclaimed it enthusiastically. To the question, "Did you come this evening because of the television broadcast?" 79 percent answered "yes." 88 percent answered "yes" to the question, "Would you come again to see a television fight program?"

In another promotion campaign, Adam Hat Stores, Inc., one of the pioneer television sponsors, distributed window posters in public places equipped with television to merchandise their "Television Sports Parade" of professional wrestling from Ridgewood Grove, Long Island. A survey was conducted two weeks after the posters were mailed out to determine their effectiveness. In answer to the question "Have more people been in your place of business to see the wrestling matches since you put up the posters?" 102 or 91.9 percent answered "yes"; 8.1 percent answered "no".

To the question "Have these customers increased your business?" 92.7 percent answered "yes" and only 7.3 percent said "no."

A breakdown of the type of receiver in the New York area by size of the viewing tube shows:

Tube diameter in inches	Percent
12 and more.....	49.3
9	18.8
5 and less.....	31.9

In reference to the adequacy of screen size the trend is to bigger pictures. Various large screens have been successfully demonstrated dur-



A Precision Crystal
Secondary
FREQUENCY STANDARD
THAT HAS BEEN
"Designed for Application"

A precision frequency standard capable of being adjusted to WWV or some other primary standard and putting out uniformly accurate calibrating signals with 10, 25, 100, 1000 KC intervals. Uses the new GENERAL ELECTRIC No. 18A 1000 KC crystal having a frequency temperature coefficient of less than one cycle /Mc/C°. The crystal is sealed in Hellum in a standard metal tube envelope. The self-contained AC power supply has VR150-30 voltage regulator tube. In addition to oscillator, multivibrators, and harmonic amplifier, a built-in mixer with phone jack and gain control on panel is incorporated.

JAMES MILLEN MFG. CO. INC.
150 EXCHANGE ST. MALDEN, MASS.

LOOK TO LINGO FOR AM-FM

Lingo AM and FM radiators are creating new performance records throughout the broadcasting field. Improved designs and exclusive features are responsible for their high efficiency, unexcelled stability and low maintenance cost.

LOOK TO LINGO—
for proven, factual
information on modern antenna systems.

LINGO VERTICAL TUBULAR STEEL RADIATORS
JOHN E. LINGO & SON, INC., CAMDEN, N. J.

ing the year. Consensus in the field would indicate an increase in screen size to approximately 16 by 24 inches.

The prices of receivers during the past six months ranged from around \$100 for kits with 3-inch screens, to approximately \$400 for large receivers with the 12-inch tubes. The NBC file also shows twelve different manufacturers with receivers in the New York market.

The Program Service

Since July 1, 1941, WNBT has been broadcasting a minimum of fifteen hours a week. This fifteen hour minimum is the government requirement for commercial operation. Three basic programming sources were used—(1) a three-camera live-talent studio, (2) a film transmitting studio, and (3) portable equipment for field pickups.

The average percentage of program time originating from each source by months is shown on an accompanying chart. Referring to this chart, it will be noted that the studio operation has accounted for approximately one-third of the program hours. For the first three months the mobile equipment in the field accounted for almost half of the service and then tapered off to approximately one-third.

The reason for the drop in field pickups was because of the season of the year. In the fair weather months, there are many more outside events such as baseball, football, tennis, track, and civic events that make good program entertainment.

From the live talent studio come full length dramatics, variety entertainment (basically vaudeville acts), civilian defense instruction, and various types of service programs such as "How to Make" and "How to Buy". From the film studio, came all types of film presentations, both 16-mm and 35-mm, full length feature films, shorts, educational films, and various slides and posters.

The mobile equipment accounted for a complete evening of boxing every week from the Jamaica Arena. Another evening offered professional wrestling. Professional boxing came from Ebbets Field. The Columbia University football games, professional football, tennis, baseball, hockey, basketball, swimming meets, a ship launching, the recruiting line at 90 Church Street the day after

Globar
REG. U. S. PAT. OFF.

CERAMIC RESISTORS

● Finding the right resistor for a specific application is likely to be no easy problem. Because the solution so often is found in Globar Brand Ceramic Resistors we urge you to acquaint yourself with the distinctive qualities of these versatile resistors. The handy chart below shows types available, together with their characteristics.

TYPE	A	B	CX
DIAMETER			
MIN.	1/16"	1/16"	1/16"
MAX.	1"	1"	1"
LENGTH			
MIN.	1/4"	1/4"	1/4"
MAX.	18"	18"	18"
WATT RATING*			
MIN.	1/4w.	1/4w.	1/4w.
MAX.	54w.	54w.	150w.
RESISTANCE per in. of length			
MIN.	25 ohms	5 ohms	1 ohm
MAX.	15 meg.	15 meg.	1000 ohms
NORMAL RATING			
w./sq. in. of radiating surf.	1	1	2-1/2

*By artificial cooling these ratings may be increased substantially.

Characteristic Coefficient:

Type A: Commercial straight line Voltage and Temperature

Type B: Negative Voltage Negative Temperature

Type CX: Commercial straight line Voltage and Temperature

Terminals: All types: Metalized ends with or without wire leads

In addition to these standard items, special resistors can be made to meet definite specifications both as to shape and characteristics. Ask for Bulletin R and give us details of your requirements.

Globar Division
THE CARBORUNDUM CO.

REG. U. S. PAT. OFF.
NIAGARA FALLS, N. Y.

{Carborundum and Globar are registered trade-marks and indicate manufacture by The Carborundum Company.}

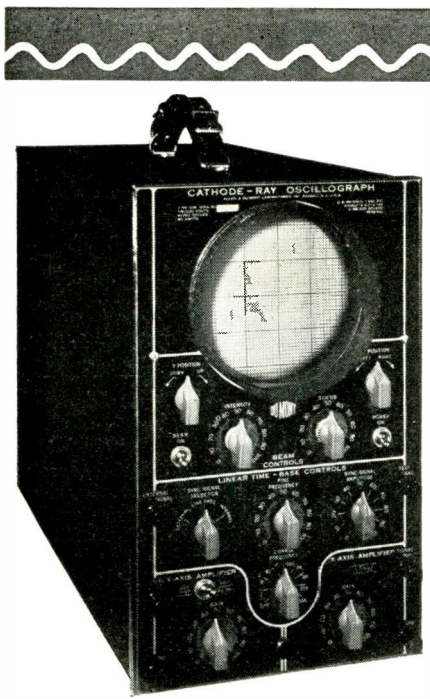

ATTENUATORS are DECEIVING!

★ Ever stop to think that the input attenuator of an oscilloscope may be causing distortion due to frequency discrimination before the signal is applied to the amplifiers? We at DuMont couldn't justify the use of a wide-band deflection amplifier if the input attenuator caused pre-distortion of the signal.

So, by including a cathode-loaded input stage in the Type 208, and placing the variable attenuator in the low-impedance cathode circuit, we eliminated the effects of changes in distributed capacitance influenced by the setting of the potentiometer rotor. Thus the overall transmissions characteristic is the same at all settings of the gain control.

This is one of the many reasons why the Type 208 is first choice for a general-purpose cathode-ray oscilloscope.



★ Write for literature . . .

DUMONT

**ALLEN B. DU MONT
LABORATORIES, Inc.**

Passaic ★ New Jersey

Cable Address: Wespexlin, New York

war was declared, pickups direct from the Town Hall during "America's Town Meeting of the Air," sound network broadcasting, and a number of other pickups, including New Year's Eve on the spot in the Rainbow Room, are on the list of events which were telecast.

How did the Audience React?

Every week NBC mails a program schedule which has a detachable self-addressed return card questionnaire to each owner of a television receiver. This questionnaire offers the television audience an opportunity to express their opinions on each program on a basis of Poor, Fair, Good and Excellent. In addition other types of information are collected periodically, such as: (1) the rating of technical reception, and (2) the number of adults and children present before receivers during various broadcast periods.

The mailing of these program schedules and report cards is coded so that the reactions of specific groups such as television dealers, public places, and private homes can be studied separately. An average weekly return of these cards is between 10 and 15 percent. Over a period of one month, an average of one out of every six receiver owners is heard from.

A steady improvement from just about "good" to almost halfway between "good" and "excellent" is a result of studying the audience's "likes" and "dislikes" very closely and improving operating technique during program production. The curve shows considerable improvement for this short period.

Each week the audience ratings are compiled in the form of a chart and put into the hands of each television staff member. In this way, program and operating techniques can be made to conform closer and closer to the audience's program preferences and changes with very little lag. It is through the dissemination of such information to every member of the Television Department that the best types of programs and techniques can be integrated quickly with the program efforts at hand.

Studying the comparative audience ratings by months for film, live-talent studio shows, and field pickups is very interesting since it shows how weaknesses in each of the three

NOW

a really high-powered

RADIO ENGINEERING LIBRARY

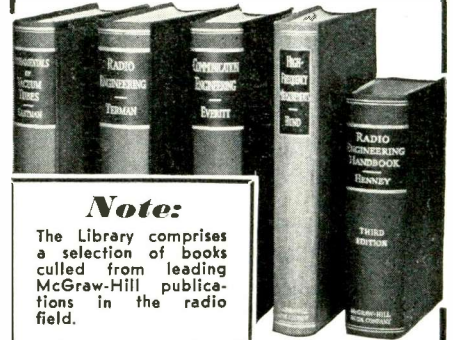

Note:
The Library comprises a selection of books culled from leading McGraw-Hill publications in the radio field.

- ◇ especially selected by radio specialists of McGraw-Hill publications
- ◇ to give most complete, dependable coverage of facts needed by all whose fields are grounded on radio fundamentals
- ◇ available at a special price and terms

These books cover circuit phenomena, tube theory, networks, measurements, and other subjects—give specialized treatments of all fields of practical design and application. They are books of recognized position in the literature—books you will refer to and be referred to often. If you are a practical designer, researcher or engineer in any field based on radio, you want these books for the help they give in hundreds of problems throughout the whole field of radio engineering.

- 5 volumes, 3559 pages, 2558 illustrations
- Eastman's FUNDAMENTALS OF VACUUM TUBES, 2nd edition
- Terman's RADIO ENGINEERING, 2nd edition
- Everitt's COMMUNICATION ENGINEERING, 2nd edition
- Hund's HIGH FREQUENCY MEASUREMENTS
- Henney's RADIO ENGINEERING HANDBOOK, 3rd edition

SPECIAL LOW PRICE • EASY TERMS
Special price under this offer less than cost of books bought separately. In addition, you have the privilege of paying in easy installments beginning with \$3.00 in 10 days after receipt of books, and \$3.00 monthly thereafter. (We pay postage on orders accompanied by remittance of first installment.)

FOR 10 DAYS EXAMINATION SEND THIS

*****ON-APPROVAL COUPON*****

McGraw-Hill Book Co., 330 W. 42nd St., N. Y.

Send me Radio Engineering Library for 10 days' examination on approval. In 10 days I will send \$3.00 plus few cents postage, and \$3.00 monthly till \$24 is paid, or return books postpaid. (We pay postage on orders accompanied by remittance of first installment.)

Name

Address

City and State.....

Position

CompanyL. 3-42

categories were corrected during the early months to the point where, after November, each program source was delivering programs of almost uniform audience acceptability.

Rates for Commercial Broadcasting

Successful commercial television broadcasting calls for profitable operation for broadcasters as well as the insurance of a profitable investment for advertisers.

When an advertiser is approached to use an advertising medium, two main thoughts hold his consideration. They are: (1) the cost per thousand circulation (viewers in this case), and (2) the effectiveness of the medium as a selling tool. Putting these thoughts another way—it means “how effective will the advertising dollar be in the medium?” Consequently, it was necessary to analyze the economic factors involved which have influence on vital advertising problems to formulate an acceptable rate structure for the use of television facilities and personnel.

The natural objective of the broadcaster is to derive sufficient income to insure a profit on operations. It so happens that during early commercial television service it is impractical to press rates of that order. The services of television to the advertiser are not worth these “profit rates” in the beginning due to the relatively small number of consumers reached compared with other “buys” in the various advertising media.

Factors such as the length of time the plant would be at the service of the broadcaster (the length of the program), the number and quality of viewers (the audience), the “selling impact” of the medium all had to be considered in setting up the first rate structure.

These studies, coupled with circulation figures and other factors established \$300 per hour as a rate which would make the use of WNBT as efficient a buy as could be found in any advertising medium.

The final rate was set even lower than this figure to bear out the philosophy that television has to be developed as a medium of greater efficiency and capable of offering new opportunities. Otherwise there would be little or no justification for

The FASTEST Graphic Recordings

EITHER FOR ACOUSTICAL OR ELECTRICAL PROBLEMS ARE ACCOMPLISHED WITH OUR

**AUTOMATIC
HIGH
SPEED
POWER
LEVEL
RECORDER**

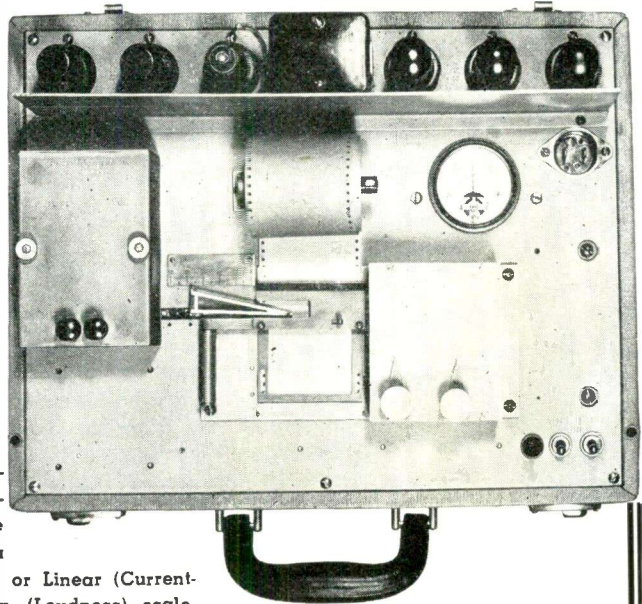

THIS instrument produces a reliable record either on a D.B. (logarithmic), or Linear (Current-voltage), or Phon (Loudness) scale.

• Those seriously interested are invited to write for our descriptive literature.

SOUND APPARATUS COMPANY

150 West 46th Street

New York, N. Y.



"Cobanic"

is used as a cathode in Mercury Vapor Rectifiers meeting the specifications of the U. S. Navy.

WILBUR B. DRIVER CO.
NEWARK, NEW JERSEY



NOTE
NEW
ADDRESS

**OUR POLICY OF SUPPLYING
ONLY HIGH-GRADE EQUIPMENT**

has helped to keep us exceptionally
busy with

**Government Contracts
& Sub Contracts**

We are now equipped to handle additional defense orders or sub contract work.

AUDIO DEVELOPMENT COMPANY
2833 Thirteenth Ave. South, Minneapolis, Minn.

- TRANSFORMERS
- REACTORS
- FILTERS
(Electrical Wave)
- JACKS
- PLUGS
- Etc.
-

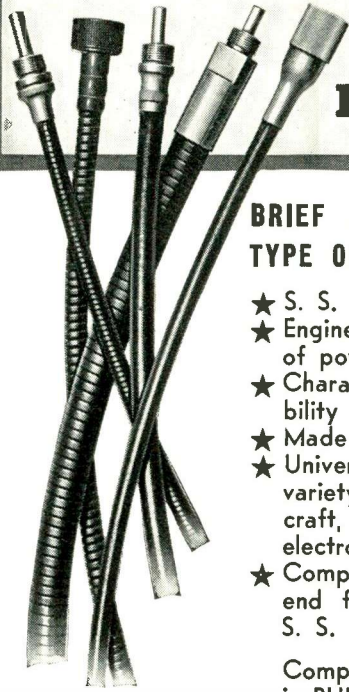

S. S. WHITE FLEXIBLE SHAFTS

BRIEF FACTS ABOUT THE POWER DRIVE TYPE OF FLEXIBLE SHAFTS . . .

- ★ S. S. White Flexible Shafts of this type are:
- ★ Engineered and built expressly for the transmission of power.
- ★ Characterized by smooth operation, strength, reliability and durability.
- ★ Made in a range of diameters from .043" to .750"
- ★ Universally used for instrument drives and a wide variety of power transmission applications in aircraft, motor vehicles, machine tools, portable tools, electronic and other equipment.
- ★ Companion flexible casings and shaft and casing end fittings for attachment are also made by S. S. WHITE.

Complete Facts about power drive shafts are given in BULLETIN 1238. Copy mailed on request.

P. S. If you are interested in flexible shafts for Remote Control ask for BULLETIN 38.

AT YOUR SERVICE
cooperation of our flexible
shaft experts for working
out actual applications.
Send details.

S. S. WHITE

The S. S. White Dental Mfg. Co.

INDUSTRIAL DIVISION

Department E, 10 East 40th St., New York, N. Y.



FAMOUS for years . . .

for their uniform accuracy and great strength . . . for the unique self-locking feature on the "Unbrako" Hollow Set Screw with the Knurled Points . . . for the Socket Head Cap Screw with the Knurled Head that gears right to the fingers and saves assembling time.

"Unbrako" Products are available in a complete range of sizes from number 4 up. For free samples and literature, write today. **KNURLING of Socket Screws originated with "UNBRAKO" years ago.**



REG. U.S. PAT. OFFICE

SCREW
PRODUCTS

STANDARD PRESSED STEEL CO.
Box 596, JENKINTOWN, PENNA.



Look at it this way

Instrument Resistors Co., design and manufacture special windings and wire wound resistors exclusively. • Our specialized, technical knowledge of winding plus our full line of resistor types and sizes will simplify the filling of your requirements. Consult Instrument Resistors Co. Catalog upon request.

INSTRUMENT RESISTORS CO. Little Falls, N. J.

its introduction to the public as an entertainment and educational force, and to the advertiser as a business tool.

With the rough figure of \$300 per hour, other conditions particular to television had to be considered. Experience showed it cost considerably more money to operate an elaborate three-camera television studio than a television film broadcasting studio. Still a different expense is involved when field pickup equipment is required. This indicated the necessity of having different rates depending upon the facilities used by an advertiser.

In sound radio, rates for time are blanket charges covering studios, personnel, etc., with little or no variation depending on the size of the studio, or amount of facilities involved. These variations however, can be absorbed in sound broadcasting without any disturbing consequences. However, in television the range in operating costs of various types of pickup facilities is wide enough to warrant different rates for the different facilities.

In operating the transmitter itself it makes little difference whether the signal originates in a live talent or film studio, or from portable equipment in the field. The cost of operation from minute to minute is the same. Therefore, the rate card shows a straight pro-rata \$120 an hour for "transmission." This makes up the first division of the rate card. It also shows one-half this base rate for daytime periods and three-quarters for Saturday and Sunday afternoon periods and between 11 P.M. and sign-off daily. These ratios were established from a study of audience availability during these periods. In other words, a transmitter's primary function is to reach receivers; hence, its value to an advertiser and its general efficiency are dependent on the number of receivers which can be reached during various times of the day.

Going back once more to different charges for facilities, the second section of the rate card shows a breakdown of the "facilities" charge. The half-hour rates for each group of facilities are 60 percent of the hour rates, the 15 minute rates are 40 percent of the hour rates and so on down. In other words, the cost per minute of operation of these facili-

ties is inversely proportional to the length of time they are used. This is established on the premise that there is just as much preparation and effort involved to get these various facilities prepared and fired up for a program which is to last five minutes as for one lasting two hours or more.

What Has Television to Offer the Advertiser?

First, television has sound; second, television adds sight and motion to sound. Here television departs from all other communication and advertising media. Television adds spontaneity or immediacy; it takes its audience right to the actual scene of action. Television adds life itself to a broadcast program.

Television is the only medium which permits the advertiser to have his best salesman and the most effective combination of selling ideas presented right in the home.

Psychologists tell us that the ratio of effectiveness between sight and hearing is about 9 to 1. Over the past three or four years many advertisers have been asked for their judgment of the added selling impact of television as compared to sound radio. Their estimates of this impact ran from 4 to 20 with an average somewhere around 10. This closely substantiates the ratio of 9 to 1 laid down by the psychologists.

Of more significance to the practical advertiser are the results of a merchandising effectiveness survey conducted in the New York market by an advertising agency after producing a series of ten television programs over a period of ten weeks. During this period the agency presented for one of its clients a group of copy points on this television series, which paralleled the same group of copy points presented by other media. The survey was conducted by selecting a random number of television receiver families out of the 4,000 in this area at the time, who presumably had been reached by their sales messages over television; and a comparable group of families whom they presumed had been exposed to their other media campaigns during the same period. The questionnaire started off with simple questions and progressed more and more to complicated aspects of the various sales messages. The various consumers were quizzed on their



THIS is no time to take chances. When you have a parts replacement to make in radio-phonograph or sound equipment, play safe and duplicate the model and make originally used by the manufacturer. Astatic Cartridges, Recording Heads, Pickups and Microphones, available at your Radio Parts Jobber's, are products of the highest type, used by a great majority of America's leading manufacturers, and sure to give you long and dependable service. Keep your equipment up and forestall any possible replacement disappointments which might result from national emergency demands upon parts manufacturing facilities.



THE ASTATIC CORPORATION
YOUNGSTOWN, OHIO

Licensed Under Brush Development Co. Patents

In Canada: Canadian Astatic Ltd. Toronto, Ontario

FERRANTI Air Cooled Industrial Transformers

It doesn't matter what your problem may be—we can solve it for you!

The field isn't new to us—we've been in it for over sixty years!

To see YOU through the present emergency we have doubled and redoubled our manufacturing facilities—and we can give you surprisingly quick deliveries.

In the interest of NATIONAL ECONOMY you can best do YOUR share by cutting operating costs with Ferranti AIR COOLED TRANSFORMERS.

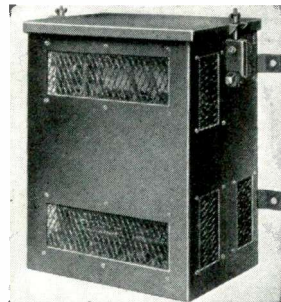

Units are supplied in standard or special types—to suit your own particular applications.

Send us your specifications—we'll do the rest!

FERRANTI ELECTRIC, INC.

30 Rockefeller Plaza

New York, N. Y.

Somewhere
EAST of SUEZ

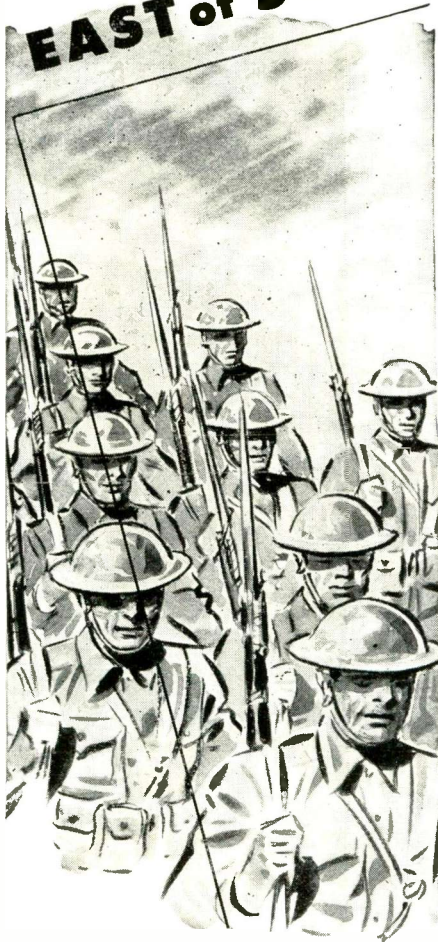

It may take a little time but we will be victorious! America's superior production methods and tremendous facilities for turning out the "World's Best" in equipment will be the determining factor.

Communications are playing an increasingly important part in our National Defense on land, at sea and in the air. We are justly proud that we have a hand in creating communications equipment for our country.

Model S-27 (illustrated) FM-AM reception. 15 tubes. 3 bands. 28 to 145 mc. \$195.00. Model S-27B. 38 to 195.00



the hallicrafters co.
CHICAGO, U. S. A.

Keep Communications Open!

124

entire store of information about this particular advertiser's products. Television was never mentioned during the interview nor was the name of the advertiser or his products. The results of this independent survey showed that the effectiveness of television selling was something between 10 and 11 times greater than all the other media combined used by the advertiser.

This is one more source of figures which substantiates the rough 9 to 1 ratio. These three arguments form the nucleus of reasoning on which to evaluate television along with other media.

Television commands 100 percent active attention from its audience as against a given percentage of passive attention received by many other media. Out of a given potential audience, television will obtain a higher actual audience than sound programs because television, having sight, sound, motion, and immediacy, has more appeal than sound alone. In addition there are fewer simultaneous television programs on the air to split the audience.

During the first six months of commercialization, NBC signed thirteen different advertisers on television representing seven different industries. They were:

Clothing, Fashions and Shoes

Abraham & Straus and Bloomingdales
Adam Hat Stores, Inc.
L. Bamberger & Company
Botany Worsted Mills
Gold Mark Hosiery Company
Hat Style Council, Inc.
Frank H. Lee Company

Jewelry and Silverware

Bulova Watch Company

Laundry Soaps and Housekeepers' Supplies

Proctor & Gamble Co. (Ivory Soap)

Food and Food Beverages

Lever Brothers (Spry)

Petroleum Products

Sun Oil Company

Radios and Musical Instruments

RCA Manufacturing Company

Travel and Hotels

Missouri Pacific Lines

During the first six months commercial time varied about an average of 6 percent of total broadcast time with 8.7 percent in November and 9.0 percent in December. Of this time live-talent studio accounted for 27.5 percent, mobile unit pickups in the field 63.0 percent, and film 9.6 percent.

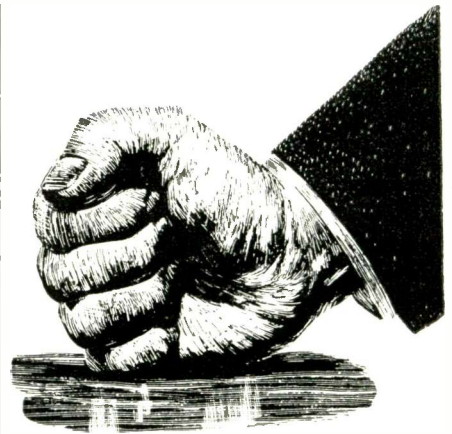

NOW *is the time!*

Opportunities for promotion from now on are going to be so great that any ambitious, intelligent radioman can advance himself much faster than has ever been possible before.

America's expanding industry is creating unusual opportunities for technically qualified radiomen. This is your opportunity of all times to go after—and get the increased pay and job security that you want. But, don't think that you can sit back and let that better position "drop into your lap". Why not join the hundreds of other determined professional radiomen who are increasing their ability with the added help of CREI spare-time technical training in Practical Radio Engineering?

Since 1927, CREI training has been known and respected throughout the radio industry. Today, its modern, basic training is more important than ever to radiomen who are more serious than ever to work at top efficiency and to take advantage of the opportunities for advancement. NOW is the time!

Write for facts today!

Let us send you our interesting booklet, together with personal recommendations for your advancement in radio through a planned program of technical training. To help us intelligently answer your inquiry, please state briefly your education, radio experience and present position.



CAPITOL RADIO ENGINEERING INSTITUTE

E. H. RIETZKE, President

Dept. E-3, 3224 — 16th Street, N.W.
WASHINGTON, D. C.

Contractors to the U. S. Signal Corps—U. S. Coast Guard
Producers of Well-trained
Technical Radiomen for Industry

March 1942 — ELECTRONICS

Transforming Circuits

(Continued from page 53)

formable) area. The L circuit of Fig. 2 diagram is found to be the *only* suitable circuit for this case. The answer to the first part of this problem is, therefore, the circuit of Fig. 2 diagram.

- b. Refer to Fig. 6 as directed on diagram, and block out the above square of impedance values and observe the limiting values for X_L and X_C by noting the curves which just touch the edges of the blocked out area. The following limiting values will be observed.

$$X_L = 0.58R_i \text{ to } 1.73 R_i = 58 \text{ to } 173 \text{ ohms}$$

$$X_C = 0.43R_i \text{ to } 1.0 R_i = 53 \text{ to } 100 \text{ ohms}$$

Complex Input Impedance

By the addition of a third reactance element in series with the chosen input resistance obtained with an L impedance matching circuit, any complex load impedance value can, of course, be transformed to any desired complex input impedance value. The charts are applicable in this case also. The reactance required in the third element, in series with the input, of course, depends upon the value of input reactance desired. If a circuit is chosen which already includes a series reactance element in the input side of the circuit such as shown on Fig. 1, diagrams a, b, e, and f, the "third" reactance required would add algebraically with the former, resulting in a single net reactance value in this position.

Balanced Circuits

If the input impedance must be balanced with respect to ground, the L circuit design curves can be used to design a suitable impedance matching circuit by treating the problem as an unbalanced one. The required *series* reactance thus obtained from the diagrams is then divided into two parts, each having one-half of the value called for on the charts. These two halves of the necessary total series reactance are then connected in series with each side of the circuit to preserve the balanced-to-ground arrangement.

Construction of Design Curves for L Circuits

All of the design charts are drawn with either circular or straight lines on rectangular coordinate paper. If it is desired to reproduce a larger more accurate set of charts it is necessary to know only the center point and radius of each curve. The formulas in the table give the construction information for the design charts on Fig. 3 to Fig. 10, inclusive, which apply to all L type impedance transforming circuits shown in Fig. 1. To avoid a confusion of intersecting curves, the design charts plotted in Fig. 3 (Fig. 3A and 3B) and Fig. 4 (Fig. 4A and 4B) show only individual families of curves, each family applying to one of the reactance elements of the circuit. Since in all other cases, namely Figs. 5 to 10, inclusive, no confusion results by superimposing two families of curves which apply to the two circuit elements of a given circuit, this has been done to reduce the number of charts required.

The correct algebraic sign for the numerical value of reactances X_C , X_{C1} , X_{C2} , X_L , X_{L1} , and X_{L2} in the formulas on page 48 should be used, i.e., for X_C , X_{C1} or X_{C2} , use a minus (-) prefixed ahead of its numerical value, and for X_L , X_{L1} , and X_{L2} , which are inductive reactances, use a plus (+) prefix.

• • •

RADIO REPAIRING

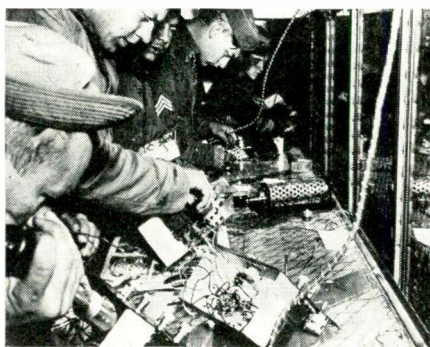

Under the command of Gen. O. W. Griswold these radio technicians repair equipment used during fourth army maneuvers. This group is part of the special troops in the Carolinas



MOBILIZED RESISTANCE

★ This Clarostat armored power rheostat is standard equipment in most fighting planes today. And it's typical of Clarostat mobilized resistance for winning the war. Indeed, that long-standing, well-known Clarostat policy of making tougher resistors, controls and resistance devices, has resulted in drafting Clarostat for the toughest jobs. Despite peak activity for our nation's safety, Clarostat continues to serve the civilian requirements as well, with:

Composition-Element Controls	Greenohm Power Resistors
Wire-Wound Controls	Automatic Line-Voltage Regulators & Ballasts
Clarostat Strip Resistors	Flexible Resistors
Power Rheostats	Glasohm or glass Insulated Resistors
Plug-in Type Resistors	T-nads, L-pads, Attenuators, Faders, Mixers
Voltage-Dropping Power Cords	Units made to customer's prints.

Send Us that Problem . . .

★ If it has to do with resistance or control, send it along for our engineering collaboration, recommendations, specs., quotations.

CLAROSTAT



MANUFACTURING CO.
Incorporated
285 North Sixth St.
Brooklyn, N. Y.

BACK TALK

This department is operated as an open forum where our readers may discuss problems of the electronics industry or comment on articles which have been published in *Electronics*

Resonant Frequency Formula

In Element 4, of the FCC questions for the first class radio-telephone examination, there is one question which requires that the resonant frequency of a tuned circuit be found when the inductive and the capacitive reactances ($X_L X_C$), at a frequency other than the resonant frequency are given. For example, what is the resonant frequency of a tuned circuit if $X_L = 12,000$ ohms; $X_C = 8,000$ ohms at a frequency of 3,000 kc?

After working it out the long way, the writer endeavored to find a formula that would simplify the amount of figuring to be done. The formula thus obtained is very convenient and, although it probably is not a new one, it is worth remembering as it cannot be found in every radio book.

We begin with two known facts; namely that:

$$X_L = 2\pi FL \text{ and } X_C = \frac{1}{2\pi FC}$$

at resonance, these reactances are numerically equal although of opposite sign:

$$\text{Thus } 2\pi F_o L = \frac{1}{2\pi F_o C}$$

$$\text{or } 2\pi F_o^2 L = \frac{1}{2\pi C}$$

$$\text{and } F_o^2 = \frac{1}{4\pi^2 LC}$$

whence $F_o = \frac{1}{2\pi \sqrt{LC}}$ = resonant frequency.

From the expressions for reactance

$$L = \frac{X_L}{2\pi F}$$

$$C = \frac{1}{(X_C)(2\pi F)}$$

$$\begin{aligned} F_o &= \frac{1}{2\pi \sqrt{\frac{X_L}{2\pi F} \times \frac{1}{X_C(2\pi F)}}} \\ &= \frac{1}{2\pi \sqrt{\frac{X_L}{(4\pi^2 F^2) X_C}}} \\ &= \frac{1}{\frac{F}{\sqrt{\frac{X_L}{X_C}}}} \end{aligned}$$

$$\text{or } F_o = \frac{F}{\sqrt{\frac{X_L}{X_C}}}$$

where F_o = resonant frequency
 F = frequency at which X_L and X_C were measured.

Now the problem posed at the beginning of this letter can be solved very simply.

$$\begin{aligned} F &= 3,000 \text{ kc} \\ X_L &= 12,000 \text{ ohms} \\ X_C &= 8,000 \text{ ohms} \\ F_o &= \frac{3,000}{\sqrt{\frac{12}{8}}} = \frac{3000}{1.5} = 2451 \text{ kc} \end{aligned}$$

FRANK L. PUCILOSKI,
Naval Section Base, Seattle

Tropical Troubles

Having read the article "Receivers for the Tropics" in March 1941 *ELECTRONICS*, I was very glad indeed to see that the American manufacturers were

to give some thought to the problem of building a receiver to suit the needs of the Latin American listeners. This problem was recognized early by European manufacturers who now make special short-wave receivers with wonderful tonal qualities enabling the listener to really enjoy musical programs coming through the high frequencies from other continents and, needless to say, along with the music comes propaganda, commercial and political. Why cannot the States give us a good tropical short-wave set, and leave off the seasonal styling and gee gaws that are merely to give the salesman a talking point?

The article, referred to above, begins with troubles developed by receivers in the tropics due to humidity, and this is a real problem. The Cuban radio service man prays for rain just as the farmer does in Georgia, for in the days following the rain, the empty shelves are going to be filled with sets lined up for inspection.

Before he gets the chassis out of the cabinet, the Cuban radio technician knows what the trouble is, according to the make and model of the set. Eight times out of ten, it is one of the following troubles: (1) open primary of the output transformer, (2) open field coil of the speaker, (3) open i-f transformer, (4) open primary of a push-pull input transformer, (5) open choke coil.

At the end of this article, reference is made to one in the July 1940 issue of *ELECTRONICS*, and frankly I do not think that the most important factor has been given proper attention in this article.

FM STATION W71NY

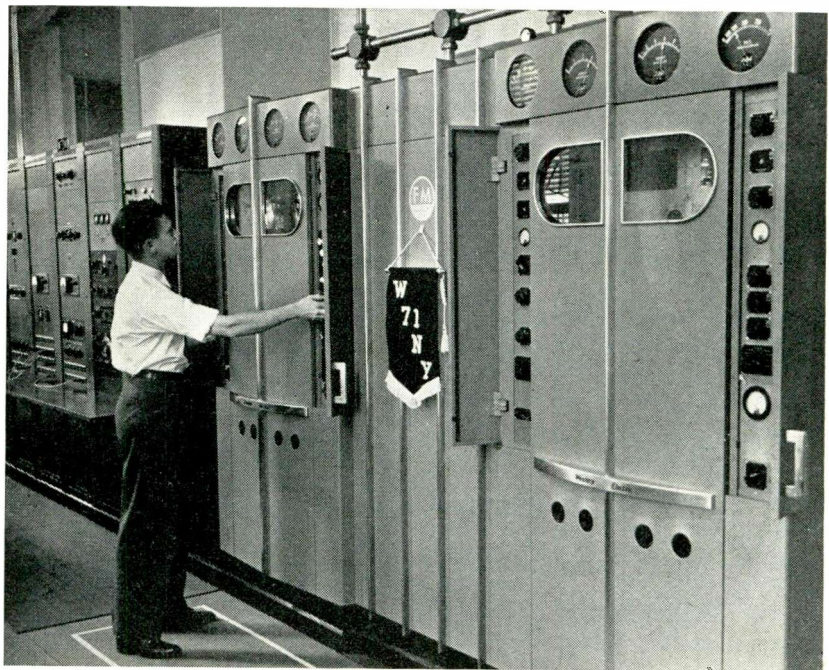

A new 10,000 watt transmitter of W71NY, frequency modulation station of WOR, N. Y., is now on a full-day broadcast schedule

PROFESSIONAL SERVICES

(Rates on Application)

INTERNATIONAL ELECTRONICS, INC.

Special Instruments, Equipment and Methods to control gauging, welding, heating, communications, signaling, safety, inspection, color and testing. Quality control and cost reduction for mechanical, electrical, metallurgical and chemical industries. Rockefeller Center New York City Telephone Circle 6-8494

HAROLD J. McCREARY

Mem. A.I.E.E. & W.S.E.

Consulting Engineer

Laboratory Facilities
 Research Electronics
 Development Television
 Design Radio
 Factory Practice Railroads Signaling
 Patent Studies Telephony

105 W. Adams St. Phone STate 4003 Chicago, Ill.

JOSEPH RAZEK, PH.D.

Consulting Physicist

Electrical and Mechanical Engineering Problems
 Instruments and Control Devices Electronics
 Specialist in Colorimetry, Spectrophotometry and
 Industrial Color Control
 Laboratory and Shop Facilities
 430 Greenview Lane Lanerch, Pa.

NO ENGINEER

whose work takes him into the field of sensitive electrical devices can say—today—that he is thoroughly grounded unless he “knows his electronics.”

Because electronic circuits more and more are getting into industrial work as an automatic hand, an automatic eye, a new means of generating heat, etc., etc., they have become the background for a new cycle of industrial progress.

Are you trying to get along without **ELECTRONICS?** Better subscribe today!

Six years ago, when I first started investigating the problem of fine copper wire corrosion, I was a member of the Cuban Telephone Company's electrolysis survey staff. Therefore I was inclined to approach it as an electrolysis problem; and I am writing you to say that all my experiences and observations since have proved the electrolysis theory to be right. It is this: the lead sheath of underground cables is considered in danger of electrolysis hazards when it is 0.2 volt positive to the adjacent medium, which might be tile ducts or the earth itself, because the negative ions that are attracted by this potential oxidize it.

Humidity in the air, always present in the tropics, is absorbed by the insulating material, this causes a leak, and current flowing through this leak will electrolyze substances present in the insulating material; and, as the negative ions deposit on the wire (which is at positive potential) they oxidize it.

Several years ago I was impressed with the fact that although the primary of a push-pull input transformer was made of wire of a larger size than the secondary, the former was always the one affected by corrosion in spite of the fact that both coils had been treated with the same compound and were in contact with the same materials. Furthermore, that particular secondary would outlive any number of primaries that might be substituted at the rewinding shop.

Due to the high duty on replacement parts, there are a number of places in Havana where a transformer can be rewound, and some of these workers have developed a real technique in this

• • •

SMALLEST ATOM SMASHER



Dr. W. R. Kanne, research physicist and assistant professor of physics at the Illinois Institute of Technology, designed and is operating the electrostatic generator which he claims is the world's smallest atom smasher

SINCE 1922

Radio's MOST COMPLETE Source of Supply

★ ★ ★

IMMEDIATE DELIVERY ON ALL STANDARD RADIO PARTS and ELECTRONIC EQUIPMENT

- CONDENSERS
- RESISTORS
- TRANSFORMERS
- RELAYS
- TUBES
- METERS
- SWITCHES
- CONNECTORS

Also

FACTORY and INTER-OFFICE COMMUNICATING SYSTEMS

• TEST EQUIPMENT

• TRANSMITTING and RECEIVING GEAR

COMPLETE 416 PAGE CATALOG—FREE! Write today on your company letterhead for this free, massive buying guide. Complete listing of all the leading lines—Thordarson, Stancor, Cornell-Dubilier, R.C.A., I.R.C., Ohmite, Triplett, Hallicrafters, Hammarlund, National, etc., etc. Address Dept. EK.

For

"SERVICE AT IT'S BEST"

Phone BARclay-7-1840

New York's Oldest Radio Organization

SUN RADIO CO.
 212 FULTON ST.
 NEW YORK, N. Y.

MEMO

Get in touch with Meissner for Coils!

Write for New 1942 Catalog.
Address Dep't. E-3.



Meissner

MT. CARMEL, ILLINOIS

"PRECISION-BUILT PRODUCTS"

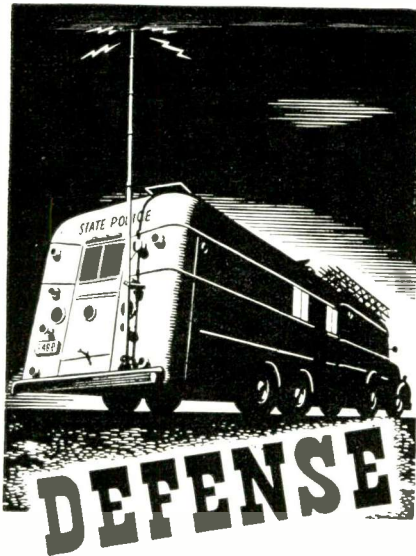

In Mobile Police Service

PREMAX ANTENNAS are doing their bit in police service—the special telescoping adjustable verticals for mobile broadcasting stations—the special police type on prowler cars.

Get the special bulletin illustrating standard Antennas and Mountings.

Premax Products

Division Chisholm-Ryder Co., Inc.
4214 Highland Ave., Niagara Falls, N. Y.

POSITIONS VACANT

ELECTRONIC ENGINEER young man under 35 as research and design engineer with Vacuum Tube hearing aid company, must be graduated EE with some electronic and acoustical experience desirable. Unusual opportunity to progress with company. Compensation secondary to proveable ability. Give age, complete education, experience and telephone number. Present staff know of this opening. Apply in complete confidence, P-296, Electronics 330 W. 42nd St., New York, N. Y.

DESIGN ENGINEER, with experience in FM and AM transmitter and receiver design. Experience in the design and construction of directional antenna coupling and phasing equipment desirable but not imperative. State age, education, experience and salary expected. P-318, Electronics, 520 N. Michigan Ave., Chicago, Ill.

POSITIONS WANTED

P.H.D., 5 YEARS RESEARCH on short waves in Sweden, 2 years chemical research in America, many publications, Austrian, not enemy alien, Christian, single, age 29, first papers. PW-319, Electronics, 330 W. 42nd St., New York, N. Y.

E. E. COLLEGE GRADUATE, Tube Engineer, 10 years of engineering and manufacturing experience on all types of radio receiving and transmitting tubes, at the present employed in other field, but would like to become associated with concern that can use part time engagement relative to specific engineering and manufacturing tube problems. PW-320, Electronics, 330 W. 42nd St., New York, N. Y.

YALE A.B., formerly with War Trade Board, desires position obtaining government contracts or defense work. Box 237, Burlington Hotel, Washington, D. C.

FOR SALE

SELLING R. C. A. eight inch electrostatic deflection cathode-ray oscillograph without amplifier; new tubes; used spare; diagrams. \$60. Lee, 2684 Boulevard, Jersey City, N. J.

line of work. Even the youngest apprentice now knows that fine transformer or relay wire is never to be touched with the fingers, and the chief is always trying out some new moisture repellent varnish that is supposed to be used on this or that type of receiver, always to get the same negative results. The rewind job merely lasts a little longer or a little shorter time.

Mr. Stewart in the March 1941 ELECTRONICS mentions different types of materials used in the manufacture of coils and materials which come in contact with the wire, as probable offenders. The part that these substances play, in my opinion, is to accelerate the electrolysis process by improving the electrolyte; while the substances mentioned by Mr. Stephens and Mr. Gehrenbeck merely slow up the corrosion.

My first experiment to prove that the corrosion of these wires was a purely electrochemical process was as follows: I took the d-c potential out of the primary of the push-pull input transformer of a Radiola 80 (which are famous for corroding in record time) by means of inductance-capacity coupling, and grounding the other end of the winding. That was four years ago and the old set is still working with the same transformer. After that, I passed the word to the radio technicians to apply this scheme whenever they got tired of dealing with a customer.

The toll terminal room of the Cuban Telephone Company, which is also the

submarine cable terminal has given me any number of experiences and observations that tend to verify this theory.

After proving to myself, beyond any doubt, that this corrosion matter was purely an electrolysis problem, I decided that it should be treated as such; and here is the solution I offer to your consideration, and which has not failed me yet: Since it is not possible to take the direct current out of all windings, insulate the part containing coils and apply a higher positive potential to the casing. Consider, for instance, a commercial receiver with the output transformer mounted on the speaker, the loudspeaker being insulated from the chassis, and the field coil being used for filtering the plate voltage. Apply the high potential that comes into the field coil from the rectifier to the speaker casing. Now, from the electrolysis standpoint, the field coil and the output transformer winding will be protected from corrosion since they are at a lower potential than the surrounding medium, and any current flowing through the leak caused by humidity, will cause positive ions to go to the wire, and protect it from corrosion.

This same procedure can be applied to any part of the radio set, with identical results.

I hope that this information obtained right here in face of the tropical problem, will be of some help to the American radio industry, as well as to Latin American radio reception.

H. C. SCHWALM

SEARCHLIGHT SECTION

(Classified Advertising)

EMPLOYMENT : "OPPORTUNITIES" **EQUIPMENT**
BUSINESS : **USED OR RESALE**

UNDISPLAYED — RATES — DISPLAYED
10 CENTS A WORD, MINIMUM CHARGE \$2.00
Positions Wanted (full or part time salaried employment only) ½ the above rates payable in advance.
Box Numbers—Care of publication New York, Chicago or San Francisco offices count as 10 words.
Discount of 10% if full payment is made in advance for 4 consecutive insertions.

Individual Spaces with border rules for prominent display of advertisements. The advertising rate is \$6.00 per inch for all advertising appearing on other than a contract basis. Contract rates quoted on request.
An advertising inch is measured ¾" vertically on a column—3 columns—30 inches to a page.

HIGH GRADE USED ELECTRON TUBE MACHINERY

Huge Stock of Every Type and Variety
KAHLE ENGINEERING CORPORATION
Specialists in Equipment for the manufacture of Neon Tubes, Radio Tubes, Incandescent Lamps, Photo Cells, X-ray Tubes, etc.
900 DeMott St., North Bergen, N. J.

DEPENDABLE

Used
ELECTRONIC TUBE EQUIPMENT
Complete line of used equipment for the manufacture of Radio Tubes, Neon Tubes, Incandescent Lamps, etc. Write for Bulletin showing 25 to 70%
CALLITE TUNGSTEN CORPORATION
formerly Einar Electric Corp.
534 39th Street, Union City, N. J.

BEST QUALITY, USED ELECTRON TUBE MACHINERY

Equipment for the manufacture of all kinds of electron tubes, radio tubes, incandescent lamps, neon tubes, photo electric cells, X-ray tubes, etc.
AMERICAN ELECTRICAL SALES CO., INC.
65-67 East 8th St. New York, N. Y.

FOR SALE—TRANSMITTER

Used as 500 watt experimental Television Transmission—Can be easily modified as 1000 watt broadcast transmitter (output now uses 4-833 tubes). Excellent condition. Complete with power supply tubes, meters, etc. Also other equipment—four Baird (British) Electron Multipliers, Cathode Ray Tubes—Transformers, etc. Offers to

FS-317, Electronics, 330 W. 42 St., N. Y. C.

OLD TRANSMITTING TUBES ARE VALUABLE

Have your old tubes rebuilt and save half the cost of new tubes. We can rebuild most any tube from 250 watts to 20 K.W.

Freeland & Olschner

922 Howard Ave. New Orleans, La.

AMBER MICA

No. 5, No. 6 and No. 7

• Distributor wishes to contact consumers. Write to
FS-321, Electronics
330 W. 42nd St., New York City

CONTACTS

FOR THE FIELD OF ELECTRONICS

CRYSTALS by HIPOWER

The Hipower Crystal Company, one of America's oldest and largest manufacturers of precision crystal units, is able to offer the broadcaster and manufacturer attractive prices because of their large production and the exclusive Hipower grinding process. Whatever your crystal need may be, Hipower can supply it. Write today for full information.

HIPOWER CRYSTAL CO.
Sales Division—205 W. Wacker Drive, Chicago
Factory—2035 Charleston Street, Chicago, Ill.

LECTROHM

Vitreous Enameled
RESISTORS

A complete range, from 1 to 200 W. wound with highest grade resistance wire. Tolerances plus or minus 5% (closer tolerances, if needed).
Wound on low loss ceramic cores. Mounting legs furnished when requested.

SEND FOR SAMPLES
Give complete data regarding resistance, maximum current, voltage drop required and mounting space available.

LECTROHM, INC.
5131 WEST 25TH PLACE
CHICAGO (CICERO P.O.) ILL.

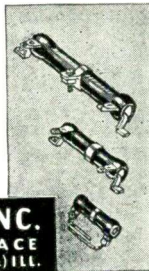

DEFENSE REQUIREMENTS

ELECTRICAL COIL WINDINGS & TRANSFORMERS

Equipped for vacuum and pressure impregnation — varnish or compound.

DINION COIL COMPANY
P.O. BOX D CALEDONIA, N. Y.



We manufacture a complete line of equipment

SPOT WELDERS, electric, from ¼ to 500 KVA
TRANSFORMERS, special and standard types
INCANDESCENT LAMP manufacturing equipment
FLUORESCENT TUBE MAKING EQUIPMENT
ELECTRONIC EQUIPMENT, vacuum pumps, etc.
WET GLASS siling and cutting machines for laboratory use
GENERAL GLASS working machines and burners
COLLEGE GLASS working units for students and laboratory
EISLER ENGINEERING CO.
751 So. 13th St. (near Avon Ave.) Newark, New Jersey



University
SOUND SYSTEMS
for
NATIONAL DEFENSE
require
the finest loudspeakers
Specify
UNIVERSITY REFLEX
The only complete loud-
speaker line which solves
ALL
Defense Sound Problems
University Laboratories
195 Christie St., N. Y. C.

HARVEY RADIO LAB'S, Inc.

Manufacturers of
Radio Transmitters

ELECTRONIC APPARATUS
447 Concord Ave., Cambridge, Mass.

FINE RIBBONS
of Tungsten and Molybdenum
Molybdenum in widths .006" to 1"
in thickness to .0005"
Tungsten Ribbon to specification
H. CROSS
15 Beekman St. New York

SIGNICO
**SIGNAL & INDICATOR
PILOT LIGHTS**
for all electrical devices.
WRITE FOR CATALOGUE
showing a complete line of
assemblies for all purposes.
SIGNAL INDICATOR Corp.
140 CEDAR ST. NEW YORK, N. Y.

NEED PARTS IN A HURRY?
Save time—
call HARRISON first!
RADIO CO.
12 West Broadway N.Y.C.
Phone WORTH 2-6276

NEED LUMINESCENT MATERIALS?
PHOSPHORESCENT OR FLUORESCENT
Chemicals
WRITE
General Luminescent Corp., 732 Federal St., Chicago

MICROMETER for
FREQUENCY checking
METER transmitters,
from 1.5 to 56 mc.,
within 0.01 per cent.
LAMPKIN LABORATORIES
Bradenton, Fla., U. S. A.

Delivery
vs.
Delay...

KNOWING where to find some specific material, part or instrument may be the difference between DELIVERY and DELAY. If the advertisements in this issue do not cover your requirements, write

ELECTRONICS

DON'T LET A FEW NEEDED PARTS HOLD UP THE PRODUCTION SCHEDULE
HARVEY HAS THEM IN STOCK

HARVEY RADIO CO.
103 WEST 43 STREET • NEW YORK, N. Y.

V-M

ATTAINING perfection is a gradual process. Only recently, engineers strove for 7,500 cycles. Again AUDAX came through and mastered wide range so thoroughly that, today, even the lowest priced MICRODYNE has a range to over 7,000 cycles—other models over 10,000 cycles.—However, just as ability to reach high "C" does not mean a quality voice,—so wide range by itself, in a pickup, does not mean quality performance. It is the all-important factor of "VIBRATORY-MOMENTUM" that determines quality. Not only does V-M control quality, but is also a serious factor in record wear. Needle pressure, needle impedance, etc., are comparatively secondary.

AUDAX succeeded in reducing "VIBRATORY-MOMENTUM" almost to the vanishing point—finally banishing that down-in-the-cellar effect.—All this bears out the contention of leading scientists that *only the Inductor Principle* makes possible high quality results—and this means MICRODYNE

"The Standard by Which Others Are Judged and Valued"

With or without Jewel Point, the sharp clean-cut facsimile reproduction of MICRODYNE—regardless of climatic conditions—is a marvel to all who have put it to the only test that really counts . . . the EAR test.

WITH OUR COMPLIMENTS

A copy of "PICKUP FACTS" is yours for the asking. It answers many questions concerning record reproduction.

Pickup List Prices

\$11.50 to \$198.00

HIGH FIDELITY CUTTERS
List to \$150.00

AUDAK COMPANY

500 Fifth Avenue New York City

[In Chicago, 'phone: Webster 4840]

"Creators of High Grade Electrical and Acoustical Apparatus since 1915."

INDEX TO ADVERTISERS

Abbott Instrument, Inc.	112	Jackson Electrical Instrument Co.	115
Acheson Colloids Corp.	115	Jones, Howard B.	113
Acme Electric & Mfg. Co.	98		
Aeroyox Corp.	103	Kenyon Transformer Corp.	7
Alden Products Co., Inc.	117	Keuffel & Esser Co.	2
Allied Radio Corp.	115		
American Gas Accumulator Co.	96	Lampkin Laboratories	129
American Lava Corp.	71	Lapp Insulator Co.	19
American Transformer Co.	105	Lectrohm, Inc.	129
Associated Research, Inc.	116	Lingo & Son, Inc., John E.	119
Astatic Corp.	123	Littelfuse, Inc.	109
Audak Co.	130		
Audio Development Co.	121	Maedel Publishing House	113
Audio Devices, Inc.	118	Mallory & Co., Inc., P. R.	24
Automatic Electric Co.	94	McGraw-Hill Book Co., Inc.	120
		Meissner Mfg. Co.	127
Ballantine Laboratories, Inc.	92	Millen Mfg. Co., Inc., James	119
Biddle Co., James G.	94	Mycalex Corporation of America	102
Blaw-Knox Co.	84		
Bliley Electric Co.	111	National Vulcanized Fibre Co.	11
Brand & Co., William	9	New York Transformer Co.	78
Bud Radio, Inc.	108		
		Ohmite Mfg. Co.	68, 69
Callite Tungsten Corp.	66	O'Neil-Irwin Mfg. Co.	118
Capitol Radio Engineering Institute	124		
Carborundum Co.	119	Panoramic Radio Corp.	100
Carter Motor Co.	109	Premax Products	128
Centralab Div. Globe-Union, Inc.	3	Presto Recording Corp.	82
Chicago Transformer Corp.	73		
Cinch Manufacturing Corp.	53	RCA Laboratories	85
Clare & Co., C. P.	91	RCA Mfg. Co.	67, Back Cover
Clarostat Mfg. Co.	125	Raytheon Mfg. Co.	114
Collins Radio Co.	89	Rea Magnet Wire Co.	87
Cornell-Dubilier Electric Corp.	23		
Cross, H.	129	Shure Brothers	70
		Signal Indicator Corp.	129
Daven Co.	Inside Back Cover	Sola Electric Co.	81
Dinion Coil Co.	129	Solar Manufacturing Corporation	77
Driver Co., Wilbur B.	121	Sound Apparatus Co.	121
Dunmont Electric Co.	113	Speer Carbon Co.	18
DuMont Labs., Allen B.	120	Sprague Specialties Co.	97
		Stackpole Carbon Co.	76
Eicor, Inc.	117	Standard Pressed Steel Co.	122
Eisler Engineering Co.	129	Sun Radio Co.	127
Eitel-McCullough, Inc.	55	Superior Tube Co.	16
Electrical Research Products, Inc.	112		
Electro-Voice Mfg. Co., Inc.	116	Taylor Fibre Co.	118
Electronic Laboratories, Inc.	22	Thomas & Skinner Steel Products Co.	116
Emby Products Co.	110	Thordarson Electric Mfg. Co.	88
Erie Resistor Corp.	8	Triplett Electrical Instrument Co.	109
Ferranti Electric, Inc.	123	United Transformer Co.	Inside Front Cover
Formica Insulation Co.	17	University Laboratories	129
General Electric Co.	12, 13, 95	Ward Leonard Electric Co.	99
General Luminescent Corp.	129	Western Electric Co.	83
General Radio Co.	79	Westinghouse Electric & Mfg. Co.	4, 5
G-M Laboratories, Inc.	114	Weston Electrical Instrument Corp.	93
Guardian Electric Mfg. Co.	74	White Dental Mfg. Co., S. S.	108, 122
		Wilson Co., H. A.	111
Halicrafters Co.	124	Wincharger Corp.	75
Hammarlund Mfg. Co., Inc.	10		
Hardwick Hindle, Inc.	20		
Harrison Radio Co.	129		
Harvey Radio Co.	129		
Harvey Radio Laboratories, Inc.	129		
H-B Electric Co.	117		
Heinemann Circuit Breaker Co.	100		
Heintz & Kaufman, Ltd.	21		
Hewlett-Packard Co.	86		
Hipower Crystal Co.	129		
Hygrade Sylvania Corp.	6		
Instrument Resistors, Inc.	122		
International Resistance Co., 57, 58, 59, 60, 61, 62, 63, 64			
International Telephone & Telegraph Corp.	14, 15		
Isolantite, Inc.	101		

Professional Services 127

SEARCHLIGHT SECTION

(Classified Advertising)

EMPLOYMENT	128
USED EQUIPMENT FOR SALE	
American Electric Sales Co., Inc.	128
Callite Tungsten Corp.	128
Freeland & Olshner	128
Kahle Engineering Corp.	128



NOT SO PUFFED WITH OUR OWN IMPORTANCE

- Yes, we do have the most complete line of precision attenuators in the world, and these **DAVEN** components are recognized, in most discriminating circles, as the best obtainable commercially.
- Equally true, our **Super DAVOHM** precision wire-wound resistors and our attenuator type, step-by-step switches have an enviable degree of acceptance.
- **Output Power Meters, Transmission Measuring Sets, Decade Resistance Boxes, Attenuation Networks, Volume Level Indicators** and many other types of **DAVEN Laboratory Test Equipment** are used extensively in electrical, broadcast, sound picture and television fields.
- Naturally we are proud of such a record. But we readily admit, and even boast, that we are indebted to those clients who have collaborated in many developments with constructive criticism and suggestions. These have always been welcome.
- And the fact that our facilities are taxed with urgent orders will in no way alter this policy.
- Please call upon us if you should encounter a problem requiring special design and construction.

THE DAVEN COMPANY
158 SUMMIT STREET • NEWARK, NEW JERSEY



10 Hammarlund's wartime improved variable cap
76-school alert

50- Tanks get there the hard way

music by phone lines

...and RCA Metal Tubes go with them!

106 - Bendix 3801 aircraft radio

You'll find RCA Metal Tubes in the transmitters and receivers of American tanks, British tanks, Russian tanks! For metal tubes afford greater ruggedness under shock and vibration—the positive pin-contact, the self-shielding and compactness—that have helped make Allied military radio equipment the finest in the world.

RCA is now turning out metal-envelope tubes at the fastest pace

in history—for radio equipment in tanks accounts for only part of the demand. Metal tubes by the millions are serving on land, at sea and in the air...meeting the rigid requirements of the armed services. Wherever radio reception must be most reliable—wherever

the going is hardest—you'll find that "metal" means *modern!*

With vast emergency demands by no means unusual today, you may find difficulty in securing metal tubes. We're doing the best we can—we're doing more than ever before—but some delays and shortages may be unavoidable. For, obviously, war equipment comes first... and war equipment needs *metal* tubes!



112 - Abbott trans-rec ad

METAL TUBES