

# electronics

radio, communication, industrial applications of electron tubes . . . engineering and manufacture

OCTOBER • 1941

PRICE 50 CENTS

McGRAW-HILL PUBLISHING CO., INC.



TWO-WAY STATION

More than 100 types of tubes for use in Commercial Broadcasting, Point to Point Communication, Ultra High Frequency Transmission, Electro Medical Apparatus, High Voltage Rectification and many Industrial Applications.



## We're in the Army\* now

\* U. S. Army, Navy, Civil, and Aeronautical Departments, etc.

... and faced with a continuous step-up in the demand for AMPEREX Transmitting and Rectifying Tubes for the armed services.

Despite the fact that your valued commercial orders for certain tube types must be subordinated to problems arising from the national emergency, the priorities situation, restrictions on certain rare refractory metals and materials, etc. . . . we are still able to fill all your orders.

However, in this period of unusual stress, we ask your consideration and cooperation in anticipating your requirements so that we may maintain our customary rapid delivery schedules.

**AMPEREX ELECTRONIC PRODUCTS**  
79 WASHINGTON STREET • BROOKLYN, NEW YORK



A McGRAW-HILL PUBLICATION

# electronics

## CONTENTS—OCTOBER, 1941

**KEITH HENNEY**  
Editor

Donald G. Fink  
Managing Editor (on leave)

Beverly Dudley                      Craig Walsh  
Acting                                      Associate Editor  
Managing Editor

M. L. Matthey                      J. M. Heron  
Assistant Editor                      Assistant Editor

Harry Phillips  
Art Director

**H. W. MATEER**  
Manager

Wallace B. Blood  
Sales Manager

Contents Copyright, 1941, by  
McGraw-Hill Publishing Company, Inc.

McGRAW-HILL  
PUBLISHING COMPANY, INC.

JAMES H. McGRAW  
Founder and Honorary Chairman

Publication Office  
99-129 North Broadway, Albany, N. Y.  
U. S. A.

Editorial and Executive Offices  
330 West 42nd St., New York, N. Y., U.S.A.  
James H. McGraw, Jr., President  
Howard Ehrlich, Executive Vice President  
Mason Britton, Vice Chairman  
B. R. Putnam, Treasurer  
D. C. McGraw, Secretary  
J. E. Blackburn, Jr., Director of Circulation

Cable Address:  
MCGRAWHILL, New York  
Member A. B. P. Member A. B. C.

### TWO-WAY STATION.....Cover

A highly compact and efficient radio transmitter and receiver unit, operated by members of Signal Company, 44th Division, U. S. Army at Fort Dix. It uses a 30-foot antenna suspended 18 inches above the ground and has a range of about 25 miles

### DEVELOPMENT OF GLASS BASE RECORDING DISC, by C. J. LeBel..... 27

Research started more than a year ago pointed the way to glass as a substitute for aluminum in recording discs. When pressure of priorities was felt, research began to pay dividends

### HOW TO GET DEFENSE CONTRACTS, by Ernst O. Eisenberg.... 31

Some pointers which should aid manufacturers to obtain their share of defense work are outlined

### CHARACTERISTICS OF FLUORESCENT MATERIALS, by L. H. Stauffer..... 32

A study is presented of the luminous and time characteristics of fluorescent substances employed in cathode-ray and similar screen materials

### INTERPOLATION OSCILLATOR, by D. R. Tibbetts..... 35

A quartz crystal oscillator as a secondary frequency standard and a direct reading interpolation oscillator with linear calibration provide a rapid means of making accurate frequency measurements

### POWER FACTOR METER, by Alexander B. Bereskin..... 38

A gas tetrode, operated as a phase controlled rectifier, forms the essential element of a meter which indicates power factor directly on the dial of a D'Arsonval instrument

### W47NV ..... 43

A page of pictures showing the transmitter of the first f-m station to go into commercial operation

### EQUIPMENT FAILURE ALARM, by E. G. Cook and A. H. Peterson 44

Electron tubes in a bridge circuit are employed to indicate the proper and continued operation of amplifying equipment. The unit has particular use as a program failure alarm unit in broadcast stations

### STORAGE PRINCIPLE IN TELEVISION, by A. H. Rosenthal..... 46

The principle of storing the television image, which has been used in transmitters for several years is also applicable to use in receiving systems article shows

### TECHNIQUE OF OBTAINING TUBE DATA, by C. C. Street..... 50

A simplification of methods of obtaining the tube characteristics on the screen of an oscilloscope are described. Necessary equipment is available in even small electronic laboratories

### FREQUENCY DEVIATION MEASUREMENTS, by L. N. Holland and L. J. Giacoletto..... 51

A graphical method is given for simplifying the determination of frequency deviation of f-m transmitters by noting the modulation frequency for which the carrier disappears

### DEPARTMENT

CROSSTALK .....	25	THE ELECTRON ART.....	84
REFERENCE SHEET .....	51	TUBES .....	100
TUBES AT WORK .....	54	INDUSTRY IN REVIEW.....	107

### INDEX TO ADVERTISERS..... 120

ELECTRONICS, October, 1941. Vol. 14, No. 10. Published monthly, price 50c a copy. Allow at least ten days for change of address. All communications about subscriptions should be addressed to the Director of Circulation, 330 West 42nd Street, New York, N. Y.  
Subscription rates—United States and possessions, Mexico, Central and South American countries, \$5.00 a year, \$8.00 for two years, \$10.00 for three years. Canada (Canadian funds accepted), \$5.50 a year, \$9.00 for two years, \$11.00 for three years. Great Britain and British possessions 36 shillings for one year, 72 shillings for three years. All other countries, \$6.00 for one year, \$12.00 for three years. Entered as Second Class matter, August 29, 1936, at Post Office, Albany, New York, under the Act of March 3, 1879. BRANCH OFFICES: 520 North Michigan Avenue, Chicago; 68 Post Street, San Francisco; Aldwych House, Aldwych, London, W.C. 2; Washington; Philadelphia; Cleveland; Detroit; St. Louis; Boston; Atlanta, Ga.

**A NEW**

*Member of the*  
**Centralab**  
*Family*

*Deluxe* TRIMMER  
 CAPACITOR

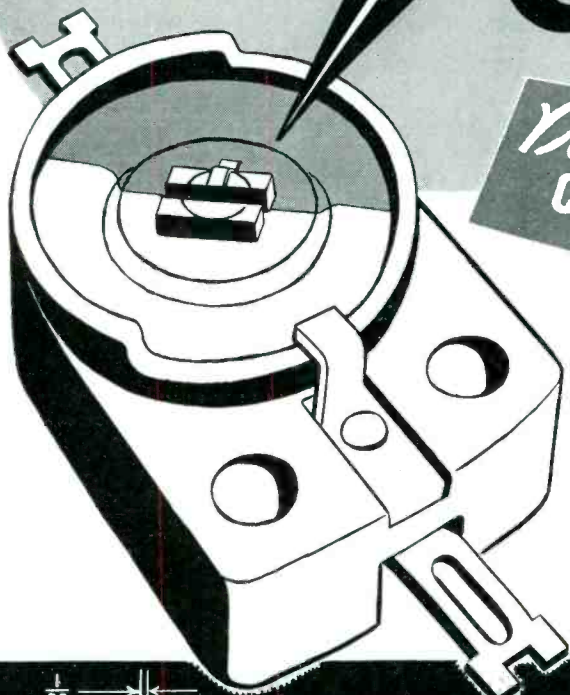

**D**ESIGNED for the exacting conditions imposed by Radio set manufacturers in defense and civilian equipment, whether in AM or FM.

Value from 5 to 50 MMF • Temperature coefficient— $.0005 \text{ MMF/MMF/C}^\circ$ . • Power factor less than .1% under normal and abnormal conditions • Rotor and stator of high grade ceramic material • Plates are silver deposited on optically ground, flat ceramic surfaces • Vibration-proof stability of adjustment rotation  $180^\circ$ , sturdy mechanical stop • No frictional contacts, 100% solid solder connections from lugs to condenser plates • Capacity free pigtail connections.

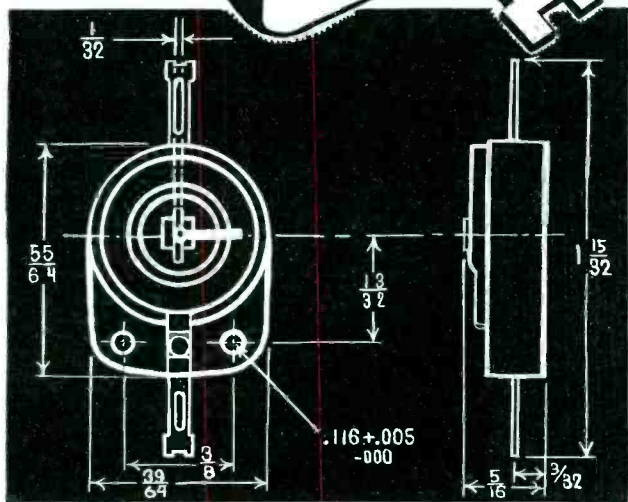

**CENTRALAB:** Div. of Globe-Union Inc., Milwaukee, Wis.

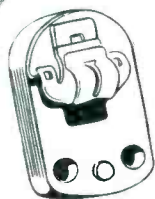

**CERAMIC TRIMMER CONDENSER**

where greater stability than ordinary types is required. Supplied with neg. temp. coefficient of  $.006 \text{ MMF/MMF/C}^\circ$ . With or without mounting brackets.

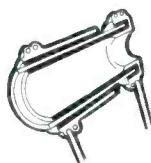

**CERAMIC FIXED CAPACITOR**

Small "special purpose" for h.f. circuits where temperature compensation, low power factor, or absolute permanence are important. 1000 V.D.C. leakage resistance more than 10,000 meg. Power factor less than 1%.

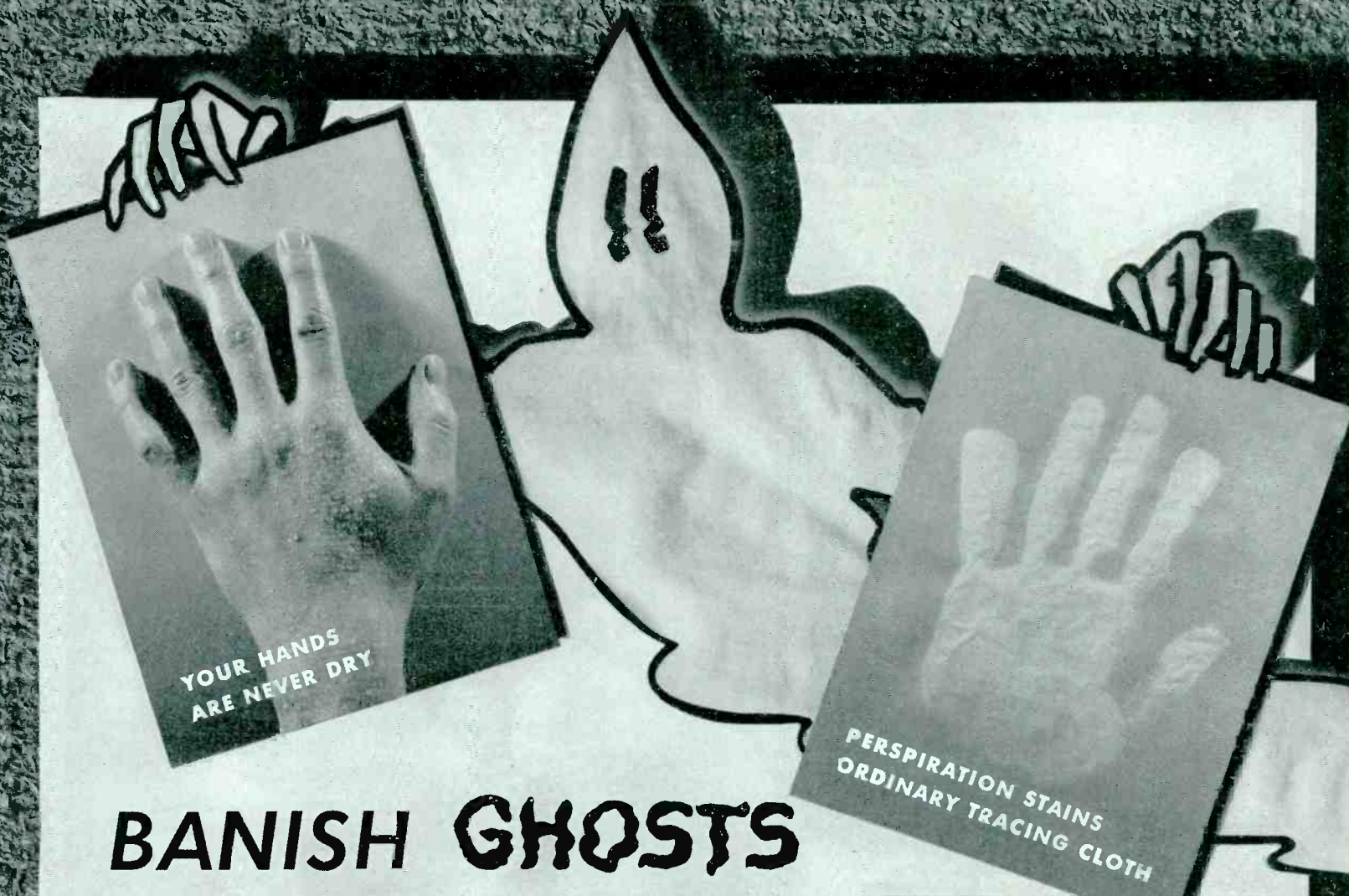

# BANISH GHOSTS

## WITH THIS NEW TRACING CLOTH

PHOENIX is the new kind of tracing cloth, proofed against perspiration stains and water marks — that holds erasure scars at a minimum. PHOENIX gives you clean tracings, in pencil or ink, free from untidy "ghosts" that reproduce on blueprints!

An exclusive new process is responsible for this amazing performance, a process which defies moisture, and gives PHOENIX its unusually durable working surface. You use harder pencils... get sharper lines with less ten-

dency to smudge. Even 6H pencil lines show clearly, and reproduce strongly. You don't mar the surface when you erase; erased areas take pencil smoothly — and ink without feathering. Its new white color and its increased transparency provide excellent drawing contrast... produce strong blueprints.

Give PHOENIX your own drawing board test. See your K&E dealer, or write for a generous working sample and an illustrated brochure.

### PHOENIX DEFIES MOISTURE GHOSTS

Perspiration and water splashes on ordinary tracing cloth create "ghosts" which reproduce on blueprints. PHOENIX Tracing Cloth withstands actual immersion in water for fully 10 minutes at a time! *Perspiration and water marks will not stain it!*



### PHOENIX LESSENS SMUDGE GHOSTS

The new improved surface of PHOENIX Tracing Cloth permits you to use harder pencils (5H and 6H) and to get sharper lines with less tendency to smudge. Result: Cleaner tracings and blueprints.



### PHOENIX REDUCES ERASURE GHOSTS

Ordinary tracing cloths become scarred when erased... erased spots produce ghosts on blueprints. PHOENIX has a durable drawing surface that reduces working scars to a minimum.

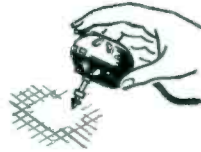

**K&E**  
**Phoenix**  
REG. U.S. PAT. OFF.  
**TRACING CLOTH**  
 for pencil and ink

EST. 1867  
**KEUFFEL & ESSER CO.**  
 NEW YORK • HOBOKEN, N. J.  
 CHICAGO • ST. LOUIS • SAN FRANCISCO • LOS ANGELES • DETROIT • MONTREAL

# One Saving is fine —but TWO savings are better!



The benefits of using *any* Self-tapping Screws are unquestioned. Every day they are enabling plants large and small to roll up big savings, by eliminating time-wasting operations in assembling thin or heavy sheet metal, die cast or plastic parts. But you gain the *full* benefits of the Self-tapping Screw Method only when *every* screw drives right, holds tight. A few "trouble-making" screws in a lot can rob you of a sizable share of the economies.

That is why you make a double saving with *Parker-Kalon* Self-tapping Screws! For the Parker-Kalon Quality-Control Laboratory — without counterpart in the industry — eliminates "doubtful screws" . . . screws that look all right but some of which fail to work right. Specify *Parker-Kalon* and you can *drive* every screw you *start* . . . fast and easily. And count on it to *hold*!

Save operations with Self-tapping Screws. Be sure they're *Parker-Kalon*, and you'll get a "bonus" in non-stop work that comes only with the genuine Parker-Kalon product. Parker-Kalon Corp., 192-194 Varick St., New York.

By eliminating needless operations on many assemblies, Fada Radio & Television Co. boosts production an estimated 25% with Parker-Kalon Self-tapping Screws. You can save operations, too, with this unique fastening method. Eliminate tapping time, costs and equipment. End fumbling with bolts and nuts. Eliminate lock washers. Do away with riveting in hard-to-get-at places.

## PARKER-KALON

*Quality-Controlled*

## SELF-TAPPING SCREWS

Give the Green Light to Defense Assemblies



SELF-TAPPING SCREWS FOR EVERY METAL AND PLASTIC ASSEMBLY . . . AND OTHER FASTENING DEVICES



**FM'S FIRST INDEPENDENT STATION**  
*on-the-air*  
 with a G-E 1-kw transmitter

**Proof That the Public Regards "FM" as More than a Strange Radio Symbol**

W47A started operation July 17 with 36 sponsored programs, none less than 15 minutes long. It serves the Capitol District of New York State—covering 6589 square miles—16½ hours daily, 18½ hours Saturdays.

Owned and operated by the Capitol Broadcasting Co., Inc.—devoted solely to FM—it is the first commercial FM station unaffiliated with any broadcast interest.

W47A is also the first station in the country to get a construction permit from the F.C.C. for STL equipment. It will operate on 331 megacycles with W2XEO as the call letters. This studio-to-transmitter equipment is being built by G.E. and will soon be installed.

General Electric offers the only comprehensive line in FM today—broadcast and relay transmitters, receivers, tubes, frequency and modulation monitors, high-gain turnstile antennas, and crystals. G.E. is the only manufacturer of FM broadcast transmitters and receivers operating an FM station as a proving ground. To benefit from actual operating experience look to General Electric for all your FM needs. Just get in touch with the nearest of our 80 offices.

Dwelle S. Hoag, Chief Engineer of W47A, takes readings on the 1-kw FM transmitter



**Free!**

**HOW TO PLAN AN FM STATION  
 HINTS ON OPERATING FM TRANSMITTERS  
 HOW TO MAKE MEASUREMENTS IN FM  
 TRANSMITTERS**

Three valuable guides, written by G-E engineers, to help you in the FM field. Get them from your G-E representative, or write General Electric, Section A160-16, Schenectady, N. Y.

**GENERAL  ELECTRIC**

160-16-6914

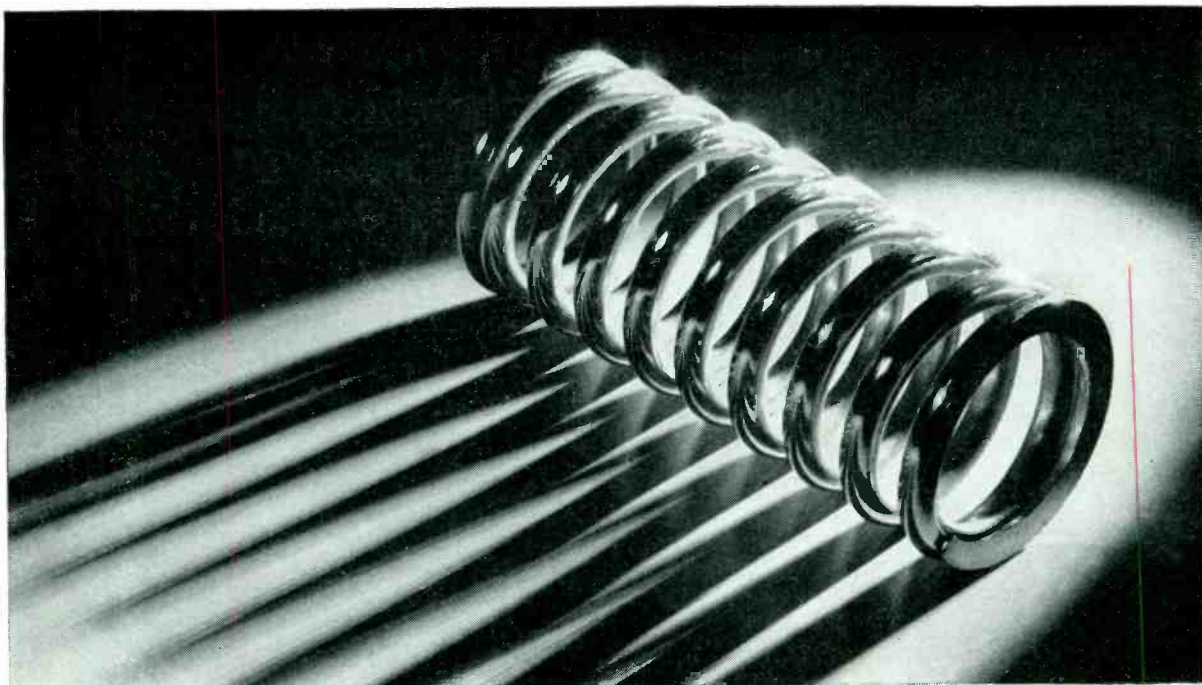

## Why We're Stepping Up Our Advertising To Bring You News About Springs

*I*N THE NEXT few months—through the advertisements of this company—you are going to see a series of stories about springs that have never been told, or well told, before. If you design, specify or buy springs, these stories will interest you. They can influence the performance of your product and increase the satisfaction of your customers.

We are going to tell this story because many people still feel that a spring is a “hunk of wire”.

The simple truth is that spring manufacturers, with few exceptions, have outgrown the

by-guess-and-by-gosh way of making springs. Rule-of-thumb methods have been replaced by scientific formula, scientific manufacturing and scientific testing.

The astronomical number and variety of springs used today, the kinds of wire and finishes, and the functional responsibilities placed on springs make the help of spring engineers not only advisable but profitable.

As you run across the next advertisement of this series in this publication, and those to follow—remember that they're worth reading.

HUNTER PRESSED STEEL COMPANY, LANSDALE, PA.





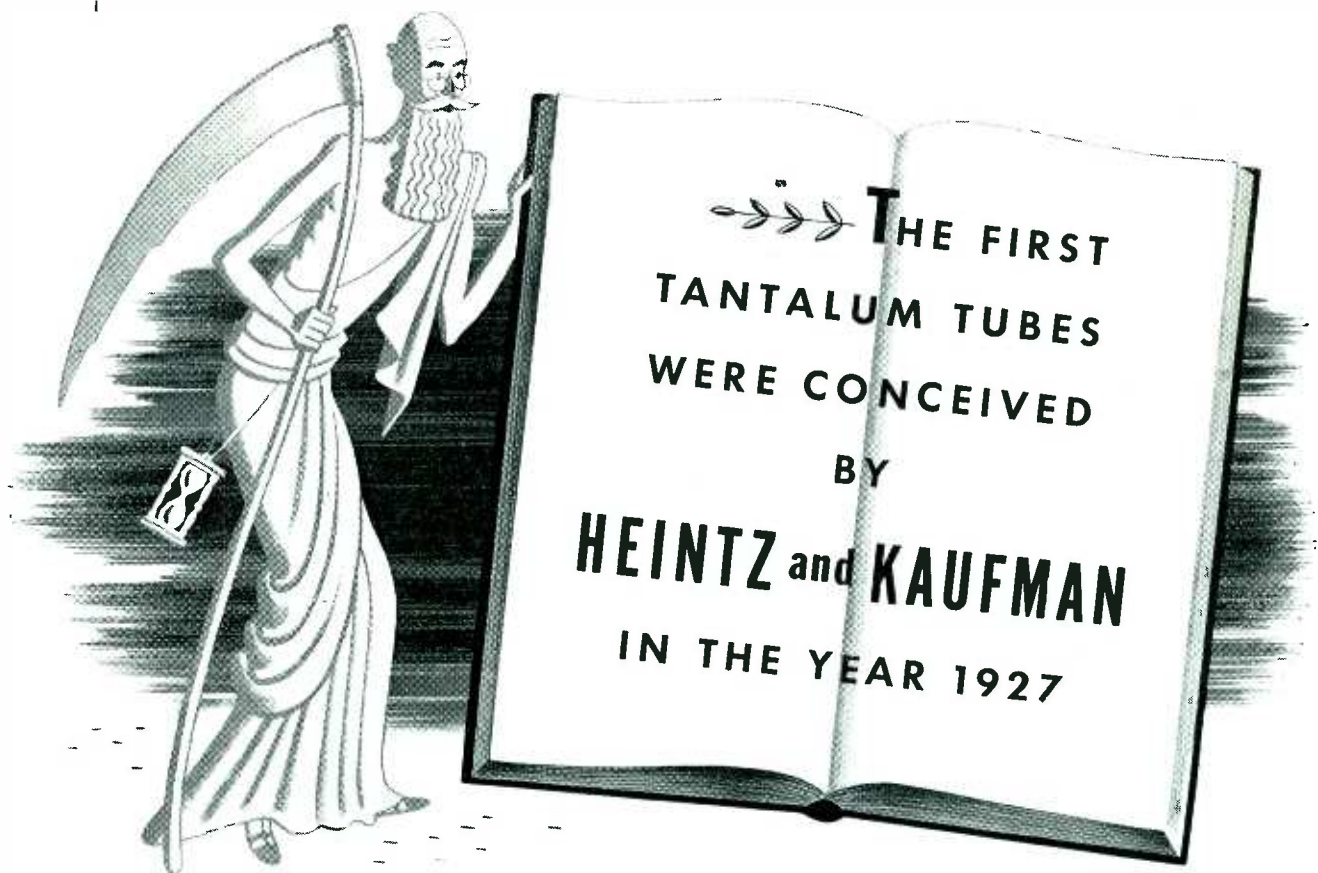



We are happy to have made this contribution to the electronic art

**14 YEARS OF PROGRESS**



**TYPE 255**  
The first tantalum tube



**TYPE 854**  
A new tantalum tube for modern UHF applications

Today tantalum tubes are doing their part in the National Defense program. It is natural that GAMMATRONS play an important role, that designers should turn to the pioneer in the field for new tantalum tube developments. It is natural that when tantalum tubes are considered users all say —

# GAMMATRONS of course!

# Where Weight *Counts*

---

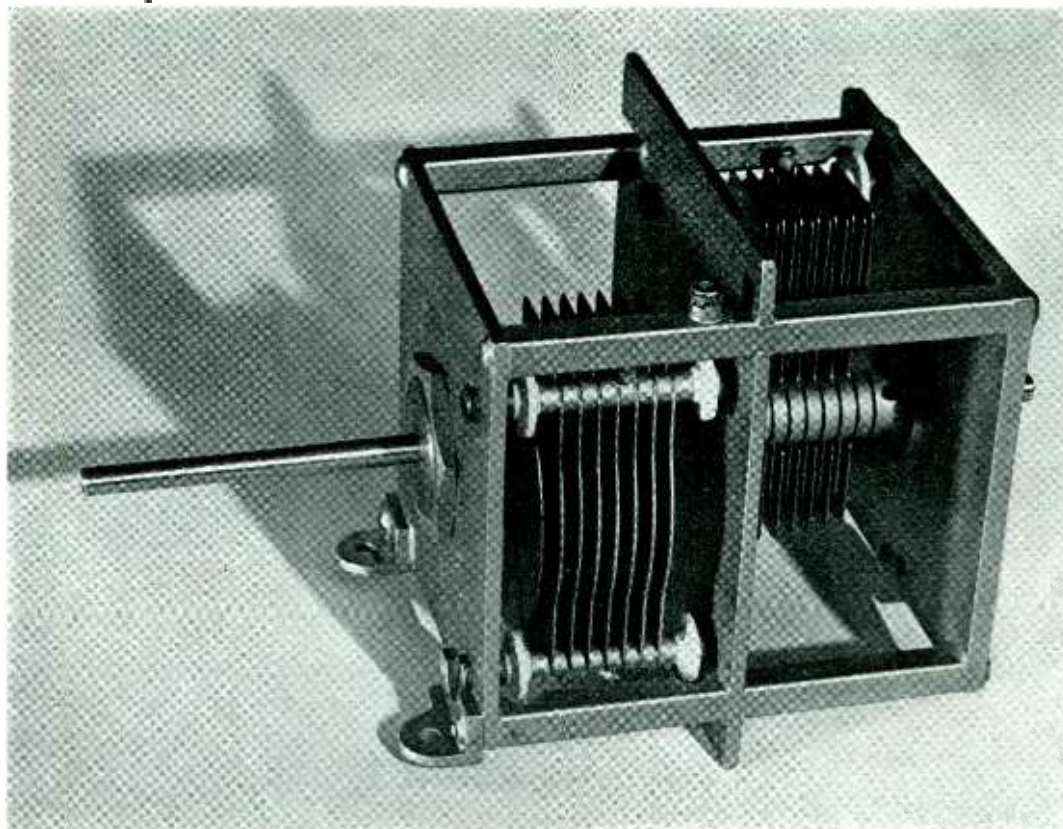

Plated Aluminum Condenser 100% Soldered

**D**EVELOPED especially for aviation, Hammarlund's plated aluminum condensers combine rigidity of soldering with the light weight of aluminum. This saving in weight makes possible greater pay-load capacity in commercial aviation and greater striking range or increased armament of military ships.

---

**THE HAMMARLUND MANUFACTURING CO., INC.**  
424-438 West 33rd Street, New York, N. Y.

**ANACONDA WIRE & CABLE COMPANY**  
INTER-OFFICE CORRESPONDENCE

New York, September 1941

To: Advertising Department  
From: Vice-President's Office  
Subject: Advertising - 1941  
Referring to: National Defense  
File Reference: WES

In line with our recent conversation will you work up ads explaining to our customers the effect of national defense on our regular business. These ads must emphasize:

1. Our true appreciation of customers who have helped us build our business in the past.
2. Our trust in their appreciation that we must make the defense program our first job; explain all copper is now allocated by OPM and use of rubber is restricted.
3. Our regret that we cannot keep them supplied as we would like because of the defense program.
4. Our sincere effort to maintain customer good will so that we all may benefit when the emergency is over.

*AWS  
This says  
everything -  
let's make  
it ad #1 EFL*

Remind everyone of this, too. No matter how long the emergency, our research laboratories will carry on in the same way as always. We'll be making product improvements, developing new and better products to the end that when it's all over, our customers and ourselves will reap the benefits of this work.

- J -

41375

# Anaconda Wire and Cable

Anaconda Wire & Cable Company, General Offices: 25 Broadway, New York City  
Chicago Office: 20 No. Wacker Drive • Subsidiary of Anaconda Copper Mining Company  
Sales Offices in Principal Cities



**Designed — electrically and  
mechanically to YOUR specifications**

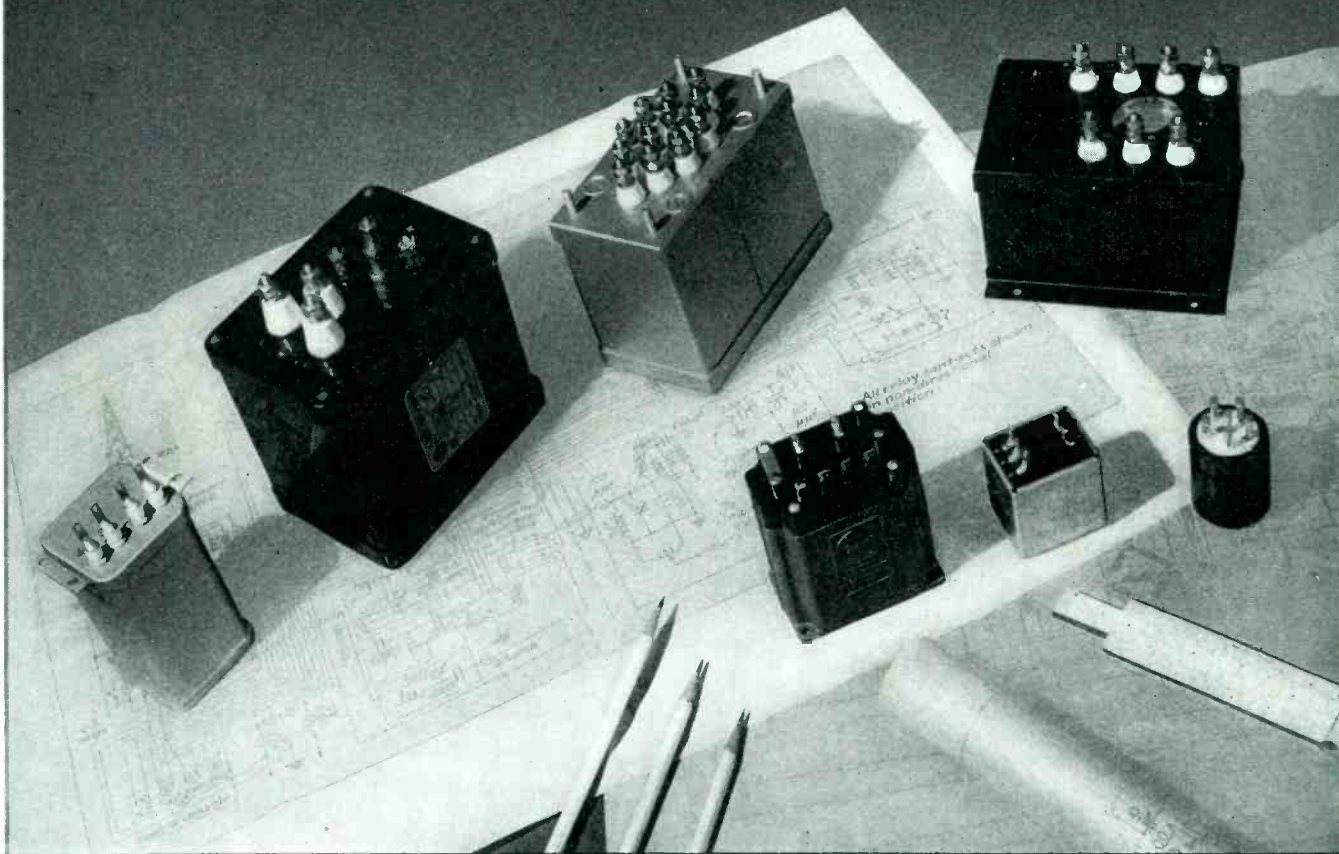

**M**ANUFACTURING transformers for all industrial, electronic and laboratory applications has been our specialized work for 40 years. Today, a very important part of this business is with the electronic industry, and especially with manufacturers who purchase components for refabrication in *their* products. For these customers, AmerTran engineers develop designs to meet exact electrical and mechanical requirements.

While the present needs of National Defense are taxing our expanded engineering and manufacturing facilities, AmerTran quality will not be impaired. The benefits resulting from present experiences will, in the future, place us in a still stronger position to serve our regular and new customers in the commercial field.

**AMERICAN TRANSFORMER CO., 178 EMMET ST., NEWARK, N. J.**



Manufacturers since 1901  
at Newark, N. J.

**AMERTRAN**

***You asked for it . . .  
and here it is!***

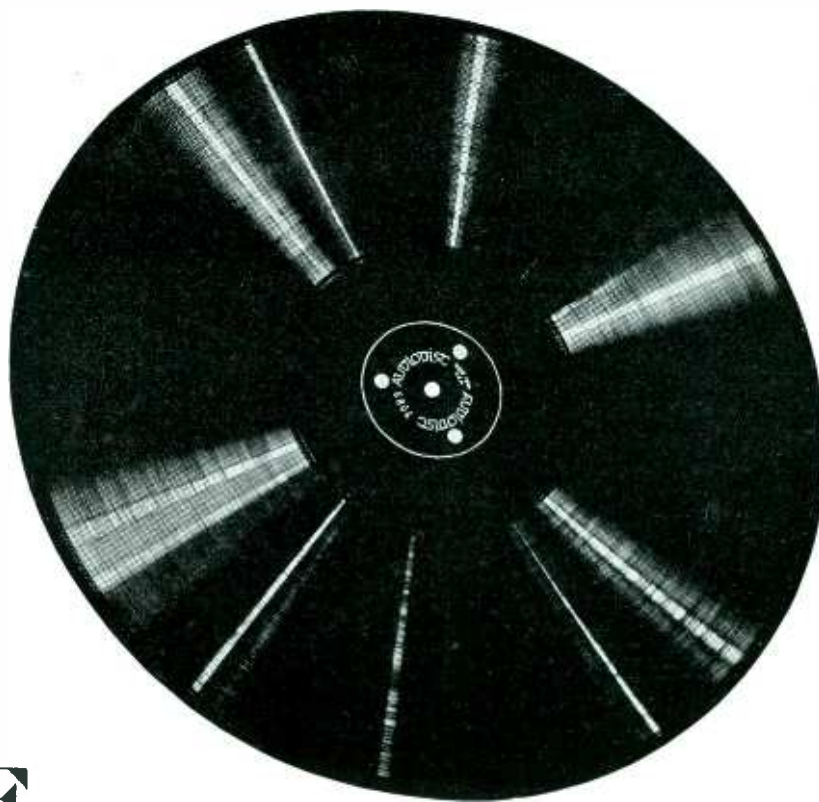

**SENSATIONAL NEW**

**4 HOLE**  
GLASS BASE  
**audioidisc**

**“Return to Normalcy”**

When aluminum vanished as a base material, you looked to AUDIO to engineer a suitable alternative — *in a hurry!* AUDIO promptly made available the first glass base discs. To AUDIO, however, these early models were but a stop-gap, pending development of this sensational new Red Label AUDIODISC.

Here is the answer to your most exacting demands — a brilliant achievement of AUDIO engineers, sparkling with exclusive AUDIO features that carry our industry a giant stride forward.

AUDIO is as grateful for your confident patience as it is proud to lead the way again, out of an era of inconvenience and expense.

**LOOK at these EXCLUSIVE FEATURES!**

SERIES 6000 — RED LABEL AUDIODISCS

- Thin, flexible glass base, with center hole and *three* drive-pin holes in new type fiber insert.
- Conventional overall thickness; cutting head adjustments and use of special turntable pads eliminated.
- New strength, the coating being a high percentage of total thickness. Perfect coating-to-glass bond.
- Amazing durability through scientifically correct strength-to-weight ratio.
- Less static charge in cutting.
- Flawless surface, lower surface noise, longer playback life, no deterioration.
- Coating formula and process now acclaimed the industry's outstanding best.
- Safe delivery. All Audioidiscs are shipped in specially designed reusable wood packing cases, approved by the transportation companies.

**Safety Package for Re-shipment**

Specially designed and equipped safety cartons, approved by the transportation companies, are now available to you *at cost* for re-shipping 1 to 3 Audioidiscs:

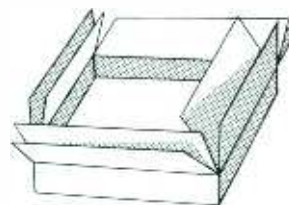

**CALL YOUR JOBBER, OR WIRE US FOR COMPLETE INFORMATION TODAY**



**AUDIO DEVICES**  
INCORPORATED

**1600 BROADWAY  
NEW YORK CITY**

# Motorola

## 2-WAY F-M RADIO SYSTEM EXPEDITES HANDLING OF ST. LOUIS STREET CAR AND BUS EMERGENCY SITUATIONS

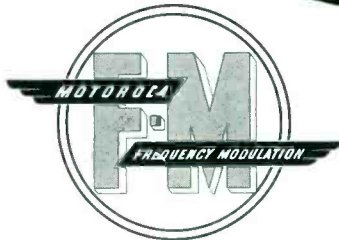

With the aid of Motorola F-M 2-Way Radio Communication System, the Public Service Company of St. Louis is now able to speed up the handling of street car and bus emergency situations . . . This modern installation of Motorola equipment was made under the direct supervision of Motorola engineers.

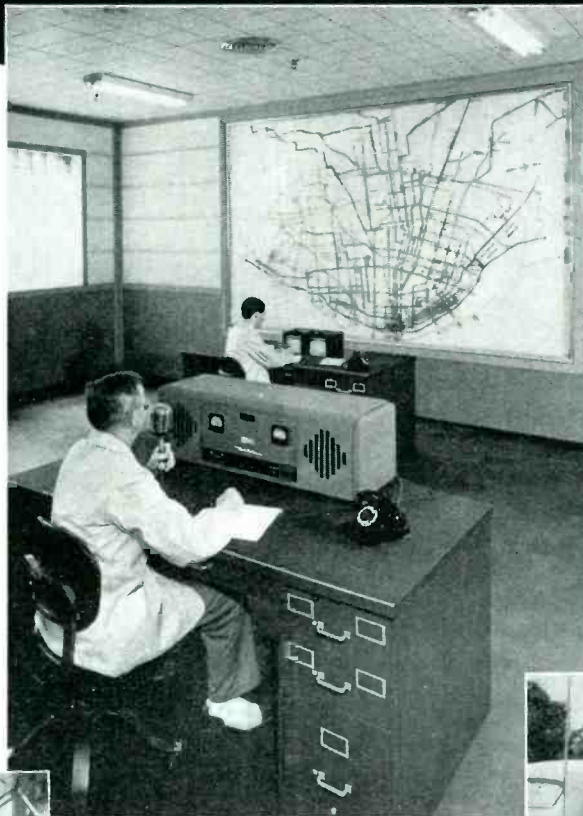

In front of central dispatcher is a map showing car and bus routes and the reverse side shows the radio districts into which the system is divided. A mobile supervisor with radio cruises each district. Headway recorders check up on the spacing of street cars. Impulses generated by cars passing over regularly spaced trolley contactors are transmitted by telephone lines to recording instruments. Delays or disruption to service are immediately apparent.

The map shows the dispatcher the radio district in which emergencies arise. 2-way radio contact is established with the supervisor who is instructed to investigate the emergency and report details. Trouble trucks dispatched to the emergency are equipped with 2-way radio.



The Public Service Company of St. Louis has trouble trucks all equipped with Motorola F-M 2-Way Communication Equipment.



The Public Service of St. Louis has 15 cruising supervisor's cars all equipped with Motorola F-M 2-Way Radio Equipment.



WRITE FOR COMPLETE DESCRIPTIVE LITERATURE AND TECHNICAL DATA

**GALVIN MFG. CORPORATION ★ CHICAGO, ILL.**

MAKERS OF THE FAMOUS MOTOROLA AUTO AND HOME RADIO

# Capacitor performance fine enough for a Flagship

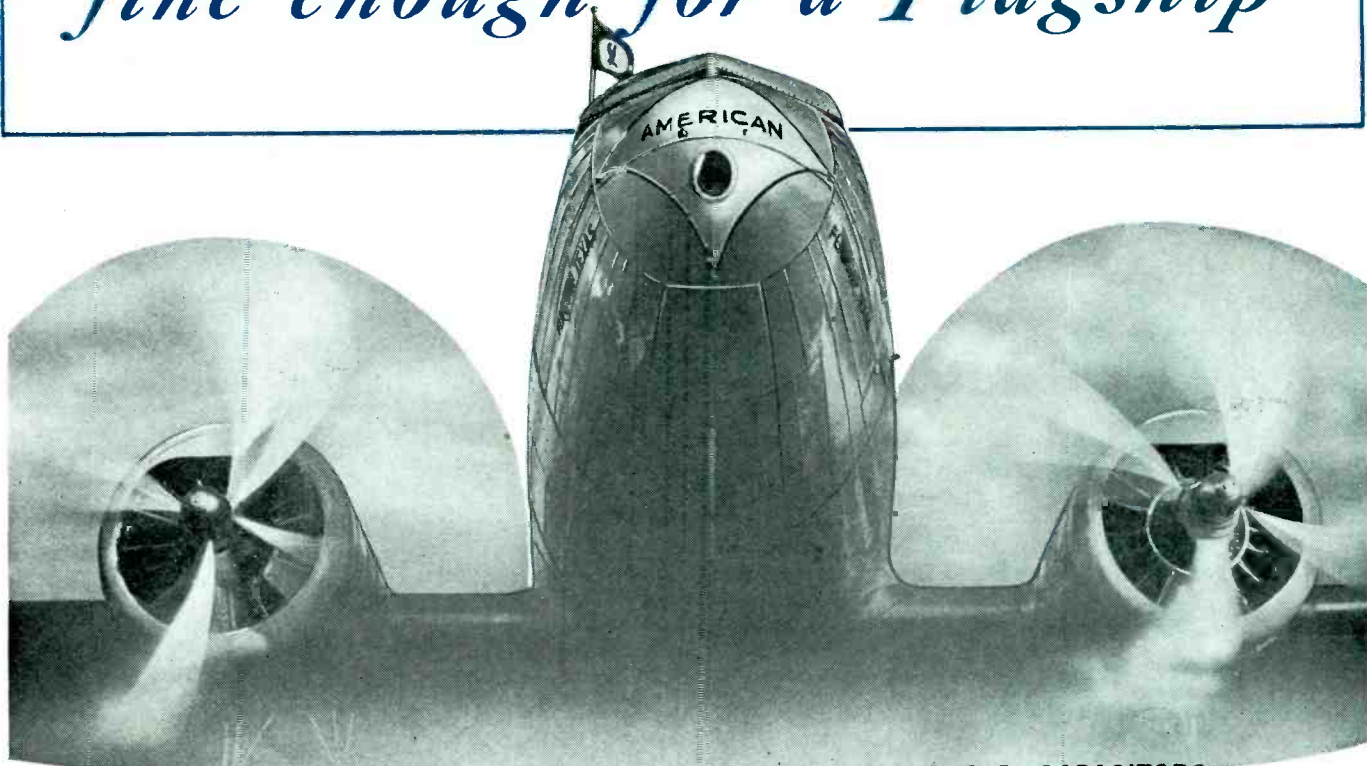

## THERE'S EXTRA DEPENDABILITY IN LONGER LASTING C-D CAPACITORS

A good test of capacitor performance occurs along the routes of the Flying Flagships. There's some difference in altitude and a great deal of temperature change between New York and Tucson . . . Toronto and Fort Worth. So it's significant that American Airlines use Cornell-Dubilier capacitors throughout its aircraft and ground transmitting and receiving communication equipment.

But not surprising. For back of today's Cornell-Dubilier capacitor looms the longest engineering experience in the industry—more than 31 years of capacitor specialization. And out of this has come the capacitor "know how" that gives C-Ds their *extra* dependability—an important reason why, *today* it *pays to FLY* . . . and pays you to specify Cornell-Dubilier, whatever your capacitor requirements.

CAPACITORS MAY LOOK ALIKE BUT . . . *There is extra long life, extra uniformity and*

*dependability built into C-Ds. Next time you specify capacitors look for the Cornell-Dubilier seal of experienced engineering. And get the hidden extras at no extra cost. Send for Catalog, Cornell-Dubilier Electric Corporation,*

*1006 Hamilton Blvd., South Plainfield, New Jersey.*



MICA • DYKANOL • PAPER • WET AND  
DRY ELECTROLYTIC CAPACITORS

# Cornell Dubilier



SOUTH PLAINFIELD, N. J.

NEW BEDFORD, MASS.

. . . MORE IN USE TODAY THAN ANY OTHER MAKE . . .

# The World's Longest Stretch

**OF LIGHTED HIGHWAY** ( **QUEEN ELIZABETH WAY**  
TORONTO TO NIAGARA FALLS )

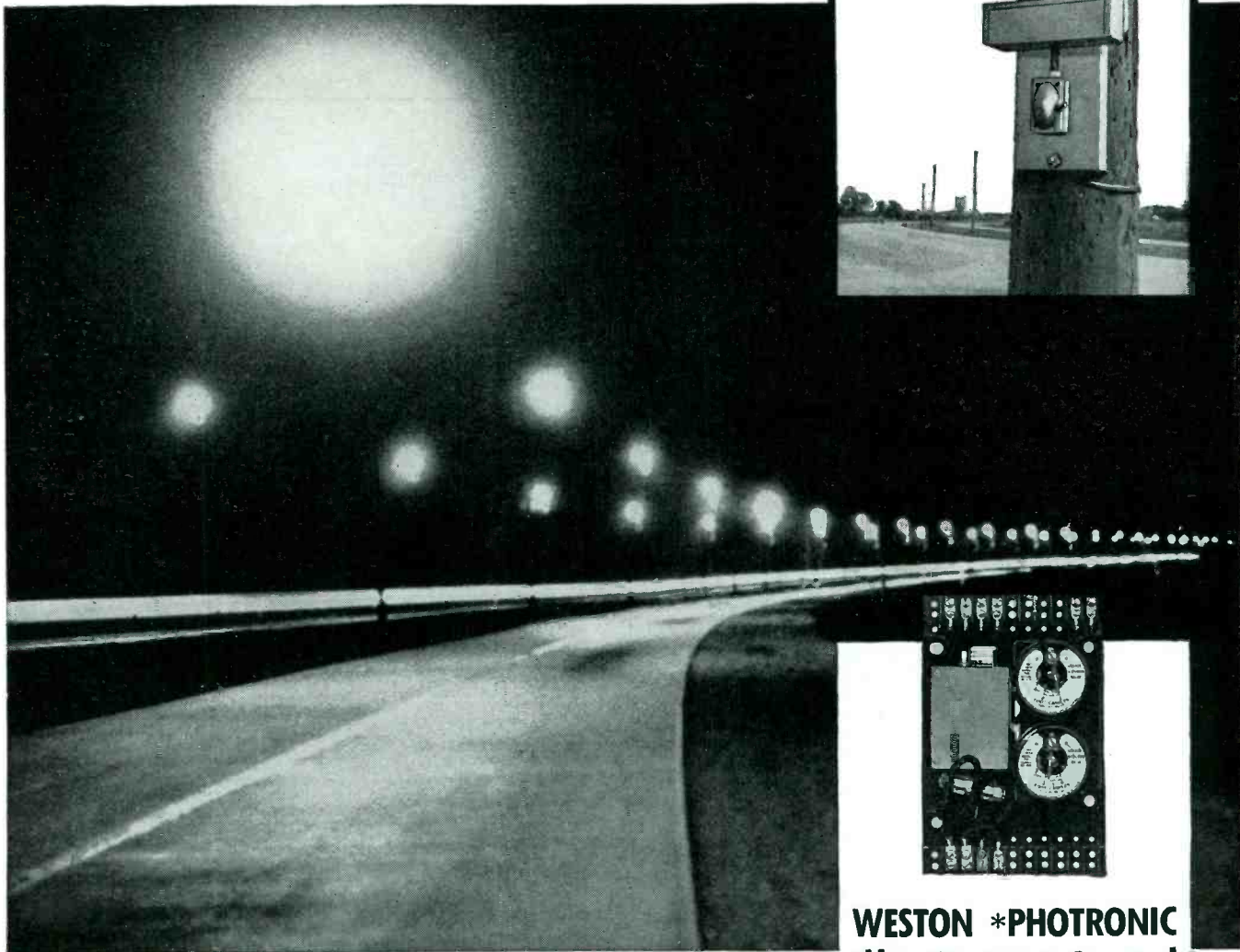

*...Another* highway with all lighting automatically controlled by the

**...SIMPLE, DEPENDABLE**

**WESTON \*PHOTRONIC METHOD**

*\*PHOTRONIC—A registered trademark designating the photoelectric cells and photoelectric devices manufactured exclusively by the Weston Electrical Instrument Corporation.*

## WESTON \*PHOTRONIC Illumination Control

The most practical, most economical lighting control for streets and highways, airways, plant illumination, etc. Employs the proved, self-generating WESTON Photronic Cell. No amplifying equipment necessary. Cell can be mounted any distance away from relay cabinet. Permits independent setting of both the "on" and "off" illumination values. Uses no energy when not operating; consumes but 2 watts during a 1 minute operating cycle. Weston Electrical Instrument Corporation, 618 Frelinghuysen Avenue, Newark, New Jersey.

Laboratory Standards . . . Precision DC and AC Portables . . . Instrument Transformers . . . Sensitive Relays . . . DC, AC, and Thermo Switchboard and Panel Instruments.

# WESTON

Specialized Test Equipment . . . Light Measurement and Control Devices . . . Exposure Meters . . . Aircraft Instruments . . . Electric Tachometers . . . Dial Thermometers.

**FOR OVER 53 YEARS LEADERS IN ELECTRICAL MEASURING INSTRUMENTS**



*Again!*

**KOOLOHMS LEAD THE WAY**  
with two long-awaited improvements



**METER MULTIPLIERS  
THAT WITHSTAND 150° C.**

**HIGHER RESISTANCE  
VALUES IN LESS SPACE**  
*(Example: 4 megohms in Type MFB)*

**THIS CONSTRUCTION REVOLUTIONIZED  
WIRE WOUND RESISTOR DESIGN**

*Resistance wire touches but  
cannot short*

Engineers will be quick to appreciate the many advantages made possible in the wire wound resistor construction by the exclusive Koolohm process of insulating the wire itself *before it is wound*. This permits layer windings for higher resistance in less space; progressive windings for non-inductive resistors that are truly non-inductive even at 50 to 100 Mc.; larger wire sizes; faster heat dissipation; greater stability; extreme accuracy and greater humidity protection. No secondary insulations such as brittle cements or enamels are needed on the windings. For double protection, however, most Koolohm types are encased in a sturdy outer ceramic shell that will not peel or chip and allows for mounting directly to metal parts. Koolohms are made in a full line of shapes, types and sizes for all needs. Write for the new edition of the Koolohm Catalog.

In conformity with standard Koolohm Resistor construction, these new Type MFA and Type MFB Meter Multipliers are made with wire that is insulated *before it is wound* with a tough, 1000° C. heat-proof, moisture-proof ceramic material (U. S. Patent No. 2,213,969). They are further protected by a Pyrex glass high-voltage insulator tube, 1/8" thick and heat-treated. By test and in actual use, they have proved their ability to withstand temperatures as high as 150° C.—considerably higher than any other resistors of this type.

**APPROVED FOR NATIONAL DEFENSE**

These units are approved for exacting defense applications where they have set new standards of performance under adverse salt water immersion conditions. Complete information gladly sent upon request. Sprague engineers will gladly cooperate in helping you choose the proper Koolohm for greater dependability, longer life on practically any wire wound resistor application.



Koolohm wire with section of ceramic insulation removed.

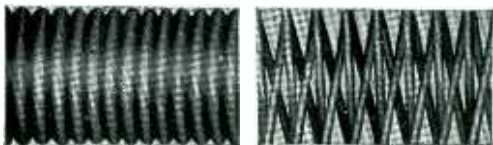

Single layer winding

Progressive winding

Type MFA KOOLOHM (9-13/16" long) is available in resistance ratings of 3.5, 4.0, 4.5, 5.0 and 6.0 megohms, with voltage ratings of 3.5, 4.0, 4.5, 5.0 and 6.0 KV respectively.

Type MFB KOOLOHM (5-5/16" long) is available in resistance ratings of 1.0, 1.5, 2.0, 2.5, 3.0, 3.5 and 4 megohms, with voltage ratings of 1.0, 1.5, 2.0, 2.5, 3.0, 3.5 and 4 KV.

**SPRAGUE SPECIALTIES CO., RESISTOR DIVISION**  
North Adams, Mass.

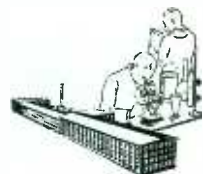

**SPRAGUE KOOLOHM RESISTORS**  
*Greatest Improvement in Wire Wound Resistor Construction in 20 Years*

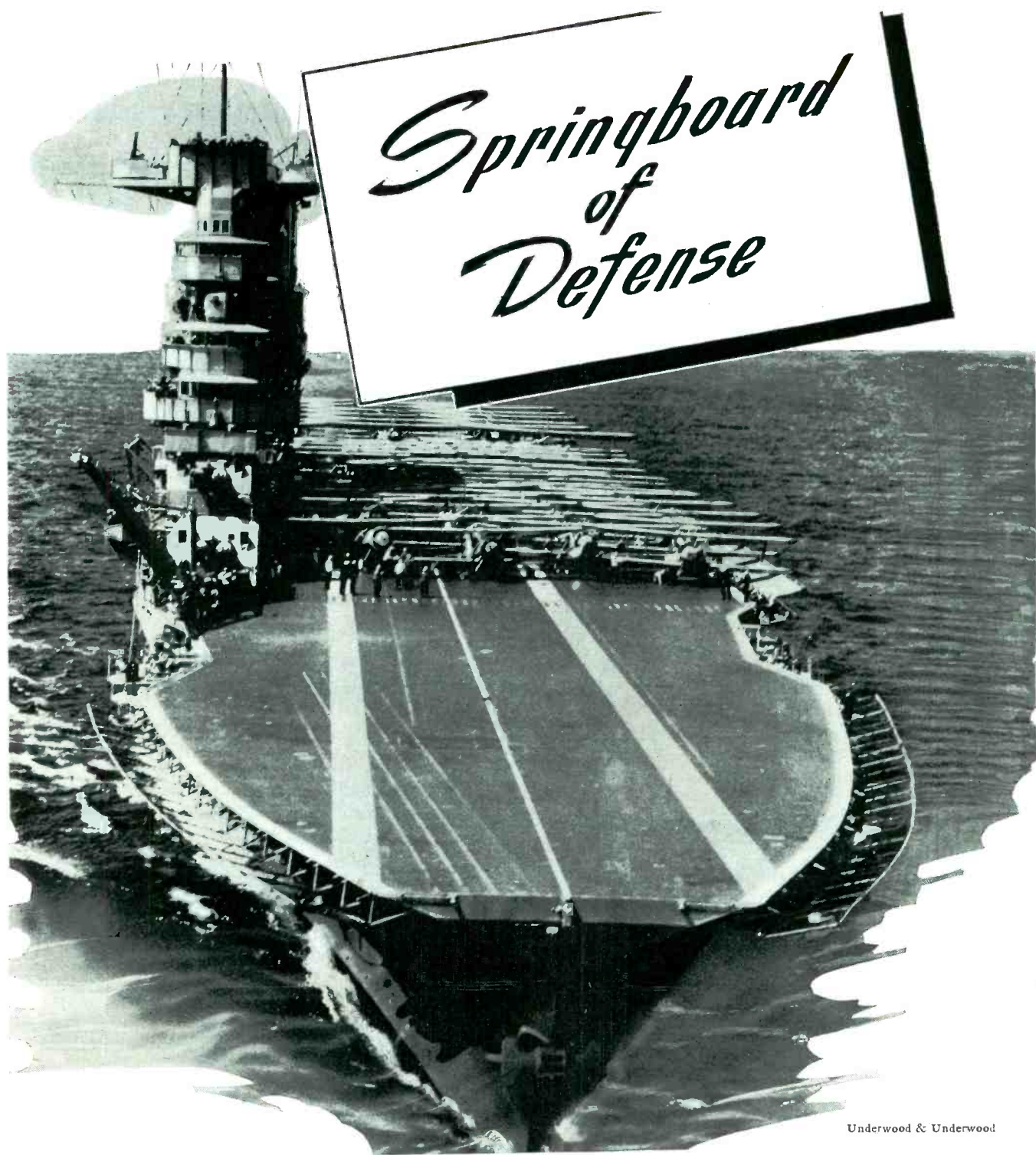

Underwood & Underwood

In shop and factory all over our land, men, machines and materials are the springboard of our defense effort. The demand for greater production has been met by rapidly expanded facilities, and by the sharply accelerated use of an increasing number of newer materials. INSUROK and other Richardson precision plastics have solved many production problems, and are firmly established as essential defense materials.

*Precision* **INSUROK**

*The* **RICHARDSON COMPANY**

MELROSE PARK, ILL.      FOUNDED 1858      LOCKLAND, OHIO  
NEW BRUNSWICK, N. J.      INDIANAPOLIS, IND.  
DETROIT OFFICE: 4-252 G. M. BUILDING  
NEW YORK OFFICE: 75 WEST STREET

# In the considered judgment of leading engineers...

When important decisions are made about vacuum tubes it is not uncommon for an Eimac tube to win the honors. Reason: the designers of Eimac tubes have consistently held as their objective the anticipation of the future requirements of the radio industry. Efforts have not been confined to the production of a tube for yesterday's requirements.

This policy has kept Eimac tubes ahead of the industry... a factor that is logical because the efficiency and progress of radio depends almost entirely upon the development of new ideas... new improvements in vacuum tube performance. Take the Eimac 250T, for example, which now possesses the most recently developed refinements. Check these features illustrated below and then check the performance of Eimac tubes in your transmitter. You'll see why Eimac tubes are found in most of the important new developments in radio.

Follow the leaders to

# Eimac TUBES

Eitel-McCullough, Inc.  
San Bruno, Calif.

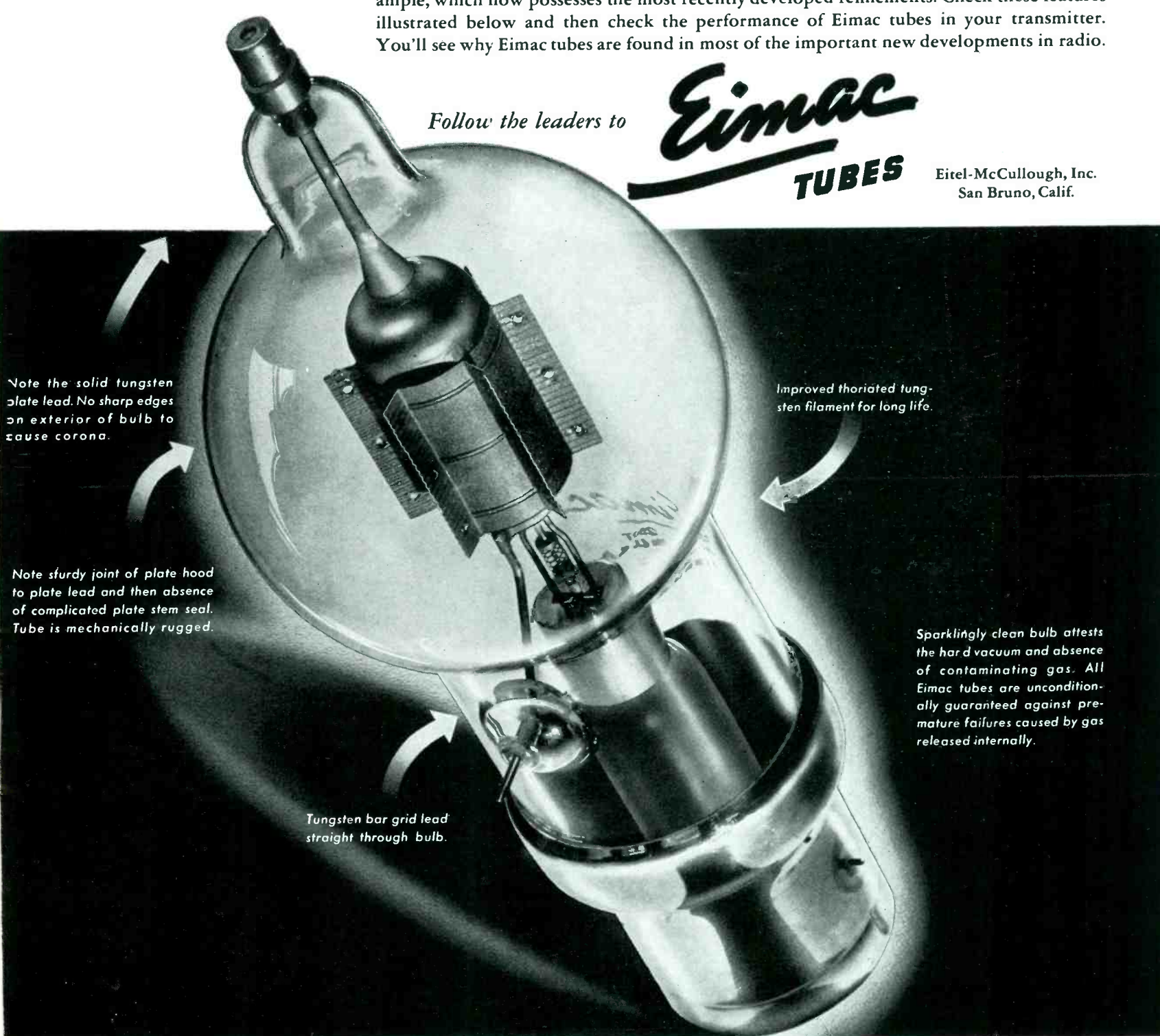

Note the solid tungsten plate lead. No sharp edges on exterior of bulb to cause corona.

Note sturdy joint of plate hood to plate lead and then absence of complicated plate stem seal. Tube is mechanically rugged.

Tungsten bar grid lead straight through bulb.

Improved thoriated tungsten filament for long life.

Sparklingly clean bulb attests the hard vacuum and absence of contaminating gas. All Eimac tubes are unconditionally guaranteed against premature failures caused by gas released internally.

## EIMAC REPRESENTATIVES

California, Nevada  
HERB BECKER, 1530 W.  
104th St., Los Angeles, Cal.  
N. Y., N. J., Penn., Md., Del.,  
Dist. of Col., Maine, N. H.,  
R. I., Conn., Mass.  
ADOLPH SCHWARTZ, 262  
Grayson Place, Teaneck, New  
Jersey.

Wash., Ore., Idaho, Mont.  
GENERAL SALES CO.,  
Verner O. Jensen, 2605-07  
Second Ave., Seattle, Wash.  
Colo., Wyo., New Mexico,  
Arizona, Utah  
RICHARD A. HYDE, 4253  
Quitman St., Denver, Colo.

Export Agents: Frazar & Co., Ltd., 301 Clay Street, San Francisco

Chicago, Illinois, Wisconsin  
G. G. RYAN, 549 W.  
Washington Blvd., Chicago,  
Ill.  
N. Caro., S. Caro., Georgia,  
Tenn., Flor., Ala., Miss.  
JAMES MILLAR, 316 Ninth  
St. N. E., Atlanta, Georgia.

Texas, La., Okla., Ark.  
J. EARL SMITH, 2821 Live  
Oak St., Dallas, Texas.  
Ohio, Mich., Ky., Ind., Minn.,  
Mo., Kan., Neb., Iowa  
PEEL SALES ENGINEER-  
ING CO., E. R. Peel, 154  
E. Erie St., Chicago, Ill.

# If You Want the Best

*We Recommend  
these new "Coaxial" Speakers*

Ideal extension reproducer for home, club, or institution. Insures full realization of the potentialities of the finest FM or AM receivers.



Excellent "across-the-room" unit for natural, more enjoyable reproduction with chairside tuners and combinations.



Recommended by manufacturers of professional type FM/AM receivers. Be sure you can enjoy FM at its best!



## Brilliant Performance plus Complete Versatility with these New Jensen "Coaxial" Speakers

Not one—but two important achievements are combined in these new Jensen Coaxial Speakers and Reproducers! First... extended-range high-fidelity performance that meets the most critical professional requirements. Second... complete versatility, made possible for the first time by the new Jensen High Frequency Control. Now one reproducer covers every listening requirement, instantly adjustable for most satisfactory results on everything from wide range FM to home phono records! And the cost is so low it will surprise you. Data Sheet No. 120 gives complete details. Write for it today.

Four complete reproducer types with 12" to 15" speaker sizes, priced at \$75.25 to \$118.75 list in striped walnut cabinets. Utility cabinet models down to \$64.25 list. Coaxial speakers only as low as \$29.50 list.

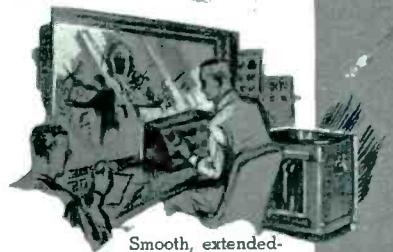

Smooth, extended-range high-fidelity response eminently qualifies these reproducers for the most exacting service in FM/AM broadcast and recording monitoring.



# Jensen

JENSEN RADIO MFG. CO., 6601 S. LARAMIE AVE., CHICAGO  
CABLE ADDRESS: "JERAD" CHICAGO

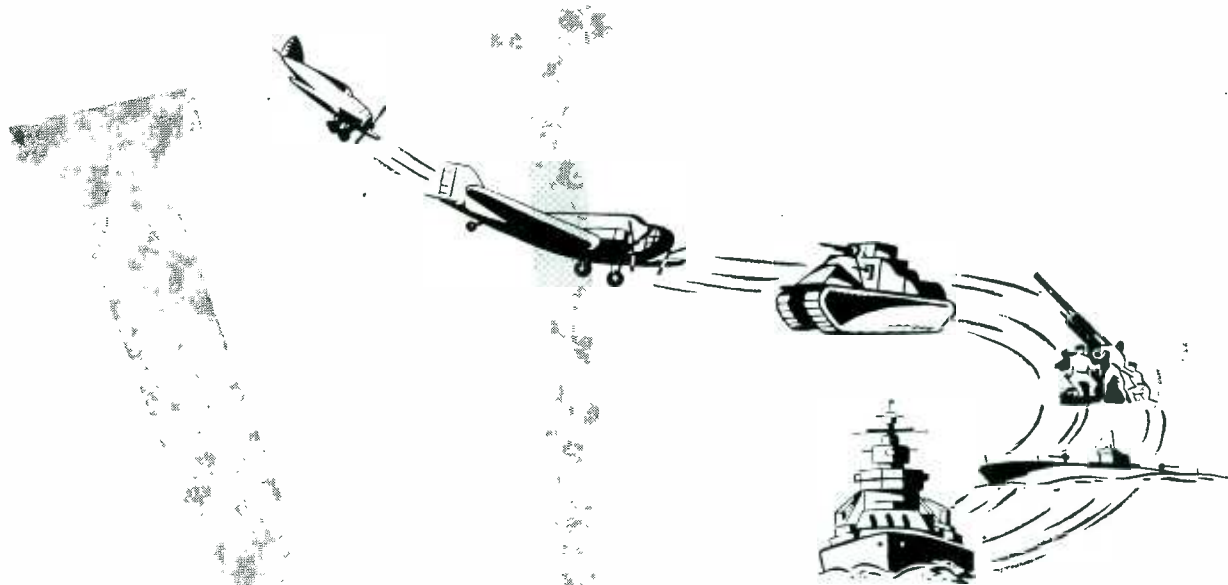

# IRC RESISTORS HELP DEFEND DEMOCRACY ON ALL FRONTS!

**F**rom Reykjavik to Singapore, from Murmansk to Sidney, from Tobruk to Chungking; at sea, ashore and aloft; at home and abroad; IRC Resistors are doing their job. In airplanes and tanks, dreadnaughts and submarines, they have been thoroughly tested in the critical laboratory of actual "shooting" war. From the world's hottest and most humid climates, to the coldest and driest, they are standing the gaff of rigorous service in practically every type of equipment where resistors are required.

This widespread use of many types of IRC Resistors in modern defense equipment is a natural result of IRC's many years of specialization as well as its close collaboration with U. S., British and Canadian defense agencies.

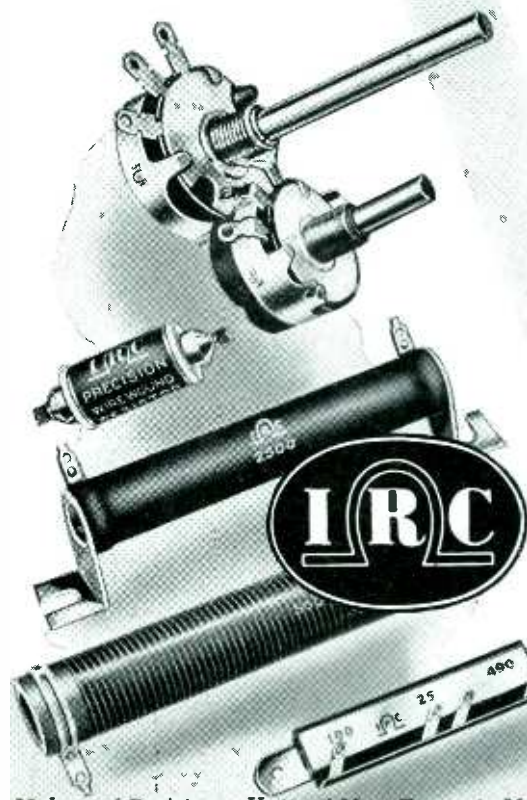

**INTERNATIONAL RESISTANCE CO.**

403 N. Broad St., Philadelphia, Pa.

*Makers of Resistance Units of More Types, in More Shapes, for More Applications Than Any Other Manufacturer in the World.*

# CONTRIBUTING TO CATHODIC PROTECTION

I. T. & T. Selenium Rectifiers  
arrest corrosion of Metal  
Pipe Lines—Steel Water Tanks  
—Underground Cables

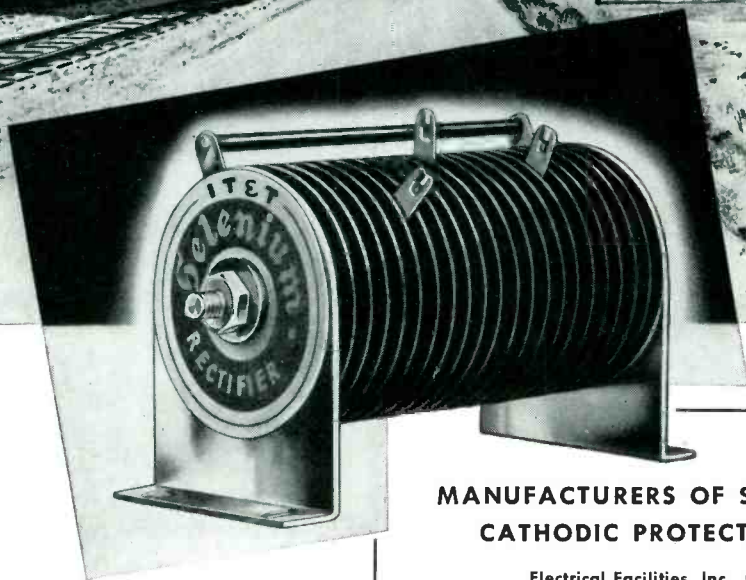

In the everlasting fight against corrosion of metallic pipe lines, underground cables, steel water tanks, etc., the introduction of the Selenium Rectifier as a cathodic corrosion eliminator has met with universal enthusiasm.

The reasons for this acceptance are many, for the I. T. & T. Selenium Rectifier, in addition to being a light weight and extremely compact unit, operates with high efficiency over an exceedingly wide temperature range . . . it has practically unlimited life and, because it is entirely metallic and rugged in construction, it requires no maintenance.

## MANUFACTURERS OF SELENIUM POWERED CATHODIC PROTECTION EQUIPMENT

Electrical Facilities, Inc., Oakland, California  
Nelson Electric Manufacturing Company, Tulsa, Oklahoma  
Rusta Restor Corporation, Fremont, Ohio

## AMONG OUR CUSTOMERS

Cities Service Gas Company · Cuban Telephone Co. · Empire Pipe  
Line Company · International Standard Electric Corp. · Montana-  
Dakota Utilities Co. · Rochester Telephone Company · San Diego  
Gas and Electric Co. · The Texas Company, [Calif.] · United Gas  
Pipe Line Co. · Valley Pipe Line Co. · Western Union Telegraph Co.

*Consulting engineering services available for specific requirements.*

*Address Rectifier Division for descriptive Bulletin*

**INTERNATIONAL TELEPHONE DEVELOPMENT CO., INC.**

**67 Broad Street, New York, N. Y.**

**YOUR ANSWER**

**TO A PRACTICAL**

*replacement*

**MATERIAL**

**FOR METALS AND CERTAIN PLASTICS . . .**

# NATIONAL VULCANIZED FIBRE

WITH emergency shortages of essential metals and certain plastics, replacement with available materials for the purpose, may be your major problem right now. In this replacement role, National Vulcanized Fibre, due to its unusual mechanical and electrical qualities, has proved, and is proving its outstanding ability. (Available in sheets, rods, tubes and special shapes.) Our engineers will gladly work with you on any application. Wire, phone or write us.

**NATIONAL VULCANIZED FIBRE CO.**

WILMINGTON  DELAWARE

Offices in Principal Cities

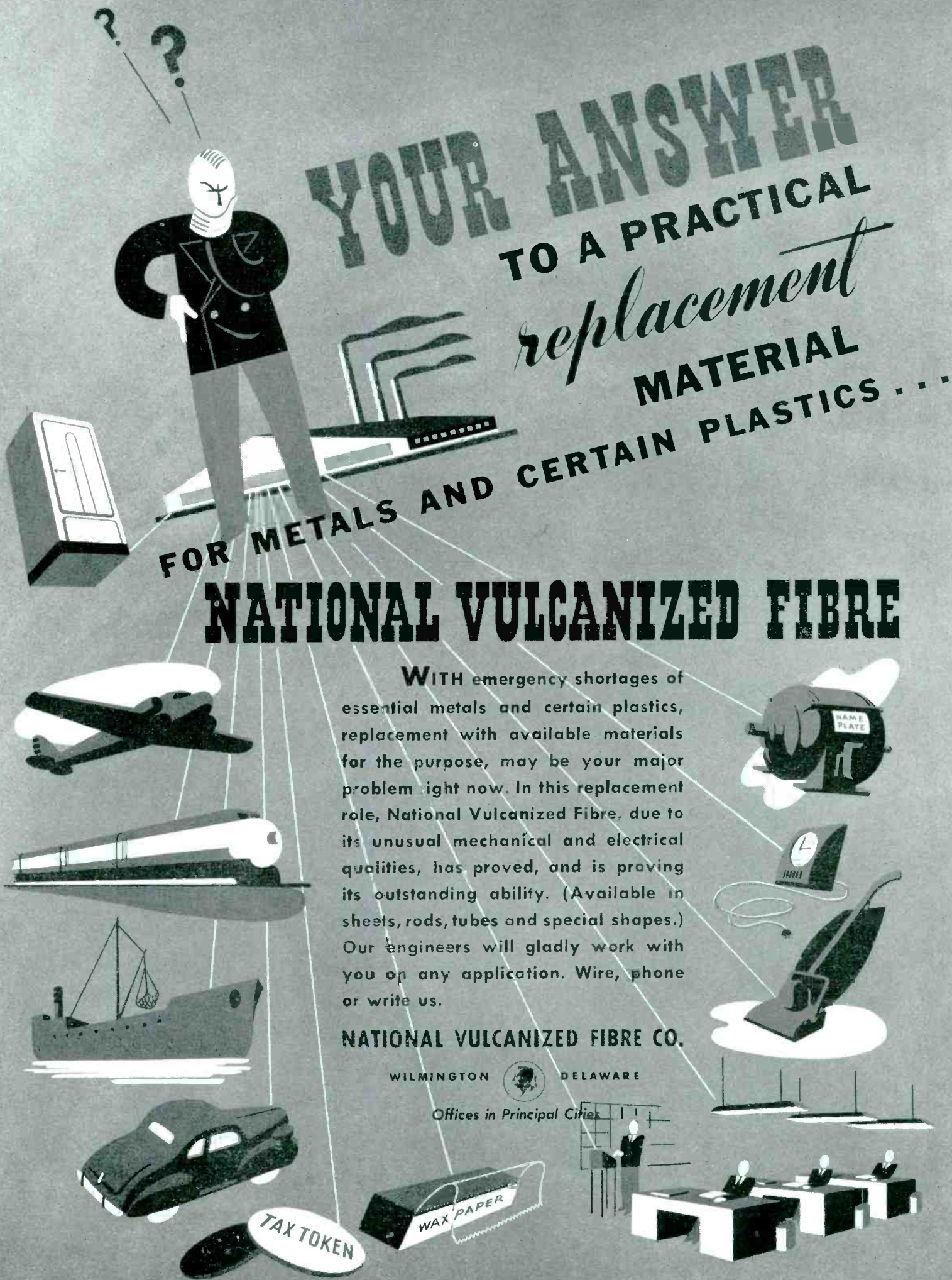

**REACTANCE STABILITY**  
*for... Defense Radio Equipment*  
 through **SIMPLE, ACCURATE, COMPENSATION**

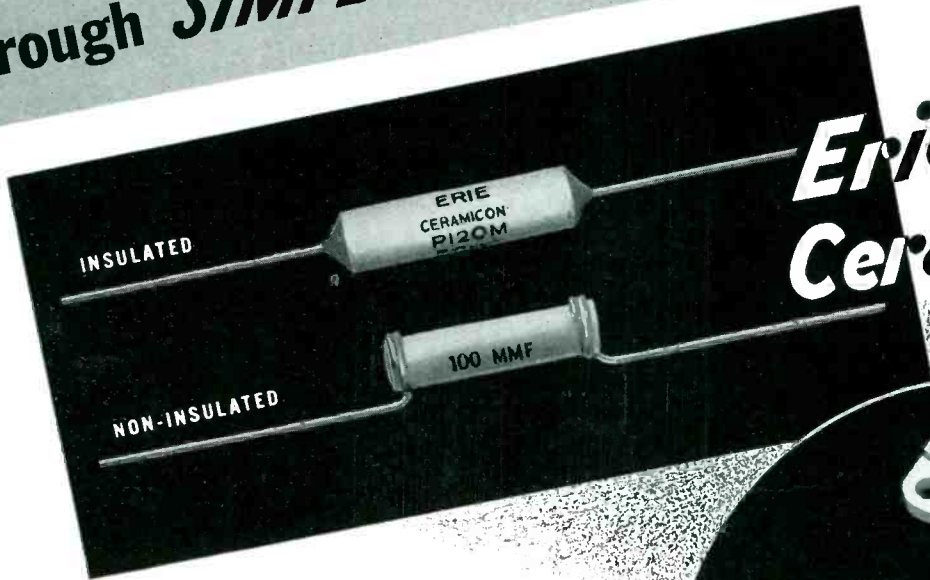

**Erie Ceramicons**  
REG. U.S. PAT. OFF.

**TUNING** stability is essential in the many forms of military and defense radio equipment. The extreme temperature variations to which these sets are subjected, can change the reactance of many components widely and result in unstable oscillator frequency.

Such undesirable frequency drift can be accurately compensated for, simply by placing a proper-value Erie Ceramicon in the oscillator, as these small ceramic-dielectric condensers have a definite and reproducible temperature coefficient. Fixed-capacity Ceramicons are made in insulated and non-insulated styles with temperature coefficients between +.00012 and -.00075 per °C. Variable capacity Ceramicon Trimmers are furnished in single and double units with temperature coefficients of zero, -.0003, and -.0005 per °C.

Many exclusive design features of these units particularly adapt them to rigorous mobile uses. For complete description write for a copy of the new, revised Ceramicon catalog.

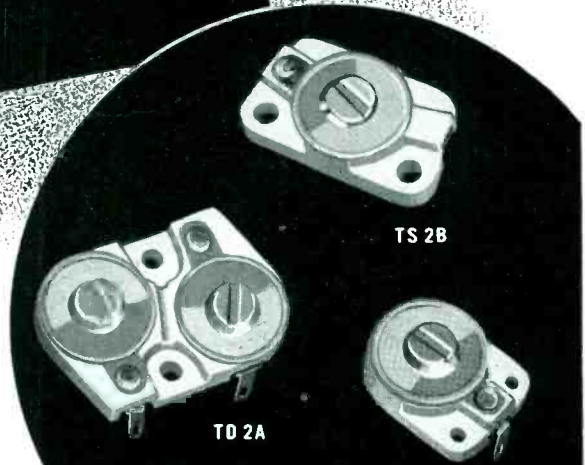

**Erie Ceramicon Trimmers**  
REG. U.S. PAT. OFF.

**ERIE RESISTOR CORP., ERIE, PA.** LONDON, ENGLAND · TORONTO, CANADA.





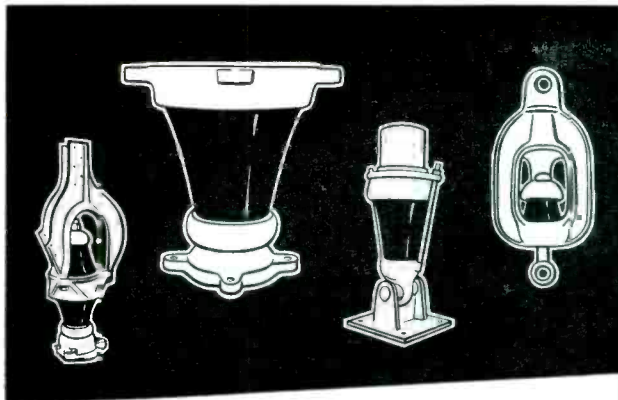

The largest and smallest. Lapp curved-side cones—for a low power pipe mast, and for the world's largest vertical radiator—1050 feet.

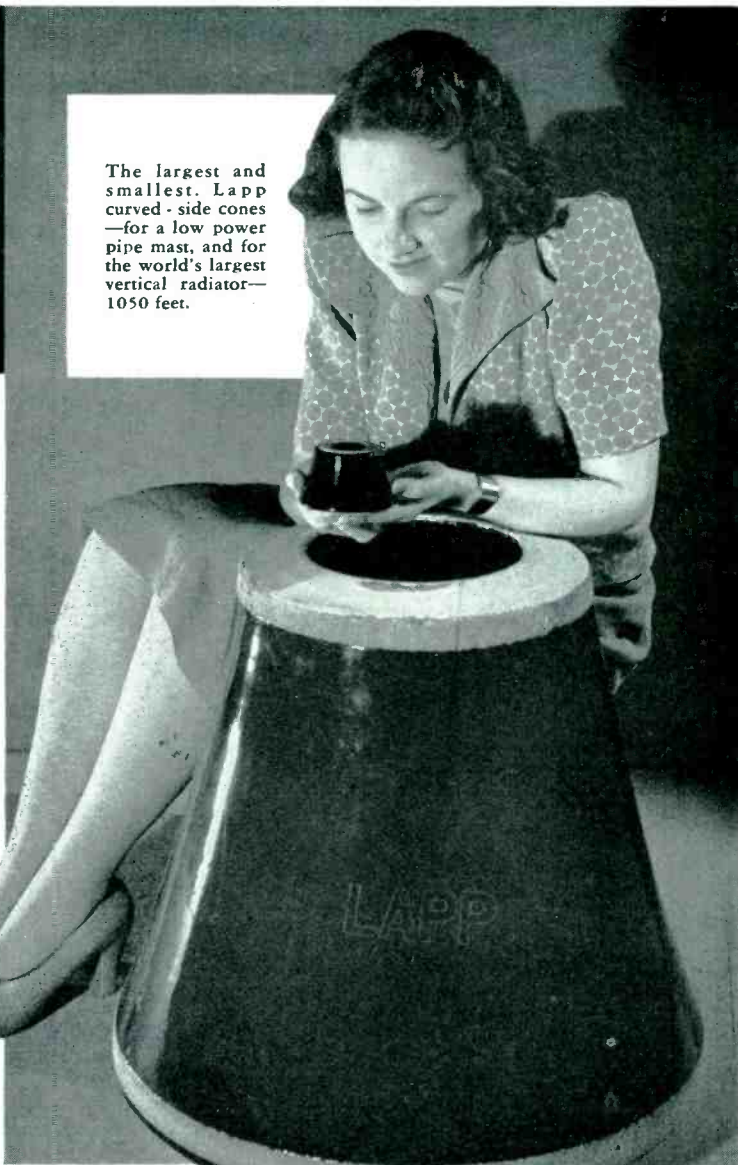

## **LAPP HAS MADE 142 DESIGNS**

**IN ANTENNA  
STRUCTURE INSULATORS**

**... ALL ARE BASED ON THE  
LAPP *CURVED-SIDE*  
COMPRESSION CONE**

Each of the 142 Lapp units—for self-supporting towers, guyed masts and mast guys—is designed around the Lapp curved-side compression cone of electrical porcelain. More than 20 years of service records prove that this Lapp design meets every operating requirement. It affords double the strength of an ordinary straight-side cone, assuring the maximum in security and permanence. Finally, each insulator, before shipment, is tested by loading to 50% more than maximum design load. Most radio engineers know they've covered the insulator question adequately when they say to their tower manufacturer, "Use Lapp Insulators." Lapp Insulator Co., Inc., LeRoy, N. Y.

*Specify* **LAPP**  
**FOR SECURITY IN ANTENNA STRUCTURE INSULATORS**

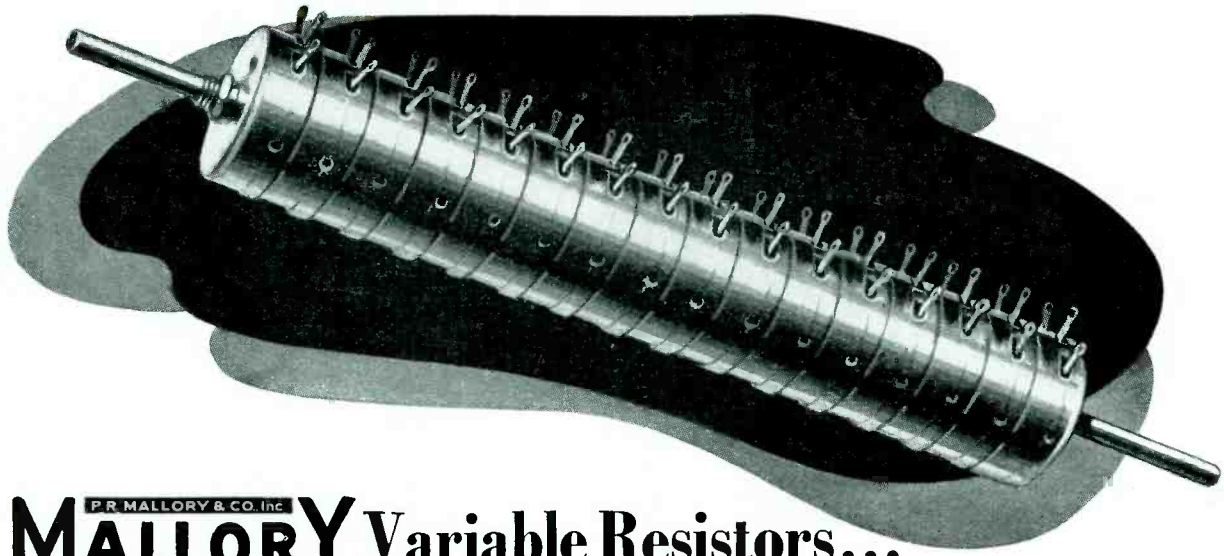

# P. R. MALLORY & CO. Inc. MALLORY Variable Resistors...

*Single Gang...or 16 Gang...It's all in a day's Orders!*



**M TYPE VARIABLE RESISTOR**  
Insulated contact arm, dissipates 4 watts. 281° effective electrical rotation.



**C TYPE VARIABLE RESISTOR**  
Grounded contact arm, dissipates 2 watts. 266° effective electrical rotation.



**E TYPE VARIABLE RESISTOR**  
Grounded contact arm, dissipates 9 watts. 304° effective electrical rotation.

A prominent manufacturer of regulating devices needed a special potentiometer of 16 gangs and needed it quickly. The problem was presented to Mallory engineers, the job put into production, finished and delivered *on time and right* from every standpoint.

Solve a problem... fill a need... find a new way... They're all in a day's orders for Mallory engineers.

In addition to the standard wire-wound rheostats and potentiometers shown at the left, Mallory also manufactures and stocks high-resistance, carbon element controls in both standard and midget types... values from 5000 ohms to 9 megohms. Special construction features insure noiseless operation.

Manufacturers in many fields have turned to Mallory Variable Resistors, potentiometers, rheostats and attenuators for laboratory equipment, test and production devices where quiet action and critical adjustments are needed.

*Send for this catalog*

Be sure of a handy reference to the entire Mallory line of approved precision products. It will save time and money.

**P. R. MALLORY & CO., Inc., INDIANAPOLIS, INDIANA**

Cable Address—PELMALLO



# CROSS TALK

► **SIGNALS** . . . With the pretty complete disruption of the radio industry so far as non-defense products is concerned, and with the vast sums of money being spent, one cannot but wonder how much of the money is going to our industry, and what the country will get for it. Our curiosity along these lines cannot be completely satisfied at the present moment because "to a military expert, disclosure of the amount of the equipment affords a vital source of deduction as to contemplated defensive or offensive measures with a corresponding increased ability to counteract those measures."

So said Under Secretary of War Patterson before the Truman Committee of the United States Senate on July 15, reporting on the actual accomplishment in Army procurement during the fiscal year ending June 30. In his report, however, are some round figures on expenditures by the Signal Corps which give an idea of the magnitude of the effort in which the communications industry is at work.

During the fiscal year 1941 some 103 millions of dollars were to be spent for aircraft communication equipment alone; by June 21, 1941, 11.5 millions had been delivered. During the fiscal year 1941 an expenditure of 38 millions was allocated for portable ground radio equipment, to be carried by man, by parachute, by truck. Radios for tanks and armored cars account for

41 millions; wire and cable (32.5 millions) and miscellaneous purchases of 7.8 millions will bring the total to some 223 millions of dollars. Part of

the portable ground equipment money went for radio locaters—but the big money for this material will be spent in 1942 as the pie chart shows.

1942  
Total Signal Corps Expenditures for Communication Equipment  
\$221,000,000

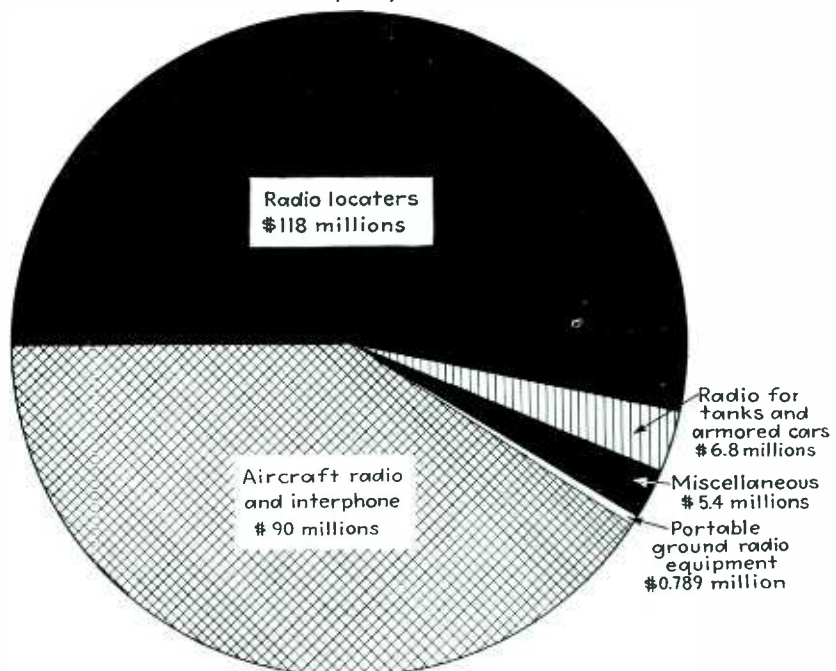

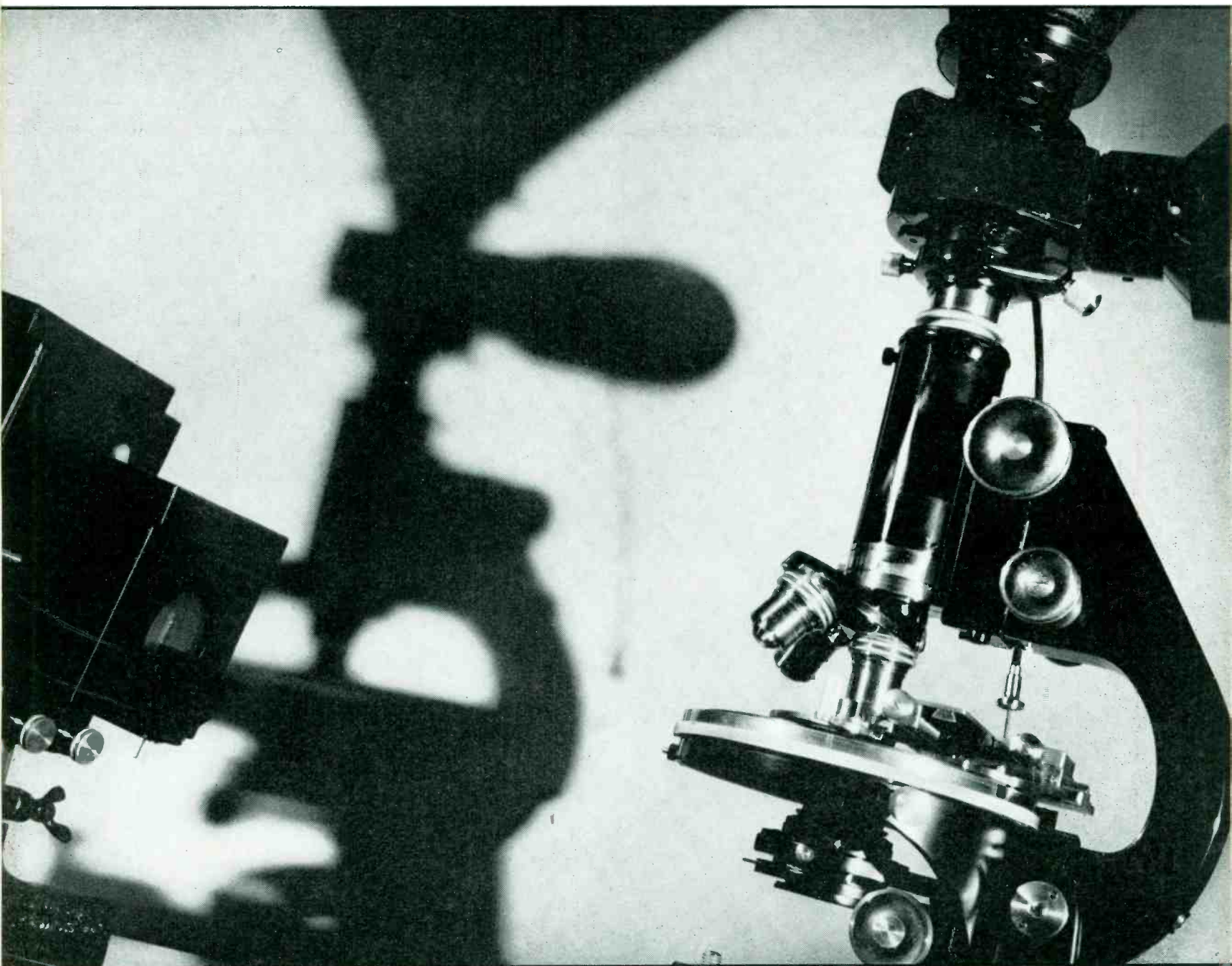

PHOTOGRAPH BY WILLIAM WARD

Research is a very powerful tool in adapting plentiful materials to do the jobs formerly done by materials now unavailable because of National Defense requirements. Mr. LeBel's article describes an outstanding example of the value of such research in that aluminum, in great demand for the production of airplanes, was replaced by readily available glass

# RESEARCH BEATS THE PRIORITIES

---

When recording disc manufacturers were forced to abandon aluminum as a base material the groans were many, but glass is proving that it is a superior material for this purpose. Events leading to the adoption of glass and some of the technique of using it are outlined

---

By C. J. LeBEL  
*Audio Devices, Inc.*

**R**ESearch often takes quite a while to yield useful results, but the preparatory work which has been done may be the saving factor in an emergency. This is the case with the aluminum substitute problem in the instantaneous recording field. For nearly two years proposed materials were studied, more with the idea of improving quality or reducing cost than with any feeling of imminent emergency. Nevertheless, when aluminum priorities were imposed at the end of February, all of this groundwork was a godsend, for it meant not starting completely fresh but completing an almost finished solution. We had found out exactly what should not be done. There was nearly enough aluminum on hand to take up the slack while a new material was put into production.

So the problem was not to decide in which direction to go, but merely to go ahead. Of course going ahead involved carload lots of material and this took some time to secure, perhaps longer than was anticipated. But there was no frantic scurrying around trying to decide what to do.

From the *professional* record user's point of view aluminum has been valued as a base material chiefly for its extreme flatness and perfectly smooth surface. To maintain the flatness within its normal range of  $\pm 0.005$  inch has further involved freedom from warping, considerable strength, fair stiffness, and no softening at moderate temperatures. Maintenance of surface smoothness involves reasonable hardness and ab-

sence of surface porosity. The problem has been to find other materials at least equal to and preferably superior to aluminum. Nothing poorer in these respects would satisfy the critical professional user.

#### The Preparatory Period

Early in 1939 the search for a new base material for professional instantaneous recordings was begun. The first tests were on records made of cardboard, hard fiber and other pressed boards. The porous surface produced a serious grain, but the worst complaint lay in the inherent tendency to buckle and twist. Special lacquer formulas adaptable to cardboard proved soft and seriously lacking in high frequency response; they were suitable for a home quality disc perhaps, but certainly not for a good professional product. Research along this line has been continued to the present day but with identical results.

The next step was in the field of synthetic resin plastics. A thermoplastic resin re-softens every time it is heated. Our experience with thermoplastics was unfortunate. A temperature considerably below the normal softening point would cause the disc to droop gradually in accelerated cold flow. This caused a great deal of difficulty in curing the records, and in fact, long before the end of the curing operation the disc assumed a U shape which made it utterly worthless. The curing operation is vital to production of a good product and so cannot be discontinued. There was a certain amount of warping after the material had cooled off as well and thermoplastics were quickly abandoned.

Thermosetting resins harden upon the application of heat and pressure and never soften up again on further heating. These seemed rather interesting and a great many tests were

The glass base recording disc contains a fiber insert at the center in which are punched four holes

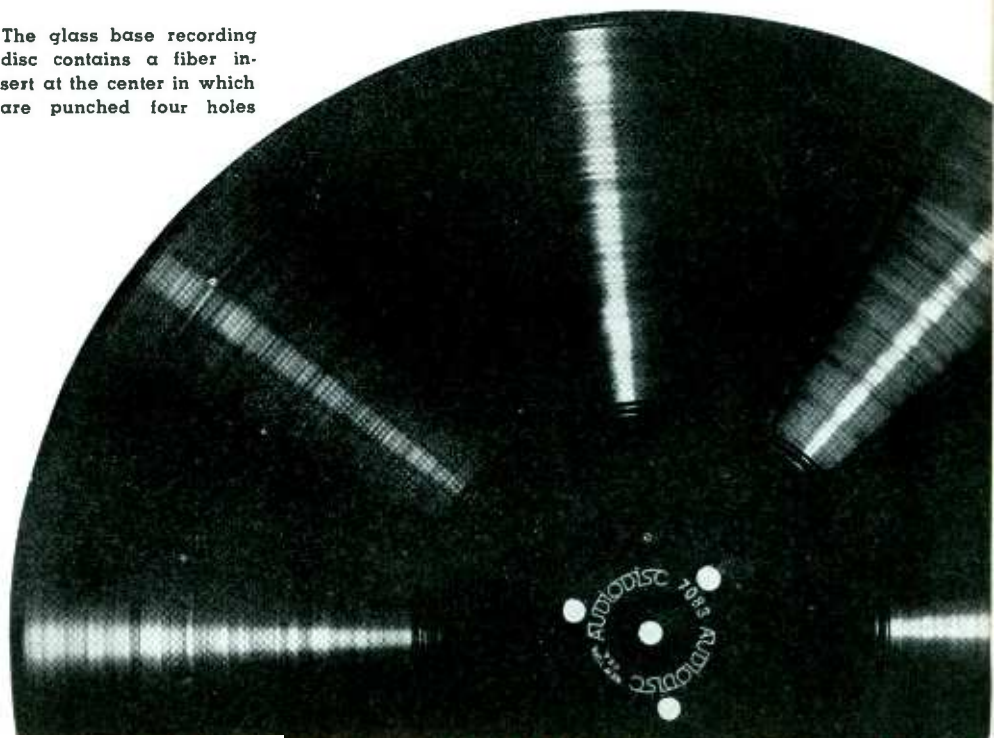



Fig. 1—Surface characteristics of several possible base materials for recording discs. Each vertical division indicates a departure from absolute smoothness of five millionths of an inch. The horizontal distance is eighty times greater than the actual distance traversed

made. However, it soon developed that such materials warp in time. It is hard to say whether this warping tendency is due to the resin itself or whether it is due to the base material, but in any case and seemingly regardless of the character of base material used, severe warping ensues. A further difficulty was the general floppiness of such sheets in any practical thickness. This floppiness could have been overcome at considerable cost by increase of thickness, but serious warping was too much to be accepted and it became necessary to study the metals.

Actually, long after this decision was adopted, tests of new resin samples continued, but always with the same general result. Incidentally, plastics have a rather curious surface grain which varies with the maker, but which is always present in one form or another. This irregularity appears in the coated disc and is rather objectionable.

#### Metals as Base Materials

Zinc had been used in France as a substitute for aluminum, and our first tests were with this metal. It

was soon found that zinc could be made with a very fine surface. However, pure zinc is heavy, but not very strong and the chance of buckling a disc is much too great. The zinc alloys which were tried were quite satisfactory. The discs possessed sufficient strength and had an excellent surface.

Steel was another obvious choice. It has good stiffness, excellent strength, and is the least floppy of the metals tried. On the other hand it is very difficult to get steel free from roll marks. These are produced by minute roughness in the rollers and can be eliminated by polishing the rollers just before use. This is costly and wholly unnecessary for any other customer, so the manufacturers were understandably reluctant to handle such a headache. Nevertheless, it was possible to get good samples. However, when the roll marks were eliminated, it was found that a characteristic grain resembling an orange peel took its place. This was less objectionable except from the appearance point of view, but it did stamp the steel disc with a characteristic appearance. An idea of the characteristics of surface grain on different materials may be obtained from Fig. 1, which is a group of charts drawn by a Brush surface analyzer. The principle of this device is shown in Fig. 2. A diamond point is drawn back and forth over the material to be tested. Roughness of the material vibrates the point, actuating a piezoelectric crystal which converts the mechanical displacement into voltage. The amplified voltage operates an oscillograph producing a graph of the rise and fall of the point. The magnification is such that one division of height (measured at right angles to the length of the chart) corresponds to five millionths of an inch. The speed of travel of the chart is such as to produce a magnification of 80 times along the length. This device is used rather widely for checking surface character. The curves speak for themselves and no particular comment is called for, beyond to point out that the glass curve is virtually as straight as though drawn by a ruler. The other graphs are for other materials, but the magnification and amplification are the same in all cases.

Results were sufficiently interesting to warrant pilot plant tests so

several thousand pounds of steel of various thicknesses were ordered. The first discs were cut on a circle cutting machine, but the resulting burr proved objectionable. It became necessary to order die sets for all the standard disc sizes. Seemingly this added trouble was a serious misfortune, but later on possession of the dies at a critical moment proved of enormous help. Good die design and skilled punching technique then turned out quantities of burr-free discs in various thicknesses. Coated discs were tried by representative customers and the optimum steel thickness determined for each diameter, as a compromise between rigidity and weight.

A technique for handling the new material and for coating it properly had to be developed. It was found, however, that even specially rolled, patent levelled, and carefully handled metal was occasionally not very flat according to the recording industry's standards. It was necessary to reject many punchings and even then steel was likely to average somewhat poorer than the aluminum then in use.

suitable for the purpose. The consumers figure of merit can be expressed as

$$M_r = 10^{-6} E/G$$

where  $E$  is the coefficient of elasticity or Young's modulus, and  $G$  is the specific gravity of the material under consideration.

A modification of this equation may be made to allow for the resistance to permanent deformation in factory handling, and the factory or producer's figure of merit may be expressed as

$$M_f = 10^{-10} SE/G$$

where  $S$  is the tensile strength of the material under consideration, and the other symbols have the meaning given above.

The cost might be introduced as a factor in the denominator, but it has little importance beside the other three as far as the recording field is concerned.

Some representative values are given in the following table; the values are suggestive only, with no pretense to being definitive:

such as chemical reasons, surface, punching character, and cost ruled out most of the other materials listed.

About the time that we had narrowed down the field to zinc alloys and steel, we found material shortages approaching. Zinc immediately went by the board, because a zinc shortage was one of the first to occur. This left steel as the only metal, and we knew that it had the faults of slight grain and occasional incompletely perfect flatness, but we also knew that it was entirely suitable for a great deal of recording work, and we knew how to process it. Therefore, when aluminum priorities were imposed, the first step was to order sufficient quantities of specially rolled steel from the best manufacturer as shown by the pilot plant tests on about 19,000 discs.

#### Rapid Start Using the New Materials

With the steel order accepted and the delivery date set we realized how lucky the pilot-plant tests had been for we had complete sets of dies proven and waiting to go to work at a time when dies in a hurry just

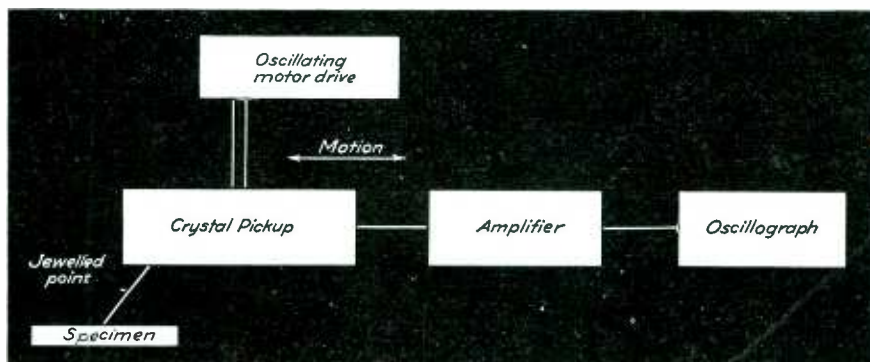

Fig. 2—Block diagram illustrating the principle of the Brush surface analyzer. A diamond point is moved across the surface and any irregularities are shown on the oscillograph

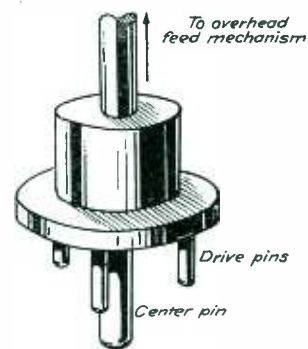

Fig. 3—Some recording machines have the drive pins attached to the flange as shown rather than to the turntable. A rubber pad raises the drive pins above the disc

The general public's reaction had to be considered. It became evident that it prized the stiff feeling of hard rolled aluminum and that any other material would have to come as close as possible to it. A mathematical study became necessary. For a given thickness and force the deflection of a material is inversely dependent on the value of Young's modulus. The force tending to bend the disc when handled is proportional to the specific gravity so that we may compute an index number which permits comparison of the materials most

Material	Users Factor	Factory Factor
Steel .....	3.9	19.5
Aluminum .....	3.8	7.6
Glass .....	3.2	1.3
Copper .....	2.0	10.2
Laminated Plastic ...	1.8	1.6
Zinc .....	1.7	4.1
Zinc Alloy .....	1.7	8.5
Phosphor bronze ....	1.6	13.1
Brass .....	1.1	7.9

It can be seen from this that steel is definitely the best at any given thickness. If we introduce the cost factor it becomes still more superior. A number of miscellaneous factors

weren't obtainable. When the steel rolled in the presses were set up and ready to go. Research had paid a dividend.

In the meantime it became evident that no new aluminum would be available, and that with airplane production stepping up daily, even melting and rerolling old discs would soon stop. A new material had to be found for the most critical users: broadcast stations, professional recording studios, and motion picture producers.

This new material had to have ex-

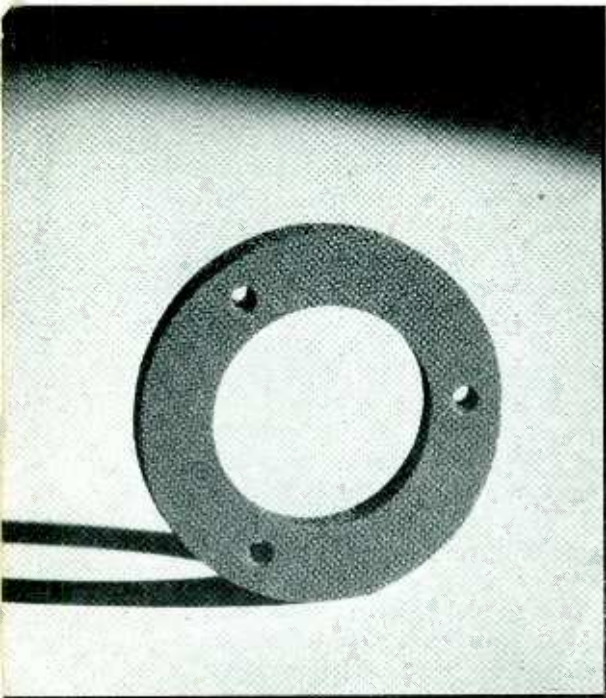

Fig. 4—Rubber pad which is used to prevent the drive pins of Fig. 3 from resting on the glass base recording disc which is not equipped with drive holes to accommodate them

treme flatness, perfect surface, and desirable chemical properties, plus little likelihood of being placed on the list of priorities. The user factor computations pointed a finger at glass, and the hint was sufficient. Glass made by the right process has a flawless surface and is the flattest of any material in its natural state. The factory superintendent sent out for a box of aspirin and work began.

The first problem was the question of thickness. A number of tests soon showed that a base thicker than about 0.065 inch produced a record of excessive thickness; excessive because any recording machine in general use would be thrown out of alignment by the increase above normal. On many machines with an overhead feed mechanism the misalignment of center pin and driving flange shaft produced intermittent change of load, resulting in growl or serious wows; in other cases it changed the cutting angle near the center, producing excessive angle variation from rim to center. This would necessitate realignment of the feed mechanism. On lathe type machines the change of angle was great enough to necessitate readjustment.

A further thought occurred in connection with durability. One's first reaction would be that the thicker the glass, within limits, the stronger it would become. This is not true as regards resistance to dropping, which is of course the chief problem. If a record is made a little thicker, its strength is increased. But at the

same time the weight of the record has gone up in direct proportion, so that the force tending to damage the record on impact has also gone up. Hence, the strength to weight ratio is unchanged. Therefore, within reasonable limits an increase of thickness produces virtually no effect on the durability. It is possible that the cushioning effect introduced by the coating and the flexibility introduced by decreased thickness has something to do with this. As a matter of fact it might be better to use a still thinner glass, whose flexibility is quite astonishing.

The question of tempered glass came up. This material is extremely strong, but the flatness is not satisfactory, undoubtedly due to the tempering operation. It was further found that whereas an ordinary glass record would crack at one point when dropped from too great a height, the tempered glass would shatter rather completely when once a break started. Therefore, while ordinary glass when cracked could be re-recorded onto another disc (the coating, of course, held the material together) the tempered glass would be utterly valueless. Also the cost of tempered glass is prohibitive.

The tenacity with which cracked glass holds together is surprising until one recalls that the principle is the same as that of automobile windshield safety glass. Windshield glass is a sandwich of glass-plastic-glass, while a disc is plastic-glass-plastic. Another reason for the enhanced durability lies in the cushioning produced by the outer unbreakable lacquer coating.

So the problems of glass production began. The first morning it was thought that cutting and drilling would present no problems at all, for hadn't glass been cut and drilled for centuries? About noon the superintendent phoned home that he wouldn't be in till midnight—the job was a little hard.

The next morning he brought a large bottle of aspirin as permanent equipment for his desk for it had soon been found that the accuracy with which these operations had been done in the past was not satisfactory for recording purposes. The diameter of the hole at the center had to be controlled to within a very few thousandths of an inch and the circle diameter and concentricity also had to be quite accurate. In addition to

that there were severe problems of surface cleanliness to insure good adhesion of the lacquer. Another interesting discovery was made. It was found that a disc with one hole was infinitely stronger than one with two or the usual four. This was traced to an area of weakness around each hole and a line of weakness joining the two holes. The obvious remedy was to use only a single hole. The question then came up of whether a single hole disc could be driven properly on standard machines. Rather gratifyingly it was found that practically all standard commercial machines hold the record between layers of rubber or Corprene and the friction produced by the normal pressure of the machine was sufficient to insure a positive drive. The expression gratifyingly is used because the completed record is worth thirty or forty times as much as the blanks and anything which protects the completed result is worth using. Many tests were made on machines of different manufacture and in different recording rooms and the results always checked; the drive was positive. This is not very surprising when we remember that European practice always used friction and that some of the best recording turntables are driven by friction. As a matter of fact in the old days discs of all sorts were driven by a pressure clamp at the center and no drive pin was even thought of with so slippery a material as waxed aluminum. Perhaps one help is the fact that the coefficient of friction between a lacquer coating and rubber is quite high and a rather small pressure will serve to produce a very great gripping force.

Skeptics should try the finger test. Draw a crayon line on the rim of the disc and another line next to it on the turntable. Start recording, then press on the record with a finger. It is amazing to see how much added pressure is needed before the disc line drops behind the other as the record starts to slip. Then try the crayon lines alone on the next few regular recordings. There is absolutely no evidence of slippage, even on a 15 minute program.

#### Experience with Glass Base Discs

Heavy production of steel and glass began in early April and from  
(Continued on page 78)



# Defense Contracts for Small Plants

Small manufacturing plants have a very definite place in the national defense effort. The procedure for fitting a small organization into its proper place by the acquisition of defense contracts or sub-contracts is given in a straightforward manner

**A**RE you getting your quota of defense contracts? If you feel that you are not, the following paragraphs are dedicated to you, regardless of the fact that you may believe your business is too small, under-capitalized, or inadequately equipped to handle defense work.

Defense is America's biggest business today. As such, it has already established priorities in the field of basic war commodities. As such, it will soon possess the authority to divert skilled labor from non-essential factories to war industries.

As of July 1, 1941, eighteen billion dollars of defense contracts were let out by the United States Army and Navy. Contracts exceeding thirty billion dollars are being planned and the end is nowhere in sight.

Where do you fit in this picture? Is the continued operation of your plant necessary for national defense, or would the interests of this nation best be served by diverting your raw materials and skilled workers to some other factory? This is the question you must ask yourself now! Ask it honestly, and answer it honestly, because if your business is non-essential in this emergency, you have no guarantee that you will remain in operation six months from today.

You can make your business essential, however, by participating in the defense program. And the best way of doing that is by securing a defense contract. The procedure for obtaining defense contracts has been greatly simplified recently. It is not necessary or even advisable for you to travel to Washington to find out what you can do.

Instead, write to your regional office of the Defense Contract Service and describe in detail your facilities for handling defense work. The Defense Contract Service is a Federal Agency set up by the Office of Production Management in cooperation

By **ERNEST O. EISENBERG**

*Institute of Public Research*

with the Federal Reserve System. Its chief purpose is to help you obtain defense contracts.

Its offices are located in each of the twelve Federal Reserve Banks, and in each of their twenty-four branch banks. These are as follows:

Atlanta, Ga.	Memphis, Tenn.
Baltimore, Md.	Minneapolis, Minn.
Birmingham, Ala.	Nashville, Tenn.
Boston, Mass.	New Orleans, La.
Buffalo, N. Y.	New York, N. Y.
Charlotte, N. C.	Oklahoma City, Okla.
Chicago, Ill.	Omaha, Neb.
Cincinnati, O.	Philadelphia, Pa.
Cleveland, O.	Pittsburgh, Pa.
Dallas, Texas	Portland, Ore.
Denver, Colo.	Richmond, Va.
Detroit, Mich.	Salt Lake City, Utah
El Paso, Texas	San Antonio, Texas
Helena, Mont.	San Francisco, Calif.
Houston, Texas	St. Louis, Mo.
Jacksonville, Fla.	Seattle, Wash.
Kansas City, Mo.	
Little Rock, Ark.	
Los Angeles, Calif.	
Louisville, Ky.	

Write to the regional office which serves your area. In your letter enclose photographs showing the interior of your plant. These photographs should be taken from several angles. In addition, supply photographs or complete descriptions of the products you are now making or have made in the past. You should also answer the following thirteen questions:

1. How many employees do you have?
2. How many people could you employ on a one-shift basis, a two-shift basis, or a three-shift basis?
3. How many shifts are now working in your plant, and what is the length of each shift?
4. How many shifts can you work

with the labor supply available in your community?

5. Do you have a design and development department?

6. List each of your machines by size, type, manufacturer's name, manufacturer's serial number, the year in which the machine was built, and the tolerances to which it will work.

7. How many machine hours do you have idle per week over and above present commitments? This information should be broken down by types of machines.

8. Is your power source adequate?

9. What are your shipping facilities?

10. Who are some of your regular customers?

11. Have you ever had a defense order and, if so, for what?

12. Have you ever been a sub-contractor and, if so, for whom?

13. Have you ever sub-contracted any of your work and, if so, to whom?

The men staffing the offices of the Defense Contract Service are prepared to give you every possible consideration and assistance. If you feel that your plant is under-capitalized for defense work, they will help you secure the necessary financing once you have been approved as having the suitable facilities and qualifications for defense contracts. If your plant is inadequately equipped to handle any particular job, they will guide you in pooling your resources with other small shop owners so that together you can participate in a contract which none of you could handle alone. If you are a sub-contractor, they will furnish you with lists of defense contracts already let out, so that you will know which prime contractors to approach for work. In short, the Federal government will cooperate to the fullest extent in helping you make your business an essential one. The rest is up to you.

By L. H. STAUFFER  
University of Idaho

# CHARACTERISTICS OF

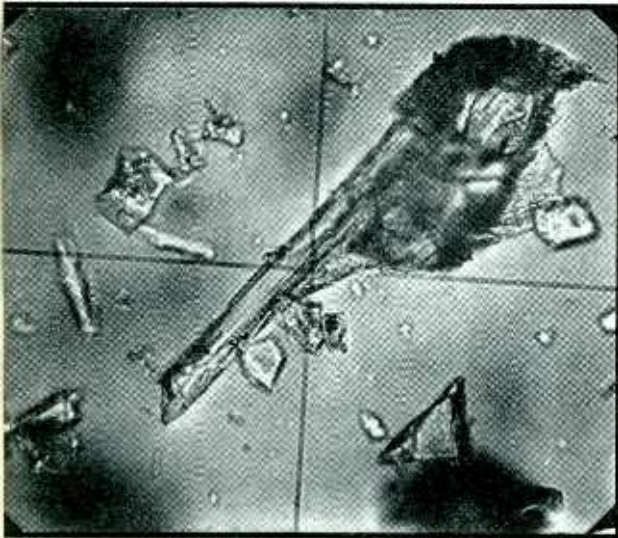

Calcium silicate crystals enlarged about 325 diameters. This phosphor will luminesce yellow under electron bombardment. Photographs were made by RCA Manufacturing Co.

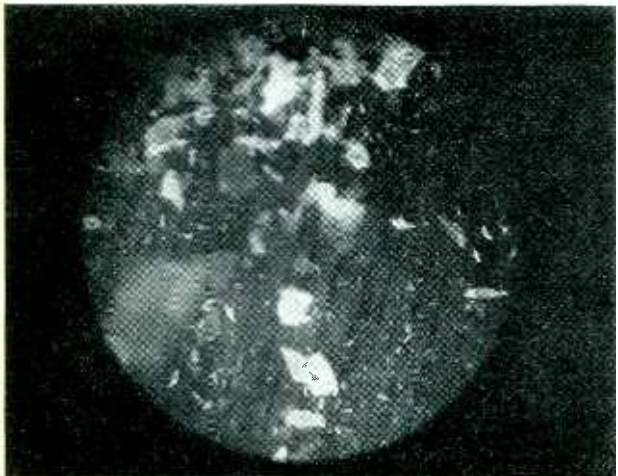

Calcium silicate phosphor magnified 80 diameters under the luminescent microscope. The particles were photographed by their own luminescence

**W**ITH the advent of commercial television and fluorescent lighting the phosphors have become the subject of intensive investigation and development. Recent improvements in luminous efficiency and color range have placed these fluorescent materials among the most important light sources now in use. Luminescent crystalline materials have been developed with efficiencies

exceeding 70 percent, for ultraviolet excitation, and almost any desired hue, including white, is obtainable. As energy converters the phosphors far outstrip the incandescent filament in efficiency, and in addition they have the advantage of quick response to variations in exciting energy.

Phosphors are made by firing a pure crystalline material with a very small amount of another element known as an activator. The kind of activator, its concentration, and the heat treatment employed have important effects on the behavior of the phosphor. There is a specific activator for each basic crystalline material, although some compounds may be activated by several different elements. Of the matrix materials now in use the metallic sulphides, silicates, and tungstates are of greatest practical interest. The table lists representative phosphors belonging to these groups together with their activators, emission peaks, and persistence times. It will be noted that the tungstates are exceptional in that they require no activator. Also, it will be seen that there is a wide variation in color and persistence time among the phosphors listed.

Fluorescent materials convert the energy of electron beams, ultraviolet light, or x-rays into visible light with widely varying efficiencies. For cathode-ray excitation the efficiency of energy conversion is about 10 percent for most phosphors, while it may be as high as 50 to 70 percent when the same phosphors are excited by ultraviolet. For x-rays the efficiency is from 1 to 5 percent depending on the hardness of the radiation. The luminescent hue of the phosphor, however, is the same for all exciting agents; it depends only on the chemical make-up and the compounding process.

Because of the variation of eye sensitivity with color the luminous efficiency of a phosphor will depend on the amount of energy it can throw into those regions of the spectrum which give the maximum visual stimulus. Figure 1 shows the re-

sponse characteristic for the normal human eye.<sup>1</sup> This characteristic is peaked in the yellow-green region which explains why willemite and other green and yellow emitting materials show such high luminous efficiencies. Some of the blue phosphors, although they are good energy converters, are not efficient from a visual standpoint because they throw too large a portion of their emission into the violet and ultraviolet regions. Since most spectral distribution curves for phosphors are now plotted on an energy basis it is necessary to multiply their ordinates by the corresponding ordinates of the eye sensitivity curve to estimate visual efficiencies. The area under the resulting curve gives a measure of the total visual effect, corresponding to the response of an eye-corrected Weston photocell.

The spectral distribution curves of Figs. 2, 3, and 4 show how some of the phosphors distribute their emitted light over the spectrum.<sup>2</sup> The effect of different activators on zinc sulphide phosphors is illustrated in Fig. 2. Each activator has its effect on the luminous efficiency and color as shown by the table accompanying Fig. 2. The effect of varying the amount of manganese activator in willemite is shown by the emission curves of Fig. 3. The emission peaks for the tungstates, shown in Fig. 4, are displaced too far toward the blue to show high luminous efficiencies.

In some cases changes in activator concentration as small as one part per million will produce a detectable change in the emission of a phosphor. Variations in heat treatment have an effect on the crystal structure which in turn affects the shape of an emission curve. For these reasons careful control of production processes is essential to insure uniform characteristics in commercial phosphors.

When a particular application demands a luminescent hue that cannot be efficiently secured by the use of any single matrix material a mechanical mixture of two or more powdered phosphors may be used.

# FLUORESCENT MATERIALS . . .

Fig. 2—Emission curves of several zinc sulphide phosphors. Pure zinc sulphide is used as the standard for comparison

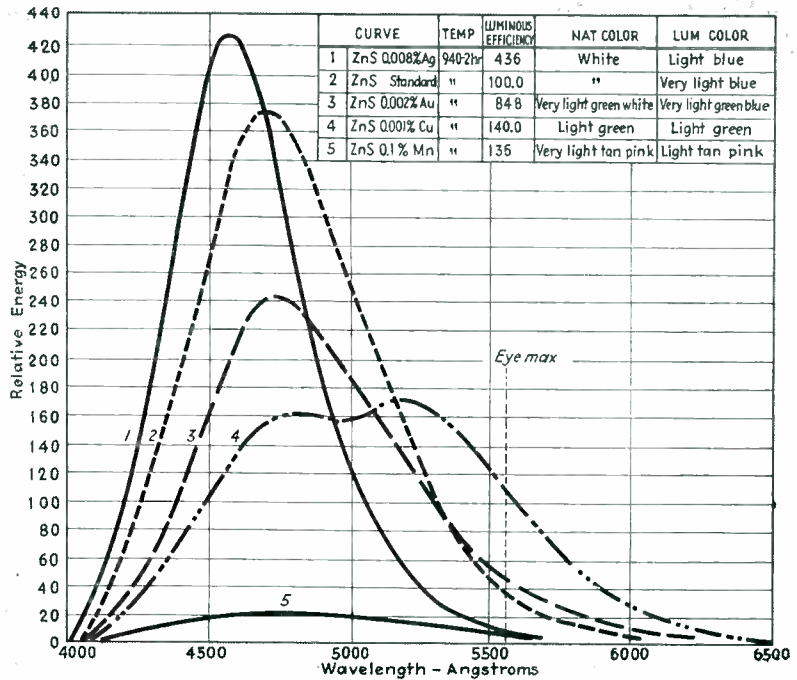
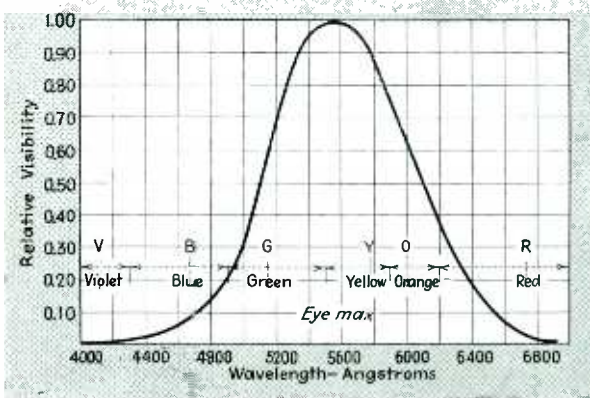

Fig. 1—Relative sensitivity of the eye to light of various wavelengths



This gives a practically unlimited choice of colors without unduly sacrificing luminous efficiency. These mixture phosphors find their most important uses in fluorescent lamps and television screens where intense white luminescence is required.

The emission curves of Fig. 5 show the results obtained by mechanically mixing zinc sulphide and cadmium sulphide phosphors activated by silver.<sup>1</sup> As the mixture proportions are varied from pure ZnS-Ag to pure CdS-Ag the emission changes from light blue, through green, yellow, and orange, to red for the pure CdS-Ag phosphor. The column headed Weston gives the comparative illuminometer readings under identical excitation conditions in a cathode-ray tube. It will be seen that the 50-50 mixture best fits the eye sensitivity curve and, therefore, gives the highest luminous efficiency. Relative visual response curves for ZnS-Ag and for the 50-50 and 20-80 mixtures are shown in the upper part of Fig. 5. These were constructed with the help of the eye sensitivity curve. Good quality white emitting screens usually employ a three component mixture of

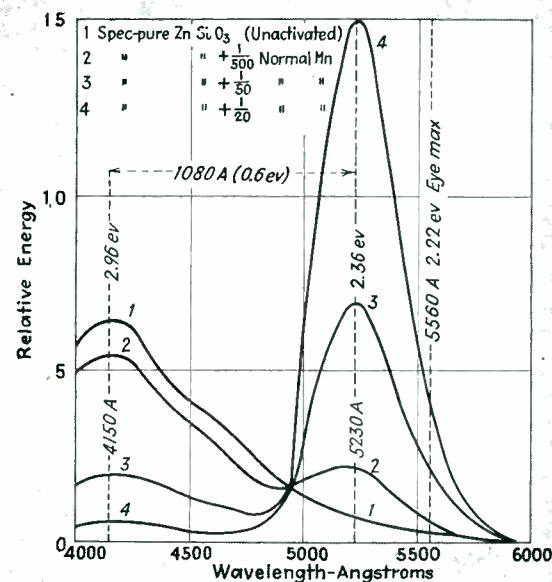

Fig. 3—Curves showing the effect of varying concentration of manganese, used as an activator, on alpha willemite

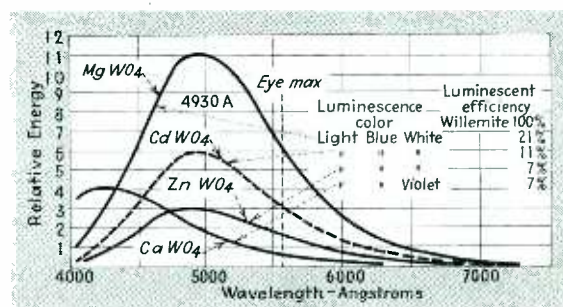

Fig. 4—Emission curves of several tungstate phosphors. The peaks are too far from the maximum eye sensitivity for high efficiencies

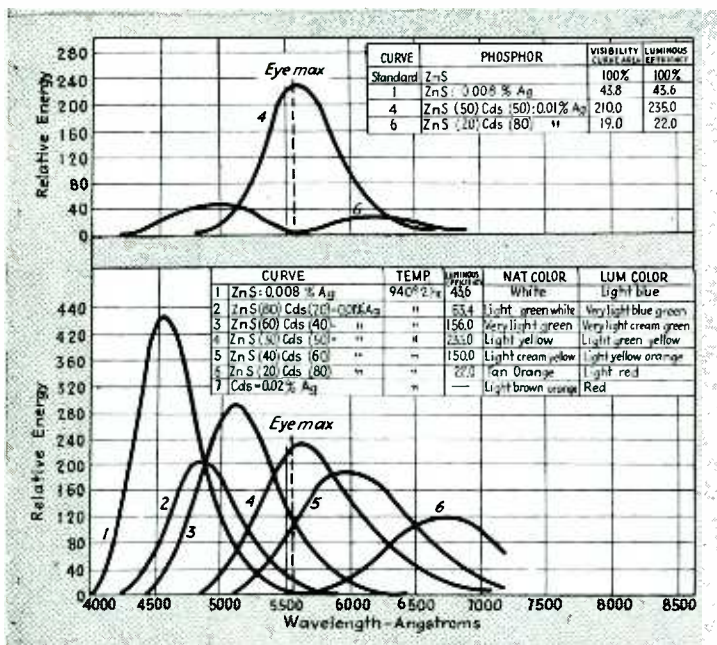

Fig. 5—Relative visibility curves and emission curves of several mixtures of zinc sulphide and cadmium sulphide phosphors

blue, green, and yellow emitting phosphors.

In selecting phosphors for use in cathode-ray tubes other properties that must be considered, in addition to emission characteristics, are: (1) stability under electron bombardment and exhaust temperatures; (2) the persistence time; (3) the limiting accelerating potential.

Sustained high temperatures may affect the emission of a phosphor by permanently altering its crystal structure. Screen materials must withstand exhaust temperatures approaching 500 deg. C and should out-gas easily. Under operating conditions high instantaneous temperatures may be encountered which

might not permanently alter the phosphor, but which may reduce the luminous efficiency. The luminous efficiencies of all phosphors decrease with increasing temperature, and at a limiting temperature, usually below the melting point, luminescence ceases. For some materials the luminous efficiency is fairly constant up to 150 deg. C or higher while for others it begins to fall off at temperatures below 100 deg. C. Many materials showing little or no fluorescence at room temperature are strongly luminescent at low temperatures.

Most phosphors continue to emit light for a measurable period after excitation ceases. This lag or after-

glow is known as phosphorescence, and the time required for the luminescence to drop to a given fraction of its initial value is called the persistence time. In the tungstates phosphorescence is negligible, but the sulphides and silicates show ap-

(Continued on page 117)

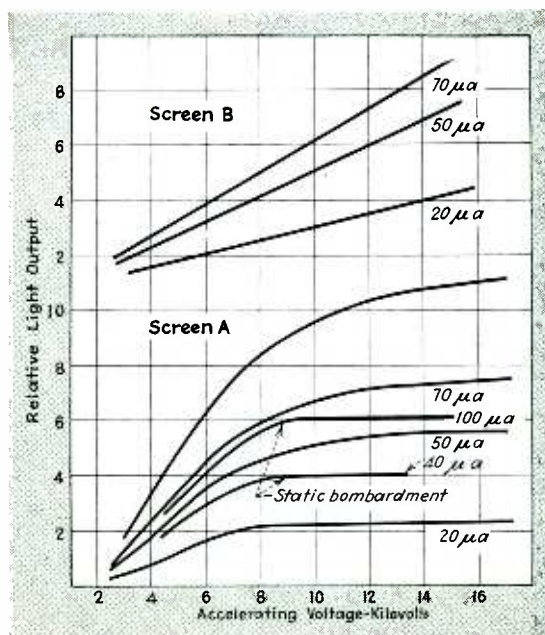

Fig. 7—Relative light output of willemite screens as a function of acceleration voltage

APPROXIMATE CHARACTERISTICS OF TYPICAL PHOSPHORS

PHOSPHOR			Color of Fluorescence	Wave-length of Maximum Emission — Angstroms	Persistence Time* — Seconds
Crystal Matrix	Formula	Activator Concentration			
Pure zinc sulphide	ZnS	None	Light blue	4700	10 <sup>-3</sup> approx
Zinc sulphide—silver	ZnS-Ag	Ag—0.032%	Blue	4550	10 <sup>-3</sup>
Zinc sulphide—copper	ZnS-Cu	Cu—0.001%	Light green	4700-5300	5 × 10 <sup>-2</sup> approx
Cadmium sulphide—silver	CdS-Ag	Ag—0.02%	Red	8000 approx	10 <sup>-3</sup>
Zinc—cadmium sulphide—silver	4ZnS:6CdS-Ag	Ag—0.01%	Yellow-orange	6000	10 <sup>-3</sup>
Alpha—zinc silicate—unactivated	Zn <sub>2</sub> SiO <sub>4</sub>	None	Pale blue	4100	2.0 approx
Alpha—zinc silicate—manganese	Zn <sub>2</sub> SiO <sub>4</sub> -Mn	Mn—1.9%	Green	5300	5 × 10 <sup>-2</sup>
Beta—zinc silicate—manganese	Zn <sub>2</sub> SiO <sub>4</sub> -Mn	Mn	Yellow	5600	10 <sup>-1</sup> approx
Zinc beryllium silicate—manganese	ZnO BeO SiO <sub>2</sub>	Mn	Green to orange	5250-6000	5 × 10 <sup>-2</sup>
Cadmium silicate—manganese	CdSiO <sub>3</sub> -Mn	Mn	Yellow-pink	5950	.....
Magnesium tungstate	MgWO <sub>4</sub>	None	Blue-white	4900	10 <sup>-5</sup> approx
Cadmium tungstate	CdWO <sub>4</sub>	None	Blue-white	4900	10 <sup>-5</sup> approx
Zinc tungstate	ZnWO <sub>4</sub>	None	Blue-white	4900	10 <sup>-5</sup> approx
Calcium tungstate	CaWO <sub>4</sub>	None	Violet	4200	10 <sup>-5</sup> approx

\* The persistence time is the time required for the luminescence to fall to 1 percent of its initial value.

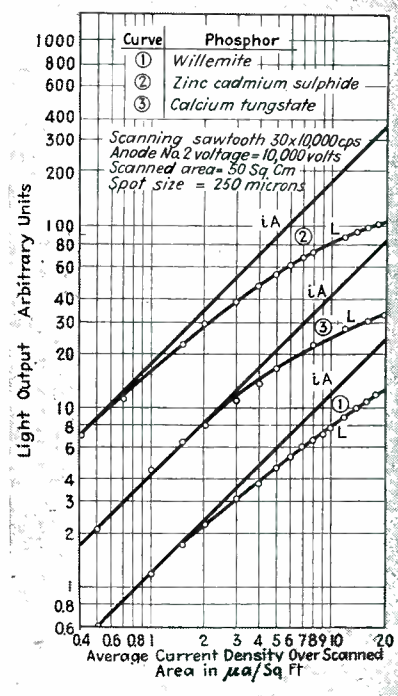
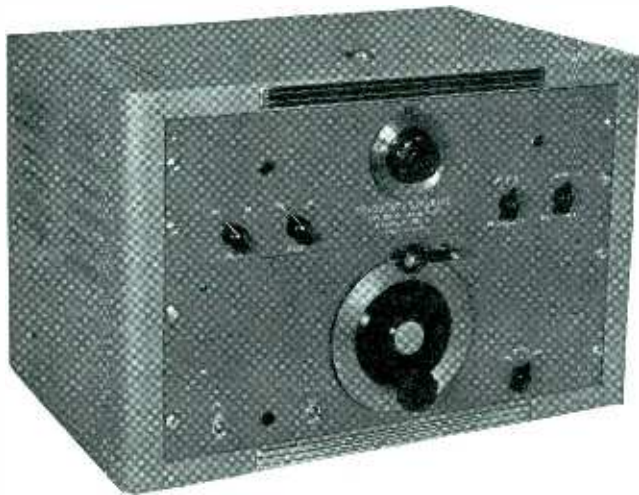

Fig. 6—Light output curves for phosphor screens uniformly scanned by an electron beam

# Direct Reading Interpolation Oscillator

A standard frequency generator and interpolation oscillator are used in combination to provide a rapid and accurate method of determining the frequency of received signals



By **D. REGINALD TIBBETTS**  
*Moraga, Calif.*

Front view of frequency standard (upper panel) and interpolation oscillator

**I**N many instances when accurate frequency measurements are to be made delay due to slide rule calculations and figuring is experienced. In order to overcome this, a frequency measuring unit was developed to enable even the inexperienced to perform interpolations. No calculations at all are necessary, and very rapid measurements can be made directly from the dial. Accurate calibration can be quickly and easily made at any time. The interpolation oscillator and frequency standard is composed of two units. The upper panel contains a secondary frequency standard with 100 kc quartz bar and multivibrators giving strong outputs at every 100, 50 and 10 kc interval. The lower panel contains the interpolation oscillator which allows precision readings between the 10 kc points given by the secondary frequency standard.

#### Secondary Frequency Standard

The 100 kc bar is mounted in a plug-in dustproof shielded case. The bar is a thick crystal with two sides

silver-plated and mounted between two wedge-shaped electrodes. The temperature coefficient is very low and, by means of a variable condenser built into the circuit, adjustment of the crystal frequency to exactly 100 kc is easily and quickly possible.

The oscillator is a 6SJ7 with the screen of the tube acting as the plate. The circuit gives some feedback to aid crystal oscillation and also provides variation of the oscillator frequency over a range of approximately 16 cycles by means of the tuning condenser. The frequency can therefore be brought exactly to 100 kc when an accurate checking source such as Station WWV is available.

Since the oscillator alone will produce harmonics useful to only about the fiftieth harmonic or 5000 kc, amplifiers are needed to get strong harmonics up to 60,000 cycles per second. The output of the oscillator is capacity-coupled to another 6SJ7 as an amplifier. For 100 kc harmonics this amplifier is in turn coupled to an 1852/6AC7. For the 50

kc harmonic series, a multivibrator is incorporated in the unit. This stage uses a single 6N7, and follows the 6SJ7 first amplifier. The 10 kc series of harmonics are similarly secured. A three position rotary switch is used to switch the output of the first amplifier to the desired harmonic output. The 1852/6AC7 second amplifier is used in all cases and serves to isolate the multivibrator from the output circuit. The first amplifier not only serves as an amplifier, but also as a buffer stage to isolate the oscillator from the multivibrator. The output circuit is coupled to the receiver antenna post through a built-in attenuator using a 500,000 ohm potentiometer. This attenuator is necessary to effect a balance between the harmonic being used and the signal observed. Otherwise the output of the unit swamps the signal observed and observation of the beat note would be difficult.

#### Interpolation Oscillator

The interpolation oscillator is similar to an accurate highly stabilized beat frequency oscillator of a good receiver. The frequency range of the unit is somewhat more than 5000 cycles per second plus or minus the intermediate frequency of the receiver. One of these units has been

Interior views of the interpolation oscillator (left unit) and frequency standard, below, show no wiring above the chassis

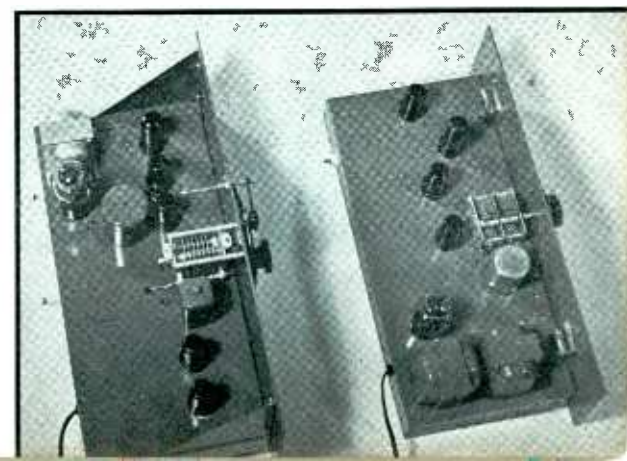

adjusted to 455 kc although this can be changed to any exact intermediate frequency between 450 and 470 kc. When set for 455 kc the dial of the unit tunes from a little less than 450 kc to a little more than 460 kc.

Stability is very high and no provision for regulated power supply is necessary. The stability is high mainly because the interpolation oscillator operates at a comparatively fixed low frequency instead of the usual variable high frequency. Calibration is linear, i.e., dial spacings are equal for the same frequency increments.

The unit must be used with and in fact is, an integral part of any unit that will supply stable 10 kc harmonics. Interpolation is accomplished between adjacent 10 kc multivibrator marker points by means of a variable oscillator operating at the receiver intermediate frequency. Thus, in reality frequency measurement is simply determined merely by measuring the beat frequency between the unknown signal and the nearest 10 kc point after both have been converted to the i-f channel frequencies.

The low frequency oscillator tunes a little more than 5000 cps either

side of the receiver i-f channel and is based on the transitron. This oscillator is very stable and can be compared to a crystal oscillator.

The 455 kc oscillator is tuned by means of a combination of a silver mica condenser whose stability is very high, especially with respect to temperature, and a variable iron core inductance. These two in the plate circuit of the 6SJ7 oscillator in combination with the 100  $\mu\mu\text{f}$  air padder, and interpolation condenser complete the basic parts of the interpolation oscillator. By means of the variable air padder and the variable inductance the range of the interpolation oscillator may be precisely adjusted while keeping the middle frequency the same as that of the intermediate frequency of the receiver.

#### 1000-Kilocycle Oscillator

As an added feature a 1000-kc oscillator is built into the interpolation oscillator. Since the 100-kc points are very close together at the very high frequencies, i.e., those above 20,000 kc, a 1000-kc (1 Mc) self-excited oscillator is used for checking. This oscillator is arranged so that it is exactly controlled by the 100 kc crystal. This portion of the

standard is operated by turning the upper multivibrator switch to the 100-kc position with output at maximum and the lower selector switch to the 1 Mc position. Output will then be secured at exactly integral multiples of 1 Mc over the entire range of the receiver. Adjustment of this 1 Mc oscillator is made by means of the trimmer located next to the type 80 tube on the lower chassis.

#### Procedure in Measuring Frequency

To check the 100-kc crystal bar to the exact point, the operator should first find either WWV or 5000 kc or select any station, broadcast or commercial, whose frequency is known. Nearly all broadcast stations keep their frequency deviation within a few cycles per second and many keep to within a single cycle per second. In any case broadcast stations are required to keep within 20 cps. The station selected is tuned in on the receiver. Next turn on the secondary frequency standard and switch to the 10 kc multivibrator. This assumes the frequency of the station to be divisible by 10 kc. Of course if the frequency is divisible by 50 or 100 kc these multivibrators can be used as well. A beat note will be

Circuit diagram of the secondary standard of frequency

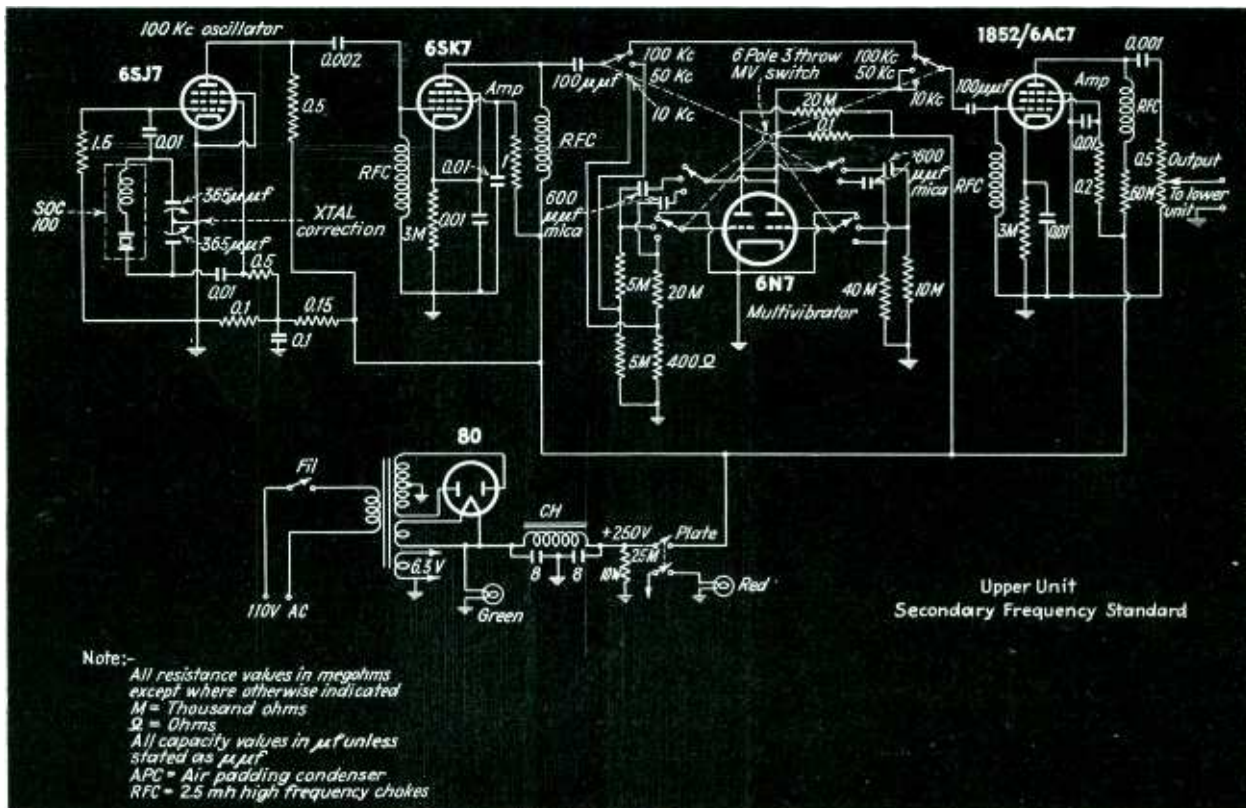

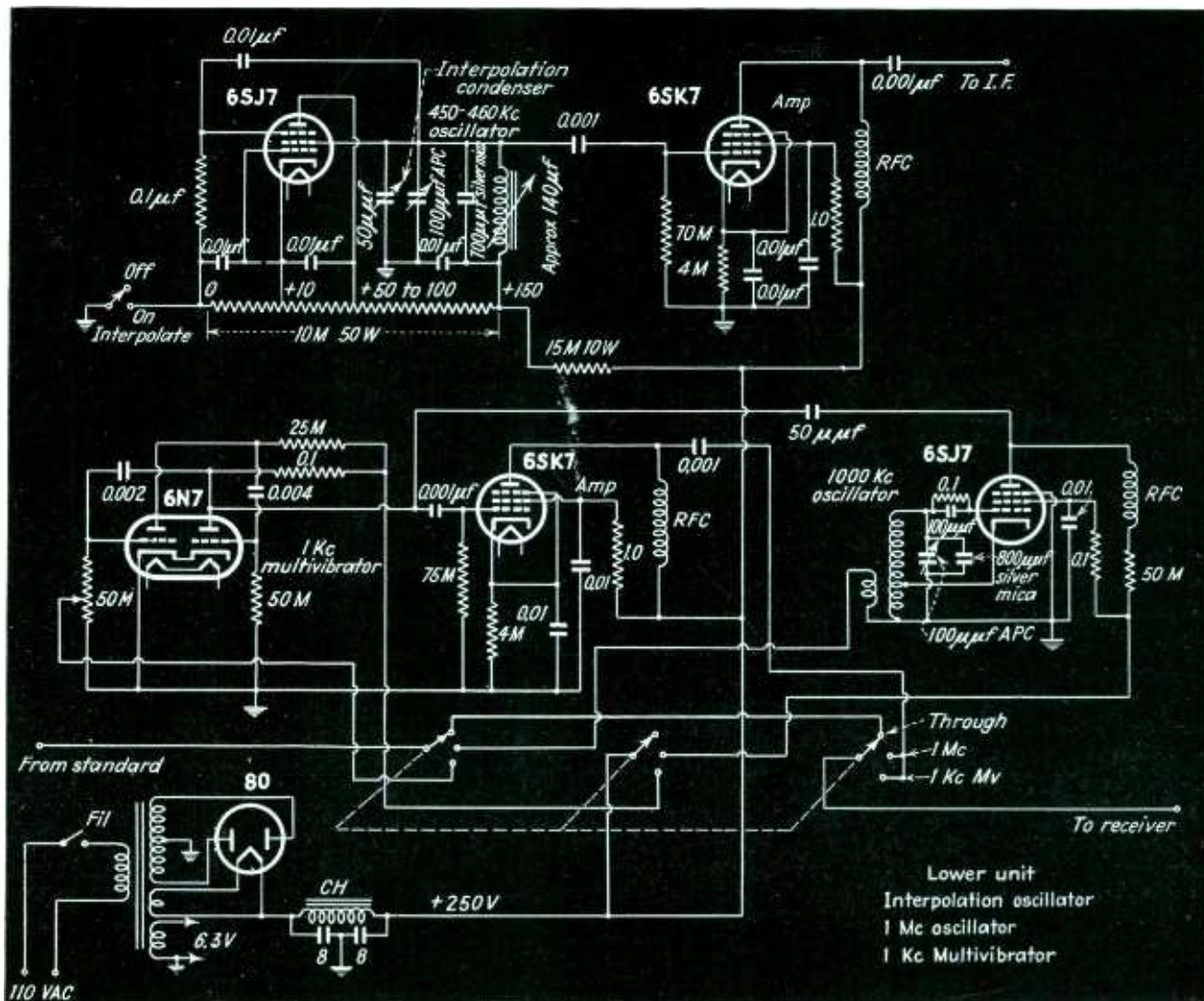

Connections and circuit components are given in this diagram for the interpolation oscillator

heard between the station observed and the multivibrator output. By adjustment of the output a balance can be secured. The correction dial is moved until the beats can be counted and brought to zero beat. If the receiver has an "S" meter, the beats can actually be seen. The actual number of swings a second is the precision to which the correction is set. From a practical standpoint, once the correction is made, good measurements can be made without the necessity of the correction. The temperature coefficient of the bar is so low that often the correction will be found to be at zero beat with a primary station. The correction is provided for better precision and any drift due to temperature, humidity or circuit changes can be corrected very easily. This can be checked both before and after measurements for accuracy.

As an example it is assumed the receiver dial can be read to within

reasonable limits and that the approximate frequency of the station to be measured is known. For instance a station is known to be operating on about 2512 kc. The station is tuned in and the 10 kc multivibrator is switched on. The dial of the interpolation oscillator is set at mid-scale, and the interpolate switch is thrown on. A beat note will be heard in the receiver. The receiver is tuned to exact zero beat at 2510 kc with a harmonic of the multivibrator. During this operation it is desirable to remove the incoming signal to avoid confusion of beat notes. The plate switch is thrown off and the station is received again. A beat note will be heard. This zero beat will be the exact difference between 2510 and the operating frequency of the station measured. This difference can be measured by tuning the interpolation oscillator to zero beat. If the station is on exactly 2512 kc the dial will read +2 kc

(100 degrees). Each division of the dial is 40 cps. If the frequency should happen to be 2508.5 kc the dial would read -1.5 kc or (187.5 degrees). To check back, turn off the received signal, turn the multivibrator on and see if the zero beat checks back at 150 degrees or the zero calibration mark of the interpolation oscillator. A convenient means of reading measurements is to read the dial in degrees. Let this dial reading be  $n$ . Then, the exact frequency in cycles per second to be added the marker frequency of the multivibrator is

$$f = 40 (150 - n).$$

For example if zero beat is obtained when the dial reads 200, then the frequency which must be added to the multivibrator marker frequency is  $f = 40 (150 - 200) = 40 (-50) = -2,000$  cycles per second. Since the sign is negative, we must subtract 2 kc from the multivibrator marker frequency.

# POWER FACTOR METER

Based on the phase control operation of gas tubes, a direct reading power factor meter has been designed for either 150 or 250 volt circuits and for currents of from 0.1 to 10 amperes. All errors are less than those in reading the indicating meter

By ALEXANDER B. BERESKIN

University of Cincinnati



Photograph of the power factor meter which reads leading or lagging power factor directly on 150 or 250 volt circuits

**T**HE determination of power factor has always been an important consideration in the utilization and distribution of power but with the advent of fluorescent lighting, with its attendant low power factors, the importance of the problem has been materially increased. The following article deals with the application of the D'Arsonval type meter movement and the thyatron tube, to the direct measurement of power factor. As a by-product the instrument is also capable of indicating amperes and volts in the circuit.

The D'Arsonval type meter movement is sensitive, reliable, and inexpensive but its indication depends upon the average value of unidirectional current flowing through its coil. For this reason, in the measurement of a large number of electrical phenomena, it is desirable to provide a suitable circuit arrangement which will produce a unidirectional flow of current having an average value which is a function

of the phenomenon being measured. It is also desirable that the measurement circuit introduce a minimum amount of disturbance into the circuit being measured.

## Review of Thyatron Principles

In view of the intimate relation existing between the theory of the power factor meter and that of the control tube, a review of the gas tube theory seems advisable to facilitate the explanation of the power factor meter.

In the gas tube, with positive plate some of the electrons flowing from the cathode to the plate will strike gas molecules and, if these electrons happen to be going fast enough, ionization by collision will occur. All of the free electrons formed will continue to go to the plate and, en route, may collide with more gas molecules. The positive ions (atoms lacking one or more electrons) will go to the negative cathode and grid.

The positive ions arriving at the cathode will unite with free electrons and, having formed neutral particles, will disperse within the envelope of the tube. Due to the great concentration of positive ions close to the cathode, the space charge will be greatly reduced and the removal of electrons from the cathode will be facilitated, thus making available a large supply of free electrons. Because of the practically complete neutralization of the space charge, the potential that will appear between the cathode and plate of the gas tube will be approximately the ionization potential of the vapor or gas for the particular operating conditions involved. The positive ions arriving at the grid, however, will

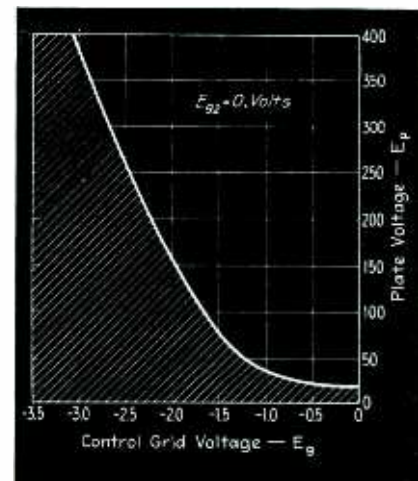

Fig. 1—Control grid characteristics of the RCA-2051 gas tetrode. Conduction cannot occur in the cross-hatched region

not find any free electrons to combine with and will form a positive ion sheath around the grid which will completely shield it from the cathode.

Due to the shielding effect of the positive ion sheath the grid has no control over the current flow in the gas tube after ionization has occurred. This means that the grid will be effective only in preventing or permitting current to start in the tube and therefore has a trigger-like effect but has no effect after ionization takes place. The magnitude of grid voltage required to prevent current flow will naturally vary for various values of plate voltage and a characteristic curve, such as shown in Fig. 1 for an RCA-2051 tube, can be plotted. Any combination of grid and plate voltage in the cross-hatched region will not produce current flow in the tube, while



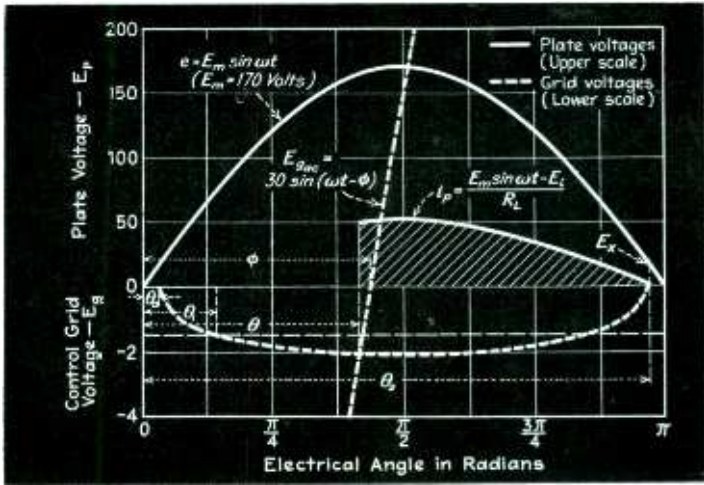

Fig. 2—Grid and plate voltage wave forms illustrating the operation of gas tetrodes. Conduction occurs for that part of the cycle which is shown cross-hatched

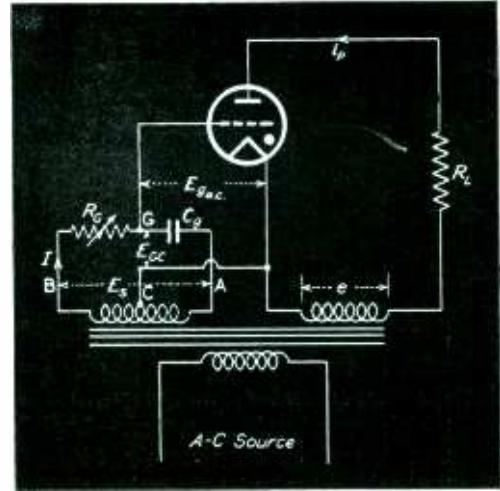

Fig. 4—Circuit diagram illustrating phase control of the conduction of a gas control tube

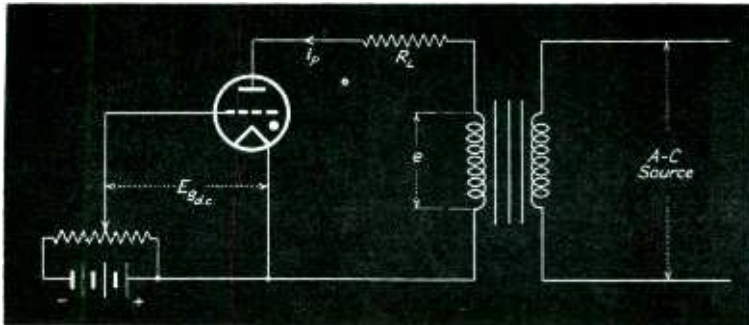

Fig. 3—Simple circuit diagram illustrating amplitude control of the conduction characteristics of gas control tube when plate is fed by alternating current

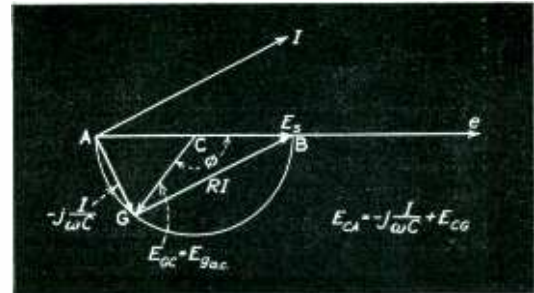

Fig. 5—Vector diagram showing the relations of current and voltage in phase controlled tube

any combination of grid and plate voltage in the clear region will produce current flow. The grid can be made to regain control only if the positive ion sheath surrounding it is destroyed, and this can be done only by reducing the voltage across the tube below the extinction potential of the gas. If an alternating voltage is applied in the plate circuit of the tube, it can be seen that it is possible for the grid to regain control once in every cycle.

If the positive half of the voltage sine wave,  $e = E_m \sin \omega t$  is plotted as a function of time, and for each value of this wave a corresponding value of grid voltage is taken from the curve in Fig. 1 and plotted to its own scale, the curves  $e$  and  $E_c$  indicated in Fig. 2 will be obtained.

There are two possible methods of control by which a tube may be made to start conducting at a pre-

determined time in the positive half of the cycle and to continue conducting for the remainder of that half cycle. The first method is known as amplitude control and the second method as phase shift control. In amplitude control a direct voltage  $E_{gdc}$  is applied between the cathode and grid, as indicated in Fig. 3, and the magnitude of this voltage will determine the point in the cycle at which  $E_c$  and  $E_{gdc}$  will intersect and therefore the angle  $\theta_1$  of Fig. 2 at which conduction will commence. Conduction will continue until the potential  $e$ , in Fig. 2, drops below the extinction potential of the tube  $E_x$ , and this point will determine the angle  $\theta_2$ . It is obvious that with fixed grid voltage the tube can not be made to conduct for less than a quarter of a cycle by this method and also that the point of intersection will not be very definite on the por-

tion of  $E_c$  which is relatively flat.

In the phase shift control method, an alternating voltage  $E_{gac}$  of constant magnitude is applied between the cathode and grid and provisions are made for shifting the phase angle between this voltage and the voltage  $e$  in the plate circuit. Referring again to Fig. 2, if the peak value of  $E_{gac}$  is large compared to the maximum value of  $E_c$ , their point of intersection will be very clearly defined. By proper phase shifting, the tube may be made to conduct over any portion of the positive half of the voltage wave  $e$ . A convenient method of obtaining the phase shift of the grid voltage is indicated in Fig. 4. The vector diagram for this circuit indicated in Fig. 5, shows that  $E_{gac}$  will be the radius vector of a semicircle and the angle,  $\phi$ , which it makes with  $e$  will be determined by the relative magnitudes of  $R_g$  and  $X_c$ .

If we call the drop in potential across the tube  $E_i$ , then the instantaneous current that will flow, after conduction commences, will be  $i_p = (e - E_i)/R_L$  as long as the numerator is positive but will be  $i_p = 0$  if the numerator becomes negative. The value of  $i_p$  averaged over a complete cycle will be

$$I_p = \frac{1}{2\pi} \int_{\theta_1}^{\theta_2} \frac{(E_m \sin \omega t - E_i)}{R_L} d(\omega t)$$

where  $\theta_1$  is the point at which conduction starts and  $\theta_2$  is the point at which conduction stops. In practice  $\theta_2$  will be very nearly 180 deg. but will actually be the value of  $(\omega t)$  at which  $E_m \sin \omega t - E_i = 0$ . The tube drop potential,  $E_i$ , depends on the amount of current flowing in the tube and is ordinarily a few volts less than the ionization potential of the tube for zero grid voltage.

#### The Power Factor Meter

The measurement of power factor must of necessity involve a circuit in which the response is independent of the relative magnitudes of the voltage and current waves but is dependent on the phase angle between the two waves. Referring to Fig. 6, if the gas tube is connected as indicated in the circuit and switch  $S$  is closed, the grid of the tube will be at zero voltage and conduction will occur over the maximum possible time interval. With  $S$  closed, if for any voltage,  $e = E_m \sin \omega t$ , the rheostat  $R_s$  is adjusted until the d-c ammeter,  $I_{dc}$ , reads full scale deflection, the current wave in the plate circuit of the tube may be almost exactly reproduced for any reasonable range of input voltages  $e$ . If switch  $S$  is now opened and the rheostat  $R_i$  is adjusted until  $E_{ac}$  reads some predetermined value of voltage, then the period of conduction, and therefore  $I_{dc}$  will depend on the phase angle between the current wave,  $i_L$ , and the voltage wave,  $e$ . As indicated in Fig. 7A, if the current wave  $i_{L1}$  is exactly in phase with  $e$  no conduction will occur since  $E_{ac1}$  will at all times, in the positive half cycle of  $e$ , be more negative than  $E_c$  and therefore  $I_{dc}$  will read zero. If the current wave  $i_L$  should lead the voltage wave  $e$  then conduction will occur for a portion of the half cycle determined by the intersection of  $E_{ac2}$  and  $E_c$ . The d-c meter reading in this case would be

Fig. 6—Elementary schematic wiring diagram of circuit for power factor meter

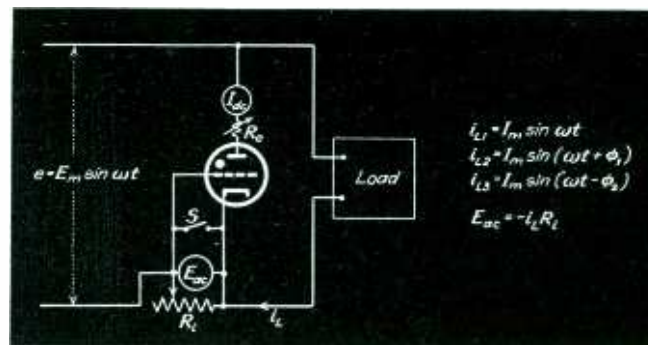

Fig. 7—Current and voltage wave forms illustrating method of operation of simple power factor meter

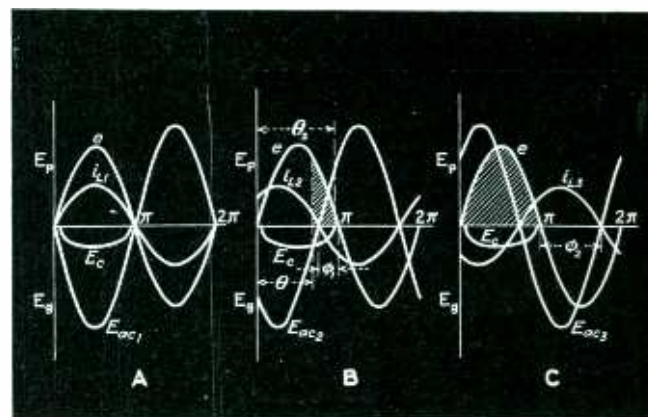
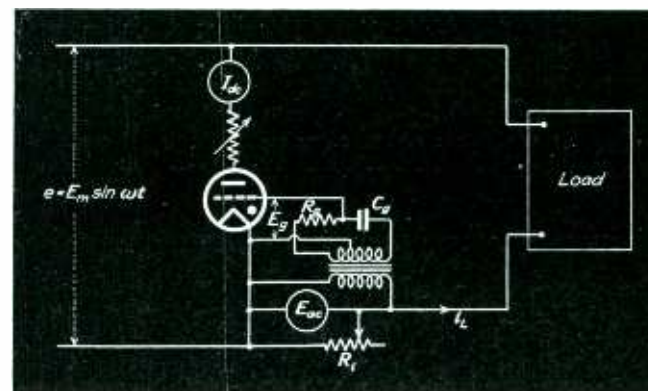

Fig. 8—Basic circuit of a somewhat more convenient and practical power factor meter



$$I_{dc} = \frac{1}{2\pi} \int_{\theta}^{\theta_2} \frac{(E_m \sin \omega t - E_i)}{R_c} d(\omega t)$$

where  $\theta$  is the angle at which  $E_{ac2}$  intersects  $E_c$  and  $\theta_2$  is the angle at which conduction ceases as indicated in Fig. 2. It is obvious from Fig. 7C that if the  $i_{L3}$  wave were to lag the  $e$  wave, conduction would occur through the full half cycle for which  $e$  is positive and  $I_{dc}$  would read full scale as previously adjusted.

For various reasons the elementary circuit in Fig. 6 is neither practical nor convenient. In the first place if  $E_{ac}$  is to be much larger than  $E_c$  (which may have a value of 3 or 4 volts for the 2051 tube) the voltage

drop across the variable shunt  $R_i$  would be too large a percentage of the load voltage. In the second place the large amount of power dissipated as heat in  $R_i$  would be difficult to get rid of. Finally, no measurement of lagging power factors would be possible since all such factors would all read the same amount on the meter.

The current requirements in the grid circuit of the tube are very small and therefore the obvious step is to use a small voltage,  $E_{ac}$ , (approximately 0.5 volt) and to use a step-up transformer to obtain the higher grid voltages required. It would also be convenient to use a

phase shifting network of the type indicated in Fig. 4 in order to be able to use any desired point in the cycle as a unity power factor reference point. These changes are shown incorporated in Fig. 8. The combination of  $R_g$  and  $C_g$  could be made such that  $E_g$  would intersect  $E_c$  at the time when  $e$  was at its maximum value as indicated by  $E_{g1}$  in Fig. 9. In this case unity power factor would be indicated by an  $I_{ac}$  reading of 0.5 of full scale deflection. Lagging power factors would be indicated by  $I_{ac}$  readings less than 0.5 of full scale deflection and leading power factors would be indicated by  $I_{ac}$  readings greater than 0.5 of full scale deflection.

It is obvious from Fig. 9, however, that the greatest changes in  $I_{ac}$  per unit change in phase angle would occur in the 90 deg. region between  $\pi/4$  and  $3\pi/4$ . This means that a more convenient arrangement would be to have the phase shifting network give a unity power factor reference point at  $\pi/4$  for lagging

power factors and at  $3\pi/4$  for leading power factors. In this manner a theoretical 70 percent of full scale  $I_{ac}$  deflection can be used for leading power factors and the same percentage of full scale deflection in the opposite direction can be used for lagging power factors. Another possible scale arrangement would be to have the unity power factor reference point at 0 for lagging power factors and at  $\pi$  radians for leading power factors. This arrangement would produce two linear power factor scales which would meet at the middle of the meter scale. The actual scale chosen, as indicated in Fig. 10, was a compromise scale which tends to have both a large scale utilization factor and a good amount of linearity.

It is also inconvenient to have an additional a-c voltmeter  $E_{ac}$  and to avoid the use of this instrument a copper oxide rectifier, in conjunction with the meter  $I_{ac}$  and suitable switching arrangements, can be used. The complete circuit diagram, with

all modifications and refinements, is shown in Fig. 11. In actual operation, with the switch thrown in the  $E_{adj}$  position, the  $I_{ac}$  meter is in parallel with the 1-ohm shunt and the grid is shorted to the cathode. With the switch in this position the rheostat in the plate circuit is adjusted till  $I_{ac}$  reads full scale deflection. With the switch in the  $I_{adj}$  position the  $I_{ac}$  meter is connected with the proper polarity across the copper oxide rectifier cell and the variable shunt is adjusted till the meter assumes some position which indicates a predetermined voltage drop across the variable shunt. This last adjustment is not at all critical for if the instrument is used on a 120-volt line and calibration was made with an rms voltage of 21 volts on the grid, doubling the grid voltage would cause an error equivalent to only 2 deg. while halving the grid voltage would produce an error equivalent to only 5 deg. If the switch is now released to its normal center position, the  $I_{ac}$  meter

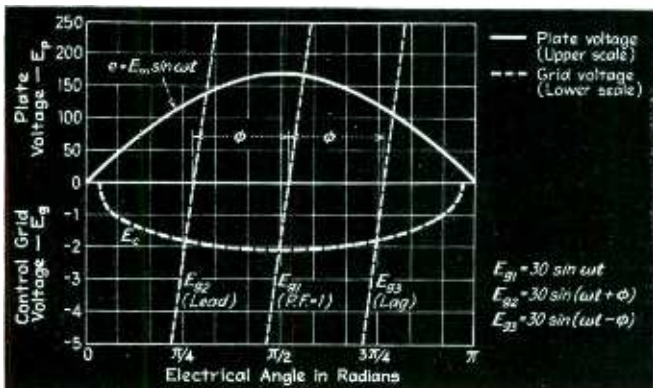

Fig. 9—Voltage and current wave forms showing how the indication of power factor meter depends upon point of cycle at which conduction begins

Fig. 10—Meter scale for power factor meter with lagging and leading factors for 150 and 250 volt circuits

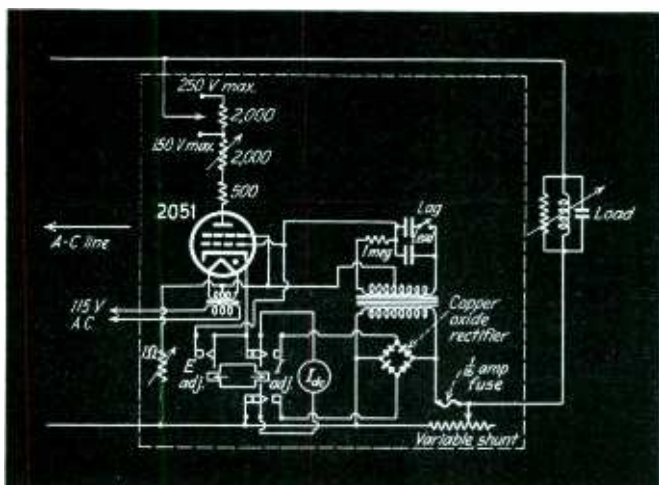

Fig. 11—Detailed wiring diagram of the complete power factor meter

is again placed in parallel with the 1-ohm shunt and the reading on the meter indicates the power factor of the load. Whether readings should be taken on the lead or lag scale is determined by the position of the lead-lag switch.

Several interesting problems arise in the design of the component parts of the power factor meter. If a 2050 or 2051 gas tetrode is used, it is desirable to have a grid voltage of about 20 volts rms. On the other hand the alternating voltage across the variable shunt should not exceed 1 volt and was arbitrarily chosen to be 0.5 volt. Since only a half of the grid transformer second-

ary voltage appears between cathode and grid, due to the phase shifting network used, a transformer with a center-tapped secondary and a ratio of transformation of about 1 to 80 was required. In addition to the above requirements it was also essential that the magnetizing current of the transformer should be very small in order that the primary voltage of the grid transformer should be very nearly in phase with the load current even at small values of load current. To satisfy these conditions the primary winding was designed to have 150 turns and it drew a magnetizing current of 7 milliamperes at 0.5 volt rms. The secondary of the grid transformer has a total of 12,000 turns and an equivalent secondary impedance of about 90,000 ohms, most of which is due to leakage reactance. For this reason the transformer requires a large value of load resistance  $R_p$  and load reactance  $X_p$ . A load resistance of 1 megohm was used. The 2050 and 2051 tubes are admirably suited for this application because of their low grid current requirements.

The design of the variable shunt presents another problem, for a constant voltage must be developed across it within the full operating load current range used. In this instrument a minimum operating current of 0.1 ampere and a maximum operating current of 10.0 ampere were chosen. This required a minimum resistance of 0.5 ohm and a maximum resistance of 5.0 ohms, all on the same control and with approximately uniform variations of voltage all along the control. This naturally dictates a tapered rheostat giving small changes of resistance at the large current end and large changes of resistance at the small current end. In order to protect the meter, the copper oxide rectifier, and the grid transformer from damage in case of failure of the variable shunt a 1/16 ampere fuse was installed as indicated in Fig. 11.

It is interesting to note that if calibrated dials are attached to the rheostat in the plate circuit and to the variable shunt, it is possible to determine the voltage and current in the circuit, and, knowing the power factor, the power in watts drawn by the load can be easily determined. The instrument therefore

serves as a combined voltmeter, ammeter, power factor meter, and wattmeter.

#### Limitations of the Power Factor Meter

With the grid shorted to the cathode, the point in the cycle at which conduction will commence ( $\theta_1$ ) will vary slightly for various values of applied voltage. In a like manner, the point at which conduction stops ( $\theta_2$ ), (at  $E_m \sin \omega t - E_i = 0$ ), will vary with the magnitude of  $E_m$ . For these two reasons and because the resistance in the plate circuit is adjusted to give an average value of  $I_{dc}$  equal to the full scale deflection of the meter, the wave shape of the current wave through the tube will vary slightly for various voltages in the plate circuit. This difference becomes negligibly small when the voltage in the plate circuit exceeds 230 volts rms. This condition can be taken care of by either calibrating the power factor meter for two common values of voltage desired such as 120 and 240 volts, as indicated in Fig. 10, and interpolating between the two values or else by using a potential transformer to supply the plate circuit. If a potential transformer is used then it would be desirable to use a base voltage of about 230 or 350 volts on the secondary and variations of plus or minus 25 percent in this voltage could be accommodated with negligible error with a single calibration of the scale on the power factor meter.

Since the grid transformer draws a small amount of current which lags the current in the variable shunt by approximately 90 deg. and the sum of these two currents is equal to the load current, the voltage across the primary of the grid transformer will not be exactly in phase with the load current. In the case of the transformer used, with a magnetizing current of 7 milliamperes, the error is negligible until the load current decreases below 0.1 ampere. If the power factor meter is calibrated for a load of 0.5 ampere the error involved in using 0.1 ampere would be that due to  $3^\circ 12'$  lag. At 1.0 ampere this error would be that due to  $0^\circ 24'$  lead and at 10.0 amperes the error would be that due to  $0^\circ 36'$  lead. In practice, all of the errors except that due to the 0.1 ampere load current would be less than the reading accuracy of the

meter employed. The obvious way to decrease this error, or to extend the current range to lower values if it should prove desirable, would be to decrease the magnetizing current requirements of the grid transformer by either increasing the number of primary turns, decreasing the primary voltage, or both.

The power requirement in the shunt of the power factor meter is but a small portion of the total volt amperes involved. If measurements are made on a 120-volt circuit then the power required in the shunt is  $(0.5 \times 100)/120 = 42$  percent of the total volt amperes involved. Measurements on a 240-volt line would require 0.21 percent of the total volt-amperes involved. The current drawn in the potential circuit is highly variable, depending on the power factor being measured. In the case of this particular instrument the peak value of this current is 62 milliamperes, its r-m-s value is 31 milliamperes, and its average value is 19.7 milliamperes.

In the design and calibration of the instrument sine waves of both current and voltage are assumed. If harmonics are present small errors will be introduced.

Since the grid voltage  $E_g$ , is much larger than the critical voltage  $E_c$ , and the tube drop  $E_i$ , is only a small portion of the total voltage involved, similar types of tubes can be substituted in the power factor meter without recalibration since the error involved would be entirely negligible.

#### Conclusion

In the present power factor meter the 2051 gas tetrode was used since it had several characteristics which were very desirable in this application. The use of this tube, however, required a 6.3-volt source of power for the filament and therefore a filament transformer. The current requirements of the plate circuit of the power factor meter are considerably lower than the current rating of the tube used and therefore it would be desirable to have a tube with lower maximum emission and which could be supplied with filament power from a 1.5-volt dry cell in the case.

A photograph of the completed power factor meter is shown. It can be seen that the power factor meter could easily be adapted to use with current and potential transformers.

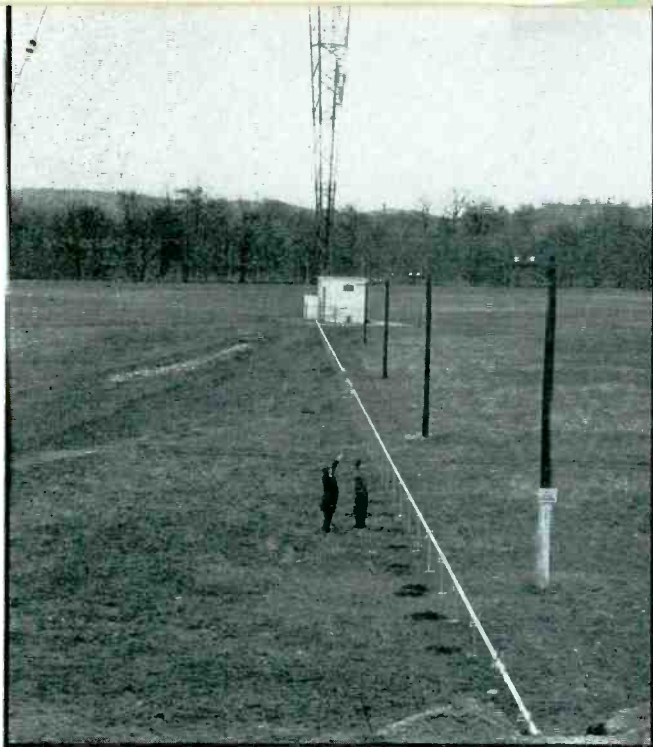

# W47NV NASHVILLE

Features of the first f-m station to operate on a commercial basis. The turnstile antenna is located on top of WSM's 758-foot antenna tower which is the tallest in this country

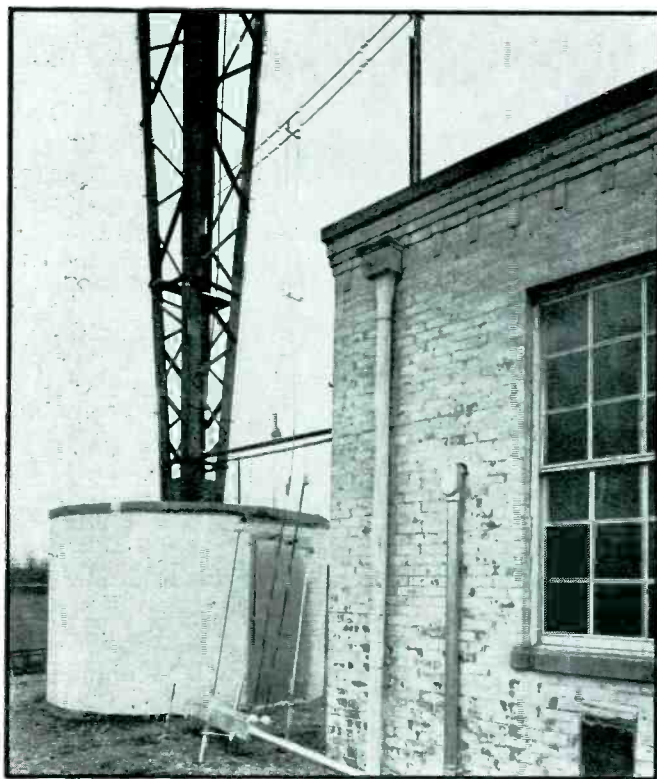

RIGHT, the antenna is a four-bay turnstile in which each element is folded back to the supporting pole where it is connected to the transmission line feeder. This permits close spacing of feed lines thereby reducing their radiation effects . . . LEFT TOP, the coaxial transmission line which serves W47NV as well as WSM



LEFT CENTER, close-up of the base of the tower showing the matching and feed circuits. . . .

LEFT, BOTTOM, the transmitter in which a 450-kc oscillator is frequency modulated by a push-pull reactance tube circuit. At maximum volume the 450-kc signal is swung 18.7-kc, one-quarter of the allowable swing of the carrier. The modulated signal is mixed with the 10.725-Mc output of a crystal-controlled oscillator, and the sum of the two frequencies is multiplied four times to give the carrier frequency which is 44.7 Mc. . . . ABOVE, rear view of the 20-kw power amplifier showing two GL-899 water cooled tubes which are used in the final stage

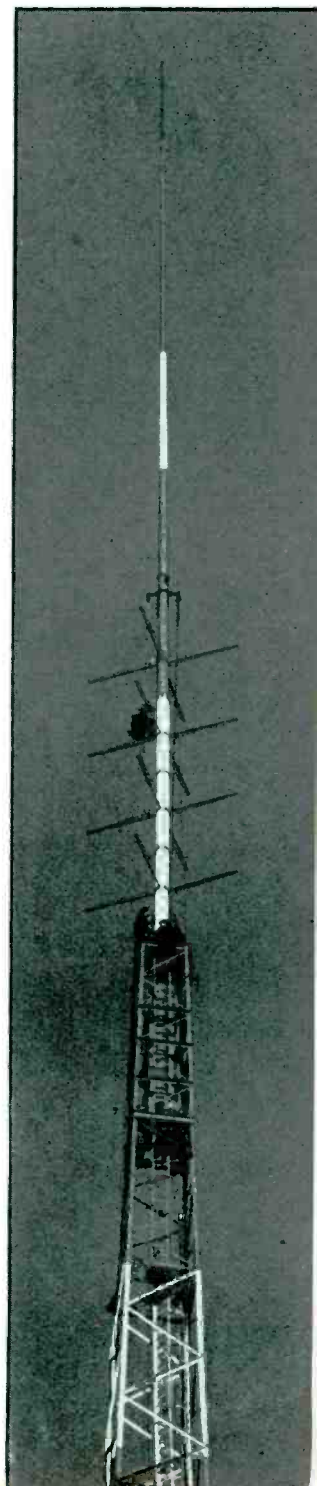
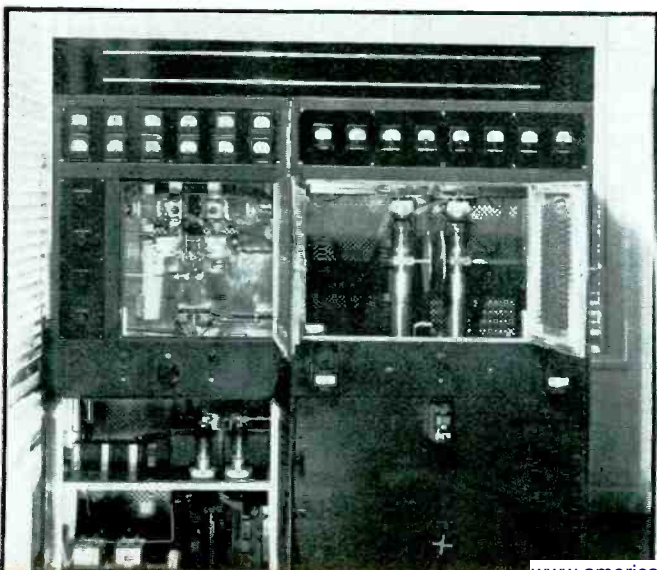

# Equipment Failure Alarm for Communication Networks

By  
**E. G. COOK**  
*Communication  
 Engineering Service*  
 and **A. H. PETERSEN**

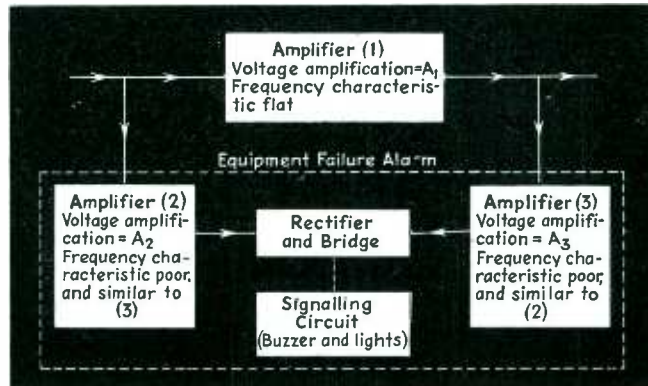

Fig. 1—Block diagram of the equipment failure alarm. Under normal conditions the output voltages of amplifiers 2 and 3 are equal. Abnormal conditions will upset this equality

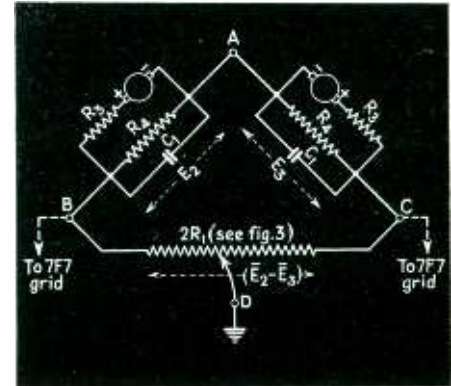

Fig. 2—Equivalent circuit of the alarm. The characteristics of the components of the two upper arms should be identical

**T**HE sharp increase in the use of two-way facilities in communication networks during the past few years has resulted in greater complexity in these circuits to such an extent that the use of an equipment failure alarm is highly desirable. Such instruments placed at strategic points in the network insure a minimum loss of time in restoring normal service.

Generally speaking, the equipment failure alarm is an inexpensive and practical way of monitoring between any two points in an audio chain when the difference in level between these two points is normally constant. For example, it may be used with any type of constant-gain amplifier as a failure or trouble indicator. With a limiting amplifier, in addition to warning of equipment failure, it may also serve as a warning signal for excessive limiting action. Connected across the modulation monitor rectifier output and the modulator input of a radio-frequency transmitter, it readily betrays any appreciable change in amplification between these two points, as well as pronounced hum or noise originating therein. Connection of equipment failure alarms with a central board may be made so that all amplifiers are monitored from the operating position. Moreover, in the case of an amplifier whose function is of the utmost im-

portance, relay switching arrangements are easily made whereby a spare unit is automatically placed in service when the regular unit fails.

### Method of Operation

Fundamentally, the idea is to bridge off the input and output terminals of an amplifier, and bring the signal which is present at the input terminals up to a usable level. The signal present at the output terminals is treated in the same manner, naturally requiring less amplification in order to bring it to the same usable level. Each of the two resulting matched signals is then impressed upon its individual rectifier and filter, and the d-c outputs

( $E_2$ ,  $E_3$ , Fig. 2) are compared in a bridge. When the d-c voltage thus derived from the original input terminals approximately equals that obtained from the output terminals at all frequencies to be transmitted, the system is balanced. If trouble should develop within the amplifier causing either a rise or fall in amplification or a large amount of hum or noise, the system will fall out of balance, causing a resultant voltage,  $E_2 - E_3$ , to appear on the bridge (Fig. 2) and be impressed on the signalling circuit. Polarity of this resultant voltage depends upon whether the amplification has increased or decreased, and determines which of two indicating panel lamps will light.

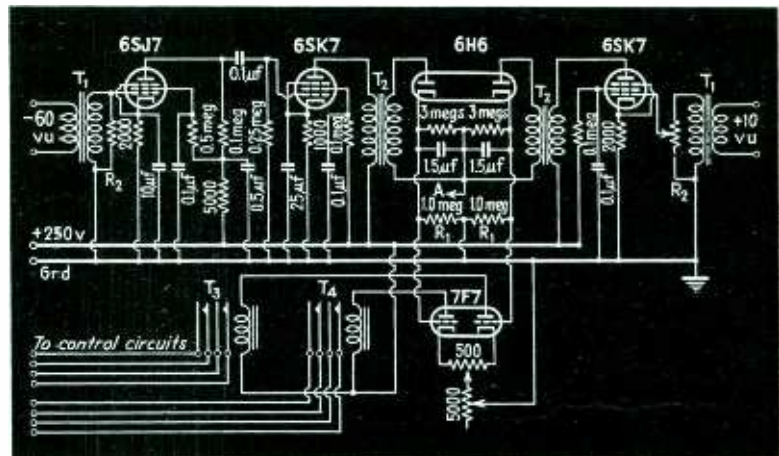

Fig. 3—Circuit diagram of the alarm. The common cathode resistor of the 7F7 increases the sensitivity of this tube as a push-pull d-c amplifier

In addition, a buzzer may be connected to operate on any unbalance without regard for polarity. If the fuse blows or power supply fails the buzzer will sound and both lamps will light. Perhaps most important of all, the equipment failure alarm monitors itself in the same way in which it monitors the amplifier in question. Only failure of the type 6H6 tube heater, or sudden and total failure of two of the three amplifiers (Fig. 1) can occur without energizing the signalling circuit. This latter possibility is certainly negligible. The 6H6 possibility suggests an occasional check during maintenance rounds to see that this tube is operating, or a relay and pilot lamp may be placed in the heater circuit.

Referring again to Fig. 1, it will be seen that across the input of the amplifier to be monitored (1) is bridged another amplifier (2) of

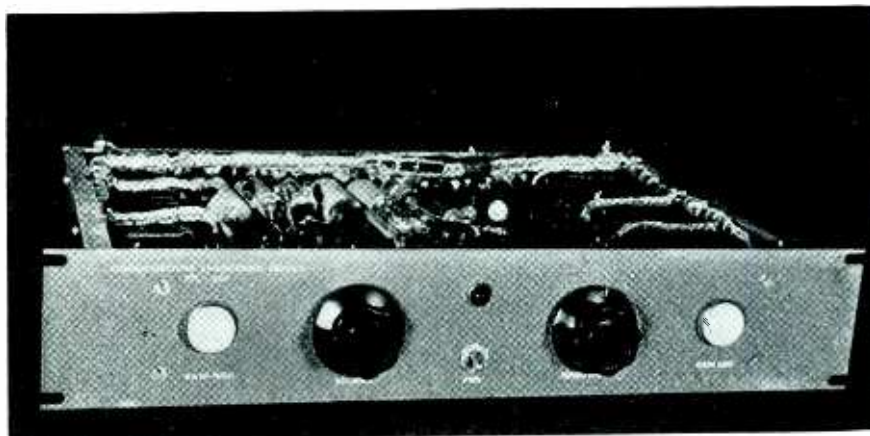

Fig. 5—The unit is accommodated in a standard rack panel 3½ inches high. The tubes are located in the rear for accessibility

whatever gain is necessary to bring the gain up to a usable level, say +10 vu. Across the output of (1) is bridged another amplifier (3) of low gain for isolation purposes, so adjusted that its output is at the same level as that of (2). These outputs are rectified and impressed upon a bridge (Figs. 2 and 3) in such a way that with an unbalance of predetermined magnitude a signalling system is actuated. Obviously, the frequency response characteristics of (2) and (3) must match each other closely, or false alarms will take place. In practice, however, the high and low frequency content of most audio signals is fairly low with reference to the middle range fre-

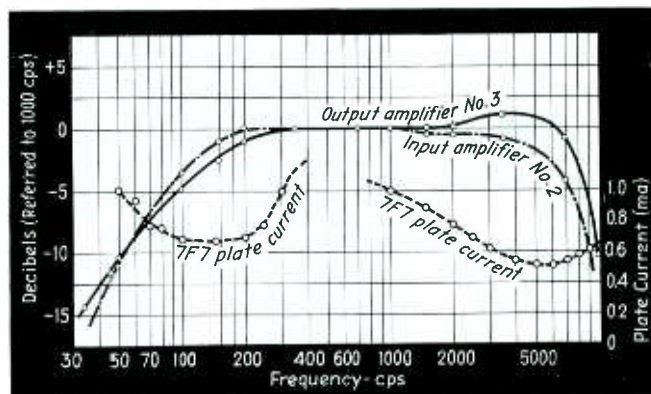

Fig. 4—Characteristic curves of the two alarm amplifiers. Because of the low energy content of the very low and high frequencies, small discrepancies between the two characteristics are not serious

quencies. Therefore some aberration of frequency characteristics at the two ends of the spectrum is not likely to be troublesome. Furthermore, the frequency response of (2) and (3) may be considerably poorer than that of (1). This assumes that (1) is intended to have an essentially flat characteristic. If in (1) there is included a line equalizer, record-

cept that care should be taken not to operate (2) and (3) very far above the overload point.

#### Adjustments for Operation

In building the equipment failure alarm, some difficulty may be experienced in adjustment of the bridge and associated circuits. The circuit constants shown in Fig. 3 are not inflexible. In general the lower the bridge impedance is, the easier it becomes to adjust. However, the lower this impedance, the more gain and driving power is required. Hence, the problem becomes an economic compromise. The time constants of this bridge, determined by  $R_1$ ,  $R_3$ ,  $R_4$ , and  $C_1$ , are important in the successful operation of the alarm. When an unbalance occurs an indicating signal is certainly wanted as soon as possible. With too high a value of  $R_3$ , due to the low average power content of some program material, several seconds may elapse before the alarm takes place. On the other hand, once an alarm sounds on intermittent trouble it should continue at least until the operator has had a fair chance to locate the difficulty. For this reason  $R_1$  and  $R_4$  should be kept as high as possible with respect to  $R_3$ . Any dissimilarity between the two upper arms of the bridge with respect to circuit values is bound to cause false alarms. It is convenient to use a potentiometer (Fig. 2) instead of the two separate fixed resistors,  $R_1$ , (Fig. 3). In this way the ground point of the bridge may be arbitrarily set at the point which gives the best balance on extraneous noise caused by the high impedance 6H6 cathodes.

A 500 ohm potentiometer will be found in the 7F7 cathode circuit (Fig. 3) to allow compensation for  
(Continued on page 105)

# STORAGE in TELEVISION RECEPTION . . .

Successfully used in television transmission, the principle of image storage may also be used with benefit in receivers. Some Scophony developments along this line are discussed

By A. H. ROSENTHAL

Optical Research Laboratories  
New York, N. Y.

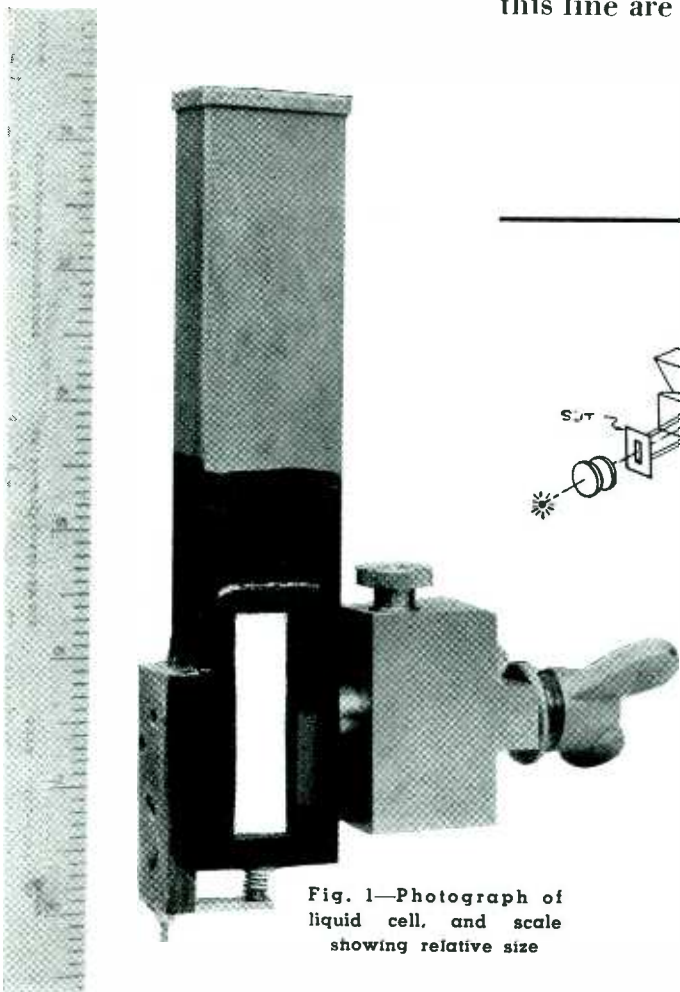

Fig. 1—Photograph of liquid cell, and scale showing relative size

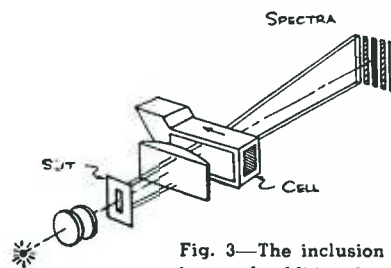

Fig. 2—Diagram illustrating construction of the liquid cell system

Fig. 3—The inclusion of a bar and additional optical elements to the system shown in Fig. 2, acts to remove light from screen when cell is not active

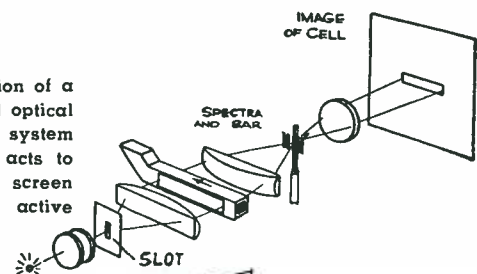
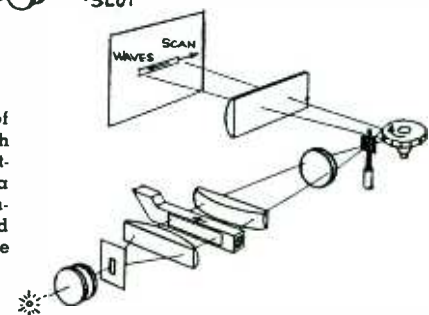

Fig. 4—The elements of Fig. 3 are combined with a multiple mirror rotating wheel to produce a line image whose intensity can be varied with time or with the position of the spot



THE recent progress of television technique has been characterized by a steady increase in definition with a consequent increasing difficulty due to the extreme shortness of the time interval available for scanning one picture element. At the transmitting end, the introduction of electrical storage over a substantial fraction of the frame period has made possible modern high-definition transmission.

A similar principle may be applied at the receiving end by introducing an optical storage of the picture elements over a substantial part of the frame period. The retention of

the illumination of each element amounts to the simultaneous illumination of a considerable fraction of the total picture area, which results in a proportional increase of the total light energy available for each picture.

### The Supersonic Light Control

The principle of optical storage is inherent in the supersonic light control, developed in the Scophony Laboratories.<sup>1, 2, 3</sup> This light-modulating device makes use of the diffraction of light by a grating consisting of supersonic waves in a liquid. This optical effect which has played an im-

portant part in various scientific researches,<sup>4</sup> has been applied as a simple and effective means of light modulation.

The supersonic light control consists of a cell having two opposite transparent walls, filled with a transparent liquid. A piezoelectric quartz crystal having a natural frequency between 10 and 20 Mc is arranged in such a way that it can transmit its vibrations to the liquid of the cell creating travelling waves therein. A photograph of such a cell is shown in Fig. 1, while the cell system is shown in Fig. 2. The crystal is excited by electrical oscilla-



tions which are amplitude-modulated by the video frequency signals received from the transmitter and transmits those modulated oscillations to the liquid of the cell in the form of compression-supersonic waves of varying intensity. These supersonic waves represent periodic compressions and rarefactions of the liquid, producing similar variations in the refraction index of the liquid which act on light transmitted through the cell like a diffraction grating.

By a lens system adjacent to the supersonic cell the optical arrangement shown in Fig. 3 forms an image of the light slot, from which the light beam traversing the cell issues, on a bar of such a size and position that practically all the light is stopped when the cell is not active. As soon as supersonic waves are excited in the liquid a certain amount of the light is diffracted but the diffraction spectra have a position outside the intervening bar. Thus, an amount of light can pass this bar in proportion to the intensity of modulation of the supersonic waves, which is in turn proportional to the intensity of the television signal.

Adjacent to the bar, or at the position of the diffraction spectra, a lens is arranged of such an aperture as to accommodate the more intense of the low-order diffraction spectra. On the picture screen of the receiver this lens forms an image of the wave-train in the supersonic light control. The supersonic waves carrying the signal modulations in the liquid, travel away from the exciting crystal with the velocity of

elastic waves of sound of these frequencies, which is in the order of 1 kilometer per second. Since, for high definition television standards, the time duration of one picture element is of the order of one quarter of a micro-second, the length of a wave train corresponding to one element is about one-fortieth of a centimeter in the cell. Such an "element train" contains about 5 waves if the crystal frequency is 20 Mc. A wave train ten centimeters long will accordingly contain the successive modulations of about 400 picture elements, corresponding to approximately one complete picture line.

If the image of a wave train of such a length is projected onto the picture screen the image of nearly a full picture line appears simultaneously on the screen. A wave train of such a length does not show a noticeable attenuation, provided a suitable liquid is used. In order to simplify the optical system about one-third to one-half of a line is simultaneously active.

This application of the supersonic light control thus enables the simultaneous projection of 200 to 300 picture elements onto the viewing screen. We may also express the performance of the supersonic light control by saying that each picture element is actively illuminated for the scanning duration of 200 to 300 elements. An "optical storage" of the picture for this duration corresponding to one third to one half of a line is thus effected by the supersonic light control.

A further advantage of the super-

sonic light control over earlier light modulating devices, for instance the Kerr cell, is the excellent high frequency response obtained as consequence of the very low capacitance between the electrodes of the quartz crystal and the very low power consumption of the device (5 to 10 watts). Special damping means and output bandpass characteristics serve to obtain a flat frequency response of 5 Mc wide, which easily accommodates a high definition single-side-band image.

#### Mechanical Scanning System

The light modulations projected on to the screen would move along the lines with a velocity corresponding to the velocity with which the supersonic waves travel in the cell. However, a mirror polygon called the "high speed scanner," having 20 or 30 faces serves to sweep the light beams across the picture screen with a speed exactly opposite to that of the movement of the waves on the screen, and of such a magnitude as to compensate this movement as shown in Fig. 4. Thus each element is immobilized on the screen.

Using a 20-mirror polygon, a motor (Fig. 5) running at 47,250 rpm is required for reproduction of a 525-line image. Using a 30-mirror high speed scanner, the same result will be obtained at 31,500 rpm.

The bearings and balancing of the rotor must be of high quality to achieve service-free operation for a time comparable with the life of standard receiving tubes. The driving mechanism consists of an asynchronous three-phase motor which

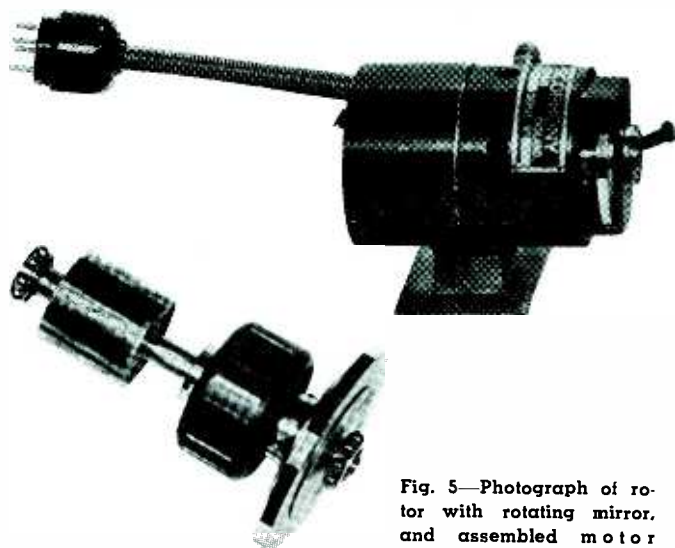

Fig. 5—Photograph of rotor with rotating mirror, and assembled motor

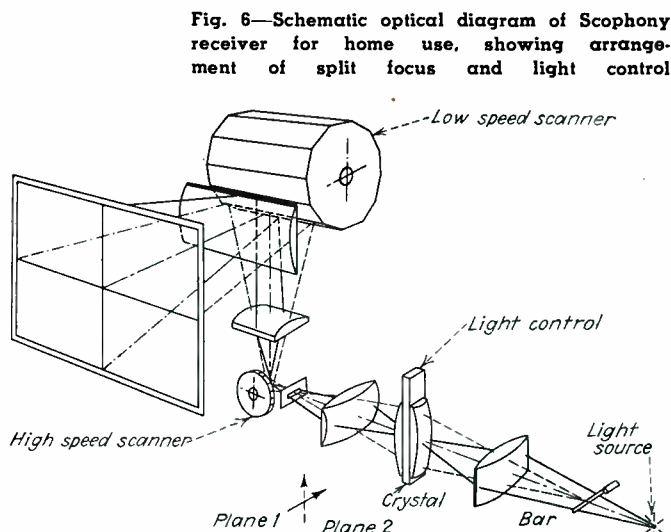

Fig. 6—Schematic optical diagram of Scophony receiver for home use, showing arrangement of split focus and light control

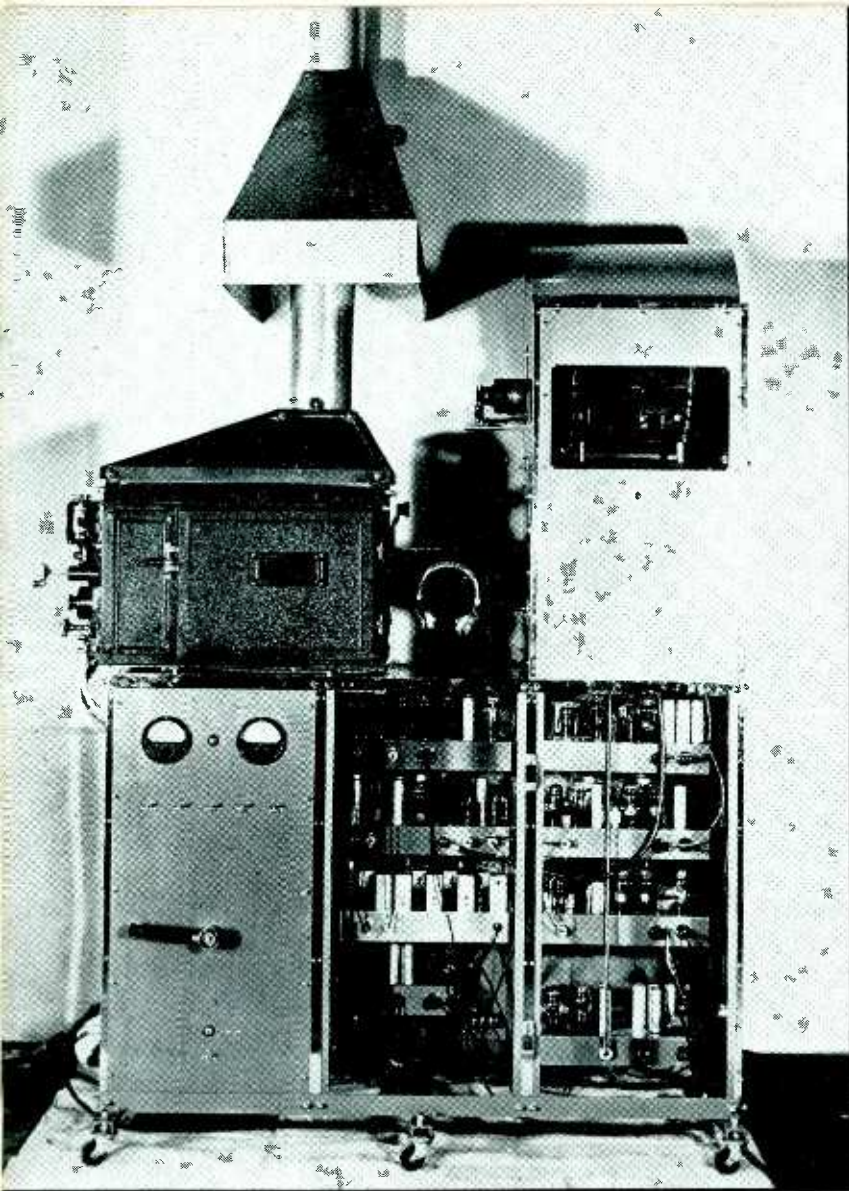

Fig. 7 Complete projector for theater use, based on the principles outlined in this article

supplies the power, and on the same shaft a phonic-wheel synchronous motor to the stator of which are fed the synchronizing signals from the receiver.

The frame-scanning movement is achieved through the use of a slow-speed scanner, a 20-mirror polygon driven at 180 rpm by means of a synchronous motor. The alternating current to drive this motor is obtained by amplifying the frame synchronizing pulse transmitted as a component of the signal radiated by the transmitting station. Figure 6 shows a schematic diagram of a Scophony receiver using this system.

#### Optical Focussing System

In order fully to utilize the advantages of optical storage made possible by the supersonic light control, and to reduce the size of the high speed scanner, optical principles have been developed which are

motor and correspondingly easy synchronization.

It may be remarked that receivers based on the principles described above can be easily adapted to color television using a small rotating filter arrangement placed where the beam has a minimum cross section, preferably near the slot or high-speed scanner. A theater projector is shown in Fig. 7.

#### Combination of Supersonic Light Control with Electronic Scanning

The main limitation of the projection cathode-ray tube is caused by the saturation of the fluorescent screen, which limits both the brilliancy obtainable and the life of the tube. If instead of exciting only one element of the picture screen at a time, many elements could be excited, it would be possible to obtain with a smaller current density a far brighter picture, and still operate below saturation. By combining the

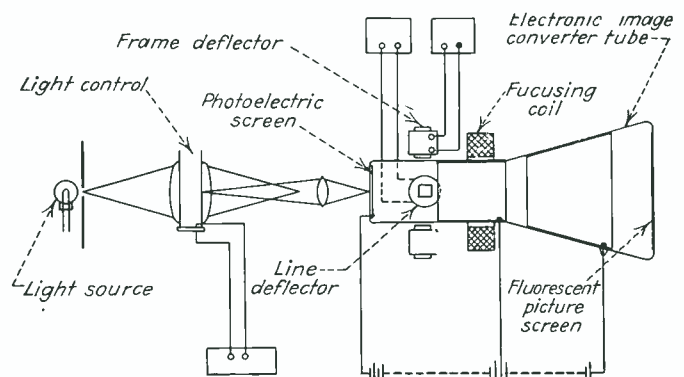

Fig. 8—Diagram illustrating principles of electronic supersonic television projection receiver

new in the art of television. A suitable combination of spherical and cylindrical lenses effects an intermediate imaging of the width of the picture line. This "split focus" arrangement (Fig. 6) focuses the beam of light from the supersonic cell in two different planes, in such a way that the light energy is concentrated on a narrow band near the surfaces of the high speed scanner. Thus, the split focus principle permits a substantial reduction in the active apertures of the high speed scanner, and, consequently, in the size of this component making possible the use of a small driving

able combination of spherical and cylindrical lenses effects an intermediate imaging of the width of the picture line. This "split focus" arrangement (Fig. 6) focuses the beam of light from the supersonic cell in two different planes, in such a way that the light energy is concentrated on a narrow band near the surfaces of the high speed scanner. Thus, the split focus principle permits a substantial reduction in the active apertures of the high speed scanner, and, consequently, in the size of this component making possible the use of a small driving

sonic light control with an electronic image converter, such a storage excitation of the fluorescent screen can be effected. Such a tube will act like a multi-beam cathode-ray tube.<sup>5</sup> The multi-beam however is produced automatically in a type of electronic image converter tube. In this tube an optical image of the supersonic light modulations of the light control is projected onto the photoelectric screen and is there transformed into an electron image. The image is at the same time amplified, and immobilized by electronic scanning means, and utilized to ex-

cite, in the form of a multiple cathode-ray beam on the fluorescent screen of the tube as many elements as the supersonic light control can handle. That means several hundred elements (Fig. 8). The system has not yet been fully developed since Scophony has been primarily interested in the development of another device, the Skiatron.

### The Skiatron

Various effects have been proposed to obtain a modulation of the light transparency of a screen by scanning it with a cathode-ray beam. The cathode-ray, for example, has been used to operate small mechanical shutters, to cause the orientation of small colloidal particles or to produce birefringence in suitable substances.<sup>4</sup>

The advantage of such a system can be utilized efficiently only if the varying transparency values of the picture elements can be retained

tween maximum and minimum illumination in the picture, and the decay constant must be chosen so that during one frame period the intensity has fallen at least to a fraction equal to  $r$ . With an exponential decay according to

$$J = J_0 e^{-\alpha t}$$

this would require a decay constant not smaller than  $\alpha = (1/T) \log_e r$  where  $J$  and  $J_0$  are the intensities at the beginning and the end of the frame period  $T$ .

The intensity-time integral  $I$ , which represents the apparent element brightness equals

$$I = J_0 T / g$$

where

$$g = \frac{r \log_e r}{r - 1}$$

is a gain factor representing the ratio of the apparent brightness of a full storage system with a rectangular intensity-time curve to that of a system with an exponential de-

which inherently offers the possibility of a full storage, that is, possesses a rectangular decay curve, the Skiatron<sup>7</sup>, has been developed in the Scophony laboratories.

As shown in Fig. 9 the Skiatron consists of a cathode-ray tube device in which a crystalline screen is exposed to the modulated and deflected cathode-ray beam. The screen material exhibits the property of "electron opacity" that is, it can be rendered opaque by being scanned by a cathode-ray beam. By subjecting the screen to a suitable electric field and temperature it is possible to cause the opacity to remain constant for substantially the whole frame period and to disappear then quickly when the beam returns to produce the opacity for the following frame.

This effect occurs in the following way: If an alkali halide crystal such as sylvine, or rock salt, is subjected to an electric field and to a cathode-ray beam, the electrons travel as free

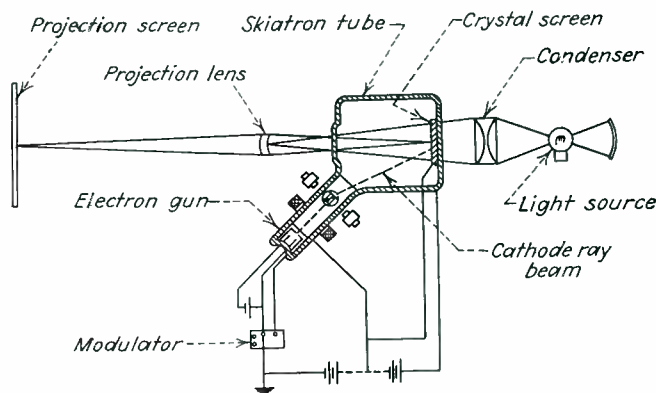
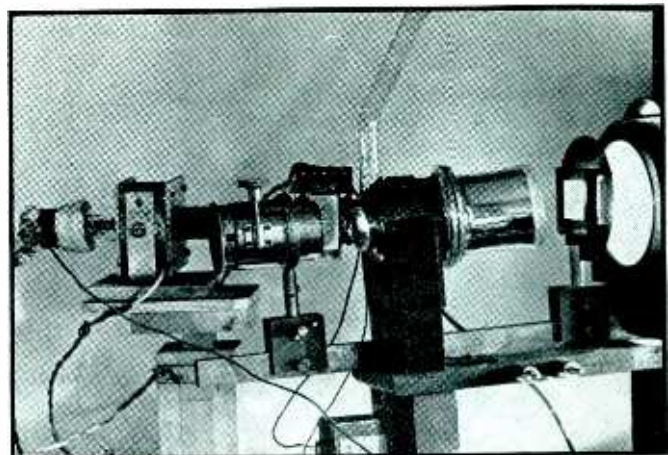

Fig. 9—Schematic diagram of the Skiatron and its associated circuits. Fig. 10—Right, demountable cathode ray tube for Skiatron making use of principle of signal storage



practically unchanged over substantially the full picture period. However, in all the above-mentioned phenomena, as in self-luminous fluorescent screens, the intensity time relation of the elements is represented by a decay curve, usually of exponential type. Hence in order to obtain as large as possible a storage of the element illumination and on the other hand to prevent an appreciable carry-over of movement from one frame to the following one, a compromise must be chosen with regard to the decay constant.

The carry-over of movements depends upon the intensity ratio  $r$  be-

between maximum and minimum illumination in the picture, and the decay constant must be chosen so that during one frame period the intensity has fallen at least to a fraction equal to  $r$ . With an exponential decay according to

$r$	$g$
5	2.0
10	2.6
30	3.5
100	4.7

An electronic television system

electrons toward the anode producing the electric field, through the crystal lattice. After a certain time however an electron is captured by a positive alkali ion, resulting in the formation of a so-called color center which causes absorption in the visible spectrum. After a certain time these color centers are split up again by the thermal oscillations of the lattice into alkali ions and electrons, the latter ones proceeding further towards the anode until a subsequent capture by an ion. Thus the effect of the impact of the cathode-ray on to the crystal is the formation of an

(Continued on page 115)

# TECHNIQUE for TUBE DATA

A versatile and simple method of taking tube characteristics as a trace on the screen of a cathode ray oscilloscope is described. Advantages of this method are the small amount of equipment required and the speed and accuracy with which desired results can be obtained

By C. C. STREET

Providence, R. I.

THE time spent in taking the characteristics of vacuum tubes is something which is dreaded by most laboratory technicians. In any case the usual point-by-point determinations are tedious, and errors in meter readings cannot be checked easily until the characteristic curves are drawn when it is often impossible or inconvenient to make a check reading. In some tube applications, the characteristics of a particular tube must be known more accurately than one can rely on the published data, and in other cases it is desirable that the transfer characteristics of the same electrode, or between two different electrodes, have some specified shape, as determined by the voltages applied to them or the impedances in their circuits. Under the conventional procedure a characteristic of prescribed form and scale, within the limitations of the tube in question, can be obtained only by successive approximations, that is, by taking point by point readings, plotting the results, altering some circuit constant or electrode voltage, and obtaining other characteristic data in this time-consuming manner. A family of curves is finally obtained from which the

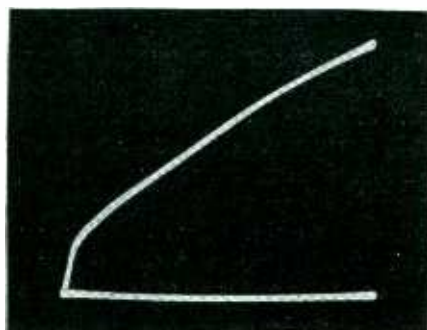

Photograph of trace on oscilloscope. Typical plate characteristics of 1G6 tube with control grid at +4 volts

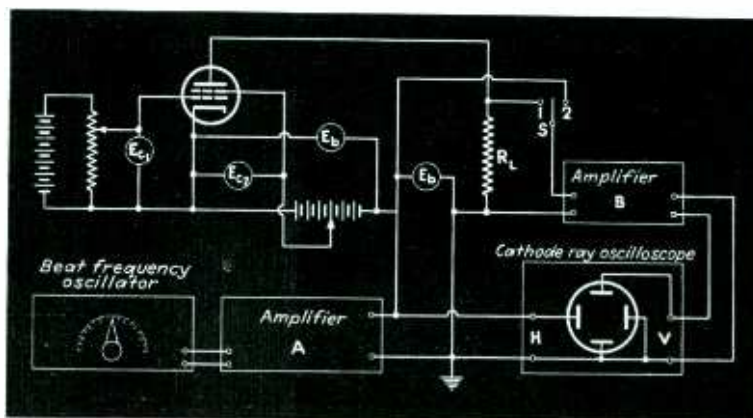

Suitable connections for determining the plate characteristics of a tetrode are indicated in the above schematic diagram

desired electrode voltages or circuit impedances required to produce the desired characteristic can be selected.

To eliminate this laborious and time consuming procedure, the method outlined here was developed and has been found to be of considerable utility within its limitations. With this method it is possible to obtain the characteristic curves of the tube in question as the trace on the screen of a cathode-ray tube. This method differs from certain other methods of tracing the characteristic curves on the screen of a cathode-ray tube in that it gives the instantaneous conductance relationship of the same electrode, or between two electrodes so long as the electrodes for which the characteristic is being determined can be connected so as to have a common junction. For example, with this method the plate-voltage plate-current characteristics of a triode, or the screen-voltage plate-current characteristic of a pentode can be reproduced as a curve on the oscilloscope for given values of the control grid bias as a parameter. By inserting the plate voltage immediately adjacent to the plate, the grid-voltage plate-current characteristics can be obtained for various values of the plate voltage as the parameter. Other possibilities

could be worked out as the need for them arises. The purpose for which this method was first worked out was to determine the operating conditions resulting in a linear characteristic between the plate voltage and the plate current in the 1G6 double triode, but the method has since been used in many other measurements. It may be pointed out here that the determination of the most suitable electrode impedances may be as important, in some applications, as the determination of the static characteristics, and this method lends itself admirably to such work.

The principle of this method has  
(Continued on page 96)

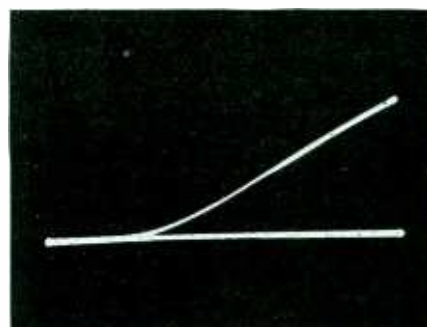

Relation between screen grid voltage and plate current for a 6J7 with control grid at -2 volts

# Frequency Deviation Measurement of F-M Transmitters

The frequency deviation can be determined by noting the constant amplitude modulating frequencies for which the carrier disappears. A graph relating the frequency deviation with the modulating frequency for zero carrier simplifies this calculation

FROM the theory of frequency modulation it is known that the generation of a frequency-modulated signal produces a carrier and side frequency terms. For a sinusoidal modulating signal, the amplitude of the carrier is directly proportional to  $J_0(Z)$  where  $J_0(Z)$  is the Bessel function of zero order and argument  $Z$ . The argument  $Z$  is usually called the modulation index and is defined by

$$Z = mf_0/f_1 \quad (1)$$

where  $f_0$  is the carrier frequency,  $mf_0$  is the frequency deviation to either side of the carrier, and  $f_1$  is the modulating frequency. The Bessel function,  $J_0(Z)$ , goes through variations having a close resemblance to a damped cosinusoidal function as is shown in Fig. 1. For certain values of  $Z$ , the carrier goes through zero or null points. The values of  $Z$  for which  $J_0(Z) = 0$  are denoted by  $Z_i$  and are tabulated in Table I.\* If the point at which the carrier disappears is known, the frequency deviation can be found because at this point

$$mf_0 = Z_i f_1 \quad (2)$$

There must also be known the order of the zero, that is, the value of  $i$ .

In order to use this method of frequency deviation measurement, there is first required an audio signal generator with a calibrated output. This generator is connected to the transmitter a-f input. A selective a-m type receiver capable of receiving c-w signals is used to ascertain the presence of the carrier. In order to make the measurements, reduce the transmitter a-f input to zero and tune in the carrier on the receiver obtaining an audible beat

\* If additional zeros are desired, note that the difference approaches  $\pi$  units as  $i$  increases.

By L. N. HOLLAND and L. J. GIACOLETTO

University of Michigan

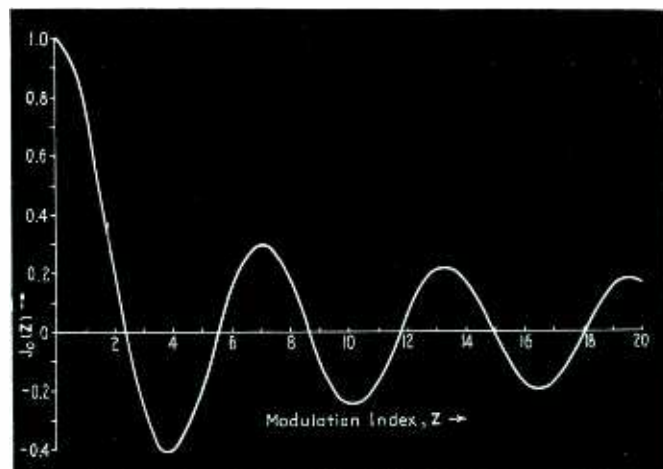

Fig. 1—Graph of Bessel function,  $J_0(Z)$ , plotted as function of modulation index,  $Z$

or heterodyne note. Slowly increase the transmitter a-f input (analogous to increasing  $m$  in Eq. (1)). The audible beat note should gradually decrease in intensity and finally disappear entirely when the amplitude of the carrier reaches zero. At this point the frequency deviation is  $mf_0 = 2.405 f_1$ . If the a-f input is again increased, the carrier beat note will return, increase to a maximum, decrease, and again disappear. For the second null point the frequency deviation is  $mf_0 = 5.520 f_1$ .

In general, the receiver will not be selective enough to admit the carrier alone, but will admit the carrier and several of the side frequencies. For this case if the receiver is tuned to give an audible beat note,  $f_a$ , it is quite possible that there will also be heard the frequencies  $f_1 \pm f_a$ ,  $2f_1 \pm f_a$ , etc. This may lead to some confusion in determining when the carrier disappears. Considerable improvement can be obtained by introducing a low pass audio filter between the receiver output and the speaker or headset. The filter should be designed to admit  $f_a$  and to attenuate the other frequencies. If the cut-off frequency for the filter is chosen as  $f_a$  then  $f_1$  must be greater than  $2f_a$  in order that the other heterodyne notes fall outside of the filter pass band.

In order to facilitate the measurement of frequency deviation, the chart has been prepared. The radial

TABLE I

$i$	$Z_i$	$i$	$Z_i$
1	2.4048	11	33.7758
2	5.5201	12	36.9171
3	8.6537	13	40.0584
4	11.7915	14	43.1998
5	14.9309	15	46.3412
6	18.0711	16	49.4826
7	21.2116	17	52.6241
8	24.3525	18	55.7655
9	27.4935	19	58.9070
10	30.6346	20	62.0485

lines are a plot of Eq. (2) (the dashed curved lines are used with another method of measuring deviation described below). Each radial line when numbered counterclockwise corresponds to the value of  $i$  in Table I. As an example of how the chart may be used, suppose that the modulating frequency is 5 kc. The deviation when the carrier disappears for the first time is found by following along the lower edge of the chart to the 5-kc ordinate and moving upward along this ordinate until it intersects the first radial line. The deviation, 12 kc, is read from the scale on the left. For the second null point continue upward along the 5 kc ordinate to the second radial line where the deviation is found to be 27.6 kc. In this manner the deviations may be determined for successive null points.

The above method of measuring deviation follows closely the method described by M. G. Crosby† A

slightly different method has been used by the authors with success. For this method the a-f input is held constant and the modulating frequency varied. If this is done, the carrier will disappear for several values of  $f_1$ . Any two successive modulating frequencies which cause the carrier to disappear will uniquely determine the frequency deviation. Suppose in this method that a modulating frequency of 7.8 kc gives a carrier null, and the frequency is decreased until another null is obtained with a modulating frequency of 5.0 kc. Then the intersection point of the ordinate at 7.8 kc (upper frequency) and the dashed curve at 5.0 kc (lower frequency) indicates a frequency deviation of 43 kc. The intersection point of the lower and higher frequency must always fall on a radial line. Also the interpolation between the dashed curves for lower frequency values is linear along any radial line.

While these methods of frequency deviation measurement are basic in that they are independent of all circuit parameters, they have certain shortcomings which limit their usefulness. First they presuppose a linear relation between input voltage and frequency deviation. A departure from linearity means that the carrier null points are no longer null points but minimum points. If the departure from linearity is very serious, it may be impossible to detect even a carrier minimum point. The carrier frequency must also remain reasonably constant. If the carrier frequency changes considerably as the input level or modulating frequency is changed (depending on which method is being used), no carrier null points will be obtained. Even a small change in carrier frequency may be bothersome in that the carrier heterodyne note will change, possibly to such an extent that the heterodyne note will move outside of the filter pass band. For this reason the filter cut-off frequency should not be too small. Also for this reason the modulating frequency should be kept at as large a value as is feasible so that the carrier heterodyne note will never be confused with the sideband heterodyne notes. In this connection, from the nature of the carrier zeros, it will be necessary to decrease the modulating frequency for measuring smaller deviations. This factor must be given additional attention when making measurements on mobile f-m transmitters where the maximum deviation is usually only 15 kc. A filter with lower cut-off may prove useful in such cases, and the receiver should be returned to the same note if the carrier shifts.

In using the first method for making deviation measurements, care must be taken to count every null point. If a null point is overlooked the deviation measurements will be incorrect. The second method is an improvement in this respect since the deviation is uniquely determined. On the other hand the second method is useless when there is appreciable variation of deviation with audio frequency. Such a situation will arise in any transmitter if either audio pre-emphasis or uncorrected phase modulation is present.

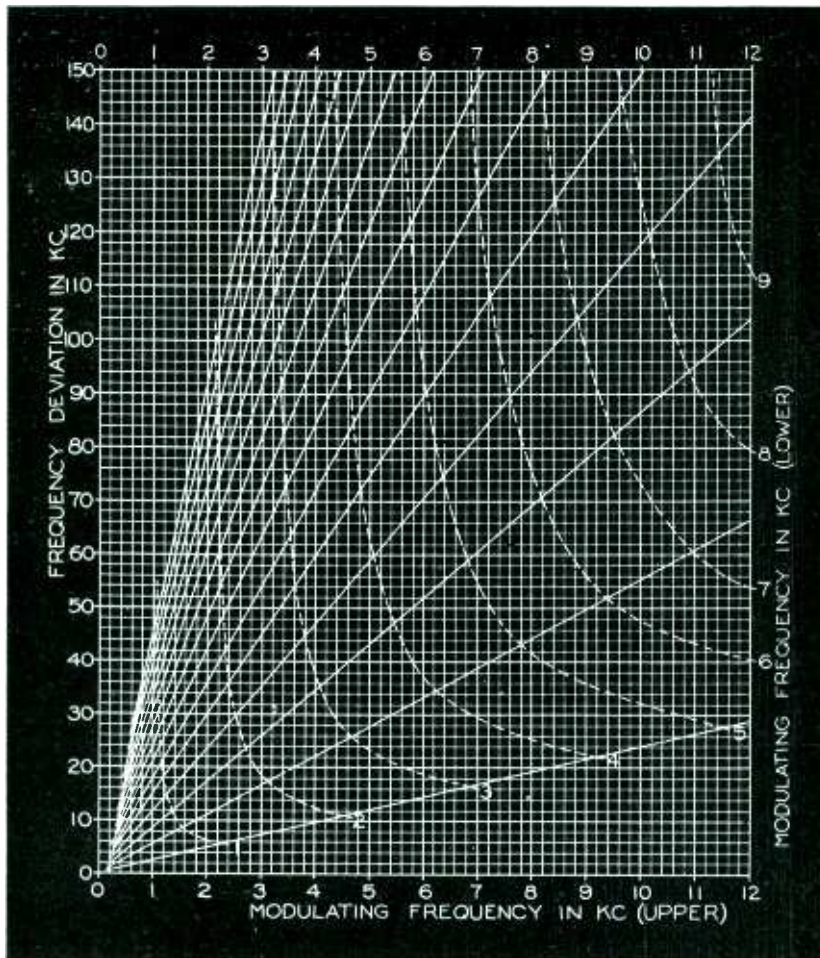

Fig. 2—Graph relating frequency deviation of f-m transmitter and modulating frequency for zero carrier

† Murray G. Crosby, "A Method of Measuring Frequency Deviation," *RCA Review*, Vol. IV, pp. 473-477, April 1940.



## ***COMMANDING A HIGH PLACE IN THE AIR WAVES***

**The small CINCH part — plays a big part in the formation** . . . of dependable communication in the defense program. In leading sets, CINCH parts are certain to be performing creditably. Sockets, binding posts, laminated terminal strips, lugs . . . all are designed for maximum service . . . made to stand up.

Production of National defense work is facilitated by adequate, special equipment available for assembling small parts in large volume. *Send us blueprints for estimates.*

*Cinch and Oak Radio Sockets are licensed under H. H. Eby Socket Patents.*

# ***CINCH***

SUBSIDIARY OF UNITED-CARR FASTENER CORP., CAMBRIDGE, MASS.

## **MANUFACTURING CORPORATION**

2335 WEST VAN BUREN STREET, CHICAGO, ILLINOIS

# TUBES AT WORK

Portable transmitter, remote amplifier with pre-emphasis, phase reversal amplifier, and Wheatstone bridge voltage regulator are discussed this month

## Automatic Voltage Regulator

By E. J. CASSELMAN

Mellon Institute, Pittsburgh, Pa.

THE INCREASING ATTENTION being given by laboratory workers to electrical and electronic methods for a wide variety of measurements has resulted in many applications for automatic voltage regulators. The inexpensive regulator tubes such as type VR-105 cover the field of very small direct current loads of the order of 30 milliamperes. The field of the much more expensive constant voltage transformers begins at 25 watts of alternating current. Between these groups there is a field that is in part covered by the device to be described. The instrument is inexpensive and can be made with few purchased parts. It is not new, but inquiry indicates it is not commonly known or used, possibly because no one has shown how simple it is in design. The principles of this instrument were first outlined by Campbell<sup>1</sup> and further elaborated by Lewis<sup>2</sup>; Walsh<sup>3</sup> proposed their use in preparing a standard light for photometry.

The device takes advantage of a characteristic of tungsten filament lamps, namely, that the resistance is proportional to the square root of the applied voltage. A bridge circuit is arranged as shown in Fig. 1. In this circuit

$R$ ,  $R$  are fixed resistors,  
 $nR$ ,  $nR$  are operating resistances of the lamps,

$mR$  is the resistance of the load, which carries

$i$ , the constant current,

$E$  is the nominal line voltage, and

$v$  is the voltage ratio  $mRi/E$

The letters  $m$  and  $n$  of course are ratios of the other resistances to that of the fixed resistors  $R$ ,  $n$  always being less than 1. The voltage across  $mR$  is the difference in potential of points  $A$

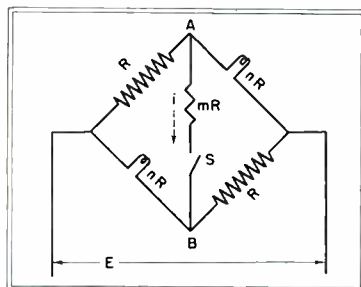

Fig. 1—Schematic diagram of Wheatstone bridge used as voltage regulator

and  $B$ . A change in line voltage  $E$  will result in a smaller proportional change across the lamps than across the fixed resistors and consequently the potential difference between  $A$  and  $B$  tends to remain the same.

It can be shown from Kirchhoff's laws that

$$i = \frac{E(1-n)}{R(m+mn+2n)} \quad (1)$$

Replacing  $E$  by  $e^2$ , and assuming the lamp filaments to have the characteristic resistances  $nR = ke$ , then

$$i = \frac{e^2 - ke^3}{R(m+kme+2ke)} \quad (2)$$

The condition for a constant value of  $i$  is that  $di/de = 0$ , that is,

$$\frac{2e(m-mn-mn^2+n-2n^2)}{R(m+mn+2n)^2} = 0 \quad (3)$$

This condition follows where

$$m = \frac{n(2n-1)}{1-n-n^2} \quad \text{and} \quad (4)$$

$$v = 2n - 1 \quad (5)$$

If these conditions were critical, the only acceptable designs would be those that happened to fit in with the available commercial tungsten lamps, between the adjacent ratings of which fairly large intervals exist. The real possibilities are shown in Fig. 2, in

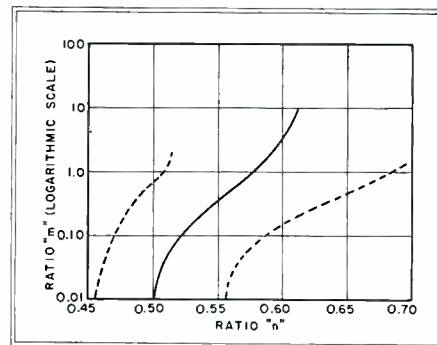

Fig. 2—Ratio of load resistance  $m$  to arm resistance  $n$  for perfect regulation (solid curve) and good regulation (dotted curves)

which the full line represents the relation between  $m$  and  $n$  for perfect voltage regulation. The broken lines show the condition for

$$di/de = 0.05e/R,$$

which is sufficiently close control for many purposes. Considerable latitude is indicated in the selection of the tungsten lamp resistors and the approximations in the derivation of the formulae are also justified. For values of  $n$  to the right of the solid line, the

instrument overcorrects, that is, reverses the effects of line voltage changes.

One example will be given beside those reported by Lewis and Walsh. It is desired to operate a 6-volt light at 5.3 volts. Tests show the lamp to have a resistance of 21.2 ohms at this voltage. The line voltage is put  $R = 89/0.523 = 170$  ohms.

$$v = 5.3/117 = 0.0453;$$

$$n = 1.0453/2 = 0.523 \text{ (Eq. 5);}$$

$$m = 0.10 \text{ (from Fig. 2.);}$$

$$R = 21.2/m = 21.2/0.10 = 212 \text{ ohms;}$$

$$nR = 0.523 \times 212 = 111 \text{ ohms.}$$

On one side of this value for  $nR$  lies the estimated operating resistance at 55 volts of 121 ohms for the 75-watt lamp, and on the other side the resistance of 89 ohms for the 100-watt lamp. We select two 100-watt lamps and compute  $R = 89/0.523 = 170$  ohms.

In an actual trial the voltage across the load was only 4.7 volts instead of the 5.3 that was wanted. Resistance  $R$  was then changed to 190 ohms and the voltage across the load then became 5.3 as desired. As a result of the change, however,  $n$  had become by estimation  $89/190 = 0.47$ , a figure that was still inside the limits for excellent regulation. Tests revealed that the voltage across the lamp remained within the range 5.2 to 5.3 volts for all line voltages from 93 to 117.

A few practical points must be noted as follows.

1. The switch  $S$  should never be closed until after the line voltage has been applied, otherwise the surge of current through the cold lamps may damage the load  $mR$ .

2. A few minutes must be allowed to warm up the various parts of the circuit before the voltage across  $mR$  becomes constant.

3. The electrical efficiency of the device is quite low in most designs.

4. As it may not be advisable to ground any part of the load, the latter will be "hot", and hence adequate insulation should be provided.

(1) A Campbell, *Proc. Inst. Elec. Eng.*, 30, 889 (1901).

(2) F. G. H. Lewis, "An Automatic Voltage Regulator", *Proc. Phys. Soc.*, 34, 17.

(3) J. W. T. Walsh, "Photometry", Constable & Co., Ltd., London, 1926.

## Compact Portable Transmitter

By E. F. KIERNAN

Bendix Aviation, Ltd.

AT THE TIME the writer designed this unit he was doing considerable traveling by air transport and had in mind the limitations on weight which baggage restrictions impose.

Although a great many so-called midget transmitters have been built, most of them either required bulky battery or other power supply equipment, or their output was limited to fleapower proportions. Desiring a reasonable amount of power without straining either the weight or dimensional limitations, an output of 10 watts was decided upon. With reasonable efficiency (66 per cent) this would require





## I was worried

when I realized our production was not geared to meet delivery dates. New business had come our way, spurred by national defense. Were we going to lag behind?

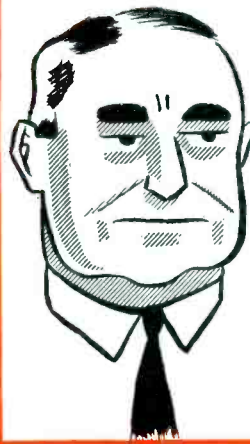

## But determined

I studied every operation . . . consulted time-and-motion experts . . . went through the plant for the hundredth time, and *there* on the assembly line . . . was a major cause of delay.



## Slow work?

"Yes," said one foreman, "our screw-driving *is* slow. Can't use power drivers, for fear of driver slippage. Hand driving is hard work . . . screws go in crooked . . . screw heads split."

## THE CAUSE . . . "Old-Fashioned Fastening"

I began to notice. Screws fumbled. Driver wobbling. Help needed to steady the parts. Everywhere — waste resulted because I had insisted, *incorrectly*, that slow-driving screws *cost less!* I decided —

# Don't Be Old-Fashioned

## Phillips Screws Will End Slow, Wasteful Fastening

It's just good sense, I found out. The driver can't slip from the Phillips recess — so pneumatic or electric drivers can be used. No more screw driver accidents — no more delays — no more unnecessary worker fatigue. No wonder so many industries are standardizing on Phillips Screws.

Don't forget—it isn't the *price* of the screws that counts. It's the cost of *using* them. Thousands agree — *Phillips Screws cost less to use!*

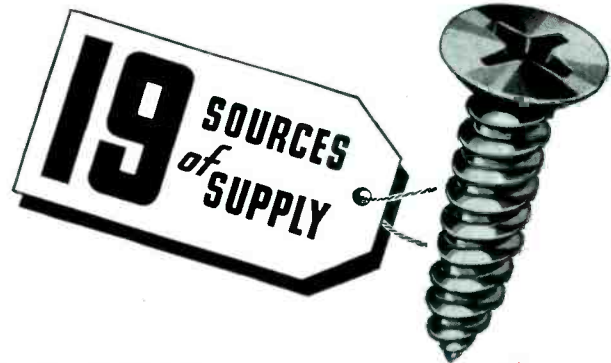

## PHILLIPS RECESSED HEAD SCREWS . . .

WOOD SCREWS • MACHINE SCREWS • SHEET METAL SCREWS • STOVE BOLTS  
SPECIAL THREAD-CUTTING SCREWS • SCREWS WITH LOCK WASHERS

U. S. Patents on Product and Methods Nos. 2,046,343; 2,046,837; 2,046,839; 2,046,840; 2,082,085; 2,084,078; 2,084,079; 2,090,338. Other Domestic and Foreign Patents Allowed and Pending.

American Screw Co., Providence, R. I.  
The Bristol Co., Waterbury, Conn.  
Central Screw Co., Chicago, Ill.  
Chandler Products Corp., Cleveland, Ohio  
Continental Screw Co., New Bedford, Mass.  
The Corbin Screw Corp., New Britain, Conn.

International Screw Co., Detroit, Mich.  
The Lamson & Sessions Co., Cleveland, Ohio  
The National Screw & Mfg. Co., Cleveland, Ohio  
New England Screw Co., Keene, N. H.  
The Charles Parker Co., Meriden, Conn.  
Parker-Kalon Corp., New York, N. Y.  
Pawtucket Screw Co., Pawtucket, R. I.

Pheoll Manufacturing Co., Chicago, Ill.  
Russell, Burdall & Ward Bolt & Nut Co., Port Chester, N. Y.  
Scovill Manufacturing Co., Waterbury, Conn.  
Shakeproof Lock Washer Co., Chicago, Ill.  
The Southington Hardware Mfg. Co., Southington, Conn.  
Whitney Screw Corp., Nashua, N. H.

*Speed Product Deliveries by  
Cutting Assembly Time*

# Bigger **QUARTERS**

## Greater **FACILITIES**

### Increased **PERSONNEL**

To help serve you better, New York Transformer Company has again enlarged its facilities, and added to its engineering and production staff of men who are experienced in both design and manufacture. Thus "N.Y.T." now takes its place among the foremost manufacturers building quality chokes and transformers entirely to specification.

- Our complete manufacturing facilities and machine shop are at the disposal of our customers. Samples supplied on exceptionally short notice.



*Suppliers to Manufacturers Demanding Highest Quality*

- Write to

### HEADQUARTERS FOR AMERICA'S TRANSFORMER PROBLEMS

*Suppliers to manufacturers demanding highest quality*

**NEW YORK TRANSFORMER CO.**

Sales Department

480 LEXINGTON AVE.

NEW YORK, N. Y.

an input to the final of 15 watts. The loctal type tubes appeared to offer the greatest possibilities; the preliminary breadboard setup utilized two 7C5's in parallel in the final with two 7B5's in push pull as modulators. It was found that a single 7C5 would take the 15 watts input and that another would give adequate modulation. The power supply was originally set up with two 117Z6's in parallel, in a voltage doubling circuit. The plate voltage was 200 volts at a drain of 135 ma. The maximum input to the final, with satisfactory results, at this voltage was 6.6 watts, less than half the desired figure. The 117Z6's were then rearranged in a voltage quadrupling circuit, but the

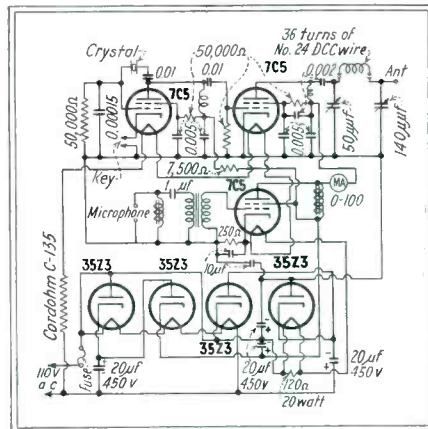

Circuit diagram of the transmitter described by Mr. Kiernan. Note quadrupling arrangement of the 35Z3's

current drain at the required input to the final gave extremely short life from the rectifiers. The use of 35Z3's in the quadrupling arrangement solved the power supply problem very nicely. At a total drain of 100 ma the voltage is 310 volts. It might appear from the circuit diagram that the filtering was inadequate. Nevertheless the hum level was entirely satisfactory.

In order to eliminate the heat liberated by the main filament dropping resistor, use was made of the combination power-cord-resistor commonly used in midget ac—dc receivers. To further simplify the equipment, no a-c switch was installed, the cord being simply plugged in and out as required. Three miniature Jones plugs provide connections to key, mike, and a-c cords. All three are plugged in whenever the transmitter is used. The key acts as a push-to-talk switch on telephony, while the modulator and final are left on

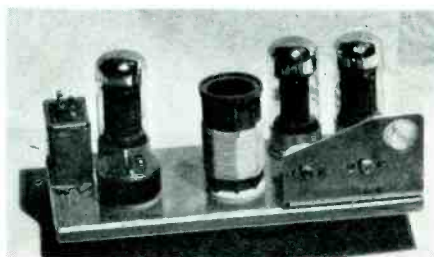

The r-f section, which comprises the top shelf of the transmitter

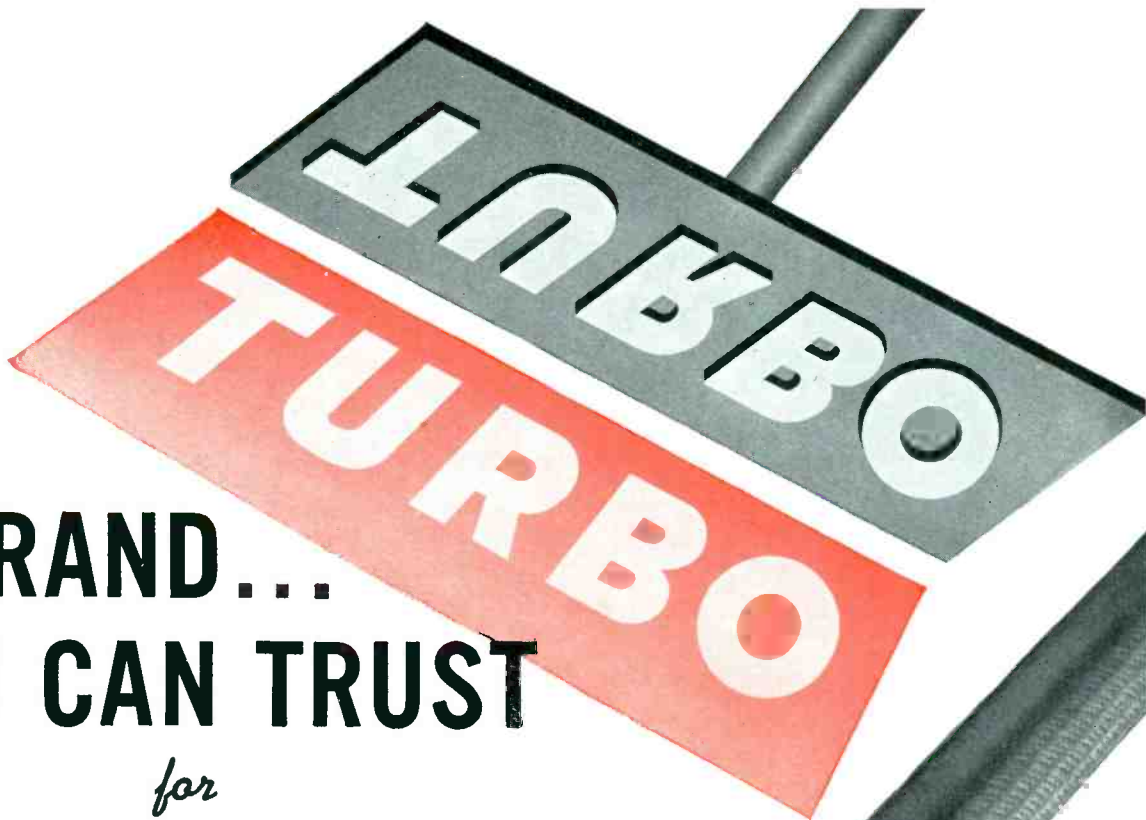

# A BRAND... YOU CAN TRUST

*for*  
**VARNISHED TUBING**  
*and*  
**SATURATED SLEEVING**

And besides the all-important factor of dependability, constantly present in TURBO electrical insulating materials, the Brand service is geared to the DEFENSE pattern

1. Prompt delivery.
2. Quality factors consistently maintained.
3. Surpassing constants and values dielectrically.

*A culmination of supreme insulation*

**WILLIAM BRAND  
& COMPANY**

276 FOURTH AVE., NEW YORK, N. Y.  
325 W. HURON ST., CHICAGO, ILL.

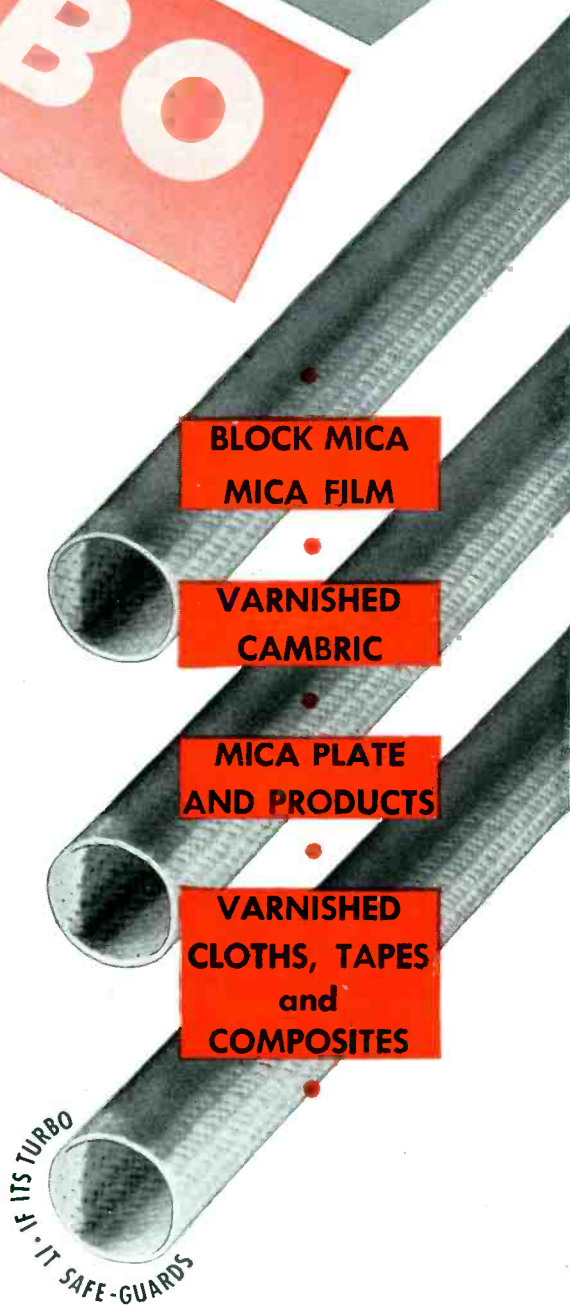

# VULCOID

## HERE MAY BE THE ANSWER TO YOUR "WHAT MATERIAL?" PROBLEM

CAUTION should be used in selecting substitute materials ... such as plastics for metals ... to make certain that shortages will not also develop in the substitute selected.

VULCOID is a NON-metallic ... a laminated plastic fibre made in sheets, rods and tubes ... readily fabricated on standard metal working machinery. It is tough ... moisture resistant ... heat resistant and oil resistant. It has high electrical insulating properties and is exceptionally resistant to carbon deposits from electrical arcs. VULCOID is approved by the Underwriters' Laboratory for the insulation of current carrying parts.

VULCOID is a product of Continental-Diamond Laboratory research. Its development has progressed over a number of years. Its availability at this time is especially opportune because in its production it

### Properties of VULCOID

#### $\frac{1}{8}$ " THICK MATERIAL

Specific gravity 1.35

Tensile Strength 7,000/11,000 PSI

Flexural Strength 16,000/20,000 PSI

Shearing Strength 10,000/12,000 PSI

Compression Strength 36,000 PSI

Moisture absorption 4% to 8%

(% weight gain in 24 hours immersion)

Dielectric Strength 250/350 volts per mil.

requires considerably less of present hard-to-get raw materials than do many other NON-metallic products.

VULCOID may be the answer to your "What Material?" problem. Let us send you Technical Data Bulletin BC-24.

# Continental-Diamond

FIBRE COMPANY

"Manufacturers of Laminated Plastics Since 1911"

N E W A R K • D E L A W A R E

during key-up intervals to insure better regulation of the plate voltage. Mike current is obtained by running the cathode return of the modulator through the coupling choke and mike. Parallel feed to the mike transformer was necessary as this unit was of the hi-permeability core type. Doubling was provided for in the final stage to eliminate the necessity of neutralizing. There is very little difference in efficiency between straight through and doubling operation of the final. This is generally true of beam power tubes. Their power gain is so high that it is difficult to obtain stable operation without neutralization. A simple remedy is to double, with little or no loss in output.

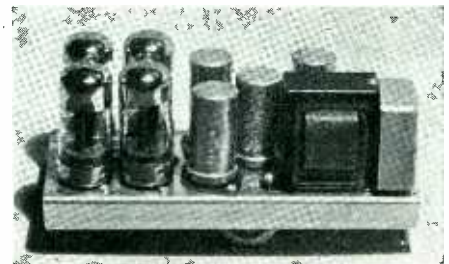

The power supply, modulation choke, coupling choke-condenser, and fuse

The pi coupler gives little trouble provided the antenna attached to it does not approach too closely a quarter wave, or a multiple of the carrier frequency. It is generally an easy matter to adjust the physical length of the antenna so that it will fall within the matching capabilities of the coupler.

The construction of the case requires the ability to get at and use sheet metal working machinery. The cutting and bending to shape is not an insurmountable task. However, the welding of the corners is a job for a professional welder. Care should be taken that a flux is used that will not continue to flake off long after the weld is made. The diagonal break at the ends of the case makes for sturdy construction, at the same time, affords considerably accessibility. If the hinge-pin is removable, the two halves of the case may be readily separated.

The transmitter is wired up in two sections. The power supply, modulation



The two sections of the transmitter mounted in the carrying case

# Easy to wind

## FORMEX REG. U.S. PAT. OFF. MAGNET WIRE

### *Safer, Too, Because THIS Wire Is TOUGH*

**T**RY Formex magnet wire after using any wire with a fabric protection which has been very tightly applied. You'll find Formex wire is not so stiff and is much easier to bend. Also, the outer surface of the film is much smoother.

Here, then, are two properties that are important if you are endeavoring to increase production. The softness and smoothness of Formex wire enables the turns of the coil to fall into place more readily, without having to be forced or jammed. After the wire is wound into position, there is little springiness, so inherent in fiber-covered wires, tending to loosen the coil and make it spongy and soft. Formex wire winds quickly and easily.

**FORMEX WIRE IS A PRODUCT OF  
GENERAL ELECTRIC RESEARCH**

#### **SAFE AT HIGH SPEEDS**

The outstanding property of Formex magnet wire is the physical toughness of its film. Tests have proved that this film is at least three times tougher and more flexible than the film on conventional oil-type enameled wire. It is also much more abrasion-resisting. These are the reasons why Formex wire is so well-suited for modern high-speed winding machines. Definitely, it cuts down rejects and lowers winding costs. That means savings—but with safety.

#### **HIGH SPACE EFFICIENCY**

Also—as compared with fibrous-covered enameled wire—it has a much higher space efficiency. It resists many solvents. It has high dielectric strength and long life. And, though a premium product, it is not high priced.

For more technical details, also information on application practices and recommendations, get in touch with the nearest G-E office, or write to General Electric, Schenectady, N. Y.



# GENERAL ELECTRIC

503-3-1200

# The Emergency

# and beyond

We join the nation's broadcasting stations in pledging our full co-operation to the U. S. government in the present emergency. Our manufacturing facilities have already been drafted for service. Along with it goes our station operating experience which has contributed so largely to the advanced design of our 50-HG Broadcast Transmitter.

As a means of disseminating vital information, radio today is more important than ever before. High-powered, more efficient broadcast equipment improves these facilities—and we are gratified that we already have put into service an important number of our advanced 50-HG sets—and that we are still in a



# Westinghouse

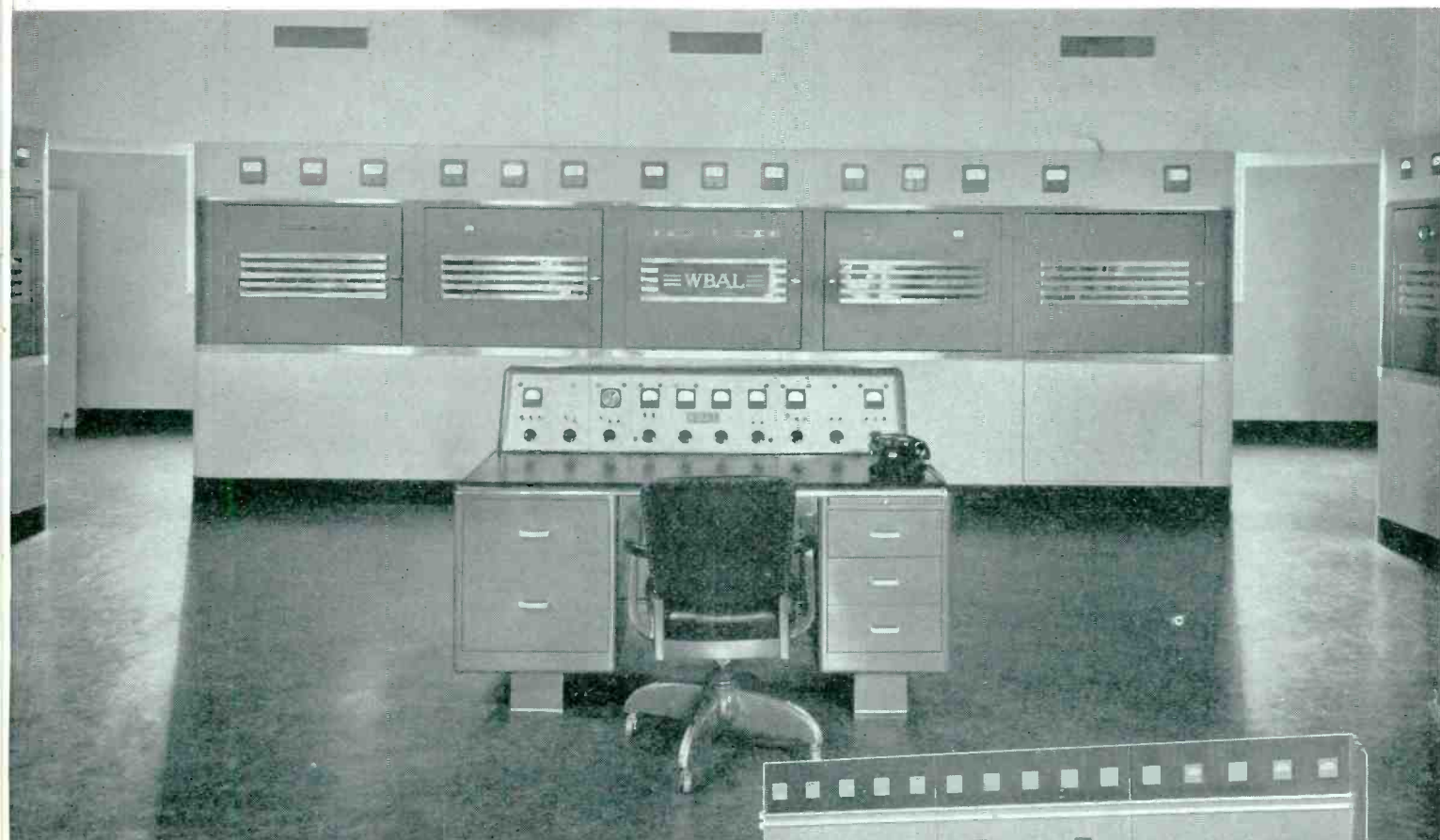

position to make prompt delivery of such equipment.

Because defense production is an intensified laboratory of radio developments, out of it may come some of the most important improvements in commercial equipment of the future.

Our experience in manufacturing commercial as well as military radio equipment plus our experience in the operation of commercial broadcasting stations since the earliest days of radio puts us in a position to know the peacetime value of new developments—and to apply them effectively in meeting the requirements of commercial broadcasting.

Westinghouse Electric & Manufacturing Co.

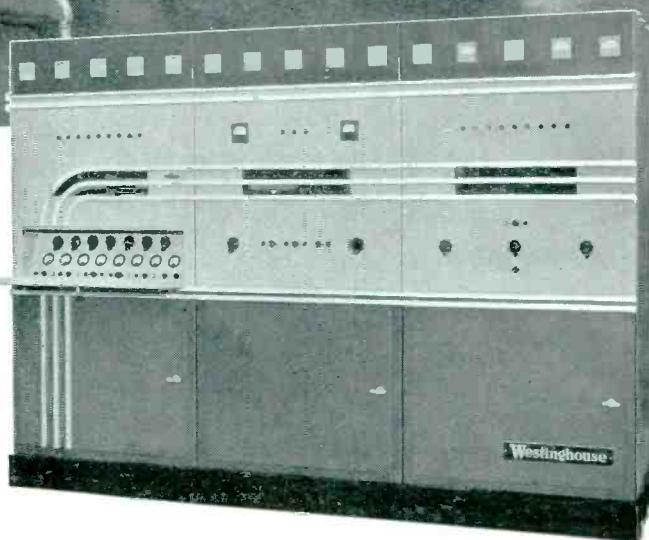

Top—Westinghouse 50-HG transmitter in station WBAL, Baltimore, Maryland.

Above—The 5-HV for 5000-watt operation provides the same advantage as the 50-HG.

J-08038

# BROADCAST EQUIPMENT

## CUSTOM-MADE APPLICATIONS



## OF RESISTORS AND RHEOSTATS

*We Are Specialists of Over  
16 Years Experience*

Ingenuity of design, painstaking care in manufacturing and sturdy construction have built our business to the point where more and more new customers call us in to discuss their requirements, and to work out with them the most efficient and economical means of handling their needs.

In addition to our regular stock of a full line of vitreous enameled resistors and rheostats, we carry a large stock of component parts for immediate custom-made jobs for unusual conditions of service.

*May we consult with you on your next order?*

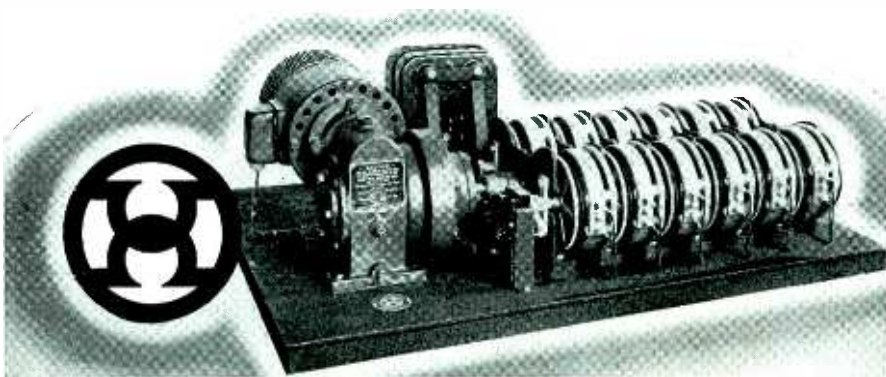

# HARDWICK, HINDLE • Inc.

NEWARK, N. J., U. S. A.



Resistors • Rheostats • Radio Frequency Reactors  
Power Line Chokes • Line Voltage Reducers  
Custom-made resistance devices of all types

choke, coupling choke-condenser, and fuse are located on the bottom shelf. The majority of the connections are sub-base. The leads to the plugs and to the upper shelf should be left long enough so that the shelf may be removed from the case by withdrawing the two six thirty-two machine screws (flat head) from the diagonally opposite bottom corners of the case. These screws thread into holes in the shelf corners which have been tapped to receive them. The top shelf is fastened on by means of the three screws through the front of the case; the majority of the leads having been fastened in place before the shelf is mounted. The details of construction and assembly are pretty well covered by the diagrams and photos. The connections between the two shelves are cabled together and brought up through a hole as marked in the sketch. The wiring does not appear in the photos as they were taken before the sections were wired.



The appearance of the transmitter closed, showing the plate current milliammeter

The three 7C5's are mounted in a row next to the case on the top shelf and plugged into low-loss sockets. The inductance and crystal holder plug into four and five prong ceramic sockets, respectively. The four 35Z3's plug into bakelite sockets on the bottom shelf together with the filter condensers which are also mounted on bakelite to insulate both terminals from ground. The mike coupling condenser is mounted on the Thordarson T-57C51 choke; one lug under the screw holding the adjacent end of the choke, the other bent over and soldered to the choke itself. The mike coupling choke was made from a partially defunct Leach relay by soldering the armature to the pole faces. The milliammeter is permanently connected in the plate supply lead to the final amplifier. It has a 0.5 ma scale, and is shunted to read 100 ma full scale. The microphone used was a single button 'airplane' type with the push-to-talk switch shorted out.

The plate currents are, oscillator; 12 ma; final, 50 ma; modulator, 40 ma. The final grid current varied between the limits of 2 and 3 ma. The rig was voice tested on 75 meter phone, and received an R-7 report at 135 miles in the middle of the afternoon.



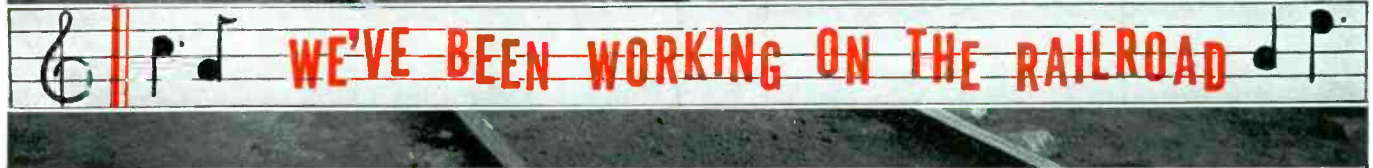
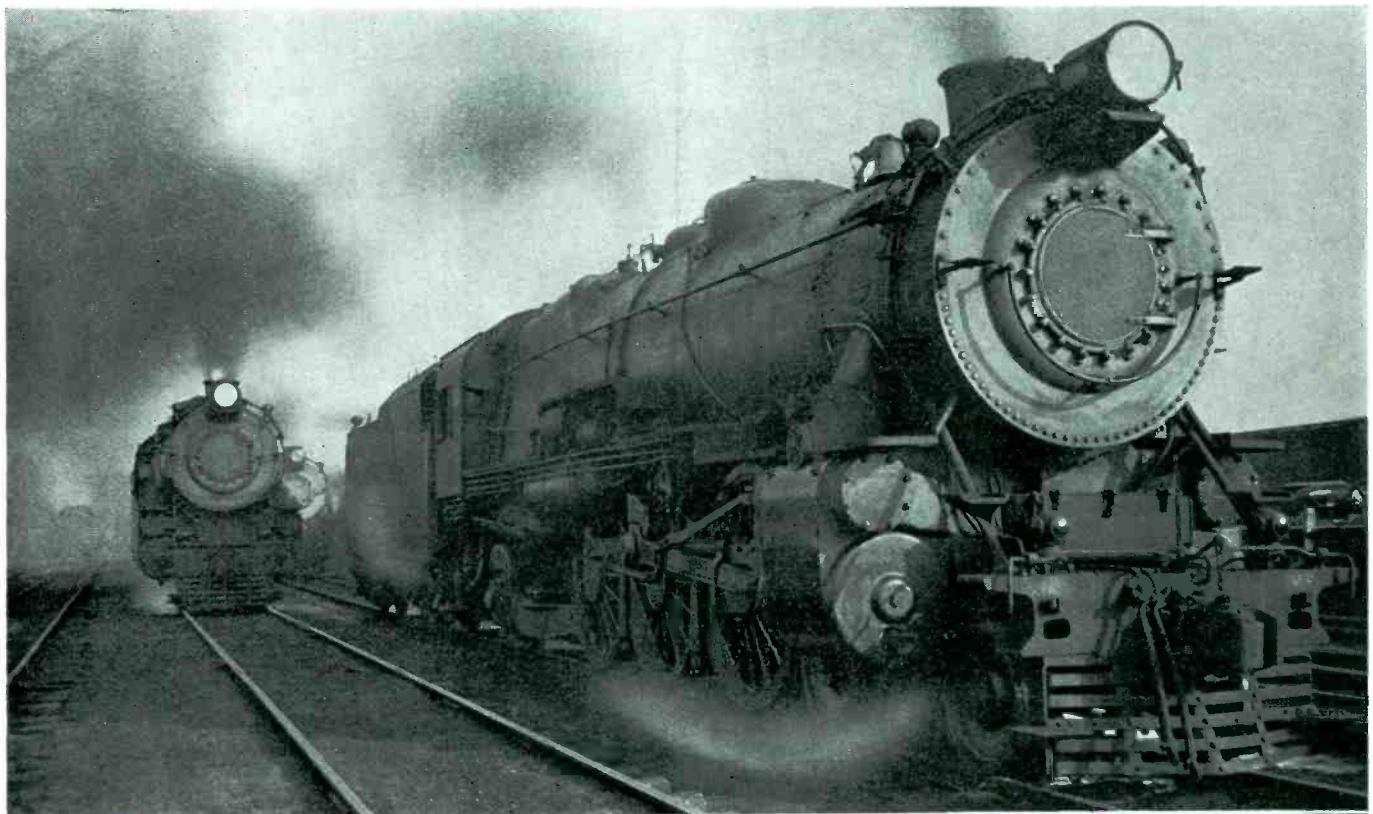

See this little sieve-like cylinder? Well, it's a mighty important part of big railroad locomotives. And, we're proud that our plant engineered a new, better, and more economical way of making it—14,600 holes and all!

Lewyt saves this manufacturer the heavy expense of complicated dies by taking a sheet of 1/16" Monel Metal, rolling it into a tube and welding it. Specially developed tools form and pierce the holes at once. Result: jewel-like precision and weight 1/5th of what it was formerly!

However, the beauty of this particular product engineering achievement is, that with the tools Lewyt made for the first job any diameter of cylinder required can be fabricated, completely eliminating different patterns for various sizes.

With simple forms and inexpensive tooling used according to many exclusive, advanced techniques, Lewyt fabricates products without the heavy expense of complicated dies. Some notable companies today enjoy worthwhile production economies through products fabricated by Lewyt.

# LEWYT

**METAL PRODUCTS MFG. CO., INC.**

64 BROADWAY

BROOKLYN, N. Y.

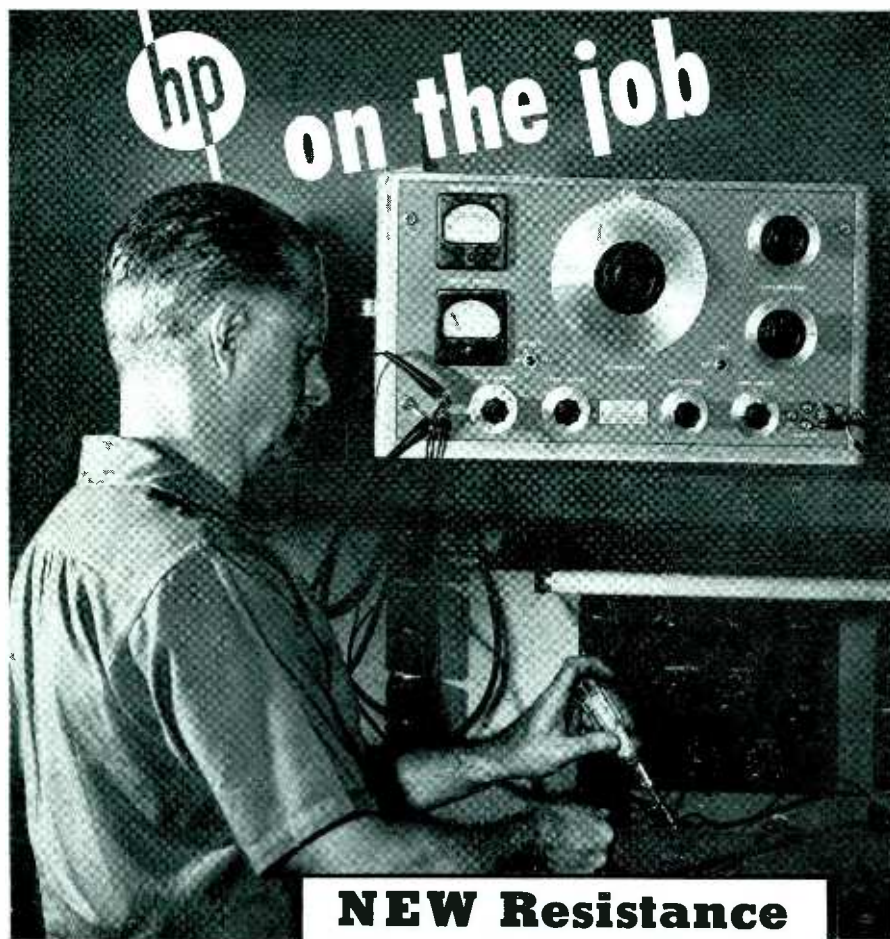

MR. WILLIAM HUTTER  
Chief Sound Engineer  
at Rockola Manufacturing  
Company is seen here  
using the -hp- 205AG  
Audio signal generator  
and 320A Distortion  
Analyzer

**NEW Resistance  
Tuned Oscillator**  
*Insures perfect tone for*  
**ROCKOLA**  
Manufacturing Company

One after another the leading manufacturers of electronic equipment ... from communications to automatic phonographs ... are placing -hp- Laboratory Instruments in service. These time and money savers are paying dividends to owners by providing an accurate, high-speed check on the performance of their products. The Rockola Manufacturing Company, for example, uses an -hp- 205AG Audio signal generator and 320A Distortion Analyzer to check the audio equipment used in the Automatic Phonographs which they manufacture.

Get the facts about -hp- Laboratory Instruments. Ask about the Wave Analyzer and other specialized -hp- instruments. You'll find the first cost surprisingly low, the time saving, money saving possibilities great. Write direct to the factory or see the nearest representative.

**HEWLETT-PACKARD COMPANY**

481 PAGE MILL ROAD • PALO ALTO, CALIFORNIA

For technical assistance in determining the application of -hp- instruments to your problem, contact any of the following -hp- representatives

ALFRED CROSSLEY  
Electro Products Laboratories  
549 West Randolph Street  
Chicago, Illinois

N. B. NEELY  
5334 Hollywood Boulevard  
Hollywood, California

BRUCE O. BURLINGAME  
ASSOCIATES  
69 Murray Street  
New York City, New York

**Automatic Phase Reversal  
Amplifier**

BY R. P. CROSBY  
*Vincennes, Ind.*

THE PHASE REVERSAL AMPLIFIER which forms the basis of this article depends upon the unsymmetrical waveforms which are characteristic of much speech and music. Since the peaks in the positive direction often exceed those in the negative direction or vice versa, it is desirable that the peaks having the greater magnitude should modulate the carrier of the transmitter in the upward direction. This permits the greatest possible coverage by the station short of introducing distortion by over-modulation.

Previously cathode-ray oscillographs have been used to determine the waveform of the sound program and the operator has manually switched the two input wires so as to carry out the upward modulation indicated above. The improvement in this type of operation is approximately equivalent to an effective gain of 6 db without causing any additional distortion. The automatic phase reversal amplifier was devised to carry out this operation automatically. An amplifier of this type has been constructed and has been in operation quite satisfactorily for more than a year.

The circuit rests fundamentally on the fact that Fig. 1 represents the simplest possible manual switching system for reversing the phase of the peak input to a transmitter. Such a

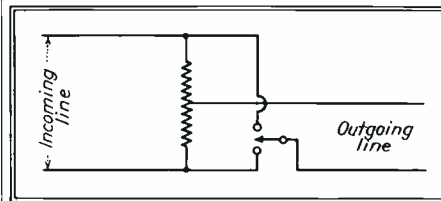

Fig. 1—Simple manual switching arrangement for reversing phase of signals in the outgoing line

manual switching arrangement of course causes a 3 db loss, but this is not a great disadvantage since the gain of any amplifier following it can be turned up by that amount.

Perhaps the operation in the diagram may be more fully considered in detail through the use of Fig. 2. Essentially this circuit consists of a normal line amplifier, a switching tube, and a push-pull amplifier whose function is to operate the switching tube in accordance with the polarity of the voltage at its output terminal. First consider the operation of the line amplifier with the 2A3 switching tube and push-pull amplifier disconnected. The signal voltage across the input of the line amplifier is  $e_s$  and for the instantaneous voltages as marked the signal voltage at the grid will be negative with respect to that of the cathode. Now assume that the 2A3 switching tube is connected. For the moment we shall disregard the grid or input circuit and shall merely assume that plate current



*We are happy to report.*  
**PROGRESS**



**ALSIMAG** has been made in the largest, best equipped steatite insulator plant in this country. Declining Government financial aid, this plant is now being expanded to provide a 300% increase in capacity.

Careful plans of more than a year swiftly bear fruit. As walls go up, they are literally built around the newest and most modern equipment. Trained men take charge. The pace of production whirls steadily upward, 24 hours a day—7 days a week.

This new plant is of glass block, brick and reinforced concrete. Large areas of it are air conditioned, all of it has the complete dust controls essential to highest quality manufacture. Wherever possible, automatic control units are a part of all equipment.

Defense requirements have the right of way in this plant. Neither you, nor we, would have it otherwise. Daily we come nearer our goal of being able to supply defense requirements and your requirements. We believe the day is close at hand when once more we will be able to care for your needs with the speed and competence that won us so many friends throughout the nation.

The cornerstone of this organization is a policy of continued improvement through research and development. The Engineering and Production Staffs of American Lava Corporation contain representatives of many of the leading technological institutions of this country. Thus it is only natural that four completely equipped new laboratories sweep across one floor of this new building. These four laboratories, electrical, chemical, mechanical and testing, are in charge of men whose skill is favorably known to leading engineers in this country and abroad. They are ready to work for you on any problem involving technical ceramics.

*39th Year of Ceramic Leadership*

**ALSIMAG**  
Trade Mark Reg. U.S. Pat. Off.

**FROM CERAMIC HEADQUARTERS**

**AMERICAN LAVA CORPORATION • CHATTANOOGA • TENNESSEE**  
CHICAGO • CLEVELAND • NEW YORK • ST. LOUIS • LOS ANGELES • SAN FRANCISCO • BOSTON • PHILADELPHIA • WASHINGTON, D. C.

# PLASTIC TUBING FOR INSULATION

The use of IRVINGTON IRV-O-LITE XTE-30 and XTE-100 and KOROSEAL EXTRUDED PLASTIC TUBING for insulation is rapidly increasing. Wise manufacturers are realizing its distinct advantages in assembly, performance and low cost.

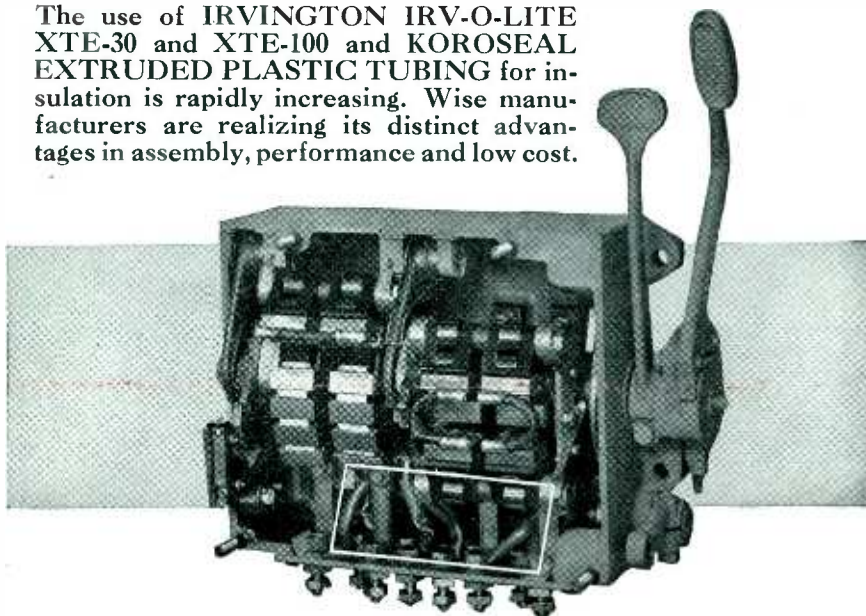

## AUTOMATIC TRANSPORTATION USES IRV-O-LITE

The Automatic Transportation Company states that IRV-O-LITE XTE-30 is used for insulation between the terminals of their Rotor Brush Truck Controllers.

IRV-O-LITE and KOROSEAL have high dielectric strength, high mechanical strength, and hitherto unattainable resistance to tearing, abrasion, heat, fire, and solvents.

Manufacturing costs are reduced by the smooth inside surfaces and extreme flexibility which enable quick assembly on wire.

### IRV-O-LITE XTE-30 & XTE-100 and KOROSEAL

Meet rigid electrical, chemical, and physical requirements. Test these tubings yourself. Let us know your requirements and we will send samples best suited for your use and with complete data on types and sizes.

Write Dept. 106



flows through this tube. The flow of plate current will set up a steady voltage across the resistor  $R_1$ , which will give a somewhat more positive bias to the line amplifier, but the signal voltage will remain unchanged. Thus, the effect is the same as if the bias control were at the point  $M$  instead of at  $N$  so far as the instantaneous voltage on the input of the line amplifier is concerned. The function of the push-pull amplifier is merely to provide a convenient and automatic switching arrangement for the 2A3 switching tube. For zero signal on the input of the push-pull tubes, the terminals  $A$  and  $B$  are at the same potential and consequently the 2A3 tube has zero negative bias.

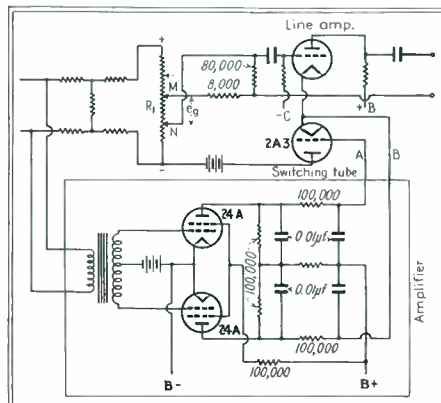

Fig. 2—Circuit diagram of automatic phase reversal amplifier

When a signal voltage is applied, one of the terminals becomes negative with respect to the other. If the terminal  $A$  is relatively negative, the 2A3 tube is biased to cut off since only a low voltage is used on the plate of the 2A3. By means of this mechanism we can automatically reverse the circuit so that the higher peaks will always modulate the transmitter upward, although for proper operation the position of the terminals  $A$  and  $B$  may have to be reversed.

Several practical points are of importance in the construction of this type of amplifier. The input circuit of the two type 24A tubes must be a transformer to obtain proper operation of the push-pull amplifier. Although type 24A tubes were chosen because of their high plate impedance, other and more modern tubes having approximately equivalent characteristics could likewise be employed. It should be noticed that the screen grid of these tubes is not at ground potential and no bypass condenser from screen to ground should be provided. The plate battery of the 2A3 tube should be of as low a voltage as possible so that a very small grid voltage will cause the tube to conduct current or to produce cut-off. The type 24A tubes are biased approximately to cut-off. The design of the optimum value of the voltage divider,  $R_1$ , following the H pad probably would not be critical and perhaps 600 to 1,500 ohms would be about right. The H pad reduces the voltage to the tube and voltage divider network so that switching is done at a low audio level.



## Don't Forget **THIS** November

Since the European war started **ELECTRONICS** advertising has gone up 66 per cent—circulation 15½ per cent.

In the first ten months of this year fifty eight new advertisers have found the need of utilizing this magazine as a selling tool.

Why?

Because the research and design engineers represent the starting point of an immense amount of speed-up equipment for industry, and a maze of new designs for radio and communication.

In the broad field of sensitive-current operation, **ELECTRONICS** bores in like no other publication to the hard-to-find man or group of men who are designing emergency equipment.

As is always the case—year after year—our November IRE-RMA issue will be read eagerly by the important men of the industry in convention at Rochester—and by more than 16,000 subscribers in radio, communication and a spread through every kind of industry.

Each year this issue is a broad index of product source, described in bigger space and greater quantity, because advertisers long ago realized that it is the catalog for a new season of activity. Certainly, *this* year is the banner one for you. Plan ample, competitive space now and get your reservations in early.

We close for copy-to-set on October 24th—complete plates on October 31st. **ISSUES WILL BE AT THE ROCHESTER CONVENTION.**

ABC **ELECTRONICS** ABP

A McGraw-Hill Publication

330 W. 42nd Street  
New York, N. Y.

Standard in the  
Electronics and  
Allied Industries



# KESTER ROSIN-CORE SOLDER Protects Against Corrosion —PERMANENTLY

● Circuits of whatever kind, no matter how intricate, are corrosion-proof and trouble-free, *permanently*, when protected by Kester Rosin-Core Solder. The pure, patented rosin flux will not destroy insulation; danger of fire is removed.

Kester alloys are virgin metals—they resist shock, vibration, expansion and contraction.

The wide range of alloys, fluxes, wire-sizes and core-sizes includes a Kester Cored Solder perfectly suited to every industrial soldering operation. All help speed up production and improve workmanship; conveniently self-contained flux, in scientific balance with the alloy, makes better results easy to obtain.

Write Kester engineers, without obligation, about any question concerning solder. They will gladly assist you.

## KESTER SOLDER COMPANY

4204 Wrightwood Avenue, Chicago, Ill.

Eastern Plant: Newark, N. J.

Canadian Plant: Brantford, Ont.

**KESTER CORED SOLDERS**  
STANDARD FOR INDUSTRY

## Remote Amplifier with Selective Pre-Emphasis

By NATHAN WILCOX

Chief Engineer KTUL  
Tulsa, Okla.

THERE ARE MANY IDEAS about remote amplifiers, for nearly every station engineer has his own opinion as to just how large a remote amplifier should be, what level it should put out, and so on.

After traveling around the country and listening to a great number of remote broadcasts from the smaller stations (and some of the larger ones) it was evident that very little, if any, equalization was being used. The idea came to mind that a simple switch on a pick-up amplifier would allow the operator to select a high frequency response curve which, if not absolutely technically correct, would at least give sounds a little more pleasing to the ear. Boosting the high frequency response of the pick-up amplifier will also materially aid in overcoming unwanted line noises. Thus we have a reason for a remote amplifier with selective pre-emphasis. It is to be understood that the effects of the line being used will compensate for the amount of pre-emphasis in use and that the net result will be a flat response with considerably less equalization than would otherwise be required. In this respect the word, pre-emphasis, is not used in its true sense.

No revolutionary claims are made for the unit about to be described, either in design or application, but the amplifier is small, light, and has reasonably good performance characteristics. The complete unit with batteries weighs 22 pounds. Two Burgess 4FH

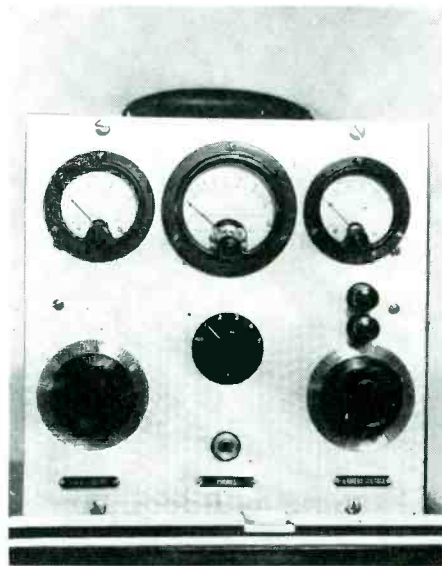

Front panel view of remote amplifier.  
Switch in center controls pre-emphasis

batteries are used in series for the three volt filament supply and three Burgess type M-30's are used as the 135 volt plate supply. The amplifier is built in a case 10 inches wide, 10 inches high and 8 inches deep. The performance curves, pictures and diagrams

# Three Good Reasons *why Engineers choose* OHMITE RHEOSTATS

**1** SMOOTH, GRADUAL, CLOSE CONTROL . . . permanently built-in and proved right in countless installations. Every turn of wire is a separate resistance step. Self-lubricating metal-graphite contact, with universal mounting, insures perfect contact with negligible wear on the wire. This means smooth electrical control unequalled in power rheostats.

**2** ALL-CERAMIC, VITREOUS ENAMELED . . . nothing to char, shrink, shift or deteriorate. The wire is wound over a solid porcelain core, permanently locked in place and insulated by special Ohmite vitreous enamel. Dissipates heat rapidly, prevents shorts and breakdowns. High strength ceramic hub insulates shaft and bushing. Many other features, all insure trouble-free performance and long life.

**3** WIDEST RANGE OF TYPES AND SIZES . . . provides the exact unit for each control need. There are ten wattage sizes, in standard or special designs, from 25 watts to 1000 watts, from 1-9/16" to 12" diameter. Many stock resistance values. Special resistances, taper windings, tandem assemblies, concentric control, off-positions and other variations produced to your specifications or engineered for you.

That's why you find Ohmite Rheostats serving Industry and National Defense on land and sea, in the air and on the ground, in industrial, aviation, radio, electronic and scientific applications.

Write on company letterhead for Helpful 96-page Catalog and Engineering Manual No. 40. Gives complete Data on Rheostats, Resistors, Tap Switches.



OHMITE MANUFACTURING CO., 4816 Flournoy Street, Chicago



*Be Right with* OHMITE  
RHEOSTATS - RESISTORS - TAP SWITCHES

# JOHNSON

*..for Dependability*

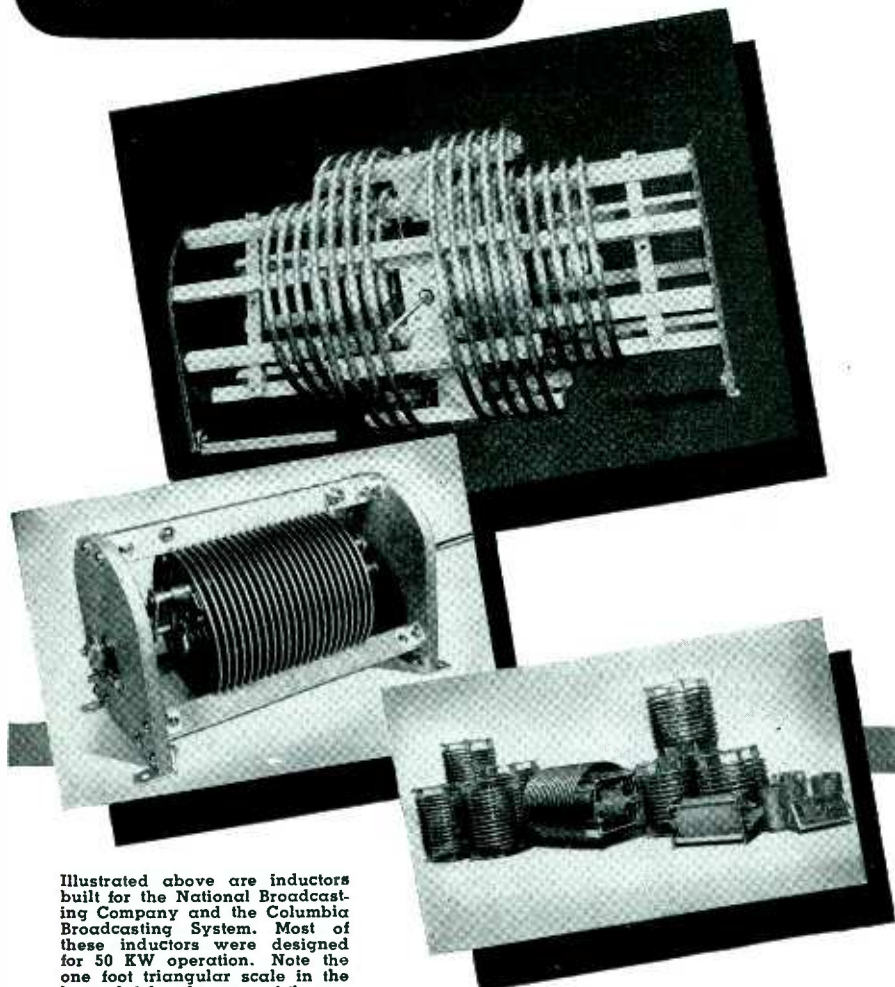

Illustrated above are inductors built for the National Broadcasting Company and the Columbia Broadcasting System. Most of these inductors were designed for 50 KW operation. Note the one foot triangular scale in the lower left-hand corner of the upper photo.

Whether your application is 50 KW or 100 watts, Johnson Inductors are Engineered with the same careful attention. Johnson Inductors are available in standard designs, your special specifications or Johnson Engineers will make circuit recommendations including suggested inductor designs for your particular application. Write today requesting help on YOUR problem—no obligation.

**NEW CATALOG 967D NOW READY.**

**E. F. JOHNSON CO**  
 WASECA, MINNESOTA  
 EXPORT, 25 WANNEK ST., NEW YORK, N. Y.  
 "MANUFACTURERS OF RADIO TRANSMITTING EQUIPMENT"

are more or less self explanatory and require little comment. The three meters shown in the front view of the amplifier are the filament voltmeter on the left, the output meter in the center and the plate current meter on the right. With the addition of another switch the output meter could be used in place of the other two meters, although three meters are desirable if it is necessary to know the entire circuit operation at a glance.

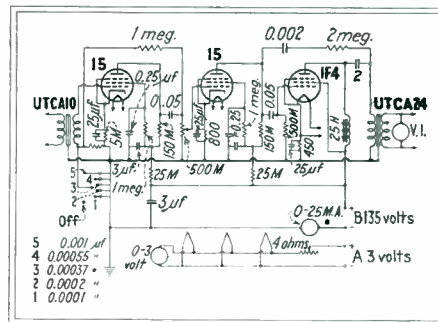

Fig. 1—Schematic circuit of amplifier, using two feedback circuits

Don't forget that the performance of an amplifier with a 500 ohm resistor tied across its output will not be the same as it will be when you put a line across it—especially if the line has a doubtful impedance and has multiples tied across it all the way from here to there. Since this particular amplifier is often used to feed open wire lines of considerable length, a 500-ohm output is used. To feed short unequalized cable circuits perhaps a 150-ohm output would be more practical. A pad may be used between the output transformer and the line if desired. The use of such a pad will materially reduce the impedance vs frequency variations reflected into the plate circuit of the output tube by the line and thus minimize amplitude and frequency distortion which might otherwise occur.

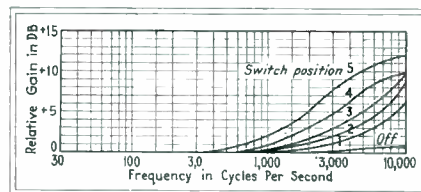

Fig. 2—Gain-frequency characteristics for various adjustments of the pre-emphasis switch

The transformers used are of the midget variety. Usually when these transformers are combined with various resistors and tubes a straight line frequency response is seldom obtained. This then, indicates the desirability of the use of negative feed-back. Two different feed-back circuits are used in Fig. 1. One is in the first stage and contains the pre-emphasis part of the unit. The second feed-back circuit is from the plate of the output tube to the plate of the second tube. The amount and design of this arrangement has a lot to do with the low frequency response of the unit as a whole.





IN THE INTERESTS OF  
**THE RADIO INDUSTRY**



---

*SUPERIOR TUBE COMPANY is doing its utmost under the restricted metals situation to serve the RADIO INDUSTRY. Since the start of production at Superior in 1935, no day has passed without shipments of Nickel Tubing for Cathodes, or Nickel Cathode Sleeves either to Seamless or Lockseam specifications.*

*Machines designed and built in our own plant have accelerated production, and this special equipment has made our service even better than we ourselves expected to attain.*

*Our latest forward move, that of membership in the RMA, we feel will make us still more helpful to the Industry.*

**WE AIM TO KEEP IN STEP**

**SUPERIOR TUBE COMPANY  
NORRISTOWN, PENNSYLVANIA**

# Build in this EXTRA Value and give your equipment MODERN Sound Reproduction

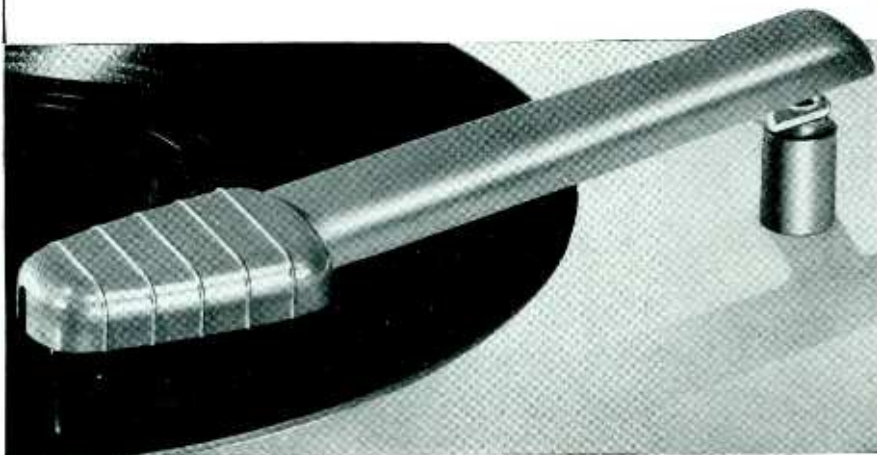

## Low Pressure Webster Electric —Model AJ1—Crystal Pick-Up for Improved Tone Quality and Longer Record Life

■ Here is recorded music at its best—a tone arm so light and perfectly balanced that it responds to every musical detail of the record track . . . brings out overtones and harmonics that reproduce true color and timbre . . . carries the surging bass notes and percussion without a suggestion of rattle.

Model AJ1 Crystal Pick-Up is truly *engineered* for the optimum in tone quality • Crystal and chuck are integrally built into the bakelite tone arm to form a precisely balanced, noiseless unit • 40 grams needle pressure reduces record wear and provides musical fidelity while keeping surface noise at a minimum • Permo-Point Needle plays thousands of records, and then may be easily changed by loosening a Phillips recessed head screw • Frequency response is balanced so that networks are not essential • Streamlined design harmonizes with modern cabinets • Available from a dependable source of supply with a background of experience and engineering that assures consistent deliveries of the very latest developments.

Webster Electric Recorder Heads make recordings outstanding for clearness and precision. They cover the entire frequency range from 30 to more than 6,000 cycles per second, and faithfully record every harmonic detail. Ask for information.

*(Licensed under patents of the Brush Development Company)*

WEBSTER ELECTRIC COMPANY, Racine, Wis., U. S. A. Established 1909. Export Dept.: 100 Varick St., New York City. Cable Address: "ARLAB" New York City

# WEBSTER ELECTRIC

"Where Quality is a Responsibility and Fair Dealing an Obligation"

If the expected frequency response is not realized try juggling the size of this condenser-resistor combination. Don't forget what happens to the reactance of a condenser at low frequencies when you change its size and remember that you want some output left, so use as little feed-back as is consistent with the apparatus at hand.

The pre-emphasis is obtained from the feed-back loop in the first tube. The feed-back loop in the amplifier has a number of condensers and a switch connected across the return resistor on the input transformer. In the front view of the amplifier this switch is located just under the output meter. By selecting a condenser which effectively short circuits the feed-back at the higher frequencies an overall rise in high frequency response is obtained. Curves for the various positions of this switch are shown in Fig. 2. Distortion vs output is shown in Fig. 3.

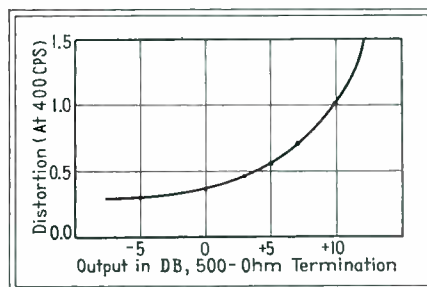

Fig. 3—Distortion plotted against output for the remote amplifier

Possibly one condenser and a variable resistor could be used instead of the switch arrangement. However, preliminary experiments indicated that it would be simpler to use the arrangement shown. If the curves do not come out to suit your particular desires, a fixed resistor can be placed in series with each condenser and the curve made to fall anywhere within the limits of the amount of feed-back being used, or a resonant circuit may be used. This should be placed in the feed-back loop since incorporating it in the plate circuit would introduce complications. If no feed-back were used then it could properly be placed in the plate circuit.

• • •

## Cathode-Ray Recording of Transients

THE RECORDING OF TRANSIENTS from the screen of the cathode-ray tube is usually accomplished by using a moving-film camera, or, with a still camera, by opening the shutter, impressing the transient signal on the fluorescent screen, and then immediately closing the camera shutter. In either case the signal occurs only once, permitting one trace of the spot to give the required negative density, and therefore limiting the maximum writing-rate which may be recorded by the emulsion speed, the magnification of the lens system, the speed of the lens system, and the

# Military and Civil Aircraft

## ...rely on ELECTRONIC VIBRATORS

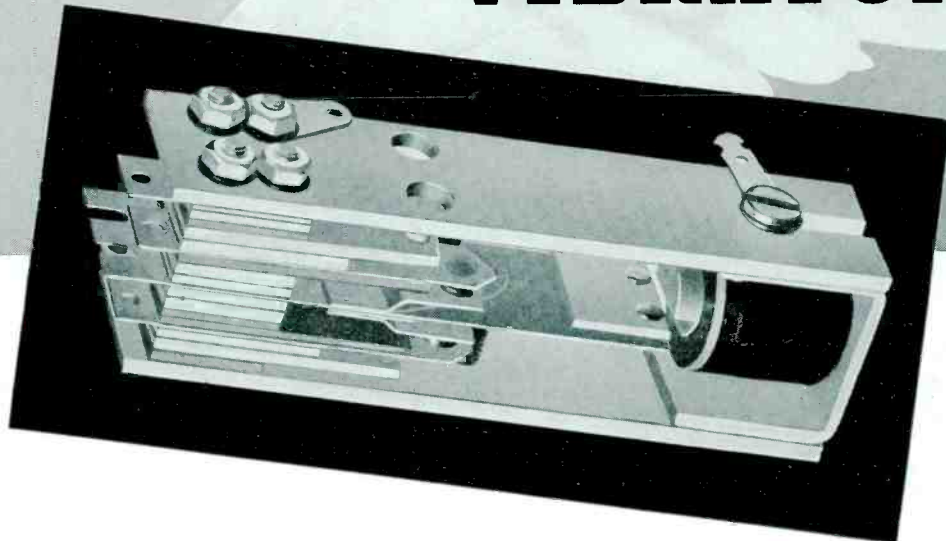

*Electronic Vibrator . . . hear of Electronic Converters . . . as used in Sperry Directional Compass.*



Military and civil aircraft require power sources of unfailing dependability under *all operating conditions*. That's why Electronic Vibrator Power Supplies are so widely used on U. S. Army, Navy and Coast Guard planes . . . as well as commercial airliners and privately owned aircraft.

The exceptional preference for Electronic Vibrators is the direct result of many vitally important features found only in this product: . . . light but rugged construction . . . constant frequencies . . . synchronous operation . . . range of 0 to 500 watts at any voltage . . . long trouble-free performance! . . . That's why there are more Electronic Vibrator Power Supplies flying *than all other makes combined*.

In addition to Vibrator-Type Power Supplies, Inverters and Control Boxes, Electronic Laboratories supply the aviation industry with Ultra-Violet "Black Light," a significant advance in aircraft instrument illumination . . . fluorescent cabin lighting . . . custom-built lamp assemblies and fixtures . . . a combination of services seldom found in one organization.

Electronic products are *trusted flight companions* of both military and civil airmen. For further technical information, address the Aircraft Division of Electronic Laboratories.

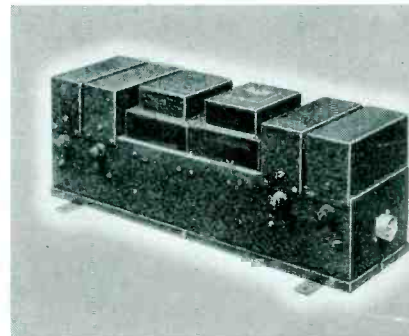

*Electronic Autosyn Inverter Type S-525 . . . power source for instruments of the great Boeing Flying Fortress.*

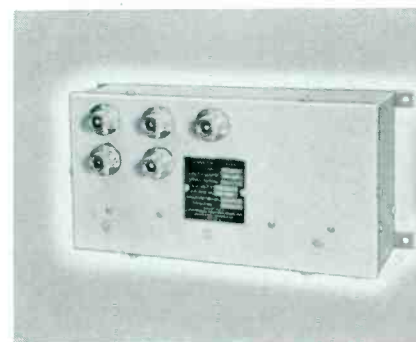

*Electronic Type S-665 . . . converts 12 or 24 Volt DC to 110 AC for operation of fluorescent lamps.*

## ELECTRONIC LABORATORIES, INC.

AIRCRAFT DIVISION, INDIANAPOLIS, INDIANA





**RESERVE  
STRENGTH**

NOW — *When You Need It . . .*  
LATER — *When You Want It!*

# STACKPOLE

## CAN SOLVE YOUR PROBLEM

### With Small Parts, Sub-Assemblies

The entire plant, personnel and facilities of the Stackpole Carbon Company have gone "all out for Defense" . . . ready to step in immediately on any sub-contracting assignment or government contract. As we keep a hand on the present . . . we have our eyes on the future by continuing our design and development work so as to be in an even better position than ever to take care of civilian business once the defense program is over.

With complete facilities and a well coordinated, highly skilled staff of engineers, experienced in the radio and electronic fields, we solicit the needs of those equipment manufacturers, who, for various reasons, are experiencing difficulty in meeting production deadlines.

#### These Facilities At Your Service!

- Bakelite Molding Equipment . . . for parts and sub-assemblies for equipment and instruments.
- Complete Punch Pressing Department . . . operated by engineer craftsmen.
- Complete Assembly Equipment . . . for production of small parts.
- Design and Production Engineering . . . to solve your small parts and sub-assembly problems in connection with motors, instruments and other equipment for Government Contracts.

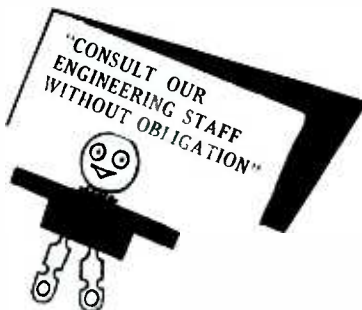

**STACKPOLE CARBON CO.**  
ST. MARYS, PENNA. U. S. A.

accelerating potential and the beam current of the cathode-ray tube.

In a report from the Allen B. Du Mont Labs. it is pointed out that their engineers have determined empirically that with a lens opening of  $f/4.5$ , accelerating potential of 1000 volts, willemite screen, magnification of 0.5, and with a panchromatic emulsion having a Weston speed rating of 24, writing-rates as great as 1500 inches per second will give satisfactory negative density. From this empirical data it should be possible to calculate the maximum writing rate which may be photographed under any conditions.

• • •

### An Electronic Electroscop

BY ESTEN MOEN

Fosston, Minn.

A CONVENIENT AND SIMPLE electrical circuit for making certain tests of polarity and voltages (within certain ranges) is shown in Fig. 1. The device may be considered somewhat analogous to the old type electroscop and has been found to be useful in experimental work. The circuit utilizes the operation of the shadow angle of 6E5 electron ray indicator or similar tube.

The circuit is shown for operation of the tube from a 250-volt supply. The 10,000-ohm variable resistor is adjusted to provide a suitable bias on the grid of the tube. It may be adjusted so that if the grid goes negative, the shadow angle will close, while if the grid goes positive the angle will open.

If the circuit is to be used in connection with low impedances, the 200  $\mu\text{f}$  grid condenser may be eliminated. The purpose of this condenser is to build up and maintain a charge for an appreciable time for those applications in which the tube is used as an electroscop. If a negatively electrified substance is brought near or into contact

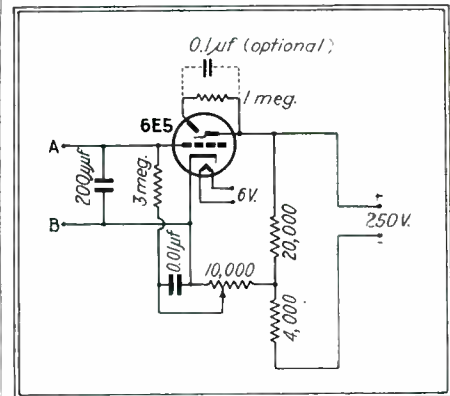

An electron ray indicator tube, connected as indicated above, is useful as a form of electroscop and polarity indicator

with terminal A, the shadow angle will close, whereas when the electrified substance is removed the shadow angle will return to its initial position. Without the use of this grid condenser, the response of the electron ray tube will not be sufficiently prolonged to be readily apparent.

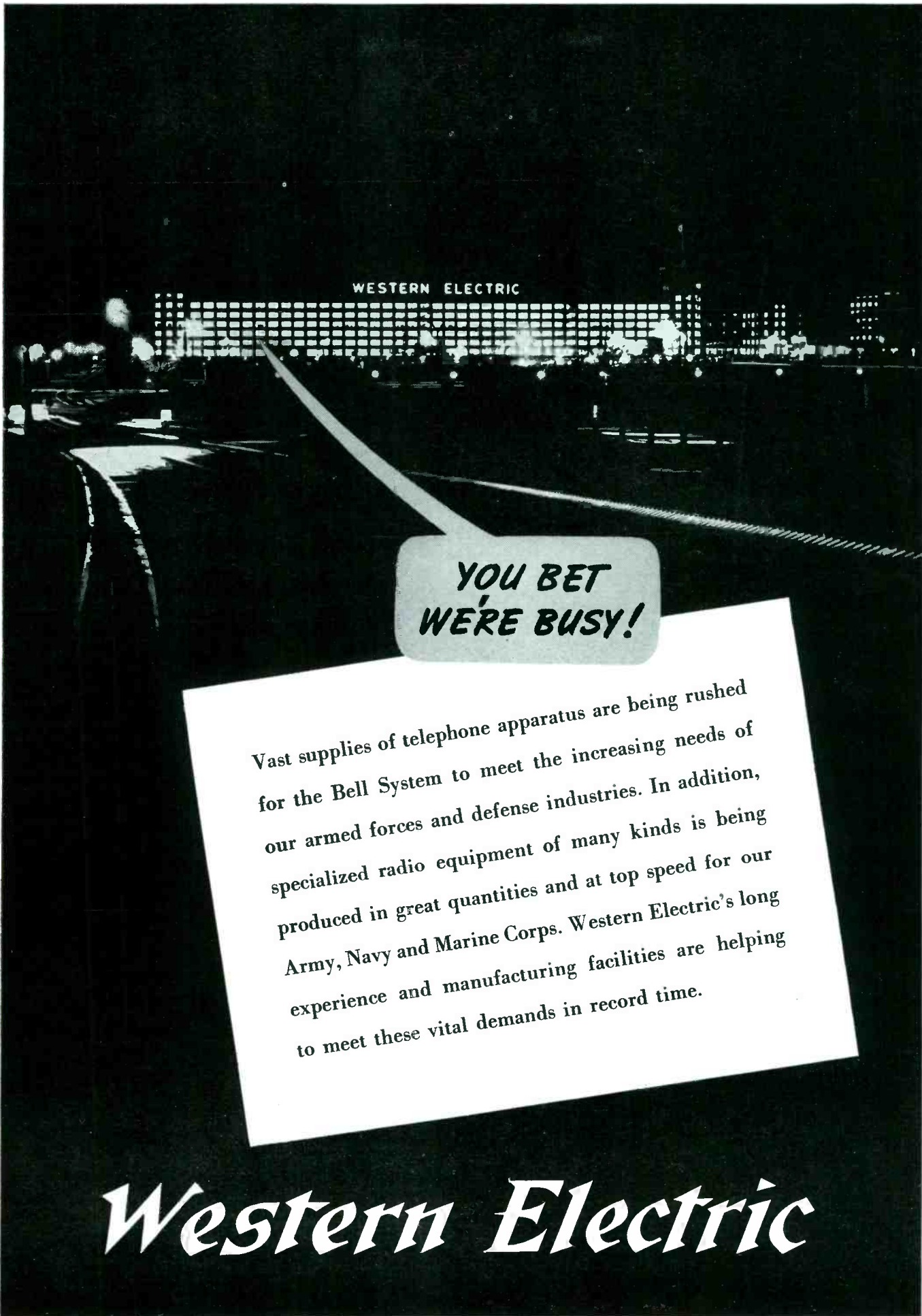

WESTERN ELECTRIC

**YOU BET  
WE'RE BUSY!**

Vast supplies of telephone apparatus are being rushed for the Bell System to meet the increasing needs of our armed forces and defense industries. In addition, specialized radio equipment of many kinds is being produced in great quantities and at top speed for our Army, Navy and Marine Corps. Western Electric's long experience and manufacturing facilities are helping to meet these vital demands in record time.

***Western Electric***



## THAT OTHERS MAY PRODUCE

Four motors opened brazen throats, four "props" screamed into the morning breeze. The "world's largest bomber" lifted her tons of men and metal and bulleted over the cheers of thousands who stood watching their handiwork. *They* had built her.

*Who* had built her? She had been built, tried and tested, designed and re-designed—*on paper*—long before the first mechanic touched her. Pencils and Paper, Slide Rules, T-Squares, Angles and Curves, these were the tools that built her. Engineers, designers and draftsmen—these were the men that created her, planned her, made her "building" possible.

To these men, the creators of Industry, whose minds and pencils hold the key to "Building", Frederick Post brings a broad choice of products refined through research and specifically adapted to the quickened tempo of today's designing engineer.

These new Post products—each supplying an unlimited service to the men who plan that others may produce—are worth your serious investigation. By 'phone in more than 50 cities—by mail to The Frederick Post Co., Box 803, Chicago. Send for Bulletin 1000.

INSTRUMENTS • EQUIPMENT • BLUE PRINT PAPER • KINDRED SENSITIZED PRODUCTS



## 1941 Rochester Fall Meeting

Sagamore Hotel,  
Rochester, New York  
November 10, 11, 12, 1941  
Program of Technical Papers

### MONDAY, NOVEMBER 10

9:30 A. M.—12:30 P. M.

"A Method of Introducing Good Synthetic Bass Response Into Small Receivers" (with demonstration) by F. H. Shepard, Jr., Revelation Patent Holding Corporation.

"The Design of Solid Dielectric Flexible R-F Transmission Line" by Harner Selvidge, American Phenolic Corporation.

"Some New Aspects of Radio Engineering Economics" by E. L. Hulse, General Electric Company.

2:00 P. M.—4:00 P. M.

"Design Considerations For a Video Signal Generator With Monoscope Signal Source" by O. H. Shade and H. De Ryder, RCA Mfg. Company, Radiotron Division.

"The Skin Effect and The Depth of Penetration" by H. A. Wheeler, Hazletine Service Corporation.

"A 300-kv Electron Microscope," by V. K. Zworykin, J. Hilliar and A. W. Vance, RCA Mfg. Company

### TUESDAY, NOVEMBER 11

9:30 A. M.—11:30 P. M.

"Annual Message of RMA Director of Engineering" by W. R. G. Baker.

"Discussion of Tube Noise Phenomena" by W. L. Krahl, Hygrade Sylvania Corporation.

"Design of a F-M Signal Generator" by C. J. Franks, Boonton Radio Corporation.

2:00 P. M.—4:00 P. M.

"New Magnetic Materials" by W. E. Ruder, General Electric Company.

"Design of a Modern 400 Mc. Signal Generator" by John M. Van Buren, Measurements Corporation.

"New Advances in Iron Cores" by W. J. Polydoroff, Consulting Engineer.

### WED., NOVEMBER 12

9:30 A. M.—12:30 P. M.

"Some Observations Concerning The Transient Behavior of Radio Noise Meters" by C. M. Burrill, RCA Mfg. Company, Victor Division.

"The Use of Plastics In The Radio Industry" by H. M. Richardson, General Electric Company.

"Civilian Receiver Design, 1942" by Dorman D. Israel, Emerson Radio & Phonograph Corporation.

"Alternate Carrier Synchronization In Television" by F. J. Bingley, Philco Corporation.

"Receiver Controlled by Transmitted Signal—Alert Receiver" (with demonstration) by S. W. Seeley and H. B. Deal, RCA License Laboratory.

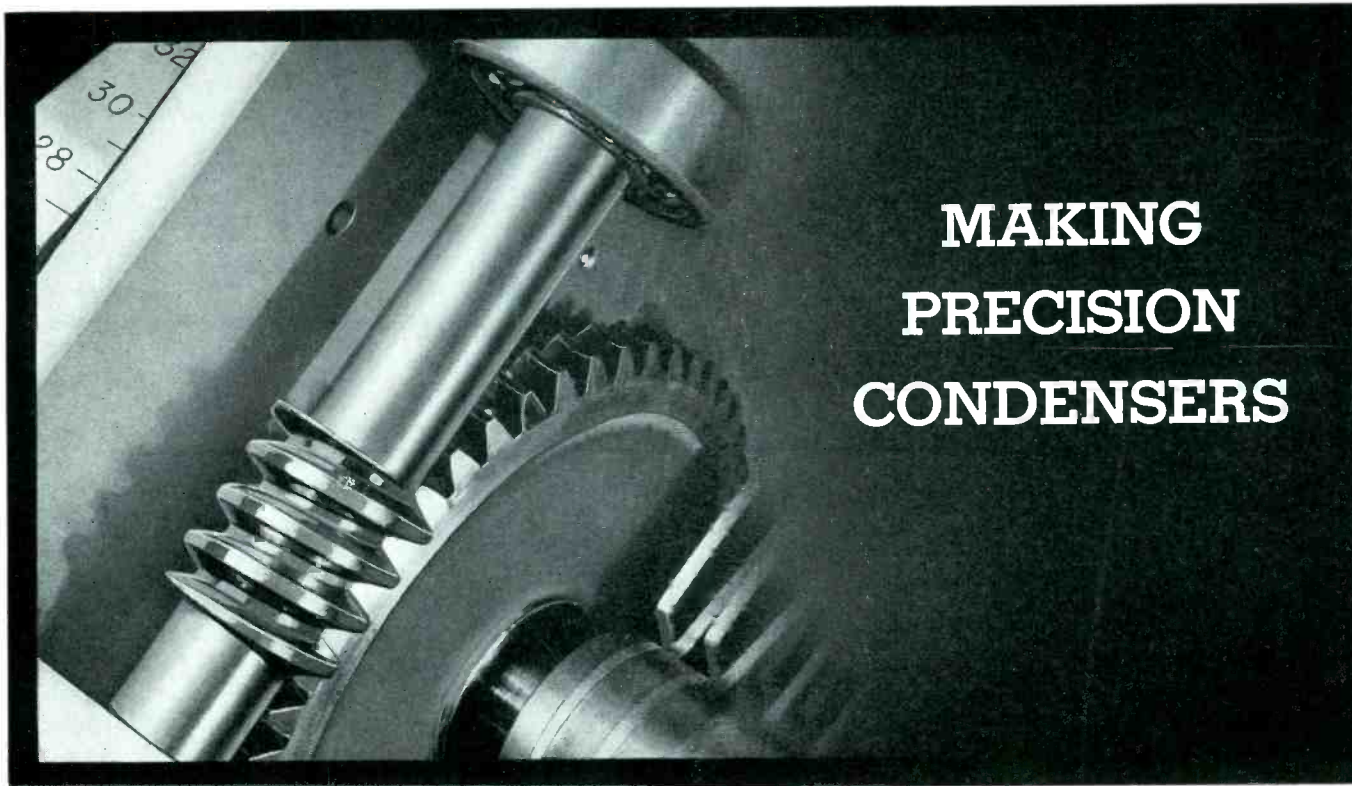

## MAKING PRECISION CONDENSERS

ILLUSTRATIVE of the precision employed in the mechanical design of GENERAL RADIO products is the popular Type 722 Condenser series. In the manufacture of precision condensers the mechanical design has considerable bearing upon the ultimate accuracy obtainable. The Type 722 Condensers can be reset to 1 part in 25,000, an accuracy comparable to that obtained only in the finest type of precision machine. To secure this accuracy of setting, exceedingly close mechanical tolerances are held.

A 50-to-1 worm drive, equipped with a  $3\frac{1}{2}$  inch dial, is used for the fine setting adjustment. Backlash in the drive is kept very low (less than one-half worm division) by cutting the worm and worm shaft from an integral steel shaft, thus eliminating eccentricity due to setscrews and misfit.

The worm shaft is held to a tolerance of 0.0004 inch; the radial eccentricity of the worm gear is held to less than 0.002 inch. The main rotor shaft is held to a radial tolerance of 0.0005 inch and its bearing surfaces to 0.0002 inch. Ball bearings are used on the worm and main rotor shafts.

To take full advantage of the mechanical refinements of the worm drive, correspondingly impor-

tant electrical and mechanical design features are incorporated in the other parts of these condensers. The main shaft, rotor and stator plates, tie rods and heavy cast frame are all fabricated from aluminum alloy. A remarkably low temperature coefficient of capacitance of only 0.0022 per cent per degree C. (22 parts per million) results from this construction.

Small, properly placed waxed Isolantite bars insulate the rotor and stator plates. A figure of merit ( $R\omega C^2$ ) of  $0.04 \times 10^{-12}$ , which is constant over the audio-frequency range and remains unchanged up to 75% relative humidity, is thus secured.

After assembly, the completed condensers pass through a number of aging cycles to relieve strains set up . . . strains which otherwise would not appear until years later. The condensers are then calibrated in our laboratories

to an accuracy considerably better than that to which they are rated.

General Radio variable condensers have been used throughout the radio industry for years as the standard of variable capacitance. These condensers typify the care used in the electrical and mechanical design, production and testing of many General Radio instruments.

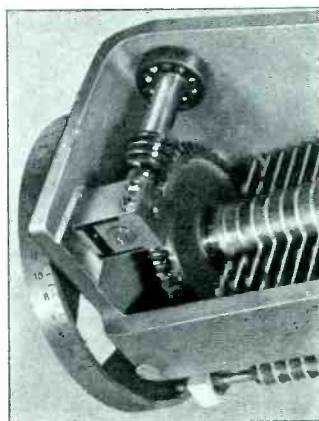

**GENERAL RADIO COMPANY**  
CAMBRIDGE, MASSACHUSETTS  
Branches in New York and Los Angeles

It has ALWAYS been  
**TEXTOLITE**  
with Guardian Electric

● There is obvious satisfaction in the knowledge that Guardian Electric Company engineers always have specified G-E Textolite alone for their signal corps relays.

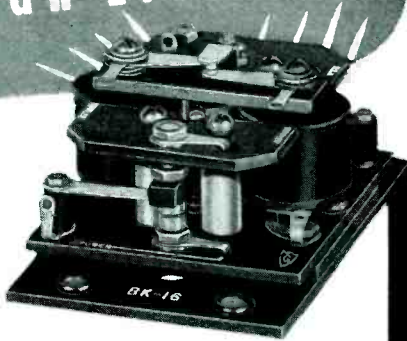

Our pride in this vote of confidence, we believe, is justified. For the high standard of Guardian products guarantees the quality of its component parts and Textolite performs a vital function.

In the BK-16 relay, shown above, seven pieces of laminated Textolite are fabricated to rigid specifications. More than 30 holes were punched and drilled with a maximum tolerance of .002 inches between any two holes. All parts—to the number of 11,000 for this particular type—have a mirror finish on all sides and ends.

Guardian Electric's success with the use of Textolite is indicative of the results obtained by hundreds of users of this material for an almost unlimited variety of applications. It is the result of a thorough plastics operation which General Electric conducts in a sincere effort to produce the best possible quality at the greatest possible speed.

For details, write Section H-45, Plastics Department, General Electric Company, One Plastics Avenue, Pittsfield, Mass.

PD-174

PLASTICS DEPARTMENT  
**GENERAL**  **ELECTRIC**

## Research Beats the Priorities

(Continued from page 30)

the beginning steel ran just about as pilot runs had shown. Flatness was a little better than had been anticipated, but steel is not yet of best broadcast standard.

From the start glass was a prodigious headache for the factory and a delight for the customer. The flatness ran very close to ideal, within  $\pm 0.002$  inch, which is about two-thirds the thickness of a human hair. The surface was ideally smooth; after all, there is nothing as smooth as glass. The production problems were such that a glass disc was either all good or all bad and so while the factory had its troubles, they never reached the customer. It is possible that this is the reason for the remarkable reputation that glass base discs have developed in the intervening months.

One little but important development occurred after a few weeks of production. It was noticed that the sharp edge of the glass was scraping recording machine center pins, and a bushing arrangement for the center hole became necessary. The obvious thing was to try a metal eyelet or grommet, spun over. This ran into several snags. First, the control of spinning pressure was too critical. Too little would make a loose, rattly center. Too much would leave heavy residual strain in the glass, which became an invitation to future trouble. Then there was the question of hole size—how closely could it be controlled? There was some doubt. Finally, and most important with a metal shortage, what was the use of standardizing on a brass or kindred metal indispensable in cartridge cases and certain to be unavailable all too soon? It was found possible to devise a special non-metallic bushing with a punched center hole. The design made it self-locking, the material did not interfere with defense activities, and the



# High Fidelity at Low Cost!

## RCA 1,000 Watt Transmitter

MODEL 1-K

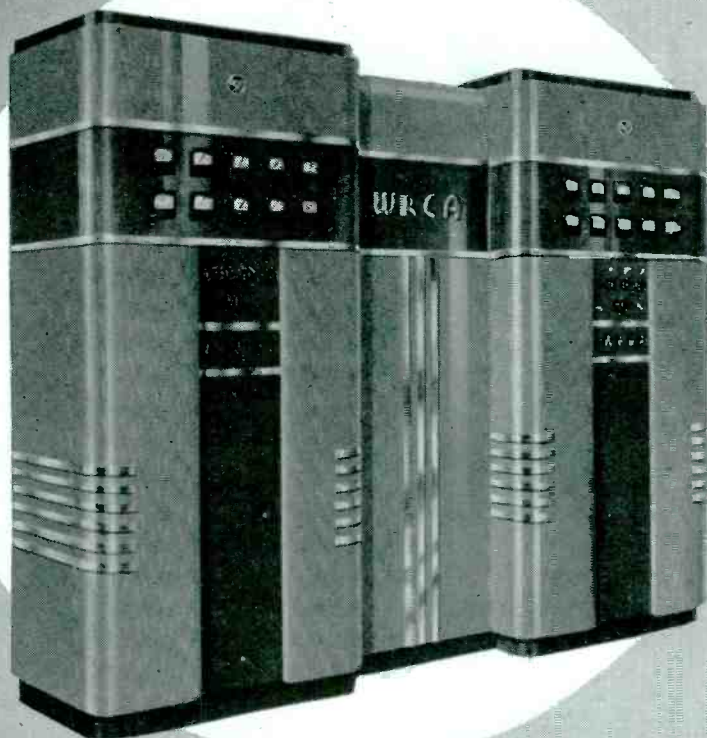

- Flat within 1.5 db., 30-10,000 cycles
- High-efficiency Class B Modulation
- Distortion less than 3%, 50-7,500 cycles
- Carrier frequency exact within  $\pm 20$  cycles
- Less than 5% Carrier Shift

**S**IMPLICITY and accessibility... extended frequency-response and low distortion... with extremely low overall operating costs... make the RCA Type 1-K Transmitter your logical choice when you go to 1,000 watts!

Excited by the famous RCA 250-K transmitter unit, the 1-K offers unusual flexibility, operating at 1,000 watts, 500 watts, 500/1000 watts, 250/1,000 watts, and 250/500 watts. Stations already equipped with the 250-K can increase their power to a maximum of 1,000 watts simply by the addition of the amplifier unit (RCA Type MI-7185), and power unit. Write for complete story, yours on request.

*The RCA Model 1-K consists basically of the Model 250-K transmitter plus a matching amplifier unit. 250-watt stations with Model 250-K can increase power to 1,000 watts easily and at very low cost.*

Use RCA Radio Tubes in your station for finer performance



# Broadcast Equipment

RCA Manufacturing Company, Inc., Camden, N.J. • A Service of the Radio Corporation of America  
In Canada: RCA Victor Co., Ltd., Montreal



New York: 411 F 5th Ave. Chicago: 529 E. Illinois St. Atlanta: 530 Citizens & Southern Bank Bldg. Dallas: Santa Fe Bldg. San Francisco: 170 Ninth St. Hollywood: 1016 N. Sycamore Ave.

# SUNLAMP—pocket size!

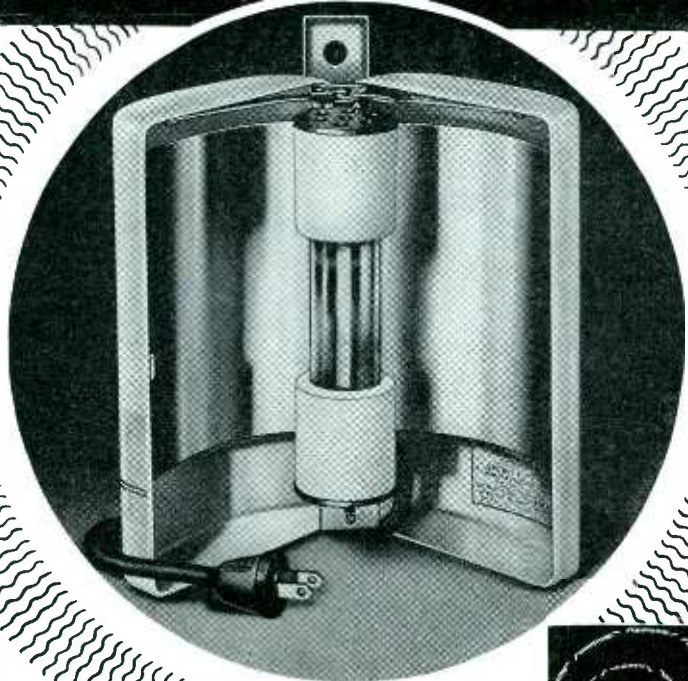

a **SPERTI** achievement  
to which **CALLITE** contributed



**A** COMPACT portable lamp, capable of producing a half-hour tropical tan in three minutes, is Sperti's new contribution to sun-starved millions. This pocket edition of Old Sol contains a "professional" high-powered ultra-violet tube producing infra-red radiation.

In selecting the components of this high intensity mercury arc unit, Sperti chose Callite weld wires, coated cathodes and filament coils. For these vital parts must represent the highest degree of accuracy, uniformity and operating dependability. As the profession well knows, such quality is characteristic of all Callite electronic products, and is the watchword of every step in Callite's engineering and manufacturing processes.

If you're seeking this type of uniform dependability, specify Callite as your source of supply. And when "metallurgent" problems arise, call on the broad knowledge and resourcefulness of Callite's engineers. Whatever your needs, Callite will serve you with efficiency and dispatch.

*Manufacturers of electrical contacts of refractory and precious metals, bi-metals, lead-in wires, filaments and grids—formed parts and raw materials for all electronic applications.*

## CALLITE TUNGSTEN

CORPORATION

544-39th STREET



UNION CITY, N. J.

CABLE:

"CALLITES"

BRANCHES: CHICAGO • CLEVELAND

punched center hole could be controlled with great accuracy. Incidentally, accuracy of center hole diameter is rather important. If the hole is too small, the disc will not fit on the machine, if too large the disc may be slightly off center when played back on another turntable and produce objectionable wows.

A rather puzzling observation was made by many rather prominent recording engineers. The glass base discs sounded better, clearer. Ordinary instrument tests gave no clue. Distortion tests were made at various frequencies up to 7500 cps and in no case was there any measurable difference between glass base and aluminum base discs. Frequency response also was identical. The question, therefore, arose and still remains, what makes the disc better?

The mere fact that instruments show no difference is not a proof that there is no difference; it is merely a proof that the instruments cannot recognize one. This is no new situation in the recording field, experienced recordists have known for many years that a cutter may have a marvelous characteristic curve and yet may sound so bad as to be utterly unusable. We seem to have something of the same sort of situation in connection with glass. It is possible that the improvement may be due to the better internal damping of vitreous material. Perhaps when a coating is cut, waves are propagated in the base; these waves may reverberate and blur ensuing recording just as excessive reverberation in a studio is objectionable. A number of tests have been made in an attempt to analyze this factor, but like many problems of dynamic characteristics, the difficulties are great. It is hoped that some crackerjack experimental technician will find a way of detecting the differences.

Handling the discs has not proven the difficulty that it was thought to be. Properly handled shipments of standard quantities suffer virtually no breakage. The first week or two there was a little trouble until expressmen learned proper handling but since then breakage had dropped to a figure very close to zero. Experimental shipments across the continent and back had revealed the proper packing structure. Shortage of steel undoubtedly will compel a change to wooden boxes as current stocks of cans are exhausted. Ship-



# CALLING ALL CARS... ...CALLING ALL CARS

**A**NYONE who has ever seen a police car tear over a bumpy road at high speed may well wonder how such delicate equipment as radio tubes can stand the pounding, jarring and impact. That's why, in this and many another application, Sylvania's new Lock-In Tubes are indispensable.

Once in place . . . they STAY in place

—upsidedown, sideways or in any position.

The solid LOCK-IN contact improves the efficiency of car and home sets too, of radio reception in airplanes, tanks, jeeps, anywhere they are used on land or at sea . . . an advantage that pays handsome dividends in customer satisfaction and confidence.

*Sylvania Radio Tube Division*

**HYGRADE SYLVANIA CORPORATION**  
**EMPORIUM, PA.**

500 FIFTH AVE., NEW YORK • SALEM, MASS. • ST. MARYS, PA. • IPSWICH, MASS. • TOWANDA, PA.  
*Also makers of Hygrade Lamp Bulbs, Hygrade Fluorescent Lamps and Miralume Fluorescent Light Fixtures*

# RELAY QUALITY

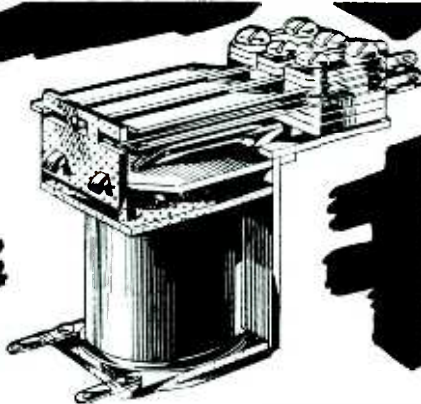

## FOUNDED ON "KNOW-HOW"

The world-famous quality of Automatic Electric relays is backed by 50 years of manufacturing experience . . . constant daily use . . . endless laboratory tests. The resulting "know-how" takes tangible shape in superior performance and dependability, for which you pay no premium!

The Automatic Electric relay line is complete—includes units for every operating condition. All have Automatic Electric built-in quality, assuring positive action and long life.

Send for your free copy of our comprehensive relay catalog.

**AMERICAN AUTOMATIC ELECTRIC SALES COMPANY**  
1033 W. Van Buren Street, Chicago

**AUTOMATIC ELECTRIC**  
RELAY MAKERS SINCE 1898

# TWINS!

Two new Sound Level Meters give greater accuracy at lower cost!

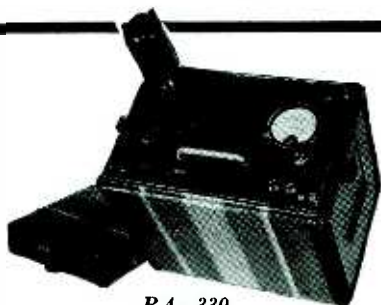

RA-330  
Battery Operated

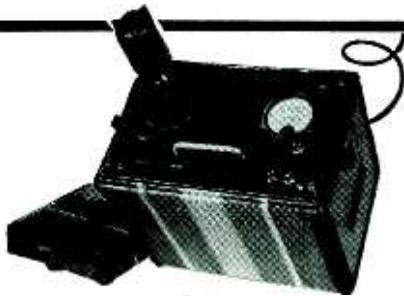

RA-331  
AC-Line Operated

**S**MALLER, lighter, simpler to operate, these new Sound Level Meters offer you highest quality at much lower cost than previous models. They're calibrated from Bell Labs primary standards—meet A.S.A. specifications—are ruggedly built to assure *lasting accuracy* in spite of hard use.

Features you'll like: Self-contained Calibration Check; Simplified Controls; Feedback Stabilized Amplifier; Moving Coil Mike. New bulletin SP-155 gives complete details. Write to the address below for your copy.

**Electrical Research Products Inc.**  
76 Varick Street, New York, N. Y.  
A Subsidiary of  
**Western Electric Company**

ping individual records also looked like a problem, but proved to be none whatever. By using a floating or cushioned inner box enough flexibility was provided so that there was simply no breakage at all.

Single hole driving has proven a problem easily overcome by application of this simple principle. Gripping the record between layers of live rubber under reasonable pressure will provide adequate friction. If trouble results nevertheless, it is well to search for difficulties in the equipment. For example, a number of complaints were traced to the use of turntable mats nearly five years old, and as slippery and hard as age could make them. Of course, the hardness had raised the disc noise level several decibels, but that had hitherto been neglected. Wax type machines have no inherent provision for applying pressure to the record center, for they rely on a drive pin for instantaneous discs and on the weight of the blank for wax. The answer is to use a center weight. One borrowed from a transcription turntable will do nicely.

In the case of only one machine has any trick been necessary. A relatively small number of overhead feed machines have been made using a center pin and three drive pins attached to the flange rather than the turntable, as illustrated in Fig. 3. The drive pins are fastened in irremovably. To avoid dismantling the mechanism and sawing off the pins it is possible to slip on the rubber pad shown in Fig. 4. Enough of the center pin protrudes to insure good centering. It is necessary to lift the outer support of the overhead feed mechanism (by loosening the appropriate screws) a bit to keep proper alignment.

In a pinch a small strip of scotch tape between the outer rim of the disc and the turntable will compensate for any equipment deficiencies. While the writer knows of no case where it has been necessary, it is a good thing to keep in mind. If the rubber mat has been made slippery by the manufacturer, try washing it off with carbon disulfide.

### A Psychological Problem and a New Remedy

In spite of this there was a definite mental problem. The recordist would worry about disc slippage, whether or not it ever happened. It

became desirable to change to a much larger diameter non-metallic center with all four holes punched simultaneously, just as with aluminum. This overcame the multiple line of weakness problem which would have resulted from drilling more than one hole in the glass. At the same time it gave the recordist a disc which handled exactly like aluminum on the machine.

Summarizing, the search for a substitute has, instead, developed a new and superior professional material with improved flatness, surface, and tone quality, a material whose use will long outlive the events that caused its adoption.

Experience with glass base may be taken as a good proof of the value of long range research. Furthermore a moral may be pointed. Don't complain about substitute materials. Do your best to use them. We are entering an era of more and more substitutes, and we can't reverse the trend. Instead of grumbling, do your best to get adapted and you will find the problem nowhere as hard as the anticipation. Your manufacturer will help you as much as he can, but in the last analysis there is no substitute for the natural ingenuity of the engineering user.

• • •

## LIGHTNING LEAVES AUTO UNDAMAGED

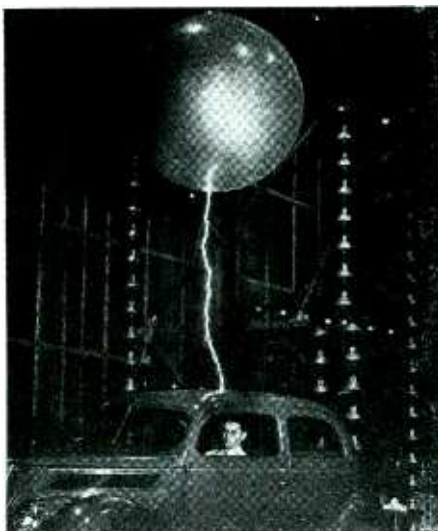

3,000,000 volts of man-made lightning failed to damage an auto or injure its driver in a recent test at the Westinghouse high voltage laboratory at Trafford, Pa.

## STILL GOING STRONG 15 HOURS A DAY!

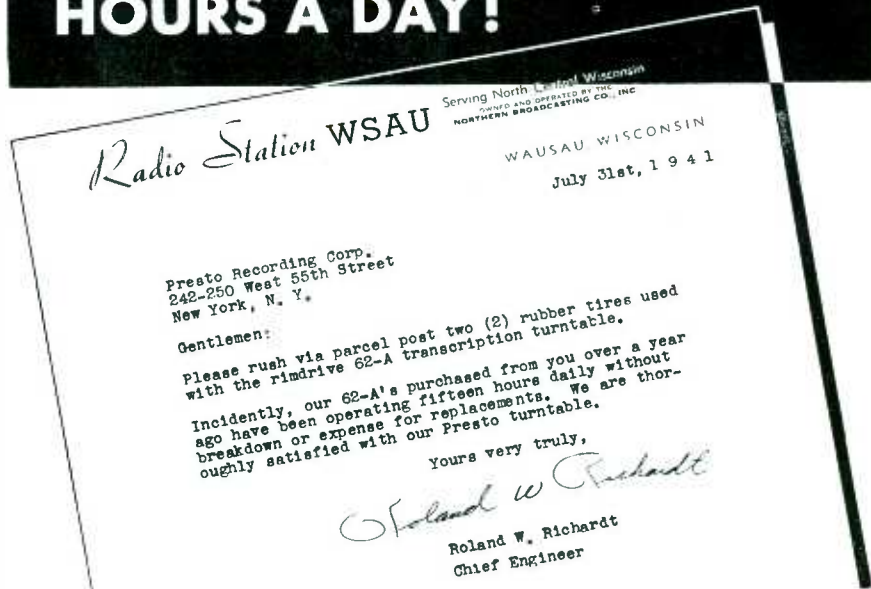

• It takes a real transcription table to keep up with a busy radio station. WSAU found what they wanted in the Presto 62-A...5000 hours of trouble-free service, one simple, inexpensive tire renewal.

If you want a table that gives you a quick jerkless start, always coming up to speed in exactly  $\frac{1}{3}$  revolution . . . if you want a table so completely vibrationless you don't know it's running . . . if you want a "wow-free" table that runs  $33\frac{1}{3}$  or 78 RPM. on the button . . . BUY PRESTO.

Once you see this Presto table in operation you'll know why an average of 15 radio stations a month are installing 1 to 3 Presto tables to replace their present equipment.

Presto tables give you the performance you've always wanted and they're ready for *immediate delivery*.

Write today for literature and the name of your nearest Presto distributor.



• Presto 62-A transcription table for lateral recordings, list price, \$385.00.



• Simple, foolproof Presto drive system—steel motor pulley drives against rubber tire on turntable rim, only 2 moving parts.

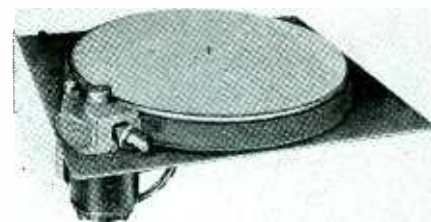

• Presto 16" dual speed turntable chassis only, list price, \$155.00.

**PRESTO**  
RECORDING CORP.  
242 WEST 55th ST. N. Y.

In Other Cities, Phone . . . ATLANTA, Jack. 4372 • BOSTON, Bel. 4510  
CHICAGO, Mar. 4240 • CLEVELAND, Ma. 1565 • DALLAS, 37093 • DENVER,  
Ch. 4277 • DETROIT, Univ. 1-0180 • HOLLYWOOD, Hil 9133 • KANSAS  
CITY, Vic. 4631 • MINNEAPOLIS, Atlantic 4216 • MONTREAL, Wel. 4218  
PHILADELPHIA, Penny. 0542 • ROCHESTER, Col. 5548 • SAN FRANCISCO,  
Yu. 0231 • SEATTLE, Sen. 2560 • WASHINGTON, D. C., Shep. 4003

World's Largest Manufacturers of Instantaneous Sound Recording Equipment and Discs

# THE ELECTRON ART

The use of mathematics in industry, characteristics of vacuum tubes in feedback circuits, method of measuring currents of short duration, a 150- to 600-Mc oscillator, and the strength of cellulose insulation are reviewed

## Industrial Mathematics

A VERY INTERESTING PAPER on this little publicized side of industry appears in the July 1941 issue of *The Bell System Technical Journal*. It is called "Industrial Mathematics," and is written by Thornton C. Fry, Mathematical Research Director of the Bell Telephone Laboratories. This discussion was prepared for the National Research Council *Survey of Industrial Research*, a survey undertaken at the request of the National Resources Planning Board.

Mr. Fry points out that not everyone who uses mathematical technique in solving a problem can be classed as a mathematician. He adopts a definition of a mathematician which is based on the character of a man's thinking rather than the ultimate use to which his thinking is put. The typical mathematician feels great confidence in a conclusion reached by careful reasoning, more so than one arrived at by experimental evidence. His argument is perfect in every detail or it is wrong. This is "rigorous thinking" for him, and "hair splitting" for the engineer. The mathematician tends to idealize situations, calling gases "ideal", conductors "perfect", and surfaces "smooth". The engineer or physicist is likely to call this "ignoring the facts". About the most predominant characteristic is the tendency to generalize. As a general rule, the mathematician is interested in solving a whole class of problems rather than one or two individual cases.

Bearing these characteristics in mind, it is easy to see that the industrial mathematician occupies a unique place in industry. He is not the sort of man to carry on an industrial project. Necessarily, he is a consultant. In this capacity, he must possess certain qualities which will assure his success as well as the success of his methods. He must be practical enough to make certain approximations which are mandatory even in the theoretical treatment of practical problems. He must be gregarious, cooperative, unselfish, and versatile. These traits make for the good relations so necessary in consulting work. Lastly, he has to be a man of outstanding ability for no one wants the advice of mediocrity. Among industrial mathematicians there is no place for the average man. The job of hiring men with such qualifications

is difficult indeed, yet it is of utmost importance that none of these be overlooked. Mathematical ability is easy to determine by referring to scholastic records. However, the other desirable traits should not be ignored, or the lack of them excused on the grounds that "all mathematicians are queer".

The supervision of the right man is not difficult. The broad objectives must be to avoid barriers which would tend to keep his associates from seeking his services. Such barriers are jealousy, red tape, and unavailability. A salary policy should be based on the size, character, and satisfaction of his clientele, and not upon the commercial importance of the work he was consulted on. It should be made easy for anyone to consult him on all problems large and small. If his value to industry is greater as a project man than as a consultant this need not be cause for regret; but to turn a good mathematician into a poor engineer, or an irre-

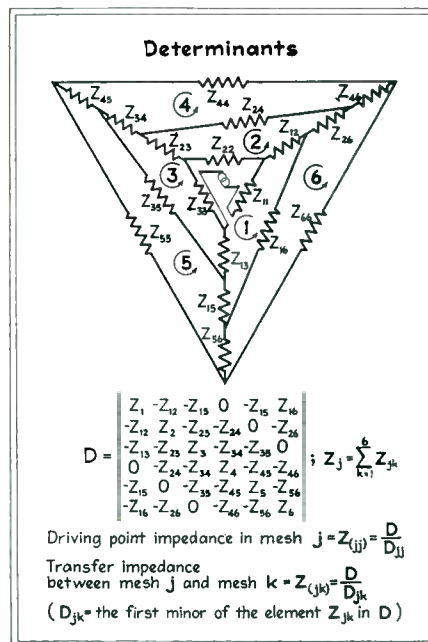

Many properties of the complicated networks studied at Bell Telephone Laboratories are most conveniently expressed by means of determinants. Above are shown a six-mesh network, its "circuit discriminant,"  $D$ ; and some formulae which illustrate how simply the properties of the system can be found from  $D$ . Note that, since  $Z_{jk} = Z_{kj}$ ,  $D$  is symmetrical

## R.A.F. OPERATIONS ROOM



In underground rooms like this, officers and girl plotters work day and night recording movements of enemy planes over Great Britain from information supplied by scattered detecting stations

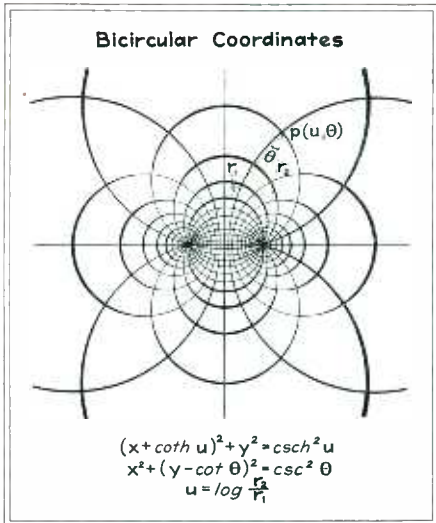

Using the bicircular system of coordinates facilitates finding the distribution of electric charge on two parallel conductors, and thence their capacity. Rotating the bicircular system about the vertical axis generates a toroidal coordinate system which facilitates determining the capacity of a torus

replaceable mathematician into a replaceable engineer is unfortunate for both employer and employee.

Mr. Fry estimates that the number of mathematicians in industry is about 150. This does not include actuaries and statisticians. He says that though the demand for mathematicians will increase in the future, their number will never reach that of physicists, chemists, or engineers. Based on this estimate he predicts a demand for 10

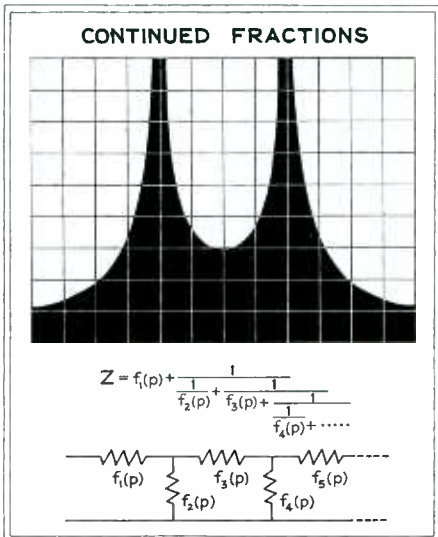

A mathematical method of systematically designing a circuit of predetermined impedance has been developed in Bell Telephone Laboratories. The given impedance, as a function of frequency, is expanded in a Stieltjes continued fraction, whose terms give the electrical constants of the desired network



should old

acquaintance



be-e forgot



Even under the pressure of National Defense work, we are making every effort to maintain our civilian contacts and to supply old friends whose patronage we have enjoyed through the years. Naturally the government comes first. Delivery dates to civilians are often long and uncertain. We are making a conscientious effort, however, to serve you and will give your inquiries the best attention within our means.

**WARD LEONARD ELECTRIC COMPANY**

32 South Street, Mount Vernon, N. Y.

**WARD LEONARD**  
relays • resistors • rheostats

**ELECTRIC CONTROL DEVICES SINCE 1892**

# films of "AQUADAG"

(Colloidal graphite in water)

**RESISTANCES:** Colloidal graphite is a resistance material widely used in volume controls, tone controls, grid leaks, and similar types of fixed and variable resistors

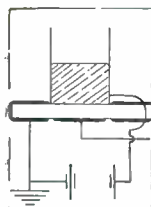
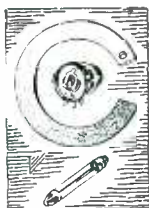

**TEST SPECIMENS:** This product also has many advantages over common foils for measuring constants of insulating substances.

**VACUUM TUBES:** Films formed with "dag" colloidal graphite discourage secondary and undesirable primary emission emanating from vacuum tube elements. Electrostatic shielding may also be accomplished.

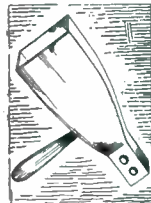

**THERMOPILES:** Radiation collectors utilize the heat conducting and high "black-body" values of "dag" deposits.

**CATHODE RAY ENVELOPES:** Interior walls coated with similar films provide "gettering", focusing, intensifying, and shielding action in television tubes.



**EVACUATED DEVICES:** Shields, guard rings, "cat's whisker" contacts, conductive cements, and special electrodes or contacts are formed conveniently with "dag" dispersions.

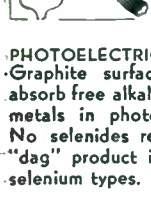

**PHOTOELECTRIC CELLS:** Graphite surfaced electrodes absorb free alkalis and alkaline metals in photoelectric cells. No selenides result when the "dag" product is used in the selenium types.



*The above is not a recommendation to use colloidal graphite in infringement of any patents.*

**ACHESON**  
COLLOIDS CORPORATION  
PORT HURON, MICHIGAN



"Aquadag" and "dag" are trade marks of the Acheson Colloids Corporation

men a year. Though this figure seems small it should be remembered that these must be exceptional men. The difficulty in getting these men is that there is no school in this country which offers the training needed to produce this type of individual. At the present time, the engineering schools seem to be the best source of men who may be further trained in industry later.

Next the subject of mathematics in industry is discussed. The subjects used, their relative usefulness, and the types of service performed by mathematics are cited with interesting illustrative examples. Some of these are

## Elliptic Integrals

$$H = \frac{4I}{r} \left[ \frac{1}{1-k^2} \int_0^{\pi/2} \frac{d\lambda}{\sqrt{1-k^2 \sin^2 \lambda}} - \int_0^{\pi/2} \frac{d\lambda}{\sqrt{1-k^2 \sin^2 \lambda}} \right]$$

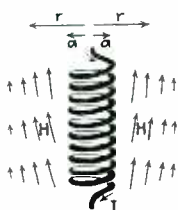

Some simple engineering problems require advanced mathematics in their solution. This is true, for example, in the computation of the magnetic field outside the spiral grid of a vacuum tube. If the grid is closely coiled, the current can be treated as a continuous cylindrical sheet of radius  $a$ . Then the component of the magnetic field parallel to the axis of the grid at a distance  $r$  from the axis is given by the above function of two Elliptic Integrals whose "modulus" is  $k = a/r$

shown in the accompanying illustration. How mathematics aids and even inspires research in communications, electrical manufacturing, the petroleum industry, and aircraft manufacture are also broadly covered. The role of statistics in industry is discussed, and here also examples of the application of this branch of mathematics are given.

The conclusions reached in this report are thought provoking enough to warrant their quotation: ". . . (1) Because of its general significance as the language of natural science, mathematics already prevades the whole of industrial research. (2) Its field of usefulness is nevertheless growing, partly through the development of new industries such as the aircraft business, and partly through the incorporation of new scientific developments into industrial research, as in the application of quantum physics in chemical manufacturing and statistical theory in the control of manufacturing processes. (3) The need for professional mathematicians in industry will grow as the complexity of industrial research increases, though their number will never

## New Carter AIRCRAFT TYPE GENEMOTORS

● **TRIPLE OUTPUT!**—Think what this means—3 separate outputs from a single Dynamotor! The new Carter Triple Output Dynamotor shown below, is winning wide acclaim in the Aircraft Industry because of its high efficiency, small size, and extra light weight.



● Write today for descriptive literature on Carter Dynamotors—D.C. to A.C. Converters—Double and Triple Output Dynamotors—Magmotors—Special Motors—High Frequency Converters—and Permanent Magnet Dynamotors.

**Carter Motor Co.**  
CHICAGO ILLINOIS

1606 Milwaukee Ave. Cable: Genemotor  
Carter, a well known name in Radio since 1922



## MEASURE SPEED Simply by Touch

Consider the advantages of a Portable Hand Tachometer that does not even "see" the rotating shaft, that has no wearing parts or pointer, that requires no belts, gears or electrical connections and that cannot lose its calibration through lack of oil or over-speeding.

Write for Bulletin 1590-E on Frahm Tachometers for speeds and rates of vibration between 900 and 30,000 r.p.m. and v.p.m.

**JAMES G. BIDDLE CO.**  
ELECTRICAL AND  
SCIENTIFIC INSTRUMENTS  
1211-13 ARCH ST. PHILADELPHIA, PA.



be comparable to that of physicists or chemists. (4) There is a serious lack of university courses for the graduate training of industrial mathematicians. (5) Management, which is already keenly alive to the importance of mathematics, is also rapidly awakening to the value of mathematicians and the peculiar relationship which they bear to other scientific personnel . . ."

• • •

### Determining Feedback Characteristics Graphically

A GRAPHICAL METHOD of determining the effects of feedback on the characteristics of a vacuum tube amplifier is described in the July 1941 *RCA Review*. The article, called "The Equivalent Characteristics of Vacuum Tubes Operating in Feedback Circuits" by John H. Pratt, describes a method of constructing a set of characteristics in which is embodied the feedback effect. The author points out that although conventional mathematical methods of treating feedback are quite simple and are probably more convenient to use when it is desired to calculate the performance of a feedback amplifier under

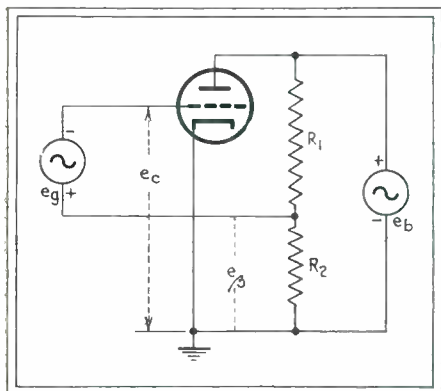

Fig. 1—Simplified circuit of inverse feedback amplifier

a single set of conditions, where several sets of conditions have to be tried to arrive at a desired result, the "feedback characteristics" are very useful. With them it is possible to judge distortion by the shape of the dynamic characteristic without going to the trouble of expressing it as a number and then applying it in an equation for the reduction due to feedback. Gain is also obtained directly from them without calculation.

The method described is most generally applicable when feedback is over one stage only and when the phase of the fraction of the output voltage applied to the input is assumed exactly 180 or zero degrees. However, the method can be extended to cover the case of feedback over several stages and also to take into account a phase angle associated with the feedback factor although the graphics become some-

## New DECADE AMPLIFIER MODEL 220



MODEL 300  
ELECTRONIC  
VOLTMETER

MODEL 220  
DECADE AMPLIFIER

### NEW ACCESSORY FOR MODEL 300 VOLTMETER FOR MEASUREMENT OF VERY LOW A-C VOLTAGES

**Decade Amplifier:** This is a highly stable amplifier giving accurately standardized gains of 10x or 100x over a frequency range of 10 to 100,000 cycles. Operated by self-contained batteries having a life of over 150 hours. Used with our Model 300 Electronic Voltmeter (as shown in cut) A-C voltages down to 0.00003 volt (30 microvolts) can be measured. By means of special circuits the gain is independent within 2% of circuit constants, battery voltages and tubes. Fully described in Bulletin 7.

**Electronic Voltmeter:** A popular instrument for the measurement of A-C voltages, 10 to 150,000 cycles, 1 millivolt to 100 volts (up to 1000 and 10,000 volts with Model 402 Multipliers). Logarithmic voltage scale and auxiliary uniform decibel scale. A-C operated. By means of special circuits indications are independent of line-voltage, tubes and circuit constants within 3% over entire frequency range. Several accessories, such as an artificial ear, vibration pickup and multipliers are available. Fully described in Bulletin 6.

MADE BY

## Ballantine Laboratories, Inc.

BOONTON, NEW JERSEY

ELECTRICAL AND ACOUSTICAL INSTRUMENTS

**PROTECTION** *where it's needed!*



## BATTERY CHARGER

made by Franklin Transformer Mfg. Co.

equipped with

## HEINEMANN "Re-Cirk-it"

Fully Electro-Magnetic  
CIRCUIT BREAKER

Between power source and equipment this small, compact, built-in circuit breaker stands guard 24 hours a day protecting rectifier tubes when a heavy overload occurs in the charger or a short circuit in the battery. The breaker opens instantly on short circuits and extreme overloads but permits harmless overloads of short duration. Made in all ratings from 250 milliamperes to 50 amperes.

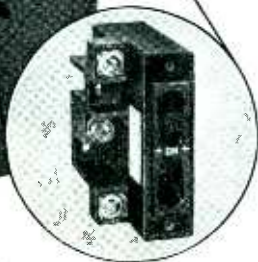

Send for Catalog No. 40 showing complete line

**HEINEMANN CIRCUIT BREAKER CO.**  
97 PLUM ST. - - - TRENTON, N. J.

## BLILEY CRYSTAL UNITS

*Engineered for Accurate Frequency Control*

LEFT: Type MO3 temperature controlled unit specially designed for high frequencies.

CENTER: Type MO2 unit is ruggedly built for portable and mobile transmitters; 2,000kc. to 30,000kc.

RIGHT: Type BC46T Precision Variable Air Gap Temperature controlled unit primarily for Broadcast frequencies. Approved by F. C. C.



**BLILEY** Crystal Units for frequencies from 20kc. to 30mc.—three of which are illustrated—conform to highest commercial standards of design and performance. Write for your copy of Catalog G-12 describing the complete line.

**BLILEY ELECTRIC COMPANY**  
UNION STATION BUILDING ERIE, PA.

what complicated and tedious in the latter cases.

A common type of inverse feedback circuit simplified to show a-c components only is shown in Fig. 1. For this circuit the following relations hold true:

$$\beta = -\frac{R_2}{R_1 R_c} \quad (1)$$

$$e_3 = \beta e_b \quad (2)$$

$$e_c = e_g - \beta e_b \quad (3)$$

where  $\beta$  is the feedback factor,  $e_3$  the voltage fed back to the grid circuit for any instantaneous value of plate volt-

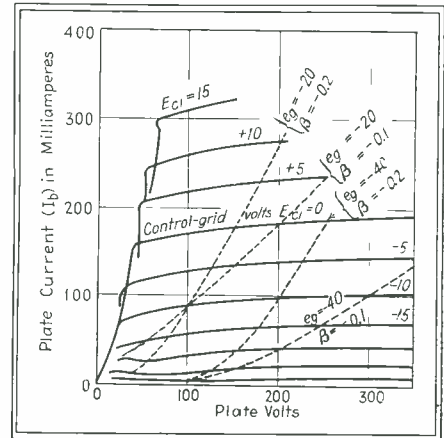

Fig. 2.—Static curves of 6L6 (solid lines) with dotted construction lines for various feedback ratios and bias

age  $e_b$ ,  $e_g$  the instantaneous signal voltage, and  $e_c$  the instantaneous grid-cathode voltage for any combination of instantaneous signal and plate voltages. By taking various values of  $e_g$  as parameters, and allowing  $e_b$  to vary, an equivalent family of plate characteristics may be obtained where the grid-cathode voltage is replaced by the instantaneous signal voltage.

For example, take the type 6L6 tube, with  $\beta$  as  $-0.1$ , and assume  $e_g$  equal to  $-40$  volts. From Eq. (3) it is seen that when  $e_b$  is 100 volts  $e_c$  becomes  $-30$  volts, when  $e_b$  is 150 volts  $e_c$  becomes  $-25$  volts, when  $e_b$  is 200 volts  $e_c$  becomes  $-20$  volts, and so on. From these calculations points could be plotted to give a curve for the signal voltage of  $-40$  volts. This procedure could be repeated for different values of signal voltage and a whole family of curves could be drawn. However, it will be noted that the grid voltage increases by intervals equal to  $-\beta$  times the plate voltage so we can write:

$$\Delta E_b = \frac{\Delta E_c}{-\beta} \quad (4)$$

We can now resort to the following procedure. Given a set of plate current-plate voltage characteristics whose feedback equivalent characteristics we wish to determine, we note the increments in which the grid voltage has been plotted. Substituting this value in Eq. (4) gives the plate voltage steps which will permit the plotting of the feedback characteristic by advancing

one grid voltage curve for every plate voltage step taken, without having to calculate each point separately. The grid curves shown in Fig. 2 are plotted in steps of 5 volts. If we take  $\beta$  as  $-0.1$ , Eq. (4) shows that the plate voltage steps have to be taken in steps of 50 volts each. If  $\beta$  is taken as  $-0.2$ ,  $\Delta E_b$  becomes 25 volts. The dashed lines are the resulting feedback characteristics

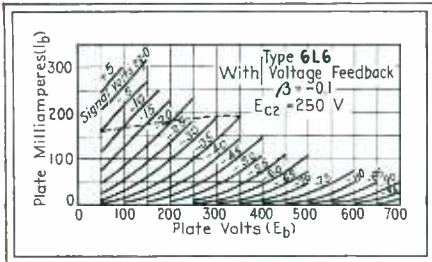

Fig. 3—Equivalent plate characteristics for type 6L6 with 10 percent voltage feedback

plotted by the method outlined above. By varying the signal voltage a whole set of equivalent curves may be obtained. In order to obtain the d-c operating point from the equivalent characteristics, Eq. (3) may be used to find the grid bias corresponding to particular values of  $e_g$  and  $e_b$ , or the desired plate voltage plate current point may be transferred to the normal characteristics and the corresponding grid bias voltage obtained from them.

A complete family of "feedback characteristics" for the 6L6 with  $\beta$  equal to  $-0.1$ , as obtained by this method is shown in Fig. 3. The article also discusses negative current feedback and

• • •

## WEATHER BALLOONS AT SEA



The radiosonde ground equipment on the S. S. Exeter, which is releasing weather balloons at sea for the first time

For both studio and mobile service  
the

# FAIRCHILD *Portable Recorder*

incorporates everything to be desired in  
**PRECISION  
RECORDING and REPRODUCING  
EQUIPMENT**



- ✓ Performance
- ✓ Higher Fidelity
- ✓ Flexibility
- ✓ Ruggedness
- ✓ Longevity

### THE FAIRCHILD COMBINATION UNIT F-26-3

(Unit 199-3 Recorder and Unit 219-2 Amplifier)

Although a conveniently transported unit, the Fairchild Portable Recorder is a precision instrument through and through—conceived and designed by Fairchild engineers, and manufactured to Fairchild standards. Your stationary or on-location use of this equipment assures excellence in instantaneous recording plus faithful reproduction. Compact. Self-contained. Set up and ready for operation in a few minutes with plug-in connectors. Write for descriptive literature, specifications and prices.

- New recording scale in minutes for all pitches, both out-in and in-out.
- Floating motor mount eliminates vibration.
- Amazing new cutterhead with frequency response flat to 8,000 cycles.
- Instantaneous variation of pitch and direction of cut—eliminates expensive feed screws.
- Instant speed change—78 or 33 1/3 r.p.m.

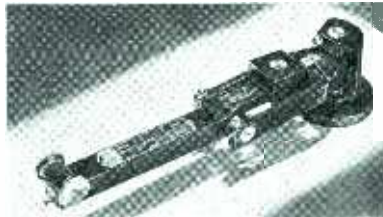

THE FAIRCHILD UNIT 209-3 PICKUP with selected crystal—adjustable counterweight and calibrated needle pressure scale—perfect tracking—minimum record wear—extended frequency range—designed for use on records up to 16" diameter.

"...it had to satisfy Fairchild first"



**Both**  
**FM and AM**  
**IN ONE U.H.F.**  
**COMMUNICATIONS**  
**RECEIVER**



**Hallicrafters**  
Model S-27, a general coverage U.H.F. Communications Receiver incorporating both FM and AM reception. Covers 3 bands: 28 to 46 mc.; 45 to 84 mc.; 81 to 145 mc. Switch changing from FM to AM reception. Controls are: RF gain Control, Band switch, Antenna Trimmer. IF selectivity control and power switch. Volume control. Pitch control. Tone control. S-meter adjustment. AVC on-off switch. Send-receive switch. Phone jack. Amplitude of frequency modulation switch. 15 tubes. 110 volt 50-60 cycle AC. Model S-27, with tubes, \$195. Model S-27B. Covers from 36 to 165 mc. \$195.

**the hallicrafters co.**  
CHICAGO, U. S. A.

USED BY 33 GOVERNMENTS  
SOLD IN 39 COUNTRIES

describes a similar method of obtaining feedback characteristics for this condition. Feedback over several stages is mentioned also, and the author outlines a procedure for applying the method to this problem.

Editor's Note. The curves and construction shown in Fig. 2 do not appear in the original article. They were drawn to assist in explaining the graphical method outlined by Mr. Pratt.

• • •

### Measuring Currents of Brief Duration

POINT-BY-POINT MEASUREMENTS of volt-ampere characteristic of substantially resistive circuit elements at currents and voltages well above the rated values of the elements is discussed in an article called "A Simple Method for Measuring Steady Currents of Brief Duration" which appears in the June 1941 *Review of Scientific Instruments*. The usual point-by-point measuring methods are not feasible because of the destructive amount of heat developed. The method devised permits such measurements to be made with ordinary indicating instruments, but it requires current durations brief enough to avoid dangerous heating effects.

The measuring circuit is shown in Fig. 1a. *T* is the device under test, and *R* is the resistance which must carry the current to be measured. An am-

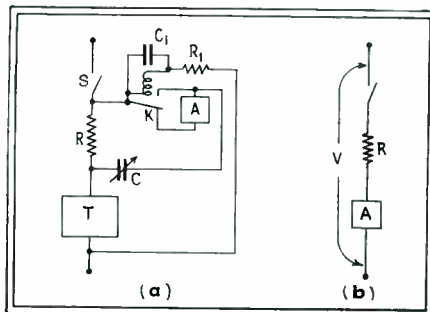

Fig. 1—Basic circuits for measuring currents of short duration

meter *A* measures ballistically the charge accumulated in the condenser *C* as the current in *R* rises to a steady value when the switch *S* is closed. The relay *K* disconnects the ammeter from the circuit after the current has reached a steady value, and also provides a discharge path around *A* for the condenser *C*. Resistor *R*<sub>1</sub> and condenser *C*<sub>1</sub> may or may not be necessary depending on the relay voltage rating and the natural speed of operation. Relays which normally operate in a few milliseconds serve the purpose well. If the circuit under test is highly reactive the operation of the relay can be delayed a fraction of a second without resorting to cumbersome values of *R*<sub>1</sub> and *C*<sub>1</sub>.

For most purposes, the duration of

**OK'd**  
by  
**ENGINEERS**

Wherever installed—Lingo Radiators have exceeded all efficiency expectations. No wonder alert engineers look to Lingo for top efficiency and managers are enthused by the increased sales made possible by increased signal strength and coverage.

Photo shows installation of the 350 ft. Lingo Tubular Steel Radiator at station WBOC, Salisbury, Md.

**LINGO**  
**VERTICAL**  
**TUBULAR STEEL**  
**RADIATORS**

JOHN E. LINGO & SON, INC., CAMDEN, N. J.

**JONES**  
**BARRIER STRIPS**  
SOLVE MOST TERMINAL PROBLEMS

No. 151

A compact, sturdy terminal strip with Bakelite Barriers that provide maximum metal to metal spacing and prevent direct shorts from frayed wires at terminals.

**6 SIZES**  
cover every requirement. From 3/4" wide and 13/32" high with 5-40 screws to 2 1/2" wide and 1/8" high with 1/4"-28 screws.

Jones Barrier Strips will improve as well as simplify your electrical intra-connecting problems. Write today for catalog and prices.

**HOWARD B. JONES**  
2300 WABANSIA AVENUE,  
CHICAGO ILLINOIS

the current which is determined by the period of closure of the switch *S* is adequately controlled by hand operation. Periods of 0.15 second were convenient, easy, and fairly reproducible by using an ordinary knife switch to open and close the circuit. The times of closure were measured by means of the circuit shown in Fig 1b. By a choice of a series resistor appropriate to the instrument which was used ballistically, and the times being measured, the instrument may be made to indicate by maximum deflection of the needle the duration of the closure in decimal fractions of a second. If the duration of closure must be controlled very accurately a second relay whose contacts open when the coil is energized may be used with an appropriate *RC* delay circuit. Precautions

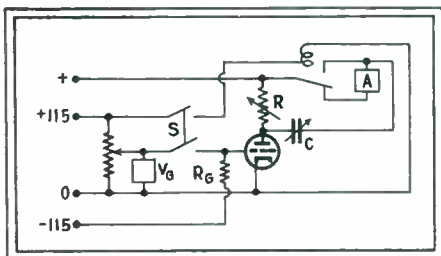

Fig. 2—Circuit for measuring characteristics of a triode

should be taken for quenching the arc by means of a series *RC* circuit in parallel with the contacts of the relay. If the source of direct voltage is not adjustable it is convenient to get different applied voltages by adjusting *R* to various known values, then adjusting *C* in each case to give an appropriate deflection. Thus, with a constant voltage source a whole series of points on a characteristic may be run by varying *R*. The instrument indicates the charge accumulated in *C*, and from the known value of *C* the voltage across *R* may be computed, and this voltage enables the calculation of the current in *R*. Subtraction of the voltage across *R* from the total line voltage gives the voltage applied to the device under test.

The indicating instrument may be any kind of a galvanometer, including the type commonly used in d-c indicating instruments. If *R* and *C* of Fig. 1a are large, small values of current can be measured. Large values of current may be measured by making *R* or *C* or both small. The magnitude of the resistance *R* must be known, and the most convenient form for this circuit element is a decade box. For receiving tube testing where the currents range up to one ampere, *R* may be a 3 or 4-dial decade box, *C* a 3-dial decade condenser, and *A* a microammeter having a range of 30 microamperes. The ballistic calibration for the instrument is also necessary.

The volt-ampere characteristic of a diode may be measured by inserting the diode at *T* in Fig. 1. To measure triode characteristics a more complicated circuit is needed. This is shown

## POPULAR DAVEN SERIES 750 DECADE RESISTANCE BOX

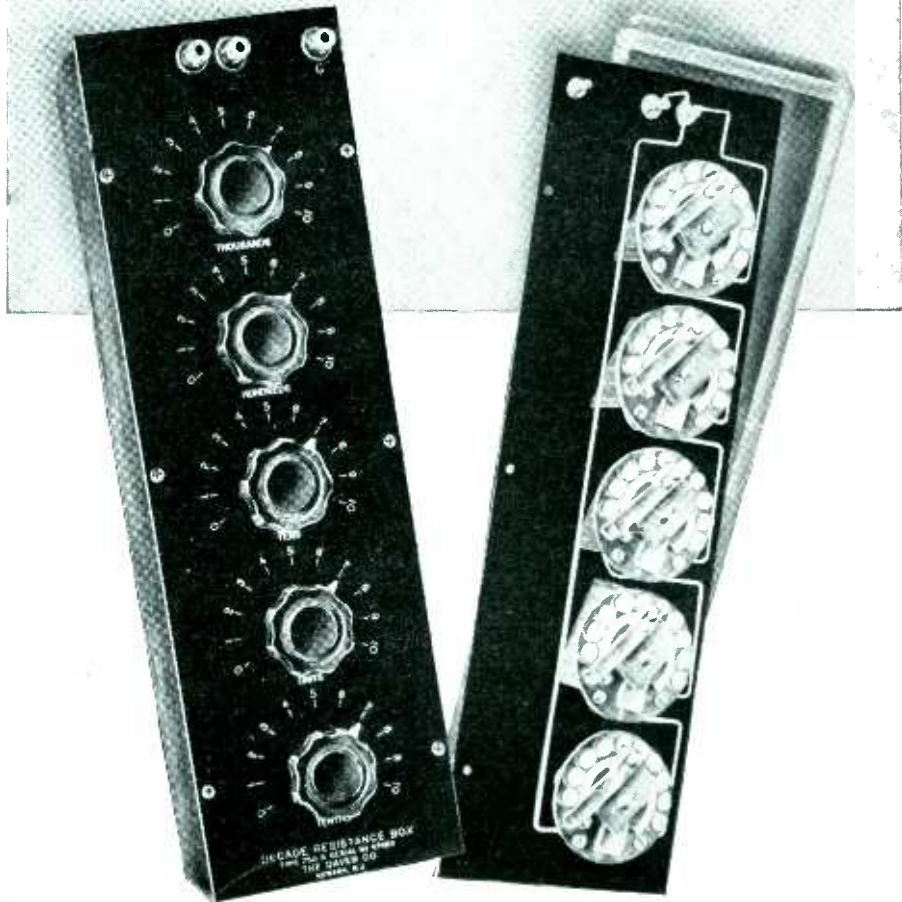

Designed for use as Laboratory Standards, as components in Bridge Circuits, and in other types of precision measuring equipment . . . the Decade Resistance Boxes are complete assemblies consisting of two or more Type 225 DAVEN Decade Units mounted on an engraved metal panel and enclosed in a shielded walnut cabinet.

Three terminals are provided, two for the resistance circuit, and a third as a ground connection. There is no electrical circuit between the resistance elements and the metal panel. Available in 12 models with resistances from 11 to 1,111,100 ohms, in from 0.10 to 10. ohm steps.

## DECADE RESISTOR UNITS

### TYPE 225 — FOR PRECISION LABORATORY STANDARDS

These Decade Resistor Units are precision type resistors and can be used individually in equipment . . . when complete Decade Boxes (Series 750) are not required. Each unit is completely enclosed in an aluminum shield and supplied with pointer-type knob and aluminized dial plate. Seven standard models covering the range from 0.10 to 10,000 ohms per step or a total of 1.0 to 1,000,000 ohms in accuracies of from 1.0 to 0.10%.



**THE DAVEN COMPANY**  
158 SUMMIT STREET • NEWARK, NEW JERSEY

**CONSTANT LABORATORY CHECK on RAW MATERIALS**  
**is only ONE of HUDSON WIRE'S TESTS for QUALITY**

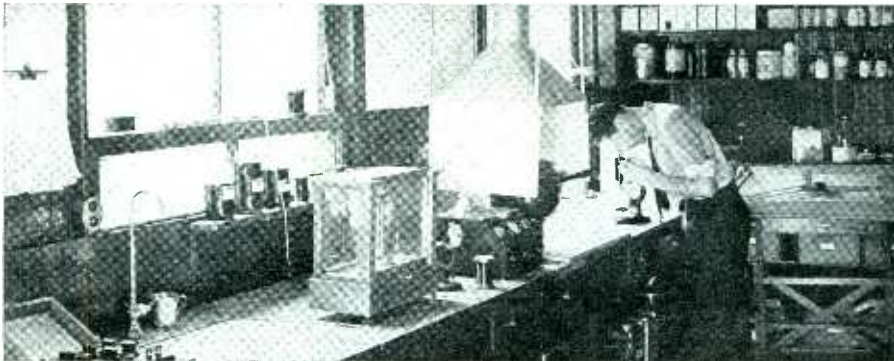

You are assured of a constant source of wire that always meets or exceeds your specifications when it comes from the Winsted Division of Hudson Wire Co. Continual checking and testing from the raw material stage through the exacting control processes guarantee the perfect uniformity you need. And with Hudson Wire's new coating method that adds great dielectric strength you are certain of getting the finest enameled wire available.

Our engineering and design facilities are at your disposal—details and quotations on request.

**HUDSON WIRE COMPANY**  
*Winsted Division*  
**WINSTED CONNECTICUT**



in Fig. 2. The voltage divider which supplies  $V_g$  should have a current carrying capacity large enough so that the value of  $V_g$  is not altered appreciably by the grid current plus the current in  $R_g$  when  $S$  is closed. At the same time  $R_g$  should be small enough to keep the tube from blocking when  $S$  is opened. The plate voltage applied is calculated from the quantity of electricity indicated by  $A$  and the values of  $R$  and  $C$ .

A power source of good regulation is needed for obtaining an  $E_p-I_p$  characteristic at constant plate voltage. We can compensate for a poorly regulated power supply by resorting to the following procedure. Adjust the source voltage to a value in excess of the voltage to be applied to the plate by the amount  $V_x$ . Then adjust  $R$  for some convenient value of  $V_g$  so that the drop in  $R$  is just equal to  $V_x$ . The drop in  $R$  is determined by the value selected for  $C$  and the quantity going into  $C$  as indicated by  $A$  with the aid of its calibration. Once  $C$  and the corresponding deflection of  $A$  have been established, as new values of  $V_g$  are selected,  $R$  is adjusted to give the same deflection of  $A$  with  $C$  kept fixed. Thus the drop in  $R$  which is  $V_x$ , is always the same, and the plate voltage is always the same. Knowing the value of  $R$ , the plate current can easily be calculated.

• • •

### UHF Oscillator

A DESCRIPTION OF AN ULTRAHIGH frequency oscillator whose range is from 150 to 600 Mc (200 to 50 cm wavelength) appears in the August 1941 *General Radio Experimenter*. The accompanying diagram shows the essentials of the circuit. The frequency is

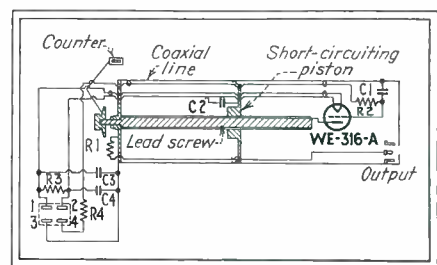

Circuit diagram of 150 to 600 Mc oscillator

varied by rotating the lead screw which drives the short-circuiting piston along the length of the coaxial line. The pitch of the lead screw and the ratio of gearing to a counter at the drive end are adjusted to make the counter indicate the approximate value of the wavelength. A conversion chart is fastened to the top of the oscillator, and by its use the wavelength can be converted into frequency values.

The power output of this generator is approximately 4 watts up to 400 Mc,

AGAIN IT'S **KENYON**

PRESENTING A BRAND NEW PLATE TRANSFORMER DESIGNED FOR THE NEW **R.C.A. 931**



AGAIN Kenyon leads the way with a Plate Transformer built right around the new R. C. A. 931, Electron Multiplier Tube. Housed in the famous T Line Case built to Kenyon's rigid standard of manufacture. Specifications are as follows:—

Type: T-211.  
 Primary: 0/105/115/125 volts 60 cycles.  
 Secondary #1:—0/100/200/300/400/500/600/700/800/900/1000 volts at 10 MA. R.M.S.  
 Secondary #2:—2.5 volts at 1.75 amperes. Case Size: 4A. List Price: \$9.50.

Kenyon Transformers available thru your nearest distributor or write direct. Complete CATALOG FREE UPON REQUEST.

**KENYON TRANSFORMER CO., Inc.**  
 840 BARRY STREET NEW YORK, N. Y.

OFFICES IN PRINCIPAL CITIES

Cleveland . . . 3292 Cedarbrook Rd. Seattle . . . 2505 Second Ave. New Orleans . . . 418 Girard St.  
 Chicago . . . 51 E. Van Buren St. Los Angeles . . . 2412 7th St., W. Lutz . . . Florida  
 Kansas City, Mo. . . 2004 Grand Ave. Dallas . . . P. O. Box 4116, Sta. A Richmond, Va. . . 2108 Edgewood Ave.

and this drops down to one watt at 600 Mc. In order to have the full output of the oscillator available at the output terminals no isolation means have been used. The result is that a reactive load coupled directly to the oscillator shifts the frequency of oscillation, but for the usual conditions of loading this shift is generally less than 2 percent. The power supply required must supply 2 volts at 3.65 amperes, and 450 volts with a maximum plate current of 80 milliamperes. The plate supply must be one which permits grounding of the positive side, since the positive side of the high voltage circuit is connected to the outer brass container.

• • •

### Cellulose Insulation

"FACTORS INFLUENCING the Mechanical Strength of Cellulose Insulation" by F. M. Clark appears in the July 1941 issue of *Electrical Engineering* and is an article of considerable value to engineers making use of cellulose insulation. Various factors having an effect upon the life of cellulose are covered in detail and a number of experimental curves are shown. The summary which appears at the end of the article is as follows:

1. Cellulose insulation will deteriorate in mechanical strength at a rate which increases with the increasing temperature of exposure. Deterioration will occur in the absence of an oxidizing atmosphere.

2. The rate of cellulose deterioration at a fixed temperature varies as the heat treatment is continued.

3. The mechanical deterioration of cellulose insulation at elevated temperature is the result of oxidation and pyrochemical decomposition.

4. When heated, cellulose passes through a "stable period" during which the mechanical properties are maintained. The presence of oxygen is chiefly effective in reducing the duration of the "stable period".

5. The single effect of oxidation is restricted to the initial periods of treatment at temperatures lower than approximately 120 degrees C. At higher temperatures, pyrochemical decomposition occurs. Even in the most favored temperature range, the effect of cellulose oxidation merges into the effects produced by pyrochemical decomposition as the deterioration progresses.

6. Heated under conditions which favor oxidation or pyrochemical change, the unimpregnated cellulose insulation deteriorates more rapidly than the same insulation after oil treatment and immersion.

7. The effect of oxidation is accelerated when pure oxygen gas is in contact with the insulation. No substantial difference in the rate of mechanical deterioration is observed when the oil-treated and oil-immersed insulation is aged in contact with nitrogen gas as compared to aging in contact with air.



## SPECIALLY DESIGNED FOR PUBLIC ADDRESS SYSTEMS

Because of their exceptionally smooth frequency response along with many other improved characteristics, Astatic N-Series Crystal Microphones are highly recommended for modern public address installations. Here is a microphone insuring faithful reproduction, with swivel joint, tilting head for adjustment to directional or non-directional positions, and concentric cable connector for the quick interchange of cables. Modern design and all chrome finish. Standard equipment includes 25-ft. low capacity, closely shielded rubber covered cable and spring protector. List price \$17.50.

### MODEL N-30

This is a hi-fidelity, wide range model, 30 to 10,000 cycles, substantially flat and free from peaks.

See your Astatic  
Radio Parts Jobber  
or write for catalog

### MODEL N-80

This is the voice range model, output level -49 db below one volt per bar with rising response to 3,500 cycles.

# ASTATIC

## THE ASTATIC CORPORATION

YOUNGSTOWN, OHIO

Licensed Under Brush  
Development Co. Patents

In Canada,  
Canadian Astatic Ltd.,  
Toronto, Ontario

## PHOTOTUBES



Type CE 11

Over forty different types are available. Our phototubes are inherently more sensitive and stable—they do not depend upon a high gas content to secure their high output. Long life and dependable.

## RECTIFIERS

These ruggedly built rectifiers have been the answer to many perplexing problems. They are built to take it and do. Available in numerous sizes and output. Guaranteed performance 2000 hours.



Type 2-RA-6

## CONTROL TUBES



Type CR-5

The CR-5 and CR-10 grid control tubes are but several in this group. They will stand hard and continuous service faithfully.

## SPECIAL TUBES

Do you have an electronic tube problem? Then let us help you. We are exceptionally well equipped to produce to your specifications.

### CONTINENTAL ELECTRIC CO.

Merchandise Mart Plant  
Chicago, Ill. Geneva, Ill.

CONTINENTAL ELECTRIC CO.  
903 Merchandise Mart, Chicago, Ill.

Please send me data on your electronic tubes.

Name.....  
Address.....  
City.....

## Photoelectric Door Opener Saves \$30 Per Day

AN INSTALLATION of a photoelectric control on the doors of the shipping and receiving departments of the Brown and Williamson Tobacco Company, Louisville, Ky., are described in the July 1941 issue of *Timely Ideas*. The doors were previously operated man-



Photoelectric door opener saves many times its cost of installation

ually at comparatively high cost both in actual operating expense and in time lost in signalling for the doors to be opened. The expense of heating these departments was also very high because the doors opened directly to the outer air and slow manual operation allowed much heat to be lost. With the installation of the photoelectric equipment incoming and outgoing shipments of tobacco approaching the doors interrupts light beams focused on the phototubes. The doors remain open only long enough for the truck to pass through. As a result not only are operating time and costs cut to a minimum, including heat loss, but also comfortable working temperatures for employees are easily maintained. It is estimated that this installation saves as much as \$30 a day in operating costs.

• • •

## Telemetry and Supervisory Control

"TELEMETERING, SUPERVISORY CONTROL, and Associated Circuits" is the title of a special publication of the American Institute of Electrical Engineers. In recognition of the ever-widening field of application for telemetry equipment, the publication has been prepared in such form and terminology as to make it readily useful to engineers in any branch of industry likely to be concerned with problems of remote measurement and control. Extensive tabulations giving comparative data are designed to enable a user of telemetry or supervisory-control equipment quickly to determine the type of apparatus best suited to his needs.

# AMPERITE

## Current & Voltage CONTROL

A BALLAST TUBE FOR **AUTOMATIC** REGULATION OF CURRENT AND VOLTAGE \*

CURRENT CAPACITY—.050 to 10 AMPS. INEXPENSIVE, SIMPLE, COMPACT.



## RELAYS AND DELAY RELAYS

A DELAY RELAY AS LOW AS 25c \*

DELAYS AVAILABLE UP TO 60 SECONDS \* HERMETICALLY SEALED \* SIMPLE, COMPACT



PROMPT DELIVERIES  
Send Us Your Problems

Making  
Regulators  
Since 1922

AMPERITE Company, 561 BROADWAY, NEW YORK

**"What do you require of a DYNAMOTOR — Watts-per-ounce?"**

"Less weight and more output" is the cry of the communications industry. Eicor Engineers have answered this demand with dynamotors designed to save every fraction of an ounce. Output in many cases has actually been increased.

Whatever your dynamotor problems may be, Eicor specialized experience can be of real assistance.



## EICOR

EICOR, Inc., 1050 W. Adams St., Chicago, U.S.A.  
Export: Ad. Aurlamo, 49 Broad St., New York



## Maintenance and Servicing of Electrical Instruments

DURING THE PRESENT NATIONAL emergency the repair departments of the manufacturers of electrical instruments are very much overcrowded and are therefore not in a position to repair instruments as quickly as the customers, even those with priorities, would desire. In this case the user of electrical instruments must do the repair job himself. A series of articles by James Spencer describing the design and operation of various types of instruments is currently appearing in *Instruments*. The first two articles appeared in the August and September 1941 issues and several additional articles are contemplated. Engineers using electrical instruments of any type cannot be urged too strongly to read these articles. They are written from the very practical viewpoint of helping the reader maintain and repair instruments. Time spent studying this series will be well repaid.

### Pinhole Detector

AN ELECTRONIC MEANS of detecting pinholes in rubberized canvas is discussed in the July 1941 issue of *Electronic Engineering*, a British journal, by A. W. Russell. Since rubberized canvas is used extensively under conditions where it must be impervious to gas, it is important to know whether the layer of rubber has taken evenly or whether

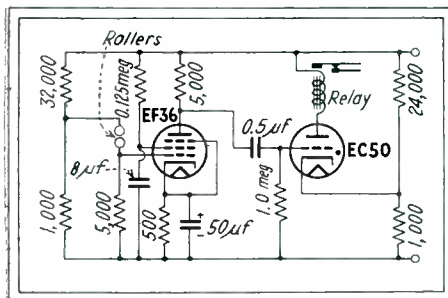

Circuit diagram of pinhole detector

minute holes have been left. These holes are difficult to detect by the human eye, even when a strong source of light is used behind the material.

The circuit shows an electronic method of detecting these holes. The rollers are saturated with some conducting liquid, and as the material passes between them any hole will permit the liquid to seep through thus shunting an extra resistor across the biasing resistor. This reduces the grid bias, causing a positive impulse to be fed to the grid of the gas triode which will fire. The firing of the triode actuates the relay which can be made to operate a bell or some marking device to show the approximate location of the hole. Though the circuit shown incorporates British tubes, any pentode and gas triode with their proper grid, cathode, and plate resistors and condensers can be substituted.



## FIXED ATTENUATION PADS

ADC FIXED PADS are designed for use in communication circuits—such as isolating equalizers, lines, and amplifiers. Used to reduce gain so as to give convenient fader settings, prevent amplifier overloading. Often used to connect lines or circuits of different impedances. Pads to match any line impedance can be supplied on special order.

They are so small and light, that mounting of these pads on switches or jacks is simple. Short connecting wires are sufficient for their support.

Attenuation is accurate within 2% and impedance accurate within 3%. Change in attenuation is negligible to above 20,000 cycles.



ATTENUATION DB.	BALANCED H 600 OHMS	T PAD 600 OHMS
3	1ZH1	1ZT1
5	1ZH2	1ZT2
6	1ZH3	1ZT3
10	1ZH4	1ZT4
15	1ZH5	1ZT5
20	1ZH6	1ZT6
25	1ZH7	1ZT7
30	1ZH8	1ZT8
Net Price—\$2.50		\$2.00
22	20,000 to 600	1ZH9
		Net Price—\$2.70

**DIMENSIONS** — 7/8" dia. 1-5/16" long. **Weight**—Less than 1 ounce.

These pads are shown in our catalog on broadcast equipment—also transformers, equalizers, patch cords, plugs, and jacks. Catalog furnished upon request.

#### REPRESENTATIVES

**NEW YORK CITY**..... Bruce O. Burlingame, 69 Murray Street  
**HOLLYWOOD, CALIFORNIA**..... Norman B. Neely, 5334 Hollywood Blvd.  
**DALLAS, TEXAS**..... Edward F. Aymond Co., 3750 Urban Avenue  
**CANADA**..... Walter P. Downs, Ltd., 2313 St. Catherine St. W. Montreal, Quebec.

**AUDIO DEVELOPMENT CO.** 123 BRYANT AVE. NO. MINNEAPOLIS, MINN.

# Low Operating Pressure

## FEATURES

# Acro-Snap SWITCH



3/4 oz.-14 oz. range

ACROSNAP SWITCHES are available for operating pressures as low as 3/4 oz. and as high as 14 oz.

Engineered on a new principle this precision switch gives unfailing service on millions of operations.

The roll spring and one piece blade provide practically frictionless movement.

Other Important Features Include: High Contact Pressure; High Operating Frequency; Unaffected by Ordinary Vibration; Small Size—Easy Installation

WRITE FOR COMPLETE INFORMATION ADVISING PURPOSE FOR WHICH SWITCHES ARE REQUIRED

## ACRO ELECTRIC CO.

3145 FULTON RD., Dept. J

CLEVELAND, OHIO

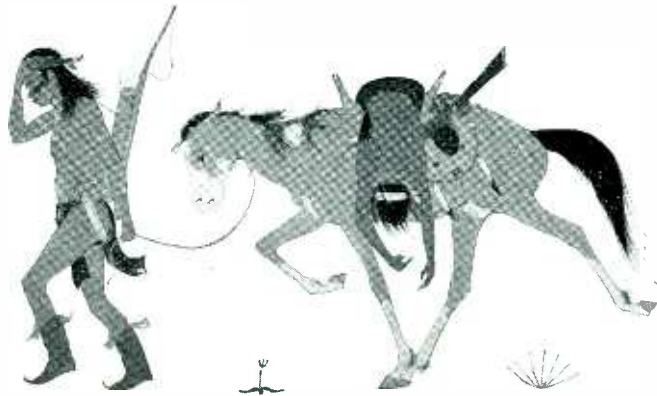

from the Original by Allen Houser, Grandson of Geronimo

## Home from the wars . . ! Live outfit . . ? Dead Injun . . ?

**TODAY . . .** Government approved Relays by Guardian can help you speed production, cut costs, prevent rejects, meet deliveries on that new Defense Contract. And, remember . . . \*7,146 stock parts go a long way toward avoiding die charges.

**TOMORROW . . .** it may be too late to make improvements to meet fiercely competitive markets when the last gun sounds the end of defense demands. Realize that complete electrical control creates greater consumer acceptance . . . cuts manufacturing and operating costs . . . boosts your profits.

### RELAYS by GUARDIAN

DESIGN NOW with defense needs and future markets in mind. Send to Guardian for new methods—circuits—controls and engineering suggestions. You know your problem. 99 times out of a hundred we know the answer. It's yours for the asking.

**FREE**—Initial Your Letterhead for New Catalog "E". Write



Series BK—16 Relay. Built to minimum tolerances and the most exacting requirements in production quantities for the U. S. Signal Corps.

\*Inventory Count Jan. 1, 1941

## GUARDIAN ELECTRIC

1625 West Walnut Street



Chicago, Illinois

LARGEST LINE OF RELAYS SERVING AMERICAN INDUSTRY

## MOLDED RESISTORS

*S. S. White* The "All-Weather" Resistors

**RANGE OF VALUES**  
S. S. WHITE RESISTORS

**STANDARD RANGE—**  
1000 ohms to 10 megohms

**HIGH VALUES—**  
15 to 1,000,000 megohms

**SEND FOR RESISTOR BULLETIN 37**

It contains illustrations of the different types of S. S. White Molded Resistors and gives details about construction, dimensions, etc. A copy, with Price List, mailed on request. Write for it today.

### NOISE TESTED

LOW NOISE LEVEL is a feature of all S. S. White Molded Resistors. But to aid manufacturers of equipment in which noiseless operation is of first importance, S. S. White, at nominal added cost, will supply resistors in the Standard Range of 1000 ohms to 10 megohms, noise tested to the following standard:

*"For the complete audio frequency range, resistors shall have less noise than corresponds to a change of resistance of 1 part in 1,000,000."*

Each and every resistor on such orders is tested and guaranteed to meet these specifications and can therefore be used as received without further test. This is one reason why S. S. White Resistors are so widely used in quality radio, telephone, telegraph, sound picture, television and other commercial, industrial and scientific equipment.

## S. S. WHITE

The S. S. White Dental Mfg. Co.

### INDUSTRIAL DIVISION

Department R, 10 East 40th St., New York, N. Y.

## Vacuum Tube Characteristics

(Continued from page 50)

its origin in the fact that if  $y = Af(t)$  and  $x = Bf(t)$ , where  $A$  and  $B$  are constants or scale factors, then  $y = Ax/B$ . By comparing this with the standard equation for a straight line,  $y = mx + b$ , it is evident that the equation we have developed is of the form of a straight line in which  $m = A/B$  and  $b = 0$ . Moreover, it is apparent that the time function, indicated by  $f(t)$  above, has disappeared from the expression relating  $x$  and  $y$ .

### Fundamentals of Circuit Operation

Physically, this means that if we apply a time varying voltage to a linear resistance and measure the voltage across this resistance and the current through it, and apply these electrical quantities appropriately to the vertical and horizontal deflecting plates of a cathode-ray tube, the resulting plot will be a straight line with slope  $A/B$ .

To extend the reasoning to electron tubes or other non-linear conducting devices, assume that the applied varying voltage,  $E_s$ , is given by

$$E_s = E \sin \omega t$$

and that the resulting electrode current is given by

$$i = s E_s \sin \omega t$$

where  $s$  is the conductance of the electrode (or the transconductance of the two electrodes) in question. By combining these two equations we find the result to be

$$i = s E_s$$

which indicates that the curve traced on the cathode-ray screen will have the shape determined by the electrode conductance. This is just the condition which is desired, so that by applying a varying signal voltage to an electrode and one set of plates of a cathode-ray tube, and by applying the electrode current to the remaining pair of deflecting plates, the resulting curve will trace the electrode conductance or transconductance no matter what form the applied voltage may have. Thus, so long as any amplifiers which may be

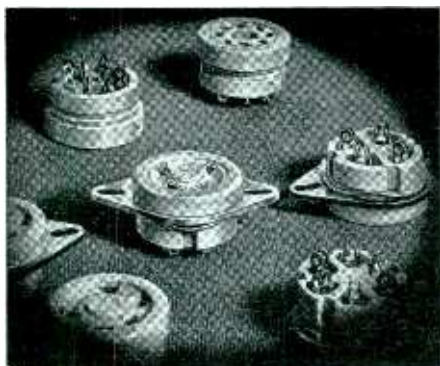

## DESIGNED for APPLICATION

MODERN SOCKETS for MODERN TUBES! Long flashover path to chassis permits use with transmitting tubes, 866 rectifiers, etc. Ideal for mounting on rugged thick cast aluminum chassis now being used on much of the better commercial equipment. Long leakage path between contacts. Contacts are type proven by hundreds of millions already in government, commercial and broadcast service, to be extremely dependable. Sockets may be mounted either with or without metal flange. Mount in standard size chassis hole. All types have barrier between contacts and chassis. All but octal also have barriers between individual contacts in addition.

Catalogues Upon Request

**JAMES MILLEN MFG. CO. Inc.**  
150 EXCHANGE ST. MALDEN, MASS.



0 to 135  
VOLTS  
stepless

### VOLTAGE REGULATION

No laboratory is complete without a means of stepless voltage control such as provided by the Acme Voltrol. Manually operated, the Acme Voltrol provides for stepless regulation of A. C. voltage from 0 to 135 volts. For production line testing this unit has no comparison. Put voltage control on all test boards and discover the performance characteristics of your product under all voltage conditions. The NEW Voltrol is lower priced than ever.

Inquiries invited from manufacturers who use small, special characteristic transformers in quantity.

**THE ACME ELECTRIC & MFG. CO.**  
31 Water Street • Cuba, New York

**Acme Electric**  
TRANSFORMERS

required do not produce too much distortion, a time varying voltage of any wave shape can be used in tracing the characteristics.

An electrical circuit which is in conformity with this basic treatment and which shows one application of the fundamental principal outlined is shown in the diagram. This circuit is shown connected for the measurement of the plate characteristics of a beam tetrode, although other arrangements are possible. Fundamentally, the circuit consists of the tube whose characteristics are to be determined, the appropriate quiescent operating electrode voltages and suitable meters for determining these voltages, a time varying voltage,  $E_s$ , covering the magnitude of voltages over which tube operation is desired and preferably whose peak amplitude is measured, two variable gain amplifiers, and the cathode-ray oscilloscope and its associated power supply circuits. All of this equipment is usually available in even the smallest of communications laboratories, which is a decided advantage of this method. In place of the variable gain amplifier  $A$  and the beat frequency oscillator as indicated in the diagram, a transformer and voltage divider or autotransformer operating from the a-c power line may be used if measurements at a single frequency will suffice. In this case, the equipment required is even less than that already listed.

In the circuit diagram illustrating the measurement of the plate characteristics of a tetrode, the quiescent electrode voltages are indicated by the meters  $E_{c1}$ ,  $E_{c2}$  and  $E_b$ . The time varying voltage,  $E_s$  is of such magnitude that when used in series with the d-c plate voltage, the instantaneous voltage varies from zero to twice the d-c value. In other words, if  $E_s$  has symmetrical wave shape, its peak value is equal to the quiescent voltage,  $E_b$ . In the original set-up, an audio oscillator was used as the source of the time varying voltage so that the effect of frequency could be observed. It is not, of course, imperative that one use a beat frequency oscillator, but this is a convenience.

Since the cathode-ray tube is a voltage operated device, it is necessary to convert any current which is to be measured, into an appropriate voltage which can be em-

# VERSATILE POWER SUPPLY for AIRCRAFT



## PINCOR Double Input Double Output DYNAMOTORS

Pincor Dual Voltage... double input and double output... dynamotor is further proof of Pincor leadership in today's fast moving developments in aircraft and other vital radio equipment. One unit for both receiving and transmitting... saving cost as well as precious space and weight. Available in a multitude of voltage combinations and ratings. Consult our engineers. Send for free NEW Pincor Dynamotor Catalog.

**PIONEER GEN-E-MOTOR**  
CHICAGO, ILLINOIS  
Export Address: 25 Warren St., N. Y., N. Y.  
Cable: SIMONTRICE, New York



A  
**NEW  
CATALOG  
FOR YOU!**

Pioneer Gen-E-Motor  
Dept. R4-J, 5841 Dickens Ave., Chicago, Ill.

Please send me NEW PINCOR DYNAMOTOR CATALOG at once!

NAME \_\_\_\_\_

ADDRESS \_\_\_\_\_

CITY \_\_\_\_\_ STATE \_\_\_\_\_

Testing that's not only  
**DEPENDABLE**  
but concentrated  
in RCP TEST EQUIPMENT

You can make more important tests with most individual RCP instruments than with any other quality test equipment. Study these two fine RCP testers. They are typical of this new line designed to meet the engineering needs of today.



Measures oscillator and amplifier grid voltages, AVC, AFC, limiter and discriminator grid voltages. Has all the needed ranges, including capacity measurements from .00003 mfd. to 1000 mfd. DC voltmeter impedance 160 megohms on high ranges, 160 megohms on low. AC voltmeter input capacity only .00005 mfd.  
DC VOLTS—0/6/30/150/500/1500/6000  
AC VOLTS—0/6/30/150/500/1500/6000  
OHMS—0/1000/10,000/100,000/1 meg/10 meg/100 meg/1000 meg.  
CAPACITY—0/.001/.01/.1/1.0/10/100/1000  
No other vacuum tube meter is so comprehensive, or so valuable now to the electronic engineer. Actually, this compact MULTITESTER is four vital, complete instruments in one!.....**\$38.95**

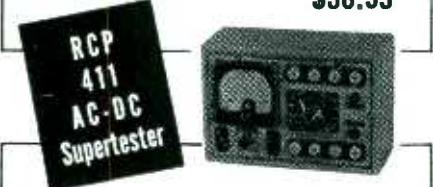

In one compact unit, the equivalent of 33 individual instruments. Unusual variety of very low and very high ranges. Combines all important meters for quick and accurate analysis in one small case. 3-inch square D'Arsonval meter with movement of 200 microamperes or 5000 ohms per volt.  
DC VOLTS 0/10/100/250/1000/5000  
DC AMPS 0/1/10/25  
DC MILLIAMPS 0/10/100  
DC MICROAMPS 0-200  
AC VOLTS 0/10/100/250/1000/5000  
AC AMPS 0/2.5/5/25  
AC MILLIAMPS 0/500  
Complete with batteries.....**\$19.45**

FOR COMPLETE DATA, write for FREE CATALOG NO. 125, describing RCP's entire line of dependable test equipment. Whatever your requirement, there's an RCP test instrument designed to meet them efficiently at the lowest cost. Send for your copy TODAY.

RCP  
dependable  
test  
instruments

**RADIO CITY**  
PRODUCTS COMPANY, INC.

88 PARK PLACE • NEW YORK, N. Y.

ployed to operate the deflection circuits. This is done by applying the voltage drop across a non-reactive resistance in the circuit measuring current to the appropriate deflecting plates. In the diagram shown, the resistor,  $R_L$ , is provided for this purpose. To obtain the usual static characteristics of a tube, this resistor should have as small a resistance as possible. In this case the voltage drop across  $R_L$  will be rather small, and the amplifier,  $B$ , will be required to have high gain and high output with low distortion. The exact value for the resistance of  $R_L$  will depend upon the tube under measurement, but in general this resistance should be of the order of tens of ohms rather than thousands of ohms. On the other hand, if the dynamic characteristics are required,  $R_L$  may have much higher resistance—equal to the external load resistance for example.

**Connections for Oscilloscope**

Since the tube characteristics are usually plotted with voltage as the independent ordinate and currents as the dependent variable, the cathode-ray tube was connected so that the horizontal displacement of the beam represented voltage variations, whereas vertical displacement of the beam represented current variations. By turning the gain of

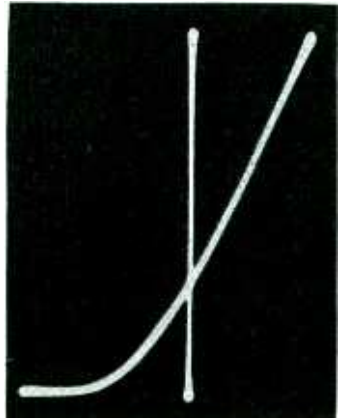

Grid voltage-plate current characteristic of 1G6 tube with plate voltage at 90 volts

the amplifier  $B$  down to zero, a base line, which acts as an axis of reference from which currents can be measured, will be traced on the oscilloscope. The base line can be used to determine the deviation from linearity of the  $E_p-I_p$  (or

**Save  
trouble  
time and  
money**

*with the aid of this  
practical radio  
engineering  
help*



1. 945 pages of carefully selected, accurate data—charts, tables, circuits, diagrams, formulas.
2. Covering all the most needed subjects for engineers, from fundamentals to specialized applications.
3. Every section prepared by one or more specialists, to assure you dependable, expert answers to your problems in design and practice.

**Just Out**

**Enlarged, Up-to-date, 3rd Edition  
RADIO ENGINEERING  
HANDBOOK**

HERE is a book that gives the radio engineering profession its own handbook, comparable to the standard handbooks available in other fields of engineering. It conveniently presents a great deal of constantly needed reference material covering all fields and aspects of radio engineering—concise, dependable, arranged in easy-to-get-at form. To meet the greatest and most lasting needs in such a rapidly developing field as radio, material has been chosen carefully for its importance to the practicing engineer. With the deletion of obsolete material and addition of material on important new developments, this new third edition brings you:—

Prepared by 23  
radio specialists  
**KEITH HENNEY**  
Editor-in-Chief  
945 pp., 836 illus.  
over 100 tables  
**\$5.00**

- new data on crystal control circuits, ultra-high frequency apparatus, modulation systems, audio-frequency transformer design, vibrator power supply, long-line oscillators, etc.
- completely rewritten sections on aircraft radio, television, detection, loud speakers, facsimile, oscillators, etc.
- revision throughout to make the book as useful as possible in modern practice.

**FOR 10 DAYS' FREE EXAMINATION**

mail this coupon

McGRAW-HILL BOOK CO., INC.  
330 W. 42nd St., N. Y. C.  
Send me Henney's Radio Engineering Handbook for 10 days' examination on approval. In 10 days I will send you \$5.00 plus few cents postage or return book postpaid. (We pay postage on orders accompanied by remittance.)  
Name .....  
Address .....  
City and State.....  
Position .....  
Company ..... FL-10-41  
(Books sent on approval in U. S. and Canada only.)

other) characteristic. Since the voltage applied to the amplifier *B* is identical with the voltage applied to the horizontal deflection plates, a straight line, whose slope depends upon the gain of the amplifier *B*, will be obtained when switch *S* is thrown to position 2 if the characteristics of the amplifier and oscilloscope are ideal. In oscilloscope amplifiers, there is often a certain amount of distortion and therefore what represents a linear response characteristic might appear as a slightly curved line on the oscilloscope screen.

The illustrations show some photographs made from the screen of the oscilloscope and indicate the type of traces obtained. Of course with this system the scale of voltage and current variations in the horizontal and vertical directions depends, respectively, upon the magnitude of the voltages applied to the horizontal and vertical deflecting plates. Since these are fed from variable gain amplifiers, it is necessary to calibrate the amplifiers and cathode-ray tube circuits so that the voltages and currents resulting in a given trace will be known. This can be done easily by applying known voltages to the input of each amplifier and measuring the resultant displacement of the spot on the screen. If such calibration is carried out with alternating voltage applied, the peak value of the applied voltage must be used rather than the root-mean-square value which is the calibration of most electrical measuring instruments.

To fully appreciate the advantages of such a system of making tube characteristics, it must be remembered that the results of any change in circuit constants or electrode voltages are instantly apparent on the screen of the oscilloscope. Any changes in the tube operation can be made, and the results will be immediately recorded. The method is, therefore, not only suitable for determining tube characteristics in the usual manner, but is likewise useful for determining circuit constants to produce a desired voltage-current relation in any electrode combination. In early work with this circuit, the method was used to good advantage in determining the circuit constants required to produce a linear  $E_p-I_p$  characteristic of a 1G6 double triode.



## A NEW fuel tank selector SWITCH

Designed in Cooperation  
with Glenn L. Martin Company

THE Shallcross Research Staff is continually developing new applications for their well-known Selector Switches . . . solid silver contacts . . . THE SWITCH OF TOMORROW—AVAILABLE TODAY!

The line is extensive . . . and varied.

If one of the many standard switches will not exactly suit the individual circuit requirements, then, either a stock switch is modified . . . or . . . a new design is created to fully answer the problem.

All Shallcross Switches are scientifically designed for the purpose . . . more than 10 years of experience helps . . . sturdily built . . . high dielectric mountings . . . arrangements of contacts are flexible . . . multi-pole, multi-throw . . . minimum contact resistance.

SW-5

**SHALLCROSS MFG. CO.** COLLINGDALE  
INSTRUMENTS • RESISTORS • SWITCHES PENNSYLVANIA



**R-B-M Midget Relays are designed and produced to dependably operate under the tremendous vibration of wartime operations. For your particular problems our specialized engineering staff will adapt relays to your needs.**

**R-B-M MANUFACTURING Co.**  
Division of  
**ESSEX WIRE CORPORATION**  
LOGANSPOBT, INDIANA

# STANCOR'S

NEW TYPE  
INDUSTRIAL  
TRANSFORMERS  
PROFESSIONAL SERIES



STANCOR PROFESSIONAL SERIES TRANSFORMERS represent the latest development in styling, safety, and stamina.

All cases are so designed that mounting is reversible to permit making connections either above or below the chassis. Each unit is equipped with rugged terminals. Each unit is vacuum impregnated before being sealed in a special compound to protect it from humidity and atmospheric conditions.

The quality of materials and workmanship used in the fabrication of the STANCOR PROFESSIONAL SERIES makes them adaptable for practically all fields of service, including governmental agencies, broadcast equipment, manufacturers of professional equipment, radio amateur and public address applications.

Quotations will be furnished upon request.



# TUBES

Characteristics of phototubes are presented in addition to the data on receiving tubes registered by the R.M.A. Data Bureau during August

## Tube Registry

Tube Types registered by R.M.A. Data Bureau During August 1941

### Type 6SH7 (M)

PENTODE voltage amplifier sharp cutoff, heater type, MT-8 metal envelope, seated height  $2\frac{1}{8}$  inches (max), small wafer 8-pin octal base.

**RATINGS**  
 $E_h = 6.3$  v  
 $I_h = 0.3$  amp  
 $E_b = 300$  v  
 $E_{c2} = 150$  v (max)  
 $E_{c1} = 0$  v (min)

#### TYPICAL OPERATION

$E_b = 250$  v  
 $E_{c2} = 150$  v  
 $E_{c1} = -1$  v  
 $I_b = 10.8$  ma  
 $I_{c2} = 4.1$  ma  
 $g_m = 4900$   $\mu$ mhos  
 $r_p = 0.9$  megohm (approx)  
 $E_{c1}$  = for plate current cutoff = -5.5 v  
Basing 8BK-1-1

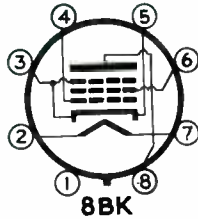

### Type 7K7 (GL)

DOUBLE diode high-mu triode, heater type, T-9 integral glass envelope-base, seated height  $2\frac{1}{4}$  inches (max), 8-pin locking-in base.

**RATINGS**  
 $E_h = 7.0$  v  
 $I_h = 0.32$  amp  
 $E_b = 250$  v  
 $E_{c2} = 150$  v (max)

#### OPERATION

**Triode Section**  
 $E_b = 250$  v  
 $E_{c2} = -2$  v  
 $I_b = 2.3$  ma  
 $\mu = 70$   
 $r_p = 44,000$  ohms  
 $g_m = 1600$   $\mu$ mhos  
**Diode**  
 $E_b = 10$  v (dc)  
 $I_b = 0.6$  ma (min)  
Basing 8BF-0-7

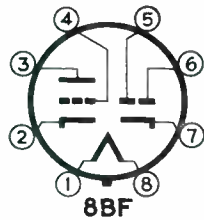

### Type 12SH7 (M)

PENTODE voltage amplifier sharp cutoff, heater type, MT-8 metal envelope, seated height  $2\frac{1}{8}$  inches (max), small wafer 8-pin octal base.

**RATINGS**  
 $E_h = 12.6$  v  
 $I_h = 0.15$  amp  
 $E_b = 300$  v (max)  
 $E_{c2} = 150$  v (max)  
 $E_{c1} = 0$  v (min)

#### TYPICAL OPERATION

$E_b = 250$  v  
 $E_{c2} = 150$  v  
 $E_{c1} = -1$  v  
 $I_b = 10.8$  ma  
 $I_{c2} = 4.1$  ma  
 $g_m = 4900$   $\mu$ mhos  
 $r_p = 0.9$  megohm (approx)  
 $E_{c1}$  = plate current cutoff = -5.5 v  
Basing 8BK-1-1



THE BASING ARRANGEMENT of types 6SG7(M) and 12SG7(M) as published in the April 1941 issue of ELECTRONICS (basing 8BC-1-1) has been modified as shown below. The suppressor grid formerly was terminated at Pin No. 1.

### Type 6SG7 (M)

R-F PENTODE, semi-remote cutoff; heater type; MT-8 metal envelope; seated height  $2\frac{1}{8}$  inches max; 8-pin octal base.

$E_h = 6.3$  v  
 $I_h = 0.3$  amps  
 $E_b = 250$  v  
 $E_{c3} = 0$  v  
 $E_{c2} = 150$  v  
 $E_c = -2.5$  v  
 $I_b = 9.2$  ma  
 $I_{c2} = 3.4$  ma  
 $g_m = 4000$   $\mu$ mhos  
 $r_p = 1$  (+) megohm  
@  $E_{c1} = -17\frac{1}{2}$  v  
 $g_m = 40$   $\mu$ mhos  
 $C_{in} = 8.5$   $\mu$ mf  
 $C_{out} = 7.0$   $\mu$ mf  
 $C_{sp} = .003$   $\mu$ mf (max)  
Basing 8BK-1-1



### Type 12SG7 (M)

R-F PENTODE, semi-remote cutoff; heater type; MT-8 metal envelope; seated height  $2\frac{1}{8}$  inches max; 8-pin octal base.

$E_h = 12.6$  v  
 $I_h = 0.15$  amp  
 $E_b = 250$  v  
 $E_{c3} = 0$  v  
 $E_{c2} = 150$  v  
 $E_c = -2.5$  v  
 $I_b = 9.2$  ma  
 $I_{c2} = 3.4$  ma  
 $g_m = 4000$   $\mu$ mhos  
 $r_p = 1$  (+) megohm  
@  $E_{c1} = -17\frac{1}{2}$  v  
 $g_m = 40$   $\mu$ mhos  
 $C_{in} = 8.5$   $\mu$ mf  
 $C_{out} = 7.0$   $\mu$ mf  
 $C_{sp} = .003$   $\mu$ mf (max)  
Basing 8BK-1-1

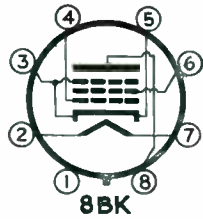

## Phototubes

### Type 53AWB

G-M Laboratories

GAS-FILLED phototube, cathode area 0.48 sq in, seated height to center line of cathode  $1\frac{1}{8}$  inch, overall height  $2\frac{1}{4}$  inches, diameter of bulb  $\frac{1}{8}$  inch, supplied without base.

Sensitivity = 130  $\mu$ a/lumen  
Max Operating Voltage = 90 v  
Max Anode Current = 25  $\mu$ a  
Max Ambient Temp = 100°C

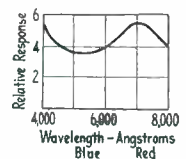

## Type 58-A

G-M Laboratories

GAS-FILLED phototube, cathode area 0.62 sq in, seated height to center line of cathode 1 3/4 inch, overall seated height 2 1/2 inches, diameter of bulb 3/8 inch, 4-pin base.

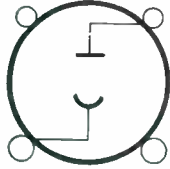
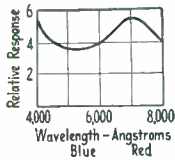

Sensitivity = 130  $\mu$ a/lumen  
Max Operating Voltage = 90 v  
Max Anode Current = 25  $\mu$ a  
Max Ambient Temp = 100° C

## Type 58AV

G-M Laboratories

VACUUM phototube, cathode area 0.62 sq in, seated height to center line of cathode 1 3/4 inch, overall seated height 2 1/2 inches, diameter of bulb 3/8 inch, 4-pin base.

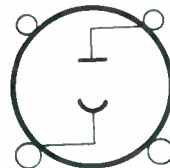
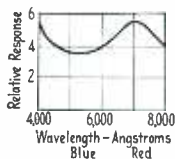

Sensitivity = 30  $\mu$ a/lumen  
Max Operating Voltage = 150 v  
Max Anode Current = 25  $\mu$ a  
Max Ambient Temp = 100° C

• • •  
**ATTENTION GIRLS!**



Before accepting the marriage proposal of Harold Dehnisch, Vera Pitts applied the lie detector and asked him, "Was it love or the draft which led you to propose?" A girl can't be too careful these days

# BUILT FOR DEFENSE!

## THE NEW G-M RELAY, TYPE "F"

1, 2, 3 or 4  
POLES  
Single Throw or  
Double Throw

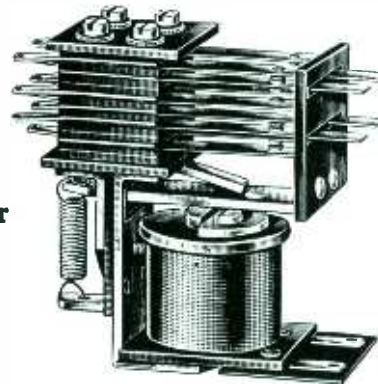

Dimensions:  
2 1/4" High  
2 1/2" Long  
1 1/8" Wide

### Install it for defense against operation failures

An electrically activated product, regardless of its nature or purpose, is only as efficient as the relay which controls its operation. In presenting the new G-M Type "F" Relay, we offer you a unit upon which you can depend to give your product a high reliability rating. When limited as to space, the compactness of G-M Type "F" is an outstanding advantage. Can be made for either A.C. or D.C. Contacts have self-cleaning, wiping action with heavy contact pressure. Underwriters' clearances can be supplied.

Send for Bulletin No. 611 giving complete description of Type "F" Relay and an outline of its particular characteristics. Other new G-M relays will be announced shortly. Let us help you with your relay problems.

**G-M LABORATORIES INC.**  
4313 NORTH KNOX AVE. CHICAGO, U. S. A.

**Because these Linear Standard Speakers are made of the Finest Materials**

• • • **Precision = Fidelity** • • •

As definite as a Mathematical Formula is the Fact that Fine Material plus Precision Workmanship, properly applied, invariably equals FIDELITY. . . . The Linear Standard presents the Ultimate in that type of reproduction.

Small wonder that CINAUDAGRAPH SPEAKERS are being chosen by the discriminating buyer—are finding their way into more and more installations!

Write now for full description in the Fall Catalog, just out, listing this, and all other models.

**CINAUDAGRAPH SPEAKERS, Inc.**

Dept. ES

921 W. Van Buren Street

Chicago, Ill.





**Use these for  
COMPACT  
ASSEMBLIES!**

● Where heavy-duty capacitors are required and where space is at a premium—the Aerovox line of transmitting capacitors offers almost unlimited choice of correct types. Type '18 shown above and similar Type '16 with terminals at top are only two of the many ultra-compact standard oil-filled paper types. Popular in aircraft, military and naval equipment. Absolutely immersion-proof terminal assembly.



As a further standard choice, there are the oil-filled drawn-case or so-called "bath-tub" Type '30 units shown below. Non-inductive oil-impregnated paper sections are enclosed in one-piece drawn metal cases with soldered bottom plate. Also provided with absolutely immersion-proof terminal assembly.



## New DATA...

● Be sure you have our latest revised pages in your Transmitting Capacitor Catalog binder. Write on your business letterhead for this up-to-the-minute data. Meanwhile, submit your condenser or capacitor problem.



### Type 58AWB

G-M Laboratories

GAS-FILLED phototube, cathode area 0.62 sq in, seated height to center line of cathode  $1\frac{1}{4}$  inch, overall height 2 inches, diameter of bulb  $\frac{3}{4}$  inch, supplied without base.

Sensitivity = 130  $\mu$ a/lumen  
Operating Voltage = 90 v  
Max Anode Current = 25  $\mu$ a  
Max Ambient Temp = 100° C

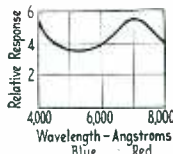

### Type 58AVWB

G-M Laboratories

VACUUM phototube, cathode area 0.62 sq in, seated height to center line of cathode  $1\frac{1}{4}$  inch, overall height 2 inches, diameter of bulb  $\frac{3}{4}$  inch, supplied without base.

Sensitivity = 33  $\mu$ a/lumen  
Max Operating Voltage = 150 v  
Max Anode Current = 25  $\mu$ a  
Max Ambient Temp = 100° C

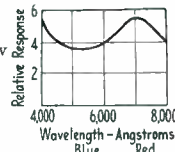

### Type 59A

G-M Laboratories

GAS-FILLED phototube, cathode area 0.62 sq in, seated height to center line of cathode  $2\frac{5}{32}$  inches, overall seated height  $3\frac{9}{32}$  inches, diameter of bulb 1 inch, 4-pin base.

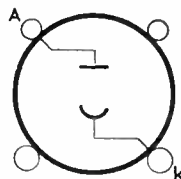
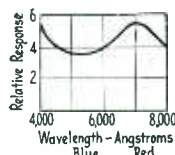

Sensitivity = 130  $\mu$ a/lumen  
Max Operating Voltage = 90 v  
Max Anode Current = 25  $\mu$ a  
Max Ambient Temp = 100° C

### Type 59AV

G-M Laboratories

VACUUM phototube, cathode area 0.86 sq in, seated height to center line of cathode  $2\frac{5}{32}$  inches, overall seated height  $3\frac{9}{32}$  inches, diameter of bulb 1 inch, 4-pin base.

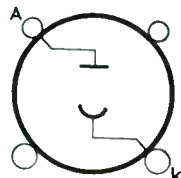
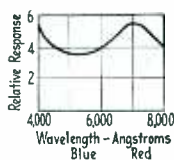

Sensitivity = 30  $\mu$ a/lumen  
Max Operating Voltage = 150 v  
Max Anode Current = 25  $\mu$ a  
Max Ambient Temp = 100° C

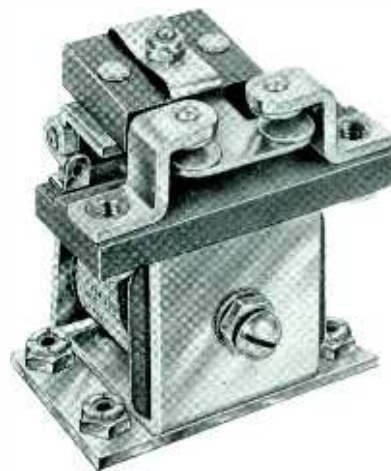

### ALLIED . . . TYPE AN RELAY

● A precision-built, heavy duty relay designed for the most exacting requirements of military and naval aircraft uses. Dependable also for use in all types of mobile equipment.

● Minimum weight, size and mounting space was placed at a premium in design. Capable of handling up to 75 amperes at 24 volts D-C. Insulation is Bakelite—wax impregnated. Fine silver or special contacts depending on rating. Many other exclusive and desirable features.

● Allied's complete line includes relays for aircraft, communication and electronic uses. Write for latest literature.

ALLIED CONTROL CO., INC.  
227 FULTON STREET NEW YORK CITY

## NO ENGINEER

Whose work takes him into the field of sensitive electrical devices can say—today—that he is thoroughly grounded unless he "knows his electronics."

Because electronic circuits more and more are getting into industrial work as an automatic hand, an automatic eye, a new means of generating heat, etc., etc., they have become the background for a new cycle of industrial progress.

Are you trying to get along without ELECTRONICS? Better subscribe today!



## Type 71-A

G-M Laboratories

GAS-FILLED phototube, cathode area 1.25 sq in, seated height to center line of cathode  $1\frac{1}{4}$  inch, overall seated height  $2\frac{3}{16}$  inches, diameter of bulb  $1\frac{1}{2}$  inch, 4-pin base.

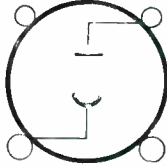
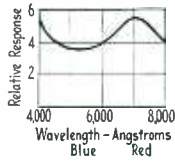

Sensitivity = 130  $\mu$ a lumen  
Max Operating Voltage = 90 v  
Max Anode Current = 25  $\mu$ a  
Max Ambient Temp = 100° C

## Type 71A $\nabla$

G-M Laboratories

VACUUM phototube, cathode area 1.25 sq in, seated height to center line of cathode  $7\frac{1}{8}$  inch, overall seated height  $2\frac{3}{16}$  inches, diameter of bulb  $1\frac{1}{2}$  inch, 4-pin base.

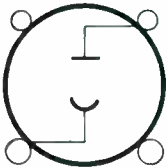
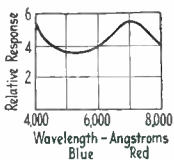

Sensitivity = 30  $\mu$ a/lumen  
Max Operating Voltage = 150 v  
Max Anode Current = 25  $\mu$ a  
Max Ambient Temp = 100° C

## COSMIC RAY CHAMBER



Closeup of cosmic ray cloud chamber showing the paths of the rays as they pass through vapor

# Fast Service ON SPECIAL TRANSFORMERS



If you have a defense order and need **QUALITY** transformers **FAST** . . . you can get them from Ferranti. That's the whole story. Large or Small orders. Standard or Special.



- (1) 60 YEARS EXPERIENCE
- (2) UNMATCHED PRESTIGE
- (3) EXPERIENCED ENGINEERING
- (4) ADEQUATE EQUIPMENT
- (5) THE ECONOMY INHERENT IN QUALITY PRODUCTS

# Ferranti

## FERRANTI PRODUCTS

Transformers for every electronic, sound, communication, industrial, and laboratory use — miniature aero transformers for aircraft and portable work — high power plate and filament transformers — filters, equalizers, modulation sets, rectifiers, etc. — electrostatic voltmeters, portable voltmeters, ammeters, phase rotation indicators, special testing equipment, and numerous other instruments.

Write to Ferranti for a quick solution to your transformer problems.

## ELECTRIC INCORPORATED

R. C. A. BUILDING, NEW YORK, N. Y.

McGraw-Hill  
**DIRECT MAIL LISTS**



As business paper publishers for over fifty years, McGraw-Hill is uniquely equipped to offer complete, authoritative direct mail coverage of industry's major markets. Extreme accuracy is maintained (guaranteed to 98%) and through careful analysis of markets, complete classification of companies and personnel, etc., the widest possible selections are available. Send for handy reference folder, "Hundreds of Thousands of Reasons Why" which describes how McGraw-Hill Lists are built and maintained.

### What Fields Do You Want to Reach?

- Aviation
- Bus & Electric Railways
- Civil Engineering and Construction
- Coal Mining
- Electrical Construction
- Electrical Industry
- Food Industries
- Metal Mining
- Metal Working Industries
- Process Industries
- Textile Industries
- Administrative Executives
- Electrical Dealers & Wholesalers
- Mill Supply Houses
- Power Services
- Product Engineering & Design
- Production and Maintenance
- Radio Dealers & Wholesalers
- Radio Engineering and Design

For further details, selections from above basic classifications, counts, prices, etc., or estimates on special lists . . . ask any representative or write to

Complete Lists Covering Industry's Major Markets



Complete Lists Covering Industry's Major Markets

## COILS

Electrical Windings



A COMPETENT and experienced organization devoted to the design and manufacture of coil windings. Paper interlayer sections—form wound and bobbin wound coils.

Equipped for prompt production on quantity or small orders.

### REPRESENTATIVES

W. A. JORDAN  
295 Madison Ave.,  
New York, N. Y.

PARAGON SALES CO.  
(C. H. Fryburg)  
402 Cherry St.,  
Philadelphia, Pa.

GILBERT GISLASON  
82 St. Paul St.,  
Rochester, N. Y.

A. J. LOEB SALES CO.  
1836 Euclid Ave.,  
Cleveland, Ohio

**MAGNETIC WINDINGS COMPANY**  
Sixteenth and Butler Streets EASTON, PENNA.

# VICTORY

American Airlines flies Victory Symbol over America



Radio Equipment by *Doolittle*  
supplied to American Airlines since 1933.

**DOOLITTLE RADIO, INC.**

7421 South Loomis Boulevard,

Chicago, Illinois, U. S. A.

**TAYLOR**  
**LAMINATED PLASTICS**  
Vulcanized Fibre • Phenol Fibre  
SHEETS, RODS, TUBES, FABRICATED PARTS  
**TAYLOR FIBRE COMPANY**  
Norristown, Pennsylvania

**FAMOUS**  
for years . . .  
for their uniform accuracy and great strength . . .  
for the unique self-locking feature on the "Unbrako" Hollow Set Screw with the Knurled Points . . . for the Socket Head Cap Screw with the Knurled Head that gears right to the fingers and saves assembling time.  
"Unbrako" Products are available in a complete range of sizes from number 4 up. For free samples and literature, write today.  
"KNURLING" of Socket Screws originated with Standard Pressed Steel Co. years ago.

**UNBRAKO**  
REG. U.S. PAT. OFFICE  
**SCREW PRODUCTS**

**STANDARD PRESSED STEEL CO.**  
Box 596, JENKINTOWN, PENNA.

## Type 71-TA

G-M Laboratories

GAS-FILLED phototube, cathode area 1.25 sq in, seated height to center line of cathode  $1\frac{1}{4}$  inch, overall seated height  $3\frac{1}{4}$  inches, diameter of bulb  $1\frac{1}{2}$  inch, 4-pin base.

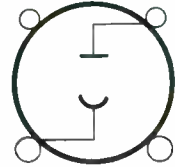
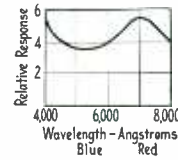

Sensitivity = 130  $\mu$ a/lumen  
Max Operating Voltage = 90 v  
Max Anode Current = 25  $\mu$ a  
Max Ambient Temp = 100° C

## Type 73-A

G-M Laboratories

GAS-FILLED phototube, cathode area 1.25 sq in, seated height to center line of cathode  $1\frac{1}{4}$  inch, overall seated height  $2\frac{3}{4}$  inches, diameter of bulb  $1\frac{1}{8}$  inch, 4-pin base.

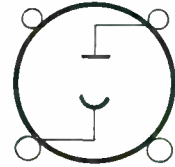
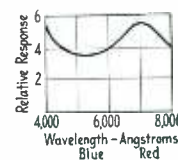

Sensitivity = 130  $\mu$ a/lumen  
Max Operating Voltage = 90 v  
Max Anode Current = 25  $\mu$ a  
Max Ambient Temp = 100° C

## Type 75-A

G-M Laboratories

GAS-FILLED phototube, cathode area 1.87 sq in, seated height to center line of cathode  $2\frac{3}{8}$  inches, overall seated height  $3\frac{3}{8}$  inches, diameter of bulb  $1\frac{1}{2}$  inch, 4-pin base.

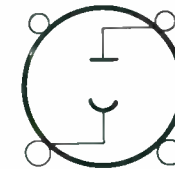
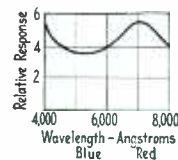

Sensitivity = 130  $\mu$ a/lumen  
Max Operating Voltage = 90 v  
Max Anode Current = 25  $\mu$ a  
Max Ambient Temp = 100° C

## Type 79-A

G-M Laboratories

GAS-FILLED phototube, cathode area 1.87 sq in, seated height to center line of cathode 3 inches, overall seated height  $4\frac{1}{4}$  inches, diameter of bulb  $2\frac{5}{8}$  inches, flexible leads.

Sensitivity = 130  $\mu$ a/lumen  
Max Operating Voltage = 90 v  
Max Anode Current = 25  $\mu$ a  
Max Ambient Temp = 100° C

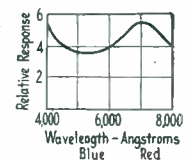

## B-L RECTIFIERS ARE TAILOR-MADE TO YOUR SPECIFICATIONS

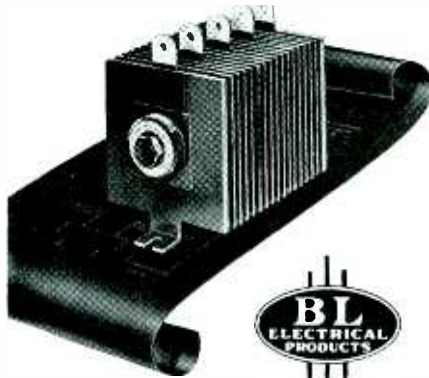

B-L Rectifiers are engineered individually for your current supply needs; be it battery charging or any other application to convert A.C. to D.C. current.

Let B-L engineers assist you. Use their long experience in solving problems like yours. Write for complete information.

**THE BENWOOD-LINZE CO.**  
Engineers • Manufacturers  
1805 Locust Street St. Louis, Mo.

## MATHEMATICS FOR RADIO AND COMMUNICATION

by **GEORGE F. MAEDEL, A.B., E.E.**  
Chief Instructor, N.Y. School, RCA Institutes

To master the technicalities of radio—to read engineering literature intelligently—you must have the mathematical groundwork covered by these absorbing books prepared for home study. Book I (314 pp.) covers the algebra, arithmetic, and geometry; Book II (329 pp.) covers the advanced algebra, trigonometry, and complex numbers necessary to read technical books and articles on radio.

MAEDEL PUBLISHING HOUSE Room 108  
593 East 38 Street, Brooklyn, New York

Send me Mathematics for Radio and Communication as checked below. I enclose payment therefor with the understanding that I may return the book(s) within 5 days in good condition and my money will be refunded.

Name .....

Address .....

- Book I at \$3.75 plus 3c postage  
 Book II at \$4.00 plus 3c postage  
 Books I and II at \$7.75 postage prepaid

## Equipment Failure Alarm

(Continued from page 45)

non-uniformity of the two sections of the 7F7. The variable 5000-ohm common cathode resistor is used to adjust the signalling circuit sensitivity to the desired tolerance. By means of this control the equipment failure alarm may be made to tolerate only a 2 vu aberration from normal gain in the monitored amplifier, or it may be backed off to a tolerance of at least 15 vu. Both of these controls are brought out at the front panel.

An important feature of the equipment failure alarm is its ability to distinguish between rise and fall in monitored amplifier gain as well as power supply failure. Plate voltage for the alarm is best obtained from the same d-c source which supplies the amplifier to be monitored. The relays  $T_3$  and  $T_4$  are of such a type that they are normally energized holding the alarm signalling contacts open. An increase or decrease in gain of the monitored amplifier will cause a correspondingly positive or negative unbalance in the bridge circuit. This will in turn make one or the other of the 7F7 grids become more negative until the relay associated with that section of the tube drops out, closing the signalling circuit. Failure of the plate voltage supply will permit both of these relays to close, energizing all signalling devices. Adjustment of these relays is best made so that they hold open at 1.0 ma, and fall out to close the signalling circuits at about 0.2 ma. For initial adjustment of the relays and associated bridge circuits, plate current meters for the 7F7 may be found necessary.

There is still another reason for the use of a common source of plate voltage. Some amplifiers and most transmitting equipment have means of automatically regulating the power supply voltage so that it is independent of any but very large changes in the a-c supply. Inasmuch as the gain of some types of amplifiers varies with the plate voltage, the common supply is indicated. In this same connection, the on-off switch, if any, should operate on the sig-



Enlisted for  
**NATIONAL  
DEFENSE**

★ Thousands upon thousands of these Clarostat armored power rheostats are being supplied for use in fighting aircraft, mainly as dimmers for instrument-panel illumination. Although rated at 25 watts, they handle that wattage even at one-third rotation settings. The exclusive Clarostat insulated-metal-core winding imbedded in inorganic cement; the graphited-copper contact shoe; the unique tripod rotor construction—these and other typical Clarostat refinements make for the extraordinary performance and dependable service.

### Also . . .

Rheostats and potentiometers with intricate windings for sections of different resistance values and tricky taps. Multiple controls even up to 24 units mounted in tandem and operated by single knob.

Greenohm power resistors both round and flat, with various terminals, taps, mountings, meeting U. S. Navy and other rigid specs.

Precise windings in various forms for the most critical resistance values and tolerances.

And many other types of special controls and resistors to meet out-of-the-ordinary requirements, in addition to the extensive line of standard stock items.

### Submit Your Problem . . .

Regardless what your control or resistance requirements may be—whether you need one or a million units—just get in touch with us. Loose-leaf engineering data sent on request.

**CLAROSTAT**  
MANUFACTURING CO.  
Incorporated  
285 North Sixth St.  
Brooklyn, N. Y.

# USE BRITISH 3-Core Solder



## ERSIN MULTICORE

— the solder wire with 3 cores of non-corrosive Ersin Flux— now enables U.S.A. manufacturers to eliminate poor soldering and corrosive joints.



- Avoids dry joints.
- Speeds up production.
- Increases electrical efficiency of joints.
- Reduces overall soldering costs.
- Three flux cores guarantee flux continuity.
- Supplied in any alloy or gauge.



Used by manufacturers making electrical apparatus for R.A.F. Aircraft.

For technical information, samples and prices, apply:

**U.S.A. Representative: M. H. Kelsey.**  
6604, Buckingham Place, CINCINNATI, OHIO.

Eastern Sales Agent & Warehouse—Ben Joseph, 258 Broadway, New York, N. Y.

**MULTICORE SOLDERS LTD., BUSH HOUSE, LONDON W.C.2, ENGLAND.**

# Streamline

## SHEET-METAL HOUSINGS

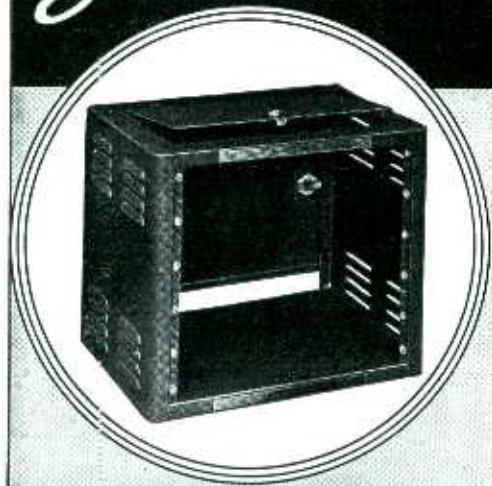

### GENERAL CABINET RACKS

Featuring Beauty, Durability and Economy, these Streamline Cabinet Racks afford the BEST in enclosures for an endless variety of industrial electronic installations. The five cabinets made in this series accommodate 19" rack panels in heights from 8 3/4" to 35".

Call on our Sheet Metal Department for estimates on your special requirements. We make custom-built cabinets, panels and punched chassis for many types of commercial applications.

### MIDGET CONDENSERS

BUD precision-built midget condensers are made in many types and capacities for a variety of commercial requirements. They feature Alsmag 196 insulation, positive wiping rotor contact, electro-soldered rotor and stator assemblies, bright cadmium plated finish, and rugged mechanical construction. We will be pleased to furnish estimates on your requirements.

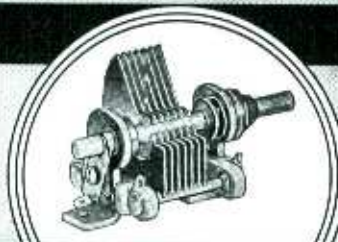

**BUD RADIO, INC.**  
CLEVELAND, OHIO

nalling circuit as well as the plate-filament supply, lest an alarm be given when the equipment failure alarm is turned off.

The entire equipment failure alarm including filament transformer is easily accommodated on a 3 1/2-inch rack panel. Placement of tubes at the rear of the chassis is permissible due to the use of all cathode type tubes. Heat is then more readily dissipated, and tube replacement facilitated. Gain controls for amplifier (3) and also, if one is needed, for amplifier (2), are located at the rear of the chassis for semi-permanent adjustment.

Due to the possibility of buzzer or signal lamp failure it is always advisable to have both audible and visual indicators in the signalling system. Usually when an entire a-c circuit fails, the operator can be depended upon to recognize the nature of the trouble at once. Any secondary relaying used in conjunction with the alarm, such as might be required for automatic throw-over to spare equipment, will usually have to be of the lock-out type, requiring a manual reset. Otherwise, when the secondary relays are energized, the audio signal causing unbalance in the rectifier bridge might be removed from the input terminals of the equipment failure alarm allowing the 7F7 relays to close out again.

• • •

### RUSSIAN RADIO



Portable radio equipment used on the battlefield of the current conflict by the Russian Army

# THE INDUSTRY IN REVIEW

## News

♦ "Communications in Air Defense" will be the subject of the first meeting of the Communications Group, New York Section of the American Institute of Electrical Engineers. The speaker will be Capt. W. C. Talbot, Signal Officer, Interceptor Command, First Air Force, now based at Mitchell Field, L. I., N. Y. The meeting will be held at the auditorium of the Western Union Telegraph Co., 60 Hudson St., New York, at 7:30 P. M. on October 30 and will be preceded by a showing of selected British defense films at 7 P. M.

Capt. Talbot will discuss in some detail the plans, methods, and organization of the elaborate communications systems and facilities essential to the efficient direction and operation of the most recently developed technique of protecting the country or specific areas from raids or bomber attack. He will discuss such topics as the methods of rapidly collecting information on the approach of hostile aircraft, methods of compiling and displaying this information on the "operations board", methods of disseminating this information to the people, methods of using such information by the Interceptor Command of the U. S. Air Corps, and direct operation of planes. He will also describe the organization and mission of the Interceptor Command and Army maneuvers which have developed or proved the efficiency of this elaborate communications organization.

The films will show war action and life in certain phases in the defense of England. The lecture will be followed by comments from men who have recently witnessed the operation of defense communications in Great Britain.

♦ The importance of National Defense lends added value to a course of lectures on communication networks to be given by the American Institute of Electrical Engineers this Fall. The series of seven lectures, entitled, "Wave Filters and Other Networks in Theory and Practice" will be co-ordinated to make a complete but concise presentation, emphasizing the practical design, use, and theory of filters and related networks. The speakers are all men of international repute in their respective fields and are particularly well qualified to select and impart to an audience the pertinent information on this timely subject. As practicing engineers, several are qualified to stress the practical limitations of theory and aspects of their construction and use.

The lectures will be heard in room 502 at the Engineering Societies Build-

ing, 33 West 39th Street, New York from 6:30 to 8:30 P. M. Registration for the course should be made in advance to H. E. Farrar at this address.

The dates, subjects and speakers are as follows:

October 20, "Functions of Filters and Other Networks" by H. A. Affel, Bell Telephone Laboratories

October 27, "General Network Theory" by Prof. E. A. Guillemin, Massachusetts Institute of Technology

November 3, "General Network Theory" by Prof. E. A. Guillemin, Massachusetts Institute of Technology

November 10, "Filter Design Practices" by A. J. Grossman, Bell Telephone Laboratories.

November 17, "Crystal Elements in Wave Filters" by A. R. D'heedene, Bell Telephone Laboratories

November 24, "Attenuation and Phase Equalizers" by A. J. Grossman, Bell Telephone Laboratories

December 1, "Coaxial Line Elements Applied to Filters or Networks" by C. W. Hansell and P. S. Carter, RCA Communications.

♦ A saving of more than five million pounds of metal vital to defense needs, including enough aluminum to build more than 275 fighter planes, is being effected by the Bell System this year through a program of material substitution. The Western Electric Company is now saving 65 tons of aluminum annually by replacing aluminum with steel on dial telephones. Other points in this conservation program will release 1,700,000 pounds of aluminum, almost a third of a million pounds of nickel, more than 3,000,000 pounds of zinc and 8,300 pounds of magnesium.

. . . D. C. Prince, president of the American Institute of Electrical Engineers has appointed Dr. Edward E. Minor, Jr., research and development engineer of the Glenn L. Martin Co. as chairman of the Committee on Air Transportation of the American Institute of Electrical Engineers. Others assisting on this committee are V. H. Grant, U. S. Navy, T. B. Holliday, U. S. Army Air Corps, E. E. Johnson, General Electric Co., W. J. Clardy, Westinghouse Electric & Mfg. Co., W. J. Morrill, General Electric Co., C. F. Savage, General Electric Co., H. A. Campbell, Solar Aircraft Co. and J. W. Barker, Columbia University.

♦ A new service shop and warehouse in Pittsburgh, and ranking among the most complete in use in this country, has recently been put into operation by the General Electric Co. The shop has 16,000 square feet of floor space allocated to the warehouse and 34,000 square feet to the service shop and office. Features of the building include dust and fume elimination sys-

tems, a 15-ton crane to handle large jobs, a 300-ton hydraulic press, and a copper reclaiming roasting oven. Fluorescent lighting is used throughout the shop and office . . . According to J. G. Mann, treasurer, the Consolidated Wire & Associated Corporations moved all production and general office facilities to new and larger quarters at 1635 S. Clinton Street, Chicago, Ill. on September 1. The move was made to facilitate the handling of orders for the numerous products of the company and will bring under one roof the handling of such items as radio, electrical and automotive wires, aerial wires and kits, resistors, volume and tone controls, test equipment and similar electrical accessories . . . Philadelphia's first television station, W3XE, owned and operated by Philco Radio & Television Corporation, has been granted a commercial license for 60 days which began September 1, pending completion of installation of full power. The station is now transmitting a minimum of 15 hours of program each week, as required by the FCC regulations. W3XE operates on channel 3, having a wavelength of 66-72 Mc. Present power is 3 kw although this will shortly be increased 10 kw.

♦ The National Broadcasting Company has added 14 stations in six Central American Republics to its Pan American network, according to Frank E. Mullen, vice president and general manager of the company. . . . Station WWVA, Wheeling, W. Va., has recently been granted a construction permit to increase its power from 5 kw to 50 kw, unlimited time, and to move its transmitter to St. Clarisville, Ohio, about seven miles west of Wheeling. . . . The fifth frequency-modulated transmitter has recently been approved for Philadelphia when the Seaboard Broadcasting Corporation of Glenside, Pa., was granted a construction permit for an f-m transmitter. Call letters will be W81PH.

♦ According to Dr. R. H. Harrington, metallurgist in the General Electric Research Laboratories in Schenectady new American plants are extracting magnesium from sea water in such quantities that the United States and England are now equalling and will surpass Germany in production of this strategic metal. Present production points to a yield of 30,000,000 pounds for 1941 and nearly 90,000,000 pounds for 1942. . . . George E. Smith, vice president and treasurer of The Crosley Corporation, has been appointed by Brigadier General Dawson Olmstead, civilian adviser and counselor to aid in the reorganization and systematization of certain Signal Corps activities with a view to expediting the delivery of critical defense materials.

# HERE IS A RESISTOR TO LICK THAT JOB!

*(Check these specifications)*

- |                       |                                       |                                       |
|-----------------------|---------------------------------------|---------------------------------------|
| 1 Ceramic             | 5 Many types and sizes                | 8 Special shapes                      |
| 2 Non-inductive       | 6 Negative voltage characteristic     | 9 Metalized terminals                 |
| 3 Chemically stable   | 7 Negative temperature characteristic | 10 Wire leads                         |
| 4 Mechanically strong |                                       | 11 Moisture proofing (where required) |

**GLOBAR DIVISION  
THE CARBORUNDUM COMPANY**

REG. U. S. PAT. OFF.  
NIAGARA FALLS, N. Y.

(Carborundum and Globar are registered trade-marks of and indicate manufacture by The Carborundum Company)

*Globar* CERAMIC RESISTORS  
TRADE

◆ Plans for a new building to be erected by the General Electric Company for the manufacture of industrial and radio tubes in Schenectady have been announced by Dr. W. R. G. Baker, manager of the company's radio and television department. The building is expected to be ready for operation by February. A single story manufacturing section will contain 120,000 square feet of floor space while 15,000 square feet of floor space will be available in a two-story office section. . . . The appointment of W. M. Ballenger to the position of assistant district engineer of the General Electric Company's central district has been announced by W. O. Batchelder, commercial vice president. Mr. Ballenger has specialized in the application of engineering to industrial problems. . . . Price reductions on shipments of aluminum made after September 30, 1941 are announced by the Aluminum Company of America. After that date the price of ingot aluminum will be reduced from 17 cents to 15 cents per pound. The company also announces completion of negotiations for the construction and operation of an alumina plant in the State of Arkansas with an annual capacity of 400,000,000 pounds, the construction of three aluminum smelting plants, one at Massena, N. Y., one in the Portland Oregon district and a third in Arkansas having a combined capacity of 340,000,000 pounds per year.

## Mix with **REMLER** Silver Tap ATTENUATORS

Enjoy the feel of self-cleaning pure silver on silver, ball bearings front and rear, precision machined in every detail. It's smooth. And those are the factors that make the REMLER silver attenuator **QUIET**—so quiet you can operate it in a low-level circuit in perfect ease and comfort. Standard impedances. \* Special values to order.

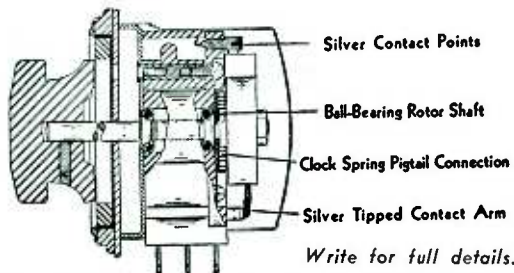

Write for full details.

**REMLER COMPANY, Ltd. • 19th at Bryant • SAN FRANCISCO**

## PERMANENT MAGNETS

ALL SHAPES — ALL SIZES  
FOR ALL PURPOSES

Stamped, Formed, and Cast; Chrome, Tungsten Cobalt and **ALNICO\*\*** (cast or sintered) under G. E. license.

**THOMAS & SKINNER**  
STEEL PRODUCTS COMPANY  
1116 E. 23rd STREET INDIANAPOLIS, INDIANA

Laminations for Radio Transformers — Tools  
Dies — Heat Treating — Stampings

**40 YEARS EXPERIENCE**

◆ Harry A. Turner has been appointed production supervisor at the Universal Microphone Company, Inglewood, Calif. Mr. Turner is an expert on time and motion study and has a background of 40 years experience in die tool design in typewriter and automobile factories. . . . Bob Barbley, sales manager of National Recording Supply Company, Hollywood, resigned in August to enter the Naval Reserve as a chief petty officer. He was assigned as chief photographer in the sound unit being formed in Hollywood. . . . Construction of a new \$1,275,000 building for the assembly and testing of radio equipment for the Army and Navy has been started in Schenectady according to Charles E. Wilson, president of the General Electric Company. The building, to be equipped at an additional cost of \$1,000,000, is part of a \$2,400,000 project of the Defense Plant Corporation for expansion of radio manufacturing facilities. It is anticipated that the single story wooden structure, 1,000 feet long and 200 feet wide will be finished by October 1 and all equipment installed by next June.

◆ The Electrovox Company has recently moved their general office from New York City to the company's large New Jersey plant at 356 Glenwood Avenue, East Orange. . . . G. E. Richter, Jr., vice president in charge of sales, announces the completion of a new plant of the American Lava Corporation, which will provide a 300 percent increase in capacity.

## Literature

**General Catalogue.** The Macquire Broadcasting Network, Sydney, Australia, has issued the second edition of its general catalogue which covers land line costs, the rates of the entire network, and the 22 individual stations grouped by states and also by capital cities. The 100-page book is indexed and contains maps, charts, diagrams, and photographs.

**Catalogue.** The new Engineering Standards Catalogue, listing the various standard shapes and sizes of Speed Nuts made by Tinnerman Products Inc., 2038 Fulton Road, Cleveland, Ohio is available on request.

**Test Oscillators.** The Aerovox Research Worker, available from Aerovox Research Corporation, New Bedford, Mass., contains in two separate issues a discussion on "Application of the A.F. Test Oscillator."

**Communication Equipment.** A booklet is available which describes marine radio telephone systems, amateur transmitters, army, navy, police, fire, forestry, and other types of emergency communication equipment made by TEMCO, Transmitter Equipment Mfg. Co., Inc., 36-01 35th Avenue, Long Island City, N. Y.

**Intercommunicators.** The various types of office and industrial intercommunicators manufactured by Webster-Rauland, 4245 North Knox Avenue, Chicago, Ill., are described in catalogue No. 241. Diagrams of the station connections, and a price list is also included.

**Temperature Measuring Instruments.** Two booklets outlining the principles of operation and the constructional features of temperature measuring devices are available from the Brown Instrument Company, Wayne and Roberts Avenues, Philadelphia, Pa. One describes the Brown Optimatic, an optical pyrometer, and the other covers the features of the Brown Continuous Balance Unit which replaces the conventional galvanometer and maintains continuous balance in the measuring and recording of temperatures.

**Communications Receiver.** Folder 108 covers the Howard Model 445 ac-dc Universal communications receiver made by the Howard Radio Company, 1735 West Belmont Avenue, Chicago, Ill.

**Transmitting Capacitors.** The second edition of the Transmitting Capacitor catalogue has been issued by Aerovox Corporation, New Bedford, Mass. This is a looseleaf book which is kept up to date by new pages issued from time to time. It is available to those engaged in designing, building, and maintenance of commercial radio and electronic equipment.

**Radio Catalogue.** The new 1942 radio catalogue of the Allied Radio Corporation, 833 West Jackson Boulevard, Chicago, Ill., is off the press. It covers communications receivers, sound systems, test equipment, fluorescent lighting apparatus, and amateur equipment, and may be had on request.

**Aircraft Transmitters.** AVT-110 which operates on a dry battery power supply, and AVT-111 which operates on a storage battery power supply are two aircraft transmitters described in leaflet 1V4295 of the RCA Manufacturing Company, Inc., Aviation Radio Section, Camden, N. J.

**Mycalex.** The nature properties, advantages, and applications of G-E Mycalex are presented in a 10-page booklet illustrated with photographs and charts. It may be had from the plastics department of the General Electric Company, Pittsfield, Mass.

**Solenoid Operated Valves.** This catalogue lists the specifications on various types of solenoid operated valves which are used for automatic and remote control of air, gas, steam, or liquids. The booklet is published by the manufacturer, the Automatic Switch Co., 41 East 11th St., New York City.

**Westinghouse Bulletins.** No. 41-291 gives the distinctive features, construction, and operation of voltage relays. Styles and prices for 25- and 60-cps relays for operation on 115- or 460-volt circuits are listed. No. 43-330 describes miniature a-c and d-c voltmeters and ammeters. Style numbers, ratings, scale divisions, and list prices are given also. These bulletins may be secured from Dept. 7-N-20, Westinghouse Electric and Manufacturing Company, East Pittsburgh, Pa.

**General Electric Bulletins.** Fractional horsepower motors for machine tools and other industrial applications are described in leaflet GEA-3579. The sizes and applications of a shielded-arc electrode for cast-iron welding are listed in bulletin GEA-3493. Notes on cast-iron welding procedure are included. These bulletins may be obtained from the General Electric Company, Schenectady, N. Y.

**Fibre Handbook.** This handbook contains technical and descriptive data on National Vulcanized Fibre. It covers general properties, different types, typical uses, and notes on forming and machining the products of the National Vulcanized Fibre Company, Wilmington, Delaware. Copies are available on request.

**Aluminum References.** The first of a series of service bulletins on aluminum has been issued by the Aluminum Company of America, Pittsburgh, Pa. This pamphlet lists 100 references on aluminum of special interest to defense manufacturers. All of these are publications by engineers of this company.



*In the history*  
of the electrical industry there is no more sensational success story than the position attained by Simpson Instruments in less than five years.

Behind this success is the advanced construction and extra value of Simpson instruments ... and behind the instruments is the experience that reaches back to the days when Ray Simpson and a group of associates, who are still with him, maintained the high standard of Jewell instruments throughout their long and successful career.

The recognition of Simpson value, and the requirements of the defense program, have momentarily taxed even the greatly increased facilities of the new Simpson plant. But today we reaffirm the pledge we made when Simpson instruments were first announced—to build ever greater value in panel instruments and radio testing equipment.

**SIMPSON ELECTRIC CO.**  
5212 Kinzie Street  
Chicago, Ill.



## 2-Way Remote Control WITH A SINGLE S. S. WHITE FLEXIBLE SHAFT

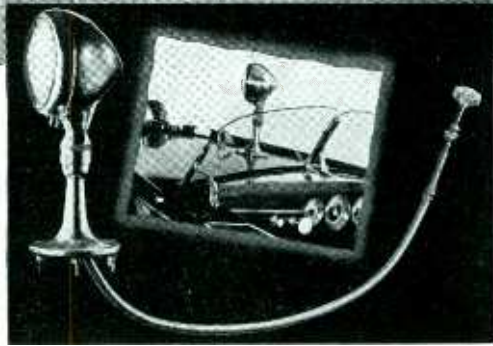

The IVALITE remote controlled marine spotlight is a product of Ivano, Inc., Chicago, Illinois.

### FIRST CHOICE FOR RADIO REMOTE CONTROL

S. S. White Remote Control type flexible shafts are universally used for remote control of aircraft, automobile, home and broadcasting radio equipment. Suitability for the job, outstanding quality, proven dependability are the reasons. Bulletin 38 tells all about these radio shafts.

If you are interested in flexible shafts for power drives, ask also for BULLETIN 1238.

The spotlight illustrated is a good example of the simple, effective way in which the problem of two-directional remote control can be solved with a single S. S. WHITE Flexible Shaft. The light is turned horizontally in a full circle by rotation of the flexible shaft and is tilted up and down by a "push-pull" movement of the same shaft.

The particular shaft used is of the type originated by S. S. WHITE expressly for remote control with characteristics essential to smooth, sensitive operation even in long lengths. S. S. WHITE Remote Control Shafts are available in diameters from .130" to .437" and in lengths up to 50 feet.

BULLETIN 38 gives full details about these shafts and their application. A copy will be mailed to you on request.

## S. S. WHITE

The S. S. White Dental Mfg. Co.

### INDUSTRIAL DIVISION

Department E, 10 East 40th St., New York, N. Y.

## STABILIZED A. C. VOLTAGE UP TO 25 KVA

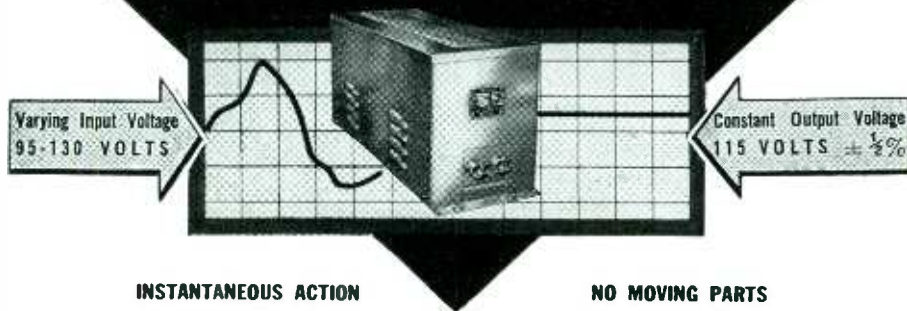

When a precision electrical device or a critical process is powered from an AC line, a Raytheon Voltage Stabilizer will permanently eliminate all of the detrimental effects caused by AC line voltage fluctuations. Made for all commercial voltages and frequencies, single or three phase.

Raytheon's twelve years of experience in successfully applying the Stabilizer to hundreds of perplexing voltage fluctuation problems is at your service. It will pay you to take advantage of our engineering skill.

Write for Bulletin DL48-71 JE describing Raytheon Stabilizers.

**RAYTHEON MANUFACTURING CO.**  
100 Willow Street, WALTHAM, Massachusetts

## New Products

### Beam Tetrodes

TWO INSTANT HEATING r-f beam tetrodes have been added to the tube line of the Hytron Corporation, 76 Lafayette Street, Salem, Mass. The HY65 comes with a ceramic octal base, is completely shielded for rf, and is intended to replace the 6V6 and the 6L6 type tubes in low power stages. The filament draws 0.8 amps at 6 volts, and the amplification factor is 100. The HY67 is an all-purpose, graphite anode r-f beam power tetrode with a rugged four-way support making it well suited for aircraft applications where the equipment is subjected to excessive vibration. With 1250 volts on the plate, 300 volts on the screen, and a driving power of 1.5 watts the power output is about 152 watts. This tube is also shielded for rf.

### Coil Winding Counter

A HIGH SPEED COIL WINDING counter called the Clipper, designed for direct connection to the motor shaft or for operation through a flexible shaft is available from the Production Instrument Co., 710-12 W. Jackson Blvd.,



Chicago. In actual service it counts at speeds as high as 9000 turns per minute. The figures on the dial read up to 10,000 turns. Reset to zero is accomplished with one motion, and turns taken off the coil are automatically deducted. An adjustable base permits easy alignment with motor.

### DK-3 Transceiver

ANNOUNCED BY ABBOTT INSTRUMENT, Inc., 8 West 18th Street, New York City is their new Model DK-3 transceiver having an effective operating range of up to 30 miles, depending upon terrain. The unit uses three 45-volt B batteries, which are self-contained for portable use, or from 135 to 180 volts d.c. from a power supply used in a circuit employing one 6G6G in the audio and modulator positions, and one 6J5GT as the super regenerative detector and r-f oscillator.



## ANSWERS By



The need for controlled processes and uniform quality in parts has been answered by Triplet in setting up manufacturing facilities that make the company practically self-sustaining in the fabrication of instrument and tester components.

Shown here is a view of one section of the automatic screw machine department in the modern Triplet plant where essential parts—some as minute as the smallest used in watches—are turned out 24 hours a day. More and more, Triplet has turned to wholly automatic fabrication of materials to speed up production and to eliminate any possibility of human error. To assure parts best suited for Triplet needs, company engineers have pioneered in the design and manufacture of countless fabricated materials including switches, bar knobs, resistors, jacks, special adapters, etc.—a complete service intended to give each user the fullest measure of satisfaction.

**THE TRIPLETT ELECTRICAL INSTRUMENT CO.**  
Bluffton, Ohio

## Relays WITHOUT Delays

Your particular needs in signalling and control devices and equipment have already been anticipated and met by Autocall. More than 30 years of leadership is your assurance of efficiency. Long, economical service is your final proof of it.

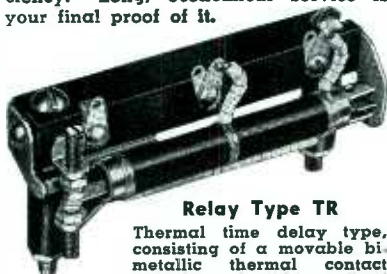

**Relay Type TR**

Thermal time delay type, consisting of a movable bimetallic thermal contact strip housed within a fixed tubular heating unit. The entire element is mounted on a bakelite block for panel installation. Can be supplied for panel mounting or with jack type base.

**The AUTOCALL Co.**  
SHELBY, OHIO

Send for **FREE** Catalog

AUTOCALL COMPANY  
Shelby, Ohio  
Without obligation, please send me a copy of your new No. R-6 catalog on signalling, control devices and equipment.

Name .....  
Address .....  
City ..... State.....

## High Frequency Power Tube

A NEW RADIO TRANSMITTING tube, especially designed for high frequency application, has been announced by the Vacuum Tube Department, General Electric Company, Schenectady, N. Y. This is a water-cooled tube known as Type GL-8009, and can be used as a Class B modulator, a radio frequency amp-



lifier, and as an oscillator. Lead inductance is minimized through the use of a six-pole terminal mount. Although primarily designed for television service, the tube is suitable for any high-frequency broadcast application, and may be used at small power rating up to 25 Mc. At reduced output it may be used for frequencies as high as 100 Mc.

## Deltabeston Wire

A NEW STANDARD Deltabeston wire was announced recently by General Electric's appliance and merchandise department at Bridgeport, Conn., but should be of interest to radio and communication engineers especially where high temperatures are likely to be involved. The wire is available in sizes from No. 20 to No. 8, is insulated with a synthetic film and a highly compressed covering of felted asbestos, and may be obtained in black, white, red, blue or green. The asbestos insulation is thoroughly saturated with a moisture and heat-resistant finishing compound.

## Time Base Generator for Oscilloscope

ENGINEERS OF THE Allen B. DuMont Laboratories, Passaic, N. J. have developed the type 215 linear time base generator for facilitating studies of low-frequency phenomenon such as vibration studies, strain analysis, physiological applications and similar usages.

The generator has a frequency range of from 0.2 to 125 cps with a maximum undistorted output voltage of 500 volts d.c. Signal blanking facilities are provided. The instrument is housed in a metal case, measuring 14x8x17½ inches. It is provided with a leather carrying handle and weighs 35 pounds.

**UTAH-CARTER PARTS**  
MIDGET MOTORS • SPEAKERS  
VIBRATORS • TRANSFORMERS

## MIDGET MOTORS



The Utah standard midget shaded pole reversible motor with various gear trains, clutch action for positive stop of driven load and thermostatic protection is being used for A. C. work, where intermittent duty torque up to 50 ounce inches is required.

Write for details about the new Utah midget .008 HP permanent magnet field motor with governor for adjustable constant speed for control work on armament and aviation devices. Dimensions 1½" x 2" x 3¼".



## VITREOUS ENAMELED RESISTORS



Utah-Carter Vitreous Enameled Resistors represent over a decade of experience, starting with the first 10- and 20-watt types made by the Carter Radio Company, and progressively improved by engineers and technicians of the present company.

A minimum of two separately fired coats of Vitreous enamel forms a hard, glassy surface—adhering permanently to the porcelain tube core, resistance wire and terminals. Resistors 5- to 200-watts are available either as Fixed—Tapped—or Adjustable. Numerous styles of mounting hardware are available to meet your individual requirements.

## UTAH WIREWOUND CONTROLS



Rheostats, Potentiometers, Attenuators. High quality resistant wire evenly wound on a substantial core is clamped tightly to the control housing, resulting in a rugged and dependable variable resistor. Five sizes—3, 4, 9, 15, and 25 watts are available in the Rheostats and Potentiometers; resistant elements can be wound linear or to special resistant-curve tapers.

## PHONE JACKS AND PLUGS



The Utah-Carter "Imp" Jacks are popular because they combine compact size, highest quality and economical price; Unique, Patented design makes them the smallest Jack-fitting standard Phone Plugs. These many features added together have made Carter Imp Jacks famous Defense Items.

Phone Plugs, 2- and 3-conductor types, designed to meet your needs—whether it be application, size or shape.

WRITE FOR FULL DETAILS

**UTAH RADIO PRODUCTS COMPANY**

837 ORLEANS STREET • CHICAGO, ILL.

Ready for  
any  
**BLACKOUT!**



★ Here's an unretouched photo made in pitch blackness of the new *Blackout Panel* now available with the DuMont Type 208 Oscilloscope.

For the first time you are offered an oscilloscope with self-illuminated panel that can be used with equal ease in darkness or in full light. There are times when such an instrument must be used under adverse lighting conditions—or even with no light at all in which case the *Blackout Panel* is indispensable.

The specially-processed steel panel is treated with luminous paint that retains its maximum luminosity for several minutes after exposure to ordinary light, and can be observed for an hour or more after that. It can be kept activated by ultra-violet light. The *Blackout Panel* is now an optional feature with the DuMont Type 208 Oscilloscope, providing still another refinement in this outstanding general-purpose instrument.

Write for Literature . . .



## Wide Range Signal Generator

A NEW SIGNAL GENERATOR covering a frequency range of from 50 to 400 Mc in one range, with an output voltage continuously variable from 0.2 microvolt to 0.2 volts, has been developed by the Measurements Corp., Boonton, N. J. The output of the impedance is a 36-ohm balanced network with an impedance to ground of 18 ohms. Continuously variable modulations up to 50 percent from 400 and 1000 cps internal oscillator or from an external source is available. The modulating amplifier is built into the equipment. The fre-

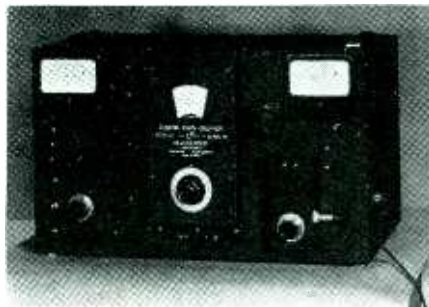

quency band is directly calibrated and has a spiral scale approximately 5 feet in length in addition to a linear scale having 6,000 divisions. A motor driven tuning dial is employed to cover the complete range. The unit is completely operated from the power line, the rectifier and filter being equipped with a built-in voltage regulator. The heater of the oscillator to operate on direct current, and a 6-step 120 db balanced resistance attenuator offers constant output impedance over the whole frequency and output range. The overall size of the unit is 14x24x14 inches and the generator weighs approximately 90 pounds. The price is \$1700.

## Mallard Speaker

ORIGINALLY DEVELOPED for the Navy the new waterproof speaker developed by Cinaudagraph Speakers, Inc., 921 W. Van Buren Street, Chicago, will be known under the trade name of "The Mallard." These speakers are of the permanent

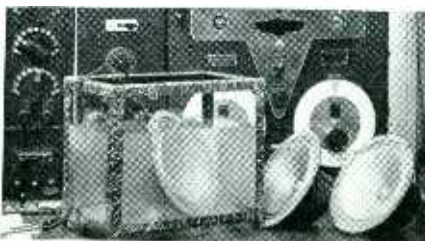

magnet type and range in size from 3½ to 12 inches. They are particularly suitable for marine and outdoor installations and were originally developed with the rigid requirements of the Navy in mind. The cone and the spider were made of water-resistant material and a non-soluble cement is used in fastening them together. All

metal parts of the unit are first plated and then treated with a water-repellant coating. Except for the greater power required to activate the unit, these speakers are said to operate as well under water as in the air. The cone action was the same in either medium, but the voice coil withstood 300 percent greater power when the speaker was completely submerged, because of the weight of the water present against the assembly.

## F-M Monitor Speaker

A NEW HIGH FIDELITY loudspeaker and high-fidelity amplifier for use in monitoring f-m broadcasts has been announced by the radio and television department of the General Electric Company, at Schenectady, N. Y. The high fidelity is achieved with the use of the single speaker, thereby departing from the previous practice of using a low-frequency speaker or "woofer" and a high-frequency speaker or "tweeter" to cover the complete audio range.

The speaker is mounted in a cabinet of walnut veneer and may be used on either a table or desk top. It is recommended for use on a special base designed as a companion unit, the base being about 18 inches high and having provision for mounting the high-fidelity amplifier.

## All-Way Speaker Baffle

A LOUDSPEAKER BAFFLE of new design, and projecting sound uniformly over an angle of 360 degrees through five evenly spaced apertures arranged in a horizontal plane, is announced as a new development of the Commercial Sound Division of the RCA Manufacturing Company, Camden, N. J. The unit is intended primarily for use in paging and announcing in industrial plants.

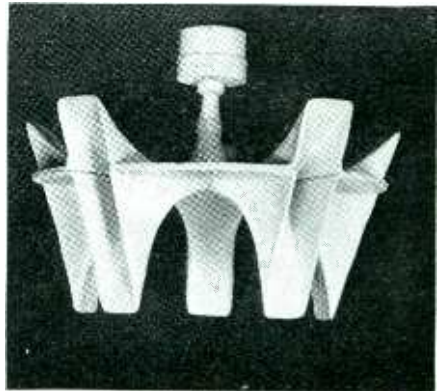

The new baffle distributes sound pressure uniformly over a radius of 50 feet. It is designed for operation with 5, 10, 12, or 15-watt loudspeaker mechanisms, all of which are interchangeable. Only one speaker driving mechanism is required. The baffle is constructed of non-metallic, non-vibratory acoustic material, which it is claimed has been especially developed for this purpose. The baffle is 20 inches high, 20 inches deep, and weighs 10 pounds.

## New Aerovox Products

THREE NEW PRODUCTS have recently been announced by the Aerovox Corporation, New Bedford, Mass. One of these is a new and smaller insulated molded carbon resistor available in  $\frac{1}{2}$  and 1-watt sizes. These units are considerably smaller than previous ones bearing the same ratings and type numbers, and the reduction in size is attributed to improvements in the resistance elements which in no way reduces the low-handling properties of the units.

A still wider choice of terminals has also recently been announced by Aerovox for their popular bathtub oil-filled

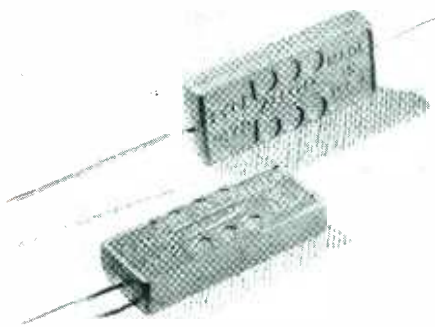

non-inductive paper condensers. The terminals are constructed of "double-rubber" bakelite, permanently riveted to the case. The fixed, riveted lug type terminal is standard, but stud-and-nut terminals with movable lugs can be had on special order.

Type 1478 is the catalog number of new postage-stamp molded bakelite receiving condensers shown in the illustration. The same molded casing is used for the Type 1479 condensers with silvered mica section. Both types have working voltage ratings of 500 volts.

## F-M Antenna Coupler

THE INCLUSION OF F-M reception along with the already well-known features of all-wave reception and minimized noise, marks the latest development in the multicoupler antenna system for apartment houses and other multi-radio buildings, according to Amy, Aceves & King, Inc., 11 W. 42nd St., New York. The new type system usually employs a doublet of two wires, one 45 feet long and the other 15 feet long. Transmission lines from the antenna connect with the outlet couplers. As many as 20 couplers can be served with a single aerial and transmission line. No switching or other changes are required in making the outlet instantly available for satisfactory broadcast, short-wave, or frequency modulation reception.

The principles of antennas for f-m reception were discussed by Mr. Aceves in the September issue of *ELECTRONICS*. Unfortunately in this article, the captions for Fig. 4 and Fig. 5 were inadvertently transposed.

★ ★ ★ ★ ★ ★ ★ ★ ★ ★

# SUN DELIVERS the GOODS!

★ **GREATEST STOCK EVER IN RADIO HISTORY!** ★  
★ **—PARTS and SUPPLIES OF ALL TYPES—** ★

★ SUN RADIO, too, has been doing its part in this great preparedness campaign! ★  
★ Our present stock of radio parts and electronic equipment is the greatest ★  
★ ever in our history. Months back, visualizing the growing tendency of gov- ★  
★ ernment restriction and allotment of material for commercial and civilian ★  
★ use we placed enormous orders with our regular factory suppliers for parts ★  
★ and supplies of all types. Therefore, why not try us when you next require ★  
★ something urgently? You'll be amazed at our prompt, rapid service even in ★  
★ the face of present, trying conditions. ★

A Complete Source of Supply for  
ENGINEERS • LABORATORIES  
INDUSTRIAL ORGANIZATIONS • MANUFACTURERS  
BROADCAST STUDIOS • RADIO AMATEURS  
SCHOOLS • COLLEGES • ARMY-NAVY POSTS • AIRPORTS

New York's Oldest Complete Radio Organization

## SUN RADIO CO.

212 FULTON STREET • BARCLAY 7-1840 • NEW YORK CITY

*The* **VIBROTEST**  
TODAY'S MODERN INSTRUMENT  
FOR INSULATION TESTING

**ACCURACY . . . SIMPLICITY**

Reliable Insulation Testing is now as simple as the twist of a knob and the press of a button! Readings are shown in Ohms and Megohms with a constant potential of 500 volts. Connection errors are eliminated through use of *only TWO* binding posts for *all* ranges. An additional, *exclusive* function of this versatile instrument is its accurate readings as a *Voltmeter*, having three AC and three DC ranges. For complete description and prices—

*Write for Bulletin No. 201-C*

**ASSOCIATED RESEARCH, INC.**  
MFRS. KEELER POLYGRAPH—THE "LIE DETECTOR"  
431 SOUTH DEARBORN STREET • CHICAGO

## "TENSITE"

*the 1.4 volt*

## FILAMENT

**WILBUR B. DRIVER CO.**  
NEWARK, NEW JERSEY

**NEW SHURE**  
**VOICE UNIDYNE**  
**CARDIOID DYNAMIC**  
*Microphones*  
**Specially Engineered for Speech and Singing**



Shure Patent No. 2,237,298.

**N**OW—a series of *voice* models in the famous "Unidyne" family! Combines emphasis on *voice* response with all the advantages of Shure \*patented "Uniphase" cardioid performance and *dynamic* ruggedness. Dead at rear. Reduces interference from background noise, reflection and reverberation indoors or outdoors. Ideal for Remote Broadcasting, Recording, Communications and Public Address. *Model 55AV*—for 35-50 ohm circuits, list price, \$47. *Model 55BV*—for 200-250 ohm circuits, list price \$49.50. *Model 55CV*—high impedance, list price \$49.50.

Write for Bulletin 171M.



**SHURE BROTHERS**  
 "Microphone Headquarters"  
 225 W. Huron St., Chicago, U. S. A.

**Precision Voltage Divider**

DECADE VOLTAGE DIVIDERS in any capacity and calibration desired are available from the Shallcross Mfg. Co., Collingdale, Pa. The standard design of the Shallcross rotary instrument switches and decade resistance boxes permit this flexible arrangement in an entirely practical manner.

The diagram shows a unit having four dials. Resistance is between AB and CD and may be used independently as

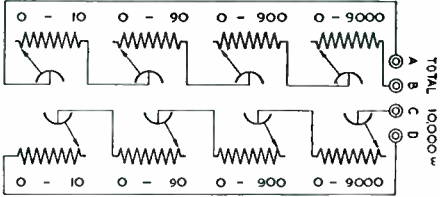

a resistance box. When the dials are rotated clock-wise, resistance between A and B will be increased, while that between C and D will be decreased. By connecting the link between terminal B and C, the instrument may be used as a voltage divider with the resistance between A and D constant at all settings of the dial. Voltage ratios of 0.0001 to 1.0 may be obtained although other ranges are available on special order.

**Voice Model Unidyne**

SHURE BROS., CHICAGO, announce that their Unidyne dynamic cardioid microphone has now been made available in a series of "voice" models for police and commercial radio use as well as for public address, paging, broadcasting and recording applications. No response is obtained immediately from behind the microphone, and low impedance models permit practically unlimited cable to the microphone and its associated amplifier. Three models are available. Model 55AV is for circuits having an impedance of 35 to 50 ohms, and lists at \$47. Model 55BV is provided with an internal transformer and operates from 200 to 250 ohms circuits and lists at \$49.50. The Model 55CV, also at \$49.50 is a high impedance unit with internal transformer.

**Decade Inductance**

A LABORATORY UNIT which will be especially appreciated by the engineer setting up experimental filters, equalizers, tuned amplifiers, phasing networks, and the like, is the decade inductance manufactured by the New York Transformer Company, 480 Lexington Avenue, New York City. These decade inductances are available in decades from 0.001 henry per step to 10 henries. The precision of adjustment is  $\pm 5$  percent. The units are intended for use between the frequencies of 50 to 20,000 cps, and for operating levels up to 30 db. The instrument can be obtained in either two or three decades in any of the inductance ranges desired.

**Tracing Cloth**

GOOD, CLEAR BLUE PRINTS are made from pencil tracings on the new white tracing cloth, Whitex, manufactured by The Frederick Post Company, Box 803, Chicago, Ill. Whitex takes colored pencils sharply and plainly, and produces a jet black on a deep blue background in the final print. Erasures are clean.

**Vibration Dampers**

TO MEET THE INCREASINGLY important problem of vibration elimination, anti-vibration mountings manufactured by the Lord Manufacturing Company,

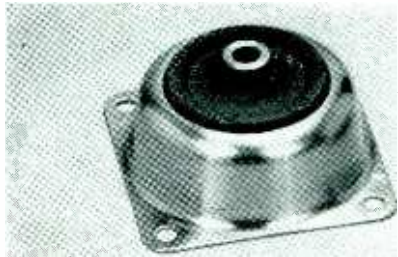

Erie, Pa., are finding extensive use. One of their important applications is as an integral part of recording equipment where noise and vibration must be reduced to a minimum.

**WAXES • COMPOUNDS for ELECTRICAL INSULATION**

Zophar offers prompt service on Insulating Compounds for a wide variety of electrical applications, including:

... insulation for CONDENSERS, TRANSFORMERS, COILS, power packs, pot heads, sockets, wiring devices, wet and dry batteries, etc. Also WAX SATURATORS for braided wire and tape. WAXES for radio parts.

Special compounds made to your order.

**ZOPHAR MILLS INC.**  
 130-26th St. Brooklyn, N. Y.  
 FOUNDED 1846

## Storage in Television Reception

(Continued from page 49)

opaque deposit which travels in the direction of the electric field through the lattice toward the anode and ultimately disappears there.

The total time of travel of the deposit through the crystal, or in other words the persistence of constant opacity at one element, depends upon the strength of the electric field and temperature and certain crystal constants. A simple calculation shows<sup>s</sup> that with a sylvine crystal one mm thick and a potential of 600 volts at its ends, the deposit would move through the crystal, or remain in visible existence, within 1/30 second, equal to the frame period of present television standards. At the same time when the deposit at a certain element enters the anode, thus disappearing, the scanning cathode-ray beam returns to this element and creates a new deposit of a value belonging to the following frame, at the cathode side of the crystal. This deposit starts on its travel through the crystal toward the anode which it reaches at the end of this frame period. It is thus possible to retain the elemental intensity values constant over the entire frame period, and change them at the end of this period to the values corresponding to the following frame, in other words to attain full storage television reception.

This system has been developed to a certain extent in England, using microcrystalline crystal screens obtained by vacuum evaporation, in demountable cathode-ray tubes, and projecting the pictures by a conventional lantern-slide-projection arrangement on a white screen. Reception results of television transmissions from the London transmitter in Alexandra Palace were very promising both regarding definition and representation of movements. These experiments led to the

RADIO? COMMUNICATIONS? ELECTRIC POWER?

There is a PRECISION INDUSTRIAL CIRCUIT TESTER to meet your INDIVIDUAL SENSITIVITY REQUIREMENTS

Ranges to 6000 Volts—60 Amps—10, 20 or 60 Megs—70 DB  
1000, 5000 or 20,000 ohms per volt!

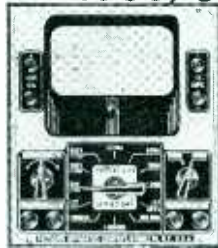

★ Series E44 (illustrated above)  
1000 ohms/volt AC and DC

★ Series E45 5000 ohms/volt DC  
Plus 1000 ohms/volt AC and DC

★ Series E56 20,000 ohms/volt DC  
Plus 1000 ohms/volt AC and DC

★ SELECT THE AC-DC  
VOLT-OHM-DECIBEL-MILLIAMMETER  
BEST SUITED TO YOUR NEEDS

ADD THE SERIES J ★  
MULTI-RANGE A.C. AMMETER

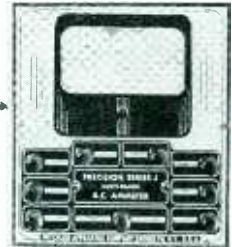
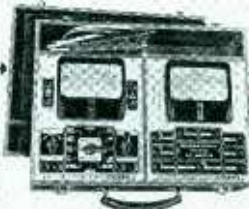

★ Series J (illustrated above). Eight AC ammeter ranges, 300 MA full scale to 60 AMPS. Available individually or as companion unit to Series 844, 845 or 856.

★ Series 844-J Combination AC-DC Industrial Circuit Tester (center illustration). Complete with ohmmeter batteries and high voltage test leads. Furnished in walnut finished hardwood portable case, size 11 x 15 x 6" \$48.95

★ Series 845-J Combination AC-DC Industrial Circuit Tester. Complete as above \$52.95

★ Series 856-J Combination AC-DC Industrial Circuit Tester. Complete as above \$59.95

WRITE FOR NEW PRECISION INDUSTRIAL TEST INSTRUMENTS CATALOG No. 42-E

**PRECISION TEST EQUIPMENT**  
**INDUSTRIAL · LABORATORY · RADIO · TELEVISION**  
PRECISION APPARATUS COMPANY • 647 KENT AVENUE • BROOKLYN, N. Y.  
Export Division: 458 Broadway, New York City, U. S. A. • Cable Address: Morhanex

# Smooth!

We planned and labored . . . suffered with our early results . . . we nursed and developed it. And now . . . the picture of health, with a surface as smooth as . . .

The **GOULD - MOODY "Perfected"**

## GLASS BASE RECORDING DISC

UNCONDITIONALLY GUARANTEED against ANY and ALL defects (mechanically, chemically, etc. . . .) as well as against breakage while in transit.

Available in 12 and 16 inch sizes, with one or two holes (center hole only or center and drive-pin holes), whichever you prefer.

Aluminum blanks may be recoated at a nominal charge  
**IMMEDIATE DELIVERIES OF ALL ORDERS**  
Recording Blank Div.

**THE GOULD-MOODY CO.**  
**395 BROADWAY NEW YORK, N. Y.**

# No chance for Argument - No NEED of any



Wire wound RESISTORS by Instrument Resistors, Inc., perform with absolute dependability wherever they



TYPE ML 1 Watt

are used. ● Our advanced winding methods cut your costs and speed up production. We stop delivery delays before they occur! ● Consult Instrument Resistors, Inc. You'll get the exact units you want - WHEN you want them. Catalog upon request.

INSTRUMENT RESISTORS, INC.

Little Falls, N. J.

## INTRODUCING UNITED DYNAMOTORS



1. The standard two commutator type from 80 to 375 watts output.
2. The dual and triple output types with any combination of A.C. and D.C. voltages as required.
3. Special generators and D.C. motors.

Write for bulletin #5M921.

**United Engineering Co.**

655-659 No. MAY ST.

CHICAGO, ILL.

## SEARCHLIGHT SECTION

(Classified Advertising)

EMPLOYMENT: BUSINESS: "OPPORTUNITIES" : EQUIPMENT USED OR RESALE

UNDISPLAYED — RATES — DISPLAYED

10 CENTS A WORD. MINIMUM CHARGE \$2.00  
Positions Wanted (full or part time salaried employment only) 1/2 the above rates payable in advance.  
Box Numbers—Care of publication New York, Chicago or San Francisco offices count as 10 words.  
Discount of 10% if full payment is made in advance for 4 consecutive insertions.

Individual Spaces with border rules for prominent display of advertisements. The advertising rate is \$8.00 per inch for all advertising appearing on other than a contract basis. Contract rates quoted on request.  
An advertising inch is measured 7/8" vertically on a column — 3 columns — 30 inches to a page.

### POSITION VACANT

EXPERIENCED ELECTRICAL ENGINEER thoroughly conversant with all types of transformers and reactors used by the Army, Navy and Air Corps desired by Midwestern transformer manufacturer. Excellent opportunity. P-293, Electronics, 520 N. Michigan Ave., Chicago, Ill.

### FOR SALE

COMPLETE PROFESSIONAL RECORDING Equipment, well engineered amplifier, Allied Tables, RCA, Amperite microphone, Miller Tuners, Jensen 15". Reasonable \$1,500. FS-292, Electronics, 330 W. 42nd St., New York, N. Y.

### WANTED

ANYTHING within reason that is wanted in the field served by Electronics can be quickly located through bringing it to the attention of thousands of men whose interest is assured because this is the business paper they read.

### At Your Service . . .

—for bringing business needs or "opportunities" to the attention of men in executive, management, sales and responsible technical, engineering and operating capacities with industries served by McGraw-Hill Publications: The SEARCHLIGHT SECTIONS (Classified Advertising).

Departmental Staff  
McGraw-Hill Publishing Co., Inc.  
330 W. 42nd Street New York, N. Y.

American Machinist  
Aviation  
Business Week  
Bus Transportation  
Chem. & Met. Engineering  
Coal Age  
Construction Methods  
Electrical Contracting  
Electrical Merchandising  
Electrical World  
Electronics

Eng. & Min. Journal  
Engineering News-Record  
E. & M. J. Markets  
Factory Management and Maintenance  
Food Industries  
Photo Technique  
Power  
Product Engineering  
Textile World  
Transit Journal

### DEPENDABLE

Used

### ELECTRONIC TUBE EQUIPMENT

Complete line of used equipment for the manufacture of Radio Tubes, Neon Tubes, Incandescent Lamps, etc. Write for Bulletin showing 25 to 75% savings.

CALLITE TUNGSTEN CORPORATION  
formerly Eister Electric Corp.  
534 39th Street, Union City, N. J.

### HIGH GRADE USED

### ELECTRON TUBE MACHINERY

Huge Stock of Every Type and Variety

### KAHLE ENGINEERING CORPORATION

Specialists in Equipment for the manufacture of Neon Tubes, Radio Tubes, Incandescent Lamps, Photo Cells, X-ray Tubes, etc.

900 DeMott St., North Bergen, N. J.

## RADIO CONTROLLED TARGET BOAT



A radio controlled target boat was recently used in a test of the coast defenses against mosquito type boats at Fort Story, Virginia. Anti-aircraft weapons and their range-finding equipment were used against this horizontal target which was controlled from an army mine-layer

### REFERENCES

1. A. H. Rosenthal, *Proc. I.R.E.*, vol. 28, p. 203, 1940.
2. D. M. Robinson, *Proc. I.R.E.*, vol. 27, p. 483, 1939.
3. J. H. Jeffree, *Television* (London), vol. 9, 260, 1936.
4. Debye and Sears, *Proc. Nat. Acad. Sci.*, vol. 18, p. 410, 1932.
5. British Patent No. 509,766.
6. V. K. Zworykin, Brit. Pat. No. 376,498; J. L. Baird, Brit. Pat. No. 454,589,470,347.
7. A. H. Rosenthal, *Electronics & Television*, Feb. & March, 1940. *Proc. I.R.E.*, vol. 28, p. 203, 1940.
8. A. H. Rosenthal, *Proc. I.R.E.*, vol. 28, p. 207, 1940.

. . .

## Fluorescent Materials

(Continued from page 34)

preciable phosphorescence. The rate of decay of luminescence varies with the type and concentration of the activator as well as with temperature. In general the rate of decay increases with increasing temperature. The table gives the approximate persistence times for a number of typical phosphors. This is the time required for the luminescence to drop to 1 percent of its initial value. Materials which show phosphorescence require a measurable time after excitation begins before reaching their full luminescent output. For willemite this built-up period is approximately 0.03 second.

In television kinescope screens phosphorescence must be kept to a minimum to avoid trailing afterglows behind rapidly moving image highlights. However, in fluorescent lamps operated on alternating current a long persistence time is advantageous since it reduces stroboscopic flicker. For cathode-ray tubes used to observe transient effects a luminescent screen with a memory is often an advantage.

Of primary interest in cathode-ray screens is the light output of the screen material as a function of the energy and current density of the electron beam. For low current densities the light output increases linearly with current density, but begins to show saturation at higher current densities. This departure from linearity is shown by the separation between the light output curves and the 45-deg. lines shown in Fig. 6. Each material shows a different degree of departure from linearity.

For a given current density, the energy of the electron beam as it strikes the screen is determined by the screen potential. This in turn depends upon the voltage applied to the accelerating electrode and upon the secondary emission of the materials making up the screen. The screen floats at a potential such that electrons leave it at the same rate at which they arrive. If one or more

**NOW MORE THAN EVER**  
*Personal* ATTENTION COUNTS

**For Tested Accuracy**  
**L. R. TEEPLE**  
insists on  
**WILCO**  
**Thermometals**



Working on defense or commercial contracts? Either way—you want accurate, dependable materials today more than ever before. In choosing your thermostatic bi-metals, follow the example of such quality manufacturers as temperature-control maker L. R. Teeple . . . insist on Wilco Thermometals. Not only is every order carefully checked during every stage of manufacture, it is supervised *personally* by Wilco principals.

And just as Wilco meets these exacting requirements for thermometals to provide absolute dependability for temperature control—or reaction from temperature change—so do Wilco Electrical Contacts assure dependable service. Write for full information without delay.



**The H. A. WILSON CO.**  
105 CHESTNUT ST., NEWARK, N. J.  
*Branches: Chicago and Detroit*

**FLUCTUATING  
LINE VOLTAGE**



**CONSTANT  
VOLTAGE**

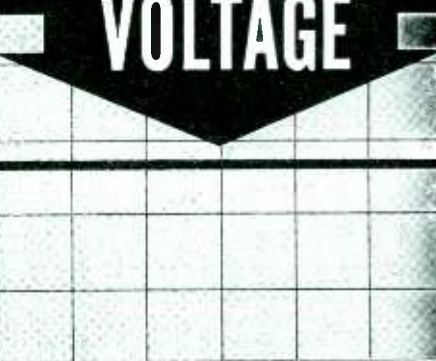

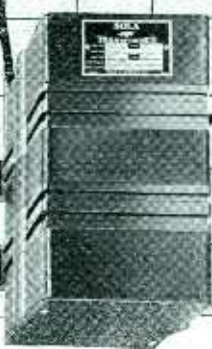

**Ask For  
BULLETIN  
DCV-74**



Whether it's 1 VA for an instrument or 10 KVA for a production line—here's constant, stable voltage for you at all times, even though the line voltage varies as much as thirty percent.

They are fully automatic and instantaneous in operation—have no moving parts—require no maintenance—and are self-protecting against short circuit.

You can build a SOLA CONSTANT VOLTAGE TRANSFORMER into your product, or incorporate it in your production line or laboratory and know that every test will be made under identical line conditions. Compact—economical. Standard designs are available, or units can be built to your special specifications.

**SOLA ELECTRIC COMPANY, 2525 Clybourn Ave., Chicago, Ill.**

**S O L A**

*Constant Voltage* **TRANSFORMERS**

## PROFESSIONAL SERVICES

(Rates on Application)

### JOHN C. BATCHELOR

INDUSTRIAL PHYSICISTS-ENGINEERS

Specialists in industrial, technical and marketing investigations for manufacturers and bankers on products being considered for production and financing.

100 E. 42nd Street New York City

### DUDLEY B. CLARK

Consulting Engineer

Industrial Tube and Circuit Design.  
Electronics as applied to Metal and Chemical Industries.

Research Laboratories and Shops  
Palm Springs Calif.

### ELECTRICAL TESTING LABORATORIES

Characteristics of Vacuum Tubes  
Tests of photo cells, glow lamps, crater lamps.  
Tests of electronics and optical devices  
East End Avenue and 79th Street  
New York, N. Y.  
Phone, Butterfield 8-2600

### INTERNATIONAL ELECTRONICS, INC.

Special Instruments, Equipment and Methods to control gauging, welding, communications, signaling, safety, inspection, color and testing.

Quality control and cost reduction for mechanical, electrical, metallurgical and chemical industries.

Rockefeller Center New York City  
Telephone Circle 6-8494

### HAROLD J. McCREARY

Mem. A.I.E.E. & W.S.E.

Consulting Engineer

Laboratory Facilities  
Research Electronics  
Development Television  
Design Radio  
Factory Practice Railroads Signaling  
Patent Studies Telephony  
105 W. Adams St. Phone State 4003 Chicago, Ill.

### JOSEPH RAZEK, PH.D.

Consulting Physicist

Electrical and Mechanical Engineering Problems  
Instruments and Control Devices Electronics  
Specialist in Colorimetry, Spectrophotometry and  
Industrial Color Control

Laboratory and Shop Facilities  
430 Greenview Lane Llanerch, Pa.

### CHARLES WATSON SIDNEY

Consultant

RESISTANCE WELDING  
INDUCTION HEATING  
WELDING POWER SYSTEMS

8 Woodcroft Rd., Summit, N. J.

### Professional Assistance . . .

in solving your most difficult problems in the specialized field of electronic devices is offered by consultants whose cards appear on this page.

secondary electrons result from the impact of each electron in the beam the screen potential will not differ greatly from the potential of the accelerating electrode, but if the accelerating voltage is such that less than one secondary electron results from each impinging electron, the screen potential becomes negative with respect to the accelerating electrode. When this latter condition sets in the light output per unit increase in accelerating voltage begins to decrease. Most phosphors are good secondary emitters, but there is considerable variation in this property from one phosphor to another.

Figure 7 shows how the light output from two willemite screens varies with the accelerating voltage. Screen A is composed of particles averaging 2 microns in diameter sprayed on glass to a density of 5.37 milligrams per sq. cm., while screen B is composed of particles 1-2 microns in diameter, and of surface density 0.77 milligrams per sq. cm. The thick screen begins to show saturation effects at 6000 volts for all values of current density, but the thin screen shows no such effects even at 15,000

volts. For static bombardment it will be noted that saturation is complete at 9000 volts.

For accelerating potentials below saturation the light output, for most phosphors, can be expressed by a law of the form  $L = Af(i)V^n$ , where  $A$  is a constant,  $f(i)$  is a function of the beam current density, and  $V$  is the accelerating potential. The exponent  $n$  varies from a value less than 2 for willemite and other zinc silicates to approximately 2 for the sulphides. For some mixture screens it may exceed 2. For Screen A of Fig. 7,  $n$  has the value 1.84 and for the thicker Screen B the value 1.23 for dynamic bombardment.

### REFERENCES

- (1.) "Optimum Efficiency Conditions for White Luminescent Screens in Kinescopes" by H. W. Leverenz. *Journal of the Optical Society of America*, 30, 309-315 (1940). Figs. 1 and 5 are taken from this article.
- (2.) "Luminescent Materials" by H. W. Leverenz and Frederick Seitz. *Journal of Applied Physics*, 10, 479-493 (1939). Figs. 2, 3, and 4 are taken from this article.
- (3.) "Light Output and Secondary Emission Characteristics of Luminescent Materials" by S. T. Martin and L. B. Headrick. *Journal of Applied Physics*, 10, 116-127 (1939). Fig. 6 is taken from this article.
- (4.) "The Behavior of Willemite Under Electron Bombardment" by E. R. Piore and G. A. Morton. *Journal of Applied Physics*, 11, 153-157 (1940). Fig. 7 is taken from this article.

## ELECTRONIC PROBLEMS quickly, accurately SOLVED

with the help of latest data on electronic devices, developments, theory—given in this new book

## Just Published ELECTRONICS

By J. Millman and S. Seely  
Dept., Elec. Engineering, C.C.N.Y.

699 pages, 6x9 illustrated, \$5.00



COORDINATING the physical theory of electronics and the theory of operation of electronic devices, this book systematically presents a lucid and well-rounded explanation of basic electronic principles together with their applications to many problems in electrical engineering and physics. General considerations of both vacuum and gas filled electronic devices are included.

Based on present-day developments, considerable attention is given to material that is of commercial importance, including television pick-up devices, secondary emission multipliers, cold cathode gas triodes, vapor and fluorescent lighting, controlled rectifiers, modern photocells, etc.

### SEND COUPON FOR 10 DAYS' FREE EXAMINATION

McGraw-Hill Book Co., 330 W. 42nd St., New York  
Send me Millman and Seely's *Electronics* for 10 days' examination on approval. In 10 days I will send you \$5.00 plus few cents postage or return book postpaid. (We pay postage if remittance accompanies order.)

Name .....  
Address .....  
City and State .....  
Position .....  
Company ..... L 10-41  
(Books sent on approval in U. S. and Canada only.)

### CHAPTERS

Introduction  
Motion of Charged Particles in Electric and Magnetic Fields  
Applications of the Motion of Particles in Applied Fields  
Electrons in Metals  
Phenomena at the Surface of Metals  
Characteristics of Thermionic Cathodes  
The High-vacuum Diode  
The Kinetic Theory of Gases  
Fundamental Processes in Gases  
Electrical Discharges in Gases  
Commercial Gas Tubes  
Rectifiers  
Controlled Rectifiers  
Filters for Rectifiers  
Photoelectricity and Photoelectric Cells  
Triode Characteristics  
Triodes as Circuit Elements  
Multielectrode Tubes  
Voltage Amplifiers  
Audio Frequency Power Amplifiers



# CONTACTS

FOR THE FIELD OF ELECTRONICS



**SIGNAL & INDICATOR PILOT LIGHTS**  
for all electrical devices.

WRITE FOR CATALOGUE showing a complete line of assemblies for all purposes.

**SIGNAL INDICATOR Corp.**  
140 CEDAR ST. NEW YORK, N. Y.



Send for Catalog  
**ROTARY DRIVE Rheostat**

3 Fox Hurst Road  
Bardonia, N. Y.

*Rex Rheostat Co.*

## NEON GLOW LAMP PILOT-LIGHT RECEPTACLES

Three different units designed especially for use with G.E. Neon Glow Lamps, types S14, G10 and T4½. All for single hole panel mounting.



**G10P Unit**  
Overall Dia. 2"  
Overall Depth Behind Panel 1¾"  
Uses 1 or ½" Watt Lamp on 120 V. 1 Watt Lamp on 220 V.  
Secure Catalogue

Distributed Nationally By  
**GRAYBAR ELECTRIC CO.**  
H. R. KIRKLAND CO. MORRISTOWN, N. J.

**We manufacture a complete line of equipment**

SPOT WELDERS, electric, from ¼ to 500 KVA	AC ARC WELDERS
TRANSFORMERS, special and standard types	WELDERS
INCANDESCENT LAMP manufacturing equipment	From 100 to 400 Amps.
FLUORESCENT TUBE MAKING EQUIPMENT	
ELECTRONIC EQUIPMENT, vacuum pumps, etc.	
WET GLASS slicing and cutting machines for laboratory use	
GENERAL GLASS working machines and burners	
COLLEGE GLASS working units for students and laboratory	

**EISLER ENGINEERING COMPANY, CHAS. EISLER, Pres.**  
751 So. 13th St. (near Avon Ave.) Newark, New Jersey

**CRYSTALS by HIPOWER**

The Hipower Crystal Company, one of America's oldest and largest manufacturers of precision crystal units, is able to offer the broadcaster and manufacturer attractive prices because of their large production and the exclusive Hipower grinding process. Whatever your crystal need may be, Hipower can supply it. Write today for full information.

**HIPOWER CRYSTAL CO.**  
Sales Division—205 W. Wacker Drive, Chicago  
Factory—2035 Charleston Street, Chicago, Ill.

**LECTROHM**  
Vitreous Enameled  
**RESISTORS**

A complete range, from 1 to 200 W. wound with highest grade resistance wire. Tolerances plus or minus 5% (closer tolerances, if needed).  
Wound on low loss ceramic cores. Mounting legs furnished when requested.

SEND FOR SAMPLES  
Give complete data regarding resistance, maximum current, voltage drop required and mounting space available.

**LECTROHM, INC.**  
5131 WEST 25TH PLACE  
CHICAGO (CICERO P.D.) ILL.

**CARE**

Care in the lesser details as well as the important ones is the result of careful and thorough training. It is especially important at Terminal where good service is our best salesman.

**TERMINAL RADIO CORP.**  
2 Stores in New York City  
68 WEST 45TH STREET  
80 CORTLANDT STREET  
Phone VAnDerbilt 6-5050

**HARVEY** Manufacturers  
**ELECTRONIC**  
**RADIO LAB'S Inc.** APPARATUS

447 Concord Ave., Cambridge, Mass.

We welcome your inquiries for  
**LUMINESCENT MATERIALS**  
Fluorescent and Phosphorescent Chemicals for Lamp and Allied Industries  
**GENERAL LUMINESCENT CORP.**  
732 S. Federal St. Chicago, Ill.

**FINE RIBBONS**  
of Tungsten and Molybdenum  
Molybdenum in widths .006" to 1"  
in thickness to .0005"  
Tungsten Ribbon to specification  
**H. CROSS**  
15 Beekman St. New York

QUALITY ABOVE ALL  
**SOLAR**  
CAPACITORS  
Write for Catalog  
**SOLAR MFG. CORP.**  
BAYONNE, N. J.

**Delivery vs. Delay . . .**

When knowing where to find what you need is the deciding factor between DELIVERY and DELAY . . . consult the advertising pages of Electronics. If the advertisements do not tell where to find what you need . . . write

**ELECTRONICS**

**ALL RADIO PARTS AND EQUIPMENT IN STOCK AT HARVEY**

Call Bryant 9-1946 for SERVICE!  
**HARVEY RADIO CO.**  
Conveniently located at Times Square  
103 W. 43 ST. • NEW YORK, N. Y.

**MICROMETER** for checking transmitters,  
**FREQUENCY** from 1.5 to 56 mc.,  
**METER** within 0.01 per cent.

**LAMPKIN LABORATORIES**  
—Bradenton, Fla., U. S. A.—



# AUDAX

## "RELAYED-FLUX" Microdyne

"The Standard by Which Others  
Are Judged and Valued"

is replacing an ever-increasing number of pick-ups on combinations and record-changers.—There must surely be a reason for this.

The "RELAYED-FLUX" principle makes possible a moving system far beyond anything yet devised . . . capable of reproducing all the fine detail engraved at the original recording — MICRODYNE bears out the contention of scientists that high-fidelity is possible only with a Moving-Inductor system.

- Flat within  $\pm 1\frac{1}{2}$  db to over 10,000 cycles
- Vibratory momentum extremely low
- Absence of distortion
- High stylus compliance
- Low Point-pressure
- Complete with special arm

With or without Jewel Point, the sharp, clean-cut *fac simile* reproduction of MICRODYNE — regardless of climatic conditions — is a marvel to all who have put it to the only test that really counts . . . the EAR test.

Pickup List Prices

**\$11.50 to \$198.00**

HIGH FIDELITY CUTTERS  
List to \$150.00

### WITH OUR COMPLIMENTS

A copy of "PICK-UP-FACTS" is yours for the asking. It answers many questions concerning record reproduction.

**AUDAX COMPANY**  
500 Fifth Avenue New York City

"Creators of High Grade Electrical and Acoustical Apparatus Since 1915"

## INDEX TO ADVERTISERS

A		L	
Acheson Colloids Corp.	86	Lampkin Laboratories	119
Acme Electric & Mfg. Co.	97	Lamson & Sessions Co.	55
Acro Electric Co.	95	Lapp Insulator Co.	23
Aerovox Corp.	102	Lectrohm, Inc.	119
Allied Control Co.	102	Lewyt Metal Products Co.	63
American Lava Corp.	65	Lingo & Son, Inc., John E.	90
American Screw Co.	55	M	
American Transformer Co.	10	Maedel Publishing House	105
Amperex Electronic Products, Inc.		Magnetic Windings Co.	103
Inside Front Cover		Mallory & Co., Inc., P. R.	24
Amperite Co.	94	McGraw-Hill Book Co., Inc.	98, 118
Anaconda Wire & Cable Co.	9	Miles Reproducer Co.	95
Associated Research, Inc.	113	Millen Mfg. Co., Inc., James	97
Astatic Corp.	93	Multicores Solders, Ltd.	106
Audak Co.	120	N	
Audio Development Co.	95	National Screw & Mfg. Co.	55
Audio Devices, Inc.	11	National Vulcanized Fibre Co.	21
Autocall Co.	111	New England Screw Co.	55
Automatic Electric Co.	82	New York Transformer Co.	56
B		O	
Bakelite Corp.		Ohmite Mfg. Co.	69
Inside Back Cover		P	
Ballantine Laboratories, Inc.	87	Parker Co., Charles	55
Benwood Linze Co.	105	Parker-Kalon Corp.	55
Biddle Co., James G.	86	Parker-Kalon Corp.	4, 55
Bliley Electric Co.	88	Post Co., Frederick	76
Brand & Co., William	57	Pawtucket Screw Co.	55
Bristol Co.	55	Pheoll Mfg. Co.	55
Bud Radio, Inc.	106	Pioneer Gen-E-Motor Corp.	97
C		Precision Apparatus Co.	115
Callite Tungsten Corp.	80	Presto Recording Corp.	83
Carborundum Co.	108	R	
Carter Motor Co.	86	R-B-M Mfg. Co.	99
Central Screw Co.	55	Radio City Products Co.	98
Centralab Div., Globe-Union, Inc.	2	RCA Mfg. Co.	79, Back Cover
Chandler Products Corp.	55	Raytheon Mfg. Co.	110
Cinadagraph Corp.	101	Remler Co., Ltd.	108
Cinch Manufacturing Corp.	53	Rex Rheostat Co.	119
Clarostat Mfg. Co.	105	Richardson Co.	16
Continental Diamond Fibre Co.	58	Russell, Burdall & Ward Bolt & Nut Co.	55
Continental Electric Co.	94	S	
Continental Screw Co.	55	Scovill Mfg. Co.	55
Corbin Screw Corp.	55	Shakeproof Lock Washer Co.	55
Cornell-Dubilier Electric Corp.	13	Shakercross Mfg. Co.	99
Cross, H.	119	Shure Brothers	114
D		Signal Indicator Corp.	119
Daven Co.	91	Simpson Electric Co.	109
Doolittle Radio, Inc.	104	Southington Hardware Mfg. Co.	55
Driver Co., Wilbur B.	113	Sola Electric Co.	117
DuMont Labs., Allen B.	112	Stackpole Carbon Co.	74
E		Standard Pressed Steel Co.	104
Eicor, Inc.	94	Standard Transformer Corp.	100
Eisler Engineering Co.	119	Standard Transformer Corp.	119
Eitel-McCullough, Inc.	17	Solar Manufacturing Corp.	15
Electrical Research Products, Inc.	82	Sprague Specialties Co.	113
Electronic Laboratories, Inc.	73	Sun Radio Co.	113
Eric Resistor Corp.	22	Superior Tube Co.	71
F		T	
Fairchild Aviation Corp.	89	Taylor Fibre Co.	104
Ferranti Electric, Inc.	103	Terminal Radio Co.	119
G		Thomas & Skinner Steel Prds. Co.	108
Galvin Mfg. Corp.	12	Triplett Electrical Instr. Co.	111
General Electric Co.	5, 59, 78	U	
General Luminescent Co.	119	United Engineering Co.	116
General Radio Co.	77	Utah Radio Products Co.	111
G-M Laboratories, Inc.	101	Union Carbide & Carbon Corp.	
Gould-Moody Co.	115	Inside Back over	
Guardian Electric Mfg. Co.	96	W	
H		Ward Leonard Electric Co.	85
Hallcrafters Co.	90	Welster Electric Co.	72
Hammarlund Mfg. Co., Inc.	8	Western Electric Co.	75
Hardwick Hindle, Inc.	62	Westinghouse Electric & Mfg. Co.	60, 61
Harvey Radio Labs, Inc.	119	Weston Electrical Instrument Corp.	14
Harvey Radio Co., Inc.	119	White Dental Mfg. Co., S. S.	96, 110
Heinemann Circuit Breaker Co.	88	Wilson Co., H. A.	117
Heintz & Kaufman, Ltd.	7	Whitney Screw Corp.	55
Hewlett-Packard Co.	64	Z	
Hipower Crystal Co.	119	Zophar Mills, Inc.	114
Hudson Wire Co.	92	Professional Services	
Hunter Pressed Steel Co.	6	118	
Hygrade Sylvania Corp.	81	SEARCHLIGHT SECTION	
I		(Classified Advertising)	
Instrument Resistors, Inc.	116	EMPLOYMENT	116
International Resistance Co.	19	USED EQUIPMENT FOR SALE	
International Screw Co.	55	Callite Tungsten Corp.	116
International Telephone Development Co.	20	Kahle Engineering Corp.	116
Irvington Varnish & Insulator Co.	66	SEARCHLIGHT SECTION	
J		(Classified Advertising)	
Jensen Radio Mfg. Co.	18	EMPLOYMENT	116
Johnson Co., E. F.	70	USED EQUIPMENT FOR SALE	
Jones, Howard B.	90	Callite Tungsten Corp.	116
K		Kahle Engineering Corp.	116
Kenyon Transformer Corp.	92	SEARCHLIGHT SECTION	
Kester Solder Co.	68	(Classified Advertising)	
Keuffel & Esser Co.	3	EMPLOYMENT	116
Kirkland Co., H. R.	119	USED EQUIPMENT FOR SALE	

# The Importance of SELECTING THE RIGHT PLASTIC

## THERE ARE OVER 2,000 "BAKELITE" PLASTIC MATERIALS TO CHOOSE FROM

When the *right* BAKELITE Plastic is specified, production may often be greatly simplified. Assembly may be speeded. Product performance, too, may be improved, and by taking full advantage of the many opportunities for savings, which the correct use of plastics makes possible, processing costs may generally be cut—sometimes to a surprising degree.

But, what is the right plastic?

There are thousands of BAKELITE Plastics to choose from. In molding materials alone, there are hundreds of different formulas. These come in powder, granular, and sheet form—in Phenolics, Ureas, Cellulose-Acetates, and Polystyrenes. There are thermosetting plastics for compression and transfer molding, and also thermoplastic types for injection molding. Each individual material provides varying degrees of toughness, strength, water resistance, chemical resistance, heat insulation, hardness, dielectric strength, and other physical and chemical properties.

It will pay you to consult Bakelite Plastics Headquarters for help in select-

BAKELITE CORPORATION, 30 EAST 42ND STREET, NEW YORK, N.Y.







*Unit of Union Carbide and Carbon Corporation*

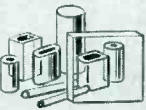

# BAKELITE

The words "Bakelite" and the  Symbol are registered trade marks identifying products of Bakelite Corporation.

## PLASTICS HEADQUARTERS

<b>MOLDING MATERIALS</b>		BAKELITE thermosetting and thermoplastic molding plastics, in powder, granular, and sheet form, including Phenolics, Ureas, Cellulose-Acetates, and Polystyrenes.
<b>LAMINATING VARNISHES</b>		BAKELITE heat-reactive resin varnishes for binding layers of cloth or paper into tough laminated plastic materials furnished in sheets, rods, tubes, and special shapes.
<b>CAST RESINS</b>		BAKELITE transparent, translucent, and opaque cast resins supplied in sheets, tubes, rods, and special castings that can be machined, sawed, drilled, engraved, and polished with standard tools.
<b>OIL-SOLUBLE RESINS</b>		BAKELITE oil-soluble resins for improving the durability, and speeding up the drying time, of paints, varnishes, lacquers, and enamels.
<b>PLYBOND ADHESIVES</b>		BAKELITE plybond adhesives, in liquid and powder form, for bonding plywoods and veneers. Both cold-setting and heat-reactive types.
<b>COATINGS AND LININGS</b>		BAKELITE varnishes and lacquers of the heat-hardenable type employed as chemical- and corrosion-resistant coatings and linings. Also, impregnating, calendering and sealing compounds.
<b>BONDING RESINS</b>		BAKELITE bonding materials are used in manufacture of abrasive wheels, carbon brushes, brake linings. Other types are used to seal incandescent lamps to their bases, or to set bristles in brushes.

ing, from this wide diversity of materials, the one plastic that will give you the best results. Bakelite engineers will welcome the opportunity to cooperate in solving your particular plastics problems.

### Write for these Informative Booklets

**BOOKLET 10P. "New Paths to Profits"**  
A 16-page summary of the principal BAKELITE Plastics now available.

**BOOKLET 10M. "Bakelite Molding Plastics"**  
A 32-page illustrated reference booklet on thermosetting and thermoplastic molding materials.

**BOOKLET 10S. "Bakelite Resins for Paints and Varnishes"**  
A 24-page illustrated booklet on modern, synthetic resin coatings.

**BOOKLET 10V. "Bakelite Heat-Hardenable Varnish, Enamel, Lacquer, Cement"**  
A 40-page illustrated booklet on heat-reactive, resinoid coating and bonding materials.

**"BAKELITE REVIEW"**  
A 24-page quarterly which presents the latest plastics developments and applications.

RCA Pledges Itself to "Beat the Promise"  
on Radio Tubes for the National Defense!



# Symbol of a Pledge



RADIO ALONE can coordinate and direct the many swift-moving units that compose modern military tactics. And *tubes* are the very heart of radio!

That's why few industries are as vital to the National Defense Program as the radio industry! And that's why the great RCA Tube Plants at Harrison, N. J. and Indianapolis, Ind., like all other RCA Plants throughout the country, will do their utmost not merely to *meet* commitments to the Government but, wherever possible, to *beat* the delivery dates promised!

Highlighting a campaign to speed National Defense, "B" in type and radio code is the symbol

"I pledge myself to do all in my power not only to fulfill all the obligations we have undertaken to meet the requirements of our Country's National Defense Program, but wherever possible to **BEAT THE PROMISE.**"

of that "Beat-the-Promise" effort. Every member of the RCA family is helping to speed production and cut down waste. Tubes are coming off the production line faster than ever before — in

greater quantities than ever before. Many defense and commercial delivery dates have already been beaten . . . and there will be no letdown in the months ahead! And—needless to say—RCA will continue to make every effort to satisfy *commercial* requirements, too . . . subject only to the provision that Defense must and will come *first!*



## Radio Tubes

RCA MANUFACTURING COMPANY, INC., Camden, N. J.

A Service of the Radio Corporation of America • In Canada: RCA Victor Company, Ltd., Montreal