

# electronics

radio, communication, industrial applications of electron tubes . . . engineering and manufacture

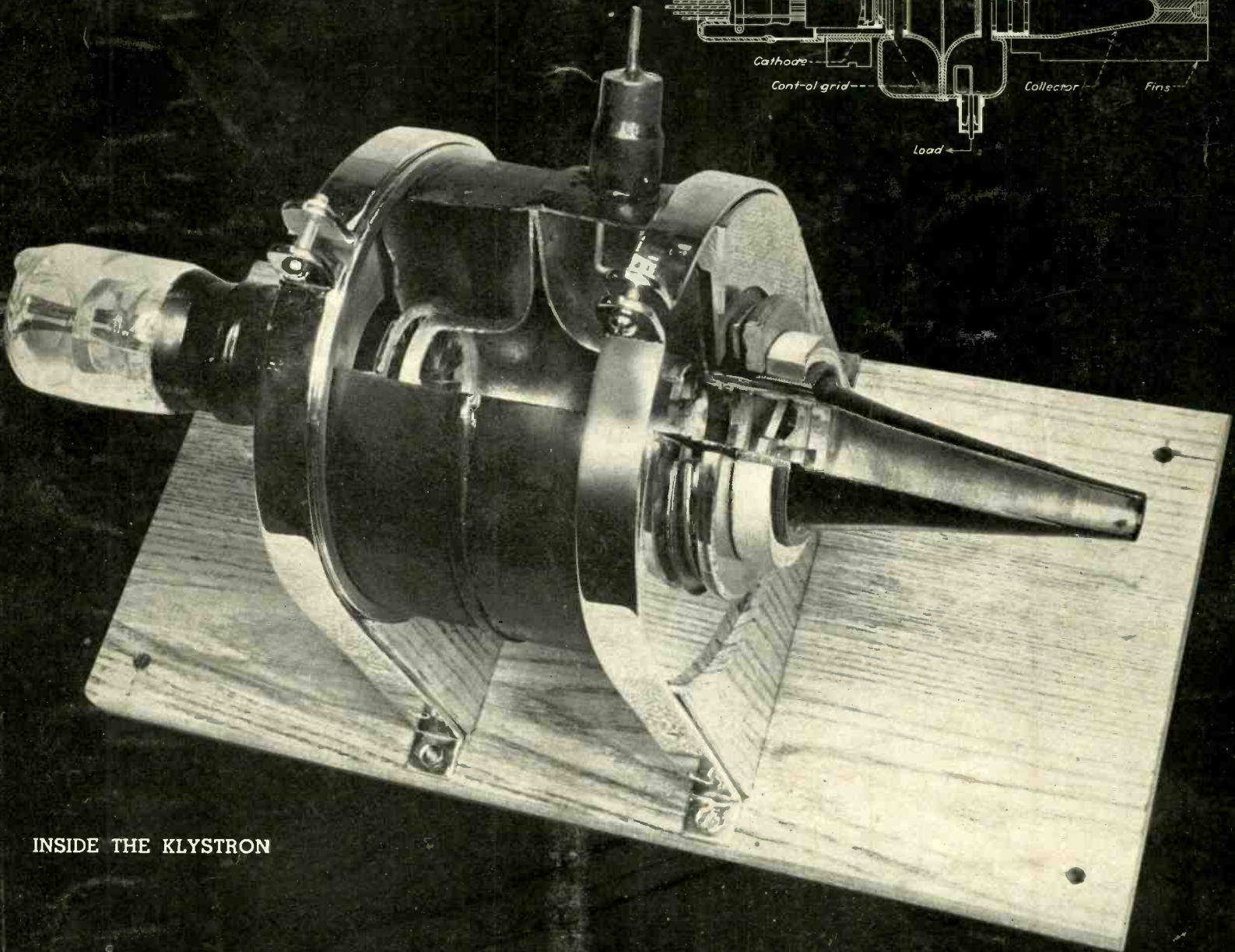

*Bell  
Phone*

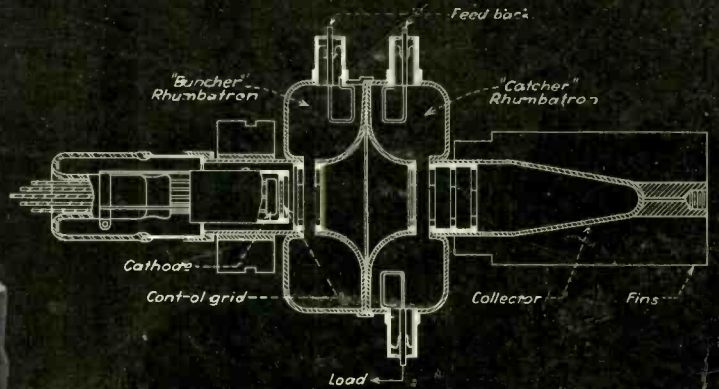

INSIDE THE KLYSTRON

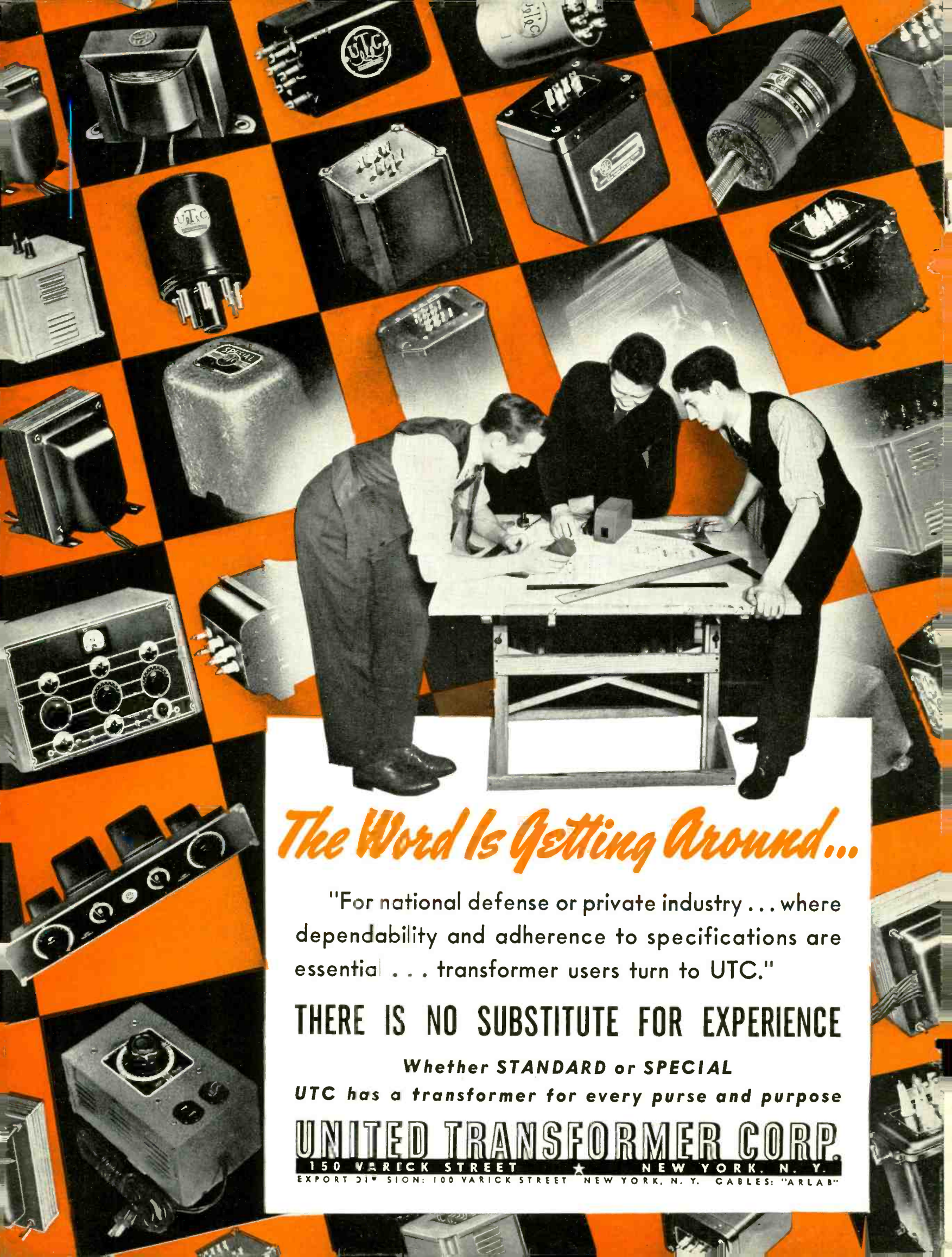

## *The Word Is Getting Around...*

"For national defense or private industry . . . where dependability and adherence to specifications are essential . . . transformer users turn to UTC."

**THERE IS NO SUBSTITUTE FOR EXPERIENCE**

*Whether STANDARD or SPECIAL  
UTC has a transformer for every purse and purpose*

**UNITED TRANSFORMER CORP.**

150 VARICK STREET ★ NEW YORK, N. Y.  
EXPORT DIVISION: 100 VARICK STREET NEW YORK, N. Y. CABLES: "ARLAB"



# electronics

## CONTENTS—NOVEMBER, 1940

**KEITH HENNEY**

Editor

Donald G. Fink  
Managing Editor

Beverly Dudley      Craig Walsh  
Associate Editor      Assistant Editor

M. L. Matthey      J. M. Heron  
Assistant Editor      Assistant Editor

Harry Phillips  
Art Director

**H. M. MATEER**

Manager

Wallace B. Blood  
Sales Manager

Contents Copyright, 1940, by  
McGraw-Hill Publishing Company, Inc.

McGRAW-HILL  
PUBLISHING COMPANY, INC.

JAMES H. MCGRAW  
Founder and Honorary Chairman

Publication Office  
99-129 North Broadway, Albany, N. Y.,  
U. S. A.

Editorial and Executive Offices  
330 West 42nd St., New York, N. Y., U.S.A.

James H. McGraw, Jr., President  
Howard Ehrlich, Executive Vice President  
Mason Britton, Vice Chairman  
B. R. Putnam, Treasurer  
D. C. McGraw, Secretary  
J. E. Blackburn, Jr., Director of Circulation

Cable Address:

MCGRAWHILL, New York  
Member A. B. P. Member A. B. C.

### INSIDE THE KLYSTRON ..... Cover

A cut-away view of the internal structure of a klystron microwave generator manufactured by Westinghouse under Sperry patents. Capable of delivering 200 watts at 40 cms with about 50 per cent efficiency

### DEFENSE SET-UP FOR THE COMMUNICATIONS INDUSTRY.... 16

A review of the functions of the six governmental agencies charged with guiding defense activities

### A STATE-WIDE F-M POLICE SYSTEM, by Daniel E. Noble..... 18

The Connecticut state police have installed a two-way f-m system using nine fixed stations and a large number of mobile units

### A PRESELECTOR CIRCUIT FOR TELEVISION, by B. F. Tyson.... 23

Presents constant gain and bandwidth over the television spectrum to 108 Mc without loss of performance

### PRECISION CRYSTAL GRINDING..... 25

Pictures showing some of the processes necessary in the manufacture of high quality quartz crystals in the General Electric plant

### THE CHRONOSCOPE, by C. I. Bradford..... 28

Application of electron tubes to the measurement of very short time intervals such as those used in determining the velocity of bullets

### HIGH SENSITIVITY PHOTOTUBE CIRCUIT, by H. S. Bull and J. M. Lafferty 31

A pentode used as the load of a phototube to give a greater percentage change in voltage output for a given change of light intensity

### WIDEBAND FM VS AM FOR AIRCRAFT, by I. R. Weir..... 34

Comparison of the two methods on the same frequencies for use in aircraft

### AN IMPROVED CATHODE RAY OSCILLOSCOPE DESIGN by William A. Geohagan..... 36

Circuits developed for other uses, such as television, applied to the cathode ray oscilloscope with an increase in flexibility and ease of operation

### FILTER DESIGN CHARTS—III, by John Borst..... 41

Graphical determination of m-derived band pass filters

### DEPARTMENTS

CROSSTALK .....	15	TUBES .....	64
TUBES AT WORK.....	40	THE ELECTRON ART.....	74
REFERENCE SHEET .....	41	THE INDUSTRY IN REVIEW.....	81
INDEX TO ADVERTISERS.....		99	

ELECTRONICS, November, 1940, Vol. 13, No. 11. Published monthly, price 50c a copy. Allow at least ten days for change of address. All communications about subscriptions should be addressed to the Director of Circulation, 330 West 42nd Street, New York, N. Y.

Subscription rates—United States and possessions, Canada, Mexico and Central American countries, \$5.00 a year, \$8.00 for two years, \$10.00 for three years. Great Britain and British Possessions 36 shillings for one year, 72 shillings for three years. All other countries \$6.00 for one year, \$12.00 for three years. Entered as Second Class matter, August 29, 1936, at Post Office, Albany, New York, under the Act of March 3, 1879. BRANCH OFFICES: 520 North Michigan Avenue, Chicago; 68 Post Street, San Francisco; Aldwych House, Aldwych, London, W.C. 2; Washington; Philadelphia; Cleveland; Detroit; St. Louis; Boston; Atlanta, Ga.

# F-M USING ARMSTRONG PHASE-

● The Armstrong phase-shift method of modulation has been universally adopted as the only practical method for obtaining frequency stabilization in communications and portable F-M transmitters. While others have been unsuccessfully experimenting with various forms of modulation, REL, as far back as 1936, recognized the Armstrong phase-shift method as the only practical type, and produced the first commercial F-M portable transmitter.

*In F-M communications and portable service, the Armstrong phase-shift method is the only method that has proved itself practical.*

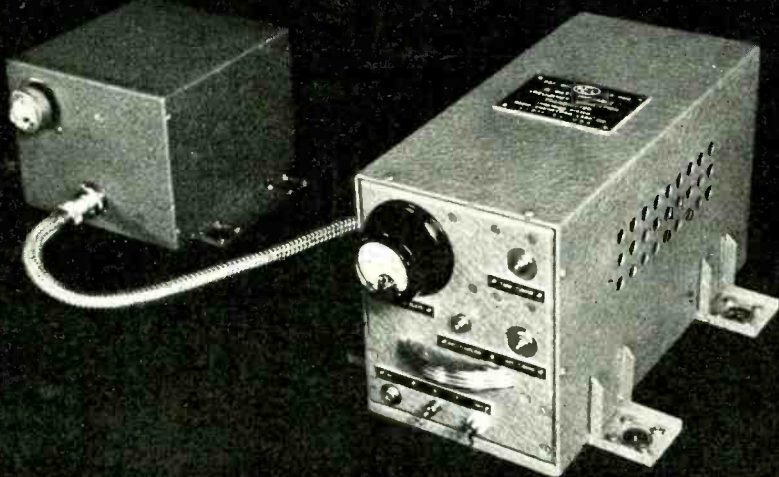

← *The first*

*This REL 15 Watt phase-shift F-M transmitter, built in August 1939, was the first successful portable F-M equipment.*

*And now, the latest* →

*Here is the latest REL phase-shift F-M portable transmitter, model 524-C. Two hundred of this model are now being constructed for the Chicago Police Department.*

● All REL F-M transmitters employ the Armstrong phase-shift method of modulation with direct crystal control of frequency. REL has led the entire field in F-M research, and has produced a greater variety of F-M equipment for broadcasting, aviation, fire, police, public utility and government two-way service than any other manufacturer. More REL F-M phase-shift transmitters are operating successfully today than any other type.

*Whatever your requirements, REL has available F-M equipment and associated receivers to fit into your specific needs.*



**RADIO ENGINEERING LABORATORIES, INC.**

35-54 36th STREET

Phone RAvenswood 8-2340  
Cable "RADENGLABS"

LONG ISLAND CITY, N. Y.

# SHIFT METHOD OF MODULATION



**THEREFORE . . . why is the phase-shift method not also the most dependable method for F-M broadcasting?**

● Major E. H. Armstrong's 40 KW F-M station, W2XMN, at Alpine, N. J. — the pioneer F-M broadcasting station — with equipment built by REL in collaboration with Major Armstrong, has conclusively helped to prove that crystal control F-M maintains frequency stability through eliminating the possibility of control failure. Armstrong phase-shift crystal controlled F-M is the only method which cannot get off frequency.

The newest, largest and most powerful F-M station of all, W1XOJ (Yankee Network), at Paxton, Mass. This view shows the 50 KW REL Cat. 521 equipment (on the air since May, 1939 with 2 KW; since February, 1940 with 50 KW). This station is completely REL equipped.



## F-M broadcasting stations serving the public daily\*

Station	Location	Owned by	On the air continuously since
W2XMN	Alpine, N. J.	Maj. E. H. Armstrong	April, 1938
W2XAG	Yonkers, N. Y.	C. R. Runyon, Jr.	Nov., 1936
W1XOJ	Paxton, Mass.	Yankee Network	May, 1939
WEOD	Boston, Mass.	Yankee Network	April, 1939
W3XO	Washington, D. C.	Jansky & Bailey	Aug., 1939
W8XVB	Rochester, N. Y.	Stromberg-Carlson	Nov., 1939
W2XQR	Long Island City, N. Y.	J. V. L. Hogan	Oct., 1939
W9XAO	Milwaukee, Wis.	The Journal Company	Jan., 1940
W8XAD	Rochester, N. Y.	WHEC, Inc.	Jan., 1940
W9XZR	Chicago, Ill.	Zenith Radio Corp.	Jan., 1940

\*All using the REL-ARMSTRONG phase-shift method



**. . . And now read what Mr. Paul deMars says:**

"I am pleased to report that this equipment, (REL 50 KW F-M transmitting equipment at STATION W1XOJ), which is the Radio Engineering Laboratories catalogue No. 521 50 KW transmitter, has not only maintained the high fidelity performance in daily operation that has been so often demonstrated as typical of the Armstrong system of phase modulation but has demonstrated that this equipment meets the high standards of dependability required in broadcasting service.

"I am sure that it is as great a source of satisfaction to you as it is to the Yankee Network to know that actual use and experience with this equipment has confirmed our judgment in selecting it for the world's first 50 KW F-M Broadcasting Station."

*Paul A. de Mars*

Vice-President, The Yankee Network

# Centralab's New Trimmer CERAMIC CONDENSER

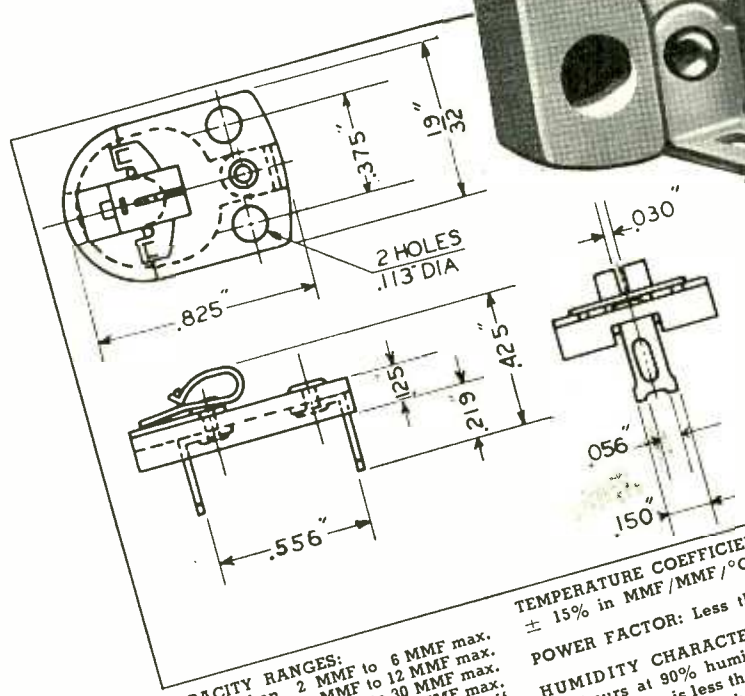
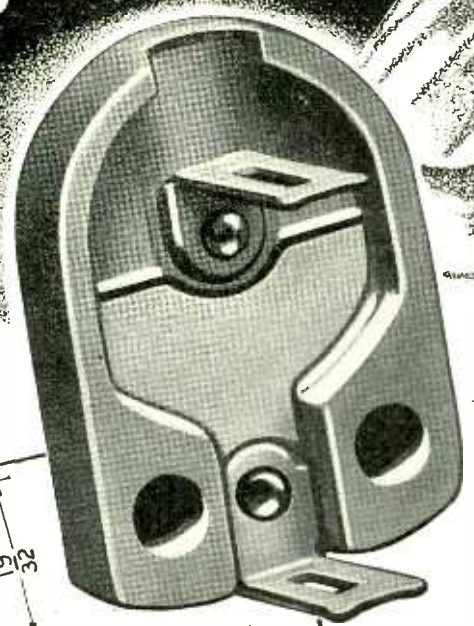

**CAPACITY RANGES:**  
 (a) Less than 2 MMF to 6 MMF max.  
 (b) Less than 3 MMF to 12 MMF max.  
 (c) Less than 7 MMF to 30 MMF max.  
 (d) Less than 60 MMF to 75 MMF max.  
 Other ranges may be manufactured if in demand.  
**RETRACKING:** After repeated cycles of heating and cooling, capacity change is less than 0.5%.

**TEMPERATURE COEFFICIENT:**  $-.0006 \pm 15\%$  in MMF/MMF/ $^{\circ}\text{C}$ .  
**POWER FACTOR:** Less than 0.1%.  
**HUMIDITY CHARACTERISTIC:** After 100 hours at 90% humidity, 40 $^{\circ}\text{C}$ , capacity change is less than 0.5%, power factor reading less than 0.15%.

There are no erratic capacity changes with the new Centralab Trimmer Condensers . . . the dielectric and base are all one piece moulded under pressure with a ceramic so dense that no temperature or humidity changes can affect it. The stationary plate is silver, bonded to the ceramic with no air film between. The movable plate is metal, rotatable on the flat ground surface of the ceramic . . . a worthy companion . . . and a new member of the famous CENTRALAB family.

**CENTRALAB Div. of Globe-Union Inc., Milwaukee, Wis.**

# Important today . . . a **DEPENDABLE** source of **STEATITE INSULATORS**

**GENERAL  
CERAMICS COMPANY  
INSULATORS**

Typical General Ceramics die-pressed Steatite and Ultra-Steatite shapes. Note the deep pressed cored-out insulators . . . also the large beehive insulator, 4" high, and the lead-in bowl, which is 5 1/4" in diameter.

Backed by up-to-date production methods, and a reputation for cooperative service and for keeping delivery promises, General Ceramics Steatite and Ultra-Steatite Insulators are widely used by leading radio and electrical manufacturers. Let us help you solve your insulation problems.

**General Ceramics Company**

RCA Building, 30 Rockefeller Plaza, New York

Factory, Keasbey, New Jersey

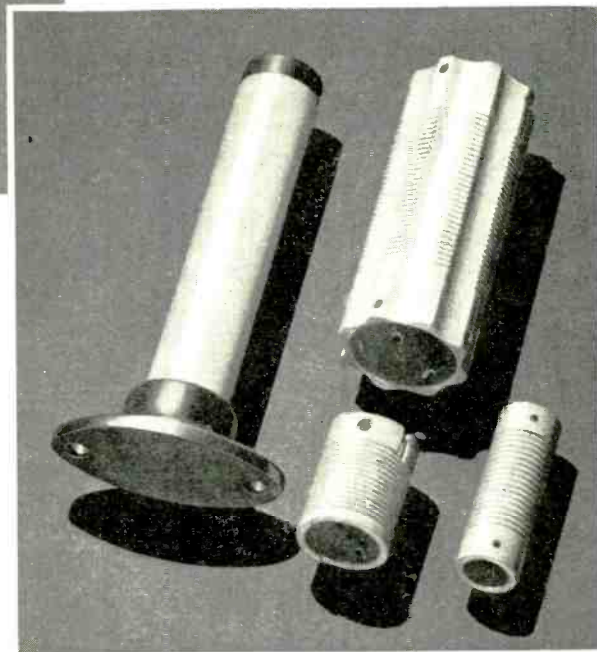

Extruded and machined coil forms and a metal-ended insulator with solid base.

• This catalogue illustrates standard insulator shapes. Send for it.



*Steatite and Ultra-Steatite*  
**INSULATORS**

# UNEQUALLED CHECK-UPS

eliminate the "Doubtful Few"

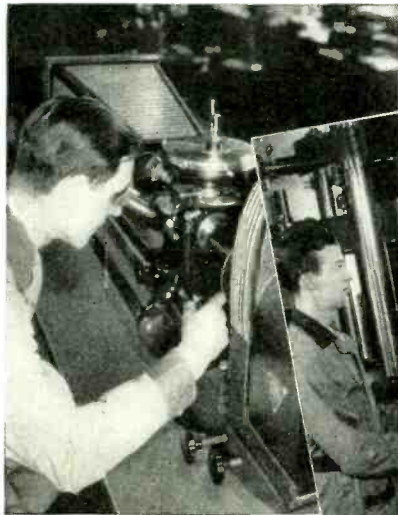

Some of the scientific check-ups in the 16-Point Quality-Control routine.

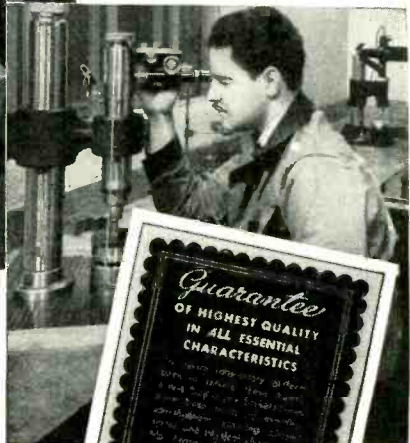
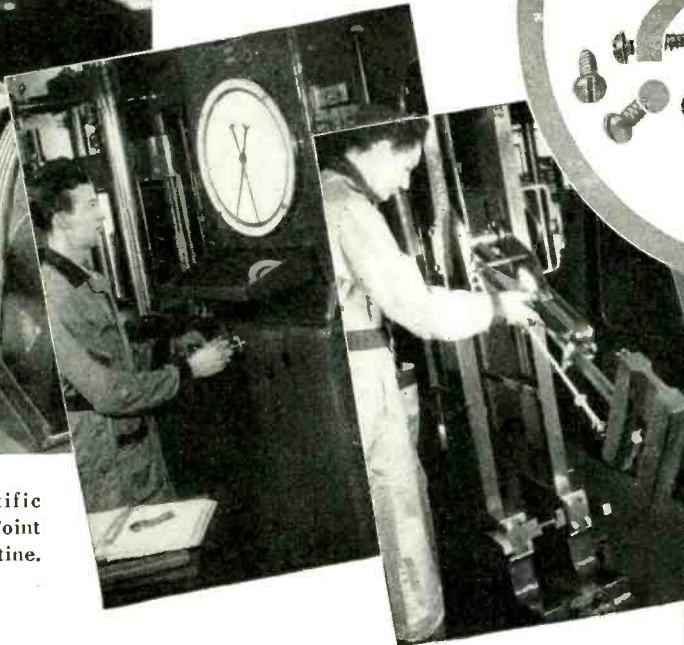

## ... when Parker-Kalon's Quality-Control Laboratory backs your fastening devices

You get an unequalled protection against time-wasting, cost-boosting "duds" among your fastening devices when you specify Parker-Kalon! For, in Parker-Kalon's plant, an unusual Quality-Control Laboratory stands guard over all production, to eliminate the "doubtful few" screws that slow-up assembly work and produce unsatisfactory fastenings.

Without counterpart in the industry, this scientific Laboratory sets standards of quality that could never be maintained without rigid quality-

control of every production step from chemical analysis of the metal to micrometric check-up of finished dimensions. It insures that every Parker-Kalon Fastening Device is more than "good enough" in both accuracy and strength.

Take no chances in your assembly jobs... buy Hardened Self-tapping Screws, Socket Screws or other fastening devices that are made in the screw industry's most modern plant. Parker-Kalon Corporation, 192-194 Varick Street, New York.

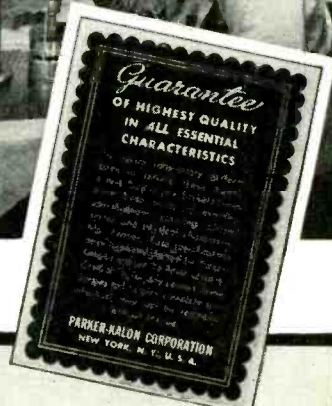

**COSTS NO MORE** to get this Parker-Kalon Quality-Control Guarantee with every box of...



**Hardened Self-tapping Screws**  
Types, sizes, head-styles for every assembly of metal or plastics

**Cold-forged Socket Screws**

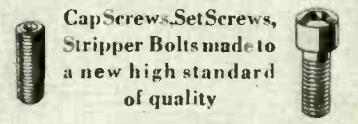

Cap Screws, Set Screws, Stripper Bolts made to a new high standard of quality

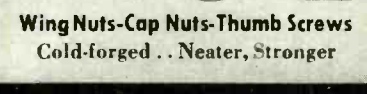

**Wing Nuts-Cap Nuts-Thumb Screws**  
Cold-forged... Neater, Stronger

SOLD ONLY THROUGH RECOGNIZED DISTRIBUTORS

*Quality-Controlled* **PARKER-KALON Fastening Devices**



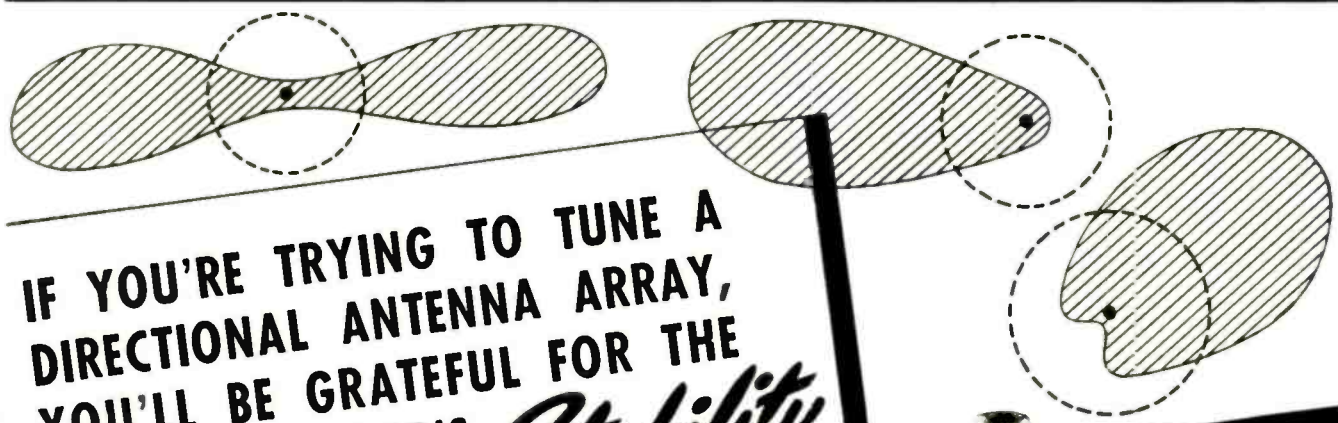

**IF YOU'RE TRYING TO TUNE A  
DIRECTIONAL ANTENNA ARRAY,  
YOU'LL BE GRATEFUL FOR THE  
LAPP CONDENSER'S *Stability***

For solving an interference problem with increased power, or for increasing signal strength over a desired area with no change in power, the modern directional antenna array offers a highly satisfactory solution.

The performance of the array depends, however, on a critically accurate and continuously maintained phase-relationship between various elements of the array.

You're likely to find yourself in water over your head if you try the delicate job of tuning an array with condensers that vary in capacitance as they heat up in operation.

The safe way to proceed is to install Lapp gas-filled condensers in your antenna circuit. For these units offer capacitance at a constant value under any temperature change. Tuning adjustments are made with full power on. Besides, more power gets to the antenna (it's practically zero loss; the only solid dielectric is a porcelain bowl that carries the rotor); with no solid dielectric to puncture, you can operate at full rating for an indefinite time without failure; space requirement is an absolute minimum.

And aren't those the properties that make this condenser the best choice for just about any application?

Write for descriptive literature and list of sizes.



**LAPP**

**INSULATOR CO., INC., LEROY, N. Y.**

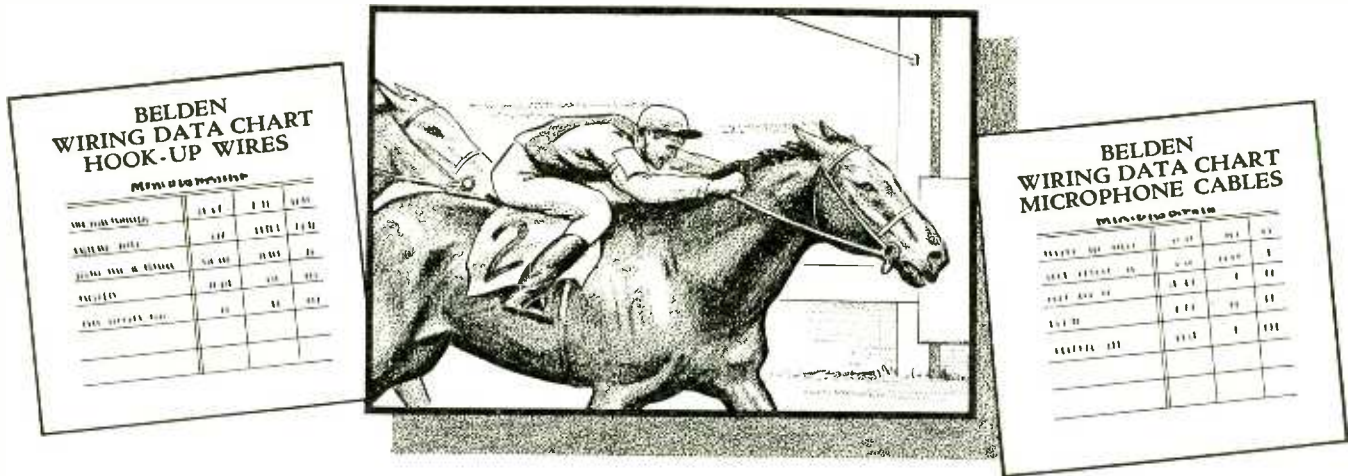

# WIRES have records, too

These Hook-up Wires are Approved  
—they're made by Belden

Characteristics at Room Temperature and Humidity

Part No.	Insulation	Material	Construction
1446	8.8	PUSH-BACK • DOUBLE BRAID • WAXED	Solid—8830 Size 20—8966 Size 18 Stranded—8931 Size 20—8967 Size 18
6900	300	RUBBER PUSH-BACK "BASKET-WEAVE" RAYON BRAID—LACQUERED	Solid—8937 Size 20 only
6900	300	HEAVY RUBBER PUSH-BACK "BASKET-WEAVE" RAYON BRAID—LACQUERED	Stranded—8938 Size 20 only
18000	500	CELLULOSE ACETATE PUSH-BACK "BASKET-WEAVE" RAYON BRAID—LACQUERED	Stranded—8933 Size 18 only
1450	225	R-F HOOK-UP WIRE	Solid—8941 Size 20—8945 Size 18 Stranded—8943 Size 20—8947 Size 18—8939 Size 14
3300	95000	COLORUBBER	Solid—8934 Size 22—8841 Size 20—8861 Size 18—8863 Size 16 Stranded—8810 Size 22—8839 Size 20—8844 Size 18—8862 Size 16
9800	400	VARNISHED CAMBRIC "BASKET-WEAVE" RAYON BRAID—LACQUERED	Stranded only—8982 Size 20—8869 Size 12
6450	475	SHIELDED GRID WIRE	Stranded only—8885 Size 20—Shield. 85% coverage
15000	1.5	FIBERGLAS BRAID HIGH TENSION CORONA RESISTANT for Cathode-Ray Television Tube Leads	Stranded Wire—8868 Size 18—Special High Tension Construction

\*D. C. Insulation per ft. Immersed in Mercury

— and Winners  
are "bred" to win for you

Don't gamble on wires when you put them to work in your products. Get their records—know their past performance—be sure they won't go "haywire."

How can you make this investigation?

Easy—when you depend on Belden. Case histories—complete performance records are available on Belden wires. You know before you start what each wire has been designed to do.

You know too that careful inspection maintains the vital characteristics in every foot of Belden wire. You have double assurance of satisfactory performance—fewer rejections.

Use the right wire—the Winner—for every job. Specify Belden.

Belden Manufacturing Company  
4625 W. Van Buren St., Chicago, Ill.

*Don't Go "Haywire"*

Go **Belden**

**WIRES FOR RADIO AND COMMUNICATIONS**

## Insulation Earned Its Wings

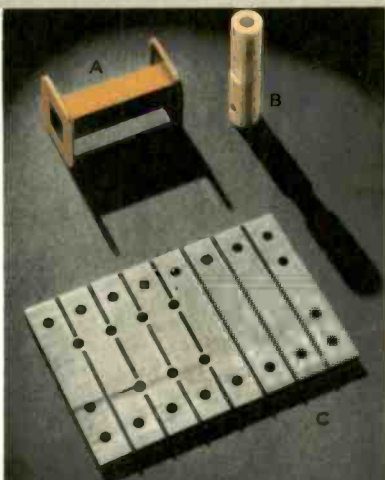

A. Square tube coll form sanded to size; flanges milled, sawed and broached. B. Insulating tube, sawed, drilled, reamed, and milled. C. Sawed, milled and drilled Terminal Panel.

ONE type of airplane propeller hub alone contains forty parts punched and machined from Synthane Bakelite-laminated. The plane which last year dived to a world's record was literally filled with Synthane fittings. These and other aviation applications have come about because Synthane, usually thought of as an electrical insulator, is also light in weight, corrosion resistant, structurally strong and easy to machine accurately.

Less spectacular than the aviation examples, though equally important, are the every-day uses for Synthane, inspired by its combination of ex-

cellent insulating characteristics, light weight, denseness, structural strength, hardness and resistance to solvents, gases, petroleum products, water and many acids and salts.

In dozens of industries and hundreds of products, Synthane's combined properties are meeting combined specifications not completely satisfied by any other material.

If you are interested in improving performance, lowering costs, reducing weight or if you have a corrosion condition to overcome, let's see whether we can help you.

SYNTHANE CORPORATION, OAKS, PENNSYLVANIA

**SYNTHANE**  
Bakelite —  laminated

**TECHNICAL PLASTICS**

SHEETS • RODS • TUBES • FABRICATED PARTS • SILENT STABILIZED GEAR MATERIAL

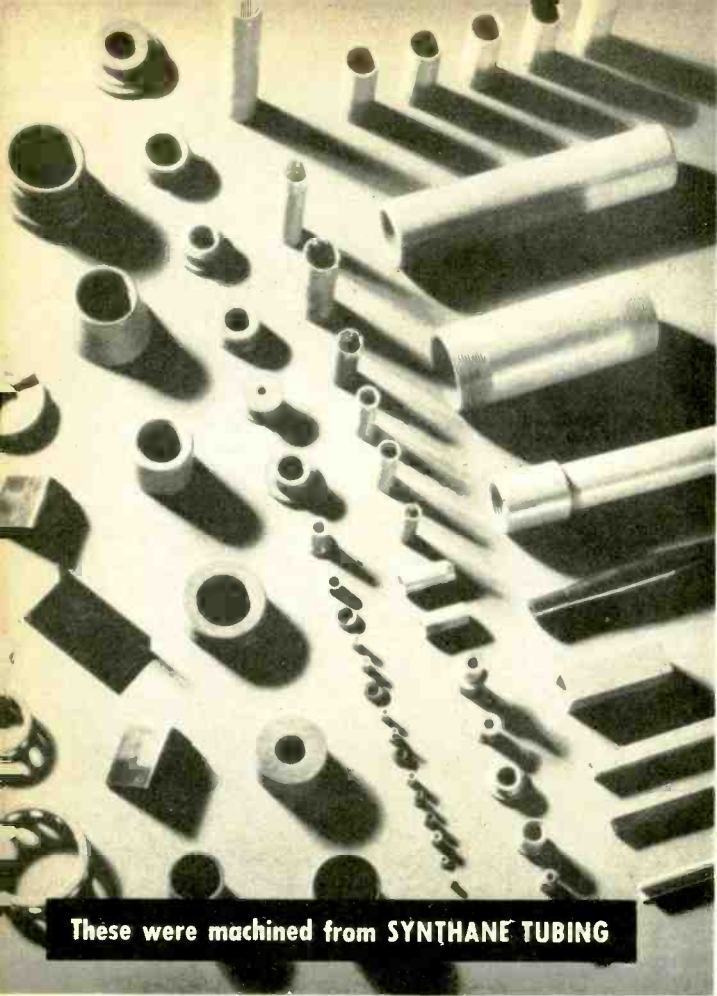

These were machined from SYNTHANE TUBING



Inside diameters from 1/8" to 22"  
Circular and special sections

# Ease of machining and combined properties of SYNTHANE [Non-Metallic] TUBING account for its thousands of uses

**SYNTHANE** Bakelite-laminated tubing is light in weight and non-metallic yet it is hard, dense, structurally strong, easy to machine, resistant to the corrosive action of oils, and many chemicals, gases and water, and one of the best of electrical insulators.

**WHO USES IT, AND WHY YOU MAY**—Synthane has many more properties in combination, therefore it is used for thousands of parts, by the aircraft, automotive, radio, electrical, chemical, textile, petroleum and other industries.

Any part which is tubular in character or any part which can be machined from a section of tubing is a likely application of Synthane tubing—especially if a combination of many properties is desired. Examples: Chemical piping, sleeves, ferrules, bushings, valve seats, ball bearing retainers, piston rings, washers, bobbins, coil forms, fuse cases and explosives containers.

**STANDARD AND SPECIAL SHAPES**—Synthane tubing is made in standard lengths from 1/8" to 22" *inside* diameter, and in wall thicknesses according to your specifications. Special shapes are also available—oval, square, rectangular or irregular variations of them. Certain irregularly shaped parts can be produced by a combination of molding and laminating, instead of machining, at an attractive saving.

**IDEAL FOR AUTOMATIC SCREW MACHINE WORK**—Many parts can be readily machined in your own shop—or we'll machine them for you. Synthane tubing is ideal for turning out small parts in large quantities because of the speed at which it can be worked.

**ARE YOU THE NEXT TO BENEFIT!**—Synthane finds its best applications where manufacturers are able to make economies by utilizing its electrical, mechanical, and corrosion-resistant properties. If you think Synthane tubing may be helpful to you, why not tell us your application, or send for a sample?

SYNTHANE CORPORATION, OAKS, PA.

Gentlemen:

- Please send me a sample of Synthane tubing.  
 Mail me a copy of your folder "Synthane Bakelite-laminated Tubing."

NAME \_\_\_\_\_

COMPANY \_\_\_\_\_

ADDRESS \_\_\_\_\_

CITY \_\_\_\_\_

STATE \_\_\_\_\_

# SYNTHANE

Bakelite —  laminated

## TECHNICAL PLASTICS

SHEETS · RODS · TUBES · FABRICATED PARTS · SILENT STABILIZED GEAR MATERIAL

*Representatives in principal cities*

TIMELY INFORMATION TO ENGINEERS

ABOUT

# Erie Ceramicon

REG. U.S. PAT. OFF.

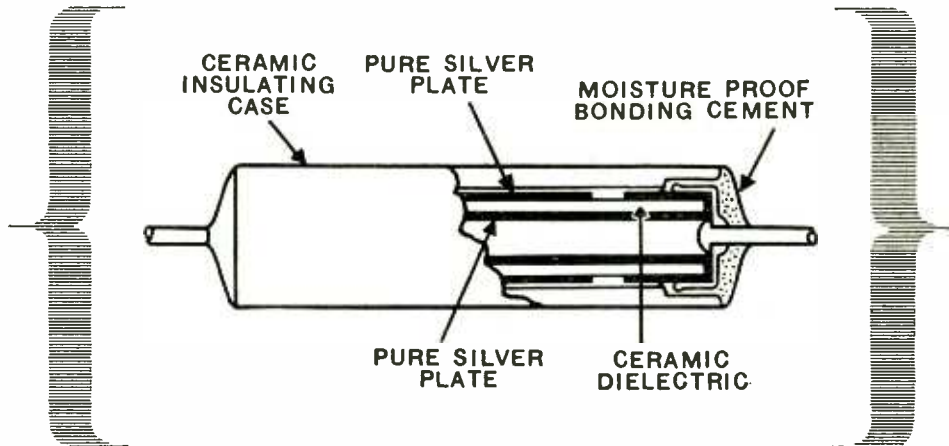

Cross section of  
Insulated Erie Ceramicon

## PERMANENCE OF CAPACITY

Erie Ceramicon, due to the unique method of applying plates directly to the surface of the dielectric, are inherently stable in capacity. A change of less than  $\frac{1}{4}$  of 1% will be found after subjecting these condensers to repeated heating and cooling cycles of 200 hours at 250° F. and 200 hours at -40° F.

250° F. is recommended as a maximum safe operating temperature.

## EFFECT OF HUMIDITY

Increase in power factor is less than 20% and change in capacity is less than  $\frac{1}{4}$  of 1% after 100 hours at 100% relative humidity at 40° C. Leakage resistance after this same test, measured at 1000 volts D.C., is over 1000 megohms.

## EFFECT OF TEMPERATURE

Condensers of the P120 type have a positive temperature coefficient of capacity of  $120 \times 10^{-6}$  per degree C. The N680 type have a negative coefficient of  $680 \times 10^{-6}$  per degree C. These values correspond to

a rise of .36% and a drop of 2.1% respectively as the temperature is raised from 30° to 60° C. Single unit Ceramicon can be supplied on special order having any desired temperature coefficient between these limits. Tolerance on temperature coefficient is  $\pm 40 \times 10^{-6}$

## POWER FACTOR

The power factor of all Ceramicon will increase slightly as the temperature increases. For example, a 20% increase in power factor will result from a change in temperature from 30° to 60° C.

## FINISHING TESTS

Erie Ceramicon are conservatively rated at 500 volts D.C. Test voltage is 1300 volts D.C. Leakage resistance at 1000 volts D.C. is over 10,000 megohms.

All Ceramicon are individually checked for capacity and power factor at 1 megacycle before shipping. Capacity tolerance is set to customer's specification. Power factor limit is .08%.

Reprints of this data for your files will be sent on request

RESISTORS  
SUPPRESSORS  
CERAMICONS  
SILVER-MICA  
CONDENSERS

*Erie*

RESISTOR CORPORATION, ERIE, PA.

TORONTO, CANADA • LONDON, ENGLAND • PARIS, FRANCE-J.E.CANETTI CO.

MOLDED BEZELS  
PUSH BUTTONS  
AND KNOBS  
POLYSTYRENE  
COIL FORMS



Type CA  
Cabinet Avail-  
able with 15"  
or 12" Speaker.

**NEW HIGH FIDELITY  
EXTENDED RANGE  
REPRODUCERS  
WITH**

*Bass Reflex*

2 Models are with New Type J Dual Loud Speaker and Frequency Dividing Network. 2 Models with PM12-CT, 12" Loud Speaker. 1 Model with PM8-CT, 8" Loud Speaker.

All with **BASS REFLEX**. Dealer price range, complete Reproducers, \$17.70 to \$56.55\*. . . All Loud Speakers are Permanent Magnet . . . All Loud Speakers are available separately . . . All Cabinets are available separately.

With the advent of Frequency Modulation in addition to the amazing interest everywhere in the reproduction of sound at High Fidelity there is a demand for these new products. Foresight together with Jensen engineering skill and facilities made these products possible. Write at once for Catalog No. 119; note the scope and wide price range of this new line and observe that each product is characteristically Jensen in every detail of performance ability, appearance and value. Jensen Radio Mfg. Co., 560 South Laramie Ave., Chicago. (cable address JERAD, Chicago)  
\*Dealer price, Loud Speakers only, from \$5.40 to \$27.90.

Type MT  
Cabinet  
Available  
with 15",  
12" or 8"  
Speakers.

**Jensen**  
*High Fidelity*  
**REPRODUCERS**

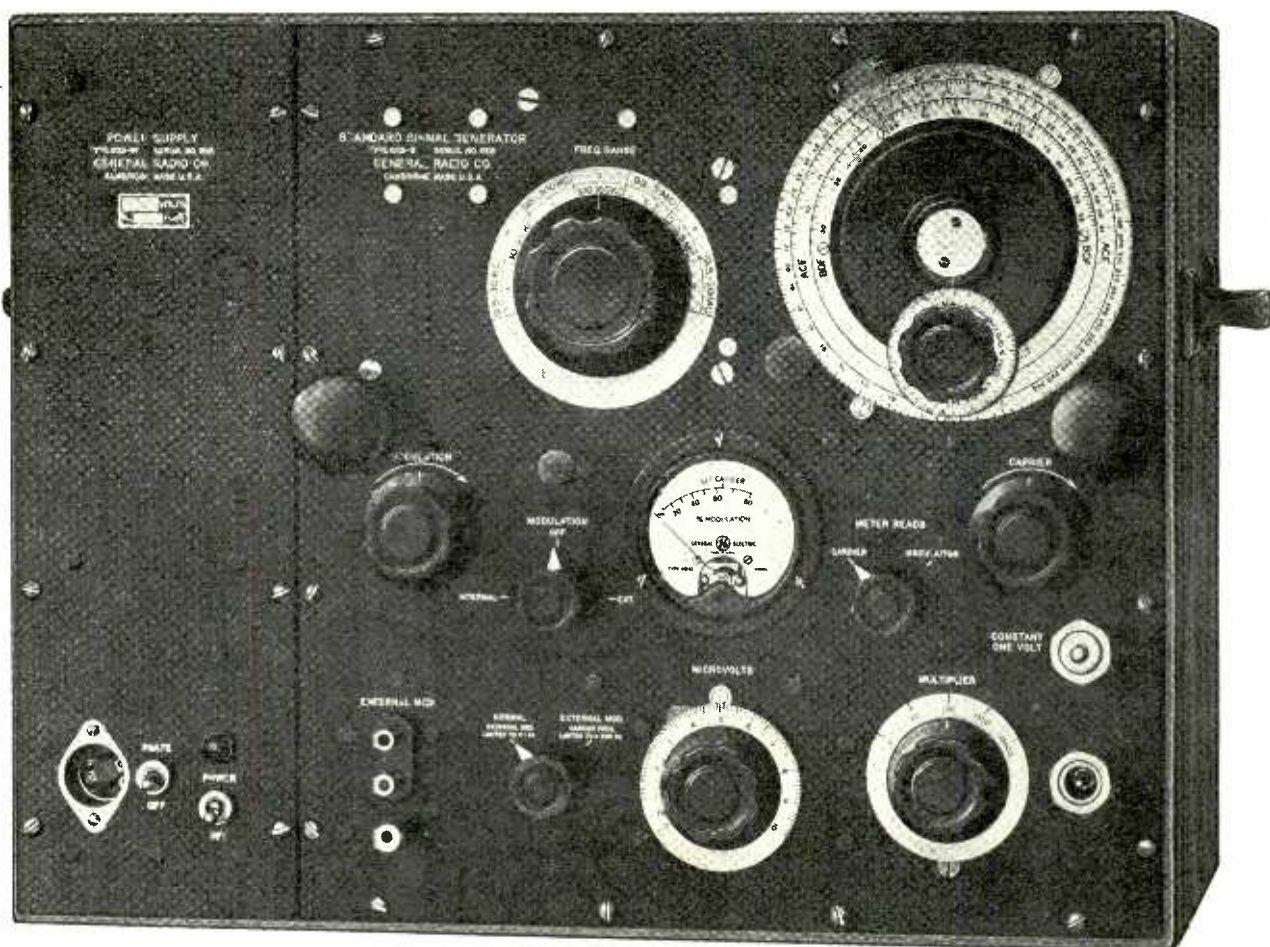

## Speed Up Receiver Production with this Standard-Signal Generator

**Accurate • Convenient to Use • Gives the Answer Quickly**

ALL of the basic receiver characteristic measurements can be made very simply and quickly with the G-R Type 605-B Standard-Signal Generator, so simply in fact that any technician can supervise the obtaining of the following measurements with assured accuracy:

- SENSITIVITY
- SELECTIVITY
- DISTORTION
- TUNING RANGE
- TUNING CALIBRATION
- FREQUENCY RESPONSE
- INTERFERENCE
- OUTPUT
- TUNING TRACKING
- I. F. ALIGNMENT
- AVC CHARACTERISTICS
- AFC CHARACTERISTICS

WRITE FOR BULLETIN 649 FOR COMPLETE DATA

A number of the design features of the G-R Signal Generator are exclusive; all of its features combine to make it the best standard-signal generator on the market at the moderate price of \$415.00.

### OPERATING FEATURES

DIRECT-READING CARRIER RANGE: 9.5 kc to 30 Mc  
 EXTRA CARRIER RANGE: 30 to 50 Mc  
 LOGARITHMIC FREQUENCY DIAL: with geared slow-motion, smooth action incremental dial reading to 0.02% for selectivity measurements  
 OUTPUT CONTINUOUSLY ADJUSTABLE: 0.5  $\mu$ v to 0.1 v  
 SEPARATE ONE-VOLT OUTPUT JACK  
 MODULATION CONTINUOUSLY ADJUSTABLE to 80%  
 INTERNAL MODULATION: 400 cycles  $\pm$  5%  
 EXTERNAL MODULATION: flat from 30 cycles to 15 kc  
 NEGLIGIBLE FREQUENCY MODULATION  
 NO ATTENUATOR REACTION ON FREQUENCY  
 EXCELLENT SHIELDING  
 A-C OPERATION with built-in voltage regulator

# GENERAL RADIO COMPANY

CAMBRIDGE, MASSACHUSETTS  
 Branches in New York and Los Angeles

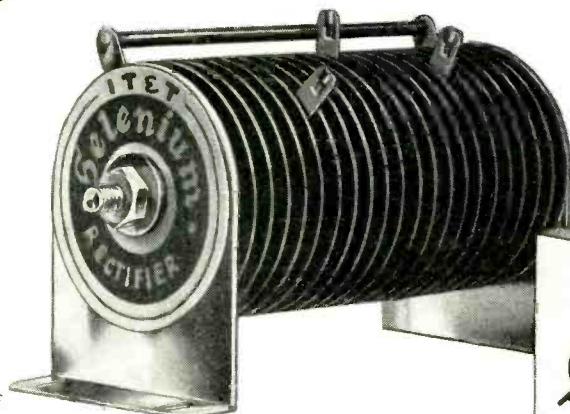
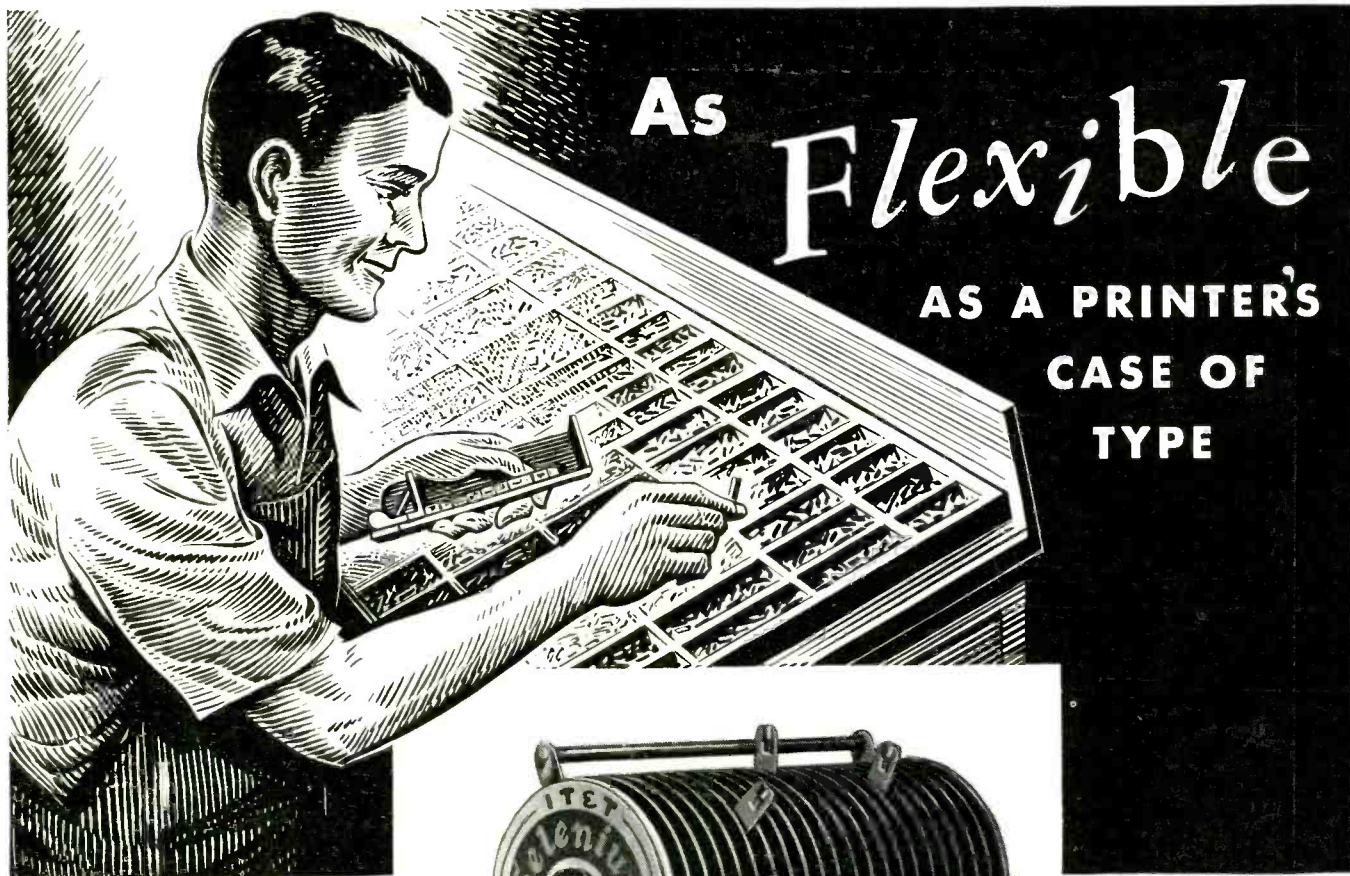

As a printer puts any combination of words together from the individual letters in his type case—so the I. T. & T. Selenium Rectifier components and combinations, readily available in stock, lend themselves to all voltage, current and power requirements. Maximum efficiency for the specific need is thus obtained—from milliamperes to thousands of amperes and

from a few volts to thousands of volts. Diversification of assembly of these components makes possible a wide variety of rectifiers conforming to almost every conceivable mechanical and physical detail—a feature of inestimable value in overcoming unusual obstacles and limitations of shape and volume.

## Other Outstanding Features of I. T. & T. Selenium Rectifiers

**The I. T. & T. Selenium Rectifier**, a 100% domestic product, finds wide, general-purpose application in a variety of forms for the rectification of large or small currents at high or low voltages. It also has many other uses, such as spark quencher, polarizer or electronic valve.

**Efficiency:** The high efficiency of the Selenium Rectifier over a wide load range assures economical operation, low costs and eliminates maintenance.

**Compactness:** The high permissible back voltage of the Selenium Rectifier plates holds to a minimum the number required. Also the high current density permits the use of small plates. These features together with simplicity of design make it a comparatively small compact unit.

**Overload Capacity:** It will withstand short overloads of ten or more times the normal rated current without damage.

**Ruggedness:** It is entirely metallic, rugged in design and construction—unaffected by shock or vibration. Not critical to assembly pressure.

**Wide Temperature Range:** It operates instantly in ambient temperatures of from  $-40^{\circ}\text{C}$ . to  $+75^{\circ}\text{C}$ . for continuous service—higher for intermittent.

**Regulation:** Stable output during years of wide use and good

regulation with varying load demands.

**Electrical Stability:** It has no moving parts, it requires no adjustments or replacements, there is nothing to get out of order. It has indefinitely long life.

**Low Back Leak:** It has negligible back leak for battery charging. No protective devices required to guard against interruptions in A.C. supply.

*Consulting engineering services available for specific requirements. Address Rectifier Division for descriptive bulletin.*

**INTERNATIONAL TELEPHONE DEVELOPMENT CO., INC.**  
 137 Varick Street, New York, N. Y.



# Eimac Tubes go into Another Important FM Station



Mr. Phillip G. Laeser  
(chief experimental engineer)  
is shown at the panel above



Above: Mr. Daniel W. Gellerup, technical supervisor

**FM Broadcast Station  
W9XAO**

Owned and Operated by  
**The Milwaukee Journal Co.**

Equipped with

*Eimac*  
**TUBES**

**EITEL-McCULLOUGH, INC.**

San Bruno, California

Mr. Daniel W. Gellerup, technical supervisor of radio for the Milwaukee Company chose Eimac 1500T tubes for the new broadcast station which uses Major Armstrong's new Frequency Modulation scheme. In making this choice, Mr. Gellerup has adopted the tube which has played an important role in the development of FM.

Take no chances on untried tubes... choose Eimac for *your* FM station. Write today for technical data or contact the nearest Eimac representative.

## EIMAC REPRESENTATIVES

California, Nevada HERB BECKER, 1530 W. 104th St., Los Angeles, Cal.	Ohio, Mich., Ky., Ind., Minn., Mo., Kan., Neb., Iowa PEEL SALES ENGINEER- ING CO., E. R. Peel, 154 E. Erie St., Chicago, Ill.	N. Caro., S. Caro., Georgia, Tenn., Flor., Ala., Miss. JAMES MILLAR, 316 Ninth St. N. E., Atlanta, Georgia. Texas, La., Okla., Ark. J. EARL SMITH, 2821 Live Oak St., Dallas, Texas.
Wash., Ore., Idaho, Mont. GENERAL SALES CO., Verner O. Jensen, 2605-07 Second Ave., Seattle, Wash.	N. Y., N. J., Penn., Md., Del., Dist. of Col., Maine, N. H. R. I., Conn., Mass. ADOLPH SCHWARTZ, 14726 Elm Ave., Flushing, New York.	Chicago, Illinois, Wisconsin G. G. RYAN, 549 W. Washington Blvd., Chicago, Ill.
Colo., Wyo., New Mexico, Arizona, Utah RICHARD A. HYDE, 4253 Quitman St., Denver, Colo.		

EITEL-McCULLOUGH, INC. • SAN BRUNO, CALIFORNIA

# You Need This Catalog



of  
*Approved*

## Precision Products

### For Your Industrial Electronic Requirements

Your engineering and designing departments should know that this Mallory Catalog is available. It is a handy reference for electronic parts—and especially may save hours of inquiry and long correspondence delays.

It may be a replacement needed for plant equipment.

—Or it may be a specified part for test or experimental work in your engineering laboratory.

—Or it may be a part that will become a fundamental of some product you plan to put into production.

Mallory manufactures a complete line of approved precision products that have innumerable applications in the aeronautical, automotive, electrical, geophysical, radio and industrial fields. It would be impossible to enumerate these products here but they are ready for reference when you have the Mallory Catalog at your elbow.

Speedy service awaits you. Mallory's organization of 253 selected distributors is well equipped to supply your needs. Each distributor is a leader in his community, maintains adequate warehouse stocks and has a staff well trained to serve you.

*Write today for the Mallory Catalog of Approved Precision Products. It will be sent promptly, along with the address of the distributor nearest you.*



P. R. MALLORY & CO., Inc., INDIANAPOLIS, INDIANA • Cable Address—PELMALLO

*Serves the Aeronautical, Automotive, Electrical, Geophysical, Radio and Industrial Fields with . . . Electrical Contacts, Welding Electrodes, Non-Ferrous Alloys and Bi-Metals . . . Rectifiers, Dry Electrolytic Capacitors, F.P. (Fabricated Plate) Capacitors, Vibrators, Vitreous Resistors, Potentiometers, Rheostats, Rotary Switches, Single and Multiple Push Button Switches, Electronic Hardware.*



## CROSS TALK

► **MICRO** . . . Certain writers of scientific papers and editors have raised with the National Research Council the question of whether there should be postponement of publication of papers which may have some bearing on national defense. The Council appointed an advisory committee to consider this matter and in accordance with this committee's recommendations a Reference Committee on Micro-Wave Radio Developments has been set up to consider manuscripts dealing with micro-waves. Dr. Alfred L. Loomis, Tuxedo Park, N. Y., is chairman and any editor or author of a potential paper dealing with u-h-f research may consult him as to whether it is wise to publish such a paper at the present time. If such an article is withheld from publication and appears later, after the needs of the defense organizations have been met, proper acknowledgment of the author's public spirit will be made.

► **LOSS** . . . Autumn of this year saw the ranks of pioneers in electronics depleted by two names of pre-eminent recognition: Paul Nipkow and Sir J. J. Thomson.

The scanning disc of Nipkow was invented in 1884, far ahead of any possible use in television, but upon so fundamental a concept was it based that only the electron displaced it as a scanner.

The work of "J. J." is best known to every modern physicist for the discovery of the electron. His achievements

are rivalled by his success in teaching younger men to carry on research of high order and to take their rightful places in the great universities.

Both men were in their 80's. Sir J. J. Thomson died in Trinity College; Dr. Nipkow in Berlin.

► **SECOND CLASS MAIL** . . . We are amused and sympathetic with the plaint of Mr. Charles Williams of Seattle who says: "I am very busy. I hope radio parts manufacturers are busy too, but some of them appear to be striving desperately after more business. They send me all sorts of literature; big, little, good, not so good. I can't imagine what I am to do with it. I can't plaster my walls with it, I can't read it all, most of it I can't file and a lot of it I can't find after filing. The "X" company sends me big folded sheets; the "Y" News is too big by an inch in each direction to go anywhere except in the wastebasket, "Z" sends me little folded sheets, two others put out nice catalogs and most of them are of uniform size, but I can't tell which are the latest issues. They don't number or date the catalogs.

"All manufacturers should number their catalogs, date them and tell which supersedes the others and in what respects. Most of them also lose sight of the fact that the consumer has to refer to old catalogs for numbers of parts that require replacement. Usually they can't be found in the new catalog and the new issue

doesn't tell what new item will be suitable as a replacement.

"Years ago I worked in the architectural profession where the same conditions were encountered relative to literature on building materials. The architects couldn't use it or file it. The American Institute of Architects printed thousands of postcards and distributed them to members. They read in substance: 'Dear Sirs: Your advertising matter has been received and consigned to the waste basket. It does not conform to standard sizes etc. prescribed by the A.I.A.' Perhaps if parts manufacturers knew what happened to their advertising matter they would make a change."

► **EYES FRONT** . . . It seems that National Union has been making radio tubes for quite a spell—ten years or more. Recently one of the staff competed at Atlantic City in a Miss America bathing beauty contest after having won over the state of New Jersey candidates. National Union sent us a photo of Miss New Jersey and while we don't lay any claims to being expert at such matters we might as well come right out and say that National Union has something pretty nice right in its factory.

But—the release says, "While the officials of National Union are very pleased with this latest development, they want it clearly understood that as far as they are concerned female beauty is secondary to the production of quality radio products."

# The Defense Set-up for the Communications Industry

---

A news report from Washington, concerning the activities of the Federal Communications Commission, the National Defense Research Committee, the National Inventors Council, the Patent Office and the Defense Communications Board—agencies on which the industry and its engineers must depend for guidance in the defense program

---

**T**HE readers of ELECTRONICS are only too well aware of the general effect of the national defense effort on civil life. The prospect of greatly increased taxes, the conscription of men into the armed services, the rapid acceleration of business activity—all these are only too evident. What is not so evident, but equally important to members of the electronics community, is the effect on the profession and the business of communications.

Here are a few startling examples:

In the three months period from July 10th to October 10th, the U. S. Army and Navy awarded contracts for communications equipment (radio transmitting and receiving equipment and components, for the most part) to the extent of \$38,786,982.10 (see table on page 98).

The Federal Communications Commission has one allocation of \$1,600,000 and a supplementary appropriation of \$175,000 to extend and improve their facilities for monitoring the ether spectrum.

The F.C.C. also has obtained the fingerprints and proof of the citizenship of more than 100,000 commercial and amateur radio operators, out of a total of 110,000 such operators licensed by the government. Similar information on from 30,000 to 50,000 operators in telephone and telegraph companies has been requested from the land-wire companies, and is being collected rapidly.

The U. S. Patent Office is now exercising its authority, granted this year by Congress, to withhold the issuance of patents and to swear the inventor to secrecy, if an invention has direct value in national defense.

The Institute of Radio Engineers, acting in cooperation with the National Resources Planning Board and the Civil Service Commission, has appointed a Preparedness Committee. This Committee has prepared a questionnaire to be sent out by the government to the I.R.E. membership list, which will list the special abilities and experience of its members. Practically every other professional society in the country has offered its services in a similar way, to aid in preparing a "National Roster of Scientific and Specialized Personnel."

All this is news of the greatest importance to radio engineers and others in the electronics field—so much so in fact that your editors have thought it advisable to present this report based on an intensive newsgathering expedition to Washington. The report is necessarily sketchy in spots, because secrecy is one of the primary attributes of the present activity.

#### *The Six Government Agencies Now at Work*

In addition to the defense activities of the Army, Navy and Coast Guard there are now actively at work six government agencies whose work bears on the communications field: The Federal Communications Commission, The National Defense Research Committee, The National Inventors Council, the Patent Office Defense Committee, the Defense Communications Board, and the National Roster being compiled by the Civil Service Commission. On its face this long list of agencies looks like traditional governmental bureaucracy, but such is not the case. Each agency has its special func-

tions, each is cooperating with the others. There is practically no duplication of effort. And all are hard at work.

The first named agency, the F.C.C., is familiar as the regulator of all non-federal interstate communication in the country. Its defense activities are those of policing the ether, in active cooperation with the Federal Bureau of Investigation, to track down unlicensed or otherwise suspicious transmissions, and to prevent the use of licensed transmitters for subversive purposes. To carry out this program the F.C.C. needs an extensive ether-monitoring set-up.

One of the problems is foreign language broadcasting. There are about 200 broadcast stations in the United States, which broadcast at one time or another in one of 30 foreign languages. The opportunity for improper alien activity is obvious, so the F.C.C. makes a practice of spot-checking such broadcasts by instantaneous recording.

Since there are some 70,000 licensed transmitters in the United States, the question of monitoring signal strength and frequency is a major one. To aid this work, the President allocated \$1,600,000 of his \$100,000,000 defense fund to the F.C.C. to extend its monitoring facilities. The plan, now in the latter stages of completion, calls for 11 primary monitoring stations, 100 secondary base monitor stations, at least one in each state, and 80 mobile units, all manned by a staff of 500 men. Each station, including the mobile trucks, contains a field-strength and frequency measuring set covering the entire spectrum from long waves to ultra-short, a

direction finder, and instantaneous recording equipment. The mobile units contain two-way f-m communication equipment for coordinating the actions of two trucks in tracking down the location of signals under investigation. Foreign sources of programs, from shortwave stations abroad, are also scrutinized with the same care.

When the F.C.C. discovers evidence of espionage, sabotage, violation of neutrality, or other subversive activities, it turns over the data to the F.B.I., which is responsible for the prosecution of such matters under Federal regulations. Not the least important aspect of this work is the fact that a large body of radio investigators is being trained, which in time of war will be of the greatest value to the Army and Navy in their own counter-espionage work.

*The Defense Communications Board*

On September 24th, the President established the Defense Communi-

cations Board, "to determine, coordinate and prepare plans for the national defense, which plans will enunciate for and during any national emergency." These plans have to do with the needs of the armed forces, the allocation of governmental and non-governmental radio, wire, and cable facilities as may be required for their use, and the control of communications to meet defense requirements. The Board is specifically prohibited from considering plans for censorship, and it has no power to make any final disposition of the matters studied, but will simply report on them. The committee is thus a fact-finding and planning board. Its reports will be submitted to the President who will take final action on them, in a national emergency, through one of his executive assistants. The members of the Board are James L. Fly, Chairman, (Chairman of the F.C.C.), Major General J. O. Mauborgne (Chief Signal Officer of the U. S. Army Signal Corps), Rear Admiral

Leigh Noyes (Director of Naval Communications) Breckenridge Long (Assistant Secretary of State in charge of international communications) and Herbert E. Gaston (Assistant Secretary of the Treasury in charge of the Coast Guard). At the time of writing the board had met three times but had made no announcements. It is understood that specialized subcommittees will be appointed, but from the very nature of its work, most of their recommendations will remain in closed files until the need for using them arises. If a state of war or national emergency arises, the importance of the work of this group can hardly be overestimated. Beyond that, little of a definite nature can be stated, at least for the present.

*The Direction of Research Work*

It appears to be an axiom of modern warfare that the strongest army is the one backed by the most  
(Continued on page 93)

This form, designed to establish the citizenship of commercial and amateur radio operators, has been filled out to date by over 100,000 of the 110,000 operators licensed by the F.C.C. Fingerprints and birth certificate (or equivalent proof of citizenship) are also on file in each case

F.C.C. FORM NO. 735

**QUESTIONNAIRE FOR COMMERCIAL AND AMATEUR RADIO OPERATORS**

1. NAME \_\_\_\_\_  
Surname First Middle

2. \_\_\_\_\_  
Your present home address

3. \_\_\_\_\_  
Date of birth \_\_\_\_\_ Your place of birth (city or town, county, state, country)

4. \_\_\_\_\_  
Name of employer \_\_\_\_\_ Address \_\_\_\_\_

5. Are you a citizen of the U. S. by birth \_\_\_\_\_ By your naturalization \_\_\_\_\_  
(Proof must be furnished in accordance with instructions)

6. If citizen by naturalization give date granted \_\_\_\_\_, Certificate No. \_\_\_\_\_  
Court of issuance \_\_\_\_\_ City and State \_\_\_\_\_

7. If you claim citizenship by naturalization of parent give date granted \_\_\_\_\_  
Certificate No. \_\_\_\_\_ Court of issuance \_\_\_\_\_ City and State \_\_\_\_\_  
State any additional facts upon which your claim of U. S. Citizenship is based.

8. \_\_\_\_\_  
(Give following information as to relatives)

	Surname	First	Middle	Country of birth	Is he (or she)	
					Birth	U. S. citizen by Naturalization
Spouse						
Father						
Mother						
Brothers						
Sisters						

(OVER)

9. The person filing this Questionnaire shall indicate any time spent outside the United States in the past ten years. State countries and number of times said countries have been entered, and time spent in country on each occasion. (Indicate directly below)

10. Have you ever served in the United States Army, Navy, Marine Corps, Coast Guard, National Guard, State Militia, Civilian Conservation Corps, in a regular or reserve status? If so, give dates served in each and character of discharge received.

11. If now serving in any of the above organizations, state which organization, giving rank, rate or title.

12. Have you ever been, or are you now, in the service of any foreign government in any capacity? If so, state which government and in what capacity.

NOTE: Your fingerprints must be impressed upon the attached finger print form in the presence of an official of a municipal, state or federal agency. Local law enforcement agencies (municipal police, or sheriff's office) and offices of the F.C.C. are prepared to make the proper impressions. After completion, attach to Questionnaire and return to the Federal Communications Commission.

STATE OF \_\_\_\_\_

COUNTY OF \_\_\_\_\_

I swear (or affirm) that the foregoing statements as and belief are true and correct, and that I have impressed my finger prints upon the attached card as a part of my response herein.

Subscribed and sworn to before me this \_\_\_\_\_ day of \_\_\_\_\_, 1940.

(Seal) \_\_\_\_\_  
Affiant  
(Signature as commonly used)

Notary Public

Instructions  
Photograph (not a group picture) must be attached to the questionnaire (Form 735). Proof of birth in the U.S. or proof of naturalization must be furnished in accordance with form and instructions attached. Finger print card must be signed in same manner as signature to the questionnaire. Official taking finger prints must sign in place for his signature.

# A STATE-WIDE F-M POLICE NETWORK . . . I

The application of frequency modulation's advantages to emergency communication is well illustrated in this description of the equipment installed by the State Police of Connecticut, a complete two-way system on 40-kc channels, using the wideband system

By  
**DANIEL E. NOBLE**

*Formerly Assistant Professor of  
Electrical Engineering  
University of Connecticut*

**W**HEN the writer undertook to develop a state-wide emergency radio-telephone system for the Connecticut State Police in July 1939, the statement of the requirements did not specify whether one-way, two-way, intermediate frequency, ultrahigh frequency, amplitude modulation or frequency modulation was to be employed, but it was understood that the use of fm for the system would be investigated immediately. The problem may be clarified by a few facts about the operating conditions which must be met by the proposed system. The State is approximately ninety miles long by sixty miles wide with very rough hilly terrain over the entire area. Hills vary in height up to 2400 feet and the elevation changes are frequent and often precipitous. The heavy lines on the map of Fig. 1 divide the State into troop areas, showing that the ten troop units, or barracks, police the State with each unit operating from its own headquarters. Headquarter locations on the map are designated by capital letters. Obviously the headquarter locations and the troop areas were not selected with a view to the requirements of emergency service radio installations.

One plan submitted by a commercial organization proposed the conventional one-way system utilizing one of the low frequency channels assigned to State Police emergency service. There are serious

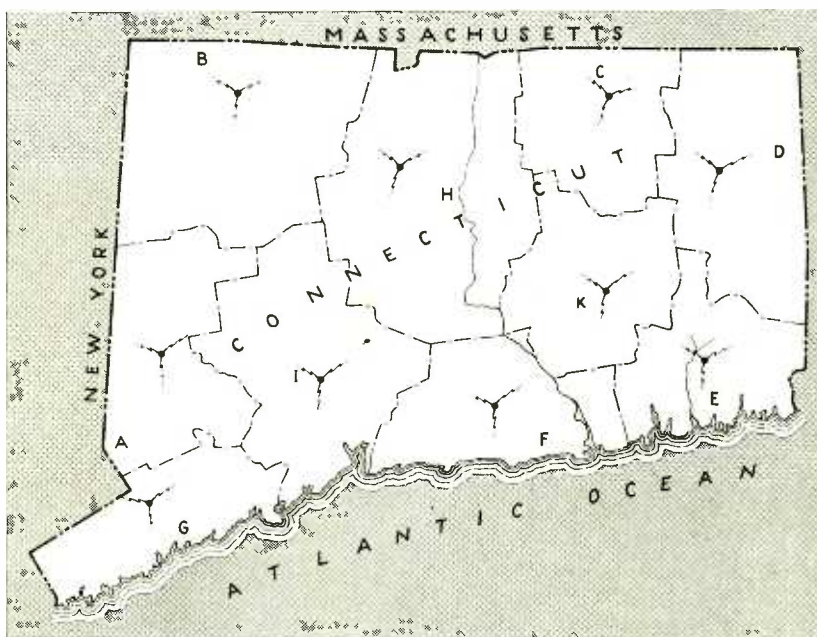

Fig. 1—Division of the State of Connecticut into troop areas, each served by a separate 250-watt fixed f-m station (locations shown by jagged lines)

objections to such a proposal. To list a few: (1) High cost of the high powered installations required. (2) Limitations set upon the use of the system by sky wave interference from out-of-state transmitters. (3) Interference caused by atmospheric static. (4) Poor adaptability to two-way operation. Objection number 4 is the most important of all since it is universally agreed that the maximum efficiency of police radio service is not possible without a two-way system.

The use of ultrahigh frequencies for one or two-way operation is possible with conventional amplitude modulated wave equipment but the service would necessarily be spotty and secondary in character. This statement is not based upon

conjecture since the writer designed the Connecticut State Forestry radio system which makes use of conventional short wave equipment. Reasonably satisfactory two-way service, adequate for forest service requirements, is possible over distances up to thirty miles where both receivers are in quiet locations. However, reliable service is impossible in heavy traffic where the ignition noise level is high. Such limited operation would not be satisfactory for police work.

#### *The Proposed Solution*

An outline of the system proposed includes the following: (1) The use of ultrahigh frequencies and fm. (2) The selection of fixed transmitter and receiver sites in high, quiet

Fig. 2—Right, the original exploration transmitter, used for testing proposed sites in each troop area



Fig. 3—Below, a later version of the exploration transmitter was mounted in the radio service truck

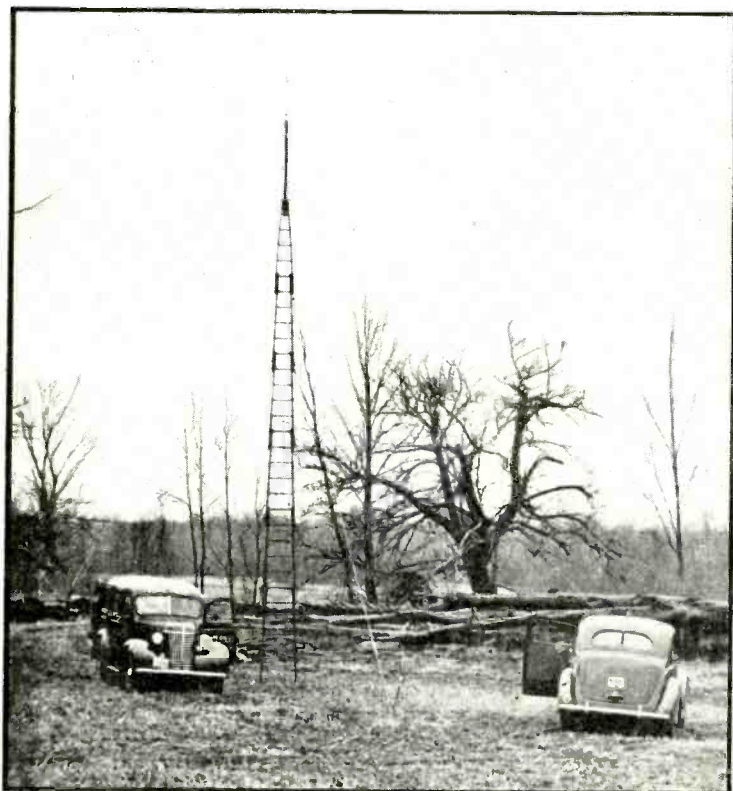
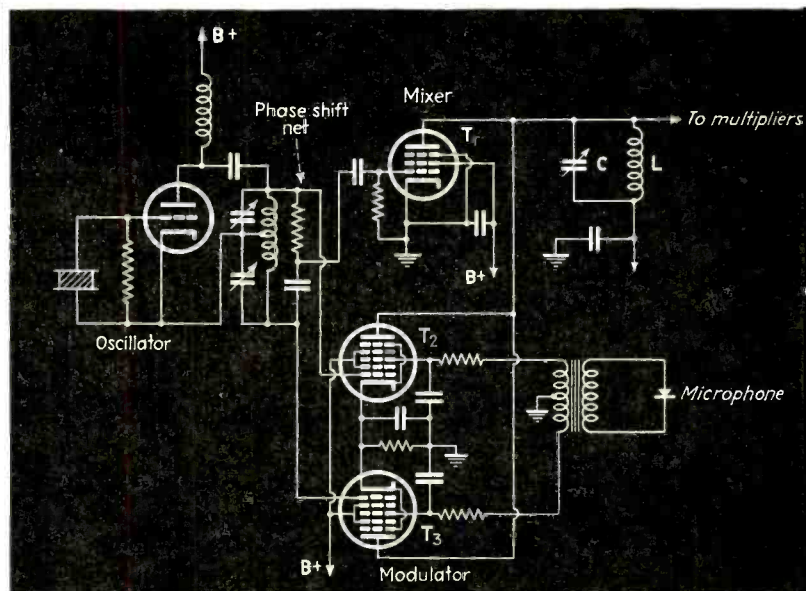

Fig. 4—Below, the phase-modulator circuit employed in the mobile transmitters, a modification of the Armstrong balanced-modulator scheme



locations near the center of each patrol area. (3) The use of a 250 watt f-m fixed transmitter for each patrol area with remote control at each headquarters. (4) The use of two frequencies (as eventually determined) 39400 kc for the fixed transmitters and 39180 kc for the mobile transmitters. (5) The locations selected for a maximum required two-way communication of twenty-four miles. (6) Design with generous factor of safety for reliable communication.

While the reasons for adopting some of the specifications in the outline are obvious, more information on the design procedure will clarify the details as the paper proceeds.

Mobile or portable mobile f-m

equipment was designed to conduct proving-out tests and to survey the proposed transmitter sites. At the beginning of the work the conventional field strength survey was used but this approach was abandoned in favor of listening surveys when it was discovered that strong ignition noise made it impossible to interpret field strength measurements in terms of intelligibility of received signals. The testing procedure was simple: A fifty-watt fixed transmitter, shown in Fig. 2, was installed at the proposed fixed site in the area and the mobile unit then traveled throughout the area to be served while observations were made to determine the reliability and intelligibility of the received signals. Later a standard

mobile unit installed in the Radio Service truck, Fig. 3, was used at the fixed locations under test and two-way communication maintained as the mobile unit travelled over the area. The speedometer of the mobile unit accumulated a mileage total of twenty thousand miles during the investigation and a fair estimate indicates that the writer carried on communication from the moving car while travelling more than two thousand miles. The results of the tests will be summarized in Part II of the article.

#### Design of Equipment

Since no commercial emergency service frequency-modulation equipment was available at the time the

design of the system was undertaken, the development of the specialized apparatus became the first requirement. To facilitate the construction of the new test units the services of F. M. Link were enlisted. With the construction of specialized amplitude-modulated mobile equipment already developed by this organization it was only necessary to introduce the new f-m circuit requirements to produce units which were satisfactory both electrically and mechanically.

The transmitter modulator circuit which proved to be most effective is shown in Fig. 4. This circuit, which is an adaptation of E. H. Armstrong's original circuit, had been previously used successfully by the writer in the University of Connecticut's experimental f-m transmitter W1XCS which was placed in operation in 1938. The writer also used a similar circuit in the design of the WDRC f-m broadcast station W1XPW.

Note that the phase shift network is arranged to feed  $T_1$  with a carrier potential ninety degrees out of phase with the voltage on  $T_2$  and  $T_3$ . The voltages from  $T_2$  and  $T_3$

are  $180^\circ$  out of phase. Tubes  $T_2$  and  $T_3$  form the balanced modulator whose output for our purpose may be expressed as

$$i = A_2 \sin(\omega t + \mu t) - A_2 \sin(\omega t - \mu t) \quad (1)$$

Since the carrier voltage to tube  $T_1$  is  $90^\circ$  out of phase according to usual amplitude modulation side-band relationships the voltage supplied by this component is

$$i_c = A_3 \sin \omega t \quad (2)$$

Assuming the plate tank LC circuit to present linear characteristics, Eqs. 1 and 2 may be combined thus:

$$i_r = i_c + i = A_3 \sin \omega t + A_2 \sin(\omega t + \mu t) - A_2 \sin(\omega t - \mu t), \quad (3)$$

which may be reduced to

$$i_r = A(t) \sin(\omega t + K \sin \mu t) \quad (4)$$

Equation 4 is the expression for a phase-modulated wave with the amplitude-modulated component  $A(t)$ . Limiting in the subsequent multiplier stages of the transmitter removes the amplitude variation so that the equation may be written

$$i_r = A_1 \sin(\omega t + K \sin \mu t). \quad (5)$$

Equation 5 is useful in the determination of design factors.

$$\text{Let } \theta = \omega t + K \sin \mu t \quad (6)$$

$$\text{Then } \frac{d\theta}{dt} = \omega + \mu K \cos \mu t \quad (7)$$

The derivative  $\frac{d\theta}{dt}$  is by the usual definition the instantaneous angular velocity of the phase modulated wave or  $\frac{d\theta}{dt} \frac{1}{2\pi}$  is the instantaneous frequency. From this it can be seen that  $\mu K$  represents the maximum change in the angular velocity during modulation and  $\frac{\mu K}{2\pi}$  maximum instantaneous frequency deviation. Thus  $\frac{\mu K}{2\pi} = \Delta f$  (8)

where  $K$  is the maximum angular displacement in radians, and  $\mu$  is the angular velocity of the modulating wave. For a modulating frequency of 500 cps and an angular displacement of one radian the maximum instantaneous frequency deviation is, from Equation (8) 500 cps. In practice, a displacement of one radian at the modulator in the type of modulation under discussion will introduce distortion but fortunately this distortion will be confined to low frequencies. It can be shown that so long as the angular displacement at the modulator remains small the distortion will be small. The deviation may then be increased to the required degree by the use of multiplier stages.

The ultrahigh frequency channels assigned to the emergency services are 40 kc apart, therefore, the emission from the f-m transmitters must not occupy bandwidths greater than 40 kc. The design of the transmitters used in the Connecticut system is based upon the modulation requirements introduced by the average male voice. Satisfactory results may be achieved in the design if this voice is assumed to possess characteristics presenting the greatest average power production in the region between 500 and 1000 cps with a substantial reduction in average power above 1000 cps. While it is true that individual voices and certain words will produce frequency spectrums with high amplitude components in the region above 1000 cps, the small number of such components and their short duration result in reducing their importance to adja-

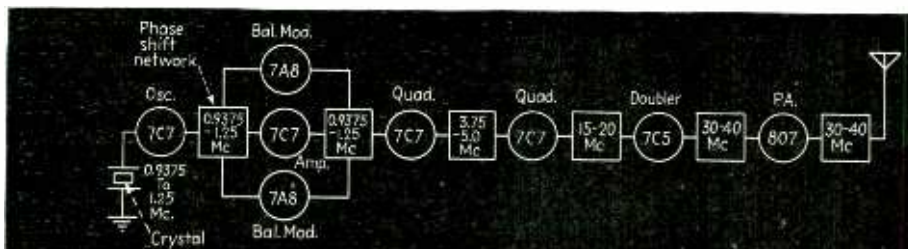

Fig. 5—Block diagram of the mobile transmitter. A frequency multiplication of 32 times is employed following the phase modulator output

Fig. 6—Front view of the mobile transmitter with cover removed. Note the coaxial jacks at the left for the antenna and connecting cable to the receiver





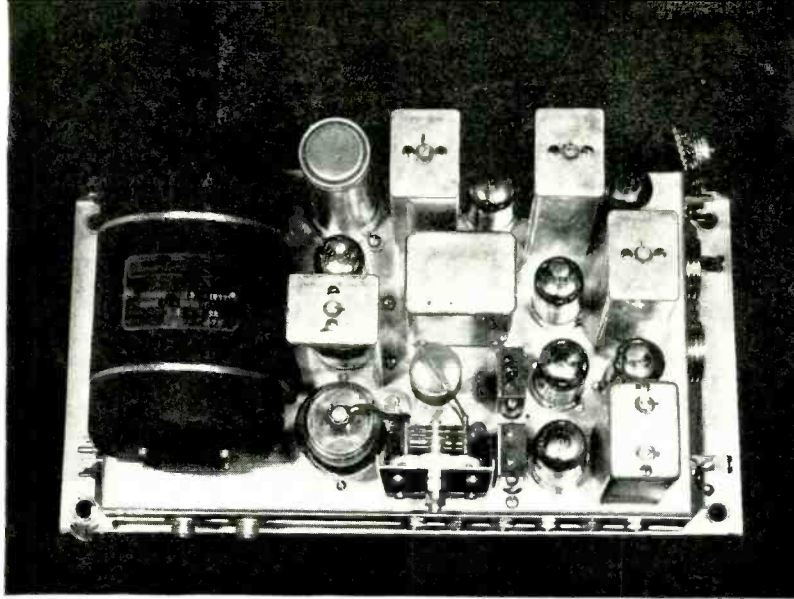
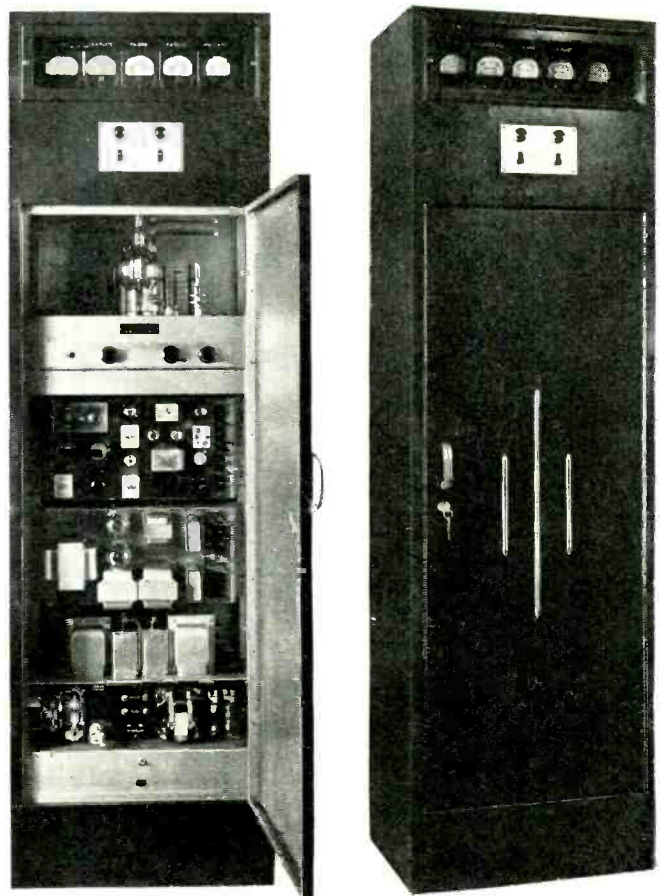

Fig. 7—Top view of the mobile transmitter. Eight tubes, with a type 807 in the final, supply 25 watts output in the 39-Mc band. The battery drain is 23 amperes

Fig. 8—Right, the 250-watt fixed station transmitter originally used to prove-out the system. The units now in use are similar except that space is provided in the cabinet for two receivers

Fig. 9—Below at right, two views of the fixed station at Westport, Conn. All of the equipment is remotely controlled by telephone line connections



cent channel interference. In practice, pre-emphasis of approximately twelve decibels from 600 to 3000 cps permits a substantial extra gain in signal-to-noise-ratio without sacrificing any noticeable voice quality requirements. In the receiver the correction network is adjusted for best intelligibility. In other words, a slight high-frequency emphasis is retained to give the received voice quality the sharpness required for high intelligibility. Figure 5 is the block diagram of the mobile transmitter. Figures 6 and 7 show the mobile transmitter unit used in the Connecticut system. Figure 5 shows that a total of 32 times multiplication is used. The modulator is designed to produce a deviation of approximately 400 cps for full modulation with a 500 cps signal. The maximum deviation at the output of the transmitter under these conditions would be 12,800 cps, which is ample for the purpose and allows the sidebands to extend beyond the maximum frequency deviation. The output of the transmitter is 25 watts at a storage battery drain of 23 amperes. This is approximately a two-to-one power gain over the demands of the usual amplitude-modulated mobile unit when the

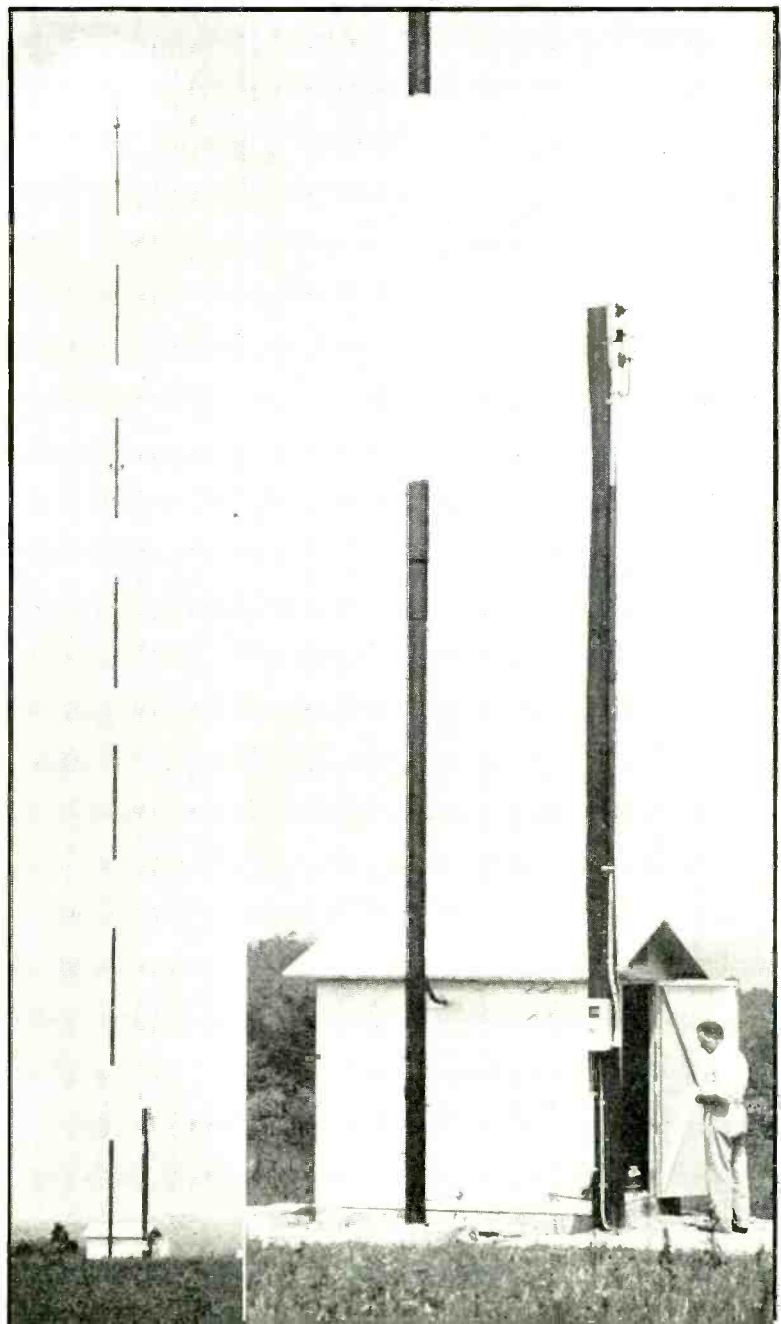



Fig. 10—The control unit at headquarters. The transmitter is put in operation when the operator pushes a button on the handset. Transmission occurs on 39,500 kc, reception on 39,180 kc

transmitter outputs are compared in terms of the primary power drain. Figure 8 shows the 250 watt f-m test transmitter which was used in the initial installation to prove-out the system. The f-m portions of the transmitter are contained in the two upper sections. The lower sections hold the power units and control relays. Two 807 tubes in parallel are used in the output stage of the exciter and their grids are fed by a 6L6 tube, otherwise this unit differs very little from the mobile transmitter. The exciter stage feeds the grid circuit of a single 250TH tube. Although the transmitter will deliver more than 250 watts output, it is conservatively rated on the basis of continuous operation with a 500 watt input to the plate of the output amplifier. The transmitter units installed permanently were similar to the one shown in Fig. 8 but with increased height of the cases to permit the installation of two receivers. Figure 9 shows the Westport unit, a typical fixed station installation. A 180 foot guyed pole supports a coaxial antenna. At the base of the pole an 8 ft by 8 ft by 8 ft welded steel building houses the 250 watt f-m transmitter and the two receivers. An automatic voltage regulator of the magnetic type insures reliable voltage regulation. Tele-

phone connections between the transmitter house and the barracks office are used to control the apparatus. Figure 10 shows a control unit in position. The circuit arrangements permit flexible operation. Normal operation with the handset on the hanger permits the operator to listen to both receivers. That is, he may receive messages from the mobile units operating on 39,180 or from the fixed stations operating on 39,500. If a call comes in from a mobile unit, the operator may cut off the audio system of the fixed station receiver by means of a relay switching operation which automatically takes place when he lifts the handset from the hanger. The message from the mobile unit is then heard by means of the ear phone and the fixed stations cannot be heard until the hanger is held down by hand or by the weight of the handset. Provision is also made for automatically opening the squelch of the mobile receiver when the handset is removed from the hanger. Such an arrangement permits perfect reception from mobile units operating far beyond the normal range of the system. Remote control of the transmitter is accomplished with the usual push-to-talk button on the handset. A two-stage amplifier, detector and vacuum tube voltmeter circuit in the control unit

indicate relative field strength at the control point so that a direct check on the transmitter output is available to the operator every time the control button is pressed. The control unit may be identified as the sloping panelled louvered unit with the two meters. The operator is shown in the act of using the radio handset. The other units in the picture are not associated with the radio communication system. This control cabinet, the only unit installed at the barracks operating position, is connected by telephone lines to the fixed station. The highest available sites near the center of the patrol areas were selected as locations for the fixed stations.

The receiver is a triple detection superheterodyne with double crystal control. The design factors may be summarized briefly. The essential design elements are:

- (1) 40 kc band pass at lowest signal level.
- (2) Sufficient gain so that the fluctuation noise in the first tube or first converter circuit will saturate the second limiter tube.
- (3) Sharp audio cutoff beginning at 3000 cps.
- (4) Sensitive squelch action with a high degree of carrier to noise discrimination.

(To be concluded)

# A PRE-SELECTOR CIRCUIT for TELEVISION RECEIVERS

By employing two tuned circuits between the antenna and the first tube grid, it is possible to obtain constant gain and constant bandwidth on all television channels from 50 to 108 Mc without sacrificing performance.

By **BENJAMIN F. TYSON**

*Hazeltine Service Corporation*

**B**EFORE the r-f signal picked up by a receiving antenna reaches the first tube in a television receiver, it passes through an input circuit or preselector which couples the antenna transmission line to the tube grid. There are four principal requirements that the preselector should meet. First, the frequency response should be wide enough to pass the television picture carrier and its sidebands to the extent they are transmitted, plus the accompanying sound carrier and its sidebands, and at the same time should be substantially flat over the desired pass band to avoid the complication of amplitude correction in subsequent circuits of the receiver. Second, good selectivity is important if undesirable cross-modulation products are to be suppressed and high image and i-f response ratios obtained. Third, the circuit gain or voltage step-up from the transmission-line terminals to the first grid should be as high as possible. This is vital in obtaining a high signal-to-noise ratio. Fourth, the bandwidth and gain of the preselector should be uniform, regardless of the mid-band frequency, if the fidelity and receiver sensitivity are to be the same for each television channel.

The first three requirements, pertaining to the shape of the response characteristic and the amount of circuit gain, may be met quite well by two tuned coupled circuits. A greater number of tuned circuits might be more effective but would

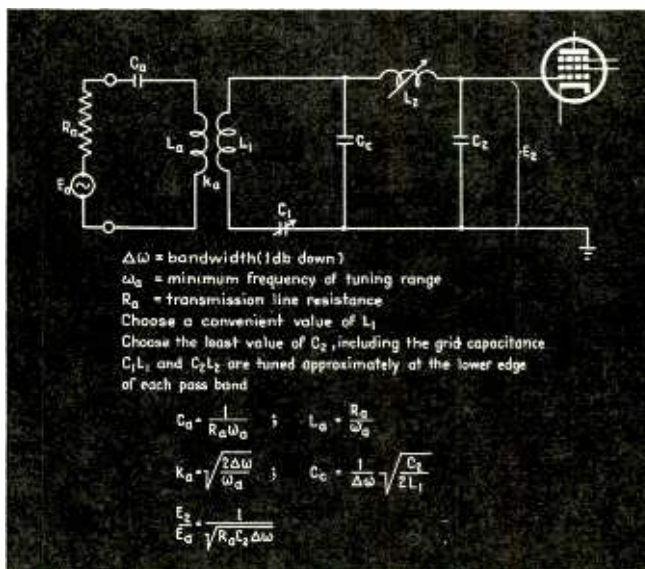
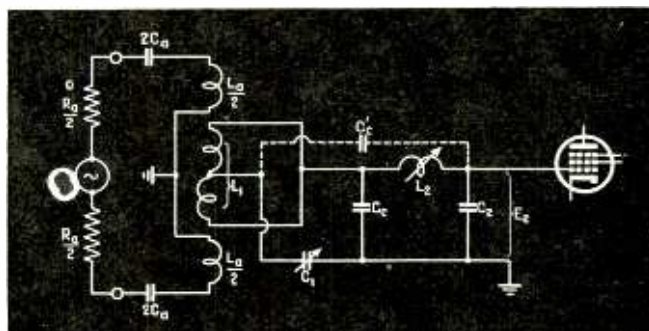

Fig. 1—Basic pre-selector circuit and equations for calculating the values

Fig. 2—Variation of the circuit in Fig. 1 for connecting a balanced-to-ground transmission line to a single-ended grid



be too complicated for practical use. The fourth requirement of uniform bandwidth and gain may be met with two tuned coupled circuits with the arrangement of Fig. 1.

A transmission line of resistance  $R_a$  and open-circuit voltage  $E_a$  is inductively coupled to the capacitance-tuned first resonant circuit  $C_1, L_1$  which in turn is capacitively coupled by  $C_c$  to the inductance-tuned second resonant circuit  $C_2, L_2$ . The capacitance-tuned first resonant

circuit uses fixed inductance and thereby circumvents the difficulties of switching transformers or adjusting the inductance of a transformer winding. The inductance-tuned second resonant circuit uses only the inherent fixed input capacitance of the first tube and thereby allows maximum impedance and hence always allows maximum voltage to be built up at the grid.

The preselector bandwidth, regardless of the mid-band frequency,

is uniform when the coefficient of coupling between the two tuned circuits varies inversely as the frequency, and the damping resistance is constant in the tuned circuit with fixed inductance ( $C_1L_1$ ). The generalized coefficient of coupling between any two circuits is the ratio of the coupling reactance over the geometric mean of the circuit reactances,

$$k = \frac{X_c}{\sqrt{X_1 X_2}} \quad (1)$$

In this preselector, the inverse variation is obtained with a capacitive coupling reactance inversely proportional to frequency and with the tuned circuits having opposite variation of reactance so the geometric mean reactance is constant. Thus

$$k = \frac{1}{\sqrt{\omega C_c}} = \frac{1}{\omega C_c} \sqrt{\frac{C_2}{L_1}} \quad (2)$$

The expression for the coefficient of coupling then contains only one variable term, the frequency in the denominator, and the remaining constant terms  $C_c$ ,  $C_2$ , and  $L_1$ . The derivation of the coefficient of coupling neglects the reactance of  $C_c$ , but the expression is a very good approximation when  $C_c$  is much greater than  $C_1$  and  $C_2$  as it is in practice.

The maximum gain from line to grid is obtained by relying on the line resistance  $R_a$  for all the damping. The resistance in the coupling circuits is minimized. This method of design requires that the coefficient of coupling between the two tuned circuits be

$$k = \sqrt{2} \frac{\Delta\omega}{\omega} \quad (3)$$

in which  $\Delta\omega$  is the bandwidth (at 1 db down) and  $\omega$  is the mean frequency of any band. Therefore the required coupling capacitance is

$$C_c = \frac{1}{\Delta\omega} \sqrt{\frac{C_2}{2L_1}} \quad (4)$$

which is the same for every band, since  $C_2$  and  $L_1$  are not variable.  $C_c$  is completely determined since  $\Delta\omega$  depends on the desired bandwidth,  $C_2$  is the input capacitance of the tube, and  $L_1$  depends on the minimum obtainable value of  $C_1$  and the highest frequency to which

$L_1C_1$  is to be tuned, in the 108 Mc band.

This method of design requires also that the resistance reflected from the line into the first tuned circuit,  $C_1L_1$ , should be

$$r_1 = 2L_1\Delta\omega \quad (5)$$

This is the same for every band; it means that the bandwidth from the line to the first tuned circuit, with the second tuned circuit removed, should be  $2\Delta\omega$  at 3 db down. It is assumed that the transmission line presents a resistance  $R_a$  which is substantially constant, by virtue of the matching of the line with the antenna at the far end of the line. Also the attenuation in the line smooths out its resistance variation.

The condition of constant damping resistance in the first tuned circuit is obtained when  $L_1$  is made the secondary of a transformer having a broadly tuned primary circuit connected with the antenna transmission line. This circuit is resonant at a frequency  $\omega_a$  at or below the minimum frequency of the tuning range. It is designed to be half-critically damped by the line resistance  $R_a$ , so it reflects in series with  $L_1$  a resistance which is nearly constant over the tuning range. This resistance is adjusted to its desired value  $r_1$  by the coupling  $k_a$ . The circuit equations for obtaining these relations are given with Fig. 1.

A straightforward analysis of the preselector with the values of its components just derived shows the gain at mid-band to be

$$\frac{E_2}{E_a} = \frac{1}{\sqrt{R_a C_2 \Delta\omega}} \quad (6)$$

The gain is independent of the actual operating frequency and is a function of only the antenna resistance, the tube input capacitance, and the bandwidth.

It may be of interest to mention that this same circuit configuration may be used with equal damping of the two tuned circuits. The second tuned circuit is damped by adding across the tube capacitance  $C_2$  a conductance  $G_2$  of value  $C_2 \Delta\omega$ . Also the coefficients of coupling  $k_a$  and  $k$  are reduced in the ratio  $1/\sqrt{2}$ , the latter by increasing  $C_c$  in the ratio  $\sqrt{2}$ . This gives the same shape of resonance curve. The desirable preselector properties of uniform bandwidth and constant gain over the tuning range are retained but the amount of gain is reduced by one-half.

Theoretically, when two tuned

#### TABLE OF CIRCUIT VALUES

$\Delta f = 6$  Mc = bandwidth (1 db down)

$R_a = 100$  ohms = transmission line resistance

$f_a = 50$  Mc = resonant frequency of antenna circuit

$C_a = 32$   $\mu\mu\text{f}$

$L_a = 0.32$   $\mu\text{h}$

$k_a = 0.49$

$L_1 = 0.24$   $\mu\text{h}$

$C_2 = 18$   $\mu\mu\text{f}$  (including grid of 6AC7 modulator)

$C_c = 160$   $\mu\mu\text{f}$

$L = 0.1$   $\mu\text{h}$  = inductance inserted in screen lead of 6AC7

Band (Mc)	$C_1$ ( $\mu\mu\text{f}$ )	$L_2$ ( $\mu\text{h}$ )
50-56	42	0.56
60-66	29	0.39
66-72	24	0.32
78-84	17	0.23
84-90	15	0.20
96-102	11	0.15
102-108	10	0.14

NOTE: These values must be adjusted by trial to correct for variations in wiring and other incidental effects.

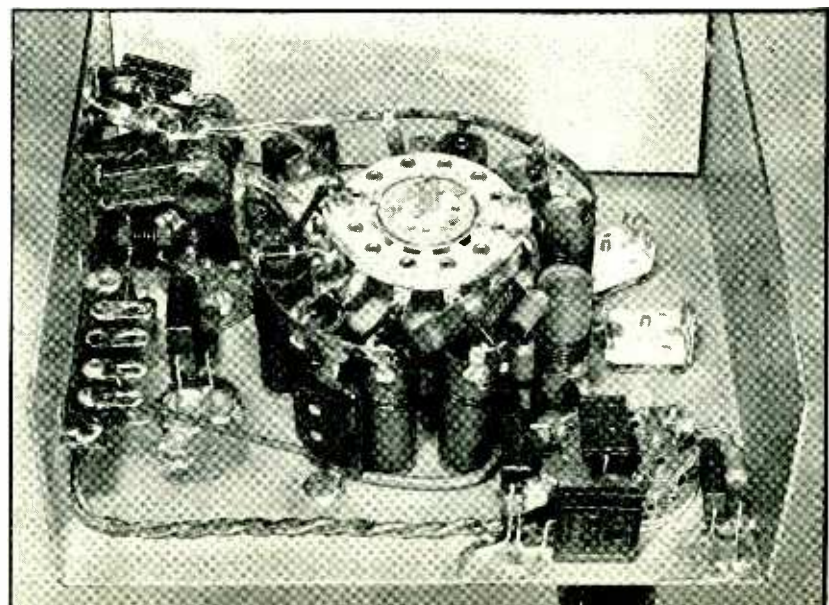

Fig. 3—Construction of a typical preselector circuit based on Fig. 2, for the two highest and three lowest channels in the 44-108 Mc range

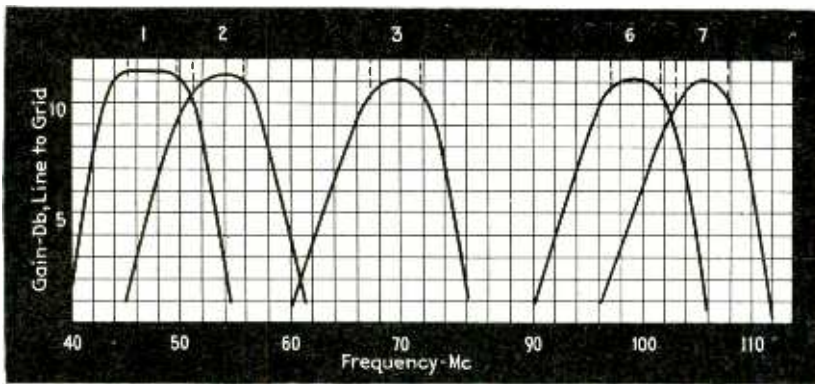

Fig. 4—Actual response curves of the pre-selector shown in Fig. 3. Less than 2 db variation in gain is obtained over the full range of channels

circuits of the types used in the preselector are coupled by a fixed condenser  $C_c$ , the resulting bandwidths should be equal at all frequencies within the tuning range. Practically, however, the inherent series inductance of the coupling condenser  $C_c$  and inherent shunt capacitance of the inductance  $L_1$  both tend to reduce the coupling at higher frequencies. This effect is cancelled by the small additional coupling capacitance  $C_c'$  connected as in Fig. 2. Its value is most easily determined by trial. The inherent shunt capacitance of inductance  $L_2$  tends to reduce the coupling in a constant ratio. This effect is cancelled by slightly decreasing  $C_c$  from its calculated value to increase its coupling reactance. Here also, the correct value is best determined by trial.

The theoretical design formulas derived above are an aid in getting the approximate magnitudes of the circuit elements; exact adjustments must be made by experiment when the preselector is under construction.

#### Practical Form of Pre-selector

The circuit diagram of Fig. 2 shows the transformer coupling the transmission line to the first resonant circuit in a practical form with balanced-to-unbalanced arrangement. To demonstrate the utility of the preselector, the model shown in Fig. 3 was constructed to cover the two highest channels and the three lowest channels of the seven which were tentatively assigned at that time in the region between 44 and 108 Mc. Tuning from channel to channel was done by switching the proper values of the variable elements  $C_1$  and  $L_2$  into their resonant circuits. The present assignment of seven channels be-

tween 50 and 108 Mc will simply reduce the range which must be covered.

The photograph of the selector in Fig. 3 shows the arrangement of the parts around a rotary switch. The coils in the foreground are those of the superheterodyne oscillator. The coils and condensers around the switch in back are the adjustable elements of the pre-selector, switched from band to band. The coils for the oscillator and for  $L_1$  of the preselector are adjustable by copper cores. The cores are mounted on screws whose heads are accessible on the other side of the base. The inductance of leads is minimized by connecting lugs directly or using copper strip. The oscillator tube is in the right foreground and the modulator tube in the left rear. Of the two sections of the switch, the one not visible is connected with the condensers  $C_1$ . The one visible is connected on the far side with the selector grid coils  $L_2$  and on the near side with the oscillator coils, the coupling from the oscillator to the modulator grid being furnished by the capacitance in the switch rotor. One section of the switch is shielded from the other by a metal disc.

The transformer  $L_a, L_1$  deserves special attention. It is a balanced-to-unbalanced transformer along the lines of that described by H. A. Wheeler in the April, 1928, *I.R.E. Proceedings*. It is the extra coil seen in the upper left corner of Fig. 3. The symmetry is maintained between balanced primary circuit and unbalanced secondary circuit by making the secondary of two coils wound in opposite directions and connected oppositely in parallel as shown in Fig. 2.

The accompanying table shows the circuit values computed for a

design covering the new channel allocation. They are adjusted by trial to take care of inherent inductance and capacitance of the parts and wiring.

The preselector coupled a 100-ohm transmission line to a 6AC7 modulator. At these frequencies the input conductance of this tube is so great that optimum performance, with no damping in the second tuned circuit, cannot ordinarily be obtained. To correct this defect, regeneration was introduced by means of a small inductance in the screen-grid circuit. This is the small coil visible in Fig. 3 near the modulator socket. The negative feedback conductance and the positive input conductance vary as the square of the frequency so they cancel and the operation is stable over the entire frequency range. More details on this subject appear in an article by R. L. Freeman in October 1939 *ELECTRONICS*.

The actual response characteristics of the unit are those of Fig. 4. The bandwidths at 1 db down are about the same for all five channels and the gain is nearly constant at 11 db. Taking the bandwidth as about 5 to 6 Mc and the capacitance  $C_2$  of the second tuned circuit as about  $18 \mu\mu\text{F}$ , the computed gain is 12 db, a good check with the measured results. The curves show that this preselector meets the requirements of selectivity, high constant gain, and uniform wide bandwidth.

This selector has given excellent performance in both laboratory sets and commercial television receivers. It has been used both with rotary switches and push-button switches. The rotary switch gives shortest leads; it can be operated by push-buttons through the medium of a motor drive, which allows the selector to be mounted in the most convenient location in the chassis.

The constant-bandwidth preselector circuit was devised by H. A. Wheeler; it is the subject of U. S. Patent No. 2196881, to which reference is made for further information on its theoretical basis. This subject was presented by the writer before the New York meeting of the I.R.E. on May 1, 1940.

# QUARTZ . . . from RAW STOCK to FINISHED CRYSTAL

These pictures, taken at the crystal laboratory of the General Electric Company, disclose optical and mechanical operations not generally known to radio engineers, but highly essential to the precision and reliability of the product

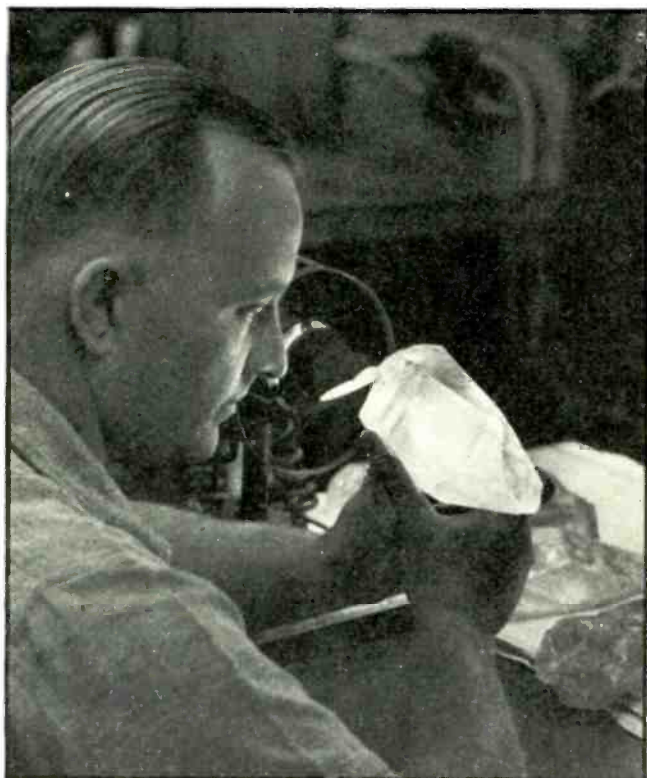

Raw Brazilian quartz crystals, averaging six inches in length and six pounds in weight, are subjected to arc-lamp examination for imperfections and "needles." The imperfections are marked on the raw quartz preliminary to cutting operations

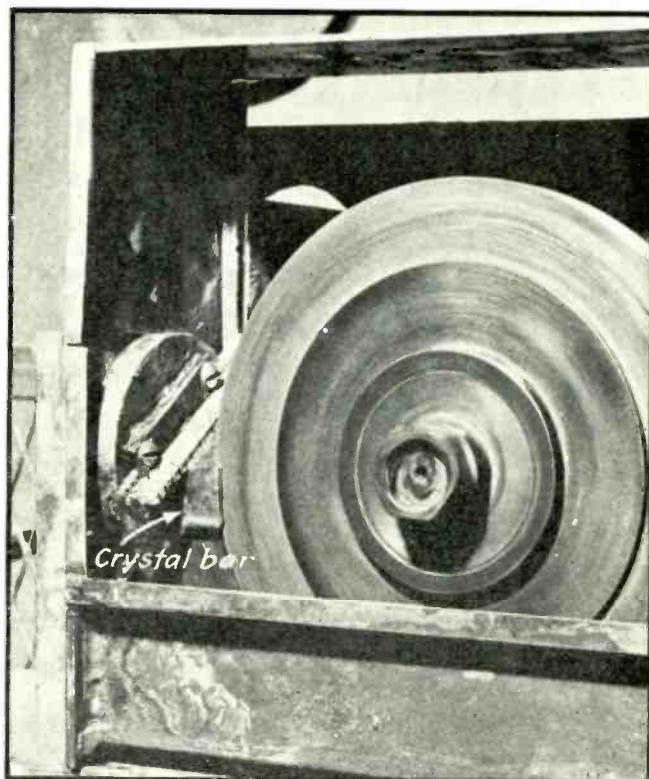

The raw quartz crystals are first cut into bars and then into thin slices called "blanks" at approximately the desired angle, with a gang-saw cutting machine using carborundum abrasive. Great care must be taken to maintain the correct angle

This hexagonal cut is being inspected by polarized light revealing what is called "twinning." Twinning may not prevent oscillation of the crystal, but it will almost invariably show up in impaired performance at some temperature, or in reduced life. All "twinned" quartz is rejected

Adjustable cylindrical fixtures hold the blanks in position on x-ray equipment so that the technician can orient them by means of x-ray reflection. Such orientation makes it possible to produce crystals whose frequency remains constant to less than 0.0001 per cent per degree Centigrade change in temperature

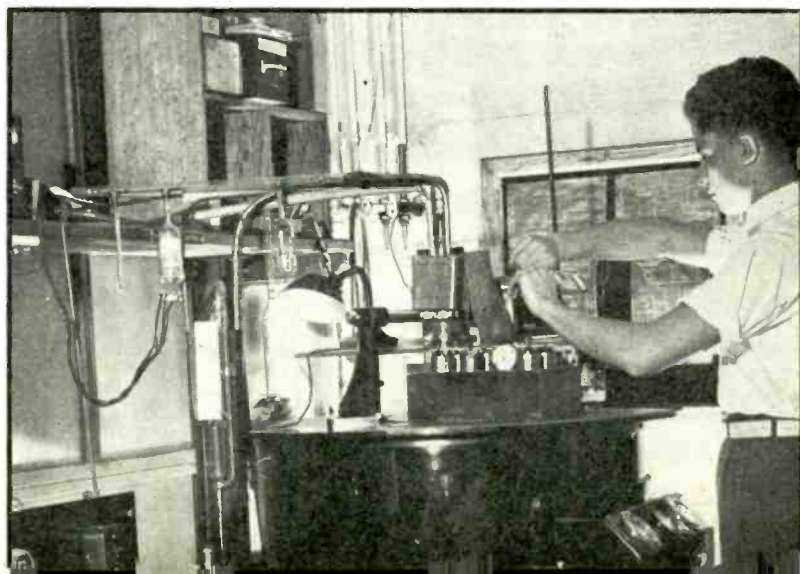
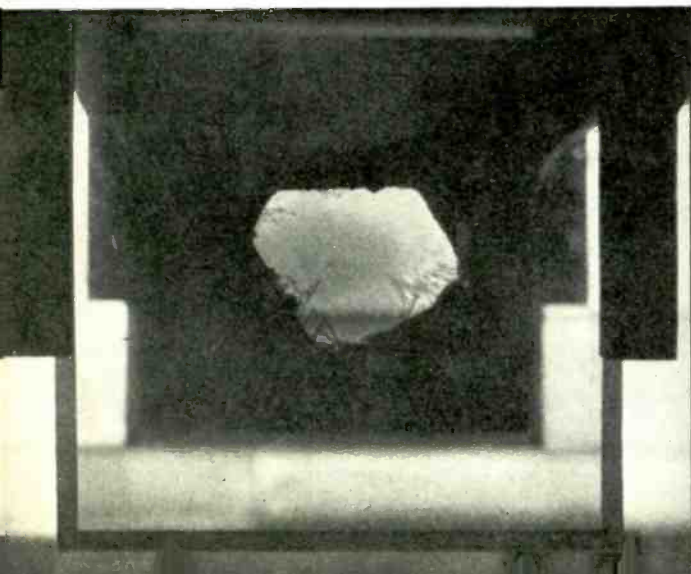



Once the correct reference face has been established by the X-ray process, the crystal, still held securely at the base of the adjustable cylinder, is ground to the correct angle on a manually operated grinding spindle. After a number of crystals have been ground on one face to the correct plane, several are placed on flat plates and the entire lot ground parallel on a grinder

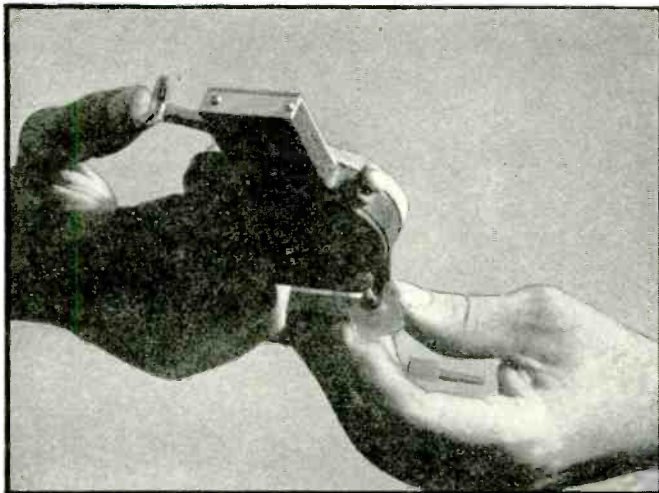

At times performance of the crystal at the finisher's bench may lead to doubts as to whether the crystal is parallel. In such cases parallelism is checked with a small thickness gauge by measuring the thickness of the crystal at various points

Final test of the complete crystal units before being cataloged for shipment takes place when several units at a time are placed in a crystal circuit for testing performance over a wide temperature range. Completed units can be seen in the tray to the right of the technician and several others in the circuit immediately in front of him

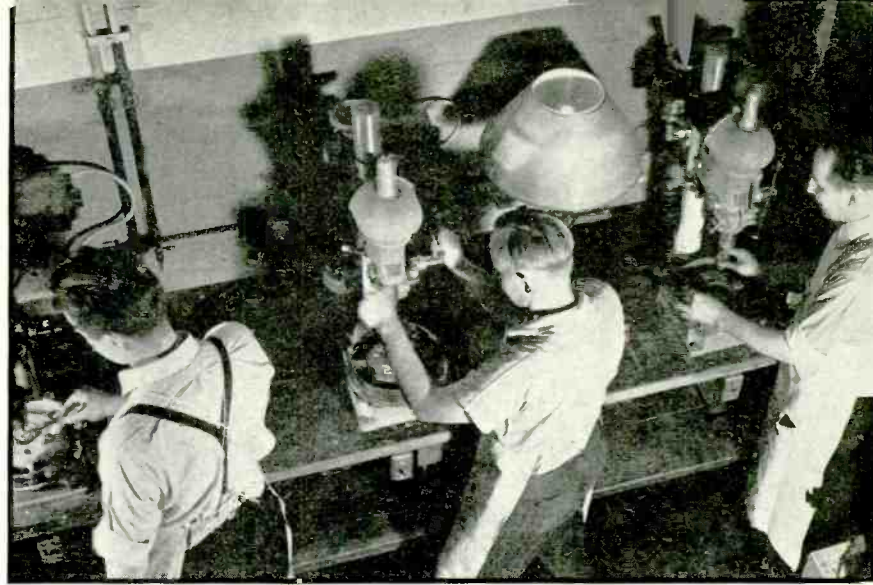

Preliminary to the more precise work of hand finishing, the thickness of the crystals is reduced by machine lapping. Each machine handles eight crystal blanks at once, lapping as close to the correct thickness as is economical in this stage of manufacture. Time-switch mechanisms control this operation

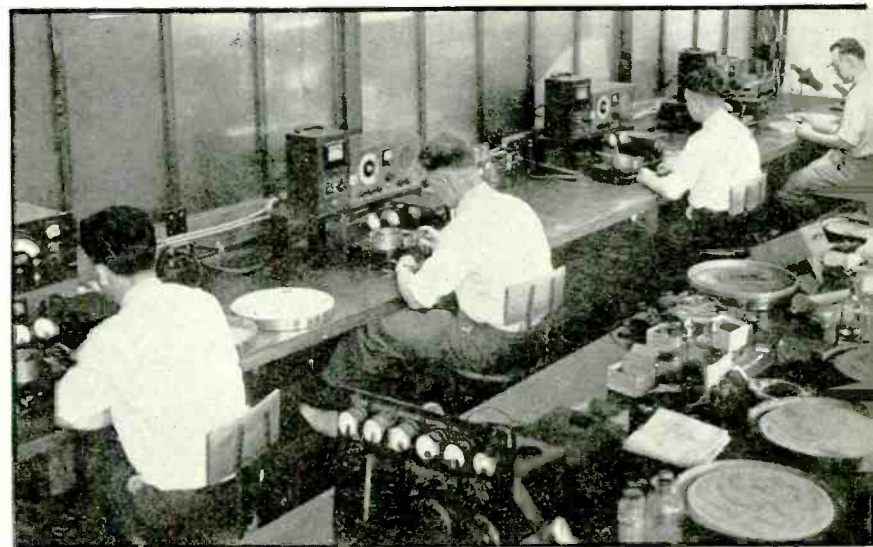

Crystal finishing demands skilled operators who are supplied with a test oscillator, lapping plates, and metal blocks for varying the temperature of the crystal during the operations. Tests of the crystal in conjunction with an audio frequency meter or audio oscillator indicate just how much the frequency must be raised. Expert finishers then know approximately how much lapping down of the crystal is necessary to bring it to that frequency. Frequency limits are so close that physical thicknesses must be controlled to a few millionths of an inch, and ordinarily the amount to be taken off will be between 0.0005 and 0.0001 inch. At the same time, finishers must be on the alert for frequency jumps and variations in crystal activity

More than 750 crystal units lined up waiting for test. In the front are completely metal-clad units and in the rear are others in stages of partial assembly

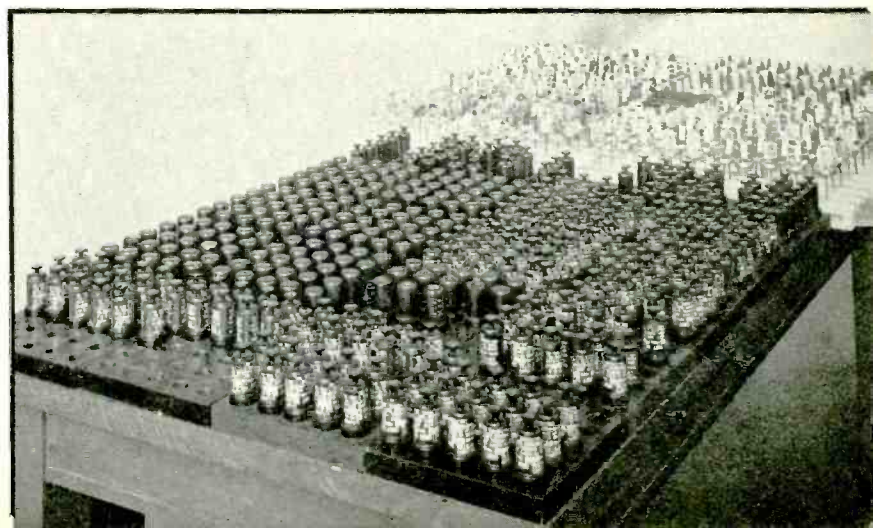

# THE CHRONOSCOPE

An electronic interval timer originally developed to test the velocity of rifle bullets, but widely applicable in the measurement of intervals from one to 200 milliseconds with one per cent accuracy. Employs two thyratrons in connection with a ballistic galvanometer

By C. I. BRADFORD, *Remington Arms Company, Inc.*

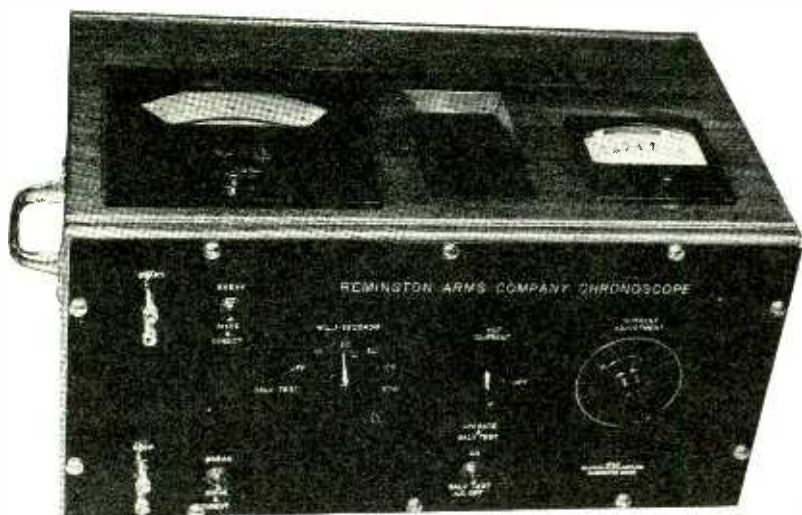

Fig. 1—External view of the chronoscope, showing controls for setting the calibration and meters for reading the time interval and the charging current

**A**N essential test on all small arms ammunition is that of the measurement of velocity or time of flight of the projectile. The device here described is an interesting application of electronic tubes to a new instrument for the measurement of time intervals in the range encountered in most ballistic tests. This device, which has been called a Chronoscope,\* measures intervals between one millisecond and two hundred milliseconds (0.001 to 0.200 seconds) on five different ranges with an accuracy within one per cent of full scale. It is completely self-contained and portable and has provision for internal calibration. Because of these features and the versatility of the device, it

\* Applications for the U. S. patents on the device are pending.

should be of interest to ELECTRONICS' readers in applications other than the one for which it was developed.

The requirement of an accuracy within one per cent on intervals of approximately ten milliseconds automatically ruled out the use of methods previously developed.<sup>1, 2, 3</sup> The principle of operation used in the Chronoscope is a very old, yet simple one, brought up to date through the use of modern tubes and circuit applications. It consists merely of passing a known current through a ballistic galvanometer during the time interval to be measured. If the length of time required for the meter to swing up scale is long compared to the time during which current flows, (the unknown interval) the maximum de-

flection will be directly proportional to the time interval.

The galvanometer used is of special design and in appearance resembles a conventional portable indicating meter. It is equipped with an illuminated scale and special pointer to facilitate reading the maximum swing. The period is approximately five seconds. The galvanometer current is supplied by self-contained batteries and the switching operation is performed electronically. The complete instrument is contained in a cabinet 9x12x19 inches as shown in Fig. 1.

## *Galvanometer as an Indicator of Time Intervals*

The general equations for a ballistic galvanometer show that the angle of deflection  $\theta$  is directly proportional to the quantity of electricity  $Q$  that has passed through the instrument. That is

$$\theta = kQ \quad (1)$$

where  $k$  includes all the instrument constants.<sup>4</sup>

When a galvanometer is used as a Chronoscope, a circuit is closed at the beginning of the time interval allowing a current  $I$  to flow through the galvanometer. At the end of the interval the circuit is opened. Then during the interval  $T$

$$Q = IT \quad (\text{See Fig. 2}) \quad (2)$$

The galvanometer deflection resulting will be

$$\theta = kIT \quad (3)$$

Then if  $k$  and  $I$  are known the time interval is

$$T = \frac{\theta}{kI} \quad (4)$$

The constant  $k$  can be determined in the following manner. If a condenser of capacity  $C$  is charged to a potential  $E_1$  the charge is  $Q = C \cdot E_1$  (see Fig. 3). If the condenser



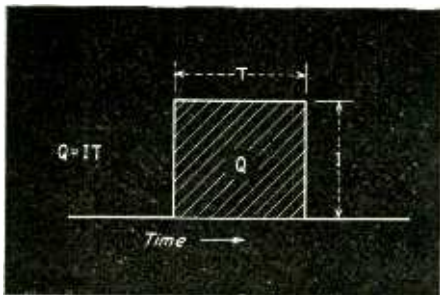

Fig. 2—Basic relationship of charge, time and current, on which ballistic galvanometer measurements are based

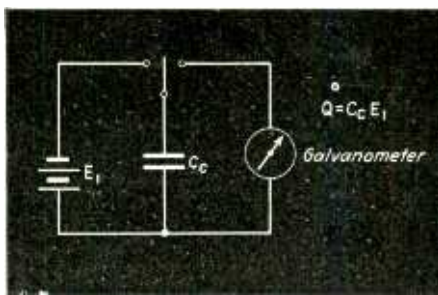

Fig. 3—Basic galvanometer calibration circuit which stores and then discharges a known quantity of charge

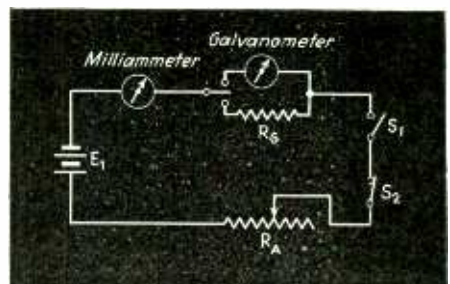

Fig. 4—Basic chronoscope circuit. Switch  $S_1$  closes at the beginning and  $S_2$  opens at the end of the timed interval

is then discharged through the galvanometer and the deflection  $D$  observed,

$$D = kC_e E_1, \text{ or } k = D/C_e E_1 \quad (5)$$

The current  $I$  can be determined by steady state measurements as follows (see Fig. 4): The switching circuits used in making the time measurements are left in the closed position. A key is used to switch a resistance  $R_g$  into the circuit equal to the resistance of the galvanometer, and a milliammeter is provided in the circuit. The current indicated by the milliammeter will be the current  $I$  which flows through the galvanometer during the time  $T$ . Hence from equations (4) and (5)

$$T = \theta \frac{(C_e E_1)}{ID} \quad (6)$$

Let  $K$ , the multiplying factor to convert deflections  $\theta$  into time  $T$  be given by  $\frac{C_e E_1}{ID}$ . For convenience  $K$  should be some integer.  $I$  can be adjusted by means of a series re-

sistance  $R_A$  to the desired value of

$$I = \frac{C_e E_1}{KD}$$

Thus the range of the instrument may be varied over wide limits by setting the current to the proper values.

#### Operation of the Chronoscope

The simplest diagram for operation of the Chronoscope is shown in Fig. 4 in which switch  $S_1$  closes at the beginning and  $S_2$  opens at the end. For measuring time intervals between 0.001 and 0.1 second it is necessary to resort to electronic tubes to perform the function  $S_1$  and  $S_2$  in order to reduce the switching time and minimize this source of error.

Consider Fig. 5 in which tubes  $V_1$  and  $V_2$  are gas filled thyratrons. With no voltages applied to the inputs no current flows through the tubes because of the negative voltage applied to the grids through  $R_g$  from  $E_3$ . An impulse on number 1

input at the beginning of the interval breaks down thyratron  $V_1$ , allowing a known current  $I$  to flow from  $E_1$  through  $R_A$ , the galvanometer  $G$  and tube  $V_2$ . The impulse on number 2 input at the end of the interval breaks down  $V_2$  connecting  $E_1$  and  $E_2$  in series through  $R_A$  and  $V_2$ . The resulting increase in voltage across  $R_A$  lowers the potential of the anode of  $V_1$  to the point where it extinguishes, thus cutting off the current through the galvanometer.

This type of thyratron switching circuit has been used instead of the conventional plate to plate capacity coupled circuit for two reasons. First, the current  $I$  which flows through the galvanometer during a time measurement can be set in steady-state without regard to transient current. Secondly, the circuit locks out so that after the galvanometer current has been cut-off, subsequent impulses on No. 1 input cannot re-ignite  $V_1$  until the circuit through  $V_2$  has been broken. Experience has indicated that when switches are used on the inputs, the chatter time is of such time as to cause  $V_1$  to re-ignite if this arrangement is not used.

In order to provide a complete and convenient instrument the basic circuit of Fig. 5 requires numerous additions and refinements. Protection must be provided for the galvanometer in case of failure of the impulse on No. 2 input, otherwise a current would continue to flow through the galvanometer many times that required for full scale steady-state deflection and would result in the destruction of the meter. Internal means must be provided for checking the ballistic constant of the galvanometer. A milliammeter and resistors must be included for adjusting the current

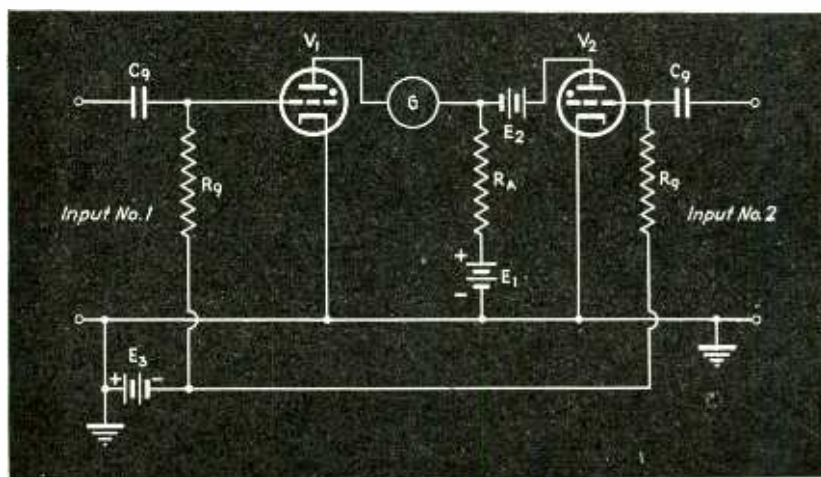

Fig. 5—Simplified chronoscope circuit with electronic switching elements. Tubes  $V_1$  and  $V_2$  perform the functions of the switches of Fig. 4.

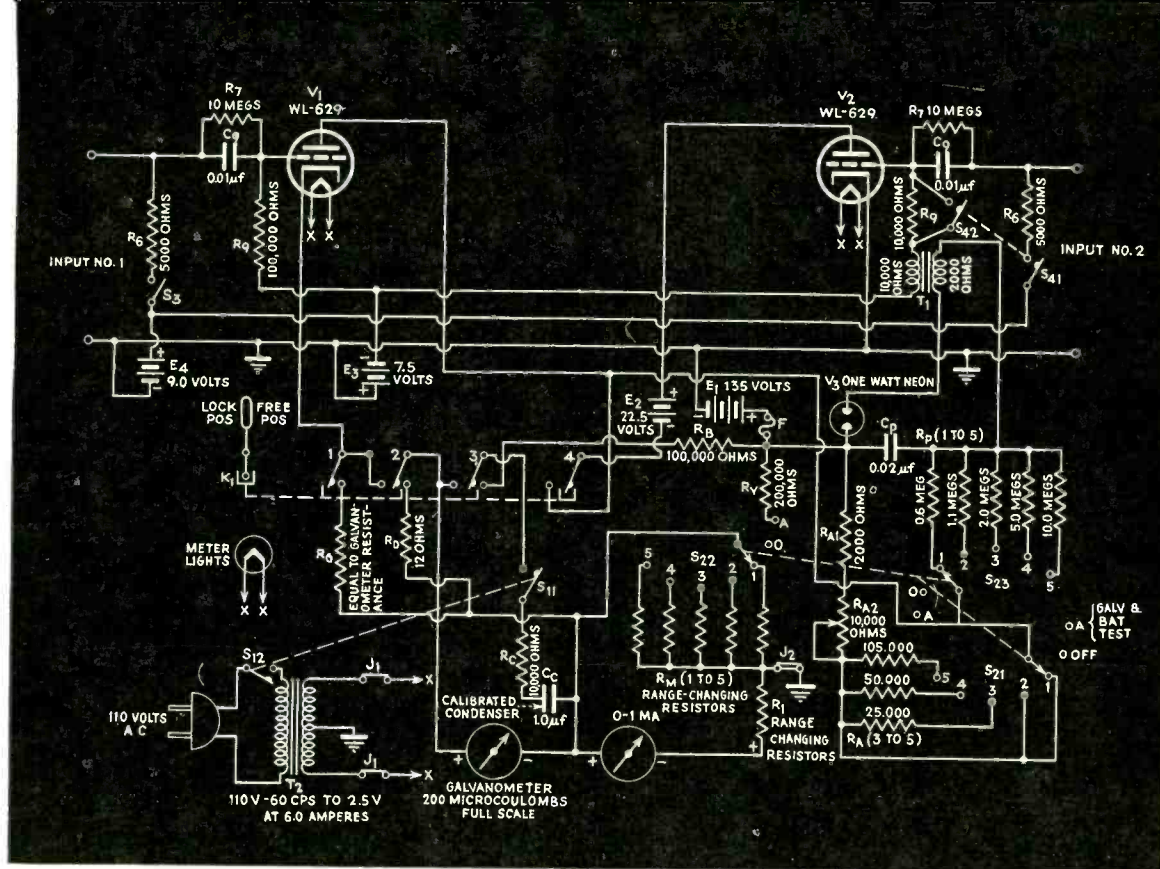

Fig. 6—Complete circuit diagram of the chronoscope, including meter-protecting circuit

to the proper values for the various scales. It also has been found desirable to provide the input circuits with an arrangement whereby they can be operated directly from either a make or a break circuit as well as from an amplifier.

#### Operation of Complete Instrument

The basic circuit as well as the above features are shown in the diagram of the complete instrument in Fig. 6. First, consider the circuit for checking the ballistic constant of the galvanometer. With key  $K_1$  in the position shown, the galvanometer is damped by the resistance  $R_D$ . With  $S_{22}$  on position A and  $S_{11}$  closed, condenser  $C_c$  charges to the voltage  $E_1$ , and the milliammeter is connected through  $R_v$  to read the voltage of  $E_1$ . When  $K_1$

is thrown to the right,  $C_c$  discharges through the galvanometer and the ballistic constant  $k$  can be determined.

In order to set the current  $I$ , the switch  $S_{11}$ - $S_{12}$  is thrown to the right thereby disconnecting the calibrating condenser and energizing the filament supply. With the selector switch  $S_{21}$ - $S_{22}$ - $S_{23}$  on positions 1 to 5 and with  $K_1$  thrown to the left a circuit is provided from the battery  $E_1$  through  $R_A$ , through  $V_1$  when it is broken down, through  $R_v$ , and through the milliammeter circuit. This makes it possible to set  $I$  by means of  $R_{12}$  to the proper value for the desired multiplying factor. The circuit provided by  $S_{22}$ ,  $R_M$ , and  $R_1$ , changes scales on the milliammeter in accordance with the time scale selected.

In regard to the input circuits, consider input number 1. The grid of  $V_1$  is always biased to cutoff from  $E_3$  in steady state. If  $S_3$  is open, and a make circuit is closed across the input, current flows from  $+E_3$  through the external circuit to charge  $C_0$  through  $R_0$ . This voltage developed across  $R_0$  applied to the grid is sufficient to cause  $V_1$  to ignite. The resistance  $R_7$  is extremely high and serves to dis-

charge  $C_0$  slowly in order to reset it for the next operation. Also with  $S_3$  open, any voltage applied to the input from an external source will appear directly on the grid of  $V_1$  and will cause it to ignite. With  $S_3$  closed the input circuit operates directly on a break as follows: The input is normally closed, and when the break occurs the voltage  $E_4$  appears across the input terminals and through  $C_0$  to the grid of  $V_1$ , causing it to ignite. The operation of input number 2 is identical to that of number 1.

Referring again to Fig. 6 the protective circuit consists of  $R_p$ ,  $V_3$ ,  $C_p$ ,  $S_{23}$  and  $T_1$ . The action is as follows: When  $V_1$  breaks down, a voltage appears across  $R_A$  which is impressed on  $R_p$  and  $C_p$  in series.  $C_p$  continues to charge until its voltage reaches the breakdown voltage of the gas filled tube  $V_3$ . The discharge of  $C_p$  through  $V_3$  through the transformer  $T_1$  produces a positive kick in the secondary and trips off  $V_2$  to turn off the galvanometer current. The length of time required for  $C_p$  to charge to the breakdown voltage of  $V_3$  is selected by means of  $S_{23}$ . These values are so adjusted that the protective circuit operates on any interval longer than that required for full scale deflection regardless of range.

Figure 1 shows the external ap-

(Continued on page 60)

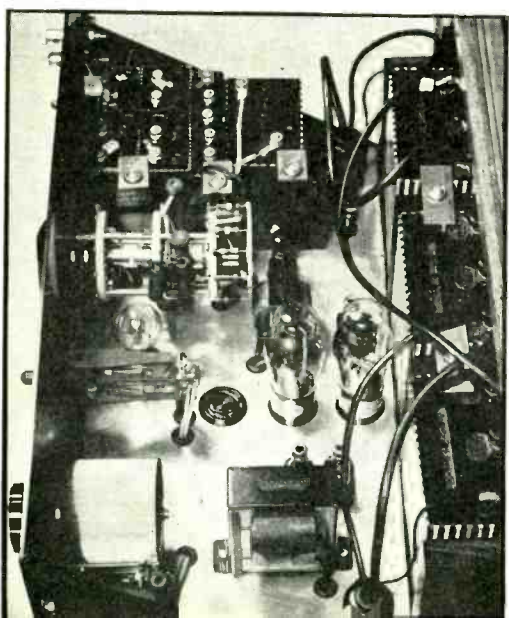

Fig. 7—Internal view of the chronoscope unit. The self-contained battery supply insures accuracy of calibration

# A HIGH-SENSITIVITY PHOTOTUBE CIRCUIT

By using a pentode as the high resistance load for a phototube, the percentage change in voltage across the phototube is made greater than the percentage change in light. The sensitivity of the circuit is thereby made considerably greater than that of the conventional circuit

By H. S. BULL and J. M. LAFFERTY

University of Michigan

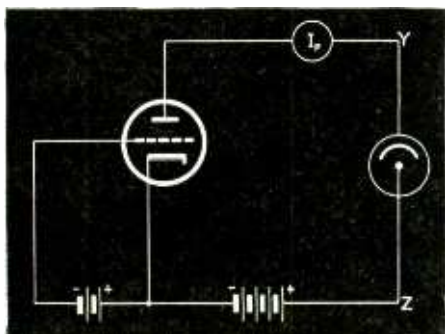

Fig. 1—Circuit showing the principle of operation. The plate circuit battery supplies voltage for the plate of triode as well as the phototube in series with it

THE possibility of using a thermionic tube as a high-resistance load for a phototube has already been recognized. Of the articles describing applications of this principle which have appeared from time to time in technical literature, the one by F. H. Shepard, Jr.<sup>1</sup> deserves special mention. It is the purpose of the present article to describe a similar circuit which may be expected to give consistently good performance without requiring unusual precautions against leakage. It should be noted in passing that the experimental work of the writers which led to the development of this circuit was carried on without previous knowledge of Mr. Shepard's contribution.

For the purpose of reviewing this interesting action consider the illustrative circuit shown in Fig. 1. A phototube of the vacuum type is connected in series with the plate of a triode whose grid is negatively biased, but not to the point of cut-off. The battery in the plate circuit supplies somewhat higher voltage than would normally be used for

the triode alone. With the phototube dark,  $I_p = 0$ . If the phototube is illuminated with light of unvarying intensity a steady current will be established in the circuit and the drop in potential from Z to Y, Fig. 1, may be expressed as

$$V_{zy} = E_{bb} - E_p$$

where  $E_{bb}$  is the battery voltage and  $E_p$  is the voltage drop in the triode.

An increase in light intensity will cause an increase in current. This will increase the value of  $E_p$  and thereby cause  $V_{zy}$  to decrease. If a triode of very high plate resistance is available, a comparatively small percentage change in light intensity will produce a large percentage change in the value of  $V_{zy}$ .

To obtain a practical benefit from this phenomenon we need merely to use the voltage  $V_{zy}$  as the input to an amplifier. That is, let the voltage drop across the phototube change the grid potential of an amplifier tube. By so doing, a small percentage change in light intensity may be made to produce a large percentage change in the plate current of the amplifier.

After careful consideration of tube characteristics a pentode, the 6K7, was chosen for the experimen-

<sup>1</sup> Some Unconventional Vacuum Tube Application. F. H. Shepard, Jr. *RCA Review*, Vol. 2, Oct. 1937.

Fig. 2—Light-current characteristic of type VB phototube. The curve for 28 volts represents the current at saturation

tal studies of this circuit. Its plate characteristic curves are quite flat, the voltages required for biasing the grids are moderate, it has a remote cut-off, and it is inexpensive. The phototube is a Westinghouse type VB, and the output voltage,  $V_{zy}$ , is supplied to the grid of a 6C5 to provide a convenient means of measuring the circuit response.

Figure 2 shows the relationship between output current and light intensity on the cathode of the type VB phototube for three selected anode voltages. The line marked  $E_{28}$  was obtained by applying 28 volts to the anode and varying the light intensity over the indicated range. It is typical of the performance to be expected for all anode voltages above the saturation level. For voltages below saturation the phototube sensitivity is decreased, as evidenced by the position of the lines  $E_{10}$  and  $E_5$ , for anode voltages of 10 and 5 volts respectively.

Figure 3 shows several plate characteristic curves for the 6K7. For

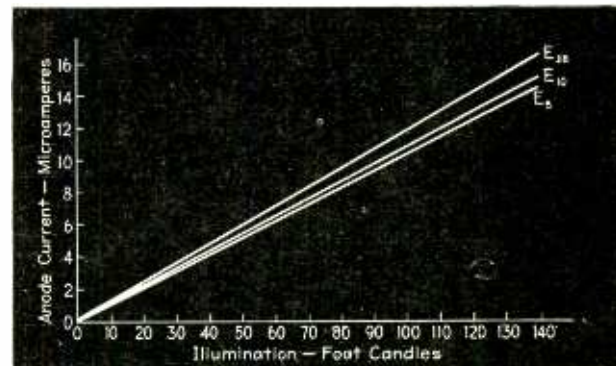

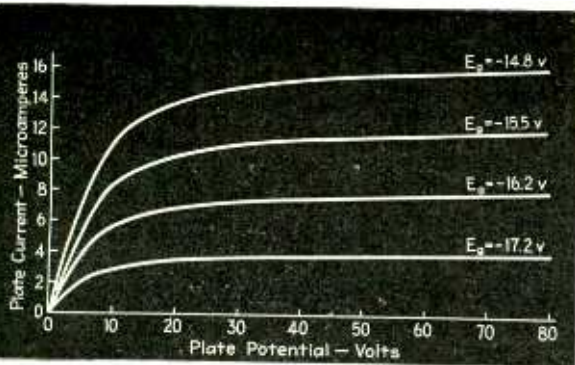

Fig. 3—Plate characteristics of the 6K7 tube.  $E_b = 6.3$  v  $E_{c2} = 40$  v  $E_{c3} = -6.5$  v

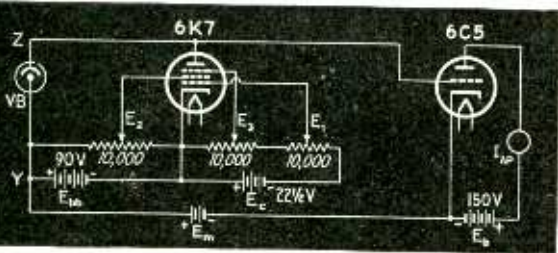

Fig. 4—Diagram of the high sensitivity phototube circuit. The value of  $E_m$  is about 30 volts when the phototube is operating above the saturation voltage

a suppressor grid potential of  $-6.5$  volts and a screen grid potential of 40 volts the curves become very nearly flat, so that large changes in plate potential accompany small changes in plate current.

The experimental circuit is shown in Fig. 4. An understanding of its operation can best be gained by examining Fig. 5. The line marked  $E_s$  in Fig. 5A indicates the relationship between phototube current and light intensity on the phototube cathode when its anode voltage is sufficiently high to produce approximate saturation. The line  $E_u$  represents the phototube behavior with a somewhat lower anode voltage. The curve of Fig. 5B is typical of the relationship between  $I_p$  and  $E_p$  for the 6K7 as used in the experimental circuit, except that the slope has been exaggerated. In Fig. 5C, the intensity of light on the phototube is plotted against  $V_{zy}$ , the voltage affecting the bias of the 6C5 amplifier tube.

Now let a definite amount of light ( $F'$ , Fig. 5A) strike the phototube cathode, with the values of  $E_{bb}$  and the control grid bias of the 6K7 so selected as to insure operation of the phototube above the saturation level. A current  $I'$  will be emitted

by the phototube (this being the ordinate of point  $a$  on line  $E_s$ ). Because of the series connection this current will become the plate current of the 6K7, and the value of the plate voltage can be determined by passing a horizontal line through point  $a$  and extending it until it cuts the curve of Fig. 5B. The output voltage,  $V'_{zy}$ , will be determined by the equation,  $V'_{zy} = E_{bb} - E'_p$  and may be plotted as the ordinate of the point  $m$ , Fig. 5C.

For a somewhat greater light intensity,  $F''$  the phototube current becomes  $I''$ , the plate current is  $I''_p = I''$  and the output voltage is  $V''_{zy}$ , which appears in Fig. 5C as the ordinate of  $n$ . It will be noted that the percentage change in the value of  $V_{zy}$  is much greater than the percentage change in light intensity.

For light intensities greater than  $F'''$  (assuming no change in control grid voltage), the phototube current can no longer be found by projecting to the line  $E_s$ , because the voltage  $V_{zy}$  across the phototube is insufficient to saturate it, and the current is now dependent upon the values of both  $E_p$  and  $V_{zy}$ . Nevertheless there will be a perfectly definite current for a given light intensity which must lie on the 6K7 characteristic and at the same time create a voltage drop in the phototube that will satisfy the equation,  $V_{zy} = E_{bb} - E_p$ . For example, assume the light intensity is  $F'''$ .

There will be a point  $c$  lying on some phototube characteristic  $E_u$ , which satisfies the requirements just mentioned and produces an output voltage  $V'''_{zy}$ , Fig. 5B, which is plotted as the ordinate of  $w$  in Fig. 5C.

It is desirable to apply the voltage  $V_{zy}$  to the grid circuit of the 6C5 in such a way that an increase in light will cause an increase in its plate current. In so doing it will usually be found that a positive biasing battery ( $E_m$ , Fig. 4) will be needed to produce partial neutralization of  $V_{zy}$  and prevent the 6C5 from being biased too far beyond cut-off when the cell is dark. It is then possible to adjust the bias so that, for an initial light intensity (such as  $F'$ , Fig. 5A), the biasing voltage,  $-V'_{zy} + E_m$ , is just right to produce cut-off. Then a very small increase in light is sufficient to cause quite a reduction in  $V_{zy}$ , the grid will become more positive and an appreciable plate current will flow.

This circuit is particularly useful for detecting small changes in light identifying numbers at the side three typical runs are shown. The identifying numbers at the side of each curve indicate the initial value of the light intensity for which the plate millimeter of the 6C5 was adjusted to zero. Thus in obtaining the curve marked 7 foot candles the control grid bias of the 6K7 and the bias of the 6C5 were so ad-

Fig. 5—These curves are used to analyze the circuit of Fig. 4. A is the light-current curve of the phototube, B is the plate characteristic of the 6K7 and C is the curve of light intensity vs voltage across the phototube

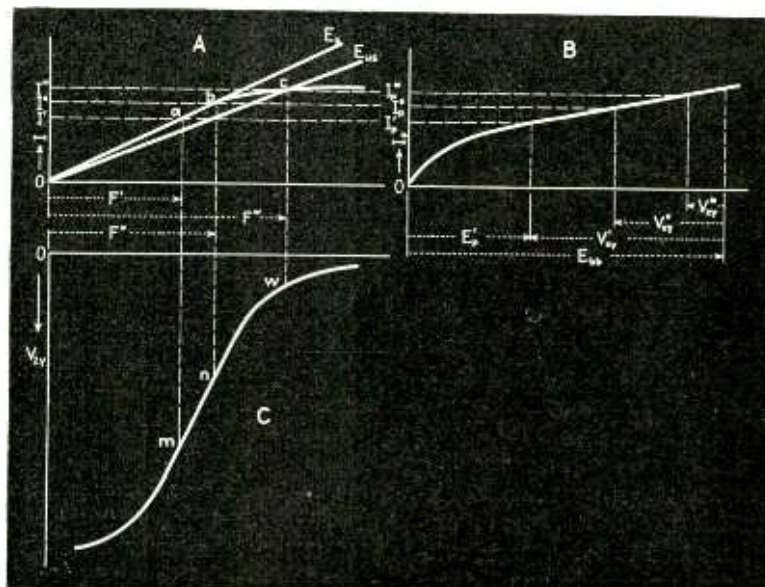

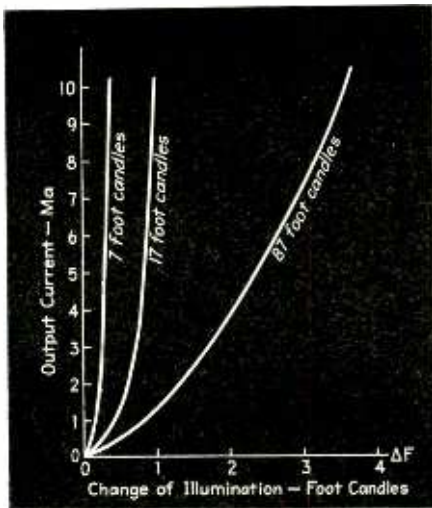

Fig. 6—Curves showing the output current of the 6C5 vs the change of illumination at several levels of light intensity. Phototube is operated above saturation voltage

Fig. 7—Same curves as Fig. 6 but with phototube operated below saturation voltage. Note that the sensitivity is not as high as when operated at saturation

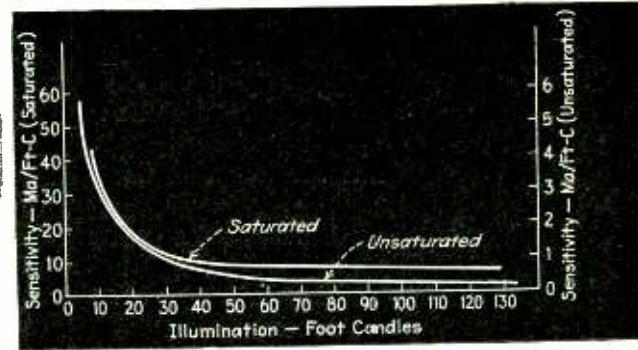
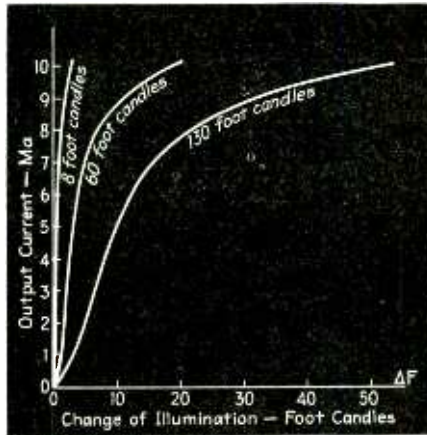

Fig. 8—Sensitivity curves for the saturated and unsaturated conditions. The circuit is approximately 10 times as sensitive when the phototube is operated at saturation

justed that the plate current of the 6C5 was zero when the phototube was exposed to a steady light intensity of 7 foot candles. Then the light intensity was increased in small increments and the output current was plotted against  $\Delta F$ , the change in light intensity. Note that the range of operation in these runs was restricted to that portion of the 6K7 characteristic for which the phototube remained saturated.

A similar set of curves showing the performance of the circuit when

the phototube becomes unsaturated is shown in Fig. 7. Note that the overall sensitivity, though still high, is not nearly as good as is obtained with the phototube saturated. This is illustrated more effectively in Fig. 8 where curves of sensitivity are plotted against light intensity. In general a sensitivity ratio of about 10 may be expected for saturated as against unsaturated operation.

The authors believe that this circuit will prove valuable for many phototube relay and measurement

applications which have heretofore required multi-stage amplification (with its attending difficulties) in order to obtain suitable sensitivity. Although it has been discussed as a d-c circuit it is evident that satisfactory half-wave operation may be expected from 60 cps voltages on the various supply terminals if careful attention is paid to instantaneous polarities. It should be noted that this circuit does not work well for initial light intensities below about one foot candle.

Experimental setup of the high sensitivity phototube circuit. The instrument is particularly valuable in the measurement of small changes in light intensity

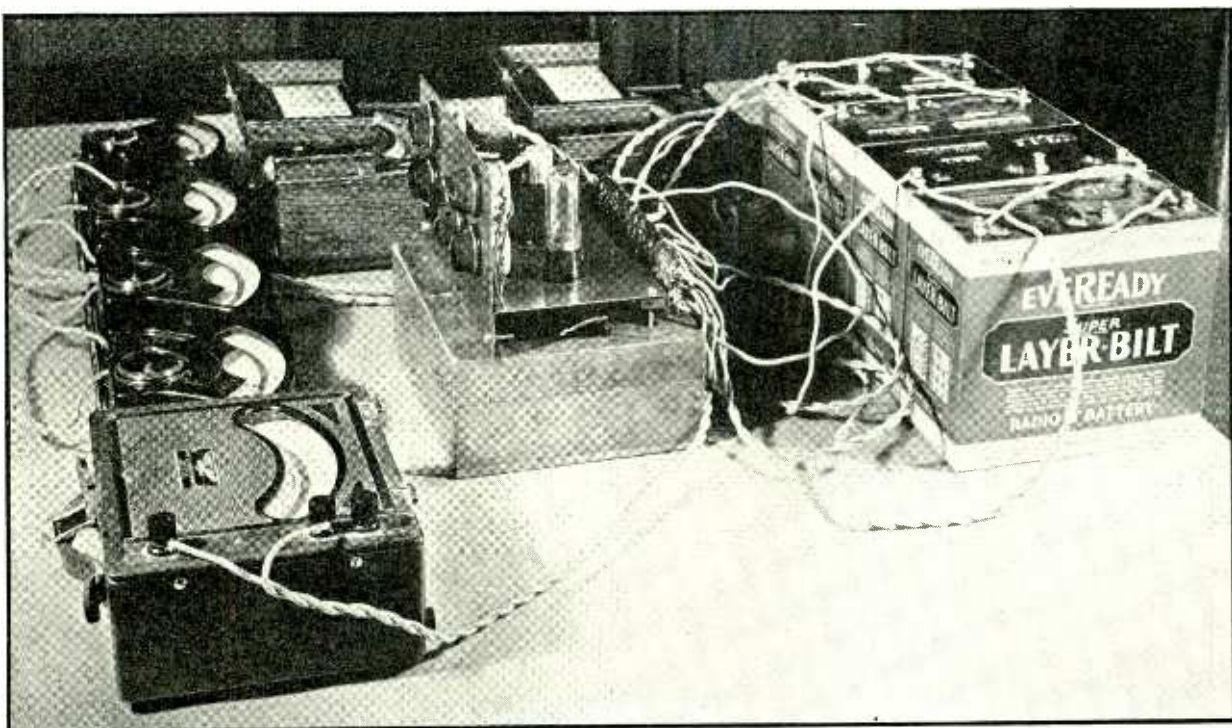

# TESTS OF FM FOR AIRCRAFT COMMUNICATION

An account of flight tests conducted in the vicinity of Schenectady, N. Y., comparing frequency- and amplitude-modulation on the same frequency, as well as investigating the effects of interference between two stations. F-m offers 50 per cent increased range

**A**IRCRAFT navigation depends so completely on radio communication that it is almost a necessity for aircraft to have the best radio communication available. Since frequency modulation has demonstrated many advantageous characteristics in broadcasting, it was felt this method of modulation should contribute to improve aircraft communication. The full significance of applying wide-band frequency modulation to airplanes can be appreciated if we measure the signal-to-noise ratio of a frequency-modulation signal in comparison with an amplitude signal. It can also be appreciated by the small size of the interference area between two common-frequency f-m stations compared with that between two common-frequency a-m stations under the same conditions.

## Test Equipment

A 150-watt (W2XOY) frequency- and amplitude-modulated transmitter was located on an office building in Albany, N. Y. The transmitter was so designed that it could be frequency or amplitude-modulated by throwing a switch. When the transmitter was 100 per cent amplitude-modulated the antenna power was 225 watts (600 watts peak). The carrier power for fm remained constant at 150 watts with all percentages of frequency modulation. This difference in power level for 100 per cent modulation for a given transmitter for the two types of modulation gives a corresponding advantage to am. The carrier frequency in each case was 41 Mc.

The receiver, described in the May, 1939 issue of *G. E. Review*,

By I. R. WEIR  
General Electric Company

used in taking all amplitude- and frequency-modulation comparison measurements consisted of a double-conversion type of superheterodyne designed to receive both amplitude and frequency modulation. A switch was provided to change the receiver from a plain diode detection for am to f-m detection using a limiter. The audio system of the receiver measured  $\pm 2$  db of 400-cps response from 60 to 10,000 cps. The selectivity of receiver was 220 kc wide at twice down and 530 kc wide at one thousand times down.

The antenna for the 150-watt transmitter consisted of vertical "J" type of antenna mounted 390 ft above the surrounding ground level. The receiver antenna was installed in an airplane and connected to a vertical "whip" antenna about six feet high.

All possible elements in the frequency- and amplitude-modulated systems were kept the same in order to compare them under nearly identical conditions. The same elements in the receiver were used for the two types of modulation except the detectors. The same trans-

mitting and receiving antennas were used.

The signal-plus-noise to noise ratio was measured by a two-scale copper-oxide voltmeter connected across the output of the receiver. The ratio of the audio output voltage of the receiver when receiving a modulated signal to the audio output voltage when receiving an unmodulated signal of the same carrier strength is the "signal-plus-noise to noise ratio".

## Field Tests of Transmissions from Albany

A constant transmitter plate voltage and plate current were maintained on the output stage for both frequency- and amplitude-modulation. The Albany transmitter was 100 per cent amplitude-modulated with a 700-cps tone and periodic voice announcements of call letters (W2XOY).

A plane proceeded west at 2,000 feet altitude until the intelligibility became poor. This was estimated as signal-plus-noise to noise ratio equal four to one. Higher altitudes were

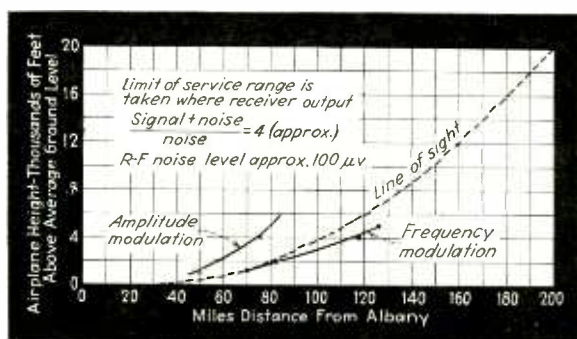

Fig. 1—Service range vs height of airplane, for 150-watt 41-Mc transmissions from Albany

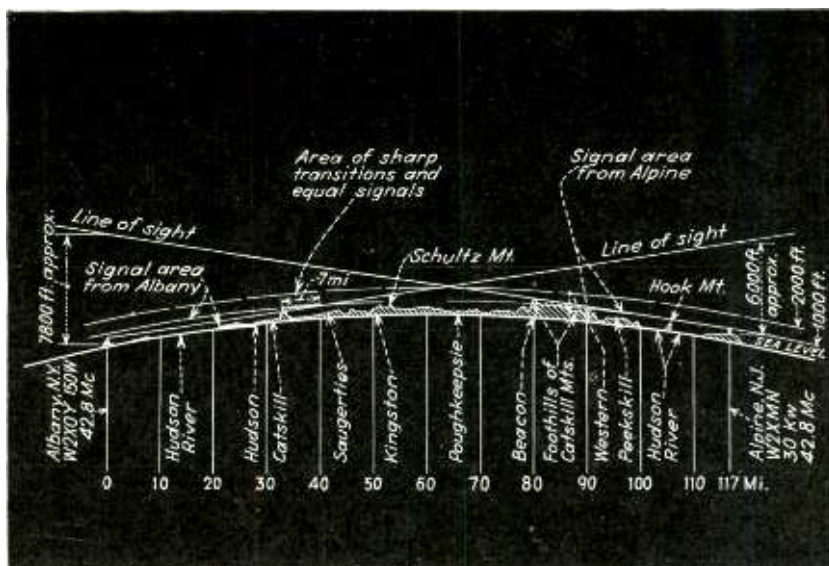

Fig. 2—Profile of terrain between Albany and Alpine, N. J., showing areas of signal control beyond line of sight

then tried and the plane proceeded west until intelligibility became poor. The plane then returned to the vicinity of Albany and the above procedure was repeated for frequency modulation. During this test the Albany transmitter utilized approximately  $\pm 75$  kc swing as 100 per cent modulation.

A slight directivity of the plane's antenna was observed in favor of the forward direction. Thus the signal improved slightly each time the plane headed back toward Albany. The results of these tests are shown in Fig. 1. It is quite evident that frequency modulation service range is about 50 per cent greater than amplitude modulation.

#### Operation of Two Stations

The Albany transmitter and Major Armstrong's station W2XMN at Alpine, N. J., operated on the same carrier frequency of 42.8 Mc and both were frequency-modulated. A different program was fed to each transmitter so each station might be identified by the program it carried. Station W2XMN had an output of about 30 kw and was modulated with high-fidelity phonograph records. W2XOY was frequency modulating a 150-watt carrier with a studio program.

A plane proceeded south from Albany at 1,000 feet. Interference with Albany reception was first noted about 3 miles south of Catskill, which is 33 miles south of Albany. The Alpine Station was in control at Saugerties, N. Y., which is

40 miles south of Albany (Fig. 2). On the return trip from Alpine, Albany started taking control a little further south, indicating some forward directivity in the receiving antenna, as noted above. No carrier beat or "flutter" was observed as would be the case with two amplitude-modulated transmitters on the same frequency.

The center of the interference zone was about 37 miles from Albany and 80 miles from Alpine as shown. This equal signal point is nearer Alpine than would be expected from the ratio of the output powers of the two stations, but it can be ex-

plained by the presence of a range of hills just to the north of Alpine which must cause considerable attenuation of the signal.

It was noted that complete change-over from Albany control to Alpine control occurred two or three times while passing over the interference zone, the exact pattern depending on the course flown. It is presumed that this is due to reflections from high hills or mountains along the path and that the multiple transition would not be present at, say, 5,000 feet. It was noted also that, when banking for a turn, the "shadow" of the wing cut off the stronger signal permitting the other to take control for a short time.

It was observed in the interference area that the Alpine signal caused more interference to the Albany signal when the latter was 100 per cent tone-modulated than for idle carrier or voice. That is, music could be heard superimposed on the Albany tone when it could not be heard with Albany announcing or idling. This can be explained on the basis that the demodulating effect of the Albany carrier is greater when it is at or near constant frequency than when it is subjected to a sustained variation over its maximum swing. A complete explanation of this effect is made by Major Armstrong (May, 1936 issue of the *Proc. I.R.E.*, page 115). This effect would

(Continued on page 92)

Fig. 3—Profile of terrain between Albany and Schenectady, showing areas of signal control under line-of-sight conditions

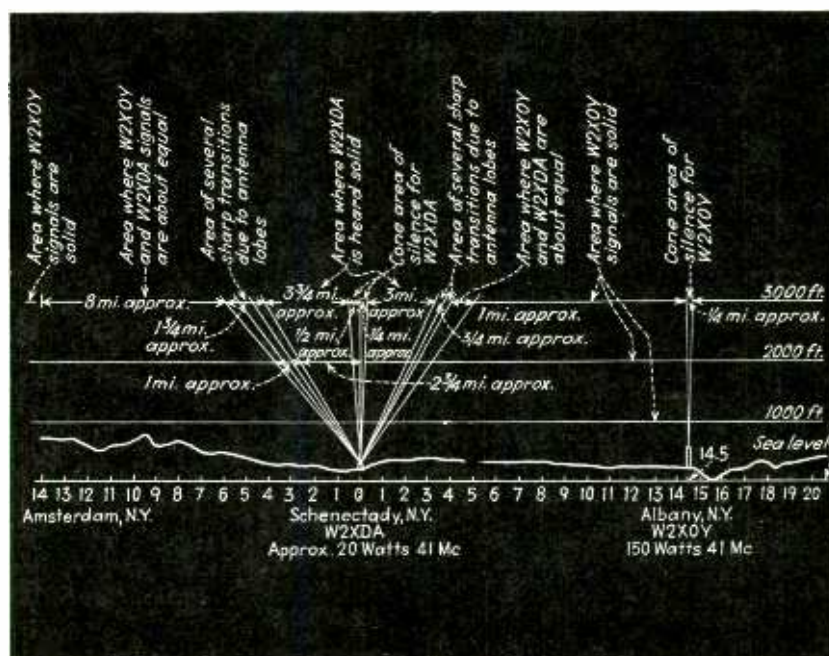

# AN IMPROVED C-R OSCILLOSCOPE DESIGN

Cathode-coupled stages and frequency compensation circuits, originally designed for other purposes, have been successfully applied to the cathode-ray oscilloscope, with resulting improvement in frequency response, deflection range, stability and independence of the controls

By WILLIAM A. GEHAGEN

Formerly, Allen B. DuMont Laboratories

**I**DEALLY, a cathode-ray oscillograph, to be used as a universal test instrument, should include the following characteristics: The input impedance should be very high, so that its connection to observe the phenomenon occurring in any circuit will in no way affect the characteristics of that circuit. Its voltage response should be uniform to signals of all frequencies so that

it will reproduce accurately any waveform applied. It should provide a means for attenuating or amplifying the applied signal in any desired amount without frequency discrimination, and further, the control of attenuation or amplification should be continuous rather than in steps. It should provide for observing an applied signal in its entirety, or for expanding a small portion of the signal to any desired size, and for bringing that portion into view on the screen. Positioning of the pattern

should follow the adjustment of the positioning control instantaneously, and without lag.

This paper describes an instrument in which departures from conventional design have been made in order to approximate more closely these ideal conditions. A complete circuit diagram of this instrument, is shown in Fig. 1.

### Attenuator and Gain Control

The simplest form of signal attenuation is shown in Fig. 2, in which  $C_2$  and  $C_3$  represent stray ca-

Fig. 1—Complete circuit diagram of the oscilloscope

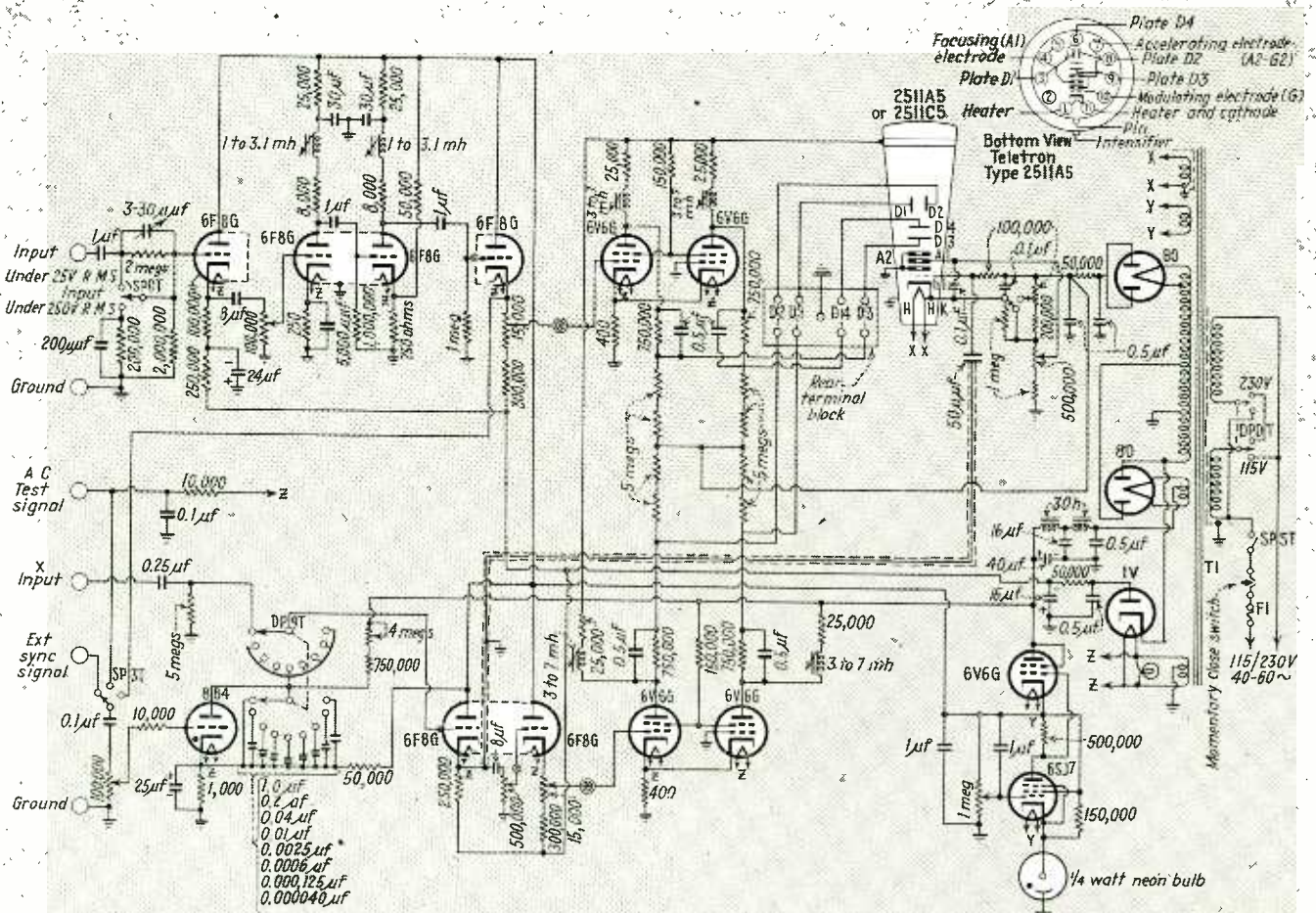



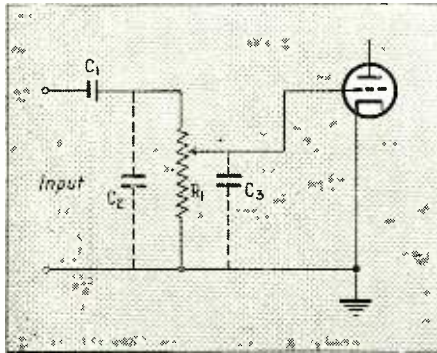

Fig. 2—Basic attenuator circuit which introduces frequency discrimination

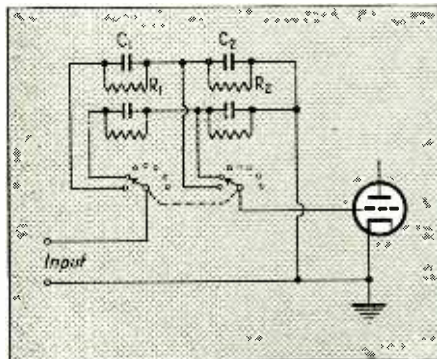

Fig. 3—Balanced circuit employing step attenuators to avoid frequency discrimination. The circuit may lack flexibility if the range to be covered is great

capacitances of circuit wiring and components to ground. Such an arrangement will fulfill the condition for continuous variation from infinite attenuation to maximum gain, but it necessitates a compromise between input impedance and frequency discrimination. For example, if  $R_1$  be made one megohm and if it be set at its midpoint for 50 per cent attenuation at low frequencies, then if  $C_3$  be  $25 \mu\text{mf}$ , a 100 kc signal will be attenuated approximately 90 per cent. If  $R_1$  is decreased to reduce this discrimination, not only will the input impedance be lowered correspondingly, but a larger value will be required for  $C_1$  to avoid undue attenuation at the very low frequencies. This, in turn, will increase the stray capacity  $C_2$ , and will further lower the input impedance.

A stepped attenuator such as that shown in Fig. 3, can be adjusted to provide a high, constant input-impedance with uniform attenuation at all frequencies, but it will not provide continuous variation, and where the ratio of maximum to minimum applied signals is large, either the number of steps must be

great, or the change between any two steps must be too great for flexible operation.

The arrangement employed in this instrument is shown in Fig. 4. The triode  $T$  acts as an impedance transformer, and permits an unusually high input impedance in spite of the low value for  $R_3$  and the high value of  $C_4$ . Two overlapping ranges are provided for input signals up to 250 volts rms, and the adjustment is continuous throughout each range. Square waves of from 2 to 30,000 cps are passed without noticeable change in shape throughout the entire range of the control.

#### Deflection Amplifiers

The vertical deflection circuit comprises two stages of triode amplification preceding a push-pull final stage. The use of a twin triode as two stages, instead of a single pentode stage, provides high sensitivity without utilizing the maxi-

mum gain of the triodes, leaving considerable additional gain available for low-frequency compensation. Further, the application of such compensation in two stages instead of one, without a corresponding increase in the number of points of low-frequency attenuation, makes it possible to extend the flat response to lower frequencies without introducing over-compensation at any point. The type of low-frequency compensation employed is conventional. Capacitors are used as short circuits across portions of the plate loads at high frequencies, and serving to increase the plate loads, and hence the gain, at very low frequencies. The low-resistance plate loads are favorable for good high-frequency response, which is extended further by the use of series inductances and the small cathode by-pass. The overall response of the instrument, as shown in the accompanying curve (Fig. 10), is flat from 2 to 100,000 cps, with a sensitivity of 10 rms millivolts per inch.

#### Positioning Circuits

The type of positioning circuit most commonly employed in the past has used condenser coupling between the final amplifier and the deflection plates of the cathode-ray tube, with a variable direct voltage applied to the deflection plates for positioning the pattern. A typical arrangement, in which the positive and negative positioning voltages are obtained from the amplifier and cathode-ray-tube power supplies respectively, is shown in Fig. 5. Such an arrangement is entirely satisfactory when response to very low frequencies is not required, but when the range uniform response is carried down to one or two cps, the time constants of  $C_1R_1$  and  $C_2R_2$  must be long, and positioning action becomes sluggish, a matter of seconds being required for the pattern to reach its new position after the control is adjusted. This condition may reach the point of making it virtually impossible to set the pattern at a desired spot on the cathode-ray-tube screen within a reasonable length of time. The circuit becomes more and more sluggish the lower the response is carried, but, paradoxically, if the final amplifier response be carried to dc or zero frequency, the positioning

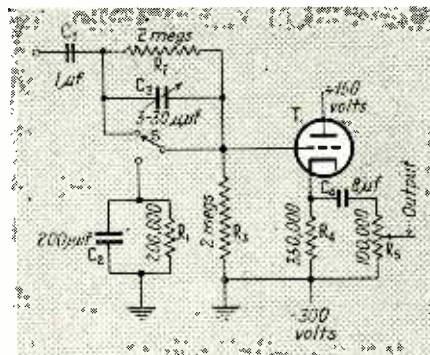

Fig. 4—Cathode-coupled input stage which avoids the difficulties inherent in the circuits shown in Figs. 2 and 3

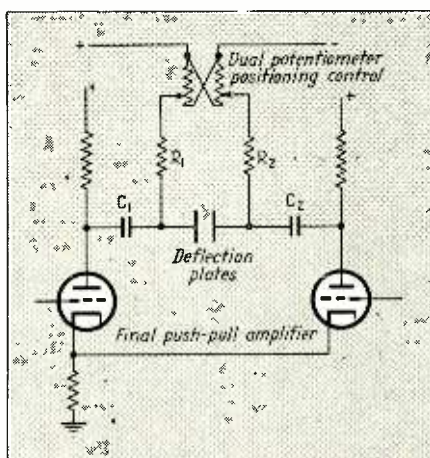

Fig. 5—Typical positive-negative positioning control circuit, which suffers from the sluggishness which may be associated with the CR circuits

response may be made substantially instantaneous.

The design of the final amplifiers, and of the coupling circuits between them and the deflection plates, is discussed later in this paper. For the sake of the present discussion, let us assume that we have available a direct-coupled amplifier with push-pull output, and a coupling circuit which effectively couples the deflection plates directly to the amplifier, yet which fulfills the desirable condition of maintaining the average deflection plate potential at ground. When an a-c signal is placed upon the grid of the final amplifier, the pattern will appear centered on the screen, but if a small amount of dc be superimposed upon the ac, the entire pattern will be shifted up or down, depending upon the polarity of the direct voltage. A variable source of dc superimposed upon the input to the final amplifier will, therefore, act as a positioning control, and with such an arrangement an immediate advantage over the conventional arrangement is realized. With a power supply in the order of 400 volts, final amplifiers will provide for only slightly more than full-screen deflection without overload. With the conventional positioning arrangement, if the edge of a pattern which is more than slightly in excess of full-screen size be brought into view on the screen, it will be distorted and valueless for observations. With the new method here described, however, the pattern, when on the screen, is always on the linear portion of the final amplifier characteristic and is, therefore, undistorted. It is thus possible to utilize the full undistorted output of the preceding stages, which can easily be made equivalent to several times full-screen deflection. With such an arrangement, a pattern may be expanded to several times full-screen size, and any portion of it brought into view undistorted.

A method devised for the superposition of dc upon the ac signal is shown in Fig. 6A. The signal from the preceding amplifier stage is fed to the grid of a cathode-follower stage, the cathode of which is returned through a high resistance to a source several hundred volts negative with respect to ground. The upper part of this resistance is shunted by a neon lamp, and is

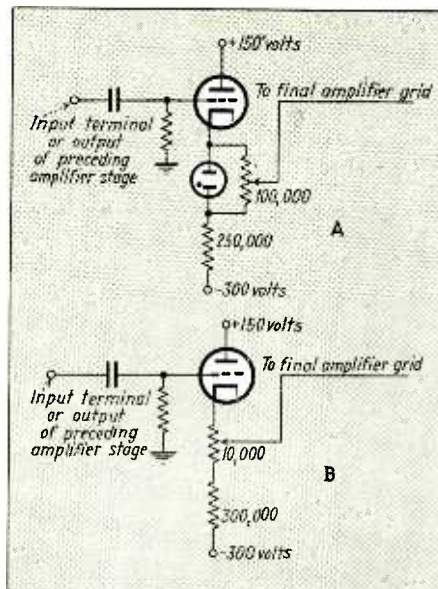

Fig. 6—A method of superimposing dc on ac with direct coupling, which gives instantaneous control of spot position. When the gain is high the neon lamp may be omitted as shown in B

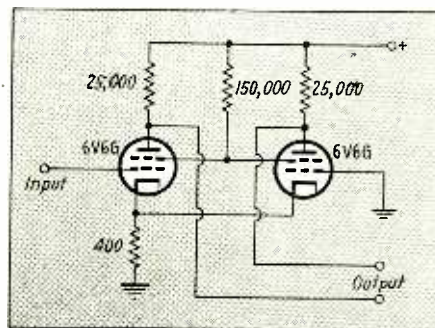

Fig. 7—Push-pull direct-coupled final amplifier, used to obtain optimum focusing of the spot over the entire screen area

utilized as the positioning control. Since the neon lamp maintains almost constant voltage over a wide range of current, the signal which was applied to the grid of the cathode-loaded stage will appear essentially the same at all points on the positioning control, but the "no-signal" direct voltage applied to the final amplifier will vary, for all intents and purpose instantaneously as the control is adjusted. Where the gain of the final amplifier is high, and a relatively small range of d-c variation is, therefore, required, the resistance of the positioning control may be made small as compared with the total cathode resistance, and the neon bulb omitted as shown in Fig. 6B. This introduces a slight gain change from one end of the positioning control to the other, but with the values shown this will be about 3 per cent over a twenty inch range of cathode-ray-

tube deflection. In practice this is an adequate deflection range.

In this instrument, positioning is instantaneous, and it is possible to expand the pattern in either axis to three times full-screen size, and still bring any part of it onto the screen, undistorted, for observation. It is thus possible to observe on a five inch cathode-ray tube, detail which with conventional arrangements would be possible only on a fifteen inch cathode-ray tube.

#### Final Amplifiers and Coupling

With such a positioning circuit, it is necessary to provide an appropriate direct-coupled amplifier, and in order to obtain the best focus of the spot over the entire screen area, it is desirable that the amplifier be designed for push-pull output. Such an amplifier was developed for this instrument, and it is shown in Fig. 7. A combination of screen and cathode coupling is used to transfer the signal from the first to the second tube in opposite phase. The outputs of the tubes are very nearly equal, and the combined output is linear over the range required for full-screen deflection. Since at no-signal the conditions on the two tubes are identical, this circuit remains in adjustment over wide ranges of line-voltage variation.

In order to avoid astigmatism of the spot in the cathode-ray tube it is desirable not only that the average potential of each pair of deflection plates remain constant throughout the deflection range, but that the average potential of the two vertical plates equal that of the two horizontal plates. Employment of identical amplifiers of the type described on the horizontal and vertical axes, with the deflection plates connected directly to the amplifier tube plates would fulfil these requirements. It is, however, frequently desirable in practice to connect one pair of deflection plates directly to an external circuit. Since this external circuit is frequently of such nature that its average potential is at ground, it is desirable for the sake of flexibility to design the oscillograph circuits so that each pair of deflection plates has potential at ground. Several methods of accomplishing this, at the same time retaining direct coupling between

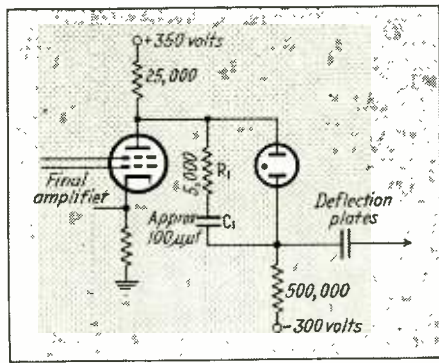

Fig. 8—Method of bringing a set of deflection plates to an average potential at ground, to permit connection to balanced external circuits

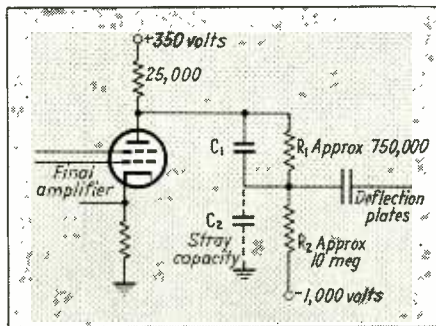

Fig. 9—Simpler method of bringing average deflection potential to ground, which has the disadvantages of variable frequency response and signal pick-up

the amplifiers and deflection plates, are possible. A small neon lamp, whose gap-maintenance voltage equals the amplifier plate voltage at no-signal, may be used as shown in Fig. 8. Because of the neon lamp's current-voltage characteristic, the signal will be transmitted from amplifier plate to deflection plate with little loss. The network  $C_1R_1$  passes the high frequencies at the same slight attenuation which is introduced by the neon bulb. This is necessary because the gap-maintenance voltage of available bulbs increases with frequency.

A simpler arrangement is shown in Fig. 9.  $R_1$  and  $R_2$  are fixed in the ratio of the no-signal plate voltage to the negative power supply voltage (In this case, the negative supply voltage for the cathode-ray tube), and  $C_1$  is balanced against the stray circuit and deflection plate capacity  $C_2$  in the ratio  $R_1/R_2 = C_2/C_1$ . This arrangement has two disadvantages. Changes in the beam current, when brilliance is changed, affect the deflection-plate impedance and alter the frequency-response characteristics. The deflection plates are left at a high impedance from ground, and are liable to be subject

to pick-up from the other pair of deflection plates and from external circuits. A satisfactory modification of this arrangement, and the one employed in this instrument, was found in making  $C_1$  relatively large. Since the d-c signal potential at the deflection plate with no condenser at point  $C_1$  is about 90 per cent of the d-c signal at the amplifier plate, the low-frequency loss in this circuit with even a fairly small condenser at point  $C_1$  will be small as compared with the losses in the usual resistance-capacitance networks of the preceding stages, and this loss is easily made up by slight over-compensation in the earlier amplifier stages. Since the voltage change across the condenser  $C_1$  when the positioning control is adjusted is only about 10 per cent of the total deflection plate potential change, a fairly large condenser can be used without introducing noticeable "overshoot" in the positioning. The value of  $0.5 \mu\text{f}$  chosen is entirely satisfactory from both standpoints, and provides the desired low-impedance path from the deflection plates to ground.

#### Sweep Circuit

A conventional gas-tube sawtooth oscillator is used to generate the linear time-base. An attenuator and positioning circuit similar to that used on the vertical axis is used to couple the sweep-oscillator to the horizontal amplifier. The grid of the impedance-transformer triode is connected directly to the plate of the gas tube, and because of the high impedance and low degree of frequency discrimination offered by this circuit, good linearity with respect to time is obtained over a range from two to 50,000 sweeps per second. A synchronization signal selector and control are provided to permit synchronization

of the sweep to external signals, power line voltage, or to signals applied to the vertical amplifier. The "frequency-range switch" is arranged in its "off" position to connect the input circuit of the horizontal amplifier and attenuator to a post on the front panel for connection to externally provided horizontal deflection voltages. The negative pulse of the sweep-oscillator during fly-back is applied through a small condenser to the grid of the cathode-ray tube to blank out the return trace.

An electronic regulator supplies plate and bias voltages to all but the final amplifiers, and virtually eliminates any tendency of the pattern to drift, even with heavy line-voltage surges. The remainder of the power supply is conventional, with a half wave rectifier and filter used to supply negative voltage for the positioning and attenuator circuits.

An unusual mechanical arrangement has been employed in this instrument to provide a compact unit with its center of gravity near its physical center for convenience in carrying, and with the power-supply components placed to minimize magnetic disturbances. A shielded transformer is used, and with the additional protection of the tube shield, this transformer virtually eliminates magnetic ripple.

The instrument described represents the application of several new principles to increase the usefulness, flexibility, and ease of operation of the cathode-ray oscillograph. As with any instrument, its design represents a compromise between ideal characteristics, cost, and size, and does not represent the maximum performance which can be obtained in a larger and more complex instrument employing the same basic principles.

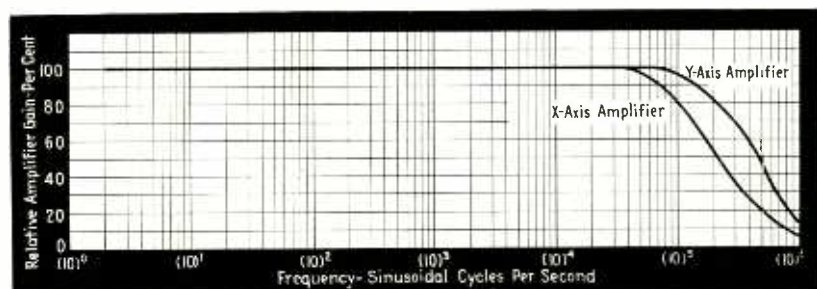

Fig. 10—Frequency response of the deflection amplifiers, showing essentially flat response on the horizontal deflection to 50,000 cps, and up to 100,000 cps on the vertical circuit

# TUBES AT WORK

## A logarithmic compression vacuum tube voltmeter using cascaded stages and a review of the advantages of autotransformers in modulation circuits

### A New Logarithmic Electronic Voltmeter

By PAUL J. SELGIN

THE PURPOSE OF THE WIDE-RANGE METER described in this article is that of converting an audio-frequency signal into a direct current of a value proportional to the signal level, expressed in decibels. The current itself may be read on an ordinary d-c instrument, or registered on a recording instrument, or it may be used to operate relays or other devices.

The above conversion is accomplished over a wide range of signal levels, so that it is not necessary to insert a variable loss, by means of an attenuating network controlled by a multiple switch, in order to bring the signal down to measurable levels, as is done in existing instruments. Thus, the following advantages are secured: Signals of widely different amplitudes can be read successively, on the same scale, without changing the range. A fluctuating signal, such as due to sound or noise, can be continuously observed or recorded. Operations involving the measurement of gains or losses varying widely and abruptly with frequency, such as filter losses, are greatly simplified. The instrument requires no periodical re-setting and contains no rotary switches or other mechanical parts. Its "damping" is controlled exclusively by the movement of the d-c instrument, as the electrical circuit introduces no retardation.

The operation of the device is based upon the action of a special non-linear network containing a number of vacuum tubes to which we shall refer as a "converting network" for lack of a better definition. Signals transmitted through the network are subject to a gain which decreases as the signal strength is increased. The rate of decrease is such that, as the signal grows from a small initial value to a value many hundreds of times greater, the output from the network rises, approximately, as the logarithm of the input, or, in other words, stays proportional to the signal level expressed in decibels. The network introduces distortion and is, therefore, not applicable where fidelity is required. However, the original waveform is

not so far altered as to introduce appreciable errors in the calibration when non-sinusoidal voltages are measured, except in extreme cases.

The overall gain is not materially affected by variations in tube characteristics. It is essentially controlled by the values of resistances forming part of the circuit. The degree of approximation with which a linear decibel calibration is approached is dependent upon exact choice of these values, as well as by the number of available stages. It is to be noted, however, that no advantage is to be gained by approaching linearity very closely, beyond certain limits.

The "converting network" comprises a number of sections, each of which is made up of two triode stages having different functions. Of the two stages making up each section, one is a low gain, stabilized, resistance-coupled

amplifying stage, whose circuit diagram and symbolic representation are shown in Fig. 1.

The operation of the second stage, which might be called a "compressing stage", is as follows (see Fig. 2): If the incoming signal is of sufficient amplitude, during part of each cycle the tube is biased beyond cut-off, and the stage acts as a voltage divider (Fig. 3A). During the remainder of the cycle, the tube conducts, and the operation of the stage is essentially that of the simplified circuit of Fig. 3B. As a result, the output voltage is related to the input voltage, at each instant, in the manner shown graphically on Fig. 4. This Figure shows a plot formed by two straight lines of different slopes, joined by a "knee". All symbols refer to Fig. 2.

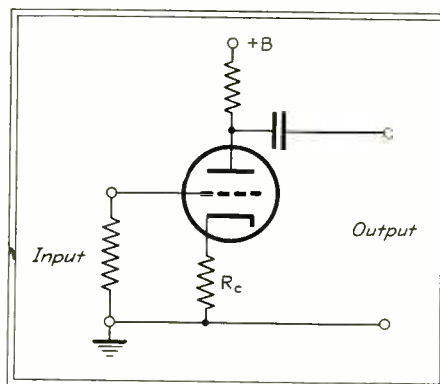
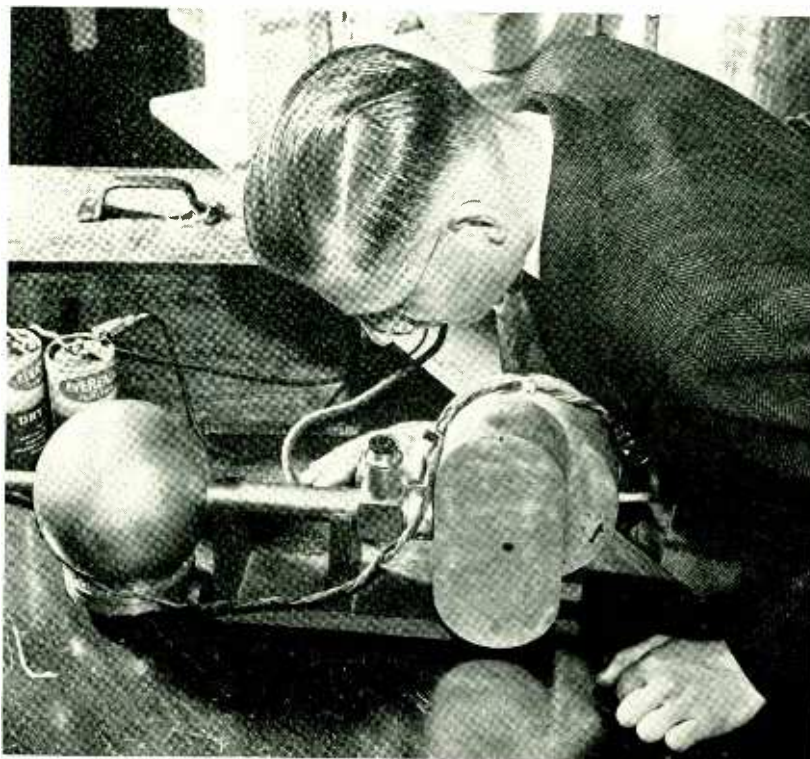

Fig. 1—Basic amplifier section of the voltmeter

## MEASURES INTENSITY OF COSMIC RAYS



Paul F. Gast attending the cosmic ray electroscope shown at a recent convention of the American Physical Society at Seattle, Washington

# Filter Design Charts—III

BY JOHN BORST

**T**HE third and concluding chart in this series, printed on the reverse side, may be used to determine the elements of  $m$ -derived bandpass filter sections from the corresponding constant- $k$  sections found by the use of the first chart (Filter Design Charts—I, ELECTRONICS, August 1940, page 35). The constant- $k$  values are marked with the subscripts "1 $k$ " or "2 $k$ ", whereas the corresponding  $m$ -derived values have the subscripts "1", "2" or "3". The relationship between the two sets of values depends on two variables, the assigned value of  $m$  (from 0.1 to 0.9), and the ratio  $f_{2i}/f_m$ , where  $f_{2i}$  is the frequency of infinite attenuation above the pass band, and  $f_m$  is the midband frequency (the geometric mean of the cut-off frequencies). As the equations in Figs. 1 and 2 show, the  $m$ -derived values are found by multiplying the constant- $k$  value by two factors, one a function of  $m$ , the other a function of the frequency ratio. Hence two alignments are necessary in using the chart, the two having a common point on the turning scale. The operations are shown schematically at the top and bottom of the chart. Two scales for the variable  $m$ , marked  $m(a)$  and  $m(b)$  are provided, as well as four scales marked  $f_{2i}/f_m$ , (a), (b), (c), (d) since these variables enter into the equations in two and four different ways, respectively.

### Instructions for series $m$ -Derived Sections

For the series-derived bandpass filter (see Fig. 1), to find  $L_1$  align the given value of  $m$  on  $m(a)$  with the point  $X$  on the scale  $f_{2i}/f_m$ , and note the intersection with the turning scale. Then align the given value of  $L_{1k}$  on the scale  $LC(a)$  with the same point on the turning scale and read  $L_1$  on the scale marked  $LC(b)$ . To find  $C_1$  align  $C_{1k}$  on  $LC(b)$  with the same intersection of the turning scale and read  $C_1$  on  $LC(a)$ . To find  $L_2$ , align the given value of the frequency ratio  $f_{2i}/f_m$  on the scale marked  $f_{2i}/f_m(a)$  with the given value of  $m$  on  $m(b)$ , and read the intersection on the

turning scale. Then align the given value of  $L_{1k}$  on  $LC(b)$  with the same point on the turning scale, and read  $L_2$  on  $LC(a)$ . To find  $C_2$  align the frequency ratio on the scale marked  $f_{2i}/f_m(b)$  with the given value of  $m$  on  $m(b)$ , and note the intersection with the turning scale. Then align the given value of  $C_{1k}$  on  $LC(a)$  with the same point on the turning scale and read  $C_2$  on  $LC(b)$ . To find  $L_3$  use the intersection on the turning scale found for  $C_2$  and align it with the given value of  $L_{1k}$  on  $LC(b)$ , finding  $L_3$  on  $LC(a)$ . To find  $C_3$  use the intersection on the turning scale found for  $L_2$ , align it with the given value of  $C_{1k}$  on  $LC(a)$  and find the required value of  $C_3$  on  $LC(b)$ .

### Shunt-derived Bandpass Sections

To find  $L_1$  (see Fig. 2), align the given value of  $m$  on  $m(a)$  with the given value of the frequency ratio on  $f_{2i}/f_m(c)$ , and note the intersection on the turning scale. Then align this intersection point with the given value of  $L_{1k}$  on

$LC(a)$ , and find the required value of  $L_1$  on  $LC(b)$ . To find  $C_1$ , align the given value of  $m$  on  $m(a)$  with the given value of the frequency ratio on  $f_{2i}/f_m(d)$ , and note the intersection. Then align the intersection point with the given value of  $C_{1k}$  on  $LC(b)$  and read the required value of  $C_1$  on  $LC(a)$ . To find  $L_2$  align the given value of  $m$  on  $m(a)$  with the point  $X$  on the frequency ratio scale, and note the intersection. Then align the intersection with the given value of  $L_{2k}$  on  $LC(b)$  and find  $L_2$  on  $LC(a)$ . To find  $C_2$  use the same intersection point found for  $L_2$  and align it with the given value of  $C_{2k}$  on  $LC(a)$ , finding the required value of  $C_2$  on  $LC(b)$ . To find  $L_3$ , use the intersection on the turning scale found for  $C_1$ , align it with the given value of  $L_{1k}$  on  $LC(a)$ , find the required value of  $L_3$  on  $LC(b)$ . To find  $C_3$ , use the intersection with the turning scale found for  $L_1$ , align it with the given value of  $C_{1k}$  on  $LC(b)$ , and find the required value of  $C_3$  on  $LC(a)$ .

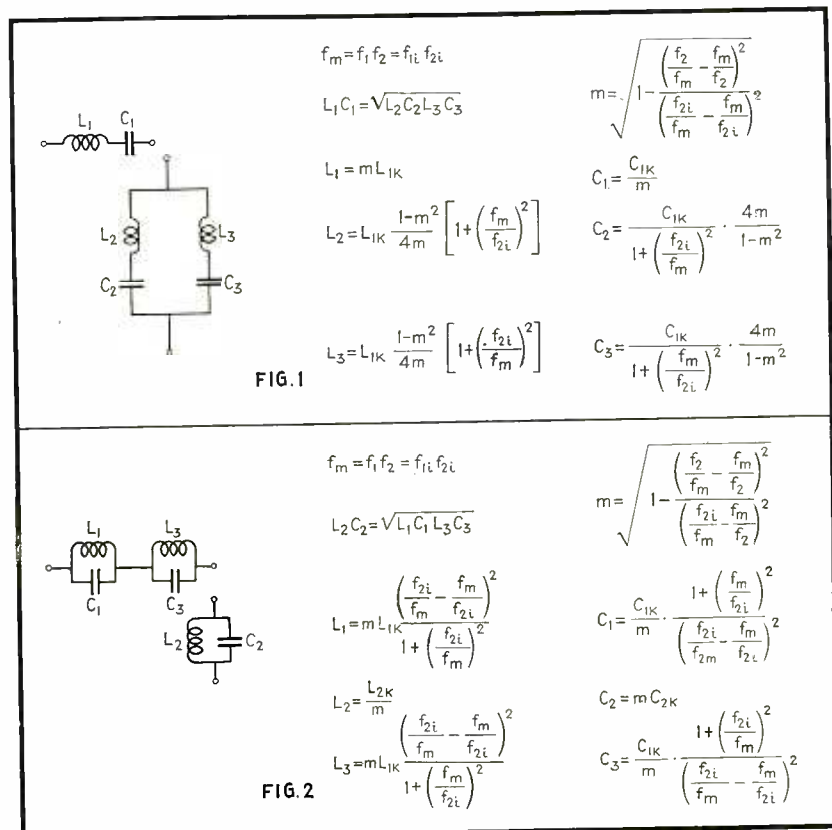

# Filter Design Charts - III

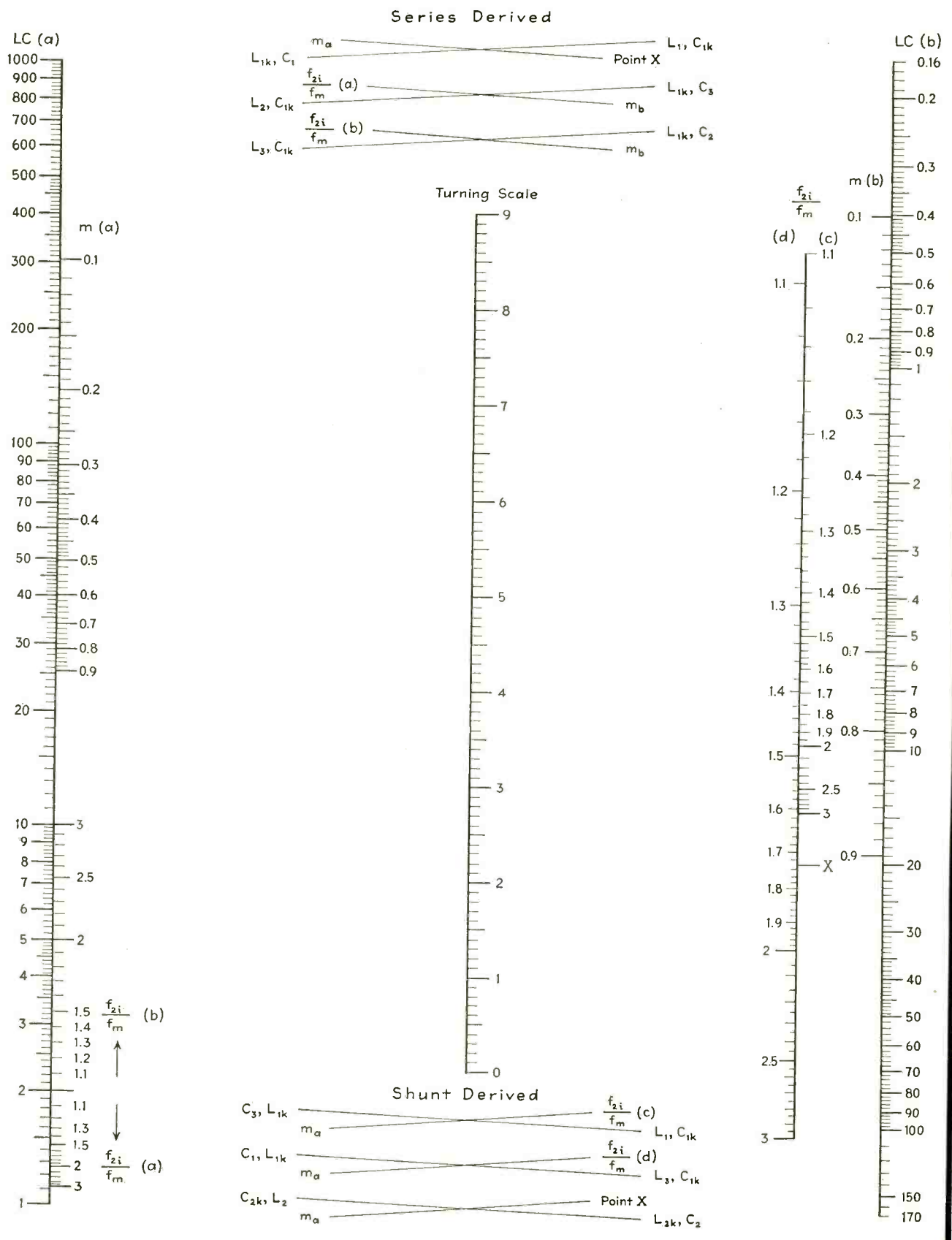

# COMPACT SOCKETS . . .

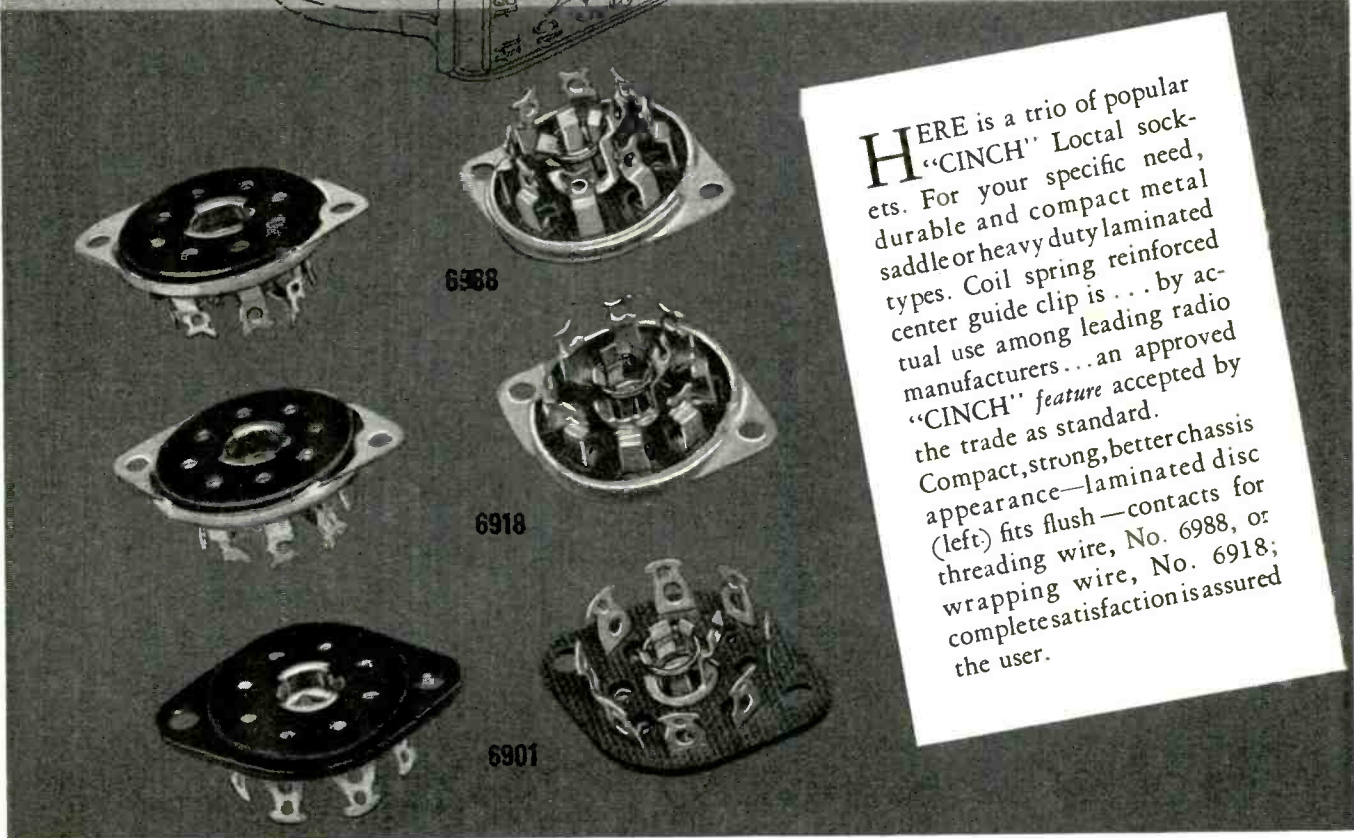

## CINCH LOCTAL SOCKETS WITH $\frac{5}{16}$ " MOUNTING CENTERS

Space saving, but sparing nothing in the making, each socket proves by dependable constant service the complete satisfaction that may be expected of "CINCH" made parts. Materials, workmanship and supervision . . . the utmost is required of all.

**CINCH**

*"Cinch" and Oak Radio Sockets are licensed under H. H. Eby socket patents.*

**MANUFACTURING CORPORATION**

2335 W. VAN BUREN STREET

CHICAGO, ILL.

SUBSIDIARY: UNITED-CARR FASTENER CORP., CAMBRIDGE, MASS.

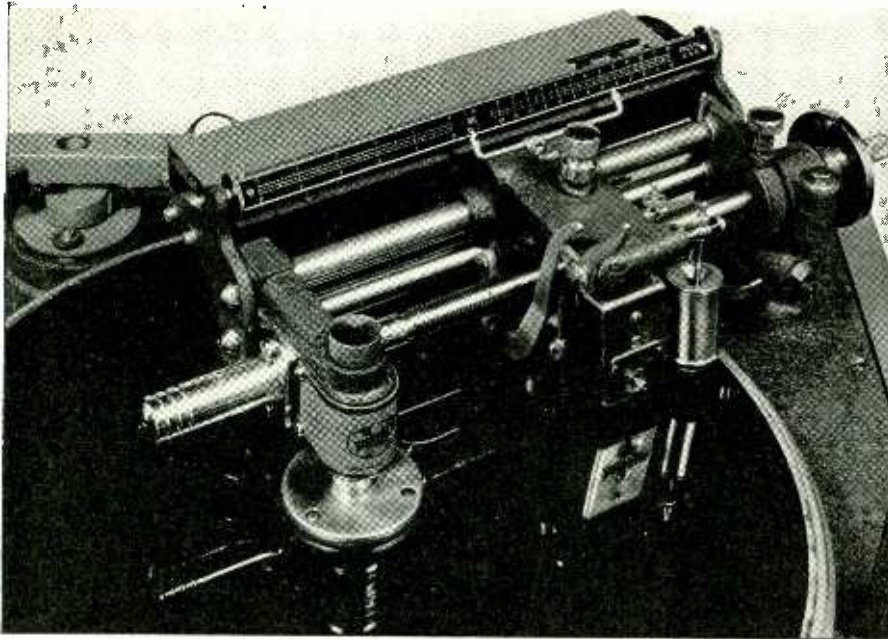

# MODERNIZE YOUR RECORDING INSTALLATION WITH THIS NEW PRESTO TURNTABLE

Here is a new turntable designed to replace the famous Presto 6-C and 6-D recording turntables which have been standard equipment in United States and Canadian broadcasting stations for the last four years.

Mounting and operating dimensions are identical with the previous equipment but the performance has been greatly improved.

### NEW FEATURES OF PRESTO 6-N TABLE:

1. **Less Vibration.** Records made on the 6-N table reproduce on the highest fidelity playback equipment without a trace of flutter or rumble.
2. **Wider Frequency Response — Higher Sound Level.** Presto 1-C cutting head records useful range of 50-8000 C.P.S.—gives 6 to 8 D B higher play-

back level than previous heads.

3. **New cutting head mounting** spaces grooves more accurately, facilitates quick change of feed screws.
4. **New overhead cutting mechanism** redesigned to simplify alignment with the turntable, can be removed for transportation by loosening one screw.
5. **Standard table includes** spiraling feed screw, vertical damper, cam lever for lowering cutting needle, 4 pitch time scale, automatic equalizer and Presto 1-C high fidelity cutting head.

LIBERAL TRADE-IN ALLOWANCE TO  
STATION OWNERS WHO WISH TO  
REPLACE EITHER 6-C or 6-D TABLES  
WITH THE NEW PRESTO 6-N TABLE.  
Write giving type and serial number  
for cost of exchange.

**PRESTO** RECORDING CORPORATION  
242 West 55th Street, New York, N. Y.  
World's Largest Manufacturers of Instantaneous Sound Recording Equipment

The steeper slope,  $S_1$ , depends on the value of the resistance  $R'_c$  only. The slope  $S_2$  depends upon the ratio  $R_1/R_2$ . (It should be noted that both the above resistances are very much larger than  $R'_c$ .) The relative position of the knee is affected by  $R'_c$  as well as by the plate voltage  $B'$ .

The above dependences can be demonstrated very clearly by viewing the plot of Fig. 4 on the screen of a cathode-ray oscilloscope. This is done simply by connecting the "H" terminals of the oscilloscope to the input side, the "V" terminals to the output side of each section.

If the input voltage amplitude is less than a given value, depending upon the cathode resistor and the plate voltage, the tube conducts all the time

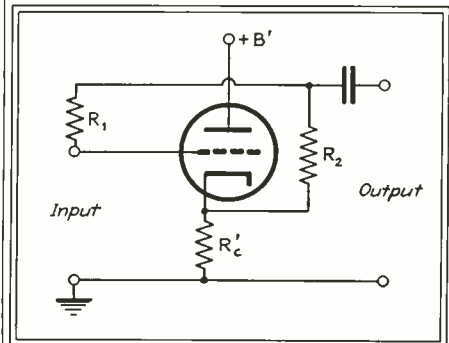

Fig. 2.—Basic compressing stage of the voltmeter

and the stage transmits the signal without distortion.

It should be noted that the distortion introduced by each "compressing" stage tends to be neutralized by the next, as there is a  $180^\circ$  change of phase, due to the amplifier, in between. The net action upon the waveform produced by a number of sections, as re-

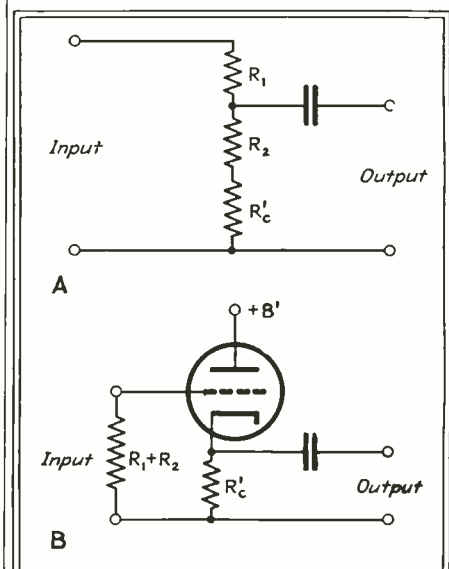
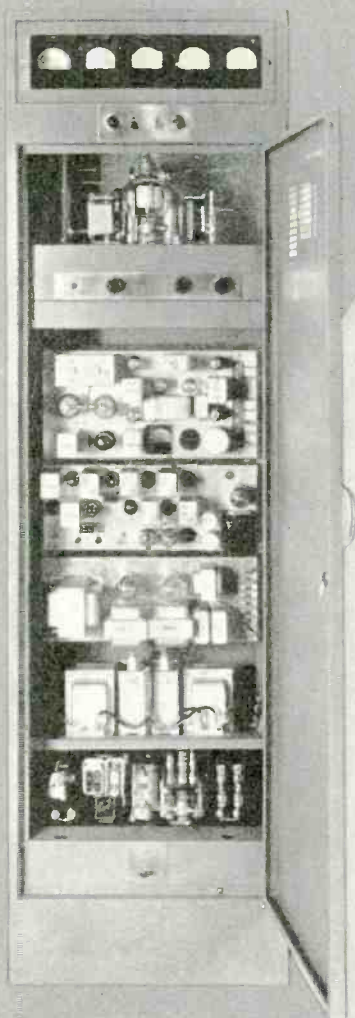

Fig. 3.—Equivalent circuits of compressor stage under different input voltage levels



# FREQUENCY MODULATION

## GOVERNMENT • PUBLIC UTILITY • POLICE • FIRE



**FIXED STATION**  
Type 250 UFS  
250/400 watts

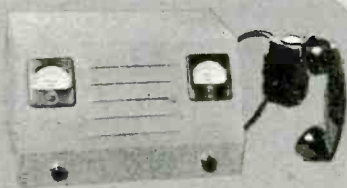

**CONTROL UNIT**  
Two-wire remote control  
for fixed station

*The*

# CONNECTICUT

state-wide

# F-M POLICE SYSTEM

manufactured by

# LINK

Other Link F-M emergency radio communication equipment is in use by:

**POLICE**  
Ohio State Police  
Maryland State  
North Carolina State

**PUBLIC UTILITIES**  
Ind. & Mich. Elec. Co.  
The Ohio Power Co.  
The Penna. Elec. Co.

**GOVERNMENT**  
U. S. Signal Corps. Labs.  
U. S. Coast Guard  
U. S. Aircraft Radio Labs.

Plus many more users in the above three and other classifications.

*Write* for new eight page bulletin describing Link F-M emergency equipment.

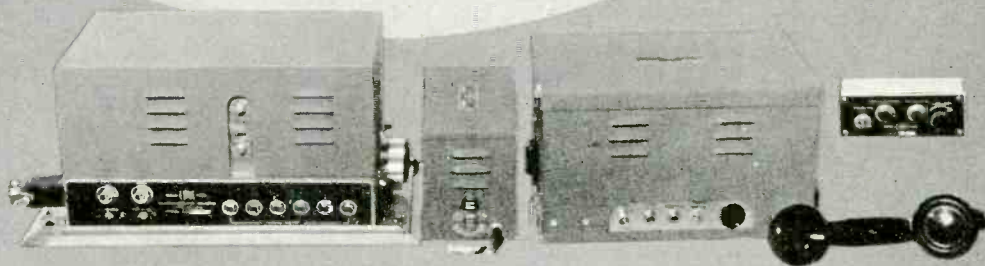

**FMTR MOBILE ASSEMBLY**  
Type 25 UFM 25/30 watt transmitter  
Type 11 UF receiver and power supply



*Fred M. Link* 125 WEST 17th ST., NEW YORK, N.Y.  
Telephone: CHELSEA 2-4462  
Engineer • Manufacturer

**FLMET****MOLYBDENUM  
TUNGSTEN****AND ALLOYS  
FOR THE  
ELECTRONIC  
INDUSTRY****POWDERS  
RODS  
WIRES  
RIBBONS  
SHEETS****AMERICAN ELECTRO METAL CORP.**Research Laboratories and Offices: 320 YONKERS AVE., YONKERS, N. Y.  
Factory: Lewiston, Maine

Cable Address: Cutanit Yonkers New York

Telephone: Marble 7-9511

vealed by the oscilloscope with plates connected to the input and output terminals of the whole chain, is a pattern, with several "knees" separated by straight sections of slopes fluctuating about an average value. This average value is indicative of the overall gain. As the signal amplitude applied to the input is increased, the non-linear action extends to more and more sections, with the result that the above-mentioned pattern acquires an increasing number of "knees", and its average slope becomes less and less.

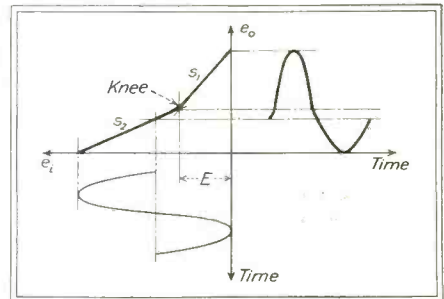

Fig. 4—Graphical analysis of compressor stage action

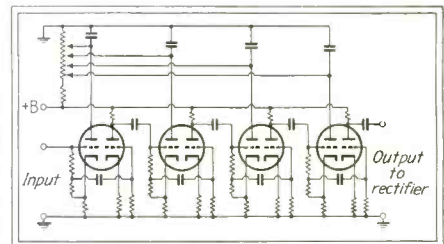
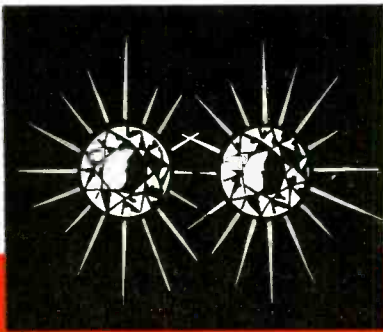

Fig. 5—Complete diagram of four-stage compressor voltmeter

A complete wiring diagram of a 4-section "converting network", as well as its symbolic representation, is shown in Fig. 5. The resistance values depend upon the upper and lower limits assigned to the linear decibel scale. Once these are set, the scale is divided into equal parts, each part corresponding to 2, 5 or 10 db depending upon the degree of linearity which it is desired to achieve. Then the resistances of each section can be adjusted independently of the others, to fit the pre-arranged calibration. This is possible because changes in the resistance values of each stage do not affect the calibration up to the point at which the stage becomes non-linear. It will be understood that this process is of a nature that, while relatively easy to demonstrate, cannot be explained in writing within a reasonably short space.

When the resistance values have been found, and inserted, with or without small changes to "round off" odd values, in the circuit, the instrument is calibrated in the ordinary manner. Small deviations from linearity will be present in any case, and will be, of course, more noticeable if the resist-



TO YOU these diamonds may look alike. But to the diamond expert, able to see beyond surface similarities, there is a difference in quality. And so it is with capacitors. The things that lie hidden are the things that count most in determining value.

# HIDDEN EXTRAS!

*That's the difference...*

AND THAT'S THE REASON FOR THE EXTRA PERFORMANCE IN C-D CAPACITORS

**M**OST capacitors look alike. But engineers know there's a big difference in C-Ds. Built into these capacitors are extra quality ... long life ... economy — extra VALUE! Specify Cornell-Dubilier capacitors and enjoy these hidden extras at no extra cost. Learn what a difference thirty years of capacitor specialization can make. Learn why there are more Cornell-Dubilier capacitors in use today than any other make — proof of extra stamina, stability, and surviving soundness in C-Ds.



Only Cornell-Dubilier Electrolytics offer all these EXTRA FEATURES!

- Special high voltage paper separator
- C-D etched plates
- Special C-D electrolyte
- Special high formation process



For complete technical information, write for engineering bulletin 170.

**CORNELL-DUBILIER  
ELECTRIC CORPORATION**  
1006 HAMILTON BLVD. • 50. PLAINFIELD, N. J.

**REMEMBER!** Only C-D union-made capacitors give you the EXTRAS at no extra cost.

*Get the extras*

— WITH CORNELL-DUBILIER CAPACITORS!

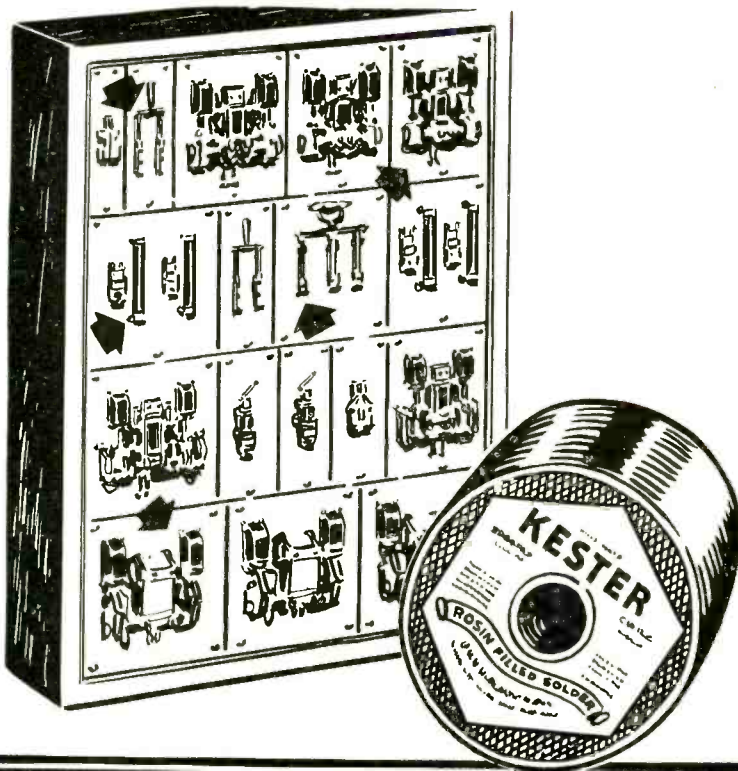

## NO CORROSION AT THE TERMINALS!

Make sure that every soldered connection is made with Kester Rosin-Core Solder and you will eliminate one big corrosion problem.

This famous solder contains a special rosin-flux in the core that will not corrode the wiring or destroy the value of the insulating material.

In addition, Kester Rosin-Core Solder eliminates an important fire hazard.

Because of these important advantages, manufacturers throughout the electrical and radio industries specify Kester for all soldering needs.

Kester Cored Solders come in a great variety of alloys, fluxes, strand-sizes and core-sizes. Put any soldering problem up to Kester engineers and they will gladly show you the best way to solve it.

This service places you under no obligation whatsoever.

### KESTER SOLDER COMPANY

4204 Wrightwood Avenue

Chicago, Illinois

*Eastern Plant: Newark, N. J.  
Canadian Plant: Brantford, Ont.*



ance values have not been selected accurately, or if the preliminary scale subdivisions were very far apart. It should be noted that each stage will take care of *two* such subdivisions, as it contains two variables, namely, the ratio:  $R_1/R_2$  and the cathode resistance  $R'$ .

Hence, if the subdivisions are spaced 5 db from one another, 5 sections (5 tubes) will cover a range of 50 db. However, for practical purposes such close spacing is unnecessary, and 4 tubes can be made to cover a 60 db range when selection of resistances is possible.

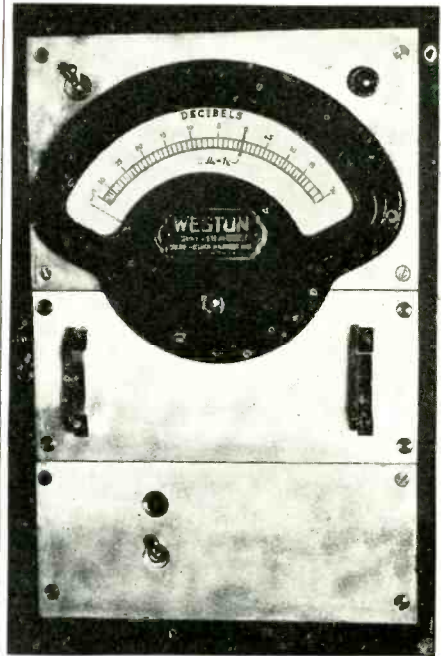

Fig. 6—External appearance of experimental four-stage voltmeter

In accordance to the above, an experimental model shown in Fig. 6, was constructed. It contains, in addition to the "converting network", a rectifying circuit and a source of regulated d-c voltage. The rectifying circuit is shown in Fig. 7. This particular circuit was found most satisfactory from the point of view of stability, and it has the advantage that it makes use of a tube of the same type as those in the "converting network" (type 6F8-G).

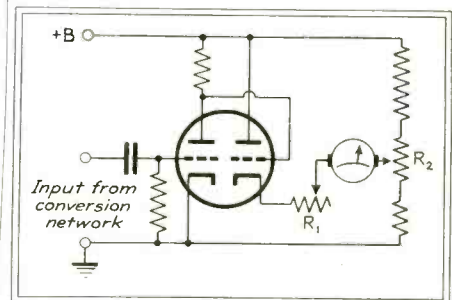
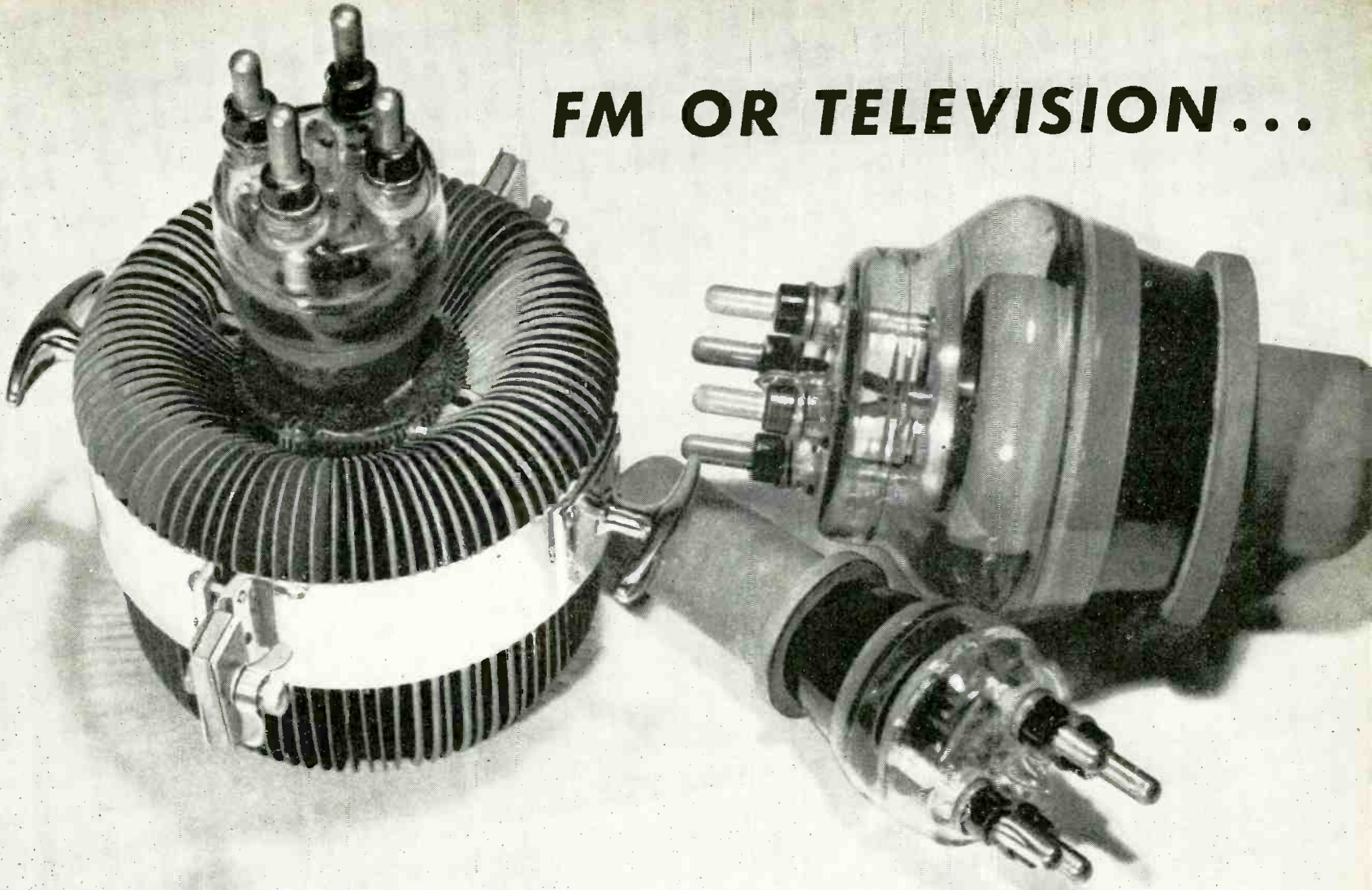

Fig. 7—Rectifying circuit for converting signal to d-c meter reading

# FM OR TELEVISION...



## INTERNATIONAL OR STANDARD BROADCASTING—

### *Here Is High Efficiency at High Power*

Primarily developed for the new high-frequency services, GL-889-R, GL-889, and GL-880 provide superior performance for all present-day broadcasting.

#### **GL-889-R**

High efficiency and economical forced-air-cooling are now available to the entire realm of broadcasting with the G-E developed GL-889-R. Its small size and short leads make it especially valuable for ultra-high-frequency operation.

At frequencies up to 25 megacycles, a pair of 889-R's is capable of 8,000 watts output plate-modulated, or 20,000 watts class C telegraph. For FM service, 10,000 watts output is very conservative operation.

Internal design is the same as the GL-889. GL-889-R's are used as output tubes in G-E 10,000-watt FM transmitters.

#### **GL-889**

Twenty-five years of G-E tube manufacturing experience contributed to the successful design of the GL-889—the tube which started a new trend in u-h-f construction. The GL-889 incorporates dual grid leads for separation of neutralizing and excitation circuits. It is fully shielded to prevent electron bombardment of the glass envelope.

Its compact construction makes possible short internal and external leads. Low driving power is required.

Water-cooled, it is rated at 10,000 watts output, class C telegraph, and 4,000 watts output in plate-modulated class C service.

#### **GL-880**

General Electric's GL-880 stands alone today in the field of high-power u-h-f transmitting tubes. Its unique construction—utilizing a re-entrant anode—resulted in a decrease in internal lead length of 10 inches compared with existing designs. Full ratings apply up to 25 megacycles. Reduced ratings to 100 mc.

A pair of GL-880's gives an easy 50,000-watt output in 42- to 50-mc FM broadcast service. Low driving power is required. The G-E 50,000-watt FM broadcast transmitter, excited by a 3,000-watt amplifier, uses push-pull GL-880's in the output stage.

*Technical information sheets on all G-E tubes are available through our local G-E representative. Place your next order for tubes with him. There are G-E sales engineers in 80 principal cities. General Electric, Schenectady, N. Y.*

# GENERAL ELECTRIC

**...SIX YEARS  
and still in  
SHIRT SLEEVES**



**I**N the short span of six years Superior Tube Company has become a major factor in the manufacture of fine small metal tubing. ••• On our 6th birthday we bring this fact to your attention—not so much to emphasize our rapid growth, but to give our sincere thanks to the industries and the men in those industries who have found within our doors the answer to their small tubing needs. ••• Our progress has been forced by these men who have given

us the "go" sign to do a very important part of their work for them. That's all a wide awake organization needs—the opportunity to roll up its sleeves and go to work on any job that needs to be done. • • • Our facilities have broadened until the name SUPERIOR is the synonym for fine small tubing. If you think that is not a challenge to us, then try Superior Tubing on your next job. We mean to stay in front! Small tubing is our only business, and we know it.



**SUPERIOR TUBE COMPANY, NORRISTOWN, PENNSYLVANIA**

**'FOR FINE SMALL TUBING'**

*Tubing from 5/8" OD down . . .* SUPERIOR  *Seamless in various analyses. WELDRAWN*  *Welded and drawn Stainless. BRAWN*  *Welded and drawn "Monel" and "Inconel". SEAMLESS and Patented LOCKSEAM Cathode Sleeves.*



## For tube power and life: SPEER GRAPHITE ANODES

Transmission and power tubes with SPEER Graphite Anodes, on any comparable basis, transmit more power and outlast tubes with anodes of any other material in commercial use.

Tubes with SPEER Graphite Anodes handle more power because their relative heat dissipating value exceeds that of all other anode materials. At 510° it exceeds that of Tungsten by 233%, Molybdenum by 316%, Tantalum by 354%, Nickel by 3500% to 9990%.

Tubes with SPEER Graphite Anodes have longer service-life because the anodes cannot be damaged by overloading. The anodes cannot warp, fuse, blow out or soften; they emit no gas; they absorb gases given off by other tube elements.

For power and life, use tubes with SPEER Graphite Anodes. List of tube makers and Anode Data Book sent on request. Write for your copy.



# SPEER

*Carbon Company*

ST. MARYS, PA.

CHICAGO • CLEVELAND • DETROIT • MILWAUKEE  
NEW YORK • PITTSBURGH

*Speer Graphite Anodes Make Good Tubes Better*

Tube replacements, of course, affect this circuit (while they do not appreciably affect the "converting network"). To correct for this two variable resistors are provided. Of these,  $R_1$  is used to correct the meter deflection, and  $R_2$  to correct the zero.

In the above discussion, no mention has been made of the behavior of the meter at increasing frequencies. No full data on this are available at this time, as the oscillator used only reached a frequency of 15,000 cps. Up to this frequency there was no change in the calibration, except a very slight one (of the order of .5 db) at the top of the scale, i.e., for signals approaching 10 volts r-m-s. It seems apparent, however, that the behavior of the instrument from this point of view is satisfactory for most practical purposes.

• • •

## Auto-Transformers in Modulation Circuits

By THOMAS A. GROSS

THE HIGH EFFICIENCY AND LOW COST of auto-transformers account for their extensive use in power service. However, in radio practice lack of co-ordinated effort between designing engineers and transformer manufacturers has prevented its widespread adoption in modulation circuits. The principles discussed here apply to all r-f, a-f, and power transformers. Because the benefits are particularly marked in their application to modulators, special emphasis is placed on this service.

### Transformer Efficiency

The insertion loss of modulation transformers is important in view of the high power levels encountered and the expense of generating the a-f power. Multiple circuit transformers (two windings or more) which are usually employed in broadcast station modulators frequently have losses twice as great as equivalent auto-transformer designs.

The decreased resistance of auto-transformer coil windings account for important gains in transfer efficiency. The percentage efficiency of a multiple circuit transformer as governed by copper loss—

$$\text{Efficiency} = \frac{100}{1 + \frac{R_p + N^2 R_s}{N^2 R_L}} \text{ per cent (1)}$$

where:

$R_p$  = D-c resistance of primary winding  
 $R_s$  = D-c resistance of secondary winding

$N$  = Primary turns/secondary turns  
 $R_L$  = Load resistance

This formula also applies to an auto-transformer where the primary and secondary circuits have part or all of a winding in common (Fig. 1B).





# VOLUME CONTROLS

Drafted for selective  
service because of  
proved dependability.

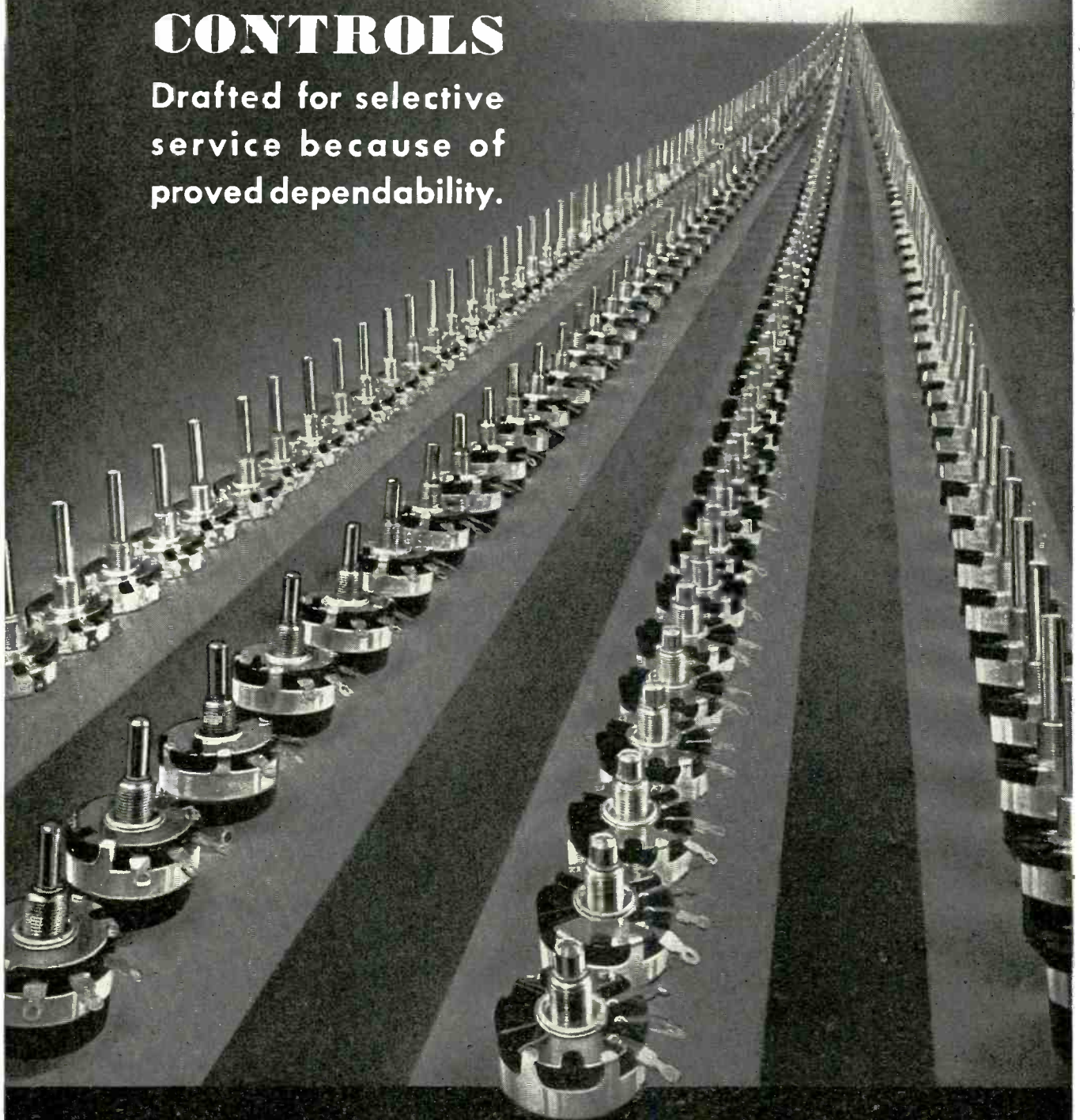

**INTERNATIONAL RESISTANCE COMPANY**

403 N. BROAD STREET, PHILADELPHIA, PA.

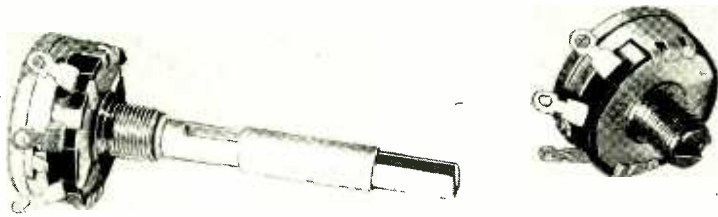

# Performance Safeguards

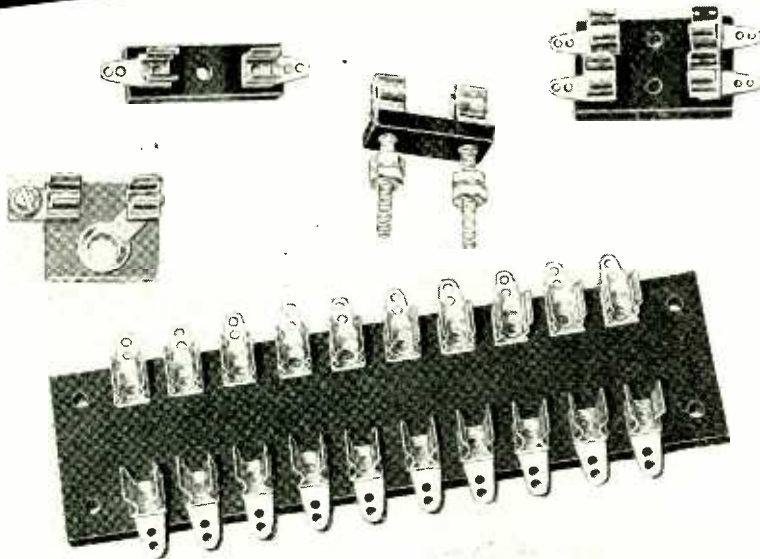

# INSUROK

## Precision Plastic for the Electrical Industry

The outstanding qualities of INSUROK, dielectric, physical and chemical, won immediate acceptance in the electrical industry, where standards are high and unfailing adherence to specifications a fundamental, inviolate requirement. INSUROK is obtainable in only one quality . . . the *finest* that modern science, equipment and craftsmanship can produce. It is made in various grades, each best suited for its intended purpose. It is produced in two types—molded or laminated (or a combination of both). INSUROK is available in sheets, rods and tubes for fabrication in your own plant, or in completely finished parts and products.

Richardson Technical Laboratories are maintained to assist those interested in the application of INSUROK plastics to present or contemplated products. Use of this service involves no obligation.

**The RICHARDSON COMPANY**  
 MELROSE PARK, CHICAGO, ILL.    FOUNDED 1858    LOCKLAND, CINCINNATI, OHIO  
 NEW BRUNSWICK, N. J.    INDIANAPOLIS, IND.  
 DETROIT OFFICE: 4-252 G. M. BUILDING, PHONE MADISON 9386  
 NEW YORK OFFICE: 75 WEST STREET, PHONE WHITEHALL 4-4487

Evidently the heat dissipation due to the a-c current in the common winding is not the scalar sum of the two currents squared times the resistance. It can be shown by Kirchoff's Laws that the a-c power loss is the same for both circuits (Figs. 1A and 1B) when the resistance of the primary windings is the same. This follows to the conclusion that Eq. (1) describes the power loss for either circuit.

The practical advantage lies in the elimination of a large portion of the transformer windings with no decrease in efficiency when the auto-transformer principle is employed. This lowers the manufacturing cost and, as we shall see later, improves the high frequency response. Similarly, the auto-transformer will have a higher efficiency compared to multiple winding transformers constructed with the same amount of core and copper.

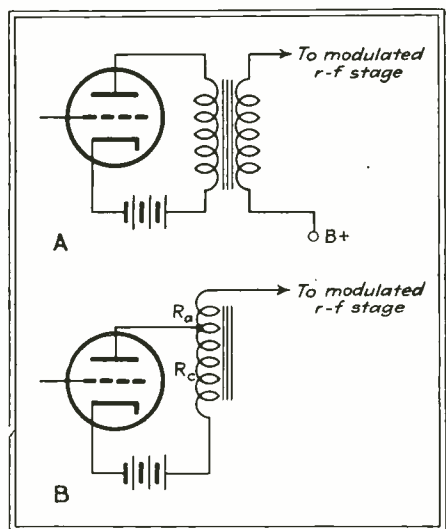

Fig. 1—Multiple circuit (A) and auto-transformer (B) modulators

The d-c losses, however, are generally higher in the auto-transformer. In the circuit of Fig. 1A the d-c power dissipation is

$$(I_p)^2 R_p + (I_s)^2 R_s$$

where:

- $I_p$  = Pri. d-c current
- $I_s$  = Sec. d-c current
- $R_p$  = Pri. d-c resistance
- $R_s$  = Sec. d-c resistance

The d-c power loss in the transformer of Fig. 1B is

$$(I_p + I_s)^2 R_c + (I_s)^2 R_a$$

where:

- $R_c$  = Resistance of the common winding
- $R_a$  = Resistance of the auxiliary winding

In the customary push-pull modulator stage it is not possible to employ the entire primary winding common to the secondary circuit because the high voltage plate supplies are at ground potential so far as ac is concerned. Thus the direct-voltages are

# LENZ WIRES & CABLES

## FOR AIRCRAFT WIRING

Lenz Wires and Cables can be made to meet the requirements of Aircraft Manufacturers and Government specifications. Such desirable qualities as flame resistance, moisture resistance and high dielectric strength are developed to a high degree. Some of the Lenz Wires that have found particularly wide acceptance among Manufacturers of Aircraft and Aircraft Instruments are described below.

### AEROLAC

A combination of spiral wrapped acetate tape and cotton textile impregnated with a flame resistant compound. Voltage breakdown at room temperature 9000 Volts. Voltage breakdown after 24 hours immersion in water 4000 Volts.

### SPIBRAC

Insulation consists of spiral wrapped varnished cambric with cotton braid and impregnated with flame resistant compound. High Voltage Breakdown. Made to U. S. Government Specifications.

### LENCEL

A wire of high dielectric characteristics but small diameter, extremely desirable for use in cables where size must be kept to a minimum.

### LENGLAS

A flameproof Fiberglas insulated wire. Insulation will not support combustion even when conductor is heated to incandescence.

### AEROGLAS

A combination of spiral wrapped acetate tape and double Fiberglas braid, lacquer impregnated. Offers extremely high voltage breakdown and excellent flame resistant qualities.

### LENZ R. F. HOOK-UP WIRE

Patent No. 2170304  
Especially recommended for High Frequency Instrument Wiring. Offers high voltage breakdown, high insulation resistance and low power factor under adverse climatic conditions. Used for aircraft radio receivers and direction finding equipment.

## LENZ SHIELDED WIRES & CABLES

All Lenz Wires are furnished in various sizes of conductors in both solid and stranded construction and with color coded insulation.

### OUR ENGINEERS

will be glad to collaborate in the design of special wires and cables to suit your exact requirements.



## LENZ ELECTRIC MANUFACTURING CO.

1751 No. Western Avenue - CHICAGO, ILLINOIS

Enjoying its 37th Year of Successful Business



**It's easy to  
stand an egg on end  
—when you know how!**

**A FEW S.S. WHITE  
FLEXIBLE SHAFT  
APPLICATIONS**

**POWER DRIVES**

- Instruments
- Counters
- Indicators
- Speedometers
- Tachometers
- Taximeters
- General
- Air Conditioners
- Aircraft Fuel Pumps
- Bottling Equipment
- Business Machines
- Concrete Surfaces
- Concrete Vibrators
- Cotton Pickers
- Engraving Machines
- Flame Cutting Machines
- Food Handling Machines
- Hair Clippers
- Home Workshops
- Kitchen Appliances
- Massage Machines
- Mechanical Toys
- Portable Tools
- Screw and Nut Setters
- Shoe Machinery
- Tube Cleaners
- Valve Grinders
- Washing Machines
- Windshield Wipers

**REMOTE  
CONTROLS**

- Automotive
- Antenna Control
- Carburetor Choke and Needle Valve Adjustment
- Clock Setting
- Crank Case Drain
- Engine Governor Control
- Gear Shift Control
- Radio Receivers
- Retractable Head Lights
- Trip Mileage Reset
- Aircraft
- Antenna Reel Control
- Beacon Receivers
- Compass Loop Control
- Gyro Pilot Control
- Heating Register Control
- Radio Receivers
- Tab Control
- Variable Pitch Propeller
- General
- Cam Position Indicator
- Centralized Machine Controls and Adjustments
- Electrical Switches
- Gun Fire Controls
- Dven Thermostat Controls on Domestic Ranges
- Valve Position Indicator
- Washstand Drain Control
- Weighing Balance Accurate Adjustment

SAVE TIME in working out flexible shaft applications. Ask our engineers for recommendations. They know flexible shafts and they have had wide experience in applying them to all kinds of requirements in many industries. They're eager to help you and their recommendations are yours without obligation.

All you need do is send details of what you want to use the flexible shaft for, with a rough sketch giving essential dimensions—all of which will be held in strictest confidence. We'll do the rest.

**SEND FOR THESE  
BULLETINS—TODAY**

Even if you have no immediate power drive or remote control problem it's a good idea to have full information about flexible shafts handy. So write for the following bulletins today!



- BULLETIN 1238**  
Flexible Shafts for POWER DRIVES
- BULLETIN 38**  
Flexible Shafts for REMOTE CONTROL
- BULLETIN 839**  
Flexible Shaft Combination for AIRCRAFT

**S. S. WHITE**

The S. S. White Dental Mfg. Co.  
**INDUSTRIAL DIVISION**  
Department E, 10 East 40th St., New York, N. Y.

**FLEXIBLE SHAFTS for POWER DRIVES, REMOTE CONTROL and COUPLING**

fed into points of zero a-c voltage, as shown in Fig. 2.

The modulated amplifier circuit is connected to an appropriate impedance tap. Note that no auxiliary winding is required if the impedance of the modulated amplifier is equal to one-quarter of the modulator plate-to-plate load. In this case the modulated amplifier is connected to one of the modulator plates. In the event that the modulated amplifier has a lower impedance, the appropriate tap is located nearer to the center of winding "c" in order to reflect a proper load to the modulator plates.

*Frequency Response*

The auto-transformer does not offer intrinsic advantages in the transfer of low frequencies excepting an improved space utilization factor making more

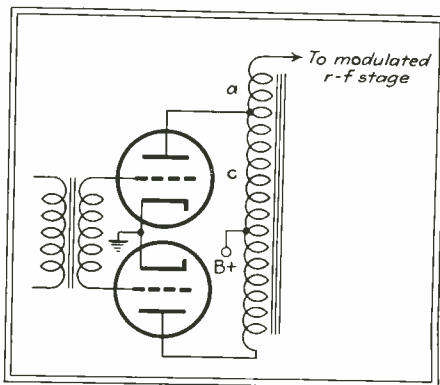

Fig. 2—System for maintaining B+ at zero a-c potential

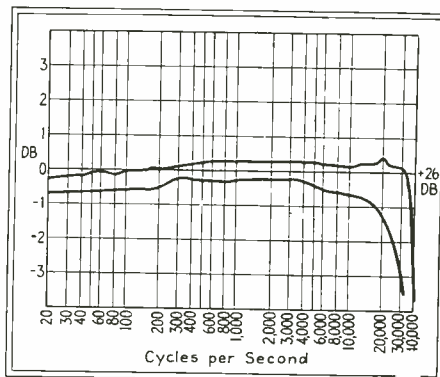

Fig. 3—Comparison of auto-transformer (top) and multiple circuit frequency response

turns possible in a given window area. The high frequencies, however, depend upon a low leakage inductance if they are to be effectively transmitted by the transformer. This leakage inductance varies inversely as the coupling coefficient between the primary and secondary windings. Close coupling can be obtained by segregating portions of each winding into pancake shaped coils and placing them close together. Unfortunately this procedure is limited by increasing capacities and manufacturing expense. When the respective circuits have common wind-



# 96 PAGES OF VALUABLE DATA ON RESISTANCE PROBLEMS



HERE'S a book that really works for you! The new Ohmite Catalog and Engineering Manual No. 40 is a complete handy reference on resistance application problems. It contains useful reference tables, complete dimensional drawings, valuable engineering data and a manual of resistance measurements. It describes the most complete line of stock units and special units for Industrial, R.F., and Precision applications. It gives a complete listing of Generator Field Control Rheostats. It tells you how to select the right units for any of your needs.

Design and Application Engineers! . . . Laboratory Men! . . . Production Managers! . . . Purchasing Departments! . . . You'll find it an invaluable guide on the use of Resistors, Rheostats, Tap Switches, Chokes, and Attenuators in radio and electronic equipment—in products, machine tools and special applications—in the control of motor speed, of generator fields, of heat and light, of signal and supervisory circuits—in instrument rooms, maintenance and production—in laboratories and electrical equipment.

You'll want it handy for ready reference—and you can have it without charge. Send for it now. Just clip this coupon to your letterhead or write us on company stationery.

**OHMITE MANUFACTURING CO.**  
4817 Flournoy St., Chicago, U. S. A.  
Please send Catalog 40.

Company \_\_\_\_\_  
 Individual \_\_\_\_\_  
 Position \_\_\_\_\_  
 Address \_\_\_\_\_  
 City \_\_\_\_\_ State \_\_\_\_\_  
*Electronics—Nov.*



ings, however, the coupling coefficient is unity. If auxiliary windings are necessary in the case where a push-pull modulator is used or when the circuit impedances differ, the coupling between these windings and the common winding is close to unity because of their spatial proximity. The extended response characteristic of the auto-transformer is probably its most important attribute. In addition, auto-transformers frequently cost 40 per cent less than their multiple-wound counterpart.

Multiple wound transformers have an advantage in flexibility over auto-

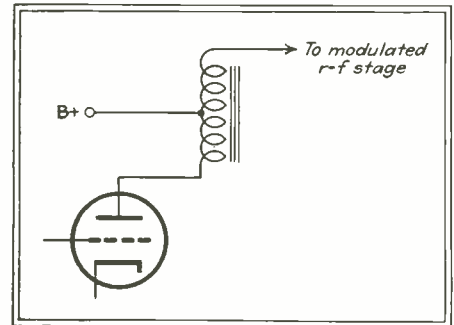

Fig. 4—D-c bucking arrangement to reduce core saturation point

transformers because the coupled circuits need not have a common d-c potential. At the present time, however, shunt fed systems are used in order that the unbalanced direct current will not decrease the permeability of the core materials. The indirect effect of the dc flowing through the modulation transformer is to increase its size and hence affecting the leakage inductance. Empirical observation indicates that auto-transformers with a series-fed modulated amplifier out-perform shunt fed-multiple circuit transformers. Shunt feed can of course be used with auto-transformers but future trends will probably show more popular use of the series-fed connections.

A variation on the common winding principle is the d-c bucking arrangement of Fig. 4. The windings are arranged so that the d-c mmf's cancel thus making a core of low reluctance possible. The mmf's cancel when:

$$(R_m/R_L)^2 = i_L/i_m$$

where:  
 $R_m$  = Reflected impedance facing modulator  
 $R_L$  = Impedance of modulated stage  
 $i_L$  and  $i_m$  = modulated amplifier and modulator currents, respectively.

For reasons already explained the circuit in Fig. 4 does not compare favorably in respect to efficiency and frequency response with the d-c "adding" circuit of Fig. 1B. Experiments however suggest its use for low power audio circuits. The example is given to show the extent of the many possible variations in common winding auto-transformer circuits.

# And the Proof Rolls In!

## W·E·B·C

DULUTH  
SUPERIOR

### HEAD OF THE LAKES BROADCASTING Co.

WEBC BUILDING  
DULUTH, MINNESOTA

August 26, 1940

Mr. W. R. David  
Radio and Television Department  
General Electric Company  
Schenectady, N. Y.

Dear Mr. David:

The Head of the Lakes Broadcasting Company has had a 250-watt General Electric Frequency Modulated transmitter in operation for the past 5 months. Recent frequency, distortion and noise level measurements show that no change has taken place in those characteristics since the installation of the transmitter. The general performance of the transmitter has been excellent with no interruptions to the program due to equipment trouble.

Public acceptance of FM broadcasting in this locality has exceeded expectations. Listeners equipped with good FM receivers are very enthusiastic over the high fidelity performance of FM. It is our opinion that the listening public needs only a demonstration of FM to completely sell them on the noise free, high fidelity advantages of this new system.

The Head of the Lakes Broadcasting Company was one of the first organizations to put an FM transmitter on the air and at present operates the only FM station west of Chicago. It is our aim to continue to set the pace in FM broadcasting in this part of the Northwest.

Very truly yours,

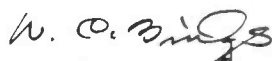

General Manager

The Head of the Lakes Broadcasting Co.

WCB/rk



Chief Engineer C. B. Persons at the controls of WEBC and W9XYH. At the extreme right is the 250-watt General Electric FM transmitter.

## Proof of the SIMPLIFIED Circuit Design

of



# FM

## Broadcast Transmitters

**S**IMPLIFIED FM circuit design was introduced by General Electric because of its many advantages and economies which no other system offers.

G.E. produces *direct* FM with only *two* tubes; G-E *instant acting* frequency control requires only *four* tubes (including crystal oscillator and the following tripler stage). There are no trick, hard-to-adjust circuits . . . no complicated, multi-tube networks . . . no moving parts.

G-E design is truly simplified. The resulting performance speaks for itself. Consult our local representative. Call or write him today. General Electric, Schenectady, N. Y.

# GENERAL ELECTRIC

160-9

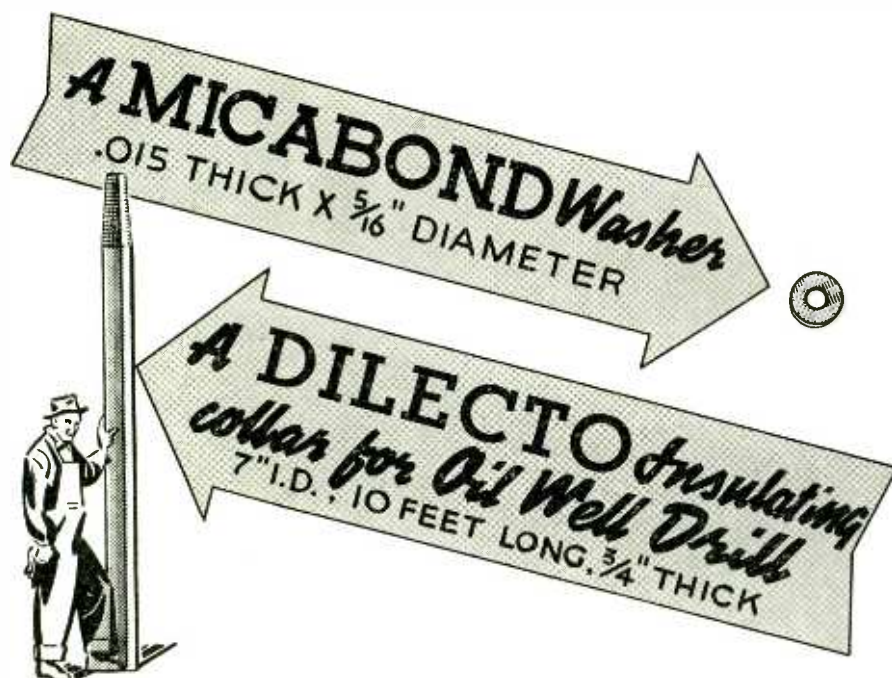

## Both are C-D Products

A vast difference in size, yes, but more important is the wide divergence in properties and purpose. One an infinitesimal wafer of insulation exactly fitted for its job in a portable radio . . . The other a structural member as well as an insulator which has withstood 1,320,000 lbs. pressure.

In between the two are a thousand and one insulating problems involving an endless variety of manufacturing and service requirements. Our technicians, in their up-to-date laboratory provide the research that has solved many of them . . . Give us the facts and we will tackle yours without fee or obligation. Write us today.

# CONTINENTAL-DIAMOND FIBRE COMPANY

NEWARK, DELAWARE

Represented in Canada by Diamond State Fibre Co. of Canada, Ltd., Toronto

## The Chronoscope

(Continued from page 30)

pearance of the Chronoscope. The input terminals are at the extreme left with their switches to change from a make to a break type of input circuit. The switch marked "Milliseconds" selects the five time ranges, 10, 20, 50, 100 and 200 milliseconds and also provides means of reading the battery voltage and checking the ballistic constant of the galvanometer. The key in the center is normally in the middle position but when thrown up the galvanometer is out of the circuit and the current can be set on the milliammeter. This key is pressed down to take readings of time on the galvanometer. The knob at the right is the fine adjustment on the current. The time indicating galvanometer is in the top of the cabinet on the left and the milliammeter for indicating the current is at the right.

Figure 7 shows the internal arrangement of parts. One set of binding posts on the chassis affords provision for the use of batteries for energizing the tube filaments in case it is desirable to use the chronoscope where an a-c power line is not available. The additional set of binding posts on the chassis is for the insertion of a meter to check the calibration of the milliammeter.

### *Accuracy, Convenience, and Reliability*

To be fully assured that the theory of operation was correct, calibrations at both ends of the scale on each of the five ranges have been made. This has been done by means of oscillograph records using a frequency standard as the time reference. The table shows the current used on each range resulting in a maximum error of 0.65 per cent.

Range in Milliseconds	Current in Milliampères
10	20.0
20	10.0
50	4.0
100	2.01
200	1.01

These data apply to a galvanometer which requires 200 microcoulombs for full scale deflection as determined by the condenser discharge



# THE EASY WAY ... to Sustain EXACTING PRODUCTION SCHEDULES!



**The WESTON multi-range  
AC Clamp-Ammeter**

Available in three models . . . each having six individual full scale ranges . . . to suit all maintenance applications. Has convenient 6 position range changing switch. Well insulated for protection. Can be used with insulated or non-insulated conductors up to 2" diameter.

**WESTON portable  
and panel type  
instruments**

Available in the types, sizes and ranges necessary for production and assembly testing. Also in multi-range, multi-purpose instruments such as volt-ohmmeters, volt-ohm-milliameters, etc., etc.

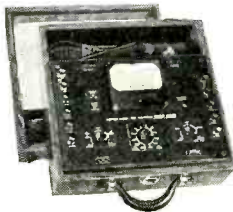
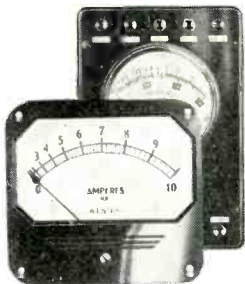

**WESTON Model 785  
Industrial Circuit  
Tester**

A compact, self-contained unit which provides all the ranges (27 in all) necessary for voltage, current and resistance measurements wherever high sensitivity is a factor . . . including signal systems, telephone circuits, sensitive relay circuits, photo-cell circuits, PA systems and amplifiers, etc., etc.

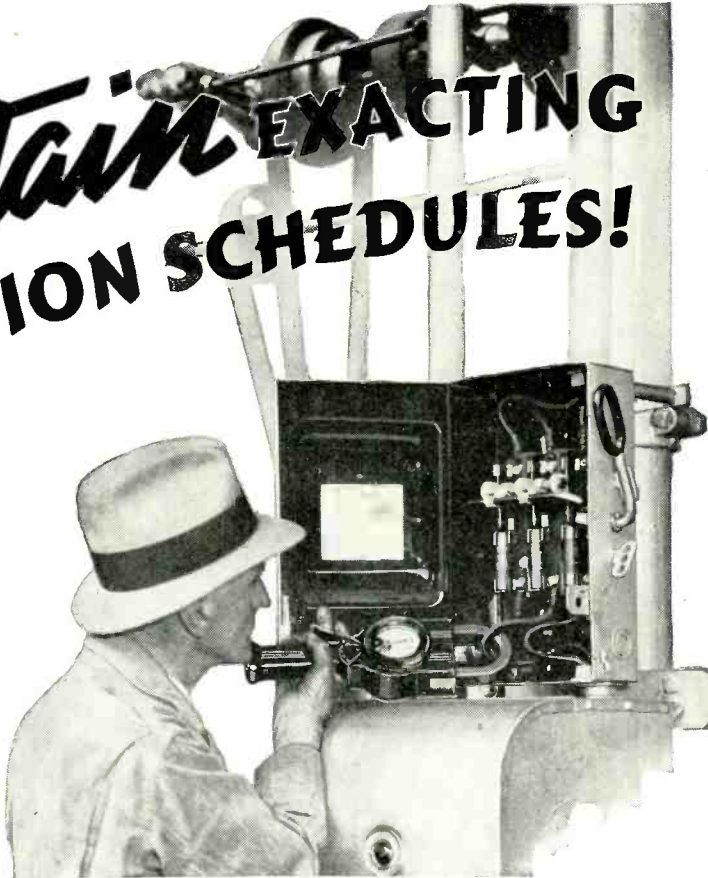

No longer is it necessary to interrupt a circuit and stop production while motors and machines are being tested. With the WESTON AC Clamp-Ammeter you do your testing with all machinery "on the line". The jaws of this compact maintenance tool are just hooked around the conductor or switch-blade, and you get your current reading. So simple, each test takes but a fraction of the time ordinarily required. Thus you save testing time and save working time, while safeguarding against equipment break-downs and costly power losses. *It's an essential tool for any shop faced with an exacting production schedule.*

And for the assembly line, the inspection department, or for other test requirements, there are WESTON instruments specifically designed to do the job quicker, simpler, and with true WESTON dependability. Make sure you are getting all the benefits of modern WESTON instrumentation. Call on your local WESTON representative for information or assistance; or write direct to Weston Electrical Instrument Corp., 618 Frelinghuysen Avenue, Newark, N. J.

Laboratory Standards . . . Precision DC and AC Portables . . . Instrument Transformers . . . Sensitive Relays . . . DC, AC, and Thermo Switchboard and Panel Instruments.

# WESTON

Specialized Test Equipment . . . Light Measurement and Control Devices . . . Exposure Meters . . . Aircraft Instruments . . . Electric Tachometers . . . Dial Thermometers.

**FOR OVER 52 YEARS LEADERS IN ELECTRICAL MEASURING INSTRUMENTS**

# RHEOSTATS

## FOR EVERY JOB



The Ward Leonard Pressed Steel Plate Type Rheostat is a most adaptable control device. It lends itself to front or back of board mounting, multiple deck assembly, concentric operation, and manual or motor drive. Thus, whatever the control requirements or method of operation may be, Ward Leonard, with their wide range of

rheostat mountings and accessories can give you on short notice the exact combination to do the job.

*Plate Type Rheostats are described in Bulletin 60. Ring Type Rheostats in Bulletin 1105. Laboratory Rheostats in Bulletin 8002. Send for Bulletins of interest to you.*

Visit our booths 225 and 226 at the Power Exhibit, Grand Central Palace, Dec. 2 to 7.

## WARD LEONARD ELECTRIC COMPANY

*Electric Control Devices Since 1892*

Ward Leonard Electric Co., 32 South Street, Mount Vernon, N. Y.

Please send me your Rheostat Bulletin No. ....

Name .....

Firm .....

Address .....

City ..... State .....



calibration. The increase in current over the theoretical value which was required on the 100 and 200 millisecond scales is due to the fact that for these scales the length of the time interval becomes comparable with the period. It agrees with the calculated increase from galvanometer theory.<sup>5</sup>

In making a series of measurements, the condition of the main batteries can be checked by the internal means provided. The ballistic constant of the meter can then be checked by the condenser discharge method also provided. After the tube filaments are energized and the range is selected, the galvanometer current can be adjusted to the correct value in steady-state. When these three points have been checked, full assurance can be had of the accuracy of the results obtained.

The principle used in the device in combination with the operation of the circuit results in high speed in making measurements. Furthermore, for the same two reasons, both tube life and battery life are extremely long. During the two years of use of the developmental model of the Chronoscope it has proved to be an accurate, reliable and convenient instrument.

#### BIBLIOGRAPHY

- (1.) Lord, H. W., Measuring Small Time Intervals, *Electronics*, Oct. 1932.
- (2.) Reich, H. J. and Toomin, II., "Electronic Circuit for the Measurement of Time and Speed," *Review of Scientific Instruments*, Dec. 1937, Vol. 8.
- (3.) Barry, T. M., A Photo Electric Time Interval Meter, *General Electric Review*, March 1940, Vol. 43 #3.
- (4.) Starling, S. G., "Electricity and Magnetism," page 253.
- (5.) Wenner, F., The Effect of the time of passage of  $Q$  on the Throw of a Ballistic Galvanometer, *Physical Review*, Aug. 1907, Vol. 25, 139.

• • •

#### FM IN PRODUCTION

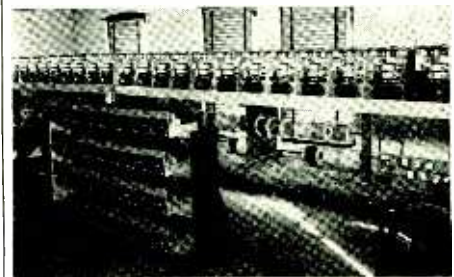

A group of quantity production f-m transmitters and receivers. They are portable-mobile, crystal controlled, and of the phase-shift type. 200 of these units are being manufactured for the Chicago police



*But that was in 1917 —*

## **Today's Electronic-Equipped Air Forces Are On 24 Hour Duty**

● Total war accepts no compromise with time and weather.

Total preparedness must be created on the same basis.

With the air forces of the Army and Navy this means men and equipment prepared for continent and hemisphere defense at any hour of the day or night, and in every possible weather condition.

Our air forces are getting that training and receiving that equipment. No air force in the world, aggressor or defender, is being as well equipped with trained personnel or with as efficient air and ground material.

We believe that no other single industry has contributed more to this efficiency than the developments of the electronic industry. Given strong, fast aircraft our air defense would still be a daytime, good-weather force without the electronic devices in use on airplanes and by their land or sea-going bases.

Radio, the invisible lifeline of communication, makes the

air services always flexible striking or defending units of the services, working in contact and harmony with the land and sea forces. Many other uses of radio and electronic devices are government secrets — but direction finding, homing devices, sound detectors, electronic gun and bomb mechanisms, electrical instruments of every type, traffic control, field and carrier lighting equipment, these are some of the electronic industry's contributions to the effective defense of our Nation.

During the current program for adequate National Preparedness the electronic industry, in cooperation with the aircraft manufacturers, the Army Air Corps, and with the Navy's Bureau of Aeronautics, will continue to provide the world's finest electronic devices for our air defense, and will continue the research that will keep future materials equally superior.

Fortunately, the electronic industry is already equipped to meet any demands of the Preparedness Program.

*An Institutional Message from ELECTRONICS, the Authoritative Voice of the Electronic and Allied Industries.*

**THE ELECTRONIC INDUSTRY IS A VITAL ELEMENT IN NATIONAL DEFENSE**

# TUBES

Tubes registered with the R.M.A. Data Bureau during the month of August, 1940 and during 1934, 1935 and 1936

## Tube Registry

Tube Types Registered by R.M.A. Data Bureau During September, 1940

### Type 5Z4GT (G)

Prototype 5Z4

FULL wave rectifier; heater type; T-9 glass envelope; seated height 2 $\frac{3}{4}$  inches; 5-pin octal base.

$E_f = 5.0$  v  
 $I_f = 2.0$  amps  
 Tube Voltage Drop at 125 ma per plate = 20 v  
 CONDENSER INPUT TO FILTER  
 $E_{ac}$  (per plate, rms) = 350 v (max)  
 $I_{dc} = 125$  ma (max)  
 CHOKE INPUT TO FILTER  
 $E_{ac}$  (per plate, rms) = 500 volts (max)  
 $I_{dc} = 125$  ma (max)  
 Basing 5L-O-O

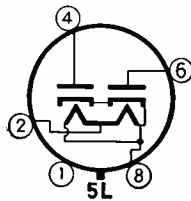

### Type 5Y3

Prototype 80

FULL-WAVE high vacuum rectifier, filament type, ST-14 glass envelope, seated height 4 $\frac{1}{8}$  inches, 5-pin octal base.

$E_f = 5.0$  v  
 $I_f = 2.0$  amp  
 CONDENSER INPUT TO FILTER  
 $E_{ac}$  (per plate, rms) = 350 v (max)  
 $I_{dc} = 125$  ma (max)  
 CONDENSER INPUT TO FILTER  
 $E_{ac}$  (per plate, rms) = 500 v (max)  
 $I_{dc} = 125$  ma (max)  
 $E_{drop} (I_{dc} = 125$  ma per plate) = 60 v  
 Basing 5T

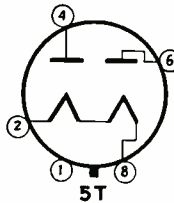

### Type 2E5

Prototype 6E5

TUNING indicator, heater type, ST-12 glass envelope, seated height 3 $\frac{1}{8}$  inches, 6-pin base.

$E_h = 2.5$  v  
 $I_h = 0.8$  amp  
 $E_h = 250$  v (max) through 1 megohm  
 $I_b = 0.24$  ma  
 $I_{control} = 4$  ma (approx)  
 $E_c$  (shadow angle = 90°) = 0 v  
 Basing 6R

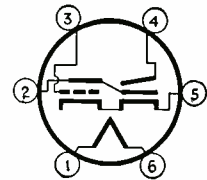

### Type 1A4 (P)

SUPER-CONTROL r-f amplifier, medium cutoff, filament type, ST-12 glass envelope, seated height 3 $\frac{1}{8}$  inches, 4-pin base.

$E_f = 2.0$  v  
 $I_f = 0.06$  amp  
 $E_b = 180$  v  
 $E_c = 67.5$  v  
 $E_c = 3$  v  
 $I_b = 2.3$  ma  
 $I_{c2} = 0.8$  ma  
 $r_p = 1$  megohm  
 $g_m = 725$   $\mu$ mhos  
 Basing 4M

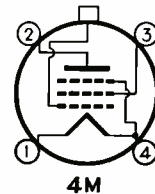

### Type 6N7GT (G)

Prototype 6N7

TWIN triode; heater type; T-9 glass envelope; seated height 2 $\frac{3}{4}$  inches; 8-pin intermediate shell octal base.

$E_f = 6.3$  v  
 $I_f = 0.8$  amp  
 TRIODES IN PARALLEL  
 $E_b = 294$  v  
 $E_c = -6$  v  
 $I_b = 7$  ma  
 $\mu = 35$   
 $r_p = 11,000$  ohms  
 $g_m = 3200$  ohms  
 Basing 8B-O-O

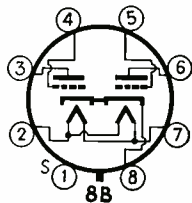

Tube Types Registered By R.M.A. Data Bureau in 1934, 1935 and 1936

### Type 6B5

DIRECT-COUPLED power amplifier, heater type, ST-14 glass envelope, seated height 4 $\frac{1}{8}$  inches, 6-pin base.

$E_h = 6.3$  v  
 $I_h = 0.8$  amp  
 $E_b$  (output) = 300 v (max)  
 $E_b$  (input) = 300 v (max)  
 $E_c$  (input) = 0 v  
 $I_b$  (output) = 42 ma  
 $I_b$  (input) = 9 ma  
 $R_i = 7000$  ohms  
 $P_o = 4$  watts (5%)  
 Basing 6AS

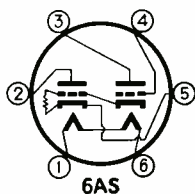

## FLYING BOAT TESTED FOR EUROPEAN SERVICE

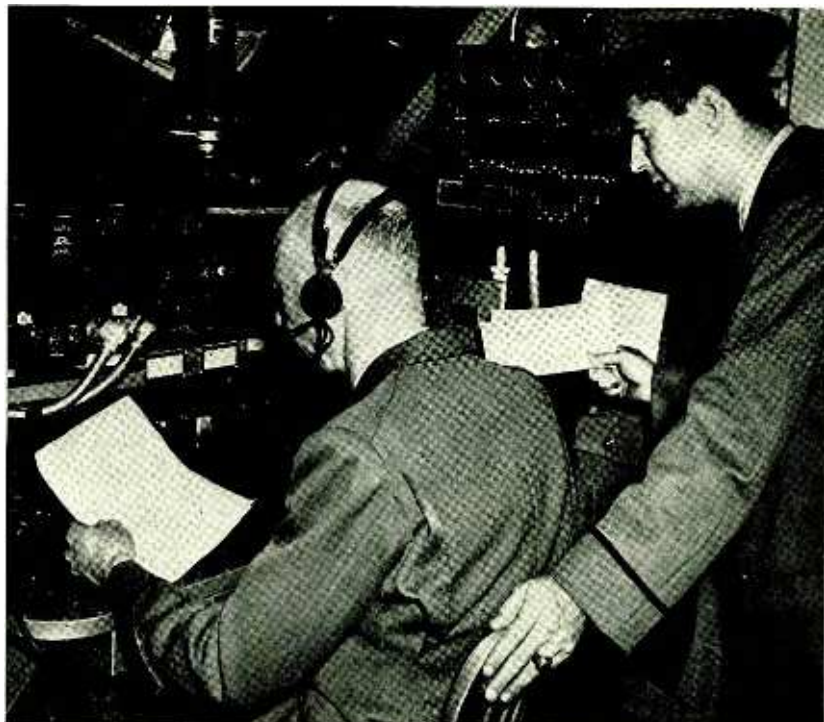

The radio room of a flying boat intended for European service undergoing tests at Floyd Bennett Airport. T. S. Terrill, first officer (right) hands Ralph Carlson, radio operator, a message to be sent

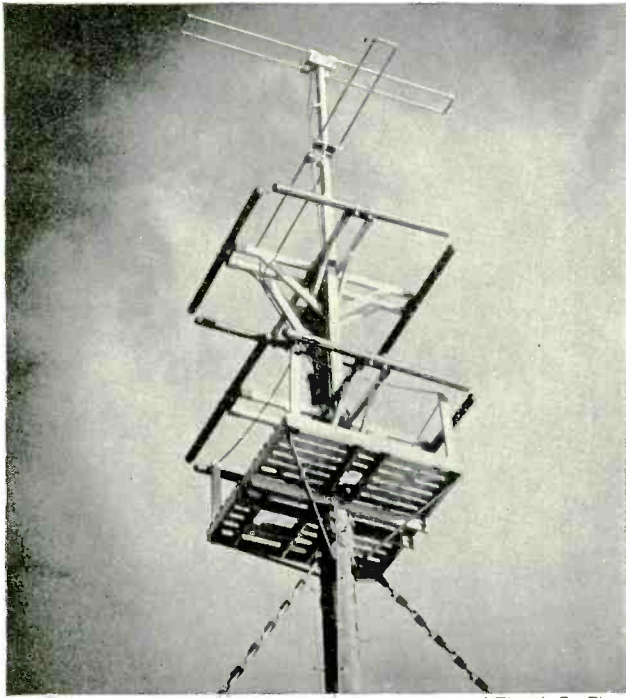

General Electric Co. Photo

▲ THIS NEW G-E DUAL-PURPOSE ANTENNA for television and FM transmission in a single compact unit symbolizes the service of Isolantite to the two newest branches of the radio industry. Isolantite engineering in insulator design has played an important role in anticipating the special requirements of these new developments.

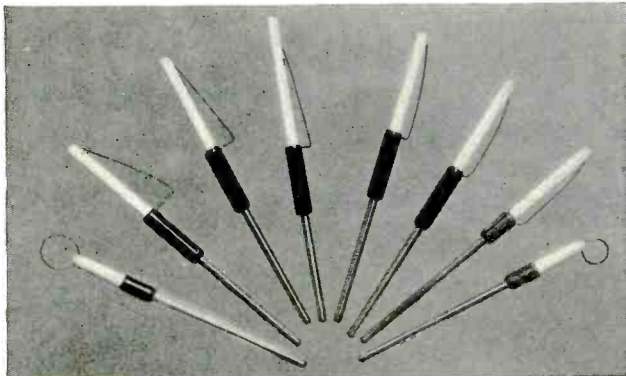

▲ UNUSUAL UTILITY of Isolantite\* extends into virtually all fields of electronics. The insulators illustrated here were specially designed for the requirements of these electrotherapeutic instruments.

▼ STRAIN INSULATORS are streamlined for airplane service — another instance of Isolantite's leadership in insulator design. Isolantite's high strength is a double advantage in aircraft service: it gives mechanical protection against shocks and stresses, permits the use of small, weight-saving sections.

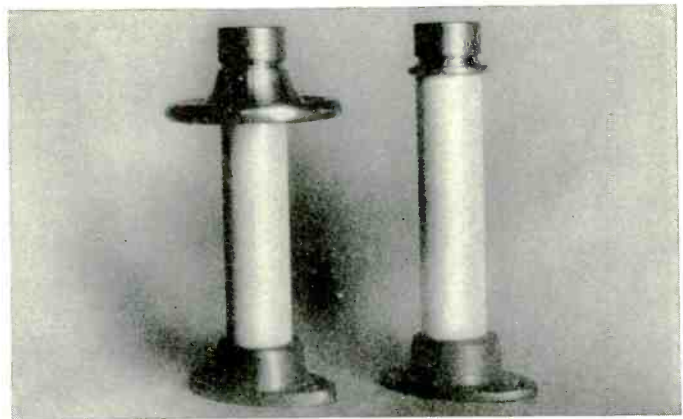

▲ NEW CORONA SHIELD on Isolantite stand-off insulators represents a still further improvement over previous designs. Shield is of spun aluminum. Insulators are engineered to relieve electrical stresses at top — point where stress is ordinarily at a maximum.

# INSULATION HIGHLIGHTS

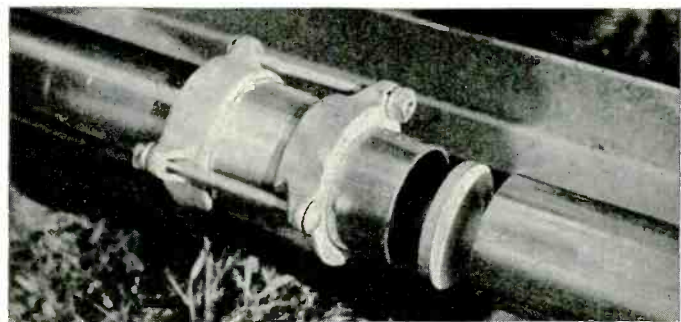

▲ SOLDERLESS GAS-TIGHT JOINTS for coaxial transmission lines manufactured by Isolantite, Inc., are accomplished by the patented Raybould coupling. A gas-tight seal is effected simply by tightening nut. End seals, junction boxes and many other special fittings employing this patented device are available for radio purposes exclusively from Isolantite, Inc. (Isolantite coaxial transmission lines are sold nationally through Graybar Electric Co.)

*\*Registered trade-name for the products of Isolantite, Inc.*

# ISOLANTITE

## CERAMIC INSULATORS

ISOLANTITE, INC. FACTORY: BELLEVILLE, NEW JERSEY  
SALES OFFICES: 233 BROADWAY, NEW YORK, N. Y.

When you sail in *airships*  
your life preserver looks like this...

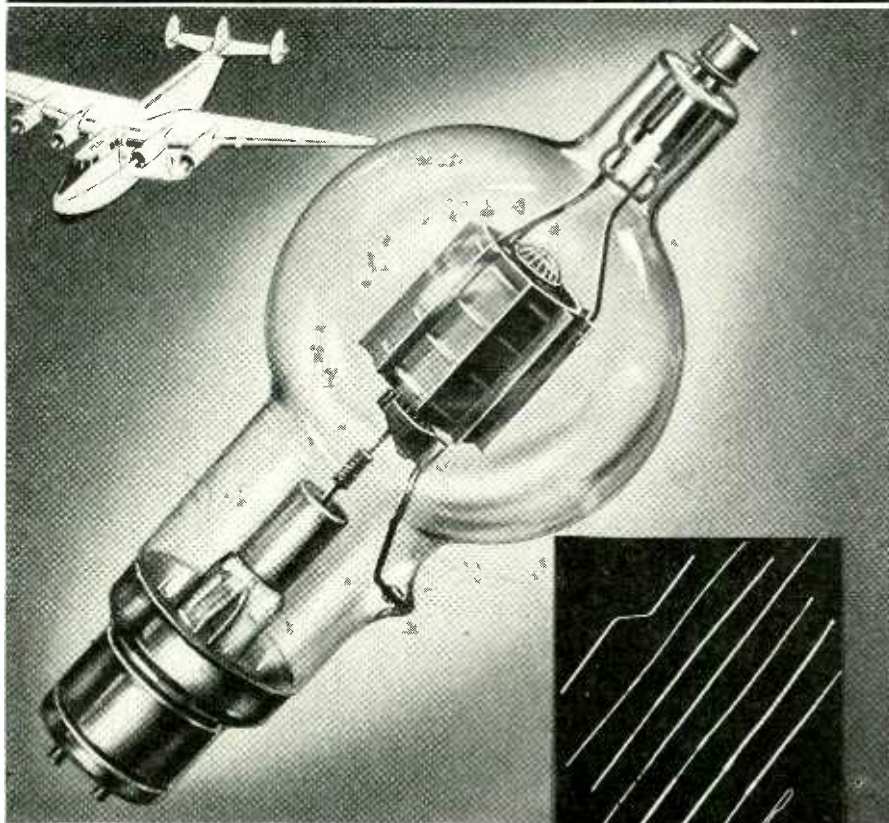

*an achievement of*  
**CALLITE WELDS and TUNGSTEN LEADS**

Few people who fly have ever seen an airplane's "life preserver". It doesn't look at all like an inner tube . . . it isn't even carried in the plane! It's just a funny glass bulb in an aircraft ground station. But each year the safety of millions of lives hangs on this radio tube's faithful performance in the field of communication.

With so much at stake, it is small wonder *Eimac* suppliers of radio tubes to practically every major U.S. airline, chose Callite lead-in wire for all grid, plate and filament leads in its famous-for-dependability 450T tubes.

As with the radio tube in aeronautics, Callite research in wires, welds and formed

parts is indirectly responsible for many of the electronic tube industry's modern miracles. This research has not only improved vastly the stamina of Callite products, but ably equipped Callite to meet "metallurgical" situations as they arise, saving manufacturers considerable time and money.

It is understandable now why Callite has become the nation's No. 1 source of supply whenever and wherever formed parts of tungsten, molybdenum or their alloys are needed for standard or special requirements. Bring your "metallurgical" problems to Callite and take advantage of their experience and resources. It costs no more. Literature on request.

**CALLITE TUNGSTEN**

**CORPORATION**

544 - 39th STREET

CABLE:



UNION CITY, N. J.

"CALLITES"

BRANCHES: CHICAGO • CLEVELAND

**Type 5Z4**

FULL-WAVE high vacuum rectifier, heater type, metal envelope, seated height  $2\frac{1}{8}$  inches, 5-pin octal base.

$E_h = 5.0$  v  
 $I_h = 2.0$  amps  
CONDENSER INPUT TO FILTER  
 $E_{ac}$  (per plate, rms) = 350 v (max)  
 $I_{dc} = 125$  ma (max)  
CHOKES INPUT TO FILTER  
 $E_{ac}$  (per plate, rms) = 500 v (max)  
 $I_{dc} = 125$  ma (max)  
 $E_{drop}$  ( $I_{dc} = 125$  ma per plate) = 20 v  
Basing 5L

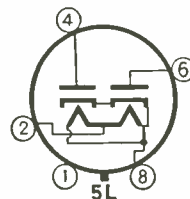

**5Z4 (G)**

FULL-WAVE high-vacuum rectifier, filament type, ST-14 glass envelope, seated height  $4\frac{1}{8}$  inches, 5-pin octal base.

$E_f = 5.0$  v  
 $I_f = 2.0$  amps  
CONDENSER INPUT TO FILTER  
 $E_{ac}$  (per plate, rms) = 350 v (max)  
 $I_{dc} = 125$  ma (max)  
CHOKES INPUT TO FILTER  
 $E_{ac}$  (per plate, rms) = 500 v (max)  
 $I_{dc} = 125$  ma (max)  
 $E_{drop}$  ( $I_{dc} = 125$  ma per plate) = 20 v  
Basing 5L

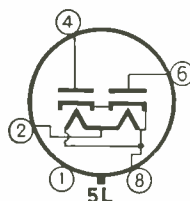

**Type 6A8**

PENTAGRID converter, heater type, metal shell, seated height  $2\frac{1}{8}$  inches, 8-pin octal base.

$E_h = 6.3$  v  
 $I_h = 0.3$  amp  
 $E_b = 250$  v  
 $E_{c3,5} = 100$  v  
 $E_{c2} = 250$  v through 20,000 ohms  
 $E_{c4} = -3$  v  
 $I_b = 3.5$  ma  
 $I_{c3,5} = 2.7$  ma  
 $I_{c2} = 4.0$  ma  
 $g_c = 550$   $\mu$ hos  
Basing 8A

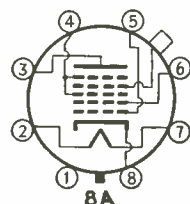

**Type 6A8 (G)**

PENTAGRID converter, heater type, ST-12 glass envelope, seated height  $3\frac{3}{8}$  inches, 8-pin octal base.

$E_h = 6.3$  v  
 $I_h = 0.3$  amp  
 $E_b = 250$  v  
 $E_{c3,5} = 100$  v  
 $E_{c2} = 250$  v through 20,000 ohms  
 $E_{c4} = -3$  v  
 $I_b = 3.5$  ma  
 $I_{c3,5} = 2.7$  ma  
 $I_{c2} = 4.0$  ma  
 $g_c = 550$   $\mu$ hos  
Basing 8A

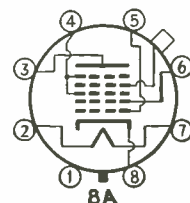

# Superior Low-Loss Insulation for your High Frequency Apparatus

WITH ECONOMICALLY-MOLDED BAKELITE PHENOLIC BM-262

PROVIDING low power factor, dimensional stability, high dielectric strength and high resistivity, as well as enduring inertness to moisture, Bakelite Phenolic BM-262 is unequalled for many high frequency insulation requirements that demand unfailingly-dependable yet economically-produced low-loss molded parts.

This valuable combination of characteristics explains why Bakelite Low-Loss Phenolic continues to be so widely used, for instance, in the manufacture of capacitor casings of every type and size, such as those illustrated, made by Cornell-Dubilier Electric Corporation.

Low-cost fabrication with this unique molding material contributes not only to improved performance of the capacitors, but also to their attractive appearance. Light weight and compactness, are other advantages—especially important in aircraft and portable equipment.

Learn how Bakelite Phenolic BM-262 can benefit *your* high frequency apparatus by enlisting the cooperation of Bakelite Research and Development Laboratories.

BAKELITE CORPORATION  
Unit of Union Carbide and Carbon Corporation  
  
30 EAST 42ND STREET, NEW YORK

## BAKELITE

The word "Bakelite" and the  Symbol are registered trade-marks of Bakelite Corporation

PLASTICS HEADQUARTERS

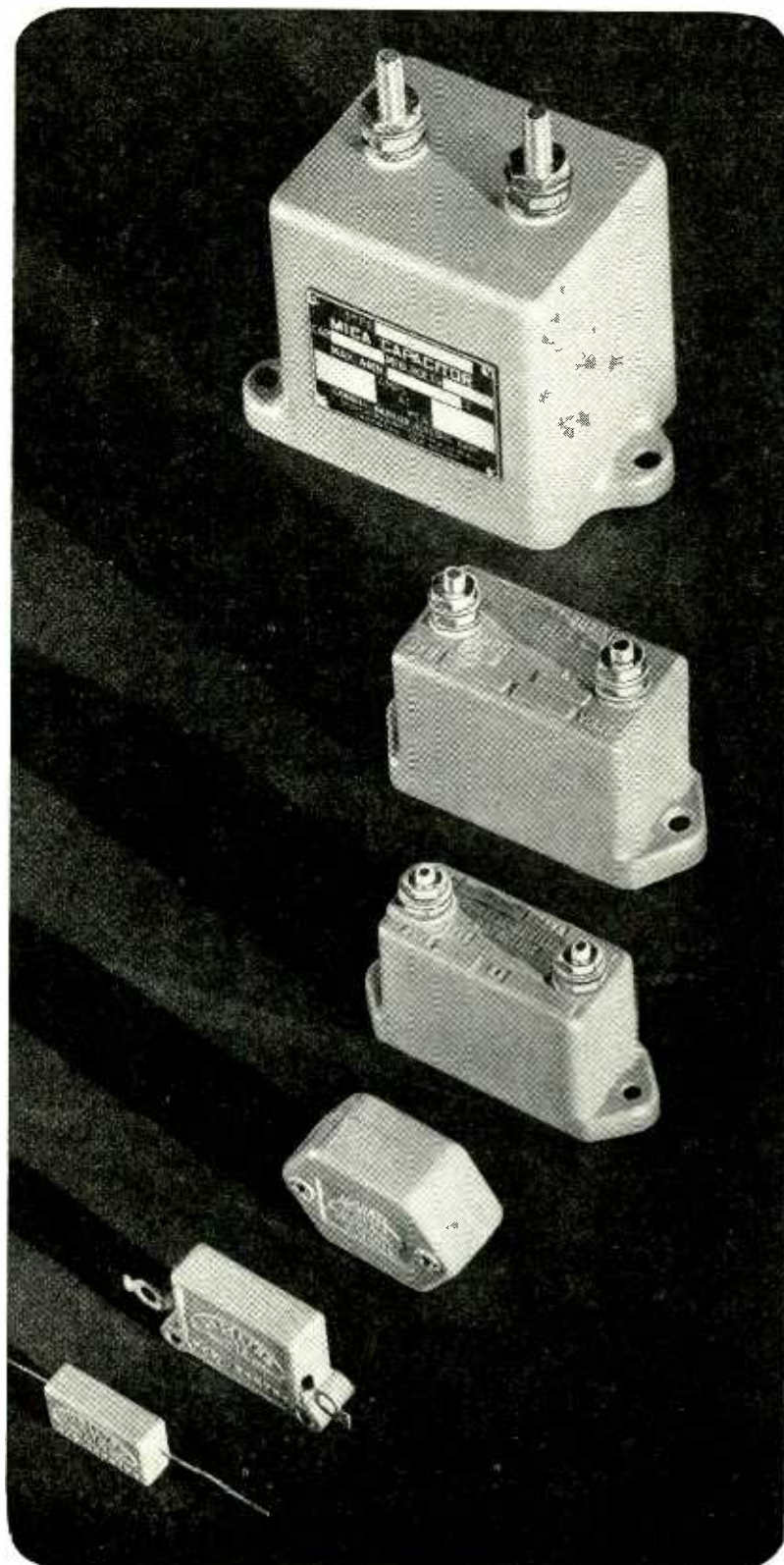

# THE RELAY

THAT SURPRISED EVEN ITS DESIGNERS  
OFFERS 4 DEFINITE  
BENEFITS TO USERS

1. Reduced user's assembly cost (relays are pre-adjusted)
2. More reliable operation (contacts have heavy pressures—are self-cleaning)
3. More positive action (armature restored by leaf spring)
4. No overheating (coil is self protecting).

You can enjoy these benefits. Write Dept. B for information.

### AN OFFER . . .

Tell us (1) Your product or operation (2) Function and performance details (3) Whether chief objective is improved performance or reduced cost. We'll send a helpful recommendation, free. Write Dept. B

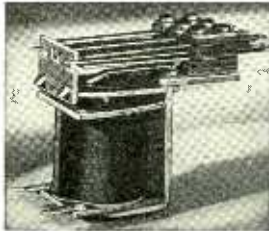

**AUTOMATIC ELECTRIC**

Relay Makers Since 1898

1033 West Van Buren Street, Chicago

# SPRAYED-METAL TERMINALS

*Simplify Mounting Problems*

● Sprayed-metal terminals of Brass, Copper and Aluminum, Monel or Nickel, with which Globar Brand Ceramic Resistors are equipped, provide the solution to many special resistor installation problems.

The metal is sprayed in a molten state under high pressure, driving the minute globules into the pores of the resistor surface. This assures a positive electrical contact and makes the use of fuse clips an ideal method of mounting.

This is only one of the many desirable features of Globar Brand Ceramic Resistors. Let us tell you the complete story.

**GLOBAR DIVISION  
THE CARBORUNDUM COMPANY**

NIAGARA FALLS, N. Y.

(Carborundum and Globar are registered trade-marks of and indicate manufacture by The Carborundum Company)

*Globar CERAMIC RESISTORS*

## Type 6R7 (G)

DOUBLE diode, medium mu triode, heater type, ST-12 glass envelope, seated height  $3\frac{3}{8}$  inches, 7-pin octal base.

$E_A = 6.3$  v  
 $I_A = 0.3$  amp  
 $E_b = 250$  v  
 $E_c = -9$  v  
 $I_b = 9.5$  ma  
 $r_p = 8500$  ohms  
 $\mu = 16$   
Basing 7V

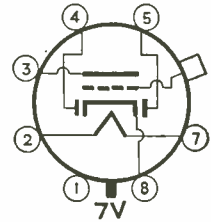

## Type 1E7 (G)

TWIN pentode power amplifier, filament type, ST-12 glass envelope, seated height  $3\frac{1}{8}$  inches, 8-pin octal base.

EACH PENTODE  
 $E_f = 2.0$  v  
 $I_f = 0.24$  amp  
 $E_b = 135$  v  
 $E_{c1} = 135$  v  
 $E_{c2} = -4.5$  v  
 $I_b = (\text{zero signal}) = 7.5$  ma  
 $I_{c2} = (\text{zero signal}) = 2.2$  ma  
 $R_1 = 16,000$  ohms  
 $P_s = 0.290$  watts (4.5 %)  
Basing 8C

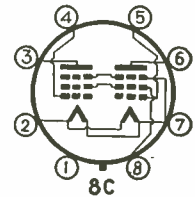

## Type 6A6

CLASS B twin triode amplifier, heater type, ST-14 glass envelope, seated height  $4\frac{1}{8}$  inches, 7-pin base.

$E_A = 6.3$  v  
 $I_A = 0.8$  amp  
TRIODES CONNECTED IN PARALLEL  
 $E_b = 250$  v  
 $E_c = -5$  v  
 $I_b = 6$  ma  
 $r_p = 11,300$  ohms  
 $\mu = 35$   
Basing 7B

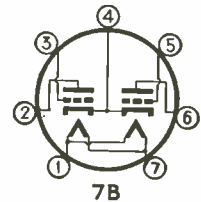

## Type 25Y5

HIGH-VACUUM rectifier and voltage doubler, heater type, ST-12 glass envelope, seated height  $3\frac{1}{8}$  inches, 6-pin base.

$E_A = 25.0$  v  
 $I_A = 0.3$  amp  
HALF-WAVE RECTIFIER  
 $E_{a1} (\text{per plate, rms}) = 235$  v (max)  
 $I_{a1} (\text{per plate}) = 75$  ma (max)  
Basing 6E



## Type 1C6

PENTAGRID converter, filament type, ST-12 glass envelope, seated height  $3\frac{3}{8}$  inches, 6-pin base.

$E_f = 2.0$  v  
 $I_f = 0.12$  amp  
 $E_b = 180$  v  
 $E_{c1,2} = 67.5$  v  
 $E_{c3} = 180$  through 20,000 ohms  
 $E_{c4} = -3$  v  
 $I_b = 1.5$  ma  
 $I_{c1} = 2.0$  ma  
 $I_{c2} = 4.0$  ma  
 $\theta_c = 325$   $\mu$ hos  
Basing 6L

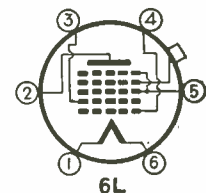



# WHY MILLER uses MONEL for CRYSTAL STABILIZERS



(Below) Monel plates, springs and screws as used in crystal stabilizers made by August E. Miller Co., 1922 Bergenwood Rd., North Bergen, N. J. At left is shown transmitter with stabilizers inserted on chassis.

*This tough  
Nickel-base alloy meets  
exceptional requirements of  
both fabrication and operation*

In big demand for amateur, commercial, police, aircraft and marine transmitters are crystal stabilizers made by August E. Miller Co. of North Bergen, N. J. Contributing to the excellent and reliable performance of these units are springs and electrodes of strong, rustless Monel.

Why do Miller crystal stabilizers give better service than others? According to Mr. Miller there are four reasons:

1. **Danger of loose contacts** due to vibration is eliminated...because use of Monel assures strong solder connections.
2. **Clips have good spring properties** and are highly resistant to fatigue...being made from spring temper Monel strip.
3. **Electrodes ground to close tolerance** resist corrosion and pitting, because made of Monel. Maintenance of even thickness assures uniform results.
4. **Location of set is no obstacle**...because even in damp and salt-laden atmospheres Monel parts stand up against corrosion.

Incidentally, Monel has proved so satisfactory in this application that all screws in Miller units are made of Monel.

How leading makers of electronic and electrical equipment are profiting by use of Nickel-base alloys

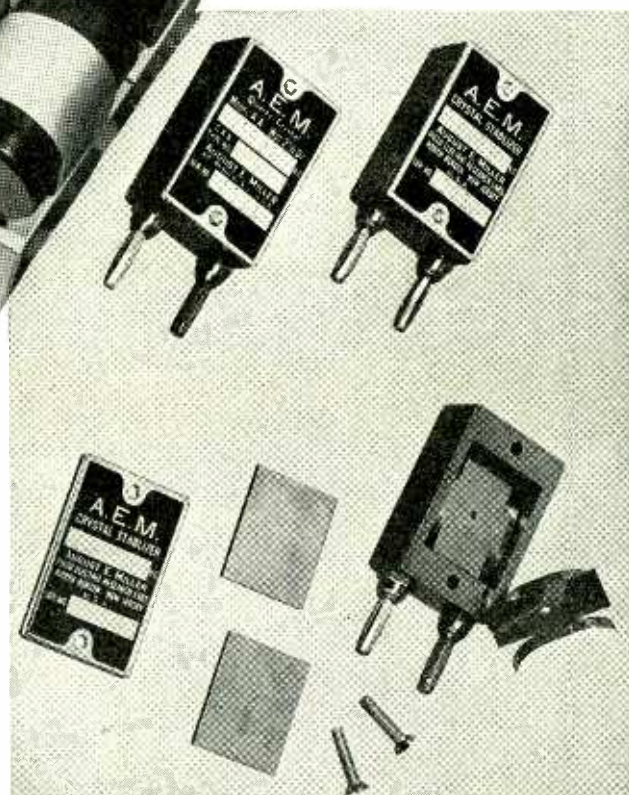

is described in the booklet "Tremendous Trifles." Write for a copy today. Address:

**THE INTERNATIONAL NICKEL COMPANY, INC.**  
67 Wall Street New York, N. Y.



"Monel" is a registered trade-mark of The International Nickel Company, Inc., which is applied to a nickel alloy containing approximately two-thirds nickel and one-third copper.

# The big show is ON THE INSIDE!



ONE look at Simpson Panel Instruments will convince you that they are unequalled in outward beauty, but—the big show is on the inside—the full bridge type movement with soft iron pole pieces. This better, more rugged assembly not only permits a higher degree of accuracy; it assures maintained accuracy—year after year.

Despite this more expensive type of construction Simpson Instruments cost no more than the ordinary kind. Make that your final reason for standardizing on the "Instruments that STAY Accurate."

Simpson Electric Co.  
5212 Kinzie St. Chicago, Ill.

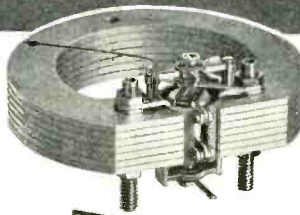

Here's a Brand New Idea in Testing Instruments  
Simpson's new line of MicroTesters includes nine compact, uniform-size testers which, singly or in combinations, cover every servicing or production testing requirement. Small handy size—ideal for portable work or to supplement panel instruments.  
Model 280, multi-range A.C. ammeter, shown here, is typical of the entire line. It combines an indicating instrument with a current transformer former to cover 5 ranges, yet sells for only \$9.75



# SIMPSON

INSTRUMENTS THAT *Stay* ACCURATE

A  
C  
C  
U  
R  
A  
T  
E

*Bliley*

D  
E  
P  
E  
N  
D  
A  
B  
L  
E

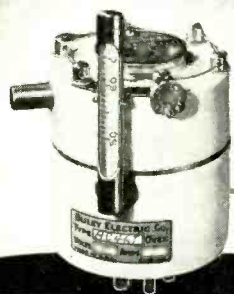

Bliley Quartz Crystals and Mountings are precision-made for all frequencies between 20Kc. and 30Mc. Catalogue G-11 describes the complete line. Write for your copy.

## QUARTZ CRYSTALS

FOR GENERAL COMMUNICATION FREQUENCIES

# BLILEY ELECTRIC COMPANY

UNION STATION BUILDING

ERIE, PA.

## Type 6H6

TWIN diode, heater type, metal envelope, seated height 1 $\frac{3}{8}$  inches, 7-pin octal base.

$E_h = 6.3$  v  
 $I_h = 0.3$  amp  
 $E_{ac}$  (per plate, rms) = 117 v (max)  
 $I_{de} = 4$  ma (max)  
Basing 7Q

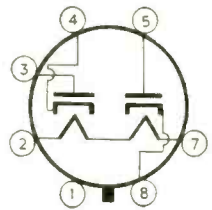

## Type 6H6 (G)

TWIN diode, heater type, ST-12 glass envelope, seated height 3 $\frac{1}{8}$  inches, 7-pin octal base.

$E_h = 6.3$  v  
 $I_h = 0.3$  amp  
 $E_{ac}$  (per plate, rms) = 117 v (max)  
 $I_{de} = 4$  ma (max)  
Basing 7Q

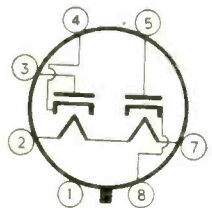

## Type 6J7

TRIPLE-GRID detector amplifier, sharp cutoff, heater type, metal envelope, seated height 2 $\frac{1}{8}$  inches, 7-pin octal base.

$E_h = 6.3$  v  
 $I_h = 0.3$  amp  
 $E_b = 250$  v  
 $E_{c1} = 100$  v  
 $E_c = -3$  v  
 $I_b = 2.0$  ma  
 $I_{c2} = 0.5$  ma  
 $r_p = \text{greater than } 1$  megohm  
 $\mu_m = 1225$   $\mu$ mhos  
Basing 7R

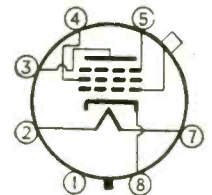

## Type 6J7 (G)

TRIPLE-GRID detector amplifier, sharp cutoff, heater type, ST-12 glass envelope, seated height 3 $\frac{1}{8}$  inches, 7-pin octal base.

$E_h = 6.3$  v  
 $I_h = 0.3$  amp  
 $E_b = 250$  v  
 $E_{c1} = 100$  v  
 $E_c = -3$  v  
 $I_b = 2.0$  ma  
 $I_{c2} = 0.5$  ma  
 $r_p = \text{greater than } 1$  megohm  
 $\mu_m = 1225$   $\mu$ mhos  
Basing 7R

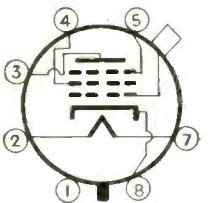

## Type 6F5

HIGH-MU triode, heater type, metal envelope, seated height 2 $\frac{1}{8}$  inches, 5-pin octal base.

$E_h = 6.3$  v  
 $I_h = 0.3$  amp  
 $E_b = 250$  v  
 $E_c = -2$  v  
 $I_b = 0.9$  ma  
 $\mu = 100$   
 $\mu_m = 1500$   $\mu$ mhos  
Basing 5M

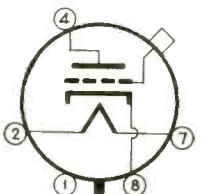

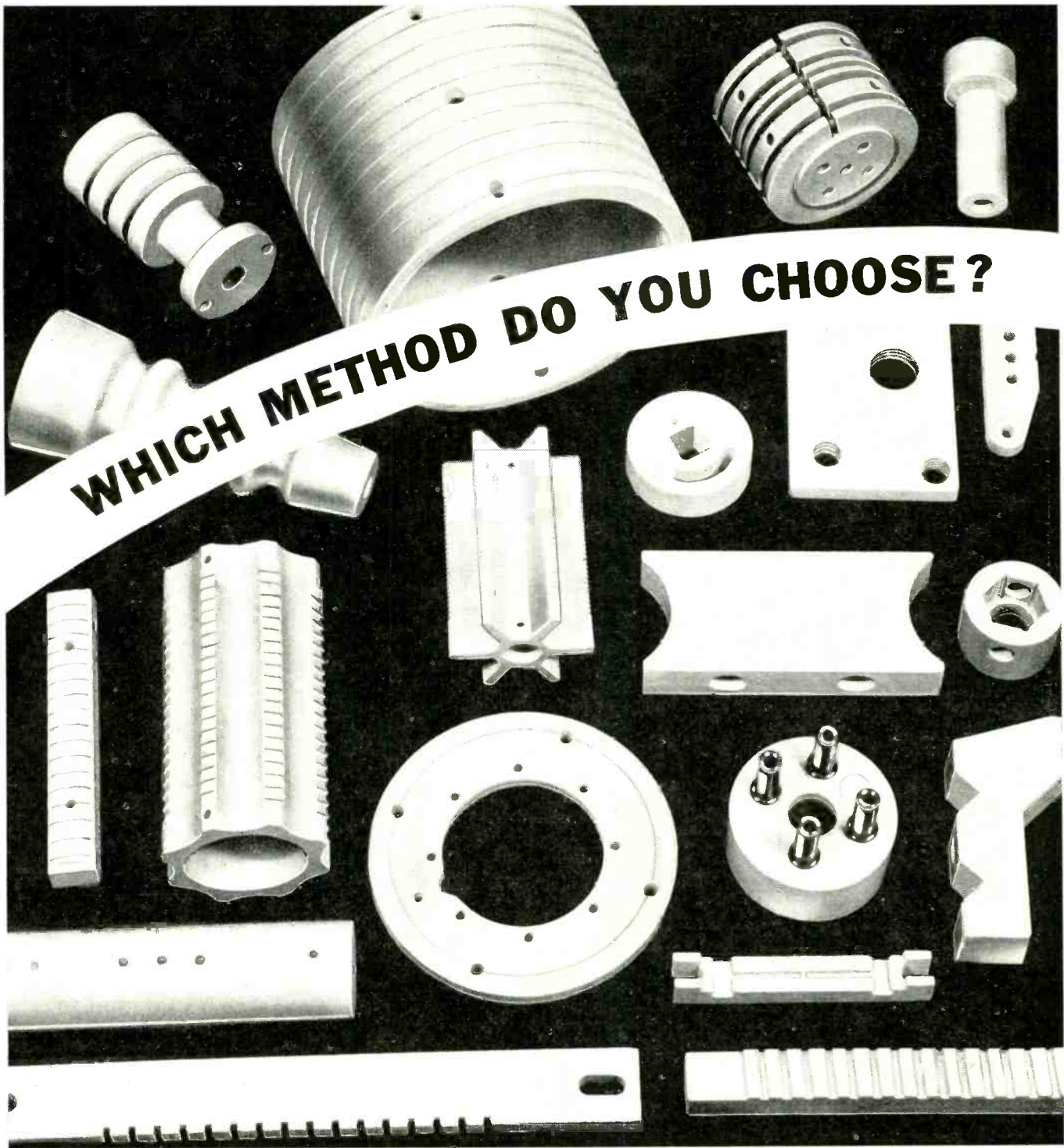

**WHICH METHOD DO YOU CHOOSE?**

Some engineers try to make their designs fit "standard" insulators. Most engineers have found better results at lower costs in AISiMag steatite ceramic insulators built to their design. Do you want the facts about AISiMag Custom-Built insulators for your product? Your letter will have careful attention.

**ALSIMAG** FROM CERAMIC HEADQUARTERS

Trade Mark Reg. U. S. Pat. Off.

**AMERICAN LAVA CORPORATION • CHATTANOOGA • TENNESSEE**  
 CHICAGO • CLEVELAND • NEW YORK • ST. LOUIS • LOS ANGELES • SAN FRANCISCO • BOSTON • PHILADELPHIA • WASHINGTON, D. C.

# More "POWER HOURS"



A SIZE FOR ANY JOB

## DYNAMOTORS

Pincor Dynamotors assure thousands of hours of smooth, quiet, trouble free service under all conditions. Available in any size, type or capacity — for aircraft, marine and broadcast service, police units, sound systems, auto radios, etc. Input, 6 to 110 volts; output up to 1750 volts, 5 to 850 watts. And, as always, Pincor is first again with its new DUAL-VOLTAGE Dynamotors affording double input and double output. Complete information on request.

### PIONEER GEN-E-MOTOR CORP.

Dept. R-4, 454 W. SUPERIOR ST., Chicago, Ill.  
Export Address: 25 WARREN ST., N. Y., N. Y.  
Cable: SIMONTRICE, New York



# PINCOR Products

AIRCRAFT • SOUND • POWER SUPPLY

### Type 6X5

FULL-WAVE high-vacuum rectifier, heater type, metal shell, seated height  $2\frac{1}{8}$  inches, 6-pin octal base.

$E_b = 6.3$  v  
 $I_A = 0.6$  amp  
CONDENSER INPUT TO FILTER  
 $E_{ac}$ (per plate, rms) = 325 v (max)  
 $I_{dc} = 70$  ma (max)  
CHOKE INPUT TO FILTER  
 $E_{ac}$ (per plate, rms) = 450 v (max)  
 $I_{dc} = 70$  ma (max)  
 $E_{drop}(I_{dc} = 70$  ma per plate) = 22 v  
Basing 6S

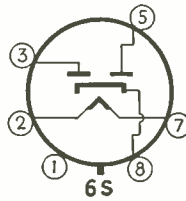

### Type 5V4 (G)

FULL-WAVE, high-vacuum rectifier, heater type, ST-14 glass envelope, seated height  $4\frac{1}{8}$  inches, 5-pin octal base.

$E_b = 5.0$  v  
 $I_A = 2.0$  amps  
CONDENSER INPUT TO FILTER  
 $E_{ac}$ (per plate, rms) = 375 v (max)  
 $I_{dc} = 175$  ma (max)  
CHOKE INPUT TO FILTER  
 $E_{ac}$ (per plate, rms) = 500 v (max)  
 $I_{dc} = 175$  ma (max)  
 $E_{drop}(I_{dc} = 175$  ma per plate) = 23 v  
Basing 5L

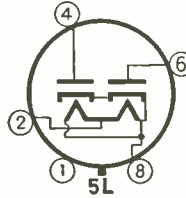

### Type 83-V

FULL-WAVE high vacuum rectifier, heater type, ST-14 glass envelope, seated height  $4\frac{1}{8}$  inches, 4-pin base.

$E_b = 5.0$  v  
 $I_A = 2.0$  amps  
CONDENSER INPUT TO FILTER  
 $E_{ac}$ (per plate, ms) = 375 v (max)  
 $I_{dc} = 175$  ma (max)  
CHOKE INPUT TO FILTER  
 $E_{ac}$ (per plate, rms) = 500 v (max)  
 $I_{dc} = 175$  ma (max)  
 $E_{drop}(I_{dc} = 175$  ma per plate) = 23 v  
Basing 4L

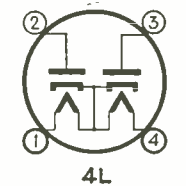

### Type 6A3

POWER amplifier triode, filament type, ST-16 glass envelope, seated height  $4\frac{3}{8}$  inches, 4-pin base.

$E_f = 6.3$  v  
 $I_f = 1.0$  amp  
 $E_b = 250$  v (max)  
 $E_c = -45$  v  
 $I_b = 60$  ma  
 $r_p = 800$  ohms  
 $\mu = 4.2$   
 $R_t = 2500$  ohms  
Basing 4D

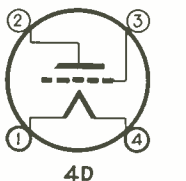

### Type 1H6 (G)

Prototype 1B5/25S

DOUBLE diode triode, filament type, ST-12 glass envelope, seated height  $3\frac{3}{8}$  inches, 8-pin octal base.

$E_f = 2.0$  v  
 $I_f = 0.06$  amp  
 $E_b = 135$  v (max)  
 $E_c = -3$  v  
 $I_b = 0.8$  ma  
 $\mu = 20$   
 $g_m = 575$   $\mu$ mhms  
Basing 7AA

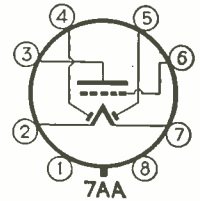

### Type 1J6 (G)

Prototype 19

CLASS B twin triode amplifier, filament type, ST-12 glass envelope, seated height  $3\frac{3}{8}$  inches, 8-pin octal base.

$E_f = 2.0$  v  
 $I_f = 0.24$  amp  
 $E_b = 135$  v  
 $E_c = 0$  v  
 $I_b$ (zero signal, per plate) = 5.0 ma  
 $R_t$ (plate to plate) = 10,000 ohms  
 $P_o = 2.1$  watts  
Basing 7AB

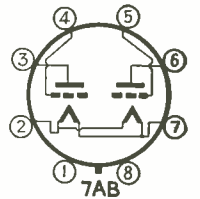

## PHOTOTUBES AID IN CAMOUFLAGE



Prof. C. L. Utterbach of the University of Washington has announced a new method of submarine camouflage. The instrument shown, a waterproof chamber containing two phototubes covered by rotating discs which in turn embody multi-colored light filters, was used in perfecting the new camouflage. The device is lowered into the sea and light rays refracted from different colored objects are recorded on a surface craft

# NEW, SENSATIONALLY SMALL



**To give you a lot of power in little space!**

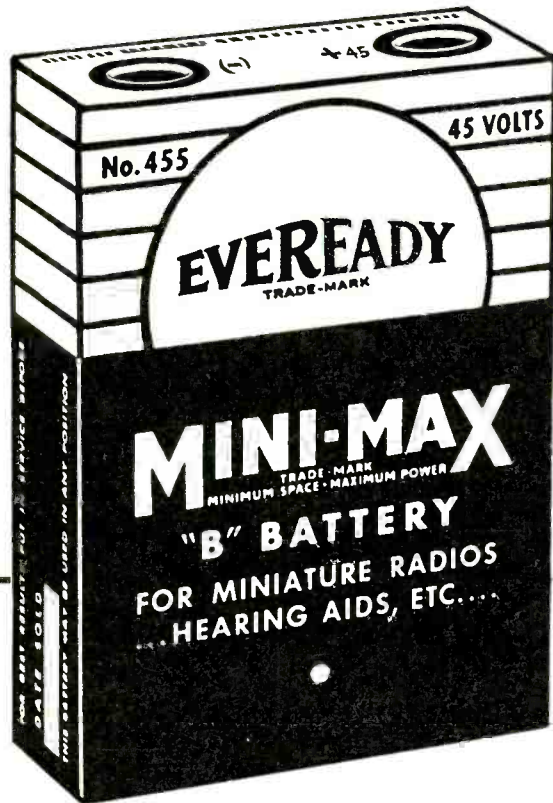

**THIS COMPARISON** between an actual-size drawing of the "Eveready" "Mini-Max" Radio "B" Battery No. 455, and a No. 950 "Eveready" flashlight cell shows you how *very* small this particular "B" battery is. A new 22½ volt miniature, No. 425, which is approximately half the size of the "B" battery shown, will be on the market by the time you read this.



When you are designing special equipment for specialized purposes, you will find reason for enthusiasm in these miniature "Eveready" "Mini-Max" Radio "B" Batteries. These batteries permit great reduction in size and weight—as much as 50% in size—as much as 30% in weight—without sacrifice of power.

Designed to operate over a range of drains up to 9 milliamperes, these miniatures will last as long as ordinary batteries twice their size. They are the only batteries that pack so much power in so little space. Try them . . . in your research . . . and in new design.

## CHOOSE FROM THESE MINIATURES

Miniature "Eveready" "Mini-Max" "B" Battery No. 467. 67½ volts. Height, 3⅝"; width, 2⅛"; thickness, 1⅞"; weight, 10½ oz.  
Miniature "Eveready" "Mini-Max" "B" Battery No. 455. 45 volts. Height, 3⅝"; width, 2⅝"; thickness, ⅜"; weight, 7 oz.  
**Just Introduced!** Miniature "Eveready" "Mini-Max" "B" Battery No. 425. 22½ volts. Height, width and weight approximately ½ that of No. 455 Battery.

## NATIONAL CARBON COMPANY, INC.

*Unit of Union Carbide and Carbon Corporation*



*The words "Eveready" and "Mini-Max" are registered trade-marks identifying products of National Carbon Company, Inc.*

# THE ELECTRON ART

Several papers on television, a square-law vacuum-tube voltmeter, compulsory patent licensing, transformer design, and crystal filters are reviewed this month in the technical literature

## Television

FOUR PAPERS DESCRIBING the various aspects of television are included in the September 1940 issue of the *Journal of the Society of Motion Picture Engineers*. They are: "Television Pick-Up of the Pasadena Rose Tournament Parade," by H. R. Lubcke; "Quality in Television Pictures," by P. C. Goldmark and J. N. Dyer; "A New Method of Synchronization for Television Systems," by T. T. Goldsmith, Jr., R. L. Campbell and S. W. Stanton, and "Remote Control Television Lighting," by W. C. Eddy. All four were presented at the 1940 spring meeting of the Society at Atlantic City.

Mr. Lubcke's paper describes the equipment used in the pick-up of a parade in Pasadena and its transmission to the Don Lee Building in downtown Los Angeles. The suitcase type portable television equipment and a 324 Mc beam transmitter were used. The transmission distance was nine miles and the line of sight was interrupted by two hills and buildings. Much effort was therefore directed toward erecting high and efficient antennas at both the transmitter and receiver. It was found that diathermy machines caused interference on frequencies as high as 324 Mc. Even though rain fell during the parade and the morning was darkly overcast, reception as far away as fifteen miles from the main transmitter was considered quite good.

Messrs. Goldmark and Dyer discuss in their paper the various factors which determine the quality of a television picture. They are: Definition, contrast range, gradation, brilliance, flicker, geometric distortion, size, color and noise. An artificial television scanner is described by means of which a photograph can be scanned to obtain a picture which is free from distortion other than that introduced by the scanning. These pictures indicate that television pictures as received today must be considerably improved before the capabilities of the present 441-line standard are fully utilized.

An automatic method of synchronizing television systems is described by Messrs. Goldsmith, Campbell and Stanton. The purpose of such automatic synchronization is to provide a means by which television pictures can be

transmitted using various numbers of scanning lines. The advantages of such a system of automatic synchronization are: (1) ease of generation at the transmitter; (2) ease of separation at the receiver and (3) automatically synchronized receivers permitting reception from high definition stations as well as low definition stations without the necessity of servicing, and permitting improvements in vertical definition as the art advances without necessitating replacement or modification of receiving equipment.

Mr. Eddy describes in his paper the remote control lighting system which is now in use in the television studios of N.B.C. in New York. A series of overhead units using inside-silvered incandescent lamps are the basic units of the system. They can be controlled in rotation, tilt and elevation by control cords, from a single point. The

flexibility of the system is such that the lighting engineer can rearrange the lighting completely without interrupting the program in progress. The weight of the system runs about the order of 13 lbs. per kw. Illumination levels as high as 2,400 foot-candles can be provided on an average set, but due to improvements in both cameras and circuits it is seldom necessary to exceed 800 foot-candles in foundation light.

## Square Law Vacuum-Tube Voltmeter

A VACUUM-TUBE VOLTMETER using the type 954 acorn pentode for use in the measurement of the r-m-s value of alternating voltages is described in the October 1940 issue of the *Review of Scientific Instruments* by J. R. Ragazzini and B. R. Boymel. In the design of this instrument the following requirements were satisfied: (1) A square-law response over a wide range; (2) a range of 0.25 to 25 volts; (3) a calibration substantially independent of frequency; (4) no turnover error since fluctuation voltages are usually unsymmetrical; (5) a high input impedance whose value is constant regardless of the range used, and (6) operation to be from power lines and the calibration to be independent of normal line voltage fluctuations. It was found necessary to restrict the plate current swing to a limited region of the characteristic curve to insure a

## GERMANS USE RADIO CONTROLLED TORPEDOES

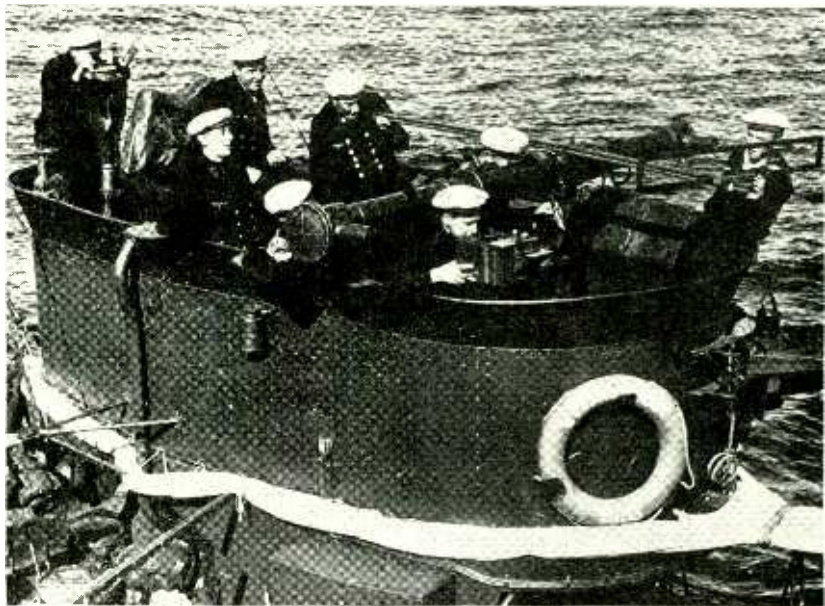

Conning tower of one of the five remote control mother ships which have operated in the English channel and in the North Sea to harass British shipping. The "Fernleitboot" (remote guide boat) has a displacement of about 800 tons and contains a radio transmitter capable of operating on several frequencies by which it controls the operation of radio controlled torpedoes. Each mother ship has room for forty-nine guided torpedoes

# Plug-in CAPACITORS



## WAX OR OIL IMPREGNATED SECTIONS

● Introduced some time ago as an electrolytic unit, Aerovox (octal-base) Plug-In Capacitors are now available with wax or oil-impregnated sections. These plug-ins are the logical choice for aircraft, military, police, sound and other equipment where continuity of service is the prime requisite.

### Type 70 . . .

● Quick-change hermetically-sealed oil-impregnated oil filled capacitors. Generous paper sections for cool, safe, economical operation at rated voltages. Standard ratings: 200, 400 and 600 v. D.C.W. Single-section units of .25 to 2 mfd. Dual sections, .05-.05 to .5-5. Triple sections, .05-.05 to .25-.25-.25. Other ratings, capacities, combinations, to order. With insulated or floating can.

### Type 71 . . .

● Similar to Type 70 but with wax-impregnated wax-filled paper section, conservatively rated, for long, trouble-free operation. Ideal for continuously-operated power supplies, amplifiers and electronic assemblies. Same ratings and capacities as for Type 70.

### Have You Our New TRANSMITTING CAPACITOR CATALOG?

● Complete data on extra-heavy-duty transmitting capacitors, including plug-in paper and electrolytic types, sent on request to professional designers and builders of radio and electronic equipment. Use business letterhead.



square-law response over all ranges of the meter. It was necessary to use an attenuator in the input of the voltmeter because of the wide range of voltages to be measured so as to use the same portion of the tube characteristic for all voltages.

The diagram shows the circuit of the voltmeter together with its power supply. The attenuator has a total

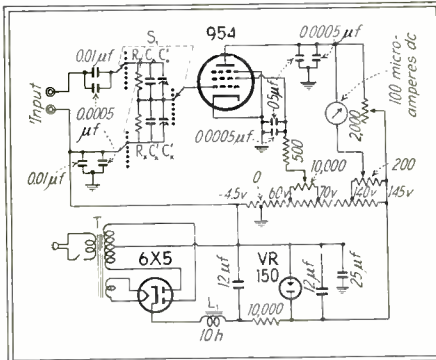

Circuit diagram of the square-law vacuum tube voltmeter including the power supply

input resistance of one megohm and the resistance voltage divider is supplemented by a capacity divider to insure correct values at high frequencies. The condensers used are silver mica padded with air trimmers to insure permanence of setting. A VR-150 tube is used in the power supply to overcome the effects of line voltage variations. A balancing-out circuit is used to remove the steady component of the plate current from the meter and cause it to read only increments resulting from the application of the signal. The response of this instrument is made to fit a pre-marked square-law scale on the microammeter by the simultaneous adjustment of the screen voltage and the microammeter shunt.

## Projection Television Making Use of the Variable Opacity Crystals

A MEANS OF OBTAINING LARGE-SIZE TELEVISION pictures, making use of a property of certain crystals in which the opacity is varied by the passage of electrons through it, is described by A. H. Rosenthal in the May 1940, issue of the *Proceedings of the I.R.E.* If an alkali halide crystal, which is subjected to an electric field, is struck by a beam of electrons, the electrons tend to travel through the crystal lattice, composed of alternate positive alkali ions and negative halogen ions, toward the anode of the electric field. During its passage through the alternate layers of positive and negative ions, an electron may be captured by a positive alkali ion. This seems to happen at points in a crystal with some defect. The positive ion, plus the electron, forms a loosely-bound alkali atom which absorbs part of the visible spectrum and becomes less transparent.

# “dag’s” versatile films

**RESISTANCES:** Colloidal graphite is a resistance material widely used in volume controls, tone controls, grid leaks, and similar types of fixed and variable resistors

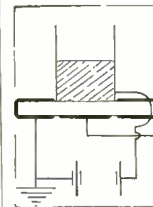
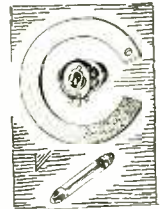

**TEST SPECIMENS:** This product also has many advantages over common foils for measuring constants of insulating substances.

**VACUUM TUBES:** Films formed with “dag” colloidal graphite discourage secondary and undesirable primary emission emanating from vacuum tube elements. Electrostatic shielding may also be accomplished.

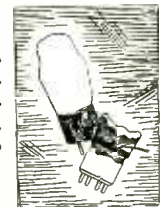

**THERMOPILES:** Radiation collectors utilize the heat conducting and high “black-body” values of “dag” deposits.

**CATHODE RAY ENVELOPES:** Interior walls coated with similar films provide “gettering”, focusing, intensifying, and shielding action in television tubes.



**EVACUATED DEVICES:** Shields, guard rings, “cat’s whisker” contacts, conductive cements, and special electrodes or contacts are formed conveniently with “dag” dispersions.

**PHOTOELECTRIC CELLS:** Graphite surfaced electrodes absorb free alkalis and alkaline metals in photoelectric cells. No selenides result when the “dag” product is used in the selenium types.

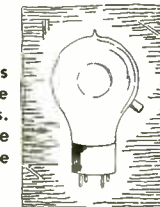

The above statements should not be considered as recommending the use of colloidal graphite in violation of any valid patents which may exist.

**ACHESON**  
COLLOIDS CORPORATION  
PORT HURON, MICHIGAN



# Super-Sensitive "MULTI-PURPOSE" TEST EQUIPMENT



## Series 854 Super-Sensitive Tester

Especially designed to meet the exacting requirements of Laboratory, Industrial, Television and Radio.

20,000 OHMS PER VOLT D. C.

1,000 OHMS PER VOLT A. C.

- SEVEN D.C. and SEVEN A.C. voltage ranges to 6,000 VOLTS • SEVEN D.C. current ranges 0-60 MICROAMPS to 0-12 AMPS
- THREE resistance ranges to 60 MEGS (self-contained batteries) • SIX D.B. ranges from -12 to +70 DB • SEVEN output ranges to 6,000 VOLTS • 4 1/2" wide-faced, 50 micro-ampere meter • 1% wire-wound bobbins and matched metallized multipliers. 2% D.C. and 3% A.C. overall accuracy.

SERIES 854P (illustrated) complete with batteries and high voltage test leads. Net Price ..... \$39.95

### Series 854J Super-Sensitive Industrial Circuit Tester



An unsurpassed portable instrument to satisfy industrial requirements for complete AC and DC circuit analysis. Combines Series 854 (described above) and Series J A.C. AMMETER providing 8 additional ranges of 0-300-600-1200 MA and 0-3-6-12-30-60 AMPS.

Series 854J (illustrated) complete with batteries and high voltage test leads. Net Price ..... \$59.95



### Series 954 Super-Sensitive AC-DC Set Tester and Dynamic Mutual Conductance Type Tube Tester

Provides all facilities of Series 854 combined with a complete free-point tube tester.

Series 954P (illustrated) complete with battery and high voltage test leads. Net Price ..... \$65.95

Write for the new "PRECISION" 1941 Catalog describing more than 40 test equipment models.

**PRECISION TEST EQUIPMENT**  
Standards of Accuracy SEE THEM AT YOUR JOBBER

**PRECISION APPARATUS COMPANY**  
647 Kent Avenue Brooklyn, N. Y.

Export Div.: 458 Broadway, New York, U. S. A.  
Cables: Morhanex

Then, due to the thermal oscillations of the lattice, the loosely-bound atom splits up again into an alkali ion and an electron and the electron proceeds through the lattice toward the anode until it is captured again by another alkali ion somewhat nearer to the anode and goes through the process once more. When the electron reaches the anode it passes into it and disappears. The velocity of migration of the electron is proportional to the field strength and increases with the temperature of the crystals.

Use is made of this phenomenon in television in the following manner. The crystal is cut into a thin sheet of suit-

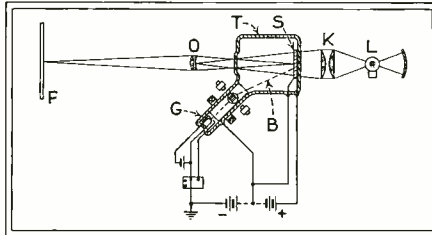

Television projection unit making use of a crystal of variable density and a conventional optical system

able dimensions and mounted inside a picture tube which is similar in construction to the iconoscope. The name Skiatron has been applied to the new tube. The crystal is mounted in the same position as the mosaic in the iconoscope and the electron gun is located in a side arm as shown in the diagram. The electron stream scans the crystal in the conventional manner. The necessary electric field is maintained across the crystal by means of very thin deposits of metal on each side of it. If desired, the crystal can be heated and maintained at any desired temperature. As the electrons impinge upon a surface element of the crystal, electrons are injected into it to form an opaque color deposit whose density depends upon the instantaneous intensity of the electron beam. As the beam leaves this area the opacity persists, moving slowly through the crystal to the anode where it disappears. The image persists long enough for a complete picture to be formed and the tube can be designed so that image will disappear just as the electron beam returns to the same surface element. This permits a complete picture to be formed similar to a lantern slide and which can be projected by means of a conventional optical system as shown in the diagram.

Up to this time only crude experiments have been performed using this type of apparatus. However, the method gives sufficient promise so that the author suggests that a television projector making use of this type of tube can be placed in the projection room of a motion picture theater and pictures of a size comparable to present day motion pictures can be projected.

## Compulsory Patent Licensing

"WHAT WOULD COMPULSORY PATENT Licensing Mean to You?" by H. V. Nye and H. S. Silver, is a discussion of the relative advantages and disadvantages of a compulsory patent licensing system appearing in the September 1940 issue of the *Allis-Chalmers Electrical Review*. As a basis for discussion, it is assumed that any compulsory license law would include the following provisions: (1) A non-exclusive license to be granted under any patent, independently of the desire of the patent owner to an applicant meeting the requirements laid down by law; (2) a provision for determination of a reasonable royalty rate to be paid the patent owner for the use of the invention; (3) a provision insuring adequate financial responsibility on the part of the proposed licensee.

Among the advantages of compulsory licensing are: 1. The right to make use of any valuable patented invention would be insured to the public independently of the whim of a patent owner. Inventions of great benefit to the public could not be withheld from use for reasons other than those of public welfare. 2. An adequate supply of a patented article would be assured. 3. The situation will be avoided in which it is impossible to make use of a patent because of prior patents owned by someone else. Many cases have arisen in which the merits of an invention have been lost to the

• • •

## POLICE USE PORTABLE RADIOS

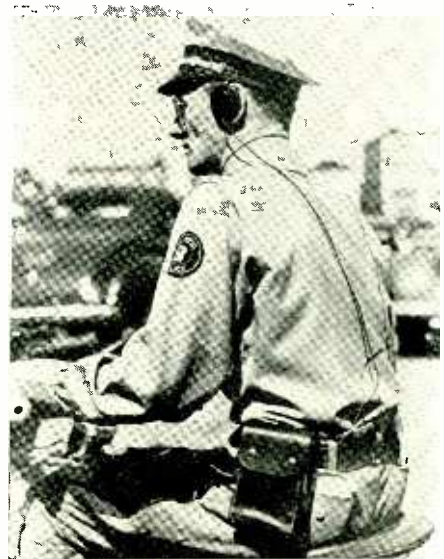

All policemen in Atlantic City are carrying portable receivers so that they may be instantly called from headquarters. The motorcycle man shown here carries the receiver on his belt, a headphone on one ear and the antenna over his shoulder. The unit consumes 11 cents worth of battery power each day



public because an invention both practical and useful could not be used because of a prior patent which of itself could not meet the needs of the trade. 4. A financial return shall be assured the inventor commensurate with the value of the patent. 5. A manufacturer would be prevented from withholding an improvement in his product from the public merely because of the commercial advantage to him of continuing his present product.

Some of the disadvantages of the system are: 1. The inventor would lose a part of his exclusive right and in the case of a particularly valuable invention he would be prevented from retaining a financial return greater than what the law had set up as a reasonable return. 2. Because of compulsory licensing a licensee might manufacture a product of such an inferior nature that it would injure the reputation of the product as manufactured by the inventor. 3. It will be impossible to build up a particular line through monopoly due to basic patents and improvements. While this may be a disadvantage to a particular inventor, it will be an advantage to the public generally. 4. The inventor would lose control of the processes used to manufacture and sell his invention.

If it is accepted that the purpose of a patent is to insure that an invention is made available to the public, the authors conclude that the advantages of a compulsory patent licensing system overwhelm the disadvantages.

• • •

### RADIO IN THE NAVAL RESERVE

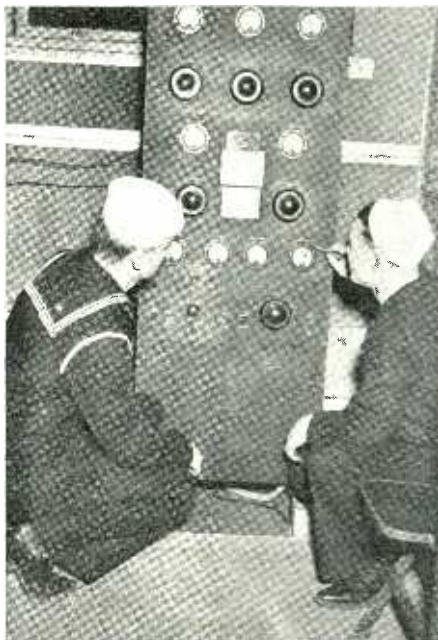

A volunteer in the naval reserve receiving instruction in the operation of radio equipment from a Radioman First Class

## BETTER BUILT CONDENSERS FOR BETTER PERFORMANCE

• BUD offers the transmitter designer a complete selection of carefully designed, precision-built transmitting condensers.

• Brass cone bearings, accurately machined spacers, Alsimag 196 and Mycalex insulation, center-rotor contact on all dual units, insulated tie rods on high frequency units—these and other special features establish BUD condensers as the outstanding "performance leader."

• Whenever your requirements call for special condensers, or any other special transmitting component not found in the comprehensive BUD line, we will be glad to place our competent engineering staff at your service. Your inquiries are cordially invited.

Write for your copy of the new No. 141 Bud Catalog.

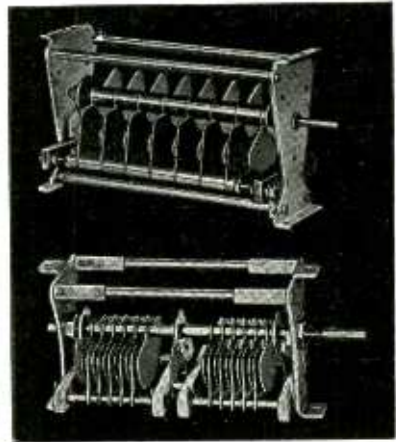

BUD GIANT CONDENSER (top)

BUD U.H.F. CONDENSER (bottom)

**BUD** **BUD RADIO, INC.** **BUD**  
CLEVELAND, OHIO



### INSURE COMPLETE SATISFACTION!

Rivets are small—but mighty important! Make sure you always use the best—T R & S Rivets. The superiority of T R & S Rivets is unquestioned. They are specified wherever quality in production is a factor, where standards of fit for stress and strain must be maintained. Such production charts call for rivets of uniform preciseness.

Many motorized models of our rivet setting machines are available in single stroke and multiple drive. Inquiries are invited with samples of work you wish to do.

## TUBULAR RIVET & STUD CO.

World's Largest Manufacturers of  
Tubular and Split Rivets

WOLLASTON (Boston)

MASSACHUSETTS

New York

Chicago

Detroit

Indianapolis

San Francisco

Nashville

Dallas

St. Louis

## STABILIZED A. C. VOLTAGE UP TO 25 KVA

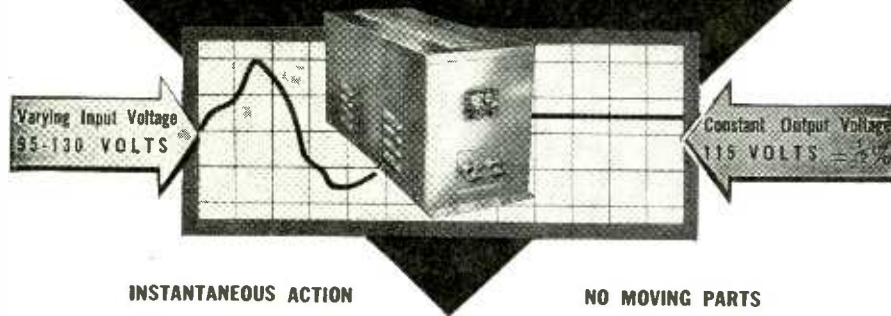

When a precision electrical device or a critical process is powered from an AC line, a Raytheon Voltage Stabilizer will permanently eliminate all of the detrimental effects caused by AC line voltage fluctuations. Made for all commercial voltages and frequencies, single or three phase.

Raytheon's twelve years of experience in successfully applying the Stabilizer to hundreds of perplexing voltage fluctuation problems is at your service. It will pay you to take advantage of our engineering skill.

Write for Bulletin DL48-71 JE describing Raytheon Stabilizers.

**RAYTHEON MANUFACTURING CO.**  
100 Willow Street, WALTHAM, Massachusetts

## NEW TRANSMISSION MEASURING SET

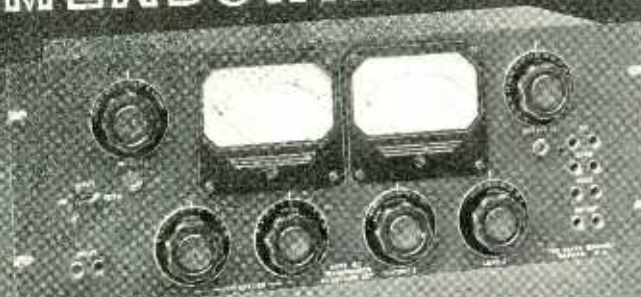

The Type 6C Measuring Set provides an accurate and rapid method for measuring the transmission characteristics of networks at audio frequencies.

This new set has the following outstanding features which contribute to its usefulness in the radio broadcasting field.

- \* REFERENCE LEVEL: New standard of 1 mw. in 600 ohms.
- \* METERS: New Type 30 standards.
- \* ATTENUATION RANGE: Zero to 110 db. in steps of 1 db.
- \* POWER RANGE: Calibrated from -16 to +45 db.
- \* FREQUENCY RANGE: 20 to 17,000 cycles.
- \* IMPEDANCES: Dial selection of useful network input and load impedances.
- \* MISMATCH ADDITIONS: No additions necessary for change of impedance.

TYPE 6C TRANSMISSION MEASURING SET . \$325.00

Write for additional technical information.

**THE DAVEN COMPANY**  
158 SLUMMIT STREET NEWARK, NEW JERSEY

The Type 6C was developed in co-ordination with the engineering department of the Columbia Broadcasting System

## The Nature of Electric Waves in Transformers

AN ARTICLE OF INTEREST to transformer designers is "Electric Oscillations and Surges in Subdivided Windings," by Reinhold Rudenberg, appearing in the October, 1940, issue of the *Journal of Applied Physics*. Two general problems are submitted, first, the effects of a finite number of elements belonging to one group of windings as for example, six coils forming a whole winding or 20 layers forming a complete coil, or 12 turns forming one layer; second, the extension of the analysis to the consideration of waves passing from one group to another one with different elements, such as from turns to layers, or from layers to coils. The author draws several conclusions from a mathematical treatment of the subject. They are as follows:

Lumped subdivision of windings into distinct elements as coils, layers or turns causes a critical frequency of its own, lower than that due to internal capacitance. Within the intermediate range of both critical frequencies attenuated standing waves appear within the winding.

Propagation of steep waves through successive turns, layers and coils effects a flattening of the front in several steps. Simultaneously, local oscillations within the layers or turns may be excited by reflections at the transition points of the group of elements.

The head length of the propagating wave and the internal stress of the insulation are favorably influenced by subdivision into elements, particularly in the case of small internal capacitance. The change in time of the internal voltage is derived for both interior and terminal elements. Formulas are given for the computation of the internal stresses between turns, layers and coils as well as between extra-insulated terminal elements.

• • •

## Crystal Filters

THE USE OF QUARTZ CRYSTALS in wave filters is described in an article by Russell E. Knox, in the October, 1940 issue of *Long Lines*, a publication of the Long Lines Department of the American Telephone & Telegraph Co. In an electrical circuit the crystal presents an impedance to current flow and can be represented by circuits such as the one shown in the accompanying diagram. The mass reaction of the crystal in vibrating motion is represented by inductance  $L$ ; the resistance  $R$  represents the energy dissipating action in the crystal as it vibrates.  $C_a$  represents the elasticity determining the storage of mechanical energy in the crystal and  $C_n$  represents the natural capacitance of the crystal when at rest. The nature of this circuit is such that it will have not only a resonant frequency, but an anti-resonant frequency as well. The ratio



**FOR DRAKE ASSEMBLIES ARE USED BY LEADING AIRPLANE MAKERS**

Airplane parts must be dependable! For serious consequences may follow the failure of even so small a part as a pilot light assembly. That's why so many of America's airplane manufacturers specify DRAKE Pilot Light Assemblies. Among radio makers, too, DRAKE Dial and Jewel Assemblies have won an enviable preference because of their dependability.

If your product calls for pilot light assemblies, ask about the complete DRAKE line. Standard and special types of every description and in any quantities are produced with amazing speed and efficiency.

*Will You Write for Our Catalog?*

**DRAKE MANUFACTURING CO.**  
1713 W. HUBBARD ST. • CHICAGO, U. S. A.



## "DUCTER" LOW RESISTANCE OHMMETER

Direct Pointer Readings  
Down To .000001 OHM

For rapid measurements of armature, field and transformer coils, soldered joints, fuses, switch and relay contacts, and other low resistances. Operates from battery. Requires no adjustment for battery voltage. Simply apply a pair of hand spikes and read the scale.

WRITE FOR BULLETIN 1635-E

**JAMES G. BIDDLE CO.**  
ELECTRICAL AND  
SCIENTIFIC INSTRUMENTS  
1211-13 ARCH ST. PHILADELPHIA, PA.

of  $C_s$  to  $C_d$  is a constant for any given crystal material and for quartz it is 125 to 1. It is this fixed ratio that determines the relation of the resonant frequency to the anti-resonant frequency.

At frequencies other than the resonant and anti-resonant points the crystal is essentially a reactance varying in value as the frequency is changed. This is illustrated in Fig. 1.

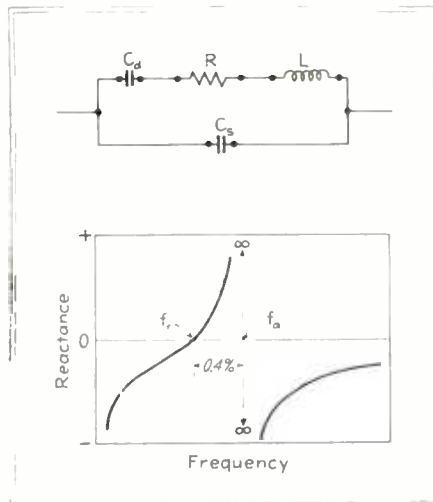

Fig. 1—Equivalent electrical circuit of a quartz crystal and its reactance characteristic

The resonant frequency  $f_r$  and the anti-resonant frequency  $f_a$  are separated by four-tenths of one per cent of the resonant frequency. This is due to the ratio of  $C_s$  and  $C_d$  and remains for all quartz crystals irrespective of the particular frequencies involved. When the reactance curve is raised by the added inductance to the point the portion on the right crosses the zero line and provides another resonance in frequency.

The distance between the new resonant point and the anti-resonant point in cps can be controlled by the size of the added series inductance. If the added inductance is selected so that the new resonant points are equal in distance from the anti-resonant point they will occur at points which are 4.5 per cent on either side of the anti-resonant point.

In the band-pass filter the crystals and inductances may be arranged in a lattice network such as that shown in Fig. 2. Each arm is designed for two resonant points an equal distance from the anti-resonant point as outlined above. The series arms  $A$  and  $A'$  are identical and the shunt arms  $B$  and  $B'$  are identical, but the anti-resonant frequency point in arms  $A$  and  $A'$  coincides with the first (lower frequency) resonant frequency point of arms  $B$  and  $B'$ . Therefore, the anti-resonant frequency point of arms  $B$  and  $B'$  coincides with the second resonant frequency of arms  $A$  and  $A'$ . The second resonant frequency of arms  $B$  and  $B'$  will be 4.5 per cent above this point.

Any alternating voltage applied at ter-



**SPECIFICALLY** designed for service, in the range from 16.2 to 2150 meters (18.5 mc. to 110 kc.). Improved image rejection at the higher frequencies is achieved through the use of 1600 kc. IF Transformers. The directly calibrated main tuning dial eliminates the use of complicated charts and tables. An efficient mechanical band-spread with separate dial provides easy logging.

**BUILT** for 110 volt AC-DC operation. Also may be operated from 6 volt battery supply with the addition of a Model No. 301 Electronic Converter. Dimensions 18½" x 9¼" x 8½" high. The SKYRIDER MARINE (Model S-22R) — Complete with tubes and speaker. Shipping weight 31 lbs. (SKYCU) \$64.50



the hallicrafters inc.  
CHICAGO, U. S. A.  
USED BY 33 GOVERNMENTS  
SOLD IN 89 COUNTRIES

**SENSITIVE ELECTRONIC  
AC VOLTMETER  
MODEL 300**



- New operating principle.
- 10-100,000 cycles.
- 1 millivolt to 100 volts in five ranges (to 1,000 and 10,000 volts with multiplier).
- Logarithmic voltage scale and uniform decibel scale.
- A-C operation, 115 or 230 volts, 50-60 cycles (rack mounting and battery-operated models also available).
- Permanent calibration, unaffected by variation in line voltage, tubes, etc. Accuracy 2%.
- Can also be used as an amplifier (70 DB gain) flat to 100,000 cycles.

**MODEL 402  
MULTIPLIER**



Newest addition to a line of accessories designed to increase the utility of the Model 300 Voltmeter. This multiplier has two important uses: (1) to provide additional ranges of 1,000 and 10,000 volts full scale, and (2) to increase the input impedance so that, when full sensitivity is not required, measurements may be made on very high impedance circuits. The input impedance on the 1,000-volt range is 4.4 megohms and on the 10,000-volt range 44 megohms.

Send for Bulletin 2E.

**Ballantine Laboratories, Inc.**  
BOONTON NEW JERSEY

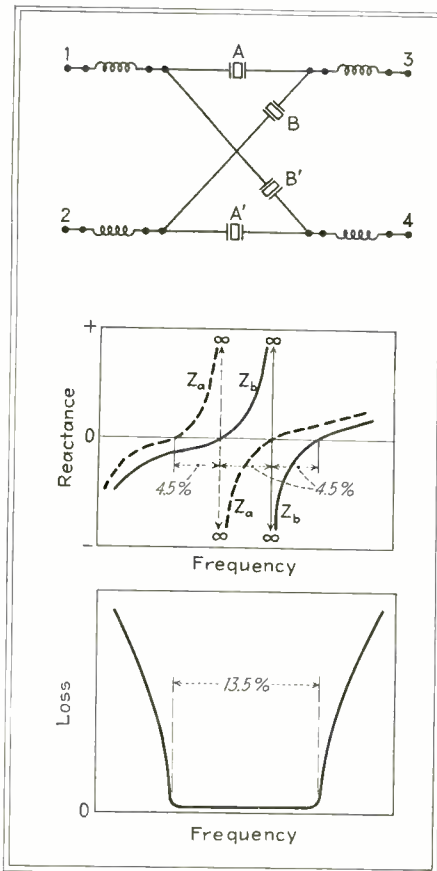

Fig. 2—Quartz crystals and inductances arranged as a band-pass filter together with the reactance and attenuation curves

minals 1-2 at a resonant or anti-resonant frequency will also appear at terminals 3-4 at the same magnitude. The voltage at any frequency outside of the frequency band from the first to the last resonant point will upset the bridge balance and will be subjected to a large loss and effectively suppressed. When such a filter is designed for frequencies in the order of 100,000 cps it will pass a band 13,500 cps wide. This pass band can be reduced, however, to any desired value by adding condensers in parallel with the crystals thus bringing their resonant and anti-resonant frequencies closer together.

**Erratum**

There appeared on page 42 of the October issue of *ELECTRONICS* an incorrectly captioned picture. The title should read "U. S. Nabs Illegal Broadcaster". The caption should read, "Sam Klaus, special U. S. prosecutor in a recent gambling case, examines the 'phono-oscillator' by which bookies, to whom phone service was denied, allegedly received race reports. The reports are said to have been phoned to a beauty parlor, where this set was secreted, and then sent by radio to the bookies in a nearby building. It was claimed that the bookies operated a radio transmitter without a license."

**FM**  
*Experience*  
*...not Experiment*

**LINGO  
Turnstile  
FM  
Antennas**  
Are Backed by  
Years on the  
"Actual  
Proving  
Ground"  
of FM at  
**W2XMN!**

★ Yes, there IS a satisfaction for engineers interested in FM to know that they can turn to Lingo for proven, factual information on planned antenna systems. The famous (patented) Lingo Turnstile Antenna was developed at the very "birthplace" of FM at Alpine, N. J. Today, it provides proven performance and an adaptability that affords its use either on towers or buildings.

★ We will be pleased to estimate on complete Turnstiles comprising the essential tubular steel mounting pole, elements, insulators, wires and bands. *Inquiries should indicate planned frequency, number of turnstile bays desired, location and height of building or supporting tower, etc.*

**JOHN E. LINGO & SON, INC.**  
Mfgs. Vertical Tubular Steel Radiators  
DEPT. E-11 CAMDEN, N. J.



# THE INDUSTRY IN REVIEW

## News

♦ On October 14th Thad H. Brown resigned as a member of F.C.C. Mr. Brown is entering the private practice of law . . . The 1940 national conference of the Associated Police Communication Officers Inc., will be held in Orlando, Fla., on December 2nd to the 5th. Subjects for discussion will include inter-city police communications, radio telegraph, teletype and two-way frequency modulation communication. . . . The Society of the Plastics Industry, Inc., recently held its Fall Meeting in Pennsylvania. The purpose of the Society is to speak authoritatively for the industry as a whole and to disseminate reliable information regarding its activities and developments. As a result of the rapid growth of the plastics industry, SPI has opened permanent offices at 295 Madison Avenue, New York City, which will serve as a clearing house for information on sales of raw material, finished products, sources of supply, employment opportunities, etc. . . . A total of forty-five applications for f-m station construction permits are awaiting official approval in Washington. Most of the applications are from owners of standard broadcast stations. If the licenses are granted in accordance with the coverage areas requested, these new f-m stations will supply service to over 75,000,000 potential listeners . . . Adequate frequencies for radio telephone service to Madrid have been set aside by the F.C.C. With the suspension of direct service to Holland, Belgium and occupied France, the demand for the Madrid circuit has increased. It gives an outlet from Lisbon, the only remaining point of contact with Continental Europe. Arrangements are being concluded for a resumption of direct telephone service with Paris . . . Federal Sales Company of Chicago is now known as Federal Screw Products Company . . . Ralph P. Glover, chief engineer for Shure Brothers for many years, has announced his resignation from that company and has joined the staff of Jensen Radio Manufacturing Company. Mr. Glover will be active in an expanded Jensen sales promotion campaign designed to place in service to the trade the facilities of the laboratory and engineering department . . . W. Richison Schofield, formerly chief engineer of Leeds & Northrup Company, Philadelphia, has recently been appointed director of engineering. John W. Harsch, assistant chief engineer, has been advanced to chief engineer. Mr. John F. Quereau is the new assistant chief engineer . . . Of the 16 radio stations now licensed to broadcast facsimile news programs, seven are completely or partially owned by newspapers, according to figures recently released by the F.C.C. The sta-

tions with newspaper affiliation using Finch Facsimile equipment are WGN, the *Chicago Tribune*; WHK, the *Cleveland Plain Dealer*, and WOKO, the Albany (N. Y.) *Knickerbocker News*. Other newspapers in facsimile broadcasting are the *Cincinnati Times-Star*, the *Louisville (Ky.) Courier-Journal*, the Pulitzer Publishing Company, St. Louis, Mo., and the St. Louis (Mo.) *Star-Times*. The non-newspaper experimenters with facsimile are WLW, Cincinnati; WOR, Newark, N. J.; WSM, Nashville, Tenn.; W2XBF, New York, and W8XUF, Jackson, Mich. (all using Finch equipment); the A. H. Belo Corp., Dallas, Texas; WQXR, New York; the Symons Broadcasting Co., Spokane, Washington, and WBEN, Buffalo, N. Y. . . . A Fellowship for the investigation of biological problems with the electron microscope recently developed in the RCA research laboratories has been established in the National Research Council through funds provided by the RCA Manufacturing Company . . . Dr. C. Guy Suits, has been appointed assistant to the director of the General Electric Research Laboratory . . . A subcommittee, under the chairmanship of John K. Hilliard of M-G-M Studio has been appointed by the Academy of Motion Picture Arts and Sciences to consider the possibilities for standardization of vacuum tubes used in sound recording work . . . Paul H. Tartak, president of Oxford-Tartak Radio Corp., Chicago, has

acquired a substantial interest in the United Teletone Corp., manufacturers of Cinaudagraph speakers . . . Station WPTF recently received permission from F.C.C. to increase the power of the station from 5,000 watts to 50,000 watts . . . Application has been made by General Electric Company to the F.C.C. for permission to extend the power of its f-m station, W2XOY, from the present licensed power of 2,500 watts to 50,000 watts . . . General Electric has taken over the complete operation of station WGY, 50 kw broadcasting station in Schenectady. This station has been operated by NBC since 1931 . . . L. O. Myhre has been appointed manager of manufacturing in the Radio Division of the Westinghouse Elec. & Mfg. Co., Baltimore. Mr. Myhre was previously in Long Island City, N. Y., where he was manager of engineering and manufacturing for the Westinghouse X-Ray Co. . . . First of three new buildings at the Westinghouse Radio Division in Baltimore is now completed, aiding the Government's preparedness program by doubling the Company's production facilities for special Army and Navy radio equipment. Two additional buildings are scheduled for completion before November 15th . . . General Electric Co. has announced that contracts have been awarded for the construction of a new building in its Schenectady works to be used in the manufacture of radio transmitters. Construction will start



End plates molded of Lumarith by Chicago Molded Products Company for Sangamo Electric Company, Springfield, Ill. Used for insertion in coil housings

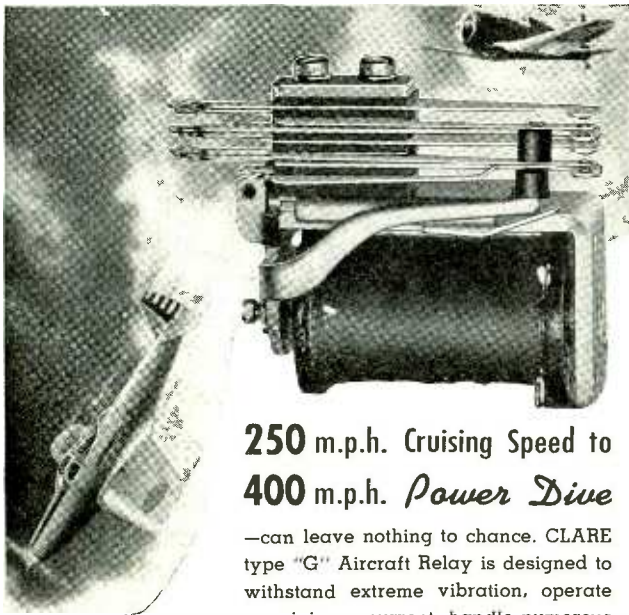

## 250 m.p.h. Cruising Speed to 400 m.p.h. Power Dive

—can leave nothing to chance. CLARE type "G" Aircraft Relay is designed to withstand extreme vibration, operate on minimum current, handle numerous contacts and occupy a minimum space. Special bushings provide extended life-time. Such utility is truly indicative of CLARE engineering.



Write for Catalog CC1  
and Relay Data Book.

CLARE is co-operating in  
America's defense.

**C. P. CLARE & CO.**  
LAWRENCE & LAMON AVES. - - CHICAGO  
15 EAST 26TH STREET, NEW YORK CITY

## SPRINGS by HUNTER

- ★ Springs by HUNTER are *guaranteed* to be exactly to specifications and of highest quality through and through.
- ★ This blanket assurance is made possible only by HUNTER control of products from start to finish; rigid pre-testing; accurate check on every manufacturing process. (And, these safeguards are the reasons why leading manufacturers in over 300 different industries rely on HUNTER to maintain their reputation for quality.)



You can  
use Spring  
Service like  
this! ★



*Springs*  
by Hunter

HUNTER PRESSED STEEL CO., LANSDALE, PA.

All sizes—All types—All materials! Send for free "Springdata" sheets as your first step in saving. Your name on your company letter-head brings them.

immediately . . . Arthur A. Brandt, who for three years has been associated with the advertising and promotional activities in connection with General Electric radio, has been appointed sales manager for the G-E radio and television receiver line . . . Niles Trammell, president of the National Broadcasting Company, announced the following appointments. John F. Royal, formerly vice-president in charge of programs, takes over new duties as vice-president in charge of the newly created post of New Activities and Developments in Broadcasting. Mr. Royal's new duties will deal with development work in programming and general public service in the fields of international and short wave broadcasting, television, frequency modulation and facsimile. Frank E. Mason will relinquish his supervision of the International Short Wave Dept. to concentrate on his duties as vice-president in charge of the Information Dept. L. P. Yandell, who formerly handled commercial short wave international broadcasting, has been appointed manager of the International Short Wave Dept. Clayland Morgan, formerly assistant to the president in charge of public relations, becomes director of Institutional Promotion. Sidney N. Strotz is the new vice-president in charge of the program department. Harry C. Kopf, sales manager in Chicago, succeeds Mr. Strotz as manager of the Central Division . . . Collins Radio Company announces the construction of a new plant. The building will have 52,000 sq ft floor space, and will be used in conjunction with the 40,000 sq ft which Collins now has. All research, engineering and precision manufacturing will be transferred to the new building which was scheduled to be available for occupancy about November 1st.

## Literature

**Lumarith Protectoid.** "Lumarith Protectoid" is a trade name for a high quality cellulose acetate film which can be obtained in gauges from .0007 to .002 inch. A booklet on the subject has been published by Celluloid Corp., 180 Madison Ave., New York City, which gives its characteristics and applications for the electrical industry. These data and specifications have been especially prepared for engineers.

**Test Equipment Catalog.** Radio City Products Co., 88 Park Place, New York City, announce a Supplementary Catalog (No. 123) covering a number of new pieces of test equipment which have been added to their line for the 1940-41 season since the issuance of the RCP Master Catalog.

**Radio Service Equipment.** Catalog No. 120 is a new issue devoted to instruments available from Hickok Electrical Instrument Co., 10514 Dupont Ave., Cleveland, Ohio, for f-m, television and a-m servicing.

## ● AUTOMATIC POWER LEVEL RECORDER

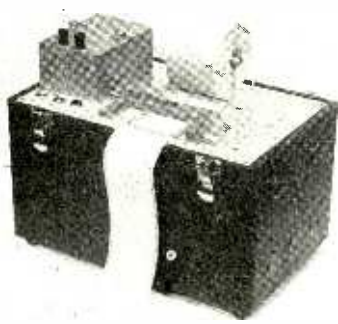

For the first time in the history of automatic measuring equipment a POWER LEVEL RECORDER is offered at a POPULAR PRICE.

The instrument can be used for all kinds of audio measurements, it makes AUTOMATICALLY a permanent continuous record in DB of the transmission characteristics of apparatus like loudspeakers, microphones, amplifiers, equalizers, etc. Laboratory and production measurements greatly facilitated.

It is AC operated and is mounted in a sturdy carrying case, dimensions, 13x11x8, the weight is 23 lbs., and the price—\$295. F. O. B. New York.

● Write for complete information on this up-to-date measuring device.

### SOUND APPARATUS COMPANY

150 West 46th St., New York City  
EXPERTS in automatic measuring apparatus.

Industrial Catalog and Engineering Manual. This new 96-page Catalog No. 40, contains helpful facts and information on the selection and application of resistors, rheostats, tap switches, chokes and attenuators. Among other things dimension drawings, illustrations, and special guide pages are included. Ohmite Mfg. Co., 4835 Flournoy St., Chicago.

Molded Plastics. A 12-page bulletin of interest to users of molded plastics has been published by the Plastics Division of Erie Resistors Corp., (640 West 12th St.) Erie, Pa. In addition to giving useful information on injection molded plastics this catalog describes the designing, engineering and production facilities of this company.

Catalog Sheets. The Hollywood Transformer Co., has just released several catalog sheets describing tapped equalizer inductors, input transformers and similar items supplied to customer specifications. These sheets are available from Norman B. Neely, 5334 Hollywood Blvd., Hollywood, Cal.

Vacuum-tube Apparatus. A new 20 page booklet entitled *Electronic Devices for Industry* (GES-2411), just published by General Electric Co., Schenectady, N. Y., briefly lists some of the more important vacuum-tube apparatus and describes its application and method of operation.

Transmitter Guide. Bulletin No. 344-E contains a wide variety of transmitters for the use of beginners and of advanced amateurs. Simplified construction methods are employed throughout the guide. The guide may be had for fifteen cents from Thordarson Electric Mfg. Co., 500 W. Huron St., Chicago.

Miniature Panel Instruments. A new twelve page illustrated catalog covering the "37" line of miniature panel instruments is announced by the Westinghouse E. and M. Co., E. Pittsburgh, Pa. These small instruments, approximately 4½ in. in diameter, and available in three mounting styles, have a broad field of application; from industrial and radio test apparatus down to the gadget of the amateur experimenter.

Selenium Rectifiers. Bulletin FI-3 entitled *Fansteel I. T. & T. Selenium Rectifiers* explains the principle of the selenium dry plate rectifier and enumerates its characteristics and advantages. Recommended circuit arrangements are detailed and illustrated with wiring diagrams. Fansteel Metallurgical Corp., North Chicago, Ill.

Oscillographic Measurement. "Oscillographic Method of Measuring Positive-Grid Characteristics" is the subject discussed in a recent issue of *Oscillographer* published by Allen B. DuMont Laboratories, Passaic, N. J.

Time Switches. Type TSA-14 time switches for control of a-c circuits are illustrated and described in bulletin GEA-2963B available from General Electric Co., Schenectady, N. Y.

## High FREQUENCY



With RED•DOT Lifetime Guaranteed Instrument

## VACUUM TUBE VOLTMETER

MODEL 1252.. ONLY \$48.34 Dealer Net Price

MODEL 1252 has the exclusive Triplett tilting type twin instrument with RED•DOT Lifetime Guarantee. One instrument indicates when bridge is in balance—the other is direct reading in peak volts. This vacuum tube voltmeter is self-calibrating with the additional advantages of the tube on the end of the cable. The initial operation of adjusting the bridge at the zero level insures exact calibration, independent of tube emission values, or when replacing tubes. Ranges are 3-15-75-300 volts. The ideal instrument for high frequency measurements.

Furnished in three-tone brown suede enamel case with highly attractive modernistic three-tone panel. Complete with tubes and accessories.....\$48.34 Dealer Net Price

### Model 666

A Complete Pocket-Size Volt-Ohm-Milliammeter with AC-DC Voltage ranges: 0-10-50-250-500-1000 at 1000 ohms per volt; DC Milliampers 0-1-10-50-250; Low Ohms, ½ to 300; High Ohms to 250,000 with provisions for higher readings by external batteries. Molded case and panel . . . Dealer Net Price . . . \$14.00.



Write for Catalog—Section 2311 Harmon Drive

THE TRIPLETT ELECTRICAL INSTRUMENT CO.  
Bluffton, Ohio

**LET TRANSFORMER HEADQUARTERS HELP YOU**

- LUMINOUS TUBE TRANSFORMERS
- 
- FLOUORESCENT LAMP BALLASTS
- 
- MERCURY VAPOR LIGHTING TRANSFORMERS
- 
- RADIO AND TELEVISION TRANSFORMERS
- 
- STEP-DOWN TRANSFORMERS
- 
- CONTROL TRANSFORMERS
- 
- GENERAL PURPOSE AIR-COOLED TRANSFORMERS
- 
- VOLTAGE REGULATING TRANSFORMERS
- 
- SAFETY TRANSFORMERS

● Development of a transformer with characteristics exactly suited to the application, requires specialized engineering knowledge, manufacturing facilities and skilled workmen.

The Acme organization offers these specialized requirements to completely relieve you of transformer problems. Acme transformer engineering service is available to improve your product, your service, your profit.

**THE ACME ELECTRIC & MFG. CO.**  
31 WATER STREET • CUBA, N. Y.

**Acme Electric**  
TRANSFORMERS

# WHAT'S TRACKWALKING TO DO WITH TRANSFORMERS?



After living twenty-five years alongside the railroad and secretly harboring the ambition to become a trackwalker, Mike O'Flaherty decided to make a try for it.

"Suppose," asked the examining official, "that two freight trains are approaching from opposite directions on a single track road. What would you do?"

"What would I do?" exclaimed Mike, "I'd run for me lantern and wave it like fury."

"And if you had no kerosene for the lantern, what would you do then?" asked the examiner.

Mike thought for a moment, "Oid build me a bonfire square on the tracks, the like of which ye've niver seen."

"But it's a rainy night, Mike and the flane won't take," suggested the official.

Mike scratched his head, then clucking his tongue, said, "Begorra, I'd run and git me wife, Maggie!"

"What would she be able to do?" asked the puzzled executive.

"Wal, now," replied Mike, "she mightn't be able to do much but I'd say, "Maggie come quick and feast yer eyes on the damndest wreck ye iver saw in yer whole life!"



You may well ask, "What has Trackwalking got to do with Transformers?"

Simply this—whether in railroading or in radio, knowledge and experience are the precious ingredients that widen the margin of safety.

The careful engineering and accurate workmanship that goes into Kenyon Transformers is your assurance that your products will perform safely and satisfactorily under even the most adverse conditions. Hot or cold, wet or dry, on land or sea—wherever there's a "Dead Man's Curve"—specify Kenyon Transformers for that "Margin of Safety."

**KENYON TRANSFORMER CO., Inc.**  
840 Barry St. New York, N. Y.

**Generators.** Three bulletins are available from Carter Motor Co., 1608 Milwaukee Ave., Chicago. Bulletin 150 gives data on heavy duty rotary converters for changing dc and ac for use, with pa amplifiers, radio receivers, phonographs, musical instruments, etc. Bulletin 50 is devoted to a new super genemotor for aircraft, marine, police, sound systems, and amateur use. Data on improved heavy duty genemotors for hi-gain amplifiers, two-way police radios, aircraft radios, etc., are contained in bulletin 510.

**Radio Service Encyclopedia.** Supplement No. 11 to the third edition of Mallory-Yaxley Radio Service Encyclopedia is devoted to the subject of "Superheterodyne First Detectors and Oscillators." P. R. Mallory & Co., Inc., Indianapolis, Ind.

**New Catalog.** A new catalog, No. 153, covers the complete line of Shure Brothers (225 W. Huron St., Chicago) products and includes new items for 1941 such as the "Stratoliner" microphones, magnetic recording heads, etc.

**Flexible Varnished Tubing.** A bulletin available from Wm. Brand & Co., 276 Fourth Ave., New York City, describes their process of varnishing flexible tubing.

**Cathode-ray Stopwatch.** A conventional cathode-ray oscillograph is employed as an indicator for determining the transit time of electrical switching equipment, such as relays and contactors, together with a graphical solution of the pattern obtained from the cathode-ray oscillograph, examples of the method and its extension to other problems, is the subject of the latest issue of the Du Mont *Oscillographer*. This paper is the first of the entries in the Du Mont Cathode-Ray Symposium and Prize Contest recently announced, and is representative of the cathode-ray application ideas being reported by contestants. A copy may be had by writing Allen B. Du Mont Labs., Inc., Passaic, N. J.

**Frequency Modulation.** A bulletin available from Fred M. Link, 125 West 17th St., New York City, describes two types of frequency modulated main station equipment, two types of frequency modulated mobile equipment, a frequency monitor fixed station coaxial antennas and mobile antennas and mounts.

**New Bulletin.** A loose-leaf binder just issued by Chicago Transformer Corp., 3501 Addison St., Chicago, contains informations about the company's history, personnel, manufacturing facilities and products. This bulletin will be published at regularly scheduled intervals and will contain information regarding the progress being made in small transformer design and construction.

**House Organ.** *Nickel Steel Topics* is published in the interest of producers and users of nickel alloy steels. It is available from the International Nickel Co., Inc., 67 Wall St., New York City.

## New Carter AIRCRAFT TYPE GENEMOTORS



• Here is a new complete line of Genemotors for Aircraft, Police, Marine Radio, and general use, where dependable and efficient service is required. Armatures are wound with double enamel and silk wire, insuring trouble free operation. There is a Carter Genemotor or Converter for every requirement from 5 to 1000 watts output. Write for further information.



1606 Milwaukee Ave. Cable: Genemotor  
Carter a well known name in Radio since 1922

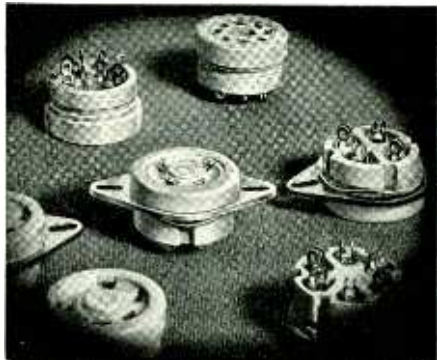

## DESIGNED for APPLICATION

MODERN SOCKETS for MODERN TUBES! Long flashover path to chassis permits use with transmitting tubes, 866 rectifiers, etc. Ideal for mounting on rugged thick cast aluminum chassis now being used on much of the better commercial equipment. Long leakage path between contacts. Contacts are type proven by hundreds of millions already in government, commercial and broadcast service, to be extremely dependable. Sockets may be mounted either with or without metal flange. Mount in standard size chassis hole. All types have barrier between contacts and chassis. All but octal also have barriers between individual contacts in addition.

Catalogue Upon Request

JAMES MILLEN MFG. CO. INC.  
150 EXCHANGE ST. MALDEN, MASS.



Fastening Devices. Tinnerman Products, Inc., Cleveland, Ohio, have available a booklet (Form No. 135) which illustrates the use of their "Speed Nuts" for assembly line production. Speed Nuts are one-piece fastening devices that afford a double lock.

## New Products

### Recording Weight Scale

UNIVERSAL MICROPHONE CO., INGLEWOOD, CAL., is now distributing its new weight scale for servicemen, recorders and others who need quickly to determine weight on cutting head or pickup. The tiny instrument is small and lightweight, but extremely accurate. It reads in ounces and has a hook for speedy connections, and enables the holder to see the weight on the needle or stylus. It will be distributed through the usual dealer-jobber channels.

### Ballast Tube

THE NEW SHAPE AND SMALLER SIZE will permit a new ballast tube, product of Amperite Co., 561 Broadway, New York City, to be placed anywhere. Better operation is obtained with the new starting resistor which puts approximately 80 volts on the receiver when it is first turned on and increasing to 110 volts after four seconds. The new Amperite is also equipped with the new fuse which automatically burns out when the ballast is connected to a set having a 110-volt tie connection to the ballast socket. After the fuse burns out the Amperite automatically adjusts itself to the set keeping the tube filaments between 6.0 to 6.6 volts with a line voltage variation of 80 to 140 volts.

### Record Playback Machine

A NEW PORTABLE TRANSCRIPTION record playback machine is being featured by Charles Michelson, 67 West 44th St., New York City. The new machine plays all records up to the 16 inch size at both 33½ and 78 rpm, and operates on ac-dc. The entire unit weighs only 18 lbs complete, and has provision for storing 3 records inside the case.

### Portable Voltmeter

FERRANTI ELECTRIC, INC., 30 ROCKEFELLER PLAZA, New York City, have placed on the market a new triple range a-c portable voltmeter designated as Model 956. This is a precision testing instrument for industrial and central station use, and for all service and field testing. While it has been designed for a-c circuits, it may be used on d-c circuits with a small sacrifice in accuracy. It conforms to A.I. E.E. and N.E.M.A. Specifications, and meets Army and Navy Specifications.

# DESIGNED

## FOR ACCURACY IN ELECTRIC CONTROL

RUGGED, COMPACT, LOW POWER CONSUMPTION OF 1.5 WATTS, HIGH POWER OUTPUT OF 2,000 WATTS

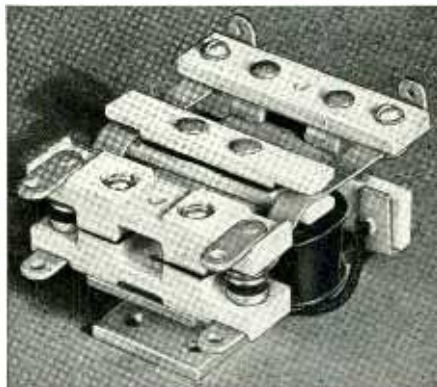
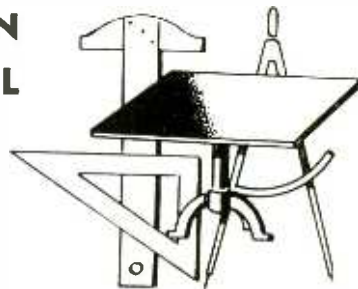

THIS KURMAN RELAY WAS DESIGNED TO MEET THE NEED FOR A HIGH QUALITY MEDIUM DUTY RELAY AT LOW COST. THE MAGNET COIL IS WOUND ON A BAKELITE CORE AND ALSIMAG NON-HYGROSCOPIC INSULATION IS EMPLOYED. CONTACTS ARE QUARTER INCH COIN SILVER.

**KURMAN ELECTRIC CO., INC.**  
241 LAFAYETTE STREET NEW YORK

*Tops*  
**IN PHOTO-CELL PERFORMANCE**



*Luxtron*  
**PHOTO ELECTRIC CELLS**  
BRADLEY LABORATORIES, INC.  
82 MEADOW ST. • NEW HAVEN, CONN.

**L**UXTRON\* Photo Electric Cells fill an important need in the field of photo-electric measuring and control equipment. For they reach new levels of current output—levels sufficient to operate instruments or sensitive relays directly from extreme low-level light sources without amplifiers or external voltage supply.

Luxtron\* Cells represent a new development too in the selenium barrier layer dry-disc type of self-generating photo-electric cell—compact, permanent in performance and indestructible.

Complete technical data will be found in Catalog No. 101. Write for your copy today.

BRADLEY LABORATORIES, Inc. Dept. E-1  
82 Meadow St., New Haven, Conn.

Please rush copy of Cat. No. 101.

NAME \_\_\_\_\_  
ADDRESS \_\_\_\_\_  
CITY \_\_\_\_\_ STATE \_\_\_\_\_

# LEADERSHIP!

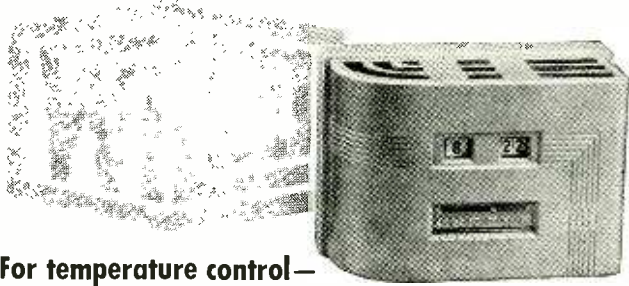

For temperature control—

## MINNEAPOLIS-HONEYWELL product relies on WILCO

Of course world leader Minneapolis-Honeywell seeks the best possible thermostatic bi-metals for such outstanding products as its new, completely automatic Chronotherm wall thermostat. And of course this top quality firm uses Wilco as a source of supply for these important thermostatic bi-metals.

Through more than 26 years of pioneering research and careful craftsmanship, Wilco has been accepted everywhere as the standard of sensitivity, accuracy and dependability among thermostatic bi-metals. For a solution of your problem, write for "Wilco Blue Book of Thermometals and Electrical Contacts."

THE H. A. WILSON CO., 105 CHESTNUT ST., NEWARK, N. J.  
Branches: Detroit, Mich. and Chicago, Ill.

**WILCO THERMOMETAL**  
(Thermostatic Bi-Metal)

## Defense Contract

*Controls*

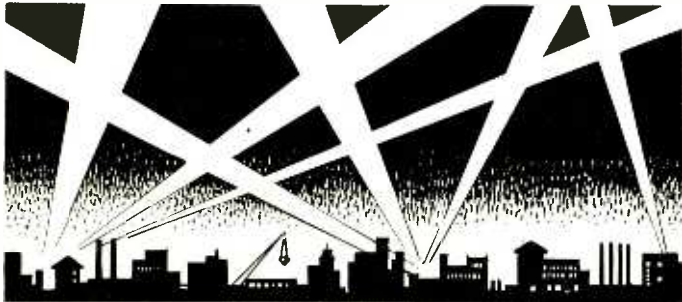

★ Are you working on a negotiated defense contract . . . or a contract including government specified equipment designed by other than government engineers?

If so . . . Guardian Electric is prepared to cooperate as a primary and secondary source of supply for electrical controls.

### RELAYS By GUARDIAN

and Complete Control Assemblies for:

Bomb Releases . . . Fire Controls . . . Communication equipment for tanks, airplanes . . . Portable Pack . . . Radio Remote Controls . . . Signal Corps requirements . . . Controls for synchronized and non-synchronized Machine Gun Fire on Aircraft . . . Anti-aircraft Gun Control . . . Special Switches for various applications to meet government specifications, and innumerable other special control assemblies, complete, or in part.

SERVICE! Guardian offers the highest speed sample and engineering service in the control industry . . . quality controls to meet the most rigid inspections and delivery schedules. Send a blue print or sketch for cost-free engineering suggestions. Your letterhead brings new Guardian Catalog "E" by return mail. Write



Type-R Stepping Relay

**GUARDIAN**  **ELECTRIC**  
1625 West Walnut Street Chicago, Illinois

## Radio Transmitters

NEW RADIO TRANSMITTERS designed expressly for use in stations where limited technical personnel requires the conservation of man-power, as in local broadcasting plants, police work and the emergency communication services, have been announced by the Western Electric Company, 195 Broadway, New York City. Code 450A-1 designates the 100 watt transmitter, while Code 451A-1 designates the 250 watt transmitter. Output power is 100-250 watts except for those stations operating on 250 watts daytime who may desire optional gear for shifting to 100 watts at night. Frequency range is 550-2750 kc depending upon coils and condensers installed. Audio frequency response is flat within  $\pm 1.5$  db from 30 to 10,000 cps. Other specifications are as follows: Manual voltage regulation to accommodate primary voltages from 200 to 240 volts; r-m-s audio harmonics show less than 3% distortion below 5,000 cps at all modulation levels to and including 100% and less than 5% from 30 to 7,500 cps; stabilized feedback and other developments enable the modulated amplifier to carry over-modulation without damage to equipment and without sharp increase in distortion; r-m-s noise level 60 db or better unweighted, 70 db or better weighted, below signal level at 100% single frequency modulation; harmonic radiation is not greater than .03%; grid bias last radio frequency stage method of modulation; quartz plate controlled carrier stability within 10 cycles; power supply for input voltage is 200-240, frequency 60 cps (50 cps can be supplied on order. Power consumption for the 450A-1 model is 1250 watts and for model 451A-1, 1750 watts.

## Magnifying Glass

PERMO PRODUCTS CORP. (6415 Ravenswood Ave., Chicago), have available a ten-power magnifying glass, mounted in a protecting rubber holder, which is useful for inspecting playback needle points, recording needles and record grooves. The magnifier is also handy for draftsmen, tool makers, etc. Permo Products Corp. will send this magnifier free to engineers, manufacturers and jobbers, who will write to them on their professional letter-head.

## Recording Motor

ALLIANCE MANUFACTURING COMPANY, ALLIANCE, OHIO, announces its new Model 90 recording motor and turntable assembly designed for use with individual feed and cutter designs. It makes available an inexpensive turntable and motor assembly suitable for incorporation in any individual complete recording mechanism. The motor is available with 9 inch turntable only, being designed to record up to 8 inch blanks with good speed regulation. The assembly is of the friction drive type which, in conjunction with a dynamically balanced rotor, provides smooth, quiet operation.

Precision Built  
for Perfect Performance...



**FAIRCHILD**  
TRANSCRIPTION TURNTABLE  
for Wow-Free Reproduction

Precision construction insures higher-fidelity reproduction — and this Fairchild Unit 227 eliminates wow, speed variations, and vibration.

Dynamically balanced 16-lb. cast-iron turntable is driven by synchronous motor through two-speed adhesion drive. Fairchild floating motor assembly eliminates objectionable motor vibration.

"...it had to satisfy Fairchild first"



**FAIRCHILD**  
Sound Equipment Division  
AVIATION CORPORATION  
83-05 Van Wyck Boulevard, Jamaica, L. I., N. Y.

**FERRANTI**  
Quality Products  
60 YEARS OF DEVELOPMENT

Transformers for every electronic, sound, communication, industrial, and laboratory use — miniature aero transformers for aircraft and portable work — high power plate and filament transformers — filters, equalizers, modulation sets, rectifiers, etc. — electrostatic voltmeters, portable voltmeters, ammeters, phase rotation indicators, special testing equipment, and numerous other instruments.

Prompt Service — Low Prices  
— Immediate Deliveries. Write for literature and prices.

*Ferranti*  
**ELECTRIC, INC.**  
R. C. A. BUILDING  
NEW YORK, N. Y.

### Handi-Mikes

UNIVERSAL MICROPHONE CO., INGLEWOOD, CAL., is now manufacturing and distributing its new handi-mikes for use in the portable sound equipment field, especially for sound trucks, sports events, small transmitters, call systems and other places where a close talking and a clear crisp reproduction unit is required. It is made of polished chrome plate with balanced grip, snap switch, an overall length of eight inches, a packed weight of slightly over a pound and six feet of flexible cord are included in the assembly. "A" circuit is standard on all models, with switch in series on carbon types, shunt on all others. "C" circuit is special for relay operation, shield of cable common ground. "T" switch is heavy duty press-to-talk, vertical toggle types, nonlocking and "P" switch is push button type, also nonlocking. Other circuits are also available from the manufacturer.

### Amateur Frequency Monitor

THE BROWNING LABORATORIES, Winchester, Mass., have recently announced a new precision amateur frequency monitor, Type M3, covering the six amateur bands from 160 meters to 2½ meters. The monitor is so designed that the amateur bands are completely band-spread over 240 degrees on a 5½-inch laboratory dial. 100 and 1000 k-c oscillators are used as secondary standards and may readily be adjusted to one part in a million against the Bureau of Standards Station, WWV. These secondary standards allow accurate checking of dial calibration in the amateur bands. The dial is direct reading and requires no counting of beats to determine the frequency of exciters, transmitters or received frequencies. Zero beat is indicated visually by the cathode ray tuning indicator and aurally in phones. This apparatus may also be used as a visual deviation meter.

### Marine Radiophone

TO MEET MORE PRECISELY the communications requirements of small boats, and of larger boats with moderate off-shore cruising range, Hallcrafters (Chicago), announce the Model HT-11 compact marine radiophone which combines modest initial cost with the low battery drain. The HT-11 includes a transmitter and receiver in one metal cabinet. The standard power supply is a separate unit connected to the other by cable. This power supply operates from either 6 volt or 12 volt battery sources, or a special 110 volt, 60 cps supply is available which may be driven from a 110-volt a-c source or from a 32 volt or 110 volt d-c converter.

The transmitter section provides 12 watts into the antenna and a choice of three gang-switched and crystal-controlled operating frequencies.

The practical data you need  
are in this book



YOUR book on the important principles of television, written in engineering language by men who know whereof they speak

### ZWORYKIN AND MORTON'S TELEVISION

Published 1940

Note these features:—Fundamental physical principles involved in electronic engineering: electron emission from solids (i.e., photoelectric emission, thermionic emission, secondary emission, shot effect, etc.), electron optics, and fluorescent materials. Analysis of fundamentals of picture transmission and resolution. Various forms of pickup tubes, viewing tubes and other electronic terminal tubes used in television. Problems of video amplification, radio transmission and reception, etc. The description of a practical television system: the RCA NBC television project.

"This book is indeed an excellent exposition of the present state of the art and will probably become a classic in its field . . . I am recommending the text to my friends and associates in the communication industry as the most complete and authoritative treatment of this subject which I have seen."

—PROFESSOR JOHN R. MARTIN,  
Case School of Applied Science

646 pages 6 by 9 \$6.00

#### ON APPROVAL COUPON

JOHN WILEY & SONS, Inc.  
440 Fourth Avenue, New York, N. Y.

Kindly send me a copy of ZWORYKIN AND MORTON'S "TELEVISION," on ten days' approval. At the end of that time, if I decide to keep it I will remit \$6.00 plus postage; otherwise, I will return the book postpaid.

Name .....

Address .....

City and State .....

Employed by ..... E-11-40



UP TO

**3,666,666**  
**OHMS per VOLT!**

Negligible Voltmeter Loading  
No Ohmmeter Resetting

**NEW RCA JUNIOR VOLTOHMYST**

Here is a D. C. *Electronic* push-pull Volt-Ohmmeter, using the famous Rider VoltOhmyst circuit—plus a convenient isolated A. C. 1000 ohms-per-volt Rectifier-type Voltmeter—all at a price scarcely higher than the price of an ordinary volt-ohmmeter!

Constant input resistance of 11,000,000 ohms on D. C. Voltmeter ranges of 0-3, 10, 30, 100, 300, 1000 volts—permits checking A. V. C. and A. F. C. voltages, and oscillator grid-bias voltages under actual operating conditions *with the signal present*, through an isolating 1-megohm signal-tracing probe! Sensitivity is as high as 3,666,666 ohms per volt!

As an ohmmeter, too, this new RCA test instrument gives accurate resistance-readings . . . from 0.1 ohms to 1000 megohms, in 6 Decade steps. No zero resetting is necessary when changing scales. See the RCA Junior VoltOhmyst at your RCA Distributor's.

Over 380,000,000 RCA Radio Tubes have been purchased by radio users . . . in tubes as in test equipment and accessories it pays to go RCA All the Way.



**RCA**  
*Test Equipment*  
RCA Manufacturing Co., Inc., Camden, N. J.  
A Service of the Radio Corporation of America

**Recording Thread Controller**

CHIP CHASER IS THE NAME of a new device developed by Audio Devices,

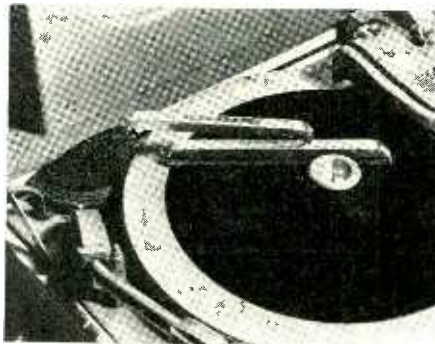

Inc., 1600 Broadway, New York City, to solve the problem of controlling the thread when cutting an instantaneous recording.

**Receiver Components**

A WIDE VARIETY OF PRODUCTS of interest to servicemen, experimenters and amateurs has been announced by Consolidated Wire & Assoc. Corp., 520 S. Peoria St., Chicago. Two items of particular interest are miniature dry electric condensers in etched foil tubular, etched foil waxed carton and midget plain foil waxed carton types, and a new series of midget double tuned i-f transformers. Other products available are radio cements and solvents, a variety of phono and record acces-

sories (including plain steel or brass plated high fidelity needles), a line of paints, varnishes and lacquers, and two new broadcast and short wave receivers.

**Combination Tester**

RADIO CITY PRODUCTS Co., Inc., 88 Park Place, New York City, announces a new addition to its line—the Model 803 "Portable Service Shop" which combines in one instrument the functions of set tester and tube tester. Dimensions are 12 1/4 x 13 x 6. Space is provided for test leads and small tools. Set tester functions include measurement ranges of 0-10/50/500/1000 for d-c voltages (at 1000 ohms-per-volt) and for ac and output voltages. D-c current ranges are: 0-1/10/100/1000 milliamperes and 0-10 amps. Ohmmeter ranges include 0-500/5000/1 meg/10 megs and decibel ranges—8 to 15, 15 to 29, 29 to 49 and 32 to 55. A self-contained battery serves for the medium ohms range and a built-in power supply for the others. Provision is made for testing all old and new tubes including the miniature, bantam junior and ballast types. The usual Dynoptimum circuit is utilized and filament voltages are available up to the full line voltage. All tests are at standard RMA plate voltages and loads and include hot interelement short and leakage tests for individual elements, individual section tests for multi-purpose tubes, etc.

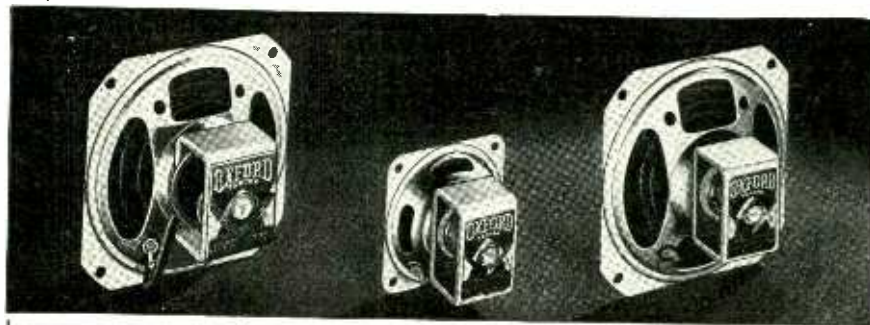

**Oxford**  
**Speakers**

*Pioneer* in designing and building the worlds smallest speakers, OXFORD today leads the field in supplying the radio industry with high quality, *precision* built miniature reproducers. Hundreds of thousands of these speakers, still in use after years of service, are testimony to the quality built into each and every unit. Specify OXFORD and be fully satisfied.

Write Dept. E-9 for details or prompt quotations.

**OXFORD-TARTAN**  
RADIO CORPORATION  
915 W. VAN BUREN ST. • CHICAGO, U. S. A.

## Wide Band Signal Generator

MODEL 188-X IS A NEW WIDE BAND UNIVERSAL crystal-controlled signal generator specifically designed for f-m and a-m servicing. It is a product of Hickok Electrical Instrument Co., 10514 Dupont Ave., Cleveland, Ohio.

With frequency coverage on fundamentals from 100 kc to 133 Mc the 12 output selections include: Electronic-controlled wide band frequency modulation output with 750 kc sweep for alignment of f-m and television receivers. F-m output, modulated internally, at 400 cps with F.C.C. standard frequency modulation sweep (150 kc) for servicing and checking f-m receivers. Amplitude modulation output as well as narrow band frequency modulation (30 kc sweep) for servicing amplitude modulation receivers. Audio frequency outputs of 400 cps fixed and 50 to 10,000 cps variable are available. Crystal-controlled outputs, modulated and unmodulated, with accuracy better than 0.01% are included with frequency coverage from 100 kc to 10 Mc in 100 kc steps and from 1000 kc to 150 Mc in 1 Mc steps. It also furnishes synchronized sweep voltage for oscillograph use. The oscillator includes a complete built-in power supply consisting of transformer, rectifier and filter. It is standard for any 110 volt a-c line, 40 to 65 cps. All necessary cables and instruction book are furnished.

## Bakelite Audio Units

UNITED TRANSFORMER CORP., 150 VARICK ST., New York City, announces a complete line of bakelite cased plug-in audio units. These units have identical characteristics to the UTC Ouncer transformers, and weigh only two ounces. Units not carrying dc have high fidelity characteristics, uniform from 40 to 15,000 cps. The transformers have standard octal sockets with overall dimension of 1- $\frac{1}{2}$  inch diameter x 1 $\frac{1}{2}$  inch high. All items are of submersion proof design. Fifteen units are available in this series for every type of low level input, output, and matching sets.

## Aircraft Dynamotors

THE CARTER MOTOR Co., 1608 Milwaukee Ave., Chicago, announce a new line of small, light weight, aircraft type dynamotors for aircraft, police and marine radio. They are made in two frame sizes, 35 and 100 watts output. The 35-watt frame weighs 4 $\frac{1}{2}$  lbs with aluminum bearing brackets, and measures 5 $\frac{3}{8}$  inches long, 3 $\frac{1}{8}$  inches wide, 3 $\frac{1}{8}$  inches high. The 100-watt frame weighs 7 $\frac{1}{2}$  lbs with similar type brackets, and measures 7 inches long, 3 $\frac{1}{2}$  inches wide, 3 $\frac{1}{8}$  inches high. Some of the features of this new line include a one-piece field ring, double enamel and silk wire, mica extension, dynamic balancing of armature, ball bearings, removable end covers, simplicity of construction and neat design.

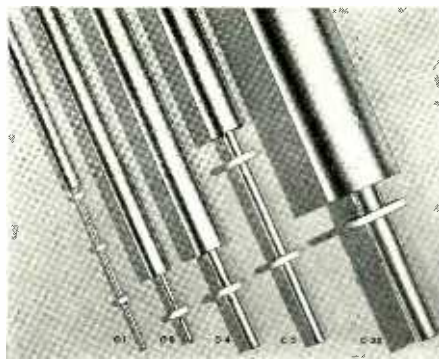

### CONCENTRIC LINE

Loss and undesirable radiation are eliminated when concentric line is used to connect your transmitter or receiver to the antenna. Seven sizes are available from  $\frac{3}{8}$ " diameter for low power transmitting and receiving up to 3 inch diameter rated at 100KW. Let us know your requirements.

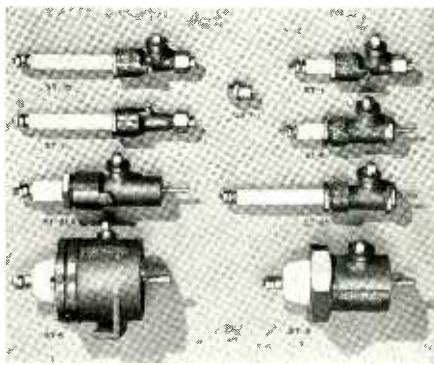

### SEALED TERMINALS

Obtain the best efficiency from your concentric line installation by filling it with gas. Be sure the gas will not leak out by installing sealed terminals. Sizes are available for any size line or application.

BY

*Doolittle*

Police Radio Transmitters & Receivers  
Broadcast Transmitters  
Field Intensity Meters  
High Frequency Antennae  
Special Radio Apparatus  
to specifications

Literature and Prices sent on request

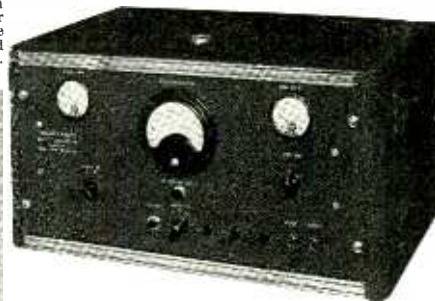

### DIRECT READING FREQUENCY MONITOR

Simplify your frequency checking by installing an FD-8 Monitor. It reads carrier frequency deviation directly on the precision Frequency Meter on the front panel. Provision is made for operation on six frequencies. Readings are guaranteed accurate within .002% of the carrier frequency.

**DOOLITTLE RADIO INC.**  
7421-23 Loomis Blvd. Chicago, Ill.



**UNBRAKO**  
REG. U.S. PAT. OFFICE  
SCREW  
PRODUCTS

**IF** you're careful about the selection of screws for electrical service, you'll compare. And having compared you'll choose "Unbrako" Products for their uniformity and strength; for their unique self-locking feature; for their knurled heads with a non-slip grip that saves assembling time. Complete range of sizes from number 4 up. Write for samples and literature.

**STANDARD PRESSED STEEL CO.**  
Box 596, JENKINTOWN, PENNA.

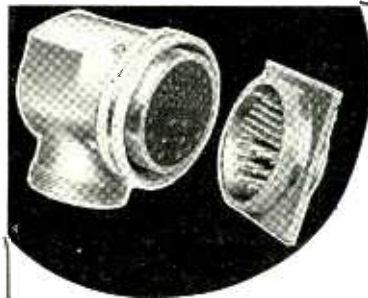

## SKILL & EXPERIENCE

A compact, skilled organization... developed through a quarter century of manufacturing... personalized service for every client... the widest variety of fittings... these factors have won for CANNON Multiple-Contact Electrical Cable Connectors recognized leadership in a world market. CANNON Plugs are pre-eminent in the fields of Sound, Aeronautics, Geophysical Research, Instrument-Control on Ships and Laboratory Panels.

Illustrated Bulletins afford valuable information on Plug Problems. Bulletin "P" & "O" devoted exclusively to Sound. Please specify your requirements when requesting Bulletins.

**CANNON ELECTRIC DEVELOPMENT CO.**

420 West Avenue 33, Los Angeles, California  
Eastern Sales Office: 220 Fifth Ave., New York, N. Y.



**CANNON PLUGS**

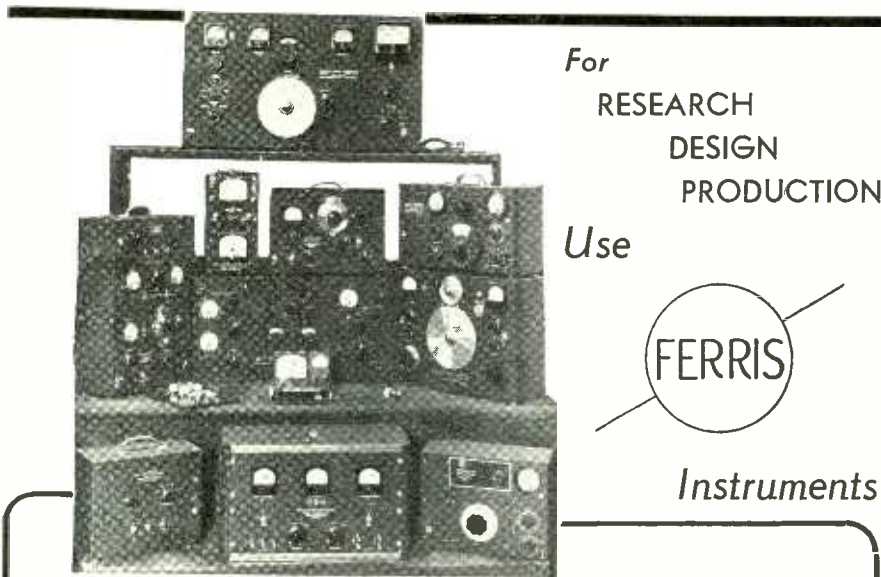

For  
RESEARCH  
DESIGN  
PRODUCTION

Use



Instruments

**MICROVOLTERS\***  
**STANDARD SIGNAL GENERATORS**  
**RADIO NOISE METERS**

Write for information on Ultra High Frequency and Crystal Controlled Signal Generators.

CATALOG E2 WILL BE FURNISHED UPON REQUEST

**FERRIS INSTRUMENT CORPORATION**  
BOONTON Telephone Boonton 8-0781 NEW JERSEY

\*Reg. U. S. Pat. Office



**PERMANENT MAGNETS**  
ALL SHAPES — ALL SIZES  
FOR ALL PURPOSES

Stamped, Formed, and Cast; Chrome, Tungsten, Cobalt and ALNICO\*\* (cast or sintered) under G. E. license.

**THOMAS & SKINNER**  
STEEL PRODUCTS COMPANY  
1116 E. 23rd STREET INDIANAPOLIS, INDIANA

Laminations for Radio Transformers — Tools  
Dies — Heat Treating — Stampings

**39 YEARS EXPERIENCE**

**KELLOGG**  
SWITCHBOARD & SUPPLY CO.

THE LOGICAL SOURCE FOR  
*Aircraft Radio Accessories*

★ Complete engineering, laboratory, and manufacturing facilities available for the design and construction of radio accessories and components required by the Aircraft Industry.

★ Manufacturers of Microphones (hand and throat), Headsets, Capacitors and miscellaneous apparatus such as plugs, jacks, keys, switchboard lamps, lamp jacks, lamp caps, multi-conductor plugs and sockets, insulated wire, cords, cord assemblies, etc., etc. Head and chest sets, Control Boxes, Filters built to your specifications. Let us solve your problems.

★ Suppliers to All U. S. Government Departments and Commercial Aviation ★

**KELLOGG SWITCHBOARD & SUPPLY COMPANY**  
6604 SOUTH CICERO AVENUE CHICAGO, ILLINOIS

**A-B Plug-In Unit**

A NEW A-B BATTERY-SUBSTITUTE UNIT, Model AD, available from Electro Products Laboratories, 549 W. Randolph St., Chicago, will convert portable and home battery radios into all-electric sets. It does away with both "A" and "B" batteries and it permits operation of portable and other 1½ volt battery radios in districts using direct current. It provides 1.4 volts "A" power and 90 volts "B" power at 18 ma.

**Quick Heating Tubes**

TWO NEW QUICK HEATING TUBES have been announced by Hytron Corp., 76 Lafayette St., Salem, Mass. They are the HY-1231Z and HY-1269. The HY-1231Z is a High-Mu twin-triode for use as a zero bias Class B modulator, r-f amplifier oscillator, or a-f amplifier. The HY-1269 is a beam tetrode for use as an r-f amplifier, oscillator, Class AB<sub>2</sub> a-f amplifier or as a frequency doubler. The filaments of both tubes are of thoriated tungsten to provide for quick heating. These tubes have been designed for use in 12 volt ignition systems such as are found in aircraft and marine installations.

**B Battery Eliminator**

A "B" battery eliminator for portable receivers has been announced by American Television & Radio Co., 300 E. 4th St., St. Paul, Minn. These eliminators are designed for operation from a storage battery or from flashlight cells. The total weight of the eliminator is approximately 3 lbs. It will deliver 110 volts ac, 60 cps, at 35 watts for the operation of 3-way portable receivers.

**Radiotelephones**

HALLICRAFTERS, INC., 2611 S. Indiana Ave., Chicago, have available marine radiotelephones which have been built to government specifications. One model (HT-11) has a 12-watt output. The transmitter can be operated on three frequencies in the marine band of 2000 to 3000 kc ship-to-ship, Coast Guard, ship-to-shore. The receiver is manually tuned and covers the standard broadcast band on range No. 1. Range No. 2 covers the marine channels. A separate noiseless vibrapack power supply is supplied for 6 or 12 volt d-c operation. Other voltages can be used with a suitable converter.

The "Seagoing" model HT-12 has 50 watts output. Ten crystal controlled transmitting and receiving (ship-to-ship, Coast Guard, ship-to-shore) channels provide communication with shore stations. Power supplies for operation on 12, 32, 110 dc and 110 volts ac are available. A booklet available from Hallicrafters contains details on the foregoing radiotelephones, as well as a revised list of frequencies in use for coastal harbor radiotelephone service.

# COILS

Electrical  Windings



A COMPETENT and experienced organization devoted to the design and manufacture of coil windings. Paper interlayer sections—form wound and bobbin wound coils.

Equipped for prompt production on quantity or small orders.

### REPRESENTATIVES

W. A. JORDAN 295 Madison Ave., New York, N. Y.	PARAGON SALES CO. (C. H. Fryburg) 402 Cherry St., Philadelphia, Pa.
GILBERT GISLASON 82 St. Paul St., Rochester, N. Y.	A. J. LOEB SALES CO. 1836 Euclid Ave., Cleveland, Ohio

**MAGNETIC WINDINGS COMPANY**  
Sixteenth and Butler Streets EASTON, PENNA.

## A SMALL FUSE That Has A Time Lag

**HOW IT WORKS**  
Has 3 Main Elements (1) A Fuse Link (2) A Resistor to furnish heat inertia and (3) A Spring for tension

- ON OVERLOADS 2 SEPARATES FROM 1
- ON SHORT CIRCUITS 1 MELTS
- THE SPRING ACTION PREVENTS CRYSTALLIZATION ON REPEATED HEATING AND COOLING OF 1

## Blows But Holds Awhile

When you want a fuse with a high time lag for use where inductive and composite surges are encountered—especially for the protection of power packs, solenoids, and small motors—you have it with the SLO-BLO Littelfuse. It safely holds on surges—protects equipment and prevents needless "blows" and fuse expense. There seem to be endless applications where the SLO-BLO Littelfuse with its time lag can be used. What's your problem? Our engineers can help. Write for literature, prices and samples.

**SLO-BLO**  
LITTELFUSE

**LITTELFUSE INC.**  
4755 RAVENSWOOD AVE. CHICAGO, ILL.

## High Speed Electronic Counter

AN ELECTRONIC COUNTER, model 475, announced by Shallcross Mfg. Co., 10 Jackson Ave., Collingdale, Pa., will count at rates up to 2000 per minute. This device multiplies by five the count as indicated on a registering counter, and the registered count increases by one for every five objects counted. If the registering counter is capable of counting 400 per minute, 2000 per minute may be counted with the use of the electronic counter. An outstanding feature of model 475 is that no minimum count per minute is required. The device operates on 110-120 volt, 60 cps supply line.

## New Phono-Motor

ALLIANCE MFG. Co., Alliance, Ohio, announce Model K-800 phonomotor which is designed specifically for 25 cps operation. This new motor is adapted to the standard friction drive assembly,

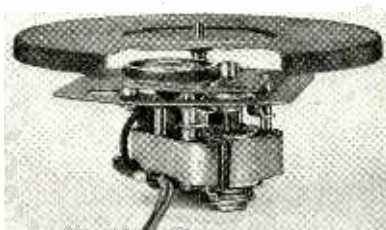

as used on Alliance's model 80, allowing interchangeability in mounting without difference in performance. Model K-800 is available for 110 or 220 volt operation, in eight- or nine-inch turntable sizes.

## Solder Pots

THREE NEW SOLDER POTS are available from Electric Soldering Iron Co., Deep River, Conn. These new products are intended for production jobs where fast dipping of parts is required. A special feature is a pilot light which indicates when the pot is heating, if the element or supply circuit fails, the light will go out. Model 12 has a capacity of  $\frac{3}{4}$  lbs and is rated at 200-watts. Model 36 is rated at 250-watts and has a capacity of 2 $\frac{1}{4}$  lbs. Model 100 has a capacity of 6 $\frac{1}{4}$  lbs and a 450-watt rating. Catalog sheet 511 is available from the manufacturer.

## Fuses

LITTELFUSE INCORPORATED are now manufacturing Underwriters approved 3-AG glass enclosed fuses in ratings up to 8 amps for 250 volt a-c or d-c service or less. The new sleeve type 3-AG fuses (four to eight amps inclusive) have a separate glass sleeve over the entire fuse element that takes the pressure shock under short circuits. The 8 amp fuse is powder packed. A bulletin which includes technical data and prices is available from Littelfuse Inc., 4757 Ravenswood Ave., Chicago.

How long is your  **DEPENDABILITY YARDSTICK?**

An engineer, you have your own yardstick for measuring dependability. RCP asks you to check these test instruments against it, believes that RCP "serviceability" and lasting peak performance tops whatever standard you have set for test equipment operation. Welcome news, too, for engineers whose test instrument requirements are many, are low RCP prices.

## RCP TUBE TESTER MODEL 310C

With ROTARY SELECTOR SWITCH

An all-quality instrument from its rotary selector switches which speed operation to the heavily silverplated contacts for low loss. Completely modern in circuit design, operation and efficiency. Has newest "Rolindex" mechanically operated roll-type tube test charts for smooth, speedy operation. Tests every type tube. Spare socket for future tube developments. Hot interelement short and leakage test. Hot cathode leakage test. Continuously variable adjustment for operation at any line voltage from 105 to 135 volts. Line voltage directly indicated on D'Arsonval meter—far more accurate and reliable. Sloping front panel, 11 $\frac{1}{2}$ "x13 $\frac{1}{2}$ "x7 $\frac{1}{2}$ ", with 3" meter. **\$21.95.**  
Net.....



## RCP POCKET MULTITESTER MODEL 413

A pocket-size multimeter with all the features and the quality of large, expensive testers, and none of the expense! Sensitivity of 2500 ohms per volt. A five-range voltmeter 0/10/50/250/1000/5000 AC and DC. Three range ohmmeter 0/500/100,000/1,000,000. DC Microamps 0/400. DC Milliamps 0/10/100/1000. DC amps 0/10. Output meter same as AC volts. **\$12.90.**  
Net.....



CATALOG describing in detail these and other instruments in RCP's complete line of dependable test equipment free on request. Write today.

**RADIO CITY PRODUCTS CO., INC.**  
88 PARK PLACE • NEW YORK, N. Y.

**RCP**  
dependable  
TEST  
instruments

## GREENOHMS for that extra OVERLOAD FACTOR

200-watt adjustable Greenohm. Note clean-cut construction and mounting brackets.



Wire-wound. Unique cold-setting inorganic cement coating.

Wire unimpaired in production. No corrosion. No weakening.

Maximum heat conduction and radiation.

10, 25, 50, 80, 100 and 200 watt ratings. Fixed and adjustable.

★ You can readily spot those Greenohm power resistors in better-grade amplifiers, transmitters, oscillographs and other assemblies that must stand up. ★ Try them. Compare them with others. Then draw your own conclusions. ★ Data on request. Also samples, quotations.

## CLAROSTAT

MANUFACTURING CO.  
Incorporated  
285 North Sixth St.  
Brooklyn, N. Y.

## HERE'S HELP

for technical and  
business men

NEW 1940  
Catalogue of  
McGraw-Hill Books



### OVER 1500 BOOKS DESCRIBED

Here is a guide to practical, expert information on many business and technical subjects. It contains clear, concise descriptions of more than 1500 authoritative, informative books written by leaders of business, industry and research. Get your copy now. In it you will find the up-to-date books that will give you the facts—experience—data—you need in solving your particular problems.

McGraw-Hill Books bring you the experience of experts in your field

Mail This Coupon for Your Free Copy

McGraw-Hill Book Co., Inc., 330 W. 42 St., N. Y.  
Please send me a free copy of the New 1940 Catalogue of McGraw-Hill Books. I want to know more about: (Name subjects of most interest to you.)

.....

Name .....

Address .....

City ..... State ..... FL-11-40

## FM vs AM for Aircraft

(Continued from page 35)

not have been noticed if a lower per cent tone modulation had been used. Voice will not maintain a 100 per cent modulation; therefore, this effect will not be noticed to any appreciable degree for voice communication.

### Operation of Two Stations Within Line of Sight

The 150-watt Albany transmitter was fully frequency-modulated with 700-cps tone and the 20-watt Schenectady transmitter W2XDA was fully modulated with a 400-cps tone. All tests were conducted with 41 Mc carriers and at 2,000 and 3,000 feet elevation between the two cities.

Flying from Albany to Schenectady, it was first observed that when approximately five miles from the Schenectady station there was a one-mile area where the Schenectady and Albany signals were nearly equal and both could be heard. Beyond this, the plane entered an area of several sharp transitions due to antenna lobes as shown in Fig. 3. Schenectady could be heard approximately the next three miles. When flying directly over the Schenectady antenna, there was a "cone of silence" about one-half mile in diameter. This "cone of silence" was, of course, in the center of the Schenectady service area. In this cone the Albany signal took control and was received very well. When leaving this "cone," going west, the same fields were observed as entering the "cone of silence". The flight was continued west and the Albany signal was again heard about six miles from Schenectady but did not take complete control until the plane was 14 miles west of Schenectady. This slow transition is explainable on the basis that both signals were decreasing with distance and the weaker station was nearer the receiver. Hence, neither signal was twice the other, so as to take complete control, for a considerable distance. When flying over the Schenectady antenna, several high-angle lobes were observed, between which Albany took control for very brief intervals.



PERMO METAL is a SMOOTH FRICTIONLESS, WEAR RESISTING, NON-CORROSIVE alloy of precious metals (Osmium, Rhodium, Ruthenium.)

Instrument bearings, long life fountain pen tips, phonograph needles and contacts . . . are just a few of countless uses of these remarkable alloys.

A greatly enlarged Metallurgy Division makes these alloys available to industry on an increased scale. An additional service of preliminary assembly of material to holder or shank is also available.

Write for detailed data.

PERMO PRODUCTS CORP.  
Manufacturing Metallurgists  
6427 RAVENSWOOD AVE. CHICAGO, ILLINOIS

## JONES 500 SERIES PLUGS and SOCKETS

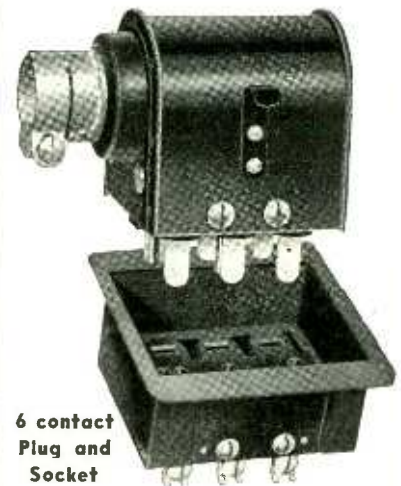

6 contact  
Plug and  
Socket

5000 volts and 25 amperes. Fulfills every electrical and mechanical requirement. Polarized to prevent incorrect connections. Easy to wire. Sizes: 2, 4, 6, 8, 10 and 12 contacts. Thousands of uses. Write for Bulletin 500 today.

HOWARD B. JONES  
2300 WABANSIA AVENUE,  
CHICAGO ILLINOIS



**JACKSON**  
presents a  
**BASICALLY NEW  
AUDIO OSCILLATOR**



Model 652

Here's all you could ask for in an Audio Frequency Oscillator. For example: it is NOT a "beat frequency" oscillator and contains no RF circuits . . . A. F. Voltage is developed at its fundamental frequency . . . Full range from 20 to 20,000 cycles . . . 3 bands provide instant and exact settings . . . Requires no zero adjustment . . . Five output impedance steps . . . 500 M. W. power output . . . Excellent waveform . . . etc. Price, \$64.50.

Write now for descriptive literature

**THE JACKSON ELECTRICAL  
INSTRUMENT COMPANY**

123 Wayne Ave. Dayton, Ohio

**Sylvaloy  
FILAMENT**

*Dependability  
Uniformity*

**"Sylvaloy"**  
made only by  
**WILBUR B. DRIVER CO.**  
NEWARK, NEW JERSEY

**Defense Set-up for  
Communications**

(Continued from page 17)

effective technical developments. For the most part the army must depend on industrial research organizations, but there are a great many other technical facilities, in schools and colleges, and in the general public, which cannot safely be ignored. To aid in organizing research, design, and engineering developments behind the defense effort, the President appointed the National Defense Research Committee, a part of the Knudsen-Stettinius Defense Commission set-up, to act as compiler and coordinator of all the research facilities in the country, in industry as well as in the academic sphere. The National Defense Research Committee is headed by Dr. Vannevar Bush, President of the Carnegie Institution, and it includes such men as Presidents Conant of Harvard, Compton of M. I. T., Colman of Cal. Tech., F. B. Jewett, of the American Telephone and Telegraph Company, C. P. Coe of the Patent Office, Brig. Gen. Strong of the War Department, and Rear Admiral Bowen of the Navy. The research and development plans of the Army and Navy have been turned over to this committee for coordination with the laboratories best fitted to handle the jobs. Subcommittees have been appointed in each major division of the research field, including communications. When a bottle neck develops in any Army or Navy project, the Research Committee can call in the most competent men and technical facilities to cope with the problem, regardless of other considerations. The organization can thus cut through yards of red tape and get action quickly on vital developmental work.

Another focal point in the question of organizing technical developments for defense is the U. S. Patent Office. The 70,000 patent applications received each year describe many inventions which have military value. This summer Congress authorized the Commissioner of Patents to withhold the issuance of patents on inventions considered to be of significance in national defense, and to issue a secrecy order

**CATHODE-RAY  
EQUIPMENT**

**Choice...**

★ Here are three popular DuMont Cathode-Ray Oscillographs. They meet the requirements and pocketbooks of three broad classes of users. That means an adequate choice in choosing the instrument best suited to your needs.



Type 164. Primarily compact, portable, inexpensive. Favorite with laboratory workers, in production work, with servicemen. 3-inch cathode-ray tube; good brilliance; sharp trace. Single-stage vertical amplifier has 70-times voltage gain in the 15-30,000 cycle frequency range. Horizontal amplifier amplifies either sweep circuit or externally provided signal. Deflection plate terminals at rear. With medium-persistence green or short-persistence blue screen for photography. Dimensions: 11-3/8" h.; 7-1/8" w.; 13" d. 25 lbs. shipping weight.

Type 168. Moderately-priced 5-inch oscillograph. Larger screen makes it ideal for more critical studies and lecture-demonstration work. Vertical amplifier gain of 450 times. Type 168-M microphone can be used directly, without preamplifier. Input signal can be connected directly to vertical deflecting plates, or through one- or two-stage amplifier. Internal or external positive synchronization by front-panel switch. Green or blue screen. Dimensions: 19-1/2" h.; 8" w.; 15 1/4" d. 40 lbs. shipping weight.



Type 208. Incorporates many desirable features and refinements, for more advanced users. New intensifier-type tube for extreme brilliance. Green or blue screen. Wide frequency range amplifiers. Symmetric deflection. Good focus over entire screen area. Extreme sensitivity and widest frequency range. Recurrent sweep available over continuously-variable range from 2 to 50,000 cycles. Extreme ease of operation. Beam follows immediately all changes in position control adjustment. Regulated power supplies minimize line-voltage surges. Dimensions: 14-1/4" h.; 8-13/16" w.; 19-1/4" d. 67 lbs. shipping weight.

**Write for DATA...**

New Catalog B covers these and other DuMont Cathode-Ray Oscillographs, the Electronic Switch, Cathode-Ray Tubes and allied equipment. Copy sent on request written on your business letterhead. And if your problems are unusual, submit them for engineering advice.

**DU MONT**

**ALLEN B. DU MONT  
LABORATORIES, Inc.**

Passaic ★ New Jersey

Cable Address: Wespeclin, New York

# Prepare to pass RADIO OPERATOR LICENSE EXAMINATIONS *this direct easy way*

Bring all your radio training, experience, and study before you in quick, direct review—make sure you know key points of all theory and practice as covered in Government examinations. Nearly 1300 questions, with full, correct answers, given in this book, make you confidently familiar with the essentials of all commercial license tests.



**Just Out**  
New 7th Edition

## RADIO OPERATING QUESTIONS and ANSWERS

By Arthur R. Nilson  
*Chief Instructor, Nilson Radio School; Lieut. (Technician) (Communications) U.S.N.R. (Retired)*  
and J. L. Hornung  
*Formerly Radio Instructor, New York University*

400 pages, 5 x 7½, illustrated, \$2.50

This is a technical review book on radio communication for prospective and experienced radio operators of all classes, condensing in question and answer form all the information covered in the new type of Government radio operator license examinations. It provides an answer to each question appearing in the FCC Publication, *Study Guide and Reference Material for Commercial Radio Operator License Examinations*, and is arranged according to the six elements upon which examinations for all grades of licenses are now based:

1. Questions on Basic Law
2. Basic Theory and Practice
3. Radiotelephony
4. Advanced Radiotelephony
5. Radiotelegraphy
6. Advanced Radiotelegraphy

Appendix of operating abbreviations, rules governing commercial operators, and radio laws

For twenty years thousands of men have used previous editions of this book with success. Now more than ever this seventh edition helps you get a quick command of all the information needed to pass tests.

Mail this coupon for  
**10 DAYS' FREE EXAMINATION**

McGraw-Hill Book Co., Inc., 330 W. 42nd St., N. Y.

Send me Nilson and Hornung's Radio Operating Questions and Answers for 10 days' examination on approval. In 10 days I will send \$2.50 plus few cents postage, or return book postpaid. (Postage paid on orders accompanied by remittance.)

Name .....

Address .....

City and State .....

Position .....

Company ..... L-11-40  
(Books sent on approval in U. S. and Canada only.)

to the inventor. If the inventor turns over the invention to the government for use, he is entitled to compensation, in addition to patriotic satisfaction in aiding where the need is greatest. To carry out this great responsibility of sifting patent applications, Commissioner Coe of the Patent Office has appointed a Patent Defense Committee, consisting of senior examining officers and others who have special knowledge in various fields. These men, working in close cooperation with the research and development sections of the Army and Navy, must decide whether a proposed invention falls within the defense category, either because it is useful to the armed forces, or because it might be useful to some other nation if divulged.

Finally, another highly important agency in the utilization of technical ideas is the National Inventors Council, set up within recent weeks to bring ideas and inventions from the civilian population to the attention of the military authorities with the least possible confusion and delay. The Council is headed by Charles F. Kettering of the General Motors Company, and includes C. P. Coe, Commissioner of Patents, Dr. W. D. Coolidge of General Electric, and others prominent in the electrical, chemical, and mechanical fields.

The Council is now building up a staff of experts who will sift and evaluate the thousands of suggestions and inventions which are received from the general public relating to national defense. When its work has been widely publicized, it is conceivable that it may be required to go over 100,000 schemes in the course of a year, only a small percentage of which will have any exceptional value. However, if only a dozen suggestions prove fruitful, it will be deemed worth the effort. Essentially the Council acts as a clearing house for suggestions or inventions which are submitted by civilians, provided that these suggestions relate clearly to the national defense. It brings the suggestions it deems useful to the attention of the proper authorities, not only in the Army and Navy but in the Defense Research Committee, so that the suggestion may be reduced to practice by the best qualified men and facilities.

The Inventors Council will also

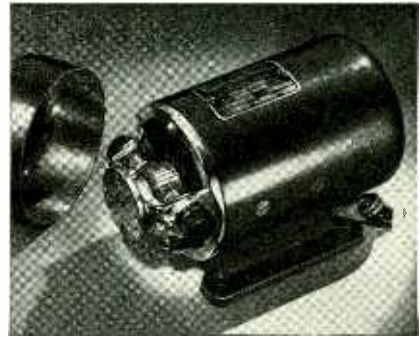

## EICOR DYNAMOTORS *Engineered for the Job!*

Whatever size—whatever use—there's an Eicor Dynamotor to meet your requirements best! Eicor Dynamotors are widely used in aircraft, police, marine mobile transmitters and receivers! Assures smooth, continuous, trouble-free service and long operating life. Necessity for filtering reduced to minimum—AC ripple practically eliminated! Lightest in weight per watt output!



Write for Complete Data Today.

### EICOR INC.

517 S. Laflin St., Chicago, U. S. A.  
Export: AD AURIEMA, Inc., 166 Broad Street,  
New York. Cable: Auriema, New York, U.S.A.



## Pictures and Text by RADIO or WIRE...

WITH the new Finch Facsimile Duplex instrument, you can receive or transmit illustrated messages the size of a telegram blank at the rate of 8 sq. in. per minute. Write for Booklet EL-10.

Finch Telecommunications, Inc.  
PASSAIC, N. J. - Also New York, N. Y.  
and Washington, D. C.



# SAPPHIRE for RECORDING PLAYBACK

Recording engineers know from experience that this jewel makes the world's finest cutting stylus—the world's finest playback needle. WALCO SAPPHIRE NEEDLES are standard with engineers who demand infallible recording—and—high-frequency, non-record-wearing playback.

- WALCO SAPPHIRE PLAYBACK and Cutting Needles are ground to the required dimensions within tolerances of plus or minus 1/10,000 inch.

- WALCO SAPPHIRE CUTTING STYLI can be resharpened 20 times, by us, on a 48 hour exchange basis.

### Special Introductory Offer

Write for details of our "Two for the price of one" offer, and special bulletin on Walco Sapphire Needles.

**ELECTROVOX COMPANY**  
424 Madison Ave. New York, N. Y.

## PROFESSIONAL SERVICES

(Rates on Application)

### ELECTRICAL TESTING LABORATORIES

Characteristics of Vacuum Tubes  
Tests of photo cells, glow lamps, crater lamps,  
Tests of electronics and optical devices  
East End Avenue and 79th Street  
New York, N. Y.  
Phone: Butterfield 8-2600

### HAROLD J. McCREARY

Mem. A.I.E.E. & W.S.E.  
**Consulting Engineer**

Laboratory Facilities  
Research Development Design  
Factory Practice Patent Studies  
Electronics Television Radio  
Railroad Signaling  
Telephone  
105 W. Adams St. Phone STate 4003 Chicago, Ill.

### JOSEPH RAZEK, PH.D.

*Consulting Physicist*

Electrical and Mechanical Engineering Problems  
Instruments and Control Devices  
Specialist in Colorimetry, Spectrophotometry and Industrial Color Control  
Laboratory and Shop Facilities  
430 Greenview Lane Llanerch, Pa.

### F. H. SHEPARD, JR.

CONSULTING ENGINEER  
ELECTRONIC APPLICATIONS

Specializing In:  
Industrial Control Follow-Up Devices  
Special Amplifier Design  
Photoelectric Applications  
Radio and Carrier Operated Remote Control  
6167 Cedar Ave., Merchantville, N. J.  
Telephone Merchantville 1111

work in reverse direction, taking the unsolved problems of the Army and Navy and bringing them to the attention of men known to be qualified in particular lines. In this aspect of its work, the Council will act in close collaboration with the National Defense Research Committee.

### How Readers of ELECTRONICS May Participate

Since communication is a vital arm of the national defense, the readers of ELECTRONICS are in a particularly good position to render service to the government, by contributing practical ideas and suggestions. The best way of bringing such suggestions to the proper authorities is to submit them in writing to the National Inventors Council, Room 7422, Department of Commerce Building, Washington, D.C. An information bulletin is available without charge from the Council and should be consulted before sending in the suggestions. Each suggestion should be made a separate document, preferably typewritten, all sheets fastened together and accompanied by suitable drawings. Models should not be submitted until asked for. Duplicates of all material submitted should be retained by the sender. Submission of a suggestion to the N.I.C. does not secure protection of the idea under the patent laws. If such protection is desired by the inventor, he should submit also a patent application in the usual form, to the U. S. Patent Office. It should be remarked that the Council is of particular value to inventors who have no connection with an established industrial concern in the field covered by the invention. Much lost time in attempts to obtain interviews in the War and Navy Departments can be saved by using the machinery already set up in the Council.

### Who's Who in Army and Navy Communications

When all's said and done, the roots of the defense tree are the Army and Navy, the men for whom the other agencies are working. The biggest job right now is procurement of needed equipment and materials, and the men charged with this duty are working overtime getting the orders out. The following roster of men in the Army contains

*For assured  
stability in your  
Transmitter*

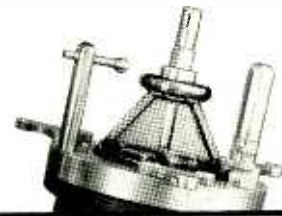

## TYPE 174 COMPRESSED GAS CONDENSER

...because it has a proven record of reliability in transmitters everywhere beginning with the first installation at station KDKA over 10 years ago. Write for data.

**HEINTZ AND KAUFMAN**  
SOUTH SAN FRANCISCO, CALIFORNIA U.S.A.

## Automatic TIME DELAY CONTROL

- ★ Synchronous Motor Driven
- ★ Fully Automatic, including instantaneous Automatic Reset
- ★ Fully Adjustable from 1 sec. to 55 minutes SPLIT-SECOND ACCURACY
- ★ Units furnished for flush or panel mounting

**SERIES TD-60**  
in durable metal case 5 1/2" x 2 1/2" Contact rating 1500 watts non-inductive  
**\$20.00**



This is but ONE of THREE important BASIC principles applied to TIME CONTROL by Industrial Timer Corp

1. TIMING cycle Control
2. TIME DELAY Control (TD 60, above)
3. NEW DUPLEX Time Control

Model TD 60 (above) now used in Magneto production control, Welding Radio Transmitters etc.

**Industrial Timer**  
CORPORATION

103 Edison Place NEWARK, N.J.

# SEARCHLIGHT SECTION

EMPLOYMENT • BUSINESS • OPPORTUNITIES • EQUIPMENT—USED or RESALE

**UNDISPLAYED RATE:**

10 cents a word, minimum charge \$2.00.  
(See ¶ on Box Numbers)

Positions Wanted (full or part-time salaried employment only), one-half the above rates.

Proposals, 50 cents a line an insertion.

NEW ADVERTISEMENTS received by 10 A.M. November 27th will appear in the December issue, subject to limitations of space available.

**INFORMATION:**

Box Numbers in care of our New York, Chicago or San Francisco offices count 10 words additional in undisplayed ads.

Discount of 10% if full payment is made in advance for four consecutive insertions of undisplayed ads (not including proposals).

**DISPLAYED—RATE PER INCH:**

The advertising rate is \$6.00 per inch for all advertising appearing on other than a contract basis. Contract rates quoted on request.

An Advertising inch is measured 7/8 inch vertically on one column. 3 columns—30 inches—to a page. E.

**WANTED**

**RADIO & MECHANICAL ENGINEERS**

Engineers with two or more years radio design experience wanted. Apply stating education, experience and salary required.

**COLONIAL RADIO CORP.**  
254 Rano St. Buffalo, N. Y.

**POSITION VACANT**  
(See also "Selling Opportunity Offered")

**SUPERINTENDENT.** Large Assembly Department. Experienced in high speed conveyorized assembly of small metal parts particularly as applied to radio industry. Thorough knowledge of Electric performance of Radio Components desirable. Write full particulars. P-249. Electronics, 330 W. 42nd St., New York, N. Y.

**POSITIONS WANTED**  
(See also "Selling Opportunity Wanted")

**BROADCAST ENGINEER.** 23, first class radio-telephone license, 2 years certified experience; Master Control, Studio Monitoring, Production, Transmitter Operator. Specializing Special Events Broadcasting, desires immediate employment anywhere. Salary secondary to future. PW-248. Electronics, 330 W. 42nd St., New York, N. Y.

Middle West—Physicist, high frequency, electronics, electricity, physical chemistry, high frequency, diathermy, radium, Radon constructions. PW-253, Electronics, 520 N. Michigan Ave., Chicago, Ill.

**12 YEARS RESPONSIBLE POSITIONS** short wave communications, airways, development work in aircraft radio, industrial electronics, high fidelity receivers, staff editor technical publication. Experienced handling men. Age 33. Supervisory, developmental, or executive position desired. PW-251. Electronics, 330 W. 42nd St., New York, N. Y.

**FIRST CLASS** telephone with one year broadcasting station experience. Also first class telegraph. Any location if position desirable. Reliability and congeniality assured gentle employers. Age 27, married. PW-252, Electronics, 520 N. Michigan Ave., Chicago, Ill.

**SELLING OPPORTUNITIES OFFERED—WANTED**  
Selling Agencies—Sales Executives  
Salesmen—Additional Lines

**OPPORTUNITY OFFERED**

**SALES ENGINEER.** Requirements are, pleasing personality, appearance and background of Radio Receiver design experience. Previous sales experience not essential. Reply must give full particulars and include photograph. SW-250. Electronics, 330 W. 42nd St., New York, N. Y.

**HIGH GRADE USED ELECTRON TUBE MACHINERY**  
*Huge Stock of Every Type and Variety*  
**KAHLE ENGINEERING CORPORATION**  
Specialists in Equipment for the manufacture of Neon Tubes, Radio Tubes, Incandescent Lamps, Photo Cells, X-ray Tubes, etc.  
900 DeMott St., North Bergen, N. J.

**DEPENDABLE**  
Used  
**ELECTRONIC TUBE EQUIPMENT**  
Complete line of used equipment for the manufacture of Radio Tubes, Neon Tubes, Incandescent Lamps, etc. Write for Bulletin showing 25 to 75% savings.  
**CALLITE TUNGSTEN CORPORATION**  
formerly Eisler Electric Corp.  
534 39th Street, Union City, N. J.

**OPPORTUNITY WANTED**

For best informed sales representative in Government contract work write Riddell, 300 B-st., S.E., Washington, D.C.

**LEGAL NOTICE**

**STATEMENT OF THE OWNERSHIP, MANAGEMENT, CIRCULATION, ETC., REQUIRED BY THE ACTS OF CONGRESS OF AUGUST 24, 1912, AND MARCH 3, 1933**

Of Electronics, published monthly at Albany, N. Y., for October 1, 1940.

State of New York ) ss.  
County of New York )

Before me, a Notary Public in and for the State and county aforesaid, personally appeared D. C. McGraw, who, having been duly sworn according to law, deposes and says that he is the Secretary of the McGraw-Hill Publishing Company, Inc., publishers of Electronics, and that the following is, to the best of his knowledge and belief, a true statement of the ownership, management (and if a daily paper, the circulation), etc., of the aforesaid publication for the date shown in the above caption, required by the Act of August 24, 1912, as amended by the Act of March 3, 1933, embodied in section 537, Postal Laws and Regulations, printed on the reverse of this form, to wit:

**LEGAL NOTICE**

1. That the names and addresses of the publisher, editor, managing editor, and business managers are: Publisher, McGraw-Hill Publishing Company, Inc., 330 West 42nd St., N. Y. C. Editor, Keith Henney, 330 West 42nd St., N. Y. C. Managing Editor, Donald G. Fink, 330 West 42nd St., N. Y. C. Business Manager, H. W. Mateer, 330 West 42nd St., N. Y. C.

2. That the owner is: (If owned by a corporation, its name and address must be stated and also immediately thereunder the names and addresses of stockholders owning or holding one per cent or more of total amount of stock. If not owned by a corporation, the names and addresses of the individual owners must be given. If owned by a firm, company, or other unincorporated concern, its name and address, as well as those of each individual member, must be given.) McGraw-Hill Publishing Company, Inc., 330 West 42nd St., N. Y. C. Stockholders of which are: James H. McGraw, 330 West 42nd St., N. Y. C. James H. McGraw, Jr., 330 West 42nd St., N. Y. C. James H. McGraw, James H. McGraw, Jr., and Curtis W. McGraw, Trustees for: Harold W. McGraw, James H. McGraw, Jr., Donald C. McGraw, Curtis W. McGraw, Curtis W. McGraw, 330 West 42nd St., N. Y. C. Donald C. McGraw, 330 West 42nd St., N. Y. C. Anne Huxar Britton, 330 West 42nd St., N. Y. C. Mildred W. McGraw, Madison, N. J. Grace W. Mehren, 73 No. Country Club Drive, Phoenix, Ariz. J. Malcolm Muir & Guaranty Trust Co. of New York, Trustees for Lida Kelly Muir, 140 Broadway N. Y. C.

3. That the known bondholders, mortgagees, and other security holders owning or holding 1 per cent or more of total amount of bonds, mortgages, or other securities are: (If there are none, so state.) None.

4. That the two paragraphs next above, giving the names of the owners, stockholders, and security holders, if any, contain not only the list of stockholders and security holders as they appear upon the books of the company but also, in cases where the stockholder or security holder appears upon the books of the company as trustee or in any other fiduciary relation, the name of the person or corporation for whom such trustee is acting, is given; also that the said two paragraphs contain statements embracing affiant's full knowledge and belief as to the circumstances and conditions under which stockholders and security holders who do not appear upon the books of the company as trustees, hold stock and securities in a capacity other than that of a bona fide owner; and this affiant has no reason to believe that any other person, association, or corporation has any interest direct or indirect in the said stock, bonds, or other securities than as so stated by him.

5. That the average number of copies of each issue of this publication sold or distributed, through the mails or otherwise, to paid subscribers during the twelve months preceding the date shown above is. (This information is required from daily publications only.)

D. C. McGRAW, Secretary.  
McGraw-Hill Publishing Company, Inc.  
Sworn to and subscribed before me this 27th day of September, 1940.

[SEAL] H. E. BEIRNE,  
Notary Public, Nassau County, Clk's No. 93, N. Y. Clk's No. 974, Reg. No. 2-B-609.  
(My commission expires March 30, 1942)

**YOUR ORGANIZATION**  
*Is it complete?*  
**Are you expanding it?**  
**Making Replacements?**

Naturally, you are anxious to secure the most suitable man or men available. You want men with the special training that will make them an asset to your organization. You can contact such men through a Position Vacant advertisement in the Searchlight Section of ELECTRONICS.

**Departmental Staff—ELECTRONICS**  
330 W. 42nd St., New York

# CONTACTS

FOR THE FIELD OF ELECTRONICS



**SIGNICO**  
**SIGNAL & INDICATOR PILOT LIGHTS**  
 for all electrical devices.

WRITE FOR CATALOGUE showing a complete line of assemblies for all purposes.

**SIGNAL INDICATOR Corp.**  
 140 CEDAR ST. NEW YORK, N. Y.

QUALITY ABOVE ALL

**SOLAR CAPACITORS**

Write for Catalog  
**SOLAR MFG. CORP.**  
 BAYONNE, N. J.

## RELAYS

AND CONTROL ACCESSORIES

- POWER
- LATCHING
- TELEPHONE
- TIME DELAY
- PLATE CIRCUIT
- PHOTO CELLS
- CAPACITY RELAYS
- COUNTERS

• IN STOCK

TECHNICAL ASSISTANCE AND LAB. FACILITIES AT YOUR DISPOSAL . . .

**DOUGLAS RADIO**  
 89 Cortlandt St. New York, N. Y.  
 BA. 7-3956

TOM WAITE ROS. AMMON

### REX FOUR-RANGE RHEOSTATS

The latest REX development



Each Rheostat incorporates 4 different resistance and corresponding current values.

Available in 350 & 650 Watt Ratings.  
 Write for Bulletin 'S'

**REX RHEOSTAT CO.** 39 W. 20th St., New York, N. Y.

We manufacture a complete line of equipment

SPOT WELDERS, electric, from ¼ to 500 KVA	AC ARC WELDERS
TRANSFORMERS, special and standard types	From 100 to 400 Amps.
INCANDESCENT LAMP manufacturing equipment	
RADIO TUBES, ex-ray cathode ray, photo cells	
ELECTRONIC EQUIPMENT, vacuum pumps, etc.	
WET GLASS slicing and cutting machines for laboratory use	
GENERAL GLASS working machines and burners	
COLLEGE GLASS working units for students and laboratory	
<b>EISLER ENGINEERING COMPANY, CHAS. EISLER, Pres.</b>	
751 So. 13th St. (near Avon Ave.)	Newark, New Jersey

**ACTONE CUTTING STYLI**



For recording direct on all coated aluminum or paper base discs. Individually lapped for a quiet, high quality cut.

**H. W. ACTON CO., Inc., 370 7th Ave., New York**

**CONSOLIDATED ENGINEERING CORPORATION**  
 ELECTRONIC ★ OPTICAL ★ VIBRATION ENGINEERING AND RESEARCH  
 INSTRUMENT DEVELOPMENT AND MANUFACTURE ★ PATENT STUDIES  
 1255 EAST GREEN STREET - PASADENA, CALIFORNIA

**TRANSMITTING TUBE PARTS**  
 "The Engineering Co." of Newark, N. J., Inc.  
 SPECIALISTS IN TUNGSTEN AND MOLYBDENUM WELDS—LEAD-IN WIRES MATERIAL AND WORKMANSHIP GUARANTEED—WE USE THE BEST ALWAYS.  
 59 Branford Street Newark, N. J. D. Kondakjian, Pres. Est. 18 Years

## "What Can It Do For Me?"

Advertising that is read with this thought in mind, may provide the solution to a problem that has kept you awake nights for weeks.

Remember, back of the signature of every Electronics advertiser is another organization, whose members have thought long and hard about your business in the course of introducing and applying their products or services to your industry.

If their offerings can improve the quality of your company's product . . . or save your company's money . . . they can contribute to your company's income.

We all know, "It pays to advertise." It pays just as big to investigate what is advertised!

Each month, Electronics advertisers, old and new, invite you and over 14,000 other subscribers to investigate further the advantages they can provide.

**Departmental Staff**  
**ELECTRONICS**

**MICROMETER** for checking transmitters, from 1.5 to 56 mc., within 0.01 per cent.

**LAMPKIN LABORATORIES**  
 —Bradenton, Fla., U. S. A.—

**FINE RIBBONS**  
 of Tungsten, Molybdenum and Special Alloys  
 To your specifications  
**H. CROSS**  
 15 BEEKMAN ST. NEW YORK

**FILTERS—EQUALIZERS**  
 Lattice Bridged-T Paralleled-T etc.  
 Designed and manufactured  
 Submit your filter problem  
**HOLLYWOOD TRANSFORMER CO.**  
 7364 Melrose Ave. Hollywood, Calif.

## BEST IN ITS CLASS

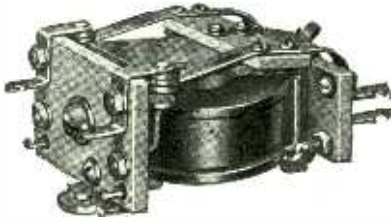

### MIDGET RF RELAY

That's why many discriminate manufacturers of transmitting equipment have adopted this Relay.

This unit has been approved as a component part of Type Certificated Aircraft Radio.

"Isolantite" insulation throughout. Contact combination Double-Pole, Double-Throw 1/4" Fine Silver Contacts.

Can be furnished with third pole. Special impregnated coils to meet Army or Navy specifications can be supplied.

Write for Bulletin MA-1

**Advance**  
ELECTRIC COMPANY  
1260 W. 2nd St., Los Angeles, Calif.  
Relay Manufacturers

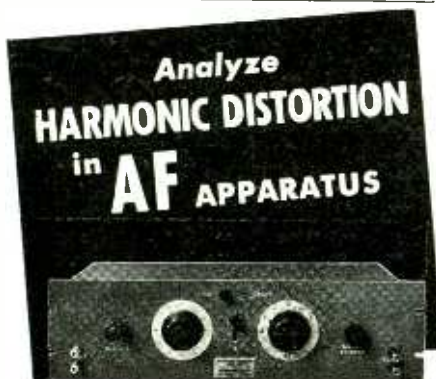

Analyze  
**HARMONIC DISTORTION**  
in **AF** APPARATUS

Simple  
Efficient  
Convenient & Economical

In a direct reading you get the amplitude of the total harmonic distortion in decibels below the fundamental. Observe the character of the distortion while making changes in the circuit... detect "peak clipping," sharp cut-off, transformer saturation and parasitics. These and many more important observations and analyses can be made quickly and accurately with this new and decidedly better distortion analyzer.

Write today for free literature. Ask for bulletin T-102. Complete specifications and technical data. Instruments available in cabinet models or for relay rack mounting.

Get full information without obligation. Put this instrument to work to save you time and money in development and production.

**HEWLETT-PACKARD CO.**  
Laboratory Instruments  
481 Page Mill Road • Palo Alto, California

## Contracts Awarded

### SIGNAL CORPS — WAR DEPARTMENT

Date	Concerns	Item	Amount
Announced	Receiving Awards		
Oct. 25	General Electric Co.	Radio Equipment	\$8,303,296.50
Oct. 10	RCA Mfg. Co., Camden	Radio Receivers	\$7,605,773.06
	Philco Corporation	Radio Receivers	671,000.00
Oct. 7	American Automatic Elec. Sales Co., Chicago	Telephone Equipment	\$54,804.72
	Ballantine Laboratories	Microphones	\$290,680.00
	Radio Receptor Co.,	Radio Set Equipment	\$70,215.75
	Bendix Radio Corp.,	Radio Set Components	\$246,641.75
Oct. 5	Bendix Radio Corp	Radio Equipment	\$3,565,802.95
	Lear Avia, Inc.	Radio Equipment	\$691,500.00
	Western Electric Co.,	Components for Radio Sets	\$3,585,954.70
Sept. 28	The Rauland Corp.,	Radio Rec. and Transmitting Equipment	\$372,596.00
Sept. 21	Conn. Tel. and Elec., Western Elec. Co.	Telephones	\$540,499.96
	American Automatic Elec. Sales	Telephones	\$445,500.00
	Stromberg-Carlson Tel. Mfg. Co.	Telephones	\$459,140.00
Sept. 13	The Rauland Corp.,	Radio Transmitting Equipment	\$412,500.00
	Federal Telegraph Company, Newark, N.J.	Radio Transmitting Equipment	\$454,415.00
Sept. 10	Allen D. Cardwell Mfg. Corp., Brooklyn	Telegraph Sets	\$543,753.50
Sept. 10	Allen D. Cardwell Mfg. Corp.	Components for Frequency Meter Sets and associated equipment	\$90,019.00
Sept. 6	General Electric Co.	Radio Transmitting Equipment	\$247,970.50
Aug. 20	Federal Telegraph Co.	Radio Transmitting Equipment	\$5,297,775.00
	General Electric Co.	Radio Components	\$121,161.13
Aug. 3	Stromberg Carlson	Field Telephones	\$452,222.50
	Graybar Electric	Field Telephones	\$148,000.00
	Circle Wire and Cable	Wire	\$162,000.00
	Phelps Dodge Copper	Wire	\$254,966.00
	Graybar Elec. Co.,	Wire	\$183,413.31
Aug. 1	The Daven Co.	Wire	\$382,800.00
		Components for remote control equipment	\$19,970.00
	Holtzer Cabot Elec. Co.	Telephones and Parts	\$537,750.00
	Stromberg Carlson	Switchboards and Parts	\$399,966.20
July 30	Graybar Elec. Co.	Radio Sets and Related Equipment	\$2,004,930.15

### NAVY DEPARTMENT

Oct. 7	Batteryless Telephone Equipment Co. Inc.	Diving Telephones	\$34,950.00
Sept. 26	RCA Mfg. Co., Camden	Sound Motion Picture Equipment	\$34,467.40
Sept. 19	Bendix Radio Corp.	Radio Equipment	\$9,353.42
Aug. 23	J. P. Friez and Sons, Div. Bendix Aviation	Radio Sondes	\$67,893.60
Aug. 8	Batteryless Telephone Equipment Co. Inc.	Diving Telephones	\$23,300.00

the names of those principally engaged in procurement of communication equipment for tanks, planes, ships, mechanized units and the like:

*The Army*

Major General Joseph O. Mauborgne, Chief of the Signal Corps:

The Signal Corps will place all orders for communications equipment for the Army. General Mauborgne will direct the procurement drive under the defense program.

Major Gilbert L. Thompson, Signal Corps Procurement officer, 78th and First Street, Brooklyn: Major

## INDEX TO ADVERTISERS

<p><b>A</b></p> <p>Acheson Colloids Corp. . . . . 75          Acme Electric &amp; Mfg. Co. . . . . 83          Acton Co., Inc., H. W. . . . . 97          Advance Electric Co. . . . . 98          Aerovox Corp. . . . . 75          American Electro Metal Corp. . . . . 46          American Lava Corp. . . . . 71          Audak Co. . . . . 99          Automatic Electric Co. . . . . 68</p> <p><b>B</b></p> <p>Bakelite Corp. . . . . 67          Ballantine Laboratories, Inc. . . . . 80          Belden Mfg. Co. . . . . 8          Biddle Co., James G. . . . . 79          Bliley Electric Co. . . . . 70          Bradley Laboratories, Inc. . . . . 85          Bud Radio, Inc. . . . . 77</p> <p><b>C</b></p> <p>Callite Tungsten Corp. . . . . 66          Cannon Electric Development Co. . . . . 89          Carborundum Co., Global Div. . . . . 68          Carter Motor Co. . . . . 84          Centralab Div. Globe Union, Inc. . . . . 4          Cinch Manufacturing Corp. . . . . 43          Clare &amp; Co., C. P. . . . . 82          Clark Controller Co. . . . . Third Cover          Clarostat Mfg. Co. . . . . 92          Consolidated Engineering Corp. . . . . 97          Continental-Diamond Fibre Co. . . . . 60          Cornell-Dubilier Electric Corp. . . . . 47          Cross, H. . . . . 97</p> <p><b>D</b></p> <p>Daven Co. . . . . 78          Doolittle Radio, Inc. . . . . 89          Douglas Radio. . . . . 97          Drake Mfg. Co. . . . . 79          Driver Co., Wilbur B. . . . . 93          Du Mont Labs., Allen B. . . . . 93</p> <p><b>E</b></p> <p>Eicor Inc. . . . . 94          Eisler Engineering Co. . . . . 97          Eitel-McCullough, Inc. . . . . 13          Electrovox Co. . . . . 95          Engineering Co. of Newark, N. J., Inc. . . . . 97          Erie Resistor Corp. . . . . 9</p> <p><b>F</b></p> <p>Fairchild Aviation Corp. . . . . 87          Ferranti Electric, Inc. . . . . 87          Ferris Instrument Corp. . . . . 90          Finch Telecommunications, Inc. . . . . 94</p> <p><b>G</b></p> <p>Gates American Corp. . . . . 100          General Ceramics Co. . . . . 5          General Electric Co. . . . . 49, 59          General Radio Co. . . . . 11          Guardian Electric Mfg. Co. . . . . 86</p> <p><b>H</b></p> <p>Hallcrafters, Inc. . . . . 79          Hewlett-Packard Co. . . . . 98          Heintz &amp; Kaufman, Ltd. . . . . 95          Hollywood Transformer Co. . . . . 97          Hunter Pressed Steel Co. . . . . 82</p> <p><b>I</b></p> <p>Industrial Timer Corp. . . . . 95          International Resistance Co. . . . . 53          International Nickel Co. . . . . 69          International Telephone Development Co. . . . . 12          Isolantite, Inc. . . . . 65</p> <p><b>J</b></p> <p>Jackson Electrical Instrument Co. . . . . 93          Jensen Radio Mfg. Co. . . . . 10          Jones, Howard B. . . . . 92</p>	<p><b>K</b></p> <p>Kellogg Switchboard &amp; Supply Co. . . . . 90          Kenyon Transformer Co. . . . . 84          Kester Solder Co. . . . . 48          Kurman Electric Co. . . . . 85</p> <p><b>L</b></p> <p>Lampkin Laboratories. . . . . 97          Lapp Insulator Co. . . . . 7          Lenz Electric Mfg. Co. . . . . 55          Lingo &amp; Son, Inc., John E. . . . . 80          Link, Fred M. . . . . 45          Littelfuse, Inc. . . . . 91</p> <p><b>M</b></p> <p>Magnetic Windings Co. . . . . 91          Mallory &amp; Co., P. R. . . . . 14          McGraw-Hill Book Co. . . . . 94          Millen Mfg. Co., Inc., James. . . . . 84</p> <p><b>N</b></p> <p>National Carbon Co. . . . . 73</p> <p><b>O</b></p> <p>Ohmite Mfg. Co. . . . . 58          Oxford-Tartak Radio Corp. . . . . 88</p> <p><b>P</b></p> <p>Parker-Kalon Corp. . . . . 6          Permo Products Corp. . . . . 92          Pioneer Gen-E-Motor Corp. . . . . 72          Precision Apparatus Co. . . . . 76          Presto Recording Corp. . . . . 44</p> <p><b>R</b></p> <p>Radio City Products Co. . . . . 91          Radio Engineering Laboratories, Inc. . . . . 2, 3          Raytheon Mfg. Co. . . . . 78          RCA Manufacturing Co. . . . . 88, Fourth Cover          Rex Rheostat Co. . . . . 97          Richardson Co. . . . . 54</p> <p><b>S</b></p> <p>Signal Indicator Corp. . . . . 97          Simpson Electric Co. . . . . 70          Solar Mfg. Co. . . . . 97          Sound Apparatus Co. . . . . 83          Speer Carbon Co. . . . . 52          Stackpole Carbon Co. . . . . 57          Standard Pressed Steel Co. . . . . 89          Superior Tube Co. . . . . 50, 51          Synthane Corp. . . . . Insert: 8a, b</p> <p><b>T</b></p> <p>Thomas &amp; Skinner Steel Pds. Co. . . . . 90          Triplet Electrical Instrument Co. . . . . 83          Tubular Rivet &amp; Stud Co. . . . . 77</p> <p><b>U</b></p> <p>Union Carbide &amp; Carbon Corp. . . . . 67          United Transformer Corp. . . . . Second Cover</p> <p><b>W</b></p> <p>Ward Leonard Electric Co. . . . . 62          Weston Electrical Instrument Corp. . . . . 61          White Dental Mfg. Co., S. S. . . . . 56          Wiley &amp; Sons, Inc., John. . . . . 87          Wilson Co., H. A. . . . . 86</p> <p><b>Professional Services . . . . . 95</b></p> <p style="text-align: center;"><b>SEARCHLIGHT SECTION</b>  <i>(Classified Advertising)</i></p> <p><b>EMPLOYMENT . . . . . 96</b>  <b>USED EQUIPMENT FOR SALE</b>          Callite Tungsten Corp. . . . . 96          Kahle Engineering Corp. . . . . 96</p>
---	---

## "RELAYED-FLUX" Microdyne



**M**OST important wide range development since the advent of the pick-up in 1926. The "RELAYED-FLUX" principle makes possible a moving system, far beyond anything yet devised . . . a system that actually approaches the theoretical ideal of zero mass . . . a system capable of reproducing all the fine detail engraved at the original recording.

- Flat within  $\pm 1\frac{1}{2}$  db to over 10,000 cycles.
- Delivers consistently uniform response, with the sharp, clean-cut definition of the finest Moving-Inductor system.
- Vibratory Momentum near vanishing point.
- Absence of distortion.
- Free-floating stylus.
- Designed for and equipped with Jewel-Point
- Point-pressure about 18 grams.
- Immune to climatic changes.
- Complete with arm.

Write for details on this truly remarkable development. . . Also on the NEW AUDAX HIGH FIDELITY CUTTERS

*Microdyne models for every purpose.*

**AUDAK COMPANY**  
 500 Fifth Avenue New York City  
 "Creators of High Grade Electrical and Acoustical Apparatus Since 1915"

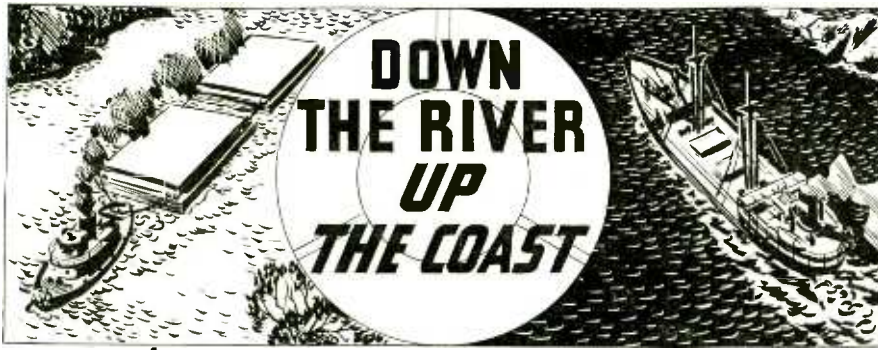

## *New!* GATES 100-watt C-40 MARINE TRANSMITTER *Adaptable for ALL TYPES of Marine Communication Service*

Moderate in price—efficient under all conditions, the new Gates C-40 Transmitter answers the demands of inland and coast-wise shipping for simple, foolproof ship-to-shore communication. This unit embodies all the new and valuable features based on Gates reputation and experience in the broadcasting field. It more than meets all requirements for those who want a first quality medium-powered voice or telegraph transmitter for multiple frequency operation.

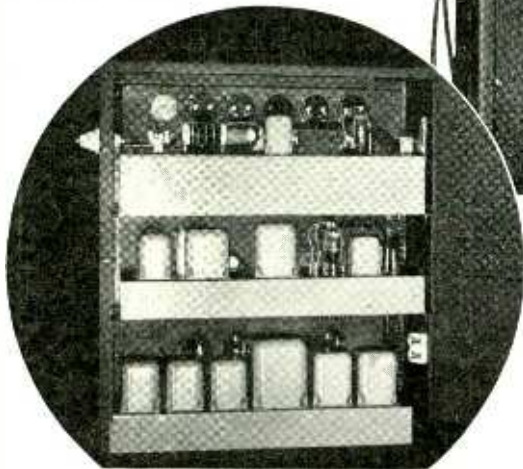

*Note the 3-deck construction of dual power supply, audio apparatus and Radio frequency equipment. Every part of the unit is easily accessible. Six of these Transmitters and one C-50 Voice operated ground station have just been installed by Erlbacher Bros., large Mississippi River fleet operators.*

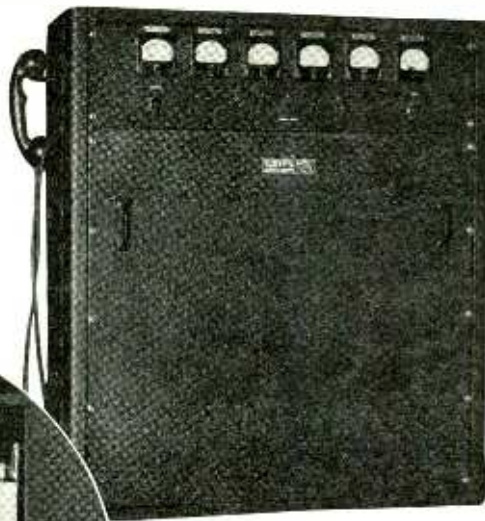

Adjustments and controls are tuned and locked, providing practically automatic service. The rapid selection of any one of five frequencies is selected by a single control. They are adjustable to lower powers where required by license stipulations, and frequency stability meets all FCC requirements. Controls are simplified to save time and increase efficiency. The cabinet is streamlined to blend with modern surroundings of yachts as well as the conservative atmosphere of commercial boats.

**WRITE TODAY**

—on your company letterhead for complete descriptive Bulletin E-40 describing the C-40 Transmitter and the companion 100-watt voice operated land station unit.



Thompson's office handles most of the orders placed by the Signal Corps. He is the personal contact man for the Corps in the vital New York and Eastern area.

Other officers of the Signal Corps and their assignments are: War Planning and Training: Major R. B. Moran, Captain F. C. Meade and Captain F. C. Lanahan, Jr. Plant and Traffic: Major Paul G. Gripper. Research and Development: Lieutenant Colonel Hugh Mitchell. Communications Liaison Division: Captain W. T. Guest. Code Section: Colonel S. B. Akin. Fiscal Division: Major J. T. Watson, Jr. Executive Officer: Colonel Clyde L. Eastman.

### *The Navy*

Rear Admiral Leigh Noyes, Director of Naval Communications in the Office of the Chief of Naval Operations: Admiral Noyes' domain is the operation of all communications in ships, submarines and naval planes after their procurement.

Captain Edward Cook Raguet, assistant Director of Naval Communications: He is next in line to Admiral Noyes in the operation of Naval communications.

Rear Admiral Samuel M. Robinson, Coordinator of Shipbuilding and Chief of the Bureau of Ships: Admiral Robinson heads up the great bulk of the Navy Communications procurement, as distinguished from communications operation which is presided over by Admiral Noyes.

Commander A. J. Spriggs, head of the radio branch of the design division of the Bureau of Ships: Commander Spriggs is charged with procurement in the Navy expansion program. He has charge of all radio equipment purchasing and procurement of under-water sound and visual signaling equipment, as well as equipment for aircraft. He supervised radio installations on the aircraft carriers Saratoga and Lexington in 1926-27. His experience has been extensive in radio research, design and installation.

Rear Admiral Stanford C. Hooper, head of the inter-departmental communications Liaison Division: Admiral Hooper, dean of Naval communication experts, has attended numerous international conferences on radio and other communications. —D.G.F.



## For Constant Line Voltage Regulation

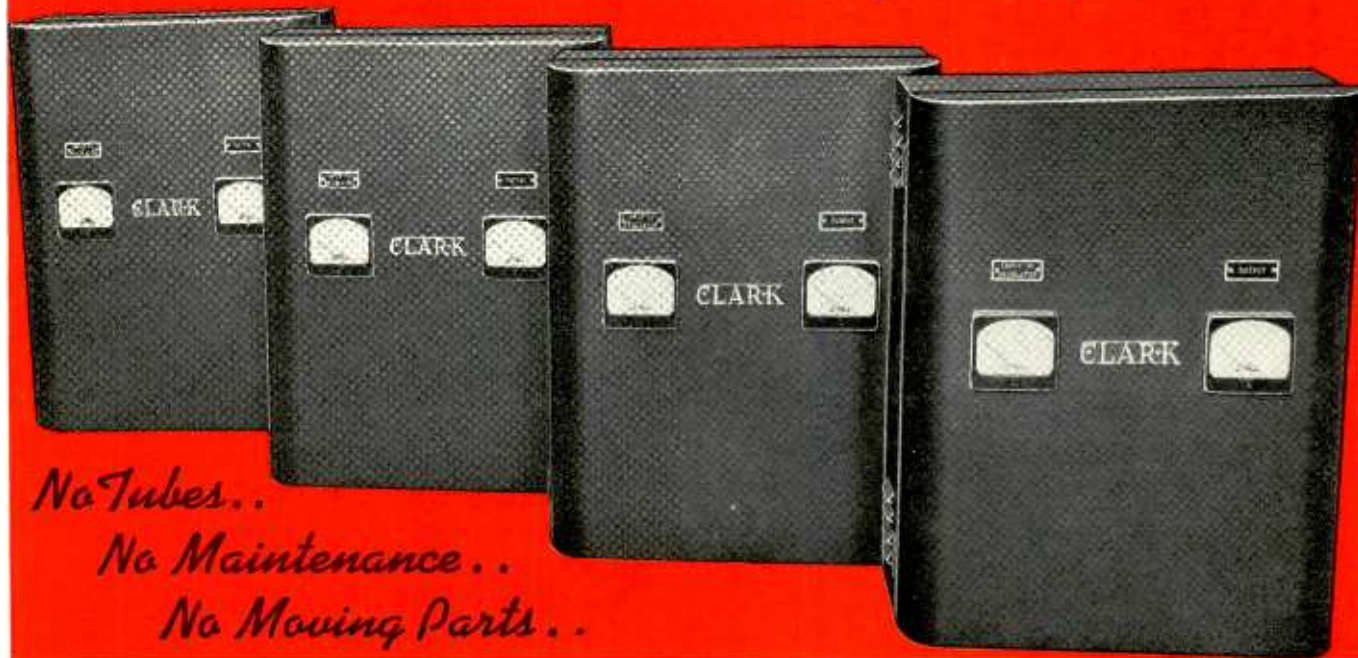

**T**HE CLARK BULLETIN 4000 Autovolt is an Automatic Line Voltage Regulator which maintains the Load Voltage within plus or minus  $\frac{1}{2}$  of 1% for load variations from zero to full capacity of the regulator. This regulation is maintained regardless of the power factor of the load.

Standard models will handle a line voltage variation of approximately 10%.

These Clark Autovolt Regulators have been in successful operation for several years in such applications as Laboratory Testing, Radio Tube Testing, Incandescent Lamp Testing, Electric Meter Calibration, X-Ray Therapy, Sound Recording Studios, and Fractional Horsepower Motor Testing.

The efficiency of these Regulators is up to 95%, depending on the size and loading of the Regulators.

They are offered in a full range of sizes up to and including 8.64 KVA, single phase, 60 cycles.

Size 1—carries 10 amperes connected load at 110 Volts

Size 2—carries 25 amperes connected load at 110 Volts

Size 3—carries 50 amperes connected load at 110 Volts

Size 4—carries 75 amperes connected load at 110 Volts

Also supplied for 220 Volts, with the same KVA ratings as above.

These Regulators introduce negligible phase shift between voltage and current, thus minimizing added reactive KVA.

Wave form shows no appreciable distortion—under very adverse conditions a total of 8% or less.

Output voltage can be adjusted continuously over 15% band under load, without opening circuit or disturbing regulation.

Your inquiries for Line Voltage Regulation will receive prompt attention.

WRITE FOR FULLY DESCRIPTIVE FOLDER

OFFICES IN PRINCIPAL CITIES



**THE CLARK CONTROLLER CO.**

1146 EAST 152<sup>ND</sup> ST.

CLEVELAND, OHIO



# 36 TYPES = 27,000,000 TUBES

## FOR 5,000,000 OF THIS YEAR'S NEW RECEIVERS!

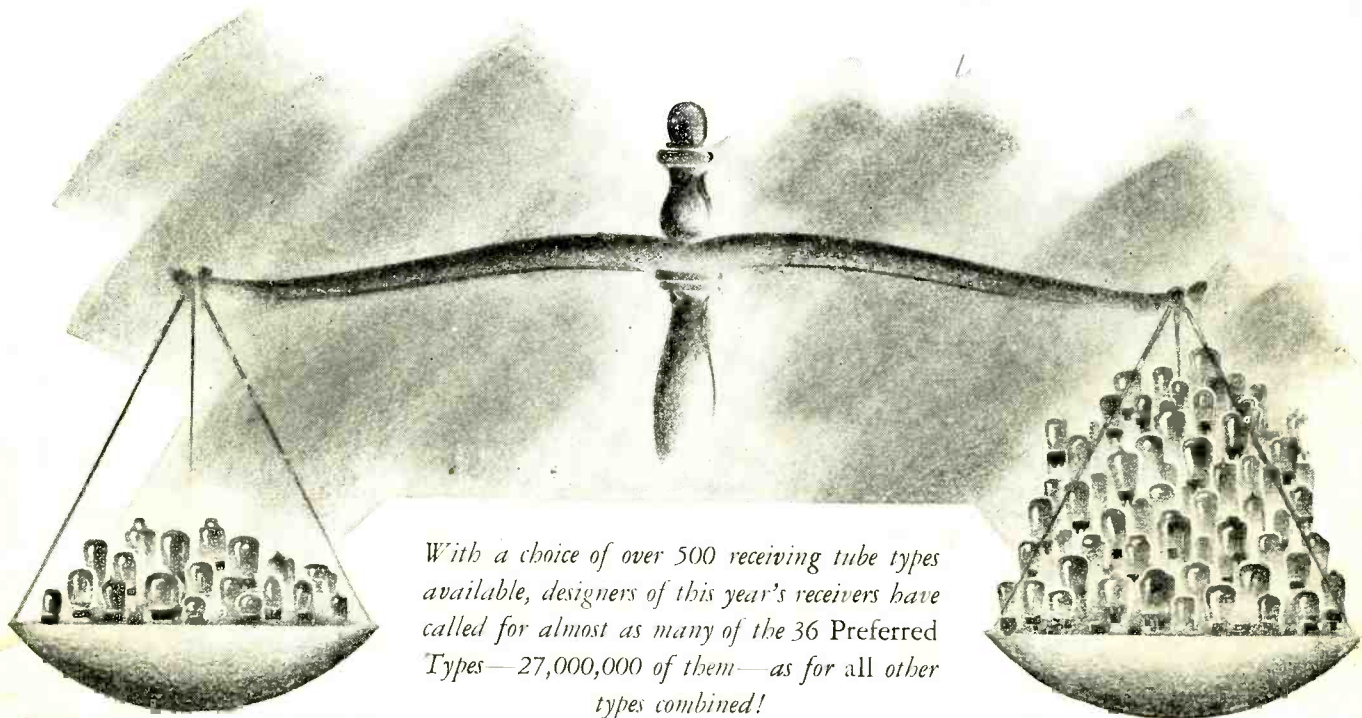

**"36 PREFERRED TYPES"**

**"490 OTHER TYPES"**

*With a choice of over 500 receiving tube types available, designers of this year's receivers have called for almost as many of the 36 Preferred Types—27,000,000 of them—as for all other types combined!*

OF ALL RCA TUBES now being supplied to set manufacturers for new radios, *better than 9 out of 10* are now Preferred Types! Of all tubes of *every* make, by *every* tube manufacturer supplying tubes for new radios, nearly half are Preferred Type numbers!

This is a good thing! Good for us. Good for *you*. It means that this year's 5,000,000 receivers using Preferred Type Tubes will simplify replacement-tube inventories for distributor, dealer and serviceman alike...will give increased turnover of fewer, faster-moving tube types—faster deliveries, from manufac-

turers' stock—and better, more uniform tubes!

18 important radio manufacturers have endorsed and adapted the RCA Preferred Type Tubes Program because they, too, have benefited. Practically any type of receiver can be designed for finest performance at lowest ultimate cost. The RCA Preferred Type Tubes Program is not only the *best* suggestion ever advanced to solve the headache of "too many tube types"...it is the *only* constructive step so far offered! It deserves your support—for your own benefit!

*Over 380 million RCA Radio Tubes have been purchased by radio users.*



# Preferred Type Tubes



RCA MANUFACTURING CO., INC., CAMDEN, N. J.  
A Service of the Radio Corporation of America