

electronics

radio, communication, industrial applications of electron tubes . . . engineering and manufacture



1930 · · APRIL · · 1940

McGRAW-HILL PUBLISHING CO., INC.

PRICE 50 CENTS

The IDEAL in a high FOR FREQUENCY MODULATION,



Products of Amperex Engineering

Power Transmitting Tube

TELEVISION and BROADCASTING

10 K.W. up to 30 megacycles in telegraphy service
70% EFFICIENCIES and better at 40 to 50 megacycles
5000 Watts per pair in Broadcast Band (*FCC approved)

Frequency Modulation and Television — so long in the offing — have finally arrived and they are accomplished facts. However, in their train have come such a multiplicity of intricate engineering problems and a complexity of design problems as to literally swamp the broadcast engineer and equipment designer.

One of the most perplexing of these is the question of tubes. High power at Ultra High Frequencies is the order of the day and the engineer and designer naturally turn to water cooled tubes. Obviously, though, the water cooled tube with its cumbersome associated equipment is not the ideal generator of Ultra High Frequencies, nor does it lend itself to simplicity and efficiency in circuit design.

With the full realization of the deficiencies of existing tubes in mind, the Amperex Engineering Staff has designed and perfected a series of high power all-glass air-cooled tubes whose efficiencies at ultra high frequencies are truly startling and which are also highly desirable substitutes for water-cooled and radiator-cooled tubes in normal broadcast transmitters.

Some of their outstanding characteristics follow:

- All Glass — Air Cooled.
- Economical in Operation.
- Simplicity in Equipment Design.
- Pure Tungsten Filament
(for reliability of operation and long life)
- High Grid to Plate Transconductance.
- Extra Low Interelectrode Capacitance.
- Low Lead Resistance.
- 5 K.W. output per pair at 40 to 50 megacycles with 70% efficiency and better.
- 10 K.W. and better in telegraphy service at all frequencies up to 30 megacycles.

PRICE each \$300.00

● **HF3000 HIGH POWER TRANSMITTING TRIODE** is characterized by a Balanced Positive Grid Plate and Grid Current characteristics for minimized natural distortion in plate modulated service. High Plate to Grid Transconductance—Low lead resistance.

Characteristics	21-22 Volts
Filament Voltage	40.5 Amps.
Filament Current	16
Amplification Constant	10,000 Volts
Maximum Ratings	1.25 Amps.
D.C. Plate Voltage	2.5 K.W.
D.C. Plate Current	
Plate Dissipation per tube	
Typical Performance Capabilities	
Plate Modulated Power Amplifier output	4000 watts
Linear R.F. Power Amplifier output	1000 watts
Unmodulated or F.M. Amplifier output	
D. C. Plate Voltage 6000 at 40 MC	4000 watts
D. C. Plate Voltage 5000 at 50 MC	3000 watts
D. C. Plate Voltage 4000 at 60 MC	2000 watts
D. C. Plate Voltage 4000 at high level	
*FCC Approval for high level or plate modulation 2500 watts	

● **AB3100. CLASS AB MODULATOR**
 An exceptionally high purveance plus a low output resistance permit the use of this tube as a class AB modulator for audio powers as high as 6 K.W. out of a pair of tubes and sufficient audio power for the plate modulation of the final stage of a 5 K.W. Broadcast Transmitter at a plate voltage as low as 5000 volts. True AB operation minimizes driving requirements and distortion.

Characteristics	15. Volts
Filament Voltage	58. Amperes
Filament Current	5. Amperes
Emission	6
Amplification Constant	10,000 Volts
Maximum Ratings	1 Ampere
Plate Voltage	2 K.W.
D.C. Plate Current	
Plate Dissipation per tube	
Typical Performance	
Class A Amplifier or Modulator	600 watts
Output	

● **ZB3200—A low distortion ZERO BIAS CLASS B MODULATOR** of relatively low driving power requirements. A high Amplification Constant plus a correspondingly high plate resistance provide extraordinary abuse tolerance for hard usage in commercial telegraphy service.

Characteristics	21-22 Volts.
Filament Voltage	40.5 Amps.
Filament Current	85
Amplification Constant	10,000 Volts
Maximum Ratings	1.25 Amperes
D.C. Plate Voltage	2.5 K.W.
D.C. Plate Current	
Plate Dissipation per tube	
Typical Performance	
Class B Zero Bias Modulator	8,000 watts
Output 2 Tubes	1,000 watts
Class B Linear R.F. Power Amplifier	
Class C Telegraphy	8000 at 30 MC
D.C. Plate Voltage	6000 at 40 MC
D.C. Plate Voltage	5000 at 50 MC
D.C. Plate Voltage	6000 watts
	4000 watts
	3000 watts

AMPEREX ELECTRONIC PRODUCTS, Inc.
 79 WASHINGTON STREET • BROOKLYN, NEW YORK
 ATLANTA • CHICAGO • SEATTLE • LOS ANGELES

OF BUILDING *dependable* RADIO COMPONENTS

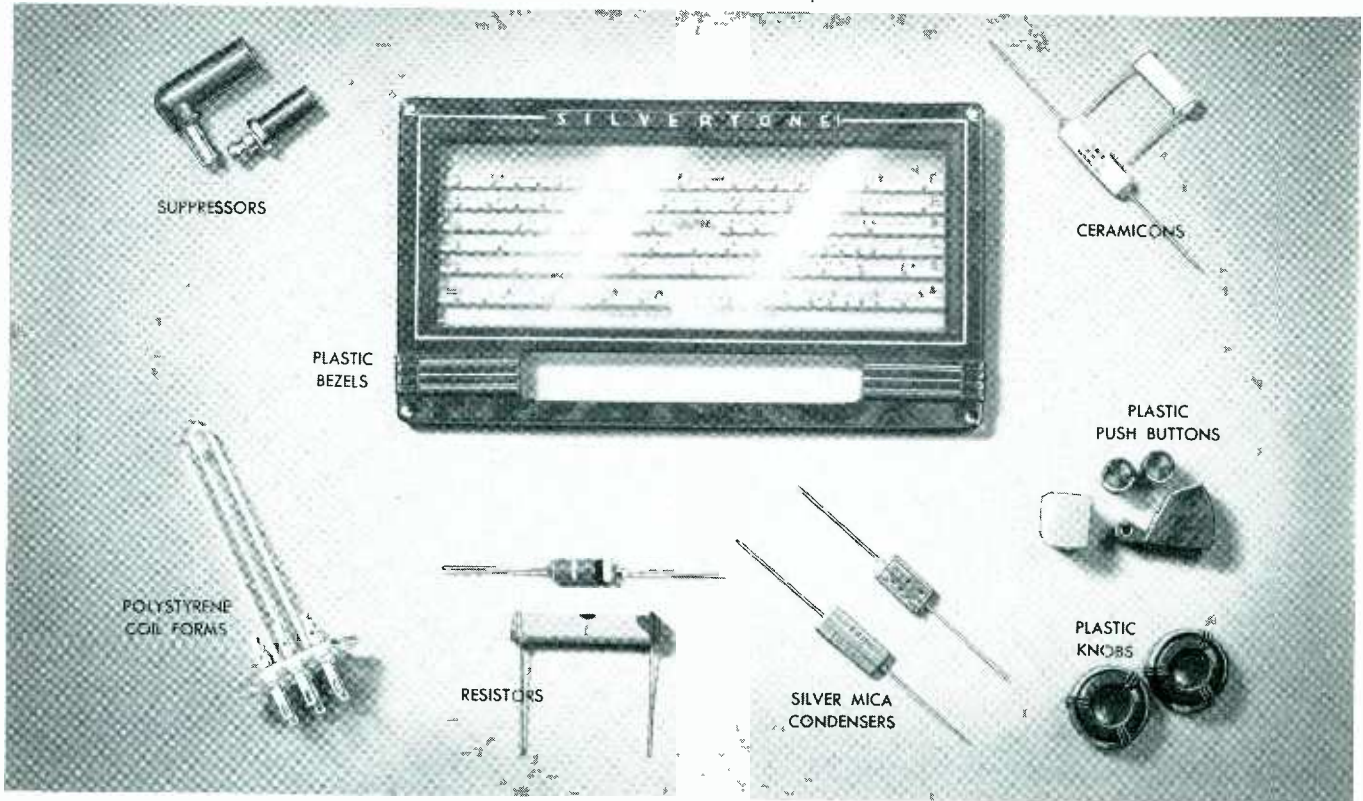

RESISTORS
SUPPRESSORS
CERAMICONS
REG. U. S. PAT. OFF.
SILVER MICAS
CUSTOM MOLDED
PLASTICS

Our advertisement in the first issue of Electronics ten years ago pointed out the exceptional dependability of millions of Erie Resistors that a well-known radio manufacturer had used in the previous two years. Since then many more millions of resistors and other radio components that have been added to the Erie line have maintained this reputation for outstanding quality. Today you can get plain and insulated Erie Resistors, Erie Suppressors, Erie Silver Mica Condensers—for preventing condenser capacity drift, and Erie Ceramicons—for compensating for frequency drift. The Erie Plastics Division has complete engineering and production facilities for custom molding plastic bezels, knobs, dials, push buttons and low-loss coil forms to your specifications. Protect your own reputation by using these dependable Erie components.



RESISTORS
 SUPPRESSORS
 CERAMICONS
 SILVER-MICA
 CONDENSERS

Erie RESISTOR CORPORATION, ERIE, PA.

MOLDED BEZELS
 PUSH BUTTONS
 AND KNOBS
 POLYSTYRENE
 COIL FORMS



electronics

**Radio . . . Communication
and Industrial Applica-
tions of Electron Tubes
. . . Design . . . Engineering
. . . Manufacture**

KEITH HENNEY
Editor

Donald G. Fink
Managing Editor

Beverly Dudley Craig Walsh
Associate Editor Assistant Editor

M. L. Matthey J. M. Heron
Assistant Editor Assistant Editor

Harry Phillips
Art Director

H. W. MATEER
Manager

Wallace B. Blood
Sales Manager

Contents Copyright, 1940, by
McGraw-Hill Publishing Company, Inc.

**McGRAW-HILL
PUBLISHING COMPANY, INC.**

JAMES H. MCGRAW
Founder and Honorary Chairman

Publication Office
99-129 North Broadway, Albany, N. Y.
U. S. A.

Editorial and Executive Offices
330 West 42nd St., New York, N. Y., U. S. A.

James H. McGraw, Jr., President
Howard Ehrlich, Executive Vice President
Mason Britton, Vice Chairman
B. R. Putnam, Treasurer
D. C. McGraw, Secretary
J. E. Blackburn, Jr., Director of Circulation

Cable Address:
MCGRAWHILL, New York
Member A. B. P. Member A. B. C.

CONTENTS — APRIL, 1940

DESIGN BY HARRY PHILLIPS	Cover
FM HAS ITS DAY IN COURT	14
A first hand report on the activities of the F.C.C. hearing on frequency modulation	
A DECADE OF ELECTRONICS , by Keith Henney	17
Electronics delves into the past to review the milestones of the industry during the past ten years	
A VIDEO SIGNAL GENERATOR—I by M. P. Wilder and J. A. Brustman	25
The first of a series of articles on the design and construction of a television signal unit in accordance with the R.M.A. television standards	
MEGACYCLE REPEATERS	30
Tubes for use in broadband coaxial cable amplifiers. Western Electric Type D-157654 has an exceptionally high figure of merit with low plate current	
COAXIAL LOUDSPEAKERS , by Benjamin Olney	32
Mounting the high frequency and low frequency speakers on a single axis provides a single source of sound of high quality	
A PRACTICAL STROBOSCOPE CIRCUIT , by C. C. Street	36
A how-to-make-it article describing the construction of a stroboscope using commonly available components	
ELECTRON GUNFIRE	38
Pictures of the patterns which may be made to appear on the screen of a cathode-ray tube under proper conditions. A by-product of television research	
VISUAL ALIGNMENT GENERATOR , by H. F. Mayer	39
A frequency-modulated generator for the visual alignment of radio-frequency transformers, useful in the development and production of radio receivers	
A SIMPLE ELECTRONIC REED ORGAN , by Frederick Merrill, Jr.	42
How a discarded reed organ may be transformed into a modern electronic musical instrument	
BROADCASTERS AT COLUMBUS	46
Pictures of the recent meeting of broadcasting engineers at Ohio State	
A FEEDBACK WELDING TIMER , by J. Kurtz	47
Spot welding of small parts requires that the time of current flow be very short and very uniform from one weld to another. The instrument described here was designed for this purpose	
ELECTRONICS SPECTRUM CHART	50-51
FORTY COMMONLY USED PADS , by Aaron Shelton	53
A chart giving the resistance values for forty T and H pads for various degrees of attenuation and terminal impedances	

DEPARTMENTS

CROSSTALK	13	TUBES	82
NEW BOOKS	48	THE ELECTRON ART	99
REFERENCE SHEET	53	THE INDUSTRY IN REVIEW	109
TUBES AT WORK	54	PATENTS	120
INDEX TO ADVERTISERS 122			

ELECTRONICS, April, 1940, Vol. 13, No. 4. Published monthly, price 50c a copy. Subscription rates—United States and possessions, Canada, Mexico and Central American countries, \$5.00 a year. All other countries, \$6.00 a year or 36 shillings. Entered as Second Class matter, August 29, 1936, at Post Office, Albany, N. Y., under the Act of March 3, 1879. Branch Offices: 520 North Michigan Ave., Chicago; 68 Post Street, San Francisco; Aldwych House, Aldwych, London, W. C. 2; Washington; Philadelphia; Cleveland; Detroit; St. Louis; Boston; Atlanta, Ga.

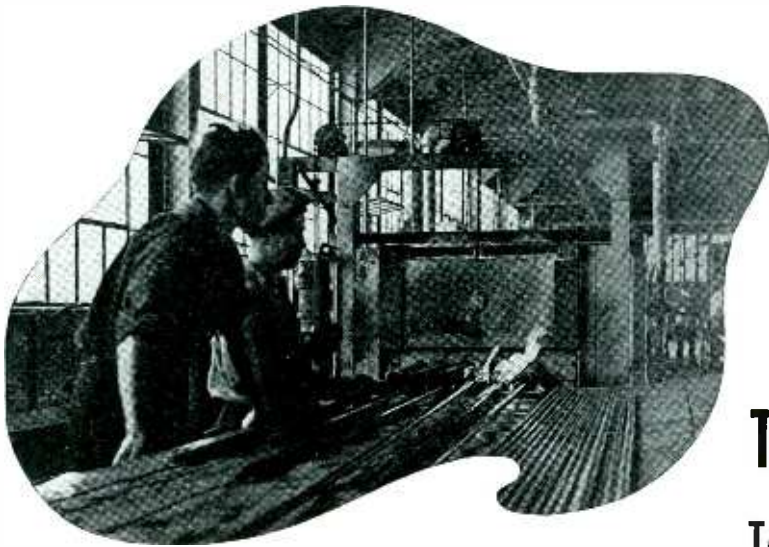

WHEN THE "HEAT" IS ON

The controlled atmosphere furnaces are important spots in the Superior plant—for two reasons.

First, by annealing, tubing which has become hard through cold drawing is made workable again. Second, the consistently bright finish which identifies Superior tubing, depends in great measure on the rigid control of atmospheres as well as temperature. There is no scale to mar the finish.

We take great care with annealing. Before a job is put in production, the annealing schedule is just as carefully worked out by our Metallurgical laboratory as the drawing schedule. We have set a limit for the Rockwell hardness beyond which no further drawing may be performed without an intermediate anneal. This is essential.



So, "When the 'heat' is on" at Superior, the proper treatment is being given at the proper time. *Infinite care to every detail is the only way we know of producing small tubing of "Superior" quality.*

SUPERIOR TUBE CO.

[THE BIG NAME IN SMALL TUBING]

NORRISTOWN, PENNSYLVANIA

★ *Tube Designers:*
Tubes for anodes and cathodes in various analyses and specifications are available. Do you have a problem . . .

Tubing from 5/8" OD down . . . SUPERIOR  Seamless
in various analyses, WELDRAWN  welded Stainless.
BRAWN  Welded "Monel" and "Inconel".
SEAMLESS and Patented LOCKSEAM Cathode Sleeves.

'FOR FINE SMALL TUBING'



*thru
the Years
with
"OLD MAN
Centralab"*

FIXED RESISTOR Insulating and conducting area baked together into one . . . copper sprayed end connection.

RADIOHM In standard or midjet . . . low noise level . . . long life

WAVE BAND SWITCHES In Isolantite or Bakelite . . . available in various combination.

CERAMIC CAPACITOR Where permanence or temperature compensation is important.

CENTRALAB DIV. of GLOBE-UNION INC., Milwaukee, Wis.

ROLLER-SMITH 4" INSTRUMENTS

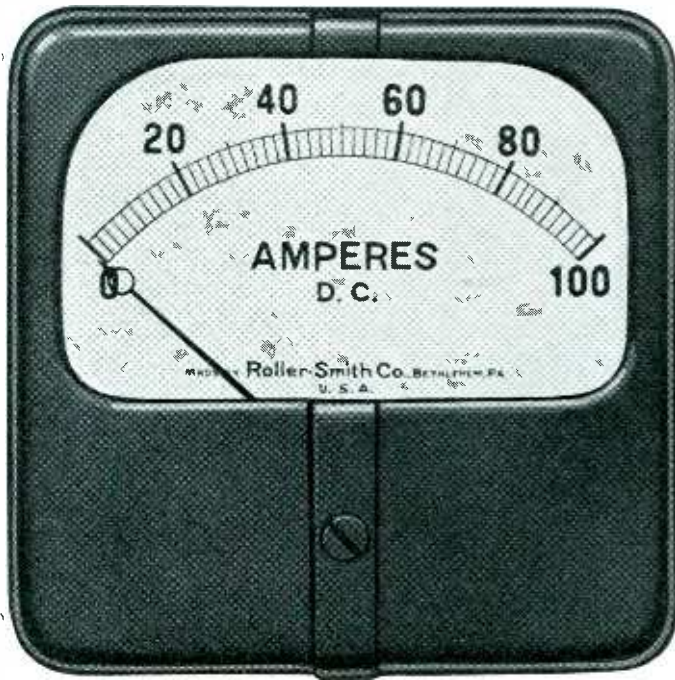

*Summing up over
40 years experience*

R-S presents a complete line of precision measuring instruments which embody all the refinements gained from 41 years of specialization.

4" instruments are available in square or round, flush or surface types in bakelite or metal cases. . . . The mechanism in D.C. instruments is of the d'Arsonval type with bridge construction both top and bottom. Highest quality materials including sapphire jewels are used throughout. . . . The A.C. mechanism is of the soft iron repulsion vane type. The same high quality of materials as are used in the D.C. instruments are also used in the A.C. types. . . . Wattmeters in the 4" size use dynamometer type mechanisms and are supplied in both single and polyphase types. . . . All dials are metal with white coated non-yellowing background with black figures. Scales are hand drawn. . . . Accuracy of most types is 1% of full scale value. . . . The same specifications as above apply to the 3" line illustrated at right except dials are printed instead of hand drawn and accuracy is 1½% of full scale value. . . . You can specify them with confidence. Send for Catalog Ak-48-a.

ROLLER-SMITH COMPANY
Electrical Measuring and Protective Apparatus

Main Office and Works:



Bethlehem, Pa., U. S. A.

Sales Agencies in Principal Cities in United States and Canada

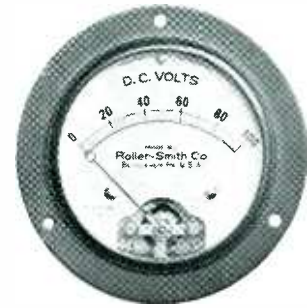

3" Round Flush, D.C.



3" Sq. Flush, D.C.



3" Round Surface, D.C.



3" Square Flush, A.C.



4" Round Surface, D.C.

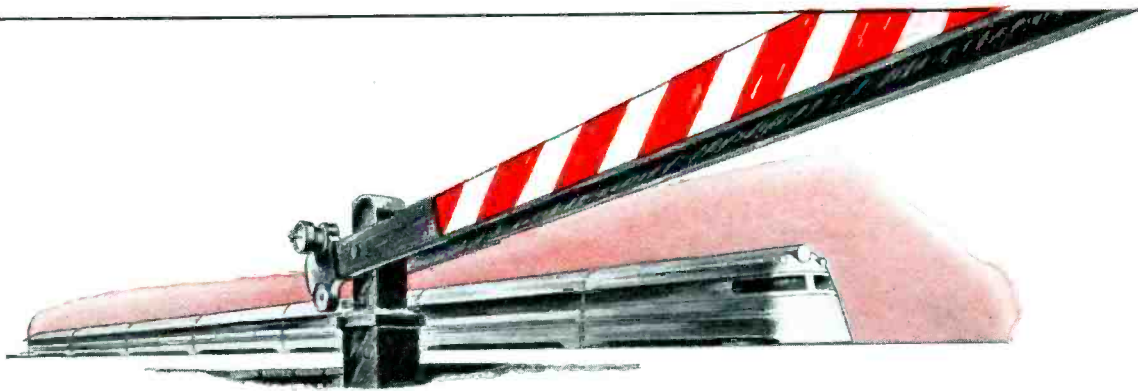

PUT YOUR ASSEMBLIES ON AN EXPRESS SCHEDULE

...CUTTING 50% OFF ASSEMBLY TIME
MEANS QUICKER DELIVERIES!



*Don't Take the Local...
It Makes Too Many Stops*

- ▶ Drill pilot hole.
- ▶ Pick up screw and driver.
- ▶ STOP. You dropped the screw.
- ▶ Pick up another screw.
- ▶ Start driving — very carefully.
- ▶ SLOW. It's going in crooked.
- ▶ Straighten it out — drive.
- ▶ SLOW. The parts are wobbling.
- ▶ STOP. The screw driver slipped.
- ▶ Start again. It's hard going.
- ▶ SLOW. You're turning up burrs.
- ▶ STOP. Can't tighten any further.
- ▶ Get file. Smooth off burrs.
- ▶ Send to refinishing department.



*Fasten with Phillips Screws
... and Get There
Faster*

- ▶ Put screw on end of driver.
- ▶ Point driver like your finger.
- ▶ ZZIP — it's done.



This space represents time saved by Phillips Recessed Head Screw — which eliminates danger of slipping drivers, needs no pilot hole, always drives straight (even with one hand steadying work), sets up tight without split head or burrs.



Two big problems these busy days—customers clamoring for shipments... inexperienced workers on the job. Help solve both problems by adopting the *modern* fastening device. Phillips Recessed Head Screws cut assembly time an average of 50% (according to users' reports) make driving easier... make assemblies stronger, better-looking.

Join the thousands of firms—big and small—who have put their assemblies on a non-stop basis. Get in touch with one of the firms listed below.

PHILLIPS RECESSED HEAD SCREWS...

MACHINE SCREWS SHEET METAL SCREWS WOOD SCREWS STOVE BOLTS

U. S. Patents on Product and Methods Nos. 2,046,343; 2,046,837; 2,046,839; 2,046,840; 2,082,085; 2,084,078; 2,084,079; 2,090,338. Other Domestic and Foreign Patents Allowed and Pending.

American Screw Co., Licensor, Providence, R. I.
Continental Screw Co., New Bedford, Mass.
Corbin Screw Corporation, New Britain, Conn.

The Lamson & Sessions Co., Cleveland, Ohio
National Screw & Mfg. Co., Cleveland, Ohio
Parker-Kalon Corporation, New York, N. Y.

*Speed Product Deliveries by
Cutting Assembly Time*

Pheoll Manufacturing Company, Chicago, Illinois
Russell, Burdsall & Ward Bolt & Nut Co., Port Chester, N. Y.
Scovill Manufacturing Co., Waterbury, Conn.
Shakeproof Lock Washer Co., Chicago, Ill.

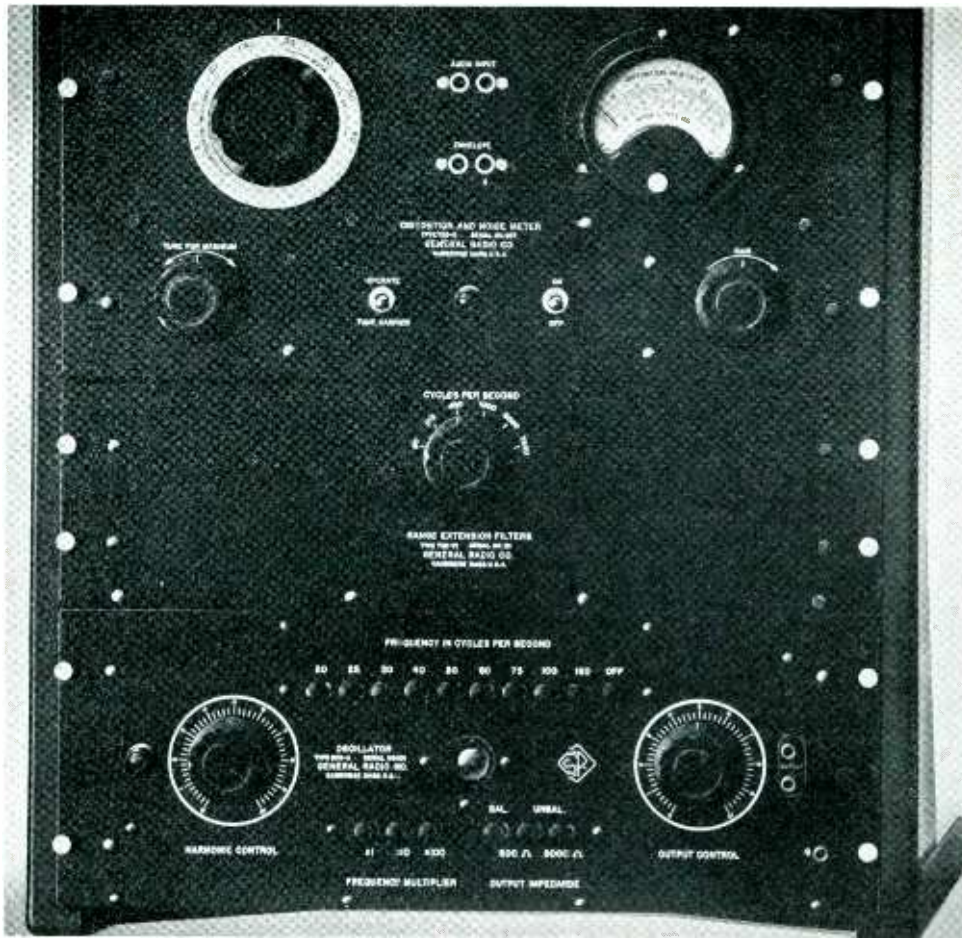

At 2 A.M. You'll be glad you have G-R Distortion and Noise Measuring Equipment

WHEN IT'S TIME to put the transmitter to bed, after a long day of it, you will be glad your equipment is made by G-R, for with the Type 732-B Distortion and Noise Meter and its associated equipment, you can make a complete distortion run on your transmitter in less than a minute!

Here are several other reasons you will be glad yours comes from G-R:

1. **VERY SIMPLE TO OPERATE**—all critical adjustments (balance) are eliminated—it's pretty difficult to make any mistakes even after a long session working in a cold transmitter room
2. **ACCURATE**—it's direct reading in all the answers you want
3. **INEXPERIENCED PERSONNEL CAN USE IT**—the chief doesn't have to worry about turning runs over to young technicians—they will get the right answer
4. **MEETS ALL THE F.C.C. REQUIREMENTS**—with the F.C.C. 6 test frequencies

The Type 732-B Distortion-Noise Meter is designed to operate with the Type 732-PI Range-Extension Filters for measurements at 50, 100, 400, 1000, 5000 and 7500 cycles—the six test frequencies recommended by the F.C.C. At distortions greater than 0.5% the error is less than 10% of the true value $\pm 0.15\%$ distortion. The r-f input operates over carrier ranges from 0.5 to 8 Mc or from 3 to 60 Mc and requires very little power.

The Type 608-A Oscillator is of the discrete-frequency type with two sets of push-button switches supplying frequencies of 20, 25, 30, 40, 50, 60, 75, 100 and 150 cycles with multipliers of 1, 10 and 100 times these frequencies. The output is exceptionally low in distortion.

TYPE 732-B DISTORTION AND NOISE METER	\$245.00
TYPE 732-PI RANGE EXTENSION FILTER	150.00
TYPE 608-A OSCILLATOR	260.00

Write for Bulletin 573

GENERAL RADIO COMPANY CAMBRIDGE MASSACHUSETTS

HOW LAPP DOUBLED THE STRENGTH

OF THE PORCELAIN COMPRESSION CONE, WITHOUT CHANGING DIMENSIONS, WALL THICKNESS OR WEIGHT

The advance of modern industrial science has been achieved largely through making minute changes in physical or chemical form to effect tremendous changes

in performance characteristics. Consider the matter of steel. *If you know how*, you can take a pound of common nails, add about $\frac{1}{8}$ ounce of carbon and make tool steel with double the tensile strength and five times the hardness.

*** As pioneers in radio tower insulation, Lapp men had to develop whole new engineering conceptions. Recognizing early that the tremendous mechanical loads could be carried by porcelain loaded only in compression, they developed the porcelain compression cone

for use in all types of footing and guy insulators. And, then, not content with their first efforts along these lines, they set out to improve the design—

with the result that by changing slightly the contour of the cone, they *doubled the strength of the insulators*. *** It's the *know-how* of Lapp engineers that has kept Lapp the dominant force in insulation for radio broadcast. Today, if you

contemplate installation of a new transmitter, or modernization of present equipment, you can't afford not to consider Lapp for tower footing and guy insulators, for porcelain water cooling systems, for pressure gas-filled condensers.

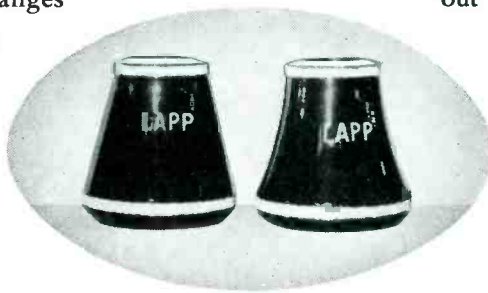

Left, early Lapp Compression Cone. Right, curved side compression cone—same dimensions, wall thickness and weight—twice the compression strength of the straight side cone—the design used in all footing and guy insulators (see below) since 1932.



LAPP

INSULATOR CO., INC., LE ROY, N. Y., U. S. A.

Another EPOCH-MAKING DEVELOPMENT

PIONEERED BY

KENYON

TUBE BASE TRANSFORMER UNITS In Standard and Submersion-Proof Types

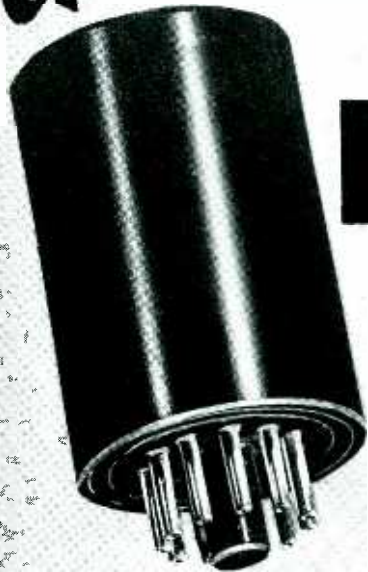

PATENT APPLIED FOR
Illustration Actual Size

Available in following types: line to line, line to grid, output, interstage, high inductance chokes, crystal mike to line, low impedance to grid.

Again Kenyon sets the pace. Here truly is an amazing new idea in transformer design... a unit with an octal base that may be plugged in just like a radio tube. Where space is at a premium and where efficiency must be maintained at a high standard—these new Kenyon "A" Line Transformers fill the bill.

We urge you to investigate the possibilities involved for their use particularly in aviation, submarine, mobile or portable equipment—in short any equipment where maximum quality and limited space are the specifications. "A" Line transformers save time in assembly and design, too. Each unit comes complete with special Kenyon Octal Socket. Size 2" high x 1 1/2" diameter. Submersion-proof types meet all Army and Navy C.A.A. specifications. Our new catalog gives complete information. Frequency response with no D.C. in windings plus or minus 2 DB, 30-20,000 cycles.

AMERICA'S LEADERS PICK KENYONS FOR THEIR DEPENDABILITY

For years many of America's leading manufacturers of radio and electrical equipment have come to Kenyon for their transformer requirements. The reason: Kenyon has never sacrificed quality to bring its products down to a price level. Even so, many manufacturers have come to realize that it is real economy to pay a little more for a vastly superior product—one that will stand up and create satisfied customers.

The list of manufacturers who are Kenyon customers reads like a Who's Who of the Industry. We are proud to have shared in the production of such outstanding equipment as the Frequency Modulation Transmitters by R.E.L., Facsimile Transmitters by Western Union and the kind of equipment usually associated with such names as: Arma Engineering, Sperry Gyroscope, Submarine Signal, Federal Telegraph, Doolittle and Falknor, Muzak, R.C.A., General Electric, Temco, Harvey, Postal Telegraph, Radio Marine, The Hallicrafters, Montgomery Elevator, Westinghouse, Western Electric, Wilcox Electric, The U. S. Army, Navy, Coast Guard, Signal Corps, and others.

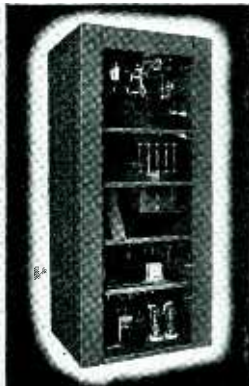

NEW CATALOG READY

The most extensive catalog we have ever produced. Profusely illustrated. Many graphs, charts and other valuable data. Everything listed including special sections on High Fidelity Laboratory Standard Units, band pass filters, quality hum-bucking transformers, broadcast and industrial units, etc. This catalog will be especially useful to designers, engineers, etc.

FREE to those requesting it on their letterheads.



KENYON TRANSFORMER CO., Inc.

840 BARRY STREET

NEW YORK, N. Y.

OFFICES IN PRINCIPAL CITIES

Cleveland 3292 Cedarbrook Rd.	Seattle 2605 Second Ave.	New Orleans 618 Girod St.
Chicago 21 E. Van Buren St.	Los Angeles 2412 7th St., W.	Lutz Florida
Kansas City, Mo. 2004 Grand Ave.	Dallas P. O. Box 4116, Sta. A	Richmond, Va. 3106 Edgewood Ave.

Only **P. R. MALLORY & CO. Inc.** **MALLORY** makes **EVERY** type
of electrical contact for **EVERY** service



RIVET, SCREW, BI-METAL, SPECIAL TYPES

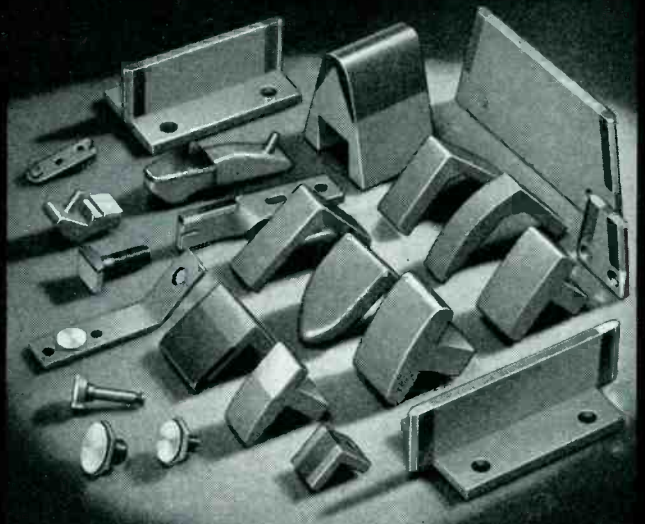

ELKONITE-EQUIPPED CONTACTORS

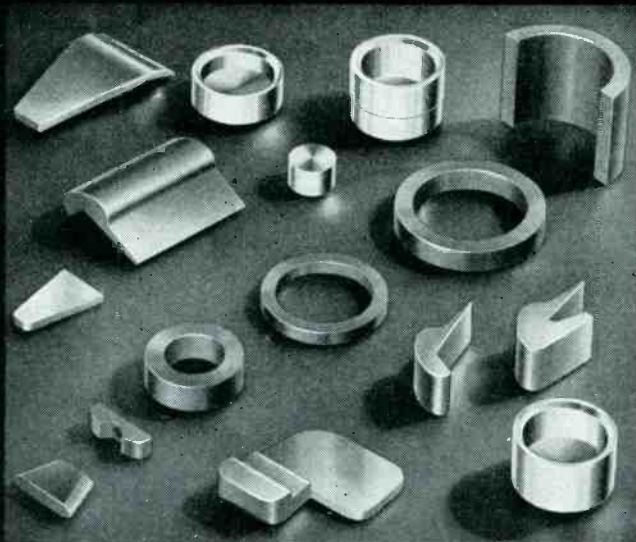

CONTACTOR FACINGS AND INSERTS

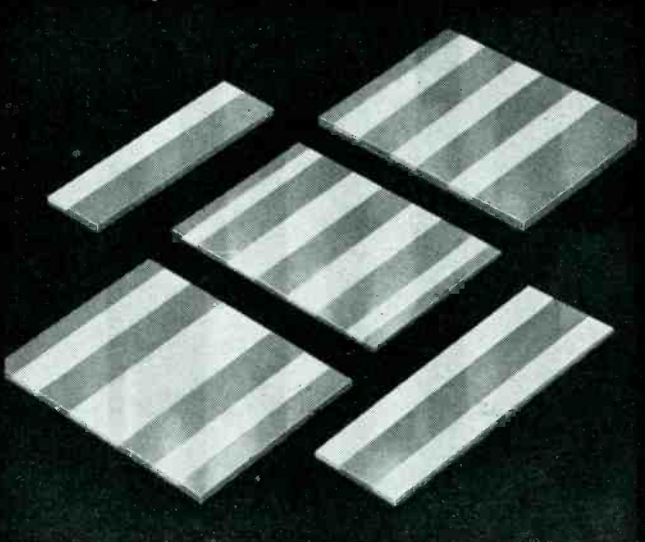

OVERLAY AND INLAY METAL

Wherever a circuit must be made or broken, Mallory offers the best electrical contact for the job. Mallory contacts of tungsten, molybdenum, silver, platinum, Elkonite and special alloys are meeting individual requirements with uniform satisfaction throughout the electrical industry.

Most of the cars built today are equipped with Mallory ignition points. Mallory contacts insure the successful operation of electrically controlled machinery on land, on

sea and in air—traffic lights, railway signals, airplane engines, elevators, fire alarms, temperature controls, marine engines, navigation beacons, household circuit breakers, typesetting machines, electric razors.

Write today for the Mallory Engineering Data Book on Electrical Contacts—or submit your contact problems to Mallory engineers for recommendation of the material best suited to your needs.

P. R. MALLORY & CO., Inc.

P. R. MALLORY & CO. Inc.
MALLORY

INDIANAPOLIS, INDIANA
Cable Address—PELMALLO

NON-FERROUS ALLOYS and ELECTRICAL CONTACTS





CROSS TALK

► FM . . . As this is being written engineers, and others, at Washington are debating what to do with frequency modulation. In response to the article "Frequency Modulation, a Revolution in Broadcasting?" in our January issue of 1940, several interesting comments have been received. Two of them are quoted below as being characteristic.

"I believe the reason the public has not been sold on high-fidelity is because the public hasn't had any. My only contact with the subject, aside from my own band-pass receiver (TRF) has been confined to sound reproducing equipment in the theatres.

"In the early days, a typical electrical reponse of a good film-reproducing system was about as shown, and acoustically very much as given on Curve 2. Due to noise and irregularities of a mechanical nature which resulted in flutter, the h-f end had to be cut to avoid harshness and 'gargle' with a consequent decrease in intelligibility.

"The most modern systems use amplifiers and circuits designed to allow full rated power with a total distortion of less than 1 per cent (1 per cent is quite noticeable). Speaker mechanisms

are more efficient and have a minimum of harmonic and phase distortion product, and improved scanning devices reduce the flutter content to less than 0.2 per cent. These improvements, combined with similarly advanced recording, plus noise reducing techniques have practically eliminated audibly reproduced extraneous noises and have allowed the extension of the frequency spectrum so as to resemble curve 3.

"Improved reproduction has been sold to the theater going public and the theater owner because there is a difference, and radio can do the same selling job when it gives the public something better."—Pierce J. Aubry, Birmingham, Alabama.

"Your article in the January, 1940 issue is very interesting to me even though I am strictly an amateur when it comes to radio mechanics, and even though I am completely unable to understand a lot of the technical terms you have used.

"However, there is one subject you cover that is more than passing interest to me; that is, the question of whether the public appreciates high fidelity or whether it doesn't. It is my opinion—

still speaking strictly as an amateur—that the apparent apathy of the public is due not to lack of appreciation, but rather to inability to pay the premium prices now being charged for so-called high fidelity receivers. Time and time again I have heard people say, in effect, 'Sure, we like to hear high fidelity reception but we can't afford to pay \$200.00 or \$300.00 to get it. We can get along with \$50.00 reception.'

"It would, therefore, appear to me that radio's problem is one of getting high fidelity at low cost rather than of getting the public to appreciate high fidelity. People will junk their old sets and buy new ones if the change-over does not mean the elimination of popular price receivers."—Louis E. Wade, President, Louis E. Wade, Inc., Fort Wayne, Ind.

► 1930-1940 . . . This is *Electronics'* 10th anniversary issue. In it will be found a brief review of these 10 years of economic troubles and technical progress. Engineers are still eminently able to produce new things for people to use, but engineers, nor statesmen, nor politicians, nor sociologists have yet devised means whereby man's own nature can be harnessed to his own use. Mathematicians are still unable to solve equations with very many variables—and man and his society is controlled by hundreds of variables most of which seem to be negative in their effect.

Electronics is happy to note the number of its readers who state they are charter subscribers, that they have bound volumes since April 1930, and is proud to number among its advertisers so many who have been with us since the initial issue. *Electronics* hopes, fervently, that the next 10 years will see a new order in which peace, and prosperity and security and equity for all will be established.

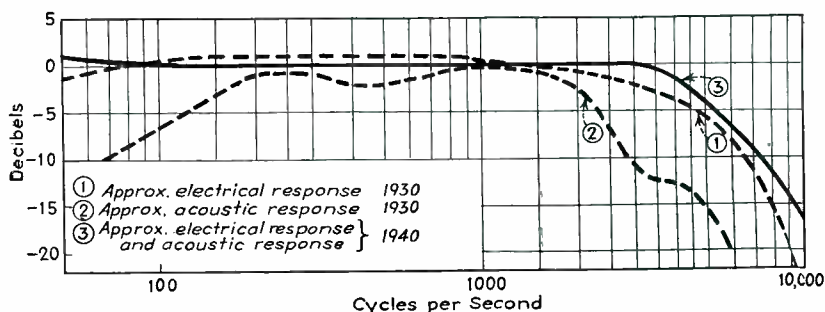

Characteristics of sound motion pictures—1930-1940

F M

GETS ITS "DAY IN COURT"

With these words, Chairman Fly of the Federal Communications Commission opened the frequency-modulation hearing in Washington on March 18th. Testimony by Major E. H. Armstrong and by witnesses for F-M Broadcasters and R.C.A. is reported here

IN one of the largest gatherings of broadcast engineers and executives ever to assemble before the Federal Communications Commission, evidence on the past record and future possibilities of frequency modulation was presented in Washington beginning March 18th. At the time of going to press, two weeks later, all the evidence had been presented. Some 29 organizations and individuals had filed their intention of appearing before the Commission, and in all 50 witnesses expected to give testimony. The present report is concerned primarily with the testimony of Major E. H. Armstrong and F-M Broadcasters, Inc., whose witnesses appeared in the early days of the hearing and that of R.C.A. which was given in the second week.

The purpose of the hearing, revealed by the issues of the agenda issued by the Commission, was to determine:

(1) Whether aural broadcasting on the frequencies above 25,000 kc has reached such a stage of development that it is acceptable for rendering regular as distinguished from experimental broadcast service to the public;

(2) The relative merits of frequency modulation and amplitude modulation when employed for aural broadcasting on frequencies above 25,000 kc;

(3) The relative merits of wide band and narrow band frequency modulation when employed for aural broadcasting on frequencies above 25,000 kc;

(4) Whether it is possible to allocate sufficient frequencies to accom-

modate stations employing frequency modulation (narrow or wide band) to provide a satisfactory program service in the United States when considered in the light of the frequency needs of other services, including television, Government, aviation, police, common carrier, amateur, etc.;

(5) Whether it is possible to allocate sufficient frequencies to accommodate stations employing amplitude modulation to provide a satisfactory program service in the United States when considered in the light of the frequency needs of other services, including television, Government, aviation, police, common carrier, amateur, etc.;

(6) Whether it would be practicable for the Commission to authorize both amplitude and frequency modulation for aural broadcasting stations operating on frequencies above 25,000 kc, or whether the Commission should recognize but one of these forms of modulation for such stations;

(7) The possible future effects of ultra-high frequency broadcasting upon standard broadcasting on the band 550-1600 kc;

(8) Whether existing allocations of frequencies above 25,000 kc to particular services shall be modified to provide frequencies for aural broadcasting;

(9) The existing patent situation respecting frequency modulation and amplitude modulation for aural broadcasting stations operating on frequencies above 25,000 kc.

The present status of frequency-modulation, so far as the affairs of

the Commission are concerned, was summarized in terms of the present channel assignments, licenses, construction permits and applications. The channel assignments to f-m are 26,300, 26,500, 26,700 and 26,900 kc; 42,600, 42,800, 43,000, 43,200, 43,400 kc; 117,190, 117,430, 117,670, 117,910 kc. As of March 12, there were 22 licenses and construction permits issued to f-m stations, all of which except one have assignments in the region from 42.6 to 43.4 Mc. On the same date there were 75 applications for f-m construction permits, and two applications for a-m permits in the u-h-f bands. All except two of the f-m applications request assignments in the 42.6 to 43.4 region of the spectrum.

Attention was focused on the band of frequencies from 41 to 44 Mc, not only because of the great number of f-m applications in this band, but because the witnesses urged that this is the most desirable portion of the spectrum for f-m transmissions. In this region, f-m assignments share the space with assignments to a-m educational stations (41.02 to 41.98 Mc), a-m broadcasting stations (42.06 to 42.46 Mc), and a-m facsimile broadcast stations (43.54 to 43.94 Mc). A good deal of the testimony related to the possibility of converting these a-m services to corresponding f-m services, and thus allowing a continuous band of f-m channels. The other questions had to do with the desirable width of channel for an f-m broadcast station, which in turn would determine the number

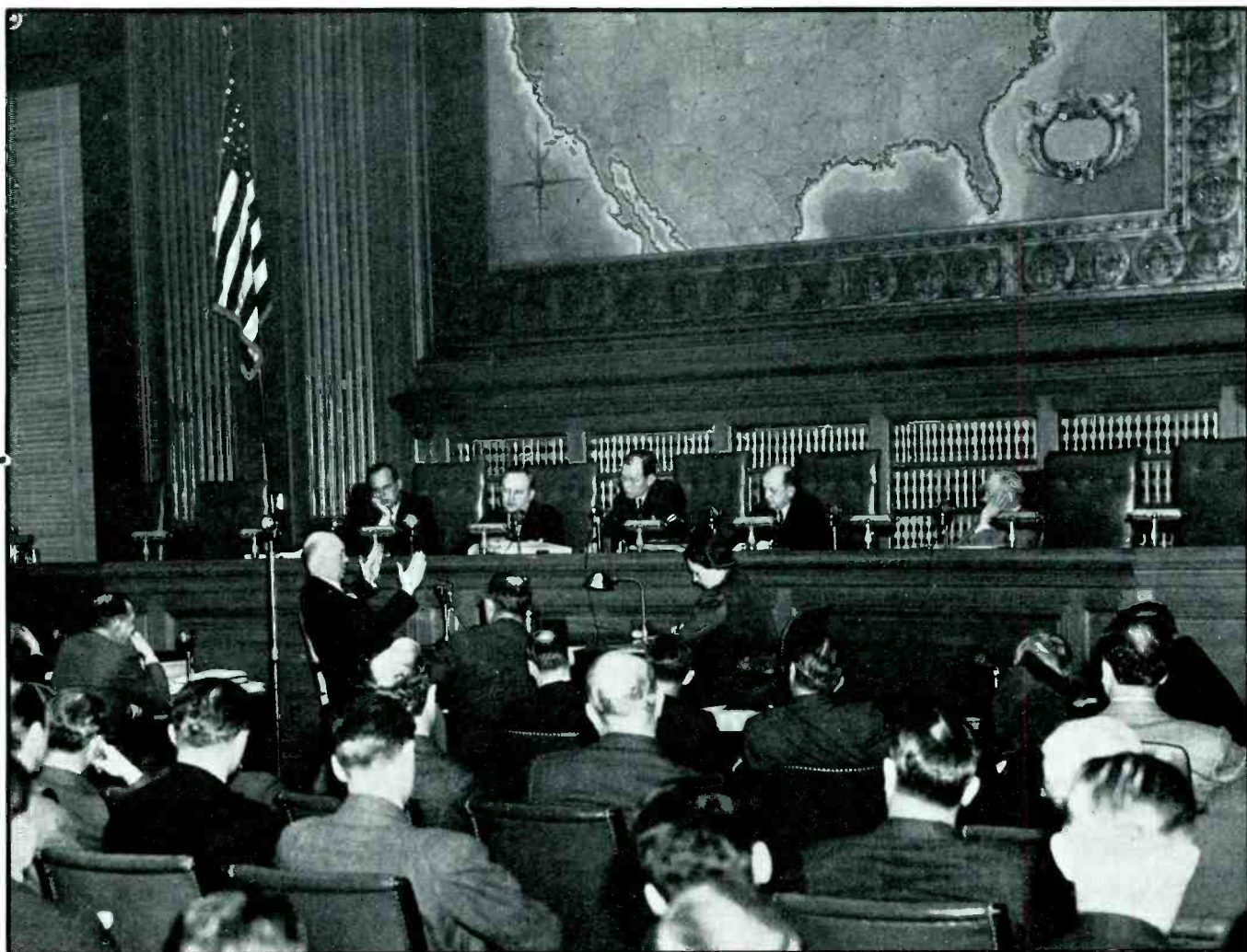

Major E. H. Armstrong brackets a portion of the u-h-f spectrum for the inspection of Federal Communications Commissioners (left to right) Craven, Brown, Chairman Fly, Walker, and Thompson. The inventor of the wideband f-m system testified for seven hours, urged that space be taken from television to allow more f-m station assignments

of channels which might be accommodated in this and any other portion of the spectrum.

Major Armstrong's Testimony

The first witness, for alphabetical as well as other reasons, was Major E. H. Armstrong the inventor and chief proponent of the wideband f-m system. Major Armstrong testified for a total of some seven hours, covering nearly two full days of the hearing. The early part of his testimony had to do with the history and principles of frequency modulation, both of which have been amply covered in past issues of *Electronics**. The early experiments in 1934 were recalled, in which tests were conducted from the NBC 2-kw transmitter located on the Empire State Building and operated in the 40-Mc band. Armstrong read into the

record excerpts from a report on the results of these tests which showed an improvement in range of roughly two and one-half times in favor of narrow-band f-m over a-m in the same frequencies, and a further increase in range of nearly two times in favor of wideband f-m. Other results taken from the same tests indicated an improvement of 16 db in favor of f-m. The decision to erect the 40-kw f-m station W2XMN

* The complete bibliography of articles on frequency modulation appearing in *Electronics* is as follows:

- Frequency Modulation Advances, June 1935, p. 188.
- Phase-Frequency Modulation, Nov. 1935, p. 17.
- High-Power Frequency Modulation, May 1936, p. 25.
- Noise in Frequency Modulation, May 1937, p. 22.
- Frequency Modulation Demonstrated, March 1939, p. 14.
- A Frequency Modulation Receiver, June 1939, p. 32.
- Frequency Modulated Transmitters, Nov. 1939, p. 20.
- Frequency Modulation—A Revolution in Broadcasting? January 1940, p. 10.

at Alpine, N. J. was made in April 1935 by Major Armstrong. Sound records made on film later in 1935, were then demonstrated to the Commission to illustrate the difference between f-m on ultra-high frequencies and a-m on the standard broadcast frequencies, over a path of about 85 miles. These records were the same ones demonstrated to the I.R.E. at the original presentation in 1935. The advantage in favor of f-m was so marked, and the static so prominent on the a-m portions of the film that Chairman Fly asked that the final record be turned off before its conclusion, granting the demonstration as conclusive. Major Armstrong then pointed out that part of the improvement in the f-m case, so far as the lesser degree of static is concerned, was due to the use of the

higher frequencies, inasmuch as natural static decreases roughly in proportion to the increase in frequency. But discrimination against man-made noise, especially prominent in the high frequencies, high quality, low signal-to-noise ratio, greater range for a given realizable fidelity—all these were pointed out as definite advantages of the f-m system on any frequency, in addition to discrimination against whatever natural static does exist.

The performance record of station W2XMN in Alpine over a period of 900 hours operation from July 18, 1939 to the end of that year was then read into the record. A total of one and one half hours off the air was accounted for on the basis of r-f amplifier tube failures, but no lost time could be attributed to the operation of the f-m circuits. Power failures and noise on the telephone line were also given as causes of shut-downs. In all, the performance compares favorably with that of the standard broadcast transmitter of the same power rating.

In response to cross-examination by Commissioner Craven it was brought out by Armstrong that a frequency-modulation transmitter cannot be said to have a secondary service area. The primary service area of a 50-kw station extends to about 100 miles, if a reasonably high (of the order of 1000 feet) and reasonably efficient antenna structure is used. Beyond this limit, the signal becomes so weak that the amplitude-limiter in the receiver fails to function, and the service becomes useless. It was pointed out in later testimony that the service area also depends, in the same manner, on the receiver sensitivity, since the limiter action fails in an insensitive receiver at higher values of signal strength. Hence to take full advantage of the primary coverage of an f-m station, high sensitivity (well under 50 microvolts for full limiter action) receivers are required, and should be made available by the set manufacturers. Abnormal refraction of the u-h-f waves occasionally gives a "secondary" service but the service is not reliable.

Regarding the noise advantage of f-m over a-m in the same band of frequencies, Armstrong testified that when the desired signal is more than twice the undesired signal, an advantage of 1000 times in power, in

favor of f-m, is obtained with fluctuation noise (tube hiss, etc.) and 100 times against impulse noise (ignition, etc.). In general the figures followed closely those quoted in the January issue of *Electronics*, pages 10-14. Armstrong reported considerable fading at the edge of the service area of an f-m station, both rapid and slow in character, but no selective fading, so that there was no audible evidence of the fading so long as the signal strength required for limiter action was available.

The wideband vs narrowband question for f-m stations is of importance since the channel width assigned to f-m stations determines the number which can be assigned in a given band. Armstrong gave 200 kc as the channel width for a wideband system and perhaps 40 kc as the channel width for a narrowband system. He stated that the power required for a given signal-to-noise ratio was about 25 times as great in the narrowband case, since the desired signal output would be one fifth in voltage for a frequency swing one fifth as great. He pointed out also that receiver design is more difficult in the narrowband system (because of the oscillator drift problem), and that multiplexing of facsimile and binaural transmission would be much more difficult in the narrowband case.

Regarding the available channels now assigned to f-m, Armstrong testified that those in the 40-Mc band were satisfactory, those in the 117-Mc band less so (but still useful) because of the difficulty in producing high powered transmitters and sensitive receivers (and also as revealed later because of the more prominent "shadows" cast by obstacles in the path of the waves); while the assignments near 25 Mc were considered practically useless because of the effects of sky-wave interference. He urged a single continuous band of f-m assignments, to simplify receiver design. He urged that a larger band be made available around 40 Mc, and another near 80 Mc, stating that in his opinion the new f-m service had a better claim to this space than did television. Specifically, he requested a transfer to f-m of the space of one television channel, but did not specify which channel. If ten channels were available for f-m, he said, a fairly good allocation job could be done for many

parts of the United States, but not in the congested New England and New York area. If 30 to 40 channels were available, the needs of all could be taken care of for "a very long time to come".

Major Armstrong envisaged two classes of f-m service corresponding roughly to the regional and local classifications now used in standard broadcasting. The regional service would be offered by powerful, say 50-kw, stations located on tall buildings or mountain peaks, which would be protected against interference to the limit of their range, say to the 5 or 10 microvolt contour. The lower-power local stations could be placed as close as 20 miles or less, and if assigned to same channel would have correspondingly restricted service areas. In the interference areas between such stations, simple antennas with reversible directivity could be used to select which of the two stations was desired. It was emphasized that the interference between stations is audible only when the ratio between signal strengths is less than 4-to-1, and this degree of differentiation can ordinarily be introduced by directional antennas.

Concerning other items on the agenda, Major Armstrong stated that the effect of f-m on standard broadcasting would be to decrease congestion on the standard broadcast frequencies, and allow a better service to be rendered to the scattered rural population which he agreed would have to be served by standard broadcasting. He predicted a gradual shift in the public listening from a-m to f-m as more f-m receivers became available at lower prices, and as more stations offered the service. That present day f-m receivers and transmitters are reliable and out of the experimental stage was definitely stated. F-m transmitters cost no more, and perhaps less, than standard-frequency a-m transmitters of the same power. F-m receivers cost more only because of the superior audio circuits and loudspeaker system, which would be necessary in an a-m set to obtain the same quality. Prices for f-m receivers ranging from about \$65 for an adapter to \$375 for a de-luxe f-m and a-m receiver were reported. These prices are capable of steady reduction, as has occurred in conventional re-

(Continued on page 74)

A DECADE OF ELECTRONICS

1930 • 1940

ON the following pages will be found a resume of some of the important events that have changed the fields of the electron tube as they existed in April 1930 (when *Electronics* first was published) to the way these industries are constituted now—on the 10th anniversary of this publication.

In April 1930, sound, via the amplifier and the phototube, had barely come to the motion pictures, engineers were dreaming of the impact of the electron tube upon industry in all its manifold phases; radio was annually overproducing, and wondering when the market for radio receivers would be saturated.

Today, April 1940, no motion picture theater can operate without vacuum tubes; industry, except for welding, sees no revolution due to electrons in motion; radio, blasé, sees no saturation but hopes for television and other things new.

Whatever the next decade may bring, electronic engineers may look with pride on their accomplishments from 1930 to 1940. There has been no depression in science or engineering!

By KEITH HENNEY, EDITOR, ELECTRONICS

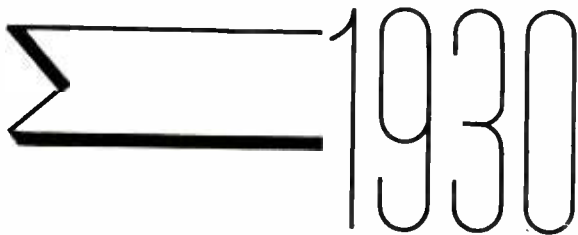

1930

.. A DECADE OF

TEN years ago this month *Electronics* made its first appearance. Its readers were recruited from the membership of the learned and engineering societies. In a circulation campaign, unique in the annals of McGraw-Hill for its immediate success, potential subscribers were told that a new era had come, an era in which the electron tube would conquer industry as it had conquered communication and as it was revolutionizing the motion picture industry. Readers responded with amazing alacrity; they wanted the new paper. Clearly there was an interest in and a need for such a periodical.

What would *Electronics* be like?

In the initial issue, O. H. Caldwell, its editor, said *Electronics* would be a "clearing-house for facts, a camp-fire for counsel". Ten years ago it seemed certain that the economic crash of 1929 would provoke only a temporary stoppage of the wheels of industry, and that another year would see America well on its way again to new economic levels. The new paper would help engineers keep abreast of what other engineers were doing and, working together, scientists and technical men would aid in creating a new era.

In the following decade the editors and publishers of the new paper have striven to make it the clearing-house for facts, a camping-ground for counsel and in a measure have succeeded. Each year of those 10 has promised to be the last year of the depression; economically everything would soon be on the upgrade; all such promises have been broken. Technically the 10 years have been most successful, engineers never cease to produce new products from the brain children of the scientists. Even a casual perusal of the bound volumes of *Electronics* for the ten years will provide a feeling that technology always moves forward.

What was the industry worrying about 10 years ago?

In the first issue, pains were taken to point out the important characteristics of the pentode tube, then coming over the horizon for the first time. There was much controversy over this multi-element vacuum device. Should it be permitted to enter the radio industry? Was it not just one more complication to upset manufacturers, dealers and set owners? Why should there be a new tube? The screen grid tube had not been thoroughly digested, but here from Europe was another complex structure. As a matter of fact there were two kinds of pentodes, according to writers in the initial issue, April 1930. There was an r-f tube and one designed for power output. Neither was much good, according to present-day standards, but both seemed mighty unpleasant new products to the radio tube and set industry which was pretty satisfied with itself.

Today, pentodes of all sorts have practically removed the demand for tubes of the simple types used in 1930. All those who objected so strenuously to introduction of new tube types have had to take them in their stride, and to witness an expansion of the receiving tube list that in 1930 would have seemed as impossible as present-day tube prices.

In this first issue, S. M. Kintner, manager of the Westinghouse research laboratory discussed the industrial uses of the vacuum tube and spoke of its place in industry. Long an electronics champion at Westinghouse, Mr. Kintner, friend of all research, unfortunately did not live to see all of his hopes achieved.

In this first issue, Dr. A. N. Goldsmith lamented the fact that sound reproduction in the theater was so poor. It was standard practice, then, to cut off all frequencies above 3500 cycles to get away from ground noise. All that is gone, of course, and in the better theaters today it is possible to listen to sound quality seldom achieved by the better radio receivers.

A Revolution in Motion Pictures

One of the original editorial staff members, F. S. Irby, related the economic revolution produced in motion pictures by the advent of sound. Then there were 22,000 theaters showing pictures in the United States and of these, about 9,250 had been equipped for sound in the two years that had elapsed since the "Jazz Singer" (October 1927) had given movie goers a new vision, one in which they could hear their favorite stars as well as see them in motion. Now, of course, no theater which does not have sound equipment can even open its doors. Its lights are permanently dark.

"At the beginning of 1927 there were perhaps not 5 companies engaged in the manufacture of sound apparatus. By the end of 1929 there were 154 manufacturers in this field and as many as 182 makes of sound reproducing apparatus on the market". Most of these manufacturers have disappeared in the ten years that have elapsed since Dr. Irby presented these statistics.

In several issues following the initial April 1930 *Electronics* there was much discussion of the wide film (Grandeur) then proposed as another motion picture innovation. Wide film no longer plagues the minds of producers and exhibitors.

In the first issue W. C. White of the General Electric Vacuum Tube Engineering Department brought engineers up to date on the possibilities of the magnetron tube. Then it was possible to generate frequencies as high as 100 megacycles (a term not used in those days) and powers as great as 2.5 kw had been produced at 75 Mc. Dr. Mendenhall of the Bell Laboratories described the new double-ended high frequency tubes engineered for the transatlantic telephone circuits. The

240-A water cooled tube would generate 10 kw and the air cooled 251-A would produce 1 kw at 30 Mc.

Among the new products mentioned in the first issue were several from companies which no longer exist. Arcturus offered the Photolytic cell, a liquid photovoltaic cell in a handsome container. It listed at \$31.50. Ten years later (1940) Arcturus as a tube producing company gave up the ghost, unable to make a profit from making tubes at present low retail prices.

Jenkins Television offered the Radiovisor kit for \$75 without the neon lamp. It would produce television images about 2-inches square, 48 lines, 15 pictures per sec. DeForest Radio presented a short wave receiver "radical in appearance". Four tubes (types 22, 01-A and 12-A) and a series of plug-in coils, the latter stuck up on top in a jaunty and much too exposed fashion, constituted the essential components. It would cover the range from 20 to 200 meters.

Of 11 new products described in this first issue from 11 manufacturers, only one remains in modified form, and of the 11 companies only 4 are in existence today.

In the News section, mention was made of a new set of equations from Professor Einstein, still in Berlin, relating gravitation and magnetism, and of the R.M.A. committee to study the pentode situation (no set manufacturer would use the things in their 1930 production), and plans were described for the super-colossal R.M.A. Radio Trade Show to be held in Atlantic City in June.

In a department devoted to brief summaries of U. S. patents were names such as Harry Nyquist, Alva B. Clark, E. L. Chaffee, Samuel Ruben, R. H. Ranger, John H. Miller, Abraham Esau, F. A. Kolster, G. W. Pierce, H. C. Rentschler, Donald G. Little, Robert L. Davis, Carl F. Goudy, H. C. Dunwoody, O. T. McIlvaine. Patent numbers ran from 1,748,000 through 1,750,000. In the February 27, 1940 issue of the Official Gazette of the U. S. Patent Office the numbers are up in the 2,192,000—nearly a half million patents had been issued in this ten-year period, surely no period of inventive depression.

The mast-head of *Electronics* of that initial issue bore four names. O. H. Caldwell was editor, a veteran McGraw-Hill editor, first of *Electrical World*, where he invented *Electrical Merchandising*, becoming its editor. Here he invented *Radio Retailing*, becoming its editor. And here he invented *Electronics* and became its editor. Mr. Caldwell left *Electronics* in 1935 founding a paper of his own. As associate editors were Franklin S. Irby and Keith Henney. Dr. Irby came from E.R.P.I. and represented the motion picture industry to *Electronics* readers. A Ph.D. under Michelson, a Lieutenant Commander in the Navy, Dr. Irby left *Electronics* several years after its founding and subsequently took a degree in law and has been admitted to the bar. Today he is in the legal department of 20th Century-Fox Films.

Keith Henney was drafted from his job with *Radio Broadcast*, a magazine long since defunct but remembered fondly by old timers in the radio industry. His contribution was his knowledge of the radio industry from the technical angle attained by experience during the war as radio operator, and as engineer at the Bell Laboratories, by technical training under Professors Pierce, Chaffee and Field at Cruft Lab and finally by his 5 years on *Radio Broadcast*. He, alone of the original editorial staff, continues on *Electronics*, now its editor. The fourth member of the editorial staff was Dr. DeForest, consulting editor. Always bullish on electronics, Dr. DeForest has often contributed sage advice and worthwhile information to the periodical during its 10 years existence.

A feature of the initial issue was a colored chart giving the radio spectrum as it was divided in 1930. Frequencies higher than 23,000 kc were assigned for experimental and amateur use. At 60 Mc the spectrum ended for there seemed no way to generate frequencies so high in quantities great enough to be useful. This chart became so popular that it was revised in 1932 and 1936 and now appears again in this anniversary issue.

May to December, 1930

In the remaining issues of the first year, important new uses for tubes were disclosed, and events which presaged later developments of considerable importance were first described. In May, Page and Carpenter, General Electric engineers, reported on the production of artificial fevers by means of high frequency fields. Since that day the application of high frequency equipment to the needs of the medical profession have been very great. A by-product of this development has been much interference to communication channels by therapeutic apparatus.

In May 1930, the editorial pages carried a fervent plea to those who controlled broadcasting not to limit transmitting power. This theme will be found repeated many times in the following 10 years, for engineers know that only good strong clear signals provide the listener with good program service. Jefferson Electric Company offered a tube checker in the May issue. It had 6 sockets, one each for the 226, 227, 224, 247, 171A and 280 type tubes.

On May 22, Dr. E. F. W. Alexanderson demonstrated television on a screen 6x7 feet, made possible by means of a high intensity arc, a new light valve (a Karolus cell) and general improvements to existing apparatus.

At the Trade Show in Atlantic City in June of 1930, engineers seemed to have displayed considerable boredom at the offerings of the set manufacturers. There was nothing startlingly new, "nothing to compare with

the introduction of a-c tubes, the dynamic speaker, or the debatable advantages of the screen-grid tube". Everyone seemed to be jumping into the public address field. One radio manufacturer provided the set owner with short wave reception by means of a separate chassis. Receivers were good enough to cause one speaker to state that sound pictures were still inferior to radio in tone reproduction. The big thing for 1930 was to be tone control, by which the listener could get more effective bass by reducing the actual treble response. This was great stuff, according to those in attendance at the Trade Show; and has continued to be great stuff ever since. A tone control is a very inexpensive device to cover up bad design and troubles due to inferior components.

At the Trade Show Mr. Aceves demonstrated high quality reproduction attained by proper compensation in the amplifier of record and loud speaker deficiencies. The audience of engineers was enthusiastic, but sales departments decided that high quality was all right for engineers but not for the public. Ten years later this impression is still prevalent.

Many Radios Still to be Sold

Saturation of radio receivers in American homes as of June 1930 was about 30 per cent. One out of every 5 non-radio homes was to buy a radio in 1930; and there were 2 million battery sets still in use. Only 7.7 million a-c receivers had been sold.

In August 1930, *Electronics* made much of the quarter-million dollar "temple of electronics" that John D. Rockefeller, Jr., was to erect in cooperation with R.C.A. and N.B.C. Three city blocks were to be razed for Radio City.

The market for home talking movies was appraised in September—a market that never appeared, much to the distress of several manufacturers who got caught in the vicious circle made up of the facts that no one would buy home equipment until there was a library of sound pictures available, and that no one would put the money into building up a library until there were many reproducers already in home use.

In September, B. J. Thompson, then of the vacuum tube engineering department of G.E., described the development of the FP-54 tube, a tube which will measure 10^{-17} amperes and will indicate the flow of current represented by 63 electrons per second. In the 10 years since this tube was first produced, many hundreds have found their way into research laboratories, astronomical observatories and other places where a sensitive electrometer tube can be utilized. The 230, 231 and 232 types of tube were introduced—operating from 2-volt batteries and requiring 0.06 to 0.15 amperes for the filaments. In November, National Carbon presented the radio world with its 2-volt Air-Cell battery, an important contribution to listeners in powerless homes.

George Throckmorton was then executive vice-president of the E. T. Cunningham Company. E. A. Nicholas had just been appointed Radiola distributor for northern Illinois. Gene Tracey had gone to the West coast to discuss the possibility of erecting a new plant for National Union Radio there; Milton Alden and Elinor Johnson had formed a new company known

as the Alden Products Company. Triad in Pawtucket announced a new and improved 210 type of tube, R.M.A. was worrying about the usual overproduction and subsequent dumping of radio receivers. Jensen Radio Mfg. Co., announced midget speakers for automobile or "mantle" receivers. They listed at \$15.00. Nowadays one can purchase, speaker, tubes, cabinet and all the components for less than this figure. In November 1930 there were 29 cities using radio service as adjuncts to their police departments and the rapid expansion of this service was signified by the fact that 22 other cities held construction permits. Howard W. Sams was general sales manager of Silver-Marshall.

The total cost of making a radio tube in late 1930 was 41.6 cents, half what it had been two years before; and it was estimated that the production of receiving tubes would mount to 69 million by the end of the year.

In November Mr. Walter F. Gifford, President of A.T.&T. said "As sure as I am standing here, this depression will soon pass. We are about to enter a period of prosperity, the like of which no country has seen before."

At the year-end of 1930 certain accomplishments had been recorded. Among them are the following: Westinghouse invented the ignitron which proved to be a very practical controlled rectifier suitable for handling high power especially in those applications where the ratio of average current rating to peak current rating was very high. Resistance welding had found a new and powerful tool. Telephone service was opened between the United States and Australia; the Bell Laboratories had demonstrated phone-booth two-way television; R.C.A. demonstrated transmission of maps and news to ships at sea by facsimile; Balantine developed the variable-mu tube (551), Western Electric introduced noiseless film recording. September, 1930, C.B.S. broadcast its first Philharmonic Orchestra program.

1931

Midget sets were the rage at \$55; the superhetrodyne, which came into wide service in 1930, became the standard circuit in spite of bad radiation characteristics; Merlin Aylesworth, president N.B.C. said "The majority of business men will have radio sets in their offices in 1931;" "toe recording" of sound on film was described in January 1931 *Electronics* by George Lewin and in this issue will be found a summary of opinions on the historic struggle to determine who invented the high vacuum. On May 25 the Supreme Court declared the Langmuir patent invalid and the Lestein Corp. of America advertised the Lestron 110-volt tube.

Hawaii, Oahu, Maui and Kauai in the Hawaiian Islands were interconnected by u-h-f radio circuits by R.C.A. for an inter-island communication system. Traffic was controlled by phototube installations in East Liberty, Penna. R.C.A. noiseless recording sound in film was introduced.

Radio sets sales in 1930 were reported in March *Electronics*. Sales were less than in 1929, dollar volume

was off to a figure nearly one-half that of 1929. The year saw a total radio set, tube, and accessory business of about a half-billion dollars compared to 842 millions the year before. The depression was really getting under way.

There was much squabbling among tube people as to the final design characteristics of the variable-mu tube, the major difficulties existing between the R.C.A. 235 and the Arcturus 551 (Ballantine's tube). The 235 won. C. W. Stone of G.E. extolled the virtues of d-c power transmission—but to date an experimental installation is as far as thyratrons and big rectifiers have gone toward revolutionizing the power networks. Clause 9 was causing much trouble, deForest Radio getting a permanent injunction against R.C.A. in February in the Federal Circuit Court of Philadelphia. Editor Caldwell prophesied "organless, choirless, bell-less and preacherless churches in 1940," all by electron tubes. All through 1931 occurred bitter wrangling between the components suppliers and the radio set manufacturers over price. Quality of receivers hit an all time low; poor workmanship, poor tone fidelity, low prices.

At the Trade Show, Stevens Hotel, Chicago, was displayed a permanent magnet loud speaker, first of a long line of speakers supplying their own field energy. Tube manufacturers were developing fancy testers as inducements to dealers to sign on the dotted line for tube franchises. Sanabria demonstrated 45-line television on a 6-foot screen using a high-intensity low-cost tube made by Taylor; General Radio displayed the Von Ardenne cathode ray tube for measurement purposes; engineers were shocked by holding the wrong end of a large Rochelle salt crystal; 71 per cent of all set models displayed were supers, 73 per cent used pentode tubes and 94.5 per cent used variable-mu tubes.

Late in the year, 1931, *Electronics* and other McGraw-Hill publications moved into their own building at the present address, 330 West 42 St. On Christmas Day, N.B.C. broadcast Hansel and Gretel from the Metropolitan Opera House.

1932

The new year opened with recognized liabilities:—radio overproduction, engineer unemployment, financing troubles, idle factory capacity. The assets:—a hoped-for automobile market for 300,000 receivers and a hoped-for increase in interest by industry in the vacuum tube as a control agent.

In January N.B.C. was completing the first television antenna on top the Empire State building, 1250 feet above the sidewalk. The R.C.A. field test of television had already begun, 8 years ago! The Federal Radio Commission, forerunner of the F.C.C., admitted that television progress had been made in 1931 but was not inclined to open the bands to paid television until more progress had been made. Mechanical scanning was used at Empire State, 120 lines 24 frames and engineers who had seen the picture were pleased. "Within six months a two-foot picture is expected with a million-cycle sideband required." "It is extremely

doubtful if any large scale sales can be possible before 1933."

Mercury vapor tubes were threatening the existence of the 80 type tube, a threat which has not come to any fruit. Tube prices to set manufacturers averaged about 40 cents following a cut in prices near the end of 1931.

In the first 1932 issue of *Electronics* E. W. Ritter, Research and Development laboratory of R.C.A. Radiotron, described the benefits of utilizing the suppressor grid in a pentode for r-f purposes. This was the 239, the forerunner of a long family of multi-element tubes for preliminary amplification and frequency conversion stages.

At the first of the year automobile radio problems were many. There was no really good converter of power for the receiver; the sets cost too much (much more than 10 per cent of the cost of the car)—and free wheeling (then the potential rage of the automotive world) was creating havoc with the charging problem. At the New York Automobile Show in January Mallory showed a half-wave rectifier using a Raytheon tube; Bosch demonstrated its "Magmotor." Prices for these convertors of several types were of the order of \$25 to \$30, high prices indeed just to convert storage battery power to a form useful by the auto radio set!

Auto Radio—the Great White Hope!

Early in the year engineers were discussing Class B amplification. David Grimes of the R.C.A. License Laboratory (established 1930) talked about it at the Chicago I.R.E. section in January, C. E. Kilgour of Crosley and J. R. Nelson of Raytheon wrote on the subject in *Electronics*.

During the early months, industrial applications of vacuum tubes involved phototube controlled elevators, continuous weighing utilizing a selenium bridge with amplified output, supersonic sterilization of milk, phototube control of humidity, synchronization of rubber conveyors using thyratrons. Several articles dealing with the theory underlying the several industrial types of tubes were published to acquaint engineers with the possible applications of such control devices. The theremin was being used by Dr. Stokowski and the Philadelphia Orchestra. Ranger and Miessner were both active in developing electric musical instruments.

Flexible cable was used for controlling automobile and home receivers by the Radio Vision Research Laboratory of the Federal Telegraph Co.

March 1932 saw the annual presentation in *Electronics* of industry figures. During 1931 some 3,340,000 receivers had been produced for the domestic market (471,000 for export) representing a dollar market of \$212,000,000; 53.5 million tubes were made and sold for 69.5 million dollars. In spite of general business lethargy radio sales held up well. Slightly over 100,000 auto radios were sold at an average price of \$55.

Automobile radios were still looking for ideal energy converter—12 being described in March at list prices varying from \$18.50 to \$40, most of them being rotat-

ing machines. Raytheon produced its LA automobile power output tube, which developed as much output as the 247 but with a filament power requirement much less.

Manufacturers were beginning the runaway announcement of new types of tubes. The 46 appeared, designed for class B, the Triple-Twin of Cable Radio for the same purpose and the Wunderlich detector double grid tube (this brought on the 55) arrived. Polydoroff was busy working on iron core coils.

In May, G. F. Metcalf of General Electric described a new cathode ray tube, the first evidence of the vast development of tubes of this general type. The FP-53 was a hot-cathode tube employing electrostatic deflection with anode voltages of 5000 to 10,000 volts. Allen DuMont had offered the first American cathode-ray tube in June, 1931. C. B. Upp of Westinghouse described the RJ-563 heavy duty industrial amplifier in the same issue.

W. P. Koechel of Ken-Rad had started his series of tube applications utilizing the "hole-in-the-meter" type of indication and control. During the early months there was much talk about Dr. Robinson's crystal filter receiver (the Stenode) circuits, and in May 1932 Professor Appleton of King's College discussed the important property of highly selective circuits of the Robinson type characterized by the fact that a strong signal demodulates a weak signal giving an effective increase in selectivity.

Radio Declines High Fidelity

Two-speaker receivers were tried out, discussed, and later dropped. Engineers were clamoring for their sales departments to permit a higher degree of tone fidelity in radio receivers, after having listened to phonograph recordings out to 9000 cps, motion picture reproduction (Providence, R. I.) out to 8000 cps. Broadcasters had pushed sidebands out to 7500 cps.

At the Stevens Hotel in Chicago in May the R.M.A. Trade Show displayed the wares of the new season. At the same time Radio Row (Cortlandt Street, New York City) was flooded with 1931 receivers "with as many big names as the movie 'Grand Hotel'." R.C.A. was threatening to bring out another tube; and the R.C.A. licensees saw cathode ray television demonstrated.

Clear channels in the broadcasting spectrum were slowly being whittled away limiting the useful range of these channels to local communities. The I.R.E. set up a committee to help unemployed engineers.

All-wave receivers amounted to 24 per cent of models shown at Chicago; 70 models used two speakers; class B was taking hold very fast, aided by the mercury vapor rectifier tubes; there were more higher priced sets shown than lower priced sets (comparing prices to the previous year) and the averages of the two groups seemed to be in the neighborhood of \$43 and \$39. Automatic tone control circuits were being developed (these never came into much use) and automatic muting circuits were appearing in small quantities. Adoption of the 6.3 volt line of tubes by Philco (tubes by Sylvania) had much to do with the later general use of these tubes by all set makers. The October 1932 issue of *Electronics* listed 300 different

types of tubes on the American market. (During 1932 the number of receiving tubes nearly doubled.)

Later in the year circuits for driving push-pull stages from a single-ended driver stage (phase reversed circuits) were described; acoustically compensated volume controls which boosted the bass at low volume levels were in use, and "the universal dc-ac receiver made by International (Ann Arbor) is attracting much attention not only for its small size and low cost, but the ingenious scheme to take care of service problems." When the set needed repairs, the owner placed a dollar bill in an envelope, placed the envelope in a slot in the receiver provided for the purpose and shipped it back to the factory. The dollar-in-the-slot idea did not last long; but the ac-dc sets are here to stay. Receivers in which the owner could make recordings were being improved.

Settlement of the Government suit against R.C.A. occurred during the year 1932. By this consent decree, G.E. and Westinghouse divested themselves of R.C.A. stock, and R.C.A. was freed from competition in the radio set field for 30 months after which G.E. and Westinghouse could enter the hazardous business of making and selling receivers on their own.

Increased use of directional broadcast antennas occurred during 1932; and at the Fall Meeting in Rochester B. V. K. French gave his long-remembered analogies between the radio and the photographic art.

The year saw increased sales of phototube relays but the manufacturers knew only in few cases the usage to which these units of package goods were to be put. Electric signs were turned on and off automatically by phototubes; automatic batching and weighing was accomplished in a practical manner; eggs were candled by phototubes; thyratrons controlled steam boilers; razor blades were inspected, raw silks were tested for thread size, colors were matched and phototube guards were put on Radio City elevators. Messrs. Lord and Livingston of G.E. began a series of articles which continued over a long period, dealing with applications of tubes to counting, to welding, to timing, etc.

The ribbon type microphone was produced during 1932; automatic repeater stations for u-h-f were demonstrated, and multiplex operation of a single transmitter speeded up traffic.

By the end of the year the industry had disposed of 2,620,000 sets, 44.3 million tubes with a market value of \$196,190,000, the smallest tube-set turn-over since 1927.

1933

In the January issue editors prophesied what 1933 might bring. Already tests from the Empire State had demonstrated the carrying power of high-altitude short-wave antennas. Engineers were becoming acquainted with automobile ignition interference. Signals from Empire State (2 kw at 44 Mc) were heard atop Mount Washington, and in Albany and Montauk

Point. An all-metal envelope tube had been developed at Schenectady. This was not the metal tube that later on jarred the radio set industry, this was a 100-amp industrial tube—but it pointed the way. The 25Z5 was on the way. A quarter million auto radios at about \$45, it was hoped, would be sold in 1933. (Actually nearly 725,000 were sold.)

Inter-carrier noise suppression, amplified AVC appeared. Description of the electron tube equipment in Radio City Music Hall appeared in the February issue. "It was the electron tube that made Radio City possible." Nearly a score of new receiving tubes were introduced in the early days of the new year. These were the 6.3 volt tubes and the 2A3, 2A5, 2A7—note the new numbering system. Gaseous indicator tubes appeared on radio receivers. Now began the urge to put two or more tubes in one glass envelope.

Old line manufacturers were caught napping by the midgets, and it took many of them a long time to get in on this market, almost the only market at the moment.

Auditory perspective or stereophonic sound reproduction was demonstrated over a wire circuit from New York to Philadelphia. Later Dr. Harvey Fletcher and his associates at the Bell Laboratories demonstrated the equipment in New York City. All-metal tubes (Catkin) tubes were announced in England and America, all unsuspecting, was not much interested. They did not take very well in England, and the Catkin is now a museum piece.

Radio Aids to Aviation

Harry Diamond of the Bureau of Standards demonstrated his blind landing system at Newark Airport. At the mid-years, industry codes under NRA occupied the time and worry of many industrialists; the ignitron was first described in *Electronics*, thyratrons were put to work welding the metal parts of all-metal high power tubes (another step toward metal receiving tubes.) Zworykin presented the iconoscope to the IRE June 26 meeting in Chicago; the Acorn tubes made their appearance early in the Fall and B. J. Thompson described them in *Electronics* (August 1933).

Indian summer, 1933 saw a surprising upturn in radio sales—but industry was worrying. Could NRA, NEMA-RMA code supervisors effect stabilization of the radio industry?

At the end of the year the balance-sheet of television stated these troublesome factors: lack of detail in pictures, high cost of receivers, expense of tube replacements, small range of transmitter, difficulty in chaining stations together for network programs, tremendous studio expense,—who will pay for television? Many of these problems still vex television people.

Five hundred kilowatts went on the air at WLW in 1933 and continued to be the talk of the industry in the following year. It was hoped that other really high power stations would keep WLW company—but this wish never materialized. Facsimile as a broadcast

service to the public began to be talked up, and in 1940 it was still being talked about but without widespread use. Between 600,000 and 700,000 auto radios were put in cars during 1933. Home receivers during 1933 sold to the number of 3.7 million with a retail value of \$130 million; tubes to the number of 63 million. Auto-radio vibrators were selling to manufacturers for about \$1.50; components were selling to set makers for about one-third of the 1930 prices. Hazeltine engineers delivered a series of papers on high fidelity at the Philadelphia I.R.E. annual convention.

1934

Shield grid thyratrons (Livingston and Maser, April 1934 *Electronics*,) appeared; double cathode phototubes were being used for sound on film recording, engineered by Dimmick of R.C.A.; television from Empire State to Camden was demonstrated to members of the press. Tower antennas for broadcasters were coming into greater use. Farnsworth demonstrated his electron multiplier tube utilizing secondary emission. Associated Press installed a large inter-city photograph transmission system engineered by Western Electric.

Donald G. Fink, of M.I.T., joined the editorial staff of *Electronics*.

Tombstone models of receivers, more new tubes, airplane dials, program pre-selecting mechanisms provided highlights for the year. Messrs Pike and Metcalf, G.E., described the all-metal industrial tube.

During the year 1934, C. J. Young, Otho Fulton, J. V. L. Hogan continued work on home facsimile. Station WTMJ installed a Hogan "radio pen" but "no immediate commercialization is planned." At the end of the year radio sales were running ahead of the previous year by an estimated 40 per cent; 4.7 million receivers were sold.

Metropolitan Opera House installed tube controlled lighting system; tube operated voltage regulators were being used in photometry; and the department "highlights of electronic devices in industry" continued to point out many applications of phototubes, amplifiers, cathode ray tubes and other members of the tube family to non-communication problems.

Late in 1934 S. Y. White read a paper before the Radio Club of America on "signal-seeking" circuits (*Electronics* January 1935) and opened up a whole new box of tricks. Automatic frequency control came in; and later went out aided by components whose frequency shift with temperature, and humidity and time became negligible.

A 400 kw tube-commutated motor was described before the A.I.E.E. in January, d-c power transmission came in for more talk, the co-axial conductor system was described.

Edgerton was working on his high speed photography experiments, later to give a new and remarkable insight into many of the motions of nature and of man's creations.

And on April 1, 1935 R.C.A. and G.E. disclosed and described the all-metal receiving tube. On April 26 Major Armstrong announced to the newspapers that he had developed a system of frequency modulation for use on high frequencies which reduced the noise level to such an extent that the range of 7-meter stations could be quadrupled. Electron beam tubes were discussed by B. J. Thompson at the Annual I.R.E. convention (this led to the 6E5 tuning indicator tube), F. B. Llewellyn received the Morris Liebmann prize.

September 1935 *Electronics* appeared in new dress, on better paper, and with expanded editorial contents. Since that date the paid circulation to the publication has doubled and each year sees an increase in the number of readers.

Automatic SOS alarms were developed. Volume expansion in radio sets came in with a boom and went out very quietly. Zworykin demonstrated his electron multiplier tube to the I.R.E. in October; in November Armstrong gave his historic paper on frequency modulation.

1935-1940

The last five years telescope. The depression continues—at least everyone thinks so. Taxes increase tremendously, one does more business but makes less profit. Engineers still tramp from one factory to another. Manufacturers find it cheaper to hire engineers than mechanics and have less trouble with unions if they do so. Industry is still allergic to electron devices except where it cannot perform the desired functions in any better way. Welding continues to be the big electron tube application, 1000 ignitron welders had been placed in service by Westinghouse alone. Register control on printing presses, trimming machines and similar equipment is the bright photo-tube application. All during the 1930-1940 period continuous improvements were made in X-ray tubes. Power is still transmitted by ac, receivers cut off pretty sharp at 4000 cps or less; Armstrong insists that FM will solve the radio problem; but radio people say that no one wants better tone fidelity. Television comes out of the laboratory and goes on the air definitely and at much cost; a few receivers are sold; war comes to the world.

During 1936 Zworykin developed his electron telescope; Professor Mimno discovered that therapeutic machines were creating the mysterious long range havoc on communication channels; the beam power tube and the turnstile antenna appeared; Doherty worked out his high efficiency modulation circuits; Barrow and Southworth demonstrated hyper-frequency waveguides; R.C.A. put unattended repeater stations between New York and Philadelphia, operating a circuit on 100 Mc, feedback amplifiers became the plaything of engineers and college professors, following Black's earlier work; R.C.A. sold a high-fidelity Victrola. It was the year of the Magic Brain, the

Magic Eye and the Magic Voice. Acoustic networks in radio sets gave some hope of higher fidelity.

During 1936 radio sets to the tune of 7.6 millions, \$300 million were sold. Radios looked and sounded alike. The industry was settling down. Troublesome, however, was the talk about frequency modulation, television. New services, new schemes provided jobs for engineers but sales departments demanding something new all the time, didn't want anything *too* new. WQXR, broadcasting high quality record music in evening hours (1937), slowly gathered to its fold many thousands of New York's critical listeners tired of blah. Push-button tuning became the vogue, Philco demonstrated 441-line television, engineers squabbled over standards for television.

In August 1937 it was reported that fewer metal tubes were used in home receivers than the previous years, substitutes for metal tubes were invented. In August 1937 Don Fink began the construction of *Electronics* laboratory television receiver, described in a series of papers in 1938. The Engstrom-Holmes series of articles on the practical aspects of television receiver design and manufacture was published in 1938. Several new methods of attaining higher modulation efficiencies were described before the I.R.E. in 1938 and came into rather general use in the following years. The 1851-1852 high mutual conductance tubes appeared to aid television receivers. The highlight of the 1938 Fall Meeting was the Seeley-Foster television demonstration.

1938 and 1939 seemed to have been years of comparative quiet, if one is to judge by looking over the periodicals of that period. Television advanced slowly, N.B.C. bearing the burden of putting programs on the air. C.B.S. bought a transmitter but continued to make changes in it at the end of 1939. Armstrong put his Alpine W2XMN f-m transmitter on the air. Radio Engineering Laboratories built several transmitters for the Yankee network and others, several receivers were made ready for the market. The arguments of am vs. fm and of wide-band vs narrow-band fm became quite acrimonious and at the end of the year 1939 plans were made to reveal all at a meeting of the F.C.C. early in 1940. Improved pictures cross the Atlantic via R.C.A. and Western Union.

This review, admittedly brief and admittedly omitting many important events cannot end without some thoughts to the future. Electron tubes continue to go into industry slowly, but there is no revolution as was dreamed of 10 years ago. Broadcast stations continue to fill the air with drivel—and then by contrast to give us the Metropolitan Opera, the Toscanini broadcasts, the Philharmonic. Mae West and Orson Welles have served their purpose. Europe and Asia at war, America continues to be the land of the free and the continent of hope. Radio has settled down; broadcasting is a necessary part of the national life. Seeing as well as hearing is on the way, even if slowly.

Continued research and development into apparatus for the ultra-high frequencies point toward a vastly increased communication service in the microwaves.

Motions of electrons under control continue to offer much to man; who can guess what another 10 years will bring?

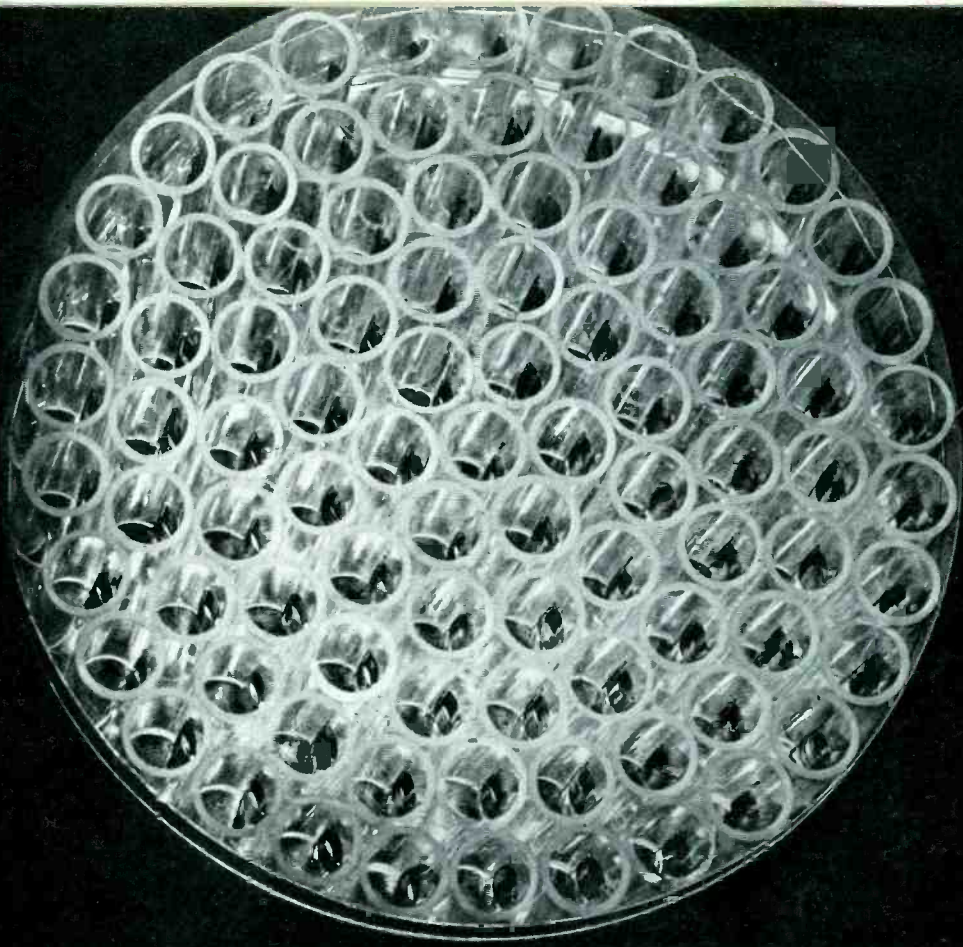

Upper left, the new tube is a pentode with a g_m value of 2600 micromhos, and a sum of input and output capacitance of $5.2 \mu\mu f$. Its figure of merit for wideband service is accordingly over 500, which puts it in a class by itself

Upper right, the control grids are perhaps the most delicate ever put into a vacuum tube: 200 turns per inch, of wire 0.001 inch in diameter. Each grid before assembly is handled in a separate cylinder of glass, and packed in the container shown above. The whole set-up looks something like the 200-inch Mt. Palomar telescope mirror in miniature

Lower left, the girls who mount the elements must have the manual dexterity of a jeweler, but once this adeptness is acquired, the time required for completing the mount is not much longer than in more conventional tubes. Here the elements are mounted on the support micas and welded to the stem

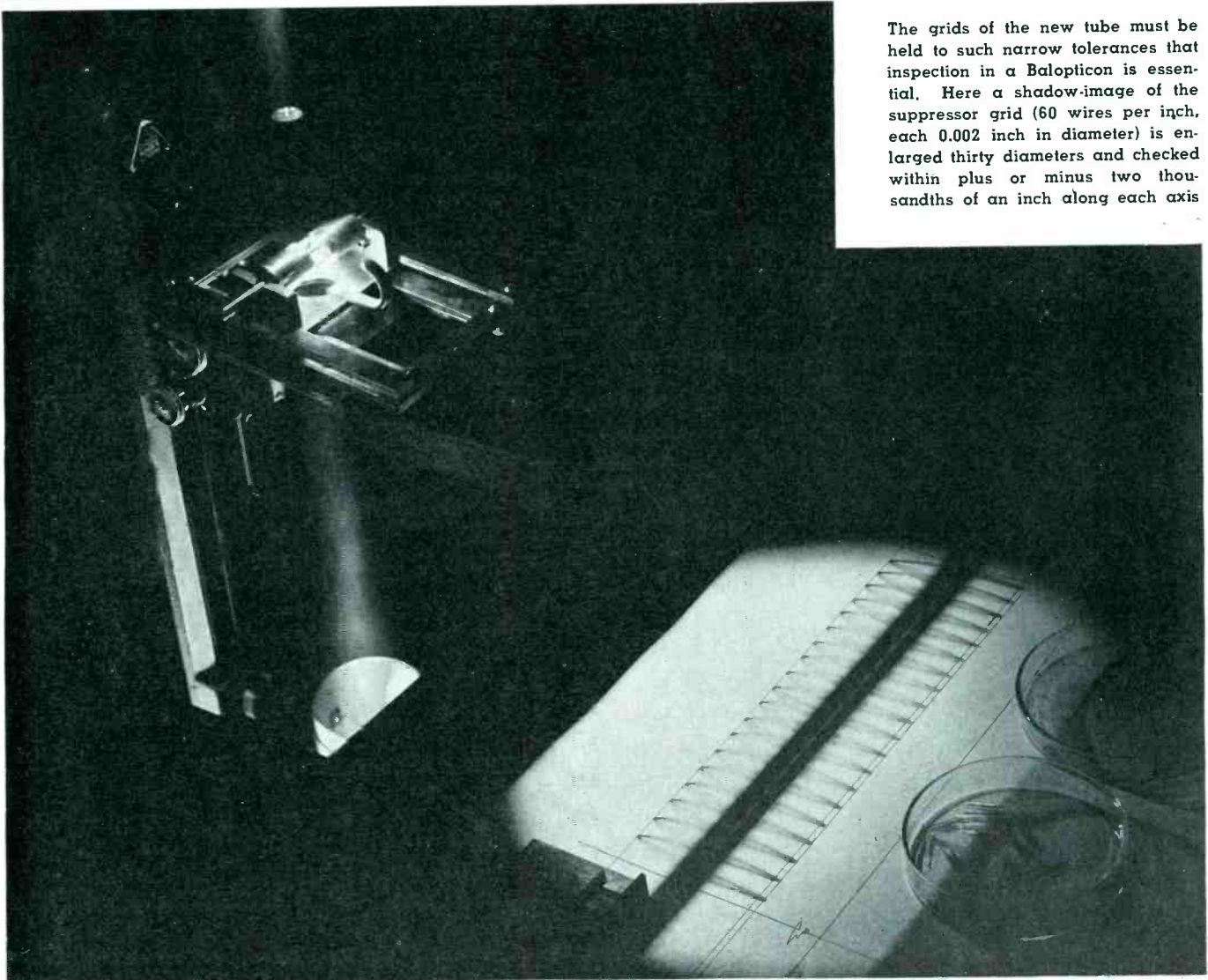

The grids of the new tube must be held to such narrow tolerances that inspection in a Balopticon is essential. Here a shadow-image of the suppressor grid (60 wires per inch, each 0.002 inch in diameter) is enlarged thirty diameters and checked within plus or minus two thousandths of an inch along each axis

The COAXIAL LOUDSPEAKER

A high-frequency speaker, nested within the cone of the low-frequency unit and protected from the low-frequency acoustic output. The combination has excellent frequency range, low distortion, wide-angle distribution, while offering a single localized source of sound

By BENJAMIN OLNEY

Stromberg-Carlson Telephone Manufacturing Co.

INTEREST in loudspeakers of wide frequency range has been heightened by the recent advent of radio transmission systems which are not subject to the usual audio frequency band width limitations. Frequency modulation systems in particular offer the possibility of reception up to the highest audible frequencies together with a large increase in signal to noise ratio. While extended frequency range loud speakers have been available for some years past, their full possibilities could not generally be realized in radio receivers, chiefly because of the increase in repro-

duced noise resulting from the widening of the frequency band. It is believed that the noise-reduction feature of the frequency modulation system together with its low non-linear distortion makes practical for the first time the utilization of the full audible range in broadcasting.

Advantages of Dual System

The loudspeaker system to be described was designed to be housed in a console radio receiver of moderate size. It is of the dual type employing separate dynamic cone loudspeakers for the high and low frequency ranges, and each speaker is

fed its appropriate frequency band through a common dividing network of the four element, constant resistance type. Its effective frequency range is from below 65 cps to above 10,000 cps.

The well known and outstanding advantage of the dual system is that each of its loudspeakers may be designed specifically for its own restricted frequency range, thus overcoming to a large extent the limitations imposed by the inherent design conflict between frequency range and power handling capacity. There are other advantages, however, that merit consideration. First, the onset of beam radiation may be postponed to a higher frequency and the directional characteristic in general may be much improved by taking advantage of the greater freedom of choice afforded in the size of the radiators to make the diameter of the high frequency cone as small as possible. Second, it is known that most cone-type, moving-coil loudspeakers are somewhat non-linear at large amplitudes. The resulting distortion of low frequency waves alone is usually not unpleasant to the ear. However, when such a loudspeaker is supplied with a complex input signal comprising components of low-frequency and large amplitude together with high frequencies, the high frequencies are modulated by the low frequencies and an aurally unpleasant form of

Fig. 1—Peak powers delivered by an orchestra within various frequency regions (after Wente and Thuras)

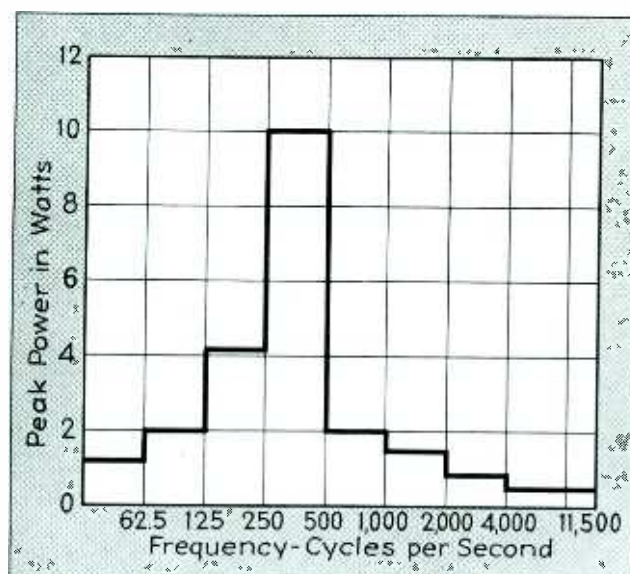

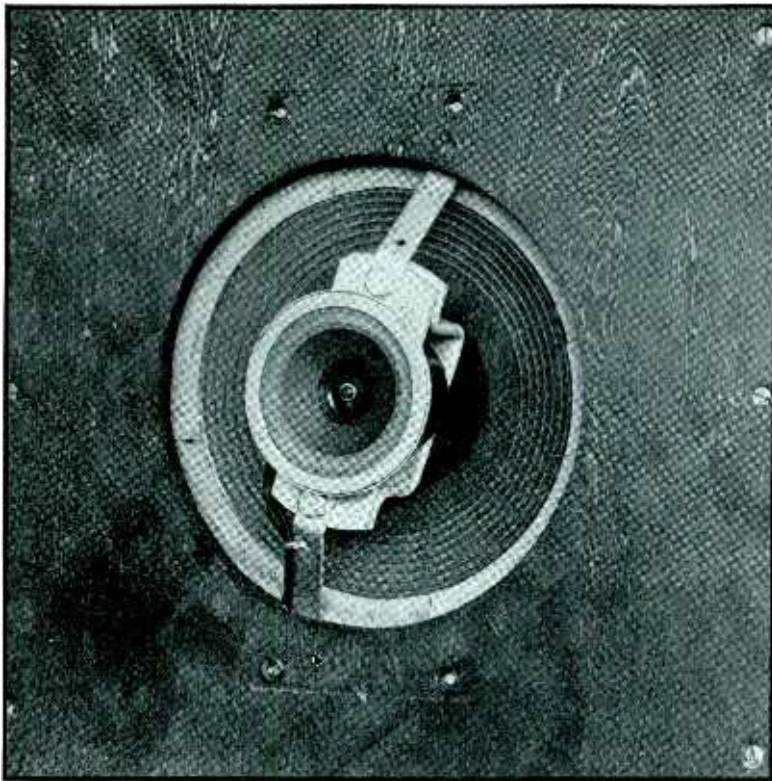

Fig. 2—Photograph of coaxial dual loudspeakers viewed from front of baffle

distortion results. Such effects are much reduced in dual systems because the restricted frequency range of the low frequency speaker curtails the modulation possibilities.

Choice of Cross-over Frequency

It is possible by careful design to produce a cone type low frequency loudspeaker of moderate size that will afford a mid-range response substantially flat up to about 1500 cps and falling off above that frequency. Also, to obtain a smooth response and wide angular distribution requires that the high frequency speaker cone be small, which restricts its power handling capacity because of amplitude considerations. As the power delivered by musical instruments is much smaller in the higher than in the lower frequency bands, it appears logical to take full advantage of the flat response range of the low frequency speaker and fix the cross-over frequency at 1500 cps. Then we may design the high frequency speaker with the smallest cone capable of handling the expected maximum input power at feasible amplitudes. That a 1500 cps cross-over frequency also is advantageous with respect to the power handling capacity required in the high frequency speaker will be appreciated upon inspection of Fig. 1, derived from the original data of Sivian, Dunn and White¹ by Wentz and Thuras². It will be seen that a higher

cross-over frequency would not greatly reduce the requirements, while a substantially lower cross-over might increase them nearly ten-fold. The fact that the chosen cross-over frequency is located in the midst of the important speech frequency range is a disadvantage in ordinary designs, but this difficulty is overcome in the present system in a manner which will be described later.

Construction of the Speakers

The low frequency loudspeaker has an 8-inch diameter cone and is provided with a large and powerful field magnet. A ribbed, moulded fiber cone of unusual rigidity is used, and is fitted with an edge suspension of carpincho leather. The leather edge was found necessary to suppress strong peaks above the cross-over frequency which otherwise would have overcome the attenuation of the dividing network. The back of the cone works into a labyrinth³, enabling this moderate sized speaker to handle comparatively large input powers at low frequencies and to radiate these low frequencies effectively and without undesirable resonances.

The moulded fiber cone of the high-frequency loudspeaker is only 2½ inches in diameter. It is driven by a very light aluminum coil in a 12500 gauss field and has an edge suspension of carpincho leather. The

latter was found essential for securing smooth response and adequate power handling capacity. Edge damping plays an important role in small cone structures because, over the frequency range wherein flexural waves are propagated through the diaphragm, large amounts of vibratory energy reach the edge over the comparatively short radial paths. At these high frequencies the leather affords strong damping, preventing excessive reflection and the development of sharp cone resonances.

The center suspension consists of a thin disc of hard aluminum alloy having a moderate degree of stiffness. Low damping is an essential requirement in this suspension as any mechanical resistance therein is directly effective in reducing the vibratory energy available for driving the cone. Substitution of a disc of the usual fibrous material causes a noticeable loss in efficiency.

The back of the high frequency cone is tightly enclosed by its supporting pan. This enclosure has three important functions. First, the air enclosed within it provides an acoustic stiffness so proportioned as to resonate broadly the mass of the moving system near the lower end of the high frequency band. The resulting increase in diaphragm velocity just offsets the falling off of radiation resistance with decreasing frequency which sets in at about 2500 cps for a 2½-inch diaphragm. The response is thus maintained substantially uniform down to about 1500 cps.

Another function of the acoustic stiffness created by the back enclosure is to protect the moving system of the high frequency speaker against damaging amplitudes due to extreme sound pressures set up by the closely adjacent low frequency speaker. Since high pressures are normally associated only with sounds whose frequencies are far below the resonance frequency of the high frequency speaker, the diaphragm of the latter presents a very high im-

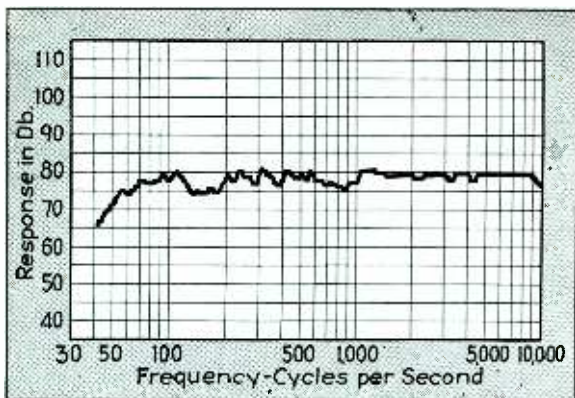

Fig. 3—Overall frequency characteristic of a frequency modulation transmitter, receiver, and coaxial loudspeaker system. Acoustic measurements made with a rotating microphone at 10 feet average distance

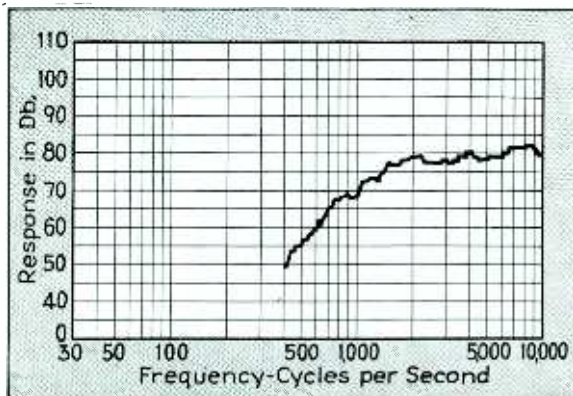

Fig. 4—Response of a high frequency loudspeaker alone at 18-inches distance on axis

pedance to such external driving. As both this driving pressure and that opposing it are distributed uniformly over opposite faces of the diaphragm, no deforming forces are exerted upon the latter. Such would not be the case, however, were the entire protective stiffness located, for example, in the cone center suspension. In addition to the possibility of damage, acoustic driving of the high frequency diaphragm at wide amplitudes by the low frequency speaker would very likely result in undesirable modulation.

The third function of the closed back is to provide a baffle for the high frequency speaker, this being necessary because of the unusual mounting arrangement described in the next section.

Mounting of Speakers

The high frequency speaker is mounted coaxially with the low frequency speaker and as far as possible within the hollow of its cone (see Fig. 2). This arrangement was adopted as the result of listening comparisons with a single loudspeaker of somewhat wider than usual frequency range. Although,

according to measurements, the dual system with its speakers mounted in the usual side-by-side relationship had a wider and smoother response than did that of a single speaker, the latter appeared to give much more natural reproduction, especially of speech, where facilities were available for direct comparison with the original. When the coaxial arrangement of speakers in the dual system was tried, however, there was an immediate reversal in the results of the tests, the dual system now being found preferable to the single speaker. The superiority of the coaxial arrangement was verified by further listening tests on a dual system where the coaxial high frequency speaker was switched against another identical one mounted in the usual location beside the low frequency speaker.

Although the differences observed in the above tests were subtle and difficult of analysis, listener preference for the coaxial arrangement was quite positive. The following is offered in explanation of the audible differences. First, it is a commonly observed fact in making listening tests that one has little difficulty in detecting which of two similar side-by-side loudspeakers is operating even when the two are located as close together as possible in the same baffle. This happens even at listening distances at which the reflected sound from walls, etc., may equal or exceed that arriving at the ears directly from the loudspeakers and is an illustration of the discrimination afforded by the binaural hearing sense. The same effect can exist with side-by-side speakers in a dual system, particularly when the frequency division is made at about the middle of the important frequency range, or higher and results in the impression of a divided sound source. Speech is more seriously affected than is music, probably because one intuitively expects speech to come from a single small source and is disturbed when the source appears to be a multiple or an extended one.

A second defect of side-by-side dual systems may reside in the possibility of phase distortion in the reproduction of transients at the listening position, arising from the spaced relationship of the loudspeakers. While it is well recognized that the ear is insensitive to phase

shift among the components of steady tones of moderate intensity, there is some reason to believe that the same is not generally true for transient sounds. The coaxial, nested arrangement of the high and low frequency speakers appears to simulate closely a unit source, thereby tending to reduce the above described distorting effects to practical insignificance.

The location of the high frequency loudspeaker in front of the low frequency cone raises the question of its possible obstructive effect upon the radiation from the latter. From a theoretical consideration of the radiation from an 8-inch piston and the diffraction around a sphere equivalent in volume to the high frequency speaker structure, it appears that the latter starts to become effective as an obstacle in the frequency region which also marks the beginning of directional radiation from the low frequency cone and which, furthermore, is not far below the crossover frequency of the system. The effectiveness of the obstacle is thus limited to a comparatively small frequency region within which measurements indicate that it acts desirably in offsetting the axial concentration which otherwise would take place.

Performance

The response curve shown in Fig. 3 is of particular interest, in that it is the directly measured overall characteristic of a complete frequency modulation system including a transmitter, a receiver and a loudspeaker system of the type described in this paper. The receiver with its loudspeaker system was a sample taken at random from production. The measurements were made with the aid of a fully automatic recording system which drew the graphs directly and whose audio oscillator was employed to modulate the frequency modulation transmitter. The receiver was located in a damped room and the sound was picked up by a rotating microphone which swept around an 8-foot diameter circle inclined at a vertical angle of 45 degrees to the speaker axis, and whose center was located at 10 feet distance on the latter. The recording system was provided with means for averaging the fluctuations in microphone output caused by standing waves in the measuring room and by the

varying distance from the loudspeakers. The curve shown is essentially the response curve of the loudspeakers, as separate measurements showed that the overall electrical characteristic of the remainder of the system was flat within 2 db.

Figure 4 shows the response of the high frequency speaker alone, measured with a stationary microphone located on the speaker axis at 18 inches distance. That the trend of this curve is not very greatly different from that of Fig. 3 above 1500 cps, indicates wide angle radiation. The difference between the curves of ordinary single cone speakers measured by the two methods mentioned is large at the high frequency end, there being invariably a pronounced droop in the rotating microphone curve. This is due to axial concentration of the radiation at high frequencies, it being recalled that the arrangement of the rotating microphone is such that the latter never crosses the axis of the loudspeaker but sweeps over an outer zone of radiation.

To show further the wide angle radiation characteristic of the coaxial-dual system, the results of comparison measurements with a single 8-inch cone speaker at 6000 cps are given in Fig. 5. There is a comparable difference at other high frequencies. These measurements were made on an 18-inch radius in a damped room, the frequency being held constant and the response recorded automatically as the microphone was moved slowly around its arc. The response is plotted in db relative to that on the axis.

It is believed that, in evaluating the performance of loudspeakers for the home, too little attention has been

paid in the past to their directional radiation characteristics. Response measurements made on the axis alone are of very limited use in estimating the performance of loudspeakers under working conditions; in fact, they may be quite misleading. This was brought forcibly to our attention in making comparative measurements and listening tests between the coaxial-dual system and a single wide range loudspeaker whose cone size was the same as that of the low frequency speaker in the former system. Although a comparison of axial response measurements showed both to have a horizontal trend, to describe the difference on listening tests with the observer stationed first on the axis and then not more than about 30 degrees off impels us reluctantly to borrow from the vocabulary of the advertising man and designate the effect as startling. When listening to music containing percussion effects rich in high frequencies, the tambourine jingles, for example, nearly disappeared from the reproduction of the single speaker when the observer moved to the off-axis position while the reproduction of the dual system changed little between the two positions. Another effect resulting from the wider angle distribution of the dual system is the sensation of spatial perception or "presence", particularly when listening to large orchestras, which arises probably not only from the greater amount of high frequency radiation directly received by an observer in an average location but also from the greatly increased high frequency reverberation in the receiving room.

In general, the reproduction afforded by this dual system with its

wide range, flat response appears to be highly natural. A rather unexpected effect is an apparent increase in dynamic range when compared with a single speaker of the same size, covering a similar frequency range, but having considerably less regularity of response and much greater directivity at high frequencies. The undistorted acoustic output of this dual system has appeared to many observers to be surprisingly high considering not only the cone sizes but also the size of the complete assembly. It can be housed in a cabinet whose inside dimensions are 25 inches high by 23 inches wide by 11 inches deep. The laboratory model has been used on a 20-watt amplifier for several months and the amplifier has frequently been driven to the threshold of overload on musical programs without damage to or noticeable distortion in the speaker system. On listening comparison with average single radio loudspeakers of similar size, the efficiency of the described system appears to be from 4 to 6 db higher.

Microphones, Studio Practice and High Fidelity Reception

Although this article is concerned primarily with the description of a loudspeaker system, it is believed, in view of new problems that may be encountered, that some comments on microphones and studio technique should be added.

One certain conclusion is that broadcasting of the highest technical quality cannot consistently be maintained without the use of monitor loudspeakers known to possess a wide, flat frequency characteristic and located in a suitable acoustic environment. The importance of the monitor loudspeaker (together with the room in which it is heard) in determining what goes out on the air can hardly be over-emphasized. Used as it is for a guide in securing the best sounding arrangement of the performers before the microphone, its frequency characteristic becomes effectively inserted in the overall transmission system. It obviously is essential that the monitor loudspeaker equal or exceed in frequency range the best loudspeakers used in receivers, for otherwise certain types of distortion, undesired noises and unnatural effects may escape the attention of the monitoring.

(Continued on page 106)

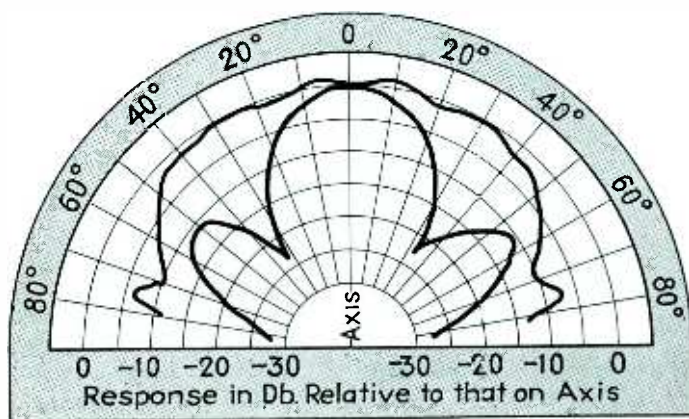

Fig. 5—Comparison of directional radiation at 6000 cps: outer curve, coaxial system; inner curve, single 8-inch speaker, both measured on 18-inch radius in horizontal plane

A PRACTICAL STROBOSCOPE CIRCUIT

Control unit for use with a conventional Cooper-Hewitt lamp, having a wide range of frequency as well as controlled duration of the light impulses, useful for industrial studies of high speed motion

By C. C. STREET

Chief Engineer, Federal Products Corp.

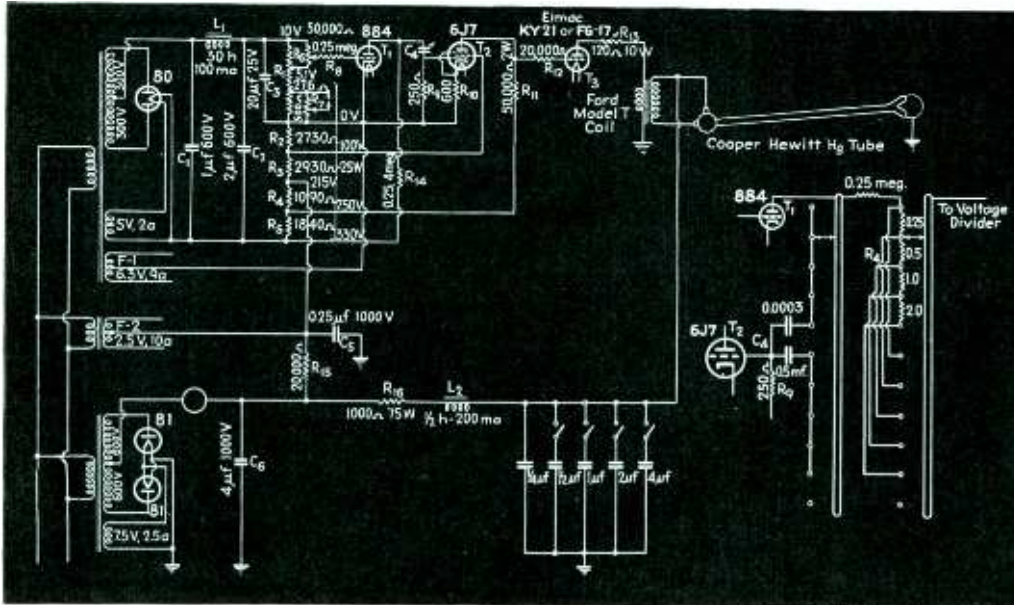

Fig. 1—Complete circuit diagram of the stroboscope. The insert diagram at the right shows push-button connection for varying the flashing rate

TO many experimenters the stroboscope has proved itself a remarkably useful instrument. Besides its conventional use on recurrent phenomena it can give much information about single-cycle transient conditions. By using a camera with a reasonably high speed lens and film sensitive to the spectrum of the illumination used, pictures may be taken of a single transient event by illuminating the object with the stroboscopic light while leaving the shutter open. This gives a series of super-imposed images, the spacing of which on the picture gives distance-time value from which velocity and acceleration curves may be drawn.

When relatively slow frequencies are to be observed such that the persistence of vision does not give a clear image, the camera again is of

value. The author has made several microscopic pictures of small objects that operate at a frequency of 150 cycles per minute.

The instrument described here can be made to a large extent from parts that most experimenters in electronics have on hand. Except for the gaseous tubes all parts are commonly used in communication equipment. The instrument has its own timing circuit and can be made to flash at frequencies between 17 cycles and 18,000 cycles per minute.

The source of light is a Cooper-Hewitt mercury vapor lamp. There is no need of securing a new one since a tube that has been retired from regular illuminating service, because of difficulty in starting, will fire satisfactorily in this circuit. Such a tube was used in the instrument described.

There are two distinct portions of the circuit, a power supply and a timing circuit. The power supply shown will supply 800 volts to the condensers at about 170 ma. This amount of power is sufficient for average work, and it can be increased as desired for more intense illumination. The timing circuit is more critical and many systems were tried before arriving at the one shown.

An independent power supply was used for the timing circuit to eliminate as much as possible the surge affects that result if the main power unit is used. The timing itself is accomplished with a relaxation oscillator similar to the saw-tooth generator of a cathode ray oscilloscope. Condenser C_4 in the grid of T_2 is charged through R_{12} from the voltage divider, to a voltage determined by the grid bias of the 884 tube (T_1), minus the drop across T_1 . This drop is constant during conduction at approximately 16 volts. The voltage developed across R_{10} is applied to the grid of T_2 , a 6J7. When T_1 is non-conducting during the charging cycle of C_4 the only bias on T_2 is produced by R_{10} . This is simply to limit the current through the tube to a reasonable value. During the discharge of C_4 through T_1 the grid of T_2 is carried negative well beyond cutoff and conduction ceases. The voltage developed across R_{11} is applied to the grid of T_2 and will keep that tube nonconducting. As T_2 goes beyond cutoff, the grid of T_1 goes 25 volts positive with respect to its cathode. This allows T_1 to ionize and discharge C_6 through the transformer. The sudden surge of current in the primary develops an extremely high

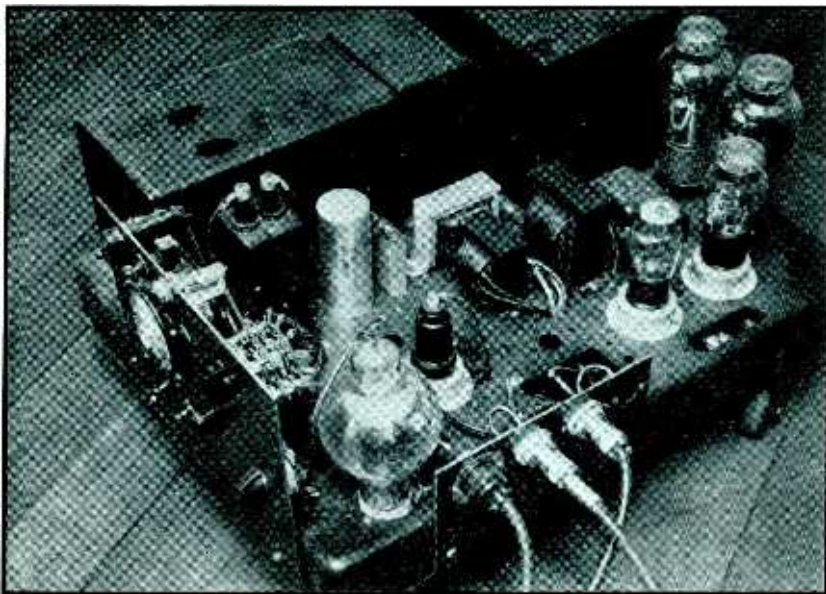

Fig. 2—Detail of chassis layout of control unit, showing discharge thyratron in foreground

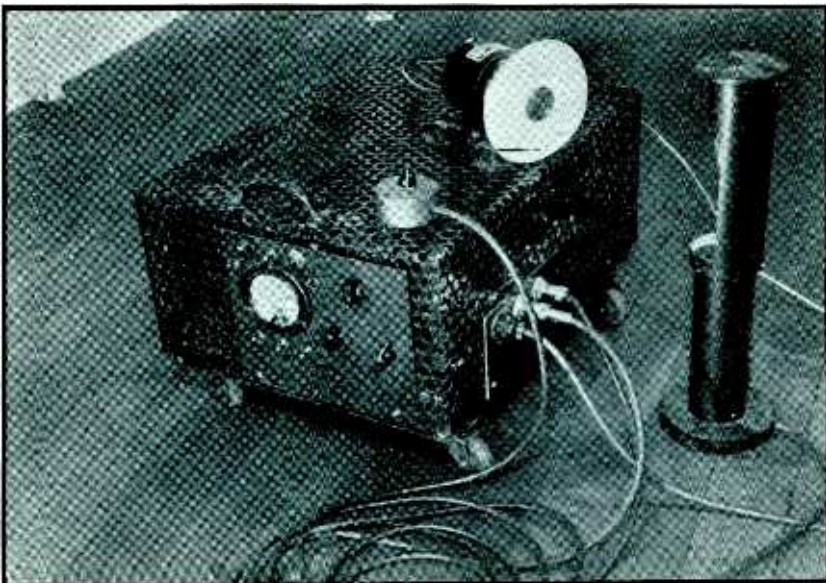

Fig. 3—Control with protective cover in place. Note control potentiometer and cable on top of cover

voltage in the secondary. This appears as an electrostatic potential between the mercury and shield of the Cooper-Hewitt tube. This high potential, in the neighborhood of 10,000 volts, ionizes the mercury vapor in its corner of the tube. As soon as free electrons are available, the power supply across the two ends of the tube, causes further ionization and the condenser bank discharges through the Cooper-Hewitt giving a brilliant light of extremely short duration.

For the grid of T_3 to regain control of the tube when C_3 is discharged, it must be negative soon after ioniza-

tion is complete. For this reason the discharge time of C_3 must be held to a minimum, limited only by the ionization time of T_3 . In most tubes of the FG-17 type ionization is complete in from 10 to 15 microseconds. The values shown will give a minimum discharge time for C_3 of 20 microseconds.

The potentiometer R_6 can be put at the end of a three wire cable and is used to control the speed of flash over a range of 2 to 1 for any setting of C_4 and R_{11} . The cable must be shielded or the stroboscope will flash at multiples of 60 cps due to external fields. R_7 is used as an external syn-

chronizing device. The breaker points may be made from an old automobile distributor and driven at the speed at which the flashing is desired. If the amount of synchronization is kept low by having the breaker points short out only a small portion of R_7 's resistance, any multiple or sub-multiple rate may be used. The layout of the chassis should be such that as little as possible of the magnetic fields of the transformers cut the two thyratrons. If desired magnetic shielding may be employed. If T_3 is exposed to a 60 cps the arc within the tube is "blown" back and forth as its timing passes in and out of phase when firing near fundamental frequency. R_{13} is used to limit the voltage in the secondary of the high tension coil. At low frequencies it is apt to spark across the exposed portion of the tube. The cable leads from the power supply to the mercury tube should be heavy. Any appreciable amount of resistance here will lengthen the duration of the flash and reduce its brilliancy. R_{11} and L_2 are used to keep C_6 from discharging through the mercury tube and allow its arc to be extinguished when the voltage of C_7 has fallen below the tube drop of approximately 75 volts.

If the high tension transformer is to be cased, it should be done with a non-conducting material such as bakelite or hard rubber since a metallic case will represent a shorted turn and impair correct operation.

The 0-300 milliamper meter is of value since it allows a check on the power load which must not exceed the rated value of the rectifier tubes. Portions of the condenser bank may be cut out as the frequency increases. At high frequencies the persistence of vision allows easy observation at reduced brilliancy.

Since the application of plate voltage to T_3 before the cathode has reached its temperature impairs the life of the tube, a switch or time-delay relay should be incorporated in the plate circuit.

The power supply of this device is dangerous since sufficient energy is stored when all the condensers are charged to be fatal if one should make good contact across the main leads. Precautions must therefore be taken to encase the high voltage wiring in insulation sturdy enough, both physically and electrically, to protect the operator.

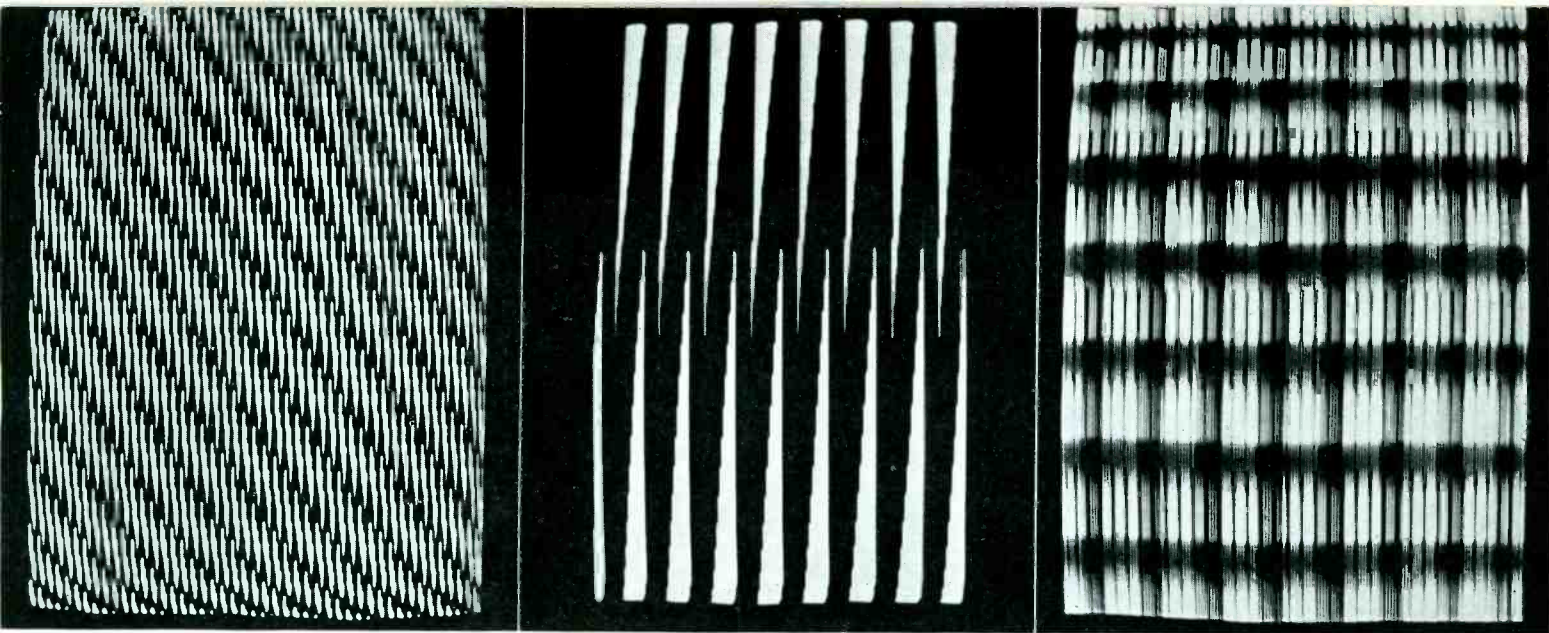

ELECTRON GUNFIRE

PATTERNS formed on a cathode-ray tube screen by C. E. Burnett of RCA Radiotron, using equipment originally designed to test the resolution of television

picture tubes. The images were produced by random manipulation of the 40 controls associated with 12 multivibrators, 10 mixing amplifiers, modulation and sync circuits

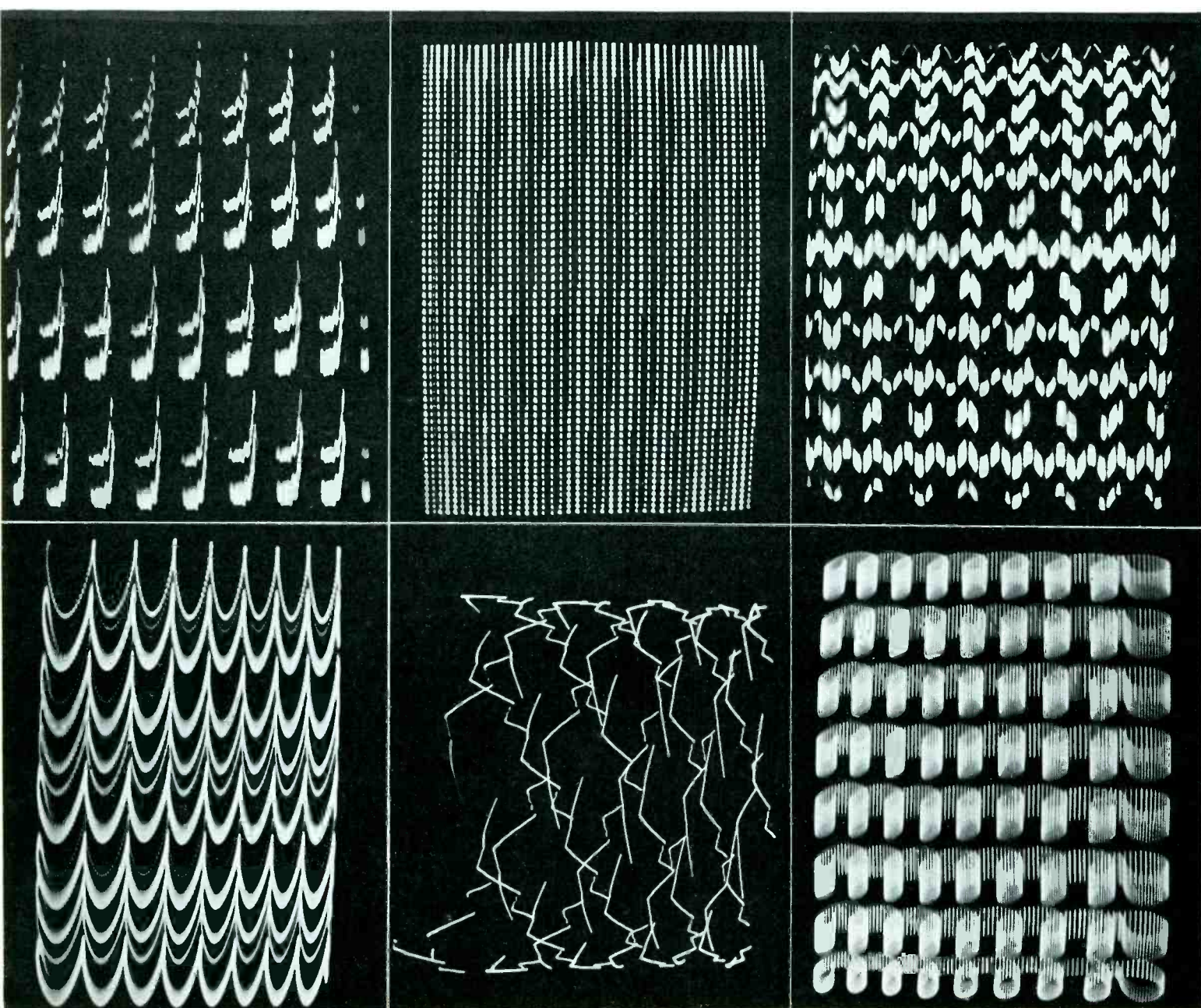

A VISUAL ALIGNMENT GENERATOR

An all-electronic frequency-modulated signal generator for r-f and i-f alignment using an oscilloscope. The central frequency is continuously variable from zero to 60 Mc, and the total frequency sweep from zero to 1.1 Mc, all without the use of moving parts

By H. F. MAYER

General Electric Company, Schenectady

HAVING once aligned a tuned radio-frequency transformer by means of a cathode ray oscillograph and frequency modulated oscillator, one is apt to wonder how it was ever done without such equipment. While the aligning of critically-coupled transformers in production simply by adjusting for maximum output on a signal of fixed frequency is easy, and accurate enough for most purposes, the aligning of over-coupled transformers, without something to indicate the shape of the selectivity curve, is next to impossible. In developmental work, it is even more important to see the selectivity curve, for a double tuned transformer may in some cases have six variables to be adjusted: primary and secondary tuning, primary and secondary damping, and inductive and capacitive coupling. In general, if the shape of the selectivity curve is one of the things of interest, then the alignment equipment should be capable of continuously showing the shape of the curve.

For broadcast receiver production the system using a motor driven variable condenser connected across the tank circuit of an oscillator has proved entirely satisfactory. Since all superheterodyne receivers in production ordinarily use intermediate-frequency systems of the same nominal frequency and approximately the same band width, the same frequency-modulated signal suffices for all alignment stations. The oscillator may be made quite stable and a smoothly running condenser may be

used to sweep the frequency consistently and uniformly over the necessary range of 20 or 25 kc.

In developmental work a more flexible system is needed. It is essential that the mean frequency of the signal be variable, the greater the range the better, and it is highly desirable that the amount of frequency modulation also be variable.

Some of these requirements are met by the simple combination of a motor-driven condenser with a multi-range variable-frequency oscillator. However, such a system, unless it is

3. The amount of frequency modulation depends upon the frequency setting, being greater, the greater the frequency. Thus, there may be insufficient modulation obtainable at the lower frequencies.

4. The wiping contact between the condenser rotor and ground may become dirty, causing unstable operation and disrupting the picture.

5. The rotating system, if not well balanced, may cause troublesome vibration.

The job of building some early models of frequency modulation re-

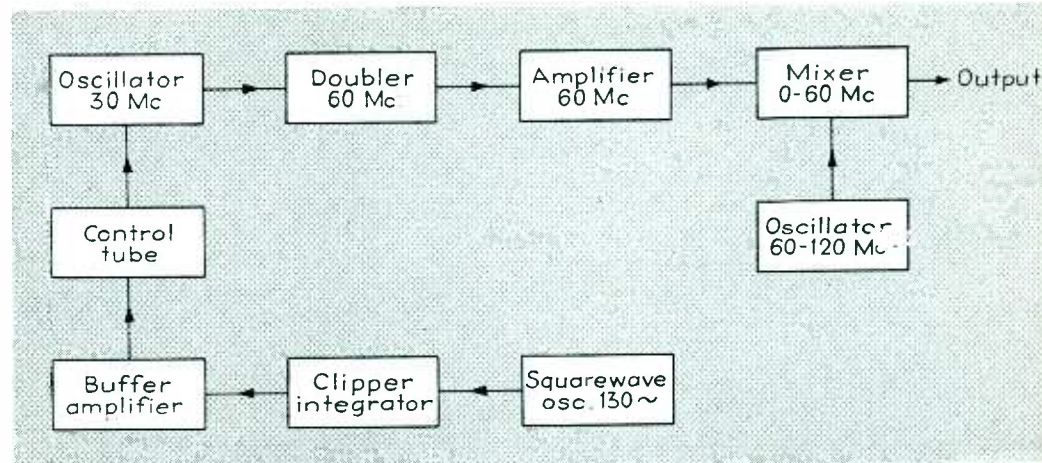

Fig. 1—Block diagram of the alignment generator, showing conventional carrier generator and electronic modulator

rather elaborate, may be quite limited in its applications. For example, the following difficulties may be encountered:

1. The frequency modulation may be accompanied by amplitude modulation, at some frequency settings.

2. The amount of frequency modulation cannot be varied, except in one or two steps at most.

receivers, in which intermediate frequencies of 6 Mc and 800 kc, with band widths of 150 kc, were used, precipitated the design of a completely electronic visual alignment signal generator, in which all the above defects were overcome. The new equipment has the following features:

1. There are no moving parts in

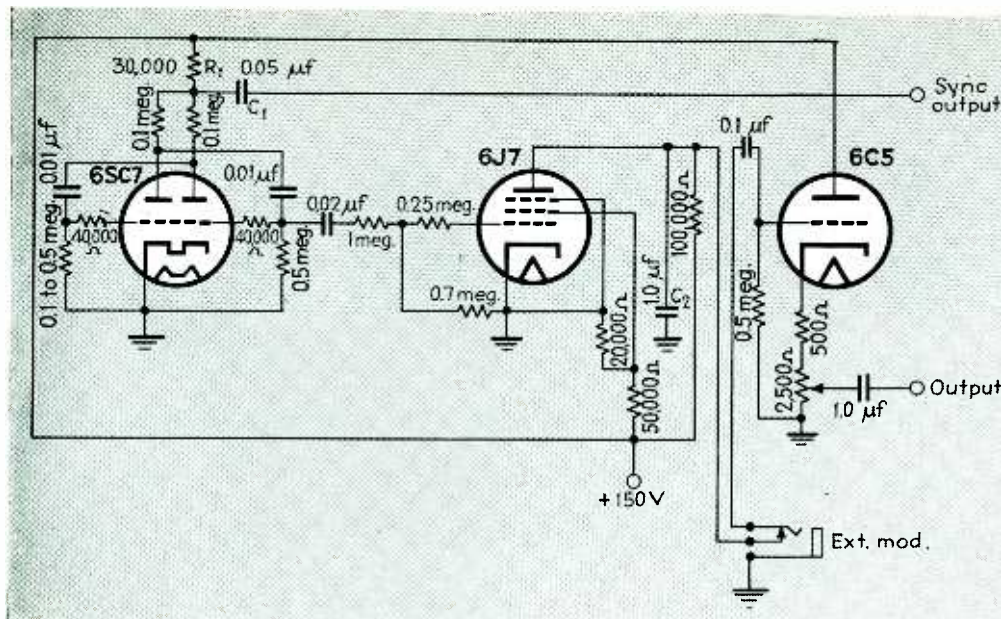

Fig. 2—Connection diagram of the "pyramid-wave" generator which controls the frequency-shifting tube. It consists of a multivibrator, clipper-integrator and buffer amplifier

the frequency modulator.

2. The mean frequency is variable from zero to 60 Mc, in a single range, without affecting the amount of frequency modulation.

3. The frequency modulation is variable from zero to 1.1 Mc.

4. By plugging in audio frequency, the oscillator may be frequency modulated with sine wave signal or program for testing frequency modulation receivers.

5. A pyramid wave of 130 cps voltage may be taken off from a jack for testing other equipment.

The block diagram (Fig. 1) shows the principle of the new device. A relaxation oscillator generates a square wave, which is clipped and integrated in the next stage to form a pyramid wave. This wave is applied through a buffer-amplifier to an electronic reactance tube circuit similar to those used to control the oscillator frequency in automatic-frequency-control circuits. This control tube is capable of causing a pyramidal undistorted frequency modulation of 550 kc peak to peak on the 30 Mc oscillator frequency. The oscillator output passes through a frequency doubler, the output of which is 60 Mc modulated 1.1 Mc total. This signal is then mixed with a signal whose frequency is manually variable from 60 to 120 Mc, resulting in an output frequency variable from 0 to 60 Mc without affecting the modulation.

Fig. 3—Outputs of the circuits in Fig. 2: A, multivibrator; B, clipper; C, pyramid wave scanned at double frequency

The circuit of the pyramid wave generator is shown in Fig. 2. This generator could have been made without the 6SC7 relaxation oscillator by using the 60 cps supply to drive the clipper. However, it was deemed much preferable to have a pyramid wave not synchronous with the 60 cps supply. The reason for this is that occasionally some defect in the equipment being tested will cause some 60 or 120 cps voltage to appear in the output circuit, along with the voltage due to the frequency modulated signal. If the frequency modulation is synchronous with the spurious voltage, a stationary pattern is formed, and the resulting distorted shape may be misconstrued as due to misalignment, whereas it is really caused by trouble in some other part of the circuit. If the pyramid wave is not synchronous with the supply voltage, the presence of any such unwanted voltage is immediately evident from the motion of the pattern.

The output wave of the relaxation oscillator is actually far from square, as the oscillogram in Fig. 3A shows, but sufficient voltage is applied to the clipper tube to cause a square wave of plate current to flow in the plate circuit. This square wave of

current, flowing through the parallel combination of a resistance and a capacitance which has small impedance at the fundamental frequency, results in a pyramid wave of voltage, as shown in Fig. 3B. A type 6C5 tube, with its load in the cathode circuit in order to obtain low impedance and low distortion, supplies the pyramid wave to the control tube. When audio voltage is plugged into the external modulation jack, it goes to the grid of the 6C5, automatically disconnecting the pyramid wave input.

Synchronizing voltage to lock the cathode ray oscillograph sweep in with the frequency sweep, in the proper phase, is obtained from resistor R_1 through a coupling condenser C_1 . In the double trace system of alignment, which is most generally used, the cathode ray sweep frequency is twice the pyramid wave frequency. This gives a pattern consisting of two superimposed selectivity curves, one of which goes from low to high frequency and the other from high to low, as the spot moves from left to right. This necessitates a synchronizing pulse every half cycle. Since the resistor R_1 is common to the plate circuits of both triodes in the relaxation oscillator, the voltage across it will have the necessary double frequency. Fortunately the pulse of current in R_1 , as one triode fires and the other cuts off, is quite adequate to synchronize the oscillograph. Since this pulse occurs exactly at the end of a half cycle, the phase is also correct. Fig. 3C shows the pyramid wave with the oscillograph externally synchronized by the double-frequency pulse.

The circuits of the oscillator and frequency modulator are shown in Fig. 4. No capacitance other than that contributed by the tubes and wiring is used across the tank circuit inductance L_s . This high L/C ratio is necessary in order to obtain the large frequency variation, since the number of micromicrofarads

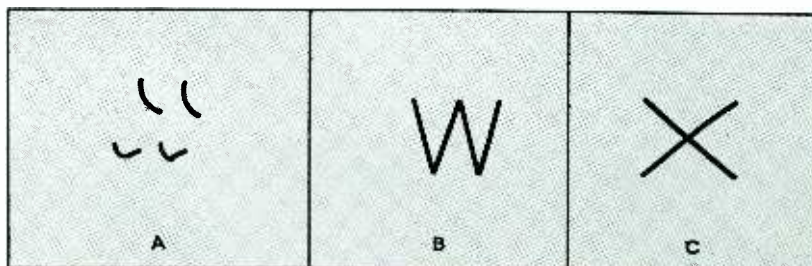

which the control tube can simulate is limited. The components C_1 , R_1 , and L_1 serve to shift the phase of the tank circuit voltage so that the voltage at the grid of the control tube is 90 degrees ahead of the tank voltage. This causes the plate current of the control tube also to be 90 degrees ahead of the tank voltage, and the tube therefore looks like a condenser and changes the frequency accordingly. The pyramid wave voltage being also applied to the grid of the control tube, there is a variation of mutual conductance in accordance with the pyramid wave so that the effective capacitance varies in a like manner.

After frequency doubling and amplifying, the frequency modulated signal is mixed with the manually variable signal, in a 6L7 mixer, to provide the output signal.

In the photograph (Fig. 5) of the first sample of the equipment may be seen, from left to right, the modulation control, the external modulation jack, the tuning control, the output attenuator and the output and synchronizing binding posts. The pyramid wave output jack was not included on this early model.

The tuning dial is directly calibrated in mean output frequency, but since it is impractical to make this highly accurate, it is necessary when aligning circuits to a particular desired frequency to use an auxiliary, accurately calibrated oscillator or signal generator. If its output be connected in parallel with the output of the visual alignment equipment, the pattern will contain a zone in which the two signals are of nearly enough the same frequency to produce a visible beat. At the center of this zone will appear a point of zero beat, at which point the modulated frequency is equal to the fixed frequency. If the fixed frequency is set to the desired value, and the tuning of the visual alignment equipment varied until the zero beat points on the two traces coincide, then the circuit will be aligned at the desired

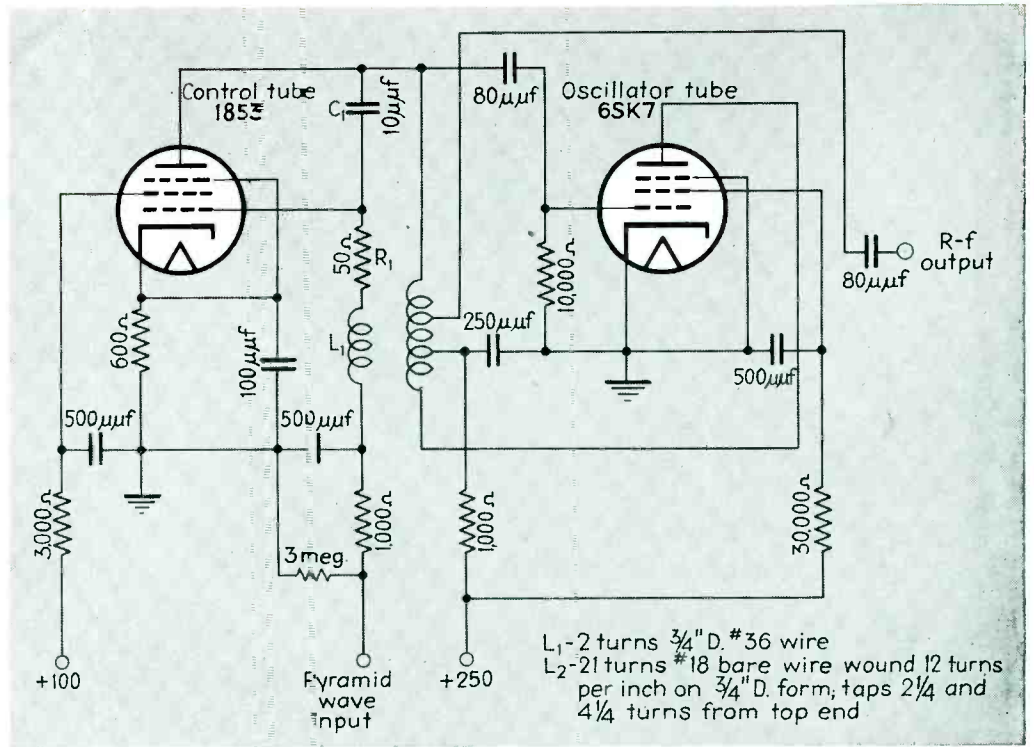

Fig. 4—Oscillator and frequency modulator. The pyramid wave acts on the control tube to vary the frequency in the oscillator

Fig. 5—External appearance of the generator. External modulation (see jack) may be used to test frequency-modulated receivers

frequency when the traces coincide. Figure 6 shows some oscillograms taken using this equipment in aligning a frequency modulation receiver. At A is the i-f characteristic up to the limiter grid. Curve B is the characteristic through the detector. Both

of these were taken with a frequency sweep of 300 kc. Curve C is the same but with a 150 kc frequency sweep.

This equipment has become an indispensable tool where it has been used. While, as pointed out above, it finds its greatest use in development work, it has on several occasions saved a great deal of time in aligning special production receivers where the quantity was not large enough to warrant the installation of a fixed frequency-modulated generator.

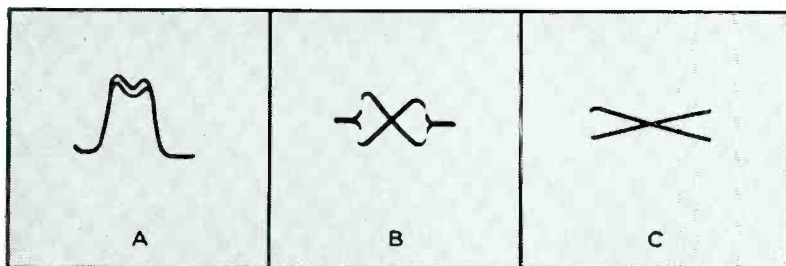

Fig. 6—Oscilloscope patterns produced in aligning f-m receiver: A, i-f response; B, overall detector characteristic; C, expanded overall characteristic

Design for an Electronic Reed Organ

Electrostatic pick-up directly from the reeds of a conventional inexpensive pneumatic harmonium, using the method employed in electronic pianos, makes it possible to enrich the tone, increase the volume range and provide new timbres. A constructional outline

By **FREDERIC D. MERRILL, JR.**

NEARLY every radio experimenter with a love for music has dreamed of having a fine pipe organ installed in his own home, if only the instrument were not so expensive. It is possible, however, to construct an electronic organ giving beautiful tones at a small fraction of the prohibitive cost of commercial instruments. Such an instrument may be constructed with the familiar reed organ as a foundation. Several different timbres can be controlled by stop buttons, the tone is truly organesque, and even the deep pedal tones may be reproduced. The usual reed sounds are much improved by electronic amplification.

Any organ may be made electronic by the simple method of threading a machine screw through the reed cell near the tongue. The screw acts as an electrostatic pick-up member. With only one rank of reeds the greatest practical variation is from bass and treble tone, but

Fig. 1—Construction of a typical pneumatic reed

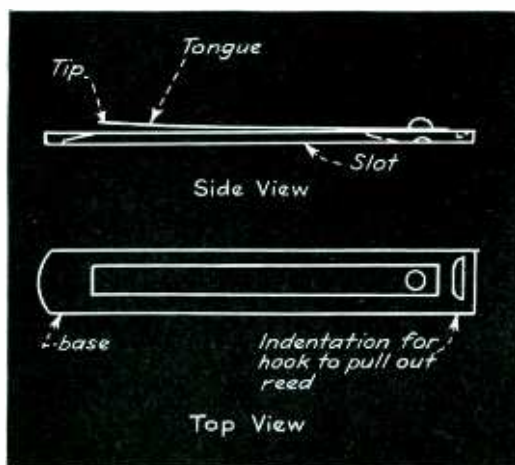

two ranks, pitched an octave above and below a third rank, permit a wide pitch and timbre range. Figure 1 illustrates a typical reed. Figure 2 shows the reed equipped with pick-up screw for converting the mechanical vibrations of the reed tongue into minute electric currents.

Reed organs are obtained very cheaply from music stores. Churches sometimes have an old unused one lying around. It is unnecessary to purchase a new one since second-hand ones can easily be found with a little searching. The better ones have several banks of reed cell blocks as well as pedal keys and swell pedal.

The Pick-up System

There is one pick-up screw for each reed. All pick-up screws are connected by a five mil diameter steel piano wire which fits tightly inside the thread of the screw, forming a full loop. A typical reed bank with electrostatic pick-up screws is shown in Fig. 3. The preferred screws are hexagonal headed brass, flat end, of diameter a little larger than the tongue width. The hexagonal head permits adjustment with an open ended wrench or pliers. The brass diminishes corrodng and the flat end advantage is illustrated in Fig. 4. A concave or convex shape reduces the effective capacity between screw and tongue.

It is important to line up the screw and tongue accurately. This is accomplished by a special tool shown in Fig. 5. The left side of tool (as shown in the side elevation) is the same size as a reed base. The right side has three holes for marking the

drilling point in the reed cell for the pick-up screw. The tool fits into the cell and a scribe marks through the hole, onto the outside wood. This operation is carried out with the top covering the reed block removed from instrument so that the drilling will be feasible. During the drilling the reeds are removed from cells to prevent injury to them. All wood splinters and dirt must be removed before the reeds are again inserted for blowing. Should a speck of dust lodge between reed tongue and its slotted base, it can be removed by sliding a thin piece of paper under tongue.

For the long low frequency reeds, the preferred pick-up point is about two-thirds the distance from the base towards the tip. With the medium frequency reeds the distance is increased to about three-quarters, and in the high frequency reeds the pick-up screw is located right at the tongue tip. There is a small change

Fig. 2—Reed equipped with electrostatic pick-up

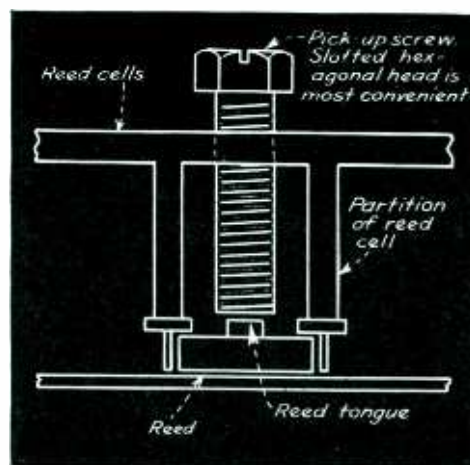

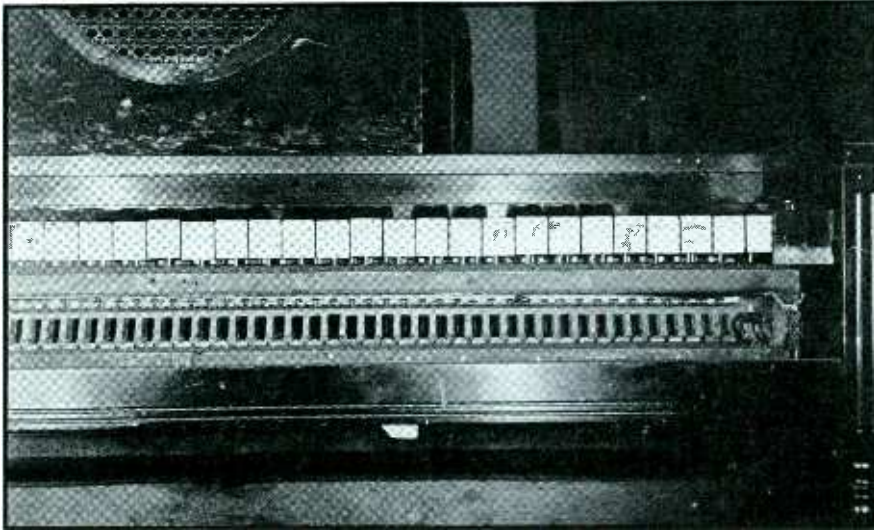

Fig. 3—Typical reed-bank equipped with pick-up screws, shown with front partition removed

in timbre as the pick-up screw is moved along towards the tip but this is relatively useless as a timbre variation method. For the lowest octave or two the output from a single pick-up screw may be too low. The output may be increased by employing two or three screws along the tongue length.

It is well to lacquer the screw end heavily so that any chance contact between tongue and screw will not produce a loud "pop" in the loudspeaker. The reed bases are connected together by a pair of fine steel wires imbedded in the felt and running the length of the bank in back of the bases.

Diminishing the Residual Acoustic Tone

Since the organ will be operated with the pedal controlling the volume of sound coming from loudspeaker, it is desirable to lessen the direct output sound from the reeds themselves. If this is not carried

out, the direct reed tone will produce a timbre different from that coming from the loudspeaker, when the gain of the amplifier is reduced. A felt-lined box covering the reeds will help. To permit air to pass into the box, several holes or slits are cut in the wood and the air allowed to suck through the felt.

Electrostatic Shielding

Electrostatic shielding must be provided to prevent stray fields from getting into the pick-up lines and causing hum. The cheapest material is gold or silver paper obtainable from stationery stores. One may also apply Aquadag, a colloidal graphite diluted in alcohol, with a paint brush. The resistance to ground when dry should not exceed 50,000 ohms. Concentrated Aquadag paste may be obtained from Acheson Oildag Corp., Port Huron, Michigan. The shielding is applied to the outside of the small box covering the reed banks. If the instrument has the entire

amplifier and loudspeaker within the same console as the reeds, then it will probably be necessary to shield the a-c cords inside the cabinet. If one listens to the loudspeaker for hum while a lamp cord carrying alternating current is moved around the console, the effectiveness of the shielding may be judged.

For reed organs already equipped with draw knobs or tabs for timbre control, it is simplest to retain that system although other electrical methods are available and will be explained later. The pneumatic system operates solely by a long wood strip surfaced with leather, pivoting down over the air inlet.

Several precautions may be necessary to prevent the movement of this strip from generating noise. When the leather surface strikes against the reed cell partitions and reed bases a loud thud may be heard from loudspeaker. This undoubtedly arises from the agitation of the leather dielectric in the electrostatic field, generating static fields which feed electric impulses into the amplifier. If the leather edge farthest from the reed base and nearest to hinges is painted with Aquadag and grounded, most of this noise will disappear. Another loudspeaker noise occurring when this wood strip is moved may resemble a rattle or scratching. This can come from the brass hinges supporting the movement of the strip and is cured by scraping a little of the lacquer off each hinge half and joining with a flexible wire by soldering. It must be emphasized that

Fig. 4—Three types of screws ends. The flat end provides the highest voltage pick-up because of greater capacitance

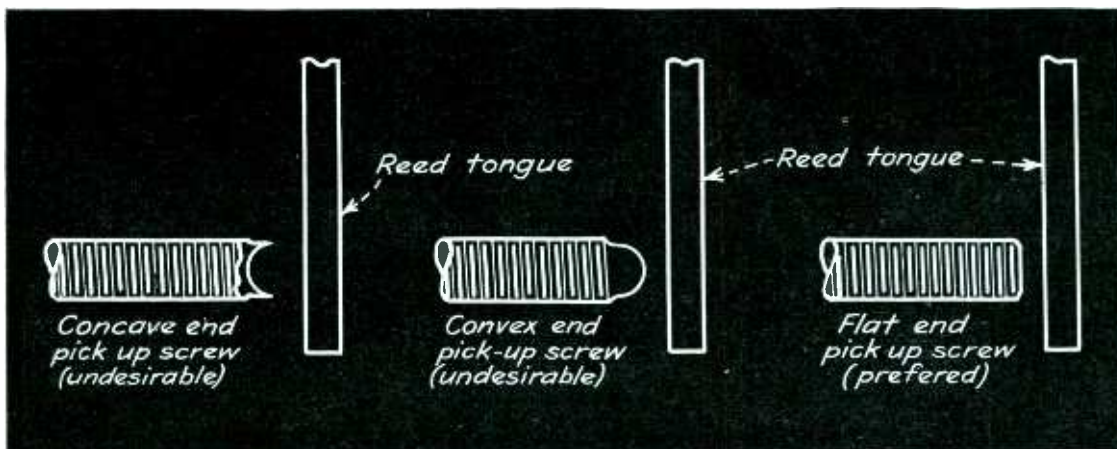
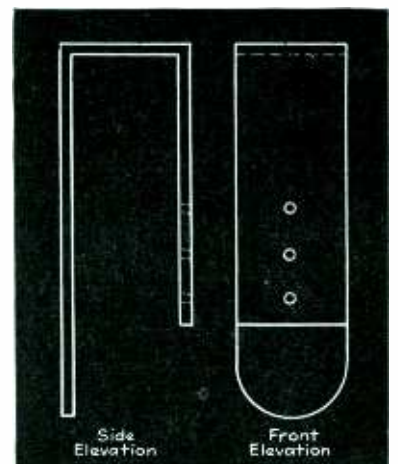

Fig. 5—Tool for locating drilling points for pick-up screws



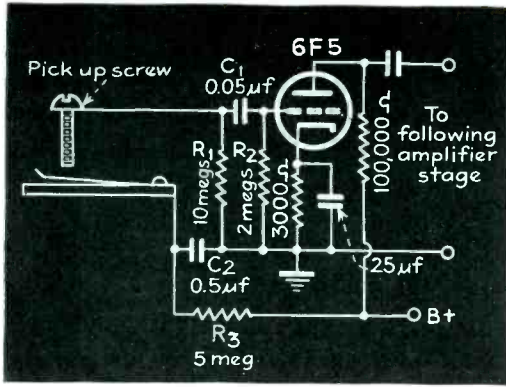

Fig. 6—Preamplifier input circuit. Care must be taken to protect the grid circuit from extraneous fields

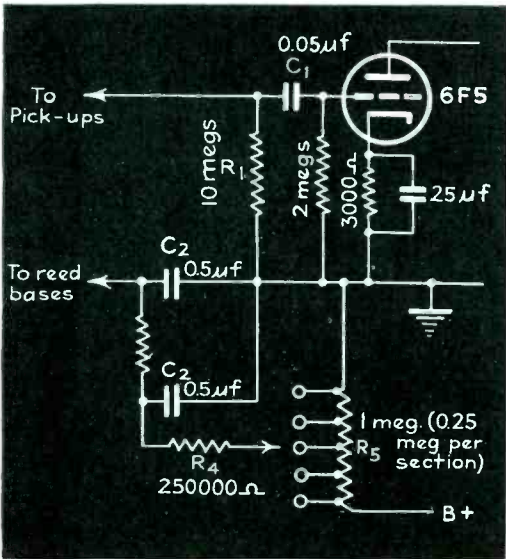

Fig. 7—Method of varying the electric output from each bank of reeds. The polarizing voltage applied to the reed bases is varied by R_4 .

est limit on the lowest frequency reed used. The upper limit is about 6000 to 8000 cps. Of course, it is useless to have available a lower frequency limit than that the loudspeaker is capable of reproducing. The coupling of harmonium reeds to the air is extremely inefficient for frequencies below 100 cps and it is here that the electronic equipment may be made to out-perform conventional reed organs greatly by giving deep, rich bass tones. Remembering that the standard pitch of middle C is 261 cps and that of the A above, 440 cps, one can easily compute the lowest frequency on the instrument. Doubtless it will be 87, 43, or about 30 cps, depending on the reed ranks found in the instrument. An amplifier of not less than 15 watts undistorted power output, such as that given by a pair of type 2A3 tubes in push pull, should be used for good bass reproduction.

The amplifier must be free of perceptible cross modulation lest difference-frequency components mar the clarity of tones when playing. With beam power tubes in push pull, for example, unless about fifteen per cent inverse feedback is employed, the chordal distortion in the treble renders the performance unsatisfactory.

A typical pre-amplifier input circuit is shown in Fig. 6. It is much easier to construct a hum-free amplifier by having the pre-amplifier on

one chassis and the power amplifier on another chassis. High impedance shielded cable leads may cause hum unless the shielding is insulated from ground except for the single connection to the one common grounding point.

Organ Stops Controlled by Electrical Methods

It is usual with pipe organs to select the desired stop by pushing down a rocking tab or pulling out a knob. The pneumatic system has already been described. Two electrical methods will be explained below.

One may adjust the output signal from a given bank of reeds by varying the polarizing voltage on the bases, as shown in Fig. 7. To eliminate switching clicks a filter time delay arrangement must be included, as indicated by the resistors R_3 , R_4 , C_2 and C_3 . Unfortunately, with full gain setting of a high power amplifier, the necessary time delay must run into seconds to eliminate all traces of clicks. If the switching could take place gradually, such as by slowly increasing pressure of a metallic conductor on soft aquadagged felt (the resistance would start at several megohms and gradually drop down to about 25,000 ohms) the

any intermittent metallic contact in the electrostatic pick-up field or grounding and shielding circuits is liable to generate noise. The prevention consists in making the contact positive at all times.

The limitation of the pneumatic stop control system lies in the difficulty of adding the electric timbre control to the draw knob motion. One may, of course, have separate bass and treble tone control potentiometer knobs. But with this pneumatic strip, the bank of reeds is either contributing 100 per cent electric output or none; there is no variation possible between those extremes.

The Pick-up Amplifier

Approximately 100 db gain is needed in the amplifier, with an input resistance of two megohms. The frequency range depends on its low-

Fig. 8—Simplified circuit showing separate two stage pre-amplifiers (6F5 and 6C5 tubes) for each bank

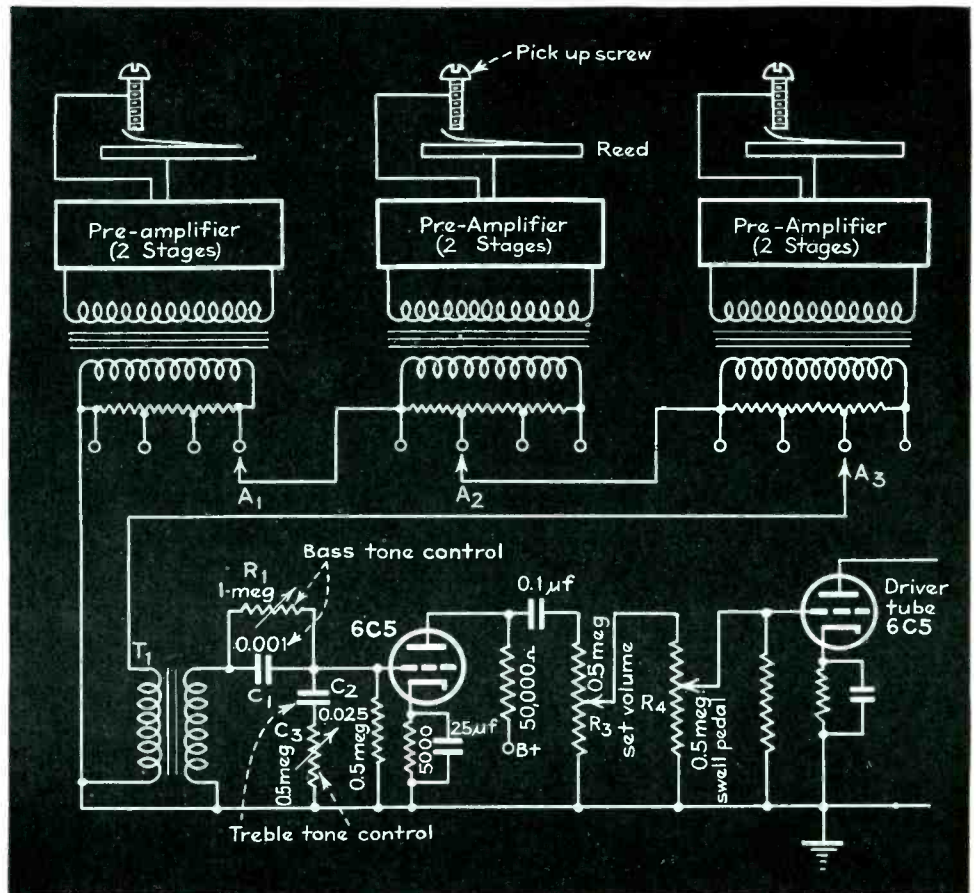

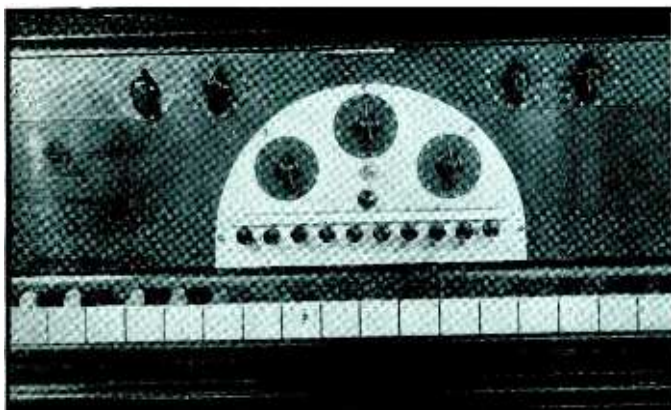

Fig. 9—Tone, set volume, and preset push-button timbre controls are mounted above the center of the keyboard

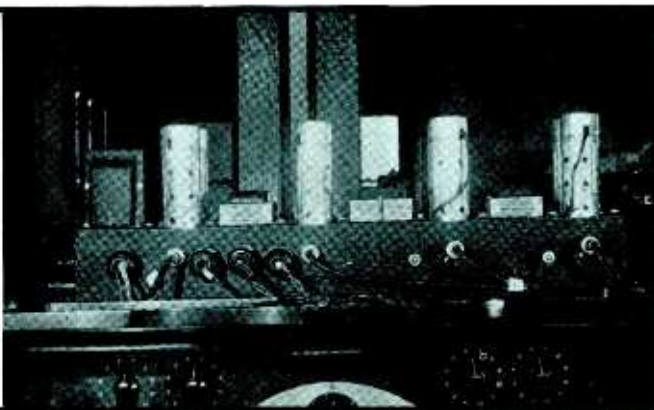

Fig. 10—Complete three-channel preamplifier chassis, arranged with widely separated grid input leads (at right)

time delay of the filter could be short to prevent click, but the design of such a multi-contact slowly closing switch does not appear practical for simple construction. Short circuiting the amplifier or loudspeaker during shifting of the polarizing voltage has no advantage since this method itself also brings in a click. A potentiometer may be useful for setting the polarizing voltage as a timbre control means, but this will not allow fast shifting of quality where there are pre-set combinations involving three reed banks and bass and treble tone controls. With the potentiometer, however, clicks will be negligible, since the voltage is varied continuously rather than in sudden jumps.

The third way to adjust the contribution from each reed bank is the most flexible, but also the most expensive and complex. It involves a separate pre-amplifier for each rank, switching and mixing each output together at low impedance such as 500 ohms, stepping up by a transformer to the following tube grid, and switching of series and shunt capacities in that grid circuit for timbre control. The simplified form of this circuit is shown in Fig. 8. In this method no clicks are produced, provided of course that no signal is being fed into the input during the switching.

The switch itself is of the interlocking type so that when one button is pushed in, another already in automatically releases. Assuming that the instrument contains three reed ranks and provision is to be made for bass, treble, and volume control, there will be six single pole single throw switches, or twelve blades in all, operated by one button. At least six and preferably twelve button sections are desirable

for setting up as many different combinations. Several manufacturers of radio push button tuning switches can furnish the desired unit inexpensively.

Volume Control Swell Pedal

The volume control is essential to the organ since the pressure or impact of the fingers on the keys has no part in regulating the loudness of the tone. If the swell pedal is of the balanced type, the foot can adjust the gain setting and then leave the pedal for operation of the pedal keys. One will save time and money in the long run by obtaining at the beginning a long-lived potentiometer guaranteed for a million or more rotations, since ordinary radio volume controls invariably become noisy after a little usage. There are several now on the market that may be obtained for less than two dollars.

A pre-set volume control in front of this potentiometer in the pre-amplifier common channel is necessary to avoid turning the gain beyond the point at which overload and distortion appears in the loudspeaker.

Choice of the Loudspeaker

A twelve-inch loudspeaker is the smallest that can be recommended for adequate volume and the 15-inch electro-dynamic is preferred. The low frequency pedal tones can only be reproduced with a large baffle plane, infinite baffle arrangement (sound absorbing back) or bass reflex. Resonant sound chambers for accentuating the bass have the undesired weakness of dulling the stridency of tones and lengthening the damping period, but some economical compromise must be effected between deepness of bass and bril-

liancy of treble. Trained ears will quickly detect a synthetic bass which lacks real strength in the fundamental, or perhaps one should say the sense of feeling detects the deficiency, since the bass tones are felt as much as they are heard.

No organ would be complete without a tremulant, which introduces a low-frequency variation in volume. The most obvious way to arrange this is to vary the amplifier gain at a periodic rate between six and twelve times a second, and thus the loudspeaker volume rises and falls. A superior scheme would raise and lower the frequency of all the notes along with a change in their volume. This may be brought about in the familiar Doppler effect by arranging a single paddle to move to and fro in front of a loudspeaker. Alternate pulses push out the air and pull it in so that the frequency fluctuates as well as the volume. The pivot axis is towards the base of the celotex board. With many reed organs there is already a pneumatic provision for tremulant by rapidly opening and shutting the air equalizer chamber.

Installation of Amplifier and Loudspeaker

The amplifier and loudspeaker are preferably placed within the organ console if space permits this. In any case, the pre-amplifier section should be inside the organ to keep the lead from pick-up screws to input short. It is best to have that lead formed of high-voltage auto ignition cable to insure against leakage noises. To eliminate loading the pick-up system with the dead capacity of shielding for this lead, no shielding is used unless it is necessary to prevent a-c hum. At this highly sensitive input,

(Continued on page 97)



War and propaganda have made America's participation in international broadcasting, discussed by Gerald Gross of the F.C.C., a vital concern



Andy Ring (right) of the F.C.C. compares f-m and a-m with Messrs. Wilmotte and Everitt. Mr. Wilkins, having heard plenty of the same, puts on his hat and coat



Raymond Guy of N.E.C. pauses on the platform after his dissertation on the Empire State Television Station, with Professor Everitt and Paul Loyet

BROADCASTERS AT COLUMBUS

Students and teachers at the 1940 Broadcast Engineering Conference, latest annual symposium held at Ohio State University under the direction of Professor Everitt

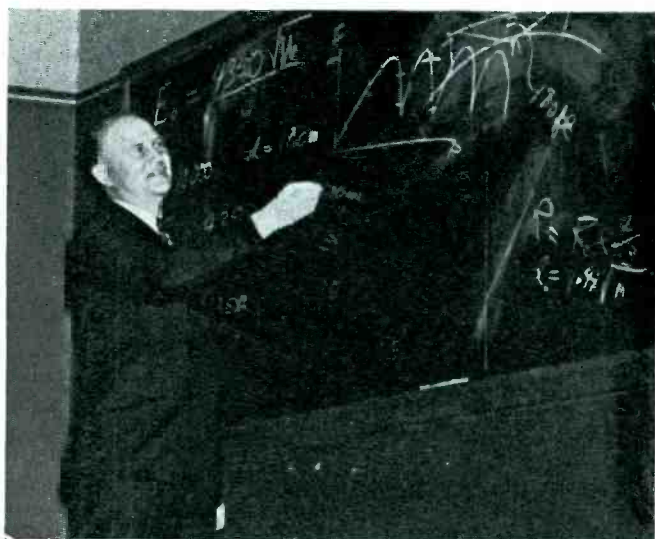

H. O. Peterson of R.C.A. Communications discussed ultra-high frequency propagation, a topic of growing interest to the broadcasting fraternity

W. H. Capen of International Telephone and Telegraph rises to ask a question, which apparently interests the rest of the audience

Direct from the foremost authority and leading exponent, the audience hears Major E. H. Armstrong describe his system of frequency modulation via the well-known vector diagram

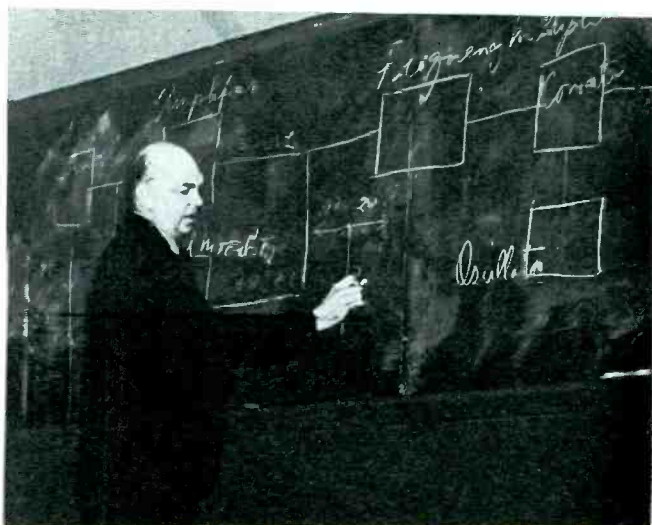
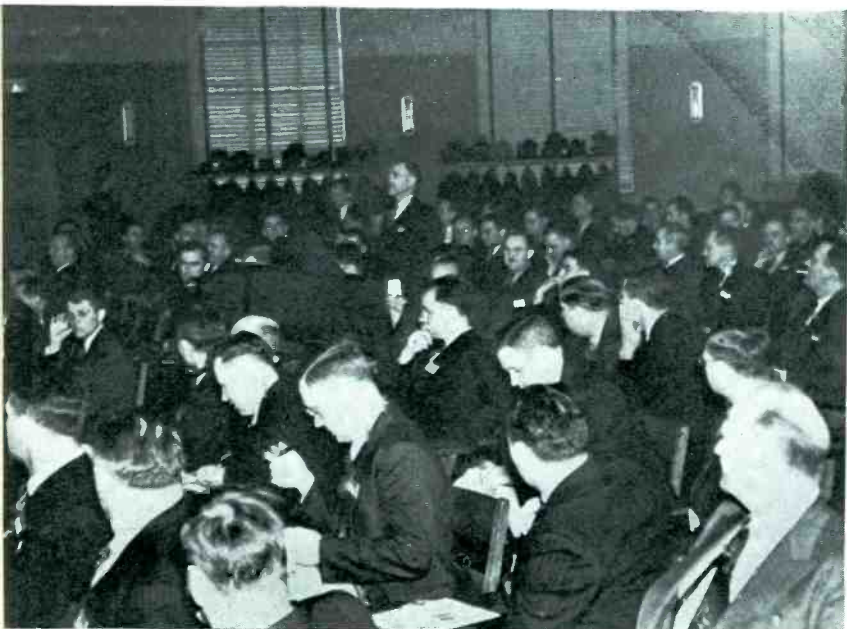

A Feedback Welding Timer

By J. KURTZ

Callite Division, Eisler Electric Corp.

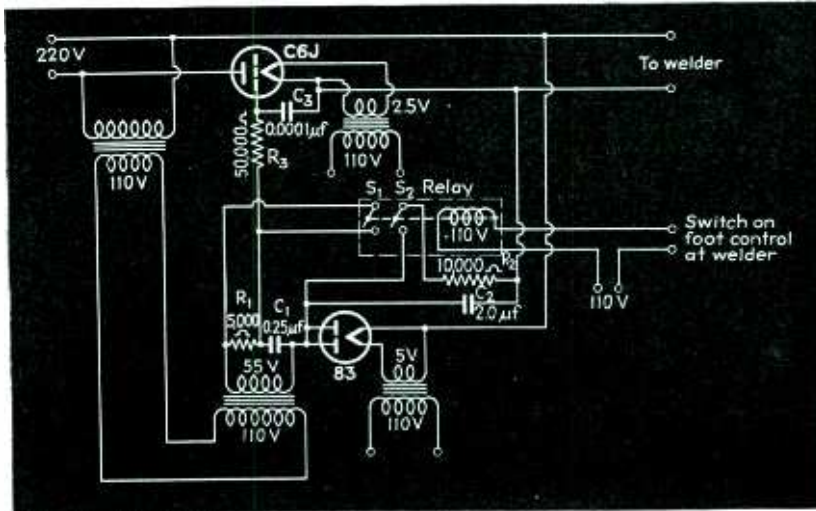

Fig. 1—Circuit of the timer. The output of the control tube is fed back to the rectifier tube and grid control circuit

THE half-cycle electronic timer for small parts welding, illustrated and described here, has been engineered and constructed for welding operations in the radio tube industry. In such work, where extremely short but uniform welding time is important, these units have proven their effectiveness over a considerable period of time, providing not only uniform welds but freedom from excessive oxidation and sticking of the electrodes.

It is not generally appreciated that in welding thin materials the weld comes up to temperature much faster than in the usual weld due to the small amount of metal being heated. Continued application of current thereafter serves only to heat up the electrodes and increase the tendency for the work to stick to the electrode.

Not the least advantage offered by this unit is its simplicity, making it inexpensive, easy to install and trouble-free in service. Fundamentally, it is a device which limits the current application for each weld to the time duration of a single and complete half-cycle of the 60-cycle supply line, regardless of the instant of closing the contactor. This is accomplished through the use of a grid-control rectifier tube in the circuit shown in Fig. 1. This tube, connected in series with the primary supply to the welder, is capable of handling primary currents up to 77 amperes

and is intended for use in 110, 220 or 440 volt supplies. The tube is a product of Electrons, Inc., Newark, N. J., and known as their type C6J.

In the idling position of the timer, alternating current is applied to the grid exactly 180 degrees out of phase with the anode so that at no time during the cycle are the firing conditions satisfied. The grid bias is obtained through a transformer providing secondary voltage of 55 and energized from the same line that supplies the anode, but connected for out-of-phase operation. Actually the schematic diagram of Fig. 1 shows two transformers here, the reason being that these are standard and more readily available than a single 220-55 volt unit.

In Fig. 1 the idling position is with relay contacts S_1 and S_2 closed. When the foot-switch at the welder is depressed it energizes this relay, opening both circuits. Opening of S_1 inserts R_1 in the 55-volt secondary circuit and this, in conjunction with C_1 , causes a phase shift of a few degrees in the voltage applied to the grid, with the result that at some point in the cycle the tube will fire, and current will be supplied to the welder. The grid is positive for the first few

degrees of the positive plate cycle. As this is the only part of the cycle during which firing conditions are satisfied, no current flows after closing S_1 until the beginning of the next succeeding positive half cycle, at which time a complete half cycle of line voltage loses control as long as the anode is positive. The current drawn during this period depends on the welder and is practically unaffected by the tube. While the tube is conducting, the capacitor C_2 is charged through the 83 rectifier with a resulting high negative bias on the C6J grid which prevents firing on succeeding cycles. The network R_2C_2 is provided to eliminate supply voltage disturbances from the grid circuit. With release of the foot-switch at the welder the relay contacts close. S_2 allows C_2 to discharge through R_2 while S_1 shorts out R_1 , allowing the 180 degree out-of-phase idling operation of the C6J tube to be resumed.

The photographs show a typical example of the unit. This unit is assembled on a standard 10 x 7-inch radio chassis and inclosed in a standard switch box the knockouts of which provide ventilation.

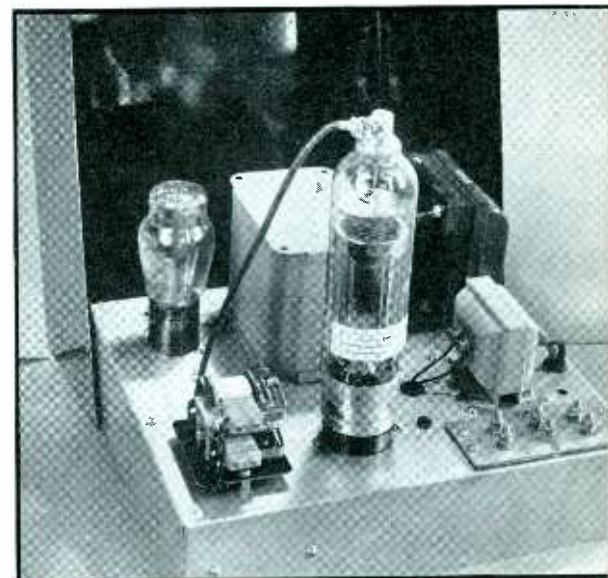

Fig. 2—The welding timer with cover removed. The large tube is the C6J control thyratron

New Books

Handbook of Physics and Chemistry

BY CHARLES D. HODGMAN, 23rd edition, 2221 pages, Chemical Rubber Publishing Co. Price, \$6.00.

EVERY EDITION OF THIS valuable reference work contains more data than the last, and in this edition not only the number of pages, but the page size has also been increased. The main sections include: mathematical tables, properties of physical constants, general chemical tables, specific gravity and properties of matter, heat, hygrometric and barometric tables, sound, electricity and magnetism, light, quantities and units, and miscellaneous. The numerous tables and constants have been brought up-to-date by two score collaborators and contributors, each of whom is a recognized authority.

The book will be of interest to all technical workers in the natural sciences. The mathematical tables and formulas, the 14 pages of radio formulas, 24 pages of tabulated tube characteristics, 2 pages of tube socket connection, conversion factors for decibels, will be among the many items which electronics engineers will find useful. The tube list is divided into receiving tubes, telephone and industrial tubes, transmitting tubes, gaseous rectifiers, high vacuum rectifiers, and grid controlled rectifiers.—B. D.

A.S.T.M. Standards on Electrical Insulating Materials

Prepared by Committee D-9, T. SMITH TAYLOR, CHAIRMAN, American Society for Testing Materials, 260 S. Broad St., Philadelphia, October 1939 (issued annually), 309 pages, \$2.00.

THIS BOOK CONTAINS specifications and methods of testing a wide variety of electrical insulating materials. The following materials are included:—Insulating varnishes, lacquers and related products, covered by seven specifications and tests; molded materials (five standards); plates, tubes and rods (five standards including a method for testing phenolic molded laminated products) and solid electrical insulation; oils; glass including pin-type lime glass insulators, glass spool insulators and electrical porcelain; rubber products including rubber tape, gloves and matting; asbestos yarns, tape and roving, and cotton tape and various filling and treating compounds, untreated paper and mica products. Also included in this book are six important standardized procedures for

electrical tests, namely, arc resistance of solid electrical insulating materials, dielectric strength, power factor, thermal conductivities of solid materials and insulation resistance. The book is certain to be of value to both producers and consumers of insulating materials in that it provides a basis for mutual understanding between the two parties.—C. W.

Radio Trouble Shooter's Handbook

BY ALFRED A. GHIRARDI. *Radio & Technical Publishing Co., New York, First Edition, 1939. Price, \$3.00, 510 pages, 134 illustrations.*

MORE THAN HALF of this book is devoted to case histories of 3,313 models of 177 different makes of home and auto receivers. It is well known that many receivers become afflicted with particular troubles which are peculiar to that receiver. This case history section points out these troubles, how to recognize them and how to correct them. There are 51 other sections included in the book covering a wide variety of subjects which are useful to the serviceman. Several sections are devoted to problems relating to auto radio servicing. Recorders, sound systems and inter-communicators are also covered. The book explains much of the mathematics and numerical standards with which the serviceman must be familiar. A directory of manufacturers of receivers and components is given. This seems to be one of the most complete radio service books published thus far.—C. W.

The Elements of Radio-Communication

BY O. F. BROWN, M.A., B.Sc. (Oxon), B.Sc. (Lond.) and E. L. GARDINER, B.Sc. (Lond.). *Oxford University Press, London, Second Edition, 1939. Price, \$6.00, 551 pages, 174 illustrations.*

TO THE GENERAL READER who desires a background of the principles and the history of radio, this book will undoubtedly prove to be of value. The clear and simple wording of the first edition is retained wherever it remains suitable. For this reason there are several subjects which are approached from the standpoint of early methods and subsequently from a more modern angle. It is stated by the author in the preface that radio communication can only be fully under-

stood if the historical stages which have led up to its present state are appreciated. It will be found that the earlier stages tend to repeat themselves in modernized form. Thus the original ultra-short waves demonstrated by Hertz, after many years in which they were considered useless, are now of great importance and the original Fleming two-electrode tube has become the widely used diode detector.

The explanations of radio phenomena and the underlying reasoning are made in a clear manner which will appeal to the general reader. In some cases it may be thought that the subject is not treated with sufficient depth, but it must be remembered that this is intended as an elementary text and such explanations should be considered as introductions to more advanced studies.

The intention of the book is to be comprehensive rather than to give explanations of great depth. Therefore, several subjects such as cathode-ray tubes and electron multipliers are included which do not ordinarily appear in elementary texts on radio. There is also a chapter on antenna design along with reference to several recent developments including air navigation by radio, ultra-short-wave transmission and the quartz crystal filter.—C. W.

Production and Direction of Radio Programs

BY JOHN S. CARLILE (*Production Manager, Columbia Broadcasting System.*) *Prentice-Hall, Inc. 397 pages, 1939, \$3.75.*

THIS BOOK FOR the non-technical departments of modern broadcasting stations covers the processes of producing and directing radio programs from the inception of the program idea to its final presentation on the air. Chapter headings give an idea of the contents, viz., The Program and Those Who Produce It, The Production of Musical Programs, Precision and Routine, Speech. Within these few chapters will be found a great deal that should be known to everyone who has anything to do with broadcasting, not excepting the engineers, the announcers, the gain control men—and the station owners. Anyone who has a yen to go on the air, with speech or musical program should be instructed properly in the art by a thorough perusal of this book, written by the production manager of one of the world's largest broadcasting systems.

This reviewer, more at home with what happens between the mike and the loud speaker, found himself vastly interested in the description of the technique of what happens within the studio and in front of the mike. It is recommended to engineers—and of course to the non-technical people. A much better idea of the importance of coordination and cooperation between technical and artistic people cannot but help both—K. H.

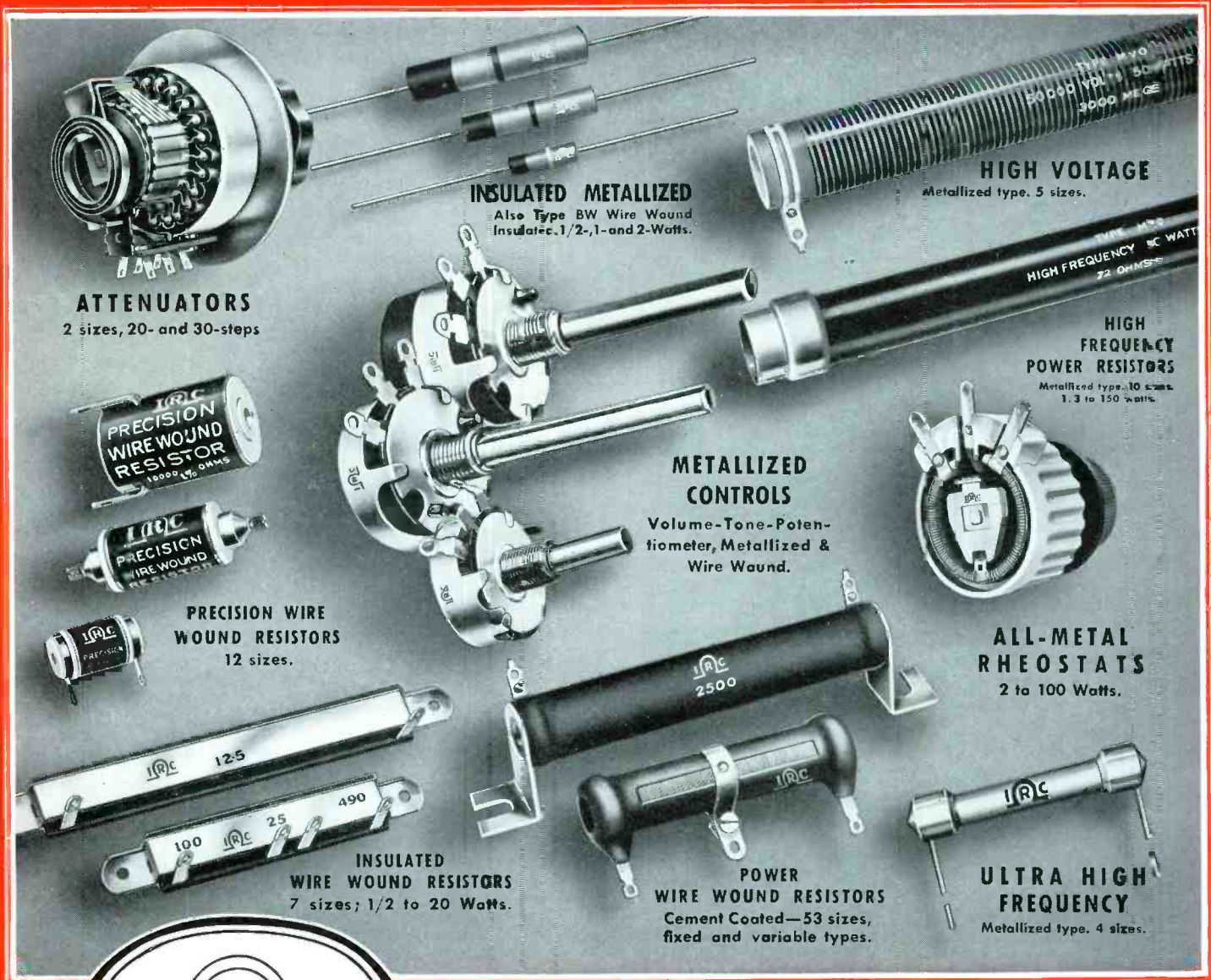

One Company That Meets ALL Resistance Needs

With so much depending upon the selection of the one right resistor for any job, the importance of having a single, specialized source of supply for all of the many fixed and variable resistance types becomes plainly evident. You gain full benefit of IRC's many years of experience in supplying the right resistors—in the right shapes—with the right terminals—protected by the right coatings—and selected with a full understanding of the specific problems involved. Above all, you are assured of dependability—the natural result of years of intense specialization on the development and production of quality resistance units only.



Makers of Resistance Units of More Types, in More Shapes, for More Applications Than Any Other Manufacturer in the World. Catalog of any type on request.

INTERNATIONAL RESISTANCE COMPANY

403 N. BROAD ST., PHILADELPHIA, PA.

The ELEMENTARY PARTICLES

NAME	COMPOSITION	CHARGE	MASS	NAME	COMPOSITION	CHARGE	MASS
Neutrino*	Unknown	Zero	Variable	Neutron	1 Proton 1 Electron	Zero	1830
Electron	Elementary	-1	1	Deuteron	1 Neutron 1 Proton	+1	3660
Positron	Elementary	+1	1	Alpha Particle	2 Neutrons 2 Protons	+2	7320
Proton	Elementary	+1	1830				

Charge: $1 = 4.803 \pm 0.003 \times 10^{-10}$ e.s.u.
 Mass: $1 = 0.911 \times 10^{-27}$ grams

*Neutrino postulated on theoretical grounds.
 Existence not yet proved

The RADIO SPECTRUM

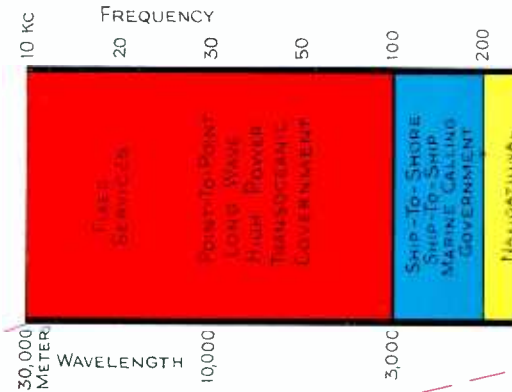

The ETHER SPECTRUM

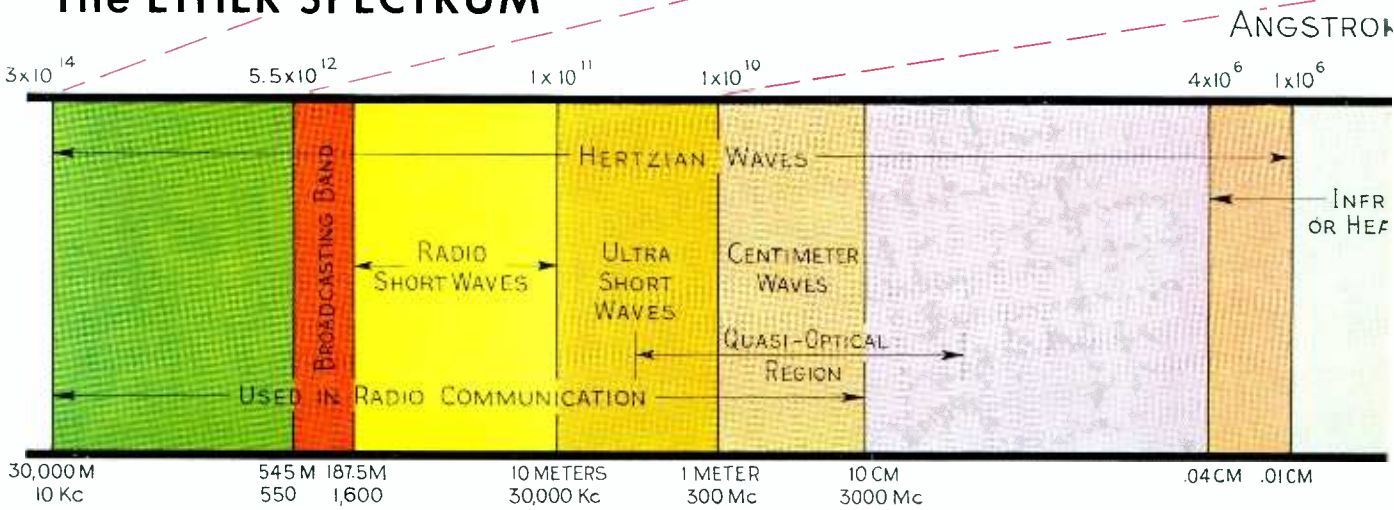

The AUDIBLE SPECTRUM

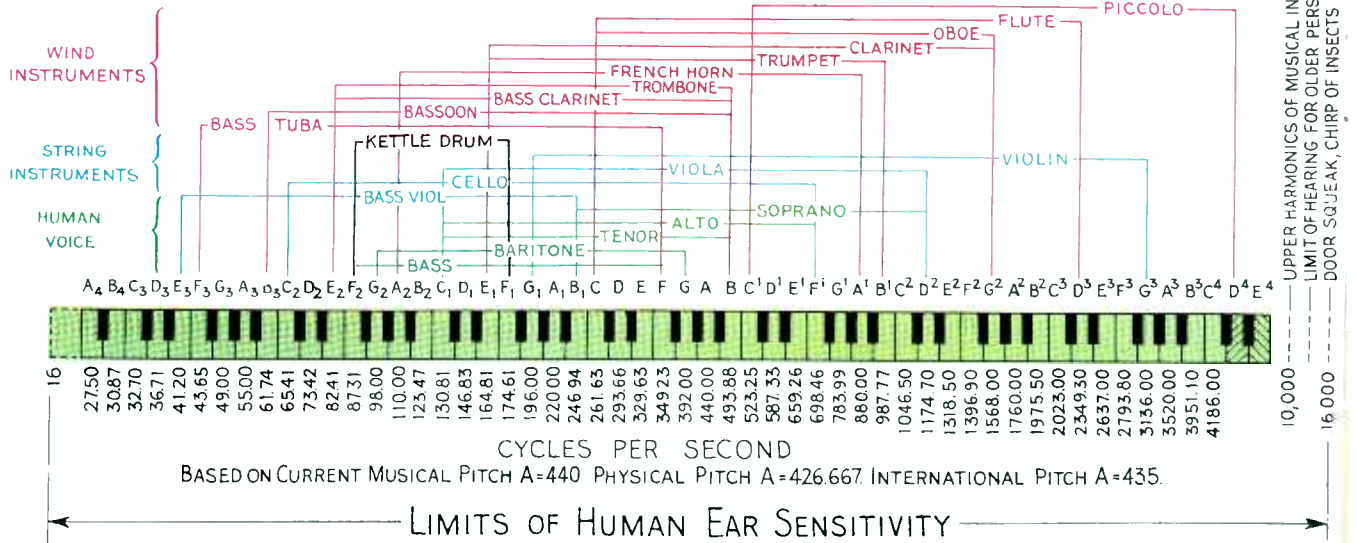

"this is our
third
tenth
anniversary"



CORNELL-DUBILIER salutes *Electronics* on its first 10th Anniversary. We know that proud feeling.

We can remember our first 10th Anniversary even though it doesn't seem only yesterday. We remember because the turn of the "Twenties" marked a milestone in the career of the capacitor, and so, in ours.

The new decade saw capacitors established. The years to come were to be — for Pioneer Cornell-Dubilier, at least — Research years . . . years devoted to experiment, development and perfection.

For Broadcasting had come into its own. Soon it was growing with the dazzling speed of Jack's storied beanstalk. With that growth came a sense of responsibility — of an obligation owed to the public. If

Radio was to serve, it would have to be reliable. Radio is reliable today. Its reliability is, in fact, the marvel of our time.

Yet to *Electronics* and its readers, this is not nearly so marvelous as the manner in which it has been accomplished. For you know that Radio's reliability rests, every hour of every day, solely upon the dependability of the equipment used.

Cornell-Dubilier is proud of the role it has played during the past thirty years in the development of Radio Broadcasting. And if "the penalty of Leadership" be untiring research and industry, then C-D has more than paid the price. For Cornell-Dubilier, the Pioneer, is, today, the world's largest exclusive capacitor manufacturer.



1910
1940

DYKANOL • MICA • PAPER • WET & DRY ELECTROLYTIC

Capacitors

CORNELL - DUBILIER ELECTRIC CORPORATION

1006 HAMILTON BOULEVARD • SOUTH PLAINFIELD, N. J.

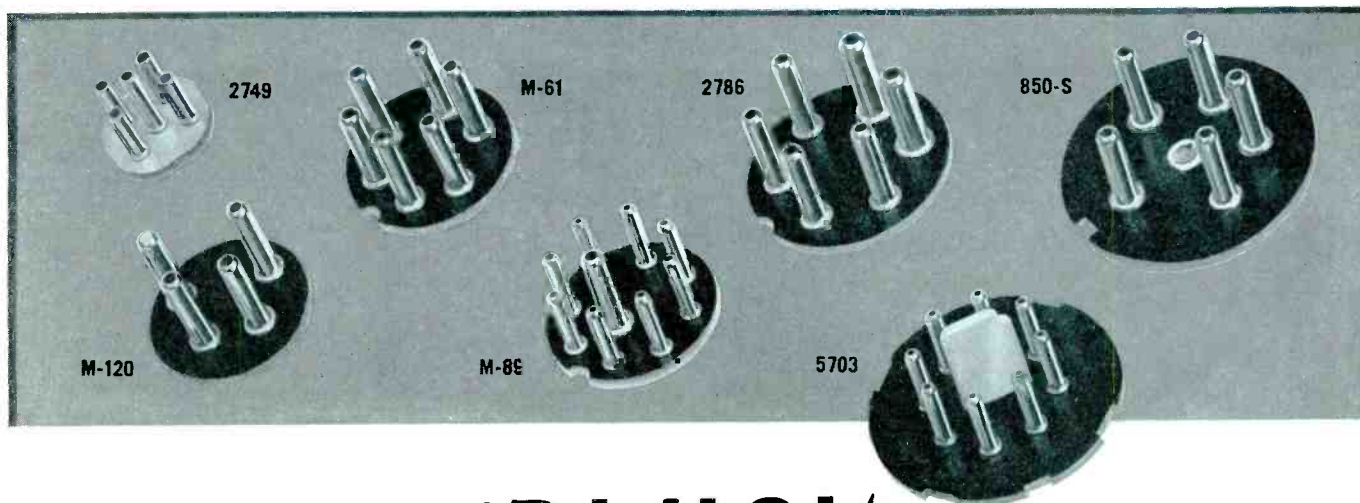

HERE'S A 'PLUG' ★ FOR YOU —

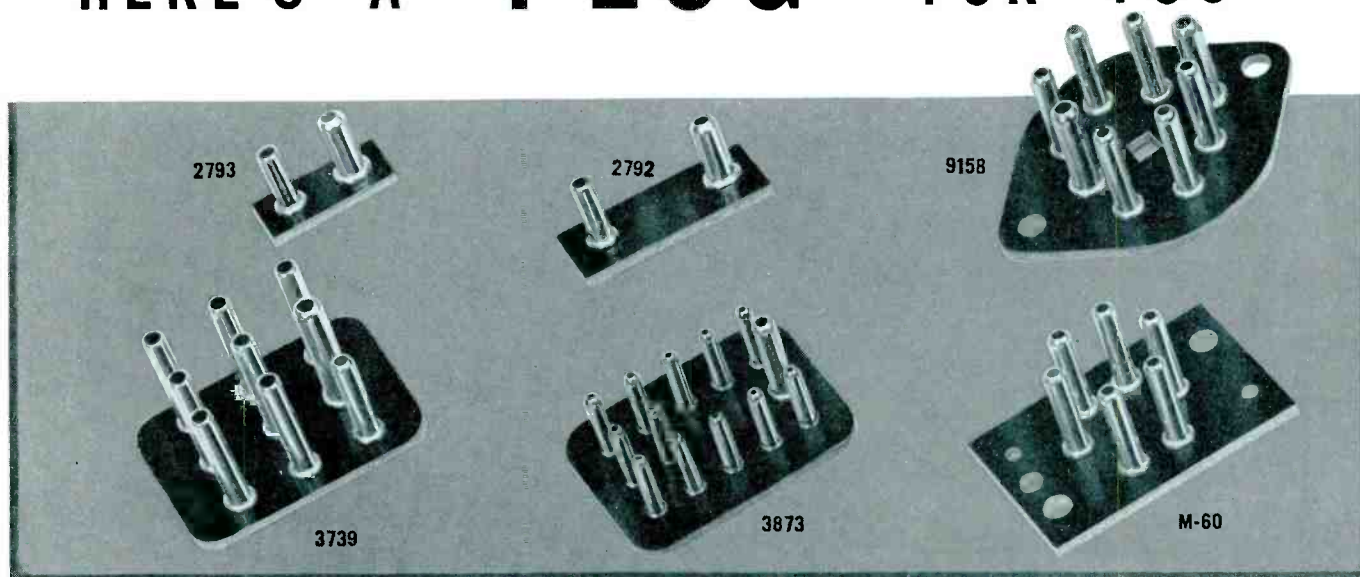

"Users of CINCH plugs and connectors are the makers of America's finest radio sets"

—and that is the record Long and certain service is the rule with Cinch parts. Just plug in and be sure with CINCH connectors. All plugs, illustrated here in actual size, are polarized and vary from one to thirteen prongs

Metal shells with substantial internal insulations are made for most of the plugs. Also supplementary plugs with shells can be had . . . There is a chassis mounting socket to match every plug illustrated.

Cinch and Oak Radio Sockets are licensed under H. H. Eby socket Patents

Pins $\frac{3}{32}$ " in diameter are available in either $\frac{3}{8}$ " or $\frac{7}{16}$ " lengths. The $\frac{1}{8}$ " and $\frac{3}{32}$ " diameter pins in either $\frac{3}{8}$ ", $\frac{9}{16}$ " or $\frac{11}{16}$ " lengths. While the standard finish of pins is nickel, silver plating or "Cinch Solder Coating" may be had on request.

CINCH MANUFACTURING CORPORATION
 2335 W. Van Buren Street, Chicago, Illinois
 SUBSIDIARY OF UNITED CARR FASTENER CORP., CAMBRIDGE, MASS.

*Here Beauty is
more than Skin deep*

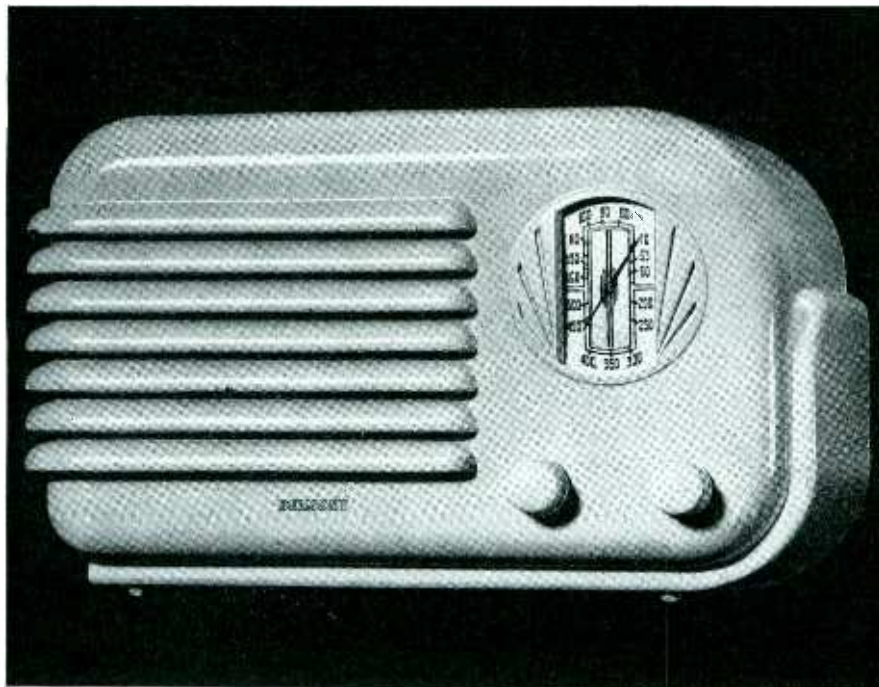

INSUROK

The Precision Plastic

Surface beauty is not enough—it must be backed by performance. For that reason every INSUROK precision molded part or product not only possesses pleasing appearance but delivers the utmost in utility and dependability. Manufacturers are quick to appreciate these advantages. More and more Richardson facilities are called upon to assist in adding eye appeal, greater salability, and improved performance to numerous diversified products. Quite likely you're missing something by not availing yourself of this service. Why not investigate?

The RICHARDSON COMPANY

Melrose Park, (Chicago) Ill. Founded 1858 Lockland, (Cincinnati) Ohio
New Brunswick, N. J. Indianapolis, Ind.
Detroit Office: 4-232 G. M. Building, Phone Madison 9386
New York Office: 75 West Street, Phone Whitehall 4-4487

from the short circuited set of brushes to the power brushes, resulting in a further gain of 100 to 1 or 10,000 to 1 overall.

Several installations of the Amplidyne type generator have already been made, particularly in the steel industry. For example, one such generator has been used in conjunction with a boring mill as a means of obtaining rapid and accurate positions of the cutting tool. The operator pre-sets the position of the next cut to be made by dials which indicate feet, inches, and thousandths of inches. These dials in turn control the input to the Amplidyne generator which positions the tool to the displacement indicated on the dials when the operator presses a button. The next cut is then made. The device has also been used as a means of controlling the speed of reeling of continuous steel strip as a means of obtaining constant tension and uniform speed in strip polishing, as a means of synchronizing flying shears and as a means of excitation of large synchronous motors. It has also been used in the paper industry to allow production of both light and heavy grades of paper with a minimum of waste. Also, in conjunction with photoelectric registering devices it is possible to maintain the exact register of paper moving through rewinding.

• • •

A Simple Chime for Station-Breaks

THE EDITORS ARE indebted to A. G. Swan of Station WRGA for information on a simple chiming device for use in broadcast stations. The ordinary hand-operated chime must be placed close to the microphone if it is to offer sufficient level relative to the rest of the program, and if this is done, the noise of the hammer is apt to be objectionably loud.

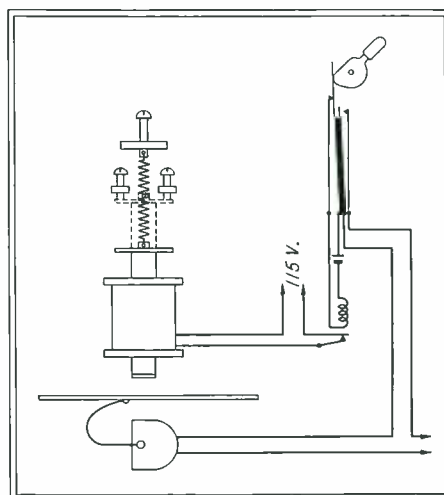

Arrangement of station-break chime

To eliminate this trouble, a simple electrically-operated chime pick-up device was installed in the control room of the station, and was arranged for operation from the announcer's posi-

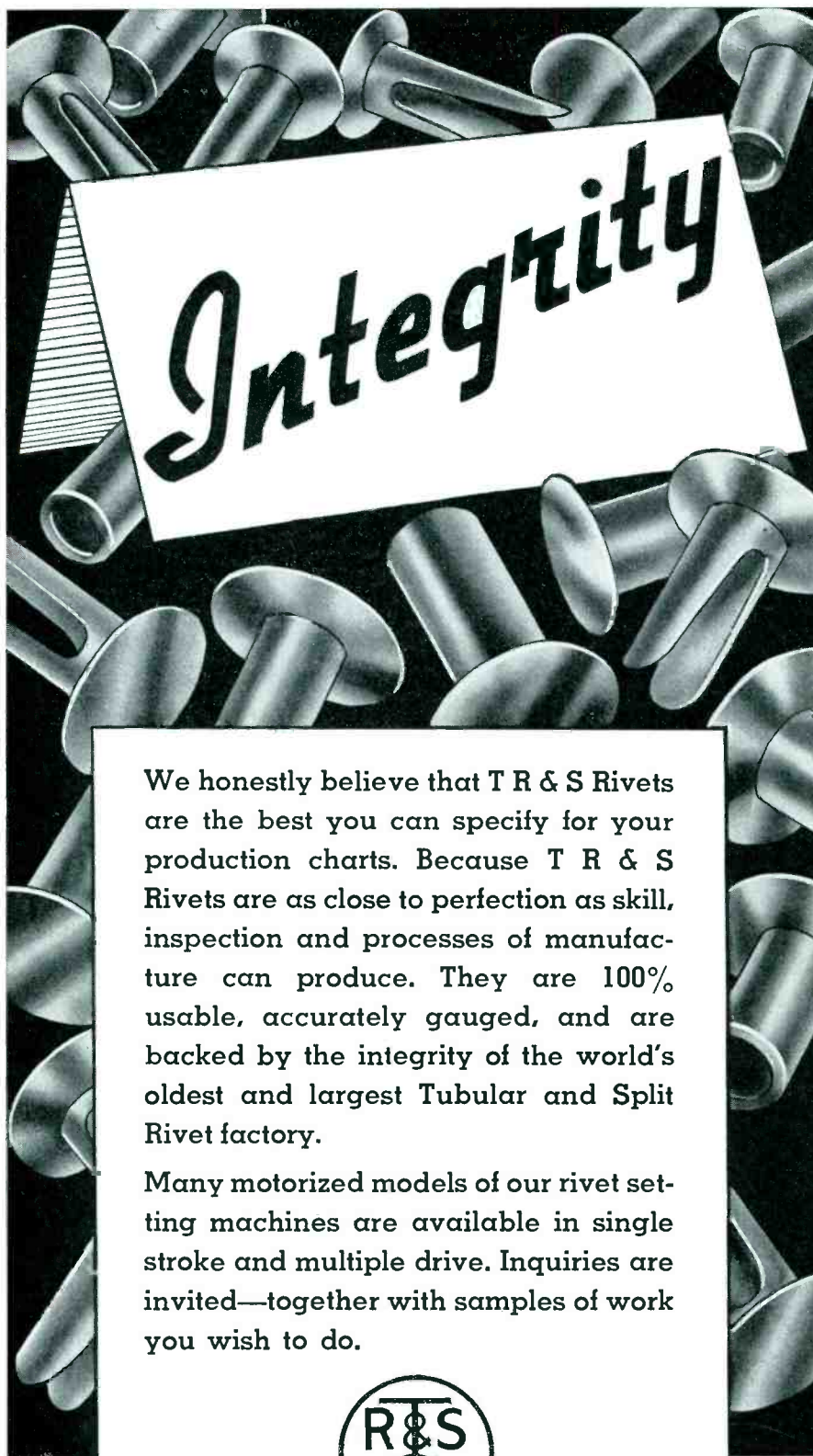

We honestly believe that T R & S Rivets are the best you can specify for your production charts. Because T R & S Rivets are as close to perfection as skill, inspection and processes of manufacture can produce. They are 100% usable, accurately gauged, and are backed by the integrity of the world's oldest and largest Tubular and Split Rivet factory.

Many motorized models of our rivet setting machines are available in single stroke and multiple drive. Inquiries are invited—together with samples of work you wish to do.



TUBULAR RIVET & STUD CO.

World's Largest Manufacturers of Tubular and Split Rivets

WOLLASTON (Boston) MASSACHUSETTS

New York Chicago Detroit Indianapolis
San Francisco Nashville Dallas St. Louis

tion. A simple key at the announcer's position closes a relay in series with 115-volt circuit, which feeds the electrically-operated chime. Chimes of this type may be obtained from hardware stores. A simple wire connection between the tone bar of the chime and the needle receptacle of a standard phonograph pick-up is used to transform the mechanical vibration into an electrical signal.

The key at the operator's position is so connected that the pick-up circuit is opened when the chime solenoid is put into the circuit. This disconnects the pick-up during the initial striking of the hammer. When the key is released the pick-up is connected to the circuit and delivers the tone to the amplifier input.

• • •

Atom Smasher Displayed at East Pittsburgh

THE HIGH VOLTAGE generator and atomic bombardment apparatus which has been under construction at the Westinghouse Research Laboratories was recently demonstrated to technical writers and educators by Dr. E. U. Condon, associate director of the laboratories. The demonstration showed how artificial radioactive substances may be produced by proton (hydrogen nuclei) bombardment. The fluorine in natural fluorite was transformed into neon by bombardment. In this case the fluorine atoms capture protons and assume the next higher atomic number, that of neon. The transformation is accompanied by the production of gamma radiation. In another demonstration, ordinary carbon in graphite form was bombarded by one microampere of current of deuterium (heavy hydrogen ions) for 15 minutes. The result was the production of radioactive nitrogen, equivalent in activity to 10 milligrams of radium.



The high voltage generator demonstrated by Dr. Condon (left)

After 10 years—

**AmerTran Transformers
are still selected by lead-
ers in industry for all
electronic applications.**

Since the first issue of "Electronics," back in 1930, AmerTran advertisements have featured transformers for electronic applications. At that time AmerTran was already the acknowledged leader in this specialized field, having had experience extending over three decades in supplying transformers to the communication industry.

Today AmerTran's position is unchanged and leaders throughout the entire electronic industry continue to specify our equipment for transformer applications. Apparatus regularly supplied covers the complete range—from the smallest audio unit of an air-craft receiver to the giant power transformers for a 50,000 watt transmitter—and all ratings are available in either small or large quantities.

Let us submit complete data on transformers for your particular requirements.

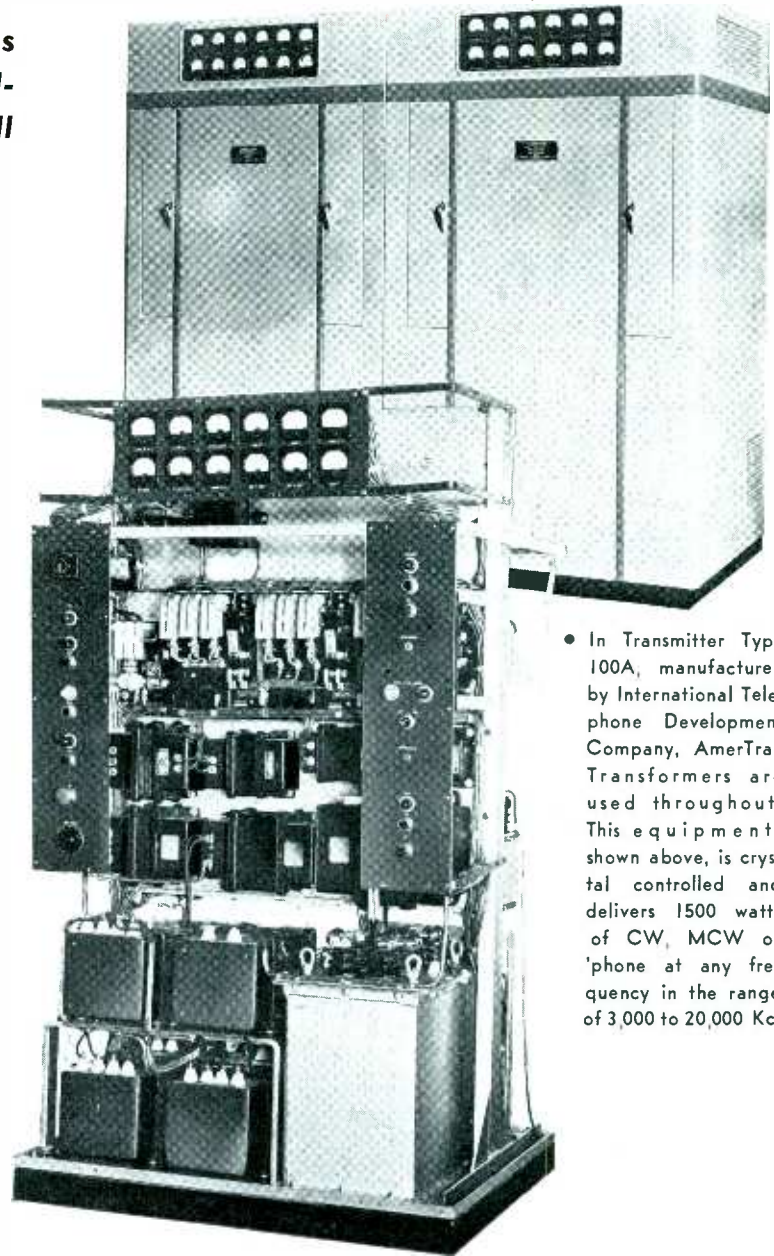

- In Transmitter Type 100A, manufactured by International Telephone Development Company, AmerTran Transformers are used throughout. This equipment, shown above, is crystal controlled and delivers 1500 watts of CW, MCW or 'phone at any frequency in the range of 3,000 to 20,000 Kc.



**AMERICAN
TRANSFORMER CO.**

178 Emmet St.

Newark, N. J.

- Coordination in transformer designs explain the excellent performance characteristics of Transmitter Type 100A. At 85 percent modulation, the transmitter output is uniform within 2 percent with harmonic distortion below 3 percent.

AMERTRAN

**Manufactured Since 1901
at Newark, N. J.**



S. S. WHITE FLEXIBLE SHAFTS have gone places since 1930

Of course, S. S. WHITE Flexible Shafts were well known and widely used long before 1930. But during the 10 years since then, applications have multiplied at a rapid rate. This has been particularly true in the automotive, aviation and electronic fields, due mainly to the origination and development by S. S. White of **Remote Control** shafting specially for radio and other applications in these fields.

A FEW APPLICATIONS OF S. S. WHITE SHAFTS

AUTOMOTIVE

Auto Radios—panel and underseat
Radio Antennas
Clock Setting
Trip Mileage Reset
Choke and Needle Valve
Engine Governor
Search Light
Gear Shift
Heaters
Air Conditioning
Taximeters
Truck Recorders
Speedometers
Windshield Wipers
Automatic Carburetor

AIRCRAFT

Radio Receivers
Beacon Receivers
Compass Loop
Antenna Loop
Antenna Reel
Heating Register
Tab Control
Turn Bank Indicator
and Bomb-Sight
Tachometers
Fuel Pumps
Controllable Pitch
Propeller Governors

MAYBE THIS LIST
WILL SUGGEST USES
OF FLEXIBLE SHAFTS
IN YOUR PRODUCTS

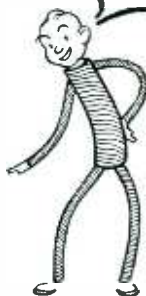

If you are not familiar with these latest flexible shaft developments, Bulletin 1238 on Power Drive Shafts, and Bulletin 38 on Remote Control Shafts, will bring you up to date. Copies are yours for the asking. Write for them.

S. S. WHITE

The S. S. White Dental Mfg. Co.

INDUSTRIAL DIVISION

Department E, 10 East 40th St., New York, N. Y.

FLEXIBLE SHAFTS for POWER DRIVES, REMOTE CONTROL and COUPLING

The atom-smashing apparatus consists of a high-voltage generator of the moving-belt (van der Graff) type which has been used at direct voltages as high as 4,000,000 volts. The constancy of the voltage produced, important in controlling the atomic transformations, is greater than that of any high voltage machine yet developed. Experiments to determine the minimum energy required to produce neutrons from lithium and carbon under proton bombardment are now under way.



X-Ray For Checking Condition of Automobile Tires

RAPID INSPECTION OF automobile tires without removal from the car or truck is made possible by a new portable X-ray device developed by the General Electric X-Ray Corp. The unit is intended to reveal the presence of tacks, nails, wire, etc or glass or stones embedded in the tire wall. It can accommodate tires of all passenger cars and of the smaller trucks, including white-wall tires which contain zinc oxide and hence are more opaque to X-radiation than is the ordinary tire. Inspection is made by means of a fluoroscopic viewing screen.

The X-ray tube itself is mounted in an all-metal head which includes all the high-voltage parts (transformers and tube) immersed in insulating oil. The construction resembles that of the standard shock-proof mounting used widely in industrial and medical practice. The unit is energized from a standard 110-volt 60 cps line. Two switches are provided: one is a lock-type line switch which can be operated only by authorized persons, and the other, a push-button switch, applies the high voltage to the X-ray tube as desired. Two values of anode voltage are available, which may be selected by a two-position selector. The higher voltage rating is used only on the thicker tires.

In use, the X-ray unit is wheeled under the car, which has previously been jacked up until the wheels are about 9 inches above the floor. The head of the machine is placed directly under the axle and close to the tire but not touching it. A handle is then turned which clamps the wheels of the X-ray unit, raises protective shields on either side to inhibit stray radiation, and places a roller against the wheel to turn it slowly past the X-ray head. The operator then presses the high voltage switch and views the tire through the fluorescent screen hood. The tire is turned by the roller, which operates under the control of the operator. When a foreign object is discovered, its exact position may be determined by slowly turning the wheel until the X-ray image of the object falls directly opposite a reference arrow marked on the screen.

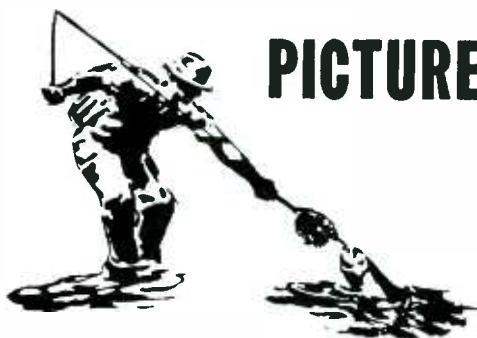

PICTURE OF ENGINEER WITH PROBLEM

and why it isn't insulation!

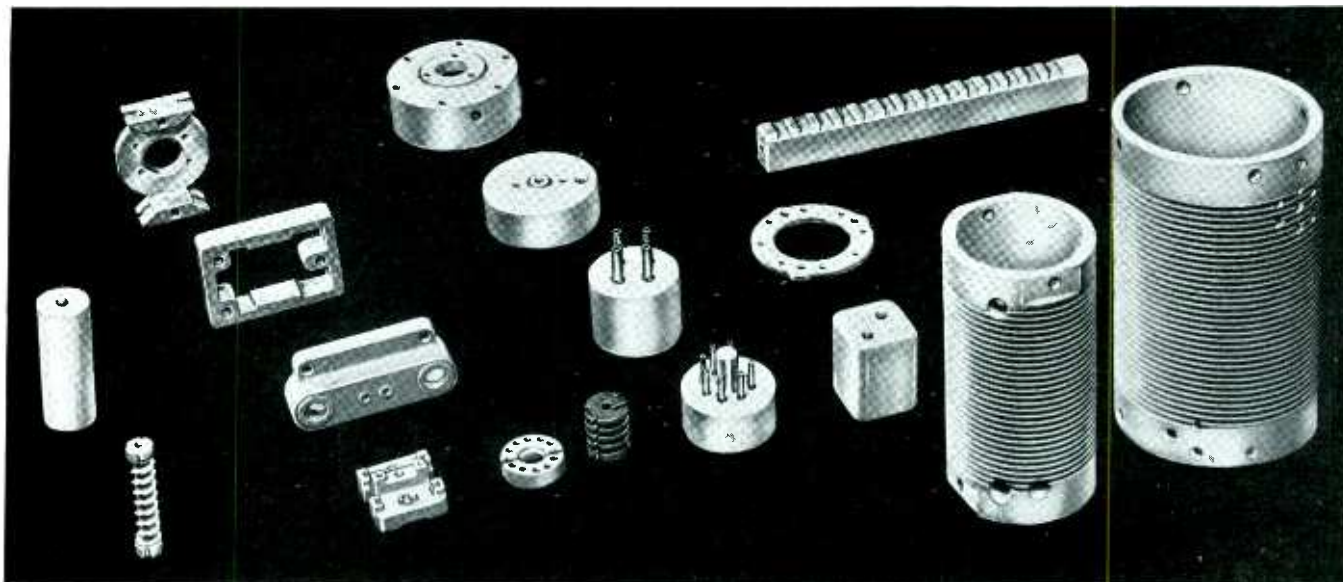

A frisky brown trout on the end of his line is all that's bothering this electronic engineer. He has solved his insulation problem—that's why he is on vacation.

If any one feature of the Alsimag Family of ceramic materials can be singled out for special mention, engineers agree it is the wide range of characteristics which can be obtained in order to meet every insulating requirement. And when you specify one of the Alsimag "bodies" even the Purchasing Department joins in the cheering, for Alsimag steatite ceramics generally cost no more! Our engineering and research staffs will be glad to help with your individual design problems.

Every designing engineer ought to have our Property Chart—costs three cents which you pay to Uncle Sam.

A TYPICAL ALSIMAG BODY IS No. 35

Heat Resistant (safe limit for const. temp.)	1000° C	Loss Factor 60 cycles	1.95%
		10 M C	1.08%
Dielectric Constant 60 cycles	6.5	Dielectric Strength 200 Volts per Mil	
10 M C	6.0		
Power Factor 60 cycles	.30%	Water Absorption Extruded Material	.02%
10 M C	.18%	Pressed Material	.069%
Vol. Resistivity (220 v. 60 cycles) 75° F—		.08	



38th Year of Ceramic Leadership

ALSIMAG

TRADE MARK REG. U.S. PAT. OFF.

FROM CERAMIC HEADQUARTERS

AMERICAN LAVA CORPORATION • CHATTANOOGA • TENNESSEE

CHICAGO • CLEVELAND • NEW YORK • ST. LOUIS • LOS ANGELES • SAN FRANCISCO • BOSTON • PHILADELPHIA • WASHINGTON, D. C.

WESTINGHOUSE RADIO

FOR



Machine-sealing the cathode mount of Type WL849 Tube.



Photomicrograph of lateral section of Westinghouse tungsten filament wire, showing interlocking crystal structure for mechanical strength and long life.



Photomicrograph of cross-section of Westinghouse thoriated-tungsten filament wire, showing properly controlled depth of tungsten-carbide layer for good strength, emission and life.

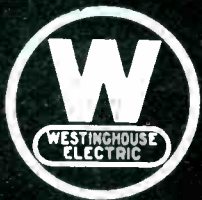

Westinghouse

TRANSMITTING TUBES

DEPENDABLE TUBES

DEPEND UPON WESTINGHOUSE

There are no "degrees" of quality in Westinghouse Radio Transmitting tubes. Each must come up to the same high standards inherent in all Westinghouse products. These standards are guaranteed to us—and to you—by specified controls and tests at every stage of manufacture, from raw materials to finished tube.

For example, Westinghouse filament wire is completely manufactured within our own plant, with every step of processing controlled by exacting specifications. Filament wire for Westinghouse tubes must run the gauntlet of more than 100 quality checks during its evolution from acceptable ore to quality wire.



This is typical of the

TUNE IN WESTINGHOUSE "MUSICAL AMERICANA", N. B. C. BLUE NETWORK, THURSDAYS, 8 P. M., E. S. T.

care and attention which we give to all phases of tube manufacture, and which permits us to say:

For dependable tubes depend upon Westinghouse

Write for descriptive tube bulletin TD-92

Westinghouse Special Products Division, Bloomfield, New Jersey

A new 50 KW transmitter with special advantages for commercial broadcasting

Hand in hand with development of radio tubes and practical operation of commercial Stations such as KDKA, Westinghouse has applied pioneering radio experience to the development of improved broadcasting equipment.

A new 50 KW transmitter, already in daily operation at Station KDKA, provides (1) Air cooling of all tubes, (2) Clean-cut modern design with every part readily accessible, (3) Fuseless protection for all circuits, (4) Extremely low operating cost.

Complete details on request: Westinghouse Radio Sales Division, Baltimore, Md.

**THE FIRST NAME
IN RADIO
BROADCASTING**

WESTINGHOUSE KDKA
The Station That Pioneered
All Radio Broadcasting

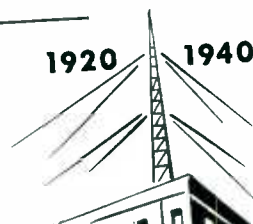

Which Resistor?



SIZES



TERMINALS



ENCLOSURES



MOUNTINGS



Your resistor requirements are no more difficult to fulfill than those of more than 10,000 Electrical and Industrial Engineers who are now using these bulletins as a reference guide.

Vitrohm Resistors, designed to satisfy these 10,000, are available in a wide variety of sizes, ratings and terminals. Your "special" problems can be solved by these combined standard Ward Leonard Resistors.

Send for these bulletins. You will find them most useful and helpful guides in solving your resistor problems.

BULLETIN 11

Tells about Vitrohm Wire Wound Resistors, gives sizes, watt ratings.

BULLETIN 19

Describes Ward Leonard Ribflex Resistors for unusually heavy duties.

BULLETIN 25

Is a treatise of standard and special mountings and enclosures.

WARD LEONARD ELECTRIC COMPANY

32 South Street

Mount Vernon, N. Y.

Electric Control Devices Since 1892

WARD LEONARD ELECTRIC CO., 32 South Street, Mount Vernon, N. Y.

Please send me your bulletins Nos.

Name

Company

Street

City State



Phototube Counts Revolutions of Watthourmeter, Compares It With Standard Unit

A new photoelectrical method of testing the calibration of revolving-disc type watthourmeters has been developed at the G.E. Laboratories at Schenectady. The phototube system employs a source of light on one side of the revolving disc of the meter under test and a phototube on the opposite side. Light passes through the "creep-holes" in the disc, registering a count twice

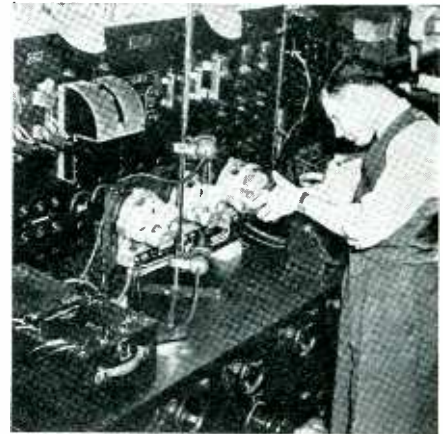

Light-source and phototube (on standard) count watthour revolutions

in each revolution. The phototube current passes to an amplifier and relay system which applies voltage to the potential circuit of the rotating standard meter, thus allowing the rates to be compared directly. Tests show that the accuracy of the comparison is within 0.004 per cent in one revolution and 0.0004 per cent in ten revolutions. This high degree of accuracy allows a much shorter running time in each test, approximately one half the time needed in the conventional counting method.

• • •

Britain Plans Television Via Cable

PLANS HAVE BEEN prepared for reopening the television service in Great Britain which was interrupted by the outbreak of war. The new arrangement is to make use of relay stations and low loss cables for transmission purposes and was experimented with by Post Office engineers before the war.

It is claimed that the new plan has certain advantages over the radio-link scheme of distribution from a central point. Chief amongst these are freedom from interference and low monetary cost, as neither the British Broadcasting Corporation nor the Government would be required to contribute anything to the finances of the scheme. The Postmaster General and his technical experts are at present considering the proposals.

**BELDEN
WIRING DATA CHART
HOOK-UP WIRES**

MINIMUMS

WIRE DIAMETER	14 AWG	16 AWG	18 AWG
MINIMUM TENSILE STRENGTH	100 LB	50 LB	25 LB
MINIMUM CAPACITY	1000 P.F.	500 P.F.	250 P.F.
MINIMUM INSULATION RESISTANCE	1000 OHM INCH	500 OHM INCH	250 OHM INCH
MINIMUM PUNCTURING VOLTAGE	1000 V	500 V	250 V
MINIMUM INSULATION RESISTANCE PER INCH	1000 OHM INCH	500 OHM INCH	250 OHM INCH



**BELDEN
WIRING DATA CHART
MICROPHONE CABLES**

MINIMUMS

WIRE DIAMETER	14 AWG	16 AWG	18 AWG
MINIMUM TENSILE STRENGTH	100 LB	50 LB	25 LB
MINIMUM CAPACITY	1000 P.F.	500 P.F.	250 P.F.
MINIMUM INSULATION RESISTANCE	1000 OHM INCH	500 OHM INCH	250 OHM INCH
MINIMUM PUNCTURING VOLTAGE	1000 V	500 V	250 V
MINIMUM INSULATION RESISTANCE PER INCH	1000 OHM INCH	500 OHM INCH	250 OHM INCH

RADIO WIRES have "PERSONALITY" too

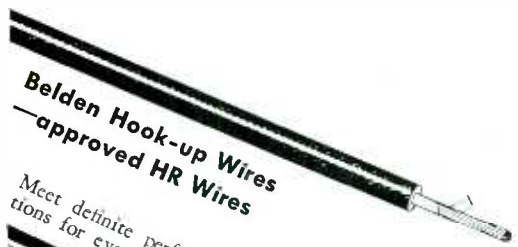

Belden Hook-up Wires
—approved HR Wires

Meet definite performance specifications for every manufacturing need.



Belden Microphone Cables
engineered to meet particular requirements

Provide great flexibility, unusual tensile strength, and long life. Specially developed shielding and low capacity rubber. One or many conductors—for all types of microphone and control circuits and test instruments.



Belden Magnet Wires
for more efficient coils

Beldenamel, Cortenamel, Silkenamel, Celenamel—paper covered—and many specially insulated types including Formvar. Belden standards assure softness and uniformity and over-all manufacturing economy.

It's easy to identify the best wire for each job

Belden wires are engineered to fit the radio industry's most exacting requirements. Belden wires in production are subjected to the most detailed inspection to obtain constant characteristics.

These wire characteristics are known. You can specify hook-up wire to such specifications as Power Factor, Q-Value, Puncturing Voltage, or Insulation Resistance, as well as size, color, and insulation.

You can specify microphone cable of known capacity between conductors and between conductors and shield. You have equal confidence in quality and uniform characteristics of every item in Belden's complete assortment of wires for radio and sound equipment manufacturers. Use the right wire for every job. Specify Belden.

Belden Manufacturing Co., 4625 W. Van Buren St., Chicago, Ill.

Don't Go "Haywire"
Go

Belden

WIRES FOR RADIO AND COMMUNICATIONS

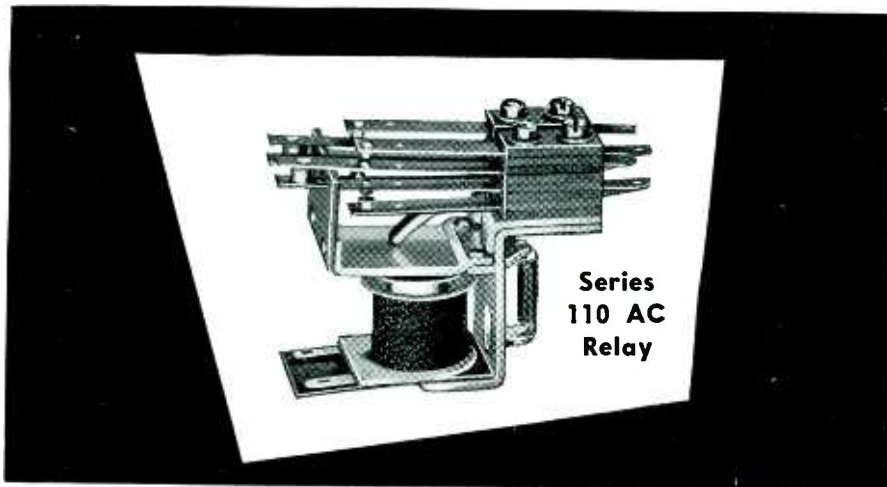

Series
110 AC
Relay

TIME TESTED AND PROVED—A SMALL RELAY FOR GENERAL APPLICATIONS

★ Bring your control problems to Guardian Electric where experience gained through the design, development and production of thousands of electrical control units—from simple small relays like the well-known Series 110 AC Relay by Guardian illustrated above—to intricate combinations—can turn your seemingly impossible control problems into quick, easy answers.

RELAYS BY GUARDIAN

Designed singly, or in complete control assemblies from 3700 standard Guardian parts—synchronized each to the other and to your machine. High speed production lines turn out ANY QUANTITY AS YOU WANT THEM WHEN YOU WANT THEM—with a plant within a plant to produce those one, two or three control units you must have now.

Quantity control orders produced in three days time. Faster if necessary, with overnight shipping service to every industrial center.

Ask Us To Make Specific Recommendations. Write

GUARDIAN  **ELECTRIC**
1625 West Walnut Street Chicago, Illinois

Easter Telecasts Observed by Weather Observation Staff at Whiteface Mountain, N. Y.

IN ONE OF THE LONGEST distance television relays ever reported, the staff of the weather observation station at Whiteface Mountain, 4872-feet high in the Adirondacks and 250 airline miles from the original program source, successfully picked up the telecast of the Easter Services and Fifth Avenue parade telecast from the N.B.C. Empire State transmitter. The weather station is maintained jointly by Rensselaer Polytechnic Institute and New York University. The reception covered two jumps, 130 miles from New York to the G. E. station, and another 120 miles to the mountain top. Snowshoes and toboggans were used to transport the aerial and a standard table model receiver over five miles to the weather station.



Prof. Corwin of R. P. I., K. G. McCaslan, weather observer, Joseph Wiggin, G. E. engineer, Willard Cody, chief observer and Ken Williams, cook, view the Easter ceremonies in New York



Messrs. Cody, Wiggin, and Corwin erect the television antenna in a 77-mile wind atop the weather observation station



Electricity does the work . . . Insulation makes it safe



A. Sawed, milled, drilled and threaded packing gland. **B.** Sawed, drilled, milled and tapped fairlead. **C.** Molded, milled and drilled arm contact.

LOOK about any modern kitchen and you'll find a dozen appliances containing Synthane Bakelite-laminated—mixer, toaster, washer, clock, range, refrigerator, protecting the housewife from restless currents. Synthane's sphere of use extends beyond kitchen and home to office, factory, ships of sea and air . . . and to hundreds of electrical, radio, chemical and mechanical products and equipment.

The variety of Synthane's properties may readily suggest an application to you. Synthane, you will discover, is a dense, hard, uniform, technical plastic (half the weight of aluminum) structurally strong, and resistant to the corrosive influence

of many acids, salts, gases, solvents, petroleum products and water.

Synthane combines many more desirable properties, and it is easy to machine. You can machine it yourself or put the job up to us—as did the three manufacturers whose problems are pictured in the panel at the left.

Better products, more customer satisfaction, more sales and less production headaches usually follow in the wake of Synthane's application. Why not see what you can do with Synthane? Send for one or more of the folders described on the back of this advertisement, using the convenient coupon. Synthane Corporation, Oaks, Pa.

SYNTHANE
Bakelite — laminated

TECHNICAL PLASTICS

SHEETS · RODS · TUBES · FABRICATED PARTS · SILENT STABILIZED GEAR MATERIAL



Send FOR ONE OR MORE OF
THESE INFORMATIVE FOLDERS

describing the properties, uses and methods of machining SYNTHANE Bakelite-laminated Technical Plastics for industry

- 1 **STANDARDS OF QUALITY FOR SYNTHANE Bakelite-laminated** — A useful, quick reference chart of the actual and relative values of Synthane sheet stock . . . including tensile strength, dielectric strength, transverse strength, compressive strength, impact strength, dielectric constant, power factor, dielectric loss factor, water absorption, corrosion resistance, and machinability.
- 2 **TECHNICAL PLASTICS FOR INDUSTRY** — A brief explanation of the composition, grades, properties, and many applications of Synthane Bakelite-laminated technical plastics. Gives you a quick picture of the uses for Synthane and stimulates possibilities in connection with your product.
- 3 **SYNTHANE Bakelite-laminated TUBING** — A comparison of the advantages of molded and rolled tubes, kinds of stock, and properties, with a table of standards of quality. Well illustrated with photographs of the manufacture of tubes and parts machined from tubing.
- 4 **PRACTICAL METHODS OF MACHINING Bakelite-laminated** — Modern methods of machining Bakelite-laminated and instructions for machining it in your own shop. In chart form, profusely illustrated. Unfolds to 11" x 25½" for hanging on shop wall.
- 5 **RADIO INSULATION** — A specialized folder on the properties of Synthane tubing, coil forms, and panels for radio and associated industries.
- 6 **SILENT STABILIZED GEAR MATERIAL** — Characteristics of Grade C Synthane Stabilized Gear Material, formula for computing horsepower of Bakelite gears, diametral pitch silhouettes and instructions for cutting gears—all in chart form suitable for hanging on your shop wall.

SYNTHANE CORPORATION, OAKS, PA.

Gentlemen: Please send me the booklets checked.

- Standards of Quality for Synthane Bakelite-laminated
- Technical Plastics for Industry
- Synthane Bakelite-laminated Tubing
- Practical Methods of Machining Bakelite-laminated
- Radio Insulation
- Silent Stabilized Gear Material

NAME _____

COMPANY _____

ADDRESS _____

CITY _____ STATE _____

SYNTHANE

Bakelite —  laminated

TECHNICAL PLASTICS

SHEETS · RODS · TUBES · FABRICATED PARTS · SILENT STABILIZED GEAR MATERIAL

Representatives in all principal cities



A 16-PAGE
COLLECTION
OF

MONEY MAKING IDEAS

*Tells how well-known
Electrical Equipment manufacturers improve
small parts and make a good product better*

ARE you bothered by a spring that fails at high temperature . . . or a vibrating part that fails through fatigue? For these and countless other metal problems you'll find a ready solution in Inco's new booklet, "Tremendous Trifles."

This new booklet is *practical* from start to finish. The ideas it presents are *successful* . . . worked out by manufacturers, as shown in the list at right. In addition, "Tremendous Trifles" contains a valuable section of Condensed Engineering Data, by which you can *compare the properties* of metals and alloys used for electrical and electronic applications.

Because of the expense of publishing this booklet, it is being mailed only on request. In reply to a single letter, 1992 electrical equipment makers have already sent for a copy. Would you like to have one? Then simply return the attached coupon . . . no charge and absolutely no obligation.

THE INTERNATIONAL NICKEL COMPANY, INC.
67 WALL STREET, NEW YORK, N. Y.



"Monel" is a registered trade-mark of The International Nickel Company, Inc., which is applied to a nickel alloy containing approximately two-thirds nickel and one-third copper.

MONEL

INSIDE FACTS

Read why Monel and other Nickel-base alloys were selected by the following and other manufacturers:

Westinghouse Electric
Thomas A. Edison, Inc.
Electronic Laboratories
Schick Electric Razor
Bead Chain Company
Edwin L. Wiegand Co.
Pass & Seymour
Square "D" Company
Scintilla Magneto
Electric Auto-Lite
Mallory Electric
North Electric Mfg.

THE INTERNATIONAL NICKEL COMPANY, INC.
67 Wall Street, New York, N. Y.

Gentlemen:

Please send me without charge or obligation a copy of your new booklet, "Tremendous Trifles."

Name.....

Address.....

E 4-40

The Climax to a decade of electrolytic condenser progress



Special octal base designed and made by AEROVOX, but fits the usual standard octal socket.

Nickel-plated brass prongs engage with similar metal socket contacts.

Junction of brass prongs and aluminum studs imbedded in molded bakelite, immune to corrosive effects.

Hi-purity aluminum tabs from electrolytic section, bonded to aluminum studs of octal base, for corrosion-proof aluminum-to-aluminum joints.

Hermetic sealing achieved by can edge spun over soft rubber gasket and bakelite plug. Vented cover for full protection.

Available with plain foil and etched foil of highest purity. Two can sizes: 1-3/8" and 1-5/32" dia. 2 1/4 to 4 1/4" high. Single, dual, triple, and quadruple section units. 25 to 500 v. D.C.W.



● To **ELECTRONICS'** Tenth Birthday party, we bring a brand new, startling, far-reaching contribution to the radio and allied arts, in the form of the **AEROVOX Series AP Plug-In Electrolytic Condenser**.

Developed primarily for the U. S. Signal Corps, and for use in aircraft, police radio, sound-system and other equipment where continuity of service is a prime requisite, this idea opens up untold possibilities. Readily removed, tested, replaced, these octal-base condensers handle as easily as a radio tube or vibrator. Assemblies can be equipped with fresh plug-in electrolytics immediately prior to shipment or actual use. Users can have "spares" on hand.

The many problems encountered in providing a tight, leak-proof, hermetically-sealed octal base, together with positive elimination of corrosion, have been fully solved. A perfected, practical, brand new class of condenser, is now available to you.

Ask for DATA . . .

Engineering data on this Series AP AEROVOX Plug-In Electrolytic Condenser will be sent on request. Also samples, specifications, quotations, to responsible parties.

AEROVOX CORPORATION
New Bedford, Mass.

Sales Offices in All Principal Cities

Television Equipment in Transport Plane Relays Pictures to NBC Audience

ON MARCH 6, a notable television broadcast was made using the new portable transmitting equipment recently developed by RCA Manufacturing Company in Camden. The equipment, including two iconoscope cameras, all synchronizing signal generation equipment, and a transmitter operating on 288 Mc, was installed in a United Airlines transport plane, and flown over New York City. A receiver relayed the 288 Mc signals to the N.B.C. Empire State transmitter which rebroadcast the program to the New York area on 44-50 Mc. Another transport plane, equipped with a standard television receiver, accompanied the transmitting plane. Observers in the second plane were able to view the plane in which they were flying, as picked up by the cameras and relayed to them.

The total weight of the equipment including cameras, gasoline driven generator, picture transmitter and sound transmitter and all auxiliaries weighed 1500 pounds. The picture equipment itself weighs 550 pounds when equipped with one camera chain, 850 pounds with two chains and 1050 pounds with three chains, less the weight of the interconnecting cables. The television camera cables are of new design, measuring only an inch in diameter and weighing 0.6 pounds per foot. However, if long cables are used (not necessary in the plane of course), the weight of the cable can become appreciable. In fact, if three cameras are used with 500-foot cables on each, the weight of the cable exceeds that of the equipment. The r-f transmitter, which operates in the frequency range from 275 to 325 Mc weighs 250 pounds, and has a peak power of from 25 to 35 watts, depending on the frequency of operation. The transmission during the flight occurred on 288 Mc with about 35 watts peak output.

The television signal equipment itself is mounted in seven packing cases which can be handled by one or two men. In fact, for simple outside broadcasts it is possible for two men to load all the necessary equipment into a station wagon and cover outside broadcasts without further help.

The pictures in the airplane demonstration were picked up by the new small-size iconoscope cameras. In the main the received images were clear and steady, at best about equal in quality to the images produced from the mobile unit trucks currently used for the N.B.C. outside broadcasts. Loss of signal as the body of the plane came between the transmitting and receiving antennas, and some interference from noise and diathermy were occasionally effective in blotting out the picture, but in the main the demonstration was a pronounced success. The route of the plane included the take-off at LaGuardia airport, a flight over the



**EASY PUNCHING
SPEEDS
PRODUCTION!**



AMONG the many types of laminated phenolic sheet supplied for electrical insulating purposes by Formica, is one, XPND33, that was developed especially to provide fast easy punching for production purposes . . . Intricate shapes can be punched cold from this material up to 5/64 in thickness with a clean edge and a minimum of surface cracking between the holes. Simple shapes may be punched up 1/8 thickness cold . . . The workability of the sheet is combined with insulating qualities that make it suitable for a great many purposes. With it you can get good insulating parts at lower costs.

FORMICA

THE FORMICA INSULATION CO.
4658 Spring Grove Avenue • Cincinnati, Ohio

HUNTER Springs

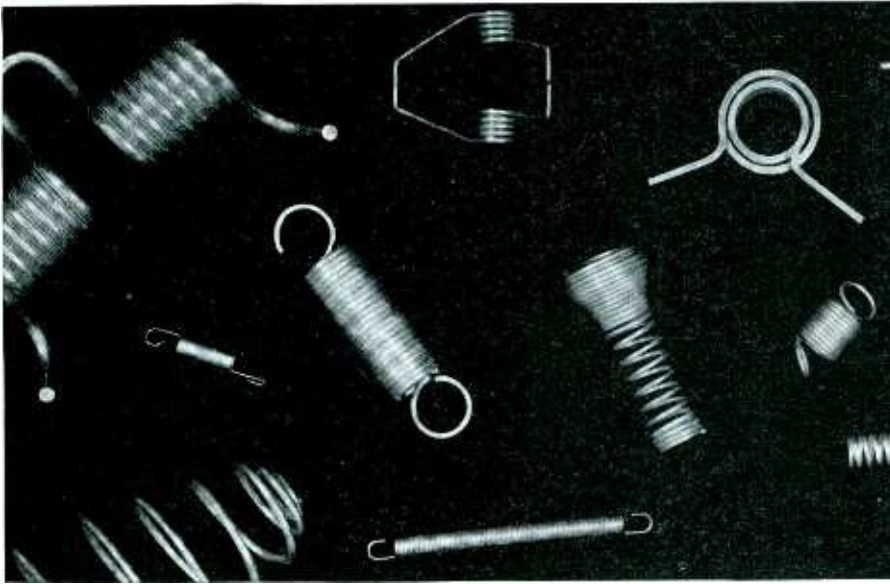

Compression — Extension — Torsion — Flat

MATERIALS—Springs of all metals. Materials purchased only from approved sources working to Hunter specifications. A complete range of sizes of all spring materials carried in stock to insure prompt delivery. Each lot of material is test inspected before acceptance.

DESIGN AND SPECIFICATIONS—Engineering department of capable and experienced personnel determines in advance the proper size, type and design of spring to meet each customer's requirements and thereby insures correct performance of springs.

PRODUCTION equipment includes modern automatic coilers for wire sizes .004" to .250" diameter. Other equipment produces springs up to a maximum wire size of .625" diameter. In addition to 4-slide and high speed presses, complete equipment is avail-

able for performing all operations incidental to spring manufacture. Small orders are handled by a specially equipped department. Standard finishes available are Pen-trate; Japan; Cadmium, Nickel, Copper and Silver Plating.

INSPECTION of production to verify the meeting of physical and test specifications and tolerances. Inspection facilities include load testing equipment with capacity ranging from grams to tons. Rockwell, torsion and magnaflux (seam detection) inspection are used as required.

EXPERIENCE covers twenty years of practical spring making combined with the most advanced engineering practice of spring design. The results are satisfied users of Hunter Springs in over three hundred distinct types of industry.

Stampings

BLANKS, FORMS, DEEP DRAWN PARTS—Light and heavy single action press work—maximum capacity 135 tons. Light four-slide stampings. Light and medium extra deep drawn stampings.

MATERIAL—all metals .004" to .250" thickness. Maximum blank size 15" x 15" x 1/8".

SHORT RUN STAMPINGS — Eliminate higher cost of permanent dies when only small lots of metal stampings are required. Especially helpful in development of models and experimental work, design changes, etc.

TOOLS, DIES AND JIGS—made in our own plant by expert tool makers.

DESIGN—the most economical stampings are designed to meet each customer's requirements. Close tolerances are held. Unusual stampings are our speciality.

EXPERIENCE—covers thirty-five years in the production of stampings including the manufacturing of the Hunter Grease and Oil Cups—a pressed steel product involving intricate problems of deep drawn work. Many of the largest and best known users of high grade stampings have long been our customers.



**HUNTER
PRESSED STEEL CO.
LANSDALE, PENNSYLVANIA**

World's Fair, over the lower Bronx to the Hudson River, the George Washington Bridge, then southward to the skyscrapers in lower Manhattan, including the Empire State building from which the program was rebroadcast. Radio City, Central Park and the Islands in New York Harbor were included in the itinerary.

Technically, the telecast was notable in that the synchronization signals were derived from a totally isolated power source, a light-weight 110-volt generator developed by D. W. Onan and Sons. The 60 cps output of this generator was fairly stable, but far from synchronous with the 60 cps power system on the ground. Despite this, most of the receivers held in synchronism steadily throughout the broadcast. The Empire State transmitter was used simply as a relay link, using the signal from the plane to modulate the transmitter output directly without attempting to tie in the signal with the local synchronizing signals. The gasoline generator has frequency stability of plus or minus one cycle. The plane used was a Boeing Model 247-D used as a "flight research" ship by United Airlines.

The portable equipment was designed to allow outside pick-ups for standard television broadcasts to be made with smaller crews and less involved preparation than are required with the mobile unit trucks. The new equipment has already gone into service in the N.B.C. telecasts.

• • •

HEAR YOURSELF AS OTHERS HEAR YOU



The Voice-O-Graph, being demonstrated recently at a coin machine show in Chicago. The machine is an automatic voice recorder attached to a coin-operated record player. The machine may be switched so that the listener can hear the reproduced voice either through the ear phone, as shown, or through a loud speaker

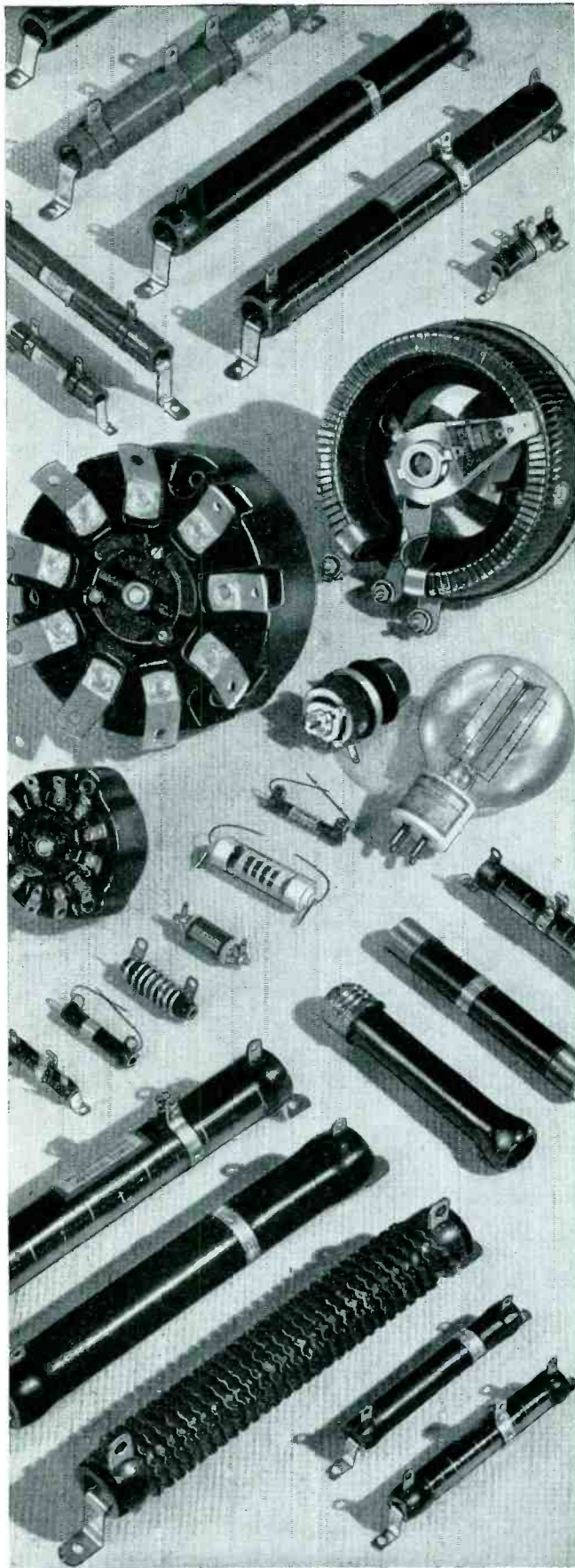

OHMITE

Helps you 5 ways!

Engineered for Your Needs

Our application engineers, with specialized experience in resistance control for all types of applications, will work out the exact, most economical units for your requirements. Just put your problem up to Ohmite.



Many Stock Units for Quick Delivery

You'll find our extensive range of stock types and sizes a great convenience in obtaining economical units quickly. We maintain the largest, most complete stock of close-control Rheostats, wire-wound Resistors, and high current Tap Switches in the world—available for immediate shipment.

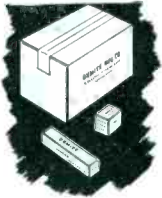

Built Right in Every Way

You get many constructional advantages in Ohmite all-porcelain vitreous-enameled Resistors, smooth-action close-control Rheostats, compact Power Tap Switches, and other Ohmite units. They're time-tested, time-proved.



Trouble-Free Performance

There's extra dependability in every Ohmite product to insure continuous, trouble-free performance on the toughest jobs in every kind of climate from the heat and humidity of the tropics to the icy cold of the arctic.



Prompt and Certain Shipment

You are sure of prompt production and delivery on the units you need. Your order is acknowledged with a definite shipping date, and this shipping promise is faithfully kept.



Write for Catalog 17 *It contains handy information about Ohmite Rheostats, Resistors, Tap Switches, R. F. Chokes and Attenuators.*

OHMITE MANUFACTURING COMPANY
4816 Flournoy Street ★ Chicago, U.S.A.

Be Right with **OHMITE**
RHEOSTATS ★ RESISTORS ★ TAP SWITCHES

FM is here

BROADCASTERS GET READY

Why experiment with unproven tubes? Practically every Broadcast station now on the air with FM uses Eimac tubes

Here's the line up

EIMAC 250T

In service now on Frequency Modulation. Eimac 250T has proven itself to be ideal for all communication and relay services as well as broadcast. Recommended for 250 to 500 watt stations.



Net Price
\$24.50

EIMAC 450T

In service now on Frequency Modulation. This tube will be most popular for FM broadcasters because it operates very efficiently on 1KW power level. Recommended for 1KW stations.



Net Price
\$75.00

1500T and 2000T

In service now on Frequency Modulation. The answer for higher power broadcast services, providing maximum power and efficiency for 2KW to 10KW stations. All of these Eimac tubes are in actual service in FM transmitters today. Don't experiment with untried tubes . . . when you install your new FM transmitter insist on

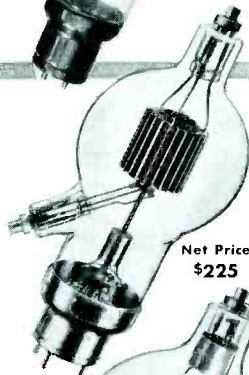

Net Price
\$225

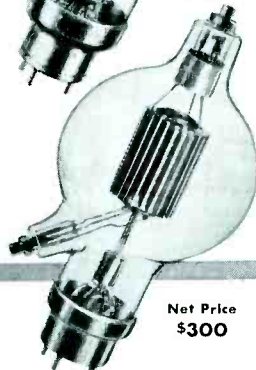

Net Price
\$300

Eimac
TUBES

For further information write to
Eitel-McCullough, Inc., San Bruno, California

FM Before FCC

(Continued from page 16)

ceiver merchandising since the early \$300 superheterodynes.

Copies of Major Armstrong's patent-license agreements with broadcast stations transmitter manufacturers and receiver manufacturers were offered for the record. It was revealed that a down payment of about \$25,000 was required of a manufacturer, but that this payment was refunded if the manufacturer agreed to spend it in research. Thus far every manufacturer has taken advantage of this arrangement, and only license fees have been collected. Licenses to transmitter manufacturers are three in number: General Electric, Western Electric and Radio Engineering Laboratories. The receiver manufacturers licensed, ten in all, are: General Electric, Hallcrafters, Hammarlund, National Co., Pilot, R. E. L., Scott Laboratories, Stewart-Warner, Stromberg-Carlson and Zenith. Major Armstrong also testified to the amounts he had received from the sales of his previous inventions. The superheterodyne and regenerative patents were sold in one sale for \$330,000; the superregenerative circuit for \$425,000. The cost incurred by Armstrong in developing frequency modulation to date was given as "between \$700,000 and \$800,000".

John Shepard Testifies for F-M Broadcasters

The first witness for F-M Broadcasters, Inc. was its president John Shepard, III, of the Yankee Network. He stated that some 55 of those broadcasters who have licenses, construction permits, or applications for f-m permits comprise the membership of the association, and that membership is open to any such broadcaster. Mr. Shepard presented eleven resolutions for the membership of the association, ratified by it on March 17th, just before the hearing opened. The resolutions are as follows:

I: The granting of regular licenses for fm instead of experimental licenses be requested.

II: The Commission be requested to raise the power limitation on f-m transmitters from 1 kw to 50 kw.

NATIONAL RESEARCH CREATES NEW PRODUCTS ★ NEW MARKETS

**LONG
LIVE
Jackson
Soldering Pencils**

..thanks to
PHENOLITE
REG. U. S. PAT. OFF.
Laminated BAKELITE

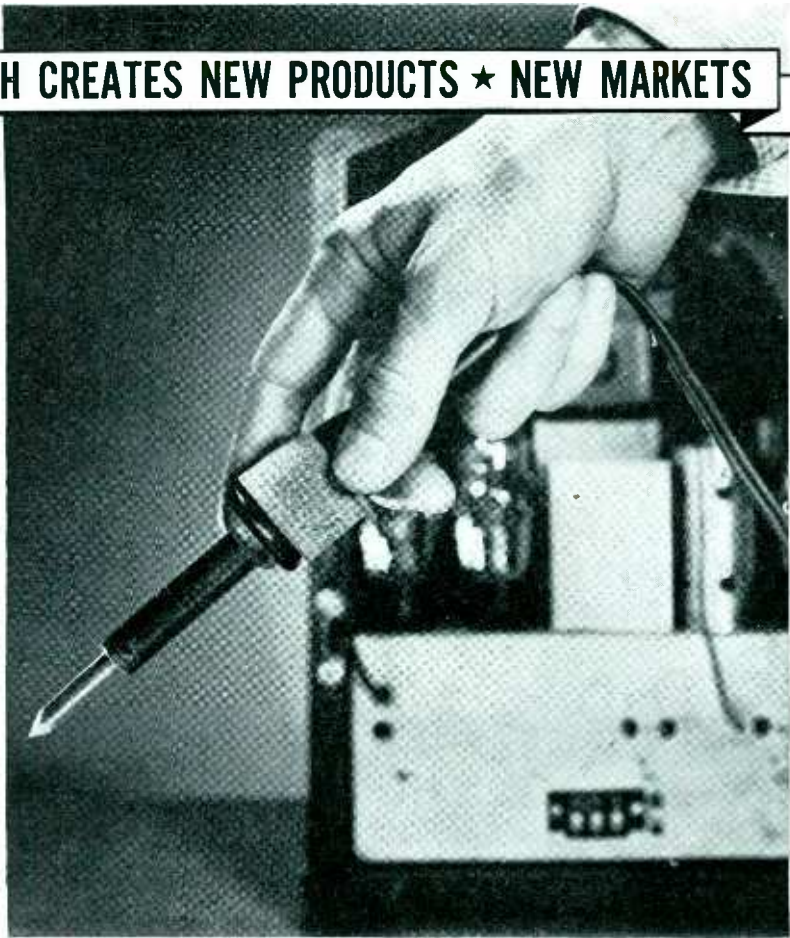

JACKSON Electro Corporation of Brooklyn, N. Y. were having difficulty with the performance of their soldering pencils. This was due to the brittleness and heat transferring qualities of the porcelain bushing used to insulate the wooden handle of the soldering pencil from the hot metallic element.

The porcelain bushing would break . . . the handle would char, quickly resulting in an unusable article. National engineers recommended the use of asbestos base (heat resisting) "Phenolite" laminated bakelite to

replace the porcelain bushings. The result: practically indefinite product life . . . widely increased sales.

Whether it is a tiny bushing or a large heavy duty gear, or one of a thousand products, Phenolite is constantly demonstrating its ability to withstand the kind of punishment other materials can't take. And National engineers are demonstrating also their ability to work with industry in the manufacture of better products through the use of Phenolite and National Vulcanized Fibre. We invite your inquiry.



NATIONAL VULCANIZED FIBRE COMPANY
FOUNDED 1873
WILMINGTON DELAWARE

NATIONAL VULCANIZED FIBRE

These NATIONAL Products have a Cost-Cutting Application in your field. We can make it easy for you to select the right product and grade.

PHENOLITE
Laminated BAKELITE

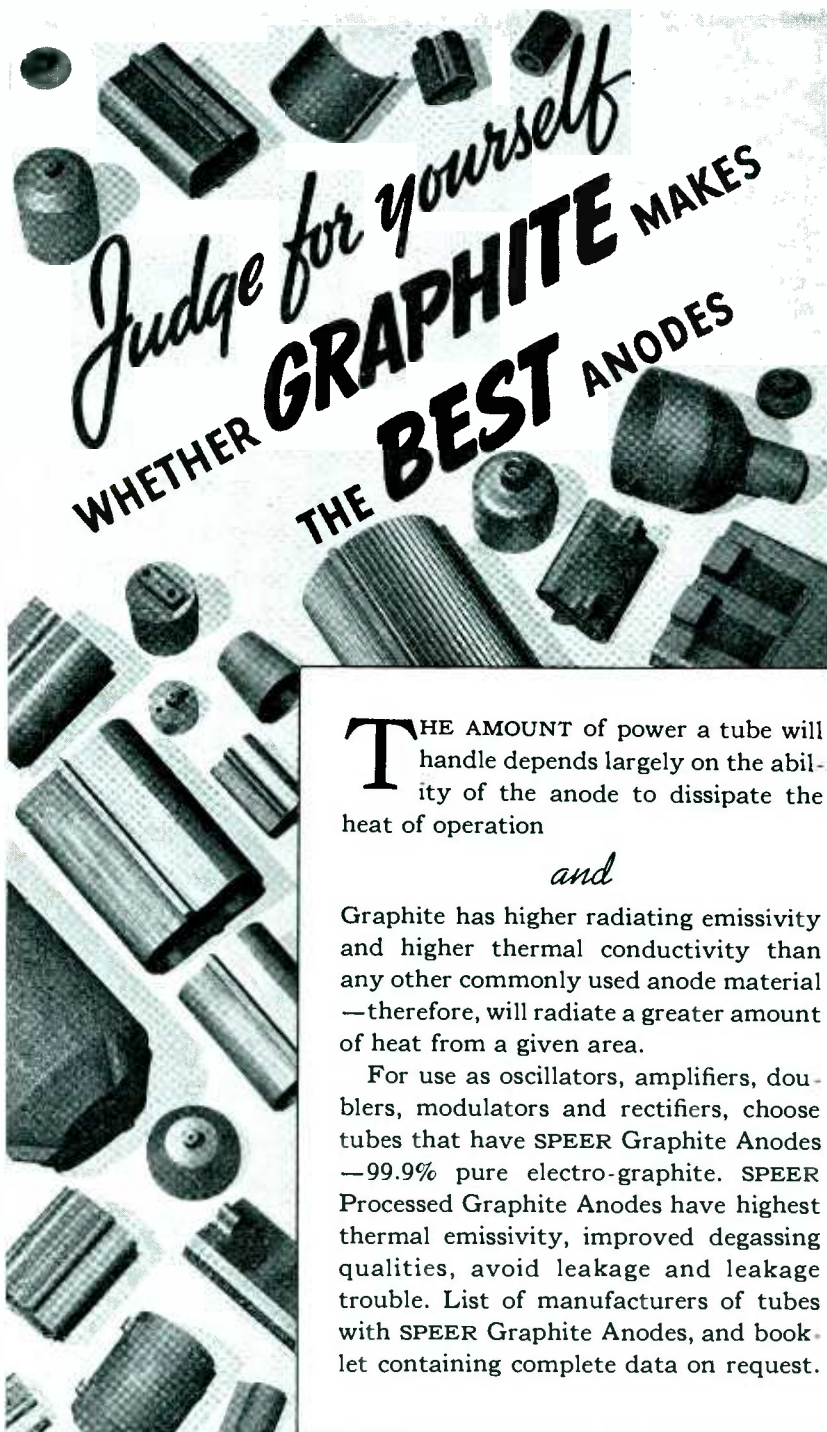

Judge for yourself
WHETHER GRAPHITE MAKES THE BEST ANODES

THE AMOUNT of power a tube will handle depends largely on the ability of the anode to dissipate the heat of operation

and

Graphite has higher radiating emissivity and higher thermal conductivity than any other commonly used anode material—therefore, will radiate a greater amount of heat from a given area.

For use as oscillators, amplifiers, doublers, modulators and rectifiers, choose tubes that have SPEER Graphite Anodes—99.9% pure electro-graphite. SPEER Processed Graphite Anodes have highest thermal emissivity, improved degassing qualities, avoid leakage and leakage trouble. List of manufacturers of tubes with SPEER Graphite Anodes, and booklet containing complete data on request.

PROPERTIES OF SPEER GRAPHITE ANODES

THERMAL CONDUCTIVITY 1.92

RADIATION EMISSIVITY (% Emissivity - Black Body = 100%) **95% at 750° C.**

RELATIVE HEAT DISSIPATING VALUE at 510° C.

Graphite 1.00	Molybdenum 0.24	Nickel No. 1 0.025
Tungsten 0.30	Tantalum 0.22	Nickel No. 2 0.001

LINEAR COEFFICIENT OF EXPANSION
 .9 to 2.8 x 10⁻⁶ per °C. (20°—700° C.)

MELTING POINT—NONE. Will not soften, warp, fuse or flow.
 Carbon sublimates without melting at 3500° C.

SPEER CARBON CO.
 ST. MARYS, PA.

SCC →

NEW YORK	MILWAUKEE	PITTSBURGH
CHICAGO	DETROIT	CLEVELAND

III: That a minimum separation of 200 kc between adjacent f-m channels is, in our judgment, essential in order to accommodate facsimile by multiplex transmission and because of the fact that narrow band transmission may be carried on within such channels.

IV: That more than 5 adjacent channels for frequency modulation are essential.

V: The 41 to 44 Mc band should be allocated to stations using f-m transmission. Facsimile broadcasting should use f-m and these frequencies should be coordinated with sound broadcasting. Due consideration should be given to educational and facsimile transmission.

VI: It is recommended that the 26 megacycle band, now assigned to fm be allocated to other services.

VII: That in our judgment 15 megacycle band, now assigned to fm, the needs of fm and immediate provision should be made which will insure the availability of additional channels in the near future and that from the point of view of the receiver design, the additional channels should be as nearly adjacent to the band 41 to 44 megacycles as possible, insofar as this can be accomplished without undue injury to other services.

VIII: We recommend to the Commission separation distances for stations on the same channels and on adjacent channels for varying power.

IX: That we request the Commission to set an established policy of permitting re-broadcasts between stations, subject only to permission of originating stations as is the rule in the regular broadcast band.

X: That we request the Commission to set an established policy of permitting relay stations on fm.

XI: Provision be made in the f-m band so as not to exclude educational and facsimile transmission from the band, the latter either on multiplex or simplex transmission.

Following Mr. Shepard, Dr. G. W. Pickard, consulting engineer for the Yankee Network, testified as a witness for F-M Broadcasters, Inc. Dr. Pickard recounted a series of field tests made to determine the signal strengths and noise in the areas surrounding the Paxton and Alpine f-m stations. The results of this survey were given in evidence. In general they proved the contentions pre-



LENZ *Presents* a NEW and IMPROVED DIAL LIGHT SOCKET

Voltage Breakdown between contacts—1200 Volts.
Voltage Breakdown to ground—5000 Volts.

Bakelite Shell is recessed for contacts, which cannot be pushed or pulled out of position.

Heavy wall Bakelite Shell.

Brackets on grounded type socket welded to shell preventing interference due to vibration.

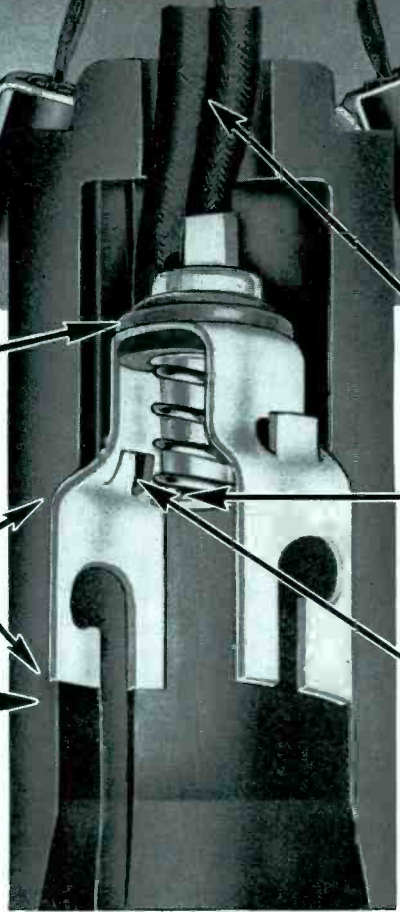

Tensile strength of leads and connections far in excess of requirements.

Center contact mounted so that it cannot protrude from shell and short on chassis when lamp is removed.

Lug on contact fits in groove in shell so that contact cannot be turned or twisted when inserting lamp.

A variety of different mounting bracket styles available, suitable for practically any mounting.

● *Complete Wire and Socket Assembly Accepted in Radio Receivers listed by Underwriters Laboratories.*

The superiority of the new Lenz Dial Light Socket, both electrically and mechanically is apparent with even the most casual inspection.

But even with its obvious superiority the use of the New Lenz Dial Light Socket will not add to the cost of your radio chassis. Samples will be gladly submitted upon receipt of specifications. Lenz Dial Light Sockets are made in both the two wire insulated type with bakelite shell and the single wire grounded type with metal shell.



**LENZ ELECTRIC
MANUFACTURING CO.**
1751 N. Western Ave., Chicago, Illinois

PRESTO offers a new Dual Turntable Transcription Recorder *complete in a single unit*



THIS new, moderately priced Presto Model F recorder makes the perfect installation for broadcasting stations, colleges, advertising agencies and personal recording studios. It records continuously, without interruption, on records up to the 17 $\frac{1}{4}$ " master size and also re-records from one record to another. The quality of the recordings made on the model F recorder makes them suitable for use by any broadcasting station.

NOTE THESE OPERATING CONVENIENCES:

- The exclusive Presto rubber-rimmed turntable driven directly by a steel pulley on the motor shaft, a drive system that eliminates idler wheels, belts, gears and other parts subject to rapid wear. Speed shift-lever changes instantly from 78 to 33-1/3 R.P.M.
- Tables are equipped with the Presto

1-C high fidelity cutting head which records uniformly a range from 50 to 8000 cycles and completely modulates the groove at a pitch of 112 lines per inch.

- A vertical damper eliminates vertical modulation in the groove and prevents rapid changes in groove depth due to surface irregularities in the disc.

- A time scale on the cutting arm shows the correct starting point for all sizes of discs and elapsed recording time at both 78 to 33-1/3 R.P.M.

- Amplifier gain 125 DB, output 10 watts, Amplifier controls include a two microphone mixer, playback gain control, combination control which increases the high frequency response for 33-1/3 R.P.M. recording and attenuates the high frequencies when playing commercial records, low frequency equalizer and a switch for changing instantaneously between cutters for continuous recording or rerecording.

- The complete equipment mounts in a wood table (Length, 67"—Depth, 21"—Height, 49") attractively finished in two tones of gray with silver trim. Height of turntable above floor level, 32".

For descriptive folder and price quotations, write:

PRESTO RECORDING CORPORATION
242 West 55th St. New York, N. Y.

viously made, i.e. that noise is greatly reduced, that extremely minute signal strengths suffice to give satisfactory service (Dr. Pickard mentioned the figure of 10 microvolts being entirely satisfactory in quiet locations if the receiver sensitivity were high enough to cause proper limiter action at such an input voltage), and that the service range under these conditions was considerably better than that of standard amplitude modulation stations of equivalent power.

Messrs. Martino of WTIC and Noble of the University of Connecticut, followed with testimony concerning the f-m receivers installed in their respective homes, reporting high quality and freedom from noise compared with a-m transmissions from more powerful and less distant stations. Messrs. Gellerup of WTMJ and Sise of the Yankee network offered complete reports showing continuous field strength measurements in territory surrounding their respective f-m transmitters, which were accepted in the record by the Commission. Mr. Gellerup's report showed a curve (average over 9 radial measurements) of field strength vs distance for a 1000-watt f-m transmitter with half-wave vertical dipole 357 feet above ground. The field strengths varied from 500 microvolts per meter at 10 miles to 10 microvolts per meter at 39 miles. The field intensity contours were roughly circular about the transmitter location at Milwaukee.

The final witness during the first week of testimony was Maurice Levy of Stromberg-Carlson, also testifying for F-M Broadcasters, Inc. He described the construction of three f-m receivers in the Stromberg-Carlson laboratories, to test the relative advantages of frequency swings at 30, 60, 120 and 150 kc. The results showed little if any difference in frequency response or harmonic distortion, but very considerable differences in signal-to-noise ratio and in the ease of tuning the receivers. The report favored the 150 kc swing as being the most desirable, stating that with a wide-open audio system only the wide swing would give sufficient freedom from noise to avoid objectionable tube hiss, etc. The need for drift-free oscillators was emphasized as an important problem if easy tuning was to be offered the public.

Sure there are **WESTONS**
for those *special*
measurement needs!

22 TO 150
MEGACYCLES



AC Clamp-Ammeter—a real time saver. Simply hook the jaws around the conductor while machinery is running, and take the current reading. No production interruptions as circuits are never disturbed. Rugged construction, with high insulation. Six current ranges answer all maintenance needs.



Hand-size AC Maintenance Voltmeter—has double range of 600 and 300 volts with push button switch for range selection—sensitivity 1000 ohms-per-volt. Case made of sturdy Bakelite with rotatable metal cover to protect instrument from rough handling. Has heavily insulated rubber covered leads and rubber sleeved test clips. Ideal for installation and maintenance testing of power and lighting circuits.

HERE are just five of them. WESTON makes many more. Each designed to meet some particular measurement problem . . . make test procedure simple . . . less time-consuming . . . more efficient. Remember this whenever you are faced with some new or unusual measurement problem. Better yet . . . investigate these WESTON instruments now . . . for chances are that one or more will exactly meet your *present* needs. Consult the WESTON representative in your vicinity, or write Weston Electrical Instrument Corporation, 618 Frelinghuysen Avenue, Newark, N. J.



Ultra High Frequency Oscillator—for checking and testing all types of communication equipment and carrier current systems operating in the high frequency bands. Has fundamental frequency coverage from 22 to 150 megacycles. Tests can be made with or without direct wire connection. Employs continuously variable inductive tuning, which provides high order of stability and resetability over entire range. Extremely portable, measuring only 8" x 8" x 11"—self contained power supply.

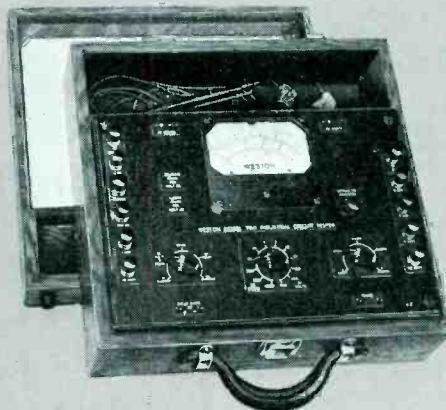

Industrial Circuit Tester—provides new convenience in testing signal, control and electronic circuits. Has 27 voltage, current and resistance ranges. High sensitivity for testing photo-cell, vacuum tube and relay circuits, and other plant maintenance and production requirements.

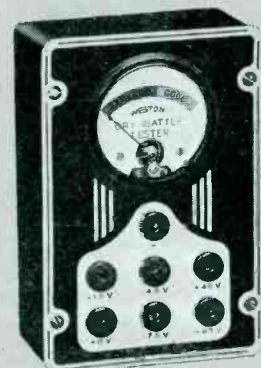

Pocket-size Dry Battery Tester—Measures "cut-off" voltages under proper load conditions. Ideal for checking dry batteries used in manufacturing or industrial control circuits. Ranges for testing batteries of following voltages . . . 1.5—4.5—6—7.5—45 and 90 volts.



WESTON *Instruments*

THE 6th of Ferranti Progress

TENTH
CHARTER
ADVERTISER
ANNIVERSARY

• 60 Years of Development

Rapid as has been the development of the Electronic Industry, FERRANTI PRODUCTS have kept pace with its demands . . . until today this outstanding organization has rightfully taken its place as one of the chief factors in the progress made in this field.

Ferranti prestige is founded upon Ferranti Quality—a standard that has never been excelled.

• FERRANTI PRODUCTS •

POWER TRANSFORMERS • AUTO TRANSFORMERS
AUDIO TRANSFORMERS • REACTORS • INDUCTORS
RECTIFIERS • POWER SUPPLIERS • AMPLIFIERS
HIGH Q COILS • LOADING COILS • CHOKE COILS
REPEATERS • FILTERS • BAND PASS FILTERS
BAND REJECTION FILTERS • INSTRUMENTS

Ferranti
ELECTRIC
INCORPORATED
RCA BUILDING
NEW YORK, N. Y.

FOR
VALUE
RECEIVED

RCA Agrees FM Should Get "Green Light"

The highlight of the second week of the hearing was the testimony of witnesses for the Radio Corporation of America and its subsidiaries. Cross-examination of the earlier witnesses by the RCA counsel had led observers to expect stiff opposition on the part of RCA. Instead, Chief Counsel Wozencraft on March 27th announced that it was the opinion of his company that frequency modulation should be given the "green light", and that it be permitted to operate on a commercial basis as a supplement to the standard broadcast service. Mr. Wozencraft pointed out however that service to rural and small-town regions must always be provided by methods now used in standard broadcasting.

The question of the competition between frequency modulation and television for ether space then took the center of interest. Regarding the proposal that television channel number 1 (44-50 Mc) be turned over to frequency modulation, Mr. Wozencraft suggested that it should be one of the other channels, since that channel is now in regular use. If the channel were assigned to f-m uses, it was proposed that exceptions be made in the allocation for cities where the television channel is now in use. Regarding the desirable bandwidth, the RCA engineers granted that the wider the band the better the signal-to-noise ratio, but urged that the proper compromise between desired signal-to-noise performance and the number of available channels might be made equitably on a narrower band than that suggested by Major Armstrong.—D.G.F.

TELEVISION ANTENNA

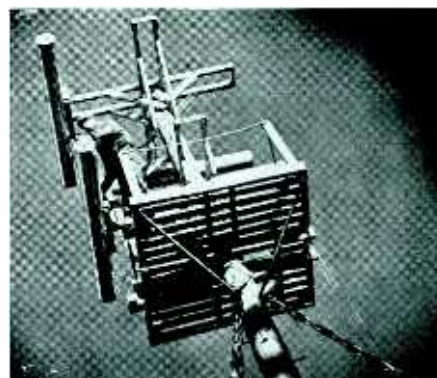

Half-cubic antenna used for picture transmission at the General Electric television station erected on Helderberg Mountain in New York State



FM

TRANSMITTERS Armstrong System

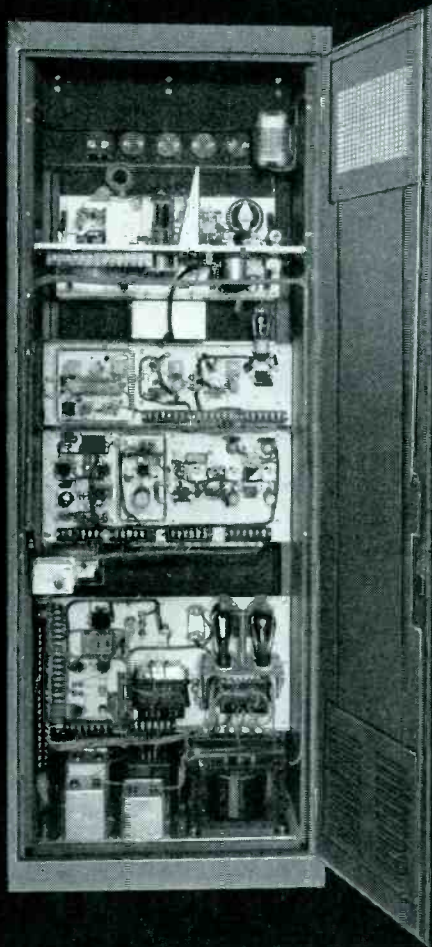
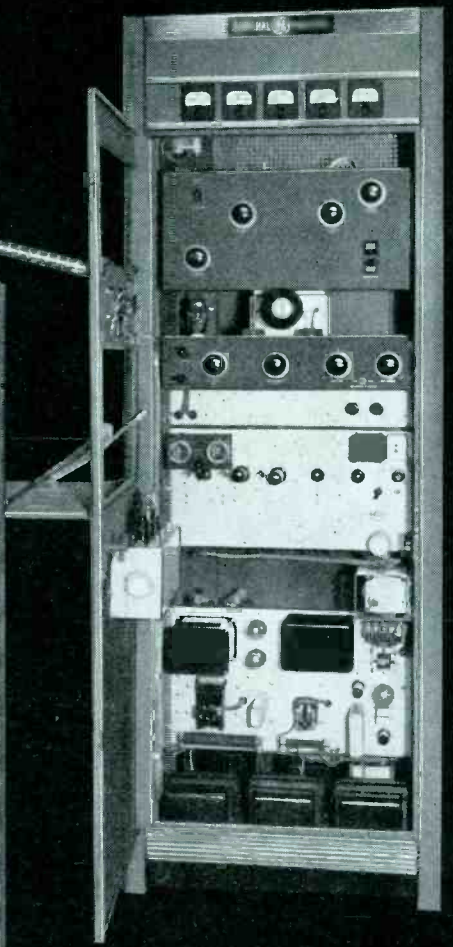
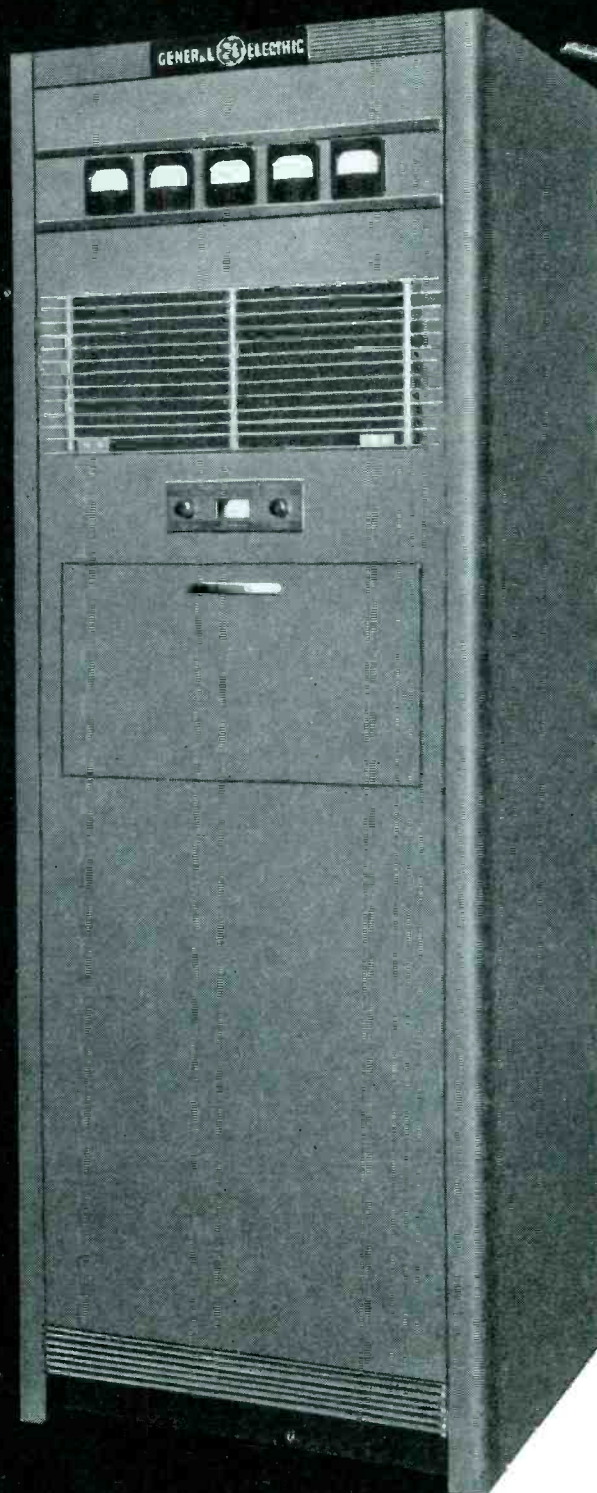

TRIM, NEAT, ACCESSIBLE — a glance tells you that. Our performance figures on this new G-E 250-watt F-M transmitter tell much more — tell, for example, that when you turn to F-M, you, your audience, your engineers, and your budget will all agree to go G-E.

Call the nearest G-E sales office, or write direct to General Electric, Radio and Television Dept., Schenectady, N. Y.

GENERAL ELECTRIC

TUBES

Methods for measuring r-f distortion in pentodes are presented together with the tube registry list for February 1940 and the last quarter of 1938

Simple Methods for Checking R-F Distortion or Cross-Modulation of Pentode Amplifier Tubes

By E. W. HEROLD
RCA Manufacturing Co., Inc.

IT HAS BEEN KNOWN for many years that the tubes used for radio frequency and intermediate-frequency amplification cause distortion of a modulated wave and cross-modulation between two modulated waves.¹ Although the theory is well understood, measured data on the performance of existing tubes in this respect have not often been published, at least in the United States. One reason for this is that the data are not so easy to obtain as the normal static characteristics of plate current, transconductance, etc. The purpose of the present note is to outline two simple methods used by the writer for determining modulation-envelope distortion and cross-modulation of screen-grid amplifier tubes. The only major equipment necessary is an accurate transconductance bridge with a sharply tuned balance indicator. Such equipment is usually available in most laboratories connected with the use or manufacture of tubes.

The methods to be described give an approximation to the exact result which is usually sufficiently close for practical purposes. It is easily shown that for small distortions, the distortion with a given signal is directly proportional to the incremental change in tube transconductance as the signal is changed from an infinitesimal value to the given signal value. Thus by measurement of the increment of transconductance when a large grid swing is present, a measure of the r-f distortion and cross-modulation is obtained. The approximate nature of the result is due to the neglect of the effect of derivatives, of higher order than the third, of plate current with respect to grid voltage. For small distortions the approximation is justified. Plate circuit distortion is not measured by the methods to be described, but this form of distortion is not usually of importance in screen-grid pentodes.

Theory

The plate current of a screen-grid tube may be expressed as a power series.

$$i_b = I_{b0} + g_{m0} e_v + \frac{1}{2!} \frac{\delta^2 i_b}{\delta e_v^2} e_v^2 + \frac{1}{3!} \frac{\delta^3 i_b}{\delta e_v^3} e_v^3$$

where the subscript *o* indicates values taken at the operating point, *e_v* is the grid voltage and *e_v*, its alternating part. If a desired modulated wave of carrier amplitude *E₁* and modulation ratio *m₁*, ie, a wave of value

$$E_1 (1 + m_1 \sin pt) \sin \omega_1 t,$$

is applied to the grid, it is readily shown that the output will be a modulated wave with a slightly different percentage of modulation and with second and third (and higher) harmonics of the *p* frequency present in the modulation envelope. Neglecting the higher order terms in the power series, because they are usually small, we find that, for the output,

Change in modulation ratio

$$= m_1 \left(\frac{1}{4} - \frac{3}{32} m_1^2 \right) \frac{\delta^3 i_b / \delta e_v^3}{g_{m0}} E_1^2 \quad (1)$$

Ratio of 2nd harmonic in envelope to fundamental

$$= \frac{3}{16} m_1 \frac{\delta^3 i_b / \delta e_v^3}{g_{m0}} E_1^2 \quad (2)$$

Ratio of 3rd harmonic in envelope to fundamental

$$= \frac{1}{32} m_1^2 \frac{\delta^3 i_b / \delta e_v^3}{g_{m0}} E_1^2 \quad (3)$$

If an additional (and, presumably, an undesired) modulated carrier is impressed on the grid of the form

$$E_2 (1 + m_2 \sin qt) \sin \omega_2 t$$

it will be found that the first carrier, of angular frequency ω_1 , will be modulated by the *q* frequency to a ratio

Cross-modulation ratio

$$= \frac{1}{2} m_2 \frac{\delta^3 i_b / \delta e_v^3}{g_{m0}} E_2^2 \quad (4)$$

These four factors are the important ones in the distortion analysis. All are seen to depend on the ratio of third to first derivative of plate current end on the square of the voltage. If an alternating grid voltage (approximately a sine wave) is applied to a tube, as in a transconductance bridge, it is easily

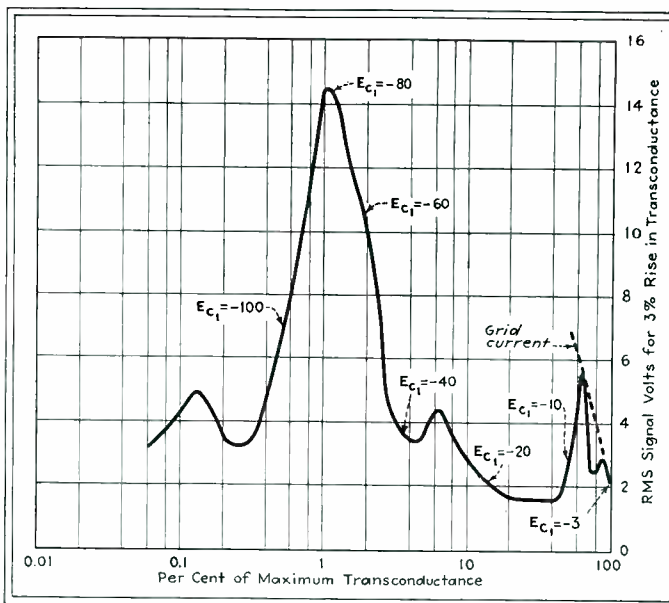
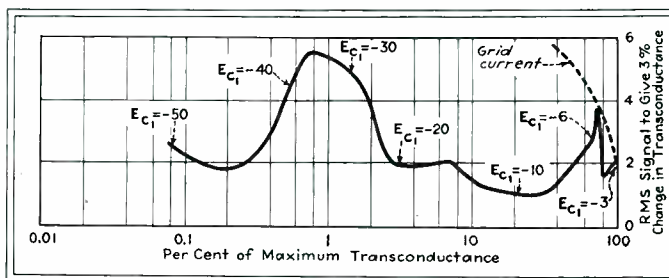

Distortion curves for tube type 6K7 by a method described here. In the top curve the screen voltage was constant at 100 v and in the lower curve the screen voltage was 250 v applied through 90000 ohms. The other electrode voltages were: $E_f = 6.3$; $E_p = 250$; $E_{c3} = 0$

ISOLANTITE INSULATORS

WITHSTAND EXTREME *VIBRATION*

Strenuous Laboratory Tests Show Isolantite's Indifference to Jolts, Jars and Jitters

THE shocks of bad landings and the bumps of rough roads are all in a day's work for radio equipment designed for today's needs. And efficient, trouble-free service under the extremes of operating conditions are "musts."

To insure rigid adherence to these standards in both design and materials, complete radio apparatus is given severe "shake-down" treatment at General Electric's Radio Engineering Laboratories. On the formidable vibration table illustrated here the "daylights" are shaken out of radio assemblies to learn what gives way first and why.

Among the parts which prove they can take more punishment than ever would be anticipated in actual use are Isolantite* Insulators. For Isolantite possesses great structural strength which assures mechanical protection against the shocks and stresses of actual use, and permits small, compact insulator design with thin, weight- and space-saving cross-sections.

Electrically, too, Isolantite is extremely efficient because of its low loss properties at high frequencies. Impervious to the effects of moisture and temperature, it assures stability under all conditions that may be encountered in service.

Isolantite is readily adaptable to new forms. Special parts — as well as standard insulators — are economically manufactured. If you are planning apparatus that may benefit from new insulator designs, call on Isolantite's engineers. Their specialized knowledge of the industries that Isolantite serves will enable them to suggest an answer to your present needs and anticipate your future requirements.

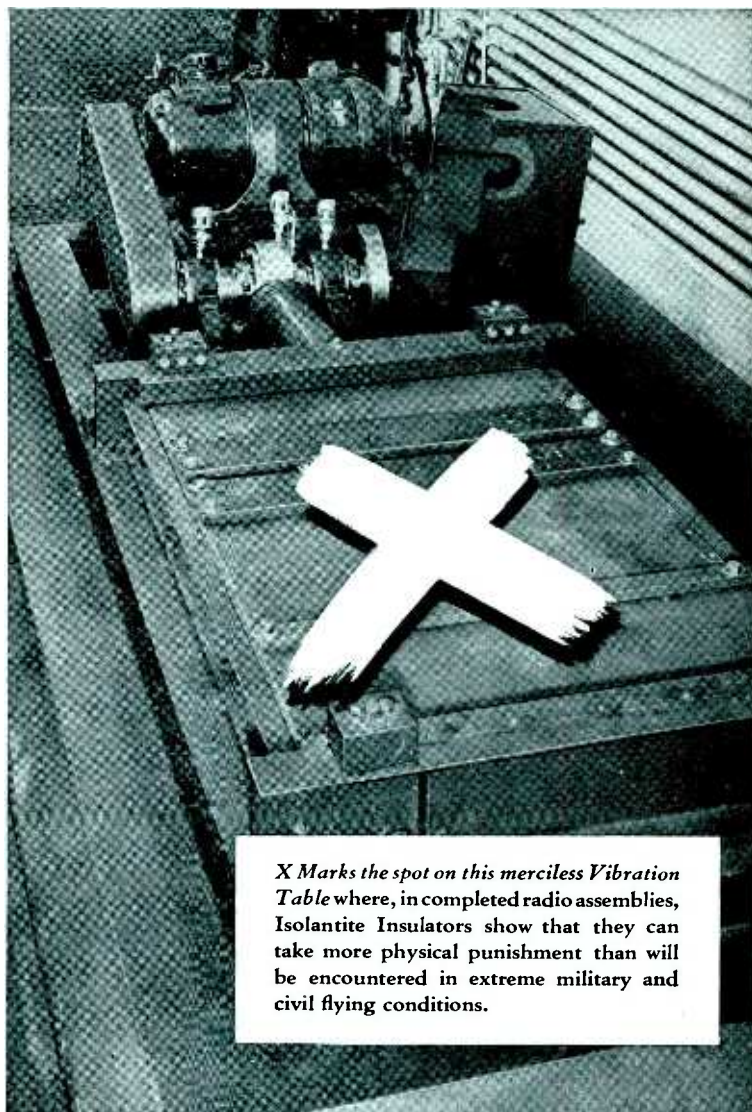

X Marks the spot on this merciless Vibration Table where, in completed radio assemblies, Isolantite Insulators show that they can take more physical punishment than will be encountered in extreme military and civil flying conditions.

*Registered trade-name for the products of Isolantite Inc.

THE NEXT TEN YEARS



Certainly the past ten years have been remarkable and far-reaching advances in electronics and in radio engineering. And Isolantite is proud to have been associated with this progress; glad to have been a contributor to the development of better, more efficient insulating equipment and materials during the past decade. We are confident, too, that the next ten years will see still further increases in the value of our services and products to these branches of the electrical industry.

ISOLANTITE

CERAMIC INSULATORS

ISOLANTITE INC. FACTORY: BELLEVILLE, NEW JERSEY
SALES OFFICE: 233 BROADWAY, NEW YORK, N. Y.

**BLAW-KNOX
VERTICAL
RADIATORS**

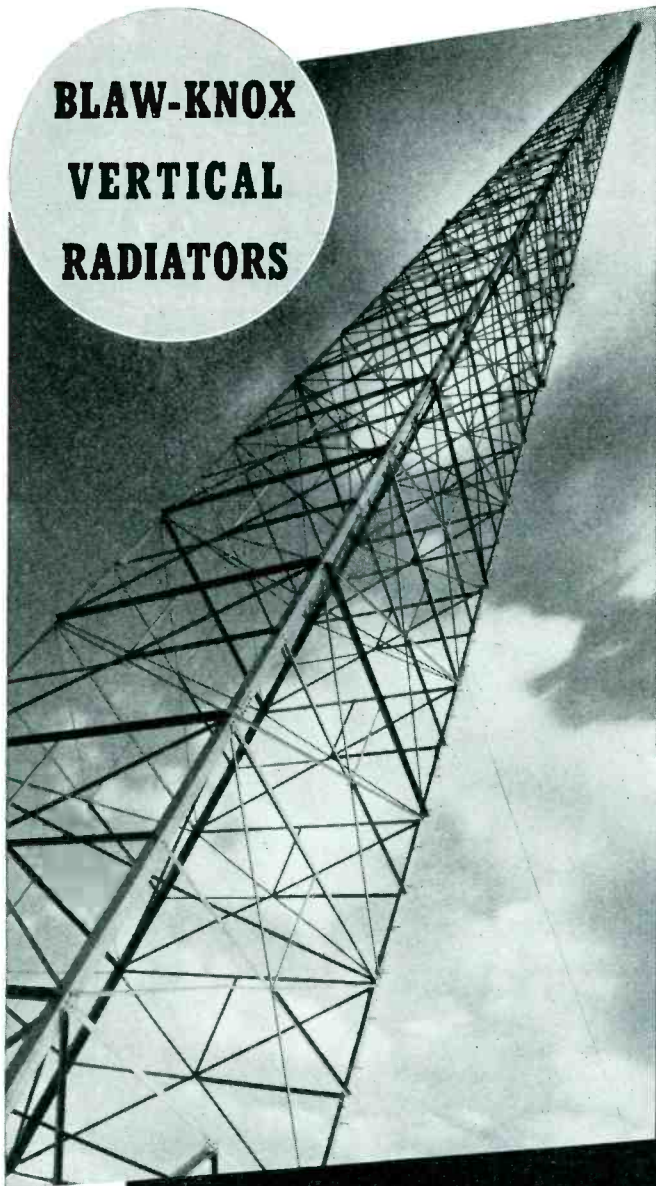

Better Coverage

Are you getting the coverage to which your location and power entitle you? When you study this question, consider the experience of Blaw-Knox in the broadcasting field, dating back to the beginning of radio. Consider also the unique facilities of Blaw-Knox for designing and fabricating vertical radiators, and the fact the radio engineers the world over turn to Blaw-Knox for high-efficiency equipment of this type. Finally, please remember that Blaw-Knox stands ready to apply its experience and facilities to your problem whenever you say the word.

BLAW-KNOX
DIVISION

OF BLAW-KNOX COMPANY
2038 Farmers Bank Bldg., Pittsburgh, Pa.
Offices in principal cities

DISTRIBUTOR
Graybar
ELECTRIC COMPANY

shown that the ratio of fundamental-frequency output current to fundamental-frequency grid voltage is

$$g_{meff} = g_{mo} + \frac{1}{8} \frac{\delta^2 i_b}{\delta e_c^3} E_o^2$$

where E_o is the peak grid alternating voltage. When E_o is small, this expression reduces to g_{mo} which is commonly defined as the transconductance. For larger values of E_o the expression may be written

$$g_{meff} = g_{mo} \left(1 + \frac{\Delta g_m}{g_{mo}} \right)$$

Thus the ratio

$$\frac{\Delta g_m}{g_{mo}} = \frac{1}{8} \frac{\delta^2 i_b / \delta e_c^3}{g_{mo}} E_o^2 \quad (5)$$

may be used to evaluate the distortion factors. Thus, if a tube is connected in a transconductance bridge, a transconductance reading taken with a small signal and the reading called g_{mo} , another reading taken with a given larger signal and the second reading called g_{meff} , all the necessary data are at hand for the determination of the distortion, provided the larger signal swing, E_{o2} is known. Letting $(g_{meff} - g_{mo}) = \Delta g_m$, Equations (1) to (5) give the following results:

• • •

**RECORDING DEVICE
DEVELOPED**

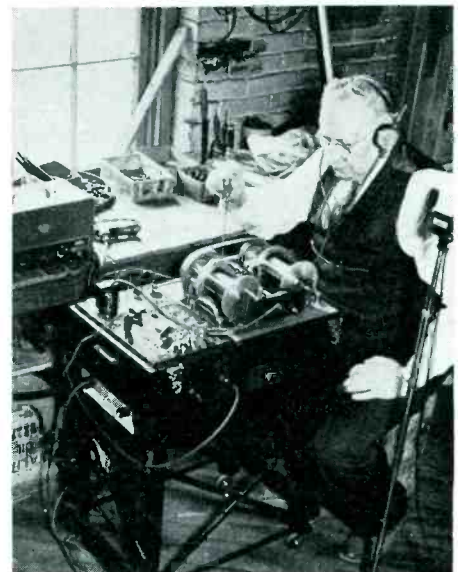

Harrison Gipe, engineer in a pretzel factory in Reading, Pa. with his "Magnaphone", a steel tape recorder whose development has been recently announced. Using wire nine-thousandths of an inch thick, the device can now make recordings one hour and fifteen minutes long, but could be designed to make recordings five or six hours in length

**WHERE MOLDED "LUCITE"
TAKES THE PUNCHES
OF MAN-MADE WEATHER**
... and likes it!

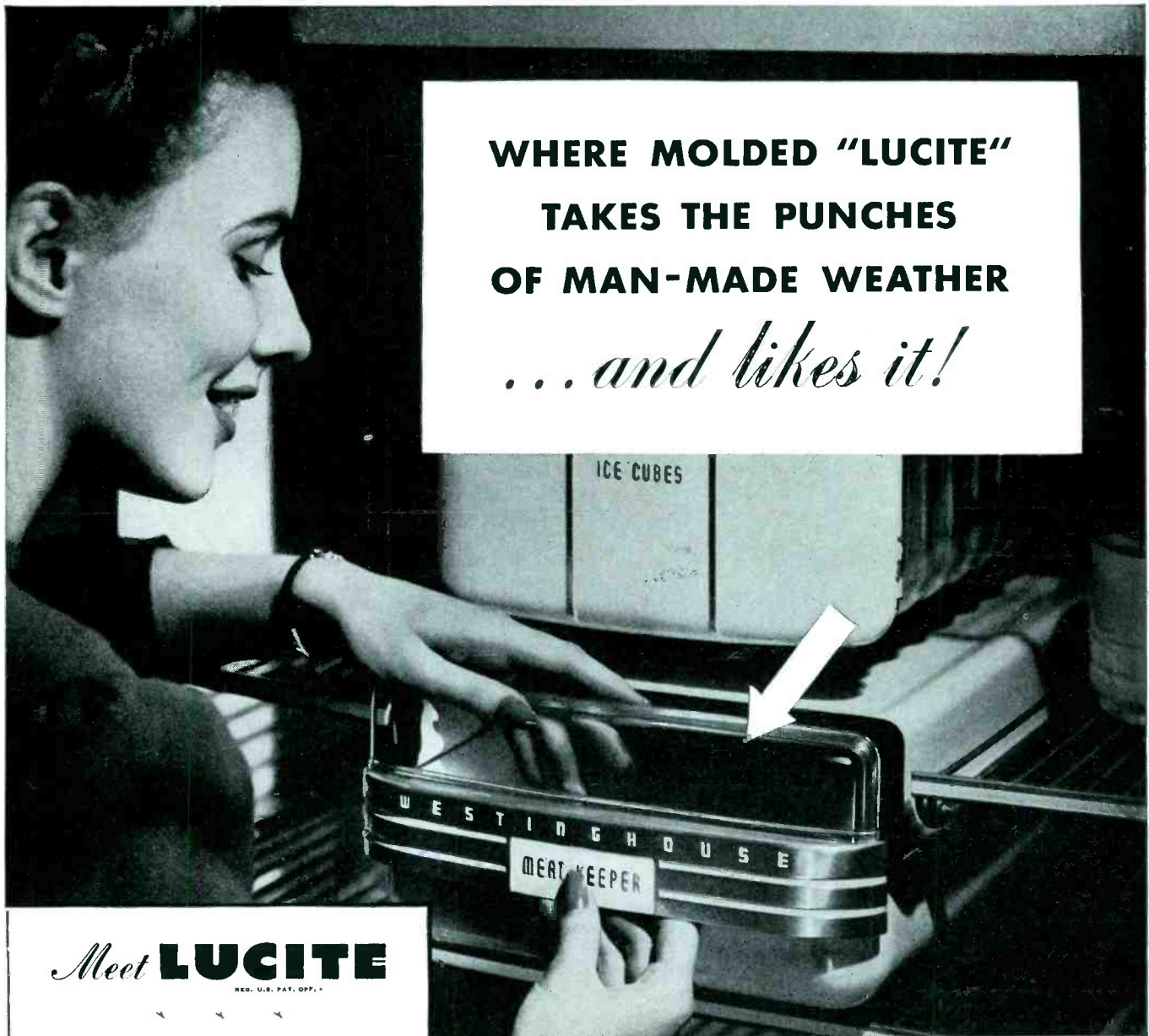

Meet **LUCITE**
REG. U.S. PAT. OFF.

It's clear—with a beautiful soft lustre. In crystal form it is practically invisible, transmitting a high percentage of light. In translucent colors its clarity gives unusual effects.

It edge-lights—for illuminated dials and numerals (without glare). Automotive and radio uses are increasing constantly.

It's safe—because it's tough and practically unbreakable. Never any sharp, jagged edges or fragments.

It's strong—with tensile strength 7,000 to 10,000 lbs. per sq. in. and flexural strength 10,000 to 12,000 lbs. per sq. in.

It's weather resistant—stable in clarity and color. Two-year test shows no apparent change.

It's chemically resistant—to dilute alcohols, alkalis and mineral salt solutions.

It has low heat conduction—pleasant to touch and promising heat insulation applications.

It's light in weight—specific gravity 1.16 to 1.20.

It has high dielectric strength—
Dielectric constant: 60 cycles, 3.5 to 4.5
10⁶ cycles, 2.5 to 3.0
Power factor: 60 cycles, 0.06 to 0.08
10⁶ cycles, 0.01 to 0.03

It's easily molded—from highway reflectors to wet cell batteries, it's helped solve scores of difficult jobs.

A transparent meat keeper panel is a brand-new selling feature for this '40 refrigerator. It's a real sales point to tell how it shows the household meat supply at a glance.

And Westinghouse salesmen tell how it must run a continual gauntlet of man-made weather. Quick changes all day from frigid 0° to the warm 80° of a kitchen.

But that's not all. Moisture is present always. Regularly it is soaped, scrubbed, scalded. Too, it is banged and knocked around.

That's why Bryant Electric Co. molds the panel from "Lucite" powder for Westinghouse. It meets refrigerator tests without cracking, discoloration or breakage.

See where you can use such a material. One that sparkles in its

crystal visibility. Stands up to strain or rough usage. Resists moisture, chemical action and temperature changes.

This is "Lucite" methyl methacrylate molding powder—the plastic with the unusual combination of qualities that gives it so many, many uses. You can depend on it for modern functional applications. Write Du Pont, Plastics Dept., Arlington, N. J.



PLASTICS

DU PONT ON THE AIR—Listen to "The Cavalcade of America" Tuesdays, 9 p. m., E. S. T., National Broadcasting Co. Networks.

SPEAKING OF THE THIRTIES

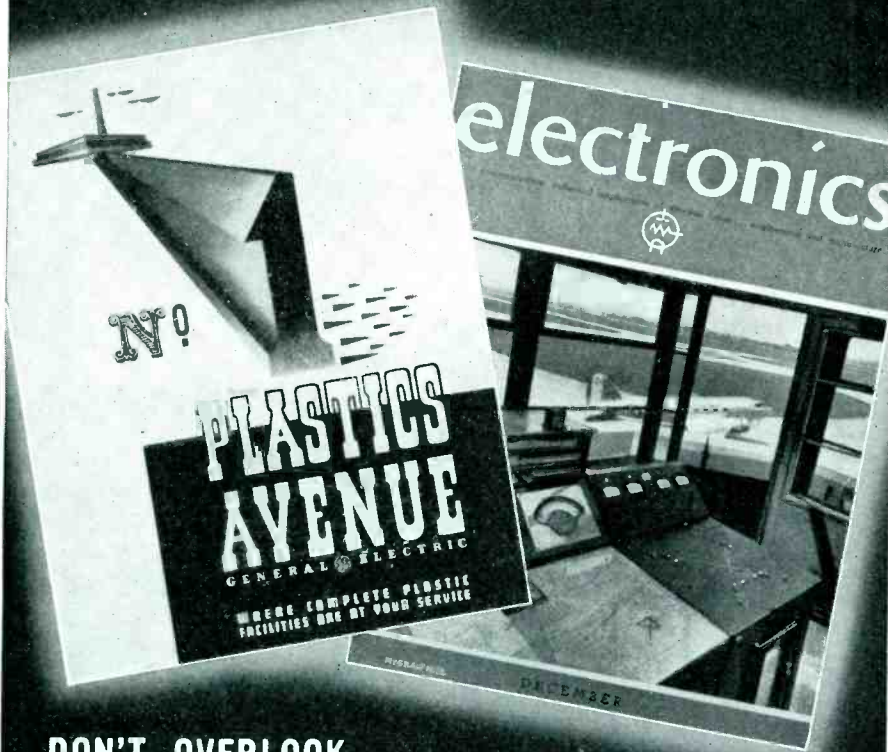

**DON'T OVERLOOK
G-E TEXTOLITE AND ELECTRONICS**



They might be called the "turbulent thirties" but there were some bright spots in the decade just passed that you cannot overlook. Take for instance the achievements of G-E Textolite and *Electronics* magazine.

Pages of this issue speak for themselves in paying tribute to McGraw-Hill's outstanding publication. So let's take a look at the record of General Electric's plastics activity in the electronics field.

Since the day ten years ago when *Electronics* first appeared, General Electric—with the help and co-operation of the industry's engineers—has developed many new applications. Standard insulating materials have been improved in quality and costs have been reduced.

Use of Textolite laminated plastics has brought about a reduction in electrical losses and, by reducing moisture absorption, has meant an improvement in circuit stability. At the same time, machinability and punchability of this material has constantly grown better.

For the radio industry, new developments in this period include speaker cones, diaphragms and dust caps. But better materials and lower costs have helped the newer electronic applications as well.

Use of Textolite molded plastics has resulted in better designed cabinets, bezels and knobs to enhance the external appearance of radios.

All this has been accomplished in the "turbulent thirties." And yet, looking ahead at the plastics development under way in General Electric's laboratories, there can be no doubt that improvement in materials and reduction in costs will proceed at an accelerated pace in the next decade to come.

PLASTICS DEPARTMENT

GENERAL  ELECTRIC

PD-403

% change in modulation

$$= 2 \left(1 - \frac{3}{8} m_1^2 \right) \frac{\Delta g_m}{g_{m0}} \times 100 \quad (6)$$

% 2nd harmonic distortion

$$= \frac{3}{2} m_1 \frac{\Delta g_m}{g_{m0}} \times 100 \quad (7)$$

% 3rd harmonic distortion

$$= \frac{1}{4} m_1^2 \frac{\Delta g_m}{g_{m0}} \times 100 \quad (8)$$

% cross-modulation by undesired carrier

$$= 4 m_2 \frac{\Delta g_m}{g_{m0}} \times 100 \quad (9)$$

where, of course, m_1 is the fractional modulation of the desired carrier and m_2 is the fractional modulation of the undesired carrier.

A second and slightly different method, which may also be used, does not require that the a-c signal supplied by the bridge to the grid of the tube under test be increased. Instead, the signal remains small but a second larger alternating voltage of another frequency is superimposed. The second voltage should be of a much higher frequency than that of the signal used in the bridge (so high that the balance indicator does not pass it or its harmonics). If the second and larger signal has an amplitude E_o , the transconductance reading will be the average over a cycle of the larger signal and is found to be

$$g_{m010} = g_{m0} \left(1 + \frac{1}{4} \frac{\delta^2 g_m / \delta e_c^2}{g_{m0}} E_o^2 \right) \\ = g_{m0} \left(1 + \frac{\Delta g'_m}{g_{m0}} \right) \quad (10)$$

where $\Delta g'_m$ is the increment found by the second method.

By reading the transconductance with the extraneous signal removed, (i.e., $E_o = 0$) the value g_{m0} is found and again the distortions may be calculated provided E_o is measured. The relations are similar to those of Equations (6) to (9) except that it must be remembered that $\Delta g'_m = 2 \Delta g_m$.

Practical Application

The two methods outlined may be applied to any transconductance bridge with a sharply tuned balance indicator and capable of accurate balance, preferably to less than one-half per cent. For the first method, the a-c supply to the bridge must be variable and, at its maximum value, must supply a grid voltage of several volts to the grid of the tube under test. In the second method, an additional signal whose fundamental frequency and harmonics do not operate the balance indicator must be applied to the grid in series with the a-c voltage supplied by the bridge. The latter should be as small as usual for transconductance measurements (e.g., of the order of 0.1 volt or less) whereas the additional signal must be larger. With both methods the alternating grid voltage must be measured.

In most cases, the most desirable

356A gets another job!

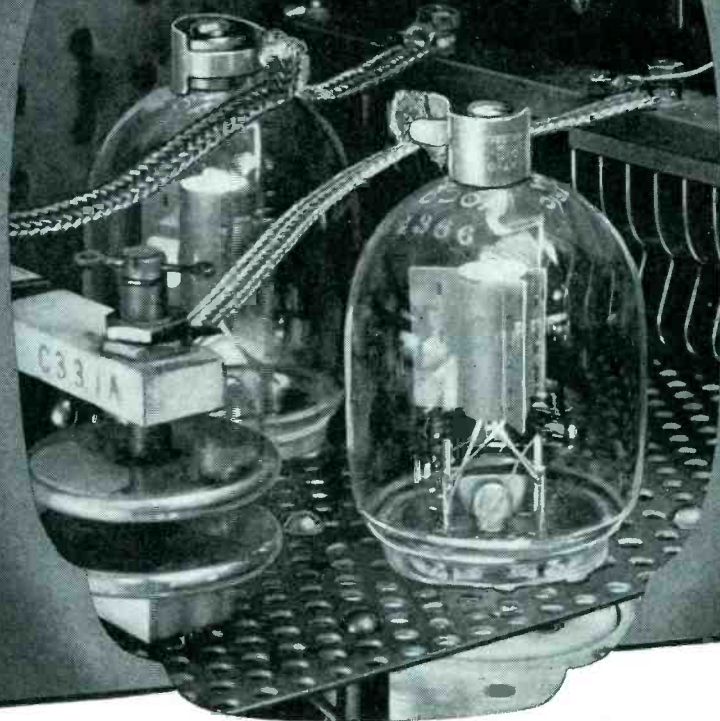

Western Electric "Ultra-High" Amplifier Tube proves ability in frequency modulated transmitters

A pair of 356A's in a push-pull oscillator will put out 150 watts at 100 megacycles or 100 watts at 150 megacycles. The tube is so short, with lead-ins of such low inductance, that a pair can be neutralized perfectly for these frequencies. The 356A can be used to advantage in frequency modulated transmitters.

All solid dielectrics are eliminated inside the envelope since the electrodes are supported directly by heavy leads. A center tap for the filament is brought out to one base stud.

The base is a standard 50 watt ceramic wafer

which fits standard 50 watt sockets without shells or specially designed Western Electric 152A type socket.

A pigmy in size but a glutton for punishment, the 356A utilizes Western Electric stemless type construction permitting the shortest grid filament and plate leads. Note that the plate terminal is welded too.

Get full details from distributors listed below.

Western Electric

CHARACTERISTICS

Filament voltage	5 volts	Maximum plate dissipation	50 watts
Filament current	5 amperes	Amplification factor	50
Maximum DC plate voltage	1500 volts	Overall height	4½ inches
Maximum DC plate current	120 milliamperes	Maximum ratings apply up to 100 megacycles	



DISTRIBUTORS: In U. S. A.: Graybar Electric Co., Graybar Bldg., New York. In Canada and Newfoundland: Northern Electric Co., Ltd. In other countries: International Standard Electric Corp.

data are the magnitude of the signals which will give rise to a given amount of distortion or cross-modulation. Such data are obtained directly by the above methods with the following procedure.

Method 1. Using a small grid signal on the tube under test, the transconductance bridge is balanced. When the distortion or cross-modulation figure is

$$\frac{\Delta g_m}{g_m}$$

chosen, Equations (6) to (9) give

the percentage change in transconductance necessary. For example, suppose 5 per cent second harmonic is chosen for

$$m_2 = 1. \text{ Equation (7) gives } \frac{\Delta g_m}{g_m} =$$

3½ per cent. The transconductance bridge is then unbalanced by 3½ per cent and the a-c supply to the bridge is increased slowly until a balance is again attained or grid current is reached. The alternating grid voltage is then the desired answer. If grid current is reached before the new balance is obtained, however, it will be necessary to reverse the direction of the 3½ per cent initial unbalance and repeat the procedure. The smallest of the two alternating grid voltages measures the signal-handling ability of the tube.

Method 2. With the additional higher frequency a-c signal turned off, the transconductance bridge is balanced. The bridge is then unbalanced by the chosen amount as in Method 1. The additional signal is then gradually increased until the bridge balances or grid current is reached. The magnitude of the grid signal is then recorded. If grid current is reached, the initial unbalance should be reversed in direction and the procedure repeated.

It is, of course, necessary with both methods that the voltages be well regulated during the measurement to prevent the electrode voltages from varying with tube current. In taking data for series-screen resistor operation, it is necessary to substitute a steady screen voltage while the actual data are taken. This is done by using the series resistor for the initial small-signal balance, and substituting a fixed voltage which will give the same balance.

As an illustration, data were obtained on the type 6K7 pentode using Method (1) and are shown in the accompanying diagrams. The data show the amount of signal at any given grid bias value which will give a 3 per cent change in effective transconductance, or a second harmonic distortion of a modulation envelope of 4½ per cent, a third harmonic distortion of ¾ per cent, or the amount of undesired signal which will, when 100 per cent modulated, give a cross-modulation of 12 per cent. The data are plotted on semi-log paper using the percentage of maximum transconductance as the abscissa scale. This method of plotting is valuable in comparing tubes.

¹ Ballantine and Snow, Reduction of Distortion and Cross-Talk in Radio Receivers by Means of Variable-Mu Tetrodes: *Proc. I.R.E.*, Vol. 18, pp. 2102-2127, Dec. 1930.

Tube Registry

NOTICE: The sponsor of tube type 6S6GT has modified the basing of this tube type from that shown on page 62, March, 1940 issue of *Electronics*. As there indicated the basing is described by designation 6AV. As modified the basing is described as 5AK.

Type 6S6 (GT)

R-F pentode, remote cutoff; heater type; (T-9) glass envelope; seated height 3½ inches (max); 5 pin octal base.

$E_h = 6.3 \text{ v}$
 $I_h = 0.45 \text{ amp}$
 $E_p = 250 \text{ v}$
 $E_{c2} = 100 \text{ v}$
 $E_{c1} = -2 \text{ v}$
 $I_p = 13 \text{ ma}$
 $I_{c2} = 3 \text{ ma}$
 $g_m = 4000 \text{ } \mu\text{mhos}$
 $r_{rp} = 0.35 \text{ megohm}$
 $C_{in} = 7 \text{ } \mu\text{f}$
 $C_{out} = 6.4 \text{ } \mu\text{f}$
 $C_{pp} = 0.01 \text{ } \mu\text{f}$
 Basing 5AK

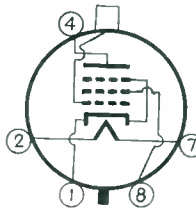

Tube Types Registered by R.M.A. Data Bureau During February 1940

Type 12J7 (G)

Prototype 6J7 (G)

R-f pentode; sharp cutoff; heater type; (ST-12) glass envelope; seated height, 3 29/32 inches (max); 7 pin octal base.

$E_h = 12.6 \text{ v}$
 $I_h = 0.15 \text{ amp}$
 $E_p = 250 \text{ v}$
 $E_{c2} = 100 \text{ v}$
 $E_{c1} = -3 \text{ v}$
 $I_p = 2.0 \text{ ma}$
 $I_{c2} = 0.5 \text{ ma}$
 $r_p = 2 \text{ megohms}$
 (approx)
 $g_m = 1225 \text{ } \mu\text{mhos}$
 $C_{opl} = 0.007 \text{ } \mu\text{f}$ (max)
 $C_{in} = 4.6 \text{ } \mu\text{f}$
 $C_{out} = 12 \text{ } \mu\text{f}$
 Basing 7-R

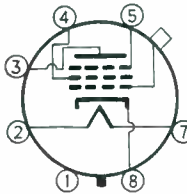

Type 12SA7 (G)

Prototype 12SA7 (GT)

PENTAGRID converter; heater type; (T-9) glass envelope; seated height 3 9/16 inches (max); 8 pin octal base.

$E_h = 12.6 \text{ v}$
 $I_h = 0.15 \text{ amp}$
 $E_p = 250 \text{ v}$
 $E_{c2} = 100 \text{ v}$
 $E_{c5} = E_{c3} = 0 \text{ v}$
 $I_p = 3.5 \text{ ma}$
 $I_{c2} + 2,4_4 = 8.5 \text{ ma}$
 $g_e = 380 \text{ } \mu\text{mhos}$
 $r_p = 1 \text{ megohm}$
 (approx)
 $E_p = E_{c2} 2,4_4 = 100 \text{ v}$
 $E_{c5} = E_{c3} = E_{c1} = 0 \text{ v}$
 $I_p = 27 \text{ ma}$
 $\mu = 13$
 $g_m = (\text{between } g_1 \text{ and } (p + g_2 + g_4)) = 4500 \text{ } \mu\text{mhos}$

$C_{if in} = 10.5 \text{ } \mu\text{f}$
 $C_{if out} = 12 \text{ } \mu\text{f}$
 Basing 8-AD



HERE'S made for

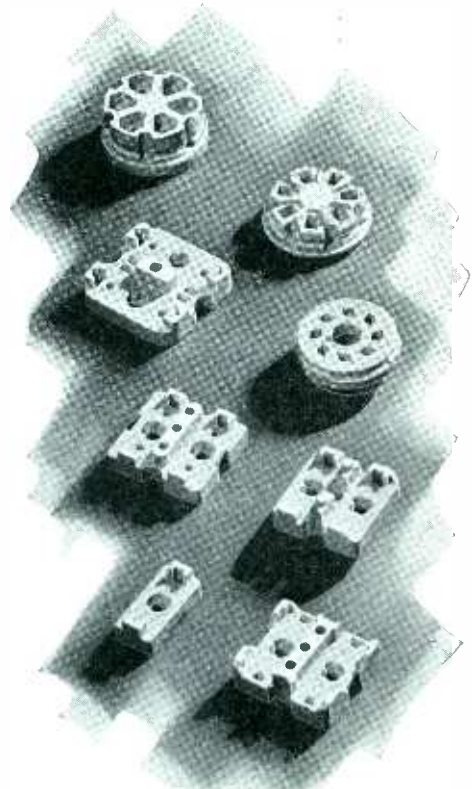

A SPECIAL PROBLEM?

Let our technical staff assist you. General Ceramics facilities for developing and fabricating special products to exacting specifications are unsurpassed.

And whether your needs are special or routine, we offer you SERVICE . . . prompt attention to your inquiries and orders . . . the advantages of up-to-date production facilities . . . and QUICK DELIVERIES.

**GENERAL
CERAMICS COMPANY
INSULATORS**

STEATITE INSULATION

tomorrow's still-higher frequencies

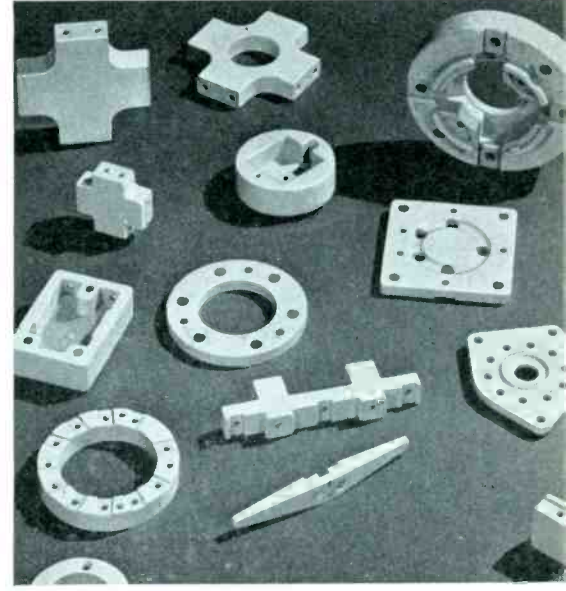
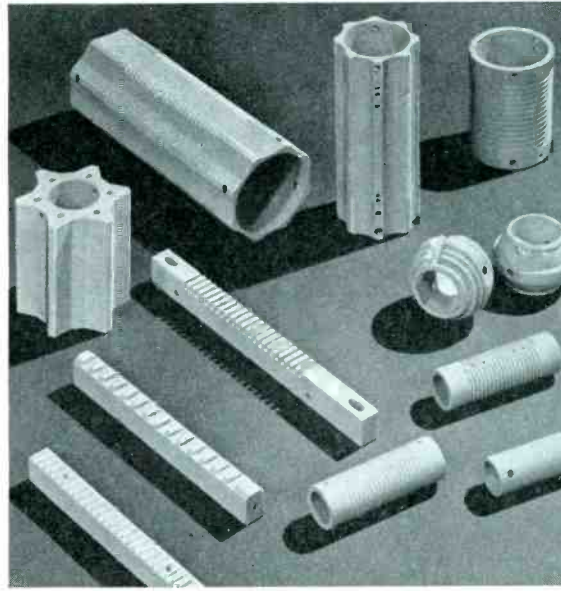
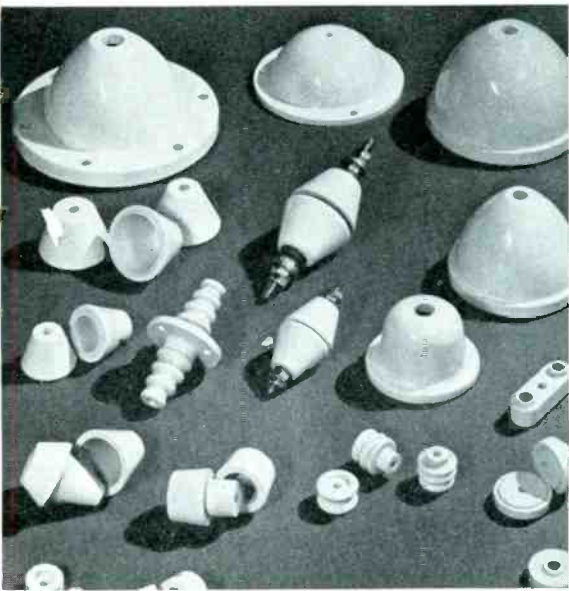

Ten years ago, when the bands above 56 megacycles were mostly silent, nearly any r.f. insulation was good enough. Today, with the extended r.f. spectrum already probing into new unknowns, the lower loss-factors of General Ceramics Ultra-Steatite insulators are *essential* to the solution of many new problems in both radio and television.

For routine requirements, too, you will find it worth while to standardize on General Ceramics equipment; for in both Ultra-Steatite and the regular Steatite, General Ceramics insulators are extremely efficient. Both are mechanically strong and stable at any temperature. There is no cold flow—no distortion under pressure. Screws stay tight and drift is minimized.

GENERAL CERAMICS COMPANY, DEPT. E
RCA BUILDING, 30 ROCKEFELLER PLAZA, NEW YORK

Whether your needs are standard or special, investigate the General Ceramics complete line of insulators. You'll find us a dependable and cooperative source of supply, with three large plants devoted to the manufacture of ceramic products and a staff that knows insulators and insulation problems.



If you have not received your copy of this new catalog, send for it now, while you have it in mind. It lists hundreds of items and contains much helpful data on insulation problems.

Steatite and Ultra-Steatite

INSULATORS

NEW ICONIC CONSOLE

Beautifully-balanced tone quality and even response throughout a long tone range are obtained in the Iconic System by the same method used in Lansing's finest theatre systems—a two-way system using a dividing network and separate speakers for the reproduction of high and low frequencies. The result is clear brilliant high tones and deep resounding lows with every subtle overtone and undertone faithfully reproduced.

The Iconic System is now offered in a beautiful new modern console cabinet. It is solidly constructed, and the polished finish has an underlying lustre of opalescent silver. It has been thoroughly tested for acoustical correctness. The Iconic System is ideal for small theatres, public address work, school auditoriums, churches, monitor and audition rooms, sound studios, and fine residential installations.

It is available with either electrodynamic or permanent magnet speakers. Models are made with various special amplifiers, also. Production has just been stepped up on the Iconics and the whole line lowered in price. Complete literature can be had upon request. It will pay you to investigate the Iconic Systems.

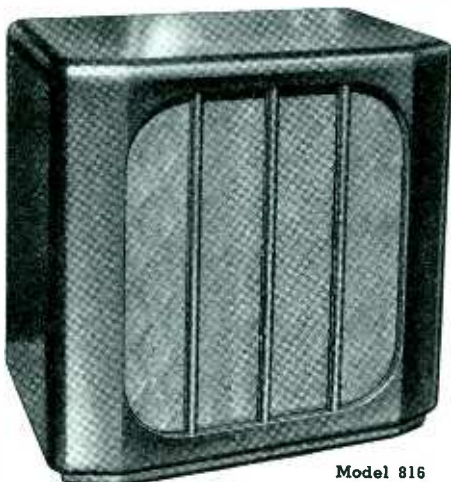

Model 816

LANSING MANUFACTURING COMPANY

6900 McKinley Avenue

Los Angeles, California, U.S.A.

NEW TYPE RELAY NOW AVAILABLE

A Sturdy and Sensitive Design at Low Cost

This new relay, just perfected, costs less because it has fewer parts. Its brand new design affords greater sensitivity, too. So you can save money and get a better relay by switching to this new model. Investigate today.

Details and prices on a wide range of contact combinations given in illustrated circular

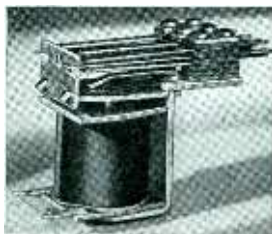

just released. Write for copy to American Automatic Electric Sales Company, 1033 W. Van Buren Street, Chicago.

AUTOMATIC ELECTRIC

MAKERS OF TELEPHONE AND SIGNALING APPARATUS
ELECTRICAL ENGINEERS, DESIGNERS, & CONSULTANTS

Type 50Y6 (G)

Prototype 50Y6 (GT)

RECTIFIER-DOUBLER; heater type; (ST-12) glass envelope; seated height, 39/16 inches (max); 7-pin octal base.

$E_A = 50$ v
 $I_A = 0.15$ amp
As Half-Wave Rectifier
 $E_{ac} = 235$ v (max)
 $I_{dc} = 75$ ma per plate (max)
 $E_{drop} = 22$ v @ 150 ma per plate
Basing 7-Q

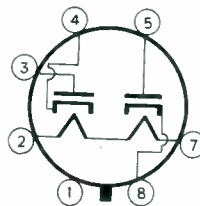

Tube Types Registered by R.M.A. Data Bureau During the Last Quarter of 1938

Type 6R6 (G)

R-f pentode, remote cutoff, heater type, glass envelope, 8 pin octal base.

$E_A = 6.3$ v
 $I_A = 0.3$ amp
 $E_p = 250$ v
 $E_c^2 = 100$ v
 $E_c = -3.0$ v
 $I_p = 7.0$ ma
 $I_{c2} = 1.7$ ma
 $r_p = 0.8$ megohm
 $\theta_m = 1450$ μ mhos
Basing 6-AA

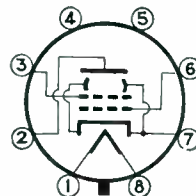

RADIUM EXPERTS WORK IN CAVES



In the Derbyshire caverns in England, 280 feet below the ground, a group of workers are engaged in extracting radon gas from radium as a war safety measure. Radon gas is said to have almost the same properties as radium and has the added advantage, for war times, of losing its effectiveness within a few days

With this issue **ELECTRONICS** has a *Tenth Birthday*

Publications, to live and prosper 10 years, must serve their fields adequately, and justify their existence.

Started in 1930, Electronics was conceived to serve an industry that had not fully developed. At that time this publication was said to be ahead of its field. Throughout the last decade it has continued to lead the industry, to report its progress and point the way to the future. As the industry has grown so has the readership of its accepted journal from 4,862 charter subscribers to over 14,172 today; a growth of 343%.

From its beginning Electronics has provided for its advertisers a responsive and powerful medium for making sales contacts with the men who specify and buy electronic and allied equipment. A good portion of the manufacturers who used advertising space in the first year of its existence have, throughout this 10 years, continued to broadcast their sales messages to a growing market. To this list of charter advertisers new names have been added from year to year, until today the increase

in advertising expenditures in Electronics is more than 128% above that of 1933, when business was at low ebb.

Naturally, we are proud of the fact that so many of our charter advertisers are still with us.

It can only mean that we have served them well. At the same time we are impressed with our continuing responsibility to maintain and improve our publishing standards which will increase and intensify our readership.

On the following pages we reproduce the representative advertisements of our charter advertisers as they appeared in 1930. These same names have appeared in 1939 issues and most of them have their current sales message in this issue.

To our old-time readers they bring back memories, to our new readers they are interesting history.

To both subscribers and advertisers, Electronics on its 10th birthday, extends its heartiest appreciation for your confidence and encouragement.

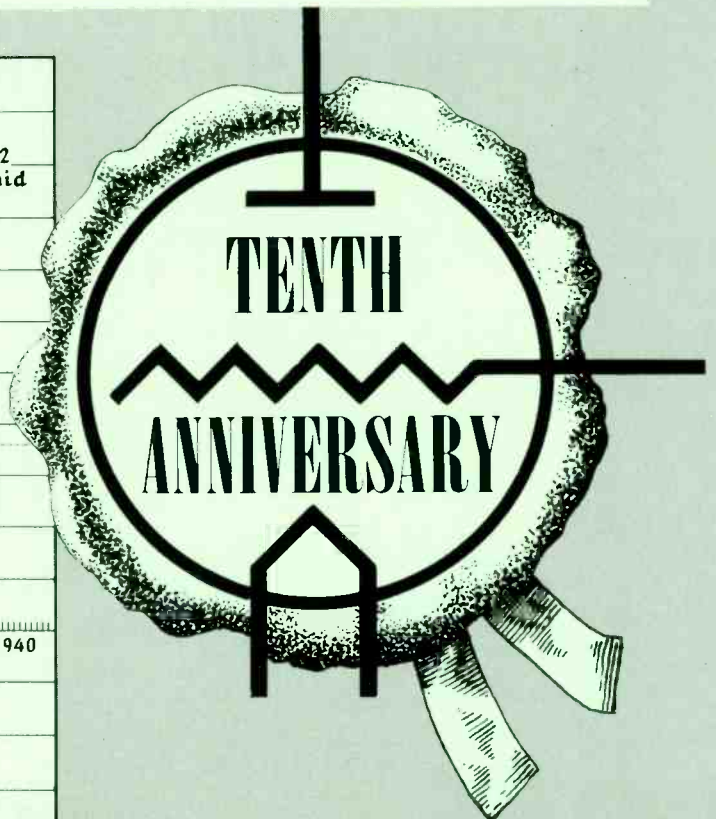
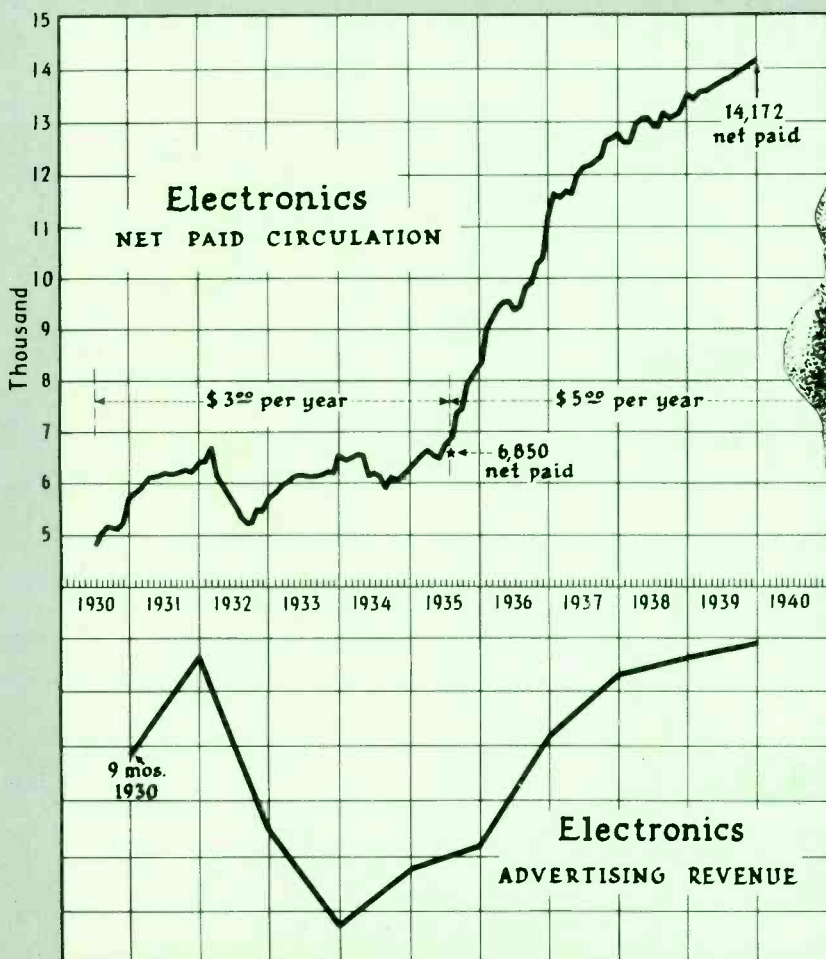

Welcome Electronics!



THE leaders of the tube industry congratulate the McGraw-Hill Publishing Company on its foresight and leadership in launching this new publication, Electronics.

But a few years ago the radio industry was an infant. Now we are on the verge of opening the markets of another industry, employing radio principles, but bidding to outshine the radio broadcast field in importance and size. The magazine the McGraw-Hill Publishing Company policy of service. The RCA Radiotron Company will continue its position of leadership, a position merited through the maintenance of a high quality product and service.

RCA Radiotron Company's Research Laboratories and Engineers to develop its field.

NO order is too large for the RCA Radiotron Company to fill—no problem too difficult to solve. With six factories located at Newark, Harrison, Cleveland, and Indianapolis, the RCA Radiotron Company is the largest producer of electron tubes in the world.

At the present time these factories provide 1,050,000 square feet of floor space, employ 6,100 people and have an installed daily output of 270,000 tubes. And as industry increases its demands, we are ready to expand to take care of them.

AND now the RCA Radiotron Company, with its staff of engineering and manufacturing experts stands ready to serve a new industry. RCA Radiotron Research Laboratories welcome new problems. Many of the developments of RCA Radiotron engineers are years ahead of industry has but to make the application.

Backed by the broad research facilities of the General Electric Company, and the Westinghouse Electric and Manufacturing Company as well as the Radio Corporation of America, places the RCA Radiotron Company in a superior position for the scientific and commercial development of the field of electronics.

We cordially invite you to bring your problems to the RCA Radiotron Company where a staff of trained and experienced engineers and scientists are at all times waiting and eager to render service.

YAXLEY MANUFACTURING CO.
MANUFACTURERS INFORMATION SHEET

SUBJECT: 10M4P - 10M4P DUAL VOLUME CONTROL CUSTOMER: _____
550-5 SOCKET
SPECIFICATIONS: DUAL VOLUME CONTROL - 10,000 OHMS FRONT; 10,000 OHMS REAR.
COMMON SHIRT, INSULATED
-SOCKET FRONT
SEE SHEET 1 FOR COMPLETE DESCRIPTION, PRICES, DELIVERY SCHEDULE, ETC.

FOR THE MOST EXACTING NEEDS OF PRECISION MANUFACTURING

has attained an unusual place in the design, development and production of finer radio parts. The manufacturers of leading radio equipment have learned to rely on this organization for that will not break down in vital places.

Before tooling and turning up for production in your own plant, it might be much to your advantage to investigate our facilities for taking good care of some of your requirements. Write today for full information.

YAXLEY MFG. CO.
1313 W. Adams St., Chicago, Ill.

VOLUME CONTROLS . . . PHONE TIP JACKS . . . FIXED AND GRID RESISTANCES . . . PLUGS . . . RHEOSTATS . . . SOCKET ASSEMBLIES . . . TERMINAL CLIPS . . . TERMINAL STRIPS, ETC., ETC.

RCA RADIOTRON CO., INC. HARRISON, N. J.

RCA Radiotron

THE HEART OF YOUR RADIO SET

Complete Coverage

TUBE INSURANCE WHICH PROTECTS MANUFACTURER - DEALER and CONSUMER

Use of the Weston Model S26 Type T Tube Tester in the final inspection protects the retailer against the shipment of defective tubes. It makes all the measurements, including characteristics, short test and statement by DIRECT INDICATION—no computations or factors necessary. Its use helps maintain a high standard, and reduces losses by rejections from the field.

The Model S47 Radio Set Tester is a portable serviceman's outfit for making a complete electrical inspection of any make of A. C. or D. C. receiver in the home. Compact, light weight and dependable.

The employment of these three instruments on the part of manufacturer, dealer and serviceman gives all concerned assurance of longer tube life and better operating performance. Install "Westons". They provide a business insurance policy which affords complete coverage to all—at lowest cost.

Weston INSTRUMENTS
PIONEERS SINCE 1890

ELECTRICAL INSTRUMENT CORP., 618 Frelinghuysen Avenue, Newark, N. J.

NOW READY!

photo-cells and their application

By V. K. Zworykin and E. D. Wilson

Provides a comprehensive discussion of the theory of photo-cells and the photomultiplier tube, its construction, characteristics and its various types of use in the scientific applications of photo-cells in the field of modern science. The book is illustrated with the latest information and improvements in the construction of photo-cells. Includes a complete bibliography of the photo-cells.

A Wiley Book
\$2.50

S. S. WHITE MOLDED RESISTANCE UNITS

Successfully endure in ANY climate

Plans of the Pan American Airways, Inc. carry Radio Equipment in which S. S. White resistance operate in the most gratifying manner.

The S. S. WHITE Dental Mfg. Co. INDUSTRIAL DIVISION
Kull-Kreber Bldg., New York, N. Y.

Charter Advertisers in ELECTRONICS First Year, 1930-31

- Acheson Oildag Corp.
- Acme Electric & Mfg. Co.
- Acme Wire Co.
- Aerovox Wireless Corp.
- Aldur Corp.
- Allen Bradley Co.
- Alloy Metal Wire Co. Inc.
- Aluminum Co. of America
- American Electro-Metal Corp.
- American Instrument Corp.
- American Lava Corp.
- American Steel Package Co.
- American Transformer Corp.
- Amperite Corp.
- Amplion Corp. of America
- Amrad Corp.
- Arcturus Radio Tube Co.
- Argo Laboratories
- B-L Electric Co.
- Bakelite Corp.
- Bass Camera Co.
- Blake Signal & Mfg. Co.
- J. H. Bunnell & Co.
- R. C. Burt Laboratories
- Cable Radio Tube Corp.
- Callite Products Co.
- A. D. Cardwell Mfg. Corp.
- Carter Radio Co.
- CeCo Mfg. Co., Inc.
- Central Radio Corp.
- Central Radio Laboratories
- Central Scientific Laboratories
- Chicago Transformer Corp.
- Clark, Paul L.
- Clarostat Mfg. Co., Inc.
- Coils, Inc.
- Condenser Corp. of America
- Continental Diamond Corp.
- Crescent Braid, Inc.
- Daven Co.
- DeForest Radio Co.
- DeJur Amco Corp.
- Dexter & Sons, Inc.
- Driver-Harris Co.
- Dubilier Condenser Corp.
- Dudlo Mfg. Co.
- Duovac Radio Tube Corp.
- Easton Coil Co.
- Eby Mfg. Co., H. H.
- Eisler Electric Corp.
- Electrad, Inc.
- Electrical Testing Laboratories
- Electro-Acoustic Products
- Elkon, Inc.
- Ellis Elec. Lab.
- Erie Resistor Corp.
- Fansteel Products Co., Inc.
- J. E. Fast & Co.
- Ferranti, Inc.
- Foot, Pierson & Co., Inc.
- Forest Electric Co.
- Formica Insulation Co.
- Free Laboratories, E. E.
- Frost, Herbert H.
- G-M Laboratories
- Gavitt Mfg. Co., Inc.
- General Amplifier
- General Electric Co.
- General Cable Co.
- General Industries, Inc.
- General Mfg. Co.
- General Radio Co.
- Gilby Wire Co.
- Gordon Co.
- Hammond Clock Co.
- Hardwick-Hindle, Inc.
- Hind & Dauch
- Holed-Tite Packing Corp.
- Igrad Condenser & Mfg. Co.
- Inca Mfg. Corp.
- International Resistance Co.
- Isolantite Co. of America
- Jefferson Electric Co.
- Jenkins & Adair, Inc.
- Jensen Radio Mfg. Co.
- Jewell Electrical Instr. Co.
- Kingston Prds. Corp.
- Kurman Engrg. Corp.
- Leach Relay Corp.
- Lepel High Frequency Corp.
- Lestein Corp. of America
- Littlefuse Laboratories
- McGraw-Hill Book Co.
- Maas & Waldenstein
- Magnavox Co.
- P. R. Mallory (Elkon Division)
- National Co.
- National Carbon Co.
- National Union Radio
- National Vulcanized Fibre Co.
- Nelson & Co., J. R.
- Newark Wire Cloth Co.
- Ohmite Mfg. Co.
- Oxford Radio Corp.
- Perryman Electric Co.
- Polymer Mfg. Corp.
- Racon Elec. Co.
- RCA Radiotron Corp.
- Radio Products Corp.
- Radio Receptor Co.
- Rawson Electrical Instr. Co.
- Rola Company
- Samson Electric Co.
- Shakeproof Lock Washer Co.
- Shallcross Mfg. Co.
- Smedley-Press
- Sprague Specialties
- Spruce Pine Mica Co.
- Stupakoff Laboratories, Inc.
- Summerill Tubing Co.
- Superior Resistor Corp.
- Synthane Corp.
- Tar-Heel Mica Co.
- Taylor Vacuum Prds.
- Triad Mfg. Co.
- Trimmed Radio Mfg. Co.
- Universal Microphone Corp.
- Universal Winding Co.
- Vitaglo Corp.
- Volkmer Radio Prds.
- Ward Leonard Co.
- Webster Co.
- Westinghouse Elec. & Mfg. Co.
- Weston Electrical Instr. Co.
- White, S. S.
- Wiley & Sons, Inc.
- Wirt Company
- Yaxley Mfg. Co.
- Zetka, Joseph B.

IN ELECTRONICS, too

...pioneering the way for Industry

THREE years ago, a Westinghouse research engineer, assigned to the study of the electron tube, realized a dream, comparable to those of the most imaginative writers of fairy tales.

Glancing at a row of glow tubes in a test rack under a window in the company's laboratories, he noticed, to his surprise, that some of the tubes were glowing. Others were not, some glowed when the sun was shining but were dark on cloudy days, while others responded when his hand touched the glass. Two had come to light—the photo-glow tube and the grid-glow tube.

This discovery had been preceded by the epochal event in radio history, which gave great stimulus to the industry—the inauguration of broadcast by KDKA on November 2, 1920. And in tube Westinghouse engineers have contributed important base developments. Outstanding among these contributions is the development of tubes of long life and great economy, so essential to industrial use.

Building upon the foundation of present applications, Westinghouse will continue this pioneering work to the end that electricity will play a greater role in the advancement of industry.

For the electronics industry Westinghouse manufactures many products, some of which are listed in the accompanying journal. For further information write our district office nearest you.

Westinghouse

Service, prompt and efficient, by a coast-to-coast chain of well-equipped shops

Taylor High Voltage RESISTORS

THE TAYLOR High Voltage Resistors provide the ideal arrangement for high voltage withstand multiple to 100,000 volts. They are made of a special material which does not draw current in the operation of a relay or switch. The resistors are made of a special material which does not draw current in the operation of a relay or switch. The resistors are made of a special material which does not draw current in the operation of a relay or switch.

Shallcross Mfg. Company
ELECTRICAL SPECIALTIES
Pittsburg, Pa.

Performance and efficiency

problems confront engineering facilities of your Company labor force for developing the best suited for your

his service in connections of the Electricians of the highest demands of efficient 26 years American and the most exacting industrial plants, and in

range of American your needs, there is sent upon request.

AMERICAN TRANSFORMERS

NEW YORK, N. Y.



BAKELITE MOLDED PROVED MOST PRACTICAL FOR "ELECTRIC EYE" OF INDUSTRY

In sound reproduction and color analysis, in fire detection and television, and in an ever increasing number of other devices, successful performance is dependent upon photo-electric cells. To function efficiently, and to assure the longest span of useful life, these cells must be insulated with a material that retains its high insulation value unimpaired under any conditions of service. The Acturus photo-electric cell provides a splendid example of the advantages of Bakelite Molding for highly sensitive electrical devices. The initial high insulation value of the material does not diminish with age or use. Its extremely low moisture absorption is a special advantage when the cells are used outdoors, and exposed to rain and fog.

Bakelite Molding also provided desired production economies, and made an attractive design practical. Each one of the three housing parts is formed in one molding operation, with lustrous internal and external finish, and threading of screwing accuracy. The rim, finish, and the cone fit, thread together to form the body, and the cone fit, thread together to form the cone.

BAKELITE
THE MATERIAL OF A THOUSAND USES



TUBES and CONTROL

In millions of radio receivers—in countless electrical apparatus where characteristic curves must be adhered to you will find one or more CENTRALAB controls.

CENTRALAB is keeping pace with tube development—and CENTRALAB controls are increasing their sphere of usefulness wherever new uses for tubes are found.

If you have a resistance problem CENTRALAB engineers are ready to serve you.

Write for Bulletin "E" on Types and Dimensions.

Centralab

CENTRAL RADIO LABORATORIES

16 KEEFE AVENUE, MILWAUKEE, WISCONSIN



CHARTER ADVERTISERS in electronics

and their advertisements of ten years ago

On these five pages are advertisements inserted in ELECTRONICS ten years ago by 41 manufacturers who are still consistent advertisers in this same publication. Nostalgic to the old-timers, educational to the younger set, but all together striking evidence of the year to year consistency with which ELECTRONICS has served its field.

electronics is known by the companies it keeps

EBY TUBE SOCKETS

EBY Moulded Bakelite Tube Sockets are standard equipment in the tube testing racks of most of the important American tube manufacturers. The unique design of their phosphor bronze contact prongs makes it impossible to damage them, even in the most abusive service. For the same reason most manufacturers of tube testing equipment use these sturdy sockets exclusively. They look like the aristocrats they are and can be assembled in any way desired. A simple twist in the built-in groove guides the prongs of the tube into the holes.



LAMINATED BAKELITE SOCKETS

EBY Laminated Bakelite Sockets are a little less expensive than the moulded type and are widely used in radio receivers. Assembled with Bakelite punchings. The two parts in addition to completely insulating the contact points in accordance with approved Underwriters' Standard also acts as a Bakelite barrier between the contacts and minimizes the chance of breakdown. Bakelite guide for tube prongs. Each socket marked with number of tube to be inserted.

The H. H. EBY MFG. CO., Inc.
22nd St. and Lehigh Ave., Philadelphia

A NEW ISOLANTITE

A new ceramic insulator known as Isolantite B77, developed by the Isolantite Company of America, Inc. in cooperation with the International Resistance Company, is now available to all fabricators of metalized resistors. This new composition is one of several Isolantite insulating bodies consisting of specially selected and processed materials, each created for a specific application.

The function of Isolantite in the metalized resistor assembly is to provide a tightly sealed cavity around the resistor element and to housing must be strong, non-porous, extremely accurate and must possess the highest electrical insulating qualities.

Isolantite B77 insulators adequately fulfill these requirements. The International Resistance Company not only uses large quantities of Isolantite, but recommends it to its fabricating licensees for similar use. Isolantite is used exclusively by this same compound products.

Isolantite, in its various forms, is the product of an organization long experienced in ceramic manufacture. Moreover, the commercial responsibility of the Isolantite Company is an appropriate balance for the superior technical excellence of its products.

Isolantite Company of America, Inc.
BELLEVILLE, N. J.
New York Sales Office:
551 FIFTH AVENUE
NEW YORK, N. Y.



JEFFERSON TRANSFORMERS

AIDS NEW INDUSTRIES

By Engineering Co-operation
Experience and Careful
Manufacturing

INVENTION is one thing. Manufacturing is another. Many a good idea has failed because its originator did not have co-operation in working out the practical details.

New industries requiring transformers secure full co-operation and valuable help at Jefferson. The radio industry for example, the oil burner industry, the neon sign industry... these and others credit Jefferson Engineers with much valuable co-operation.

The co-operation of Jefferson Engineers is valuable because of the long experience behind their advice... experience which is equally valuable when the design is finally completed. It means transformers designed right for the job.

JEFFERSON ELECTRIC COMPANY
1595 S. LaSalle Street
Chicago, Illinois



REPRODUCING nation's entertainment

The greatest tribute ever paid to any product of the radio industry... Reproduces nation's entertainment... Approval voiced so effectively by leading engineers and critics that Jensen Electro-Dynamic Speakers are now more widely used than ever before. At Atlantic City R. M. A. Trade Show more radio receivers will be equipped with Jensen Speakers than with any other make. These receivers are destined to be the season's best sell for they will offer the finest possible tone quality. To the manufacturers of these receivers, public address and allied apparatus have also voiced their approval, particularly of the new Jensen Auditorium, with 12-inch cone, and Auditorium, Jr., with 10-inch cone, Speakers... The new model D-B Jensen Concert Speaker, with 10-inch cone, has been designed particularly for use in radio receivers... All of these new reproducers represent the culmination of Peter L. Jensen's genius and twenty years of experience. All are available for either AC or DC operation from any convenient source of power supply.

JENSEN RADIO MANUFACTURING CO.
6601 S. LA SALLE AVE., CHICAGO, ILL.

It is a mandatory duty for new Jensen Folder No. 27 to carry green complete information, company name and other essential data on all three of these new Jensen Electro-Dynamic Speakers.



three new Jensen
ELECTRO-DYNAMIC SPEAKERS

SPEAKER BY OXFORD



THE MOST COMPLETE LINE OF ELECTRO-DYNAMIC SPEAKERS IN THE WORLD

There is an Oxford Speaker for Every Radio, Public Address and Theatre Purpose.

Write for our new literature, listing our New Speakers in Eighty-Four Models.

Lectophone Licenses—Manufactured under designs and Patents of Frank Reichmann.

OXFORD RADIO CORPORATION Chicago, Illinois
New Address: 2035 West Parkland Place

The ELKON Non-Aqueous

450 Working Volts
Any Combination of Capacities
Wide Variety of Can Sizes



- Outstanding Characteristics**
- 1 High Working Voltage, 450 volts—withstanding without injury repeated peaks in excess of 575 volts.
 - 2 Non-leakage by all water in atmosphere.
 - 3 Low Leakage, Normal rated leakage 0.11 mil per mil (After operating above normal dielectric strength 2500 volts per mil.)
 - 4 Insulation in Low Temperature. Operates efficiently from below 40° F to 150° F.
 - 5 Long Life. To reduce replacement and interrupted service, available in a maintenance-free design.
 - 6 Self-Heating. Transient peaks in excess of 575 volts do not injure the Elkondensator.
 - 7 Compactness. Smallest capacity per volume per microfarad of any condenser on the market.
 - 8 Maximum Efficiency. Due to low power factor, the Elkondensator has the greatest filtering action of any electrolytic capacitor in operation.
 - 9 Stability. Resistant to mechanical shock and electrical variation that would affect action of the circuit.
 - 10 Low Cost Per Microfarad. The best value factor in any condenser available.

THE Elkondensator Non-Aqueous Hi-Volt condenser marks a new milestone in the condenser art.

Although the Elkondensator was favorably introduced to the commercial field in October 1930, its development extends over a period of seven years.

This new condenser has all of the essential characteristics of a high grade filter.

It has the smallest capacity content per microfarad of any condenser. It has the greatest filtering capacity of any electrolytic condenser—and closely approximates the filtering capacity of a paper condenser. It is self-heating. It operates at 450 volts D.C. It is not injured by transient peaks even in excess of 575 volts. Study the oscillograms and charts on the opposite page. They tell the story.

Already a number of leading set and instrument manufacturers have adopted Elkondensator as standard equipment. Samples built to your specifications will be sent in all recognized manufacturers. Send for the booklet which gives complete description and technical data.

Standard Can Sizes and Their Microfarad Capacities

MFD. Capacity of Sections	Vertical and Horizontal Cans		MFD. Capacity of Sections	Can Size	MFD. Capacity of Sections	Can Size
	Capacity of Sections	Can Size				
1	2 1/2 x 1 1/2	1 1/2 x 1 1/2	6	4 1/2 x 1 1/2 x 1 1/2	4	1 3/4 x 1 1/2 x 1 1/2
2	2 1/2 x 1 1/2	1 1/2 x 1 1/2	8	4 1/2 x 1 1/2 x 1 1/2	4	1 3/4 x 1 1/2 x 1 1/2
3	2 1/2 x 1 1/2	1 1/2 x 1 1/2	10	4 1/2 x 1 1/2 x 1 1/2	4	1 3/4 x 1 1/2 x 1 1/2
4	2 1/2 x 1 1/2	1 1/2 x 1 1/2	12	4 1/2 x 1 1/2 x 1 1/2	4	1 3/4 x 1 1/2 x 1 1/2
5	2 1/2 x 1 1/2	1 1/2 x 1 1/2	15	4 1/2 x 1 1/2 x 1 1/2	4	1 3/4 x 1 1/2 x 1 1/2
6	2 1/2 x 1 1/2	1 1/2 x 1 1/2	20	4 1/2 x 1 1/2 x 1 1/2	4	1 3/4 x 1 1/2 x 1 1/2
7	2 1/2 x 1 1/2	1 1/2 x 1 1/2	25	4 1/2 x 1 1/2 x 1 1/2	4	1 3/4 x 1 1/2 x 1 1/2
8	2 1/2 x 1 1/2	1 1/2 x 1 1/2	30	4 1/2 x 1 1/2 x 1 1/2	4	1 3/4 x 1 1/2 x 1 1/2
9	2 1/2 x 1 1/2	1 1/2 x 1 1/2	35	4 1/2 x 1 1/2 x 1 1/2	4	1 3/4 x 1 1/2 x 1 1/2
10	2 1/2 x 1 1/2	1 1/2 x 1 1/2	40	4 1/2 x 1 1/2 x 1 1/2	4	1 3/4 x 1 1/2 x 1 1/2

— A Condenser for All Power Pack Assemblies —

Hi-Volt Condenser

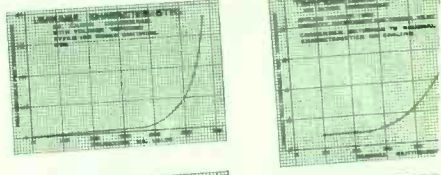

These oscillograms show comparative filtering action of the Elkondensator, the paper and wet types of condensers. Note the variation between the Elkondensator and the wet condenser.

Photographs show comparative filtering action of the Elkondensator, the paper and wet types of condensers. Note the variation between the Elkondensator and the wet condenser.

Booklet with complete data upon request.

WEST ELECTROLYTIC CONDENSER ELKON DIVISION
P. R. MALLORY & CO., Incorporated - INDIANAPOLIS

What SHAKEPROOF means to the Radio Industry



EVERY radio manufacturer realizes he is facing a serious situation today. The public is demanding exceptional radio performance at extremely low prices. This means costs must be lowered but it also means that quality must be improved.

That is why practically every leading radio manufacturer is using Shakeproof Locking Terminals to insure absolutely tight connections. They have found by exhaustive tests that the Shakeproof principle circuits and holds the terminals absolutely rigid thus preventing short circuits or faulty connections. These terminals also cut down production costs and make possible neater assembly work.

Shakeproof Lock Washers are what you need under your nut and screw. A test will show that they can improve the performance of your product and reduce service requirements to a minimum. Write for samples today!

SHAKEPROOF Lock Washer Company
231 N. KEELER AVE. CHICAGO, ILLINOIS

When Your problems are Ours



When you invite us to help decide the proper resistor for use in your equipment, the chances are good that you will save time and future expense. Make your choice which comes from more than 30 years' experience in the design and manufacture of Vitrohm Resistors.

It is surprising how frequently difficulties in space, mounting or heat dissipation are difficulties no longer when reference is made to the records of one of the more-than-a-million jobs turned out by Ward Leonard.

You have in Ward Leonard an auxiliary plant, modern, skilled in the development of new resistor requirements, and accurate in production, and capable of meeting your production requirements, however large.

Meet and know the Ward Leonard Sales Engineer, serving and central equipment in particular will interest you. Ward Leonard manufactures a wide variety of products, and operates in many divisions of the electrical industry.

WARD LEONARD ELECTRIC CO.
31 South Street Mount Vernon, N. Y.
Resistor Specialists for More Than Thirty-Two Years

For Electronic Engineers



Completely illustrating and fully describing the entire Webster-Chicago line of amplifying equipment, the new Webster Catalog should be in the hands of every Electronic Engineer.

Familiarize yourself with the scope and quality of this most complete line. From the simplest unit to the latest Public Addressing System, for use with Radio, Phonograph, or Microphone, you will find a Webster-Chicago Power Amplifier to fill your need.

A glance through this new catalog will give you some impression of Webster-Chicago workmanship and design. The excellent reputation of Webster products is well known to every engineer, and the character of the engineering that has gone into their design. Just a line to us through our nearest distributor will bring you this new, superbly illustrated, comprehensive catalog so that you may acquaint yourself with Webster-Chicago products and policy. Where quality is demanded—Webster serves.

WEBSTER CHICAGO
850 Blackhawk Street Chicago, Illinois

STOP or GO

Uninterrupted production rests largely on the dependability of your sources of supply. Synthane understands this. Synthane, the product, carries with it Synthane service—service more conscientious in your behalf. By close application to your specifications, by vigilant care in each step of production, by rigid inspection of your order before shipment—Synthane is consistently reliable in meeting your demands for prompt and accurate delivery. Your production need never slow down on Synthane's account. We are jealous of this reputation! Turn the page—and study the product.

SYNTHANE
Laminated Bakelite

SYNTHANE LAMINATED BAKELITE FOR EVERY SPECIFICATION

No matter what your requirements, you will find a grade of Synthane specially designed to meet them.

Special grades made at no additional cost. All standard grades of Synthane, listed according to N. E. M. A. standards, are ready for immediate shipment.

GRADE X. For General Use where low moisture absorption and good machining and electrical properties are required. Paper base. Will punch up to 1/32" cold and when heated to greater thickness. Available in sheets, tubes, rods.

GRADE XX. For Extremely Low Moisture Absorption and High Dielectric Strength. Paper base. Good machining qualities. Low moisture absorption. See "Sheets", "Tubes", "Rods".

GRADE XX-F. For Punching Operations. Paper base. Flexible and shear strength. Will punch up to 5/32" punches and shear in thicker sheet depending on design of die and temperature of material. See "Sheets".

GRADE C. For Exceptional Structural and Impact Strength. Canvas base. Flexible and machine ready. For use where high impact and transverse strength are required in connection with good machining qualities. See "Sheets", "Tubes", "Rods".

GRADE L. For Fine Machining. Linen base. Usually required cut over 1/8". See "Sheets", "Tubes", "Rods".

SHEETS. Size—36" square. Thickness—.010" upwards to 8" Glass. —Natural, Chocolate Brown and Black. Heat-Dull, High Gloss. Grades—X, XX, XXX, XP, C, L. Special as required.

TUBES. Length—36". Diameter—inside diameter from 1/8" upwards outside diameter as required. Color—Natural and Black. Finish—Dull, High Gloss, Smooth—Round, Square, Rectangular. Grades—X, XX, XXX, XP, C, L. Special as required. —Wrapped X, C, L. Inside X, XX, C, L. Special as required.

RODS. Length—36". Diameter—1/8" upwards. Color—Natural, Black, Finish—Dull, High Gloss, Smooth—Round, Square. Grades—Molded X, C, L.

FABRICATED PARTS. Complete fabricated parts made to specification in any of the above grades. Prompt delivery. Reactions in any of the above grades. Prompt delivery. Reactions in any of the above grades. Prompt delivery.

SYNTHANE STABILIZED GEAR STOCK for Silent Gears. Standard sheet 3/8" square. Thickness—upwards to 8". Easy to machine. Strong, resistant and light. Gear blanks of any diameter in stock for immediate shipment.

SYNTHANE does not crack, break, dent, swell, warp, or cold flow. It has high dielectric strength, low moisture absorption, low surface coefficient of expansion, easy machinability, and high strength, good punching qualities, easy machinability, and high resistance to oils and chemicals. Genuine Bakelite resin, high grade raw materials, specially designed machinery, controlled processes and supervised workmanship insure absolute uniformity of all Synthane products.

SYNTHANE CORPORATION OAKS - PENNA.
NEW YORK - CHICAGO - BOSTON - DAYTON - LOS ANGELES - SAN FRANCISCO

Westinghouse Serves the Electronic Industry with:



Amplifier Tubes
Grid-Close Tubes
Photo-Beam Cells
Micros
Precision Ap. Motors
Transformers

Condensers
Vacuum Tubes
Resistors
Light Rectifiers
Magnetic Relays
Condensers

YOU ARE READING . . .

The biggest issue of ELECTRONICS ever published — biggest in circulation, editorial and advertising content of any of the 121 issues brought out since volume 1, number 1, April, 1930.

Represented in the advertising columns are a majority of the existing charter advertisers, and a who's who of the important companies in the electronic and allied fields.

ELECTRONICS

IS PROUD OF THE COMPANIES IT KEEPS



**One Engineer
Tells Another...**

**"Unattenuation
field of station is
equivalent to 270
mvm for a power
of 1000 watts ..."**



Here is more evidence of the excellent efficiency of Lingo Vertical Tubular Steel Radiators. Such statements, and others from letters in our files, testify to the fact that Lingo Radiators are not only living up to claims, but are creating new ones! More and more alert engineers are becoming aware of the unusual results made possible by Lingo's fine quality design and construction.

Lingo "Tube" Radiators are constructed of new full-weight copper-bearing seamless steel tubing, which provides a considerably higher tensile strength than is found in other types. Combined with this assurance of stability, goes 43 years of experience and single responsibility in constructing and erecting our own radiators. There are many other features of interest. . . .

May we send you a complete technical report?

Simply send us the location, power and frequency of your station. We will send you full details without obligation.

**JOHN E. LINGO
& SON, INC.**

Dept. E-4, CAMDEN, N. J.

**LINGO
VERTICAL
TUBULAR STEEL
RADIATORS**

Type 2W3

HALF-WAVE high vacuum rectifier, filament type, metal envelope, 5 pin octal base.

$E_f = 2.5$ v
 $I_f = 1.5$ amp
 $E_{ac} = 350$ v (max)
 $I_{ac} = 55$ ma (max)
Basing 4-X

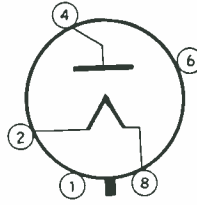

Type 6P8 (G)

TRIODE-HEXODE converter, heater type, glass envelope, 8 pin octal base.

$E_A = 6.3$ v
 $I_A = 0.8$ amp
 $E_{p \text{ hexode}} = 250$ v (max)
 $E_{c2, 4 \text{ hex}} = 75$ v
 $E_c = -2.0$ v
 $E_{p \text{ triode}} = 100$ v
 $R_{grid \text{ triode}} = 50000$ ohms
 $g_c = 650$ μ mbhos
 $I_{p \text{ hex}} = 1.5$ ma
 $I_{c2, 4 \text{ hex}} = 1.4$ ma
 $I_{p \text{ triode}} = 2.2$ ma
Basing 8-K

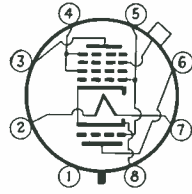

Type 25AC5 (G)

POWER amplifier triode, heater type, glass envelope, 6 pin octal base.

$E_A = 25.0$ v
 $I_A = 0.3$ amp
 $E_p = 110$ v
 $E_c = 4-15$ v
 $I_p = 45$ ma
 $I_c = 7$ ma
 $g_m = 3800$ μ mbhos
 $H_i = 3500$ ohms
 $P_o = 3.3$ watts (10%)
Basing 6-Q

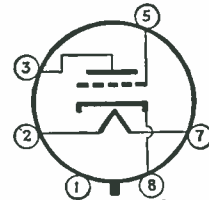

Type 6U5-6G5

TUNING indicator, heater type, (T9) glass envelope, 6 pin base.

$E_A = 6.3$ v
 $I_A = 0.3$ amp
Basing 6-R

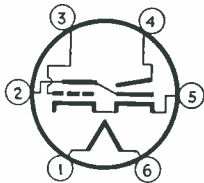

Type 6SA7

SINGLE ended pentagrid converter, heater type, metal envelope, 8 pin octal base.

$E_A = 6.3$ v
 $I_A = 0.3$ amp
 $E_p = 250$ v
 $E_{c2, 4} = 100$ v
 $E_{c3} = -2$ v
 $I_p = 3.4$ ma
 $I_{c2, 4} = 8$ ma
 $g_c = 450$ μ mbhos
 $r_p = 0.9$ megohm
Basing 8-R

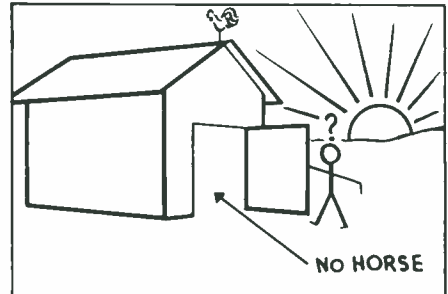
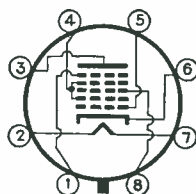

**"Locking the door after
the horse is stolen" - -**

IS FOLLY, but no more so than trying to save time and money winding your own resistors.

Our quality wire-wound resistors have helped many manufacturers boost the quality of their products and speed up production.

We take the resistance out of resistor problems.

Catalogue upon Request

Instrument Resistors, Inc.

LITTLE FALLS, NEW JERSEY

MAKERS OF WIRE-WOUND RESISTORS
FOR THE ELECTRONIC INDUSTRY



SCRATCHY?

Remler Attenuators assure s-m-o-o-t-h mixing . . . completely eliminate "scratch." Silver blades on silver taps (.030" solid silver) machined to precision, "floated" on ball-bearings. Self-cleaning—soft thin silver oxide automatically wipes off with blade! Always quiet, even in low-level circuits. For complete specifications write:

REMLER COMPANY, Ltd.
19th at Bryant San Francisco

Type 6SC7

TWIN triode amplifier, heater type, metal envelope, 8 pin octal base.

$E_h = 6.3$ v
 $I_h = 0.3$ amp
 (Each triode)
 $E_p = 250$ v (max)
 $E_c = -2.0$ v
 $I_p = 2.0$ ma
 $r_p = 53000$ ohms
 $\theta_m = 1325$ μ hos
 $\mu = 70$
 Basing 8-S

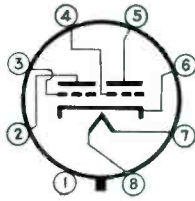

Type 6SF5

SINGLE ended high mu triode, heater type, metal envelope, 6 pin octal base.

$E_h = 6.3$ v
 $I_h = 0.3$ amp
 $E_p = 250$ v (max)
 $E_c = -2.0$ v
 $I_p = 0.9$ ma
 $r_p = 66000$ ohms
 $\mu = 100$
 Basing 8-P

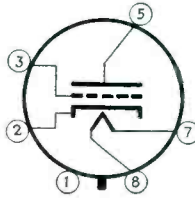

Type 6SJ7

SINGLE ended r-f pentode, sharp cutoff, heater type, metal envelope, 8 pin octal base.

$E_h = 6.3$ v
 $I_h = 0.3$ amp
 $E_p = 250$ v (max)
 $E_c = 100$ v
 $E_c = -3.0$ v
 $I_p = 3.0$ ma
 $I_{c2} = 0.8$ ma
 $r_p = 1.5$ megohms
 $\theta_m = 1630$ μ hos
 Basing 8-N

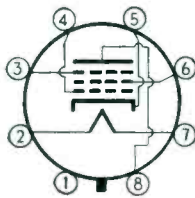

Type 6SK7

SINGLE ended r-f pentode, remote cutoff, heater type, metal envelope, 8 pin octal base.

$E_h = 6.3$ v
 $I_h = 0.3$ amp
 $E_p = 250$ v (max)
 $E_c = 100$ v
 $E_c = -3.0$ v
 $I_p = 9.2$ ma
 $I_{c2} = 2.4$ ma
 $r_p = 0.8$ megohm
 $\theta_m = 2000$ μ hos
 Basing 8-N

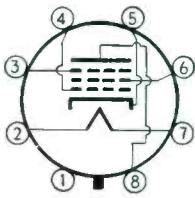

Type 6SQ7

SINGLE ended double diode high mu triode, heater type, metal envelope, 8 pin octal base.

$E_h = 6.3$ v
 $I_h = 0.3$ amp
 $E_p = 250$ v
 $E_c = -2.0$ v
 $I_p = 0.5$ ma
 $\theta_m = 1100$ μ hos
 $\mu = 100$
 Basing 8-Q

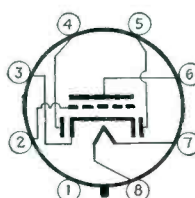

DIRECT READING FREQUENCY MONITOR

MODEL FD8 BY

Doolittle

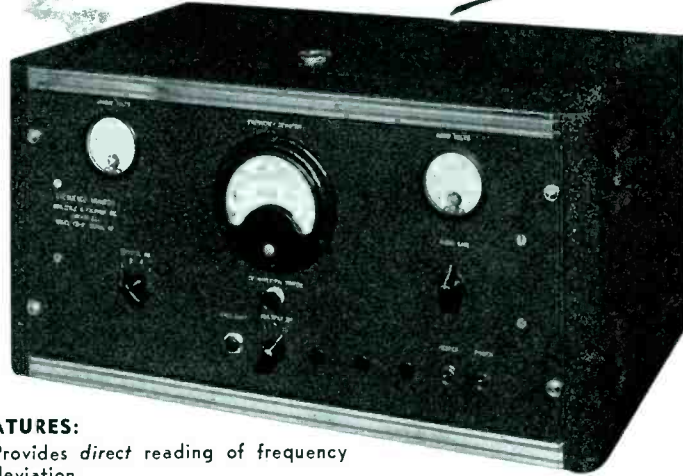

FEATURES:

- Provides direct reading of frequency deviation.
- Temperature controlled crystal chamber.
- Monitors four frequencies.
- Operates on any frequency—1500 to 50,000 KC
- Accuracy of the monitoring frequency is .002 per cent
- Three ranges of measurement—1000, 5000, and 10,000 cycles

For further details write

DOOLITTLE & FALKNOR, Inc.

7421 S. LOOMIS BLVD.
CHICAGO, ILLINOIS

*"Very Active ...
Accurately Calibrated"*

BLILEY Electric Company,
Union Station Bldg.,
Erie, Penna.

Gentlemen:
The last shipment of fifty (50) crystals, received from you, ground for 8445 Kilocycles, were placed in service three weeks ago and to date are performing perfectly in our Port Huron Police transmitters.

They are used in a double-double manner for 33780 Kcs., and have been found to be very active, as well as accurately calibrated, which are the important factors for so many units in one coordinated system.

I am well pleased with them in every way.

Yours truly,
POLICE RADIO BUREAU
CITY OF GRAND RAPIDS, MICH.
A. A. Kirchner
Lieut. A. A. Kirchner,
CHIEF ENGINEER



BLILEY
CRYSTAL UNITS
FROM 20KC. TO 30MC.

WRITE FOR CATALOG G-11 DESCRIBING COMPLETE LINE
BLILEY ELECTRIC CO., ERIE, PA.

Specifically

FOR THE ULTRA-HIGHS



Designed to meet the particular requirements of Ultra-High Frequency Transmitting Equipment, the BUD lines of V. H. F. Transmitting Condensers assure peak tank circuit efficiency in such applications. Outstanding features include:

- (1) Completely insulated tie rods—no closed metallic loop in condenser frame.
- (2) Center-of-rod Rotor Contacts—permit perfect circuit balance.
- (3) Highest grade low-loss ceramic used throughout.

Inquiries welcomed concerning your specific problems. Catalog Free on request.

BUD RADIO, INC. • Cleveland, Ohio



Now they're
known as

the "All-Weather" resistors . . .

When this advertisement was run 10 years ago, the ability of S. S. WHITE Resistors to function efficiently under extremes of temperature, humidity and climatic changes, had already won wide recognition. This recognition was earned principally by the trouble-free performance of S. S. WHITE Resistors in radio equipment being used in planes flying in all parts of the world.

Today, the designation "All-Weather" resistors is fully and positively established and it accounts for the widespread use of S. S. WHITE Resistors in Commercial, Industrial and Scientific Equipment. S. S. WHITE Resistors are available in values from 1000 ohms to 1,000,000 megohms. Full details are given in RESISTOR BULLETIN 37. A copy, with Price List, mailed on request.

S. S. WHITE

The S. S. White Dental Mfg. Co.

INDUSTRIAL DIVISION

Department R, 10 East 40th St., New York, N. Y.

S. S. WHITE MOLDED RESISTANCE UNITS

Successfully endure
in ANY climate

Planes of the Pan American Airways,
for every Radio Equipment in which
S. S. White resistors operate in the most
gratifying manner.

The S. S. WHITE Dental Mfg. Co.
INDUSTRIAL DIVISION
Knickerbocker Bldg., New York, N. Y.



Type 6AE5 (G)

TRIODE amplifier, heater type, glass envelope, 6 pin octal base.

$E_A = 6.3 \text{ v}$
 $I_A = 0.3 \text{ amp}$
 $E_p = 95 \text{ v}$
 $E_c = -15 \text{ v}$
 $I_p = 7 \text{ ma}$
 $r_p = 3500 \text{ ohms}$
 $\theta_m = 1200 \text{ } \mu\text{mhos}$
 $\mu = 4.2$
 Basing 6-Q

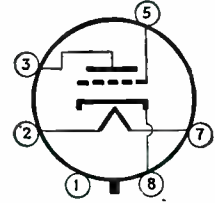

Type 35L6 (GT)

BEAM power amplifier, heater type, bantam glass, 7 pin octal base.

$E_A = 35 \text{ v}$
 $I_A = 0.15 \text{ amp}$
 $E_p = 110 \text{ v (max)}$
 $E_{c2} = 110 \text{ v (max)}$
 $E_c = -7.5 \text{ v}$
 $I_p = 40 \text{ ma}$
 $I_{c2} = 3 \text{ ma}$
 $\theta_m = 5800 \text{ } \mu\text{mhos}$
 $\mu = 80$
 $R_t = 2500 \text{ ohms}$
 $P_o = 1.5 \text{ watts}$
 Basing 7-AC

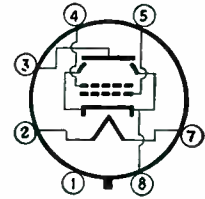

Type 35Z4 (GT)

HALF-WAVE high vacuum rectifier, heater type, bantam glass, 6 pin octal base.

$E_A = 35 \text{ v}$
 $I_A = 0.15 \text{ amp}$
 $E_{ac} = 125 \text{ v (max)}$
 $I_{ac} = 100 \text{ ma (max)}$
 $E_{drop} @ 200 \text{ ma} = 16 \text{ v}$
 Basing 5-AA

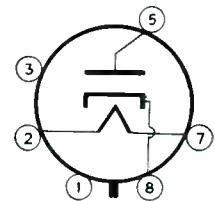

Type 2Y2

HALF-WAVE high vacuum rectifier, heater type, glass envelope, 4 pin base.

$E_A = 2.5 \text{ v}$
 $I_A = 1.75 \text{ amps}$
 $E_{ac} = 4400 \text{ v (max)}$
 $I_{ac} = 5.0 \text{ ma}$
 Basing 4-AB

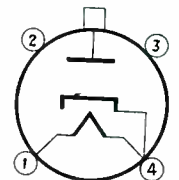

Type 35Z3 (GL)

HALF-WAVE high vacuum rectifier, heater type, glass base-envelope 8 pin loctal base.

$E_A = 35.0 \text{ v}$
 $I_A = 0.16 \text{ amp}$
 $E_{ac} = 250 \text{ v (max)}$
 $I_{ac} = 100 \text{ ma (max)}$
 $E_{drop} @ 200 \text{ ma} = 22 \text{ v}$
 Basing 4-Z

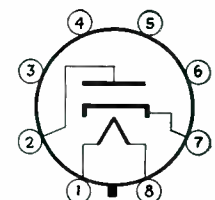

JAGABI *Lubri-tact* RHEOSTATS

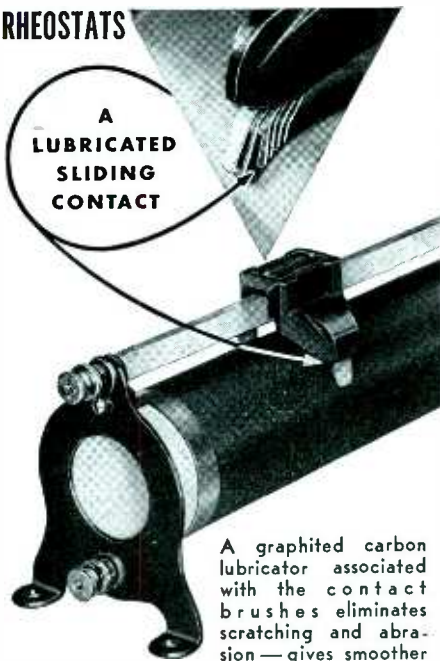

Write for Bulletin 1620-E which lists new lower prices.

A graphited carbon lubricator associated with the contact brushes eliminates scratching and abrasion—gives smoother operation and a better contact. Makes Jagabi Rheostats better rheostats.

JAMES G. BIDDLE CO.
Electrical Instruments
1211-13 Arch Street Philadelphia, Pa.

ASTATIC CRYSTAL RECORDING HEAD



MODEL X-26

Designed for use in recording on acetate coated blanks. Also used on wax master plates. Especially suitable for home recording equipment. Heavy die-cast cartridge assembly develops remarkable power sensitivity capable of recording a range of frequencies far greater than formerly possible. Due to constant amplitude characteristic, higher volume levels can be recorded without groove crossover.

LIST PRICE NOW \$11.50
(See Your Astatic Jobber)



Astatic Microphone Laboratory, Inc.
YOUNGSTOWN, OHIO

In Canada: Canadian Astatic Ltd., Toronto, Ontario
Astatic Crystal Products Licensed Under Brush Development Co. Patents

Type 35A5 (GL)

BEAM power amplifier, heater type, glass base-envelope, 8 pin loktal base.

$E_A = 35.0$ v
 $I_A = 0.16$ ma
 $E_P = 110$ v (max)
 $E_{\Delta 3} = 110$ v (max)
 $E_c = -7.5$ v (min)
 $I_P = 35$ ma
 $I_{c2} = 2.8$ ma
 $\phi_m = 5500$ μ mhos
 $R_l = 2500$ ohms
 $P_o = 1.4$ watts
Basing 6-AA

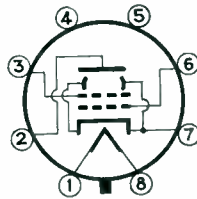

Type 7A7 (GL)

R-f pentode, remote cutoff, heater type, glass base-envelope, 8 pin loktal base.

$E_A = 7.0$ v
 $I_A = 0.32$ amp
 $E_P = 250$ v (max)
 $E_{c2} = 100$ v (max)
 $E_c = -3.0$ v
 $I_P = 8.6$ ma
 $I_{c2} = 2.0$ ma
 $r_p = 0.8$ megohm
 $\phi_m = 2000$ μ mhos
 $\mu = 1600$
Basing 8-V

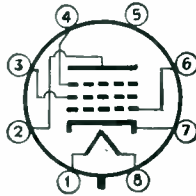

Type 7B7 (GL)

R-f pentode, remote cutoff, heater type, glass base-envelope, 8 pin loktal base.

$E_A = 7.0$ v
 $I_A = 0.16$ amp
 $E_P = 250$ v (max)
 $E_{c2} = 100$ v (max)
 $E_c = -3$ v
 $I_P = 8.5$ ma
 $I_{c2} = 0.7$ ma
 $\phi_m = 1700$ μ mhos
 $r_p = 0.7$ megohm
 $\mu = 1200$
Basing 8-V



Type 7C6 (GL)

DUODIODE triode, heater type, glass base-envelope, 8 pin loktal base.

$E_k = 7.0$ v
 $I_k = 0.16$ amp
 $E_P = 250$ v (max)
 $R_{grid} = 10$ megohms
 $I_P = 1.3$ ma
 $r_p = 0.1$ megohm
 $\phi_m = 1000$ μ mhos
 $\mu = 100$
Basing 8-W

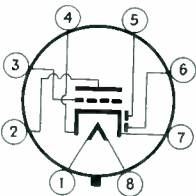

Type 7Y4 (GL)

FULL-WAVE high vacuum rectifier, heater type, glass base-envelope, 8 pin loktal base.

$E_f = 7.0$ v
 $I_f = 0.53$ amp
 $E_{ac} = 350$ v per plate (max)
 $I_{dc} = 60$ ma (max)
Basing 5-AB

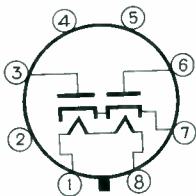

PINCOR PRODUCTS FOR AIRCRAFT AND OTHER SOUND OR POWER SUPPLY USES



HIGH FREQUENCY CONVERTERS

Pincor High Frequency Converters are precision built for smooth, silent, dependable performance. 5 to 500 watts. 400 and 500 cycles. Special units designed to meet any output or requirements.



SMALL MOTORS A.C. and D.C.

These small motors are particularly adapted for band switching, remote control, etc., for aircraft use or wherever a small light weight motor is required for unfailing service. 20 watts output. Others as required.



DYNAMOTORS

Pincor Dynamotors afford a dependable "B" power supply for aircraft, marine and broadcast service, mobile units, etc. Highest efficiency and regulation. 5 to 850 watts. Input 6 to 110 volts; output up to 1750 volts.

PIONEER GEN-E-MOTOR CORP.

CHICAGO, ILLINOIS
Export Address: 25 Warren St., New York, N.Y.
Cable: Simontrice, New York

PIONEER GEN-E-MOTOR CORPORATION
Dept. R-4 D. 466 W. Superior St., Chicago, Ill.
Please send information on the following:
 High Frequency Converters. Small Motors.
 Dynamotors. Rotary Converters.

Name
Address
City State

Attention!

**MANUFACTURERS OF
TELEPHONE RECEIVERS AND
HEARING AIDS—**



Model 505 Artificial Ear
and Model 300A Voltmeter

Manufacturers, research workers, otologists, service agencies and laboratories will find this combination ideal for accurately measuring the efficiency and frequency response characteristics of telephone and hearing-aid receivers under the same conditions which exist when the receiver is worn on the ear. The Model 505 Artificial Ear has been completely redesigned, simplified and reduced in cost. The Model 300A Electronic Voltmeter will be found extremely useful around the shop and laboratory for other measurements. Voltmeter range .001 to 100 volts, 10 to 150,000 cycles, logarithmic scale, AC operation. Adapters can be furnished for various types of hearing-aid receivers. In use by leading manufacturers and U. S. Government departments.

Send for Bulletin 6G

BOONTON **Ballantine Laboratories, Inc.** NEW JERSEY
ELECTROACOUSTICAL INSTRUMENTS

Stand by
All Broadcasters
Vacuum Tube Protection
250 WATT R. C. A.
Transmitter Equipped with
HEINEMANN
CIRCUIT BREAKERS

These accurately calibrated, factory set and adjusted circuit breakers are used in many N.B.C. Studios for the protection of vacuum tubes. They increase tube life, eliminate the need for costly fuses and resultant interruption of broadcasts due to their failure. The device can be reclosed immediately after opening for overload or short circuit. Heinemann Circuit Breakers are made in ratings from 50 milliamperes to 50 amperes.

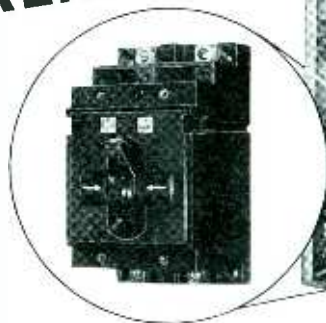

HEINEMANN CIRCUIT BREAKER CO.
97 PLUM ST. - - - TRENTON, N. J.

Type 5X3

FULL-WAVE high vacuum rectifier, filament type, glass envelope, 4 pin base.

$E_f = 5.0$ v
 $I_f = 2.0$ amps
High voltage operation
 $E_{ac} = 1275$ v
 $I_{dc} = 30$ ma
Low voltage operation
 $E_{ac} = 400$ v
 $I_{dc} = 110$ ma
Basing 4-C

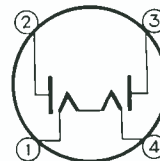

Type 6AD5 (G)

HIGH mu triode, heater type, glass envelope, 6 pin octal base.

$E_b = 6.3$ v
 $I_A = 0.8$ amp
 $E_p = 250$ v
 $E_c = -2.0$ v
 $I_p = 0.9$ ma
 $R_p = 66000$ ohms
 $\mu = 100$
Basing 6-Q

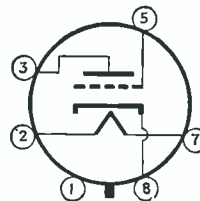

Type 6AG6 (G)

POWER amplifier pentode, heater type, glass envelope, 7 pin octal base.

$E_b = 6.3$ v
 $I_A = 1.25$ amps
 $E_p = 250$ v (max)
 $E_{c2} = 250$ v (max)
 $E_c = -6.0$ v
 $I_p = 32$ ma
 $I_{c2} = 6.0$ ma
 $g_m = 10000$ μ hos
 $R_t = 8500$ ohms
 $P_o = 3.75$ watts (7%)
Basing 7-S

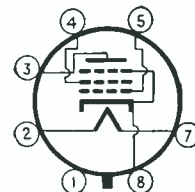

Type 6M6 (G)

POWER amplifier pentode, heater type, glass envelope, 7 pin octal base.

$E_b = 6.3$ v
 $I_A = 1.2$ amps
 $E_p = 250$ v
 $E_{c2} = 250$ v
 $E_c = -6.0$ v
 $I_p = 36$ ma
 $I_{c2} = 4$ ma
 $g_m = 9500$ μ hos
 $R_t = 7000$ ohms
 $P_o = 4.4$ watts (10%)
Basing 7-S

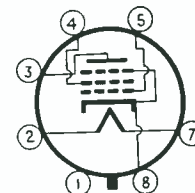

Type 25Z4

HALF-WAVE high vacuum rectifier, heater type, metal envelope, 6 pin octal base.

$E_b = 25$ v
 $I_A = 0.3$ amp
 $E_{ac} = 125$ v (max)
 $I_{dc} = 125$ ma (dc)
 $E_{drop} @ 125$ ma = 12 v
Basing 5-AA

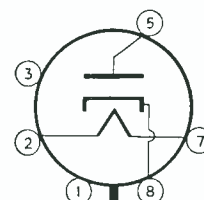

Electronic Organ

(Continued from page 45)

the insulation resistance must be high—at least a hundred megohms. Ordinary tape insulation is unsatisfactory and all leakage paths should have a full inch length.

Accessibility of all parts warrants careful consideration. Where separate channels are used for preamplifiers, the outputs can be arranged with detachable plugs.

Voicing of Pick-up Screws

Having connected all the electric parts, one next proceeds to the voicing or adjustment of pick-up screws for uniform loudness from the loudspeaker. The first stage of this rough adjustment can take place by blowing a reed in normal manner while the screw is threaded in until a buzzing indicates contact is being made with vibrating tongue and then the screw is backed off a full turn.

The first precaution is to hold down adjoining bass keys and observe, when they are suddenly released, whether sharp clicks come from loudspeaker. If disagreeable noises do result, then the reed tongues are slapping against the screws so the latter must be backed off farther. When all such thumps have been eliminated by checking with various key combinations, then one can start to drop down the volume of the louder reeds to balance with the softer ones all over the keyboard. The extreme bass and treble may be a little weaker than the middle region but that is unimportant if there is no abrupt shift in volume going from one key to another. An a-c voltmeter across the voice coil furnishes the most convenient indication for volume equality, although the ear must be the final judge. Each rank of reeds is voiced separately before their outputs are combined.

Setting up the Stops

If there are already stop draw knobs on the console, these may be marked 16 feet, 8 feet, and 4 feet, and this designation refers to the frequency of each set of reeds. For

STABILIZED A. C. VOLTAGE

UP TO 25 KVA

INSTANTANEOUS ACTION NO MOVING PARTS

When a precision electrical device or a critical process is powered from an AC line, a Raytheon Voltage Stabilizer will permanently eliminate all of the detrimental effects caused by AC line voltage fluctuations. Made for all commercial voltages and frequencies, single or three phase.

Raytheon's twelve years of experience in successfully applying the Stabilizer to hundreds of perplexing voltage fluctuation problems is at your service. It will pay you to take advantage of our engineering skill.

Write for Bulletin DL48-71 JE describing Raytheon Stabilizers.

RAYTHEON MANUFACTURING CO.
100 Willow Street, WALTHAM, Massachusetts

CALLITE FORMED PARTS of TUNGSTEN . . . MOLYBDENUM
for your specific applications

Makers of x-ray and high power transmission tubes can tell you about Callite service in formed parts. Never have specifications been more exacting. Callite's demonstrated ability to "meet every requirement" in this field is your guarantee of satisfaction when Callite is called in on your particular problem. Consult Callite today—take advantage of its modern laboratory facilities and over 20 years of research and experience. Write for Bulletin No. 30.



CALLITE PRODUCTS DIVISION

EISLER ELECTRIC CORP. • 544 39th ST. • UNION CITY, N. J.

THEN [1930]

as

NOW [1940]



UNIVERSAL follows no beaten paths, but blazes trails of its own. First, with microphones, stands and accessories, and later with recording machines, blank discs, needles and allied equipment, UNIVERSAL has pioneered in this field of science.

Now UNIVERSAL has more than one hundred different items in its microphone list; as well as professional, wax, instantaneous, portable and other recorders, including the new Uni-Cord [78 RPM].

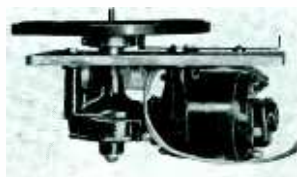

Universal Microphone Co., Ltd.
INGLEWOOD, CALIFORNIA, U.S.A.

EXPORT AGENTS: FRAZER & CO., 7 FRONT ST., SAN FRANCISCO

the 8-foot stop depressing the middle A key gives the expected tone frequency of 440 cps. The same key with the 16-foot stop gives the octave below and the 4-foot stop the octave above middle A.

In this case there are seven stops which can be quickly set up: (1) 16 feet alone; (2) 8 feet alone; (3) 4 feet alone; (4) 16 feet and 8 feet together; (5) 8 feet and 4 feet together; (6) 16 feet and 4 feet together; (7) 16 feet, 8 feet, and 4 feet together. Other combinations take into consideration the bass and treble tone controls. A general objective is to determine the thinnest timbre (rich in upper harmonics) and the thickest timbre (strong fundamental and weak in overtones) and divide the stops between these extremes. Another desirable pair of stops is (1) strong volume treble section tapering down to weak bass section; (2) the reverse. Also the 16 feet, 8 feet, and 4 feet stops may be combined in percentages other than 100 or zero when the separate channel mixing system is used. It is impractical to give more specific directions on setting up the timbres since tastes and the instrument itself vary so much. That is, one instrument may have just one bank of reeds while another may have a half dozen or more.

To aid setting up the timbres, one button of the switch should be selected to throw on manually operated controls for each reed bank, the bass and treble tone controls and volume control. Thus one may mix the tones at will and use this arrangement to compare with the stops previously set up. The six knobs of the potentiometers (assuming separate channel system for inputs) may be inside the console, or left outside for the musician playing the finished instrument to modulate from one timbre to another in continuous fashion rather than to break up the tone continuity by pushing another button to obtain a different timbre.

The loudspeaker volume output for a given gain setting should be about the same for all the stops, since the swell pedal can cover the full range from minimum to maximum undistorted amplifier output.

It is hoped that this general description will be found sufficiently clear and complete to enable the experimenter to carry out the construction of an electronic organ.



JOHNSON Phasing Equipment

When KMBC of Kansas City selected JOHNSON to build the phasing equipment for their new tower, it added another demonstration to the growing list of modern stations who have turned to JOHNSON for precision equipment of special design.

For 17 years, JOHNSON engineers have been designing and building apparatus to meet special problems and exacting requirements of broadcast and shortwave stations. This experience is particularly valuable now in view of the forthcoming frequency changes and the attendant opportunity to modernize transmitters and install directional antenna systems.

If you have a problem, write JOHNSON. Catalogs 301D and 966D free upon request.



E. F. JOHNSON CO.

WANICA, MINNESOTA

INCORPORATED IN MINNESOTA, U.S.A.

"MANUFACTURERS OF RADIO TRANSMITTING EQUIPMENT"