

FEBRUARY • 1942

electronics

radio, communication, industrial applications of electron tubes . . . engineering and manufacture

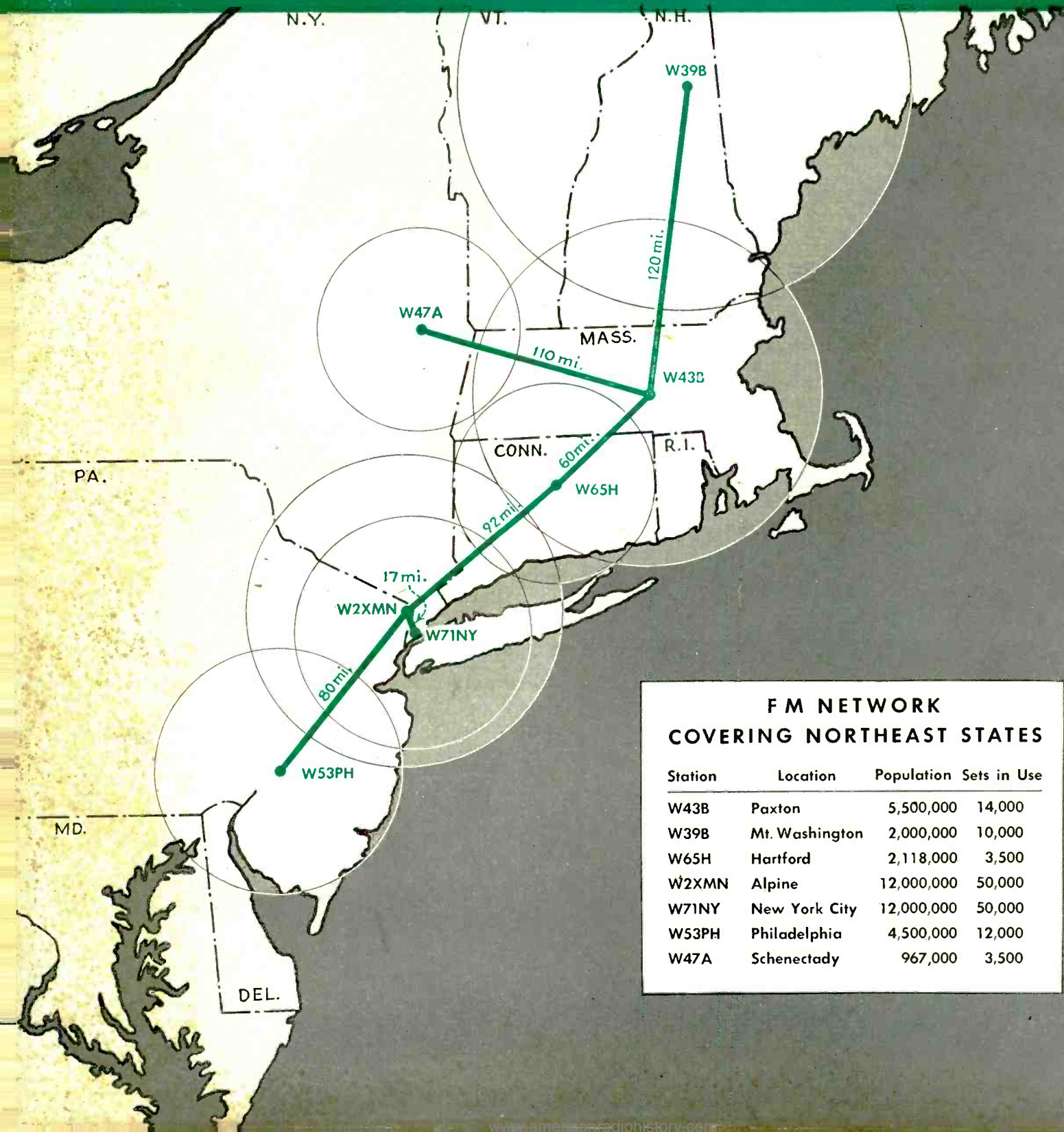

F M NETWORK COVERING NORTHEAST STATES

Station	Location	Population	Sets in Use
W43B	Paxton	5,500,000	14,000
W39B	Mt. Washington	2,000,000	10,000
W65H	Hartford	2,118,000	3,500
W2XMN	Alpine	12,000,000	50,000
W71NY	New York City	12,000,000	50,000
W53PH	Philadelphia	4,500,000	12,000
W47A	Schenectady	967,000	3,500



In a world at war



BUSINESS AS USUAL? . . . Hardly! We'd say that it's a "topsy-turvy" business, at best.

Unprecedented requirements for our military services . . . as well as for the armies and navies of the United Nations . . . have transformed our normal surpluses into acute shortages.

However, despite many severe curtailments, our regular clients have not been unduly inconvenienced, and every possible effort is being made to continue serving them.

You can help us expedite such deliveries by scheduling your requirements for the future, NOW . . . and by forwarding priorities extension certificates, whenever these are available.

AMPEREX ELECTRONIC PRODUCTS

79 WASHINGTON STREET

BROOKLYN, NEW YORK



electronics

CONTENTS—FEBRUARY, 1942

KEITH HENNEY
Editor

Donald G. Fink Beverly Dudley
Managing Editor Acting
(on leave) Managing Editor

W. W. MacDonald Craig Walsh
Associate Editor Associate Editor

M. L. Matthey J. M. Heron
Assistant Editor Assistant Editor

Harry Phillips
Art Director

H. W. MATEER
Publisher

Wallace B. Blood
Sales Manager

Contents Copyright, 1942, by
McGraw-Hill Publishing Company, Inc.

**McGRAW-HILL
PUBLISHING COMPANY, INC.**

JAMES H. MCGRAW
Founder and Honorary Chairman

Publication Office
99-129 North Broadway, Albany, N. Y.
U. S. A.

Editorial and Executive Offices
330 West 42nd St., New York, N. Y., U.S.A.
James H. McGraw, Jr., President
Howard Ehrlich, Executive Vice President
Mason Britton, Vice President
B. R. Putnam, Treasurer
D. C. McGraw, Secretary
J. E. Blackburn, Jr., Director of Circulation

Cable Address:
MCGRAWHILL, New York
Member A. B. P. Member A. B. C.

THE RHEOTRON—A NEW ELECTRONIC DEVICE..... 22

A new, doughnut shaped whirligig speeds up electrons in the newest approach to atom smashing recently made at the G-E research laboratories

RECORD CHANGERS 24

A discussion of the mechanical design of automatic record changers is given. The seemingly complicated action is analyzed and is shown to be composed of several simple motions controlled by cams

TRACKING PROBLEM IN SUPERHETERODYNE RECEIVERS, by Rinaldo de Cola 29

A straightforward procedure for designing tuning circuits for superheterodyne receivers is presented. It enables the designer to determine the necessary padding capacitances and inductances for proper tracking

REPORT ON CONVENTION OF THE INSTITUTE OF RADIO ENGINEERS 31

Although pressure of everyday work prevented many engineers from attending, there was a record attendance at the I.R.E. Convention in January. Key-note of the convention related to defense and to radio's expanding role in international solidarity

USES OF POWDERED IRON CORES IN RADIO COMMUNICATION 35

Powder metallurgy has made vast strides in recent years. Some of the radio applications of powdered iron cores are indicated

ELECTRON TUBES FOR PREVENTION OF INTRUSION..... 38

A systematic survey of the various means in which electron tubes are employed to guard valuable property, prevent sabotage, or give indications of the presence of undesired persons. A "must" article for all concerned with property protection or possible sabotage

SKIN EFFECT FORMULAS, by J. R. Whinnery 44

A collection of formulas on skin effects, in convenient graphical form and ready for instant use

IMPEDANCE CALCULATIONS FOR ECCENTRIC LINES, by George H. Brown 49

The derivations of formulas for the calculation of the characteristics of eccentric transmission lines is given

CHARACTERISTIC IMPEDANCE OF ECCENTRIC LINES, by William Barclay and Karl Spangenberg 50

A convenient graphical method of representing the characteristics of eccentric transmission lines, suitable for use in impedance matching

DEPARTMENTS

CROSSTALK	21	THE ELECTRON ART.....	72
REFERENCE SHEET	49	TUBES	88
NEW BOOKS	52 & 86	NEWS OF THE INDUSTRY.....	96
TUBES AT WORK.....	54	NEW PRODUCTS	98

INDEX TO ADVERTISERS..... 120

ELECTRONICS, February, 1942, Vol. 15; No. 2. Published monthly, price 50c a copy. Allow at least ten days for change of address. All communications about subscriptions should be addressed to the Director of Circulation, 330 West 42nd Street, New York, N. Y.

Subscription rates—United States and possessions, Mexico, Central and South American countries, \$5.00 a year, \$8.00 for two years, \$10.00 for three years. Canada (Canadian funds accepted), \$5.50 a year, \$9.00 for two years, \$11.00 for three years. Great Britain and British possessions 36 shillings for one year, 72 shillings for three years. All other countries, \$6.00 for one year, \$12.00 for three years. Entered as Second Class matter, August 29, 1936, at Post Office, Albany, New York, under the Act of March 3, 1879. BRANCH OFFICES: 520 North Michigan Avenue, Chicago; 68 Post Street, San Francisco; Aldwych House, Aldwych, London, W.C. 2; Washington; Philadelphia; Cleveland; Detroit; St. Louis; Boston; Atlanta, Ga.

AXIAL LEAD RESISTORS



Mapping from another company's specifications and specific Centralab features:

AXIAL LEAD RESISTORS
Resistors are the most important component of a circuit. They are used to control the flow of current and to convert electrical energy into heat. They are also used to provide a path for current to flow to ground.

Old Man Centralab continues to solve a host of problems for the radio and electronics industry. His new resistors are made of the finest materials and are built to the highest standards. They are available in a wide range of values and are guaranteed to last for years.

PARALLEL PLUSTERS
The parallel plusters are used to hold the resistors in place. They are made of a special material and are built to the highest standards. They are available in a wide range of sizes and are guaranteed to last for years.

Centralab
CENTRALAB, Division of Globe Union Inc., Milwaukee, Wis.

Complete NET only \$10.56

Always THE RIGHT REPLACEMENT CONTROL WITH THIS CENTRALAB PORTABLE Adastaff Kit

You name the set and it's a bet that you've got a replacement control with this CENTRALAB PORTABLE Adastaff Kit. It's the only kit that gives you a complete set of replacement controls for a wide range of portable sets. It's the only kit that gives you a complete set of replacement controls for a wide range of portable sets.

INCLUDES IN THIS ADASTAFF KIT	VALUES
1 1/2" POLARIZED CAPACITORS	1 250
1 LAMP OF CURRY	2 250
1 100 ohms	3 250
1 200 ohms	4 250
1 500 ohms	5 250
1 1000 ohms	6 250
1 2000 ohms	7 250
1 5000 ohms	8 250
1 10000 ohms	9 250
1 20000 ohms	10 250
1 50000 ohms	11 250
1 100000 ohms	12 250
1 200000 ohms	13 250
1 500000 ohms	14 250
1 1000000 ohms	15 250
1 2000000 ohms	16 250
1 5000000 ohms	17 250
1 10000000 ohms	18 250
1 20000000 ohms	19 250
1 50000000 ohms	20 250
1 100000000 ohms	21 250
1 200000000 ohms	22 250
1 500000000 ohms	23 250
1 1000000000 ohms	24 250
1 2000000000 ohms	25 250
1 5000000000 ohms	26 250
1 10000000000 ohms	27 250
1 20000000000 ohms	28 250
1 50000000000 ohms	29 250
1 100000000000 ohms	30 250
1 200000000000 ohms	31 250
1 500000000000 ohms	32 250
1 1000000000000 ohms	33 250
1 2000000000000 ohms	34 250
1 5000000000000 ohms	35 250
1 10000000000000 ohms	36 250
1 20000000000000 ohms	37 250
1 50000000000000 ohms	38 250
1 100000000000000 ohms	39 250
1 200000000000000 ohms	40 250
1 500000000000000 ohms	41 250
1 1000000000000000 ohms	42 250
1 2000000000000000 ohms	43 250
1 5000000000000000 ohms	44 250
1 10000000000000000 ohms	45 250
1 20000000000000000 ohms	46 250
1 50000000000000000 ohms	47 250
1 100000000000000000 ohms	48 250
1 200000000000000000 ohms	49 250
1 500000000000000000 ohms	50 250

Centralab

Rigid Tests Demand **CENTRALAB Switches** in Your Communication Systems



Important Features of Centralab Selector Switches:

1. Rugged construction - built to last.
2. Positive contact action - no arcing.
3. Positive contact separation - no welding.
4. Positive contact contact - no pitting.
5. Positive contact contact - no oxidation.
6. Positive contact contact - no corrosion.
7. Positive contact contact - no scaling.
8. Positive contact contact - no cracking.
9. Positive contact contact - no chipping.
10. Positive contact contact - no flaking.
11. Positive contact contact - no delamination.
12. Positive contact contact - no voiding.
13. Positive contact contact - no inclusions.
14. Positive contact contact - no foreign matter.
15. Positive contact contact - no debris.
16. Positive contact contact - no dust.
17. Positive contact contact - no lint.
18. Positive contact contact - no oil.
19. Positive contact contact - no grease.
20. Positive contact contact - no dirt.
21. Positive contact contact - no moisture.
22. Positive contact contact - no salt.
23. Positive contact contact - no acid.
24. Positive contact contact - no alkali.
25. Positive contact contact - no gas.
26. Positive contact contact - no vapor.
27. Positive contact contact - no liquid.
28. Positive contact contact - no solid.
29. Positive contact contact - no plasma.
30. Positive contact contact - no radiation.
31. Positive contact contact - no magnetic field.
32. Positive contact contact - no electric field.
33. Positive contact contact - no mechanical stress.
34. Positive contact contact - no thermal stress.
35. Positive contact contact - no chemical stress.
36. Positive contact contact - no biological stress.
37. Positive contact contact - no environmental stress.
38. Positive contact contact - no human stress.
39. Positive contact contact - no animal stress.
40. Positive contact contact - no plant stress.
41. Positive contact contact - no mineral stress.
42. Positive contact contact - no organic stress.
43. Positive contact contact - no inorganic stress.
44. Positive contact contact - no synthetic stress.
45. Positive contact contact - no natural stress.
46. Positive contact contact - no artificial stress.
47. Positive contact contact - no man-made stress.
48. Positive contact contact - no God-given stress.
49. Positive contact contact - no devil-given stress.
50. Positive contact contact - no Satan-given stress.

Centralab

A NEW Member of the Centralab Family

TRIMMED CAPACITOR



DESIGNED for the exacting conditions imposed by Radio set manufacturers in defense and civilian equipment, whether in AM or FM.

Value: 5 to 50 MMF • Temperature coefficient: -0.005 MMF/MSE C • Power factor: less than 1% under normal and abnormal conditions • Bias and center of high grade ceramic material • Plates are silver deposited on specially ground, flat ceramic surfaces • Vibration proof stability • Adjustment rotation 180° sturdy machine design • Multifactor construction 100's solid solder connections from base to construction plates • Capacity free-pipeal recognition.

CENTRALAB, Div. of Globe Union Inc., Milwaukee, Wis.

CERAMIC TRIMMER CONDENSER
These trimmer condensers are used to tune the circuits of radio receivers and transmitters. They are made of a special material and are built to the highest standards. They are available in a wide range of values and are guaranteed to last for years.

CERAMIC FIXED CAPACITOR
These fixed capacitors are used to store electrical energy in circuits. They are made of a special material and are built to the highest standards. They are available in a wide range of values and are guaranteed to last for years.

'41 PASSES IN REVIEW



The history of CENTRALAB can be read in its advertisements down through the years. New developments... the result of research and pioneering... keep Centralab constantly in the vanguard.

Today... research alone is not enough... the demands of the present emergency call for an "ALL OUT" program of production.

In '42 CENTRALAB will not fail to maintain its record. In '42 as in '22 and '32... always "SPECIFY CENTRALAB".

Centralab
Div. of Globe-Union Inc., Milwaukee, Wis.

CONTROLS • SWITCHES
RESISTORS
CAPACITORS

Another "First" for Centralab

To satisfy an ever increasing demand for standardization and interchangeability of parts Centralab introduces the **REMOVABLE FLAT SHAFT**.

When material conservation is so important, this development is doubly significant because it conserves two thirds of the material formerly needed for shafts.

Manufacturers can take advantage of the standard flat shaft in the use of one volume control... one tone control... one switch... one dial drive mechanism... which may be used with 54 different flat shaft lengths. By virtue of this, one chassis may be utilized for 54 different models.

A bulletin on the **REMOVABLE FLAT SHAFT** and its adaptations is in preparation... write for it.

CENTRALAB Div. Globe-Union Inc., Milwaukee, Wis.



Centralab
Div. of Globe-Union Inc., Milwaukee, Wis.

CONTROLS • SWITCHES
RESISTORS
CAPACITORS

Centralab

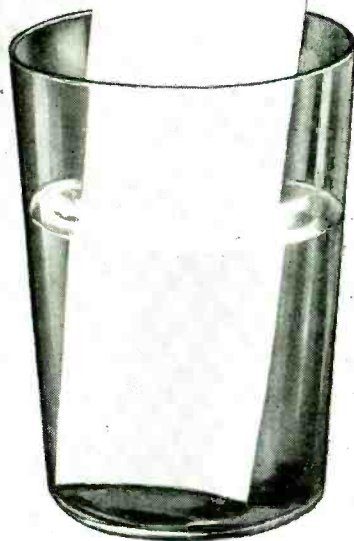

This new tracing cloth defies moisture stains and erasure scars

This new tracing cloth won't show perspiration stains or water marks—*bolds pencil smudges and erasure scars at a minimum*. Now you can have clean tracings, in pencil or ink, free from these untidy "ghosts" that reproduce on blueprints!

For PHOENIX is ghost-proofed by a remarkable new process that defies moisture and gives you an unusually durable working surface. You can use harder pencils with this improved cloth and get sharper lines with less tendency to smudge. Even 6H lines show clearly, and reproduce sharply! Erasing does not mar the drawing surface; erased areas take pencil smoothly—and ink without feathering. Its new white color and increased transparency give you excellent drawing contrast and produce strong blueprints.

Put PHOENIX through your own drawing board test. See your K&E dealer, or write for a generous working sample and an illustrated brochure.

K&E
Phoenix

REG. U.S. PAT. OFF.

TRACING CLOTH

for pencil and ink

EST. 1867
KEUFFEL & ESSER CO.
NEW YORK • HOBOKEN, N. J.

CHICAGO • ST. LOUIS • SAN FRANCISCO • LOS ANGELES
DETROIT • MONTREAL



PHOENIX DEFIES MOISTURE GHOSTS . . .

Perspiration and water splashes on ordinary tracing cloth create "ghosts" which reproduce on blueprints. PHOENIX Tracing Cloth withstands actual immersion in water for fully 10 minutes at a time! *Perspiration and water marks will not stain it!*



PHOENIX LESSENS SMUDGE GHOSTS . . .

The new improved surface of PHOENIX Tracing Cloth permits you to use harder pencils (5H and 6H) and to get sharper lines with less tendency to smudge.

Result: Cleaner tracings and blueprints.



PHOENIX REDUCES ERASURE GHOSTS . . .

Ordinary tracing cloths become scarred when erased . . . erased spots produce ghosts on blueprints.

PHOENIX has a durable drawing surface that reduces working scars to a minimum.

TWICE-TESTED ..INDIVIDUALLY ADJUSTED!

62AXX

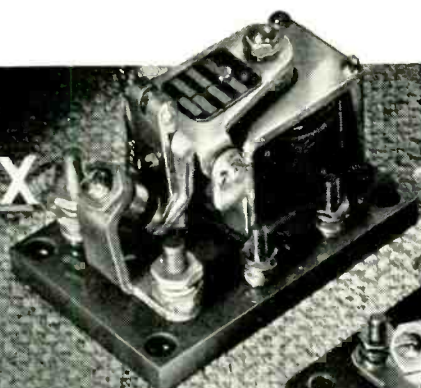

68AXX



61AXX

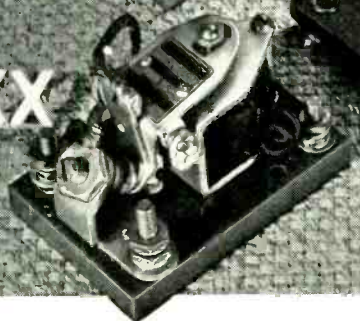

67AXX



There's a secret to making fine relays quite aside from sound design and the use of quality materials. This is summed up in just one word, "Care." Care, as we at Dunco see it, calls for painstaking inspection of individual parts before and during manufacture, a complete test of the finished unit, plus another final test which includes individual adjustment for the job it has been designed to fill.

In brief, Dunco's production objective is "Not only how many—but how well." This, we believe, is the big secret behind the widespread selection of Dunco Relays and Timers by leading users for applications where the call is for the utmost in dependability and durability.

Dunco Types Include:

30 Ampere • 6 Ampere (midget)
• Sensitive • Low Voltage, Heavy Current, D. C. • Instrument Controlled Mechanical Latch-in (Electrical Reset)
• Mercury Contact • Telephone Auxiliary • Lamp Controlling • Polarized
• Overload Motor Reversing • Sequence, Ratchet Type • Close Differential • Timing . . . and countless "Customer Specials" designed or adapted to meet your exact specifications.



CATALOG gladly sent on request. Dunco engineers welcome the opportunity to cooperate in solving your Relay and Timer Problems.

DUNCO RELAYS • TIMERS

STRUTHERS DUNN, INC. • 1326 CHERRY STREET • PHILADELPHIA, PA.

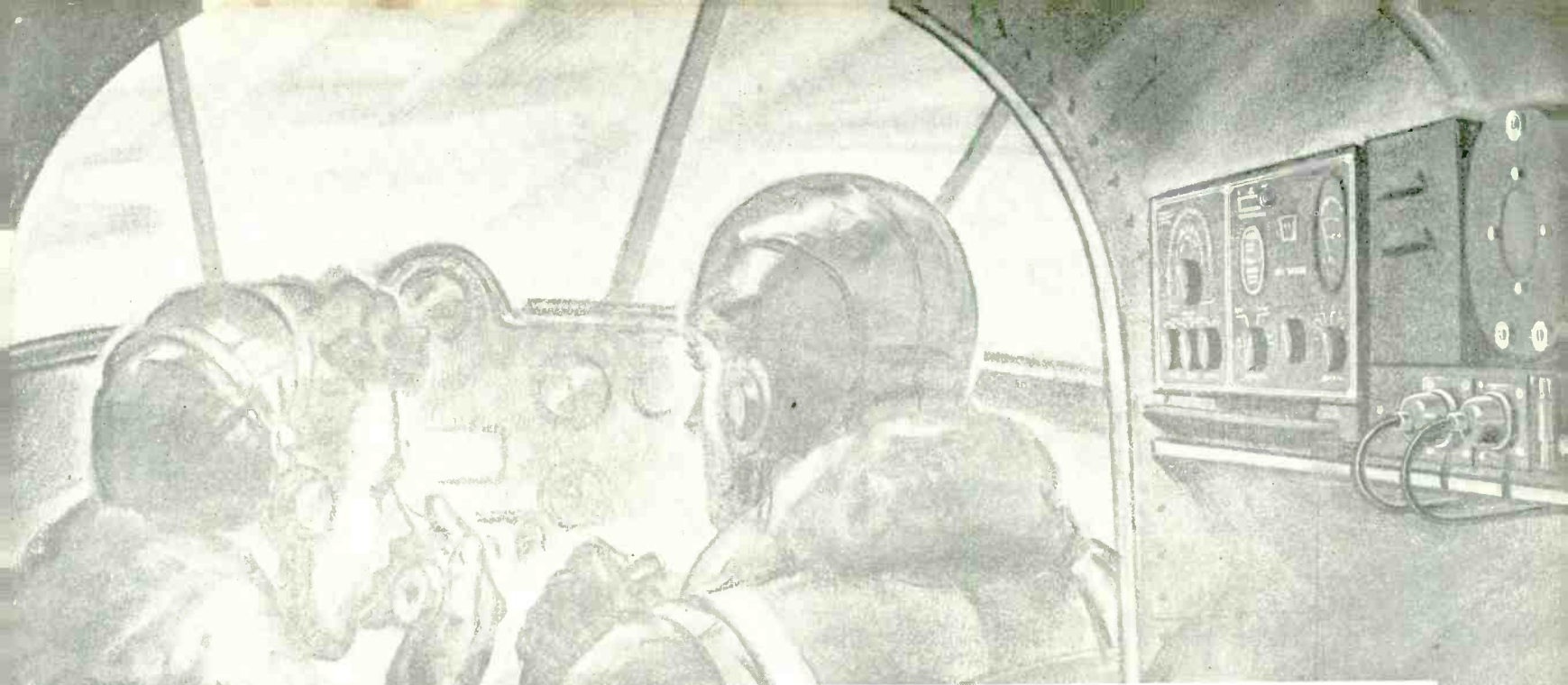

**NOW... UNLIMITED
PERFORMANCE WITH
THIS 25 LB. SYSTEM**

A *LIGHTWEIGHT AIRCRAFT COMMUNICATION SYSTEM* that compares in performance with heavy, high powered equipment is announced by Bendix Aviation, Ltd.

Although designed for aircraft requiring the most compact installation, performance of the Bendix system has proved so outstanding that numerous military installations have been made in large patrol airplanes. Radio operators have reported that constant two-way communication has been maintained over a 2500-mile range.

The Transmitter-Receiver is a small compact unit which may be installed in any convenient location. The power supply and audio systems are housed separately. The receiver is a six tube superheterodyne with one stage of tuned radio frequency. A number of the tubes serve a multiple purpose. The set provides beacon and communication reception, and also functions as an interphone system within the airplane. The transmitter is crystal controlled and coupled to the antenna through a continuous variable inductor. Three crystals provide operation on the fundamental or second harmonic or both, allowing up to six crystal controlled frequencies. Radio telephone, Interphone, Modulated CW, or CW transmission are available.

The Bendix Communication System, complete with power supply, weighs but twenty-five pounds. As a 12-volt system the set draws a maximum of 13 amperes, while the 24-volt system draws only 6 amperes. Complete data will be supplied business inquiries addressed on company letterhead.



BENDIX AVIATION, LTD.
Subsidiary of  Bendix Aviation Corporation
NORTH HOLLYWOOD, CALIFORNIA

**BENDIX
COMMUNICATION SYSTEM**

INTERPHONE SYSTEMS • TRANSMITTERS • COMMUNICATION UNITS • RANGE FILTERS • CONTROL PANELS • JACK BOXES • ANTENNA SWITCHES • MICROPHONES
VACUUM SWITCHES • FABRICATION OF ELECTRICAL CABLES • INTERFERENCE FILTERS • INSTALLATION ENGINEERING • HYDRAULIC AIRCRAFT UNITS

SPECIALIZED

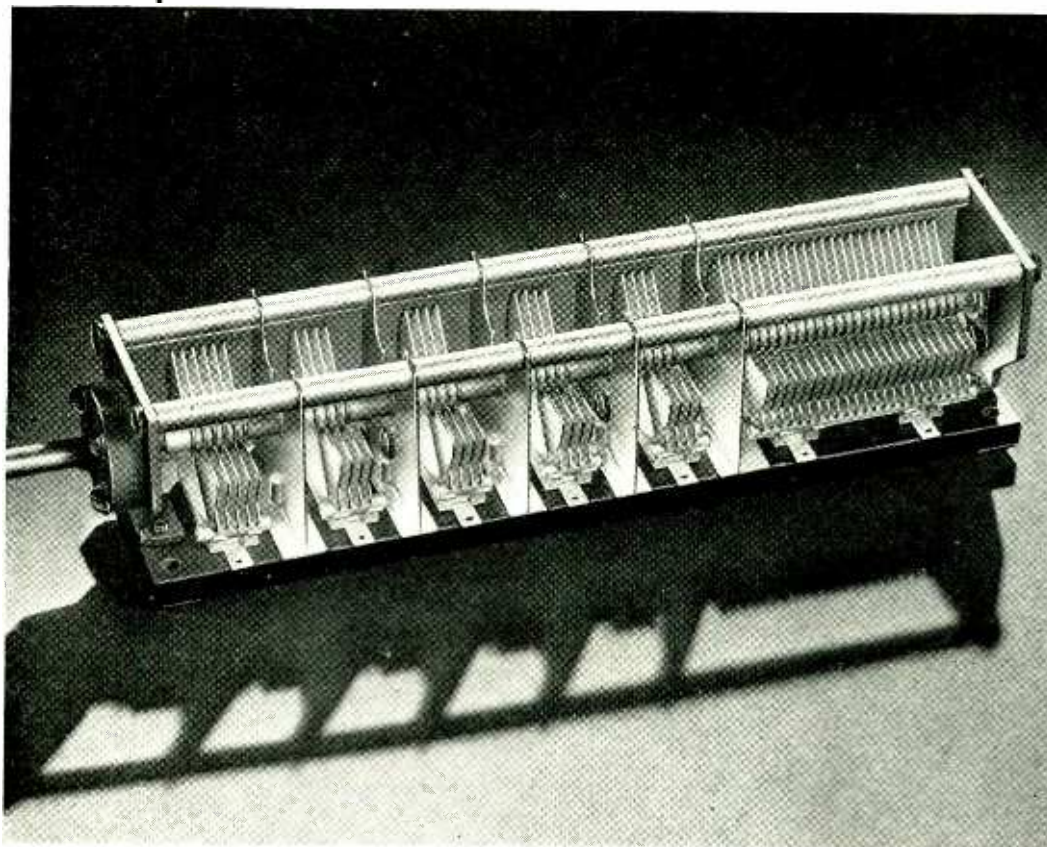

Example of highly specialized design

MYRIADS of ideas, gained through more than thirty years of creative engineering, have equipped Hammarlund to produce almost over-night, highly specialized designs to meet specific requirements of Army, Navy and Aviation radio equipment.

THE HAMMARLUND MANUFACTURING CO., INC.

424-438 West 33rd Street, New York, N. Y.

WHEN MINUTES COUNT

Catalin SAVES DAYS

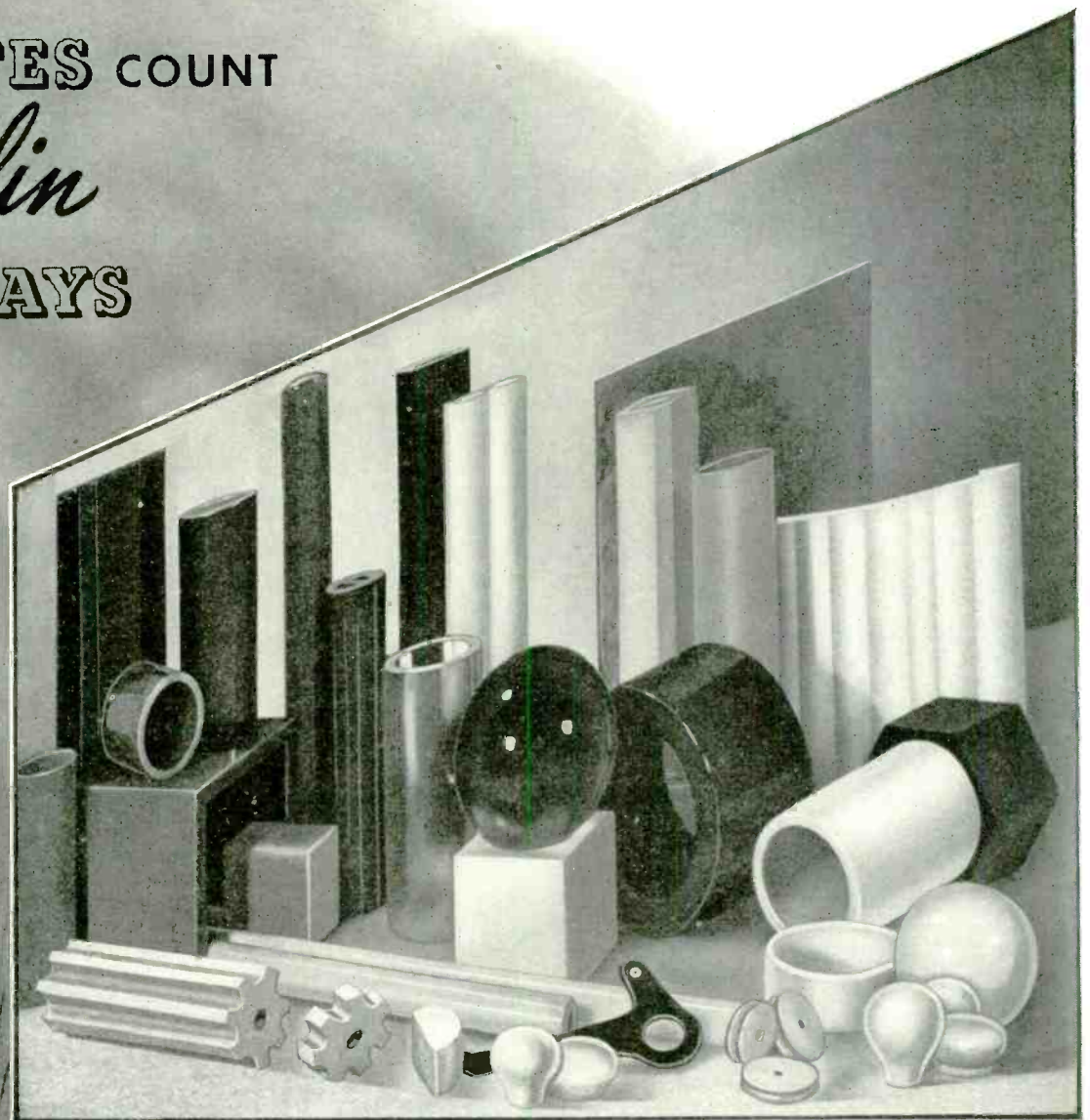

★ SHEETS ★ RODS ★

TUBES AND

LARGE CASTINGS

MANY an essential part is being turned out from stock Catalin!... On regular machine shop equipment!... At a tremendous saving in time! From the thousands of standard castings on hand, hundreds are being adapted to the imperative needs of the moment in order that days, and weeks of days be saved for production's gain. ★ As it saves... Catalin also serves! Its physical fitness has qualified it to don a uniform. It is strong, chemically resistant, non-inflammable and practically non-water-absorbent. ★ Even special shapes, regardless of size or thickness, can be tooled up for and cast in fractions of the starting time required for molding. Of all plastic materials, Catalin, therefore, offers most to those who are pressed to produce. ★ In addition, a well trained army of Catalin fabricators are in the field and ready to assist as sub-contractors to busy manufacturers. Therefore, whether your problem is one of materials or production, and if the effort is essential to national defense, contact Catalin!

CATALIN CORPORATION • ONE PARK AVENUE • NEW YORK, N. Y.

CAST PHENOLIC RESINS • POLYSTYRENE MOLDING COMPOUNDS
MELAMINE AND PHENOLIC LIQUID RESINS



New Booklet.. Manual E 3.. Yours for the Asking

A valuable source of Catalin information brought up to date in 64 pages... profusely illustrated. Outlines fabricating techniques and equipment, casting methods, arbors. Presents design data, cost analysis and physical property charts. Write for your copy today!



For
**HIGH FREQUENCIES,
 or HIGH VOLTAGES—**
HIGH
INSULATING QUALITY.

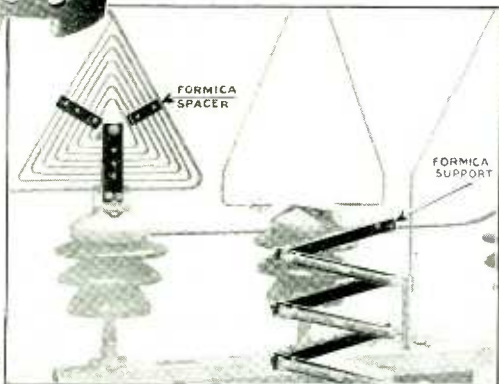

**MANY GRADES FOR
 VARIED REQUIREMENTS!**

AMONG the many grades of Formica, developed to meet the requirements of particular applications, there are varieties to meet a vast number of electrical needs. It is a material of first usefulness for heavy power circuits as well as for high frequency communication circuits.

The material maintains its dimensions under changes in humidity and temperature; it may be had with an unusually low power factor, or with high insulation resistance. There are many grades developed to provide maximum workability for mass production operations.

Sheets, tubes, and rods, and machined and molded parts are finding an ever increasing use in the work of the navy and signal corps, and aviation industry.

Let us send you the Formica data book which contains engineering test data on all the grades.

THE FORMICA INSULATION COMPANY
 4661 Spring Grove Ave., Cincinnati, Ohio

MOISTURE RESISTANT!

LOW POWER FACTOR!

**HIGH INSULATION
 RESISTANCE!**

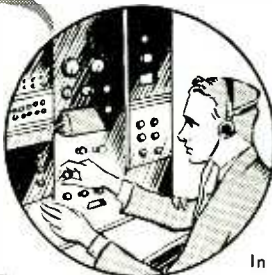

FORMICA

★ ★ ★ ★ ★ ★ ★ ★ ★ ★ ★ ★ ★ ★

Formica In DEFENSE!

In the vast production of communications equipment which is necessary for the navy, the army and the air corps Formica is being used in unparalleled quantity. Nearly 80 per cent of current output is for defense.

★ ★ ★ ★ ★ ★ ★ ★ ★ ★ ★ ★ ★ ★

FM JUMPS TO 50,000 WATTS

with GL-880's

ZENITH RADIO CORPORATION

PHONE
BRANDHIRE 7500

ZENITH
RADIO
8001 DICKENS AVENUE
CHICAGO, U.S.A.

CABLE ADDRESS
ZENITHRAD
ALL CODES

October 27, 1941

Mr. Earl Abbott
General Electric Company
840 South Canal Street
Chicago, Illinois

Dear Mr. Abbott:

We have been operating W51C Zenith's Frequency-Modulated Radio Station in Chicago and its predecessor W9XZR for almost two years. Early in October we raised the power of this station to fifty thousand watts in accordance with the terms of our Construction Permit.

The original installation was planned more than a year ago on the basis of ultimately using two GL-880's in the final stage. These plans were based on the fact that the 830's appeared to us to be the most efficient transmitting tubes for high power operation on the high frequencies. It seemed very evident to us at the time that these tubes would permit the best circuit design and should, therefore, be most practical in a high-power frequency-modulation transmitter. Even though these tubes had not been seen any commercial field service at the time of our original planning, we believed their use was logical and would represent a forward step.

We are glad to say that we have been very happy with their performance, and feel that we have without doubt made the correct choice. We have found them easy to drive, easy to neutralize, and have found no cooling problems. We believe we are going to receive excellent service from them.

Yours very truly,

ZENITH RADIO CORPORATION

G. E. Gustafson
J. E. BROWN
ENGINEERING DEPARTMENT

JEB:BG

THE WORLD'S LARGEST RADIO FACTORY ON ONE FLOOR

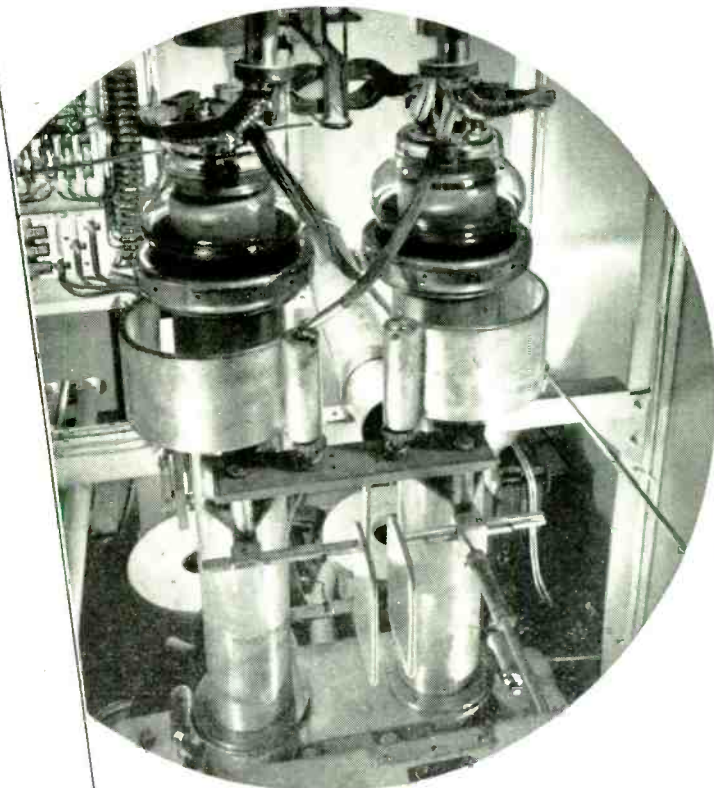

"the most efficient tubes ... for high frequencies"

The GL-880's ingenious "folded" anode reduces internal lead lengths by 10 inches without sacrificing cooling surface.

"easy to drive"

Two GL-880's with only 1500 watts driving power will deliver an easy 50 kw of FM at 50 mc.

"easy to neutralize"

Dual grid leads for separation of excitation and neutralization minimize neutralizing problems.

"no cooling problems"

Electric's complete line of top performers. Specify "G-E" on your next tube order, and measure the difference yourself. Ask your nearby G-E representative or dealer for your copy of our transmitting-tube bulletin (GEA-3315C), or write General Electric, Schenectady, N. Y.

(Left) G. E. Gustafson, Asst. Vice President in Charge of Engineering; (right) J. E. Brown, Executive Engineer

This tube, although developed primarily for FM and television, has unusual efficiency at international and standard broadcast frequencies, and as a modulator. A pair will give a 50-kw plate-modulated carrier at 25 mc!

The GL-880 is just one tube in General



FM Broadcast Transmitters
250 to 50,000 Watts



S-T Transmitters



Measuring & Testing
Equipment



Receivers for Home
and S-T Service



FM Police and Emergency
Transmitters and Receivers



Tubes

GENERAL ELECTRIC

IT'S AN *Electronic* WAR

ERIE RESISTOR COMPONENTS ARE HELPING
MAINTAIN DEPENDABLE COMMUNICATIONS
IN THE ARMED FORCES OF THIS COUNTRY...

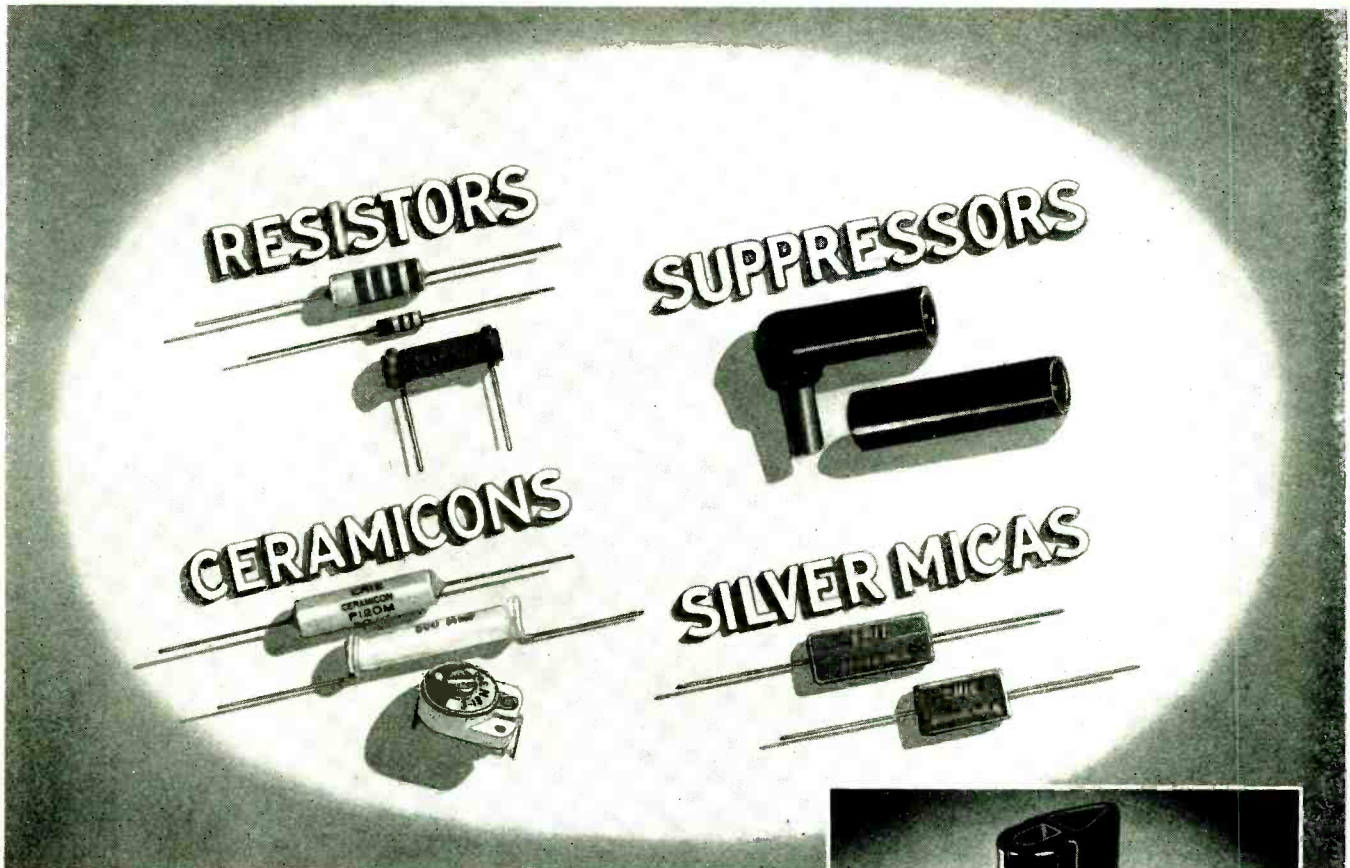

ELECTRONIC communications equipment is the nerve-center of our armed forces. Erie Resistor communications components, pictured above, are being used by both the U. S. Army and Navy and are providing the dependability required for these important services.

In the Erie Resistor Plastics Division, are high-speed, injection molding presses with capacities up to 16 oz. This equipment is capable of producing knobs, dials, handles, and other plastics parts, such as the large aircraft radio mast stanchion shown at the right, for military communications equipment.

Literature, giving complete engineering information on Erie Resistor products will be sent to radio engineers on request.



ERIE RESISTOR CORP., ERIE, PA. LONDON, ENGLAND · TORONTO, CANADA.

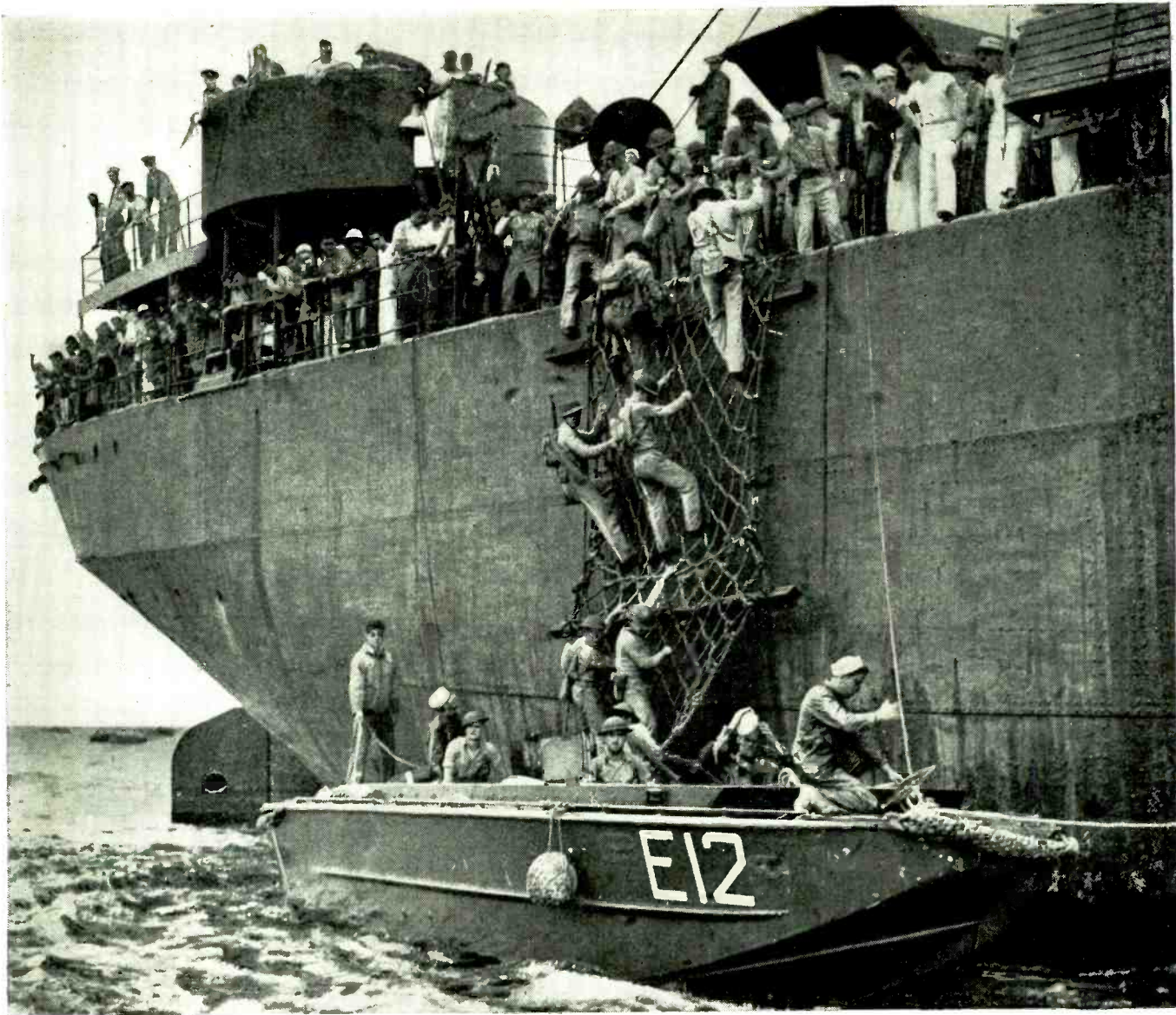

Serving with the Marines...

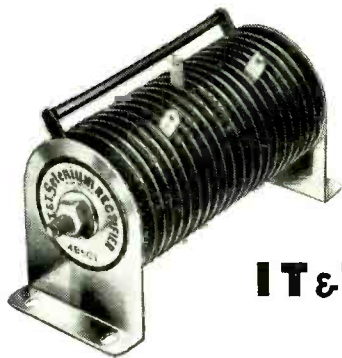

The Marines are landing and the situation is well in hand! And in the thick of things, wherever vital equipment requires direct current from an A.C. source, IT&T Selenium Rectifiers are on the job.

Vibration-proof... dust-proof... electrically and mechanically stable, the Selenium Rectifier has no moving parts to wear out or cause failure at crucial moments. Of particular importance to Marine equipment, the IT & T Selenium Rectifier can be supplied to resist moist, salt-laden air.

Consulting engineering services available for specific requirements. Address Rectifier Division for descriptive bulletins.

IT&T Selenium RECTIFIERS

International Telephone & Radio Manufacturing Corporation — 67 BROAD STREET, NEW YORK, N. Y.

ELECTRONICS — February 1942

11



WARD LEONARD CONTROLS

We are proud that Ward Leonard Controls developed during the past fifty years, now contribute their part in increasing safety, comfort and efficiency of our men in the service.

RHEOSTATS FOR SEARCH LIGHTS

The search-lights of tonight that can locate flying death in the heavens are far different equipment from the much publicized lights that guided gun fire on Admiral Dewey's ships. Improvements in search-lights during the past fifty years have been comparable with improvements in all

electrical equipment. It has been the privilege of the Ward Leonard organization to design and build most of the controls for search-lights through the entire development period. It is not surprising, therefore, that this invaluable experience should be enlisted by our government.

WARD LEONARD
RELAYS • RESISTORS • RHEOSTATS
Electric control  devices since 1892.

WARD LEONARD ELECTRIC COMPANY, 32 SOUTH STREET, MOUNT VERNON, NEW YORK

THE MOST WATCHED-FOR SHIP IN THE WORLD

depends upon **ALSiMag** insulation in its communications equipment



LONDON CALLING

 "When does the next Clipper leave Lisbon?"

WASHINGTON CALLING

 "Who was on yesterday's Clipper?"

HAVANA CALLING

 "Reserve four seats on the first Clipper"

BUENOS AIRES CALLING

 "Rush shipment by Clipper"

MIAMI CALLING

 "Decision awaits arrival of Clipper"

AT THIS VERY MINUTE in half a hundred far-flung countries, Pan American Clippers are helping to shape history. They carry the hopes of democracy everywhere that war permits. Upon their prompt arrival hinge decisions and events of world importance. Flying Clippers speed their vital cargo of men, mail, materials and merchandise along 86,893 miles of scheduled routes. Under wartime conditions, speed and certainty of communications is, more than ever, vital to this

far-flung network. Only the best in insulation will suffice. Every conceivable climatic condition is faced in Pan American Clippers linking the United States and Europe—binding Alaska, North and South America together—bringing the distant Orient, and Australasia within days of our shores. American Lava Corporation is proud that the performance of ALSiMAG has led it to be the preferred insulation in all communications equipment throughout the Pan American Airways System.

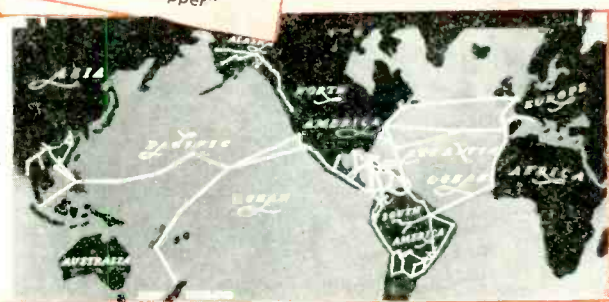

America's Merchant Marine of the Air is a **DAILY PROVING GROUND** for **ALSiMAG INSULATION**

CHICAGO - CLEVELAND - NEW YORK - ST. LOUIS - LOS ANGELES
 SAN FRANCISCO - BOSTON - PHILADELPHIA - WASHINGTON, D. C.

ALSiMAG FROM CERAMIC HEADQUARTERS
Trade Mark Reg. U. S. Pat. Off.
AMERICAN LAVA CORPORATION - CHATTANOOGA - TENNESSEE

HARDWICK, HINDLE PRODUCTS ARE SERVING WITH DISTINCTION

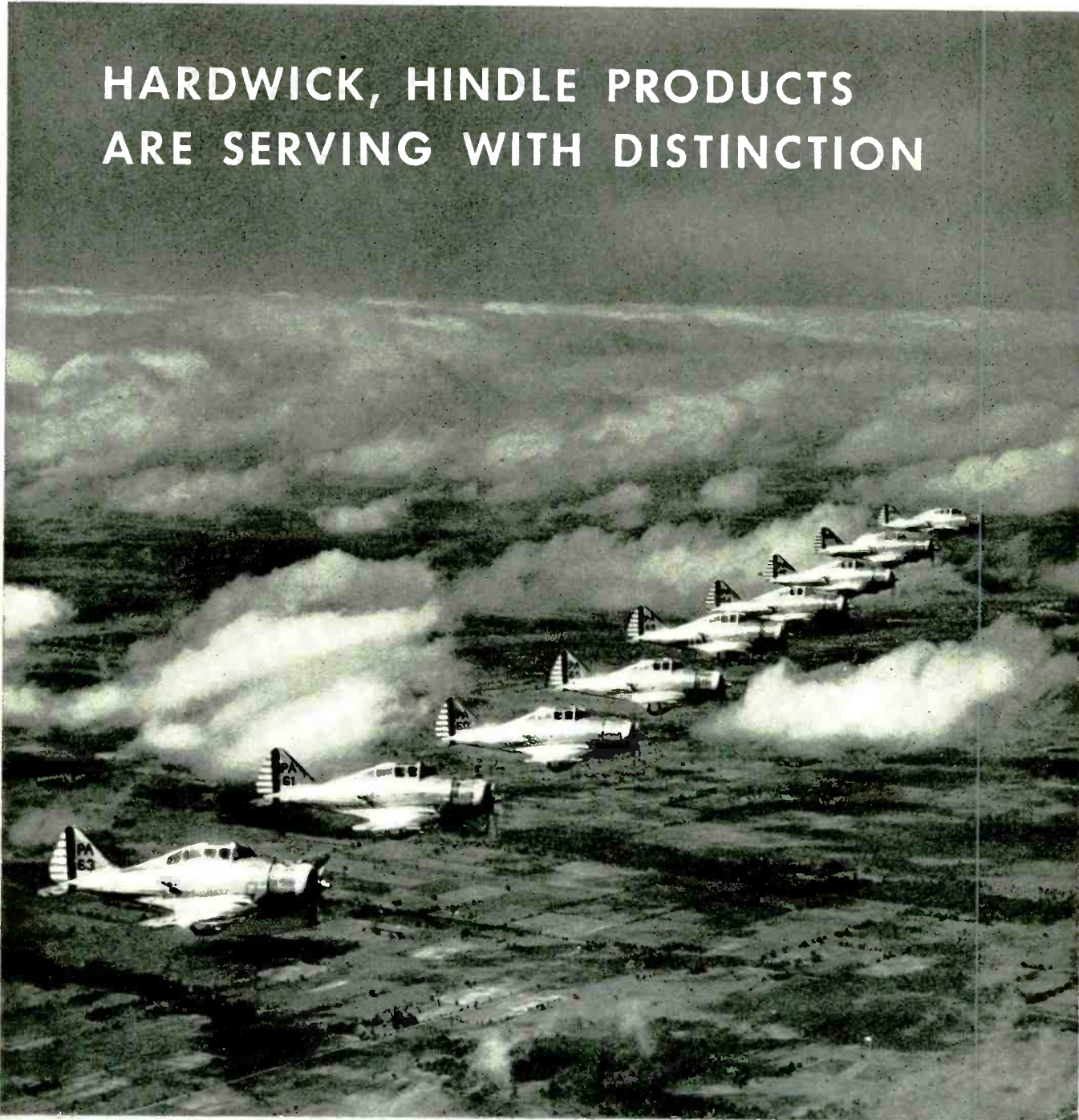

In planes, tanks, ships, mechanized
equipment, and in innumerable
other vital defense needs.



HARDWICK, HINDLE, Inc.
Newark, N. J., U. S. A.

Manufacturers of
RHEOSTATS and RESISTORS

THIS GIANT BASE INSULATOR SUPPORTS
ONE CORNER OF THE NEW WABC TOWER

**THE SERVICE RECORD
OF 21,000 COMPRESSION
CONES IS YOUR
MARGIN OF SAFETY
IN SPECIFYING "LAPP"
FOR ANTENNA
STRUCTURE INSULATORS**



SINCE Lapp engineers conceived the compression cone of electrical porcelain as the most suitable design for radio antenna structure insulators, more than 21,000 of these cones have gone into service. They range from tiny 3" cones for pipe masts to the large units shown above and recently installed in the new WABC transmitter. And, in the history of these insulators, covering more than 20 years, we have never heard of a tower failure due to failure of a Lapp porcelain part. This record, we submit, is adequate reason for confidence on your part as you specify "Lapp" for tower footing insulators. Lapp Insulator Co., Inc., LeRoy, New York.



Specify

LAPP

FOR SECURITY IN ANTENNA STRUCTURE INSULATORS



THE INSULATION FOR DEFENSE AND INDUSTRY



A vital component for defense and industrial use—TURBO is the efficient insulation for ultimate protection. Offering extreme resistance to oils, moisture and acids, TURBO Varnished Tubing and Saturated Sleeving is impervious to commonly encountered break-down influences. TURBO has the added feature and extra protection of inside impregnation, will bend and twist without cracking or splitting and is used extensively in transformers, motors, switchboards, generators and all vital elements in electrical apparatus for enduring dependability.

If you are feeling the pinch of rubber-covered conductor scarcity, let us tell you how Turbo Varnished Tubing or Sleeving can solve the problem.

WILLIAM BRAND & CO.
276 Fourth Ave., New York, N. Y.
325 W. Huron St., Chicago, Ill.

NOW . . .

TURBO *Glass*

VARNISHED TUBING

in complete range of A.S.T.M. standard sizes.
Send for sample strands and engineering data.
IN GLASS TUBING, TOO—IT'S THE VARNISH THAT COUNTS

**... resistant to
all commonly
encountered
break-down
influences**

Turbo

VARNISHED TUBING, SATURATED SLEEVING, CAMBRICS

“Consider a Capacitor’s Dependability”

THERE’S EXTRA DEPENDABILITY IN LONGER LASTING C-D CAPACITORS

Sound advice to engineers and purchasing agents is the capacitor recommendation of Canadian Colonial Airways. Consider dependability. You get *extra* dependability when you specify Cornell-Dubilier capacitors, because the broadest experience in the industry is behind them — more than 31 years of specialization in capacitor manufacturing.

Cornell-Dubilier superiority is hidden to the eye. But it’s there in the capacitor ingredients . . . in the quality of parts, in the skillfulness of fabrication — and it shows in service. So much so that Cornell-Dubilier capacitors are the unanimous choice today of America’s leading airlines for all aircraft and ground transmitting and receiving communications equipment. Whatever your capacitor requirements, it pays to specify C-Ds.

CANADIAN COLONIAL AIRWAYS inc.
COMMUNICATIONS DEPT.
EQUIPMENT CHART

PART	50515859806125019
BEACON RECEIVER	27105397
AUXILIARY RECEIVER	1009 1003 1076
COMP.	439 186 86
MA	
MICROPHONES	
HEADSETS	
AUXILIARY BATT	
LOOP	
LOOP AMPLI	
LOOP DRIV	
AZIMUT	

MICA • DYKANOL • PAPER • WET & DRY ELECTROLYTIC CAPACITORS

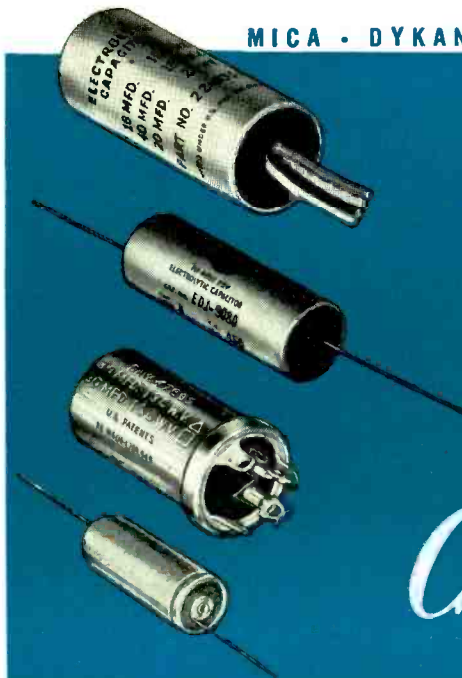

CAPACITORS MAY LOOK ALIKE BUT . . .

There is extra long life, extra uniformity and dependability built into C-Ds. Next time you specify capacitors look for the Cornell-Dubilier seal of experienced engineering. And get the hidden extras at no extra cost. Send for Catalog, Cornell-Dubilier Electric Corporation, 1012 Hamilton Blvd., South Plainfield, New Jersey.

Cornell Dubilier



SOUTH PLAINFIELD, N. J.

NEW BEDFORD, MASS.

. . . MORE IN USE TODAY THAN ANY OTHER MAKE . . .

AS THE BLUEPRINTS "PRESCRIBE"...

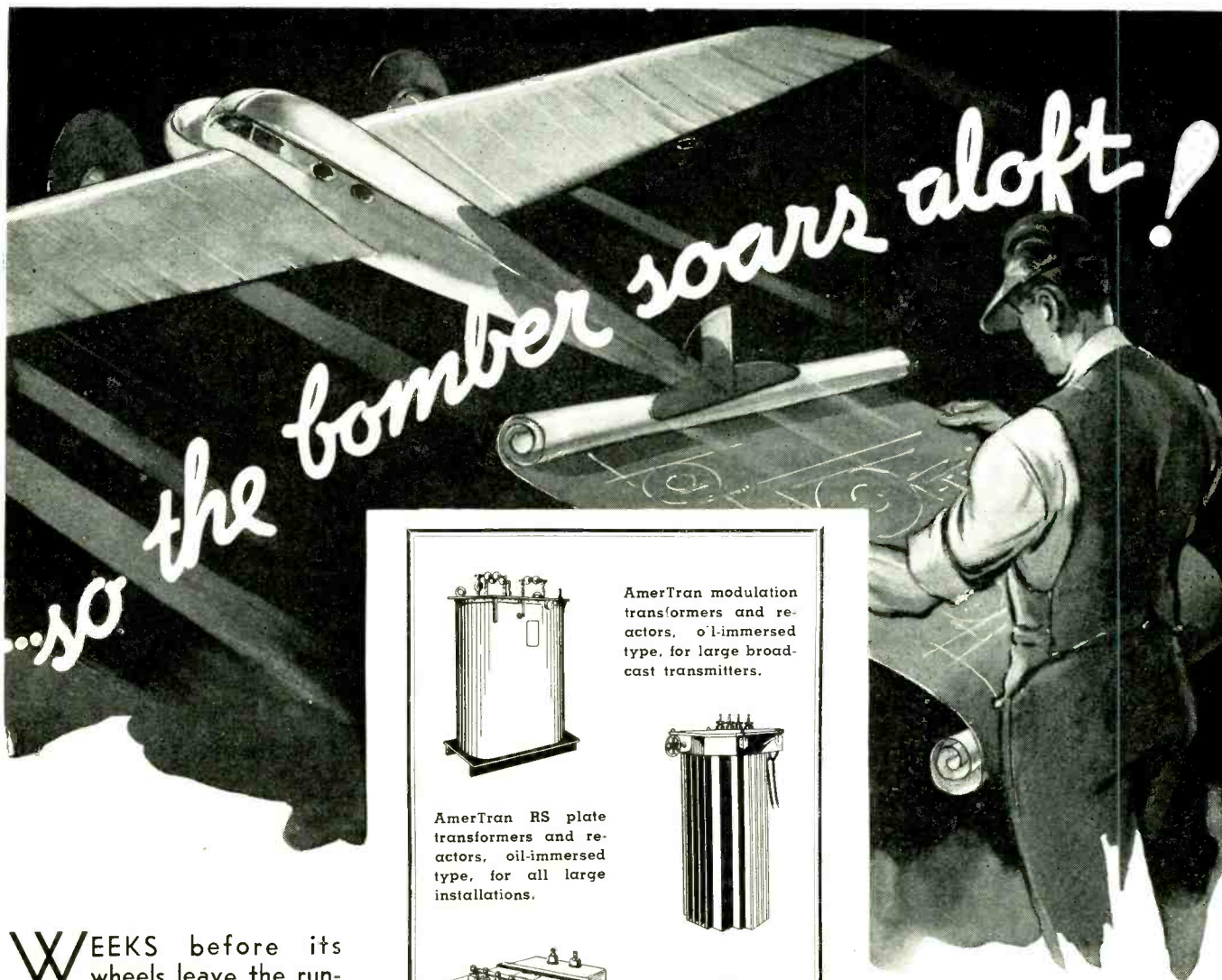

WEEKS before its wheels leave the runway, every detail of the modern bomber has been engineered to meet exact specifications, for the service it is to render. So, too, you can have TRANSFORMERS engineered, mechanically and electrically, to your specifications and your particular service requirements. To the production of transformers for the electronic field, AmerTran brings wide experience, complete facilities and a 40-year record of satisfactory

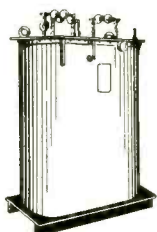

AmerTran RS plate transformers and reactors, oil-immersed type, for all large installations.



AmerTran W plate transformers and reactors for all small and medium installations.

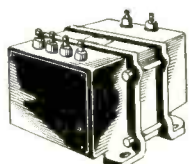

AmerTran modulation transformers and reactors, oil-immersed type, for large broadcast transmitters.



service rendered to broadcast stations, manufacturers and other users the country over. AmerTran transformers are available for every industrial, laboratory and electronic requirement in both large and small quantities. Let us quote on equipment for your needs.

AMERICAN TRANSFORMER CO., 178 Emmet St., Newark, N. J.

Manufactured Since 1901 at Newark, N. J.

AMERTRAN

Built to your Specifications

WHICH WOULD YOU HIRE FOR A STRONGER FASTENING?

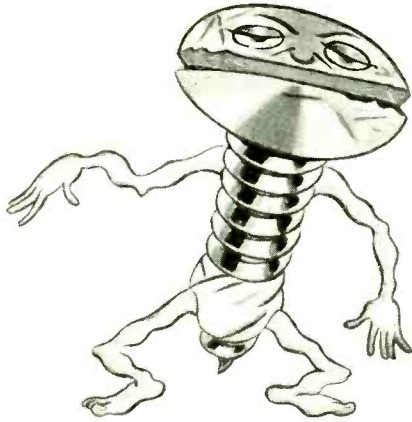

SHIMMYING SAM



OR SURE-FOOTED PHIL

We're afraid Shimmying Sam is losing his grip.

For a fastening that can remain firm and sure over a lifetime of vibration . . . the Phillips Recessed Head Screw is the one the electrical industry is picking . . . in increasing proportion.

The Phillips Screw gets in there and holds. Long after a hard-to-turn slotted screw would have made the operator quit, the Phillips

Screw is still easy to turn. Under conditions where a slotted screw might have split at the head, the Phillips Screw is still taking the driving pressure. Where a slotted screw would be showing torn-up metal, the Phillips recess is intact and clean.

And since Phillips Screws cost less to use (an average of 50% less), you can get this *better* fastening at a *saving!* Ask one of the firms listed below.

HERE'S WHERE THE SAVING COMES FROM...



TIME: Phillips Screws save *time* — electric and pneumatic drivers can be used more often

WORK: Phillips Screws save *work* — they cling to the driver's point, freeing one of the operator's hands to keep the parts from wobbling

ACCIDENTS: Phillips Screws save *accidents* — the tapered driver cannot slip from the tapered recess

SCREWS: Phillips Screws save *screws* — fewer screws or smaller sizes can often be used.

And the Phillips recess — familiar to car-owners — is a sign of a quality product.

*Get Tighter Assemblies...
Lower Assembly Cost with*

Phillips RECESSED HEAD Screws

WOOD SCREWS • MACHINE SCREWS • SHEET METAL SCREWS • STOVE BOLTS
SPECIAL THREAD-CUTTING SCREWS • SCREWS WITH LOCK WASHERS

U. S. Patents on Product and Methods Nos. 2,046,343; 2,046,837; 2,046,839; 2,046,840; 2,082,085; 2,084,078; 2,084,079; 2,090,338. Other Domestic and Foreign Patents Allowed and Pending.

Order stronger, cost-cutting Phillips from any of these sources



**19 SOURCES
of
SUPPLY**

American Screw Co., Providence, R. I.

The Bristol Co., Waterbury, Conn.

Central Screw Co., Chicago, Ill.

Chandler Products Corp., Cleveland, Ohio

Continental Screw Co., New Bedford, Mass.

The Corbin Screw Corp., New Britain, Conn.

International Screw Co., Detroit, Mich.

The Lamson & Sessions Co., Cleveland, Ohio

The National Screw & Mfg. Co., Cleveland, Ohio

Whitney Screw Corp., Nashua, N.H.

New England Screw Co., Keene, N.H.

The Charles Parker Co., Meriden, Conn.

Parker-Kalon Corp., New York, N.Y.

Pawtucket Screw Co., Pawtucket, R.I.

Pheoll Manufacturing Co., Chicago, Ill.

Russell, Burdall & Ward Bolt & Nut Co., Port Chester, N.Y.

Scovill Manufacturing Co., Waterbury, Conn.

Shakenroof Inc., Chicago, Ill.

The Southington Hardware Mfg. Co., Southington, Conn.

WHAT IS THE ARC-SUPPRESSION METHOD ?

WHAT IS THE CLOSED-CONTACT PRESSURE ?

WHAT IS THE ACTUATING METHOD ?

WHAT IS THE ACTION OF CONTACT... BUTTING... WIPING OR ROTARY ?

WHAT SEVERE ACTIONS MUST BE PLANNED FOR... MECHANICAL... GASEOUS CORROSIVE ?

WHAT IS THE ALLOWABLE TEMPERATURE-RISE ?

*See
Mallory
for
Contact-
Assemblies*

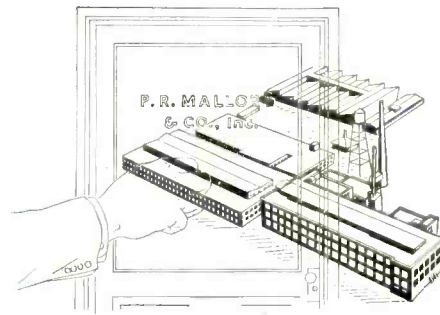

Tap Mallory Experience for the Complete Contact Assembly that "Blends with the Blueprint"

While you are seeking mechanical perfection in the design, make certain of the efficiency of the electrical contacts. Blend Mallory's contact experience with your blueprints.

Years of specialization in electrical contacts have made it apparent that often the selection of the right contact material, the proper contact design, furnish only partial answers to certain problems. Composition and design of contact members may be equally important in attaining adequate efficiency.

The result has been an added Mallory Service—the recommendation of complete contact assemblies. Through its staff of experienced metallurgists and design engineers, Mallory has found effective solutions for a host of contact problems. Mallory complete contact assemblies have given the answer time and again to greater electrical efficiency, and not infrequently, at a substantial reduction in production costs.

The Mallory representative will be glad to tell you the full story of contact assemblies.

Be Sure to Get Your Copy! Mallory Contact Catalog

Complete information on every phase of electrical contact selection, design and service. You need it for your technical library. Write today. No obligation.

P. R. MALLORY & CO., Inc.
INDIANAPOLIS INDIANA
Cable Address—PELMALLO



**ELECTRICAL CONTACTS AND CONTACT ASSEMBLIES
NON FERROUS ALLOYS, POWDERED METAL ALLOYS**



CROSS TALK

► **DRAFT** . . . At the IRE convention, January 12-14, several men expressed concern regarding the new age limits for selective service, and as to the attitude of the government regarding men with dependents or with responsible jobs. The following statement from Brig. Gen. Lewis B. Hershey, director of Selective Service, has been secured by *ELECTRONICS*; it contributes a clear-cut analysis of his attitude:

"Most of the actual combat fighting in this war will be done by young men. Modern warfare is of such a nature that it requires the greatest in physical stamina, coordination, and reflex action. Generally speaking, the fitness of men for modern combat service is in inverse ratio to their age.

"Under recent legislation, more than 26 million men between the ages of 20 and 44, inclusive, are liable for military service. There are an additional 13 million men 18 and 19 years of age, and 45 to 65 years of age, who are to be registered. This gives America a total manpower of some 41 millions of men who must do the tasks that are necessary in total war for total victory.

"Selective service in total war is not going to deviate from the fundamental principles which governed its operations during the peacetime training program. Men will continue to be deferred from military service when they have dependents. Men will continue to be deferred from military service when they are necessary men, and are difficult or impossible to replace.

"However" (and this is a most important point for our industry) "management and industry must recognize that the man who is deferred as a necessary man is deferred temporarily and each

employer has the responsibility to secure and train replacements for such deferred men who are physically fit and would otherwise be available for military service. Occupational deferments are usually for a 6-month period. Such deferment may be continued for additional 6-month periods, but only where their continuance in the present job is absolutely necessary for the maintenance of our national health, safety, and interest.

"There is an adequate supply of replacements for necessary men among those who are physically unfit for military service, those who are presently deferred because they have dependents, those who are above the ages liable for military service—45 to 65—and in many cases among the women of this country.

"Employers must be honest and sincere in their requests for deferments and must limit such requests to cases of men who are in fact necessary. No industry or activity, no matter how closely identified with national production for war, can ever become a refuge for those who seek to avoid their obligation to their country."

► **SECRECY** . . . All this secrecy business leads to unnecessary complications. A certain manufacturer of equipment wanted a tube of given characteristics. But because of the nature of the device he did not dare tell the tube manufacturer the purpose of the apparatus nor the frequency on which the tube was to operate. He, therefore, asked the tube manufacturer for all characteristics on all tubes so he could pick out what he wanted.

On the other hand, the tube manufacturer is making tubes of new types

with new characteristics which might fit into the picture very beautifully—but the tube maker dared not tell about these tubes.

There should be some central agency in which data on all new things could be pooled and to which all seekers of new devices or materials or tools could turn. Thus neither would have to reveal his "secrets" to any but the central agency which could act as clearing house.

► **FM** . . . Most encouraging is the rate at which f-m receivers are going into service; but somewhat discouraging is the tone fidelity standards of most of the receivers sold. It is obvious, of course, that cheap receivers cannot utilize the wide frequency band transmitted by fm and it is also obvious that most of the receivers sold will be in the inexpensive class. Until people are willing to spend their money for tone quality instead of for gadgets (like all-wave reception) they will get only part of the benefits of fm.

► **WHEW!** . . . Standardization in this country will receive a big boost as the result of the war. In 5 months beginning with the July issue, *ELECTRONICS* has published in its Tubes department data on 83 phototubes. Many of these have exactly similar electrical characteristics, the only difference being that some people want the upper left hand prong to be cathode, others want the cathode to come out somewhere else. Thus for every 4-prong phototube there are 12 possible variations which a manufacturer must list and stock as separate items. Some fun, eh boss?

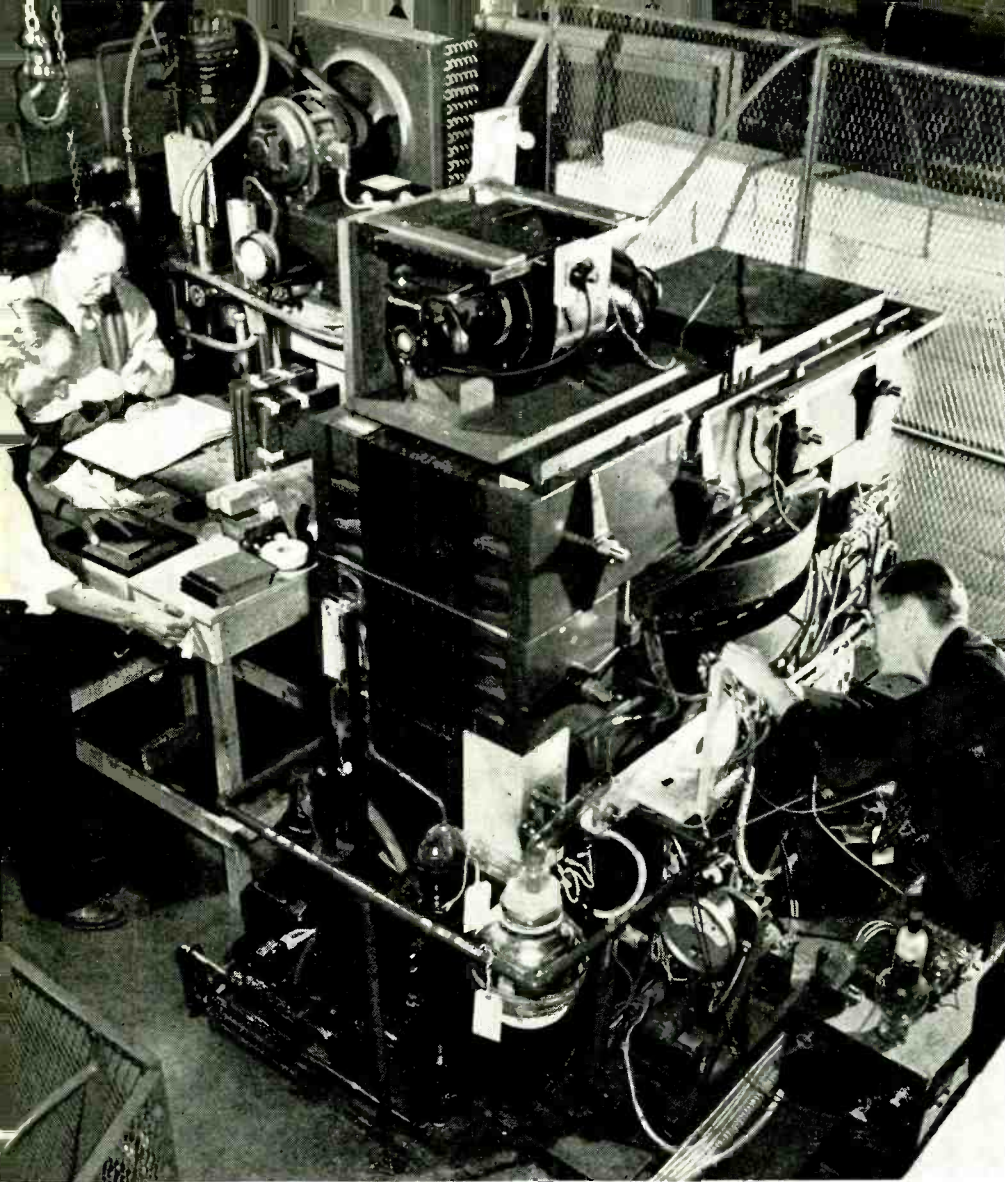

The RHEOTRON... a new electronic tool

already started work on a new rheotron still more powerful; this one will whirl electrons to an energy of 100 million volts. It will cost a quarter of a million dollars to build.

Though much more powerful than machines previously used to accelerate electrons to high speeds, the rheotron is a comparatively small device, the magnet of the 20 million volt machine being 5 feet long by 3 feet high and 2 feet wide. The machine weighs 4 tons. The pole pieces of the two electromagnets are 19 inches in diameter.

Between these pole pieces is a vac-

Over-all view of the electron accelerator showing the magnetic field structure and the pancake pole pieces between which the tube fits

ACCCELERATING electrons just as the cyclotron accelerates positive ions (although with a different mechanism) a new scientific tool known as the "rheotron" was announced by the General Electric Research Laboratory in the last few days of 1941. This new electronic device has the ability to speed up electrons to a point never before reached by man-made apparatus. It will give to these elementary particles energy corresponding to 20 million volts and it also produces x-rays corresponding to this voltage. Thus the machine will produce electron streams far more penetrating than electrons produced from radium.

This apparatus is the result of preliminary work done at the Uni-



A close-up of the rheotron with W. F. Westendorp of the G-E Research Laboratory making an adjustment

versity of Illinois by Dr. Donald W. Kerst who built a small model out of which has come the larger unit constructed in the Schenectady laboratories with the aid of G-E engineers and scientists. Dr. Kerst continues his work at the University of Illinois, and the G-E laboratories have

um tube containing a heated filament. The tube is doughnut in shape, about 2 inches thick, and is made of glass. It has an outside diameter of 19 inches and an inside diameter of 11 inches. Vacuum is maintained by means of pumps which are operated continuously.

Science secures a new device with which to batter down defenses, behind which the secrets of the ultimate nature of things still hide, in an instrument which will accelerate electrons to extremely high velocities

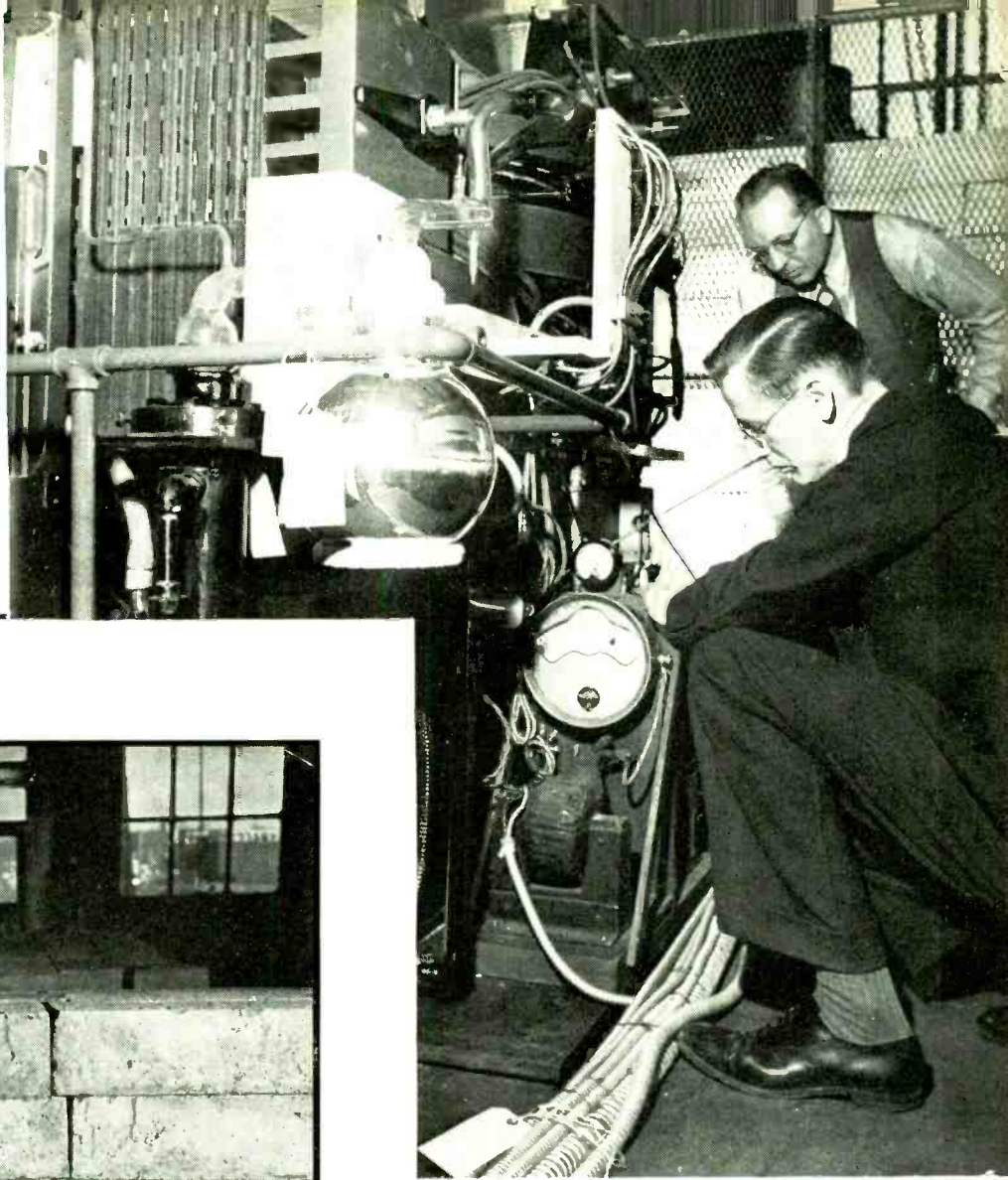

Another view of the rheotron showing accessory equipment. Dr. Kerst is in the immediate foreground

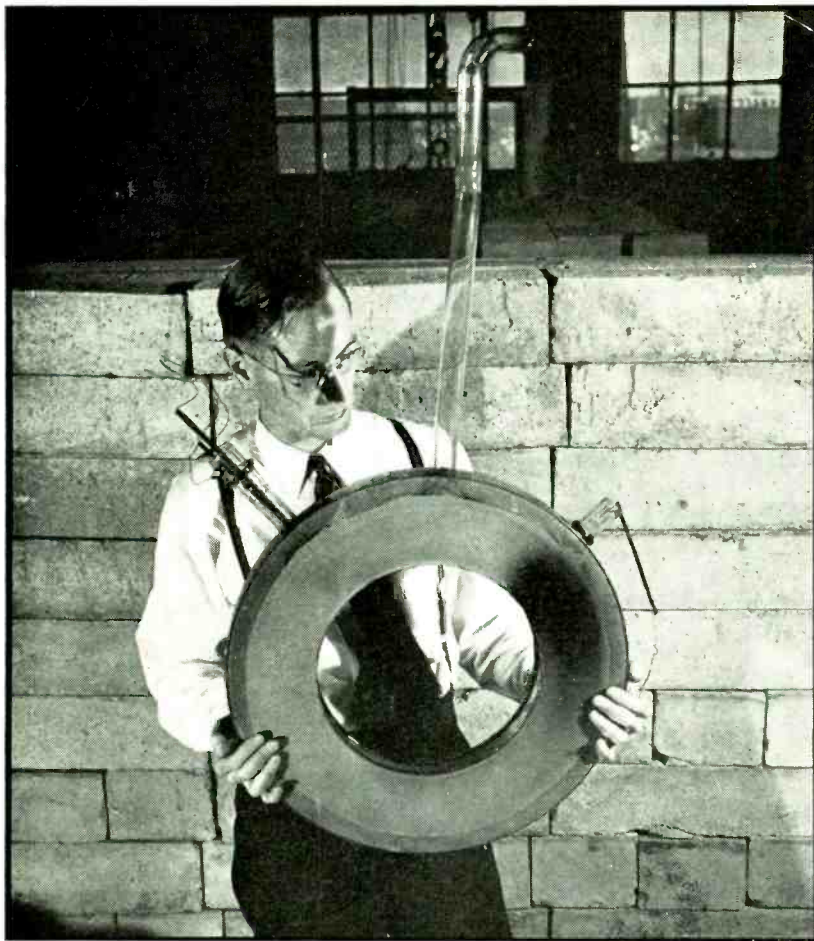

In the rheotron, electrons are accelerated in this doughnut-shaped glass vacuum tube held by Dr. Donald W. Kerst

The magnet assembly is made up of thin sheets of silicon steel instead of solid material since the field is produced by an alternating current instead of direct current as in the cyclotron.

Magnetically guided, each electron travels along a circular path for

about 400,000 revolutions, receiving as much as 70 volts push each time around, and traveling some 200 miles in a small fraction of a second to gain a speed within a tenth of one percent of that of light. By causing these electrons to collide with a metal target, x-radiation equal in intensity,

as determined by ionizing power, to the gamma radiation in a corresponding beam from more than 1000 grams of radium, more than the world's existing supply, can be produced by the machine.

Previous machines for accelerating electrons seem to have had a practical limit in power of about half the effective voltage of the rheotron which, apparently, has no such limit. With it electrons have been given sufficient speed to penetrate an inch of aluminum. They have made copper radioactive and other results will be described by Dr. Kerst in future publications.

Thus the rheotron seems to be a complement to the cyclotron, being able to accelerate electrons which the cyclotron cannot do.

AUTOMATIC RECORD

A survey of the many different types of automatic record changers which are sold in large quantities as integral parts of radio receivers. Among many purely mechanical problems to be solved by the radio industry, these ingenious instruments, catering to man's inherent laziness (sic), are outstanding examples

WHEN the phonograph was introduced to the public some 40 or 50 years ago it was considered a marvel of ingenuity. And indeed it was. However, the many developments of engineers have brought about a certain callousness to marvels in the American people. They now demand convenience with their marvels. The engineers have accepted this challenge by heaping marvel upon marvel. The phonograph is no exception. For many years there has been an insistent demand to remove the limitation of short playing time from the phonograph. Several workable systems have been developed including the continuous tape instrument and the 33½ rpm phonograph. These are very satisfactory for certain specialized uses such as broadcast and business conference applications. For the mass home market, however, reasons of economy and conditions of the

phonograph market rule them out. Because a tremendous library of conventional phonograph records has been built up over a period of years, and because the conventional record provides satisfactory service, it has been considered wiser to increase the convenience of its use rather than to introduce a radically new system of musical reproduction to the mass home market. Therefore, efforts to increase the playing time of phonographs have been concentrated upon changing the short-playing conventional record, 10 or 12 inches in diameter and operating at 78 rpm, so that one selection after another may be played without attention of any kind.

Problems of Design

The essential problem in the design of a record changer can be described in the following manner. When the playing of a record is finished, an-

other record must be placed in position and the pickup must be placed properly to play the new record. Like many other seemingly complicated problems, this one has a relatively simple solution. Judged by today's instruments the early record changers were very clumsy and complicated, but several years work has produced cleanly designed record changing instruments which might be classed as mechanical masterpieces.

Record changers are divided into two broad classes, the single-side players and the two-side players. The single-side players are further subdivided by different methods of supporting and feeding the records. The different types of changers in this group were developed by slightly different engineering approaches and also for reasons of economy. There are three record changers on the market, with different degrees of availability, which play both sides of a record before proceeding to play the next record. Here again different engineering approaches have produced radically different instruments. The newest one, that manufactured by RCA Manufacturing Co., uses a small diameter turntable, about the size of the label on the record, and plays first the top side and then the bottom side of the record by reversing the direction of rotation and using a double pickup mounted on one tone arm. The Garrard two-side player first plays one side of the record, then picks up the record, turns it over, and plays the other side. The Caphart two-side player also turns the record over after one side is played, but in a different manner. The records to be played are contained in a magazine which holds them in a nearly ver-



The RCA two-side playing automatic record changer uses a dual pickup, one unit for the top of the record and the other for the bottom. A small-diameter turntable permits the playing of the bottom side

CHANGERS

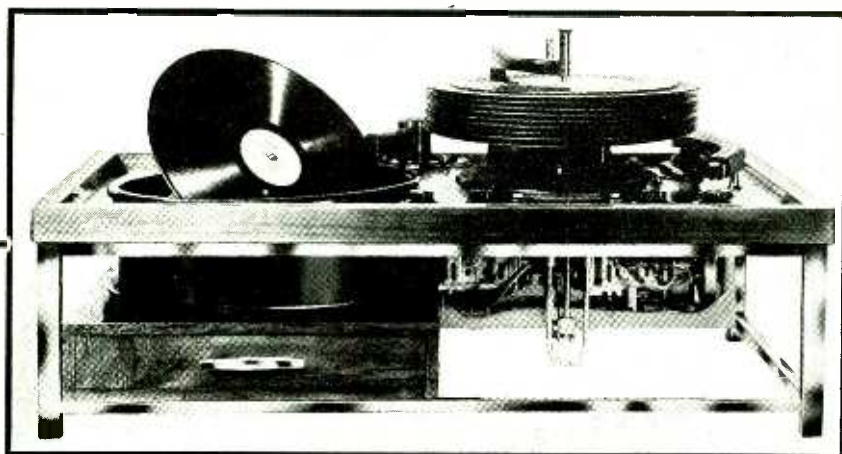

The Garrard two-side playing changer lifts the record off the turntable after one side is played, moves it over to the side, turns it over and returns it to the turntable for the other side to be played

tical position. As the first record is fed to the turntable, the magazine tilts to an almost horizontal position. At this point the record at what is then the bottom of the stack slides out onto the turntable. When the first selection is finished the record is picked up around its edges. It is brought to a vertical position, and a little beyond, when it is permitted to slide down to the turntable, this time with the other side up for playing. The action is very similar to that of a simple breakfast table toaster where the bread is placed horizontally on the open bracket of the toaster. The bracket is lifted to place the bread in a position beyond the vertical, that is, leaning toward the heating coil. When the bread is to be turned over the bracket is opened permitting the bread to slide out, bottom first, so that the untoasted side is up. Try it.

Single-Side Changers

The simplest method of operation for a single-side record changer is generally recognized to be that of stacking the records horizontally above the turntable and permitting the records to drop one by one to playing position. In fact, all record changers now on the American market use this method. The mechanical action of all such changers is fundamentally the same and can be reduced to a few simple operations which must be performed during

the change cycle. Assume in this description that the playing of a record has just been finished. The first operation necessary is to set the mechanism in motion. The time of starting the cycle is determined either by the position of the tone arm (carrying the pickup) or its motion in the eccentric groove which is provided in practically all modern records. The next requirement is to move the tone arm out of the way to permit the next record to drop into the playing position. This is separated into two distinct motions. The first is to lift the pickup off the record. This is done by a cam and lever mechanism. The second is to move the tone arm laterally out beyond the edge of the record stack. This is also performed by a cam and lever mechanism. Next, the new record must be dropped from the stack to playing position. Once again, a cam and lever mechanism comes into action. The methods of dropping the records and supporting them previous to playing are the points in which there is the greatest difference between manufacturers and will be discussed more fully later. After the new record is ready for playing, the tone arm must be positioned above the edge of the record and the pickup lowered onto the record. A slight sidewise pressure, generally from a light spring, must also be exerted to move the pickup into the first groove. The cycle is now completed



The record stack in the RCA changer is supported at one edge by the separator post and at the other by a stationary support

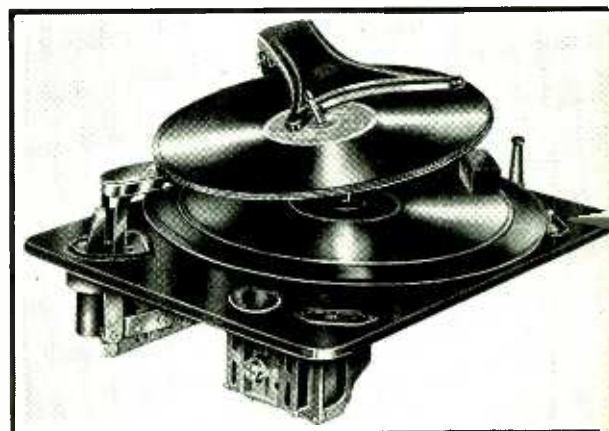

In the Garrard changer the record stack is supported at the edge by the separator post and at the center hole by an offset in the spindle



The bottom record is pushed off the two supporting areas by an arm in the separator post in this changer by General Instrument

In the Farnsworth changer the bottom is pushed back and forth until it rests on a pair of hooks which are removed simultaneously



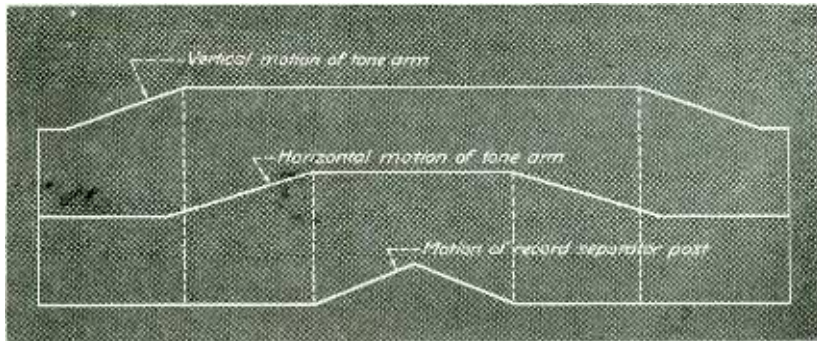

Timing diagram of the three fundamental operations which must be performed to place the new record in position and start playing it. These motions are controlled by the main cam which contains three cam surfaces

and the new record is ready to be played.

An analysis of these operations shows that it is necessary to provide several mechanical devices: A starting mechanism to engage a clutch which transfers power from the driving motor to the cycling mechanism. When the tone arm reaches the innermost part of the record groove or, as in several cases, as the tone arm is moving away from the center of the record in the eccentric groove, a pawl on an arm connected to the tone arm underneath the chassis engages a ratchet. The ratchet arm is then pushed so that it causes a clutch to engage so that the cycling mechanism is driven by the motor through the turntable and center spindle.

To perform the operations of lifting the pickup off the record at the start of the cycle and lower it again at the end of the cycle, to move the tone arm to the side and return it, and to operate the record dropping device, three cams together with suitable lever systems must be provided. The universal American practice is to combine these three cams and a driving gear on one wheel called the main cam and gear. Naturally these cams do not interfere with each other. Several typical examples of the main cam and gear are shown in the accompanying photograph. A timing chart is also shown to illustrate the sequence of operations. The tone arm must be completely out of the way before the record can be dropped into playing position. Therefore, the tone arm must be lifted vertically and moved laterally before the record dropping mechanism can be operated. Also, the tone arm cannot be moved back into place until the record is in position for playing. The cycling time is long enough (6

to 8 seconds) for these operations to be performed smoothly and without undue accelerations of any moving part.

Incidentally, the coordinating of the motions of the various members so that they do not interfere with each other is a very fascinating mechanical problem. At least one company designed its record changers entirely by graphical methods. All the design work was done on paper, frequently using drawings on transparent paper to determine the positions of one part relative to other moving parts at all times throughout the cycle.

Supporting the Records

Probably the greatest difference in the outward appearance of commercial record changers lies in the method of supporting the stack of unused records. In one type, the stack of records rests on two rotatable platforms located diametrically opposite each other. The center post or the spindle of the turntable acts merely as a guide in the center hole of the records. When the time comes to play a new record, the main cam below the chassis operates a lever mechanism which simultaneously removes the two rotatable platforms from under the stack of records and places between the bottom record and the one directly above it dull knife-edged platforms. After the bottom record drops to playing position, the rotatable platforms, together with the knife-edged platforms, return to their original positions and the stack of records is supported as before.

A modification of this method is



(Above) Typical cams used in automatic record changers. The main cam is the heart of the changer mechanism in that it controls all of the operations after it is started

(Right) Bottom view of the RCA changer. The tone arm is at the lower left corner. Note that the cam and cam follower shown control the motion of the record separator post. The other cams are on the top surface

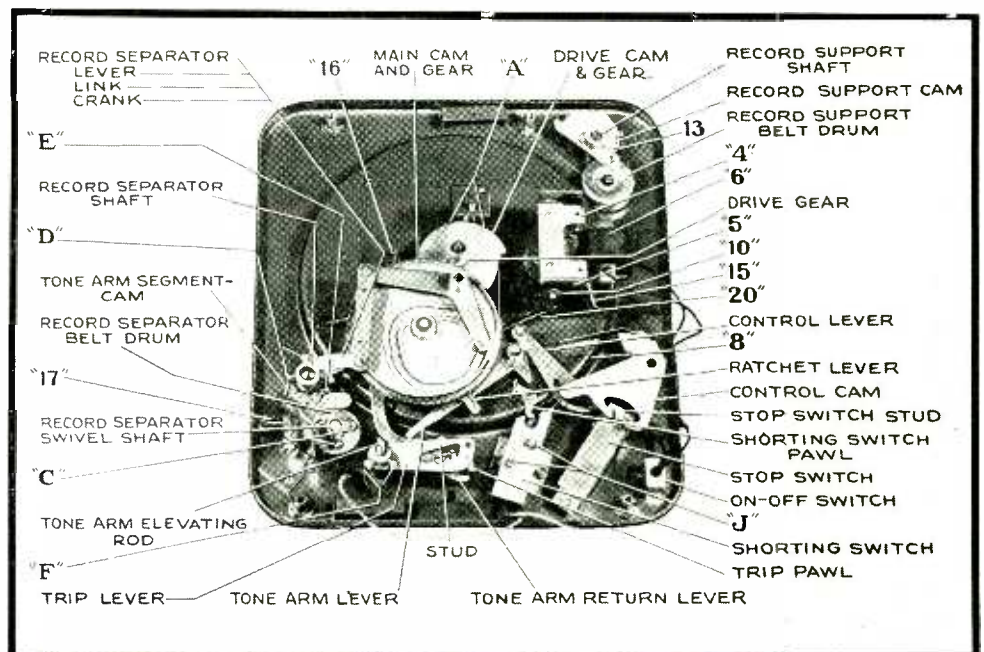

to eliminate one of the separator posts and replace it with a fixed platform. This works just as well and by eliminating a little complication produces a more reasonably priced instrument.

The other widely used method of supporting the record stack is to have one edge of the stack rest on a fixed platform and have the other point of support at the center hole. The spindle, rather than being a straight rod, is offset at the same level as the fixed platform at the edge of the stack to provide a small step on which the records rest. When a new record is desired, it is only necessary to have a small arm at the edge platform push the record a short distance so that it falls off the two platforms into playing position.

Another variation is to support the stack on two shelves diametrically opposite each other, but with a different method of dropping the record. The bottom record is first pushed, for instance, to the rear until its edge falls off the front shelf

onto what are called the "front hooks." Then the record is pushed to the front until it falls off the rear shelf and falls on to the "rear hooks." The center spindle is shaped so that the record may be moved forward and back at the level of the two shelves. When the record is resting on the front and rear hooks it is centered about the spindle. The hooks are then snapped from under the record which then falls to playing position. The remainder of the records in the stack rest on the front and rear shelves as before.

Provisions for Two Sizes of Records

Phonograph records are produced in two standard sizes, 10 inches and 12 inches in diameter, and automatic record changers must be made to accommodate both sizes. The great majority of changers will take a load of records of either size, but not both sizes and some few will take both sizes in a single load. The reason for this is that all popular music is recorded on 10-inch records

and practically all classical and symphonic music on 12-inch records, and it is seldom that people want to hear both types of music at one sitting. Thus, economics dictates the use of records of a single size in one loading.

Two changes are necessary in changing the size of records used. First the separator post or posts must be changed in location so as to be one inch further from the center of the turntable for the 12-inch records than for the 10-inch. This is done by twisting one of the posts about its axis to use another set of platforms set at a different distance to the center. The other post is simultaneously positioned, generally by means of a metallic belt running from the first post. Secondly, provision must be made to have the pickup come to rest at either of two points, depending on the size of record used. This is also taken care of when one of the separating posts is turned. The lateral motion of the tone arm is controlled or limited by

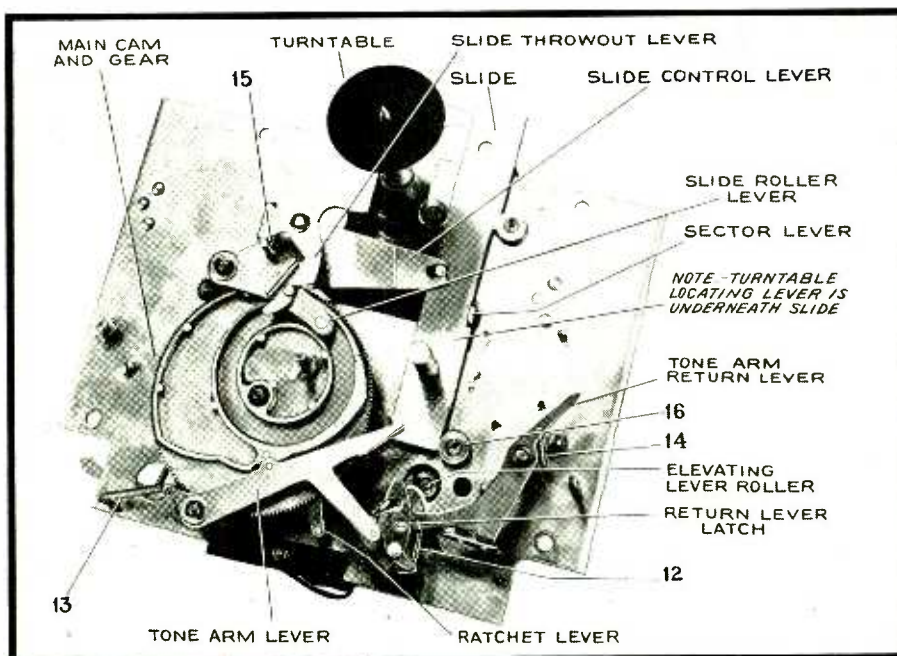
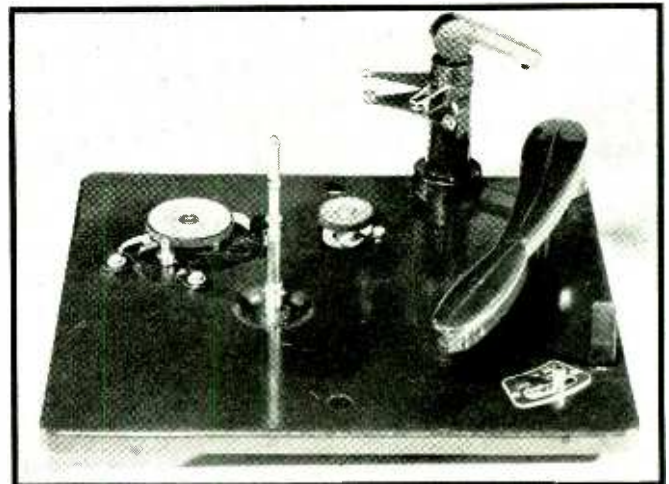
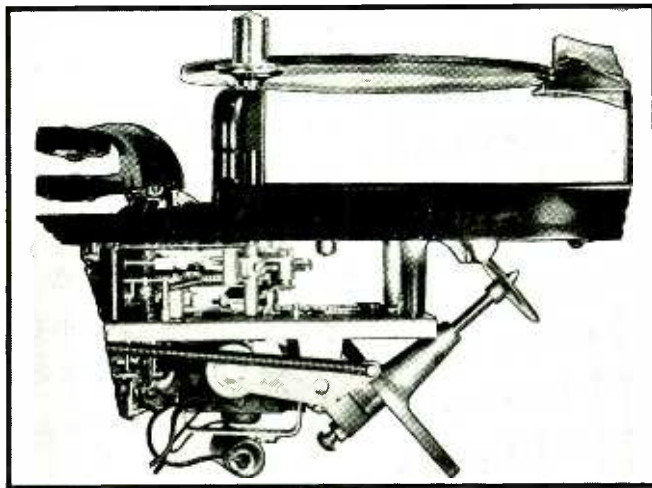

(Above) Here the turntable is removed from the General Instrument changer to show the method of driving the mechanism. The motor drives the turntable at the rim and during cycling the turntable drives the main cam

(Upper Left) Mechanism of the RCA two-side player with the turntable tilted to discharge the played record. The output of each pickup is adjusted by a trimmer condenser to equalize the volumes

(Left) Top view of the RCA two-side player showing the small turntable, main cam, and the slide bar which is used to control additional motions involved in playing both sides of the record

the action of a set of levers underneath the chassis. In at least one case, the cam follower for tone arm lateral motion is made to follow different paths over a dual cam for the two record sizes. When an intermixed stack is used, the 10-inch size will drop to the turntable and the pickup will be lowered at its edge. However, when a 12-inch record is dropped, it will move a small lever as it passes by. This lever is connected to another lever underneath the chassis which causes the pickup to be lowered at the edge of the larger record automatically.

Limitation of Number of Records

As the records are played and succeeding records placed on top of them, the angle of the reproducing stylus changes. There is a definite limitation to the change of this angle if good results are wanted. It is generally accepted that a good compromise between the stylus angle change and playing time is given by

a limit of about 12 10-inch records or 10 12-inch records. The 12-inch records are slightly thicker because greater strength is required. When the last record is played most changers repeat it until the instrument is turned off manually, but at least one is turned off automatically after the last record. This is just one of the many details required in this type of instrument if it is to fulfill its purpose of increasing the convenience of operating a phonograph.

Changers for Playing Both Sides of a Record

A record changer which plays both sides of a record can be considered almost the ultimate in convenience. There are now three such changers more or less available to the public. The Capehart two-side player has already been briefly described. The Garrard changer also turns the record over to play its other side, but uses a much different method of doing it. Here the records are stacked

in much the same manner as in the one-side players. The record is dropped onto the turntable and played in the normal manner. After it is played, however, it is lifted, by the edges, a short distance to clear the turntable and the center pin. An arm then swings in and extends an expandable pin through the center hole and carries it to the side and turns it over as shown in the photograph. The record is then returned to the turntable for further playing.

The RCA two-side automatic record changers uses the very simple idea of a small diameter turntable, large enough to provide plenty of driving power to the record and about the size of the record label, and playing the bottom side of the record with an additional pickup as well as playing the top side. After both sides are played the turntable is tilted to discharge the record into a storage space. This instrument, which at first glance looks extremely complicated, is the result of providing several additional simple operations in the mechanism. In addition to the main cam and gear, a slide bar is used to control some of the motions. There are two basic types of cycles performed in playing both sides of the record. One type, called an intermediate cycle, is to change from top side playing to bottom side playing and the other, called the main cycle, is to reject the record which is being played and place the next record in playing position.

Thus, when playing one side of each record it is necessary to have the main cam and gear rotate one revolution and the slide to move down and back once. This is the main cycle. When playing two sides, the cycle at the completion of the second side is also a main cycle. However, when the first side is completed the intermediate cycle, that of changing from the top side to the bottom side, takes place. This is performed by one revolution of the main cam and gear. The slide does not move during this cycle. The accompanying table shows the sequence of operations performed by both the main cam and gear and the slide. Incidentally, the design of this record changer justifies the use of separate motors for driving the turntable and for driving the cycling mechanism. Thus, each motor can be designed to do its particular job most efficiently.

—C.W.

Sequence of Motions of the RCA Two-Side Automatic Record Changer Controlled by the Main Cam and Gear and the Slide Bar

RATCHET LEVER CLOSSES CYCLE SWITCH

ACTIONS CONTROLLED BY MAIN CAM

Raise or lower pickup arm as necessary to bring it to neutral position

Close pickup shorting switch

Move pickup arm outward and latch it to pickup arm return lever

Latch reversing switch lever with its pawl

Reset ratchet lever

Move pickup arm in to 10 inch or 12 inch position (governed by position of record supports)

Rotate star wheel 90 degrees if control lever is in "two sides" position

Raise or lower pickup arm to playing position

Open cycling motor switch

Open pickup shorting switch

Unlatch pickup arm from return lever, feed-in spring pushes pickup into music groove

ACTIONS CONTROLLED BY SLIDE BAR

Tilt turntable slightly toward tone arm and return to level position

Tilt turntable down toward record magazine to discharge record

Unlatch reversing switch lever from its pawl

Rotate record separate posts and drop bottom record

Raise turntable, tilt it slightly toward tone arm to pick up record, return it to level position

Rotate record separator posts to original position

A Superheterodyne TRACKING SOLUTION

Combination of tuned amplifier and tuned oscillator in a superheterodyne circuit has always called for compromises in design. Here is a solution which includes the trimmer problem as encountered in receivers using permeability tuning

By RINALDO DE COLA

Belmont Radio Corp.

IT is well recognized that the analysis of the tracking problem involves the solution of a somewhat awkward cubic equation.¹ The final solution of this cubic leads to cumbersome design equations which, from the practical design standpoint, leave much to be desired. If certain basic considerations are recognized, however, the problem can be solved without the necessity of solving the cubic equation, which in itself saves much labor, but what is more important, the final design equations are much simpler, and consequently have considerably more practical utility.

Figure 1A shows a typical r-f circuit, where C_T is the r-f trimmer and C the main tuning condenser. Figure 1B shows the conventional oscillator circuit, where C_H is the shunt trimmer, C_S the series trimmer, and C the oscillator tuning condenser. For the moment both tuning condensers will be considered as being identical, although this is not a necessary condition. The only thing required to know about C is its minimum and maximum capacity. This information is supplied by the manufacturer of the gang condenser, or can be readily measured. The condensers C in Fig. 1 are assumed to vary from zero to maximum capacity. In other words the minimum capacity is considered to be part of the shunt trimmers in both the r-f and oscillator circuits.

¹ Terman, Radio Engineering, 2nd Ed.

Since a cubic equation is involved three solutions or tracking points at best can be obtained. Since three tracking points are involved, three equations can be written, representing the oscillator frequency at each of the three tracking points. Assume that when the oscillator frequency is f_1 , the capacity C becomes equal to a value C_1 . With the further rotation of the gang condenser the oscillator frequency and capacity C assume the successive values f_2 , C_2 , and f_3 , C_3 . The equations for the three oscillator frequencies become,

$$\frac{1}{L} \left[\frac{1}{C_1 + C_H} + \frac{1}{C_S} \right] = f_1^2 4\pi^2 \quad (1)$$

$$\frac{1}{L} \left[\frac{1}{C_2 + C_H} + \frac{1}{C_S} \right] = f_2^2 4\pi^2 \quad (2)$$

$$\frac{1}{L} \left[\frac{1}{C_3 + C_H} + \frac{1}{C_S} \right] = f_3^2 4\pi^2 \quad (3)$$

These can be re-written as follows,

$$\frac{1}{C_1 + C_H} + \frac{1}{C_S} - L 4\pi^2 f_1^2 = 0 \quad (4)$$

$$\frac{1}{C_2 + C_H} + \frac{1}{C_S} - L 4\pi^2 f_2^2 = 0 \quad (5)$$

$$\frac{1}{C_3 + C_H} + \frac{1}{C_S} - L 4\pi^2 f_3^2 = 0 \quad (6)$$

Into Eqs. (5) and (6) substitute the value of $1/C_S$ obtained from Eq. (4) and rearrange,

$$L + \left[\frac{1}{C_2 + C_H} - \frac{1}{C_1 + C_H} \right] \times \frac{1}{(f_1^2 - f_2^2) 4\pi^2} = 0 \quad (7)$$

$$L + \left[\frac{1}{C_3 + C_H} - \frac{1}{C_1 + C_H} \right] \times \frac{1}{(f_1^2 - f_3^2) 4\pi^2} = 0 \quad (8)$$

From Eqs. (7) and (8) eliminate L , and solve for C_H , the unknown oscillator shunt capacity,

$$C_H = \frac{C_2 \left[\frac{C_1 - C_3}{C_1 - C_2} \right] \left[\frac{f_1^2 - f_2^2}{f_1^2 - f_3^2} \right] - C_3}{1 - \left[\frac{C_1 - C_3}{C_1 - C_2} \right] \left[\frac{f_1^2 - f_2^2}{f_1^2 - f_3^2} \right]} \quad (9)$$

All the quantities involved in Eq. (9) are easily obtained from simple computations. The oscillator frequencies are obtained from the desired signal tracking frequencies and the intermediate frequency. Eq. (9) is legitimate whether the oscillator is operated above or below the signal frequency. The values for C_1 , C_2 and C_3 , are obtained from the r-f circuit of Fig. 1A, since if the two condensers for the r-f and oscillator are identical, the values of C_1 , C_2 and C_3 can be determined from the signal frequencies which correspond to the desired oscillator frequencies f_1 , f_2 and f_3 . A practical example of this operation will be given later in this paper.

Returning to Eqs. (4), (5) and (6), substitute the value of L from Eq. (4) into Eq. (5). (Substitution into (6) would be just as valid.)

$$\frac{1}{C_2 + C_H} - \frac{f_2^2}{f_1^2} \left[\frac{1}{C_1 + C_H} \right] + \frac{1}{C_S} \left[1 - \frac{f_2^2}{f_1^2} \right] = 0 \quad (10)$$

From which,

$$C_S = \frac{[C_2 + C_H] \left[\frac{f_2^2}{f_1^2} - 1 \right]}{1 - \frac{f_2^2}{f_1^2} \left[\frac{C_2 + C_H}{C_1 + C_H} \right]} \quad (11)$$

The required inductance L can now be determined from either Eq. (4), (5) or (6). From Eq. (4),

$$L = \frac{C_1 + C_S + C_H}{4\pi^2 f_1^2 C_S (C_1 + C_H)} \quad (12)$$

Equations (9), (11) and (12) yield all the necessary information for tracking the circuit of Fig. 1.

Before continuing with the analysis of other oscillator arrangements, it is perhaps best to give a practical example in the use of Eqs. (9), (11) and (12).

Assume the following conditions,

- (1) R-f range 530 to 1600 kc.
- (2) Gang maximum capacity (not including minimum) 482 $\mu\mu\text{f}$.
- (3) Gang minimum capacity 13 $\mu\mu\text{f}$.
- (4) R-f tuning range is 1600/530 or 3.02 = F.

The fixed capacity C_T , across the r-f condenser to cover the required range of 3.02 is, $C_{\text{max}}/(F^2 - 1) = 482/((3.02)^2 - 1) = 59.5 \mu\mu\text{f}$.

At 1600 kc, the required inductance L_n , for the r-f circuit can be computed from the known frequency (1600) and the known capacity C_T (59.5 $\mu\mu\text{f}$). The required inductance L_n , becomes 165 μh .

The total capacity, C_T , in the r-f circuit to tune to 1600 kc is 59.5 $\mu\mu\text{f}$.

The total capacity in the r-f circuit to tune to 1500 kc is $(1600/1500)^2 \times 59.5$ or 67.7 $\mu\mu\text{f}$.

The total capacity in the r-f circuit to tune to 1000 kc is $(1600/1000)^2 \times 59.5$ or 152.5 $\mu\mu\text{f}$.

The total capacity in the r-f circuit to tune to 600 kc is $(1600/600)^2 \times 59.5$ or 423 $\mu\mu\text{f}$.

The other conditions are: The intermediate frequency is to be 455 kc, the oscillator to operate above the signal frequency, and the tracking frequencies are 1500, 1000 and 600 kc.

Required C_1 for the oscillator at 1500 + 455 kc (f_1) is 67.7-59.5 = 8.2 $\mu\mu\text{f}$.

Required C_2 for the oscillator at 1000 + 455 kc (f_2) is 152.5-59.5 = 93 $\mu\mu\text{f}$.

Required C_3 for the oscillator at 600 + 455 kc (f_3) is 423-59.5 = 363.5 $\mu\mu\text{f}$.

Collecting the necessary information for the oscillator in order to substitute into Eqs. (9), (11) and (12),

$$\begin{aligned} C_1 &= 8.2 \mu\mu\text{f} & f_1 &= 1.955 \times 10^6 \\ C_2 &= 93.0 \mu\mu\text{f} & f_2 &= 1.455 \times 10^6 \\ C_3 &= 363.5 \mu\mu\text{f} & f_3 &= 1.055 \times 10^6 \\ f_1^2 &= 3.82 \times 10^{12} \\ f_2^2 &= 2.12 \times 10^{12} \\ f_3^2 &= 1.11 \times 10^{12} \end{aligned}$$

Substituting into Equation (9),

$$C_H = \frac{92.5 \left[\frac{8.2 - 363.5}{8.2 - 93.0} \right] \left[\frac{3.82 - 2.12}{3.82 - 1.11} \right] - 363.5}{1 - \left[\frac{8.2 - 363.5}{8.2 - 93.0} \right] \left[\frac{3.82 - 2.12}{3.82 - 1.11} \right]} = 71.2 \mu\mu\text{f}$$

As stated previously, C_H is the total shunt capacity across C , and of course includes the minimum of the gang section, incidental stray capacities, and the necessary trimmer to bring the value of C_H to the required value.

By substitution into Eq. (11),

$$C_S = \frac{[93.0 + 71.2] \left[\frac{2.12}{3.82} - 1 \right]}{1 - \frac{2.12}{3.82} \left[\frac{93.0 + 71.2}{8.2 + 71.2} \right]} = 503 \mu\mu\text{f}$$

This is the required series capacity. Substitution into Eq. (12)

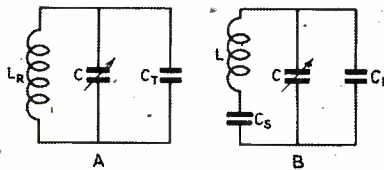

Fig. 1 — Oscillator with shunt trimmer across tuning condenser

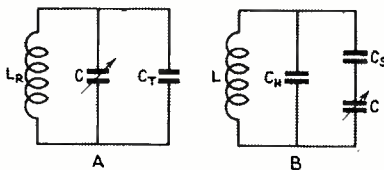

Fig. 2 — Variation with shunt trimmer across the inductance

$$L = \frac{(8.2 + 503 + 71.2) \times 10^{12}}{4\pi^2 \times 3.82 \times 10^{12} \times 503 \times 10^{-12}} \times \frac{1}{(9.2 + 71.2) \times 10^{-12}} = 96.5 \mu\text{h}$$

which is the required inductance.

To make sure that no errors have been made in the computations, the values of C_H , C_S , L , and corresponding values of C and f should be substituted into Eqs. (1), (2) and (3) and checked for accuracy.

Equations for Alternative Condenser-tuned Circuit

The alternative circuit is shown in Fig. 2. It is the same as the circuit of Fig. 1B except that the oscillator trimmer capacity C_H is shunted across the inductance L in-

stead of the tuning capacity C . The analysis is similar to that for Fig. 1B and yields the following tracking equations.

For the series condenser,

$$C_S = \frac{\left[\frac{1 - f_1^2/f_2^2}{1 - f_1^2/f_3^2} \right] \left[\frac{C_3 - C_1}{C_2 - C_1} \right] C_2 - C_3}{1 - \left[\frac{C_3 - C_1}{C_2 - C_1} \right] \left[\frac{1 - f_1^2/f_2^2}{1 - f_1^2/f_3^2} \right]} \quad (13)$$

For the shunt capacity,

$$C_H = \frac{\left[\frac{C_1 C_S}{C_1 + C_S} \right] \frac{f_1^2}{f_2^2} - \left[\frac{C_2 C_S}{C_2 + C_S} \right]}{\left[1 - \frac{f_1^2}{f_2^2} \right]} \quad (14)$$

And for the inductance,

$$L = \frac{1}{4\pi^2 f_1^2 \left[C_H + \frac{C_1 C_S}{C_1 + C_S} \right]} \quad (15)$$

The constants in Eqs. (13), (14) and (15) are similar to those in Eqs. (9), (11) and (12), with the important exception that the corresponding values of C (C_1 , C_2 and C_3), should be assigned their absolute values and not the differential values. This is obvious from an examination of Fig. 2B. To illustrate this point, refer to the previous example for the value of C_1 . This is given as 8.2 $\mu\mu\text{f}$, for 1955 kc. The minimum capacity of C is 13 $\mu\mu\text{f}$. Then the absolute value of C_1 would become 21.2 $\mu\mu\text{f}$. This same technique will of course apply also for the determination of the values C_2 and C_3 .

Conditions for Permeability-tuned Systems

The solution for inductively-tuned systems involves the same general solution as the condenser-tuned systems. Three real solutions are possible. The permeability-tuned circuits of Fig. 3 and 4 are analyzed in the same fashion as for the two condenser tuned systems.

The design equations for Fig. 3 become, for the series inductance,

$$L_S = \frac{L_2 \left[\frac{L_1 - L_3}{L_1 - L_2} \right] \left[\frac{f_1^2 - f_2^2}{f_1^2 - f_3^2} \right] - L_3}{1 - \left[\frac{L_1 - L_3}{L_1 - L_2} \right] \left[\frac{f_1^2 - f_2^2}{f_1^2 - f_3^2} \right]} \quad (16)$$

for the shunt inductance,

$$L_H = \frac{[L_2 + L_S] \left[\frac{f_2^2}{f_1^2} - 1 \right]}{1 - \frac{f_2^2}{f_1^2} \left[\frac{L_2 + L_S}{L_1 + L_S} \right]} \quad (17)$$

and for the capacity,

(Continued on page 91)

I. R. E. CONVENTION

Outlines Radio's Expanding Role

First I.R.E. Convention to be held during war times places heavy emphasis on the importance of communications in winning the war. Fewer papers presented because of needs of military secrecy, but record attendance is achieved. Unity with South America stressed. Session for college students new innovation. A. Hoyt Taylor awarded Medal of Honor for developments in short wave communication

IN spite of severe handicaps and limitations imposed directly or indirectly by this country's recent entry into the war, the winter convention of the Institute of Radio Engineers held at the Hotel Commodore in New York on Jan. 12-14, inclusive was outstanding in many respects. Particularly encouraging was the fact that the total registration of 1,582 exceeded, by a small margin, that of previous conventions, but the unregistered attendance at the last technical session on Wednesday evening brought the attendance to an all time high of 1,770.

Throughout the convention evidence of war activities was apparent by the large number of engineers appearing in uniforms of the various services, by restrictions imposed on certain types of technical discussions, and by cancellations of trips which had long been planned. The total number of papers given was smaller than those that are customary for I.R.E. conventions, but some compensation was achieved by permitting each author to speak for a longer time than had been customary. Consequently, while fewer topics could be covered, those which were discussed were more thoroughly treated than normally.

Highlight of the convention was the banquet on Wednesday night, which not only celebrated the induction of Arthur Van Dyck into office as president of the Institute for 1942, but also celebrated the Institute's 30th birthday.

At the banquet, remarks by

Adolfo T. Cosentino, director of communications of the Argentine and retiring vice president, were broadcast by shortwave radio to South America, thereby tending to further cement the relations between the two continents. Mr. Don Francisco, director of communications, office of the Coordinator of the International American Affairs spoke on "Radio's Expanding Role in International Affairs" outlining the important progress radio communica-

tion and radio engineering were playing in modern civilization. The Medal of Honor of the Institute was awarded to Dr. A. Hoyt Taylor, research director of the Naval Research Laboratory for his pioneering work in the investigation of high frequency wave propagation, the application of piezoelectric crystal control to practical high frequency transmitters, and his executive ability in administrating the research activities of the Naval Research



Arthur F. Van Dyck, president of the Institute of Radio Engineers for 1942 presents the Institute's Medal of Honor to Dr. Albert Hoyt Taylor, Director of the Naval Research Laboratories, in recognition of his pioneering work in high frequency communication and the practical application of piezoelectric frequency stabilizers to high power radio transmitters

Laboratories. Finally, the awards of Fellow grade of members were made to the following men: W. L. Barrow, George H. Brown, Geoffrey Builder, Adolf B. Chamberlain, Ellsworth D. Cook, Hugh S. Knowles, Warren P. Mason, Harold O. Peterson, and George C. Southworth.

Under the able leadership of I. S. Coggeshall, convention chairman, efforts were made by engineers residing in New York, to make out-of-town visitors as welcome as possible. To this end "Dutch treat" luncheons were organized in which various well-known New York engineers made a point to have noon-day luncheons with four to six out-of-town members for the express purpose of exchanging ideas and becoming better acquainted. Another innovation at this convention was a session on Wednesday morning, particularly set aside for students "within thumbing distance" of New York. A program of three tutorial papers was prepared for the students and they took an active part in the get-together luncheon.

Some fifteen or eighteen manufacturers took exhibition booths and brought to the attention of engineers some of their most recent activities. In a number of cases it was impossible to make the usual commercial contacts because the manufacturing facilities of the exhibitors are already so thoroughly taxed that no activities outside of national defense could be considered. In a number of cases the exhibitors even found it impossible to maintain a staff of engineers at their booths throughout the entire convention.

War Activities, the Keynote

After the registration on Monday morning, I. S. Coggeshall, convention committee chairman, struck the keynote of the convention by pointing out the fact that the character of the program was determined to a large extent by present war conditions. Following Mr. Coggeshall, Professor F. Terman, president of the Institute for 1941, delivered the message of the retiring president. Dr. Terman outlined in considerable detail, and with extreme frankness, a number of changes which have taken place in Institute policies and activities during his regime. Undoubtedly a considerable amount of credit is due to Professor Terman for the new ideas he brought to the

presidency and the enthusiasm and tenacity with which many of the ideas were produced. But equal, or perhaps even greater credit, is deserved by those who helped carry out the policies and did much of the routine labor required for their execution.

In taking over the presidency of the Institute for 1942, A. F. Van Dyck recognized the seriousness of the problems facing the Institute for the coming year but refrained from making any wild predictions as to anticipated achievements of his administration.

Highlights of the morning opening session was a paper read by Frank B. Jewett, president of the National Academy of Sciences and member of the National Defense Research Committee of the Office of Scientific Research and Development. Dr. Jewett spoke on "The Mobilization of Science with Special Reference to Communication", and gave a thorough outline of the manner in which the research and engineering talents of the country had been mobilized for purposes of national defense and victory. In his address Dr. Jewett showed that although the National Academy of Sciences had been in existence since the time of the Civil War for the specific purpose of providing an organization to which the United States Government might go for scientific information and research in its relation to national welfare, the existing mechanism was such that the initiative had to be made by the United States Government rather than by the National Academy of Sciences who would frequently be in the better position to make suitable recommendations. About two years ago the National Defense Research Committee was organized and later the Office of Scientific Research and Development, both of which are mobilizing the scientists and engineers of the country for the active participation in this country's war efforts.

Six Months of Commercial Television

Commercial operation of television since July 1, 1941, was analyzed in an exceptionally good paper by Noran E. Kersta of the National Broadcasting Co. At the present time about 22 percent of the population of this country are receiving some kind of television service. As an aid in

demonstrating the penetration of television service into the population, the speaker made use of a population distorted map in which the size of each state was proportional to its population. Thus, the importance of transmitters in large population centers such as New York, Philadelphia, Chicago and Los Angeles was properly considered. Figures were shown to indicate that relayed programs had a quality very close to locally produced programs as far as listener acceptance is concerned.

Advertising over television stations has reached such proportions

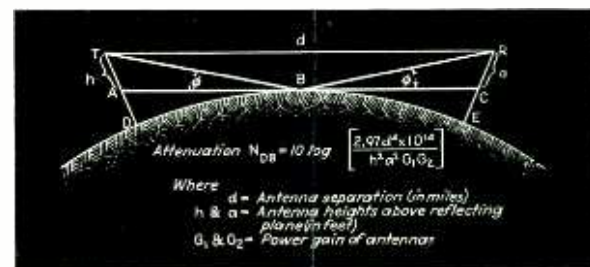

Fig. 1—Attenuation of short waves generated at the transmitting antenna, T, and picked up at the receiving antenna, R, when the transmission path is over reflecting surface of the earth

that at the present time ten percent of the total time on the air of WNBT is being used by advertisers. Also, the results are such that the cost per new customer compares favorably with other forms of advertising.

"Automatic Radio Relay Systems for Frequencies Above 500 Megacycles" was the title of a paper delivered by J. E. Smith of RCA Communications. The discussion had special reference to television relay systems and the relay setup between Camp Upton on Long Island and New York City was described in some detail. Several relay stations are used here with little degradation in the quality of the signal. Wave propagation as applied to the transmission of 500-Mc signals over a reflecting surface, such as the earth, was discussed and the illustration of Fig. 1 shows a typical arrangement of transmitting and receiving antennas with respect to the earth's surface together with the formula for attenuation over such a path. It was stated that atmospheric noises in this part of the spectrum do not interfere to any considerable degree with the signal, but that thermal noise in the circuits and fluctuation noises do cause interference. In this type of service the speaker said that

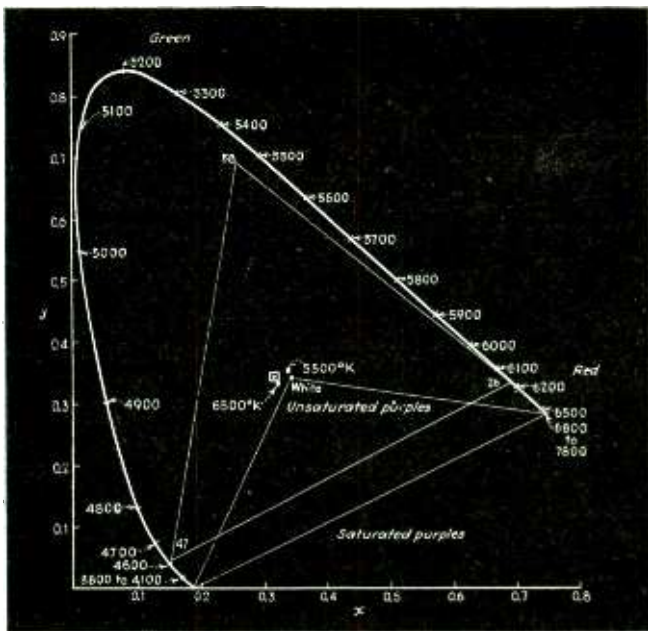
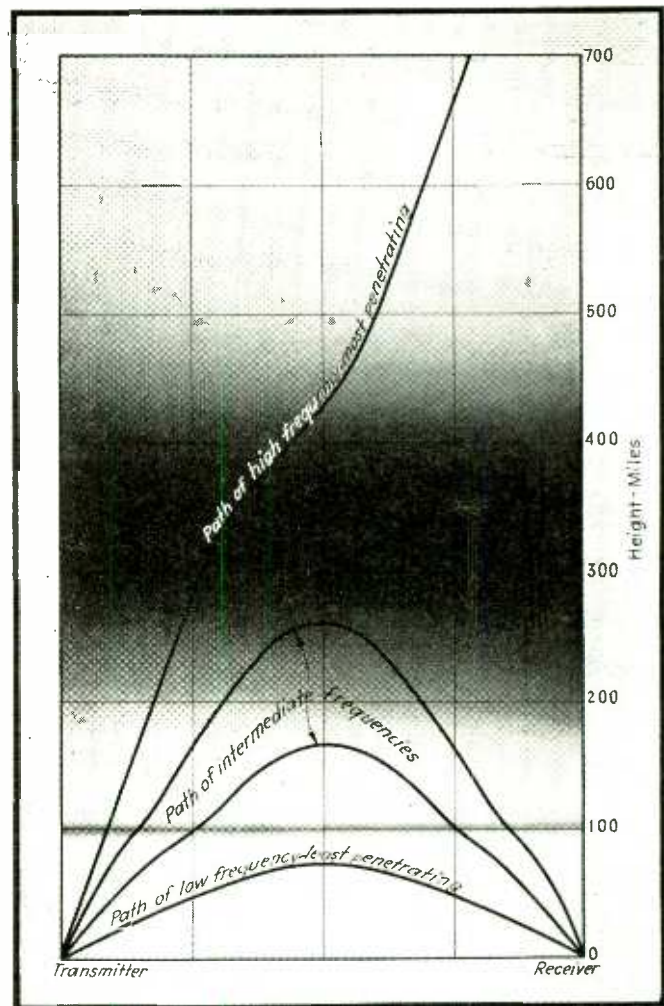

Fig. 2—Chromaticity diagram, in which the position in the curved triangle designates the characteristics of color. The numbers 26, 47, and 58 indicate the characteristics of the filters used in the CBS tri-color television system. Chromaticity data on two typical light sources are also indicated

Fig. 3—Diagram illustrating the paths of waves of different length in travelling through the ionosphere. The distribution of ions is indicated by the density of the shading. In studies of ionosphere characteristics, the transmitter and receiver are at the same location rather than being separated as shown for normal communication purposes



it is desirable to use a frequency-modulated wave. In conclusion the relay units installed in the Long Island system were described.

Color Television

The paper on color television presented by P. C. Goldmark, J. N. Dyer, E. R. Piore and J. M. Hollywood, all of the Columbia Broadcasting System, was concerned to a large degree with an analysis of color as it is applied to color television. Fluorescent lighting is now used to illuminate the color television scenes with the effect of increasing the color temperature of the light to 6500 degrees K. rather than the 5500 degrees K. of incandescent lamps. The effect of this change, however, is comparatively minor. Trichromatic theory and the color triangle and their relations to television were discussed in considerable detail. The color triangle with the colors of the filters used in the CBS color television system, the color of both incandescent and fluorescent studio lamps are shown in the illustration of Fig. 2. Note that the blue and red filters are on or very close to the curve of saturated colors, but that the green filter is far from being a saturated color.

An automatic method for synchronizing the filter discs in the transmitter and receiver was described. At a certain time in the synchronizing portion of every third field a pulse is transmitted to control a magnetic brake on the receiver filter shaft. The receiver disc is rotated by an induction motor and held at constant speed by a magnetic brake. Therefore it rotates faster than the transmitter disc unless it is controlled by the magnetic brake. If the proper filter is not in position when the synchronizing pulse occurs, a commutator prevents the pulse from affecting the brake and the disc rotates until the proper filter and the pulse coincide. Then the commutator permits the pulse to operate the brake which in turn holds the disc speed at the proper value.

Ionosphere Vagaries

H. W. Wells of the Carnegie Institution of Washington delivered a paper entitled "Ionospheric Investigations at Huancayo Magnetic Observatory (Peru) with Applications to Wave Transmission Theory". The first portion of this very interesting paper was concerned with the behavior of radio signals in the ionosphere. Low frequency waves and

medium waves are reflected by the ionized layer commonly known as the ionosphere and high frequency signals pass through it out into space. The speaker explained how the characteristics of the ionosphere varied from day to night and from one part of the year to the next. A curious phase of the behavior of the ionosphere is that when it changes in the northern hemisphere at the beginning of the northern winter, it would ordinarily be expected to make the converse change in the southern hemisphere, but it doesn't. The same changes seem to take place at the same time throughout the world. The observations made at the Huancayo observatory are correlated with two other observatories operated by the Carnegie Institution in Alaska and in Australia. Mr. Wells described briefly the multi-frequency apparatus in use at Huancayo for the determinations of ionosphere characteristics at that location.

The effect of sunspot activity on the characteristics of the ionosphere and consequently on radio communication was also discussed. Slides of photographs of the sun showing the travel and growth of sunspots were shown together with ionosphere characteristics as in Fig. 3. It was

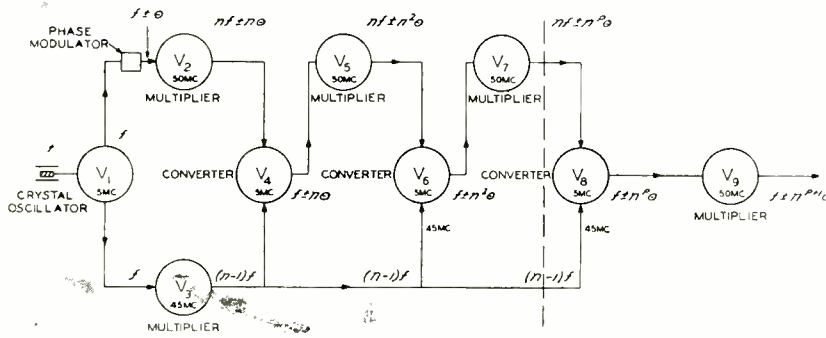

Fig. 4—Block diagram illustrating the essential elements in frequency stabilizing system for f-m transmitters

indicated that at certain phases of sunspot life, the ionized layer disappeared from our atmosphere and with it radio communication. The aurora borealis which was visible over a large portion of the earth on the evening of September 18, 1941 and caused widespread disruption in radio communication occurred two days after sunspots were on that part of the sun's surface which was "aimed at the earth" as Mr. Wells put it. It was said that two days traveling time was necessary for the corpuscles of energy associated with the sunspots to reach the earth and have an effect.

Stabilized F-M System

Robert J. Pieracci, of the Collins Radio Company, described a wide band frequency modulation system in which the center frequency is directly controlled by a single quartz crystal oscillator and by a system of distortion correction in a phase modulator in which the maximum

angle of phase shift may be 60 deg or more with low attendant distortion. This distortion correction is accomplished by modulation of both carrier and sidebands.

A block diagram illustrating the basic operation of the frequency stabilizing circuit is shown in Fig. 4. A crystal controlled oscillator of conventional type is indicated at V_1 , the radio frequency energy channel is phase modulated while the energy in the second channel is modulated in a manner described by Armstrong in previous literature. The output of the phase modulator is applied to the multipliers at V_2 , where the center frequency and phase shift are multiplied n times.

The energy of the unmodulated channel from the crystal oscillator is carried to the frequency multipliers at V_3 , where the frequency is multiplied $(n+1)$ times to $(n+1)f$. Frequencies of the modulated channel V_2 and the unmodulated channel V_3 are subtracted in the converter V_4 , where it yields the original oscillator frequency f but with n times the amount of phase shift at the modulator. The output frequency and

phase at the converter V_4 is then $f \pm n\theta$. The output of the converter V_4 is carried to a third frequency multiplier at V_5 which may also have a multiplication factor of n . Modulated energy from V_5 and unmodulated energy from V_3 is carried to the converter V_6 which again yields the original oscillator frequency but with n^2 times the amount of phase modulation at the phase modulator. This conversion process can be carried on indefinitely to any desired degree of phase multiplication and at the same time retain the original crystal frequency and stability. The output of the converters V_4 , V_6 , and V_8 have precisely the same stability as the crystal oscillator V_1 .

As far as center frequency stability is concerned, the system acts as if the crystal is located directly at the last converter. In actual application, the number of converters may be limited to one or may be as high as three or four depending upon the amount of phase multiplication desired. For example, if the crystal oscillator frequency is chosen as 5 Mc and the operating frequency 50 Mc, n would be 10. If three converters were used, the total phase multiplication of the system is $10^{3+1} = 10^4$ or 10,000.

In the past, phase modulators used in the production of f-m signals have been limited to a maximum phase shift angle of 30 degrees. The system described permits maximum phase shift angle of 60 degrees or more with low attendant distortion. This is done by providing a linear relation between phase shift angle and sideband amplitude. The mechanism of the system by vector representation of the carrier and the sidebands is shown in Fig. 5. The sidebands are added at an angle of 90 deg. and their amplitude varied in accordance with the audio frequency; however, the carrier is also amplitude modulated simultaneously at twice the audio frequency.

The phase shift angle θ is given by

$$\theta = \tan^{-1} \frac{\sin pt}{K_1 + K_2 \cos 2pt}$$

The expression $K_1 + K_2 \cos 2pt$ represents the carrier modulation. If K_1 and K_2 are properly chosen, an approximately linear relation between phase shift angle θ and sideband amplitude $\sin pt$ exists. A maximum phase shift angle of 60 deg can be obtained.

(Continued on page 110)

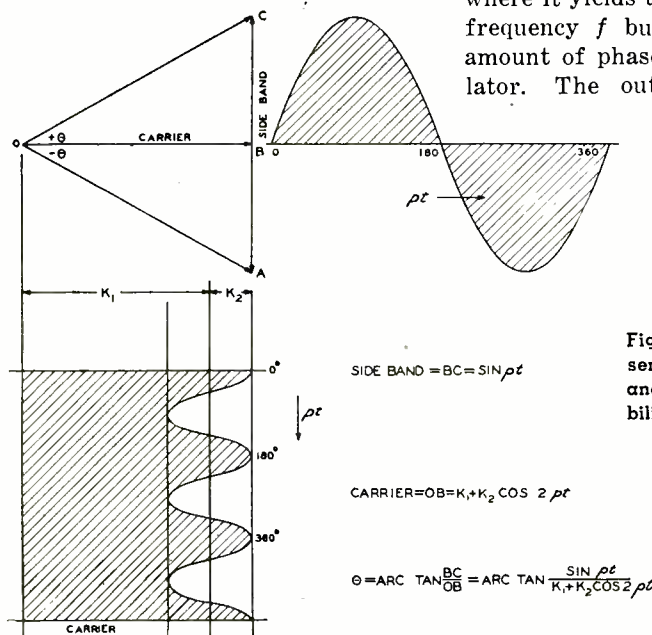
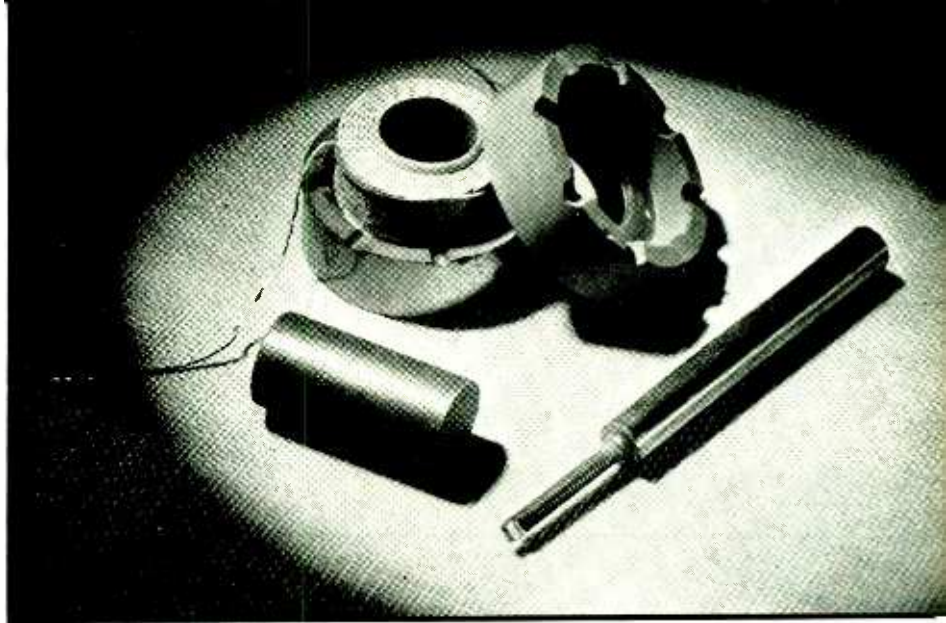

Fig. 5—Vector representation of carrier and sidebands for stabilized f-m transmitter

Cores for communication circuit elements, showing cups and center core, with coil, for completely enclosed coil, and a typical permeability core with screw insert



Radio Uses of Powdered Iron Cores

Improvements in powder metallurgy make possible loop antennas of reduced size, simplified tuning mechanisms on high-frequency receivers as well as on low-power transmitters, and result in improved coils up to 100 Mc. Magnetic circuits of unusual shape are also made possible

THE use of finely divided particles of magnetic material pressed into shape and held together with a suitable bonding material has been employed for electrical purposes for at least half a century. The improvements in manufacturing technique, the lowering of costs, and the ability to produce materials having relatively high permeability and comparatively low losses, for frequencies even as high as 100 megacycles, have resulted in a substantial use of powdered core materials for communications circuits. The practical uses of powdered ferromagnetic materials for use in communications circuits date back about ten years. The increased use of iron core material, especially within the past two or three years, gives every indication that iron core inductors will continue to be of increasing importance in the communications field, especially since there is at present no indication that the ultimate goal has been reached in the use, application, and design of such components.

Fundamentally, the advantage of using an iron core rather than an air core inductor depends upon the fact that the inductance for a given coil depends directly upon the permeability of the surrounding me-

dium. For air core solenoids, the effective permeability is of course unity but for cores of ferromagnetic material the effective permeability may be increased several fold, depending upon the core structure, the effective permeability of the core material, the frequency at which the coil is to be operated, and the manner in which the core is employed.

The presence of ferromagnetic core material in the proximity of an air core coil introduces additional losses due to the hysteresis and eddy current losses in the iron. At the same time, by virtue of the increased permeability, a coil of given inductance may have appreciably fewer turns. Consequently with fewer turns the ohmic losses of the coil can be decreased. Consequently, the advisability of using an iron core coil depends upon whether or not such a coil can be made to have the same or greater ratio of inductance to resistance, commonly known as Q , as can be obtained with an air core. The increased Q of a coil depends upon the characteristics of the core material, the effectiveness with which the core is employed, and the frequency at which the coil is operated.

Through the use of suitable core

material, properly processed and formed to provide cores of good effectiveness, it has been possible to produce inductances with iron cores showing characteristics improved over those of air core coils for frequencies as high as 100 megacycles. However, it has not been found possible to manufacture a single type of core material which is equally suitable at all frequencies. A particular type of core material will produce its optimum effectiveness over a frequency range having a ratio of perhaps 3 to 1. Of course, a given core material can be used over a much greater frequency range, but for best results the optimum type of core material for that frequency should be chosen. Within the past few years, tremendous strides have been made in the production of high quality domestic powdered ferromagnetic materials suitable for use in communications circuits and there is little, if any, problem in satisfying the commercial requirements for satisfactory core material at frequencies in the broadcast or shortwave bands.

From the point of view of the coil designer, the effectiveness of an iron core coil depends upon three factors: (1) the Q , or ratio of inductive re-

actance to resistance, of the coil in air; (2) the effectiveness with which the core material is utilized, and (3) the effective permeability and core losses, at the particular frequency range of interest, for the core material selected. The first of these factors is entirely up to the coil manufacturer, while the third factor is very largely determined by the processors of core materials as well as the suppliers of such material. The second factor involves both the coil designer and the manufacturer of core materials.

Since hysteresis and eddy current losses are of primary concern in any type of iron core structure, it is highly desirable that material with a small hysteresis loop be used in core material. Likewise, the eddy current losses should be reduced so far as possible. This may be accomplished by dividing the particles of magnetic material into as small a size as possible, by coating them either chemically or mechanically with suitable non-conducting material and by compressing the particles properly with a suitable binding agent. The effective permeability of such a non-homogeneous core, composed of small particles of high intrinsic permeability in a binding agent whose permeability is sensibly unity, depends upon: (1) the permeability of the individual particles and (2) the percentage of the binding material making up the volume of the complete core, as shown in the graph below. So far as effecting any improvements in the core material is

concerned, it is anticipated that some improvement may be achieved through the use of finely divided magnetic alloys (rather than iron) having high permeability coupled with high resistivity so that the eddy currents in the individual particles may be kept to a minimum.

Powdered iron cores are used widely in the manufacture of coils and tuning elements for broadcast and high frequency receivers, but the use of such materials is not limited to applications in high frequency receivers. With a favorable economic situation, the use of pressed cores might be extended to other uses as well. For example, audio frequency transformers might be made with cores of powdered ferromagnetic materials rather than of laminated cores built up of thin stampings of iron. Furthermore, since core material can be pressed into complicated shapes which would otherwise be difficult to machine, powdered core material may be employed in communications or industrial circuits where magnetic paths of unusual or intricate shape may be required. Already suitably prepared cores are finding application in tuning transmitters of relatively low power, that is, powers of 50 watts or less. The application of iron core tuning methods to transmitters of power higher than about 50 watts depends upon overcoming the difficulty of dissipating the power loss within the core itself, and as materials with improved characteristics are developed, extensions of this ap-



Photomicrographs of two typical types of carbonyl iron

plication may be expected. Modern iron cores are finding important applications in small loop antennas for directional finding applications, especially on aircraft. Through the use of suitable core material an airplane loop antenna normally 9 in. in diameter may be reduced to something like 2 in. in diameter, thereby greatly reducing the space requirements and minimizing wind resistance. Other application in which the ease of molding powdered iron into special forms may be utilized is in the manufacture of powdered iron motor frames and armatures, special relay bobbins, audio and modulation transformers, etc. It appears probable that the processing of powdered iron magnetic materials could be advantageously combined with the molding of plastics to further simplify communication and industrial electronic equipment of the future. The use of iron cores as electromagnetic shields is also a comparatively recent innovation in the communications field.

Source of the Core Material

Today the sources of raw materials for coils are entirely domestic. Up until the Fall of 1940 or there-

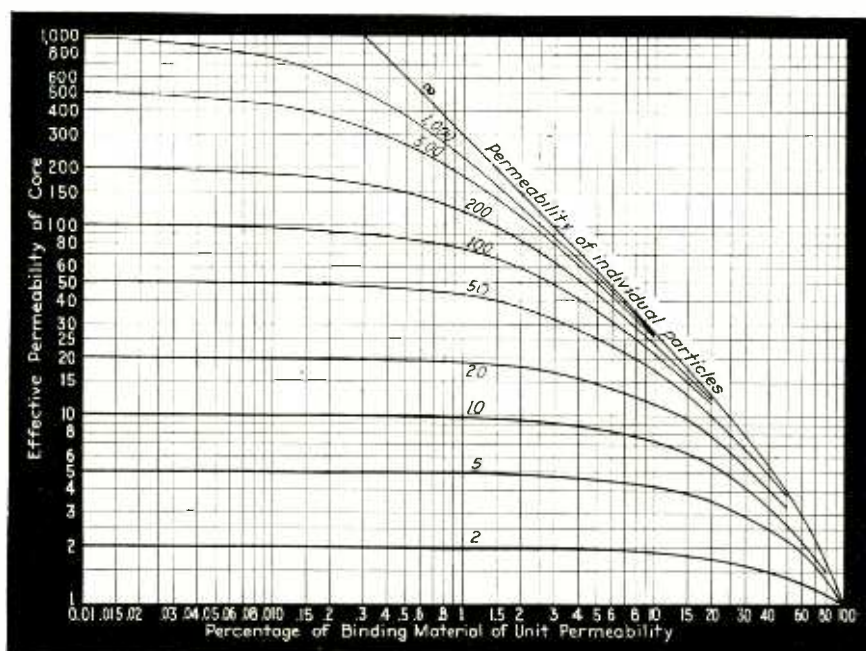

Graph illustrating how the effective permeability of pressed core material varies with the permeability of individual particles and the relative portions of magnetic material and bonding agent, as calculated from data by Howe

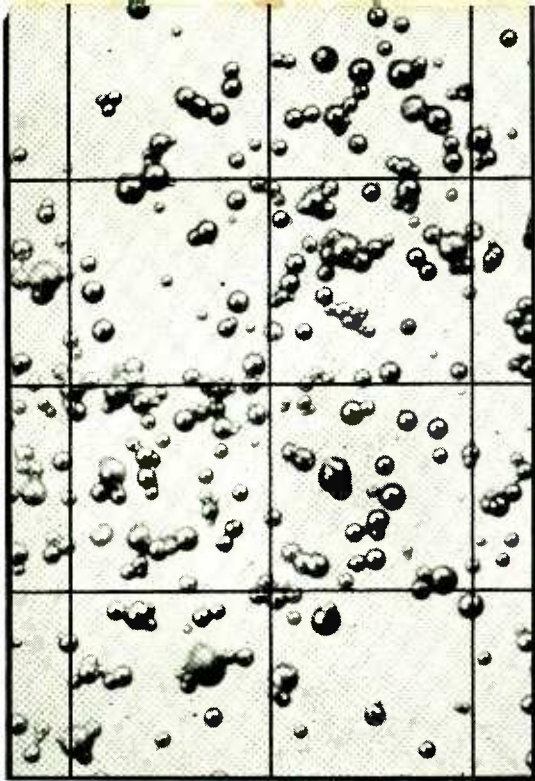

powder used for communication circuits. Magnification 515X

about as much of the powdered iron used in communication equipment in this country was of German origin. Anticipating the danger of a war, several concerns attempted to meet future demands by piling up stores of core material. At the same time, efforts were made to produce domestic sources of ferromagnetic core material. Comparative tests indicate that American made materials are superior to those made of the best German powdered iron of which accurate knowledge is available.

The sources of core material processed by one manufacturer include (a) carbonyl iron powder, (b) hydrogen reduced powder, (c) electrolytic iron, (d) various forms of magnetic oxides.

General Method of Processing

The essential steps in the processing of iron cores include mixing the powdered iron material with suitable resinous binder, followed by pressing and heating the mixture into the finished cores. The pressing and heating operations are done on automatic machines, some of which are of the rotating type for continuous flow of production with a minimum of labor. Iron powders produced by electro-deposition process result in a practically pure iron which may be recovered from iron ore, scrap, or other sources of iron. The purity may run as high as 99.95 percent.

In general, the process used to

convert the powdered iron material into a finished core is as follows:

First of all, the iron particles themselves are covered with an insulation either by chemical means or by mechanical means. This is extremely important to keep down the eddy current losses. The insulated iron particles are then mixed with a suitable binding material or bonding agent. This mixture of insulated iron particles and bonding agent is then molded under pressure to the size and shape desired. In most cases where an adjusting screw is desired in the core, this adjusting screw is molded into the core at the same time the core body is formed. However, in some cases this is not possible—the core is drilled and the screw is cemented into the drilled hole after the core is finished.

After the material has been pressed into the desired size and shape, it is then baked at a suitable temperature for the type of bond employed so as to fix the bonding agent and thus produce a mechanically strong core. The cores are then given a rust-proofing treatment so as to protect them against rust under high humidity conditions.

The cores are then tested for permeability and loss characteristics based on standards mutually agreed upon between customer and supplier, and are then ready for shipment.

Production of Cores

It is difficult, if not completely impossible, to obtain production figures on various types of iron core products. One plant indicates that its production capacity is as high as 100,000 pieces a day. Another producer reports that production for 1941 was double that of 1940 and it is expected that the 1942 production will probably lie somewhere between figures for these two years. A third organization indicates that 1941 usage of cores far exceeded that of 1940 and a still further increase for 1942 is anticipated. A producer of radio sets using iron core inductances indicates that his production figures for the past several years are as follows:

Year	Production in No. of Units
1939	15,100
1940	104,000
1941	328,100
1942	74,000 (estimated)

MANUFACTURERS OF CORE POWDERS

Advance Solvents and Chemical Corp.,
245 Fifth Ave.,
New York, N. Y.

Aladdin Radio Industries,
501 West 35 St.,
Chicago, Ill.

George S. Mephram Corp.,
2001 Lynch Ave.,
East St. Louis, Ill.

Plastics Metals, Inc.,
Johnstown, Pa.

PROCESSERS OF CORE MATERIALS

Aladdin Radio Industries,
501 West 35 St.,
Chicago, Ill.

Henry L. Crowley,
1 Central Ave.,
West Orange, N. J.

Ferrocart Corporation of America
Hastings-on-Hudson, N. Y.

General Laminated Products Inc.,
175 Varick St.,
New York, N. Y.

Stackpole Carbon Co.,
St. Mary's, Pa.

RCA Manufacturing Co.,
Camden, N. J.

Wirt Co.,
1270 Broadway,
New York, N. Y.

CONSULTANT

W. J. Polydoroff,
Engineers Bldg.,
Wacker Drive and Wells St.,
Chicago, Ill.

In reply to a question as to what is regarded as the most important developments which are likely to occur in this field in the next year or so, the following answers from various sources are typical.

Likely Developments

Powdered iron cores are simply one example of what can be done in the new art of powdered metallurgy. This art is moving pretty rapidly and promises to prove as big in its way as plastics proved in their field. Powder metallurgy lends itself to the quick, economical and very satisfactory shaping of certain metals, and it is very likely that powdered metallurgical activity will be developed far beyond present high frequency iron cores. There is certainly an enormous field here for expansion during the next year or two, and we

(Continued on page 93)

ELECTRONIC INTRUSION

A review of burglar-alarm devices employing photoelectric, capacity and acoustic relays, with particular emphasis upon recent design refinements adapting them to control of sabotage

FOR MANY YEARS industrial, mercantile and residential premises have been protected against burglary by electrical alarm devices supplementing the work of guards. Early equipment involved manually-operated switches with which watchmen could signal remote points for help over simple signal circuit wiring. Time-clock switches and other semi-automatic signalling devices were soon added to bring assistance if, for any reason, patrols failed to regularly "ring in" while making their rounds.

Automatic protection further supplemented the work of guards. Switches were installed at points of entry such as windows, doors and skylights, causing intruders themselves to open normally closed alarm circuits upon attempting to "jimmy" these closures. Webs of easily-broken metal foil adhering to the interior surfaces of window, door and skylight glass were later included in series-circuit arrangements to prevent entry by breakage, as were intricate networks of fine wire covering walls, and ceilings.

Floor-traps, consisting of switches actuated by trip-cords stretched about the premises, further complicated the life of any burglar who somehow succeeded in avoiding entrance alarms. Attempts to break into safes or vaults eventually found these objectives protected by additional switches and wire networks (as well as by vibration, temperature and air-pressure operated alarms).

Such electrical systems have since been joined by the electronic intrusion-detection devices with which we are here concerned. These are proving useful where supplemental protection is desired, where series wiring cannot readily be installed and where alarms must signal at the approach of an intruder rather than after an attack upon premises or fixtures begins. The last-mentioned consideration is of particular importance in the control of sabotage.

Static-Beam Photoelectric Types

Photoelectric intrusion-detectors substitute a beam of light for series-circuit protective wiring. Here, in-

terruption of the beam projected from light source to light detector actuates a local or remote signal. Early examples used a miscellaneous variety of incandescent lamps as light sources, many of them not especially desirable for projection service. Projection lenses originally designed for other duties frequently sprayed light over wastefully large areas rather than concentrating it upon the phototube to obtain maximum intensity at that point. Relatively crude phototubes were worked to their output limit in order to drive delicate intermediate control relays connected directly in phototube circuits. Maximum commercially useful beam range rarely exceeded 20 feet.

Makers of modern photoelectric alarm equipment use standard automobile headlight lamps as light sources for many applications (the most commonly used lamps being 6-8 volt, 32 and 50 cp. prefocussed types) but there is a growing tendency to specify modifications in this general type of lamp to insure longer life. Motion-picture projection lamps are frequently used for special applications and these, too, are sometimes modified slightly by suppliers to better serve the alarm business. Lenses are used at both projector and detector and are generally of the single-element type, although multi-element lenses are used in certain cases requiring particularly sharp beam patterns. They are provided with focusing adjustments and are specifically designed for alarm service, keeping beams reasonably parallel over relatively long distances. Phototubes of the vacuum or gas-filled types are followed by d-c amplifiers. Rugged relays in the anode circuit of such amplifiers render reliable service and it is not uncommon to find their contacts making or breaking 100 watts. Com-

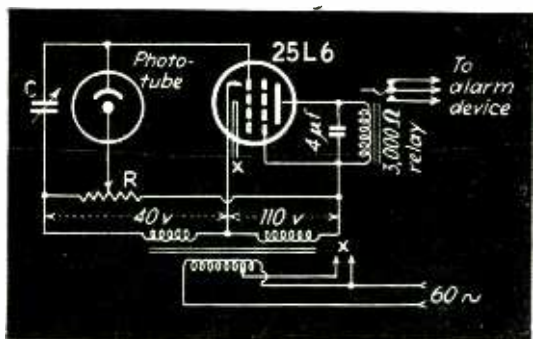
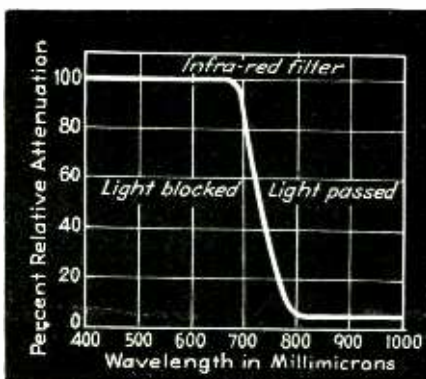

Fig. 1—Schematic of simple static-beam intrusion-detector suitable for short beam-throw distances. Phototube d-c output is amplified by the 25L6. Capacitor C and potentiometer R provide sensitivity adjustments. Self-rectification is used in this elemental version. Majority of systems now use d-c powerpacks

Fig. 2—Graph showing portion of light-spectrum used by average photoelectric burglar alarm device. Human eye responds to colors between violet and red, i.e., between 400 and 700 millimicrons



-DETECTION SYSTEMS



Fig. 3—(Left)—Worner static-beam projector and detector. Protective case designed to house either unit pictured in center. Note black, box-like mask encasing phototube in detector unit to shield it against ambient light variations and increase directivity

Fig. 4—(Right)—Two of several photoelectric intrusion-detection units laying down criss-crossed pattern of protective beams around oil-storage plant. Beam alignment is maintained despite need for 500-foot outdoor "throws" by avoiding use of mirrors, mounting units on heavy iron pipes embedded in concrete

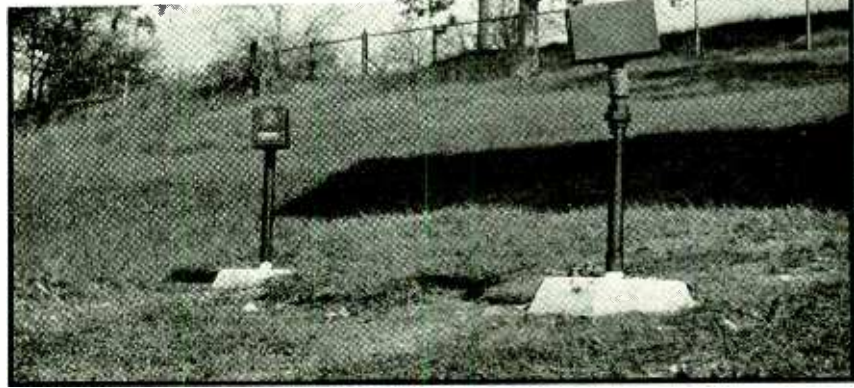

mercially useful beam ranges of 100 feet or more result from these improvements.

Speed of operation is generally such that, at their least sensitive settings, alarms trigger when a cylindrical object six inches in diameter with its axis and direction of motion perpendicular to the beam axis travels through the beam at a speed of 8.8 feet per second (6 miles per hour) or less.

D-c amplifiers used in systems of the type described (Fig. 1) generally employ a single stage, one tube or at the most two apparently providing all the gain that can be conveniently used in an average installation. This represents a compromise between sensitivity and stability, excessive amplification rendering systems too susceptible to paralysis or triggering by slight variations in ambient light. The limiting effect of ambient light is frequently minimized by placing hoods over projector and detector lenses. Masking of phototubes within detector units is also effective. Hoods and masks

serve to exclude extraneous light from the phototube, confining energy reaching the light-sensitive surface as much as possible to that originating at the projector unit.

Sharply-focused lenses, hoods, and masks simultaneously make it difficult for intruders to paralyze photoelectric alarm systems by shining the beam from a flashlight into a phototube and walking through while the relay is held in the stand-by position. The angle at which light must enter to keep relays closed is quite critical. Systems are less readily defeated in this manner than laymen suppose because of this directivity factor and because light sources are difficult to find, frequently being recessed or otherwise partially concealed from all angles except the "business end." Lightbeams are very nearly invisible from the side even in smoky or dusty air as most projectors now contain optical filters confining emission (Fig. 2) largely to the infrared region. Until recently most of these filters were imported from Jena,

Germany. Transmission loss due to their use is sufficient, despite the infrared output of light sources and infrared sensitivity of phototubes employed, to induce conservative manufacturers to reduce recommended beam-throw distance by a factor of 50 percent or more over "white light" applications. (Phototubes appear to retain overall sensitivity for satisfactorily long periods of use but some slight troubles are still experienced with slow drift in spectral response as they age.)

The Mirror Problem

Mirrors are generally used indoors to break beams up into curtains of light criss-crossing the area to be protected. Three or four reflections are commonplace and as many as a dozen have been successfully used. The difficulty of maintaining accurate beam alignment is, of course, multiplied by mirrors, particularly when beam-throw distances are long. Misalignment is minimized by mounting mirrors in rigid frames and where considerable vibration is

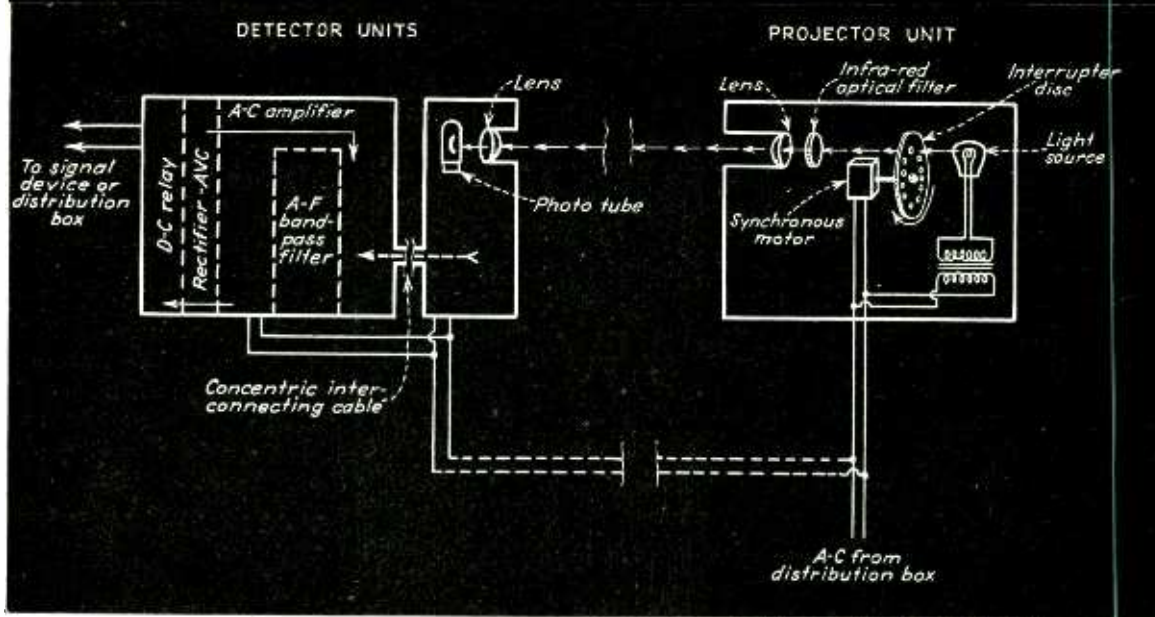

Fig. 5—Block diagram of typical modulated-beam photoelectric alarm system. Beam-throw distances of 1000 feet or more are proving practical with such systems, outdoors as well as indoors

encountered it is not uncommon to find them supported by strong brackets fastened to the floor instead of to walls. Despite careful design and placement of mirror-mounts experience indicates a marked difference in their ability to maintain alignment when installed in wooden buildings as compared with structures made of concrete, stone or brick. Further limiting the number of mirrors which may be used with a given beam, is the light reflection loss introduced by such reflectors. It is noted in this connection that mirrors are seldom called upon to reflect beams at angles greater than 45 degrees with respect to their surfaces (90 degree angle between incoming and outgoing beams). Even at smaller angles the loss is sufficient to warrant some reduction in beam-throw ratings for each successive reflection. Mirrors using special crystal glass reduce part of this loss. Formation of dust on mirror surfaces continues to be a major problem and one that has fathered many protective frame designs, including several with slides which may be closed over reflecting surfaces when alarm systems are not in use.

Weather-proof cases and carefully chosen components which continue to function properly despite wide variations in temperature and humidity permit systems of the type described (Fig. 3) to function outdoors. Useful beam-throws of as much as 500 feet have been achieved by mounting projector and detector units on heavy pipes embedded in concrete blocks (Fig. 4) sunk into the ground to maintain alignment. Where such extremely long beam-throws are required, duplicate pro-

jectors and detectors rather than mirrors are advisable for turning of property boundary corners. The comparatively low cost of static-beam equipment makes duplication of units economically practical in many instances and avoids mirror troubles due to multiplication of angular beam error, formation of moisture and ice on these reflecting surfaces.

Limitations imposed upon static-beam photoelectric intrusion-detect-

ors chiefly by the effects of ambient light variation have brought the development of modulated-light types. These are proving particularly valuable for protection of outdoor boundaries since useful beam-throw distances of 1000 feet or more are practical. Long range coverage is particularly important at this time when many industrial plants engaged in production of war material wish to electronically guard extensive property borders. Because of other advantages inherent in design such equipment is useful for indoor as well as outdoor applications where somewhat greater cost appears justified by the additional protection afforded.

Modulated-Light Protective Devices

Modulated-beam systems (Fig. 5) use projector units similar to those found in static-beam alarm systems insofar as lamps, optical filters and lenses are concerned. But the light

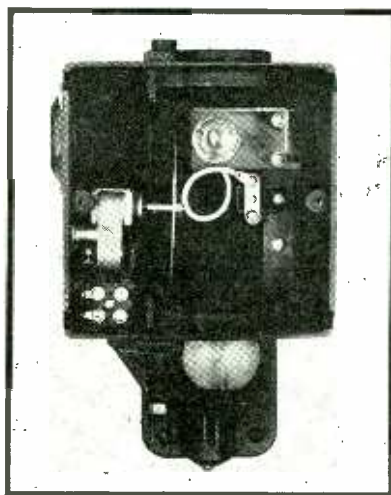
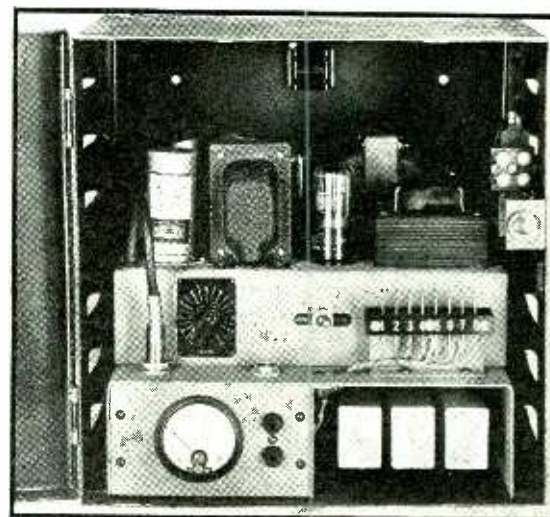

Fig. 6—Projector unit of modulated-beam photoelectric system rented and maintained by Holmes. Edge of disc which interrupts light appears as vertical white line just to left of center

Fig. 7—Holmes a-c amplifier, band-pass filter and power supply unit. (Photo-tube detector "head", not illustrated, is mounted few feet away.) Plug at lower left may be removed and inserted in jack few inches to right to test performance of system without a-f filter. One of three relays visible at lower right may be tripped from remote office to extinguish lightsource and check system performance



is broken up before projection by a whirling disc with holes punched in its periphery and interposed between lamp and lens. Discs, technically termed "episkotisters," in designs seen to date (Fig. 6) are rotated by small synchronous a-c motors and interrupt the beam somewhere between 500 and 1500 times per second. At the distant detector unit, a phototube receives the modulated light in the usual manner. The phototube is followed by a two- or three-stage a-c amplifier (Fig. 7) incorporating an audio band-pass filter tuned to the modulation frequency. The a-c amplifier is followed by a diode rectifier which converts received impulses into power with which a d-c signal relay may be operated. Phototube detector heads are generally installed within a few feet of their associated amplifiers and connected to them through concentric cables. In some instances heads and amplifiers are integral.

So long as sufficient light intensity is received by the phototube to satisfy its threshold operating requirements, comparatively wide variations in ambient light intensity obviously do not paralyze or trigger the system because amplification occurs only at the critical modulation frequency. Relay current may be held within desirable limits by incorporating some form of AVC in the amplifier circuit, rendering the system still more tolerant to the effects of transient increases or decreases in light intensity. Unmodulated light such as that from the sun or from a flashlight, or light modulated at other frequencies such as that generated by incandescent

lamps operated from 60-cycle power lines, has little effect upon performance. (Modulation frequencies having a harmonic relationship to 60-cycles are avoided in design.) Equally important is the fact that dirt on lenses, dust or smoke in the air intervening between projector and detector units has much less effect upon such systems than it has upon static-beam devices operating on the light intensity-differential principle. Installation men frequently mask out (Fig. 8) up to 90 percent of the transmitted light without triggering modulated-beam alarms (Fig. 9) as a test of their light-intensity latitude while making initial adjustments. Where beamthrows are comparatively short a pocket handkerchief may be placed over projector lenses to simulate fog in the transmission path.

One unusual installation has been seen which has effectively guarded a waterfront stretch of nearly 3000 feet for more than five years, transmitting few false-alarms despite dense harbor fogs. A special projector unit using an 18-inch lens and an airplane beacon lamp (to widen beam-spread and avoid operation of the alarm by sea-gulls) was

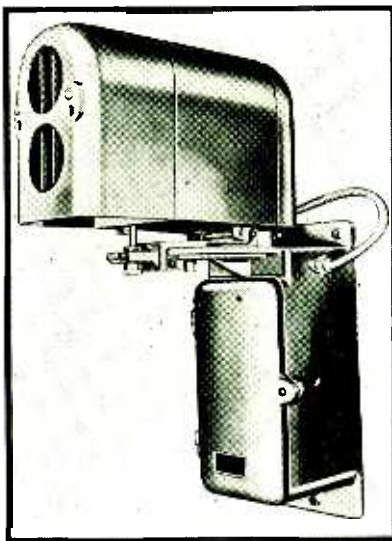

Fig. 9—Projector of ADT modulated-beam photoelectric system. Twin lightsources are used, widening pattern to eliminate triggering by birds flying through beam. Insertion of special key by central-station serviceman permits infrared filter to be swung out of lightpaths, permitting visual checkup of beam alignment

Fig. 8—Integrally-mounted phototube detector head and amplifier. Test mask illustrated in temporary use over lens has variable apertures permitting light-intensity latitude of system to be checked

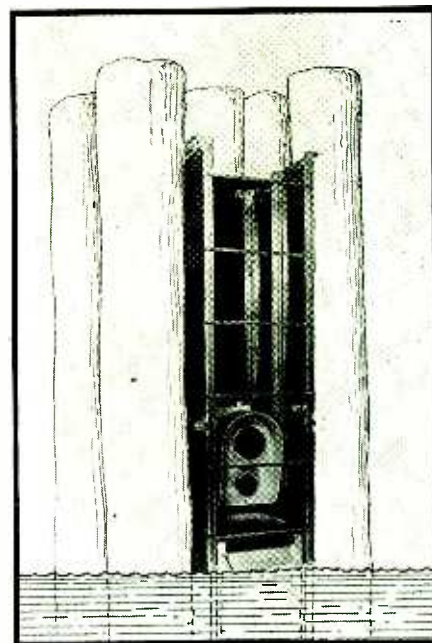
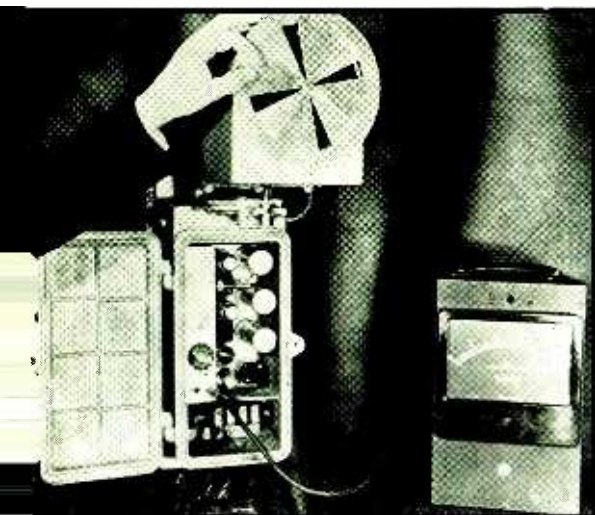

Fig. 10—ADT double-lightsource projector designed for use in tidal water off end of dock, throwing beam 3000 feet to similarly floated detector unit. Vertical but not lateral movement is permitted by bronze channel assembly, protected by wooden piling

built for this job and the projector unit as well as the detector unit floats in comparatively calm tidal water off the end of a dock. Its purpose is to detect intrusion from the sea side of the property. Standard projector (Fig. 10) and receiver units have since been designed for such marine applications.

Protection against the elements, important in all types of devices intended for outdoor use, has been carried to considerable lengths in modulated-beam equipment. Dehumidified and hermetically sealed protective cases for equipment are not unusual and cast metal cases are often used. In one or two instances these are electrically heated and thermostatically controlled to minimize formation of moisture on lenses and phototubes and to protect other parts against failure due to severe temperature changes or abnormally high humidity. Snow, ice, bits of blowing paper and leaves have a habit of sticking to outdoor lenses so the latter are very often recessed into protective cases. Birds and small animals have exhibited some interest in such recesses as nesting places so recesses are sometimes equipped with metal louvres set on edge to keep such fauna out without excluding light. Mirrors are occasionally used to deflect beams



around property angles but, as in the case of static-alarms, their use is discouraged for long-throw applications wherever it is economically practical to turn corners with duplicating projector and detector units. More than one mirror is seldom used outdoors. Where it is necessary that mirrors be used, one manufacturer recommends a reflector equipped with an electric heating unit designed to raise surface temperature above the average dew-point. Formation of fog on mirror surfaces is reduced by such units and, in addition, ice or snow is melted and the resultant moisture vaporized.

Capacity Relays For Boundary Service

Photoelectric intrusion-detectors are at a disadvantage where industrial plants are laid out on extremely irregular property plots and on hilly ground requiring coverage of many vertical as well as horizontal angles. A multiplicity of units and mirrors may be used in such cases for boundary protection but the cost is apt to be excessive and the alarm system complicated. Capacity-operated relays are beginning to exhibit useful characteristics for such work.

Capacity relays have been used for protection indoors for several years. Safes, for example, are insulated from ground and connected to serve as the antenna for a control device. Satisfactory performance is readily secured by any one of a number of circuits because the capacity between antenna and ground is relatively small and the capacity-to-ground added by an intruder approaching the system represents a considerable increase in total circuit capacity. The control device need not be especially sensitive as it has plenty of capacity-change on which to function. Adjustments hold over long periods because the capacity between safe and ground remains fairly constant.

Capacity-alarm systems designed to protect extensive areas or long boundaries instead of relatively small objects such as a metal safe encounter more difficult design problems. For one thing, capacity to ground of a long antenna is certain to be high by comparison with the change produced when an intruder enters the antenna field. This requires much greater control sensitivity since the control must func-

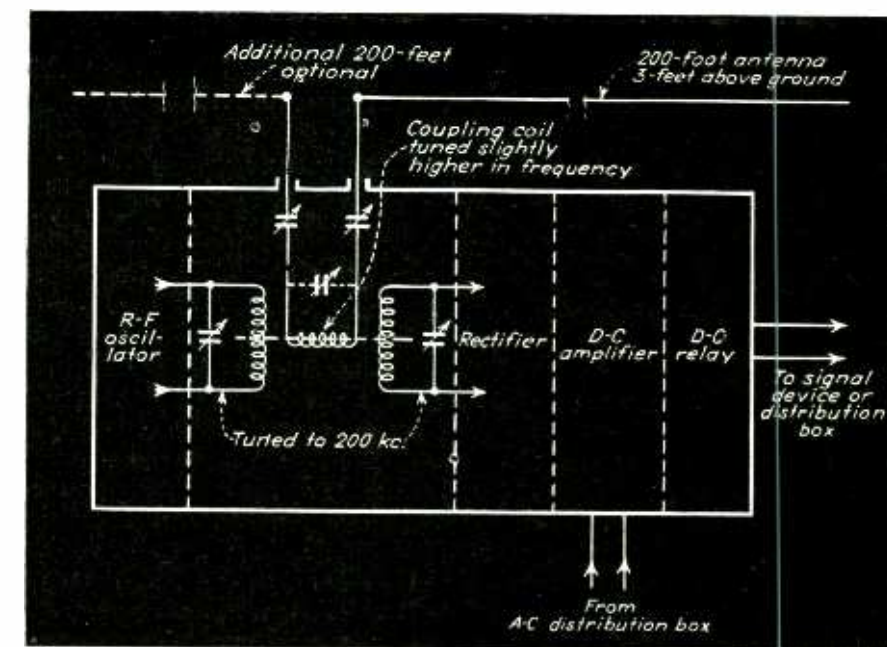

Fig. 11—Block-diagram of capacity-relay alarm designed for outdoor boundary protection service. It employs circuit minimizing effects of ambient changes caused by growing weeds and by rain, ice and snow

tion on a small proportional capacity change. Also, the capacity between antenna and ground is likely to vary and is certain to change materially where antenna systems are outdoors. Grass and weeds growing up beneath antennas produce week-to-week changes. More rapid and, therefore, more troublesome ambient variations are caused by rain, snow and ice on the antenna itself, on the ground beneath it or on antenna insulators.

One capacity-type boundary alarm system out of the laboratory stage and into limited production after several years of experimentation and field work will accommodate up to 200 feet of antenna wire each side of the control unit (400 feet overall) where the wire is tightly stretched three feet above the ground on insulated stakes spaced 25 feet apart. Antenna-to-ground capacity in this case is said to average 1000 $\mu\mu\text{f}$. The control unit is designed to trigger on a 0.5 $\mu\mu\text{f}$ change in 1000 and this gives sufficient sensitivity to transmit an alarm if an intruder approaches within approximately three feet of the antenna.

The device referred to (Fig. 11) contains a low-power r-f oscillator tuned to 200 kc. It also contains a diode detector tuned to 200 kc. Inserted between oscillator output coil and detector input coil is a third tuned circuit, to which the antenna

is connected. Transfer of r.f. from oscillator to detector is controllable by varying the resonant frequency of this intermediate coupling coil. When it is tuned to resonance at 200 kc, the d-c diode detector output current in a typical instrument reaches 30 microamperes. In use, the coupling circuit is de-tuned higher in frequency until diode current drops to 17 microamperes. Entry of a foreign body into the antenna field introduces additional capacitive reactance back into the coupling coil to which the antenna is attached and tunes the coupling circuit in the direction of resonance at 200 kc. A sharp increase in diode current results.

The diode is followed by a resistance-capacitance coupled d-c amplifier, with the signalling relay inserted in the final stage of this amplifier. Triggering of the circuit by slow ambient variations in antenna-to-ground capacitance is minimized by using coupling capacitors of several microfarads between amplifier stages. Capacitor charges occurring at an extremely slow rate discharge through amplifier grid-leaks before they build up to a value sufficient to trigger the relay in the output stage. Circuit values are adjusted so that it is virtually impossible for an intruder to move into the antenna field slowly enough to take advantage of this effect.

When an intruder remains in the

field of the antenna of this particular alarm, after triggering the circuit during approach, the alarm shuts itself off in several seconds due to the leakage characteristic outlined above.

Acoustically-Actuated Alarms

Design engineers have devoted much of their time in recent months to photoelectric and capacity-relay intrusion-detection devices because these lend themselves readily to outdoor boundary protection service so much in demand for control of sabotage as well as for more exacting indoor uses. Brief discussion of acoustically-actuated types nevertheless seems desirable in order to round out this review since these are electronic in principle and there are instances in which industrialists may wish to store important plans and records in vaults when not in use.

Acoustically-actuated intrusion-detectors are designed to operate an alarm when physical attack upon walls, floors, or ceilings occur rather than to trigger on relatively low-level sounds produced by intruders moving around within vaults entered by stealthier means. Pickup devices, installed within vaults to be protected and functioning upon sounds transmitted to them through walls, ceilings or floors from the outside, range from special high-gain sound-pressure actuated a-c "switches" to crystal and other type microphones having an inherently low noise-level. Pickup output voltage is amplified and diode-rectified and the resulting d.c. actuates a signal relay. Amplifier gain requirements vary widely, depending upon the type of pickup unit used and upon the construction of the vault and its contents. According to the Burglary Protection Department of Underwriters Laboratories, Inc., operation of acoustic intrusion-detectors is most satisfactory when vaults are of masonry construction.

Sensitivity required of vault alarms depends upon whether or not vaults are reverberant or non-reverberant, a non-reverberant vault being normally defined as one in which the average coefficient of sound absorption of exposed interior surfaces exceeds 0.5, or is variable because of merchandise in storage. In reverberant vaults it is customary to

adjust alarms to transmit a signal at sound levels of the order of 80 to 90 db for a sound of impact origin. In non-reverberant vaults the alarm systems must transmit a signal at a sound level 15 db above the normal ambient, a much more difficult condition to meet.

Required amplifier frequency response varies with the type of vault and its contents (Fig. 12), most frequently encountered conditions requiring a range readily obtained through conventional a-f amplifier design.

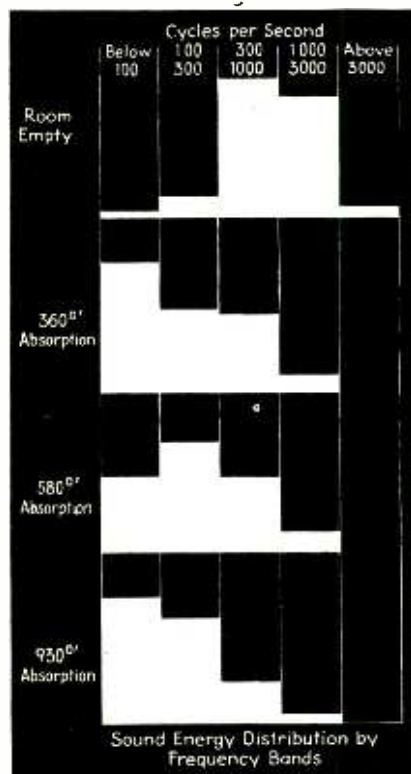

Fig. 12—Chart showing frequency response required of an amplifier used in connection with acoustic alarm, as function of sound absorption within a vault. Study by Underwriters Laboratories with fixed impact and varied absorption indicates that satisfactory range is readily obtainable through conventional a-f amplifier design. Data concerning required sensitivity is given in text

Many design safeguards have become standard practice in the alarm business. Equipment is normally designed, for example, in such a manner that failure of parts transmits an alarm rather than paralyzing the system. Parts are invariably operated at extremely conservative current and voltage values to prolong their life and to mitigate the effects of gradual deterioration. Tampering with equipment by an intruder usually results in an alarm.

Constant-voltage transformers and electrically-stabilized power supplies are commonly used to keep circuits in adjustment despite variations of as much as 20 percent in a-c supply line voltage. Power sources independent of a-c supply lines are the exception rather than the rule, because such auxiliaries add considerably to initial equipment cost and maintenance, but electronic intrusion-detector manufacturers do arrange circuits so that interruption of power causes a warning signal to be transmitted. In more elaborate systems provision is made for distinguishing between momentary power interruptions of about 10 seconds duration and legitimate alarms.

Electronic intrusion-detectors may operate "local" signals, ringing bells, blowing horns or whistles and turning on floodlights. They may also actuate "proprietary" system signals, calling guards from somewhere within the protected premises to the threatened point. They may also operate remote signals in "central station" offices maintained elsewhere by firms specializing in the installation, operation and maintenance of protective system. It is interesting to note in this latter case that the design of central-station-supervised intrusion-detectors almost invariably permits their operation to be checked from the remote control point. Photoelectric system light sources may be extinguished to note performance of alarms under conditions simulating beam-interruption. Dummy capacitance may similarly be shunted from antenna to ground in the case of capacity-relay devices.

Electronic engineering has obviously become a major factor in the intrusion-detection field. One company alone has installed 4100 photoelectric alarms, of which 1300 are operating outdoors. Capacity systems protecting safes and acoustic systems guarding vaults electronically are too numerous to estimate. —W. MACD.

Firms supplying data for use in connection with survey include: American District Telegraph Company (ADT), executive offices in New York and branches in 116 principal cities; Electronic Control Corporation of Detroit; Holmes Electric Protective Company of New York, Philadelphia and Pittsburgh; O. B. McChintock Company of Minneapolis; Smith Detective Agency & Nightwatch Service, Inc. of Dallas; Photoswitch Incorporated of Cambridge, Mass.; United Cinephone Corporation of Torrington, Conn. and Warner Products Corporation of Chicago.

SKIN EFFECT FORMULAS

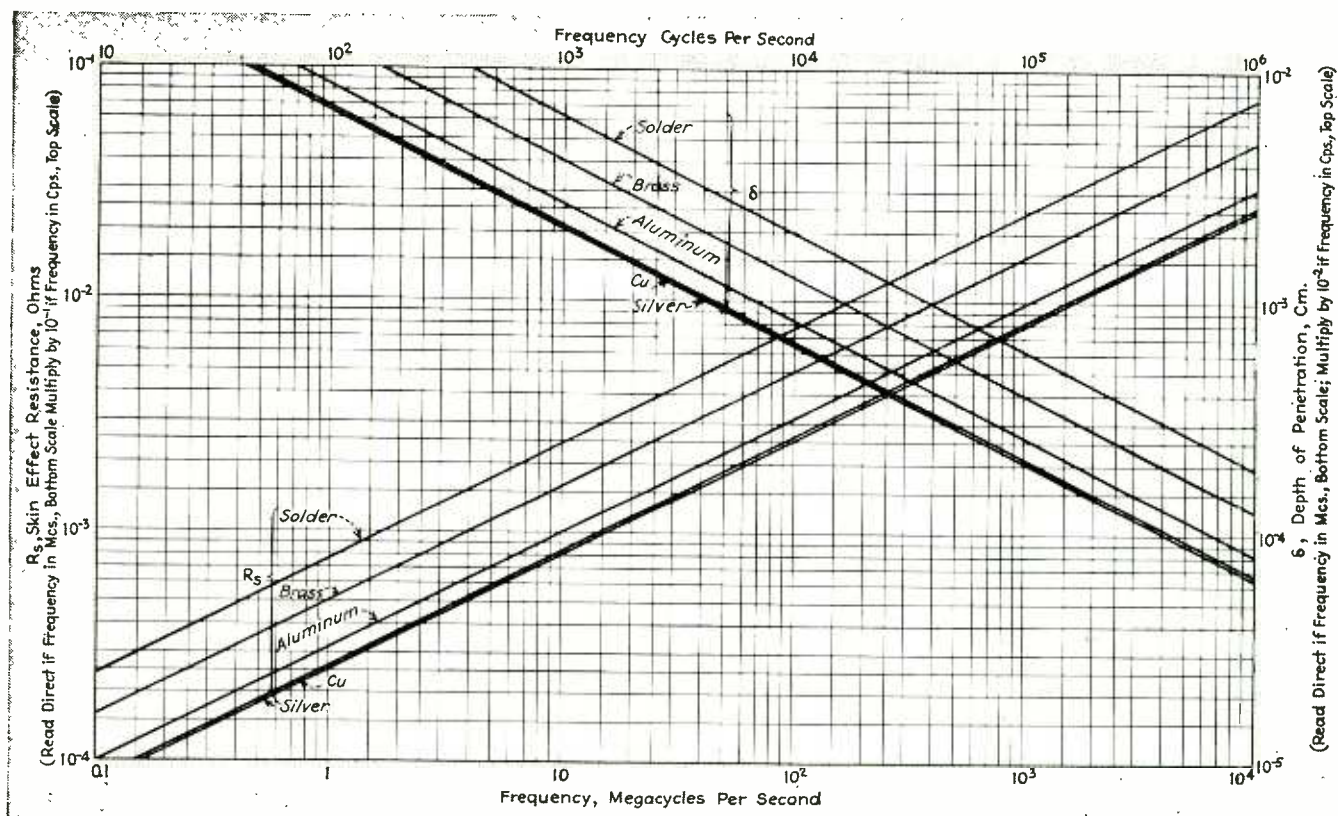

Fig. 1—Skin effect quantities to be used in the following curves

ALTHOUGH skin effect phenomena are well known, there have recently been many requests for design curves and formulas convenient for engineering use. This article is a compilation of these formulas and curves. The theoretical analysis is not included since it appears in many other references.¹ The curves for coated conductors are of special interest in modern u-h-f applications. The cases treated are:

- A. Plane solid of infinite depth
- B. Round wire at low frequencies
- C. Round wire at very high frequencies
- D. Round wire at any frequency

¹ See for instance Hund "Phenomena in High Frequency Systems". McGraw-Hill Book Co.

- E. Tubular conductors at very low frequency
- F. Tubular conductors at very high frequency
- G. Thin-walled tubular conductors at any frequency
- H. Conductors coated with other conductors
- I. Conductor coated with thin layer of poor conductor or imperfect dielectric.

In all the following results, it has been assumed that all conductors (except the imperfect dielectric in the last section) are good enough conductors so that displacement currents in them are unimportant compared to conduction currents. It has been assumed that

current does not vary along the conductor in a distance comparable to depth of penetration into the conductor. Both of these are excellent approximations for all but very poor conductors (such as earth) at any radio frequency. It is also assumed that there are no other conducting paths close enough to seriously disturb the current distributions calculated. This assumption is not good, for instance, for the wire in a closely wound coil. Other assumptions are listed in specific sections.

UNITS AND NOMENCLATURE

$$f = \text{frequency in cps}$$

$$\omega = 2\pi f$$

$$\sigma = \text{conductivity in } \frac{1}{\text{ohm cm}} = \text{mhos/cm}$$

Originally prepared as an inter-department memorandum for engineers at the General Electric Company, this material has proved so useful, in light of present interest in the higher frequencies, that it was released for publication in **ELECTRONICS** in this manner

By **J. R. WHINNERY** *Engineering General Department, General Electric Company*

- μ = permeability on the basis of unity permeability for non-magnetic materials
- ϵ = dielectric constant on basis of unity for air or space
- δ = depth of penetration, in cm. For a plane solid of infinite depth, this is the depth to which current density has fallen to $1/e$ (about 37 per cent) of its value at the surface; it is also the thickness of a plane conductor having d-c resistance equal to the h-f resistance of the plane conductor of infinite depth
- R_s = skin effect resistance in ohms, the resistance for a unit width and unit length of the plane solid of infinite depth
- R_o = d-c resistance of any conductor
- r_o = radius of a solid round wire, or outer radius of a hollow tubular conductor, cm
- r_i = inner radius of a hollow tubular conductor, cm
- d = wall thickness of tubular conductor or coating thickness for coated conductor
- $j = \sqrt{-1}$
- λ = wavelength, measured in the dielectric coating = $\frac{3 \times 10^{10}}{f \sqrt{\mu_1 \epsilon_1}}$ cm
- L_i = internal inductance of any conductor, or contribution to inductance of a circuit from flux inside the conductor
- $(L_i)_o$ = internal inductance of a conductor at very low frequencies

WORKING FORMULAS

A. Plane solid of infinite depth

Practically, this merely means any conductor whose depth and surface curvatures are large compared to depth of penetration into that conductor.

$$\delta = \frac{1}{2\pi \sqrt{f\mu\sigma} \times 10^{-9}} \text{ cm} \quad (1)$$

$$R_s = \frac{1}{\sigma\delta} = 2\pi \sqrt{\frac{f\mu \times 10^{-9}}{\sigma}} \text{ ohms} \quad (2)$$

Internal reactance $(\omega L_i) = R_s = 1/\sigma\delta$ ohms

R_s and ωL_i are exactly equal numerically for the plane solid of infinite depth at any frequency and for conductors of any size or shape at any frequency. This is approximately true for the other cases given below.

Representative Values at 20°C

	Conductivity mhos/cm (σ)	Depth of Penetration cm (δ)	Skin effect resistance ohms (R_s)
Silver	6.17×10^6	$\frac{6.41}{\sqrt{f}}$	$2.52 \times 10^{-7} \sqrt{f}$

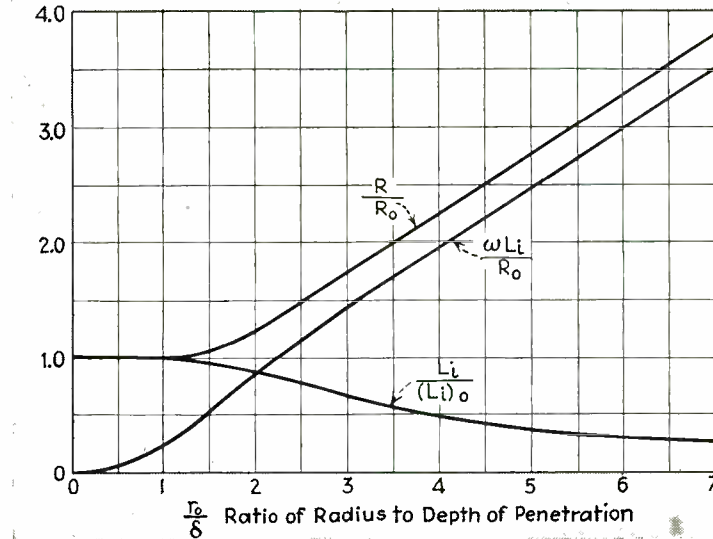

Fig. 2—Solid round wire. Skin effect quantities compared to d-c values. R_o = d-c resistance of round wire; L_i = internal inductance; R = true resistance of round wire; $(L_i)_o$ = internal inductance at very low frequencies

Copper	5.80×10^6	$\frac{6.60}{\sqrt{f}}$	$2.61 \times 10^{-7} \sqrt{f}$	$(\omega L_i)_o = \frac{\omega\mu}{2} \times 10^{-9}$ ohms/cm length (4)
Pure aluminum	3.72×10^6	$\frac{8.26}{\sqrt{f}}$	$3.26 \times 10^{-7} \sqrt{f}$	The equation for resistance, including the first correction term which appears as the frequency increases, is
Brass	1.57×10^6	$\frac{12.7}{\sqrt{f}}$	$5.01 \times 10^{-7} \sqrt{f}$	
Solder	0.665×10^6	$\frac{19.5}{\sqrt{f}}$	$7.70 \times 10^{-7} \sqrt{f}$	

Curves of δ and R_s as functions of frequency are given for these materials in Fig. 1.

B. Round Wire at Low Frequencies

At frequencies low enough so that skin effect has not appreciably changed current from a uniform distribution, resistance and internal inductance are practically those calculated for d-c conditions. Note that resistance is inversely proportional to area, or square of radius.

$$R_o = \frac{1}{\pi\sigma r_o^2} \text{ ohms/cm length} \quad (3)$$

C. Round Wire at Very High Frequencies

At high frequencies, penetration into the conductor is slight, curvature of the surface is unimportant, and the round wire acts practically as a plane solid of great depth and width equal to circumference of the wire. Note that resistance is now inversely proportional to circumference, or first power of radius.

$$R_{h-f} = (\omega L_i)_{h-f} = \frac{R_i}{2\pi r_o} \quad (6)$$

R_i is given by Eq. (2) or Fig. 1.

D. Round Wire at Any Frequency

Resistance and internal reactance in general may be best expressed in terms of ratios. Below are ratios to d-c resistance, and to the values of resistance and reactance calculated from the high frequency formula Eq. (6). There is also given the ratio of internal inductance to that at very low frequencies.

$$\frac{R_{h-f}}{R_o} = \frac{q}{2} \left[\frac{\text{Ber } q \text{ Bei}' q - \text{Bei } q \text{ Ber}' q}{(\text{Ber}' q)^2 + (\text{Bei}' q)^2} \right] \quad (7)$$

$$\frac{\omega L_i}{R_o} = \frac{q}{2} \left[\frac{\text{Ber } q \text{ Ber}' q + \text{Bei } q \text{ Bei}' q}{(\text{Ber}' q)^2 + (\text{Bei}' q)^2} \right] \quad (8)$$

$$\frac{R_{h-f}}{R_{h-f}} = \sqrt{2} \left[\frac{\text{Ber } q \text{ Bei}' q - \text{Bei } q \text{ Ber}' q}{(\text{Ber}' q)^2 + (\text{Bei}' q)^2} \right] \quad (9)$$

$$\frac{(\omega L_i)}{R_{h-f}} = \sqrt{2} \left[\frac{\text{Ber } q \text{ Ber}' q + \text{Bei } q \text{ Bei}' q}{(\text{Ber}' q)^2 + (\text{Bei}' q)^2} \right] \quad (10)$$

$$\frac{L_i}{(L_i)_o} = \frac{4}{q} \left[\frac{\text{Ber } q \text{ Ber}' q + \text{Bei } q \text{ Bei}' q}{(\text{Ber}' q)^2 + (\text{Bei}' q)^2} \right] \quad (11)$$

$$q = \frac{\sqrt{2} r_o}{\delta} \quad (\delta \text{ given Eq. (1) or Fig. 1).}$$

In the above formulas, $\text{Ber } q$, $\text{Bei } q$, etc. are Bessel functions tabulated widely in references and the prime mark indicates the first derivative.²

Equations 7 to 11 are more exact than Eq. 3 to 6 and are plotted in Figs. 2 and 3. Eqs. 3 to 6 are approximate only and the errors from using them are as follows:

Resistance from h-f Eq. (6):

error < 10 percent if $\frac{r_o}{\delta} > 5.5$

error < 5 percent if $\frac{r_o}{\delta} > 10$

Reactance from h-f Eq. (6):

error < 10 percent if $\frac{r_o}{\delta} > 2.2$

error < 5 percent if $\frac{r_o}{\delta} > 2.8$

Resistance from l-f Eq. (3):

error < 10 percent if $\frac{r_o}{\delta} < 1.5$

error < 5 percent if $\frac{r_o}{\delta} < 1.2$

Reactance from l-f Eq. (4):

error < 10 percent if $\frac{r_o}{\delta} < 1.9$

error < 5 percent if $\frac{r_o}{\delta} < 1.5$

² See for instance Dwight—Tables of Integrals and Other Mathematical Data, or McLachlan—Bessel Functions for Engineers.

E. Tubular Conductors at Very Low Frequency $d/\delta < 3/4$

1. Voltage applied at outer radius (as for inner conductor of a coaxial line)

$$R_o = \frac{1}{\pi \sigma (r_o^2 - r_i^2)} \text{ ohms/cm length} \quad (12)$$

$$(L_i)_o = \frac{2 \times 10^{-9} \mu}{(r_o^2 - r_i^2)^2} \left[\frac{r_o^4 - r_i^4}{4} - r_i^2 (r_o^2 - r_i^2) + r_i^2 \log_e \left(\frac{r_o}{r_i} \right) \right] \text{ henrys/cm} \quad (13)$$

2. Voltage applied at inner radius (as for outer conductor of a coaxial line)

$$R_o = \frac{1}{\pi \sigma (r_o^2 - r_i^2)} \text{ ohms/cm} \quad (14)$$

$$(L_i)_o = \frac{2 \times 10^{-9} \mu}{(r_o^2 - r_i^2)^2} \left[\frac{r_o^4 - r_i^4}{4} - r_o^2 (r_o^2 - r_i^2) + r_o^2 \log_e \left(\frac{r_o}{r_i} \right) \right] \text{ henrys/cm} \quad (15)$$

Fig. 4—Tubular conductor. Skin effect quantities compared to d-c values.
 R_o = d-c resistance of tubular conductor
 R = resistance of tubular conductor
 L_i = internal inductance

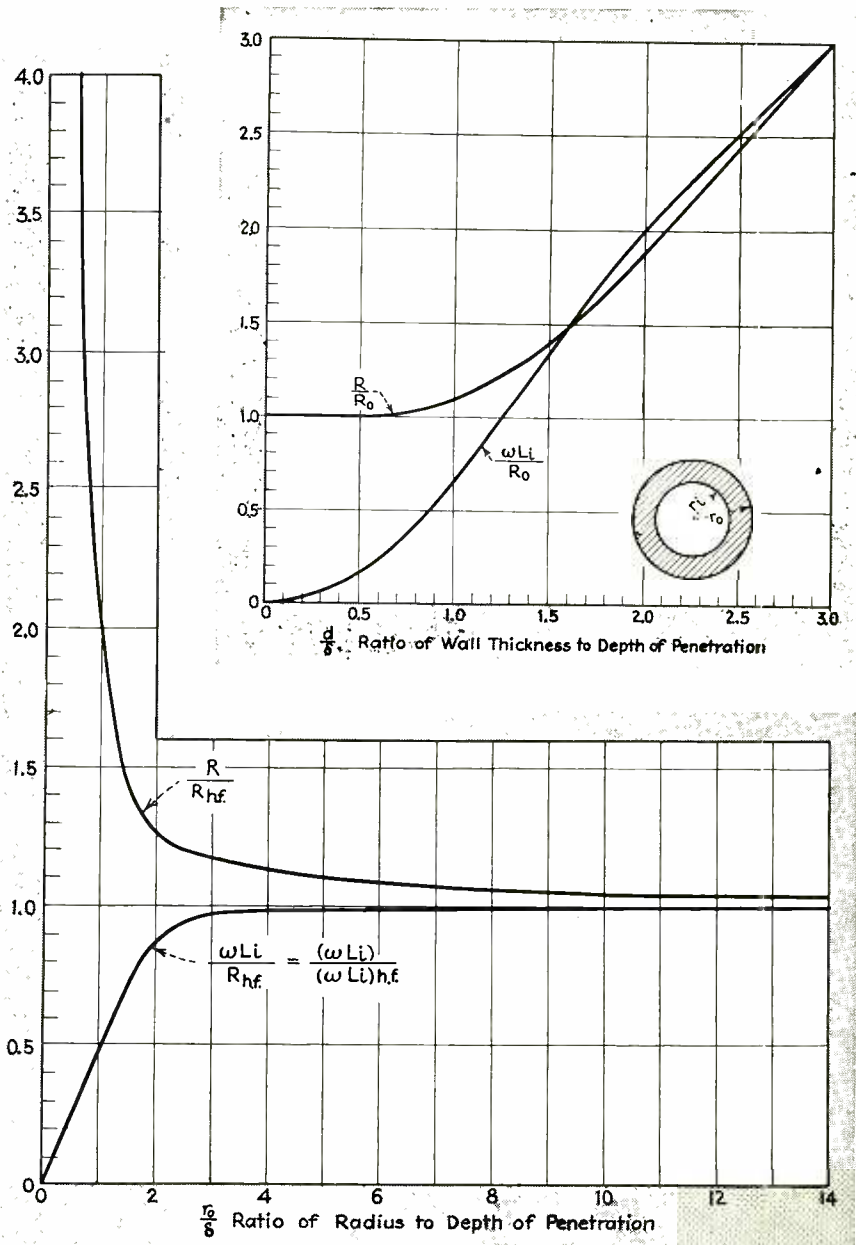

Fig. 3—Solid round wire. Skin effect resistance and reactance compared to values calculated from h-f formulas.
 R = actual resistance of round wire
 ω = frequency $\times 2\pi$
 R_{h-f} = resistance calculated from h-f formulas
 L_i = internal inductance

R_o = d-c resistance of tubular conductor
 R = resistance of tubular conductor
 L_i = internal inductance

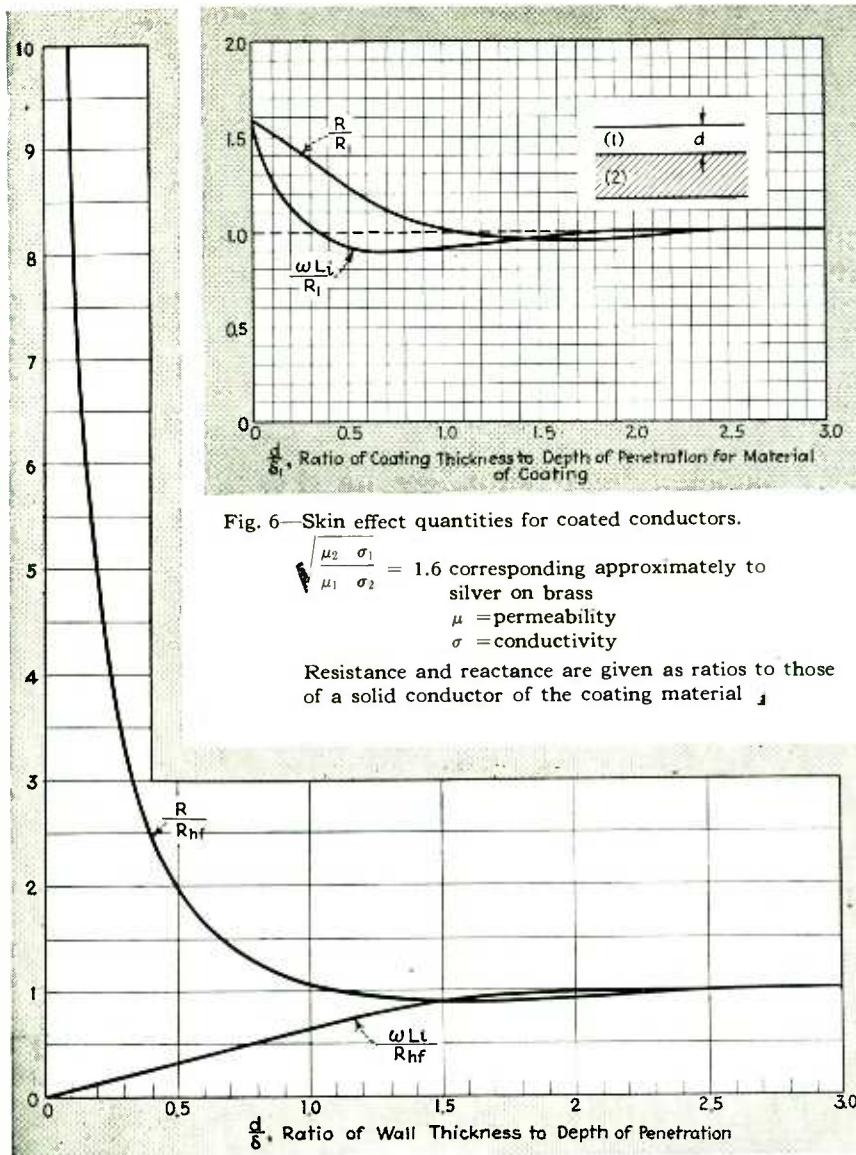

Fig. 6—Skin effect quantities for coated conductors.

$\sqrt{\frac{\mu_2 \sigma_1}{\mu_1 \sigma_2}} = 1.6$ corresponding approximately to silver on brass
 μ = permeability
 σ = conductivity
 Resistance and reactance are given as ratios to those of a solid conductor of the coating material

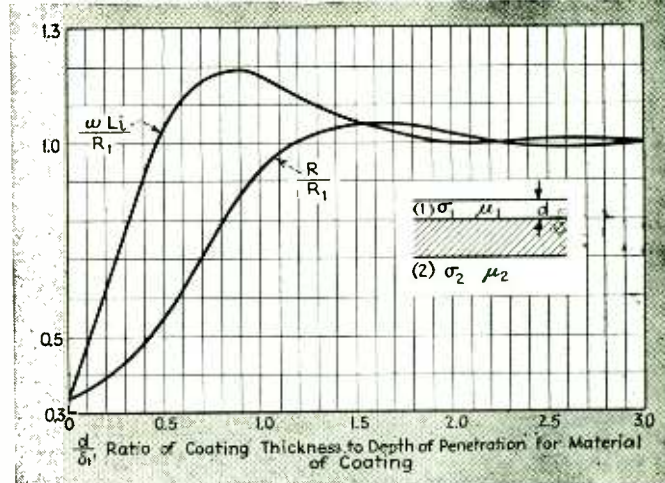

Fig. 7—Skin effect quantities for coated conductors.

$\sqrt{\frac{\mu_2 \sigma_1}{\mu_1 \sigma_2}} = 0.34$ corresponding approximately to solder on copper
 μ = permeability
 σ = conductivity

Fig. 5—Thin-walled tubular conductor. Skin effect resistance and internal reactance compared to values calculated from h-f formulas.
 R = actual resistance of conductor
 R_{h-f} = resistance calculated from h-f formulas
 L_i = internal inductance

F. Tubular Conductors at Very High Frequency $d/\delta > 2$

1. Voltage applied at outer radius

$$R_{h-f} = (\omega L_i)_{h-f} = \frac{R_o}{2\pi\tau_o} \quad (16)$$

2. Voltage applied at inner radius

$$R_{h-f} = (\omega L_i)_{h-f} = \frac{R_i}{2\pi\tau_i} \quad (17)$$

G. Thin-walled Tubular Conductor at Any Frequency

It is assumed only that the wall thickness is small compared to the radius of the tube (say less than 1/5). Values are given again as ratios to d-c resistance calculated from (12), (14), or h-f resistance calculated from (16), (17).

$$\frac{R}{R_o} = \frac{d}{\delta} \left[\frac{\sinh\left(\frac{2d}{\delta}\right) + \sin\left(\frac{2d}{\delta}\right)}{\cosh\left(\frac{2d}{\delta}\right) - \cos\left(\frac{2d}{\delta}\right)} \right] \quad (18)$$

$$\frac{(\omega L_i)}{R_o} = \frac{d}{\delta} \left[\frac{\sinh\left(\frac{2d}{\delta}\right) - \sin\left(\frac{2d}{\delta}\right)}{\cosh\left(\frac{2d}{\delta}\right) - \cos\left(\frac{2d}{\delta}\right)} \right] \quad (19)$$

$$\frac{R}{R_{h-f}} = \left[\frac{\sinh\left(\frac{2d}{\delta}\right) + \sin\left(\frac{2d}{\delta}\right)}{\cosh\left(\frac{2d}{\delta}\right) - \cos\left(\frac{2d}{\delta}\right)} \right] \quad (20)$$

$$\frac{\omega L_i}{R_{h-f}} = \left[\frac{\sinh\left(\frac{2d}{\delta}\right) - \sin\left(\frac{2d}{\delta}\right)}{\cosh\left(\frac{2d}{\delta}\right) - \cos\left(\frac{2d}{\delta}\right)} \right] \quad (21)$$

d is wall thickness. δ is given by Eq. 1 or Fig. 1.

These ratios are plotted as curves in Figs. 4 and 5, as functions of d/δ . The error in using the high frequency Eqs. (16) or (17) is less than 5 percent if wall thickness is more than two times the depth of penetration.

H. Conductors Coated with Other Conductors

It is assumed that the coated material (but not necessarily the coating) is thick compared to depth of penetration in it, and that the coating thickness is small compared to any curvature of the surface. Results are given as ratios of resistance and reactance of the composite conductor to that of a similar conductor made entirely of the material of the coating.

$$\frac{(R + j\omega L_i)}{R_1} = (1 + j) \times \left[\frac{\sinh \gamma_1 d + \frac{R_{s2}}{R_{s1}} \cosh \gamma_1 d}{\cosh \gamma_1 d + \frac{R_{s2}}{R_{s1}} \sinh \gamma_1 d} \right] \quad (22)$$

$$\text{where } \frac{R_{s2}}{R_{s1}} = \sqrt{\frac{\mu_2 \sigma_1}{\mu_1 \sigma_2}} \text{ and } \gamma_1 = \frac{(1 + j)}{\delta_1}$$

R_1 is the resistance if the coating were of infinite depth.

δ_1 is given by Eq. (1) or Fig. 1.

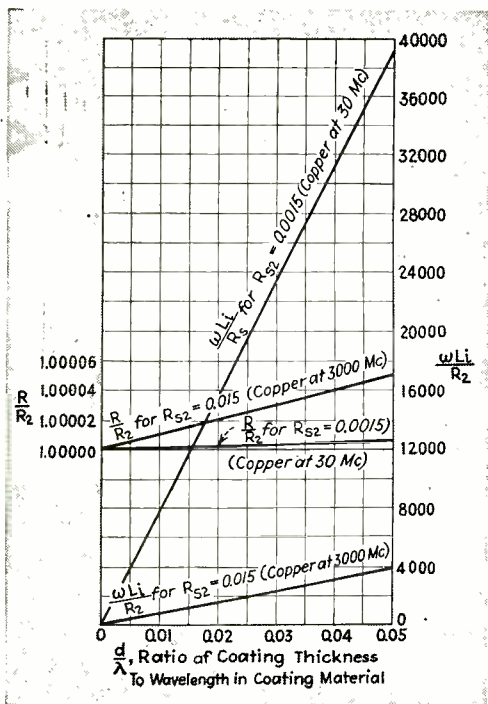

Fig. 9—Skin effect quantities for conductor with a coating of dielectric or poor conductor.

- R_2 = resistance (also internal reactance) if coating were not present
- ωL_i = internal reactance of coated conductor
- R = resistance of coated conductor
- Dielectric constant of coating material = 4

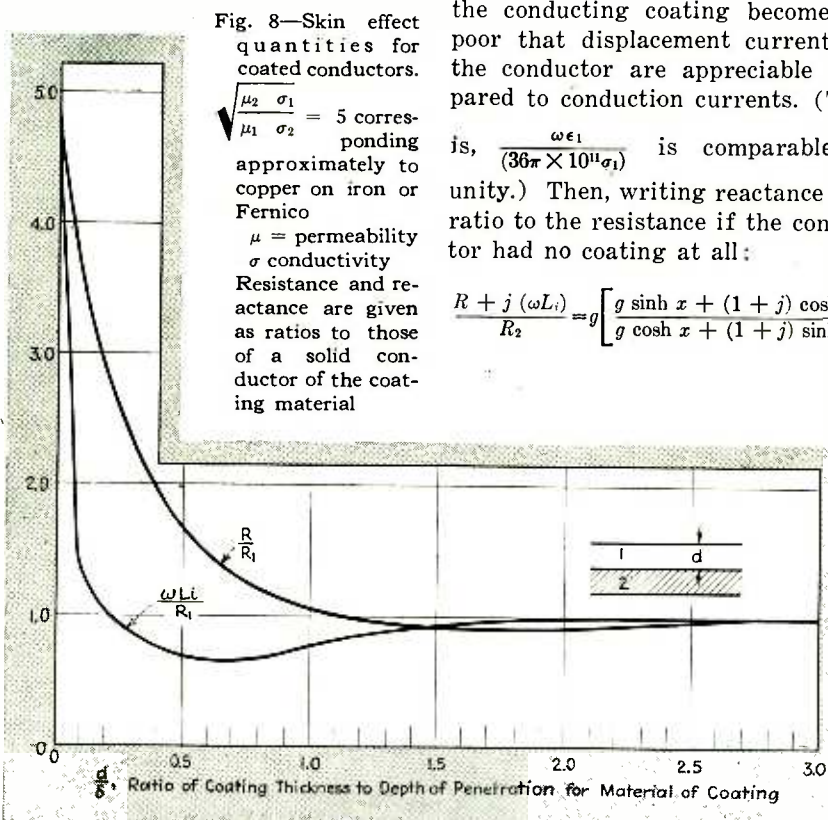

Fig. 8—Skin effect quantities for coated conductors.

$\sqrt{\frac{\mu_2 \sigma_1}{\mu_1 \sigma_2}} = 5$ corresponding approximately to copper on iron or Fernico
 μ = permeability
 σ conductivity
 Resistance and reactance are given as ratios to those of a solid conductor of the coating material

Curves are plotted in Figs. 6, 7, and 8 as functions of the ratio of coating thickness to depth of penetration, for values of $\frac{R_{s2}}{R_{s1}} = 1.6, 0.34, \text{ and } 5$. These correspond approximately to silver coating on brass, solder coating on copper, and copper coating on iron or Fernico. It is seen that in all cases when coating thickness is equal to or greater than the depth of penetration, δ_1 , for the material of the coating (obtained from Eq. 1 or Fig. 1), the composite conductor is nearly as good, or as bad, as though the conductor were made entirely of the coating material.

Note on the curves that in the neighborhood of $d/\delta = 1.5$, the silver-coated brass conductor has slightly lower resistance than a solid silver conductor, copper-coated iron has lower resistance than solid copper, and solder-coated copper has greater resistance than solid solder. This effect arises from the redistribution of current in the coating because of the presence of the base material.

I. Conductor Coated with Thin Layer of Poor Conductor or Imperfect Dielectric

Equation (22) is applicable until the conducting coating becomes so poor that displacement currents in the conductor are appreciable compared to conduction currents. (That is, $\frac{\omega \epsilon_1}{(36\pi \times 10^{11} \sigma_1)}$ is comparable to unity.) Then, writing reactance as a ratio to the resistance if the conductor had no coating at all:

$$\frac{R + j(\omega L_i)}{R_2} = g \left[\frac{g \sinh x + (1 + j) \cosh x}{g \cosh x + (1 + j) \sinh x} \right] \quad (23)$$

$$\text{where } g = \frac{120 \pi \sqrt{\frac{\mu_1}{\epsilon_1}}}{R_{s2} \sqrt{1 - jp}}$$

$$x = j \frac{2\pi d}{\lambda} \sqrt{1 - jp}$$

$$p = \frac{\sigma_1 \times 36 \pi \times 10^{11}}{\omega \epsilon_1} =$$

power factor of coating provided $p \ll \text{unity}$.

R_2 given by Eq. (2) or Fig. 1.

$$\lambda = \text{wavelength in the coating} = \frac{\lambda_0}{\sqrt{\mu_1 \epsilon_1}}$$

λ_0 = free space wavelength
 d = coating thickness

All quantities are complex, so that calculations using Eq. (23) are not simple. Usually the coating is a small part of a wavelength in thickness. Then, if p is not large, the first order correction terms found from an expansion of Eq. (23) are

$$\frac{R}{R_2} \approx 1 + \frac{d R_{s2}}{30 \lambda} \sqrt{\frac{\epsilon_1}{\mu_1}} \quad (24)$$

$$\frac{\omega L_i}{R_2} \approx 1 + \frac{240 \pi^2 d}{\lambda R_{s2}} \sqrt{\frac{\mu_1}{\epsilon_1}} \quad (25)$$

It is of interest to find that the first order corrections are independent of conductivity of the coating. For any practical cases (d/λ small and R_{s2} less than one, as shown by Fig. 1) the correction to resistance is always small, but the correction to internal reactance may be very large since the coating may be much thicker than depth of penetration in the coated conductor, and so may contain much more magnetic flux than the coated conductor.

The unimportance of conductivity of the coating comes about since under the above assumptions the coating is not thick compared to δ for the material of the coating (which is large since conductivity is poor), and so most of the current is confined to the coated material. It is then the coated material, not the coating, that is important in determining the power loss, or resistance component.

If coating is comparable to δ for the coating material, Eq. (23) should be used completely. If coating is thick and comparable to wavelength, the problem is usually one of "wave matching" and should be treated somewhat differently.

In Fig. 9 are plotted curves of R/R_2 and $\omega L_i/R_2$ as functions of d/λ for $\epsilon_1 = 4, \mu_1 = 1$, and $R_{s2} = 0.0015$ ohms and 0.015 ohms, corresponding approximately to a thin dielectric or semi-conducting coating on copper at 30 Mc and 3000 Mc, respectively.

Impedance Determinations of Eccentric Lines

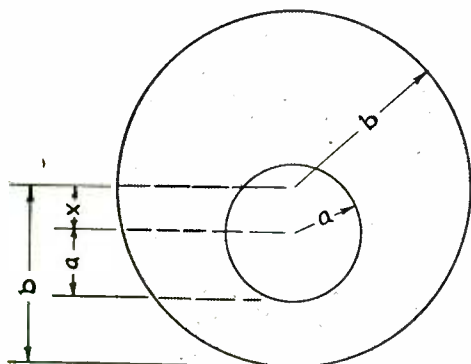

Fig. 1—Configuration of eccentric transmission line with inner conductor displaced by amount x

IT is the purpose of this note to examine the effect on the characteristic impedance of displacing the inner conductor somewhat from its central or coaxial position.

Calculation of Characteristic Impedance

In a well-constructed transmission line, which has low leakage conductance and low conductor resistance, the characteristic impedance is

$$Z_c \text{ (ohm)} = \sqrt{\frac{L}{C}} \quad (1)$$

where L is the inductance per cm length, measured in henries, and C is the capacitance per cm length, measured in farads.

Since the velocity of a wave on the line is

$$v \text{ (cm per sec)} = \frac{1}{\sqrt{LC}} \quad (2)$$

the characteristic impedance may be written

$$Z_c = \frac{1}{vC} \quad (3)$$

If there is no insulation present in the transmission line, we may use $v = 3 \times 10^{10}$ cm per second, and compute C from the static capacitance between conductors. The configuration in which we are interested is shown in Fig. 1. The radius of the outer conductor is b , the radius of the inner conductor is a , while the axis of the inner conductor is displaced an amount x from the axis of the outer conductor. The capacitance of this configuration is¹

$$C \text{ (farads per cm)} = \frac{2\pi p_o}{\cosh^{-1} \left(\frac{b^2 + a^2 - x^2}{2ba} \right)} \quad (4)$$

where p_o (permittivity of free space) = 8.85×10^{-14}

Then from Eq. (3), the characteristic impedance becomes

$$Z_c = 60 \cosh^{-1} \left(\frac{b^2 + a^2 - x^2}{2ba} \right) \quad (5)$$

The characteristic impedance may thus be calculated directly from tables of hyperbolic functions. The expression may also be transformed into the logarithmic form, by making use of the relation²

$$\cosh^{-1}(y) = \log(y + \sqrt{y^2 - 1}) \quad (6)$$

Let

$$y = \frac{b^2 + a^2 - x^2}{2ba} \quad (7)$$

and

$$\begin{aligned} y^2 - 1 &= \frac{[b^2 + a^2 - x^2]^2}{4b^2a^2} - 1 = \\ &= \frac{[b^2 + a^2]^2 + x^4 - 2x^2(b^2 + a^2) - 4b^2a^2}{4b^2a^2} \\ &= \frac{[b^2 - a^2]^2 + x^4 - 2x^2(b^2 + a^2)}{4b^2a^2} \end{aligned} \quad (8)$$

Then

$$\begin{aligned} y + \sqrt{y^2 - 1} &= \\ &= \frac{b^2 + a^2 - x^2 + \sqrt{[b^2 - a^2]^2 + x^4 - 2x^2(b^2 + a^2)}}{2ba} \end{aligned} \quad (9)$$

Fig. 2—Curves showing the effect of eccentricity expressed in ratio of eccentric to concentric impedance

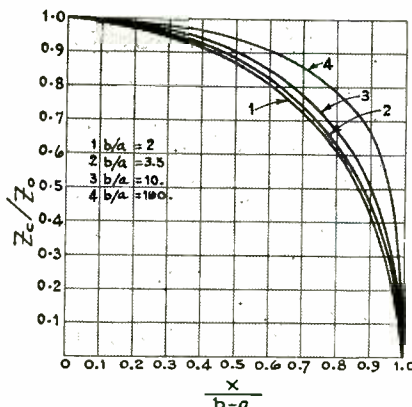

so that the impedance is given by

$$Z_c = 60 \log \left\{ \frac{b^2 + a^2 - x^2 + \sqrt{[b^2 - a^2]^2 + x^4 - 2x^2(b^2 + a^2)}}{2ba} \right\} \quad (10)$$

When the conductors are arranged to have exactly the same axis, that is, when $x = 0$, Eq. (10) becomes

$$Z_c(x=0) = Z_o = 60 \log \left(\frac{b}{a} \right) \quad (11)$$

When $x = b - a$, the conductors are touching, so that the capacitance per unit length is infinite and the characteristic impedance is zero.

The parameter x may then vary between zero and $b-a$. In Fig. 2, the abscissa is $x/(b-a)$, while the ordinate is Z_c/Z_o , that is, the ratio of eccentric characteristic impedance to the perfectly concentric impedance is shown, for a number of ratios of b/a .

When the transmission line is filled with a solid dielectric which has a dielectric constant greater than unity, both Eqs. (10) and (11) should be divided by the square root of the dielectric constant. This leaves the ratios shown in Fig. 2 unchanged.

Figure 2 shows that the ratio of eccentric to concentric characteristic impedance, when expressed in terms of percentage of total possible shift, is very nearly independent of the ratio of the radii of the two conductors. When the inner conductor is shifted fifty percent of the total possible amount, the characteristic impedance is dropped about ten percent.

(1.) William R. Smythe, "Static and Dynamic Electricity," first edition, McGraw-Hill Book Company, Inc., p. 76, Equation (5).

(2.) B. O. Peirce, "A Short Table of Integrals," second edition, Ginn and Company, p. 82, Equation (680)..

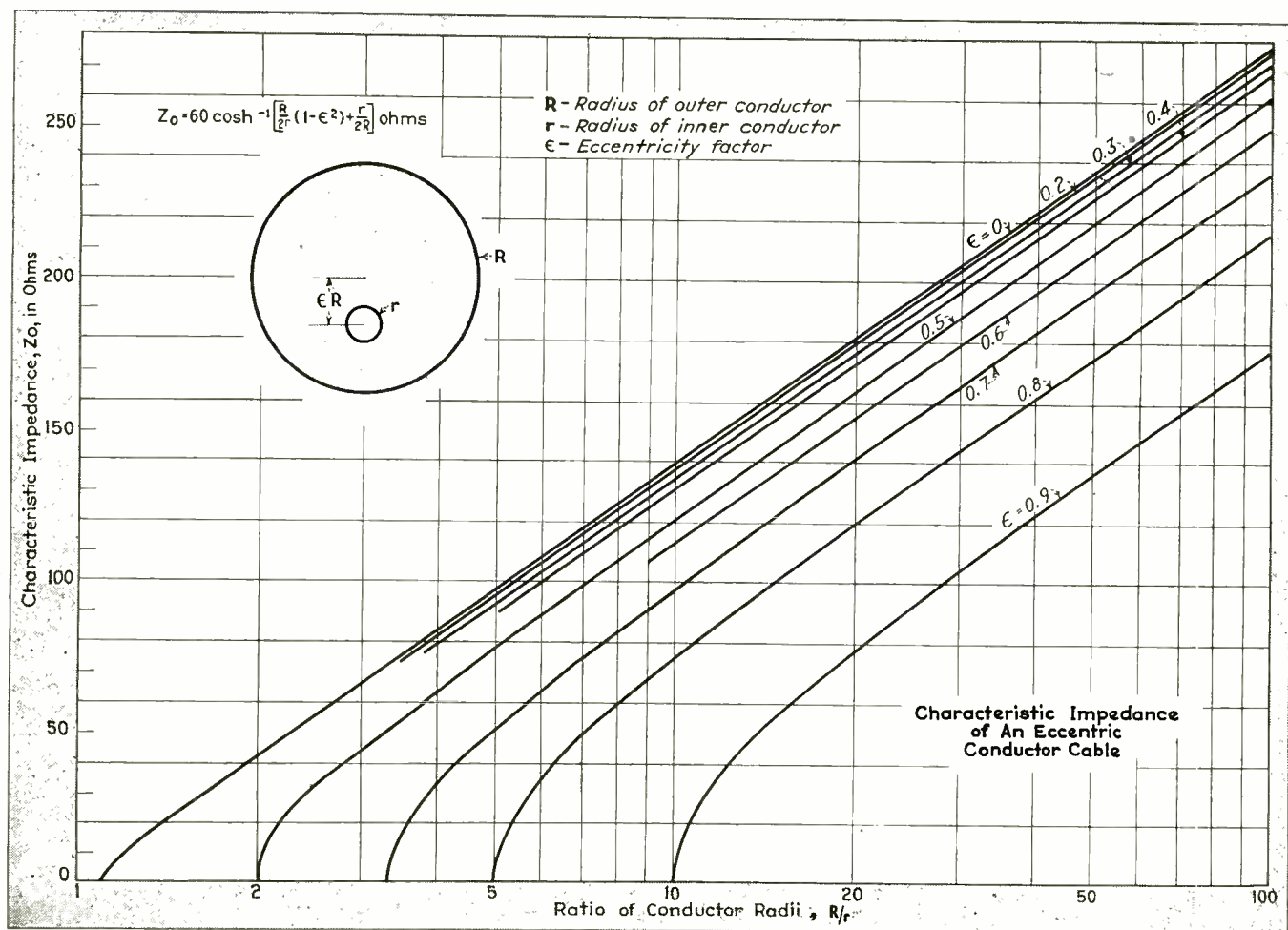

GRAPH of IMPEDANCE of Eccentric Conductor Cable

THE characteristic impedance of a transmission line composed of cylindrical conductors concentrically spaced with regard to their common axis depends upon the ratio of the inner radius of the outer conductor and the outer radius of the inner conductor, for a given dielectric. For such a transmission line, the impedance is constant if the construction is uniform throughout its length.

It is sometimes desirable to vary the characteristic impedance for impedance matching purposes. While this could be accomplished by altering the relative sizes of the conductors, this procedure is not always advisable since it introduces discontinuities and manufacturing difficulties. Another method of varying the impedance is to make the interior con-

By **WILLIAM J. BARCLAY**
and
KARL SPANGENBERG

*Department of Electrical Engineering
Stanford University*

ductor eccentric, rather than concentric. This method has the advantage of permitting the impedance to be varied without altering the size or shape of either conductor. Furthermore, since the characteristic impedance decreases as the eccentricity factor is increased, any reasonable characteristic impedance less than that for the equivalent concentric case can be obtained.

A graph showing the characteristic impedance of a conductor cable for various degrees of eccentricity is shown above. The eccentricity fac-

tor, ϵ , is expressed as a fraction of the inner radius of the outer conductor, R , and ϵR is the displacement of the inner conductor from the axis of the outer conductor. The graph may be used in the design of conductor cable transmission lines, or to determine the impedance of an existing cable provided the eccentricity factor, ϵ , and the ratio, R/r , are both known. The graph is also useful in indicating what variations in impedance are to be expected from slight deviations of centering of the inner conductor of conductor cables.

If a straight line is drawn through $R/r = 1$, $Z_0 = 30$ and through $R/r = 60$, $Z_0 = 120$, the portion of the impedance curves above this pencil line can, for all practical purposes, be regarded as straight lines.

"CINCH FOR US" ★

FROM THE GROUND UP

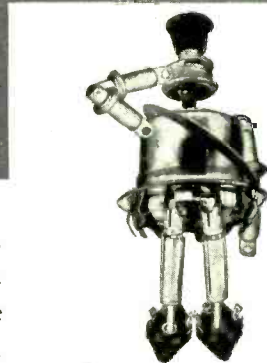
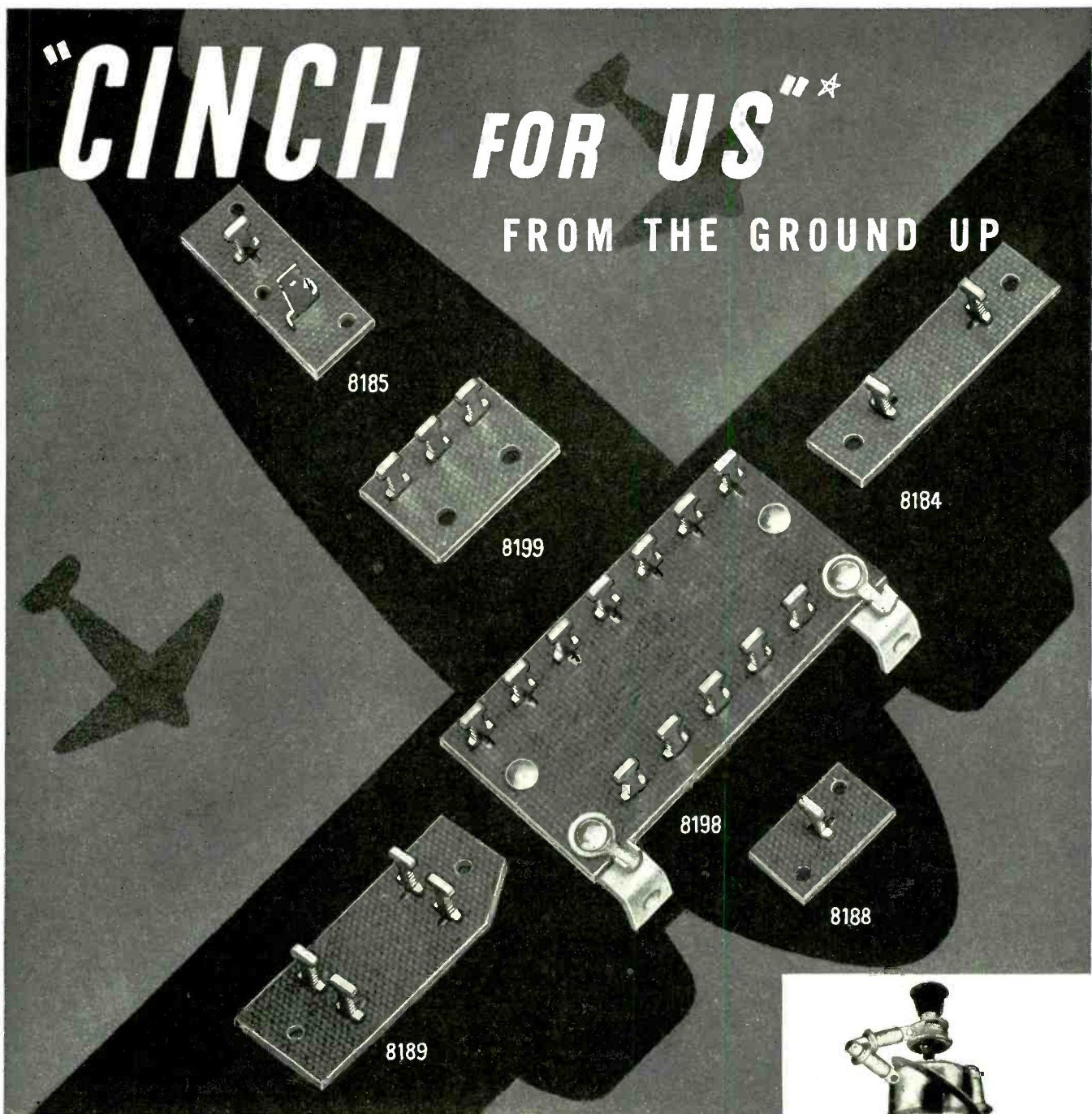

THESE Cinch Terminal Boards are made for heavy duty. Substantial, sturdy, of fabricated *Ucinite*, Cinch's own laminated material. The lugs are stamped from copper eliminating screw machine parts . . . a signal contribution to the defense program. Wires can be soldered and removed several times without loosening lug. The specially treated 1/16 and 3/32 canvas base Ucinite is impervious to moisture. The copper lugs with serrated edges firmly hold wires in place—all hot tin dipped for quick and easy soldering. Many different types of these terminal boards—and similarly assembled parts—are available for your defense program requirements.

★ Says the radio engineering authority . . . More often than not, a survey of radio engineers would get "endorsement by use" of CINCH parts as its result.

— Cinch and Oak Radio Sockets are licensed under H. H. Eby Socket Patents.

CINCH MANUFACTURING CORPORATION • 2335 WEST VAN BUREN STREET • CHICAGO, ILLINOIS
SUBSIDIARY: UNITED-CARR FASTENER CORP. • CAMBRIDGE, MASS.

New Books

Glass, The Miracle Maker

BY C. J. PHILLIPS, *Corning Glass Works*. (424 pages. Illustrated. Fiberglass bookmark provided. Price \$4.50. Pittman Publishing Co., New York.)

AT FIRST THOUGHT it would seem that a book on glass has little place for review in *ELECTRONICS* which aims to devote itself to the uses and applications of electron tubes. Still, tube manufacturers have considerable use for glass in spite of rather extensive use of metal envelopes, and when it is realized that this volume contains some rather interesting technical material on the properties and manufacture of glass, it is realized that Mr. Phillips' work will probably interest many of our readers. Besides, Mr. Phillips has contributed to *ELECTRONICS*.

"Glass, The Miracle Maker" is one of those rare pieces of writing which, although "pretty technical" in spots, contains information for readers of all educational levels. You may be interested in the physical properties of glass or the work which culminated in the Houskeeper glass-metal seal, but you can leave the volume on the library table with the knowledge that the chapters on glass in the home and decorative glassware will form a suitable topic of discussion at next Wednesday's sewing circle.

In brief, this volume deals with the history, technology, manufacture, and various applications of glass. The first part, comprising 248 pages, deals with the mechanical and other physical properties of glass, its chemical mixture, its manufacture, and history. This is the section of main interest to the technically minded who can find out more about each subject from the references at the end of the chapter. Part two, of some 230 pages, deals with the applications of glass and treats the use of glass in such diverse subjects as building construction, home furnishings, electrical communication, power transmission, illumination, science and research, acoustic insulation and the textile industry.

The book is well written and illustrated and covers subjects of interest to everyone. It is well documented and can easily serve as a reference work in spite of its easy readability, and fascinating story. In short, it is the kind of book you might buy to give as a Christmas gift, but decide to keep for yourself.—B. D.

Insulation and Electrical Apparatus

BY DOUGLAS F. MINER, *George Westinghouse Professor of Engineering, Carnegie Institute of Technology*. McGraw-Hill Book Co., New York, 1941. Price \$5.00, 452 pages, illustrated.

MR. MINER'S BOOK is an excellent survey of modern techniques in insulating electrical equipment. Our present rather meager knowledge of dielectric behavior and the factors affecting this behavior are covered in the first three chapters. Then, the various insulating materials used in modern practice, and how they are applied in industrial rotating equipment, control apparatus, transformers and reactors, circuit breakers, capacitors, heating appliances, lamps and tubes, instruments, and relays are discussed in great detail. Many illustrations and diagrams graphically show where and why insulation is used.

The final section of the book covers insulation testing and insulation testing equipment. Tables and curves showing the properties and performance characteristics of insulation, and a plastics directory which lists trade names, types, and manufacturers of plastics in the U. S. is included in the appendix section.

The book is well worth the attention of electrical engineers since it gives a clear insight into a little-understood phase of their art.—E. E. G.

Foundations of Short Wave Therapy

By WOLFGANG HOLZER AND EUGEN WEISSENBERG, translated by Justina Wilson. Published in England, distributed in the United States by Chemical Publishing Co., New York City. 228 pages, price \$5.00.

IN READING BOOKS FROM ENGLAND or from Germany, the American engineer (or in this case the medical man) must first contend with the different terminology. For example the Germans use Hertz (Hz) for cycle per second, pulsance for angular velocity of the rotating vector ($2\pi f$). The first section of this book is devoted to the fundamental electrical theory involved in combining circuit elements of capacitance and resistance, characteristics of

damped and undamped oscillation, resonance phenomena, etc.

Under "theory of the electric field" the reader will learn much about the technique of applying high-frequency treatments, the importance of the spacing and form of electrodes on the configuration of the electric fields produced, the effect of the size and position of the treated object, the effect of standing waves when very short waves are used, etc. This is followed by a discussion of the electrical properties of biological materials such as specific resistance, dielectric constant, polarization of the molecules, etc. Technique of shielding (screening), technical hints for the construction and operation of the apparatus are parts of a final section of the first half of the book.

The second portion of the book is devoted to the therapeutic applications and as such has more interest to the medical reader than to the electronic man. The book is well illustrated, and a very large bibliography, largely to German literature, is an important part.—K.H.

The Mechanism of the Electric Spark

By L. B. LOEB, *Professor of Physics at University of California*, and JOHN M. MEEK, *Research Engineer, Metropolitan Vickers Co.* (188 pages. Illustrated. Price, \$3.50. Stanford University Press)

PERHAPS THIS VOLUME may best be regarded as a graduate thesis setting forth the extensive material on hand, and quantitative theory of spark discharges based on the streamer concept. Both authors, individually, have made substantial contributions to the development of this theory, but the present volume arises from their collaboration at the University of California where Mr. Meek was Commonwealth Fund Fellow.

The book analyzes the status of theory of the mechanism of the electric spark in air, develops the streamer theory of spark discharge, and presents a general unified theory applicable to various gaps and electrode configurations so that the breakdown potential for any d-c gap, in the absence of space charge, can be predicted. The work is divided into three chapters, the first of 33 pages discusses the Townsend theory of the spark, the second of 73 pages, deals with the streamer theory of spark discharge, while the final chapter devotes 68 pages to the calculation of breakdown in various types of gaps. The spark theory is developed logically throughout the book, but the method of treatment is such that the work does not serve well for reference purposes for one who has not completed the text from start to finish. Each chapter contains many references and a surprisingly complete index, for a book of this size, completes the text.—B. D.



ALL-METAL

RHEOSTATS

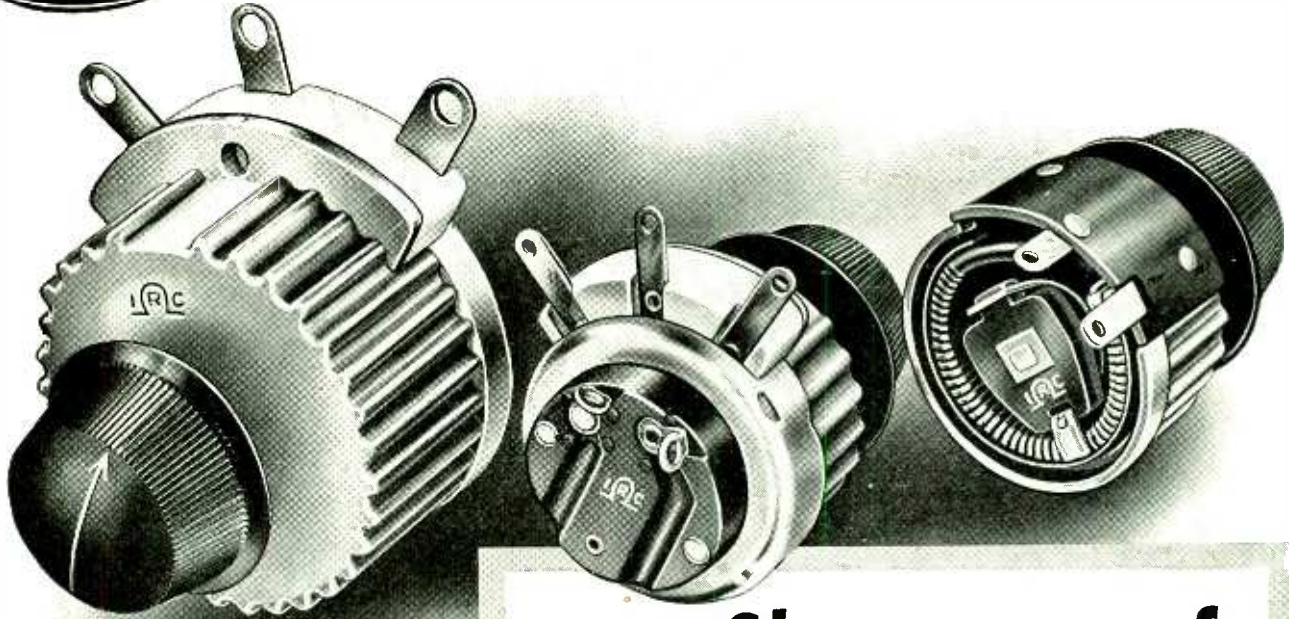

DURABILITY to withstand the concussions of big bombs and gunfire, dependability under conditions of high humidity and other temperature extremes, lighter weight construction, and faster heat dissipation—these, in brief, are the advantages of all-metal construction, that have brought IRC Rheostats to the fore for War-purpose applications. Ask for the IRC Rheostat Catalogs Nos. VI and VI-a.

WRITE FOR THESE DATA BULLETINS

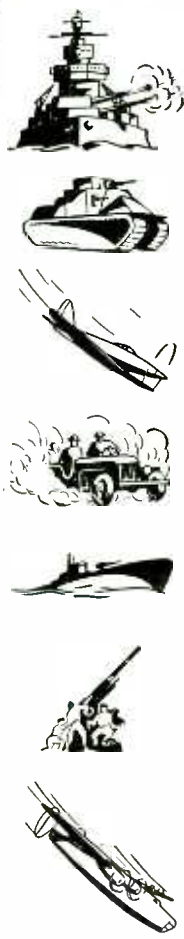

**Shatter-proof
Mechanically rugged...**

Lighter in weight...

50% lower temperature rise for equal size in other types...

Available for 200-hour salt-spray test requirement...

Designs available for special aircraft and ordnance use...

Made for high- and low-temperature operation...

25- and 50-watt sizes

INTERNATIONAL RESISTANCE COMPANY

403 North Broad Street, Philadelphia, Penna. • Makers of Resistance Units in More Types, Shapes and Sizes, and for More Applications Than Any Other Manufacturer in the World.

TUBES AT WORK

A simple carrier-current communication system, a cathode-ray oscilloscope impedance comparator, and a technique for making laboratory records

Simple Uni-Directional Carrier-Current Communicator

By JAMES L. SMITH

KQJF, Moscow, Idaho

OUR POLICE TRANSMITTER and fixed-frequency u-h-f receiver are both located in the county sheriff's office and must be remotely operated from a distant police station. Until six months ago this necessitated leasing of two balanced telephone lines between these points, one to carry control current and audio from the police station to the transmitter and the other to carry audio output from the receiver back to the remote control point.

We have eliminated the need for one of these telephone lines. Control current and audio to operate the transmitter continues to flow over the remaining line from police station to sheriff's office in the usual manner. A carrier-current system of our own manufacture carries audio output of the u-h-f receiver back over the same line and, despite its simplicity, is rendering satisfactory 24-hour service. Two

simple units are used, a carrier-current or "wired-radio" transmitter and a carrier-current receiver.

The carrier-current transmitter, located at the sheriff's office, is a conventional modulated oscillator employing the electron-coupled circuit shown in Fig. 1. L_1 is a 125-ma, 2.5- μ h receiving-type r-f choke which we tapped $\frac{1}{2}$ -way up from the grounded end. Condensers tuning this grid circuit are both of the mica variety. L_2 consists of 185 turns of No. 28 enameled magnet wire close-wound on a $1\frac{1}{2}$ -inch form and resonates sufficiently close to the grid circuit when shunted by the high-voltage type mica condenser shown to insure oscillation. Variable tuning in this plate circuit is unnecessary. L_3 consists of 20 turns of No. 28 enameled magnet wire close-wound on a $1\frac{1}{2}$ -inch form and loosely coupled to L_2 . T_1 is a "universal" type modulation transformer and T_2 is an ordinary line-to-grid transformer. Interference with nearby radio receivers is minimized by thoroughly shielding the entire transmitter, tuning it to a frequency (190 kc) not normally used in superheterodyne i-f amplifiers and coupling r-f output to the telephone line as loosely as satisfactory reception at the remote point permits.

The carrier-current receiver, located at the police station, employs two stages of t-r-f amplification at 190 kc, diode detection and two stages of audio as shown in Fig. 2. Tuned circuits are standard superheterodyne i-f transformers. The primary winding was removed from the first transformer and 20 turns of wire closely coupled to the remaining secondary substituted. Some experimenting was necessary in order to secure the correct degree of coupling for optimum pickup from the telephone line.

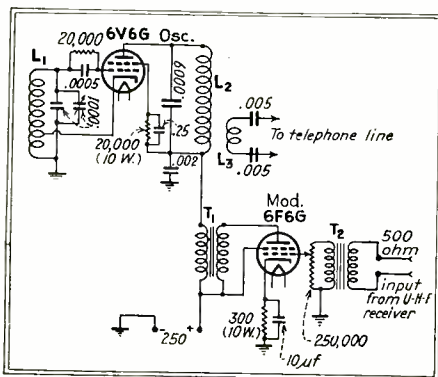

Fig. 1—Carrier-current transmitter

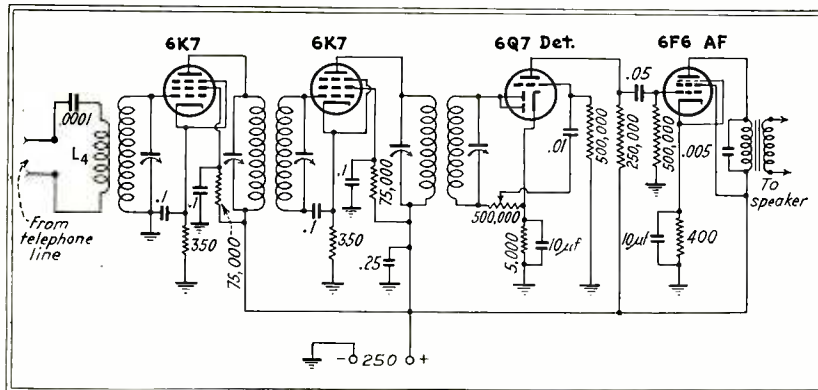

Fig. 2—Carrier-current receiver

A Cathode-ray Oscilloscope Impedance Comparator

By VINCENT SALMON

Jensen Radio Mfg. Co.
Chicago, Ill.

EVERY COMMUNICATIONS LABORATORY has at some time felt the need for a simple and rapid means of visualizing and measuring both the vector and scalar impedance-frequency characteristics of audio frequency apparatus. It was for this purpose that the cathode-ray oscilloscope impedance comparator to be described was developed.

The circuit consists of known, adjustable resistance and reactance elements in series with the unknown impedance Z_u , the combination being supplied from an ungrounded variable frequency source. A cathode-ray oscilloscope (CRO) is used to compare the voltages across each impedance in both vector and scalar senses by means of the switching arrangement shown

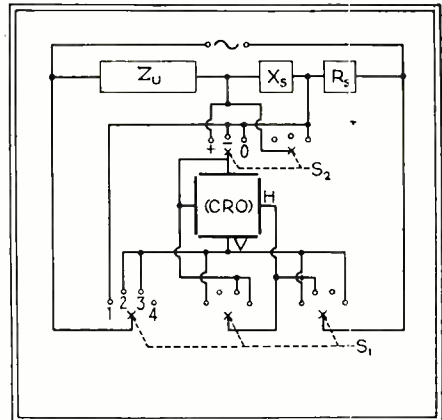

Fig. 1—Schematic of cathode-ray oscilloscope impedance comparator

schematically in Fig. 1. Switches S_1 and S_2 are made up of ganged sections, with the pole or movable arm denoted by an x. The principle of operation is best presented by reference to Figs. 2a, 2b, 2c and 2d, giving the connections for each position of the selector switch S_1 .

Explanation of Switching

Figures 2a and 2b show connections for comparing impedances in the vector sense by applying in space quadrature to the CR tube the voltages across the standard and unknown impedances. Since the CRO loads the tested circuit very little in the majority of applications, the voltages indicated are closely proportional to the impedances. When these have the same phase angle the pattern on the CRO screen will be a straight line inclined at an angle depending on the relative magnitudes of the deflecting voltages. However, unbalanced residual capacitances will cause the line to open to an ellipse at the higher frequencies even when the same voltage feeds both sets of deflecting plates. This is the condition checked in position 1 of S_1 , as in Fig. 2a. Minor unbalance may usually be removed by a trimmer condenser across one of the

You Get these Advantages in OHMITE High Current Tap Switches

- ★ Compact, All Enclosed
- ★ Ceramic Construction
- ★ High Current Ratings
- ★ Many Contacts
- ★ Slow-Break, Quick-Make
- ★ Silver-to-Silver Contacts
- ★ Back-of-Panel Mounting

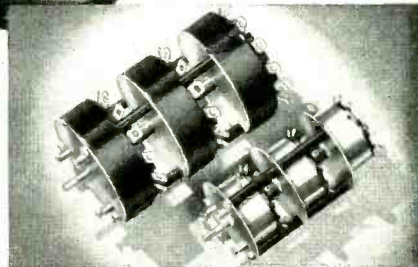
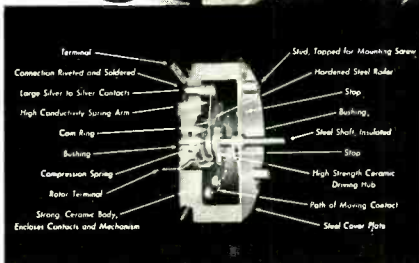
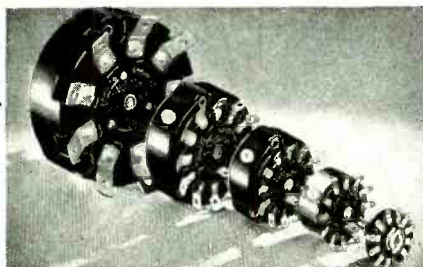

FIVE COMPACT MODELS RATED AT 10, 15, 25, 50 AND 100 AMPERES, A. C.

These unique load-break, single-pole, multi-point rotary selectors have greatly simplified high current circuit switching in a variety of applications. They are especially useful in military aircraft, battery chargers, tapped transformers, welders, radio transmitters and other equipment.

Non-shorting type. Available in five sizes from 10 to 100 amperes, 150, 300 volts, A.C.; from 1 3/4" diam. to 6" diam.; with any number of taps up to 8, 11 or 12 depending on the model. Never before have so many high current taps been so compactly arranged yet perfectly insulated and protected. Two or three units can be

connected in tandem to form multi-pole assemblies. Special constructional features insure trouble-free operation and extra long life. May also be used on low voltage direct current at reduced current ratings. Underwriters' Laboratories Listed models available. Write for details.

Send for Catalog and Engineering Manual No. 40

Most complete, helpful guide in the selection and application of Rheostats, Resistors, Tap Switches. Write on company letterhead for your copy today.



OHMITE MANUFACTURING COMPANY, 4817 Flournoy Street, Chicago, U. S. A.



Be Right with **OHMITE**
RHEOSTATS • RESISTORS • TAP SWITCHES

SEE your signal
before
you HEAR it!
with the

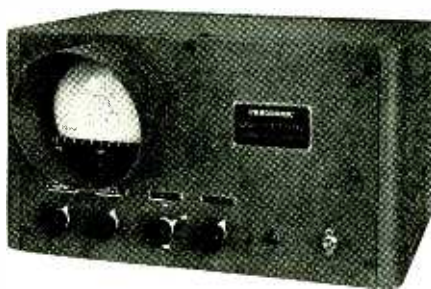

PANORAMIC ADAPTOR

THE Panoramic Radio Adaptor may be attached to any conventional superheterodyne, with an IF frequency of 450 to 480 K.C.

It permits continuous observation of ALL signals present 50 K.C. above and below the frequency to which the receiver is tuned.

Important Applications of the Panoramic Adaptor:

- Effective supervision of a band, because every point on the band is under much longer observation.
- Intermittent signals will not be missed.
- Less operator concentration and nerve fatigue is required to do a faster, better supervisory job with the ADAPTOR.
- Operator can more intelligently select his transmission frequency to avoid interference. Open channels instantly visible.
- Operator can more intelligently use available means to eliminate interference with reception.
- Makes possible rapid, or simultaneous taking of bearings on two or more stations.
- Transmitter frequency can be accurately monitored over a broad band.
- Modulation of transmitters can be monitored, FM as well as AM.
- Field strength and frequency of transmitter can be accurately compared with a standard signal.
- Valuable in the study of behavior of UHF oscillators, tracking or matching of variable condenser sections, IF Transformers, RF stages, etc.
- Fast and accurate on production tests, matching or classifying inductances, capacitors, resistors, and comparing with standards.

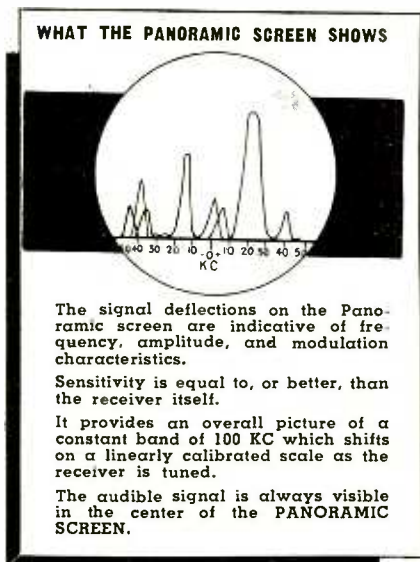

PANORAMIC RADIO CORP.
298 BROADWAY NEW YORK CITY
Phone: COrtlandt 7-4753-4 • Cable: Panoramic, New York

Canadian Representative: Canadian-Marconi Co., Ltd., Montreal, Can.

inputs; for loud-speaker impedance measurement no correction is necessary up to about 4000 cps.

When the circuit balance is thus checked, position 2 of S_1 furnishes the vector impedance comparison; see Fig. 2b. By adjusting the components of the standard impedance Z_s , the condition of equal phase angles is again indicated by the closing of the pattern. Although in loud-speaker work the reactance is usually inductive, it sometimes assumes small negative values. For obtaining these with a variable inductor, switch S_2 may be set to the minus position which makes the reactance element a part of Z_u ; thus the reactance is effectively given the opposite sign.

To observe resonance as defined by zero reactance, S_2 is set at its third position 0 (zero): here the reactance element is shorted, and as the frequency range is swept through, resonance is indicated by the closing of the pattern. Frequencies of maximum or minimum resistance or reactance are arrived at by noting trends in the values of the adjustable elements and by observing reversals in the change of shape of the pattern.

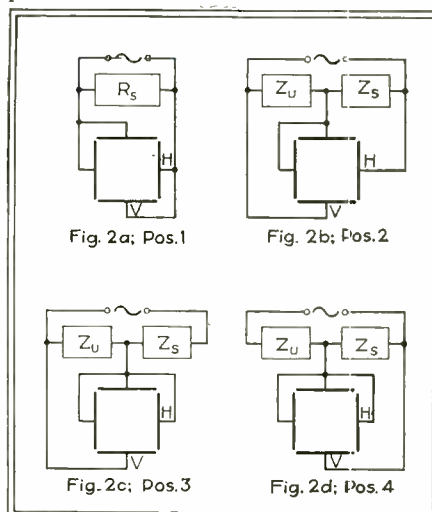

Fig. 2—Equivalent circuits of various CRO impedance comparator switch positions.

While the qualitative information derived from the above observations is usually sufficient, more often the actual value of Z_u is required. There are two methods of obtaining this, the most direct being the adjustment of both R_s and X_s until the pattern closes to the same angle and length as in the check position 1 of S_1 . However, the values necessary may be out of range of the standard elements available, and the adjustment is tedious for anyone unaccustomed to such manipulations; in such cases the second method is preferable. Since the angles have been made equal in position 2 of S_1 , all that is needed is a comparison of the magnitudes, which is afforded in positions 3 and 4. Here vertical line traces are obtained representing voltages proportional to $|Z_u|$ and $|Z_s|$ respectively; in addition the horizontal input is shorted

Benefiting { DESIGNERS
MANUFACTURERS
OPERATORS } of { COMMUNICATIONS
EQUIPMENT }

... G. A. W. Carbonyl Iron Powder

As this war-time year of 1942 progresses, the radio industry gives increasing recognition to the potentialities inherent in the application of iron core devices to modern radio design.

The employment of inductances embodying G.A.W. Carbonyl Iron Powder as the core material builds a high standard of dependability and efficiency into present-day communications equipment.

1

2

The use of G.A.W. Carbonyl Iron Powder means that worth-while savings in
C O P P E R
and
A L U M I N U M
are effected.

Etched specimen of G. A. W. Carbonyl Iron Powder "E"
(Magn. 2000 x)

Note the remarkable inner structure of these minute spheroidal particles.



Product of
General
Aniline
Works,
435
Hudson Street,
New York,
N. Y.

SOLE DISTRIBUTOR:

★ ★ **ADVANCE** ★ ★
SOLVENTS & CHEMICAL CORPORATION
245 FIFTH AVENUE NEW YORK, N.Y.

*Powered
by Thordarson!*

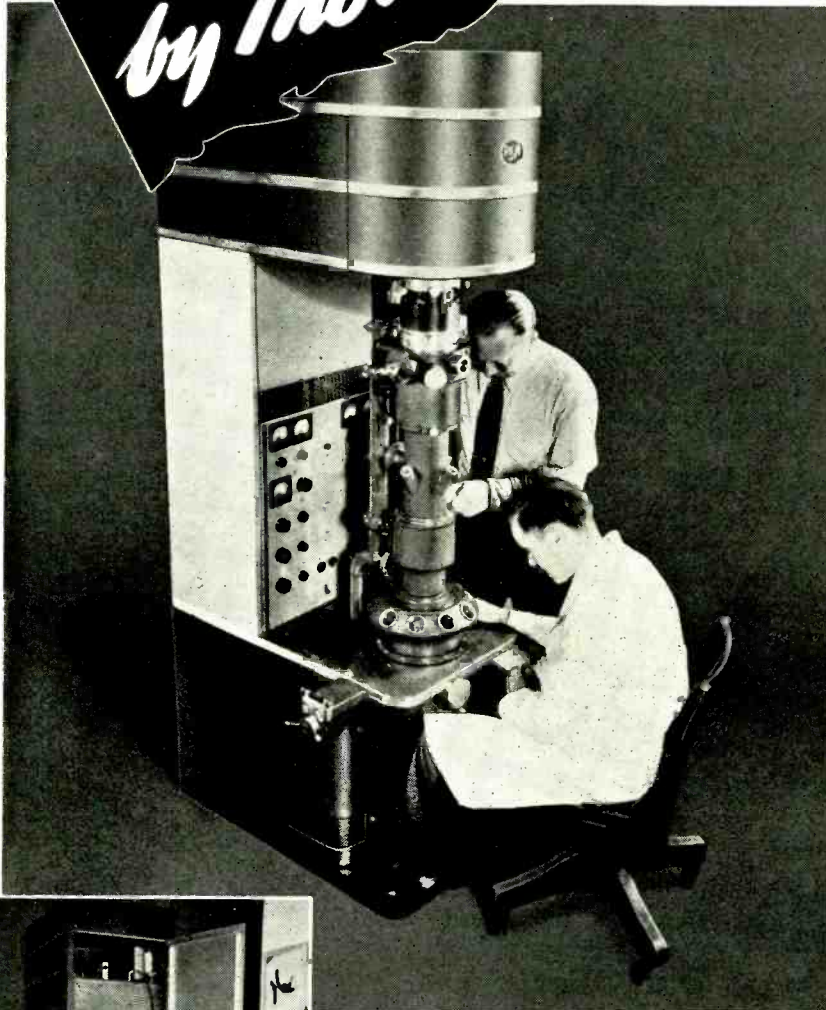

(Large Photo)
Front view of RCA Electron Microscope with Dr. V. K. Zworykin (standing), head of the RCA Electronic Research Laboratory, and James Hillier, who played an important role in the instrument's development.

(Small Photo)
Rear view of microscope with panels removed showing Power Supply Units.
(Photographs Courtesy Proceedings of the I.R.E.)

ONE OF THE GREATEST ACHIEVEMENTS of modern science is the new RCA Electron Microscope. This electron microscope affords magnifications as great as 450,000 times, or nearly half a million, whereas the best optical microscopes cannot usually give magnifications beyond 2,000 times. Thordarson transformers were used in the completely self-contained and extremely compact power supply system. Thordarson is proud of the essential part Thordarson transformers played in the development of this delicate and highly scientific piece of equipment.

For 46 years Thordarson transformers have been designed and manufactured to the highest quality standards, resulting in the selection of Thordarson transformers where precision and dependability are vital.

THORDARSON

ELECTRIC MFG. CO.
500 WEST HURON STREET, CHICAGO, ILL.

TRANSFORMER SPECIALISTS SINCE 1895

to avoid broadening of the trace by extraneous pickup. If D_u and D_s are the deflections, then the unknown impedance is given by $Z_u = Z_s (D_u/D_s)$. Whenever Z_u is easily in the range of elements available for Z_s , it is often more accurate to get an exact phase and approximate amplitude balance by the first method, and then to use the second to furnish a correction factor near unity.

In position 3 (Fig. 2c) the length of the trace may also be used to indicate resonance as defined by maximum or minimum modulus of the impedance. In seeking the maximum it is important that the signal source be of sufficiently high impedance so that an output current substantially independent of frequency is obtained. By comparing resonance frequencies obtained by this criterion with those from the zero reactance condition, it is easily demonstrated that for complicated circuits the two definitions of resonance are not equivalent.

Occasionally measurements of the scalar impedance as a function of frequency are required. For this first set S_2 at its zero reactance position; then by switching S_1 between positions 3 and 4 and adjusting R_1 in the latter position until the vertical deflections are equal, the desired condition $|Z_u| = R_1$ will be reached. The amount of switching necessary will be greatly reduced if R_1 is a potentiometer with its total resistance in series with Z_u and

(Continued on page 62)





• • •

WHAT THE WELL-DRESSED COP WILL WEAR

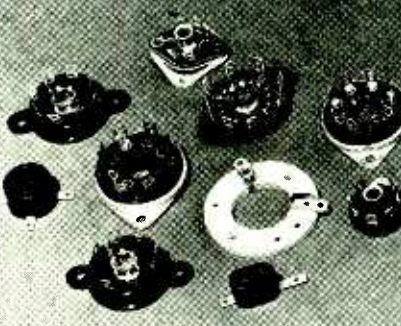

J. Edgar Hoover, director of the Federal Bureau of Investigation, examines a suit worn by a London policeman during blackouts which was exhibited during a demonstration of London's blackout devices at the FBI recently. The suit is made of oilskin. The police carry special blackout lamps, "walkie-talkie" radiophone equipment, and rubber boots

FRANKLIN Can Help You STEP UP DEFENSE DELIVERIES

 <p>SOCKETS</p>	 <p>METAL STAMPINGS</p>	 <p>PLUGS AND SWITCHES</p>
 <p>TERMINAL STRIPS</p>	 <p>BAKELITE STAMPINGS AND MACHININGS</p>	<p>COMPLETE TOOL ROOM FACILITIES</p> <p><i>Punch and Drill Presses</i></p> <p>★</p> <p>BAKELITE AND METAL ASSEMBLIES</p>

Ready for Large or Small Orders

WE have produced many millions of the above illustrated items for leading radio and electrical apparatus Manufacturers. Today we have the facilities to render similar service to any manufacturing organization engaged in defense production, in large or small quantities, standard or special designs. Quotations made promptly from your blueprints.

A. W. FRANKLIN MFG. CORP.
175 Varick Street **New York, N. Y.**
 Telephone: **WAlker 5-6037**

The Liberty Fleet...

*standardized for fast production
... adopts standard Radio Unit by*

IT&T

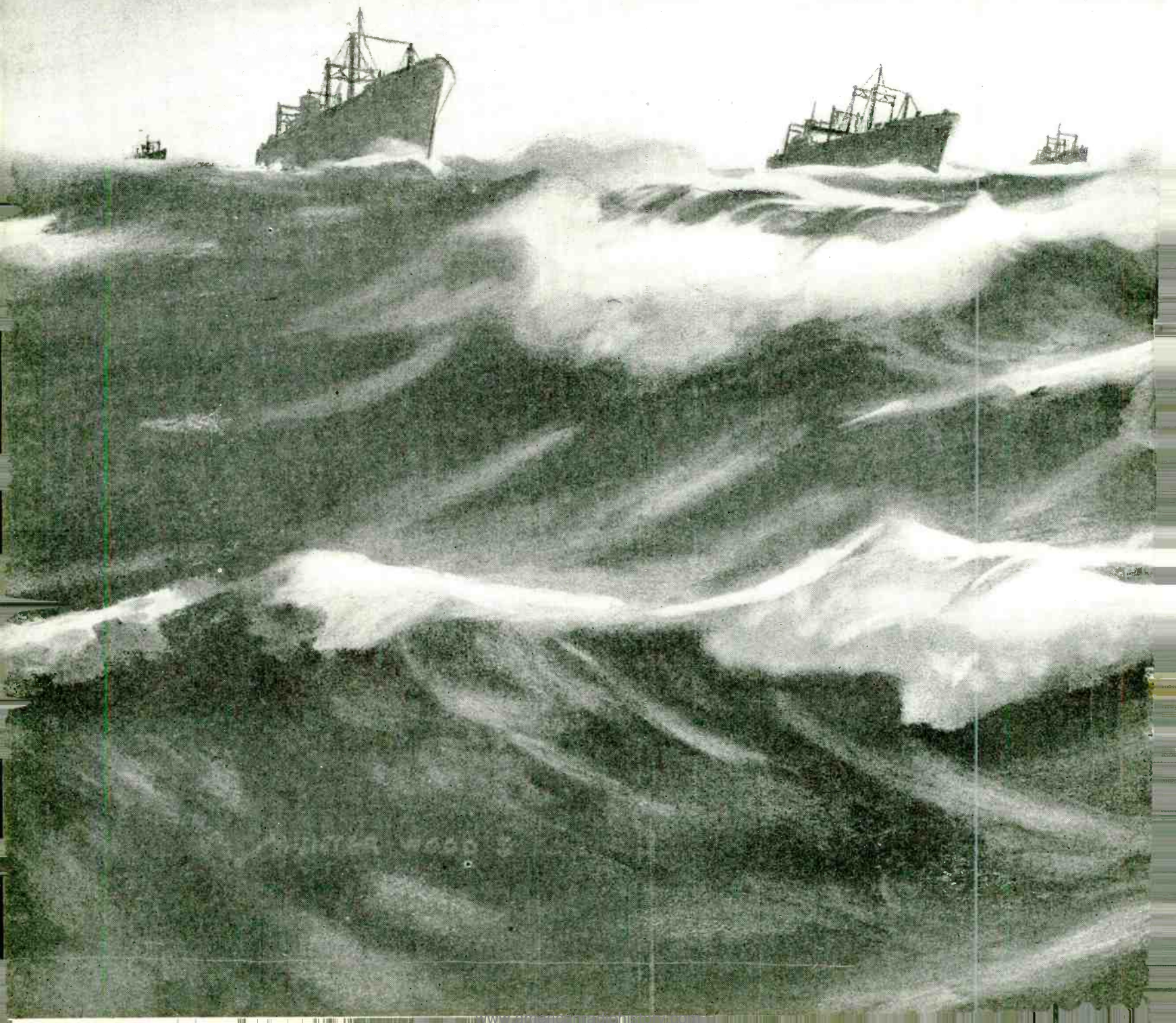

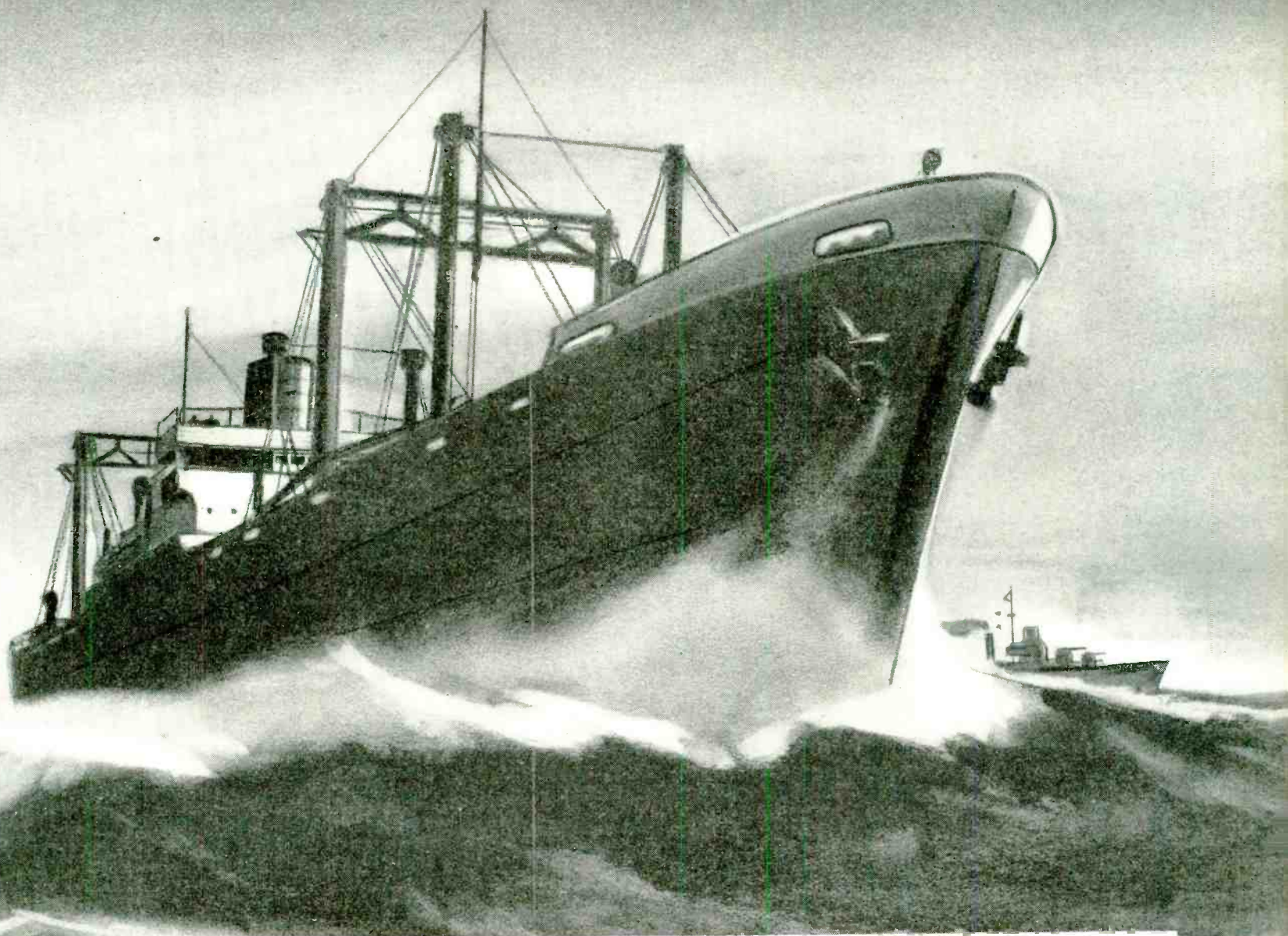

New Idea in Marine Radio Design Speeds Installation . . . Saves Space

Off the ways . . . and on the way, go America's Liberty Ships . . . mile after mile of new cargo vessels, stretching off endlessly down the ocean roadway toward America's allies and united victory. And this vast Armada of Liberty's Arsenal is a credit to the shipbuilders' craft.

Every cubic foot has been made to account for itself against the grim demand for precious cargo space. For example, in the radio room, not eight or ten, but *one*

compact marine radio telegraph unit supplies all needed communications facilities.

This all-in-one radio unit makes it possible to do at the factory practically all wiring and other work usually done aboard ship. Installed in one-fifth the time normally required — practically ready to tune in and plug in—it was designed and manufactured for the first 312 Liberty Ships by I. T. & T.'s subsidiary, The Federal Telegraph Company.



The compact, all-in-one radio unit designed and manufactured for the Maritime Commission by I. T. & T.'s subsidiary, The Federal Telegraph Company.

INTERNATIONAL TELEPHONE AND TELEGRAPH CORPORATION
67 Broad Street, New York, N. Y.

WHERE PERFORMANCE MEANS MOST!

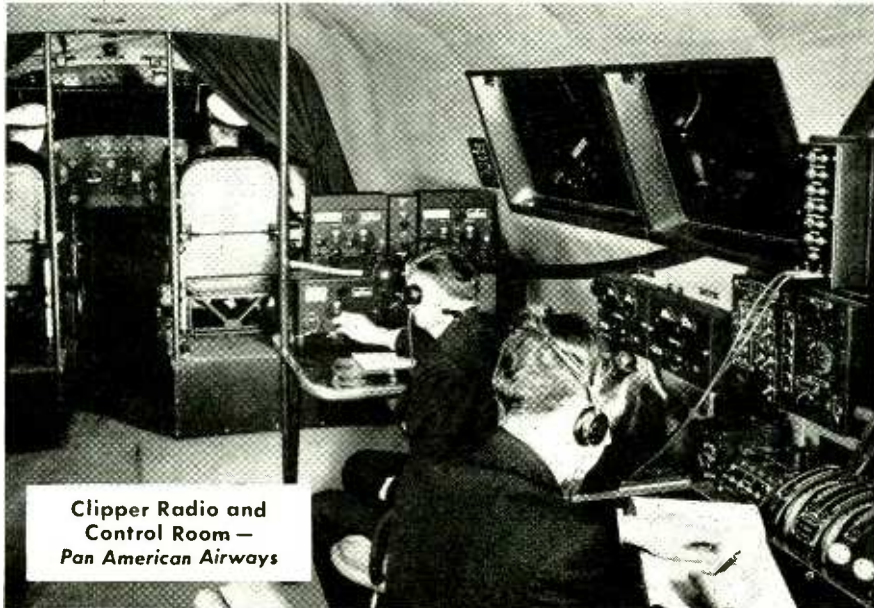

Clipper Radio and Control Room — Pan American Airways

THERE You'll Find KESTER CORED SOLDERS

● KESTER ROSIN-CORE SOLDER spans the oceans with the giant Clippers of Pan American Airways, making a vital contribution to perfect instrument performance by safeguarding electrical circuits against failures due to corrosion or other causes.

● Circuits "sealed" with Kester Rosin-Core Solder are permanently corrosion-proof and trouble-free. The patented plastic rosin flux will not injure insulating material. Fire hazard is eliminated. The virgin-metal purity of Kester alloys enables them to resist vibration, shock, bending, contraction and expansion.

● Kester Acid-Core Solder is the ideal general-purpose solder for less critical instruments of measurement and control. Parts are permanently joined, and precision production is made easier by the conveniently self-contained flux.

● All Kester Cored Solders exceed the purity demand of ASTM Specification "A". Flux and alloy are in perfect balance—both as to kind and quantity—to do any job best. Consult Kester engineers without obligation on any soldering question. They'll gladly suggest the proper formula for any operation.

KESTER SOLDER COMPANY

4204 Wrightwood Ave., Chicago, Illinois

Eastern Plant: Newark, N. J.

Canadian Plant: Brantford, Ont.



KESTER

Cored Solders

STANDARD FOR INDUSTRY

(Continued from page 58)

the source, and the lead to the CRO taken from the tap. Thus D_u becomes independent of D_s , which is not the case if R_s is a simple rheostat and the source is not constant current.

While S_1 is in positions 3 and 4 the sweep circuit may be cut in and the wave forms of the voltages across Z_u and Z , observed. When a pure constant-current signal source is used, the purity of the wave indicated is a direct check on the linearity of the impedances.

A further use of the CRO impedance comparator is for checking equivalent circuits against the actual apparatus. The theoretical equivalent circuits of loud-speakers, transformers, etc., may be constructed and used as Z , to balance against the actual devices. Deviations from the predicted circuit are easily spotted by running through the frequency range and by observing departures from a straight line pattern. Phase defects appear as changes to an ellipse, while variation of modulus is indicated by changes in the inclination of the pattern. Both usually occur together, but a little experience will reveal which needs the more urgent correction.

Applications of the Comparator

The precision obtained from the comparator is not high enough to compete with a well-built a-c bridge, but two significant figures may be attained with little difficulty. However, with the comparator, circuit conditions are much easier to visualize than with a bridge, and rates of change, sharpness of resonance, etc., are more clearly apparent. The CRO impedance comparator was originally used in the measurement of moving coil loud-speakers; the effects of cone treatment, horns, baffles, and even of nearby reflecting surfaces were easily evaluated both qualitatively and quantitatively. Residual unbalanced capacitances had a negligible effect in the frequency range of interest. However, if high impedance devices, such as those using crystals, are to be measured, much more care will be necessary in the switch wiring, as well as in the balancing of the signal source with respect to ground. If the CRO is to load such circuits very lightly, then the working impedances are restricted to at most about one-tenth the input resistance of the CRO.

The switches used are of the rotary ganged type common in communications laboratories and should have low leakage. Decade resistors, capacitors, and variable inductors of appropriate range are suitable as standard elements for Z_s . For the loud-speaker measurements R_s was a three-decade resistance box reading down to 0.1 ohm, and X_s was a variometer covering 0.15 to 5 mh.

To summarize, this CRO impedance comparator is useful for the observation and measurement of vector or scalar electrical impedance; it can locate resonance as defined by zero phase angle or by maximum or minimum modulus; and it is a convenient device for checking equivalent circuits.

ELECTRONS IN ACTION!



With the aid of this Electron Microscope, one can actually observe the action of electrons being emitted from a heated filament. Like a moving picture, the emission characteristics of a filament are projected on a lens-like screen. Observations, thus made, enable Eimac engineers to maintain the enviable record of dependability and superior performance enjoyed by Eimac tubes.



Before filament assemblies are sealed into the tubes they are placed under a temporary vacuum and heated to much higher temperatures than normal. This vital test enables technicians to weed out faulty parts before tube is actually pumped.

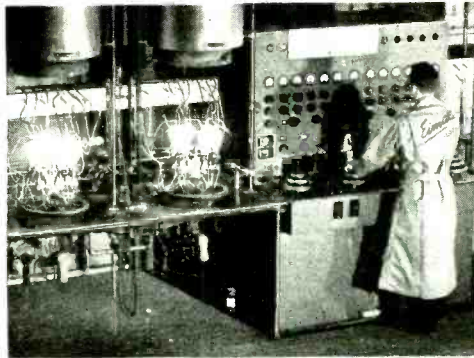

Hard vacuum is essential to preserve peak filament emission. Special pumps are built in the Eimac laboratories to fit the exact requirements of Eimac tubes. During the pumping process, plate dissipation is run up to ten times normal. Tubes that cannot stand this abuse never leave the factory.

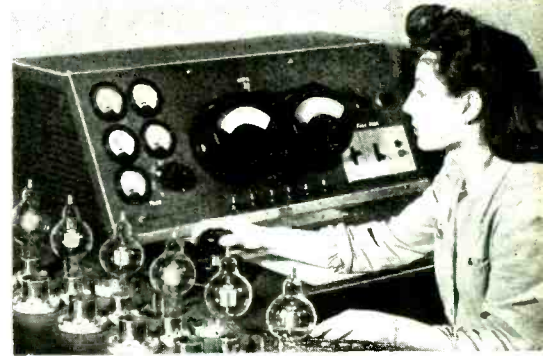

Here is a special Emission Tester which enables laboratory men to ascertain the actual performance capabilities of filaments after the tubes are completed. Under this test filaments are made to perform much more difficult tasks than could possibly be required under normal operating conditions.

MAXIMUM FILAMENT EMISSION ASSURED IN EIMAC TUBES

All Eimac tubes are unconditionally guaranteed against tube failures resulting from gas released internally. No other tube carries such a guarantee. This guarantee plus the fact that leading engineers throughout the world use and recommend them provides ample reasons for you to consider Eimac tubes for your application.

Follow the leaders to

Eimac
TUBES

Eitel-McCullough, Inc., San Bruno, Calif., U. S. A.

FRAZAR & CO., LTD., 301 Clay Street, San Francisco, California, U. S. A.

Eimac's unusual performance capabilities are receiving the enthusiastic acceptance in all branches of the service . . . ARMY, NAVY, AIR CORPS.

EIMAC 450T

(In use by practically every major airline in the U. S. A.!)

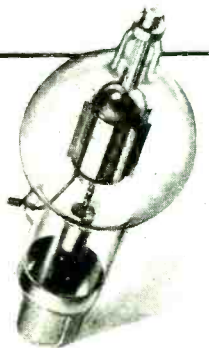

Filament Voltage 7.5 to 7.7 Volts
 Filament Current (approx.) 12 Amperes
 Maximum Plate Voltage 6000 Volts
 Continuous Plate Dissipation 450 Watts
 Power output at 75% efficiency 1350 Watts

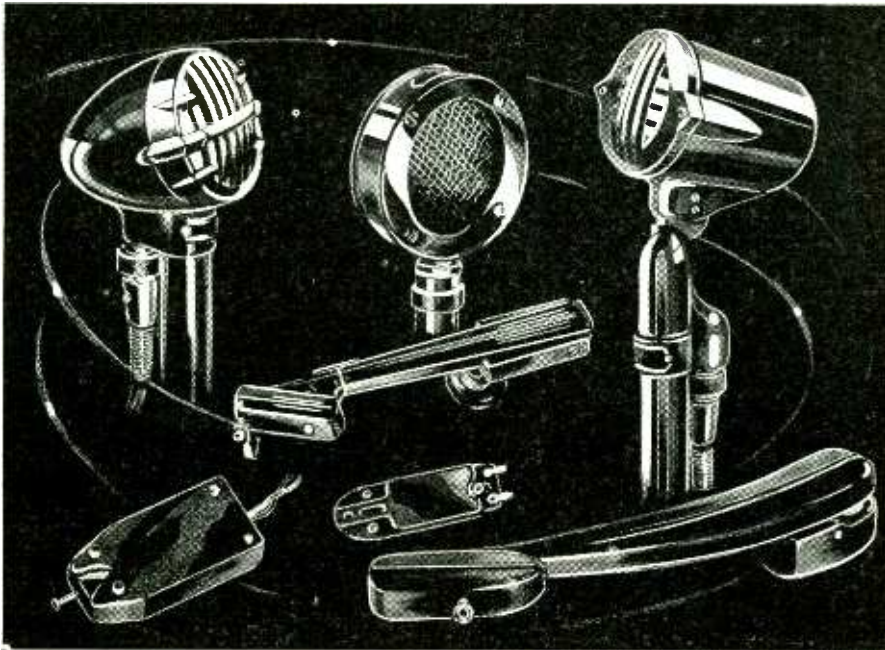

Confidence in Astatic Products Shown by Manufacturers' Use

Most convincing proof of the dependability of these products is shown in the fact that Astatic Cartridges are used by a great majority of America's leading manufacturers of radio-phonograph and sound equipment. Confirmation of this statement is found in a "REPLACEMENT MANUAL for Astatic Pickup Cartridges" which includes a listing of manufacturers using various type pickup cartridges. This Manual, published for the convenience of Radio Jobbers, Dealers and Service Men, was compiled by The Astatic Corporation with the kind cooperation of radio set and phonograph equipment manufacturers.

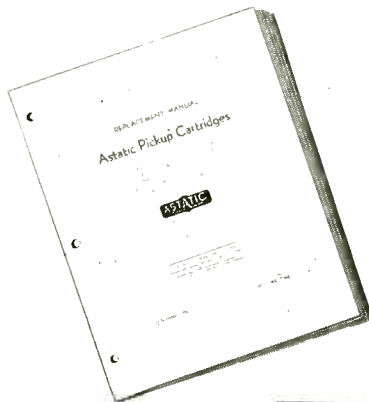

To obtain your FREE
copy of this handy
MANUAL, see your
Radio Parts Jobber

ASTATIC

THE ASTATIC CORPORATION

YOUNGSTOWN, OHIO

Licensed Under Brush
Development Co. Patents

In Canada:
Canadian Astatic Ltd.
Toronto, Ontario

Photographic Short Cut in Making Laboratory Records

By S. GORDON TAYLOR

THERE CAN BE NO QUESTION as to the advantages gained by making photographs a part of the experimental or laboratory note book. However, the practice is not a common one primarily because, even to the engineer who is an experienced photographer, the time required in shooting the pictures and processing them is considerable. At least this is true where the ordinary photographic routine is followed.

In recent months the writer has been using a scheme which has proved highly practical in providing entirely satisfactory illustrations. The photographic procedure is simplified to a point where it becomes practical for those with little or no experience in the use of a camera and in the processing of pictures. This method provides a speedy means for photographing laboratory set-ups, experimental models of devices under development, and even references from text books or other data which it may be desired to include in the laboratory records.

In the ordinary photographic procedure the subject is photographed on film, then the film is developed, fixed, washed and dried. Then prints are made on paper from the resulting negative and these prints must likewise be developed, fixed, washed and dried. Because it is difficult for any but the experienced photographer to evaluate a picture from the negative, it is not until the print is developed that the average amateur photographer really sees the picture.

In the method to be described here the film is eliminated entirely. This not only saves the film processing time (close to 2 hours including drying) but likewise eliminates the need for processing in total darkness. What is more important to the less experienced operator is that within two minutes after he has snapped the picture it is ready for visual inspection under normal room lights (or daylight). The method still requires the usual fixing, washing and drying but if results are unsatisfactory they can be discarded immediately and another shot made to correct the fault of the first. If the processing is done in a closet or washroom right at the lab, lighted by the usual red or orange darkroom bulb, maximum convenience is provided.

It is not generally recognized that standard photographic paper can be used in the camera in place of film and that pictures taken directly on this paper will have excellent definition, although requiring longer exposure. Such paper can be used in any camera, indoors or out. It does not have the "color sensitivity" of panchromatic film but this is seldom an important factor in photographing technical subjects. Exposure is somewhat more critical than film as paper will reproduce a light range of only about 30 or 40 to 1 as

This is their big **BENDING** moment—

SPRING NEWS

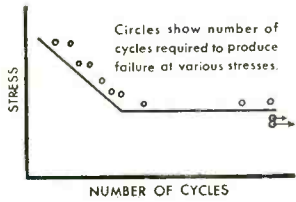

The results of the Rotating Beam Fatigue Test are graphically shown by the SN curve in which the bending stresses are plotted against the number of cycles of stress reversal at failure. All SN curves have the same characteristic shape. As the stress decreases the number of cycles increases until a stress is reached where no failures occur. This stress is called the endurance value of the material.

THEY look like gracefully curved fencing foils—but these four lengths of wire are being subjected to the Rotating Beam Fatigue Test in the Hunter Laboratory. Specimens from a coil of wire are bent at various radii and whirled at a controlled speed for hours . . . even days . . . until they fail . . . or reveal their actual endurance values.

Tests on every conceivable spring material have been made by Hunter, including important studies on the effect of various heat treatments, surface finishes and elec-

troplating. These tests, correlated with fatigue tests on actual springs, provide a wealth of valuable spring design data for use by our engineers.

Along with this research work additional fatigue "heads" are in constant operation, making routine checks on the uniformity of the fatigue resistance of materials received from the various approved sources . . . an unusual but very effective adjunct to the many other tests required for maximum quality control of springs.

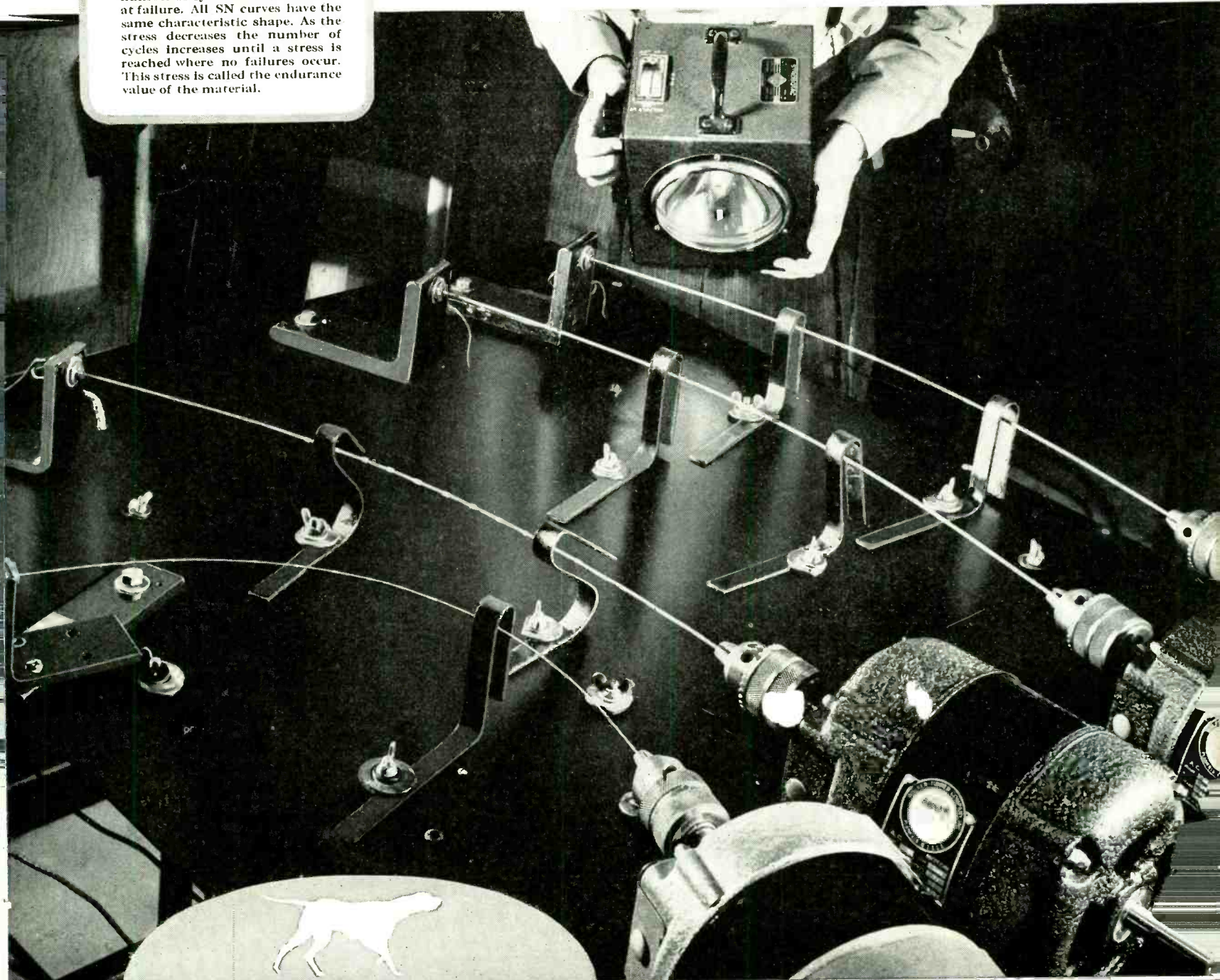

HUNTER
Science in Springs

HUNTER PRESSED STEEL COMPANY, LANSDALE, PENNA.



"I wanna do some
REAL work, please . . ."

Dear Boss:

I've been with you for a long time. Some of those years were mighty lean and some pretty good. I've worked hard at every job you've given me . . . and now I'm an executive.

Honest, boss, I appreciate the promotions, and when things were running normally I felt OK about being top man in my division.

Now you've got me behind by desk answering a thousand and one questions from our customers about delivery dates and promises and schedules, etc. . . I know it's important. But Gee Whiz!

I'm running myself and the kids in this office bow-legged. I'm getting myself disliked by all the foremen in the plant for breathing on their necks all day. I'm not helping matters by trying to "push" them. Those boys are giving all they've got.

And I can do some "production" too. Honest, boss, I haven't forgotten how, and there are plenty of things I can do that will help get the stuff out. If we could only find some way of telling our customers that they can help us, by letting us put *EVERY* available man to work!

Wouldn't it be a good idea to ask them, in our ads, to go easy on the correspondence, on the telegrams and on the phone calls? We could then take some of our office personnel and put them on **WORK**, including me, please, boss . . .

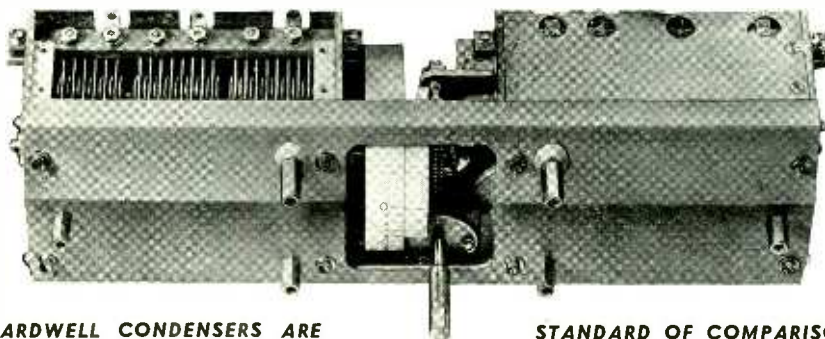

CARDWELL CONDENSERS ARE

STANDARD OF COMPARISON

**THE ALLEN D. CARDWELL
MANUFACTURING CORPORATION**
81 PROSPECT STREET • BROOKLYN NEW YORK

compared with a range of about 130 to 1 for modern film. This is more than compensated for by being able to see the finished image within two minutes, and make a retake with longer or shorter exposure if the need is indicated by this examination.

The picture obtained when paper is placed directly in the camera is, of course, a negative. In it white objects will be black and vice versa, and the physical positions of everything in the picture will be transposed. There is this major difference between it and a film negative, however. The paper negative is viewed normally by reflected light, just like any other picture. The film negative, on the other hand must be viewed by transmitted light. The paper negative is a picture; the film negative a transparency. As such the paper negative may be inserted directly in laboratory records and will show all details of a subject clearly.

Contact prints can be made from the paper negative in the same manner as they are made from film, and will show reasonably good detail although usually not equal to that of prints made from film negatives. The important point is that for laboratory record purposes the paper negative will usually serve without the trouble of making "positive" prints. But where such prints are desired, Fig. 1 shows the quality of de-

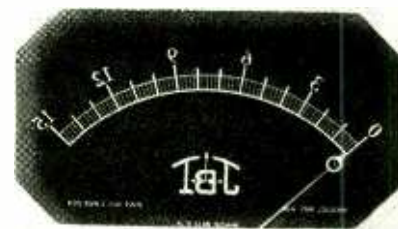

Fig. 1a—This photograph was made directly on paper rather than film. Note the reversal of the subject matter

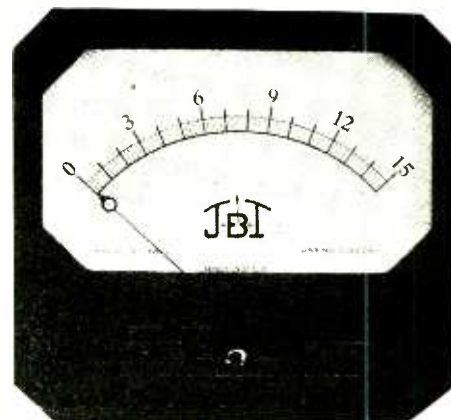
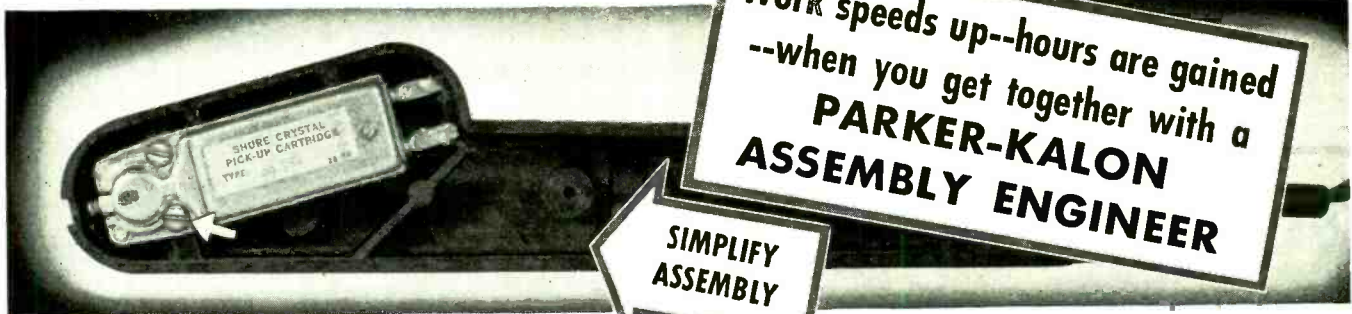

Fig. 1b—A positive print made from the paper negative above. The detail is quite adequate for most purposes

Want "9 hours' work" from each 8 hour shift?



Work speeds up--hours are gained
--when you get together with a
**PARKER-KALON
ASSEMBLY ENGINEER**

**SIMPLIFY
ASSEMBLY**

No inserts are required in this plastic pick-up arm made by Shure Co. The crystal cartridge is held securely by two Parker-Kalon Type "F" Self-tapping Screws, driven right into drilled holes in the plastic.

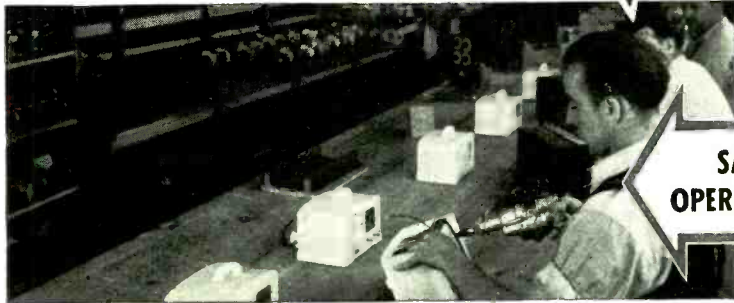

**SAVE
OPERATIONS**

Final assembly at Fada Radio was speeded up more than 25% when Parker-Kalon Type "Z" Self-tapping Screws replaced machine screws and time-wasting tapping operations! You can make similar savings and increase the efficiency of your assembly, too. You begin by eliminating costly tapping, tap breakage and mistapped work. You eliminate lock washers, fumbling with bolts and nuts, and tedious riveting.

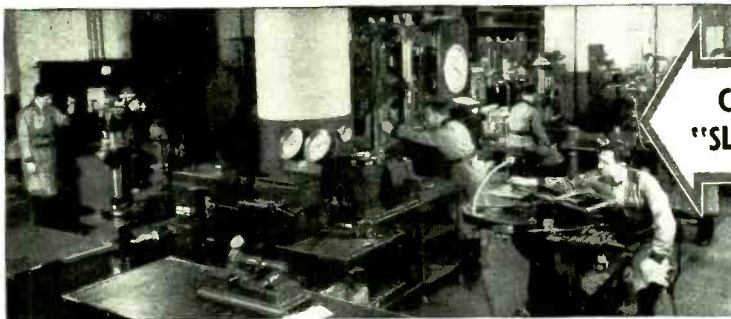

**CUT OUT
"SLOW UPS"**

Your production won't be slowed up by "doubtful screws" . . . screws that *look* all right but some of which fail to work right . . . when you use genuine Parker-Kalon Self-tapping Screws. For the Parker-Kalon Laboratory - without counterpart in the industry - maintains a rigid quality-control over all Parker-Kalon fastening devices.

EASY TO CHANGE OVER—NO SKILL —NO SPECIAL TOOLS NEEDED!

The Parker-Kalon Assembly Engineer - thoroughly familiar with present-day assembly practises - can help you simplify assembly, save operations, cut out "slow-ups" . . . give your fastenings greater holding power, yet eliminate costly tapping and inserts. He can help you save the expense of salvaging parts rejected for crossed or mis-tapped threads . . . do away with the fumbling that goes with bolts and nuts. He will show you that no special tools or skilled hands are required to start gaining man-hours *immediately*.

Mail a description of your assembly to Parker-Kalon Assembly Engineers, for recommendations and samples. Better still, let a Parker-Kalon Assembly Engineer call at your plant and point out ways of speeding up your assemblies with Parker-Kalon Self-tapping Screws. Parker-Kalon Corp., 192-200 Varick St., New York, N. Y.

PARKER-KALON
Quality-Controlled
SELF-TAPPING SCREWS

Give the Green Light to Defense Assemblies



SELF-TAPPING SCREWS FOR EVERY METAL AND PLASTIC ASSEMBLY . . . AND OTHER FASTENING DEVICES

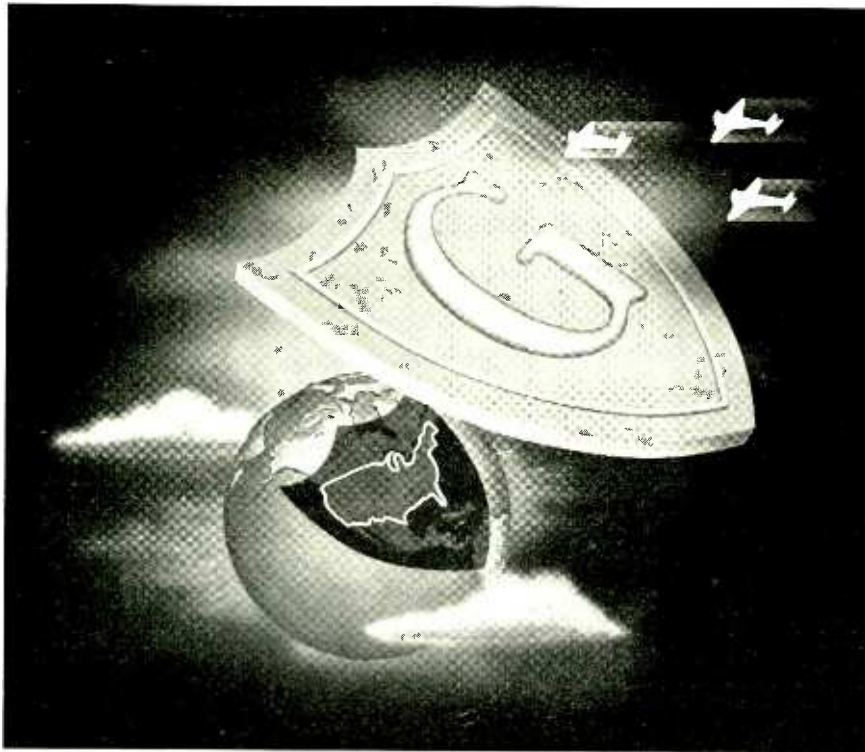

AMERICA DEPENDS ON
RELAYS by GUARDIAN

This "G" in the shield . . . high in the air—scouring the sea—sweeping the land . . . in jeeps—guns—tanks—planes—ships—is doing a 100% "all out" job for America!

Strictly defense, production time open for government approved items, with samples immediately available for any job for the U. S. Army, Army Air Corps, Navy, Naval Air Corps, Marine Corps, Signal Corps, Ordnance.

WRITE—WIRE—PHONE

**SAMPLES OF APPROVED CONTROLS
 AVAILABLE ON SHORT NOTICE**

- GUN SWITCH HANDLES
- REMOTE FIRING EQUIPMENT
- TURRET CONTROLS
- RADIO CONTROLS
- NAVIGATION CONTROLS
- AIRCRAFT CONTROLS
- BOMB RELEASES

GUARDIAN  **ELECTRIC**

1625 WEST WALNUT STREET

CHICAGO, ILLINOIS

LARGEST LINE OF RELAYS SERVING AMERICAN INDUSTRY

tail that can be obtained. In this illustration (a) shows the paper negative of a meter face while (b) shows a positive print made from this negative.

It has been stated that paper can be used in place of film in any camera. It should be pointed out, however, that for practical reasons the camera should be one which provides pictures of reasonable size. Obviously a miniature camera which normally uses 35 mm film will not be satisfactory for laboratory record work because of the small negative size. The illustrations shown here were all made with 5x7 inch or 9x12cm (3½x4¾ inch) cameras. Plate cameras are most suitable because their ground-glass backs permit more accurate "framing" and focusing. With such cameras the paper is cut to size, and inserted in the film holders exactly as is cut film. Where a roll-film camera is employed the paper is cut into single sheets just large enough to fit inside the back, resting on the rollers over which the film normally moves. With this type of camera the paper must be inserted and unloaded one piece at a time in a darkened room whereas with the plate type camera the paper is loaded into the film holders in the darkened room without the necessity for taking the camera along.

The accompanying illustrations show some of the negatives and some posi-

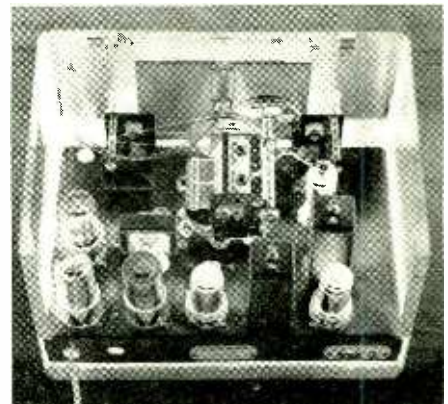

A negative photograph made on paper placed directly in the camera

tives made by this method and demonstrate its effectiveness for various types of subjects. It is likely that some of these will lose some detail in the photo engraving and printing processes but will still show plenty of evidence of the entirely adequate sharpness of detail.

For those who desire to try out this means for improving their notebooks (and oftentimes simplifying the drawings and written descriptions) the following pointers will be helpful.

The paper used is Eastman Kodabrom No. 1, glossy, single weight. This is a "soft" paper with relatively wide exposure range and is available in any photographic supply store. It comes in packages of 12 sheets and the most common sizes are 5x7 inches and 8x10 inches. These can be cut up to the size required for the camera to be used. This paper should not be exposed to

The ability to design and produce so many specialized types in a short time is important. It is, however, only a secondary consideration in the selection of Sprague Condensers for Defense applications. Far more important is the assurance of utmost dependability for each and every unit given by Sprague's long record of performance as a leading supplier to the Radio Trade. . . .

Although new condenser mechanical arrangements are sometimes made overnight, basic condenser section design and resulting dependability are not.

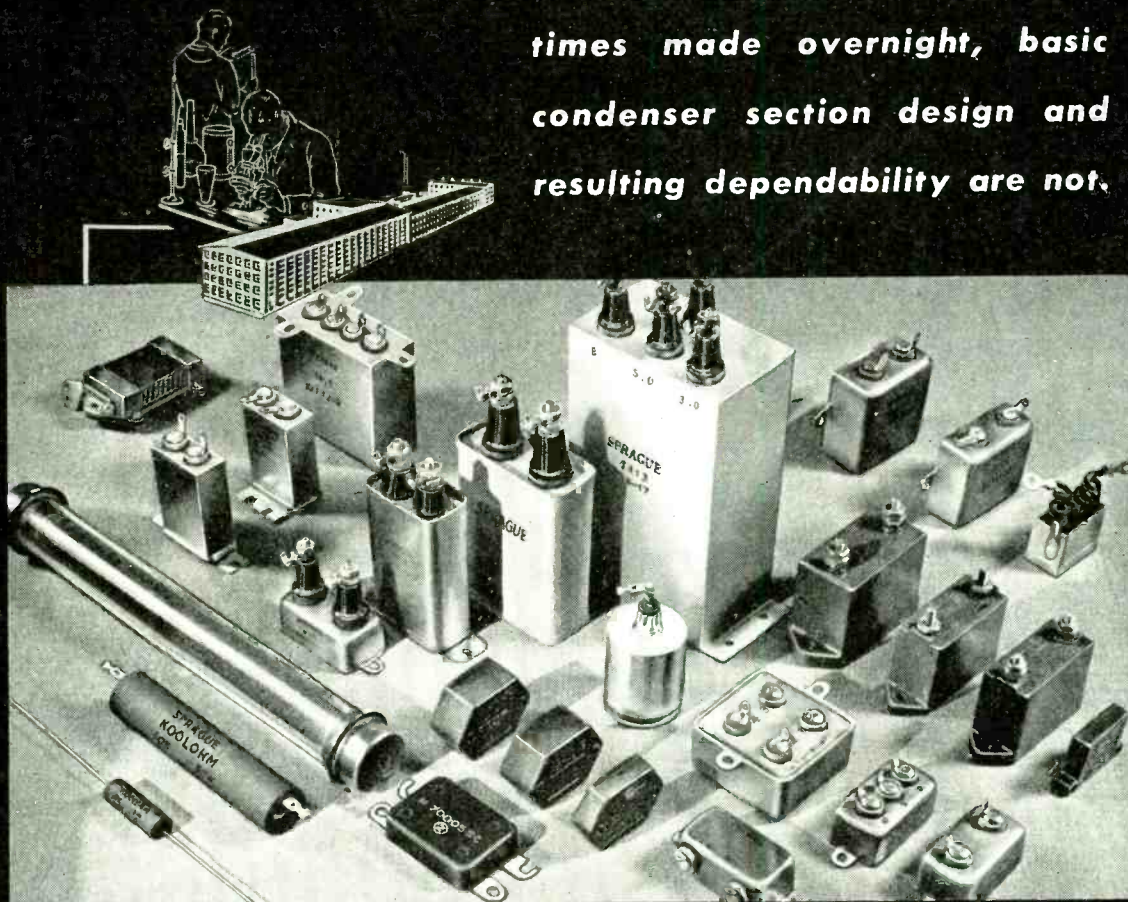

SPRAGUE

CONDENSERS—KOOLOHM RESISTORS

Quality Components • Expertly Engineered • Competently Produced

SPRAGUE SPECIALTIES COMPANY, NORTH ADAMS, MASS.

Pro-O-Volt INSULATION

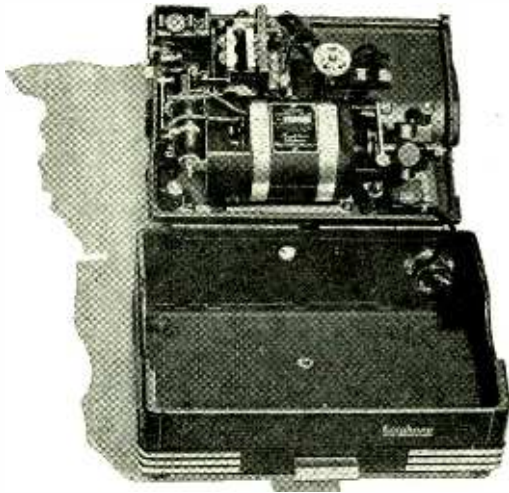

AIDS *Ediphone's* EFFICIENCY

As a protection and insulation of the electric magnet, sanitube switch and motor in the Ediphone, Thomas A. Edison, Inc. uses IRV-O-VOLT Varnished Inside-and-Out Tubing.

IRV-O-VOLT, because of its resistance to heat, moisture and wear, assures long life. Electrical, radio and instrument manufacturers demand a flexible varnished tubing, thoroughly impregnated and varnish coated inside and out, which will meet all published standards and specifications.

IRV-O-VOLT fulfills this need. Its flexibility with high tensile strength meets every bending, twisting, pulling and other assembly requirements. Because of its smooth inside surface, it slips easily over wires, permitting rapid snaking and fishing. Has high heat endurance, will not soften, blister or flow.

Comes in two grades of dielectric strength. Standard colors are black and yellow with green, brown, red, and blue on special order.

For more data Write Dept. 106

***Irvington* VARNISH & INSULATOR CO.**

IRVINGTON, NEW JERSEY, U. S. A.



PLANTS AT IRVINGTON, N. J. and HAMILTON, ONT., CAN.
Representatives in 20 Principal Cities

ordinary light until after the negative has been developed and has been fixed for at least one minute. It can safely be handled under a red or ruby light bulb at any time but should be kept at least 2 feet from this if it is the standard 8 cp. darkroom bulb and proportionately more distant if a more powerful bulb is used. Even at these distances the emulsion side (smooth) of the paper should be kept away from the light as much as possible.

Exposure required is approximately fifty times greater than that required for Verichrome film. In the Weston scale of film speed factors, this paper is equivalent to 0.3. If an exposure meter is employed its film-speed scale can be set at this figure to read exposure time directly. Or if its scale does not extend this far down it can be set for a speed of 3.0 and the indicated exposure time multiplied by 10. It will usually be found desirable to close down the lens opening to $f/8$ or smaller in order to provide satisfactory depth of field, particularly as most shots for this purpose will be made rather close up to insure adequate image size.

For lighting either one or two Photo-flood No. 2 bulbs can be used, in inexpensive reflectors which can be clamped onto anything convenient for support. In photographing light surfaces such as aluminum chassis, etc., it is often desirable to diffuse this light by hanging thin tissue paper in front of the lamps. This avoids excessive contrast and dense shadows.

After the paper has been exposed in the camera it is immersed in a standard 2-to-1 solution of Eastman D-72 developer for 60 seconds, then in turn in a standard hypo fixing solution. A 10-minute immersion in the hypo is needed, but after one minute it is safe to turn on the normal room lights to permit critical examination of the negative. If satisfactory the 10-minute fixing period is completed and the negative then placed in a tray or dish under running water to rinse for an hour. Finally the paper negative is dried. If a glossy finish is desired it can be obtained by rolling the print face down on a standard ferrotype plate and leaving it there to dry. Otherwise, after pressing or rolling out surplus moisture, it is placed face down on a blotter or cloth to dry.

If it is desired to make positive prints from the negative the procedure, paper, etc., is identical with that employed in making contact prints from film negatives. The only difference is that either stronger light or somewhat longer exposure will be needed because of the relative opaqueness of the paper negative. The negative and print paper are placed with their emulsion surfaces together, with the printing light passing through the back of the negative. The contact prints are developed, fixed and washed precisely as was the negative. In all this processing it is desirable to maintain the solutions at a temperature of approximately 70 degrees. This applies also to the rinse water used during processing.



Zero driving power at 235 watts output*

A full 235 watts of RF power with zero drive is now possible with the HK-257. New screen and plate voltage ratings make this amazing performance possible. It is the tube to use for modern transmitters requiring a minimum of stages, no neutralization adjustment, instant channel switching, few tuning controls, minimum driver equipment, and exceptional overall efficiency. It is the tube that will stand high plate voltages, abuse from overload and operate up to frequencies of 150 megacycles.

*The tube requires no driving power as the grid current is zero. However, some power will be required to supply losses in the resonant circuit developing the grid driving voltage. This loss is on the order of 0.2 watt in practical circuits.

OPERATING DATA		
Radio Frequency Power Amplifier, Class "C" Unmodulated	Maximum Rating	Typical Operation
Power Output		235 Watts
Driving Power		0 Watts
DC Plate Volts	4000	3000 Volts
DC Plate Current	150	100 M. A.
DC Suppressor Voltage		60 Volts
DC Suppressor Current		3 M. A.
DC Screen Voltage	750	750 Volts
DC Screen Current	30	8 M. A.
DC Control Grid Voltage	-500	-200 Volts
DC Control Grid Current	25	0 M. A.
Peak RF Control Voltage		170 Volts
Plate Dissipation	75	65 Watts

WRITE FOR FULL DATA



GAMMATRONS of course!

THE ELECTRON ART

Application of phototubes to modern four-color process printing to insure accurate register, an oscilloscope good to 10 Mc, use of electrical principals in machine tool applications

Phototubes in Multicolor Printing

MODERN COLOR PRINTING by the intaglio or rotogravure process requires a fine nicety of control. How this has been achieved by the use of phototubes is told by W. L. Wright in the November 1941 issue of the *General Electric Review*. The phototubes are used to control the register of successive impressions of four colors in the rotogravure type press.

A full color picture is usually made by making four color impressions, yellow, red, blue, and black. Each successive impression must be made very accurately so that the colors blend correctly to give the full color picture. This is where the problem of control comes in. Varying speed of the motors, a sag or a tension in the paper due to a previous impression, or a drying operation are some of the factors which make it difficult to have the next impression register exactly where it should.

The phototube system of register control is so arranged that it detects and corrects misregister. Detection of mis-

register is accomplished by comparing, photoelectrically, the instantaneous positions of the initial positions of the initial impression on the strip or web with the mechanical position of each of the respective color cylinders. This is done by matching regularly spaced voltage pulses or signals from two scanning units, one actuated by register marks printed simultaneously with the first color impression, and the second by an equally pitched slotted disk attached to each successive cylinder.

Small correction motors correct for misregister. These are either geared to regulate the angular position of the printing cylinders through a differential gear train, or to actuate compensator rolls in place of the usual manual control method. Direction of correction and the rate of correction is determined by the timed relaxation of the two signals received at the "mixing panel" where they are compared, and a resultant signal is relayed to thyratrons that energize the correcting motors. The scheme is shown in Fig. 1. One set of register marks is printed in a clear track such as the margin or fold

of the web and serves, simultaneously with the first impression, as a common index for all subsequent colors printed. Each color unit is served by a separate electronic detector. The scanning disks are tightly coupled to the cylinder shafts to prevent errors due to backlash and lost motion.

Since an impulse for correction can occur only when an index mark passes through the optical field of the phototube, the marks must be placed sufficiently close together to allow the control to follow effectively any sudden web distortions thus preventing the accumulation of errors. Good practice dictates that photoelectric observations should be made at the rate of approximately three or four per foot of web. This results in about 50 to 65 signals per second when the web is traveling at a normal rate of 1000 feet per minute. The index marks, which are about 10 mils wide by one-half inch long are spaced $22\frac{1}{2}$ deg. apart on the surface of the yellow cylinder making a total of 16 equally spaced marks. These are printed from carefully engraved lines in the surface of the yellow cylinder. The entire control system is simple to operate, requiring no more skill than that necessary to tune a radio receiver. Fluorescent indicators give a visual indication of the condition of register.

10-Megacycle Oscilloscope

UNTIL A FEW YEARS AGO, sweep frequencies up to 100-kc were high enough to cover most of the studies being made with cathode-ray oscilloscopes. The increasing use of high frequencies in recent years has created a need for a high-frequency sweep circuit. Such a circuit is described in the December 1941 issue of the *Bell Laboratories Record* in an article called "A Ten-Megacycle Oscilloscope" by J. O. Edson.

Previous oscilloscopes have usually employed a gas-filled tube in the sweep circuit. A saw-toothed wave was produced by discharging a condenser through the ionized gas in the tube. However, before the condenser can start its charging cycle, the gas in the tube must become deionized so that the tube will become non-conducting. This requires a small but appreciable time which makes the tube unsuitable for high frequency sweep circuits. In the 10-Mc sweep circuit a high vacuum tube is used to provide the high frequency sweep frequency. The circuit is shown in Fig. 1.

The sweep voltage E_s is taken off across the condenser C_s in the cathode circuit of tube V_s . When this condenser is charged to a voltage higher than E_s , the cathode is at a higher potential than the grid, and the current flow through the tube ceases. The condenser then stops charging and at once starts to discharge through the high resistance R_s . Though the discharge current of a condenser through a resistance is exponential, over a short initial section of the discharge the decrease is nearly linear. It is this

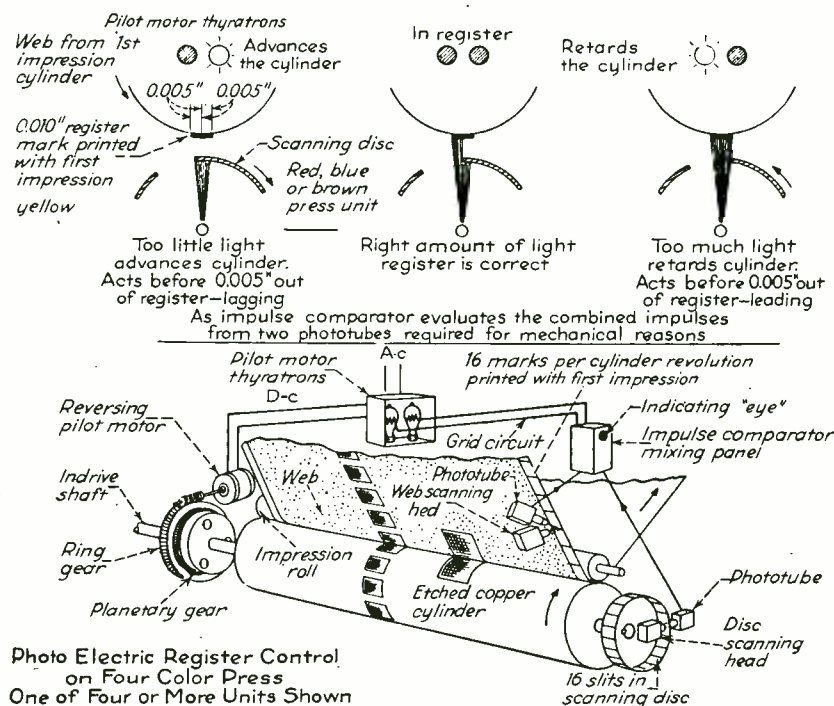

Photo Electric Register Control on Four Color Press One of Four or More Units Shown

Function and arrangement of the automatic register control by regulation of angular position of printing cylinder

Isolate

RADIOS, RECORDERS and INDUSTRIAL ELECTRONIC CONTROLS

Vibration

FROM

TO LENGTHEN OPERATING LIFE

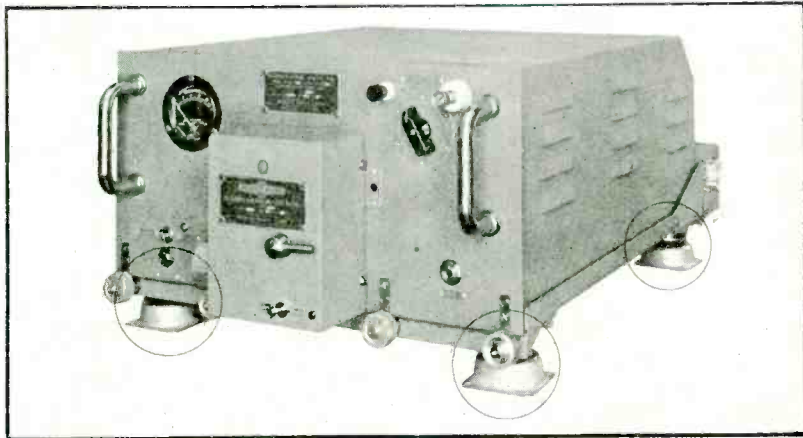

Manufacturers of all types of electronic apparatus from radios to industrial photo-electric cell controls can protect their equipment from vibration by mounting their assemblies on Lord Bonded Rubber Shear Type Mountings.

When an assembly is flexibly mounted, the natural frequency of the system is a function of the deflection of the mountings. The degree of vibration isolation obtained is a function of the ratio of the natural frequency to the disturbing frequency. Therefore, mountings selected for the lowest natural frequency of the system produce the maximum degree of isolation of the disturbing forces. This is illustrated in the chart at the right which shows the per cent reduction in vibration for various deflections and disturbing frequencies.

Lord Mountings, when loaded, deflect freely in shear, and thus provide efficient vibration isolation. They are made in a variety of sizes and styles for supporting loads from a few ounces up to 1500 pounds each.

The extensive use of Lord Mountings in radios, sound recorders and electronic controls offers proof of their ability to lengthen operating life of delicate electronic equipment through control of vibration.



The engineering principles of vibration control and complete information on Lord Mountings are given in Bulletin 104, which will be sent on request. Lord Engineers, who have had wide experience in vibration control, are available for consultation on your vibration problems.

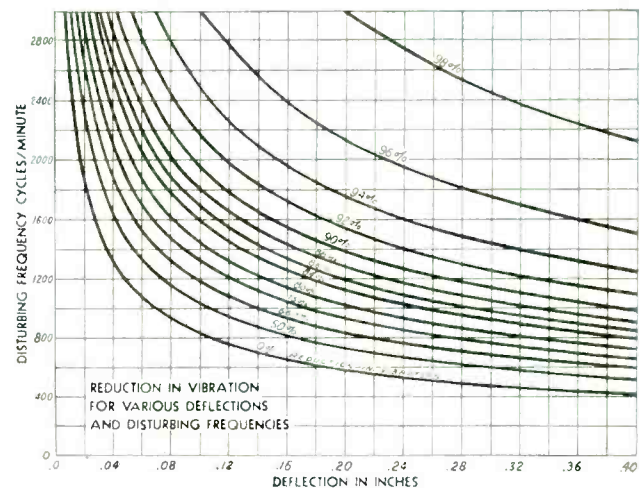
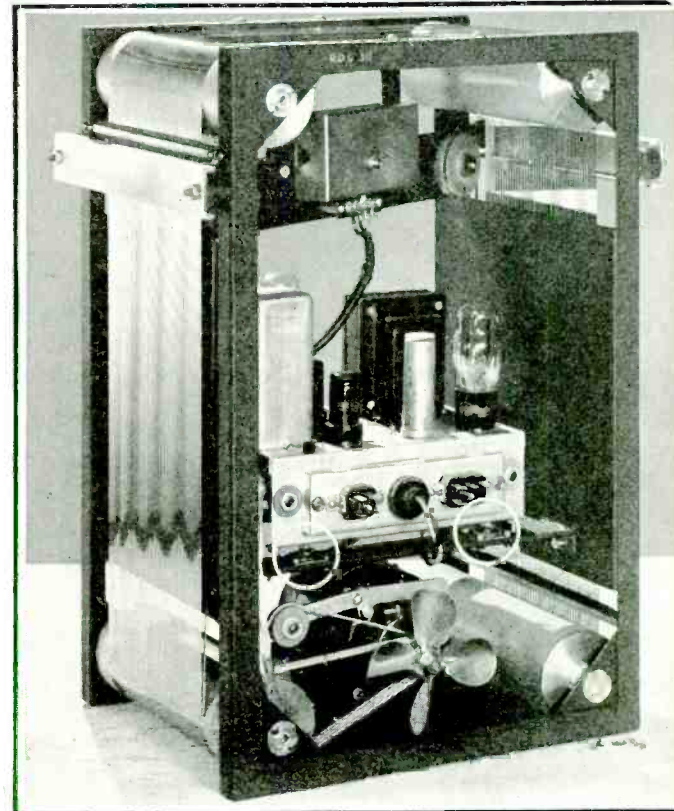

LORD MANUFACTURING COMPANY... ERIE, PA.

245 E. OLIVE AVE., BURBANK, CAL.

280 MADISON AVE., NEW YORK

844 N. RUSH ST., CHICAGO



PLATE FORM MOUNTINGS



LORD
BONDED RUBBER
**SHEAR TYPE
VIBRATION
MOUNTINGS**



TUBE FORM MOUNTINGS



FRACTIONAL H. P.
FLEXIBLE COUPLINGS

IT TAKES RUBBER IN SHEAR TO ABSORB VIBRATION

*A New
Concept of
Directional
Performance*



**NEW SHURE BROADCAST DYNAMIC
SUPER-CARDIOID**

New "556" Super-Cardioid Dynamic Microphone offers further simplification of sound pick-up problems in studio and remote broadcasting.

Super-Cardioid pattern achieves maximum unidirectional action over a wide frequency range — yet retains wide-angle front pick-up. Provides an easier means of eliminating undesired noises — gives full reproduction of music, clear reproduction of speech. Shure Uniphase* single-unit moving-coil construction. Extremely rugged. Insures better performance outdoors as well as indoors — yet is surprisingly moderate in cost.

30-day Free Trial. Broadcast Engineers: Try the "Super-Cardioid" for 30-days in your station without obligation. Available for immediate delivery. Write us today.

*Patented by Shure Brothers



Model 556A for 35-50 ohms.
Model 556B for 200-250 ohms.
and Model 556C high impedance — at only \$75.00 list



New Features

Twice as unidirectional as the cardioid — yet has wide-angle front pick-up

Decreases pick-up of reverberation energy and random noise 73%.

Improved wide-range frequency response from 40 to 10,000 cycles.

Symmetrical axial polar pattern at all frequencies.

Highly immune to mechanical vibration and wind noises.

SHURE BROTHERS

Designers and Manufacturers of
Microphones and Acoustic Devices
225 West Huron St., Chicago

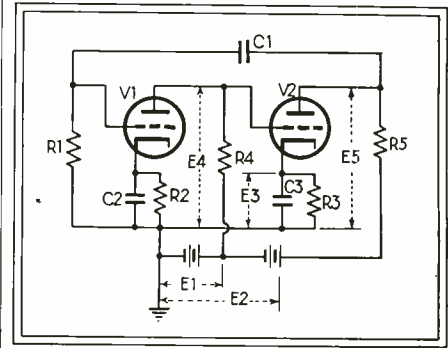

Fig. 1—Essential circuit of the 10-Mc oscilloscope which uses a high vacuum tube as sweep frequency generator in place of the usual gas tube

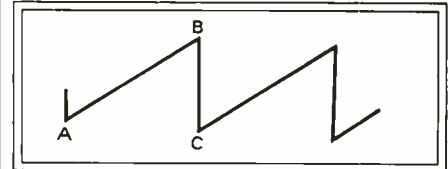

Fig. 2—Waveform of the sweep frequency signals generated in the circuit shown above

linear drop which is used to produce section AB of the desired sweep wave form shown in Fig. 2.

During the discharge, the plate current of V_1 passing through R_1 reduces the grid voltage of V_2 below E_{11} , and finally E_3 falls below the voltage of the grid. Then at some definite voltage which is fixed by the characteristics of the tube and the operating voltages, V_2 starts to pass current. As soon as plate current flows through R_3 , the voltage E_3 begins to drop. This drop reduces the grid voltage of V_1 through coupling condenser C_1 . The plate current of V_1 falls, decreasing the drop across R_4 and increasing the grid voltage of V_2 which results in a rapid increase in the plate current of V_2 thus causing the condenser C_3 to charge very rapidly.

The voltage E_3 rises, decreasing the plate current in V_2 and the drop across R_3 and so E_3 begins to build up. This rise in E_3 again affects the grid voltage of V_1 increasing the plate current and thus decreasing E_4 which is impressed on V_2 . The decrease in E_4 together with the increase of E_3 very quickly blocks the flow of current through V_2 , and another cycle is ready to begin. The interaction between the plate voltage of V_2 and the grid voltage of V_1 , and between the plate voltage of V_1 and the grid voltage of V_2 , causes a very rapid increase and decrease of the plate current of V_2 . The complete increase and decrease takes place during the period BC shown in Fig. 2.

Condenser C_1 is adjustable in steps, and R_3 is continuously adjustable. Since the relative values of these two elements determine the sweep period, the sweep frequency is continuously adjustable. Synchronization of the input and the sweep voltage is obtained by feeding a small portion of the input to V_2 . This voltage has considerable influence on the point at which discharge of V_2

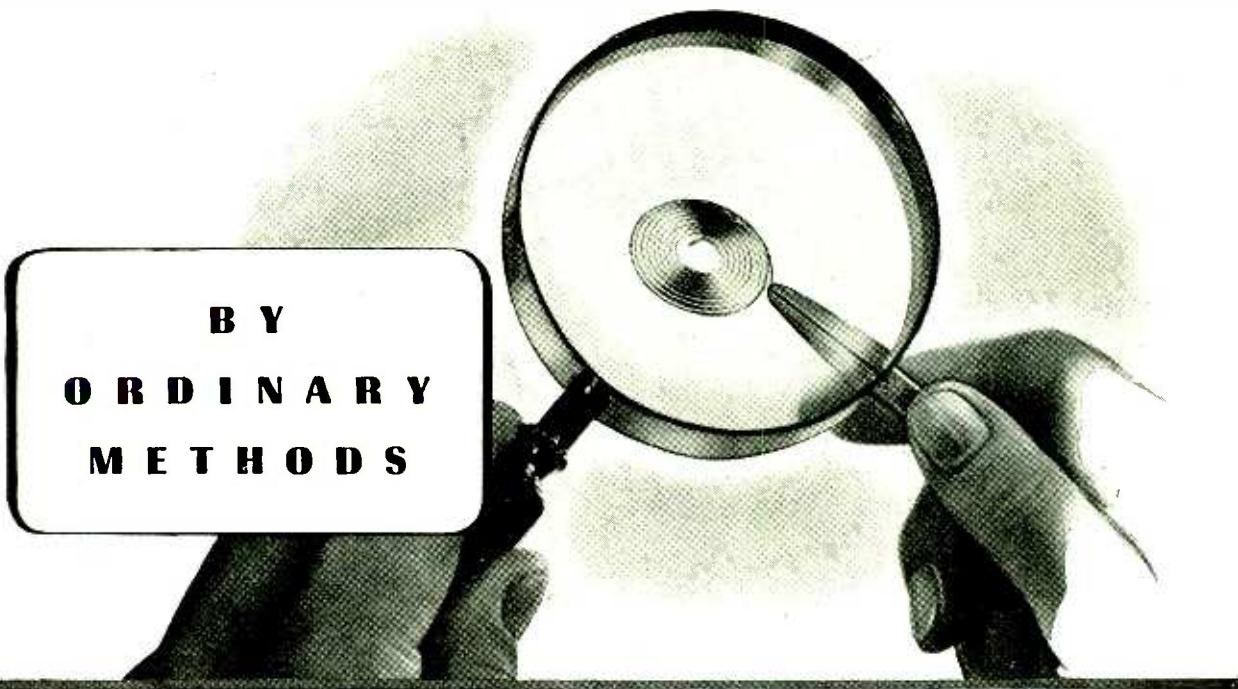

... these could not be such **EXTRAORDINARY** springs!



Checking wire to the correct 1/100,000 inch calls for a very unusual micrometer, plus the feel and skill of expert craftsmanship. Here the wire for WESTON springs is being checked on this specially designed electrical gauge.

Possibly millions of times during the life of a WESTON instrument tiny springs such as these . . . some made of strip drawn to an incredible thinness of 0.0005 inch . . . will oppose and exactly balance the turning forces in a moving coil. They will often be under tension for long periods. They will be subject to extreme changes in temperature . . . and probably vibration and shock.

Yet these springs must resist even temporary distortion; and their electrical and mechanical characteristics must remain unchanged. For even a slight variation in an instrument spring will cause a change in instrument calibration, and allow serious errors to creep in. These *must be* extraordinary springs.

So WESTON controls *every* operation in

spring manufacture . . . compounding its own special, non-magnetic alloys...drawing the wire and accurately checking it to within 1/100,000 inch . . . heat treating and forming by exclusive methods . . . all to insure in these springs the electrical and mechanical permanency essential for true instrument dependability.

Yes, spring making at WESTON is a serious business . . . a long, painstaking sequence of exacting processes and control . . . supplemented by the skill and knowledge of craftsmen who "know how." In no other way could WESTON obtain springs to meet the required standards . . . to insure true WESTON dependability in measurement. Weston Electrical Instrument Corporation, 618 Frelinghuysen Avenue, Newark, New Jersey.



LABORATORY STANDARDS . . . PRECISION DC AND AC PORTABLES . . . DC, AC, AND THERMO SWITCHBOARD AND PANEL INSTRUMENTS . . . INSTRUMENT TRANSFORMERS . . . SENSITIVE RELAYS . . . SPECIALIZED TEST EQUIPMENT . . . LIGHT MEASUREMENT AND CONTROL DEVICES . . . EXPOSURE METERS . . . AIRCRAFT INSTRUMENTS . . . ELECTRIC TACHOMETERS . . . DIAL THERMOMETERS



Seven Quick Facts

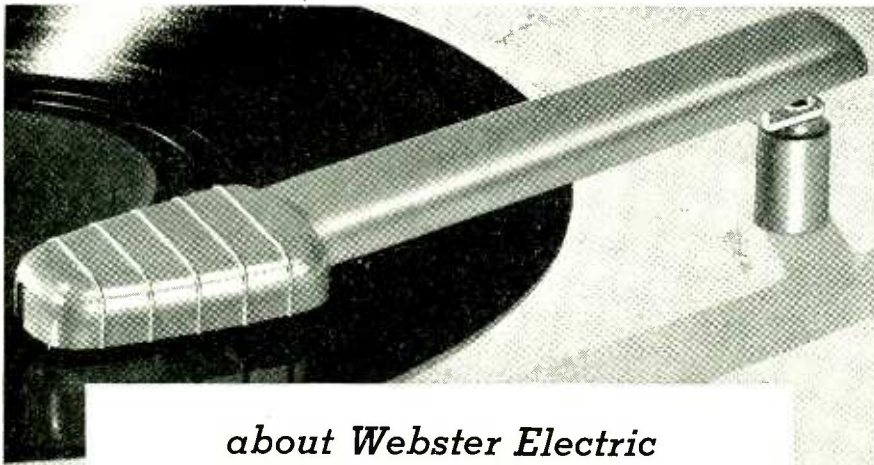

about Webster Electric MODEL AJ1 Low-Pressure Crystal Pick-Ups

1. 40 grams needle pressure reduces record wear and provides musical fidelity while keeping surface noises at a minimum.
2. Permo-Point Needle plays thousands of records, and then may be easily changed by loosening a Phillips recessed head screw.
3. Crystal and chuck are integrally built into the bakelite tone arm to form a precisely balanced, noiseless unit.
4. Frequency response is balanced so that networks are not essential.
5. Streamlined design harmonizes with modern cabinets.
6. Engineered for the optimum in tone quality.
7. Available from a dependable source of supply.

• Precision mechanical balance in this light-weight crystal pick-up assures long record life and minimum surface noise. The Model AJ1 rides lightly and evenly over the record track, responding to every musical detail. Carries the surging base notes and percussion without a suggestion of rattle. High quality performance is combined with practical simplicity in the Model AJ1 by Webster Electric engineering skill and manufacturing experience. Change to modern Webster Electric equipment now!

CRYSTAL PICK-UP CARTRIDGES

—available in a number of different models covering a wide range of mechanical and physical characteristics. All are described in Bulletin RC-144.

WEBSTER ELECTRIC RECORDER HEADS

make recordings outstanding for clearness and precision. Cover the frequency range from 30 to more than 6000 c.p.s., and faithfully record every harmonic detail. Described in Bul. RC-145.

(Licensed under patents of the Brush Development Company)

WEBSTER ELECTRIC COMPANY, Racine, Wis., U. S. A. Established 1909. Export Dept.: 100 Varick St., New York City. Cable Address: "ARLAB" New York City

WEBSTER ELECTRIC

"Where Quality is a Responsibility and Fair Dealing an Obligation"

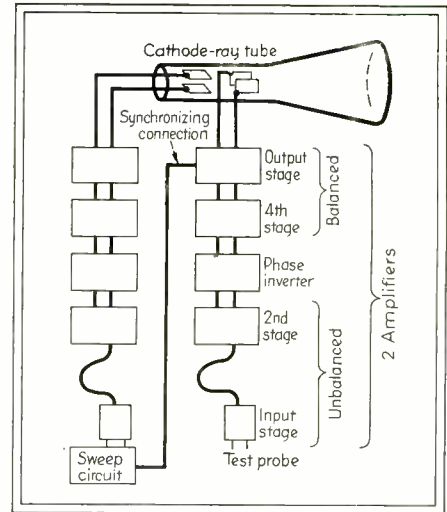

Fig. 3—Block diagram of the high-frequency oscilloscope which is useful in a frequency range not before explored with similar equipment

begins. By supplying an adjustable portion of the voltage on the vertical plates of the cathode-ray tube, the sweep cycle can be made to begin always at the same point of the wave being studied. A block diagram of the oscilloscope circuit is shown in Fig. 3. Amplifiers are used between the sweep circuit and the horizontal plates to secure the necessary high potential. Since the output required for the test voltage is the same, identical amplifiers are used. At their output, these amplifiers must be connected in push-pull because the deflecting plates of the cathode-ray tube must be balanced with respect to the anode of the tube. The input should be unbalanced because the most common measurements are of voltages to ground. The third stage amplifier acts as a phase inverter to transform from an unbalanced to a balanced circuit. A portion of the output is fed back to the sweep input for timing.

Patent Law Handbook

FROM TIME TO TIME numerous articles on patent law have been published in the *Allis-Chalmers Electrical Review*. These articles have stimulated so much interest among readers that the editors have reprinted them as an engineer's handbook on patent law, and have called it "Patent Background for Engineers". A number of these articles have been reviewed in these columns in past issues.

Among the various subjects discussed are patent fallacies, protection of new inventions, joint inventorship, patent interference, public use of new inventions, the trend in American patent law, trade marks, and the effect of compulsory patent licensing on inventors. Engineers will find these articles very interesting. The inherent nature of an engineer's work makes a knowledge of the subject matter of this pamphlet mandatory and potentially very useful.



With the VARIAC . . . the *right* voltage every time

Thousands of enthusiastic users testify to the general usefulness of the VARIAC *continuously adjustable* auto-transformer for use in hundreds of different applications where the voltage on any a-c operated device must be set *exactly right*.

The VARIAC is the original continuously-adjustable, manually-operated voltage control with these exclusive features found in no type of resistive control.

- **EXCELLENT REGULATION**—Output voltages are independent of load up to the full load rating of the VARIAC.
- **HIGH OUTPUT VOLTAGES**—VARIACS supply output voltages 15% higher than the line voltage.
- **SMOOTH CONTROL**—The VARIAC may be set to supply any predetermined output voltage with absolutely smooth and stepless variation.
- **HIGH EFFICIENCY**—Exceptionally low losses at both no load and at full power.
- **SMALL SIZE**—VARIACS are much smaller than any other voltage control of equal power rating.
- **LINEAR OUTPUT VOLTAGE**—Output voltages are continuously adjustable from zero by means of a 320 degree rotation of the control knob.
- **CALIBRATED DIALS**—VARIACS are supplied with reversible dials which read directly in output voltage from zero to line voltage or from zero to 15% above line.
- **SMALL TEMPERATURE RISE**—Less than 50 degrees C. for continuous duty.
- **ADVANCED MECHANICAL DESIGN**—Rugged construction—no delicate parts or wires.

VARIACS are stocked in fifteen models with power ratings from 170 watts to 7 kw; prices range between \$10.00 and \$100.00.

Because practically all of our manufacturing facilities are devoted to National Defense projects, to secure any of these products a preference rating certificate or other approved priority rating will be necessary to secure scheduled delivery.

Write for Bulletin 752 for Complete Data

GENERAL RADIO COMPANY

CAMBRIDGE, MASSACHUSETTS

BRANCHES: NEW YORK ● LOS ANGELES

MANUFACTURERS OF PRECISION ELECTRICAL LABORATORY APPARATUS



hp

Mr. Lloyd Morris, Ass't Director of Research at Galvin Mfg. Co. with 205A and 300A

Mr. William Huster, Chief Sound Engineer of Rockola Mfg. Co. with -hp- 205AG

Important manufacturers such as these
DEPEND UPON -hp- INSTRUMENTS
 for speed and accuracy in testing

New instruments that save you time and money in making production tests and measurements. For example, the model 300A harmonic wave analyzer makes it possible for you to measure the individual components of a complex wave with utmost speed and accuracy. Variable selectivity of this instrument facilitates high frequency measurements. A 300A is shown above in service at the Galvin Mfg. Corp. together with the model 205A resistance tuned audio oscillator. These new audio oscillators have set a new standard of operation in both laboratory and field testing. The Rockola Mfg. Co., shown here with the model 205AG and the Brush Development Company uses the smaller model 200A. These and other well known firms have had excellent service in the many important jobs for which they use -hp- instruments.

GET THE FACTS ABOUT THESE NEWER, BETTER LABORATORY INSTRUMENTS

Ask about the new model 400 vacuum tube voltmeter with frequency response from 10 cps to 1 mc.

HEWLETT  **PACKARD**
 481 Page Mill Road Palo Alto, California

Brush Development Co. operator shown with model 200A

Electric Tool-Pressure Gage

IN THESE DAYS of accelerated industrial production, a problem uppermost in the minds of manufacturers is the improvement of machine tool performance. By applying simple electrical principles, A. R. Hand presents a quick, accurate method of determining the best tool shapes, feeds, depths of cuts, coolants, and machineability of materials in the November 1941 issue of the *General Electric Review*.

To improve machine tool performance, Mr. Hand suggests the use of an electric tool-pressure gage. This is simply a device which will indicate horizontal and vertical forces exerted on the tool edge as it cuts into the work. It consists of a gage head comprising the tool-bit holder and the gage coils, a balancing unit which is part of the electrical bridge circuit of the gage, and the indicating and control unit which contains the pressure indicating instruments and their associated control circuits. The location of the gage coils and the position of the tool bits are shown in the diagrams below.

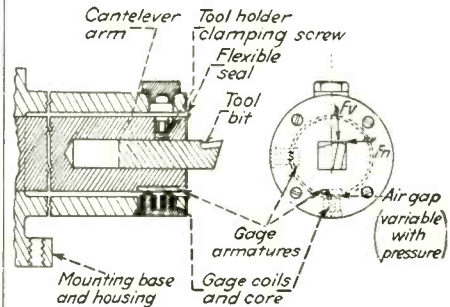

Location of the electrical aids with respect to the tool bits as they cut into the metal of the workpiece

The tool bit is mounted in a fairly rigid cantilever arm. The arm is placed in the gage head and is so arranged that there is a small air gap between the gage head and the tool bit holder. The gage coils are mounted in the gage head and are spaced 90 deg. apart. Any force exerted on the tool bit will deflect the cantilever arm and thus will vary the air gap. The change in air gap will vary the balance of the reactance bridges, of which the gage coils are a part. The two coils are connected to separate bridge circuits. This arrangement permits independent horizontal and vertical readings to be taken.

Several interesting applications of the gage are listed. The device is useful in determining the most suitable tool form and design of tools for special applications. It can help to compare relative merits of different tool materials, and accurately indicate how well a particular coolant is doing its job. Optimum operating conditions such as best rates of feed, correct depth of cut, and best rates of speed of work are among the other variable factors in tool performance that are quickly measured by the gage.

NO BLACK-OUT



... for radio research!

Behind closed doors, the engineers at Bell Labs and Western Electric are developing new ideas in radio at an unheard of rate.

Right now, secrecy must surround these things. They're going into many kinds of equipment for war that we're rolling out by the trainload for Uncle Sam.

But there's a time coming when many of these developments can and will be adapted to equipment for better broadcasting. Here's looking forward to the day when we can share them with you!



DISTRIBUTORS: In U.S.A.: Graybar Electric Co., New York, N. Y. In Canada and Newfoundland: Northern Electric Co., Ltd. In other countries: International Standard Electric Corp.

Western Electric

JOHNSON for tube sockets

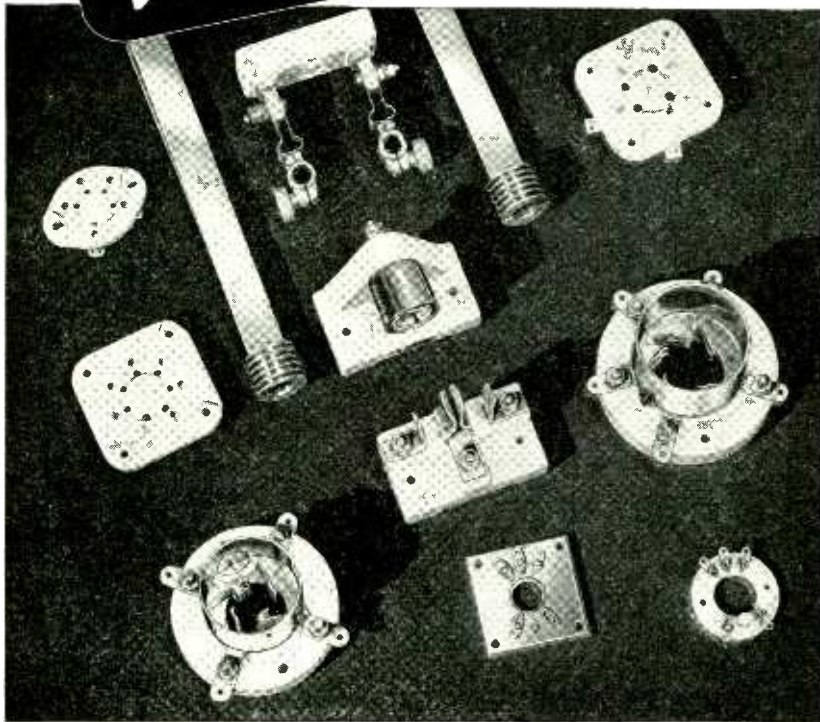

A PARTIAL LISTING

SOCKET	FOR	SOCKET	FOR
209	5 watt	224	4 prong
210	5 watt	225	5 prong
211	50 watt	226	6 prong
212	RCA 833	227	7 prong
213	152TL	228	8 prong
214	1500TH	235	Acorn
215	250 watt	237	RCA 813
216	204A	245	Acorn
217	7 prong	247	RCA 829

Whether you need one or 100,000, Johnson quality is available. Some of the more common types available from better Jobbers are listed. Others can be supplied on special order or to your specifications.

Illustrated are many old familiar friends as well as the new 212 for RCA 833 and the 245 with built in by-pass condensers for the Acorn tube. Write us about your socket problems.



ASK FOR THE NEW CATALOG 967D

E. F. JOHNSON CO.

WASECA, MINNESOTA

EXPORT: 25 WARREN ST., NEW YORK, N. Y.

"MANUFACTURERS OF RADIO TRANSMITTING EQUIPMENT"

Wired Radio Controls Street Light Circuits

RADIO SIGNALS TRANSMITTED over telephone dispatching circuits turn street lights on and off in eight outlying districts of a large Pennsylvania city. This idea is discussed by Floyd M. Fuller in the December 13, 1941 issue of the *Electrical World*.

The street lighting circuits supplied from eight outlying substations are controlled by a wired radio control operated from a central substation over telephone dispatching circuits. Carrier frequency signal is supplied from a phono-oscillator amplified through conventional tubes. Pushing the proper button starts the phono-oscillator, applies power to the filaments of the tubes, and at a predetermined later time, the plate power is applied and a coded signal is sent out. When this sequence of operations is completed the transmitter automatically shuts down. The oscillator is a small high-frequency generator driven by an 1,800 rpm synchronous motor to give a frequency of 4,950 cps. This output is amplified so that a minimum signal of two volts is delivered to each remote substation.

Control units or receivers are mounted like a plug-in type of watt-hour meter. The major parts are the selector unit, signal relay, timer disk and motor, and load switches and motor. The first signal sent out in each control cycle starts the synchronous motor which drives the timer disk. Once started it continues until one revolution is completed in one minute. At a predetermined time interval after the "start" signal is sent, an operation signal is sent. Each control relay timer disk carries an adjustable brass section which reaches the "on" or "off" brushes at a certain time after the start signal is sent. If an on or off signal is sent when the brushes make contact the relay operates and the lights are turned on or off in accordance with the signal sent.

Before this new system was installed

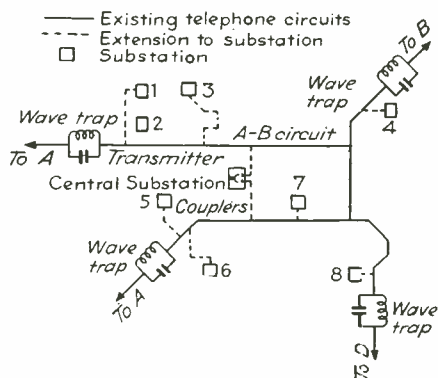

Simplified diagram of the wired radio control for outlying districts

the lights were controlled by clock-controlled Sauter time switches. When the radio control was put in, the motor



Why your Red Cross urgently needs

FIFTY MILLION DOLLARS, NOW

How the fund is allocated . . .

What it does in service

Every dollar that you give now to your Red Cross marches into the thick of things where humanitarian help is needed most—up to the fronts and battle stations where the fighting is heaviest. Into the Red Cross hospitals and First Aid units where prompt medical attention and supplies may save innumerable lives. And throughout our broad land to train and equip volunteers to meet any emergency that may strike.

How the \$50,000,000 War Fund is Used

SERVICE TO THE ARMED FORCES \$ 25,000,000

Provides for the care, welfare and morale of the Army and Navy, including services to men in hospitals and during convalescence. • Provides an important link between the service men and their families; keeps the families from breaking up, supplies food, shelter, medicine, and even jobs where necessary. • Provides essential medical and other supplies outside of standard Government equipment. • Operates Red Cross headquarters at camps and naval stations. • Enrolls blood donors and medical technologists for Army and Navy needs. • Provides millions of surgical dressings, sweaters, socks, etc. through volunteer workers.

DISASTER AND CIVILIAN EMERGENCY RELIEF • \$ 10,000,000

Supplies emergency needs for food, clothing, shelter and medical attention for disaster victims. • Assists stricken families in repair of homes and other adjustments; provides minimum reserves of essential relief supplies to prevent unnecessary delays.

CIVILIAN DEFENSE SERVICES \$ 5,000,000

Trains volunteers for home nursing and nurses' aides. • Trains nurses, men and women, for active duty with the Army and Navy. • Trains volunteers in First Aid and accident prevention. • Trains volunteers for work in Motor Corps, Canteen and Production. • Instructs men, women and children in preparedness against explosive and incendiary bombs. • Organizes for evacuation of children and their families from stricken areas. • Assists Red Cross Chapters in establishing effective coordination of emergency relief with local and State defense authorities.

SERVICE AND ASSISTANCE THROUGH CHAPTERS • \$ 4,000,000

Gives assistance and service to the 3,740 Red Cross Chapters with their 6,131 Branches responsible for local Red Cross activities, particularly welfare work among the service men and their families.

OTHER ACTIVITIES AND CONTINGENCIES . . . \$ 6,000,000

Provides for unforeseen expansions in program and for new activities made necessary by unexpected developments.

TOTAL \$50,000,000

THE AMERICAN RED CROSS \$50,000,000 WAR FUND

Note to Red Cross Canvassers: Use the material on this page to better inform contributors how their donations are being expended.

This space contributed to The American Red Cross by ELECTRONICS

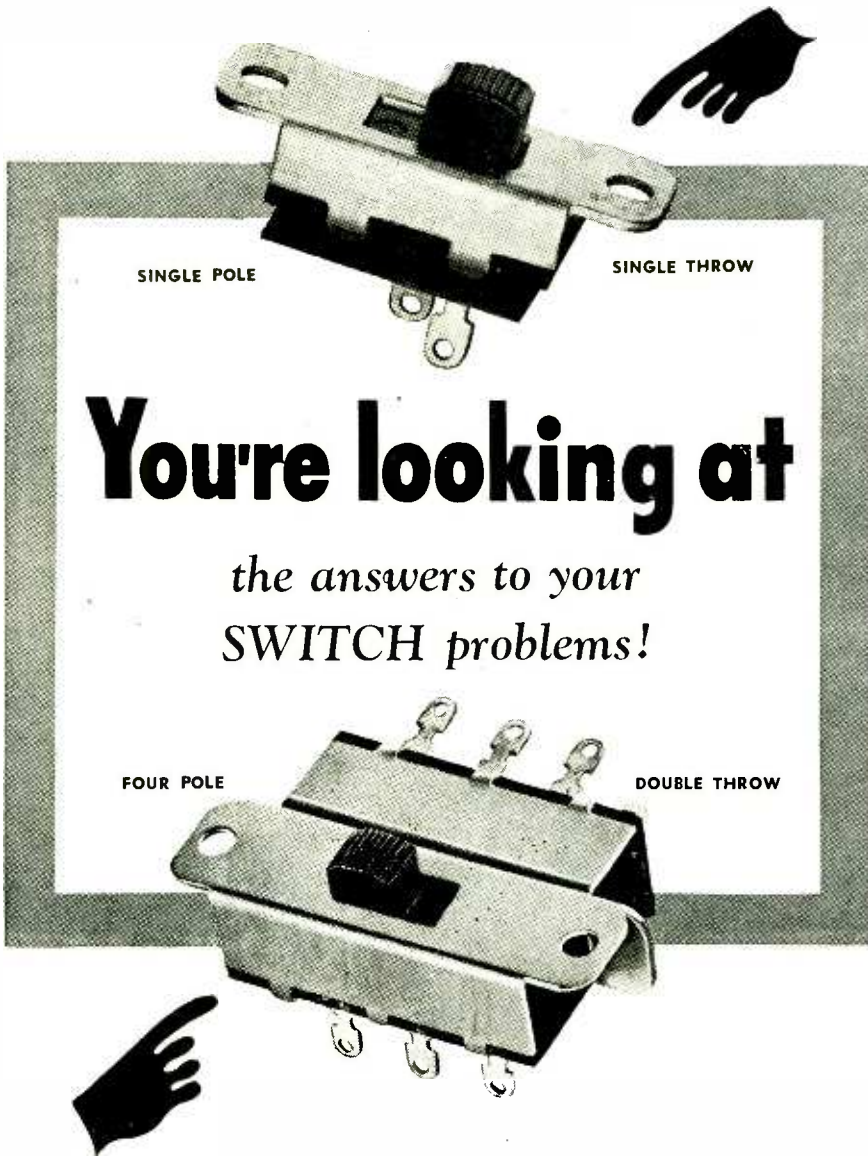

(at top) MODEL SS-1 . . . Slide action switch suitable for two-position tone control, sensitivity control, line switch for small sets, small motor control, tap switch for power transformers and many other uses. Carries Underwriters' Approval for .75 amp., 125 volts.

(below) MODEL SS-12 . . . Slide action switch for circuit changing and a wide variety of applications to all types of electrical equipment. Underwriters' Approval with a .5 amp., 125 volt rating. Terminals in two planes, extremely accessible for wiring. Mechanically rugged; fully enclosed.

There's a COMPLETE range of

STACKPOLE SWITCHES

for every small circuit job!

On tough jobs, where dependability is essential. Stackpole Switches prove their superiority. The fact that so many manufacturers tell us that Stackpole Switches are the sturdiest, longest-lasting of them all, is a fact of which we are justly proud—and something for you to think about NOW, when these features are more important than ever! Available in a full range of sizes from single pole to four pole models—and any combination between these extremes.

SAMPLES AND PRICES SENT ON REQUEST.

STACKPOLE CARBON CO.
ST. MARYS, PENNA. U. S. A.

switch operated by the clock mechanism on each switch was disconnected and the circuit connected to the relay switch of the receiving unit. All 2,350 lights for the entire community can now be lighted and extinguished almost at the same time. This offers easy control of street lights for black-out purposes.

On Corrosion

ONE OF THE TROUBLES that is always impairing the reliability of communication equipment is corrosion. The results of a recent study of the factors affecting the rate of corrosion are outlined in the November issue of the *Bell Laboratories Record* under the title "Environmental Factor in Corrosion" by V. J. Albano.

Corrosion is a normal attribute of ordinary metals. It results from their natural tendency to revert to stable states by combining with elements which surround them. Under certain conditions of exposure, protective films form on many metals. This action requires in the environment a substance that reacts with the metal to form an insoluble, impervious, and adherent compound on its surface. Corrosive substances in the environment prevent the formation of such a film. Thus the relative amounts of corrosive and film-

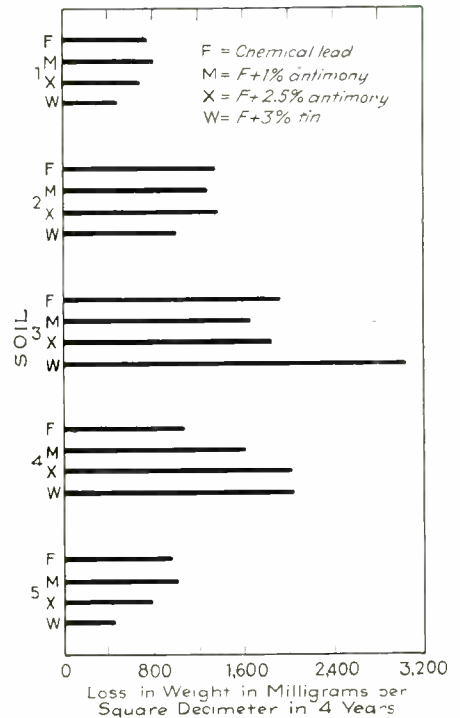

A comparison of the rates of corrosion of lead alloys in five different soils shows that the nature of the soil rather than the composition of the alloy is the predominant factor

forming substances determines whether or not a protective film will be formed.

Tests at the Bell Telephone Laboratories showed that the character of the environment was the predominant factor rather than the composition of the material being tested. Thirteen differ-

ent alloys of lead were buried in five different soils. At the end of the test, four years later, the degree of corrosion of these metals varied among themselves in each of the soils and this variation could not be correlated with the alloy composition. The test indicated that the character of the soil was the predominant factor in determining the progress of corrosion. A graphical representation of some of these findings is shown in the diagram. Similar tests on other materials showed similar results.

When wrought iron pipe and steel pipe were tested to determine which was more resistant to water corrosion, it was found that the nature of the water determined the rate of corrosion. No significant difference between the corrodibility of either pipe could be distinguished. The rate of attack was determined by the character and relative concentrations of dissolved substances rather than by the combined concentrations of all substances present in the water. When tested in various soils, the nature of the soils was found to be more important than the metal in determining rates of corrosion.

Corrosion can be controlled by choosing a metal to suit a given environment or by altering the environment to suit the metal. The most direct way of reducing the corrosiveness of an environment is to remove the corroding constituents as is sometimes done by air conditioning. The addition of film-forming substances such as silicates and carbonates to water reduces the corrosiveness of water. Where the environment can not be controlled economically the proper selection of a material for the environment gives good results.

• • •

AUTOMATIC PIN SETTER

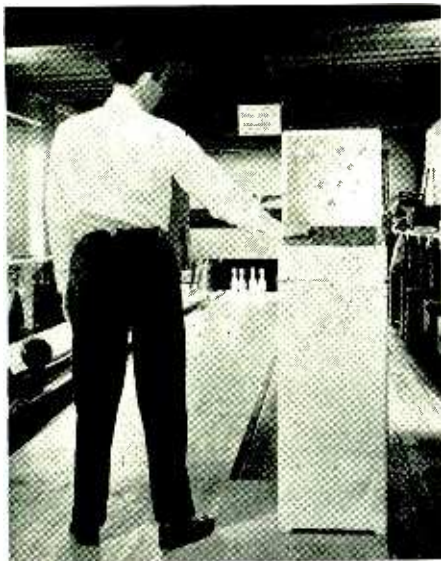

D. W. Davis of Minneapolis believes he has perfected what has long been sought, an automatic pin setter for bowling alleys. The device clears and sets up the pins in ten seconds

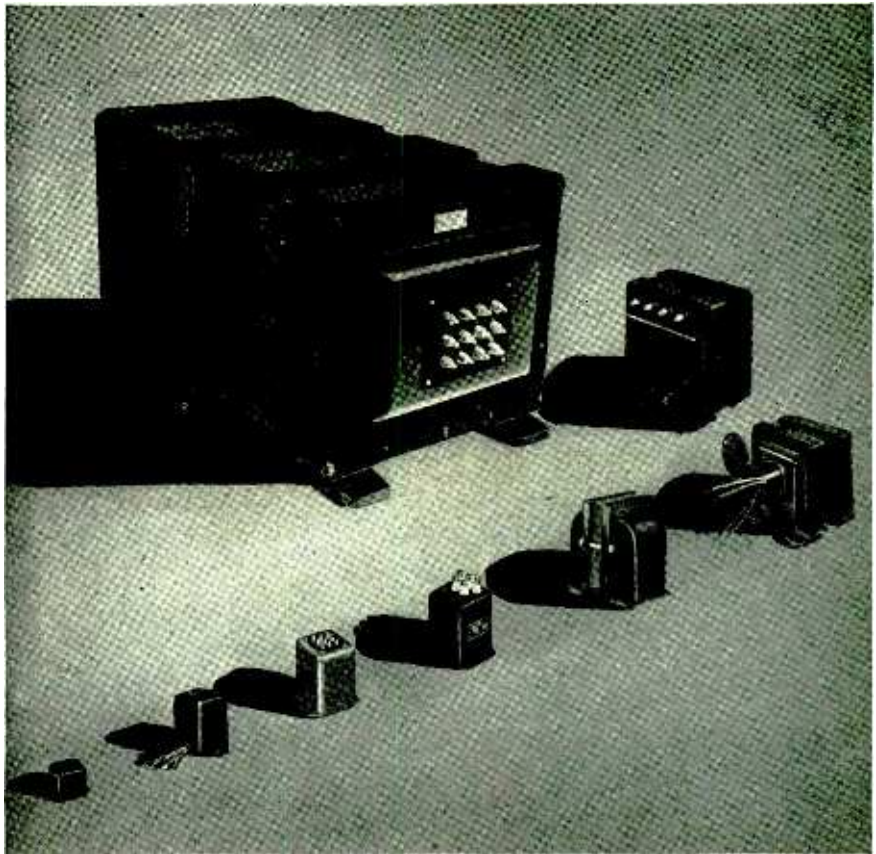

Custom Designed

TRANSFORMERS OF ALL TYPES UP TO 10KVA...

The Chicago Transformer Corporation specializes in, and is unusually well equipped to handle, both the design and the manufacture of Custom Order Transformers for new and difficult applications.

A large and competent staff of electrical and mechanical engineers, working in a most modernly equipped laboratory, have spent experience-building years in creating transformers for unusual uses.

Given the application description, and the electrical results desired, the Chicago Transformer organization should best be able to solve your new and difficult transformer problems.



CHICAGO TRANSFORMER CORPORATION

3505 WEST ADDISON STREET • CHICAGO

ROTALIX

definition of modern radiography

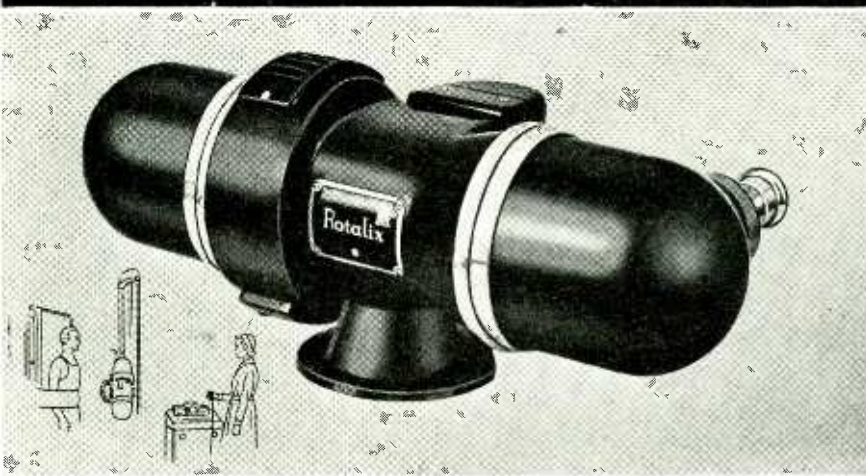

an achievement of **PHILIPS METALIX**
to which **CALLITE** *contributed*

IN busy hospitals and laboratories, *Rotalix* is the choice today for radiography. No other tube of its type has so impressively stood the test of time. In daily operation, the *Rotalix* continues to produce radiographs of superb image definition.

In engineering the *Rotalix*, practically every component was of new and fundamental construction. It is the *Rotalix*' unique anode design, however, which sets this near-vibrationless tube apart from all others. The anode face is built up of thin Callite tungsten ribbon tightly wound spirally. Cracking or pitting is thus reduced to a negligible minimum.

The resulting longer tube life — one of the distinguishing characteristics of the Philips *Rotalix* — represents another of the many Callite contributions to modern industrial and scientific development . . . as well as living proof that Callite dependability is more than just a word to advertise. If your product would benefit by the knowledge and skill of Callite's engineers, in these days of "metallurgent" production, call on our technical staff at once.

Manufacturers of electrical contacts of refractory and precious metals, bi-metals, lead-in wires, filaments and grids—formed parts and raw materials for all electronic applications.

CALLITE TUNGSTEN
CORPORATION

544-39th STREET  UNION CITY, N. J.

CABLE:  "CALLITES"

BRANCHES: CHICAGO • CLEVELAND

Program of the Fifth Annual Broadcast Engineering Conference

February 23, 24, 25, 26, 27
The Ohio State University
Columbus, Ohio

MONDAY, FEBRUARY 23

11:00 A. M.—1:00 P. M.
"Communications in National Defense", E. K. Jett
2:30 P. M.—4:30 P. M.
"Emergency Operation of Broadcast Transmitters," Orrin W. Towner

TUESDAY, FEBRUARY 24

9:00 A. M.—11:00 A. M.
"Engine Driven Emergency Power Plants", Karl Troeglen
11:00 A. M.—1:00 P. M.
"Mobile FM", Daniel E. Noble
2:30 P. M.—4:30 P. M.
"Transmitter Maintenance Round Table", Charles Singer, Chairman

WEDNESDAY, FEBRUARY 25

9:00 A. M.—11:00 A. M.
"Broadcast Station Operation During War Time—I", "Priorities", Lynn C. Smeby, "Wire Facilities", Frank Cowan. "Property Protection and Fire Fighting", J. D'Agostino. "Auxiliary Antennas", Raymond Guy. "Broadcast Operation on Coast", R. V. Howard, "BC Committee of DCB", Andrew King
11:00 A. M.—1:00 P. M.
"Round Table on Training of Engineers and Technicians", W. L. Everitt, C. M. Jansky, G. F. Leydorf, Carl Smith
2:30 P. M.—4:30 P. M.
"Transmitter Maintenance Round Table", Charles Singer, Chairman

THURSDAY, FEBRUARY 26

9:00 A. M.—11:00 A. M.
"Broadcast Station Operation During War Time—II"
11:00 A. M.—1:00 P. M.
"War Time Broadcast Experiences in England", Gerald C. Gross
2:30 P. M.—4:30 P. M.
"Recording Standards", Howard Chinn

FRIDAY, FEBRUARY 27

9:00 A. M.—11:00 A. M.
"Broadcast Station Operation During War Time—III"
11:00 A. M.—1:00 P. M.
"Studio-Transmitter-Links and High Frequency Antennas", J. H. DeWitt
2:30 P. M.—4:30 P. M.
"Alert Calling System", Arthur VanDyck and Stuart Seely



A WAR MESSAGE to ALL EMPLOYERS

★ From the United States Treasury Department ★

WINNING THIS WAR is going to take the mightiest effort America has ever made—in men, in materials, and in money! Every dollar, every dime that is not urgently needed for the civilian necessities of food, clothing, and shelter, must, if we are to secure final Victory, be put into the war effort.

An important part of the billions required to produce the planes, tanks, ships, and guns our Army and Navy need must come from the sale of Defense Bonds. Only by regular, week by week, pay-day by pay-day investment of the American people can this be done.

This is the American way to win. This is the way to preserve our democratic way of life.

Facing these facts, your Government needs, urgently, your cooperation with your employees in *immediately* enrolling them in a

PAY-ROLL SAVINGS PLAN

The Pay-Roll Savings Plan is simple and efficient. It provides, simply, for regular purchases by your employees of United States Defense Bonds through systematic—yet voluntary—pay-roll allotments. All you do is hold the total funds collected from these pay-roll allotments in a separate account and deliver a Defense Bond to the employee each time his allotments accumulate to an amount sufficient to purchase a Bond.

The Pay-Roll Savings Plan has the approval of the American Federation of Labor, the Congress for Industrial Organization, and the Railroad Brotherhoods. It is now in effect in several thousand companies varying in number of employees from 3 to over 10,000.

In sending the coupon below, you are under no obligation, other than your own interest in the future of your country, to install the Plan after you have given it your

consideration. You will receive—1, a booklet describing how the Plan works; 2, samples of free literature furnished to companies installing the Plan; 3, a sample employee Pay-Roll Savings authorization card; and 4, the name of your State Defense Bond administrator who can supply experienced aid in setting up the Plan.

To get full facts, send the coupon below—today! Or write, Treasury Department, Section B, 709 Twelfth St., NW., Washington, D. C.

HOW THE PAY-ROLL SAVINGS PLAN HELPS YOUR COUNTRY

- 1 It provides immediate cash now to produce the finest, deadliest fighting equipment an Army and Navy ever needed to win.
- 2 It gives every American wage earner the opportunity for financial participation in National Defense.
- 3 By storing up wages, it will reduce the current demand for consumer goods while they are scarce, thus retarding inflation.
- 4 It reduces the percentage of Defense financing that must be placed with banks, thus putting our emergency financing on a sounder basis.
- 5 It builds a reserve buying power for the post-war purchase of civilian goods to keep our factories running after the war.
- 6 It helps your employees provide for their future.

MAIL THIS COUPON NOW

Treasury Department, Section B
709-12th St., NW.
Washington, D. C.

We want to do our part. Please
rush full information regarding
the Pay-Roll Savings Plan.

NAME

POSITION

COMPANY NAME

ADDRESS

NUMBER OF EMPLOYEES



MAKE EVERY PAY-DAY... BOND DAY!
U. S. Defense BONDS ★ STAMPS

This space is a contribution to NATIONAL DEFENSE by Electronics.

GPO 16-25943-1 Form No. DSS-BP-2

New Books

Higher Mathematics for Engineers and Physicists

BY IVAN S. SOKOLNIKOFF, AND ELIZABETH S. SOKOLNIKOFF *Second Edition.* 587 pages. McGraw-Hill Book Co. 1941. Price, \$4.50.

THE GENERAL IMPRESSION of engineers has often been that mathematics is a necessary evil. Perhaps there has been some justification for this point of view when it is considered that mathematics is taught by mathematicians and not by engineers, with the result that the practical application of many theorems (and indeed many important and fundamental mathematical concepts) have completely escaped many a student until years after his graduation from college. Perhaps it is too often forgotten, as is admirably pointed out in Hogben's "Mathematics for the Million," that mathematics is a language which describes the sizes of things in contrast to ordinary language which is used to describe the sorts of things in the world; it is a necessary language to answer "how much" just as English, French, German, is a necessary language to answer the question, "what."

Of course, this present volume will have no appeal to those whose interest does not extend to the quantitative, but no graduate engineer who has derived benefit from the usual courses in the mathematics department to which he has been exposed, should find much difficulty in reading and understanding at first sight a large portion of "Higher Mathematics" in spite of its awe inspiring title. This does not infer that the volume is easy, or that it is necessarily the basis of a "snap course" for the graduate student. Rather should this statement be interpreted as indicating the lucidity of treatment to be found in the book written by the Sokolnikoffs, a lucidity and logical treatment which eliminates much of the difficulty of many mathematical texts.

According to the authors, the "chief purpose of the book is to help bridge the gap which separates many engineers from mathematics by giving them a bird's eye view of those mathematical topics which are indispensable in the study of the physical science." Keynote of the course for which this volume is used as a text is "the practical utility of mathematics," and considerable effort has been made to select those topics which are of frequent and most immediate use in applied sciences.

Chapters in the book cover the following topics: infinite series, Fourier series, solution of equations, partial

differentiation, multiple integrals, line integrals, ordinary differential equations, partial differential equations, vector analysis, complex variable, probability, and empirical formulas and curve fitting.

The logical arrangement of the book is well illustrated by the chapters on vector analysis which is immediately followed by the chapter on the complex variable. All of the necessary fundamentals for a quantity having direction as well as magnitude have been developed in the chapter on vector analysis, so that by the time one comes to consider the complex variable, the student should be thoroughly familiar with the philosophy behind the complex numbers. The one-to-one correspondence between the vectors in the xy -plane and the complex numbers is immediately established, so there should be no confusion as to the importance and significance of "imaginary" numbers. There are also frequent discussions, as in the section on conformal mapping, of the properties of certain mathematical concepts, which give a graphical picturization of the principles involved, or as in the case of the discussion of probability and chance.—B.D.

The Radio Amateur's Hand Book

BY THE HEADQUARTERS STAFF OF THE AMERICAN RELAY LEAGUE, *West Hartford, Conn. 19th edition.* Approximately 600 pages. Price \$1.

FROM A RELATIVELY HUMBLE BEGINNING in 1926, "The Radio Amateur's Hand Book" has gone through nineteen editions in which more than three quarters of a million copies have been printed and sold. In fact, the book is so well known that the mere announcement that a new edition is practically all the review which is required.

As usual, the current edition represents the latest practice of amateur radio activities. In this edition the principles and designs of radio equipment have been placed in a section totally divorced from another section dealing with the construction and operation of amateur transmitters and receivers. The 120 pages of principles and designs may be expected to change relatively little from issue to issue and consequently the A.R.R.L. staff may be relieved, in the future, of much arduous work of annual revision.

The section on Principles and Designs cover the general subject of vacuum tubes, oscillators, radio telegraphy, keying, receivers, power supplies and antenna systems and wave propagation. The text is written in the descriptive and generally non-mathematical style "for busy, practical people of average education. A major objective has been to provide the answers to the questions which naturally arise in the course of amateur operation."

In the section on construction and data approximately 225 pages are devoted to the construction of receiving and transmitting equipment, antennas, emergency equipment and two chapters are devoted to ultrahigh frequency equipment. A catalog of about 100 pages of equipment suitable for the amateur, together with a complete 8-page index concludes the volume.

As has been true of all editions of the Handbook, the 19th edition is an unusually good buy, not only for the person who intends to establish his own amateur transmitting and receiving station but for those who require an introductory treatise into radio theory, or for those who wish to brush up on current practice in high frequency technique.—B.D.

Electrical and Radio Notes for Wireless Operators

Reprinted from the English publication by the Chemical Publishing Company, New York City. 1941. 246 pages. Price \$2.50.

Radio Laboratory Job Sheet Manual

By SOL D. PRENSKY, *Instructor in Radio, Jefferson High School, Brooklyn.* Radiolab Publishing Co., Brooklyn, N. Y. 1941. 78 pages. Price \$1.80.

THESE ARE ELEMENTARY BOOKS aimed at men learning radio science. The first has chapters dealing with the elements of electrical and electronic circuits and circuit elements; the mechanism of a simple transmitter, the principles of detection, amplification, superheterodyne receivers and power supply systems, etc.

The second is made up of a spiral bound collection of 24 experiments which may be performed by students. Principles of electromagnets, induced voltages, microphones, amplifiers, current and voltage measurements, diodes, t-r-f receivers etc. are treated in these experiments. The procedure of setting up the apparatus, a description of what to look for, and explanation of the principles involved make each experiment a useful adjunct to any theoretical work the student may have as part of his course.—K.H.

INSULATION HIGHLIGHTS



(Above) CONSTRUCTION is proceeding rapidly at Isolantite's Belleville plant, where the expansion program now under way will double present capacity for the production of ceramic insulators. Major phase in the program is the construction of a new three-story building which will add 95,000 square feet to existing productive areas, and facilities in existing buildings are being rearranged to facilitate production flow. Overtime shifts have been added to accelerate construction progress, and it is expected that the new facilities will be ready for operation in May. With the completion of this program, Isolantite will be enabled to render more efficient service in meeting the growing demand for its products.

**Registered trade-name for the products of Isolantite Inc.*

ISOLANTITE

CERAMIC INSULATORS

ISOLANTITE INC. FACTORY: BELLEVILLE, NEW JERSEY
SALES OFFICE: 233 BROADWAY, NEW YORK, N. Y.

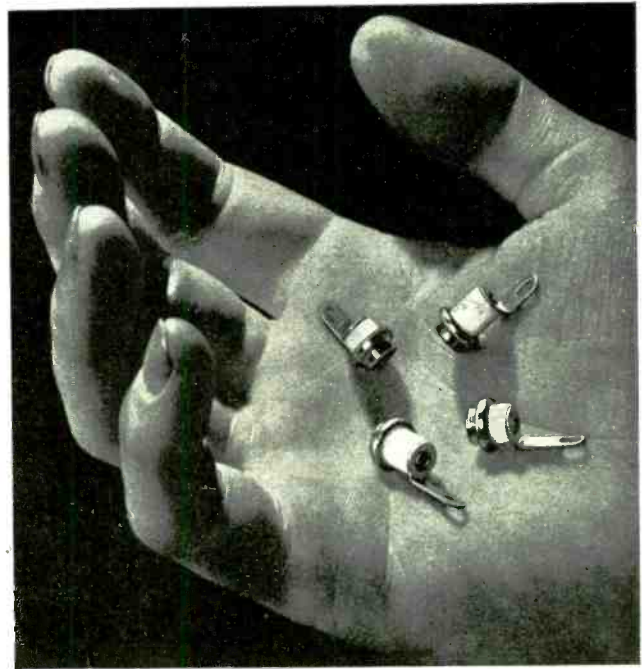

(Above) MINIATURE TERMINAL BUSHINGS, especially suitable for condensers, transformers, and similar applications in the radio and electrical industries, have recently been added to the Isolantite line. Bushings are supplied complete with hard tinned copper terminals and nickel-plated copper flanges. Insulator bodies are of glazed Isolantite*. Bushings are supplied in two terminal lengths and two insulator lengths. Detailed specifications and dimensions are given in Bulletin No. 104-A, available on request.

(Below) PROGRESSIVE ENGINEERING characterizes the design of the new Type TMK condenser built by National Company, Inc., for exciters and low power transmitters. Swivel plug-in mount is provided to permit easy mounting of series coils. In keeping with this up-to-the-minute design, National selects Isolantite insulation for use both in the TMK condenser and in the Type AR-16 coil shown mounted on the condenser.

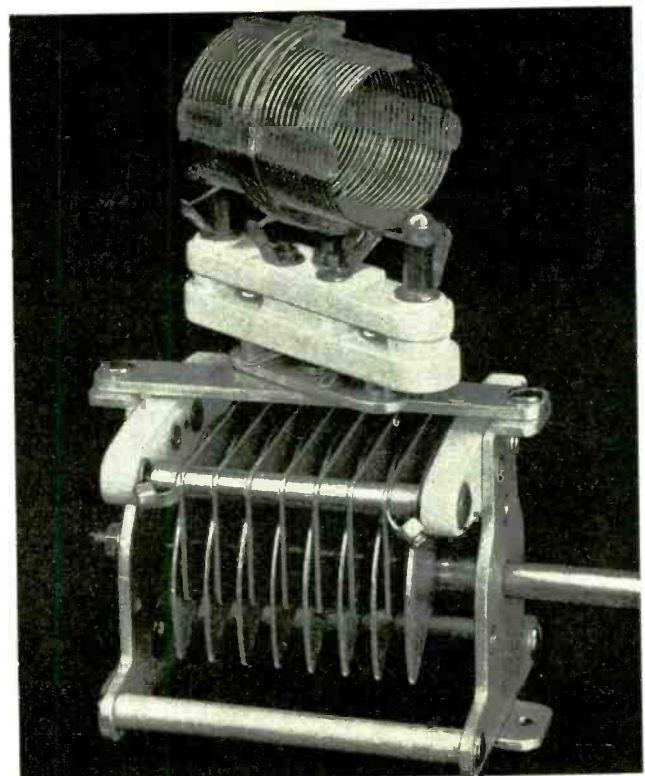

TO BUILD SPECIAL UNITS MORE EASILY

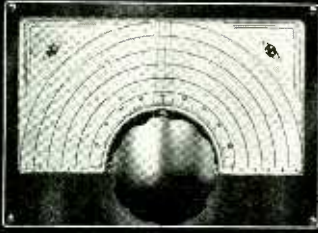

A DIAL DESIGNED FOR INDIVIDUAL CALIBRATION

TYPE ACN DIAL

- Dial bezel acts as drilling template.
- Blank scales for direct calibration.
- Index holes in pointer for pricking calibration points.
- Scale removable without dismounting mechanism.
- Employs Velvet Vernier Drive Unit.

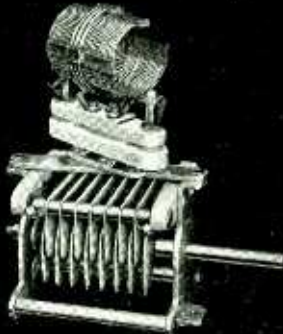

A UNIT COMBINATION OF COIL AND CONDENSER

TYPE AR-16 COIL & TMK CONDENSER

- Plug-in coils fit swivel mount.
- Air-spaced coils or plain coil forms available.
- Low loss construction throughout.
- Rigid condenser frame for permanent calibration.
- Condenser mounts on panel, chassis or standoff insulators.
- Condenser capacities to 250 mmf.



AN INSULATED COUPLING THAT WORKS AROUND CORNERS

TYPE TX-12

- Isolantite insulation.
- High quality flexible shafting.
- Fits 1/4" shafts.

NATIONAL COMPANY, INC.

MALDEN  MASS.

TUBES

Characteristics of cathode-ray and television picture tubes are presented this month in addition to the new receiving tube types registered by the RMA Data Bureau during December 1941

Tube Registry

New tube types registered by the RMA Data Bureau during December 1941

Cathode-Ray Tubes

Type 2503A3

DuMont

CATHODE-RAY tube; medium-persistence, green fluorescent screen; electrostatic focus and deflection; usual application—oscillographic and balanced deflection; diameter 3 inches; 7-pin base.

$E_f = 2.5$ v
 $I_f = 2.1$ amps
 E (anode 1) = 500 v (max)
 E (anode 2) = 1500 v (max)
 E (grid) for cutoff = -80 v
 Deflection Factor
 $D_1 - D_2 = 100$ v (d.c.)/kilo-volt-inch
 $D_3 - D_4 = 100$ v (d.c.)/kilo-volt-inch

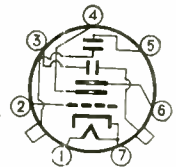

2503A3-C3

6ST7 (M)

DOUBLE diode, triode, heater type, MT-8 metal envelope, seated height 2 1/8 inches (max), 8-pin octal base.

$E_f = 6.3$ v
 $I_f = 0.15$ amp
 $E_b = 250$ v
 $E_c = -9$ v
 $I_b = 9.5$ ma
 $\mu = 16 \times 10^4$
 $r_p = 8500$ ohms
 $g_m = 1900$ μ mhos
 $C_{in} = 2.8$ μ mf
 $C_{out} = 3.0$ μ mf
 $C_{exp} = 1.5$ μ mf
 Basing 8Q-1-1

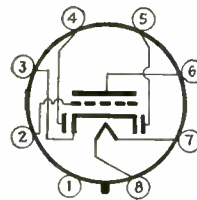

Type 2503C3

DuMont

CATHODE-RAY tube; short-persistence, blue fluorescent screen; electrostatic focus and deflection; usual application—oscillographic and balanced deflection; diameter 3 inches; 7-pin base.

$E_f = 2.5$ v
 $I_f = 2.1$ amps
 E (anode 1) = 500 v (max)
 E (anode 2) = 1500 v (max)
 E (grid) for cutoff = -80 v
 Deflection Factor
 $D_1 - D_3 = 100$ v (d.c.)/kilo-volt-inch
 $D_2 - D_4 = 100$ v (d.c.)/kilo-volt-inch

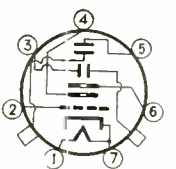

2503A3-C3

TUBE TYPES of the G and GT series have been combined into one type with the suffix GT/G as follows.

Type 6SA7GT/G

FOR CHARACTERISTICS see February 1940 issue, page 92.

Type 12SA7GT/G

FOR CHARACTERISTICS see February 1940 issue, page 51 or April 1940 issue, page 88.

Type 6SK7GT/G

FOR CHARACTERISTICS see January 1940 issue, page 60.

Type 12SK7GT/G

FOR CHARACTERISTICS see January 1940 issue, page 64.

Type 2505A5

DuMont

CATHODE-RAY tube; medium-persistence, green fluorescent screen; electrostatic focus and deflection; usual 5 inches; 7-pin base.

$E_f = 2.5$ v
 $I_f = 2.1$ amps
 E (anode 1) = 500 v (max)
 E (anode 2) = 1500 v (max)
 E (grid) for cutoff = -80 v
 Deflection Factor
 $D_1 - D_3 = 60$ v (d.c.)/kilo-volt-inch
 $D_2 - D_4 = 60$ v (d.c.)/kilo-volt-inch

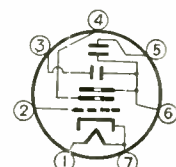

2505A5-C5

Type 2505C5

DuMont

CATHODE-RAY tube; short-persistence, blue fluorescent screen; electrostatic focus and deflection; usual application—oscillographic; diameter 5-inches, 7-pin base.

$E_f = 2.5$ v
 $I_f = 2.1$ amps
 E (anode 1) = 500 v (max)
 E (anode 2) = 1500 v (max)
 E (grid) for cutoff = - 80 v
 Deflection Factor
 $D_1 - D_2 = 60$ v (d.c.)/kilo-volt-inch
 $D_3 - D_4 = 60$ v (d.c.)/kilo-volt-inch

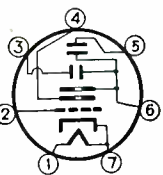

2505A5-C5

Type 2507A5

DuMont

CATHODE-RAY tube; medium-persistence, green fluorescent screen; electrostatic focus and deflection; usual application—oscillographic and high voltage; diameter 5 inches, 5-pin base.

$E_f = 2.5$ v
 $I_f = 2.1$ amps
 E (anode 1) = 1000 v (max)
 E (anode 2) = 3000 v (max)
 E (grid) for cutoff = - 120 v
 Deflection Factor
 $D_1 - D_2 = 55$ v (d.c.)/kilo-volt-inch
 $D_3 - D_4 = 50$ v (d.c.)/kilo-volt-inch

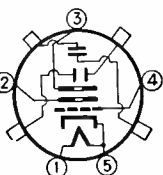

2507A5-B5-C5

Type 2511B5

DuMont

CATHODE-RAY tube; long persistence, green fluorescent screen; electrostatic focus and deflection; usual application—oscillographic, balanced deflection and television; diameter 5 inches; 11-pin magnal base.

$E_f = 6.3$ v
 $I_f = 0.8$ amp
 E (anode 1) = 600 v (max)
 E (anode 2) = 2000 v (max)
 E (intensifier) = 6000 v (max)
 E (grid) for cutoff = - 50 v
 Deflection Factor
 $D_1 - D_2 = 28$ v (d.c.)/kilo-volt-inch
 $D_3 - D_4 = 25$ v (d.c.)/kilo-volt-inch

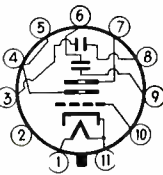

2511A5-B5-C5-D5

Type 2511C5

DuMont

CATHODE-RAY tube; short-persistence, blue fluorescent screen; electrostatic focus and deflection; usual application—oscillographic, balanced deflection, and television; diameter 5 inches; 11-pin magnal base.

$E_f = 6.3$ v
 $I_f = 0.8$ amp
 E (anode 1) = 600 v (max)
 E (anode 2) = 2000 v (max)
 E (intensifier) = 6000 v (max)
 E (grid) for cutoff = - 50 v
 Deflection Factor
 $D_1 - D_2 = 28$ v (d.c.)/kilo-volt-inch
 $D_3 - D_4 = 25$ v (d.c.)/kilo-volt-inch

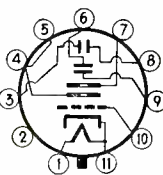

2511A5-B5-C5-D5

"Now it can be told"



COMPLETE MECHANICAL, PHYSICAL AND ELECTRICAL CHARACTERISTICS OF **PRECISION** **METAL SHIELDED WIRE**

SIX months ago we started a project—a project to provide the Design Engineer with complete Mechanical and Electrical specifications of PRECISION METAL SHIELDED WIRE. We realize that if such information could be assembled intelligently and accurately, much guesswork would be eliminated in the application of Shielded Wire to Electronic Circuits.

Unbiased laboratory tests have revealed just why top-flight Engineers in the Aviation, Marine, Electronic and associated industries have specified this new material to solve their Shielding Problems. Today, no up-to-the-minute Engineer can afford to be without this highly important information. A complete guide to the intelligent application of Moisture-proof, Static-proof, and Mechanical damage-proof Metal Shielded Wire. Send for your free copy AT ONCE.

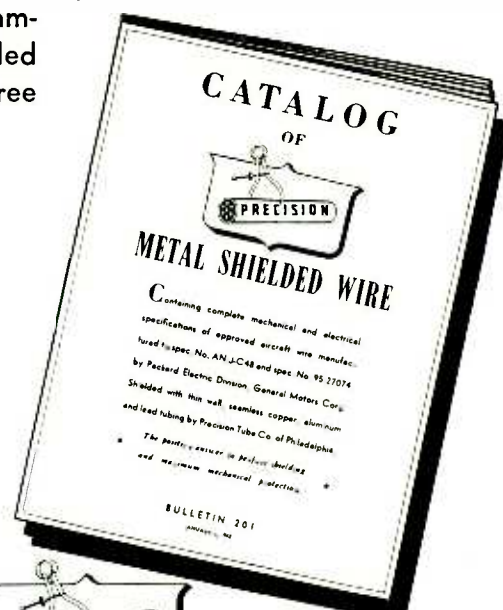

Complete but condensed to assure accuracy of estimates and calculations.



PRECISION TUBE CO.

SPECIALISTS IN ACCURATELY DRAWN TUBING OF EVERY DESCRIPTION
 3824-26-28 TERRACE STREET - PHILADELPHIA, PA.
BRANCHES IN ALL PRINCIPAL CITIES

Meeting a pressing need

—for defense communications improvement
—demanding extension of services, development of refinements, more specially-trained engineers

Prepare for specialization in this important field

with the aid of these books

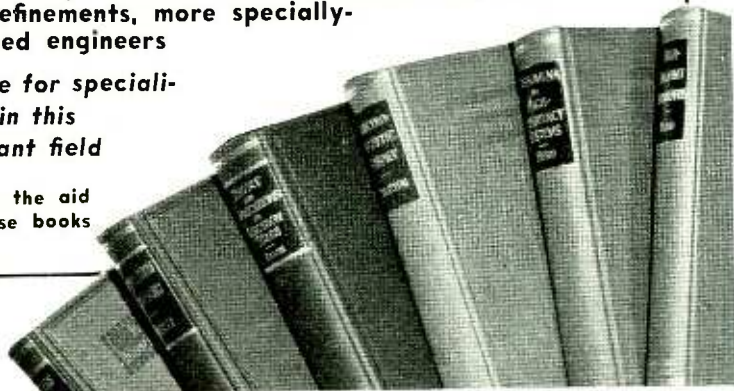

THIS LIBRARY was selected by radio engineering specialists of the McGraw-Hill publications to give a well-rounded view of communications engineering theory, applications, and special techniques. From important tube and radio fundamentals to special emphasis on high-frequency prob-

lems, the essentials of this field and its complete modern background are grouped here, for the aid of those who wish to prepare quickly for design and research work in the vitally important and expanding field of defense communications engineering.

The newly-assembled . . .

DEFENSE COMMUNICATIONS LIBRARY

6 volumes, 3662 pages, 6 x 9, 2111 illustrations, many tables and charts

These books give the basis for comprehensive practical working knowledge of ultra-high frequencies

1. Hund's PHENOMENA IN HIGH FREQUENCY SYSTEMS

A complete survey of theories, practices, and equipment the high frequency communications engineer requires in design and development of ultra-high frequency systems. Chapters on High Frequency Generators, Electromagnetic Theory, Theory of the Ionized Layer, Lines of Long and Short Electrical Length, and on Directive Systems have particular application in the present emergency.

2. Hund's HIGH-FREQUENCY MEASUREMENTS

An authoritative treatise on measurements of voltage, current, power frequency, L, C, R, tube constants and characteristics, radiation, and other high frequency electrical quantities. Of special timeliness is the material on measurements of frequency and phase modulation, the discussion of the use of cathode ray tubes in high-frequency measurements, and the determination of radiation, directivity and other transmission phenomena.

3. Stratton's ELECTROMAGNETIC THEORY

An advanced text on electromagnetic theory, treated mathematically through the extensive application of vector analysis. The first chapters deal with electrostatic and electromagnetic fields, which are followed by chapters on plane, cylindrical and spherical waves. Of particular interest to the engineer en-

gaged in ultra-high frequency phenomena, is the material on radiation from antennas of various types, effect of the earth on the propagation of radio waves, and the refraction and reflection of waves. A "must" for advanced workers engaged in wave propagation phenomena.

4. Reich's THEORY AND APPLICATION OF ELECTRON TUBES

A Standard and authoritative text on electron tubes, the heart of modern communication system, giving thorough, coordinated groundwork in tube and circuit theory, with emphasis on fundamental principles and their use in many applications in electronics, communications, power, and measurements.

5. Everitt's COMMUNICATION ENGINEERING

A standard and well-known text covering communication practice at all usual frequencies, emphasis is on theorems which apply fundamental similarities of simple networks to new complicated structures.

6. Glasgow's PRINCIPLES OF RADIO ENGINEERING

A well-known text, relating theory of the thermionic vacuum tube and its associated circuits to communications without slighting necessary mathematical explanations. Used in Government-sponsored defense communications courses.

10 DAYS' FREE EXAMINATION

Special low price Easy terms

Bought singly, these 6 books would cost you \$31.00. Under this offer you save \$2.50 and in addition have the privilege of paying in easy installments, beginning with \$3.50 ten days after receipt of the books, and continuing at \$5.00 monthly for 5 months.

No installment charge

These books assemble for your convenience facts, standards, practice, data, for the whole field of communications engineering, with emphasis on training in ultra-high frequencies. Add them to your library now, under this advantageous offer.

EXAMINATION COUPON

Send me Defense Communications Library for 10 days' examination on approval. In 10 days I will send you \$3.50, plus few cents postage, and \$5.00 monthly till \$28.50 is paid, or return books postpaid. (We pay postage if you send first installment with order.)

Name

Address

City and State

Position

Company L. 2-42
(Books sent on approval in U. S. and Canada only.)

Type 2511D5

DuMont

CATHODE-RAY tube; medium-persistence, green fluorescent screen; electrostatic focus and deflection; usual application—oscillographic, balanced deflection, and television; diameter 5 inches; 11-pin magal base.

$E_f = 6.3$ v
 $I_f = 0.8$ amp
 E (anode 1) = 600 v (max)
 E (anode 2) = 2000 v (max)
 E (intensifier) = 6000 v (max)
 E (grid) for cutoff = - 50 v
Deflection Factor
 $D_1 - D_2 = 28$ v (d.c.)/kilo-volt-inch
 $D_3 - D_4 = 25$ v (d.c.)/kilo-volt-inch

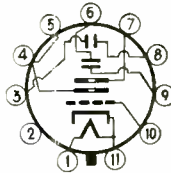

2511A5-B5-C5-D5

Type 2512A9

DuMont

CATHODE-RAY tube; medium-persistence, green fluorescent screen; electrostatic focus and deflection, usual application—oscillographic and high voltage; diameter, 9 inches; 5-pin base.

$E_f = 2.5$ v
 $I_f = 2.1$ amps
 E (anode 1) = 1000 v (max)
 E (anode 2) = 3000 v (max)
 E (grid) for cutoff = - 120 v
Deflection Factor
 $D_1 - D_2 = 28$ v (d.c.)/kilo-volt-inch
 $D_3 - D_4 = 28$ v (d.c.)/kilo-volt-inch

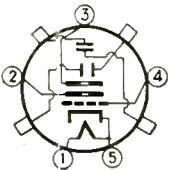

2512A9-B9-C9

Type 2512B9

DuMont

CATHODE-RAY tube; long-persistence, green fluorescent screen; electrostatic focus and deflection; usual application—oscillographic and high voltage; diameter, 9 inches; 5-pin base.

$E_f = 2.5$ v
 $I_f = 2.1$ amps
 E (anode 1) = 1000 v (max)
 E (anode 2) = 3000 v (max)
 E (grid) for cutoff = - 120 v
Deflection Factor
 $D_1 - D_2 = 28$ v (d.c.)/kilo-volt-inch
 $D_3 - D_4 = 28$ v (d.c.)/kilo-volt-inch

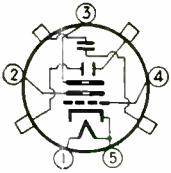

2512A9-B9-C9

Type 2512C9

DuMont

CATHODE-RAY tube; short-persistence, blue fluorescent screen; electrostatic focus and deflection; usual application—oscillographic and high voltage; diameter 9 inches; 5-pin base.

$E_f = 2.5$ v
 $I_f = 2.1$ amps
 E (anode 1) = 1000 v (max)
 E (anode 2) = 3000 v (max)
 E (grid) for cutoff = - 120 v
Deflection Factor
 $D_1 - D_2 = 28$ v (d.c.)/kilo-volt-inch
 $D_3 - D_4 = 28$ v (d.c.)/kilo-volt-inch

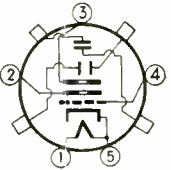

2512A9-B9-C9

Tracking Solution

(Continued from page 30)

$$C = \frac{L_1 + L_S + L_H}{4\pi^2 f_1^2 L_H (L_1 + L_S)} \quad (18)$$

The constants for Eqs. (16), (17) and (18) are determined in the same manner as the constants for Fig. 1, given in Eqs. (9), (11) and (12). Thus L_1 , represents a differential change in the value of L , which in turn corresponds to the oscillator frequency f_1 . The similarity between Eqs. (9) and (16), (11) and (17), (12) and (18) should be noted.

Equations for Alternative Permeability-tuned Circuit

This circuit, shown in Fig. 4, is similar in form to that of Fig. 2. The design equations are derived in a manner similar to that in the previous cases. The equations are,

$$L_H = \frac{L_2 \left[\frac{L_3 - L_1}{L_2 - L_1} \right] \left[\frac{1 - f_1^2/f_2^2}{1 - f_1^2/f_3^2} \right] - L_3}{1 - \left[\frac{L_3 - L_1}{L_2 - L_1} \right] \left[\frac{1 - f_1^2/f_2^2}{1 - f_1^2/f_3^2} \right]} \quad (19)$$

for the shunting inductance,

$$L_S = \frac{\left[\frac{L_H L_1}{L_H + L_1} \right] \frac{f_1^2}{f_2^2} - \left[\frac{L_H L_2}{L_H + L_2} \right]}{\left[1 - \frac{f_1^2}{f_2^2} \right]} \quad (20)$$

for the series inductance, and

$$C = \frac{1}{4\pi^2 f_1^2 \left[L_S + \frac{L_H L_1}{L_H + L_1} \right]} \quad (21)$$

for the capacity.

The same precaution regarding the assignment of absolute values

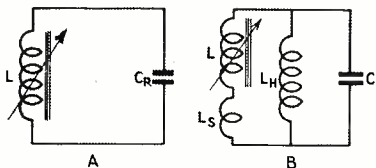

Fig. 3. Permeability tuned circuit; trimmer in series with the inductance

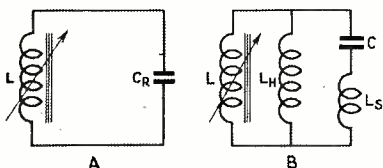

Fig. 4. Permeability tuned circuit; trimmer in series with the capacitance

WHEN THE NATION CALLS

DURING an emergency—building morale—providing entertainment for our effectives—instruction on local defense problems—selling defense bonds—dissemination of news—

YOUR STATION WANTS MAXIMUM COVERAGE IN YOUR DEFINED AREAS

BLAW-KNOX VERTICAL RADIATORS mean greater coverage—more listeners. They are backed by experience covering the entire history of radio.

BLAW-KNOX VERTICAL RADIATORS
FM AND TELEVISION TOWERS

BLAW-KNOX DIVISION
of Blaw-Knox Company
Farmers Bank Building, Pittsburgh, Pa.

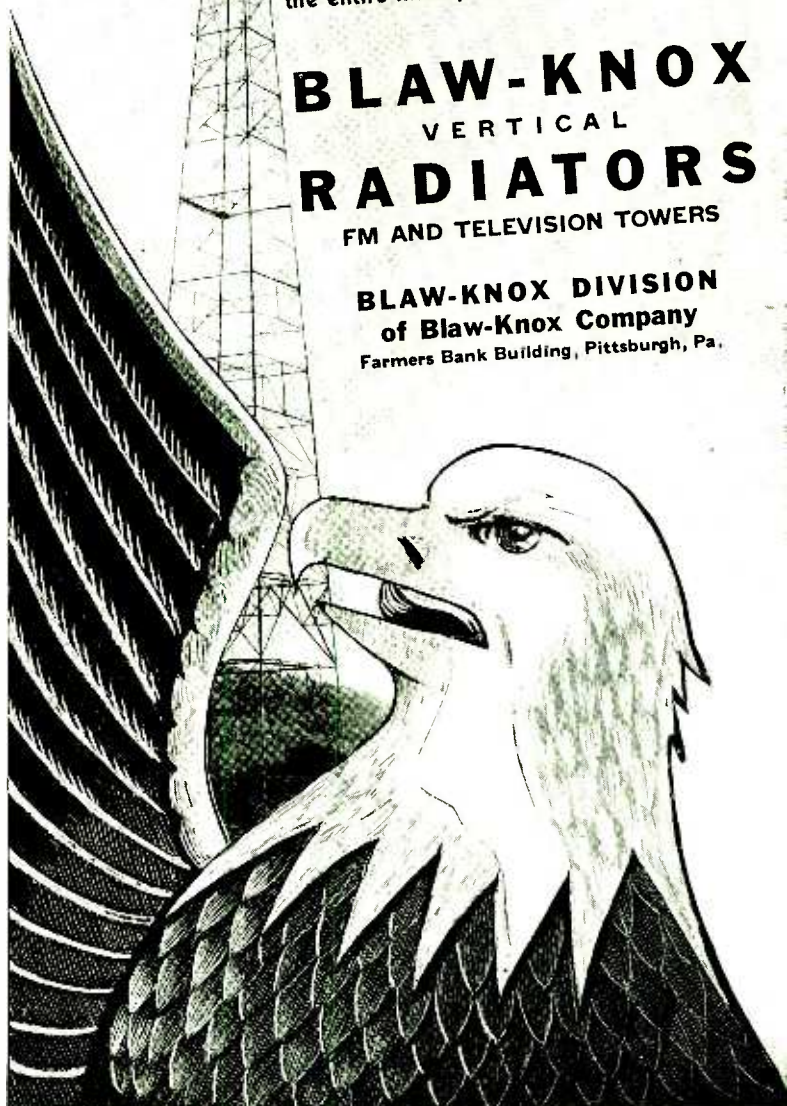



The Mark of Excellence

No greater tribute than *the best* can be paid to those whose very existence depends upon unfailing communication.

We are proud to be a part in the lives of our armed forces and fully realize the great responsibility that is ours.

With all sincerity *they* may rest assured that no compromise with quality will ever be made—that the combination of the finest in material and skilled craftsmanship will always justify . . . this *mark of excellence*.

KENYON TRANSFORMER CO., INC.

840 BARRY STREET

NEW YORK, N. Y.



BLILEY CRYSTAL UNITS

PRECISION-BUILT . . . For Reliable Frequency Control

OUR NO. 1 JOB NATIONAL DEFENSE

Day and night, with ever increasing rate, Bliley Crystal Units are being produced for National Defense in all its phases. Essential needs must come first—immediate attention can be given only when the preference rating is A-10 or better. To avoid delays, secure your highest applicable ratings in advance.

THE present-day emergency demands longer operating hours—an unusual strain on equipment and personnel. More than ever before, breakdowns and subsequent interruptions of service must be avoided. Now is the time that Bliley built-in dependability and precision really pays dividends.

Bliley Crystal Units for all applications and for all frequencies from .20kc. to 30mc. are described in Catalog G-12. Consult your Bliley Distributor or write for your copy.

BLILEY ELECTRIC CO., ERIE, PA.

and not differential values for values of L in Fig. 4 should be kept in mind as in the previous equivalent case of Fig. 2, where absolute values of C are assigned. Here again the similarity between Eqs. (13) and (19), (14) and (20), (15) and (21) should be noted.

The above equations are not restricted to identical-section gang condensers, nor to identical-section permeability tuning units. Thus, in the case of cut-plate condensers designed to track in the broadcast band, it is sometimes required that this same gang be used also to cover some higher frequency band. With a knowledge of the "capacity vs. rotation" for both sections of this gang it is possible to obtain values of required series and shunt capacitance to procure three point tracking. These same considerations apply to permeability-tuned systems.

• • •

LOCATING TRAPPED PERSONS



A special device for locating persons trapped in the ruins of bombed houses is shown in the photograph above. It is the invention of Mr. Moore of Brighton and was recently inspected by Mr. Herbert Morrison, Home Secretary. The unit is a combination of a loudspeaker and microphone, built to remove all external noises and designed to pick up the slightest sound under the ruins of a house. In a demonstration, shown above, Mr. Morrison clearly conversed with a man located underground to simulate actual bombing conditions.

Powdered Iron Cores

(Continued from page 37)

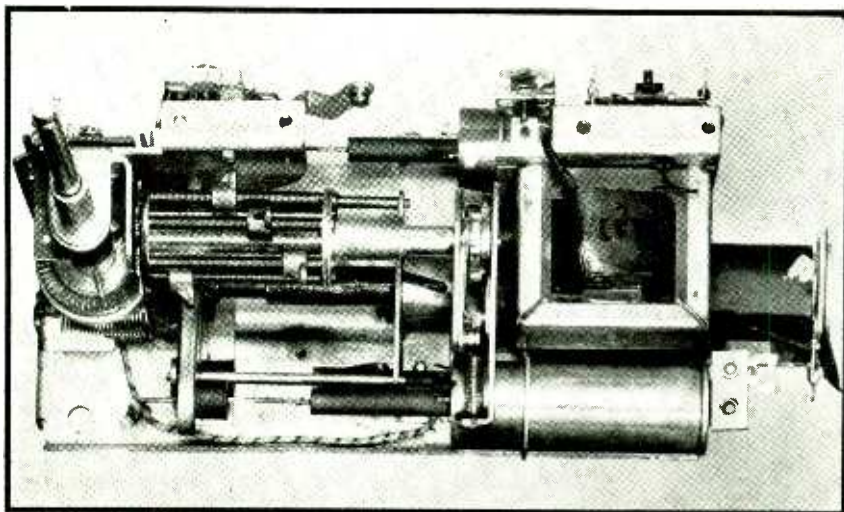

Typical tuning unit for automobile receivers using permeability tuning system

shall see some very startling developments in the powder metallurgical field.

One firm believes that the most important recent development in iron cores is the widespread practical application of permeability tuning, not only to broadcast band frequencies but also to higher frequencies. Other very important developments in the iron core industry have been the development of sources of supply for iron powders, particularly high grade powders in the United States, whereas in the past it was necessary to depend on foreign sources of supply. Naturally, many improvements have been made in both mechanical and electrical characteristics of iron cores in recent years.

From the viewpoint of a large manufacturer, one of the most important developments of the past several years has been the introduction of improved core molding technique which made possible the production of large quantities of uniform long tuning cores (1½ inches by ¼ inch and other related sizes).

Adjustable cores for automatic tuning circuits have made possible the commercial production of stable push button receivers in both the automotive and household fields.

Midget pot cores for intermediate-

frequency transformers have contributed to compact receiver design.

Another manufacturer considers as important contributions in the past the development of increased permeability in small cores for wide range tuning, and the development of low loss materials for high frequency work. Likewise important are the improvements in *Q* and the permeability of cores and improved mechanical strength. Improved processes resulting in greater uniformity of finished cores is also an important contribution of recent years.

In general, experience has indicated that there has been a widespread increase in the commercial

application of available materials with steady progressive improvements rather than any startling and sudden development.

Future Outlook

One manufacturer believes that the most important development of iron cores in the next year or so, will be in the direction of extending the use of iron coils into higher and higher frequencies, and a considerable amount of work is being done on this problem at the present time.

Another manufacturer feels that iron core applications will be extended further into the high-frequency bands and will contribute to the design improvements along the line of: (1) compactness, (2) simplicity of mechanical structure, (3) ease of band spread and tuning control, and (4) stability of electrical circuits.

There has been a strong tendency on the part of designers to use the adjustable iron core as a substitute for the familiar variable condenser. The future will find the iron tuning core in applications where it will do a better job than the previously used adjustable tuning elements. There has already been some progress along this line. The first mechanical automatic tuner used with permeability tuning systems were make-shift modifications of designs originally developed for use with variable condensers. A relatively small mass of the moving core assembly in a permeability tuning system has made possible great improvements. A recent design used in automobile receivers is power-

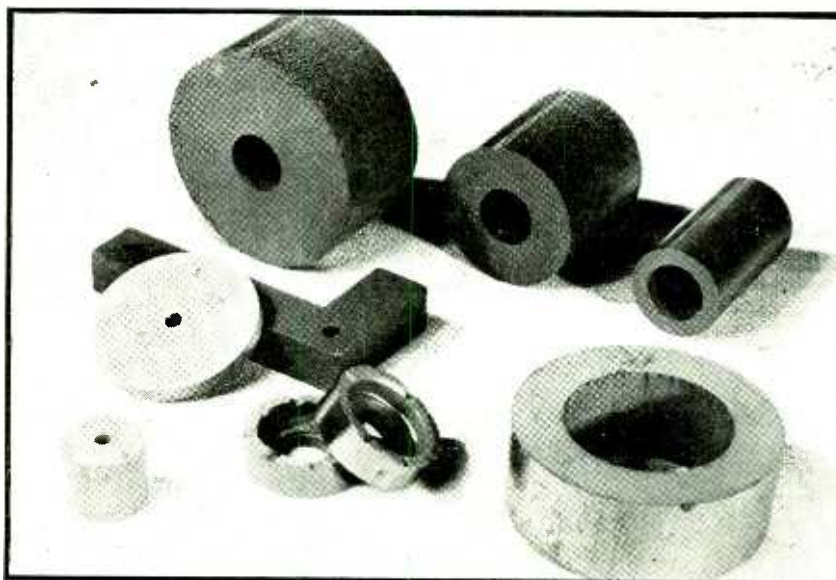

Typical iron cores which can be processed for communication or industrial applications where ferromagnetic cores are required

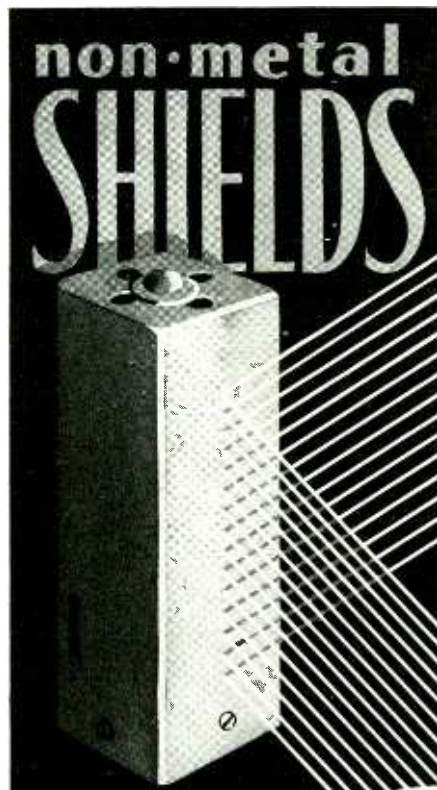

non-metal SHIELDS

for ELECTRONIC DEVICES

Electrostatic shields can be formed conveniently on non-conductors by means of "dag" colloidal graphite dispersions . . . Graphite films so produced are tenacious and homogeneous and possess conductivity. . . . Write for bulletin No. 31 for complete details.

"dag" is a registered trade-mark of Acheson Colloids Corporation.

ACHESON COLLOIDS CORPORATION
PORT HURON, MICH.



operated by means of a compact solenoid. A rotating turret carrying mechanical positioning stops makes possible the selection in sequence of five pre-selected stations in a normal tuning position. Station set-up is accomplished by pulling out the tuning knob slightly and tuning the station in the usual manner. Pre-set stations are selected by actuation of a switch mounted in the receiver, or by actuation of a switch included in the safety foot control which is mounted on the car floor board.

The important point is that the "ideal" performance specifications for an automobile receiver tuner, which includes safe and foolproof automatic operation under high speed driving conditions, the quick station set-up without tools and a high standard of "station repeat" accuracy, have been met in a low cost, compact and commercially practical design. This has been accomplished by taking full advantage of the simple basic mechanical action of a permeability tuner.

A wider application of permeability tuning will undoubtedly result in certain improvements. A three-gang variable condenser has generally been accepted as the commercial limit. It certainly is practical and may prove to be desirable and economically sound, to gang six or even more iron tuning cores in a common moving assembly. True band tuning circuits are the commercial possibilities.

Unfortunately it is not very convenient to specify the characteristics of iron core materials, since no standard method of measurement appears to have been established. Nevertheless, work is being undertaken to standardize the measuring techniques and methods.

Characteristics of Iron Cores

The characteristics of an iron core are tied in so definitely with the coil in which it is used, that it is almost impossible to set down on paper any characteristics which are very significant or universally accepted for iron cores. The particular type of iron which might be used in any application is influenced by three sets of factors, (1) frequently at which the coil is to operate, (2) the type of winding which is to be used and the spacing between winding



FOR EVERYTHING
IN ELECTRONIC
AND RADIO
EQUIPMENT

You Can Depend on ALLIED

- FOR:
- Electronic Tubes
 - Test Equipment
 - Public Address
 - Xmitting Gear
 - Photo Cells
 - Receivers
 - 15,000 Parts, etc.

VAST COMPLETE STOCKS

IMMEDIATE DELIVERY

ONE DEPENDABLE SOURCE

GET YOUR 208 PAGE BOOK

All the leading lines:
RCA, National, Hammarlund, Mallory, Raytheon, Hallicrafters, Triplett, Thordarson, Bliley, etc.

Here's everything in Radio and Electronic equipment for engineering communications, laboratory and industrial application. You'll want the 208 Page ALLIED Buying Guide handy. For your FREE copy, write Dept. 24-B-2.



ALLIED RADIO
833 W. JACKSON • CHICAGO

New Carter AIRCRAFT TYPE GENEMOTORS

● SENSATIONAL!! That's the word for the new Carter Multi-Output Dynamotor. Since its introduction a year ago, Police Departments, Government Agencies, and manufacturers of Tank Radio Equipment have found it has no equal for small size, high efficiency, and extra light weight. It's the coming thing for all Transmitter and Receiver installations



● Write today for descriptive literature on Carter Dynamotors—D.C. to A.C. Converters—Magmotors—Heavy Duty Permanent Magnet Hand Generators—Special Motors—High Frequency Converters—Extra Small A.C. Generators—Permanent Magnet Dynamotors and Generators.

Carter Motor Co.
CHICAGO ILLINOIS

1606 Milwaukee Ave. Cable: Genemotor
Carter, a well known name in radio since 1922

and core, and (3) the results desired, which may be (a) better performance, (b) cheaper construction, or (c) reduction of size. Since the selection of material is tied in so definitely with the results desired, the difficulty of establishing any definite figures on core characteristics may be well appreciated. A much needed program of standardization is required before the effectiveness of iron core inductances can be specified in a satisfactory and generally accepted manner, but efforts along this line are being made.

Firms and individuals who have cooperated in providing information from which this article was prepared include:

Advance Solvents & Chemical Corp., Aladdin Radio Industries, Inc., Bendix Radio, Division of Bendix Aviation Corp., Colonial Radio Corp., Henry L. Crowley & Company, Inc., Ferrocarr Corporation of America, Austin C. Lescarbourea, Magnetic Windings Co., George S. Mepharm Corp., James E. Millen Mfg. Co., The Muter Company, Plastics Metals Inc., W. J. Polydoroff, RCA Manufacturing Co., Stackpole Carbon Co., Western Union Telegraph Co., Zenith Radio Corp.—B.D.

Bibliography on Iron Cores

- Magnetic Properties of Compressed Powdered Iron (Electrolytic Iron) B. Speed & G. W. Elmen. *Trans AIEE*, Vol. 40, 1921, p. 596.
- Compressed Powdered Permalloy Manufacturers and Magnetic Properties, W. J. Shackleton & J. G. Barber. *Trans AIEE*, Vol. 47, 1928, p. 429.
- Tuning by Permeability Variation, R. H. Langley. *ELECTRONICS*, July, 1931.
- Manufacture and Use of Powdered Metals, Charles Hardy. *Metal Progress*, Vol. 22, No. 1, p. 32-37 & 80, 1932.
- Powder Metallurgy, Charles Hardy. *Met. Ind. (N. Y.)*, Vol. 30, p. 179-180, 1932.
- Iron Powder Compound Cores for Coils, G. W. O. Howe. *Wireless Engr.*, Vol. 10, p. 1, 1933.
- Iron Core Intermediate Frequency Transformer, A. Crossley. *ELECTRONICS*, Nov. 1933.
- Ferro-inductors and Permeability Tuning. *Proc. IRE*, May 1933.
- Further Notes on Iron-core Coils, W. J. Polydoroff. *ELECTRONICS*, Jan. 1934.
- Ferrocarr and Its Applications, J. V. Fill. *ELECTRONICS*, Nov. 1934.
- Powder Metallurgy as Illustrated by Tungsten, W. P. Sykes. *Metal Progress*, Vol. 25, p. 24-29, 1934.
- Iron Carbonyls: Their Physical & Chemical Properties, A. C. Fieldner & G. W. Jones. *American Gas Assoc. Monthly*, Vol. 6, p. 439, 1934.
- Survey of Magnetic Materials in Relation to Structure, W. C. Ellis & E. E. Schumacher. *B.S.T.J.*, Vol. 14, 1935, p. 8.
- Manufacture and Uses of Metal Powders, J. C. Chaston. *Elect. Communication*, Vol. 14, p. 133, Oct. 1935.
- 1937 Radio Receivers. *ELECTRONICS*, July 1936.
- Magnetic Brain Receiver, K. A. Chittick. *Radio Engr.*, Nov. 1936.
- Radio Progress During 1936. *IRE*, Vol. 25, No. 2, p. 135, Feb. 1937.
- Iron in H.F. Circuits, J. N. Britton. *Pro. IRE Australia*, Sept. 1937, Vol. 1, No. 2.
- Compressed Powdered Molybdenum Permalloy for High Quality Inductance, V. E. Legg & F. J. Given. *B.S.T.J.*, July 1940, Vol. 19, No. 3, p. 385-406.

For Extra Quality in De Luxe Plugs

BRYANT ELECTRIC USES WILCO SILVER FACED CONTACT FINGERS



As a substitute for copper in certain industrial applications, investigate Wilco Silver Clad Steel.

A permanent bond of fine silver and steel, this material has an electrical conductivity approximately equal to 70-30 bronze . . . combines the corrosion resistance of pure silver with the stiffness of steel. Write for new descriptive folder.



The H. A. WILSON CO.

105 CHESTNUT ST., NEWARK, N. J.
Branches: Chicago and Detroit

MOLDED S. S. White RESISTORS *The All-Weather Resistor*



TYPE 65X

Actual Size

Other types available in the lower values

RESISTOR BULLETIN 37
GIVES FULL DETAILS . . .

It shows illustrations of the different types of S. S. White Molded Resistors and gives details about construction, dimensions, etc. A copy, with Price List, will be mailed on request. Write for it—today.

THESE widely used Resistors are favored because of their noiseless operation and durability and because they retain their values and characteristics under extremes of temperature, humidity and climatic changes.

STANDARD RANGE

1000 ohms to 10 megohms.

NOISE TESTED

At slight additional cost, resistors in the Standard Range are supplied with each resistor noise tested to the following standard: "For the complete audio frequency range, resistors shall have less noise than corresponds to a change of resistance of 1 part in 1,000,000."

HIGH VALUES

15 to 1,000,000 megohms.

S. S. WHITE

The S. S. White Dental Mfg. Co.

INDUSTRIAL DIVISION

Department R, 10 East 48th St., New York, N. Y.

NEWS OF THE INDUSTRY

General Electric establishes new electronics laboratory. FM forges ahead. Television used to train fire wardens

Personnel News

A NEW ELECTRONICS LABORATORY established at the General Electric Company, Schenectady, has been placed under the direction of William C. White, for a number of years in charge of the vacuum tube division of the radio and television department of the company. Mr. White is succeeded in his former post by O. W. Pike, with R. W. Larson as assistant. Messrs. White and Pike are both well known to readers of *ELECTRONICS* and both have made numerous contributions to the editorial pages of this magazine in past years.

Dr. Charles B. Jolliffe has been appointed assistant to the president of the Radio Corporation of America. In making the announcement, Mr. Sarnoff stated that Dr. Jolliffe would continue to act as chief engineer of the RCA Laboratories and that his work with the NDRC would continue.

Lieutenant William C. Eddy, USN, Retired, has been placed in charge of the high frequency classes at a new Naval primary school for training men in h-f technique. The school is located in Chicago in space donated for the purpose by Balaban and Katz, owner of television station W9XBK, of which Lieut. Eddy is director. Students at this conditioning school must

be high school graduates and amateur operators or possess equivalent qualifications.

Edward F. McGrady, RCA vice-president in charge of labor relations, has been appointed one of a five-man commission to survey present patents and new inventions for the post-war period. This commission, known as the Patent Planning Commission, was appointed by the President to assist in preparing for the adjustment period following hostilities. The other members are C. F. Kettering, Owen D. Young, Chester C. Davis, of the Federal Reserve Board and Francis P. Gaines of Washington & Lee University.

Radio Manufacturers Soon to Hear from OPM

ALTHOUGH NO WHOLESALE curtailment of radio set production was anticipated in orders from OPM, some compulsory decrease in manufacture of civilian radios was certain at the time this was written. According to Bond Geddes of RMA, the curtailment for the first three months of this year was expected to be about 30 percent. The industry has been striving for a decision to limit production not by units but by quan-

ties of raw materials to be allocated for civilian equipment. Under such system the ingenuity of the engineering staffs of the individual companies would be brought into play, enabling some to get more units out of a given amount of material than others.

During the month of September, the latest month for which production figures were available from the RCA group of licensees, 1,462,541 units were produced. These are broken down as follows:

Table sets	637,347
Console sets	81,567
Portable sets	165,164
Auto sets	254,781
Farm battery sets	71,524
F-M adapters	1,887
Electric phonographs	26,273
Table combination sets	93,666
Console combinations	85,399
Radio, recorder and phonograph	6,569
Television sets	28
Apparatus without cabinets	37,327
Separate control devices	1,009

Total units

1,462,541

This total figure compares with 1,149,897 of 1940; the dollar sales value of these sets amounted to slightly over 27 million dollars. The nine-month total amounted to 10,049,962 units or a dollar volume of \$152,598,200.

P. S. On January 24, War Production Board ordered curtailment in output of radios and phonographs to the extent of 45 percent for manufacturers who sold more than a million dollars worth of radios during the first 9 months of 1941, and 35 percent for manufacturers who sold less than this amount. This is to hold for a 90-day period from time of issuance of the order.

FM Moves Ahead

ACCORDING TO FM Broadcasters, January 1 saw approximately 50,000 sets equipped for f-m in operation in or near New York City. The f-m population of other cities as of that date was as follows: New England states, 22,000, Chicago, 25,000, Philadelphia, 12,000, Los Angeles, 15,000, Milwaukee, 6,500, Detroit, 12,000, Pittsburgh, 8,000. There are now 63 authorizations for f-m transmitting stations; of whom 6 are regularly on the air in New York City with 4 more building; and soon there will be six transmitters in Philadelphia.

In the New England territory, stations W43B and W39B, Yankee Network, are now operating 20 hours per day, except on Sunday when the period is two hours shorter.

In a Chicago hospital a mother gave birth to a five-pound boy while listening to Tchaikowsky's Concerto in B Flat Minor, transmitted from W51C, Zenith's f-m transmitter. The experiment was performed to determine the relaxing quality of music.

Cover of this month's *Electronics* shows f-m network at opening of W71NY.

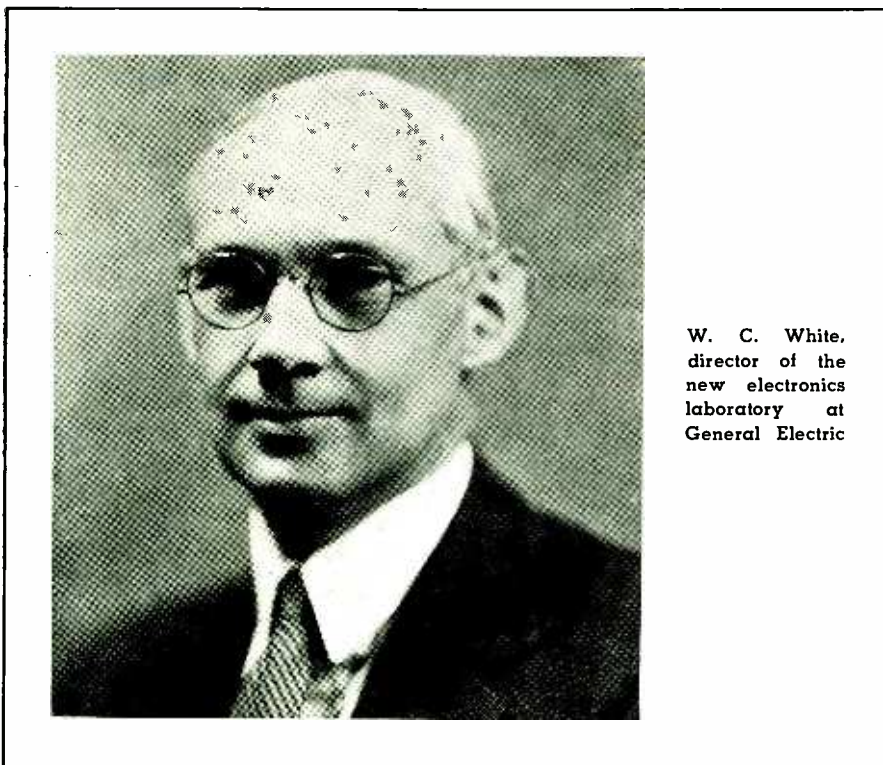

W. C. White, director of the new electronics laboratory at General Electric



• This already popular type electrolytic is made still more popular because of certain Aerovox refinements. It will pay you to check these refinements for yourself, when considering prong-base electrolytics.

featuring . . .

- Square cap shoulder instead of sloped. Cap or plug rests solidly in place. No sharp edges. No danger of shearing cathode tabs.
- Lugs rigidly riveted to bakelite disc which fits in cup-shaped soft-rubber plug.
- Slotted protrusions or sleeves in rubber plug, surround and seal-in the tabs and lugs. No electrolyte leakage. No terminal corrosion.
- No danger of bakelite corrosive effects since rubber sleeves protect raw bakelite slots.
- Positive pin-hole vent instantly responds to excess gas pressure, yet normally self-closing.

• Check these features for yourself. Sample cheerfully submitted. Let us quote on your requirements. Literature on request.



Patent Deal

CONSUMMATION OF A TELEVISION patent interchange agreement between the Don Lee Broadcasting System and RCA has been announced. Under this agreement, Don Lee gets a non-exclusive, non-transferable license from RCA in return for a similar license for certain Don Lee equipment and a monetary consideration. The Don Lee inventions are concerned with synchronization, scanning, and other aspects of both transmission and reception by television.

On Electronic Control

SPEAKING BEFORE THE Philadelphia District Section of the Association of Iron and Steel Engineers, Philadelphia, January 3, E. H. Alexander, engineer, control division General Electronic had this to say about the future of electronic control "No longer are we able to be 'isolationists' and set apart the electron tube from its justly deserved place in industrial control problems. In fact, in many modern equipments it is now the only 'line of communication' between those tiny amounts of energy which tell of certain conditions existing in some process requiring control, and the brute-force conventional magnetic control.

"Electronic control greatly simplifies the measurement and control of heat energy, of speed as a function of tension, of speed as a function of some other means, and of positioning. In other words, by amplifying signals to usable levels where conventional control can take over, the electron tube lends a helping hand in a noiseless, high-speed, inertia-less manner to those signals so weak as to be incapable of use by conventional control.

"Obviously, there are many other important developments in this field for our war program about which nothing can be said. However, it is hoped that experience with new designs rapidly brought into production for war use will provide a wealth of experience and new thinking for better industrial control when the war is over."

Training by Television

A MOST INTERESTING experiment in education by television was conducted in December by RCA-NBC when air wardens at 123 viewing posts from 50 precincts in New York City, as well as in Schenectady, Philadelphia, Bridgeport and other cities saw demonstrations of methods and equipment for fighting incendiary bombs. The desirability of equipping all precinct houses in the city with television receivers was evident as a result of this experiment which enabled lookers-in to get instruction on their home grounds. Police department officials were enthusiastic about the possibilities after this single demonstration.



FOR TRIPLETT CUSTOMERS ONLY

Long before the state of emergency was proclaimed, the Triplet Company was getting ready to do its part in building our national security. We knew that we must meet important new responsibilities. At the same time, we felt keenly our continuing obligations to our customers—old friends with whom we have had happy business relations through many years.

We doubled—then tripled—our output to fill the needs of our old accounts. We added to our production facilities . . . hired many more men . . . are working extra shifts at time-and-a-half.

All this has not been enough. We have been called on to produce more and more for national defense. We are proud of the job we are doing to help meet the emergency, but it is difficult not to be able to serve our old friends equally as well. In the face of these conditions, the Triplet Company has adopted these policies "for the duration."

First: We will continue to serve you by our service to our mutual responsibility — the national emergency.

Second: We will continue to do everything we can to fill orders from our regular customers, even though some deliveries may be temporarily delayed. No business from new accounts has been nor will be accepted until after our old friends have been served, except where priorities make it impossible to do so.

Third: Our engineering and research departments will continue to work on the development of superior equipment and improved methods to serve you still better when we can resume normal operations.

The present emergency is incidental and as we work towards the future, we will do our best to continue to merit your confidence and loyalty.

C. H. Triplett
President

The Triplet Electrical Instrument Company
Manufacturers of
Precision Electrical Instruments

NEW PRODUCTS

Month after month, manufacturers develop new materials, new components, new measuring equipment; issue new technical bulletins, new catalogs. Each month descriptions of these new items will be found here

New Relays

SERIES 165 24-volt d-c vibration resistant relay (also available for alternating current as Series 160) is a compactly constructed unit which is specifically designed for applications having a serious vibration problem such as aircraft, generator mountings, etc. Resistance to vibration is achieved largely by careful counterbalancing of the armature assembly and the compact design of contact assemblies.

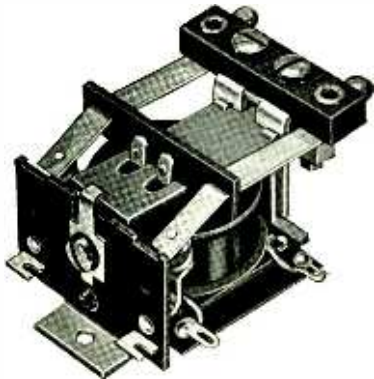

Series 165 standard type relay

Contact combinations up to double pole, double throw are available, with contact capacity up to 12.5 amps per pole, measured at 110 volts, 60 cps, non-inductive alternating current. Contact rating for aircraft use is 8 amps at 24 volts direct current. Other voltages and contact combinations are also available. On inductive loads, condensers are sometimes recommended to suppress arcing, their value being determined by test. Overall dimensions are $2\frac{1}{2} \times 1\frac{1}{2} \times 1\frac{1}{2}$ inches. It weighs 5 ounces.

Another type relay is the Series 195 d-c midget relay. Maximum contact ca-

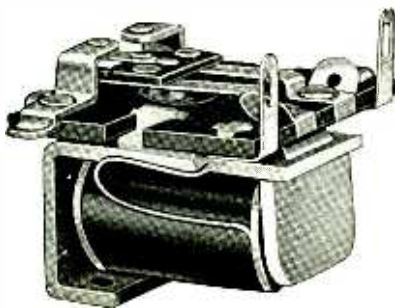

Series 195 midget relay

capacity of Series 195 relays is approximately 150 watts, measured at 110 volts, 60 cps, non-inductive alternating current. The maximum contact combination available is double pole, double throw. A relay coil is available for any voltage up to 75 volts direct current with a maximum resistance of 3000 ohms. The average power requirements of the coil is 2.5 watts. A light armature operates the contacts which are mounted on and insulated from the field piece through a direct lever action. Contact blades are tinned phosphor bronze with contact points of fine silver. Field piece and armature are annealed magnetic iron.

Both of these relays are available from the manufacturer, Guardian Electric Company, 162 West Walnut Street, Chicago.

New Tubes

FIVE NEW TYPES of tubes have been announced by General Electric Company, Schenectady, N. Y.

The first of these is a radio transmitting tube (available from the Radio and Television Department) which is especially suitable for operation as an u-h-f power amplifier. Designated as type GL 8010-R, this tube has a coated



Transmitting tube type GL-8010-R

cathode heated by electron bombardment from an auxiliary filament. Anode and cathode are fitted with coolers for forced-air cooling. The parallel plane electrodes are closely spaced to facilitate neutralization. Grid plate capacitance is $1.5 \mu\text{f}$, grid cathode capacitance

is $2.3 \mu\text{f}$ and plate cathode capacitance is $0.07 \mu\text{f}$. Low lead inductance is provided by the disk-type terminals. When used as a class C r-f amplifier, the tube has a maximum dc plate voltage of 1350. Maximum plate current is 150 ma; maximum plate input, 100 watts; and maximum plate dissipation, 50 watts. The tube has an amplification factor of 30.

Three new industrial tubes—a thyatron, a kenotron, and a phototube sensitive to blue—are available from the Vacuum Tube Department. The newly designed GL-414 thyatron is an all-metal, negative-grid tube for general purpose industrial applications. It has a shield grid, and is especially suitable for control circuits where the available grid power is very small, and where it is desirable to actuate the grid from a high-impedance source. Featuring mechanical strength, ease of installation, and the low voltage drop characteristic of mercury-vapor, the tube has an indirectly heated cathode

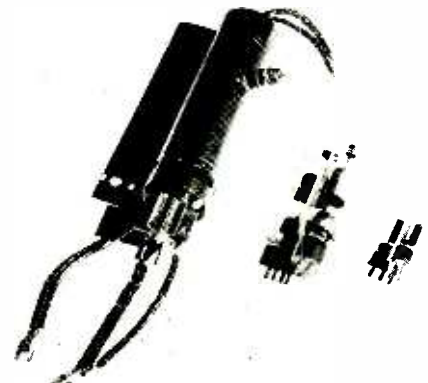

Industrial tubes from left to right, the GL-414 thyatron, GL-451 kenotron, and GL-441 phototube

rated at 5 volts, 20 amps. Maximum peak inverse anode voltage is 2000 volts, and average anode current is 12.5 amps.

The GL-451 kenotron is a half-wave rectifier, rated 30,000 volts peak inverse, 500 ma peak, 100 ma average. Its thoriated tungsten filament makes possible a higher rating for size than when a pure tungsten filament is used. Light weight and a tantalum anode permit construction unaffected by ordinary vibration. This tube is designed to meet high-voltage, low-current requirements. It is especially suitable



Ignitron tube type GL-427

for use with smoke-precipitation and air-cleaning devices.

The GL-441 phototube is especially designed for a high response in the blue region of the spectrum, and has thirty times the quantum efficiency of red-sensitive tubes. Sensitivity is 45 μ a per lumen at an anode voltage of 90.

A fifth type tube available from General Electric is a new glass ignitron tube designed for educational purposes. Designated as GL-427, this air-cooled, three-electrode tube embodies the instructive advantages of simple design and visibility of operation. Sturdy construction makes it particularly suitable for classroom demonstrations or laboratory experiments. The tube has a maximum inverse and forward anode voltage of 350, a maximum instantaneous positive ignitor potential voltage of 350, and a maximum instantaneous ignitor current of 100 amps. When used with an average anode current of 5 amps, free air cooling is sufficient. An ordinary desk fan will provide adequate cooling for most uses over this rating.

Broadcast Microphone

THREE MODELS OF A broadcast dynamic microphone known as "Super-Cardioid" (Series 556) are available. Model 556-A is for 35 to 50 ohm circuits. Model 556-B is for 200 to 250 ohm circuits. Model 556-C is a high impedance microphone. All of these list at \$75.00. These units utilize the patented



"Uniphase" single unit construction which was designed to eliminate the necessity of using two dissimilar microphone elements in one microphone for obtaining unidirectional operation. "Super Cardioid" designates a polar pattern more unidirectional than the Cardioid, from the standpoint of receiving front sounds and rejecting rear sounds. It has wide-angle front pick-up. The manufacturer states that it decreases pick-up of reverberation energy and random noise 73 percent. The axial polar pattern is symmetrical at all frequencies. These microphones have a frequency response from 40 to 10,000 cps. The microphones are easy to handle in a studio and can be used as removed.

These are available from Shure Brothers, 225 West Huron Street, Chicago.

NEW! Wide-range frequency standard!

Measure frequencies accurately—in less time. New Western Electric instrument weighing only 150 lbs.—measuring only 28" x 21" x 15"—has all the features of the old bulky types and more!



Compact assembly gives frequency accurate to one part per million

Read these features of the Western Electric Frequency Standard Assembly.

(1) Frequency Standard and Harmonic Generator (lower panel) gives stable signal—harmonically rich or sinusoidal. Fundamental output frequencies of 100, 50, 20 and 10 kc. Harmonic output to 1000th harmonic. Accurate to better than 1 part per million without temperature control.

(2) Reference Frequency and Heterodyne unit (center panel)—crystal controlled

oscillator circuit; modulator and amplifiers. 8 crystals give fundamental frequencies from 2 to 10 megacycles.

(3) Frequency Indicator Unit (upper panel) gives direct frequency reading of input signal from 0 to 100,000 c.p.s.

Send for details. Write to:

Electrical Research Products Division

of
Western Electric Company

76 VARICK STREET, NEW YORK, N. Y.

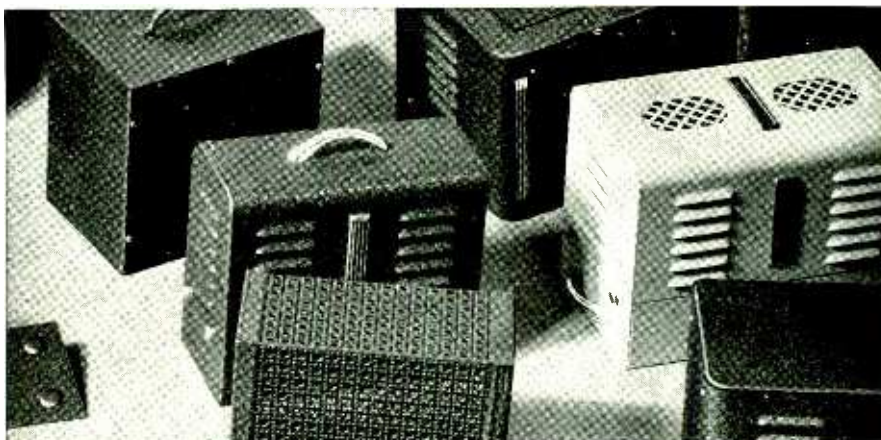

You Can Always Rely on BUD

... for your sheet metal requirements. We specialize in the manufacture of custom-built CABINETS, RACKS, PANELS and CHASSIS for radio, electronic and electrical equipment. For prompt quotations, send us a copy of your prints or specifications.



BUD RADIO, INC.

CLEVELAND, OHIO

**GET THE ECONOMY
THAT COMES
WITH QUALITY**

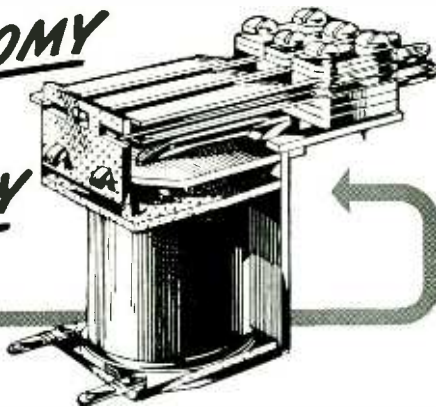

IN AUTOMATIC ELECTRIC RELAYS!

Automatic Electric relays are world-famous for quality. Tested by time through years of exacting use . . . constantly improved by endless laboratory tests . . . backed by the "know how" gained from 50 years of specialized manufacturing experience—these relays give you the superior performance and long life that mean genuine economy.

The complete Automatic Electric line includes relays, stepping switches, switching keys and many other electrical control products.

We invite inquiries for these devices, and in most cases are able to supply them for use in products important to the war effort. Our catalog bulges with information and engineering data you will want to have. Write for your copy.

AMERICAN AUTOMATIC ELECTRIC SALES COMPANY
1033 W. Van Buren Street, Chicago

AUTOMATIC ELECTRIC
RELAY MAKERS SINCE 1898

15-Watt Amplifier

A NEWLY DEVELOPED 15-watt amplifier which achieves an increase in operating efficiency when compared with an earlier model it replaces, has been announced by the Commercial Sound Division of the RCA Manufacturing Company, Camden, N. J. It is known as Model MI-12222.

Although rated at 15 watts, the new unit is capable of 21 watts of output as a maximum. At its rated output, distortion is less than 3½ percent. Provision is made for microphone and phonograph inputs, the former at 560,-



000 ohms, and latter at 500,000 ohms. A terminal board is provided for making output connections. Separate volume controls are supplied for the microphone and phonograph inputs. A continuously variable tone control and voice-music switch are also incorporated in this amplifier. Gain of 125 db is provided for the microphone input, 85 db for phonograph. Frequency response is from 30 to 10,000 cycles. Dual control intro-tube mixing is another feature of the new unit. The fuse is easily accessible. A microphone plug is furnished with the unit.

CONSTANT VOLTAGE
is the answer to the precision demands of
SCIENCE and INDUSTRY for DEFENSE

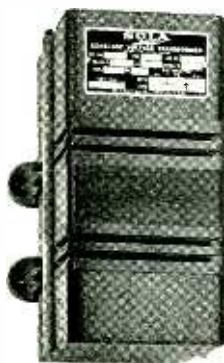

Every COMMUNICATIONS system—every electrical INSTRUMENT employed in the production of materials of war needs CONSTANT VOLTAGE protection against line surges and fluctuating voltage levels caused by overloaded power lines. Sola CONSTANT VOLTAGE TRANSFORMERS will deliver a perfectly stabilized output voltage, even though line voltages vary as much as 30%. No moving parts. Instantaneous in action. Self-protecting against overload or short circuit.

Ask for Bulletin DCV-74

SOLA ELECTRIC COMPANY



Constant Voltage

TRANSFORMERS

2525 CLYBOURN AVE., CHICAGO, ILL.

High Voltage Rectifiers

A NEW LINE OF HIGH voltage rectifiers has been developed to meet the requirements of both the production line and the laboratory. These rectifiers are available in 20, 50, 100 and 200 kv units with a current range from microamps to milliamps. On all standard models the polarity of the unit can be reversed in a short time. The units can be used without a warm-up period. They can be operated continuously on full load. The manufacturer can supply units which will provide substantially no ripple, or large amounts of ripple.

The rectifiers are housed in a grounded metal case, with all the necessary metering devices built in as an integral part of the case. These instruments are portable, and eliminate the need for a special chamber and permanent installation since, for example, the 100 kilovolt, 1000 watt unit, measures 3x3x6 ft and weighs 450 lbs with all its controls.

Slayter Electronic Corporation, Newark, Ohio, are the manufacturers of these rectifiers.

RCA
BEAT - FREQUENCY
AUDIO OSCILLATOR
 In Stock for
 Immediate Delivery



RCA No. 154 . . .

The RCA Beat-Frequency Audio Oscillator is a precise instrument for audio testing. Output frequency of from 30 to 15,000 cycles—more than the range of the finest radio receivers—makes the RCA Model 154 ideal for running fidelity curves on receivers, amplifiers and loudspeakers. Complete with 5 RCA tubes

\$57.50

No Priority Required

TERMINAL RADIO CORP.
 85 CORTLANDT ST., N. Y. C.
 Phone: WOrth 2-4416

Plastic Tubing

PLASTIC TUBING FOR electrical insulation has been announced. This new sleeve insulation has resistance to low temperature (30 to 40 degrees below zero) and possesses high dielectric strength of approximately 23,800 volts. The tensile strength is rated at 3,140 lbs. per sq inch. Moisture absorption factor is less than one-half of 1% in 24 hours of water immersion.

Other characteristics of this new product (known as "Turbo" extruded tubing) is its resiliency and its ability

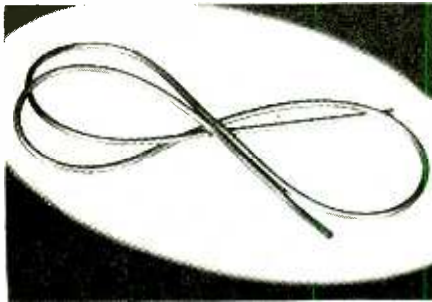

to retain its original shape and size regardless of reasonable subjection to hot and cold variations. The material is available in a variety of colors, in standard ASTM diameters of 36 inch lengths, or in coils of continuous length in minimum lengths of 25 feet.

The manufacturer is William Brand & Co., 276 Fourth Avenue, New York, N. Y.

U-H-F Transceptor

MODEL TR-4 TRANSCePTOR, designed for radiophone or i-c-w transmission and reception between 112 and 116 Mc, is portable and may be operated from auxiliary 300-volt, 100 ma vibrator or a-c powerpacks. Operation is thus permitted from storage batteries or alternating current lines. The transmitting oscillator is an HY75 triode capable of handling up to 20-watts input. The super-regenerative detector is an HY615 with 25-volts on its anode to minimize radiation. Separate tuning dials are provided for oscillator and detector circuits. A 7F7 and a 6L6 (or 6V6) comprises the audio amplifier feeding a built-in 5-inch pm speaker in the receive position, functions as speech stage for a single-button carbon microphone and modulator in the transmit position. Jacks are provided for measuring oscillator and modulator anode currents with external meters. Front-of-panel controls include send-receive switch, regeneration control, separate oscillator and detector coupling adjustments. One antenna serves for both transmitting and receiving. Abbot Instrument, Inc., 8 West 18th Street, New York, N. Y.



PINCOR
Products are
AT THE FRONT

Being "At The Front" has a different meaning in war than in peace. But to achieve both distinctions requires the "tops" in dependability, economy, and versatility. In the estimation of Military and Civilian experts, PINCOR Products have through the years, first in peace and now in war, proven that their just position is "At The Front"

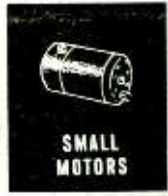

PIONEER GEN-E-MOTOR
 CHICAGO, ILLINOIS
 Export Address: 30 Warren Street, N. Y., N. Y.
 Cable: SIMONTRICE, New York

OK'd
 by
ENGINEERS

Wherever installed—Lingo Radiators have exceeded all efficiency expectations. No wonder alert engineers look to Lingo for top efficiency and managers are enthused by the increased sales made possible by increased signal strength and coverage.

Photo shows installation of the 150 ft. Lingo Tubular Steel Radiator at station WBOC, Salisbury, Md.

LINGO
VERTICAL
TUBULAR STEEL
RADIATORS
 JOHN E. LINGO & SON, INC., CAMDEN, N. J.

EXACTING TESTS!

**SX-28
MAKES
POSSIBLE**



Model SX-28,
fifteen tubes.
Six bands.
Covers from
550 kc. to 42
mc. \$179.50.

ONE of the uses of the Model SX-28 in defense industries is the checking of crystals for the British Air Ministry in the plant of Aircraft Accessories Corporation at Kansas City. Crystal checking is an exacting operation and we are justly proud that the Model SX-28 was selected to do this important job. It is a great tribute to the engineering skill which is incorporated in every Hallicrafters communications receiver.

the hallicrafters co.
CHICAGO, U. S. A.
Keep Communications Open

Relay

AS PART OF THE PROGRAM of new products for national defense, G-M Laboratories, Inc., Chicago, announces an addition to its line of quality relays. These are the Type J relays, whose main characteristics are small size, low weight, and exceptionally rugged construction. It is designed to withstand aircraft vibration from high acceleration and will operate satisfactorily under conditions of high humidity and

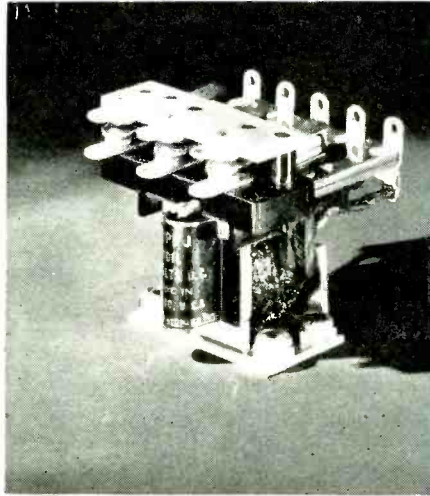

high altitude. The relay has two holes and self-cleaning contacts and is available in quantities. The overall dimensions of the Type J relay are $1\frac{1}{8}$ inches high, $1\frac{1}{8}$ inches long and $1\frac{1}{8}$ inches wide. Coils are designed for operation on direct current and are particularly suitable for excess voltages.

Thermoplastic Material

SHEETS OF THERMOPLASTIC material (such as cellulose acetate) may be molded into intricate shapes with a single operation and may be used in radio cabinets, or other articles having compound curves and angles. Incorporating a new mold construction combined with a pretreating process before molding the sheets provide low die cost and make production runs economical. This new material is available from Walco Plastics, 356 Glenwood Ave., East Orange, N. J.

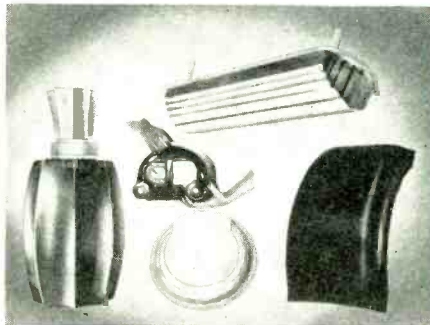

porating a new mold construction combined with a pretreating process before molding the sheets provide low die cost and make production runs economical. This new material is available from Walco Plastics, 356 Glenwood Ave., East Orange, N. J.

MEMO

Get in touch
with Meissner
for Coils!

Write for New 1942 Catalog.
Address Dep't. E.

Meissner
MT. CARMEL, ILLINOIS
"PRECISION-BUILT PRODUCTS"

JONES 500 SERIES PLUGS and SOCKETS

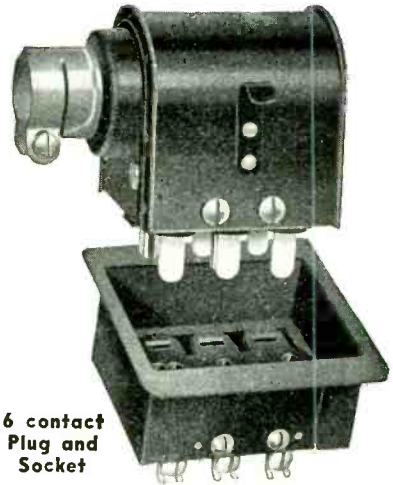

6 contact
Plug and
Socket

5000 volts and 25 amperes. Fulfills every electrical and mechanical requirement. Polarized to prevent incorrect connections. Easy to wire. Sizes: 2, 4, 5, 8, 10 and 12 contacts. Thousands of uses. Write for Bulletin 500 today.

HOWARD B. JONES
2300 WABANSIA AVENUE
CHICAGO ILLINOIS

Air Raid Siren

USING VACUUM TUBES instead of electric motors, an air raid siren composed of a microphone to pick up sound from a small mechanical or electric siren, a high-powered amplifier and loud speakers of considerable power handling ability has been tried out in Los Angeles with considerable success. The amplifier used in the experimental tryouts had an output of 100 watts and contained an automatic volume control system to maintain the output at a high volume level.

A portable 10-watt unit operating from 6-volt battery made by the same company is offered for fire and police emergency work, direction of soldiers in the field or for actors in motion picture productions, crowd control etc. Complete information about these systems can be obtained from Newcomb Products Company, Los Angeles, California.

Vibration Machine

THIS INSTRUMENT WAS designed for use in aircraft and industrial plants where there exists a need for a machine capable of producing vibrations of assorted accelerations and velocities to test products for defects in castings, assemblies, and operation under actual dynamic conditions. It is a vibration producing machine for fatigue testing. It produces vibrations from 0 to 26 times gravity, frequency variations from 600 to 3000 cpm, while the machine is in operation. A calibrated speedometer gives 2 percent accuracy. The amplitude is variable from 0 to 0.250 inches total peak to trough, continuously variable with a precision engraved machine dial, resettable to an accuracy of 1 percent.

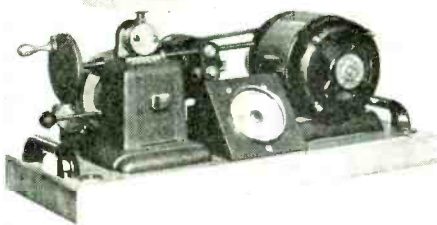

The vibrating test table is cast aluminum with a multitude of holes to facilitate quick change of products under test. A 6-inch square table carries up to 10 lbs at maximum vibration. The machine is approximately 3 ft long and weighs 65 lbs with a 2 inch hardwood base equipped with handles and sunken steel mounting inserts in its four corners for anchoring when necessary. The unit is finished in black wrinkle baked enamel and all machine parts are cyanide treated. Operation is from 105/120 volts, 60 cps on standard models.

The vibrator is available from Televiso Products, Inc., 2400 North Sheffield Boulevard, Chicago. It is described in Bulletin No. 83.

GM RELAYS

Gaining Greater PREFERENCE on Important Jobs

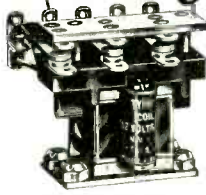

TYPE "J" RELAY
Small, compact, with extra power for small size. 2 or 3 pole. Contacts have self-cleaning "wiping" action. Designed to meet the rigid temperature, humidity and vibration specifications established for military and naval aircraft.

Now that production schedules are tense . . . and dependability means more than even before, the quality of G-M Relays becomes more apparent to the critical buyer. No matter how rigid your relay specifications, you'll find that a G-M meets them with a plus factor, which is your assurance of satisfaction.

Write for Descriptive Bulletins

TYPE "F" RELAY
Small, compact Relay for 1, 2, 3 or 4 Poles: Single Throw or Double Throw. Dimensions: 2 1/2" High, 2 1/2" Long, 1 1/2" Wide.

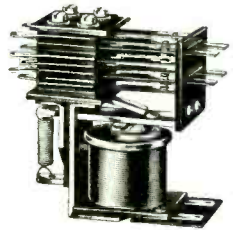

G-M LABORATORIES INC.
4313 NORTH KNOX AVE. CHICAGO, U. S. A.

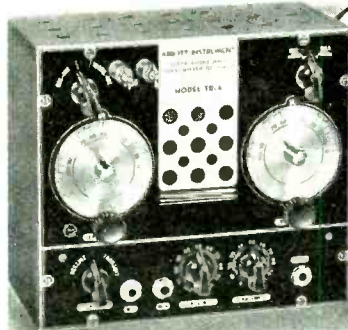

**SOLUTION to the
U. H. F. LOCAL
COMMUNICATIONS
DEFENSE PROBLEM**

ABBOTT TR-4, 2 1/2 METER TRANSMITTER-RECEIVER

A compact, efficient unit, designed for either fixed station or mobile operation. Transmitter and receiver sections are completely separated. The 5 inch PM speaker is self-contained. Single interconnected switch permits use of a common antenna for both transmitter and receiver. The TR-4 requires a 6 volt battery or 110 volt, 60 cycle AC power supply. Receiver radiation is necessarily reduced to a minimum.

● **FREQUENCY:** 112 to 116 MC. ● **RANGE:** Varying from 5 to 75 miles, depending upon terrain. Contacts up to 150 miles have been completed in field tests. ● **TUBES USED:** One each of Hytron HY-615, Hytron HY-75, 7F7, 6V6 or 6L6. ● **MICROPHONE:** Any good single button microphone.

TR-4 Overall size 9" x 8" x 4 1/2", less tubes and power supply. **\$65.00**
list price

ABBOTT
INSTRUMENT, INC.
8 WEST 18 STREET • NEW YORK, N. Y.



"CONTACT"

WITH
**Electro-Voice
MICROPHONES**

Because of the adaptability of Electro-Voice microphone manufacturing and design facilities, we have "keyed" our machinery and manpower to the requirements of defense services.

Needless to say, we are steadily increasing our regular productive capacity, and while it may not now be possible to supply all commercial and non-defense requirements, we are meeting a fair portion of these demands.

If you have a microphone problem, see if Electro-Voice can take care of it. Write. Our engineers will give your request prompt and confidential attention.

ELECTRO-VOICE MFG. CO., Inc.
1239 SOUTH BEND AVENUE, SOUTH BEND, INDIANA
Export Division: 100 Varick St., New York, N. Y.—Cables: "Arlab"



FAMOUS
for years . . .
for their uniform accuracy and great strength . . . for the unique self-locking feature on the "Unbrako" Hollow Set Screw with the Knurled Points . . . for the Socket Head Cap Screw with the Knurled Head that gears right to the fingers and saves assembling time.

UNBRAKO
REG. U.S. PAT. OFFICE

SCREW PRODUCTS

STANDARD PRESSED STEEL CO.
Box 596, JENKINTOWN, PENNA.

"Unbrako" Products are available in a complete range of sizes from number 4 up. For free samples and literature, write today.

KNURLING of Socket Screws originated with "UNBRAKO" years ago.

Mix with **REMLER Silver Tap**
ATTENUATORS

Enjoy the feel of self-cleaning pure silver on silver, ball bearings front and rear, precision machined in every detail. It's smooth. And those are the factors that make the REMLER silver attenuator QUIET—so quiet you can operate it in a low-level circuit in perfect ease and comfort. Standard impedances. Special values to order.

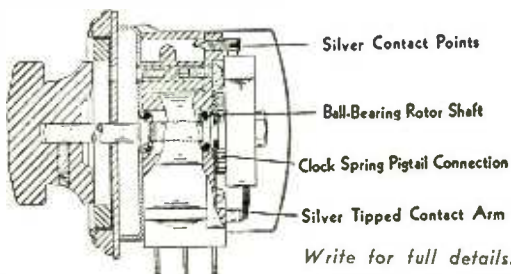

REMLER COMPANY, Ltd. • 19th at Bryant • SAN FRANCISCO

Vacuum Tube Voltmeter

A NEW VACUUM TUBE voltmeter is available for all types of audio frequency work, and particularly for such work as carrier current, supersonic measurements, television, and measurements throughout the broadcast field. The meter is primarily a laboratory instrument, but is simple to operate and will save time in production testing.



Model 400-A is illustrated. It has a frequency range from 10 cps to 1 Mc. Nine voltage ranges are provided with full scale sensitivities from 0.03 volts to 300 volts. The voltage scale is linear and a decibel scale based on 600 ohms and 1 milliwatt is provided. The reading of the meter is independent of line voltage and tube characteristics. No precautions are necessary for operation and there are no adjustments to make or check before taking a reading. Its high input impedance will not affect the circuit being measured. A large overload will not damage the instrument. Accuracy is assured because waveform errors and turn-over effects are minimized.

Hewlett-Packard Co., 481 Page Mill Road, Palo Alto, Cal., are the manufacturers.

Insulation Breakdown Tester

A NEW PORTABLE TESTER for use in checking electrical circuits and for general testing in electrical repair work will indicate grounds, shorts or opens and provides checking of circuits at approved standard testing voltages. It also permits the application of high voltages to prove the safety qualification of the electrical device or apparatus under test. The unit may be adjusted to supply voltages to double the rated voltage plus 1000 in accordance with Underwriters' testing recommendations. It is compact and complete and weighs 26 lbs. Illustrated and described in Bulletin 140. Available from The Acme Electric & Manufacturing Company, 1440 Hamilton Avenue, Cleveland, Ohio.



MORE PRODUCTION!

In the present crisis, you as users and we as producers of Dynamotors, D.C. Motors, Converters and Generators, have a mutual task of achieving the maximum output of materials for war. We must Keep 'em Flying!

Eicor Products are going forth in ever increasing quantities to do their part—every effort is being made to meet unprecedented demands—necessitating a considerable expansion of plant and personnel, which is steadily eliminating inconveniences and delays to those depending on our products.



EICOR

EICOR, Inc., 1050 W. Adams St., Chicago, U.S.A.
Export: Ad Aurlima, 89 Broad St., New York

Broadcast Power Standby

NEWLY DESIGNED POWER plants are now available in 7½ and 10 kw sizes at 1200 or 1800 rpm, and in 15 kw sizes at 1800 rpm. These models may be purchased in either the self-exciter type or with an exciter attachment. The self-exciter type can be made self-cranking by connecting it to 18 or 24 volts of battery. Either of these types will supply 25 amps of direct current at 24 volts for battery recharging. The self-exciter type generators can be remotely controlled at distances of from 40 to 500 ft.

Oversize a-c brushes and large collector rings are accessible for inspection and adjustment. The voltage regulation is approximately 8 percent. The unit is filtered for radio operation. The engine of these power plants is of the 4 cylinder, 4 cycle, watercooled type. Literature describing these power plants in more detail is available from Kato Engineering Company, Mankato, Minn.

Tape Recorder

IT HAS BEEN ANNOUNCED that Jefferson-Travis Radio Mfg. Corp., 380 Second Ave., New York, N. Y., has taken over the manufacture and sales of the Fonda AV Tape Recorder. This is a new type of portable equipment which makes use of non-inflammable acetate film as a means of permanent high fidelity reference recording and automatic play-back. It is particularly suitable for continuous recordings which

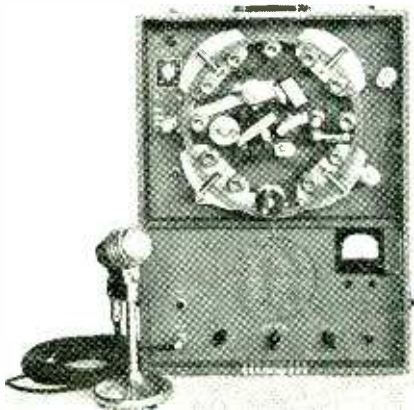

take up to four hours, and requires no supervision with the exception of changing the tape at the end of the four hour period. The unit consists of a recording and play-back mechanism, an amplifier, and a microphone, and comes in a carrying case. It is made to operate by simply plugging the power cord into an electric outlet and then connecting the recorder to a radio or telephone line, or to a microphone. Titles of reference material can be marked directly on the tape and its filing carton.

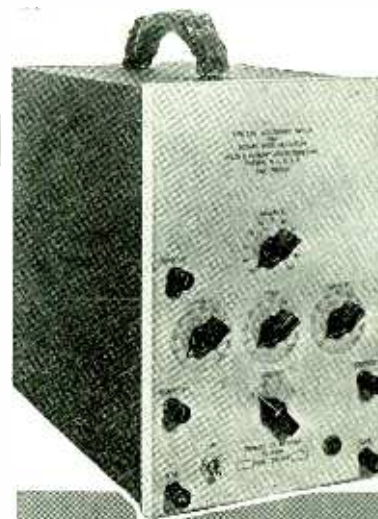

Simplified MONITORING OF MODULATION %

★ Monitoring the modulation percentage of radio transmitters at remote locations has always involved rather elaborate equipment, difficult to adjust and operate, and calling for a specially-modified radio receiver.



Such complications can now be minimized through the use of the DuMont Type 185 Electronic Switch. Any good superheterodyne radio receiver having a linear diode detector and covering the prescribed tuning range, can be used to pick up the signal. No modification of the receiver's circuits is necessary. No radio-frequency connections need be made to the cathode-ray oscillograph. Any good cathode-ray oscillograph having uniform audio-frequency response, may be used as the indicating medium.



★ The simplification of modulation study at remote locations may be the answer to some of your transmitter-performance problems. Write for DuMont Oscillographer Vol. 3 No. 6, which gives the details.

DU MONT

ALLEN B. DU MONT LABORATORIES, Inc.

Passaic ★ New Jersey

Cable Address: Wesplexin, New York

RACKS CHASSIS PAR-METAL CABINETS PANELS



Shown here, Cabinet Rack #R6618. Typical of a complete line listed in our

Catalog No. 41. Also custom-made jobs, precision engineered to specifications.

ENGINEERS WORKING ON DEFENSE ORDERS: — Write on your company letterhead for our Catalog No. 41.

PAR-METAL PRODUCTS CORP.

32-62 49th ST., LONG ISLAND CITY, N. Y.
Export Dept.: 100 Varick St., New York, N. Y.

New DECADE AMPLIFIER MODEL 220



A highly stable amplifier giving gains of exactly 10 and 100 times. Operated by self-contained batteries. Through the use of special circuits the gain is independent of battery voltage, circuit constants and tubes within 2% from 10 to 100,000 cycles. Particularly useful with our Model 300 Electronic Voltmeter to increase its sensitivity, permitting voltage measurements down to 30 microvolts. Send for Bulletin 7.

SENSITIVE ELECTRONIC AC VOLTMETER

MODEL 300



10 to 150,000 cycles,
1 millivolt to 100 volts in five ranges (to 1,000 and 10,000 volts with multipliers),
Logarithmic voltage scale,
AC operation, 115 volts, 60 cycles,
Accurate and stable calibration.

Ballantine Laboratories, Inc.

BOONTON

NEW JERSEY

Transceiver and Rectifier

TWO INSTRUMENTS HAVE been announced by Weltronic Corporation, East Outer Drive, Detroit, Mich.

The first of these instruments designated as "Trans-Ceiver" is a completely self-contained radio telephone combination transmitter and receiver weighing 4 lbs. The built-in battery power supply has a rating of about eight hours under continuous operation. On and off switches and finger-operated selectors are provided to change from transmitting to receiving and vice versa. Also provided on the units are a volume control and a detachable adjustable



short fish-pole type of aerial. Although these "Transceivers" are designed for operation on a single wavelength (requiring no tuning in service) the frequency range is adjustable from 112 to 300 Mc by adjusting an easily accessible screw.

A complete line of full-wave industrial rectifiers, in eleven models, ranging from 100 to 15,000 watt capacity, has also been announced by Weltronic Corporation. The rectifiers are designed for use in the operation of such devices as magnetic chucks, variable speed d-c motors, telephone switch boards, motion picture equipment, electroplating installations, circuit breaker reclosing mechanisms, etc.

Two long life high-capacity single plate tubes (one for each half cycle, with a 2000 hour guarantee) are used in the units. These are housed in enclosed cabinets which are designed for wall mounting.

Voltmeter Multiplier Resistors

TWO TYPES OF SEALED precision voltmeter multiplier resistors are designed for use in severely humid conditions such as marine service. These resistors are hermetically sealed and are encased in a glazed ceramic tube. They consist of a number of wire wound resistors which are mounted and interconnected.

Type MFA is 8 1/8 inches long and is available in resistance ranges of 3.5, 4.0, 4.5 and 5.0 megohms with corresponding kv ratings. Type MFB is 4 1/8 inches long, and is available in ranges of 1.0, 1.5, 2.0, 2.5 and 3.0 megohms with corresponding voltage ratings. Bulletin IV-B gives complete details and is available from the manufacturer, International Resistance Company, 401 North Broad Street, Philadelphia, Pa.

Insulation Material

VULCANIZED FIBRE SURFACES on a laminated phenolic material provides a new insulation material which is especially suited to arcing conditions. The vulcanized fibre quenches the arc without carbonizing or tracking, and the phenol fibre gives necessary rigidity and moisture resistant qualities. This material may be punched, sawed, drilled or tapped and is available from N. S. Baer Company, 13 Evans Place, Hillside, N. J.

Time Delay Relays

A SERIES OF AUTOMATIC time-delay relays which combine simplicity and low cost has been announced. These relays are of the thermostatic type in which one or more bi-metallic arms carrying contacts are made to open or close circuits with a predetermined time lapse after application of the voltage to the built-in heater filament.

Type R6V is illustrated. This is a s.p.s.t. circuit closing unit used primarily to delay application of high voltage to rectifiers or other tubes until filaments or heaters have been brought to operating temperatures. The heater is of the 6.3 volts, 0.3 amps. type. This assembly is hermetically sealed in hydrogen to avoid oxidation of the con-

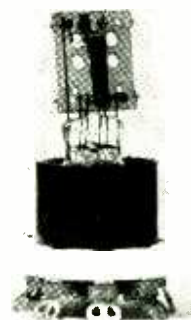

tacts. Time delay of approximately 30 seconds is provided, although this can be extended to as much as two minutes by insertion of a resistor in the heater circuit to reduce the applied voltage. Contacts and leads are capable of handling 2.5 amps in either continuous or intermittent service. Other relays of this type can be supplied for either opening or closing circuits and with contact arrangements from s.p.s.t. to d.p.d.t. They can also be supplied with any specified delay time from a second to minutes, and with any desired heater voltage ratings. These are available from Amperite Company, 561 Broadway, New York, N. Y.

Playback Recorder

MODEL 88-C IS A compact recording-playback assembly which consists of amplifier, speaker, microphone with desk type stand, motor, turntable and gearing mechanism. The amplifier has three stages of amplification. Frequency range is up to 6,000 cps. Frequency compensation is provided for slow speed operation. The power output is 5 watts. Dual speed (78 and 33½ rpm) enables



one to record up to 24 minutes on a 10 inch record. The instrument will also play 12 inch records.

An ortho-acoustic speaker arrangement has been designed as an integral part of the lid of the carrying case, using an 8-inch built-in heavy duty Jensen dynamic speaker. The tracking mechanism of the instrument is completely positive. This playback unit is available from Speak-O-Phone Recording & Equipment Company, 23 West 60th Street, New York, N. Y.

Retractable Aircraft Antenna

THE AVA-414 ANTENNA System presents improvements in retractable trailing antenna design. It was designed for installation in any type of aircraft and is suggested for use with transmitters of 50 watts or less, at frequencies from 2,500 to 13,000 kc.

Three different installations may be used for particular needs depending upon conditions in the plane.

Items which make up a complete installation of the CAA approved accessories include an insulated flexible antenna conduit, entrance fairlead, rear guide fairlead, antenna drag unit and antenna wire. These accessories are completely described in a 4-page folder available from Aviation Radio Section, RCA Manufacturing Co., Camden, N. J. Illustrations of the three assemblies are included in this bulletin.

Percent Limit Bridge

MODEL No. 621-A is a percent limit bridge which is completely self-contained and is designed for rapid and precise production measurement of resistances from 1 to 1,111,110 ohms. Other ranges are also available. One

ALLIED PRECISION BUILT AIRCRAFT RELAYS

ALLIED offers a new line of aircraft relays of unique design, ranging from small miniature relays to power type relays with a rating of 100 amperes at 24 Volts D.C. Contacts range from single pole throw to six pole, double throw. The line also varies from power relays to highly sensitive units.

This line represents many years of intensive development work resulting in important features such as, compactness, light weight, minimum base mounting area, and easy availability of contacts for connections.

These relays have been tested and approved for many important new aircraft applications where resistance to vibration, wide temperature variations, resistance to corrosion, and low wattage operation are essential.

Allied offers precision manufacturing, highly skilled and specialized testing, and above all, reliable and competent manufacturing.

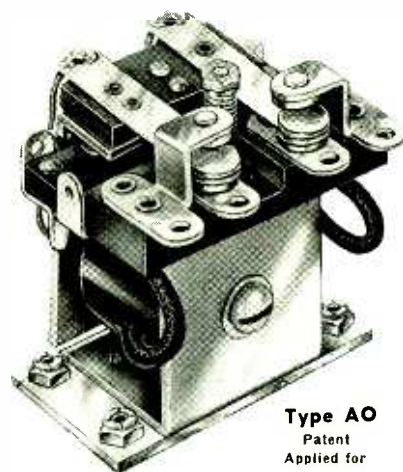

Type AO
Patent
Applied for

Inquiries from aircraft and other designing engineers will receive prompt attention.

ALLIED CONTROL COMPANY, INC.

227 FULTON STREET

NEW YORK CITY

On and after March 2nd, 1942, new address is: 48-02 48th Ave., Woodside, L. I., N. Y.

Ferranti

TRANSFORMERS

*for every Industrial and
ELECTRONIC Application*

● Quality transformers for every industrial, electronic, sound, communication, and laboratory use.—Air cooled transformers and reactors for any industrial application. Miniature aero transformers for aircraft and portable work.—High power plate and filament transformers.—Filters, equalizers, modulation sets and rectifiers . . . TO YOUR SPECIFICATIONS. Immediate service to all manufacturers and laboratories!

Send us your specifications.

Let us work with you on your transformer problems!



FERRANTI ELECTRIC, Inc.

RCA BUILDING . . . NEW YORK CITY, N. Y.



Standard types in 10 and 20 watt fixed; adjustable up to 200 watt. All popular resistance values. Special units with other mountings, terminals, sections, taps.

★ Those green-colored cement-coated power resistors you see in quality sets, amplifiers, power packs, oscillographs and other fine instruments, are GREENOHMS. Likewise you'll find them in radio transmitters and various electronic "rigs". The reason is simple: GREENOHMS are now chosen by builders of equipment that must stand up. Also by maintenance men who must keep equipment going.

★ Let Us Quote . . .

Whether your power resistor requirements are standard or special, one or a million, let us quote. Data and listings on request.

CLAROSTAT
MANUFACTURING CO.
Incorporated
285 North Sixth St.
Brooklyn, N. Y.

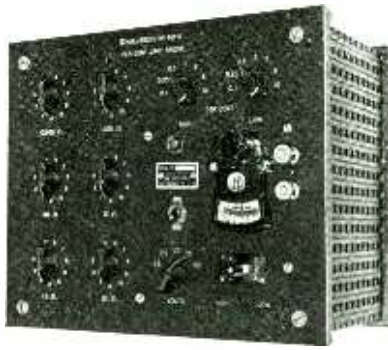

of its features is that a selection of tolerance percentages from 0.25 to 10 percent can be made. Plus-or-minus tolerances may be set individually and independently of each other. The unit may also be used to measure the actual resistance of the units under test. For measuring low resistances, there is provided a standard No. 6 dry cell. For higher resistances, an a-c operated rectifier tube is available. The galvanometer has a sensitivity of 1 micro-amp per millimeter division.

Price for the complete instrument is less than \$150.00 and it is available from Shallcross Mfg. Company, Collingdale, Pa.

Literature

Industrial Electronics. An issue of *The Aerovox Research Worker* entitled "Industrial Applications of Electronic Devices" contains the first of a series of three articles on this subject. Part 1 of this series covers subjects under the following subheads: Vacuum Tubes, Determination of Weight and Thickness, The Stroboscope, Sound and Noise Measurement, Moisture Control, Smoke Control, Checking of Turbidity of Solutions, Oil Analysis, Control of Packaging Machinery, and Application to Wire Drawing. These papers are prepared by the engineering staff of Aerovox Corp., New Bedford, Mass.

Engineering Data. This is a booklet compiled for the radio, television, electronic, electric and aeronautical industries and contains technical data as well as illustrations on potentiometers, rheostats, controls, resistors, attenuators and decade boxes manufactured by Clarostat Mfg. Co., Inc., 281 North Sixth Street, Brooklyn, N. Y.

Vibrator Power Supply. Included in an 8-page bulletin, Form No. E-555-C, is technical data, applications, selection and installation instructions on "Vibrapacks", portable power units for radio transmitters and receivers, PA systems and scientific apparatus. This bulletin is available from P. R. Mallory & Co., Inc., Indianapolis, Ind.

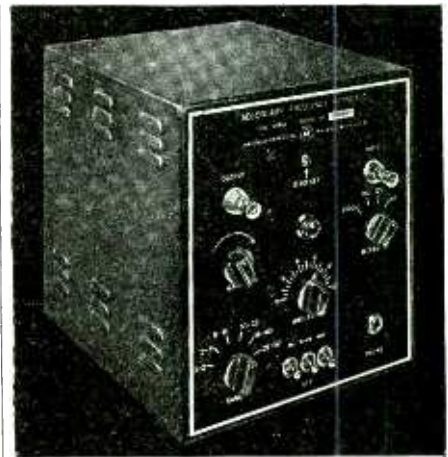

A Precision Crystal Secondary FREQUENCY STANDARD THAT HAS BEEN "Designed for Application"

A precision frequency standard capable of being adjusted to WWV or some other primary standard and putting out uniformly accurate calibrating signals with 10, 25, 100, 1000 KC intervals. Uses the new GENERAL ELECTRIC No. 18A 1000 KC crystal having a frequency temperature coefficient of less than one cycle/Mc/C°. The crystal is sealed in Helium in a standard metal tube envelope. The self-contained AC power supply has VR150-30 voltage regulator tube. In addition to oscillator, multivibrators, and harmonic amplifier, a built-in mixer with phone jack and gain control on panel is incorporated.

JAMES MILLEN MFG. CO. INC.
150 EXCHANGE ST. MALDEN, MASS.

NO ENGINEER

whose work takes him into the field of sensitive electrical devices can say—today—that he is thoroughly grounded unless he "knows his electronics."

Because electronic circuits more and more are getting into industrial work as an automatic hand, an automatic eye, a new means of generating heat, etc., etc., they have become the background for a new cycle of industrial progress.

Are you trying to get along without ELECTRONICS? Better subscribe today!

H-F Iron Core Data. A loose-leaf form of a technical and specialized nature is available only to engineers who want the booklet and who will write for it on their business stationery. This booklet contains facts, figures and curves dealing with the electrical and mechanical characteristics of various h-f powdered iron materials and cores available from Henry L. Crowley & Co., Inc., 1 Central Ave., West Orange, N. J.

Noise Filters. Thirteen different types of noise filters are described and illustrated in a 4-page bulletin designated as Form No. NF-100. An interference elimination chart is also included. Available from P. R. Mallory & Co., Indianapolis, Ind.

Mica Capacitors. A nicely edited and illustrated 32-page booklet designated as Catalog 12-Section E describes mica capacitors which are available from Solar Mfg. Corp., Bayonne, N. J. Requests for this book must be made on letterhead stationery.

Locknuts. Locknuts that embody a doublelocking action against vibration are thoroughly illustrated and described in a 12-page booklet issued by The Palnut Co., Irvington, N. J.

Resinox Molding Materials. A booklet which includes colored illustrations also contains technical data, range of properties, and tells about molding and the uses of Resinox molding materials and phenolic resins. The booklet is available from Monsanto Chemical Co., Plastics Div., Springfield, Mass.

FM Bibliography. A bibliography of articles published on frequency modulation has been compiled by Elizabeth Kelscy, Engineer at Zenith Radio Corp., Chicago, Ill. The booklet is available from Zenith.

Diesel Electric Sets. "One Cent Per KW Hour Electricity" is the title of a 20-page booklet which tells of the advantages of making one's own electricity. It illustrates many types of installations. Form 6905 identifies the booklet which is available from Caterpillar Tractor Co., Peoria, Ill.

Cyanamid Plastic. A new cyanamid plastic known as Melmac 494 which has the properties of high arc resistance, high dielectric strength, dimensional stability and low moisture absorption is described in a bulletin available from American Cyanamid Co., Plastics Div., 30 Rockefeller Plaza, New York, N. Y.

Test Equipment. Various pieces of radio test equipment are described in Catalog-T published by The Triplett Electrical Instrument Co., Bluffton, Ohio.

A New **AUTOMATIC FREQUENCY RESPONSE RECORDER**

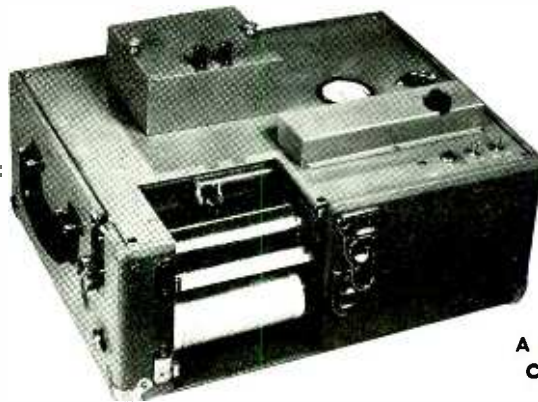

**MANY
NEW
EXCLUSIVE
FEATURES**

**A RECORD YOU
CAN RELY ON**

As its name implies, it will draw automatically and continually (on semi-log. paper, 4" wide) an accurate frequency characteristic of any audio transmission component or complete installation. Indispensable where rapid changes with respect to frequency occur and a continuous record is desirable. (Loudspeakers, microphones, etc.)

The frequency response is essentially flat from 40 to 40 KC; it responds to a .2 of a DB change of the input signal.

If the DB Potentiometer is replaced by a linear type potentiometer, the instrument will be a recording ampere meter or volt meter.

Completely AC operated — light weight (40 lbs)—compact and portable.

The AUTOMATIC FREQUENCY RESPONSE RECORDER has many other new and exclusive features which are fully described in our Bulletin which we will send upon request.

• • • • •

SOUND APPARATUS COMPANY
150 West 46th St. New York, N. Y.



"RADIOCARB A"

is the accepted superior carbonized nickel for power tubes meeting the specifications of the U. S. Navy.



WILBUR B. DRIVER CO.
NEWARK, NEW JERSEY



Engineers, Production Men and Purchasing Agents agree . . .



that Wire Wound Resistors do a better job, frequently at less expense.

INSTRUMENT RESISTORS CO., produces many types of dependable, Wire Wound Resistors, each designed to do a specific job and do it well.

Our twenty-four hour production schedule assures rapid delivery. Catalog on Request.

Instrument Resistors Co., LITTLE FALLS
NEW JERSEY

IRE Convention

(Continued from page 34)

with distortion of the order of 2 to 3 percent. The uncorrected distortion would be 28 to 30 percent. The advantage of a wider angle of phase shift is that it decreases the amount of phase multiplication necessary for wide-band frequency modulation and results in simpler apparatus and reduction of noise due to random disturbances in the phase modulator and initial multipliers.

Antennas for Aircraft

A discussion of the problems of design of directional loop antennas for aircraft was presented by George F. Levy of United Air Lines. Such antennas are very useful for aircraft operation because they are highly efficient, small in size, directional in response, and can be electrostatically shielded to eliminate precipitation static. They are generally mounted outside the fuselage of an airplane and therefore they produce considerable drag. It was estimated that a loop contained in a tubular metal shield $1\frac{1}{2}$ inch thick and 12 inches in diameter, and mounted in the conventional manner, requires 7 horsepower to carry it at 180 miles per hour. If the same antenna becomes covered with ice so that its open center is a mass of solid ice, and its broad surface to the front, it will require 25 horsepower.

The low impedance loop consisting of about six turns of wire enclosed in an electrostatic shield is commonly used. Also widely used, especially in automatic direction finders, is the high impedance loop consisting of from 7 to 20 turns enclosed in a streamlined housing. In this case the position of the housing is fixed and the loop rotates within it.

Mr. Levy also discussed the several characteristics of loop antennas which impaired the directional pattern. Among these characteristics are displacement current effect of a solenoid loop, winding pitch effect in a pancake loop, and the antenna effect present in both types. The antenna effect can be greatly reduced by electrostatically shielding the loop. By connecting a solenoid loop and a pancake loop, in series, the other two effects can be eliminated.

Simultaneous aural and panoramic reception of radio signals was discussed by Marcel Wallace of the Panoramic Radio Corp. A panoramic

adapter unit is connected to the converter output of a conventional superheterodyne receiver to produce on the screen of a cathode-ray tube visual indications of any radio signals present in a considerable portion of the band above and below the tuned frequency of the receiver. The signal to which the receiver is tuned is delivered to the loudspeaker in the normal manner. The type of modulation, and relative signal strength can be determined by analysis of the visual indication of any signal within the band. A description of this system was published in *ELECTRONICS*, December 1941.

How to Present Technical Papers

The Tuesday morning technical session was opened with a paper by Beverly Dudley on the preparation of technical papers for publication. Five important attributes of a good article were outlined as follows: (1) Selection of material to include all that needed to bring out the principal idea, and rejection of irrelevant matters, (2) adaptation of the material to the intellectual and professional level of the reader, (3) arrangement of the various parts of the article in a logical order with related topics kept together, (4) suitable articulation for clear and unmistakable indication of the relationship of the various parts of the article, and (5) correct proportion so that each part of the article utilizes space in accordance with its relative importance. It was pointed out that the authors of technical papers could improve them considerably by making adequate outline preparation before writing the article, by giving completely and thoroughly a list of all symbolic notations used, and by including abstracts or summaries in which the significance of the research reported on is given with its practical interpretation rather than merely as a statement of the fact that research was undertaken.

Professor Herbert J. Reich, of the University of Illinois, described the use of vacuum tubes as variable impedance elements. The circuits discussed were divided into two classifications: (1) those using a single tube, such as a triode, with impedances in the grid or plate circuit so as to present the characteristics of an impedance in the plate circuit,

and (2) multistage amplifiers having an even number of stages. For certain types of circuit operations, the vacuum tube arrangement exhibits the characteristic of a negative resistance and in such cases the circuit may be used as an essential element in the construction of an oscillator. The mathematical treatment was not given since it is expected that Professor Reich's paper will appear in the Proceedings at an early date. The physical operations were indicated and it was shown that at least in some cases the capacitances and inductances could be interchanged to utilize the tube as a different impedance element; that when these elements were in the plate circuit of the tube, no magnification of the apparent reactance is possible, although possible when these are inserted in the grid circuit.

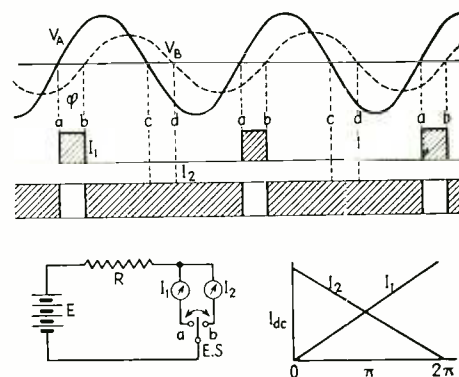

Fig. 6—Phase displacement, ϕ , between two sine waves, V_a and V_b , can be determined uniquely by means of the elementary circuit shown at the lower left. An electronic switch, E.S., switches from one meter to another when sine voltages cross the zero axis. The ratio of the currents I_1 and I_2 can be used to provide a calibration of phase angle

An excellent presentation by J. E. Shepherd, formerly of Harvard University described a wide range, linear, unambiguous electronic phase-meter originally developed primarily for laboratory use in investigating the properties of degenerative feedback amplifiers. The phasemeter was designed to operate in the audio frequency range between 30 and 15,000 cps, with an input voltage of from 0.01 to 500 volts. However, through the use of a beat method, the instrument may be applied to higher frequencies so long as the beat note is within the audio range of the instrument. As was brought out in the discussion, the instrument measures phase angle as referred to a sine wave; the indications for waves of appreciable distortion are not then

**NOW . . . you can secure
the mathematical
background you need**

*for the solving of everyday
electrical and radio problems*

Radiomen and electricians know that the language and the habit of mathematics are essential to them for real grasp of, and progress in their chosen field. They know that mathematics is a tool for them that they are helpless without.

Now out of the U. S. Navy Radio Material School at Anacostia Station comes a complete home-study textbook that is so thorough, so careful in its explanations, so detailed in its examples that any reader "who can perform arithmetical computations rapidly and accurately is capable of mastering the principles laid down in this text."

JUST OUT!



**MATHEMATICS FOR
ELECTRICIANS
AND RADIOMEN**

By **NELSON M. COOKE**
Chief Radio Electrician, U. S. Navy
Member, Institute of Radio Engineers
604 pages, 6 x 9, \$4.00

This book teaches you mathematics from elementary algebra through quadratic equations, logarithms, trigonometry, plane vectors and elementary vector algebra with direct applications to electrical and radio problems. It teaches you how to apply this mathematical knowledge in the solutions of radio and circuit problems. In other words, it gives you the grasp of mathematics you need and then shows you how to use your knowledge.

Keep these 3 points in mind

- gives you 600 illustrative problems worked out in detail;
- gives over 3000 problems for practice, with answers so you can check your work;
- based on more than 8 years' experience teaching mathematics to U. S. Navy electricians and radio operators.

10 DAYS' FREE EXAMINATION

McGraw-Hill Book Co., 330 W. 42nd St., New York
Send me Cooke's Mathematics for Electricians and Radiomen for 10 days' examination on approval. In 10 days I will send you \$4.00 plus few cents postage, or return book postpaid. (We pay postage if remittance accompanies order.)

Name

Address

City and State

Position

Company L. 2-42

(Books sent on approval in U. S. and Canada only.)

defined nor do they have the same physical interpretation as for a sine wave.

Basically the phasemeter may be considered to operate on the principle illustrated in Fig. 6 in which there are two sine waves, *A* and *B*, passing through the zero axis at points *a* and *b*, respectively, with a phase angle θ . As shown in the simple series circuit, consisting of a battery of voltage *E* and resistors, two meters *I*₁ and *I*₂ are used to give an indication of the phase displacement of the two waves. A rapidly varying electronic switch is indicated diagrammatically at *ES* and this switch permits the independent measurement of the current pulses *I*₁ and *I*₂. These pulses are so determined that *I*₁ flows for that part of the cycle represented by the phase angle for which positive portions of the wave *V*_a, the voltage *V*_b is negative. On the other hand, *I*₂ flows for the remainder of the cycle. By noting that the calibration of the two currents is linear with respect to the phase angle and by determining the ratio of the two current readings, the phase angle may be uniquely determined.

Instead of an elementary switch crudely shown as *ES*, elaborate amplifying clipping and differentiating circuits are employed to switch from one wave to another in the proper part of the cycle. Conversely, by using a zero center-reading type of instrument instead of the two meters designated as *I*₁ or *I*₂ a single dial may be calibrated to read phase angles directly. These and other details were ably described by Mr. Shepherd who demonstrated some of the fundamental principles involved by means of what might be termed a "motion picture slide" in which the periodic alternations of the electronic switch, *ES*, was graphically portrayed by making this switch in the form of a pendulum and affixing it to the slide so that its motion represented that of the switch, *ES*.

Variable frequency bridge stabilized oscillators were described in a paper by W. G. Shepherd and R. O. Wise in which it was shown that it has been the aim of many researches to improve the frequency stability of electronic oscillators. Such stability is most desirable when the oscillators are employed for experimental or test work with sharply tuned circuits. Harmonics produced by the

**ATR
VIBRATORS
"for DEFENSE!!"**



**PROVEN UNITS
of the
HIGHEST QUALITY**

Engineered to perfection, ATR Vibrators set high standards of performance and construction. Available for any operating input voltage from 6 volts DC to 220 volts DC in a wide variety of designs for practically any application.

In addition to the most complete line of vibrators, ATR offers a very extensive line of Inverters and other Vibrator-Operated Power Supplies for changing one DC voltage to another DC voltage or to invert DC to AC.

ATR vibrators, the heart of vibrator-operated power supplies, are proven units of the highest quality, engineered to perfection. They are backed by more than ten years of vibrator design and research, development and manufacturing—ATR pioneered in the vibrator field. American Television & Radio Co. has consistently devoted its efforts and energies to the perfection and production of vibrators and associated equipment, and today, after ten years of painstaking, persistent and diligent work resulting in steady development and progress, is considered the World's leader in its field. All ATR Products incorporate only the best materials and workmanship and are carefully manufactured under rigid engineering inspections and tests, making them the finest that can be built.

For Additional Information
Address ATR Vibrator Division of

**AMERICAN TELEVISION & RADIO CO.
ST. PAUL, MINN., U.S.A.**



Globar
REG. U. S. PAT. OFF.

CERAMIC RESISTORS

● Finding the right resistor for a specific application is likely to be no easy problem. Because the solution so often is found in Globar Brand Ceramic Resistors we urge you to acquaint yourself with the distinctive qualities of these versatile resistors. The handy chart below shows types available, together with their characteristics.

TYPE	A	B	CX
DIAMETER			
MIN.	1/16"	1/16"	1/16"
MAX.	1"	1"	1"
LENGTH			
MIN.	1/4"	1/4"	1/4"
MAX.	18"	18"	18"
WATT RATING*			
MIN.	1/4w.	1/4w.	1/4w.
MAX.	54w.	54w.	150w.
RESISTANCE per in. of length			
MIN.	25 ohms	5 ohms	1 ohm
MAX.	15 meg.	15 meg.	1000 ohms
NORMAL RATING w./sq. in. of radiating surf.	1	1	2-1/2

*By artificial cooling these ratings may be increased substantially.

Characteristic Coefficient

Type A: Commercial straight line Voltage and Temperature

Type B: Negative Voltage Negative Temperature

Type CX: Commercial straight line Voltage and Temperature

Terminals: All types: Metalized ends with or without wire leads

In addition to these standard items, special resistors can be made to meet definite specifications both as to shape and characteristics. Ask for Bulletin R and give us details of your requirements.

Globar Division
THE CARBORUNDUM CO.

REG. U. S. PAT. OFF.
NIAGARA FALLS, N. Y.

{ Carborundum and Globar are registered trade-marks of and indicate manufacture by The Carborundum Company. }

nonlinear behavior of the vacuum tube affect the frequency of the fundamental. This effect occurs since any changes in the supply voltages which produce relative changes in the amplitude of the harmonics will cause a change in the reactance at the fundamental frequency and hence a shift in that frequency.

Recently a number of investigators, in particular L. A. Meacham, have removed the function of limitation of the amplitude of the oscillation from the vacuum tube. This has been done by employing as an element of a bridge network a circuit component such as a lamp, whose resistance is a function of its temperature. This element by tending to balance the bridge adjusts the gain-loss balance of the network and thus limits the amplitude of oscillation.

Previous work of this type was applied particularly to fixed frequency oscillators and enabled the achievement of a remarkable degree of stability. The present work is an endeavor to extend this same principle to variable frequency oscillators. Two types of oscillators were investigated. One is particularly

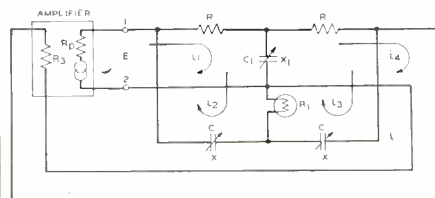

Fig. 7—Circuit of stabilized oscillator suitable for low frequencies

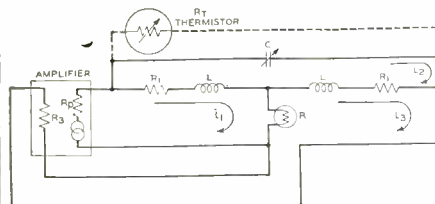

Fig. 8—Functional wiring diagram of oscillator for frequencies above the audio range

adapted to low frequency operation since the frequency determining network which is of the parallel T type employs only capacitances and resistances, Fig. 7. This enables one to obtain operation at very low frequencies without the use of physically large or iron core coils the latter of which may be a source of instability. The frequency of oscillation for this circuit is obtained from

$$f_0^2 = \frac{1}{8\pi^2 R^2 C_1 C}$$

and the condition for a balance is

$$R_1 = \frac{K RC_1}{4C}$$

where $K < 1$ and its value is determined by the amplifier gain.

From the above it is apparent that frequency change may be obtained by varying R , C_1 or C individually. Separate variation, however, requires that R_1 shall vary and since the value of R_1 is determined by the amplitude of oscillation this would mean that the amplitude of oscillation would be a function of frequency. However, by varying the capacitances simultaneously, with a fixed ratio, the amplitude becomes independent of frequency as do all the other characteristics of the oscillator provided that the amplifier characteristics are independent of frequency. A theoretical analysis shows that the stability of such an oscillator may be made very high by incorporating a small phase shift in the amplifier. For very large values of g , the amplifier transconductance, this phase shift approaches zero and the theoretical expression for the instability becomes

$$\frac{d}{dE} \left(\frac{\delta f}{f_0} \right) = \frac{g \sin \theta}{2 X_0 g^2} \frac{dg}{dE}$$

where θ is the amplifier phase shift, X_0 is the capacitive reactance at f_0 , and

f is the deviation from f_0 .

Experimental oscillators were constructed which gave general experimental agreement with the theoretical results.

The second type of oscillator investigated is shown in Fig. 8. It is well adapted to frequencies above the audio range. The general properties of the network are similar but better than those of the resistance-capacitance oscillator. Two types of control are possible. One uses the shunt leg of the bridged T circuit as an amplitude control and this requires a positive thermal coefficient. The other uses a resistance indicated by the dashed lines as R_7 . This requires a negative temperature coefficient. The latter type of control is the more advantageous for this circuit since negative temperature coefficient thermistors are available whose resistance is many times more sensitive to temperature changes than is the resistance of a positive thermal coefficient resistance.

The conditions for oscillation for this circuit with the control at R_r are approximately

$$f_o^2 = \frac{1}{8\pi^2 LC}$$

$$R_{T0} = \frac{4R}{1 - Q_{L0} p_o L}$$

where R must be $Q_{L0} p_o L/2$ and $Q_{L0} = p_o L/R_1$ and $p_o = 2\pi f_o$

The instability of such an oscillator for changes in the amplifier transconductance, g , with any supply voltage for large values of g is

$$\frac{d}{dE} \left(\frac{\delta f}{f_o} \right) = - \frac{p_o L \sin \left(\theta + \tan^{-1} \frac{p_o L}{2R} \right)^2}{4g^2 R^2} \frac{dg}{dB}$$

This indicates that optimum stability occurs for a small phase shift. For a broad range oscillator it is difficult to maintain the optimum phase shift and hence the stability will be inferior to that for fixed frequency oscillators. Optimum results will be obtained by using a high gain amplifier.

Dr. E. U. Condon of Westinghouse Electric and Manufacturing Co. presented a mathematical treatment of the problem of a plane cathode and a plane anode with a potential across them and in a magnetic field parallel to the two electrodes. Child's law is expressed by the following equation.

$$I = 2.33 \frac{E^{3/2}}{E^2} \mu a/cm^2$$

This indicates that the voltage-saturation current varies as the three-halves power of the plate potential when applied to two electrodes and infinite in a perfect vacuum. When a magnetic field exists parallel to the cathode and anode, and of sufficient strength to cause current cutoff because of deflection of the electron stream, the current at voltage-saturation is 71.7 percent of the value without the magnetic field.

Bioelectric Research Equipment

Dr. Harold Goldberg described equipment which has been designed and used at the University of Wisconsin and which represents modifications and improvements of the equipment described in the August, 1941 issue of *ELECTRONICS*. He described a complete amplifying and cathode-ray tube system suitable for most bioelectric research applications. Three independent amplifying channels, working into a three-trace cathode-ray tube allow the recording

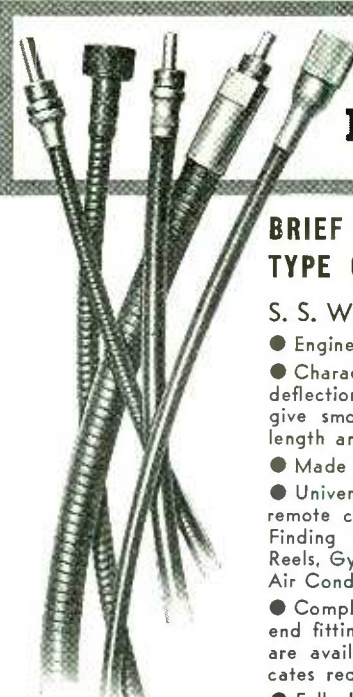

S. S. WHITE FLEXIBLE SHAFTS

BRIEF FACTS ABOUT THE REMOTE CONTROL TYPE OF FLEXIBLE SHAFTS . . .

S. S. White Flexible Shafts of this type are:

- Engineered and built expressly for remote control service.
- Characterized by minimum deflection under load and equal deflection in either direction of rotation—the reason why they give smooth, jumpless operation under varying conditions of length and curvature.
- Made in a range of diameters from .130" to .437".
- Universally used in Commercial and Military Aircraft for remote control of Radio Receivers, Transmitters and Direction Finding Equipment, Antenna and Compass Loops, Antenna Reels, Gyro Pilots, Heating Registers, Tabs, Turn Bank Indicators, Air Conditioning and other equipment requiring remote control.
- Complete combinations of flexible shaft, flexible casings and end fittings—many of them made to Army and Navy specs.—are available for these applications. Preference rating certificates required.
- Full details about these shafts are given in *Bulletin 38*. Write for a copy.

P. S. If you are interested in flexible shafts for Power Transmission ask for Bulletin 1238.

AT YOUR SERVICE
cooperation of our flexible shaft experts for working out actual applications. Send details.

S. S. WHITE

The S. S. White Dental Mfg. Co.

INDUSTRIAL DIVISION

Department E, 10 East 40th St., New York, N. Y.



APPROVED

Leakproof

**ENAMELED
MAGNET WIRE**

● Much of the success of this Hudson Wire product is due to a new coating method that gives a smooth, permanently-adherent enameling. Mercury-process tests guarantee perfect uniformity; great tensile strength assures perfect laying even at high winding speeds. Especially adaptable for reduction in coil dimensions without sacrificing electrical values.

Our engineering and design facilities are at your disposal—details and quotations on request.

HUDSON WIRE COMPANY

Winsted Division

WINSTED
CONNECTICUT

STABILIZED A. C. VOLTAGE UP TO 25 KVA

INSTANTANEOUS ACTION NO MOVING PARTS

When a precision electrical device or a critical process is powered from an AC line, a Raytheon Voltage Stabilizer will permanently eliminate all of the detrimental effects caused by AC line voltage fluctuations. Made for all commercial voltages and frequencies, single or three phase.

Raytheon's twelve years of experience in successfully applying the Stabilizer to hundreds of perplexing voltage fluctuation problems is at your service. It will pay you to take advantage of our engineering skill.

Write for Bulletin DL48-71 JE describing Raytheon Stabilizers.

RAYTHEON MANUFACTURING CO.
100 Willow Street, WALTHAM, Massachusetts

TAYLOR
LAMINATED PLASTICS
Vulcanized Fibre • Phenol Fibre
SHEETS, RODS, TUBES, FABRICATED PARTS
TAYLOR FIBRE COMPANY
Norristown, Pennsylvania

PERMANENT MAGNETS
ALL SHAPES — ALL SIZES
FOR ALL PURPOSES

Stamped, Formed, and Cast; Chrome, Tungsten Cobalt and **ALNICO**** (cast or sintered) under G. E. license.

THOMAS & SKINNER
STEEL PRODUCTS COMPANY
1116 E. 23rd STREET INDIANAPOLIS, INDIANA

Laminations for Radio Transformers — Tools
Dies — Heat Treating — Stampings

40 YEARS EXPERIENCE

of three independent simultaneous phenomena. The three traces may be partially or wholly superimposed as desired. Each amplifying channel consists of a battery-operated 3-phase d-c amplifier coupled to a power line and a d-c output stage. All channels operate from a common battery and power line supply. Cathode-ray tube sweep circuits are d-c coupled and entirely operated from the power line. Individual control of centering and sweep beats is provided. An associated stimulating circuit, synchronized with the sweep provides stimuli for biologic specimens under study. Because d-c amplification is employed throughout the system, any event will always appear at the same position of the cathode-ray tube screen when repeated, provided the control settings remain unchanged.

While the requirements for apparatus for bioelectric research work were outlined in the early part of the paper, the principal emphasis was placed upon the description of equipment built at the University of Wisconsin for studying physiological reaction and for carrying out bioelectric research. The equipment is mounted on a relay rack and operated in a shielded room.

Dyneric Balancer

The "Dyneric Balancing Machine" was the subject of the paper delivered by H. P. Vore of Westinghouse Electric and Manufacturing Co. This machine makes use of a vibration pickup, similar in operation to the phonograph pickup, mounted on each of two bearing posts between which is rotating the object to be dynamically balanced by the addition of weight at certain points determined by the balancing machine.

Activities at Fort Monmouth

The Signal Corps Laboratory at Fort Monmouth, N. J. was described by Lieutenant Colonel Rex V. D. Corput, Jr., who is in charge of the laboratories. Since 1940 the number of workers at the laboratories increased from 200 to more than 2400 at the present time and the number is still increasing. The personnel is predominantly civilian and Col. Corput stated that there is still a need for more technical radio men. Long before this country became involved in the war the Signal Corps worked

very closely with private industry in developing new equipment so that now it is able to procure large amounts of necessary apparatus with a minimum of difficulty. Colonel Corput discussed briefly the various divisions at Fort Monmouth and their work. He said that the work of the Signal Corps Laboratory on radio direction finding has been closely coordinated with that of the Naval Research Laboratory and with industrial laboratories and the National Defense Research Council, so that the Signal Corps now occupies an outstanding position in this field.

The field radio section is mainly concerned with the development of walkie-talkie radio equipment for use by soldiers of foot. The radio direction finding section develops equipment for determining the position of enemy forces and also of friendly aircraft to aid them in their navigation. Also at Fort Monmouth is a meteorological section for the development of special equipment for obtaining meteorological information.

Spurious Radiation

A paper by A. J. Ebel, WILL, University of Illinois, showed that considerable study has been given to, and considerable conjecture about, the origin of combination signals generated when the high intensity fields of two broadcast stations overlap. It is generally agreed that the signals are due to some nonlinear element external to the receiver. (Many receivers show such nonlinearity and cross modulation as a result but this was not the subject of the paper). By coupling a calibrated loop receiver to various metallic structures, varying amounts of the combination signal were noted. Further study showed that these structures, lightning rods and their associated cables for the most part, reradiated over a very small area, ten to fifteen feet in most cases. The nonlinear element in these systems had to be the connection with the earth since they were continuous copper cable throughout. There seemed to be a correlation between the age of the installation and the amount of the combination signal generated. Radio receiving antenna systems also show this nonlinear characteristic at the ground connection. This is probably the main



If your need for instruments is essential enough to give you the right to buy, it is essential enough to rate the *best*.

To those who have searched out the facts, *best* means *Simpson!*

SIMPSON ELECTRIC COMPANY
5212 Kinzie St., Chicago, Ill.

Simpson

INSTRUMENTS THAT STAY ACCURATE

Doolittle



MODEL FD-8 DIRECT READING FREQUENCY MONITOR

- Provides *direct* reading of frequency deviation
- Temperature controlled crystal chamber
- Monitors four frequencies
- Operates on any frequency—1500 to 50,000 KC
- Accuracy of the monitoring frequency is .002 per cent
- Three ranges of measurement—1000, 5000, and 10,000 cycles



- Police Radio Transmitters and Receivers
- Broadcast Transmitters
- Concentric Line and Fittings
- High Frequency Antennae
- Special Radio Apparatus to specifications

Literature and Prices sent on request

MODEL FD-9 FM MONITOR



Direct reading of Center Frequency Deviation, with or without Modulation. Single or Dual frequency operation crystal controlled for maximum stability. Adjustable Flasher for Modulation Limit. High Fidelity Audio Monitor Output. 20 KC Maximum Swing Indication. Center Frequency Deviation Range plus or minus 15 KC for general service. Frequency Range 30 to 40 megacycles.

DOOLITTLE RADIO, INC.

7421 LOOMIS BLVD.

CHICAGO, ILL.

PROFESSIONAL SERVICES

(Rates on Application)

F. ALEXANDER, E. E.

High Vacuum Laboratory, Special Lamps and Tubes, Rare Gases, Fluorescence, Special Glass Apparatuses, Quartz, Pyrex, etc. Metal to Glass Seals, Graded Seals, Quartz to Pyrex or Soft glass, Consulting.

115 West 23rd St., New York

INTERNATIONAL ELECTRONICS, INC.

Special Instruments, Equipment and Methods to control gauging, welding, heating, communications, signaling, safety, inspection, color and testing. Quality control and cost reduction for mechanical, electrical, metallurgical and chemical industries.

Rockefeller Center New York City
Telephone Circle 6-8494

HAROLD J. McCREARY

Mem. A.I.E.E. & W.S.E.

Consulting Engineer

Laboratory Facilities

Research	Electronics
Development	Television
Design	Radio
Factory Practice	Railroads Signaling
Patent Studies	Telephony

105 W. Adams St. Phone STate 4003 Chicago, Ill.

JOSEPH RAZEK, PH.D.

Consulting Physicist

Electrical and Mechanical Engineering Problems, Instruments and Control Devices, Electronics Specialist in Colorimetry, Spectrophotometry and Industrial Color Control
Laboratory and Shop Facilities

430 Greenvlew Lane Lanerch, Pa.

When
time
is
short . . .

put the solution of some of your design or production problems up to some specialized Consultant whose advertisement appears on this page. His broad experience may save you months of costly experimentation.

ELECTRONICS,

330 West 42nd St., New York City

source of the troublesome interference due to the generation of combination signals where the fields concerned are strong. Antenna systems that are balanced against ground do not show the combination signal unless closely coupled to some wiring system or metallic structure with nonlinear characteristics. The doublet antenna with twisted pair transmission line balanced against ground shows a remarkable freedom from the combination signals.

College Session

College men interested in radio as a profession were invited to the technical session on Wednesday morning. The program was especially planned with their interests in mind. J. V. L. Hogan of the Interstate Broadcasting System (WQXR) presented the first lecture entitled "Modern Techniques in Broadcasting", but which was much broader in scope. He first outlined the opportunities for young engineers in radio engineering and how the profession developed from a very small group before the first World War to the present. Toward the end of his talk Mr. Hogan settled down to talk about his official subject matter. Here he stressed the high fidelity aspect of broadcasting and the effect of the introduction of frequency modulation as a factor in broadcasting.

B. J. Thompson of the RCA Manufacturing Co. described some of the outstanding developments of electronics of the past few years. The most important of these are television and the electron microscope which he described in detail. He showed a number of slides to illustrate the operation of the iconoscope and the orthicon, the quality of television pictures transmitted over the Long Island relay system, and also a number of specimens magnified in the electron microscope. A description and demonstration of the newest type of facsimile equipment for transmission of telegrams was presented by J. H. Hackenberg of the Western Union Telegraph Co.

10 KW F-M Transmitter

A paper by E. S. Winlund and C. S. Perry described a 10 kw f-m transmitter installed at W69PH (WCAU) in Philadelphia. The unit consists of an RCA type FM-10A amplifier and a type FM-1B f-m

transmitter and power supply to complete the 10 kw transmitter.

The FM-1B transmitter or exciter has a rating of 1 kw and may be used at frequencies from 26 to 108 Mc. Throughout this frequency range it has been found convenient to use conventional lumped circuits instead of transmission lines or other distributed constant networks. Resonant tuning for the grid tank circuit is accomplished by means of a motor driven condenser shunting a three-quarter wavelength tuning line at an impedance matching point. To insure non-critical tuning, the shafts of the motors are geared to rotate one revolution in 20 min. although only 15 deg. of arc are required. A type 807 tube is used as an electron-coupled oscillator and this is modulated by two type 807 reactance tubes to provide the required frequency modulation. To maintain the high degree of frequency stability required, the Crosby automatic frequency control circuit is provided to hold the average carrier frequency within close limits. A separate quartz crystal controlled oscillator is arranged so that its output excites one grid of a type 1613 mixer tube. The other grid of this tube is supplied with energy from a type 807 amplifier stage following the oscillator. An interlock circuit so arranged that failure of any component in the automatic frequency control circuit actuates a relay which is used to sound an alarm or take the transmitter off the air is also provided.

Two audio frequency input circuits are provided, one following the standard 100 microsecond RMA pre-emphasis curve from 30 to 15,000 cps for high fidelity audio transmission and the other flat from 30 to 25,000 cps to provide for multiplexed transmission of facsimile on a sub-carrier frequency as well.

The 10-kw amplifier employs a pair of 889-R tubes which are excited by the 1-kw unit. The measured distortion between 30 and 15,000 cps at 100 kc deviation is 1 percent and the frequency response curve is well within the plus or minus 1 db limit. The f-m noise level is more than 70 db down, and the amplitude modulated hum 64 db down. Further details on this paper will not be given at this time since it is anticipated that an article on this transmitter will appear in an early issue of ELECTRONICS.

The largest attendance at any of the technical sessions occurred for the series of papers given on Wednesday evening. The first paper, on the absolute sensitivity of radio receivers was delivered by Dr. D. O. North, of the RCA Manufacturing Company, Harrison, N. J., who described the method for rating and measuring the noise in a complete receiving system including the antenna. It was shown that the total random noise originating in a receiver had customarily been described in terms of equivalent noise voltage at the receiver input terminal. Comparison of the signal-to-noise ratios of two receivers working out of identical antennas is facilitated through the use of this conception, but only so long as the coupling between the antenna and receiver input is extremely loose. The method of rating and determining random noise proposed by Dr. North is particularly applicable to u-h-f services or to any service in which the signal-to-noise ratio is a prime consideration in receiver design. A mathematical theory of noise was developed which included a formula for the determination of absolute sensitivity. This equation shows that the minimum usable signal-field strength is related to the operating wavelength, the antenna directivity, the local noise field strength, the receiver bandwidth and a number called the noise factor which is a basic measure of the internal noise source of the receiver.

A companion paper on an analysis of signal to noise ratio of u-h-f receivers was presented by E. W. Herold of the RCA Manufacturing Company. Particular attention was given to the generation of noise in

the first tube of a receiver and equivalent circuits were developed illustrating the use of equivalent generators for producing the noise. It was shown that the equivalent noise voltage, the bandwidth, the signal voltage on the grid of the first tube, and the signal-to-noise ratio varied with the coupling m of the output or antenna transformer. These variations were illustrated in a curve in

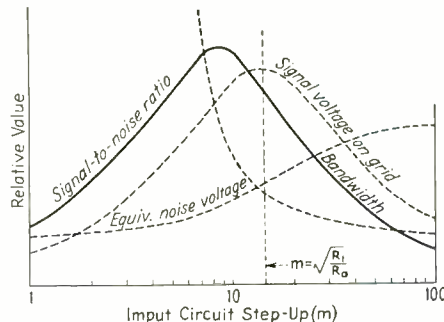
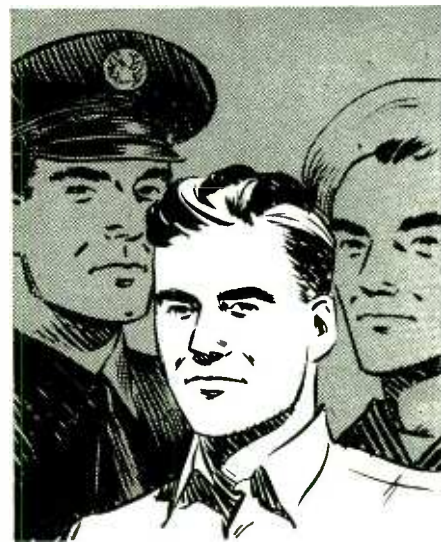

Fig. 9—Operation of high frequency receivers, as affected by noise, plotted as a function of step-up ratio of the antenna or input coupling transformer m

which it was evident that the optimum signal-to-noise ratio occurs for a smaller value of m than the value for maximum signal voltage on the grid. It was also shown that the adjustment of the coupling for the best signal-to-noise ratio was somewhat more critical than the adjustment for maximum gain but in general produced the more desirable results. Some mention was also made of the effects of various types of tubes used as converters and the effects of operating the oscillator at a harmonic.

I. E. Fair presented a paper entitled "A New Direct Crystal Control Oscillator for Ultra-Shortwave Frequencies" by W. T. Mason and I. E. Fair of the Bell Telephone Laboratories. Fundamentally the oscillator made use of quartz crystals oscil-

• To Serve Well the Professional Radioman



The STRONGEST DEFENSE

for the technical radioman who wants to be a success

CREI ARMS YOU with the ability to succeed . . . at a time when technical ability is more important than ever

Every technical radioman has a responsibility to his company and to his country to work at top efficiency. In the face of the present emergency CREI training takes on new importance—becomes the *strongest defense*—for professional radiomen who realize that technical ability is more important than ever today. In improving your own technical ability you are performing a duty to your country, your company and *yourself*. NOW is a better time than ever before to prepare yourself for the important, better-paying positions in radio engineering. No matter how arduous your duties now, a CREI planned system of study for your self-improvement during your spare hours will pay great dividends. More than 5000 professional radiomen are doing it now. How about you?

Write for facts today!

Let us send you our interesting booklet, together with personal recommendations for your advancement in radio through a planned program of technical training. To help us intelligently answer your inquiry, please state briefly your education, radio experience and present position.



CAPITOL RADIO ENGINEERING INSTITUTE

E. H. RIETZKE, President

Dept. E-2, 3224—16th Street, N.W.
WASHINGTON, D. C.

Contractors to the U. S. Signal Corps
Contractors to the U. S. Coast Guard
Producers of Well-trained Technical Radiomen for Industry

WAXES • COMPOUNDS for ELECTRICAL INSULATION

Zophar offers prompt service on Insulating Compounds for a wide variety of electrical applications, including:

. . . insulation for CONDENSERS, TRANSFORMERS, COILS, power packs, pot heads, sockets, wiring devices, wet and dry batteries, etc. Also WAX SATURATORS for braided wire and tape. WAXES for radio parts.
Special compounds made to your order.

ZOPHAR MILLS INC.
130-26th St. Brooklyn, N. Y.
FOUNDED 1846

lating at a multiple of the natural frequency of oscillation with the crystal oscillating in several modes of vibration. It was shown that a crystal operating with an even number of modes produced no useful output voltage but that when the crystal oscillated at 1, 3, 5, 7 or other uneven modes of oscillation, a useful output voltage could be obtained. Special crystal holders were designed to make use of such modes of oscillation and the crystals were used in a type of bridge network which took particular advantage of their capability at high frequencies. It was reported that crystals had been used to control the frequency of oscillators up to as high as 197 Mc. With this system, it is possible to obtain the frequency stability which is customary with crystal controlled circuits and to extend the range of operation into that region between those frequencies normally controlled by quartz crystals and those which are controlled by transmission lines or other networks of distributed circuit constants.

The final paper of the session by Andrew Alford and A. G. Kandoian of International Telephone & Radio Laboratories discussed "An Ultra-High Frequency Two-Course Radio Range with Sector Identification". It was shown that earlier types of the A-N radio beacon produced a certain amount of off-course ambiguity which was undesirable since it did not permit the operator to relocate himself if he should accidentally lose the course. A primary objective in designing the new radio range beacon was to eliminate this off-course uncertainty.

Visual as well as aural indications of the course were provided in the new beacon and the radiated patterns were so distributed in space and in signal character so that at any time the operator could determine his position with respect with the radio range beacon even though off course by as much as 10 deg. either side of the center line.

Mr. Kandoian described the work involved in producing the complicated radiation patterns to transmit the carrier and sidebands for the visual and aural signals without interference or inter-reaction between the antenna elements. The results of the completed installation were found to be in good agreement with the theoretical radiation pattern.

SEARCHLIGHT SECTION

(Classified Advertising)

EMPLOYMENT: "OPPORTUNITIES" : EQUIPMENT
BUSINESS: : USED OR RESALE

UNDISPLAYED RATES
10 CENTS A WORD, MINIMUM CHARGE \$2.00
Positions Wanted (full or part time salaried employment only) ½ the above rates payable in advance.
Box Numbers—Care of publication New York, Chicago or San Francisco offices count as 10 words.
Discount of 10% if full payment is made in advance for 4 consecutive insertions.

DISPLAYED
Individual Spaces with border rules for prominent display of advertisements. The advertising rate is \$6.00 per inch for all advertising appearing on other than a contract basis. Contract rates quoted on request.
An advertising inch is measured ¾" vertically on a column—3 columns—30 inches to a page.

ENGINEER WANTED

for manufacture of
RADIO CRYSTALS

capable of erecting a new plant and knows how to supervise its operation. Tell us your experience in detail. Location near Phila. Address your reply to

MR. J. L. HAWLEY,

P. O. Box 4204 Phila., Pa.

POSITIONS VACANT

ELECTRONIC ENGINEER young man under 35 as research and design engineer with Vacuum Tube hearing aid company, must be graduated EE with some electronic and acoustical experience desirable. Unusual opportunity to progress with company. Compensation secondary to proveable ability. Give age, complete education, experience and telephone number. Present staff know of this opening. Apply in complete confidence, P-296, Electronics, 330 W. 42nd St., New York, N. Y.

MECHANICAL ENGINEER WANTED. Experienced product designer having technical training. Work will be establishing design and supervision of production engineering for mechanical parts and mountings for interesting national defense radio and electrical products. This work will develop into a line of commercial electronics products after the present emergency is over. Write giving information covering education and experience. Salary arranged. All communications will be treated confidentially. Raytheon Manufacturing Company, 199 Willow Street, Waltham, Massachusetts.

ELECTRICAL ENGINEER, with considerable editorial experience, for position on editorial staff of leading industrial paper. College publication experience will count. Should be between 30 and 38. Give age, education, experience, present connection, salary expected. Include photograph. All replies will be held in strict confidence. P-309, Electronics, 330 W. 42nd St., New York, N. Y.

ENGINEER WANTED by Ohio manufacturer to develop and design airport lighting fixtures, beacon and flood lights. Must be thoroughly experienced lighting engineer on this or similar class of work. Good opportunity. P-310, Electronics, 520 N. Michigan Avenue, Chicago, Ill.

CRYSTAL ENGINEER: If you have sufficient experience to assist in design and supervision of all departments here is opportunity for permanent position and advancement with progressive organization with Government contract in large midwestern city. Full particulars please. P-311, Electronics, 520 N. Michigan Avenue, Chicago, Ill.

ELECTRICAL ENGINEER for the development of sound systems, oscillators and other electronic equipment. Must be thoroughly experienced and have excellent knowledge of current equipment. Good opportunity. P-316, Electronics, 520 N. Michigan Ave., Chicago, Ill.

POSITIONS WANTED

MAN 37 with 11 years experience in Sound and Radio engineering desires change in position. New England or New York City district only. PW-308, Electronics, 330 W. 42nd St., New York, N. Y.

HIGH GRADE USED

ELECTRON TUBE MACHINERY

Huge Stock of Every Type and Variety

KAHLE ENGINEERING CORPORATION

Specialists in Equipment for the manufacture of Neon Tubes, Radio Tubes, Incandescent Lamps, Photo Cells, X-ray Tubes, etc.

900 DeMott St., North Bergen, N. J.

DEPENDABLE

Used

ELECTRONIC TUBE EQUIPMENT

Complete line of used equipment for the manufacture of Radio Tubes, Neon Tubes, Incandescent Lamps, etc. Write for Bulletin showing 25 to 75%

CALLITE TUNGSTEN CORPORATION

formerly Eisler Electric Corp.
534 39th Street, Union City, N. J.

BEST QUALITY, USED

ELECTRON TUBE MACHINERY

Equipment for the manufacture of all kinds of electron tubes, radio tubes, incandescent lamps, neon tubes, photo electric cells, X ray tubes, etc.

AMERICAN ELECTRICAL SALES CO., INC.

65-67 East 8th St. New York, N. Y.

NOTICE

OLD TRANSMITTING TUBES ARE VALUABLE

You can make your old tubes worth 50% of their new cost by having them rebuilt. Contact us for further particulars.

Freeland & Olschner

922 Howard Ave. New Orleans, La.

POSITIONS WANTED

LIAISON ENGINEER. Electro-mechanical engineer, now employed, desires vocation re-association as industrial technologist to manufacturer. Extensive radio presence as laboratory technician, technical writer, schematic draftsman, model designer, and amateur operator; circuit patent holder. Experienced in modern production methods for precision and defense manufacture. Knowledge of automatic (screw) machines machine shop practice, apprentice instruction, routing inspection, time study, special project supervision and production schedules. American-born citizen, age 30, offers versatile experience with practical training, technical knowledge, academic education—Ph. D. Socially congenial, assiduous, honest, responsible character. PW-312, Electronics, 330 W. 42nd St., New York, N. Y.

ENGINEER desires part-time work writing or editing instruction manuals for radio and electronic equipment. Located in Washington, D. C.; thoroughly familiar with Signal Corps Instruction Book specifications. Will supervise illustrating and printing if desired. PW-313, Electronics, 330 W. 42nd St., New York, N. Y.

ELECTRONIC ENGINEER, excellent background, experienced in industrial applications, control and measurement, wants responsible position in this line. PW-314, Electronics, 520 N. Michigan Ave., Chicago, Ill.

ELECTRICAL ENGINEER and Physicist (Ph.D.) 29, experienced in high-frequency, sound, thermionic tubes, photo-electric cells, gas-discharges, high-vacuum, good mechanical background, machine-shop practice, seeks adequate responsible position research, development, design. PW-315, Electronics, 520 N. Michigan Ave., Chicago, Ill.

CONTACTS

FOR THE FIELD OF ELECTRONICS

Avoid Die Expense

and time delay in making a great variety of parts or pieces with DI-ACRO Bender, Brake, Shear—"Metal Duplicating Without Dies". For instance the DI-ACRO SHEAR NO. 1 Trims or squares duplicated stampings, cuts strips, makes slits or notches. Shearing width 6". All DI-ACRO Machines are accurate to .001".



Send for Catalog

O'NEIL-IRWIN MFG. CO.

321-8th Ave. S.,
Minneapolis, Minn.



DEFENSE REQUIREMENTS

ELECTRICAL COIL WINDINGS & TRANSFORMERS

An experienced organization at your service prepared to assist in design or cooperate on problems.

DINION COIL COMPANY

P.O. BOX D CALEDONIA, N. Y.

University
SOUND SYSTEMS
for
NATIONAL DEFENSE
require
the finest loudspeakers
Specify
UNIVERSITY REFLEX
The only complete loud-
speaker line which solves
ALL
Defense Sound Problems
University Laboratories
195 Chrystie St., N. Y. C.

LECTROHM

Vitreous Enameled
RESISTORS

A complete range, from 1 to 200 W. wound with highest grade resistance wire. Tolerances plus or minus 5% (closer tolerances, if needed).
Wound on low loss ceramic cores. Mounting legs furnished when requested.

SEND FOR SAMPLES
Give complete data regarding resistance, maximum current, voltage drop required and mounting space available.

LECTROHM, INC.
5131 WEST 25TH PLACE
CHICAGO (CICERO P.O. 1111)



**SIGNAL & INDICATOR
PILOT LIGHTS**
for all electrical devices.
WRITE FOR CATALOGUE
showing a complete line of
assemblies for all purposes.
SIGNAL INDICATOR Corp.
140 CEDAR ST. NEW YORK, N. Y.

We manufacture a complete line of equipment

SPOT WELDERS, electric, from 1/4 to 500 KVA	AC ARC WELDERS From 100 to 400 Amps.
TRANSFORMERS, special and standard types	
INCANDESCENT LAMP manufacturing equipment	
FLUORESCENT TUBE MAKING EQUIPMENT	
ELECTRONIC EQUIPMENT: vacuum bombs, etc.	
WITH GLASS slicing and cutting machines for laboratory use	
CENTRAL GLASS working units and burners	
COLLEGE GLASS working units for students and laboratory	

EISLER ENGINEERING CO.
751 So. 13th St. (near Avon Ave.) Newark, New Jersey

MICROMETER for
FREQUENCY checking
METER from 1.5 to 56 mc.,
within 0.01 per cent.
LAMPKIN LABORATORIES
Bradenton, Fla., U. S. A.

DON'T LET A FEW NEEDED
PARTS HOLD UP THE
PRODUCTION SCHEDULE
HARVEY HAS THEM
IN STOCK

HARVEY RADIO CO.
103 WEST 43 STREET • NEW YORK, N. Y.

Rex Rheostat Co.
3 Foxhurst Road, Baldwin • L. I., N. Y.

Write
For
Details

1 2

COMPARE THESE FIGURES!
Fig. 1 DAMAGED WINDING using METAL BRUSHES. Fig. 2: UNDAAGED WINDING using same brush with REX-LUBRICATOR

**CRYSTALS by
HIPOWER**

The Hipower Crystal Company, one of America's oldest and largest manufacturers of precision crystal units, is able to offer the broadcaster and manufacturer attractive prices because of their large production and the exclusive Hipower grinding process. Whatever your crystal need may be, Hipower can supply it. Write today for full information.

HIPOWER CRYSTAL CO.
Sales Division—205 W. Wacker Drive, Chicago
Factory—2035 Charleston Street, Chicago, Ill.

We welcome your inquiries for
LUMINESCENT MATERIALS
Fluorescent and Phosphorescent Chemicals for Lamp and Allied Industries
GENERAL LUMINESCENT CORP.
732 S. Federal St. Chicago, Ill.

**DO YOU NEED
RADIO/ELECTRONIC
PARTS IN A HURRY?**

Save time—
call **HARRISON first!**
RADIO CO.
12 West Broadway N.Y.C.
Phone **WORTH 2-6276**

HARVEY RADIO LAB'S, Inc.
Manufacturers of
Radio Transmitters
ELECTRONIC APPARATUS
447 Concord Ave., Cambridge, Mass.

New Handy
**UNIVERSAL
REPLACEMENT**
Capacitors

Write for
Catalog

SOLAR MFG. CORP., Bayonne, N. J.

FINE RIBBONS
of Tungsten and Molybdenum
Molybdenum in widths .006" to 1"
in thickness to .0005"
Tungsten Ribbon to specification
H. CROSS
15 Beekman St. New York

V-M

ATTAINING perfection is a slow process. Only recently, engineers strove for 7,500 cycles. Again AUDAX came through and mastered wide range so thoroughly that, today, even the lowest priced MICRODYNE has a range to over 7,000 cycles—other models over 10,000 cycles.—However, just as ability to reach high “C” does not mean a quality voice,—so wide range by itself, in a pickup, does not mean quality performance. It is the all important factor of “VIBRATORY-MOMENTUM” that determines quality. Not only does V-M control quality, but is also a serious factor in record wear. Needle pressure, needle impedance, etc., are comparatively secondary.

AUDAX succeeded in reducing “VIBRATORY-MOMENTUM” almost to the vanishing point—finally banishing that down-in-the-cellar effect.—All this bears out the contention of leading scientists that *only the Inductor Principle* makes possible high quality results—and this means MICRODYNE

“The Standard by Which Others Are Judged and Valued”

With or without Jewel Point, the sharp clean-cut facsimile reproduction of MICRODYNE—regardless of climatic conditions—is a marvel to all who have put it to the only test that really counts . . . the EAR test.

WITH OUR COMPLIMENTS

A copy of “PICKUP FACTS” is yours for the asking. It answers many questions concerning record reproduction.

Pickup List Prices

\$11.50 to \$198.00

HIGH FIDELITY CUTTERS

List to \$150.00

AUDAK COMPANY

500 Fifth Avenue New York City

[In Chicago, phone: Webster 4840]

“Creators of High Grade Electrical and Acoustical Apparatus since 1915.”

INDEX TO ADVERTISERS

Abbott Instrument, Inc.	103	Johnson Co., E. F.	80
Acheson Colloids Corp.	94	Jones, Howard B.	102
Advance Solvents & Chemical Corp.	57	Kenyon Transformer Corp.	92
Aerovox Corp.	97	Kester Solder Co.	62
Allied Control Co.	107	Keuffel & Esser Co.	3
Allied Radio Corp.	94	Lampkin Laboratories	119
American Lava Corp.	13	Lamson & Sessions Co.	19
American Screw Co.	19	Lapp Insulator Co.	15
American Television & Radio Co.	111	Lectrohm, Inc.	119
American Transformer Co.	18	Lingo & Son, Inc., John E.	101
Amperex Electronic Products.		Lord Manufacturing Co.	73
	Inside Front Cover	Mallory & Co., Inc., P. R.	20
Astatic Corp.	64	McGraw-Hill Book Co., Inc.	90, 111
Audak Co.	120	Meissner Mfg. Co.	102
Automatic Electric Co.	100	Millen Mfg. Co., Inc., James.	108
Ballantine Laboratories, Inc.	106	National Company	88
Bendix Aviation, Ltd.	5	National Screw & Mfg. Co.	19
Blaw-Knox Co.	91	New England Screw Co.	19
Bliley Electric Co.	92	Ohmite Mfg. Co.	55
Brand & Co., William	16	O'Neil-Irwin Mfg. Co.	119
Bristol Co.	19	Panoramic Radio Corp.	56
Bud Radio, Inc.	99	Parker Co., Charles.	19
Callite Tungsten Corp.	84	Parker-Kalon Corp.	19, 67
Capitol Radio Engineering Institute.	117	Par-Metal Products Corp.	105
Carborundum Co.	112	Pawtucket Screw Co.	19
Cardwell Mfg. Corp., Allen D.	66	Pheoll Mfg. Co.	19
Carter Motor Co.	94	Pioneer Gen-E-Motor Corp.	101
Catalin Corporation	7	Precision Tube Co.	89
Centralab Div., Globe-Union, Inc.	2	Raytheon Mfg. Co.	114
Central Screw Co.	19	RCA Mfg. Co., Inc.	Back Cover
Chandler Products Corp.	19	Remler Co., Ltd.	104
Chicago Transformer Corp.	83	Rex Rheostat Co.	119
Cinch Manufacturing Corp.	51	Russell, Burdall & Ward Bolt & Nut Co.	19
Clarostat Mfg. Co.	108	Seovill Mfg. Co.	19
Continental Screw Co.	19	Shakeproof Lock Washer Co.	19
Corbin Screw Corp.	19	Shure Brothers	74
Cornell-Dubilier Electric Corp.	17	Signal Indicator Corp.	119
Cross, H.	119	Simpson Electric Co.	115
Daven Co.	Inside Back Cover	Sola Electric Co.	100
Dionin Coil Co.	119	Solar Manufacturing Corporation.	119
Doolittle Radio, Inc.	115	Sound Apparatus Co.	109
Driver Co., Wilbur B.	109	Southington Hardware Mfg. Co.	19
DuMont Labs., Allen B.	105	Stackpole Carbon Co.	82
Dunn, Inc., Struthers.	4	Standard Pressed Steel Co.	104
Eicor, Inc.	105	Sprague Specialties Co.	69
Eisler Engineering Co.	119	Taylor Fibre Co.	114
Eitel-McCullough, Inc.	63	Terminal Radio Corp.	101
Electrical Research Products, Inc.	99	Thomas & Skinner Steel Products Co.	114
Electro-Voice Mfg. Co., Inc.	104	Thordarson Electric Mfg. Co.	58
Eric Resister Corp.	10	Triplett Electrical Instrument Co.	97
Ferranti Electric, Inc.	107	University Laboratories	119
Formica Insulation Co.	8	Ward Leonard Electric Co.	12
Franklin Mfg. Co., A. W.	59	Webster Electric Co.	76
General Aniline Works.	57	Western Electric Co.	79
General Electric Co.	9	Weston Electrical Instrument Corp.	75
General Luminescent Corp.	119	White Dental Mfg. Co., S. S.	95, 113
General Radio Co.	77	Wilson Co., H. A.	95
G-M Laboratories, Inc.	103	Whitney Screw Corp.	19
Guardian Electric Mfg. Co.	68	Zophar Mills, Inc.	117
Hallicrafters Co.	102		
Hammarlund Mfg. Co., Inc.	6	Professional Services	116
Hardwick Hindle, Inc.	14		
Harrison Radio Co.	119	SEARCHLIGHT SECTION	
Harvey Radio Co., Inc.	119	<i>(Classified Advertising)</i>	
Harvey Radio Lab's, Inc.	119	EMPLOYMENT	118
Heintz & Kaufman, Ltd.	71	USED EQUIPMENT FOR SALE	
Hewlett-Packard Co.	78	American Electric Sales Co., Inc.	118
Hipower Crystal Co.	119	Callite Tungsten Corp.	118
Hudson Wire Co.	113	Freeland & Olshner	118
Hunter Pressed Steel Co.	65	Kahle Engineering Corp.	118
Instrument Resistors, Inc.	109		
International Resistance Co.	53		
International Screw Co.	19		
International Telephone & Radio Mfg. Corp.	11		
International Telephone & Telegraph Corp.	60, 61		
Irvington Varnish & Insulator Co.	70		
Isolantite, Inc.	87		

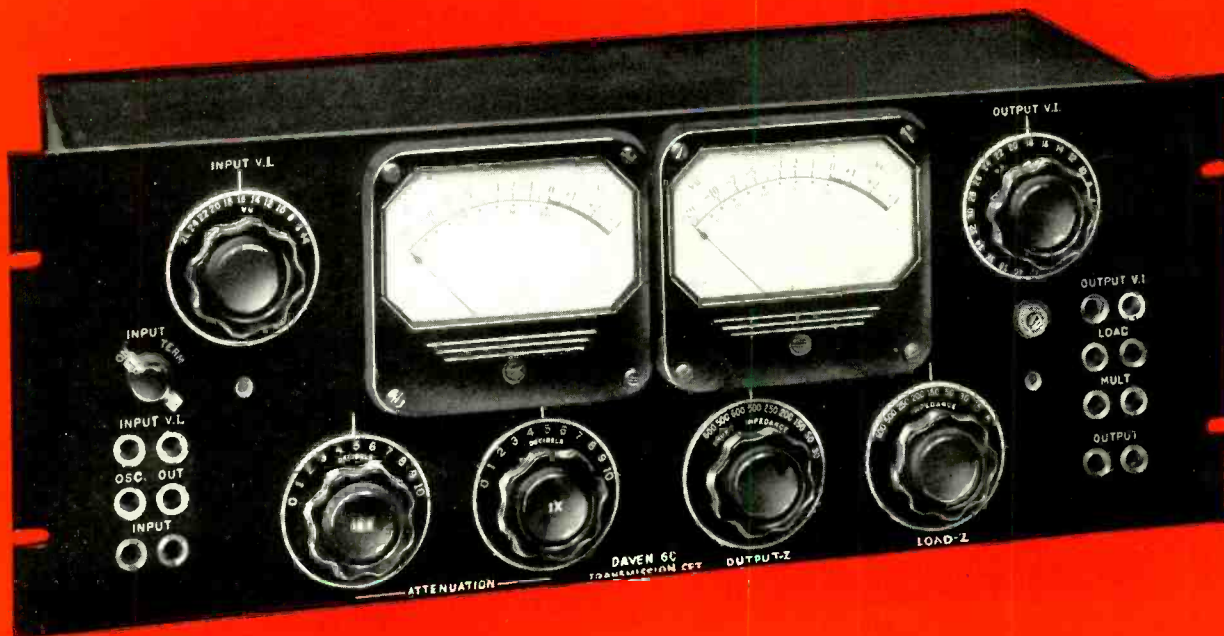

TYPE 6-C

TRANSMISSION MEASURING SETS

TYPE 6-C Designed in co-ordination with the General Engineering Department of the Columbia Broadcasting System, the 6-C Transmission Measuring Set consists of complete transmission and load units assembled on a single rack type panel. With a frequency range from 30 to 17,000 cycles, this set provides an accurate and rapid method for measuring the transmission characteristics of networks at audio frequencies.

The reference level is the new standard of 1 mw. across 600 ohms. New Weston Type 30 meters are employed. The attenuation range is from Zero to 110 db. in steps of 1 db. Power range is calibrated from -16 to +45 db. Dial selection of useful network input and load impedances. No correction is required when changing impedances. Overall error is 2%..... **\$325**

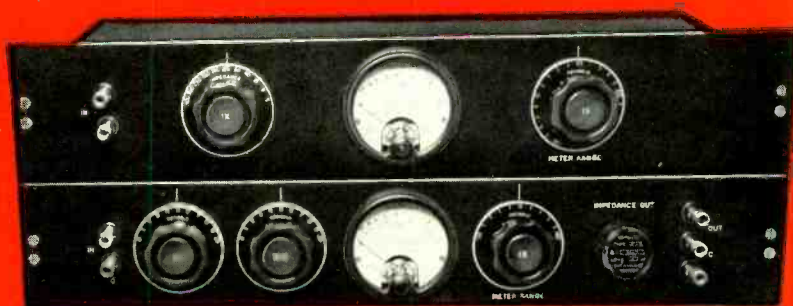
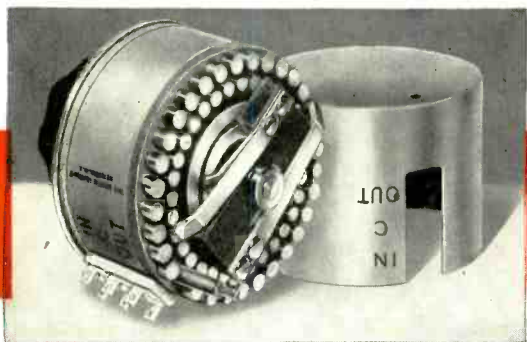

TYPE 685

TYPE 685 An unusually flexible, universal gain measuring instrument for rapid and accurate measurement of overall gain, frequency response and power output of audio amplifiers, this assembly has a useful frequency range from 30 to 17 000 cycles.

It is direct reading in decibels and does not require correction factors or calibration charts. All networks meters and associated apparatus are shielded and carefully balanced, matched for uniform accuracy over this wide frequency range.

Attenuation range is +10 db. to -120 db. in steps of 1 db. Power measuring range is -20 db. to +36 db. Eleven load impedance values, ranging from 5 to 600 ohms are available. Output impedances may be changed from "balanced" to "unbalanced" and to any loss impedance by means of plug-in type matching networks. Overall error is 2%..... **\$225**

Many of your needs can be filled by standard DAVEN equipment. However, due to the specialized nature of high fidelity audio apparatus, a large number of requirements are encountered where existing units may not be suitable. If you have such a problem, write to our engineering department.

THE DAVEN COMPANY

158 SUMMIT STREET

NEWARK, NEW JERSEY

MOST COMPLETE LINE OF PRECISION ATTENUATORS IN THE WORLD

USE THESE RCA TRANSMITTING TUBE INSTRUCTION SHEETS AS YOUR GUIDE



RCA
891
R-F Power Amplifier, Modulator

RCA-891 is a three-electrode transmitting tube of the double-filament type for use as a radio-frequency amplifier, oscillator, modulator and Class B modulator. The construction of this tube is capable of dissipating 450 watts in operation from direct current, for all classes of operation in which the tube is used.

RCA
833-A
R-F Power Amplifier, Class B Modulator

RCA-833-A is a three electrode transmitting tube of the high-mu type having a maximum plate dissipation rating of 450 watts (100% efficiency). It is for use as a radio-frequency amplifier, oscillator, modulator. Because of its high perveance, the construction of this tube is capable of dissipating 450 watts in operation from direct current, for all classes of operation in which the tube is used.

DUAL RATINGS

These tubes are designed for a system of dual ratings compatible with the service.

RCA
807
Transmitting Beam Power Amplifier

RCA-807 is a beam power transmitting tube of the heater-cathode type having a maximum plate dissipation rating of 30 watts (100% efficiency). It is for use as a radio-frequency amplifier, oscillator, modulator, and Class C telegraph service (ICAS). The construction of this tube is capable of dissipating 30 watts in operation from direct current, for all classes of operation in which the tube is used.

INSURE LONGER LIFE FOR TUBES THAT MAY BE DIFFICULT TO REPLACE!

FOR LONGER TUBE LIFE—

For types using pure tungsten filaments, a reduction in filament voltage greatly lengthens tube life.

For types using thoriated-tungsten filaments, maintaining filament at rated voltage results in longer life. Operation either under or over normal voltage may result in shorter life.

For types using oxide-coated cathodes, maintain filaments at rated voltage.

For all types, reduce dissipation in grids and plates to a minimum to avoid overloading and to obtain materially longer life.

MANY new Transmitting Tubes for commercial and civilian uses may become even harder to obtain because of the tremendous War-purpose demand. It is, therefore, not only a patriotic duty, but sound business policy as well, for tube users to conserve tube life by observing special care and operating practices which may add thousands of hours of life to tubes now in operation.

It is an old story that RCA Transmitting Tubes are built to withstand plenty of abuse — so much so that abnormal operating conditions are frequently accepted as "normal." Even though tube life has been entirely satisfactory under such conditions, it is by no means as long as might be obtained, simply by careful, conservative use of the tubes as outlined in the Instruction Booklet packed with each one.

In short, these are days when it is essential

to give tubes all the care you can give them. Maximum life now becomes far more important than optimum performance. RCA welcomes the opportunity to cooperate in helping RCA Transmitting Tube users extend tube life to its fullest!

If you do not have Instruction Booklets on the RCA Tube types in your transmitter, write Commercial Engineering Section, RCA Mfg. Co., Inc., Harrison, N. J. for free copies. Be sure to mention type number.



Transmitting Tubes



RCA MANUFACTURING CO., Inc., Camden, N.J. • A Service of The Radio Corporation of America

In Canada: RCA Victor Company Limited, Montreal