

electronics

radio, sound, industrial applications of electron tubes ♦ ♦ ♦ design, engineering, manufacture

Statistics of radio and tube sales

Electronic music

Push-push amplifiers

B-eliminators for auto-radio

Can tubes be exported?

Radio holds up well despite depression — Exports increase.

See pages 77-79

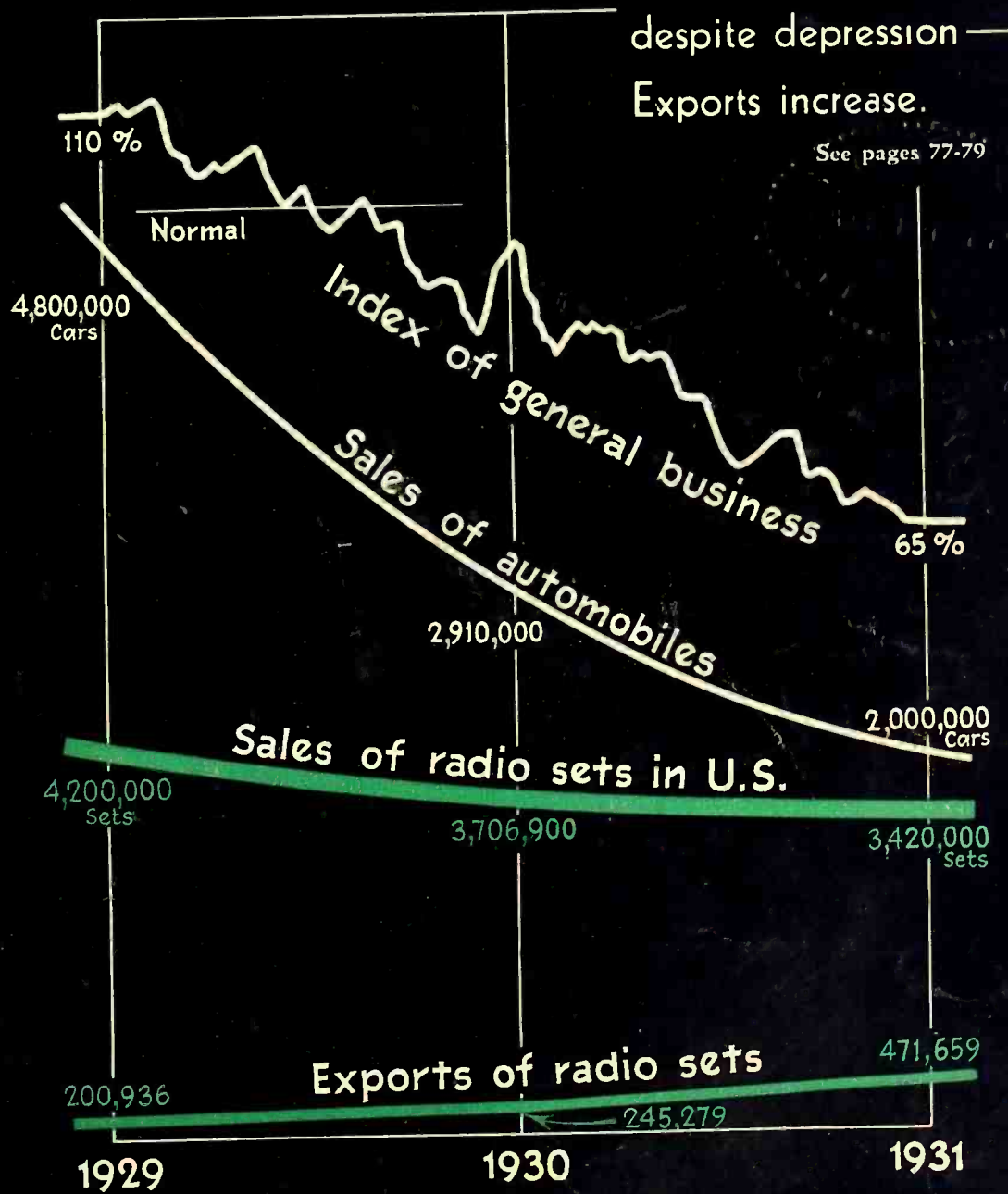

McGRAW-HILL PUBLISHING COMPANY, INC.

Price 35 Cents

MARCH 1932

3

ARCTURUS 50 WATT TUBES

*New, Rugged Design..
Consistently Uniform*

Bringing to transmitting tubes the same skill and quality shown in its receiving tubes, Arcturus announces these newest additions to its line of high-power tubes.

New—not only in performance and stability—but in construction. In developing these new power tubes, Arcturus has incorporated the “unitary structure” principle made famous by the *blue* receiving tubes.

In uniformity, performance and construction, these Arcturus 50-watters establish new standards. Seldom in the swiftly changing history of electronic research has a product been offered that represents such a decided improvement over existing devices. Yet these power tubes are interchangeable with corresponding type numbers, and their advantages are immediately applied to present apparatus.

Technical data bulletins on these three types, as well as Mercury Vapor Rectifiers E766 and E772, are available to interested parties on request.

Arcturus Radio Tube Company, Newark, N. J.

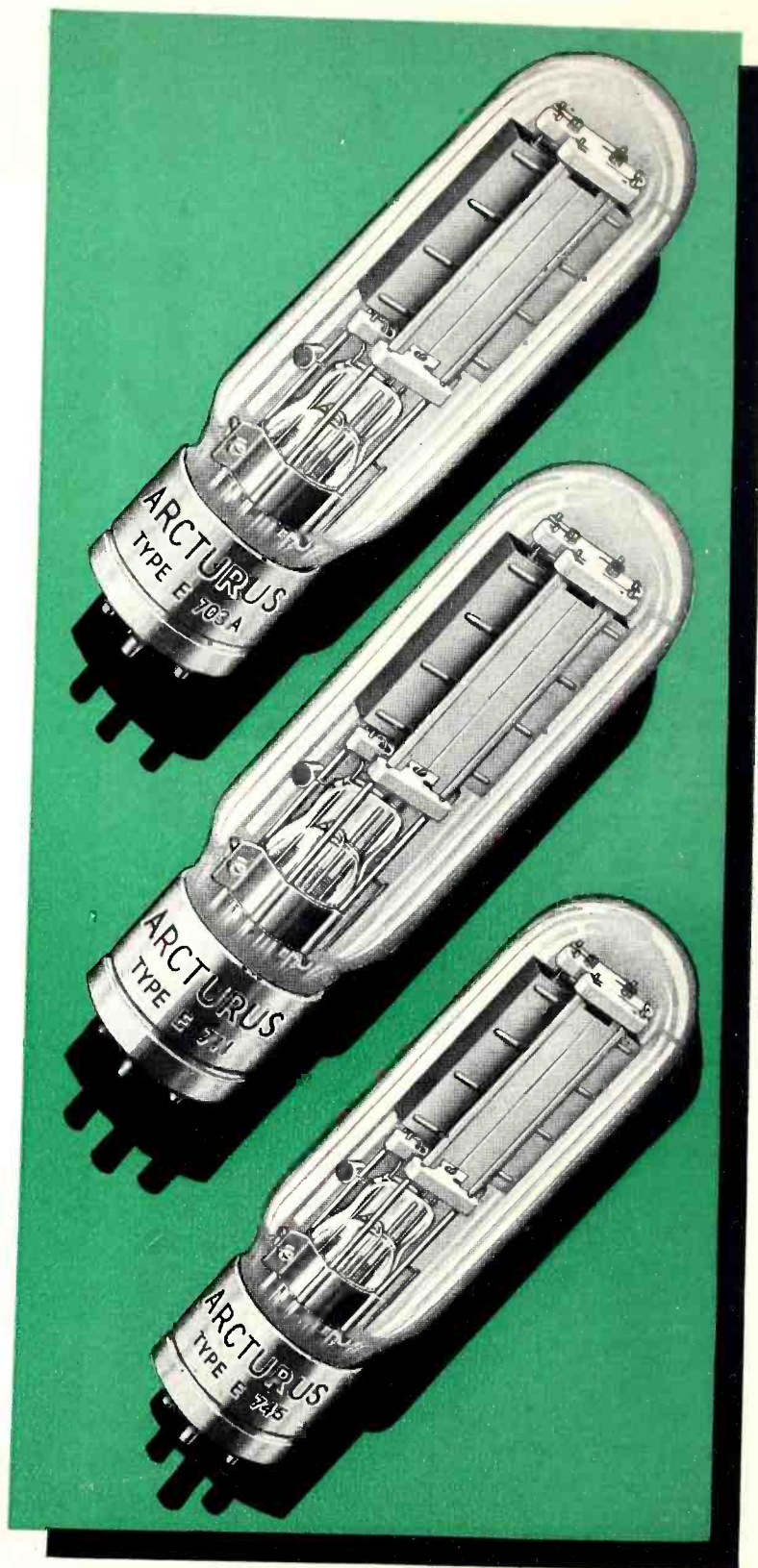

EXCLUSIVE ARCTURUS CONSTRUCTION

Note the extreme rigidity of these tubes. The Unitary Structure principle of interlocking the elements maintains the precise interrelation of parts through interdependence. Each rugged element is securely clamped at the top and bottom and the complete assembly is a sturdy unit—insuring constant uniformity.

This compact unit is supported by a rugged rectangular structure.

The increased area of the plate provides generous heat dissipation resulting in cooler operating temperatures.

ARCTURUS

*Quality Tubes for
Transmitting, Receiving
and Industrial Uses*

electronics

McGraw-Hill Publishing Company, Inc.

New York, March, 1932

O. H. CALDWELL
Editor

KEITH HENNEY
Associate Editor

FRANKLIN S. IRBY, Ph.D.
Contributing Editor

Here are the figures

WITH this issue *Electronics* presents its annual summary of statistics covering production operations of the preceding calendar year. Most interesting of all are the figures for the radio industry in 1931, which may be summarized as follows, all the items being at retail prices:

Products	Units	Dollars
Radio sets (including phonograph combinations, automobile receivers, etc.)	3,420,000*	\$212,040,000†
Radio tubes	53,500,000	69,550,000
Batteries, A, B, C, dry		13,100,000
Miscellaneous accessories		8,580,000
Parts (does not include sales to manufacturers)		6,000,000
Total		\$309,270,000

Particularly significant was the way the number of radio receivers sold held up through 1931, in spite of the drop in general business, sale of automobiles, etc., as shown on the front cover of this issue.

NOTEWORTHY also was the remarkable increase in the number of radio sets exported (471,659 for 1931, as compared with 245,279 for 1930), thus nearly doubling the shipment of American-made sets to countries abroad. Since the figure for 1931 units sales above, 3,420,000 sets, does not include the 471,659 exported abroad, it is apparent that the total 1931 set sales, 3,891,000, compares well with the corresponding total for 1930.

These figures show the magnitude of the radio business even in the second year of the depression. The production of radio receivers, tubes, parts, accessories, etc., at the rate of nearly four million receiving sets a year, is still a huge business and one that has profit possibilities for all, if those in the industry will get back to a basis of sound business operation.

*Does not include 471,659 sets exported during 1931, nor equipment used in centralized-radio or public-address installations, police systems, police cars, etc. The above total of 3,420,000 sets sold in U. S. includes 108,000 automobile radio sets at an average price of \$55 each.
†Does not include tubes shipped with sets, which are listed in tube sales figures in second line.

radio
sound
pictures
telephony
broadcasting
telegraphy
counting
grading
carrier
systems
beam
transmission
photo
cells
facsimile
electric
recording
amplifiers
phonographs
measurements
receivers
therapeutics
traffic
control
musical
instruments
machine
control
television
metering
analysis
aviation
metallurgy
beacons
compasses
automatic
processing
crime
detection
geophysics

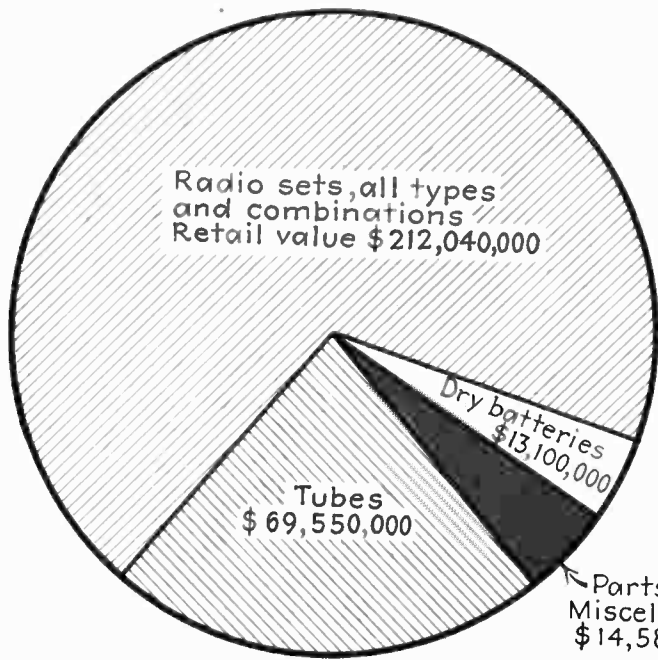

1931 Sales
Retail Values

Ten Years of Radio Sales

Copyrighted by
Electronics
330 West 42d St., New York City

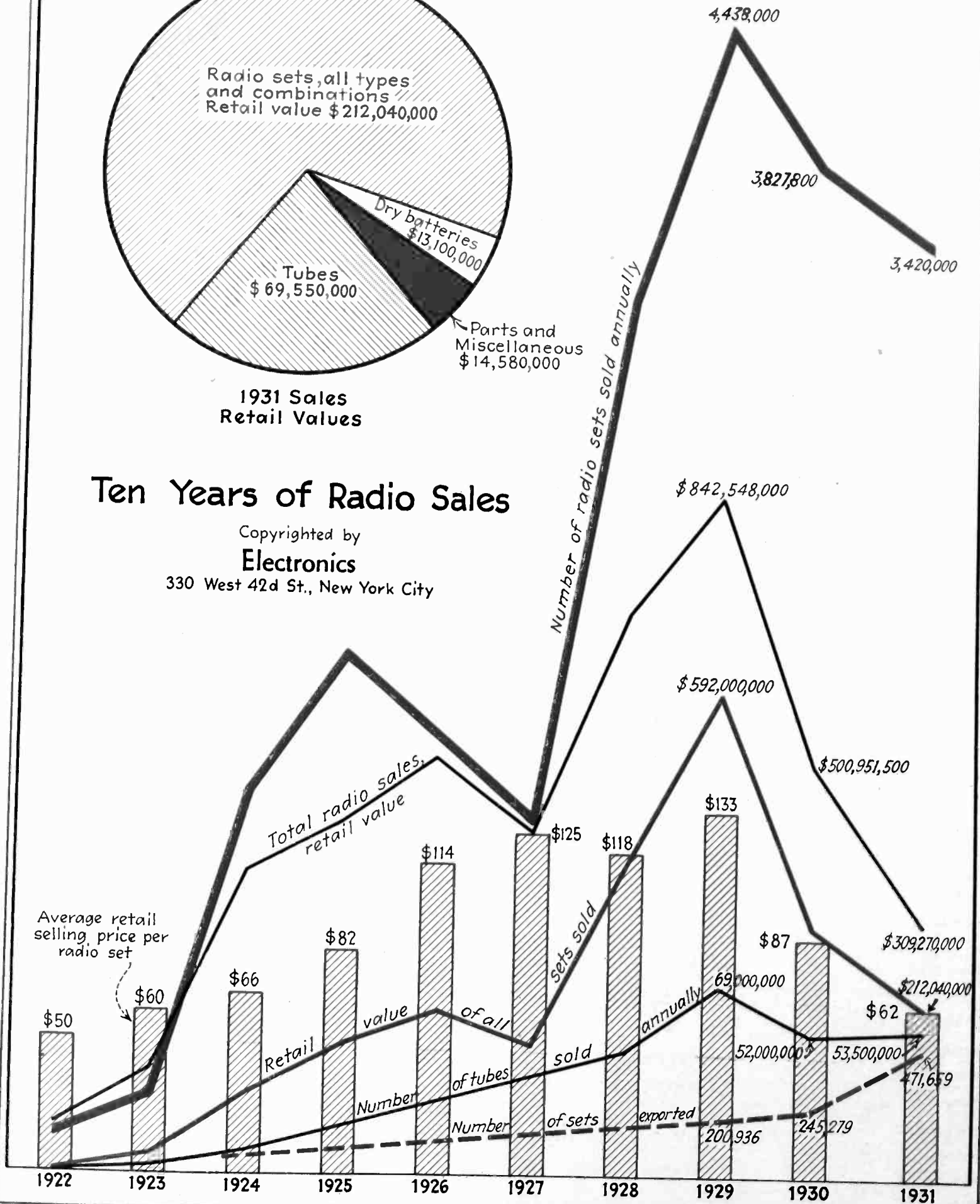

Statistics of radio and sound-pictures

(Statistics in this issue are copyrighted but may be quoted providing credit is given *Electronics*.)

	Total investment United States	Annual gross revenue	Number of employees	Annual payroll
Radio manufacturers, ¹ distributors, etc.....	\$150,000,000	\$309,000,000	² 100,000	\$150,000,000
Broadcasting stations.....	\$25,000,000	\$50,000,000	10,000	\$25,000,000
Listeners' sets (16,500,000).....	\$1,600,000,000			³ \$200,000,000
Commercial radio stations.....	\$25,000,000	\$10,000,000	17,000	\$5,000,000

¹Radio set manufacturers, licensed and unlicensed, now number 155.

²Employes at peak of seasonal employment.

³Annual operating expense of listeners' sets, for tube replacements, electricity, batteries, servicing, etc.

HOMES IN THE U. S. WITH RADIO SETS

State	U. S. census Homes with radio as of April, 1930	Since census Sales to homes with-out radio	Homes with radio as of March 1, 1932
Maine.....	77,803	29,300	107,103
New Hampshire.....	53,111	19,700	72,811
Vermont.....	39,913	14,750	54,663
Massachusetts.....	590,105	218,000	808,105
Rhode Island.....	94,594	35,000	129,594
Connecticut.....	213,821	80,000	293,821
New York.....	1,829,123	675,000	2,504,123
New Jersey.....	625,639	231,000	856,639
Pennsylvania.....	1,076,770	400,000	1,476,770
Ohio.....	810,767	300,000	1,110,767
Indiana.....	351,540	130,000	481,540
Illinois.....	1,075,134	400,000	1,475,134
Michigan.....	599,196	221,500	820,500
Wisconsin.....	364,425	133,300	497,725
Minnesota.....	287,880	106,000	393,880
Iowa.....	309,327	114,000	423,327
Missouri.....	352,252	130,000	482,252
North Dakota.....	59,352	22,000	81,352
South Dakota.....	71,361	26,400	97,761
Nebraska.....	164,324	60,700	225,024
Kansas.....	189,527	70,300	259,827
Delaware.....	27,183	10,000	37,183
Maryland.....	165,465	61,300	226,765
Dist. of Columbia.....	67,880	25,000	92,880
Virginia.....	96,569	35,800	132,369
West Virginia.....	87,469	32,400	119,869
North Carolina.....	72,329	26,800	99,129
South Carolina.....	28,007	10,400	38,407
Georgia.....	64,908	24,000	88,908
Florida.....	58,446	21,600	80,046
Kentucky.....	111,452	41,200	152,652
Tennessee.....	86,229	31,800	118,029
Alabama.....	56,491	20,900	77,391
Mississippi.....	25,475	9,400	34,875
Arkansas.....	40,248	14,900	55,148
Louisiana.....	54,364	19,800	74,164
Oklahoma.....	121,973	45,000	166,973
Texas.....	257,686	95,000	352,686
Montana.....	43,809	16,300	60,109
Idaho.....	32,869	12,200	45,069
Wyoming.....	19,482	7,200	26,682
Colorado.....	101,376	37,500	138,876
New Mexico.....	11,404	4,300	15,704
Arizona.....	19,295	7,150	26,150
Utah.....	47,729	17,600	65,329
Nevada.....	7,869	2,900	10,769
Washington.....	180,229	66,500	246,729
Oregon.....	116,299	43,000	159,299
California.....	839,846	310,000	1,149,846
Total for United States	12,078,345	4,466,900	16,545,245

U. S. LICENSED RADIO TRANSMITTERS

Aeronautical.....	170
Air craft.....	293
Amateur.....	22,739
Broadcasting.....	612
Coastal.....	143
Experimental.....	160
Geophysics.....	113
Marine relay.....	36
Point-to-point.....	297
Police and fire.....	67
Power companies.....	22
Relay broadcasting.....	13
Ships.....	2,213
Television.....	21
Miscellaneous.....	25
Total.....	26,924

RADIO-PHONOGRAPH COMBINATION UNITS

In previous years radio-set figures compiled by *Electronics* and *Radio Retailing* were classified into straight radio sets and radio-phonograph combinations. Thus for the peak year, 1929, the sales of consoles and midgets numbered 4,200,000, and phonograph combinations 238,000,—making a grand total for the year of 4,438,000 sets. Total sales of all types of sets for 1930 numbered 3,827,000, if sales of radio-phonograph combinations for that year are included.

MOTION PICTURE THEATERS THROUGHOUT THE WORLD 1931

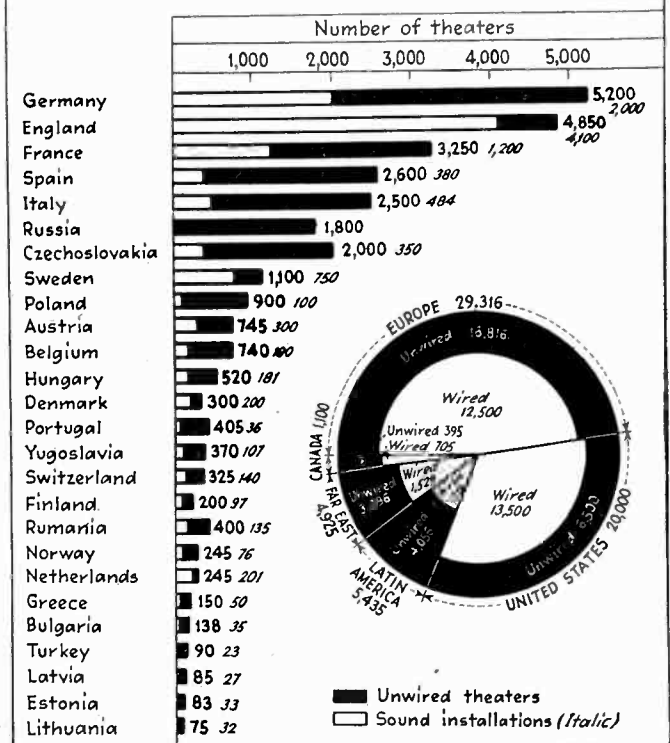

Development of B-battery devices for auto-radio

WITH the advent of gaseous and, later, thermionic rectifiers for use in home radio receivers, the day of the B-eliminator waxed and then waned. Sets, after 1925-1926 were made with built-in power equipment and large scale purchases of batteries by radio listeners were over.

Now, the advent of automobile radio, brings back to mind the days when rotating machinery, chemical rectifiers, and other devices, (complicated, often inefficient, usually noisy, frequently destructive to rugs and floors) formed a part of a radio, a disconnected part at that.

The problem in auto radio, however, is somewhat different and withal more difficult. The task is not merely to get fairly high voltage d.c. out of a.c. (and in the eliminator days the poor regulation and the amount of hum bothered few people) but to get highly pure d.c. at considerable current drain and at higher voltages and all this out of a storage battery, already overburdened. To do this, the battery voltage must be converted to some form of a.c. stepped up in voltage, rectified, filtered, or a rotating machine must be used.

Dynamotor versus interruptor

So far there are two general types of battery substitutes on the market—there are at least eleven devices being sold, all to do away with the necessity of hauling about with the radio three or four B-batteries. The dynamotor type has more adherents to date, probably because the dynamotor art is better known. The vibrator

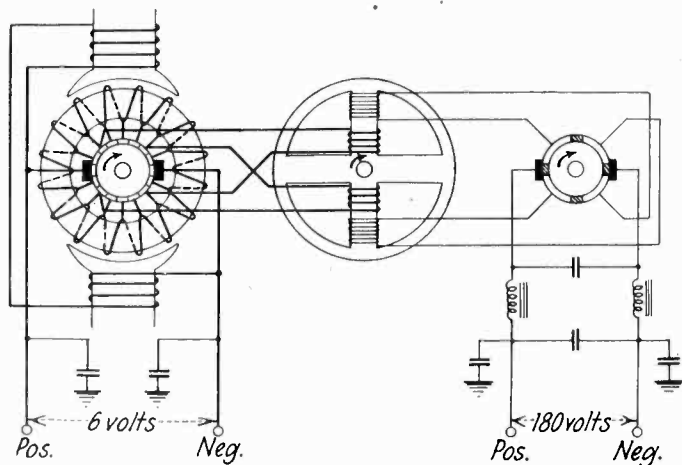

Diagram of ingenious rotary transformer type of eliminator

type, of which there are several variations, interrupts the d.c. to get a pulsating wave of some form, which is stepped up, rectified and then filtered. A smoothing circuit is provided for all the units, and is included in the prices shown in the accompanying table. The dynamotor has a commutator ripple which must be ironed out, the vibrator types produce radio frequency disturbances which must be kept from entering the receiver through the plate-voltage supply. The smoothing circuits vary from conventional choke-condenser affairs to resistance capacity filters. Some use as much as 16 mfd. capacity next to the receiver, several are two-section brute force systems, others have parts of the filter tuned to the offending frequency.

Prices, required space, battery drain

Manufacturers of these units are almost unanimous in encouraging the car owner to boost the charging rate of his generator. The actual battery drains vary from below 2 amperes to six or seven amperes. The average is about 3 amperes with an efficiency of approximately 40 per cent. The table given herewith shows the essential data on eleven makes now on the market. These are the units on which *Electronics* has been able to get information from the manufacturer. There are several other units in process of development, and it is reasonable to expect to see other names in the field before summer begins to make serious demands on manufacturers of auto-radio receivers.

In general the units will fit into the same space or less than is required by equivalent voltage supply from B-batteries. One unit takes the room required by a single heavy-duty battery and draws as much current as the parking lights of the average automobile. Another manufacturer states that the device will pay for itself within less than a year in eliminating the battery renewal problem.

All things considered the designers of the units described in the table seem to have done very well in attaining the minimum possible drain from the car battery, an essential feature that is well recognized. Efficiencies of the order of 35 to 50 per cent are attained by nearly all the units. A good idea of the performance under load of such devices may be obtained from the curves shown here, as well as from the table below giving characteristics of the Generator, (U. S. Electric Works.)

Estimates on the 1932 output and sales of automobile radio receivers point to a market of about one-quarter million. In addition, many such receivers will find their

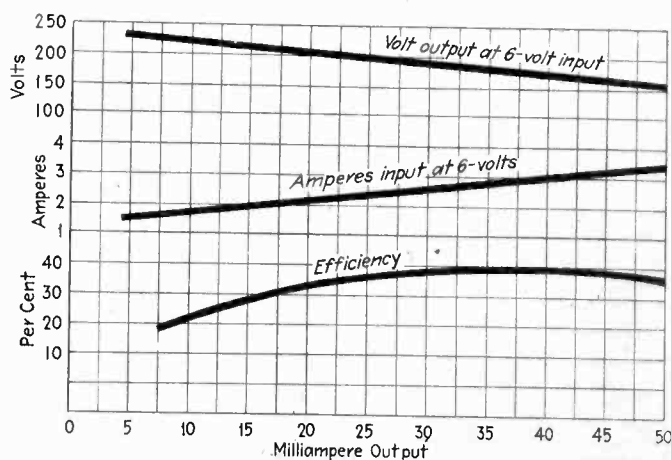

At 2,400 r.p.m., Pines B unit has above characteristics

Manufacturer	Type	Output characteristics	Battery drain	List price	Dimensions
Electric Specialty Co., Stamford, Conn.	Dynamotor Dynamotor	135 v., 25 ma. 180 v., 30 ma.	2.2 amp. 2.8 amp.	\$40.00 \$40.00	Smaller than batteries
Emerson Elec. Mfg. Co., St. Louis, Mo.	Dynamotor	180 v., 40 ma.	2.0 amp.	\$29.75	7½x7¼x6 in.
Howard Radio Co., South Haven, Mich.	Commutator Commutator	180 v., 46 ma. (or 210 v., 30 ma.) 175 v., 35 ma.	6.5 amp. 4.2 amp.	Smaller than batteries 4¼x6x12¼ in.
Hutch-Gard Corp., Ltd., San Francisco, Calif.	A. C. output	110 v., 60 cycles (60 watts)	6-7 amp.	\$39.50	4x4x9½ in.
Janette Mfg. Co., Chicago, Ill.	Dynamotor Dynamotor	135 v., 50 ma. 180 v., 40 ma.	3.0 amp. 3.0 amp.	\$34.50	12x5½x6 in. 12x5½x6 in.
Mallory, P. R. & Co., Indianapolis, Ind.	Vibrator Vibrator	180 v., 35 ma. 135 v., 26 ma.	2.4 amp. 1.5 amp.	\$24.50	7x10x3 in. 7x10x3 in.
Motor Car Devices Co., Los Angeles, Calif.	Vibrator		1.0 amp.	\$18.50	4½x4½x3½ in.
Pines Winterfront Co., Chicago, Ill.	{ Rotary Transformer }	135 v., 30 ma. 180 v., 30 ma.	2.5 amp.	\$30.00 \$30.00	5¾x8x6¼ in. 5¾x8x6¼ in.
United Amer. Bosch Corp. Springfield, Mass.	Perm. Magnet Field Dynamotor	160 v., 40 ma.	2.6 amp.	\$25.00	10x4x5¼ in.
Universal Auto Radio Corp., Chicago, Ill.	*Vibrator	135-180 v.	1.8 amp.	\$20.00	2½x8x5 in.
U. S. Electric Works., Chicago, Ill.	Dynamotor	180 v., 35 ma.	2.0 amp.	\$29.50	5x5¾x9½ in.
Utah Radio Products Co.,* Chicago, Ill.					*Device in process of design

way into motorboats, summer camps, and into rural homes where 32-volt systems are in use. These B-eliminators can be made to fit very nicely into the 32-volt picture. In addition tube invertors may be developed to supply a.c. for this market.

of radio, is no longer justified. A glance at the table will show that at least eleven manufacturers stand ready to deliver units making unnecessary the maintenance of plate batteries.

DATA ON GENEMOTOR DEVICE

Volts	Input, amps.	Watts	Output, Volts	Output, amps.	Watts	Efficiency, %	Regulation
6	1.5	9.0	200	.020	4	44.4	.93
6	1.7	10.2	195	.025	4.875	47.79	.91
6	1.83	11.1	190	.030	5.7	51.35	.89
6	2.03	12.3	185	.035	6.475	52.64	.86
6	2.2	13.2	178	.040	7.12	53.86	.83

At any rate this is the market at which eleven (probably there will be more later) manufacturers are aiming their products. Whether the units will be sold to the set maker, the set user, or the automobile maker remains to be seen. In all probability the set manufacturer will design the radio for batteries and will let the purchaser do as he pleases about the problem of keeping the amplifier plates supplied with power. Receivers using class B amplification may force the user to use batteries because of difficulties with regulation. In such cases, however, the drain from the batteries will be small and hence economics as well as regulation may dictate the use of batteries. More efficient amplifier tubes with small filament current drain will undoubtedly make their appearance on the market so the automobile set can put as much into the loudspeaker (or more) than its counterpart in the home.

Without a doubt the plea of automobile manufacturers that radios in cars will never be anything but a toy as long as batteries must be carted about, as in the old days

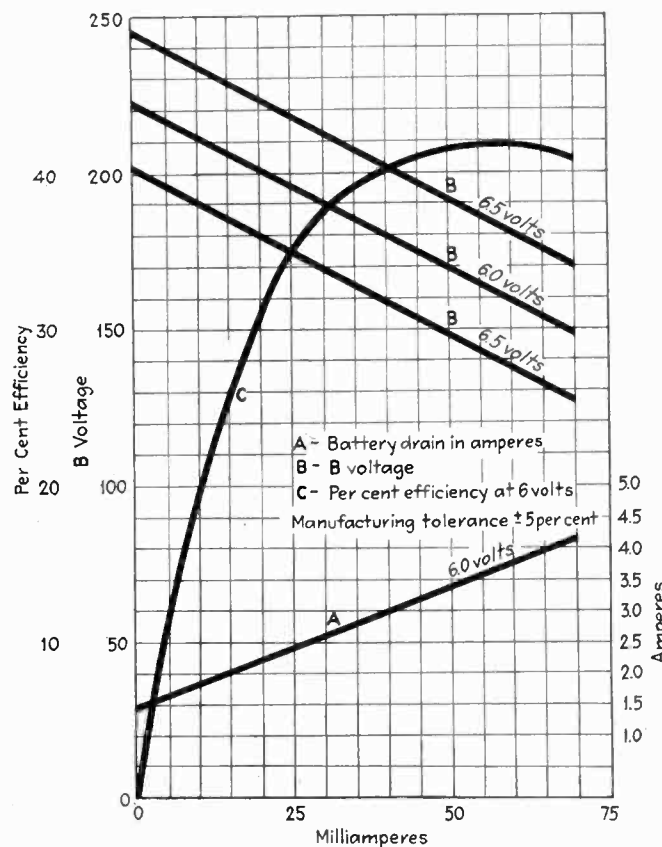

Characteristics of Janett Auto-B-Power

Problems of push-push amplification

By C. E. KILGOUR

Crosley Radio Corporation

THE term push-push is used when a two-tube, parallel, out-of-phase stage of amplification is so biased as to cause first one tube to "push" and then the other, in distinction to the case where the tubes are so biased that one "pushes" while the other "pulls" as in the well known push-pull amplifier.

In Fig. 1 we have represented the plate current-grid voltage curve of an amplifier tube by the idealized line CBDE. We have further assumed that this characteristic has been taken with a suitable load in the plate circuit. While this broken line is not an accurate representation of a tube's performance it will serve to bring out the basic features involved in push-push amplification.¹ It has been common practice ever since tubes were understood to any extent to bias an amplifier at the point "A" halfway between "O" and "B" and to keep the grid swing within these limits. Evidently no distortion will be developed under the ideal conditions we have assumed. Such an arrangement is known as a class "A" amplifier.

The radio transmission engineer has for some time found it advantageous to use vacuum with the bias at "B." With this arrangement a specified tube is capable of delivering considerably more power when used for radio-frequency amplification. The plate current in this case may be represented approximately as in Fig. 2 and consists of a series of half sine waves. However, since a selective tuned circuit is used for the plate load, voltage at or near the fundamental frequency only can be developed. Such an amplifier is designated as class "B."

The engineer also found that it was advantageous in some cases to operate with the bias still more negative, that is at some point such as "C." The class "C" amplifier has the peculiar characteristic of increasing modulation depth when properly employed.

The possibility of using the push-pull type of audio amplifier with bias at approximate cut-off was discussed by N. W. McLachlan in a series of articles appearing in 1928 and 1929 in the *Wireless World*.² Interest has been

stimulated recently in this arrangement through a paper presented by Loy E. Barton at the June convention of the Institute of Radio Engineers held in Chicago.³ Mr. Barton covered the many phases of the subject, pointing out the precautions to be taken when the grids are made to swing positive and the advantages that accrue and the difficulties that develop with the push-push circuit.

Using the simplified broken line characteristic let us compare push-push and push-pull amplification. If we combine two tubes having identical performance as idealized in Fig. 1 arranging them with out-of-phase input and output circuits with class "B" bias the net result would be an overall characteristic as shown in Fig. 3. With the same two tubes biased as class "A" amplifiers the net characteristic would be as shown in Fig. 4. This is the standard push-pull condition.

In the push-push case, Fig. 3, the grid may be swung from D to D' with linear output, thus making use of the whole of the straight sloping portion, for the push-pull type it will be necessary to reduce the bias of the two tubes somewhat so that the overall characteristic shown in Fig. 5 is obtained. For the present we will assume that no difficulty is encountered when the grids swing positive.

To investigate the power and the efficiency that may be obtained with the two systems let us look at the plate current-plate voltage characteristic of one of the tubes we are using. This is shown ideally in Fig. 6 with a load line drawn in. We may assume that the load is suitable for both class "A" and "B" operation although the best load may slightly differ for the two cases. With any known tube it is impossible to reduce the plate voltage exactly to zero by varying the grid potential. However the comparison will still be substantially correct and easier made if we assume that the plate voltage swings to zero. If we set up the expressions for the instantaneous voltage and current by integration determine the average power over one cycle of a sine wave we arrive at the results tabulated below. The figures are for a single tube, but it is assumed that two tubes are used so that the combined output is sinusoidal.

Power relations for full grid swing

Class A	Class B
$W_B = E_o I_o =$ power from plate supply	$W_B = \frac{4}{\pi} E_o I_o = 1.27 E_o I_o$
$W_L = \frac{1}{2} E_o I_o = 0.50 E_o I_o =$ power in load	$W_L = E_o I_o$
$W_P = \frac{1}{2} E_o I_o = 0.50 E_o I_o =$ plate dissipation	$W_P = \frac{4}{\pi} - 1 E_o I_o = 0.27 E_o I_o$
$Eff. = 0.50$	$Eff. = \frac{\pi}{4} = 0.78$

For half grid swing

$W_B = E_o I_o =$ power from plate supply	$W_B = \frac{2}{\pi} E_o I_o = 0.64 E_o I_o$
$W_L = 1/8 E_o I_o = 0.125 E_o I_o =$ power in load	$W_L = \frac{1}{2} E_o I_o = 0.25 E_o I_o$
$W_P = 7/8 E_o I_o = 0.875 E_o I_o =$ plate dissipation	$W_P = \frac{2}{\pi} - \frac{1}{2} E_o I_o = 0.39 E_o I_o$
$Eff. = 0.125$	$Eff. = \frac{\pi}{8} = 0.39$

Some interesting facts are apparent. With full grid swing the power output is twice as large for the push-push case, while the power required of the supply source is 27 per cent greater. This last may be somewhat unexpected, but it must be remembered that since output

¹"Calculations on Vacuum Tubes and the Design of Triodes" by Yuziro Kusunose. In this research paper, No. 237 of the Electro Technical Laboratory of Tokyo, Japan, use is made of such an idealized characteristic.

²*Wireless World*; June 13, 1928; Jan. 30, 1929; May 15, 1929.

³*Proceedings of the Institute of Radio Engineers*, July 1931. "High Audio Power from Relatively Small Tubes," by Loy E. Barton.

tubes are coupled to their load with a device having negligible d.c. resistance that "E₀" represents the supply voltage for the class "A" case and "2 E₀" the voltage for the class "B" amplifier. However, the plate dissipation for class "B" is but slightly more than half of that of the other type and the theoretical maximum efficiency to be obtained with class "B" is 78 per cent while for class "A" it is only 50 per cent.

This of course indicates that in the push-push condition the tube will develop less heat and that if class "A" operation is safe we may increase the plate voltage to a value greater than 2E₀ and so obtain still greater output. Making the dissipation equal in the two cases, class "B" would yield 3.7 times the output of class "A."

All this is for full grid swing. When we consider an input of half this amount we find that the output is of course cut to one fourth in both cases but in the class "A" type the power delivered by the supply source remains the same while in the class "B" case the battery power is halved; thus the power required varies directly with the grid swing, with push-pull the efficiency drops with the square of the input voltage while for push-push the efficiency is directly proportional to the grid swing.

The plate dissipation rises as the input falls in class A. This fact is well known to anyone who has operated a tube transmitter. With no input the plate loss must equal the supply power. In the class "B" case the plate loss must be zero under the ideal conditions we are considering. The maximum dissipation with class "B" is $\frac{4}{\pi^2} E_0 I_0$ or 0.41 E₀I₀ and is developed with a grid swing of $\frac{2}{\pi}$ or 0.64 times the maximum.

We have considered positive grid swing for class "A" as well as class "B" although in most class "A" work it is assumed that the grid will stay negative. However, there appears to be no reason for differentiating between the two cases in this respect providing that the power limitations of the tubes are not exceeded. This requirement has been responsible for restricting the use of class "A" with positive grid swing largely to applications where the normal plate voltage is not available. In the 110-volt d.c. receiver such practice has been used.

Distortion with push-push tubes

So far we have considered idealized plate characteristics. Since the plate voltage cannot be swung to zero actual efficiencies will be somewhat lower than those indicated. Since the characteristics are not linear some distortion will be present. At this point push-pull is considerably ahead of its competitor. The combination of characteristics shown in Figs. 4 and 5 will cancel all even harmonics due to plate current curvature. Since in triodes the second harmonic is most important the output will be relatively pure with the push-pull arrangement. With class "B" however, non-linearity of the individual tubes will show up in the result as is evident from an inspection of Fig. 3. For this reason the proper bias for class "B" work is usually a compromise. Reasonably pure output at high levels is often obtained by allowing noticeable distortion at low levels.

Push-pull amplification has an important advantage over single tube class "A" work due to the fact it impresses little alternating voltage effect on the plate current supply source. Push-push loses all this advantage because the current must be supplied in double frequency pulses

[Please turn to page 112]

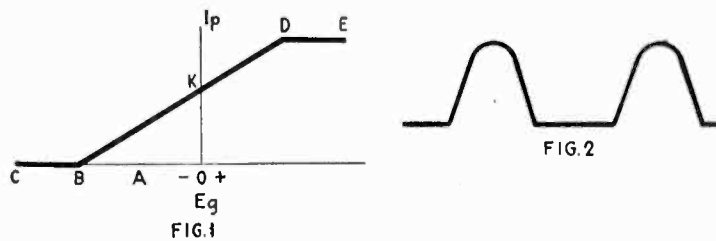

Fig. 1—Idealized tube characteristic

Fig. 2—Effect of operating tube at point B

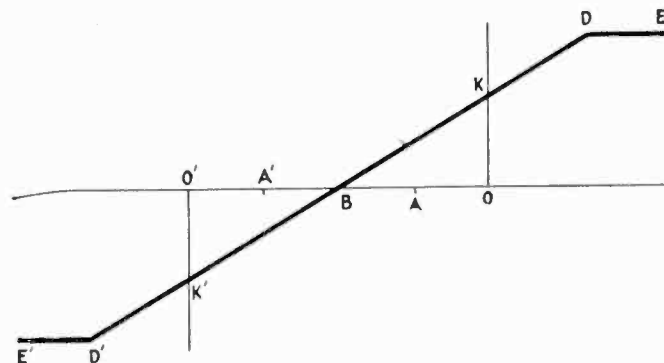

Fig. 3—Push-push characteristic

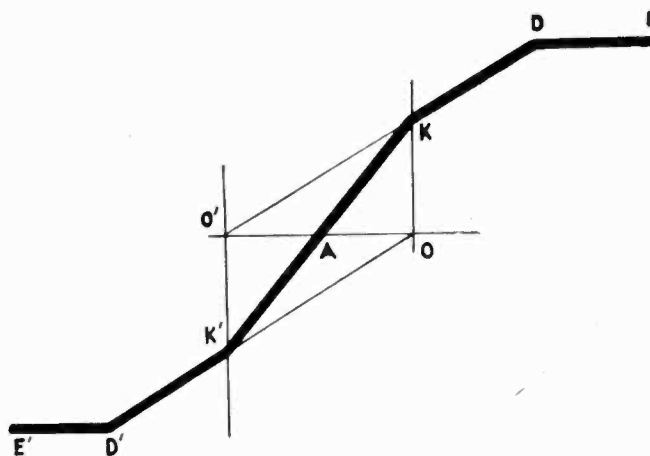

Fig. 4—Class A amplifier operation

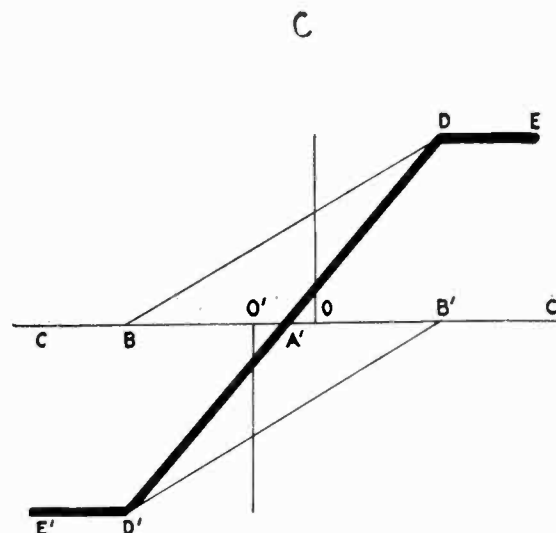
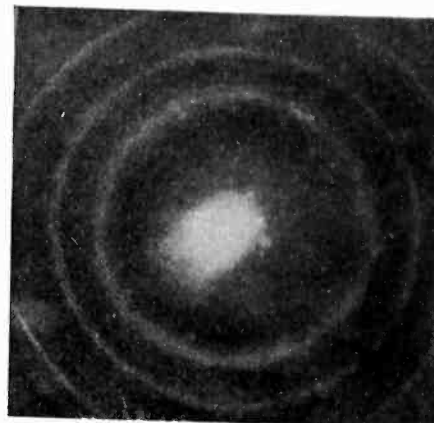
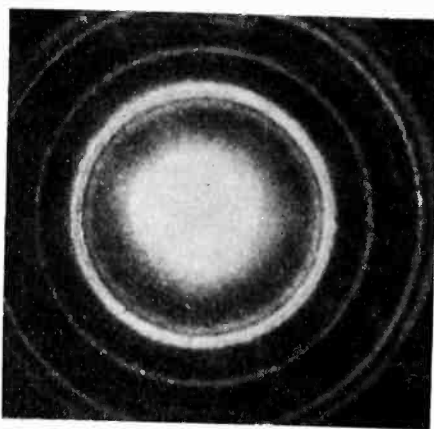

Fig. 5—Two tubes operated in push-pull

Industrial uses of Electronic diffraction

By C. J. PHILLIPS

Physical Laboratory,
Corning Glass Works, Corning, N. Y.



Characteristic electron diffraction rings. The photo at the left shows six of the rings clearly, and there are at least two other fainter rings present

SCIENCE and its applications have come a long, tortuous way since Sir William Crookes first discovered cathode rays in the 80's. From a crude, unstable plaything, the electron tube has been so improved that today we use cathode rays to build up a picture in the television receiver, in which use tomorrow they may be the accepted type. Far from being a delicate, fussy bit of apparatus the cathode ray oscilloscope developed by Zworykin, for example, requires no trained technician on the receiving end, is noiseless in operation, and has no mechanical moving parts whatever. Furthermore, we use cathode rays to excite X-rays for medical use in clinical diagnosis, while in industry these X-rays disclose hidden faults in substances so diverse as glass, metal, and wood.

A striking phenomenon, until recently unknown, which occurs when electrons are shot completely through very thin metallic films must be placed well in the vanguard of the discoveries promising wide industrial application.

The films used are of the order of 10^{-6} cms. in thickness. In a well evacuated cathode discharge tube the pattern formed on a photographic plate normal to the path of the electrons shot through the film, consists of an intense central spot due to unscattered electrons, surrounded by a fainter region containing several rings concentric about the central region.

These rings are due to electrons which have been diffracted by the crystalline planes within the film in a manner exactly analogous to that of X-rays in a powder photograph. From these rings much can be learned about the internal structure of the film—often more than can be discovered by use of X-rays. The most important fact is that the number and form of the rings is closely dependent upon the nature of the film's surface, its external

form, and the gaseous films adsorbed by it. Since it is not yet possible to physically describe a "surface"; i.e., to specify the exact conditions influencing the emergence of electrons from surfaces, the significance of an apparatus which permits study of such conditions should be apparent to anyone interested in industrial applications of electronics.

Materials showing diffraction rings

Polished metal surfaces, for example, show no electron diffraction rings. The process of polishing presumably produces an amorphous outer layer so that the emergent electrons are irregularly diffused. A surface of aluminum etched with caustic potash will also fail to give a pattern, probably because the electrons cannot strike at a small enough angle upon the coarse surface obtained by the etching. Finally, gold and copper electrolytically deposited do not show diffraction rings. But gold sputtered on quartz, or nearly any metal beaten sufficiently thin, will give very good rings.

The very slow diffraction beams of Davisson and Germer are extremely sensitive in another manner—to gas conditions and layers of moisture upon the diffracting substance. From a study of the variation of beam intensity with gas present, they have estimated the distance of certain gas layers from a nickel surface to be about 3 Angstrom units.

In one set of rings recently photographed, and shown at the left of the accompanying pair of pictures, application of the usual diffraction theory to these rings (they are of a film of *gold* approx. 8×10^{-6} cms. in thickness) lead to the value 4.071 Å for the unit cube, as compared to the accepted value, 4.06 Å, an error of about 0.3 of 1 per cent. The exactness of the results is apparent. Exposure was for 15 seconds at 4400 volts, the latter being a value of particular interest because easily obtainable practically. The film was obtained by beating.

Applications of the surface effects

It is immediately apparent that a quantitative study of surface effects discoverable by electron diffraction will be of value in investigation of photo-electric cells. Here surface conditions have long played a dominant rôle. Thus, it is not certain even now, after a decade of controversy, whether extraction of adsorbed gas increases or decreases the photo-emission from a given surface.

[Please turn to page 114]

Recording of long programs or books

An Austrian device

By Dr. IRVING J. SAXL
Consulting Physicist

HOW the phonograph business, once highly prosperous, suffered at the birth of radio and how the renaissance of that older industry is being brought about by the electron tube amplifier, the very device that put it nearly in the grave, are well known to readers of *Electronics*. Research in recording and reproducing music does not stand still even after long-playing records, greatly improved fidelity, and vastly increased volume have been achieved.

In Europe, as in America, newer methods of recording are being developed. In Austria for example the method of recording on small film or on glossy printing paper explained here is well on the way to commercial sale.

In the present heavy competition with radio, only a reproducing machine with excellent sound quality will be able to stand up. Electronic amplification naturally is the proper means for doing this. In addition if long records are supposed to be played, proper means have to be found to make possible an editing of these records so that if a little mistake occurs somewhere in the middle of the performance the entire recording procedure does not have to be begun all over again.

In the Austrian machine illustrated here a strip of film about one-quarter inch wide travels from one coil to the other past a source of light and a light sensitive device, and is recoiled on the other spool. The variable area method of recording is used. The apparatus can be made to use glossy printing paper and two records can

be put on one roll of paper, one record on the top and the other on the bottom. If film is used the light shines through the record, if paper is used which is opaque, reflected and diffused light is employed by a slightly different method.

In the reflected light system using opaque paper, illumination from two sides is used and by a focussing scheme the center of the film is projected on the photo-sensitive cell. A small motor provides the power to pull the paper past the light source and slit.

In the Austrian device selenium is the light sensitive material and excellent fidelity of all useful frequencies is claimed. The length of playing depends entirely upon the length of paper or film used, and the advantage of being able to edit the record is a very great one indeed. Records to play 25 or more minutes are easily possible.

Talking books for the blind

For years the blind have watched the growth of the idea of recorded speech and music. The libraries of music and books which long-playing records of high-quality could open to the blind would be of particular humanitarian value. At the present time there are laws in many states which provide from \$125 to \$300 for each blind student per year for which he is supposed to have some one read to him works which will increase his further study. Here is a great market for such a device as the talking book.

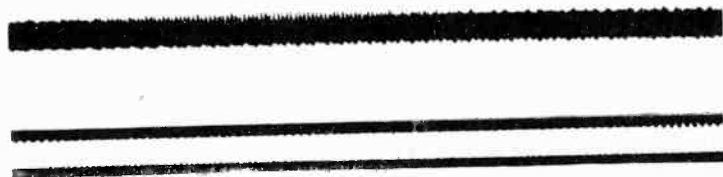

Sample recordings on film (above) and on paper (below). In practice the record is run through twice, programs being recorded on both edges

The expense of recording a film, a book, an opera or a symphony and of making as many contact glossy prints as desired, would be very small indeed compared to any other method of getting the information and entertainment to an equivalent number of blind students.

In this Austrian device there are several obvious advantages. The first is the fact that long playing records are easily possible, the space required for the 6-millimeter film, or paper, being small compared with an equivalent playing time in disk-type records. Secondly, there is the advantage that editing can take place very simply, small parts of the recorded film being taken out and replaced with a new recording if desired. The use of selenium which gives an appreciable current change with variations in light, eliminates some of the amplification necessary in many other reproducing equipments. In the Austrian machine variations in output of the cell with frequency seem to have been compensated.

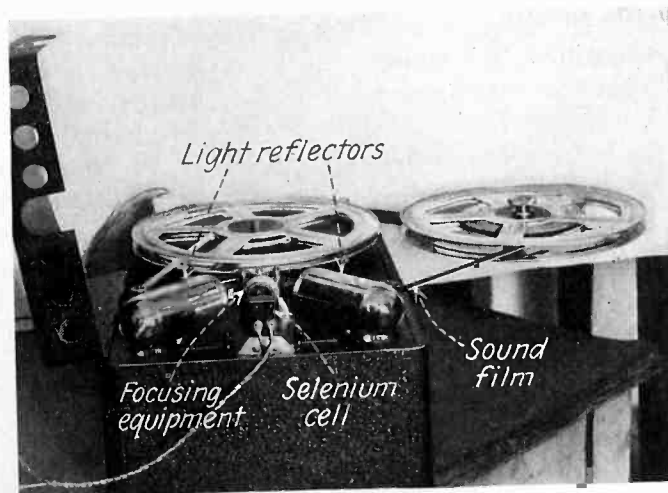

Sound film apparatus using opaque or transparent film and a selenium cell as the light-sensitive unit.

The new music of Electronic oscillations

The latest instruments of
Theremin, Ranger and Miessner

DEMONSTRATIONS of several of the most interesting of the new developments in electronic musical instruments were given at a general meeting of the New York Section of the American Institute of Electrical Engineers, February 26, when Benjamin F. Miessner of Milburn, N. J., showed for the first time his new electronic organ-piano; Professor Leon Theremin exhibited his instruments of the space-control, keyboard, and fingerboard types, and Captain Richard H. Ranger, presented the theory and operation of the Rangertone organ, played over control wires from his home in Newark, N. J. Walter Damrosch discussed the future of electrical music, which he regards as being now in an experimental but hopeful stage; and Leopold Stokowski, absent in Mexico, sent a message: "There is much opposition, but in time we shall overcome it."

The new Miessner instrument was played successively as a piano and as an organ, and as the source of tones duplicating those of the flute, French horn, violin, piccolo, music-box, etc. Mr. Miessner uses piano strings as the source of his vibrations, which are then amplified and recombined electrically, and heard through a loud-speaker, no sound coming from the piano itself. By manipulating a series of switches, the wide range of timbre and tone quality can be obtained.

Mr. Miessner explains his organ

"To manipulate the mechanical vibrations of a string on a soundboard in operation is almost inconceivable,—certainly impractical," said Mr. Miessner. "But, suppose we convert the string's *mechanical* oscillation into a corresponding *electrical* oscillation before it appears as sound? What truly amazing possibilities are presented to the acoustical physicist! Once in this plastic, flexible form, the imagination alone is the limit of its possible transmutations. The developments of twenty years of electronics are at one's elbow to suggest, to assist, and to realize these possibilities.

"Does one wish to change the harmonic composition of the string tone? We need only select the appropriate point along the string in effecting the translation into electrical form to change the quality considerably. To change it greatly we may simultaneously translate at several points and add or subtract, multiply or divide

these electrical translations in infinite variety of combinations. Is the bass too thin or the treble too weak, or both? Control of the frequency characteristic of the amplification system enables us to meet any demand or caprice of composer or artist.

"Would a volume swell help the artist better to express his musical ideas? An electrical volume control, operated by a foot pedal, gives him this effect without the slightest difficulty. Does he wish to alter the shape of the tone dynamically, to increase or decrease, its damping rate? Means for this too are available.

"Perhaps the performer would like to convert his piano into an organ!—to obtain organ tones from strings! Strange to say—even this is possible. And in this organ performance, I may add that the keys, as in a piano, but not in an organ, are touch-responsive, so that dynamic expression becomes possible by touch on the keys and so that the almost universal piano technique may be used for organ playing. All of these features are just as interesting to the composer as to the artist. For the composer is always seeking new means, new modes of musical expression to widen and extend the translation of his artistic ideas into tonal beauty.

"While no plans have yet been formulated for commercial production of these instruments, I believe they can be produced to sell in the price range of grand pianos, and complete in one case."

Principles employed in the Theremin devices

Preceding the demonstration of his space-controlled instrument, the keyboard console, and the fingerboard Theremin which resembles a bass viol and is played by manipulating the pitch by the left hand, while working the volume-lever with the right hand (see illustration opposite), Professor Theremin said:

"In order to obtain the tonal material necessary for a musical performance it is insufficient to vary the tone color peculiarities characterized by the use of certain harmonics. The similarity to one or another existing instrument depends to a great extent upon the manner in which the instrument is played. The most characteristic ways of playing these electrical instruments are: the control in space (vocal character), the fingerboard control (string character) and the keyboard control (wind and keyboard character). For the realization of these objects the following methods of application of electronic tubes are used:

1. The heterodyne method of obtaining audio frequencies.
2. The obtaining of necessary harmonics:
 - a. in separate high frequency circuits,
 - b. by the variation of the degree of intensity of the mutual entrainment of oscillatory circuits,
 - c. by the application of combined characteristics of electronic tubes.
3. The use of exponential processes of charge and discharge of condensers through definite resistances and self-inductances and the obtaining of various time constants.
4. Compensation of the natural periods of audio circuits through electrical absorption.
5. The control of frequencies by the influence upon R or L or C through resonant auto transformer circuits.
6. The stabilization of oscillatory circuits.

[Please turn to page 114]

Some recent electronic musical instruments



Benjamin F. Miessner and his electronic organ-piano. The piano-strings when struck, produce vibrations, which are amplified, modulated and recombined, and heard through a loudspeaker, producing many new and unusual effects



Maurice Martenot and his instrument brought from France, which can produce various sounds

Captain Richard H. Ranger at the keyboard of his Ranger-tone electric organ. Fixed-ratio alternators provide the source of the fundamentals and harmonics, which can be combined in various proportions, creating a wide range of effects, including some strikingly new musical characteristics

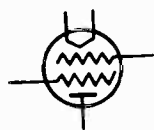

Professor Leon Theremin and his fingerboard cello instrument. With the left hand, the player fingers a contact strip, much as he would the strings of a viol, and with the right hand he works the volume lever.

Broadcast transmitter

measurement

using a common wavemeter

By E. A. LAPORT

Westinghouse Elec. & Mfg. Co.
Chicopee Falls, Mass.

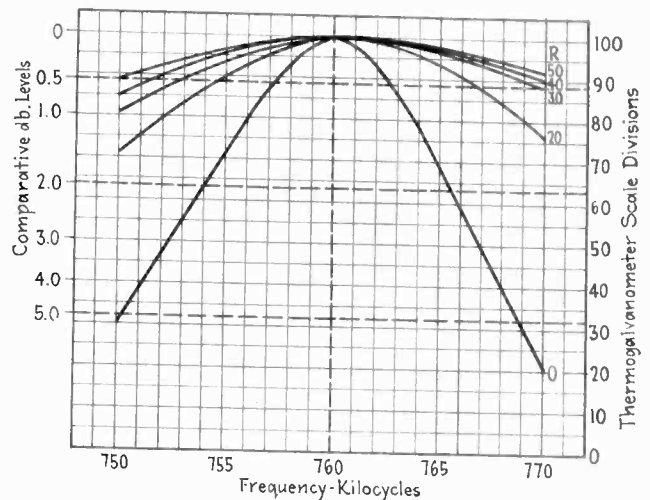

Wavemeter resonance curves with added resistance

IT frequently happens that broadcasting stations lack the equipment necessary for checking their transmitters for percentage of modulation, frequency fidelity characteristic and amplitude linearity. Yet these three points of performance are of primary importance and should be known to the station engineer at all times. These properties of a transmitter should be periodically measured because they are vitally affected by changes of tubes, circuit tuning, loading, etc.

Most stations have (and every station should have) a good wavemeter equipped with a thermo-galvanometer. Also, most stations have an audio oscillator, or can obtain one when needed. By means of these two instruments accurate measurements of important modulation characteristics of a transmitter can be made.

Measuring percentage modulation

It is well known that as a transmitter is modulated the antenna current (or tank current) increases. For low percentages of modulation this increase is inappreciable, but as the percentage gets above approximately 50 per cent, the increase becomes marked, and when 100 per cent modulation has been obtained, the antenna current has increased 22½ per cent above the unmodulated cw. value. The formula stating the relation between antenna current and percentage modulation (or modulation factor) is

$$I = \sqrt{I_o^2 + I_o^2 \frac{M^2}{2}}$$

I_o is unmodulated carrier antenna current

I is the current during modulation

M is the modulation factor (per cent written as a decimal fraction)

Since power is proportional to the square of the current, this same equation can be written in terms of power.

$$W = W_o + W_o \frac{M^2}{2}$$

W is average power during modulation

W_o is power when there is no modulation

A current squared scale thermogalvanometer can be used to measure power by its relative scale readings, since the scale divisions are proportional to average power. The first term is the carrier and the second term is the power introduced by the sidebands. The sideband power can be seen to increase as the square of the modulation factor. We therefore have a direct relation between percentage modulation and galvanometer reading.

Tune the wavemeter to exact resonance by coupling it to the antenna or to the output circuit of the transmitter. Assuming 100 divisions as full scale deflection on the meter, adjust coupling of the wavemeter until the scale reading is 60 for unmodulated carrier output, under normal operating adjustments of the set. It may be necessary to ground one side of the wavemeter circuit to eliminate body effect as it is essential that the wavemeter be quite accurate in its adjustment. Then introduce modulation at a frequency of 200 or 500 cycles. The rise in galvanometer reading indicates the percentage of modulation from the following table, which was computed from relations given in preceding formulas.

These figures depend upon essentially sinusoidal symmetrical modulation. If the modulation departs widely from these conditions, the above figures will not hold exactly. To measure the modulation capacity of a transmitter, increase the input until the galvanometer just shows a tendency to reach a maximum and record the scale reading compared with the carrier value.

Measuring frequency fidelity characteristic

If one holds the voltage of the audio input to the transmitter constant at different frequencies, and measures the output percentage with the wavemeter in the manner just outlined, it is possible to get the fidelity characteristic by reading the wavemeter. But a good wavemeter is so sharply tuned that the high frequency sidebands are greatly attenuated. By adding enough resistance in series with the wavemeter tuned circuit to flatten out the resonance curve sufficiently for essentially uniform attenuation of sidebands within the modulating range of say 30 to 10,000 cycles, the wavemeter can be used for measuring the frequency fidelity characteristic very accurately. To do this, measure the wavemeter resonance curve with an oscillator. First set the oscil-

lator to the operating wavelength of the station in question. Then calibrate the oscillator by means of the wavemeter for frequencies 5 kc. and 10 kc. on each side of the operating frequency so that the oscillator can be reset to these frequencies at will. Then tune the wavemeter to the operating frequency again and couple it up so that full scale galvanometer reading is obtained. Tune the oscillator to 5 kc. and 10 kc. separations on each side of the operating frequency and plot the various meter readings against frequency, as shown in the figure.

Next add a resistance of say 50 ohms in series with the wavemeter tuned circuit (a decade box or other good resistor for radio frequency use) and couple it up to full scale deflection and take another resonance curve. This will be much broader than before. When the wavemeter galvanometer reading for frequencies 10 kc. each side of the operating wavelength is 90 per cent of the reading at the operating frequency, the wavemeter audio characteristic at 10,000 cycles will be only 0.5 db. from perfectly flat. When the 10 kc. separations are more than 90 per cent the error is less than 0.5 db., but this value is sufficiently low for usual requirements.

A family of resonance curves is given showing the audio characteristic of the wavemeter for various values of resistance at 760 kc. In the absence of a suitable radio frequency oscillator for taking characteristics in the manner outlined, one can add about 60 ohms of resistance and feel sure that the wavemeter characteristic is essentially flat. In adding the resistance in the wavemeter circuit, it will be necessary to retune the wavemeter slightly to return it to exact resonance on which the measurements to be made depend.

The audio measurement is made by comparing the output at all the modulation frequencies with the output at one reference frequency. It is customary to use 1,000 cycles as the reference frequency. Set the wavemeter for a scale reading of 60 for unmodulated carrier. If the transmitter is capable of 100 per cent modulation, it is well to use a reference modulation percentage of 60 per cent or 70 per cent which allows the characteristic curve room to register rises and falls within a range of about 3 db. within which limits most decent transmitters will come. If 70 per cent reference level is chosen, modulate the transmitter with 1,000 cycles and increase the audio input until the galvanometer rises from 60 to 75 divisions. Note the audio input level to obtain this percentage modulation. Then start at the lowest audio frequency and hold the input voltage constant with a good volume indicator for each frequency. Record the wavemeter reading for each frequency, and note when modulation is removed each time that the needle drops back

**TABLE I — CONVERSION TABLE —
SCALE READINGS TO PER CENT MODULATION**

Scale Reading	Increase	Percentage Modulation	Scale Reading	Increase	Percentage Modulation
60	0	0	76	16	73
62	2	26	77	17	75
63	3	31.6	78	18	77.5
64	4	36.5	79	19	79.7
65	5	41	80	20	81.6
66	6	45	81	21	83.6
67	7	48.3	82	22	85.6
68	8	51.6	83	23	87.5
69	9	55	84	24	89.5
70	10	57.7	85	25	91
71	11	60.5	86	26	93
72	12	63.3	87	27	95
73	13	65.8	88	28	96.5
74	14	68.2	89	29	98
75	15	70.7	90	30	100

**TABLE II — CONVERSION TABLE —
GALVANOMETER SCALE DIVISIONS TO DECIBELS**

Scale	52 per cent level db.	70 per cent level db.	80 per cent level db.
60 (cw)
62	-6.0	-8.75	-10.00
63	-4.27	-7.0	-8.24
64	-3.0	-5.74	-7.00
65	-2.05	-4.78	-6.00
66	-1.26	-4.0	-5.22
67	-0.6	-3.31	-4.56
68	0.00	-2.73	-4.00
69	+0.5	-2.22	-3.46
70	+0.97	-1.76	-3.0
71	+1.4	-1.35	-2.6
72	+1.76	-1.0	-2.22
73	+2.1	-0.62	-1.87
74	+2.43	-0.3	-1.55
75	+2.73	0.00	-1.25
76	+3.0	+0.28	-0.97
77	+3.27	+0.54	-0.7
78	+3.52	+0.79	-0.46
79	+3.76	+1.03	-0.23
80	+4.0	+1.25	0.00
81	+4.2	+1.46	+0.21
82	+4.4	+1.66	+0.4
83	+4.58	+1.86	+0.6
84	+4.77	+2.04	+0.8
85	+4.95	+2.22	+0.97
86	+5.12	+2.4	+1.14
87	+5.29	+2.56	+1.13
88	+5.44	+2.71	+1.46
89	+5.6	+2.87	+1.6
90	+5.74	+3.0	+1.76

to exactly 60. After taking the meter readings the conversion to decibels difference in level from the reference level at the reference frequency is made from the table given below.

A transmitter capable of a maximum modulation of 75 per cent or 80 per cent would use a lower reference level, and accordingly a convenient table based on 52 per cent modulation is included. Transmitters capable of 100 per cent modulation and whose frequency characteristic is flat enough so that there are no rises greater than 1.5 db. may use 80 per cent modulation as the reference level and get much more accurate meter readings at the higher deflections.

Readings can be made to the degree of accuracy given in the table if body-effect near the wavemeter is eliminated and readings are free from parallax. Body-effects are not troublesome except when measuring high-power transmitters where the coupling is so loose that the field is considerably affected by a moving person. Grounding one side of the wavemeter is then necessary. This method of measuring the frequency characteristic is useful in checking the fidelity of a monitoring rectifier and associated circuits in stations where routine frequency checks are made by means of an output rectifier and volume indicators. When the audio input voltage is held absolutely constant the only inaccuracy would occur in reading the wavemeter galvanometer. With reasonable care, observations can be made with an accuracy equal to those made with the best volume indicators and associated rectifier circuits.

It is frequently desirable, or necessary, to know how well a transmitter reproduces in the output the waveform of the input audio voltages. If the transmitter is perfect, the amplitude of the output is always directly proportional to the input voltages. If this is true of voltages, it must also be true of power. Since power is readily measurable in decibels, one way of checking the linearity is by increasing the input level in fixed steps

[Please turn to page 114]

An electronic high-speed timing device

By W. M. ROBERDS
University of Arkansas

IN a previous paper¹ the author described a vacuum tube relay and timing device which is accurate to less than .01 second. Since that publication the apparatus has been simplified and made applicable to so many purposes that it seems appropriate to describe it in its modified and more useful form.

The indicating device is a Cenco impulse counter² through which a 60-cycle current is passed. Since the indicator hand of this instrument moves one division each time the current rises to a maximum it therefore marks each .00825 second and is as accurate as the frequency of the supply.

In developing a successful timing apparatus embodying the above instrument the problems were (1) to devise a method of opening and closing the circuit to the impulse counter in a time appreciably less than .01 second; and (2) to make the circuit sensitive enough to be actuated by very small currents or voltages. Mechanical relays³ have been used to accomplish such purposes, care being taken that the same relay acted to open and to close the circuit in order to eliminate the time of action of the relay. However, the vacuum tube relay herein described accomplishes the purpose simply, in less than .002 second and is much less likely to get out of adjustment. Figure 1 shows a diagram which illustrates the principle of the relay.

Circuit operation

Normally, the plate current from T_1 flowing through the leak R holds the grid of T_2 so far negative that there is no plate current in the later. If however the grid of T_1 is made slightly negative (for instance, by an e.m.f. impressed at X) the plate current is decreased, thus raising the potential of the grid of T_2 which in turn starts the plate current in this tube. This current returning through r impresses a negative potential on the grid of T_1 . Thus a regenerative action is set up which quickly builds up the plate current of T_2 to a maximum and maintains it at that value. In this manner, the relay is "closed" and remains so until some outside impulse

¹W. M. Roberds—*Review of Scientific Instruments*, Vol. 2, 519; Sept., 1931.

²P. E. Klopsteg—*J.O.S.A. and R.S.I.*, 19, 345; 1929.

³E. A. Speakman—*R.S.I.*, 2, 297; 1931.

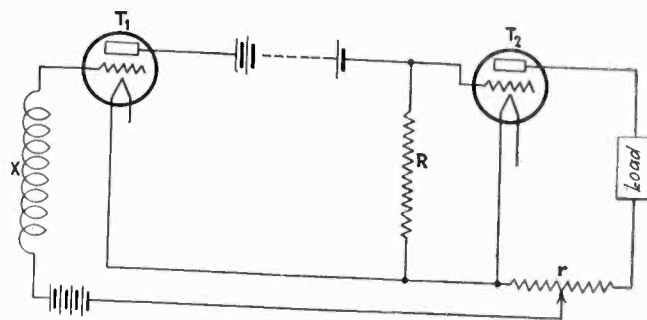

Fig. 1—Fundamental circuit of the vacuum tube timer

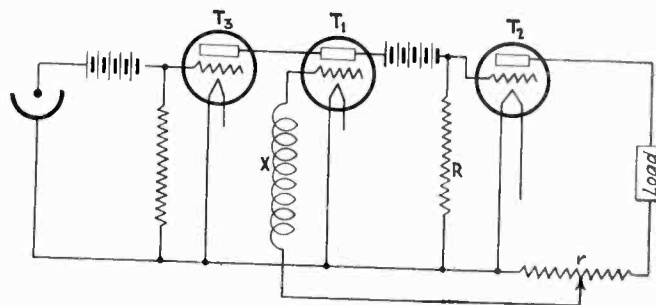

Fig. 2—A phototube may be used to supply the impulse that starts the timer

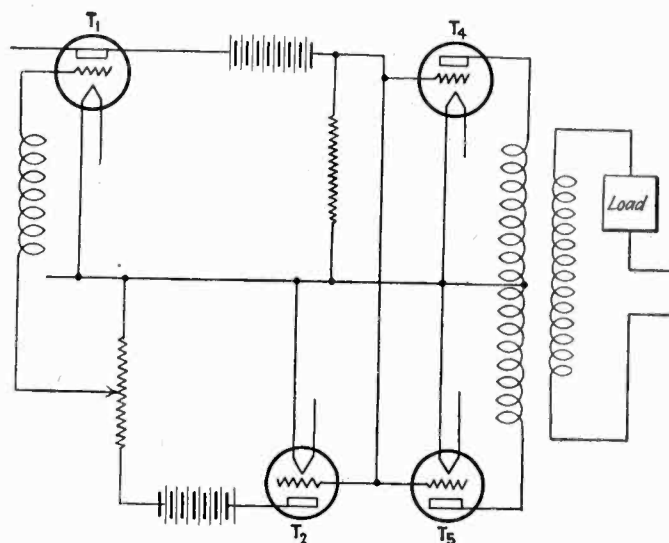

Fig. 3—Differential system useful when appreciable power is needed

impresses a negative potential on the grid of T_2 sufficient to stop the plate current. Once this current is stopped, the plate current of T_1 flows and again holds the relay "open." The sensitivity of the apparatus is controlled by varying the slide on r . In fact, the relay may be "opened" or "closed" merely by varying the slide far enough one way or the other.

The "outside impulse" is applied to the grid T_2 by means of a photoelectric cell and amplifier tube T_3 which are connected as shown in Fig. 2. Normally, a beam of light on the cell causes sufficient current to maintain the grid of T_3 several volts negative which is enough to prevent any plate current flowing in this tube. While the relay is "closed," an instantaneous breaking of the light beam will allow a pulse of plate current from T_3 to flow through R and open "open" the relay as explained above.

If the load is small a power tube in the place of T_2

may be sufficient to supply the necessary power. However, in case several watts are required, such as are needed by the impulse counted, a different arrangement is desirable in this part of the circuit. A very satisfactory scheme is that shown in Fig. 3. Here two tubes T_4 and T_5 have been connected in push-pull with their grids in parallel with that of T_2 . In this arrangement T_2 acts merely as the control of the relay. The plate voltages of T_4 and T_5 are supplied from the secondary of a well constructed, high ratio transformer. The load is in the primary circuit of this transformer. While the relay is open and there are no plate currents in T_4 and T_5 then the impedance of the transformer is so great that only a small part of the supply voltage is impressed on the load. But when the relay is "closed" and T_4 and T_5 are drawing a few milliamperes of current the impedance of the transformer is greatly reduced and the supply voltage drop is largely across the load. This arrangement allows the relay to control large loads.

A microphone may be used to supply the initial impulse at X (Fig. 2) which "closes" the relay; in this case a single tube of amplification is necessary. This tube is shown as T_6 in Fig. 4 which also shows the complete wiring diagram. The meter A may be used to measure the plate current in either T_1 or T_3 or the current in the microphone. Such readings aid in adjusting the apparatus while being set up. All tubes are of the a.c. type and the whole apparatus with the exception of microphone, photoelectric cell, and illuminator fits readily in a cabinet 18 in. by 10 in. by 20 in. It was found necessary to shield this cabinet if the instrument is to be used near a powerful radio broadcasting station.

Race timer

Among the several uses of the apparatus is that of a race timer at track meets. For this purpose, the apparatus is set up near the finish line with control leads running to the microphone at the starting position, and to the photo-electric cell directly on the finish line.

The starter plugs the microphone into a jack at the starting point and by means of it may talk to the official timer who wears the headphones shown in Fig. 4. Thus the starter may tell those at the finish that the runners are ready to start, without the customary whistling and wild gesticulating. To prevent the speech from starting the timing device the potentiometer r is set at the least sensitive position. (However this is unnecessary for ordinary speech.) The finish judge may then signal the starter that everything is ready and the timer moves r to the most sensitive position. The sound of the gun then starts the apparatus. A beam of light is directed along the finish tape and falls on the photoelectric cell. As the first runner breaks the tape he also interrupts the beam of light which opens the relay and stops the indicator. Thus the first man is timed accurately to less than .01 second.

If the runners are to make more than one crossing of the finish line, such as in a race requiring more than one lap of the track, then the switch S_1 is opened, and is closed only just before the finish.

The device may be used in the laboratory to measure the acceleration of gravity. For this purpose a block of

wood one inch thick and three inches square serves as a falling body and its time of fall over a known distance is measured. "Gravity" is then calculated by means of the familiar formula.

Along the top edge of the block is a strip of metal. Before it is released this metal strip makes contact with leads from m_1 and G , (Fig. 4) thus allowing a current to flow through the transformer. As the block starts to fall this circuit is broken and the resulting emf. induced in the transformer closes the relay. After falling a measured distance the block breaks the beam of light to the photoelectric cell which stops the device. The elapsed time is measured, accurate to .00825 second, and if the distance fallen is four feet or more the value, the value of the acceleration of gravity may be obtained accurate to less than 1 per cent.

Measurement of reaction times

The apparatus is also useful for measuring human reaction time to a fair degree of accuracy. It is seen that the switch S_2 , when closed, grounds the grid of T_1 thus providing a simple means of stopping the device. A sharp sound in the microphone or the flash of a light is used to start the timer and the subject presses S_2 as soon as he hears the sound or sees the flash. The timer then indicates the time elapsing between the occurrence of the stimulus and the closing of the switch.

The subject's reaction to touch may also be measured by bringing lead P into contact with his body. The body capacity is generally sufficient to start the timer and the subject stops it as soon as possible by closing S_2 . If the body capacity is not enough to start the timer, then a 45 volt battery between G and an electrode in contact with the subject raises his potential so that when he is touched with lead P the conduction current will close the relay. Of course, in both cases, the electrode P must be well insulated from the experimenter.

Such a timing device provides a simple and accurate means of measuring time intervals of the order of 0.5 second to 15 seconds. Since it may be actuated by photoelectric currents or microphone voltages it is applicable to a great number of uses.

In the relay part of the circuit all coupling is made by means of high resistances so that the time of opening or closing is extremely short. The longest time involved is that required to charge condenser C (.1 mfd.) by the grid current of T_1 . This time is less than .002 second which is small in comparison with .00825 second, the smallest division on the impulse counter.

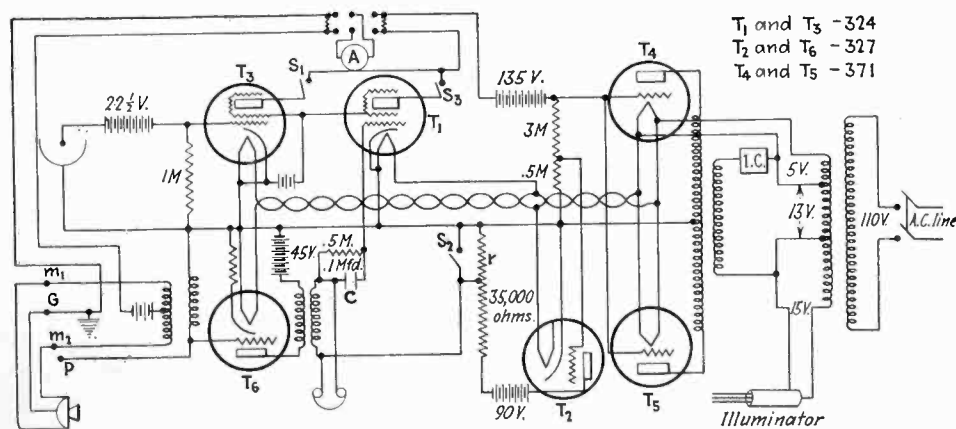

Fig. 4—Use of microphone to start timing mechanism for races. A phototube marks the instant the end line is crossed

Can radio tubes be sold abroad?

By S. E. LASZLO

Export Engineer

TOTAL United States exports of radio receiving tubes in 1931 increased about 30 per cent over the previous year. In 1930 the total number of tubes shipped abroad was 1,773,700, valued at \$2,363,234. The corresponding number for 1931 is estimated to be between 2,300,000 and 2,500,000. Official figures are not yet available. American tube manufacturers unfortunately have not received a correspondingly larger profit. The reasons for the increase in our tube exports, in spite of the general trend of business and the decline in purchasing power all over the world, are too numerous to mention. Some of the factors that were mainly responsible for this increase, were the large exports of radio sets and component parts. Overproduction and the consequent fall of prices in the domestic market had an unfavorable effect upon export prices. American tube manufacturers received an average of \$1.33 for each exported tube in 1930. In 1931 they got only 85 cents. These figures of course represent the whole year's average, and the present figures could safely be put somewhere between 65 and 70 cents.

Analysis of export market

Roughly, four-fifths of our radio exports were absorbed by fourteen countries, widely scattered all over the world, and the remainder, one-fifth, was taken by seventy-eight countries. Europe took the most tubes, followed by South America and Australia. The fourteen most important markets were Australia, Italy, Canada, New Zealand, United Kingdom, France, Switzerland, Spain, Uruguay, Brazil, Belgium, Cuba and Chile. While Australia, Canada, New Zealand and Spain have kept their respective places in the export list, Argentine moved to the second place last year, United Kingdom to the sixth from the thirteenth, France to the seventh from the twelfth. Each of these countries took over 100,000 tubes.

In recent months several countries have put up restrictions, others have raised their tariffs, still others are considering special restrictive measures against the importation of radio tubes. The most outstanding of these restrictions are the new British tariff in force since December 19, 1931, and a quota system in France in force since January 2, 1932.

The imposition of a 50 per cent duty on receiving tubes in addition to the key industry duty of 33½ per cent, ad valorem, in operation since December 19, 1931, aroused a great interest among British and foreign manufacturers. In the last three months of 1931, a

large number of tubes was dumped in Great Britain, in anticipation of this duty.

During 1930, the average quantity imported monthly was 149,000 while in October of 1931 the figures had risen to 426,000. In November, no less than 573,000 tubes were imported, this being slightly less than four times the monthly average for 1930. Only 4 per cent in September, 3½ per cent in October and about 5 per cent in November were re-exported into other countries. Figures issued by the Department of Commerce are not yet available for the whole of 1931. The figures for the first ten months indicate that our radio tube export to the United Kingdom has greatly increased during the year. We have shipped to that market during the period indicated 106,448 units, against 29,027 units in the whole of 1930. The unit value of our tubes exported into the United Kingdom in 1930 was \$1.53 which figure has fallen in the last quarter of 1931 over 50 per cent to 66 cents.

Great Britain has a well-established radio tube manufacturing industry supplying domestic needs, but due to the various needs of the market as well as to the peculiarly advantageous position of certain tube manufacturers on the Continent, 1,505,679 tubes were imported in 1929 and 1,783,021 units in 1930. Her export in radio tubes amounted to about one-ninth of the total import in 1929 and about one-fifth in 1930.

France

The French radio industry is alarmed. Authorities and leaders of the industry state that American radio sets have flooded the French market and the public has quickly recognized the superiority of American sets and tubes. All important radio manufacturers have attempted to manufacture sets which are able to compete with imported sets, and the tube manufacturers are now offering receiving tubes with European and American characteristics.

Attempts to enact measures to protect the French industry are being made by the SRIR, the French Manufacturers and Traders Association, which has instituted a fund to enable protective propaganda to be carried out. The fund subscribed by members of that association proved to be insufficient. Soon it was discovered that a very large fund would be required to

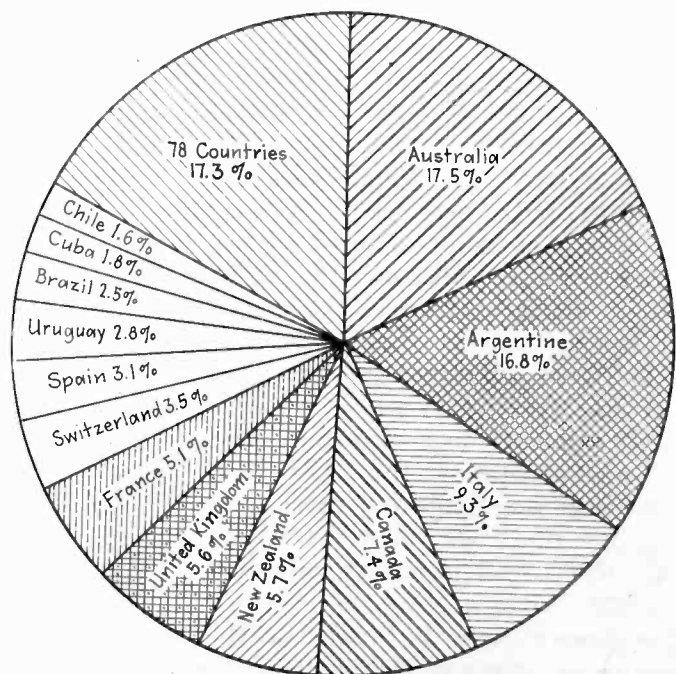

Where American tubes go abroad

put the scheme in operation. The association has now decided to use its limited resources in a campaign to impress the public with the necessity of buying French made goods, adapting thus a "Buy French" campaign.

More important is a Governmental decree, in force since January 2, 1932, restricting the importation of foreign radio sets and tubes. The decree orders that for the first three months of the current year, imports of radio shall be restricted to 154.1 metric tons monthly. Of that amount Holland is allowed 79.2, Germany 50, United States 16.6, Great Britain 4.6 and all others combined 3.7 metric tons. The quota allotted to us is about one-quarter of what we are now exporting to France. The quota for receiving tubes is 15 metric tons monthly for all countries. Of this, Holland's share is 6, the United Kingdom's 3.4, Germany's 2, the United States' 1.7 and that of all other countries 1.9 metric tons. The exact basis for the allotments to the exporting nations is believed to cover a period of years as far back, perhaps, as 1929.

Our radio set export into France in 1931 has increased approximately 850 per cent over 1930, and our receiving tube export about 350 per cent. We have shipped to France in the first ten months of 1931 12,057 sets and 97,547 receiving tubes, against 1,172 sets and 32,507 tubes for the whole of 1930.

Agreements have recently been concluded between the leading producers of radio tubes, which will probably result in a great reduction in competition and mutual regulation of the various problems in connection with the manufacturing and marketing of tubes. Siemens & Halske Co. and the German General Electric Co. (A.E.G.), have agreed with the jointly owned Telefunken Co., that all of their radio business shall be concentrated in the latter concern. Telefunken in turn agreed with Tekade (South German Telephone Apparatus and Wire Works Co.), an important producer of radio tubes, that both production and sale in the future shall be concentrated in the former concern. Tekade will only manufacture special tubes and tubes for the sound picture industry. Negotiations have also taken place between Telefunken and Valvo interests with the object of coming to an understanding.

Although it is unquestionable that some loose agreements have hitherto existed between the chief producers, and a gentleman's agreement has ruled with regard to prices and technical problems, the Telefunken-Tekade agreement introduces a new era in the whole radio tube industry. Of course in the open market a very keen rivalry has prevailed. The German radio tube industry is practically controlled by Telefunken, Valvo and Tekade Companies in order of their importance. Telefunken is manufacturing more than half of the German production.

The tendency towards concentration in the German radio tube industry is of special interest to the American manufacturers, when it is considered that important patents will expire in 1934 and unrestricted competition may be expected, in which British, French and American radio tube makers will logically participate. This is probably the reason for this concentration process, which would prevent rivalry among German manufacturers after the expiration of patents. Whether the German market will be open for American tubes after the lapse of these patents is a matter of conjecture, but our manufacturers will do well to keep in touch with developments in Germany, with a view to a possible new market, within the next few years.

Receiving tube export and import of the United Kingdom in 1929 and 1930*

Country of Destination or Origin	Export		Import	
	1929	1930	1929	1930
Austria			752,654	1,221,286
France	27,973	220,243	267,754	267,501
Holland	70,019	27,123	425,828	45,999
Hungary			15,830	115,475
Germany			25,512	59,472
United States			15,880	51,525
Belgium	16,518	43,206		
Argentine	14,212	8,818		
Total of all countries	175,087	352,681	1,505,679	1,783,021

*Figures in quantity, as given by the Board of Trade.

Receiving tubes imported to the United Kingdom in 1931 (Quantity)*

Country of Origin	September	October	November
Austria	126,234	164,631	225,869
Hungary	12,575	98,960	38,755
United States	26,519	71,806	155,806
France	39,222	50,034	56,645
Holland	5,615	38,334	94,425
Germany	4,633	1,862	1,281

*Figures as given by the Board of Trade.

During the last two years there has been an immense effort made to increase the manufacture of radio apparatus within the Commonwealth, and the Amalgamated Wireless Company of Australia has made a strong attempt to secure a lion's share of the business. The largest selling organization in Australia, that of the Australian General Electric Company, is concentrating its efforts very largely on selling Australian made apparatus, as the embargo upon the importation of this kind of equipment means that the larger organizations previously importing from Great Britain, the Continent and the United States must either follow this course or lose their radio connections.

Australia and New Zealand

Comparatively few radio tubes are manufactured now in Australia and the market is almost entirely dependent upon the tubes made abroad. The best known brands on the market are Osram, Mullard, British; Philips, Dutch; Radiotron, American; besides the less known Cossor, British and several American made tubes. During the first ten months of 1931, we exported into Australia 335,582 receiving tubes, during the whole of 1930 about 297,675 units. This is an approximate increase of nearly 50 per cent in volume in 1931, as against the preceding year. The exported unit value to this country was \$1.10 in 1930 but only 85 cents in the following year.

New Zealand is an important market for sets and tubes. She ranks as sixth on the United States export list for tubes. In 1930 we shipped to New Zealand 11,963 assembled sets, and during the same period Great Britain, Canada and Australia combined sent 16,816 apparatus. In the first ten months of last year we increased our shipments to 16,027 units, a proportionate increase of 60 per cent in volume over 1930. Our tube export for 1930 was 138,641 units and for the first ten months of 1931 some 108,245. The duty on sets is 12½ per cent preferential. The general tariff is 42⅞ per cent plus a sur-tax amounting to nine-fortieth of the duty, ad valorem.

* * * ELECTRONIC TUBES

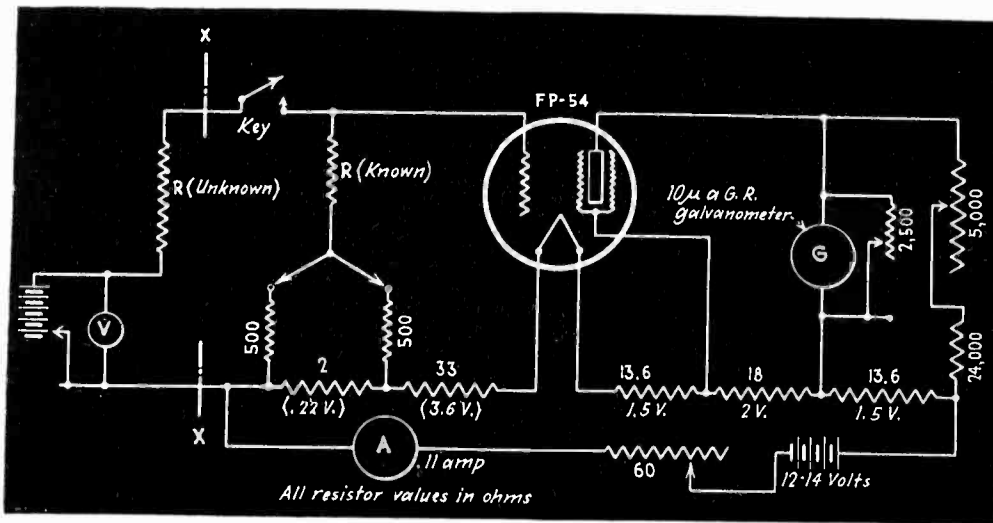

Low grid-current tube in high resistance measurement

High resistance measurement

By F. A. LIBBURY

THE GENERAL ELECTRIC low grid-current tube (FP-54) described in *Electronics*, September, 1930, makes possible a readily portable, cheap, practically foolproof, rapid and accurate setup for the measurement of very high resistances. The circuit used is shown below; it is a series circuit so that once the filament current is attained all voltage drops will be correct.

First, plate current is balanced out by an adjustable resistor so that the microammeter reads zero, or approximately zero. By flipping the switch *S*, the control grid bias is reduced by .22 volts. This brings the microammeter reading up to about 70 on the scale if a 10 microammeter G.R. galvanometer is used. Next the switch is flipped back and a voltage applied through the unknown resistance (left of *XX*) to the control grid, this voltage being slowly increased until the microammeter assumes its previous reading of approximately 70. Or the switch can be left as it was and the voltage applied in the reverse direction until the microammeter returns to its original (zero) position. You then know that you have applied a back voltage of .22, and knowing the total voltage applied to the circuit consisting of the unknown is a matter of simple proportion.

Accuracy clearly depends only on the following factors:

(a) Accuracy of reading the current in the main battery circuit (about 1 per cent with a cheap milliammeter, and of course much more closely with a Weston Standard).

(b) Accuracy of 2-ohm resistor in grid bias circuit. This can be measured to any degree of accuracy required. These two factors determine the change of bias voltage by flipping the switch.

Of course this voltage can also be determined, or checked, by an L. & N. potentiometer across *XX*.

(c) Degree of accuracy with which the microammeter can be read. (Much better than 1 per cent.)

(d) Degree of accuracy to which the voltmeter on source supplying variable to resistor network can be read. This again depends upon type of instrument used; even a rough one, if calibrated, is capable of better than 1 per cent accuracy.

(e) Degree of accuracy of "known" grid resistor. This can be measured as unknown against a standard 100,00 ohm as known. For this purpose a wire and plug arrangement (not shown in diagram) is added by which grid resistance can be shunted, enabling this resistance to be changed without disturbing the tube circuit. Since the grid resistance can be accurately and rapidly measured, any well-built type of high resistance from 5 to 100 megs can be used.

There are only two adjustments to make to put the affair into operation, though about half an hour is required before the tube attains steady conditions. There are

(1) Adjustment of rheostat in main battery circuit so as to give .11 amp in that circuit.

(2) Adjustment of resistor in balancing out circuit so as to reduce plate current through microammeter to zero or practically zero. The microammeter is protected by a 2,500-ohm variable resistor in parallel. When this resistor is short circuited no current passes through the microammeter. As resistance is inserted, more and more current passes. When the knob is turned right around the resistance passes from 2,500 ohms to infinitive; this means that at the moment of opening the current in the microammeter approximately doubles.

Low-thermal-expansion ceramic

A COMMUNICATION FROM Mr. William W. Winship, 58 Schenectady Avenue, Brooklyn, gives some interesting data on thermal expansion of various materials. Mr. Winship says:

"We have been interested in the article 'Low Thermal Expansion Ceramic' in your December, 1931, issue (page 245).

"Fused quartz or fused silica, which has a much smaller expansion than any of the materials named, has for some reason been omitted entirely from this list and we submit the following corrected table, arranged in order of increasing expansions, and using the author's values for his own product:

Material	Linear expansion per °C.
Fused pure silica or quartz (0-1,000° C.)	.00000054
Invar (36 per cent Ni)	.0000009
Crolite No. 7 (0-100° C.)	.0000009
Crolite No. 7 (0-200° C.)	.0000012
Crolite No. 7 (0-1,000° C.)	.0000027
Glass, Pyrex chemical	.0000032

"The first figure given is taken from Bureau of Standards Scientific Paper No. 524 'Measurements on the Thermal Expansion of Fused Silica' and the second from National Physical Laboratory investigations reported in Kaye and Labys 'Physical and Chemical Constants.'"

Tubes in a physiological laboratory

"PERHAPS YOU MAY BE interested in knowing some of the uses to which we have thus far put the various tubes, here in the Physiological Laboratory of the Washington University School of Medicine, St. Louis," writes Dr. Hubert B. Peugnet of that institution.

"As you may already know, in our various departments, there is considerable study of the electrical phenomena associated with the activities of various animal tissues. For the study of these phenomena, we employ several cathode-ray oscillographs, string galvanometers, capillary electrometers, and various other recording devices, in connection with suitable amplifiers designed for operation with the respective instruments.

"We also find considerable use for other types of tubes, such as the neon glow-tube which has thus far found its widest application, with us, for use as a source of easily variable frequencies of electrical discharges, for the stimulation of tissues.

"We are always on the lookout for improvements in electrical methods."

IN THE LABORATORY + + +

Cost of engineering radio sets

FIGURES VARY ON what it costs to engineer present-day radio receivers. Some chief engineers have about 1.5 per cent of the net sales price to spend on engineering and development, others go as high as 5 to 8 per cent. A product typical of the mass production of the past year where extremely low price is essential costs about 1.5 per cent to engineer. Specialty items such as expensive record-playing machines cost as much as 8 per cent to engineer, chiefly because the annual sales are small compared to a midget set brought out by one of the very large companies.

In 1929 a company which had a gross retail sales of about a million dollars employed 9 men in the engineering department at an average monthly salary of \$210. The value of laboratory property was about \$3,000. In 1930 another company selling only to mail order houses paid 10 laboratory men \$260 each per month and had an engineering equipment investment of \$6,000. A similar company doing about the same amount of business employed 14 technical men, paid them \$230 each (average) per month and had \$3,500 tied up in equipment.

A company which in 1931 ranked very high (in quantity of output) paid its 14 technical men \$405 each per month and had test and laboratory equipment, including desks, etc., to the amount of something over \$10,000.

Another company, which experienced considerable difficulty in negotiating the heavy cross-currents of the radio industry, had charged as engineering 4.2 per cent of the net sales price of receivers sold in 1930. This figure is based on the less-than 100,000 sets actually sold and not on total production. The equipment in the engineering department exclusive of the model shop was about \$20,000 and the average number of engineers and draftsmen, laboratory assistants employed was 47. Still another company, operating in the high-class, high-price field paid about 5 per cent for engineering in 1930 but only 3 per cent the year before. The higher figure was due solely to smaller sales.

Instruments measure loss of ultra-violet by smoke

HARMFULNESS OF CITY SMOKE, less because of smoke particles breathed into the lungs than because smoke decreases the transparency of the air and shuts out part of the health-giving rays of sunlight, was emphasized by an exhibit on clean air and clean streets arranged recently by the committee on public

health relations of the New York Academy of Medicine. One new instrument shown was a portable meter and recorder for ultra-violet rays. Two such meters, one inside the smoky area of a city and another somewhere outside the smoke zone, provide a continuous record of the percentage decrease of the solar rays by smoke. Contrary to common opinion, most of the smoke of cities does not come from large factories or power-houses, it was stated by experts attending the exhibit, but from the much larger number of smaller furnaces in small apartment houses, small office buildings and private houses.

Making new emulsions at 300,000 cycles

OSCILLATIONS AT VERY high frequencies, —in the range from 200,000 to 300,000 cycles per second—have shown more results in their reactions on liquids placed in test tubes and vibrated at these rapid rates.

If water only is placed in the flask, minute bubbles appear—the vibration acting to expel the dissolved air just as in the case of heating. The air will not leave the liquid immediately, however, but will gather first at sharply defined points or nodes in the liquid, where interference effects cause it to collect.

If a heavy substance is then poured

in, such as mercury, the metal will immediately begin to mix with the water, though normally it would lie on the bottom. In a short time the entire contents of the flask will be black with mercury. In this way many other normally unmixable substances may be caused to mix. It has been suggested that this effect could be turned to use in making emulsions.

Electronic charges build up million volts

FOR STUDYING LIGHTNING discharges and their effects upon electrical apparatus, a 1,000,000-volt lightning generator of Purdue University, Lafayette, Ind., employs 44 condensers charged by subdividing them into eleven parallel groups of four each and applying a d.-c. potential of 100-kv. through resistances of 200,000 ohms per bank.

Charging potential is obtained from two 150-kv. 250-milliamperere kenotrons, and can be varied by means of a full 100-per cent buck or boost regulator connected to the primary winding of the 5-kva. transformer supplying these tubes. The charging apparatus is remote-controlled from a push-button station, while discharge is initiated by a three-electrode and trigger-gap arrangement which makes possible also the synchronizing of a cathode-ray oscillograph with the discharge.

HIGH-SPEED MERCURY VAPOR VACUUM PUMP

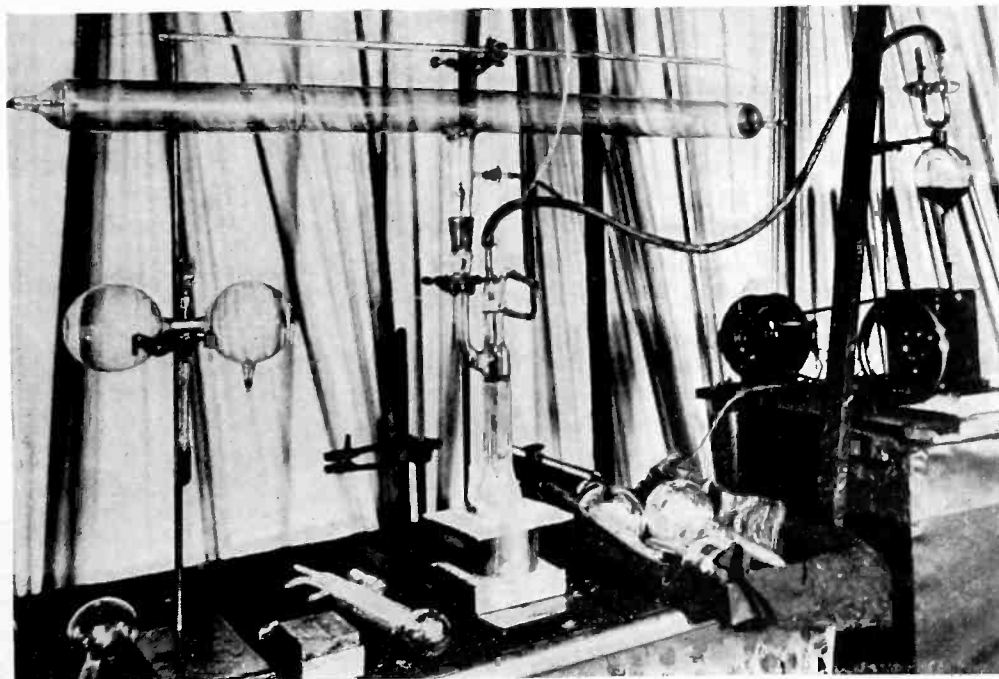

This pump, the vertical apparatus, developed by Prof. C. P. Knipp at the University of Illinois, will exhaust a two-liter tube from the Geissler stage (0.05 mm. mercury) to the X-ray stage (about 0.00001 mm.) in seven seconds

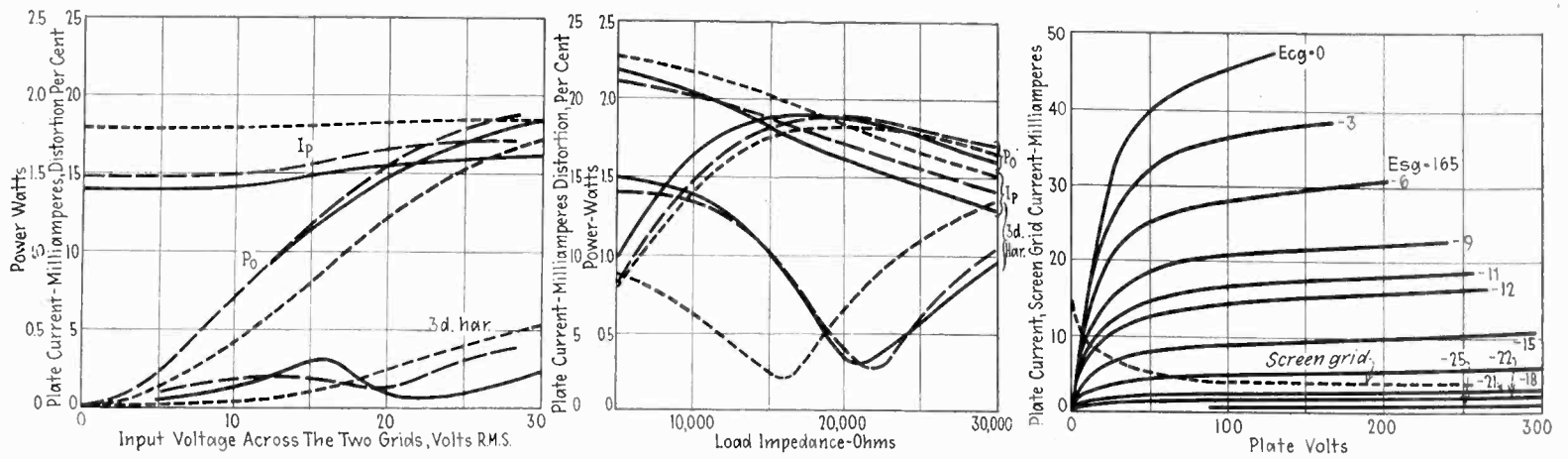

New tube, 238 and 247 as Class B amplifiers with 180 plate volts, 900-ohm C bias resistor, and 20,000 ohm load, for left curve and input adjusted to grid current flow for center curve. Curve at right gives characteristics of the new tube. Solid curves are for the new tube, dotted curves for the 238 and dashed curves for the 247.

An automobile tube of increased output

By M. BAREISS
Raytheon Production Corporation

ONE of the most important problems in automobile receivers is that of supplying sufficient audio output. The signal level should be high enough so that driving noises will not interfere.

The plate supply power is very limited. Dry batteries of 135 and later of 180 volts have been generally used as "B" supply. Also the B-eliminators introduced recently are designed to give only 30-35 m.a. current, because they operate on the car battery already loaded up to maximum capacity. Allowing about 10 m.a. for the other tubes in the set, this leaves a maximum of 25 m.a. for the output tubes. After subtracting the bias voltage, about 4 watts B-power remain and have to be used most economically. It is easy to see that 2 watts audio power is the highest possible output under these conditions.

Of the automobile tubes, the 238 type has proven satisfactory but a tube with greater output and greater sensitivity is needed. The 233 type has a filament which does not seem to stand up in automobile use. The 247 has been used but its high filament current of 1.75 amperes (1.5 ampere for Eveready Raytheon ER-247) is much too high and its bulb size is inconvenient.

A new tube (Eveready Raytheon type LA) has been designed to combine the advantage of these several tubes.

It has the output of a 247 with low battery drain for the filament. Most economical and distortionless operation result from use of two tubes in push-pull, with greater than normal self-bias. The total power is somewhat less, but by proper choice of bias and load impedance, second and third harmonics become low.

The figures below show how the distortion balance is maintained with all input voltages up to the value at which grid current starts. The self-bias eliminates a difficulty usually encountered in class "B" amplifiers, the fluctuation of plate current is not much higher than with class "A" amplifiers. The new tube gives as much power as the 247 with greater sensitivity than the 238; not counting the screen-grid current and grid bias losses, the plate efficiency is about 70 per cent. Taking these losses into account the efficiency is about 45 per cent comparing favorably with other pentodes in normal operation.

Rating and characteristics of Eveready type LA

Filament voltage	6.3 volts d.c.
Filament current	.30 ampere
Plate and screen-grid voltage	135 165 V. max.
Control grid voltage	-9 -11 volts
Plate current	12 17 m.a.
Screen grid current	2.5 3.5 m.a.
Amplification factor	100 100
Mutual conductance	1900 2100 micromhos
Power output	700 1200 m.w.
Load impedance	9500 8000 ohms
Overall dimensions length	4 11/16 in.
diameter	1 13/16 in.
Base	5 prong

Comparative output of power tubes

Type	171-A	233	238	247	LA
Filament					
E_f volts...	5.0	2.0	6.3	2.5	6.3
I_f ampere...	.25	.26	.30	*1.50	.30
At $E_p = E_{c0} = 100V$					
E_{c0} volts...	18	8	9	6	6
I_p m.a....	13.5	10.5	8	8	8.5
P_o m.w....	170	350	270	300	300
At $E_p = E_{c0} = 135V$					
E_{c0} volts...	27	13.5	13.5	8	9
I_p m.a....	17.5	14	9.5	13	12
P_o m.w....	370	750	525	650	700
At $E_p = E_{c0} = 165V$					
E_{c0} volts...	38	not	17	10	11
I_p m.a....	19	recom-	11.8	17	17
P_o m.w....	580	mended	850	1100	1200

*1.75 in the case of many makes of 247 pentodes.

I.F. transformers— cost vs. quality

By CHARLES C. HENRY
and R. E. STEMM

Lear Developments, Inc.

MIDGET radio sets brought about cutting of size and price of receivers with pressure being brought to bear on raw material and parts suppliers. The drive has been for lower prices with the manufacturers continually cutting their prices and receiver size. From this there is slowly emerging the call for quality performance merchandise at a moderate price. This is a healthy symptom for the future receiver market from the viewpoint of the consumer and manufacturer. The fulfilling of the demand will call for greater effort on the part of engineers for better quality at the same time maintaining low costs.

The superheterodyne lends itself to such a market, and since the intermediate system plays such an important part in the cost and performance, much research has been made to achieve the best results for the least expenditure.

Figure 1 shows a family of curves made to determine how inductance varies with turns in lattice wound coils made of silk-covered solid wire. The general shape of these curves will be the same for various coil widths, form diameters and traverses across the coil per turn. From families of such curves for numerous form diameters, coil widths and wire specifications, preliminary tuning requirements may be arrived at for any given intermediate frequency.

The quality of any coil under consideration may be measured by the ratio of its reactance to r.f. resistance at any fixed frequency. With all other variables held constant this quality ratio may vary markedly with the ratio of height to width. The height is then the coil outside diameter minus the form diameter divided by two. To illustrate this point, Fig. 2 shows how, by increasing the inductance, and thereby the height, of coils of certain widths, it is possible to reach an optimum quality at any fixed frequency. This is particularly demonstrated by the shape of the curve for stranded (individually insulated) wire. The cam which

causes the wire to traverse from one side of the coil to another results in coils that vary slightly in width dependent upon various mechanical features. It is, however, a very close expression of the coil width.

Figure 3 indicates how closely coil resistance is linked with cross-section in coils of given inductance resonated to a fixed frequency. A study has been made in Fig. 4 to determine the relation between quality and cost. The wire specifications are caused to vary and the form diameter, inductance and frequency are held constant. In each wire size, the best H/W ratio has been used. Diminishing returns in the form of quality are seen to set in as the wire becomes more and more expensive to produce and wind. The choice would ordinarily lie in the area from 7 to 10 strands of enameled 41 B & S gage.

Figure 5 shows the effect of this X/R factor upon the shape of the resonance curve of a single intermediate frequency transformer working out of a 51 type tube. The increased amplification and selectivity available per stage at optimum coupling using a lower loss coil structure is of interest to those who desire circuit efficiency and selectivity. Solid wire coils of 36 S.S.E. are compared with those made of Litzendraht of nine strands of No. 41 E. The coil inductances were the same in the units compared.

Although the compiled data has been discussed from the intermediate frequency angle, it is equally useful in design of domestic aircraft receivers and foreign long-wave broadcast sets.

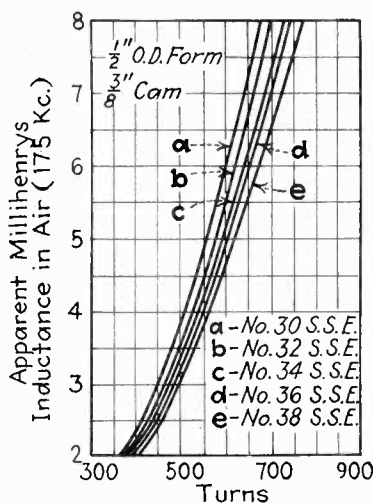

Fig. 1—Inductance vs. wire size

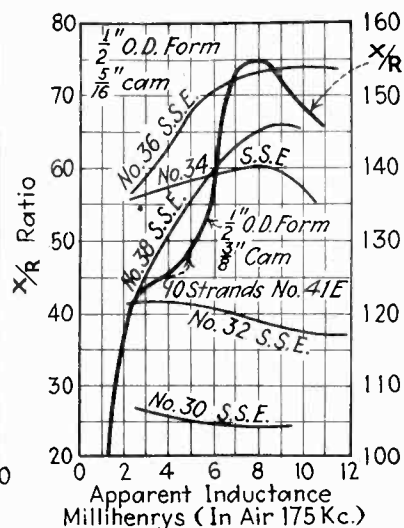

Fig. 2—Coil quality vs. inductance

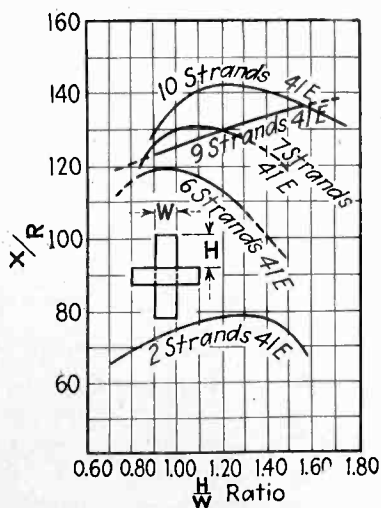

Fig. 3—Coil resistance vs. size

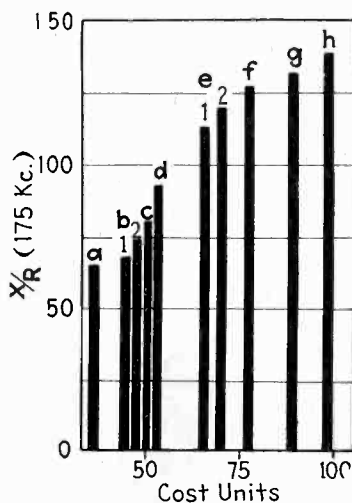

Fig. 4—Quality vs. cost of coil

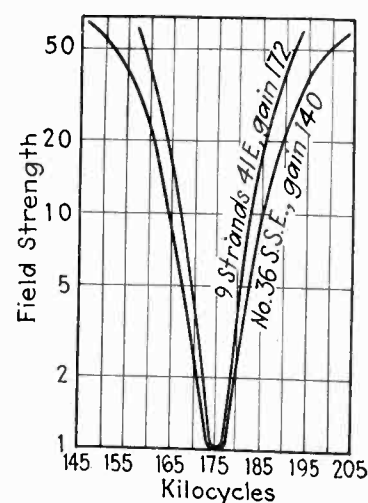

Fig. 5—Selectivity vs. coil loss

HIGH LIGHTS ON ELECTRONIC

Photo-cell integrator for irregular areas

THE PHOTOELECTRIC CELL has been applied as an integrator or computer of irregular areas, by Dr. T. S. Gray of the Massachusetts Institute of Technology, utilizing the method of first cutting out the space below the graph or curve to be measured. Light is then allowed to shine through this opening, and the ratio of this light to that passing through a unit area, at once gives the area of the irregular graph in terms of the measurable area.

Graphs of the varying flow of the Ohio River, when compared by the light "brain," showed the cycles of high and low water, and that they have a certain rhythm. These figures are useful in predicting future behavior of the Ohio. The flow of the Susquehanna River also has been studied through this new instrument.

"With it" says Dr. Gray, "the solution of extremely intricate mathematical problems is accomplished with astounding rapidity and accuracy. It is expected to play a somewhat similar part

for the scientists or engineer that the adding machine plays for the banker and accountant, with a distinct saving of time and improvement in accuracy."

Controlling street lights and water-heaters by "carrier" currents"

By GUY BARTLETT

SPRINGFIELD, MASS., makes use of a new application of carrier currents or high-frequency impulses on the power wires, to control 800 local street lights. The regular power service is 60 cycles, while the control impulses for the street lights are 480 cycles, and those for turning on and off the water heaters are 720 cycles. Use of carrier currents, of course, eliminates the necessity of a separate circuit for the control mechanism, hence making possible a pronounced saving. The double-control method, employing currents of two frequencies, is already so practical that it is suitable for general utility purposes.

Water heaters of the type included in this system are supplied with heating current during night hours when the demand upon electric lines is the lightest. Thus the operator at the distribution power station can control a multitude of water heaters in all parts of the city, just as readily as one snaps on and off an ordinary electric light in the home. Previously there was no way of controlling this load from a central point without the expense of extra wire circuits, which in most cases would have made this type of electric service too costly for general use.

With the present system, however, the cost of control is very low, being almost totally confined to the terminating apparatus.

Similar control, directly at the distribution sub-station, can be had over series and multiple street lights, off-peak water heaters, off-peak house heaters, sign lights, show-window lighting, distribution circuit breakers, or other groups of loads within the area fed by the distribution substation. The total load to be controlled and the number of controllers are, of course, practically unlimited. One General Electric transmitter controls two distinct groups of loads; and, in the case of all-night and midnight lighting schedules, three groups can be controlled. Operation can be by pushbutton or full automatic control. There are no pilot-wires or other outdoor control wiring. Except while the controllers are being opened or closed, practically no power is consumed.

Tubes permit automatic weighing of batches

ACCURACY IN INDUSTRIAL compounding and predetermined weighing operations is substituted for guesswork with the introduction of the new electronic cut-off attachment illustrated. For com-

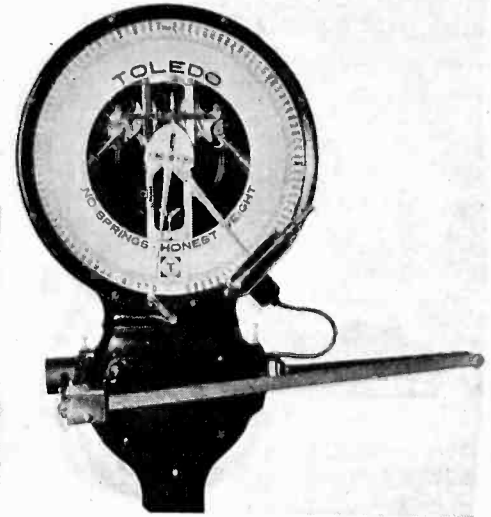

A photocell is mounted behind a slot in the scale dial, and is "eclipsed" when the desired weight of material has been fed into the scale hopper

pounding materials, a multiple adjustable indicator is also available. After the indicators are properly set, the operation is automatic. An operator presses an electric button to start the flow of each ingredient.

The cut-off attachment consists of a photoelectric tube which effects a connection between the scale, and the gate, valve or conveyor. This light-sensitive element is mounted inside the dial housing of the scale, directly behind a slot in the dial. On the outside of the dial housing and in front of the slot, is an electric lamp. In operation, the device works as follows: The photoelectric tube is attached to a Toledo scale, having a clockwise front dial and a counterclockwise rear dial. The rear dial is equipped with an adjustable indicator. The slot for the light-sensitive element is located near the zero graduation. If, for example, batches of 120 pounds are to be weighed, the adjustable indicator is set at 120 on the rear dial. Hence, the slot is uncovered, and the pressure of a button opens the gate. As the material falls upon scale, the adjustable indicator returns to zero, at which point the photoelectric cut-off closes the gate. Now the front indicator reads 120 pounds. After the indicator is once properly set, the operation of weighing is automatic, requiring no hand opera-

PHOTO-CELL FOUNTAIN



Intercepting beam of light focused on photocell, turns on water

DEVICES IN INDUSTRY * *

tions as long as the amounts to be weighed remain the same.

For use in liquid packing, mixing or filling operations, a solenoid valve is available. This attachment is suitable for production operations. The relay which transfers the impulse of the photoelectric tube to a gate, valve, conveyor, belt, bell or any connecting device, is capable of breaking 15 amperes at 110 volts or $7\frac{1}{2}$ amperes at 220 volts. A standard electric light socket with alternating current is the only connection necessary. For accumulating batch weighing, 1, 2, 3 or 4 adjustable indicators can be furnished. The Toledo electric cut-off attachment can be attached to any type of late Toledo dial scale.

Electric eye operates huge sign

By GORDON S. MITCHELL

A HUGE ELECTRIC SIGN, embracing several novel features of operation, has just been installed on one of the leading highways outside Los Angeles, Calif. This sign, announcing the Olympic Games, measures 75 ft. across the bottom and rises 75 ft. above the roof of the supporting building.

Probably the most interesting feature of the assembly is the "electric eye" mechanism by means of which the sign is automatically turned on and off. This consists of a light sensitive photoelectric cell, connected to a relay in such a manner that with the approach of darkness the decreasing intensity of the light falling upon the cell causes the cell to operate a relay, which throws a switch and turns the lights of the sign on. At daybreak, the reverse action takes place and the lights are turned off, the only necessary attention being an occasional inspection to replace burned

out globes. In the event of a dark overclouded day, the sign automatically turns on whenever the light falls below a predetermined intensity.

Photocell measurement of tube efficiency

GROSKOWSKI, writing in *L'Onde Electrique*, Paris, describes use of the new Lange-Schottky photocell, $\text{Cu}_2\text{O-Cu}$, specially sensitive to the ultra-red radiations. A quartz lens forms the image of part of the anode of the tube under test on the sensitive surface of the cell, thus eliminating the effect of the glass bulb, of daylight, and of the cathode luminosity.

Noise recorder for comparing street-car sounds

By GEORGE PHILLIPS

ABOUT FOUR YEARS AGO, the Boston Elevated Railway was experimenting with certain modifications of car equipments in the hope of reducing operating noises. Use was made of a special radio interference apparatus, which was designed to obtain a graphic record. As there was insufficient amplification, however, readings were taken with a Weston voltmeter in the output circuit.

The averaged figures gave a fair indication of the results sought, but it was felt that graphical data would be very desirable. This led to further experiments, as a result of which a new noise-recording apparatus was designed. This noise recorder consists of a three-stage audio amplifier, into which is fed electrical impulses generated in a magnetic type of microphone, which impulses are amplified, rectified and finally recorded on an automatic Esterline recording voltmeter.

Means is provided to bias the first tube, and for fine adjustment a 400-ohm potentiometer is available. During the experiments, however, it was found that if a voltage of 4.5 volts was maintained across the filaments of the tubes and plate voltages of the values indicated, no external C bias was required for the first tube, the potentiometer being sufficient for good results. The second tube works only on the normal bias of the A battery. By use of a 9-volt C battery bias of the last tube, the pen of the recorder floats practically on the zero line with no input.

This apparatus has been used to compare the noises of different types of cars passing certain points; in analyzing the clicking at trolley ears of different design; the study of the benefits of shockproof trolley poles; to compare the noise of pneumatic tools with and without mufflers and in an analysis of silencers on turnstiles.

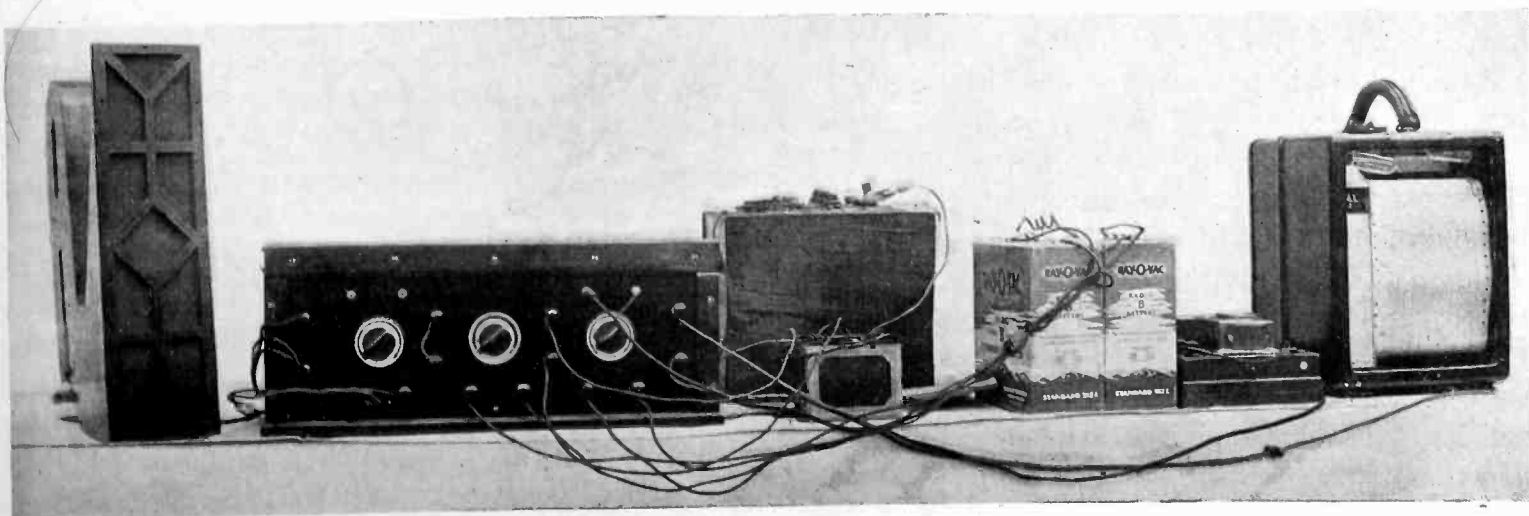
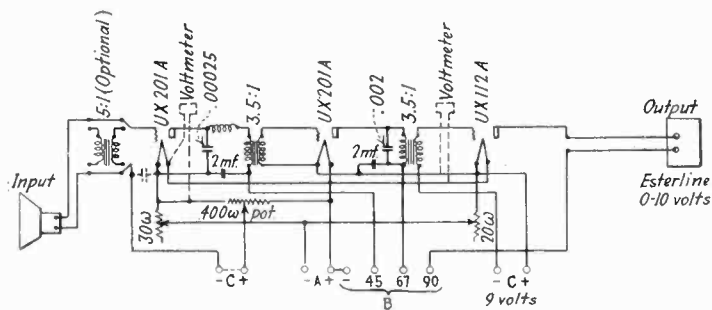

Noise recorder developed by Boston Elevated Railway for comparing amplitudes of various sounds encountered on its system.

electronics

McGraw-Hill Publishing Company, Inc.
330 West 42d Street
New York City

O. H. CALDWELL, *Editor*

Volume IV — MARCH, 1932 — Number 3

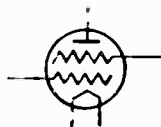

An industry campaign for "Satisfactory Radio Reception"

READERS of *Electronics* are not directly interested in radio "servicing" problems, but they are concerned with efforts to bring satisfactory radio reception to the general public, which in turn will make for greater popularity of radio, greater sales of new sets, and immediate sales of replacement tubes, parts, etc.

During March, under the leadership of the editors of *Electronics* and its associated trade organ *Radio Retailing*, there will get underway a nation-wide campaign to bring better radio reception conditions to millions of radio listeners,—a campaign which will prove of tremendous benefit to the listening public, dealers, jobbers, manufacturers and broadcasters.

With the help of the broadcasting stations, newspapers, magazine articles, etc., the listening public will be reminded and informed of the standards of good reception which it should be enjoying, to wit:

1. Freedom from noises, clicks, and buzzes
2. Fidelity of tone—"reality"
3. Ability to hear clearly all nearby stations.

Every reader will admit that radio reception conditions in millions of homes and for millions of listeners can be greatly improved, through calls and overhauls by local dealers or service men.

Radio Retailing is therefore urging radio dealers to begin at once making canvasses of their neighborhoods to improve listeners' reception. Such canvasses and calls will open large opportunities for tube replacements, antenna reconstruction, parts sales, etc., besides leading to many sales of new sets.

In this work of bringing "Satisfactory Radio" to customers the industry will have its way paved by informative broadcasts over the great broadcasting chains telling the listener about the standards of good reception he should be getting, and by frequent 20-word reminder announcements, morning, noon and night urging the listener to "See Your Nearest Radio Dealer."

All up and down the industry all forces are thus being marshaled to bring to every home "Satisfactory Radio," and in this effort every reader of *Electronics* can help!



Utilizing electron refraction in industry

PROBABLY it has been the view of many that the close connection of electron diffraction to the complex theories of wave mechanics makes this subject a matter solely of theoretical interest. The article on a preceding page, however, would seem to thoroughly dispel this erroneous idea. Electron diffraction, should prove of fundamental and practical importance to industrial processes of many kinds.

The information contained in that article has been authenticated by many workers including G. P. Thomson, Rupp, Davisson, Germer, Kikuchi and others. The author's own work was done in the laboratories of Oberlin College.

With Mr. Phillips' clear presentation of electronic refraction one more tool is given to commercial analysts and industrial operators.



Super selectivity versus sidebands

WHILE most of the acrimonious arguments for and against sidebands which disturbed the British radio papers have died down, the idea which started these arguments—the use of highly selective circuits—is not dead by any means. Perusal of the technical journals recently indi-

cates that considerable merit exists in excessive selectivity with audio compensation to bring back to the required strength the higher modulating tones.

No matter how this selectivity is obtained, i.e., by tuned circuits, by mechanical resonance as by crystals, or in other ways, the advantages of such circuits are several, especially when worked into linear detectors. In the first place such selectivity decreases the modulation with respect to the carrier. Then if selective fading is experienced such that the carrier under normal circumstances would become weaker than the sidebands, with resultant bad mushing, in the highly selective receiver, the carrier would still be stronger than the stronger sideband and good quality would not suffer.

In the second place, worked into a linear detector, a weak carrier suffers demodulation to a marked degree when received at the same time as a strong carrier. Thus even if the modulation of the undesired weak carrier were within the signal domain of the desired carrier, this unwelcome modulation would not be apparent in the desired output.



Bass drum and tympani — the 5000-cycle limit

ADVERTISING claims to the contrary, very few radio receivers now on the market, or in the home, transmit faithfully up to 5000 cycles. The majority of them are practically dead at this frequency, especially those equipped with tone controls. On the other hand the broadcast stations have continually increased their audio-frequency range, wires between studios and cross country have been improved, so have repeaters and the other transmitting paraphernalia.

At the Bell Laboratories tests were made of all musical instruments to see when trained and untrained listeners could tell when certain high and low frequencies were cut out. It was observed that very little transmission below 60 cycles was necessary. But there were only two instruments that could be transmitted faithfully through a radio that cut off at 5000 cycles—the tympani and the bass drum!

The new synthetic music of electrons

MUSICAL tones of a sweetness and purity never before produced; instruments permitting a range and delicacy of touch to do justice to which a new generation of composers will be required; violins that turn into French horns at the twist of a switch,—these are among the revolutionary new electronic musical instruments now being demonstrated before the public and attracting wide interest among both musicians and laymen. Dr. Walter Damrosch discussed the future of these new instruments from the musician's standpoint at a meeting in New York last month. Dr. Leopold Stokowski has been making use of similar electronic oscillators.

Thus for the first time in the history of music, it is now possible to create any desired quality of musical tone by scientific analytical methods. When one comes to think of it, all musical devices of the past have been mere accidental contraptions of hammers, skins, cat-gut, horsehair, brass pipe, strings, etc. For ages, musicians have had to use what they could get, with the crude means at hand. Our musical mechanisms thus have been hardly more than one step removed from the tom-tom of the savage.

But the new electronic oscillators make it possible for the musician to create any wave-form, timbre or tone effect he desires, and they afford a delicacy of control and touch, undreamt of with our present gross musical mechanisms which are operated by pounding, scraping or blowing!



Three models of one of the latest forms of musical instruments developed in Europe—played by running the hands over the bars shown

The march of the electronic arts

"Business" keynote of Radio Trade Show, Chicago, May 23-28

BUSINESS, WITHOUT BALLYHOO, again will be the keynote of the annual conclave of radio manufacturers, jobbers and dealers in Chicago May 23 to 28 for the Eighth Annual RMA Convention and Trade Show. The gathering has been shortened to four days and is staged earlier to precede, with its display of new radio, television and electrical products, the radio sales stimulation of the Republican and Democratic presidential nominating conventions which soon follow the trade show. Display of the progress of television also is a scheduled feature of the trade show, affording an opportunity to jobbers and dealers to view the latest television as well as radio and electrical products of RMA manufacturers. Admission to the trade show as usual, will be limited to the trade.

The official hotels, the Stevens and Blackstone, already have received advance reservations. Regular hotel rates will be accorded convention and trade show visitors who numbered 22,000 last year. "Radio special" trains on the New York Central and Pennsylvania Railroads from New York are being arranged and other special trains and cars are being planned from other parts of the country.

RESONATOR SPEAKER

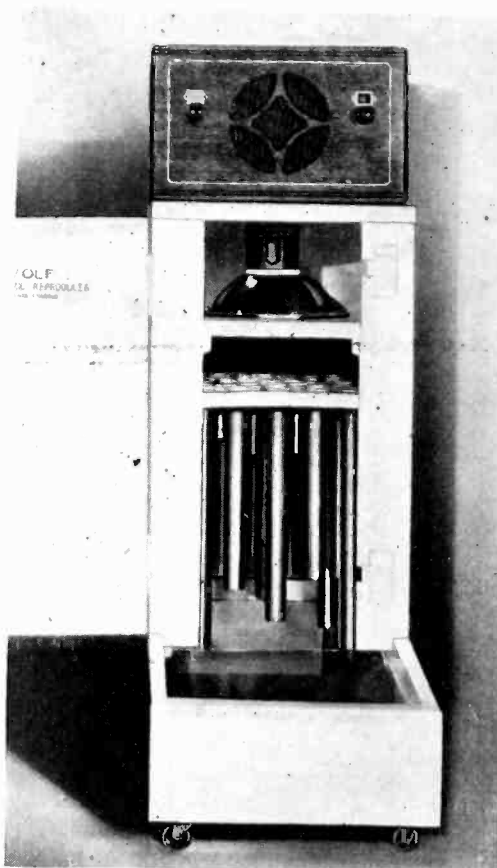

The principle of the Helmholtz resonator, with many tuned tubes, echoing onto water, is employed in this Volf loudspeaker

To build 15,000,000-volt tube at M.I.T.

DR. KARL T. COMPTON, president of the Massachusetts Institute of Technology, has announced that construction will shortly begin on a 15,000,000-volt x-ray tube, to be operated by a Van de Graaff electrostatic generator. This new tube will be of the double-acceleration type, and will be fifteen times as powerful as the 900,000-volt tube built by Dr. W. D. Coolidge at Schenectady, N. Y., and nearly eight times as large as the 2,000,000-volt tube built by Dr. M. A. Tuve of the Carnegie Institution, Washington, D. C.

The new electrostatic generator is to be set up in a hangar belonging to Colonel E. H. R. Green at South Dartmouth, Mass., and will consist of two highly-polished hollow aluminum spheres each 15-ft. in diameter and $\frac{1}{4}$ in. thick, and each carried on a hollow paper insulator 6 ft. in diameter and 28 ft. high. The cylinders will be mounted on iron castings carried on four-wheel trucks running on railway tracks 14 ft. apart. When fully charged it is expected the spheres will spark a distance of 15 ft. between the two globes charged respectively positively and negatively.

Completion of the new 15,000,000-volt generator and tube is expected this summer.



Pittsburgh Convention, Institute of Radio Engineers, April 7, 8, 9

Thursday, April 7

Morning Session

"Radio Dissemination of the National Standard of Frequency," by J. H. Dellinger and E. L. Hall, Bureau of Standards.

"Precision Frequency Checking System of the RCA Central Frequency Bureau and RCA Communications, Inc.," by H. O. Peterson and A. N. Braaton, RCA Communications.

"Kennelly - Heaviside Layer Studies Employing a Rapid Method of Virtual Height Determination," by J. P. Shafer and W. M. Goodall, Bell Telephone Laboratories.

Friday, April 8

Morning Session

"Recent Trends in Receiving Tube Design," by J. C. Warner, E. W. Ritter, and D. F. Schmit, RCA Radiotron.

"Triple-Twin Tube," by Charles Stromeyer, Cable Radio Tube Corporation.

"Application of Class B Amplifiers to A-C Operated Receivers," by L. E. Barton, RCA Victor Company.

"Analysis and Reduction of Output Disturbances Resulting from the A-C Operation and the Heater

of Indirectly Heated Cathode Triodes," by J. O. McNally, Bell Telephone Laboratories.

"Dynamic Symmetry," by A. F. Van Dyck, Radio Corporation of America.

"Radio Test Methods and Equipment," by W. F. Diehl, RCA Victor Company.

Afternoon Session

"Modern Radio Equipment for Air Mail and Transport Use," by C. G. Fick, General Electric Company.

"Two-Way Radiotelephone Circuits," by S. B. Wright, American Telephone and Telegraph Company.

"Sound Collection and Directional Microphones," by H. F. Olson, RCA Photophone Company.

"A New Field Strength Meter," by P. B. Taylor, Westinghouse Electric and Manufacturing Company.

"Campbell - Shackleton Shielded Ratio Box," by Leo Behr and A. J. Williams, Leeds and Northrup Company.

Saturday, April 9

Morning Session

"A New Circuit for the Produc-

tion of Ultra Short Waves Oscillation," by H. N. Kozanowski, Westinghouse Electric and Manufacturing Company.

"A Standing Wave Type of High Power Ultra Short Wave Oscillator," by I. E. Mourmtoff and H. V. Noble, Westinghouse Electric and Manufacturing Company.

"Magnetic-Static Tubes for Variation of Ultra Short Waves," by G. R. Kilgore, Westinghouse Electric and Manufacturing Company.

"Transmission Lines for Short Wave Radio Systems," by E. J. Sterba and C. B. Feldman, Bell Telephone Laboratories.

"Calculation of Directivity and Mutual Effects in Directive Antenna Systems," by P. S. Carter, RCA Communications.

"Design of Resistors for Precise High Frequency Measurements," by Leo Behr and R. E. Tarpley, Leeds and Northrup Company.

Afternoon Session

KDKA SYMPOSIUM

"The Saxonburg Station of KDKA," by R. L. Davis, I. E. Mourmtoff and J. C. Hutchinson, Westinghouse Electric and Manufacturing Company.

Discovers "neutron"—bound positive and negative particles

WORKING IN THE Cavendish Laboratory at Cambridge, England, James Chadwick reports having discovered the presence of the neutron, which comprises a proton and an electron bound together without an electric charge. This primary form of matter is believed to represent the first step in the formation of the simplest atom out of electricity.

"The discovery is of the greatest interest and importance—possibly the greatest since the artificial disintegration of the atom," declared Lord Rutherford, director of the Cavendish Laboratory. "It already has afforded a number of examples of unexpected types of atomic disintegration and offers a promising approach to a number of important problems."

Chain broadcasting incomes up for 1931

AN INCREASE OF \$7,500,000 in gross revenue during 1931 over the preceding year, derived by the National Broadcasting Company principally from furnishing facilities to backers of programs, was announced by M. H. Aylesworth, president, in his annual report to the company's advisory council. The company's gross revenue during the past year reached \$29,500,000, as compared with \$22,000,000 in 1930. The clients during 1931 totaled 231, compared with 263 the preceding year.

The gross volume of business done by the Columbia Broadcasting System during 1931 is stated unofficially as \$11,000,000, as compared with \$9,000,000 gross for 1930, an increase of two million dollars.

Photocell timed skating races

CONTESTANTS IN THE Massachusetts speed championship races, Feb. 25, at Springfield, Mass., were timed electrically to a hundredth of a second. Using thyatron, the equipment eliminated human errors such as time-lag resulting from human reaction and errors caused by optical illusion.

The device went into operation with the sound of the starter's gun. The report of the gun was picked up by a microphone at the starting line, amplified, and used for automatically setting in operation the electric machinery. A narrow beam of light was projected across the finish, and concentrated on a photoelectric tube. The first skater to cross this beam thus timed himself on a recording clock.

School handbook on radio and sound apparatus

A BOOKLET IS UNDER PREPARATION by the Radio Manufacturers Association in cooperation with the U. S. Office of Education, Department of the Interior, to promote equipment of schools with radio and sound apparatus. A. C. Kleckner of Racine, Wis., is summarizing the data from manufacturers, while Orrin E. Dunlap, Jr., radio editor of the *New York Times*, is preparing other editorial features for the booklet. The project is in immediate charge of Dr. C. M. Koon, chief of radio activities of the U. S. Office of Education.

New freight rates on radio products

THE RMA TRAFFIC BUREAU reports several changes in freight rates and practices affecting radio products. The Traffic Bureau was successful in securing new ratings on cabinets which became effective Feb. 25. New class rates on export and import and coastal traffic, effective Dec. 3, in lieu of the general 15 per cent rate advance requested by carriers, also are in operation.

The association's Traffic Committee has also secured a ruling on shipments of midget sets, made effective January 30.

RMA members have been advised by special traffic bureau bulletins of these and other traffic matters in detail, according to R. T. Pierson, traffic committee chairman, and W. J. M. Lahl, traffic manager.

DR. ARTHUR H. COMPTON

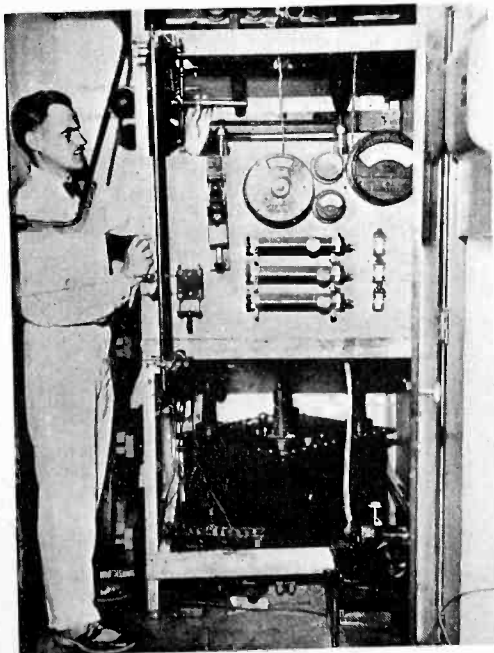

Ten million volts will eventually be used in experiments at the University of Chicago to release atomic energy

Senate inquires into Government broadcasting

TO GUIDE THE SENATE in deciding what remedial legislation may be necessary to make radio more entertaining and instructive, the Radio Commission has been called upon to furnish specific information as to present broadcasting practices. On motion of Senator Couzens of Michigan, chairman of the Interstate Commerce Committee, the Senate has adopted a resolution directing the Radio Commission to supply data on the extent to which radio stations are being used for commercial advertising purposes, the net income of representative broadcasting companies, and the use being made of broadcasting facilities for educational purposes. The resolution also requests the Commission to send to the Senate any information available on the feasibility of government ownership of broadcasting facilities.

Senator Couzens believes that there are three courses that may be followed by Congress in seeking to curb commercialism on the air. 1. The government can legislate itself into ownership of all broadcasting stations. 2. All advertising matter can be eliminated from programs by an enactment by Congress. 3. A law can be passed limiting advertising over the air to the sponsorship of programs. Senator Couzens feels that something should be done this session.

Army hospitals to get central radio systems

CENTRAL RADIO RECEIVING SYSTEMS, over which radio programs will be tuned in and then relayed by special wiring to patients in their beds, have been ordered installed in 105 U. S. Army hospitals in the United States, Panama, Porto Rico, Hawaii and the Philippines. The newly developed "pillow receiver," a diminutive radio speaker encased in a sponge rubber cushion with an outlet to permit of undisturbed reception, will be part of the equipment ordered by the War Department.

Test new SOS device

AUTHORITY TO EXPERIMENT on the SOS wavelength with a new automatic radio distress signaling device, it has perfected, has been granted by the Federal Radio Commission to the Submarine Signal Company of Boston. Tests will be conducted in cooperation with radio inspectors of the Department of Commerce on the Great Lakes. The new apparatus was designed for use both by surface and submarine craft.

REVIEW OF ELECTRONICS LITERATURE

HERE AND ABROAD

Marconi's recent ultra-short-wave experiments

[GNESUTTA] These related more to improvements in known circuits, especially as regards the increase of power, than to new conceptions. The use of two tubes in push-pull in the transmitter, as shown in the diagram, is considered an important modification, as also the use of more than one transmitter in phase.

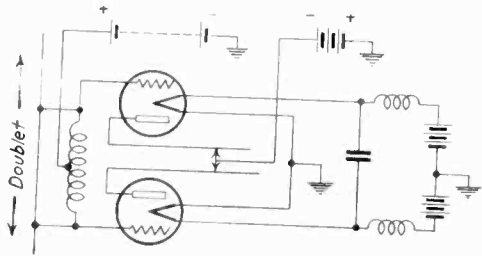

As reflectors a system of doublets supported by a parabolic tube was used, photographs are given. The receiver used a circuit similar to that shown, but with the anodes connected to the doublet, superregeneration was employed. Distances of 40 kilometers were covered. The power used is not stated.—*Radiogiornale, Milan, January, 1932.*

Luminous phenomena in monatomic gases

[LEDERER] Laboratory research at the University of Vienna has led to the production of lamps for a.c. and d.c., consisting essentially of a wolfram filament within a nickel or iron cylinder, this being coated with an electron-emitting substance (oxides of calcium, barium, strontium, or a mixture). The whole is enclosed in a glass bulb with a suitable gas according to the colour desired (a mixture of neon and mercury vapour is especially suitable, giving a warm light resembling daylight). It is believed that some entirely new phenomenon is involved. Lamps up to 100 watts have been constructed, with a life of at least 1,000 hours. The voltage-drop across the lamp is less than 20 volts.—*Radio Amateur, Vienna, February, 1932.*

The latest

[H.G.] Ganz and Co. of Vienna are producing rectifier tubes suitable for direct connection to the 220 volt a.c. lines, without any transformer. Similar tubes for 110 volts are to be produced, for use in the so-called "Greinach" (voltage doubling) circuit.—*Radio B.F.f.A., Stuttgart, February, 1932.*

"Decimeter" circuits

[NOACK] For waves below one meter Kohl uses a typical Barkhausen circuit, but instead of chokes in the anode and grid feeders a metal bridge is laid across but isolated from them (i.e., to form essentially a condenser shunt between them) and slid along them to a suitable position according to the wavelength in use. Modulation is in the anode lead. A similar circuit is used for the receiver.—*Radio B.F.f.A., Stuttgart, January, 1932.*

Science and hydrography

[SINAT] Contains a good description of the Chilowski-Marti sounding system using frequencies from 30,000 to 50,000, emitted by a quartz crystal fitted between steel plates, of which one is in contact with the water and the other is periodically connected to a small tube transmitter, the time taken for the echo to return to the ship being measured by an oscillograph.—*Science et la Vie, Paris, January, 1932.*

Amplification circuit with bandfilter effect

[SCHR.] French patent 696806 in which a triple-grid tube is used, the innermost grid being connected to a circuit tuned to the frequency to be received, the central and the outer grids to two circuits tuned respectively to slightly higher and slightly lower frequencies. The anode circuit is coupled to the next tube in the usual way.—*Funk, Berlin, February 12, 1932.*

High-frequency switching

[L.] German patent 525569. The two condensers and the two inductances being respectively of the same value, and the circuit composed of one of each being tuned to the frequency of the cur-

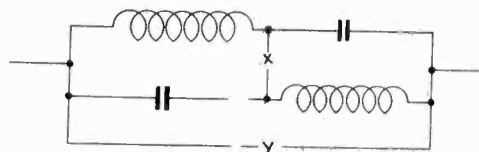

rent to be interrupted, to break the current Y is opened and then X is closed, to remake it, Y is closed and then X is opened.—*Funk, Berlin, January 29, 1932.*

International frequency comparisons

[DECAUX] Report of visit with a special French quartz oscillator (having a temperature coefficient of 3×10^{-6} per degree) to German, Italian, and British Government laboratories, with descriptions of the frequency standards and measurements there used. In all cases but one the base is a tuning-fork (never a quartz crystal). The Italian Naval laboratory uses direct demultiplication, with a maximum of six stages, until the frequency being measured is low enough for direct comparison with a pendulum. Full details of all systems are given. The precision in general is of the order of one in one million.—*L'Onde Electrique, Paris, December, 1931 (published January 23, 1932).*

Short-wave transmitter

GERMAN PATENT 535863. Simplified construction in which the tubes (up to 8 in parallel) and all inductances and condensers are carried on a single insulating pillar, constructional diagrams and circuits are given.—*Funk, Berlin, February 5, 1932.*

Short-wave transmitter

[L.] German patent 527879 in which the blocking condenser B of such a circuit as that shown is replaced by the distributed capacity between the

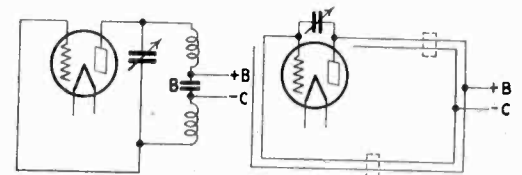

feeding leads and dead-end leads separated from them by mica, the inductance being adjusted by isolated metal bridges from lead to lead which can be varied in position.—*Funk, Berlin, January 29, 1932.*

Carrier-wave stopping

AUSTRIAN PATENT 122222. To prevent carrier (high-frequency) currents leaving the main conductors at spur lines, instead of tuned circuits at these points short sections of the spur conductors are replaced by iron wire, or iron wrapped over the copper conductors. Efficiency and economy are claimed.—*Funk, Berlin, February 5, 1932.*

Television systems in Germany

[M. VON ARDENNE, E. H. TRAUB] In the German post office short-wave television system the transmitter is of the Nipkow disk type (60 lines, 4,800 picture elements, 25 pictures per second). The disk is provided with 60 small radial slits in addition to the loop-holes. A cathode-ray tube is used for reception. The photocell amplifier contains five stages and is capable of dealing with a band from 25 to 100,000 cycles. At the end of each line a short synchronizing impulse is transmitted which possesses a greater amplitude than the actual picture current and may be isolated from it with the aid of an amplifier filter. A longer impulse is transmitted at the end of each picture; to this end the space between two radial slits on the disk is cut out in one place. These impulses, on the same wave as the picture, control two generators of saw-tooth waves, which charge the two pairs of deflecting plates, the horizontal deflection giving the strip frequency, the vertical deflection being for the image frequency. There is a small interval between successive lines or pictures.

In the opinion of the English observer at the Berlin Radio Show the disk receiver of the Fernseh A.G., an amalgamation of Bosch, Loewe, Zeiss-Ikon and Baird, gave better results with 90 lines and 10,800 elements than the post office receiver using 13,000 elements. In a scene showing two cars in motion the make of the cars could be recognized quite easily. The holes on the disk are hexagonal and arranged upon a continuous double spiral. A second disk containing a broad spiral is geared to the main disk which is run at double the correct speed so that one hole only is given free at a time. The positive column of a neon discharge tube claimed to have no lag serves as the source of light (10 watts at 50 milliamp.).

The Tekade group showed the mirror screw scanner, a pile of mirrors helically arranged like a spiral stair case (84 mirrors each 10 cm. long and 1 mm. wide). The Ardenne system was shown by Loewe Radio.—*Journal of the Television Society*, December, 1931.

Submarine eye

[UNSIGNED] Hartmann has developed an apparatus containing powerful sources of light and a photocell with rotating disk, the impulses being taken over the suspending cable to a receiver of the normal television type. It contains also an electrically-driven cinema camera which can be switched on by the observer above water, to record what is "seen" by the photo-cell. An excellent constructional photograph is given, with full mechanical details.—*Funk*, Berlin, January 1, 1932.

New scanning method

[TOULON] Instead of scanning strip by strip over the object, lines are scanned in irregular order and in such a way that the whole object is rapidly covered, the eye thus receives a rough impression which is then, so to speak, made more precise as the other intervening strips are scanned. A reduction of 50 per cent in the number of points per second for equal definition is claimed, together with absence of flicker. Scanning can be by a specially perforated Nipkow disk, or by two superposed normal disks. The system is particularly suitable for the transmission of cinematograph films, using a continuous and not a step-by-step motion. Correction of faulty synchronism is stated to be easier with the new system than previously.—*T.S.F.p.T.* (supplement "La Télévision"), Paris, January, 1932.

Balance of "radio first aid"

IN 1930, VOLUNTARY COMMITTEES were formed in Germany to investigate reports of interference. During 1931 about 125,000 such reports were investigated, 29 per cent being from medical high-frequency apparatus, 23 per cent from small domestic motors, 14 per cent from undue use of regeneration, 11 per cent from faults in the complainant's own apparatus, and 23 per cent due to street-cars, lighting and power transformers, traffic signals, electric heating-pads, irons, etc.—*Funk*, Berlin, February 5, 1932.

Improved electrostatic loudspeaker

[HANS VOGT] The fact that a lecture to radio engineers on an improved electrostatic loudspeaker had to be repeated shows that the shortcomings of the electrodynamic speaker, its weight, the limited directly-driven area and its resonance band in the low frequency range, are keenly felt. The grounded moving surface, a membrane rolled of an aluminum magnesium alloy, is placed between two positively charged electrodes to which the audio potentials from a center-tapped transformer are also applied. The 3-watt loudspeaker has a diameter of 16 inches, and weighs 5 lb. The oscillating membrane (aluminum 96.8, magnesium 2.2, silicon 0.4, iron 0.5 and copper 0.1) is about one mil thick. Its elongation is small, its strength close to that of steel. The average distance between the membrane and the electrodes is 0.25 mm., increasing to about 1 mm. at the center so that sufficient space is left for strong low-frequency vibrations. The capacity of the system amounts to 2,000 $\mu\mu$ f. The electrodes are of bakelite, pierced by about 25 circular slots, covered with colloidal carbon and protected by an insulating layer. With 1,500 volts d.c. applied, the field produced between membrane and electrode is 37.5 kilovolts per cm. Tungsten spark gaps protect the system. A price of a few dollars is mentioned.—*E.T.Z.* November, 1931. *Zeitschr. techn. Physik*, December, 1931. (This article was translated in Radio News.)

AWARDED HEINRICH HERTZ MEDAL

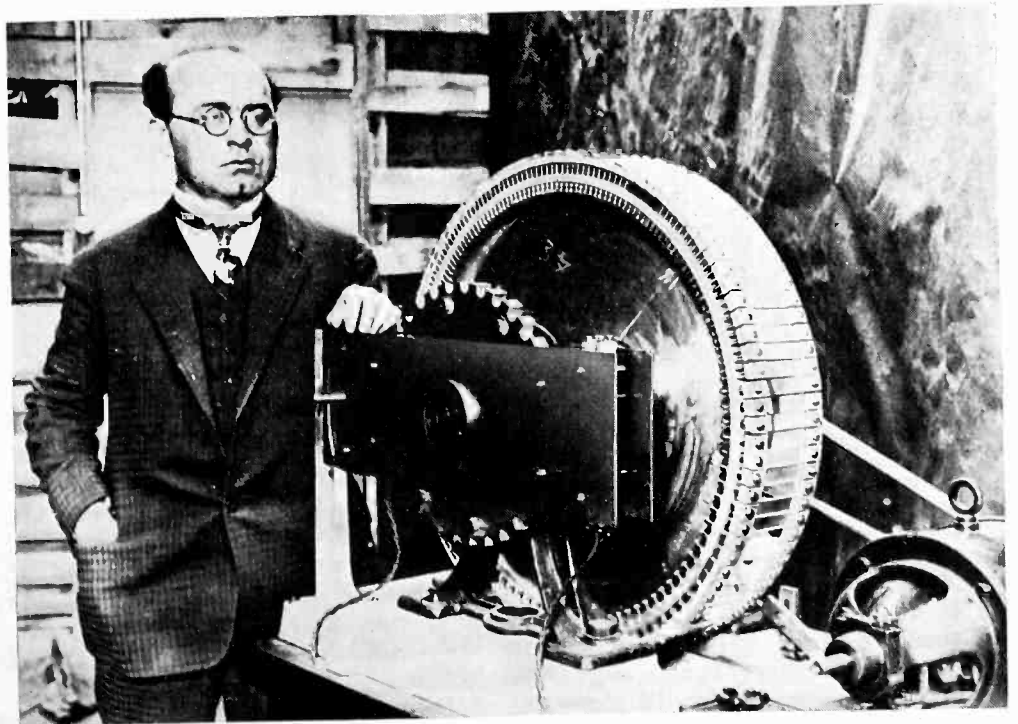

Professor H. Karolus and his mirror wheel for television, recipient of gold medal at the recent Heinrich Hertz Festival in Berlin

NEW BOOKS ON ELECTRONIC SUBJECTS

Experimental radio engineering

By John H. Morecroft, John Wiley, Inc., New York. 350 pages. Price, \$3.50.

PROFESSOR MORECROFT HAS COLLECTED some fifty pertinent experiments to be performed in the average college laboratory giving a course in radio engineering. He discusses at some length the difference between low and high frequency measurements, with space devoted to the instruments to be used at radio frequencies. The experiments are conventional in form and subject but as is typical of other Morecroft books the author brings to the text many quantitative data.

The student, and indeed the commercial engineer, will not only find how to perform the experiments but the actual results of such work as performed in the author's laboratory. Thus the book is valuable not only as a laboratory text but as a source of data which such experiments reveal.

Resonance phenomena, mutual inductance measurements, power tubes as amplifiers and as oscillators, various kinds of rectifiers now in common use, studies on filters, and even an experiment on the superheterodyne receiving showing importance of the strength of the local signal are found in the book.

Projecting sound-pictures

By Aaron Nadell, McGraw-Hill Book Company, Inc., New York. 260 pages, illustrated. Price, \$2.50.

THIS BOOK IS INTENDED to be a practical text book for projectionists, engineers, theater managers and others directly interested in the problems of sound-picture operation and maintenance. The principal systems of sound reproduction, both for film and disk, are covered with illustrations showing the principal component parts. It should prove a good instruction book, as each chapter is followed with a series of questions and answers. While it is realized that it is difficult to include in a book of this size detailed information on maintenance covering every type of sound equipment, the pages that are devoted to this subject cover at least the principal maintenance problems, and should be of great assistance in maintaining sound-equipment in good condition. Those not familiar with the operation of amplifiers will find a simple explanation of the principal functions of vacuum tubes and associated circuits.

Official radio service manual

Vol. 2, 1932. Gernsback Publications, Inc., 96-98 Park Place, New York, N. Y.

ALTHOUGH AMBITIOUSLY CLAIMING on the cover to be a "complete directory of all 1931-1932 radio receivers" and dated October, 1931, the book is undeniably a valuable assembly of information on modern radio circuits, useful not only to the service man but to the engineer as well. It is worth the \$5 price. Prior to plunging into page after page (some 400 of them) of circuit diagrams, many of them with complete information on values of resistors, capacitors, etc., the book has material on servicing automobile radios, sound picture installations, calculation of ballast tube resistances, descriptions on short wave receivers and convertors.

The nature of a gas

By Leonard B. Loeb, John Wiley & Sons, New York City. 153 pages. Price, \$2.50.

THIS IS THE FIRST OF a series of monographs planned by the Committee on Electrical Insulation of the Division of Engineering and Industrial Research, National Research Council, a committee which concerns itself with all matters bearing on theory, experimental study, and performance of dielectric materials as utilized for electrical insulation. As the first of such a series Prof. Loeb's book is excellent. The material presented is fundamental not only to the study of insulation but to the study of all electrical phenomena. The selective presentation of the great mass of observation and fact gives a coherent and clear picture of the steps leading to the present concept of the structure of matter. The assembly of electrons and protons into atomic nuclei and into atomic arrangements is developed and followed by an explanation of molecular formations and their physical and chemical properties as explainable in terms of inter and intra atomic electrical forces. As an essential element of modern physical theory the Rutherford-Bohr-Sommerfeld model of the atom and the mechanism of radiation which it furnishes is set forth. However, the author throughout the book allows no implication of finality to creep in and is very careful to warn the reader of the danger of "model building."

Following this careful summary which serves as an introduction is a discussion of the behavior of atoms and

molecules in gases as elaborated by the kinetic theory.

The one criticism which comes to mind is the choice of the title, for although the book treats beautifully of the nature of a gas, it does a great deal more, giving a very straight forward and readable account of the present status of theory and fact behind all electrical phenomena. It is unfortunate that the title may be passed up by many in the electronic science not specifically interested in gaseous problems.

Photoelectric phenomena

By Arthur Llewelyn Hughes, D.Sc. and Lee Alvin DuBridge, Ph.D. McGraw-Hill Book Company, 531 pages, price \$5.00

THE AUTHORS ARE WELL KNOWN in the scientific literature for their work in photoelectric phenomena; their concise yet comprehensive survey of one of the most important fields of physics will undoubtedly prove to be a milestone in a new art, that of using light sensitive devices for other-than-laboratory purposes. For those merely wishing to obtain a general idea of the recent progress in a particular field of photoelectric phenomena, a book will save a tiresome search through voluminous literature in several languages. The book provides a fairly complete summary of experimental methods and results and theories, and the exhaustive bibliography will direct research workers to original sources.

Even the technicians, seeking to put the photon to work will find value in this book, the fundamental principles underlying the engineering and commercial applications are well handled.

The book starts with the Einstein photoelectric equation, probably the most important single equation in the whole quantum theory which, at the same time, is the key to a vast number of results outside the restricted field of photoelectricity.

Einstein's theoretical work, Hertz' classic discovery of the surface photoelectric effect, later work of Hallwachs, Elster and Geitel, Lenard, J. J. Thomson, will be found described, contributions of Maxwell and Planck and Millikan are noted in detail.

Primarily the book is by physicists for physicists but the practical worker will not be disappointed. An extensive bibliography dealing with the use of photocells in photometry, spectrophotometry, transmission of picture and sound, is built up and sufficient space in this large book is devoted to these practical uses of the photoelectric effect to make it a most valuable contribution.

+ NEW PRODUCTS

THE MANUFACTURERS OFFER

Condenser microphone

THE CARRIER MICROPHONE COMPANY, 525 South Commercial St., Los Angeles, Calif., has placed on the market its Model 47 condenser microphone intended primarily for announcing. The device can be used on table or stand. Bail mountings can also be provided, on order, for suspending from overhead support. The case is made of

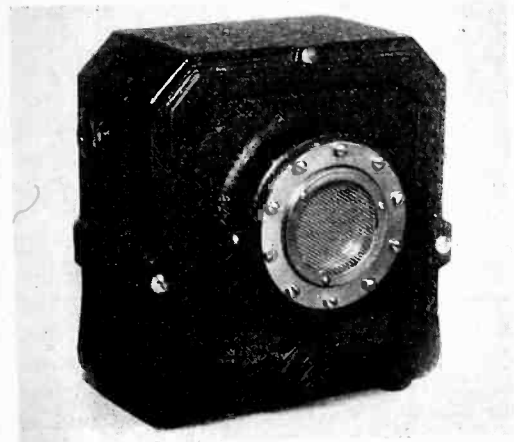

aluminum alloy and is finished in black crackle. This microphone is provided with standard plug connectors and 20 feet of shielded cable. It is normally provided with No. 30 tubes, or No. 64 tubes can be furnished on order. The transmitter head is equipped with barometric adjustment. Frequency response is from 30 to 8,000 cycles. It is built with either single or 2-stage amplifier.—*Electronics, March, 1932.*

Cartridge-type paper condensers

POLYMET MANUFACTURING CORPORATION, 829 E. 134th St., New York City, has announced a new line of cartridge-type paper condensers, made with self-supporting stiff wire leads. These are especially designed for rapid assembly. The condensers incorporate special features of thorough sealing, a distinctive



Polymet method which gives these convenient units their name "Waxtite." Various capacities are available from .002 mfd. to 1 mfd. Most of these capacities are furnished in a range of voltage ratings up to 600 volts direct current.—*Electronics, March, 1932.*

New insulated mounting strips

INSULATED MOUNTING STRIPS with one or more soldering lugs and in various combinations are now being furnished by the Cinch Manufacturing Corporation, Chicago. The strips are of $\frac{1}{8}$ -in. bakelite with brass mounting and soldering lugs with Cinch solder coating. This coating assures uniformly perfect soldering lugs.

The mounting strips are designed for use on radio-set chassis and dynamic speakers, and for holding voltage divider resistors, bias resistors and grid leaks.—*Electronics, March, 1932.*

Sound attachment

THE WEBER MACHINE CORPORATION, 59 Rutter St., Rochester, N. Y., manufacturers of Syncrofilm sound equipment, announces the completion of new sound reproducing attachment for all makes of 35-mm. portable projectors. This device represents a new departure from conventional practice in that, the projector is driven from the sound head. Use of this sound head facilitates changing over any 35-mm. projector to combine sound reproduction, without

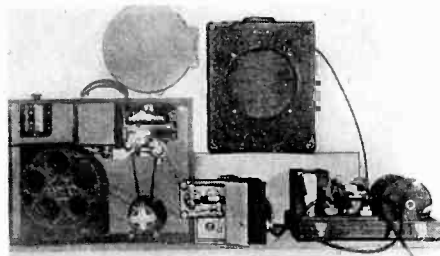

making alterations to projector mechanism.

The driving motor is within the sound-head unit, which insures a smooth even feed of film at light source or point of reproduction.

The projector is driven from sound head by means of a flexible shaft, which is of sufficient elasticity to prevent any unevenness in projector transferring back to driving source in sound head.

Provision has been made for maintaining a loop of film between projector and sound head, thus preventing any projector mechanism imperfections from interfering with the positive feed of film in the sound head. This feature also eliminates the necessity of perfect alignment of projector and sound head.—*Electronics, March, 1932.*

Tube tester

THE APPARATUS DESIGN COMPANY, Inc., Little Rock, Ark., has brought out a tube test reading in "plain English" the character of emission, spacing of elements, plate impedance, presence of

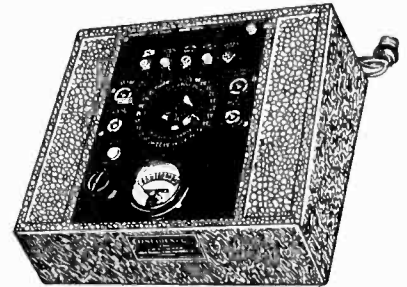

gas, etc. It indicates on one jewelled lamp every possible short-circuit in a tube. The device is simple in operation and is made in both portable and counter types, each selling at \$59.50 net.—*Electronics, March, 1932.*

Transformers for neon signs

HAVING LONG AGO pioneered the indoor skeleton sign transformer and the standing or combination types, the Thordarson Electric Manufacturing Company, Chicago, Ill., now offers a complete line of thin-type transformers, the "thin" dimension being as small as can consistently be made in a conservative design. These transformers can be used for store front or cove lighting, either indoor or outdoor, wherever depth is at a premium. One suggested application for these transformers is in making a reasonably-priced double-faced outdoor sign. A single thickness

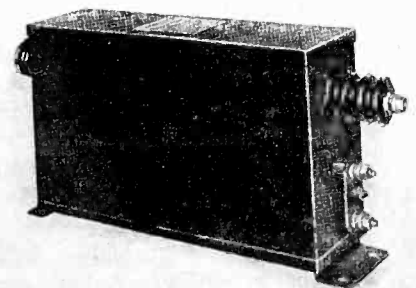

of metal is used for the background and the transformer is housed in the moulding along the top. Electrode receptacles are arranged so the glass can be readily plugged in. No angle frame work is required.—*Electronics, March, 1932.*

Synchronous motor for 33 1/3 r.p.m.

THE SYNCHRO-MOTIVE INSTRUMENT COMPANY, General Motors Building, 57th St. and Broadway, New York City, is marketing a 33 1/3 r.p.m. synchronous motor which has no gears, dash pots, mechanical filters, springs or other dampening devices. The armature is free to follow the rotating magnetic flux of the field at the pre-determined speed of 33 1/3 r.p.m. with an accuracy 54 times



greater than the controlling frequency at 60 cycles, according to R. Helmer of the company.

The motor proper is encased in cast-iron ends. For reproducing, it is mounted on an upright standard with pick-up guard affixed. As a driving motor for recording machines it is mounted on a cast-iron base with adjustable feet to permit alignment with the drive shaft.

These motors are made for single or three-phase operation on any of the commercial frequencies, and for a speed of 33 1/3 r.p.m. or a combination of 33 1/3 and 80 r.p.m. The change-over is effected by throwing a switch for the desired speed. — *Electronics, March, 1932.*

All-wave nine-coil super-heterodyne

AN ALL-WAVE RECEIVER, covering 18 to 550 meters, employing a nine-coil super-heterodyne circuit which is tuned by a single knob, is announced by the Pilot Radio and Tube Corporation of Lawrence, Mass. This new Dragon receiver will be priced at \$59.50.

By developing precision factory methods to a new degree of accuracy, and with the assistance of original methods of production testing, it is declared possible to build the set at the factory in such a way that the tuning circuits track over the entire wavelength range without the need of any trimmer adjustment by the listener. — *Electronics, March, 1932.*

Low-loss sockets

AT HIGH FREQUENCIES, low-loss sockets are as important as low-loss coils or low-loss condensers. Accordingly, the Hammarlund Manufacturing Company, 424 West 33rd St., New York City, has recently developed a new type low-loss Isolantite socket.

Isolantite is generally regarded as equivalent to fused quartz for almost every purpose requiring lowest losses and highest surface resistivity. Its electrical efficiency is not affected by either temperature or humidity. The top and sides of the socket are glazed. Perfect contact is assured by reinforced side gripping contact springs of rust-proof construction.

The sockets are made for either sub-panel or base mounting and are available in four, five and six-prong types. They measure 2 1/4 in. long and 1 5/8 in. wide, with standard 1 3/8 in. mounting centers. — *Electronics, March, 1932.*

Full-wave mercury-vapor rectifier

THE JOHNSONBURG RADIO CORPORATION, Johnsonburg, Pa., offers a new full-wave hot-cathode mercury-vapor rectifier tube designed to take the place of the 280 in all old and new radio sets. Its chief advantage is declared to be the increased volume and improved tone resulting from its use. The presence of mercury vapor gives the tube a current-carrying capacity far in excess of the requirements of any present set. The

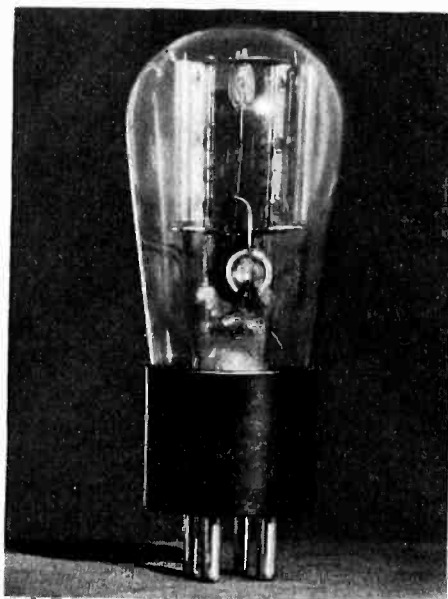

increase in volume is due to the low voltage drop in the tube itself. Its high efficiency causes it to deliver more power to the set without itself drawing any more current from the line. The tube is conservatively rated as follows, by Arthur V. Baldwin, chief engineer: Filament voltage 5.0, filament current 1.0, maximum recommended r.m.s. voltage plate 500, maximum recommended plate current 150 ma. — *Electronics, March, 1932.*

Synchronous clocks for radio sets

THE WARREN TELECHRON COMPANY, Ashland, Mass., pioneers in the self-starting synchronous electric-clock field, now has available a midget Telechron electric clock for radio sets.

The diameter of this clock including the outside diameter of the bezel around the dial is 3 1/4 inches, while the overall dimensions from the panel face to the back of the movement is 2 1/4 inches. On the lower part of the bezel is a resetting knob which can be pulled out and turned to set the hands of the clock. — *Electronics, March, 1932.*

Crater lamp of hot-cathode type

THE VAS CORPORATION, 125 N. Third St., Newark, N. J., has developed a new crater lamp of the hot-cathode type which is provided with a cathode heated at 3 volts, 5 amperes. Arc striking voltage is 230; operating voltages between 82 and 64 volts.

The lamp has a crater diameter of .060 in. but can be made with any desired orifice. It can also be supplied with a slot instead of a round opening, for recording purposes. Its operation is steady and positive, with no tendency of the bright spot to creep or widen. Some readings are given below:

Volts	Milliamperes
82	16
80	30
78	54
70	104
68	128
64	188

— *Electronics, March, 1932.*

B-battery eliminator for automobile radios

PINES TRANSVERTER, a new B-battery eliminator for automobile radio, consists of a very efficient motor in combination with a rotary transformer. It receives its operating current from the regular A battery, which, through the medium of a rotary transformer, is stepped up to the required high a.c. voltage, rectified, and filtered through a filter pack which is self-contained in the transverter, and delivers a smooth d.c. voltage to the radio set. The transverter can be quickly installed on new cars or to replace the present B batteries in sets already in use. Installation is very simple as the transverter requires a space of only 5 3/8 in. by 8 in., and is only 6 1/4 in. deep, approximately one-third of the space required for ordinary B batteries. It is regularly supplied in two models, by the Pines Winterfront Company, 1135 N. Cicero Ave., Chicago, Ill. — *Electronics, March, 1932.*

U. S. PATENTS

IN THE FIELD OF ELECTRONICS

A list of patents (Feb. 16) granted by the United States Patent Office, chosen by the editors of *Electronics* for their interest to workers in the fields of the radio, visio, audio and industrial applications of the vacuum tube

Amplification, Detection, Etc.

Neutralized circuit. Patent application filed in 1923, of a tuned radio frequency amplifier with method of preventing oscillation. L. J. Sivian, assigned to B.T.L. No. 1,841,501.

Electron relay. Gaseous discharge tube which conducts, when subjected to a voltage above a critical positive or below a critical negative value, and a circuit arrangement so that discharge takes place only on attainment of one critical value. C. Stansbury and G. C. Brown, assigned to Cutler-Hammer, Inc. No. 1,841,765.

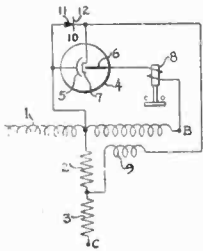

Oscillation generator. A generator controlled by two tuning forks, the ratio of whose frequency of vibration is equal to the reciprocal of the ratio of their temperature coefficients of frequency. W. A. Marrison, assigned to B.T.L. No. 1,841,489.

Voltage compensating system. A method of maintaining a potential difference between cathode and grid of a vacuum tube constant, regardless of changes in voltage of the battery. J. E. Bachelet, assigned to B.T.L., Inc. No. 1,841,394.

Frequency modulation. In a crystal controlled oscillator, a method of varying intermittently the pressure applied to the crystal faces. A. H. Taylor, assigned to Wired Radio, Inc. No. 1,841,459.

Frequency equalizing system. In an impedance-coupled amplifier, normally producing greater amplification at one end of the desired range than at the other, a condenser shunted by a resistance is directly across the grid and cathode of the second tube, and in series with the grid and the anode of the first tube is an inductance. The network resonates to a frequency at the end of the frequency band where amplification normally falls. H. J. Round, assigned to RCA. No. 1,841,383.

Station indicator. A lamp, connected between points in the power supply circuit of a radio receiver, between which exists a potential difference which increases when signals are being received. A. Senauke, New York, N. Y. No. 1,839,419.

Crystal controlled calibrator. Means are taken for producing a flat plate impedance characteristic of an amplifier tube driven by an oscillator, crystal controlled, so that all of the harmonic frequencies will be equally attenuated. Alfred Crossley, assigned to Federal Tel. Co. No. 1,843,415.

Rectifying system. Between a single phase current source and a direct current source are means for changing the single into a two-phase, and the two-phase into a three-phase current, and a rectifier and filter. C. G. Smith, assigned to Raytheon, Inc. No. 1,843,521.

Control circuit. A modulated oscillator has part of its output coupled to a glow tube which shines into a light-sensitive cell. This cell controls a triode, which acts as a power-limiting valve. S. E. Leonard, Jr., East Cleveland, Ohio. No. 1,843,288.

Band filter. Band filter section having the following characteristics:

$$C_1 = \frac{1}{2\pi Z_1} \frac{1}{f_1 - f_2}$$

$$L_1 = \frac{Z_1 f_1 - f_2}{2\pi f_1 \times f_2}$$

$$k = \frac{f_1 - f_2}{\sqrt{f_1^2 - f_1 f_2 + f_2^2}}$$

$$L_2 = \frac{Z_2 f_1^2 - f_1 f_2 + f_2^2}{2\pi f_1 f_2 (f_1 - f_2)}$$

$$C_2 = \frac{1}{2\pi Z_2} \frac{f_1 - f_2}{f_1 \times f_2}$$

M. Vos and H. K. A. Sterky, assigned to Ericson, Stockholm, Sweden. No. 1,843,892.

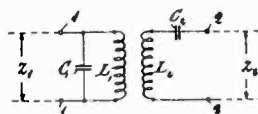

Oscillation generator. In a tuned plate circuit with grid feed-back, a

second grid within the tube is connected through a diode to an intermediate point on the "B" battery. G. Holst, B. van der Pol, and K. Posthumus, assigned to RCA. No. 1,839,481.

Power source. A method of deriving modulating energy from existing transmitting station equipment, comprising filtering out and utilizing the commutator ripples in existing d.c. supply generators. Paul Taetz, assigned to G.D.T. No. 1,839,451.

Transformer testing system. A circuit for testing the characteristics of an audio transformer. A. J. Christopher. Assigned to B.T.L. No. 1,841,088.

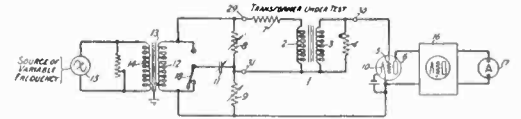

Interference preventer. A method of confining undesirable oscillations in any source of current energy from interfering with radio receivers, by confining the oscillations to a circuit tuned to a frequency which will not affect adjacent radio equipment. F. H. Kroger, assigned to RCA. No. 1,829,523.

Damping control. A means for controlling damping in an oscillatory system without altering the resonant frequency. The damping circuit is composed of an untuned circuit, made up of an inductance coil of high resistance wire. N. H. Clough, assigned to RCA. No. 1,829,706.

Oscillation preventer. In a receiving circuit, method of impressing a radio frequency potential drop between the input electrodes of certain tubes, in opposition to the corresponding potential drop impressed thereon as a result of undesirable feed back. Boyd Phelps, assigned to R. E. Thompson Mfg. Co. No. 1,829,013.

Transmitter keyer. An antenna system is coupled to an oscillating tube, and also to an additional tuned circuit in series with which there is a key. The resistance to this tuned circuit is transferred from the antenna system into the oscillator, so that when the key is up signals are generated, but when the key is closed the resistance is sufficient to cause no current to flow in the antenna. Erich Tod, assigned to G.D.T. No. 1,828,852.

Gaseous discharge device. High frequency generator operative on the exciting potential of the discharge, but inoperative on the operating potential of the discharge. K. Wiegand, Hans Ewest and Martin Reger, assigned to G.E. No. 1,844,375.

Resistance coupled amplifier. Inter-stage coupling circuit consisting of resistances and condensers. K. Posthumus, assigned to RCA. No. 1,844,177.

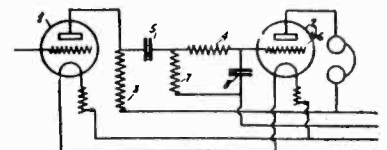

Power supply circuit. Conventional filter-rectifier system and means by which the voltage of the anode current is initially limited. G. R. Eaton, assigned to Kellogg Switchboard and Supply Co. No. 1,844,502.

Constant current translating circuits. A combination of vacuum tubes and rectifiers for transmitting energy between constant potential alternating current supply circuit, and the constant current load. H. D. Brown and C. A. Sabbah, assigned to G.E. No. 1,844,633.

Coupling circuits. Interstage coupling network. H. A. Wheeler, assigned to Hazeltine Corp. No. 1,844,374.

Grid circuit amplifier. A tube circuit in which the input and output impedances are arranged in the form of a Wheatstone bridge with the balancing capacities. Stuart Ballantine, assigned to Boonton Research Corp. No. 1,844,456.

Vapor electric amplifier. Applying a.c. to both grid and anode but anode of a high frequency and filtering from output all frequencies higher and lower than the grid voltage frequency. T. S. Farley, G. E. Co. No. 1,830,599.

Uni-directional antenna. Two antennas, each a half wave-length long, and situated a quarter wave length apart and properly connected together by phase transformers. Edmund Bruce, assigned to B.T.L. No. 1,841,085.

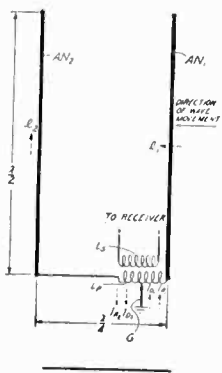

Power converting system. In a two-tube system of inversion, method of connecting certain capacitors in parallel during period of some abnormal condition. D. C. Prince, G. E. Co. No. 1,830,561.

Television, Facsimile, Etc.

Photographic recording. The use of several light sources for recording photographically sound on film, by applying to these sources alternating currents differing in phase and projecting the combined light onto the film. O. Whelan, assigned to G. E. No. 1,844,708.

Electronic Applications

Voltage regulator. A combined thermoelectric and thermionic method of controlling the voltage of a generator. E. R. Evans, Washington, D. C. No. 1,844,149.

Motor controller. Method of using a vacuum tube and a discharge circuit for controlling motor speed. Prescott Crout, assigned to Cutler-Hammer, Inc. No. 1,844,243.

Vacuum Tubes, Etc.

Cathode system. A vacuum tube having two cathodes which are supplied with alternating current 90 degrees out of phase with each other. Stuart Ballantine, Mt. Lakes, N. J. No. 1,834,443.

Vacuum tube construction. A V-shaped filament, the grid surrounding the filament and a flat strip secured at points along its side to the turns of the grid coil, said strip extending laterally between two legs of the filament. B. F. Miessner, RCA. No. 1,834,131.

Acoustical Apparatus

Condenser reproducer apparatus. Means for momentarily shocking the speaker to condition it for normal operation. W. S. McClintock, Jr., Ekko Company, Chicago. No. 1,836,266.

Patent Suits

1,606,212. Dunmore and Lowell, Power amplifier, appeal filed June 25, 1931, C. C. A., 3d Cir., Doc. 4656-7-8, U. S. v. Dubilier Condenser Corp.

1,173,079, E. F. Alexanderson, Selective tuning system; 1,195,632, W. C. White, Circuit connections of electron discharge apparatus; 1,251,377, A. W. Hull, Method of and means for obtaining constant direct current potentials; 1,282,439, I. Langmuir, System for amplifying variable currents; 1,297,188, same, System for amplifying variable currents, filed Jan. 15, 1931, D. C., N. D. Ill., E. Div., Doc. 10282, Radio Corp. of America et al. v. Ozarka, Inc.

1,789,949, A. Georgiev, Electrolytic cell, filed July 7, 1931, D. C., E. D. N. Y., Doc. E 5559, Aerovox Wireless Corp. v. S. Roth (Federal Purchaser).

1,719,805, L. Hammond, Alternating current clock, D. C., S. D. Ohio, W. Div., Doc. E 621, The Hammond Clock Co. v. The Kodel Electric & Mfg. Co. Dismissed under rule 57 Oct. 6, 1931.

Re. 16,870, T. H. Nakken, Means for transforming light impulses into electric current impulses, filed Nov. 3, 1931, D. C. Del., Doc. E. 918, Nakken Patents Corp. v. Universal Sound System, Inc.

Re. 17,245 (a), Re. 17,247, W. G. Cady, Method of maintaining electric currents of constant frequency; Re. 17,355, same, Piezo-electric resonator; 1,537,708, W. Schottsky, Thermionic vacuum tube; 1,558,437, I. Langmuir, Electrical discharge apparatus; 1,239,852, F. K. Vreeland, Receiver of electrical impulses; 1,243,166, G. W. Hart, Electric switch, D. C., W. D. N. Y., Doc. 211, Radio Corp. of America et al. v. Universal Wireless Communication Co., Inc. Dismissed for lack of prosecution Nov. 10, 1931.

Re. 17,245 (b), Re. 17,247, W. G. Cady, Method of maintaining electric currents of constant frequency; Re. 17,355, same, Piezo-electric resonator; 1,537,708, W. Schottsky, Thermionic vacuum tube; 1,558,437, I. Langmuir, Electrical discharge apparatus, D. C., W. D. N. Y., Doc. 137, Radio Corp. of America et al. v. Universal Wireless Communication Co., Inc. Dismissed for lack of prosecution Nov. 10, 1931.

1,173,079, E. F. Alexanderson, Selective tuning system; 1,195,632, W. C. White, Circuit connections of electron discharge apparatus; 1,251,377, A. W. Hull, Method of and means for obtaining constant direct current potentials; 1,297,188, I. Langmuir, System for amplifying variable currents; 1,728,879, Rice & Kellogg, Amplifying system, filed March 13, 1931, D. C., N. D. Ill., E. Div., Doc. 10381, Radio Corp. of America et al. v. Zaney-Gill Corp.

1,294,466, W. G. Housekeeper, Combined metal and glass structure and method of forming same; 1,536,855, same, Electron discharge device, D. C., W. D. N. Y., Doc. 139 and 210, Radio Corp. of America et al. v. Universal Wireless Communication Co., Inc. Dismissed for lack of prosecution Nov. 10, 1931.

1,231,764 (a), F. Lowenstein, Telephone relay; 1,353,976, E. R. Stokle, Vacuum tube device, D. C., W. D. N. Y., Doc. 138 and 212, Radio Corp. of America et al. v. Universal Wireless Communication Co., Inc. Dismissed for lack of prosecution Nov. 10, 1931.

1,507,016, L. de Forest, Radio signaling system; 1,507,017, same, Wireless telegraph and telephone system, filed July 28, 1931, D. C., E. D. N. Y., Doc. E 5580, Radio Corp. of America et al. v. Radio Engineering Laboratories, Inc.

1,577,030, A. S. Howell, Intermittent feed mechanism; 1,620,726, same, Motion picture camera, D. C., S. D. Iowa (Davenport), Doc. 4101, The Bell & Howell Co. v. Victor Animatograph Co. Dismissed without prejudice (notice Apr. 20, 1931).

1,466,701, L. De forest, Method of and means for controlling electric-currents by and in accordance with light variations; 1,603,071, same, Sound recording attachment for motion picture cameras; 1,695,414, same, Talking moving picture machine; 1,607,480, E. E. Ries, Method of reproducing photographic sound records, C. C. A., 3d Cir., Doc. 4461-4462, General Talking Pictures Corp. et al. v. Stanley Co. of America. Decree to effect that no one of the patents in suit is infringed Mar. 2, 1931.

Adjudicated Patents

(D. C. Mass.) Thorpe patent, No. 1,040,461, for head-covering, claims 1 and 2 Held not infringed. Thorpe v. William Filene's Sons Co., 52 F. (2d) 445.

(D. C. Wis.) Conradson patent, No. 1,140,299, for automatic multiple-spindle lathe, claims 1-7, 29-32, Held infringed. Joseph T. Ryerson, Inc., v. Harley Davidson Motor Co., 52 F. (2d) 464.

(C. C. A. Minn.) Bolger patent, No. 1,209,544, for refrigerator construction, claims 1 and 2 Held valid, but not infringed. Seeger Refrigerator Co. v. Bohn Refrigerator Co., 52 F. (2d) 416.

(C. C. A. Minn.) Bohn patent, No. 1,263,843, for refrigerator door, claim 3 Held invalid. Id.

(D. C. N. Y.) Hazeltine patent, No. 1,533,858, for method and means for neutralizing capacity coupling in audions, claims 1, 2, 5, 9, 11, 12, 14, and 16 Held valid and infringed. Hazeltine Corporation v. Radio Corporation of America, 52 F. (2d) 504.

BRITISH PATENTS

IN THE FIELD OF ELECTRONICS

Because patents are issued in Great Britain some months before issuance in the United States, and because British patents reflect what is going on in Europe better than the American Patent Gazette, the editors of *Electronics* choose representative disclosures each month for this page.

Radio Circuits

Direction-finding system. A transmitter producing waves so the phase is different at all points of the compass, and a receiver giving the direction indication produced by comparing the phase of the received signal and the standard phase also sent from the transmitter. C. R. Englund, Electrical Research Products, Inc. No. 357,640.

Distortion corrective system. In a superheterodyne receiver, the intermediate frequency is so low that a high order of selectivity is obtained, and means are provided to correct for the distortion, due to the high selectivity. J. Robinson, London. No. 357,647.

Frequency stabilizer. Scanning waves in a line react back on the oscillator to stabilize the frequency. C. W. Hansell, Marconi Co. No. 358,264.

Interstage coupling. A band-pass coupling, including two tuned circuits, and a means for diverting current with a rise in frequency from the magnetic coupling between them, so that the accepted band width is practically constant at all frequencies. R. A. Braden, Marconi Co. No. 357,866.

Short-long-wave receiver. A tube used for amplifying on long waves is used as a quenching oscillator when the receiver is used with a super-regenerating circuit. Telefunken, No. 357,913.

Short-wave oscillator. A highly positive charged grid and a plate nearly at zero potential, an oscillatory circuit of a different natural frequency from the primary oscillation, connected in the plate or grid circuit. The drooping part of the dynamic characteristic is used, so that the ultra high frequency primary oscillations are modulated by a second oscillation of a lower frequency. E. Gerhardt, Bavaria. No. 358,064.

Ultra short-wave modulating system. In the circuit in which the frequency is dependent upon the speed of electronic oscillation, an oscillatory circuit tuned to a low audio frequency modulates the primary frequency. H. E. Hollmann, Charlottenburg, Berlin. No. 358,145.

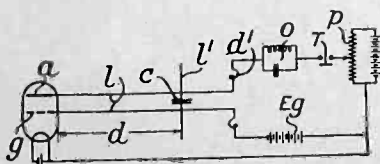

Automatic volume control. Grid bias of a high frequency tube is controlled in accordance with signals by utilizing the bias from the grid of a valve acting as a grid detector through a high resistance or other impedance. Philips, Holland. No. 358,861.

Push-pull amplifier. Two tubes operating without a grid bias battery, and impedances interposed between the cathodes and the input circuit, so that the valves are alternately active. H. A. Wheeler, assigned to Hazeltine. No. 358,887.

Regenerative circuit. Means for reducing the damping of an oscillatory circuit to zero, comprising a reacting valve of high mutual conductance to which a small portion of the input is applied, so the action of the valve under impressed signals is substantially linear. H. J. Round and P. K. Turner, Marconi Co. No. 358,932.

Constant gain circuit. Across the tuned circuit inductance there are two condensers (one of them variable) in series. The low potential end in the primary of this transformer is connected into the secondary at the point which connects the two condensers together. W. M. Cusick, Boston, Mass. No. 358,996.

Push-pull amplifier. An amplifier operating without grid bias, using a pair of tubes connected oppositely in parallel to the input and impedances arranged in series with the grids. H. A. Wheeler, assigned to Hazeltine. No. 358,132.

Television

Light source. A flaming arc is used as a source of light on account of its brightness and the rapidity with which it can be modulated. I. Langmuir, British Thomson-Houston Co. No. 357,941.

Scanning system. A rotatable mirror and means for varying the angular relation between its surface and its rotational axis. D. M. Moore, British Thomson-Houston Co. No. 358,050.

Scanning apparatus. A polarized light system. L. M. J. Loiseau, Paris. No. 358,087.

Scanning device. An electric arc moves in a predetermined path under action of a magnetic field. Communication Patents, Inc., 60 Broadway, New York. No. 358,183.

Electronic Applications

Elevator control. A magnetic method, which, operating through vacuum tubes, controls elevators, railway cars, etc. R. J. Stevens, Surrey. No. 358,516.

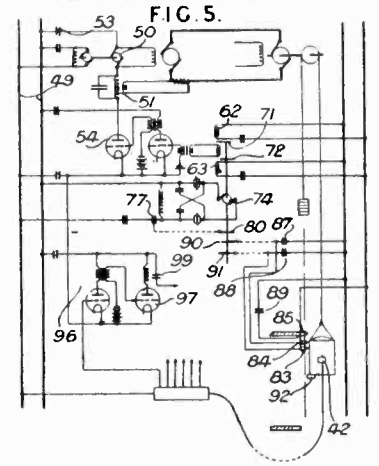
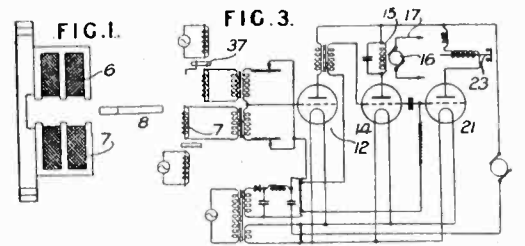

Electronics direction-finder. A vacuum tube with an anode, two auxiliary electrodes, arranged so that by means of four pieces of high magnetic permeability and low permanent magnetism, the earth's magnetic field will draw the electrons to one or the other of the electrodes. P. Schwerin, Perryman Electric Co. No. 358,758.

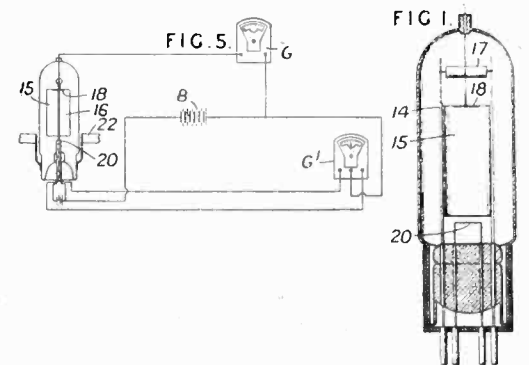

Power Equipment

Mercury vapor rectifier. A method of applying a magnetic field at right angles to the discharge path in a discharge rectifier. Gramophone Company, Ltd., Middlesex, England. No. 350,070.

Modulating system. In a modulator-oscillator system, means are provided for keeping out of the low frequency circuit radio frequency oscillations, and to keep speech potentials in their proper place. H. O. Peterson, assigned to Marconi. No. 350,152.

Neutralizing circuit. Compensation for the reactance of the anode load constituted by the winding of an electromagnetic relay on the control voltage of a thermionic detector. Ericsson, Stockholm. No. 350,254.

Problems of push-push amplification

[Continued from page 83]

without any steady d.c. component, which means that not only must the alternating current be taken care of but also that the supply source must have a very low internal resistance so that the change in average current, caused by change in signal level, can be accommodated without appreciable change in voltage. If this last condition is not met the output of the push-push stage will not come up to expectations and the slow swing in supply voltage may affect some earlier stage of the amplifier.

Class "B" input requirements

So far we have talked only of plate circuit distortion and have not mentioned the difficulties that arise in the grid circuit when the grid is allowed to go positive. The vacuum tube is commonly regarded as a voltage controlled device, one that absorbs no power in its input circuit, and such is substantially the case as long as the grid remains negative. However, when the grid is made positive with respect to the emitter grid current flows and the input impedance of the tube may fall in value to a few thousand ohms. If this occurs when the input voltage is dependent on a more or less aperiodic circuit of fairly high impedance the input wave form will be dis-

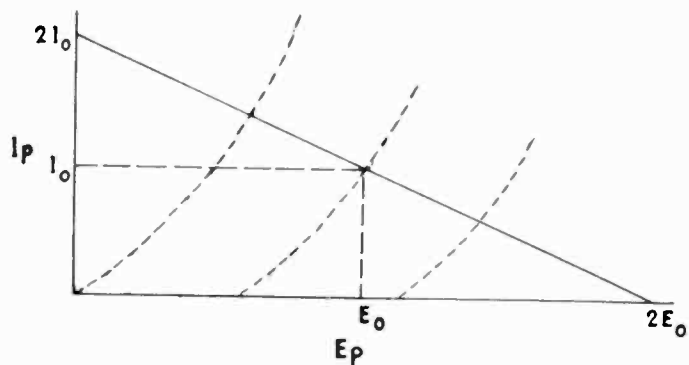

Fig. 6—Load line for push-push calculations

torted during the intervals of grid current flow. With either the push-pull or push-push amplifier the negative and positive peaks of each cycle will be "knocked down" giving rise to odd harmonic generation which reduces the amount of fundamental developed in addition to causing unpleasant distortion. However if the input transformer is so designed that the instantaneous voltage supplied to the grids of the output stage is not affected by the intermittent grid load this distortion is avoided.

Another way of putting this is to say that since the output tubes are not voltage controlled devices the stage feeding them must be capable of supplying a certain amount of power. To fulfill these requirements a tube of low impedance is used with a coupling transformer of low or step-down ratio. Looking into the primary side of the transformer the effective load due to grid current must be high compared to the plate resistance of the feeding tube or, better, looking at the transformer from the secondary side the effective generator impedance must be low compared to the load due to grid current. It is well to remember that this effective generator impedance includes the leakage reactance and the resistance of the windings figured with due regard to the turn ratio.

In considering how much the grid current can be allowed to alter the form of the input wave we must bear in mind that distortion which causes a sharp break in wave form even though not generating a high per cent of harmonic power seems to have the faculty of producing very unpleasant distortion which may be characterized as a rattling sound. These rattles may be caused as are Trautwein's "Tone Formers" which are damped oscillations of some part of the acoustical system excited by the sharp break in the wave form of the fundamental.⁴

If tubes were available with approximate cut-off at zero bias so that operation at this point gave class "B" conditions, a fairly constant grid load would be applied continuously to one side or the other of the transformer causing no appreciable distortion but merely reducing the applied voltage somewhat. Triodes with a fairly high amplification constant are best suited for push-push use because of the relatively low input required, for we must remember that actual power is required to drive tubes with positive grid swings and that the push-push circuit usually moves the bottle neck of the audio system back to the stage ahead of the output tubes.

Pentodes fill the bill nicely as far as requiring a small grid swing but fall down when linearity is considered.

For these reasons and because of the particular adaptability of push-push to battery receivers the 230 tube has received considerable mention for this use. Slightly more than a watt output with low measured harmonics may be obtained from a pair of these tubes in push-push when driven by a third 230. With unlimited grid power available two of these tubes may produce approximately three watts. When we consider that the 230 is rated at 16 milliwatts for standard class "A" operation it is evident that the push-push circuit may be of great value.

⁴"Neon Musical Oscillator"; by R. Raven Hart; *Wireless World*, Dec. 10, 1930.

"Elektrische Musik"; Dr. Trautwein. Published by the *Weidmannsche Buchhandlung*, Berlin.



ELECTRONIC ROBOTS OF 1932

ELECTRON tubes now sort thousands of cards, bills and checks daily. They simplify the process of taking gold, silver, cement, sulphuric acid, arsenic, coal tar products and other valuables out of smoke and flue gases, and they match colors perfectly. Others containing resistances of several billion ohms, make possible the amplification of photoelectric currents 10,000 times.

—S. M. KINTNER,

Westinghouse Electric & Manufacturing Co.

Chapter
II and III
in the
Dramatic Story
of the
CENTRALAB
Fixed Resistor

A TRULY different booklet, the "Bap-
tism of Fire" which tells the dramatic
story of how Centralab Fixed Resistors
are made, is now ready for distribution.

The bold, two-color modern illustrations
and descriptive text tell a graphic story
of these very different and superior
resistors.

Why not send for it today—it's
free.

Centralab
FIXED RESISTORS

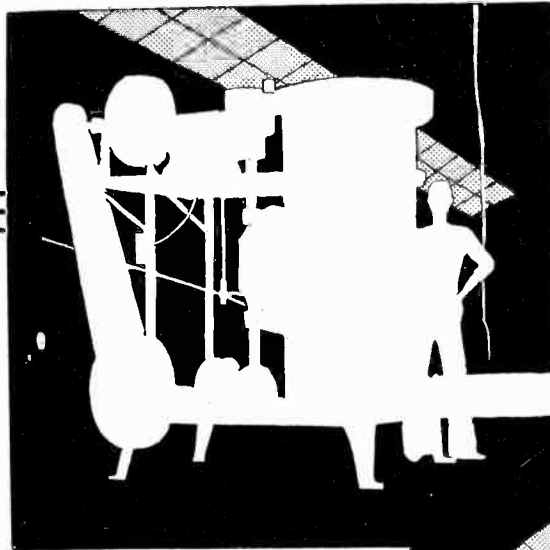

the mixer

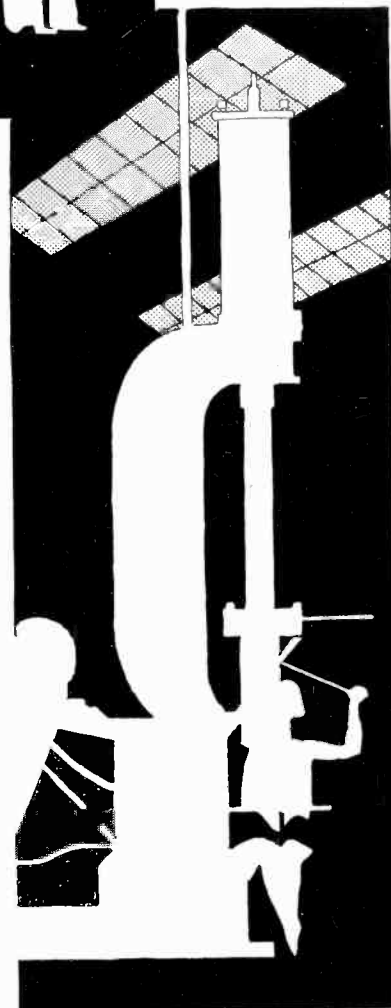

one of the
hydraulic
presses



This Book
Will
Interest You

There is no charge for
this book. Use the coupon
below.

**CENTRAL RADIO LABORATORY
MILWAUKEE, WIS.**

Please send me your FREE Book, "A
Baptism of Fire".

Name

Address

City

State

Electronics

Broadcast transmitter measurement

[Continued from page 89]

and measuring to find out if the output level increases by the same amount up to the limit of the modulation capacity of the transmitter. Using a calibrated volume indicator to measure the differences in input level, and using the wavemeter to measure the various corresponding output levels, a curve can be drawn with input db. levels on one coordinate and output levels on the other. Such a linearity curve shows, in one way, the ability of a transmitter to reproduce the waveform of the input voltage. While not readily analyzable into harmonic components, nevertheless it has great practical value because of the ease of measuring and comparing transmitter performance of this sort.

The relative differences of output level are measured by setting the wavemeter for a galvanometer reading of 60 for cw as before and reading the meter for each increase in input. The readings are then converted into percentages of modulation by table 1 or into decibels by any of the db columns of table 2, taking the db difference between the successive readings.

Computation of tables for other values

To compute the percentages of modulation for cw settings other than 60 as given, equation 2 is solved for the value of M by considering W_0 as equal to unity. Then the value of W (carrier plus sideband power) is to W_0 as the galvanometer reading with modulation is to the reading with carrier unmodulated. For example,

if the carrier setting was 50, and with modulation increased to 60, the ratio is 1.2. By substitution, this becomes

$$\frac{W}{W_0} = \frac{60}{50} = 1.2 = 1 + \frac{M^2}{2} \quad M = 0.63$$

To compute the decibels difference of level between two readings, take the ratio of the *increases* with modulation and substitute them in the formula

$$db = 10 \log_{10} \frac{P_1}{P_0}$$

making P_0 the increase in meter reading corresponding to the reference level and P_1 the increase for a second reading. For example, with a carrier setting of 50, and a reference modulation level of 80 per cent the meter will read 66, or an increase of 16. If on the next reading the meter reads 69, an increase of 19, the db difference of level is

$$db = 10 \log_{10} \frac{19}{16} = 10 \times 0.103 = 1.03 \text{ db}$$

The same measurements could be made on a transmitter by reading the tank current. This involves more arithmetic because the currents could not be depended upon to come at convenient values or even identical values at different times, necessitating a complete new set of calculations for each measurement. The wavemeter can be adjusted by coupling for a given convenient deflection for which tables are prepared, and reset to this value at any time for comparing results.

A new music of electronic oscillation

[Continued from page 86]

7. The selective absorption in high frequency oscillatory circuits.
8. The control of phase displacement in oscillatory circuits."

Operation of the Rangertone organ

"Perhaps the outstanding feature of our electric organ, besides the extent of its range and its appointments," explained Captain Ranger, "is the fact that a separate amplifier with its associated loudspeaker is assigned to any individual note played. There are eleven such amplifiers, each with its individual loudspeaker, for any eleven notes, including the pedals, that may be played at any one time. This makes for far greater clarity, in that each note is given the best possible treatment in its individual amplifier, before it emerges to drive the loudspeaker, which then creates the movements of the air which constitute the sound waves we recognize as music. It is also possible by this plan to give each note special

effects and even special tonalities apart from the others by this method of individual treatment. The selection of the amplifiers is accomplished by relays which pick the free amplifiers in definite rotation as the keys are played.

"The fade-out tones are especially novel. These tones either gradually fade out, as would a piano tone for example; or what is even more interesting, they change their character slowly, after being struck. This makes an entirely new type of tone, which composers have as yet not written to. It is but one of the many new possibilities of these electrically produced sounds.

"The basic purpose behind the instrument, is to give the player all the various frequencies at his command, in much the same manner that an artist has all the color shades on his palette. He may then mix these frequencies in any desirable way. Naturally such facilities require true musical knowledge on the part of the player to make pleasing and accurate combinations.

"Our problem has been to produce the maximum musical effectiveness with the minimum manual effort on the part of the player. We have been guided in the elimination of the less necessary and emphasis of the salient features by many eminent musicians whose help is gratefully acknowledged."

Industrial uses of electronic diffraction

[Continued from page 84]

Nor is it at all certain why, when metals are purified from gas, they require an abnormally high potential for discharge when used as cathodes in an X-ray tube.

Finally, we have no really definite explanation as to why adsorbed ions enhance the photo-chemical sensitivity of silver bromide to such an extent that it is actually decomposed by radiation of longer wave lengths than usual.

In nearly every industrial application of electronics—to sound pictures, television, and photo-cells—electron diffraction should thus prove of value. Certainly so fundamental an effect is deserving of further intensive study.