

Harold Schaefer

electronics

electron tubes—their radio, audio, visio and industrial applications

radio
 sound pictures
 telephony
 broadcasting
 telegraphy
 carrier systems
 beam transmission
 photo-electric cells
 facsimile
 amplifiers
 phonographs
 measurements
 receivers
 therapeutics
 television
 counting, grading
 musical instruments
 traffic control
 metering
 machine control
 electric recording
 analysis
 aviation
 metallurgy
 beacons, compasses
 automatic processing
 crime detection
 geophysics

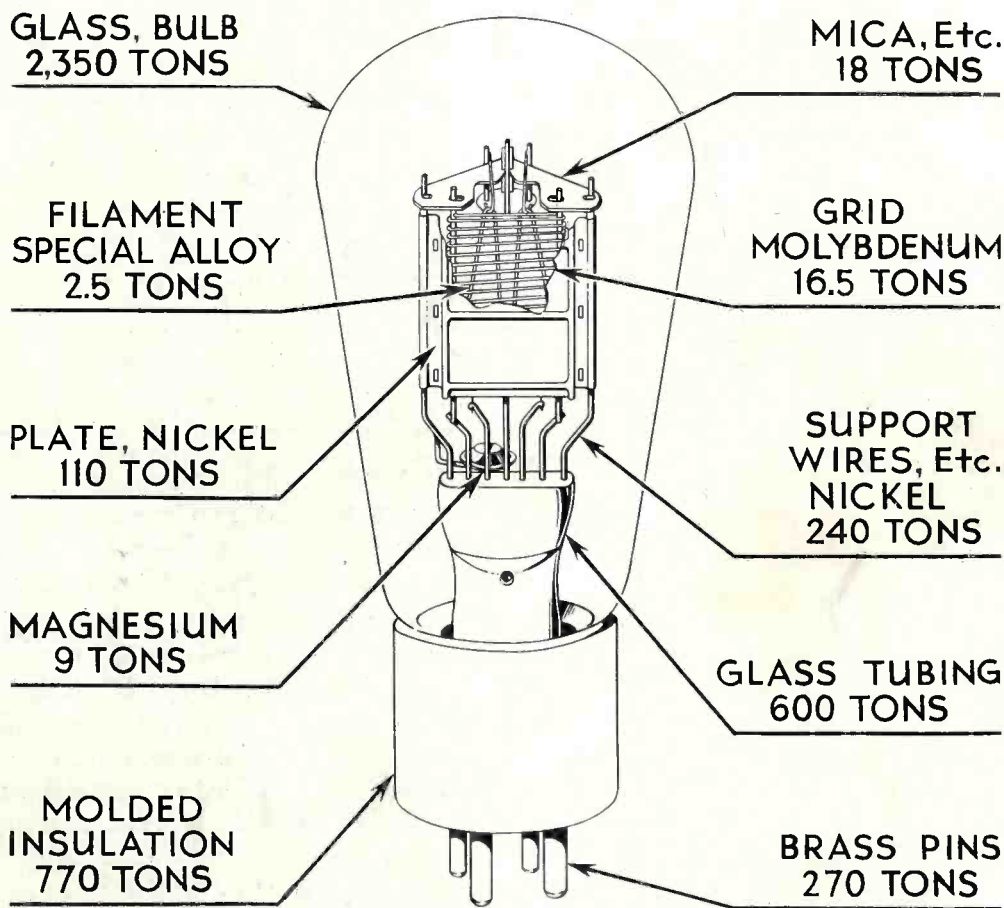

Raw materials in tube manufacture Page 366

Sound "dubbing" in motion pictures Page 371

Detection in super-heterodynes Page 386



A MCGRAW-HILL PUBLICATION

Price 35 Cents

NOVEMBER 1930

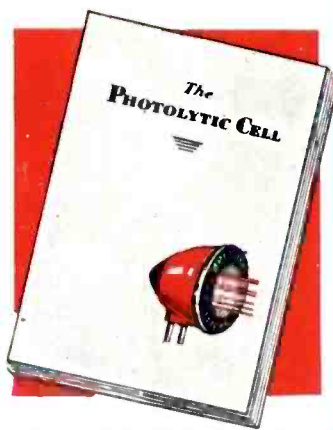
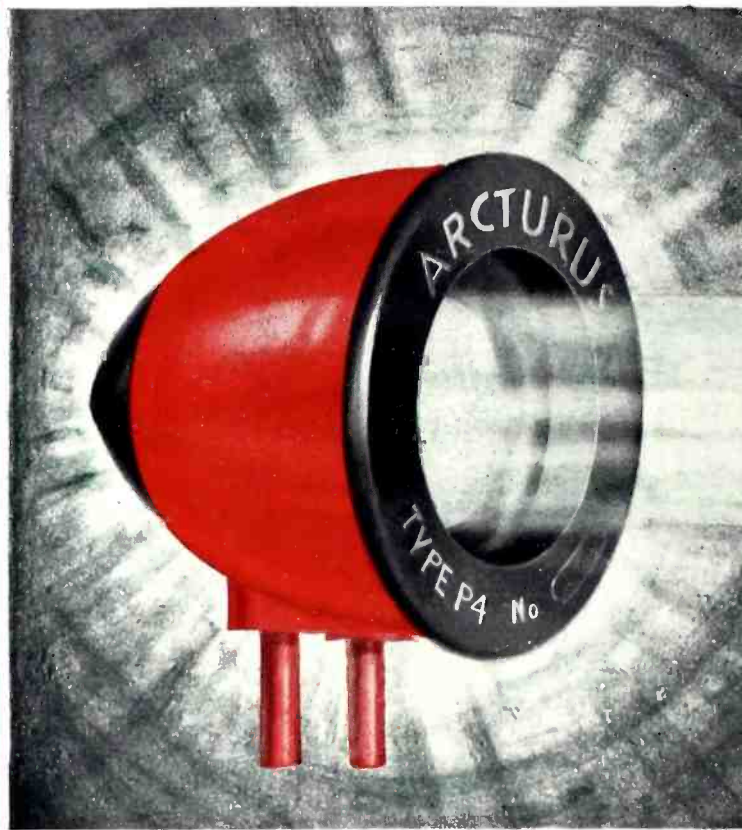

40-PAGE BOOK FREE

This interesting book gives performance facts, operating curves, and wiring diagrams for many uses of the Arcturus Photolytic Cell. Your copy is ready.

Have You Tried This **NEW-TYPE** Photo-Electric Cell?

JUST seven months ago we announced the Arcturus Photolytic Cell—a distinct departure from all existing types of photo-cells.

Based on a principle never before applied to photo-cell design, this new-type cell soon proved its superior performance. In speed and fidelity of response it surpassed the best gas-filled cells. Because it required no initial excitation or delicate adjustment it was far easier to operate. Its rugged shock-proof design made it adaptable to any photo-electric device.

These features, together with other important points, made the Arcturus Photolytic Cell a favorite with photo-electric engineers. If you have not tried this advanced cell we suggest you write today for operating data. Our 40-page book, giving complete information on the Arcturus Photolytic Cell, will be sent you free.

Photo-Electric Division, Arcturus Radio Tube Company, Newark, N. J.

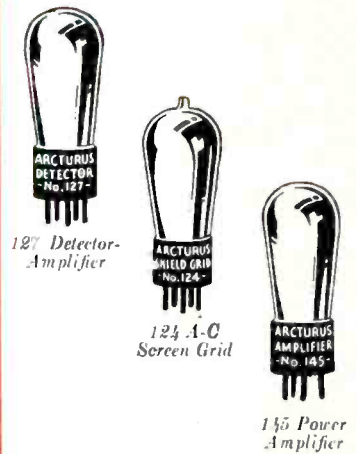

Use these Arcturus Tubes for best results with the Arcturus Photolytic Cell or any other photo-electronic equipment.



ARCTURUS

PHOTOLYTIC CELL

The Electric Eye for Every Industry

PRODUCT OF ARCTURUS RADIO TUBE COMPANY . . . MAKERS OF ARCTURUS BLUE TUBES

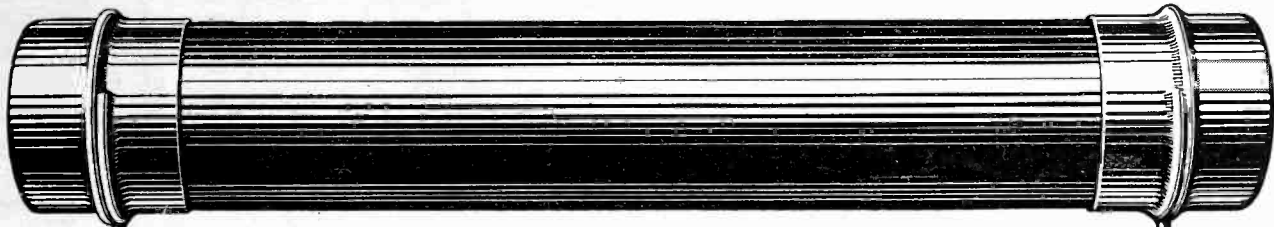

With Leads

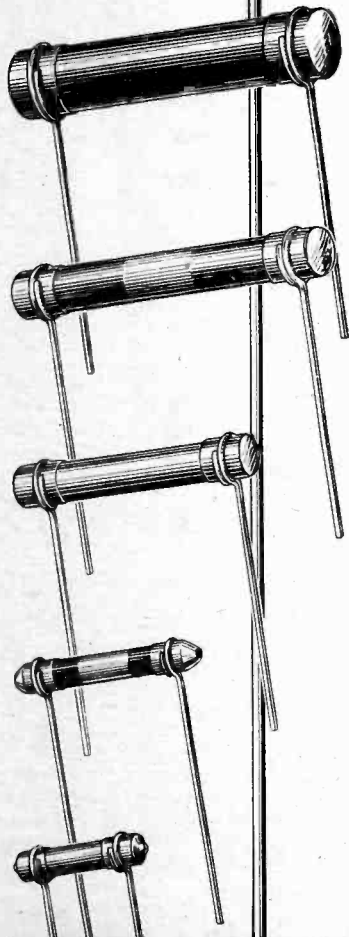

Bradleyunit Resistors

Solid Molded for Permanence

Research, more than a quarter century of painstaking costly research, is behind Bradleyunit Resistors.

Years of practical experience in meeting the demands of radio set manufacturers have led to the development of these solid molded resistors, famous for their permanence and accuracy. A huge plant with exceptional facilities for volume production turns out Bradleyunit Solid Molded Resistors by the millions.

These are the factors that produce uniformity in the quality and performance of Bradleyunit Resistors. Get an Allen-Bradley quotation on your next order.

ALLEN-BRADLEY CO.

110 West Greenfield Ave. Milwaukee, Wisconsin

Without Leads

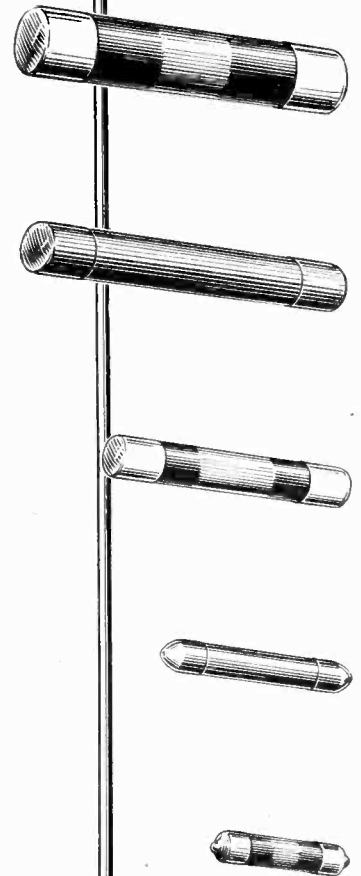

Bradleyometer



Bradley Suppressors

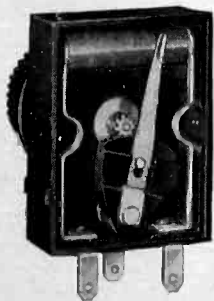

This remarkable "stepped" potentiometer has astounded radio engineers who were skeptical of its advertised performance. They have tried the new Bradleyometer and now know that no other type of potentiometer can rival it in flexibility and adaptability to every electronic unit. Any type of resistance-rotation curve can be arranged to meet your requirements. Samples will be sent to established manufacturers of electronic apparatus for test and trial.

These fixed resistance units, known as Bradley Suppressors, are doing astonishing things for motor car radio. By using them with suitable by-pass condensers in other parts of the ignition circuit, shielded ignition cables are no longer necessary. For simplicity, reliability and low cost, these units are in a class by themselves. Heat, moisture and age have no effect upon them. They are the last word for motor car radio.

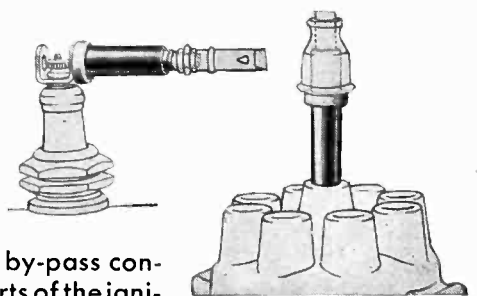

ALLEN-BRADLEY RESISTORS

Produced by the makers of Allen-Bradley Control Apparatus

REDUCE COSTS

WITH THE NEW
FANSTEEL
MOLYBDENUM WIRE

AND
DUCTILE "MOLY" ROD

HERE is a better Molybdenum! One that is really ductile, malleable and workable, even in large diameter rods! Less breakage, less spoilage and shrinkage, simpler cleaning processes. Your rejections and your tube costs should go down.

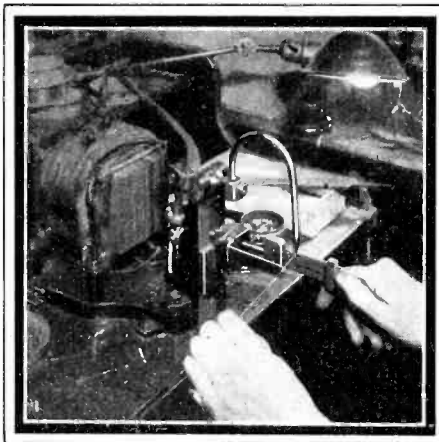

Refined by Fansteel from basic materials, especially for use in tubes, it is made remarkably

pliable for such material, easily shaped and fastened, easily degassed and cleaned.

You've never used Molybdenum like this! Offered at no increase in price.

Send for samples! Ask also for samples and prices of any other Fansteel Metals and Alloys you may be interested in—available in all commercial forms.

FANSTEEL PRODUCTS COMPANY, INC.
NORTH CHICAGO, ILLINOIS

TANTALUM · TUNGSTEN · MOLYBDENUM · CAESIUM · RUBIDIUM · ALLOYS

RESEARCH

challenges existing coil design

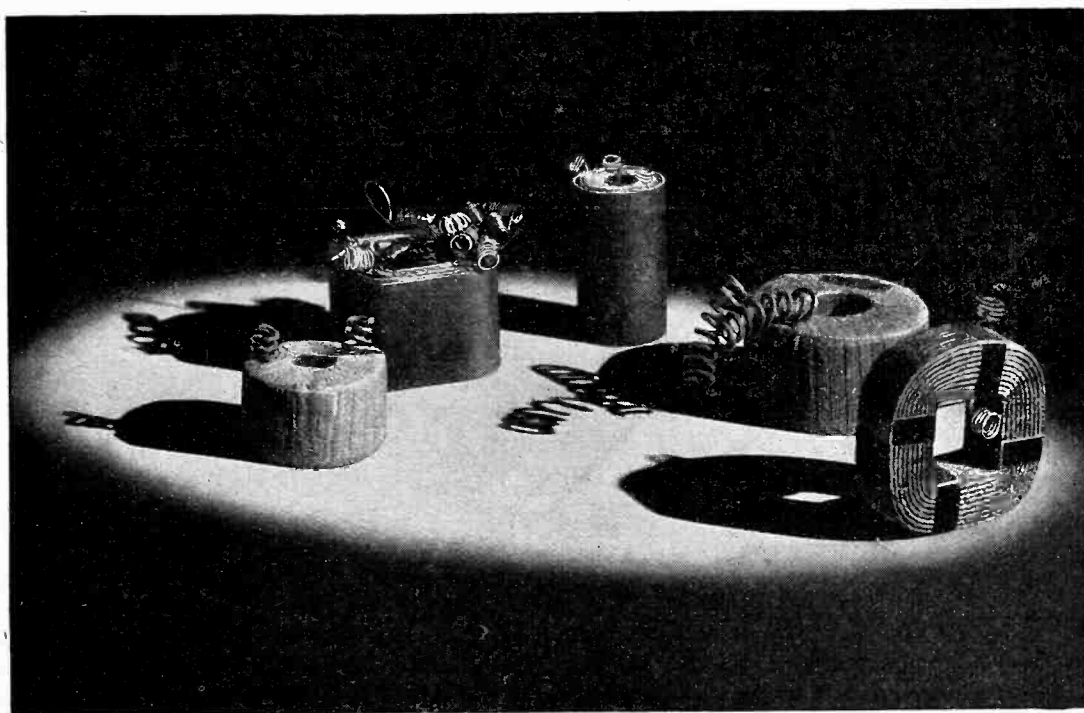

Franklin's research — the researches of Farraday, Edison, Steinmetz, Hertz and many others — gave us, step by step, the great science on which all electrical industry is founded.

Many fundamentals are known and classified. Many great basic researches are done. Their contributions have been applied.

Still, electrical research goes on! General Cable has accepted the never-ending challenge for improvement. In its specialized research on coils — and in other fields — it has already brought forth much new knowledge.

This new knowledge has had its practical tests. And General Cable is ready to apply it to assist you in redesigning the coils you use.

General Cable's experience and knowledge, its research and engineering staffs, its wide manufacturing facilities are all at your command.

GENERAL CABLE CORPORATION

EXECUTIVE OFFICES: 420 LEXINGTON AVENUE, NEW YORK • OFFICES IN PRINCIPAL CITIES



*Fine radio tubes
result from perfection
of many small parts*

SUMMERILL
PURE NICKEL SEAMLESS
TUBING

*contributes to
fine tubes . . .*

Summerill tubing alone cannot make a fine tube, *but*, used in conjunction with other fine parts and careful workmanship, it will contribute much to the operating efficiency of the tube.

Many tube manufacturers are aware of this fact, and the performance of their tubes is the best proof of our claims.

Summerill tubing is chemically pure and mechanically accurate,—which means long life, constant characteristics and ease of assembly. Our facilities are such that we can readily handle your complete requirements to guaranteed schedules.

Make "Summerill" your nickel-tubing department.

**The SUMMERILL
TUBING COMPANY**

FOUNDED 1899

Bridgeport, Penna.
(Philadelphia District)



PROMPT DELIVERIES
—anywhere—any time
—any quantity

The scientific care used in making Summerill Seamless Nickel Tubing is carried through until it reaches you. It is packed in a sturdy box carefully made to insure the contents against all shocks in transport. It assures perfect condition of the tubing when it reaches you.

INCA PRODUCTS *afford* PROTECTION

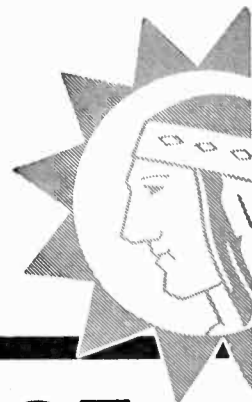

— from the **ROBBERS OF ELECTRICAL EFFICIENCY**

COILS and magnet wire may appear perfect to the naked eye. But this is an unsafe way to judge them. Defects, hidden beneath the thousands of turns preceding the outer layers may show up quickly or may not come to light for months.

Robbers of electrical efficiency! Short circuited turns, wrong number of turns, poor enamel, off gauge bare wire, high or low resistance — there are many of these "sneak thieves" invisible to the naked eye but which are likely to appear in any but the most carefully engineered products.

Inca magnet wire and coils are made to stand the supreme test, namely, *continuous operation in the field*. The necessary burglary insurance giving protection from the attacks of these robbers is provided through new and modern methods of manufacture; specially designed equipment; wire of high quality; skilled operators long experienced in wire drawing, enameling and winding, and a system of rigid tests for all products. As a result, Inca wire, inch by inch, is the best, and Inca coils, turn by turn, the most efficient it is possible to manufacture.

It is always a pleasure for Inca engineers to give you the benefit of their knowledge, facilities and experience.

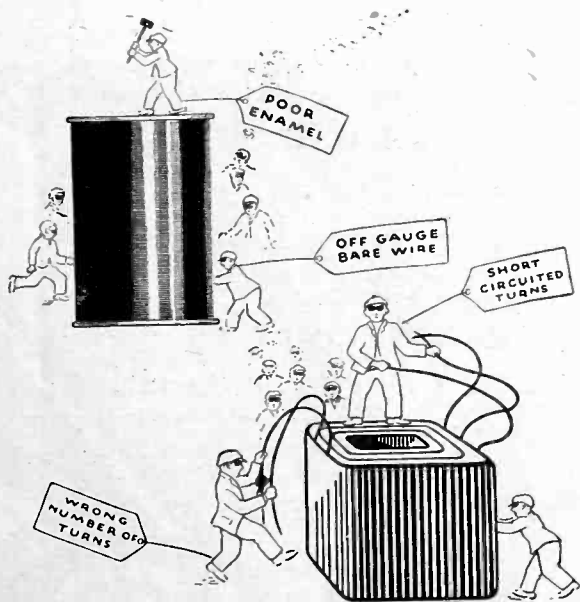

NATIONAL ELECTRIC PRODUCTS CORPORATION

Inca Manufacturing Division

Copper Wire Products — Fort Wayne, Indiana

EASTERN OFFICE: Newark, New Jersey

WESTERN PLANT AND OFFICE: 1547 Venice Blvd.

Industrial Office Building

Los Angeles, California

Many things to many different men

MORE than 500 broadcasting stations will use the ether tonight for programs of music, educational or political speeches, bedtime stories, news flashes. Different members of any one family may wish to listen in on programs from different stations being broadcast at identical hours. The need for a "second radio"—as for a "second car"—is definitely here. Thanks to the electronic tube this need is met—and met economically in the new portable home radio set.

In its unfailing ability to do many things the electronic tube is super-human. It brings entertainment through radio and sound pictures. It guides airplanes safely through fog. It sorts food. It hears the faintest sounds. Sees the slightest variation in light.

Men of vision have harnessed the electronic tube. Toiling long hours in the laboratory they have made life richer and fuller for millions of people. Through their efforts, every citizen now possesses the equivalent of hundreds of slave-power in the form of mechanical energy—energy that has substituted a myriad of labor-saving devices for man-power. Great credit is due these scientists—pioneers in electronics.

In their search for materials which fit their definite needs these men have time and again turned to Alcoa Aluminum—have found in it a metal that resists corrosion—that is as strong as structural steel, yet only $\frac{1}{3}$ its weight.

In every development of the electronic tube Aluminum has played a part. In radio, where the tube is tuned to sound, both for the tube itself and upwards of 25 other parts, aluminum has been found indispensable. In the "electric eye" or photo-cell—when the tube is sensitive to light—aluminum also serves. Indeed aluminum brings its advantages to a wide range of needs in electronics.

Patient and intelligent research work in the laboratories of Aluminum Company of America has developed a whole

family of light strong Alloys of Alcoa Aluminum. These Alloys possess unique physical and chemical characteristics.

Some of the light strong Alloys of Alcoa Aluminum have tensile strengths as high as 55,000 lbs. per square inch minimum. They are good conductors of electricity. They conduct heat 5 times faster than iron or steel. Weight for weight, they have the highest electrical efficiency of any metal commonly used.

Builders of all types of equipment utilizing the electronic tube need Alcoa Aluminum—use it. For a dependable source of supply, they come to Aluminum Company of America. Quick delivery, absolute uniformity are assured. Your inquiries are solicited for Ingot; Sheet; Extruded Shapes; Rolled Shapes; Tubing; Forgings; Die, Sand and Permanent Mold Castings; Stampings; Screw Machine Products; Draw Press Products; Wire; Bar; Rod. Available in large or small quantities; Address ALUMINUM COMPANY of AMERICA; 2474 Oliver Building, PITTSBURGH, PENNSYLVANIA.



ALCOA ALUMINUM

electronics

A MCGRAW-HILL PUBLICATION

New York, November, 1930



O. H. CALDWELL
Editor

FRANKLIN S. IRBY, Ph. D.
Associate Editor

KEITH HENNEY, M.A.
Associate Editor

The march of the electronic arts

Basic radio case to Supreme Court

Out of the welter of litigation in which the Federal Radio Commission has become involved, the Supreme Court of the United States will get the case of a relatively small Chicago broadcasting station this year for the first real showdown on the basic radio law.

Docketed at No. 29 on its fall calendar, the case of WCRW is expected to come before the highest tribunal in the land some time this month or next. This case, arising out of an order of the commission reducing the power of the Chicago station from 500 to 100 watts, will definitely determine the constitutionality of the Radio Act of 1927 which created the commission and under which that body has been functioning for nearly three years.

Another point raised in this case is whether the waiver of vested or priority rights, signed by each station owner in applying for a federal license, is constitutional. In certifying the case to the higher court, the Court of Appeals did not certify whether the Commission's action was void; in fact stated nothing concerning the Commission's authority, so that the station has been in status quo since it reduced its power.

The case of WMBB-WOK, also of Chicago, a 5,000-watt station which was ordered off the air altogether in one of the earliest decisions of the Commission, has been combined with the WCRW case, inasmuch as many of the same issues are involved. Besides the deprivation of property issue, however, the WMBB-WOK case raises the point that radio is not interstate commerce and attacks the validity of the Davis amendment equalizing broadcasting facilities among the zones and states.

The standards prescribed for radio stations in the radio act are also a point at issue.

U. S. radio exports ahead of last year

United States exports of radio apparatus during the eight months ended August 31, 1930 registered a gain over the corresponding period of last year, according to the Electrical Division, Department of Commerce.

Total exports of radio apparatus during the 1930 period amounted to \$11,904,171, an increase of \$15,050 over the total for the eight months of 1929.

Shipments of receiving sets alone totaled \$5,583,301 during the 1930

DR. R. A. MILLIKAN



with the electroscope he used at the north magnetic pole to determine effect of earth's field on cosmic rays

period as compared with \$4,620,922 for the eight months of 1929; receiving tubes \$1,592,578 in comparison with \$1,112,096, and receiving set components, \$2,201,736 as against \$2,194,200.

Canada was the leading market for radio apparatus during the first eight months of 1930. Italy is becoming an increasingly more important market for radio apparatus and during the month of August shipments of receiving sets to that country were valued at \$52,325 and receiving set components at \$38,128, while shipments of loudspeakers amounted to \$11,436. Mexico imported \$89,379 worth of radio receiving sets from the United States and New Zealand, \$77,727 worth. Argentina and Uruguay each took approximately \$39,000 worth of these sets. Argentina also imported \$32,223 worth of American receiving set components.

Atom is X-rayed by new process

Invention of a new X-ray tube which takes "snapshots of atoms" was announced to the New York section of the American Chemical Society at a meeting in the Engineering Society Building Oct. 17. The new tube takes in one minute difficult pictures that formerly required 100 hours and in one-fiftieth of a second "simple" pictures that took two hours.

The pictures are not the familiar shadow photos, such as taking the bones of a human hand, but a newer branch of X-ray photography known as diffraction patterns. These are pictures which show the arrangement of atoms in crystals. The tube was developed by Dr. George L. Clark, Professor of Chemistry of the University of Illinois. Dr. Clark stated the new tube would have wide applications in industrial development.

Fifty-one cities to use radio to catch criminals

So useful has radio proven in the apprehension of criminals in the larger cities that the Federal Radio Commission has been besieged with applications from smaller cities for radio stations. At present there are 29 cities utilizing short-wave communication service and 22 other cities hold construction permits.

Stories of robbers being caught within a few minutes after they had held up a bank or forced a safe continue to multiply in the municipalities where this radio service is in operation. Radio-equipped automobiles patrol the city and are ready to speed to the scene of a crime immediately upon receipt of the signal. Thus the chances of a criminal escaping are greatly lessened from those of the time when police had to be reached by telephone or dispatched from headquarters or a precinct station. The service is being adopted in a few instances by Fire Departments.

The national capital is one of the most recent cities to obtain a permit to erect a station and equip its police cars with receivers. The contract has just been let, and the service is expected to be in operation before many weeks.

Construction permits have been awarded to Berkeley, Calif.; Philadelphia, Pa.; Beaumont, Texas; Buffalo, N. Y.; Chicago, Ill.; Auburn, N. Y.; Youngstown, Ohio; Lansing, Mich.; State of Missouri; Kansas City, Kan.; Portland, Ore.; Rochester, N. Y.; San Antonio, Texas; San Francisco, Calif.;

Toledo, Ohio; Seattle, Wash.; Akron, Ohio; Washington, D. C.; Vallejo, Calif.; Oklahoma City, Okla.; New York Fire Department and El Paso, Texas.

PHOTOTUBE ALARM AT N. Y. BUSINESS SHOW

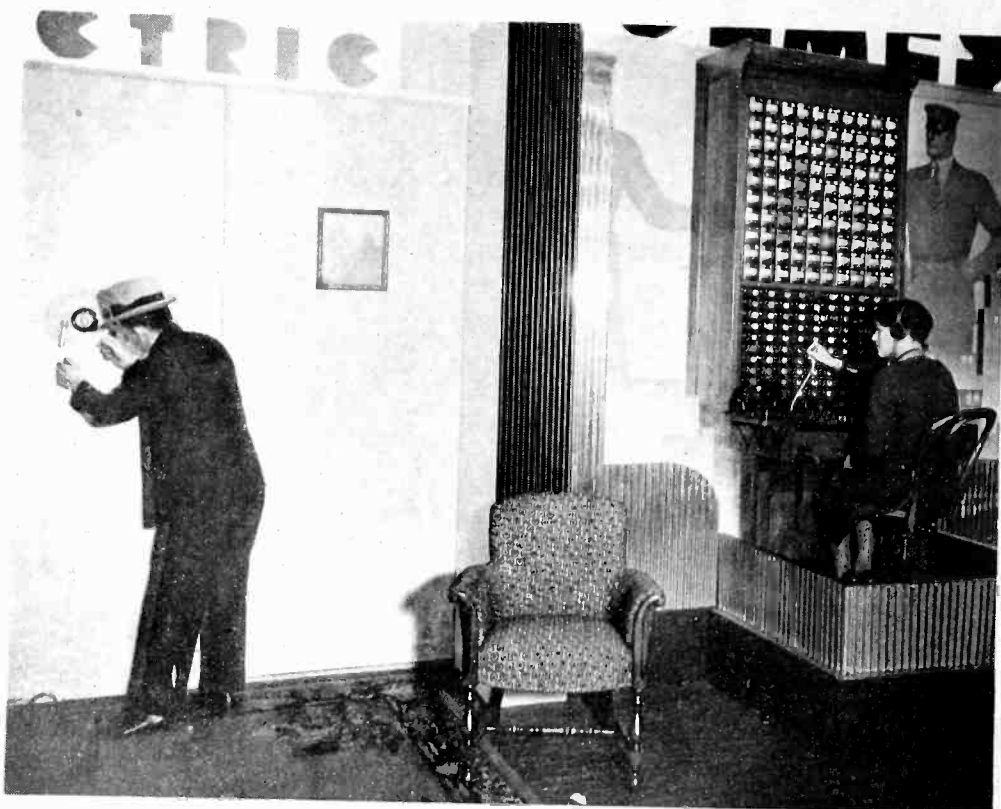

As yeggman unknowingly obstructs invisible light beam an alarm is sent to switchboard. Device demonstrated by Holmes Electric Protective Company at New York Business Show, October 20-25

◆ ◆ ◆

NBC admits practicability of synchronizing

In a statement to the Federal Radio Commission, October 20, M. H. Aylesworth, president, National Broadcasting Company, reported the success of recent experiments in synchronizing the 50-kw. stations of WEAJ, WGY and KDKA on the 660-kc. channel, under the direction of C. W. Horn, chief engineer.

These experiments thus indicate that a nation-wide broadcasting chain can be operated on one or two broadcasting wave lengths—instead of the present use of 15 to 25 wave lengths, all carrying the same program (which results in the mid-west listener hearing the Eveready Hour at 25 different places on his dial).

How the new "synchronization" plan is to be commercially applied remains to be seen. Undoubtedly some present large broadcasters will willingly transfer to the chain wave length for regular operation and thus become more chain outlets. Other owners will certainly insist on keeping their stations' own identity, making it necessary for the chain management to build its own high power transmitters to cover such regions, at an estimated total expense of \$35,000,000.

In any event, as pointed out by Mr. Aylesworth, the development will be a slow evolution, involving considerable reallocation of present broadcasters, and resulting in many more regional programs of high signal intensity.

POLISH RADIO STATION TO HOWL DOWN REDS

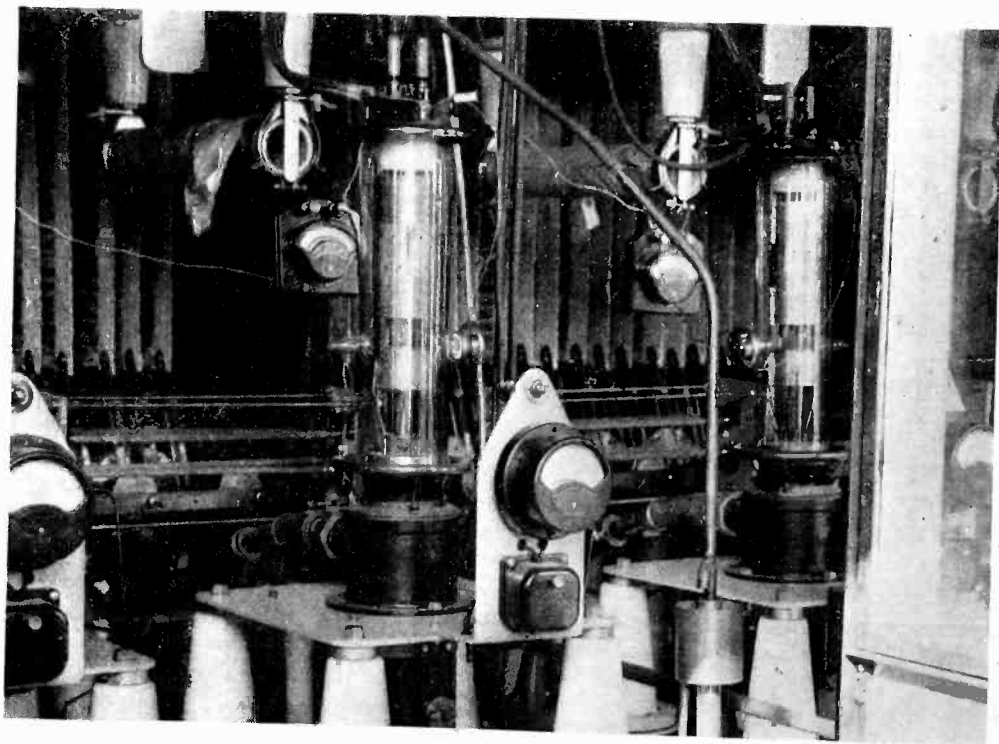

To combat Soviet propaganda broadcast from Moscow, Poland is building one of the most powerful stations in Europe. Six 100-kilo-watt water-cooled tubes built by the Marconi works will be used

American College of Surgeons favors "electronic knife"

Preliminary results of a survey by the American College of Surgeons to determine the actual worth of the electrical knife in combating disease were the subject of an enthusiastic report at a symposium on electro-surgery conducted October 15, at Philadelphia, Pa. during the clinical congress of the college. The survey was made to determine the merits of the instrument specifically in neuro-surgery and the surgery of malignant diseases.

Dr. Howard A. Kelly of Baltimore declared that electro-surgery was as far ahead of scalpel surgery "as the modern electric tram is ahead of the lumbering horse car."

He asserted that the new technique permits the extension of surgery of the brain into delicate areas not dreamed of hitherto and opens up the possibility of greatly extending the application of surgical measures to the spinal cord. Almost never is electro-surgery halted because of hemorrhage, he said.

Dr. Ernest Sachs of St. Louis described the development of the electrical knife as one of the three great epochal discoveries for assisting the neurosurgeon in his work. Where hitherto it was sometimes necessary to use sixty or seventy silver clips for ligating severed blood vessels, large tumors are now removed without recourse to clips.

Electrical transcriptions are being used by many radio stations

Radio broadcast stations are experimenting with a new form of program presentation. This new form which is called electrical transcriptions consists of a pick-up from a disc record. These records are not played on regular phonographs but by a special reproducing machine designed to meet the requirements of broadcasting.

The sponsors of this type of entertainment see numerous advantages to encourage them. In the first place, the records can be made in a studio designed for the best accoustical effects. If an artist makes an error the record can be made again which would not be possible under normal broadcasting conditions. Another advantage claimed is that the program may be presented at the selected hour for any station. This of course is not possible with present national hook-ups for big programs with a difference of three hours in time from coast to coast. Also the expense of wire lines to connect stations is eliminated by using the record system.

BROADCASTING SPORTS



Designed for short wave use this transmitter may be easily carried by two persons in following athletic events

Carrier-current talk reaches 445 miles

Carrier-current communication for regular operating service has been installed between Pine Bluff, Ark., and New

Orleans, a distance of 445 miles. This is said to be the longest communication distance ever covered in this way for regular service.

Incident to the construction of a 10-kv. line between Amite, La., and New Orleans, forming the final connecting link in the interconnection between the Market Street plant of the New Orleans Public Service, Inc., and the Sterlington steam plant of the Louisiana Power & Light Company, in the northern part of Louisiana, General Electric carrier-current equipment is used to permit communication between New Orleans and Amite, La.; Jackson and Indianola, Miss., and Pine Bluff, Ark.

Soviets spending millions on radio

A network of 62 radiotelegraph stations, furnishing service to strategic points throughout Soviet Russia, is planned by the Soviet government as part of its revised five-year program for the development of communications, the Department of Commerce has learned. The entire communications program of the Commissariat for Posts and Telegraphs involves capital investments aggregating about \$683,000,000. Soviet Russia is paying particular attention to "wired wireless" or the transmission of radio programs along telephone wires.

NAVY ADOPTS RADIO-OPERATED TYPEWRITER

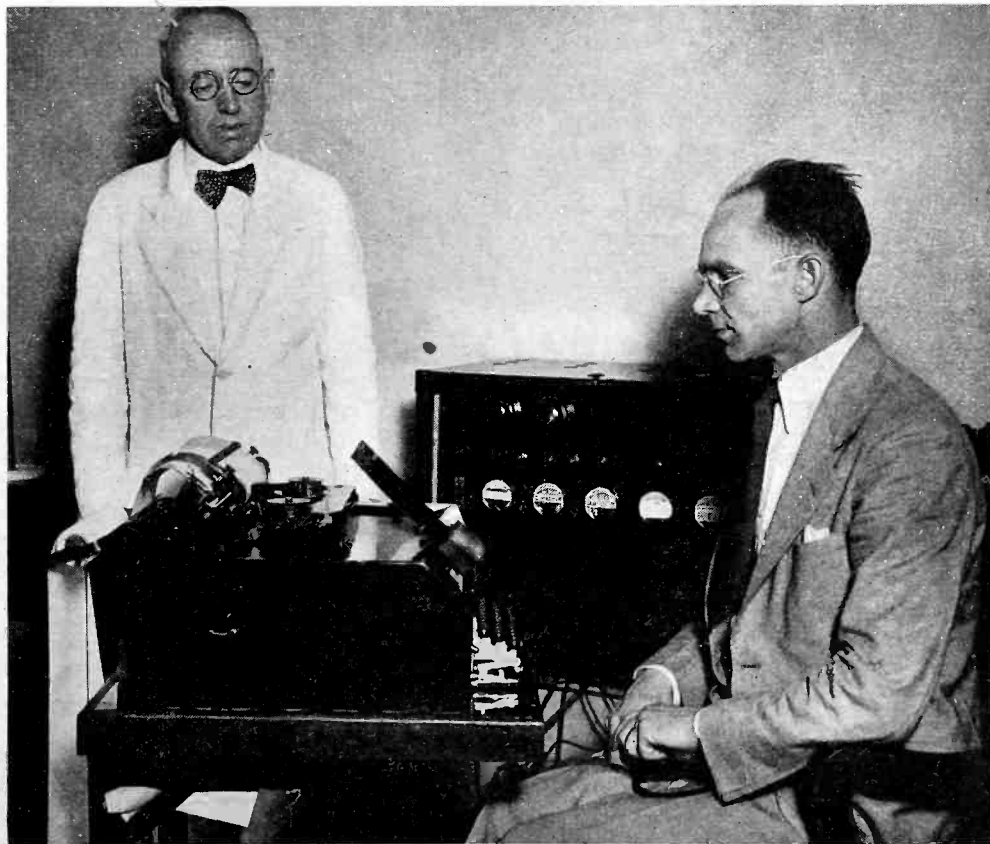

Radio impulses are used to transmit typewritten messages direct from the Navy Department, Washington, to the Naval Operating Base, Hampton Roads, Va. Captain S. C. Hooper, Chief of Naval Communications is shown standing

RAW MATERIALS, COSTS—

Price ranges
over ten-year period.
Labor and overhead factors
in finished cost

CONSERVATIVE estimates indicate that 69,000,000 tubes of the types used in radio receivers were produced during 1929 and that the 1930 production will be of the order of 80,000,000.

The first "big" year of vacuum-tube production was 1923, when 4,500,000 tubes were made; since then the production has had an annual increase of about 10,000,000 tubes. During this period the costs of raw materials, labor, and other expenses have changed, with the results shown here. At the same time greater use of automatic machinery, coupled with quantity production, has lowered the tube cost; manufacturing experience and research during this period have given the consumer better tubes.

This vast assembly of glass, rare earths and common metals has consumed thousands of tons of raw materials

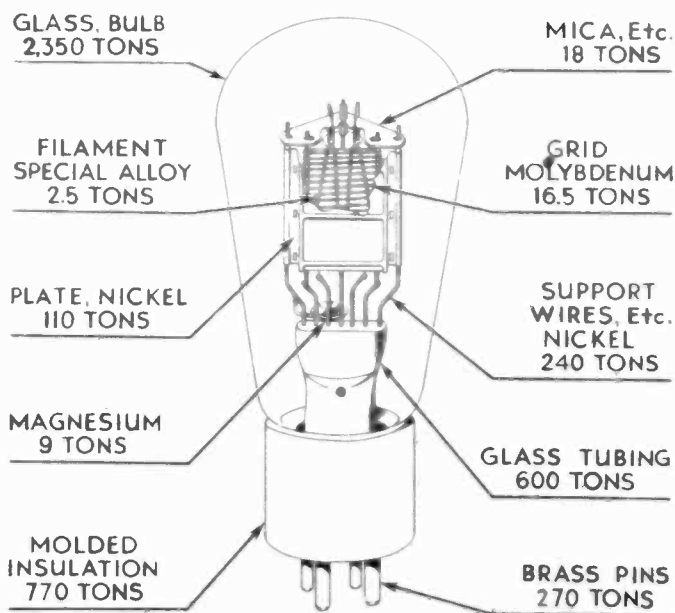

Total material used in 69 million receiving tubes

	Tons		Tons
Glass	2,950	Magnesium	8.9
Nickel	350	Copper-steel	50
Molybdenum	16.5	Molded material (base)	770
Brass	280	Barium, strontium compounds	

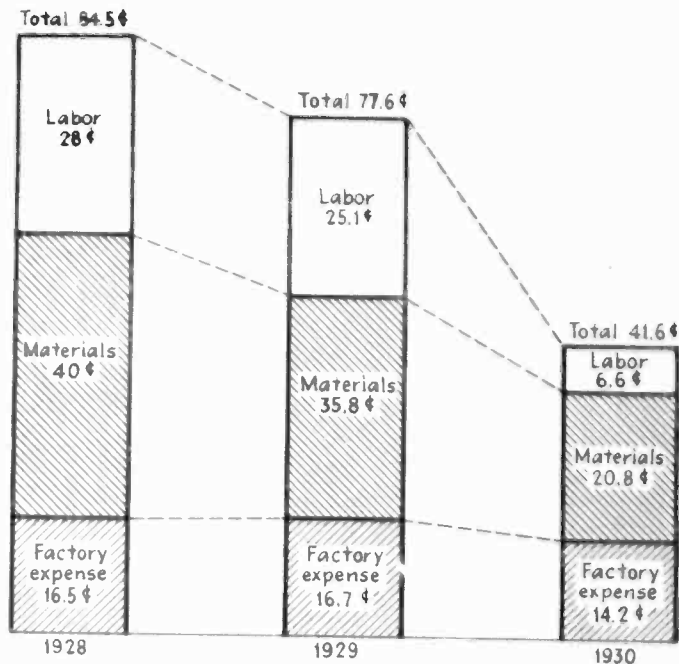

How the factors entering into manufacturing cost of tubes have been reduced since 1928. Material costs have come down, but owing to automatic machinery the labor cost per tube has been even more greatly reduced

made from 37 of the 90-odd elements found in the universe. Some of these elements are used in extremely minute quantities, but at great saving to the users of the tubes, strontium, barium, and thorium, for example (see page 390, this issue of *ELECTRONICS*); other elements are used in enormous quantities. In ten years the prices of these raw materials have fluctuated appreciably; the chart presented herewith shows these variations and points out how low present prices are.

Kaleidoscopic changes in industry

During this decade the uses of some of the elements entering into vacuum-tube production have increased; at the same time there has been a change in the metals used for specific parts of tubes, so that the entire picture of ten-year history is rather kaleidoscopic. The production of molybdenum is an interesting example. In 1920 three sales were made by one company. The prices were 80 cents, \$1 and 60 cents. At that time very little use had been found for the now well-known "moly." Since then other uses than tube manufacture have appeared, so that the stock on hand of one company is sufficient to last tube manufacturers about 200 years. Molybdenum is mined in Colorado as molybdenum sulphide (MoS_2), the concentration of the ore being about 85 per cent. This sulphide, about 60 per cent of which is molybdenum, is sold to chemical concerns, which in turn sell it to tube manufacturers and suppliers of tube parts as an ammonium compound of molybdenum. From this material grid wires are wound.

IN TUBE MANUFACTURE

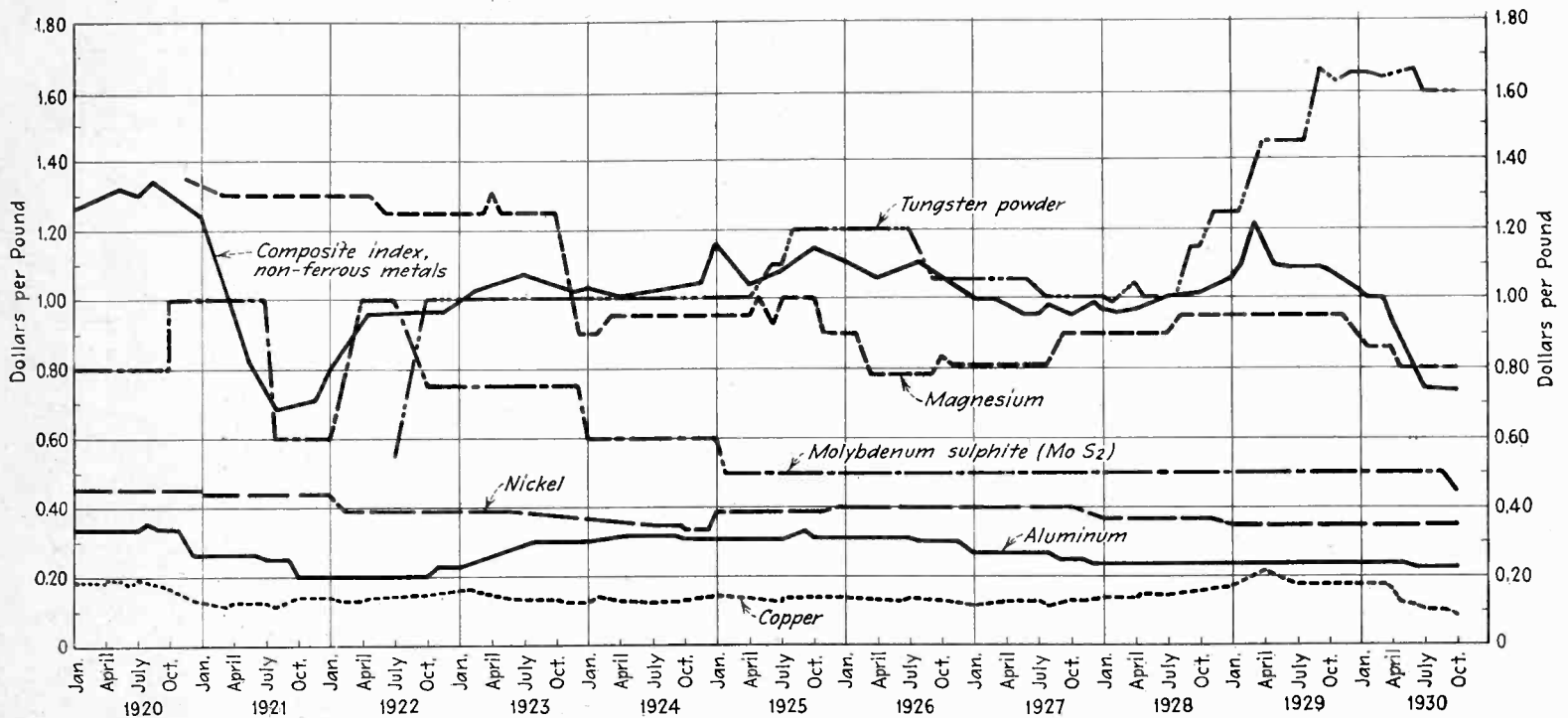

How the prices of some of the raw materials and commercial metals entering into the electronic-tube industry have varied during the past decade. In general, the price movement is seen to have been downward. As the chart shows, prices for most materials are now at the lowest point reached during the past ten years

In ten years the prices of tubes have dropped appreciably due to development of automatic machinery, simpler construction, or other economies. As an example, the cost to produce a 227 by a well-known manufacturer in the month of September in three successive years is given here. It is broken down into labor, materials cost, and factory expense, the latter item including retirement and replacement of machinery at the rate of 20 per cent per year, rent, light, heat, power, etc., in the factory. The most startling reduction in cost is that due to labor, occasioned by the greater use of automatic machinery. This cost has been cut in four; at the same time the materials cost has been halved in three years. The over-all cost has been halved, and at the same time better and better tubes have been made.

Estimates of material consumed

Quantities of material indicated here as entering into the production of 69,000,000 tubes were estimated in the following manner: The weight of material used in constructing 227, 224, and 245 types of tube were averaged and this value multiplied by 69,000,000. It is a representative but not accurate estimate of the tons of material consumed by tube manufacturers in 1929. It does not include power tubes of the types used in transmitters, telephone repeater tubes (of which there are a quarter-million in use), or special tubes of various types sold by hundreds or thousands for various purposes.

Roll-Call of Materials Entering Into Electronic Tubes

Glass		Supports
Silica	Iron	Glass
Sodium carbonate	Titanium	Mica
Calcium oxide	Silicon	Lava
Sodium nitrate	Barium carbonate	Isolantite
Lead oxide	Strontium carbonate	Nickel
Borax	Calcium	Molybdenum
Zinc oxide	Barium nitrate	Monel
Cobalt oxide	Strontium	
Potassium carbonate		
	Grids	Getters
Base	Nickel	Magnesium
Bakelite	Monel	Calcium
Porcelain	Molybdenum	Strontium
Glass	Copper	Barium
Wood fiber	Chromium	Sodium
Zinc		Potassium
Copper	Plates	Caesium
Nickel	Nickel	Phosphorus
Tin	Monel	Carbon
Marble flour	Molybdenum	Tantalum
Ethyl alcohol	Iron	Mischmetal
	Tantalum	
Filament	Leads	Gases
Tungsten	Zinc	Hydrogen
Thorium nitrate	Iron	Helium
Carbon	Nickel	Neon
Nickel	Copper	Argon
Cobalt	Borax	Nitrogen
		Oxygen

Electronic control of Complex auditorium lighting

By DEAN H. HOLDEN*

Keyboard manipulation of color effects in great new Severance Hall, Cleveland

WITH much of the success of the decoration of Severance Hall dependent on the subtle control of its light, the main switchboard required very special design. The synthetic system of red, green and blue lights, combined to give any hue, necessitated proportional dimming. A dimming preset mechanism with simple control of fadeout and fadein from setup to setup was vitally essential.

Basically, the intent of the designers of this system was to make it possible for a single operator, seated at a movable console, of organ type, to control, singly and in combination, all lighting circuits of the main auditorium and stage in a manner analogous to an organist's control of sound. All operating devices are in easy reach of hand or foot, and of sizes consonant with the finger or foot, respectively. The operation of all moving parts is not unlike the touch of a typewriter or organ.

All this is a far cry from the average switchboard of today, which has been aptly likened to a fourteenth century organ, struck with clenched fists. It was, then, the thought that centuries of development by organ builders could be applied to lighting control, and in the completed board in Cleveland there will be many standard organ parts. In fact most of the console equipment has been borrowed direct from either radio, telephone or organ practice.

Reactor and vacuum-tube system

Down in the basement apparatus room is a rack some twenty feet long and seven feet high which contains 114 reactors and their associated tube units. One reactor per load is provided. To make the operation of these units clear we will take any reactance dimmer as an example. The a.-c. load current flowing in the reactor is directly dependent on the d.-c. saturation current flowing in the other coil of the same unit. This d.-c. is sup-

plied by two neon-filled rectifier tubes. Incidentally, the life of these tubes should be several thousand hours and means are provided for compensation as the tubes age, as well as for easy testing.

The output of these rectifiers is controlled by varying their grid bias. This is accomplished by a small tube of conventional radio amplifier type. In turn, this amplifier has its output controlled by a variation of the d.-c. or conventional radio "C" battery bias on its grid. The control wires to this grid come from one of the one hundred and ten *vertical* busses on a relay panel, the nerve center of the cross connecting mechanism.

The relay cross-connecting panel is also in the apparatus room, very near to the tube system. It consists of 36 horizontal rows of relays, 110 in each row. Each *horizontal* row is connected with one of the 36 dimmer control drums on the console. Each vertical row is connected to a one-tube control unit, its associated reactor and in turn, load. It will be seen that by closing any relay at the intersection of a *horizontal* with a *vertical* bus, any one of the 3,960 possible connections can be made.

Operating console

It was obviously impossible to run four thousand wires to the console or accommodate that number of switches. The architects developed a diagram wherein there are 110 load switches and 36 control selectors at the console. The operation of connecting loads No. 3 and No. 91 to control No. 17 is as follows:

- (1) Throw load switches No. 3 and No. 91 to "On".
- (2) Touch control selector button No. 17 which completes the circuit to the closing coils of the two appropriate relays, which are then automatically latched closed. Had the operator touched control selector No. 2 instead, then these loads would have been connected to control drum No. 2. The above

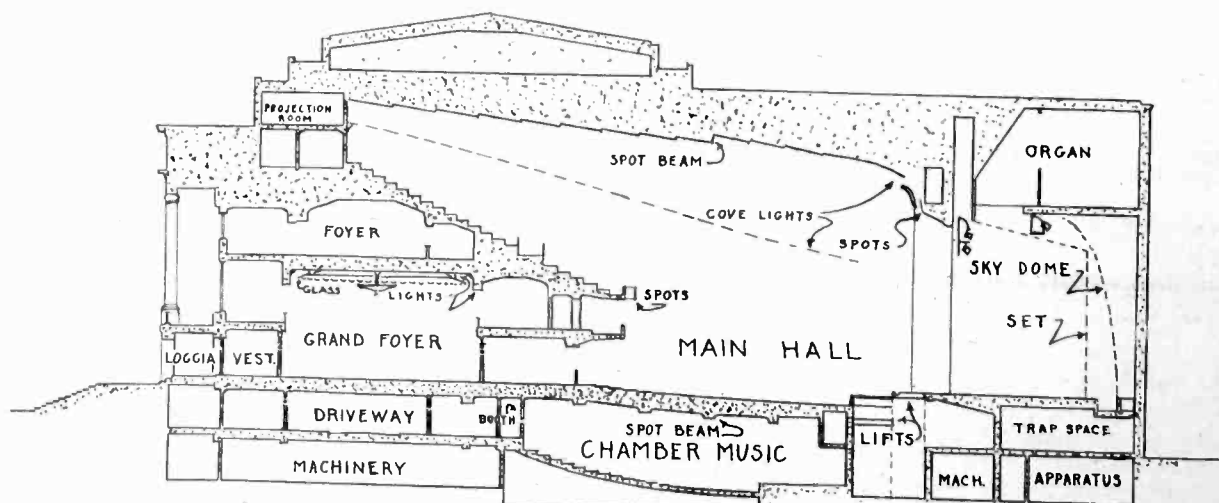

Cross-section through main auditorium which seats eighteen hundred persons

TUBE MANUFACTURING

controls which it may be desired to connect to and master, foot or motor operated, capable of electrically any or all individual controls or group

reset dimming device associated with each individual drum, but with individual scene faders operation gang shaft by motor or hand. Small sliders or presets of dimming on each control unit. Individual controls and one master for handling lighting.

individual control for 20 four-color boomerangs

individual "Joy Stick" control for direction and spotlights.

and remote iris diaphragm control to nine arc e to ten stations.

illumination for cue sheet rack and all work-sole, including pedal portion.

can be plugged in at two positions, one orchestra lift and the other near the prompt s a forty foot cable attached to it, con-neighborhood of 1,200 wires, encased in er hose. The weight of the console will exceed half a ton.

le are located the potentiometers which bias on the small amplifier tubes men- Each individual control drum operates distance units. In turn these units can be h sub-group or through group master, n turn can be fed from the variable volt-ter bus or from direct feed. The in-oo, can operate direct from feed, in-ie mastering system. Lastly, any com-ividual controls can be fed from the is, without first going through group or ers.

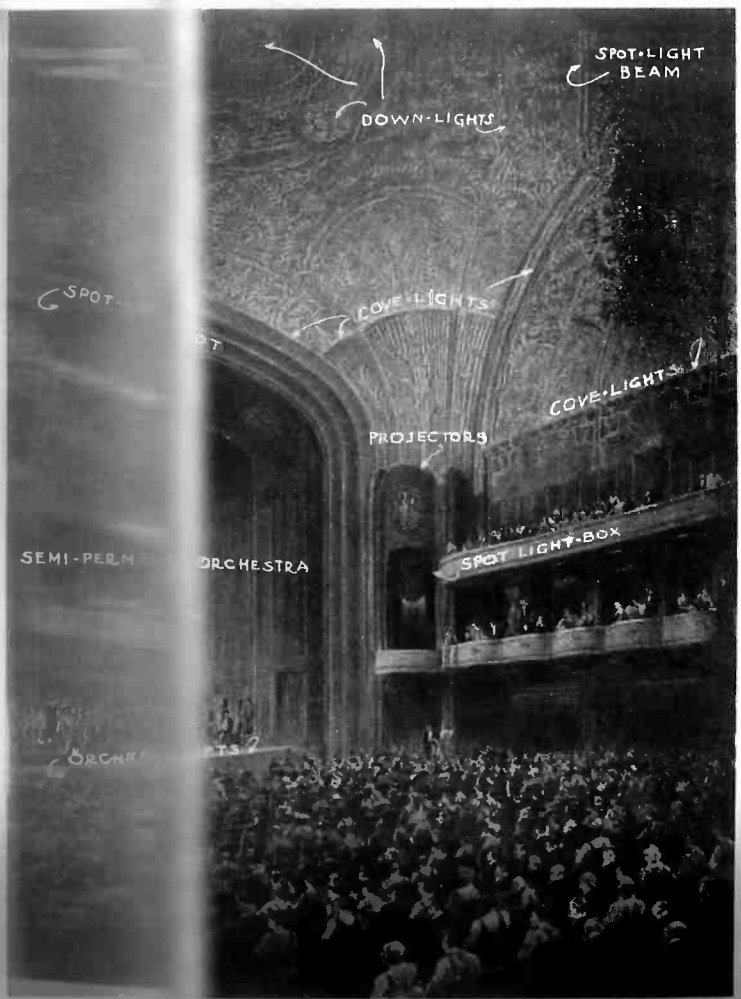

Location of light-sources in auditorium

ad run s ac-

which buttons By closing whose relay board setup. ze and design Hall switch- lighting circuits ming controls, and not pass through the ese latter are perma- ights in the auditorium.

g the switching of any one or circuits to any one of the 36 in-

al control drums which remotely nning of whatever circuits may be switching under (a). foot pedals, each capable of electrically of the corresponding sub-group of four

masters, foot or motor operated, each cap- controlling any combination of the 36 in-

Architects, Cleveland, Ohio. ore Illuminating Engineering Society. October

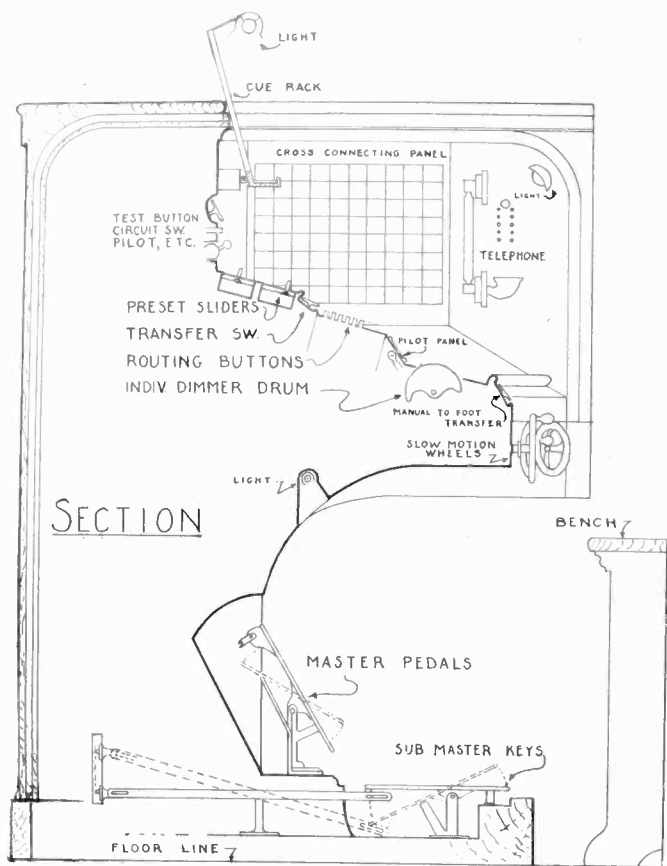

Physical arrangement and function of controls

Beginning at the floor, there are inclined foot pedals comparable to the swells of an organ, one for each group master and one for the grand master. In front of these are nine broad foot keys. These operate the sub-master potentiometers.

Next above, and at the edge of the operating manual position are thirty-six tilt tablet switches, again of the usual organ type. Each of these is associated with one of the thirty-six individual control drums, and in turn, each group of four tablets is tied to one of the foot-pedal sub-group masters. These switches enable the operator to transfer control of all individual circuits to foot operation in a given sub-group of four dimmers, or any one singly, thus freeing his hands when necessary. Immediately above these on a sloping ledge are thirty-six individual drum controls.

These are six inches in diameter and protrude three quarters of an inch above the panel face. They have milled edges and a scale for definite recording of settings. Like all controls on the board, they are spaced fifteen sixteenths of an inch on centers, the usual spacing of piano and organ keys. Drum type control was adopted because experiment proved it possible thus to operate several with one hand, some going up and others down simultaneously.

On the slope containing the preset, slider-type potentiometers, there are four of these to each of the thirty-six control circuits. They are crowded into a panel only six inches high yet they are easy to work. It is these sliders that are set to predetermined points to set up the brilliance of any circuit for four scenes in advance. Associated with these, but behind the panel, is a preset fader potentiometer. All of these faders are ganged on a common shaft and give smooth change of light from scene to scene whether one circuit is going up and another down, all moving in the same direction, or individual lights changing at various ratios. So, a single motion of a single drum, can completely change one lighting scheme into another, an achievement impossible on any other board.

The last row at the top of the board has thirty-six tilt tablet switches to throw a given control on or off, and a test button which lights pilots on load circuit switches, showing they are hooked to the particular control being examined.

A four-inch wide panel running from top to bottom through the center face of the console contains all master controls. At the top is a clock, below, the master fader drum. The grand master drum follows. Below this are the four group master interlocks from foot to motor control. Lock and master switches and other miscellaneous items are worked into the spare space just above these. Scene pilot lights are provided which fade from scene to scene.

On the diagonal sides of the board in the vertical faces, are the 110 cross connecting switches and pilots, fifty-five on each side of the operator. On the inclined face at the left are the house light dimmers and above these are located the boomerang controls. In the right-hand inclined panel are the "joy sticks" for remote directional spot control. They also are the arc spot signals and diaphragm controls.

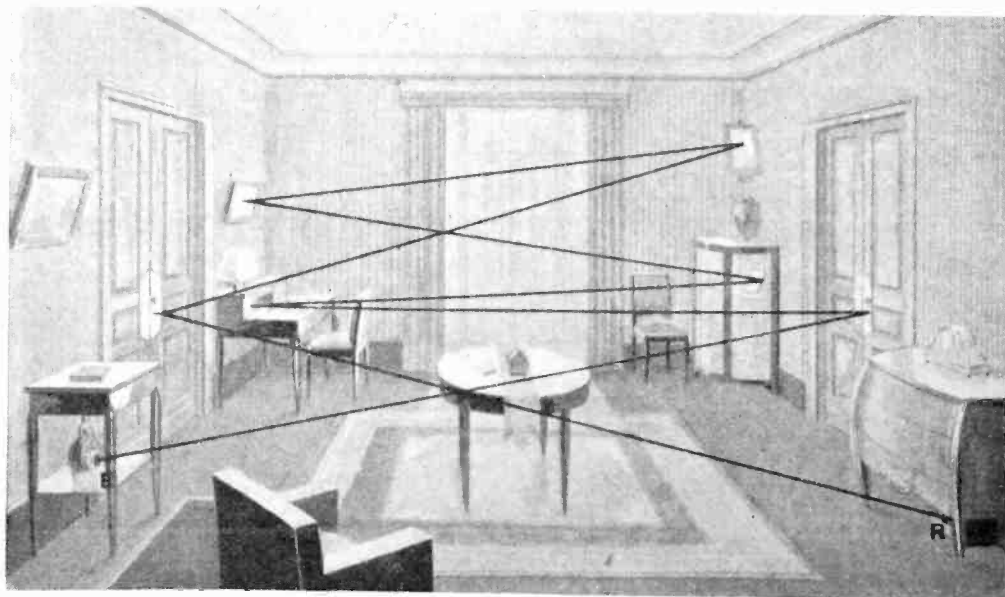

Reflected infra-red-beam safeguards whole room

METHOD proposed by French police for protecting a room against entry by burglars, utilizing an invisible beam of infra-red-light. The beam from reflector *R* is projected back and forth between successive reflective surfaces so that it criss-crosses the entire room before finally reaching the photo-electric cell *E*. Interception of this beam at any point rings a bell.

Sound "tricks" in picture production

By CARL DREHER*

THE making of a moving picture is essentially a composite process. Scenes which dovetail smoothly to produce comical or dramatic effects were originally made in disjointed form and in an order dictated solely by considerations of convenience and expense. The picture, as it is finally seen and heard from the screen, is a synthetic product in which many special and cleverly applied processes play a part. Some of these fall within the field of engineering, particularly those having to do with the recording of sound in conjunction with the photographing of action. This article describes some of the special devices in use, particularly as they affect sound recording.

What is known as trick photography, or in more dignified terms, special process photography, was of

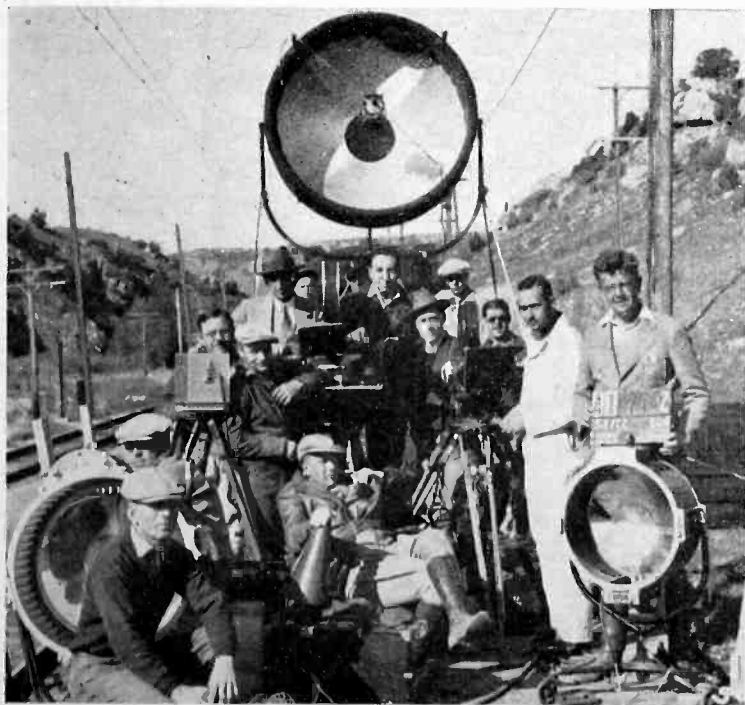

Beam microphone mounted on railway car to obtain long distance pick-up for outdoor scenes in sound recording

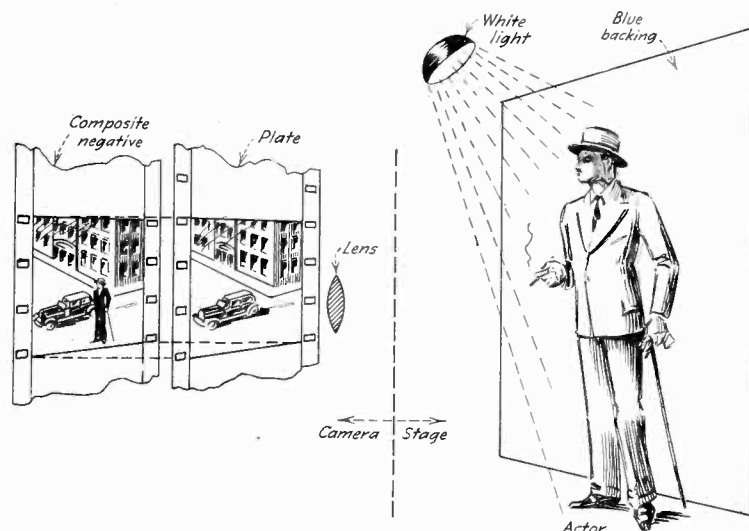

Fig. 1—Schematic diagram of composite photographic process to show an actor against a street background which could not be easily simulated by other processes

course well known in the art before the introduction of sound. Sound, in fact, was at first a severe handicap to the camera man and trick expert with creative ideas, and only recently have the two arts assumed a normal relationship in which each is an aid rather than an obstacle to the other.

The principal application of composite photography is in providing a background which is not actually available in the place where the foreground action is to be photographed. For example, an actor may be available for work in a Hollywood moving picture studio at a particular time, but it may be desired to show him against a Mississippi river background. Instead of taking the actor to the river, the river may be brought photographically to the actor. The means used will first be outlined in their purely optical aspects and later we will see how the problem is handled with the additional complication of sound.

Figure 1 shows the process schematically. An actor is represented on the stage where he is to be photographed. It is desired to show him against a street background with moving traffic and other features which could not be simulated by an ordinary painted back drop. The street scene which is to provide the background is first photographed, if it is not already available. Usually all kinds of background scenes are on hand in the producer's library in negative form. From the negative of an appropriate scene a double image print is made. This double image print contains a superimposed positive image in color and a neutral negative image. The color (perhaps red) and the neutral or gray shade are selected by careful testing so that when interposed positive image in color and a neutral negative of white light, the two will give an equal fogging effect. Thus no image results as long as the printing light is white, since for white light the superimposed tones neutralize each other over the entire area. But if the light impinging on the double image transparency is suitably colored, some of it will pass through the transparency and a black and white image will result on the developed negative.

In Fig. 1, the actor is shown under white lighting against a blue backing. He may of course have around him any desired foreground props, which in the illustration have been omitted for the sake of simplicity.

*Director of Sound, RKO Productions, Inc., Hollywood, Calif.

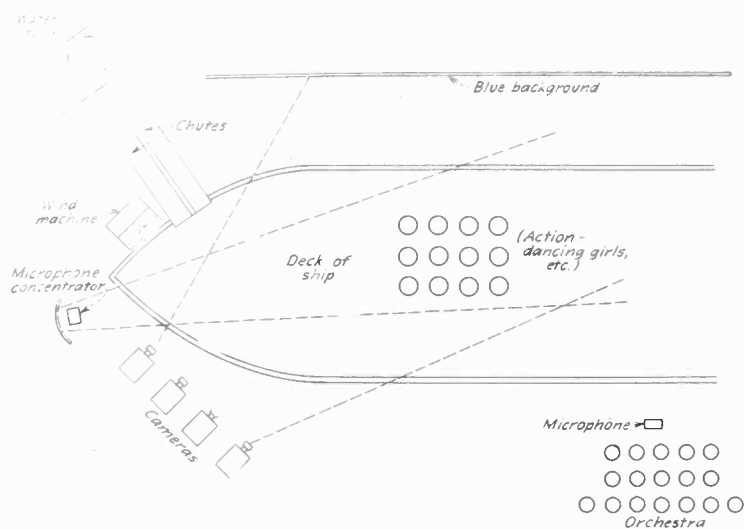

Fig. 2—Set-up of a ship scene for composite photography with sound pick-up

To the left of the figure is shown the camera lens, next the double image transparency or "plate" of the street scene, and finally, the negative on which the composite picture is to be photographed. In the special camera used in this technique, the transparency is unrolled from an intermediate magazine and threaded across the camera aperture in front of and in contact with the unexposed film stock. The light reflected from the actor is not affected by the "plate" except for a certain diminution in intensity. Hence, all that this light does is to produce an image of the actor on the raw stock. But the blue light reflected from the backing where it is not covered by the actor, does carry with it a print of the street scene, since the double image transparency is balanced or neutralized for white light but not for blue light. Blue objects in the foreground must of course be avoided since they will cause a phantom image of the street scene over the foreground image. But with this restriction it is readily possible to photograph persons and objects on a stage with the utmost convenience and at moderate expense, and then to represent them against a background which in the final released prints will appear just as real as if the work had been done in the actual setting. In up to date practice the blue background is generally illuminated by hard white light, while the foreground is under orange light, the double image transparency being balanced for the latter illumination.

Readers who are interested in composite photography will find further data in an article by C. Dodge Dunning: "Composite Photography," *Transactions S.M.P.E. Vol. XII, No. 36, September, 1928*. The Dunning Process Company does most of the work in this line in Hollywood.

Figure 2 shows a rather complicated case of composite photography with sound pick-up. The scene to be photographed is the forward deck of a ship. The ship is built outdoors against a background of deep blue curtain, several hundred feet long and about fifty feet high. The deck is arranged so that it may be swung or oscillated by a number of men to give the illusion of rolling. Everything on or above the deck, such as the railing, mast, halyards, and the part of the ship's superstructure included in the picture, is made very realistic, but of course at the point where the cameras cut, all pretense at reality is dispensed with. In this figure the cameras are shown taking in a part of the deck in which the

action takes place. Since the picture is a musical comedy, a large chorus of dancing girls goes through its evolutions, using the deck as a stage. An orchestra is placed to one side off stage and picked up with a microphone close by. The footsteps of the dancing girls are picked up by an additional microphone outside the camera line, provided with a parabolic reflector so that it will function efficiently at a distance of thirty or forty feet from the sources of sound. During the part of the action where it is desired to produce the illusion of a rough sea, water is released from four large tanks erected on towers some fifty feet high. This deluge sweeps over the deck, to the discomfiture of the players in the action at that time. At the same time a wind machine, consisting of an electric motor and airplane propeller, sweeps the spray before it. This part of the action is shot silent, as the wind machine is too noisy to permit recording. Since there is no dialogue in this section, it is a simple matter to add a sound track later containing synthetic wind and wave noises. An ocean background of rolling waves and tilting horizon is photographed in by the composite process described above. When the picture is finished, we have to all intents and appearances a vessel rolling in the ocean waves, with an occasional comber sweeping over the forward deck, and this result has been secured at a far lower cost than would be entailed in taking a large company out on an ocean steamer and hoping for a storm to blow up obligingly at the right time.

Use of play-backs, pre-scoring and "dubbing"

Often it is expedient to shoot a scene silent, wholly or in part, and to add a musical accompaniment at another time. This is because the acoustic conditions on a set may not be favorable for recording, or because, owing to the camera shots required, it is impossible to place microphones for good pick-up without getting them into the camera field. Figure 3 shows a practical instance.

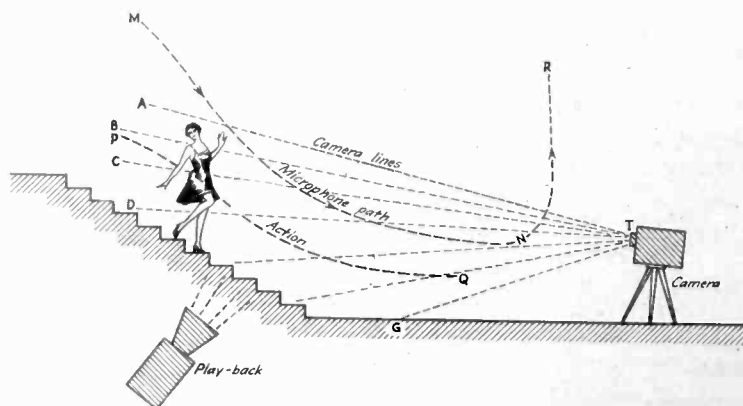

Fig. 3—Dancing scene requiring recording sound and action with playback to get proper effects for close-up and long picture shots

Here we have a grand staircase, at the top of which an actress begins a song and dance which takes her down the stairs and into a final rapid dance with a number of performers at the foot. Both close-up and long picture shots are required in order to give the proper effect. The procedure in this case is as follows: the girl does her dance with the camera following her down the stairs in a close-up shot, so that the upper limit of the camera field is represented successively by the lines AT, BT, CT, etc. The action follows the line PQ. Accompaniment is supplied by an orchestra off-stage, with its own stationary microphone. The microphone for the girl is

swung on a boom or other overhead suspension along the path NR, always keeping just out of range of the camera. This gives us a close-up sound track of the girl's song and a close-up picture only, since the microphone is too low to permit the taking of a long shot photograph including the entire staircase and the landings above and below it. This close-up sound take is rushed to the laboratory, developed and printed. The next day the sound track thus secured is played back on the set through a film phonograph in combination with a small public address system, retaining, of course, the normal running speed of ninety feet a minute at which the record was made. The girl is now photographed, dancing and singing in time with this reproduction, in a long shot against the background of staircase and landings. Synchronism is readily maintained, since all that the girl has to do is to dance in time to the music and, if she is a little out of time with her singing, it will not be noticeable in a long shot. Two complete picture films are now available, one giving the close-up and the other the long shot. In a musical number it is generally permissible to match a close-up sound track with a long shot, so all the elements which facilitate a good job of cutting are now available. However, the method is somewhat costly, since the cast must be brought back a second day for the long shot.

It is also possible to make the entire musical take in a scoring room separate from the stage. This room may be built to afford excellent characteristics for musical recording and pick-up. Here the orchestra plays and the girl goes through her song and dance for sound pick-up only, no photographing being involved. Later the record is played back and long shot and close-up photographs are made on the set. This is called the pre-scoring method.

A third procedure, less expensive, but also less convenient and artistic, could have been used. This would have involved starting the scene at the top of the staircase with long shot and close-up cameras shooting simultaneously and with the microphone suspended high up and out of range of even the long shot camera. As the song begins, the microphone is moved down to the long shot, which is thereupon terminated for cutting purposes while the close shooting for both sound and picture continues to the bottom of the staircase. The microphone is then once more lifted out of camera range, and the long camera shot is again available for the dance. A stationary microphone remains with the orchestra off-stage. By this method there is no long shot available for the interval during which the girl is coming down the steps, and likewise a close-up sound record has been dispensed with in the beginning and end sections of the take. The cutter is therefore limited in his operations and some of the potential effect of the scene may be lost.

The question may be asked, "Why cannot one actress in such a procedure be used for the vocal portion of the show, and then another girl be put in her place for the cameras on the stage?" The answer is that it is possible; there is no technical reason why one person's voice cannot be recorded and then another performer be used in the picture, in the long shots, at any rate. However, even if the operation is feasible technically, it is not done, for the reason that it would be bad business to turn out pictures on this basis. In the very early days of sound picture production, such illicit "dubbing" (from "doubling") was resorted to in a number of instances where the producer had a great deal of money invested in stars who could not sing or whose diction

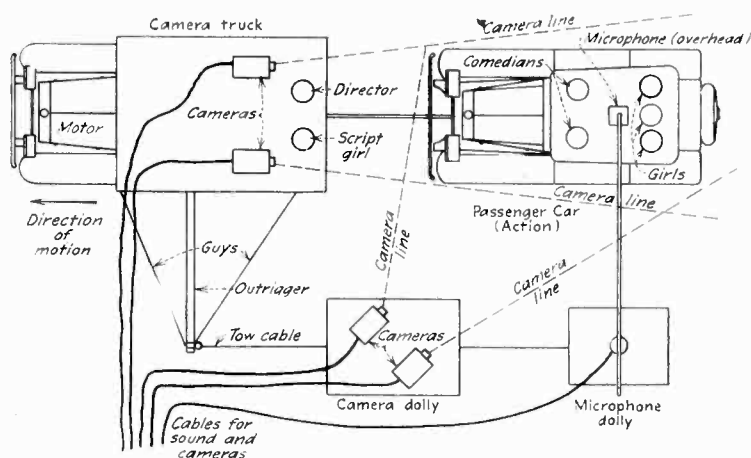

Fig. 4—Intricate set-up for sound recording requiring four moving units to obtain necessary action in special street scene

was not good, and before the dangers inherent in the practice were realized. When anything like this is done there is no possibility of keeping it secret, since a large number of technicians, actors, musicians, and other studio employees are necessarily aware of what is afoot. As soon as the public gets wind of the deception, and realizes that the captivating voice issuing from the loud speakers does not belong to the attractive face on the screen, the reaction is very adverse.

There is a legitimate form of "dubbing" which is used to some extent in the production of foreign dialogue versions to be added to pictures originally made in English. Here the picture is projected silently for a group of foreign players who talk into a microphone just as they would for the broadcasting of a play, the voices being recorded, however, on another sound negative, which is then synchronized with the original picture. The foreign voice "dubbers" watch the action on the screen and synchronize the words as closely as possible with the screen lip movements. Of course, it is necessary to make many modifications in the wording and idiom of the foreign dialogue in order to match it even approximately with the lip movements of the original English speech. Even after many trials, the result usually contains portions in which the synchronism leaves much to be desired. Accordingly, many Hollywood observers doubt whether this particular technical device has any future in the art. However, there is a compromise scheme which may develop into extensive use. This involves shooting the picture and sound with American actors and then getting the same actors to learn the foreign dialogue used in the close-up portions. These people are then re-photographed in silent close-ups, and then foreign players "dub" in the same lines by the method previously described. Under these conditions it is possible to get accurate synchronism in the close-ups, while for long and medium shots the ordinary foreign "dubbing" procedure is sufficient. The practicability of the method depends upon whether American stars with box office value abroad can become proficient enough in foreign languages to carry out their part of the enterprise.

Traveling shots

With the advent of sound, the operation of "panning" the camera to afford a changing point of view became a more complicated process than in silent motion picture photography. Figure 4 shows an intricate moving shot.

[Continued on page 408]

A simplified harmonic analyzer

By A. W. BARBER*

IN THE development and manufacture of radio receivers it is often desirable to supplement the ordinary routine measurements of sensitivity, selectivity and fidelity by measurements of the distortion present, i.e. harmonics.

Prohibitive cost and complexity have prevented the general adoption of the apparatus hitherto available for such measurements. Indeed, if a range of frequencies is to be covered one may hardly hope to avoid such complexity in any device for analyzing electrical wave forms by means of tuned circuits.

Fortunately, one may go some distance on the road of harmonic analysis with a quite simple analyzer, adapted for work at a single frequency. The information so gained is sufficient to give a good general view of the performance of the radio set under investigation. This follows from the nature of the causes which generate harmonics within the set. They are dependent more on amplitude than on frequency.

Apparatus based on this simplified procedure has been devised at Radio Frequency Laboratories by P. O. Farnham, C. J. Franks and A. W. Barber, primarily for the study of some special audio amplifiers. The circuits are such as to make a considerable variety of uses possible. The general arrangement of a setup is shown in Fig. 1. In Case "A" the audio source must have a wave form which is nearly sinusoidal or at least whose harmonic content is known under all conditions of loading. Since the sources ordinarily available are not pure, it is a great convenience to have available the analyzer in its present form which permits investigation of the wave form at the input terminals of the set, as well as at the output terminals. One is thus certain what was fed to the set originally.

In Case "B" of Fig. 1 the source may be the usual standard signal generator, whose modulation is almost invariably at 400 cycles, of a known percentage, and of good wave form.

The analyzer consists of an input attenuator, a filter to remove the fundamental 400 cycle wave during the

investigation of a harmonic, a second attenuator and a tunable circuit across which appear voltages which may be measured by means of the vacuum tube amplifier and rectifier. The circuit diagram is shown in Fig. 2 and a photograph of the completed instrument in Fig. 3.

Since the analyzer is a voltage-operated device, its input circuits must be of high impedance. The wire-wound voltage divider R_1 accordingly has a resistance of 18,000 ohms. Connected between the slider and the grounded end of R_1 is a series of resistors totaling 1,000 ohms, of which 900 ohms lies in R_2 . Thus only 10 per cent of the voltage picked off by the slider of R_1 is fed to the high-pass filter, which loss must be made up later by the amplifier. The advantages of this arrangement are that the series resistor R_2 prevents excessive changes of input impedance as the slider is moved upward on

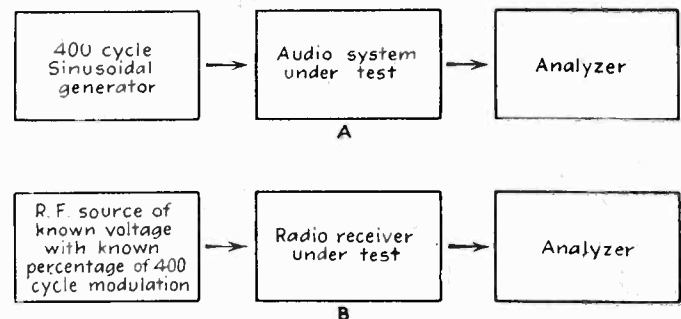

Fig. 1—Two methods by which the harmonic analyzer can be put to use

R_1 , and that the filter is fed from a source of the proper impedance.

The filter has two high-pass sections with 636 cycle cutoff and is designed to work between 100 ohm terminal impedances. When switched into the circuit it attenuates the fundamental 400 cycle frequency, making it possible to measure the relatively weak harmonics which pass through it almost undiminished. About 2 per cent of the fundamental 400 cycle wave passes through the filter, the transmission rising so rapidly at higher frequencies that even at the 2nd harmonic (800 cycles) 88 per cent transmission occurs. The coils of the filter are wound with No. 14 enameled copper wire and are so proportioned as to give a low power factor (0.02 at 1,000 cycles). These coils are mounted at right angles to each other inside a heavy aluminum shield which also encloses the filter condensers which are of the ordinary paper-and-foil bypass type.

The filter output is fed to the calibrated 100 ohm attenuator. The construction of R_7 and R_8 is somewhat unusual. Two heavy insulated copper wires are used as cores for a single-layer winding of double-cotton-covered resistance wire. The two elements are then fitted around a bakelite drum and the cotton insulation partly removed so that a slider traveling around the drum may connect the two resistors together at any desired point. Both the filter and the calibrated attenuator can be by-passed when it is desired to work with the 400 cycle fundamental.

The filter is followed by a series-resonance circuit used to select the frequency to be measured. The tuning system consists of the iron-core inductor L_3 and the condensers C_4 to C_{11} inclusive. The latter are so connected to two rotary cam switches as to permit steps of 500 micro-microfarads from 500 to 30,000. The 500 mmf. variable air condenser C_7 makes the range continuous. One of the cam switches is so connected that when it is

*Radio Frequency Laboratories, Boonton, N. J.

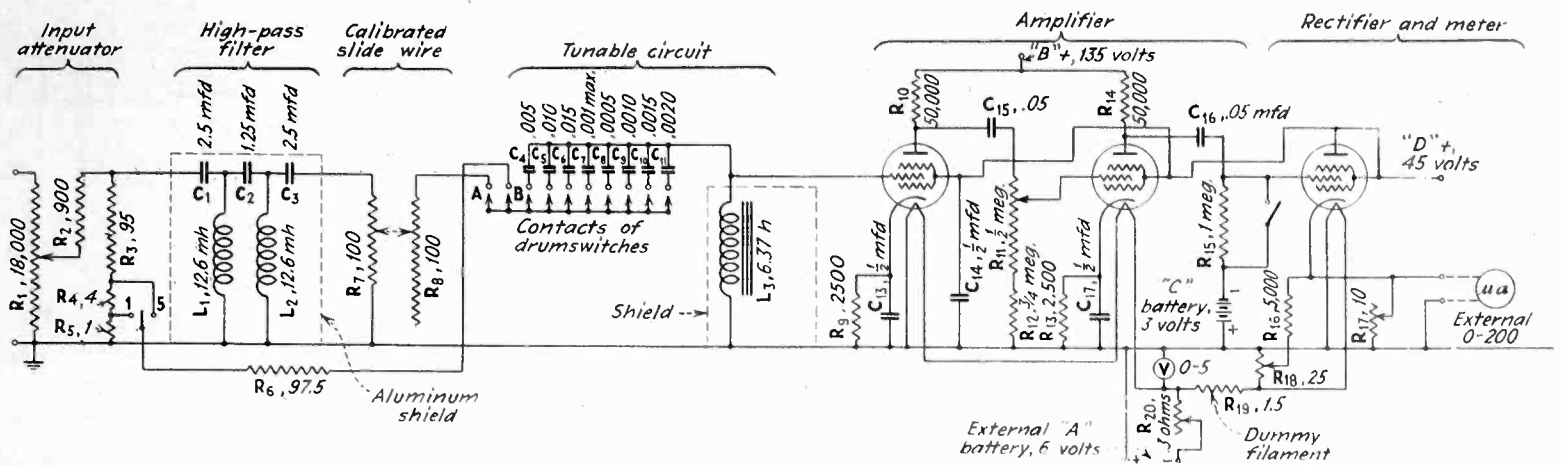

Fig. 2—Circuit diagram of the complete instrument

set to tune to 400 cycles the fundamental is shunted around the filter and the calibrated slide wire.

Since the purpose of the tuned circuit is to select a desired frequency it is important that this circuit be highly selective and that there be a known ratio between the voltage fed to the tuned circuit and the voltage which in consequence appears across L_3 where it is applied to the amplifier. A very good coil is necessary to secure good selectivity, good gain, and reasonable flatness of gain against frequency. Of many coils tried, the one giving the best gain has a 1,000 cycle inductance of 6.37 henries. It consisted of 10,000 turns of No. 28 enameled wire wound on an open core measuring $3\frac{3}{8}$ in. x $\frac{9}{16}$ in. x $\frac{9}{16}$ in. To decrease pickup the coil is enclosed in a cubical aluminum can 10 in. on a side. A smaller can decreased the efficiency greatly. With constant voltage applied at point "A" or "B" (L_3 and tuning condensers in series) the voltage appearing across L_3 varies as follows:

Frequency	Per cent of 1,200 Cycle Voltage
400	81.3
800	95
1,200	100
1,600	96
2,000	86
2,400	73.6
2,800	68.7

Since it is desired to work with constant output-meter reading this variation necessitates a compensating adjustment beyond the tuned circuit. This is provided by the slider on R_{11} . As to the selectivity of the tuned circuit,

it is found that the 2 per cent of the 400 cycle fundamental which comes through the filter is so suppressed by the tuned circuit that it cannot be detected at the output meter at 800 cycles or above. No harmonic shows any reading when tuned to another unless the "unwanted" harmonic has the higher amplitude in a ratio of more than 20 to 1.

The resistance-coupled amplifier uses 224-type tubes. The first two tubes give a gain of 300 while the voltmeter tube shows a 100 microampere change in plate current when one volt is impressed on the grid. Over the 400-2,800 cycle range essentially flat amplification is obtained. The gain potentiometer R_{11} permits a one-third reduction in gain to provide the means of compensating for the variation with frequency of transmission through the filter and tuned circuit. Batteries are used on the heaters, as a.c. operation proved unsatisfactory because of magnetic field pickup in the tuned circuit and fluctuations in the line voltage. For economy, two heaters are placed in series in one circuit and the remaining heater is run in series with the dummy heater R_{19} .

The first adjustment to be made is that of "bucking" out the steady cathode current through the microammeter (output meter). Next it is necessary to set the fundamental at a convenient level. The tuned circuit is set to 400 cycles, whereby contact B is automatically closed, making available the "detour" via R_6 . The tuned circuit now strongly suppresses any harmonics which may be present so that only 400 cycles is being fed to the amplifier. The slider of R_1 is now turned up until a 100 micro-

(Continued on page 408)

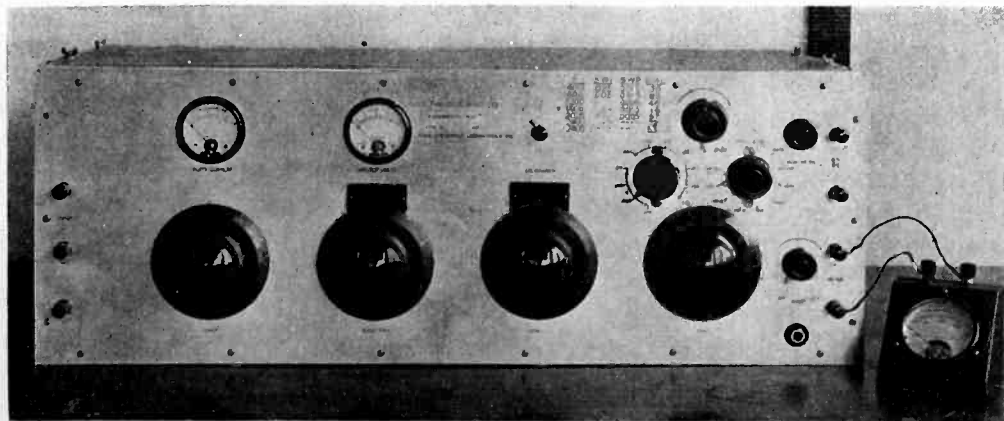

Fig. 3—Photograph of the analyzer as used at Radio Frequency Laboratories

Developments in ultra-high frequency generation

By C. W. LOEBER

SINCE the use of short wave lengths for radio communication has become of great importance, radio engineers have been investigating the utility of the so-called ultra-short wave lengths, those lying in the electro-magnetic spectrum between five meters and the wave length of light. The various methods of generating these oscillations have all been developed in the past decade or so.

Whiddington¹, in 1919, found that gassy triodes could be made to generate oscillations of very high frequency. In the same year Barkhausen and Kurz² described vacuum tube apparatus with which they were able to produce oscillations of a wave length below one meter.

Barkhausen-Kurz effect

This effect was produced with a triode connected as shown in Fig. 1. It will be noted that a strong positive voltage was applied to the grid while a relatively weak negative voltage was applied to the plate. Variations of capacitance and inductance in the external circuit of the vacuum tube were found to have practically no effect upon the wave length, but when either grid or plate voltage was changed, the frequency also changed. Increasing the emission from the filament also affected the frequency. Oscillations could not be produced unless the vacuum tubes used had cylindrical concentric elements with the filament passing through the geometrical axis of the grid and plate. Grid voltages were varied from 80 to 200 volts positive while the plate was kept between + volts positive and 40 volts negative.

Theory of operation

Since it was found that only changes in applied voltage affected the frequency of the oscillator, Barkhausen and Kurz believed that the oscillations existed within the

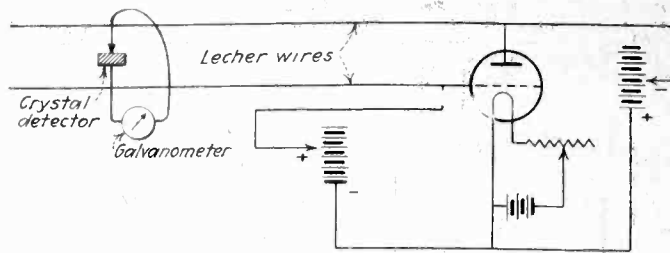

Fig. 1—Ultra-high frequency oscillator of Barkhausen and Kurz, in which the voltages determined the frequency. Wave length was measured by moving the crystal detector along the Lecher wires

tube and were caused by the motion of electrons. Briefly their theory was as follows: If a high positive potential is applied to the grid and a low negative potential to the plate, electrons emitted by the cathode will be attracted to the grid. Because of the construction of the latter and the speed with which the electrons are moving, many of these will pass through the grid to the field of the plate where they will be repelled. Upon returning to the grid, some will again pass through and reach the region of the cathode where they originated. Thus one cycle will be completed. The period of one oscillation will be very short because of the short distance between electrodes of the tube and because of the velocity of the electrons.

The results of the Barkhausen-Kurz investigations

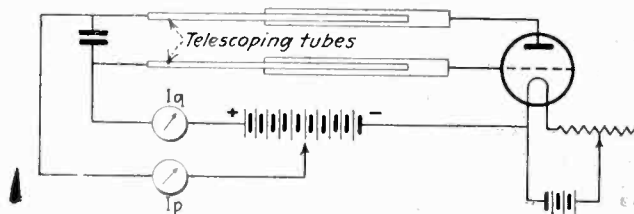

Fig. 2—Gill and Morrell's oscillating circuit. The frequency could be varied by the telescoping tubes

were substantiated by Scheibe³, but he, as well as later investigators, discovered the existence of still other oscillations at these frequencies, and it is quite likely that these account for the irregularities which were observed by the early investigators. Gill and Morrell⁴, with apparatus shown in Fig. 2, were able to vary the wave length of their oscillator by changing the constants of the circuit. The Gill-Morrell oscillator differed from that of Barkhausen and Kurz in that a positive potential was applied to the plate. The theory was advanced that with this arrangement all electrons which pass the grid are absorbed by the plate where they cause secondary emission. The secondary electrons thus liberated pass to the grid where they in turn are absorbed. Thus the oscillations are not confined to the tube and exist in the external circuit as well as in the inter-electrode space.

At this time it is difficult to estimate the range of transmission that may be obtained at ultra-high frequencies since little quantitative work has been done in measuring signal strength at appreciable distances.

REFERENCES AND BIBLIOGRAPHY

- ¹Rad. Review, November, 1919.
- ²Phy. Ztsft., 21, p. 1, 1920.
- ³Ann. d. Phys., 73, p. 54, 1924.
- ⁴Phil. Mag., 49, p. 369, 1925.
- Kohl, Ztsft. f. Tech. Phy., 9, p. 472, No. 12, 1928.
- Spitzer, Thesis for M.Sc., Mass. Inst. Tech., 1927.
- Gill & Morrell, Phil. Mag., 49, p. 369, 1925.
- W. Wechsung, Jahrb. d. Drahtl. Tel., 32, p. 15 and p. 58.
- A. Esau, Elektrotech. u. Machb., Part 2, 46, p. 78, 1928.
- H. E. Hollmann, Proc. I.R.E., 17, p. 229, February, 1929.
- H. E. Hollmann, Zeitsft. f. Hochf. tek., 33, p. 128, 1929.

Electronics
in diagnosis

Measuring the heart's EMF

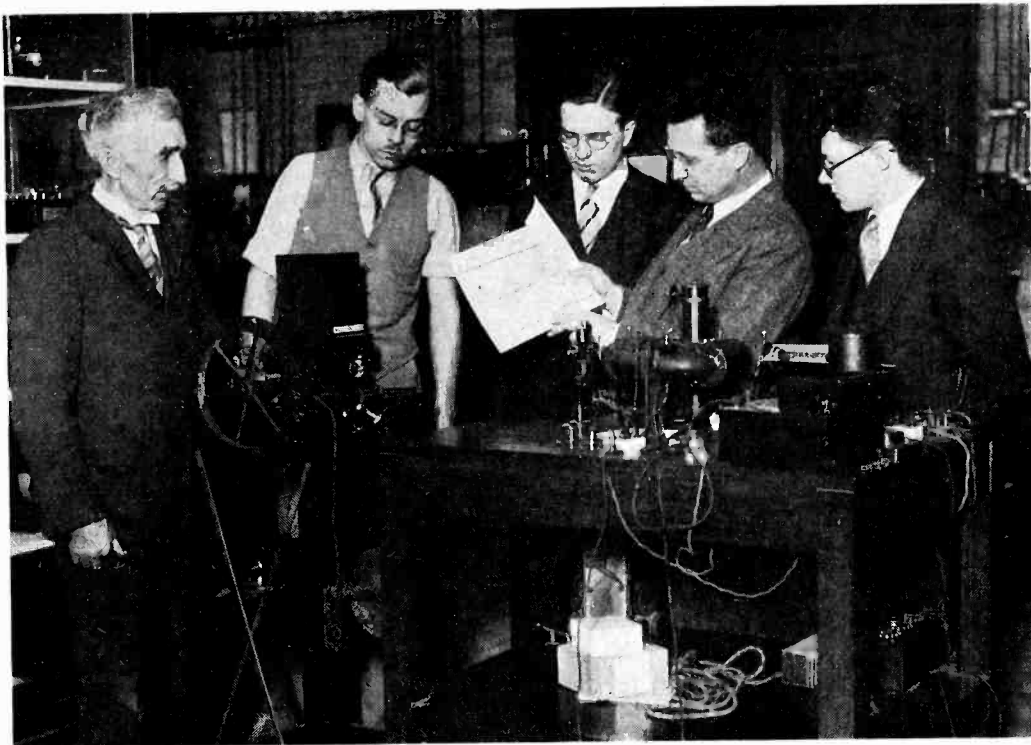

Every human being is an alternating-current generator, his output emf being about one milli-volt (one-thousandth of a volt), and his frequency being that of his heart-beats. The "cardiograph," using this method of detecting and amplifying the heart's voltage, is widely employed by specialists to diagnose heart diseases

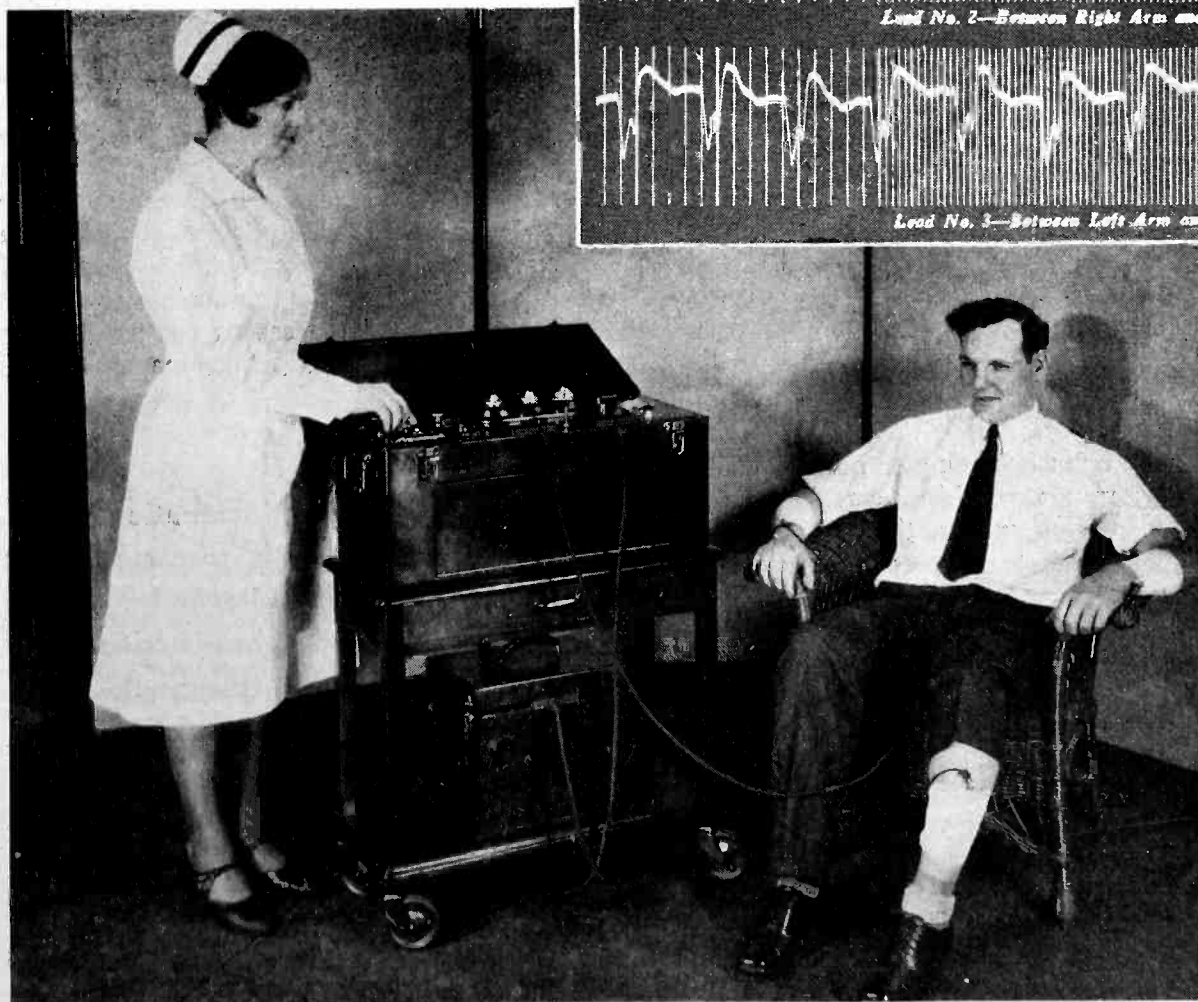
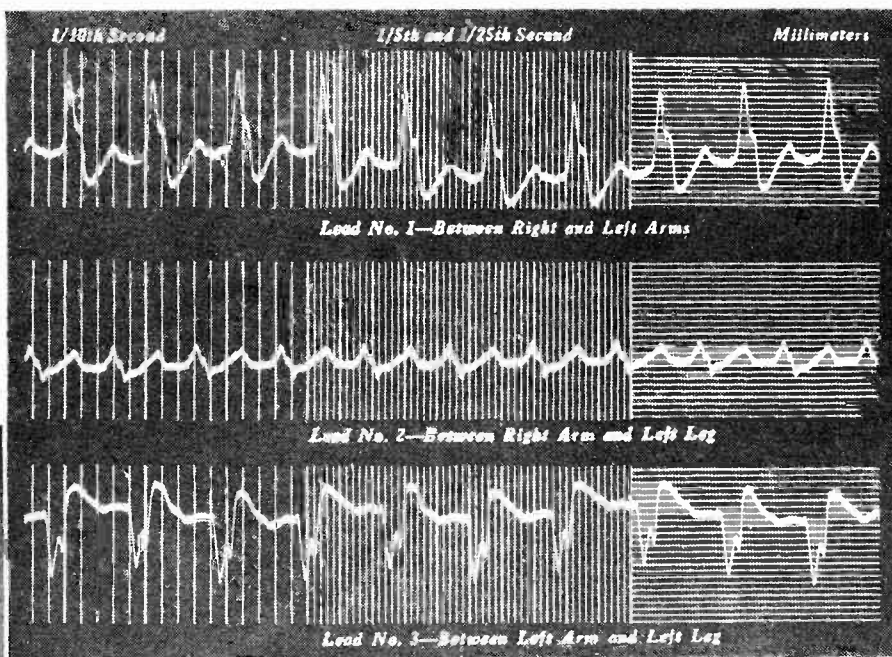

Three electrodes are employed, one on each wrist and one on the leg. This micro-voltage developed is multiplied by a group of amplifier tubes very much like an ordinary radio receiving set, and is recorded by an oscillograph, as above. The three sets of curves can be combined by vector analysis to show actual positions of the heart muscles

The phototube in automatic weaving

By ARTHUR KORN*



WEAVING is an art that has been practiced since the early days of history. It consists essentially in passing one series of threads called the shoots or wefts or woofs partly below and partly above a second series of threads called the warps. If the weft is white and the warp is black, the cloth will appear black when a weft passes below a warp, and white where a weft passes above the warp. To obtain the design wanted, the proper warps must be lifted for every weft and every weft must find the warp prepared for it.

In former times the lifting of the warps according to a given design was done entirely by hand. Automatic weaving was made possible by the invention of Jacquard (1728) which utilized a series of cards with holes punched in them to correspond with the design. Pins (one for each warp) entered the holes in the cards; this placed a small hook in position to be lifted; the raising of the hook prepared the corresponding warp for the shoot or weft. When the pin did not encounter a hole in the card, the warp remained unlifted and the weft passed over it. Thus hand labor was reduced to the task of preparing the cards according to given designs and to the attendance of the weaving machines.

In order to prevent the cards from becoming too long the holes of the Jacquard cards are arranged in a certain number of rows; when there are 400 warps, the holes are often arranged in eight lines; in other cases twelve lines, etc. The workman punching these cards uses a special punching machine provided with eight, twelve, or more punches according to the number of rows comprising a card.

The design serving as a basis for the work of punching has to be arranged in such a way as to allow the white and black spots of the weaving to be distinguished on a special design paper. In this design every line corresponds to one shoot. In every line each square corresponds to one warp; when the square is filled in (black or colored) on the design, this means that the

warp is to be lifted, and a hole must be punched at the corresponding spot in the card.

The punching is first done for the eight squares in the upper-left corner of the design. The workman has eight keys similar to those on a piano in the punching machine before him. He presses down these keys corresponding to the dark squares on the diagram, and brings into action the punches on the card by means of a foot lever. Then the card is moved to the left, and the workman punches the next eight squares on the first line, and so on. When one line is finished a new card is put on the machine, and the new card is punched according to the squares on the second line in the design; as many cards have to be prepared as there are lines in the design. To give an idea how difficult a work the punching of these cards is, let me explain that one to two thousand of such cards are generally required for one design and that it takes even an expert laborer one to two weeks to finish one set of cards. The workmen used to do this as homework in the villages surrounding the big weaving centers, having in their homes a simple kind of punching machine.

▼

PROFESSOR KORN is internationally known for his work in transmission of photographs by wire and by radio. In 1907 he used light-sensitive cells in transmitting photographs between Munich, Berlin, Paris and London. His most recent work, described here, is an improvement in the art of weaving, again employing photoelectric cells.

▲

*Professor in Technische Hochschule, Berlin, Germany.

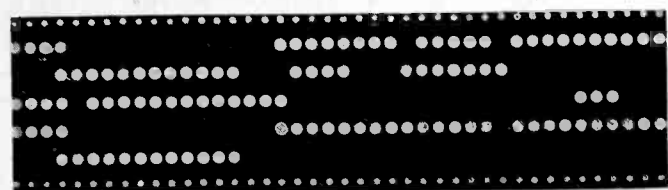
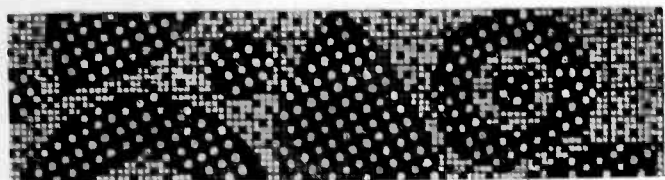

Patterns of design to be punched on card by phototube apparatus

The progress which I am now going to demonstrate will be found in the mechanical manufacture of the cards according to given designs by the aid of photoelectric cells, so that this painstaking hand labor can be entirely done away with.

Application of phototubes

In the new machine the design is wound upon a cylinder rotated by an electric motor and shifting somewhat in the direction of the axis of the cylinder. The light of a lamp is concentrated upon one of the little squares by the aid of a lens, and the light reflected from the square falling upon a second lens is directed onto a photoelectric cell. As the illuminated square is white or colored, the cell receives more or less light. After proper amplification of the current produced by the illumination of the cell, a relay is put into action which controls the punching of the Jacquard cards. When the cylinder rotates, one square after another is explored by the photo-cell, and the lever of the relay moves to one side or the other, closing one of two electric circuits.

Operation of the improved system

Two sets "a" and "b" of eight polarized relays each (in the 8-line cards) are controlled by these currents. A collector-like distributor turning with the cylinder sends the current to each relay in turn as the squares are scanned. For the first line the "a" relays are used, for the second the "b" relays, and for the third we begin again with the "a" relays.

Meanwhile a piston driven by the same motor as the sending cylinder shifts up and down above a card fitted upon a special carriage and would set into motion all eight punches unless means are provided for putting out of action those punches corresponding to colored squares. To effect this the lower part of the piston is divided into

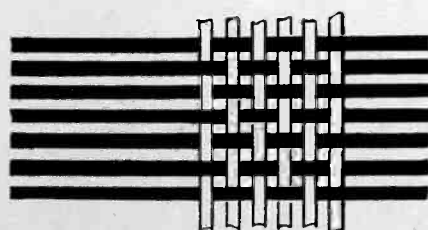

Enlargement of element of weaving pattern showing warp and weft

eight movable rods, individually rotatable around a horizontal axis and each provided with a protruding arm; these arms are stopped during the downward motion of the piston when the armature of a corresponding magnet is attracted by the latter, and will result in turning the corresponding rod in such a way as to prevent the punch from being struck. When the magnet is not energized, its armature will be withdrawn by a spring, and the rod will go down to its vertical position and punch the card. The armature is energized only by a corresponding white square on the design.

Before the piston shifts down for the first time, the magnets are connected with the first set of polarized relays. When the punching of the first row is finished and the piston begins its upward motion, the magnets return to their normal position. When the piston begins its second downward motion, the magnets will, by means of the distributor, be connected with the second set of polarized relays, so that the second row is punched; before the next upward motion of the piston the magnets

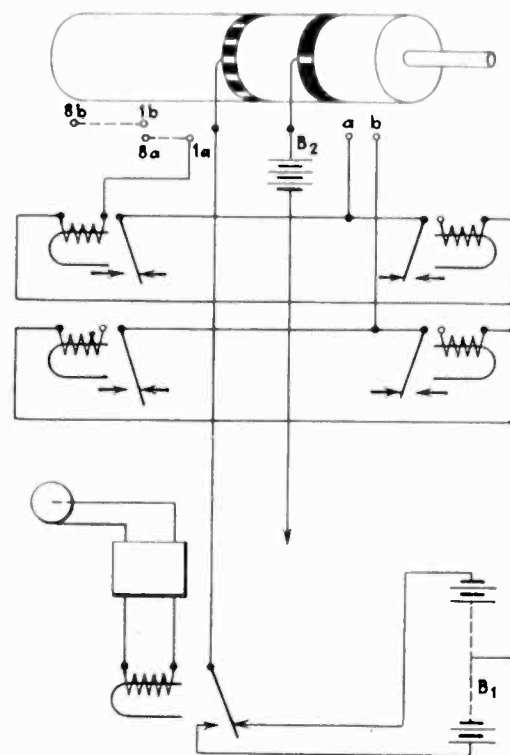

Phototube apparatus for punching design into Jacquard cards for weaving

will be again disconnected, and at the third downward motion of the piston they will be reconnected with the first set of relays for the third section of the line. After each action of punching, the carriage holding the card is shifted to the left to place the card in position for the next punching. When one card is complete it is automatically numbered and removed; the carriage runs back and takes up the next card.

For the time reserved for the exchanging of the cards the punches do not work. To obtain this a dead track is provided on the cylinder by making the technical design so that it does not cover the whole cylinder but leaves a small part of it blank, and when the exploring light runs upon this part of the cylinder, the punches are put out of operation while the machine takes up the new card.

All in all, the application of photoelectric cells to a weaving industry seems not only to save time and labor but to effect savings in cost. It is but one more application of results of scientific research to the more practical pursuits of industry.

Sound film reproduction without mechanical slit

PROFESSOR L. Dunoyer, of the Société de Construction d'Appareils de Laboratoire, Paris, France, has developed an optical system for reproduction of sound-on-film without the use of a mechanical slit.

Due to the normal speed of film in reproduction, the height available for the individual modulation, for the higher frequencies, is very small. The exploring beam of light will only pass through the film over a very small height. The greatest admissible height is at present 0.05 mm., and in fact, 0.02 mm. is generally used. The problem of illumination of the photoelectric cell through the film is similar to that in all recording microphotometers for the analysis of spectrograms.

The illuminating apparatus for sound films in general use is provided with a sound slit. In some equipments, this slit is in contact with the film, or is very close to it—in others, the image of the slit is formed upon the film. In the first case, the height of the slit must be equal to the height of the illumination required for the film, i.e., 0.02 mm. The distance between the film and the slit must be less than this value, or of the same order. Dust, which is usually present on the surface of the film, or the atmospheric dust, which it draws with it, will soon accumulate on the edges of the slit; this accumulation not only causes a diminution of the amplitude of the sound, but, as it is irregular, it also causes undesirable ground noise. This effect is not present in apparatus with a projected slit, but such apparatus is subject to other faults.

The apparatus shown in the accompanying illustrations has no slit. The illuminant is a straight filament lamp, especially designed so that it will not be affected by vibration. A parallel faced window is used to close the

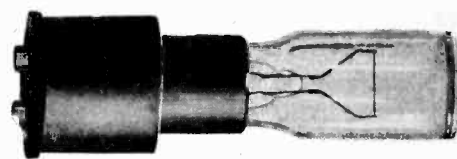

Exciter lamp with rectilinear filament and flat soldered window cut optically

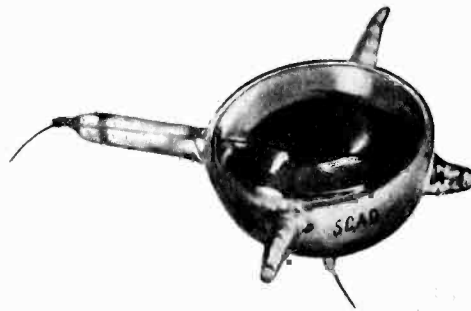

Hemispherical photoelectric cell of L. Dunoyer

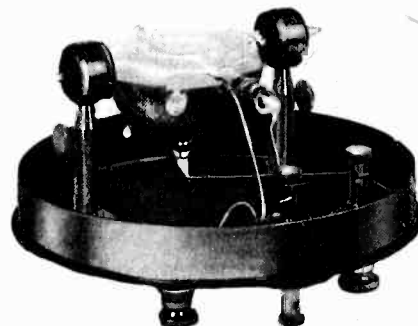

The photoelectric cell shown mounted in holder

end of the lamp and is soldered to the walls. The light falls upon a photographic lens of high quality and large opening, by which the image of the filament is formed upon the film. By the use of a parallel faced window of known thickness, it is possible to take account of astigmatism which this window causes in the calculation of the lens. Since the filament is only 0.1 mm. diameter, one can readily obtain an image of 0.01 mm. height, by maintaining a considerable focal distance between the lens and the film, which is often convenient.

It is easy to obtain an exploring image which is still narrower, enabling the higher harmonics to be reproduced. A wide opening of the lens provides a larger quantity of light. The exciter lamp is fed by a current of 1.5 amperes at 3 volts. The apparatus, which is combined with a hemispherical photoelectric cell, will furnish a useful current of about 2 micro-amperes. The lamp, when operating, uses a moderate voltage and will last for several hundred hours.

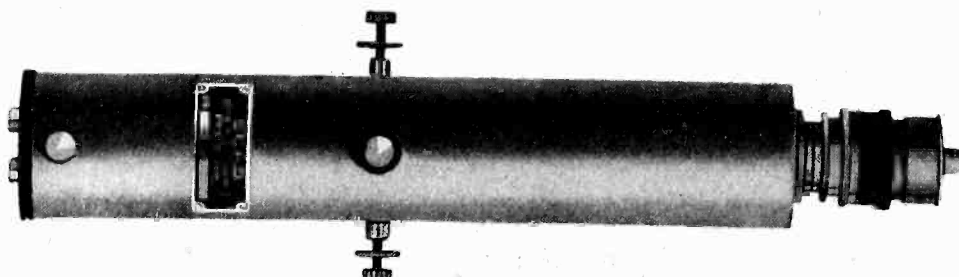

Complete assembly of exciter lamp and optical system for lighting sound track without slit

Design of the output transformer

By R. C. HITCHCOCK and W. O. OSBON*

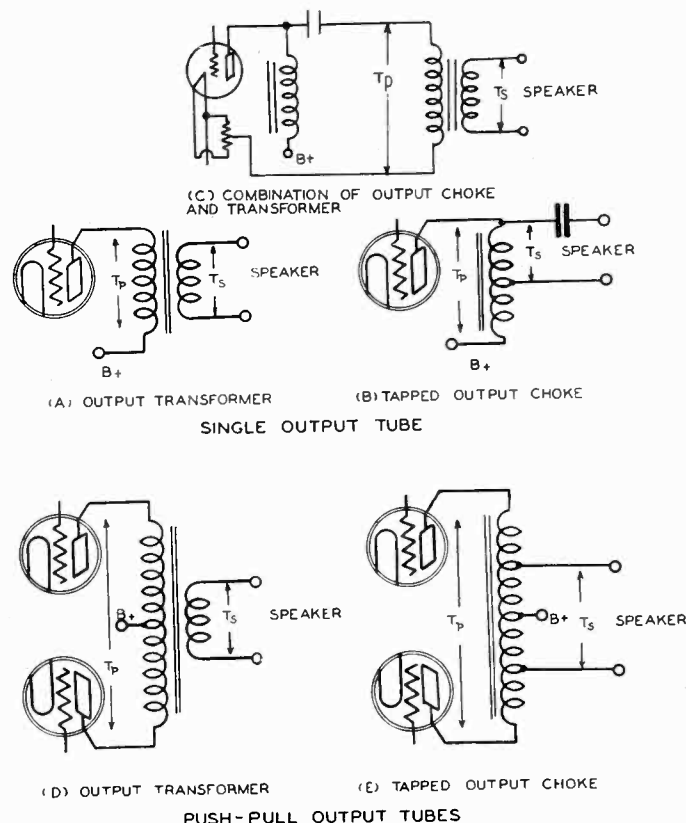

Fig. 1—Commonly used methods of connecting output tubes to loudspeaker

TO OPERATE the power stage of an audio-frequency amplifier under optimum conditions it is essential that the coupling unit between the power tubes and loudspeaker be designed properly. Fig. 1 gives five commonly used circuits for single and push-pull audio-frequency tubes. In Fig. 1-B a condenser in series with the loudspeaker prevents the steady plate current from flowing through the loudspeaker. This condenser may be omitted and the loudspeaker

by the use of Fig. 4, as will be explained on another page.

Of the various types of coupling arrangements illustrated in Fig. 1 the transformer presents the greatest number of design problems; and a discussion of these problems will include solutions for other coupling devices. The authors know of no single article which discusses the effect of the various transformer constants on the quality of the transformer, and which at the same time presents data for designing transformers with predetermined constants. In this paper information gathered from various sources will be applied to the specific problem of output transformer design.

The three transformer constants which affect the efficiency of the output stage are the ratio of turns, primary inductance, and leakage inductance. The turns

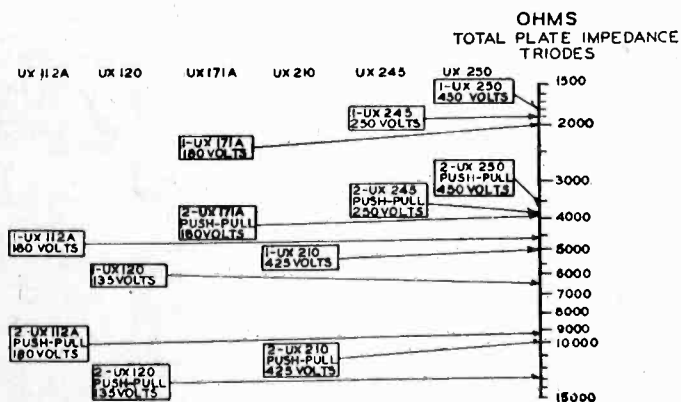

Fig. 2—Output impedance of commonly used tubes at maximum rated plate voltages

connected directly across the choke if the loudspeaker resistance is several times the choke d.c. resistance, which is usually the case. The tapped push-pull choke of Fig. 1-E follows usual practice in spacing the loudspeaker turns on each side of the B-plus tap, so that the steady plate current does not flow in the loudspeaker circuit. The combination of choke and output transformer, as shown in 1-C, is frequently used, especially when an electrodynamic loudspeaker is a unit separated from the radio set. The correct ratio of T_p and T_s , the terms used to indicate plate and speaker turns, respectively, in the diagrams of Fig. 1, is found

THE three important output transformer constants are the turns ratio, primary inductance, and leakage inductance. Each of these factors has some effect upon the transfer of power from an output tube to a loudspeaker, whether that speaker is part of a radio receiver, a public address system, or a sound-picture installation. These effects are discussed in this part; in Part 2 the authors will discuss the design of the transformer.

*Research Department, Westinghouse Electric and Manufacturing Company.

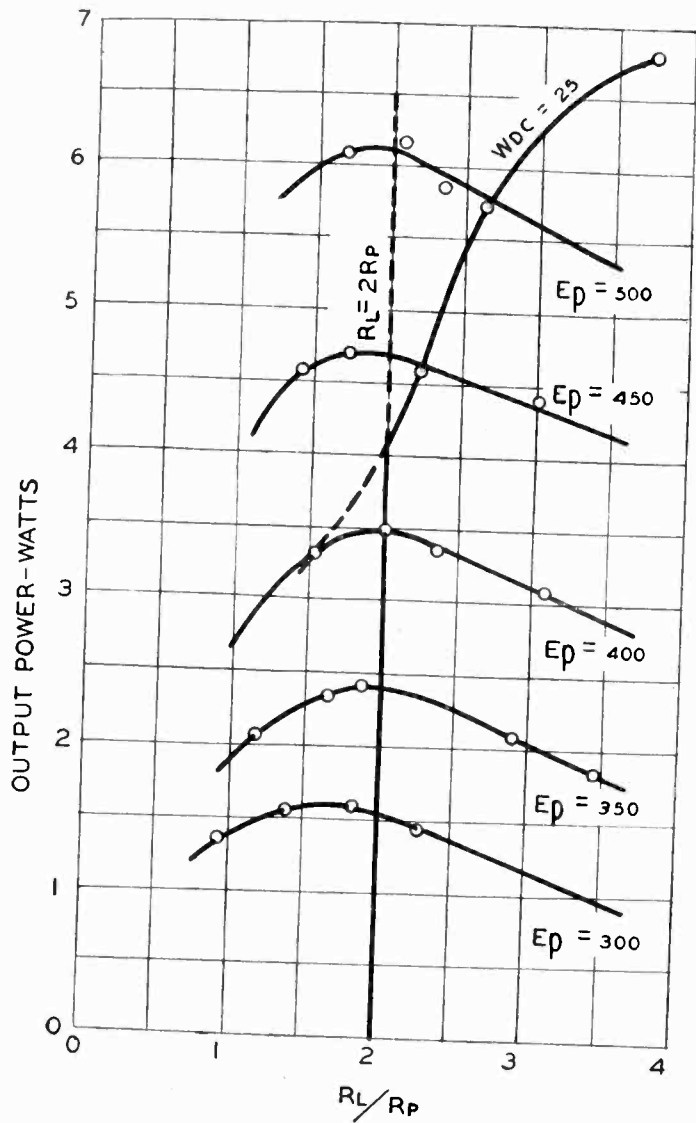

Fig. 3—Effect of load impedance on output power of UX-250

ratio determines the output of the power stage in the middle range of frequencies, that is, in the range where the response is uniform. The primary inductance determines the response at low frequencies, and the leakage inductance determines the response at high frequencies. The nature and magnitude of the effect of each of these constants, and the methods of designing a transformer when the correct constants are known will now be considered.

Ratio of turns

Several writers^{1,2} have found that the maximum undistorted power output of a tube will be obtained when the load impedance into which the tube works is twice the impedance of the tube. This condition is not very critical, however, as is indicated by Fig. 3 which shows the effect of load impedance on the output of ux-250 for various values of plate potential. This figure is taken from the paper by Messrs. Hanna, Sutherlin, and Upp.² At a plate voltage of 450 it is seen that for values of R_L/R_p between $1\frac{1}{4}$ and 3 the greatest loss in power is only 7 per cent. Although the curves of Fig. 3 apply directly to the ux-250, the general conclusions drawn from them apply to all tubes. It should be noted in the case of the ux-250 that the ratio of load to plate impedance should be greater than 2 for high values of plate voltage in order not to exceed the maximum safe plate dissipation of 25 watts. Fig. 2 gives the plate impedances for output tubes now on the market.

The primary equivalent of the load on the secondary is determined, then, by the foregoing considerations. The impedances of the various types of loudspeakers are well-known, so that the necessary transformer ratio K , can be determined by the relation—

$$K = \frac{T_P}{T_S} = \sqrt{\frac{R_L}{Z_s}} \quad (1)$$

where R_L = load impedance required by tube for optimum power conditions

Z_s = loudspeaker impedance.

Fig. 4 is an alignment chart for equation (1) based on the condition that $R_L = 2R_p$.

The fact that the value of R_L is not critical is a fortunate circumstance, because the impedance of most types of loudspeakers varies with frequency through rather wide limits. In using the alignment chart or equation (1) to determine the correct ratio, it is satisfactory to use the nominal value of Z_s .

As an example, suppose two ux-250 tubes are to be connected in push pull with a plate potential of 450 volts. In Fig. 2 the impedance is found to be 3,600 ohms. Using the nominal value of 3,000 ohms as representing the impedance of the usual magnetic loudspeaker, or the primary of the output transformer of an electrodynamic loudspeaker, the turns ratio in Fig. 4 is found to be 1.5 : 1. Similarly, using 12 ohms as the usual impedance of the moving coil of the loudspeaker, the turns ratio is 25 : 1. These values are indicated by the dotted lines of Fig. 4.

The equivalent circuit of the output stage is shown in Fig. 5-A, where

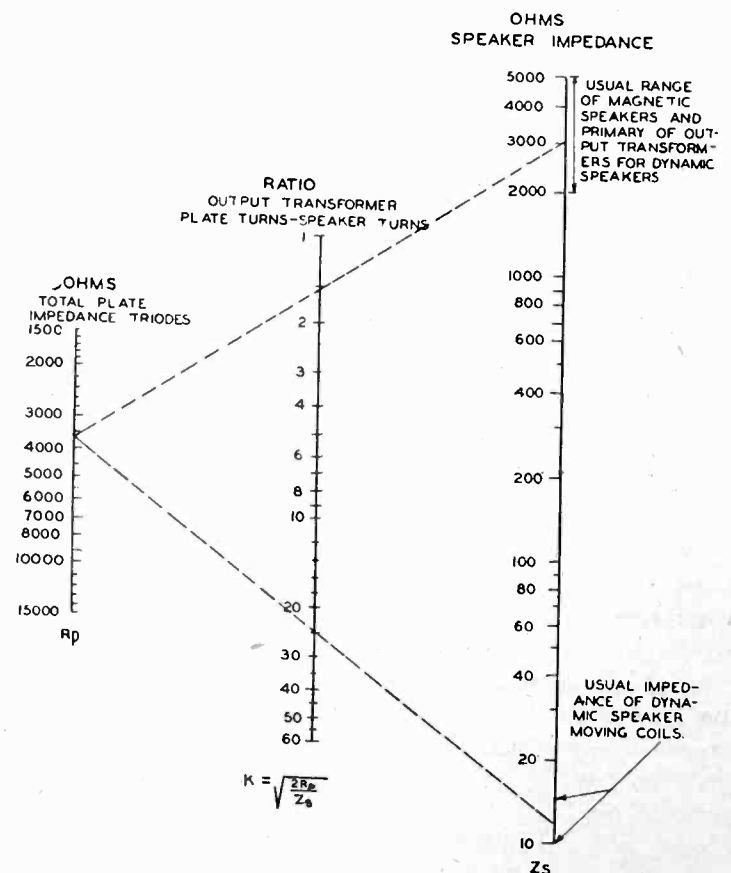

Fig. 4—Alignment chart correlating turns ratio of transformer with resistance of tube and loudspeaker

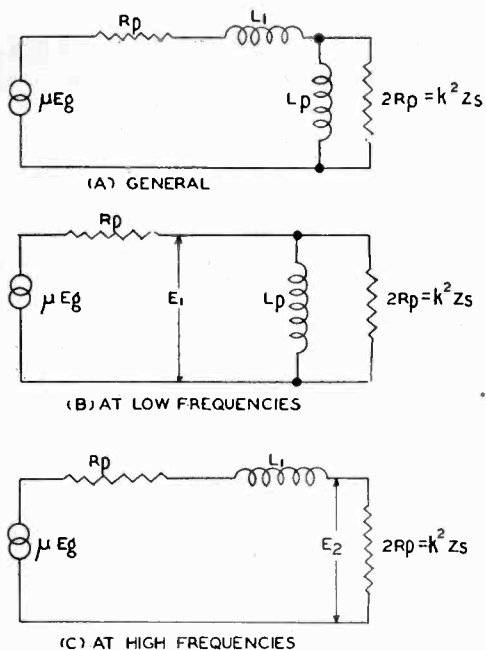

Fig. 5—Equivalent circuit of output stage

- μE_g = voltage available in plate circuit
- R_p = plate resistance
- L_1 = leakage inductance referred to the primary.
- L_p = primary inductance of transformer
- $2R_p$ = primary equivalent of secondary load

At low frequencies the leakage reactance is small compared to R_p , so that for these frequencies the circuit reduces to Fig. 5-B. At low frequencies then, the voltage across the load is—

$$E = \frac{\mu E_g Z_L}{R_p + Z_L} \quad \text{--- (2)}$$

$$\text{WHERE } Z_L = \frac{1}{\frac{1}{2R_p} + \frac{1}{j\omega L_p}} = \frac{2j\omega L_p R_p}{2R_p + j\omega L_p} \quad \text{--- (3)}$$

$$E_1 = \frac{\mu E_g}{R_p + \frac{2j\omega L_p R_p}{2R_p + j\omega L_p}} = \frac{2j\omega L_p R_p}{2R_p + j\omega L_p}$$

$$= \mu E_g \frac{2j\omega L_p}{2R_p + 3j\omega L_p}$$

$$= \mu E_g \frac{2}{\sqrt{4\left\{\frac{R_p}{\omega L_p}\right\}^2 + 9}} \quad \text{--- (4)}$$

It is evident from (4) that the greatest possible voltage is obtained at high frequencies when $\omega L_p/R_p$ is large, and that this maximum voltage is $E_m = \frac{2}{3}\mu E_g$. The actual voltage expressed as a percentage of the maximum is then given by—

$$\frac{E_1}{E_m} = \frac{1}{\sqrt{\frac{4}{9}\left\{\frac{R_p}{\omega L_p}\right\}^2 + 1}} \quad \text{--- (5)}$$

Using equation (5) the per cent of maximum voltage can be found for various values of $\omega L_p/R_p$ and the results plotted as in Curve 1, Fig. 6. Since the power delivered to the load is proportional to the square of the voltage, the per cent of maximum undistorted power is given by the square of the ordinates of Curve 1, and is shown by Curve 2, Fig. 6.

The value of L_p to choose for a given tube depends upon the degree of uniformity desired in the low-frequency range. Curve 2 of Fig. 6 indicates that at the frequency at which the primary reactance equals the load impedance ($\omega L_p/R_p = 2$), the loss in power is only 12 per cent, and that at the frequency where L_p equals the tube impedance ($\omega L_p/R_p = 1$) the power

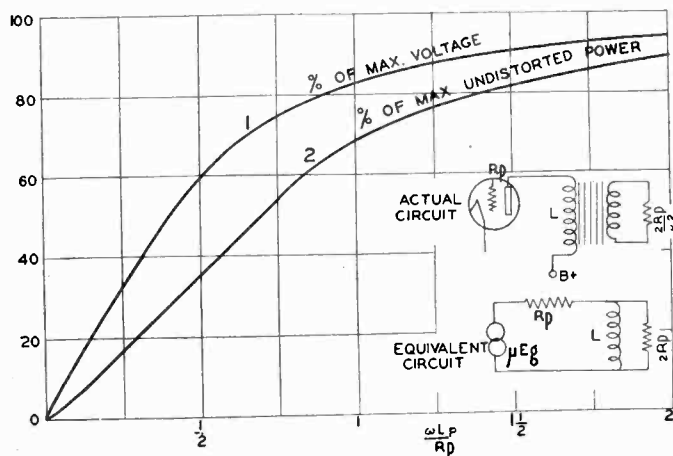

Fig. 6—Effect of primary inductance on power output of tube

has dropped to 69 per cent of the maximum. The actual design of the transformer will be given in Part 2.

¹"Discussion, Symposium on Loud Speakers," *Proc. London Phys. Soc.*, 36, Part III; Apr. 1, 1924.
²C. R. Hanna, L. Sutherland and C. B. Upp, "Development of a New Power Amplifier Tube," *Proceedings I.R.E.*, 16, 162; April, 1928.

IN BIO-PHYSICS, SPECTROSCOPY AND GEO-PHYSICS

The electron tube has given physicists a new and wonderfully sensitive instrument with which minute currents and potentials may be almost incredibly magnified. The circuits are extremely sensitive to small changes in capacity and inductance.

One of the most recent developments is in the field of high-frequency oscillations, which have interesting possibilities not only in short-wave transmission but also in spectroscopy and biophysics. There are also possibilities in the application of vacuum-tube circuits to some of the important problems of geophysics.

HENRY G. GALE,
 President, American Physical Society

Sound-picture engineers discuss economics,



AT THE annual meeting of the Society of Motion Picture Engineers held in New York October 20-23, many interesting papers were given covering the advances in sound picture development, color films, and changing economic conditions in the industry. J. I. Crabtree, president of the society, presided. The high point of the convention was the banquet October 22, at which the leading motion picture producers were represented. Will H. Hays, one of the speakers on this evening's program, which also included Jesse B. Lasky, H. B. Charlesworth, Dr. A. N. Goldsmith and others, stated that an upward trend in business was at hand, and the future for the industry was bright. Serge Eisenstein, the Russian director, stated the American film industry has developed its mechanical and electrical art to a high state, but had neglected the background of training for its artistic side.

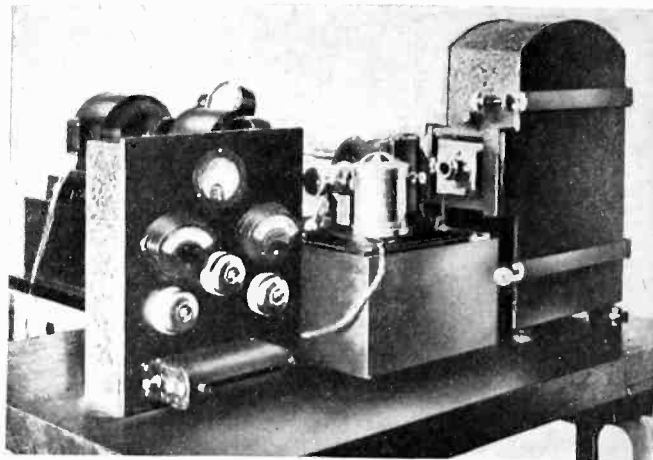

Sound-recording unit built in Russia employs an oscillograph with one ribbon suitable for either variable width or variable density recording

Meeting sound picture competition abroad

C. J. NORTH and N. B. GOLDEN
Bureau of Foreign and Domestic Commerce

The American film industry will continue to meet greater competition in non-English countries. European studios will probably supply not less than 300 feature sound pictures in their own language during the coming year. These studios are already achieving greater popularity with sound pictures recently released than formerly with silent films. This is attributed to the stage traditions of England, France and Germany, enabling these countries to adapt themselves more readily to the "talkies," which as an art form approaches more nearly the stage than did the silent films. In the latter two countries, likewise, the language barrier will undoubtedly cut down the American supply, and open play dates hitherto closed to the local product. This same barrier will have an important influence in other non-English speaking countries, heretofore large purchasers of American silent films.

American companies are going ahead vigorously with production of multi-lingual pictures, and will have close

to 175 such pictures on the European market in the coming season. These will be made either in Hollywood or in American studios abroad, and foreign casts and directors will be used, as it has been proved that devices such as voice-doubling are not popular. There is every reason to believe, however, that while American revenues probably won't be as large from non-English speaking areas as in silent film days, they will, nevertheless, attain considerable volume.

Europe has gone sound, Mr. Golden stated, as indicated by the fact that whereas only a year ago less than 650 theaters in Europe were wired, the number has now increased to over 4,950, including all the deluxe theaters. Outside of Europe, about 1850 theaters have installed sound equipment. As a result, the silent theater owner must choose between wiring or closing, because he cannot compete with the sound theater, and furthermore, will have increasing difficulty in getting suitable silent films. This means there is a wide market still open for installation of sound equipment of suitable type, for the smaller theaters throughout the world.

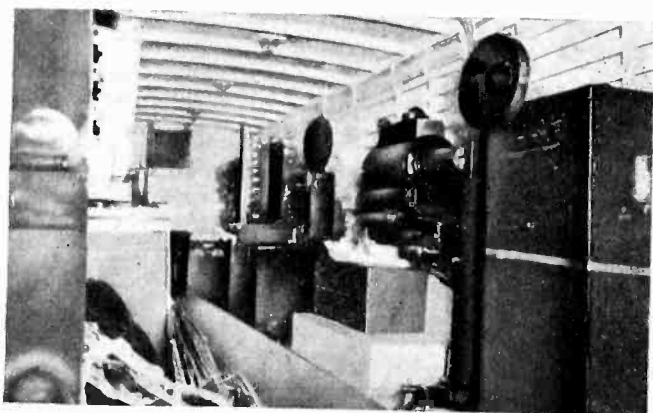

Motor truck containing two complete sound projectors brings sound pictures to French theaters not equipped with sound apparatus

Report of committee on progress

G. E. MATTHEWS, *Chairman, Eastman Kodak Company*

A system of recording being developed in Russia employs an oscillograph with one ribbon and is stated to be suitable for either variable width or variable density recording. Another sound-on-film process utilizes a sound print having the record engraved in the edge of the film. A sapphire roller pick-up device is employed in the reproduction. A roll of clear celluloid is engraved in preparing the master record and this record is then transferred to the sound print. No preliminary stages of amplification are said to be necessary in reproduction.

A number of theaters throughout the United States have increased the size of their screens anticipating the advent of the wide-screen picture. Practically all the theaters in one circuit on the Pacific Coast have in-

progress and new problems of industry

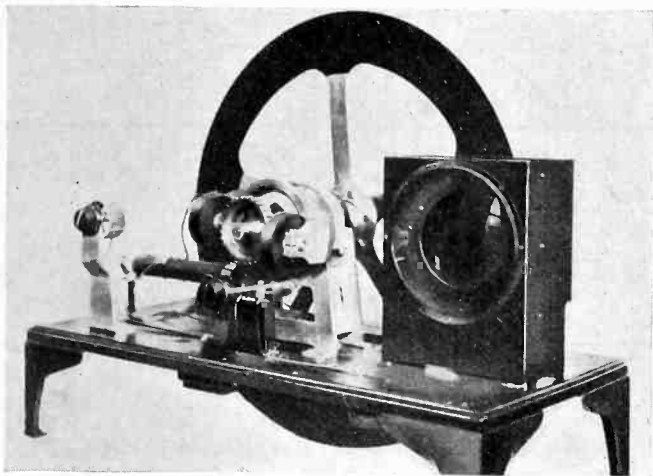

New form of television receiver developed by Baird Television, Ltd., London

stalled larger screens. A survey indicated, however, that about 60 per cent of the theaters in this country lack space for screens of more than 24 ft. width.

Sound prints by the Technicolor process are now made with a silver image sound track having a contrast or "gamma" of unity which is claimed to represent a material advance in the art of reproduction. The feature picture "Whoopie" was made with a sound track which was developed in this way. It is stated to be impractical to control the gamma of the sound track as closely as this on black and white prints.

A power level indicator has been announced for reading the signal amplitude in voice transmission circuits; levels from minus ten to plus thirty-six decibels can be measured. A monitor has been developed to meet the needs for accurate indication of volume levels from power amplifiers in sound reproducing equipment.

Sound film records made in England at the Wembley studios are identified by photographing at intervals on the film, a lantern slide carrying the scene and shot numbers. Each half minute, figures up to 10, in Morse code, are printed on the side of the film opposite the sound track. Corresponding figures are recorded on the picture negative in the space reserved for the sound track.



A damped diaphragm reproducer

RUDOLPH MIEHLING, *Universal Sound System, Inc.*

This paper deals with a new type of speaker recently perfected which differs from both exponential and cone type horns. It is termed the damped diaphragm reproducer because of the peculiar construction of this portion of the instrument. It employs a large, metallic diaphragm rigidly attached to a heavy iron ring. The dynamic driving system is attached to the center of the diaphragm and serves to actuate the diaphragm. The diaphragm, which is made of duralumin, 0.002 of an inch thick, is not stretched on the ring to the extent that its natural period of vibration is above audibility, the tension however is such as to place its resonance point within the audible range.

To prevent resonance at this particular frequency the diaphragm is damped by attaching strips of balsa wood directly to it. By the proper arrangement of damping strips, adjustment of air gap and diaphragm tension, it is possible to tune the speaker so that it will have a rising characteristic as the frequency increases or a falling characteristic as may be most desirable under the conditions met with in its use.

The driving system is of the dynamic type employing a field coil consuming 0.75 amperes at 5 volts with 100 per cent safety factor. The voice coil wound with No. 36 aluminum wire 0.006 Bakelite enamel, has an impedance of 15 ohms and moves in a gap giving a clearance of 0.015 inches on each side. This large speaker requires no baffle but back stage treatment often is necessary to prevent undesirable echoes.



Improvements in dynamic speakers

I. BOBROVSKY SERGE, *Consulting Engineer*
Utah Radio Products Corporation

Acoustical problems are considered on the basis of a point source of sound. The number of sound sources leads to a number of technical problems. One unit is the ultimate solution, not yet reached, but necessity of fewer units is imperative. The ideal conditions may be approached by developing a cone type dynamic speaker which will have large power ratio. Problems of developing cone dynamic speakers for auditorium use are numerous of which some of the following are important.

1. Increase of output results in increased size of voice coil.
2. Maintaining as high flux density in the air gap to obtain highest ratio between mechanical watts radiated to electrical watts input.
3. Proper design of magnetic circuit which will develop maximum useful flux in the air gap for the total given flux. This results in selection of a set of dimensions to obtain minimum leakage flux. Substantial reduction of leakage is secured in design of new super dynamic speaker.
4. Increase of pole face to give a large and uniform density in the air gap. This will result in maintaining voice coil in uniform flux densities at all amplitudes to prevent subsequent variations in impedance that are detrimental to conversion efficiencies.

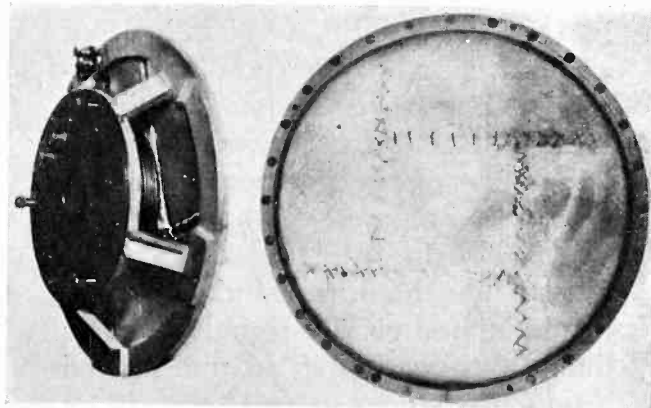

Loud speaker with a diaphragm three feet in diameter made of duralumin 0.002 in. thick

Linear detection of heterodyne signals

By F. E. TERMAN*

IN A radio broadcasting station the signals are modulated by causing the amplitude of the radiated waves to vary in accordance with the sound pressure that is to be transmitted. In reproducing the original signal without distortion it is therefore necessary that the detector in the receiving set give an output that is exactly proportional to the amplitude of the wave being rectified. Such a rectifier is known as a linear detector and will reproduce the ordinary modulated wave without distortion. Any other type of detector characteristic will introduce more or less distortion. Thus a rectifier developing an output proportional to the square of the amplitude of the wave will give proportionately more output when the amplitude is maximum than when it is minimum, with a resultant introduction of frequency components in the rectified output that were not present in the original signal modulated upon the transmitted wave.

In heterodyne signals, that is, in signals consisting of two superimposed waves of different frequencies, the object of detection is to obtain from the combination a rectified current that varies sinusoidally at a frequency that is the difference frequency of the two waves present in the signal. When this result is obtained the detection

▼

PROFESSOR TERMAN points out an interesting phenomenon in connection with superheterodyne receivers. Linear detection produces distortion unless one of the component signals is strong compared to the other—as is usually the case in superheterodynes. On the other hand, detection of modulated carrier signals requires linear rectification if an undistorted product is desired.

▲

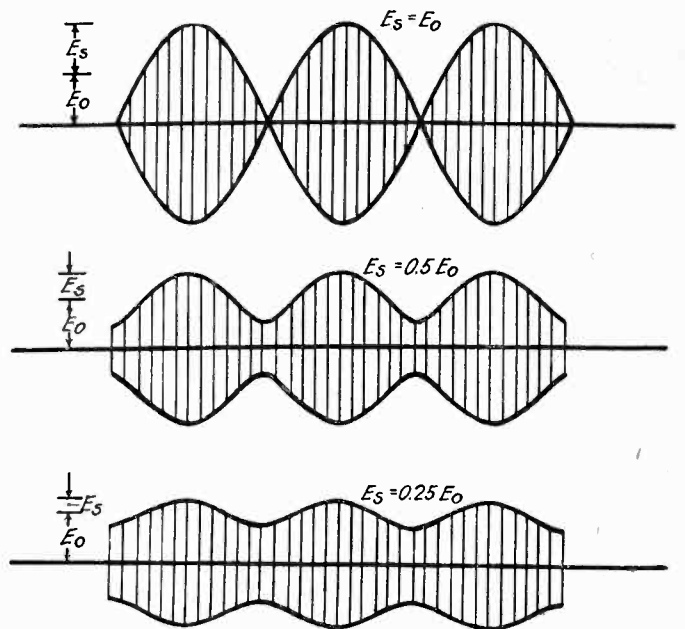

Fig. 1—Envelopes given by heterodyne signals having different values of E_s/E_0 .

of a heterodyne signal is distortionless, while if in addition, harmonics of this difference frequency are present the detector can be said to introduce distortion.

Characteristics of heterodyne signal

In contrast with the situation existing in the detection of modulated waves, where a linear detector gives a distortionless output in the circuit, in the case of heterodyne signals a square law detector gives distortionless detection while a linear detector will introduce distortion. This is because the amplitude of a heterodyne signal does not vary sinusoidally, with the result that a linear detector, which gives an output proportional to the amplitude, cannot be expected to give a sine wave output from a heterodyne signal. The way in which the amplitude of the heterodyne signal varies depends upon the ratio of the amplitudes of the individual frequency components contained in the signal. The departure from the sine wave variation is maximum when the two waves are of equal amplitude and becomes less as one of the components is made weaker with respect to the other. This effect is clearly brought out in Fig. 1, which shows the envelopes that are obtained for a series of representative conditions. The exact way in which the amplitude varies is given by the following equation:

$$\left. \begin{array}{l} \text{Amplitude of} \\ \text{envelope heter-} \\ \text{odyne signal} \end{array} \right\} = \sqrt{E_s^2 + E_o^2 + 2E_sE_o \sin \omega t} \quad (1)$$

in which E_o and E_s represent the amplitudes of the component frequencies contained in the heterodyne signal and ω represents 2π times the difference frequency of the two components. The method of deriving this equation is outlined in the appendix. It is apparent that a detector producing an output proportional to the square of the amplitude of the envelope will give distortionless detection of the heterodyne signal, since when Eq. (1) is squared, the right-hand member acquires a sinusoidal variation.

When the heterodyne signal given by Eq. (1) is rectified by a linear detector the output varies in accordance with Eq. (1), which is plotted in Fig. 2 for several

*Associate Professor, Electrical Engineering, Stanford University.

values of $\frac{E_s}{E_o}$. The nature of the detector output of

Fig. 2 can be most conveniently analyzed by expanding Eq. (1) according to the Binomial Theorem and then applying a Fourier analysis to the result. When this is done the following is obtained:

$$\begin{aligned}
 e = & E_o \sqrt{1+r^2} (1 - 0.0625k^2 \\
 & - 0.0146k^4 - 0.0064k^6 - \dots) \\
 & + \frac{E_s \cos \omega t}{\sqrt{1+r^2}} (1 + 0.0938k^2 \\
 & + 0.0341k^4 + \dots) \\
 & - \frac{E_s r \cos 2\omega t}{4(1+r^2)^{3/2}} (1 + 0.313k^2 \\
 & + 0.1535k^4 + \dots) \\
 & + \frac{E_s r^2 \cos 3\omega t}{8(1+r^2)^{5/2}} (1 + 0.548k^2 + \dots) \\
 & - \dots \dots \dots \quad (2)
 \end{aligned}$$

where

- E_s = weaker component of signal voltage
- E_o = larger component of signal voltage
- $r = E_s/E_o$ = ratio of weak to strong signal components
- $k = 2r/(1+r^2)$
- $\omega = 2\pi$ times the difference frequency of E_s and E_o .

In inspecting these equations it is of assistance to note that k depends upon the ratio E_s/E_o , and reaches a maximum value of unity when $E_s = E_o$ ($r = 1$). For this condition the equation of the envelope simplifies to

$$\begin{aligned}
 e = & E_s (1.274 + 0.851 \cos \omega t - 0.170 \cos 2\omega t \\
 & + 0.0729 \cos 3\omega t - 0.052 \cos 4\omega t \\
 & + \dots \dots \dots) \quad (3)
 \end{aligned}$$

The fundamental properties of linear detection of heterodyne signals are incorporated in equations (2) and (3). These equations show that the difference frequency output is largely independent of the amplitude of the stronger signal component E_o and is nearly proportional to the strength of the weaker component E_s . The magnitude of the deviations from these approximate relations is indicated by the fact that increasing the stronger signal component E_o from equality with E_s to a value many times E_s , while holding the amplitude of the latter constant, increases the difference frequency output 1.00/0.851 times or nearly 18 per cent.

The distortion frequencies produced in the linear detection of heterodyne signals are greatest when the two signal components have equal amplitudes, under which conditions the second harmonic of the difference frequency is seen from equation (3) to be 20 per cent of the difference frequency. This distortion is reduced when one signal component is much stronger than the other, and is less than 2.5 per cent when the weaker signal E_s is less than one-tenth the stronger E_o .

Application to beat frequency oscillator

The foregoing shows that distortionless rectification of heterodyne signals with linear detectors can be obtained only when the strong oscillation E_o (ordinarily locally produced) is much stronger than E_s (which is usually the signal). Under these conditions the rectified output, in addition to being distortionless, will be proportional to E_s (i.e., the signal), and independent of the magnitude of E_o (i.e., the local oscillation).

A direct practical application of the above to the

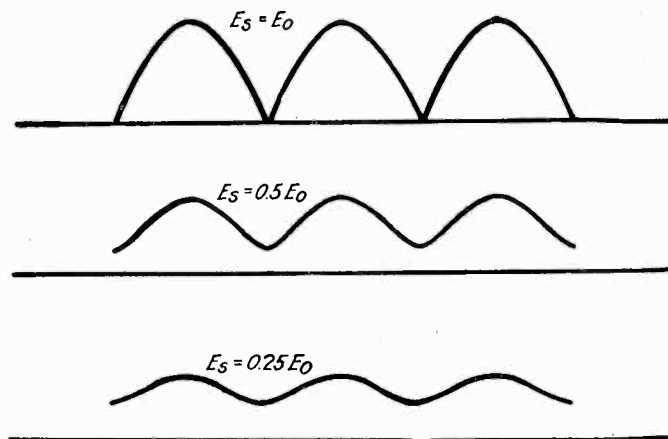

Fig. 2—Wave shapes obtained by linear detection of heterodyne signals. The detector output acquires a variation that is nearly sinusoidal if one of the components is small

heterodyne method of generating audio frequencies indicates the desirability of using linear rectification in the "mixer" tube, and making one of the oscillations much weaker than the other. This gives a distortionless difference frequency output that is proportional to the weaker oscillation and independent of the stronger

Straight line rectification is to be avoided in the first detector of the super-heterodyne receiver because of interference effects resulting from distortion components of the difference frequency. Thus a super-heterodyne receiver with a linear rectifier will respond to strong signals when the beat frequency is one-half, one-third, one-fourth, and so on, of the intermediate frequency. Inasmuch as the first detector is very likely to have a linear characteristic because of the large amplitude of the local oscillation, it is important that this point be carefully considered in the design of super-heterodyne receivers. The same effect can also produce cross-talk effects in the demodulation of single side band carrier current communication signals.

APPENDIX

Envelope equation of heterodyne signal

The problem is to find the envelope of a signal having the equation

$$\begin{aligned}
 e = & E_o \sin \omega t + E_1 \sin [(\omega + \delta_1)t + \phi_1] \\
 & + E_2 \sin (\omega + \delta_2)t + \phi_2 + \dots \quad (4)
 \end{aligned}$$

where ϕ_1, ϕ_2 , etc., are phase angle constants, and δ_1, δ_2 , etc., are 2π times the frequency by which their respective terms differ from the E_o term's frequency. The envelope of equation (4) can be found in the usual manner,¹ which when applied to (4) consists in solving (4) for zero, equating to zero the partial derivative with respect to ω of this transposed equation, and simultaneously solving the resultant equation with (4) to eliminate ω . Carrying out these operations give the result

$$\begin{aligned}
 \text{Envelope} = & [E_o^2 + E_1^2 + E_2^2 + \dots \quad (5) \\
 & + 2E_o E_1 \cos (\delta_1 t + \phi_1) \\
 & + 2E_o E_2 \cos (\delta_2 t + \phi_2) + \dots \\
 & + 2E_1 E_2 \cos (\delta_1 - \delta_2)t \\
 & + (\phi_1 - \phi_2) + \dots \dots \dots]
 \end{aligned}$$

When only two components are present and ϕ_1 is taken as zero, this equation reduces to (1).

¹For example, see *Mathematical Analysis*, by Goursat-Hedrick, Vol. I, page 426.

HIGH LIGHTS ON ELECTRONIC

Detecting adulteration with filtered ultra-violet or "black light"

"During a recent study of bootleg whiskey products it was possible to detect under the ultra-violet, or black, light the fluorescence of the adulterant of the industrial alcohol from which the bootleg whiskey was made, despite the fact that the original commercial alcohol had been distilled and that casual laboratory examinations for diethyl-phthalate had been reported negative," said Dr. Herman Goodman, in a recent talk before the Society of Medical Jurisprudence at New York. "By the judicious use of various colored fluorescing dyes it should be possible to determine the source of industrial alcohol used in the bootleg trade. The various districts could each have its individual dye and fluorescing signature."

One source of the near ultra-violet or black light shown by Dr. Goodman was a Cooper Hewitt low-pressure mercury-vapor lamp. Instead of the usual glass tube, used when the lamp is intended as a source of ordinary light, or the quartz tube used when the lamp is intended as a source of short, or far, ultra-violet radiation, the lamp used by Dr. Goodman was made of a dark blue-black glass. This glass, containing nickel and cobalt, is opaque to both the visible light to which glass is transparent and the far ultra-violet to which quartz is transparent. It is, however, transparent to the near ultra-violet, or longer wave-lengths than the middle ultra-violet, found in sunlight and produced

by health lamps, and the short or medial wave lengths. Since the light to which the human eye is sensitive is cut off by the blue-black nickel-cobalt glass, this emission has come to be known as black light. Such tubes have been used in spectacular theatrical illumination work, but have not been applied commercially otherwise.

Counterfeiting of bank notes and stock certificates, alteration of bank checks, and erasures in account books can be detected with black light, since papers, even from the same manufacturer, which seem alike under ordinary light are at once revealed as different by ultra-violet. Similarly, invisible inks which glow under ultra-violet can be used as a protection against forgers and check raisers. Such inks could also be used in marking cloth and other commodities as an invisible mark of ownership and protection against loss by theft.

Natural teeth fluoresce with a brilliant white light. False teeth, no matter how cleverly matched to the natural ones in ordinary light seem chocolate colored under black light if made by one manufacturer, or yellow if of another composition. A record of the fluorescence of the teeth could be added to identification charts.

An important place for black light in the cosmetic industry has to do with the substitution of cheap imitations for well known trade marked perfumes. By the addition of a tiny amount of a secret fluorescent dye it would be possible to detect substitution.



Analyzing industry and traffic noises

Dr. E. E. Free, consulting engineer, New York City, who has made surveys of the noise conditions in several cities and industrial centers, reports on the results of the New York Noise Abatement Commission's work as follows:

"A necessary first step in organized attack on the noise problems of any city is the accurate measurement of the noises which actually exist, with the determination of their sources and the preparation of a 'noise map' of the city.

"All noise surveys which have been made indicate that the chief source of city noise is street traffic. In most instances, the noisiest points are also the points of greatest traffic concentration. Our New York City measurements indicate that the average sources of noise at a noisy street corner are approximately as follows:

Automobile trucks 40 per cent
The elevated railway . . . 25 per cent

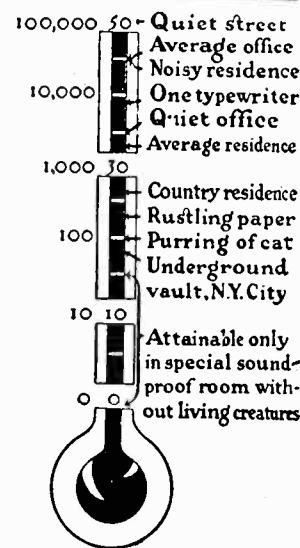
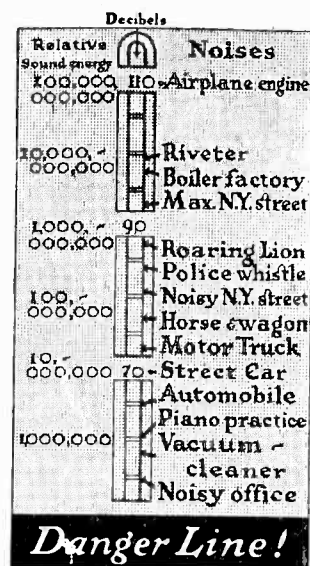

"Noise thermometer" showing sound levels existing under various conditions



Scrutinizing bank checks for erasures, under ultra-violet light

Street-cars 20 per cent
Other noise sources . . . 15 per cent
"The reduction of total city noise to be expected from a successful campaign will range between 20 and 50 per cent.

"Noise surveys, recommended as the essential basis of such a noise commission's activities, are now usually made by noise-measuring instruments called acoustimeters, which instruments consist essentially of a microphone similar to the microphones used in radio-broadcasting, a vacuum-tube amplifier like those used for radio-receivers, and an electric-meter on which the output of this amplifier is measured.

"The microphone picks up the noise energy from the air and converts this into electric oscillations, just as it does in radio-broadcasting. The amplifier magnifies these electric oscillations several million times, keeping the magnified energy exactly proportional to the energy entering the microphone. This magnified energy then is measured on the meter."

DEVICES IN INDUSTRY ★ ★

Hold cup under faucet; water flows

The accompanying diagram shows the circuit employed in the "automatic water cooler" which was exhibited at Atlantic City by the Arcturus Radio Tube Company. According to H. L. Haltermann, the amplifier used consisted of two 124 tubes, resistance-coupled, which worked a relay in the output circuit whose secondary contacts were capable of passing five amperes at 110 volts. The output of this relay was in turn connected to a solenoid valve which controlled the flow of water.

By placing a cup under the faucet the light was interrupted and the change of potential on the grid of the first tube produced by the photolytic-cell caused the relays in the output circuit of the amplifier to function.

Smoke-prevention methods. Photo-tube starts blower

Several methods of using the vacuum-tube to prevent the production of smoke in plant stacks are now available and in regular service.

Some of these remarkable devices actually "see" smoke released by a careless fireman by day or night and instantly apply correctives without the intervention of a human hand. For example, there is the electronic "smoke inspector" now installed in a number of power plants. This device comprises an electric eye or photo-electric cell near the bottom of the smoke stack. Opposite it, across the stack, is an ever-burning electric light. If a cloud of black smoke, resulting from careless firing, starts up the stack the photo-cell is eclipsed and instantly operates switches to start up big blowers. These at once deliver an excess of fresh oxygen to the furnace and the smoke is burned up. All this happens automatically and is in full operation before the smoke gust has even reached the top of the chimney.

The photo-cell also can be arranged to light a sign indicating "smoking" and to ring an alarm bell in the boiler room and to record occurrences of smoke on a twenty-four-hour recording tape on the desk of the big boss, either at the plant or elsewhere.

There is special significance in the fact that the electronic smoke warning and the remedies it applies are equally effective day or night.

Automatic detection of night smoke is especially important in doing away with the city's smoke pall. Despite human watchfulness, many chimneys are now allowed to pour forth great clouds of

Circuit of automatic water cooler. When cup is held under the faucet, intercepting the light beam, the photo cell operates the solenoid valve

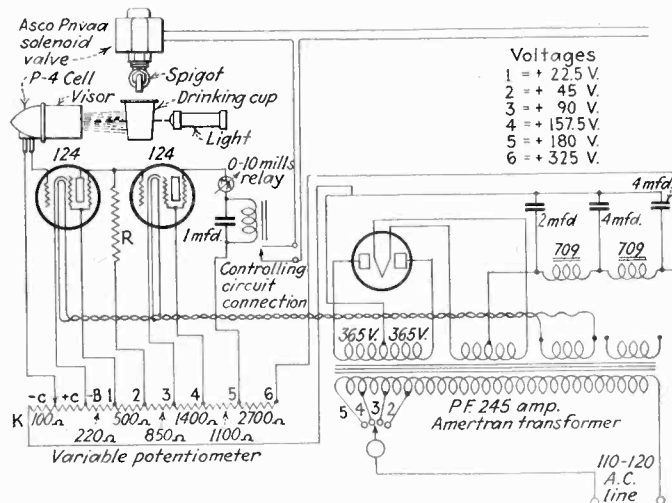

smoke under cover of darkness. Usually there is little wind in the early morning, therefore these smoke clouds settle on the community and produce the familiar black gloom which overhangs the city until nine or ten o'clock in the morning.

Electronic tubes are being used in other ways to suppress soot and dust. Electro-static smoke preventers now installed in plant chimneys have high-voltage plates charged with static electricity which attracts the soot and dust particles out of the flue gases in the same way that the static electricity in a comb attracts hair or paper particles on any frosty morning. Electron-tube rectifiers are used to produce high-tension direct current for charging these precipitator plates with static electricity.

A mechanized "Army Band"

The Acting Secretary of War, Honorable F. Trubee Davison, has authorized the Quartermaster General to procure for service test one mechanical substitute for an army band. This device will be issued to Fort Washington, Maryland, for a test by the 3rd Battalion of the 12th Infantry.

This equipment is built into a three-fourths ton truck. The volume of music is equivalent to two large bands, and the volume may be controlled as desired. It is contemplated, if this apparatus is finally adopted for use by the army, to utilize it at stations which have no band, of which there are some sixteen such stations at present.

SEARCHES OUT FIRES; EXTINGUISHES THEM



Before the A.I.E.E. at New York, Oct. 24. L. W. Chubb, Westinghouse' director of research, demonstrated this "fire scanner." Four flames were lighted on the screen, the scanner was set in motion, and as it came in line with each fire, it stopped, aimed a stream of water, and then, the flame extinguished, went on to the next fire

The role of barium in vacuum tubes

By J. A. BECKER*

AMONG the filament characteristics most desired in the design of vacuum tubes are long life and low power for heating. The most desirable filament yet discovered for telephonic purposes consists of a platinum alloy whose surface is coated with a mixture of barium oxide and strontium oxide. A very minute amount of barium has been found to effect a vast increase in electron emission for each watt of power used to heat it—an obvious advantage when one considers that in the Bell Telephone system there are 250,000 tubes in use. Why the coated filament should liberate electrons more economically and how to increase these economies with added improvements in life and reliability have been important problems basic to tube development.

From the results of extensive research initiated by Dr. H. D. Arnold and followed by W. Wilson, J. E. Harris and M. J. Kelly certain facts have been established. An accompanying figure shows the remarkable effect that barium has upon the activity of a platinum filament. For filaments which are maintained at the same

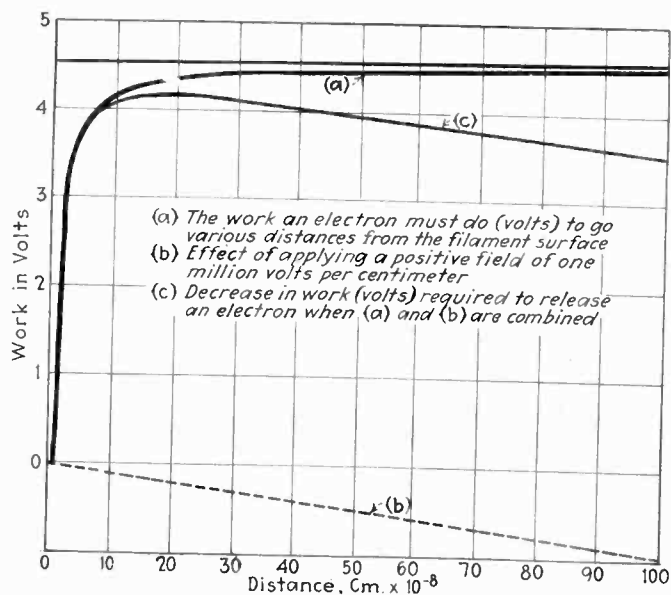

Barium supplies a positive field tending to pull the electrons from the filament

temperature, there is a very much greater emission—in fact, more than a hundred million times as much as for a clean platinum surface without barium—when the filament surface is just completely covered with a single layer of barium atoms. When the surface is only half-covered the electron emission is too small to show on the scale used in plotting the figure. Emission increases rapidly as more and more of the surface is covered until about 80 per cent is covered, when an enormous increase is noted. When filaments were studied with more than enough barium to cover their surfaces, it was found that the current decreased and approached the value which it would have for bulk barium.

The remarkable fact is that the electron current which is possible at any heating temperature from a single layer of barium atoms on a platinum wire is enormously greater than the current which could be obtained from a filament of either substance alone.

In the filament of the standard repeater tube, the platinum core is covered by a thick layer of the oxide coating. In the course of the treatment of the tube some of this oxide is electrolyzed and barium is stored up in the core and in the oxide. While the tube is being used some of this barium is adsorbed on the surface of the oxide as an invisible monatomic film. This adsorbed barium film is responsible for the high efficiency of the oxide coated filament.

Experiments have shown that barium on top of the oxide coating behaves qualitatively like barium on platinum. Its characteristics are even more desirable. Apparently the forces brought into play between the barium and the oxide coating are essentially the same as those between a platinum core and a single layer of barium atoms deposited upon it.

These are the facts but to understand the rôle played by barium atoms it is necessary to understand first how emission takes place from a clean filament surface. The electrons in the metal must have a certain speed in order to break away from the forces holding them to the metal and escape into the vacuum. Because of the heat energy of the metal, at any temperature a certain very small fraction of the electrons have enough speed to escape, and some do so. As the temperature goes up, the thermal agitation of the electrons increases and the fraction that escape increases rapidly. Therefore, the amount of electron current goes up with increasing temperature.

To make more electrons come out without raising the temperature, it is necessary to arrange matters to make it easier for them to get out. As the electrons tend to escape from the surface, they must overcome forces pulling them back. These forces might be likened to those acting on a ball which is started rolling up-hill. The heavy line (a) in the accompanying figure illustrates such an electrical hill for metallic tungsten. It shows the work an electron must do to go from the surface to various distances from the surface. For practical purposes if an electron ever gets out to a distance of 100×10^{-8} cm., or one millionth of a centimeter, it permanently escapes from the filament and reaches the plate. To do this it must have had at least 4.5 equivalent volts of energy when it left the surface.

The electrons of the filament are continually taking a try at this hill, but only a very small fraction of them start with sufficient velocity to reach the top and escape. Of course, if the height of this hill can be reduced, many more electrons can, at any given filament temperature,

*Bell Telephone Laboratories, Inc.

pass over it. One way of accomplishing this is to apply an external electric field which pulls the electrons out. This field can be produced by raising the plate of the tube to a positive potential. In the figure, the dotted straight line which slopes downward represents an applied field of a million volts per centimeter. By combining this field with the original field, we obtain a new electrical hill whose height has been reduced. An electron may now escape if it leaves the surface with 4.2 equivalent volts and reaches a distance of 20×10^{-8} centimeter.

Why the barium atoms on the surface increase the efficiency of the filament is a question. When the barium sticks to the surface, some of the atoms become ionized, that is, they give up one of their electrons to the surface and become positively charged.† These barium ions act much the same as would a very fine-meshed positively-charged grid placed exceedingly close to the filament. Such a grid produces fields which, close to the surface, help the electrons escape. Due to the fact that this ion grid is very close to the surface, the fields produced by it are tremendously great—several million volts per centimeter—and consequently the effect is proportionately great. The greater the number of ions on the surface the greater is the field and consequently the greater the electron emission.

This is true only so long as the surface is covered with less than one layer of barium atoms. Beyond this point, additional barium atoms cover up the spaces through which the electrons come from the surface, and decrease the number of ions on the surface. Consequently the electron emission is reduced more and more until it reaches a value characteristic of a solid barium surface.

This same picture of barium ions stuck to the surface receives strong support from another set of experiments. As has been described a positive potential, applied to the plate of a tube, increases the emission from its filament. From the careful analysis of such current-voltage curves, one can deduce the exact value of the forces which act on an electron while it escapes from the surface. Experiment discloses the interesting fact that beyond a distance of about ten atom diameters from clean surfaces, the only forces which tend to pull the electron back are those induced by its own electrical image.‡ Near a clean metal filament there are thus no electrical fields excepting those produced by the escaping electron. If, now, this clean surface is covered with a partial layer of barium ions, other fields are superposed on the image fields. These fields are presumably produced by the adsorbed barium and may be called adsorption fields. Very close to the surface these adsorption fields are tremendous and in a direction to pull electrons out of the surface. Further from the surface these fields decrease and actually reverse their direction; for a while they then increase in magnitude, come to a maximum and gradually decrease. These characteristics of the adsorption field, revealed by experiment, are just those which would be expected from a non-uniform positively charged ion grid very close to the surface.

Such adsorption fields have a marked effect on the current-voltage or saturation curves. It was long ago noticed that while clean tungsten yielded curves which saturated very well, the corresponding curves obtained with coated filament saturated very poorly in comparison. The cause of this marked failure to saturate is due to the adsorbed barium atoms.

To be of much value, the barium atoms must stick tenaciously to the surface even at high temperatures. It, therefore, becomes of interest to inquire what holds them

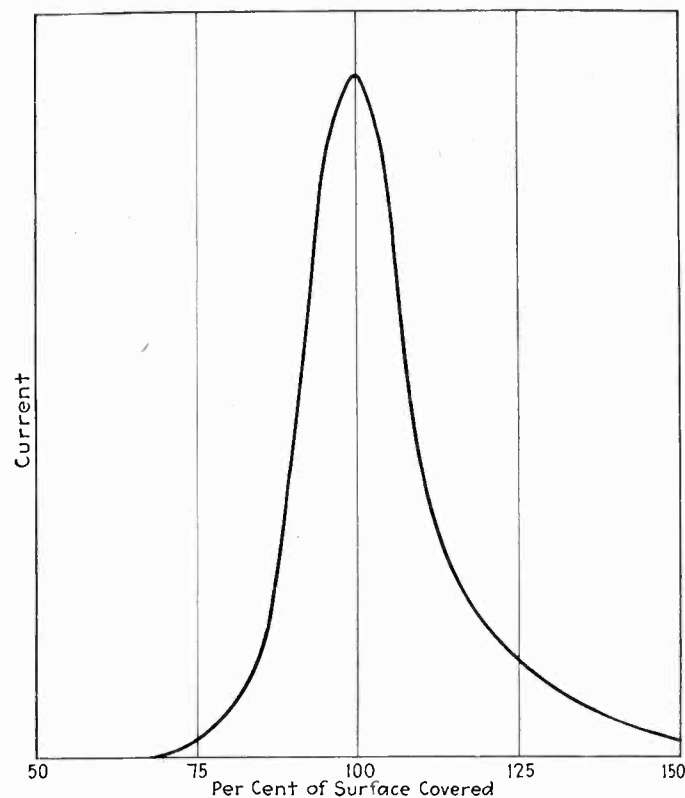

Effect of barium, expressed as per cent of surface covered, on electron current

to the surface. Here again our picture helps us out. Since some of the barium atoms are barium ions on the surface, they are positively charged and hence are held to the surface by the negative charge they induce on it. Furthermore, since the field produced by the ions helps electrons from the surface, it hinders positive particles from leaving the surface. Consequently each ion helps hold its neighbor to the surface even at temperatures at which solid barium would vaporize rapidly.

Still another prediction from our picture receives experimental verification. Since the electrical forces are chiefly toward and away from the surface rather than parallel to or along the surface, we should expect that each adsorbed ion would not be attached firmly to one particular spot on the surface but should be able to move about on the surface. This prediction was verified experimentally by putting barium atoms on one side of a flat ribbon. After this ribbon had been heated at a moderate temperature, barium atoms were detected on the other side. This surface creepage continued until only half the original deposit remained on one side.

We thus see how the simple picture of the ionic barium grid accounts for many of the observed emission characteristics of coated filaments. The economical side of the picture is just as remarkable.

In the ordinary telephone repeater tube the single layer of barium weighs about one-sixth of a microgram. For all the thousands of tubes in use in the Bell System the total amount of barium effective in the emission of electrons is not more than a twentieth of a gram.

Each barium coated filament requires only about 2.2 watts for heating as compared to about 35 for a clean tungsten filament. Multiplying this saving by the 250,000 tubes used in the Bell System gives an indication of the tremendous importance of barium to the vacuum tube.

†"The Life History of an Adsorbed Atom." *Bell Laboratories Record*, Vol. V, No. 1, p. 12.

‡"On Electrical Fields Near Metallic Surfaces." J. A. Becker and D. W. Mueller, Bell Reprint B-300.

electronics

McGraw-Hill Publishing Company, Inc.
Tenth Avenue at 36th Street
New York City

O. H. CALDWELL, *Editor*

Volume 1 — NOVEMBER, 1930 — Number 8

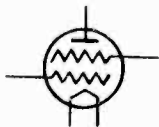

Motion Picture Engineers look into future

AT THE annual convention of the Society of Motion Picture Engineers held in New York City, Oct. 20 to 23, nothing very new in the development of equipment was brought out. The standardization of wide film is one step nearer solution, however, with the definite recommendation of the standards committee for a picture area of 1.8 to 1 (ratio of width to height), with the possibility of 50-mm. overall width becoming standard.

One paper scheduled covering a 16-mm. sound-on-film home projector, was withdrawn and not presented. This was unfortunate as the device which was to have been described would have been at least a new step in the home entertainment field.

Serge Eisenstein speaking at the banquet of the society stated: "Mechanical and electrical developments in the industry are now far ahead of the artistic side of motion pictures." This may mean that some of the kind of effort spent on engineering might be turned to advantage on the program side in order that progress of the industry as a whole may go forward.

Much advance, however, yet remains to be made in sound pictures if the public's interest is to be held. Improvements throughout the sound recording and reproducing system, especially the loud speakers, should be looked for to more nearly approach the natural voice of the artist or the music from an orchestra. Acoustic treatment of the great majority of theaters is far from satisfactory; the owners apparently are merely hoping to ride the present wave of popularity of sound films as far as this tide will take them.

Cold-cathode tubes

ELSEWHERE in this issue of *Electronics* is given notice of a new tube produced in Germany, with a cold cathode. To do away with the heating of cathodes has been the dream of tube engineers and users for a number of years, and this is probably the first description of the actual production and use of such tubes. In this particular case, the source of electrons is a photoelectric surface which is illuminated by an incandescent lamp nearby. Other sources of electrons which have been suggested are radio-active substances. These tubes are not practical for present-day circuits, because of their very high internal impedance and low amplification factor and engineers will probably classify them as curiosities. It should be remembered, however, that the "audion" of de Forest was a curiosity for many years.



Obstructing the farmers' use of radio—

EVERY man who has taken the oath as Federal Radio Commissioner has thereby obligated himself to exert all possible effort to bring better radio reception to the people of the United States. The members of the Commission thus have both a great personal responsibility—and an inspiring opportunity—to enrich and brighten the lives of millions. It is their duty to so shape the radio channels with sufficient broadcasting power, that strong, clear radio signals will be laid down in every home in the United States,—so that the most modest farm dwelling with the simplest radio set, will enjoy the same priceless boon of radio entertainment as do people in the great cities and nearby communities.

High-power stations on every clear channel, is the only answer to the demand for satisfactory broadcast reception on the farms and in small towns remote from city centers.

There is now no reason why the farmers of the United States, the farmers' wives, and the boys and girls growing up on the farms and in small towns should not receive a high standard of radio broadcasting—substantially the equal of the service supplied to cities and nearby communities.

The radio art, after costly research, is ready to

supply broadcasting service of high technical quality to every home. The channels are cleared ready for it. Twenty-seven responsible broadcasters are willing to invest several hundred thousand dollars each, to bring city-quality to additional rural millions in their sections.

Only the Federal Radio Commission now blocks the way to better radio on the farm and in the small towns of the nation.

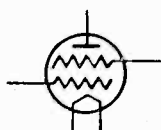

Home recording devices may point new methods

WITH the addition of home disc-recording equipment to the latest designs of phonograph-radio combinations placed on the market, a new and interesting device has been made available for home entertainment. The simplified microphone which is supplied as a part of the recording equipment, together with the six-inch discs on which the grooves are previously cut, is not expected to furnish the same quality of recording as the elaborate recording equipment used in the professional studios.

The ground noise level is quite high in such records, resulting from the hard texture in which the cutting stylus has to operate. New materials may be developed that will furnish the necessary base for cutting, with low ground noise and still have the desired wearing qualities. From the thousands of users of such equipment, perhaps new ideas and methods may be advanced which will result in unlooked-for improvements in both home and professional use.

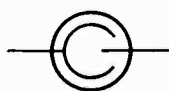

Sic transit "photo-cell"

MEMBERS of the Vacuum Tube Technical Committee of the Institute of Radio Engineers recently decided to standardize the term "phototube" in place of "photo cell," a much older word. On this committee are engineers from the large laboratories building and using phototubes, where the new designation is in common use.

The committee has arbitrarily limited itself to

the "Hallwachs" phenomenon in which a pure electron stream is liberated by the reception of light energy, or in which this electron stream—through the medium of a gas—produces a tube of increased sensitivity. The committee has not considered photo-conductive cells such as selenium or the photo-voltaic types which are now being made and sold, and which will probably be used in increasing quantities.

Shall the term "phototube" be applied to all light sensitive devices, or should the photo-conductive and photo-voltaic types of cells be called by other names? Since most of the definitions which will be agreed upon by the committee and written into the year's I.R.E. year book will apply to these other types of cells as well as to the so-called "photo-electric" type it appears that a decision regarding the terms by which the cells are called, is desirable.

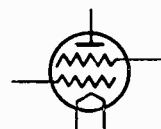

Alongside "celestial mechanics," now comes "celestial electronics"

FOR hundreds of years men have viewed the solar system and the universe as a magnificent piece of mere mechanics—a superb machine of purely mechanical elements—until we had come to accept the term "celestial mechanics" to describe the whole vast system.

But within the last few years astronomers are finding that the heavenly bodies involve much more than the mechanistic considerations of the old-time astronomy. For now it is realized that the sun and other stars are huge and complex magnetic structures, that they radiate electrical vibrations of a wide range of frequencies, that space is threaded and cross-threaded by a maze of electromagnetic impulses of various wave lengths, that gravitation itself is perhaps electro-magnetic in nature, and that in the final analysis even the matter of which the stars and planets are made, is itself built up of countless minute "solar systems" of electrons or particles of electricity.

In the light of 1930, then, we must shape our ideas of astronomy around an *electro-magnetic universe*, and parallel to the old "celestial mechanics" we shall have to set up the new science of "celestial electronics" or "celestial electro-magnetics."

REVIEW OF ELECTRONIC LITERATURE

HERE AND ABROAD

Some measurements of optimum heterodyne

[J. F. HERD.] By taking static characteristic curves and their rectification curves for a triode it may be shown that the rectification characteristics of a given set of tubes show less variation than do the static characteristics. Moreover a glance at these curves indicates the point where the mean plate current is most sensitive to a change in grid voltage and so indicates the point of optimum heterodyne. Starting from this optimum point measurements were made with the following:

- (a) a two stage choke coupled amplifier (as load on the detector tube)
- (b) a tuned audio frequency amplifier
- (c) an ordinary commercial transformer coupled amplifier.

All data showed: that the audio frequency output bore a linear relation to the input for small signals; that the point of optimum heterodyne corresponded to that obtained from the rectification characteristic; and that the gain in amplification of weak signals with optimum heterodyne was thousands of times that with equal heterodyne.—*Experimental Wireless*, September, 1930.

High frequency oscillator for general laboratory use

[F. S. EVANS.] In connection with the discharge of electricity through gases need was felt for an ultra high frequency oscillator. The basis of the oscillator described is the Gill and Donaldson circuit which consists essentially of two parallel equal Lecher wires connecting grid and plate, with a variable condenser forming the junction between them. The circuit oscillates readily with all low impedance valves and may be readily adjusted to a frequency of about 30 megacycles. The energy is supplied to the discharge tube through a coupled circuit consisting of two Lecher wires closed at the end near the valve.—*Journal Scientific Instruments*, August, 1930, p. 261.

Recent progress in the construction of photo-electric cells

[ROY-POCHON.] Summary of the basic theories, details of construction (cathode, anode, gas, tube): with a bibliography.—*L'Onde Electrique*, Paris, August, 1930, published September 26.

Television glow lamps

[H. W. WEINHART.] Developments in the design of glow discharge lamps for television are recounted. The earlier lamps for monochromatic television had flat plates for electrodes, cooled only by radiation, so that the intensity of their glow was limited by a current capacity of only 50 milliamperes. Introduction of water-cooling permitted the use of currents as high as 500 milliamperes, giving a very bright glow on the cathode. For the more recent work on monochromatic television, the glow discharge is confined to a flat square surface by mica shielding; and the anode is a metal strip fencing off this active area. The cathode is clamped in contact with a glass tube through which the cooling water circulates. The more recent tubes for color television employ the same scheme for water cooling; mica is used on the cathode to provide a long insulating path and to prevent the glow from forming anywhere but on the desired flat rectangular area.

Hydrogen which must be added to the gas within the bulb periodically is admitted from a separate glass chamber attached to the main bulb. Two porous plugs, one sealed in an extension of the lamp and one in the end of the hydrogen supply bulb, are normally sealed with mercury but when pressed together permit the passage of hydrogen into the tube. Lavite is used for the plugs and is heat treated until it is porous enough to pass hydrogen but not mercury.

The uniformity of the glow of neon tubes and the sputtering from the active surface depend on the use of the proper technique in preparing the cathode surface. It has been found that beryllium deposited by the vaporization and condensation method sputters far less than other materials and so is used for the final plating of the surface. For monochromatic television and for the red component in color television neon is used as the discharge gas. For the blue and green components argon is employed. Color filters are used with the lamps for color work.—*Bell Laboratories Record*, October, 1930.

Customs regulations for travelers

[UNSIGNED.] Very useful summary of the conditions governing the temporary import of radio receivers in to European countries.—*Radio B.F.f.A.*, Stuttgart, October, 1930.

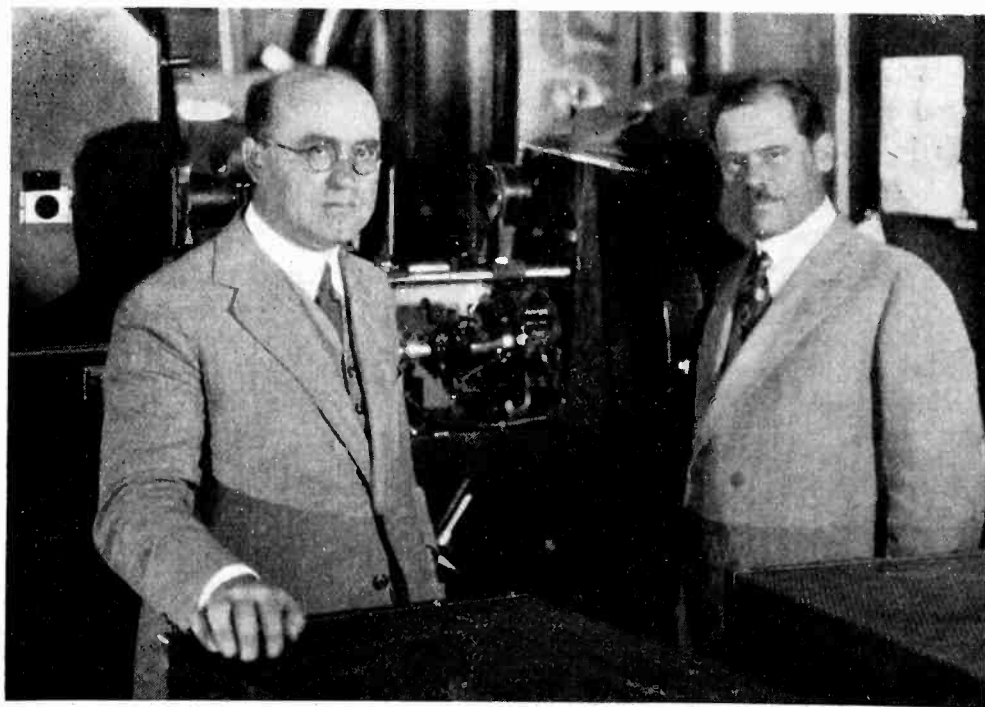

DR. KAROLUS AND DR. ALEXANDERSON

Dr. Karolus, of Germany, inventor of the Karolus cell for modulating polarized light, used in the Alexanderson system of movie-screen television, visits Dr. E. F. W. Alexanderson in the latter's laboratory at Schenectady

Origin of word "electron"

[DONALD McNICOL.] Although it was not until 1896 that the electron as we know it today was identified and determinations made relative to its physical characteristics, it is history that the ancient Greek poets called the sun $\eta\lambda\epsilon\chi\tau\omicron\rho$ and Homer repeatedly so terms it (Iliad Z/513: T./398). "Electron" was used indefinitely by the Greek classic writers. In the minds of the Greeks, gold and the gold alloys were all children of the sun "elector," and, in common with these, amber, in Hellenic speech, came to be called "electron."

A thorough search of historical electrical records might disclose that the word has been used long after the Greeks used it to refer to amber. That the term was current and had some significance in scientific circles is evident from the fact that in the electrical journal, *The Telegrapher*, of December 26, 1864, the word electron appears on page 36, at the bottom of the first column.—*Radio Engineering, New York, October, 1930.*

Frequency modulation and distortion

[T. L. ECKERSLEY.] Due to the different paths traveled by the direct and reflected waves the signal received at a given point is composed of components which the transmitter sent out at different times. With frequency modulation this means components of different frequencies so that in addition to the normal beat tones between the carrier and each of the side bands for each of the components there will be beat notes between the two carriers and also between each carrier and the two side bands of the other component so that appalling distortion results. Experimental checks with frequency stabilized transmission show that this explanation is probably correct for the cause of distortion in short-wave radio-telephonic transmission on alleged amplitude modulated type.—*Experimental Wireless, September, 1930.*

Capacitive and inductive coupling

[R. A. WILMOTTE.] An able presentation of an important but complex and difficult problem. The one objection which your reviewer has is the convention employed for the sign of the mutual inductance, which leads, for instance, to the concept that the mutual inductance between adjacent wires on the same coil is negative. This is, however, the convention normally employed by the National Physical Laboratory and so,

no doubt, much may be said in its favor.

After a preliminary explanation of impurities in condensers and mutual inductances the author presents two transformations, the first that of two self-inductances with mutual, connected at a common point, to a star arrangement of self inductances, and the second the star-delta conversions of Campbell (Kennelley?). By the aid of these transformations he shows how to convert capacitive coupling to its equivalent in magnetic coupling and vice versa. A means of measuring mutual inductance and its impurity is then disclosed and the paper ends with the comparison of the two types of coupling and a discussion of the limitations of the above mentioned transformations.—*Experimental Wireless, September, 1930.*

Vacuum-tube voltage regulator for power alternators

[L. C. VERMAN AND L. A. RICHARDS.] Two novel features are incorporated in this vacuum-tube voltage regulator for a.c. power units. First, saturation current from the filament of a thermionic tube is used as the control element; and second, a feed-back stabilization system is employed which makes it possible to obtain stable regulated voltage conditions with high sensitivity. Operation of this regulator involves conversion of the a.c. line voltage fluctuations into d.c., amplifying these fluctuations, and applying them to the field of an exciter which supplies the main alternator field, thus controlling the line voltage. The exciter field winding is the only special piece of apparatus used in the system, all the other parts being standard and readily obtainable. The first tube (a UX 210) is operated at a low filament temperature and high plate voltage so as to obtain saturated plate current. Under these conditions the current through the coupling resistance R_2 is nearly independent of the plate voltage but changes rapidly with the filament temperature and hence with the r.m.s. value of the line voltage. A UX 240 is resistance-coupled to the first tube, so that a decrease in the line voltage makes the grid of the 240 tube more negative, cutting down the current through R_3 , making the grid of the third tube (210) more positive and building up its plate current. The almost instantaneous response of the vacuum-tube system to small line voltage fluctuations tends to cause hunting, because of the considerable time lags in the fields of the exciter and main alternator. This has been overcome by a feed-back coupling system with

condenser C and resistance R_1 , which reacts on the grid of the first tube, virtually delaying the response of the regulator. This arrangement gives voltage regulation of 1.5 per cent at full load unity power factor as compared to 45 per cent with fixed excitation. The regulator also functions as overload circuit breaker.—*Review of Scientific Instruments, October, 1930.*

New radioelectrical instruments

[WEISS.] I. Radioelectric piano and organ, Givélet-Coupleux. Chiefly a general discussion of possible methods, with little details as to those actually used. II. Boreau "Radiotone." Full descriptions: the system is entirely new, a string in tension between a fixed support and the armature of a telephone receiver being "bowed" by a revolving wheel, and the currents induced in the receiver coils amplified. The critical positions of the bowing wheel for various pitches and its speed of rotation are discussed. Volume is controlled by a pedal. A system of filters controls the tone quality.—*La Nature, Paris, September 15, 1930.*

Technical questions at the Vienna program convention

[UNSIGNED.] Descriptions of some of the demonstrations at this Convention of the German Radio Program Committee, more especially of: the ultramicroscope, using variation in condenser capacity and the heterodyne principle to measure changes in length of the order of one millionth of a centimeter; and the Scheminzky electro-stethoscope, in which a special arrangement of a semi-flexible cup attached to a telephone diaphragm is used to absorb the mechanical vibrations associated with heart-beats and with breathing. The same inventor also demonstrated the minute bioelectrical currents associated with muscular movements.—*Funk, Berlin, October 10, 1930.*

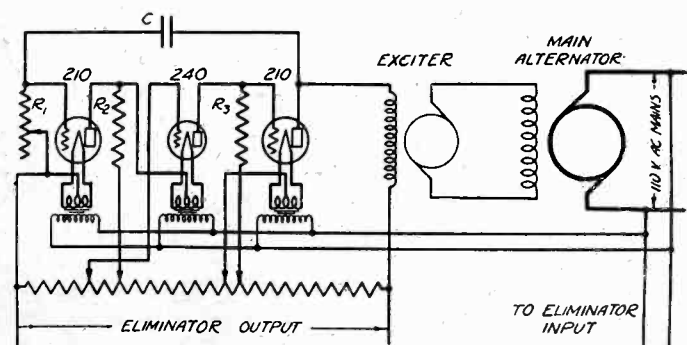

Circuit diagram of vacuum tube voltage regulator

Distant control with very short waves

[BESSON.] Waves of 3 to 5 meters length are used (near La Rochelle) to start and stop the fog-signal, consisting of an acetylene-operated gun, at an isolated lighthouse without attendant distant 2.5 kilometers. The transmitter uses two tubes in a symmetrical arrangement (Mesny-Vallauri circuit) with a small dipole antenna. The receiver uses a similar antenna, and is itself of the super-regenerative type: it is switched on by a clock mechanism during seven seconds each 5 minutes only. The reception of a signal switches the gun into operation, the reception of a second signal switches it off: in order that a second impulse intended in reality to form part of the energizing signal may not de-energize, the receiver not only switches on the gun but simultaneously switches itself off, thus ensuring that the gun will actuate for at least five minutes. An anti-parasitic device is suggested, based on the saturation of a super-regenerative receiver by continuous wave signals. The system is to be extended on the Brittany coasts.—*L'Onde Electrique, Paris, August, 1930, published September 26.*

A photo-electric cell with semi-conducting dielectric

[VON HARTEL.] Discussion of the theory of the new Lange cell as compared with the normal types: in these cells a copper-oxide layer replaces the vacuum, and separates a film of copper (cathode) so thin as to be transparent, from the anode which may also be of copper. The maximum sensitiveness occurs towards the red end of the spectrum, even with copper as the cathode, thus rendering the use of rare metals unnecessary. A striking advantage of these cells is that no auxiliary voltage is necessary: the sensitivity is also much greater than in the case of the normal cell (about ten times that of a vacuum cell). The internal resistance is of some hundred ohms only.—*Funk, Berlin, September 19, 1930.*

Electrical musical instrument

[WEISS] Description of the "Ondium Péchadre," using the heterodyne beat-note. Pitch is controlled by a variable condenser, actuated by the right hand: the left hand controls the volume, by depressing a key to a greater or less extent, and also the tone-quality (no details of this are given).—*La Nature, Paris, July 15, 1930.*

Cold cathode amplifiers

[M. VON ARDENNE.] Employing a cathode of photo-electric material, valves with an audio frequency voltage amplification of 30 in sunlight, and of as high as 17 under the illumination of a 50 cp., half-watt lamp have been successfully produced in Berlin. The greatest advantage of this method is the total absence of hum and line noises, although search for a cold-cathode tube was the original incentive. The effect of line voltage fluctuations can be entirely eliminated on either d.c. or a.c. by the proper choice of a light source. In addition, a whole series of receiving circuits in which the cathodes of the various valves do not have a common potential can quite easily be realized.

The valves for experimental work employed a potassium cathode of several square centimeters area, which was sensitized with hydrogen, and the valve filled with an inert gas. The ionic current due to the gas does not appreciably affect the operation of the valve as an amplifier, though it necessitates the use of different grid-bias voltages. The amplification factor of the valve itself is about 40, and its a.c. resistance is of the



Baron Manfred von Ardenne, German scientist and inventor, whose writings on radio and allied subjects have appeared in scientific journals throughout the world

order of two megohms. In the experiments described a plate resistance of ten megohms was used. The grid current curves have a shape which indicates that grid current will have no appreciable influence on amplification. A three-stage amplifier, resistance-coupled, with the three tubes grouped about a single motor-car headlamp, was found to work very satisfactorily. It was also found that a glow discharge in close proximity to the cathode, either in the same bulb or in a separate one, will provide as great a surface illumination as an ordinary electric lamp. This glow was energized from a battery eliminator. The results obtained are extremely interesting.—*Wireless World, September 3, 1930.*

Equivalent circuit of the thermionic valve

[N. R. BLYTH.] Barkhausen and Van der Pol have already shown that if, in any given equation, all voltages and currents are interchanged and admittances substituted for the corresponding impedances a new equation is produced which represents, as well as the original equation, the phenomenon under investigation. Applying this principle to the triode Mr. Blyth has derived the equations for various types of loading. The simple circuit which is usually represented as a voltage μe_g working through an internal impedance r_p and external impedance Z is thus converted into a constant current generator $G_m e_g$ acting across an impedance consisting of r_p and Z in parallel. Either form gives as the current through the load

$$i = \frac{\mu e_g}{R_p + Z}$$

The great advantage of the alternative method of representation is that all the external impedances in the anode circuit are thrown in parallel with the internal impedance and the plate-filament reactance so that the combination of series and shunt impedances is avoided.—*Experimental Wireless, September, 1930.*

A valve-operated coreless induction furnace

[FRANK ADCOCK.] The oscillator consists of two 2.5 kw. valves in push pull fed with raw a.c. The circuit is of the tuned plate type with the coil feeding the energy into the furnace. Various methods of applying grid bias to the oscillating valves were tested. Finally a combination of grid-leak and condenser in conjunction with a steady negative C bias of 36 volts was adopted. The grid-leak and condenser combination when used alone did not yield sufficient protection when the valves were oscillating under inefficient conditions; on the other hand a high permanent bias unduly restricted the oscillations. Much trouble was experienced in melting magnetic materials due to the change of their magnetic properties, and hence loading on the oscillator, with temperature. A solution was found in a specially designed condenser switch.—*Transactions of the Faraday Society, September, 1930.*

Continuous-wave diathermy and its surgical applications

[COLOMBIER.] More complete details with diagrams and photographs of the actual apparatus, based on the principle previously described (these Digests, July, 1930).—*Radioélectricité, Paris, October, 1930.*

Sound recording under difficulties

Conditions under which sound recording equipment has to work. Illustrations taken from *Recording Sound for Motion Pictures*, to be published by McGraw-Hill Book Company this winter.



The cameraman submerges for undersea sequences in Paramount's picture *The Sea God* with a water-proof camera connected by a motor to sound recording apparatus at the surface

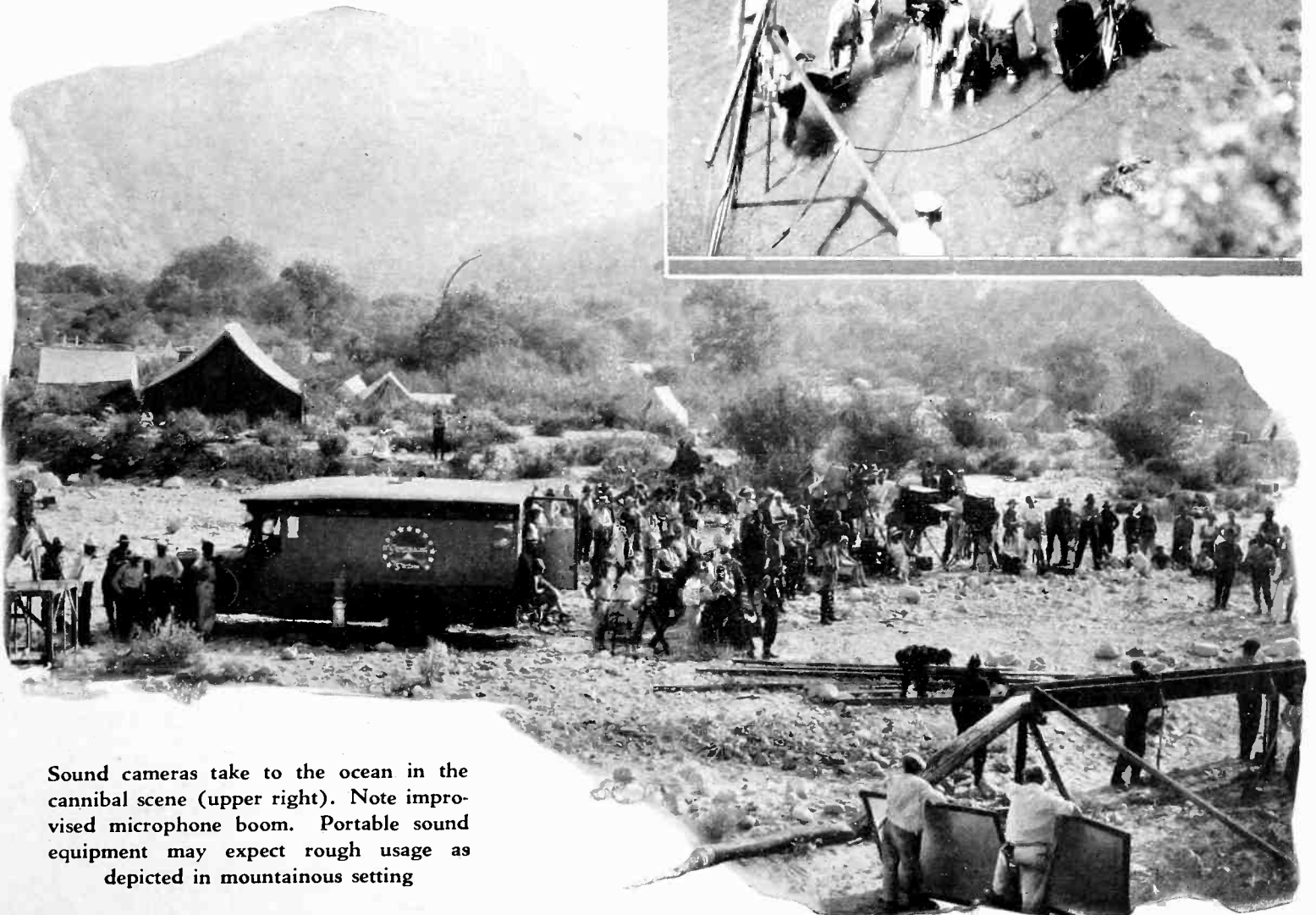
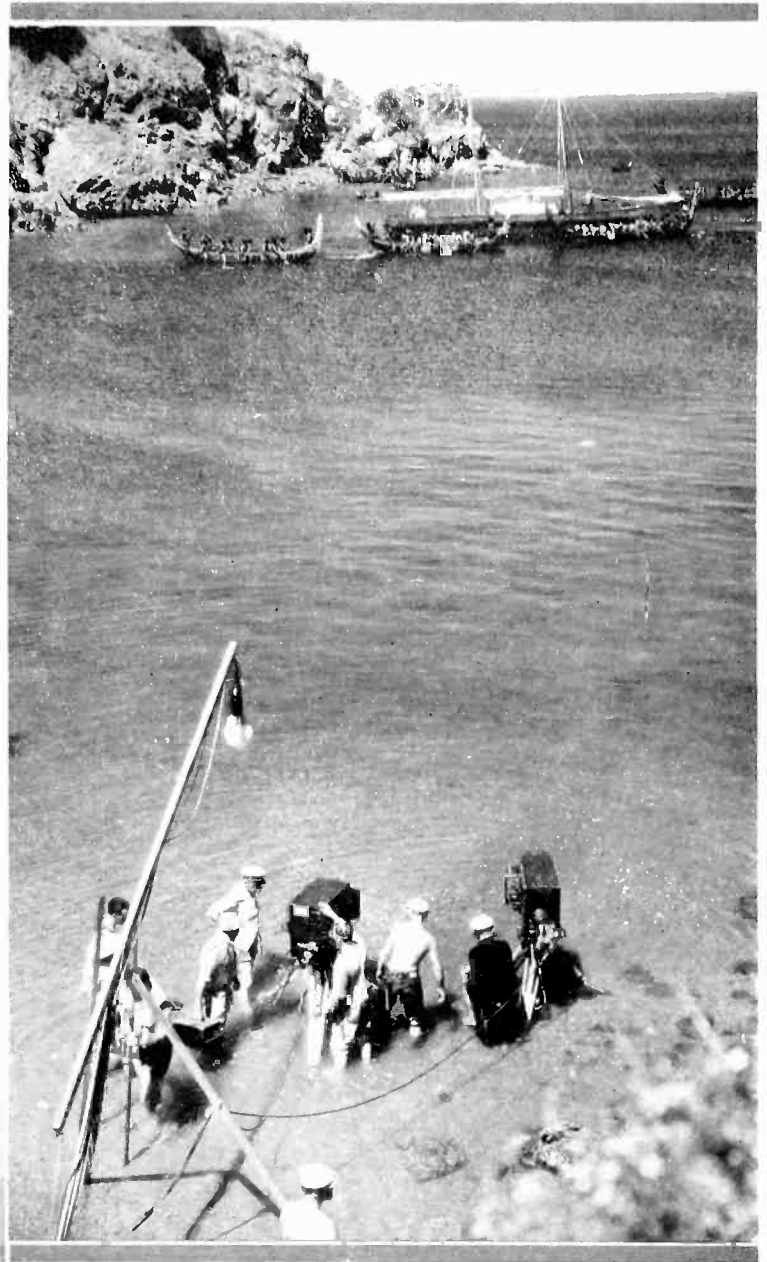

Sound cameras take to the ocean in the cannibal scene (upper right). Note improvised microphone boom. Portable sound equipment may expect rough usage as depicted in mountainous setting

Quality Maintained

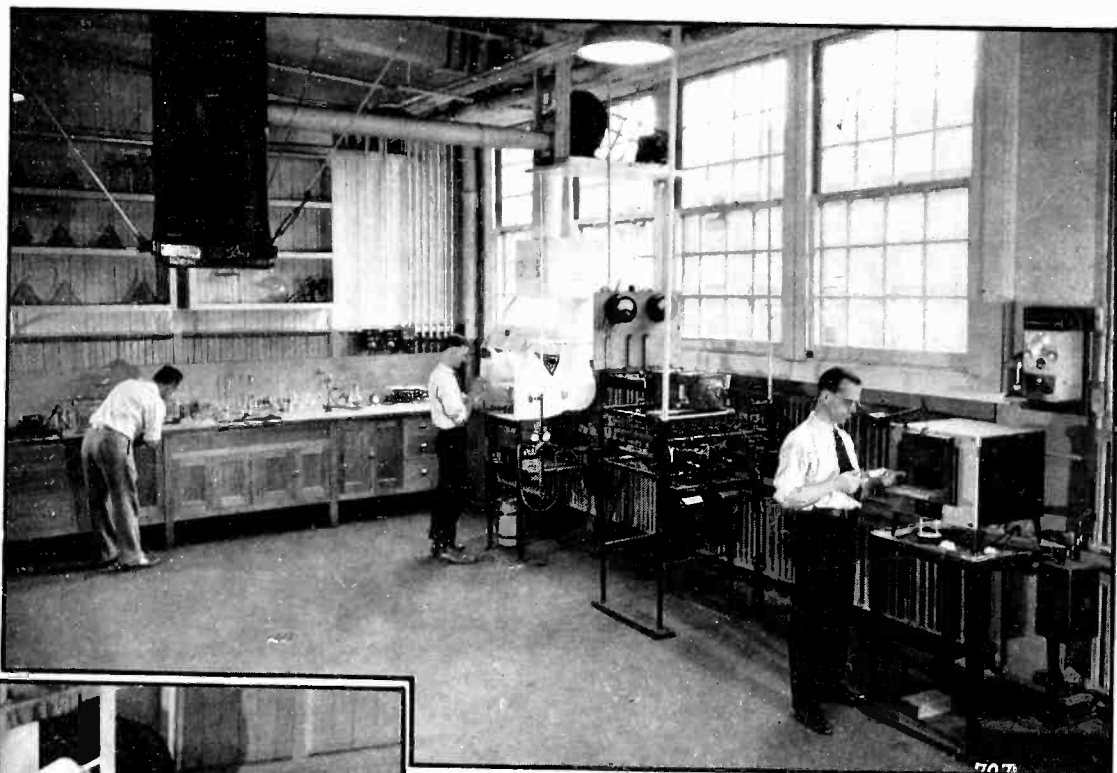
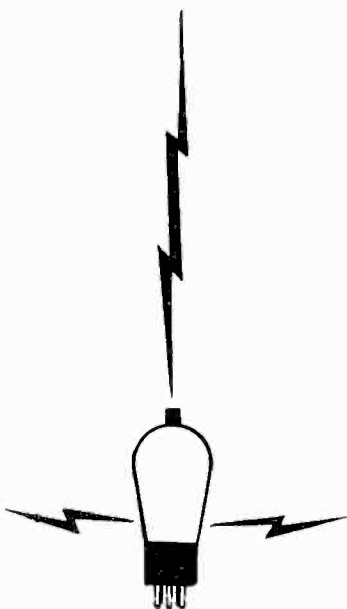

A corner of one of the chemical laboratories.

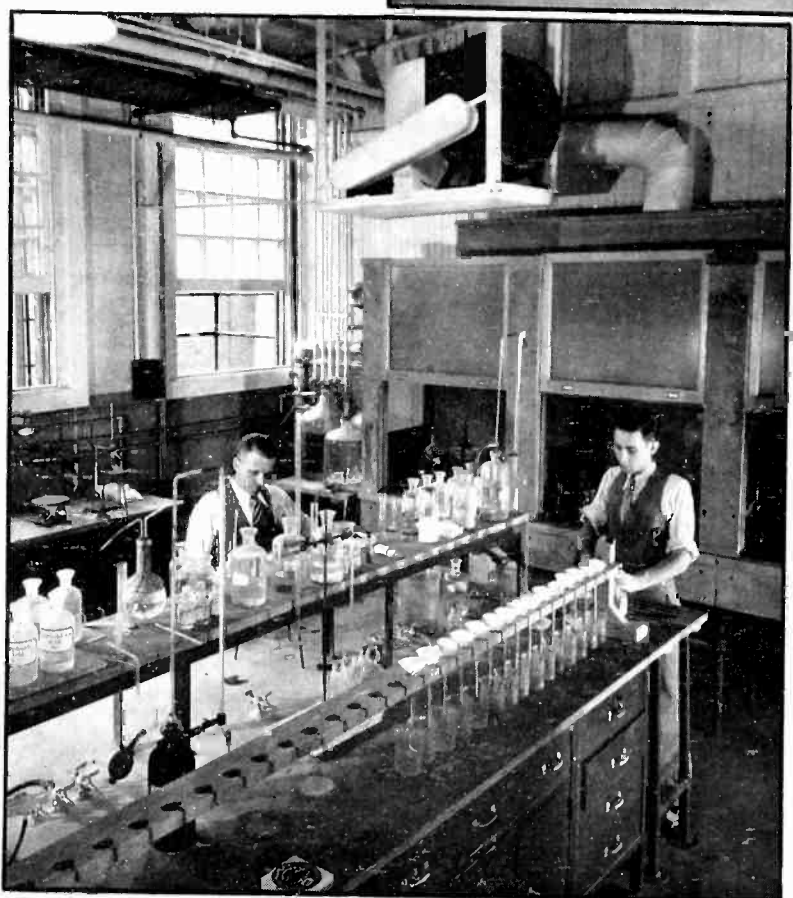

Another section of the chemical laboratory.

IT is through constant research that RCA Radiotrons have been developed to their present stage of perfection. It is only by thorough and intense investigation that advances are made in any art. When you use RCA Radiotrons you do so with a sense of security that comes from knowing that every one is backed by the latest scientific knowledge. RCA Radiotron laboratories are doing purely research work as well as answering every day manufacturing problems.

RCA RADIOTRON

« « « HARRISON

by Constant Research

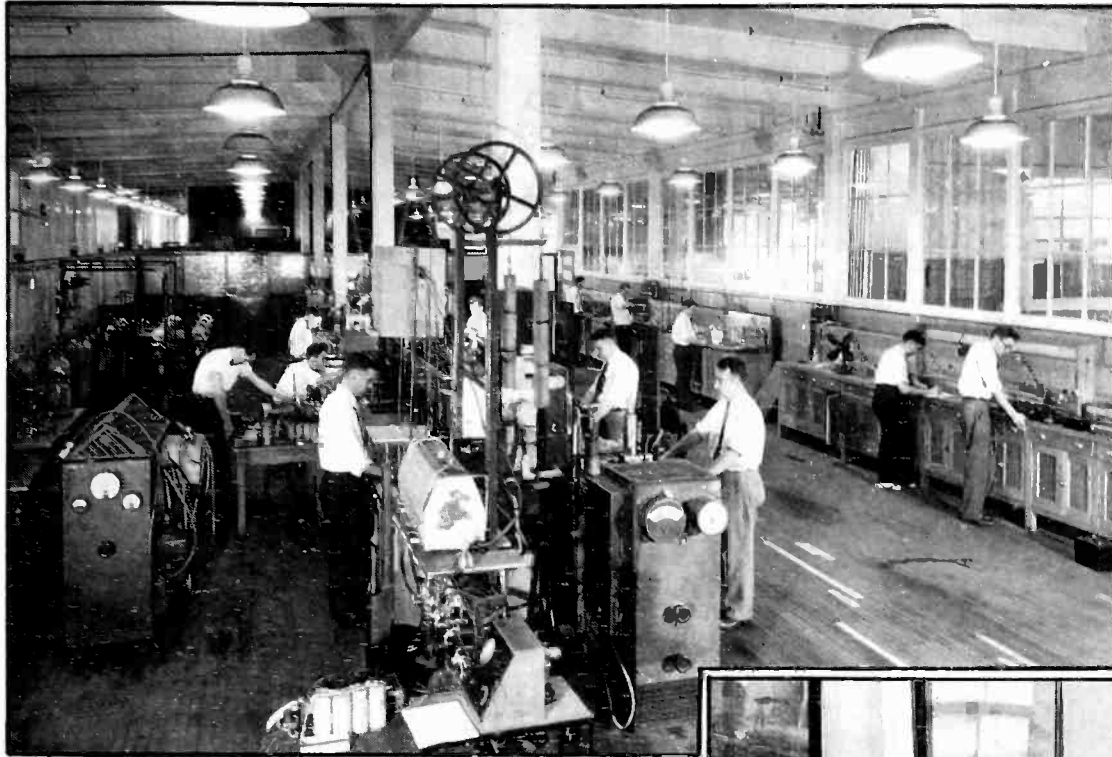

General view, chemical and physical research laboratory.

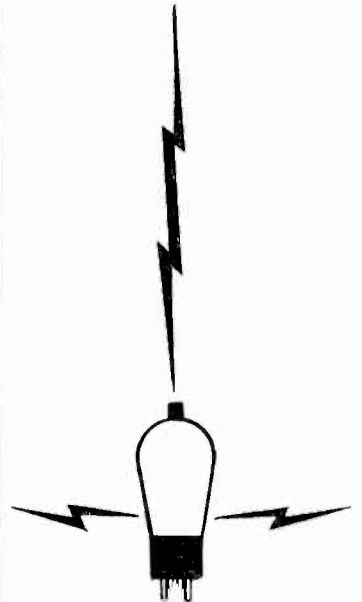

The pictures of these two pages show a few views of the research chemical and physical laboratories of the RCA Radiotron Company, Inc., at Harrison, N. J. In these laboratories are many men, all experts in their chosen fields, who are constantly striving to find means of improving the quality of RCA Radiotrons. If you have any problems in connection with vacuum tubes, bring them to RCA Radiotron engineers. They will be glad to help you.

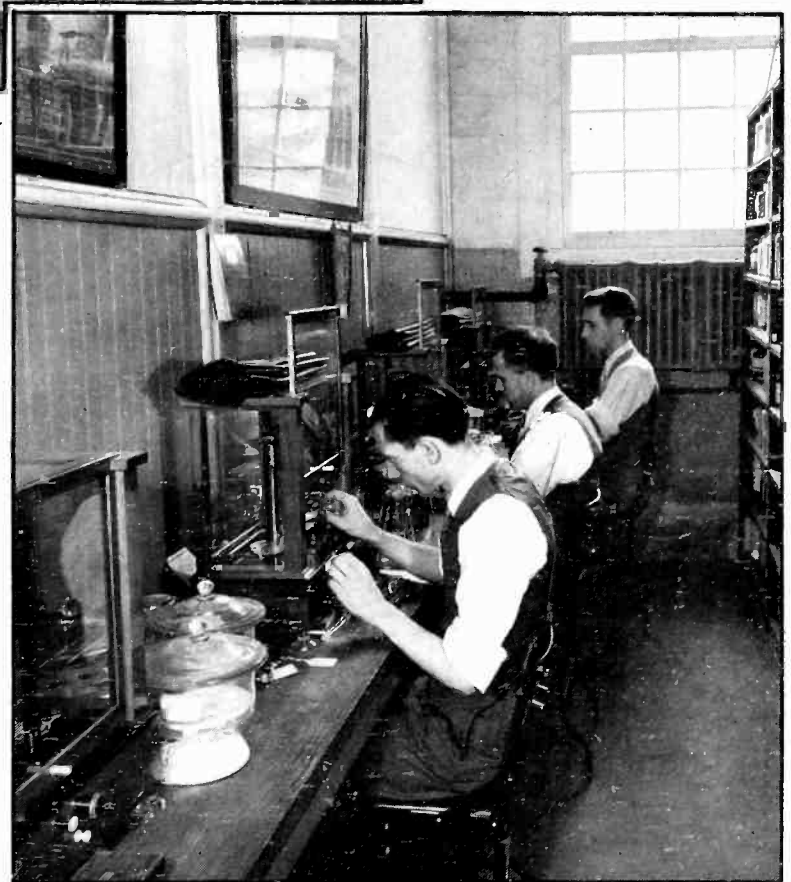

The analytical balance room.

COMPANY » » INC.

NEW JERSEY » » »

WITH ELECTRONICS'

CAMERA



This thermo-couple, used with vacuum-tube amplifiers, will measure one-millionth degree, F. At Mt. Wilson, California, it detects heat rays of stars invisible to naked eye

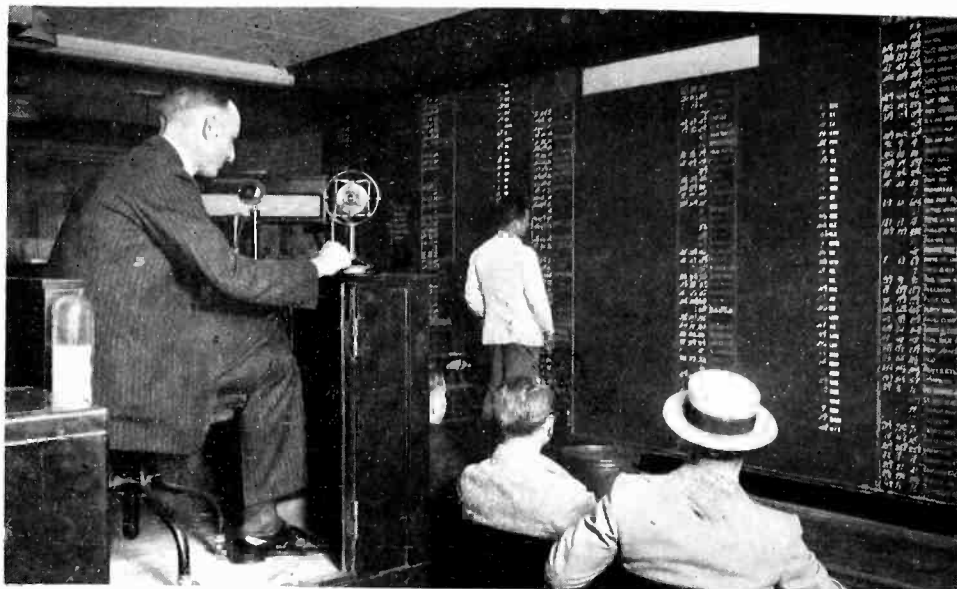

Chicago stock brokers are using microphones in their customers' rooms, connecting to loudspeakers throughout their offices, so that every employee can be kept posted on stock movements

Ultra-violet light illuminates this Pittsburgh indoor golf course, assuring health and tan on darkest winter days

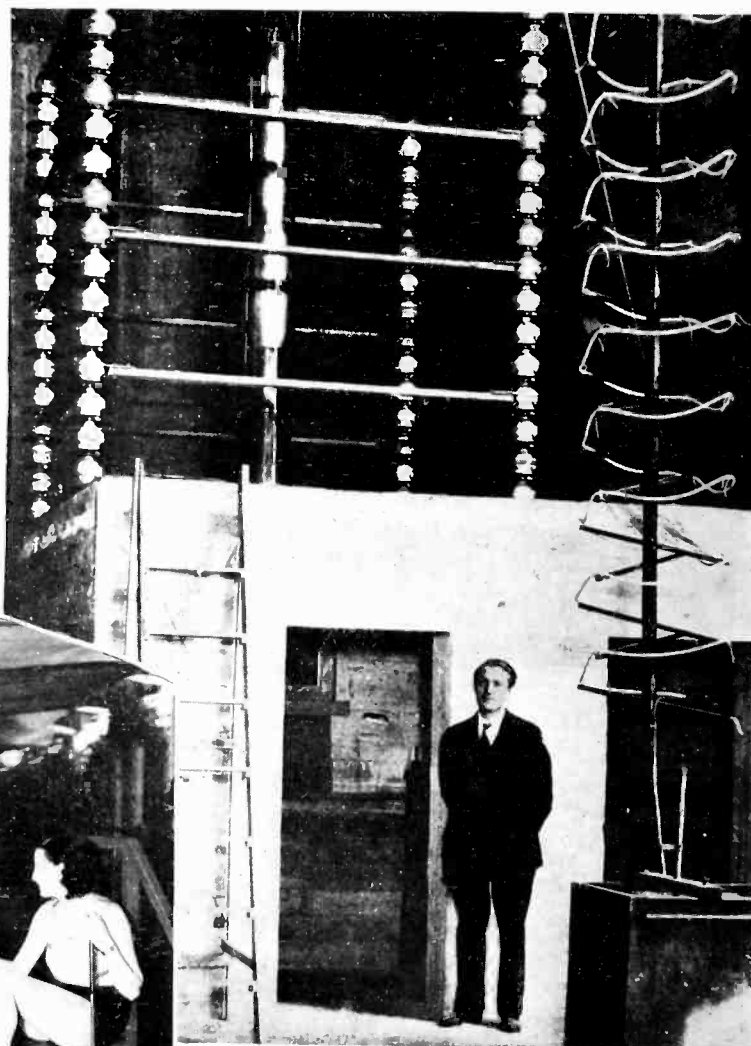
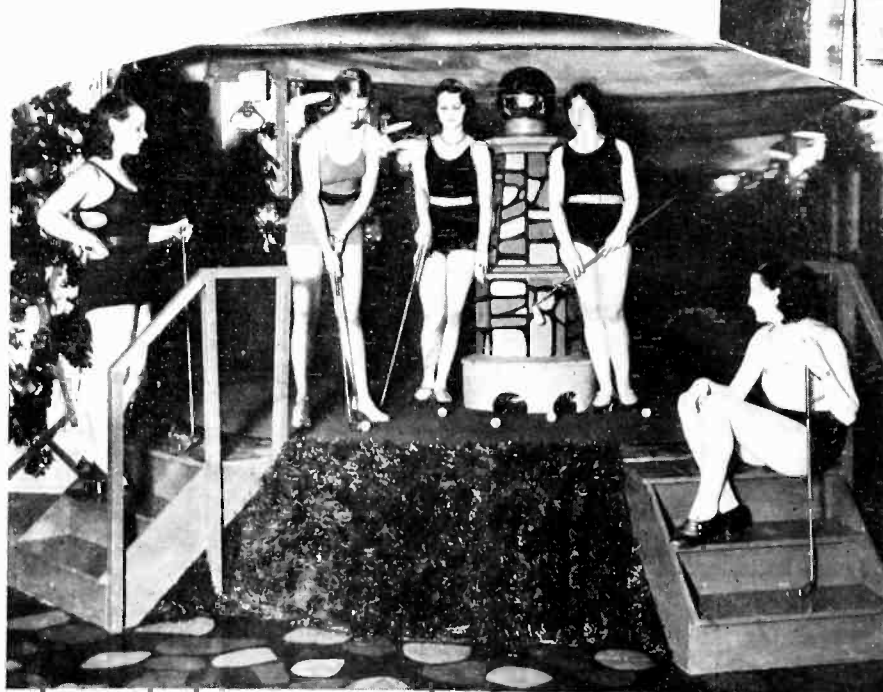

Here is the 600,000-volt X-ray outfit produced under direction of Dr. Robert A. Millikan, California Institute of Technology. For therapeutic use, its rays equal those from radium

NEWS

OF THE ELECTRON INDUSTRIES



Total radio sets placed at 13,478,600

Every other family in the United States has a radio receiving set, according to a pre-census estimate of Marshall T. Jones, Chief of the Electrical Division of the Department of Commerce. The total sets in use on July 1 is placed at 13,478,600, whereas the families in this country number approximately 28,500,000.

New York, doubtless because of its leadership in population, boasts the most sets, while California and Illinois come second and third. Pennsylvania is fourth. These four States, with 29 per cent of the population, possess 39 per cent of the radios.

There were only 11,500,000 sets in this country in January and but 9,500,000 in July, 1929.

An increase was also reported in the exports. The total for the first eight months of this year was \$11,904,171 for all radio apparatus, an increase of \$15,050 over that of the same period in 1929. Canada continued to lead as the market for American radio products.

The estimated number of sets by States was given as follows:

Ala.	87,700	Neb.	203,000
Aris.	46,600	Nev.	23,000
Ark.	90,500	N. H.	47,000
Cal.	1,470,000	N. J.	453,000
Col.	172,000	N. Mex.	28,000
Conn.	219,000	N. Y.	1,752,000
Del.	29,000	N. C.	92,000
D. C.	105,000	N. D.	61,000
Fla.	124,000	Ohio.	845,000
Ga.	111,000	Okla.	182,000
Idaho.	42,000	Ore.	219,000
Ill.	1,060,000	Pa.	977,000
Ind.	348,000	R. I.	111,000
Iowa.	310,000	S. C.	44,000
Kan.	195,000	S. D.	77,000
Ky.	92,000	Tenn.	104,000
La.	121,000	Texas.	364,000
Maine.	80,000	Utah.	72,000
Md.	115,000	Vt.	45,000
Mass.	656,000	Va.	114,000
Mich.	627,000	Wash.	351,000
Minn.	239,000	W. Va.	86,000
Miss.	48,000	Wis.	322,000
Mo.	433,000	Wyo.	32,000
Mont.	54,000		

Webster Electric Company reports increased foreign demand. Proof that electrical reproduction and amplification of sound is fast gaining favor in foreign countries, is shown by a greatly heightened demand for necessary equipment. This company, manufacturers of electric pick-ups and power amplifiers, is now shipping its products to over forty foreign markets. The volume of export sales of Webster pick-ups, for the first eight months of 1930, shows an increase of 130 per cent over the corresponding period in 1929. The sale of Webster power amplifiers, comparing similar months, has increased almost 350 per cent.

The Acme Electric and Manufacturing Company, 1444 Hamilton Ave., Cleveland, Ohio, has just issued an interesting bulletin (No. 121) which describes Acme step-down transformers for the export field where the voltage supply ranges from 200 to 240 volts.

Robert C. Sprague, President of the Sprague Specialties Company, electrical condenser manufacturer, Quincy, Mass., has announced the expansion of its group insurance program and the extension of its benefits to the workers in the North Adams, Mass., branch. To the \$130,000 of both life insurance and accidental death and dismemberment protection now in force, health and non-occupational accident insurance now rounds out the plan. The entire contract remains under the administration of the Metropolitan Life Insurance Company, and features the cooperative method of paying premiums, by which employer and employees jointly share the cost.

B. H. Noden, secretary Pacent Electric Company, New York City, sailed October 14 on the S. S. *Bremen* for Europe, where he will conduct important business for Pacent in the radio and talking picture fields. It was announced coincident with Mr. Noden's departure that both the Pacent Electric Company and the Pacent Reproducer Corporation have plans under way for the manufacture abroad of their radio, radio-phonograph and sound-reproducing products for the European market.

Howard W. Sams, general sales manager of Silver-Marshall, Inc., announces the appointment of Howard C. Briggs as assistant general sales manager. Mr. Briggs is a well known man in the radio industry in the middle west, having been five years with E. T. Cunningham, Inc., a year as district manager of Michigan for Grigsby-Grunow, and a year with the radio division of the Kellogg Switchboard & Supply Company before joining the sales organization of Silver-Marshall.

The Radio Corporation of America and others filed suits for patent infringement on October 17, 1930, in Brooklyn, New York, against DuoVac Radio Tube Corporation, because of the sale of DuoVac radio tubes, types 224, 227 and others, similar to RCA tubes, types 224, 227 and others. The plaintiffs claim that the unlicensed DuoVac tubes infringe their patents.

Goat Radio Tube Parts, Inc., 33 35th St., Bush Terminal Bldg., Brooklyn, N. Y., has published a comprehensive loose-leaf catalog, made up in the form of a handbook, with the idea of promoting standardization of tube parts. It is all in tabular form, classified under the types of tube, printed in large type, illustrated with many half-tones, and including specifications of various materials entering into tube parts. Engineers, purchasing agents and others connected with the manufacture of radio tubes will find this handbook of much assistance in ordering equipment.

Westinghouse Electric & Mfg. Company has issued in a new leaflet a description of the construction and uses for universal motors. Copies of this leaflet, No. L-20503, may be obtained from any district office or directly from the Advertising Department at East Pittsburgh, Pa.

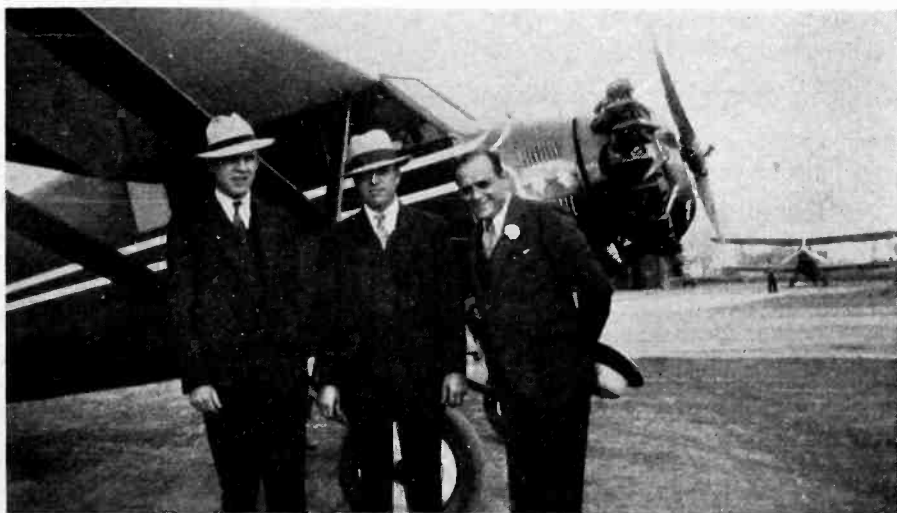

Henry S. Tenny, president of the Rola Company, Cleveland, Ohio, uses his own airplane to inspect company's plants in Cleveland and in Oakland, Calif. B. A. Engholm, vice-president, and Leon Golder, sales manager, are shown with Mr. Tenny

Coming meetings

- Institute of Radio Engineers—Philadelphia Section, Nov. 18.
- Institute of Radio Engineers—Fall meeting, Nov. 21, Rochester, N. Y.
- The American Physical Society—Chicago, Ill., Nov. 28-29.
- American Chemical Society—Richmond, Va., Dec. 12.
- Acoustical Society of America—Los Angeles, Calif., Dec. 12-13. Joint meeting with American Physical Society.

Control amplifier for broadcast use

FOR REMOTE CONTROL of broadcast station amplifier work, the Gates Radio & Supply Company, Quincy, Ill., has announced its Model 102C amplifier. The amplifier uses a three-stage combination capacity and transformer coupled circuit, a pair of UX 171A tubes being used in the final audio stage in a push-pull circuit giving a possible undistorted

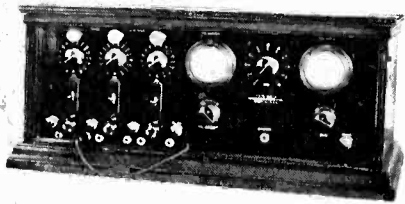

output of 1.4 watts with a gain of 80 db. overall. A microphone mixer is incorporated which has the ability to mix three carbon or condenser microphones. Each microphone circuit is controlled by a cam type anti-capacity switch. Signal lights designate which circuits are in operation. The mixer is featured with noiseless mixing and current controls and is designed for unrepulsive operation. A volume indicator is part of the equipment with separate indicator and monitor tubes employed. The output impedance is either 600 ohms for the input to a telephone line or 3800 ohms for the input of the final high stage amplifier where this equipment is used as a station amplifier. Price, F.O.B. Quincy, \$325.—*Electronics, November, 1930.*

Simplified unit for remote tuning

REMOTE TUNING from any number of desired points is simplified by a new unit manufactured by the Pacent Electric Company, 91 Seventh Ave., New York City. The unit through which the set is remotely operated is smaller than a half-pound candy box, and, according to the inventor, it can be made even more compact in final manufactured form for radio manufacturers' use. On top of the single unit—combining remote tuning, automatic station selection when desired, remote control and on-off control, and calibrated station scale—are three small push buttons. By manipulation of one or more of them, the entire receiving range of the receiver is placed at the operator's command. The exact point of best reception of each station is before the eye on the graduated scale, above the tuning buttons. While the characteristic selectivity of a particular set is maintained, it is in no way made critical by the application of this system. Any one or number of programs may also be automatically tuned, as desired, with unwanted stations remaining silent during

the tuning process. On the front of the unit is built a combined volume and power supply control, which provides remote control of the volume level along with on-off control of current to be set. A red light indicates whether or not the receiver is operative.—*Electronics, November, 1930.*

Rectifier type instruments

USEFUL IN THE measurement of alternating currents of such small magnitude that they cannot be measured readily by means of the ordinary types of a.c. instruments, dry rectifier type meters are now available from the Weston Electrical Instrument Corporation, Newark, N. J. This type of instrument is applicable also where accuracy is not of so much importance as ruggedness and ability to withstand heavy overloads without damage. It consists of a sensitive d.c. permanent

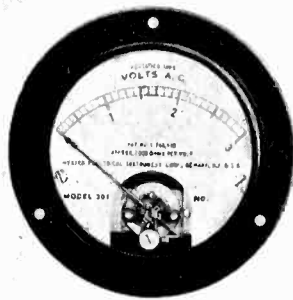

magnet movable coil instrument, similar to that illustrated, used in connection with a rectifier made of four sets of copper oxide disks arranged in the four arms of a Wheatstone bridge circuit. Instruments embodying such rectifiers are subject to errors from several sources, among which are temperature, frequency, wave form, and the fact that the resistance of the rectifier varies with the amount of current passing through the disks. The instrument is discussed together with its sources of error and their corrections, in a bulletin issued by the Weston Company.—*Electronics, November, 1930.*

Dry electrolytic condensers

DRY, SELF-HEALING under overvoltage, and with a power factor better than the ordinary, an electrolytic condenser has been announced by the Concourse Electric Company, 294 East 137th St., New York City. This dry condenser, made in several types, is housed in either round or rectangular containers, and may be mounted in any position. It is designed for peak voltages of 500, or higher. Capacities range from 1 mfd. to 200 mfd. Samples and prices may be obtained from the company, who is also prepared to build its condensers to specifications.—*Electronics, November, 1930.*

Power supply units for precision amplifiers

ONE OF THE LATEST developments of the American Transformer Company, 178 Emmet Street, Newark, N. J., is the type P-77 power supply, a device capable of supplying filtered d.c. plate voltages to precision amplifiers where the slightest a.c. hum cannot be tolerated in the output. This unit operates directly from standard 110- or 220-volt a.c. circuits and supplies potentials of the order of 375 volts at 200 milliamperes as well as intermediate voltages. It has been designed especially for use with equipment using 205D-type tubes, but similar rectifiers with different output ratings are also available. The type P-77 power supply units employ two 66-type mercury-vapor tubes in a full-wave rectifier circuit, and the equipment is so designed that, should one tube fail while in operation, the other tube will provide full output as a half-wave rectifier until the operator has an opportunity to make a replacement. This fact insures continuous operation without the necessity of a duplicate rectifier circuit. The units are mounted on aluminum panels of standard 19-in. width and may be installed on conventional mounting racks.—*Electronics, November, 1930.*

High-voltage filter condensers

A LINE of high-voltage filter condensers is announced by the Dubilier Condenser Corporation, 342 Madison Ave., New York City. These condensers are conservatively designed with a high safety factor, thus eliminating possibility of breakdown at rated voltages. They are available in a medium-voltage range, with 600, 1,000 and 2,000 volt units of wax-filled and oil-impregnated construction, and in a high-voltage range, of 3,500, 5,000, 6,000 and 10,000 volt units. The high-voltage condensers

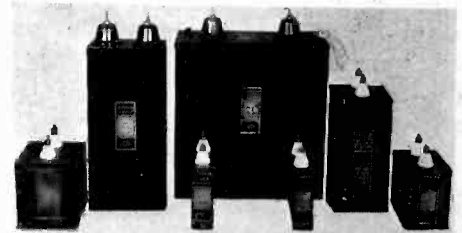

also employ paper dielectrics, but are oil impregnated and oil filled, and are enclosed in a steel container. The internal construction is radically different from anything now employed in the way of paper condensers. These units are also of the single-section type, conservatively rated, and provided with a protective device.—*Electronics, November, 1930.*

PATENTS

IN THE FIELD OF ELECTRONICS

A list of patents (up to Oct. 28) granted by the United States Patent Office, chosen by the editors of *Electronics* for their interest to workers in the fields of the radio, visio, audio and industrial applications of the vacuum tube

Generation, Rectification, Control

Automatic control. One of the two frequency converters is connected between two a.c. circuits and the other is connected to one of the circuits so that the relative positions of the rotors of the first converter automatically reverse the excitation of the second converter. H. A. McCrea, assigned to G. E. Co. No. 1,777,175.

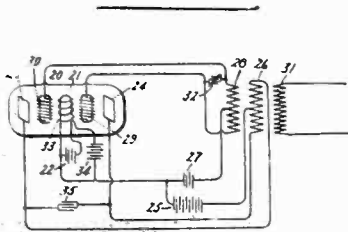

A.c. generation. Two patents, Nos. 1,778,456 and 7, covering oscillating tubes, one with two grids and two plates, the other a triode. Irving Langmuir, assigned to G. E. Co. Filed Oct., 1913.

Rectifier circuit. In a full-wave rectifier circuit, a solenoid is energized when the rectifier is delivering power, which shorts out a resistance in series with the a.c. input. L. J. Buttolph, assigned to G. E. Vapor Lamp Co. Filed Dec., 1926. No. 1,778,416.

Dry rectifier. A selenium layer between two electrodes, one a ferrous metal and the other of the tin group. Ernst Presser, assigned to Süddeutsche Telefonapparate, Kabel- und Drahtwerke Aktiengesellschaft, Nuremberg, Germany. No. 1,778,645.

Voltage regulator. In parallel with the exciting winding of a generator is a discharge tube with filament current controlled by the generator load. N. A. J. Voorhoeve and J. C. de Haas, assigned to N. V. Philips' Gloeilampenfabrieken, Eindhoven, Netherlands. Filed Dec., 1927. No. 1,778,614.

Voltage regulator. Full-wave rectifier provides a unidirectional magnetomotive force in each of two coils for regulation of a.c. supply. A. A. Oswald and E. J. Sterba, assigned to W. E. Co. Filed Sept., 1924. No. 1,778,725.

Control of electrical variations. An amplifier with a resistance in the input circuit maintained at such a low temperature as to be independent of local temperature changes. O. E. Buckley and J. B. Johnson, assigned to Bell Telephone Labs. No. 1,778,751.

Carrier signalling. A high-frequency current superimposed on a power distribution circuit with means for controlling the frequency. E. R. Evans, assigned to Westinghouse E. & M. Filed Nov., 1926. No. 1,778,827.

Harmonic generation. An arc converter tuned to a fundamental frequency with a coupled circuit tuned to a harmonic. H. O. Storm, assigned to Federal Telegraph Co. No. 1,779,198.

Oscillation generator. System employing conductive films exhibiting the Hall effect for generating electrical oscillations. P. H. Craig, Cincinnati, Ohio. No. 1,778,796.

Automatic volume control. Two patents, Nos. 1,776,821 and 1,776,822, utilizing a combination of neon tubes which break down in succession as the input voltage to the amplifier varies, thus controlling the gain of the amplifier. M. E. Strieby, assigned to A. T. & T.

Sound Recording and Reproducing

Binaural sound recording and reproducing. Two differently-colored sound tracks are superimposed on a film, and separated by photo-cells sensitive to light of different wave lengths. See also patents Nos. 1,769,907 and 8, illustrated in *Electronics*, August, 1930. Lee de Forest, assigned to de Forest Phonofilm Corp. No. 1,777,037.

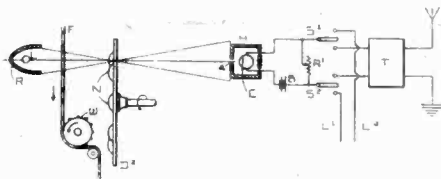

Motion picture transmission. Each elemental area of a moving film is magnified by the scanning disc. C. F. Jenkins, assigned to Jenkins Laboratories, Washington, D. C. No. 1,777,409.

Combined motion picture and sound camera. E. I. Sponable, assigned to Fox Case Corp. No. 1,777,682.

Sound recording. Apparatus for synchronizing simultaneous photography and recording of scene and sound. E. H. Foley, Astoria, L. I., 99 per cent assigned to Sound Films Corp., Tacoma, Wash. No. 1,776,969.

Sound reproduction. Two sets of film-controlled switches start and stop the turntable. H. W. Rogers, New York, N. Y. No. 1,777,418.

Sound picture photography. A plurality of cameras at different focal distances from the scene are driven in synchronism. Lee de Forest, assigned to General Talking Pictures Corp. Filed Nov., 1924. No. 1,777,828.

Song film synchronization. A method of determining the number of frames to carry song words in a song film so that the words will synchronize with the music of the song. W. J. Conkie, assigned to Alexander Industries, Inc., Englewood, Colo. No. 1,778,104.

Electro-static pick-up. W. D. Crozier, assigned to United Reproducers Patents Corp., St. Charles, Ill. No. 1,777,397.

Phonograph drive. A method for progressively reducing the speed of a phonograph turntable as the record is played. L. L. C. Jaffard, Paris, France. No. 1,777,973.

Acoustic device. Coln Kyle, San Jose, Calif., assigned to United Reproducers Patents Corp., St. Charles, Ill. No. 1,777,170.

Heterodyning horn. Conduit to which are attached two diaphragm assemblies whereby a superimposed vibratory effect is produced upon the air column within the conduit, not only by the two diaphragms, but also by the reaction of the sound waves against the conduit wall. Butler Ames, Lowell, Mass. No. 1,778,206.

Loud speaker. A conical sounding board is secured to a rigid conductor in the form of a loop. F. Cutting and I. G. Maloff, part assigned to United Reproducers Corp. No. 1,779,114.

Radio Circuits and Apparatus

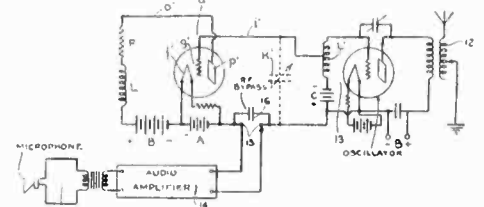

Demodulation. Demodulation system involving changes in condenser capacity. L. L. Jones, Oradell, N. J. No. 1,777,410.

Amplifying system. A series of vacuum tube push-pull stages, resistance-coupled, for distortionless amplification. Harry Nyquist, assigned to A. T. & T. Filed Nov., 1926. No. 1,778,085.

Amplifying system. Two-stage amplification system fed from a.c. mains. F. C. Barton, assigned to G. E. Co. Filed Nov. 1925. No. 1,778,058.

Receiving circuit. Detector and amplifier circuit using unipotential cathode tubes. Volume controlled by varying plate voltage. H. D. Currier, assigned to Kellogg Switchboard and Supply Co., Chicago. Filed Jan., 1926. No. 1,778,311.

Radio receiver. Tube filaments are connected in series, the d.c. voltage source being also used for plate supply. T. A. Willard, assigned to R.C.A. Filed Aug., 1922. No. 1,777,538.

Demodulation. System for demodulating radio signals by electrostatic means. G. W. Hale, London, England. Filed Oct., 1924. No. 1,777,433.

Wave antenna. A receiving circuit is connected to one end of the antenna, with an amplifier at the distant end. D. K. Martin, assigned to A. T. & T. Filed Nov., 1925. No. 1,777,374.

Demodulator. Heterodyne detector for telephone carrier circuits. E. Bruce, assigned to Bell Telephone Labs. Filed Dec., 1926. No. 1,778,750.

Negative impedance circuits. Three patents, all assigned to Bell Telephone Labs., No. 1,779,126 by F. H. Graham; No. 1,779,380 by H. W. Dudley; and No. 1,779,382 by R. C. Mathes; covering negative impedance circuits in telephone networks.

PATENTS—

Amplifying system. Two triodes, two batteries, and a variable resistance form the elements of a bridge circuit. Andre Rio and Lucien Levy, Paris, France. No. 1,779,292.

Modulation. Circuit for the modulation of static frequency changer current utilizing saturated core. M. Osnos, assigned to Gesellschaft für Drahtlose Telegraphie, m.b.H., Berlin, Germany. Filed Dec., 1925. No. 1,778,724.

Remote control. Remote tuning control for radio receivers. R. A. Heising, assigned to W. E. Co. Filed March, 1924. No. 1,778,761.

Radio relaying system. A method of transforming a singly modulated carrier wave into a doubly modulated carrier wave of a lower frequency. E. E. Clement, assigned to E. F. Colladay, Washington, D. C. Filed Aug., 1925. No. 1,777,690.

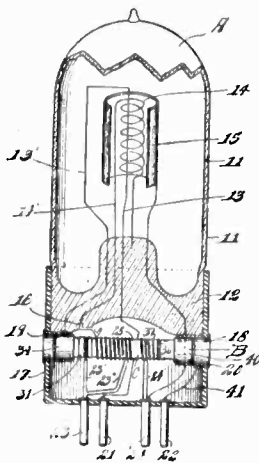

Vacuum tube. A three-element vacuum tube with means within the base for obtaining regeneration. E. G. Murphy, Chicago, Ill. No. 1,777,011.

Amplifying system. Automatic tuning, in which the frequency range is divided into portions and the circuit constants of the amplifying stages adjusted for automatic tuning in the different portions. L. L. Jones, Oradell, N. J. No. 1,779,881.

Amplifying system. An additional stage of amplification may be switched into the circuit between the initial stage and the output stage. H. I. Danziger, New York, N. Y., and L. L. Jones, Oradell, N. J. Filed August, 1924. No. 1,779,931.

Television and Facsimile

Television receiver. Synchronization of the receiving disc by means of a stationary electromagnet and armatures revolving on the disc. R. D. Kell, assigned to G. E. Co. No. 1,778,674.

Facsimile transmission. The wave is phase-modulated in accordance with the tone values of the image scanned. R. K. Potter, assigned to A. T. & T. Co. No. 1,777,016.

Television receiver. A magnifying mirror reflects the picture from a slightly inclined scanning disc. C. D. Fahrney, Cambridge, Mass. No. 1,777,556.

Colored facsimile system. A method for reproducing transmitted pictures in color. F. G. Morehouse, assigned to R.C.A. No. 1,779,261.

Television system. Three patents covering the method and apparatus for high speed television utilizing a wire screen, the wires forming electrodes which cause glow discharges at predetermined points on the screen. A. M. Nicolson, New York, N. Y., assigned to Communication Patents, Inc. Filed Sept., 1927. Nos. 1,779,747 to 1,779,749.

Scanning disc. A. O. Tate, Toronto, Ontario, Canada. No. 1,779,518.

Electron Tubes, Manufacture, Etc.

Photo-electric cell. The light-sensitive cathode has a high ohmic resistance, so that a moving light beam varies the voltage drop in the circuit. R. K. Potter, assigned to A. T. & T. Co. Filed Sept., 1926. No. 1,777,378.

Vapor lamp. Supplying a vapor lamp containing two anodes and two cathodes with d.c. voltage by means of a pair of diode rectifiers. L. J. Buttolph, assigned to G. E. Vapor Lamp Co. Filed Jan., 1927. No. 1,778,417.

Oxide cathode. An electron-emitting filament, comprising a metal wire helically wound on a core of refractory metal. J. Bruijnes, J. Vander Hoeven, and E. Oosterhuis, assigned to N. V. Philips' Gloeilampen-Fabrieken, Eindhoven, Netherlands. Filed Feb., 1927. No. 1,777,253.

Tube evacuation. A device for protecting the exhausting socket of vacuum tubes containing mercury. Erich Schott, Jena, Germany, assigned to Jenaer Glaswerk Schott & Gen., Jena, Germany. No. 1,777,861.

Gaseous fluid switch. Reception of radiant energy causes gas to expand and force a liquid conductor within the sealed tube to make or break contacts. I. E. McCabe, Chicago, Ill. Filed Apr., 1926. No. 1,777,887.

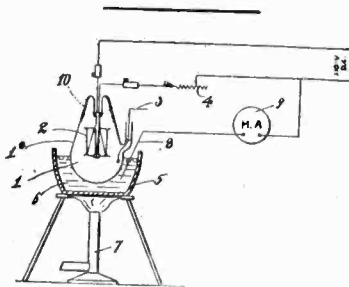

Photo-cell manufacture. The glass bulb is immersed in a molten alkali salt, and an electrical field set up between the salt and the bulb filament, whereby the alkali metal migrates through the glass, to serve as a cathode. R. C. Burt, assigned to California Institute of Technology. No. 1,776,993.

Vacuum tube. A triode in which the filament is held under tension. H. J. Nolte and W. I. Relyea, assigned to G. E. Co. Filed March, 1927. No. 1,780,033.

Thermionic tube. Several control grids, a space charge grid, and a cylindrical anode arranged concentrically. Siegmund Loewe, Berlin, Germany, assigned to R.C.A. Filed July, 1926. No. 1,779,550.

Direct-reading photometer. A portable instrument consisting of a light sensitive cell and a meter, mounted integrally. Samuel Wein, assigned to Radiovision Corp., New York. No. 1,779,574.

Miscellaneous Applications

Radiation meters. Patents covering two methods of measuring invisible radiations by transforming them into visible radiations and comparing with a standard light. T. E. Foulke, assigned to G. E. Vapor Lamp Co. Filed Sept., 1926. Nos. 1,777,999 and 1,778,000.

Telegraph repeater. The input to a triode is made through an impedance high relative to the cathode-grid impedance of the tube, so as to attenuate all portions of the waves between an amplitude capable of saturating the tube and a predetermined lesser amplitude. E. T. Burton, assigned to Bell Telephone Labs. No. 1,778,377.

Noise suppression device. Acoustical wave filter for selectively suppressing the interfering speech currents in a telephone line. W. P. Mason, assigned to Bell Telephone Labs. No. 1,778,035.

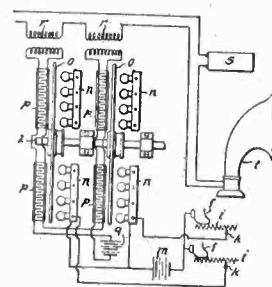

Electric musical instrument. Sliding contacts controlled by keys vary the intensity of glow lamps, and photo-electric cells transmit the variations to a sound reproducer. Emerich Spielmann, Vienna, Austria. No. 1,778,374.

Transmission-level control. Method for maintaining constant the transmission equivalent of a line using a variable-frequency carrier. C. H. Fetter, assigned to A. T. & T. Filed Sept., 1926. No. 1,777,355.

Vacuum measurement. Gas pressures in the evacuation of incandescent lamps are measured by a bridge circuit containing resistance tubes, one a standard, the other connected to lamps to be evacuated. J. S. Peoples, Oak Park, Ill., assigned to W. E. Co. Filed Oct., 1925. No. 1,778,508.

Electrical measuring instrument. D.c. wattmeter with slotted squirrel-cage armature. P. H. Craig, Cincinnati, Ohio. No. 1,778,795.

Measurement of hearing acuteness. Apparatus containing a mechanical vibrator and a vacuum-tube circuit which may be switched to give either a rectifying or an amplifying action, for measurements of the acuteness of hearing. Helmut Sell, assigned to Siemens & Halske, Aktiengesellschaft, Siemensstadt, Germany. No. 1,778,985.

Photometric apparatus. A reflector mounted to rotate about a light source directs the light into a photo-electric cell during its complete movement. G. A. Long, Jr., assigned to G. E. Co. Filed Aug., 1926. No. 1,779,324.

Liquid temperature regulator. The resistance of an element immersed in a liquid varies with the temperature of the liquid, causing a galvanometer in a bridged circuit to deflect. Rays of light are reflected from the galvanometer mirror, striking one of two photo-cells and varying the heat supplied to the liquid. H. Essex, O. Gelormini, and Teresa Masterson, Syracuse, N. Y. No. 1,776,901.

TUBES and CONTROL

Silicon vs. Vacuum Tube

It is a far cry from the silicon and loose coupler days of twenty years ago to the modern eight or nine tube receiver.

"Hats off" to the scientists, engineers and technicians who have brought radio to its present state of perfection.

... in our humble way we are proud of our part in this pageant of progress.

In millions of radio receivers (and now in hundreds of theatre projection rooms) CENTRALAB volume controls are doing splendid service ... bringing in clear, sputterless, smooth reception.

Have you a resistance problem?
Our engineering staff is at your service.
Send 25c. for Volume Control Guide showing circuits for old and new sets.

New T Type Volume Controls are ready. Write for special Bulletin portraying curves and graphs of performance of these controls in sound projection.

Centralab

CENTRAL
RADIO
LABORATORIES

16 KEEFE AVENUE, MILWAUKEE, WISCONSIN

A simplified harmonic analyzer

[Continued from page 375]

ampere reading is obtained on the output meter corresponding to about 3.2 millivolts on the first amplifier grid. It should be noted that the potential which is now being applied to the tuned circuit is derived from R_5 , which is but 1 ohm. Thus the tuned circuit receives but 1 per cent of the voltage across the filter input.

Harmonics may now be investigated. The tuned circuit is first set to 800 cycles. In this process contact B is opened automatically and contact A closed, thereby supplying the full drop (minus filter losses) across 100 ohms instead of that across 1 ohm only. If then we have the same reading of 100 microamperes it is evident that the harmonic (800 cycles) has 1 per cent the amplitude of the fundamental. If the meter reads more than 100 microamperes the calibrated slider R_7R_8 is turned down until the standard 100 microampere reading is

Unequal passage of different frequencies through the system is compensated with R_{11} . This adjustment is permanently calibrated by means of an audio oscillator and is thereafter adjusted as a routine part of the process of tuning to 400 cycles, 800 cycles, etc.

Coupling between the filter and the tuned circuit was avoided by very careful shielding and placement of parts. Further shielding was added to prevent feedback from the voltmeter tube to the amplifier input. If this is not done the higher harmonics will regenerate and produce exaggerated readings.

An obvious precaution is to check the purity of the wave form of the source before it has passed through the radio receiver or amplifier which is being investigated. In such cases as that of Fig. 1A the procedure is obvious. In the case of Fig. 1B the test signal must first be demodulated by a linear detector.

The sort of work that can be done with such a harmonic analyzer may be seen from the accompanying illustrations. Many problems relating to the production

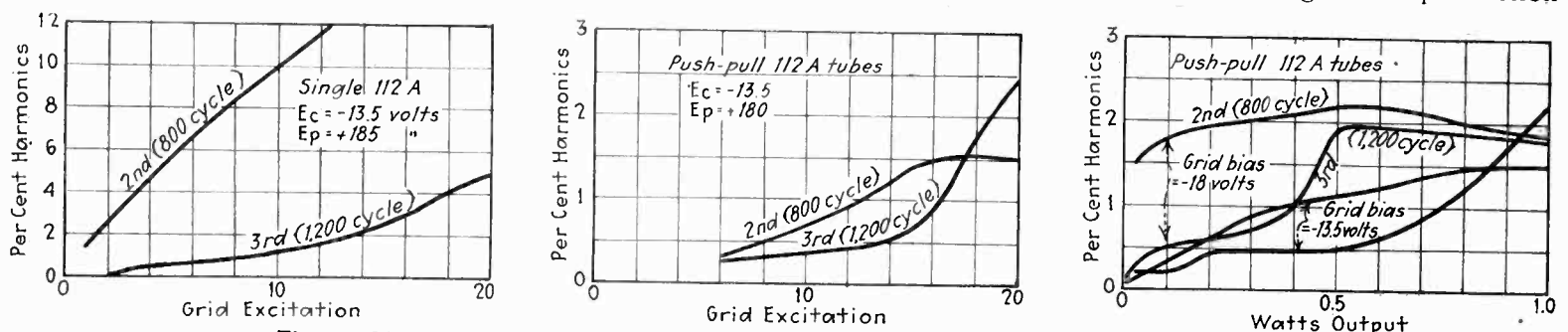

Fig. 4—Typical distortion analysis curves as made with the simplified harmonic analyzer

obtained. If the slider must be turned down half-way there is 2 per cent of the harmonic, and so on. The slider may therefore be calibrated and made direct reading. The scale, however, is an inconvenient one because the percentages above 5 become very crowded. For this reason a switch provides an additional position which permits one to make a fresh start at 5 per cent of the fundamental, thus multiplying the readings by five.

of distortion in audio or modulated radio systems may be solved by having handy a fairly simple mechanism for determining the harmonics in the output of the device or system suspected of distortion.

The range of the device as described is from 400 cycles to 2,800 cycles with any fundamental input from 160 millivolts to 50 volts. Harmonics in the range of 1.0 per cent to 50 per cent may be measured.

Sound "tricks" in picture production

[Continued from page 373]

The action takes place in the passenger car, which does not run under its own power but is drawn by a camera truck provided with a sufficiently powerful motor to handle the additional load. In the rear of the passenger car there are three girls and in the front seat two male comedians, one of whom pretends to be driving. The camera truck in the front carries two cameras shooting straight back to the passenger car where the action takes place. Besides the camera men, this truck carries the director and a script girl sitting underneath the cameras and out of the field in a position where they can hear the lines. The camera truck also tows, by means of the outrigger arrangement shown in the figure, a camera dolly, which is in this case merely a platform on airplane wheels, carrying two cameras which photograph the action in the passenger car from the side. This camera dolly in turn tows a microphone dolly carrying a boom which is manipulated by a sound man riding on the dolly. The microphone is kept above the upper border of the camera field.

This grotesque procession moves around a large outdoor set representing a Parisian square. French taxi-

cabs, U. S. Army trucks and other vehicles (the time is 1918) move with it, supplying appropriate traffic noises, against a background of French restaurants, statues, public buildings, and walls plastered with war posters. With the caravan, behind the cameras, there moves a collection of assistant directors, sound supervisors, and "grips." The "grips" have the job of handling the various cables running to the camera motors and microphone so that they will not get into the picture nor into the way of the moving cars.

The task of the sound man in charge of the microphone boom, it may be imagined, is not easy. As the various cars move around the circle his unit swings through a curve which cannot be accurately forefold, but it is his business to keep the microphone at each instant over the head of the character that happens to be talking, and not to allow any erratic variations in the sound pick-up. At times it is necessary for the grips walking beside the microphone dolly to prevent it from tipping over as the sound man attempts to keep his microphone where it ought to be. Usually a shot like this must be gone through six or eight times in order to secure two good takes. It is well worth while if, after all the processing and cutting and editing, something mechanical, synthetic and artificial is transmuted into the vital elements of comedy or drama.

AVOID CONTACT TROUBLE

by using our Precision Wire Wound Resistors

OUR exclusive moulding process gives a long length of contact actually moulded into the end assembly. This prevents any corrosive action of the wire and forms a protective seal. It also eliminates the weakness of spot soldering or welding operation, poor contacts and wire breakage.

Among the other features are our special ceramic form, our special wire, our exclusive winding process and our double testing.

Made by the Makers of
DURHAM

Metallized
RESISTORS

INTERNATIONAL RESISTANCE CO.
2006 CHESTNUT ST. PHILADELPHIA, PA.



VACUUM TUBES FOR INDUSTRY, SCIENCE, AND ART

The
G-E THYRATRON-

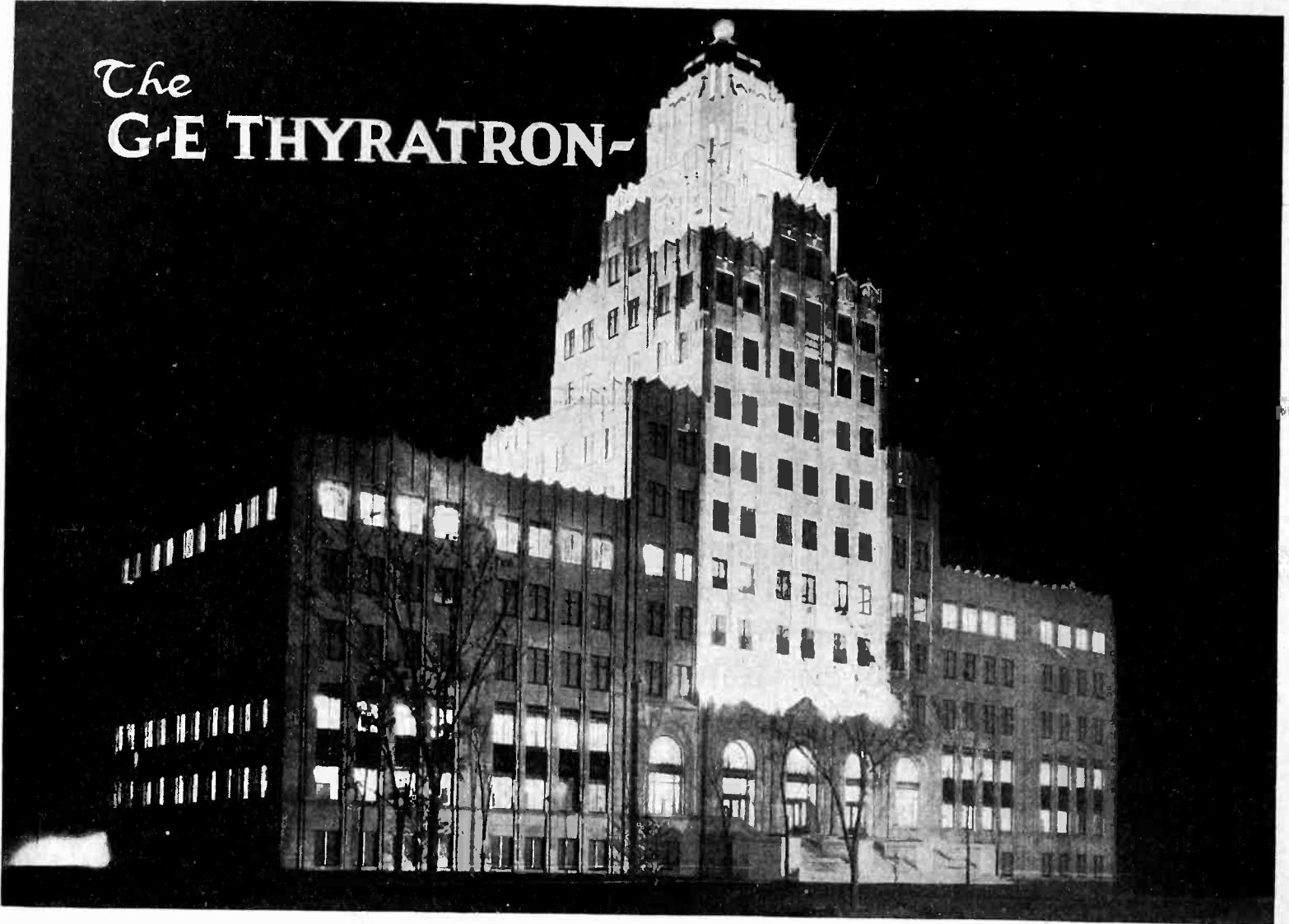

A. E. Staley Administration Building, Decatur, Ill. Four-color floodlighting controlled by G-E Thyatron mobile-lighting control equipment

A BRUSH THAT PAINTS WITH LIGHT

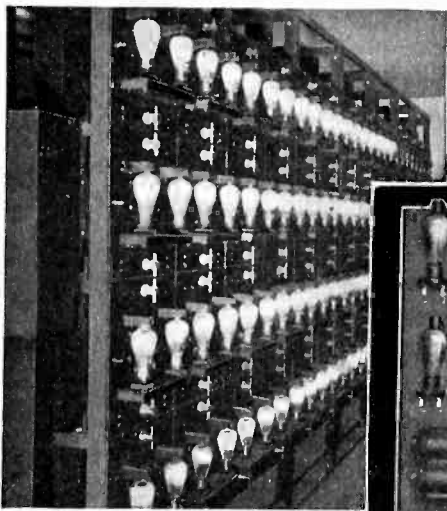

G-E Thyatron-tube control equipment for stage and auditorium lighting, Chicago Civic Opera, Chicago, Illinois

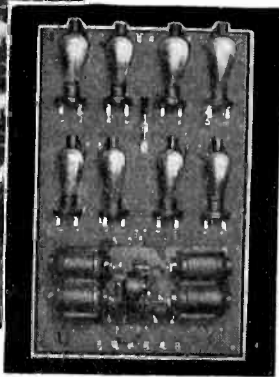

(Right) G-E Thyatron floodlighting and show-window lighting control unit, CR7502-A1

To the architect, to the master of show-window effects, and to the creator of modern stage settings, G-E engineers have brought a new instrument—Thyatron-tube control of mobile color lighting.

With this new control system, exact coördination of color cycles is easily maintained. There are no arcing contacts, hence decreased maintenance, and freedom from disturbing noises. Reactors minimize power losses. Absence of mechanically interlocking parts permits greater flexibility. Richer and more impressive color effects are obtained.

General Electric invites the inquiries of architects and others interested in this modern producer of lighting effects—G-E Thyatron control.

JOIN US IN THE GENERAL ELECTRIC PROGRAM, BROADCAST EVERY SATURDAY EVENING ON A NATION-WIDE N.B.C. NETWORK

GENERAL  **ELECTRIC** 301-65

SALES AND ENGINEERING SERVICE IN PRINCIPAL CITIES

It Packs The Punch

Capacity
8 MFD
Peak Voltage
430 DC
Can Negative



RADIO SET designers, builders and service men are invited to get in touch with our engineering department, and hear more about successful tested circuits embodying Sprague Condensers in their design.

HERE'S a heavy-weight wallop in fly-weight form—the new Sprague electrolytic condenser. Packing 8 MFD capacity and a rating of 430 volts DC into a space of only $1\frac{3}{8}$ " diameter x $4\frac{1}{8}$ " high overall.

And what advanced construction you'll find inside the can! A one-piece rolled edged anode of pure aluminum, without welded joint or soldering. Absolute prevention of liquid leakage thru practically a one-piece rubber top with integral vent. Unequalled flexibility in mounting, due to standardized size and form. And individual screw socket mounting that makes attachment or adjustment almost instantaneous.

The Sprague Condenser is engineered and constructed for maximum efficiency in practical use. Let us send you illustrated folder showing in detail how the Sprague excels all other types.

SPRAGUE SPECIALTIES COMPANY
North Adams, Mass.

SPRAGUE Electrolytic CONDENSER

GILBY

FILAMENT WIRE
PLAIN NICKEL MESH

NICKEL RIBBON PLAIN
AND CARBONIZED



PRODUCTS

GILBY SEAMLESS MESH
SUPPORT WIRE

GRID WIRE
SEAMLESS TUBING

A COOPERATIVE SERVICE—ON TUBE ELEMENTS AND RESISTANCE WIRE TO ASSIST MANUFACTURERS TO STILL GREATER ACHIEVEMENTS

That electron tube makers may produce with the rapid developments in tube production, this company proffers a cooperative service. You are invited to draw upon the technical knowledge and wide experience of the Gilby Wire staff. As specialists in the application of pure nickel to electron tube construction we can be of great help to manufacturers in the solution of tube problems.

We supply nickel of the highest commercial purity—free from cobalt if required—in wire, ribbon and sheets for plates, cathodes, support wires

and other uses. Gilby Pure Nickel Filament Wire, for example, is recognized as the Standard by many leading manufacturers—they rely implicitly on its accuracy, uniformity and long life.

We also furnish Gilby Resistance material in wire, sheet and strip of every recognized commercial alloy—bare, enamelled, cotton covered and silk covered—all of highest quality. Our handbook gives details of regular line. We can supply special alloys for unusual needs.

*Samples of Gilby products will be sent to responsible manufacturers.
We invite your inquiries.*

GILBY WIRE COMPANY

Wilbur B. Driver, President

NEWARK, NEW JERSEY

“CeCo Radio Tubes are the standards by which we make our radio tube comparisons.”

J. N. SCHOENBERG, Post Standard Stores, Philadelphia, Pa.

Increasing use of high-quality phone transmitters for specialized service created demand for rugged, long-lived, powerful modulator tubes . . . capable of withstanding heavy overloads and high voltages. The new CeCo 250 Tube with its rugged filament, high emission, negligible grid current and super vacuum is well adapted to this work.”

Ernest Bauer
President,
CeCo Manufacturing Co., Inc.
Providence, R. I.

DO YOU KNOW?

1. The CeCo Engineering Laboratory operates station WIXAC for testing and developing power tubes.
2. The CeCo Power Pentode P5 can be used as a buffer amplifier in transmitters or as an output amplifier in receivers.
3. CeCo Radio Tubes are licensed under the patents and applications of the Radio Corporation of America and affiliated companies.

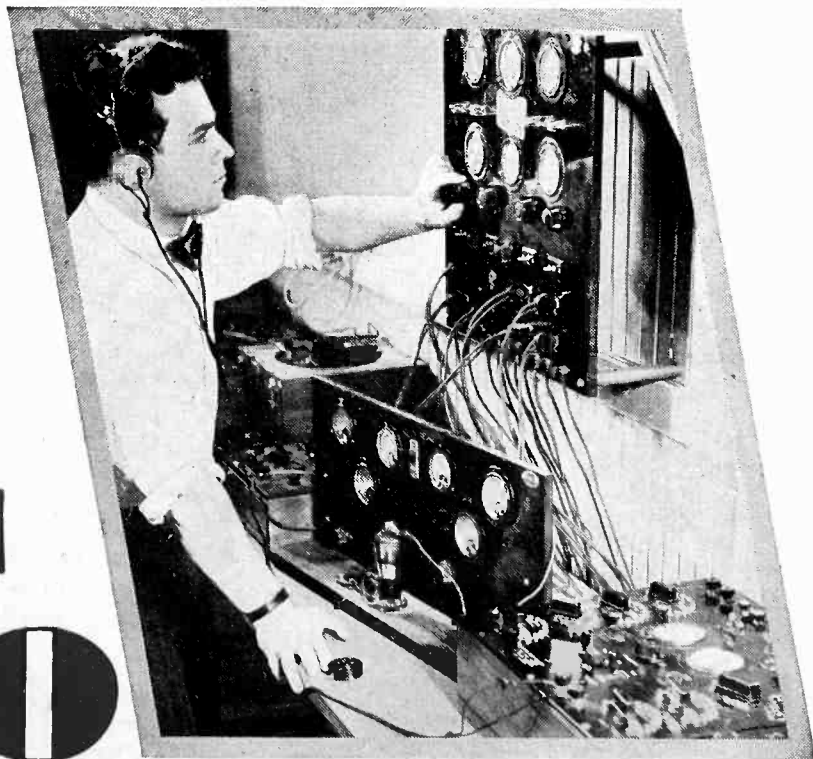

AN INSPECTOR OF INSPECTORS: Samples of CeCo Tubes taken at random from cases sealed for shipment are subjected to this extra test to check inspection standards.

CeCo

Radio Tubes

FOOTE PIERSON & COMPANY, Inc.

Confidential experimental work and the quantity production of special instruments. We would be pleased to estimate on your requirements. Cuts shown are two instruments recently manufactured by us.

Phasing Out Code Transmitter

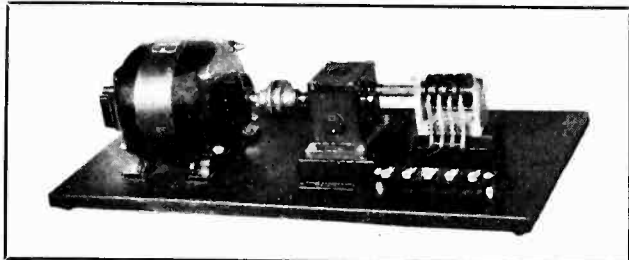

This instrument, designed by The Public Service Electric and Gas Company of Newark, N. J., is used to transmit a coded signal in continuous rotation to the 4 wires in a 3 phase distributor circuit as a means of identifying phases at any point in the cable.

A self starting and stopping 4 circuit motor driven recorder which indicates in ink the opening or closing of the circuits. Can be used for recording any electrical signal.

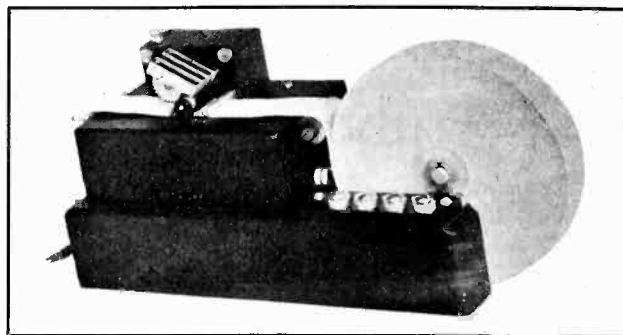

Foote Pierson Motor Driven Recorder

FOOTE PIERSON & CO., Inc.

*For 35 years manufacturers of electrical and mechanical devices
and instruments of precision*

75 Hudson Street, Newark, N. J.

The American Electro Metal Corporation

Executive and Sales Offices:
65-67 Madison Ave.
New York
N. Y.

Introduces

"ELMET" LEAD-IN WELDS



Superior
for
Radio Tubes
and
**Incandescent
Lamps**

*Factory—*LEWISTON, MAINE

Specialists in Tubes

for industrial applications



BECAUSE industrial applications require special qualifications in tubes, Westinghouse has specialized in tubes for such purposes. This specialization has resulted in photo-electric tubes, Grid-glow tubes, and amplifier tubes that have demonstrated their superiority. Continuous operating records to date of two and three years in industrial installations give evidence of their dependable operation.

COMPLETE UNIT FOR LIGHT SENSITIVE DEVICES

In most applications, photo-tubes require an amplifier.

Westinghouse amplifier units provide, in compact form, a photo-tube and the necessary stages of amplification to operate commercial devices. Standard units with assorted circuits are obtainable.

Ask our district office near you for L. 20456, entitled, Photo-Electric Cell and Amplifier.

Westinghouse Products for Electronic Applications:

Amplifier tubes	Ammeters
Grid-glow tubes	Voltmeters
Photo-electric tubes	Rectifiers
Micarta	Light relays
Fractional-hp. motors	Magnetic relays
Transformers	Condensers



Service, prompt and efficient, by a coast-to-coast chain of well-equipped shops

Westinghouse

T 31464

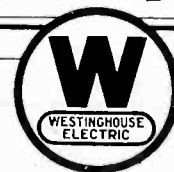

TUNE IN THE WESTINGHOUSE SALUTE OVER THE N. B. C. NATION-WIDE NETWORK EVERY TUESDAY EVENING.

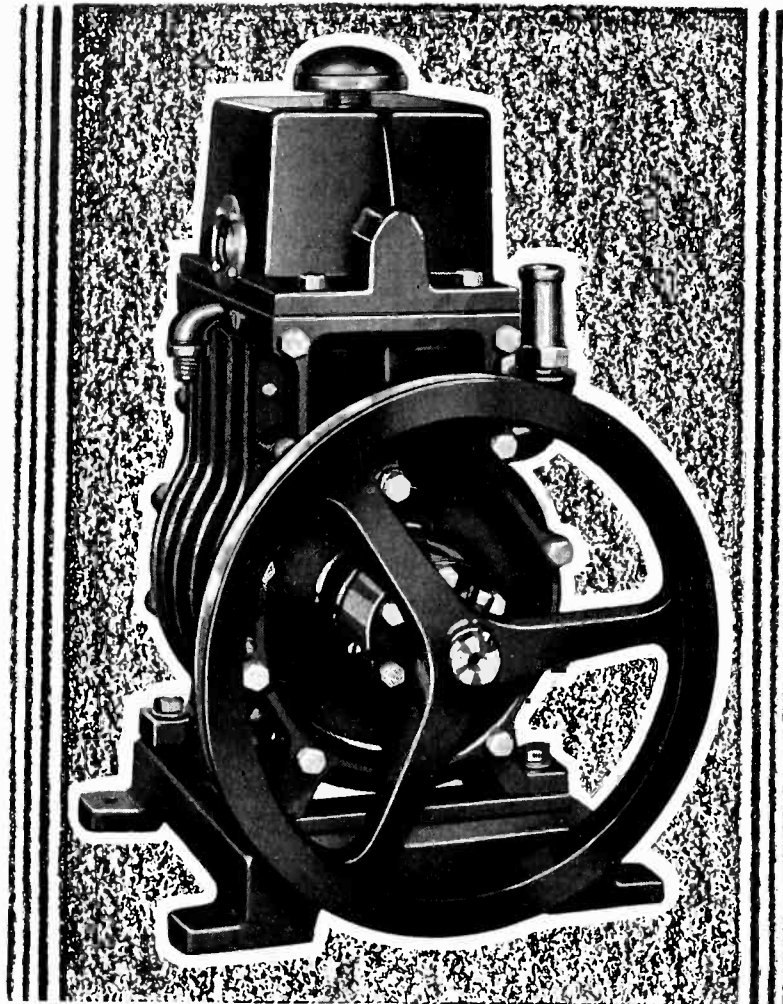

A STRAIGHT LINE TO HIGH VACUUM

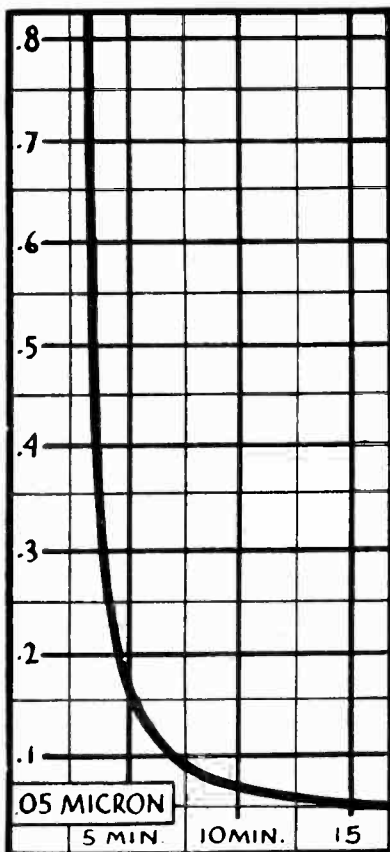

The exhaust curve of the CENCO HYPERVAC PUMP is a straight line, almost parallel along the time axis from atmospheric pressure into the tenths micron pressure region. In terms of pressure, a straight vertical path to lower pressures than before. In terms of time—a complete exhaust job from roughing to finishing in a few seconds.

Only by exhausting extremely large volumes can the time factor be actually measured in minutes to supply the curve at the left—where the finishing end of the Hypervac straight line exhaust curve cleans up a twenty-two liter volume.

Applied to usual high vacuum work in smaller volume, the Cenco Hypervac pump offers instant exhaustion to lower ultimate pressures.

Address inquiries to the Central Scientific Company, 460 East Ohio Street, Chicago, Illinois.

CENTRAL SCIENTIFIC COMPANY
CENCO HIGH VACUUM PUMPS
 Hyvac Megavac Super TRADE-MARK **CENCO** REGISTERED vac Rotovac Hypervac
 NEW YORK - BOSTON - CHICAGO - TORONTO - LOS ANGELES

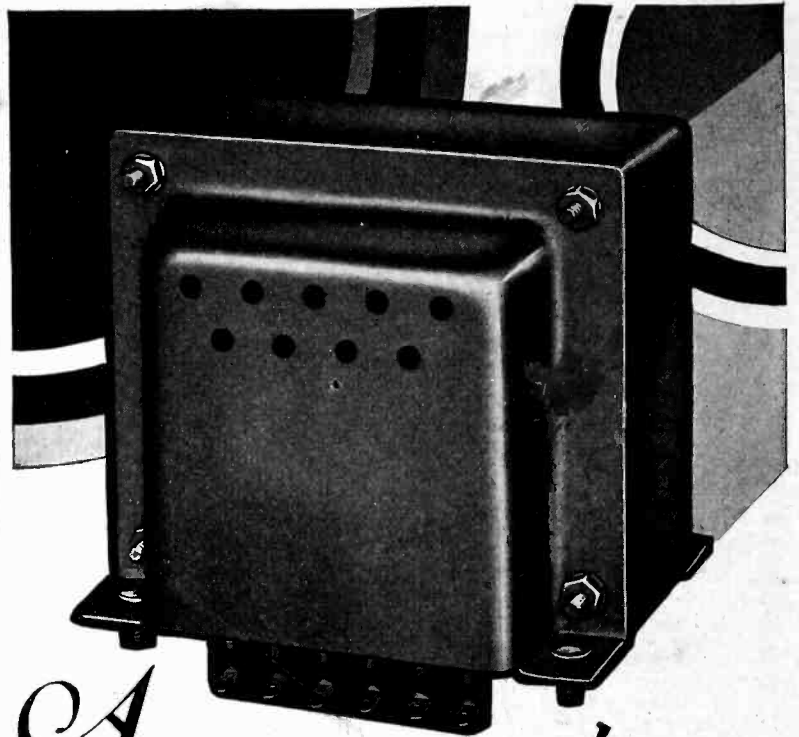

A POWER TRANSFORMER in KEEPING with KINGSTON tradition

Products of the Kingston organization have always been distinguished ones, and the high-lights of the Kingston Power Transformer place it entirely in keeping with Kingston tradition:

..... a foundation of correct construction, both mechanically and electrically

..... unusually effective terminal design, and a mounting that is practical and unique

..... no mechanical vibration winding baked in varnish usually low temperature rise sizes available to meet your individual requirements

Kingston engineers, offering competent advisory service, invite correspondence regarding your problems.

KINGSTON PRODUCTS CORPORATION

Kokomo, Indiana, U. S. A.

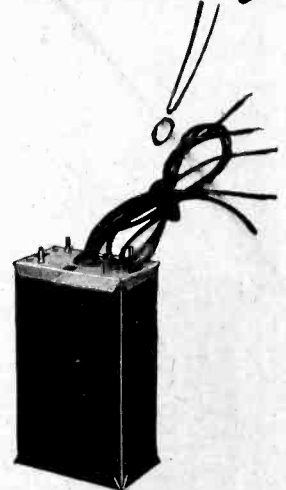

Kingston Filter Condensers



Kingston Filter Reactors

KINGSTON
 Specialists In Power Transformers,
 Filter Condensers, Filter Reactors

STOP Trouble at it's source with

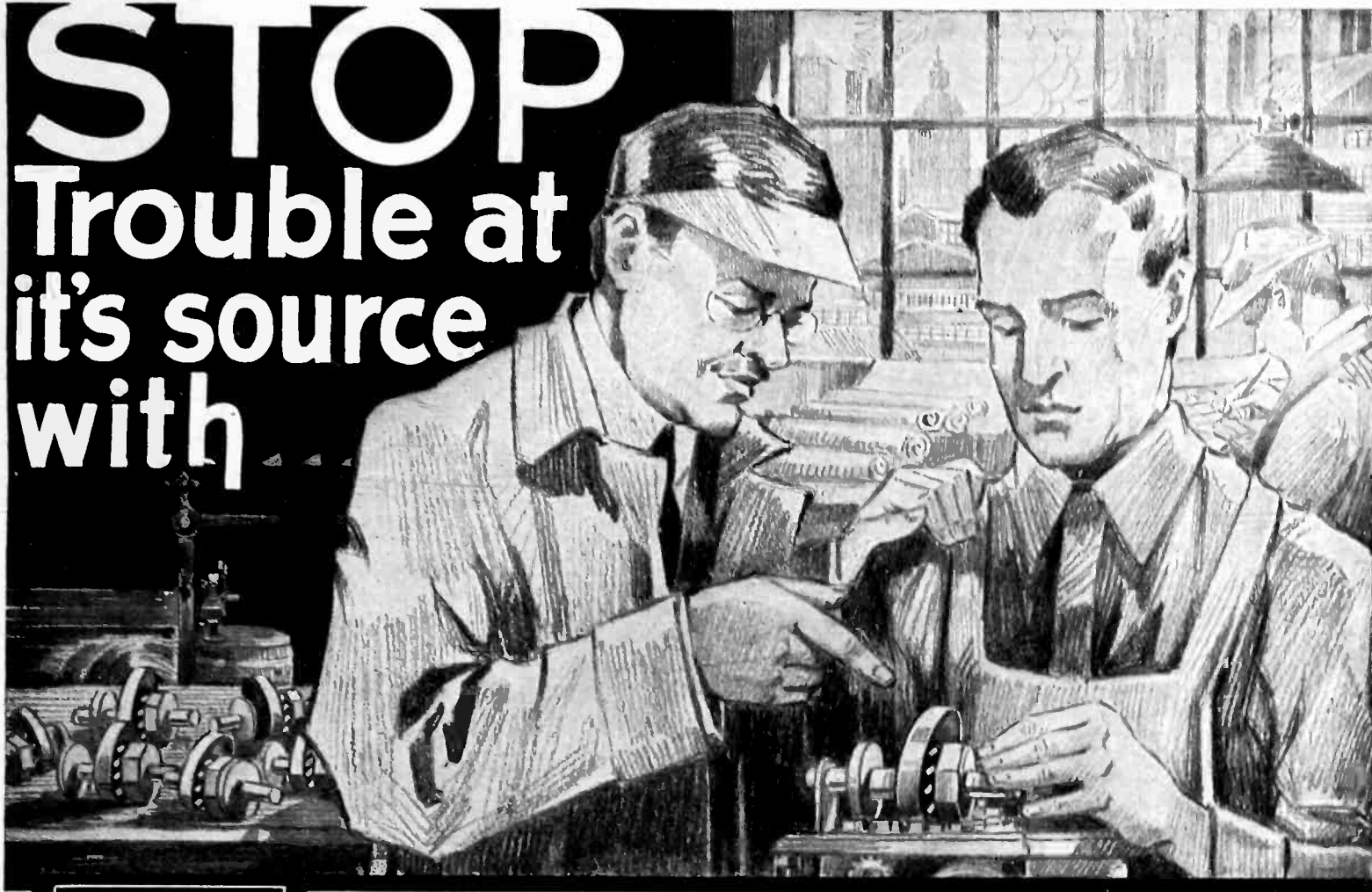

SHAKEPROOF *Lock Washers*

FAILURE to provide protection from the damaging action of vibration is costing industry hundreds of thousands of dollars. A large part of this tremendous waste can be overcome by greater care in designing and manufacturing.

Nuts and screws that are not tightly locked on soon shake loose—and then trouble starts. That's why it pays to use Shakeproof Lock Washers on your products. Their twisted steel teeth form a multiple lock that will not loosen even under the most intense vibration. Shakeproof is spread proof, too, and they cannot tangle which means faster and neater assembly work.

Test Shakeproof Lock Washers in your own shop—see for yourself how they improve performance and add to the life of any product. Liberal samples will be sent on request—write for a supply today!

SHAKEPROOF *Lock Washer Company*

{Division of Illinois Tool Works}

2539 N. Keeler Avenue, Chicago, Illinois

U. S. Patents: 1,418,564
1,604,122—1,697,954
Other patents pending.
Foreign patents.



"It's the
Twisted
Teeth
that
LOCK"

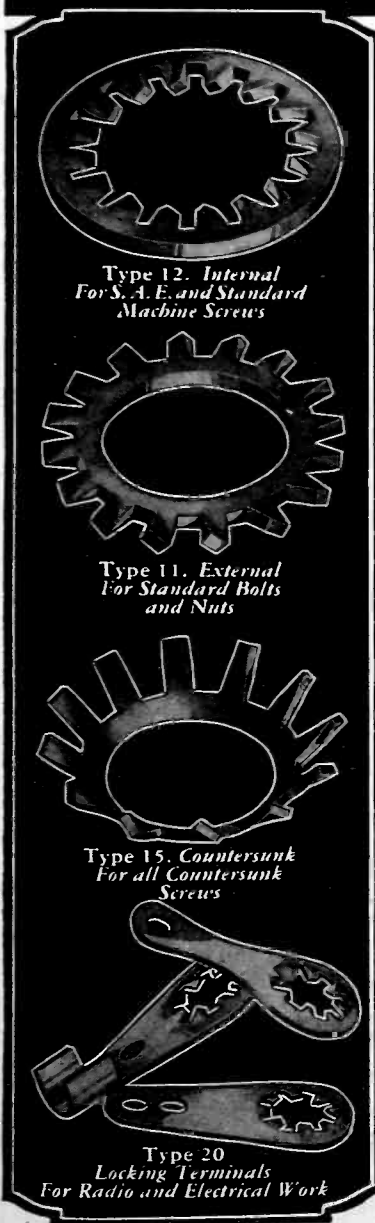

Type 12. Internal
For S. A. E. and Standard
Machine Screws

Type 11. External
For Standard Bolts
and Nuts

Type 15. Countersunk
For all Countersunk
Screws

Type 20
Locking Terminals
For Radio and Electrical Work

The American Electro Metal Corporation

Executive and Sales Offices:
65-67 Madison Ave.
New York,
N. Y.

"ELMET" MOLY WIRE



The
Best Wire
Made for
Radio Tubes
and
Incandescent
Lamps

Factory—LEWISTON, MAINE

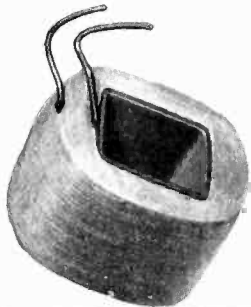

**Any size
or any
shape**

COILS



Here you can get any size or shape layer-wound coil up to No. 36 wire.

We are coil specialists and employ every modern facility, coupled with ripe experience, to insure exactness in conforming with electrical or radio specifications.

May we send more details?

Manufactured by
COILS, INC.
1183 Eddy Street
PROVIDENCE, R. I.

A New Akra Ohm Wire-Wound Resistor



Type R-M



Type R-W

Types R-M and R-W, as pictured above, are capable of dissipating 5 watts and have a tolerance of 2½% to 5%. They are available in resistances from 1 ohm to 100,000 ohms—size ½ in. x 2 in.

These types can be economically employed in production—efficiently replacing ordinary carbon resistors, at very little additional cost.

They can be used wherever radio, audio, visio, and industrial apparatus employs the electronic tube.

Our accurate method of manufacturing and careful selection of materials make these types especially suitable for set production and ideal for resistance-coupled amplification.

Send us your resistance specifications and we will submit samples and prices.



Shalleross Mfg. Company



ELECTRICAL SPECIALTIES
700 PARKER AVENUE
Collingdale, Pa.
(NEAR PHILADELPHIA)



ELECTRICAL PARTS

promptly and accurately »»

FORMICA for electrical uses is made in every variety required for insulating purposes in devices of all kinds.

Manufacturers who do their own fabricating may get the characteristics they require in Formica sheet.

Those who buy fabricated parts may have them in quantity accurately shaped very promptly, for Formica has one of the largest installations of fabricating machinery in the industry.

For seventeen years leading American technical organizations have depended on Formica as a source of supply for these materials.

Send your blue prints for quotations.

THE FORMICA INSULATION COMPANY

4638 Spring Grove Avenue

Cincinnati, Ohio



FORMICA

**Announcing the private
publication of a limited
edition of the life of**

Dr. Lee de Forest

*Engineer, Scientist, Poet, and Inventor
of the Audion Tube*

by

C. S. THOMPSON

Author short stories; Police Captain Burke: An Old Theory of Happiness, etc. Publicity Director, De Forest Radio Telephone Company, 1916-1922; De Forest Phonofilm Company, 1922-1923; Theodore Roosevelt Presidential Campaign, 1912; Eastern Headquarters, Republican National Campaign, 1924; Eastern District, National Republican Congressional Committee, 1930.

**Here is an authentic story—
a romance startling in its
frankness, almost unbeliev-
able in its confidences—a
book to be read, reread and
treasured by friends and
rivals of de Forest.**

**This limited edition for pri-
vate circulation only will in-
crease in value with the years.
As a permanent record of the
electronic art it is of histori-
cal importance—a souvenir
to be prized in the office, pro-
fessional or home library by
all lovers of fine books.**

**May we suggest—in view of
the limited edition—that you
make immediate reservation
for your copies.**

Address

THE SMEDLEY PRESS
10 EAST 43rd STREET
NEW YORK, N. Y.

LOCAL PICK-UPS

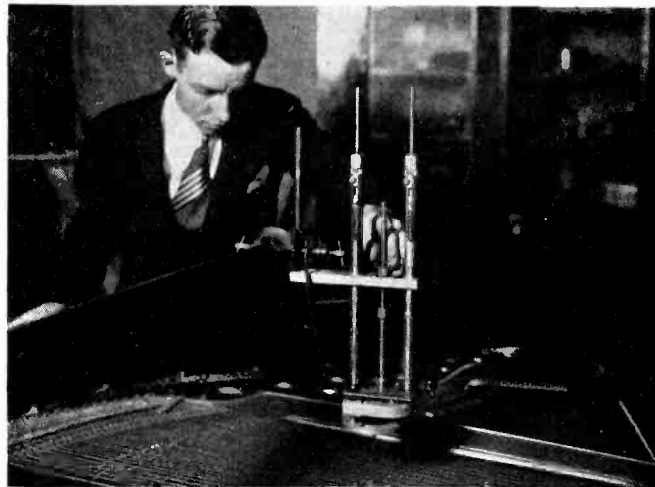

*To explore piano sounding boards we developed
this precision pick-up, sensitive only to sound from
one square inch of board. Sounds from individual
parts of any machine may be isolated similarly.*

E. E. FREE LABORATORIES

Consultation—Research—Development

175 Fifth Avenue, New York City

Clarence C. Clark, Laurence M. Cockaday, Carl Dorf, E. E. Free,
Raymond B. Hartman, Carl A. Johnson, Ronald Millar, J. L. Sheek.

Consultation invited, without obligation.

ACME WIRE PRODUCTS

Parvolt Filter and By-Pass Condensers
Coils — Magnet Wire Wound
Varnished Insulations
Magnet Wire — All Insulations

All products made to Recognized Com-
mercial Standards, including those of:

National Electric Mfrs. Assn.

Radio Manufacturers' Assn.

American Society for Testing Materials

For more than 25 years manufacturers
and suppliers to the largest and most
discriminating users.

THE ACME WIRE CO.

NEW HAVEN, CONN.

Branch Offices

New York
52 Vanderbilt Ave.

Chicago
842 N. Michigan Ave.

Cleveland
Guardian Bldg.

Some of the tough problems put up and solved to the Perryman laboratory successfully solved by Perryman engineers have included the development of (1) reproducing tubes for talking-movies (2) amplifying tubes for wired radio telephone work (3) special tubes for mobile radio (4) special pentodes for midget receiving sets (5) special tubes for coin-operated radio sets (6) AC resistance coupled amplifying tubes (7) H.V. non-arcing A.C. valves for interrupting high voltage circuits (8) special mercury vapor rectifiers for H. V. line material testing and for traffic control signals. Our technical staff and facilities are freely offered for the solution of any of your problems. All inquiries and correspondence will be held strictly confidential.

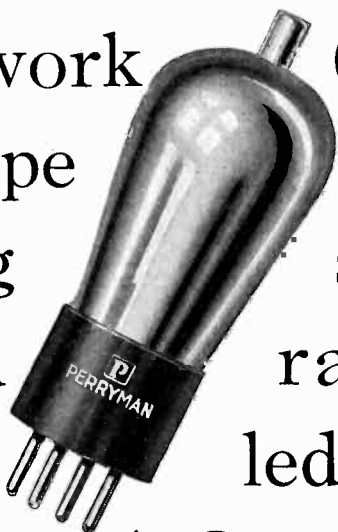

PERRYMAN ELECTRIC Co., Inc.

NORTH BERGEN, N. J.

New WESTON

MODEL 565

The Complete Test Set for Radio Servicing



THE new Weston Model 565 is the most complete instrument designed for radio service work. It makes every required test on every modern set, and checks every type A.C., D.C., Pentode and Rectifier tubes. Besides, it is made in the typical Weston fashion with the refinements in design, ruggedness in construction, precision in manufacture, and dependability in performance such as only Weston can build with its years of experience as manufacturers of the world's highest quality electrical measuring instruments.

In this one instrument, the Weston Model 565, you have a complete radio service laboratory—Set Tester, Tube Checker, Oscillator, Ohmmeter, A.C. Ammeter, D.C. Milliammeter, A.C. and D.C. Voltmeter, with more and wider ranges than ever before.

The new Weston Model 565 set and tube service unit with its compact construction and complete testing facilities is designed to save you time and money. It operates similarly to the popular Weston Model 547 Set Tester—quickly, conveniently, accurately, and with the widely-known Weston dependability.

So valuable is this new Weston Model 565 that every radio dealer and service man who builds his business prestige on quality service work cannot afford to be without it.

[Write today for illustrated folder
which gives complete information.]



WESTON ELECTRICAL INSTRUMENT CORP.
618 Frelinghuysen Avenue, Newark, N. J.

Used in broadcast
stations, sound recording
studios and sound theaters
for HUMLESS SOUND



FOREST RECTIFIER

You simply turn a switch to convert a 110 or 220 volt A.C. into a full wave, fully filtered D.C. Supersedes battery current—famous for its absence of hum, noise and moving parts—interchangeable with your present storage battery. Built in several types to meet every sound equipment need.

Get full details at once!

FOREST ELECTRIC CO.

New and Wilsey St., Newark, N. J.

SUPER-DAVOHM

Wire Wound Precision Resistors



Super-Davohms are known and used in the entire world. Instrument manufacturers have adopted the Super-Davohm as an integral part of their assembled unit. Universities, electrical, physical, instrument and radio research laboratories are using Super-Davohms as laboratory standards because of their excellent characteristics.

Recommended for: Television Amplifiers, Telephone Equipment, Sound Picture Equipment, Fire Alarm Equipment, Voltmeter Multipliers, Resistance Amplifiers, Electrical Instruments, Laboratory Standard Resistors, Attenuators and Fading Controls.



Send Us Your Resistor Specifications
Samples on Request

THE DAVEN COMPANY

RESISTOR SPECIALISTS

General Office and Factory

158-160 Summit Street, Newark, New Jersey

Magnetostriction Oscillators

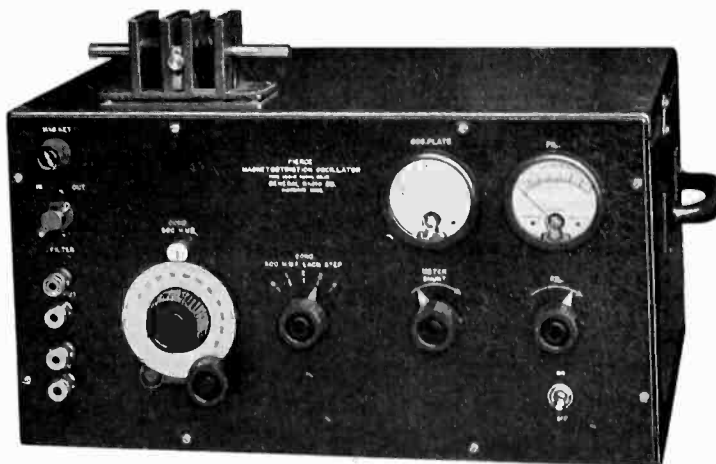

TYPE 389-B Pierce
Magnetostriction Oscil-
lator. Price \$150.00

RODS of certain nickel alloys exhibit the property of magnetostriction when placed in a longitudinal magnetic field. This enables them to stabilize the frequency of a vacuum-tube oscillator in a manner analogous to that of a piezo-electric quartz plate in a piezo-electric oscillator.

Magnetostriction oscillators make useful frequency standards in the high audio- and supersonic-frequency ranges. They are highly stable and hold their calibration over long periods of time. Variations in frequency with temperature are small.

General Radio magnetostriction rods for use in either of our two types of magnetostriction oscillators can be supplied for any frequency between 5 and 50 kilocycles per second. The accuracy of calibration for all rods is 0.01 per cent. or better.

Catalog F-E contains a complete description of our magnetostriction oscillators and magnetostriction oscillator rods. If you haven't a copy, a request on your business letterhead will bring you one.

GENERAL RADIO COMPANY

OFFICES v LABORATORIES v FACTORY
CAMBRIDGE A, MASSACHUSETTS

Pacific Coast Warehouse: 274 BRANNAN STREET, SAN FRANCISCO



Quality Built

If it's RADIO TUBE
or INCANDESCENT LAMP
MACHINERY, consult
**EISLER ELECTRIC
CORPORATION**
756 SOUTH 13TH STREET
NEWARK, N. J.

SPRUCE PINE MICA

Accurately Processed from the Particular
Type and Quality of PURE MICA to meet
your requirements, **ECONOMICALLY**

Adequate Resources.	Cut, Stamped and
Technical Processing.	Died Patterns.
Insulation Engineering.	Dies for Special Shapes.
Prompt Deliveries.	Stove Mica.
Uncut Mica in India Gradings.	

Permit us to Advise and Quote on Your Mica Needs

SPRUCE PINE MICA CO.
Spruce Pine—North Carolina



A Photoelectric Cell
designed for industrial application

The VISITRON Type "A" Photoelectric Cell, with its high sensitivity and physical sturdiness is ideal for use in industrial control devices. **HIGH SENSITIVITY** insures faithful operation, and makes possible the detection of slight changes in color or light intensity. **PHYSICAL STURDINESS** permits application under unfavorable conditions. For full details write for our descriptive bulletin, No. 119.

GM LABORATORIES INC
1810 GRACE ST. CHICAGO, ILL.

**No More
Stolen Microphones**
with the **ELLIS 'Demountable'**

The Ellis Demountable Microphone provides an easy method of removing and replacing the unit. When not in use the microphone may be removed to a place safe from theft or exposure to the elements. Write for complete details.

ELLIS ELECTRICAL LABORATORY
Sales Corporation
337 WEST MADISON ST. Chicago, Illinois

Just published —
**An up-to-date handbook
of telephone fundamentals**

Here is a book that gives a thorough introduction to modern telephony—that covers the rapid advances of recent years in this industry—that gives the picture of basic theory and elements of apparatus needed for a thorough understanding of the practical telephony of today.

**Telephone
Theory and Practice**
(Theory and Elements)

by **Kempster B. Miller**
Author of *American Telephone Practice*, 1904, and Joint Author of *Telephony*, 1912.

ALTHOUGH the first volume of a three-volume series, this book, *Theory and Elements*, represents an independent and complete treatment of the fundamentals of telephony. A thorough groundwork in the background and principles of telephony is given, which will serve—

492 pages,
6 x 9,
272 illustrations,
\$5.00

- the rank-and-file telephone worker as a preparation for an understanding of the practical phases of his job
- the more advanced telephone worker who is specializing in some particular phase of the industry and who may wish to see more clearly how his job is related to the rest of the business
- the general technical reader who is interested in the broad phases and general workings of this industry

The book is by an authority—Kempster B. Miller has had long practical telephone experience—his previous book *American Telephone Practice* has been recognized as the standard reference work on telephony.

- The treatment is divided into three parts:
1. Introductory—covering the subject from the historical standpoint.
 2. Elementary Theory—covering sound in both its physical and physiological aspects—multi-frequency alternating currents—thermionic emission and the principal uses of vacuum tubes in telephony—magnetic materials.
 3. Elements of Apparatus—covering such elemental parts as coils, make-and-break contacts, flexible cords, and condensers. The properties and functions of these parts are discussed to make plain their application in more advanced and involved stages of telephone practice.

The book is written in understandable language and mathematical applications are reduced to a minimum.

**Examine this book
for 10 days free**
Mail coupon today

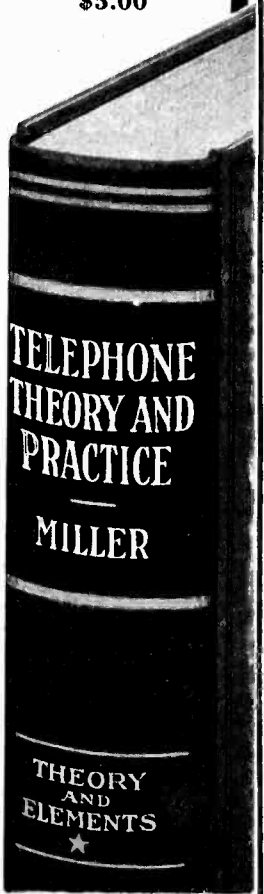

**McGraw-Hill
FREE EXAMINATION COUPON**

McGraw-Hill Book Co., Inc., 370 Seventh Avenue, New York.

Please send me for 10 days' free examination a copy of Miller—**TELEPHONE THEORY AND PRACTICE—THEORY AND ELEMENTS**, \$5.00 postpaid. I agree to remit for the book or return it postpaid within 10 days of receipt.

Name

Home Address

City and State

Name of Company

Occupation

(Books sent on approval to retail purchasers in U. S. and Canada only.)

L. 11-30

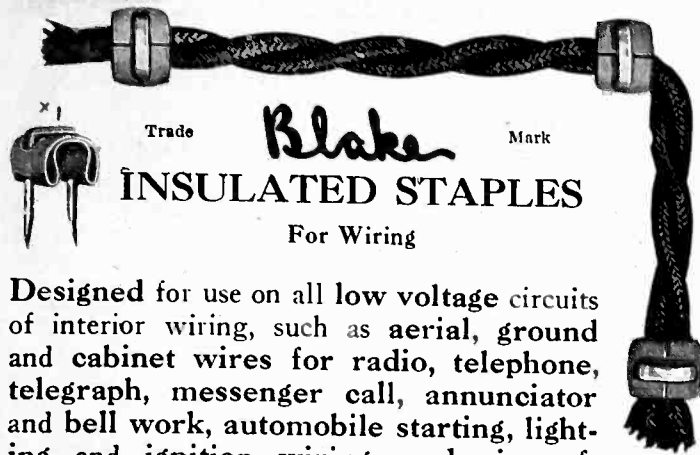

Trade **Blake** Mark
INSULATED STAPLES
 For Wiring

Designed for use on all low voltage circuits of interior wiring, such as aerial, ground and cabinet wires for radio, telephone, telegraph, messenger call, annunciator and bell work, automobile starting, lighting and ignition wiring, and air-craft wiring.

The insulation on these staples gives an added protection from leaks on grounds on the wiring. When used in damp places it also protects the braiding on the wire from rust or corrosion of the staple.

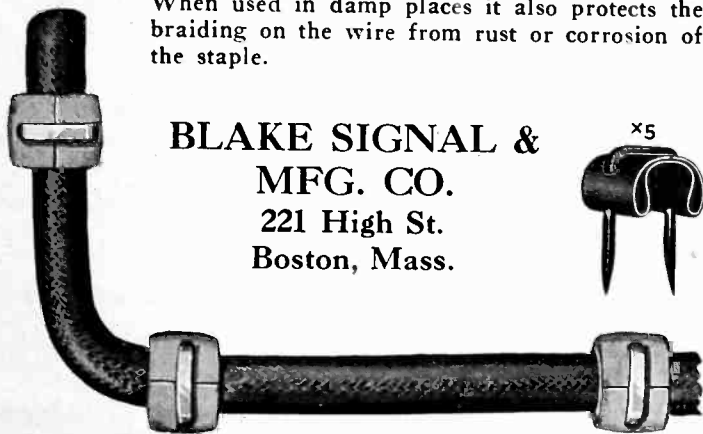

BLAKE SIGNAL & MFG. CO.
 221 High St.
 Boston, Mass.

**THE STRONGEST ADVERTISEMENT
 EVER WRITTEN FOR
 POLYMET PRODUCTS**

*The Testimony of Satisfied Customers
 as Expressed by Their Engineers*

CROSLLEY

"Powel Crosley, Jr. sets for us the task of making Crosley Radio Receivers as nearly perfect as radio engineering knows how. Polymet specialized Parts go far to help us to accomplish this."

GULBRANSEN

"The really vital things of radio are the hidden parts the average listener never thinks of. In the Gulbransen he doesn't have to. Thanks to Polymet, we can depend on these parts to operate without attention or care."

FADA

"We use Polymet Products because a specialized part is needed to complete the high quality of Fada Sets."



We use Polymet Products because they are definitely superior specialized parts.

EDISON

"Exhaustive tests in Edison Laboratories showed Polymet Condensers worthy of incorporation in fine Edison Light-O-Matic Radios."

STEWART-WARNER

"We specify Polymet Parts in Stewart-Warner Sets because we know that quality radios can be made only with quality parts!"



"That Polymet Condensers are used in all Silver Radio Receivers is the most powerful endorsement we can give."

KING

"We want King Sets to give complete satisfaction; with Polymet specialized Parts, we know that perfect service is assured."

POLYMET MANUFACTURING CORPORATION

838-A EAST 134TH STREET . . . NEW YORK CITY

**SERVING OVER 80% OF THE INDUSTRY WITH
 CONDENSERS - RESISTANCES - COILS - TRANSFORMERS**

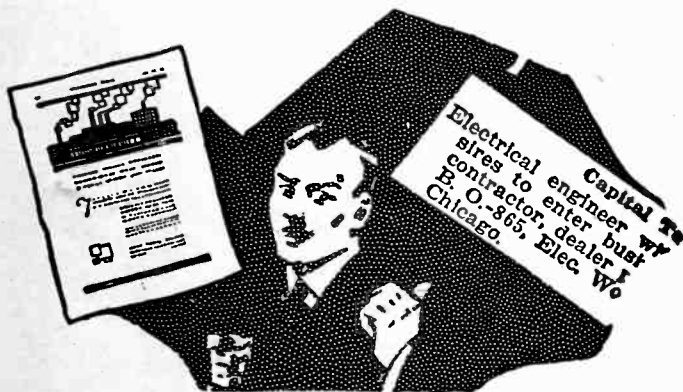

**Don't Overlook
 Opportunities**

Men who regularly keep in touch with the market through other channels often overlook the many opportunities that are to be found in the

SEARCHLIGHT SECTION

For Every Business Want
 "Think SEARCHLIGHT First"



**Ultra Sensitive
 Semi-Suspended Meters**

*Suitable for experimental work
 with Photo Electric Cells*

Currents as low as .003 Microampere can be measured. Suitable multipliers can be added to extend the range to any desired value, controlled by a well designed selector switch.

These meters can also be supplied in type 507 and type 505.

Write for information.

**RAWSON
 ELECTRICAL INSTRUMENT Co.**

Incorporated 1918
 Cambridge 39, Mass.

BRANCH
 91 Seventh Ave.,
 New York City

Mid Western Representative
 Earl N. Webber
 Daily News Bldg., Chicago

electronics, A.B.C.

« « « YOUR magazine, "electronics," will shortly be permitted to write after its name the three letters "A.B.C." While not a degree, these letters are equally important an honor—they signify that "electronics" will have passed a rigid examination and has been admitted into membership in the Audit Bureau of Circulations, Inc.

What is this A.B.C., this Audit Bureau of Circulations? To answer that natural query without using magazine publishers' shop terms, the A.B.C. is the Bureau of Standards of the publishing world—its testing laboratory. The A.B.C. is that impartial third party which examines circulation methods of magazines and newspapers and checks circulation figures so that advertisers and prospective advertisers may have regular and unbiased reports on the number of readers a magazine actually possesses.

To quote the A.B.C. itself,

“ The Objects of the Audit Bureau of Circulations shall be to issue Standardized Statements of Circulation; to verify the figures shown in these statements. . . . Each report issued shall embrace verified figures and facts bearing on the quantity, quality, distribution of circulation and circulation methods; thereby enabling quality as well as quantity to be established. *Facts*, without opinion, to be reported. ”

TODAY "electronics" has a total circulation of 6,500 copies monthly and a paid circulation of over 5,800. The fact that so many men in the electronic tube industries have already recognized the value of "electronics" by sending in their subscriptions—the magazine is only eight months old—is gratifying to its publishers, the McGraw-Hill organization.

"electronics" has found a real niche—as a magazine and an advertising medium.

—a McGraw-Hill publication

Tenth Avenue at 36th Street
New York, N. Y.

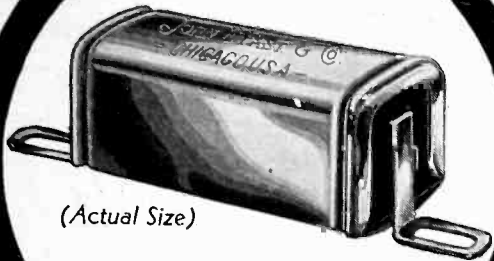

(Actual Size)

The Outstanding BY-PASS CONDENSER

Again Fast has anticipated the industry's needs . . . and offers this tiny by-pass condenser which conserves chassis space, assembling time, and first cost. Completely enclosed. Moisture proof . . . leak proof . . . trouble proof.

Quick deliveries on any quantity.
Samples and specifications on request.

FAST

Specialists in Radio Condensers
JOHN E. FAST & CO.
3123 N. Crawford Ave., Chicago, Ill.

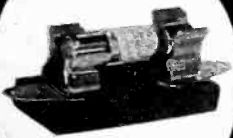

QUICKER than a Short-Circuit

LITTELFUSE

NEW! 1000, 5000 and 10,000 Volts. 1/16, 1/8, 1/4, 3/8, 1/2, 1 amp. Renewable, to protect power tube, rectifiers, amplifiers, etc. Low-Voltage line: 10 mill, 1/32, 1/16, 1/8, 1/4, 3/8, 1/2, 1 and 2 amps. For galvanometers, milliammeters, instruments, etc.

Send today for our new catalog.

Littelfuse Laboratories, 1772 Wilson Ave., Chicago

STANDARD MICA SHAPES

Accurately cut to size and micrometered to thickness, special and intricate shapes available.

Tar Heel Mica is used by many prominent concerns—its excellent quality making it especially suitable for even the most exacting requirements.

The Tar Heel Mica Co.
Miners and Manufacturers
Plumtree, North Carolina

VITROHM (WL) RESISTORS

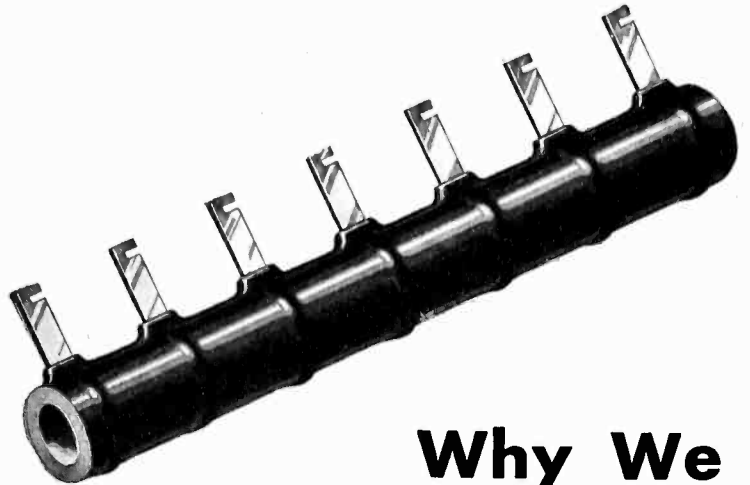

Why We ENAMEL Resistors

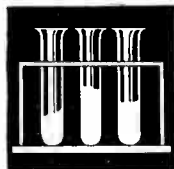

Ward Leonard has always developed and made its own vitreous enamel

WE do not enamel our resistors to imitate another's product and thus provide sales talk.

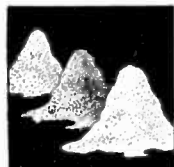

Practically every application demands a different enamel

Vitreous enamels are used by us for the protection of wire and terminal connections against chemical action, mechanical injury and for the rapid conduction of heat from the wire.

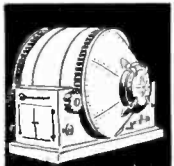

Enamels are mixed in ball mills for many hours

One enamel won't cover all requirements. We use 150 formulae, developed and made by us exclusively to provide for all needs. Specify VITROHM (WL) RESISTORS—It's been safety insurance for 39 years.



This, together with large batches, makes uniformity certain

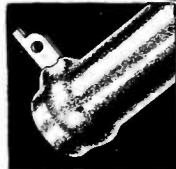

The enamel bonds with wire, terminals and refractory

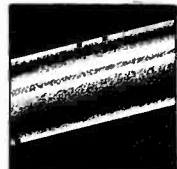

The final, tough, hard, tenacious coating is perfect protection.

**WARD LEONARD
ELECTRIC CO.**
Mount Vernon, New York
resistor specialists for more than 39 years

M.&W.C.^o
1876

LACQUERS
ENAMELS

NEW
Prismlac Lacquers

METAL FINISHES
Beautiful Decorative Transparent Colors are obtainable by mixing into Clear Prismlac No. 23 small quantities of—
TINTING PRISMLAC

WOOD FINISHES
CLEAR PRISMLAC WOOD SEALER No. 28
COLORED PRISMLAC WOOD SEALERS
Clear or opaque Sealers which provide a smooth undercoat and background for Clear Prismlac No. 23.
TOP COAT LACQUER
PRISMLAC TOP COAT LACQUER No. 27
Adds lustre and durability without disturbing the crystal pattern of CLEAR PRISMLAC No. 23.
May we suggest how your finish may be improved with Prismlac?

MAAS & WALDSTEIN
COMPANY
Executive Offices and Plants:
438 Riverside Ave., Newark, N. J.
Chicago Office and Warehouse: 1115 W. Washington Blvd.
Los Angeles Office and Warehouse: 1214 Venice Blvd.

The border of this advertisement is a photographic reproduction of M & W Prismlac.

AMPLIFIERS FOR ALL PURPOSES

Photo Cell, Microphone, Public Address, etc.

This Company specializes in the design and manufacture of Audio Frequency Amplifiers. Your problems are solicited.

NEW LOW PRICES ON STOCK MODELS

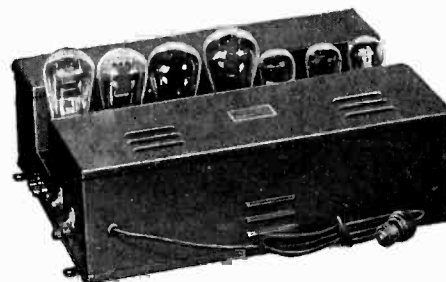

Model
GA 20

NET
PRICE
\$75.00

SPECIFICATIONS

Number of stages—3
Maximum undistorted output—10 watts
Tubes required—1—'27, 2—'26, 2—'50, 2—'81.
Input signal for maximum output—0.2 volts.
Gain at 1000 cycles—68 db.
Power consumption—160 watts.
Supply voltage 105-120 volts, 50-60 cycles A.C.

Descriptive literature will be sent on request.

GENERAL AMPLIFIER COMPANY
27 Commercial Ave. Cambridge, Mass.

In 1931 Advertising

economic facts will govern the selection of media. Facts about markets about buyers their buying and reading preferences.

A large industrial advertiser has just completed a survey of reading preferences in the radio, sound and allied fields. Complete facts are available on request.

electronics

A McGraw-Hill Publication

Tenth Avenue and 36th Street, New York

PROFESSIONAL SERVICES

AMY, ACEVES & KING, Inc.
Consulting Engineers
 Inventors of The Multicoupler Antenna System for apartment houses.
 Specializing in Radio Design—Test—Development.
 55 W. 42nd St., New York City
 Phone: Longacre 6622.

NICHOLAS HEYMAN, M. E.
Consulting Industrial Engineer
 Specializing in Light-Sensitive devices.
 Engineering—Sales—Service
 Verona, N. J. Verona 5725

ROBERT S. KRUSE, E. E.
 Consultant to Radio Manufacturers and Stations
 103 Meadowbrook Road Telephone
 West Hartford, Conn. Hartford 4-5327

ELECTRON RESEARCH LABORATORY
 Vacuum tube and photocell applications. Surveys of industrial plants made for application of electronic devices.
HOWARD E. RHODES
 Garden City, N. Y.

W. J. HITCHCOCK
 CONSULTING VACUUM TUBE ENGINEER
 APPLICATIONS :: RESEARCH MANUFACTURE
 203 Alexander Avenue, Scotia, N. Y.

H. R. VAN DEVENTER
 PATENTS
 Sound Pictures, Television, Photo Cells
 Consulting Engineer — Patent Attorney
 342 Madison Ave., New York

ELECTRICAL TESTING LABORATORIES
 TUBE TESTING
 Electrical—Mechanical—Chemical and Photometric Tests.
 Inspection at manufacturers' plants.
 80th St. and East End Ave., New York

JENKINS & ADAIR, INC.
Engineers
 Designers, developers, and manufacturers of accessories and essentials for recording, broadcasting and testing at sound frequencies.
 3333 Belmont Avenue, Chicago, U. S. A.
 Cable Address: Jenkadair Telephone: Keystone 2130

SAMUEL WEIN
Specialist in Light Sensitive Cells for 30 years.
 Consultant in Design, Manufacture and Applications. Complete Technical and Patent Library.
 1985 Davidson Ave., New York City

PATENTS
WM. G. H. FINCH
Patent Attorney
 (Registered U. S. & Canada)
 Mem. I. R. E. Mem. A. I. E. E.
 303 Fifth Ave., New York
 Bogardus 1263

YOUR card here builds prestige for you and helps to make your name familiar in the field. The cost is extremely small in proportion to its value as a business aid.

THE J. G. WHITE
ENGINEERING CORPORATION
 ENGINEERS—CONSTRUCTORS
Builders of New York Radio Central
 43 Exchange Place, New York City

SEARCHLIGHT SECTION

LEGAL NOTICE

STATEMENT OF THE OWNERSHIP, MANAGEMENT, CIRCULATION, ETC., REQUIRED BY THE ACT OF CONGRESS OF AUGUST 24, 1912

Of Electronics, published monthly at New York, N. Y., for Oct. 1, 1930.

State of New York) ss.
 County of New York

Before me, a Notary Public in and for the State and county aforesaid, personally appeared C. H. Thompson, who, having been duly sworn according to law, deposes and says that he is the Secretary of the McGraw-Hill Publishing Company, Inc., publishers of Electronics, and that the following is, to the best of his knowledge and belief, a true statement of the ownership, management (and if a daily paper, the circulation), etc., of the aforesaid publication for the date shown in the above caption, required by the Act of August 24, 1912, embodied in section 411, Postal Laws and Regulations, printed on the reverse of this form, to wit:

1. That the names and addresses of the publisher, editor, managing editor, and business managers are: Publisher, McGraw-Hill Publishing Company, Inc., 10th Ave. & 36th St., N. Y. C. Editor, O. H. Caldwell, 10th Ave. & 36th St., N. Y. C. Managing Editor, None. Business Manager, Maurice Clements, 10th Ave. & 36th St., N. Y. C.

2. That the owner is: (if owned by a corporation, its name and address must be stated and also immediately thereunder the names and addresses of stockholders owning or holding one per cent or more of total amount of stock. If not owned by a corporation the names and addresses of the individual owners must be given. If owned by a firm, company, or other unincorporated concern, its name and address, as well as those of each individual member, must be given.) McGraw-Hill Publishing Company, Inc., 10th Ave. & 36th St., N. Y. C. Stockholders of which are: James H. McGraw, 10th Ave. & 36th St., N. Y. C. James H. McGraw, Jr., 10th Ave. & 36th St., N. Y. C. James H. McGraw, James H. McGraw, Jr., and Malcolm Muir, 10th Ave. & 36th St., N. Y. C. Trustees for: Harold W. McGraw, James H. McGraw, Jr., Donald C. McGraw, Curtis W. McGraw, Curtis W. McGraw, 370 Seventh Ave., N. Y. C. Donald C. McGraw, 10th Ave. & 36th St., N. Y. C. Harold W.

LEGAL NOTICE

McGraw, 285 Madison Ave., N. Y. C. Anne Hugus Britton, 10th Ave. & 36th St., N. Y. C. Mason Britton, 10th Ave. & 36th St., N. Y. C. Edgar Kobak, 10th Ave. & 36th St., N. Y. C. Grace W. Mehren, 2440 Lakeview Ave., Chicago, Ill. J. Malcolm Muir & Guaranty Trust Co. of New York, Trustees for Lida Kelly Muir, 524 Fifth Ave., N. Y. C. F. S. Weatherby, 271 Clinton Road, Brookline, Mass. Edwin S. Wilsey, 10th Ave. & 36th St., N. Y. C. Goldman, Sachs & Co., 30 Pine St., N. Y. C.

3. That the known bondholders, mortgagees, and other security holders owning or holding 1 per cent or more of total amount of bonds, mortgages, or other securities are: (If there are none, so state.) None.

4. That the two paragraphs next above, giving the names of the owners, stockholders, and security holders, if any, contain not only the list of stockholders and security holders as they appear upon the books of the company but also, in cases where the stockholder or security holder appears upon the books of the company as trustee or in any other fiduciary relation, the name of the person or corporation for whom such trustee is acting, is given; also that the said two paragraphs contain statements embracing affiant's full knowledge and belief as to the circumstances and conditions under which stockholders and security holders who do not appear upon the books of the company as trustees, hold stock and securities in a capacity other than that of a bona fide owner; and this affiant has no reason to believe that any other person, association, or corporation has any interest direct or indirect in the said stock, bonds, or other securities than as so stated by him.

5. That the average number of copies of each issue of this publication sold or distributed, through the mails or otherwise, to paid subscribers during the six months preceding the date shown above is (This information is required from daily publications only.)

C. H. THOMPSON, Secretary.
 MCGRAW-HILL PUBLISHING COMPANY, INC.
 Sworn to and subscribed before me this 30th day of September, 1930.

[SEAL] H. E. BEIRNE.
 Notary Public N. Y. Co. Clk's No. 97, Reg. No. 1B84.
 Kings Co. Clk's No. 646, Reg. No. 10899.

(My Commission expires March 30, 1931.)

PATENTS

Time counts in applying for patents. Don't risk delay in protecting your ideas. Send sketch or model for instructions or write for FREE book, "How to Obtain a Patent," and "Record of Invention" form. No charge for information on how to proceed. Communications strictly confidential. Prompt, careful efficient service. Clarence A. O'Brien, Registered Patent Attorney, 516A Security Savings and Commercial Bank Building. (Directly across street from Patent Office), Washington, D. C.

FOR SALE

MERCURY TUBE SWITCHES

75c. Each

Electrical Engineering & Equipment Co.
 Long Island City, N. Y.

STUPAKOFF NO. 287 PURE MAGNESIA INSULATORS

have solved insulation problems for many tube manufacturers.

Accurate and thoroughly tested — Stupakoff *No. 287 Pure Magnesia Insulators are indispensable for low manufacturing costs—performance and long life of any radio tube.

Over 600 types and sizes are carried in stock—insuring prompt delivery in any quantities.

Write now for samples to make your own conclusive tests.

*Now—a new series of insulators—B-90—Similar to the famous No. 287, but 125% stronger—made possible by special processing. Especially valuable for extremely small sizes.

STUPAKOFF LABORATORIES, Inc.

6617 Hamilton Ave.
Pittsburgh (6), Pa.



electronics

M. E. HERRING
Publishing Director



M. CLEMENTS
Sales Manager

Contents for November, 1930

Copyright, 1930, by McGraw-Hill Publishing Company, Inc.

The march of the electronic arts	363
Raw materials and costs in tube manufacture	366
Electronic control of complex auditorium lighting .. 368	
BY DEAN H. HOLDEN	
Sound "tricks" in picture production	371
BY CARL DREHER	
A simplified harmonic analyzer	374
BY A. W. BARBER	
Developments in ultra-high frequency generation .. 376	
BY C. W. LOEBER	
Measuring the heart's E M F	377
The phototube in automatic weaving	378
BY ARTHUR KORN	
Sound film reproduction without mechanical slit	380
Design of the output transformer	381
BY R. C. HITCHCOCK and W. O. OSBON	
Sound-picture engineers discuss economics, progress and new problems of industry	384
Linear detection of heterodyne signals	386
BY F. E. TERMAN	
The rôle of barium in vacuum tubes	390
BY J. A. BECKER	
Sound recording under difficulties	397
With electronics' camera	400

DEPARTMENTS

High lights on electronic devices in industry	388
Editorials	392
Review of electronic literature here and abroad	394
News of the electron industries	401
New products	402
Patents	405

McGRAW-HILL PUBLISHING COMPANY

Cable Address:

JAMES H. MCGRAW, Chairman of the Board MASON BRITTON, Vice-President
MALCOLM MUIR, President EDGAR KOBAK, Vice-President
JAMES H. MCGRAW, JR., Vice-Pres. and Treas. HAROLD W. MCGRAW, Vice-President
EDWARD J. MEHREN, Vice-President H. C. PARMELEE, Editorial Director
C. H. THOMPSON, Secretary

Index to Advertisers

Acme Wire Co., The	18
Allen-Bradley Co.	1
Aluminum Co. of America	6
American Electro Metal Corp.	12-16
American Magnesia & Lava Corporation	29
American Transformer Co.	30
Arcturus Radio Tube Company	Inside Front Cover
Blake Signal & Mfg. Co.	23
CeCo Manufacturing Co., Inc.	11
Central Radio Laboratories	7 opposite 406
Central Scientific Co.	14
Coils, Inc.	16
Daven Co., The	20
DeForest Radio Company	Back Cover
Eisler Electric Corporation	22
Ellis Elec. Lab.	22
Fansteel Products Company, Inc.	2
Fast & Company, John E.	25
Foote, Pierson & Co., Inc.	12
Forest Elec. Co.	20
Formica Insulation Co., The	17
Free Laboratories, E. E.	18
GM Laboratories, Inc.	22
General Amplifier Co.	26
General Cable Corp.	3
General Electric Company	8a
General Radio Company	21
Gilby Wire Company	10
Inca Div., Nat'l Elec. Prod. Corp.	5
International Resistance Company	8 opposite 408
Jewell Electrical Instrument Company	Inside Back Cover
Kingston Products Corporation	14
Littlefuse Laboratories	25
Maas & Waldstein Co.	26
McGraw-Hill Book Co.	22
Perryman Electric Co., Inc.	19
Polymet Manufacturing Corporation	23
Professional Services	27
RCA Radiotron Company, Inc.	Sepia Pictorial Section
Rawson Electrical Instrument Co.	23
Shakeproof Lock Washer Company	15
Shallcross Mfg. Company	16
Smedley Press	18
Sprague Specialties Co.	9
Spruce Pine Mica Co.	22
Stupakoff Laboratories, Inc.	28
Summerhill Tubing Co.	4
Tar-Heel Mica Company	25
Ward Leonard Electric Co.	25
Westinghouse Elec. & Mfg. Co.	13
Weston Electrical Instrument Corp.	20

Searchlight Section — Classified Advertising

EQUIPMENT (Used, etc.)	
Electrical Engineering & Equipment Co.	27
PATENTS	
O'Brien, Clarence A.	27

INC., Tenth Ave. at 36th St., New York, N. Y.

"Machinist, N. Y."

New York District Office, 285 Madison Ave.
 WASHINGTON, National Press Building
 CHICAGO, 520 North Michigan Ave.
 PHILADELPHIA, 1000 Arch Street
 CLEVELAND, Guardian Building
 ST. LOUIS, Bell Telephone Building

SAN FRANCISCO, 883 Mission Street
 BOSTON, 1427 Statler Bldg.
 GREENVILLE, S. C., 1301 Woodside Bldg.
 DETROIT, 2-257 General Motors Bldg.
 LOS ANGELES, 832 Chamber of Com. Bldg.
 LONDON, 6 Boulevard St., London, E. C. 4

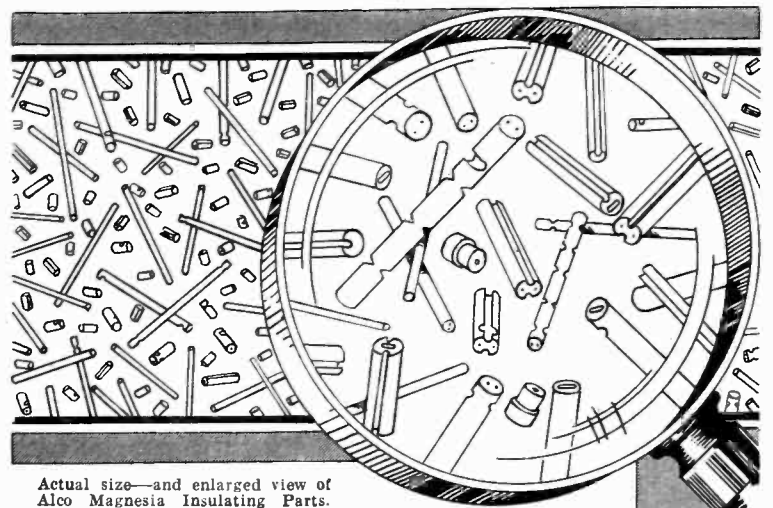

Actual size—and enlarged view of
Alco Magnesia Insulating Parts.

MAGNESIA INSULATION MEMBERS

for Tube Construction

1. Alco Magnesia (Pure MgO) insulation members possess the highest possible magnesia content. The extreme purity of the material is an outstanding feature of these members.
2. Made to unusually close tolerances. Individually gauged.
3. Precision machined with square cut ends. The elimination of broken ends is a detail appreciated by tube manufacturers.
4. These extruded pure magnesia insulating parts meet the particular requirements of manufacturers of superior tubes.

*Inquiries should be accompanied
by samples and drawings.*

**AMERICAN
MAGNESIA and LAVA
CORPORATION**
 CHATTANOOGA, TENNESSEE



Proved Dependable for Radio Power

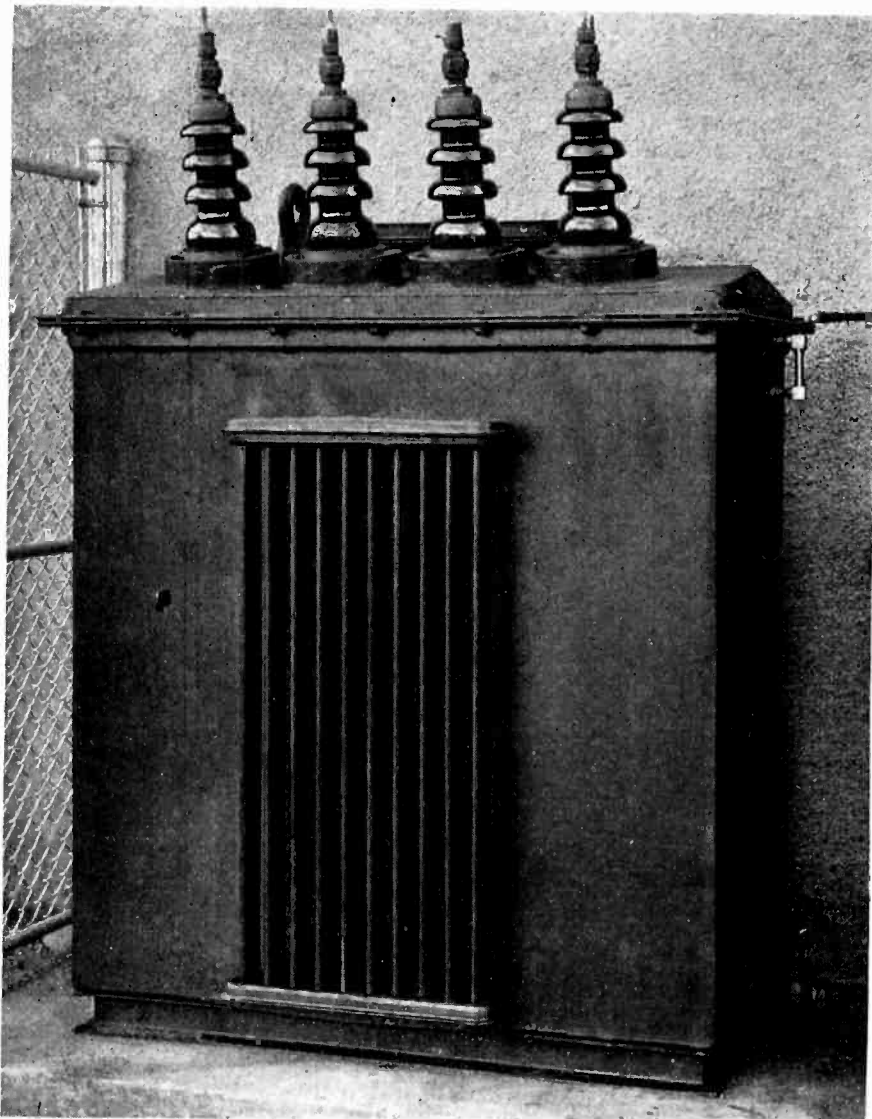

This illustration shows an AmerTran three-phase plate-supply transformer which was specially built for station WBAL. It is an oil-immersed, self-cooled, outdoor-type unit and has a rating of 50/65 kva.

When many world-famous radio stations use one particular make of transformer, that apparatus must possess exceptional merit and be especially suited to the requirements of radio.

AmerTran power transformers have been manufactured for radio applications for more than 29 years, having been used in some of the earliest radio-telegraph transmitters. Since the advent of broadcasting, AmerTran transformers and retard coils have also been installed in many of the largest and most efficiently equipped stations.

Our transformer engineers understand radio. They are ready to assist you in designing the most satisfactory transformer equipment for your station's requirements.

A Few AmerTran Products

- Filament-Lighting Transformers
- Plate-Supply Transformers
- Loading Transformers
- Audio Transformers
- Retardation Coils
- Testing Sets

AMERICAN TRANSFORMER COMPANY

Transformer Builders for Over 29 Years

176 EMMET STREET

NEWARK, N. J.

Representatives

- | | |
|---|--|
| Atlanta, Ga.—H. Douglas Stier, 101 Marietta St. | Minneapolis, Minn.—Elliott Equipment Co., 708 Sixth Ave., South. |
| Boston, Mass.—Electrical Apparatus Sales Co., 10 High St. | Philadelphia, Pa.—L. D. Joralemon, 112 So. 16th St. |
| Chicago, Ill.—Westburg Engineering Co., 53 West Jackson Blvd. | San Francisco, Calif. — James H. Southard, 682 Mission St. |
| Knoxville, Tenn.—Arthur L. Pollard, 910 West Clinch Ave. | St. Louis, Mo. — J. W. Jones, 432 Pennant Bldg. |
| Montreal, Que.—W. O. Taylor & Co., 415 Canada Cement Bldg. | |



AMERTRAN TRANSFORMERS



Testing Instruments

for Manufacturers of Radio Sets and Parts

**A METER FOR EVERY
LABORATORY OR PRODUCTION TEST**



Wire Size Indicator

A direct reading instrument for determining wire sizes from 26 to 42. Other ranges available.



Condenser Capacity Meter

A direct reading indicator for measuring condenser capacities. Open scale is easily read.



**A Single Point
Voltmeter**

For rapid production testing, calibrated to necessary test voltages at this point. Used with rotary selector switch, the highest speed in testing transformer voltages is obtained.

Makeshift testing equipment for laboratory or production tests introduces errors and wastes valuable factory time.

The urgent demand for specialized instruments to be used by manufacturers of radio sets and other electronic tube equipment has been met by this Jewell line of measuring instruments, which includes:

- Wire size indicators
- Multi-range voltmeters
- Resistor bridges
- Limit bridges
- Vacuum tube voltmeters
- Vacuum tube checkers
- Preheaters and short checkers
- Condenser testers
- Capacity meters
- Magnet testers
- Oscillators
- Ohmmeters



Magnet Tester

For factory testing of permanent magnets such as used in magnetic speakers and pickups. Tests for flux and coercive force.

Put your laboratory and plant departments on a reliable and time-saving basis by selecting the proper Jewell special test instrument for each job.

A new bulletin is just off the press describing the complete line. Send for it today.

**Jewell Electrical Instrument Co.
1642 - O Walnut Street, Chicago**

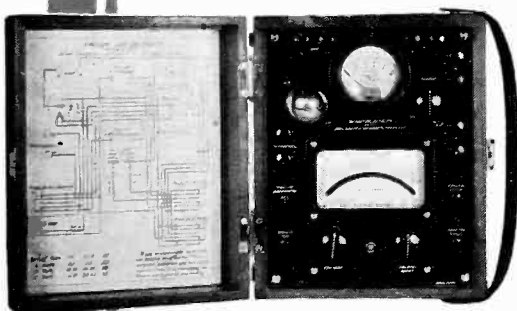

**Pattern 573
Vacuum Tube Voltmeter**

Carries a 0-200 microammeter with buck-out potentiometer for plate current. Small instrument reads plate, filament, and grid voltages.

Testing Instruments

A new 16-page booklet describing the complete line of Jewell instruments specially designed for use in manufacture of radio receivers, parts and electronic tube equipment. Send for it today.



30 YEARS. MAKING GOOD INSTRUMENTS

JEWELL

Radio Joins the Police

IN the battle of wits between criminal and society, radio has joined the police force. The modern hue and cry is instantaneously flashed to police automobiles equipped with radio receivers. Quick getaway is matched by quick action: criminals are apprehended

in short order. And so the Department of Public Safety, State of Michigan, ever ready to adopt the most effective measures, has installed its 5000-watt radiophone transmitter at East Lansing, specifying De Forest through-out. Here are the outstanding details:

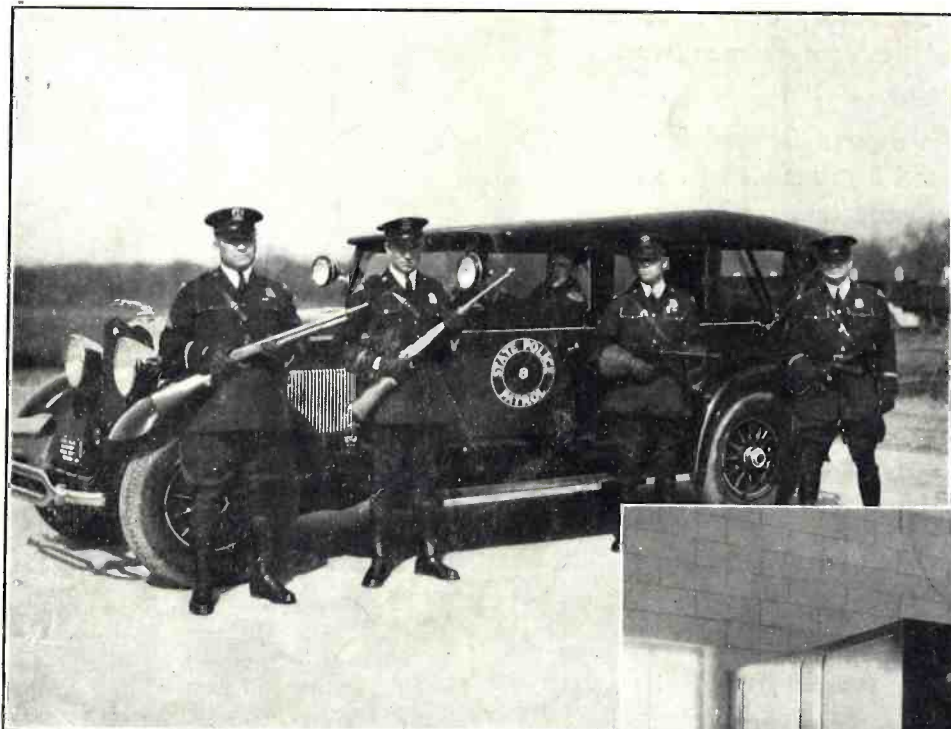

Formerly, it required one to two hours for the telephone operator at the State Police Barracks to flash the hue and cry to all sheriff's offices, municipal police departments and State Police detachments. Today, the operator, speaking into the radiophone microphone, flashes the information in ten seconds to all parties concerned. Each police automobile is equipped with a receiver, constantly tuned in on Station WRDS. Vital information, plus speedy automobiles, brings the intrepid Michigan police officers in prompt contact with fleeing criminals.

The WRDS 5000-watt De Forest radiophone transmitter, designed, built and installed by De Forest engineers in record time, incorporates the latest and most advanced features. Tubes constantly warm, ready for immediate use. 100% modulation. No motor generators—all A.C. operated. Mercury vapor rectifiers for B and C voltages. Remote or local control. Progressive automatic switching. Full protection for all circuits. DeForest water-cooled tubes with special cooling system. Automatic recording of time on air and number of calls handled. Complete in four panels.

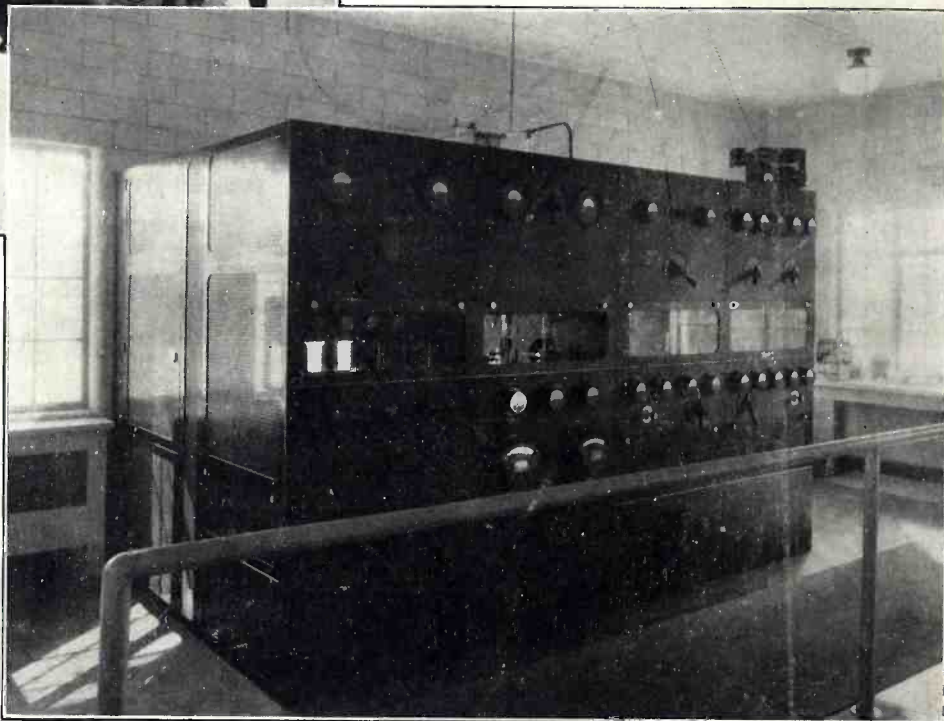

For over two decades the De Forest organization, the pioneer and oldest organization in the radiophone field, has been building radio transmitters. Today, with greater facilities and resources than ever before, it is putting its long and unmatched experience to work in designing, building and installing radio telephone and telegraph transmitters and receivers, in addition to supplying radio tubes for every purpose.

de Forest

For further technical information
address our Engineering Department

DE FOREST RADIO COMPANY
PASSAIC, NEW JERSEY



Radio Joins the Police

IN the battle of wits between criminal and society, radio has joined the police force. The modern hue and cry is instantaneously flashed to police automobiles equipped with radio receivers. Quick getaway is matched by quick action: criminals are apprehended

in short order. And so the Department of Public Safety, State of Michigan, ever ready to adopt the most effective measures, has installed its 5000-watt radiophone transmitter at East Lansing, specifying De Forest through-out. Here are the outstanding details:

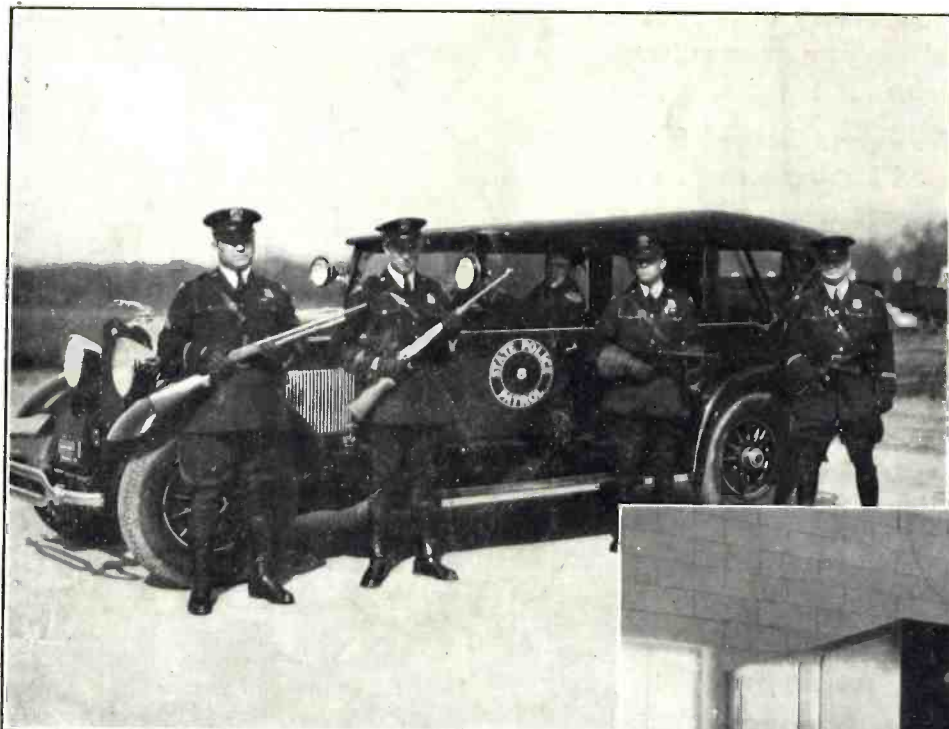

Formerly, it required one to two hours for the telephone operator at the State Police Barracks to flash the hue and cry to all sheriff's offices, municipal police departments and State Police detachments. Today, the operator, speaking into the radiophone microphone, flashes the information in ten seconds to all parties concerned. Each police automobile is equipped with a receiver, constantly tuned in on Station WRDS. Vital information, plus speedy automobiles, brings the intrepid Michigan police officers in prompt contact with fleeing criminals.

The WRDS 5000-watt De Forest radiophone transmitter, designed, built and installed by De Forest engineers in record time, incorporates the latest and most advanced features. Tubes constantly warm, ready for immediate use. 100% modulation. No motor generators—all A.C. operated. Mercury vapor rectifiers for B and C voltages. Remote or local control. Progressive automatic switching. Full protection for all circuits. DeForest water-cooled tubes with special cooling system. Automatic recording of time on air and number of calls handled. Complete in four panels.

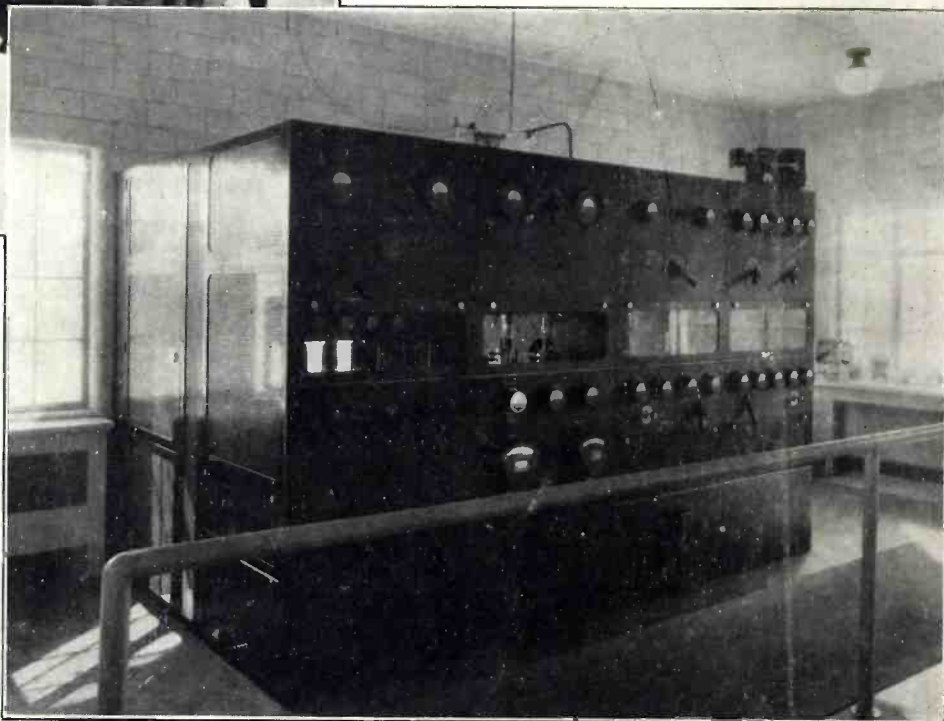

For over two decades the De Forest organization, the pioneer and oldest organization in the radiophone field, has been building radio transmitters. Today, with greater facilities and resources than ever before, it is putting its long and unmatched experience to work in designing, building and installing radio telephone and telegraph transmitters and receivers, in addition to supplying radio tubes for every purpose.

de Forest

For further technical information
address our Engineering Department

DE FOREST RADIO COMPANY
PASSAIC, NEW JERSEY



Harold Schaefer

electronics

electron tubes—their radio, audio, visio and industrial applications

radio
 sound pictures
 telephony
 broadcasting
 telegraphy
 carrier systems
 beam transmission
 photo-electric cells
 facsimile
 amplifiers
 phonographs
 measurements
 receivers
 therapeutics
 television
 counting, grading
 musical instruments
 traffic control
 metering
 machine control
 electric recording
 analysis
 aviation
 metallurgy
 beacons, compasses
 automatic processing
 crime detection
 geophysics

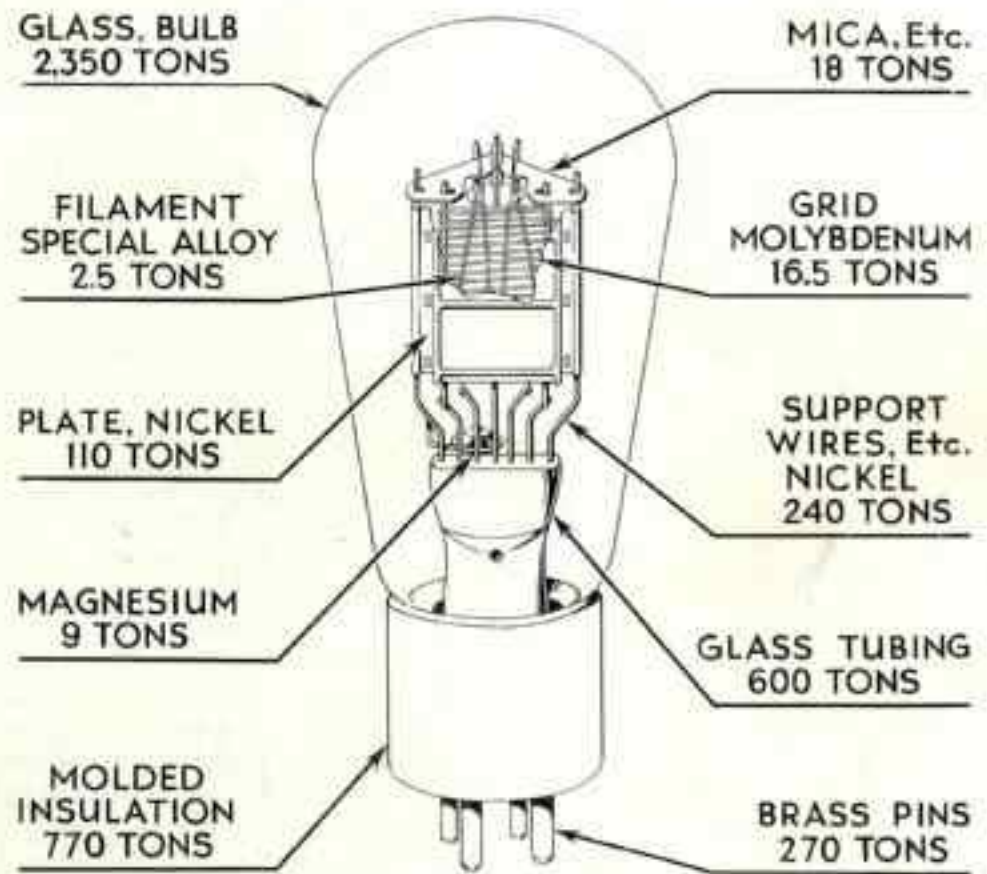

Raw materials in tube manufacture Page 346

Sound "dubbing" in motion pictures Page 311

Detection in super-heterodynes Page 314



A MCGRAW-HILL PUBLICATION

Price 35 Cents

NOVEMBER 1930