

Electronic Design 17

VOL. 25 NO.

FOR ENGINEERS AND ENGINEERING MANAGERS

AUG. 16, 1977

Semi memories are exploding with “moire” bits per chip than ever before. Access time, power and prices are dropping and new technologies are emerging. But

beware—don’t see something that isn’t there. All those parameters can play tricks on the senses and your “second source” may turn into a phantom. Page 56.

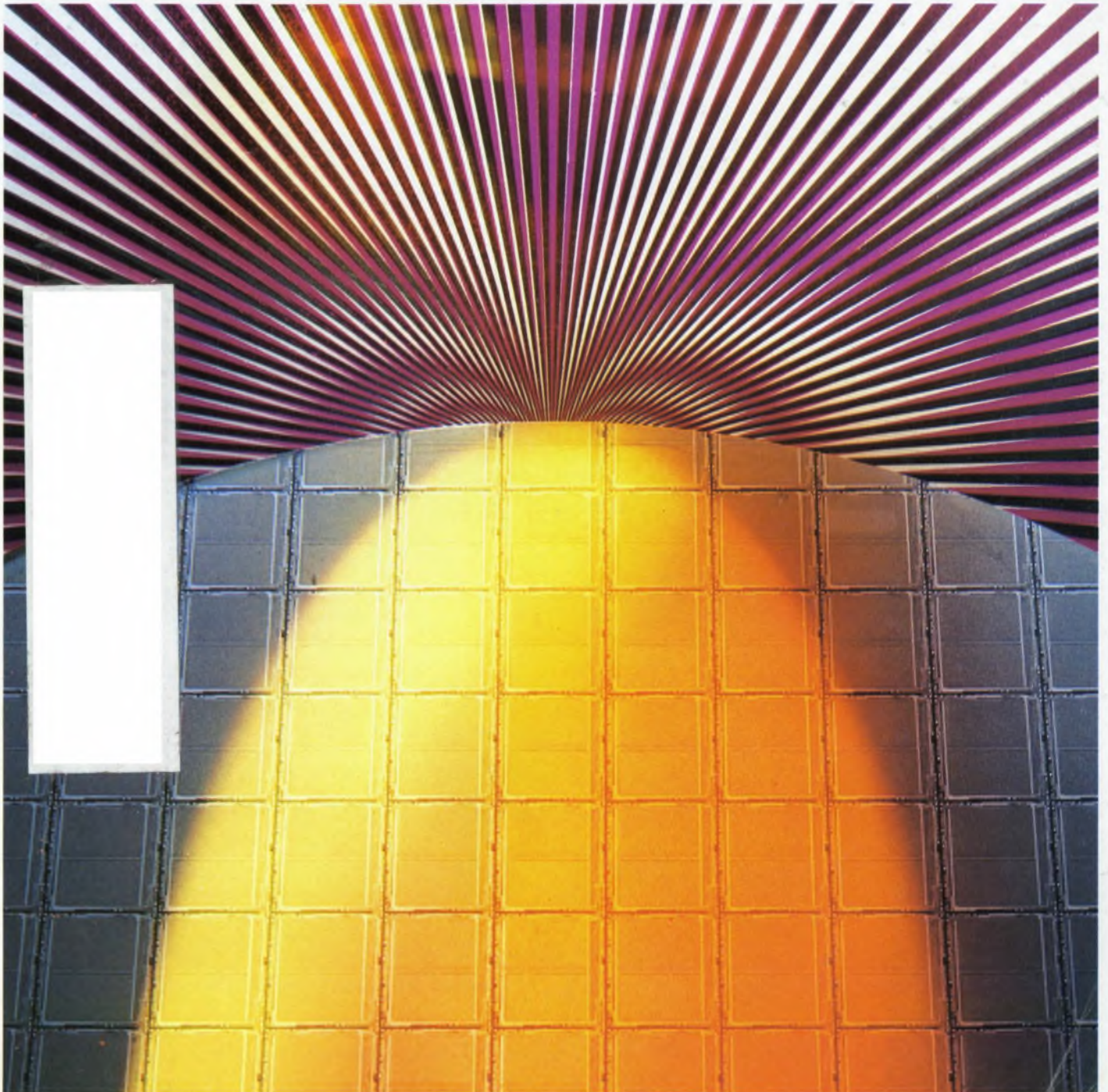

The \$2 Pot with the \$5 Linearity...

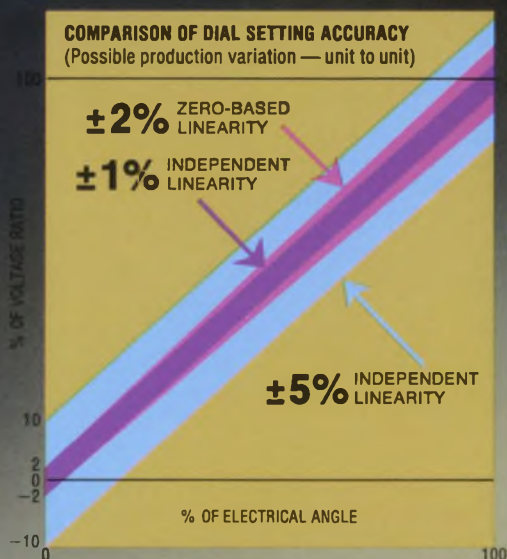

PERFORMANCE/COST COMPARISON			
Type	Element	Linearity	Approx. Cost
HIGHER COST PRECISION POTS	Conductive Plastic	±1% Independent	\$5.00
BOURNS 87/88 SEMI-PRECISION POTENTIOMETERS	Conductive Plastic	±2% Zero-Based	\$2.00
	Cermet	±2.5% Zero-Based	
LOWER PERFORMANCE CONTROLS	Conductive Plastic/Cermet	±5 - 10% Independent	\$1.00

Your alternative to lower performance controls and higher cost precisions.

LASER-TRIMMED SAVINGS

Now, for about \$2*, the Bourns® Model 87/88 semi-precision, single-turn potentiometer delivers ±2% zero-based linearity. Compare the accuracy to the \$5 precision pot with ±1% independent linearity that you're buying now . . . especially the performance at the low end setting, where dial setting accuracy is most critical. Laser trimming and advanced element design† deliver performance and savings in a 5/8" square modular package.

MOVE UP FROM INDUSTRIAL GRADE CONTROLS

Again, for about \$2, the Model 87/88 offers 200-300% greater panel setting accuracy over industrial grade controls. They're perfect for applications requiring close, consistent calibration of output-to-panel setting and versatility of design.

MODEL 87/88 — THE ALTERNATIVE

Don't compromise your application with lower performance controls or pay a premium for precision pots. Specify the alternative — Bourns Model 87/88. Write or call today for complete technical information.

\$2 SEMI-PRECISION MODULAR POTS . . . BEAUTIFUL!

TRIMPOT PRODUCTS DIVISION, BOURNS, INC., 1200 Columbia Avenue, Riverside, California 92507, Telephone (714) 781-5122 — TWX 910 332-1252.

* Production quantities, Domestic U.S.A. price, Single cup unit only.
† Patent Pending



International Marketing Offices: European Headquarters — Switzerland 042/23 22 42 • Belgium 02/218 2005 • France 01/2039633 • Germany 0711/24 29 36 • Italy 02/32 56 88 • Netherlands 70/87 44 00 • United Kingdom 01/572 6531 • Norway 2/71 18 72 • Sweden 764/20 110 • Japan 075/921 9111 • Australia 02/55-0411 03/95-9566 • Israel 77 71 15/6/7

For Immediate Application — Circle 130
For Future Application — Circle 230

SURPRISE!



The World's First Rectangular LED Lamps

For the first time LED's are offered in a rectangular epoxy package. Available in high-efficiency red, yellow and green, they feature a flat, high intensity, light emitting surface.

And, since they're end or side stackable, they're ideal for flush mounted panel indicators, backlighting legends, and linear arrays. Plus you get long life and solid state reliability. And they're in stock right now. Choose our 5082-4570 for yellow, the 5082-4670 for high efficiency red, or the 5082-4970 for green. Priced at \$1.00* in quantities of 1000. *U.S. Domestic prices only

In the U.S., contact Hall-Mark, Schweber, Wilshire or the Wyle Distribution Group (Liberty-Elmar) for immediate delivery.

In Canada, contact Schweber Electronics or Zentronics, Ltd.

HEWLETT  **PACKARD**

Sales and service from 172 offices in 65 countries.
1501 Page Mill Road, Palo Alto, California 94304

MIL-SSR UPDATE

Ready for military service: Our new AC power SSR.

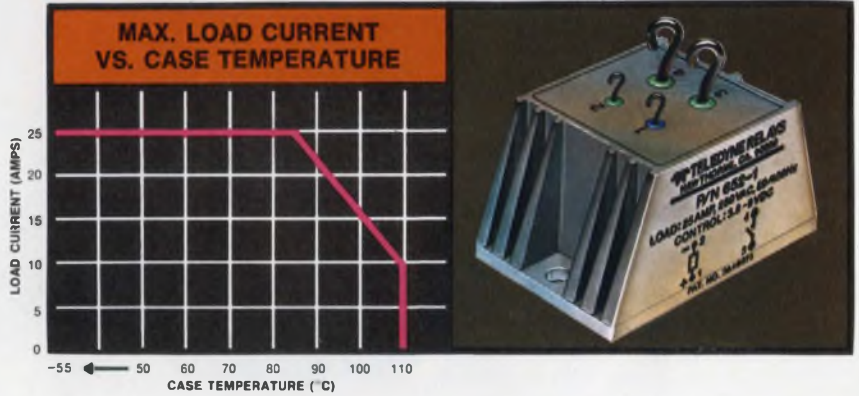

Commercial relays are no match for severe military or aerospace environments. But there's no doubt about our new 652 Series. Designed expressly for military and aerospace applications, this new AC SSR is packaged in a rugged, hermetically sealed aluminum case with the internal circuit assembly encapsulated to resist shock and vibration. What's more, all circuit components are military grade including the inverse parallel SCRs that provide reliable output switching — up to 25 Amps — over the frequency range of 45-440Hz.

Other features include logic compatible input drive

circuitry, optical isolation, and zero voltage turn-on to reduce EMI.

To top it all off, our 652 Series is designed to meet MIL-R-28750 and all categories of MIL-STD-704A, with an operating ambient temperature range of -55°C to $+110^{\circ}\text{C}$.

For complete specification data, contact your nearest Teledyne Relays sales office listed in EEM, Gold Book and Electronics Buyers' Guide. You'll find we have the experience, products, and technical support to meet all your SSR needs — including a quick reaction capability to design SSRs specifically for your application.

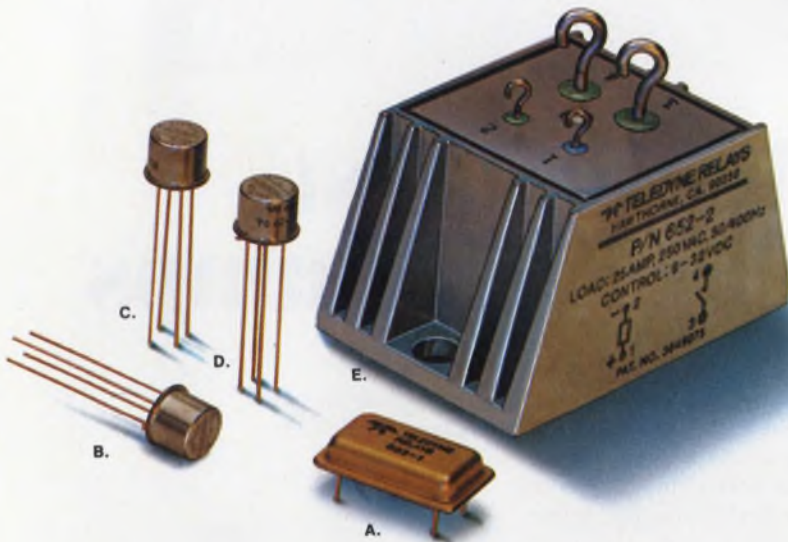

TELEDYNE'S MILITARY SSRs

- A. P/N 683-1 DC SSR
DIP package, with output rated at 600mA/50VDC
- B. P/N JM640-1 Bi-polar SSR
Mil P/N M28750/5. TO-5 package, with bi-polar (AC/DC) output rated at 60mA/40V
- C. P/N JM643-1 DC SSR
Mil P/N M28750/6. TO-5 package, with output rated at 300mA/40VDC
- D. P/N JM643-2 DC SSR
Mil P/N M28750/7. TO-5 package, with output rated at 100mA/250VDC
- E. 652 Series AC Power SSR
Output rated at 25A/250VRMS

 **TELEDYNE RELAYS**

3155 West El Segundo Boulevard, Hawthorne, California 90250
Telephone (213) 973-4545

CIRCLE NUMBER 3

NEWS

- 19 **News Scope**
- 28 **New York's blackout:** Too many questions, not enough answers.
- 32 **Computer-graphic photo montage** simplifies land-use projects.
- 34 **Real-time digital audio processor** picks out distorted speech.
- 36 **Manpack satellite communications** links soldiers with air-sea support.
- 47 **Washington Report**

TECHNOLOGY

- 56 **FOCUS on semiconductor memories:** Second-sourced devices may provide a false sense of security. Supposedly identical memories may not be. Caution is necessary with specs marked "typical."
- 66 **Memory Technology: Part 1. Standards for dynamic MOS RAMs are emerging.** But among equivalent parts, some are more equal than others.
- 72 **Model RAMs automatically** for gate-level logic simulators with RAMGEN. Such a model lets you develop test programs for complex PC boards with ease.
- 78 **Predict a 4-k RAM's average I_{DD}** with a few simple calculations. The method accounts for both the transient and steady-state components.
- 82 **Microprocessor Basics: Part 18. Cut your processor's computation time** by storing information in tables. Accessing a table can take less time than doing an algorithm.
- 92 **Simplify analog/computer interfacing.** Choose the data-acquisition configuration that's best for your system, then use the right analog-to-digital converter.
- 102 **Ideas for Design:**
Control the speed and phase of a dc motor by comparison.
Get 32 times the bit rate instead of 16 from a programmable baud generator.
Logic interfacing circuit translates many levels to TTL regardless of polarity.
Float charger independently recharges two lead-acid cells connected in series.
- 111 **International Technology**

PRODUCTS

- | | | | |
|-----|----------------------|-----|-------------------------|
| 115 | Micro/Mini Computing | 138 | Packaging & Materials |
| 124 | Data Processing | 143 | Modules & Subassemblies |
| 130 | ICs & Semiconductors | 146 | Instrumentation |
| 135 | Components | 150 | Power Sources |

DEPARTMENTS

- | | | | |
|-----|---|-----|----------------------------|
| 51 | Editorial: The man who was wrong | | |
| 7 | Across the Desk | | |
| 152 | New Literature | 166 | Advertisers' Index |
| 154 | Application Notes | 168 | Product Index |
| 154 | Bulletin Board | 168 | Information Retrieval Card |
- Cover:** Photo of a 4-inch, 4-kbit, static-RAM wafer by Frank Saude, courtesy of Advanced Micro Devices.

**How
to do three
things at the
same part:**

Advanced Micro Devices, Inc. • 901 Thompson Place, Sunnyvale, California 94086 • Telephone (408) 732-2400 •
Distributed nationally by Hamilton/Avnet, Cramer and Schweber Electronics and regionally by Arrow, Bell,
Century Electronics, Future Electronics and RAE Electronics.

If you want a great 8-bit D-type register with common clear, get our Am25LS273. If you want one with three-state outputs, get our terrific Am25LS374. If you're looking for a sensational common enable, you want our Am25LS377. However, if you'd be willing to settle for all three, read on.

Advanced Micro Devices announces the Am25LS2520 8-bit D-type register. With common clock enable. With common asynchronous clear. With three-state outputs. With MIL-STD-883 for free. And all in a super-convenient 22-pin DIP. Look:

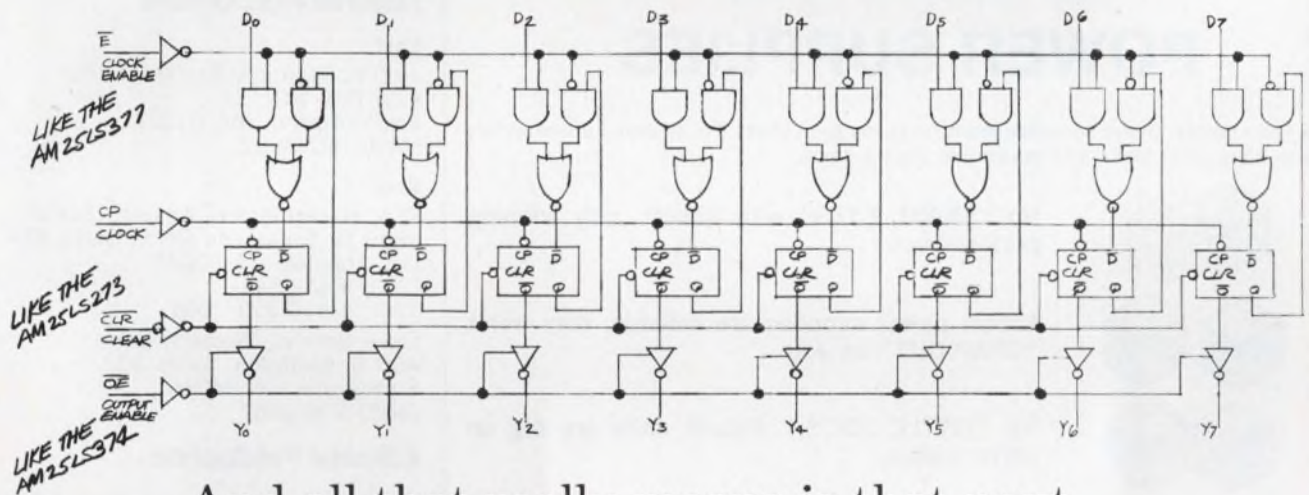

And all that really means is that next time you're thinking about registers, low power Schottky and TI, you should also be thinking about AMD. Or calling. Or writing.

(After all, where else can you do three things at the same part?)

Advanced Micro Devices

Bipolar LSI. N-channel, silicon gate MOS. Low-power Schottky.
Multiple technologies. One product: excellence.



CIRCLE NUMBER 19



TAKE THE GAMBLE OUT OF SPECIFYING POWER SUPPLIES

When you specify power supplies manufactured by Abbott Transistor Laboratories, you minimize your risks and maximize your return.

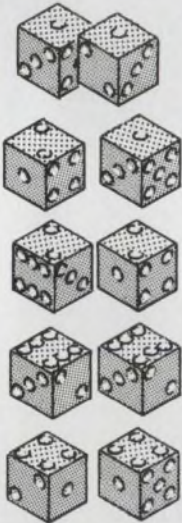

No "SNAKE EYES" with Abbott, only winning performance

Abbott power supplies are reliable, they won't "CRAP OUT" on you

No "LITTLE JOE'S," Abbott units are big on performance

No "BOX CARS" either — Abbott units are compact

Don't go the "HARD WAY," specify Abbott, the easy way to solve your power supply requirements

Abbott makes a wide variety of industrial/commercial, OEM, military and aerospace power supplies. Each and every unit is subjected to rigorous quality control and electrical testing before shipment to insure that when you put it on the line, it will pass every time.

So when you want a reliable power supply, come to Abbott, the winner for price and performance.

Please see pages 1836-1848 of your 1976-77 EEM (ELECTRONIC ENGINEERS MASTER Catalog) or pages 672-682 Volume 2 of your 1976-77 GOLD BOOK for information on Abbott Modules.

Send for our new 60 page FREE catalog.

abbott transistor
LABORATORIES, INCORPORATED

GENERAL OFFICES
5200 W. Jefferson Blvd.
Los Angeles, CA 90016
(213) 936-8185
Telex 69-1398

EASTERN OFFICES
1224 Anderson Ave.
Fort Lee, NJ 07024
(201) 224-6900
Telex 13-5332

CIRCLE NUMBER 4

Sr. Vice President, Publisher

Peter Coley

Editors

Editorial Offices
50 Essex St.
Rochelle Park, NJ 07662
(201) 843-0550
TWX: 710-990-5071
(HAYDENPUB ROPK)
Cable: Haydenpubs Rochellepark

Editor-in-Chief George Rostky

Managing Editors:

Ralph Dobriner
Michael Elphick

Senior Associate Editor

Stanley Runyon

Associate Editors:

Sid Adlerstein
Dave Bursky
Morris Grossman
Gene Heftman
Andy Santoni
Max Schindler

Contributing Editors:

Peter N. Budzilovich, Jules H. Gilder,
John Kessler, Nathan Sussman

Editorial Field Offices

East

Jim McDermott, Eastern Editor
P.O. Box 272
Easthampton, MA 01027
(413) 527-3632

West

Dick Hackmeister, Western Editor
8939 S. Sepulveda Blvd., Suite 414
Los Angeles, CA 90045
(213) 641-6544
TWX: 1-910-328-7240
Dave Barnes, Western Editor
465 S. Mathilda, Suite 302
Sunnyvale, CA 94086
(408) 736-6667

Editorial Production

Marjorie A. Duffy, Production Editor
James Keane, Copy Editor

Art

Art Director, William Kelly
Richard Luce, Anthony J. Fischetto

Production

Manager, Dollie S. Viebig
Helen De Polo, Nancy Hurey

Circulation

Director, Barbara Freundlich

Information Retrieval

Paula Greenleaf

Advertising Promotion

Judith Nappo

Reprints

Maxine Correal

Across the desk

Slow-down circuit can cause problems

In the Idea for Design, "Digital-Integrator for Intrusion Systems" (ED No. 5, March 1, 1977, p. 74) author Gross' slow-down circuit at pins 1 and 9 of the 4015A dual 4-bit register can be troublesome for two reasons:

1. If the comparator output "bounces," the clock signal could hover close to its transition level, and thus defeat the 15- μ s transition spec for the 4015A.
2. The circuit increases the power-supply noise susceptibility.

My solution: Use an MC14015B with a dc clock circuit and insert a hysteresis slow-down circuit having a fast transition time (see figure).

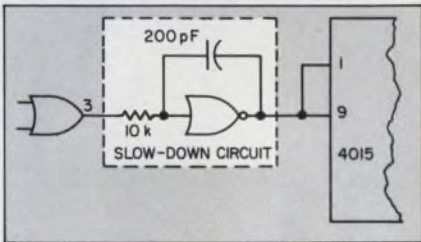

A. Frisch
VP, Engineering

Zygo Industries Inc.
P.O. Box 1008
Portland, OR 97207

The author agrees, but...

The circuit shown in my article works. However, should it not function properly because the clock signal "hovers," or because of power-supply noise, the failure is safe. We agree with reader Frisch that his proposed circuit is an improvement, which we and other readers should use when cost considerations allow.

Thomas B. Gross

T. A. O. Gross & Associates
Lincoln, MA 01773

Audio-amplifier delivers regulated dc power

Some of your readers may have a

need for a continuously adjustable, regulated, bipolar dc power supply that can deliver 20 A at 100 V. We recently had a requirement for just such a device to drive the highly inductive field coil in a homopolar generator. After a lengthy search, we decided to use a Model M-600 audio amplifier manufactured by Crown International, Inc., of Elkhart, IN.

This amplifier can deliver the required dc power continuously. By simply adding an SPDT switch, a pair of 1960- Ω resistors and a 2-k Ω , 10-turn pot to the front panel plug-in circuit board, one obtains a completely self-contained, well regulated power supply at a fraction of the cost of the nearest commercial equivalent.

Gilbert A. Miranda

University of California
Los Alamos Scientific Laboratory
P.O. Box 1663
Los Alamos, NM 87545

Misplaced Caption Dept.



Actually, the floppy disc concept isn't all that new.

Sorry. That's Rembrandt Van Rijn's "Portrait of a Young Women," which hangs in The National Gallery of Ireland in Dublin.

(continued on page 10)

Electronic Design welcomes the opinions of its readers on the issues raised in the magazine's editorial columns. Address letters to Managing Editor, Electronic Design, 50 Essex St., Rochelle Park, NJ 07662. Try to keep letters under 200 words. Letters must be signed. Names will be withheld upon request.



OPTICALLY COUPLED INTERRUPTER MODULES

OPTRON OFFERS IMMEDIATE DELIVERY OF NEW, LOW COST SERIES

OPTRON's new, low cost optically coupled interrupter module series combines non-contact switching and solid state reliability for applications requiring sensing of position or motion of an opaque object such as motion limit, paper edge or shaft encoding.

The new OPB 813, OPB 814 and OPB 815 consist of a gallium arsenide infrared LED coupled with a silicon phototransistor in an economical molded plastic housing. With a LED input of 20 mA, the OPB 813 and OPB 815 have typical unblocked current outputs of 2.0 mA and 3.0 mA, respectively. Typical output of the OPB 814 is 3.0 mA with a 10 mA input. The entire series is available from stock.

Background illumination noise is eliminated by a built-in infrared transmitting filter and dust cover in each device type. The OPB 813 also is available with a 0.010 inch aperture for high resolution applications.

New OPTRON optically coupled interrupter modules are interchangeable with similar products as follows:

OPTRON	GE
OPB 813	H13A1
OPB 813	H13A2
OPB 814	H13B1
OPB 814	H13B2

Detailed technical information on these and other OPTRON standard interrupter and reflective modules, as well as versions for specific applications is available on request.



OPTRON, INC.

1201 Tappan Circle
Carrollton, Texas 75006, U.S.A.
214/242-6571 • TELEX-73-0701
© TWX-910-860-5958

Intel delivers the growing

Our 2114 has already become the most widely second-sourced 4K static RAM for the same reason Intel's 2102A is the industry standard 1K static RAM. The 2114 simplifies system design, like the 2102A, and provides the highest possible density and modularity in static memories.

The 2114 is the first of several new generation Intel static 4K RAMs. We are now delivering both the standard 2114 series and the low-power 2114L series in production volumes. The 2114L is just as fast as the 2114 but consumes 30 percent less power. We will soon be shipping the 2142 to designers who want an extra chip select and output disable control inputs. Next, we'll add the super high-speed 2147.

This new generation assures a continuing reduction in static RAM costs. We fabricate the 4K chips with an evolution of our 2102A technology. At 181 mils square area, the 2114/2114L packs four times the bits in only twice the silicon area. The chips fit into standard 18-pin plastic or ceramic packages, keeping volume production costs low.

Our 4K RAMs also inherit the 2102A's ease of use and low overhead. You don't need a clock, address setup timing, or refreshing. You don't even need pullup resistors or output gating. These RAMs operate at TTL levels on a single



+ 5v supply and have buffered, three-state outputs. We guarantee identical access and cycle times, so you can surpass the performance of clocked RAMs. For instance, you can achieve a data rate of 20 million bits a second with our 200-nanosecond parts. That's up to twice the rate of clocked RAMs with 200-ns access time. Intel specs also guarantee that even at such high throughput you'll need only 25 to 50 percent of the power of first-generation static RAMs.



4K static RAM family.

As for board density, look at the pinouts. The 18-pin 2114/2114L configuration provides the highest density possible in 4K static RAMs.

Our 20-pin 2142 adds a second chip select—so you can go to 4K without external decoders—and an output disable for direct control of the output buffers. And since it is a simple modification of the 2114, it promises similar production economies.

You can minimize package count at any number of kilobytes since these new RAMs store 1Kx4 bits. With our compatible 256x4-bit static RAMs, you now have the widest range of modular design options. They are all listed in our new Static RAM Family Album.

Intel's 4K Static RAMs		
1K x 4	Access Time (max) Cycle Time (min) 0-70°C	I _{CC} (max) 0-70°C
2114-2 2114L2 2142-2	200 ns	100 mA 70 mA 100 mA
2114-3 2114L3 2142-3	300 ns	100 mA 70 mA 100 mA
2114 2114L 2142	450 ns	100 mA 70 mA 100 mA
4K x 1 with low power standby		
2147	70 ns	160 mA Active 20 mA Deselected

The 2114/2114L series is already as easy to get from stock as the 2102A. The 2142 soon will be. Contact any Intel franchised distributor: Almac Stroum, Component Specialties, Cramer, Elmar, Hamilton/Avnet, Harvey Electronics,

Industrial Components, Liberty, Pioneer, Sheridan, L. A. Varah or Zentronics.

For your copy of our Static RAM Family Album, write:
Intel Corporation, Literature Department, 3065 Bowers Avenue, Santa Clara, California 95051.

In Europe, contact Intel International Corporation S. A., Rue du Moulin a Papier, 51-Boite 1, B-1160, Brussels, Belgium. Telex 24814. In Japan, contact Intel Japan Corporation, Flower Hill-Shinmachi East Building 1-23-9, Shinmachi, Setagaya-ku, Tokyo 154.

intel® delivers.

Across the desk

(continued from page 7)

Markets, not people make the differences

In response to your editorial challenge about the differences in consumption patterns between countries (ED No. 2, Jan. 18, 1977, p. 51), let me suggest some marketing reasons for dissimilarities by relating them to automatic transmissions:

- The American market may include a greater population of women who make the purchasing decisions and prefer automatics.

- The American market may have a higher level of expendable income, thus more interest in accessories.

- The American pricing structure may emphasize the profit in accessories, thus motivating dealers and salesmen to sell them.

- The American cultural background may make automation more acceptable.

I submit, then, that the *markets* are different—much more so than the innate differences in any two comparable individuals, one from each market.

Charles F. Turner
Engineer

Cricket Hill
Amherst, NH 03031

Try depending on personal values

I don't know if all men are brothers (see "Are All Men Brothers?" ED No. 2, Jan. 18, 1977, p. 51), but there sure are a few I would hate to see marry my sister. Some differences really do go pretty deep—or else we wouldn't need police. Still, most people are very much the same the world over—as your editorial pointed out. Including the habit of absorbing their concepts of *value* from those around them, by a process akin to osmosis. An extreme example: it is not really necessary to tell one's children that it is not *nice* to barbecue the neighbors for lunch. The idea is obvious, because the matters involved are both so important and so obviously objective.

However, the value of remote controls in television receivers isn't obvious. Most consumers' grasp of what remote controls are good for and what they mean to them is derived entirely from the implicit "idea pool" in their

market area. And their resultant purchases are the expression of these ideas in action. It would be interesting to see what would happen if the idea took hold that each individual consumer has to grasp the values involved for himself—and live with the results of his evaluation. Marketing patterns might change in rather surprising ways.

Richard W. Bowser
President

R.W.B. Research Co.
5648 Pierce
Omaha, NE 68106

What's in a name...

In your editorial of Jan. 18, 1977 (ED No. 2, p. 51), you asked for help in explaining the buying habits of Europeans. Why this is bought instead of that—not even market-research ex-

perts can explain. I have no answer either. However, there is one thing I know: Johann Schiller did not write the "Ode to Joy." It was Friedrich von Schiller (1759 to 1805).

Also, the German, "Alle Menschen werden Brüder," translates into "All men become brothers," not "are brothers."

Manfred Moerre
Consumer Products Group

The Singer Co.
321 First St.
Elizabeth, NJ 07207

Ed. Note: We bow to Mr. Moerre's superior fluency in German but, in apology, wish to point out that our "All men are brothers" is from a free translation by the poet and anthologist, Louis Untermeyer. We disagree with the statement that Johann did not write the Ode, but agree that Friedrich did. The man's name was Johann Christoph Friedrich von Schiller.

Headlight circuit works as advertised

In reply to William Sloan's letter appearing in the March 1 issue (ED No. 5, p. 7) concerning my headlight delay circuit (ED No. 18, Sept. 1, 1976, p. 114): I maintain that the circuit will work "as advertised" if the switch, S_1 , in the original circuit—with no other modifications—has a center-off position. This subtlety, which was not fully explained, provides the versatility of three functions: delay, automatic shut-off and bypass.

In the delay mode, the delay begins after the ignition is turned off regardless of the light-switch position. In the automatic shut-off position (S_1 in center-off mode), the delay starts after the ignition is switched off, provided

the light switch is in the on position. The delay is terminated, if the light switch is turned off first.

The center-off-position switch is more efficient than Mr. Sloan's circuit, which adds extra components. Furthermore, Mr. Sloan reduces the three-function capability of the original circuit to two functions.

To improve the original circuit further, substitute a DPDT switch (with center off) for the SPDT S_1 to provide two different time-outs: a long delay for the delay mode and a short (or no) delay for the automatic shut-off mode (see circuit).

John Okolowicz

Honeywell Inc.
1100 Virginia Dr.
Fort Washington, PA 19034

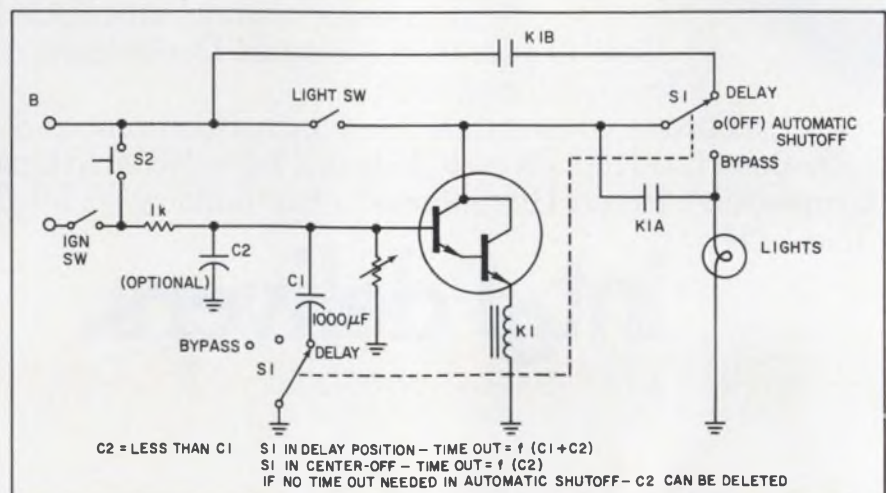

CCD MEMORY



**FAIRCHILD
ANNOUNCES
THE
GREATEST
BREAKTHROUGH
IN BULK
MEMORY
SINCE
THE DISC.**



FINALLY. BULK MEMORY WITHOUT THE BULK.

Introducing the Fairchild 64K F464.

The first semiconductor CCD memory designed for the bulk memory market.

It plugs the gap between MOS and magnetic memories.

It's as important to bulk memory systems as the semiconductor RAM was to core.

It's a higher-density, lower-cost alternative to discs and drums.

The fact is, the new F464 is the densest memory ever made. A compact die size of less than

40,000 mil² — not much larger than today's 16K RAMs.

All packaged neatly in a standard 0.3-inch 16-pin DIP.

This isn't a preview of coming attractions.

The Fairchild F464 is available right now. With a second source already signed up.

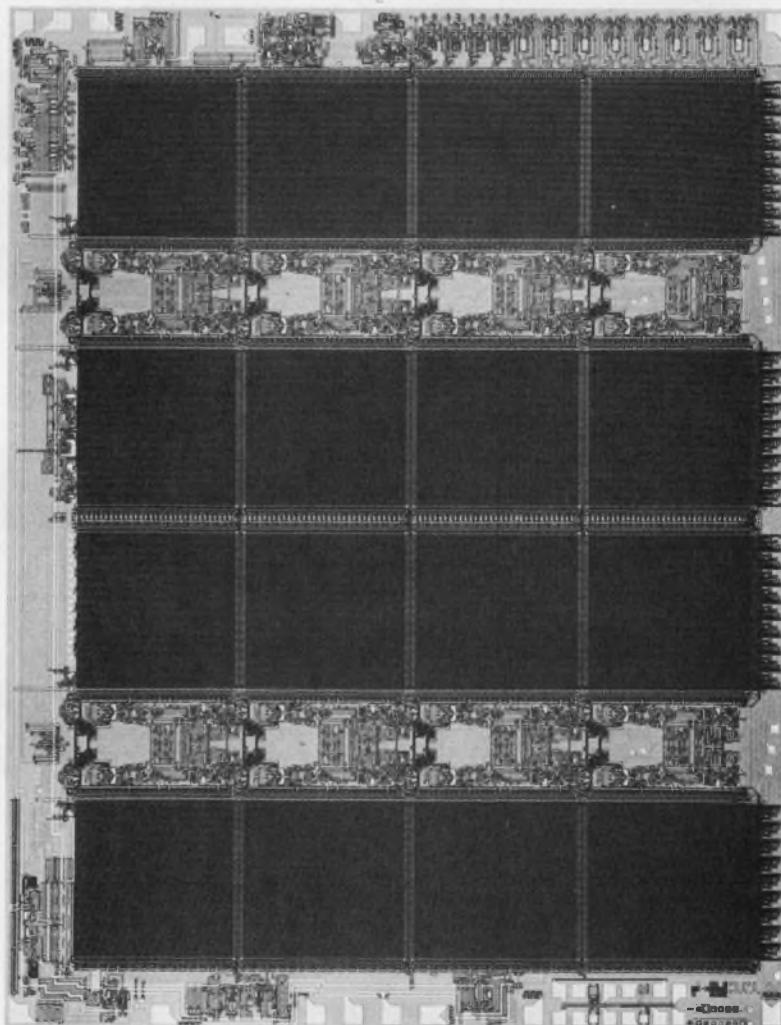

THE STUFF INDUSTRY STANDARDS ARE MADE OF.

There has never been a device like the new F464.

It's a 65,536 x 1-bit dynamic serial memory organized as 16 randomly accessible shift registers of 4096 bits each. The four address bits are decoded on-chip to select which one of these 16 shift registers is to be accessed. Control inputs include Write Enable and Chip Select. It requires standard power supplies of +12V and $\pm 5V$.

All inputs (except the clocks) are directly TTL compatible.

The two high-frequency and two low-frequency clock inputs are low capacitance 12V signals which can be easily generated with simple logic.

The data rate ranges from 1 MHz to 5 MHz. Since all 16 registers shift simultaneously, the average random access time (called latency) is only 410 μs at 5 MHz — a truly significant performance improvement over other bulk memory technologies! And, at the

same time, the power dissipation remains low: typically 3.5 μW /bit at 5 MHz, and 0.6 μW /bit during standby at 1 MHz.

These performance benefits make the F464 a natural for hybrid head-per-tracks and fixed-head discs, extended cache, and many other high-density memory applications.

LOW COST FROM DAY ONE.

The new F464 is three to four times less expensive than RAMs. It is also cost-competitive with all fixed-head and many movable-head discs. So there are no trade-offs between price and performance. The Fairchild F464 gives you the best of both.

We also give you excellent delivery. Fairchild has a plant in San Jose, California totally dedicated to VLSI technology and production.

FOLLOW THE LEADER.

Fairchild pioneered CCD technology. We introduced the world's first commercially available charge-coupled device in 1973. Today, we offer the world's broadest line of CCD products.

It stands to reason we'd be the ones to make CCD memories a reality.

For more information on the F464 (or our other CCD products), contact your Fairchild sales office or representative today. Or use the direct line at the bottom of this ad to reach our MOS/CCD Division. Fairchild Camera and Instrument Corporation, 464 Ellis Street, Mountain View, Calif. 94042. Tel: (415) 962-3941. TWX: 910-373-1227.

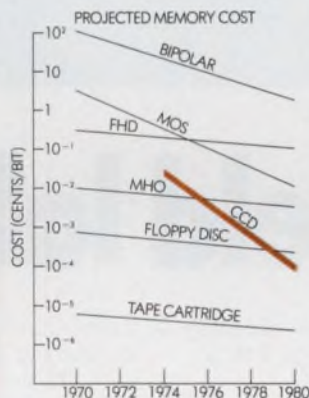
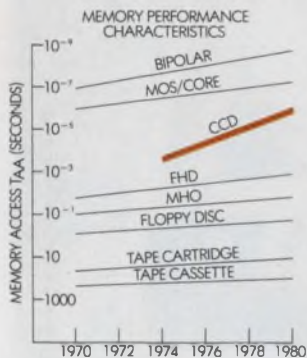

FAIRCHILD

**CALL US ON IT.
(415) 962-3941**

CIRCLE NUMBER 9



Field lab!

Now you can take advanced multi-channel recording technology out of the laboratory and into the field. EMI's proven SE7000 rivals the versatility, fidelity and performance of the most expensive lab recording systems. Yet it's rugged enough, compact enough to travel to the factory floor, the launch pad or any other operation site.

The SE7000 handles the full range of requirements from routine 14-track midband all the way to 42-track recording capability. It offers a choice of eight speeds between 15/16 and 120 ips providing 600 kHz DR or dc to 80 kHz FM at 120 ips. Equalizers and filters for all tape speeds are built in as standard. And it has a built-in

calibration module, eliminating the need for time-consuming cross-patching.

All these features are packed into a transportable unit so rugged that the system is warranted unconditionally for a full year. Complete with its internal AC or DC power supply, the weight is less than 100 pounds.

The SE7000 has gone into the field in automotive, aerospace, petrochemical and transportation applications all over the world. Applications, like yours, that need laboratory precision but can't be brought to the lab.

EMI Technology Inc., Instrumentation Division,
55 Kenosia Avenue, Danbury, CT 06810 (203) 744-3500,
TWX: 710-456-3068



EMI Technology Inc., Instrumentation Division.
A member of the EMI Group. International leaders in music, electronics and leisure.

CIRCLE NUMBER 10

Revolutionary NEW 64-bit 15 MHz Digital Correlator.

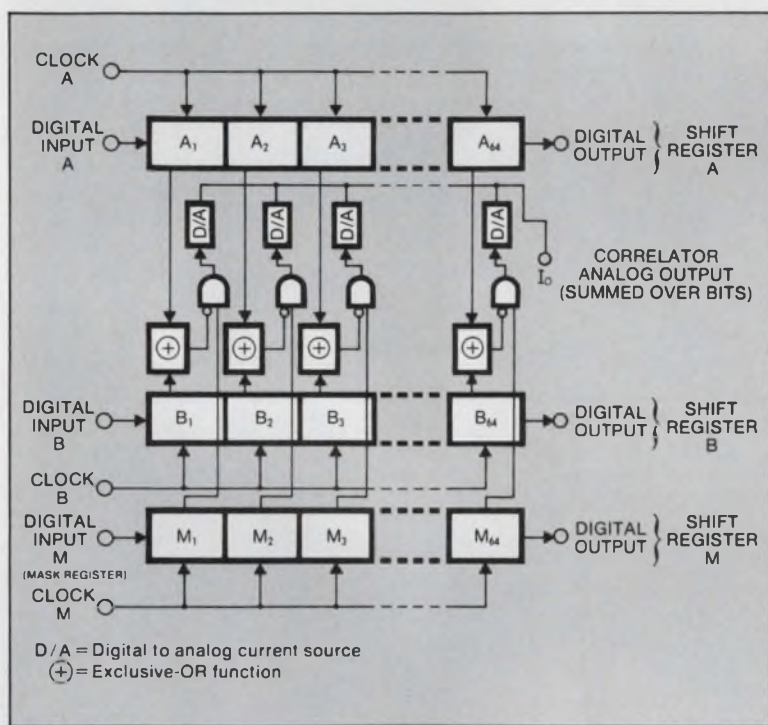

TDC-1004J

Features:

- 15 MHz correlator speed
- 30 MHz shift speed (static shift registers)
- Analog current output, proportional to degree of correlation between registers
- Mask register: Used to select "Don't Care" (no effect on correlation) bit positions if desired
- Monolithic, bipolar TTL
- 16 pin C DIP
- 0-70°C operation
- 200 mW power consumption
- Only \$150 each in 100's

Applications:

- Image comparison/recognition
- Bit/word synchronization
- Bit/word detection
- Error correction coding
- Pulse compression
- One's or zero's counter

The TRW TDC-1004J is a 64-bit digital correlator capable of operating at 15 MHz with analog correlation output. Digital parallel correlation is a signal processing technique used for bit synchronization, bit detection, error correction coding, pulse compression and other applications. Correlation takes place when two binary words are serially shifted into two independently clocked shift registers. The two words are continually compared bit-for-bit by exclusive-OR circuits.

Each exclusive-OR circuit controls a current source D/A. The current outputs of the D/A circuits are summed to produce the correlation function.

The mask register allows the user to selectively choose "no-compare" bit positions.

For detailed data, applications information and prices, contact your local TRW components sales office or call (213) 535-1831 or write TRW LSI Products, An Electronics Components Division of TRW, Inc., One Space Park, Redondo Beach, Calif. 90278.

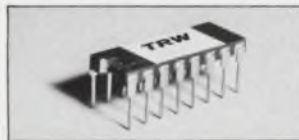

TRW LSI PRODUCTS

...from a company called TRW

BRAND NEW MINICOMPUTERS

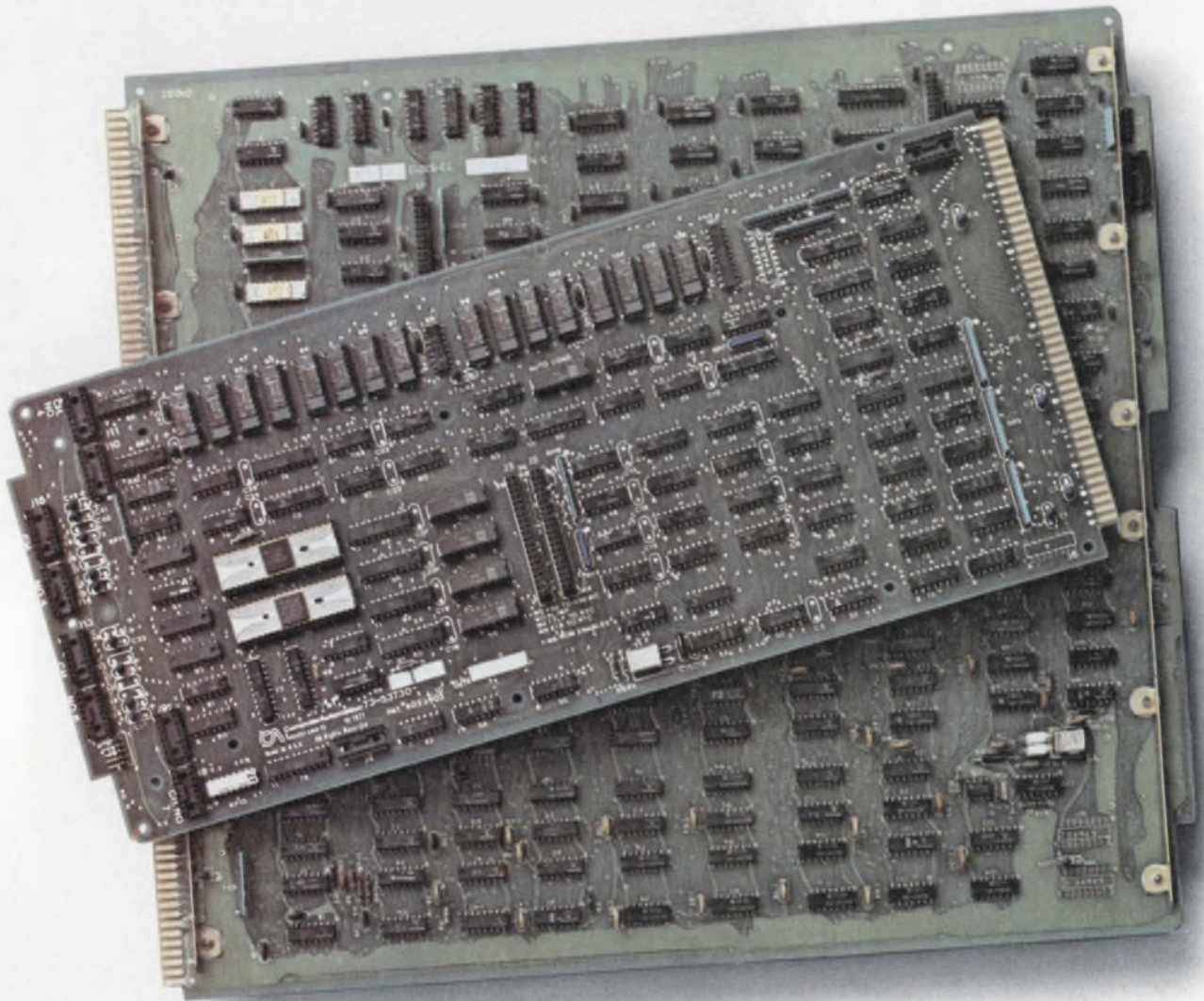

BRAND NEW BROCHURE



Circle Reader Response No. 270

 **ComputerAutomation®**
NAKED MINI® Division
18651 Von Karman, Irvine, California 92713
Phone (714) 833-8830

©1977 Computer Automation, Inc.

You Can Do More with HP Microprocessor Power Supplies...

BECAUSE YOU GET TRIPLE OUTPUT!



for the design stage...

of your microprocessor system, HP's compact, low cost lab power supplies offer more. For example, Models 6236B and 6237B offer three adjustable output voltages. Model 6236B covers 0 to 6V at up to 2.5A. Model 6237B is 0 to 18V at up to 1A. Both have plus and minus outputs of 0 to 20V that track within 1%, or you can switch

to a variable tracking mode which allows the negative output to be separately set lower than the positive providing three different output voltages. There are no turn-on/off voltage transients so your circuit is protected against damage. Both models are designed to make development work with microprocessors easier.



for the end product...

where you can feature a triple output OEM Modular Supply specifically designed for powering microprocessor systems. Model 62312D provides three isolated, independently adjustable outputs. The main output is rated at 4.75V to 5.25V at 3A. Two others each range from 4.75V at 0.38A to 12.6V at 0.6A. Other standard

features to help optimize your microprocessor design include an internal AC line fuse, fixed foldback current limit, over voltage protection on the main 5V output, remote programming terminals for margin testing and much more. Write for complete details or contact your nearby HP field sales office.

HEWLETT **hp** PACKARD

1507 Page Mill Road, Palo Alto, California 94304

For assistance call: Washington (301) 948-6370, Chicago (312) 255-9800, Atlanta (404) 434-4000, Los Angeles (213) 877-1282

21701

Low-cost logic analyzers aim to fill more needs

As prices for logic-state and logic-timing analyzers fall, digital test techniques using these analyzers are filtering down from research and design labs to production floors, out into the field, and even to the hobbyist. In fact, the latest logic analyzers are so inexpensive that engineers may no longer have to share a lab's single analyzer.

"Each digital-circuit designer can have a logic analyzer," says Dave Blecki, marketing vice-president at Biomation Corp., "just like he has his own oscilloscope." The Cupertino, CA, firm's latest logic-timing analyzer, the Model 920-D, is priced at \$1295—about the same as a high-quality scope like the Tektronix 465. Biomation's older models are 10 times more expensive.

Hewlett-Packard Co., too, has introduced a low-cost logic analyzer, the Model 1602A. Priced at \$1800, the HP logic-state analyzer is aimed at production-line and field-service testing, says Bruce Farly, product planning manager for digital products at HP's Colorado Springs division.

An even less expensive analyzer, from Paratronics Inc., San Jose, CA, is the \$429 Model 150. Available for \$349 in kit form, the 150 has a single card that plugs into the S-100 small-computer bus and monitors 64 of the bus's lines. The S-100 bus lines monitored include data in, data out, address, status, control, and interrupts, with an additional eight user-selected lines.

"It's an easy way to look at the bus," says Ira Spector, Paratronics president. What's more, "Sophisticated logic-analyzer functions can now be an integral, resident part of a mainframe computer system." A small control pod connected to the analyzer through a ribbon cable allows the operator to set the 150's triggering, display formatting, and operational modes. A coaxial cable brings signals from the analyzer to an oscilloscope.

Data on the scope screen can be in octal or hexadecimal format, with 16



A low-cost bit-grabber, Paratronics' Model 150 plugs into an S-100 computer bus.

eight-bit data words grouped in threes or fours.

The Model 150 can be triggered to store data by the 16 bus-address lines or by eight input-data lines, or both for a 24-bit trigger word. The clock can be external or taken directly from the S-100 bus. Data collection rate is up to 8 megabytes/s.

HP's Model 1602A, controlled by an F8 microprocessor, has a memory 16 bits wide and 64 words deep. It automatically tests itself every time power is turned on, and has an optional IEEE-488 interface.

Setting the 1602A is simplified by the F8—a feature necessary for field-service applications. Pushbuttons select logic polarity and clock-pulse polarity, and set the display to hex, decimal, octal or binary. A trigger word is selected, and a delay of anywhere from 0 to 65,535 clock intervals before data trace can be specified.

A clip-on probe set plugs into an edge connector on the 1602A probe. The connector mates with similar connectors at test points on new equipment—which simplifies point-to-point probing.

Biomation's 920-D is a 20-MHz logic-timing analyzer that has eight channels plus a ninth input that can serve as either an extra signal input or as a trigger marker and qualifier. Besides

the eight combinational trigger and qualifier switches, an extra switch works with the auxiliary input. Delay can be by events or by as many as 9990 periods.

The 17-lb 920-D has a latch input mode that can capture narrow pulses or glitches as short as 10 ns.

For Biomation Circle No. 316

For Hewlett-Packard Circle No. 317

For Paratronics Circle No. 318

Plastic-cased PROM matches EPROM for less

A PROM housed in an expensive plastic package not only costs less than half as much as a 2708 EPROM, but can fit into every socket that uses a 2708.

There is one catch. Unlike the 2708 EPROM, the MCM2708P from Motorola, Austin, TX, can't be reprogrammed. The opaque plastic housing prevents UV light from erasing the memory contents.

However, in many cases, a 2708 EPROM isn't reprogrammed anyway. Normally used to hold a program during its development, the EPROM is often left in a final product until the designer can replace it with a less expensive, mask-programmed ROM. And the designer may have to wait anywhere from four to 12 weeks for it.

But with the MCM2708P, there is no wait. The chip slips right into a 2708 EPROM socket, programs just like a 2708 EPROM, and matches its performance. The Motorola chip accesses in 450 ns and dissipates 600 mW.

When purchased in 100-qty lots, the MCM2708P is expected to go for less than \$10.

CIRCLE NO. 319

Yak it up long-distance—but watch the charges

Dial a number—any number—in the U.S. or Canada, and a μ P-based telephone system, the Extension I, knows the current long-distance rates. Even as you talk, a LED display shows you how much the call is costing. (An audible "beep" warns you six seconds before you incur the next cost increment.) When you hang up, you get a hard-copy record of the call, including the number you called, how long you spoke, and exactly how much you owe.

But what happens when telephone rates change? A master computer simply feeds new tariff data to the computer-phone over WATS lines.

The Extension I designed by Tele-neutronics of San Jose, CA, is a 7-lb, 11 × 17-in. desk telephone that looks like a standard Call Director. But the similarity ends right there. The Extension I uses a Motorola 6800 μ P, a 6-kbit memory, four keyboards and a thermal printer for both accounting and nonaccounting jobs. Tap in a three-letter code and the computer telephone will dial one of 100 commonly dialed numbers of your choosing. Used as an event timer for meetings and incoming calls, the Extension I will add the charges onto clients' monthly totals.

This 10-line business-phone system also has a five-function calculator and an appointment-calendar system, both with printouts. An alphanumeric "typing" keyboard lets you add notations into the printed reports.

But even with these many convenience features, plus the ability to call you half an hour early to remind you of key appointments, the main reason for developing the Extension I was to attack cost-control problems.

Dwight R. Nunes, now president of Teleneutronics, was running a chemical brokerage firm, and helplessly watching his phone bill hit \$3000 a month. "I had no control over the charges, and that's when I went to work on this idea," he recalls.

Scheduled for September deliveries, the \$1995 Extension I only handles calls to specific area codes, but permits exceptions for certain allowed numbers. However, the telephone won't work at all unless you first "unlock" it by identifying yourself with a special code. If Extension I is accidentally or illicitly unplugged from the computer-telephone network, it sounds an alarm and "locks" itself so that no calls can be made.

High density tape head reads data at 240 Mbit/s

A 240-million-bit-per-second digital tape recorder features three times the data rate of available units. Demonstrated by RCA's Government Recording Systems, Camden, NJ, and under development for 5 years, the recorder uses two new high-performance 70-track-per-inch magnetic heads to produce a packing density greater than 1.5-million bits per square inch. Two inch magnetic tape is used.

Dubbed HDMR, for high density multitrack recording, it is the first digital tape recorder device to handle

data at such a high rate by itself. According to Charles Horton, manager of government Recording Systems, prior to HDMR, rates in excess of 100-million bits per second could only be handled by using several synchronized tape transports.

Unlike other magnetic head assemblies that are individually fabricated, the HDMR's head assembly is one long unit cut into individual heads. This construction raises the limit of track density from under 50 tracks/in. to 70 tracks/in. Work is under way to increase the density to 100 tracks/in.

The HDMR will make possible the real-time, direct, digital recording of signals from wideband sensors. Such a recorder will be needed by the Space Shuttle and for recording data from future satellite-borne earth-sensing equipment.

Home computer spells out errors in plain English

The latest entry in the personal computer market—Pecos 1016—uses an extension of JOSS language to make it easier for the user to spot his own errors.

JOSS, developed by the Rand Corp., is similar to BASIC but has a superior plain-language error commentary, according to Ken Boilen, chief engineer for APF Electronics, New York, which developed the personal computer. For example, if the user inadvertently tries to divide a number by zero, Pecos will say, "I have a zero divisor."

The Pecos, which will be initially supplied with a 9-in. CRT monitor, is based on MOS Technology's 6502, 8-bit microprocessor. A later model will be able to use a home TV screen the way video games do.

The computer has a keyboard similar to a typewriter, plus additional keys to simplify communication with the Pecos. To request action or input information, a user types in simple English sentences with up to 80 characters per sentence. The output is up to 40 characters per line, with up to 16 lines at a time. Moreover, when the screen is filled, Pecos can scroll. That is, it shifts the top line off of the screen and adds a new one on the bottom.

There are two main computer memories, one holding 16-k 8-bit bytes of dynamic RAM, the other a 14-k operating-system ROM. Two 30-min. tape cassettes handle programs that exceed the internal-memory storage. These decks can store 1000 lines of

commands at 80 characters per line—a maximum of 80,000 bytes.

Once the tapes are engaged, the operator can tell Pecos to read or write. The computer then takes control. An address track on each tape tells the computer where to find specific data. In addition, information on one tape can be transferred to the other.

The Pecos can process arithmetical, logical and textural strings. It has a floating-point-arithmetic capability of nine digits with a calculations range of 10^{-99} through 10^{99} .

The keyboard is full ASCII, with both upper and lower case letters. An RS-232 output is provided for the Pecos printer, which can be operated at 110, 150, 300 or 1200 bauds.

Deliveries start in December. Price is projected to be between \$1000 and \$1500.

MOSFET-type IC detects smoke, measures humidity

An IC device can detect smoke or measure humidity by combining thin films of special polymers—similar to plastic—with the structure of a so-called "charge-flow transistor." The transistor resembles a MOSFET, but with a portion of a MOSFET's metallic gate structure replaced by the polymer film.

The detector and the circuitry necessary to operate it can be put on a chip 0.05 in. square, according to its inventor, Dr. Stephen D. Senturia, associate professor of electrical engineering at MIT.

The humidity and smoke-sensitive polymers are just two of many polymer materials developed by Senturia to respond to the pressure of microscopic particles in the air. As a matter of fact, Senturia adds, "We hope to find other polymers that will respond to a number of hazardous gases and pollutants."

The sensor is fabricated with the standard four-mask process for p-channel MOSFETs. Depositing the polymer film is the final step. A change in sheet resistance of the film is the key to device operation.

The charge transistor was developed with the support of the National Aeronautics and Space Administration. "We are now finding that the charge-flow transistor is an excellent tool for studying the properties of thin films," says Senturia. "Our current experiments are aimed at developing a theory to explain the behavior of thin films."

MIL/NASA QUALIFIED RECTIFIERS

WE HELPED WRITE THE "BOOK"!



What's in a Number ?

For over a decade Military Specifications have been written around Semtech E.I.A. registered medium power rectifiers. Many suppliers can provide parts with the same JAN, JANTX or JANTXV label. Although these devices may comply with the appropriate military specification, there can be significant differences in the design and manufacture that may affect the reliability; such as, different lead materials, pin materials, body materials, junction types and junction areas. Devices of one manufacturer are not necessarily the same as those of another, even though they are labeled with the same part number.

Semtech Corporation is one of the few manufacturers in the industry that has its own government approved Qualification Test Facilities equipped to perform tests that meet the requirements of Military and Space programs. A NASA approved Radiographic Inspection (X-Ray) facility rounds out the total capability of Semtech's environmental and test facilities.

We have earned the confidence of the Military establishment by supplying reliable devices to government specifications throughout our history.



Military Specifications

MIL-S-19500/2400

JAN, JANTX, JANTXV 1N645* -1
JAN, JANTX, JANTXV 1N647* -1
JAN, JANTX, JANTXV 1N649* -1

MIL-S-19500/279C (NAVY)

JAN, JANTX 1N3644*
JAN, JANTX 1N3645*
JAN, JANTX 1N3646*
JAN, JANTX 1N3647*

MIL-S-19500/286C

JAN, JANTX, JANTXV 1N4245
JAN, JANTX, JANTXV 1N4246
JAN, JANTX, JANTXV 1N4247
JAN, JANTX, JANTXV 1N4248
JAN, JANTX, JANTXV 1N4249

MIL-S-19500/359B

JAN, JANTX, JANTXV 1N4942
JAN, JANTX, JANTXV 1N4944
JAN, JANTX, JANTXV 1N4946
JAN, JANTX, JANTXV 1N4947
JAN, JANTX, JANTXV 1N4948

MIL-S-19500/411C

JAN, JANTX, JANTXV 1N5415
JAN, JANTX, JANTXV 1N5416
JAN, JANTX, JANTXV 1N5417
JAN, JANTX, JANTXV 1N5418
JAN, JANTX, JANTXV 1N5419

MIL-S-19500/420A

JAN, JANTX, JANTXV 1N5550
JAN, JANTX, JANTXV 1N5551
JAN, JANTX, JANTXV 1N5552
JAN, JANTX, JANTXV 1N5553
JAN, JANTX, JANTXV 1N5554

MIL-S-19500/427B

JAN, JANTX, JANTXV 1N5614
JAN, JANTX, JANTXV 1N5616
JAN, JANTX, JANTXV 1N5618
JAN, JANTX, JANTXV 1N5620
JAN, JANTX, JANTXV 1N5622

MIL-S-19500/429B

JAN, JANTX, JANTXV 1N5615
JAN, JANTX, JANTXV 1N5617
JAN, JANTX, JANTXV 1N5619
JAN, JANTX, JANTXV 1N5621
JAN, JANTX, JANTXV 1N5623

*Not E.I.A. registered by Semtech Corporation.

MIL-S-19500/484(EL)

JAN, JANTX 1N5835
JAN, JANTX 1N5836

MIL-S-19500/503(EL)

JAN, JANTX, JANTXV 1N6073
JAN, JANTX, JANTXV 1N6074
JAN, JANTX, JANTXV 1N6075
JAN, JANTX, JANTXV 1N6076
JAN, JANTX, JANTXV 1N6077
JAN, JANTX, JANTXV 1N6078
JAN, JANTX, JANTXV 1N6079
JAN, JANTX, JANTXV 1N6080
JAN, JANTX, JANTXV 1N6081

NEW! Transient Voltage Suppressors

MIL-S-19500/516(EL)

JAN, JANTX, JANTXV 1N6102 thru 1N6137
JAN, JANTX, JANTXV 1N6102A thru 1N6137A
JAN, JANTX, JANTXV 1N6138 thru 1N6173
JAN, JANTX, JANTXV 1N6138A thru 1N6173A

NASA (MSFC) Approvals

85M01645 (NASA) S1N645S & S1N649S

85M03895 (NASA) S1N4245-1, S1N4247-1, S1N4249-1,
S1N4942-1, S1N4946-1 & S1N4948-1

85M03896 (NASA) S1N5199, S1N5201, S1N5417-1 &
S1N5419-1

RELIABILITY COSTS LESS !

1975 NATIONAL SBA SUBCONTRACTOR OF THE YEAR



652 Mitchell Road, Newbury Park, California 91320
(805) 498-2111 • (213) 628-5392 • TWX: 910-336-1264
CHICAGO: (312) 352-3227 • DALLAS: (214) 234-6523
FLORIDA: (305) 644-5404 • MARYLAND: (301) 937-0070
NEW JERSEY: (201) 654-4884 • SAN FRANCISCO: (415) 494-0113
EUROPEAN SALES: Bourns AG Zug, Switzerland (042) 232-242

CIRCLE NUMBER 14

CENSORED



unless you
want to know
the most intimate
details about
threaded
fasteners

Send for a copy for
your own business library.

*If it were made into a movie,
it would probably be rated
Q—that is to say,
suitable only for mature,
responsible adults
interested in high quality
fasteners. But it's a
Reference Guide on the
subject. Look into it. You
might be shocked by the
savings you could make
and the extensive line
of fasteners we make.*

IF WE
DON'T MAKE
THE FASTENERS
YOU NEED
(UNLIKELY!),
WE'LL CUSTOM-MAKE
THEM FOR YOU

accurate

THREADED FASTENERS, INC.

Division of Beatrice Foods Co.
3550 West Pratt Avenue
Chicago, Illinois 60645
(312) 583-5300

This is what the designer SEES.

A REPLACEABLE LAMP LIGHTED PUSH BUTTON SWITCH

10400/10410
10420 Series

DESCRIPTION

Molex has introduced a new U.L. listed replaceable bulb/lens lighted push button switch family. The buttons may be molded in an assortment of colors and shapes to enhance the appearance of your assembled unit. Switch actions include SPST, SPDT, DPST, and DPDT with momentary or alternate action. Applications include office machines, appliances, computers and the home entertainment field.

FEATURES

50,000 minimum life cycle. In addition to the 10.1 AMP rating, the entire series offers reliable switching action at low levels (100 milli-amps at 30 volts), and a replaceable T 1 3/4 bulb in all but the 125 Neon version.

Molex offers a wide variety of button colors, bezels, and legends as

10400 Rectangular bezel w/molded mounting ears

10410 Rectangular bezel w/spring clip mounting

10420 Square bezel w/spring clip mounting

Patent Pending

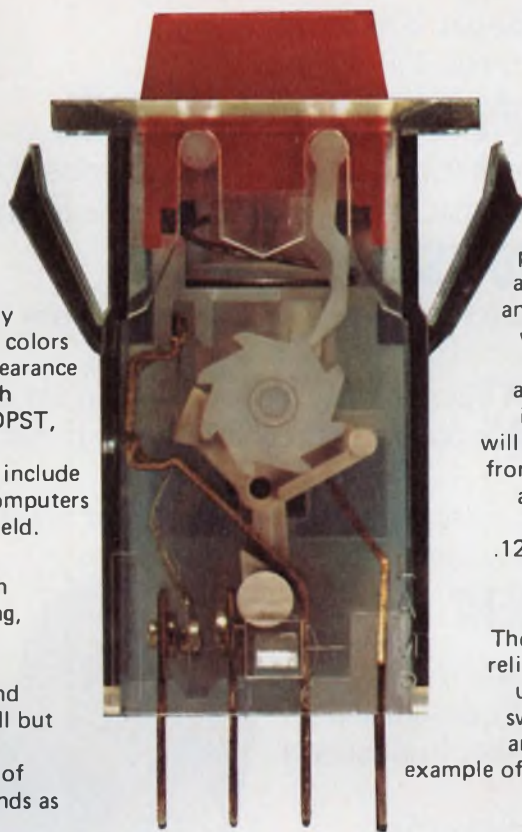
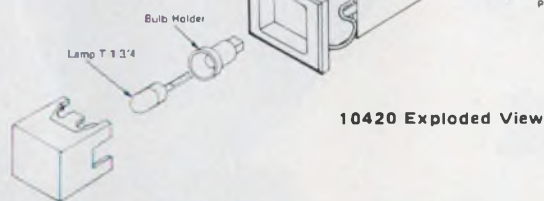

well as a square or pyramidal shaped lens. Recommended panel cutout dimensions include an .875 x .875 (10410 and 10420) and .875 x 1.050 (10400 versions) which are compatible with most comparable switches presently available today. The 10400 with integrally molded mounting ears will accommodate a panel thickness from .030 to .093, while the 10410 and 10420 versions offer a front removable feature from .030 to .125 thick panels. Spade terminals are .02 x .19 x .30 length.

FOR "UNDER A BUCK"

The Molex product is designed as a reliable, low cost unit with features usually found only on expensive switches. In 5M quantities SPST are 99¢ each (including bulb). An example of Molex "affordable technology".

10400

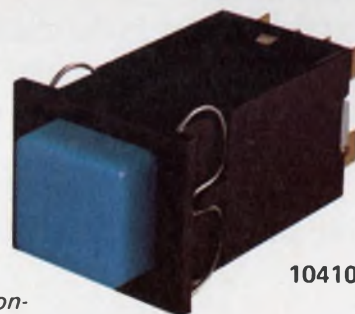

10410

MOLEX SERVICE

Molex has a nationwide network of representatives and authorized distributors to handle your off-the-shelf and large quantity orders. Field engineers are at your service to solve your tooling problems.

LITERATURE

For your FREE 16-page Switch Catalog including photos, line drawings and specifications of the Molex line, call (312) 969-4550; or write Molex Incorporated, 2222 Wellington Court, Lisle, IL 60532.



... Affordable Technology

NEC IS BULLISH ON

1. WE'RE THE COMPANY WITH ALL FOUR KINDS.

Now with the introduction of these four new families, we're the company with every kind of dynamic RAM you could need:

The μ PD414 Series — 4K, 16-pin, 200-350ns.

The μ PD418 Series — 4K, 18-pin, 150-300ns.

The μ PD411A Series — 4K, 22-pin, 200-350ns.

The μ PD416 Series — 16K, 16-pin, 150-300ns.

2. WE GIVE YOU A $\pm 10\%$ OPERATING MARGIN.

In all four families. Compare that with other people's margins of $\pm 5\%$. Imagine the manufacturing care that takes. And the added flexibility you get.

3. WE DESIGN THEM TO USE LESS POWER.

Our μ PD414's and 416's have as low a power dissipation as any comparable product in the industry.

And our μ PD418's and 411A's actually use less power than any other standard 18- or 22-pin 4K RAMs on the market. In fact, our 18-pin uses 60% less power.

And with this kind of power dissipation, we can offer all our RAMs in plastic, as well as cerdip, packages.

4. WE'LL EVEN PUT THEM ON A BOARD.

If you want any of our products on a board, we'll gladly design and build it for you. However you like. In whatever quantity you need.

So next time you're in the market for dynamic RAMs, why not contact one of our reps or distributors. They've got everything you need. And that's no bull.

NEC Microcomputers, Inc., Five Militia Dr.
Lexington, MA 02173, 617-862-6410.

NEC microcomputers, inc.

REPS: East — C&D Sales 301-296-4306. Contact Sales 617-273-1520. Harry Nash Assoc. 215-657-2213. Tech-Mark 607-748-7473. 716-223-1252. 315-652-6229. Trionic Assoc. 516-466-2300; South — Perrott Assoc. 305-792-2211. 813-585-3327. 305-275-1132. Wolfs Sales Serv. Co. 919-781-0164; Midwest — Electronic Innovators 612-884-7471. W. Pat Fralia Co. 817-640-9101. 817-649-8981. 713-772-1572. K-MAR Eng. & Sales 816-763-5385. R.C. Nordstrom & Co. 313-559-7373. 616-429-8560. Technology Sales 312-438-3300; West — Mike Duffy Assoc. 303-934-7392. Electronic Component Marketing 714-524-9899. 213-649-5374. Spedden Assoc. 714-295-6122. Summit Sales 602-994-4587. Trident Assoc. 408-734-5900. Tri Tronix 206-232-4993. 505-265-8409; Canada — R.F.Q. Ltd. 416-626-1445. 514-626-8324.

DISTRIBUTORS: Century Electronics (Albuquerque, Salt Lake City, Wheatridge CO), Diplomat (Chicopee Falls MA, Clearwater FL, Elk Grove Village IL, Farmington MI, Minneapolis, Mt. Laurel NJ, Salt Lake City, St. Louis, Sunnysvale, Totowa NJ, Woodbury NY), Future Electronics (Montreal, Ottawa, Rexdale, Canada), Harvey Electronics (Fairfield NJ, Lexington MA, Norwalk CT, Woodbury NY), Intermark Electronics (San Diego, Santa Ana, Sunnysvale), Lionex (Burlington MA), G.S. Marshall (Sunnysvale), Mirco Electronics (Phoenix), Resco (Raleigh), R-M Electronic (Kentwood MI, Madison Hgts MI), Serricomp (Newport Beach CA), Semiconductor Specialists (Burlington MA, Chicago, Dallas, Dayton, Farmington MI, Hazelwood MO, Indianapolis, Kansas City, Milwaukee, Minneapolis, Pittsburgh, St. Louis, Malton Canada), Sterling Electronics (Albuquerque, Dallas, Houston, New Orleans, Phoenix, San Diego, Seattle, Sun Valley CA, Watertown MA), Technico (Columbia MD, Roanoke VA), Zeus Components (Elmsford NY).



DYNAMIC RAMS.



No other conformal coating can make this statement.



Dow Corning 3140 RTV silicone coating is the only conformal coating that has UL recognition to 180°C and also meets the requirements of Mil Spec MIL-I-45608. But, there's more.

Dow Corning 3140 silicone coating stands up to the toughest environments. It is a one-part coating that is non-corrosive to copper and other sensitive materials. Its high tear strength allows you to use it anywhere you need good shock insulation. Dielectric properties are excellent. 3140 really performs when the heat is on. As we said, it's UL-listed to 180 C.

Dow Corning 3140 is fast and easy to apply or repair. You can brush, dip, flow coat or spray it on at room temperature. It goes on clear, so you can easily identify coated components. It can be handled in 24 hours or less, and a little goes a long way.

If you have an application that requires proven durability, toughness and resistance to heat and corrosion, you just can't afford less.

Decide for yourself. Write for literature and a how-to-apply brochure to Dow Corning Corporation, Dept. A7-512, Midland, Michigan 48640.

DOW CORNING



Intel delivers PDP-11 memory for people who can't afford to wait.

When you're in a hurry for more semiconductor memory for your PDP-11, call Intel. We deliver memory for the full PDP-11 line. And because we're the largest manufacturer of semiconductor memory in the world, delivery is when you want it.

Why wait? Since you've chosen the leader to supply your minicomputer, it makes sense to go to the leader for memory, too. That's us.

Intel memory systems save you more than time. Our in-1670 add-on memory for the PDP-11/70 is one example. It gives you four times the capacity in the same frame compared to the DEC MJ11-A core memory. And built in Error Correction Code (ECC) and Error Logging improve up-time and reduce maintenance time by automatically correcting and recording single-bit failures and detecting and recording double-bit errors.

For PDP-11 add-in memory go with our in-4711 plug in boards. You'll get memory that's even faster than DEC's. 16K words per hex-wide board. With or without parity. To further expand PDP-11 memory and reduce UNIBUS™ loading choose our in-4011 add-on. With memory management you can expand to 128K words in 16K increments. And since the in-4011 requires only one UNIBUS load, you get added system flexibility.

Get more memory for your LSI-11 and PDP-11/03 in less space with our in-1611 add-in memory. You get up to 32K words, in 8K increments, on a single, two-wide, board. That's up to eight times the memory you get with a DEC board.

When you can't afford to wait call us at 800-538-8476. In California and Canada, call 408-734-8102, x575. We'll save you time, and much more.

intel delivers.

Intel Memory Systems
1302 N. Mathilda Avenue
Sunnyvale, California 94086

I can't wait! Must have delivery in 5 Days 30 Days _____ Days

Please call me at _____/_____ Ext. _____

Please send me information on semiconductor memory for the following:

LSI-11, PDP-11/03

PDP-11/04

PDP-11/05

PDP-11/34

PDP-11/35

PDP-11/40

PDP-11/45

PDP-11/55

PDP-11/70

Name/Title _____
Company _____ Mail Station _____
Address _____
City/State/Zip _____

UNIBUS is a trademark of Digital Equipment Corp. Maynard, Mass.

New York's blackout: Too many questions, not enough answers

Was it an "act of God"? Or was it "gross negligence" on the part of Consolidated Edison Co., New York's electric-utility company, that left sections of the city without power for as long as 25 hours? Could better protective circuitry on the company's power lines have prevented the disaster? Or did the protective circuits installed in response to the last Great Blackout, in 1965, actually contribute to this year's outage?

In 1965, a failure at a distribution center near Buffalo knocked out utilities one by one across the northeast. Some large generators were damaged as they tried to keep power flowing.

To prevent a recurrence, automatic disconnect relays were installed between utilities, so that a severe drain in one would not drag others along. In addition, Con Ed added power lines north of New York City so that no one line would have to carry the whole burden. Additional relays were put in to disconnect overloaded generators from the system.

Even with these safeguards, Con Ed went down. Though the problem was limited to Con Ed, and no damage was done to any of Con Ed's generators, the precautions designed to prevent a blackout failed. New York City went dark again.

The city, whose mayor, Abraham Beame, considers Con Ed negligent, will investigate. Con Ed, whose chairman Charles Luce, blames God, will investigate. So will New York State's Public Utilities Commission and the Federal Power Commission. But all that's really known right now is that 9-million people in the six counties served by Con Ed were unplugged at about 9:35 p.m. on July 13, and that service to some of Con Ed's customers



Power problems cascaded from the north as Consolidated Edison Co. of New York lost power from Indian Point, then the tie lines to upstate sources. Tie lines to New Jersey and Long Island overloaded and cut out, leaving the burden on Con Ed's major power plants in Queens.

wasn't restored until 10:30 the following night.

Lightning strikes

Trouble actually started at about 8:30 p.m., when a severe thunderstorm passed through Westchester county, north of New York. Lightning apparently struck two 345-kV transmission lines near a substation at Buchanan, NY (see map). Without the

substation, 900 MW then being supplied by the Power Authority of New York's nuclear power plant at Indian Point—Indian Point 3—were disconnected from the rest of the power grid. Indian Point 2, which is owned by Con Ed, was out of service for repairs, and the obsolete Indian Point 1 has been shut down for years.

According to Arthur Hauspurg, president of Con Ed, the loss of the Indian Point generators was easily made up by drawing more power from upstate New York and Canadian sources. Of the 5800-MW demand on Con Ed at the time, half—2900 MW—was already being drawn from outside sources.

Con Ed is required by New York State law to deliver power to its customers at the lowest possible cost, explains Luce. And it is less expensive to buy power from outside sources than to generate it within New York City.

When power-line problems occur, an operator at Con Ed's energy control center on the west side of Manhattan begins switching in alternate sources of power and planning for the possibility of further losses. The control center, built in 1962, employs 100 technicians to monitor and supervise power generation and transmission through Con Ed's network of 325 substations.

At the control center, six system operators, one on duty at all times, forecast the expected load for each day based on weather reports and historical demands. The operator interfaces with Con Ed's control computer through a CRT terminal on which information from every substation can be displayed. Visible and audible alarms warn of problems, and a row of seven switches cuts off power to sections of the Con Ed service area when the demand for electricity exceeds the supply.

With part of Con Ed's capacity out

The only Double-Balanced Mixers with a 2-YEAR GUARANTEE*

featuring Hi-Rel tested diodes -

Introduced in 1971 at \$7.95...
still only

\$7.95
(500 pieces)
\$9.95 (1-49)

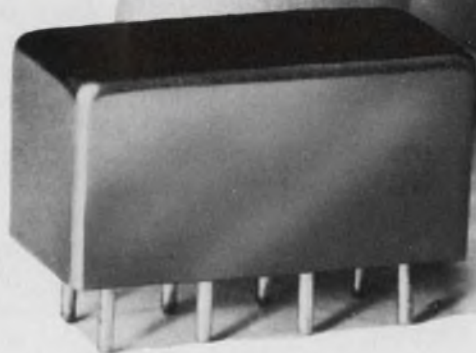

*including diodes!

Yes, a two-year guarantee for hermetically sealed DBM's is now a reality . . . made possible by an accelerated life diode screening program adopted at Mini-Circuits.

Each Schottky diode used in Mini-Circuits' SRA-1 mixers is now preconditioned by the HTRB (High Temperature Reverse Bias) technique, previously reserved almost exclusively for semiconductor applications assigned to space applications. With HTRB testing, each diode is operated for 168 hours at 150°C with one volt reverse bias applied.

To screen out "infant mortality", the diodes are deliberately stressed to accelerate aging and to force time-related failure modes to take their toll. In conventional testing or "baking", the diode does not experience anywhere near the stress encountered with the HTRB program. Hence, the ability at Mini-Circuits' to locate the potentially-unreliable diodes before they are assembled into SRA-1 units. And, with double-balanced mixers, the overall reliability hinges almost entirely on the diodes used.

Yes, the HTRB procedure costs us more and screens out more devices. But our goal is to improve reliability to a level unmatched for off-the-shelf DBM's at no increase in cost to our customers. You — our customers by your overwhelming confidence in our product line have made us the number one supplier of DBM's in the world.

To earn your continuing support, we are now employing HTRB Hi-Rel testing for every diode used in the SRA-1, at no increase in cost to you. So, for the same low price of \$7.95, you can purchase our SRA-1, with a two-year guarantee, including diodes.

To ensure highest system reliability demand highest quality diodes on your source-control drawings and purchase orders. Specify SRA-1 mixers, with HTRB tested diodes from Mini-Circuits!.. where low price now goes hand-in-hand with unmatched quality.

MODEL SRA-1

Freq. range (MHz) LO - 0.5-500 RF 0.5-500 IF dc-500

Conversion loss (dB)	Typ	Max.
One octave from band edge	5.5	7.0
Total range	6.5	8.5
Isolation (dB)	Typ.	Min.
Lower band edge to one decade higher	LO-RF 50	45
	LO-IF 45	35
Mid range	LO-RF 45	30
	LO-IF 40	25
Upper band edge to one octave lower	LO-RF 35	25
	LO-IF 30	20

Min. Electronic attenuation (20 mA) 3 dB

Signal, 1 dB compression level + 1 dBm

Impedance all ports 50 ohms



WE'VE GROWN

Customer acceptance of our products has been so overwhelming, we've been forced to move to larger facilities — THANKS

International Representatives: **AFRICA:** Afira (PTY) Ltd P.O. Box 9813 Johannesburg 2000 S Africa **AUSTRALIA:** General Electronic Services 99 Alexander Street New South Wales Australia 2065 **ENGLAND:** Dale Electronics, Dale House, Wharf Road, Frimley Green Camberley Surrey **EASTERN CANADA:** B.D. Hummel 2224 Maynard Avenue, Ulica, NY 13502 (315) 7367821 **FRANCE:** SCIE - D I M E S 31 Rue George - Sand 91120 Palaiseau France **GERMANY, AUSTRIA, SWITZERLAND:** Industrial Electronics GMBH 6000 Frankfurt/Main Klüberstrasse 14 West Germany **INDIA:** Gaekwar Enterprise Kama Mahal, M.L. Dananurkar Marg, Bombay 400 026, India **ISRAEL:** Vectronics, Ltd. 69 Gordon Street Tel-Aviv, Israel **NETHERLANDS, BELGIUM, LUXEMBOURG:** Coimex Veldweg 11, Hattem, Holland **NORWAY:** Datamatik AS, Ostensjoveien 62 Oslo 6, Norway **SINGAPORE & MALAYSIA:** Electronics Trading Co. (PTE) Ltd 87 Bukit Timah Road, Singapore 9, Malay Peninsula. **SWEDEN:** Intergrad Elektronik AB Box 43 S-18251 Djursholm, Sweden

U.S. Distributors: **NORTHERN CALIFORNIA:** Cain-White Co. Foothill Office Center 105 Fremont Avenue, Los Altos, CA 94022 (415) 948-6533 **SOUTHERN CALIFORNIA, ARIZONA:** Crown Electronics 11440 Collins Street No. Hollywood, CA 91601 (213) 877-3550

World's largest supplier of Double-Balanced Mixers



Mini-Circuits

MINI-CIRCUITS LABORATORY

A Division Scientific Components Corp

2625 EAST 14th STREET
BROOKLYN, NEW YORK 11235
(212) 769-0200

OUR NEW ADDRESS
AND PHONE NO. IS

DOMESTIC TLX 125460 • INTERNATIONAL TELEX 620156



Technicians monitor and control power flow through 325 substations from Con Ed's Energy Control Center.

of service, the operator began increasing power generated within the system. About 1000 MW are available from other Con Ed plants by computer command or telephone instructions to plant crews.

Suddenly, at 8:56, two more transmission lines went out—also apparently struck by lightning. These lines, just east of Buchanan, carry power from the northeast power-sharing grid. So now only one line was still connected to the north. Smaller ties were still connecting Con Ed to the Long Island Lighting Co., east of the city, and to Public Service Electric and Gas Co., in New Jersey.

Outside power drawn

Before lightning struck, 250 MW of power was actually flowing from Con Ed to Long Island via the LILCO tie line. But with Indian Point and the lines to the north out of service, Con Ed began drawing power from LILCO, as well as PSE&G.

To protect its system, Con Ed dropped voltage first by 5%, then by 8%, and disconnected power from Mount Vernon and Elmsford in Westchester county. That cut the load on Con Ed to between 5000 and 5500 MW.

But at 9:19, for a still-unknown reason, the third and last line to the northeast power grid was lost. This left Con Ed with its own capacity and the two smaller tie lines: LILCO could supply about 300 MW and PSE&G between 400 and 500 MW. But the combined demand from these two lines was at least 1100 MW, and surged to as much as 2500 MW.

One minute later, the LILCO tie line tripped out—a protective measure developed after the 1965 blackout. Circuit breakers prevented the "domino" effect from reaching outside Con Ed's service area.

Phase-angle regulators sense changes in line frequency quickly, and as

power demand exceeds supply and generators slow, power-line frequency begins to change. Thus, the tie to PSE&G disconnected at 9:30 to prevent that utility from joining Con Ed in darkness.

Now Con Ed was left with about 3000 MW of its own generating capacity, and a demand still around 5000 MW. Line frequency dropped to less than 59 Hz, from its normal 60 Hz, and lights began to dim throughout the service area.

Another feature of the protective system developed after the 1965 blackout is the ability of Con Ed to drop sections of its service area. The seven load-shedding switches in the Con Ed energy-control center can cut off up to 50% of the load, according to chairman Luce. But the manually operated switches were not thrown in time—perhaps because operators thought alternatives were still available.

Most of Con Ed's power had been coming from its Ravenswood 3 plant, popularly known as "Big Allis" after its manufacturer, Allis Chalmers. Without sufficient load shedding, Ravenswood 3 couldn't supply enough power. As line frequency changed, says Hauspurg, "controls regulating the voltage began to have difficulty following the swing. The machines became unstable."

To protect itself from overload damage, Ravenswood 3 automatically disconnected itself from the Con Ed system. Protection had been installed after the 1965 blackout to prevent a recurrence of the damage sustained by the generator when its oil pumps lost power, and a loss of lubrication destroyed the machine's bearings and windings.

The Ravenswood 3 relays had operated before another protective series of relays, installed after the 1965 blackout, could shed load automatically. The phase-sensing relays did not trip because the line frequency did not change

enough before Ravenswood 3 cut out.

Without "Big Allis," Con Ed's other generators shut down. Total failure struck at 9:34.

In the hour between the first sign of trouble and the loss of Big Allis, not enough of Con Ed's standby generating capacity could be brought up to handle the load. The next day, after power had been restored, Con Ed began staffing its standby plants around the clock, to speed turn-on when necessary. One suggestion made—an expensive one—was to keep standby generators spinning, even if they are delivering little power. Otherwise, checking out the generator, getting oil into its bearings, and bringing it up to speed and in synchronism with the rest of the power grid could take an hour or more, as this year's blackout proved.

Trying to cope without power

In the city's commercial centers, computers without backup power went off the air immediately. Those with battery-based uninterruptible power supplies shut down in a more orderly fashion, first storing data in non-volatile memories. A few sites, like the Citicorp banking computer center, had emergency generators and kept working with only an hour or two lost.

Computer-service crews raced around the city—carefully, since traffic lights were out—checking for damage and preparing equipment for a sudden surge of power and the voltage spikes that are inevitable when air conditioners, elevators, lights, and water pumps all come on at once.

New York Telephone Co., which once suffered from equipment shortages that led to waiting minutes for a dial tone, came through. Since almost all its customers are served by battery-backup power systems, even the unusual volume of emergency calls during the blackout didn't clog the system.

Power begins to return

To bring power back on without surges that would simply knock the system out again, Con Ed first had to open breakers on feeder lines throughout the city. Unlike virtually all other utilities, Con Ed maintains most of its lines underground. The lines are insulated and cooled by oil, so each segment has to wait for oil pressure to build up before coming on stream. As capacity was brought up, sections of the service area were cut in one at a time, matching supply to demand. ■■

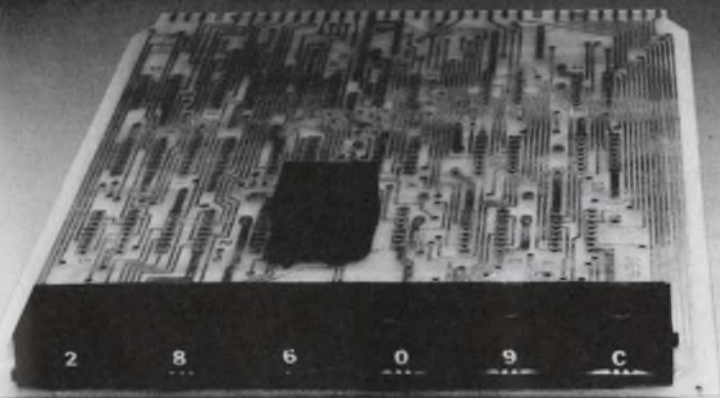

SNAPPY LITTLE NUMBERS

Save time and money with SAE Strip-Pak™ rotary PCB switches. These snappy little numbers come in a wide range of output codes, and are the most reliable PC board rotary switches you can buy.

The unique modular design of Strip-Pak switches lets you snap them together in strings. You can even mix output codes within the same gang. And Strip-Pak switches can be placed individually, too, either horizontally or vertically, any place on a board.

Additional versatility is provided by a choice of three operating methods: by thumb pressure, with a screwdriver, or with an optional snap-in knob.

SAE Strip-Pak switches are every bit as tough as they are versatile. We use a beryllium copper detent spring instead of plastic teeth or gears, for an operating lifetime of 500,000 detents. And that's a snappy *big* number.



More reliability comes from total in-house manufacture. SAE makes every part, inspects every part, and controls every detail of assembly.

We use tighter tolerances and we demand more precise registration of code discs and contacts. Every switch is a work of art.

Preformed, heat-treated terminals are made from 30 percent thicker stock, and the glass filled polyester housing resists both moisture and solvents. The terminals are completely sealed so you can wavesolder without flux wicking.

SAE makes a complete selection of switches, including large thumbwheels, programmable Bit™ switches and Strip-Pak switches. Write or call us and ask for a catalog.

We're Stanford Applied Engineering, 340 Martin Avenue, Santa Clara, California 95050. 408/243-9200.



The OEM Connection

CIRCLE NUMBER 23

Computer-graphic photo montage simplifies land-use projects

A new computer-graphics technique may make environmental reports easier to produce and may cut the costs of landscape architecture.

A computer is used to draw oblique pictures that represent landscape changes. The resulting photo montage will reduce the cost, time and subjectivity of artists' concepts.

Such a system has been developed for the U.S. Department of Agriculture by the Aerospace Corp., El Segundo, CA. It is installed at the U.S. Forest Service headquarters at Fort Collins, CO, to evaluate the visual impact of new fuel breaks—clear-cut strips designed to contain forest fires in inaccessible areas.

The Environmental Protection Agency (EPA) frequently demands environmental impact reports to illustrate the visual aspects of land-use projects such as refineries, man-made lakes, mountain roads and ski roads.

It starts with a camera

The process begins with a photo of the proposed site. A camera is positioned at a vantage point of concern, say a picturesque bend in a distant road.

Next, a U.S. geological-survey map of the area with a resolution of 7-1/2 minutes is digitized along its contour lines and fed to the computer.

"Up to 40,000 individual points on the map can be digitized in one day," says Aerospace program manager Al Stevenson. "And the process can cost as little as \$50."

At least four ground-reference points are selected to key the photo to the map. Using these references, the computer rotates the "bird's eye" view of the map down to coincide with the camera's more normal perspective.

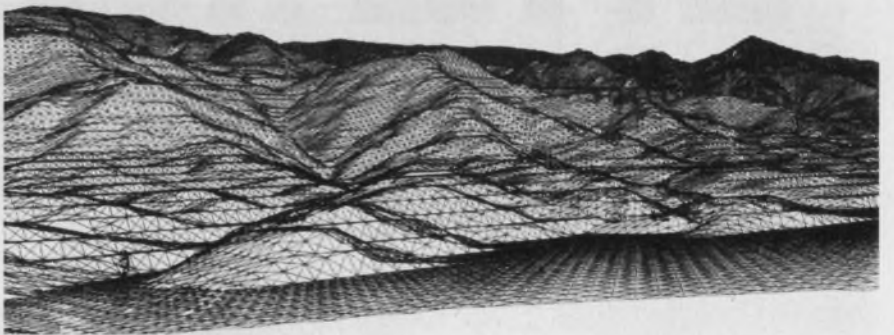

Taking a picture of a lake that isn't there yet is less costly than surveying, more accurate than an artist's concept and quicker than building a model. Photograph of actual site (top) is matched to a survey map of the area. The map is digitized along its contour lines, software-rotated to the camera's vantage point and outputted to a pen plotter (middle). A photographic process superimposes the two into a montage; an artist adds color and texture (bottom).

Dick Hackmeister
Western Editor

AN OPEN CHALLENGE:

**“We defy you
to find a
more reliable
DIP socket
or a less
expensive one.”**

A close-up photograph of a man with dark hair, wearing a grey plaid suit jacket, a white shirt, and a dark tie. He is looking directly at the camera with a serious expression. He is holding a small, black, rectangular electronic component (a DIP socket) between his fingers. The background is a plain, light-colored wall.

Joe Bradley,
Mktg. V.P.
Burndy
Corporation

“Here’s proof!”

Burndy DIP sockets outperform the others in economy and reliability.

Forget everything you’ve ever known — or thought you knew — about DIP sockets. And especially about DIP socket costs.

Burndy’s new low-cost, high-reliability GTH DIP sockets have changed everything for the better. Now, for just pennies you can use DIP sockets where you never dreamed of using them before — to enhance your product without pricing it out of the market.

And in most cases, using our DIP sockets adds nothing to overall costs. It can even result in a net cost reduction in many applications by simplifying design. Speeding installation.

Improving quality control and reducing your reject ratios.

In short, you enjoy all the advantages of IC pluggability (field serviceability, simplified design, faster installation, improved quality control and fewer rejects) without sacrificing reliability or adding significantly to costs. If you think that’s promising a lot — it is! And we’re ready to deliver on everything we promise. For proof, use the convenient Quick Response Card. Or write: Burndy Corporation, Norwalk, Connecticut 06856. And see how fast we get back to you.

Laboratory Proof

TESTS CONDUCTED PER MIL-S-83734A(USAF) REPORT NO. F7608-762 SUMMARY				COMPARATIVE TEST DATA (Durability and Moisture)																									
TEST PERFORMED	MIN.	MAX.	AVG.	Milliohms																									
				5	10	15	20	25	30	35	40	45	50	55	60	65													
GROUP 1 Mating Force (lbs./contact)	0.600	0.730	0.643	Burndy GTH Contacts	6.11	CHANGE IN MAXIMUM CONTACT RESISTANCE (with identical target areas) AFTER: • 10 cycles of Mate-Unmate • 10 cycles of Moisture Resistance per MIL STD 202: Method 106 (-25°C +65°C 95% RH)																							
Contact Withdrawal Force (oz. w/.008" blade)	2.500	8.100	4.940	Brand A Type 1 Tin Contacts	8.19	Brand B Tin Contacts	13.55	Brand C Tin Contacts	14.14	Brand D Type 1 Gold Contacts	16.32	Brand E Tin Contacts	20.90	Brand F Gold Contacts	24.05	Brand A Type 2 Tin Contacts	25.39	Brand C Gold Contacts	96.54	Brand G Gold Contacts	211	Brand D Type 2 Gold Contacts	693	Brand G Tin Contacts	915	Brand E Gold Contacts	9,400	Brand H Tin Contacts	15,000
Insulation Resistance (600 VAC for 1 min.)	2x10 ⁶	2x10 ⁶	2x10 ⁶																										
Contact Resistance	2.950	5.860	4.650																										
GROUP 2 Vibr & Mech Shock	5.050	5.930	5.420																										
Durability (50 cycles)	5.050	6.750	5.520																										
GROUP 3 Insulation Resistance (5,000 megohms min.)	>2x10 ⁶	>2x10 ⁶	>2x10 ⁶																										
Ins. Res. after Moist. Res. (5,000 megohms min.)	>2x10 ⁶	>2x10 ⁶	>2x10 ⁶																										
GROUP 4 Contact Resistance after Corrosive Atmos.	5.200	6.350	5.545																										
	4.850	6.350	5.519																										

Low-cost DIP sockets for all types of applications

Burndy DIP Sockets are currently being used in a wide variety of applications where high reliability and economy are required.



Burndy DIP Sockets are used in the Dictaphone Thought Center 293, a multiple-cassette, central dictation system for word processing applications.



Burndy DIP Sockets have been specified for the Model 1430 print-plus-display calculator by Monroe, The Calculator Company.



Burndy DIP Sockets have helped simplify design for Fairchild's popular Video Entertainment System.

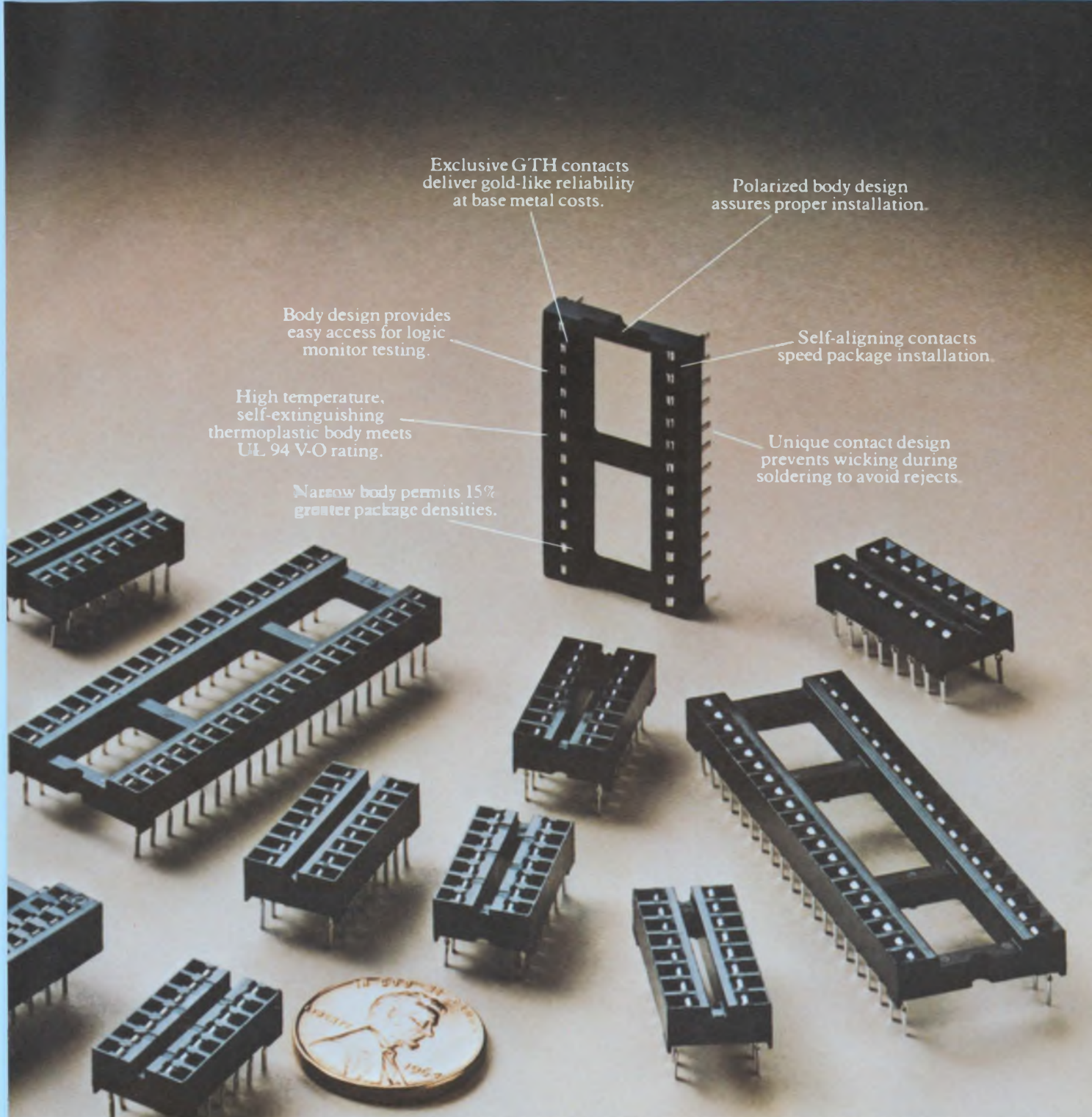

Exclusive GTH contacts deliver gold-like reliability at base metal costs.

Polarized body design assures proper installation.

Body design provides easy access for logic monitor testing.

Self-aligning contacts speed package installation.

High temperature, self-extinguishing thermoplastic body meets UL 94 V-O rating.

Unique contact design prevents wicking during soldering to avoid rejects.

Narrow body permits 15% greater package densities.

“MAKE ME PROVE IT.

Use this Quick Response Card and I'll send you data worth its weight in gold.”



Dear Joe: I like what you're saying but you've got to prove it to me in my own application. Here are my requirements:

Product Application _____

Operating Temperature _____

Mating Cycles _____

Name _____ Title _____

Firm _____

Address _____

City _____ State _____ Zip _____

Leaded or leadless Burndy leads the way in DIP Socket Design

Leaded or leadless. Solder tail or surface mount. Standard or hybrid. Top, bottom or side pad. Any required shape or size. Burndy makes DIP sockets to fit virtually every application need, any performance level. And they all have two things in common. Low cost and high reliability. That's because they all feature our patented GTH contact design that delivers good-as-gold connections without the cost of gold. And that's why you find our DIP sockets in such a wide variety of applications from highly sophisticated computers to TV receivers, from automotive applications to complex process control systems.

Burndy Corporation, Norwalk,
Connecticut 06856.



FIRST CLASS
Permit No. 100
Norwalk, Ct.

Business Reply Mail

No Postage Necessary if Mailed in The United States

Postage will be paid by —

BURNDY CORPORATION
Norwalk, Connecticut 06856

Attention: MS-100

AVAILABLE NOW THROUGH THESE BURNDY DISTRIBUTORS

- ARIZONA, Phoenix**
Kierulff Electronics, 602-243-4101
- CALIFORNIA, Irvine**
Cramer Electronics, 714-979-3000
- Los Angeles**
Kierulff Electronics, 213-685-5511
- Palo Alto**
Kierulff Electronics, 415-968-6292
- San Carlos**
Sterling Electronics, 415-592-2353
- San Diego**
Cramer Electronics, 714-565-1881
Kierulff Electronics, 714-278-2112
- COLORADO, Denver**
Kierulff Electronics, 303-371-6500
- CONNECTICUT, Hamden**
Arrow Electronics, 203-248-3801
- New Haven**
Cramer Electronics, 203-239-5641
- DISTRICT OF COLUMBIA**
Cramer Electronics, 301-948-0110
- FLORIDA, Ft. Lauderdale**
Arrow Electronics, 305-776-7790
- Hollywood**
Cramer Electronics, 305-923-8181
- Orlando**
Cramer Electronics, 305-894-1511
- GEORGIA, Norcross**
Cramer Electronics, 404-448-9050
Lykes Electronics, 404-449-9400
- ILLINOIS, Elk Grove Village**
Kierulff Electronics, 312-640-0200
- Mt. Prospect**
Cramer Electronics, 312-593-8230
- MARYLAND, Baltimore**
Arrow Electronics, 301-247-5200
- MASSACHUSETTS, Lexington**
Harvey Electronics, 617-861-9200
- Newton**
Cramer Electronics, 617-969-7700
- MICHIGAN, Kentwood**
R-M Electronics, 616-531-9300
- MINNESOTA, Bloomington**
Arrow Electronics, 612-888-5522
- Edina**
Cramer Electronics, 612-835-7811
- MISSOURI, St. Charles**
Lectronix, Inc., 800-325-3348
- NEW JERSEY, Moorestown**
Arrow Electronics, 609-235-1900
- Rutherford**
Kierulff Electronics, 201-935-2120
- Saddlebrook**
Arrow Electronics, 201-797-5800
- NEW YORK, Binghamton**
Harvey Electronics, 607-748-8211
- Farmingdale**
Arrow Electronics, 212-995-2100
- Iris Electronics, 516-420-8400**
- Rochester**
Cramer Electronics, 716-275-0300
- Syracuse**
Cramer Electronics, 315-437-6671
- NORTH CAROLINA, Winston Salem**
Cramer Electronics, 919-725-8711
- OHIO, Cleveland**
Cramer Electronics, 216-248-8400
Arrow Electronics, 216-464-2000
- Dayton**
Arrow Electronics, 513-253-9176
- PENNSYLVANIA, Montgomeryville**
Pytronic Industries, 215-643-2850
- TEXAS, Dallas**
Cramer Electronics, 214-661-9300
Sterling Electronics, 214-357-9131
- WASHINGTON, Tuckwila**
Kierulff Electronics, 206-575-4420
- WISCONSIN, New Berlin**
Arrow Electronics, 414-782-2801

For more information on how Burndy low-cost, high-reliability DIP sockets can help you improve your product without pricing it out of the market, send us your particular requirements.

HP's new Display Trace says a lot:

So does the quality behind the trace:

Large 500 cm² (77.4 in²) viewing area says the 1304A is excellent for applications in electronic analyzer systems; analytical instruments; weather, harbor or fire-control radar; plus medical patient monitoring systems.

Complex graphic display plus a large number of characters says high-writing speed and fast settling time. HP's new 1304A Large Screen Display has a linear writing speed greater than 25 cm/psec, and settles to within one spot diameter in 300 nsec.

A variety of options means the 1304A is easily tailored for your specific system requirements. For example, choose from various X and Y input configurations, analog or digital blanking, various CRT phosphors and graticules, UL medical equipment listing, and more.

Electrostatic deflection means low power consumption (just 60W average), thus higher reliability due to lower operating temperature. Light weight compared to magnetic displays is another plus.

Small spot size (0.020") and high brightness says sharp pictures and good readability...even in normally lighted industrial environments.

The price of just \$2400* means benefits and performance of electrostatic displays at a cost approaching that of magnetic displays.

Modular construction and an uncluttered interior means easy servicing and calibration.

Controls and user-settable adjustments concealed behind a front-panel door means fast access while discouraging knob twiddlers.

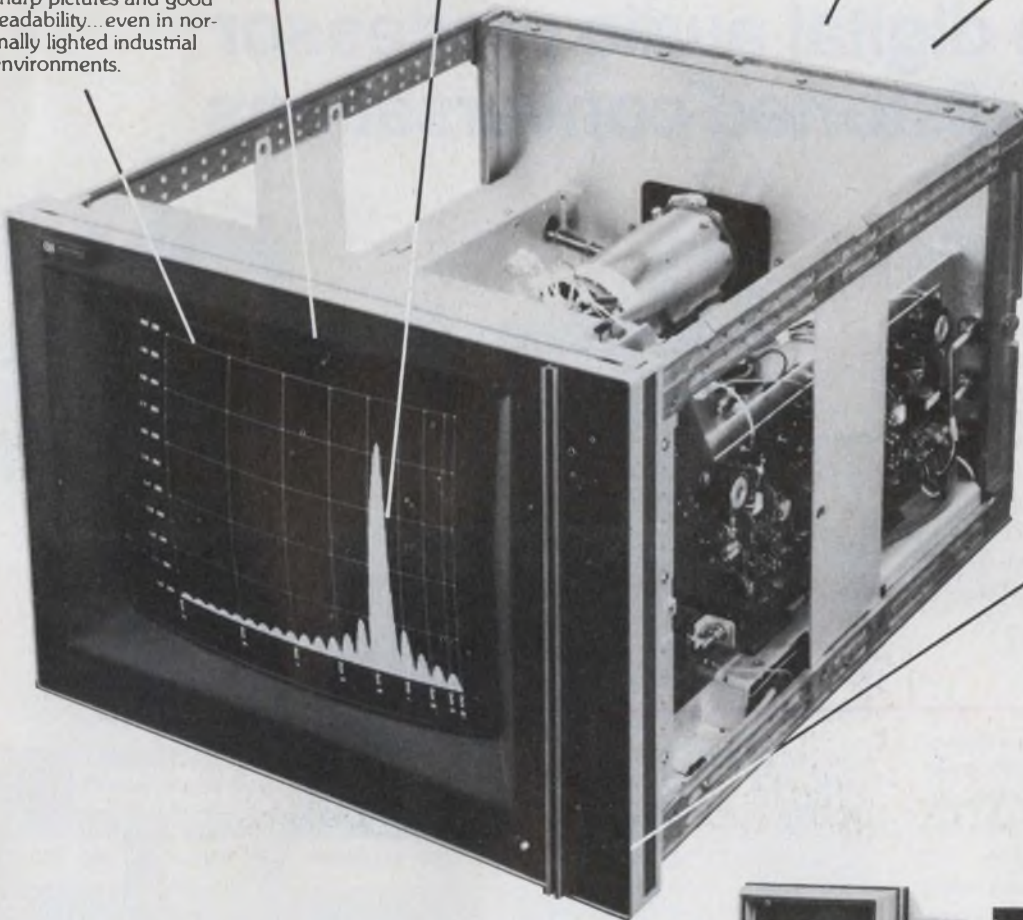

It all adds up to value. Low cost, high performance, high reliability, flexibility and after-sales service. A good combination for any display system. Ask your HP field engineer for all the details including OEM and quantity discount prices. He can also give you details on other models in HP's growing family of large and small screen displays.

* Domestic U.S.A. price only.



HEWLETT  PACKARD

1507 Page Mill Road, Palo Alto, California 94304

For assistance call: Washington (301) 948-6370, Chicago (312) 255-9800, Atlanta (404) 955-1500, Los Angeles (213) 877-1282

CIRCLE NUMBER 24

Then it outputs the entire rotated image to a pen plotter to see if it registers with the photo.

For registration, three or more points on the map and the photo must align. "You can select roads, storage tanks, or mountain peaks," according to Gerry Harju, Aerospace department head who did the programming. "But if you pick a point on the map that turns out to be hidden in the photo, you will have to reiterate the process."

Once the two images are in registration, a drawing of the proposed landscape alteration gets digitized and

inputted to the computer. The system can handle three types of alterations:

- Political boundaries and ski runs that lie on the surface of the terrain.
- Lakes and strip mines that actually change the topology of the area.
- Man-made structures, like towers, buildings and smokestacks.

Alphanumerics can be generated and used for identifying particular features.

After being digitized, registered, and integrated with the scene, the proposed alterations can be manipulated to determine how best to implement them.

If, say, a proposed ski run looks too far to the left or to the right, software can move it over.

Alterations can be mathematically manipulated, too. A series of images showing the progression of a strip mine's boundaries over a period of time (as a function of the volume of earth removed) can be generated.

"A movie showing the evolution of a strip mine over its entire lifetime can be enlightening," remarks Stevenson. "The technique will show where the overburden is piled, stored and ultimately returned as fill." ■■

Real-time digital audio processor picks out distorted conversations

The FBI is using industry's first real-time digital audio processor to solve a case involving America's national security. This Automatic Digital Audio Processor (ADAP) from Rockwell International, Anaheim, CA, uses digital spectral analysis to strip away masking noise from a recorded clandestine conversation.

If the FBI gets its man, it should have little trouble convincing a court of what was actually said. The noise will be filtered out well enough for the remaining audio to be admitted as evidence.

The "real" key

The spectral-analysis technique enables the self-contained ADAP to operate in real time by bypassing the conventional reiterative recording step used by other audio processors.

"Two different audio-enhancement schemes are at work in this instrument," explains Program Manager Dr. James Paul, "and they are both adaptive in nature."

One process, called "adaptive predictive deconvolution," wrings out such signal-related noise as echoes, reverberations and other signal convolutions.

In this single-input mode, ADAP uses a 150th-order digital filter to estimate the amount of noise associated with a signal. The filter's response time is adjustable from the front panel.

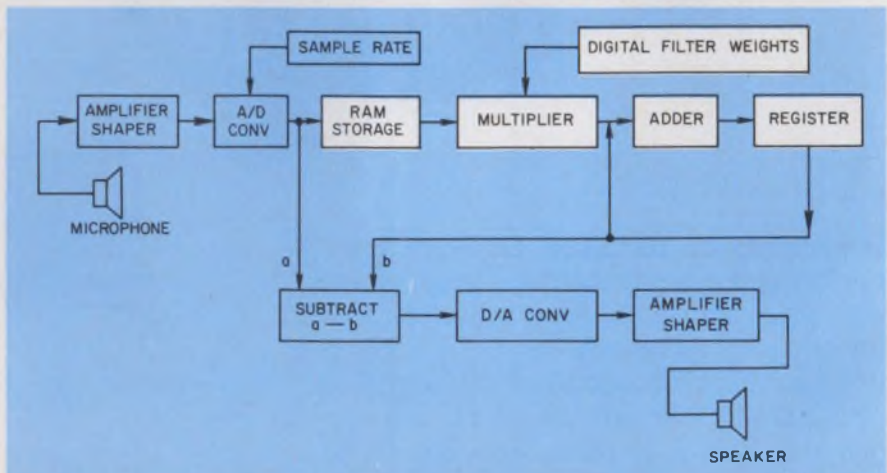

This digital audio processor is the first to operate in real time. Since it eliminates the conventional recording step required in other digital audio processors, it can be used in real-time communications systems.

Hello, 25% Higher Current, 45 V @ 150°C, Switchmode Schottkys. Goodbye, TRW.

Meet the world's first power Schottky rectifiers to give top performance at high temperatures with no derating, backing off or baloney. Motorola Switchmode* Schottkys.

Switchmodes are full-rated at 150 A, 45 V, 150°C conditions *simultaneously*. You-know-who's aren't.

And the MBR7520-45 series can save you 20% in power at 100 A because of lower V_F —or 12 W less power loss vs competition. The 1,000 A surge current rating is something to welcome, too.

The whole family has unique guarding construction providing *avalanche* characteristics for transient protection plus low leakage for added reliability.

Schottky Type	Peak Forward Current** (Rated VR) (Amps)	Average Forward Current† (Rated VR) (Amps)	Max VR @ T _J = 150°C (Volts)
MBR7545‡	150 (T _C = 90°C)	70 (T _C = 90°C)	45
SD51†	120 (T _C = ?)	—	32
MBR6045‡	120 (T _C = 90°C)	50 (T _C = 90°C)	45
1N6098	—	50 (T _C = 70°C)	40
MBR3545‡	70 (T _C = 90°C)	30 (T _C = 90°C)	45
SD41†	—	30 (T _C = ?)	32
1N6096	—	25 (T _C = 70°C)	40

†Yes, We've Got 'Em

‡Top-of-the-Line; lower voltages available

**60 Hz, 180° conduction angle

***Square wave, 50% duty cycle

Even dv/dt is better . . . 1,000 V/ μ s for the MBR7545. And θ_{JC} : It's just 0.8°C/W instead of the usual 1.0 for more efficiency.

And that's what Schottkys are all about—superior performance and efficiency in high-frequency switching applications. The new series will be state-of-the-art industry standards in those designs.

Prices are more attractive, too!

Say hello to our good buys. Send for Switchmode Schottky data sheets and get spec-by-spec, side-by-side comparison of these new DO-4s and DO-5s with outgoing standards. It's an eye-opener.

Write Motorola Semiconductors Inc., P.O. Box 20912, Phoenix, Arizona 85036.

*Trademark of Motorola Inc.



MOTOROLA Semiconductors
The mind to imagine . . . the skill to do.

CIRCLE NUMBER 25

When adjusted to a slow adaption rate, ADAP cancels out echoes and other long-term stationary effects. Dialing in a faster adaption rate lets the instrument track and kill shorter-term interfering signals like background music or another, unwanted voice. ADAP can even clear up a telephone voice disguised with the old handkerchief-over-the-mouthpiece trick or one with background music.

Two mikes help

The other enhancement scheme, called real-time adaptive filtering, uses two simultaneous inputs from two dif-

ferent microphones. One input contains the desired audio signal combined with all on-site ambient noise. The other comes from a microphone that samples the background noise alone.

This second input's noise may differ quite a bit from the first, but the signal is modified by a transversal filter that adjusts noise amplitude and phase. This produces an estimate of the noise component in the first audio signal.

This estimate is subtracted from the (first) composite signal and then fed back to the transversal filter to null out the audio signal's noise component.

The instrument's adaption speed ranges from less than 200 ms to over

5 s, according to Dr. Paul. It attenuates convolution and additive noise by over 40 dB, and has 12-bit d/a and a/d resolution. The digital filter can be adjusted as high as the 256th order.

Many crimes have already been solved with the ADAP, including murder, rape and burglary.

It can also be used in live communications systems like air-traffic control or on-location radio and television news coverage. Pretaped audio from police "bugs" or cockpit recordings from wrecked airplanes are also candidates for audio cleanup.

ADAP measures 3-1/2 × 19 × 21 in., weighs 40 lb and costs \$25,000. ■■

Manpack satellite communications links soldiers with air, sea support

Both voice and digital-data satellite communications can now be conducted between soldiers in battle and ships, aircraft and ground stations with a manpack communications system. The AN/PSC-1, a 25-lb transceiver, can output 35 W of power directly to an orbiting satellite to achieve long-range, interference-free communications—as far as 9000 miles.

The power required for the transmitter has been kept to a minimum by using a special modulation scheme. As a result, the transceiver can achieve extremely low signal-to-noise ratios.

The transceiver uses time-interleaved quadrature binary phase-shift-keyed modulation to transmit digital data at 300 bps. And with a combination of offset quadrature-phase, shift-keyed modulation and continuously variable slope-delta modulation, the transceiver can transmit voices to within 2 dB of the theoretical signal-to-noise ratio, according to Ed Rueve, project manager for Cincinnati Electronics in Ohio, which developed the AN/PSC-1 for the Army Satellite Communications Agency.

The transmitter can operate in either



Using only 35 W of power and a satellite relay, the AN/PSC-1 can communicate with support units as far as 9000 miles away.

a satellite or line-of-sight mode. In the satellite mode it sends out 35 W. But the line-of-sight mode of operation requires only 2 W.

For satellite operation, a medium-gain helical antenna is provided, with a minimum gain of 6 dB. The antenna folds up into 300 cubic inches and can

be assembled and ready for operation within two minutes. For line-of-sight operation, a whip antenna is used.

Transceiver is brainy

While the transmitter and receiver portions of the set are based on conven-

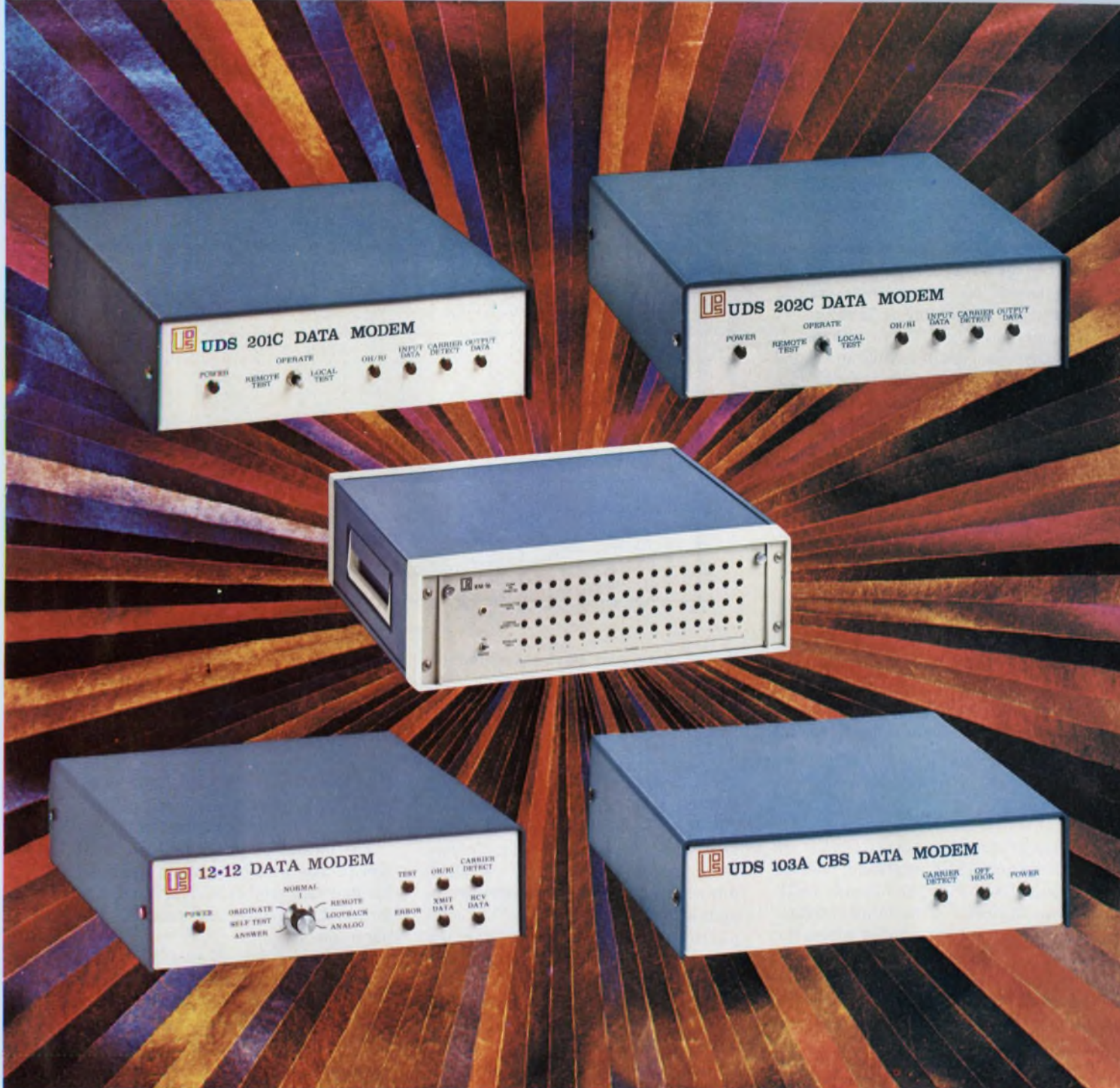

UNIVERSAL MODEMS

Making data move is the name of the game in today's switched or dedicated-line networks. If you're moving it at any speed up to 2400 BPS, Universal Data Systems has the proper modem for reliability, economy and efficiency in your system.

UDS has more than 30,000 modems in active field service, and the total is growing by more than 1,000 units per month. Our product line includes CMOS 201s, plus 103s, 202s, ACUs and the new 12-12, which permits full-duplex 1200 BPS communication over only two wires. UDS also offers the multiple modem RM-16, which contains up to 16 units in any configuration mix you desire.

In addition to our products, we're extremely proud of our customer service. Check us out: Call us on the telephone. You'll like what you hear.



universal data systems

4900 Bradford Drive • Huntsville, Alabama 35805 • Telephone (205) 837-8100 • TWX 810-726-2100

Created by Hall & McKeen Advertising, Winter Park, Florida

member of
IDCMA

tional uhf designs, the control section of the transceiver is unusual, notes Rueve. A CMOS microprocessor uses an internal frequency synthesizer to control the frequency of operation, mode and the receiver's offset frequency. The micro does it with an internal frequency synthesizer.

Besides voice transmission, the transceiver features secure voice, data, selective calling and conference calling. It can receive any one of 15 selectable channels plus a conference channel. It also carries separate audible and visual alarms for selective and conference signals.

Unlike most military field-communications systems designed for voice transmissions, the AN/PSC-1 can accommodate digital-data transmissions as well. This is done with a digital message-entry device (DMED), which is basically a hand-held battery-powered terminal.

An Intersil 6100 microprocessor enables the DMED not only to send and receive digital alphanumeric data, but to edit the data as well. The DMED can change, delete or insert any character in the output message. In addition, input or output messages can be reread as often as desired.

Mini keyboard enters data

Data are entered into the DMED via its 32-switch ASCII keyboard, and are presented on 16 alphanumeric LED-display devices. An incoming or outgoing message may be scrolled across the display in ticker-tape fashion.

Several scrolling speeds can be selected for the keyboard. Scrolling may be stopped and started at will, and even reversed if desired.

In addition to the alphanumeric LED displays, the DMED has six LED status indicators, five of which are

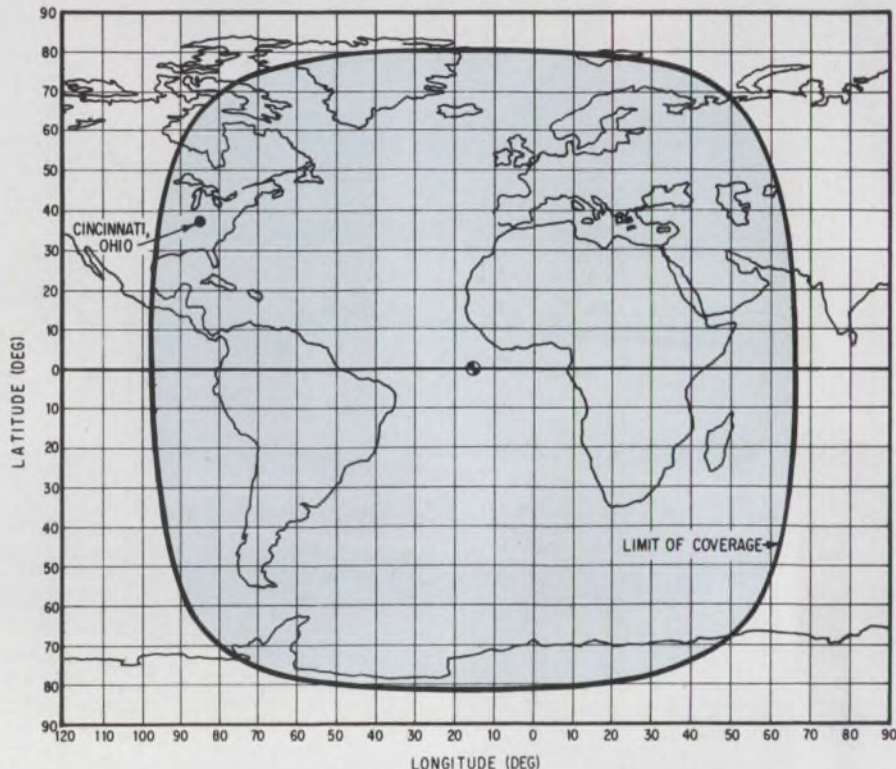

Digital data can be transmitted from soldiers in the field by using a uhf transceiver and a hand-held computer terminal developed by Cincinnati Electronics.

software-controlled. The displays indicate low battery, memory overflow, edit mode or acknowledge, shift mode, illegal operation and receive. To conserve power, the display is automatically shut off approximately 8 seconds after the microprocessor has completed its cycle. A change of either the frequency, receive offset or function controls will cause the microprocessor to start a new cycle and illuminate the display.

The DMED also features a serial, asynchronous I/O with selectable transmit and receive rates. If a modem is used, rates of 150, 300, 500 and 1200

bps can be selected. If not, 2400, 4800, 9600 and 19,200 bps rates can be used as well as the four modem rates.

The output of the device is a 6-bit ASCII code with odd parity, one start bit and two stop bits. The hand-held terminal transmits and receives in a burst mode.

In a recent test of two AN/PSC-1 systems, communication was established over a distance of 9000 miles via the Marisat satellite—which is in stationary orbit 22,300 miles above the earth near West Africa. Two terminals located in Cincinnati talked to each other via the satellite. ■■

Laser scanner finds textile flaws

One of America's largest textile manufacturers is now using a laser-scanning system to detect and identify flaws in woven goods.

The high-speed fabric inspection system, developed by Ford Aerospace & Communications Corp.'s Western Development Laboratories, Charlotte, NC, is being used at Springs Mills, Inc.,

Leroy Plant in Fort Lawn, SC.

The system includes three parallel laser-scanning heads, each with a rotating mirror that moves the laser beam across the material. Fiber optics catch light passing through and bouncing off the surface of the cloth.

For scanning, fabric rolls feed through an optical inspection frame.

When a flaw or abnormality is detected, a mark is automatically placed on the selvage edge of the fabric.

The output of the laser scanners is correlated by analog and digital-signal processors. A computer readout is provided.

Fabrics can be inspected at speeds up to 250 yards per minute. ■■



About that 'new' kid on the block...

Actually, he's not that new. He's been around for quite a while now. Other vendors keep announcing miniature cylindrical ceramic capacitor 'innovations', but Sprague Electric, the pioneer in layer-built ceramics, can state with pride that this type of capacitor was introduced by Sprague more than ten years ago.

Sprague Type 292C MONOLYTHIC® Capacitors are the industry's best-constructed axial-lead capacitors, thanks to MFT*, a closely-monitored material modification of electrode metal and ceramic reacted with glass. The result—less capacitance change with temperature change, improved stability with life, and improved impedance with frequency characteristic.

These low-cost miniature capacitors feature a dimensionally-precise molded construction and can be ordered taped and reeled for automatic insertion. They are available in body formulations to meet characteristics Z5U (general application), X7R (semi-stable), and C0G (NP0).

For complete technical data, write for Engineering Bulletin 6250B to: Technical Literature Service, Sprague Electric Co., 347 Marshall St., North Adams, Mass. 01247.



Illustrated approx.
4x actual size



* Modified Formulation Technology

THE BROAD-LINE PRODUCER OF ELECTRONIC PARTS

CIRCLE NUMBER 27





TIME INTERVAL MULTIMETER HEWLETT • PACKARD

2.83

LINE
OFF ON



V

A



SCOPE (275 MHz)

INTENSITY

TIME INTERVAL

START

STOP



1 You simply set two intensified markers at the desired points using the START and STOP controls.

2 For maximum accuracy, switch to delayed sweep and use the STOP control to overlap the expanded traces.

SIGNAL
OVERLAY
($\Delta T=0$)

ΔT
OFF

CH A
START

CH B
START



1725A OSCILLOSCOPE (275 MHz) HEWLETT • PACKARD

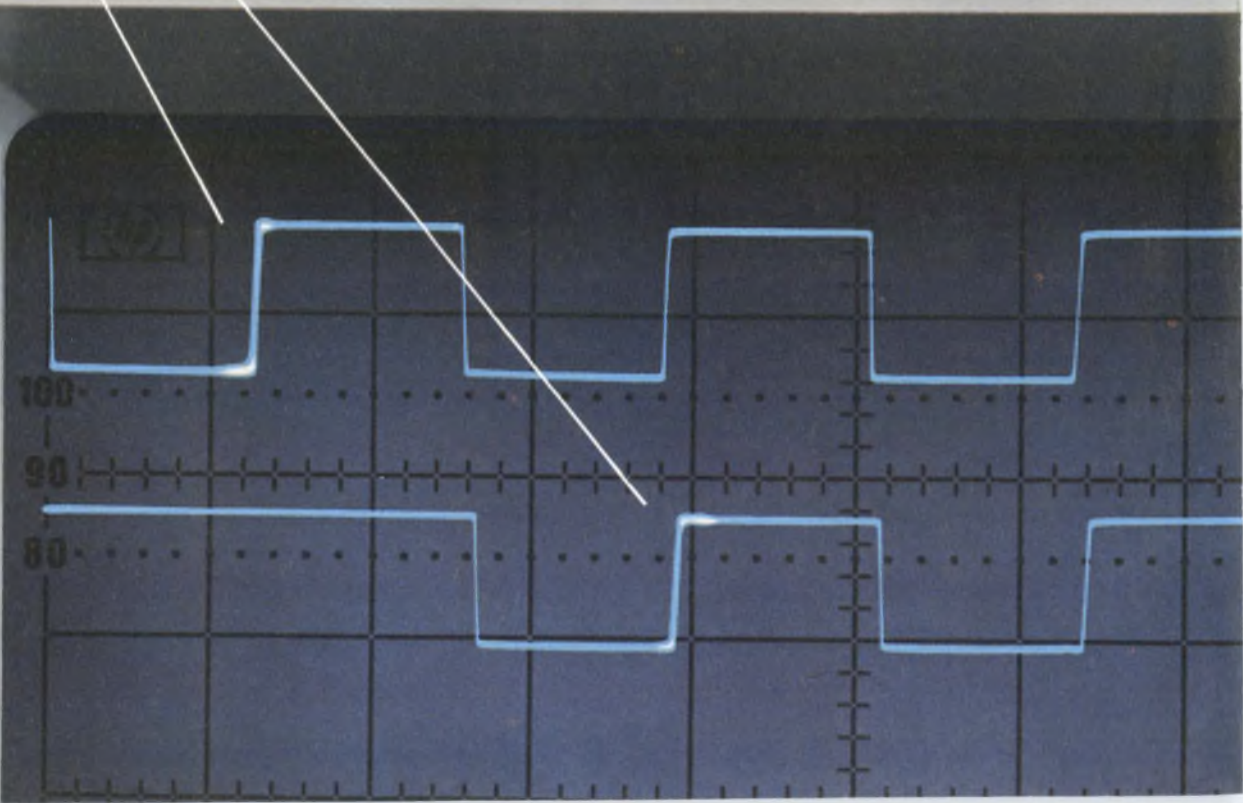

MULTIMETER
ME INTERVAL
RANGE
Ω AUTO HOLD

EXT TRIG
1MO

3 Read the time interval directly on the digital display. (Without the DMM option, read the interval directly from the STOP control dial.)

For improved Δ -time measurements, plus autoranging AC/DC volts, amps and ohms ...

HP's the Answer.

Now you can choose from two new scopes with improved Δ -time capability: The 200 MHz **1715A** priced at \$3000* or the 275 MHz **1725A** for \$3300*. Both offer an optional built-in DMM for direct Δ -time readout, plus autoranging AC/DC volts, amps, and ohms.

Δ -time measurements are now faster with the 1715A and 1725A. They're more accurate because scope and operator errors are significantly reduced. Plus you have switch selection of channel A or B as the starting point for Δ -time measurements, often eliminating the need to move probes and simplifying trace overlap for zeroing. But you can still select conventional delayed sweep with the flip of a switch, for brighter low-rep-rate traces and convenient trace expansion.

The optional autoranging 3½ digit DMM is priced at \$325* factory installed. Or, for easy field installation, there's a kit priced at \$375*. Another option, HP's "Gold Button" for \$150*, gives you pushbutton selection of either time domain or data domain when the 1715A or 1725A is used with HP's 1607A Logic State Analyzer.

Like all new high-frequency HP scopes, the 1715A and 1725A have switch selectable 50 ohm or 1 Megohm inputs. And the 1725A, with 275 MHz

bandwidth, is the fastest 1 Megohm-input scope available. That reduces the need for active probes when working with fast logic near maximum fan-out.

The story with both of these scopes is user convenience—from front-panel controls to the minimum of adjustments for servicing. Your local HP field engineer can give you all the details.



And here's something NEW for scopes. HP's **Easy-IC Probes**. A new idea for probing high-density IC circuits that eliminates shorting hazards, simplifies probe connection to DIPs and generally speeds IC troubleshooting. The probes are standard equipment with these two scopes.

*Domestic U.S.A. price only.



HEWLETT **hp** PACKARD

1507 Page Mill Road, Palo Alto, California 94304

For assistance call: Washington (301) 948-6370, Chicago (312) 255-9800, Atlanta (404) 955-1500, Los Angeles (213) 877-1282

CIRCLE NUMBER 28

The Simpson DIGITAL MULTIMETER FAMILY KEEPS GROWING!

Here's our latest addition
For \$130



New Compact Portable Model 461
Complete with nickel-cadmium batteries, AC charger/adapter, test leads and instruction manual

- 8 FULL HOURS continuous battery operation . . . a full day's work without interruption
- 0.25% DC V accuracy
- Large bright 0.3" LED display
- Automatic zero and polarity
- 100 μ V, 0.1 Ω , 100 nA sensitivity
- 26 pushbutton selected ranges
- High energy fuse safely contained in case
- Folding bench stand
- Only 2 x 5.6 x 4.6"; 1 1/2 lb.

ALL SIMPSON DMM'S HAVE

- Reliable overload-protected LSI circuitry
- Easy-to-read 3 1/2 digit red LED displays with automatic polarity
- Performance proven with a 200-hour burn-in, backed up by a one-year guarantee
- Complete line of accessories is available

For \$210

Popular Priced Model 464A

- 0.1% DC V accuracy
- 28 pushbutton ranges including 10A AC/DC
- Bright 0.43" LEDs, automatic zero
- High-impact case with tilt-view adjustable handle
- For AC line operation. Optional AC/rechargeable version available for \$247



For \$285

Deluxe 460-3A

- 0.1% DC V accuracy, custom MOS/LSI circuitry
- 32 ranges including low power resistance ranges and 10A AC/DC current
- Bright 0.43" LEDs, automatic ZERO
- Calibrated auxiliary analog meter
- For AC line operation. Optional AC/rechargeable version available for \$322



For \$295

Autoranging Model 465A

- Automatically selects and displays the proper measuring range
- High 0.1% DC V accuracy, custom MOS/LSI circuitry, 0.43" LEDs
- Measures DC voltage to 1000 V, AC voltage to 600 V, resistance to 20 megohms, low power ohms ranges AC/DC current to 10A
- AC line operation. Optional AC/rechargeable version available for \$332



For \$257

Digital VOM — the 360-2

- AC line and rechargeable operation standard
- 0.25% DC V accuracy exclusive MOS/LSI circuitry, automatic zero
- 29 ranges including low power resistance
- Calibrated zero center analog meter
- Recorder output



CHOOSE THE ONE THAT'S BEST FOR YOU
AT YOUR LOCAL ELECTRONICS DISTRIBUTOR

Simpson
INSTRUMENTS THAT STAY ACCURATE

SIMPSON ELECTRIC COMPANY

853 Dundee Avenue, Elgin, Illinois 60120
(312) 697-2260 • Cable SIMELCO • Telex 72-2416

KATY INDUSTRIES



If you're designing with the TL081 series, you made the right choice!

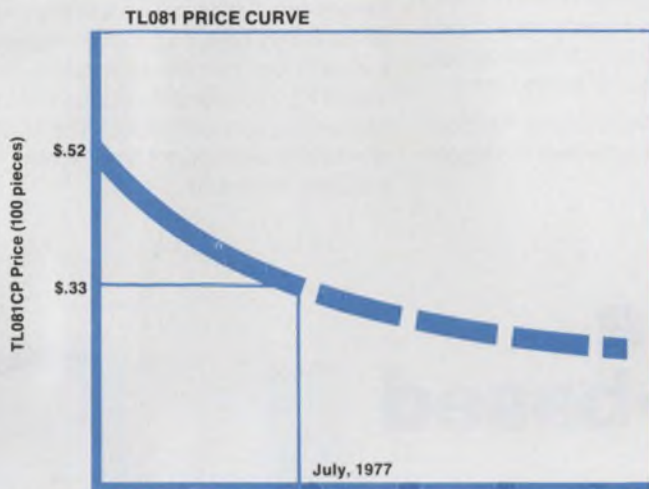

ALL FIVE POPULAR OP AMP PINOUTS

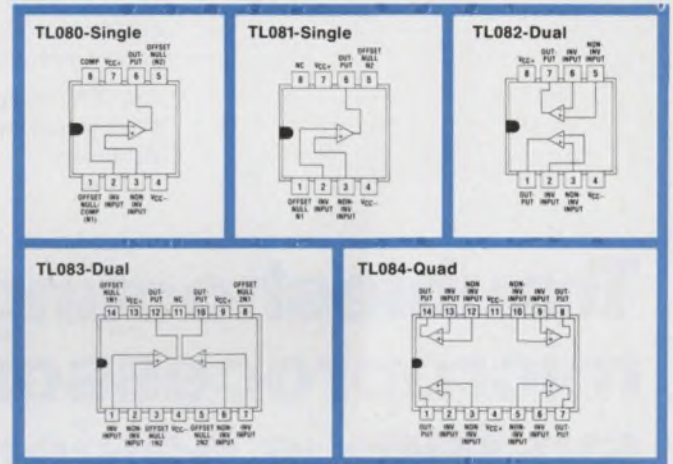

BIFET op amps from Texas Instruments. Now priced to replace bipolars.

By designing with the TL081 Series, you're using the first BIFET op amps priced to replace such widely used bipolars as the $\mu A741$, $MC1458$, $LM308$, $LM324$, $\mu A747$, $RC4558$ and the $RC4136$. They're now priced as low as 33 cents each for 100 pieces. And look what you're getting for your money!

You're getting tomorrow's technology for today's products. High-impedance JFET inputs and a low-distortion bipolar output backed by ion implant reliability that ensures uniform device characteristics. The TL081 Series simplicity, small chip size and ease of manufacturing result in low cost for you.

The TL081 Series gives you two singles, two duals and a quad with the broadest selection offered in operational amplifiers. Five devices with identical specifications that allow you to *standardize virtually all of your op amp requirements in just one family*, the TL081 Series from Texas Instruments.

- Input bias current—0.4 nA max.
- Input offset voltage—15 mV max.
- Unity gain bandwidth—3 MHz
- Slew rate—12V/ μ s
- I_{CC} per op amp—2.8 mA max.

And there's more! You're also getting the benefit of TI's long experience in plastic packaging. The same

experience, the same plastic, the same outstanding performance TI has instilled in hundreds of millions of Linear, TTL and MOS products.

BIFET op amps in a proven plastic package at a price on a par with bipolar op amps. They're on the shelf now, waiting for you at TI or your local authorized TI distributor.

Mail the coupon below for your free copy of the BIFET op amp brochure that provides a complete description of the TL081 Series including data sheets, applications circuits, comparative specifications and price information. It's yours for the asking.



FREE BROCHURE

BIFET OP AMP Family from Texas Instruments

Schematics • Specification comparisons • Ordering information • Data sheets • Application circuits • Price information

Texas Instruments Incorporated
Inquiry Answering Service
P.O. Box 5012, M/S 308
Dallas, Texas 75222

Please send my free copy of the TI BIFET op amp brochure.

Name _____ Title _____

Company _____

Address _____

City _____ State _____ Zip _____

ED

TEXAS INSTRUMENTS

INCORPORATED
CIRCLE NUMBER 30

You've designed, debugged, and loaded your system software. Now you need several powerful capabilities to ensure trouble-free execution on the prototype: the ability to look at data in different ways . . . to compare known good data with new data quickly and easily . . . to analyze both system and peripheral-interface timing.

The TEKTRONIX 7D01F Logic Analyzer offers you all those capabilities in a single instrument.

Look at data in different ways.

The 7D01F lets you choose from five display modes: maps; state tables in hexadecimal, binary, or octal code; or timing diagrams. How often have you encountered a problem you knew you could spot just by scanning overall program flow? How often have you wished you could compare state tables in the hexadecimal code you work with as well as the binary code your microprocessor knows? How often have you wanted to switch from a state table display to its corresponding timing diagram? The 7D01F can help at each step of this troubleshooting procedure.

Troubleshooting a microprocessor-based system is easier...

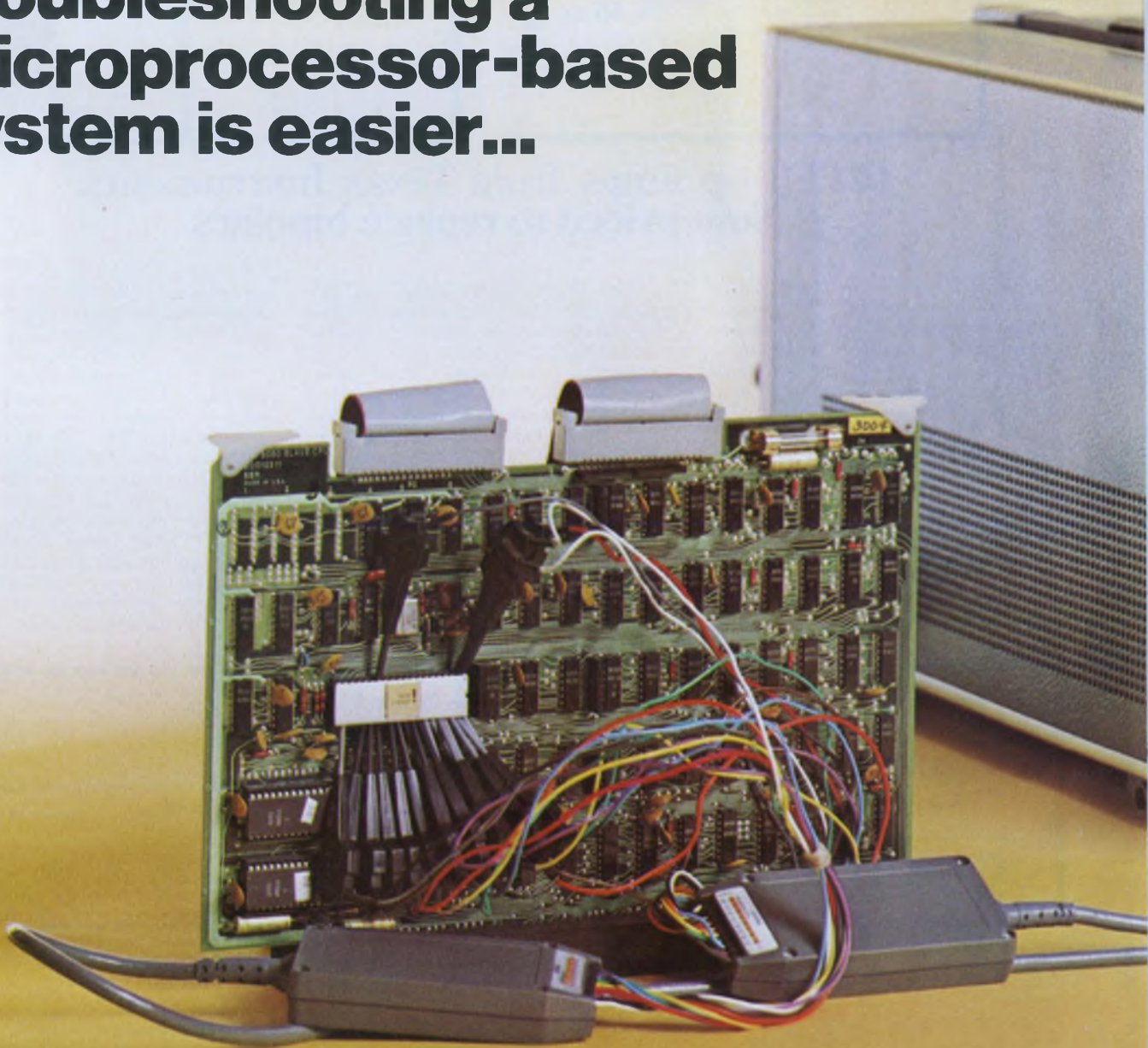

Compare known good data with new data.

The 7D01F features two comparison modes which facilitate in-depth software/hardware debugging. The EXCLUSIVE-OR and RESET-IF modes speed up what would otherwise be a very tedious process: checking the program flow chart against what falls out when the program is run.

For an EXCLUSIVE-OR comparison, simply verify known good data, store it in reference memory; acquire new data, and select a table comparison mode. The reference table and the compared table (which may be in hex, octal, or binary) will be displayed side by side, and the differences between the two will be highlighted for ready identification.

Use RESET-IF to track down an intermittent fault. In this mode the 7D01F can automatically acquire and compare up to 4096 bits of new data to 4096 bits of reference data. Data is continually reacquired until a mismatch occurs. If there is a mismatch, the instrument holds the display, highlights the differences, and displays the number of resets that occurred. This frees the operator from continually monitoring for wandering programs, intermittent loops, or ragged-edge timing problems.

Analyze system and interface timing.

The 7D01F offers synchronous data acquisition at speeds up to 50 MHz. But it is sometimes necessary to view microprocessor operation with increased timing resolution, as well as to locate timing discrepancies in the system's interface with the outside world. You may, for example, need to asynchronously examine data coming into the I/O port before you can determine whether incorrect information is coming from the I/O port itself or the hardware on the other side. The 7D01F offers asynchronous data acquisition at sample intervals of up to 100 MHz.

...with the Tektronix 7D01F Logic Analyzer.

All these unique features are available only in the TEKTRONIX Logic Analyzer. To find out more about how the 7D01F can simplify your work with microprocessor-based systems, just call your local Tektronix Field Engineer. He'll demonstrate the 7D01F in your application, and acquaint you with its many other features, including 16-channel word recognition, 1M Ω /5 pf logic probes, 16-channel data acquisition, 4k formattable memory, and 7000-Series mainframe compatibility.

You should also send for our newest application note, describing in detail how a 7D01F can be used with microprocessor-based systems. Write Tektronix, Inc., P.O. Box 500, Beaverton, Oregon 97077. In Europe, write Tektronix Limited, P.O. Box 36, St. Peter Port, Guernsey, Channel Islands.

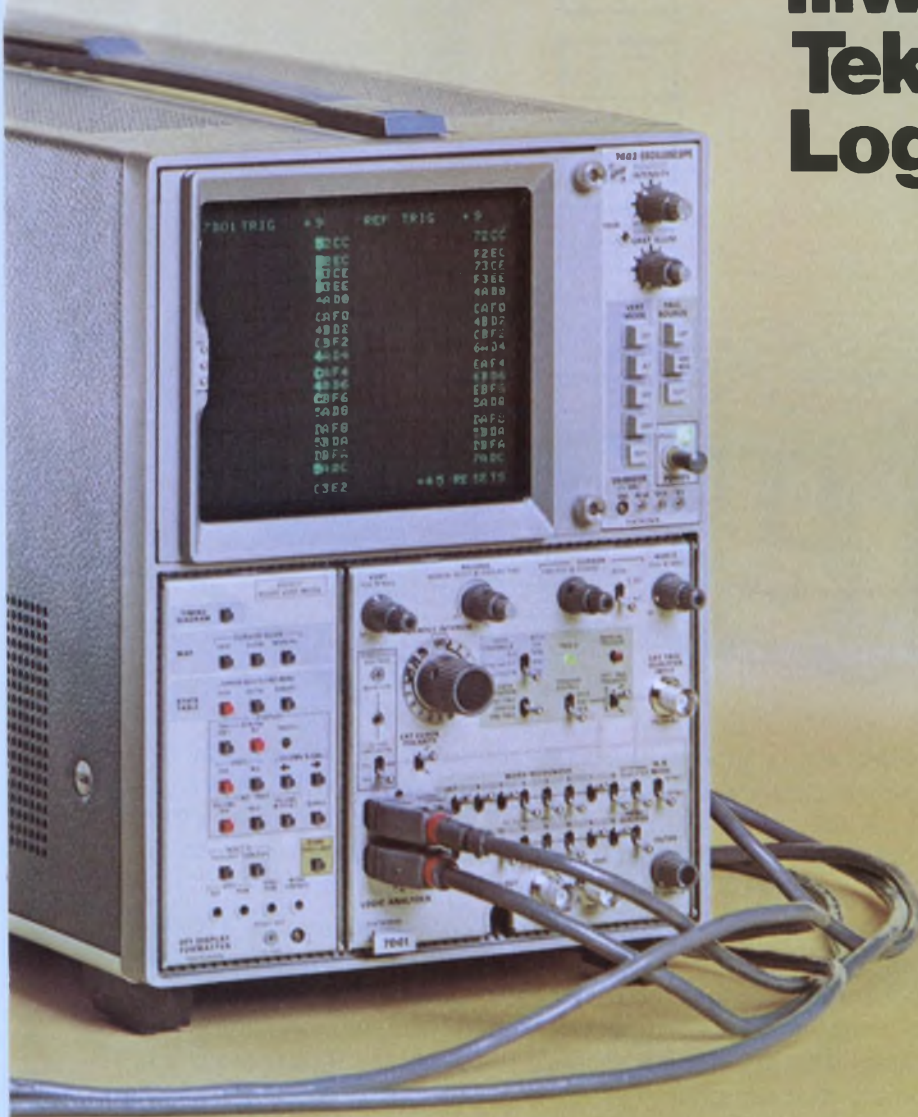

Tektronix[®]
COMMITTED TO EXCELLENCE

FOR TECHNICAL DATA CIRCLE 31
FOR DEMONSTRATION CIRCLE 32

COME-

talk to our power supplies

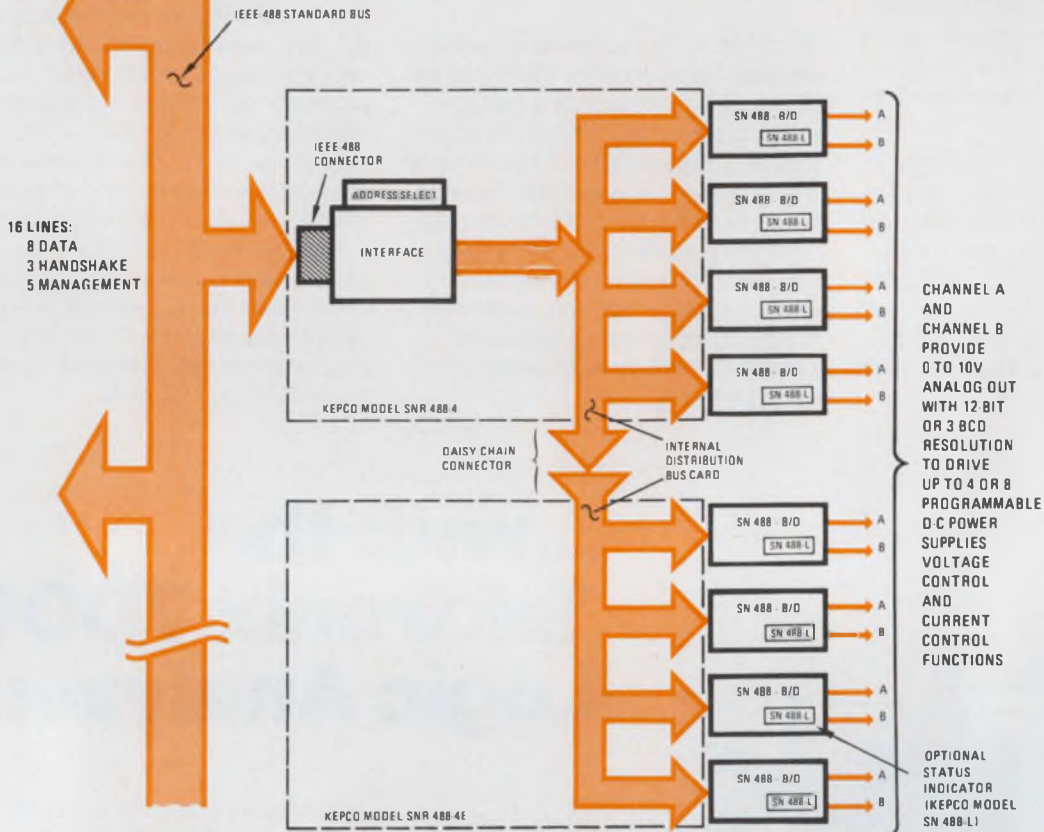

KEPCO

SN-488

programming system

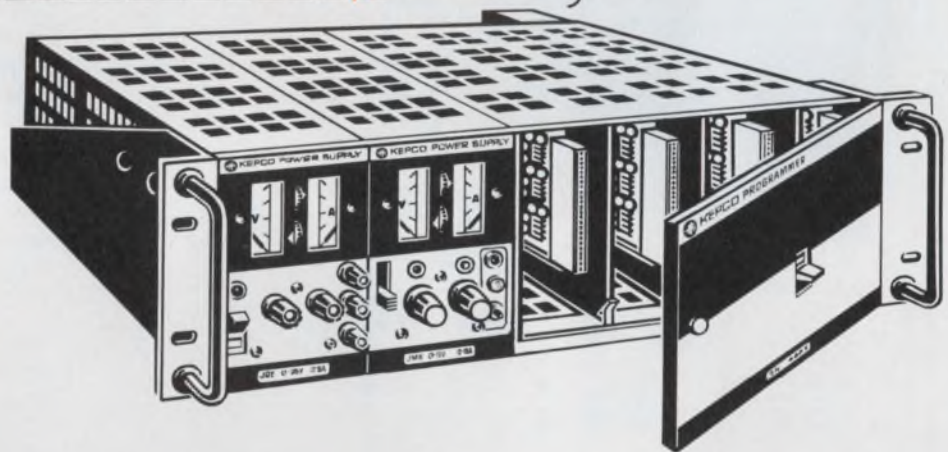

Kepeco's new SN-488 digital interface provides you with a convenient way to put our programmable power supplies on your General Purpose Interface bus. The model SN-488 responds to the "listen" instruction, provides the "handshake" interaction and gives you two addressable channels on each card. Up to eight cards can be addressed through a single bus connector.

Each channel provides 12 bits resolution with programmable range (10:1) and programmable polarity (for use with bipolar power supplies). Kepeco makes hundreds of power supplies that can listen on your bus through the SN-488 interface: fast models, slow models, high voltage and low; unipolar, bipolar, voltage stabilizers and current stabilizers . . . power supplies designed for today's automatic test equipment.

For complete specs, write Dept. BYF-05

KEPCO 131-38 SANFORD AVENUE • FLUSHING, N.Y. 11352 U.S.A. • (212) 461-7000 • TWX #710-582-2631

See them in action during ELECTRO '77. Our Hospitality Suite is Room 1802. Holiday Inn, 440 W. 57th St., N.Y.C.

CIRCLE NUMBER 33

Washington report

ASPJ may be biggest-ever ECM procurement

The Navy plans to issue requests for proposals in October for what may be the biggest procurement of electronic countermeasures in military history.

The program is the Airborne Self-Protection Jammer (ASPJ), and potential contractors are forming teams to submit bids. Slated for 800 planned F-18 and A-18 Navy fighters at an estimated cost production of \$300,000 each, ASPJ represents at least \$250-million worth of business.

The system also may be retrofitted into as many as 500 F-14 fighters as well as some A-6 attack aircraft—both used by the Navy and Marine Corps—and is a candidate for the Air Force's new F-16 fighter. The Air Force plans to buy more than 1300 F-16s for its own use, while 650 F-16s have been ordered by four European countries.

Teams will submit common designs, but will split the procurement based on annual competitive price proposals. Teams already formed include ITT Avionics and Westinghouse Defense Electronic Systems Center, Sanders Associates Electronic Warfare Div., Northrop Defense Systems Div., and Raytheon with its recently acquired Kuras-Alterman subsidiary and Loral Electronics.

Tomahawk, ASALM to get B-1 funds

The Navy's Tomahawk cruise missile was the major recipient of the money made available from the cancellation of the B-1 bomber, but the Pentagon is also seeking funds to begin developing a supersonic Air Force cruise missile. An amended budget request sent to Congress by Defense Secretary Harold Brown asked permission to redirect part of the \$1.4-billion already sought for five B-1 bombers for fiscal 1978. About \$380-million would be shifted to cruise missiles and other weapons while \$1-billion would be subtracted from the fiscal 1978 budget.

Tomahawk would get an extra \$103-million for development of a version that can be launched from a B-52 bomber, and \$64-million for initial production. But hidden in the Pentagon's amended budget request under an item labeled "strategic bomber penetration" is \$14-million to accelerate testing of a supersonic cruise missile, the Advanced Strategic Air Launched Missile. Another \$90-million is earmarked for a new cruise missile-carrying aircraft, probably a version of the Boeing 747 or some other wide-bodied jet.

Meanwhile, the Air Force canceled a new Short Range Attack Missile, the SRAM-B, which was being developed by Boeing for the B-1.

Seasat-A users won't get digital data

The National Aeronautics and Space Administration (NASA) plans to supply users of the Seasat-A environmental satellite with optical processed film rather than digital data from the satellite's synthetic-aperture radar. As a result, information is likely to be more costly and harder to use. The film will not be fully corrected geometrically or radiometrically.

These films will be provided in strips covering 30 to 50 km of the radar's 100-km swath, and the users will have to match them up to create photo mosaics.

Digital outputs would have covered the whole swath.

The step was taken to save \$2-million after NASA discovered it had overspent the \$66.5-million budgeted for Seasat-A by \$2.2-million.

The cost overrun was caused, according to NASA, by changes required by the Air Force to make the satellite compatible with the Atlas-Agena launch vehicle, which the Air Force will use to launch Seasat-A for NASA in May, 1978.

Navy uses MLS to land jet fighter

The Navy has successfully landed one of its high-performance fighter aircraft fully automatically with the Bendix narrowband microwave landing system (MLS). The device from Texas Instruments incorporates L-band distance-measuring equipment.

The MLS picked up the aircraft seven miles from touchdown and guided it straight down the glide path for an automated landing. The test was conducted at the Federal Aviation Administration's National Aviation Facilities Experimental Center (NAFEC), Atlantic City, NJ, and involved an F-4J from the Naval Air Test Center, Patuxent River, MD, piloted by Lt. James O. Ellis.

Further tests are planned for the MLS in November at the Navy's own instrumented range at Crow's Landing, CA. These tests, to be conducted jointly with the Ames Research Center of the National Aeronautics and Space Administration, will involve curved and segmented approaches that will require digital computers instead of the present hybrid analog-digital systems.

U.S. overseas arms-sale backlog skyrockets

The U.S. backlog of foreign military sales (FMS) orders is now more than \$30-billion, according to a State Department report required by Congress, and includes weapons to be delivered as late as 1982. As a result, the U.S. will have to honor these commitments, and any changes in U.S. arms-sales policies should focus on new requests, contends Secretary of State Cyrus Vance.

Among the proposals currently before Congress are limiting annual FMS to \$8.5-million (in 1975 dollars), holding next year's sales to 40% below this year's level, and cutting sales by 10% each year for the next four years.

U.S. arms sales abroad are declining anyway. From a peak of nearly \$11-billion in 1974, they have fallen below \$9-billion. An additional \$1-billion a year, handled by individual American companies working directly with foreign governments, doesn't go through the Pentagon's FMS machinery.

The report stressed that U.S. cutbacks might not affect the global-weapons trade. Other suppliers might leap in to fill the void—even though they cannot offer the variety and advanced technology of U.S. weapons. France, Britain, Israel, West Germany, Italy, Belgium, the Soviet Union and Sweden were cited.

Capital Capsules: The Royal Australian Air Force will be in the market for \$22-million worth of **Barnes and Fairchild serial cameras** to outfit four of its F-111C fighters for reconnaissance missions. The cameras are currently used on U.S. RF-4Cs. . . . The Air Force for the first time has had two of its **Big Bird reconnaissance satellites operating in orbit at the same time**. The first, launched last Dec. 19, has established a new longevity record. It was joined by a second on June 27. The Air Force is operating the satellites in higher orbits (up to 530 km), which suggests that more powerful cameras may be operational. . . . Final information requests to the two competitors in the Air Force's Advanced Nodulum STOL Transport (AMST) program, the Boeing YC-14 and the McDonnell Douglas YC-15, are now scheduled to be sent out in late August. One will be selected to be a cargo aircraft employing advanced avionics. The solicitations were originally planned for June.

WIN A TENNIS VACATION IN HAWAII

or other valuable prizes





40 THIRD PRIZES

Wilson tennis bags made of tough vinyl. These bags feature two outside racquet pockets and inside zippered "wet" pocket for damp clothing. (Winners can select from four colors when notified).

25 SECOND PRIZES

Wilson T-2000 metal racquet plus cover, or choose the Wilson Kramer or Evert autograph racquet. (Winners will be able to select their grip size and weight when notified).

400 FOURTH PRIZES

Wilson optic yellow tennis balls. 3 balls per can.

THE MONSANTO TENNIS SWEEPSTAKES

GRAND PRIZE





6 nights at the Royal Lahaina Hotel at the beautiful Kaahanapali Beach Resort, Maui, Hawaii, for 2. Prize includes round-trip coach air transportation from the U.S. mainland to Hawaii; transportation between the Honolulu Airport and Royal Lahaina Hotel also included. Modified American plan (includes double room and 2 meals per day), local sight seeing trip, and tennis lessons at your option.

TOTAL VALUE OF PRIZES IS \$4,800.

IT'S EASY TO WIN.

Check over our quality products and fill out the R.F.Q. on the back.

DISPLAYS

DIGIT SIZE	DESCRIPTION*	COLOR			
		RED	ORANGE	YELLOW	GREEN
 0.3"	CA; RHDP	MAN71A	MAN3610A	MAN81A	MAN51A
	CA; LHDP	MAN72A	MAN3620A	MAN82A	MAN52A
	CA; RHDP; (± 1)	MAN73A	MAN3630A	MAN83A	MAN53A
	CA; RHDP	MAN74A	MAN3640A	MAN84A	MAN54A
 0.6"	2 Digit; CA; RHDP	MAN6710	MAN6610		
	1½ Digit; CA; RHDP	MAN6730	MAN6630		
	2 Digit; CC; RHDP	MAN6740	MAN6640		
	1½ Digit; CC; RHDP	MAN6750	MAN6650		
	Single Digit; CA; RHDP	MAN6760	MAN6660		
	Single Digit; CC; RHDP	MAN6780	MAN6680		
.350"	5 x 7 (35 dot) Alpha-numeric	MAN2A			

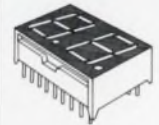

*CA = Common Anode; CC = Common Cathode; RHDP = Rt. Hand Decimal; LHDP = Left Hand Decimal

FEATURED



- .6" Double Digits
- Available in red (MAN6710) or orange (MAN6640)
- Matching single digits also available

DISCRETE LAMPS

SIZE	DESCRIPTION	COLOR			
		RED	ORANGE	YELLOW	GREEN
Rectangular	Rectangular legend lamp	MV57124	TO BE ANNOUNCED		
 T-1 1/4" (.2" diam.)	Narrow beam; point source	MV5052 MV5752	MV5152	MV5352	MV5252
	Wide beam; diffused lens	MV5053 MV5753	MV5153	MV5353	MV5253
	Narrow beam; diffused lens	MV5054 MV5754	MV5154	MV5354	MV5254
 T-1 (1/8" diam.)	2" lens ht.; .6" lead	MV5074B MV5774B	MV5174B	MV5374B	MV5274B
	2" lens ht.; 1" lead	MV5074C MV5774C	MV5174C	MV5374C	MV5274C
	.135" lens ht.; .6" lead	MV5077B MV5777B	MV5177B	MV5377C	MV5277C
	.135" lens ht.; 1" lead	MV5077C MV5777C	MV5177C	MV5377C	MV5277C

NEW



- Rectangular legend light (MV57124)
- High Brightness
- Stackable

OPTOISOLATORS

NEW "DESIGNER SERIES"

	MODEL NO.	CURRENT TRANSFER RATIO	SPEED (MAX. t_{on} , t_{off})	U.L. APPROVED ISOLATION VOLTAGE (rms)
 CONTROLLED GAIN	MCT271	45-90%	7 usec	2500
	MCT272	75-150%	10 usec	2500
	MCT273	125-250%	20 usec	2500
	MCT274	225-400%	25 usec	2500
HIGH VOLTAGE OUTPUT (80 volts)	MCT275	70-210%	15 usec	2500
HIGH SPEED	MCT276	15-60%	2.5 usec	2500
TTL/TEMP COMPENSATED	MCT277	100% MIN.	15 usec	1500
GENERAL PURPOSE	MCT2E	20% MIN.		2500

ENTRY BLANK

Monsanto Request for Quotation

Gentlemen: Please give me your quote on the following Monsanto products and enter my name in the Monsanto Tennis sweepstakes drawing.

PART #	DESCRIPTION	QUANTITY
_____	_____	_____
_____	_____	_____
_____	_____	_____



My entry sent to _____

(dist. name)

Mfg. Name: _____ Part # _____ Part Type: Display Lamp Optoisolator

Or describe: _____

I don't need a quotation now, but enter my name in your drawing.

Name _____
LAST FIRST MIDDLE INITIAL TITLE

Company Name _____

Company Address _____
STREET CITY STATE ZIP PHONE NUMBER

Home Address _____
STREET CITY STATE ZIP

OFFICIAL RULES:

- To enter, submit the official entry blank/request for quotation to your Monsanto distributor by October 17, 1977. Entry may also be made by sending a letter, postcard or the above entry blank, without a request for quotation, to your Monsanto distributor by October 17, 1977. No purchase is necessary to enter.
- Winners will be determined by random drawing conducted by an independent certified public accountant. Winners will be notified by mail. Entrants can obtain a list of all prize winners by sending a stamped, self-addressed envelope to Monsanto, Palo Alto, California.
- Taxes, if any, are the responsibility of the winners. All prizes will be awarded. Prizes are non-refundable and Monsanto is not obligated to offer other prizes of cash in lieu of the prizes specified. Trip must be taken within one year of its award.
- Sweepstakes is open to residents of the United States, except employees and their families of Monsanto Company, its subsidiaries, affiliates and advertising agencies. Void in Missouri and wherever else prohibited or restricted by law.

NO PURCHASE NECESSARY.

SEND THIS ENTRY BLANK/RFQ TO YOUR MOST CONVENIENT MONSANTO DISTRIBUTOR.

MONSANTO DISTRIBUTORS

Alta Electronics, Inc.
 2280 South Main Street
 Salt Lake City, UT 84115

Avnet Electronics
 350 McCormick Avenue
 Costa Mesa, CA 92626

Elmar Electronics
 6777 East 50th Avenue
 Commerce City, CO 80022
 2288 Charleston Road
 Mt. View, CA 94040

Hamilton/Avnet
 10912 W. Washington Blvd.
 Culver City, CA 90230
 805 Oster Drive N.W.
 Huntsville, AL 35805
 2615 South 21st Street
 Phoenix, AZ 85034

575 E. Middlefield Road
 Mt. View, CA 94040
 8917 Complex Drive
 San Diego, CA 92123
 5921 North Broadway
 Denver, CO 80216
 643 Danbury Road
 Georgetown, CT 06829
 6800 N.W. 20th Avenue
 Ft. Lauderdale, FL 33309
 6700 N.E. 185/Suite 1E
 Norcross, GA 30071

3900 North 25th Avenue
 Schiller Park, IL 60176
 37 Lenexa Ind. Center
 9900 Pflumm Rd.
 Lenexa, KS 66215

7235 Standard Drive
 Hanover, MD 21076

100 East Commerce Way
 Woburn, MA 01801
 32487 Schoolcraft
 Livonia, MI 48150
 7683 Washington Ave. South
 Edina, MN 55435

396 Brookes Lane
 Hazelwood, MO 63042
 218 Little Falls Road
 Cedar Grove, NJ 07009
 Eastgate Industrial Park
 113 Gaither Drive
 Mount Laurel, NJ 08057
 2450 Baylor Drive SE
 Albuquerque, NM 87119
 167 Clay Road
 Rochester, NY 14623
 6500 Joy Road
 Syracuse, NY 13057

70 State Street
 Westbury, L.I., NY 11590
 761 Beta Drive/Suite E
 Cleveland, OH 44143
 118 Westpark Road
 Dayton, OH 45459
 4445 Sigma Road
 Dallas, TX 75240
 3939 Ann Arbor
 Houston, TX 77042
 1585 W. 2100 South
 Salt Lake City, UT 84119
 13407 Northrup Way
 Bellevue, WA 98005
 2975 South Moorland Road
 New Berlin, WI 53151

Hammond Electronics
 1230 West Central Blvd.
 P.O. B. 3671
 Orlando, FL 32805

P.O. B. 21728
 2923 Pacific Avenue
 Greensboro, NC 27406

Harrison Equipment Co., Inc.
 1616 McGowen Avenue
 Box 3268
 Houston, TX 77001

Kierulf Electronics
 4134 East Wood Street
 Phoenix, AZ 85040
 2585 Commerce Way
 Los Angeles, CA 90040
 3969 East Bayshore Road
 Palo Alto, CA 94303
 8797 Balboa Avenue
 San Diego, CA 92123
 10890 East 47th Avenue
 Denver, CO 80239
 85 Gordon Street
 Elk Grove Village, IL 60007

16021 Industrial Drive
 Gaithersburg, MD 20760
 13 Fortune Drive
 Billerica, MA 01821
 5 Industrial Drive
 Rutherford, NJ 07070
 12 Midland Avenue
 Hicksville, L.I., NY 11802
 1005 Andover Park, East
 Tukwila, WA 98188

Liberty Electronics
 3130 North 27th Avenue
 Phoenix, AZ 85017

124 Maryland Street
 El Segundo, CA 90245
 8248 Mercury Court
 San Diego, CA 92111

5305 2nd Avenue South
 Box 80546
 Seattle, WA 98108

Schweber Electronics
 Jericho Turnpike
 Westbury, L.I., NY 11590
 Finance Drive
 Commerce Industrial Park
 Danbury, CT 06810
 2830 North 28th Terrace
 Hollywood, FL 33020

4126 Pleasantdale Road
 Atlanta, GA 30340
 1275 Brummel Avenue
 Elk Grove Village, IL 60007
 213 Third Street
 Waltham, MA 02154
 5640 Fisher Lane
 Rockville, MD 20852
 86 Executive Drive
 Troy, MI 48084

7402 Washington Avenue South
 Eden Prairie, MN 55343
 43 Belmont Drive
 Somerset, NJ 08873
 2 Townline Circle
 Rochester, NY 14623
 23880 Commerce Park Road
 Beachwood, OH 44122

101 Rock Road
 Horsham, PA 19044
 14177 Proton Road
 Dallas, TX 75221
 7420 Harwin Drive
 Houston, TX 77036

Semiconductor Specialists
 195 Spangler Avenue
 Elmhurst Industrial Park
 Elmhurst, IL 60126

P.O. BOX 41630
 1885 South Banner
 Weir Cook Airport
 Indianapolis, IN 46241
 33505 State Street
 Farmington, MI 48024
 8030 Cedar Avenue South
 Suite 115
 Minneapolis, MN 55420
 1020 Anglum Drive
 Lakeview Square
 Hazelwood, MO 63042
 3805 North Oak Trafficway
 Kansas City, MO 64116
 4500 Wadsworth
 Dayton, OH 45414

1000 RIDC Plaza, Suite 207
 Pittsburgh, PA 15238
 9990 Monroe Drive
 Suite 112
 Dallas, TX 75220
 10855 West Potter Road
 Milwaukee, WI 53226

Sheridan Associates
 1717 Penn Ave./Suite 5009
 Pittsburgh, PA 15221

Monsanto

3400 Hillview Avenue, Palo Alto, California 94304

The Ansley "D" Connector...



Our new series of male and female "D" connectors offer you a cost effective external mass termination cable and connector system second to none. Its uniqueness begins with a one-piece "D" connector package that meets industry standards for size, pin spacing, and contact reliability. With no loose parts to match up, positive cable-to-contact alignment is assured. Conductors are mass terminated in seconds with our standard BLUE MACS™ hand or bench tools. The results? Faster installation, higher reliability.

Contact pins are spaced on .0545" centers — a perfect fit for any standard inter-cabinet "D" type connector application. Our new "D" connectors are designed to mate with standard .050" pitch flat cable as well as our new, improved jacketed cable — the only flexible flat cable engineered specifically for out-of-cabinet use.



a new meaning to cost effectiveness.



The Ansley BLUE MACS™ jacketed cable is U.L. listed for external interconnection of electronic equipment. Electrically, it outperforms standard jacketed twisted pairs in typical I/O applications. And there's no special zipper lock tubing required — reducing the need for an extra cable accessory. Installation is faster, easier. And like all Ansley connectors, you can daisy chain our "D" types anywhere in the cable — along with our DIP socket, card edge, or pc board connectors.

Cable alignment and high contact reliability is assured — because both cable and connector are grooved for absolute alignment. Our patented TULIP™ 4-point insulation-displacing contacts are permanently fixed and sealed-in to provide a reliable, gas-tight, corrosion-free mass termination.

For the full reliability/cost effectiveness story and technical data, call or write:

T&B / Ansley

The mass termination company.

**T&B/Ansley Corporation • Subsidiary
of Thomas & Betts Corporation**
3208 Humboldt St. • Los Angeles, CA
90031 • Tel. (213) 223-2331 •
TWX 910-321-3938

**Available through authorized
Ansley distributors**

In Canada: T&B/Ansley, Ltd.
700 Thomas Ave.,
Industrial Park
Iberville, P.Q.

CIRCLE NUMBER 34

THIS WILL SOLVE SOME 555 TIMER PROBLEMS



THIS WILL SOLVE THEM ALL



When the output of a 555 timer switches high, a large current spike is generated which can drag down your power supply and upset your flip-flops. One way to cure it is with several hundred μF of capacitance. But that's awkward and space-consuming. Teledyne's new 355 timer is a better way.

The 355 Timer is a pin-for-pin substitute for the 555. It is part of Teledyne's High Noise Immunity Logic (HiNIL) family. It, too, generates a current spike — but only on the order of 1 mA, as compared to 300 mA for the 555.

Two other problems encountered with the 555 are a potential failure to reset on command, and a tendency to exceed the power dissipation ratings when running at 15V. The Teledyne 355 is designed specifically to answer these two potential problems as well.

If you'd like full technical information on our new 355 Timer — or any other members of the Teledyne HiNIL family of logic — call us at (415) 968-9241, or contact your local Teledyne Semiconductor distributor.

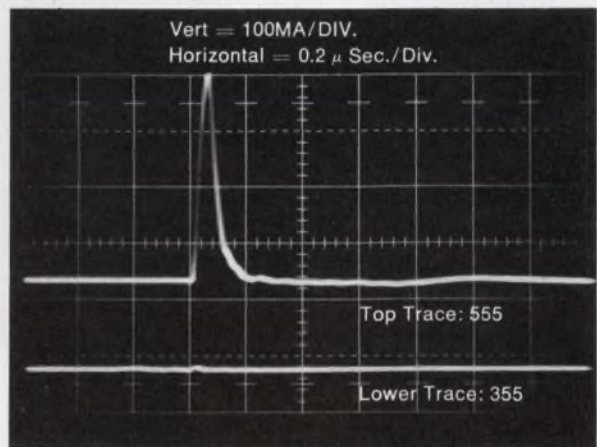

TELEDYNE SEMICONDUCTOR

1300 Terra Bella Ave., Mountain View, Calif. 94043 Tel: (415) 968-9241 TWX: 910-370-6494 Telex: 34-8416
SALES OFFICES: DOMESTIC: Salem, N.H. (603) 893-8551; Stony Brook, N.Y. (516) 751-5640;
Des Plaines, IL (312) 299-9198; Los Angeles, CA (213) 826-6639; Mountain View, CA (415) 968-9241
INTERNATIONAL: Hounslow, Middlesex, England (44) 01-887-2503; Tiengen, West Germany 7741-5066;
Kowloon, Hong Kong 3-240122; Tokyo, Japan 03-405-5738

The man who was wrong

Charlie and Joe were both strong executives. Both knew how to make decisions—even tough ones. They would assemble available background data, knowing that they would frequently lack some of the information they'd want. And they'd decide.

Then, each in his own way, they would move ahead to implement the decision. And each would march ahead as if there were 100% certainty that the correct decision had been made. Well, maybe 95% in Charlie's case.

Charlie knew he wasn't perfect. So he always left some room to maneuver out of his position if he found he had erred. In those cases—there weren't many—when he felt he had made the wrong decision, he would admit it. And here's where Charlie and Joe differed. For Joe was never wrong.

If any of Joe's decisions ran into a snag, he'd know why. "My decision was right," he'd point out. "The problem is that our engineers can't get the hang of designing out some of the bugs. And the sales guys aren't selling it right." So Joe would spend his efforts trying to get his engineering and sales people straightened out. That was always the problem—never the decision.

Charlie, in contrast, would freely confess: "I was wrong. That's why things ain't working right. Let's see how we can get back on the right course." And he'd devote his efforts to fixing the results of his off-target decision.

Some people feel that Joe was the stronger leader. Once he chose a course, he never wavered. But I'll put my money on the guy who's wrong sometimes—if he knows how to admit it. It's true that Charlie changed course once in a while. And it's true he occasionally hesitated. So he'd sometimes get to a goal somewhat slower than Joe did. But almost invariably Charlie got to the goal.



A handwritten signature in cursive script that reads "George Rostky".

GEORGE ROSTKY
Editor-in-Chief

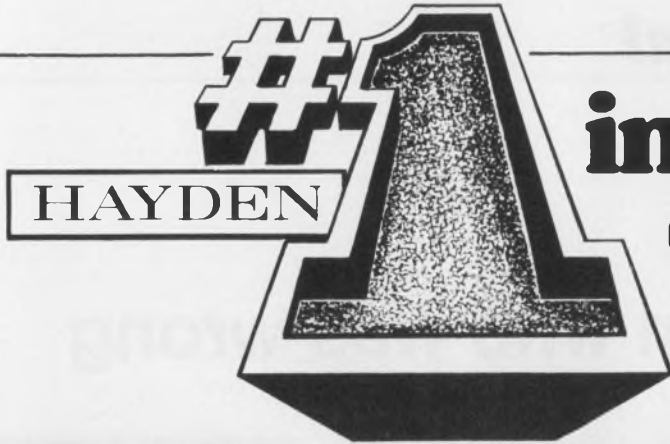

in personal computing books!

See for yourself the reasons why:

- 1. MICROPROCESSORS: New Directions for Designers** by Edward A. Torrero, #5777-6, paper, 1975, 144 pp., 8½ x 11, illus., \$10.95.
- 2. GAME PLAYING WITH COMPUTERS** Rev. 2nd Ed., by Donald D. Spencer, #5103-4, cloth, 1976, 320 pp., 6 x 9, illus. \$16.95.
- 3. FUNDAMENTALS AND APPLICATIONS OF DIGITAL LOGIC CIRCUITS** by Sol Libes, #5505-6, paper, (\$6.95), #5506-4, cloth, (\$9.95), 1975, 192 pp., 6 x 9, illus.
- 4. COMPUTERS IN ACTION: How Computers Work** by Donald D. Spencer, #5861-6, paper, 1974, 160 pp., 6 x 9, illus., \$5.50.
- 5. COMPUTERS IN SOCIETY: The Wheres, Whys and Hows of Computer Use** by Donald D. Spencer, #5915-9, paper, (\$5.50), #5916-7, cloth, (\$7.50), 1974, 208 pp., 6 x 9, illus.
- 6. PROGRAMMING PROVERBS** by Henry F. Ledgard, #5522-6, paper, 1975, 144 pp., 6 x 9, illus., \$6.50.
- 7. PROGRAMMING PROVERBS FOR FORTRAN PROGRAMMERS** by Henry F. Ledgard, #5820-9, paper, 1975, 144 pp., 6 x 9, illus., \$6.50.
- 8. COBOL WITH STYLE: Programming Proverbs** by Louis J. Chmura, Jr., and Henry F. Ledgard, #5781-4, paper, 1976, 144 pp., 6 x 9, illus. \$5.45.
- 9. MINICOMPUTERS: Structure and Programming**, by T.G. Lewis and J.W. Doerr, #5642-7, cloth, 1976, 288 pp., 6 x 9, illus., \$12.95.
- 10. PATTERN RECOGNITION** by M. Bongard, #9165, cloth, 1970, 256 pp., 6 x 9 illus., \$14.90.
- 11. DIGITAL SIGNAL ANALYSIS** by Samuel D. Stearns, #5828-4, cloth, 1975, 288 pp., 6 x 9, illus., \$19.95.
- 12. BASIC BASIC: An Introduction to Computer Programming in BASIC LANGUAGE** by James S. Coan, #5872-1, paper, (\$7.95), #5873-X, cloth, (\$9.95), 1970, 256 pp., 6 x 9, illus.
- 13. ADVANCED BASIC: Applications and Problems**, by James S. Coan, #5856-X, cloth, (\$8.95), #5855-1, paper, (\$6.95), 1976, 192 pp., 6 x 9, illus.
- 14. FORTRAN FUNDAMENTALS: A Short Course** by Jack Steingraber, #5860-8, paper, 1975, 96 pp., 6 x 9, illus., \$4.95.
- 15. DIGITAL TROUBLESHOOTING: Practical Digital Theory and Troubleshooting Tips** by Richard E. Gasperini, #5708-3, paper, 1976, 180 pp., 8½ x 11, illus., \$9.95.
- 16. DIGITAL EXPERIMENTS** by Richard E. Gasperini, #5713-X, paper, 1976, 192 pp., 8½ x 11, illus., \$8.95.

Write for 15-day examination copies of any of these books!

At the end of 15 days, please remit payment plus postage and handling, or return the books and owe nothing. Prices subject to change without notice. If payment

accompanies order, we pay postage and handling. Outside USA, cash must accompany order — include \$2.00 per book for shipping and handling.



Hayden Book Company, Inc.

50 Essex Street, Rochelle Park, New Jersey 07662

phone: (201) 843-0550



How to get the benefits of CMOS in your static RAM sockets:

Unplug your 2102's Plug in our CMOS 5102's.

It's truly simple. Our 1Kx1 SY5102 static RAM is a pin-compatible CMOS replacement for the popular but power hungry 2102.

With our new 5102 you can just replace parts in your existing designs and immediately cut power — both operating and standby. And the standby requirement is only 1 (one!) mW at 5 Volts. No power-down circuitry needed.

Whenever our 5102 is not enabled, it's in standby. You can use power-down circuitry if you want, but it's not required. Terrific for systems that use battery backup. It runs at 5V, keeps memory alive at 2V!

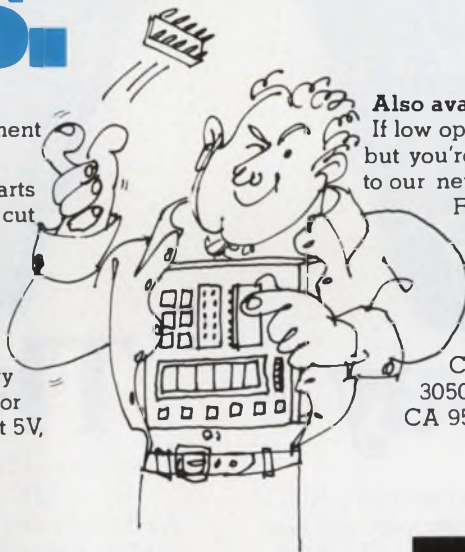

Also available: SY21L02

If low operating power is interesting to you, but you're building low-cost memories, turn to our new SY21L02 N-Channel static 1K RAM. It needs only 15mA operating. The data sheet will give you all the details.

For data sheets, samples or information about either SY5102 or our SY21L02, call or write Bob Cushman. (408) 984-8900.

3050 Coronado Drive, Santa Clara, CA 95051.

Synertek Saves.

Synertek.
Solutions.
Not problems.

CIRCLE NUMBER 36

One way or the other, you're going to profit from plugging a Plessey 32K memory card into your PDP-11.

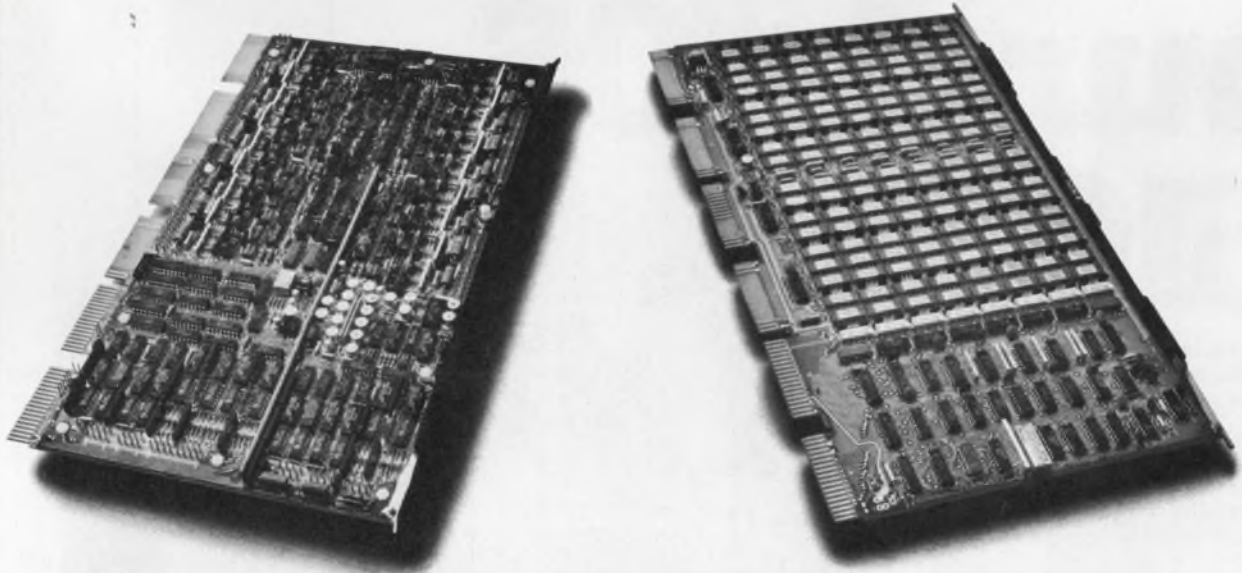

One way

The Plessey PM-1132.

32K words of non-volatile core memory on a single plug-compatible card that occupies just two slots in your PDP-11 mainframe. Compatible with either the standard or the new modified UNIBUS backplane. Available with and without parity.

The other

The Plessey PM-S1132.

Up to 32K words of high-speed NMOS semiconductor memory on a single plug-compatible card that occupies only a single slot in your PDP-11 mainframe. Choose a full-complement 32K word card, or one of 7 depopulated versions, then expand in 4K increments as your data storage needs increase. Available with and without parity.



Plessey Microsystems

Either way, you get reliable high-density storage at a refreshing low-density price.

If that's more memory than you need, we also have a full range of 8K and 16K plug-in cards that are fully compatible with your DEC, Data General and Interdata minis. All supported with the backplanes, cables and expansion chassis you need.

And all available now. Contact us today.

Irvine, CA: (714) 540-9945. Los Angeles, CA: (213) 473-4581. Mountain View, CA: (415) 965-1400. Chicago, IL: (312) 671-4554.
Wheaton, MD: (301) 949-1664. Boston, MA: (617) 890-2654. Minneapolis, MN: (612) 881-0190. Kansas, City, MO: (816) 444-0166.
South Plainfield, NJ: (201) 757-2211. Albuquerque, NM: (505) 294-5790. Dallas, TX: (214) 387-0229. Toronto, Canada: (416) 661-3711.

CIRCLE NUMBER 37

What's TRW up to now?

Optimizing metal film.



TRW thin film resistors optimize parameters like real estate, accuracy, speed, reliability, and resistance range.

In discrete devices, sets, or networks.

For instance, our ultra-precision MAR series does all of the above with absolute TC's and tolerances to ± 5 ppm/ $^{\circ}$ C, $\pm 0.1\%$. Our smallest discrete uses $< .016$ in² of PCB space. Complex sets and networks include 16 Bit Binary Ladders, input

attenuators and others up to 28 pins.

In straightforward precision, we have a range of standards in R2R Ladder, MIL-R-83401 flat pack, and RNC resistors with a verified MTBF of 280×10^6 unit hours.

Contact TRW/IRC Resistors, 4222 South Staples, Corpus Christi, Texas 78411. (512) 854-4872, Dept. M. For standards in all types of resistors, call your local TRW distributor.

TRW IRC RESISTORS

ANOTHER PRODUCT OF A COMPANY CALLED TRW

FOCUS

On
Semiconductor
RAMs

A ravenous appetite for bit storage has propelled semiconductor memories so far along that each new product generation doubles and redoubles its bit density.

And this creates problems.

Manufacturers, eager to be the first on their block to announce yet another round of increased density, have developed a reputation for jumping the gun. To further complicate matters, it's not at all apparent which manufacturer's parts can be substituted for

another's: A device that is second-sourced means only that there is another manufacturer who can supply a part with a similar function and pinout—but not necessarily the same performance.

The onus of true alternate sourcing is on you. You've got to nit-pick the specs to determine if you can safely swap one part for another. Not easy.

Try selecting a 4096 × 1-bit dynamic MOS RAM:

Dick Hackmeister
Western Editor

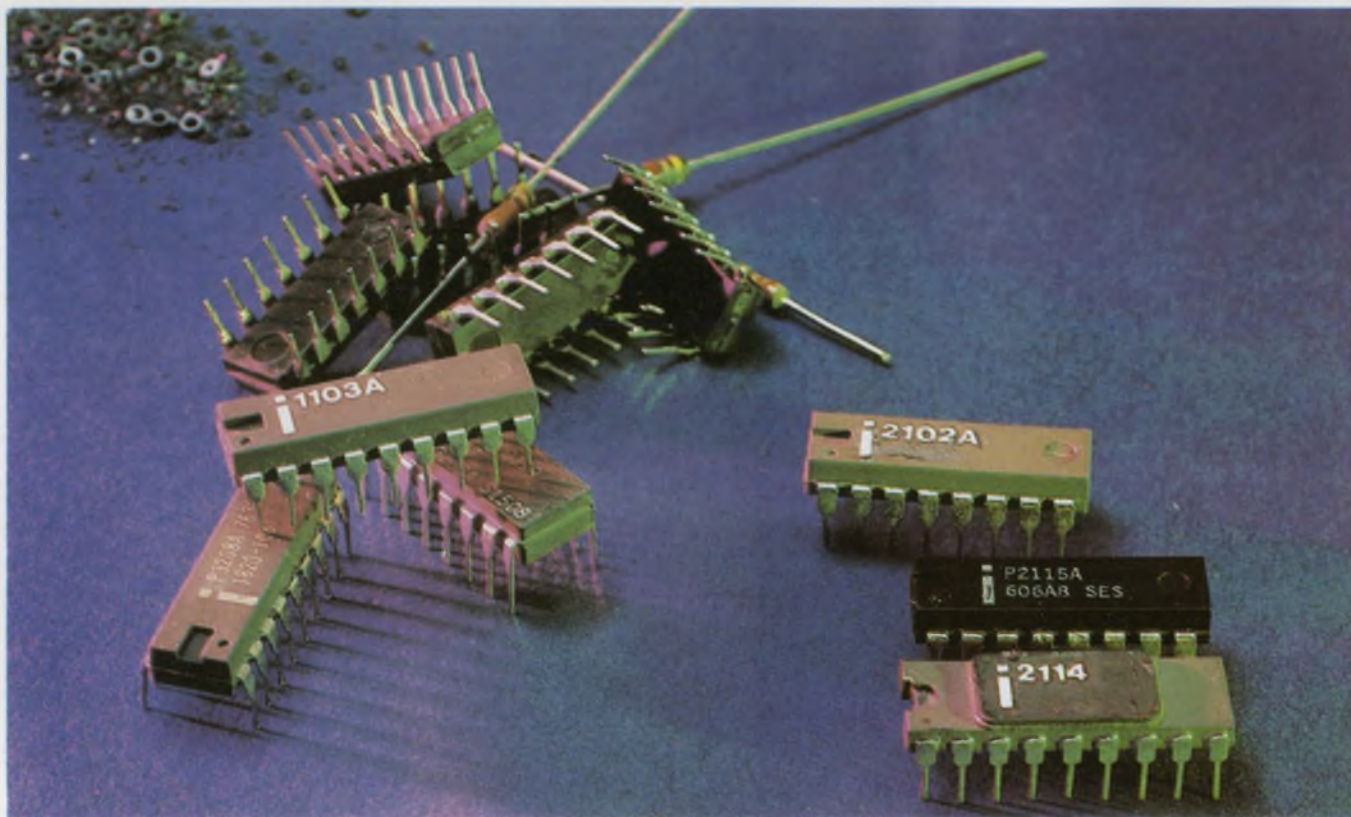

Memory-systems design gets easier and easier, as you go from core to dynamic then static semiconductor RAMs. Dynamic MOS-memory design is no cinch, however—it

takes TTL-to-MOS level shifters, output sense amplifiers and a handful of parts to refresh the RAM. Static RAMs at right are the easy way out (Intel).

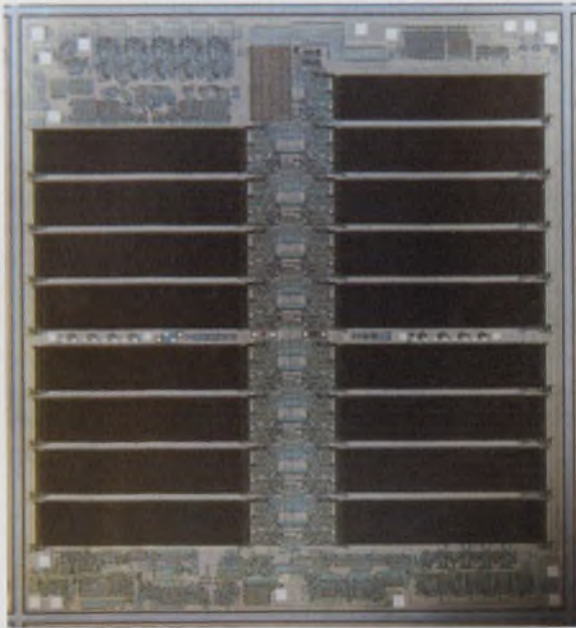

The advantage of CCD memories over dynamic RAMs is that about 70% of the chip area is used for storage, while dynamic RAMs use less than half. TI's CCD, the TMS-3064 (a), is organized as an array of 16 shift-register loops, each

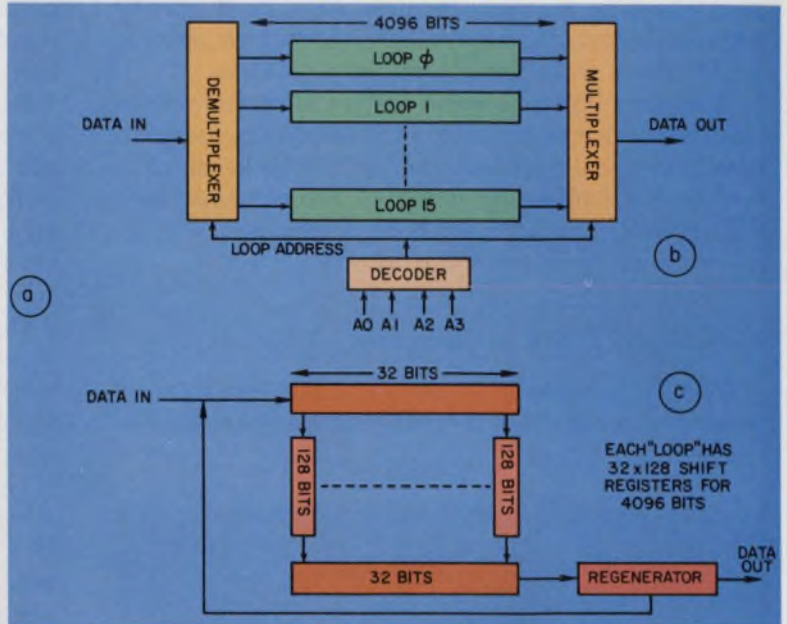

loop 4096-bits long. Four address pins describe which loop accepts or delivers data (b). Each loop is actually an arrangement of serial-parallel-serial shift registers, in a format of $32 \times 128 \times 32$ bits (c).

One source specifies 39 ac parameters, repeated for each of four different grade parts, plus 13 common dc parameters, six timing diagrams and 22 footnotes. Selecting a MOS RAM means matching all those data to all the alternatives—and not just the “typical” numbers, either.

You've got to reckon with both the max and the min values because if you read the fine print, you'll find that “typical” is specified at room temperature—certainly not a valid condition in the real world, where memory devices sometimes operate hot as a pistol.

The parameter-priority paradox

With so many parameters to weigh, it is far too easy to take a pin-the-tail-on-the-donkey approach to device selection. But by listing the memories' parameters in order of importance, then comparing numbers, you can avoid feeling like a donkey's rear end.

Start with the power supply. Unless you're working on a full-blown mainframe EDP system, or something of that magnitude, you'll probably want to avoid designing-in a special power supply just for bit storage. Smaller μ P-based control systems may not be able to justify the extra 12-V and -5-V supplies. So look for a memory that uses TTL power—just 5 V.

Basically it's a TTL world, and the memory manufacturers know it; the trend is to provide parts that are compatible with your host system's power supply. For example, the available 2102-type static RAMs are second-generation 1101s. Unlike the older 1101s, which needed three supplies, the 2102s require only a single 5-V source.

Once you've narrowed the field down to single-supply parts, scrutinize the I/O levels and noise-

margin specs. Those numbers, too, should conform to the host system. Adding level translators and the like can only complicate matters and leave more room for things to go wrong.

Don't use typical values—they represent the over-all average of a great many pieces and are not

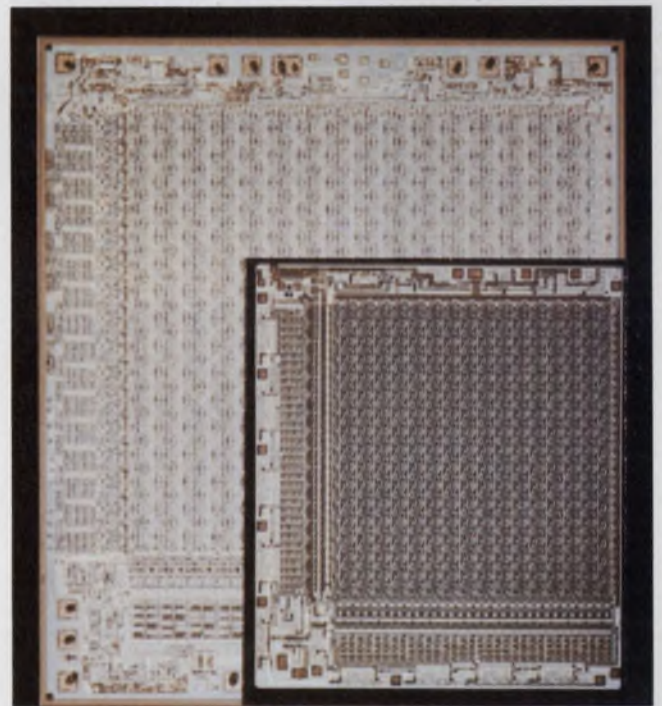

The size of the die directly affects the cost of a semi memory. The original design of this 1024-bit memory from Signetics is shown in the background; it requires 25,000 sq mil of silicon. The present design, shown in the foreground, is only 14,500 sq mil. Data sheets often indicate the die size.

guaranteed by the manufacturer. Also, parts may be screened before shipment, so the average may actually be far away from the typical values stated.

"Min/max limits at worst-case voltages and worst-case temperature are the only responsible way to specify any semiconductor memory," a spokesman for Harris Semiconductor asserts. Some firms, like EM&M Semiconductor, are finally dropping the "typical" column from their data sheets.

After levels, check performance

With system power supplies and I/O levels out of the way, dive right into the performance specs. It takes



Nonvolatile semiconductor memories don't forget after the power is off. Nitron's 256-bit electrically alterable, read-only memory (EAROM) retains data for a year. Serial data input and output keep pin count low.

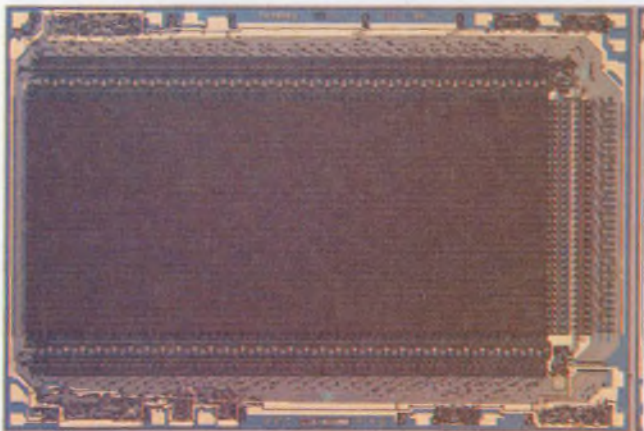

This colorful dynamic, bipolar RAM combines the good attributes of bipolar technology (5 V, 280-ns t_{cy} , 120-ns t_{acc}) with low MOS power (350 mW active), and high density (4096 \times 1 bits). Fairchild makes this memory with isoplanar integrated injection logic.

power to move bits quickly, and the manufacturer who supplies rapid access time with low power consumption is offering high performance.

Here, too, you should specify in terms of the host system—a CMOS part may not be as fast as ECL, but it runs cool and might save you a lot of money on power supplies. On the other hand, bipolar devices are high performers that run hot. NMOS parts generally fall in between. Performance costs, so if you don't need the speed, save the money for a year-end bonus.

The Gaussian distribution ensures a spread of access times for any given production lot. After the manufacturing process is complete, semi houses almost always sort out the faster chips from the slower ones; the faster ones, of course, command a premium price.

Lowest performers are often identified with the basic part number, while faster ones get "dash numbers" (part-1, part-2). But there is no standard for such labeling, or binning. Remember that access doesn't start until all the address bits are presented to the chip—so be careful, and deskew the host system to get all the bits nicely lined up in time. Otherwise, you may think the part doesn't conform to the data sheet.

If you're buying many memories, give the vendor your production schedule. He may be able to integrate your requirements with those of another customer's, and thereby save you money.

When analyzing input-threshold specs, which are sometimes given in terms of one of the supply voltages, be sure to use the worst-case situation. Output drive should be specified at the more rigorous V_{CCmin} . Check the test conditions for load capacitance; for a given access time (t_{acc}), less capacitance means less performance.

For timing specs, look at the timing diagrams, and check the reference points. Worst-case evaluation should include 90% of the rising and falling edges on the waveform under consideration.

Some firms will offer you a precalculated power-dissipation parameter. Beware. There are several ways to calculate P_d , and you may not be getting the whole picture, especially if the memory is dynamic. It's best to calculate it yourself.

The graphs that often accompany semi-memory specs are to be used for trend projection only. These data, too, are only typical, and any individual part may not agree with the curve.

Some high-volume users write their own data sheets rather than trust published specs. "Rolling your own" avoids that ominous footnote: "Subject to change without notice." But don't try to incorporate all the best features of all the manufacturers into one phantasmagorical part. It can't be done. Like everything else in life, you get a semi memory only by compromising.

Which package?

Like most semiconductor products, a memory's package is important to both design and price. Ceramic

packages are the top of the line. They perform well under the most adverse conditions and often cost as much as the chip inside, sometimes more. The chip fits into a cavity, which is sealed after bonding to protect the die and the bonding wires.

Plastic packages cost much less than the top-of-the-liners. But they're molded, and the plastic strains the die and bonding wires by flowing right over them. It doesn't take much to break a golden wire that is half the size of a blonde hair; consequently, the yields are lower. The ones that don't break are the ones that ship.

Manufacturers go to great lengths to match the plastic's coefficient of expansion to that of the silicon

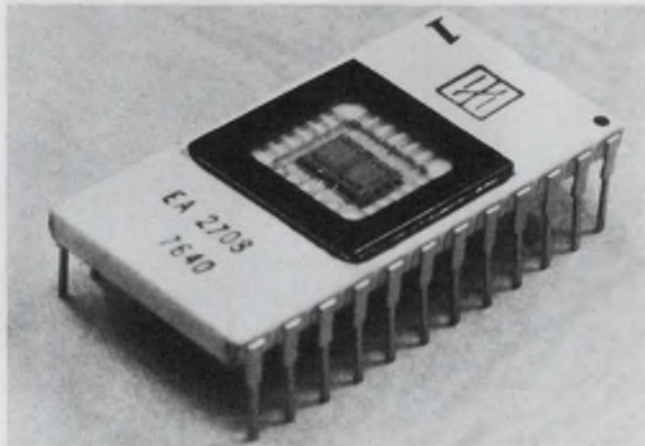

Programmable read-only memories (PROMs) help you develop microprocessor-based computer programs. Data, usually microcode, are stored in the chip as charges on a floating-gate FET and can be erased and rewritten many times. Manufacturers claim data will remain intact for 10 years because the charges have no leakage paths. Exposing the die to intense ultraviolet light (through the quartz lid) for several minutes dissipates the charges, erasing the stored data pattern. Many PROMs have pinouts compatible with static RAMs and factory-programmed ROMs (electronic arrays).

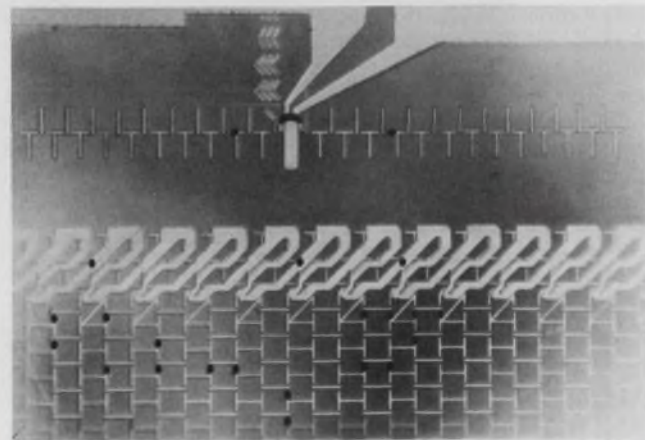

Bubble memories are no longer a laboratory curiosity. This 92,304-bit memory is available from Texas Instruments as the TBM-0103. The technology may provide even greater bit density—a million-bit device is expected within a year. The package contains a permanent magnet, the bubble-memory chip, and two coils that produce a rotating magnetic field. The chip is fabricated on a garnet substrate rather than silicon. Price: \$200.

chip and bonding wires, but nothing is ever perfect. If the memory will experience many drastic temperature changes or will require a high degree of reliability, the chances are you can justify the extra cost of a ceramic package. A good compromise is "Cerdip," a modified-ceramic "sandwich" that offers the stability of conventional ceramic at lower cost.

Don't reinvent the wheel

After you've painstakingly picked through the specs for power-supply compatibility, I/O levels, noise margins, power-supply drain, access and cycle times, you will appreciate the opportunity to ignore something—the input leakage current. With MOS memories, leakage is usually not very significant. In practice, the device is either an open or a short.

Once you've narrowed the field to just a few candidates, contact the manufacturers for applications and reliability data—only then will you have covered all the bases. Semi firms put a lot of effort into their app notes, and one note might just have your complete design. Motorola, for example, offers an app note entitled *A Non-Volatile Microprocessor Memory Using 4-k NMOS RAM (AN-732A)*.

Don't be afraid to specify a device that's been around for a long time. Older types, which presumably have their bugs ironed out and their designs optimized, get better yields. And since most manufacturers' specs have had a chance to converge, a pseudo-standardized part can emerge. Also, since they've been designed into a great many OEM products that still enjoy healthy sales volumes, they're not likely to be discontinued.

On the other end of the stick—new memories—watch out for the data sheet that's stamped "PRELIMINARY." That usually means the manufacturer hopes to ship a lot of devices, but right now the part is "being sampled"—a euphemistic way of saying that the producing semi house is sticking its big toe in to see if the market is hot or cold.

Having pored over the specifications, you are ready to select a RAM. Different RAMs have different attributes—and some have special needs.

Move slowly with dynamic RAMs

For example, dynamic RAMs require refreshing, and that can lead to trouble. When you specify a dynamic RAM, be especially careful to consider all the timing details. Watch out for specs that don't, without good reason, include 90% of the transition edges.

Vendors balance density, power and speed, so you can specify a part that optimizes the characteristics most important to you and trade off those you don't need. Another compromise to consider is density vs dollars. The new 16-pin, 16-k parts will soon be cheap enough to compete with the assortment of 4-k devices now available.

If it's a 4-k you're considering, maybe you can

replace it with a 16-k part, pin for pin, level for level and nanosecond for nanosecond. For instance, the chip-select pin—pin 13 in the standard Mostek pinout—becomes A_6 in many of the 16-k devices. With a DIP switch or a jumper, you can design a field-upgradable memory board—just pop out the 4-k, do a little hardware change and pop in the 16-k. Presto! You've increased the board's capacity by four—that is, with 4-k RAMs that allow you to do so.

Desirable features to look for in 16-k RAMs include: page-mode addressing, row-address-strobe refreshing and (long overdue) $\pm 10\%$ power-supply variations. Choose between latched or unlatched outputs and 64 or 128-cycle refresh.

You should understand the difference between Read-Modify-Write cycles and plain old Read cycles and Write cycles. R-M-W is a timing mode that slices nanoseconds off the cycle time. If you expect the software to be doing a lot of file updating (as opposed to number crunching), use R-M-W to access a word, modify all or part of the word, then restore it immediately. You'll design a more efficient machine.

If *anything* on your data sheet is unclear, don't hesitate to contact the manufacturer. Almost everything on a timing diagram is interrelated, and if you don't completely understand what's going on inside the part, you can't make a valid selection. Besides, once you know one device thoroughly, you'll be able to comprehend all the others.

The standard pinout for the 16-k generation will probably be Mostek's 16-pin arrangement: a power supply in each corner, input and output across from each other, and address bits increasing in significance in a counterclockwise manner. Most likely, the next generation of 16-k memories will see no change in the refresh rate—it will remain one or two ms.

The 16-k generation

Dynamic RAMs—almost always implemented in NMOS—are available in 16, 18, and 22-pin DIPs. Be sure to check out all the manufacturer's types—some may be more readily available than others.

The MK4116 family of 16-k memories from Mostek offers access times down to 150 ns. The company's 4-k \times 1 families include the MK4022, 4027, 4096, and 4200, with 200-ns devices over the full commercial temp range of 0 to 70 C.

A 250-ns, 16-k \times 1 device from Intel, the 2116, comes in three different t_{acc} bins. This industry leader's 2108 is an 8-k \times 1 chip with 200-ns access. Intel's 4-k parts include a number of bin selections in the 2104 and 2107 families.

A 16-k \times 1 memory from Texas Instruments, the TMS4070, comes in three bins, according to access and cycle times. TI's 4-k line includes the TMS 4030, 4050 and 4060. Another 4 k, the 4051, takes TTL-compatible clocks.

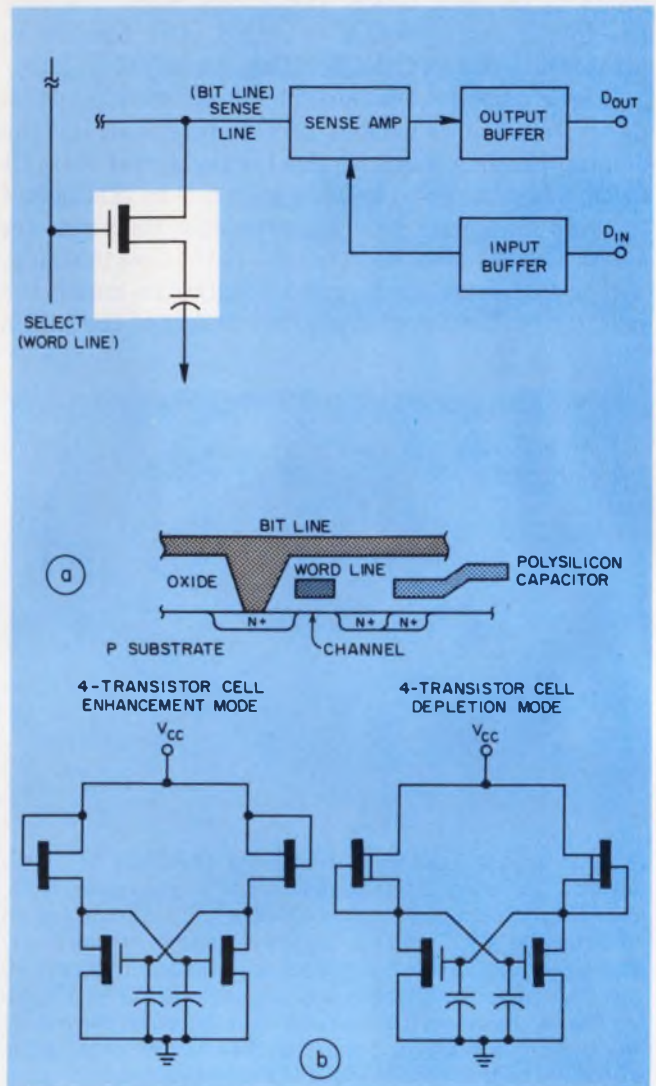

Dynamic RAMs store data in small capacitors. The presence or absence of a charge represents a ONE or a ZERO. Since the capacitor will leak away most of its charge in a few milliseconds, it must be continually refreshed (a). **A static RAM is basically an array of flip-flops.** One side or the other of each memory cell is "ON" at any time, and this defines whether the cell is storing a ONE or a ZERO. At least four transistors are needed to make a single memory cell. Consequently, static RAMs consume more power and need more chip area (b).

A 16,384-bit dynamic RAM, the MCM-6616, is produced by Motorola in four bins. And for something in a 4096, look into the company's 6604 and 6605. Access times are as low as 150 ns for the 6605.

A 16-k chip offered by Fairchild has the most meaningful designation: F16k. You can get it in three timing bins. Fairchild also makes the only bipolar 4-k dynamic RAM—the 93481C, and it's fast—100 ns from 0 to 70 C.

The quickest 8-k chip anywhere is the 7008-10 with a 150-ns t_{acc} . It's from newly merged Intersil/AMS, which also produces a 16 k, the 7116, as well as a good

Introducing $\overline{\text{CAS}}$ and $\overline{\text{RAS}}$

The column-address strobe ($\overline{\text{CAS}}$) and the row-address strobe ($\overline{\text{RAS}}$) appeared around 1974, when linear addressing began to limit the number of addresses in cost-effective 16 and 18-pin packages.

The old 1103, with 1024×1 addressable words in an 18-pin package, used 10 precious pins just for address definition. Going to 2-k and then to 4-k addresses would have required 11, and then 12 pins—clearly unacceptable for a part meant to be inexpensive.

$\overline{\text{CAS}}$ and $\overline{\text{RAS}}$ solve the dilemma by splitting the address bits into most and least-significant halves and delivering the bits to the memory in two "waves." Thus, the number of pins required to define any given address can be cut in half.

With $\overline{\text{CAS}}$ and $\overline{\text{RAS}}$, up to 65,536 discrete addresses can be described with a mere eight pins. These eight pins describe one of 256 rows—as well as one of 256

columns. (Both row address and column address are internally latched and decoded.)

Consequently, only 10 pins— $\overline{\text{CAS}}$, $\overline{\text{RAS}}$ plus eight more—are necessary, and that is why Intel's 4096×1 dynamic MOS RAM (type 2104) needs only a 16-pin DIP, whereas the older, smaller 1103 needed 18 pins.

Multiplexed addressing is one reason that chip density will continue to quadruple, rather than merely double: One more pin devoted to addressing doubles the number of columns, but also doubles the number of rows. So the size of the internal cell matrix can grow by a factor of four.

The 65-k limit of eight address pins will probably be breached by one of two schemes. Adding a ninth address pin will allow for up to 262,144 addressable locations. But adding a third multiplex pin will provide "three-dimensional" addressing, with a whopping 16,777,216 locations in a single package.

selection of 4-k devices: the 7005, 7027, 7270, 7271, 7280, 7505, and 7507. Another 16 k: NEC's $\mu\text{PD-416}$. The 411, 414 and 418 are NEC's 4096-bit parts.

Fujitsu rounds out the 16-k choices with its MB8116, and its 4-k contributions include the 8107, 8215 and 8224.

National Semiconductor has six 4096-bit dynamic RAMs—the MM4270, 4280, 5270, 5271, 5280 and 5281. Access times range from 150 to 270 ns, a pretty tight span.

Signetics offers the 2660, 2675, and 2780—all 4-k $\times 1$. The 2260 is one of the better specified devices.

Other manufacturers of 4096×1 dynamic NMOS RAMs include Advanced Micro Devices, Electronic Arrays, RCA, Panasonic, Rockwell, Synertek, Toshiba, Western Digital, Monolithic Memories, Hitachi and Siemens.

Static RAMs: smaller but steadier

Static RAMs usually lag behind dynamic ones in density, but come in a wide assortment of sizes and technologies. For example, static emitter-coupled logic (ECL) RAMs are the fastest of all commercially available memories. They get down to 10-ns t_{acc} , and illustrate nicely the balance of density, speed and power. ECL RAMs span the density spectrum from 64 to 1024 bits, and they run hot. (Beware of the smaller ones— t_{acc} may not be specified at high temperatures.)

Representative 1-k ECL RAMs include Motorola's MCM10146 and 10415, Fairchild's 10415 and Fujitsu's 10415.

TTL RAMs can't go quite as fast as ECLs—they bottom out at about 50 ns. But then, TTLs consume fewer milliwatts than ECLs while covering the same density range.

With one notable exception (Fairchild), the densest bipolar TTL RAMs are made by Signetics (82S110), Fairchild (93415), TI (54 S 314), National (93425), Raytheon (5500), AMD (93415), Intersil (55 S 08), NEC (2205) and Hitachi (2501). These are all 1024×1 bits. Fairchild's 4 k, the 93471, is a TTL-compatible static RAM with an eye-popping 55 ns access time. It uses an integrated-injection-logic technique.

At $15 \mu\text{W/bit}$, complementary MOS (CMOS) RAMs take the low end of the power scale. CMOS memories are available in 16 to 1024-bit arrays, and in access times from 80 all the way to 1500 ns.

The highest-density CMOS RAMs are made by Harris (6508), RCA (5501), Intersil (6508), Solid State Scientific (5502), AMI (6508), National (74 C 929) and Toshiba (5007). Hughes has recently entered this arena with a 32×8 CMOS RAM and two shift registers.

The line between p-channel and n-channel MOS is quite distinct. While the highest-density PMOS RAM is a mere 256 bits, static NMOS RAMs are available from 1024 to 4096 bits. Almost all new designs are being implemented in NMOS.

An NMOS process that promises to provide even denser memories than standard NMOS is the vertical MOS technique developed by American Microsystems. Fabricating the transistors vertically in a V-shaped groove—instead of in a horizontal plane—reduces RAM cell size by almost 50%, yielding a smaller, faster part. The first VMOS product is the AMI S4015-3, a

45-ns static RAM, with a chip size of only 4400 square mils—about half that of the Fairchild 93415, a bipolar equivalent of the 1-k × 1 VMOS RAM.

The one on the cover

Today's largest capacity static NMOS RAMs are all organized as either 4 k × 1 or 1 k × 4. (For clarity, those devices with 1-k × 4 organization will be indicated in italics: 4 k × 1 will be in normal type.)

EM&M Semi's 4402 ties NEC's μ PD 410 for the quickest t_{acc} . The former yields its data in 100 ns maximum over 0 to 70 C—very good performance for a MOS device. The latter is available in three bins. Other 4-k parts from EM&M are the 4104, 4200, 4801 and 4804, each with a number of bin selections.

Intel's recently introduced family of 4-k static RAMs boils down to two basic type numbers with a total of six bin selections. The 2114 comes in an 18-pin DIP; the 2142 features two additional control pins.

Mostek's MK4404 needs only a single 5-V supply. Mostek's other static RAM, the 4104, carries a 200-ns t_{acc} , as does the MK4404. Signetics offers one of each—the 2614 and the 2316.

National's two static RAMs, the 5255 and the 5256 are "nibble" (half-byte) organized. Also, its 5257 4 k is a "× 1." Intersil's 7114 is available in four bins and the 7141 also has 4 grades of t_{acc} .

Nitron has two "× 1" parts—the 4402 and 4200. The 4200 uses only two power supplies, -5 and 12 V. The 4104 is Nitron's 1-k × 4. Another Fairchild memory, the 3445, is nibble-organized.

The fastest (55 ns) 4096-bit static RAMs in the business are in Fairchild's 93470/71 series. Implemented in TTL, the /70 is usable over the full military temperature range of -55 to 125 C.

General Instrument makes two kinds of NMOS static RAMs—the RA3-4402 and RA3-4200.

Advanced Micro Devices offers the 9130 and the 9140 series. The 9145, an unconventional 4-k × 1 NMOS RAM, uses a relatively new technique—clocking—that cuts down on the power consumed. You can consider it a hybrid, falling somewhere between dynamic and static, whose popularity will increase as static devices grow in density. The 9145, in wafer form, is shown on the cover. ■■

A special thanks to the following individuals for their help in organizing the material in this article: Bill Blood, Motorola; Brian Cayton, GI; Richard Florence, CompuCorp; Joe Heesbeen, Macrodata; John Hewkin, TI; Ralph Kaplan, Signetics; Fran Krch, EM&M; John Latham, Rockwell; Harry Masuda, Signetics; Jerry Prioste, Motorola; Bill Regitz, Intel.

Need more information?

The products cited in this report don't necessarily represent the manufacturers' complete lines. For complete details, circle the appropriate reader service card number. More vendors and information may be found in ELECTRONIC DESIGN'S GOLD BOOK.

Advanced Micro Devices, 901 Thompson Pl., Sunnyvale, CA 94086 (408) 732-2400. (Ben Anixter) **Circle No. 501**
 American Microsystems, Inc., 3800 Homestead Rd., Santa Clara, CA 95051. (408) 246-0330 (Russ Knapp) **Circle No. 502**
 Electronic Arrays, Inc., 550 E. Middlefield Rd., Mountain View, CA 94043 (415) 964-4321 (John Lipnisky) **Circle No. 503**
 EM&M Semiconductors, Inc., 3883 N. 28th Ave., Phoenix, AZ 85017. (602) 263-0203. (F. L. Krch) **Circle No. 504**
 Fairchild Semiconductor Div., 464 Ellis St., Mountain View, CA 94042. (415) 962-5011. (Frank Rittiman) **Circle No. 505**
 Fujitsu America, Inc., 2945 Kifer Rd., Santa Clara, CA 95051. (408) 985-2300. (Ron Gorshe) **Circle No. 506**
 General Instrument Corp., 600 W. John St., Hicksville, NY 11802. (516) 733-3099 (Brian Cayton) **Circle No. 507**
 Harris Semiconductors, Inc., P.O. Box 883, Melbourne, FL 32901. (305) 724-7257 (Steve Harris) **Circle No. 508**
 Hitachi America, Inc., 2700 River Rd., Des Plaines, IL 60018. (312) 298-0840. (Yukio Suzuki) **Circle No. 509**
 Hughes Aircraft Co., 500 Superior Ave., Newport Beach, CA 92663. (714) 548-0671. (Gary Desrochers) **Circle No. 510**
 Intel Corp., 3065 Bowers Ave., Santa Clara, CA 95051. (415) 246-7501. (Bill Regitz) **Circle No. 511**
 Intersil/AMS, 10900 N. Tantau Ave., Cupertino, CA 95014. (408) 996-5000. (John Cosack) **Circle No. 512**
 ITT Semiconductors, 74 Commerce Way, Woburn, MA 01801. (617) 935-7910. (Don Gradzewicz) **Circle No. 513**
 Monolithic Memories, Inc., 1165 E. Arques Ave., Sunnyvale, CA 94086. (408) 739-3535. (Ray Gouldsberry) **Circle No. 514**
 MOS Technology, Inc., 950 Rittenhouse Rd., Norristown, PA 19401. (215) 666-7950 (Jules Hertsch) **Circle No. 515**

Mostek Corp., 1215 W. Crosby Rd., Carrollton, TX 75006. (214) 245-6921. (Derrell Coker) **Circle No. 516**
 Motorola Semiconductors, Inc., 5005 E. McDowell Rd., Phoenix, AZ 85008. (602) 962-2821. (Jerry Prioste) **Circle No. 517**
 National Cash Register, 8181 Byers Rd., Miamisburg, OH 45342. (513) 866-7471 **Circle No. 518**
 National Semiconductor, 2900 Semiconductor Dr., Santa Clara, CA 95051. (408) 737-5891. (Ron Livingston) **Circle No. 519**
 NEC Microcomputers, 5 Militia Dr., Lexington, MA 02173. (617) 862-6410. (Dick Koerner) **Circle No. 520**
 Nitron, 10420 Bubb Rd., Cupertino, CA 95014. (408) 255-7550. (Dave Fletcher) **Circle No. 521**
 Nortec Electronics Corp., 3697 Tahoe Way, Santa Clara, CA 95051. (408) 732-2204. (Leon Mittman) **Circle No. 522**
 Panasonic Industrial Div., 1 Panasonic Way, Secaucus, NJ 07094. (201) 348-7275. (Terry Kobayashi) **Circle No. 523**
 Raytheon Semiconductor, 350 Ellis St., Mountain View, CA 94042. (415) 968-9211. (Dave Uimari) **Circle No. 524**
 RCA, Rt. 202, Somerville, NJ 08876. (201) 685-6810. (Don Carley) **Circle No. 525**
 SGS-ATES, 79 Massasoit St., Waltham, MA 02154. (617) 891-3710. (Ruben Sonnino) **Circle No. 526**
 Siemens Corp., 186 Wood Ave. S., Iselin, NJ 08830. (201) 494-1000. (Claus Bahr) **Circle No. 527**
 Signetics, 811 E. Arques Ave., Sunnyvale, CA 94086. (408) 739-7700. (Ralph Kaplan) **Circle No. 528**
 SMC Microsystems, Inc., 35 Marcus Blvd., Hauppauge, NY 11787. (516) 273-3100. (Don Lewis) **Circle No. 529**
 Solid State Scientific, Industrial Center, Montgomeryville, PA 18936. (215) 855-8400. (Al Genchi) **Circle No. 530**
 Stewart Warner Microcircuits, 730 E. Evelyn Ave., Sunnyvale, CA 94086. (408) 245-9200. (Fred Soufal) **Circle No. 531**
 Synertek, Inc., 3050 Coronado Dr., Santa Clara, CA 95051. (408) 984-8900. (Bob Cushman) **Circle No. 532**
 Texas Instruments, Inc., PO Box 1443, Houston TX 77001. (713) 494-5115. (John Hewkin) **Circle No. 533**
 Toshiba America, 5235 N. Elston Ave., Chicago, IL 60630. (312) 545-5123. (Ken Motoe) **Circle No. 534**
 Western Digital Corp., 3128 Red Hill Ave., Newport Beach, CA 92663. (714) 557-3550. (George Gregoire) **Circle No. 535**
 Zilog, Inc., 10460 Bubb Rd., Cupertino, CA 95014. (408) 446-4666. (Dave West) **Circle No. 536**



**Get
professional
coaching on
your solenoid
problems.**

Nobody, but nobody, builds more solenoids than Dormeyer Industries. So when you need a laminated, folded frame, box frame, "C" frame, or tubular type solenoid for commercial applications, give a holler for Dormeyer.

We have plenty of standard units that can be shipped immediately from stock. Or, if you want fast help on solving solenoid application problems just watch our engineering team go into action. You'll have the competitive edge with Dormeyer's know-how and economical prices on your side.

Make it easy on yourself. Write or call today for the new Dormeyer "Coach's Kit" with a complete solenoid catalog.

DORMEYER INDUSTRIES, A Division of A. F. DORMEYER MFG. CO., INC.
3418 N. Milwaukee Avenue, Chicago, IL 60641 • (312) 283-4000 • TWX: 910-221-3831



TM

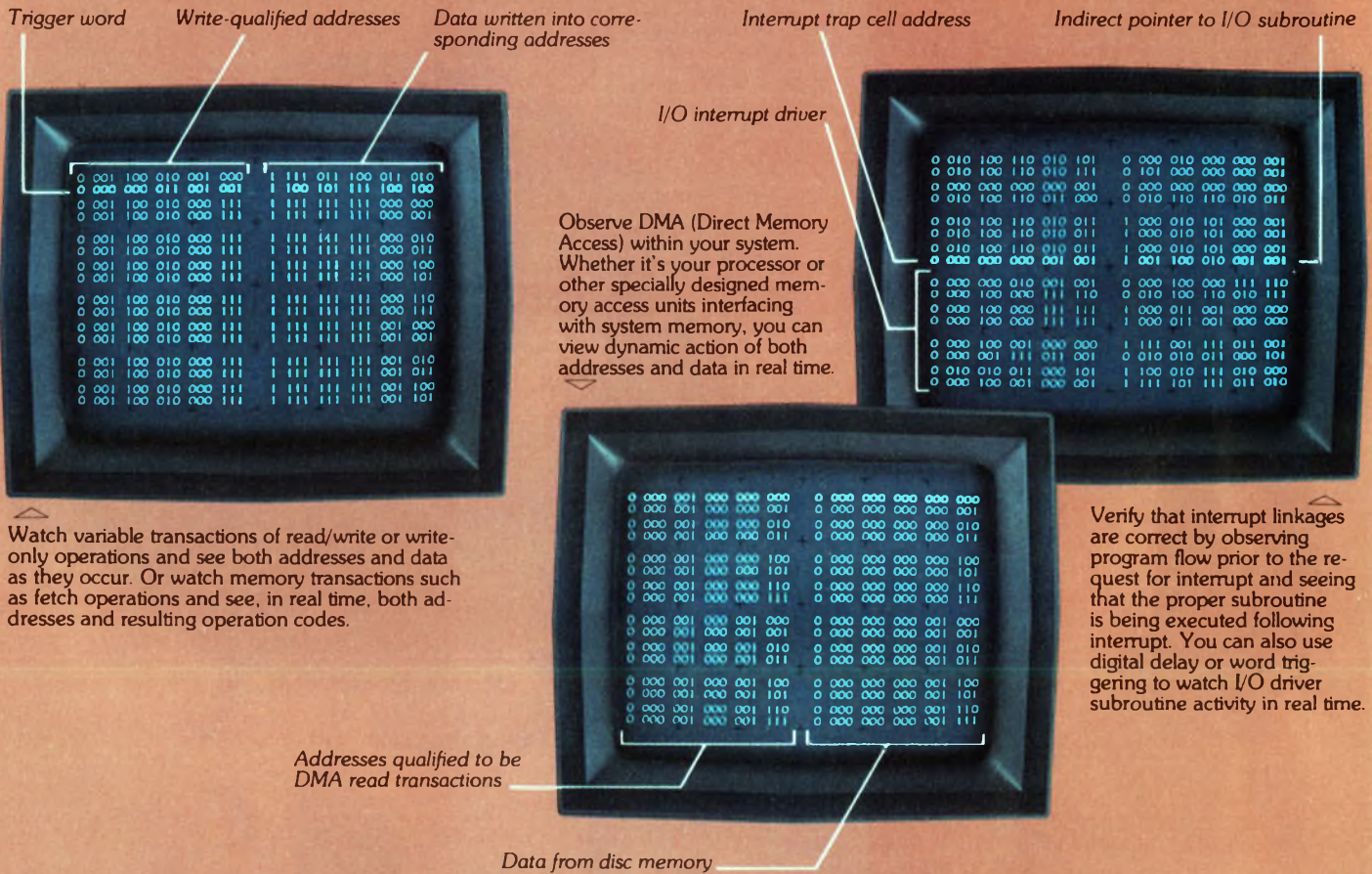

If you're designing minicomputer based systems,

only HP Logic State Analyzers show you real time like this.

Logic State Analyzers effectively put you inside your operating minicomputer system for faster design and debugging. Here's the difference HP's real-time view makes.

HP's 1600S Logic State Analyzer (priced at \$7100*) plus 10254A Serial-to-Parallel Converter (priced at \$975*) gives you a better way to spot and diagnose intermittent system operation. They give you greater insight for better understanding of your system's capability. The combination can mean earlier product introduction, lower development costs, a faster return on the development investment.

Your local HP field engineer has all the technical details. Give him a call today. And also ask him about HP's FREE seminars—An Introduction to the Data Domain.

*Domestic U.S.A. prices only

Dynamic real time photograph (time exposed) of incrementing counter used as system clock

Get a system overview with this memory map. It shows how your memory is being utilized in an operating program. If you know how your memory is organized, the map tells you at a glance what your program is doing and the relative time being spent in any one memory location. That makes it easy to spot things that shouldn't be happening, or to determine that part of your program isn't being implemented.

Disc address (cylinder, head, sector)

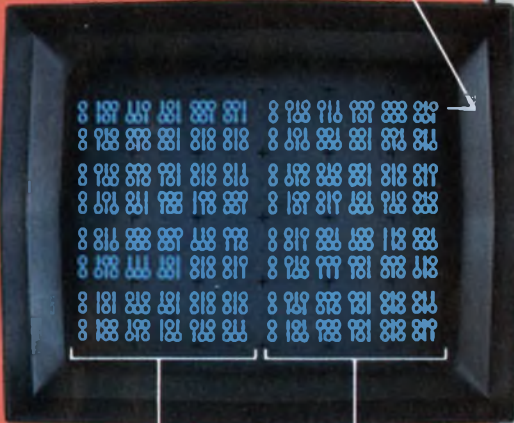

Parallel data inside computer

Serial data from 10254A

ASCII code

View I/O transactions in real time. Straddle an interface with the 1600S and you can evaluate handshake signals and compare input and output data directly—even if the clock rates differ and you're comparing serial data to parallel.

Qualifiers, digital delay and various local or bus-triggering modes give you pinpoint selection of data flow for effective program tracing.

Output triggers drive your scope—at the right instant—for making electrical measurements in the time domain.

Up to 32 channels let you see all the action on a 16-bit system main bus plus 16 bits in the control section, I/O, or any other logic section in your minicomputer system.

Dual clock means you can easily relate bus activity to events occurring elsewhere at a different clock rate—in system peripherals, for example.

Serial-to-Parallel Converter (HP's 10254A) lets you directly view serial data in relation to parallel data on the system bus.

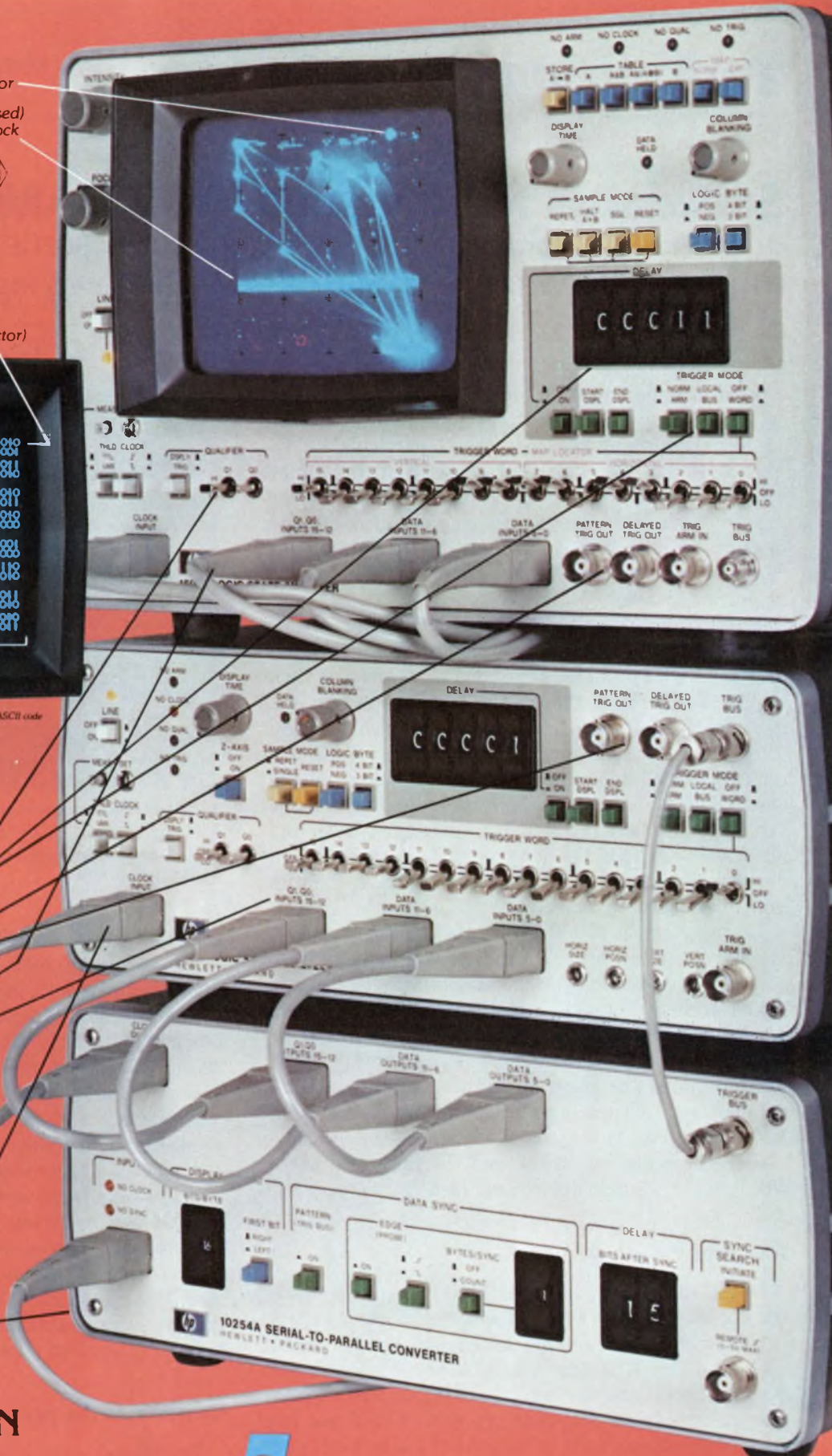

FREE DATA DOMAIN SEMINAR

Find out for yourself how HP Logic State Analyzers can broaden your view of the data domain and speed digital design and debugging. Seminars are scheduled in a number of cities throughout the country. Ask your HP field engineer about specific details on seminars in your area.



1507 Page Mill Road, Palo Alto, California 94304

For assistance call: Washington (301) 948-6370, Chicago (312) 255-9800, Atlanta (404) 955-1500, Los Angeles (213) 877-1282

Standards for dynamic MOS RAMs are emerging. But among equivalent parts, some are more equal than others. Static-RAM standards lag.

Increasing demands for lower cost, higher bit density, and better performance have caused a proliferation of new semiconductor memories—particularly dynamic MOS RAM chips. But, instead of developing a line of standard parts, manufacturers have devoted most of their efforts to maximizing performance and density—which usually means devices with unique “new” problems that result from not eliminating problems in available families.

Today, available 4-k, n-channel dynamic RAMs include at least five pin-out versions of three different packages, with numerous electrical-specification variations. Yet perhaps 90% of the market needs might have been satisfied with but one standard chip design.

This variety stems largely from the lack of a single part with good enough performance and low-enough cost to command undisputed leadership. Some of the types produced are fast, but draw excessive power and are noise sensitive. Other types offer good PC-board density, but have doubtful manufacturing economies and few alternate sources.

However, as the 16-k RAMs are beginning to appear, standards for dynamic RAMs are also beginning to emerge. In dynamic RAMs, Mostek parts have established a clear technical lead. Their specs have been sufficiently tight to delay alternate sourcing of their parts and even to discourage some companies enough to drop out of the game altogether. In static RAMs, standards are coalescing more painfully. The Mostek MK 4104 will likely set one standard. But the competition of the scaled-up 2102A and the fast Intel parts will prevent a single device standard from emerging.

Who sets the standards?

In the early days, the Intel 1103 was pretty much the standard. Tricky to build and even trickier to use, it was still second-sourced by enough companies to lead the field. With the coming of the 4-k RAM, the Motorola 6605 and the Intel 2107 introduced the 22-pin package (with different pinouts). But Texas Instruments' 22-pin version became the standard, and

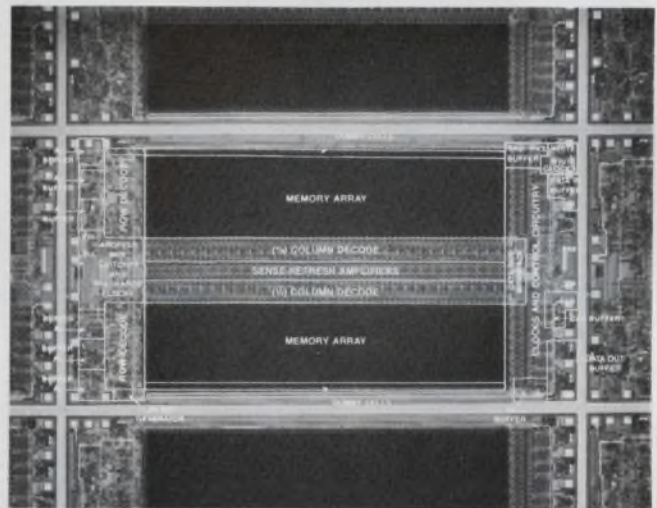

1. A combination of high speed and low power in this 16-k Mostek MK 4116 dynamic RAM results from new approaches in the design of on-chip peripheral circuits and sense amplifiers.

the Intel 2107A and 2107B followed.

Meanwhile, Mostek pioneered the 16-pin, multiplexed-address part, the MK 4096. With the emergence of the Mostek 4-k MK 4027 in 1976 and the general acceptance of the 16-pin, multiplexed-address concept, 22-pin parts and their 18-pin derivatives became obsolete. One important factor influencing this move was that the 4027, unlike its predecessors—the 4096—used standard silicon-gate processing.

A powerful argument for the 16-pin format is that it can be readily converted to a high-board-density 16-k RAM, by replacing the \overline{CS} input with an input carrying the two extra address bits. So far, only Mostek (MK 4116) and Intel (2116) have shipped significant quantities. But despite the common pinning there are substantial differences between these seemingly similar memories.

Mostek sets the pace

The Mostek 4116 is setting the standards because of its circuit design (Fig. 1). A combination of high speed and low power requires new approaches to the on-chip peripheral circuits and to the sense amplifiers. Nearly all earlier designs, including the 2216, use sense amplifiers in which load current drawn from V_{DD} is

R.C. Foss, President, and R. Harland, Vice President, Mosaid, Inc., P.O. Box 11123 Station H, Ottawa, Canada K2H 7TB

traded off for cycle time set by the period needed to pull up a bit-line.

To escape this compromise requires balanced, all-dynamic sense amplifiers. Such circuits are more complex and difficult to lay out. More serious still, are the design problems created by the need for the Y-access circuits to connect both sides of the divided bit line to the read/write circuits when a bit line is selected. If this is not done, an all-dynamic sense amplifier will not allow read-modify-write cycles (see box).

Prior to MK 4027 and MK 4116, only the National

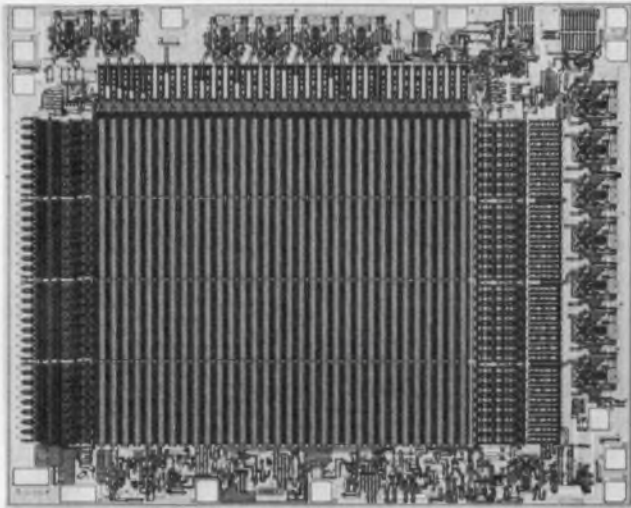

2. Folded bit lines and a dynamic load-steering circuit minimize power drain in the Intel 2104A 4-k dynamic RAM. The device, which is a second source to the Mostek 4027, has a 16-pin package.

18 and 22-pin parts used balanced all-dynamic sensing. Failure to do so accounts for other companies' first attempts at 16-pin designs winding up with specifications incompatible with either the older 4096 (which uses all-dynamic, but unbalanced, sensing) or the 4027. It now seems certain that all future dynamic-RAM designs must feature all-dynamic sensing to be performance-competitive.

A second key area in dynamic-RAM design in which Mostek sets the pace is the address buffer.¹ Although detecting TTL levels should be a slight problem compared with the correct sensing of less than 10^6 electrons of stored charge in a memory cell, poor address-buffer design has caused many designs to founder. Unfortunately, a poor buffer shows up by its effects on the decoders, and the obscure errors created are very pattern-dependent.

Finally, Mostek is leading the way in shrinking the chip dimensions. A reduction in line widths by x tends to give a speed advantage of x^2 since transistor gains increase by x and gate-capacitance loads diminish by x . A reduction in all linear dimensions achieves similar results, since transistor gains now stay constant and capacitance loads decrease as the square. When the MK 4027 first appeared, it used layout dimensions close to accepted industry standards. But later ver-

sions shrank 15%. The MK 4116 has come out in this smaller version from the start, and further size reductions are forecast.

Second sourcing—but how?

A key element in the success of any part is the degree to which it is "second-sourced." But in memories especially, care must be taken when defining a second source. On the one hand, users can sometimes accept quite different parts, maintaining system compatibility only at the board level. On the other hand, identical parts might be used interchangeably to simplify procurement, testing, spares logistics and maintenance.

Until very recently, this latter option was hardly available. Parts to the same nominal specification usually differed so much in second-order "unwritten spec" parameters that they were not fully interchangeable. The MK 4027 was the first n-channel dynamic RAM to be copied exactly by second-sourcers.

There is a hidden paradox in second-sourcing: While having identical multisourced parts seems ideal, if a design problem emerges in production, all identical second sources will be affected. Some 1103 pioneers were hurt in this way when the now-famous "column disturb" problem was discovered.

So despite the inconvenience, using different designs aimed at the same specifications has its advantages. For example, the new Intel 2104A approach to balanced all-dynamic sensing is totally different from that in the 4027, which it second-sources (Fig. 2). However the differences are minor and can be accommodated by users. But, as always with differing designs, it would be risky to consider the parts entirely interchangeable or intermixable.

Meanwhile, the pin-out for 64-k RAMs has been defined by JEDEC as identical to 16-k parts but with the V_{CC} pin converted over to the eighth-pair of address bits. What is not yet generally agreed is whether V_{DD} stays at 12 V, or is established at 5 V or some other intermediate nonstandard voltage. If V_{DD} is not 5 V, then V_{CC} must be derived internally for the output buffer which can be done readily.

The problem in fixing the V_{DD} level comes from having to reduce line widths and clearances to keep chip size compatible with standard 16-pin package-well dimensions. A 12-V supply bootstrapped internally to 16 V or even 20 V is likely to be incompatible with smaller dimensions. On the other hand, a nominal 5-V V_{DD} will give intolerably small internal voltage margins.

One possible way to increase operating margins is to use two cells per bit, as in the 2104A. This ensures that a stored ONE is always compared with a stored ZERO and vice versa, rather than being compared with an intermediate-reference level. Near-perfect balance can be achieved, too, but only by increasing the silicon area of the chip. However, the increase isn't so great, since the array itself does not double in size,

and is in any case only 30% to 45% of the total chip area. Indeed, the total chip area might actually be reduced if the fabricating technique allows fine line widths and a 5-V V_{DD} .

Eliminating the $-V_{BB}$ supply is another way to reduce chip area. An on-chip generator might replace the external supply, as in several present static RAM designs. But the problem with using an on-chip generator for dynamic parts is that large peaks of substrate current occur because of capacitance coupling from the bit lines and other parts of the circuit. To minimize such current spikes calls for either an external decoupling capacitor or still more constraints

on the circuit design.

As an intermediate step on the road to the 64 k, 16-k parts may emerge with 5-V-only power requirements. The problems will not be easy to solve, but unless some way is found to exploit advanced fine-line-width processes in dynamic designs then static RAMs, which use them now, will become more attractive than dynamic RAMs in performance and cost.

The future of dynamic RAMs

While 64-k dynamic RAM chips are now being promised, 4-k parts are still being actively developed

Why all-dynamic sensing?

The balanced flip-flop sense amplifier, used in all first-generation, balanced, one-transistor-cell RAM designs, gives the classic speed-power trade-off. Current taken by the sense-amplifier loads can be reduced only by increasing the time taken to pull up the 1 pF or so of bit-line capacitance. However, sense time or access time needn't be affected, because bit lines can be precharged high. It is the read-modify-write cycle, in particular, which is extended.

The extension occurs because the Y decoder gives access to only one half of the divided bit-line; and a ZERO read-out from the side remote from this access can be written back in only as a ONE at a rate set

by the charging current available from the sense-amplifier load. If a dynamic circuit is used to cut off the wasted load current fed to the low side, then a ONE level cannot be written back in.

Thus, the key problem is arranging the Y decoder to give balanced access to both sides of the divided bit line. One method, used in the MK 4116, is to run the decoder up the center of the array along with the sense amplifiers. Another is to fold the bit-line halves parallel to each other, giving access to both halves at either end. This method is used in the NEC μ PD 414D and Intel 2104A, and lends itself to a two-cells-per-bit format.

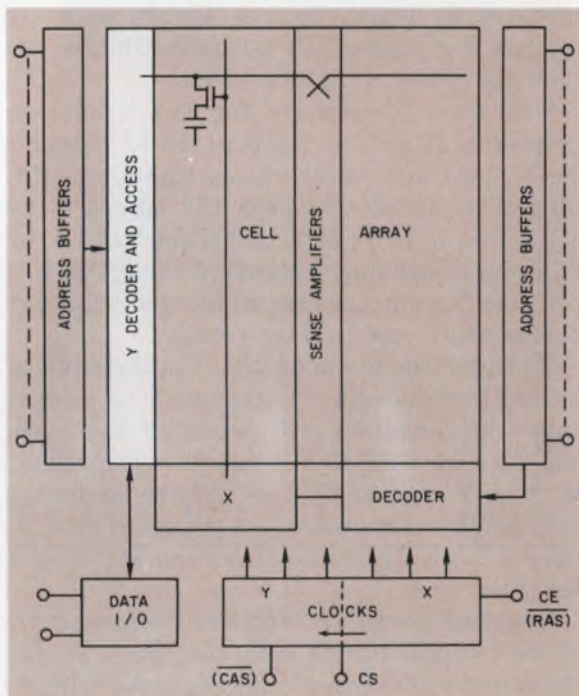

A first-generation dynamic RAM, which used a balanced flip-flop sense amplifier, has Y-access to only one half of a divided bit line.

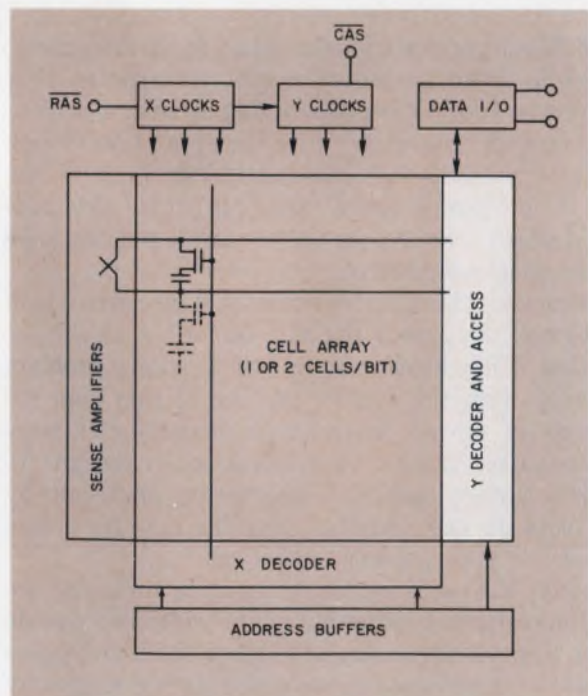

An Intel 2104A-style RAM with folded bit lines. These lines allow easy Y-access to both halves of a divided bit line.

to serve the real market. In early 1976, 16-k RAMs before year's end were promised by every supplier. Most have yet to emerge and it still seems reasonable to expect volume availability of multisourced equivalent parts in 1978.

Beyond the 16-k, the crystal ball gets cloudy. The 16-k dynamic RAM is a happy combination of reasonably well-proven processing and well-developed circuit techniques that fit a chip nicely into a standard package, while offering a good balance of performance features. This act will be hard to follow.

Advanced MOS processes at or beyond the limits of optical photolithography will be needed to improve real densities. (A 64-k chip in a larger package will be only a marginal benefit.) Smaller geometries will likely require that the 12-V supply and the still higher bootstrap levels currently used be eliminated. This would match the trend to 5-V-only parts but would create a new set of design problems.

While such difficulties probably will be overcome during this decade, it is also likely that different companies will solve the problems in different ways, and what happened in the early days of 4-k parts will happen again. As a result, acceptance of any one approach would be delayed, and the 16-k would have an unusually long-life—several years at least.

Outlook for static RAMs

Right now, a MOS static RAM has more than twice the area of a dynamic RAM, but this ratio may not stay constant if short-channel advanced MOS technologies now emerging in static RAMs can't be applied to dynamic RAMs. Unfortunately, the 4-k static is being standardized in an ad hoc way resembling the early history of the 4-k dynamic RAM. The situation is also complicated by three distinct though overlapping areas of static-RAM use—and a design that is best for one won't necessarily serve another as well.

One area is the replacement of bipolar RAMs in applications requiring access times faster than 50 ns. Such parts use all-static design to match bipolar functions. But they are more difficult to fabricate, and then they require more power than the slower static RAMs. But even with these two drawbacks, these fast static RAMs are likely to be an improvement over bipolar standards.

A second area—microprocessors—has been traditionally served by simple all-static parts like the 2102 and its 4-k successor, the 2114. But this area is now diverging. Since μ P systems are nearly always synchronous, it is better to design a static RAM cell with clocked peripheral circuits as in the MK 4104. This largely avoids the speed-power trade-off inherent in the static inversions of the address buffers and decoders in all-static parts.

Clocked-periphery circuits result in much lower power consumption, which particularly benefits systems with battery back-up and may even allow n-

channel MOS to replace CMOS in some applications.

Compounding the variation in circuit techniques is a divergence in package styles and pinnings. An early 4-k static part, the AMD 9130/9140, used a 22-pin package. But later 4-k memory designs are all aimed at 18-pin packages for reduced cost and better board-packing density.

Process standards

In the 4-k RAM, several variations of n-channel technology were used. Most were silicon gate processes, but the industry was about evenly divided between "coplanar" processing and "standard" processing, whereby a uniformly grown field oxide is etched to define active device locations. In the former, field oxide is selectively grown and device areas are screened by silicon nitride to inhibit the field-oxide's growth. Coplanarity reduces step heights and can save an ion-implant masking step used in controlling field-threshold voltage. On the other hand, coplanar processes have been associated with gate-oxide-quality problems giving "stuck ONEs" and/or refresh failures.

Other variations existed: Some parts used a "buried-contact" masking step to provide direct connection between polysilicon and n-diffused regions. Even "philosophical" differences existed. Some companies used relatively large chips, claiming that relatively generous layout rules increased yields. Others used tight rules to achieve small chip sizes.

At the 16-k level, however, there is more standardization—for now. Silicon-gate coplanar processing is standard. The two layers of polysilicon reduce cell area that doesn't contribute to cell capacitance. A diffused bit line and a metal word line are used in the process. The extra pitch between bit lines allows sense amplifiers to be laid out without a buried-contact masking step.

In addition, relatively tight layout rules are forced on 16-k chip design by the need to ensure that the chip will fit in the well area of a 16-pin package. As a result, the maximum allowable chip width of the 16-k memory is about 145 mil.

Prices keep tumbling

This year, 4-k RAMs have become readily available at less than 0.1¢ per bit, which has reduced the cost of memory systems dramatically. By year's end, according to predictions, 16-k RAMs will be at this level. And the 16-k devices are already saving in overhead circuitry and board area, among other things.

However, the same techniques that can lower the 16-k prices might produce still cheaper 4-k parts. A chip area of less than 15,000 mil² on a basic four-mask process with scratch protection should give yields of 150 good chips per wafer or more—provided that the

Design it for safety!

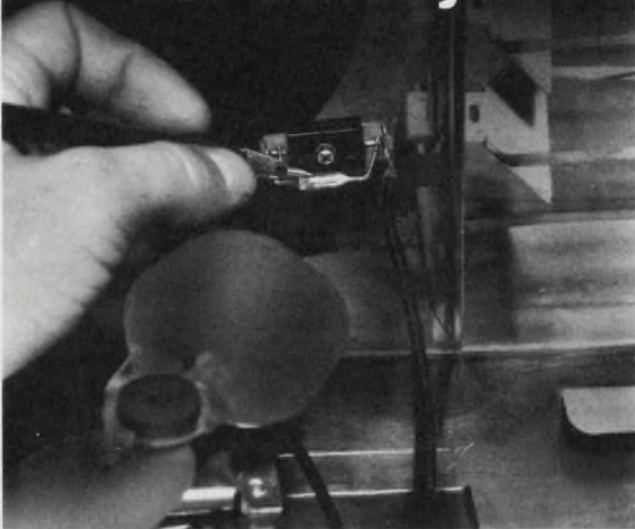

4000 Series MICROTEMP® thermal cutoff in electric space heater

Guard your products and profits with MICROTEMP® thermal cutoffs

This electric space heater is designed for safety... using the low-cost, yet precise 4000 Series MICROTEMP® thermal cutoff. It not only protects those who use the heater, but also the good name of those who make and sell it.

If the heater's thermostat fails—or if the unit overheats for any reason—the MICROTEMP® promptly cuts off the power. Before the appliance can be used again, the fault must be corrected and the MICROTEMP® replaced.

The MICROTEMP® thermal cutoff is available for a wide range of design applications with cut-

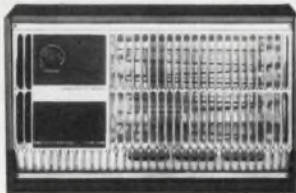

off ratings from 136 to 468°F (60 to 240°C) and operating accuracy within +0 -4°C.

Millions of our MICROTEMP® thermal cutoffs are now protecting hundreds of successful products.

We offer assorted terminations, mounting packages, and insulation to suit your design and production needs. Write or call us for your test samples and data.



MICRO DEVICES

EMERSON DIVISION OF EMERSON ELECTRIC CO.
1881 SOUTHTOWN BLVD.
DAYTON OH 45439 513-294-0581

CIRCLE NUMBER 42

Progress in dynamic RAMs, 1973 to the present

Mfg.	Part no.	Bits	Pins	Remarks
T.I.	TMS 4030	4 k	22	1st commercial 1-T cell
M.I.L.	MF 2107C	4 k	22	1st clocked-source sensing
Intel	i 2107B	4 k	22	
T.I.	TMS 4050	4 k	18	1st 18-pin part
T.I.	TMS 4051	4 k	18	TTL-level CE clock
T.I.	TMS 4060	4 k	22	Re-specified TMS 4030
National	MM 5280	4 k	22	1st All-dynamic sensing
National	MM 5270	4 k	18	Nonstandard 18-pin
Intel	i 2104	4 k	16	
Motorola	MCM 6604	4 k	16	
AMD	Am 9060	4 k	22	Similar to TMS 4060
AMD	Am 9050	4 k	18	Similar to TMS 4050
Mostek	MK 4027	4 k	16	Leading 4-k part
Intel	i 2104A	4 k	16	Mosaid Inc. patents cover these two
NEC	μPD 414D	4 k	16	
Intel	i 2116	16 k	16	1st 16-k RAM
Mostek	MK 4116	16 k	16	Leading 16-k part

part design and/or spec do not cause significant parametric yield loss. With low-cost assembly, a price in the region of \$2 seems attainable.

With most interest centered on 16-k parts, such prices may not materialize. But if they do, then 16-k parts will find it difficult to beat the 4-k price per bit until 1979. As always, price may not follow costs too closely in such a competitive market. At any rate, the pace of RAM development shows no sign of slackening in the near future. ■■

References

1. Foss, R. C. and Harland, R., "Should MOS RAMs be TTL-compatible?" *Electronic Design*, June 7, 1976, p. 107.

Coming through...

with a vital part in product design

It's what's up front that counts. That's why it pays off to involve Belden in the early stages of a project.

We know the codes, specs and electrical/environmental parameters your faced with. We've come through with answers to some extraordinary new applications.

As much as any component, wire, cable and cord, can make a critical difference in your product's performance. And your costs. By drawing on thousands of high-quality standards—and a wealth of custom engineering knowhow—we can tailor an answer to fit your needs. Exactly.

We can even help you cope with the economics of wire processing, assembly and installation. Our problem solving experience ranges from innovative

packaging to total manufacturing analysis.

Whether you need cord sets, special harnesses, shielded cable construction, flat cable—or help putting it all together, involve a Belden Wire Specialist. He'll come through with everything we've got. For answers right now, phone:

317-966-6661 Electronic Division or mark 400 on reader service card.

312-986-1600 Electrical Division or mark 401 on reader service card.

312-887-1800 Transportation Division or mark 402 on reader service card.

Or write Belden Corporation, 2000 S. Batavia Ave., Geneva, IL 60134

BELDEN



Coming through...
with new ideas for moving electrical energy

Model RAMs automatically for gate-level logic simulators with RAMGEN. Such a model lets you develop test programs for complex PC boards with ease.

Printed-circuit boards are getting more and more complex as microcomputers employ more ROMs and RAMs for program storage and scratchpad memories. To ensure that such boards will work under all foreseeable logic combinations, tests of ever increasing complexity are needed, forcing you to use logic simulators for their development.

Instead of trying your test plan on the actual PC board, you use a simulator program that applies the tests to a model of the board, and pinpoints areas that need improvement. Naturally, you must supply the computer with a model of every component on the PC board, including RAMs and ROMs.

Modeling of ROMs has already been discussed in ED No. 20, Sept. 27, 1976, p. 88. To automatically model RAMs for use in gate-level logic simulators, you can use a program called RAMGEN.

The program can model any RAM from a minimum of four input address lines, up to a maximum of ten input address lines. It accommodates up to eight output-data lines. But RAMs with 10 input address lines are limited to one output.

Developed for a General Automation SPC 16/45 minicomputer, the program is written in Fortran IV. The output is punched into computer cards so that it can be incorporated into the circuit model.

Models for the Lasar

Gate-level logic simulators have been defined as "describing the system by a collection of gates and their interconnections."¹ The simulator output not only summarizes the thoroughness of the test pattern, but also pinpoints timing problems that may exist on the PC board. One gate-level logic simulator, the D-Lasar by Digitest is widely used for both commercial and military systems. It uses NAND, AND, OR, and Wired-OR gates, and flip-flops as building blocks for more complex functions.

RAMGEN generates NAND-gate models of RAMs in D-Lasar format, which has the general form $XXXCC/I_1, I_2, \dots, I_n/O_1, O_2, \dots, O_n/1$ where XXX is the

James J. Hanratty, Electronic Engineer, Automatic Test Equipment Engineering Div., Naval Air Rework Facility, Alameda, CA 94501.

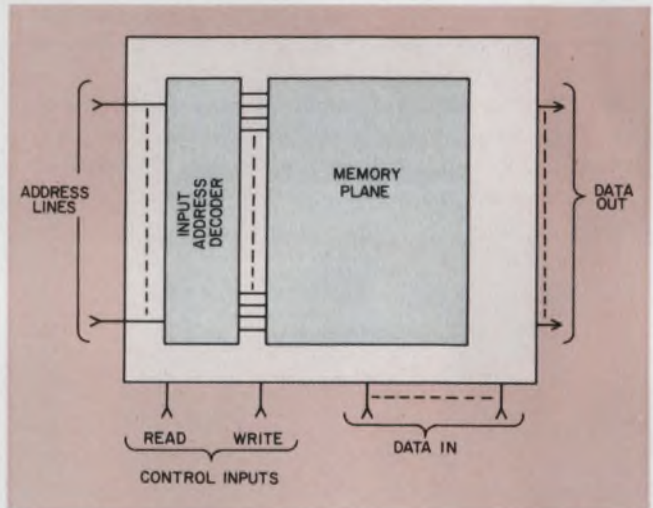

1. The basic RAM communicates with the outside world over three groups of lines: data lines (in and out), address lines, and control inputs.

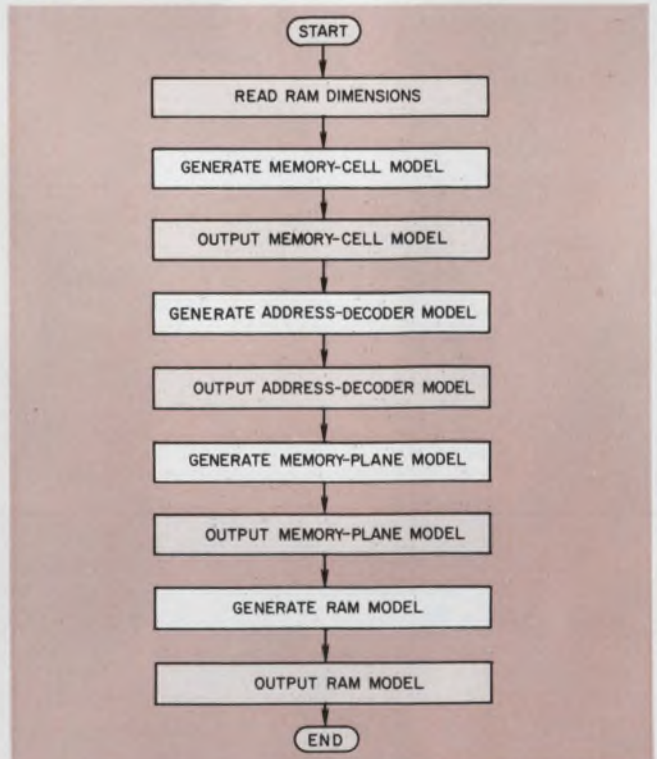

2. The RAMGEN flow chart shows how the over-all RAM model is put together from three subsystem models.

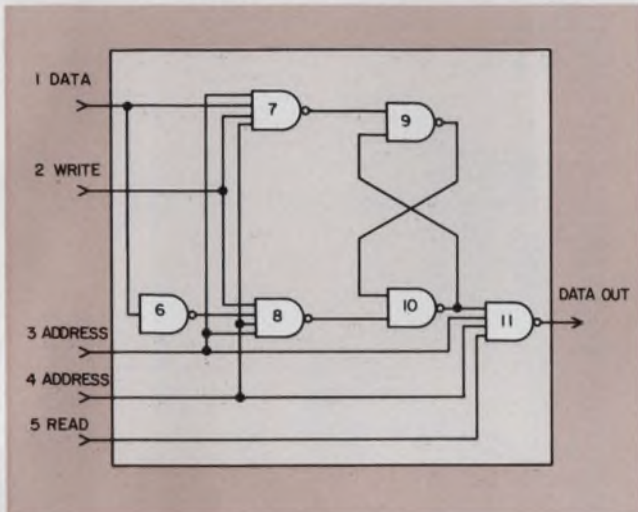

3. In the D-Lasar, the memory cells are interconnected by data (in and out), address, read and write lines.

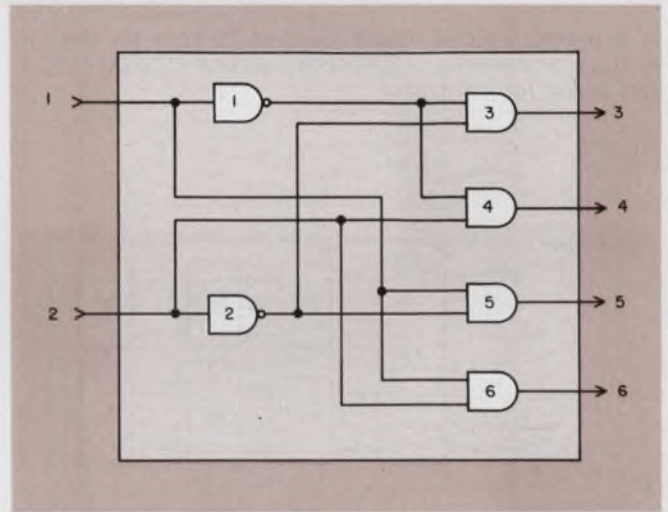

4. The input-address decoder is modeled by an array of AND and NAND gates that satisfies the D-Lasar format.

gate number, CC is the component name, I_n are the component inputs, and O_n are the component outputs.²

To model a RAM you must know its basic operation and configuration (Fig. 1). Every RAM has input address lines, data input lines, control inputs, and data output lines. A memory plane contains memory cells which store the data bits. An input-address decoder directs a read or write request to the desired memory location.

To write into the RAM, the data are placed on the data-input lines. Then the address of the desired memory location is placed on the input-address lines. Finally, the write-control line is brought to the appropriate voltage level.

To read data from the RAM, the address of the desired memory location is placed on the input-address lines, the read-control line is brought to the appropriate voltage level, and the data are read on the RAM output data lines.

Putting it all together

As the flow chart of RAMGEN (Fig. 2) shows, the program sequentially generates models for the RAM's basic parts: the input address decoder, the memory plane, and the memory cell. Then all of these models

are combined to model the RAM.

The memory cell model must provide the basic control functions—read, write, address, and data input—and exhibit memory. The NAND-gate model and D-Lasar description in Fig. 3 fulfill the memory-cell functions required.

The model provides memory with cross-coupled NANDs, and has inputs for all control functions. This memory cell is designated component BC. Component AD is the input-address decoder (Fig. 4). It is modeled as an m -to- n decoder where m is the number of inputs and n equals 2^m .

The next model in the flow chart simulates the memory plane, which is a collection of memory cells. The memory plane, MP, consists of 16 memory cells (Fig. 5) whose data, read, write, and column address lines are tied together, as are the data output lines. The RAM-model component, RM, incorporates all of these models.

RAMGEN uses two basic RAM configurations (Fig. 6)—one for RAMs with four to nine inputs, and one to eight outputs, the other for RAMs with 10 inputs and one output. The general model generated by RAMGEN requires some additional gating to represent any specific RAM exactly. The basic model becomes a component in the final RAM model, which

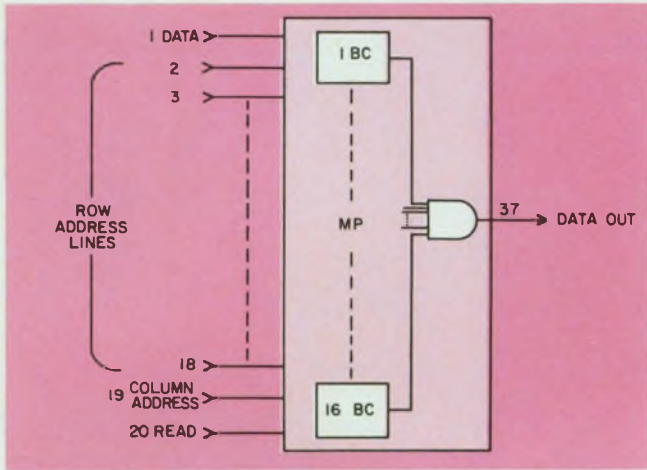

5. A memory-plane model reserves 16 lines for the row address, one for the column address, one for data output, and three for control.

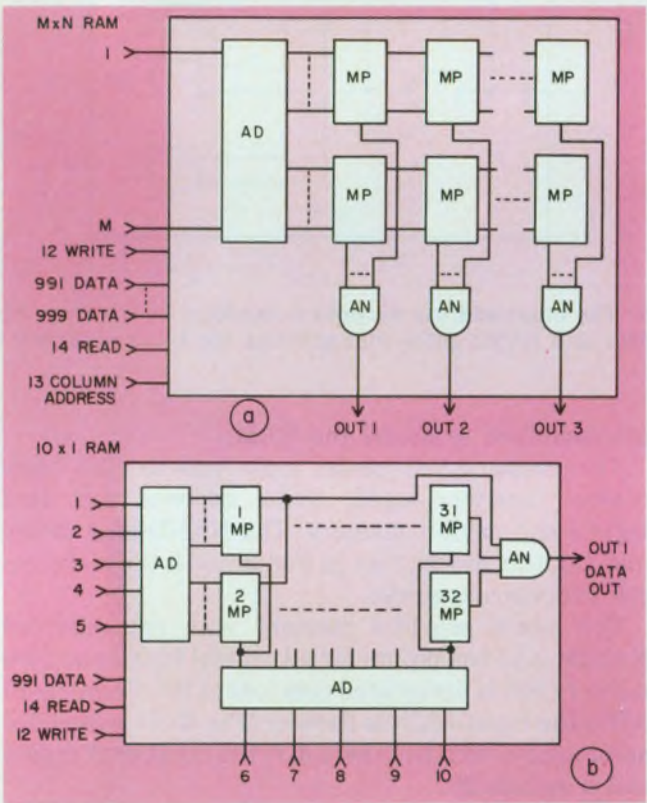

6. In an $m \times n$ RAM (top), the model has m input lines and n output lines. A different model is used for a 10×1 RAM (bottom).

in turn is a part of the over-all circuit description inputted to the logic simulator.

If you wish to model a 4×2 RAM, which has the configuration of Fig. 6a, use the RAM description shown in Fig. 7. To model any RAM, all you have to specify is the number of inputs and the number of outputs.

In the test-simulation program that uses the RAM model of Fig. 8, a given sequence of program steps

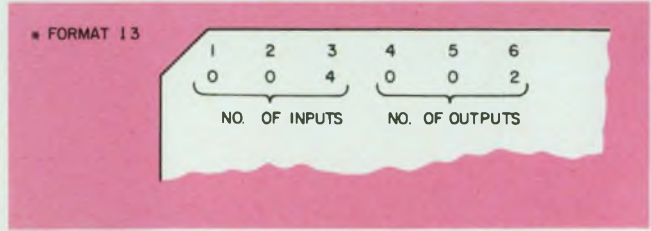

7. The RAMGEN input consists of one card—all that's required is the number of inputs and outputs.

```

ADD BIT CELL
NAME=RC
MODEL/
06NA/1//
07NA/1,4,2,4//
08NA/2,3,6,4//
09NA/7,10//
10NA/8,4//
11NA/3,4,5,10//
INPUT/1,2,3,4,5/
OUTPUT/1/
ADD ADDRESS DECODER
NAME=AD
MODEL/
990NA/1//
991NA/2//
992NA/3//
993NA/4//
11AN/990,991,992,993/ 11/
12AN/990,991,992/ 4/ 12/
13AN/990,991/ 3,993/ 13/
14AN/990,991/ 3/ 4/ 14/
15AN/990/ 2,992,993/ 15/
16AN/990/ 2,992/ 4/ 16/
17AN/990/ 2/ 3,993/ 17/
18AN/990/ 2/ 3/ 4/ 18/
19AN/ 1,991,992,993/ 19/
20AN/ 1,991,992/ 4/ 20/
21AN/ 1,991/ 3,993/ 21/
22AN/ 1,991/ 3/ 4/ 22/
23AN/ 1/ 2,992,993/ 23/
24AN/ 1/ 2,992/ 4/ 24/
25AN/ 1/ 2/ 3,993/ 25/
26AN/ 1/ 2/ 3/ 4/ 26/
INPUT/ 1/ 2/ 3/ 4/
OUTPUT/ 11, 12, 13, 14, 15, 16, 17, 18, 19, 20, 21, 22, 23, 24, 25, 26/
ADD MEMORY PLANE
NAME=MP
MODEL/
21BC/ 1/ 2/ 3, 19, 20//
22BC/ 1/ 2/ 4, 19, 20//
23BC/ 1/ 2/ 5, 19, 20//
24BC/ 1/ 2/ 6, 19, 20//
25BC/ 1/ 2/ 7, 19, 20//
26BC/ 1/ 2/ 8, 19, 20//
27BC/ 1/ 2/ 9, 19, 20//
28BC/ 1/ 2/ 10, 19, 20//
29BC/ 1/ 2/ 11, 19, 20//
30BC/ 1/ 2/ 12, 19, 20//
31BC/ 1/ 2/ 13, 19, 20//
32BC/ 1/ 2/ 14, 19, 20//
33BC/ 1/ 2/ 15, 19, 20//
34BC/ 1/ 2/ 16, 19, 20//
35BC/ 1/ 2/ 17, 19, 20//
36BC/ 1/ 2/ 18, 19, 20//
37BC/ 21, 22, 23, 24, 25, 26, 27, 28, 29, 30, 31, 32, 33, 34, 35, 36//
INPUT/1,2,3,4,5,6,7,8,9,10,11,12,13,14,15,16,17,18,19,20/
OUTPUT/17/
ADD RAM
NAME=RM
MODEL/
1AD/ 1/ 2/ 3/ 4/ 14, 16, 17, 18, 19, 20, 21, 22, 23, 24, 25, 26, 27, 28, 29, 30/
2MP/991, 10, 19, 16, 17, 18, 19, 20, 21, 22, 23, 24, 25, 26, 27, 28, 29, 30, 31, 34/ 31/
3MP/992, 12, 15, 16, 17, 18, 19, 20, 21, 22, 23, 24, 25, 26, 27, 28, 29, 30, 33, 34/ 32/
4NO/ 11/ 33/
5NL/ 32/ 34/
INPUT/ 1/ 2/ 3/ 4,991,992, 12, 13, 14/
OUTPUT/ 33, 34/

```

8. The RAM-model printout identifies inputs and outputs for all the submodels as well as for the whole RAM.

must be observed. To perform a write operation to the model, the READ and WRITE inputs (pins 14 and 12 in Fig. 6a) must first be set to ZERO. Then, the desired address and data are fed in, and the WRITE input (pin 12) is set to ONE. For a read operation, the sequence is similar. ■■

References

1. Breuer, M.A., "Recent Developments in the Automated Design of Digital Systems," *Proceedings of the IEEE*, January, 1972, p. 14.
2. *D-Lasar User's Guide*, University Computing Co., Dallas, TX, November, 1973.

RAMGEN program listing

```

IMPLICIT INTEGER(A-Z)
DIMENSION BUFFER(100),BIN(9),TEMP(16)
DATA A,B,C,D,M,N,O,P,Q,R,'A','B','C','D','M','N','O','P','Q','R',/
DATA COMMA,SLASH,'/',',','/'
READ(11,1) NI,ND
FORMAT(2I3)
1
C
C
C
GENERATE BIT CELL MODEL
WRITE(5,2)
2
F0RMAT(' ', 'ADD BIT CELL',/, ' ', 'NAME=BC',/, ' ', 'MODEL',/ )
BUFFER(1)=0
BUFFER(2)=6
BUFFER(3)=N
BUFFER(4)=A
BUFFER(5)=SLASH
BUFFER(6)=1
BUFFER(7)=SLASH
BUFFER(8)=SLASH
WRITE(5,3) (BUFFER(I),I=1,8)
3
F0RMAT(' ',2I1,3A1,1I,2A1)
BUFFER(2)=7
BUFFER(7)=COMMA
BUFFER(8)=3
BUFFER(9)=COMMA
BUFFER(10)=2
RUFFER(11)=COMMA
BUFFER(12)=4
RUFFER(13)=SLASH
BUFFER(14)=SLASH
WRITE(5,4) (BUFFER(I),I=1,14)
4
F0RMAT(' ',2I1,4A1,1I,A1,1I,A1,1I,A1,1I,2A1)
RUFFER(2)=8
RUFFER(6)=2
RUFFER(10)=6
RUFFER(11)=COMMA
RUFFER(12)=4
RUFFER(13)=SLASH
RUFFER(14)=SLASH
WRITE(5,4) (BUFFER(I),I=1,14)
RUFFER(2)=9
RUFFER(6)=7
RUFFER(8)=1
RUFFER(9)=0
RUFFER(10)=SLASH
RUFFER(11)=SLASH
WRITE(5,5) (BUFFER(I),I=1,11)
5
F0RMAT(' ',2I1,4A1,1I,A1,2I1,2A1)
RUFFER(1)=1
RUFFER(2)=0
RUFFER(6)=8
RUFFER(8)=9
RUFFER(9)=SLASH
RUFFER(10)=SLASH
WRITE(5,6) (BUFFER(I),I=1,10)
6
F0RMAT(' ',2I1,3A1,1I,A1,1I,2A1)
BUFFER(2)=1
RUFFER(6)=3
RUFFER(8)=4
RUFFER(9)=COMMA
RUFFER(10)=5
RUFFER(11)=COMMA
RUFFER(12)=1
RUFFER(13)=0
RUFFER(14)=SLASH
RUFFER(15)=SLASH
WRITE(5,7) (BUFFER(I),I=1,15)
7
F0RMAT(' ',2I1,4A1,1I,A1,1I,A1,1I,2I1,2A1)
WRITE(5,8)
8
F0RMAT(' ', 'INPUT',/2,3,4,5,/, ' ', 'OUTPUT',/11,/)
9
C
C
C
GENERATE ADDRESS DECODER
INPUT INVERTERS
WRITE(5,9)
9
F0RMAT(' ', 'ADD ADDRESS DECODER',/, ' ', 'NAME=AD',/, ' ', 'MODEL',/ )
NII=NI
IF(NI.EQ.10) NIT=5
L=0
RUFFER(1)=990+L
RUFFER(2)=N
RUFFER(3)=N
RUFFER(4)=SLASH
RUFFER(5)=L+1
RUFFER(6)=SLASH
RUFFER(7)=SLASH
WRITE(5,10) (RUFFER(I),I=1,7)
10
F0RMAT(' ',13,3A1,1I,2A1)
L=L+1
IF(L.GT.NII-1)GO TO 11
GO TO 9
11
C
C
C
OUTPUT AND GATES
L=1
CALL DBCON(IX,NII,4IN)
RUFFER(1)=10+I
RUFFER(2)=A
RUFFER(3)=N
RUFFER(4)=SLASH
DO 13 I=1,NII
IF(BIN(I),EQ.1) RUFFER(2+I*3)=1
IF(BIN(I),EQ.0) RUFFER(2+I*3)=989+1
13
CONTINUE
END=NII-1
DO 14 I=1,END
RUFFER(2+I*4)=COMMA
CONTINUE
RUFFER(2+NI+4)=SLASH
RUFFER(2+NI*5)=RUFFER(11)
RUFFER(2+NI*6)=SLASH
END=2+NI*6
WRITE(5,15) (RUFFER(I),I=1,END)
15
F0RMAT(' ',13,3A1,18(13,A1))
IX=IX+1
IF(IX.EQ.2+NI)GO TO 17
L=L+1
GO TO 16
16
C
C
C
I/O DESCRIPTION
17
MN=1
END=2+NI-1
DO 18 I=1,END,2
RUFFER(I)=MN
MN=MN+1
18
CONTINUE
END=2+NI-2
DO 19 I=1,END,2
RUFFER(I)=COMMA
CONTINUE
RUFFER(2+NI)=SLASH
END=2+NI
WRITE(5,20) (RUFFER(I),I=1,END)
20
F0RMAT(' ', 'INPUT',/18(13,A1))
MN=1
END=2+NI-1
DO 21 I=1,END,2
RUFFER(I)=MN
MN=MN+1
21
CONTINUE
END=2+NI-2
DO 22 I=1,END,2
RUFFER(I)=COMMA
CONTINUE
RUFFER(2+NI)=SLASH
END=2+NI
WRITE(5,23) (RUFFER(I),I=1,END)
23
F0RMAT(1X, 'OUTPUT',/18(13,A1)/1X,20(13,A1))
24
C
C
GENERATE MEMORY PLANE MODEL
WRITE(5,24)
24
F0RMAT(' ', 'ADD MEMORY PLANE',/, ' ', 'NAME=MP',/, ' ', 'MODEL',/ )
DO 25 I=1,16
RUFFER(1)=20+I
RUFFER(2)=8
RUFFER(3)=C
RUFFER(4)=SLASH
RUFFER(5)=1
RUFFER(6)=COMMA
RUFFER(7)=2
RUFFER(8)=COMMA
RUFFER(9)=2+I
RUFFER(10)=COMMA
RUFFER(11)=19
RUFFER(12)=COMMA
RUFFER(13)=20
RUFFER(14)=SLASH
RUFFER(15)=SLASH
WRITE(5,26) (RUFFER(I),I=1,15)
26
F0RMAT(' ',13,3A1,6(13,A1),13,2A1)
27
CONTINUE
WRITE(5,27)
27
F0RMAT(' ',137W0/2)1,2,23,24,25,26,27,28,29,30,31,32,33,34,35,36//
5,/, ' ', 'INPUT',/1,2,3,4,5,6,7,8,9,10,11,12,13,14,15,16,17,18,19,20//
3)
WRITE(5,28)
28
F0RMAT(' ', 'OUTPUT',/37,/)
29
C
C
GENERATE RAM MODEL USING BIT CELL, ADDRESS DECODER, AND MEMORY PLANE MODEL
WRITE(5,29)
29
F0RMAT(' ', 'ADD RAM',/, ' ', 'NAME=RM',/, ' ', 'MODEL',/ )
IF(NI.EQ.10) NIT=5
ADDRESS DECODER
IN=0
ICS=0
ON=0
RUFFER(1)=ICS+1
RUFFER(2)=A
RUFFER(3)=0
RUFFER(4)=SLASH
MN=IN+1
END=2+NI-1
DO 30 I=1,END,2
RUFFER(4+I)=MN
MN=MN+1
30
CONTINUE
END=2+NI-2
DO 31 I=1,END,2
RUFFER(5+I)=COMMA
CONTINUE
RUFFER(2+NI+4)=SLASH
MN=19+ON
END=2+2+NI-1
DO 32 I=1,END,2
RUFFER(2+NI+4+I)=MN
MN=MN+1
32
CONTINUE
END=2+2+NI-2
DO 33 I=1,END,2
RUFFER(2+NI+5+I)=COMMA
CONTINUE
RUFFER(2+NI+2+2+NI+4)=SLASH
WRITE(5,34) (RUFFER(I),I=1,END)
34
F0RMAT(1X,13,3A1,18(13,A1)/1X,20(13,A1))
IF(NI.EQ.10,AND,ICS.EQ.0)GO TO 36
GO TO 37
36
IN=5
ON=2+NI
ICS=ICS+1
GO TO 38
37
NN=0
RR=0
II=0
NN=0
PP=0
MM=0
MEMORY PLANE
ICS=ICS+1
RUFFER(1)=ICS+1
RUFFER(2)=M
RUFFER(3)=P
RUFFER(4)=SLASH
RUFFER(5)=991+BP
RUFFER(6)=COMMA
RUFFER(7)=12
RUFFER(8)=COMMA
LN=15+16*NN
DO 39 I=1,32,2
RUFFER(8+I)=L
LN=L+1
39
CONTINUE
DO 40 I=1,31,2
RUFFER(9+I)=COMMA
CONTINUE
CONTINUE
IF(NI.LE.9) RUFFER(41)=13
IF(NI.EQ.10) RUFFER(41)=47+11
RUFFER(42)=COMMA

```

(continued on page 76)

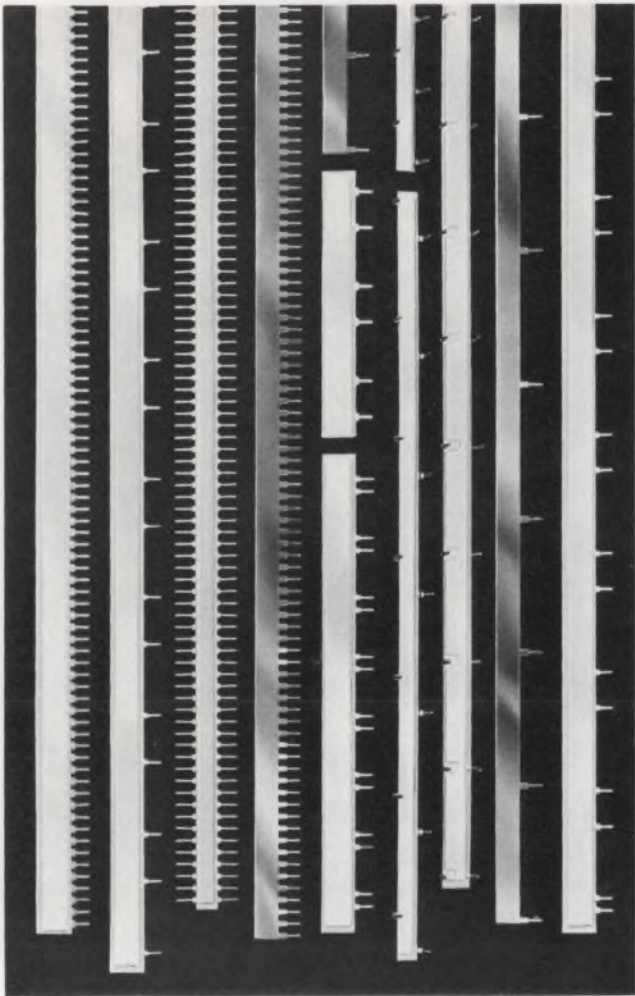

MINI/BUS[®] Printed Circuit Board Bus Bars STANDARDS IN STOCK

Low-cost, noise-reducing voltage distribution comes in a wide variety of ready-to-ship designs.

Call or write Product Specialist for a listing of Rogers' Mini/BUS standards.

Prototype kits also available from stock — \$25.00



ROGERS CORPORATION

Chandler, AZ 85224 (602) 963-4584

EUROPE: Mektron NV, Gent, Belgium. JAPAN: Nippon Mektron, Tokyo.

CIRCLE NUMBER 44

(continued from page 75)

```

BUFFER(43)=14
BUFFER(44)=SLASH
IF(NI.EQ.10) LN=15+2*2*NI*NNN
IF(NI.LE.9) LN=15+2*NI*NNN
BUFFER(45)=LN
BUFFER(46)=SLASH
43 WRITE(5,43) (BUFFER(I),I=1,46)
FORMAT(1X,13,A1,1F(13,A1)/1X,20(13,A1))
MPC=MPC+1
IF(2*NI.EQ.16+MPC) GO TO 44
NN=NN+1
NN=NN+1
44 GO TO 48
MPC=MPC+1
IF(NI.LE.9.AND.MPC.EQ.NO) GO TO 45
IF(NI.EQ.10.AND.MPC.EQ.32) GO TO 45
IF(IND.GT.1) BR=BR+1
NN=0
MPC=0
NN=NN+1
II=II+1
GO TO 48
C OUTPUT WIRED ORC
45 LL=1
CC=0
XXX=1
IF(NI.EQ.10) FNN=128
IF(NI.LE.9) END=2+(2*NI/16)
IF(NI.EQ.10) LN=15+2*NI
IF(NI.LE.9) LN=15+2*NI
53 ICS=ICS+1
BUFFER(1)=ICS+1
BUFFER(2)=W
BUFFER(3)=0
BUFFER(4)=SLASH
DN 50 I=1,END,2
BUFFER(4+I)=LN
LN=LN+1
50 CONTINUE
BUFFER(1+5)=SLASH
IF(IND.GT.1) BUFFER(1+6)=LN
IF(IND.GT.1.AND.LL.FQ.1.AND.NI.GT.4) BUFFER(1+6)=BUFFER(1+4)+1*(NO-
51 51)*(2*NI/16)
IF(IND.GT.1.AND.LL.EQ.1.AND.NI.EQ.4) BUFFER(1+6)=BUFFER(1+4)*NO
IF(IND.GT.1.AND.LL.GT.1) BUFFER(1+6)=BUFFER(1+6)+1
BUFFER(1+7)=SIASH
TFMP(XXX)=BUFFER(1+6)
IF(NI.EQ.4) GO TC 62
LST=END-3
DN 51 III=1,LST,2
BUFFER(15+III)=COPPA
51 CONTINUE
52 LST=LST+7
WRITE(5,52) (BUFFER(K),K=1,LST)
FORMAT(1X,13,A1,1F(13,A1)/1X,20(13,A1))
52 CC=CC+1
IF(IND.EQ.1.OR.CC.EQ.NO) GO TO 54
LI=LI+1
XXX=XXX+1
GO TO 53
C I/O DESCRIPTION
54 XX=1
END=2*NI
DN 55 I=1,END,2
BUFFER(I)=XX
XX=XX+1
55 CONTINUE
END=2*NO
XX=0
DN 56 II=1,END,2
BUFFER(1+II+1)=951*XX
XX=XX+1
56 CONTINUE
BUFFER(1+II+3)=12
IF(NI.EQ.10) BUFFER(1+II+5)=14
IF(NI.LE.9) BUFFER(1+II+5)=13
IF(NI.EQ.10) BUFFER(1+II+6)=SLASH
IF(NI.LE.9) BUFFER(1+II+7)=14
BUFFER(1+II+8)=SLASH
IF(NI.EQ.10) LST=1+II+4
IF(NI.LE.9) LST=1+II+6
DN 57 III=1,LST,2
57 BUFFER(1+II+1)=COPPA
CONTINUE
IF(NI.EQ.10) FNN=1+II+6
IF(NI.LE.9) END=1+II+8
WRITE(5,58) (BUFFER(K),K=1,END)
58 FORMAT(1X,'INPUT',18(13,A1)/1X,20(13,A1))
A=0
DN 59 I=1,XXX
59 BUFFER(I+X)=TFMP(I)
X=X+1
CONTINUE
END=2*XXX-2
DN 60 I=1,END,2
60 BUFFER(I+1)=COPPA
CONTINUE
BUFFER(2+XXX)=SLASH
END=2*XXX
WRITE(5,61) (BUFFER(K),K=1,END)
61 FORMAT(1X,'OUTPUT',18(13,A1)/1X,20(13,A1))
STOP
END
SUBROUTINE DBCON (IV,NI,RIN)
INTEGER RIN(9)
II=NI
K=IX
1 INIV=K/2
RINV=FLOAT(K)/2.0
IF(IDIV.EQ.RINIVIGC TO 2
RIN(II)=1
II=II-1
IF(II.EQ.0) GO TO 3
K=IDIV
GO TO 1
2 BIN(II)=0
II=II-1
IF(II.EQ.0) GO TO 3
K=IDIV
GO TO 1
3 RETURN
END

```

Opening new frontiers with electro optics

PMT with big new "teacup" dynode gives scintillation counters better PHR.

We expect quite a tempest over this teacup. It's a radically different RCA approach to large-diameter PMT's: The teacup is a large, cup-shaped first dynode that is an improvement over conventional venetian-blind types. It has better spatial uniformity and better off-axis uniformity. As a result, PHR (Pulse Height Resolution) is improved by 0.3% for Cs^{137} [NaI (Tl)] and 0.7% for Co^{57} [NaI (Tl)].

RCA 4900 is the first in a whole new family of 2" to 5" circular and hexagonal face PMT's with teacup first dynodes. It has a 3" diameter, 10 stages, and "blue" cathode responsivity of $10 \mu A/blue \text{ lm}$ minimum, $10.5 \mu A/blue \text{ lm}$ typical. Available with voltage divider network.

High performance in exacting applications

Besides scintillation counting, the teacup PMT can also be useful in gamma ray spectroscopy

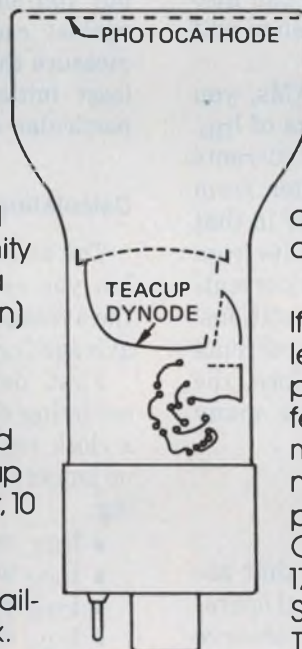

for medical applications. Several leading manufacturers of medical diagnostic equipment recently conducted their own tests on these gamma-camera type tubes, and pronounced them a giant step forward in improving camera performance.

If electro optics can solve your problem, remember: EO and RCA are practically synonymous. No one offers a broader product spectrum. Or more success in meeting special needs. Call on us for design help or product information. RCA Electro Optics, Lancaster, Pennsylvania 17604. Telephone 717-397-7661. Sunbury-on-Thames, Middlesex TW16 7HW, England; Ste.-Anne-de-Bellevue, Quebec, Canada; Belo Horizonte, Brazil; Hong Kong.

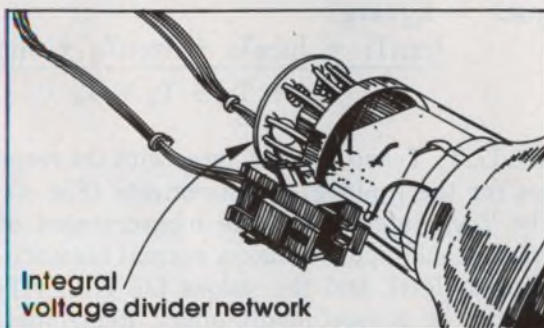
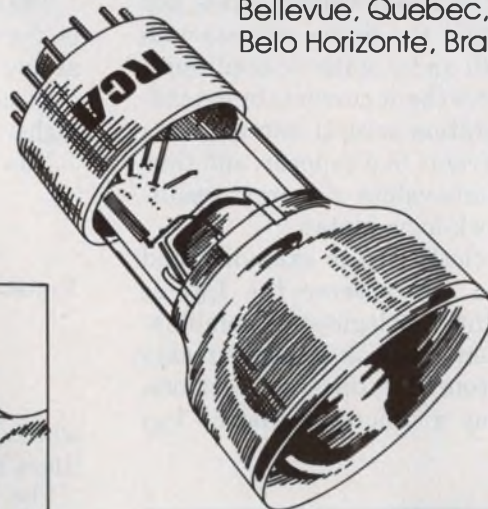

RCA

Predict a 4-k RAM's average I_{DD}

with a few simple calculations. The method accounts for both the transient and steady-state components.

When working with 4-k NMOS RAMs, you can accurately predict the average I_{DD} under any timing conditions and at any operating frequency. All you have to do is specify an average I_{DD} at one defined frequency and clock-duty cycle, then specify the dc components of I_{DD} for the various clock-signal logic states. The results for any I_{DD} follow. You can also calculate the worst-case I_{DD} for any frequency and clock timing arrangement.

During the dynamic operation of 4-k RAMs, you must consider both the ac and dc components of I_{DD} . The former component stems from transient currents associated with signal edges, and the latter from signal-logic levels. The two components differ in that the ac is unrelated to clock durations and results from the charge or discharge of capacitive nodes or current-spiking caused by signal-transition timing conditions.

The current-time integral of the transient currents is constant over one memory cycle. Therefore, the average magnitude of this component over many cycles is directly related to frequency.

Looking at the dc component

The steady component flows in dc paths that are switched on by clock-logic levels during normal operation. Since the 4-k RAM is dynamic, you can't observe the dc currents by applying steady voltage levels, nor can you generate or sustain the charge necessary to turn on or access a dc path under static dc conditions.

However, you can observe the dc currents by extending the clock signals' duration several microseconds to allow the transient currents to disappear, and thus display only the steady-state values of current resulting from the various clock-logic states.

If the \overline{RAS} and \overline{CAS} clocks are so extended, and also offset in time, you can observe the I_{DD} dc components for each of the four logic-state combinations of the signals. When you look at the currents for 16-pin, 4-k RAMs from five different vendors, you'll find that each has a unique profile of I_{DD}

magnitudes; the worst-case I_{DD} current for the different types occurs at different logic-state combinations of \overline{RAS} and \overline{CAS} . Thus, you must specify a maximum current for all combinations.

The specification writer may choose to make the maximum current the same for all logic combinations, but you should place a limit on the spec to guard against excessive dc components. And you should measure the I_{DD} currents for all four logic states (at least initially) to determine the worst case in a particular design.

Calculating the ac component

The ac component is not easy to measure directly, but you can calculate it, knowing the dc value and the average I_{DD} . This calculation is possible since the average I_{DD} is the sum of the dc and ac components.

First, define the four steady-state values of I_{DD} occurring during extended clock durations, but with a clock repetition rate that provides a cycle interval no longer than the refresh period. Measure the following:

- I_{DD1} with \overline{RAS} false and \overline{CAS} false.
- I_{DD2} with \overline{RAS} true and \overline{CAS} true.
- I_{DD3} with \overline{RAS} true and \overline{CAS} false.
- I_{DD4} with \overline{RAS} false and \overline{CAS} true.

The last factor needed to calculate the ac component is the average I_{DD} . It can be theoretically measured at any frequency and clock duty factor, although the accuracy of the resulting ac calculation increases at higher frequencies, since the ac component gets larger.

Now you can calculate the ac component:

$$I_{DD}(\text{ac}) = I_{DD}(\text{avg}) - I_{DD}(\text{dc});$$

$$I_{DD}(\text{ac}) = I_{DD}(\text{avg}) - \frac{I_{DD1}T_1 + I_{DD2}T_2 + I_{DD3}T_3 + I_{DD4}T_4}{T_1 + T_2 + T_3 + T_4},$$

where T_1 , T_2 , T_3 and T_4 must agree with the respective times for the $I_{DD}(\text{avg})$ measurements (Fig. 4).

The T_{CYC} interval for the measurement of I_{DD} average should approximate a normal memory cycle (500 ns or less), and the values for T_1 , T_2 , T_3 and T_4 should be proportionally short. Remember that

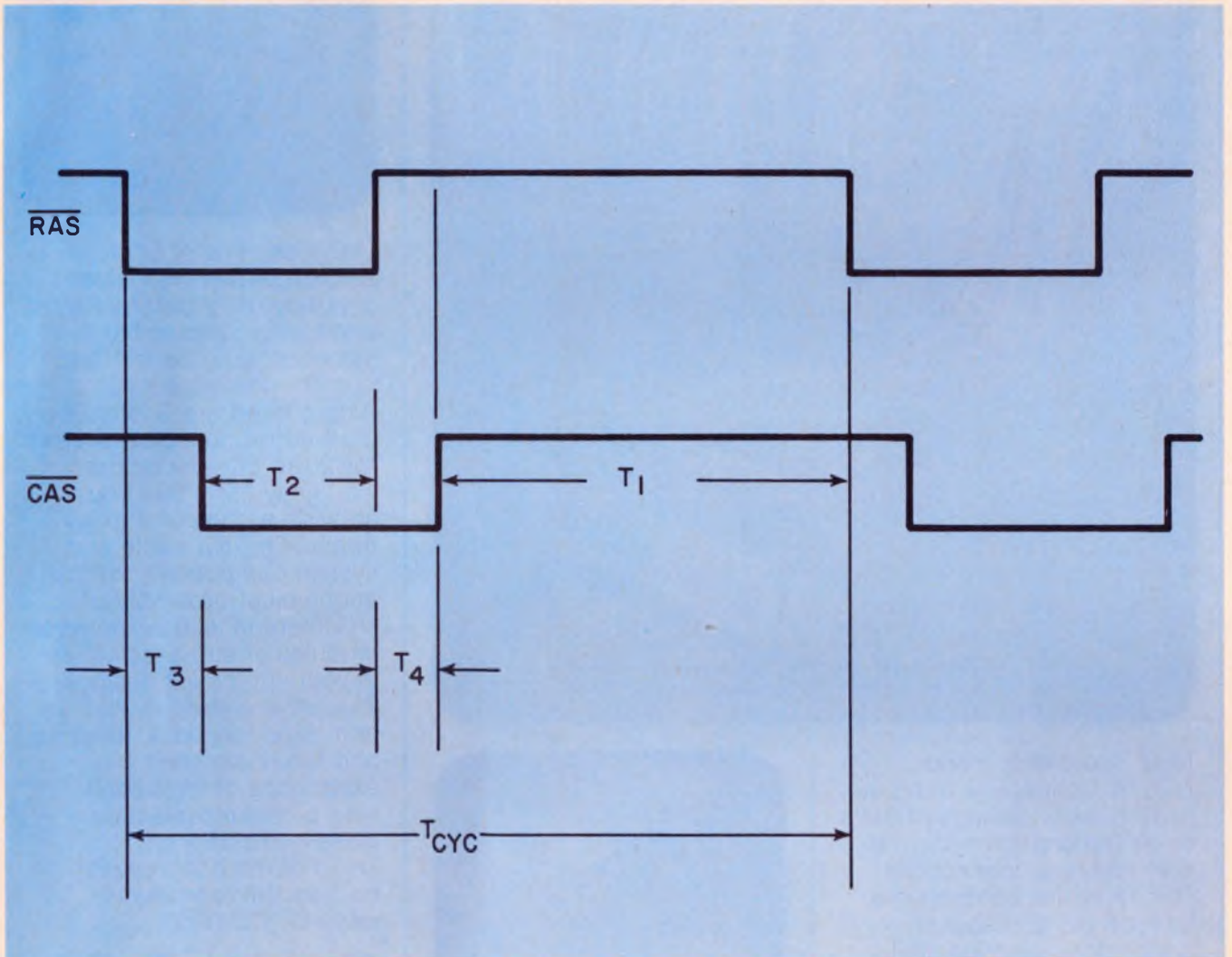

1. Timing waveforms for a 4-k RAM read/write cycle show relationships needed to calculate the ac component of I_{DD} .

measurements of I_{DD1} , I_{DD2} , I_{DD3} , and I_{DD4} should be made at an extended cycle.

By specifying the average I_{DD} at stated conditions of cycle interval and clock timing and, in addition, by specifying I_{DD1} , I_{DD2} , I_{DD3} , and I_{DD4} , you can calculate the ac component for the defined cycle time. Moreover, you can calculate the average I_{DD} for any cycle time and clock duty factor. Simply multiply the ac component at the known frequency by the propor-

tionality factor between that frequency and the frequency of interest. This method is valid since the ac component is directly proportional to the frequency and is independent of the clock duty cycle.

You can calculate the dc component from the known values for I_{DD1} , I_{DD2} , I_{DD3} , I_{DD4} and the respective clock duty factors. The calculated average I_{DD} , then, is the sum of the calculated components, $I_{\text{DD}}(\text{ac})$ and $I_{\text{DD}}(\text{dc})$. ■■

Want mass terminations for I/O interconnecting?

We have the widest choice.

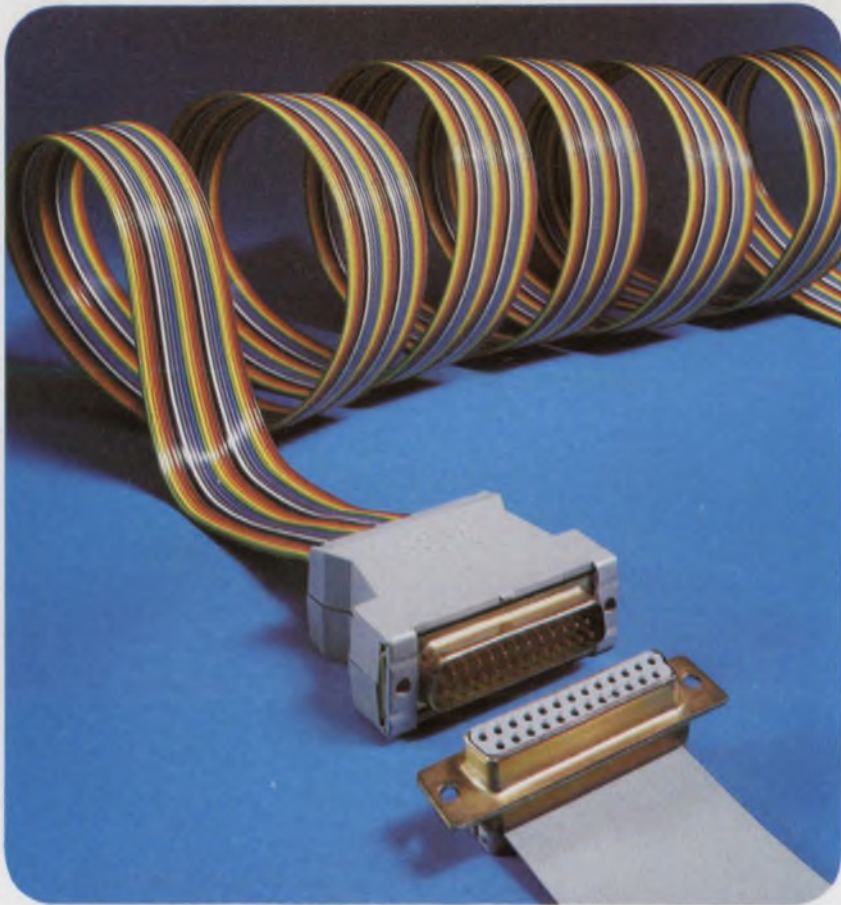

Now Scotchflex brand DELTA Connectors bring the proved labor-savings of 3M's mass termination system to subminiature connections. DELTA series components include pin and socket connectors, junction shells, 25-conductor flat cable and strain relief clips. These system assemblies interface directly with all other industry standard "D" series subminiature connectors. They're also compatible with all connectors in our complete Scotchflex line.



A family of Scotchflex male plug connectors is now available in sizes from 10 to 50 contacts to mate with Scotchflex socket connectors for T-tap or mid-span connections or rack and panel applications.

"Scotchflex" is a registered trademark of 3M Co.



Our broad line of Scotchflex socket connectors includes a variety of 12 different sizes and center spacings to fit standard wrap panels and custom configurations. Also offered are Scotchflex card-edge connectors in sizes for 20 to 50 conductors.

Only 3M offers you so wide a choice of mass terminating flat cable and system components for fast, economical assembly of I/O interconnections between modules or sub-assemblies in your equipment designs. Plus off-the-shelf availability from experienced distributors, and the unmatched experience of the people who pioneered electronic mass terminations.

For more information on Scotchflex products call 612-733-3350.

Scotchflex[®] systems from 3M. The source.



See our
catalog in EEM,
page 1056

How to operate your MPUs at 2x their rated power... or 1/2 their case temperature.

Unique new Micro-Clip heat sinks permit MPU operation in much hotter environments

Time was when micro-processors posed no thermal problems for designers. That's because earlier MPUs required very little power — up to 250 mw or maybe 1/2 watt at most. Then, too, designers usually spec'd only one to a circuit board. Surrounded by plenty of air, the lonely MPU did its job without generating much heat. So nobody worried much about heat dissipation.

Today's reality: serious MPU thermal problems

Today, designers are specing many MPUs on the same board. And these boards often must operate in military-type environments where ambient temperatures reach 71°C. Also, today's MPUs do more and, therefore, generate much more heat than earlier models. For example, they often function as both the arithmetic logic unit and the control section of a computer. These factors combine to cause serious thermal problems. Coping with these problems has become an increasingly important part of a circuit designer's job.

IERC finds efficient solution

To solve growing MPU thermal problems, IERC recently introduced its two-piece "Micro-Clip" series of heat dissipators. These units adjust to fit all double DIP, CMOS, MOS-FET, and microprocessor packages within the 20- to 40-pin range.

As the adjacent drawing shows, the Micro-Clip's unique spring-finger design lets the dissipator make good, solid contact with both the top and bottom of the MPU,

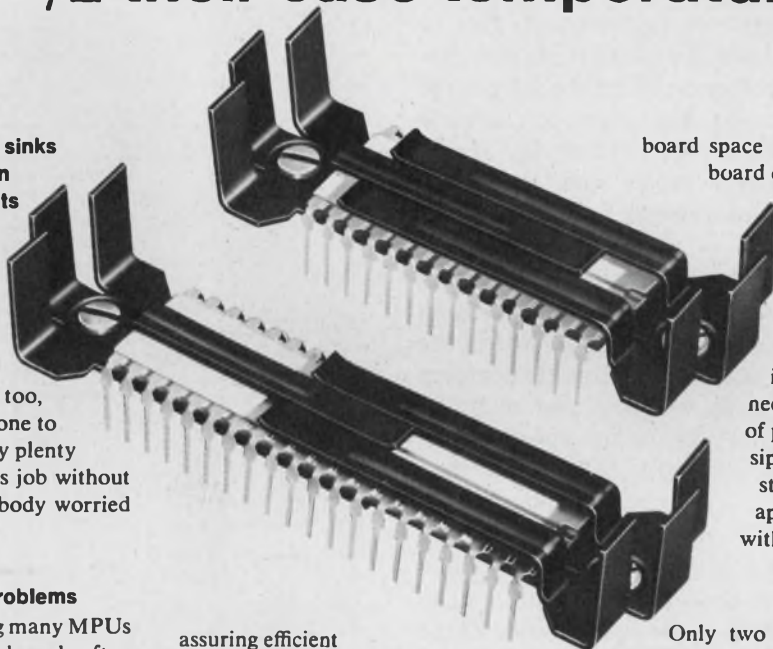

assuring efficient heat transfer from case to dissipator. Tests show these units dissipate up to 100 percent more heat than conventional glued-down devices.

Staggered-finger design also assures more efficient heat dissipation

Micro-Clip series dissipators capitalize on IERC's patented staggered finger design. Heat radiates to the ambient, never transfers from one finger to another. In forced air modes, the staggered fingers maximize turbulence, further increasing heat transfer efficiency. Three finger heights are available —

1/4 in., 1/2 in., and 3/4 in. — to meet varying space and dissipation requirements. Micro-Clip dissipators weigh only 4 grams and require only .6 in.² more

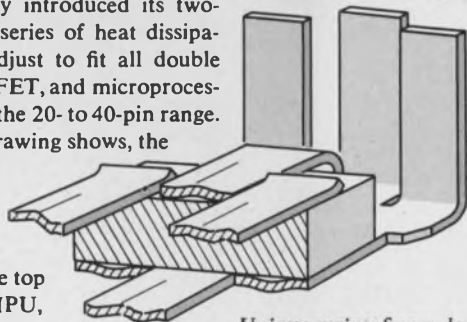

Unique spring-finger design helps assure efficient heat transfer.

board space than the IC device itself. So board densities and spacing between rows of, for example, double DIPs and CMOSs are unaffected.

Stocking problems greatly reduced

Designed to (1) meet an infinite number of application needs and (2) fit an entire range of package sizes, Micro-Clip dissipators greatly simplify a user's stocking problems. This benefit appeals especially to companies with high-volume manufacturing operations.

Easy to attach

Only two screws or rivets or dots of thermally conductive epoxy are needed to fasten Micro-Clip dissipators securely into position. Mounting Micro-Clip units to MPUs already mounted to boards requires no disassembly.

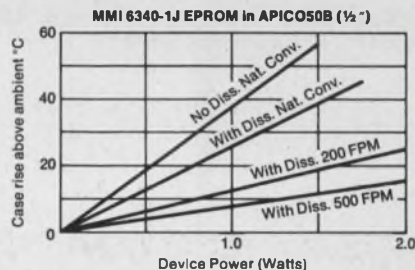

To learn more about how IERC's Micro-Clip series can help you solve your heat dissipation problems, write or call today. Ask for Bulletin 186. International Electronic Research Corporation/A subsidiary of Dynamics Corporation of America/ 135 West Magnolia Blvd., Burbank, California 91502 • (213) 849-2481.



Heat Sinks/Dissipators

Cut your processor's computation time

by storing information in tables. Accessing a table can take less time than doing an algorithm but you'll use memory space.

Tables can speed microprocessor operations such as converting codes, doing look-up calculations and providing messages or test patterns. The main advantage of using a table is that you don't have to calculate answers or deal with each case separately. Microprocessors can easily handle tables since they have special instructions and addressing modes to access them.

Note, however, that tables don't save time if there is a simple relationship between input and desired output, e.g., the output is twice the input. Nor is the table useful if there is an easy way to directly perform the calculation. When using a table, you must be willing to trade off memory space for speed.

Tables themselves are just simple lists of data that are stored sequentially in a memory array. A telephone directory is a good example of an alphabetical read-only table. Variable tables stored in RAM allow the system user to assign meanings to inputs and to determine sequences of tests or output patterns. Some function generators even use ROMs that hold the

Dr. Lance A. Leventhal, Instructor, Engineering and Technology Dept., Grossmont College, 8800 Grossmont College Dr., El Cajon, CA 92020.

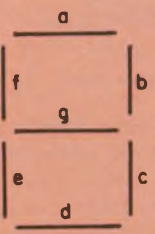

Digit	Seven-Segment Code (Common-cathode) (Common-anode)
	1=Display on 0=Display on
0	3F 40
1	06 79
2	5B 24
3	4F 30
4	66 19
5	6D 12
6	7D 02
7	07 78
8	7F 00
9	6F 10

The table contains the codes in hexadecimal with the most significant bit always 0, followed by the bits for segments g, f, e, d, c, b, and a in that order.

1. **Converting decimal inputs into seven-segment drive signals** requires a simple table with a separate entry for each decimal number (a). An easy three-step procedure is all that's needed to access the table (b). Assembly-

```

graph TD
    START([START]) --> B["INDEX = DIGIT  
BASE = STARTING ADDRESS OF TABLE"]
    B --> P["POINTER = BASE + INDEX"]
    P --> C["CODE = (POINTER)"]
    C --> END([END])
  
```

Assume the table is:

MEMORY ADDRESS (HEX)	MEMORY CONTENTS (HEX)
1000	3F
1001	06
1002	5B
1003	4F
1004	66
1005	6D
1006	7D
1007	07
1008	7F
1009	6F

If DIGIT = 4, the process is

STEP 1) BASE = 1000
INDEX = 4

STEP 2) POINTER = BASE + INDEX
= 1004

STEP 3) CODE = (POINTER)
= (1004) = 66

```

LDA DIGIT ;GET DECIMAL DIGIT
MOV L, A ;MAKE DIGIT INTO 16-BIT INDEX
MVI H, 0
LXI D, SSEG ;GET STARTING ADDRESS OF 7-SEGMENT TABLE
DAD D ;INDEX TABLE
MOV A, M ;GET 7-SEGMENT CODE
STA SCODE
HLT
  
```

(c)

```

LDX #SSEG GET STARTING ADDRESS OF 7-SEGMENT TABLE
LDAA DIGIT GET DECIMAL DIGIT
INX BNE SRTAB GET ELEMENT IF INCREMENTING DONE
INX INDEX TABLE ONE ELEMENT AT A TIME
DECA
BRA INDX
SRTAB LDAA X GET 7-SEGMENT CODE
STAA SCODE
WAI
  
```

language programs for the 8080 (c) and the 6800 (d and e) require less than 10 lines of code. Note that # indicates "immediate" and X means "indexed" on the 6800 assembler. Also, 0, X can be abbreviated to just X.

envelope values of a sine wave and generate waveform outputs by reading out the tabular information in cycles. A processor can also form a variable table much as it forms any other data array. (For more about data-array handling, see reference 1).

Besides mathematical data and standard codes, tables can contain starting addresses for programs. Such tables are very useful for performing special program operations by interpreting a coded input from a keyboard as a starting address for a subroutine. An obvious task for a table, though, is to perform a code conversion when no simple relationship exists between input and output.

A simple code conversion problem

A common output task for a μ P is to convert a decimal digit to a seven-segment display code. The code table for the display can be set up for common-anode or common cathode LED displays very easily (Fig. 1a). However, before the table is used, some questions must be answered:

- Where does the table start?
- How is the table organized?
- Which entry do you want?

In this simple conversion, the table is short and entries are in consecutive order, from 0 to 9. To use the table, you must obtain its starting address, add the entry number (the decimal number to be converted), and use the resulting address as a pointer.¹

Most minicomputers and some μ Ps can get an answer from a table with a single instruction by using indexed addressing.² In indexed addressing, the starting address of the table is part of the instruction and the entry number or index is in an index register. The processor adds the two together and uses that address to get the data (Fig. 1b). But since neither the 8080 nor the 6800 has true indexing capability, the procedure takes several instructions instead of just one.

The 8080³ program to convert the code uses register-indirect addressing where the address of the data is in registers H and L of the 8080. A Double Add instruction (DAD) can do the indexing by adding the contents of another register pair to the H and L registers.

The assembly-language program to do the table accessing is shown in Fig. 1c. The program must extend the 8-bit data into a 16-bit number before

```

LDAA #SSEGM GET MSBs OF STARTING AD-
           DRESS
STAA TEMP
LDAA DIGIT GET DECIMAL DIGIT
STAA TEMP+1
LDX TEMP MOVE OFFSET ADDRESS TO IN-
           DEX REGISTER
LDAA SSEGL,X GET 7-SEGMENT CODE
STAA SCODE
WAI

```

(e)

```

LDA DIGIT ;GET DECIMAL DIGIT
ADI #SSEGL ;INDEX LSBs OF 7-SEGMENT
           TABLE
MOV L, A
MVI H, SSEGM ;GET MSBs OF 7-SEGMENT
           TABLE
MOV A, M ;GET 7-SEGMENT CODE
STA SCODE
HLT

```

(a)

```

LDA DIGIT ;GET DECIMAL DIGIT
MOV L, A ;USE AS LSBs OF ADDRESS
MVI H, SSEGM ;GET MSBs OF 7-SEGMENT
           TABLE
MOV A, M ;GET 7-SEGMENT CODE
STA SCODE
HLT

```

(b)

2. Handling a table can be simplified by keeping the entire table on one 256 word page (a) or by starting the table at the beginning of a page (b).

adding it to the base address (SSEG) of the table.

Accessing a table with a 6800 μ P requires that its so-called indexing mode be used, but this takes some effort.⁴ You actually have two alternatives:

- Increment the index register the appropriate number of times (see program Fig. 1d).
- Place the data and the eight most significant bits (MSBs) of the starting address in the index register and use the eight least significant bits (LSBs) of the starting address as the offset in the instruction (see Fig. 1e).

The transfer through memory is awkward, but necessary for the 6800 since there is no other way to move data from the 8-bit accumulator to the 16-bit index register. The 16-bit index register must hold eight bits of the starting address and eight bits of the index since the 6800 only uses an 8-bit offset with the instruction. (Remember, the instruction is typically in ROM so the data can't be part of it.) However, since the 6800 adds the offset to the contents of the index register as part of the normal addressing procedure, no explicit addition instruction is necessary.

The 8080's program can be simplified by placing the table so that it's all on one page (a page is a 256 word section of memory in which the eight MSBs of all addresses are the same.) Thus there are never any carries into the MSBs from the starting address to the indexed address. For example, the decimal-to-seven-segment table could occupy memory addresses E034 to E03D. In general, if the table starts at an address given by SSEGM (eight MSBs) and SSEGL (eight LSBs) and it is contained on a single page, the conversion program simplifies to the extent shown in Fig. 2a.

The program can be made even simpler (Fig. 2b) if the table starts at an address that is an even multiple of $\emptyset100_{16}$. Then SSEGL = 0, and addition is unneces-

sary. However, the total program savings is small compared to the size of the table; the more general approach shown in Fig. 1c permits the table to be placed anywhere in memory.

Indeed, if you want, assembler pseudo-operations can place a table at the beginning of a page—but look out for problems if the table has to be moved or expanded beyond the page. Also, you may have to waste memory to keep the table in the proper place and avoid overlapping with other programs.

The 6800, on the other hand, does indexing as part of its normal instruction execution. Nothing is saved by aligning tables. Even if the offset value is zero, the 6800 has to store the offset in program memory and add it to the index register. Page boundaries are automatically handled because even though the offset is only eight bits long, the indexing is a 16-bit operation with carry. However, all 6800 indexing operations take extra cycles because the ALU is just eight bits long.

Other μ Ps also handle tables

Other processors have their own ways of accessing tables. For instance, the F8 μ P⁵ uses a Load DC Immediate (DCI) instruction to place a 16-bit starting address in the data counter (DC), an Add to Data Counter (ADC) instruction to add the contents of the

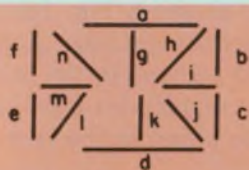

The codes are organized as follows:
 most significant byte = 00nmkji
 least significant byte = hgfedcba
 1 = light on, 0 = light off.

HEXADECIMAL DIGIT	CODE (HEXADECIMAL)
0	003F
1	0440
2	111B
3	110F
4	1126
5	112D
6	113D
7	0007
8	113F
9	1127
A	1137
B	054F
C	0039
D	044F
E	1139
F	1131

(a)

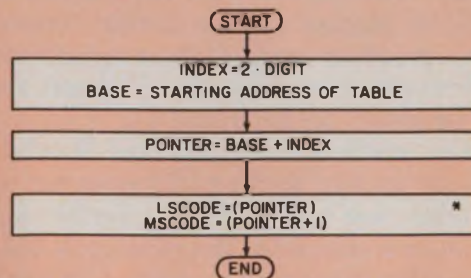

*The Intel 8080 generally stores 16-bit numbers or addresses with the LSBs first while the Motorola 6800 stores them with the MSBs first. LSCODE and MSCODE are thus reversed in 6800 memory.

(For the 8080)
 Assume the table is:

MEMORY ADDRESS (HEX)	MEMORY CONTENTS (HEX)
1000	3F
1001	00
1002	40
1003	04
1004	1B
1005	11
1006	0F
1007	11
1008	26
1009	11
100A	2D
100B	11
100C	3D
100D	11
100E	07
100F	00
1010	3F
1011	11
1012	27
1013	11
1014	37
1015	11
1016	4F
1017	05
1018	39
1019	00
101A	4F
101B	04
101C	39
101D	11
101E	31
101F	11

If DIGIT = 9, the process is:

- STEP 1) BASE = 1000
 INDEX = 9 * 2 = 18 (decimal)
 = 12 (hex)
- STEP 2) POINTER = BASE + INDEX
 = 1012
- STEP 3) LSCODE = (POINTER)
 = (1012)
 = 27
 MSCODE = (POINTER + 1)
 = (1013)
 = 11

(b)

3. When each table entry requires more than one byte, as with this 14-segment display example (a), an extra operation must be added to the program flow chart (b).

Both the 8080 (c) and the 6800 (d) programs have to multiply the input hexadecimal digit by two to get the index so the character can be located.

A typical error code table would be:

CODE	STARTING ADDRESS (HEX)
0	1000
1	1015
2	1027
3	1037
4	1050
.	.
.	.
.	.

The error messages could be:

STARTING ADDRESS	ERROR MESSAGE
1000	TOO MANY TEST POINTS
1015	ILLEGAL CHARACTER
1027	NO SUCH COMMAND

The error messages are stored as character codes and each ends with a carriage return.

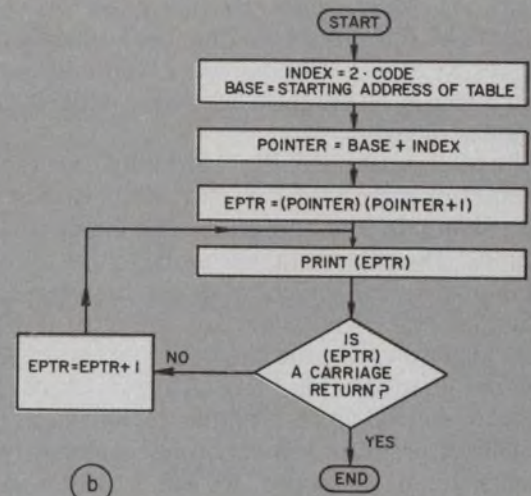

4. Tables can also hold message addresses, where each message is stored as a string of character codes and ends

with a carriage return (a). The program flow chart now has to detect the end of message code (b).

5. The error-handling routines for both the 8080 (a) and the 6800 (b) are single subroutines that print all the error messages. When the main program (c) detects an error it loads the accumulator with the appropriate code and forces the processor to execute the subroutine.

accumulator to the data counter (a 16-bit operation with carry) and a Load Memory (LM) command to load the accumulator with the contents of the memory location specified by the data counter.

On the 2650 μP^6 instruction LODA R0 BASE, R0 loads register R0 with the contents of the address BASE plus the old contents of R0. Therefore, the 2650 can perform indexing with a single instruction. For the 6502 μP , indexing is done by the instruction LDA

```

LDA DIGIT ;GET HEXADECIMAL DIGIT
ADD A
MOV L,A ;INDEX = 2*HEXADECIMAL DIGIT
MVI H,0
LXI D, SEG14 ;BASE = STARTING ADDRESS OF
TABLE
DAD D ;POINTER = INDEX + BASE
MOV E,M ;LSBs OF CODE = (POINTER)
INX H
MOV D,M ;MSBs OF CODE = (POINTER + 1)
XCHG
SHLD SCODE ;STORE 14 SEGMENT CODE
HLT
  
```

(c)

```

LDAA DIGIT GET HEXADECIMAL DIGIT
ASLA INDEX = 2* HEXADECIMAL DIGIT
STAA TEMP+1
LDAA #SEG14M GET MSBs of STARTING ADDRESS
STAA TEMP
LDX TEMP MOVE OFFSET ADDRESS TO INDEX
REGISTER
LDX SEG14L, X GET 14-SEGMENT CODE
STX SCODE STORE 14-SEGMENT CODE
WAI
  
```

(d)

```

8080
EPRNT: ADD A ;INDEX = 2 * CODE
MOV L, A
MVI H, 0
LXI D, ETAB ;BASE = STARTING AD-
ADDRESS OF ADDRESS TABLE
DAD D ;POINTER = INDEX + BASE
MOV E,M ;LSBs OF MESSAGE AD-
ADDRESS = (POINTER)
INX H
MOV D,M ;MSBs OF MESSAGE AD-
ADDRESS = (POINTER + 1)
XCHG
ERRP: MOV A,M ;GET A CHARACTER FROM
MESSAGE
CALL SEND ;AND PRINT IT
INX H
CPI CR ;IS CHARACTER "CAR-
RIAGE RETURN"?
JNZ ERRP ;NO, KEEP PRINTING
RET
  
```

(a)

```

6800
EPRNT ASLA INDEX = 2 * CODE
STAA TEMP+1
LDAA #ETABU GET 8 MSBs OF ADDRESS
TABLE
STAA TEMP
LDX TEMP MOVE OFFSET POINTER
TO INDEX REGISTER
LDX ETABL, X GET MESSAGE ADDRESS
FROM TABLE
ERRP LDAA X GET A CHARACTER FROM
MESSAGE
JSR SEND AND PRINT IT
INX
CMPA #CR IS CHARACTER "CAR-
RIAGE RETURN"?
BNE ERRP NO, KEEP PRINTING
RTS
  
```

(b)

```

8080
MVI A, ECODE ;GET ERROR CODE
CALL EPRNT ;PRINT OPERATOR MESSAGE
6800
LDAA #ECODE GET ERROR CODE
JSR EPRNT PRINT OPERATOR MESSAGE
  
```

(c)

BASE, X, which loads the accumulator with the contents of address BASE plus the contents of index register X. BASE is a complete 16-bit address stored in two words of program memory, while X is an 8-bit index register.

The table example in Fig. 1 assumes that each entry only occupies one byte. However, when entries require more than one byte, programming gets a little more complex: The program must multiply the data by the number of bytes per entry to get the correct index. Then the program must fetch all the bytes of the entry.

For example, assume the table output drives a 14-segment display (Fig. 3a). A flow chart for the program as well as an example are shown in Fig. 3b. The 8080's program has only a few changes from the seven-segment program: two bytes of data are used for each entry and the hexadecimal digit must be multiplied by two to get the index. To do the multiplication, add the data to the data (Fig. 3c). The 6800 program is similar, except that all 16 bits of the answer can be fetched with a single Load Index Register (LDX) instruction. An arithmetic left shift does the multiplication by two (Fig. 3d).

Tables can contain addresses, too

Tables can contain more than just data. An error routine, for example, can use a table to find the starting point of an operator message from a code in the accumulator. This single error routine can thus print the code and the error message for all possible

errors (Fig. 4a). Furthermore, you can easily add more error messages by expanding the table. The programs are similar to the previous examples except that the entry from the table is the starting address for the output routine (see the flow chart in Fig. 4b). Remember that addresses are 16 bits long.

Both the 8080 and 6800 programs (Fig. 5a and b) print the error message ending with a carriage return (SEND is an output routine for one character). The main programs for both the 8080 and 6800 place the code in the accumulator and call the error routine (Fig. 5c).

The same technique can be used to interpret switch closures. Assume that a keyboard contains a numeric keypad and function keys similar to a calculator keyboard (Fig. 6a). An encoder or PROM can translate each key closure into a unique code, 0 to 9 for the digit keys and 10 on for the function keys. Here, a table organized as in Fig. 6b will do the job. The program, shown in flow-chart form in Fig. 7a, performs the following steps:

Step 1: Fetch keyboard data.

Step 2: If key number is less than 10, the key is a digit, so go to Digit routine.

Step 3: Otherwise, use key number to access the table of subroutines. The index is $2 \times (\text{key number} - 10)$, since each entry is 2 bytes long.

Step 4: Transfer control to the proper subroutine by jumping to the address obtained from the table.

The 8080 program uses PCHL, an indirect jump that transfers the contents of registers H and L to the program counter (Fig. 7b). The 6800 program uses an indirect jump to the address in the index register (Fig. 7c). Remember that the 6800 has no separate I/O instructions, so LDAA PIADRA is equivalent to IN KBD on the 8080. Even though the 6800 indexes awkwardly, it can fetch the 16-bit address with a single instruction. An actual example is shown in Fig. 7d. Note how easy it is to add more function keys—all you have to do is write the new function subroutine and place it in program memory. Then place the starting address of the function subroutine in the jump table, and wire the new key so that it produces the correct input.

A similar procedure can interpret single-letter commands from a full alphanumeric keyboard (Fig. 8). The only difference is that to index the table, you must subtract the internal representation of A from the character-coded input. Undefined letters can simply cause a jump to a reset or error routine. Adding extra commands won't change the keyboard program. All you have to do is place the address of the new subroutine—instead of the error-routine address—in the table.

Implement equations in tables, too

Tables can do still more. Say you have an analog input to interpret or an output to produce or a trigonometric function, logarithm, or exponential to

The diagram shows a calculator keyboard with keys: REPEAT, ENTER, CLR, %, 7, 8, 9, ÷, 4, 5, 6, x, 1, 2, 3, -, 0, +. Below the keyboard is a table with two columns: ENTRY NO. and CONTENTS. The table lists entries 0 through 7, each containing the starting address for a specific key. A note below the table states: 'Each entry is a 16-bit address. You can add new function keys by simply adding new entries.'

ENTRY NO.	CONTENTS
0	STARTING ADDRESS FOR KEY #10
1	STARTING ADDRESS FOR KEY #11
2	STARTING ADDRESS FOR KEY #12
3	STARTING ADDRESS FOR KEY #13
4	STARTING ADDRESS FOR KEY #14
5	STARTING ADDRESS FOR KEY #15
6	STARTING ADDRESS FOR KEY #16
7	STARTING ADDRESS FOR KEY #17

6. Even keyboard inputs can be handled by a table (a) since each key closure can be made to generate an index, which directs the processor to a particular subroutine.

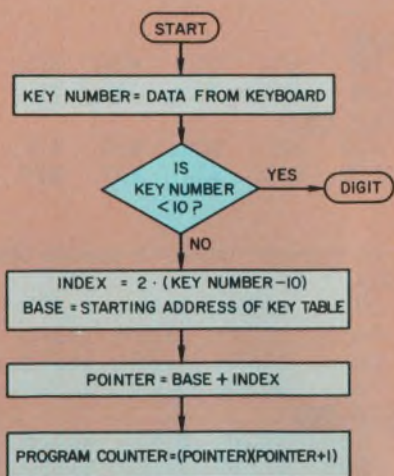

ⓐ DISTINGUISH FUNCTION AND DIGIT KEYS

```

IN KBD      ;GET KEY NUMBER
CPI 10      ;IS KEY NUMBER ≥ 10?
JC DIGIT    ;NO, KEY IS DIGIT

;INTERPRET FUNCTION KEYS BY JUMPING TO
;CORRECT SUBROUTINE IN JUMP TABLE

SUI 10      ;INDEX = 2 · (KEY NUMBER - 10)
ADD A
MOV L,A
MVI H,0
LXI D,KTAB ;BASE = STARTING ADDRESS OF
            ;JUMP TABLE
DAD D      ;POINTER = BASE + INDEX
MOV E,M    ;GET LSBs of JUMP ADDRESS
INX H
MOV D,M    ;GET MSBs OF JUMP ADDRESS
XCHG
PCHL      ;AND JUMP TO SUBROUTINE
  
```

ⓑ

*DISTINGUISH FUNCTION AND DIGIT KEYS

```

*
LDAA PIADRA GET KEY NUMBER
CMPA #10    IS KEY NUMBER ≥ 10?
BCS DIGIT   NO, KEY IS DIGIT
*
;INTERPRET FUNCTION KEYS BY JUMPING TO COR-
;RECT SUBROUTINE IN JUMP TABLE
*
SUBA #10    INDEX = 2 · (KEY NUMBER - 10)
ASLA
STAA TEMP+1
LDAA #KTABU BASE = 8 MSBs OF STARTING
            ADDRESS OF JUMP TABLE
STAA TEMP
LDX TEMP   MOVE OFFSET POINTER TO IN-
            DEX REGISTER
LDX KTABL,X GET JUMP ADDRESS
JMP X      AND JUMP TO IT
  
```

ⓒ

7. To handle keyboard inputs, the processor must make a decision and determine whether the key pressed is a number or a function (a). Both the 8080 (b) and the 6800 (c) can handle the task, as shown by these simple programs. An example, using one of the table entries, is also shown.

Assume the table is:

MEMORY LOCATION (HEX)	KEY NUMBER	MEMORY CONTENTS (HEX)
1000	10	00
1001		20
1002	11	43
1003		20
1004	12	67
1005		20
1006	13	7E
1007		20
1008	14	A1
1009		20
100A	15	B7
100B		20
100C	16	D5
100D		20
100E	17	E3
100F		20

If the key number is 14, the process is:

```

STEP 1) INDEX = 2 · (KEY NUMBER - 10)
           = 8
           BASE = 1000
STEP 2) POINTER = BASE + INDEX
           = 1008
STEP 3) LSBs of PC = (POINTER)
           = (1008) = A1
           MSBs of PC = (POINTER + 1)
           = (1009) = 20
  
```

So the next instruction to be executed will be the one in memory location 20A1. Remember that the 6800 stores its addresses with the most significant bits first.

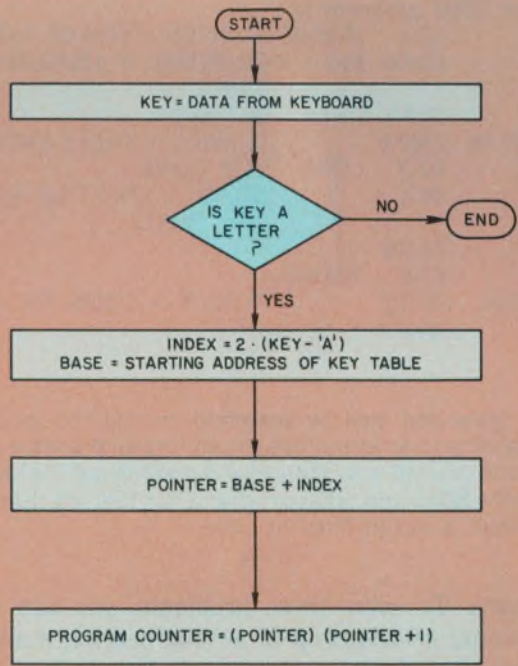

'A' IS THE KEYBOARD REPRESENTATION OF THE LETTER A

8. A more complex keyboard can also be handled by the processor. Just expand the table of look-up functions and allow enough space in memory.

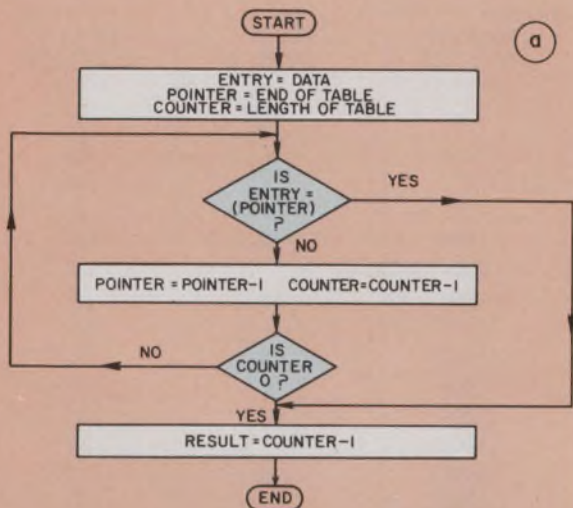

For example, if the data is 6D, the program would search through the memory starting in location 1009 (see Figure 2) and ending when it finds the code in location 1005. The backward search is convenient since the counter is always one more than the index.

The 8080 program is:

```

LXI H
SSEGE ;POINTER = END OF TABLE
MVI B, 10 ;COUNTER = LENGTH OF TABLE
LDA DATA ;GET DATA
SRTAB: CMP M ;IS DATA = TABLE ENTRY?
JZ DONE ;YES, DONE
DCX H ;NO, GO TO NEXT ENTRY IF ONE EXISTS
DCR B
JNZ SRTAB
DONE: DCR B ;RESULT = COUNTER - 1
HLT
  
```

The 6800 program is:

```

LDX #SSEGE POINTER = END OF TABLE
LDAB #10 COUNTER = LENGTH OF TABLE
LDA DATA GET DATA
SRTAB: CMPA X IS DATA = TABLE ENTRY?
BEQ DONE YES, DONE
DEX NO, GO TO NEXT ENTRY IF ONE EXISTS
DECB
BNE SRTAB
DONE: DECB RESULT = COUNTER - 1
WAI
  
```

9. A table can also be searched to find the index corresponding to an entry (a) by scanning all the table entries until the desired one is found and reading out the location. Both the 8080 and 6800 programs for this job (b) require less than a dozen lines of code.

evaluate. To solve these problems, you can find a functional relationship in an engineering manual or a book of algorithms. Or you can simply use a table.

For an analog input or output, the table is often a calibration table. To handle an input, the calibration table contains the actual reading that corresponds to the input data. To handle an output, the calibration table contains the data required to produce that result.

INTEL 8080

SSEG: DB	3FH,	06H,	5BH,	4FH,	66H
DB	6DH,	7DH,	07H,	7FH,	6FH

MOTOROLA 6800

SSEG	FCB	\$3F,	\$06,	\$5B,	\$4F,	\$66
FCB	\$6D,	\$7D,	\$07,	\$7F,	\$6F	

For the 14 segment table the pseudo-ops are:

INTEL 8080

SSEG: DW	003FH,	0440H,	111BH,	110FH
DW	1126H,	112DH,	113DH,	0007H
DW	113FH,	1127H,	1137H,	054FH
DW	0039H,	044FH,	1139H,	1131H

MOTOROLA 6800

SSEG	FDB	\$003F,	\$0440,	\$111B,	\$110F
FDB	\$1126,	\$112D,	\$113D,	\$0007	
FDB	\$113F,	\$1127,	\$1137,	\$054F	
FDB	\$0039,	\$044F,	\$1139,	\$1131	

10. To actually store the tables in memory, you can use pseudo-ops if you're working with an assembler. For the examples used in Fig. 1 and Fig. 3, the required pseudo-ops are shown in (a) and (b), respectively. Note that the 8080 assembler uses a final H to indicate hexadecimal notation while the 6800 assembler uses an initial \$.

The table must store all the possible results, so if the input and output are both 8 bits long, 256 8-bit words are required. In more concrete terms, that amount of memory translates to one 1702 PROM or one-quarter of a 2708 PROM.

Of course, not all tables are organized in a simple consecutive order. Perhaps only a few inputs will ever occur. But you can get the right entry from the table without first having to store a lot of entries.

In simple cases, searching through a table for the data will do the job. Often, you can check data against each entry in the table until you find a match. The answer will be the index of the matching entry. For example, you can use the table from Fig. 1 in reverse to convert a seven-segment code to a decimal digit (the seven-segment code might be an output from a calculator chip). If the code is in the table, the answer will be the digit. If not, the answer will be -1. The procedure, flow-charted in Fig. 9a, boils down to:

Step 1: Initialization

Pointer = End of table

Counter = Length of table

Step 2: Search table

If (Pointer) = Data, go to step 4.

Step 3: Decision and loop

Pointer = Pointer - 1

Counter = Counter - 1

If Counter = 0, go to Step 2.

Step 4:

Result = Counter - 1

Of course, if the table is long, this procedure is slow; it's like looking up a telephone number by starting

at the front of the book and checking every name. For long tables, some better search procedures include

- A binary search, which checks the halfway point of an ordered table, determines which half of the table the entry is in, then halves the correct half, and so on. The procedure is much like that used by a successive-approximation analog-to-digital converter.

- Two-level indexing, whose first level gives you a starting point much as the letter tabs in a dictionary do, while the second level provides the exact location.

- Hashing, whereby you derive a starting point from the data by using some kind of function.^{7,8}

One problem remains—how to store the tables in memory. Most assemblers have a pseudo-operation (often called DATA) to do this. Microprocessor assemblers, in fact, usually have two pseudo-operations, one for 8-bit data and one for 16-bit addresses. The Intel 8080 pseudo-ops are DEFINE BYTE (DB) and DEFINE WORD (DW). The Motorola 6800 pseudo-operations are FORM CONSTANT BYTE (FCB) and FORM DOUBLE CONSTANT BYTE (FDB). The required pseudo-ops to place the seven-segment and the 14-segment tables in memory are shown in Fig. 10a and 10b, respectively.

As mentioned earlier, you can often simplify table-accessing programs by aligning the tables so that they start at the beginning of a page, e.g.:

```
SSEG EQU 1300H (for the 8080), or
SSEG EQU $1300 (for the 6800)
```

Then the program needn't consider carries into the more significant digits when performing the indexing. If you want to be able to vary the page number, try either of the following routines:

For the 8080

```
TPAGE EQU 25H
TBASE EQU TPAGE *256
```

For the 6800

```
TPAGE EQU $25
TBASE EQU TPAGE *256
```

The 256, of course, is 2⁸, and multiplying by it moves the page number to the eight MSBs. Now you can assign the table to a particular page by giving TPAGE a value before assembling the program. ■■

References

1. For more about pointers, see Leventhal, L.A., "Microprocessor Basics: Part 13, Take Advantage of 8080 and 6800 Data-Manipulation Capabilities," *Electronic Design*, April 12, 1977, p. 90.

2. For more about addressing techniques, see Leventhal, L.A., "Microprocessor Basics: Part 5, Put Microprocessor Software to Work," *Electronic Design*, No. 16, Aug. 2, 1976, p. 58.

3. For more about the 8080, see Nichols, A.J. and McKenzie, J., "Microprocessor Basics: Part 2, Build a Compact Microcomputer with the 8080," *Electronic Design*, No. 10, May 10, 1976, p. 84.

4. For more about the 6800, see Mazur, T., "Microprocessor Basics: Part 4, Put Together a Complete Microcomputer," *Electronic Design*, No. 14, July 10, 1976, p. 66.

5. For more about the F-8 see Sullivan, L., "Microprocessor Basics: Part 3, A Microcomputer Needn't Take Many ICs," *Electronic Design*, No. 12, June 7, 1976, p. 126.

6. For more about the 2650 see Uimari, D., "Microprocessor Basics: Part 6, Using the 2650 Microprocessor," *Electronic Design*, No. 18, Sept. 1, 1976, p. 70.

7. Knuth, D.E., "Algorithms," *Scientific American*, April 1977, p. 63.

8. Knuth, D.E., "The Art of Computer Programming, Volume III, Searching and Sorting," Addison Wesley, Reading, MA, 1973.

CIRCLE NUMBER 48 ►

This coupon will bring you instant data on Intech's Modular and Monolithic V/F and F/V Converters... which give you accuracy from .005% to .4% max., operational to 1Mhz, at prices from \$8.95 to \$179.00. They're available. Now!

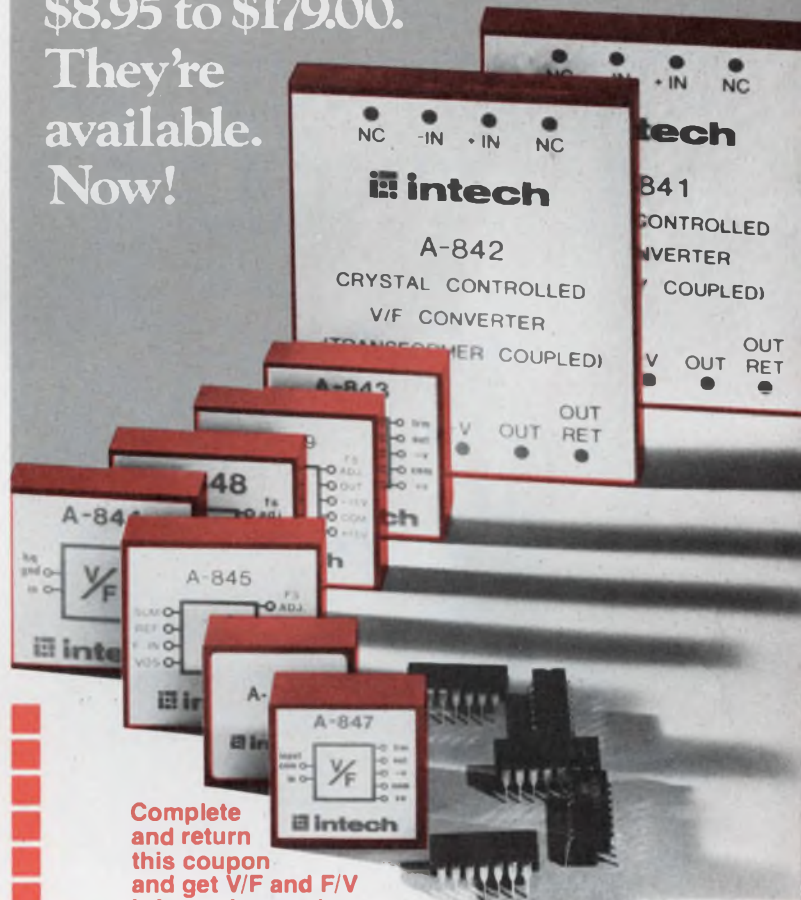

Complete and return this coupon and get V/F and F/V information on the broadest line of converters on the market today!

intech/function modules

282 Brokaw Road, Santa Clara, California 95050
Phone (408) 244-0500 TWX: 910-338-0254

- I need Modular performance. Tell me more.
- I'm a Monolithic type. What have you?
- I don't know you, Intech. Convert me.
- Phone me, IMMEDIATELY, at _____ (A.C.) _____ (Number)

Name _____ Title _____

Organization _____

Address _____ Mail Stop _____

City/State/Zip _____

Phone _____

The Cube widens the gap...

In Power-Ferrite EC cores for switching power supply chokes

Now available from Ferroxcube are standardized gapped EC cores in four sizes: 35, 41, 52 and 70 mm. The gap lengths have been optimized to prevent saturation of the core due to a high DC field while simultaneously providing maximum impedance to the AC ripple current.

For worst case DC bias, two gapped cores should be used. Under less stringent conditions, one gapped and one ungapped core in combination may be used. The chart below shows the DC ampere-turns which can be supported for both 2-gapped and gapped/ungapped combinations that will not decrease incremental permeability more than 10%.

EC Core	2 Gapped Cores	1 Gapped + 1 Ungapped Core
35 mm	325 AT	200 AT
41 mm	370 AT	220 AT
52 mm	540 AT	330 AT
70 mm	860 AT	570 AT

For complete specifications on gapped EC cores, bobbins and hardware, call on The Cube.

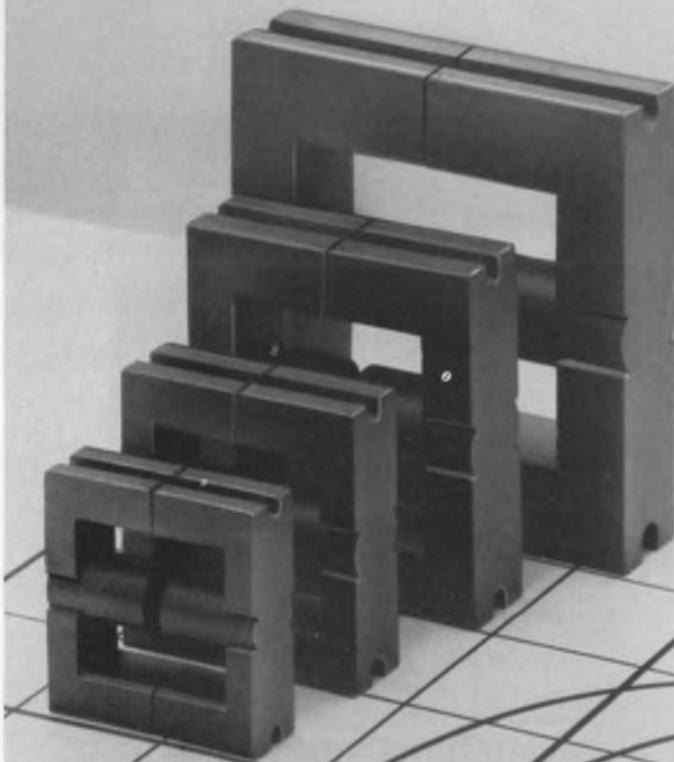

Call
on the
cube



FERROXCUBE Division of Amperex Electronic Corporation,
Saugerties, New York 12477 (914) 246-2811
A North American Philips Company

Overprotection can affect a CMOS switch for life.

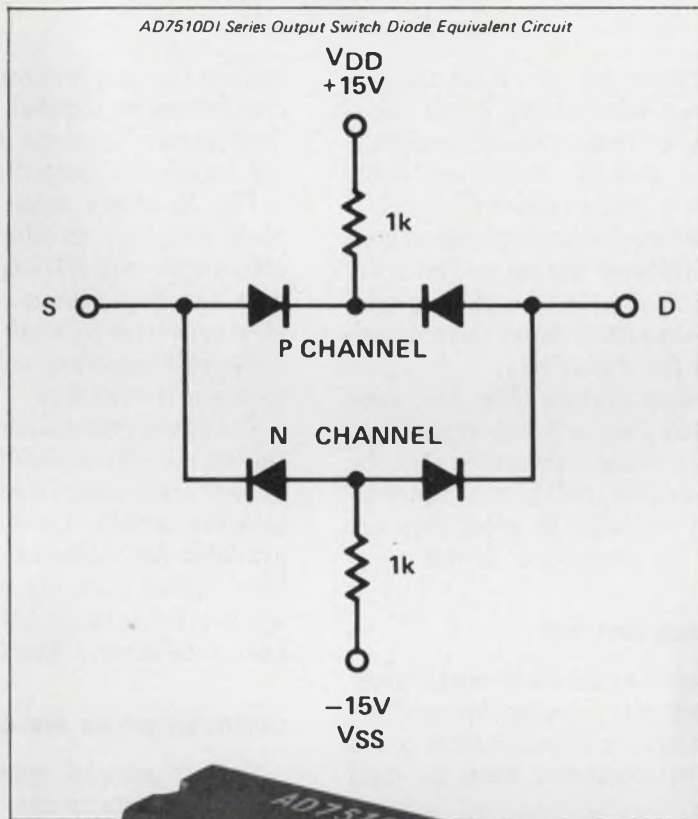

But not Analog Devices' AD7510 family of DI CMOS analog switches. They belong to a whole new generation. With positive overvoltage protection, but without any inhibition on performance.

We accomplished it through a unique design, utilizing "on-chip" resistors in series with the power supply. It provides as much as $\pm 25V$ overvoltage protection. But the resistors only switch in when an overvoltage condition occurs. So normal performance never suffers. And you get both the main assets of an analog switch: a low "ON" resistance of 75Ω and a low leakage current of $400pA$.

The equivalent circuit of the output switch element shows that, indeed, the $1k\Omega$ limiting resistors are in series with the back-gates of the P- and N-channel output devices — not in series with the signal path between the S and D terminals.

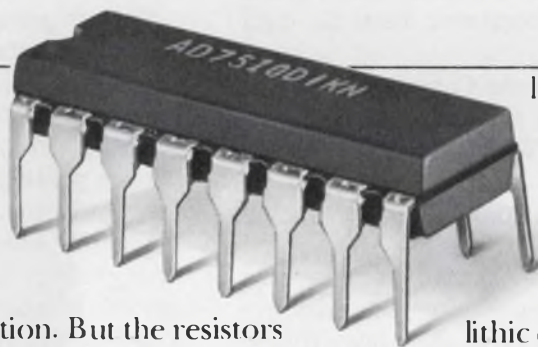

This design, combined with our dielectrically-isolated CMOS fabrication process, prevents latch-up. And allows TTL/CMOS direct interfacing.

We also included two other measures of security. Silicon nitride passivation to ensure long term stability and monolithic construction for reliability. Now when it comes to protecting

CMOS switches so they can survive in the real world, Analog Devices knows best. Write for our 8-page technical bulletin on the entire family of DI CMOS protected analog switches, to Analog Devices, the real company in precision measurement and control.

▶ ANALOG DEVICES

The real CMOS switch company

Analog Devices, Inc., Box 280, Norwood, Massachusetts 02062. East Coast: (617) 329-4700, Midwest: (312) 894-3300, West Coast: (213) 595-1783, Texas: (214) 231-5094. Belgium: 03 3827 07, Denmark: 97 95 99, England: 01/94 10 466, France: 686-7760, Germany: 089/53 03 19, Japan: 03/26 36 826, Holland: 076-879251, Switzerland: 022/319704 and representatives around the world.

Simplify analog/computer interfacing.

Choose the data-acquisition configuration that's best for your system, then use the right analog-to-digital converter.

The choice of configuration for your data-acquisition system can influence your choice of a/d converters, and it can influence system speed, accuracy, data latency, power and dollars. There are three important data-acquisition configurations.

In the multiplexed random-channel-addressed configuration (Fig. 1a), multiplexed analog switches deliver one sensor's signal at a time to a sample-and-hold (s/h) circuit. This looks at and stores the momentary value of the signal for digitizing.

In the parallel-conversion system (Fig. 1b), each analog channel has a dedicated a/d converter. And in the multiplexed-with-memory system (Fig. 1c), the inputs are multiplexed, as in a multiplexed random-addressed system; while the outputs, after they are digitized, are all stored for immediate access.

Converters are more than just a/d

The multiplexed random-channel-addressed system boasts advantages of simplicity, straightforward design and low cost. Such a system then operates in the Command mode and so the computer waits for data once a conversion starts.

The operating sequence for the Command mode is:

- The computer addresses a specific channel.
- The analog multiplexer (MUX) selects the desired channel.
- An s/h circuit acquires and holds the analog signal.
- An a/d converter digitizes the signal and returns a Ready signal to the computer after the data are presented to the data bus via three-state bus drivers.

Unfortunately, when the acquisition system operates in the Command mode, the computer must enter a Wait mode while the data are readied; or proceed with its assigned task, watch for a Data Ready flag, and return for the data. All this takes up processor time.

A microprocessor wastes less time when it accesses input data as it would memory.¹ In addition, when input-data and main-memory access times are equal,

waiting for data is eliminated. So some systems make conversions in parallel. On each input-data channel, these parallel systems use one a/d converter containing three-state output-data latches.

Fig. 1b shows such a parallel-conversion system containing only an address decoder and multiple a/d converters, with all outputs wired in parallel onto the data bus. This system doesn't use s/h circuitry. The ideal converter package for this system would include buffered three-state output-data latches in addition to the a/d converter.

The system should convert continuously. Data from the last conversion should remain in the output latches until the next completed conversion transfers its data into the latches. Latest valid data are thus always available for readout on the data bus, except for the brief period when the data are updated. In contrast, a converter without buffered output latches does not hold data after a Start Conversion signal.

Converter prices are coming down

Though parallel conversion provides simple and immediate data access, the cost of one a/d converter per channel has, in the past, been a heavy burden. However, the low cost of many monolithic and even some hybrid a/d converters now make parallel conversion practical. Furthermore, the downward trend for converter prices should continue as more monolithic units are released.

At present a/d converter prices, however, one can get immediate access, particularly for 12-bit data at a lower cost than that of parallel conversion. The multiplexed system with memory, Fig. 1c, interfaces to a computer in the Memory Access mode—without any waiting period.

One particular system with memory features a dedicated, on-card, 16 × 12-bit RAM that supplants buffered output latches. One can, of course, replace the RAM with main-memory locations, but writing into memory then uses valuable machine time. With the dedicated RAM, the latest data are available in the acquisition system and the processor software is simplified.

But cost and simple software aren't the only considerations. There is, of course, the matter of data bandwidth. The bandwidth of a sampled-data system is limited by Shannon's sampling criterion and prac-

Jim Sherwin, Data-Acquisition Applications Manager, National Semiconductor, 2900 Semiconductor Dr., Santa Clara, CA 95051

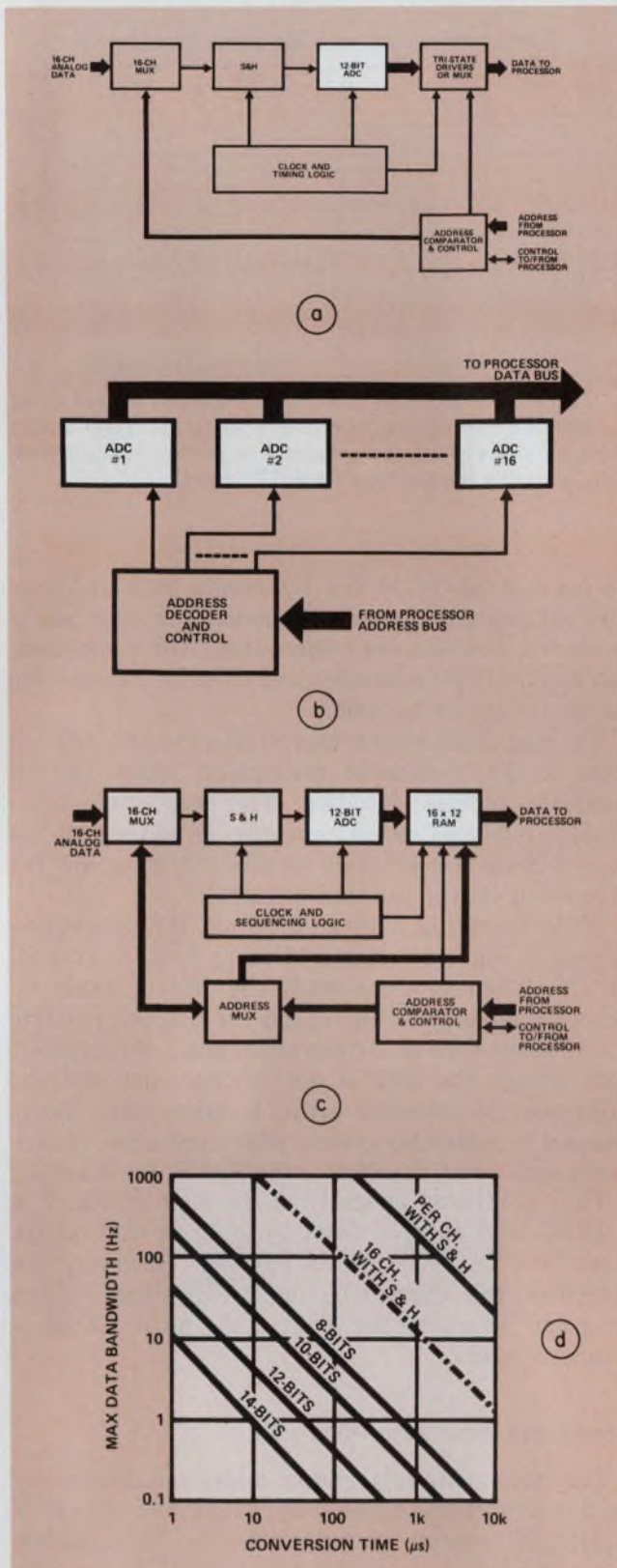

1. Random-addressed multiplexed systems make computers wait while the lone a/d converter processes the selected input channel (a). Parallel-conversion systems (b) process each input channel with a dedicated converter and so eliminate an error source—the analog multiplexer. In the multiplexed system with memory (c) a RAM stores the converted data from the single a/d unit and so the computer has immediate access to any channel. Data-bandwidth curves for 8 to 14-bit systems, with and without s/h, indicate that parallel-conversion systems without s/h can process only low-bandwidth data.

tical considerations to, say, one-fifth of the reciprocal of the conversion time. For example, a data bandwidth of about 4 kHz results from a 50- μ s conversion cycle.

Without s/h, conversion must be fast

In a system where there is no s/h, as in parallel-conversion, digitizing must take place within the time it takes the input signal to change by $\pm 1/2$ LSB or by one part in 2^{n+1} , where n is the resolution in bits. The data bandwidth for a sine wave is $2^{-(n+1)}$ divided by the conversion time. For the same 50- μ s conversion cycle as in the sampled-data system and an 8-bit accuracy requirement of $\pm 1/2$ LSB, the unsampled-data bandwidth is 12 Hz. Data bandwidths for 8 to 14-bit systems with and without s/h are compared in Fig. 1d.

Adding an s/h module in front of each converter in a parallel-conversion system can easily double the cost per channel of an 8-bit system. The cost also climbs when conversion speed increases significantly, except with tracking converters.

With a system that can afford to go into a Wait mode after it requests data, a random-accessed system costs less than any other. The waiting period can be as short as 10 to 20 μ s with fast s/h and a/d circuits, but these are expensive.

Lower-cost systems can prolong the waiting period to 100 to 200 μ s. With complex software, the computer can remain busy during the conversion cycle, and return when the data are ready.

The curves in Fig. 1d show that system sampling each channel every 20 ms can process 16 channels of 10-Hz data. This is a data-throughput rate of 16 divided by 20 ms—which is 800 Hz. The higher cost systems of this type are capable of 50 to 100-kHz throughput rates.

Parallel-conversion systems without s/h circuits can process only low bandwidths (Fig. 4). Parallel conversion uses many converters, so it's advisable to avoid expensive ones. That leaves only 8 or 10-bit successive-approximation-register (SAR) converters or 12-bit integrating monolithic converters. Cost alone, then, limits parallel-conversion systems to 10 to 30 Hz for 8 bits, 2 to 5 Hz for 10 bits, and lower than 1 Hz for 12 bits. Replacing SARs with tracking converters can raise bandwidths of 8 and 10-bit systems by 8 to 10 times.

Unlike the situation in parallel-conversion systems, in multiplexed systems with memory, the bandwidths and data-throughput rates are mainly limited by s/h and converter operating times. At only a slightly higher cost per channel than even a random-addressed system, the system with memory lets the computer operate efficiently.

Consider all the costs

To be valid, cost and performance comparisons for the three types of acquisition systems must include all the required hardware and even the software. With

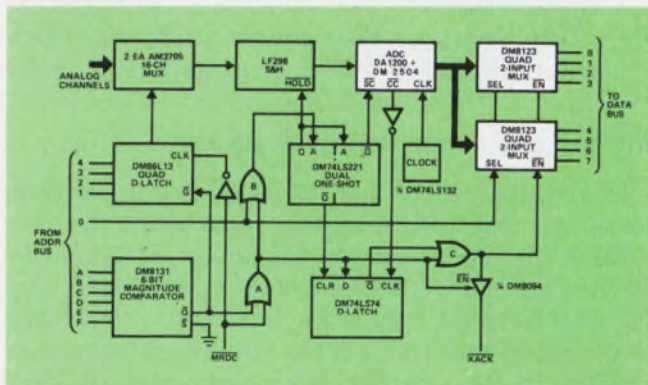

2. Three-state outputs and address-LSB compatibility of the Select inputs, allow the quad two-input MUX units to easily split the 12-bit data from the a/d converter into two bytes for the microprocessor's data bus.

16 channels, a random-addressed multiplexed system uses an a/d converter, an s/h module, a 16-channel multiplexer, complex control circuits, complex software, and 16 anti-aliasing filters. (Anti-aliasing filters are low-pass devices that prevent frequency-folding or aliasing errors caused by sampling rates too low for the data bandwidth.) Access to the data is slow.

Parallel conversion for 16 channels requires 16 a/d converters, 16 anti-aliasing filters, simple control circuits, power for the converters and simple software. The data bandwidth is low, however. A 16-channel multiplexed system with memory takes an a/d converter, an s/h module, a 16-channel multiplexer, 16 anti-aliasing filters, a 16-word by 12-bit-per-word RAM, complex control circuits and simple software. Access to data, via the memory, is fast.

Fig. 2 shows an 8080-compatible, random-addressed, 16-channel, 12-bit system. The analog section contains a 16-channel analog multiplexer, an s/h block and a 12-bit a/d converter. Before the s/h block, the multiplexer might be a differential type and differential or even instrumentation amplifiers could be useful to simplify system integration.

The data-output circuits can interface directly to an 8-bit data bus, like those of the 8080 and 6800 microprocessors. An 8-bit μ P must accept the 12-bit data word in two 8-bit bytes. Since a processor usually accesses a 12-bit word with two consecutive addresses (0 and 1 as LSB), multiplexers like the DM8123 work well here. They have three-state outputs and the address LSB can directly drive the Channel Select input. To interface a 16-bit address bus, such as in the PACE μ C, replace the output multiplexers with three-state output buffers such as the DM8097. For a lightly loaded data bus, low-power versions of these parts provide adequate drive and save power.

Address comparators raise capacity

For address decoding, a 6-bit magnitude comparator (DM8131 is one type) looks at the six MSBs of the address. With only these six bits, a single system has

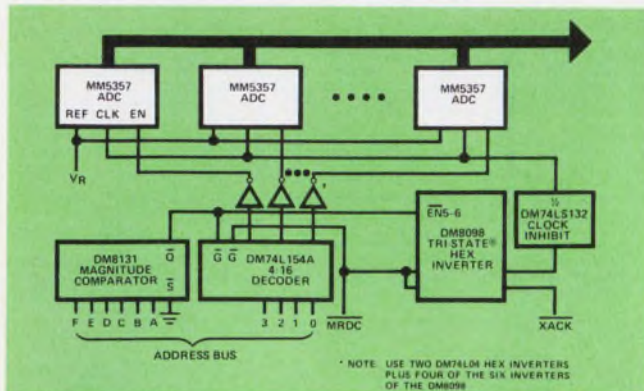

3. There is no waiting period in the Memory Read cycle for an 8080 microprocessor interfaced to this 16-channel, 8-bit, parallel-conversion system. The converters can drive only a lightly loaded bus (one TTL load).

64 possible sets of 16 input channels each and uses up to 64 pages of memory. When more input capacity is needed, two address comparators, ORed together, can handle 12-bit addresses and thereby increase the 64 sets of inputs to 4096.

The magnitude comparator(s) plus the four address lines to the 16-channel decoder make up the complete address decoding. The magnitude comparator indicates which converter is addressed; the four address lines select one of 16 channels for processing by the selected converter.

When operating with an 8080 μ P, the acquisition system in Fig. 2 receives a Memory Read command, $\overline{\text{MRDC}}$. When data are ready the system issues an acknowledgment, $\overline{\text{XACK}}$. This is the simplest possible interface between an a/d converter and any computer. And though the 8080 is one of the least complex processors to interface with, it takes only minor changes to mate this system with most other microcomputers—with the 6800 or the PACE, for example.

The only timing anomaly in the logic of Fig. 2 is a ZERO-level pulse of from 10 to 40 ns that occurs when the $\overline{\text{XACK}}$ buffer is enabled. However, the computer isn't affected by the $\overline{\text{XACK}}$ signal at this time and so enters the Wait mode until $\overline{\text{XACK}}$ is returned later.

Speed and accuracy—that's all

The converter in this random-addressed system can be a conventional type; only speed and accuracy matter. Three-state output buffers or data latches aren't needed because the data are latched in the register until a new Start Conversion command occurs.

As shown in Fig. 2, a complete a/d converter, adequate for the 8080-compatible, random-addressed system can be made up of a 12-bit a/d converter block that is specifically tailored for use with a successive-approximation register. Devices such as DM74C905 and DM2504 SARs mate with converters like the DA1200. Many other converters that will work well

in this system can either be put together from components or purchased complete. The component cost for the converter shown in Fig. 2 is about \$9.50 per channel and it uses 2.8 W total.

Parallel a/d's give fresh data fast

Though the random-addressed system of Fig. 2 may be the simplest to interface with most microcomputers, a parallel-conversion system is most likely the simplest microcomputer-compatible system in which the latest input data can be accessed as if they were in main memory. But because so many a/d converters are used, each must use only very little power. The individual a/d converters in Fig. 1b include three-state outputs for Wire-ORing on the data bus. However, making each converter capable of driving a heavily loaded bus would raise the power significantly. Accordingly, when the bus loading so requires, add a set of three-state TTL buffers.

The control circuits are simple; primarily, they accept the Memory Read command and then return the Memory Ready signal. Any control-circuit complexity stems from processors that accept data in two 8-bit bytes rather than in one of 16 bits. And even this doesn't make the controls very messy. Small differences in the address decoder and control circuits will exist, depending on the computer.

The 16-channel parallel-conversion system in Fig. 3 interfaces with an 8080, without a waiting period in the Memory Read cycle. Components for this unit cost about \$10 per channel. It is, however, a minimal system, capable only of driving a lightly loaded bus. For heavier loads, use two quad three-state buffers.

Handshaking follows addressing

A 4-to-16-line decoder selects the addressed channel using the address' four LSBs. The six MSBs select one of the 64 memory pages. These six MSBs also operate the comparator that gates the 4-to-16 decoder. In addition the comparator, gated by the Memory Read command \overline{MRDC} , inhibits the clock to prevent data change in the output during the data-access period.

A Data Ready acknowledgment returns to the processor when the address is correct and \overline{MRDC} is true. No other logic is required; however, inverters are necessary in the converters' Enable lines due to a sense mismatch between these Enables and the 4-to-16-decoder outputs.

Fig. 4a shows a 16-channel, 12-bit, parallel-conversion system for the 8080. The converters are hypothetical units containing d/a switches, ladder network, comparator, up/down counter (for tracking conversion), control logic and three-state buffered outputs. The converters operate continuously, with the output-data buffer updated at the end of each conversion.

Such converters can settle in 1 to 4 μ s (after an initial but longer acquisition period) without being costly. Also, this sort of converter can provide 12-bit accuracy

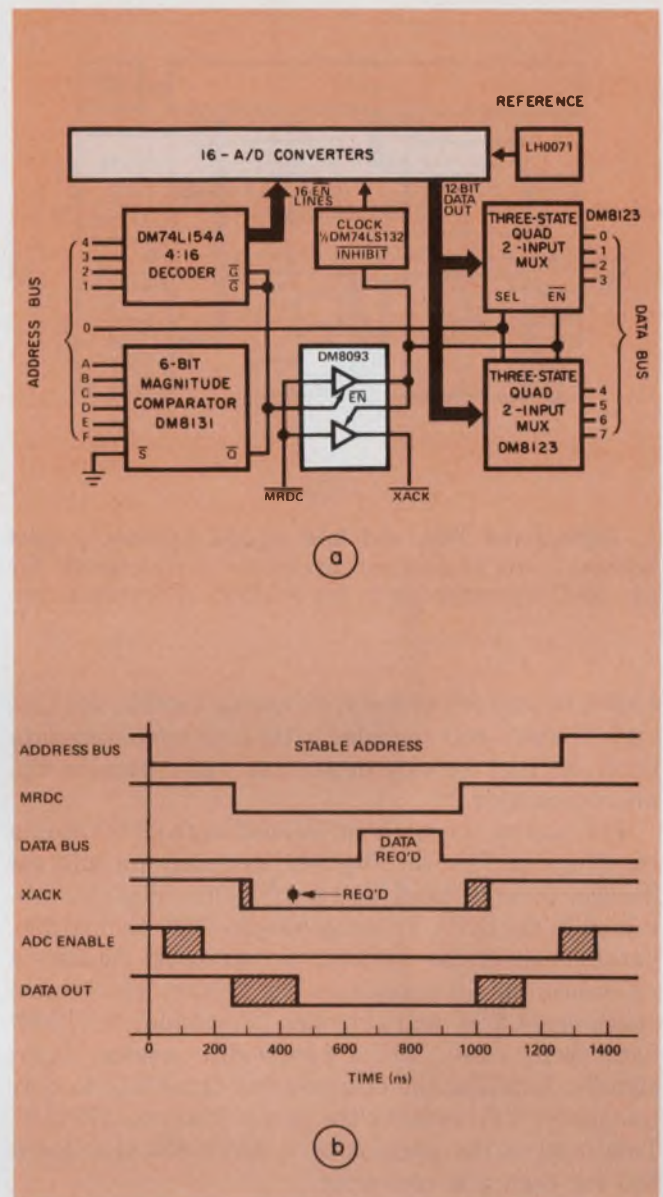

4. A data-ready signal \overline{MRDC} returns to the 8080 μ P from the 16-channel parallel-conversion system (a) to prevent extending the Memory Access cycle. \overline{MRDC} goes out on the XACK line at least 300 ns before it is needed (b).

to $\pm 1/2$ LSB at a data bandwidth of 10 to 20 Hz. A single external buffered reference can handle all channels. An external gated clock can drive all the converters.

The address decoding is the same as that for the 8-bit system. The LSB of the address selects either byte 1 or 2 of the 12-bit output-data word via the two quad, three-state, two-input, multiplexers. A ZERO selects the eight LSBs of data (byte 1) and a ONE selects the four MSBs (byte 2). ZEROs are placed on the four remaining data lines of byte 2.

Address bits 1 to 4 are decoded into 1 of 16 Select bits that enable the three-state output of the selected converter. Since ZERO is the true state for the decoder DM75L154A, it is desirable that ZERO also be the true state for the converter's Enable input. Otherwise, 16 inverters would be required. For two's complement

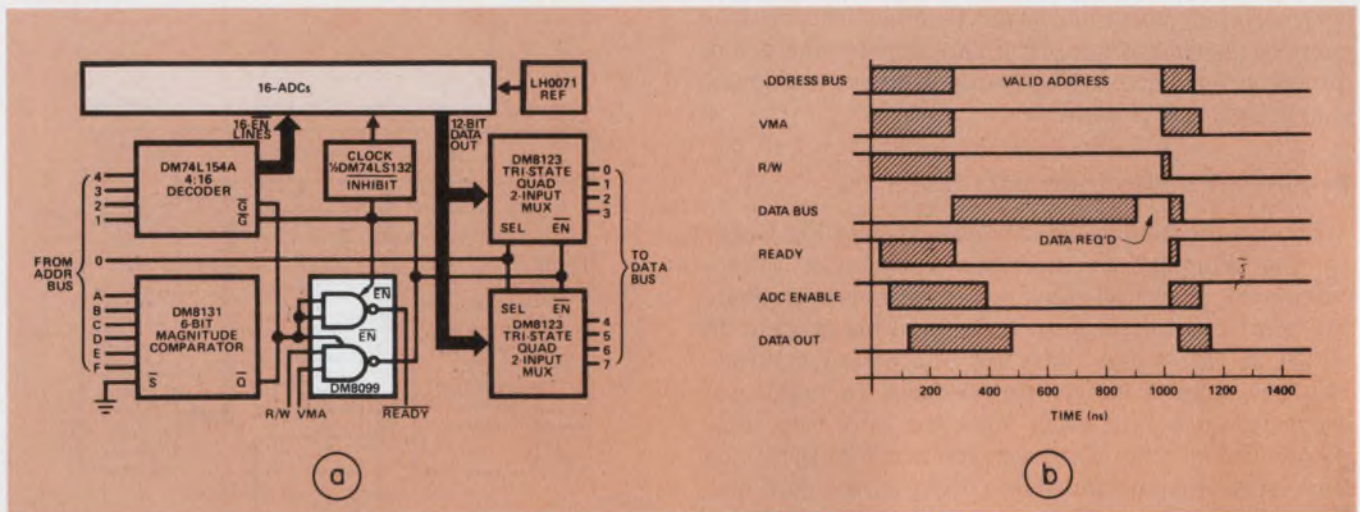

5. ANDing the VMA and R/W signals decodes a valid address in the 16-channel parallel-conversion system for the 6800 microprocessor (a). Address information, the

valid-memory-address signal, VMA, and the read/write signal, W/R, all come up together. Data are due at the data bus 100 ns before Ready changes state (b).

coding of positive or negative analog signals, the 12th bit is inverted and extended to the four remaining data lines, so that signals appear as valid data to the microprocessor.

The control timing is referenced to the 8080 timing as shown in Fig. 4b. The total circuitry for address decode, control, clock and output-drive logic is contained in six DIPs. To complete this 8080-compatible, parallel-conversion system, a code-select header, a reference and 16 converters are needed. The system consumes 4.2 W and provides 16 channels of 12-bit data from ± 5 -V, 10-Hz bandwidth, analog, input signals. Limiting the output-drive capability to only low-power TTL reduces the power drain by 370 mW. Total cost of the parts runs to about \$16 plus about \$25 for each a/d converter.

Similar logic ties in most micros

For systems feeding most other microcomputers the logic changes only slightly. Fig. 5a details the logic section of the acquisition system of Fig. 4a, modified to interface with the 6800 microprocessor. The 6800 timing and control signals are shown in Fig. 5b. In the 6800, the address, the Valid Memory Address (VMA) signal and the Read/Write (R/W) signal all appear almost simultaneously and remain active for at least 1 μ s. The data need not be on the data bus until the final 100 ns.

The valid address is decoded by ANDing the VMA and R/W signals in a three-state two-input gate. When enabled by the comparator output, this gate returns a Ready signal to the processor and also enables the output multiplexers. As with the 8080 system, the address LSB selects the appropriate data byte. Delays in disabling the output multiplexers and the a/d converter provide the required 10-ns data-hold time. The rest of the system is the same as in Fig. 4a. The cost and power required in this 6800-based system are

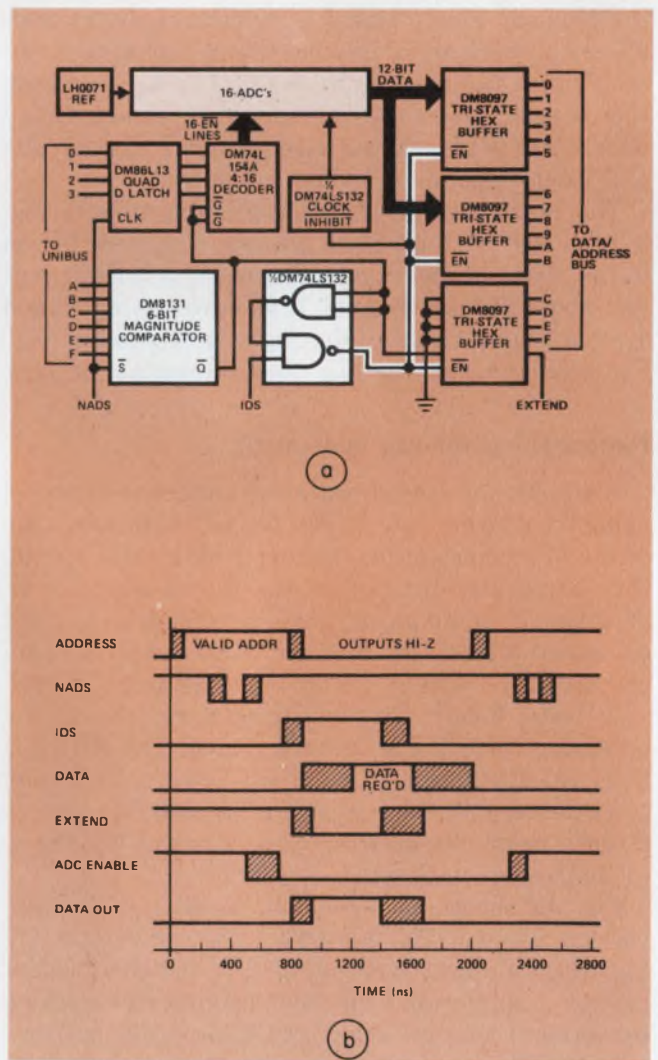

6. The comparator output ANDed with IDS enables the three-state output buffers and inhibits the clock in the 16-channel, 12-bit, parallel-conversion system for the PACE (a). Data are put on the PACE's Data/Address bus about 500 ns after the IDS signal comes up.

close to those for the 8080-based system.

Fig. 6a shows the logic section of the system of Fig. 4a modified to interface with a PACE microcomputer. The PACE timing is shown in Fig. 6b. Since the PACE μ C has but a single bus for both address and data, address decoding requires latches. These latches are included on PACE CPU cards, but when using just the PACE chip, latches must be added to the system as needed. The address comparator used in this system (DM8131) contains output latches, but the 4-to-16-decoder (DM74L154A) does not, so a quad latch is inserted ahead of the decoder.

The latches set on the rising edge of the NADS signal which comes from PACE when the bus has address information. The latches reset on the next NADS signal. The comparator output then gates the decoder and so provides an Enable ADC signal that lasts until the falling edge of the next NADS pulse. The IDS signal, ANDed with the comparator output, enables the three-state output buffers and inhibits the clock.

An additional MSB inverter is needed for positive and negative analog signals to provide the two's complement code. All the circuitry for address decode, control, clock, and output drive is contained in seven DIPs—one more than required for the 8080 system interface. Total power and cost are comparable to those for the 8080-based system.

Three-state latches are a must

The a/d converter for a parallel-conversion system must contain three-state output-data latches. Otherwise, it can be a conventional type. Several 8-bit a/d converters, intended to connect directly to a data bus, contain the necessary output latches.

To be ideal for an 8-bit parallel-conversion system, a converter should be of the tracking variety, with ZERO the true state for its Enable and ONE true for the binary outputs. But, data polarity isn't very important because most systems need bus drivers and these can be either inverting or noninverting. On the other hand, matching the polarity of the Enable with the decoder output can save 16 inverters.

For this parallel-conversion data system the data bandwidth is limited to about 10 Hz for 8-bit SAR converters. It can be increased to 150 or 300 Hz with 8-bit tracking converters. For 12-bit systems the data bandwidth is 1/16 that of 8-bit systems. On the other hand, no s/h module is required. Data rates can be considerably increased with s/h modules added to each channel; but costs per channel would more than double. For use with s/h modules, SAR converters are faster than tracking types, allowing data bandwidths of over 600 Hz per channel for 12-bit data.

MUXed system with memory outputs fast

A multiplexed data-acquisition system containing memory is probably the most cost-effective way of providing an immediate data-access interface to processors. To obtain data, the processor addresses the

peripheral data-acquisition system, without entering a Wait mode, just as if it were accessing main memory. Latest valid data are always present within the acquisition system's memory, which is updated at a rate determined by the channel-multiplexer rate and the conversion speed.

The multiplexed system with memory shown in Fig. 1c takes care of routinely updating its memory by sequentially sampling each data channel, digitizing the channel signals, and writing data into its self-contained memory. When the system is interrogated, the sequential process is momentarily interrupted, the RAMs are addressed by the processor, and data are read out to the data bus. The memory can be implemented with three 16 \times 4-bit RAMs.

The microcomputer interfaces shown in Figs. 7a and 7b are similar to that of Fig. 2. The PACE interface is slightly less complex than that of Fig. 7a for 8-bit data-bus machines. A single card with plug-in or strap options could interface any of the three micros con-

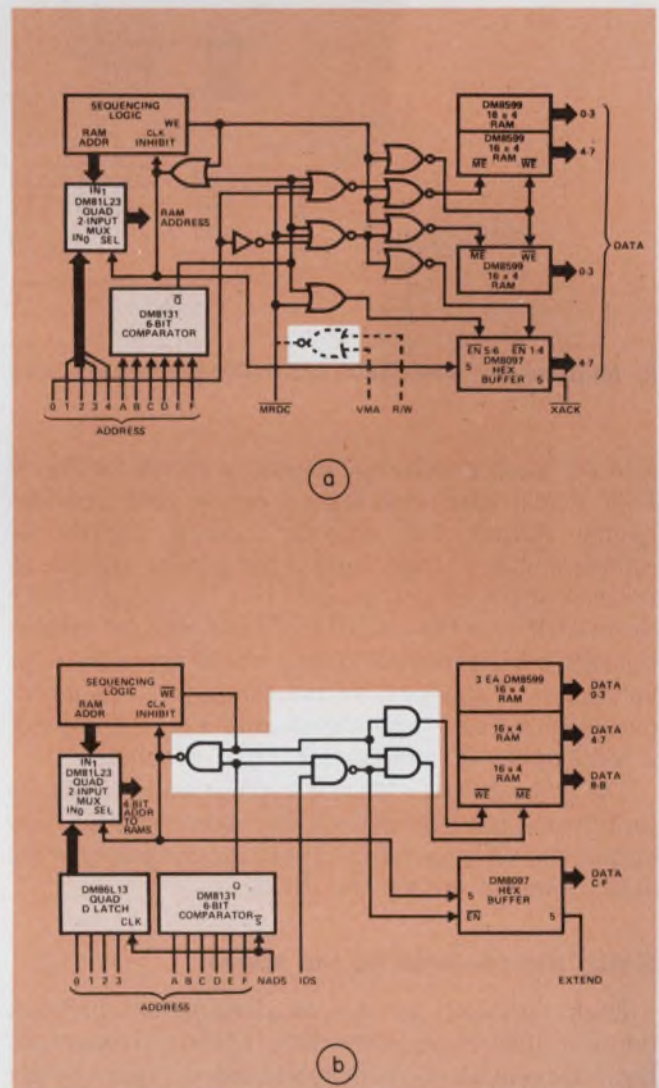

7. The address comparator and control for the multiplexed system with memory for the 8080 and 6800 microprocessors (a) only differ by a NOR gate. Logic for the PACE-based system (b) is the simplest.

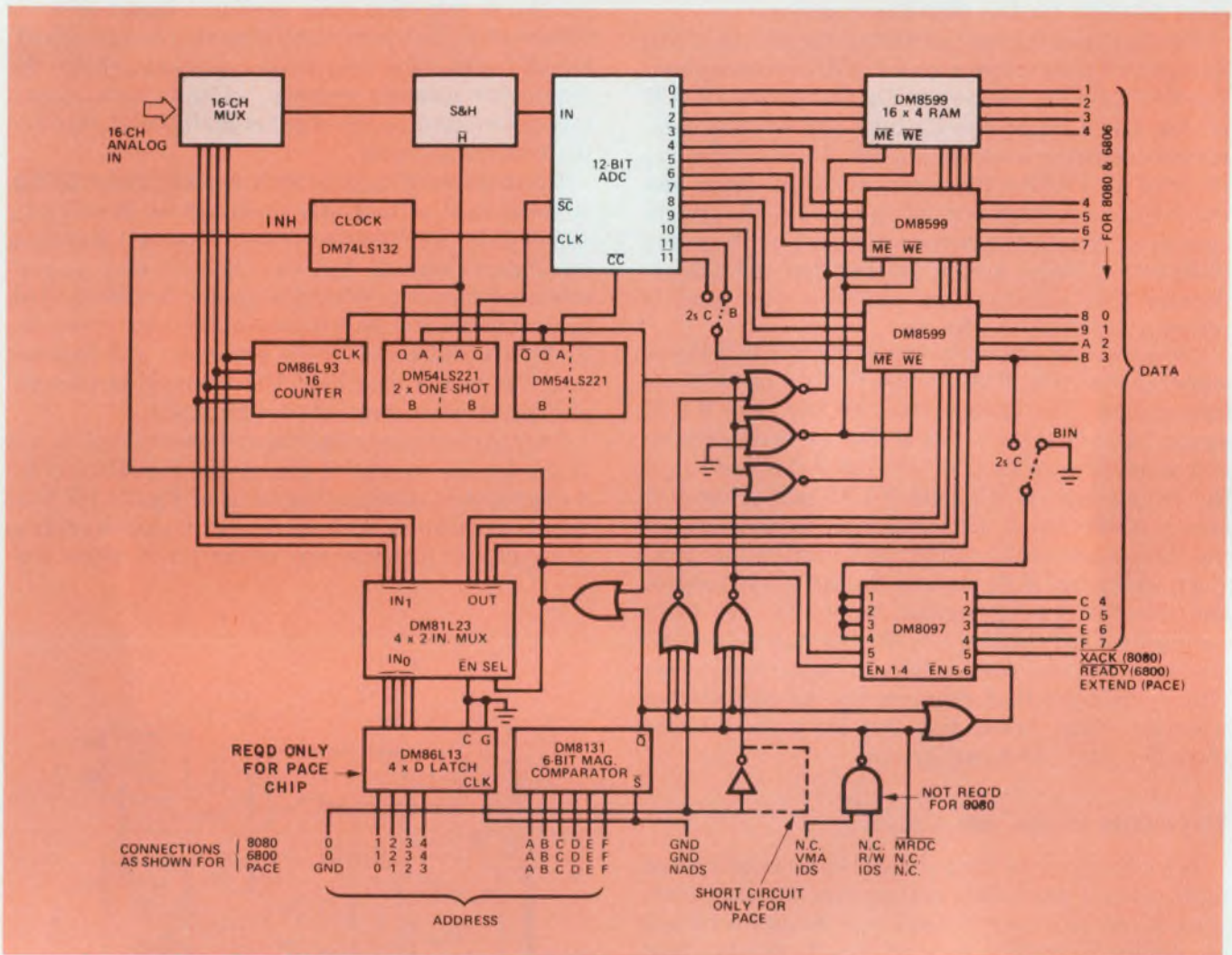

8. All three μ Ps (8080, 6800 and PACE) are served by this 16-channel, 12-bit, multiplexed system with memory.

sidered. Such a universal circuit is shown in Fig. 8. This circuit also includes an option that provides binary output for unipolar analog signals or complementary-binary output for bipolar signals. In the case of binary output, data bits 13 through 16 are set to ZERO. In the case of two's complement binary, the sign bit is extended to data bits 13 through 16 for validation of the sign by the computer. The multiplexed immediate-access system of Fig. 8 dissipates a total of 3.5 W and costs \$11 per channel.

The a/d converter for this application is similar to that for the conventional system except that the data output should be complemented to compensate for the data inversion within the RAMs.

Match the converter to the system

Each approach to the data-acquisition problem requires different characteristics of the a/d converter. Both sequential or random-addressed types require similar converters. If the random-addressed system includes bus drivers, the converter is identical to that for the system with memory. Only the parallel-conversion type must contain buffered three-state

output latches to hold each converter's data.

It is desirable that the a/d converter for parallel conversion also have the other characteristics listed in the table.

The first two items (three-state output latches and TTL control and data signals) are by far the most important.

TTL-compatible control and data signals are desirable so that TTL-to-MOS and MOS-to-TTL interface buffers are not required between the a/d converter and the rest of the system. Dual-output strobing allows wire-ORing the interface directly to an 8-bit data bus, or using only an 8-line buffer without output multiplexers as shown in Fig. 2. However, a separate buffer is required in most systems. Tracking operation provides higher speed for a conversion circuit without an s/h. Inhibiting data transfer into the output-data latches, when the output is enabled, prevents reading changing data. An external gate can perform this inhibit function but it's easier if the converter does the job. Straight-binary output is preferred for all microprocessor interfaces (except the 8080 when it operates with Intel's system-bus drivers and receivers). It may be necessary to add

Desired a/d converter characteristics for data-acquisition systems

	Parallel conversion	Sequential with memory	Addressed without memory
Buffered three-state output data latches	X		?
TTL-compatible control & data signals	X	X	X
Dual output-enable (Bits 0-7 & Bits 8-11)	X		X
Counter logic	UP/DN	SAR	SAR
Internal comparator	X	X	X
Both Q & \bar{Q} outputs on MSB	X	X	X
Binary output polarity	Data*	Data	Data*
Busy output (three-state w/enable)	?		X
Internal clock		X	X
Continuous recycle when CC = SC	X		
Inhibit data XFR to latches when enabled	X		

*Unimportant if Bus drivers used.

three-state line drivers to drive the data bus; so data can be complemented with inverting buffers, when required. Having both the MSB and its inverse MSB simplifies data readout in binary or two's complement without adding an external inverter. The table shows a/d converter characteristics in approximate order of importance for parallel-conversion systems; the order is different for multiplexed-data systems.

More converters are coming

Several monolithic a/d converters of 8 to 12-bits have been announced. Some have three-state output latches. These monolithic converters and future versions of them promise to bring converter prices down to a level which will make parallel conversion economically feasible. Several hybrid converters also have been announced with attractive prices; however, it is the monolithics that promise the lowest ultimate cost.

In the future, an a/d converter most suited for parallel-conversion might appear as in Fig. 9a. This design meets all the goals set forth in the table. It could run at a clock rate of 0.25 to 1 MHz (1 to 4- μ s conversion time) because it is a tracking converter. It should contain three-state, buffered, output-data latches and separate High and Low Bit-Enable lines allow two-byte operation of an 8-bit data bus; the output latches should not change state when the output is enabled; and the \overline{CC} and \overline{SC} terminals should be strappable for continuous conversion.

An 8 or 10-bit converter and possibly a 12-bit converter of this type might be built on a single chip. A hybrid or two-chip design is certainly practical. Where speed is not of importance, monolithic 10 or 12-bit converters can be built with integrating or voltage-to-frequency conversion techniques. The integrating technique seems to provide highest accuracy with the least circuitry, and therefore is a prime contender. Because the integrating a/d converter

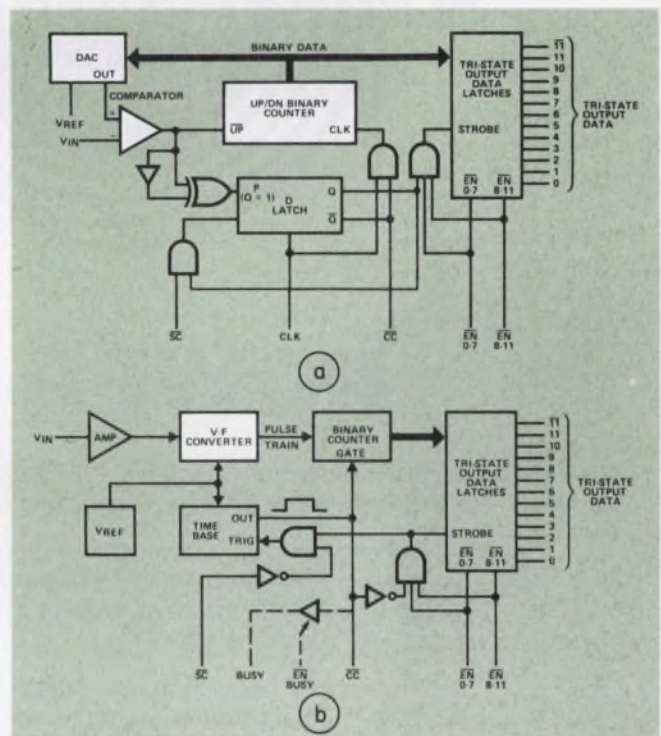

9. Simple a/d converters for parallel-conversion systems can be made with either tracking (a) or voltage-to-frequency (b) converters.

consists of both linear and digital circuits, it is normally multichip. However, as technology advances, it will become increasingly practical to produce, on a single chip, the low-drift low-offset amplifiers, integrators, and current sources required in a 12-bit a/d converter, along with the necessary logic. A two-chip approach is the likely choice now. ■■

Reference

- Schmid, H. and Mrozowski, G., "Mating Microprocessors with Converters," *Electronic Design*, Sept. 1, 1975, p. 76.

COMING IN



POWER SUPPLIES

The 8th in *Electronic Design's* 1977 series of award-winning FOCUS reports is scheduled for the September 27 issue. The Topic: Multiple-output DC Power Supplies.

There is growing interest in power supplies that deliver more than one voltage. These units have all the problems of ordinary power supplies, plus special ones of their own. The report will help engineer-readers avoid pitfalls in specification, application and use. It will look at questions like:

- *Why should you select one supplier over another?*
- *What special features do companies offer in their products?*
- *How do they obtain these features?*
- *What specs are deceptive, ambiguous or omitted?*
- *Where is confusion most apt to occur?*
- *How do you select a power supply most appropriate to your needs?*

As usual, the FOCUS will dig beneath the surface to tell it like it is.

Don't miss this report, it's one you will want to read and keep.

FOCUS ON MULTIPLE-OUTPUT DC POWER SUPPLIES

**ANOTHER REASON ELECTRONIC DESIGN IS THE BEST
READ ELECTRONICS PUBLICATION IN THE WORLD.**

Our R-10 series Relays will switch you 7 ways to Sunday.

Giving you more design options
than any other relay.

It's about as close as one relay can get to being all things to all designs. The R10 series.

A compact, reliable multipole relay, the R10 is specified for a wide variety of critical applications. Business machines, computer peripherals, copiers, communications equipment, precision instruments and more.

Consider these options that are available with the R10. Ratings from dry circuit to 10 amperes. Contact arrangements to 8PDT. Six styles of contacts including bifurcated types. Sockets with solder or printed circuit terminals, including one for mounting the relay parallel to a printed circuit board. All with or without grounding provision.

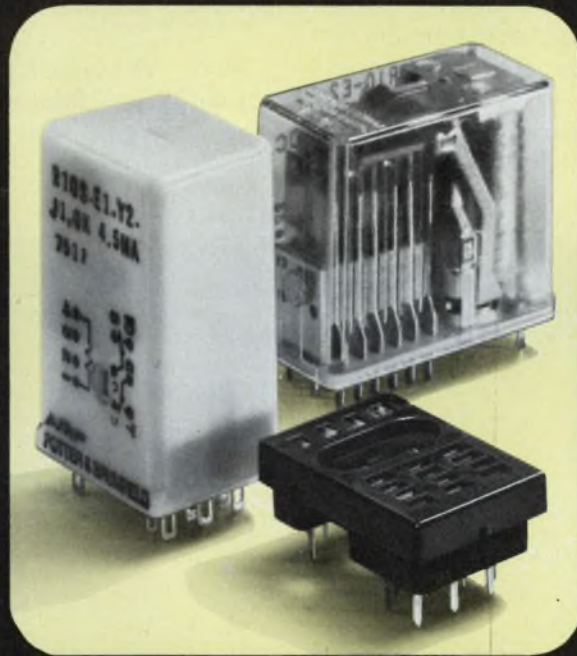

Mechanical life expectancy of the R10 is to 100 million operations—except W contacts, 1 million—and is available with a voltage or current-sensitive coil. It weighs, depending on the number of contacts, from 22 to 40 grams. Pickup ranges from 2.25 to 86 VDC, 5 to 86 VAC, or 0.6 to 45 milliamp with proper power supply.

Design options by the dozen, all from a single relay. The R10. It's in stock now at your distributor. Call your P&B Representative or write to us

direct for a copy of our latest catalog, Potter & Brumfield Division of AMF Incorporated, 200 Richland Creek Drive, Princeton, Indiana 47671. 812/386-1000.

AMF
Potter & Brumfield

Potter & Brumfield

CIRCLE NUMBER 52

Ideas for design

Control the speed and phase of a dc motor by comparison against a control frequency

The speed and phase position of a small dc motor can be controlled with a Norton op amp operating as a frequency comparator. The op amp amplifies the difference between two frequencies:

$$V_0 = K (f_2 - f_1),$$

where V_0 is the average voltage output of the op amp, K is a constant, f_2 is an input control frequency from an external source, and f_1 is a frequency derived from a chopped-light source driven by the motor (see figure).

A feedback loop from the phototransistor, Q_3 , via monostable IC_2 feeds f_1 to the inverting input of an LM3900 Norton op amp. When the speed of the motor is slow, the comparator output is a high (greater than 50%) duty-cycle signal. As a result, transistors Q_1 and Q_2 stay on proportionately longer and produce a high average voltage, which increases the motor's speed. With the control frequency, f_2 , slower than f_1 produced by the motor speed, the comparator produces a lower average voltage.

The phase between the motor speed and the control input is based on monostable IC_3 's duty cycle and can

be varied between the leading and trailing edges of the control-input signal by adjusting R_7 . A phase lock within $\pm 250 \mu s$ can be achieved. And varying potentiometer R_1 allows a wide range of speeds—240 to 3600 rpm—for the motor as f_1 and f_2 vary between 4 and 60 Hz.

Diode D_2 minimizes voltage transients from the motor, and Q_2 should have a heat sink to correspond to the size of the motor. The motor's voltage supply should exceed the maximum motor needs by 2 V to allow for Q_2 's saturation drop.

An opaque 3-in. disc with eight small holes evenly spaced along its edge is mounted on the motor's shaft. The disc chops a light beam into pulses to represent the motor's speed. A phototransistor, Q_3 , and a type-47 light bulb, aligned on opposite sides of the holes, generates the pulses.

Mike Yakymyshyn, Edmonton Telephones, 10405-104 Ave., Edmonton, Alberta, Canada T5J-OK7.

CIRCLE NO. 311

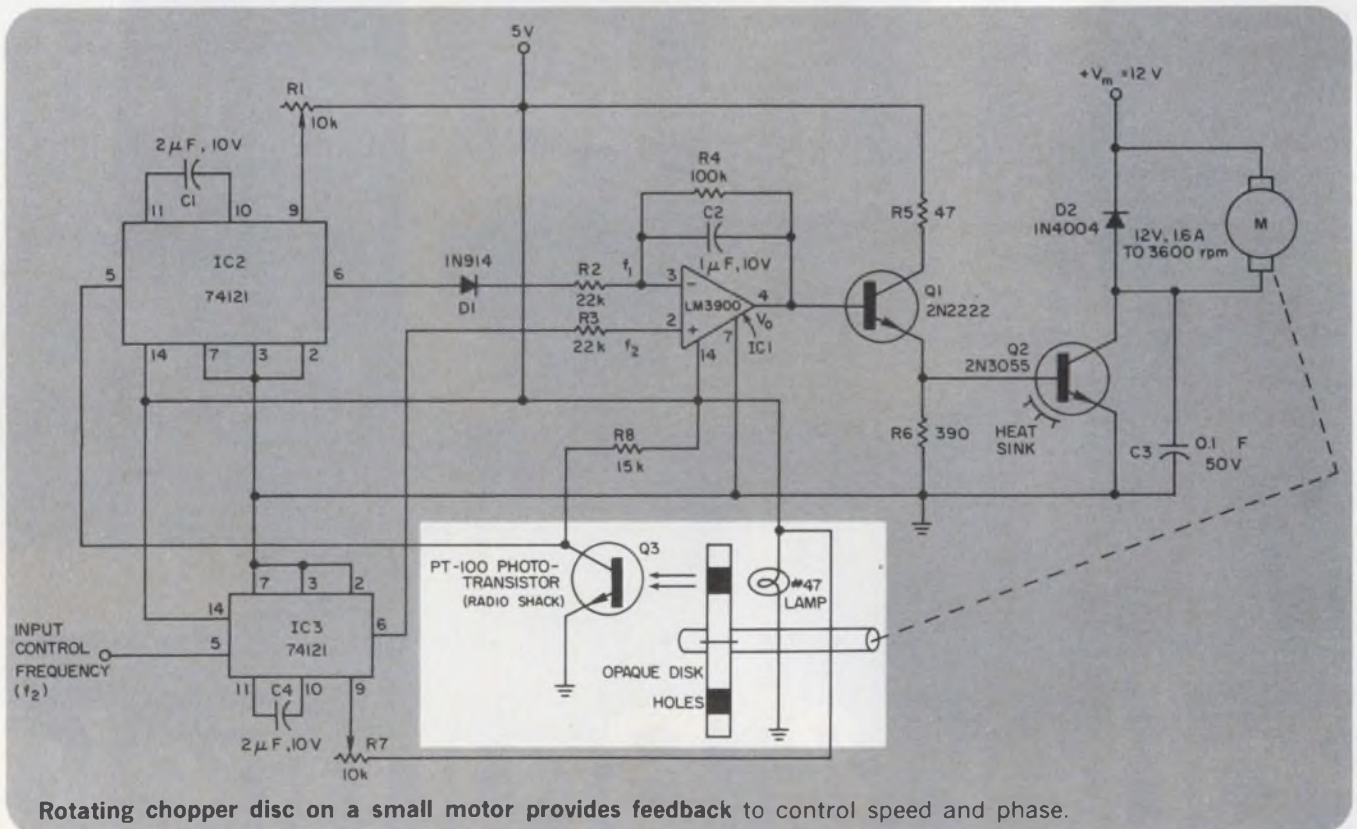

Rotating chopper disc on a small motor provides feedback to control speed and phase.

If you need
top-quality
panel
instruments
 with a clean,
 modern look...

Buy
Triplett's
 Series GL
 or GL/B

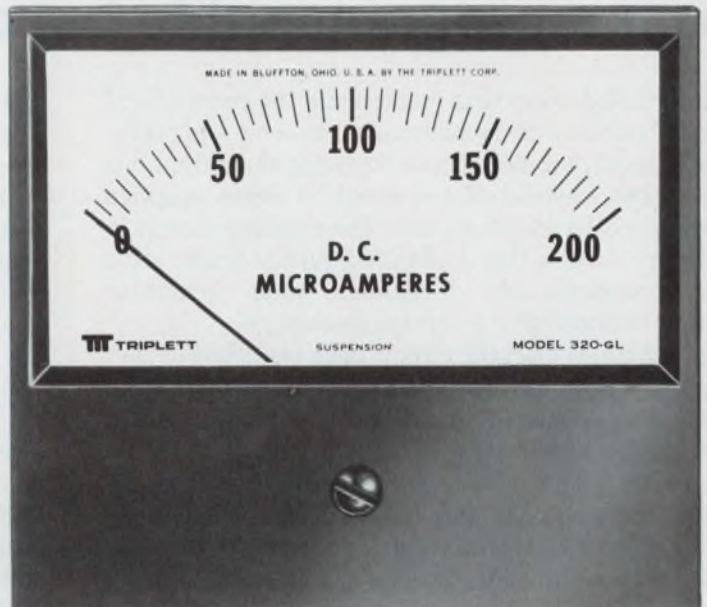

GL



GL/B (mounted appearance)

Triplet's newest panel instruments, the Series GL and GL/B, feature glass windows, matte-finish phenolic cases and a dial design that can readily accommodate multiple scales. They are available in 3½", 4½" and 5½" sizes.

The GL Series features a standard 2-stud mount with 3- and 4-stud mounts available.

The feature of the GL/B Series is behind-the-panel mounting with a bezel which is an integral part of the case.

There's a choice of more than 275 stock sizes and ranges — in DC microammeters, milliammeters, ammeters, millivoltmeters and voltmeters; AC milliammeters, ammeters, and voltmeters; RF thermoammeters; dB meters and VU meters. For those who need special instruments . . . custom dials, pointers, scales, accuracy, tracking, resistance, response time or practically any combination of unusual specs can be put into these new cases. For quick, dependable delivery

of small quantities of these adaptable new instruments, contact your Triplet Sales/Service/Modification Center or distributor. For prototypes or production quantities, contact your Triplet representative. Triplet Corporation, Bluffton, Ohio 45817.

TRIPLETT
 BLUFFTON, OHIO 45817
 Manufacturers of the World's
 most complete line of V-O-M's

CIRCLE # 53 FOR INFORMATION

CIRCLE # 54 FOR FREE DEMONSTRATION

See them and the Triplet testers Booths 1844, 46 at WESCON

Ideas for design

Get 32 times the bit rate instead of 16 from a programmable baud generator

Some LSI devices that incorporate the functions of a UART (Universal asynchronous receiver and transmitter) require a clock input 32 times their final bit-rate output, instead of the usual 16 times supplied by standard baud generators. The clocking circuit in the figure derives this doubled frequency from a 4702 fully programmable 8-channel baud generator without increasing its crystal frequency.

The 32-times clocking circuit uses two 9LS170, 4×4 register files to store the channel-frequency selection information, which is supplied on a per-channel basis. (For clarity, the write circuitry for these devices is not shown.) The 4702's two least-significant scan-counter outputs, Q_0 and Q_1 , are the read-address inputs of the 9LS170s, A_0 and A_1 , and Q_2 provides the read enables. In addition, the Q_0 through Q_2 4702 outputs address the 9LS138 decoder.

Consider the LOW-to-HIGH transition of the 4702's clock output (CO), when its internal 3-bit scan counter changes from state 7 (HHH) to state zero (LLL): The Q_0 through Q_2 outputs of the 4702 are LOW until the next LOW-to-HIGH transition of the CO output; information for channel zero, now available at the 9LS170s' outputs, feeds the S_0 -through- S_3 bit-rate selection inputs of the 4702; and data from the output

flip-flop in the 4702, clocked by the same LOW-to-HIGH transition; appears at the Z output and also is clocked into a 9LS164 shift register.

As clocking continues and the Q_0 , Q_1 and Q_2 outputs of the 4702 change, the 9LS170 locations are read out sequentially and information is shifted into the 9LS164. After each of the eight clock transitions, a channel-7 output from Z appears at the Q_7 output of the 9LS164.

Although the 4702's Z output is 16 times the selected bit rate, the Exclusive-NOR output is 32 times the selected bit rate. As the clocking continues, each channel signal appears serially at the Q_7 output of the 9LS164 and is compared with the corresponding current-channel output by the Exclusive-NOR gate. But because of the eight-clock-pulse delay between them, each channel-output transition at Z results in two at the Exclusive-NOR output. Clearly, the Exclusive-NOR and the 9LS138 decoder operate as a transition detector and a synchronous demultiplexer.

Krishna Rallapalli, Manager of Applications Engineering, Fairchild Camera and Instrument Corp., 464 Ellis St., Mountain View, CA 94042.

CIRCLE NO. 312

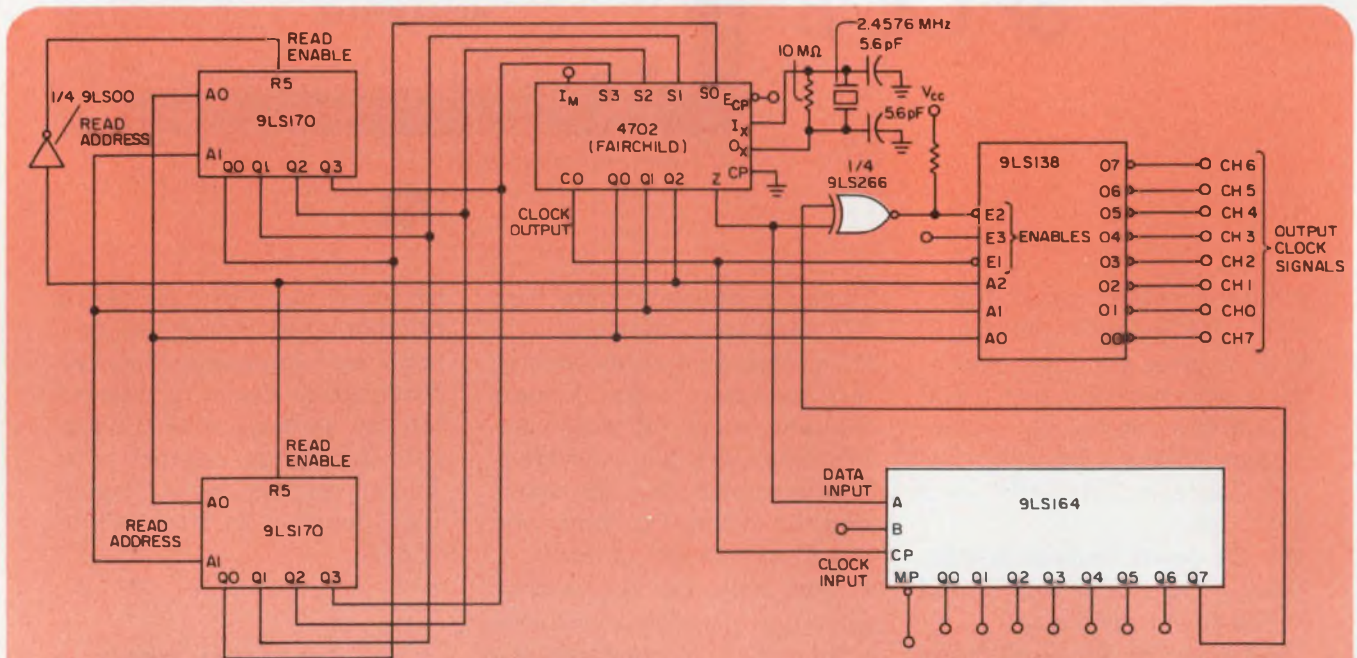

The addition of an Exclusive-NOR gate and a shift register generates 32 times the final bit rate instead of the usual 16 produced by a programmable baud

generator. And the circuit does it without doubling the crystal frequency that is fed into the 4702 generator.

Datel's 64-Channel Data Logger for Unmanned Recording

MODEL DL-2

FEATURES:

- ▶ 16-Channel analog input
- ▶ 12 Bit A/D resolution
- ▶ 12VDC battery operated
- ▶ 900 Milliwatts maximum power consumption
- ▶ True incremental recording
- ▶ 2.2 Million bit capacity
- ▶ Total Weight 2 LBS.
- ▶ Cassette Reader for computer entry
- ▶ From \$1195

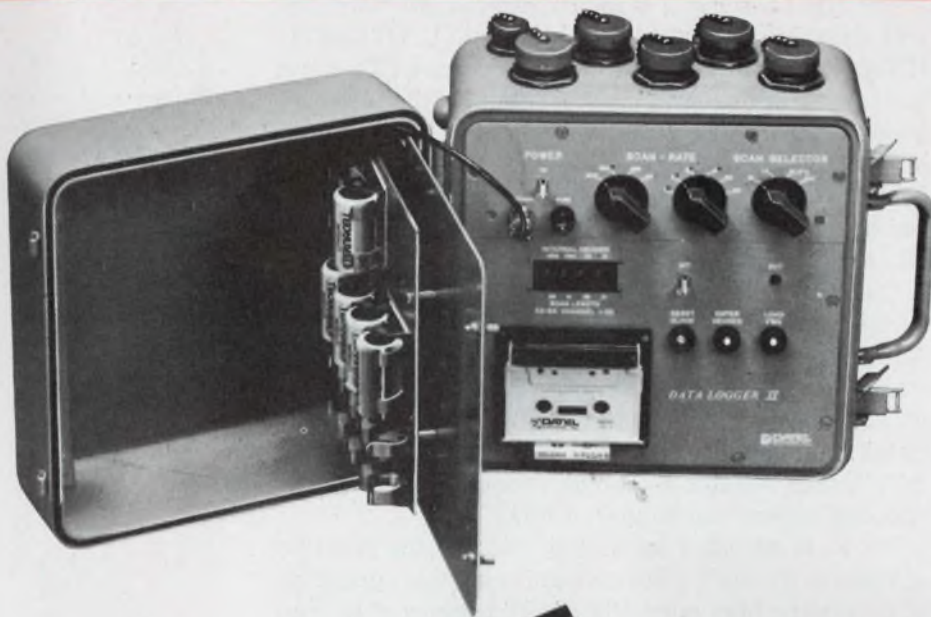

You'll find complete specifications on this product and more than 300 data conversion circuits and systems in Gold Book.

Just check Gold Book's Volume 3. That's Datel's complete Engineering Product Handbook, in its own separate volume. More than 290 pages of D/A & A/D Converters, Multiplexers, Sample-Holds, Op Amps, Power Supplies, Digital Panel Meters, and Printers, Digital Panel Instruments, Data Loggers, Digital Cassette Recorders, and Data Acquisition Systems. Each fully detailed on individual data sheets.

And it's available to you in Gold Book.

**DATEL**
SYSTEMS, INC.

1020 Turnpike St., Canton, MA 02021
Phone: (617) 828-8000



See Electronic Design's 1977-78
"GOLD BOOK"-Vol. 3, page 266

Santa Ana, CA (714) 835-2751, (L.A. Exchange) (213) 933-7256 • Sunnyvale, CA (408) 733-2424 • Gaithersburg, MD (301) 840-9490
OVERSEAS: DATEL (UK) LTD—TEL: ANDOVER (0264) 51055 • DATEL SYSTEMS SARL 620-06-74 • DATELEK SYSTEMS GmbH (089) 78-40-45

CIRCLE NUMBER 55

Logic interfacing circuit translates many levels to TTL regardless of polarity

The circuit in Fig. 1 is an instrument interface that will allow almost any logic system—TTL, DTL, RTL, HNIL, ECL or any voltage CMOS—to drive TTL-input instrumentation. And this is done without worry about polarity. The circuit responds to input signals of 1 to 15 V without the need of level adjustment or polarity selection. Moreover, the input impedance of the basic circuit (Fig. 1a) to signals below 5 V is 1 M Ω shunted by only a few picofarads.

Dual FET Q_1 is a dc source follower that presents a high input impedance to the interfaced logic circuit. An input-standardizing trimmer capacitor, C_2 , can be added to allow connection of a 10 \times scope probe for no-load observation of 10-to-15-V CMOS logic. Resistor R_2 and diodes D_1 and D_2 clip input voltages over ± 5.5 V, but resistor R_2 is high enough in value so the clipping action won't upset CMOS logic.

Pot R_4 is adjusted for zero dc volts at the junction of resistor R_3 and R_5 . Positive-going signals appearing at this point bias normally cutoff transistor Q_2 into conduction, driving the normally high input of the TTL gate low. Similarly, negative-going signals bias normally cutoff transistor Q_1 into conduction. This drops the gate bias of FET Q_4 to near zero. The resulting low drain-source resistance also allows the TTL input to go low.

Biasing via the scheme shown in Fig. 1b greatly increases the sensitivity of the circuit at the cost of three additional parts—diodes D_3 , D_4 and D_5 . Diode D_3 reduces the required trigger voltage to only 0.4 V, allowing the use of a 10 \times scope probe on 5-V CMOS. Shunt diodes D_4 and D_5 protect the base-emitter junctions of Q_2 and Q_3 from reverse breakdown.

The basic circuit can even be used as a frequency doubler under certain circumstances. Because of the auto-polarity feature, the circuit will respond in both directions to signals symmetrically disposed about ground, and produce a pulse output at twice the incoming rep rate. However, unlike many digital frequency doublers, the width of the output pulses is roughly proportional to period.

Doubling will not occur with unidirectional logic. However, for maximum versatility, a switch can be installed at the input to the TTL gate to select positive logic only, negative logic only or both (Fig. 1c).

M. J. Salvatti, Engineer, Sony Corp., 47-47 Van Dam St., Long Island City, NY 11101. CIRCLE NO. 313

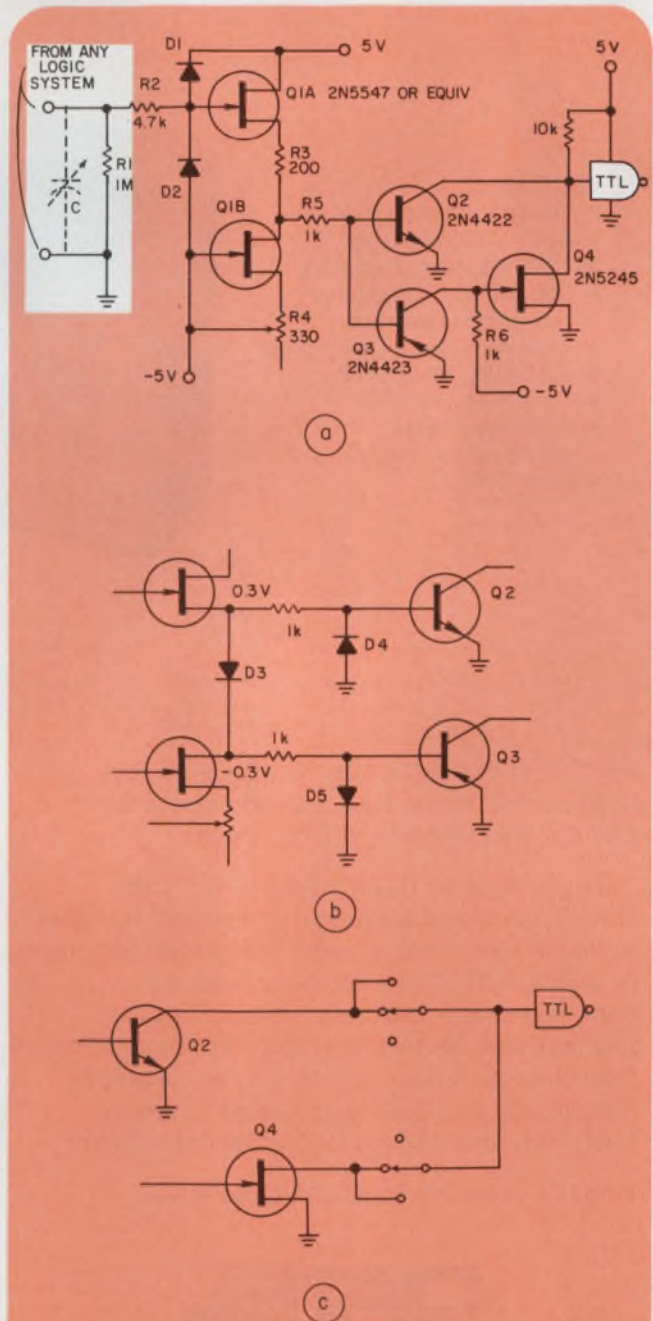

1. The basic level-converting circuit (a) can couple a wide range of logic families of either voltage polarity to TTL. The 1-to-15-V range of the basic circuit is extended down to 0.4 V with the addition of three diodes (b) and an optional switch can be added to make the circuit polarity-sensitive (c).

Datel's Miniature 16-Channel Data Acquisition Module

MODEL MDAS-16

- 16 Channels Single Ended or 8 Channels Differential
- 12 Bits Resolution
- 50 kHz Throughput Rate
- Tri-State Outputs
- Low Cost — \$295
- Miniature Size

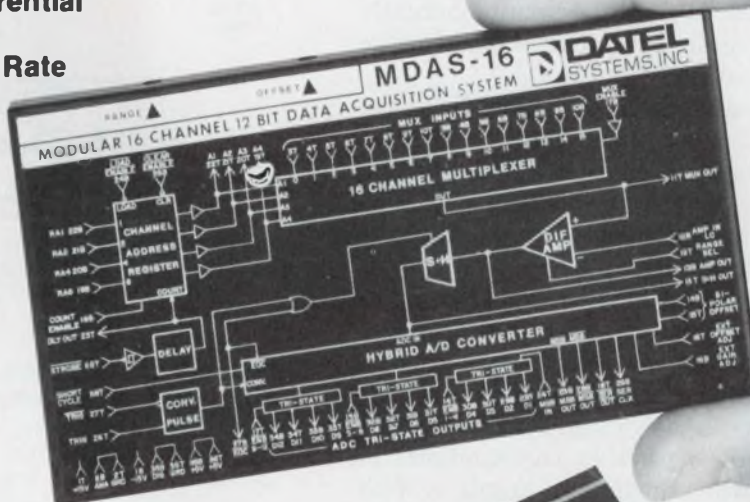

You'll find complete specifications on this product and more than 300 data conversion circuits and systems in Gold Book.

Just check Gold Book's Volume 3. That's Datel's complete Engineering Product Handbook, in its own separate volume. More than 290 pages of D/A & A/D Converters, Multiplexers, Sample-Holds, Op Amps, Power Supplies, Digital Panel Meters, and Printers, Digital Panel Instruments, Data Loggers, Digital Cassette Recorders, and Data Acquisition Systems. Each fully detailed on individual data sheets. And it's available to you in Gold Book.

COVERED BY GSA CONTRACT

D **DATTEL**
SYSTEMS, INC.

1020 Turnpike St., Canton, MA 02021
Phone: (617) 828-8000

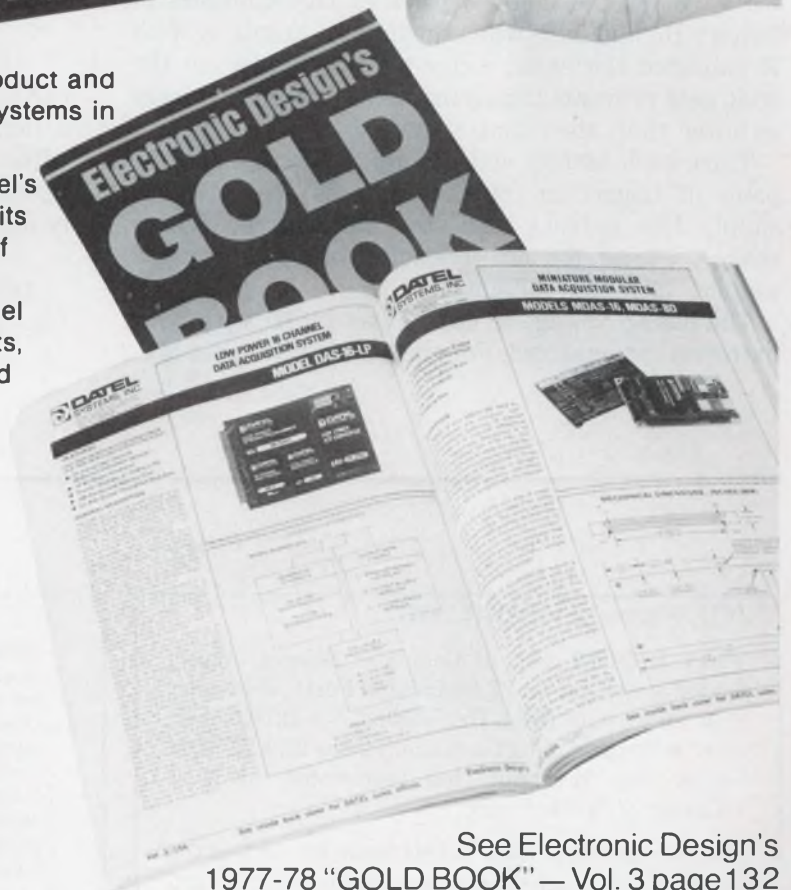

See Electronic Design's
1977-78 "GOLD BOOK" — Vol. 3 page 132

Santa Ana, CA (714) 835-2751, (L.A. Exchange) (213) 933-7256 • Sunnyvale, CA (408) 733-2424 • Gaithersburg, MD (301) 840-9490
OVERSEAS: DATTEL (UK) LTD — TEL: ANDOVER (0264) 51055 • DATTEL SYSTEMS SARL 620-06-74 • DATELEK SYSTEMS GmbH (089) 78-40-45

CIRCLE NUMBER 56

Ideas for design

Float charger independently recharges two lead-acid cells connected in series

The deceptively simple circuit in the figure can simultaneously float-charge two series-connected sealed lead-acid batteries, with only one adjustable float voltage. As an added bonus, the circuit inherently compensates for the required variation of float voltage with ambient temperature.

When two rechargeable batteries—especially sealed lead-acid—are wired in series and have different capacities, or have been discharged to an unequal degree, you ordinarily use a separate charger for each battery. However, this float-charger circuit can do as good a job as two chargers.

The values shown are for a series combination of two 6-V, 1.2 A-h batteries, but they can be scaled to other batteries. With R_4 fully counterclockwise, Q_1 doesn't conduct and the triac can trigger each time the input voltage exceeds the voltage at MT_1 by about 1.5 V. When the input is positive, current flows in battery B_1 , and in B_2 when the input is negative. With R_4 adjusted clockwise, a clamp level produced at the triac gate prevents triggering, unless the MT_1 voltage is lower than the clamp voltage by about 1 V.

Thus, each battery charges independently, and the point of triggering for each retards separately to supply less current until the batteries no longer charge, except for an occasional burst to boost a sagging terminal voltage.

The clamp voltage at MT_1 is set by R_4 with both batteries disconnected. For the 6-V batteries, set MT_1

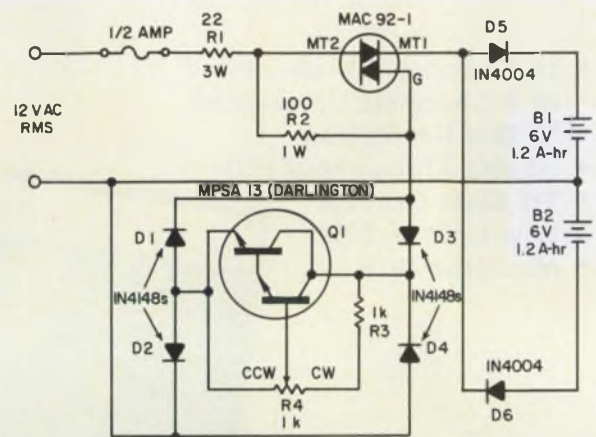

Battery-charger circuit charges two series-connected batteries independently with only one voltage-level adjustment, R_4 . Moreover, the circuit's temperature coefficient automatically adjusts for proper charging as the temperature changes.

to 8.8 V (17.6-V pk-pk clipped sine wave), which yields a float voltage of 7 V. For best results make the adjustments at 25 C. The float voltage will then vary with temperature by about $-15 \text{ mV}/^\circ\text{C}$ and effectively match the charge voltage needed by the battery.

Arnold Frisch, VP/Engineering, Zygo Industries, Inc., P.O. Box 1008, Portland, OR 97207.

CIRCLE NO. 314

IFD Winner of April 12, 1977

Terry Dollhoff, Dir. of Computer Science, Acuity Systems, Reston, VA 22090 and **Jim Ferry**, President, Ross Corp., 9218 Brian Dr., Vienna, VA 22180. Their idea "A Programming Controller for the 2708 EPROM Copies Data In-circuit" has been voted the Most Valuable of Issue Award.

Vote for the Best Idea in this issue by circling the number of your selection on the Reader Service Card at the back of this issue.

SEND US YOUR IDEAS FOR DESIGN. You may win a grand total of \$1050 (cash)! Here's how. Submit your IFD describing a new or important circuit or design technique, the clever use of a new component or test equipment, packaging tips, cost-saving ideas to our Ideas for Design editor. Ideas can only be considered for publication if they are submitted exclusively to ELECTRONIC DESIGN. You will receive \$20 for each published idea, \$30 more if it is voted best of issue by our readers. The best-of-issue winners become eligible for the Idea of the Year award of \$1000.

Datel's Monolithic Integrating Analog to Digital Converters

ADC-EK SERIES

FEATURES

- ▶ Monolithic CMOS
- ▶ Binary or BCD Models
- ▶ 20mW Power Consumption
- ▶ To 12 Bit Accuracy
- ▶ No Missing Codes
- ▶ Priced from \$11.50

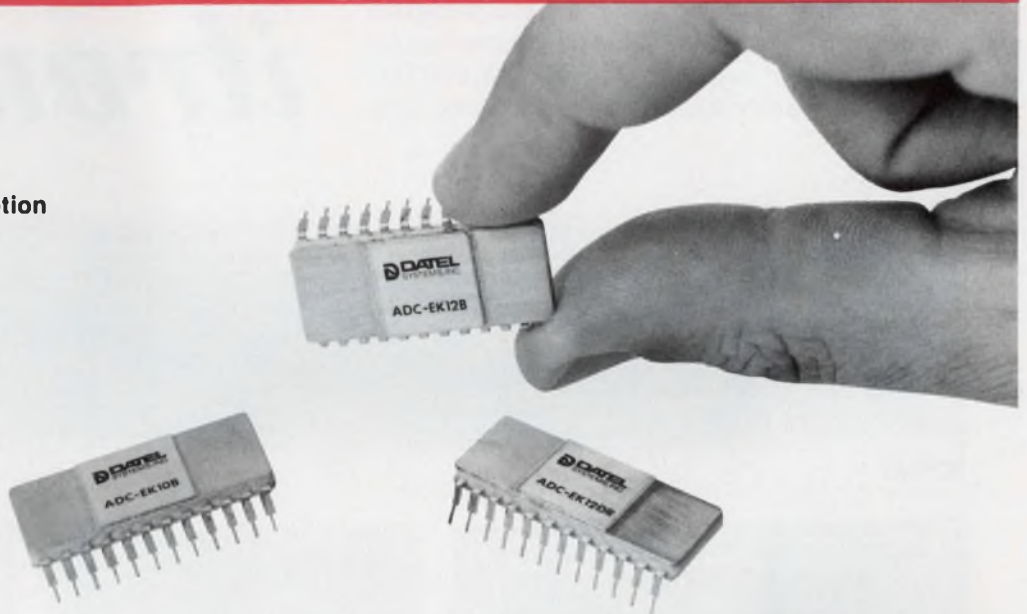

You'll find complete specifications on this product and more than 300 data conversion circuits and systems in Gold Book.

Just check Gold Book's Volume 3. That's Datel's complete Engineering Product Handbook, in its own separate volume. More than 290 pages of D/A & A/D Converters, Multiplexers, Sample-Holds, Op Amps, Power Supplies, Digital Panel Meters, and Printers, Digital Panel Instruments, Data Loggers, Digital Cassette Recorders, and Data Acquisition Systems. Each fully detailed on individual data sheets.

And it's available to you in Gold Book.



DATEL
SYSTEMS, INC.

1020 Turnpike St., Canton, MA 02021
Phone: (617) 828-8000

See Electronic Design's 1977-78
"GOLD BOOK"-Vol. 3, page 30

Santa Ana, CA (714) 835-2751, (L.A. Exchange) (213) 933-7256 • Sunnyvale, CA (408) 733-2424 • Gaithersburg, MD (301) 840-9490
OVERSEAS: DATEL (UK) LTD-TEL: ANDOVER (0264) 51055 • DATEL SYSTEMS SARL 620-06-74 • DATELEK SYSTEMS GmbH (089) 78-40-45

CIRCLE NUMBER 57

Same great name. Same great color.
And now a neat new way to definitive display performance.

DOT MATRIX

Consider the new Noritake-Ise dot-matrix line-up—
 9, 10, 16, 20 and 40-character line displays.
 Variety aimed at giving you more design potential.
 Or consider our unique 400-dot graphics display
 with 17m/m depth and low 35V drive rating.
 It's aimed at helping you think low voltage,
 portability and economy all at the same time.

In short, consider Noritake-Ise period
 for dot matrix (or segmental) displays.
 Itrons always help you design more competitively.

itron[®]



DC209A2
 Dimension: 41(H) x 208(W) x 10.5(D)mm Character Size: 9.0(H) x 6.3(W)mm



DM400A1
 Dimension: 114(H) x 130(W) x 17(D)mm



DC95A2
 Dimension: 24(H) x 75(W) x 7.2(D)mm
 Character Size: 5.05(H) x 3.55(W)mm



FG48D6
 Dimension: 25.5(H) x 56.5(W) x 7(D)mm
 Character Size: 8.0(H) x 4.2(W)mm



FG120S1
 Dimension: 39(H) x 138(W) x 12.5(D)mm

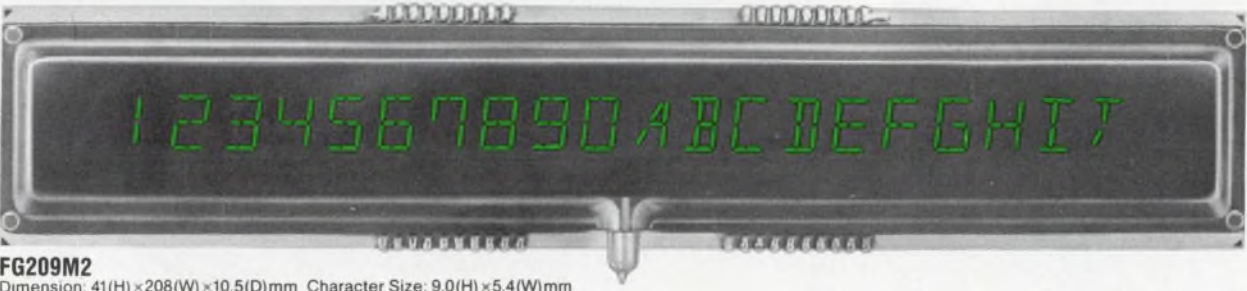

FG209M2
 Dimension: 41(H) x 208(W) x 10.5(D)mm Character Size: 9.0(H) x 5.4(W)mm

NORITAKE CO., LTD.

Electronics Division
 1-1, Noritake-Shinmachi
 Nishi-ku Nagoya-Shi
 Japan
 Phone: NAGOYA
 (052) 561-7111
 Telex: J59738 NORITAKE

Electronics Office (U.S.A.)
 22410 Hawthorne Blvd
 Torrance California 90505
 U.S.A.
 Phone: (213) 373-6704
 Telex: 230674910

F.R. Germany
 NEUMULLER GmbH B
 München 2
 Karlstrasse 55.
 F.R. Germany
 Phone: 089 (599) 1230
 Telex: 522106

U.K.
 ITT Component Service
 Edinburgh Way Harlow,
 Essex, U.K.
 Phone: 0279-3351
 Telex: 81146

Europavia France
 5-Avenue Leon Harmel 92167
 Antony Cedex, France
 Phone: 666 21-10
 Telex: 42204381

Hong Kong
 Room 1403 Shing Loon Bldg
 24-26 Stanley Street, Hong Kong
 Phone: 5-232420 Telex: HX83151
 Taipei
 72-9 SEC 2 JEN AI RD Taipei
 Phone: 351-0293 Telex: 11176

Manufacturer:
ISE ELECTRONICS CORP.
 P.O. Box 46, Ise-shi,
 Mie-Pref., Japan
 Phone: (0596) 39-1111
 Telex: 4969523

BCL devices faster, use less power than ECLs

With a new kind of subnanosecond logic called "base-coupled logic" (BCL), logic devices developed for future digital telecommunications systems promise more than 1-Gbit/s bit rates. And more.

Composed of base-coupled current-mode switches and emitter followers, the BCL elements use a 2.2-V supply, which is lower than that for ECL. In fact, BCL elements dissipate less power and have propagation delays, rise times and fall times of about 300 ps.

Fabricated by Siemens of West Germany, the BCL devices beat ECL elements further by having negligible Miller capacitance and using only one temperature-sensitive base-emitter junction in series with the supply line.

In the basic BCL gate structure, Q_1 and Q_2 form a current mode switch (see Fig. 1). The gate input is applied to the base of one of the emitter followers (Q_3). Two complementary outputs are available from the collectors of Q_1 and Q_2 . The current source, I_B , is provided to prevent saturation, which would reduce switching speeds.

The switching curves for the BCL logic-gate inverter (Fig. 1) are shown in Fig. 2. These curves apply for a reference voltage (V_R) of -0.3 V and a supply (V_{EE}) of -2.2 V.

The AND and OR functions are obtained by replacing Q_1 with a multi-emitter transistor (Q_{1A} in Fig. 3), in which each emitter has its own input emitter follower. A NAND output is also available from the Q_2 output. Parallel-input emitter followers driving a single emitter-version of Q_{1A} give the OR/NOR functions.

A fast R-S flip-flop can be made with only six transistors, and a D-type flip-flop with seven.

The prototype devices are hybrids using thin-film technology. This avoids the parasitic inductances and capacitances associated with transistor packages.

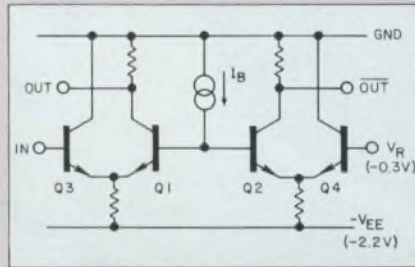

1. Basic BCL logic-gate inverter

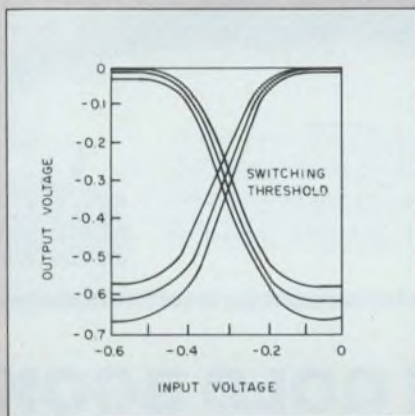

2. Switching curves for the BCL logic-gate inverter

Noise down, speed up in low-voltage photodiode

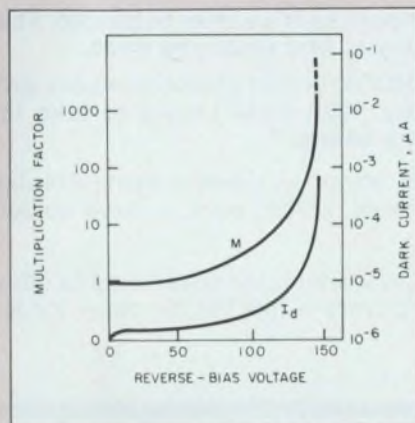

Low noise, high speed, high quantum efficiency and relatively low operating voltage characterize an avalanche

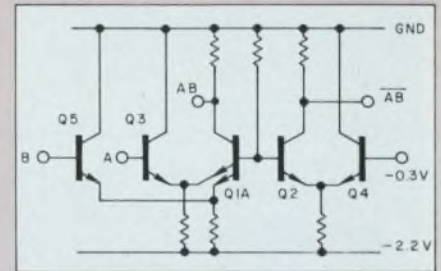

3. AND/NAND BCL circuit

photodiode (APD) to be used in fiber-optic communication systems.

The device responds to wavelengths between 0.6 and $0.94 \mu\text{m}$ with better than 80% external quantum efficiency. At room temperature, the dark current is only a few picoamperes.

In the new device, developed at the Central Research Laboratories of Nippon Electric Company Ltd., Japan, both avalanche and drift regions are formed by epitaxial growth. Moreover, double epitaxy simplifies the subsequent processing and leads to good reproducibility.

The variation of the multiplication factor and dark current with the bias voltage are shown in the figure. The APD consists of high-low $p\text{-}\pi$ layers and a planar junction with an n-type guard ring. The π -layers have more than $60 \Omega\text{-}\mu\text{m}$ resistivity, typically, and are about $20 \mu\text{m}$ wide. For the p layers, $3 \times 10^{15}/\text{cm}^3$ impurity concentrations and $6.8 \mu\text{m}$ widths have been used. But these values can be altered for tradeoffs between noise and operating voltage.

A shallow phosphorus diffusion forms the n^+ layer; the junction is about $0.3 \mu\text{m}$ deep with a diameter of $270 \mu\text{m}$. The APD's optical window has an antireflection coating.

Because the relationship between multiplication factor and bias voltage is fairly smooth, automatic gain control and temperature-stabilization circuitry can be relatively simple.

The device was tested in a $0.83\text{-}\mu\text{m}$ optical pulse communication system. The average signal level required to achieve a bit-error rate of 1×10^{-9} was found to be -51 dBm at 100 Mbits/s and -42 dBm at 400 Mbits/s.



I PREFER THE GOLD BOOK OVER EEM...

**IT'S EASIER TO HANDLE... EASIER TO LOCATE PRODUCTS AND PHONE NUMBERS
ARE LISTED EACH TIME A COMPANY'S NAME APPEARS**

Lillian Herold is Purchasing Manager, Kantz Electronics Industries, Clifton, New Jersey. Kantz designs and prepares prototype circuitry for printed circuit boards and provides manufacturing facilities for PC board production. Her directory? *Electronic Design's* GOLD BOOK.

"I prefer the GOLD BOOK over EEM because it's easier to handle. The print is easier to read, too, and it's better organized. You can scan quickly to find what you need.

"Another great feature of the GOLD BOOK is that phone numbers are listed with each company's name and address in the Product Directory. With EEM I have to take the extra step to refer back to the Manufacturers Directory for the phone listing."

Ms. Herold uses the GOLD BOOK about 15 times a week. Among other purchases, she has recently ordered 300,000 resistors, 20,000 sockets, solder bars, a wave soldering machine and an axial forming machine through its use.

Electronic Design's GOLD BOOK is working for advertisers because it's working for 90,000 engineers, engineering managers, specifiers and buyers — like Ms. Herold — throughout the U.S. and overseas. Is your company represented in its pages?

IF IT'S ELECTRONIC...IT'S IN THE GOLD BOOK!



Attractive in so many ways.

We can make ferrite magnets into any shape you want. They have a superb cost performance, and what's more, their properties are attractive sales points.

You can use them in any number of applications from speakers and motors to automobiles. We guarantee that their performance and quality are second to none. To meet the demand in the U.S., we mobilize production lines just over the border in Mexico.

Ferrite magnets. Another attractive part of TDK.

If you've heard of us, you'll probably know about our ferrite magnets. They're TDK's main line, we hear people saying. They're right. And wrong, too. The fact is that they're just a part of our line-up which features dozens of other electronic parts.

We have to tell people that we make ferrite cores — they play key roles in televisions, radios and communications equipment — and point out our secondary products like coils and transformers.

People are usually surprised to hear

that we have used ferrite production techniques to turn out ceramic capacitors. They're amazed at the variety of our unique line-up.

Then again, others hear that we do a roaring business in magnetic cassette tapes. We do. We sell them all over the world. In the U.S., for example, our SD, ED and SA series of cassettes more than hold their own against local brands. But even our tapes owe a debt to magnetic material techniques which started our ferrites off.

We want to get the record straight.

Based on our toplevel 'magnetic' knowhow, we have developed into a broad-line manufacturer of electronic parts. Today, you can find our parts attracting users not only in the electronics industry, but also in automobiles and business machines as well as in industrial and biomedical equipment. So the next time you hear of our ferrite magnets, think of our other items. You just might find them attractive parts, too.



TDK ELECTRONICS CO. LTD. 1-6 Uchikanda 2-chome, Chiyoda-ku, Tokyo 101, Japan Phone: Tokyo 031-257-2525
TDK CORPORATION OF AMERICA 431 South Douglas Street, El Segundo, California 90245 U.S.A. Phone: (213) 644-8625 **CHICAGO BRANCH** 2906 West Peterson Avenue, Chicago, Illinois 60659 U.S.A. Phone: (312) 973-1222
NEW YORK BRANCH 705 Eastgate Blvd., Garden City, N.Y. 11530 U.S.A. Phone: (516) 748-5230 **EL PASO BRANCH** 3501 Frutas Street, El Paso, Texas 79905 U.S.A. Phone: (915) 533-5799
TDK ELECTRONICS CORP. (Handles recording tapes only) 755 Eastgate Blvd., Garden City, N.Y. 11530 U.S.A. Phone: (516) 746-0880
TDK DE MEXICO S.A. de C.V. (Handles ferrite magnets only) Carr. Juárez-Parvenir, Parque Ind. A. J. Bermúdez, Cd. Juárez, Chih. Mexico Phone: 3-88-27
M&W INTERNATIONAL CORP. (Handles professional ferrites only) 14 Leighton Place, Mahwah, New Jersey 07430 U.S.A. Phone: (201) 891-8800
M&W INTERNATIONAL (CANADA) LTD. (Handles professional ferrites only) 81 Kelfield Str., Rexdale, Ont. M9W 5A3 CANADA Phone: 416-245-3606

CIRCLE NUMBER 60



HOLD DOWN PROM SOFTWARE DEVELOPMENT COSTS WITH DATA I/O SYSTEMS.

With Data I/O PROM programming systems you can develop and test PROM programs before committing a single PROM.

You simply load your program into the system using the Data I/O PROM Programmer keyboard or remote interface. The programmer system can emulate any commercially available PROM—including MOS.

You can then review the program as many times as you need to check against truth tables, edit or make changes. Once the program is perfect, you can begin programming with the assurance that the first PROM you program will work.

Data I/O Universal Programmers interface with all microprocessor developmental systems.



Programmers from \$1095.00

**HOW TO SELECT
THE RIGHT PROM
PROGRAMMER
FOR YOUR NEEDS.**

We'd like to tell you more.

This fact filled tabloid gives you valuable information about PROM programming technology. To get your copy, circle reader service number or contact Data I/O Corporation, P.O. Box 308, Issaquah, WA 98027. Phone 206/455-3990.

DATA I/O

THE PROM PROGRAMMER PEOPLE.

For more information, Circle No. 180.

New products

Software for SBC-80 μ Cs comes in 2 kwords

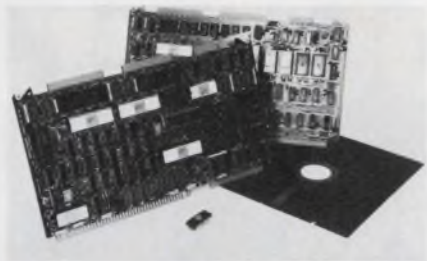

Intel, 3065 Bowers Ave., Santa Clara, CA 95051. Rob Walker (408) 246-7501. \$1950 (all modules and 1 year of free updates); stock.

The RMX/80 real-time multitasking executive software package runs on SBC 80 family microcomputers. Unlike conventional operating systems, RMX/80 does not require bootstrap devices. It gives the designer the option of storing the total program in either EPROM or ROM and occupies only a fraction of the memory contained on SBC 80 computer boards. The RMX/80 package includes Nucleus modules and optional modules for operator console, several SBC 80 enhancement boards, diskette subsystem, free space management and program debugging. After selecting the modules required for a particular SBC 80 or System 80 computer application, the OEM designer can link on an almost unlimited variety of task modules. The Nucleus requires only 2 kbytes of memory space and all generally required real-time system functions are contained in the Nucleus—task-to-task and I/O communications, real-time clock control, interrupt and priority resolution. The first set of optional RMX/80 modules support standard off-board units, including a CRT or teletypewriter console and analog I/O boards, diskette controllers and high-speed mathematics unit. The optional diskette subsystem is also modular. It can be used to manage data files and program overlay files or it can be subsetted down to a small, interrupt-driven diskette handler for read/write operations.

CIRCLE NO. 301

Alphanumeric printer handles 240 char/s

Centronics, Hudson, NH 03051. Thomas Eifler (603) 883-0111. P&A: See text; 4 to 8 wks.

A high-speed, low cost printer, the Micro-1, prints at 240 characters per second. Aimed at the home, hobby and microprocessor markets, the printer costs just \$595 including case, power supply, 96 character ASCII generator and interface, paper roll holder, low paper detector, bell, and multiline asynchronous input buffer. Producing copy on aluminum coated paper by discharging an electric arc to penetrate the coating, the printed characters are impervious to light, temperature and humidity. The microprinter can produce copy at a rate of 180 lines per minute on 4.75-in. wide roll paper and provides the user software selection of 20, 40, or 80 columns.

CIRCLE NO. 302

Combination μ P includes RAM, CPU and clock

Motorola Semiconductor, 3501 Ed Bluestein Blvd., Austin, TX 78721. (512) 928-2600. From \$25 (unit qty); stock.

The MC6802, a combination μ P, contains the CPU, a 128 \times 8 RAM and a clock oscillator with driver circuit. And, the MC6802 is completely software compatible with the MC6800. It can be used with the entire M6800 family of parts and is expandable to 65 kwords. When combined with the MC6846 (to be introduced later this year) a two-chip microcomputer is possible for those systems where a minimum configuration with full expandability is desired. The on-chip RAM has an additional feature: the first 32-byte section has a low-power mode that, when coupled with a V_{CC} standby source, will retain memory during power-down conditions. The MC6802 is available in either a plastic or ceramic 40-pin DIP.

CIRCLE NO. 303

Personality modules let programmer do any PROM



Pro Log, 2411 Garden Rd., Monterey, CA 93940. (408) 372-4593. From \$450; 2 to 4 wks.

Generic PROM personality modules, designed for use with the company's Series 90 PROM programmer and Series 92 PROM programmer/duplicator, are available or in development for bipolar PROMs from Fairchild, Texas Instruments, Harris, National Semiconductor, Monolithic Memories and Intel. Adaptors can configure the generic PROM modules for different pinouts (16, 18, 20, 22 and 24-pin configurations), bit structures (4 and 8 bit), and PROM sizes (32 \times 8 up to 4096 \times 8). The pinout adaptors include sockets for both master and copy PROMs.

CIRCLE NO. 304

PROM memory card fits in LSI-11 backplane

RDA Inc., 5012 Herzel Pl., Beltsville, MD 20705. W.R. Davies (301) 937-2215. \$285 (unit qty); stock.

The RMRV-8K, an 8 k \times 16 E/PROM memory board, is designed for use with the LSI-11 microcomputer from Digital Equipment Corp. It occupies one dual height module slot in an LSI-11 backplane. Packaging density is achieved by using the UV erasable 2708, an 8192 bit PROM. Addressing is jumper selectable for any two 4-k banks in the 0 to 28-k address space. Bus handshake logic is handled in 1-k segments, allowing for 1 to all 8 k to be enabled in reply to a memory send request.

CIRCLE NO. 305

Mostek 3870 single-chip microcomputer.

Under \$10.00.[†]

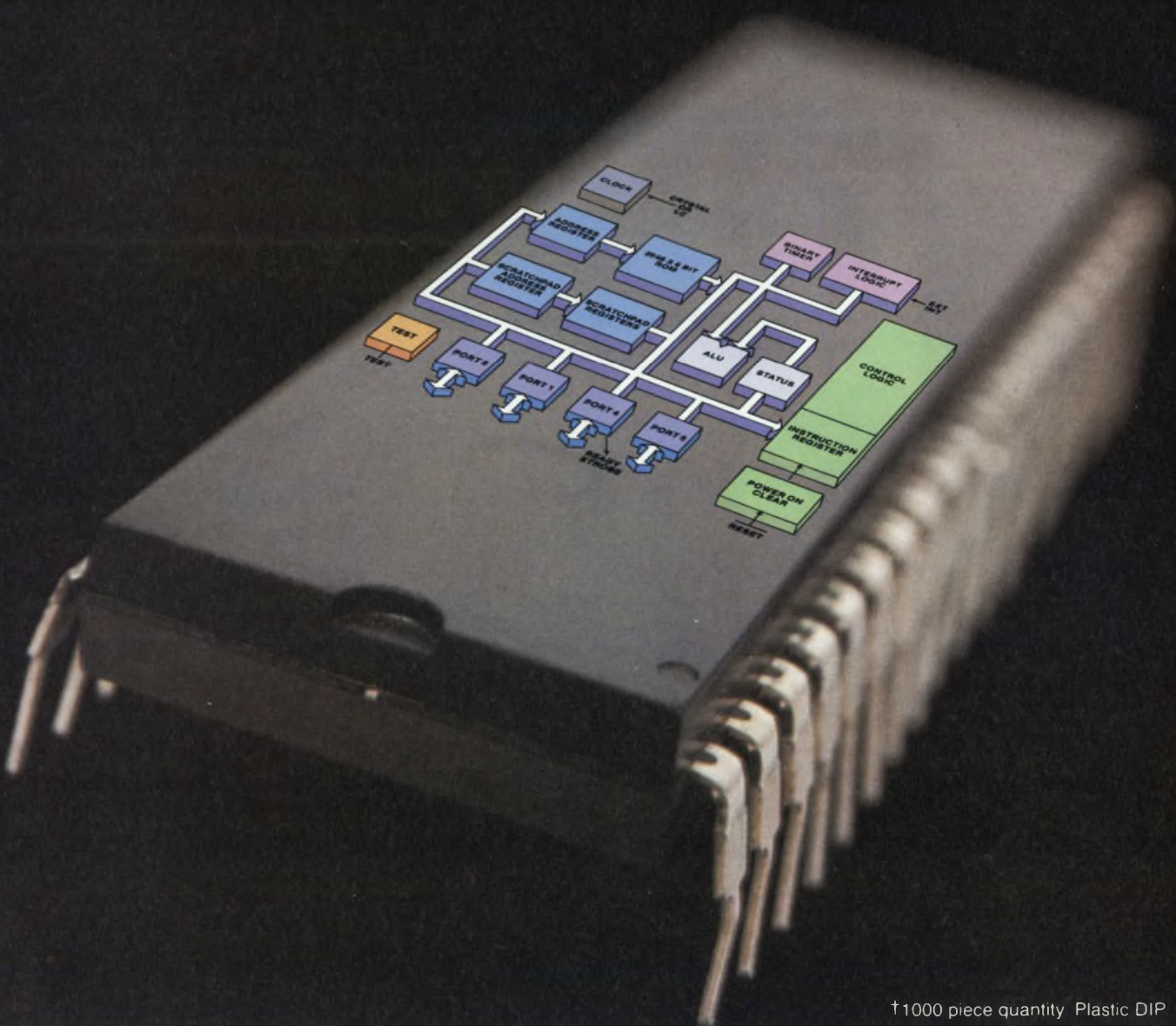

[†]1000 piece quantity Plastic DIP

Higher performance. Lower cost. * Immediate availability.

Features:

- 2K × 8 ROM
- 64 × 8 RAM
- 32 bits I/O + Strobe
- Programmable timer
- On-chip OSC/clock
- 5V ± 10% power supply
- Multi-chip expandability
- Low power (typ 300 mW)

F8 Software Compatibility.

Mostek's new MK 3870 is the first single-chip microcomputer designed with complete system capability and offering full compatibility with a multi-chip processor family. It features twice the program storage of other single-chip devices—2048 bytes of ROM, 64 bytes of scratchpad RAM, four 8-bit I/O ports, and a single +5 volt power supply requirement. The device can execute the complete F8 instruction set of more than 70 commands, providing complete software compatibility with the versatile F8 multi-chip family.

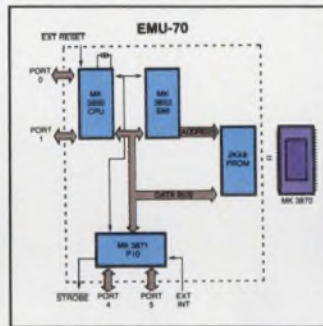
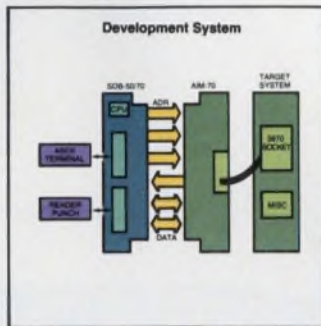

then be copied to AIM-70 for execution. This is a true in-circuit-emulation configuration. Real time execution of the target system code, breakpoint insertion, and single-step operation are a few of the features available with this system.

With completion of software development and debugging, prototypes may be emulated for field testing and evaluation using the compact PROM-based EMU-70. This capability allows exact verification of code before committing to mask programmed MK 3870's.

* The MK 3870-based VAB-2: a typical example of logic replacement.

For customers desiring to evaluate the MK 3870 in an actual application, a pre-programmed version is available for \$50. This particular device has been designed to replace much of the logic normally required for sophisticated video terminal applications. The complete Video Adaptor Board (VAB-2), is available through our distributors for \$195. Call or write today for a data sheet.



MK 3870-based video adaptor board (VAB-2).

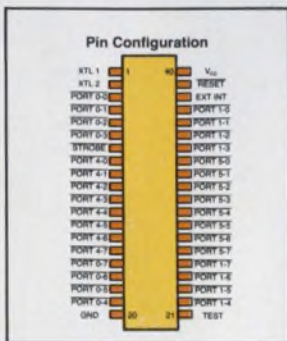

Development Aids Simplify Design

The SDB/AIM provides the user with the ability to create and edit Source Listings using the Resident Text Editor and assemble into Object Code using the Resident Assembler. Object Code may

MOSTEK

1215 West Crosby Road • Carrollton, Texas
75006 • (214) 242-0444 • MOSTEK GmbH • West
Germany • Telephone: (0711) 701096 • MOSTEK
ASIA • Hong Kong • Telex: 85148MKA HX

How to defend against attack by air,

Series 1 panel sealed lighted pushbuttons are qualified under MIL-S-22885.

FW solid state self-contained proximity controls provide high reliability and long life.

Panel sealed solid state keyboards in a variety of arrays.

TL toggles offer environment-proof sealing and many circuit options. TW provides switching versatility in a smaller size.

SE and XE miniature basic switches are environment-proof. HM version provides hermetic sealing and larger-sized HT withstands extreme temperatures.

EN is environment-proof limit switch with variety of actuators, circuitries, and electrical ratings. HE is hermetically-sealed version.

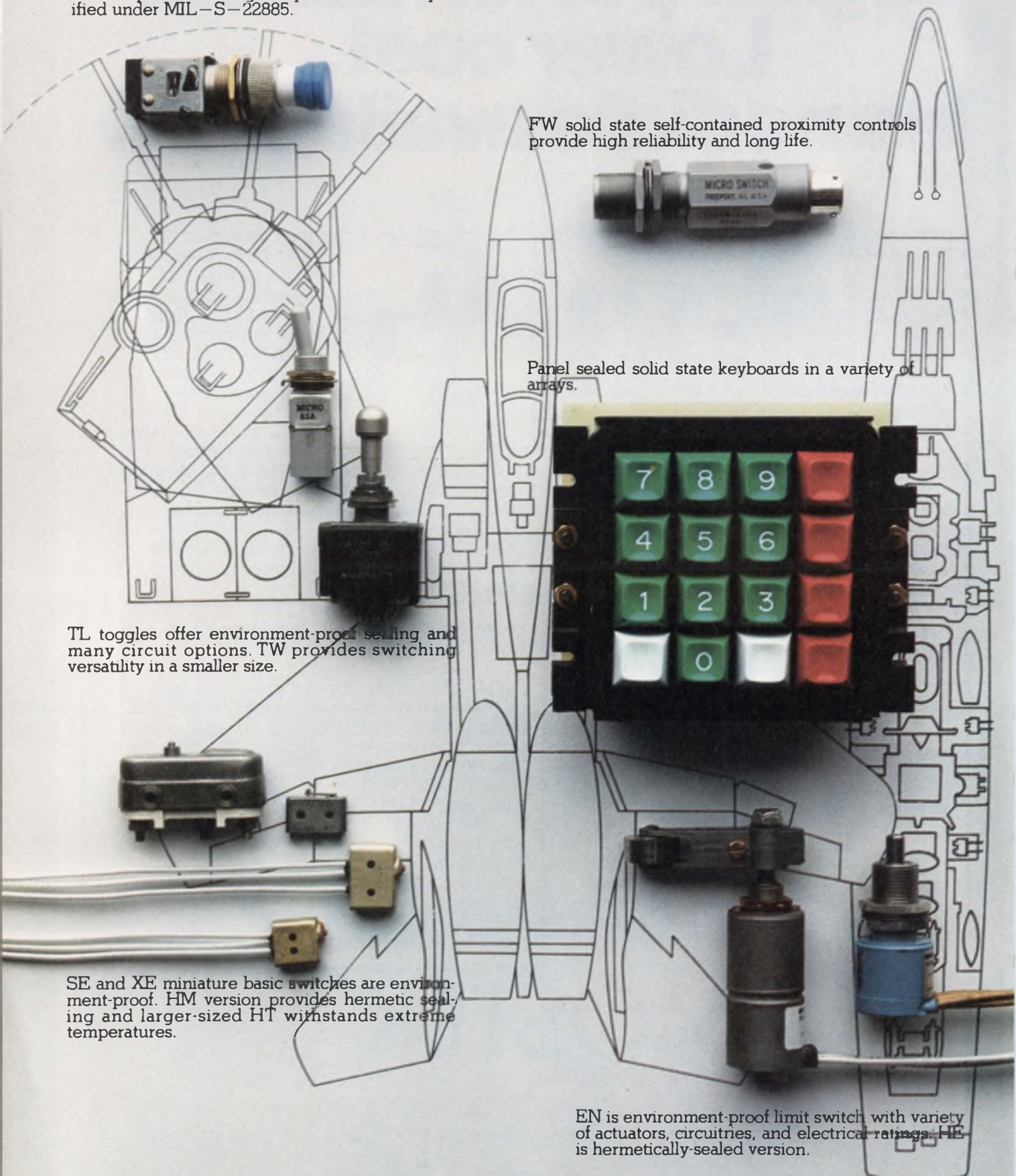

sea or dust.

For use in extraordinary conditions, MICRO SWITCH builds some pretty extraordinary devices. Sealed to keep the environment out and keep on working in a wide variety of aerospace, transportation, ordnance and marine uses.

Uses where they simply can't afford to fail.

HE and HM switches offer true hermetic sealing, with metal-to-metal, glass-to-metal construction.

There's the FW solid state proximity control for high reliability in severe environments. For high temperature uses up to +1,000°F, there's the HT line. The SE and XE basic switches are the smallest environment-proof basic switches offered by MICRO SWITCH.

MICRO SWITCH also makes toggles with a variety of locking configurations and different-shaped levers, including colored tab levers. Integrated Wire Termination System is also available.

And there's also a complete line of Series 1 lighted pushbuttons. They're built to last hundreds of thousands of operations, and offer round or square buttons, momentary or alternate action and solid state options.

Every bit as rugged as the buttons, switches and toggles, MICRO SWITCH keyboards offer panel sealing plus solid state Hall-effect technology for reliability.

MICRO SWITCH will provide you with factory-trained field engineers for application assistance and a network of Authorized Distributors for local availability. For complete information, write us for details or call 815/235-6600.

MICRO SWITCH

FREEMONT, ILLINOIS 61032

A DIVISION OF HONEYWELL

MICRO SWITCH products are available worldwide through Honeywell International.

MICRO/MINI COMPUTING

Programmer boards do EPROMs or bipolar PROMs

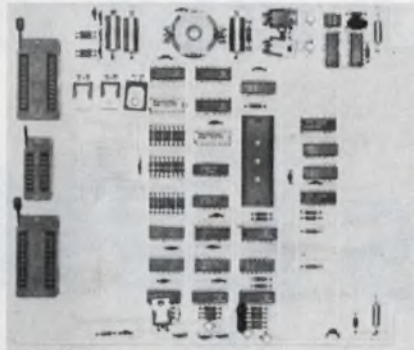

Zilog, 10460 Bubb Rd., Cupertino, CA 95014. Dave West (408) 446-4666. From \$475; 30 days.

Three programmer boards have been added to the company's MCB family of microcomputer boards. The Z80-PPB/EPROM programmer board is designed for programming 24-pin EPROMs of the 2708 or 2704 variety. Software provides the user with the capability to program, verify, list and duplicate. The Z80-PPB/PROM programmer board is intended to program 16 and 24-pin Harris PROMs of the 7620, 7621, 7640, or 7641 type. Like the PPB/EPROM version, the PPB/PROM board gives the user the software to program, verify, list and duplicate. A composite of the two boards is the Z80-CPB/PROM that allows users to program 2708/2704 EPROMs and Harris 7620, 7621, 7640 and 7641-type PROMs.

CIRCLE NO. 306

Pre-etched boards hold Z80 CPU or 8 k of RAM

Ithaca Audio, Box 91, Ithaca, NY 14850. Steven Edelman (607) 272-3271. \$25 (2102 board); \$35 (Z80 board); stock.

Pre-etched printed-circuit boards, compatible with the S-100 bus, are available for either an 8-k memory bank or for a Z80 CPU. The memory board holds 64 of the 2102 or equivalent static RAMs and includes full buffering on all address and data lines, memory protect/unprotected and optional selectable wait states. The Z80 CPU board provides all 8080 compatible control signals, including phase 1 and phase 2 clocks and sync. Provisions are also made for one 2708 EPROM on the board for reset and jump so that the board can operate without a front panel.

CIRCLE NO. 307

Microcomputer diagnostic system goes to the field



Intel, 3065 Bowers Ave., Santa Clara, CA 95051. Rob Walker (408) 246-7501. \$1520 (console); \$480 (Probe 8080A); 90 days.

The μ Scope 820 microprocessor system console is a portable microcomputer system developed to support OEM test and maintenance of μ P systems. Unlike conventional instruments, the μ Scope console provides active control over microprocessor-based systems. The unit is a general purpose support system based on the 8085 μ P and uses "personality probes" and overlays for its keyboard-display panel to reconfigure the system. For 8080 systems, the μ Scope's 8080A probe can be used with the console. The probe is supplied with a keyboard-display overlay and personality ROM that uniquely configure the basic instrument. The panel can be used to monitor, display and alter register, memory and I/O values of the system under test. It also gives complete control over microprocessor operations including halt, single-step, run with display and run in real-time. For more rigorous diagnostic tasks, the console has a 32-bit maskable hardware breakpoint with optional courses of action after a breakpoint match, a 256 \times 32-bit trace memory, and a 128-byte overlay RAM for real-time entry of test routines via the keyboard. The console is packaged in a 19 \times 15.5 \times 7-in. carrying case and has a self-contained power supply.

CIRCLE NO. 308

Filler

It's really fortunate that we have such terrible reliability. That gives us a chance to show how great our Service Department is.

Hurrayyy!

PMI's DAC-08 does have a second source!

Whaddayaknow! When we challenged the DAC-08's "second sources" to come forward with 100 1/4LSB-grade equivalents, we really didn't think anyone would come forward. But someone did. And we're glad. National, Signetics and AMD didn't show at all. Not a word. Then, at the eleventh hour, Fairchild sent over an entry.

And they worked O.K. They didn't meet **all** of our data sheet specs, but they were pretty fast. In settling time, they were faster than we are at the **trailing** edge. But then, we were faster at the rising edge, so it came out a wash. In other areas such as zero scale offset, power consumption, and non-linearity, PMI's were better, but theirs did meet the spec.

The tests, by the way, were made with our standard DAC-08 production test fixtures and equipment, and supervised by DCA Reliability Laboratory. Copies of the test report are available—just ask for one on your letterhead.

It's good to know that our DAC-08 now has a second source. Good for business. Good for customers.

So now we all know who **really** makes and delivers DAC-08's and their "equivalents." You can get the original, high-quality DAC-08 from PMI and its distributors.



Tests supervised by DCA
Reliability Laboratory.



Precision Monolithics, Incorporated
1500 Space Park Drive
Santa Clara, California 95050
(408) 246-9222

CIRCLE NUMBER 63

We're ready and waiting
at the starting line.

DAC-08 CHALLENGE:

Precision Monolithics, Inc.

To clear the air of unrealistic claims and promises, we ran this ad in April, asking the so-called DAC-08 second sources to put up or clam up.

For DAC-08's call your nearest PMI Distributor:



ALABAMA
HUNTSVILLE
Hall-Mark Elect.
(205) 837-8700

ARIZONA
PHOENIX
Sterling Electronics
(602) 258-4531
Wyle Dist. Group
Liberty Electronics
(602) 257-1272

CALIFORNIA
CHATSWORTH
Westates Electronics
(213) 341-4411
COSTA MESA
Westates Electronics
(714) 549-8401
EL SEGUNDO
Wyle Dist. Group
Liberty Electronics
(213) 322-8100
(714) 638-7601
GARDENA
Bell Industries
(213) 321-5802
(714) 521-4914
MOUNTAIN VIEW
Wyle Dist. Group
Elmar Electronics
(415) 961-3611
SAN DIEGO
Intermark Electronics
(714) 279-5200
Wyle Dist. Group
Liberty Electronics
(714) 565-9171
SANTA ANA
Intermark Electronics
(714) 540-1322
SUNNYVALE
Bell Industries
(408) 734-8570
Intermark Electronics
(408) 738-1111

COLORADO
DENVER
Wyle Dist. Group
Elmar Electronics
(303) 287-9611
WHEATRIDGE
Century Electronics
(303) 424-1985

CONNECTICUT
NORWALK
Harvey Electronics
(203) 853-1515

FLORIDA
FT. LAUDERDALE
Hall-Mark Elect.
(305) 971-9280
ORLANDO
Hall-Mark Elect.
(305) 855-4020

ILLINOIS
ELK GROVE VILLAGE
Hall-Mark Elect.
(312) 437-8800
Pioneer Electronics
(312) 437-9680

INDIANA
INDIANAPOLIS
Pioneer Electronics
(317) 849-7300

KANSAS
SHAWNEE MISSION
Hall-Mark Elect.
(913) 888-4747

MARYLAND
BALTIMORE
Hall-Mark Elect.
(301) 796-9300

MASSACHUSETTS
DEDHAM
Gerber Electronics
(617) 329-2400
LEXINGTON
Harvey Electronics
(617) 861-9200

MICHIGAN
LIVONIA
Pioneer Electronics
(313) 525-1800

MINNESOTA
BLOOMINGTON
Hall-Mark Elect.
(612) 884-9056

MISSOURI
EARTH CITY
Hall-Mark Elect.
(314) 291-5350

NEW JERSEY
FAIRFIELD
Harvey Electronics
(201) 227-1262

NEW MEXICO
ALBUQUERQUE
Century Electronics
(505) 292-2700

NEW YORK
BINGHAMTON
Harvey Elect. (Fed)
(607) 748-8211
W. HENRIETTA
Harvey Electronics
(716) 334-5920
WOODBURY
Harvey Electronics
(516) 921-8700

NORTH CAROLINA
RALEIGH
Hall-Mark Elect.
(919) 832-4465

OHIO
CLEVELAND
Pioneer Electronics
(216) 587-3600
DAYTON
Pioneer Electronics
(513) 236-9900

OKLAHOMA
TULSA
Hall-Mark Elect.
(918) 835-8458

PENNSYLVANIA
HUNTINGDON VALLEY
Hall-Mark Elect.
(215) 355-7300
PITTSBURGH
Pioneer Electronics
(412) 782-2300

TEXAS
AUSTIN
Hall-Mark Elect.
(512) 837-2814
DALLAS
Sterling Electronics
(214) 357-9131
Hall-Mark Elect.
(214) 231-5101
HOUSTON
Hall-Mark Elect.
(713) 781-6100
Sterling Electronics
(713) 627-9800

UTAH
SALT LAKE CITY
Century Electronics
(801) 487-8551

WASHINGTON
SEATTLE
Wyle Dist. Group
Liberty Electronics
(206) 453-8300

WISCONSIN
WEST ALLIS
Hall-Mark Elect.
(414) 476-1270

CANADA
QUEBEC
MONTREAL
Cesco Electronics
(514) 735-5511

ONTARIO
TORONTO
Wesburne Elect.
(416) 635-2980

BRITISH COLUMBIA
VANCOUVER
Intek Electronics
(604) 324-6831

MICRO/MINI COMPUTING

Z80-based microcomputer comes with floppy drive

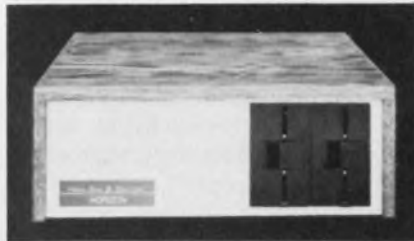

North Star Computer, 2465 Fourth St., Berkeley, CA 94710. (415) 549-0858. From \$1599 (one drive); stock.

Using the 4 MHz Z80, the Horizon microcomputer comes with 16 kbytes of memory and a disc controller with one or two Shugart minifloppy disc drives, and full extended disc Basic. A serial I/O port is included for connection to any standard baud-rate terminal. Options for the Horizon computer include additional disc drives, hardware floating point arithmetic board, 24-line by 80-character upper and lower-case video display controller (VDC) board, and a 16 k memory board with parity check. When used in conjunction with the 16 k memory board, the VDC board will provide high resolution (480 by 250) graphics on a TV monitor. The Horizon computer uses the widely supported S-100 bus, allowing possible use of a large selection of available peripheral products.

CIRCLE NO. 309

Assembled microcomputer comes ready to operate

Audio Engineering, 121 Wisconsin NE, Albuquerque, NM 87108. (505) 255-6451. See text; stock.

Fully assembled and ready to operate, the Motorola MEK6800D2 kit just needs a regulated 5-V, 1-A supply. The assembled version, Model SY1-068, includes sockets for all ICs, a stand for the CPU board, and an attractive case for the keyboard/display board. The SY1-068 has a 1-k monitor, 256 bytes of RAM, serial I/O (used for cassette interface), parallel I/O, and crystal clock. The assembled system costs \$269, and the case for the keyboard costs an additional \$12.50. An extra 128 x 8 RAM can be obtained for \$7.50 and a power supply kit with 60-Hz clock adds another \$29.95.

CIRCLE NO. 310

Test and debug system checks μ P-based products

Arthur D. Little, 25 Acorn Park, Cambridge, MA 02140. Daniel Shepard (617) 864-5770. P&A: See text.

The MDSS, a test and debug system for prototype microprocessor products, is available for about \$10,000 in a limited production version. The MDSS interfaces directly with most microprocessor systems by means of custom-personality boards containing appropriate circuitry and a short program. When the prototype is hooked up the MDSS provides the operator with a console for testing and debugging. It detects not only programming bugs but also hardware problems, such as defects in the main chip, timing element, memories, and other supporting components as well as poor interconnections among them. The MDSS can be used interactively, with the operator monitoring and controlling the performance of the prototype in real-time via a terminal. A Trace command enables the operator to monitor the performance of the prototype by causing the MDSS to store as many as 63 instructions in RAM during real-time operation. A Freeze command, used in conjunction with a Step command, will force the prototype to execute one instruction at a time for more detailed analysis.

CIRCLE NO. 320

Expansion memory for 4051 holds 32 kbytes

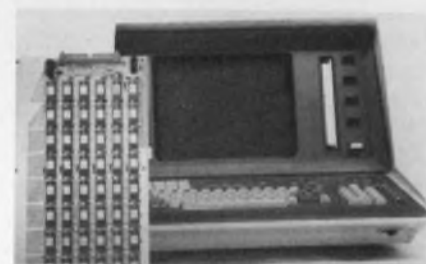

SDX Inc., P.O. Box 41, Orange Cove, CA 93646. Susan Murray (209) 332-2332. \$2395 (unit qty); stock.

Designed for the Tektronix 4051 computer system, the S32K expands the unit's memory system from 8192 to 32,768 words of main storage. The S32K memory is a plug-compatible memory with all functions transparent to the user. The memory is contained on a 7 x 12-in. circuit board and fits within the 4051 cabinet. All necessary drive and refresh signals are handled on the board with power supplied by the parent computer.

CIRCLE NO. 321

MICRO/MINI COMPUTING

Single board computer uses 8080 processor

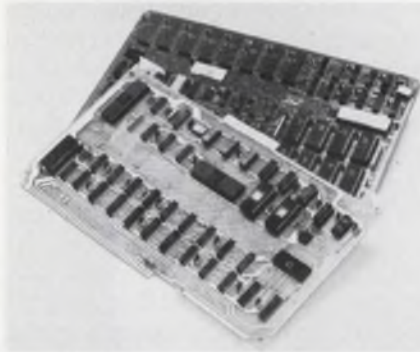

Intel Corp., 3065 Bowers Ave., Santa Clara, CA 95051. Rob Walker (408) 246-7501. P&A: See text.

The SBC 80/05 single board computer, at a cost of less than \$200 in OEM quantities, is only one-third as much as previous systems with multi-processor bus structures. The board also cuts the power requirement since it operates from just a +5-V supply. In addition to a complete central processor with crystal clock, four-level vectored interrupt control and arbitration/control logic for operation on the company's Multibus, the SBC 80/05 computer contains memory, parallel and serial I/O (input-output), and an interval timer. Also available is the SBC 80P05 prototyping package. It includes a complete SBC 80/05 with a resident monitor program that facilitates program loading, execution and debugging, a modular card-edge/backplane, a full complement of I/O and power supply cables, EPROMs, I/O drivers and terminators, and complete documentation.

CIRCLE NO. 322

Expansion memory for 6800 system holds 16 k

Motorola Semiconductor, 3501 Ed Bluestein Blvd., Austin, TX 78721. (512) 928-2600. \$395 (1 to 10); 4 wks.

A new memory system for expanding the memory capacity of the MEK6800D2 kit, the MMS 69104, provides up to 16 k × 8 of RAM storage. The board is pinout compatible with the "D2" kit and measures 6 × 9.75 × 0.44 in. Access time is 650 ns, max, and read or write cycle times are 1.6 μs. The board requires +5 V at 920 mA, +12 at 450 mA and -12 V at 10 mA when active.

CIRCLE NO. 323

Magnetic card & reader provide data storage

Vertel, 167 Worcester St., Wellesley Hills, MA 02181. August Toda (617) 235-2330. \$99 (less electronics), \$258 (complete); 60 days.

Using a credit-card sized, 1024 byte, programming media called the Kilobyte Card, the Series KB-31 Microloader is designed for low cost program loading. The Kilobyte Card uses four magnetic stripes (tracks), with two "F2F" channels encoded on each track. The KB-31 "Microloader" records and reads both channels per stripe in one cycle, at 5 kbytes per minute. Measuring only 3.2 × 8.19 × 2.48 in. (8.2 × 20.8 × 6.3 cm), the Microloader has a diecast frame and chassis, and a constant-speed governed motor.

CIRCLE NO. 324

Core memory provides 8 k for micro storage

Micro Memory, 9438 Irondale Ave., Chatsworth, CA 91311. (213) 998-0070. \$650; stock.

Designed specifically for nonvolatile operation with the S-100 bus Imsai and Altair microcomputers, the MM-S100 memory provides 8 k × 8 of core storage. The memory system eliminates data loss upon power removal and can plug directly into existing S-100 bus microcomputers. Cycle time is 1 μs, with no wait states required. On board module selection is available in 4-k increments up to 64 k. The memory module measures 6 × 10 × 1 in.

CIRCLE NO. 325

Microcomputer hardware includes all components

Wintek, 902 N. 9th St., Lafayette, IN 47904. Paul Wintz (317) 742-6802.

A complete line of backplanes, card racks, power supplies, and associated items has been added to the company's microprocessor support. These accessories allow the user to quickly assemble a customized microcomputer system using the company's 4.5 × 6.5-in. microprocessor printed-circuit boards with standard, 44-pin connectors. Available cards include the control, RAM, ROM, EROM programmer, analog interface, data acquisition, relay driver/sensor, cassette interface, floppy-disc interface, console, CMOS RAM with battery back-up, and telephone tone transmit/receive modem.

CIRCLE NO. 326

Microcomputer trainer gives hands-on practice



Integrated Computer Systems, 4445 Overland Ave., Culver City, CA 90230. (213) 559-9265. \$545; stock.

A beginner-oriented, software/hardware training course, based on the 8080A, is designed for self-study. With built-in keyboard and display, no expensive teletypewriter or CRT terminal is required. Designed for use in the home or office, the course (No. 126) includes all system hardware, software and information best suited for learning to program and use an 8080-type microcomputer system. A 650-page workbook/text teaches 8080 instructions, programming, debugging and hardware interfacing through 33 hands-on exercises. Memory includes 512 bytes of CMOS RAM (maximum 1 k on board) and 1 k of electrically erasable PROM. I/O ports for hardware experiments, cassette interface, etc. are also included.

CIRCLE NO. 327

Microprocessor system built around the 6800

Digimetric, Div. of Sybron Corp., 730 Kalamath St., Denver, CO 80204. Mike McGinnis (303) 534-1190. \$5000 (typical); stock.

Designed for OEM users, the Series 6000 microcomputer system comes with a 16-slot mainframe and uses the 6800 μP. The 6015 processor board comes complete with powerfail auto restart, real-time clock and hardware priority interrupt, a loader and Demon monitor in ROM and 32 k of static RAM. A full floppy-disc operating system is available, which supports an assembler, editor and the real-time Basic 6 interpreter. The system also supports a macroassembler and linking loader. Memory is available in 2-k or 8-k increments of static RAM and in 4-k increments of PROM. A full line of I/O cards is available including an integrating a/d and a control interface card with eight independent triacs.

CIRCLE NO. 328

Here are two ways to measure
ceramic capacitor reliability

40

Major Hi-Rel Programs

You'll find our ceramic capacitors functioning in some of the toughest environments known to man. Here are just a few of the programs. Space: Surveyor, Mercury, Gemini, Apollo (Command Module, LEM, PLSS). Defense: Minuteman II and III, F-14, F-15 and F-16, Polaris and Poseidon, Sparrow, Hawk and Maverick, F-111 and the B-1 bomber.



15

Years of Hi-Rel Experience

Founded in 1960 to supply ceramic capacitors for Hi-Rel programs, we were a technology leader almost from the start. We were the first to develop precious metal alloy electrode systems; the first to automate chip production to meet a proven failure rate level of .001% per 1000 hours; the first to perfect the use of base metals in electrodes. Latest — the totally redundant fail-safe feed-thru capacitor.

Unlike many companies, we do not have separate chip lines for Hi-Rel military and commercial MonoKap products. You get the same high quality in both. And, you can buy MonoKaps right off our distributor's shelves.



CENTRALAB/USCC

Electronics • GLOBE-UNION INC.

4561 Colorado Blvd., Los Angeles, CA 90039 (213) 240-4880

CERAMIC CAPACITORS • FILTERS • THICK FILM CIRCUITS • SWITCHES
TOUCH SWITCHES • POTENTIOMETERS • TRIMMER RESISTORS

Our attenuators will always level with you.



Honest attenuation.

In your equipment or on the bench, Telonic Attenuators provide reliable "specs or better" performance. We make sure, because we use them in our own instruments.

Our thick film resistive elements are made in-house to assure you of top quality. Their operating parameters enable us to guarantee accuracies in some models to $\pm .02$ dB, frequency coverage to 4GHz and power-handling capabilities up to 25 watts. Here's the selection, in 50- or 75-ohm versions:

Variable (Rotary) Types

1, 10, 69, 100, or 110 dB ranges
0.1, 1.0, and 10 dB steps.

Fixed Value Types

3, 6, 10, 20, 30, 40, 50, or 60 dB
SMA, TNC, BNC, or N connectors.

Telonic also supplies bench-top versions incorporating sequenced rotary models, and special versions to fit your requirements. Call us TOLL

FREE (except in Calif.) for

further specs, prices, more information, or our new Attenuator

Catalog. Telonic Altair, 2825 Laguna Canyon Road, Box 277, Laguna Beach, CA 92652. Phone: 714/494-9401 TOLL FREE: 800-854-2436.



TelonicAltair

CIRCLE NUMBER 98

DATA PROCESSING

Digitizing tables boast high accuracy



Altek Corp., 2150 Industrial Pkwy., Silver Spring, MD 20904. (301) 622-3906. From \$5000.

A new method of grid manufacture improves the accuracy of Datatab digitizing tables for computer-aided drafting and mapping. The glass-based grids are easily backlit to permit digitization of film negatives and other translucent materials, and provide an absolute accuracy of up to ± 0.002 in. Table sizes range from 12 x 12 to 42 x 60 in. The variable-intensity lightbox uses standard fluorescent bulbs and a sheet of translucent plastic to mask out the shadows produced by the grid wires.

CIRCLE NO. 329

Dual-floppy smashes \$1000 barrier



Southwest Technical Products, 219 W. Rhapsody, San Antonio, TX 78216. \$995 (Kit).

The MF-68 Minifloppy dual-disc kit is designed for use with the SWTPC 6800 system and provides all hardware and software for a dual-disc operating system including two assembled Shugart drives. It can be expanded to four drives with the MF-6X expansion kit (\$850). Software includes disc Basic and a floppy-disc operating system (FDOS). The expansion kit includes power supply, chassis, cover, and two assembled Shugart drives.

CIRCLE NO. 330

Make us your headquarters for

EMI/RFI FILTERS



Passive Filter Headquarters:

Centralab Los Angeles is a one-stop source for reliable miniature ceramic low pass Feed Thru's/Filters. They're cost effective from 30 KHz to beyond 1 GHz. Threaded or solder mount for easy installation. Proven in AC as well as DC applications. Monolithic and multi-element. Standard products or computerized custom designs, including multi-circuit custom packages. Call Rich Colburn at (213) 240-4880.

Active Filter Headquarters:

That's Centralab Milwaukee. Solve design problems and cut costs with our thick film hybrids. Band pass, low pass, high pass and band reject. Cost effective for low to medium frequencies. Let us put our design and manufacturing expertise to work for you. Call Don Weiland at (414) 228-2872.



CENTRALAB
Electronics • GLOBE-UNION INC.

4561 Colorado Blvd., Los Angeles, California 90039
5757 North Green Bay Ave., Milwaukee, Wisconsin 53201

CERAMIC CAPACITORS • FILTERS • POTENTIOMETERS • SWITCHES
THICK FILM CIRCUITS • TRIMMER RESISTORS

SEE OUR COMPLETE CATALOG IN EEM; PAGES 317 to 335; AND GOLD BOOK PAGES 103 to 121; OR CONTACT US DIRECTLY.



There's another name for high-flying MIL-approved connectors. AMP.

And there are more of them than ever before. Because now our externally-keyed 0.100" center line Box Connectors are approved to MIL-C-55302. And they are specified on F-16 and F-18 avionics systems. External keying eliminates the need to use contact positions. So you can make even higher density connections . . . up to 110 positions. And do it with all of the versatility our unique four-beam box contact design allows.

We've also added a new super-small member to the Box Connector family . . . the Mil-approved Mini-Box. It's available with up to 128 positions, has external keying and contacts on 0.050" center lines. It has all the high reliability advantages of our regular Box Connector design plus low insertion/withdrawal force and extra space savings. For more information, call (717) 564-0100, or write AMP Incorporated, Harrisburg, Pa. 17105.

Or take a look at our versatile, extremely rugged high-voltage Lead Assemblies and Receptacles. Meeting a wide range of military requirements, you'll find them in heads-up displays for tactical aircraft. They're fully shielded against RFI, and designed to withstand severe vibration, shock and handling. Integrally molded ends provide positive mating and a perfect seal. Accommodates up to 50 KVDC at altitude. And a wide choice of mounting and operational design is available. For more information, call (717) 367-1105, or write AMP Capatron Division, Elizabethtown, Pa. 17022.

AMP has a better way.

SEE US AT
INELTEC, BASEL

AMP INCORPORATED

CIRCLE NUMBER 64

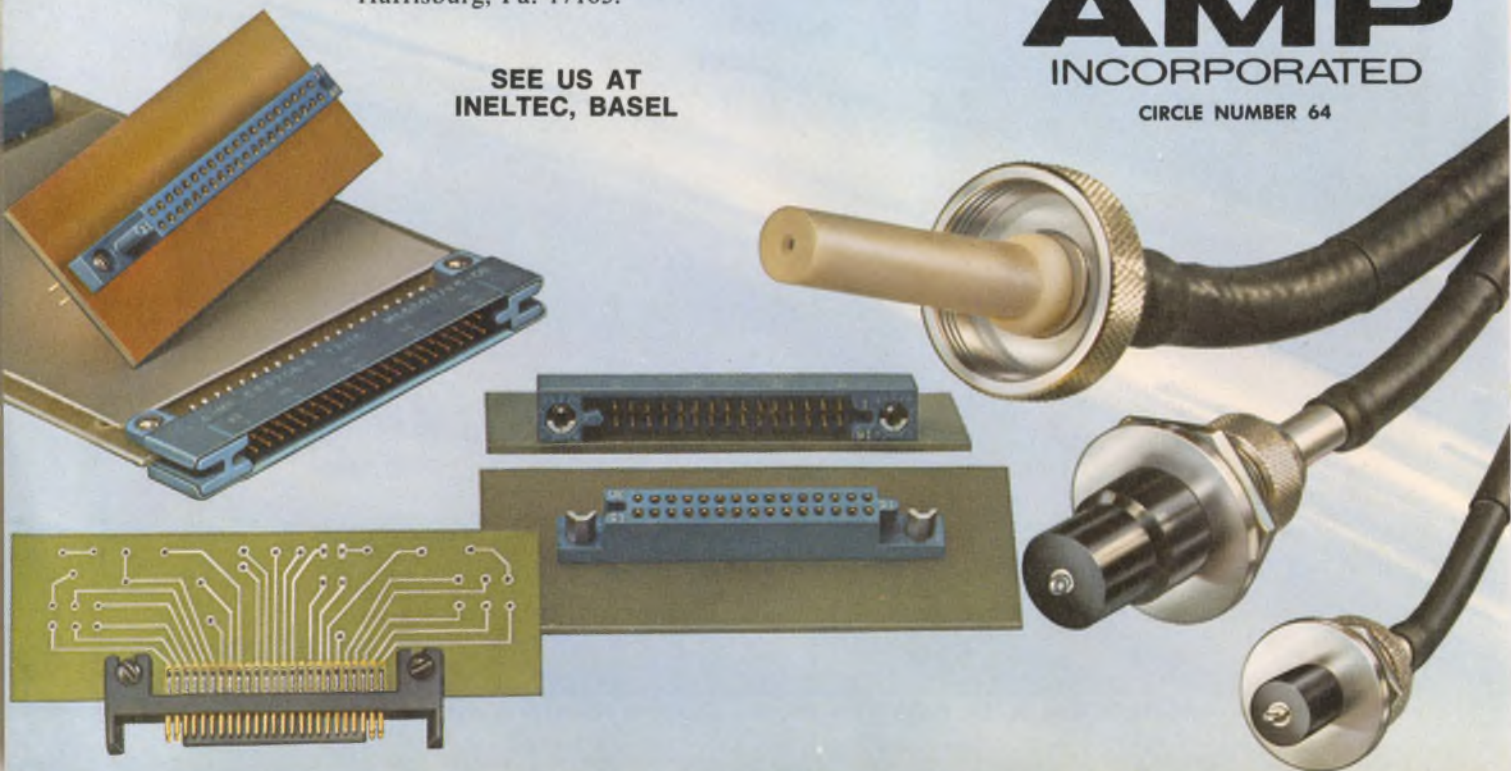

AMP EUROPE

Austria — AMP Austria. Branch of AMP Deutschland GmbH, Markgraf-Ruediger Str. 6-8, 1150 Vienna. Phone: 924191/92

Belgium — AMP Belgium. Branch of AMP-Holland B.V., Rue de Brabant 62-66, Brussels. Phone: 322.17.55.17

Finland — AMP Finland OY Postilakero 3, 00401 Helsinki 40 Phone: 90/584122

France — AMP de France, 29 Chaussée Jules-César, Boite Postale No. 39, 95301 Pantaise France. Phone: 030 82 20, 030 92 30

Germany — AMP Deutschland GmbH, Ampèrestrasse 7-11, 607 Langen, B. FFM., West Germany. Phone: (06103) 7091

Great Britain — AMP of Great Britain Limited, Terminal House, Stanmore, Middlesex, England. Phone: 01-954-2356

Holland — AMP Holland B.V., Papierstraat 2-4 5223 AW 's-Hertogenbosch, Holland. Phone: (073) 125221

Italy — AMP Italia S.p.A., Via Fratelli Cervi 15, 10093 Callegna (Torino), Italy. Phone: 785-656

Spain — AMP Española, S.A., Apartado 5294, Pedro IV, 491, 495, Barcelona 5, Spain. Phone: 307-75-50

Sweden — AMP Scandinavia AB, Datavägen 5, 17500 Jakobsberg, Sweden, Mailing Address: Fack S-175 20 JARFALLA 1, Sweden. Phone: 0758/10400

Switzerland — AMP AG, Haldenstrasse 11, 6006 Luzern, Switzerland. Phone: (414) 235421, 235422, 235423

AMP NORTH AMERICA

Canada — AMP OF CANADA LTD., 20 Esna Park Drive, Markham, Ontario, Ph: 416-499-1251

Mexico — AMP de Mexico, S.A., Apartado Postal 179, Neocalpan de Juarez, Edo. de Mexico, Phone: Mexico City 576-41-55

Puerto Rico — AMP OF CANADA LTD., 677 Calé de Diego, Rio Piedras, Puerto Rico 00924, Phone: (809) 766-2346

United States — AMP Incorporated, Harrisburg, Pa. 17105, Phone: 717-564-0100

AMP SOUTH AMERICA

Argentina — AMP S.A. Argentina 4 de Febrero, 76 Villa Zagla — SAN MARTIN, Buenos Aires, Argentina, Phone: 752-4612

Brazil — AMP do Brasil Ltda., AV Comendador Martinelli 185, Lapa, Sao Paulo, Phone: 262-4353

AMP PACIFIC

Australia — Australian AMP Pty. Limited, 155 Briens Road, Northmead, N.S.W. 2152 Australia, Mailing Address: P.O. Box 194, Baulkham Hills, N.S.W. 2153 Aus. Ph: 630-7377

Japan — AMP (Japan), Ltd., No. 15-14, 7-Chome, Roppongi Minato-Ku, Tokyo, Japan, Ph: 404-7171

Products and services for many specialized industries are provided by the AMPLIVERSAL Division. In the United States, this division is known as AMP Special Industries.

For Amp products and services in other countries, write: AMP International Division, Harrisburg, PA 17105, USA.

DATA PROCESSING

Portable terminal never forgets



Computer Devices, 25 N. Ave., P.O. Box 421, Burlington, MA 01803. (617) 273-1550. \$3985.

The Miniterm Model 1205 portable data terminal combines 8-k RAM, Mini-cassette tape transport, and modem/acoustic coupler in a compact package. Editing memory and Mini-cassette storage make it possible to edit data off-line, then send them directly to the computer at high speed. Each cassette stores 68,000 characters and the RAM is expandable to 32 k. Other features include 35 char/s printing speed, 1000-char line buffer, upper/lower case typewriter, built-in acoustic coupler with automatic error compensation and RS-232 interface. The terminal can also be rented at \$195/mo.

CIRCLE NO. 331

Wand reads more characters

Recognition Equipment Inc., P.O. Box 22307, Dallas, TX 75222. (214) 438-8611. \$1310 (100 qty).

An improved hand-held OCR WAND-reader, the Class 600 system, reads a substantially longer line of alphanumeric characters than previous WANDs. Connected directly to terminal, computer and other data processing equipment, the optical character-recognition system accepts human-readable source data and transmits the information directly to a terminal or computer. The Class 600 reads data at speeds of 30 to 130 char/s with less than one error per 10,000 characters scanned. In addition to the OCR-A and B fonts, the Class 600 also reads the numerics in type fonts 1403, 12-F and 407-1.

CIRCLE NO. 332

Output driver sinks 300 mA

Adac Corp., 15 Cummings Park, Woburn, MA 01801. (617) 935-6668. \$300 (1-4 qty); 4-6 wks.

The Model 1632-HCO module contains 32 discrete latched outputs with 300-mA current capability on a half-quad card (8-1/2 x 5 in.). It plugs directly into the backplane of a DEC LSI-11 microcomputer and contains bus transceivers, 16-bit status register, and flexible addressing. Two 20-pin headers and cables allow direct connection to the loads. A 16-bit unit (1616-HCO) is also available at \$225.

CIRCLE NO. 333

One head for every track

Alpha Data, 20750 Marilla St., Chatsworth, CA 91311. (213) 882-6500. From \$3000; 12 wks.

The Model Eighty disc has a maximum capacity of 8 Mbytes with an average access time of 8.5 ns. It uses one retractable head per track, and a metal-plated disc, sealed in a head chamber, eliminating the contamination of oxide-coated discs. The Model Eighty features new head/disc magnetics, efficient data coding, modern read-back signal equalization, good noise immunity, and easy access to all replaceable parts. The unit is compatible with all Alpha Data controllers for Data General and DEC computers. A simple change of one interface card permits emulation of other manufacturers' products.

CIRCLE NO. 334

Speed up data communications

Syntech Corp., 11810 Parklawn Dr., Rockville, MD 20852. G. Fritkin (301) 770-0550.

A character-oriented converter/buffer, the MPB-200C, allows most asynchronous communications systems to be upgraded to the higher speeds of synchronous modems. It can be used on the dial network or on private lines, both point-to-point and multipoint, in full duplex, half duplex or simplex. The MPB-200C accepts synchronous data from the modem receiver and delivers it to the terminal or computer in the original character format, but at the higher data rate.

CIRCLE NO. 335



DATA PROCESSING

Feed mini/micros with 'Serial Box'

Computer Operations, Inc., 9700-B Palmer Hwy., Lanham, MD 20801. Michael Keating (301) 459-2100. \$3850 (unit qty); September, 1977.

The 23-lb "Serial Box" is a portable, interactive terminal that interfaces with any mini/microcomputer through

an RS-232 or current loop port, at data speeds from 110 to 9600 baud. Dubbed the Model CO-4420, it consists of a 1-Mbyte direct-access tape drive, a full ASCII keyboard, a 40-character plasma display, an RS-232 port and a μ P controller, all built into an attache case. The CO-4420's high reliability results from the LINC tape drive. Without display or keyboard as Model CO-4410, the unit adds mass-storage capability to terminals for \$2850.

CIRCLE NO. 336

Line printer switches character sets

Data 100 Corp., 6110 Blue Circle Dr., Minneapolis, MN 55435. (612) 941-6500. See text; Sept. 1977.

Optical character-recognition printers with speeds of 125 and 250 lines/min meet National Retail Merchants Association (NRMA) standards. Both OCR A and OCR B character codes are available. The printers can also be used for normal data processing applications by simply changing the print ribbon. Up to 132 columns are printed on fan-fold paper widths up to 17-1/2 in., at six lines/in. and 10 char./in. The 125 lines/min printer costs \$5000, the 250 lines/min \$7000.

CIRCLE NO. 337



24 GHz

-30 dBm sensitivity, FM tolerance standard

Just those three features alone put Systron-Donner's new Model 6054B Microwave Counter in a class by itself! But there's lots more...

- **Coverage:** 0.02 to 24 GHz in one band with one connector input.
- **Sensitivity:** -30 dBm to 10 GHz; -25 dBm to 18 GHz; -20 dBm to 24 GHz.
- **Dynamic range:** No dead zone! Operative over the complete range up to +30 dBm (1 watt).
- **Protection:** Flashing LED's provide early warning of pending overload.
- **FM tolerance:** Full channel loading and heavily modulated signals with rates up to 10 MHz are measured easily.
- **Models:** If you don't need 24 GHz coverage, S-D also offers 1.25, 4.5, 6.5 and 18 GHz automatic counters.
- **Information:** Call Scientific Devices or contact S-D at 10 Systron Drive, Concord, CA 94518. Phone (415) 676-5000. Overseas, contact Systron-Donner in Munich; Leamington Spa, U.K.; Paris (Le Port Marly); Melbourne.

SYSTRON  DONNER

CIRCLE NUMBER 65

Laser scanner zips through bar code



NEC America Inc., 532 Broadhollow Rd., Melville, NY 11746. Jun Oyamada (516) 752-9700.

Two models of bar-code-reading laser scanners were developed for materials handling (Model OBR-70-1) and data entry systems (OBR-70-2). Both models consist of a scanner unit and a decoder unit. The scanner of the 70-1 has a wide scanning range (up to 55 in.), great depth of field (40 in.), and high reading speed for objects moving up to 150 in/s. Model OBR-70-2 is compact in size and thus most suitable as an input device in data-entry systems.

CIRCLE NO. 338

Replacement terminal has diagnostics

Trivex, Inc., 3180 Red Hill Ave., Costa Mesa, CA 92626. R. J. Martin (714) 546-7781. \$3950.

The Model 0752 stand-alone data entry terminal is a plug-compatible replacement for the IBM 3775, and supports IBM 3784, 3786, and 3788 printers. The unit offers light pen, OCR wand, and diagnostics which test the 0752 completely in the local mode. The Model 0752 can also be leased for \$98/mo.

CIRCLE NO. 339

Featherweight printer is fast, versatile



Datel Systems, 1020 Turnpike St., Canton, MA 02021. (617) 828-8000. From \$425.

The AIP-40 prints up to 40 columns on adding-machine roll paper using a 5 × 7 dot matrix impact printer. Up to 64 ASCII-coded characters are printed at a rate of 50 char/s, directly from the interface circuits offered with 8080, 6800 and other μ Ps. Printing mechanism life is 400 million characters and one 170-ft paper roll is good for 12,000 lines. The AIP-40 measures 13.5 × 13.25 × 7.12 in. (343 × 337 × 181 mm) and weighs 6 lb (2.7 kg). Serial input models are available (\$625).

CIRCLE NO. 340

Let the ADAS do the walking

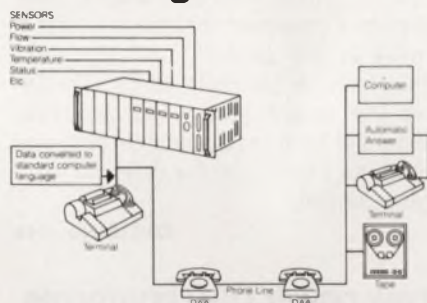

Mojave U.S.A. Inc., 500 "B" St., Suite 2350, San Diego, CA 92101. (714) 231-3737.

The ADAS Universal Data Reporting System permits users to obtain readings from remote instruments by dialing a telephone number. The unattended remote stations automatically digitize the desired variables, insert the values into a pre-programmed 256-word memory, and transmit the formatted report into the user's teleprinter, computer or tape recorder. The system transmits in ASCII, RS-232 and Bell 103, and interfaces directly with 8-bit (or larger) μ Ps, minis, or time-share terminals. ADAS also permits continuous switch-selectable supervision of multiple remote stations through an ASCII video monitor.

CIRCLE NO. 341

PREMIER PLUS FACTORS

- Cabinets
- Consoles
- Cases

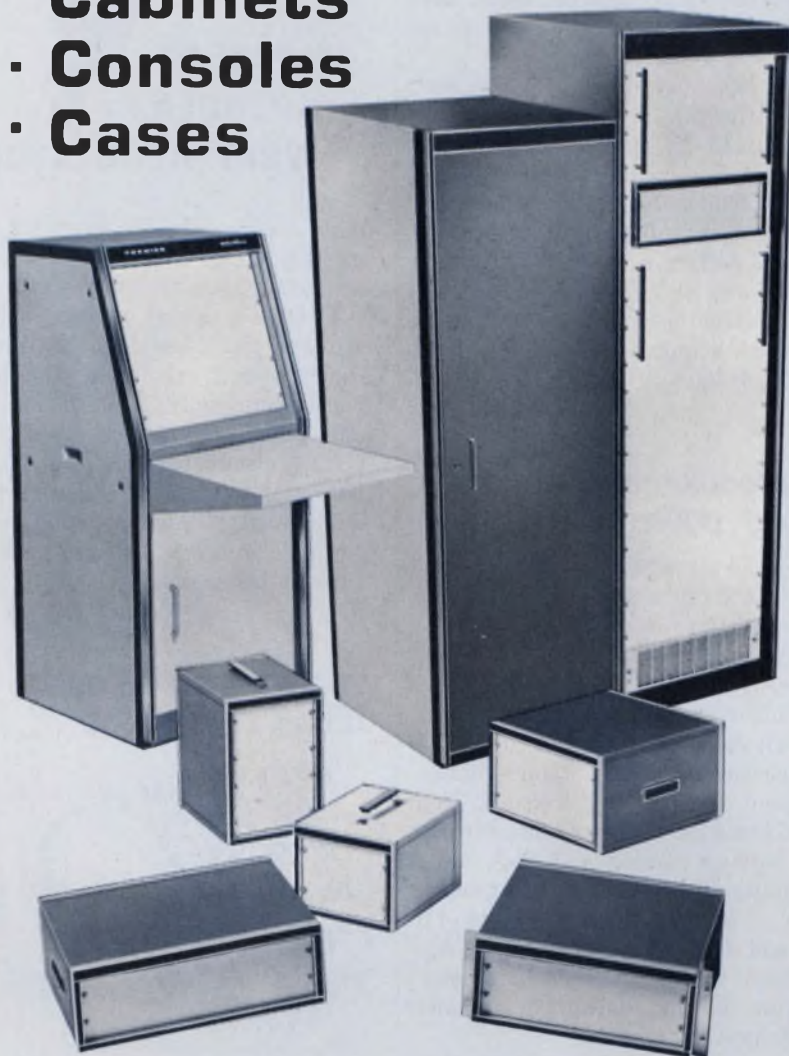

Standard Models in many sizes

PLUS

Modifications for special needs

PLUS

Custom Built for complete specials

PLUS

Facilities from sheet metal to finishing

PLUS

Accessories: panels, fans, blowers, slides, shelves, drawers, outlet strips, chassis, hardware, etc.

You can rely on Premier for quality, good delivery, and surprisingly low prices.



PREMIER METAL PRODUCTS CO.

381 CANAL PLACE • BRONX, N.Y. 10451

CIRCLE NUMBER 66

ICs & SEMICONDUCTORS

Rectifiers handle up to 16 kV

Solid State Devices, Inc., 14830 Valley View Ave., La Mirada, CA 90638. Dee Peden (213) 921-9660. \$0.49 to \$1.98 (unit qty); stock.

The S093-4044 series of power rectifiers offer peak inverse voltages from 4 kV to 16 kV in 2-kV increments. Specifications include a recovery time of 250 ns and a maximum average half-wave current of 10 mA. Maximum forward voltage drop is 12 V up to 8-kV PIV and 24 V from 10-kV to 16-kV PIV. Maximum reverse current at 25 C is 1 μ A at maximum rated voltage, 40 μ A at 100 C.

CIRCLE NO. 342

Four package types in high power SCRs

Teccor Electronics, 1101 Pamela Dr., Euless, TX 76039. R. L. Saunders (817) 267-2601. \$0.18 to \$0.27 (10,000-qty).

Current ratings of up to 4 A at 400 V rms are available in four versions of the industry standard TO-202AB package. Designated T-106 and T-107, the packages can also be configured in five different lead bending versions. The T-106 has a 200-mA gate sensitivity, 3-mA holding current and 20-A surge capability. The T-107 has a gate sensitivity of 500 mA, holding current of 5 mA and a 15-A surge capability. Applications for the devices include motor controls, lighting controls, timers, and small ignition systems.

CIRCLE NO. 343

Opto-isolators operate at megabit data rates

Spectronics, 830 E. Arapaho Rd., Richardson, TX 75080. (214) 234-4271. 6N135: \$1.90 (1000-qty), 6N136: \$2.10 (1000-qty), 30 days.

Two high speed optically coupled isolators are TTL compatible and operate at 1 Mbit/s data rates. The 6N135 with a 7% current transfer ratio (CTR) minimum and the 6N136 with a 19% CTR minimum are pin-for-pin compatible with the HP 6N135 and HP 6N136. Housed in 8-pin DIPs, the integrated diode-transistor photodetector circuit is capable of very high speeds. The devices can isolate voltages as high as 3 kV dc and feature a 2 MHz bandwidth.

CIRCLE NO. 344

Error accuracy less than 3% in 5-V regulator

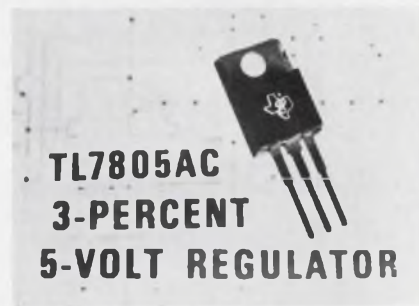

Texas Instruments, P.O. Box 5012, Dallas, TX 75222. Dale Pippenger (214) 238-3527. \$1.31 (100-qty); stock.

A three-terminal positive voltage regulator yields less than $\pm 3\%$ error in accuracy and regulation. Operating over a temperature range of from 0 to 150 C, the TL7805AC is housed in the TO-220 plastic package. The IC can deliver up to 1.5 A of output current, and integral current-limiting and thermal-shutdown features make it difficult to overload.

CIRCLE NO. 345

Improved VMOS offers JEDEC registration



Siliconix, 2201 Laurelwood Rd., Santa Clara, CA 95054. Jim Graham (408) 246-8000. 2N6657: \$4.79 (999-qty), 2N6660: \$3.33 (999-qty).

Replacements for the VMP1 and VMP2 power MOSFET devices are available with upgraded specs. The 2N6657 (VMP1) and 2N6660 (VMP2) offer lower input current and lower ON resistance than their earlier counterparts, resulting in greater circuit efficiency and decreased power dissipation. Housed in a TO-39 package, the 2N6660 can dissipate 6.25 W—1.25 W greater than the 5 W VMP2. The 2N6657, in a TO-3 package, dissipates 25 W. Both units switch typically in 10 ns, have 60-V breakdowns, and can handle up to 3 A. Low drive requirements (100 nA) allow the units to directly interface with CMOS, TTL and other logic families.

CIRCLE NO. 346

Multiply 12 bits and accumulate in 175 ns

TRW, One Space Park, Redondo Beach, CA 90278. William Koral (213) 535-1831. \$150 (499-qty); stock.

The bipolar TDC-1003J is capable of performing a 12×12 multiplication and has a 27-bit accumulation capacity. On chip, 27-bit registers allow the accumulator contents to be subtracted from the next product instead of being added. Designed as a central arithmetic block for digital filters, the unit provides faster operating time than MSI equivalent multipliers. The 64-pin DIP operates from a single +5-V-dc supply over a 0 to 70 C temperature range. A heat sink is integral with the package.

CIRCLE NO. 347

Demodulate FM signals with a phase locked loop

Sigmetrics, 811 E. Arques Ave., Sunnyvale, CA 94086. (408) 739-7700. \$4.25 (100-qty); stock.

The demodulation of FM and FSK signals can be performed without additional circuitry using the NE564. Operating from a single +5-V-dc supply, the TTL-compatible unit contains a VCO, limiter, phase detector and a post-detection processor. Frequency drift is rated at 400 ppm/ $^{\circ}$ C and signal-to-noise ratio is typically 40 dB. The 16-pin DIP uses Schottky clamped transistors at both inputs and outputs and contains a provision for external loop-gain control.

CIRCLE NO. 348

Low power DAC conforms to European PCM systems

Precision Monolithics, 1500 Space Park Dr., Santa Clara, CA 95050. Al Chame (408) 246-9222. DAC-87EX: \$9.90, DAC-87CX: \$9.00 (100-qty); stock.

A digital-to-analog converter, the DAC-87 is specifically designed to conform with the CCITT exponential "A" characteristic in European PCM systems. Features include 500-ns settling time and power consumption of 141 mW. The device is available in two models covering the 0 to 70 C temperature range: the DAC-87EX with $\pm 1/2$ step accuracy and DAC-87CX with ± 1 step accuracy. Housed in an 18-pin hermetically sealed DIP, the device interfaces with DTL, TTL, HTL, MECL or CMOS inputs.

CIRCLE NO. 349

Berg Quickie Connectors are the logical cable interface for Digital minicomputers

Berg Quickie™ Connectors rapidly, reliably terminate multi-lead, flat, round conductor cable—without pre-stripping. Quickie designs allow for visual inspection before and after assembly.

Digital Equipment Corporation likes the Quickie connector's ease of termination and how its askewed tines strip away insulation to assure positive electrical contact. They like the way Quickie Headers latch to maintain connection integrity through vibration and impact. Digital has found it can rely on Berg . . . to supply the products and the application

machines that precisely meet its demanding interconnection needs.

Berg is experienced. We read interconnection needs like Digital computers read data. We have the products, the background, and the back-up to do the job. Your job. Let's work on it, together. Berg Electronics, Division E. I. du Pont de Nemours & Co., New Cumberland, Pa. 17070—Phone (717) 938-6711.



BERG ELECTRONICS

CIRCLE NUMBER 67

We serve special interests—yours!

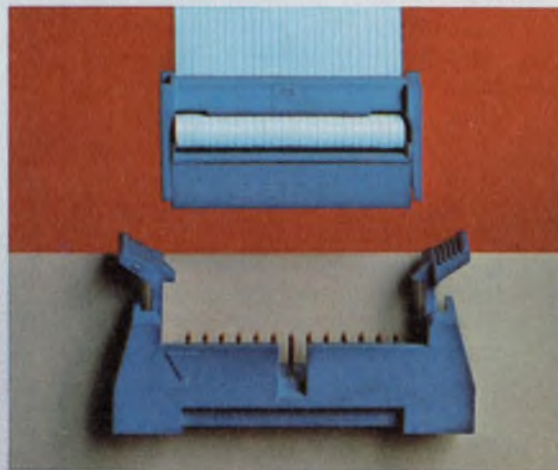

Microwave transistor offers low noise figure

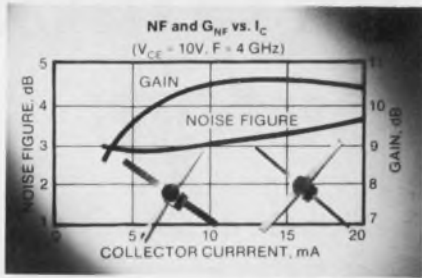

Avantek, 3175 Bowers Ave., Santa Clara, CA 95051. William Berridge (408) 249-0700. Stock.

The AT-4691 bipolar microwave transistor has a typical noise figure of 0.8 dB at 4 GHz for collector currents between 2.5 and 20 mA. Packaged in a hermetically sealed 0.07-in. square alumina stripline, the 0.5-micron emitter structure gives the device a shallow curve for noise figure vs collector current. Typical figures are G_{NF} of 9.5 dB, minimum gain of 12 dB, both at 4 GHz. Testing includes 100% dc, rf and fine leak with additional screening and burn-in available.

CIRCLE NO. 356

10-year life predicted for pulsed operation LED

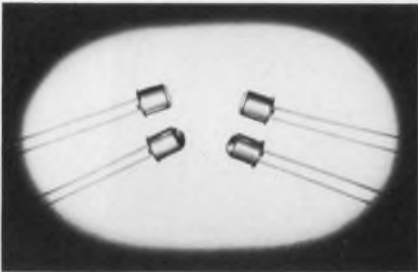

Optron, 1201 Tappan Cir., Carrollton, TX 75006. (214) 242-6571. OP 135: \$1.44 (1000-qty), OP 136: \$0.74 (1000-qty); stock.

Average power degradation of less than 10% after 1 million hours of operation is claimed for the OP 135 and OP 136 devices. The gallium-arsenide chips have typical power outputs of 20 mW for the OP 135 and 35 mW for the OP 136 with an input pulse of 1 A, 10 ms at a 10 pps rate. Both units are available in a standard TO-18 package with a choice of either lens or flat window. Although specifically designed for pulse applications, the devices can be operated in a continuous mode.

CIRCLE NO. 357

Temp compensation improves BIFET op amp

Precision Monolithics, 1500 Space Park Dr., Santa Clara, CA 95050. Shelby Givens (408) 246-9222. Stock.

Input bias currents of 9-nA maximum at 125-C ambient are maintained by a temperature compensation circuit in the OP-15. This can result in significantly lower droop rates in high speed sample-and-hold circuits. The op-amp features a maximum input offset voltage of 500 μ V, a slew rate of 17 V/ μ s and a settling time of 900 ns. Two models, one covering the 0 to 70 C and the other covering the -55 to +125 C temperature range, are available in 8-lead TO-99 packages. The unit was designed to hold error correcting manual adjustments in systems to a minimum.

CIRCLE NO. 358

Solid-state controller aims at consumer market

Fairchild Consumer Prod., 4001 Miranda Ave., Palo Alto, CA 94043. Bill Callahan (415) 962-3816.

A clock/timer circuit with full time-keeping and alarm capability has on-board circuitry to directly drive a four-digit display. The FCM7040 also contains two independent keyboard settable registers—a 99-min, 59-s count-down timer and a 24-h start/stop timer. Common anode LED displays of up to 25 mA in the duplex mode can be driven under single-pin control. Other on-board features are a back-up oscillator, internally generated alarm tone, power-up-clear and an additional 10-min timer. Clocks and clock radios, microwave ovens and thermostat timers are typical applications for the device.

CIRCLE NO. 359

Create musical sounds with digital noise unit

American Microsystems, 3800 Homestead Rd., Santa Clara, CA 95051. (408) 246-0330. \$2.25 (999-qty).

The S2688 noise generator provides the sounds of drums, maracas, brushes and other musical instruments electronically. A 17-stage shift register and exclusive-OR logic produce a pseudo-random broadband white-noise signal. The unit, an exact replacement for the MM5837, contains a resettability feature to ease parts testing. Output amplitude and noise quality are uniform over the frequency range.

CIRCLE NO. 360

Call your nearest ISC sales representative.

- ALABAMA: Huntsville
W. A. Brown Inst. Inc. 205/539-4411
- ARIZONA: Phoenix
Thorson Co. 602/956-5300
- CALIFORNIA: Goleta
Thorson Co. 805/964-8751
- CALIFORNIA: Los Angeles
Thorson Co. 213/476-1241
- CALIFORNIA: Mountain View
Thorson Co. 415/964-9300
- CALIFORNIA: San Diego
Thorson Co. 714/298-8385
- CALIFORNIA: Tustin
Thorson Co. 714/544-5121
- COLORADO: Denver
Thorson Co. 303/759-0809
- FLORIDA: Ft. Lauderdale
W. A. Brown Inst. Inc. 305/776-4800
- FLORIDA: Melbourne
W. A. Brown Inst. Inc. 305/723-0766
- FLORIDA: Orlando
W. A. Brown Inst. Inc. 305/425-5505
- FLORIDA: Valparaiso
W. A. Brown Inst. Inc. 904/678-7932
- GEORGIA: Atlanta
W. A. Brown Inst. Inc. 404/939-1674
- ILLINOIS: Arlington Hts.
Future Systems 312/640-6091
- LOUISIANA: Gretna
W. A. Brown Inst. Inc. 504/366-5766
- MARYLAND: Bethesda
Bartlett Assoc. 301/656-3061
- MASSACHUSETTS: Framingham
Bartlett Assoc. 617/879-7530
- MICHIGAN: Madison Hts.
WKM Associates 313/588-2300
- NEW MEXICO: Albuquerque
Thorson Co. 505/265-5655
- NEW YORK: White Plains
Bartlett Assoc. 914/949-6476
- NORTH CAROLINA: Durham
W. A. Brown Inst. Inc. 919/682-2383
- OHIO: Cleveland
WKM Associates 216/267-0445
- OKLAHOMA: Norman
Data Marketing Assoc. 405/364-8320
- PENNSYLVANIA: Pittsburgh
WKM Associates 412/892-2953
- PENNSYLVANIA: Wayne
Bartlett Assoc. 215/688-7325
- SOUTH CAROLINA: Columbia
W. A. Brown Inst. Inc. 803/798-3297
- TENNESSEE: Knoxville
McCain Elec. Equip. 615/584-8411
- TEXAS: Austin
Data Marketing Assoc. 512/451-5174
- TEXAS: Dallas
Data Marketing Assoc. 214/661-0300
- TEXAS: Houston
Data Marketing Assoc. 713/780-2511
- TEXAS: San Antonio
Data Marketing Assoc. 512/828-0937
- WASHINGTON: Bellevue
Thorson Co. 206/455-9180
- AUSTRALIA: Mt. Waverly, Victoria
Anderson Digital Elec. 03-543-2077
- CANADA: Montreal
Cantec Rep. 514/620-3121
- CANADA: Ottawa
Cantec Rep. 613/225-0363
- CANADA: Toronto
Cantec Rep. 416/624-9696
- EUROPE: England
Techex, Ltd. 0202-293-115
- EUROPE: France
Peritec 749-40-37
- EUROPE: Switzerland
Intertest, AG 031-224481
- JAPAN: Tokyo
Munzing International 586-2701



Intelligent Systems Corp.



Unretouched photograph of screen.

The Intecolor 8001 CRT. Buy One or Buy One Hundred. Just \$1495.*

That's the price tag we'll put on the Intecolor 8001 if you place your order right now for 100 or more units. \$1495. That's also the price we'll give you on a one-shot cash basis on an Intecolor 8001 CRT evaluation unit. Now, we'll never get rich with a price structure like that, but we look at it this way. That price is an investment in your future. We know that once you get your hands on the Intecolor 8001, once you see what it can do, you'll be back for more.

And it's because you'll be getting an Intelligent, 8-Color CRT that'll outperform any CRT on the market on a dollar for dollar and character for character basis. And it's complete. You won't have to lay out more cash for a keyboard, or 8080 CPU, or any of the standard features you'd expect to find on a good color CRT. It'll be ready to go. You can put it to work as a stand-alone CRT, incorporate it into your present system, or use it to upgrade the CRT's in the systems you're currently marketing. Whatever your application, it'll work for you.

But if your needs call for a more sophisticated CRT, a CRT that'll give you higher-level functions — no problem. We'll be glad to work with you to help you come up with an options package to fit your requirements. Like additional RAM to 32K, Roll, Background Color, Light pens, Graphics, 48 Line X 80 Characters/Line and up to 64 Special Graphics Characters. You define your needs, and we'll give you the capabilities to get the job done. It's that simple.

But if you'd like to see for yourself, look over our rep list on the adjacent page and ask the rep in your area for a demonstration. Whatever your application, he can show you the right Intecolor 8001 CRT at just the right price.



Intelligent Systems Corp.[®]
5965 Peachtree Corners East
Norcross, Georgia 30071
(404) 449-5961

*Quantity 100 price — \$1495 each, net 20 Days
Evaluation unit price — \$1495, Limit one to a customer, cash with order
Domestic U.S.A. prices

New Rustrak OEM 4" Servo Recorders

Offer more features and options than any OEM recorder in their price range.

Features/Options

Plug in range cards — over 50 for temperature, volts, amps.

Performance — to 1 mV sensitivity, 1/2% f.s. accuracy, 1/2 sec. f.s. response.

Three chart configurations — select from tear-off, rewind and Z-fold.

Choose from 8 chart speeds — 1.5, 3, 6, 15, 30, 60, 150 and 300 cm/hr.

Standard features — all controls adjustable from front, zero adjustment up to 100% of full scale, readily multiplexed.

Special options — event pen, high/low alarm contacts, electric pen lift, eight speed chart drive, five switch selectable spans, protective door, rack mounting panels, escutcheons.

Send for comprehensive new catalog.

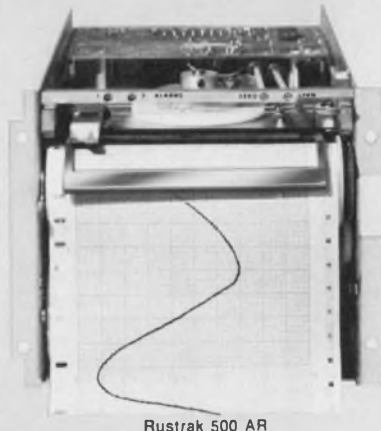

Rustrak 500 AR

gulton®

Measurement & Control Systems Division
Gulton Industries Inc., East Greenwich, Rhode Island 02818
401-884-6800 • TWX 710-387-1500

CIRCLE NUMBER 69

A "LIGHT" TOUCH

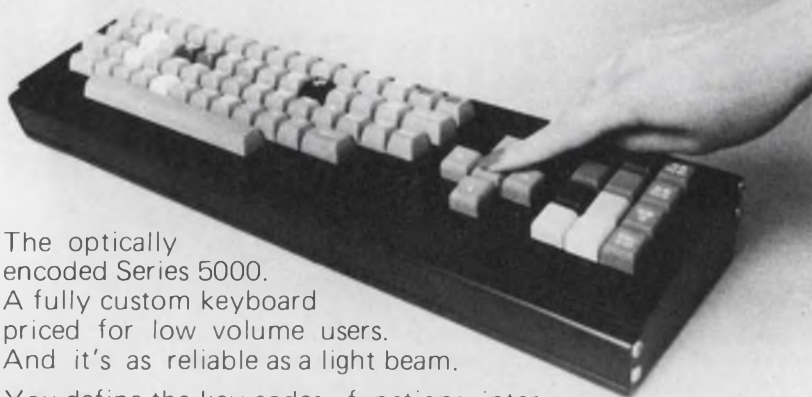

The optically encoded Series 5000.

A fully custom keyboard priced for low volume users. And it's as reliable as a light beam.

You define the key codes, functions, interface, key locations and cap markings. If you can make do with a choice of only 2048 different codes, 360 keys or less, n-key lockout, 2-key rollover and logical or non-logical pairing, we'll make it up to you with fast delivery and no NRE or tooling charges.

Series 5000. The most sensible keyboard technology available today. Affordable in any quantity.

ADI

APPLIED DYNAMICS INTERNATIONAL
KEYBOARD PRODUCTS DIVISION
3800 Stone School Road
Ann Arbor, Michigan 48104
Phone: 313-971-7840 Telex: 230238

CIRCLE NUMBER 70

ICs & SEMICONDUCTORS

Reference diodes have 2-ppm temperature specs

American Power Services, 7 Andover St., Andover, MA 01810. Robert Dimodana (617) 475-4074.

Low level temperature-compensated zeners in JEDEC registered 250-mW and 500-mW series are made with oxide-passivated junctions. The DO-7 packaged units have tolerances of ± 2 ppm/ $^{\circ}\text{C}$ for the 500 mW series and ± 5 ppm/ $^{\circ}\text{C}$ for the 250 mW series. The 6.2 V dc devices included in the 500 mW series are the JEDEC types 1N935, 1N940, 1N941, 1N3154, 1N3779 and 1N4565. In the 250 mW series, also at 6.2 V dc, are the 1N821, 1N4765, 1N3496 and 1N4775. The units are also available in either dice or wafer form.

CIRCLE NO. 361

Generate musical scale with 7-stage counter

Fairchild, 464 Ellis St., Mountain View, CA 94042. Bill Callahan (415) 962-3816. \$1.17 (1000-qty); stock.

All of the tones of the chromatic musical scale, across eight octaves, are generated by the F4727 counter. Based on a primary chromatic scale, the device generates each of the 12 flats, sharps and natural notes of the seven additional octaves of the primary scale. To generate the entire musical spectrum requires 12 F4727s. Design features of the seven-stage counter minimize interface and cross-talk problems.

CIRCLE NO. 362

4-input gate boasts 500-ps switching speed

Plessey Semiconductors, 1641 Kaiser Ave., Irvine, CA 92714. (714) 540-9979. \$12 (100-qty); stock.

Designed to be fully compatible with ECL III and ECL 10K, the SP16F60 dual OR/NOR gate typically switches in 500 ps. The 16-pin ceramic DIP drives 50- Ω loads and is internally temperature compensated to keep its threshold point in the center of the transistor region. System operation and wiring is simplified since unused gate inputs can be left open circuited. Typical power dissipation is 120 mW under no load conditions, and the unit operates over a temperature range of -30 to $+85$ C.

CIRCLE NO. 363

COMPONENTS

Noncontact level control senses with infrared



Aikenwood Corp., 2151 Park Blvd., Box 26, Palo Alto, CA 94302. (415) 326-2151. From \$162 (unit qty); 15 days.

A modulated infrared beam in the Series 3000 level control provides non-contacting level detection. The sensors work with virtually any liquid or solid. Four different sensor heads have ranges of 1, 3, 6, and 12 ft. The sensor heads can operate through glass windows. Electronic control circuits provide multiple output signals for alarm and pump control purposes.

CIRCLE NO. 364

Float-control switch needs no bearings



Signal Systems International, P.O. Box 8, Farmingdale, NJ 07727. (201) 938-3535. \$2.95 (unit qty); stock to 4 wks.

The FS101 float-control switch is a welded-steel, omnidirectional, mercury-switch position sensor. The position sensor is encapsulated within a sealed ball float. The float is weighted at the top. Two flexible, insulated control wires extend upward from the float. In normal operation, the ball is suspended by the leads. When the liquid level reaches the suspended float, the weighted ball rises slightly, then tips 180 degrees, which activates the mercury contacts. As the liquid level drops, the sequence of operation reverses. Tests at loads ranging from 1 A at 12 V dc to 0.25 A at 115 V ac have produced no failures before one million actuations. Repeatability of the point of actuation is within 0.25 in. of the liquid level.

CIRCLE NO. 365

Magnetostrictive switch needs small displacement

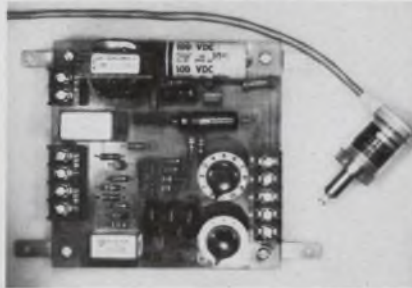

Magnetoelastic Devices, Crane Ave., Pittsfield, MA 01201. (413) 445-5608. \$70 to \$120 (unit qty).

Model BS-6, a precision electromechanical limit switch, combines a displacement transducer with a remotely connected solid-state control unit. A signal from a high-compliance magnetostrictive element in a transducer is compared with a signal from a similar adjustable element in the control unit to determine the state of the outputs. The nominal displacement range of the transducer is 0.025 in. and repeatability is within 0.0002 in. Standard options include one or two set points, LED status indicators, fixed or adjustable on-off differentials and logic-level or solid-state relay outputs.

CIRCLE NO. 366

Solid-state relays don't trigger falsely



Theta-J Relays Inc., 1 DeAngelo Dr., Bedford, MA 01730. (617) 275-2575. \$9 (1000 qty); 6 to 8 wks.

As with zero crossing, the TA1201Q SSRs generate no RFI regardless of the power factor. The relays are 100% immune to dv/dt false triggering induced by line transients, because a custom power transistor, not thyristors, is the output switching element. The relays are rated up to 140 V ac at 0.75 A. Even without a thyristor output, the devices still carry a one-cycle surge rating of 8 A. Nominal control current is 15 mA at optional control voltages of 5 or 12 V dc.

CIRCLE NO. 367

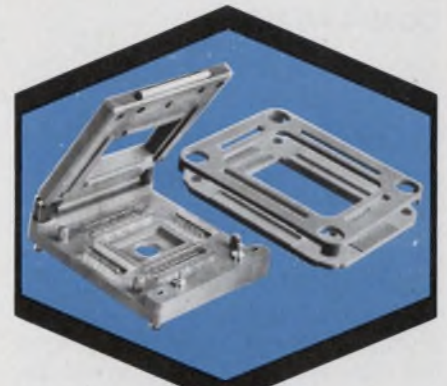

NEW Socket/Carrier Systems Highlight Expanded TEXTOOL Flat-Pack Test Series

Two new socket/carrier systems highlight an expanded TEXTOOL flat-pack test series capable of handling the larger LSI and MSI packages (1 1/4 x 1 1/4" maximum) with up to 96 leads.

A unique feature of the -2620 plastic lid socket (above with carrier) is the availability of up to 192 contacts (96 lead Kelvin) for single or Kelvin measurements. The 96 pin - 4160 socket (left) is basically a metal lid version of the -2620 socket, yet pin for pin, is less expensive for such applications as burn-in where Kelvin contact is not necessarily required.

Standard or custom "snap-together" carriers fit both sockets to completely encase and protect device leads, yet are open for circuit repair.

The new series also includes a versatile new staggered axial lead ZIP STRIP (below) offering zero insertion pressure testing without lead damage to flat-packs for which no carriers are available.

TEXTOOL's complete flat-pack test socket line now includes units to accept devices with 50, 52, 64, 70, 76, 82 and 96 leads (two and four sided). All sockets feature maximum device protection while insuring consistently good electrical contact. Wiping contacts eliminate "dimpling" or gold removal, and lids are reinforced in the contact area.

Detailed technical information on these and other TEXTOOL flat-pack test sockets is available from your nearest TEXTOOL sales representative or the factory direct.



PRODUCTS, INC.

1410 W. Pioneer Drive • Irving, Texas 75061
214/259-2676

CIRCLE NUMBER 71

COMPONENTS

Thick-film resistors provide ± 50 ppm/ $^{\circ}\text{C}$

Du Pont Co., Wilmington, DE 19898.
(302) 774-2358.

Birox 1700-Series thick-film resistors for microelectronic circuitry provide temperature coefficients of less than ± 50 ppm/ $^{\circ}\text{C}$ throughout the

100 Ω /square to 100 k Ω /square resistivity range. Load life, 150-C storage, humidity and thermal shock tests indicate that well under 0.5% end-of-life stability can be expected. Stability after laser trimming and subsequent processing steps permit high yields of close-tolerance resistors. Average change in resistance is 0.05% in 1000 h after laser trimming, with maximum change of less than 0.15%. Resistors change less than 0.05% during solder dipping.

CIRCLE NO. 368

See-through power plug allows easy inspection



Westinghouse Electric Corp., 1421 State St., Bridgeport, CT 06602.

A new hospital-grade, all-nylon angle plug can be assembled in any one of 12 different positions for maximum outlet convenience. Called the C-Thru angle plug, this transparent unit offers users the safety of straight-in wiring and also allows visual inspection of the wire terminations. Power cords exit parallel to a receptacle face and eliminate the space needed for the cord to bend. The designer also allows machinery to be placed close to a wall, and the possibility of cord breakage and internal shorts are minimized. Other features of the plug include dead-front construction, clamp-type terminals, nonmetallic cord grip, individually identified wire pockets and no exposed metal parts, once the plug enters the receptacle.

CIRCLE NO. 369

85% OF OUR CUSTOMER-DESIGNED MONOCHIPS ARE INTEGRATED SUCCESSFULLY ON THE FIRST TRY!

THE OTHER 15% TAKE AN EXTRA WEEK OR TWO.

You can start converting your linear or digital discrete circuits to IC's today! The new Monochip Design Kit guides you through circuit design, breadboarding, analysis, and layout.

The kit sells for \$59. And that includes all the free applications engineering and design consulting you'll need.



It's easy, it's fast, and it's practically risk free. The pay-offs are size reduction, less cost, more reliability, and absolute protection from competitive analysis of your IC's.

And you'll have prototypes in a mere four weeks after layout.

Order today! Complete and mail the coupon or better yet, phone us for immediate delivery.

Please ship _____ MO-K Design Kits @ 59.00 (Ca res. add 6½% sales tax) ED

Date _____ P.O. Number _____

Name _____

Company _____ Dept. _____

Address _____

City, State, Zip _____

Phone _____

interdesign

P.O. Box 7065 1225 Reamwood Ave. Sunnyvale, CA 94086 (408) 734-8666

CIRCLE NUMBER 99

Flat-pack relays mount flat or vertically

Omron Electronics Inc., Sears Tower, 233 S. Wacker Dr., Chicago, IL 60606.
(312) 876-0800. \$2.07 to \$3.95; stock.

A series of flat-pack power relays, SPDT Type G2L, are rated to switch up to 8 A at 240 V ac or 24 V dc. They are packaged in a low-profile configuration for PC boards on ½-in. centers, or for stacking in an upright configuration. Low-profile-mounted, dimensions are 0.41-in. high \times 1-in. wide \times 1.122-in. long; vertically mounted height measures 1.004 in. and the base area is 0.413 \times 1.122 in. Six coil voltages range from 3 to 48 V dc and power consumption in continuous operation does not exceed 520 mW. Operate time is 6 ms max and release time is 4 ms max. Mechanical service life is rated at 200-million operations minimum.

CIRCLE NO. 370

Low profile trimmers come in three options

Allen-Bradley, 1201 S. Second St., Milwaukee, WI 53204. (414) 671-2000. \$0.96 (1000 qty) stock.

The 1/4-in. dia, single-turn, cermet Type A trimmer offered by A-B have three new options: A4C, A4D and A2C. A4C and A4D are low-profile horizontal versions; A4C, reverse rotation of the A4D and A4B; and A2C, reverse rotation of the A2B. In addition, Type A now uses a new ink with a TCR of typically less than ± 35 ppm/ $^{\circ}$ C above 250 Ω . The trimmers are furnished with TO-5 or 0.1-in.-grid terminal spacings for top or side adjustments. Multifingered wipers ensure good wiping action. Power rating is 0.5 W at 85 C. Standard values range from 10 Ω to 2 M Ω with $\pm 10\%$ tolerance. End resistance is less than 2 Ω at both ends of rotation. Contact resistance is typically less than 1% or 1 Ω .

CIRCLE NO. 371

Rotary switches provide binary-coded outputs



Professional Electronics, Stackpole Components Co., P. O. Box 14466, Raleigh, NC 27610. (919) 828-6201.

Rotary switches in special configurations for binary-coded applications are available in Series 100 and Series 80 switches. The Series 100 is offered with 22-1/2, 30 and 26-degree index angles for up to 10, 12 or 16-position applications. The switches have a single-input terminal and one terminal for each binary output. They are fully enclosed in environment-proof packages and come with either PC pins or solder-lug terminations.

CIRCLE NO. 372

CHECK DIGITAL IC'S FASTER THAN A SCOPE, SAFER THAN A VOLTMETER

You're looking at the most convenient and efficient way developed to check digital IC's: CSC's Logic Monitor. It speeds digital design and testing by accurately and automatically displaying static and dynamic logic states of DTL, TTL, HTL and CMOS DIP IC's. All in a compact, self-contained 16-pin circuit-powered unit.

Use it to effortlessly trace signals through counters, shift registers, gating networks, flip-flops, decoders... even entire systems made up of mixed logic families. It's a great way to cut minutes, even hours all along the line from design through debugging.

Nothing could be simpler: just clip it over any DIP IC up to 16 pins, and the Logic Monitor does the rest. Precision plastic guides and unique flexible web insure positive connections between non-corrosive nickel-silver contacts and IC leads. Each contact connects to a single "bit" detector with high-intensity LED readout, activated when the applied voltage exceeds a fixed 2V threshold. Logic "1" (high voltage) turns LED on; Logic "0" (low voltage or open circuit) keeps LED off. A power-seeking gate network automatically locates supply leads and feeds them

to the Logic Monitor's internal circuitry.

Very clever. Very portable. Very effective. And very reasonable, at \$84.95*. See the Logic Monitor at your CSC dealer, or write for our catalog and distributor list.



CONTINENTAL SPECIALTIES CORPORATION



EASY DOES IT

44 Kendall Street, Box 1942, New Haven, CT 06509
203-624-3103 TWX 710-465-1227
West Coast: 351 California St., San Francisco, CA 94104
415-421-8872 TWX 910-372-7992

© 1976, Continental Specialties Corp.

*Manufacturer's suggested price. Prices and specifications subject to change without notice.

CIRCLE NUMBER 72

where weight
and space are
critical...
like this magnetron...

Redesign with Alnico 8 and 9 MAGNETS

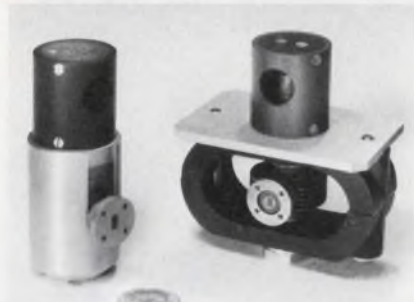

New Alnico 9
Design

Previous Alnico 5
Design

For minimum space and weight, maximum power efficiency and consistent performance, design your unit around T & S high performance magnetic alloys... Alnicos 8C, 8HC, 8HE, and 9Nb. You can get up to twice the energy product, permitting the use of smaller pieces and assemblies, with less weight and at a lower unit cost. The high coercive force of these magnetic alloys... up to four times that of Alnico 5... reduces stray fields and allows lower leakage factors, permitting more efficient structures for replacing Alnico 5 designs. And these alloys have low temperature coefficients and extreme magnetic stability... are easy to magnetize and stabilize.

APPLICATIONS

Alnico 8 and 9 alloys are ideally suited for: Meters • Motors • Microwave Tubes • Generators • Alternators • Tachometers • Latching Relays • Stepping Motors • Medium hp Precision Motors and Torquers • D'Arsonval Type Movement Systems.

Improve your products magnetically... Come to the Magneticsians!

Take advantage of our long years of experience in the development, refinement and successful production of these high performance magnet materials. T & S was the original manufacturer, and has been the only continuous manufacturer of Alnico 9 for over ten years. And we have produced Alnico 8 alloys since 1960.

BEFORE YOU DESIGN... Send for Bulletin M-304 CR which gives details on all T & S metallic alloy permanent magnets. Or better yet, call on T & S experts to help solve your magnet design problems... large or small... unique or ordinary.

Thomas & Skinner, Inc.

MAGNETICIANS

P.O. BOX 150-B, 1120 EAST 23RD ST.
INDIANAPOLIS, IND. 46208
PHONE: (317) 923-2501

CIRCLE NUMBER 73

PACKAGING & MATERIALS

Magnetic catches mount with adhesive



Southco Inc., Brinton Lake Rd., Concordville, PA 19331. T. Grant (215) 643-2220.

Southco's No. 02 magnetic catches now can be ordered with adhesive back for quick mounting. Available in 2, 1-1/4 and 1-1/8 in. over-all lengths, they offer a selection of break-away forces. Installation is simple: Peel away the protective paper backing and press the catch against the door frame. They are easy to use where thick frame members make conventional attachment difficult. The housing and pin of the magnetic catch are aluminum; the pole pieces are zinc-plated steel; the magnet is barium ferrite.

CIRCLE NO. 373

Terminal-strip cover protects against shorts



Kulka Electronic Corp., 520 S. Fulton Ave., Mount Vernon, NY 10551. (914) 664-4024.

Terminal strip safety covers, called Safe-Ti-Caps, protect the wiring connections and terminations. These covers are intended for high-risk areas where spills, dirt and accidentally dropped tools could cause a short circuit. Made of nonflammable pliable rubber, the covers are easy to position and remove. But when in place, they grip the terminal board barriers securely and will not easily come loose or slide. The covers can be marked with terminal identification.

CIRCLE NO. 374

50-contact connectors mass terminated in field



Viking Industries Inc., 9324 Topanga Canyon Blvd., Chatsworth, CA 91311. (213) 882-6275. \$2.52 (50-249); stock.

A low-cost connector, called Vitel-F, can be mass-terminated in the field. The connectors can have up to 50 conductors. The connector can also be reterminated in the field to change the conductor pattern. A terminating tool displaces the wire insulation as it presses the conductors into place with a carrier strip. Four stable contact-to-conductor junctions are produced having an apparent junction area of up to 1000 circular mils per coupling. To reterminate, you merely remove the carrier strip back, then reposition the conductors and press the carrier strip into place.

CIRCLE NO. 375

Ferrite antenna cores come in almost any size



Ceramic Magnetics Inc., 87 Fairfield Rd., Fairfield, NJ 07006. (201) 227-4222.

Uniform ferrite rods for low and very low-frequency antennas come in lengths exceeding 40 in. and diameters greater than 3-1/2 in. The high permeability and low-loss characteristics of these rods result in low coil mass and compact antennas of high efficiency. Engineering and technical assistance in the design of antenna rods is available from Ceramic Magnetics.

CIRCLE NO. 376

Arrow-M R Relays

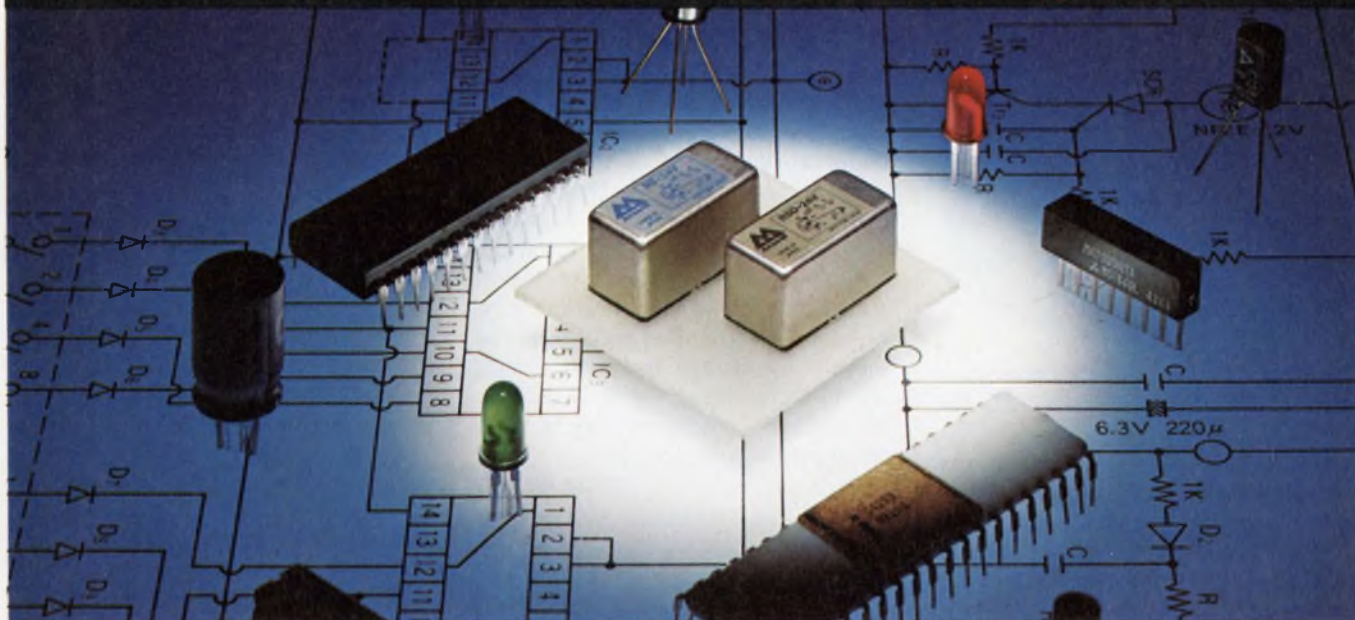

The many advantages and unique capabilities of Arrow-M's R Relays are far too extensive to be covered here. Therefore, we'd like to whet your creative appetite with a few outstanding facts:

1. Arrow-M R Relays are available in 1 Form C contacts which can carry a high current capacity of 1 Ampere 20 watts, and are capable of resisting welding at higher inrush currents. The dry circuit type which can switch current as low-level as 100uA is available in addition to the power type.

2. *High Speed:* Arrow-M R Relays can be operated at 500 cycles/sec.

The tiny power memory reed



3. Greater reliability and lower cost, due to simultaneous automatic fabrication of coil bobbin, contact and terminal.

4. In addition to the standard there are 1 coil and 2 coil latching types, which are useful for logic circuit design as a memory component.

5. Not only can they be automatically wave soldered on PC boards with a high density of electronic parts, but they are simple to clean with most degreasers and detergents without affecting maximum contact reliability.

6. *High Sensitivity:* Minimum operating power: Single Side Stable 80 mw/Bistable 40 mw

7. *Longer Life:* Mechanical: More than 10^9 operations.
Electrical: More than 10^6 operations.
(1A 20vdc, 0.3A 110vac)

Hungry for more information?
For exact specifications on all of our relays, write or call your nearest Arrow-M office.

Arrow-M Corporation
250 Sheffield Street
Mountainside, NJ 07092
(201) 232-4260

Mid-Western Office:
600 E. Higgins Rd.
Elk Grove Village, Ill. 60007
(312) 593-8535

Western Office:
22010 So. Wilmington Ave.
Suites 300 & 301
Carson, Calif. 90745
(213) 775-3512

Relays for Advanced Technology



Arrow-M

Member of Matsushita Group

CIRCLE NUMBER 74

PACKAGING & MATERIALS

'Lazy susan' trays aid in circuit assembly

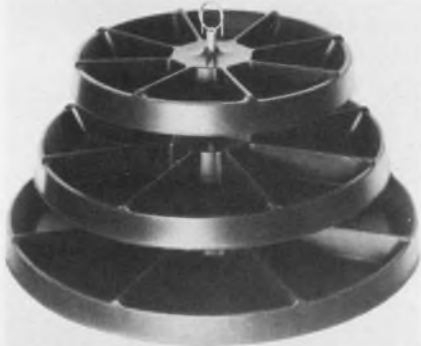

Wescorp, 1601 Stierlin Rd., Mountain View, CA 94040. (415) 969-7717. See text.

Models 8000 and 8000-A plastic-tray sets eliminate static-electricity problems associated with the production of hybrid ICs and other circuits. Each set consists of three round polyolefin trays that are chip-proof and resist alkalis, acids, paints and stains. The 24 compartments have rounded corners and edges for easy pick-up of small parts. Model 8000 costs \$59.95 and has trays in diameters of 24, 20, and 16 in. Model 8000-A costs \$44.95 and has trays in diameters of 20, 16, and 12 in.

CIRCLE NO. 377

Grounding kit outfits total work station

The Simco Co., 920 Walnut St., Lansdale, PA 19446. (215) 368-2220. \$75 (unit qty).

A grounding kit for component assembly, manufacturing and test areas consists of 13 items. In the Neutro-Stat work-station grounding kit, four of the items are for personnel grounding—wrist strap, sleeve protectors, heel grounder and an anti-static fabric lab coat. The other kit pieces include a floor and work-surface mat, seat cover, high and low-density foam, storage tray, tote box, shorting strip and electrically conductive bags. To ensure a static-free work station, the manufacturer recommends ionizing air devices, and offers as optional equipment a portable unit, for ionizing the work area; a system for laminar flow areas, clean benches and rooms; and a filtered, ionizing air gun, for simultaneously neutralizing and cleaning components.

CIRCLE NO. 378

Burn-in test sockets can be packed densely

Robinson Nugent Inc., 800 E. Eighth St., New Albany, IN 47150. J. Gribbins (812) 945-0211. \$9.41 (1000 qty).

Burn-in and test sockets, series TSN, for DIP ICs are low insertion-force units—just 0.495-in. wide—and allow burn-in board densities to be increased more than 50% over old designs. Other features include socket terminals spaced exactly as the IC; a 0.125-in. slot in center of socket that permits easy use of sword-type extraction tools; and a 0.107-in. clearance slot on bottom of socket that allows mounting space for resistors or decoupling capacitors. The sockets are offered in both standard and hi-temp versions with 14 through 40 contacts; body material is polyphenylene sulfide (Ryton).

CIRCLE NO. 379

Lab PC etcher does professional job



Hutchinson Industrial Corp., 40 W. Highland Park, Hutchinson, MN 55350. T. Probst (612) 879-2371. \$2700 list price.

A self-contained etcher produces individual boards for experimental, teaching, prototype or preproduction work. The Model 1012 etcher can handle work up to 10 × 12 in. In operation, both sides of the PC board are covered by 32 high-pressure overlap nozzles that spray temperature-controlled etchant to produce professional-quality etching. A 1/3-hp motor drives the centrifugal spray pump, and a temperature controller holds etchants within ±2 F. The unit plugs into any convenient 117-V-ac outlet. The etcher comes complete with a timer (1 s to 60 h), temperature controller, 20-gpm pump and 5-gallon sump.

CIRCLE NO. 380

Desoldering braid has tell-tale color



Wik-it Electronics, 140 Commercial St., Sunnyvale, CA 94086. (408) 732-8560. see text.

Desoldering braid, Chroma Wik-it, is now available in a distinctive color. The braid is pretinned for working speed and long shelf life and guaranteed for one year. The built-in color indicates exactly where to snip off used braid with no waste. A typical desoldering of a connection uses one-half cent's worth of the product. A Chroma Wik-it's flux coating is smooth, continuous and non-powdering. The product works with any regular 30-to-75-W iron and removes solder from the connection in a 1-s operation. It is available in 5-ft rolls of 1/16-in. braid at \$1.49 (Cat. #1007A), or 1/8-in. braid at \$1.69 (Cat. #1006A). Bulk packs and other lengths and widths may be ordered.

CIRCLE NO. 381

Extender card mates with S-100 bus systems

Vector Electronics, 12460 Gladstone Ave., Sylmar, CA 91342. Floyd Hill (213) 365-9661. \$25 (unit qty.); stock.

A circuit card extender, the 3690-12, is form and plug compatible with Altair 8800, Imsai 8080, and other similar microcomputer systems. Designated the 3690-12, the extender facilitates out-of-chassis troubleshooting and hardware debugging. The 7.5 × 9.99-in. extenders are 0.0625-in. thick epoxy-glass composite material. The 2-oz copper conductors are solder tinned while the card edge connectors are gold-flashed nickel plate for low contact resistance and reduced wear. The mating receptacle has 100 contacts (50 each side) on 0.125-in. centers.

CIRCLE NO. 382



Choice!

New Dale MSP Networks let you match profile, power and package to meet your resistance needs.

Dale's new MSP single-in-line networks are the shape of things to come in resistance. Rugged. Machine insertable. And available in your choice of profiles: .350" with up to .3 watts per resistor or .195" (.19 watts) to meet critical board spacing requirements. Both are molded for extra protection. Both give you the kind of quality assurance we developed for Dale's SDM—the first network to meet MIL-R-83401. Sample the MSP now. It's available fast in quantity from stock... and it's only part of Dale's complete line of SIP and DIP networks.

Contact your Dale Representative or phone 402-371-0080

DALE ELECTRONICS, INC.
Box 74, Norfolk, Nebraska 68701
In Canada: Dale Electronics Canada Ltd.
In Europe: Dale Electronics GmbH
8 Munchen 60, Falkweg 51, West Germany
A subsidiary of The Lionel Corporation.

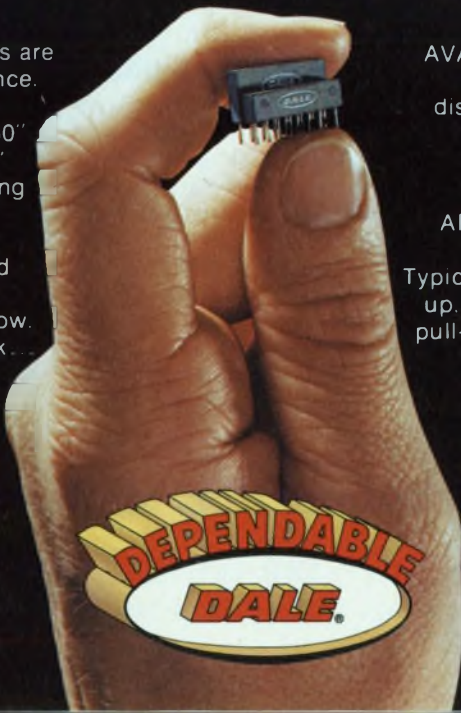

AVAILABLE FAST: .350" model (MSPXXXC) available in 1 week from factory or from distributor stock. 6, 8 or 10 pin models (-01 circuit) in 49 standard values. Consult factory for fast delivery times on other configurations and schematics.

APPLICATIONS: Standard circuit (-01) has 5, 7 or 9 resistors with 1 pin common. Typical applications include "wired OR" pull-up, power gate pull-up, MOS/ROM pull-up/pull-down, open collector pull-up, TTL input pull-down, TTL unused gate pull-up.

SPECIFICATIONS: Power: .350" model=.3 watts max. per resistor; .195" model=.19 watts max. per resistor. Resistance: 33 Ω to 1 Meg. standard. Tolerance: $\pm 2\%$ standard. T.C. ± 100 PPM/ $^{\circ}$ C. T.C. Tracking: 50 PPM/ $^{\circ}$ C. Operating Temperature: -55° C to $+125^{\circ}$ C.

Bliley

first name in frequency control

We have a reputation that can mean as much to you as it does to us. Here's why.

By manufacturing our own crystals and growing and sweeping our own quartz, we control product quality from raw material to finished unit.

Next, we specialize in the design and production of units whose level of precision is difficult—if not impossible—to find elsewhere.

Finally, our total commitment to quality makes us the preferred supplier to the more sophisticated levels of electronics.

If that's your level, you've found your peer in Bliley. Tell us about your present requirements or, simply request our catalog of complete product information and call later when you need us.

QUARTZ CRYSTALS • CRYSTAL OSCILLATORS • CRYSTAL FILTERS

BLILEY ELECTRIC COMPANY
2545 West Grandview Boulevard,
P.O. Box 3428, Erie, PA. 16508
Tel. (814) 838-3571 TWX 510-696-6886



CIRCLE NUMBER 76

PACKAGING & MATERIALS

Marker pens apply bright fluorescent ink



Metron Optics, Box 690, Solana Beach, CA 92075. (714) 755-4477. \$2.95 (unit qty); stock.

Marker pens with a choice of removable or permanent inks for board inspection are also available with special-purpose inks, electrical-contact lubricant, solder fluxes and liquid two-way tape. The pens contain an ink supply of more than 12,000 dots per pen. An optional microtip-needle applicator (orifice 0.013 in.) provides over 25,000 dots per pen. The brilliant fluorescent color of the ink makes the smallest dot highly visible and allows marking with very fine lines. Removable inks can be flicked off with the fingernail or wiped off with any solvent.

CIRCLE NO. 383

TIME SAVER FOR OEM PARTS

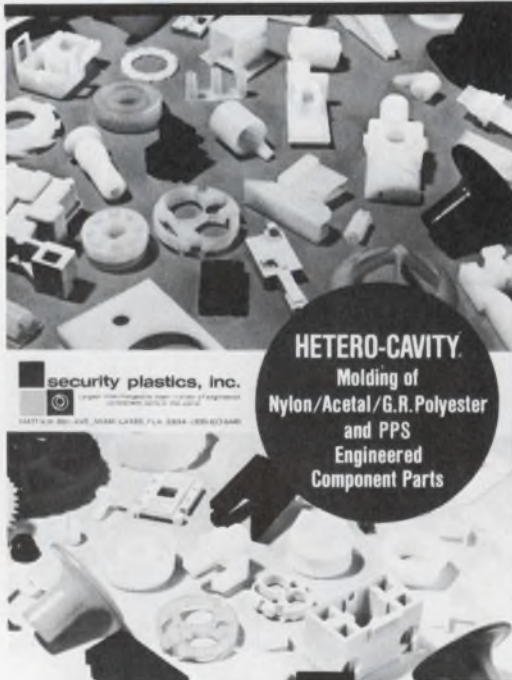

HETERO-CAVITY
Molding of
Nylon/Acetal/G.R. Polyester
and PPS
Engineered
Component Parts

What it is...

How to design for it...



FREE DESIGN GUIDE

gives full details on faster tooling and production plus MONEY-saving advantages of Hetero-cavity® molding of nylon/acetal/GR polyester/PPS engineered component parts.

Now molding OVER TWO BILLION parts a year. Security can save YOU time and money on your small parts needs. Call or write for free copy of newly-revised full color brochure today!

security plastics, inc.

14427 N.W. 60th Avenue,
Miami Lakes, FL 33014/(305) 823-5440

Largest interchangeable insert molder of engineered component parts in the world

CIRCLE NUMBER 77

PC board carriers prevent contamination

Multi Tool & Manufacturing Inc., P.O. Box 553, Cape Canaveral, FL 32920. John Wright (305) 783-2310. From \$40 (unit qty); 3 wks.

When PC boards are stored in cardboard boxes during the assembly process, they can become contaminated. Chemicals and moisture in the cardboard can tarnish gold fingers and affect the solderability of the board. Special carriers that eliminate these problems, and improve PC-board handling, feature uprights that adjust to handle boards from 1-1/2 to 25 in. in width. And they have nylon guides that can be moved in 3/4-in. increments to match board height. The carrier handles PC boards in a horizontal position throughout assembly. If boards are handled vertically prior to soldering, loose components and wires can fall off.

CIRCLE NO. 384

Select four outputs with one active filter

Datel Systems, 1020 Turnpike St., Canton, MA 02021. Eugene Murphy (617) 828-8000. \$16 (1-9 qty); stock.

Low-pass, bandpass and high-pass transfer functions are simultaneously produced at the output of the FLT-U2 hybrid filter. A fourth uncommitted op amp is available as a summing or buffer amplifier. The 16-pin ceramic DIP operates with ± 5 to ± 18 V dc power supplies over a 0 to 70 C temperature range. An output voltage range of ± 10 V dc for ± 12 -V dc input makes the unit compatible with other op amps. Gain-bandwidth product is 3 MHz and center frequency accuracy is $\pm 5\%$ from 0.001 Hz to 200 kHz.

CIRCLE NO. 385

Data-acquisition unit plugs directly to 6800

Burr-Brown, International Airport Industrial Park, Tucson, AZ 85734. C. Teeple (602) 294-1431. \$140 (100 qty); stock.

The MP21, a complete 16-channel data-acquisition system, interfaces directly to 6800, 650X and F-8 type μ Ps. Timing and logic-level compatibility eliminate any need for external logic. The hybrid, quad-in-line package houses a 16-channel analog multiplexer, a high-gain instrumentation amp, an 8-bit a/d converter plus all necessary address, data and control-bus interfaces. Without external gain or offset adjustments absolute accuracy is better than $\pm 0.4\%$ (1 LSB) on high-level ranges. Low-level signals such as thermocouple outputs can also be handled directly, but with reduced accuracy. The instrumentation amplifier can be programmed with a single external resistor to provide input-signal ranges as low as ± 10 -mV FS. The μ P accesses the data-acquisition unit as memory. Each analog-input channel occupies one memory location. Any memory-reference instruction can be used to access data. The unit can be used with or without halting the CPU or on an interrupt basis. $1.7 \times 2.1 \times 0.22$ in. 0 to 70-C operation. ± 15 and ± 5 -V-dc power.

CIRCLE NO. 386

Video d/a converter outputs current

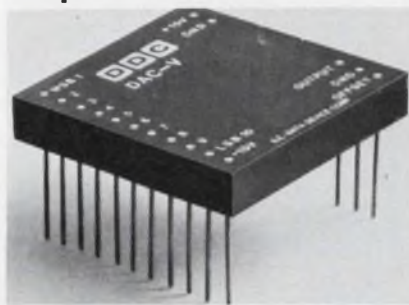

ILC Data Device Corp., Airport International Plaza, Bohemia, NY 11716. P. Roberts (516) 567-5600. From \$110.

Designed for summing-point applications (current rather than voltage output), the DAC-V d/a converter comes in an 8 or 10-bit version. The 10-bit-resolution unit boasts output accuracy, including linearity, of $\pm 0.05\%$ FSR and typ settling time to ± 1 LSB of 20 ns for a full-scale input change. The 8-bit version offers $\pm 0.2\%$ FSR accuracy and 15-ns typ settling time. Accuracy tempco is ± 15 ppm/ $^{\circ}$ C for the 10-bit unit and ± 30 ppm/ $^{\circ}$ C for the 8-bit unit from -20 to $+75$ C. The TTL/DTL compatible inputs accept either binary coding for unipolar operation with a 0 to $+15$ -mA output, or offset-binary coding for bipolar ± 7.5 -mA output. A temperature-compensated reference is included in the module. $2.3 \times 2.3 \times 0.4$ in.

CIRCLE NO. 387

8-bit video converters come on a board

Tektronix, P.O. Box 500, Beaverton, OR 97077. C. Payne (503) 644-0161. See text.

Two video converters, the ADC 820, an 8-bit 20-MHz a/d and the DAC 850, an 8-bit 50-MHz d/a, each come on a board measuring $6 \times 8 \times 1$ in. The a/d unit dissipates 7 W. It has an on-board anti-aliasing filter at the quantizer input. Differential phase and gain are $\frac{1}{2}^{\circ}$ and 1% rms, respectively. The unit does not use a s/h. The d/a converter dissipates 5 W. It comes with 3- \times or 4- \times -subcarrier output filters or with no filter. Differential phase and gain are $\frac{1}{4}^{\circ}$ and $\frac{3}{4}\%$ rms respectively. Both units are available for evaluation with TTL logic compatibility. Prices start at \$1650 for the a/d and \$525 for the d/a. Power required is ± 12 , $+5$ and -5.2 V. Production quantities are scheduled for fall; ECL versions are expected several months later.

CIRCLE NO. 388

THE LOW PRICED DC/DC CONVERTERS...

that out-perform the higher priced brands



ONE LOW PRICE: \$40.50 (1-249)

THE I/O RATINGS YOU NEED...

Input Voltage Vdc	Output Vdc @ mA	Model No.
5	$\pm 12V @ \pm 150mA$	A5-12D150
12		A12-12D150
5	$\pm 15V @ \pm 150mA$	A5-15D150
12		A12-15D150

QUALITY PERFORMANCE...

Regulation: 0.1% Line/Load
Efficiency: to 55%
I/O Isolation: 300Vdc Min.
MTBF: >100,000 Hrs.

Input...

Reflected Ripple: 1% V_{in}
Range: $\pm 5\%$

Output...

Ripple & Noise: 20mV (typ)
Short Ckt. Protection: Yes

HERE'S THE PINOUT...

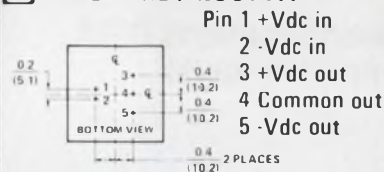

Order your newly designed A Series converters now. We've shaved cost - not quality. That's why SCI is the No. 1 SOURCE

Get Complete Information FAST!
Circle the number for our new 1977 FREE CATALOG.



SEMICONDUCTOR CIRCUITS, INC.

POWER SOURCES DIVISION

306 RIVER ST., HAVERHILL, MA 01830
TEL. (617) 373 9104, TWX. 710 347 0269

MODULES & SUBASSEMBLIES

Instrumentation amp isolates also



Instrumentation Amplifier Input
2000 Vp Isolation Voltage
1 $\mu\text{V}/^\circ\text{C}$ Input Voltage Drift
Adjustable Gain, 1 to 1000
20 mA Voltage or Current Programmable Output

Burr-Brown, International Airport Industrial Park, Tucson, AZ 85734. N. Shah (602) 294-1431. From \$109 (100 qty); 4 to 6 wks.

The 3456 Isolated Instrumentation Amp gives you a true three-wire-input instrumentation amplifier together with input-to-output isolation plus self-contained isolated power supply, in one module. This amp has a differential input plus a separate input common and provides continuous pk-isolation rating of 2000 V. Isolation impedance is $10^{12} \Omega$ in parallel with 14 pF, and isolation-mode rejection is 120 dB at 60 Hz. Among other key specifications are: max gain nonlinearity of $\pm 0.02\%$ at 100 gain and max input-offset-voltage drift of 1 $\mu\text{V}/^\circ\text{C}$ at 1000 gain for the B version and 2.2 $\mu\text{V}/^\circ\text{C}$ for the A. CMR is 110-dB min, at 100 gain and one resistor programs the gain from 1 to 1000. Operates from -25 to $+85$ C; $2.3 \times 3.5 \times 7$ in.

CIRCLE NO. 389

Board converts DPM into ohmmeter

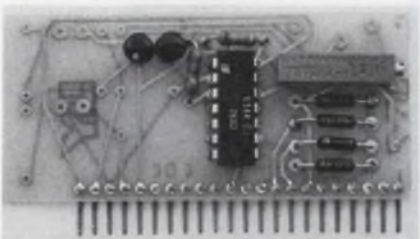

International Microtronics Corp., 4016 E. Tennessee St., Tucson, AZ 85714. (602) 748-7900. \$40 (1-24 qty); 2 wks.

With the 303 A Ω -converter option, Series 300 DPMs digitally display the value of an unknown resistor. Ranges are 0.199, 1.999, 19.99, and 199.9 k Ω and accuracy is $\pm 0.1\%$, when the PC-board option works into the company's series 300 DPMs.

CIRCLE NO. 390

Multiplexer plugs four peripherals into mini

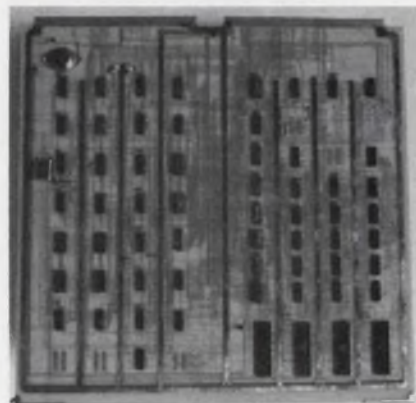

Applied Management Systems, P.O. Box 4795, Whittier, CA 90605. (213) 696-2002. From \$600; 30 days.

The AMS-4000 four-port multiplexer interfaces up to four RS-232 devices (CRTs, printers, etc.) with a Nova, Eclipse or most Data General emulators. The 15×15 -in. PC-board multiplexer contains a selectable real-time clock of 10 or 100 Hz. Each port has its own address and a selectable 110 to 9500-baud rate.

CIRCLE NO. 391

12-bit DAC ignores wide temp swings



Datel Systems, 1020 Turnpike St., Canton, MA 02021. E. Murphy (617) 828-8000. \$139 (1-9 qty); stock to 4 wks.

Thin-film-hybrid 12-bit d/a converters feature a 10 ppm/ $^\circ\text{C}$ gain tempo. This means the full scale output stays within ± 1 LSB in the face of a $\pm 24^\circ\text{C}$ ambient change. The 24-pin metal-packaged DAC-HZ12BMR-1 (binary-coded) and DAC-HZ12DMR-1 (3-digit, BCD-coded) also feature a settling time of 3 μs for a 10-V output change. The output voltage has five pin-programmable ranges. Output-drive capability is ± 5 mA min, and the power-supply requirement is ± 15 V dc at 35 mA. The differential-nonlinearity tempo of 2 ppm/ $^\circ\text{C}$ for both devices assures monotonic output over the -25 to $+85$ -C operating range.

CIRCLE NO. 392

Rf amps offer very wide bandwidth

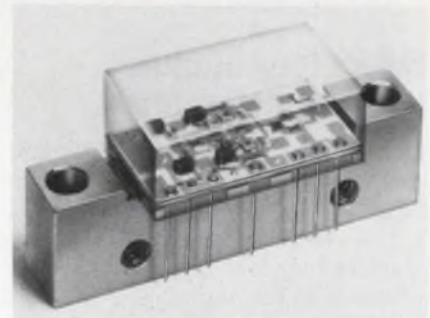

Motorola Semiconductor Products, P.O. Box 20912, Phoenix, AZ 85036. Alan Wagstaff (602) 244-6394. \$51.75 (1-24 qty); stock.

Four wideband rf amplifier modules covering the frequency ranges of 1 to 250 MHz and 10 to 400 MHz can be used in communication systems. The MHW 590-93 units operate from either 13.6 or 24-V-dc supplies over a temperature range from -20 to $+90$ C. A hybrid construction technique using thin film gold metalization on an alumina substrate results in a linear response of ± 1 dB over the designated bandwidth. Power gain is typically 34 dB and all modules have a noise figure of 5 dB at 250 MHz.

CIRCLE NO. 393

12-bit d/a converters span MIL temperature



Hybrid Systems, Crosby Dr., Bedford, MA 01730. L. Lauenger (617) 275-1570. From \$120; 4 wks.

DAC335 d/a converters are pin-for-pin compatible with the DAC 85-12V converter series from Burr-Brown. With the 12-bit DAC335s you get a typ power drain of 300 mW, operation from -55 to $+125$ C and a choice of either commercial or 883A Class-B processing. Logic input codes are complementary binary (unipolar) and complementary offset binary (bipolar) at TTL, DTL and CMOS-compatible levels. Three-decade complementary-BCD models are also available. Key specifications are: $\pm 1/2$ -LSB linearity error, 3- μs settling time, 2-ppm/ $^\circ\text{C}$ linearity tempo. 24-pin DIP, $+5$ - and ± 15 -V power.

CIRCLE NO. 394

Need ROM retention and RAM alterability?



Design in Nitron Non-Volatile Memories.

Our Metal Nitride Oxide Silicon NVM are fully reprogrammable in-circuit. They offer long-duration storage security without battery backup or "power-on" auxiliaries.

HIGH DATA RETENTION

Data is secure for a minimum of 10,000 hours and can be read 10^{10} times between refresh cycles.

PROGRAM VERSATILITY

Nitron NVMs offer entire memory or word alterability. And it can all be done in-circuit a minimum of 10^5 times. Millisecond write times are ideal for applications in the human-response range.

SYSTEM COMPATIBILITY

We built in on-chip decoding, and TTL and CMOS compatibility. Plus, Nitron NVMs can be reprogrammed without additional power supplies or power supply switching.

PRODUCT AVAILABILITY

Nitron NVMs are available off-the-shelf for parallel data applications in 64x4 and 256x4 configurations;

and for serial data applications in 21x16, 16x18 and 1024x1 configurations. If you don't see what you need, tell us about it. We custom design NVMs, too.

Unique Nitron process puts silicon nitride and silicon dioxide layers between MOS gate and substrate. When voltage is applied, trapped charge offsets threshold voltage. Charge remains after voltage is removed.

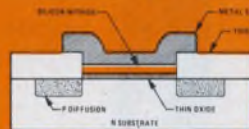

Need information fast? Call Nitron NVM Marketing at (408) 255-7550. Or fill in the coupon below for your NVM Fact Kit.

NITRON
MCDONNELL DOUGLAS

Mail to:
NITRON NVM Marketing
10420 Bubb Road
Cupertino, CA 95014

TELL ME MORE!

I'm interested in (check box):

- 64x4 NC7040 21x16 NC7033
 256x4 NC7050 16x18 NC7035
 1024x1 NC7051 Complete NVM Fact Kit

Send to:

name & title

company

address

city

state

zip

ED-8

DUAL OUTPUT REGULATED

± 15v DC power sources

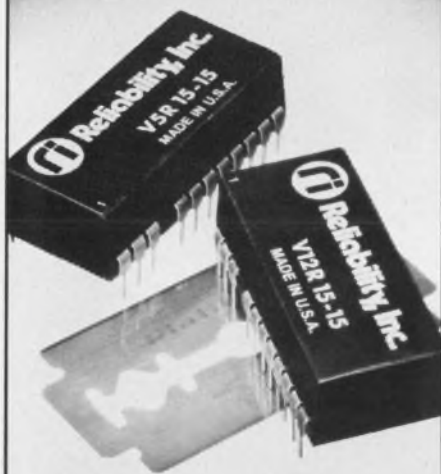

For . . .

- Operational amplifiers
- Comparators
- D-A Converters

**ONE WATT OUTPUT • COMPACT
DIP PACKAGE • LOW NOISE
ISOLATED • LOW PRICE**

Ultra compact "V-PAC" *DC-DC power sources use 5v or 12v input, provide ±15v regulated low noise output, which can be balanced.

Output Voltage	___ ± 15v
Output tolerance	___ ± 5%
Output ripple	___ 30 mv, P-P max.
Line regulation	___ .3%
Load regulation	___ .3%
Operating temp	___ 0° to 70°C
Isolation	___ 10 MΩ @ 50v
Price	___ \$20.20 (100 pcs)



Reliability, Inc.

5325 Glenmont/Houston, Texas 77036
713-666-3261 / TWX: 910-881-1739

International: Reliability Nederland, B. V.
Summerhill, Nenagh, Co. Tipperary, Ireland

*Trademark, Reliability, Inc.
Price subject to change without notice

CIRCLE NUMBER 79

INSTRUMENTATION

120-MHz sig gen offers versatile modulation



Marconi Instruments, 100 Stonehurst Ct., Northvale, NJ 07647. (201) 767-7250. \$2650; 90 days.

Model 2016 AM/FM signal generator covers the spectrum from 10 kHz to 120 MHz. The unit uses fundamental frequency generation to cover the range in 12 switched bands. Modulation facilities include two internal oscillators at 400 Hz and 1 kHz, which may be used independently for FM to 75-kHz deviation or AM depth to 100%, or combined with external signals for simultaneous AM and FM.

CIRCLE NO. 395

Mini DMM stresses long battery life



Control & Information Systems, 10 Spring Valley Village, Richardson, TX 75080. (800) 527-4634. Texas residents (214) 234-4173. \$99.95; stock.

The Autoranger digital multimeter gives readings on a 3-1/2-digit liquid-crystal display. That, plus CMOS logic design, assures low power drain from the unit's single 9-V battery. Featured are autoranging, autozeroing, and automatic lead reversal. Capabilities include ac/dc voltage to 1000 V and resistance to 1000 kΩ.

CIRCLE NO. 396

3-1/2-digit DMM features 0.1% accuracy



Sencore, 3200 Sencore Dr., Sioux Falls, SD 57107. (605) 339-0100. \$248.

Model DVM37 3-1/2-digit DMM provides 0.1% dc accuracy in a portable package. Features include one-third less circuit loading for greater accuracy with 15-MΩ input impedance, rather than the conventional 10 MΩ; High/Low-power ohms on all resistance ranges through 20 MΩ; and a battery saving feature with a push-to-test switch on the test probe. Also included are autopolarity, autozero, auto-overrange, and a rugged case.

CIRCLE NO. 397

Watch those sags with disturbance recorder

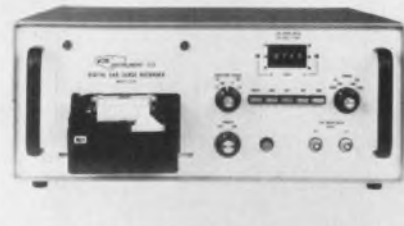

Micro Instrument Co., 2250 Micro Pl., Escondido, CA 92025. (714) 746-2010. \$3495; stock.

Model 5229 portable, power-line transient-amplitude and duration-disturbance recorder (digital sag/surge recorder) prints out all power-line disturbances, sags and surges, over the entire range of dc to 1 MHz, 0 to 1000 V. Sags (increases in line waveform) and surges (decreases in line waveform) over this range are identified and recorded, along with the time of day. The transient-duration measurement is of true time duration, correlated to the sag or surge producing it, and resolves down to 1 μs.

CIRCLE NO. 398

8 Bit A to D/D to A Converter - the first priced at only \$4.50*

The Ferranti Model ZN425E—an 8 bit dual mode analog to digital/digital to analog converter features:

- Single chip monolithic construction
- Typical settling time 1.0 μ s for 1 L.S.B. step
- 8 bit binary counter, R-2R ladder network and switches
- On-chip precision voltage reference
- Self-contained, precision ramp generator
- TTL and CMOS compatible



better by design



FERRANTI
semiconductors

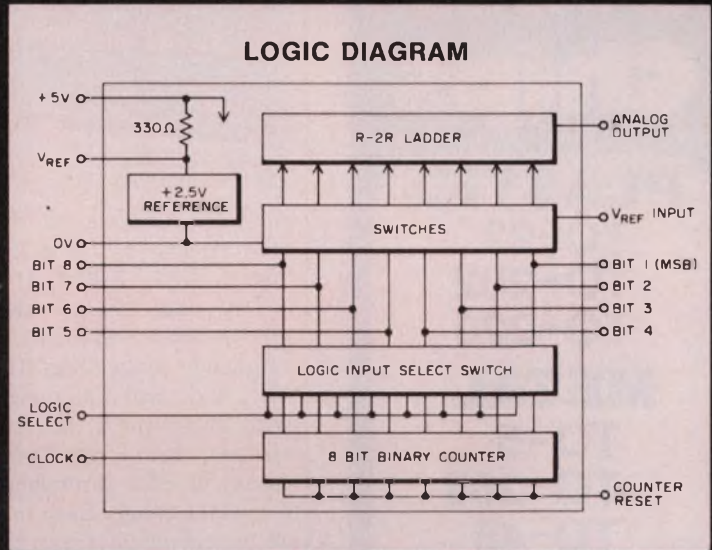

*1000 piece price

FOR COMPLETE SPECIFICATIONS, CONTACT: FERRANTI ELECTRIC, INC. / SEMICONDUCTOR PRODUCTS
EAST BETHPAGE ROAD, PLAINVIEW, NEW YORK 11803 PHONE: (516) 293-8383 / TWX: 510-224-6483

CIRCLE NUMBER 80

NEW! HIGH PERFORMANCE LOW INERTIA MOTORS

Up to 120% higher peak torque
with only a 7% increase in diameter
over 15mm diameters.



The new line of MICRO-MO 1616 and 1624 ironless rotor, high efficiency motors provides up to 120% more starting torque or comparable improvements in torque constants and efficiency.

Precious metal brushes and commutators assure low starting voltages and long life. Standard voltages available are 3, 4, 6 and 12 volts. With or without gearboxes.

For more information, see EEM under "Motors and Drives", or the Gold Book under "Motors and Rotating Components".

MICRO-MO ELECTRONICS, INC.

3691 LEE ROAD/LEE-DALE BLDG./CLEVELAND, OHIO 44120/PHONE: 216/921-1131

MME-1634

CIRCLE NUMBER 85

ELECTRONIC DESIGN 17, August 16, 1977

ALCOSWITCH®

PC mountables



your no. 1 source

Alco offers the best variety in PC switches including: DIPS, slides, toggles, pushbuttons, etc. with mounting options. All types feature 0.1" centers and gold plated contacts for low level needs. Competitive pricing. Ample inventory of all models for limited production needs. Call or write today!

ALCO

ELECTRONIC PRODUCTS, INC.

150 WASHINGTON STREET, NORTH ANDOVER, MA 01845, U.S.A.

Tel: (617) 685-4371

TWX: 710 342-0552

A SUBSIDIARY OF

AUGAT® INC.

CIRCLE NUMBER 81

SCRs Triacs Diacs Chips

PLASTIC

TO-92
TO-202
TO-220

METAL

TO-5
TO-203
TO-48

DIAC
DO-7

Hutson is producing more devices than ever before! You can get rapid delivery PLUS improved reliability because Hutson computer tests all devices!



HUTSON INDUSTRIES

P.O. BOX 34235, DALLAS,
TEX. 75234
2019 W. VALLEY VIEW
LANE
(214) 241-3511
TWX 910-860-5537

EUROPEAN OFFICE:
30 RUE PIERRE SEMARD
YERRES, 91, FRANCE
TEL: Paris 948-8258
TELEX 21311

CIRCLE NUMBER 82

INSTRUMENTATION

Variable filters resolve 10 mHz



Rockland Systems, 230 W. Nyack Rd.,
West Nyack, NY 10994. (914) 623-6666.
452-01, \$1375; 852-01, \$1995; 30 days.

Two dual Hi/Lo variable filters, Models 452-01 and 852-01, offer a cutoff frequency range from 0.01 Hz to 111 kHz, and resolution down to 0.01 Hz, with Butterworth and linear phase responses, and a cutoff frequency accuracy of $\pm 2\%$ throughout the entire frequency range. Each model consists of two identical filter channels contained in a common cabinet, with separate input/output terminals. Rolloff of the 452-01 is 24 dB/octave/channel, and of the 852, 48 dB/octave/channel.

CIRCLE NO. 403

Scope or DVM 'probe' reads magnetic fields



Perfection Mica Co., 740 N. Thomas
Dr., Bensenville, IL 60106. (312)
766-7800. \$79.50.

The ac magnetic-field evaluator probe operates with a VTVM or oscilloscope. The shielded banana plugs on $\frac{3}{8}$ -in. centers fit most input jacks. Sensitivity is 60 millivolts per gauss. Either axial (shown) or transverse pick-up coil positions are available. The probes are useful for accurate measurement of the disturbing field intensity in gauss.

CIRCLE NO. 404

DPM sports low price tag

Datel, 1020 Turnpike St., Canton, MA
02021. (617) 828-8000. \$29 (100s).

Model DM-3100L display-only DPM sells for \$29 in hundreds. The unit features differential inputs and auto-zeroing and is housed in a miniature Lexan case measuring $3.0 \times 1.8 \times 2.2$ in. All models feature common-mode voltage ranges of ± 2 V at 80 dB CMR. Temperature drift is 50 ppm rdg/ $^{\circ}$ C typical, with displayed accuracy of 0.2% of reading, ± 1 count at 25 C.

CIRCLE NO. 405

Logic analyzer debugs hardware or software



BP Instruments, 10601 South De Anza
Blvd., Cupertino, CA 95014. (408)
446-4322. \$4558.

Model 50DI6 16-channel, 50-MHz logic analyzer is designed for the microprocessor system designer who needs to debug not only hardware, but software as well. The 50DI6 features a Data-Trigger mode that allows the user to insert up to three sample bits of delay in the trigger. According to the company, this mode eliminates unwanted triggering on static, noise—or even anomalies appearing on a three-state bus at the time of device transfer.

CIRCLE NO. 406

Unit traps data flow for later analysis

International Data Sciences, 100 Nashua
St., Providence, RI 02904. (401)
274-5100. \$9975; 60 days.

The Hawk 4000 traps 2000 data characters for later recall and study. The Hawk unit is interactive. It can monitor, transmit, and receive data between a modem and a terminal on a 9-in., 512-character screen. The operator issues commands via a simple keyboard. All switches are "stored" in memory which means the Hawk will never become extinct.

CIRCLE NO. 407

have a gripe?



let us know about it!

We'll help you put pressure on any company that makes promises in its ads... then fails to deliver.

Electronic Design refuses to run advertisements deemed to be misleading or fraudulent.

ACCURACY is everybody's business. So if you have a gripe about a misstatement or inaccuracy in either editorial or advertising material in *Electronic Design*... tell us about it. We'll do everything we can to find out what happened and see that it's corrected. Notify...

George Rostky

Editor-in-Chief

Electronic Design

50 Essex Street
Rochelle Park, New Jersey 07662

Instant Modulation



Just Plug-in and Read...

The low cost AM/FM Modulation Meter mi 2304 Tunes... Levels... Automatically... and Presents the Read-out Within 2 Seconds! Ideal for Mobile Radio Production and Maintenance. Covers All Bands Thru 960 MHz.

mi MARCONI INSTRUMENTS

100 STONEHURST COURT, NORTHVALE, NEW JERSEY 07647
TELEPHONE: 201/767-7250 • TWX: 710-991-9752

CIRCLE NUMBER 83

The \$60 OEM freebie.



We build the finest control meters in the business. And we'll prove it. Contact us and we'll arrange to send you an Airpax meter scaled to your specifications. No charge.

Try the meter. If you decide to buy it, you'll find we're priced about 25% under competition. Or, return the meter and no harm done.

Offer good for OEM's with at least a 100-units-per-year potential. After all, we don't give freebies to just anybody.

mi
1977

AIRPAX™

CIRCLE NUMBER 84

OUR PROTO-CLIP™ CAN PAY FOR ITSELF THE 1ST TIME YOU USE IT.

The reason's as simple as the time you'll save testing, signal tracing or wiring in DIP's. Not to mention the cost of IC's ruined by accidental shorts. A Proto-Clip is the foolproof, short proof way to bring up leads from crowded circuit boards. Its patented, molded design and unique gripping teeth free hands for other work. Built to withstand tough day-to-day use, CSC clips are available with or without cable for 14-, 16-, 24- and 40 pin DIP's, starting at \$4.50* For more information, see your dealer or write for our full-line catalog and distributor list.



CONTINENTAL SPECIALTIES CORPORATION



44 Kendall Street
Box 1942, New Haven, CT 06509
203-624-3103 TWX 710-465-1227
West Coast: 351 California St.,
San Francisco, CA 94104
415-421-8872 TWX 910-372-7992

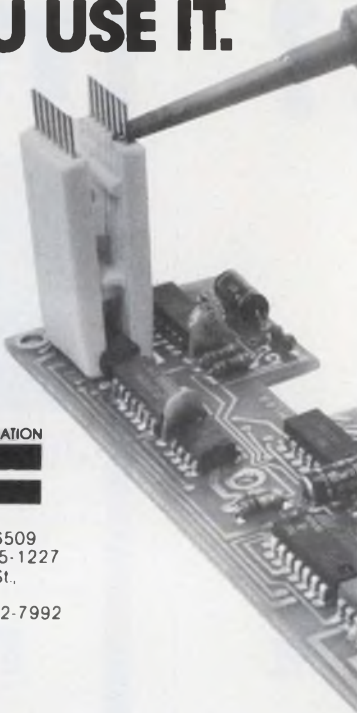

U.S. Pat No 3,914,007
*Mfr's sugg retail

© 1975, Continental Specialties Corp

CIRCLE NUMBER 86

POWER SOURCES

Rechargeable battery comes in popular case



General Electric, P.O. Box 992 C,
Gainesville, FL 32602. T. Traeger (904)
462-4762. \$3.53 (OEM qty).

Models SD-1 C/10 and /3 are, respectively, standard and quick-charge nickel-cd batteries in the first 9-V-sized package that meets ANSI dimensional specs with max of 1.938 × 1.031 × 0.656 in. These power sources are 9-V type only mechanically—their nominal potential is 7.5 V. Among the principal specs at 25 C, min rated capacity is 65 mAh at 65 mA and 70 mAh at 15 mA, max continuous discharge is 150 mA and max momentary discharge is 600 mA. The batteries stand up to 1000 recharges and sustain long continuous overcharging. For standard units recharging takes 16 h while it drops to 5 h for the specially selected /3 quick chargers. Quick-charge units carry a 5% price premium. Safe temps: charging, 5 to 50 C; discharging, -20 to +50 C; storage, -40 to +50 C.

CIRCLE NO. 408

Open-frame family offers 55 supplies

Acme Electric, Cuba, NY 14727. (716)
968-2400.

You can choose from among seven package sizes and 55 models in the Power House ALM series of open-frame supplies. All units feature 0.1% regulation (line and load), 1.5-mV rms or 5-mV pk-pk ripple and noise, from 47 to 63 Hz. An adjustable current-limit range of 50 to 125%, adjustable output-voltage resolution of 1.1%, inherent short-circuit and overload protection, remote-sense terminals (with 0.25 V provided to compensate for line-load loss) and an operating range of 0 to 60 C are all standard. Both single and ±2%-tracking dual-output models are available. Single outputs range from 2 V at 1.5 to 20 A through 24 V at 0.5 to 10.5 A. Dual outputs range from 11.8 to 15.2 V at 0.55 to 8.0 A. Overvoltage protection modules are optional. Inputs: 100 to 125 or 200 to 250 V at 47 to 440 Hz.

CIRCLE NO. 409

To The Point



WRITING AT WORK: DOs, DON'Ts, and HOW TOs

by Ernst Jacobi, Xerox Corporation.

"Jacobi's book is great . . .

He's written a new, original, readable, usable book on writing for business and professional people. . . ." Jim Lufkin, Manager, Professional Publications, Honeywell.

*The book on writing for
business and professional
people!*

#5730-X, cloth,
208 pp., \$10.95.

Order your
15-day exam
copy today!

Rid yourself of stiff, awkward writing with this lively, easy-to-read guide. No pat rules or formulas here. Instead, you get practical advice and sound wisdom to help you make your reports and proposals sharper, more interesting, and informative.



**Hayden Book
Company**

50 Essex Street
Rochelle Park, N.J. 07662

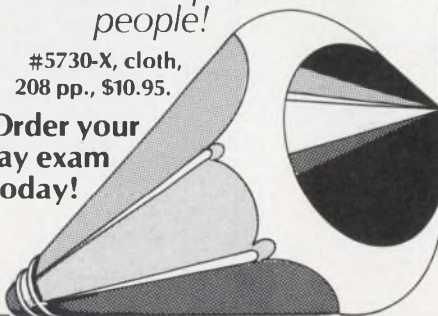

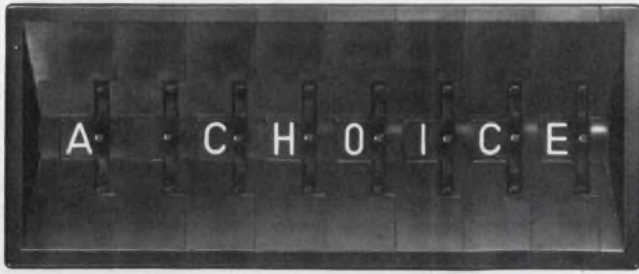

...of thumbwheel switches

6 2 7 2 4 2 7 5

- 10 MODELS—FRONT & REAR MOUNTED
 - 4 BASIC SIZES
 - 6 DIFFERENT WHEEL COLORS
 - 250 DIFFERENT SWITCH CODES
 - OFF-THE-SHELF DELIVERY
 - MANY OTHER OPTIONS ALSO AVAILABLE
- CALL US FOR DETAILED INFORMATION

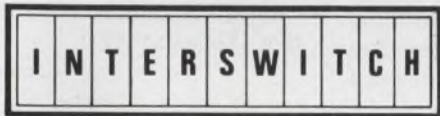

ONE OF THE PURDY GROUP OF COMPANIES
 770 Airport Blvd., Burlingame, CA 94010
 Phone (415) 347-8217 TWX 910-374-2353 TELEX 34-9373

CIRCLE NUMBER 88



SINGLE & DUAL

McLEAN CENTRIFUGALS

Std. or Mil. Spec. Over 25 models with airflows from 50 to 2000 CFM. Static pressures from 0." to 3.0". Motors and wheels precision balanced — quiet, vibration free. UL approved motors for any AC frequency or power, single or three phase. Custom-built units available.

SEND FOR CATALOG

McLEAN McLEAN

ENGINEERING LABORATORIES
 Princeton Junction, NJ 08550
 609-799-0100 • Telex 84-3422

ENGINEERING MIDWEST
 9560 Eighty-Fifth Ave. N.
 Maple Grove, MN 55369 • 612-425-4747

CIRCLE NUMBER 90

COST - CUTTING WESTON BREAKTHROUGH!

3/8" MULTITURN CERMET TRIMMER

FOR ONLY **99¢** (1,000-Pc. Price)

Same High Weston Quality At A Real Savings In Price!



Weston has done it with the new #850! We took this widely used square multiturn trimmer, and by radically improving manufacturing techniques have been able to trim the price without sacrificing quality, performance or uniformity. It can give you an important new competitive edge.

WRITE FOR SPECS AND DETAILED PRICE INFORMATION.

SANGAMO WESTON Schlumberger

WESTON COMPONENTS & CONTROLS
 A Division of Sangamo Weston, Inc.
 Archbald, Pa 18403
 Tel: (717) 876-1500
 TWX 510 656-2902
 Telex 83-1873

CIRCLE NUMBER 89

ELECTRONIC DESIGN 17, August 16, 1977

FOR HOME AND INDUSTRY PRODUCTS

WORLD'S MOST PRACTICAL SOLDER HANDLING TOOLS

SOLDERING + DESOLDERING + RESOLDERING =

SOLDER Ability ELEMENTARY TO ELITE

LONER[®]

SOLDERING INSTRUMENT

ELECTRONIC COMPONENTS ARTIFICIALLY AGED FOR **LONG TERM TEMPERATURE STABILITY**

★ ★ ★ ★ ★ **5 YEAR GUARANTEE**

UL LISTED TIP TO PLUG



Solid State Closed Loop Control
Model 950A CLO80
 115 VAC 9W to 50W - 590°F to 750°F

A soldering instrument with nothing to hide, we left everything in plain view so that you can best see how a soldering instrument differs from a soldering iron. One instrument performs soldering cycles from heavy to micro termination — THE LONER SOLDERING INSTRUMENT. Temperature control knob for precise adjustment of tip temperature — FAST, ACCURATE SOLDERING CYCLES — FAST INITIAL WARM-UP — NO STICK TIPS.

OPTIONAL LISTED **8168** BURN RESISTANT 115V LINE CORDS

contact your local **DISTRIBUTOR** inquiries invited

EDSYN
 15524 ARMINTA ST., VAN NUYS, CALIF. 91410
 24 HR. PHONES Local (213) 986-2324 L.A. (213) 873-5115
 CABLE: EDSYNEZ VAN TELER 05-1480

144 PAGE TRAINING MANUAL
NEW! OVER 1,000 ILLUSTRATIONS



CIRCLE NUMBER 91

an investment in capitol buys rugged switch design and long, trouble-free life

For Example!
Our Extremely
Dependable,
Multiple-Position
Push Button Strip
Switches

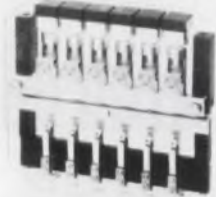

Basic frames are anodized aluminum. Plungers are 5/32" square brass with a nylon actuator molded on them. Hence, they will not bend or warp.

Mechanical linking of all switch positions prevents operation of more than one position at a time. A released button will return to the "up" position before the next button can be actuated. These switches can be illuminated either by an external circuit or directly from the switch. Lamps do not travel when positions are engaged, eliminating shock to the bulb.

Capitol switches are tested with 2 to 3 million operations to assure life-long, trouble-free performance.

Our 28-page catalog will give you all the "specs" on CAPITOL's entire line of quality switches. **CAPITOL SWITCHES are rated at 3 Amps, 110 Volts AC, non-inductive.**



CAPITOL manufactures a complete, high-quality line of push button and lever switches — illuminated if desired — standard and custom designs to fit your every need.

CAPITOL

The Capitol Machine and Switch Co.
87 Newtown Road, Danbury, Conn. 06810
Phone: 203-744-3300

CIRCLE NUMBER 92

New literature



Power supplies

A 40-page application and selection guide provides a glossary of power-supply terminology, presents test procedures and recommended practices for the user of both line-operated and dc/dc-converter power supplies and defines the special requirements for safely powering μ Ps. Semiconductor Circuits, Haverhill, MA

CIRCLE NO. 410

Noise suppression

Technical data and typical applications are included in this basic text on the protection of electronic equipment from line noise and transients. Topaz, San Diego, CA

CIRCLE NO. 411

Test instruments

A 48-page catalog describes applications and specifications of scopes, multimeters, counters, and other equipment. Leader Instruments, Plainview, NY

CIRCLE NO. 412

Temperature instruments

"Energy Conservation by the Use of Portable Temperature Instruments," a 32-page handbook, shows how to choose the correct thermometer, 50 examples of energy-related temperature measurements and a table that summarizes the features of the instruments along with their advantages and limitations. William Wahl Corp., Los Angeles, CA

CIRCLE NO. 413

Executive software

Real-time executive software used with HP 21MX computers and 1000 computer systems is described in a 60-page catalog. Separate sections discuss the system diagnostics library, product support and product training. Hewlett-Packard, Palo Alto, CA

CIRCLE NO. 414

BITE indicators

A four-page brochure covers BITE (Built-In-Test-Equipment) indicators used for fault isolation. Schematics included. North American Philips Controls Corp., Cheshire, CT

CIRCLE NO. 415

Alarm products

Over 900 professional-grade alarm products are described in a 72-page catalog. Mountain West Alarm System, Phoenix, AZ

CIRCLE NO. 416

Data communications

Descriptions and illustrations of modems, network-diagnostic and control systems, and terminals are given in a 16-page catalog. International Communications Corp., Miami, FL

CIRCLE NO. 417

Encoder

The "Logic Engine," an encoder for solid-state-switch arrays, is featured in a six-page catalog. Keytron^{ic}, Spokane, WA

CIRCLE NO. 418

L-C filters

Custom-built precision L-C filters in frequencies from 20 Hz to 400 MHz are presented in a 20-page catalog. Allen Avionics, Mineola, NY

CIRCLE NO. 419

Capacitors and resistors

Glass, glass-ceramic, ceramic and subminiature solid-tantalum capacitors and metal-film resistors are described in this 72-page catalog. Convenient features include product index tabs and specs in both English and metric units. Corning Glass Works, Corning, NY

CIRCLE NO. 420

Cabinets

Technical details for cabinet housings, front and rear panels, covers, keyboard housings, chassis, internal-slide units, bases, spacers and CRT housings are shown in a 12-page brochure. Backer-Loring, Peabody, MA

CIRCLE NO. 421

Analog input controller

Technical information, typical applications and ordering information for the RTP7471 low-level analog-input controller are provided in an eight-page bulletin. Computer Products, Fort Lauderdale, FL

CIRCLE NO. 422

Power supplies

A 66-page design-data catalog features power supplies by application requirements: extreme environment MIL-qualified; military; industrial; commercial and OEM. Technipower, Ridgefield, CT

CIRCLE NO. 423

Real-time systems

"Real-Time Systems" describes the hardware and software components of DEC's real-time computing systems based around the PDP-11 family of computers. Digital Equipment, Northboro, MA

CIRCLE NO. 424

X-Y recorders

General specifications, ordering information, OEM and control modules, supplies and accessories for the 2000 X-Y recorder are covered in an eight-page catalog. Houston Instrument, Austin, TX

CIRCLE NO. 425

Phototransistors

Phototransistors and photo-Darlington transistors are featured in a four-page brochure. The brochure includes electro-optical parameters, graphs of characteristics and environmental information. Vactec, Maryland Heights, MO

CIRCLE NO. 426

Counters, timers

A 23-page "kit" of application/design bulletins covers mechanical counters and timers. The bulletins illustrate the easy, inexpensive modifications and changes that are possible by building upon the basic unit. Guardian Electric Manufacturing, Chicago, IL

CIRCLE NO. 427

Fiber optics

"An Introduction of Communication Fiber-optics Design," 20 pages, provides a brief historical perspective; reasons for designing with fiber optics; initial costs, hardware savings, installation, reliability/survivability; and applications. Valtec, West Boylston, MA

CIRCLE NO. 428

Power semiconductors

The selection of power transistors, triacs, and SCRs for a wide variety of power circuits is covered in a 48-page brochure. Detailed applications and data sections are provided. RCA, Somerville, NJ

CIRCLE NO. 429

PYROFILM MAKES IT!

HIGH VOLTAGE RESISTORS

- Up to 40,000 Volts
- 10 sizes
- Up to 1,000M Ohms
- Temp. Coef. as low as 0 ± 100 PPM/°C
- Up to 5¼ Watts

Setting New Standards in Reliability

PYROFILM

60 S. Jefferson Road • Whippany, N. J. 07981 • (201) 887-8100

CIRCLE NUMBER 93

**IT'S
CONCORD
FOR...**

CONNECTORS/P.C.

**PRINTED
CIRCUIT
JACKS**



**BERYLLIUM
COPPER
CAGES**

**JACKS, PINS
SOLDER
TERMINALS**



***DUPONT T.M.
PINS**

**TEFLON*
TERMINALS**



& TERMINALS

CONCORD ELECTRONICS CORPORATION
37 GREAT JONES STREET NEW YORK, N.Y. 10012
(212) 777-6571 TWX 710-581-4930

FREE CATALOG AVAILABLE

CIRCLE NUMBER 94

KEEP

Electronic Design's

GOLD BOOK

HANDY



When You Call

Save time when you contact suppliers. Check their catalog pages first in *Electronic Design's* GOLD BOOK. Maybe the information you need is right at your fingertips.

Application notes

Interface bus

A concise, easy-to-read explanation of instrument/computer interfacing, and the development and use of the HP Interface Bus are shown in a 12-page brochure. Hewlett-Packard, Palo Alto, CA

CIRCLE NO. 430

Digital plug-ins

Applications of the digital plug-ins available for 7000-series oscilloscopes are described in "Digital Accuracy—Analog Interpretation." Tektronix, Beaverton, OR

CIRCLE NO. 431

Multiplexer parameters

"Specifying and Testing Multiplexers" details multiplexer parameters and their measurement. Teledyne Philbrick, Dedham, MA

CIRCLE NO. 432

Resistor networks

"Designers Guide to Thin-Film Resistor Networks" contains information on typical applications, key parameters and the construction and processing of both custom and standard thin-film resistor networks. Micro Networks, Worcester, MA

CIRCLE NO. 433

CRT graphics controllers

How to use the company's line of high-resolution-TV CRT-graphics controllers is explained in a 24-page brochure. Detailed pinout descriptions as well as interface diagrams for μ Ps are provided. Matrox Electronic Systems, Montreal, Quebec.

CIRCLE NO. 434

Count/time data system

A 28-page bulletin explains a data-acquisition system that gathers data from machines, networks, or experimental setups on up to 248 channels, all easily programmed through an on-board keyboard. Esterline Angus Instrument Corp., Indianapolis, IN

CIRCLE NO. 435

Bulletin board

Faster NMOS CPUs are available as retrofits on SC/MP kits from National for only \$18.50.

CIRCLE NO. 436

Texas Instruments is second-sourcing National Semiconductor's 3-terminal adjustable regulators, the LM117, LM217 and LM317.

CIRCLE NO. 437

Wintek has added a two-day "Hands on Interfacing Workshop" to its standard three-day "Hands on Microprocessor Short Course with Free Take-home Microcomputer." Tuition is \$299. The Fall '77 workshops will be in Dallas; Houston; Washington, DC; Melbourne, FL; Denver; Palo Alto; San Diego; Indianapolis; Boston; Detroit; Chicago and a yet unspecified city in Puerto Rico.

CIRCLE NO. 438

Motorola is expanding its line of wideband video amplifiers by second-sourcing NE592/SE592 device types.

CIRCLE NO. 439

Analog Devices has cut prices of 4 and 3/4-digit DPMs 10 to 20% across the board.

CIRCLE NO. 440

Raytheon Co. Semiconductor Div.'s 2901A 4-bit μ P slice is 20 to 30% faster than the standard unit over both the commercial and military temperature ranges. It is designed to be pin-for-pin and functionally compatible with the standard 2901.

CIRCLE NO. 441

Fairchild's 9408 microprogram sequencer now comes in a military temperature-range version.

CIRCLE NO. 442

Zilog has started production of a Z80A μ P with a standard clock rate of 4.0 MHz.

CIRCLE NO. 443

Interdata has lowered prices up to 35% for its computer memory systems and 32-bit processor, the Model 7/32CII.

CIRCLE NO. 444

Electronic Design

ELECTRONIC DESIGN's function is:

- To aid progress in the electronics manufacturing industry by promoting good design.
- To give the electronic design engineer concepts and ideas that make his job easier and more productive.
- To provide a central source of timely electronics information.
- To promote communication among members of the electronics engineering community.

Want a subscription? ELECTRONIC DESIGN is circulated free of charge to those individuals in the United States and Western Europe who function in design and development engineering in companies that incorporate electronics in their end product and government or military agencies involved in electronics activities. For a free subscription, use the application form bound in the magazine or write for an application form.

If you do not qualify, paid subscription rates are as follows: \$30.00 per year (26 issues) U.S./Canada/Mexico, \$40.00 per year (26 issues) all other countries. Single copies are \$2.50 U.S. and all other countries. The Gold Book (27th issue) may be purchased for \$30.00 U.S./Canada/Mexico, and \$40.00 all other countries.

If you change your address, send us an old mailing label and your new address; there is generally a postcard for this in the magazine. You will have to requalify to continue receiving ELECTRONIC DESIGN free.

The accuracy policy of ELECTRONIC DESIGN is:

- To make diligent efforts to ensure the accuracy of editorial matter.
- To publish prompt corrections whenever inaccuracies are brought to our attention. Corrections appear in "Across the Desk."
- To encourage our readers as responsible members of our business community to report to us misleading or fraudulent advertising.
- To refuse any advertisement deemed to be misleading or fraudulent.

Individual article reprints and microfilm copies of complete annual volumes are available. Reprints cost \$6.00 each, prepaid (\$.50 for each additional copy of the same article), no matter how long the article. Microfilmed volumes cost \$23 for 1976 (Vol. 24); \$30 for 1973-75 (Vols. 21-23), varied prices for 1952-72 (Vols. 1-20). Prices may change. For further details and to place orders, contact Customer Services Dept. University Microfilms, 300 N. Zeeb Rd., Ann Arbor, MI 48106. (313) 761-4700.

Want to contact us? If you have any comments or wish to submit a manuscript or article outline, address your correspondence to:

Editor
ELECTRONIC DESIGN
50 Essex St.
Rochelle Park, NJ 07662

Electronic Design

Advertising Sales Staff

Tom W. Carr, Sales Director
Sue Apolant
Sales Coordinator

Rochelle Park, NJ 07662

Robert W. Gascoigne
Thomas P. Barth
Stan Tessler
50 Essex St.
(201) 843-0550
TWX: 710-990-5071
(HAYDENPUB ROPK)

Philadelphia

Thomas P. Barth
(201) 843-0550

Boston 02178

Gene Pritchard
P.O. Box 379
Belmont, MA 02178
(617) 489-2340

Chicago 60611

Thomas P. Kavooras
Berry Conner, Jr.
200 East Ontario
(312) 337-0588

Cleveland

Thomas P. Kavooras
(312) 337-0588

Los Angeles 90045

Stanley I. Ehrenclou
Burt Underwood
8939 Sepulveda Blvd.
(213) 641-6544

Texas

Burt Underwood
(213) 641-6544

San Francisco

Robert A. Lukas
465 S. Mathilda, Suite 302
Sunnyvale, CA 94086
(408) 736-6667

England

Constance McKinley
50 Essex St.
Rochelle Park, N.J. 07662
Phone: (201) 843-0550

Europe

Sanders, W. J. M.
Raadhuisstraat 24
Graft-De Ryp, Holland
Phone: 02997-1303
Telegrams: Euradteam-Amsterdam
Telex: 13039-SIPAS

G. Nebut
Promotion Presse Internationale
7 ter Cour des Petites Ecuries
75010 Paris, France
Telephone: 5231917, 1918, 1919

Dieter Wollenberg
Erikastrasse 8
D-8011 Baldham/Muenchen
Germany
Telephone: 0 8106/4541

Tokyo

Haruki Hirayama
EMS, Inc.
5th Floor, Lila Bldg.,
4-9-8 Roppongi
Minato-ku, Tokyo, Japan
Phone: 402-4556
Cable: EMSINCPERIOD, Tokyo



MONOLITHIC CRYSTAL FILTERS



THANK YOU, MA BELL

For years, mobile radios operating in urban areas have been plagued with interference problems. One of the biggest is intermodulation. This is where Ma Bell comes in. Mobile telephone channels assigned to her can cause IM products to be generated at nearby frequencies allocated to local taxi-cab companies.

The solution — a monolithic front-end filter in each cab radio to protect the first stage. We make these filters as custom jobs for end users with interference problems. We also make them in low-cost OEM quantities for improving the performance of VHF single-channel receivers — paging receivers for instance. Interested? Ask about our Model 2133F.

SPEAKING OF INTERMODULATION . . .

It should be noted that crystal filters — even ours — can generate IM products. Happily, this non-linear proclivity can be controlled. If your application involves IM requirements for either out-of-band or in-band signals, we may be able to help where others have failed.

Whether it's a tough IM spec, a VHF application or a plain vanilla 10.7 MHz IF filter, we've got the monolithic filter know-how to help you. Just drop us a line or, if you're in a hurry, call us via Ma Bell at (305) 298-2000.

Pi

Piezo Technology Inc.

2525 Shader Road, Orlando, FL 32804
(305) 298-2000

The standard in
monolithic crystal filters.

CIRCLE NUMBER 95

quick ads

New and current products
for the electronic designer
presented by their manufacturers.



MINIATURE CERAMIC TRIMMER CAPACITORS 9371 series of ceramic trimmer capacitors are compact, economical and rugged. They are 50% smaller than other trimmers of this type yet provide high capacitance values. Available in 4 capacitance ranges, 1.5 to 4, 3.0 to 10, 3.5 to 18 and 5.0 to 25 pf with Q's > 300 at 10 MHz. They have an overall diameter of .225" with .215" above board height. JOHANSON MANUFACTURING CORPORATION, Rockaway Valley Road, Boonton, N.J. 07005 201-334-2676

TRIMMER CAPACITORS 181



MAGNETIC SHIELDING Take advantage of Eagle's 23-year background in shield design and production. Custom and standard models. Full service includes design, engineering, fabrication, heat treating, finishing, testing. Also wide selection of sheet and foil so you can form your own shields. For helpful design and cost data, request Bulletin E-77. Eagle Magnetic Co., Inc., Box 24283, Indianapolis, IN 46224, 317-297-1030.

MAGNETIC SHIELDING 184



CMOS Crystal Oscillators in Low profile TO-5. Frequency range is 10 kHz to 300 kHz (divided outputs to 1 kHz, low as one cycle per month available). Low milli-amp current consumption. Accuracy $\pm 0.01\%$. Shock 1000 g. Hybrid thick and thin film chip and wire design is rugged and ideally suited for portable equipment. Details in Gold Book & EEM * STATEK CORP * 512 N. Main, Orange, Ca. 92668 * (714) 639-7810 * Telex 67-8394.

CRYSTAL OSCILLATOR 187

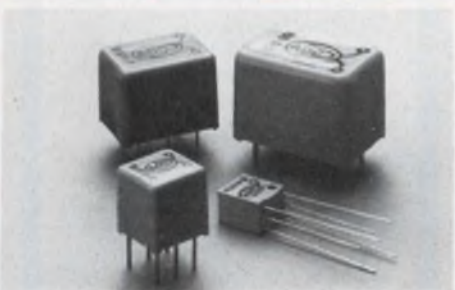

LADY BUG AUDIO TRANSFORMERS give you the reliability you'd expect from military transformers, at a commercial price. 46 different electrical configurations. Power ratings from 50mw to 2 watts. Operating frequencies from 100Hz to 100KHz. 4 case sizes (smallest: 1/3 cubic inch). ADC Products, 4900 W. 78th, Minneapolis, MN 55435. (612) 835-6800.

AUDIO TRANSFORMERS 182

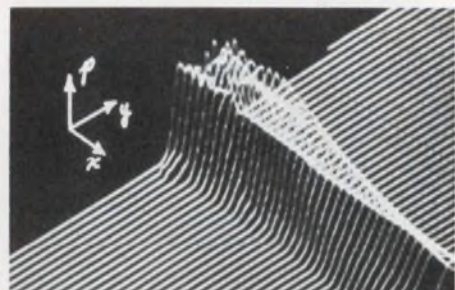

ELECTRONIC ISOMETRIC PROJECTOR generates 3D images of data applied to X, Y, Z inputs. Single-wide plug-in fits the Tektronix TM500 system. Image can be rotated, tilted, and magnified with front panel controls for optimum view. Image may be presented on CRT display, recorder, etc. Input and output offset controls are incorporated. Applications include ultrasonic field mapping and imaging, infrared imaging, eddy current testing, scanning electron microscopy. METROTEK, INC. (509) 946-4778

ISOMETRIC PROJECTOR 185



YOU'LL GET IT THE DAY BEFORE you order it as soon as we perfect a time-travel machine. Meanwhile 3 working days is typical turn-around for rack-mounting chassis units, card cages, desk-top & floor-standing cabinets, mini-consoles, subassembly housings. Circle our number or phone Techmar, 213-478-0046, and stand away from the door!

FREE CATALOG 188



Free New '77 catalog contains over 34,500 quality power supplies from the world's largest manufacturer, Power/Mate Corp. Power Supplies for every application including submodulars, open frame, varigated, encapsulated, laboratory & system. All units UL approved and meet most military and commercial specs for industrial and computer uses. Power/Mate Corp., 514 S. River St., Hackensack, NJ 07601 (201) 343-6294

POWER SUPPLIES 183



COMPUTER PROGRAMMABLE MAGNETIC FIELD CONTROLLER. Model FFC-4DP can interface with most regulated power supplies and virtually any computer with 6 decades of BCD output. Offers 1 part in 10^6 full range setting of field amplitude of an electromagnet. Manual input also provided. Features stray field compensation and elimination of hysteresis effects and temperature gradient effects. Many applications. Write: Walker Scientific, Inc., Rockdale Street, Worcester, MA 01606

COMPUTER CONTROLLER 186

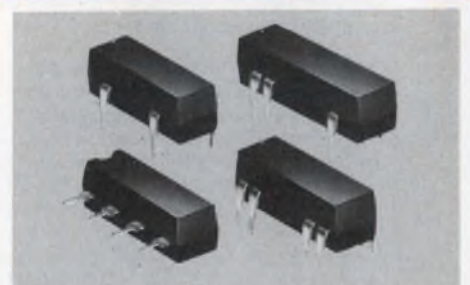

MOLDED-EPOXY DIP REED RELAYS. Industry's widest selection, offering six basic series with 4, 6 and 8-pin standard and single-in-line versions. Contact Forms A, B and C. 1 and 2 poles available in Form A. Dry reed (Forms A, B, C), high-voltage (Form A) and mercury-wetted (Forms A, C) versions. All designs compatible with auto-insertion equipment. Logic compatibility and environmental immunity are prime features. Request Bulletin RR407: Gordos Corp., 250 Glenwood Ave., Bloomfield, N.J. 07003; (201) 743-6800.

DIP REED RELAYS 189

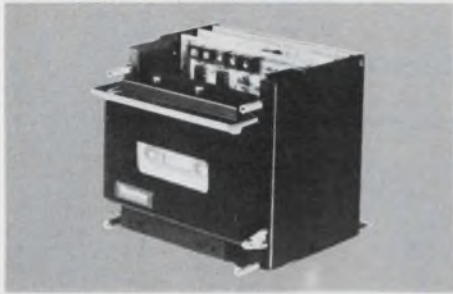

HIGH SPEED RECORDER FOR MICRO-PROCESSORS Model 764 has a patented constant speed tape drive using only 2 moving parts. No capstans, tachometers or clock tracks are necessary. Records up to 32,000 bits per second. Searches at 100 inches per second. Can store up to 5 megabits per 300 foot cassette. ANSI/ECMA compatible. Priced under \$500.00/OEM quantities. MEMODYNE CORPORATION, 385 Elliot Street, Newton Upper Falls, MA 02164. Telephone (617) 527-6600.

MICROPROCESSOR RECORDER 190

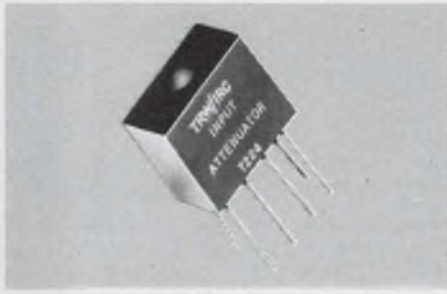

AR Ultra-Precision Resistor Networks from TRW provide maximum environmental protection. They feature lower effective cost, high density packaging, and all-welded construction. And, the AR Matched Resistor Sets provide ultra-precision performance at the lowest possible cost. TRW/IRC Resistors, an operation of TRW Electronic Components, 401 N. Broad St., Phila., Pa. 19108. (215) 922-8900.

AR MODULES 193

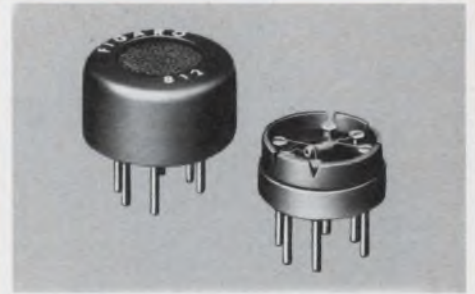

FIGARO GAS SENSOR TGS is a gas sensitive semiconductor. When combustible gas is absorbed on the sensor surface, a marked decrease of electrical resistance occurs. Major features of the sensor include high sensitivity, long term reliability and low cost. The applications are: GAS-LEAK ALARM, AUTOMATIC FAN CONTROL, FIRE ALARM, ALCOHOL DETECTOR, etc. Figaro Engineering Inc., North America Office-3303 Harbor Boulevard, Suite D-8, Costa Mesa, Calif. 92626 Tel: (714) 751-4103 Telex: 678396

GAS SENSOR 196

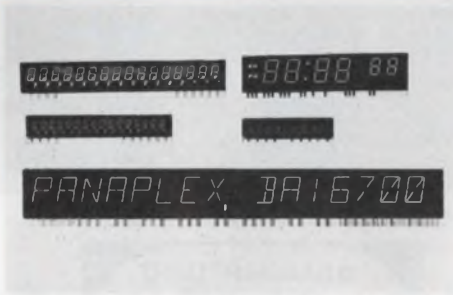

IN-STOCK AT VERY ATTRACTIVE PRICES Ready now for off-the-shelf delivery are several popular Burroughs Panaplex displays. These gas plasma panels provide exceptional readability in low or high ambient light plus uniform brightness and high/shock vibration resistance. Applications range from instruments to cash registers to pin-ball machines. Circle reader service number below for additional information. Or call Hamilton/Avnet or Cramer Electronics.

GAS PLASMA PANELS 191



New medium-scale, multi-use computer system from Harris. Powerful VULCAN Virtual Memory Operating System supports more than 50 terminals simultaneously. Greater I/O throughput. MOS Memory with error correction. Powerful micro processor based CPU. Operates with ANSI 74 COBOL, FORGO, SNOBOL, FORTRAN, RPG II, extended BASIC. Handles multi-stream batch processing, multi-concurrent RJE's (host and remote). Harris Computer Systems, 1200 Gateway Dr., Ft. Lauderdale, Fl. 33309 (305) 974-1700.

COMPUTER SYSTEMS 194



FREE HIGH VOLTAGE CAPACITOR CATALOG. Complete source listings for over 1000 power, pulse, high voltage, and special purpose capacitors and high voltage power supplies in glass, plastic and CP72 styles. Special low inductance types for laser and high energy applications. Many "custom" designs are standard with us. High reliability, long life, moderate cost, and fast delivery assured. To get your catalog, just drop us a line. Condenser Products Corporation, P.O. Box 997, Brooksville, FL 33512.

HIGH VOLTAGE CAPACITOR CATALOG 197



MINIATURE HIGH VOLTAGE POWER SUPPLIES • Output: 0-15 KV @ 10 μ a. • Input: 0-15 V @ 50 ma. • Available in Sync or Astable Modes. • Operates from -40°C. to +52°C. • Miniature (1.56" x 1.18" x 0.93"). • 24 Hour "Burn-in" Cycle Prior to Shipment. • For additional information or special requirements, please contact: Galileo Electro-Optics Corporation, Galileo Park, Sturbridge, MA 01518. 617-347-9191.

POWER SUPPLIES 192



MAGNETIC FLUX DETECTOR . . . Provides continuous north reference. Has sensing element that uses standard flux gate windings suspended in a pendulous position. For use with directional gyros or servo-compass systems. TSO C6c for use in autopilots. Model No. FD01-020-1 recommended for guidance and control systems on RPV's target drones, reconnaissance vehicles, oceanographic applications. 2.28" diameter x 1.91" high. Humphrey Inc., 9212 Balboa Ave., San Diego, CA 92123 Telephone (714) 565-6631.

MAGNETIC FLUX DETECTOR 195



FREE TAKE HOME MICROCOMPUTER included in tuition. 3-day HANDS ON μ P WORKSHOP \$499. NEW 2-day HANDS ON μ P INTERFACING WORKSHOP \$299. Free micro has 6800 MPU, RAM, PIA, ACIA, ROM with FANTOM-II monitor/debug (single step, break points, etc.), expandable to 65k. Fall 77 Dallas, Houston, Washington, Melbourne, FL, Denver, Palo Alto, San Diego, Indianapolis, Boston, Detroit, Chicago, Puerto Rico. Call Jerilyn 317-742-6802 or write WINTEK Corp., 902 N. 9th St., Lafayette, IN 47904.

MICROPROCESSOR COURSE 198

Electronic Design

recruitment and classified ads

PLACE YOUR AD AT ONLY \$45 PER COLUMN INCH IN

Electronic Design

— GET A REPEAT AD FREE!

With our 2 for 1 plan, your net cost in *Electronic Design* is only \$22.50 per column inch, lowest among all the national newspapers and electronics media. You get a total of 165,402 exposures to OEM engineers and engineering managers (not counting 10,600 more among general or corporate managers) at only 27¢ per thousand! You can't beat the price. You can't beat the coverage and you can't beat the quality.

YOU REACH ENGINEERS WITH TITLES LIKE THESE:

• Chief Engineer • Development Engineer • Design Engineer • Project Engineer • Electronic Engineer • Engineer-Supervisor • Section Leader • Staff Engineer • Systems Engineer • Test Engineer • Standards Engineer • Master Engineer

Electronic Design RECRUITMENT ADVERTISING RATES

15% commission to recognized agencies supplying offset film negatives. 2% 10 days, net 30 days. Four column make-up. Column width 1-3/4" x 10".

SPACE	DIMENSIONS		COST
	Wide	Deep	
One column inch	1-3/4" x 1"		\$45.
2 col. in.	1-3/4" x 2"		\$90.
1/16 page (1/4 col.)	1-3/4" x 2-1/2"		\$112
1/8 page (1/2 col.)	1-3/4" x 5"		\$225.
1/4 page (1 col.)	1-3/4" x 10" Vert.		\$450.
	3-1/2" x 5" Hor.		
1/2 page (2 cols.)	3-1/2" x 10" Vert.		\$900.
	7" x 5" Hor.		
3/4 page (3 cols.)	5-1/4" x 10"		\$1350.
1 page	7" x 10"		\$1800.

NOTE: EACH RECRUITMENT AD YOU PLACE WILL BE REPEATED FREE OF CHARGE!

LATE CLOSING DATES

Electronic Design is mailed every two weeks. Because of its timeliness, personnel recruitment advertising closes only two weeks before each issue's mailing date.

1977 Mailing Date	Recruitment Closing Date	Issue Date on Cover
July 15	July 1	Aug. 2
July 29	July 15	Aug. 16
Aug. 12	July 29	Sept. 1
Aug. 26	Aug. 12	Sept. 13
Sept. 9	Aug. 26	Sept. 27
Sept. 23	Sept. 9	Oct. 11
Oct. 7	Sept. 23	Oct. 25
Oct. 21	Oct. 7	Nov. 8
Nov. 4	Oct. 21	Nov. 22
Nov. 18	Nov. 4	Dec. 6
Dec. 2	Nov. 18	Dec. 20



HOW TO PLACE YOUR AD CALL THE RECRUITMENT HOT LINE 201-843-0550

Camera-ready film (right reading negatives, emulsion side down) or camera-ready mechanicals must be received by deadline. Or, if you wish us to set your ad (typesetting is free) simply pick up the phone and call our RECRUITMENT HOT LINE — (201) 843-0550. Ask for:

Constance McKinley
RECRUITMENT ADVERTISING MANAGER
ELECTRONIC DESIGN

50 Essex Street, Rochelle Park, New Jersey 07662

ENGINEERS STABILITY GROWTH CHALLENGE

Our forte is the knowledge of nationally recognized Electronic firms which can offer the professional

Stability...Growth...Challenge

Our clients serve both the commercial and defense industries and have immediate openings for management oriented engineers.

Circuit Design Signal Processing
System Design Communications
Systems Analysis EW/ASW Systems
Computer Architect C3-Radar-Nav
Microprocessors Process Controls
Manufacturing Operations Research

For immediate and confidential consideration please submit resume and salary history and geographic preference to R.A. Cooke, President.

Representing an Equal
Opportunity Employer M/F

Alden Associates Inc.
414 Hungerford Dr.
Rockville,
Maryland 20850

ELECTRONIC ENGINEERS

Sals. open. Varied current openings, particularly in Aerospace. Sonar & Reliability Engineering fields. BSEE & U.S. citizenship req'd. (firm). Replies kept confidential. EOE Fee Pd. Agcy. To save time, pls send res. 1st D. Jones Tech-Prof Empl., Est. 1967, 3111 St. Paul St., Balto., Md. 21218. 301-243-1545

ENGINEER

B.S.E.E. M.E. or Tech Degree for Richmond Va. based company. Extensive travel. Sales experience preferred. new graduates considered. Salary plus commission. Send full resume to Post Office Box 27306, Richmond Virginia 23261. Attention: Bonnie Henry

Engineer

Software Engineer

Continuing growth of north suburban Chicago manufacturer of electronic based telecommunications terminals has several challenging opportunities available for Engineering Programmers. Individuals selected will assume responsibility for software development of micro-processor based telecommunications equipment.

This position requires a minimum of 2 years experience in assembly level design and implementation of mini/micro computer equipment.

Individuals willing to respond to challenge and contribute to a rapidly expanding development manufacturing effort should send resume of work experience and salary history to:

Personnel Department
EXTEL CORP.
310 Anthony Trail
Northbrook, Illinois 60062
an equal opportunity employer m/f

UNADVERTISED OPENINGS \$16-33K

- Hd Software Des
- Pwr Supply Des
- Test Engng
- Mfg Engr & QC
- Radar
- Electro Optics
- Microwave Comm
- Marketing

Let our professional engineers assist you in advancing your career, or improving your choice of location. Due to our success, many NATIONWIDE companies have retained us to fill their confidential, unadvertised openings. Discretion assured. Contact Technical Dir.

Corporate Advisors
12955 Biscayne Blvd., Miami, 33181
Professional Placement
(305) 891-4801

FIELD ENGINEER

Sal \$12-30K, depending on exp. 360/370 or other CPU training. Peripheral exp. acceptable. Nationwide & international

FIELD SERVICE GROUP
2715 Via Montecito, San Clemente, CA
92672, Steve Andersen 714/498-0600
All Fees Paid by Client Companies



ENGINEERS
Needed for FEE-PAID positions THROUGHOUT THE U.S. Over 1,000 client companies. Send resume and salary history or request confidential application today.
ATOMIC PERSONNEL, INC.
Suite D-2 1518 Walnut St. Phila Pa 19102
Empl. Agcy. All Technical Fields
Est. 1959

Recruitment Ads Pull

Technological Leadership for 3 Decades!

Ampex, headquartered on the San Francisco Peninsula, is the company that "invented" the magnetic recording industry.

The technology pioneered by Ampex over three decades has affected many aspects of our modern lifestyles, and has established Ampex as a leader in magnetic recording. Our continued effort in developing new technology has always been the key to our leadership. Right now our Advanced Technology, Data Products and Audio-Video Systems Divisions are embarking on several new programs. To insure the success of these programs we are seeking innovative graduate engineers with experience in the fields listed below.

Opportunities like this don't happen very often. But they're happening at Ampex now.

Advanced Technology Division

- electron beam and optical recording
- magnetic recording
- tape or film handling
- servos
- high-bit rate digital circuit design
- optics
- signal analysis
- pattern recognition
- high frequency circuit
- communications theory

Data Products Division

- circuit / systems design of very high-bit rate systems

- disk read/write systems and equalizing systems for tape recorders
- codes for magnetic recording
- precision servo systems for both linear positioners and rotating systems
- mechanical design of high precision systems in disk recorders and in longitudinal, helical and transverse scan tape recorders

Audio-Video Systems Division

- analog videotape signal systems
- digital video signal processing
- servo systems
- videotape editing
- professional audio recorders
- head technology
- TV cameras

If you think you have something valuable to offer in any of these or closely related areas, and if you would like to join some of America's most talented engineers, please send your resume or a letter outlining your qualifications to: Ampex Corporation, ATTN: Corporate Staffing Manager, Building 2, 2655 Bay Road, Redwood City, CA 94063. Or you can send us this coupon and we'll get back to you. We are an equal opportunity employer m/f.

**Manager Corporate Staffing
AMPEX Corporation
Building 2, 2655 Bay Road
Redwood City, CA 94063**

Dept. 9

Name _____
Address _____
City, State, Zip _____
Phone _____

Occupation _____
Years of Experience _____
Employer _____



Join a Leader

Electrical Engineers & Electronic Engineers

If you're the best, why not join the best?

OCLI, a leader in the design of optical thin film coating, is looking for BSEE or MSEE candidates for a variety of project tasks in our Corporate Equipment Engineering Group.

If you have a strong design background in electronic control systems and instrumentation and/or experience with design and troubleshooting of electrical power supplies, we'd like to talk with you.

Please forward your resume to the attention of P. Lang, Optical Coating Laboratory, Inc., P.O. Box 1599, Santa Rosa, CA 95402, or call collect: (707) 545-6440. We are an equal opportunity employer m/f.

Optical Coating

Laboratory, Inc.

LOCAL INTERVIEWS IN 1977

Microprocessor Hardware & Software Engineers
Computer Design Engineers & Programmers
Radar & Communication Engineers
Electro-Optics & Laser Systems Engineers
Automatic Test Equipment Engineers

Regional Consultants, Inc. is a nationwide technical search firm representing a broad base of clients serving the Electronics field.

We will be conducting interviews in all areas of the country where there are concentrations of technical talent. Our clients are willing to come to you. To meet with them and us, send your resume, including present salary and geographic preferences. If you don't have a prepared resume, drop us a brief hand-written outline of your background.

Search Director

REGIONAL CONSULTANTS, INC.

213 W. 9th Street, Cincinnati, Ohio 45202
(513) 579-1513

Our Clients are Equal Opportunity Employers



ENGINEERS TECHNICIANS

SILICONIX, the technology leader in JFETS, MOSFETS, VMOS, has career opportunities for engineers and technicians with experience in the semiconductor industry. If you are interested in joining a company where the individual is still important, take a look at SILICONIX.

WE HAVE IMMEDIATE OPENINGS FOR:

Device Engineers
Assembly Process Engineers
Sales Engineers
Reliability Engineers
Design Drafting Engineers

Engineering Aides
Electronic Techs (Maintenance)
Line Maintenance Techs
Calibration Maintenance Techs

Siliconix offers excellent compensation plus a liberal benefit package including dental insurance, profit sharing, tuition assistance and a stock purchase plan.

For consideration, send your resume to Technical Employment, 2201 Laurelwood Road, Santa Clara, CA 95054. An Affirmative Action Employer.

Siliconix

SYSTEMS ARCHITECTS

Systems Architects needed for architectural planning and systems design of the next generation "General Merchandise" Real Time Multi Level Point-of-Sale systems. Responsibilities will include definition of systems requirements, formulation of architectural concepts and performance criteria, development of system specifications, and analysis of cost performance tradeoff.

These positions require a BS/MSEE, Computer Science or Software Engineering degree with 3-10 years experience in hardware/software design and development. Experience in system simulation, knowledge of communications protocols and operations evaluation techniques would be helpful. Candidates should be knowledgeable in operating systems, microprocessors, semiconductors, memories and peripheral devices.

This is a highly visible work environment and the work position is needed to respond to the exploding P.O.S. market and the growth of NCR's retail Terminal Systems Division in Cambridge, Ohio.

We invite your consideration at your earliest convenience:

Robert W. Donovan
Terminal Systems Division — Cambridge
NCR Corporation
Cambridge, Ohio 43725

Phone: 614/439-0291

NCR

An Equal Opportunity Employer

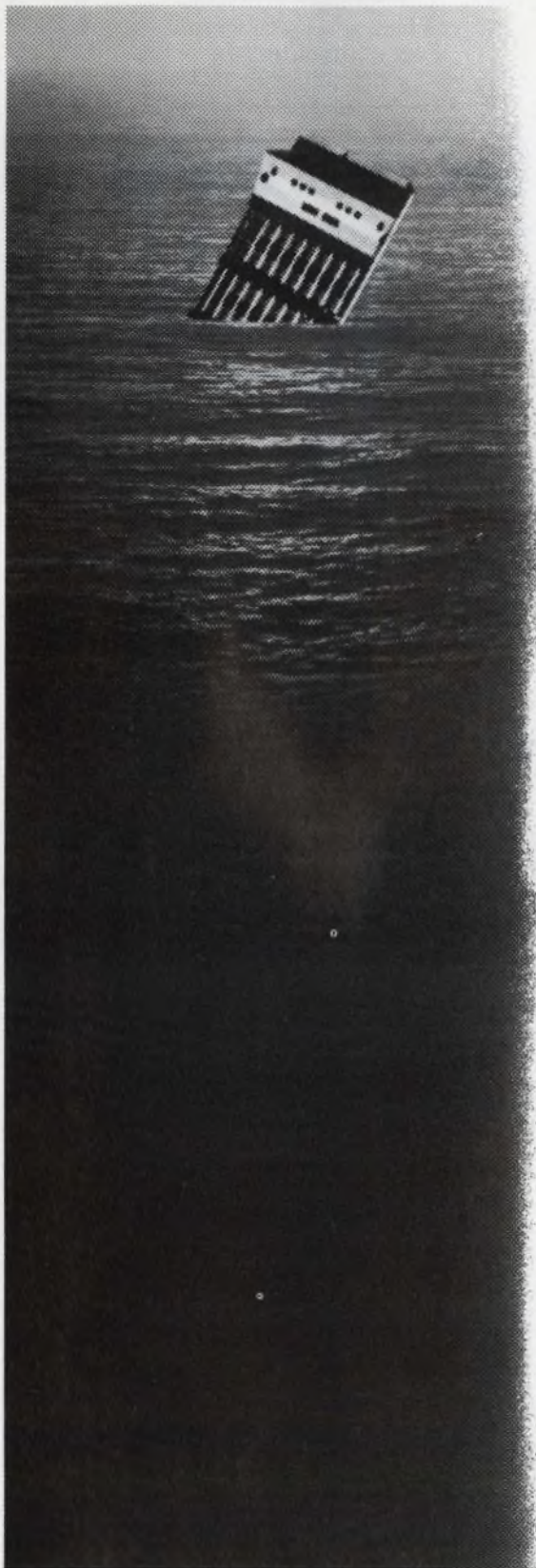

The Tip of an Iceberg

There's much more to **GTE**
Automatic Electric Laboratories'
involvement in the digital hardware
and software evolution in
Telecommunications.

The #3EAX computer-controlled switching system, a portion of which is portraying our iceberg tip, features a digital PCM network and stored program control. It is one of a family of advanced systems spearheading our digital evolution in telecommunications. Our primary assignment is to research and develop the communications systems of the future. Sophisticated systems employing state-of-the-art techniques in digital hardware, and the development of complex software architecture, support systems and programming.

GTE Automatic Electric is a major member of the GTE Family whose research and development expenditures ranked among the top 50 Research and Development spenders in U.S. industry in 1976.

We are embarking on a major expansion of our technical and laboratory staffs.

We're talking with skilled professionals... not only those with telecommunications experience, but individuals with experience in virtually every segment of the computer, and computer related hardware/software industry, including marketing and manufacturing support. If you have hardware/software skills in any of these areas, talk with us about a growth future in a massive growth field: Application Software, Digital switching systems, logic design, diagnostics, Software/Hardware interface and testing, data base systems, real-time systems design, CAD/CAM, mainframe design, micro/mini systems and design, and related areas.

For more information about your growth future in Telecommunications, talk with one of our representatives TODAY. Call Toll-Free: (800) 323-1966 or if in Illinois or surrounding areas call Toll-Free (800) 942-0491.

**GTE AUTOMATIC
ELECTRIC**

400 N. Wolf Road
Northlake, Illinois 60164

Equal Opportunity Employer M/F

Join TRW In So. California!

TRW Defense and Space Systems Group, headquartered in Redondo Beach, California and employing over 11,500 people, is a major operating unit of the worldwide corporation of TRW, Inc. Our modern facilities offer an unmatched, campus-like environment and are surrounded by beaches, mountains, deserts, varied cultural centers and the joys of sunny Southern California living! major operations within our division are located in San Bernardino, Vandenberg AFB, San Juan Capistrano and Sunnyvale, California and in Washington, D.C.

We are a team-oriented company committed to quality...quality in the work we turn out and in the professionals we bring in. The recent award of the TD-1193 Multiplexer/Demultiplexer, AM/FRC Digital Radio contract has created extraordinary opportunities for telecommunications professionals. In addition, our long-term contractual commitments in support of the National Military Command System (NMCS) and the Worldwide Military Command and Control System (WWMCCS) have created unique positions for progressive individuals capable of creative and innovative analysis in the areas of national level C³ systems. We invite you to explore exceptional career opportunities in the following positions:

- Digital Circuit Designer
- Multiplexer Design Engineer
- Operations Research Analysts
- Applications Engineers
- Test Engineers
- Digital Systems Engineers
- Antenna Design Engineers
- Systems Test Engineers
- RF Engineers
- RF System Designer
- Digital Modem Designer
- Product Design Engineers
- LSI Applications Engineers
- Communications Systems Engineers
- Communications Systems Analysts
- Signal Processing Systems Engineers
- Microwave Engineers

At TRW, you will be a recipient of our nationally recognized Flexible Benefits Plan. If you thrive on challenge in an atmosphere which stresses professional freedom and achievement, please send your resume in complete confidence to:

Professional Placement, Box AE-100

One Space Park
Redondo Beach, Calif. 90278

An equal opportunity employer M/F/H

TRW
DEFENSE AND SPACE SYSTEMS GROUP

ENGINEERS SCIENTISTS
TECH-SALES
\$15,000 to \$30,000
Fee Paid Nationwide coverage
TECH-PLACE IN.
421-D S 2nd St. Elkhart, IN 46514
Licensed employment agency

Engineers, Designers, Draftsmen
Electronics, Civil, Pipe,
Mechanical
U.S. and overseas jobs Send resumes to:
Adia Technical Services
465 So. Mathilda, Suite 101
Sunnyvale, CA 94086 — 408-733-2882

DESIGN ENGINEERS TO \$30,000

CRT DISPLAY CIRCUITS
LINEAR DEFLECTN AMPLS
SECURE COMM SYSTEMS
CONTROL SPACE AND INSTRN

BRJ ASSOCIATES

1590 E22nd St. Scotch Plains, N.J. 07076
201-322-8050

Electronic Design

BRINGS YOU THE HIGHEST
NUMBER OF QUALIFIED EOEM
ENGINEERS AND ENGINEERING
MANAGERS ANYWHERE
... AT THE LOWEST COST
ANYWHERE!

SPECIAL 2 RECRUITMENT ADS FOR THE PRICE OF 1!

Double the coverage . . .
double the effectiveness
of every ad you place!

Constance McKinley
RECRUITMENT ADVERTISING MANAGER
ELECTRONIC DESIGN

50 Essex Street, Rochelle Park, New Jersey 07662

(201) 843-0550

I'm interested in placing recruitment
advertising in *Electronic Design*

Issue _____ Size of ad _____
 My copy is enclosed I need more information
Name _____
Title _____
Company _____
Address _____
City _____ State _____ Zip _____
Telephone _____

Engineers... are you pigeonholed?

We won't keep you pigeonholed in the same old assignment, year after year. After all, variety is the spice of a life's work. And we have a commitment to it. We make our living selling variety: command and control systems, complete air defense systems, radar systems, sonar systems, computer systems and much more. We're part of a company of 36,000 people, active in more than 550 major product areas in 80 technologies. Plenty of room for developing interests, plenty of room for growth.

Our Systems Division engineers enjoy technical diversity because of our program variety, and growth opportunities that we're steadily expanding. They benefit from the technically oriented management which put us on our strong growth curve. And they enjoy a good professional environment, where many of our people wear 10, 15, and 20 year service pins.

Any more good news? Well, yes. We're hiring now.

For quick action, reach for your phone instead of your resume... call Richard Navarro collect (714) 871-4080, Ext. 2136 between 8 A.M. and 4 P.M. Monday through Friday. Or send your resume to: Professional Employment — Ground Systems Group C, 1901 W. Malvern, Fullerton, CA 92634.

U.S. citizenship required • Equal opportunity M/F/H/C employer

HUGHES

HUGHES AIRCRAFT COMPANY

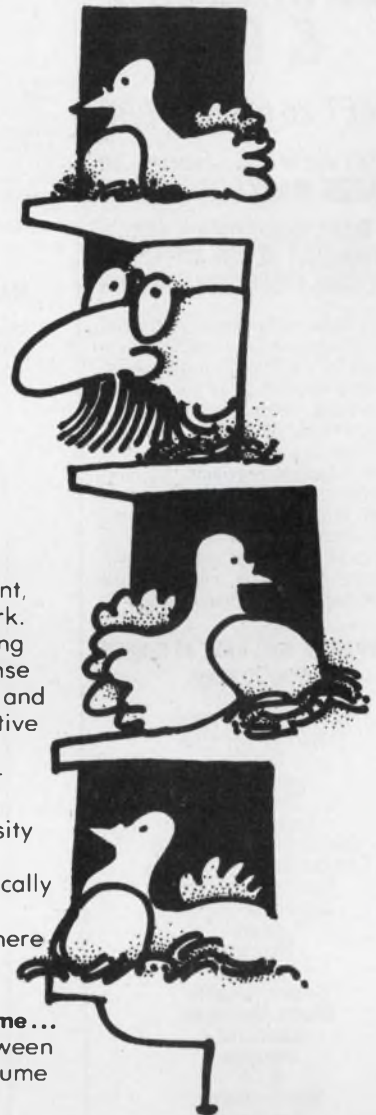

Communications System Engineers. Must understand hardware/software interaction, signal processing, spread spectrum.

Senior Systems Engineers. Tactical, strategic system application of radar, sonar communications, electro-optical software, data processing and command and control technologies.

Communication Analysts. Lead/direct application of systems theory, applied math, estimation, probability to communication system problems.

Data Processing and Software Analysts. System level data processing architecture analysis, design, performance evaluation for multisensor systems.

Display System Engineers. Long term opportunity to lead display product definition/selection for military C&C Systems.

Radar Systems Engineers. Lead/direct radar system conceptual design/analysis. Integration of radar, weapon, command and control systems.

Senior Air Defense Engineers. BSEE, Math or Physics, project management experience in real-time hardware software systems.

Hardware System Engineers. Large scale data processing, peripheral, display systems design, specification, integration checkout.

Systems Analysts. Systems Theory, applied math background. Variety of problems requiring modern analysis techniques.

ENGINEERS & EDP

MEET 26 EMPLOYERS

Interviewing Soon in MAJOR MARKETING AREAS

MANY REQUIREMENTS FOR AFFIRMATIVE ACTION APPLICANTS INCLUDING PROFESSIONAL WOMEN

At an Opportunity Center, you have a unique opportunity to meet representatives of top firms in private interviewing sessions all in a single day or evening. When you apply, your resume minus your name and present employer, is reviewed by representatives of Opportunity Center sponsoring firms. You are notified as to which firms would like to meet you. Your identity is revealed only after you have expressed interest in this corporation. Private interviews are scheduled at your convenience.

COMPANIES WHO HAVE ATTENDED

Allen Bradley
Ashland Oil
Automatic Sprinkler
American Air Filter
Bendix
Borg Warner
Burroughs
Carborundum
Combustion Engineering
Commonwealth Associates
Computer Science
Digital Equipment
Dravo
Emerson
Fairchild
General Electric
Gilbert Associates
Gould, Inc.
Goodyear
G.T.E.
Harris Electric
Honeywell
I.T.T.
Jas. Schlitz
Koppers Company
Litton
Martin Marietta
3M
McDonnell Douglas
Monsanto
Miles Laboratories
NCR
Owens Illinois
Picker X-Ray
Simmonds Precision
Singer
Stone and Webster
Sundstrand
Teledyne
Texas Instruments
TRW
Union Carbide
Westinghouse
Xerox

NO FEES OR CHARGES TO APPLICANTS
SEND RESUME TO:

OPPORTUNITY CENTER

Akron Savings Bld., Suite 1113
7 W. Bowery St., Akron, Ohio 44308

CHALLENGING GROWTH OPPORTUNITIES

\$15,000-\$30,000

We are the Midwest's exclusive recruiter for electronic project and design engineers. Through our "third-party approach" we offer you the opportunity to explore the best career growth positions in the ELECTRONIC INDUSTRY. Fees and relocation expenses paid. Mail your resume in confidence to LEN TERESINSKI, our Electronic Specialist, or call (414) 437-4353 daily, at home (414) 494-4674

GREEN BAY MANAGEMENT RECRUITERS

115 S. Jefferson St., Suite 302
Green Bay, Wisconsin 54301

Licensed Employment Agent

ENGINEERS

We are currently searching for Engineers with 1-10 years of Design/Analysis and/or Integration/Test experience in AVIONICS, MICROWAVE, DIGITAL PROCESS CONTROL, MESSAGE SWITCHING, SATELLITE SIGNAL PROCESSING, TELEPHONE TRANSMISSION or MICROPROCESSOR/COMPUTER SYSTEMS. BS Degree & US Citizenship Required. Salaries \$14,000 to \$35,000. CALL COLLECT (301) 474-6266 or Submit Resume to:

TECH-ED SERVICES

10011 Rhode Island Avenue
College Park, Maryland 20740

A 100% Employer Fee Paid Agency Representing Companies throughout the United States.

Systems Engineers

Since 1969, we've been providing Confidential and Industry-Knowledgeable placement for Hardware/Systems Design professionals.

Listed below are Current and Immediate requirements of Local and National client companies. These openings represent a cross-section of commercial electronics firms. If you have been thinking of investigating new opportunities, we urge you to contact Robert Norton for individual discussions of particular opportunities in your career field, or to submit confidential resume with salary information for review. All interviews are by appointment. Client companies assume all fees. Professional resume preparation and career path counseling are provided free of charge. For those who find it inconvenient to call during working hours, our office will be open until 7:30 p.m.

Computer Architects - BS/MSEE and some experience in the Definition and Development of Micro-Minicomputer Systems. Will be a principal participant in the development of a new family of computer systems. **Salary to \$35,000**

Microprocessor Design Engineers - BS/MSEE with some familiarity with Microprocessor utilization for Distributed Systems. Knowledge of any of the following would be highly regarded: 8080, 6800, LSI-11, F-8, 2901. **Salary to \$30,000**

Circuit Design Engineers - BSEE and at least 2 years of experience Developing Circuit Use Rules, Clock Distribution Systems and Power Distribution Systems as related to ECL utilized in small and medium systems. **Salary to \$25,000**

Peripheral Interface Design Engineers - BS/MSEE and experience in the Design of Interface Controllers between Magnetic Peripheral devices and Computer I/O Bus. **Salary to \$24,000**

CPU Design Engineers - BSEE/BSCS and experience in the Design of Digital Computers or Microprocessor Systems. Requires an understanding of Software, i.e., ASSEMBLY, FORTRAN or PL-1. **Salary to \$25,000**

Digital Logic and Circuit Design Engineers - BSEE and some experience in Logic and Circuit Design including a familiarity with TTL, CMOS, etc. **Salary to \$24,000**

Process Control Engineers - Degree in Engineering with background in Computer Sciences. 3-5 years of experience in the Application of Process Control Computers within the Petrochemical, Chemical, Pulp and Paper or Textile Industries. **Salary to \$16,000**

A/D-D/A Converter Engineers - 3-5 years of experience in Analog and Digital design utilizing discrete components, Hybrid Thick and Thin Film Processes and Monolithic IC's. **Salary to \$24,000**

Circuit Designers - BS/MSEE and some Hands/On Design experience employing ECL, SCHOTTKY, etc. **Salary to \$20,000**

nk Norton, Kleven and Co., Inc.
INDUSTRIAL RELATIONS MANAGEMENT CONSULTANTS

Three Fletcher Avenue, Lexington, Massachusetts 02173
Telephone (617) 861-1020

Member Massachusetts Professional Placement Consultants
Representing Equal Opportunity Employers M/F

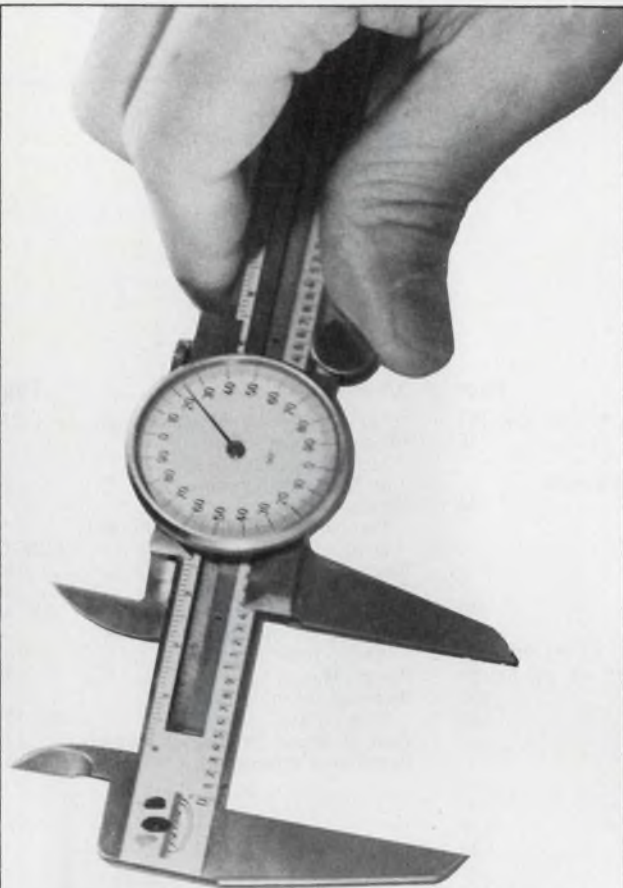

ACCURACY

Electronic Design makes every effort to be accurate. If you spot a misstatement in either editorial or advertising matter, please bring it to our attention. Corrections are made promptly and appear in "Across the Desk."

If you find that an advertiser has made promises . . . then failed to deliver . . . we'll help you. Send us the details and we'll add our pressure to yours to help rectify the situation, or if it's an honest mistake, we'll try to find out why it happened.

Electronic Design refuses to run any advertisement deemed to be misleading or fraudulent. Our accuracy statement appears in every issue. Accuracy is everybody's business. To put teeth in our policy, we need your help and support.

Send comments to:

George Rostky

Editor-in-Chief

Electronic Design

50 Essex Street

Rochelle Park, New Jersey 07662

BIOELECTRONICS ENGINEER

FOR DEVELOPMENT OF ELECTRONIC INSTRUMENTATION FOR EYES

We are looking for a person experienced with lasers and optical systems, preferably with a knowledge of biomedical applications, to work at a large medical center. Projects will involve the design and construction of electronic instrumentation for eyes. A background in electronics and electrical engineering is required; a knowledge of computer technology would also be helpful.* Ph.D. degree not necessary.

REPLY TO:

Ophthalmic Research Foundation, Inc.

18 East 73rd Street

New York, N.Y. 10021

*This is an opportunity to exercise initiative and innovation.

The New 1977-1978 **GOLD BOOK** Has Just Been Published



And Completely Outdates Last Year's Edition

If you are currently a subscriber on **ELECTRONIC DESIGN's** qualified circulation file, you need do nothing. You will receive your new **GOLD BOOK** automatically. If you wish additional copies for other members of your company, you may order them now using the convenient coupon form below.

If you are not currently an **ELECTRONIC DESIGN** subscriber on our controlled circulation list, you may order your own multi-section set of the new **GOLD BOOK** by completing the form below. Shipment will be made promptly on receipt of your payment or company purchase order.

**HERE IS WHAT YOU AND YOUR COMPANY
WILL FIND IN THE UPDATED 1977-78**

GOLD BOOK

- **Three sections** containing 2,496 pages of information to quickly locate products used by the electronics industry.
- **A Product Directory** with 5,434 product categories.
- **A Trade Name Directory** of 9,814 listings.
- **A Manufacturers' Directory** listing 8,057 companies in the electronics industry.
- **Two Distributors' Directories** with 2,050 distributors listed.
- **A Giant Compendium of Manufacturers' Data Pages** with specifications.

MAIL TODAY WITH PURCHASE ORDER

Electronic Design's **GOLD BOOK** 449R
Hayden Publishing Co., Inc.
P.O. Box 13803, Philadelphia, Pa. 19101 U.S.A.

Here is our purchase order for _____ sets of the 1977-1978 **GOLD BOOK** at \$30.00 per set—for U.S., Canada and Mexico.
(All other countries: \$40.00 per set)

Check enclosed for \$_____. Bill us.

Name (Print) _____
Title _____
Company _____
Address _____
City/Province _____
State/Country _____
Zip or Postal Code No. _____

QUANTITIES ARE LIMITED. PLACE ORDER TODAY!

Product index

Information Retrieval Service. New Products, Evaluation Samples (ES), Design Aids (DA), Application Notes (AN), and New Literature (NL) in this issue are listed here with page and Reader Service numbers. Reader requests will be promptly processed by computer and mailed to the manufacturer within three days.

Category	Page	RSN	Category	Page	RSN	Category	Page	RSN
Components			Instrumentation			connectors	49	34
capacitor, ceramic	39	27	control meter	149	84	connectors	80	46
crystals	142	76	DMM	146	397	connectors	126	64
displays, small-screen	33	24	DMM	146	396	connectors	131	67
keyboard	134	70	DMMs	42	29	connectors and terminals	154	94
lamps, LEDs	1	2	DPM	148	405	connectors, mass term.	138	375
magnets	138	73	datatrap	148	407	covers, terminal-strip	138	374
magnets, ferrite	113	60	frequency counter	128	65	enclosures	129	66
potentiometers	11	230	logic analyzer	45	29	engineered component		
relays, solid-state	2	3	logic analyzer	148	406	parts	142	77
relays, solid-state	135	367	magnetic probe	148	404	etching equipment, lab	140	380
resistor networks	141	75	modulation meter	149	83	fasteners, threaded	22	15
resistors	153	93	panel instruments	103	53	ferrite-antenna cores	138	376
resistors, thick-film	136	368	recorders, 4 in. servo	134	69	grounding kit	140	378
resistors, thin-film	55	38	recording system, lab	14	10	marker pens	142	383
resistors, trimmer	137	37	signal generator	146	395	socket/carrier systems	135	71
switch, limit	135	366	test clips, IC	150	86	soldering instrument	151	91
switches	147	81				test clip	137	72
switches	152	92	Micro/Mini Computing			test sockets, IC-DIP	140	379
switches, rotary	137	372	boards, pre-etched	119	307	trays, anti-static	140	377
switches, PB	23	16	boards programmer	119	306	wire, bare-braided	140	381
switches, PCB	31	23	card, memory	115	305	wire, cable and cord	71	400
switches, thumbwheel	151	88	computer, single-board	122	322			
thermal cutoffs	76	44	course, μ C training	122	327	Power Sources		
trimmer, cermet	151	89	hardware, μ C	122	326	battery, 9-V-size	150	408
			memory card	54	37	converters, dc/dc	143	78
			memory, core	122	325	power sources	146	79
			memory, expansion	121	321	power supplies	6	4
			memory, expansion	122	323	power supplies	46	33
Data Processing			microcomputer	121	310	power supply	150	409
data modems	37	26	microcomputer, Z80	121	309			
disc memory	127	334	microprocessor	115	303	new literature		
driver output	127	333	printer, alphanumeric	115	302	alarm products	152	416
laser scanner	128	338	programmer, PROM	115	304	BITE indicators	152	415
line printer	128	337	reader, card	122	324	cabinets	153	421
minifloppy	124	330	software	115	301	capacitors	152	420
optical reader	127	332	system, diagnostic	119	308	controller	153	422
printer	129	340	system, microprocessor	122	328	counters, timers	153	427
programming system	114	180	system, test & debug	121	320	data communications	152	417
terminal	127	331				encoder	152	418
terminal	128	336	Modules & Subassemblies			executive software	152	414
terminal	128	339	amp, instrumentation	144	389	fiber optics	153	428
			amplifiers-rf	144	393	L-C filters	152	419
ICs & Semiconductors			converter, a/d	147	80	noise suppression	152	411
controller, timer	132	359	converter, d/a	144	392	phototransistors	153	426
converter, d/a	120	63	converter, d/a	144	394	power semiconductors	153	429
converter, d/a	130	349	converter, video d/a	143	387	power supplies	152	410
digital correlator	15	11	converters, a/d-d/a	143	388	power supplies	153	423
diodes, zener	134	361	converters, v/f	89	48	power supplies	153	424
generator, noise	132	360	crystal filters	155	95	real-time systems	153	424
ICs	134	362	DPM	144	390	recorders, X-Y	153	425
ICs	134	363	data acquisition	143	386	temperature instruments	152	413
I/O devices	14	232	electro-optics	77	45	test instruments	152	412
LEDs	132	357	filter, active	143	385			
op-amp, BIFET	132	358	interrupter modules	7	5	application notes		
op-amps, BIFET	43	30	multiplexer, digital	144	391	bus, interface	154	430
phase-locked loops	130	348	power amplifier, rf	111	231	controllers	154	434
RAM, 4-k static	9	6				data systems	154	435
RAM, static	53	36	Packaging & Materials			digital plug-ins	154	431
rectifier, Schottky	35	25	board carriers	142	384	multiplexer parameters	154	432
rectifiers	21	14	bus	70	42	resistor networks	154	433
register, 8-bit D-type	5	19	card, extender	140	382			
regulator, voltage	130	345	catches, magnetic	138	373			
semi memory	27	21	centrifugals	151	90			
timer, 555	50	35	coatings, conformal	26	20			
transistor, FET	130	346						
transistor, microwave	132	356						

Tomorrow ideas today.



Using solid-state technology to replace bulky tube-type equipment, ENI's broadband amplifiers are tomorrow ideas available today. ENI's Class A power amplifiers already cover the frequency spectrum of 10 kHz to 1 GHz, with power outputs ranging from 300 milliwatts to over 4000 watts. And we're still climbing. Driven by any signal generator, frequency synthesizer or sweeper, ENI's compact portable amplifiers are completely broadband and untuned. Amplifying inputs of AM, FM, SSB, TV and pulse modulations with minimum distortion, these rugged units are

versatile power sources for general laboratory work, RFI/EMI testing, signal distribution, RF transmission, laser modulation, data transmission, NMR, ultrasonics and more. Designed to be unconditionally stable and failsafe (impervious to severe load conditions including open or short circuit loads), ENI power amplifiers will deliver their rated power to any load, regardless of match. For information write: ENI, 3000 Winton Rd. So., Rochester, New York 14623. Call 716-473-6900. TELEX 97-8283 ENI ROC.

ENI

World's Leader in Solid State Power Amplifiers

CIRCLE NUMBER 231

Cash in on the CMOS advantage ...

New I/O devices make RCA 1800 μ P even more flexible.

Here is further proof of how flexible and cost-effective the CMOS RCA 1800 is compared to other microprocessor systems. Easily, and with minimum parts count, you get maximum flexibility—through these versatile, low-cost I/O devices. And CMOS itself helps reduce costs. Thanks to a single, non-critical voltage supply. Low power. High speed and noise immunity. And full military temperature range.

1 Two-mode UART

Unique among industry standard UARTs, the CDP1854 operates in two modes and is pin-out selectable by a single mode control. In Mode 0 it works as an industry standard 1602 UART. Mode 1 makes it compatible with the RCA 1802 and other 8-bit CPUs. And either mode gives high speed—up to 400K baud.

2 Address latch/decoders

These two devices, the CDP1858 and CDP1859, make it easy to expand the RCA 1800 memory. They interface directly with the CDP1802 memory address bus and serve as memory system decoders for large RAM systems. The CDP1858 is designed for use with CDP1821 type memories and the CDP1859 for use with CDP1822 type memories.

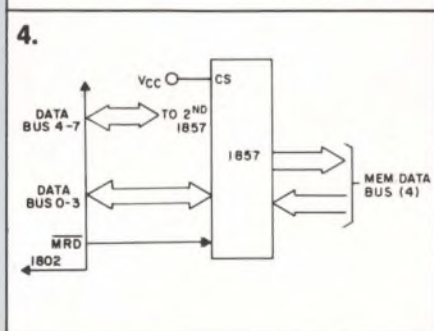
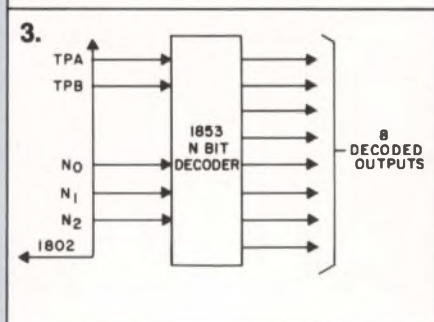
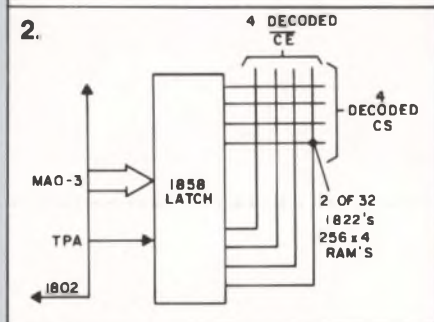
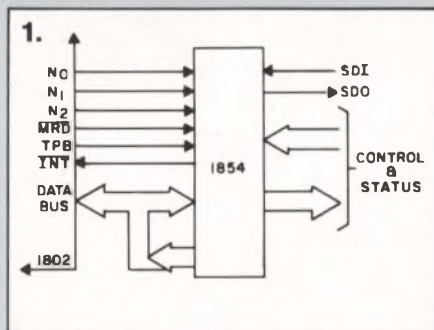

3 N-bit decoder

If you need a high-speed, low-power 3-to-8-line decoder circuit with the added feature of optional strobed outputs for spike free decoding, we've got that too. The CDP1853 has buffered inputs and outputs. It is fully compatible with the CDP1802 and is used in I/O decoding applications.

4 Bus buffer separators

For easy connection of standard memory and I/O devices to the CDP1802 microprocessor data bus, use the CDP1856 and CDP1857 non-inverting bus buffer separators. The CDP1856 is designed for data bus to memory interfacing and the CDP1857 for data bus to I/O interfacing.

For more information, contact your RCA Solid State distributor. Or RCA.

Write: RCA Solid State.

Box 3200, Somerville, NJ 08876;
Sunbury-on-Thames, Middlesex
TW16 7HW, England; Quickborn
2085, W. Germany; Ste.-Anne-
de-Bellevue, Quebec, Canada;
Fuji Bldg., Tokyo, Japan.

Easy I/O.
Part of the
CMOS advantage.

RCA