

# Electronic Design<sup>®</sup> 22

VOL. 24 NO.

FOR ENGINEERS AND ENGINEERING MANAGERS

OCT. 25, 1976

**Computers are everywhere.** In mass transit, maxis, minis and micros are improving safety and performance. In industry, they are performing a multiprocessing

role. The military uses computers for command and control. In the home,  $\mu$ Cs are converting the TV set into an interactive video terminal. For details see p. 50.

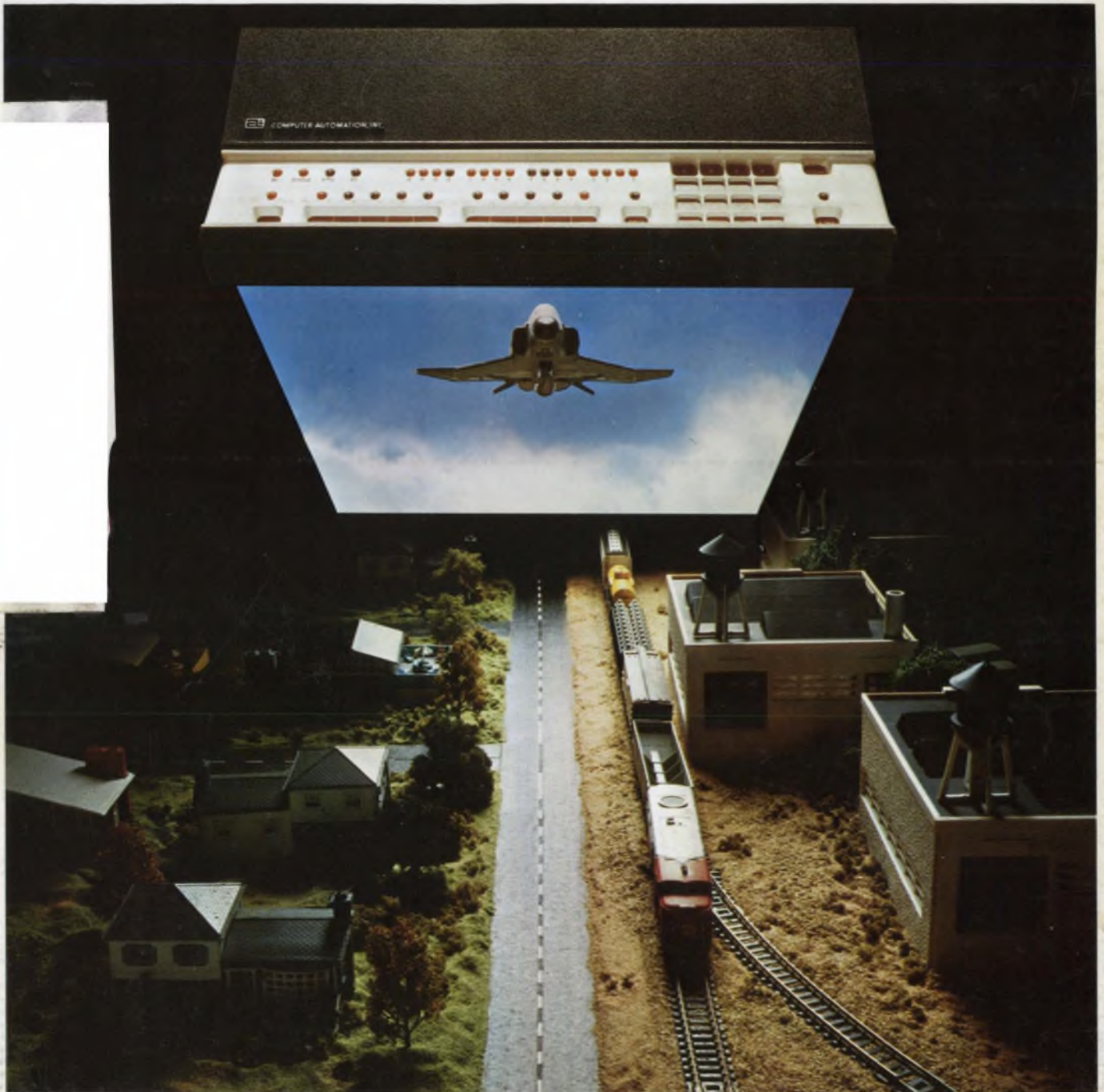



# the **DIP** **HIGH** **SIP**

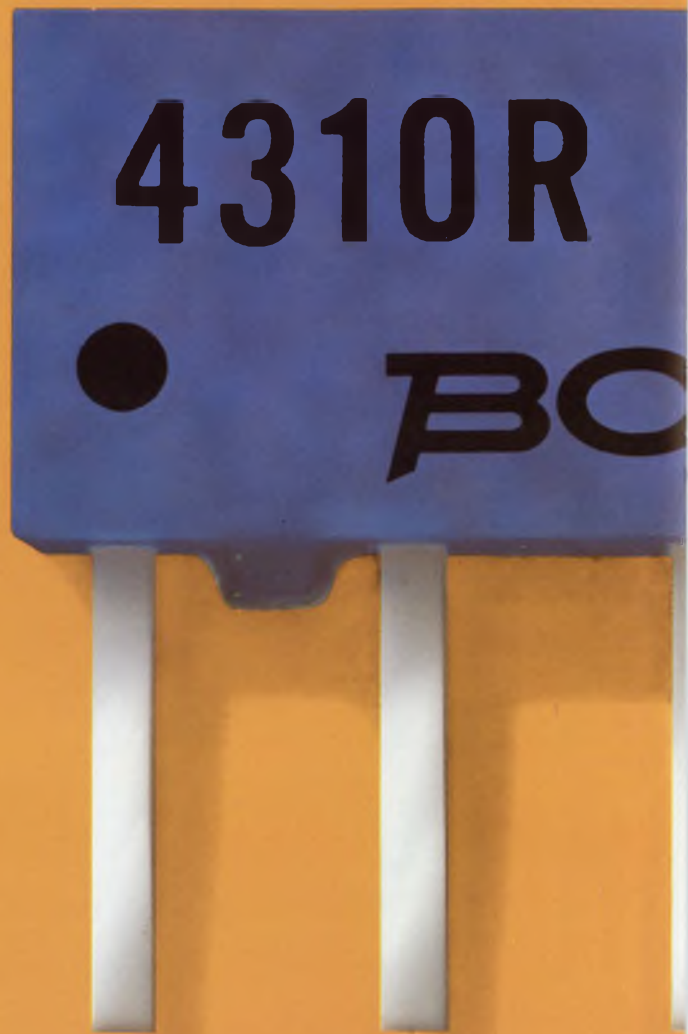

## Now in the only full line of super low profile SIP Resistor Networks.

If you haven't designed in Single In-line Package resistor networks because of their high profile, take another look. THE HEIGHT ON BOURNS SIPs IS ONLY .190 INCH! And that's standard for all 6, 8 and 10 pin configurations with:

- 5, 7 or 9 resistors and 1 common pin
- 3, 4 or 5 isolated resistors
- 12 resistors, dual terminator (8 pin)

Now you can fit the same number of resistors into less area and yet maintain close P.C. Board spacing. Something you can't do when using other SIP networks with .250 or .350 inch high profiles.

And only Bourns SIPs offer the same reliable Krimp-Joint™ lead termination design as our DIP packages, high-copper alloy leads and uniform molded package design. With added features like MACHINE INSERTABILITY, COMPETITIVE PRICING AND DISTRIBUTOR AVAILABILITY —

Why specify other than Bourns?

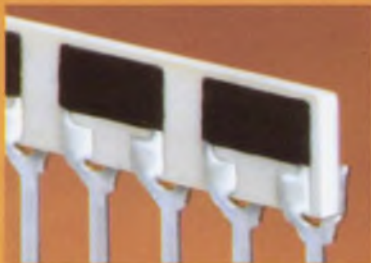

Bourns Krimp-Joint™ offers both a mechanical and electrical bond that lap or butt joint construction can't provide. The lead is crimped on the network element and a high-temp, reflow-resistant solder is used to prevent failure during wave soldering and in circuit thermal cycling and vibration.

### FREE SIP and DIP SAMPLES!

Write on your company letterhead and let us know your requirements, we'll rush you a SIP or DIP resistor network sample and complete specifications.

**TRIMPOT PRODUCTS DIVISION, BOURNS, INC.**, 1200 Columbia Avenue, Riverside, California 92507. Telephone 714 781-5415 — TWX 910 332-1252.





You probably remember our Model 3000 (shown at left)—the AM/FM phase-locked signal generator that covers the 1 to 520 MHz frequency range? Well, now we've got a companion model that's even better. The new Model 3001 is identical to the 3000 except: (1) FM accuracy is now 0.001%; (2) A  $\pm 5$  kHz frequency vernier is provided in all modes; (3) You can lock the 3001 to an external frequency standard (optional at \$150); and (4) An internal reference frequency standard (with  $5 \times 10^{-9}$ /day stability) is also an available option at just \$500.

At just \$2,600, the Model 3001 is a downright bargain when you consider its accuracy, stability, programmability, and ease of operation.

We'll gladly send you detailed specifications on our competitive new signal generator. When we're competing with ourselves, we know everything about the competition.

Model 3001 Specifications:

Frequency Range: 1-520 MHz  
 Frequency Accuracy:  $\pm 0.001\%$   
 (all operating modes)  
 Resolution: 1 kHz  
 Stability: 0.2 ppm per hour  
 Output Range: +13 dBm to

-137 dBm  
 Flatness:  $\pm 0.75$  dB  
 AM Modulation Range: 0-90%  
 FM Deviation Ranges: 0-10 kHz  
 and 0-100 kHz  
 Internal Modulation Rates:  
 400 Hz and 1 kHz  
 Dimensions:

12" wide x 5½" high x 13¾" deep  
 WAVETEK Indiana Incorporated,  
 P.O. Box 190, 66 North First Avenue,  
 Beech Grove, Indiana 46107,  
 Phone (317) 783-3221,  
 TWX 810-341-3226.

**WAVETEK®**

# The signal generator competition never showed up. So we're it.



The Model 3000.

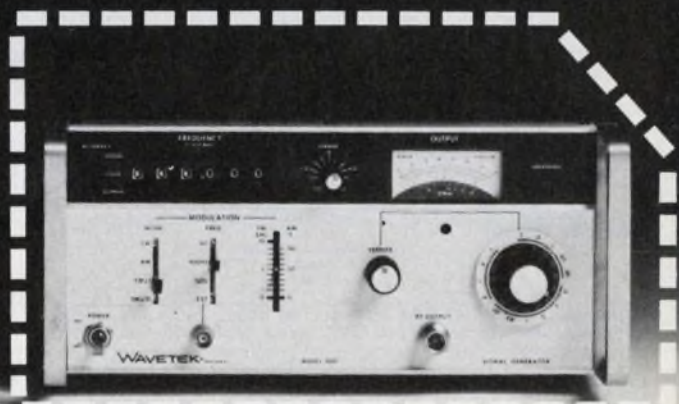

The New Model 3001.



# The largest selection of "OFF-THE-SHELF" POWER SPLITTERS/COMBINERS Available!

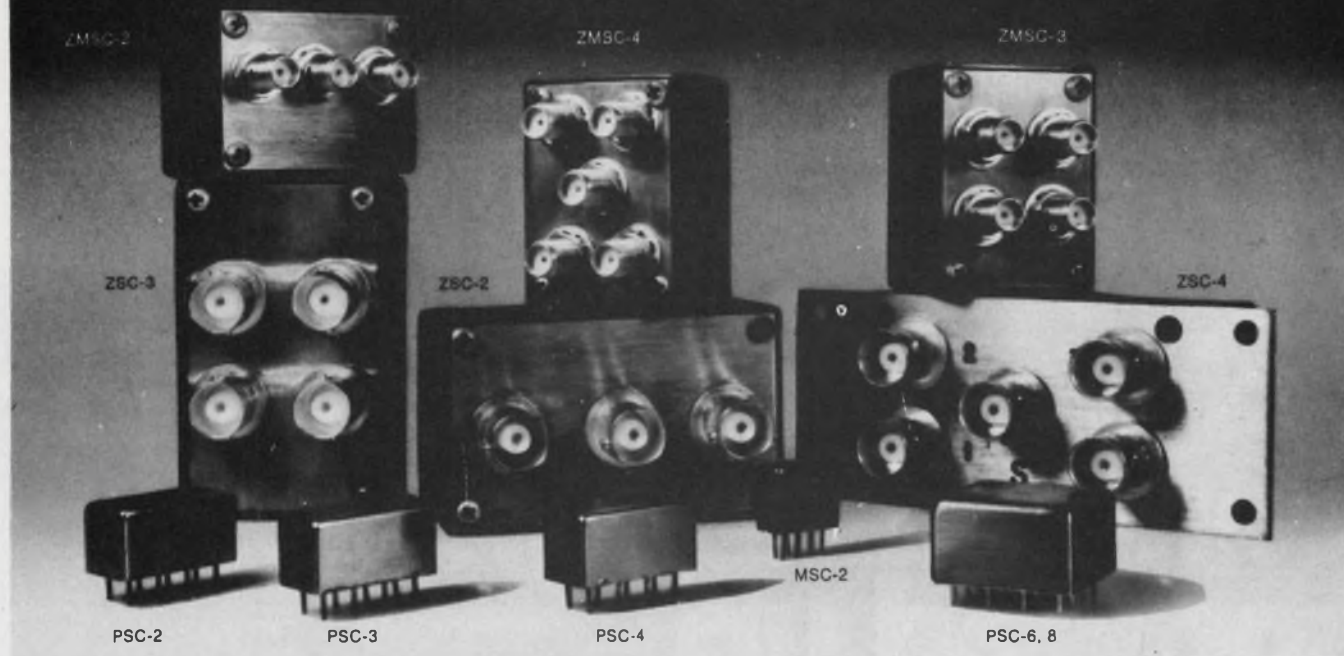

## TWO-WAY, THREE-WAY, FOUR-WAY, SIX-WAY AND EIGHT-WAY POWER SPLITTER/COMBINERS

Model No.	Freq. range (MHz)	Isolation between outputs (dB) typical	Insertion loss (dB) (typical)	Unbalance		Price (Quantity)	Model No.	Freq. range (MHz)	Isolation between outputs (dB) typical	Insertion loss (dB) (typical)	Unbalance		Price (Quantity)
				$\phi$ (deg)	Amp. (dB)						$\phi$ (deg)	Amp. (dB)	
<b>Two-way 0°</b>							<b>Three-way 0°</b>						
PSC 2-1	0.1-400	25	0.4 above	1	0.1	\$ 9.95 (6-49)	PSC 3-1	1-200	30	0.4 above	2	0.1	\$19.95 (6-49)
ZSC 2-1			3dB split			\$24.95 (4-24)	ZSC 3-1			4.8 split			\$34.95 (4-24)
ZMSC 2-1						\$34.95 (4-24)	ZMSC 3-1						\$44.95 (4-24)
PSC 2-2	0.002-60	40	0.3 above	1	0.1	\$19.95 (6-49)	PSC 3-2	0.01-30	40	0.25 above	2	0.1	\$29.95 (6-49)
ZSC 2-2			3dB split			\$34.95 (4-24)	ZSC 3-2			4.8 split			\$44.95 (4-24)
ZMSC 2-2						\$44.95 (4-24)	ZMSC 3-2						\$54.95 (4-24)
<b>Two-way 90°</b>							<b>Four-way 0°</b>						
PSC 2-1W	1-650	25	0.5 above	3	0.20	\$14.95 (6-49)	PSC 4-1	0.1-200	30	0.5 above	2	0.1	\$26.95 (6-49)
ZSC 2-1W			3dB split			\$29.95 (4-24)	ZSC 4-1			6dB split			\$41.95 (4-24)
ZMSC 2-1W						\$39.95 (6-49)	ZMSC 4-1						\$51.95 (4-24)
PSC 2-1.75*	0.25-300	25	0.4 above	1	0.05	\$11.95 (6-49)	ZSC 4-2	0.002-20	33	0.45 above	2	0.1	\$64.95 (4-24)
MSC 2-1	0.1-450	30	0.4 above	1	0.1	\$16.95 (6-24)	ZMSC 4-2			6dB split			\$74.95 (4-24)
<b>Two-way 180°</b>							<b>Two-way 90°</b>						
PSCJ 2-1**	1-200	33	0.6 above	2.5	.15	\$19.95 (5-49)	PSC 4-3	0.25-250	30	0.5 above	2	0.1	\$23.95 (6-49)
ZSCJ 2-1			3dB split			\$34.95 (4-24)	ZSC 4-3			6dB split			\$38.95 (4-24)
ZMSC 2-1W							ZMSC 4-3						\$48.95 (4-24)
<b>Two-way 90°</b>							<b>Six-way 0°</b>						
PSCQ 2-90	55-90	30	average of coupled outputs less 3dB, 0.3	3	1.0	\$19.95 (5-49)	PSC 6-1	1-175	30	0.75 above	4	0.2	\$59.95 (1-5)
							<b>Eight-way 0°</b>						
							PSC 8-1	0.5-175	30	0.8 above	3	0.2	\$59.95 (1-5)

COMMON SPECIFICATIONS FOR ALL MODELS: Impedance all ports, 50 ohms \*Except 75 suffix denotes 75 ohms VSWR:1.1-1.2 typical Nominal phase difference between output ports, 0° \*\*Except J suffix denotes 180° Q denotes 90° Delivery from stock; One week max.

### NEW MODELS AVAILABLE!

Check with MicroWaves' Product Data Directory, Electronic Design's Gold Book or Electronic Engineers Master (EEM) for the latest models available along with complete specifications.

World's largest supplier of double balanced mixers

**Mini-Circuits Laboratory**

A Division Scientific Components Corp

837-843 Utica Avenue, Brooklyn, NY 11203

(212) 342-2500 Int'l Telex 620156 Domestic Telex 125460

International Representatives:  AUSTRALIA General Electronic Services, 99 Alexander Street, New South Wales, Australia 2065;  ENGLAND Dale Electronics, Dale House, Wharf Road, Frimley Green, Camberley Surrey;  FRANCE S C I E - D I M E S S, 31 Rue George Sand, 91120 Palaiseau, France;  GERMANY, AUSTRIA, SWITZERLAND Industrial Electronics GMBH, Klüberstrasse 14, 6000 Frankfurt/Main, Germany;  ISRAEL Vectronics, Ltd., 69 Gordon Street, Tel-Aviv, Israel;  JAPAN Densho Kaisha, Ltd., Eguchi Building, 8-1 Chome Hamamatsucho Minato-ku, Tokyo;  EASTERN CANADA B D Hummel, 2224 Maynard Avenue, Utica, NY 13502 (315) 736-7821;  NETHERLANDS, BELGIUM, LUXEMBOURG: Coimex, veidweg 11, Hattem, Holland;  NORWAY Datamatik AS, Ostensjoveien 62, Oslo 6, Norway

US Distributors:  NORTHERN CALIFORNIA Cain-White & Co., Foothill Office Center, 105 Fremont Avenue, Los Altos, CA 94022 (415) 948-6533;  SOUTHERN CALIFORNIA, ARIZONA Crown Electronics, 11440 Collins Street, No. Hollywood, CA 91601 (213) 877-3550



# Electronic Design 22

FOR ENGINEERS AND ENGINEERING MANAGERS

VOL 24 NO

OCT 25, 1976

## NEWS

- 25 **News Scope**
- 35 **Washington Report**
- 50 **Computer '76 special issue**, featuring major trends in computer technology.
- 52 **Consumer electronics**— $\mu$ Ps mean lower cost and better performance.
- 60 **Industrial electronics**—The hardware is becoming ever more intelligent.
- 66 **Transportation**—Computers are everywhere, in cars, trucks, trains and so on.
- 74 **Military and aerospace**—Distributed processing has become a way of life.
- 82 **An interview with Grace Hopper**—The grand lady of software.
- 92 **Electronica '76**—A panorama of products at the world's largest electronics show.
- 106 **Bipolar controllers**—They're fast, cheap and easy to use.

## TECHNOLOGY

- 115 **MICROPROCESSOR DESIGN**
- 122 **FOCUS on keyboards:** Each keyboard manufacturer emphasizes the virtues of his switching technique. But reliability is the key spec.
- 136 **Getting to know the Cosmac** microprocessor is simple. Its single-byte instructions and CMOS structure make it easy to apply, simplifying microcomputer design.
- 148 **Use  $\mu$ Ps in minicomputer systems.** The mini can test and code the  $\mu$ P. And the  $\mu$ P can relieve the mini of time-consuming simple tasks.
- 156 **Let a  $\mu$ P cut test time.** With an LSI chip controlling programmable instruments, you can speed circuit measurements and improve accuracy, too.
- 164 **For sequential control, FPLAs** make sense. Like computers they can be programmed, but they are simpler to use and straightforward in application.
- 172 **Build a PROM programmer** and program your own devices. An inexpensive instrument verifies unprogrammed PROMs and includes a seven-segment LED address display.
- 180 **A bidirectional pulse stretcher** has many uses. Superior to conventional stretchers, this dc-coupled circuit handles noisy signals and has Schmitt action.
- 186 **Ideas for Design:** AM detector deflutters analog-signal tape outputs with only three IC packages. . . . Battery monitor operates on only a few microamperes. . . . Display-blanking circuit saves power, improves readability. . . . Simple circuit detects data edges; advanced circuit provides complex outputs. . . . Circuit monitors blinking phone lights and provides soft but commanding tone.
- 196 **International Technology**

## PRODUCTS

- |                                                                                |                                        |
|--------------------------------------------------------------------------------|----------------------------------------|
| 208 <b>Components:</b> Cost cuts in flat-keyboards encourage new applications. |                                        |
| 214 <b>Packaging &amp; Materials</b>                                           | 244 <b>Integrated Circuits</b>         |
| 220 <b>Instrumentation</b>                                                     | 252 <b>Modules &amp; Subassemblies</b> |
| 230 <b>Data Processing</b>                                                     | 256 <b>Microwaves &amp; Lasers</b>     |
| 240 <b>Discrete Semiconductors</b>                                             | 261 <b>Power Sources</b>               |

## DEPARTMENTS

- |                                                  |                                       |
|--------------------------------------------------|---------------------------------------|
| 47 <b>Editorial:</b> The man who couldn't let go |                                       |
| 7 <b>Across the Desk</b>                         | 276 <b>Advertisers' Index</b>         |
| 266 <b>New Literature</b>                        | 278 <b>Product Index</b>              |
| 272 <b>Bulletin Board</b>                        | 280 <b>Information Retrieval Card</b> |
| 272 <b>Vendors Report</b>                        |                                       |

**Cover:** Photo by Bill Braly, photo composition by Custom Graphics, courtesy of Computer Automation.

ELECTRONIC DESIGN is published biweekly by Hayden Publishing Company, Inc., 50 Essex St. Rochelle Park, NJ 07662. James S. Mulholland Jr., President. Printed at Brown Printing Co., Waseca, MN. Controlled circulation postage paid at Waseca, MN and New York, NY, postage pending Rochelle Park, NJ. Copyright © 1976. Hayden Publishing Company, Inc. All right reserved. POSTMASTER: Please send form 3579 to ELECTRONIC DESIGN, P.O. Box 13803, Philadelphia, PA 19101.



# Intel 8080 peripherals

Now you can get microcomputer based products out of the lab and into production faster than ever before. Intel® 8080 programmable LSI peripherals give you the competitive advantage by helping you reduce design time, component count and manufacturing and inventory costs. Most of all they'll help you get to market first.

Intel 8080 programmable peripherals are software controlled LSI replacements for hardwired SSI/MSI logic assemblies. You simply attach the appropriate peripherals to the system bus and the +5V supply. Then, with system software, you personalize device operating configurations to suit your applications. Reconfiguration and design changes are made with software. No expensive and time consuming hardware redesigns are necessary.

One peripheral, the 8253 Programmable Interval Timer, is the first LSI solution to system timing problems. It counts out I/O servicing delays, eliminating software timing loops and increasing CPU throughput. It also saves hardware when you need event counters, rate generators or real-time clocks. Each 8253 contains three 16-bit timer/counters.

Our 8257 Programmable DMA Controller is the lowest cost way to handle applications that require high speed data transfer such as disks, magnetic tape, analog interfaces and high speed communication controllers. The four channel 8257 contains all the logic necessary for bus acquisition, cycle counting and priority resolving of the channel requests.

The 8259 Priority Interrupt Controller replaces complex TTL arrays and minimizes component costs. The CPU can change interrupt structure "on the fly" to suit changes in the operating environment, such as time of day or process control parameters. The 8259 handles up to eight vectored priority interrupts. Multiple 8259's can control up to 64 interrupt levels.

Use the 8251 Programmable Communication Controller for "serial I/O." The first true USART in a single chip, the 8251 implements all popular com-

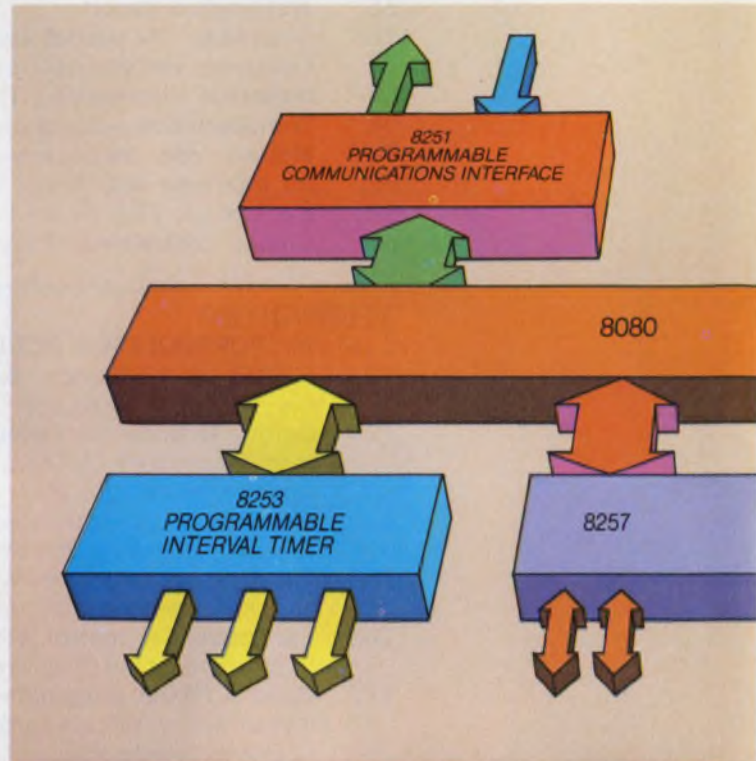



# get you to market first.

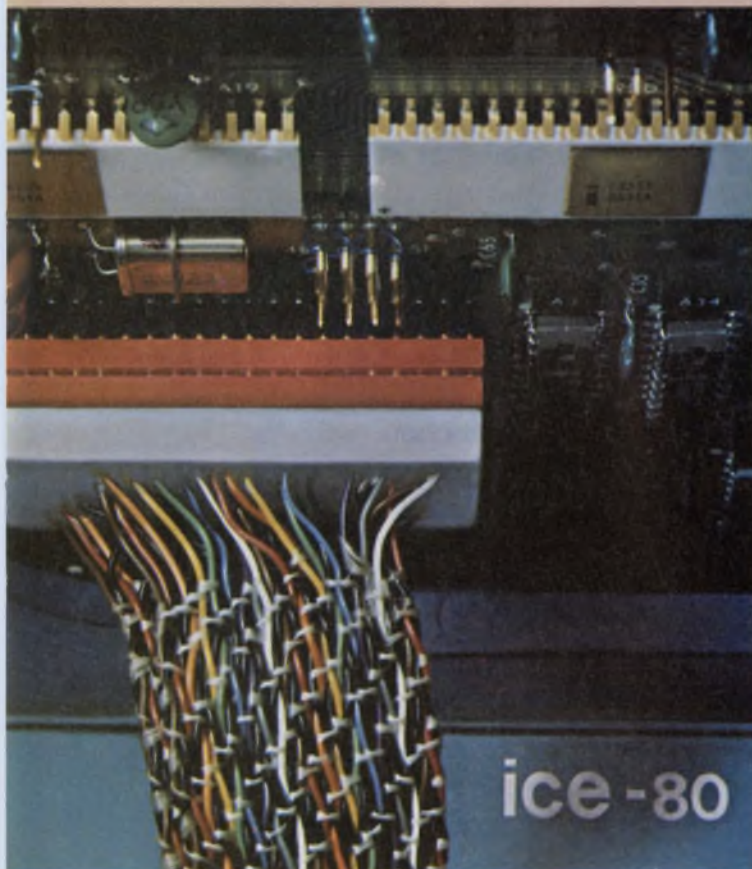
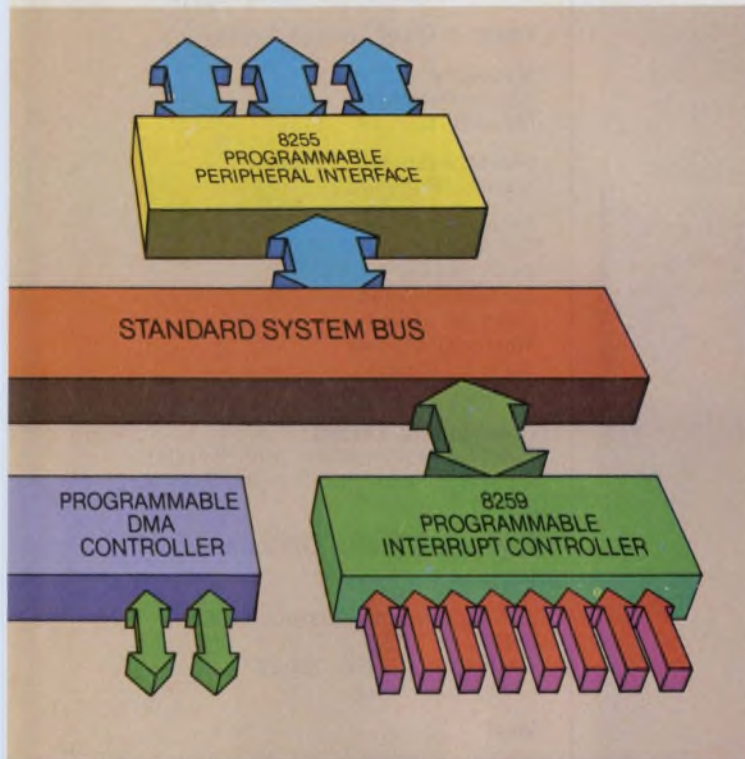

munication protocols, including IBM Bi-Sync. For "parallel I/O," each 8255 Programmable Peripheral Interface gives you 24 versatile I/O lines to interface relays, motor drives, printers, keyboard/display and other parallel equipment.

Once you've selected the peripherals to fit your application, use the Intel<sup>®</sup> Microcomputer Development System for both software and hardware development. Using the Intel<sup>®</sup> CRT terminal, call up the resident text editor. Write the source program to initialize the peripheral and the subroutines for peripheral/system operation. Then you assemble or compile the source programs into an object file using resident macroassembler or resident PL/M compiler—and store the object file on the Intel<sup>®</sup> diskette. With the relocation and linkage capability of the Intel<sup>®</sup> ISIS II diskette operating system, these routines can be added to a system library and called from user programs as needed. Once the main system program is written, the new peripheral device routines are easily linked in. The entire program is now ready to be run on your prototype via the Intel<sup>®</sup> ICE-80™ in-circuit emulation module. ICE-80 lets you debug your software and hardware in your actual prototype environment. Move from system integration and debugging to production in a fraction of the time previously required.

Intel also provides applications assistance, training programs, the largest user's program library, and volume production support. Intel's 8080 programmable peripherals give you the competitive advantage from start to finish. Be first to market.

To order the new peripherals, contact our franchised distributors: Almac/Stroum, Components Specialties, Components Plus, Cramer, Elmar, Hamilton/Avnet, Industrial Components, Liberty, Pioneer, Sheridan or L.A. Varah. For your copy of our 8080 System brochure write: Intel Corporation, 3065 Bowers Avenue, Santa Clara, California 95051.

**intel**<sup>®</sup>

Microcomputers. First from the beginning.



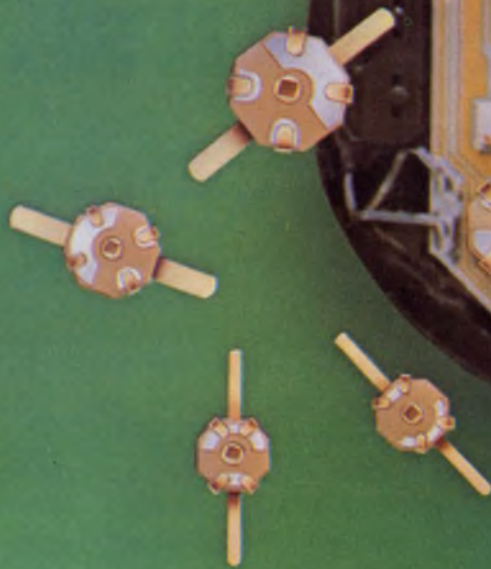

# Thin-Trim capacitors

Tucked in the corner of this Pulsar Watch is a miniature capacitor which is used to trim the crystal. This Thin-Trim capacitor is one of our 9410 series, has an adjustable range of 7 to 45 pf., and is .200" x .200" x .050" thick.

The Thin-Trim concept provides a variable device to replace fixed tuning techniques and cut-and-try methods of adjustment. Thin-Trim capacitors are available in a variety of lead configurations making them easy to mount.

A smaller version of the 9410 is the 9402 series with a maximum capacitance value of 25 pf. These are perfect for applications in sub-miniature circuits such as ladies' electronic wrist watches and phased array MIC's.

The logo for Johanson Manufacturing Corporation, featuring the name "Johanson" in a stylized, cursive script font enclosed within an oval border.

Johanson Manufacturing Corporation  
Rockaway Valley Road  
Boonton, New Jersey 07005  
(201) 334-2676 TWX 710-987-8367

**Sr. Vice President, Publisher**  
Peter Coley

## Editors

Editorial Offices  
50 Essex St.  
Rochelle Park, NJ 07662  
(201) 843-0550  
TWX: 710-990-5071  
Cable: Haydenpubs Rochellepark

**Editor-in-Chief** George Rostky

**Managing Editors:**  
Ralph Dobriner  
Michael Elphick

**Senior Associate Editor**  
Stanley Runyon

**Associate Editors:**  
Sid Adlerstein  
Dave Bursky  
Samuel Derman  
Jules H. Gilder  
Morris Grossman  
John F. Mason  
Michael Shunfenthal

**Contributing Editors:**  
Peter N. Budzilovich, John Kessler  
Alberto Socolovsky, Nathan Sussman

## Editorial Field Offices

### East

Jim McDermott, Eastern Editor  
P.O. Box 272  
Easthampton, MA 01027  
(413) 527-3632

### West

Jim Gold, Western Editor  
1537 Shasta Ave.  
San Jose, CA 95128  
(408) 279-8588

## Editorial Production

Marjorie A. Duffy, Production Editor  
James Keane, Copy Editor

## Art

**Art Director,** William Kelly  
Richard Luce, Anthony J. Fischetto

## Production

**Manager,** Dollie S. Viebig  
Helen De Polo, Anne Molfetas

## Circulation

**Director,** Barbara Freundlich  
Trish Edelman

## Information Retrieval

Paula Greenleaf

## Advertising Promotion

Susan G. Apolant



# Across the Desk

## Active filter performance: Is it really that poor?

It is unbelievable that a technical article (by Arthur D. Delagrangé, Ph.D., ED No. 4, Feb. 16, 1976, p. 156) so replete with flaws and ignorance was published without so much as an apparent cursory checkout. I have designed, as have many of my competitors, conventional (nontranslating) active filters with performances that drastically conflict with the non-sense listed in Table 1 of the article:

- Cutoff-frequency selection is accurate to  $\pm 1\%$  (Ithaco) and  $\pm 2\%$  (Krohn-Hite).

- Typical attenuation slopes are 24 or 48 dB/octave. (I have designed tunable elliptic filters with 63 and 78-dB loss for the first octave.)

- Cutoff frequency has typically, but not correctly, been defined as the 3-dB point. This is okay for the Butterworth but not for the Chebyshev or elliptic. Cutoff should be defined as the frequency where the stopband attenuation first equals the minima of the passband ripple.

- Alas, it's true that "squareness" of frequency cutoff must be traded off for phase linearity—in the region of the cutoff frequency! This is what causes the transient response.

- The practical low-pass mode usually includes response to dc. Krohn-Hite, however, offers a unit for which rolloff occurs at around 2 Hz.

- Passband gain need not be unity. It can easily be made higher without the use of post or pre-amplifiers.

- External programming of conventional active filters isn't difficult. It is simply achieved by use of multipliers controlled by "cold" dc, or of FET switches also con-

trolled by "cold" dc.

- Linearity is limited only by the components.

- Component count is small. Precision-ganged pots aren't needed—one pot can control many multipliers. Fixed-precision components are used for decade-switching assemblies.

- Panel controls need not carry analog signals. Complete control of cutoff frequency, number of poles and passband gain can be achieved simply and accurately by using "cold" dc.

- An excellent, five-pole active filter can be built with about the same number of components as the circuit of Fig. 7 in Dr. Delagrangé's article. However, an extra op amp is needed. LM318 or LF356 op amps are recommended to avoid the slew-rate limitation of the  $\mu A741$ .

Dr. Delagrangé said that a conventional filter is useless if one needs to reject a 1002-Hz signal while retaining a 998-Hz signal. But to do this, you would use a single-section notch filter rather than a low-pass filter. For a notch filter tuned to 1002 Hz with a Q of 500, the loss at 998 Hz would be 0.26 dB. If the Q were only 158, the loss would rise to 2.1 dB. In both cases, the rejection at 1002 Hz would be over 70 dB—much greater than the 30-dB limit cited by Dr. Delagrangé.

*Irving Weiner  
Electrical Engineer*

Bio Physics Systems  
1940 Commerce Rd.  
Yorktown Heights, NY 10598

## The author replies

In general, Mr. Weiner completely missed the point of my article on the translating filter. I have several Krohn-Hite filters and they are excellent. I'm familiar

*(continued on page 12)*

Electronic Design welcomes the opinions of its readers on the issues raised in the magazine's editorial columns. Address letters to Managing Editor, Electronic Design, 50 Essex St. Rochelle Park, N.J. 07662. Try to keep letters under 200 words. Letters must be signed. Names will be withheld on request.

## The smallest\*



## re-lampable indicators are



## Illuminated Products' QT Series incandescent, neon, and LED indicators

- Long-life reliability
- Simplified press-in panel mounting
- All popular lens colors and styles
- Distributor on-shelf availability now

*\*Actual size shown*

*Lighten your decisions  
contact...*

### ILLUMINATED PRODUCTS INC.

A subsidiary of OAK Industries Inc.

2620 South Susan St., P.O. Box 11930  
Santa Ana, California 92711  
Tel: (714) 540-9471 • TWX 910-595-1504



COMPONENTS GROUP

CIRCLE NUMBER 6



# Draw one of these:

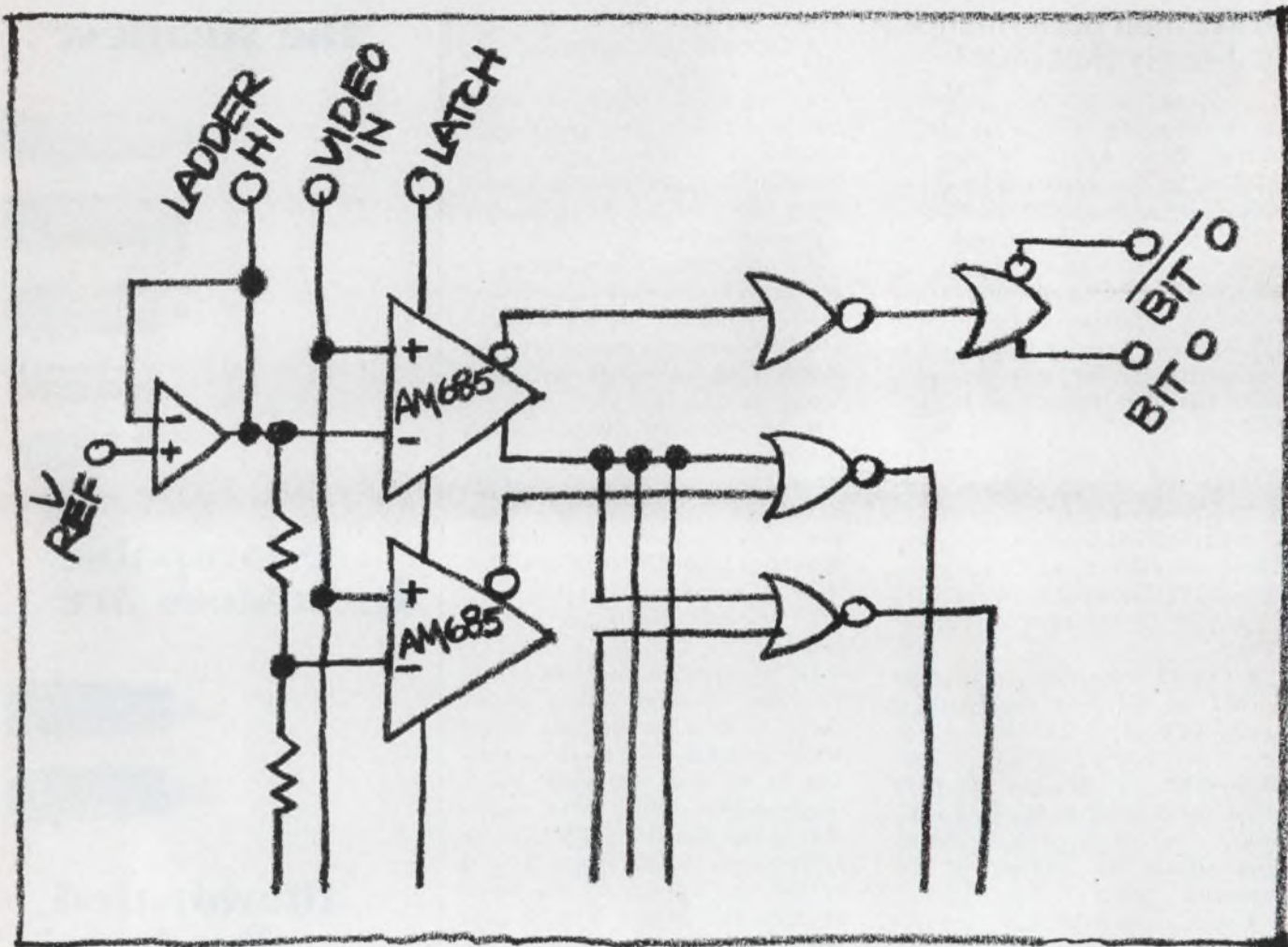

Never thought you'd own a Porsche, did you? Well, there's only one way to find out: fill out the coupon.

Advanced Micro Devices will send you a contest kit that includes two samples of your choice of three terrific high-speed comparators—the Am685, Am686 or Am687—applications materials, data sheets and contest entry form.

Then you design an original application using the high-speed comparator you've chosen. That

shouldn't be too hard to do because Advanced Micro Devices' comparators are the fastest, most accurate parts you can get. Anywhere.

If you're the winner, you'll own a brand new, shiny, speedy Porsche 924. Which is one of the fastest, most accurate cars you can get. If your design comes in second or third you'll win a Porsche Chronometer. The next six winners win Porsche Racing Team Jackets.

You must have your entries in by January 15th. A panel of impar-

tial experts will pick the top 10 designs. A drawing will be held to determine the winners. And we'll announce the names of the winners by March 1, 1977.

In the meantime, you've got some very important things to think about. Like what color you want. Do you want a silver body with black interior? Red with saddle? Blue with tan? How about a gold racing stripe along the side?

And you thought linear comparators were boring.

## Advanced Linear



Advanced Micro Devices • 901 Thompson Place, Sunnyvale, California 94086 • Telephone (408) 732-2400 • Distributed nationally by Hamilton/Avnet, Cramer and Schweber Electronics.



# Drive one of these:



## First, the kit. Then, the car.

Don't wait around! Only the first 3,000 entries will be eligible. Send us the coupon, attached to your company's letterhead. No letterhead, no kit.

Advanced Micro Devices, 901 Thompson Place  
Sunnyvale, California 94086

I'm a player. Here's my coupon and letterhead. Send me the kit and the parts.

NAME \_\_\_\_\_

COMPANY \_\_\_\_\_

ADDRESS \_\_\_\_\_

PART TYPE Am685  Am686  Am687   
(Check Box)

CIRCLE NUMBER 7



It's easy to inspect, test and repair  
AMP Latch multi-conductor  
connectors.

Even after they're in use.





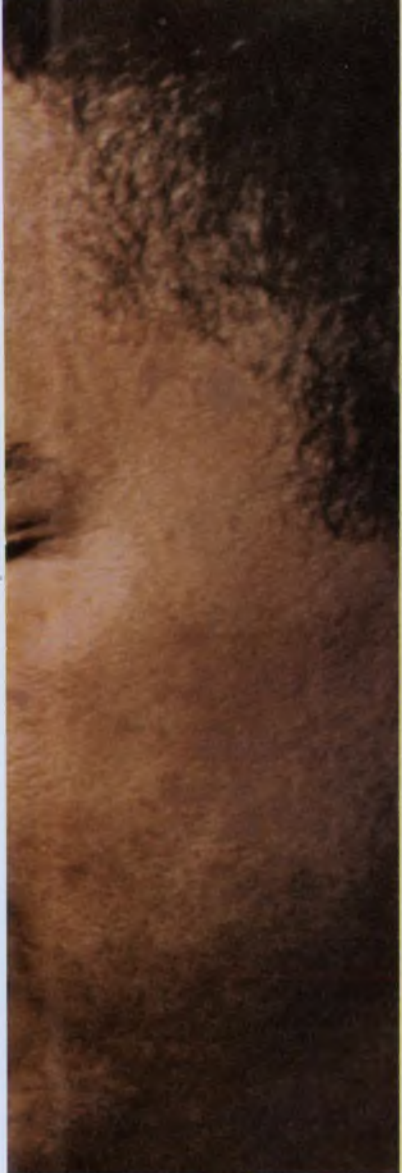

We designed them that way. Because a mass termination connector should help you save time and effort before, during and after assembly.

Their unique folded contact design, with dual camming and latching ears, assures you of four-point electrical contact and mechanical grip for each conductor. And that means superior overall reliability and protection. In addition, these fork-type contacts make it especially easy to visually inspect each termination before the cover is applied.

And even after the cover is on, each contact can still be visually checked for proper locking and latching. Because every AMP Latch cover has a built-in inspection port over each termination. This also permits electrical testing without cover removal, saving additional production time. And if repair ever is necessary, we've made that easier, too, by designing special hand and pen tools.

There are more reasons why you should choose AMP Latch connectors such as quick, easy terminating with the AMP shuttle tool, and the broad variety of pin headers and connectors. You also get AMP backup . . . expert design and production help that's yours for the asking from AMP connector engineers.

Why not contact Customer Service, at (717) 564-0100 for complete details on the AMP Latch connector line? Or write us direct. AMP Incorporated, Harrisburg, PA 17105.

**SEE US AT  
MUNICH ELECTRONICA**

**AMP  
INCORPORATED**

CIRCLE NUMBER 8

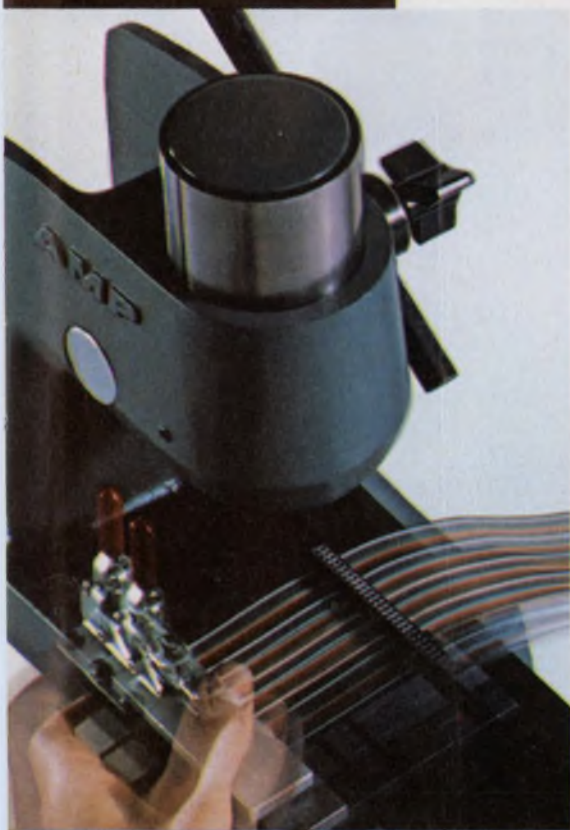

AMP is a trademark of AMP Incorporated.



# RCL

is

#1

## in the Hi Rel Wire-Wound Resistor Field!

RCL has more military approvals on power and precision fixed wire-wound resistors than any other manufacturer.

AMF

**RCL Electronics**

195 McGregor St.  
Manchester, N.H. 03102  
(603) 627-3831

CIRCLE NUMBER 9

## ACROSS THE DESK

(continued from page 7)

with the specs of the Ithaco 4120, and it seems to be an excellent filter. But neither can do certain things that can be done by the translating filter.

Here are my answers to Mr. Weiner's specific comments:

- My Krohn-Hite is specified as  $\pm 5\%$  or worse, depending on settings. The Ithaco is indeed accurate to  $\pm 1\%$ , but settable only to  $\pm 10\%$ . The translating filter is set in 10-Hz steps, and 1 Hz is possible. (10 Hz at 1 kHz is  $\pm 0.5\%$ , and 1 Hz at 10 kHz would be  $\pm 0.005\%$ .) I stated in the article that phase response was poor.

- I pointed out that dB/octave is meaningless for the translating filter. But, if Mr. Weiner insists, the slope at the band edge is 30,000 dB/octave at the higher frequencies.

- I simply claimed that some passband attenuation exists, and 3 dB is the most common cutoff point. I would point out that if a conventional filter is set for passband gain other than unity, then gain accuracy will depend on the circuit components as it does for the translating filter. (See my article in EDN, Feb. 5, 1973, p. 91).

- A conventional filter can indeed be "cold" switched. But analog voltages are necessary for control of multipliers or FETs. Then dc-bias errors become frequency errors, and noise and hum pickup must be considered. To solve these problems, the cost increases. The translating filter, on the other hand, switches only digital signals. It is, if you please, "colder than cold."

- The example given in the article was intended to show that a translating filter works with relatively crude analog filters. The 741 op amps are marginal; but they work, and their cost is a fifth that for type-318 or 356 op amps.

- The point of the article was that the "impractical" application of a low-pass filter to reject 1002 Hz from 998 Hz becomes not only practical but easy with the translating filter.

Arthur D. Delagrangue  
Naval Surface Weapons Center

Signal and Digital  
Processing Branch  
White Oak, Silver Spring, MD  
02910

## Oops—twice

The July 5th FOCUS report on Crystals for Frequency Control failed to list an important vendor—United States Crystal Corp. of 3605 McCart St., Fort Worth, TX 76115. Interested?

CIRCLE NO. 318

Not much later, in the August 2nd issue, we somehow managed to quote the price of an alphanumeric Litronix LED display at \$4 instead of \$15 in 1000-and-up quantities. The display has four 16-segment characters. Interested?

CIRCLE NO. 319

## Case of the missing 2

Ed Note: Somewhere between the galley and the printed page, we managed to delete a number 2 from reader Cass R. Lewart's binomial-coefficient program for the HP-25 calculator (ED No. 15, July 19, 1976, p. 11). We apologize and reprint the corrected (hopefully) program:

```
STO 2
CLX
1
STO 3
+
STO 1
RCL 1
RCL 2    17 steps
X = 0
GTO 17
÷
1
STO - 2
-
STO × 3
GTO 07
RCL 3
```

## Reader objects to lack of consistent brilliance

The proper function of language is to communicate, not obfuscate! I was just reading your interesting article on wireless power

(continued on page 16)

For Demonstration, Circle 216 ►  
For Additional Information, Circle 217 ►



# This is the most popular 4<sup>1</sup>/<sub>2</sub> digit DMM ever made.

With over 30,000 units in the field, this is the most popular 4<sup>1</sup>/<sub>2</sub> digit DMM ever made.

When we first introduced the Model 245 it was immediately recognized as "a revolutionary step in miniaturized instrumentation."

It still is.

Today, more than 30,000 Model 245s later, it is still the world's smallest, lightest and most accurate 4<sup>1</sup>/<sub>2</sub> digit portable multi-meter.

It still sells for \$295.00\* Complete.

Small enough to fit in the palm of your hand. Big enough to do whatever you want it to do, the Model 245 is a rugged, truly mini-

ature, lab-quality 4<sup>1</sup>/<sub>2</sub> digit multi-meter. It measures AC volts, DC volts, AC current, DC current and resistance with .005% resolution and a basic accuracy of  $\pm .05\%$  with 100% overranging. Line and battery operation.

For complete information or a demonstration, contact your local Data Precision representative or Data Precision Corporation, Audubon Road, Wakefield, MA. 01880, (617) 246-1600. TELEX (0650) 949341.

\*price USA

 DATA PRECISION  
...years ahead





# The only microcomputer with the power of a PDP-11. The PDP-11/03.

If you've been looking for a microcomputer with minicomputer power at a micro price, join the hundreds of OEMs who've already found it with the DIGITAL microcomputer. The PDP-11/03.

The 11/03 gives you everything you could ask for in a small computer. High performance. High reliability. And a low price — just \$1,357 in quantities of 50. And that micro price buys you mini features that quickly translate into benefits OEMs appreciate. Features like full PDP-11 instructions with eight general purpose

registers for fast program development. RAM (MOS or Core) and PROM memories that let you match the memory with the application. Hardware vectored interrupts with stack processing for real computer power. And multiple-sourced components for sure delivery.

Buying our 11/03 also buys you the chance to start small without staying small. Because you can add up to 32K words of memory, fast floating point instructions, and more. Whenever you and your customers are ready.

Besides growing bigger in size, the 11/03 lets you grow bigger in scope. It's software compatible with every other PDP-11 we offer. From our LSI-11 all the way up to our medium scale PDP-11/70. That means you can take full advantage of Digital PDP-11 software and services.

You can also take advantage of Digital's OEM Referral program — your chance to take on an international marketing and support team without hiring them. The OEM Referral program can help you locate new custom-

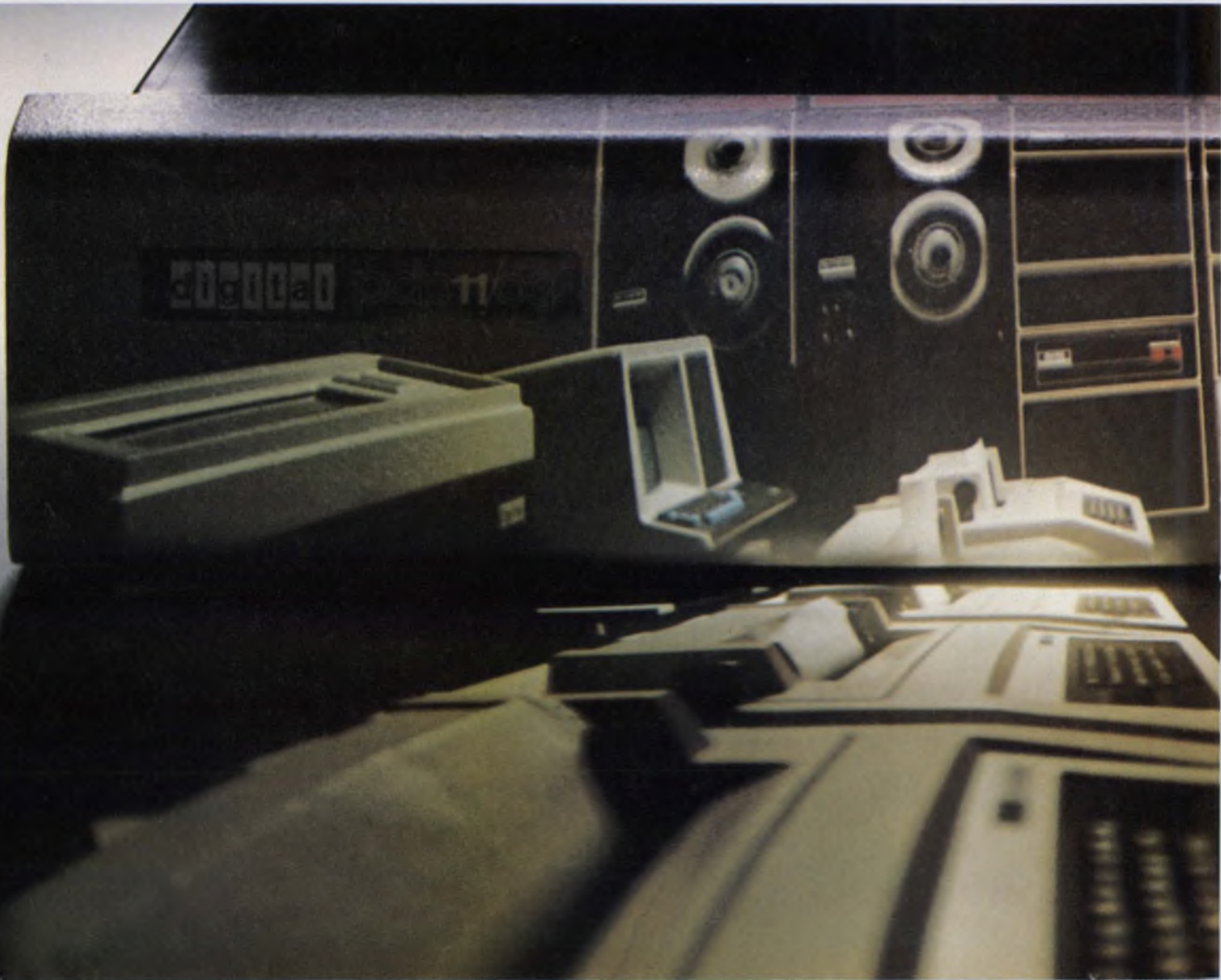



ers and new markets around town and around the world. And it can all start with the PDP-11/03. So if you're looking for a

proven microcomputer with proven power and performance, get the micro with all the power and performance of a PDP-11.

Digital's PDP-11/03. Call your nearest Digital sales office. Or send the coupon to Digital Equipment Corporation, Maynard, Massachusetts 01754. (617) 897-5111. European headquarters: 81 Route de l'Aire, 1211 Geneva 26. In Canada: Digital Equipment of Canada, Ltd.

Digital Equipment Corporation, Maynard, Massachusetts

- I'm interested. Please send information.  
 I'm more than interested. Please have your nearest Digital sales representative contact me.

Name \_\_\_\_\_ Title \_\_\_\_\_

Company \_\_\_\_\_

Address \_\_\_\_\_ Phone \_\_\_\_\_

City \_\_\_\_\_ State \_\_\_\_\_ Zip \_\_\_\_\_

ED106

**digital**

**50,000 computers saving managers millions.**





# Our newest air variable capacitor's biggest feature:



**It's small size.**

As you can plainly see, our new air variable capacitor is nearly as small as many sub-miniature ceramic trimmers. It also features the same mounting configuration which means you can use it in many of the same applications.

But small size isn't the only reason for buying our new Micro T™ capacitor. Because it's air variable, it offers you

great stability. Q is typically 1000 at 100 MHz. TC is  $\pm 45 \pm 45$  PPM/°C. And it's available in maximum capacities of 3, 6.5, 12.7, and 19.0 pF in either vertical or horizontal tuning PC and stripline mounting versions. What's more, it gives you all this for a very small price.

E. F. Johnson Company /Dept. E.D., Waseca, MN 56093

Please send me technical information on sub-miniature air variable capacitors.

Please send me samples. You can call me at \_\_\_\_\_

Name \_\_\_\_\_

Firm \_\_\_\_\_

Address \_\_\_\_\_

City \_\_\_\_\_ State \_\_\_\_\_

Zip \_\_\_\_\_

For fast service, contact your local Johnson Distributor.



**JOHNSON**

CIRCLE NUMBER 11

## ACROSS THE DESK

(continued from page 12)

transmission in the December 6, 1975 ELECTRONIC DESIGN (Vol. 23, No. 25, p. 32).

I note that a typical system will provide 10,000 MW. Fine! Then I note that each diode in the system "... operates at a power level of + 39 dBm." Does this really convey more meaning than stating that each diode "operates at an 8-watt level?"

This might seem like nitpicking. However, your readers are busy people. We expect writers and editors to strive to facilitate the transfer of information.

Later in the article you demonstrate your knowledge of the fact that rf-to-dc conversion can be considered an inverse Fourier transform. If we were considering information transfer, I would accept some significance in this fact. In the power extraction context, I feel it just gets in the way of communication.

Please—try to help us, not hinder.

W. Marvin Bunker  
Advanced Technologies  
Engineering  
General Electric Company  
Daytona Beach, FL 32015

## Misplaced Caption Dept.



With a little automation here, we can triple our output.

Sorry. That's Diego Velaquez' "The Spinners," which hangs in the Prado Museum in Madrid.

## Forgetting 'granddad'

It was with interest that I read the "Microprocessor Design" notes in your March 1, 1976, issue (ED No. 5, p. 29). Only one thing was (continued on page 20)



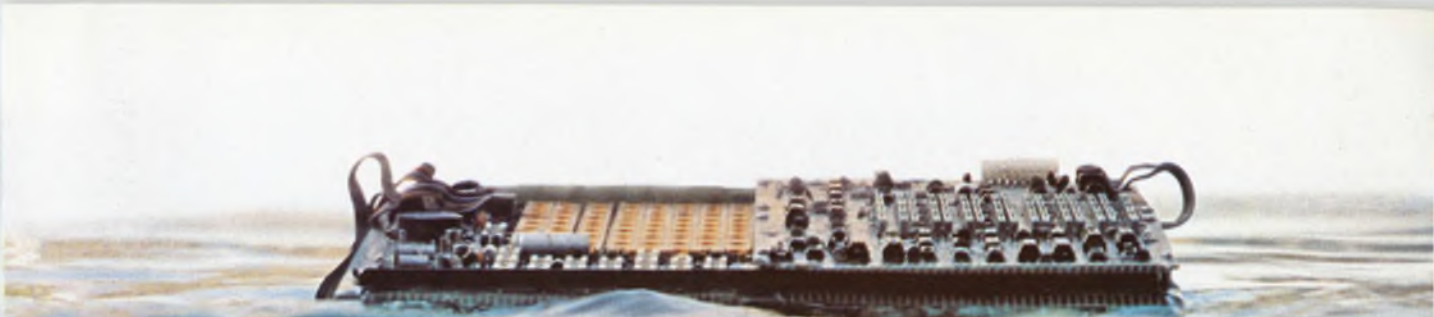

**When you're buying  
low-cost computers,  
it pays to look  
beneath the surface.**



# The computeriz



**Paper Peripheral Controller.** Model 14223-00. Single device controller for paper tape reader, paper tape punch, line printer or card reader. Cabling separate.

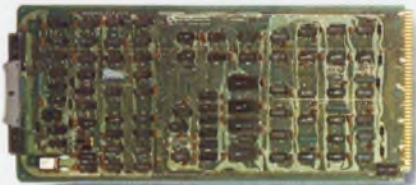

**Floppy Disk Controller.** Model 14566-01. Provides interfaces for one to four IBM-compatible standard floppy disks, or equivalent. Cabling separate.

**Piggyback Teletype Interface.** Model 12635-01. For LSI-3/05 processor. On-board mounting provides bit-serial interface. (For byte-serial interface, use Distributed I/O System with Current-Loop Serial Intelligent Cable.)



**I/O Terminator Module.** Model 14511-00. Convenient means for terminating user-designed I/O cables. Plugs onto rear of I/O cards (uses 100 pin connector) with rigid termination. Pads for mounting termination components provided.



**Utility I/O Interface Module.** Model 14223-00. General purpose interface with 8 or 12-bit output transfers with 4 control bits in parallel.



**64-bit Input Module.** Model 13219-00. Provides 64, 32, 16 or 8-bit inputs with individual strobes.



**16-bit Digital Input/Output Module.** Model 13213-00. Provides input and output registers which may be used as one 16-bit or two 8-bit registers. DTL/TTL compatible.



**I/O Driver Module.** Model 13222-00. Units drive the computer I/O bus up to 25 feet, buffer internal I/O bus from external noise. Does not include memory signals.

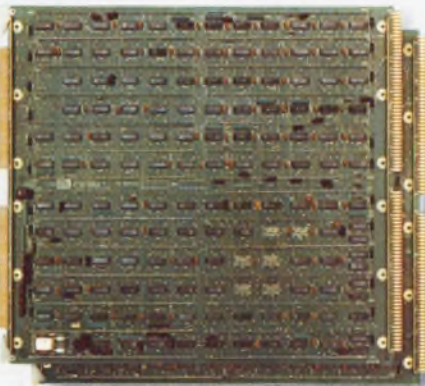

**Moving Head Disk Controller.** Model 14530-XX. Provides interfaces for one to four standard moving head disk drives, or equivalent. 1500 or 2400 RPM. Cabling separate.



**32-bit Relay Input Module.** Model 13215-00. Operates as one 32-bit, two 16-bit, or four 8-bit inputs.



**32-bit Relay Output Module.** Model 13214-20. Operates as one 32-bit, two 16-bit, or four 8-bit outputs.



**Asynchronous Modem Control Module.** Model 14535-0X. For one asynchronous line (point-to-point, multipoint, or dial). Fully programmable for mode, character size, parity, echoplex, diagonal loop-back, special character detect, variable stop bits. Send/receive speed individually selectable with jumpers - to 9600 baud. Available as EIA Interface with full Data Set Controls or as Current Loop Interface.

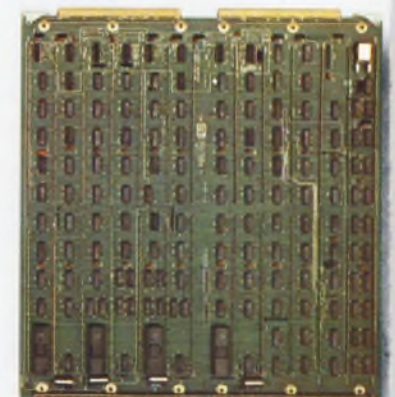

**Asynchronous Modem Multiple Module.** Model 14512-XX. As above, but for two or four independent asynchronous lines. Multiple vectored interrupts for each



# ization solution.



**Dual TTY Interface.** Model 14236-21. For two modified ASR-33 Teletypes. 20 mA Current loop, 110 baud, two half-duplex channels. Has circuit for programmed motor on/off.



**EIA RS232 Interface.** Model 14236-5X. For one CRT at baud rates from 110 to 9600. Half-duplex operations only.



**Automatic Calling Unit (ACU) Multiplexer.** Model 13523-0X. Provides interfaces for one to four Model 801 ACU's, or equivalent. Simultaneous operations, full digit buffering and sense date-line busy. Four vectored interrupts per ACU. Available for either two or four ACU's.



**Dual CRT Interface.** Model 14236-1X. For two CRT's or leased line modems. EIA RS232 interface with two half-duplex channels, each with one output control line and one input status line. Baud rates from 110 to 9600.



**Synchronous Modem Controller.** Model 14513-00. Double buffered, half or full-duplex interface for synchronous communications line (point-to-point, multipoint, or direct dial). EIA RS232C/CCITT compatible, programmable synchronous character, and one special character detect. Odd, even or no parity and 5-8 bit frame size program selectable. Transfer to 9600 baud.

Model 14513-01 provides internal clock with strappable options for 1200, 2400, 3600, 4800, 7200 or 9600 baud operation and full Data Set Controls.



**64-bit Output Module.** Model 13216-00. Provides output for use as 64-bit word or multiples of 32, 16, or 8-bits with individual strobes.



**Processor Chassis.** Model 12034-00/20500-01. Full-card chassis. Available in 5-slot and 9-slot versions. Includes motherboard and fans.



**Card Expansion Modules.** Model 12098-00/12099-00. Five and nine-slot versions include chassis, blank panel with expansion buffer controller, interconnecting cables and power supply.

**Card Cage, LSI-3/05.** Model 12095-0X. Available in either 3-card or 5-card versions. Includes motherboard, card guides, and retaining hardware.

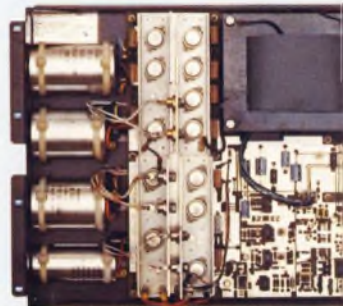

**Standard Power Supply.** Model 12044-00. Supplies +5V @ 25 Amps, +12V @ 4 Amps and -12V @ 9 Amps.



**Power supplies for LSI-3/05.** Model 12046-0X. Open frame power supplies mount in any plane. Supplies +5V @ 10 Amps, +12V @ 0.8 Amps, -12V @ 0.8 Amps; +12V @ 1 Amp, -12V @ 1.5 Amps. With fan.



**Jumbo Power Supply.** Model 20441-00. Supplies +5V @ 36 Amps, +12V @ 5.6 Amps, -12V @ 10.7 Amps.

**MegaByters.** Model 109 Series. High-speed 16-bit systems for real-time, communications and business applications. Features include LSI Family compatibility; four standard input-output modes including Direct Memory Access; vectored priority interrupts; and a comprehensive set of 224 instructions. Includes Jumbo Chassis, Jumbo Power Supply, Programmer Console, Power Fail Restart, Basic Time Clock, AutoLoad



# zation problem.

picked doesn't offer all the interface he needs.

Or, in some cases, the supplier's interface solution is so expensive it forces the OEM to go his own way.

So, at a time when he needs to concentrate all his energies on his own product development, the OEM finds himself committing substantial resources to a peripheral project. One that can be deceptively time-consuming and costly.

Suddenly the designers are coming in, more test equipment is being designed/built/ordered, ditto for new jigs and test fixturing, the documentation hassle is getting under way, and the dollar and time costs start really piling up.

ComputerAutomation is the only computer company that has solved that problem. You can see it here in the picture. Our exclusive Distributed I/O System. Probably the closest thing to a universal interface you'll ever come across.

The Distributed I/O System only works with our computers, but it works with *all* our computers.

The way it works is this: one half-card I/O Distributor handles the commonalities for up to eight interfaces. (There's a four interface version, too.) The actual interface is accomplished by an Intelligent Cable — so-called because of the microcoded PicoProcessor molded into the cable.

This system offers amazing versatility: any and all kinds of interface can be mixed in any combination — serial, parallel or whatever. And not just standard peripherals, either. The Distributed I/O System accommodates special purpose black box kinds of things, too. There's even a version you can custom microcode yourself.

The cost? Typically under \$200 per interface in OEM quantities of 100.

## Maintenance Costs.

The cost of keeping a computer in service over the long haul can be enormous. The proof of which is the huge service revenues reported by some computer companies. (Up to \$2,000 per year per computer!)

ComputerAutomation's service revenues, by comparison, are minuscule. The reason is that our equipment is so reliable that breakdowns are few and far between. And when there is a malfunction, the fix is almost always a matter of plugging in a spare board and sending the bad board back to us. No tricky fine-tuning to worry about and no high-priced junior technician in there messing around with your customer's equipment.

## The Computerization Solution.

The computerization problem obviously goes far beyond computers. So it makes sense that the solution is not only a computer solution, but a systems solution as well.

To find that solution you have to look at the big picture...which we invite you to do by turning the page.





# The computeriz

The cost of an OEM computer can be a lot different than the price on the P.O.

In fact, everything considered, the purchase price could be as little as ten percent of the costs incurred over the life of the computer.

To be brutally blunt, it all depends on whose hardware you buy. That's because the cost of computerizing goes way up with most machines.

The cost of hardware integration, for example.

The cost of developing interface electronics.

The cost of developing software.

The cost to maintain the machine once it's out in the field.

Any one of which could seriously impact the profitability of your product. Given that possibility, here's what you need to know to protect those profits.

## **Engineering Costs.**

Prototyping and systems integration is a high-cost area where, traditionally, the OEM has been left to his own devices, so to speak.

ComputerAutomation doesn't work that way. We've accumulated enormous experience in systems integration because we get involved in our customer's projects.

What's more, we've put together a program for sharing that experience with our customers... free, of course. Part of it includes extraordinarily comprehensive documentation provided on an on-going basis. But more importantly, it's a people-to-people program that even provides on-board support personnel when they're needed.

## **Programming Costs.**

No other endeavor consumes time and money quite like programming. For the OEM who's usually racing to release a new product ASAP, even a minor programming effort can be a major setback.

The solution is to concentrate on the applications end of it and not re-invent software that's already on somebody's shelf — ours.

ComputerAutomation has an enormous library of powerful software that will cost you next-to-nothing. Everything from humble assemblers to high-powered compilers in BASIC and FORTRAN IV.

The powerful instruction set that comes with our computers will spare you countless hours of programming effort, too, because it's designed with that objective in mind.

Remember, too, that all our computers are buss compatible. Which means you won't have to start programming all over again when you switch to another computer in our LSI Family.

## **Interface Costs.**

Many times an OEM is forced to invent his own interface... usually a very expensive proposition... because the supplier he's





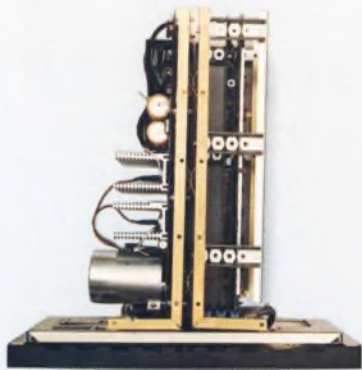

**ALPHA LSI-3/05, NAKED MILLI Series.** Model 10373-XX. Includes LSI-3/05 CPU (Type 1), with LSI Family compatibility, three half-card chassis, 10-Amp power supply and Operator's Console. This small, low-cost computer offers exceptional power and features, including 95 instructions, Power Fail Restart, vectored priority interrupts, Real-Time Clock, AutoLoad capability and 16-bit DMA port. Full memory options.

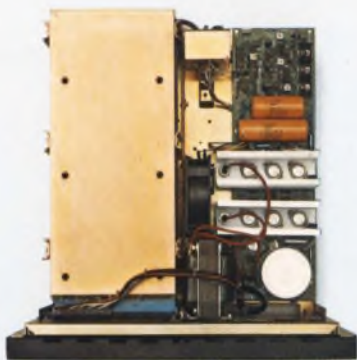

**ALPHA LSI-3/05 B, NAKED MILLI Series.** Model 10375-XX. Includes LSI-3/05 CPU (Type 1) described at left, plus 5 half-card chassis with fan, 15-Amp power supply and Operator's Console. Full memory options.

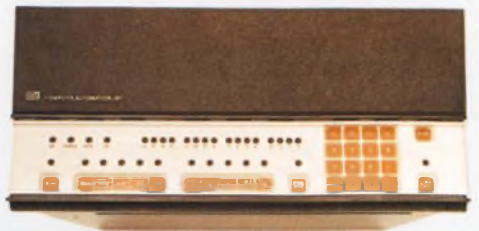

**ALPHA LSI-3/05 C, NAKED MILLI Series.** Model 10376-XX. Same as LSI-3/05 B configuration with addition of Programmer's Console.



**ALPHA LSI-3/05 D, NAKED MILLI Series.** Model 10356-XX. Includes LSI-3/05 CPU (Type 1) as above, standard five full-slot processor chassis, 25-Amp power supply and Operator's Console. Core memory in either 4K, 8K or 16K word sizes.



**ALPHA LSI-3/05 E, NAKED MILLI Series.** Model 10366-XX. Same as LSI-3/05 D configuration with addition of Programmer's Console. Either RAM-only or Core Memory in 4K, 8K, or 16K sizes.



**ALPHA LSI-2/10 T, NAKED MINI Series.** Model 1074X-XX. A 16-bit mini-computer offering twice the speed of our LSI-3/05 computers. CPU provides 188 major instructions, including multiple stack handling, hardware multiply/divide, memory scan, and extensive byte capability. Five vectored priority interrupts are expandable to 256; two direct memory channels may be increased to 64. Direct Memory Access is standard. Includes Power Fail Restart. Also includes chassis with power supply and Operator's Console. Available in either 5-card or 9-card (Jumbo) versions. 4K or 8K Core 980 Memory or 16K Core 1200 Memory. Memory modules may be added up to 256K words using Memory Bank Control.

**ALPHA LSI-2/20 T, NAKED MINI Series.** Model 1055X-XX. Same as LSI-2/10 configuration except with high performance LSI-2/20 CPU offering twice the speed of the LSI-2/10.



**ALPHA LSI-2/20 G, NAKED MINI Series.** Model 1055X-XX. Same as LSI-2/10 G configuration except with high performance LSI-2/20 CPU, as above.

**ALPHA LSI-2/10 G, NAKED MINI Series.** Model 1074X-XX. Same as LSI-2/10 T configuration with addition of Programmer's Console.



**Software and Documentation Packages.**

Advanced software and documentation packages, including BASIC, FORTRAN IV, Real-Time Executive and Operating System are available. Plus a complete inventory of diagnostics, editors, assemblers.



Variables. Teletype or EIA CRT interface, Real-Time and AutoLoad ROM Set. Full Memory options.





**NAKED MILLI LSI-3/05 CPU, Type 0.** Model 10300-00. Small low-cost processor offers exceptional power and features. 95 instructions, Power Fail Restart, vectored priority interrupts and 16-bit DMA port.



**NAKED MILLI LSI-3/05 CPU, Type 1.** Model 10300-01. Same as Type 0 at left, but also includes Real-Time Clock and AutoLoad capability.



**I/O Distributor.** Model 14629-XX. In conjunction with Intelligent Cables (see text), the I/O Distributor provides up to eight interfaces—serial or parallel in any mix. Small version accommodates four interfaces. A DMA version allows data transfer rates up to 250K bytes per second.

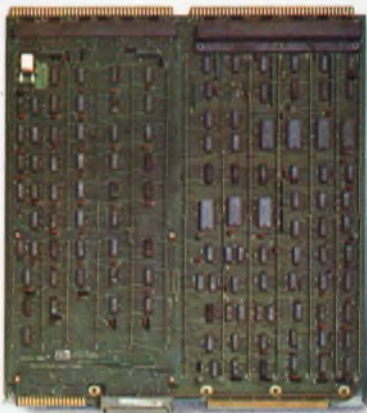

**NAKED MINI LSI-2/10 CPU.** Model 10600-00. 16-bit minicomputer processor offers twice the speed of LSI-3/05 processors. Includes Power Fail Restart option. See ALPHA LSI-2/10 description.

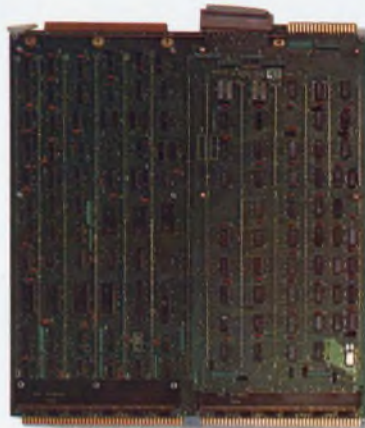

**NAKED MINI LSI-2/20 CPU.** Model 10400-00. Designed for high-performance applications. Twice the performance of the LSI-2/10 for only a nominal increase in cost. Also includes Power Fail Restart.



**Magnetic Tape Controller.** Model 14224-00. Provides interfaces for four 9-track standard tape units, or equivalent. Cabling separate.

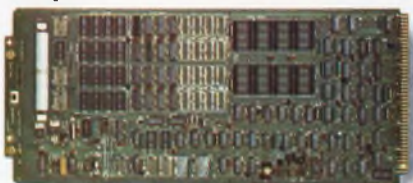

**RAM/ROM/PROM Memories.** Model 11650-XX. Includes semiconductor RAM in choice of 256, 1K or 2K words; sockets for 8K words of ROM and sockets for 2K words of PROM. Available with On-card Battery Backup.



**RAM-only Memories.** Model 11642-XX. Choice of 4K or 8K words. Available with Battery Pack.



**Intelligent Cables.** Model 14631-XX. A broad assortment of models offers off-the-shelf interface for most standard and special user devices: Line Printer Reader, Paper Tape Reader, Paper Tape Punch, Current Loop, CRT, Modem, General Purpose and Custom Program versions.



**RAM/EPROM Memories.** Model 11530-XX. Includes semiconductor RAM in choice of 1K or 2K words and sockets for 4K words of ultra-violet Erasable Programmable ROM. Available with On-card Battery Backup; also, optional EPROM Programmer.

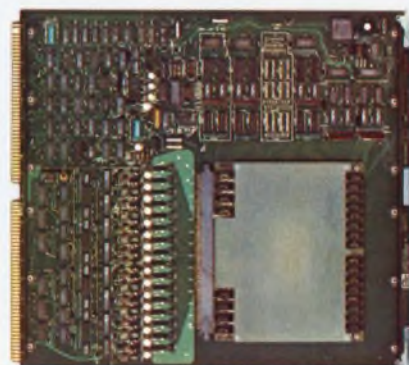

**Full-card Core Memories.** Model 115X0-XX. Choice of 8K words of Core 980 Memory or 16K words of Core 1200 Memory. For Standard or Jumbo Chassis only.



**Half-card Core Memory.** Model 11671-XX. 4K words. For either NAKED MILLI/ALPHA LSI-3/05 or NAKED MINI/ALPHA LSI-2 Series Computers.



**16-channel Priority Interrupt Module.** Model 13220-00. 16 interrupts with acknowledgement lines.



# ComputerAutomation cuts the cost of computerizing.

Knowing what the OEM needs... understanding the OEM predicament. That's what sets ComputerAutomation apart. It's the reason we ship over 100 computers per week — the second highest shipping rate in the industry.

## Guaranteed savings.

OEM's buy our computers because they're the most reliable machines made.

Every IC, subassembly, memory subsystem and completed computer is temperature, shock and vibration tested.

That's why ComputerAutomation can offer the only one-year warranty in the industry — when we send a computer out, we know it's not coming back for a long time.

## We deliver.

In an industry where one delinquent diode can (and sooner or later will) shut down an entire assembly line, that's saying a lot.

It especially says a lot to OEM's who know they're at the mercy of their sole source computer supplier. One thing you can't do is stick somebody else's machine in that slot.

So here's a thought you might want to stick in the back of your mind for future use:

ComputerAutomation delivers on time.

The reason is that we deliver from inventory — usually a comfortable 30-day cushion of computers sitting around getting more reliable by the minute because they're kept under power and constant test scrutiny.

A lot more trouble for us, but a lot less worry for you. And it does tend to prove our point. We understand the problem.

## From the people who brought you the NAKED MINI.<sup>®</sup>

The people who brought you the first solution to high-cost computers.

And the most recent solution as well.

And all the solutions in between. Including low-cost memory. And the Distributed I/O System.

Plus on-time delivery. And the only full-year warranty in the business.

The total solution to computerization.

So if you can't spare the time and money to re-invent the wheel, there's a simple solution... from the people who came up with all the other solutions.



Temperature chambers stress computers to isolate marginal components. Computers are continuously tested during 72-hour burn-in at 50°C. Any error starts the test over from the beginning. To further stress the computer, power is cycled on and off approximately 2000 times during test.



Computers awaiting shipment idle away the hours under test. Reliability benefits from the additional component aging.



**ComputerAutomation**  
Naked Mini. Division

ComputerAutomation, Naked Mini Division, 18651 Von Karman, Irvine, California 92713/Eastern Regional Office, 79 North Franklin Turnpike, Ramsey, New Jersey 07446. (201) 825-0990/Midwestern Regional Office, 2621 Greenleaf Avenue, Elk Grove Village, Illinois 60007. (312) 956-6400/Western Regional Office, 18651 Von Karman, Irvine, California 92713. (714) 833-8830/Europe, CA1 Ltd., Hertford House, Denham Way, Maple Cross, Rickmansworth, Hertfordshire, WD3, 2XD, England. Telephone Rickmansworth 71211

LITHO IN U.S.A.





# If practically anyone can build a programmer for these proms who needs Data I/O?

Practically anyone who understands semiconductor memory can make a box to program a PROM, or maybe two different PROMs. That may be fine today, but the way things are, you could be programming ten or twenty different PROMs tomorrow.

Only a Data I/O PROM Programmer will program them all — 165 at last count.



Our Programmer V lets you enter data in a variety of input modes (keyboard, master ROM, paper tape,

computer, etc.), review the data, and then select from a variety of output modes.

Our MOS Memory Module Programmer can program eight MOS PROMs simultaneously, with eight different programs, in less than 30 seconds!

We also make a portable programmer, FPLA programmer and the Romulator™. The Romulator allows you to emulate/simulate PROM operation — in your circuit — without PROMs. PROM data is easily altered

and updated on the Romulator keyboard, all prior to PROM programming.

Data I/O programmer calibration

standards let you calibrate to each PROM manufacturer's specs before you program, insuring maximum yields and reliability.

## Data I/O total three point service.

1. Every Data I/O customer receives a quarterly update on currently available PROMs.

2. Through our direct (computerized) mailing program, Data I/O customers are kept constantly up-to-date on PROM specification changes and technological innovations.

3. Nine field offices in the U.S.A. and 22 distributors worldwide provide our customers with direct sales support, installation, operator training and service.

## Get the facts

If you would like to know more about our products, or want copies of our quarterly PROM Comparison Chart and PROMBITS (our periodic technical bulletin on PROM applications and innovations), mail this coupon or call one of our offices. Data I/O Corporation, P.O. Box 308, Issaquah, Washington 98027.

Name \_\_\_\_\_

Title \_\_\_\_\_

Company \_\_\_\_\_

Address \_\_\_\_\_ M/S \_\_\_\_\_

City/State/Zip \_\_\_\_\_



# Data I/O

CIRCLE NUMBER 12



# AVX quality. It's automatic.

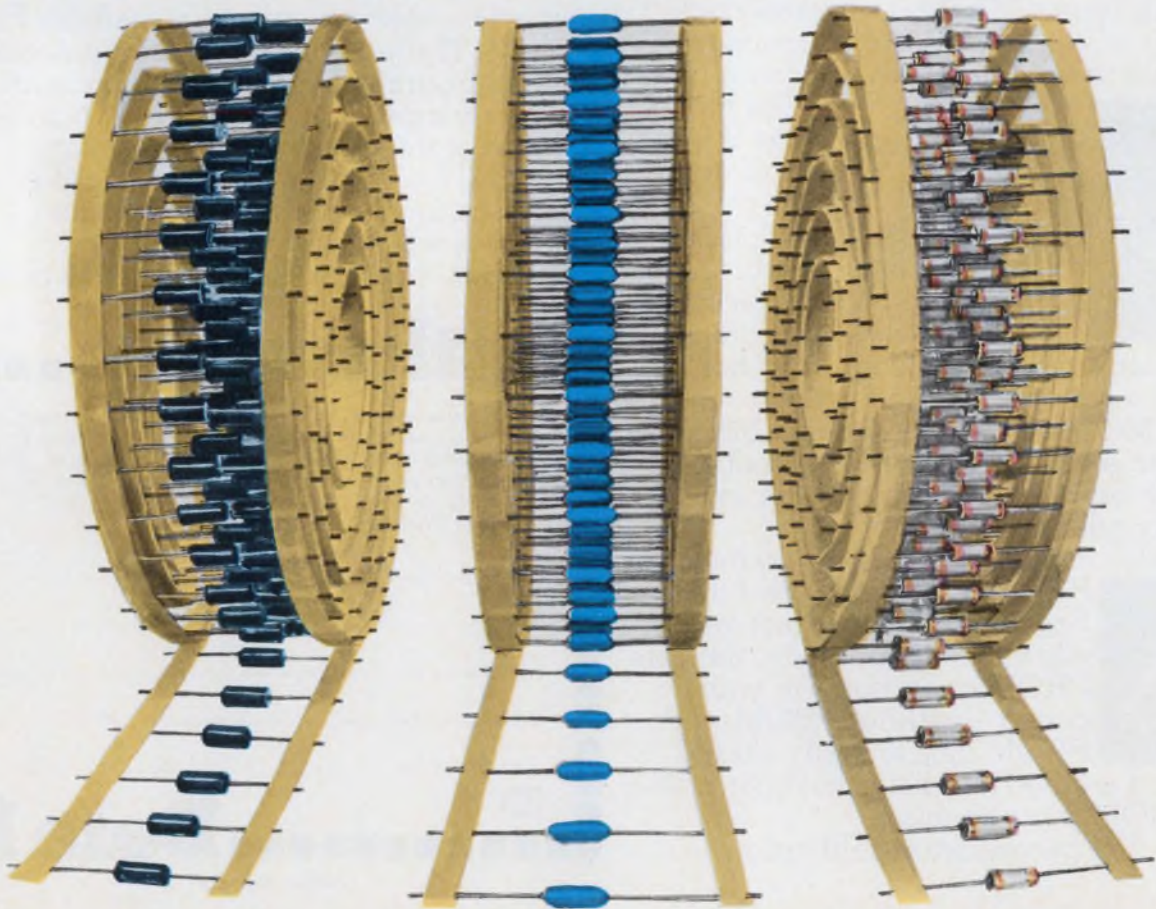



Putting AVX quality inside your products is automatic. With AVX molded axials. GlasGuard®. And AVX's new low cost axial SpinGuard®.

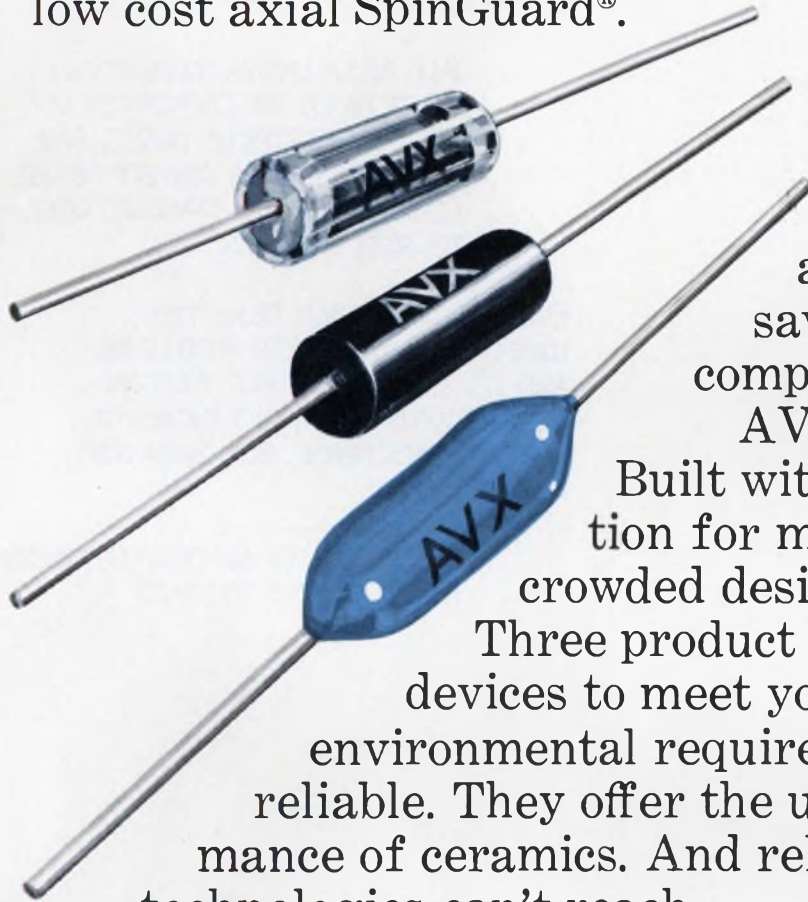

They're multilayer ceramic capacitors. Taped and reel packed. Configured for fast, automatic insertion to save time and money in component assembly.

AVX axials are efficient. Built with multilayer construction for more capacitance in crowded designs. They're flexible. Three product lines of axial leaded devices to meet your exact size, voltage, environmental requirements. And they're reliable. They offer the unequalled performance of ceramics. And reliability ratings other technologies can't reach.

If you have automatic insertion equipment, you can build your products faster. With AVX, you can build them better.

AVX Ceramics, P.O. Box 867, Myrtle Beach, SC 29577  
(803) 448-3191, TWX: 810-661-2252  
Olean, NY (716) 372-6611, TWX: 510-245-2815

# AVX: The Insiders



## ACROSS THE DESK

(continued from page 16)

missing, the inclusion of Wang programmable calculators/mini-computers in an otherwise fine explanation of the subject.

Wang is, to my knowledge at least, the granddaddy of them all in regard to product innovation. While not wishing to get involved in comparisons, costs, etc., I would note that Wang is more than competitive with HP, IBM, and Tektronix.

A. K. Rosenhan, P.E.

Mississippi State University  
Dept. of Industrial Engineering  
P.O. Drawer U  
Mississippi State, MS 39762

## Sorry, wrong number

In our July 5, 1976 Issue (Vol. 24, No. 14) on pg. 88 the wrong phone number appeared for Plessey Semiconductors. The correct phone number is (714) 540-9945.

## This 'second source' is pin-compatible, but . . . .

I was interested to read your news-survey article, "Designers are Looking Closely at New Monolithic DACs and ADCs" (ED No. 13, June 21, 1976, p. 28). It is certainly true that designers are looking closely at these devices, thus it would be appropriate to correct your statement that "The Analog Devices AD559 produced in Norwood, MA, is a direct second source for the MC1408/1508." While the AD559 is pin-compatible, it does not have the capability of being operated with either a negative or a positive reference, being limited to the latter only.

D. S. Cutler

Electronic Engineer

Burroughs Machines Ltd.  
Detroit Rd.  
Glenrothes, Fife KY6 2RJ  
UK

## Hold it: What about our major breakthrough?

I am disappointed that your tabulation on high-voltage power supply manufacturers (ED No. 13,

THIS TIME  
MICRODATA  
HAS GONE TOO FAR!

THEIR OEM PERIPHERALS WERE UNFAIR BEFORE. BUT LODESTAR IS TOO MUCH! NOW THEY'VE FOUND A WAY TO PUT 10 MEGABYTES ON A 3M-TYPE CARTRIDGE. 6400 BPI ON 1/4 INCH TAPE!

TALK ABOUT UNFAIR COMPETITION! THAT'S TWICE THE CAPACITY OF MY BEST 3M CARTRIDGE DRIVES. AND LODESTAR IS PLUG AND SOFTWARE COMPATIBLE WITH STANDARD REEL-TO-REEL SYSTEMS.

EVEN AT THOSE HIGH DENSITIES, LODESTAR'S MTBF IS OVER 4000 HOURS. AND IT'S SO DARN COMPACT YOU CAN MOUNT TWO OF THEM IN 7 INCHES OF VERTICAL RACK SPACE. BOY, THEY DON'T MISS A TRICK.

I HOPE NONE OF MY OEM CUSTOMERS FIND OUT ABOUT THIS ONE!



- Unformatted Storage Capacity: 11.5 megabytes at 6400 bpi
- Recording Method: Serial, 4 tracks
- Transfer Rate: 192 KHz at 6400 bpi
- Full Tape Write: 10 minutes
- Full Tape Read: 8 minutes, bi-directional
- Error Rate: less than 1 bit in  $1 \times 10^9$
- MTBF: over 4000 hours
- MTTR: less than 1/2 hour
- Size: mechanism, data and motion electronics, 5"H x 8"W x 11"D; optional single or dual drive rack mount version with formatter and power supply, 7"H x 17"W x 12"D.



REFLEX? HERE'S MY REFLEX!  
IT'S INCREDIBLE! NOW MICRODATA'S  
UNHOOKING MY DISC MEMORY  
BUSINESS!

THIS NEW REFLEX DRIVE HAS THE  
RELIABILITY OF FIXED MEDIA AND  
THE SPEED OF WINCHESTER TECHNOLOGY  
AT A LOWER COST PER BIT THAN ANY-  
THING ELSE ON THE MARKET.

THEY'VE CUT ACCESS TIME WITH FASTER  
HEAD POSITIONING, FASTER ROTATION  
AND TWO HEADS PER SURFACE. THERE'S  
EVEN A FIXED HEAD-PER-TRACK OPTION.

YOU'D THINK THAT WOULD BE ENOUGH.  
BUT NOT FOR MICRODATA. THEY LOVE  
TO PILE IT ON. COMPATIBILITY WITH  
STORAGE MODULE. BETTER RELIABILITY,  
BETTER PERFORMANCE,  
COMPACT 7-INCH RACK MOUNT  
PACKAGE. IT JUST NEVER  
STOPS.

MY ONLY HOPE IS MAYBE  
THEY CAN'T DELIVER.

Sorry, Chuck, we're taking orders right  
now. OEM's should call or write  
directly to Microdata Corporation,  
P.O. Box 19501, Irvine, California 92713,  
Telephone: 714/540-6730.



- Unformatted Storage Capacity: 12.5, 37.6 or 62.7 megabytes • Bit Density: 5,636 bits/inch • Data Transfer Rate: 7.08 MHz • Rotation Speed: 2964 rpm
- Track Density: 300 tpi • Position Time: 30 msec avg. • Track-to-Track Position Time: 6 msec • Error Rate: Recoverable, 1 bit in  $1 \times 10^{10}$  bits; Nonrecoverable, 1 bit in  $1 \times 10^{13}$  bits • MTBF: 6500 hrs.
- Size: 7"H x 17"W x 28"D.

## Microdata

Microdata Corporation, 17481 Red Hill Avenue, Irvine, CA 92714,  
Telephone: 714/540-6730. TWX: 910-595-1764.

FOR IMMEDIATE USE CIRCLE NUMBER 210  
FOR INFORMATION ONLY CIRCLE NUMBER 211

June 21, 1976, p. 74) does not include Capacitor Specialists, Inc. I also disagree with the statement, "In the past few years there have been no major breakthroughs in HV supply design," as we consider the constant power feature of our capacitor-charging units to be such a major improvement. Since it is the only such supply on the market, I would have thought the concept worthy of mention.

Bruce R. Hayworth  
President

Capacitor Specialists, Inc.  
P.O. Box 2052  
Escondido, CA 92025

*Ed Note: Due to the specialized nature of the supply, we decided not to cover it at the time.*

## Sequerra's Sequerra 1 isn't even number 2

The Sequerra 1 (ED No. 16, Aug. 2, 1976, p. 26) is not "the first consumer device to incorporate a multifunction oscilloscope for visual, as well as aural, evaluation of the rf input and of the demodulated stereo or quadraphonic audio of the station to which it is tuned."

Priority probably goes to the Marantz 10B tuner of several years ago (long enough ago to be a vacuum tube design)—which I believe Dick Sequerra also had a hand in designing. The 10B has been followed by other Marantz tuners and receivers, and by one model from SAE, as I recall. There have also been oscilloscopes designed for such display from Heathkit, McIntosh, and Pioneer, also Kenwood and TEAC, and the number of tuners with output jacks for such displays is by now fairly large.

Where the Sequerra is first is in its "Panoramic" display mode (shown in your photo), which shows not only the station being received, but any signals on adjacent or alternate channels as well. Incidentally, the "Tuning" display shared by the Sequerra and other tuners mentioned above can also "be used to orient the FM antenna for greatest signal strength."

Ivan Berger

Electronics & Photography Editor  
Popular Mechanics  
224 W. 57 St.  
New York, NY 10019



# OAK does more than provide a complete



It isn't just the wide range of switches. It's what Oak will do with them—for you—that should make Oak your preferred supplier.

You can get switch assemblies mounted on a custom PC board or metal bracket, or completely wired with cables, harnesses and connectors, including stamped or machined parts ready for installation in your equipment. And it's all done in-house on Oak production equipment and assembly lines.

Of course, we can supply all of your simpler requirements as well, including an almost unlimited selection of switching configurations, cap legends, styles and colors for lighted or unlighted switches. Contact your Oak sales offices, distributors or call for price and delivery information.

1. Data input keyboard for financial systems. Series 400 switches with aluminum panel and PC board. Special removable caps permit rapid legend changes for reprogramming.
2. Banking terminal input device using Series 300 switches. Completely wired with harness and connectors.
3. Data input using Series 475 switches, flow soldered to customer's PC board.
4. Series 415 and 415 Light Emitting Diode Switches on PC board, with discrete components attached on back.
5. Program selector keyboard of Series 475 switches assembled with aluminum panel and printed circuit boards used for coin operated equipment.



# line of push-button and keyboard switches

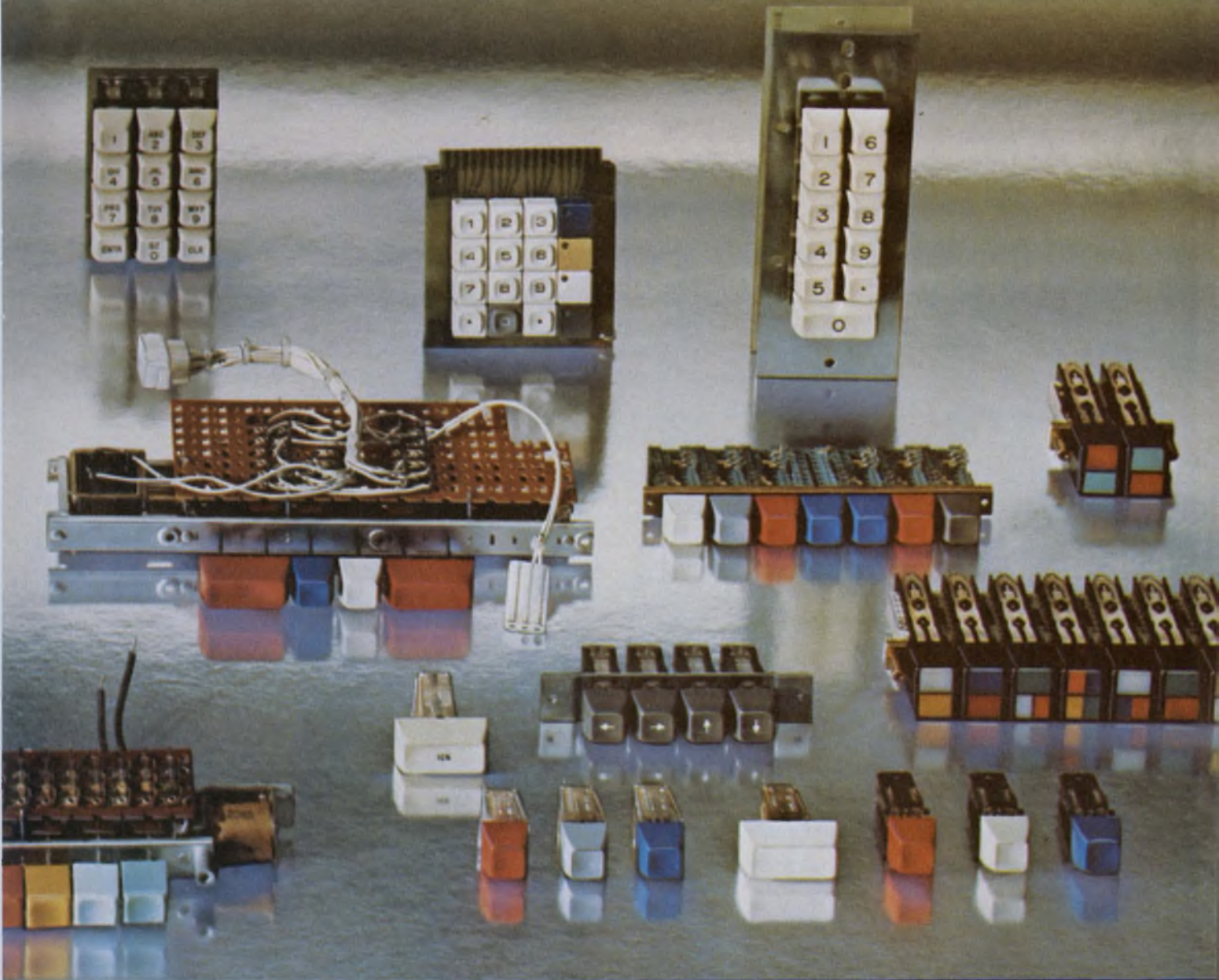

6. Series 300 switches, single and ganged, lighted and unlighted, can be supplied completely wired.

7. Series 130 switch, for rugged applications where more switching capability is required. Terminal board is integral part of switch assembly.

8. Microwave oven switch assembly with quick-disconnect terminals using Series 130.

9. Facsimile transmission assembly with special mounting bracket, wiring, cable and connector, and solenoid for clearing all Series 130 switches.

10. Unlighted Series 300 switches can be supplied in almost any conceivable switching combination of alternate, momentary, interlock and lockout.

11. Bank security code system uses 4-lamp, 4-display Series 300 switches. As many as 12 switches can be prewired, to customer specifications, in a single bank.

12. Very low profile, low cost Series 415 switches are available in five different button styles in a wide range of colors.

13. Series 415 switches with LEDs, on a separate circuit, vastly improve error-free operator performance of data input devices.

14. Microwave oven assembly with solenoid for latching release, partially wired to customer requirements.

15. Series 400 and 475 keyboard switches can be supplied assembled in Oak produced brackets, or individually, with or without snap-in mountings.



**OAK Industries Inc.**

**SWITCH DIVISION** / CRYSTAL LAKE, ILLINOIS 60014  
 TELEPHONE: 815-459-5000 ■ TWX: 910-634-3353 ■ TELEX: 72-2447

CIRCLE NUMBER 235



# World Travelers

Kennedy tape recording equipment—it's the finest in the world, and that's why it's in use around the world. Kennedy recorders are monitoring and recording airport traffic and arrivals in Holland; solar activity to determine the Earth's weather, in Switzerland; gasoline usage at stations in Sweden; banking systems for up-dating payments and billing in Japan; computerized feed lots in India; utility power distribution to industry in England and telephone usage analysis, toll ticketing, message switching control and automatic program load for virtually every country with a telephone service.

These are only a few of the countries and applications where Kennedy products are solving problems.

Asynchronous tape drives, vacuum column tape drives and a complete line of cartridge recorders are available for any application.

To service Kennedy products, there is a European service center and parts depot to handle factory warranties, repairs and parts stocking. If you're an OEM doing business in Europe, that's something to think about.

Kennedy tape products—they're the finest in the world. If you're thinking international, think

**KENNEDY CO.**

540 W. WOODBURY RD., ALTADENA, CALIF. 91001  
(213) 798-0953

**KENNEDY · QUALITY · COUNT ON IT**





OCTOBER 25, 1976

## Three microprocessors can be better than one

Three microprocessors are better than one for automating industrial-control systems—if they are arranged to handle distributed processing effectively.

The architecture should use a shared memory to provide high throughput for logic testing and other functions, such as high-speed arithmetic operations, according to Odo J. Struger and Ernst Dummermuth, principal engineers at Allen Bradley, Cleveland, in a paper presented at the Instrument Society of America Conference in Houston, TX.

Processor No. 1 should be a logic processor that executes the programmable-controller instructions. Solid-state programmable controllers simply mean that the control functions via the execution of a stored program, says Struger. Unlike the hardware-relay implementations, the controlling equations are not executed simultaneously, but sequentially.

To obtain a quasi-simultaneous execution, the controller must repeat the evaluation of all equations approximately every 10 to 20 ms. These equations relate the input conditions to output drive signals. Consequently, the scan rate applies to the I/O points. The use of two or more processors in a system reduces scanning time.

Processor No. 2 is a special processor running in parallel with and sharing an I/O image table in the logic processor's main memory that duplicates the status of all inputs and outputs, and shares the data tables in that memory. The program memory, however, is not shared.

Processor No. 3 is an 8-bit microprocessor that functions as a computer interface. It has its own program, but shares the I/O image table.

The key advantage to sharing

the I/O image table, explains Struger, is the optimization of throughput time. Also, the system's reliability is increased because unlike a conventional computer, where inputs and outputs are fairly close together, they may be 50 feet or more away from each other in an individual control system. Testing a bit for logic instructions can take 10 or 20 microseconds before the validated data are returned.

By maintaining an image table of the status of the inputs and outputs, the access time is limited only by the speed of the memory itself and not by the I/O data-transfer time.

Other types of processors can be added to improve the basic system even more, Struger points out. Adding an arithmetic microprocessor would speed up the system by removing any computational load from the main logic processor. Adding a data-handling processor—a microcomputer—would permit several parameter tables to be stored in a dormant part of the logic processor's main memory.

For example, on a production line used to test different types of gasoline engines, parameters can be stored for the individual engine tests.

Upon command, the data-handling module loads the parameter table for a particular engine into the programmable controller, and makes appropriate changes in the test program. In addition, the module controls the generation of reports for the operator on a teletypewriter or some other display.

A pseudo-recording function can be added to this module to record the key states in matrix form the first time the system is run through a full operating cycle. That is, the system recognizes various input/output states at different

time intervals. During subsequent runs, Struger points out, the module compares the various states with the first-run value and, if there is something wrong, notifies the operator.

## Pentagon C<sup>3</sup> investment will rise by FY1982

The Pentagon's investment in the development and procurement of military command, control and communications system will rise from \$1.2-billion for the fiscal year just ended to \$2.7-billion for fiscal year 1982, predict Will Gray of Honeywell and James Lee of Hughes Aircraft. Presenting their outlook for the military electronics market at this year's Electronic Industries Association convention in Los Angeles, the two market researchers also foresee a leveling off of operating costs for the C<sup>3</sup> systems, thus making more funds available to industry.

The Pentagon's \$1.2-billion investment represents 36% of the total \$3.3-billion in C<sup>3</sup> expenditures last year. However, add Gray and Lee, the Pentagon's investment will rise to 54% of the projected \$5-billion in outlays for fiscal 1982: Increased automation is expected to hold down operation and maintenance costs to a steady \$2-billion a year.

Command and control equipment has become a first-priority tactical requirement of the Defense Dept., according to Gray and Lee, and much of the Department's communications equipment is of World War II and Korean War vintage.

Base communications, special-purpose communications and long-haul communications also loom as major business opportunities, note Gray and Lee, who predict that a new strategic-communications system will follow the currently planned Seafarer extremely-low-frequency (ELF) system for communicating with submerged nuclear missile-carrying submarines. The follow-on system is projected to generate \$2-billion worth of business in the 1990s.

Among critical needs, and consequent industry opportunities, Lee and Gray also assigned high priority to electronic counter countermeasures in anti-jam transmission and data links.



## Antenna tracks a key to learning star formation

A high-gain steerable antenna on the largest millimeter-wave radio telescope in the U.S. is helping astronomers study the origins of stars by detecting carbon monoxide (CO) molecules in outer space. CO compounds act as tracers of molecular hydrogen, a form of neutral hydrogen currently undetectable at optical, infrared or ordinary radio frequencies, whose study is absolutely necessary to understanding star formation.

Built near the Amherst campus of the University of Massachusetts by Electronic Space Systems Corp., Concord, MA, the 45-foot-in-diameter parabolic antenna reportedly has a beam width of only 40 arc seconds with a pointing accuracy of better than 2 arc seconds—an angle whose size is comparable to what can be seen of a 4-ft object 100 miles away.

CO molecules radiate energy at millimeter-wave frequencies of 115 GHz and its multiples—230, 345, and so on. A reflector mounted at the antenna's parabolic focus causes the received signals to converge at the main feed and receiver mounted at the center of the parabolic surface.

This casagrain arrangement has two advantages, according to Richard Huguenin, director of the Radio Astronomy Observatory near Amherst, Massachusetts:

- Lower system noise, since any spurious signals entering the main feed come from the sky, not the noisier earth.

- Greater structural support for a relatively massive cryogenically cooled maser, one of a number of low-noise receivers to be tested in the telescope.

The antenna's high degree of pointing accuracy comes from machining the surface of the parabola to an over-all smoothness of 0.1 millimeter rms (root mean square). The dish surface is actually 72 individual aluminum panels all carefully fitted together to form a parabolic surface.

The machining accuracy of each component panel is kept to 0.06 millimeters rms, according to a company spokesman. The entire antenna (dish and pedestal) is housed in a radome.

## Mum's the word for electrothermal relay

A three-year development program has combined something old—a bimetal strip—and something new—a polyimide coating with an etched metal resistor and contacts on top—to produce a noiseless electrothermal relay. Developed by Oak Industries, Crystal Lakes, IL, the relay has a time lag sufficient to hold a circuit closed, despite transient interruption of the energizing current.

That isn't all. Undesirable transient voltages generated by solenoid-operated relay coils have been eliminated by the polyimide-coated relays. Moreover, the new relays cost less than the solenoid-actuated counterparts, says Dean Bach, director of product planning for the Oak Industries Switch Division.

The speed of operation is limited. The norm has been 500 ms, but one prototype design has switched as fast as 90 ms.

The first relay to be introduced on a production basis early next year will be a single-pole, double-throw unit operating in the 5-to-18-V range. Current-carrying capacity will be in the order of 5 A maximum.

## Minicomputers offer fast microprogramming

A family of small computer systems developed by Hewlett-Packard permits the user to develop and load microprograms while running an existing application program. Consisting of four models, the 30, 31, 80 and 81, the HP 1000 systems are typically 9% lower in cost than comparable HP equipment.

The central processor, common to all four models, executes programs 60% to 100% faster than previous HP models. The higher speed is attained through multi-level subroutines and dynamic microcycle timing. This timing technique allows the processor to complete most of its operations in a timing period of 175 ns, but allots 280 ns to the occasional slower function. Competing processors must operate continually at the slowest worst-case timing period.

The desk-styled Model 30, a medium-priced (\$37,000) unit, em-

ployes 64 kbytes of main memory, a 15-Mbyte disc with an average access time of 25 ms, a 9600-baud CRT console with two minicartridge tape drives, and operating-system software. Larger memories and other software can be used, including IMAGE/1000 data-base management and networking software. Model 31 (\$33,500) is cabinet-mounted and uses a 5-Mbyte disc.

The desk-mounted Model 80 (\$62,600) has the same disc equipment and CRT console as Model 30, but uses 128 kbytes of memory, a 200-lpm line printer and a 1600-bpi tape drive. IMAGE/1000 software with QUERY is standard. Model 81 (\$63,600) is cabinet-mounted.

## I<sup>2</sup>L design cuts down DPM's component count

The first commercial application of I<sup>2</sup>L design in a digital panel meter has produced the AD2026 by Analog Devices, Norwood, MA, a compact, low-priced instrument with just 14 components and increased reliability.

Integrating all analog and digital circuitry on a single LSI chip

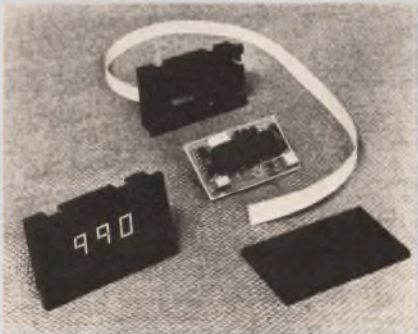

With all analog and digital circuits on one I<sup>2</sup>L chip, only 13 other components make up a complete DPM.

not only reduces the number of components dramatically, but reportedly increases the digital panel meter's MTBF to over 250,000 hours.

The I<sup>2</sup>L design permits a power draw of only 0.6 W from a single 5-V supply, and the low dissipation keeps the internal temperature rise to 10 C.

With its low price (\$39 in quantities of 100) and its compact size (3.4 × 2.0 × 0.8 in.), the AD2026 is expected to draw a substantial number of users away from analog meters. **CIRCLE NO. 316**



# We saw your microprocessor

coming. So we designed an entire family of socket homes for it. Socket cards for card file mounting, and we've even got the card files.

Socket boards for LSI mounting in frames, drawers, and racks,

and we've even got the frames, drawers, and racks.

Our socket cards, the 3D Series, come with built-in test points, a ceramic monolithic bypass capacitor

at each socket, and solder tab connection to pins on LSI chips.

Our socket boards, the 2D Series,

offer a good selection of socket complements, and are compatible with other boards for hybrid installations. We also offer automated wiring service. We're ready for you.

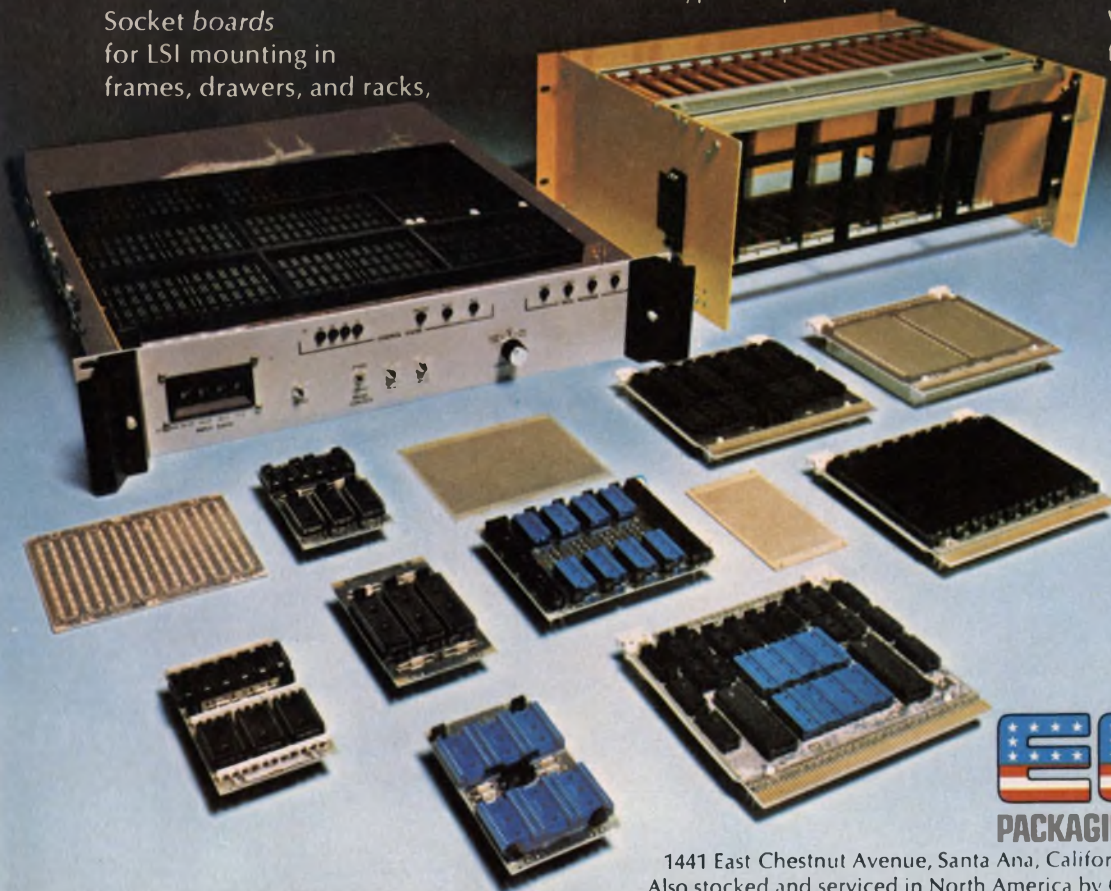

**EECO**

PACKAGING/SWITCHES/READERS

1441 East Chestnut Avenue, Santa Ana, California 92701 Phone 714/835-6000  
Also stocked and serviced in North America by G. S. Marshall, R-A-E, Zentronics.



# CHERRY

and keep on working.

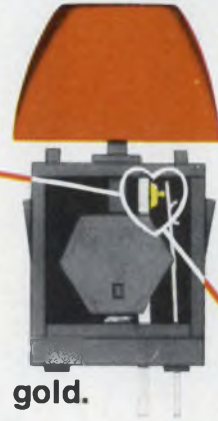

**RELIABLE**  
because they have a heart of gold.



*B80-22AA Cherry Keyboard used on ADDS Consul 880/880A series,  
made by Applied Digital Data Systems, Hauppauge, NY 11787.*



# Keyboards work year...after year...after year.

Why are Cherry keyboards so reliable? One reason is that the gold crosspoint contacts at the heart of the keyswitches *just can't fail*. The knife-edge contact area is so small (9 millionths of a square inch) . . . the contact force so great (approximately 5,000 psi) . . . and the gold alloy so pure and film-free . . . you're absolutely assured of positive contact every time.

Another reason for Cherry keyboard dependability is our uniquely simple design that combines the most advanced technology with a minimum of component parts. This yields a product whose susceptibility to field failure is inherently low. A fact substantiated by the remarkable record Cherry keyboards have achieved in all kinds of environments and demanding applications—like remote terminals, data com-

munications and point of sale equipment.

Still another reason for this excellent field performance is that we build our keyboards from scratch. We start with raw materials and go all the way to the two-shot molded keycaps right in our own plant. Even the printed circuit board is a product of our in-house design and fabrication. Painstakingly bonded to this are the gold crosspoint contact key modules, TTL and other electronic components with all connections 100% wave soldered. Finally, a sturdy frame protects against shock.

Cherry's keyboards draw low power—both quiescent and in use—and generate clean IC logic signals. They are not temperature or humidity sensitive and can be designed to meet your specific requirement at surprisingly low cost.

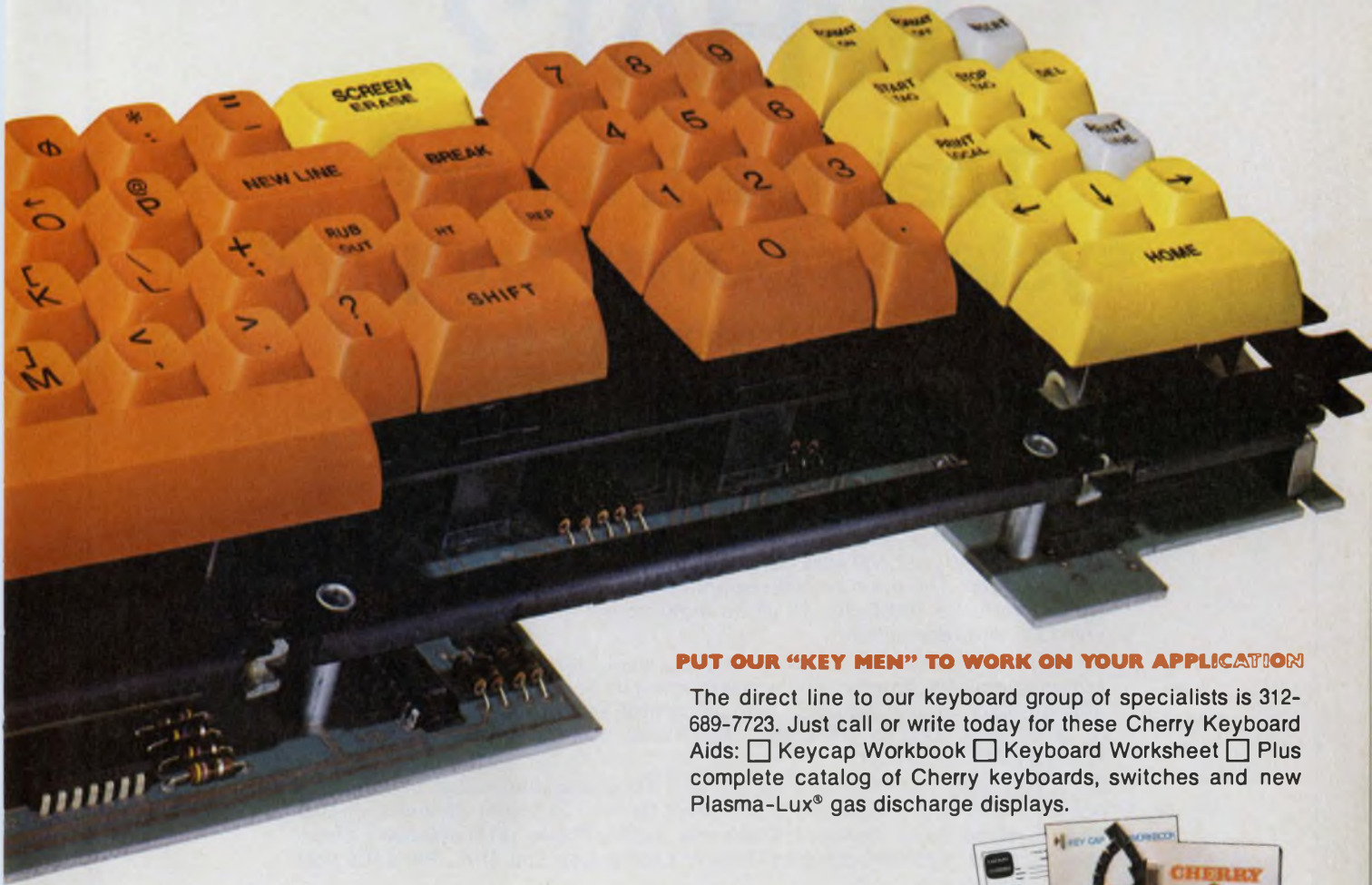

## PUT OUR "KEY MEN" TO WORK ON YOUR APPLICATION

The direct line to our keyboard group of specialists is 312-689-7723. Just call or write today for these Cherry Keyboard Aids:  Keycap Workbook  Keyboard Worksheet  Plus complete catalog of Cherry keyboards, switches and new Plasma-Lux® gas discharge displays.

SWITCHES • KEYBOARDS • DISPLAYS  
Available locally from authorized Distributors.

# CHERRY



CHERRY ELECTRICAL PRODUCTS CORPORATION  
3609 Sunset Avenue—Waukegan, IL 60085

CIRCLE NUMBER 18



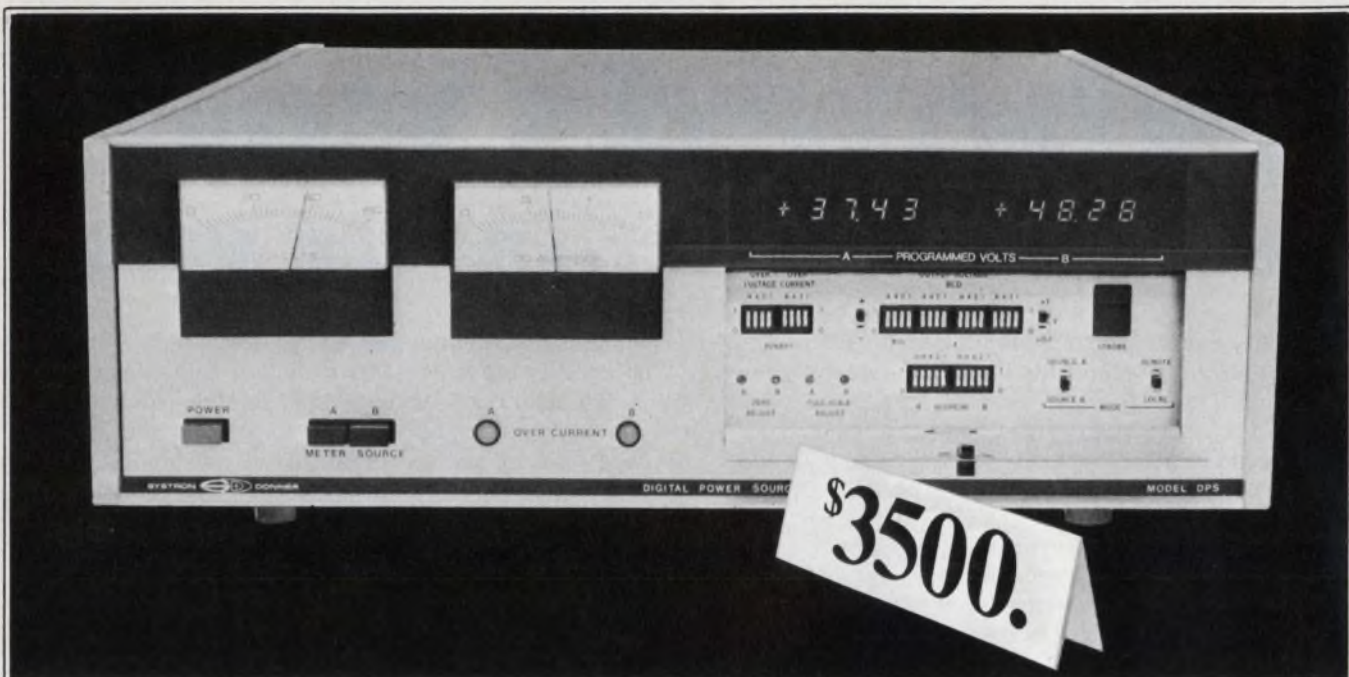

# WHAT?

## That much for one systems power supply?

No. That much for two.

Look closely and you'll see that Systron-Donner's new Model DPSD-50 has two independent floating precision power sources in *one* 5¼-inch rack. Each provides 0 to ±50 volts at 1 amp. Now, there's no need to fill up your system with one-output power supplies. Use the DPSD-50 Digital Power Source instead, and cut your space requirements in half!

It's not only space you'll save, either. Buying one Model DPSD-50 with two power sources at \$3,500 sure beats buying *two* single-output models at \$2,000 or more *each*. The price of other supplies spirals upward as you add options. Not so with the DPSD-50. *All* of its features are standard, except the IEEE 488-1975 interface option.

And look at these features! Everything you want, standard: programmable voltage and polarity, both channels; overcurrent limit, overvoltage limit, addressable memory, optical isolation, manual control, self-verification, visual display of input data. Key specifications: resolution, 1 mV; basic accuracy, 1 mV; stability, 300 microvolts.

So, if you need more than one supply as a programmable voltage source, why not start with the one supply that's two? Contact Scientific Devices, or S-D at 10 Systron Drive, Concord, California 94518. Phone (415) 676-5000. Overseas, contact Systron-Donner in Munich; Leamington Spa, U. K.; Paris (Le Port Marly); Melbourne.

SYSTRON  DONNER



# Coming through...



with wire, cable and cord  
that delivers quality,  
performance, economy...

Belden has it: a total service capability. Extensive design and application know-how. What it takes to deliver complex cable configurations, special harnesses, cords, lead wires, and even special packages to fit your requirements.

Our specialists and engineers will meet with your people at your plant to discuss problems in processing, assembly, installation, ordering, human engineering, color coordination, physical and electrical parameters, opportunities for cost reduction. And when we can't help you using standard products, we'll innovate a solution to your problem.

Talk to a Belden specialist about your new applications, product ideas, processing problems—all your wire, cable and cord needs. He has thousands of standard items to draw from. And standard or special, he'll come through with the best wire buy around. For answers right now, phone:

317-966-6661 Electronic Div. or mark No. 400 on reader service card  
312-986-1600 Electrical Div. or mark No. 401 on reader service card  
312-887-1800 Transportation Div. or mark No. 402 on reader service card,  
or write Belden Corporation, 2000 S. Batavia Ave., Geneva, IL 60134.



**Coming through...**

*with new ideas for moving electrical energy*



# If the eagle's flown...



If the 30" x 21½" full-color military semiconductor wall chart inserted here has taken flight into someone else's files, you can get your copy by contacting your Motorola representative or your authorized Motorola distributor.

Listing the broadest range of discrete and IC devices ever qualified to 19500 and 38510 specs, the chart is oriented to engineer and buyer so each will find it easy to use for device selection and general information value.

Get a copy.

Specify Motorola Military Semiconductors... No. 1 in all the world.

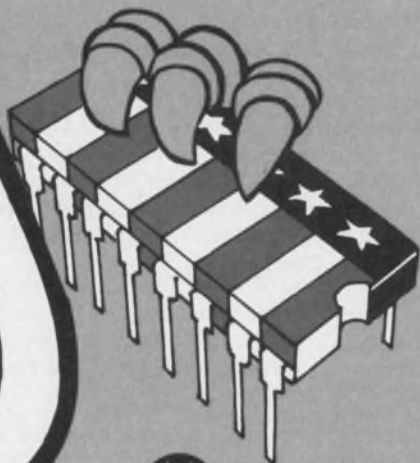

**MOTOROLA Semiconductors**

P.O. Box 20912, Phoenix, AZ 85036



# ON NOV. 22 Electronic Design

Presents:

# INSTRUMENTS '76



**DRAMATIC CHANGES ARE TAKING PLACE  
IN THE WORLD OF INSTRUMENTS . . .**

## **DON'T MISS THIS MAJOR EDITORIAL WRAP-UP**

- **PROGRAMMABLE INSTRUMENTS**

Exactly what "programmable" means. Discussion of the IEEE-488 and CAMAC interface busses.

- **SMART INSTRUMENTS**

Instruments that include  $\mu$ Ps, memories or other advanced circuits for calculations, self diagnosis, automatic operation, etc.

- **COMBINED INSTRUMENTS**

Instruments that combine several functions — e.g. scope, DVM and counter — with special emphasis on synergistic results.

- **BATTERY-POWERED INSTRUMENTS**

Circuit and packaging techniques used to achieve power efficiency, portability, ruggedness, small size and other desirable features.

- **SAFE INSTRUMENTS**

Design techniques to avoid hurting operator or damaging external equipment. Discussion of safety codes.

- **STANDARDS AND CALIBRATION**

A look at primary and secondary standards and stable transfer instruments for calibration. Questions the meaning of "traceable to NBS."

- **MEDICAL ELECTRONIC INSTRUMENTS**

Update on diagnostic and clinical instruments with emphasis on design problems rather than applications.

## **INSTRUMENTS '76**

A full-scale, full-staff report with emphasis on the incorporation of microprocessors in instruments and the new sophistication that is sweeping the instrument field. Watch for it November 22.

**IT'S ANOTHER REASON WHY ELECTRONIC DESIGN IS THE  
BEST READ ELECTRONICS PUBLICATION IN THE WORLD!**



# LED SUPERSTARS

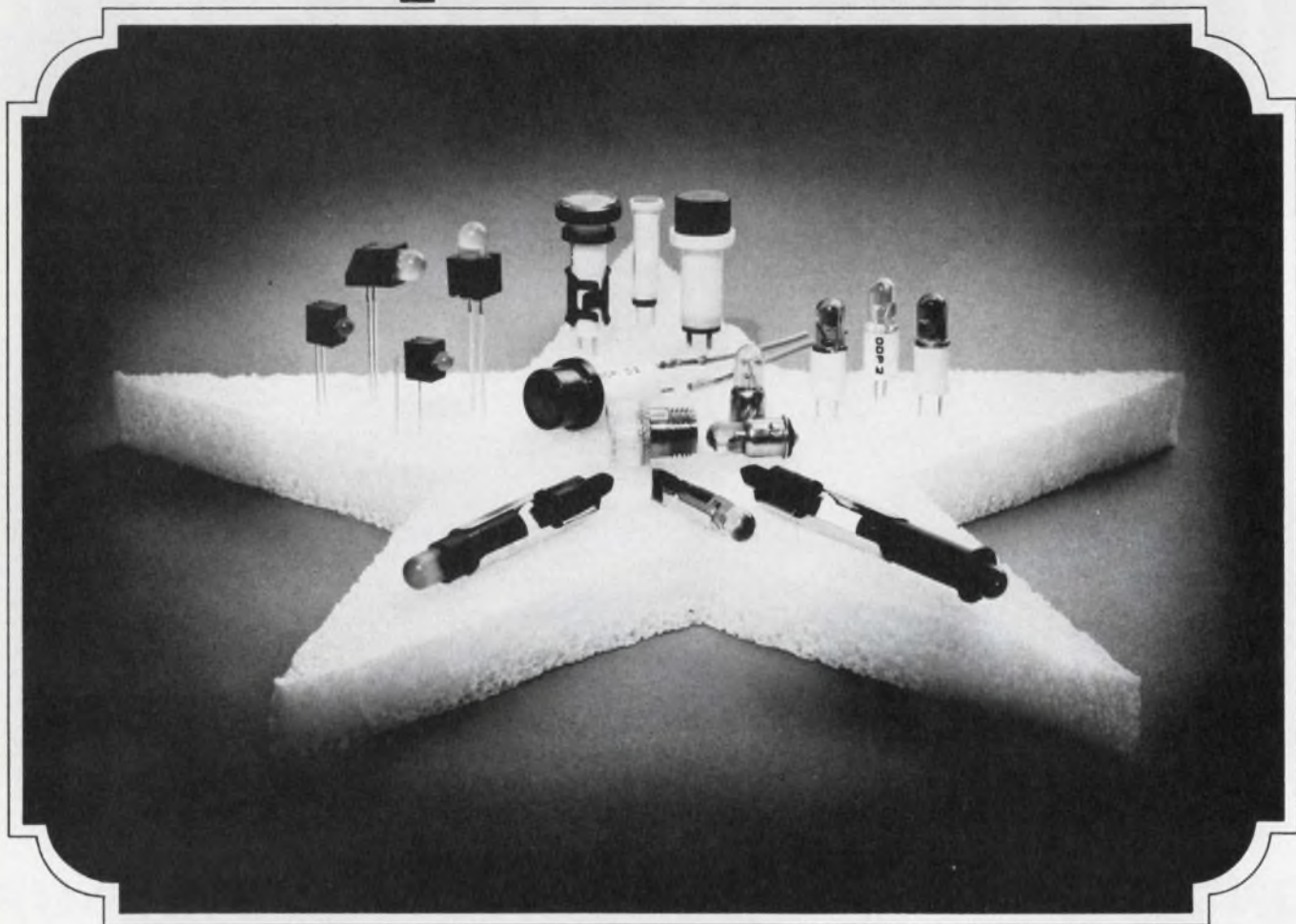

## As bright as many incandescents!

Meet the LED Superstars . . . red, amber and green superbright panel and PCB lights. Their high brightness 50 MCD @ 20 MA (typical clear red) make them the perfect cost and power saving replacements for incandescents. Available with built-in resistors for all popular voltages.

**Subminiature Panel LED's** (also suitable for PCB mounting)—available in hundreds of sizes, shapes and styles.

**PCB LED's**—Horizontal or vertical viewing . . . optional built-in resistor for 5V applications.

**Bi-Pin (T1-3/4) LED's**—Ideal for dead front panel applications, e.g. DEC's PDP Series computers.

**Midget-Flanged (T1-3/4) LED's**—Direct replacements for incandescents in panel light and switch applications.

**Replacement Lenses**—Specifically designed for use with Midget-Flanged LED's.

**Slide Base LED's**—Direct replacements for incandescent types.

There's lots more too, and they're all Superstars! Send for our Catalog today: Data Display Products, P.O. Box 91072, Los Angeles, Ca. 90009, (213) 641-1232.

Produced by the original "little light" people.

**DATA DISPLAY PRODUCTS**



# Washington Report

## U.S. British MLS proposals in a dead heat

An impasse looms over the selection of a standard international microwave landing system (MLS).

Five countries are in the running, but only two seem to have a chance for approval by the International Civil Aviation Organization (ICAO): Britain, with its doppler system, or the U.S. with its time-reference scanning beam (TRSB) microwave system. Australia, France and West Germany are expected to lose out.

Now, both the U.K. and the U.S. are talking about continuing with their own systems if the ICAO decision goes against them, according to recent testimony before a House subcommittee investigating the MLS imbroglio.

Multipathing problems have been discovered in the British doppler system during tests at Lincoln Laboratories, and the U.S. might not accept the system as the international standard unless the problem is corrected, said Jefferson Cochran, FAA's acting deputy administrator.

The British, on the other hand, have told Rep. Dale Milford (D-TX), chairman of the House Aviation and Transportation subcommittee on research and development, that if the American TRSB system wins out they will not accept it.

ICAO's All Weather Operations Panel Working Group A is due to meet in London Nov. 1 to evaluate the various MLS approaches and submit a recommendation to ICAO's Air Navigation Commission next February. The final decision is expected late next year.

Although the subcommittee is urging FAA to conduct further tests of the British system, the agency fears the tests will not be considered objective unless the British agree to participate in them—and the British have been reluctant to do so, according to Cochran.

## Japan comsat lead concerns EASCON panel

Japanese penetration of the global satellite communications market was the greatest concern voiced at a panel discussion at the recent EASCON meeting in Washington entitled "Is the U.S. Losing its Technical Leadership?"

The answer is yes, if satellite ground stations are any indication, according to Dr. Burt Edelson, director of Comsat Laboratories. He reported that Nippon Electric Co. had participated in the construction of more than half the 130 ground stations in the Intelsat system—and in 20% of the cases supplied the entire station.

Sidney Topol of Scientific-Atlanta, a major ground-station supplier, attributed the Japanese success more to superior marketing and financing than to technology. The U.S. still dominates the high-volume, ground-station markets, such as the 10, 11 and 12-meter antennas, said Topol, and has supplied virtually all shipboard terminals. Japan's dominates the large (30-meter) terminals.



The panel agreed, however, that Japan is establishing leadership in three critical growth areas: high speed digital techniques, low noise receivers and 14/12-GHz communication bands. Moreover, Edelson revealed, Comsat had to turn to a Japanese supplier for 30-GHz Impatt diodes, which Edelson described as "at the cutting edge of technology."

## **Navy eyes V/STOL as replacement for E-2C and S-3A**

The Navy has quietly put out feelers to the aerospace industry to come up with its best ideas for a new V/STOL multimission aircraft that can be operational for its fleet by 1990. The basic idea is to replace fixed-wing aircraft with V/STOL throughout the Navy. The first V/STOL family would replace Grumman's E-2C airborne early warning (AEW) aircraft and the Lockheed S-3A antisubmarine warfare (ASW) aircraft.

The major aerospace manufacturers have begun in-house studies even though the Navy will not formally request any proposals until next summer. In addition to Grumman and Lockheed, whose aircraft would be directly affected, Boeing, McDonnell Douglas, Rockwell and Vought have taken up the project.

At least 2000 aircraft would be procured beginning in the late 1980s, according to preliminary Navy estimates. Although the avionics requirements have not yet been defined, any new aircraft at that time would likely use the Navy standard airborne computer and joint Air Force-Navy electronic-warfare suite currently being developed.

## **Air Force plans new laser weapons tests**

The Air Force is apparently intensifying its interest in high energy laser (HEL) weapons.

Although the program is highly classified, two recent moves indicate the diversity of the Air Force interest. The Aero Propulsion Laboratory at Wright Patterson Air Force Base, OH, is launching a two-year study of the damage effects of laser weapons on aircraft fuel tanks. And the Armament Development and Test Center at Eglin Air Force Base, FL, is planning to buy some target flight vehicles specifically for HEL tests.

The Propulsion Lab studies will attempt to assess the effects of both continuous-wave (CW) and pulsed lasers on the fuel tanks. The flying targets will be built by Hayes International Corp. In the past, the Air Force has used surplus Army drone aircraft to demonstrate the effect of ground-based HEL weapons against flying targets.

**Capital Capsules:** Sanders Associates is building two prototypes of a warning system to be used on helicopters to detect optically directed weapons. The firm beat Hughes, Martin-Marietta and Westinghouse in a highly classified program sponsored by the Army Electronics Command's Electronic Warfare Laboratory. . . . TAI, a subsidiary of E-Systems at Falls Church, VA, is preparing a telecommunications plan for the republic of El Salvador. The study is due to be completed by the end of the year. . . . Westinghouse and the AIL Div. of Cutler Hammer have delivered their prototype tail warning radars to the Air Force's test range at Eglin Air Force Base, FL, for competitive tests on a B-52. One of the two companies is due to be selected next spring to supply production warning systems to the B-52 bomber and F-15 fighter.



# "As the first interactive small plotter, it was the only intelligent choice."

**Problem: Until now, no small plotter could carry on an intelligent conversation.**

Because most B-sized plotters have been pretty much the same: slow, unreliable, and dumb. Even with large off-line plotters you can wait hours, even days, for results . . . and if there's a mistake—start over.

**Solution: Tektronix' new microprocessor-based 4662. For interactive plotting, page scaling, digitizing, and camera-ready output. Just \$3995.†**

The 4662 is the first smart buy among 11"x17" flatbed plotters. Its digital design and vector generation offer exceptional accuracy and repeatability without drift or slidewire dirt build-up. Its 1600-byte buffer lets the host work while the 4662 plots . . . at speeds up to 22 ips.

**It's the first B-sized plotter with graphic input.** Digitizing capability and built-in joystick mean you can input corrections in seconds, experiment with designs, and run off camera-ready copies practically as fast as you load paper.

**It's plug-to-plug compatible with virtually any RS-232 system . . . from minis to mainframes.** You can plot circles around any other B-sized plotter, for about the same price as the competition. For a demonstration, call your local Tektronix Sales Engineer, or write:



The 4662 contains its own character generator, alpha rotation, and page scaling, thus minimizing support software. Proven graphic and plotter software is provided by Tektronix.

**Tektronix, Inc.**  
Information Display Group  
P.O. Box 500  
Beaverton, Oregon 97077  
**Tektronix Datatek NV**  
P.O. Box 159  
Badhoevedorp, The Netherlands



## The 4662. Plug it in. It speaks for itself.

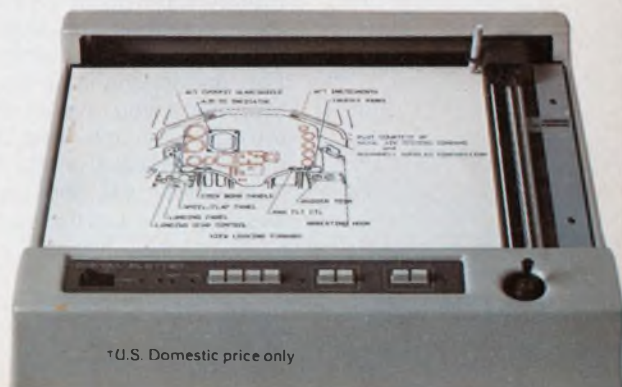



# Tektronix TM 500

## designed for configurability.

Collections of monolithic instruments assembled for a particular application often present a mind-boggling hodge-podge of interconnecting cables, instrument sizes and shapes, front panel nomenclatures, and questions of compatibility. Imagine, trying to get four or five separate units into the confines of a control console for troubleshooting.

**Tektronix TM 500 is the one full line of test and measurement instrumentation on the market today that is designed with plug-in modular instruments, mainframes, and accessories so you can configure your instruments mechanically and electrically to best fulfill your needs.**

While you can select TM 500 instruments as independent units, to work individually on the merits of their performance alone (just as you might a separate function generator, pulse generator, universal counter, or digital multimeter), **you gain unequalled capabilities when you select TM 500 for its unique design:** Bench-top mainframes for research and design labs. Rackmounting for production and quality control, or built-in test sets. Scope cart packages for time share or mobility through fixed equipment. And the Travel Lab mainframe lets you put the same instruments you use in the lab conveniently into field service. This is what we mean by mechanical configurability.

Plus . . . **TM 500 instruments can work together as powerful systems.**

As TM 500 plug-in modular instruments share a common power supply and main-frame enclosure, **they also share a common interface circuit board.** Inputs and outputs can be routed internally. Front-panel cable clutter can be reduced. Since compatibility is assured, instrument capabilities can be combined. For example, a trigger level from a universal counter can be displayed on a digital multimeter at the touch of an INT pushbutton. Or (what is most exciting) **signal parameters within the instruments, such as sweeps, ramps, or gate pulses, can be routed through the rear interfacing, so otherwise conventional TM 500 instruments can work together in ways as limitless as the vision of your imagination!** And this is what we mean by electrical configurability.

**Next time you evaluate instrumentation, include configurability.**

Tektronix, Inc. will introduce you to TM 500 instrumentation with a free catalog, application notes, and Field Engineer consultation. For further information circle the reader service number, write or call Tektronix, Inc., P.O. Box 500, Beaverton, Oregon 97077, (503) 644-0161 ext. 5283. In Europe write: Tektronix Limited, P.O. Box 36, St. Peter Port, Guernsey, Channel Islands.



**TEKTRONIX®**

committed to  
technical excellence



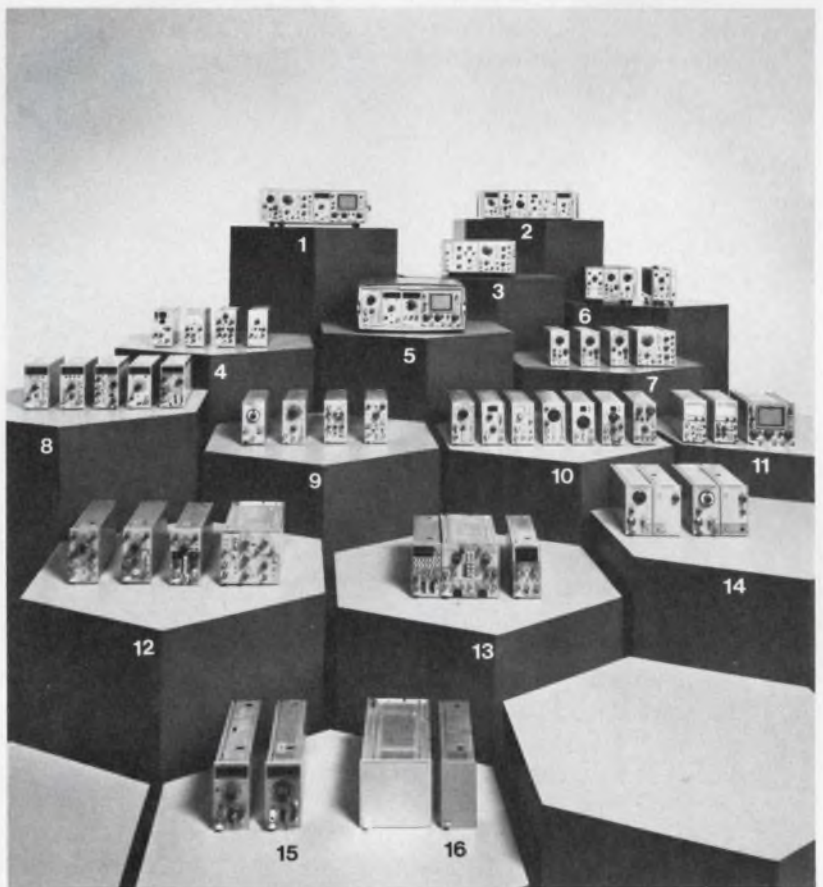
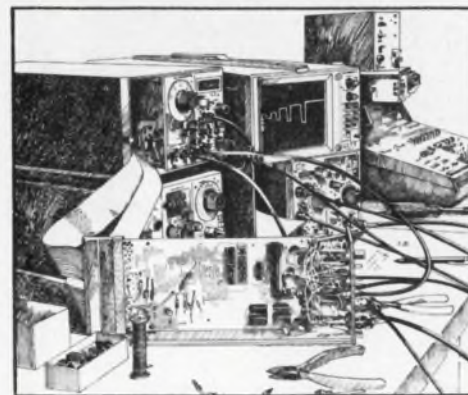
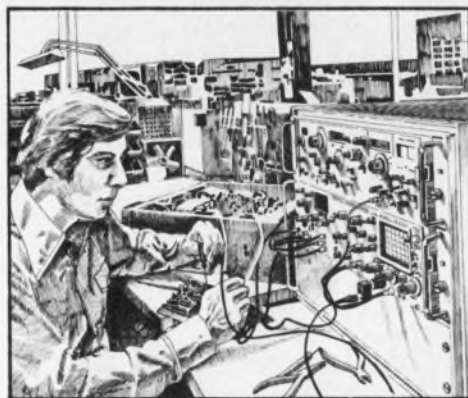

The TM 500 Family of Instrumentation

- 1. Bench-top mainframe holds up to 6 modular instruments.
- 2. Rackmounting mainframe for up to 6 modular instruments.
- 3. Bench-top mainframe (also mounts in TEK LAB CART MODEL 3) holds up to 4 modular instruments.
- 4. Plug-in modular power supplies.
- 5. Traveler mainframe — an "attache case" that powers up to 5 modular instruments.
- 6. Bench-top mainframes with 1 and 3 compartments.
- 7. Function generators.
- 8. Counters.
- 9. Amplifiers.
- 10. Sweep, calibration, and signal generators.
- 11. Oscilloscopes.
- 12. Pulse generators.
- 13. Logic analyzer and digital delay.
- 14. Tracking generators.
- 15. DMM's.
- 16. Blank plug-in kits.



# THE MIRACLE OF SILICON GULCH

In the beginning there was the Op Amp. And it was good. Unfortunately, it had high bias current and was slow. So, we created the LM108, with Super Beta. Super Beta reduced the high bias current. But it was still slow. So we developed the LM118. A beautiful thing, with feed-forward, large BW and slew. Well, that made it faster. But it left us with the bias current problem all over again.

Then a long silence enveloped the Op Amp world. Everyone waited. There was even some talk that linear was dead.

Months passed. Then, a wondrous event.

National succeeded in putting Bipolar and JFET together on a single chip.

Hallelujah!

The result is called BI-FET.

BI-FET is the first major new linear process in a decade. Easily the biggest thing to hit linear since the original Op Amp.

BI-FET has ion-implanted, ultra-matched, super fast, low noise and high voltage JFETS plus Bipolar, on the same chip. The best low input current, high speed, low noise, low drift combination ever.

And BI-FET features low offset voltage and offset voltage drift. Both coupled with offset adjust that doesn't degrade drift or common mode rejection.

The LF156 was designed for high slew rate, wide bandwidth and an incredibly fast setting time.

2mV maximum offset.  
5 $\mu$ V/C maximum drift.

10 pA maximum offset current and 50 pA maximum bias current.

100 Hz noise of .01 pA/ $\sqrt{\text{Hz}}$  and 15 nV/ $\sqrt{\text{Hz}}$ .

12V/ $\mu$  sec. slew rate.

5 MHz bandwidth.

The LF156 is the most accurate, high speed amplifier in the industry: 1.5 $\mu$  sec. settling time to 0.01%.



BI-FET

And, if that's not fast enough for you, why don't you try our LF157 Series.

Or for very low current drain there's nothing better than our LF155 Series.

Whichever one you choose BI-FET Op Amps pack a lot of performance in a small package, at low cost. Only \$2.50 in quantities of 100 and up for commercial TO-99.

BI-FET. Bipolar and JFET together, forever. Amen.

**NATIONAL SEMICONDUCTOR** 

National Semiconductor Corp., 2800 Semiconductor Drive, Santa Clara, Calif. 95051, Scotts Valley, Ariz. (602) 948-8473, Mountain View, Calif. (415) 961-4740, Sherman Oaks, Calif. (213) 783-8272, Torrance, Calif. (714) 932-8113, Miami, Fla. (305) 446-8800, Chicago, Ill. (312) 662-2900, Indianapolis, Ind. (317) 235-5822, Lenexa, Kan. (913) 336-8122, Glen Burnie, Md. (301) 763-5220, Burlington, Mass. (617) 271-1150, Farmington, Mich. (313) 472-3400, Minneapolis, Minn. (612) 855-4600, Englewood Cliffs, N.J. (201) 871-4410, Syracuse, N.Y. (315) 455-5858, Dayton, Ohio (513) 434-0397, Dallas, Tex. (214) 231-6800



# A miracle is a tough act to follow.

Matter of fact, with a thing as heavenly as our Bi-FET, it's almost impossible.

But not quite.

Now we've topped our old story a bit by coming up with some *new* Bi-FET products, to extend the range of Bi-FET's applications.

For one, the wondrous LF 13741 op amp. It replaces the 741 op amp when you need extremely low input current.

And other terrifically good stuff like the LF 13331 family of analog switches (with no latch-up or static blow out problems) and the LF 352 instrumentation amplifier (combining low input current and excellent linearity), and the LF 398 sample and hold amplifier (a delightfully pleasant combination of noise, acquisition time and price numbers).

And what they all have in common is that they're the least

expensive way to get the kind of performance they offer.

So, to our original Amen we can only add, Amen.

National Semiconductor  
2900 Semiconductor Drive, Santa Clara, CA 95051

Gentlemen:  
Please send me info on your new Bi-FET's.

NAME \_\_\_\_\_ TITLE \_\_\_\_\_

COMPANY \_\_\_\_\_

ADDRESS \_\_\_\_\_

CITY \_\_\_\_\_ STATE \_\_\_\_\_ ZIP \_\_\_\_\_

 **National Semiconductor**



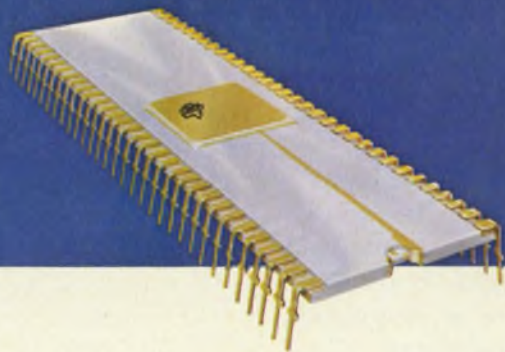
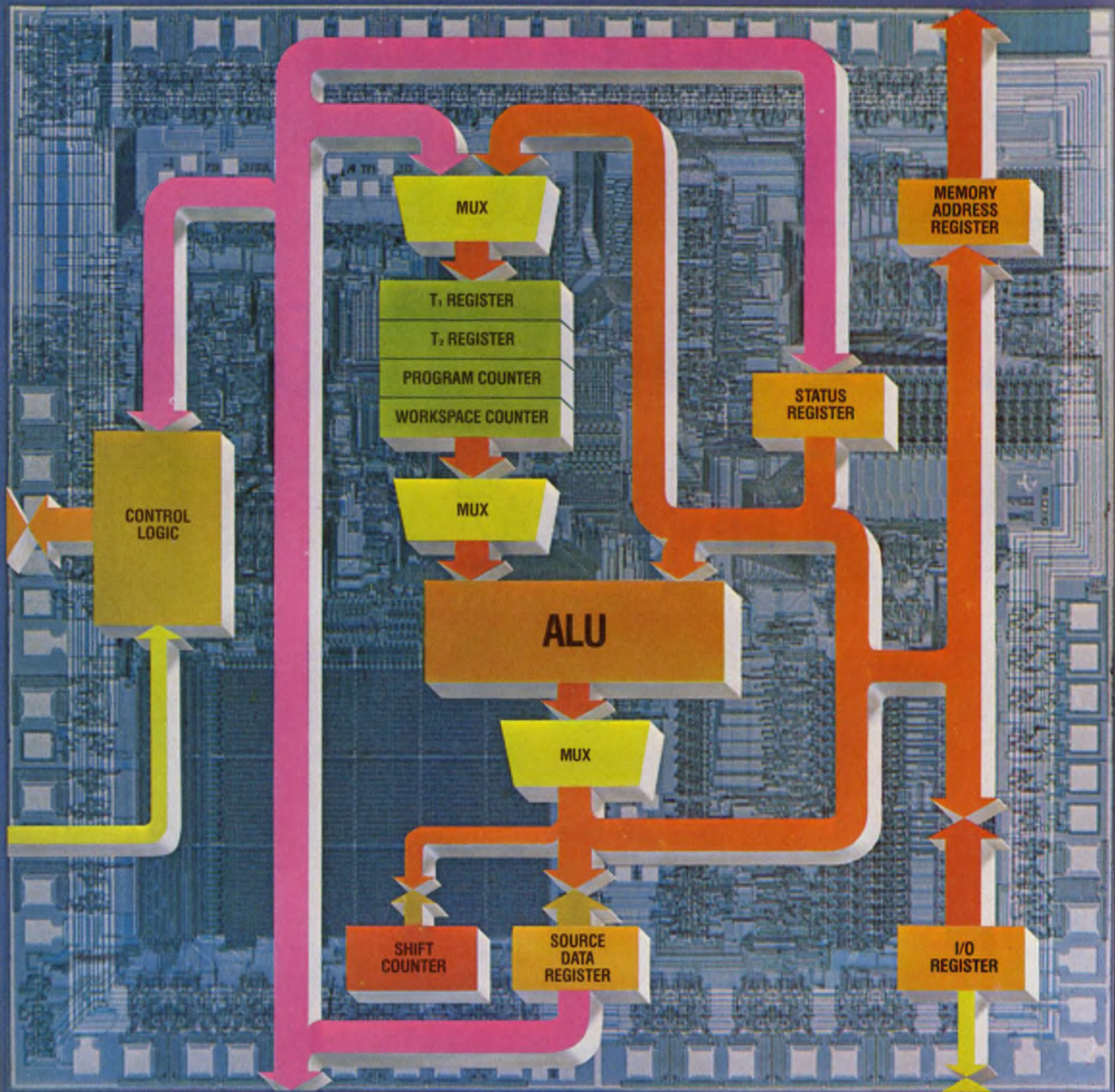

## FIRST FAMILY

*TI's new single-chip, 16-bit TMS9900 microprocessor is the frontrunner of a revolutionary new family. The first family of software-compatible microprocessors, support circuits, microcomputers and minicomputers. To give you unlimited design flexibility. A technological milestone achievable only by a leader in both integrated circuits and minicomputers.*



# Now, minicomputer performance from a 16-bit microprocessor: TI's new TMS9900. ...And it's only the beginning.

Unmatched. In word size. Instruction set. Addressing capabilities. TI's 16-bit TMS9900 microprocessor.

Powerful enough to be the heart of a minicomputer. Ideal for terminals. Instrumentation. Machine control. Scores of OEM applications. Destined to become today's and tomorrow's design standard.

Because the TMS9900 microprocessor represents more than just a single device. It introduces a new family concept allowing full design flexibility. Enabling you to move freely and easily over your entire range of applications. Now. And in the future. With less redesign. Less software reinvestment. Less re-learning. Less obsolescence.

**Improved System Cost/Performance**  
Compared to 8-bit  $\mu$ Ps, TI's TMS9900 microprocessor provides these unmatched savings:

- 30% faster execution time
- 50% saving in program coding
- 50% saving on system interface costs
- 50% more efficient interrupt handling
- 20% reduction in memory bit requirements

These benefits stem from the TMS9900's advanced features:

*16-bit instruction word* with full 16-bit data precision.

*Operation at 3.3 MHz clock rate.*

*Full minicomputer instruction set* including hardware multiply and divide.

*Advanced memory-to-memory architecture* that locates general-purpose register files in memory.

*Separate address, data, I/O and interrupt buses.*

### Complete Design Support

Hardware and software development tools are available to help you utilize the 9900. For evaluation and development work, there's the 990/4 board level microcomputer. In a desk-top chassis, the 990/4 serves as a fully supported prototyping system. And for larger software development, there's the 990/10 TTL minicomputer. All available now.

For design assistance, TI microprocessor applications specialists are located in 12 TI field sales offices.

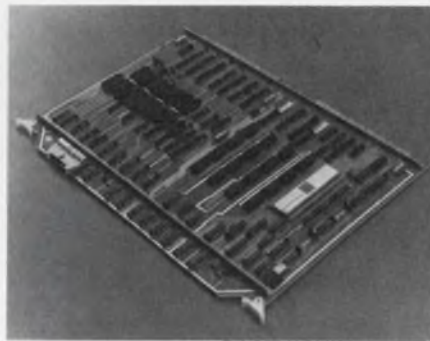

990/4 Board System

### Fully Compatible Software

The 9900/990 software has been tested and proven in more than 1000 systems. Any software you develop for the TMS9900 can be used with the 990/4 and 990/10 minicomputers — or the SBP9900 and TMS9980 microprocessors. In fact, any software developed for the TMS9900 can be used with any other family member — at present and in the future.



990/4 Prototyping System

### More 9900 Family Soon

The TMS9900 is just the beginning. Future family circuits, all software compatible: SBP9900, an I<sup>2</sup>L microprocessor designed to handle military temperature ranges. TMS9980, an N-channel  $\mu$ P with an 8-bit data bus for smaller systems.

Also coming are 9900 peripheral support circuits: TMS9901 programmable systems interface. TMS9902 asynchronous communication controller. TMS9903 synchronous communications controller. And the TIM9904 low power Schottky TTL 4-phase clock generator.

### Applications Workshops

TI distributors are sponsoring applications workshops in 36 locations across the nation beginning in November. For more information about the workshops, the 9900 First Family, or price and availability, contact your TI field sales office. Or write Texas Instruments Incorporated, P. O. Box 1443, M/S 669, Houston, Texas 77001.



**TEXAS INSTRUMENTS**  
INCORPORATED  
CIRCLE NUMBER 28



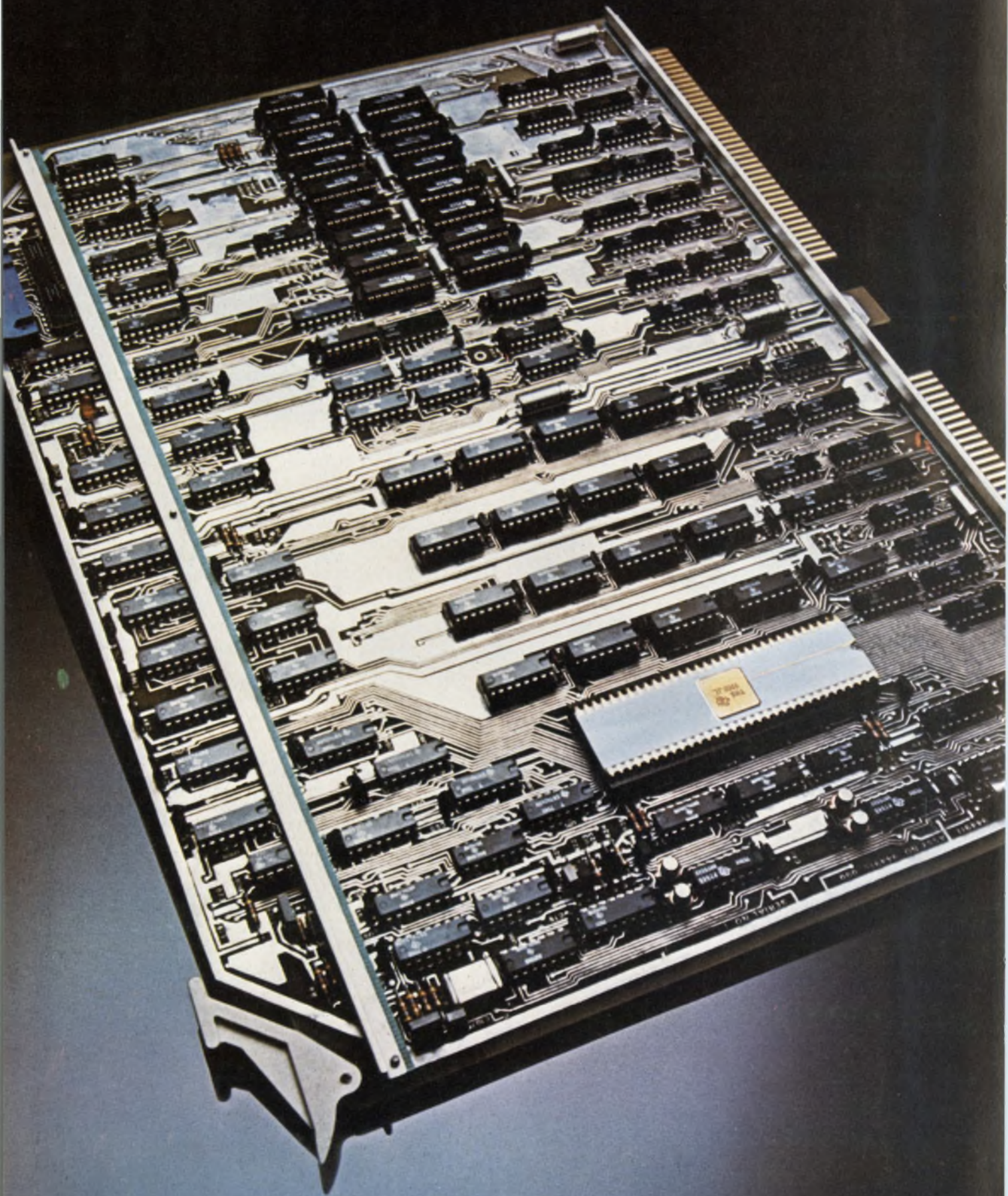



**When you're  
designing microprocessors  
into your products...  
our 990 computer products  
can give you a head start.**

# TEXAS INSTRUMENTS.

Start with the TMS 9900 microprocessor.

It delivers surprising power, speed and flexibility in a low-cost, single-chip 16-bit package. Its repertoire of versatile instructions and high-speed interrupt capabilities provide computing power usually associated with a 16-bit TTL minicomputer.

Hardware multiply and divide is standard and the software you develop for the TMS 9900 is upward compatible with any other member of the 990 computer family.

When your application calls for a microcomputer—start with the 990/4 microcomputer on a board.

It offers all the advantages of the TMS 9900, plus flexible memory and CPU options ideally suited to manufacturers' applications: up to 8K bytes of dynamic RAM memory, up to 2K bytes of RAM and/or PROM, real-time clock input, eight vectored interrupts, expansion interface and optional ROM utilities. It's our off-the-shelf answer for many production needs.

The 990/4 microcomputer is also available in a low-cost three-slot OEM chassis... or housed in a 6- or 13-slot rack-mount chassis with programmer's panel... or in a 6-slot



tabletop chassis. And, the 990/4 is available as a complete computer system supported by your choice of performance options and peripherals.

For applications requiring greater speed, we offer the most powerful member of the 990 computer family... the 990/10 minicomputer. It uses a TTL implementation of the 990 architecture and features TILINE\*, an asynchronous, high-speed 16-bit parallel I/O data bus which links the CPU, memory, and high-speed peripheral devices.



Rack-Mount 990 Computer

And to help you get on line faster and surer, there's a prototyping system using 990 computer hardware and software packages.

In addition, the 990 family is well supported by a substantial library of software development packages.

Whatever your needs... the TMS 9900 microprocessor, the 990/4 microcomputer, or the 990/10 minicomputer... you'll be working with some of the most attractive



990/9900 Prototyping System

computer component values on the OEM market. Price/performance leadership you expect from Texas Instruments.

You can start today by getting more information on the entire 990 computer family. Contact your nearest TI sales office, or phone (512) 258-5121, Computer Equipment Marketing, for your local distributor. Write Texas Instruments Incorporated, P.O. Box 1444, M/S 784, Houston, Texas 77001.



\*Trademark of Texas Instruments Incorporated

**TEXAS INSTRUMENTS**  
INCORPORATED

CIRCLE NUMBER 29



# FREE

292 PAGES

# Designer's Handbook

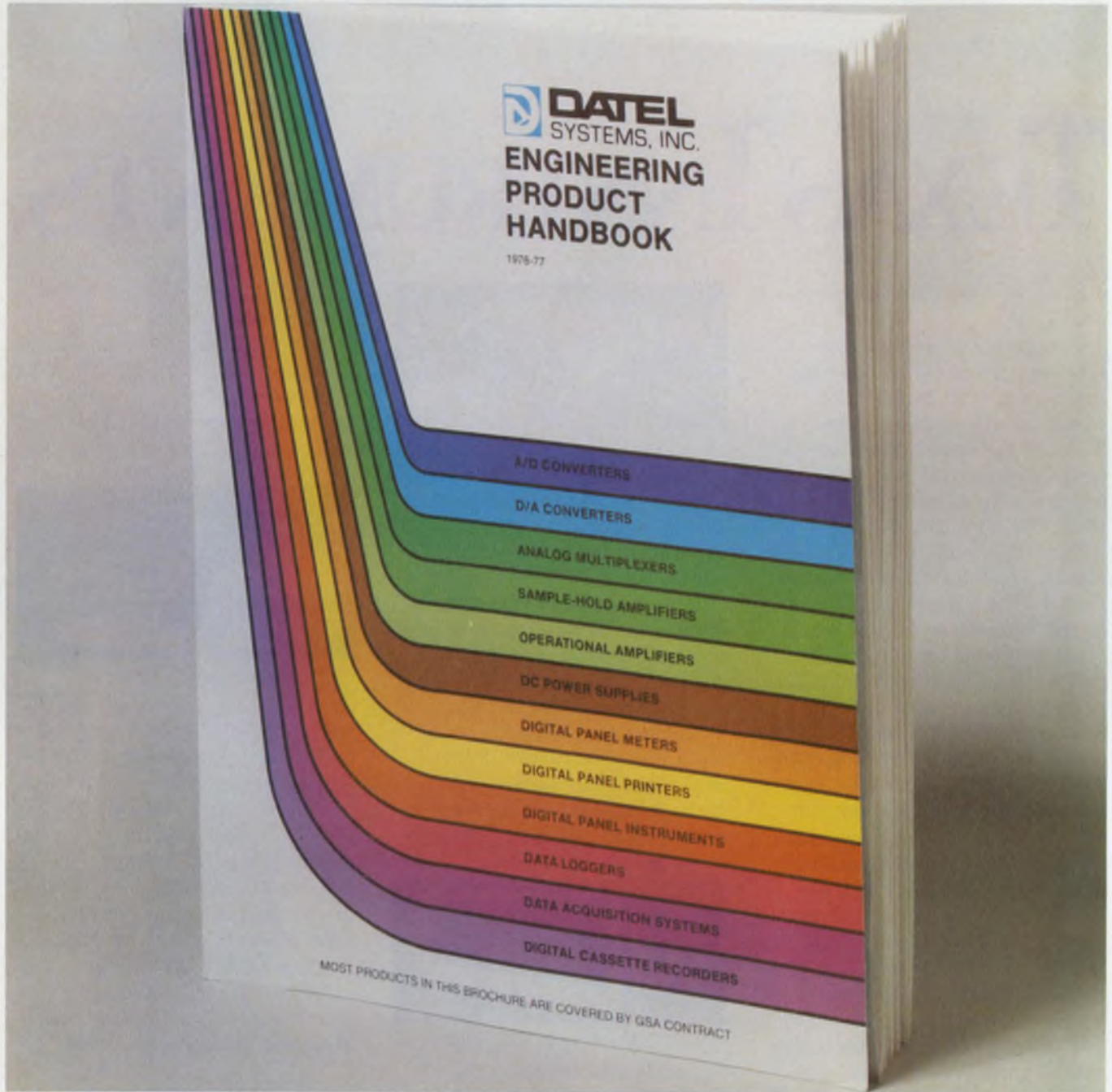

1020 Turnpike St., Canton, Ma 02021 • Phone (617) 828-8000  
• Santa Ana, Calif. (714) 835-2751 • Santa Ana (L. A. Exchange) (213) 933-7256  
• Sunnyvale, Calif. (408) 733-2424 • Gaithersburg, Md. (301) 840-9490

#### FRANCE SUBSIDIARY

**DATEL SYSTEMS SARL**  
11 Avenue Ferdinand Buisson  
75016 Paris France  
Tel 603-06-74  
Telex (842)204280

#### JAPAN SUBSIDIARY

**DATEL KK**  
Kobayashi Building  
3-26-3 Higashi  
Shibuya-ku Tokyo 150  
Tel Tokyo 499-0631  
Telex 2422389  
Yachiyo Bldg Higashikan  
33 Daikuchō  
Kita-Ku Osaka 530  
Tel (06) 354-2025

#### UNITED KINGDOM SUBSIDIARY

**DATEL (U.K.) LTD.**  
Sealine House  
Priestley Road  
Basingstoke  
Hampshire RG-24 9NT U.K.  
Tel Basingstoke (0256) 66721  
Telex (651)858845

#### WEST GERMANY SUBSIDIARY

**DATELEK SYSTEMS GmbH**  
8 MUENCHEN 71  
BECKER-GUNDAHLSTRASSE 1  
Postlf 71-03-04  
Tel (089) 78-40-45  
Telex 5212855

CIRCLE NUMBER 30



## The man who couldn't let go

Nobody knew power-supplies better than Joe did. So it was no surprise when he started his own power-supply company. His early success didn't surprise anybody either. After all he knew the markets; he knew the customers; and he knew everything about power-supply design and manufacture.

Joe knew a lot about running a business too. So in addition to serving as chief engineer, he served as sales manager, production manager, purchasing manager, controller and personnel director. When his staff comprised some twenty souls and the customer list wasn't much bigger, this was a real advantage. All the senior people knew what all the other senior people were doing since they were all Joe. And business grew.

In time, Joe saw that he couldn't multiplex himself adequately and there weren't enough hours in the day nor days in the week to get everything done. He needed more senior people. No problem. He hired more.

Then the problems began. Joe saw he knew more than any of his hired managers. So he spent most of his time teaching the chief engineer how to design; teaching the sales manager how to sell; teaching the purchasing manager how to buy; teaching the controller how to keep books and manage cash flow; and teaching the personnel director how to hire. It wasn't long before Joe was doing lots of hiring himself because he kept losing chief engineers and managers of production, purchasing, finance and personnel.

Joe's company began to stagnate. He couldn't find good senior people who could accept the idea that only he knew their jobs. And so he settled for weaker executives who did just what he told them to do. He had people with the titles he used to carry himself, but they lacked the authority.

Joe dreams now and then of seeing renewed growth in his company. If only he could find some strong executives—people who knew as much as he did about engineering, sales, production and everything else. Unfortunately things are getting tougher. Many of the executives who left Joe's company are working with other companies whose presidents aren't smart enough to know everything. They are giving Joe one hell of a rough time.



RECOGNIZED BY  
AMERICAN REVOLUTION  
BICENTENNIAL  
ADMINISTRATION

ELECTRONIC DESIGN is deeply honored to have received official recognition as a participant in the American Revolution Bicentennial Celebration, with authority to display the Bicentennial Symbol.

A handwritten signature in dark ink, which appears to read "George Rostky". The signature is fluid and cursive.

GEORGE ROSTKY  
Editor-in-Chief



**We not only wrote the book,**

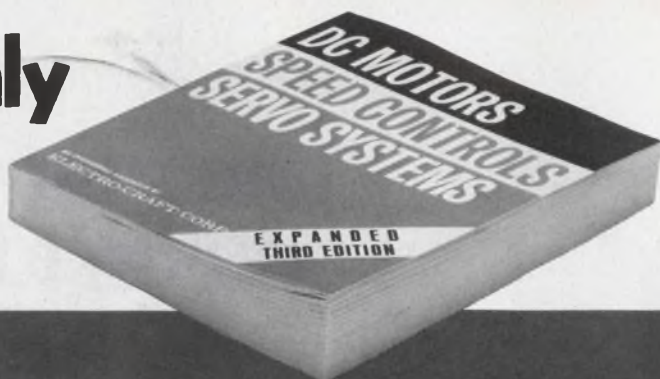

**SPEED CONTROLS**

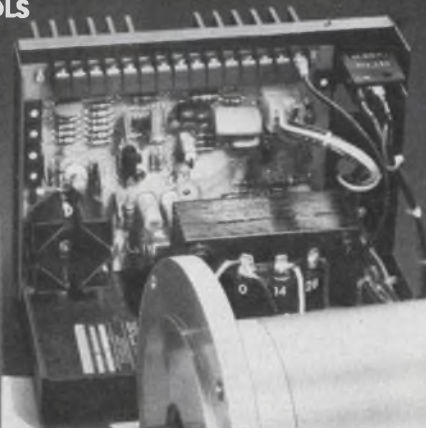
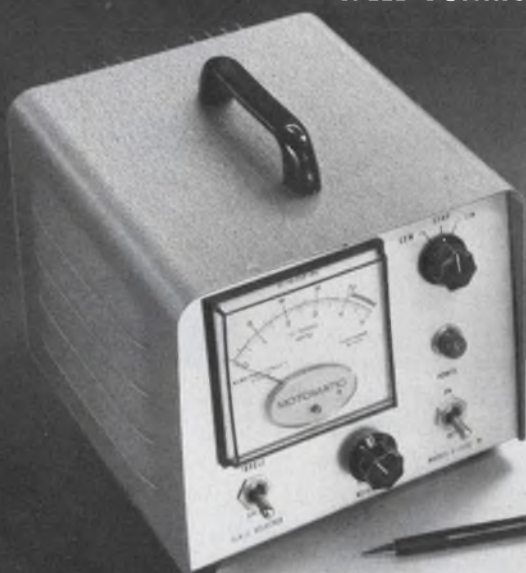

**DC MOTORS**

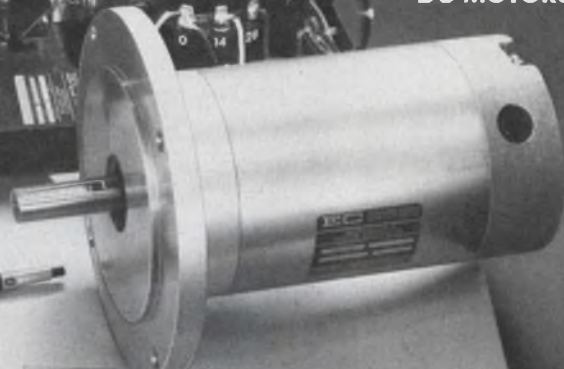

**SERVO SYSTEMS**

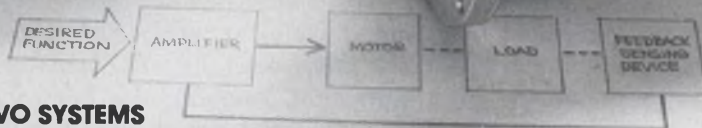

## **we make the products, too.**

The "bible" of the industry. Over 35,000 now out in use. In its third edition. And Electro-Craft wrote the book.

That's expertise. And our products reflect it. Over 100 different products. And 300 different applications that we know of for sure. We stake our reputation on every product. A reputation earned by 16 years of innovation, reliability and integrity. That's a lot of years of experience in a

young dynamic industry like ours.

You can put this expertise to work for you. In custom designs or off-the-shelf standards. One unit or thousands. You get our service both ways. Just give us a call at (612) 935-8226.

If by chance you don't have the Electro-Craft Handbook shown here, a \$10.00 value, just send us your business card and \$1.00 to cover handling and postage. (Overseas \$5.00)



**ELECTRO-CRAFT CORPORATION**

1600 Second Street South, Hopkins, Minn. 55343 • Tel. (612) 935-8226

CIRCLE NUMBER 31





**COMING ATTRACTIONS  
4K STATIC RAMS  
DOWN TO 100NS.**

## They're gonna make you a star.

In just a very short while, we'll be giving static RAM users the same thing we've already given dynamic RAM users.

The fastest MOS device on the market.

Using the same super technology that gave you the world's first 150ns 4K dynamic RAM, we'll soon be giving you the  $\mu$ PD410 series of 4K static RAMs with speeds down to 100ns.

So right now you can start

designing products where that kind of speed at that kind of density can really help make you a star.

For your present applications, we'll also have slower versions you'll want to use right away.

In addition to access times down to 100ns, our n-channel silicon gate 4K x 1 static RAMs will also feature cycle times down to 200ns, 12  $\mu$ W/bit maximum standby power, three-state output, proven cross-coupled Flip-

Flop storage cell structure to eliminate soft errors and the need for refresh circuitry.

And they'll be pin compatible with the industry standard 22-pin dynamic part.

The  $\mu$ PD410 series of 4K static RAMS.

For people into terminals, add-on memories, mainframes, and minis, it's quite a coming attraction.

NEC Microcomputers, Inc.,  
Five Militia Drive, Lexington,  
MA 02173. 617-862-6410.

### NEC microcomputers, inc.

(Data sheets now at reps and distributors.)

REPS: East—C & D Sales 301-296-4306, Contact Sales 617-273-1520, Trionic Assoc. 516-466-2300; South—Merino Sales 214-233-6002, Perrott Assoc. 305-792-2211, 305-275-1132, 813-585-3327, Wolffs Sales Serv. 919-781-0164; Midwest—K-MAR Eng. & Sales 816-763-5385, McFadden Sales 614-221-3363, R.C. Nordstrom 313-559-7373, 616-429-8560, R.F. Specialists 312-698-2044; West—Mike Duffy Assoc. 303-934-7392, Electronic Component Marketing 714-524-9899, 714-295-6122, 213-340-1745, Summit Sales 602-994-4587, Trident Assoc. 408-734-5900, Tri-Tronix 505-265-8409, 206-454-0940; Canada—R.F.Q. Ltd. 416-626-1445, 514-626-8324 DISTRIBUTORS: Century Electronics, Diplomat (Chicopee Falls, Woodbury, Mount Laurel, Little Falls, Newport Beach, Clearwater, Dayton, Elk Grove Village, Farmington, Minneapolis, St. Louis, Salt Lake City, Sunnyvale), G. S. Marshall (Sunnyvale), Harvey Electronics (Lexington, Norwalk, Woodbury, Fairfield), Intermark (Santa Ana, San Diego, Sunnyvale, Seattle), Lionex Corporation, Mirco Electronics, R-M Electronics, Semiconductor Specialists, Technico.



# **Allen-Bradley Trimmers:**

**We have what  
you need.**

**Our distributors have  
them when your  
need is now.**





## CERMET TRIMMERS



**Type A:** 1/4" diameter, single turn, 10 ohms to 2 megs  $\pm 10\%$ , 0.5W at 85°C, immersion sealed, 3 terminal options, Publication 5238. **1000 piece price \$1.12 to 1.68.**



**Type S:** 3/8" dia., single turn, 50 ohms to 1 meg  $\pm 10\%$ , 0.5W at 85°C, immersion sealed, top or side adjust, Publication 5208. **1000 piece price \$1.15 or 1.40.**



**Type E:** 3/8" square, single turn, 10 ohms to 2 megs  $\pm 10\%$ , 0.5W at 70°C, immersion sealed, 13 terminal options, Publication 5219. **1000 piece price \$0.49.**



**Type D:** 3/8" diameter, single turn, 10 ohms to 2 megs  $\pm 20\%$ , 0.5W at 70°C, dust cover, 6 terminal options, Publication 5240. **1000 piece price \$0.42.**



**Type 90:** Approx. 7/16" square, single turn, 100 ohms to 2 megs  $\pm 20\%$ , 0.5W at 70°C, open frame, 2 terminal options, Publication 5242. **1000 piece price \$0.55.**



**Type MT:** 3/8" square, 20 turn, 10 ohms to 2 megs  $\pm 10\%$ , 0.5W at 70°C, immersion sealed, 3 terminal options, Publication 5241. **1000 piece price \$1.18.**



**Type RT:** 3/4" long, 20 turn, 10 ohms to 2 megs  $\pm 10\%$ , 0.75W at 70°C, immersion sealed, 3 terminal options, Publication 5237. **1000 piece price \$0.65 or 0.93.**

## CARBON COMPOSITION TRIMMERS



**Type Y:** 1/2" dia., single turn, 100 ohms to 5 megs  $\pm 10\%$  or 20%, 0.25W at 50°C, dust/splash resistant, 5 styles, non-linear tapers, Pub. 5209. **1000 piece price \$0.90 to 1.59.**



**Type F:** 1/2" dia., single turn, 100 ohms to 5 megs  $\pm 10\%$  or 20%, 0.25W at 70°C, immersion sealed, 6 styles, non-linear tapers, Pub. 5234. **1000 piece price \$1.00 to 1.62.**



**Type O:** 1/2" dia., single turn, 100 ohms to 5 megs  $\pm 10\%$  or 20%, 0.40W at 70°C, immersion sealed, 4 styles, non-linear tapers, Pub. 5235. **1000 piece price \$1.20 to 1.58.**



**Type FD:** 1/2" dia., 2 sec., 1 turn, 100 ohms to 5 megs  $\pm 10\%$  or 20%, 0.25W at 70°C, immersion sealed, 4 styles, 5 tapers, 2 atten. Pub. 5231. **1000 piece price \$2.65 to 4.10.**



**Type BT:** 1/2" dia., 2 section, 1 turn, for 75 ohm Bridged-T pad applications, dust/splash resistant, side and top adjust versions, Pub. 5236. **1000 piece price \$2.49.**



**Type N:** 1 1/4" long, 25 turn, 100 ohms to 2.5 megs  $\pm 10\%$  or 20%, 0.33W at 50°C, immersion sealed, Publication 5206. **1000 piece price \$2.50 or 2.65.**



**Type R:** 1 1/4" long, 25 turn, 100 ohms to 2.5 megs  $\pm 10\%$  or 20%, 0.25W at 70°C, immersion sealed, bushing mount option, Pub. 5205. **1000 piece price \$2.87 to 3.73.**

# Quality in the best tradition.



## ALLEN-BRADLEY

Milwaukee, Wisconsin 53204

CIRCLE NUMBER 191

EC120

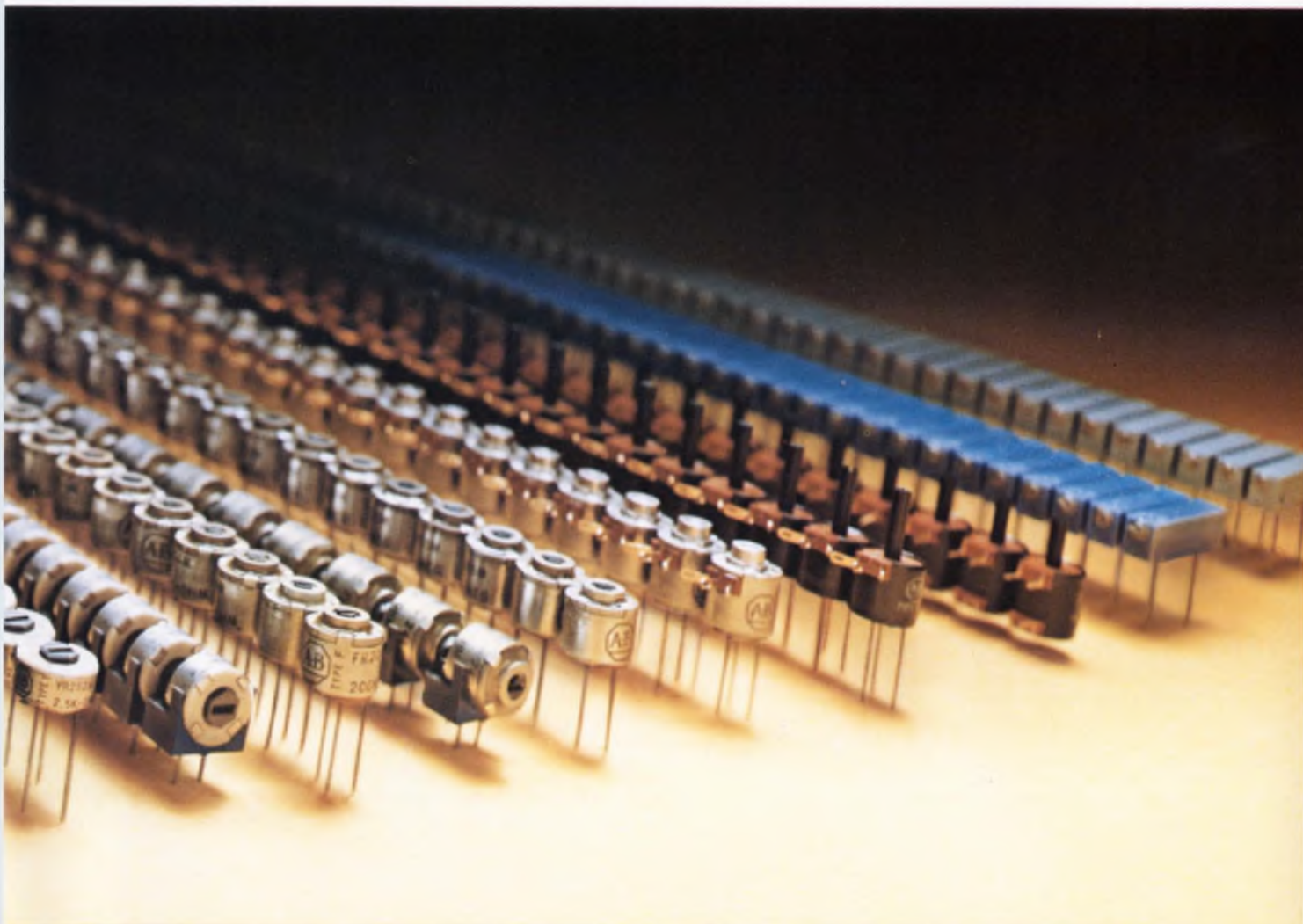



# Touch & Trigger

## Automatic displays to 25 MHz at 2 mV

As illustrated, the PM 3212 has an impressive combination of features that add up to unbeatable all-round performance.

Bandwidth, sensitivity, triggering facilities, weight and dimensions are all what you need and what you might expect for this price class.

*"Auto" triggering on the PM 3212 is more than a trace finder - much more. In this mode not only is a zero line displayed when there is no input signal, but in the presence of a signal the trigger level is derived from the peak-to-peak amplitude of the signal. This gives instant and unambiguous triggering for a wide variety of measurement conditions.*

But we give you more. A brighter trace, a sharper display, a double insulated supply, battery operation and versatile X-Y facilities. And the usual Philips plus: the unbeatable front panel layout.

For further details contact, Philips Test & Measuring Instruments, Inc.

*High light output displays through 10 kV tube  
Small spot size  
Continuously variable illumination of fine-line internal graticule*

*Continuously variable timebase for easier measurements of phase, for timing comparisons and to avoid "double writing" problems in digital applications*

*Composite triggering when both buttons are depressed. When used in the alternate mode this gives a stable display of two unrelated signals*

*DC coupled triggering without which variable duty cycle waveforms cannot be handled. This is a vital feature for digital measurements.*

*Automatic TV triggering at the touch of a button. Frame triggering occurs in the lower sweep speeds, changing over automatically to line from 200  $\mu$ s/div upwards.*

*Level control can be used instead of "Auto" when the instrument needs to be triggered at an exact point in the input signal.*

*PM 3212 has compact dimensions of 445 x 300 x 145 mm (l x w x h). Weight approx. 7.9 kg (17.4 lb)*

*Double-insulated power supply eliminates need for earth connection (i.e. 2-wire line cord).*

*Any of the selected trigger sources can be switched to the horizontal channel.*

*Separate source triggering for unambiguous, stable displays without the inconvenience of changing probes.*

*Carrying handle automatically protects crt and controls.*

Philips Test & Measuring Instruments, Inc.

A NORTH AMERICAN PHILIPS COMPANY

In the United States:  
400 Crossways Park Drive  
Woodbury, N.Y. 11797  
Tel: (516) 921-8880

In Canada:  
6 Leswyn Road  
Toronto, Ontario Canada M6A 1K2  
Tel: (416) 789-7188

Toll-free HOT LINE number 800 645-3043  
N.Y.S. residents call (516) 921-8880 collect



Test & Measuring  
Instruments

# PHILIPS



# our 2-piece pc connectors use just 1 contact.



Elco has a habit of coming up with innovations in connector design. And Varicon™ contacts prove the point once more. This unique, spring-action mutually embracing, hermetic contact has logged millions of operating hours and continues to be the most reliable and trusted contact available, bar none.



Used in both the receptacle and the plug, Varicon's mating surfaces are gas-tight for protection against corrosion. The design itself, provides low contact resistance which provides high current capacity. And the Varicon contact's interlocking design makes it highly resistant to shock and vibration.



You just can't find 2-piece connectors more reliable than Elco's single-contact Varicon designs. You won't find a greater selection either.

Elco makes 2-piece connectors for 1/16" and 3/32" thick P.C. cards with from 18 to 165 contacts or more, all using a single Varicon contact. They're priced competitively and available off-the-shelf.

We'll fill your order fast. So get your 2-piece connector with just 1 contact, now.

"GREAT CONNECTIONS... WORLDWIDE"

Elco Corporation  
2250 Park Place, El Segundo, Ca. 90245  
213-675-3311 / TWX 910-325-6602



**Elco Corporation**

A GULF • WESTERN MANUFACTURING COMPANY



Computer '76

# New applications



Trans World Airlines computer reservation system runs on an IBM System/370 Model 168.



# challenge the designer

It's become a real challenge these days for both the computer designer and user to keep up with the pace of new developments and applications in both hardware and software.

Microprocessors and microcomputers are not only lowering the cost and improving the performance of existing consumer products, such as sewing machines and ovens, but they have also created a host of new products, including TV games, self-service gas-pumping systems and police and public-safety scanners.

In the industrial area, both minis and micros are increasing hardware intelligence. Computer numerically controlled (CNC) machine-tool systems are rapidly replacing direct numerical control equipment. The reason? CNC hardware is cheaper and more flexible.

Minis and micros are also controlling ongoing processes in distributed systems in such facilities as hydroelectric projects and aluminum-refining plants.

In the transportation field, all types of com-

puters, from micros to maxis, are having an increasing impact. A microprocessor regulates the spark timing in the 1977 Oldsmobile Toronado, while Chrysler's Lean-Burn engine system will be controlled by a  $\mu$ P in the 1979 models. The new Metro subway system in Washington, DC, is operated by an Automatic Train Control System directed by two Xerox Sigma-5 computers.

The 13-mile Airtrans system at Dallas-Ft. Worth Airport—one of the most automated airport ground-transportation systems—is controlled and supervised by a hierarchy of computers.

For years, the medium-sized digital computer has been the mainstay of military avionics subsystems, such as radar, navigation-weapons delivery and electronic countermeasures. But now minicomputers and microprocessors, with their increased speed and reasonable price tag, have provided subsystems with their own processor.

For these and other developments turn to the pages of this special section.

## Contents

<b>Consumer electronics—</b>	
Thanks to $\mu$ Ps, the trend is to lower cost and improved performance .....	52
<b>Industrial electronics—</b>	
In all areas the hardware is becoming ever more intelligent .....	60
<b>Transportation—</b>	
Computers are everywhere—in cars, trucks, trains and even traffic control .....	66
<b>Military and aerospace—</b>	
In avionics, distributed processing has become a way of life .....	74
<b>An interview with Grace Hopper—</b> The grand lady of software .....	82



## Consumer electronics

# Thanks to $\mu$ Ps, the trend is to lower cost and improved performance

**A** growing emphasis in consumer electronics design is on the use of microcontrollers, microprocessors and microcomputers to obtain better performance, lower cost and other previously unattainable advantages in consumer products. Examples of consumer applications with features previously infeasible due to budget and technology limitations include the following:

- The Athena 2000 electronic sewing machine by Singer, which has a dedicated microcontroller whose use results in the elimination of about half the 700 parts associated with the mechanical version of the machine.

- Chips incorporated in the latest microwave ovens from Amana, Litton and Magic Chef, which give programming capabilities in both the timing and heat-level settings and permit the use of touch-panel controls.

- A single-crystal, microprocessor-controlled police and public safety scanner by Tennelec, which can scan up to 12,000 vhf and uhf channels on command. The best all-crystal-controlled units scan 16.

- Microcomputer-controlled, self-service gas-pumping systems by Bennett Pump Co., which can do extensive bookkeeping and data processing

as well as provide pump control comparable to that of the most competitive solid-state systems.

- The recently developed, microcomputer-controlled, interactive programmable TV games as well as the growing number of personal microprocessor-based computers built from hobby kits, which forecast a revolution in home entertainment and education.

### Microcontroller for the Athena

The first and only sewing machine, to use a microcontroller, Singer's Athena 2000 is considered (by Singer, at least) not only the easiest to operate but also the most foolproof machine capable of complex stitching. By simply touching a control button, the user can select any one of 24 different functional and decorative stitching patterns stored in a 6-k bit ROM.

The ROM is on the same PMOS custom chip by American Microsystems that has the control

logic and I/O circuitry to provide controlling signals to two linear servos—essentially, voice coils moving over a speaker magnet. One servo moves the needle left and right while the other controls the back-and-forth movement of the fabric-feed system.

Even though about half the usual 700 cams and gears in a sewing machine are eliminated in the 2000 by the microcontroller, the cost remains about the same because of the higher cost of the electronics. Nonetheless designers feel that the increased ease in use and the simplified maintenance make the big difference.

### The microwave oven race is on

Manufacturing microwave ovens that use microprocessors and microcomputers to control cooking periods and heat-level cycles has become a three-way race involving Amana, which came out with the first Touchmatic oven, the RR-6, in July, 1975; Litton, which unveiled its version in July, 1976; and Magic Chef, which revealed the most advanced processor model this past August.

The Amana oven's control package, developed by Essex International, contains four basic elements: a touch plate—instead of pushbuttons—for oven control; a four-digit LED display, a custom microprocessor/computer; and a PC board with I/O interface circuits.





The world's first microcontroller-operated sewing machine, Singer's Athena 2000, has 24 stitching designs

Cooking, timing and operating functions are controlled by a chip that contains a CPU, a ROM, a RAM and I/O circuitry. The chip is programmed to provide a single defrost, rest (power off) and cook cycle.

Litton, using a calculator chip by Mostek, has added to the programming complexity by providing two programmable options, including an in-

finite variety of heat levels. Litton selected Mostek's calculator chip because its architecture readily interfaces with a Touchplate keyboard and LED displays. Litton rejected the use of general-purpose microprocessors, for example, the F-8, because of the added expense in design and software to provide calculator-chip type interfacing.

Magic Chef, using a TMS 1000 microprocessor chip from Texas Instruments, has increased the programming complexity by including three independent programmed memories that enable the oven user to input three sets of independent instructions. Each programmed cooking function has 10 heat settings. In addition, the output of an oven thermometer can be fed to the processor as a separate means of heat control.

Magic Chef selected the TMS 1000 because it cost less than having a dedicated custom processor designed and produced.

Interference stymied

#### Interference stymied

Microprocessor clocks produce RFI and, when incorporated in a sensitive receiver, pose tough design problems. These problems have been licked in the development of a new 0.5- $\mu$ V, 12,000-channel vhf and uhf automatic scanner, Tennelec's Memoryscan MCP-1.

The Oak Ridge, TN, company's scanner uses



This self-service gasoline-station dispenser control system, by Bennett Pump Co., is an 8008A-based microcomputer that services a three-hose station module.



a Rockwell PPS-4/2 to search for stations on the police, fire, weather, marine and business bands. The  $\mu\text{P}$  controls a phase-locked loop synthesizer that in turn produces the searching local-oscillator signal. The processor also coordinates the numbers on a six-digit LED display with the frequencies being scanned.

"We had to isolate the microprocessor against RFI through the use of feed-throughs, filters and shielding," says William Baker, Tennelec's chief engineer. "Without the RFI-proofing, the receiver would have to be desensitized, or excessive spurious responses would occur—an undesirable situation."

It was also necessary to isolate the dc control lines between the processor and the synthesizer to provide a pure oscillator output. Any noise on the control line to the VCO would modulate the synthesizer.

A principal advantage of using the  $\mu\text{P}$ , according to Baker, is that design changes that ordinarily involve changes in hardware now only require a change in the system software—a new ROM.

All operator commands in the MCP-1 are inserted through a front-panel, calculator-like keyboard. Upon command, the processor automatically searches over a 10-MHz bandwidth within the following bands: 33.1 to 45 MHz, 151.180 to 163 MHz, and 453 to 460 MHz. Up to 16 arbitrarily assigned channels can be stored.

"We interrogate our keyboard in software," Baker notes. "We strobe the keyboard and look for key-down return signals. At the same time, the same strobes interrogate the six-digit LED display.

"When a special-function key is operated—for example, to insert a desired search frequency—a lot of things go on in the processor. First, it reads the number in the display because that's the frequency to which the receiver is tuned.

"The  $\mu\text{P}$  tests to find out what those numbers represent, at the same time inspecting the number to determine which band is being selected. Then it does an error check to make sure that the band selected is a valid one; and it finally tucks this information into memory.

"Then it takes the rest of the numbers that are displayed and computes from that a unique binary code that represents that specific frequency within the selected band—and stuffs the code into memory. The data are all outputted to drive the receiver to the desired frequency.

"Then, as a further error check, the processor goes back and reverses the processes. It looks at the binary code in memory, then recomputes the band and the frequency within the band and displays that. So there is no way we can get a mistake between the keyboard and the memory. Whatever is displayed is really what's contained



Terminals of Control Data's Plato university education system are designed around human interface requirements. A touch panel gives users access to the system.

in the memory."

The next major development at Tennelec is a 40-channel,  $\mu\text{P}$ -controlled CB transceiver, a first for the industry.

#### Now it pumps gas

Making a microcomputer operate like a different system by simply changing the ROMs containing the software has proved valuable in the design of the first generation of  $\mu\text{P}$ -controlled gasoline dispensing systems for self-service gas stations.

The Bennett Pump Co., Muskegon, MI, has just introduced a "Gentle Benn" microcomputer-controlled system capable of handling 12 gas pumps as well as the totalling and billing via a CRT terminal in the operator's station. In addition, Bennett is selling three variations of "Baby Benn," a scaled-down system capable of handling three pumps by means of an operator's control station no bigger than a desk-top calculator. The "baby" uses LED readouts for keeping track of sales.

These gasoline systems were designed for Bennett by Process Computer Control, Flint, MI. "For all of these systems, we've designed one main computer circuit board that looks like five different dispensing control systems simply by changing the software chips," says R. H. Mendelsohn, Process Computer's project manager for gasoline dispensing systems. "Two or three years ago, without the microprocessor technology, we couldn't have done it."

To function in the adverse environment of a gas station, all the ICs are specified for operation up to 85 C, Mendelsohn points out. And supporting components must have an excellent MTBF with good survivability ratings.

Solid-state-controlled gas dispensing systems have existed since 1974. But Bennett's microcom-





The newest microcomputer-driven microwave oven, by Magic Chef, has three pre-programmed memories that control independent timing and heating cycles plus associated displays.

puter-controlled CRT-console system not only controls pump operation equally as well as the competing solid-state units, but also can perform such data-processing jobs as automatically keeping track of gasoline inventory and maintaining a daily record on sales, among other duties.

#### Home revolution fanned

A revolution in home entertainment and home education is on the way from two sources. One is the development of interactive, programmable color-TV games—complex interactive systems that can be microcomputer-controlled and programmed with tape cassettes, cartridges or specially programmed ROMs.

The ROMs are being used by manufacturers like Fairchild to avoid wholesale bootleg duplication of game and education programs. Universal Research, Des Plaines, IL, uses video tape cartridges in its interactive system. The company is currently working with software houses and book publishers to develop a library of information for use with the system. One possible way to defeat the bootleg duplication of such tapes lies in the development of specially coded data formats.

This revolution is also being fostered by a new and growing phenomenon—thousands of personal or hobby-computer fans. Encouraged by the low-cost computing power provided by microcomputers, these computer amateurs—like radio amateurs—have acquired their own systems by building low-cost kits largely based on the Intel 8080 or the Motorola 6800  $\mu$ Ps.

Kits like the Altair 8800, which uses the 8080, and 680, which uses the 6800, were first produced by MITS, Inc., Albuquerque, NM, and described



TV pictures and messages are flashed to Olympic Stadium spectators in Montreal on two computer-driven scoreboards designed by Conrac. Images from on-field and remote TV cameras are piped to 33 x 65-ft screens composed of 19,200 40-W incandescent lamps.

in *Popular Electronics*. Since then, a second generation—the Altair 8800-b and 680-b—has emerged along with a number of other kit and system producers. Several of these second generation producers have made their products bus-compatible with the Altair systems. In addition, Altair Basic is the common software language.

The complexity of systems varies generally with the enthusiasm of the hobbyist, but primarily with the size of his wallet. Some systems have only the basic CPU and memory elements plus an input/output device, for example, a "glass teletypewriter"—a small TV screen outfitted with a computer interface. Other systems have large memories, floppy discs and CRT terminals.

Whereas the first kits were confined to essentials, over 100 functional PC boards (and kits) have recently and rapidly appeared. These boards plug into the Altair bus structure and expand the repertoire of all Altair-bus compatible computers.

The bus has become the unofficial standard in the hobby field. Four kit manufacturers produce compatible hardware: MITS, the Altair 8800-a/d; IMS Associates, San Leandro, CA, the



IMSAI 8080; Polymorphic Systems, Goleta, CA, the Poly 88; and Processor Technology, the Sol.

These boards can contain an audio cassette interface, a floppy disc interface, a multiply-divide board, a video interface board, a read/write memory board, or parallel-serial and analog interfaces.

Voice synthesizer and music synthesizer boards are already in the developmental and prototype stages.

### Personal computer interest expands

A major involvement of the hobby computers is cybernetic games—man vs computer. But other uses are popping up all the time.



Instant cash is available, day or night, through outlets like this IBM 3614 consumer-transaction facility. To get money, the customer inserts his plastic magnetic-stripe I.D. card into the self-service banking terminal and also keys in a personal I.D. number for verification.



Home-built computer kits control Don Alexander's Columbus, OH, amateur radio-teletypewriter station. The system consists of an Altair 8800 computer with 8-k of memory, an ASCII keyboard, a CRT video display, a Baudot teletypewriter converter, and a standard amateur radio transmitter and receiver.

For example, Don Alexander of Columbus, OH, has designed his own Altair-computer-controlled ham radio-teletypewriter station. Alexander entered the system in a Radio-Teletype contest at the MITS World Altair Computer Convention Demonstration Contests.

The object was to make as many contacts as possible. Alexander programmed his Altair to control all aspects of the operation. It performed ASCII/Baudot translation, received calls, edited them and put them on the video display. It checked its memory for station-contact duplications (invalid operations); transmitted time and message numbers along with the lines of text generated on command from the keyboard; and printed a log entry on the teletypewriter after every exchange. Alexander's radio teletypewriter station took the Grand Prize.

David Ahl, editor of *Creative Computing Magazine*, Morristown, NJ, points out that he and many other computer owners use the home machine with drill and practice programs of the mathematics their children are studying in school.

### Computer kits go to school

Surprisingly, these hobby computer systems are now beginning to appear in elementary and secondary schools.

"I've worked with the San Jose Unified School District here in California," says Bob Albrecht, a computer-education specialist and Basic language expert who heads People's Computer Co., Menlo Park, CA. "Six IMSAIs will be assembled in the district. The purpose is to promote a program to get both the primary and secondary schools turned on to using microprocessors instead of using PDP's and HP-2000s, which have been standard in the educational market at the secondary school level.

"The high school districts have technical schools that can assemble equipment like this. We'll be promoting this kit-building throughout the Bay Area."

In fact, computer-industry interest in all aspects of personal computing has increased to the point where a Personal Computing Fair and two days of Personal Computing papers and panel sessions are scheduled for the 1977 National Computer Conference, to be held next June in Dallas.

Along with the growing number of computer fans, yet another phenomenon has appeared. Just last year, the world's first Computer Store—the computer equivalent of Radio Shack—was opened in Los Angeles. Since then, some 150 have been opened across the U.S. ■■



# Sharpen your competitive edge.

## Use an HP computing calculator for design, analysis, control, and test.

In the highly competitive, high-technology electronics business, everything counts: keeping costs in line, exploring promising design alternatives, shortening lead times, product and prototype testing, increasing productivity. That's where HP computing calculators, software, peripherals, and interfacing capabilities come in. They can help you get and maintain a competitive edge.

### Three computing calculators and plenty of peripherals: it's your choice.

Three different models—the low-cost HP 9815, the powerful HP 9825 and the all-purpose HP 9830—offer a range of computing power.

HP peripherals include paper tape punch and readers, printers, storage devices, a digitizer, a CRT, and an X-Y plotter. You choose the model and I/O options to configure a system just right for you.

### Software, specialized and generalized, helps you look at more alternatives.

HP engineers developed software to optimize designs and analyze engineering problems quickly. There's a State Variable package for control system analysis. There's CNAP for circuit design and analysis, BAMP for microwave design and analysis, and Digital Simulation for state and timing analysis.

You can add other programs, too—commonly needed math routines and statistical programs to name but two. Programs are also available for accounting applications, report generation, and financial analysis.

### Automate your instruments. We make the connection friendly.

From simple data logging to complex integration, our programming commands and interface cards make instrument interfacing easy. Whether your instruments require BCD, bit-parallel, RS-232-C, or HP-IB (HP's implementation of IEEE Standard 488-1975), you plug the correct interface into the calculator and connect the cable to your instrument. It's the friendly connection.

**HP computing calculators: from initial design to final test.** Whether you're in research, design, production, or test—or all four—we can provide the computing power and programs to help you increase productivity and sharpen your competitive edge. Our new brochure for electronic engineers will show you how. Get a copy from your HP representative, or circle our reader service number in this magazine.



*HP desktop computing systems put the power where the problems are.*

HEWLETT  PACKARD

Sales and service from 172 offices in 65 countries.

P.O. Box 301, Loveland, Colorado 80537  
For assistance call: Washington (301) 948-6370, Chicago (312) 677-0400,  
Atlanta (404) 434-4000, Los Angeles (213) 877-1282, Toronto (416) 678-9430

FOR INFORMATION OEM APPLICATIONS

CIRCLE NUMBER 209

CIRCLE NUMBER 208



# Designers ... Have It Your Way!

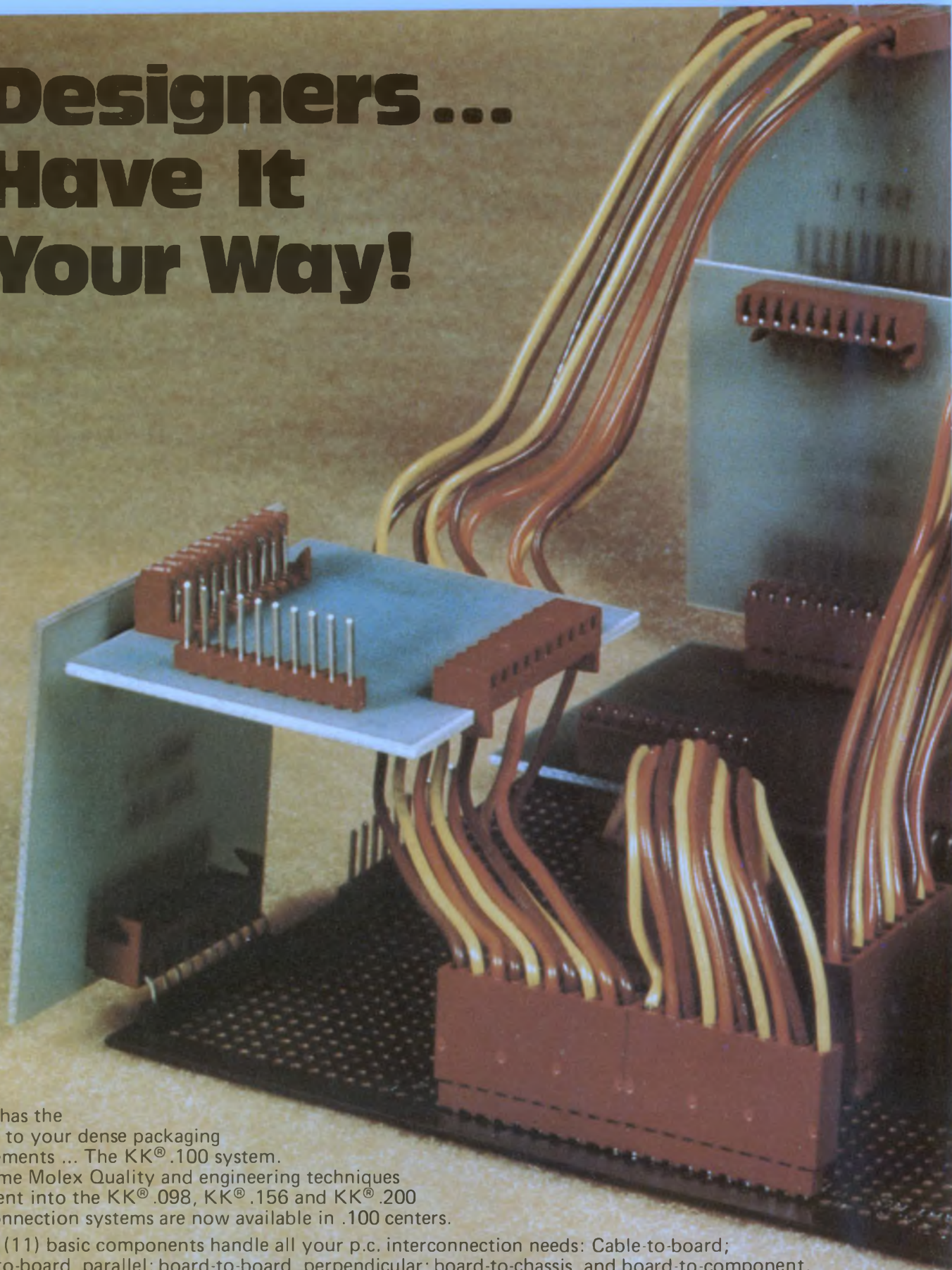

Molex has the answer to your dense packaging requirements ... The KK<sup>®</sup>.100 system. The same Molex Quality and engineering techniques that went into the KK<sup>®</sup>.098, KK<sup>®</sup>.156 and KK<sup>®</sup>.200 interconnection systems are now available in .100 centers.

Eleven (11) basic components handle all your p.c. interconnection needs: Cable-to-board; board-to-board, parallel; board-to-board, perpendicular; board-to-chassis, and board-to-component.

The photo illustrates examples of typical applications, configurations and components. The KK<sup>®</sup>.100 system consists of .025 pins; right angle, straight and polarized wafers; female connector housings, both crimp type and p.c. board mount; polarizing keys; and crimp or solder tail terminals, featuring the Molex patented dual cantilever term system. Non-flammable 94V-0 material is used in all KK<sup>®</sup>.100 connector housings and wafer bases.

To compliment this system, Molex has developed the most economical and fastest pinsetting equipment in the industry. The patented equipment can offer single or multiple pinsetting capabilities and the unique Molex honeycomb vibratory can set 12,000 pins in 3 minutes! Now you can really have it your way!!!



# The New Molex KK<sup>®</sup> 100 Interconnection System

see us at  
ELECTRONICA 1976  
Munich Germany  
November 25 - December 1  
stand 14312



**molex** ... Affordable Technology

For complete information on the Molex KK<sup>®</sup>.100, KK<sup>®</sup>.098, KK<sup>®</sup>.156  
and KK<sup>®</sup>.200 Interconnection Systems, call or write:

**Molex Incorporated, 2222 Wellington Court, Lisle, Illinois 60532**  
(312) 969-4500

CIRCLE NUMBER 34

Our  
m which



# In all areas, the hardware is becoming ever more intelligent

**S**ince microprocessor prices are plummeting while the costs of raw materials and labor skyrocket, manufacturers are using the easily available computer power of the  $\mu$ Ps to increase automation in their industrial equipment.

Areas where designers are increasing hardware intelligence include:

- The machine tool industry, where computer numerical control (CNC) is rapidly replacing direct numerical control (DNC).
- Process control, where computers are being used to direct as well as monitor a particular process, and correct errors that occur.
- Energy conservation, where computers determine how and when energy should be used.

### Much talk, little action

Although computerized machine tools have been talked about for some time and even produced in limited quantities, the high cost of the central processing unit, be it mini or micro, has limited computer-controlled tools to only about 10% of the possible market.

Some of those early computer-controlled machines were direct numerical control (DNC)

devices, whose chief characteristic was a control computer that could control from 5 to 256 machines. But their high cost kept them out of the reach of most users. And the central computer prepared lengthy, punched-paper tapes to tell the tools how to operate.

Consequently, the cheaper, more flexible CNC systems are rapidly replacing the DNCs. While they also rely on paper tape to provide input data, only basic information, such as coordinates, is entered. The actual program to be executed is stored in the CNC's memory. And since the program is in software, it can be easily changed. Moreover, with the decreasing price of microcomputers, most manufacturers of machine tools are designing new units that contain these little brains.

Computer numerical control has finally arrived, declares Jerome W. Price, director of marketing for Bendix's Industrial Control Div. in Detroit. About

80% of the machine tools shipped in the next 2 years will be computer-controlled, according to Price.

### Computer controls pipe bending

One example of computer-controlled equipment is a pipe-bending machine used by Hayes-Albion Corp., a manufacturer of automobile parts in West Unity, OH. The automatic pipe bender has increased production by 24% while cutting the required setup time by 50%, according to Ralph Amburgey, division manager. And, he adds, all without the need for additional personnel.

The heart of the pipe bender is a 16-bit Computer Automation Naked Mini with 8-k of memory. When activated, the computer prompts the operator by asking specific questions, the answers to which are used as input for the operation of the system.

Even an operator who is unfamiliar with computer equipment can operate the pipe bender, notes Amburgey. All he has to do is load tubes into the hopper, feed in a program and push a button. The machine does the rest.

With computerless numerical control machines, the design first has to be worked out on paper, translated into numerical control language, punched out on tape and then read into the machine. That takes a lot of advanced preparation



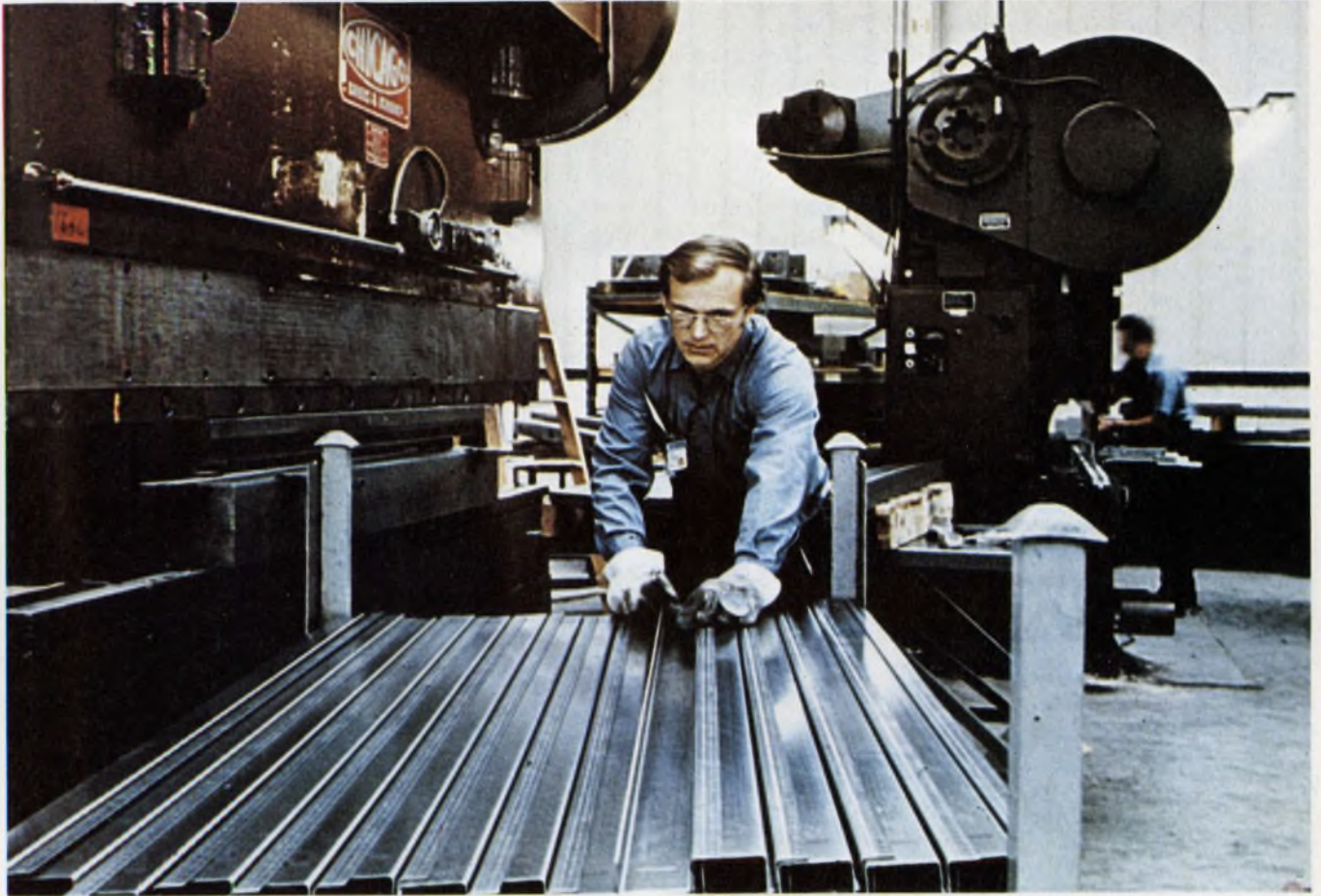

**Metal forming and fabrication** is an area where minicomputers are being used to automate production and in-

crease throughput. Equipment in this plant is controlled by a Digital Equipment Corp. mini.

and expensive programming skill, Amburgey observes. In addition, a new set of instructions must be generated for each different part.

#### **CAM is the ultimate goal**

The ultimate goal of manufacturers is to string a lot of CNC machines together to produce a totally automated manufacturing facility. Commonly referred to as CAM (for computer-aided manufacturing), such systems consist of a computer hierarchy in which several "smart" machines are controlled by a central computer.

This setup should not be confused with DNC, in which a central computer also controls several machines. In the case of DNC, the computer supplies manufacturing data to "dumb" machines, not smart ones. With CAM, the built-in micro supplies the manufacturing data, not the central computer. However, the central computer does provide the manufacturing supervision required.

An ideal CAM system begins with a purchase order for its basic input. The rest is automatic. Whatever parts must be manufactured in-house as well as whatever parts must be purchased are

ordered. Production and shipping schedules are produced, and the necessary accounting is figured.

CAM does not yet exist. But many companies today have parts of such a system.

#### **Distributed processing on the move**

Minis and micros are also being used to control ongoing processes in distributed systems. One such application is the Millers Ferry Hydroelectric Project in Alabama. There, a trio of IMP-16C/200 microprocessor cards, join with an Interdata Model 70 minicomputer to control the generators and water flow.

Designed by engineers at Progress Electronics in Oregon, the distributed processing system has brought about a savings of \$20,000 over conventional, hardwired logic designs.

One of the IMP-16s is used to monitor parameters at the Jones Bluff Dam, 40 miles from Millers Ferry. Transducer inputs are both digital and analog. In all, 23 channels are monitored. Another micro acts as a dam controller: It lowers head gates, trips or closes breakers, sets regulation levels, controls generators and monitors



plant and switchyard equipment status. Control subroutines reside in a 10k-by-16 PROM.

Back at Millers Ferry, the third IMP-16 serves as the supervisory switchboard controller: It coordinates activities at the remote location by requesting specific information, such as acquired data status and alarm conditions.

The Interdata 70 host computer communicates with the remotely located micros and interfaces with the 25-MW hydroelectric units at Millers Ferry. It also manipulates data and maintains archival records.

Hardware costs have been cut, by developing one set of control subroutines and then applying them to each of the four generators as required,



A computer model of a textile mill that runs on an IBM 5100 computer is used to examine production rates and calculate manufacturing costs.

reports George Munce, Progress' systems engineer. "With hardwired logic we would have to duplicate the system for each generator," Munce adds. "So with one microprocessor we actually eliminated 400 logic systems."

### Computers control aluminum refining

The electrolytic refining of aluminum requires that a constant 130,000-A dc current be maintained on the lines feeding the refining pots. Since the rate of aluminum production is proportional to this current, the resistance of the pots must be monitored constantly.

A network of four Nova 1200 minicomputers from Data General has helped Intalco Aluminum of Ferndale, WA, overcome this problem. Each Nova provides real-time monitoring of a refining line. When the resistance in a particular refining pot increases because the ore in it is used up, the Nova helps lower the resistance by adjusting the anode-to-cathode distance with a motor. If adjustment cannot be made, the Nova triggers an alarm.

The computer controlled method is working out

very well, according to Kenneth D. Williams, a project engineer at Intalco.

With a manual approach, an operator could only check and adjust one refining pot at a time. And since pots often operated incorrectly for several minutes before voltage abnormalities could be found, the operators simply could not give each pot the attention it required. Thanks to the Nova, these problems no longer exist.

### Micros replace mechanical cams

Environmental test chambers, an application that has traditionally used mechanical cams to program heat, humidity and pressure cycles, are



Control of processes and monitoring of quality control are performed in many plants by minicomputers such as this one from Digital Equipment Corp.

now being controlled by microprocessors.

One such cam programmer replacement is the Digitenn from Tenney Engineering of Union, N.J. Cams have many disadvantages, according to John Urruida design engineer. They are usually made out of metal or plastic and must be cut to shape, filed, tried and then recut and filed. The whole process usually takes several days, he reports. Another approach attempted, motorized potentiometers, doesn't work well either.

With microprocessors, however, it becomes a simple and quick job to make a programmer that will control an environmental test chamber. "It is the answer to a designer's dream," notes Urruida.

The Digitenn uses the Signetics 2650 micro and costs just about the same to design as a cam programmer. But the Digitenn is much more versatile, Urruida points out. It has a built-in clock that makes it possible to begin testing at a specific time of day without anyone being present. It also features automatic stop, cycle-counting capability and auxiliary event switching so that it can be remotely controlled.

Another big plus for the micro, says Urruida,





A microprocessor-based control system monitors the head waters and controls the gates of the Jones Bluff Dam. Data acquisition for the system is performed by three IMP-16C/200  $\mu$ P cards, while an Interdata 70 controls the hydroelectric units.

is its extremely simple calibration. All that is needed is a few potentiometer adjustments that take a few minutes. Cam units often take hours to calibrate. And it is now possible to calibrate the controller and the sensors individually.

#### Mini helps to conserve energy

A minicomputer that controls the operation of welding equipment at the Chevrolet Parma, OH plant is saving hundreds of dollars.

Built by Weltronic of Southfield, MI, the system controls 100 welders and prevents all the units from operating simultaneously and causing a power failure. The energy saved results from the computer's ability to sequence operations. Delaying or sequencing loads until there are similar loads ready to go on each of the three phases of the power line saves a great deal of power.

The computer has preset data stored as a machine-sequence record for each of the 100 welding machines. Closure of a switch at any welder starts the computerized control of the weld cycle. The computer compares the kVA demanded by the welder with what is available on the power line. If the power needed is less than what is available, welding proceeds. If not, a delay is initiated until enough power is available.

Since welds are performed in a fraction of a second, the computer control also makes it possible to use smaller power cables which reduce copper costs significantly. Rollie Conners, senior engineer explains: "Even though we have 100 welders which require 50 kVA each, we only have a 350-kVA cable feeding the department. This is possible because the computer limits the line load to only six welding guns at any one time." The computer holds a gun off until there is room for it on the line. The computer works so fast, adds Conners, that an operator never

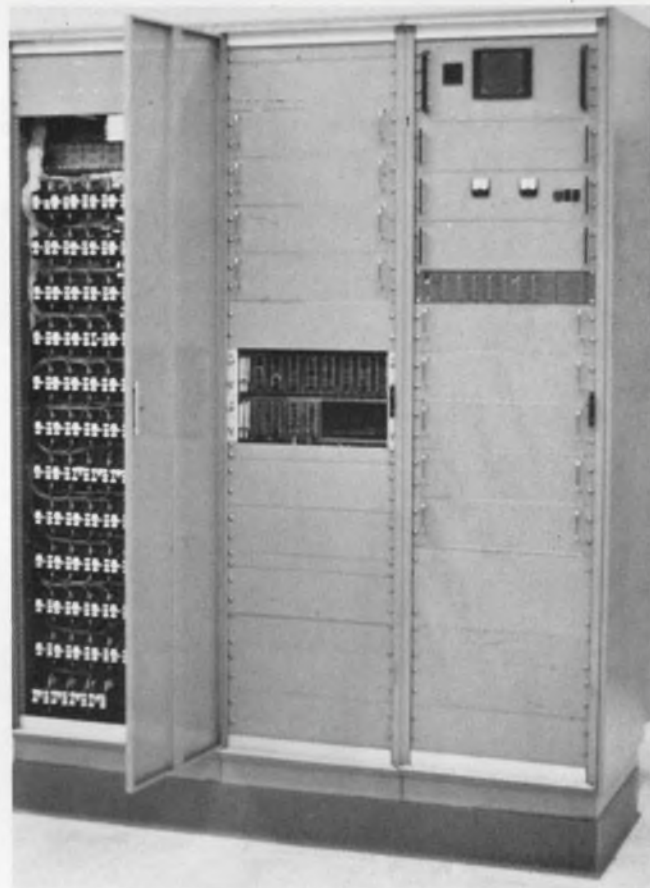

knows he is on hold.

Another energy saving system comes from Systems Technology of Flint, MI. Designed to reduce the cost of heating a building by 25%, the system combines a mini with several micros. The micros gather and process sensor data, then send these data to a mini to automatically turn heating and cooling equipment on and off each day. In addition, use of this equipment is minimized when power consumption approaches a peak-demand level, according to William Buyers, president of Systems Technology.

The system can also be used to cycle ventilation equipment. By sensing outdoor temperatures and sending data to the mini, the system automatically determines when ventilation equipment can be shut off inside the building without any noticeable changes. Typically, whenever outside air is brought into a building, power must be consumed to circulate, heat or cool it.

But sometimes it is desirable to circulate outside air because it can be used to obtain the same temperatures as those provided by air conditioning, Buyers points out. For example, during winter, when a lot of people are in a building, the air heats up. Then outside air is cheaper to use to cool the building than the air conditioning. And a computer that monitors inside and outside temperature can determine when outside air should be used. ■■



# NEW FROM KEITHLEY: TWO "BEST BUY" DMMs.



Model 173



Model 172

**4½ DIGITS. 30000 COUNTS.  
UNDER \$500.**



Advanced features are found in both these general-purpose DMMs:

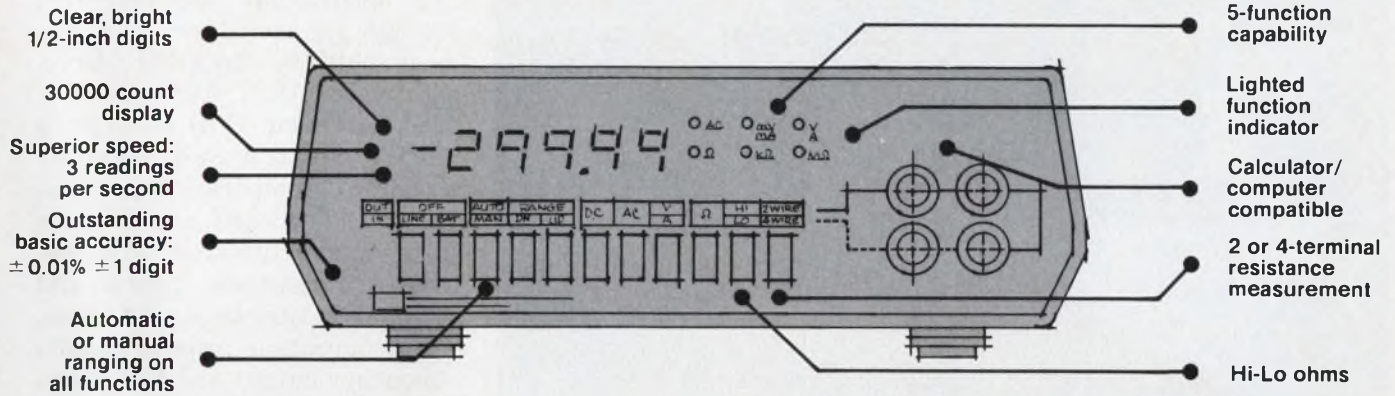

Take a look at the remarkable features of the new Keithley Digital Multimeters. They're unmatched in the industry.

Now consider price. At \$499 we think you'll agree the Keithley 172 is the best buy in a general purpose 4½-digit DMM.

There isn't another 4½ that matches the price-performance value of the 172. Except for its higher-rated companion, the Keithley 173.

**For \$499: the exceptional 172.**

To begin with, you get a dependable, durable, portable, easy-to-use, autoranging instrument with five functions. Designed for research, engineering or production applications.

Measure from 10 microvolts to 1200 volts dc, 10 microvolts to 1000 volts ac, 10 milliohms to 300 megohms, 10 microamps to 2 amps, ac or dc. DC accuracy is 0.01% ± 1 digit.

There's more: 3 month recal cycle. No-nonsense, full-year guarantee on parts, workmanship, and specs. 30000-count display yields maximum accuracy for 15, 18, 24 and 28-volt measurements.

**For \$625: the even more exceptional 173.**

The Keithley 173 is our top-rated 4½-digit DMM. It gives you all the performance and accuracy of the 172 plus superior autoranging current measurements from 10 nanoamps to 3 amps. This makes the 173 the most complete and versatile general purpose 4½-digit DMM in the world — at any price.

**More versatility. Now or later.**

Options and accessories expand the 172 or 173 to your specific needs: Rechargeable battery pack you can buy now or add later. Digital output/control. RF probe. 50-amp shunt. Clamp-

on ammeter. High-voltage probe. Rack mount kits. Test lead sets. Carrying case. IEEE 488 interface.

**Make this easy decision.**

For most 4½-digit DMM applications, the new Keithley 172 is your best buy. When you require more current measuring capability, the 173 is.

For convincing proof, send for detailed specs or request a demonstration. Or if you're already convinced, send your order to: Keithley Instruments, 28775 Aurora Road, Cleveland, Ohio 44139. (216) 248-0400. Europe: Heighhofstrasse 5, D-8000 München 70, West Germany. (089) 7144065.

**DMMs for all your needs.**

We know you have a variety of measurement requirements. So we offer a growing family of DMMs to meet your application and price objectives. Send for details.

3½ digits	4½ digits	5½ & 6½ digits
<p><b>Model 168</b> General purpose. Low cost.</p> <p><b>Model 160B</b> 1 µV and 10 pA sensitivity.</p> <p><b>Model 616</b> Super-sensitive. 0.1 pA full-scale.</p>	<p><b>Models 172 and 173</b> Two "Best-Buys."</p> <p><b>Model 171</b> 1 µV sensitivity. 5-functions.</p> <p><b>Model 174</b> 0.1 µV sensitivity. (coming soon)</p> <p><b>Model 180</b> 30 nV sensitivity.</p>	<p><b>Model 190</b> Multi-function. Low cost.</p> <p><b>Model 5900</b> 0.001% accuracy. High stability.</p> <p><b>Model 6900</b> Accuracy, stability and sensitivity measured in ppm.</p>

**KEITHLEY**  
The measurement engineers.

FOR DEMONSTRATION, CIRCLE 35  
FOR TECHNICAL DATA, CIRCLE 36



## Transportation

# Computers are everywhere--in cars, trucks, trains and even taxi meters

Computer usage in transportation is burgeoning. In automobiles, computers figure prominently in engine control, anti-skid braking, service diagnosis and even taxi-fare metering. In rapid transit, they help with collecting fares, controlling speed, and supervising all systems. To ensure more effective traffic control, computers help operate the central control as well as the local controllers. And computers stabilize hydrofoils as they skim over the water.

In transportation, then, the question is no longer: "Will we use computers?" Rather: "How much?" "When?" and "What types?"

### GM explodes into microprocessors

The on-board digital computer has come to cars with the arrival of the Microprocessed Sensing and Regulation (Misar) spark-timing system by the Delco-Remy Div. of GM. Installed in the 1977 Toronado, the Misar provides open-loop (preprogrammed), spark-timing control. Now processing engine speed, crankshaft position, manifold vacuum pressure and engine-coolant temperature, Delco-Remy's Misar has reportedly achieved an 8% fuel-economy benefit at 1977 emission levels.

Sid Adlerstein  
Associate Editor

More inputs are planned.

The PMOS, two-chip Misar computer, a 10-bit serial design for small chip size and fast enough for near-term uses, has been built by Rockwell Microelectronics Div., Anaheim, CA. The processor chip contains a CPU; scratch-pad memory registers; temporary I/O storage registers; and an extensive I/O section consisting of 5 discrete I/O channels, a serial I/O channel, a variable-count pulse-train output, a programmable-frequency output and two pulse-rate inputs. The other chip is a  $1024 \times 10$ -bit ROM.

Elliot M. Estes, President of GMC, wasn't fooling when he told the Society of Automotive Engineers in San Francisco that he foresaw a broader use of electronics for engine control. In addition to continuing research on Misar, GM has under development a closed-loop (feedback),  $\mu$ P-based Knock-Limiter system. With it, an engine can automatically operate on that

very narrow edge between maximum fuel economy and the start of (trace) knock. GM is also experimenting with closed-loop,  $\mu$ P-based emission controls to monitor the oxygen content of the exhaust fumes. The  $\mu$ P makes corrections to the air/fuel ratio, either through fuel injection or electronic-carburetor control.

"We have a good beginning in applying computer science and semiconductor technology to the inherent problems of automotive engine controls. Now we feel there is an unlimited future," says Edward P. Czapor, General Manager of the GM Division. In that future might be a  $\mu$ P-based, on-board central computer handling diagnosis, more sophisticated engine controls, digital read-outs, anti-skid braking, and simpler wiring.

### Chrysler's present is analog

In Chrysler's Lean-Burn engine system, the electronic ignition operates under the control of the spark control computer—an under-the-hood analog system. It accommodates a constant, 18-to-1 air/fuel ratio, under widely varying and fast changing conditions, by precisely controlling the spark firing. The chances of engine misfire, power loss, and high emission are too great to use the slower mechanical methods.

The computer inputs come from engine-mounted sensors monitoring engine speed, intake mani-





An analog computer ensures the smooth ride of Boeing's surface-skimming hydrofoil. On board, an automatic control system stabilizes the craft and controls trim and altitude while compensating for disturbances in the sea.

Ship motion and altitude, manual commands and control surface positions are fed to the computer which continuously adjusts the hydrofoil's control servos. The canoe is not computerized—yet.



Displays of computer-controlled-traffic data plug operators into LFE's system. Their inputs and overrides are fed to the central processor by means of English-language instructions, in this 5000 series system.

fold vacuum pressure, throttle position, rate of change of throttle position, intake air temperature, engine-coolant temperature, and engine condition at start-up.

The spark control computer is made up of two separate analog computers: the program-control module and the ignition-control module. Both units use temperature-compensated circuits because of the wide temperature range under the hood. Rf interference is filtered rather than shielded.

The Lean-Burn system is available on the 400-cubic-inch displacement engines this year, but by the end of 1977, all Chrysler V-8s are expected to have the system.

In 1979, Chrysler expects to replace the analog computer, built at its Huntsville, AL, plant, with a  $\mu P$  to make the Lean-Burn system digital. RCA and Texas Instruments are the front runners for supplying that  $\mu P$ , according to Chrysler.

Ford's approach to the "smart car," the on-board computer, will probably use a custom-made, 12-bit, N-channel  $\mu P$ ; an 8-bit a/d; an 8-channel multiplexer under the  $\mu P$ 's control; and a 4096-word memory. The  $\mu P$  has integral multiply and divide instructions performed in 50 to 75  $\mu s$ . A1-



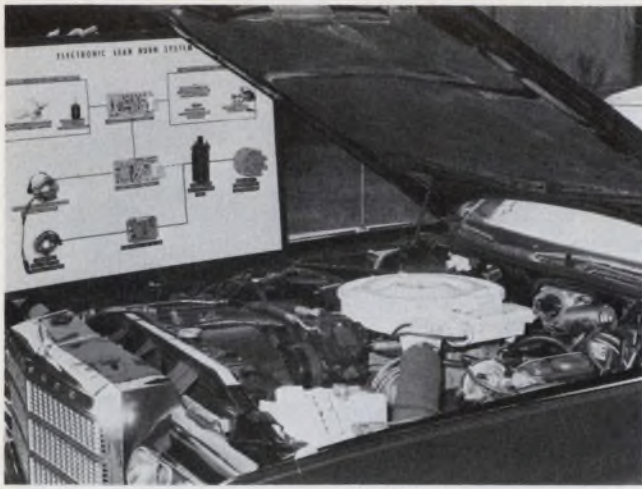

Ignition timing in Chrysler's Lean-Burn engine system is controlled by an analog-based Spark Control computer mounted under the hood, near the sensors.



The  $\mu$ P-based taxi-fare meter easily accommodates rate changes with pluggable PROMs. The meter computes five fares simultaneously, permitting ride sharing.

though Ford's applications require only an 8-bit precision, 12 bits are needed for intermediate calculations. Ford has considered using CMOS but has decided that the resulting chip is too big.

#### Anti-skid has new solutions

Wheels locked while braking can cause skids and loss of control, so experienced drivers pump their brakes. A better way to make short, in-lane stops is a computer-controlled, anti-skid braking system. Braking systems using analog or digital computers are practically mandated for tractors, trailers and buses by the Federal Motor Vehicle Safety Standard (FMVSS-121) of 1975.

Skid-Trol, from Rockwell's Automotive Operations Div., Troy, MI, is a  $\mu$ P-based, anti-wheel-lock braking system. Its magnetic sensors send speed data from each wheel to the computer located in each axle's air valve. Should a wheel approach lock-up during braking, the computer-con-

trolled valve adjusts the air pressure for optimum brake torque. This adjustment minimizes the stopping distance while preventing sustained wheel-lock.

The computer—a single-chip, P-channel, MOS device—is made by Rockwell's Microelectronics Div., Anaheim, CA. The computer chip is more properly a dedicated, real-time controller, not a general purpose (programmable)  $\mu$ P. The system's constants, parameters, and program are manufactured into the chip. The  $\mu$ P, which can make decisions on 500 system and braking conditions 50 times a second, can operate within a temperature range of  $-40$  to  $+160$  F.

Wagner Electric, Parsippany, NJ, which has installed 50,000 to 100,000 analog controllers in tractors and trailers, is currently considering 8-bit, parallel  $\mu$ Ps with ROM-program storage from Intel. Wagner engineers are working on the control algorithms.

#### Beetles undergo tests

Since 1972, owners of Volkswagen "beetles" have been able to have their bugs undergo 70 checks in a half hour. A digital computer, built by Siemens to Volkswagen's specifications, can be connected to the bug's test socket.

The test results are compared to the standard specifications for a particular model, which the computer reads from a plastic card inserted into its reader prior to the testing. The computer then produces a printed diagnosis sheet that indicates the condition of the car's major components and whatever servicing is necessary. The technician making the visual or manual tests is guided by a film strip in his hand-held unit.

#### Taxis have on-board $\mu$ Ps

The taxi industry can now use a fully flexible fare-computing system capable of accommodating a diverse range of fare structures—from simple single rates to multiple, rate-shared rides. A  $\mu$ P-based meter capable of handling five separate fares simultaneously has been developed by Bruder Instrument Co., North Vancouver, B.C., Canada. The meter uses an Intel 4040. Rates are contained in programmed, dual in-line chips so that rate changes can be handled simply by plugging in a chip replacement.

#### Computers can run urban transit

In the late 1960s, concern mounted for the declining qualities of urban life: air pollution, traffic jams and decaying mass-transit facilities. But only when the vague predictions of impending, long-term petroleum shortages began to materialize did the federal government move to up-



grade urban rapid transit.

Finally, in 1971, the Personal Rapid Transit (PRT) system, a research and demonstration project for automatic urban transit, was funded by Washington in an effort to reverse 25 years of decreasing transit usage.

Conceived by Dr. Samy E. G. Elias, Chairman of the Industrial Engineering Dept. at the University of West Virginia, the PRT is now operating in Morgantown, WV, under computer control. PRT vehicles carry up to 20 riders at 30 mph—without operators or ticket takers. The system's current capacity is 1100 people every 20 minutes.

The system has two distinct operating modes. During rush hours, its cars follow a computerized schedule. At off hours, a passenger can push a button, and the computer sends a personal car.

The PRT is a multicomputer system with the DEC PDP-11-20s at each station constantly communicating with the system's nerve center—the PDP-11-40 in the control room. Boeing's analog vehicle control and communications subsystem is the final unit in the motion-control chain. PRT was designed by Boeing, Seattle, WA; Bendix, Ann Arbor, MI; and F. R. Harris, Stamford, CT.

Engineers at the University of West Virginia have also developed a phase-locked-loop speed control and collision-avoidance system. They expect that this system, in conjunction with a small, on-board analog computer, will double the number of cars the existing system can safely handle.

### DC's Metro is automated

This year, Washington, DC's new Metro subway system began operations. The system is controlled by an automatic train control system (ATCS), developed by General Railway Signal (GRS), Rochester, NY. ATCS consists of three interacting major subsystems:

- Automatic train supervision (ATS) by TRW Controls Inc., Houston, TX, which enables control center personnel to manage train movement and Metro's support systems.

- Automatic train operation (ATO) by GRS, which provides the operational commands for each train.

- Automatic train protection (ATP) by GRS, which oversees the operation of each train, with safety its top priority.

The ATS equipment is concentrated mainly in the control center, where two identical consoles house two Xerox Sigma-5 mainframes and connect to two rows of four CRTs. Dwell timers, storage schedulers and support-system status sensors are located throughout Metro. The operation equipment is in the control center and at wayside locations; the protection units are also at wayside locations as well as on board the trains.

Under trouble-free conditions, the ATS maximizes performance by advising trains as to speed, spacing intervals (headway) and proper length of stay in a station. ATO converts the data into operational commands for each train; ATP oversees the operation and sets safe speed limits. If necessary, ATP can even stop a train.

Normally, Metro's control center regulates train speed and headway, but should the center be disabled, the trains can still run automatically and on schedule under the control of General Railway Signal's equipment.

At the control center, one four-CRT display bank shows data relating to train movement: tracks, crossovers, stations (depicted as rectangles), and trains (shown as triangles). The

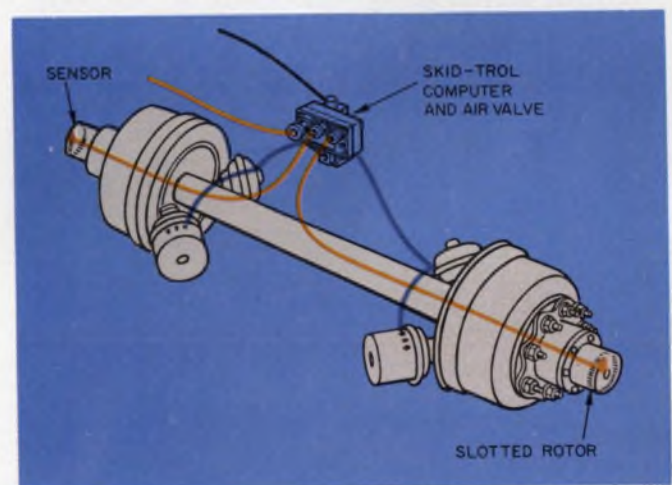

A  $\mu$ P regulates truck braking by controlling Skid-Trol's air valves. Sensors in the wheel hubs transmit data to the valve-mounted microprocessor.

other four-CRT set displays the status of electrical substations, station air conditioning, tunnel ventilation, drainage, station-fire and intrusion alarms, and other Metro support-system functions.

When alerted to a problem by the display information, control center personnel dispatch repair crews and perform emergency supervision via Metro's emergency communications network. Personnel may query the computer when a problem arises and get a solution.

### Computers run airport transit, too

The 13-mile Airtrans system at the Dallas-Fort Worth airport is perhaps the most automated approach to airport ground transportation. Everything but the jets moves via one of 68 driverless Airtrans vehicles. Passengers, personnel, baggage, mail, supplies and even rubbish travel along guideways linking Airtrans' 53 stations—a traffic system whose every facet is con-



trolled by a hierarchy of computers.

In the control room, a central processor supervises all traffic. It monitors systems status; commands speed, switching, dispatching and routing; and controls bunching. The central processor also operates a lighted guideway schematic that displays for control room personnel the status and condition of vehicles, guideway switches, system power and stations. The central processor is a Mod-Comp II with a 64-k word memory by Modular Computers, Fort Lauderdale, FL.

Four digital processors, Mod-Comp I's with 16-k memories, interface the central processor to standard, transit-type vehicle control and collision-avoidance equipment, located along the routes and on board each car.

A fifth digital processor, located in the main-



**A hierarchy of computers runs Airtrans**, Vought's total ground-transportation system at Dallas-Ft. Worth Airport. The master computer has 8 satellites.

tenance area, constantly communicates with the control room's central processor for scheduling, dispatching and over-all supervision. The maintenance processor is a Mod-Comp III with a 32-k memory. Three additional digital processors, Mod-Comp I's with 2-k memories, advise the master computer about conditions in the parking lots and the hotel.

The central processor controls headways by accessing each car's vehicle control unit through the appropriate wayside digital processor.

As more operational data become available, Vought of Dallas, TX, the prime contractor for Airtrans, expects to upgrade the system easily. Except for the standard transit equipment, the vehicle control is the only nonprogrammable control system in Airtrans.

Vought is currently developing a more flexible,  $\mu$ P-based vehicle control unit to replace the present hard-wired unit. It will use National Semiconductor's IMP-16C/300 card, and for easy

change, its control functions will reside in firmware.

The redesign to a  $\mu$ P-based unit is planned to proceed in two stages. First, the longitudinal control system by which the  $\mu$ P processes grade, line voltage, car weight, acceleration, velocity and distance data will be installed. Then the vehicle's digital communications will be placed under  $\mu$ P control.

#### $\mu$ Ps even collect fares

In an effort to stem the tide of ever increasing personnel costs in rapid transit, Cubic Western Data of San Diego, CA, has developed the Automatic Fare Collection System. (Its microprocessors—Intel 8000 series—don't object to late hours



**Computer displays tell Airtrans controllers** how well every aspect of the airport's ground-transportation system is working so they can interact with it.

and are pushovers at contract negotiations.)

This  $\mu$ P-based fare processing system is now part of San Francisco's Bay Area Rapid Transit (BART) operations, at Illinois Central and Gulf RR's operations in Chicago, the Philadelphia Transit Authority's operation at Lindewald and PRT's operation in Morgantown. The system will operate in Washington, DC's Metro in 1977. Even Hong Kong is installing an automated fare system.

The Automatic Fare Collection System is a total system for fare processing that includes ticket vending, gating, add-fare collection, auditing, and over-all network control. The system uses 8-bit CPU micros under PROM control so that changes can be made by simply reprogramming the PROMs.

When the rider buys his magnetic-striped fare-card, the  $\mu$ P in the ticket-vending machine encodes the purchased value on the card. The machine also makes change. Entry and exit gates



adjust the farecard under  $\mu$ P control. Add-fare machines allow the commuter to buy added value, if needed, to exit at a given station, and its  $\mu$ P adds this value to the ticket. The  $\mu$ P-based auditing and network controls are usually housed in a central kiosk at each station.

The only drawback to  $\mu$ Ps in rail transit is that they live on a steady diet of dc, and power in rail-transit stations is notoriously noisy and irregular.

### Computers ease traffic woes

Remember that feeling of helplessness when you were jammed bumper-to-bumper on a crowded roadway? Fortunately, traffic-control engineers aren't helpless. They are now using a variety of computers to reduce vehicular congestion. "We are running out of roadway and gasoline (and patience), so we've got to use our roads more efficiently," says John L. Barker. He helped write the NEMA Traffic Control Standard PS-1-1976, which favors using  $\mu$ Ps in local controllers.

Today, more than 200 U.S. cities enjoy computer-based control. Many of these cities employ analog systems, which are constantly being updated with added intersection controls, intersections tied into networks and central control. Digital computers, with greater flexibility, easier maintenance and ability to withstand severe environments, are replacing the older analog work horses. However, software maintenance can be a problem, as the Toronto Rapid Transit Authority learned when it began to go digital 10 years ago.

There are two basic types of traffic-control systems: pretimed and traffic-actuated. The pretimed systems are primarily used for downtown urban-area streets (grids), where the daily traffic patterns are well known. Traffic-actuated control is used where traffic is not predictable, as on arterial roadways. Many other traffic situations are a combination of these, and the system used is a blend of the appropriate features of both types.

A typical, medium-scale, traffic intelligence system consists of a master minicomputer, central displays that ease human interaction (input and override) with the system, local controllers, sensors (speed, volume, density) and software—various programs for timing traffic that are suited to the traffic conditions at a particular time.

An example of how computer usage can improve an existing traffic system can be found in Nassau County, NY. Previously, an average rush-hour trip of 8 miles through 44 intersections required 16 stops and took 21 minutes. With Auto-



Two MCS-4  $\mu$ Ps compute navigational functions in the ML 1000 Loran-C navigator by Micrologic of Chatsworth, CA. Piloting data are also provided.

matic Signal's 5000-series, mini-based system, the trip can now be made with 6 stops in 15 minutes. An even greater reduction is expected after the programming is fine-tuned to operational data.

The LFE Division of Automatic Signal, Norwalk, CT, is heavily into digital computers. The company systems interface in-house minis or commercial equipment, ranging in size from DEC's PDP-8 to PDP-11-20, 35, and 45, with their local controllers. Local controllers using Intel's 8080 and Motorola's 6090 are currently in the works.

### Hydrofoils are analog-stabilized

As 192 passengers comfortably skim across the blue waters of Honolulu harbor, their Boeing hydrofoil responds to precise, full-time automatic control. Submerged foils improve riding quality by isolating the ship from seaway disturbances, but at the expense of inherent stability. That's where the automatic control system (ACS) comes in. The ACS provides stabilization, automatically banked turn maneuvers, trim and altitude control, and seaway disturbance alleviation.

The heart of the control system is an analog computer, which receives ship-motion and altitude signals from the sensors, command signals from the manual inputs, and control-surface-position signals from the control actuators. The computer processes these signals and feeds the control-surface servos.

The control computer uses integrated circuit operational amplifiers and discrete semiconductors, mounted on plug-in printed circuit boards for easy maintenance. The computer contains active filters in which small precise capacitors provide the large time constants which are typical for a ship's control systems. ■■



25-bit words:

# **Biomation's 16+8+1 answer to $\mu$ Processor analysis.**

**The first microprocessor analyzer that really analyzes.**

Biomation has developed a new instrument to solve a new problem: How to get inside the mind of your microprocessor. The instrument is our 168-D. The Mind Reader.

In the process, we've invented a new word. 25 bits long. Contains 16 bits of address, 8 bits of data, and one bit that tells you whether your machine is reading or writing. All in hex characters, just like your program listing.

The Mind Reader starts by capturing up to 256 of those 25-bit words at synchronous rates as fast as 10MHz. That's fast enough for anybody. You can dial in a hardware breakpoint and step your system through its program. Or you can monitor your system as it runs free. But that's just the beginning. Now watch:





### First, the Big Picture

The Mind Reader takes a first macro-bite out of the territory you're investigating. 256 big words. In Memory Mode you can see the areas of memory where the action occurred. (You're writing into ROM, for heaven's sake!?)

### Then zoom in!

The 168-D gives you a movable cursor that locks onto a location and stays with it through the analysis modes. Once you spot the action you've been looking for, stake it out with the cursor and switch to Page Mode. That gives you the address, data, and read/write information.

### Now: A whole new perspective . . .

You've found the program, now switch to Sequential Mode and find out **how it got there**. Where were you coming from, and where did you go from there? Study all time relationships. A powerful new way to analyze the problem!

By switching to the List Mode you display the twenty words surrounding the cursor location you selected in the Page Mode. Address and data are presented in hex along with the R/W bit to let you compare the sequence to your program listing.

**In summary: The 168-D lets you record with respect to time and analyze with respect to location.**

It's the first microprocessor analyzer that really analyzes. You can put it to work today on **8080A** and **6800** problems. Personality modules for other  $\mu$ P's are currently under development.

So if you're working with microprocessors and want to know whether your software or hardware is giving you problems, Biomation's 168-D Mind Reader will tell all: What happened . . . where . . . and when. You've got to get the data sheet. Circle the number below. Better yet, call Biomation for a demo. Biomation, 10411 Bubb Road, Cupertino, CA 95014, (408) 255-9500. TWX: 910-338-0226.

**biomation**  
Creating tools for technology

CIRCLE NUMBER 37





# In avionics, distributed processing has become a way of life

**S**hould a central computer be installed in a military aircraft to handle the radar, the navigation, the weapon delivery and the electronic countermeasures? Or should each subsystem have its own little computer?

That was the dilemma 10 years ago. The idea of a central computer was attractive—not only to the avionics designers but also to designers of ships and other multisubsystem weapons throughout the military.

The medium-sized digital computer had improved. It had speed and even built-in, self-test capability. And its expense was justified because it managed several aircraft subsystems instead of just one.

But what if that central unit conked out?

As if in response, the improved minicomputer emerged with its increased speed and reasonable price tag. Now, every subsystem had its own computer.

But then came the microprocessor—and distributed processing along with it. The scientists and engineers who make the decisions in the Air Force believe that distributed processing is here to stay. "Avionics architecture built around a central large digital computer will disappear just

like the central low-voltage power supply of the 1950s," says Louis J. Urban, technical director of the Avionics Engineering Directorate of the Air Force Systems Command's Aeronautical System Div. at Wright-Patterson Air Force Base, OH.

This is the philosophy behind today's designs for tomorrow's weapons. But meanwhile, a variety of systems still flying must be maintained and retrofitted before they are phased out.

### The early airborne digital machines

One of the earliest digital computers flown by the Air Force was Kearfott's AN/ASN-24, a 24-bit computer built with electromechanical servos and a 4-k drum.

Built in 1957, "the machine has served well, and still does. It's just slow and can't be expanded," Urban says of the computer, which is essentially a digital machine performing in-

cremental computations.

"It's a digital-differential analyzer (DDA) machine with some general-purpose capability," Urban explains. The computer is organized around the drum.

The Air Force's first truly general-purpose digital computer still flies in the A-7D attack plane. It also flew in the AC-130 Gunship over Vietnam. Built by IBM in 1967, the TC-2 was designed with a 16-k, 16-bit core memory tied to an integral a/d converter. "Although it was certainly a step in the right direction, the TC-2 is hard to program," Urban says. "This, of course, is true of all larger machines," he adds, "especially when interfaced with a large converter."

There was a general scepticism about digital computers in those days, Urban recalls. "We didn't have a lot of experience with them," he explains. "There were even people in the office of Defense Research and Engineering in the Pentagon who thought that for an aircraft like the F-111 we might need four digital computers arranged in cascading design as a backup."

Instead, two IBM CP-2s were selected in 1965 for the Mark II avionics suite which would be installed in the later F-111s—the F-111D/F and the FB-111A bomber. But almost at once there was a problem. IBM had expected an MTBF of 2000 hours for the CP-2 but appeared to be getting 100—sometimes as little as 15. The trouble,



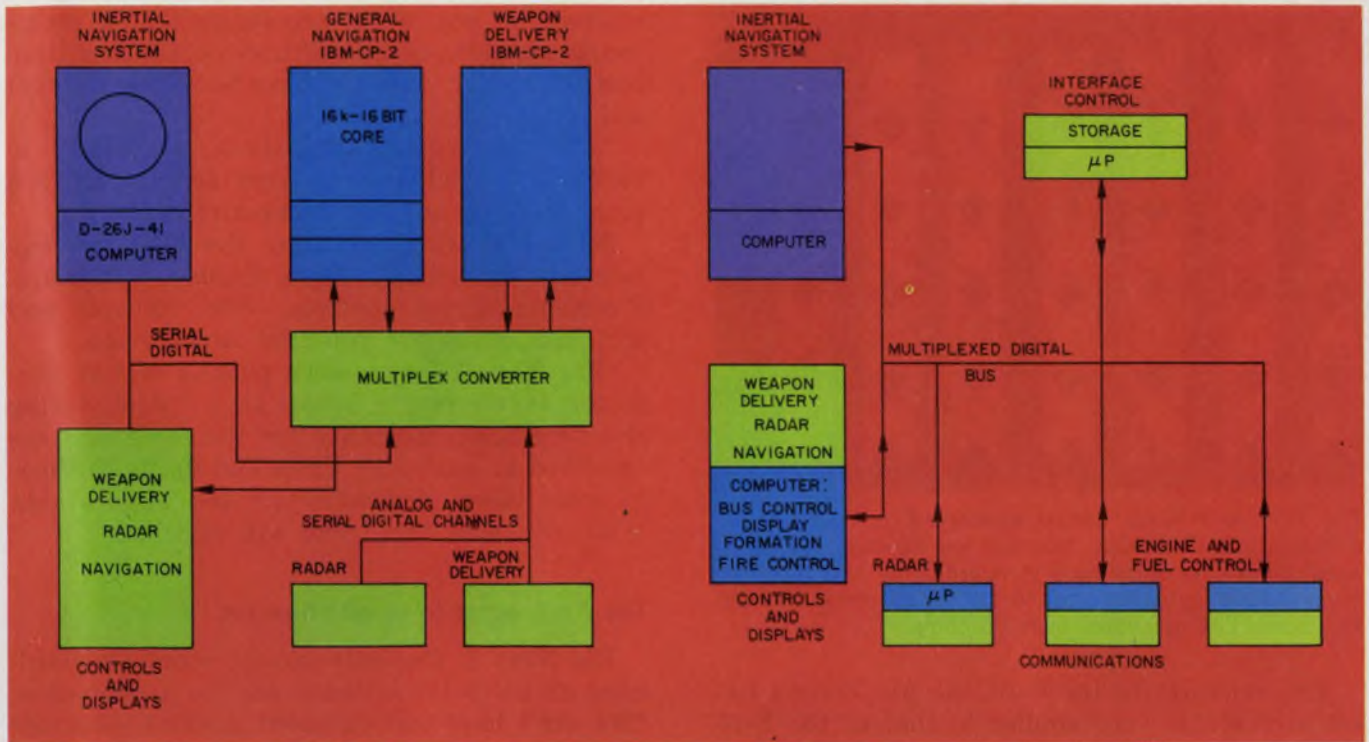

The aircraft system of the future (diagram right) will use distributed processing instead of central processing in the older, F-111 system (diagram left). A standardized,

high speed multiplexed data bus will carry all data to and from the individual processors distributed throughout the aircraft.

it turned out, was the associated, but separate, a/d converter built from some 10,000 parts with 18-million solder joints. When this converter was replaced, the CP-2 computer's MTBF increased to about 1200 hours—still spectacular for 1965.

### The first modern digital computer

The Air Force flew the first of the really modern general-purpose digital computers in the F-15 in 1969. The plane was extremely sophisticated for that time: It carried state-of-the-art devices and used the first multiplex bus. The bus eliminated an enormous amount of dedicated wire and made the aircraft easier to retrofit. The bus also permitted the use of standardized interfaces.

"This was a real accomplishment," Urban observes. The processing in the F-15 is distributed according to function: An IBM AP-1 core-memory machine—16 k, 32 bits—handles the central navigation; a Hughes Aircraft HCM-231—16 k, 24 bits—provides data processing for the radar; and a Texas Instruments 2520-2—32 k, 16 bits—manages the electronic countermeasures.

"This architecture is something we'd dreamed about for years but hadn't been able to have because of cost. It actually distributed the processing away from one large central machine. "We had finally started to evolve into distributed and dedicated operations."

*(continued on page 76)*



The Navy and Army have invested in Boram, a block-oriented, random-access memory that will store 16.8 Mbits of data (Westinghouse).



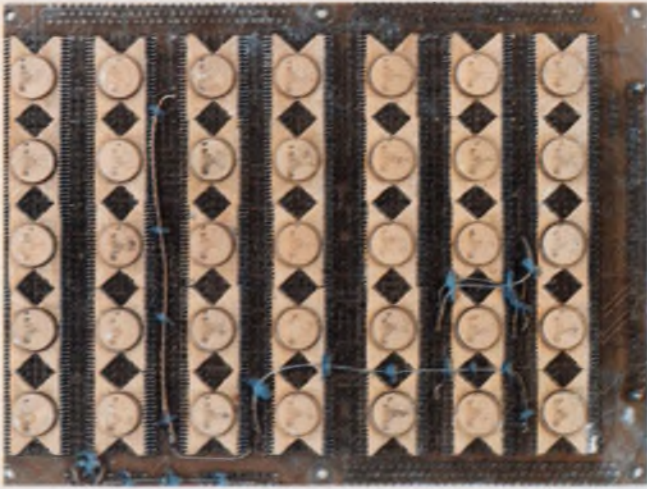

The AOP in NASA's Lansat spacecraft is made of 26 different LS TTL chips mounted on 40-lead flat packages. Each chip contains a standard array of 116 three-input NAND gates interconnected to perform different functions. The processor uses 66 chips.

The avionics for the F-16, the Air Force's latest aircraft, is very similar to that of the F-15 in basic architecture "except that by the time we started designing the F-16, the Defense Dept. had agreed on a multiplex-formatting signal protocol—MIL Standard 1553A data bus."

The 1553 multiplex data bus will also be used in the Navy's F-18, possibly the Air Force's B-52 update, and the JTIDS (joint tactical information distribution system).

The F-16's distributed processing is divided between a Singer SKC2400 computer for navigation and a Westinghouse millicomputer embedded within the radar. A Delco 362-F handles the F-16's fire-control system. Other sensors will be controlled by  $\mu$ Ps.

The Air Force was reluctant in the past to standardize its use of computers. "Our people were vindicated in not standardizing in the 1970s," Urban says. "The computers that are available today are one-third the weight and volume and one-fourth the cost of those available five years ago."

One danger in standardizing, Urban points out, is freezing on old technology. Standardizing on interface characteristics, however, does not result in freezing. With standard interfaces, a new subsystem using the latest technology can still be installed while the rest of the system continues to perform as usual.

#### Air Force looks to the future

The Aeronautical Systems Division is enthusiastic about  $\mu$ Ps. "In the near future," says Urban, "we hope that  $\mu$ Ps will give us a simple executive bus controller that will check the health of a system, make sure that everything is working, and take action if something goes wrong. If

a sensor, or one of the processors that is monitoring a sensor, should malfunction, the execution controller could possibly reconfigure the system and continue the mission.

"With  $\mu$ P costs coming down, we expect to have this capability in the very near future. We could use it on any Air Force aircraft."

Several aircraft, including the F-16, already have  $\mu$ Ps embedded in their Heads-Up Displays. Electronic engine controls, inlet controls and anti-skid brakes are potential applications.

"For 20 years we've been putting digital computers in aircraft," Urban says. "And during this time their capability for the same size has improved at least four times and up to 10 times in some cases, depending on the applications. With  $\mu$ Ps, now, this trend will continue."

#### The Navy wants to standardize too

The Navy is also enthusiastic about standardizing its computer systems, and for good reason. "We can't have 100 different systems, each optimized for a particular application," says James S. Campbell, special assistant for Systems Integration to the Assistant Secretary of the Navy, Research and Development.

Campbell adds: "We would like to establish standards on form, fit and function; on protocol between the devices and the computers; on a language, operating system, and, if possible, architecture. With all this, we'd then have software that was easy to maintain and that could be moved from one machine to the next."

In the past, Campbell says, the Navy tended to build a new weapon, then a computer for it, and then software for the computer. If other systems were to work with the new one, their software had to be recoded.

"We want to reverse that," Campbell reports, "and the way to do that is to make computers compatible at the machine-language level. I want to be able to run a problem on one computer and then take it and run it on another.

"We have the AN/UYK-7 computer, for example which is a 32-bit machine, and we have the 16-bit UYK-20. Both machines accept the same software. Now, we're going to get a new 16-bit computer for the F-18 Navy aircraft that will be compatible with the UYK-20. That way, all our facilities will support all three."

Campbell is pleased with the competing prototype models of the new AYK-14 computer for the F-18 fighter now under development.

"With the cost of  $\mu$ Ps coming down, we will probably go to distributed, dedicated systems with their own local storage," Campbell says. "Because of  $\mu$ Ps we are making smarter terminals, and we are transmitting more conditioned data."



The Navy wants higher memory speeds. "Right now we're working at very close to 1- $\mu$ s access time on the core memory. We want to work down in the 500-to-700-ns region," says Campbell.

Magnetic cores are still the most popular memory in the Navy inventory, but now there's interest in a mated film memory that has been used in the UYK-7. The memory is double the density of the core memory and nonvolatile.

The Navy is also considering bubble memories, but finds their temperature instability undesirable. CCDs appear to have more promise, Campbell says. "In the next four to five years, the cost of CCDs will be down to 0.001¢ per bit, power consumption will be down 20 to 1, and weight and space down 40 to 1. CCDs have a good future in the Navy."

### A $\mu$ P that's worth its weight

A microcomputer has already extended the load-carrying capacity of one of the Navy's heavy-duty helicopters. Although the chopper could lift more than its own weight, it got into trouble when the load shifted back and forth. When the pendulum-like motion got too wide the helicopter was pulled around like a toy balloon.

Finally, a position sensor and  $\mu$ P were placed on the load, to send stabilization data to the helicopter's flight control system. The result: The chopper can safely lift even more.

### The Army keeps the man in the loop

Because of the large number of unexpected variables that can suddenly appear on a battlefield, the Army is particularly interested in keeping a man in control of the computer-weapon loop. And the Army wants to use smart terminals to avoid sending unprocessed, highly critical data that might be intercepted by the enemy by radio link to a central computer.

"Smartness in individual terminals would enable us to manipulate and compose messages without sending everything back and forth to a central computer," says Rudolf Riehs, Deputy Director of the Communications-Electronics Systems Integration Office, Army Electronics Command, Fort Monmouth, NJ.

The Army will equip its individual artillery batteries with more advanced minicomputer systems that can calculate trajectories for each artillery piece. Currently, a central computer calculates trajectories only for the middle of the battery.

As for memories: "We're trying to get away from the drum disc and tape memories. We're more interested in memories that are electronic, solid-state and nonvolatile," Riehs reports.

The Army's AN/TTC-39 automated telephone

central office, currently under development, will use two of Litton's AN/GYK-12 computers, each containing a 131-k word, mass-core memory unit, eight magnetic tape transports, one teletypewriter, two 8-megabyte, random-access storage units and 80 column-line printers. The GYK-12 is also used in Tacfire, the Army's tactical-fire direction system for field artillery.

The Army plans to standardize on a family of computers so that identical software can be used on all of them. The choice involves three popular commercial lines of computers.

### As NASA moves out into space . . . .

"Am proceeding as planned," reports the roving vehicle from the surface of Mars—ignoring a cliff just ahead that the mission-control team on earth can see on the television link.

Unless the vehicle has on-board sensors and

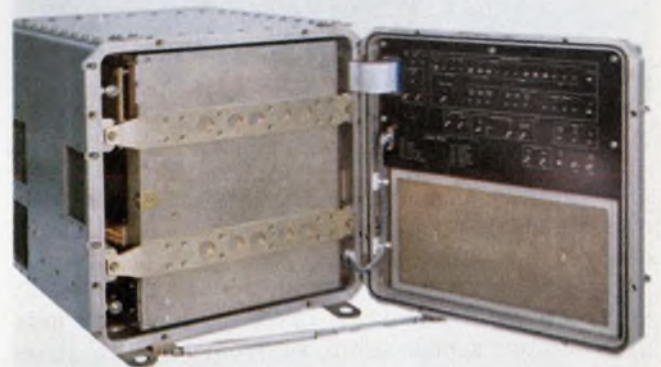

The Univac AN/UYK-20, opened to show maintenance panel, is organized around a microprogrammed controller and a two-bus data exchange structure.

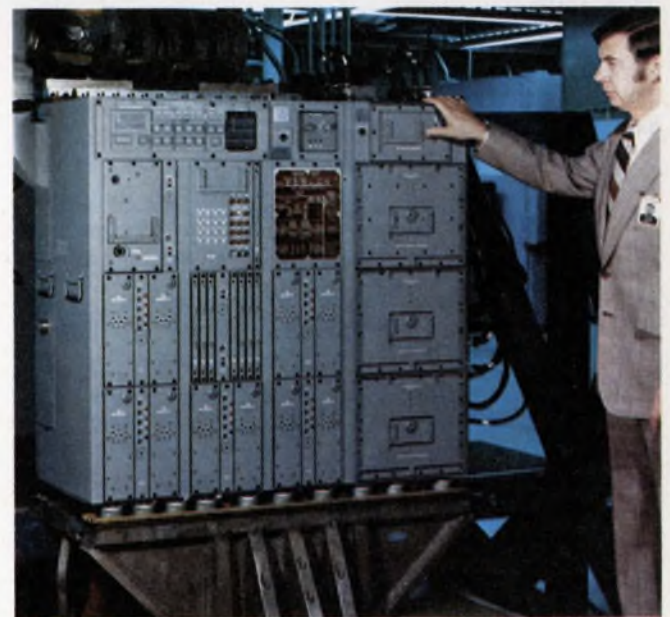

Litton's L-304 56-k dual processor is used in the Navy's E-2C Hawkeye electronic warfare aircraft.



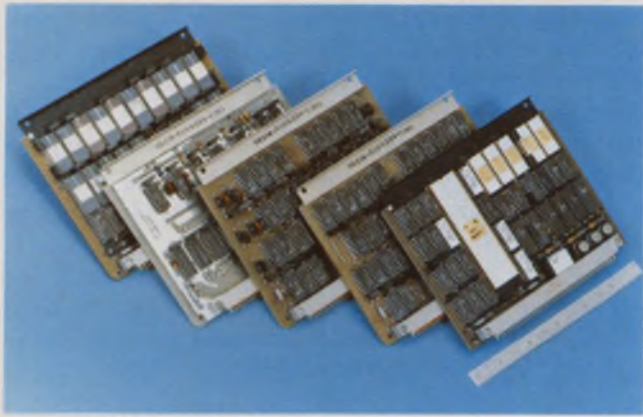

A family of  $\mu$ C cards by Texas Instruments is designed for military systems. The family includes a 9900  $\mu$ P, PROM, RAM, and I/O modules.

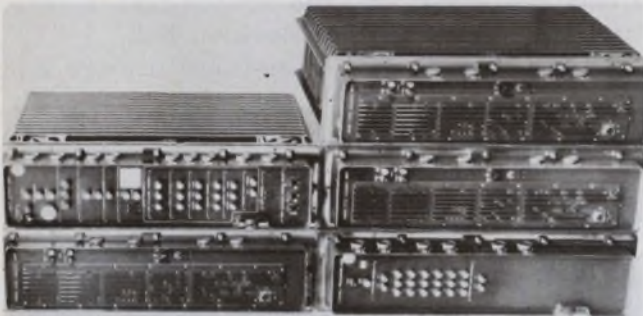

The AN/TSQ-12 computer, built by Litton, is used in the Army's Tacfire system, Missile Minder and the Tri-Tac AN/TTC-39 communications switch. Each of three core-memory units has  $131\text{-k} \times 32\text{-bit}$  words.

the intelligence to advise it to stop, the mission is effectively finished. It takes too long—19 minutes—to get a message to or from Mars to direct the vehicle from earth.

Fortunately, as NASA has moved farther out into space, technology has been able to provide new tools.

NASA's AOP, Advanced Onboard Processor, computer, for example, is one giant step beyond its predecessors: It allows more functions to be handled on board, and it's smaller, to boot.

A typical configuration, including power converter and a 4-k memory, weighs 14 lb, consumes 14 W and occupies 275 in<sup>3</sup>. Its predecessor weighed 29 lb, consumed 23 W and took up 585 in<sup>3</sup>.

The AOP controls an earth-orbiting satellite called Lansat-2 that observes the earth through infrared and visible-light cameras, and transfers telemetry, data and commands between the ground stations and the satellite. The AOP also monitors impending malfunctions and sends corrections for them.

NASA plans to upgrade the AOP and its other main computers as quickly as time and money will permit. LSI technology, particularly CMOS, will be used despite CMOS's relative vulnerability to radiation.

CMOS packs many functions into a small area. It is immune to power supply variations, is more immune than other LSI technologies to logic noise and doesn't use much power.

For memory, present spacecraft computers use plated wire because it uses the least power of any other nonvolatile memory and is small. Core memory, while also nonvolatile, has no technical advantage over plated wire, but costs less and will therefore continue to be used.

NASA is looking with favor at another nonvolatile memory, the electrically alterable ROM (EAROM). While already in commercial use, EAROMs are slower than core memories, and aren't space qualified.

### Space computers must be ultra-reliable

Two current methods to prevent an entire space mission from aborting when one portion of a computer fails are redundancy of the main computer and distributed, dedicated processors for each function.

The Viking orbiter computer, for example, uses six computers—two for each of its three subsystems.

Two of the pairs use 54L TTL technology and differ only in I/O characteristics. The third pair uses CMOS technology.

Spacecraft that operate for five years or longer for the Air Force will use an ultra-reliable computer system that will reconfigure itself if any part fails. The reconfiguring will be done by a module that is, itself, redundant—there are three of them.

In addition to three configuration control units, the computers will contain four central processors, three memory modules, two serial I/O modules and two DMA modules.

NASA, in conjunction with RCA, has developed the CD4057, a CMOS bit-slice chip for processing. The 4-bit chip is space qualified and is now being integrated into a general-purpose, 16-bit computer called the  $\mu$ Scope.

The  $\mu$ Scope will be used first in a gamma-ray-burst processor, which will be part of a spacecraft launched to observe high energy phenomena in space.

The  $\mu$ Scope computer captures the data that might not only last one second but also occur only once in several days. Only information of interest is stored and transmitted to earth for analysis.

Because each instrument has different input-data rates, output format and control, a standard CMOS 12-bit  $\mu$ P that can do all of these functions is being investigated. Only programming need be changed from one instrument to another, rather than engineering a completely new interface for every instrument. ■■



# 12 reasons why *only* Buchanan® Terminal Blocks provide **Lowest Total Applied Cost!**

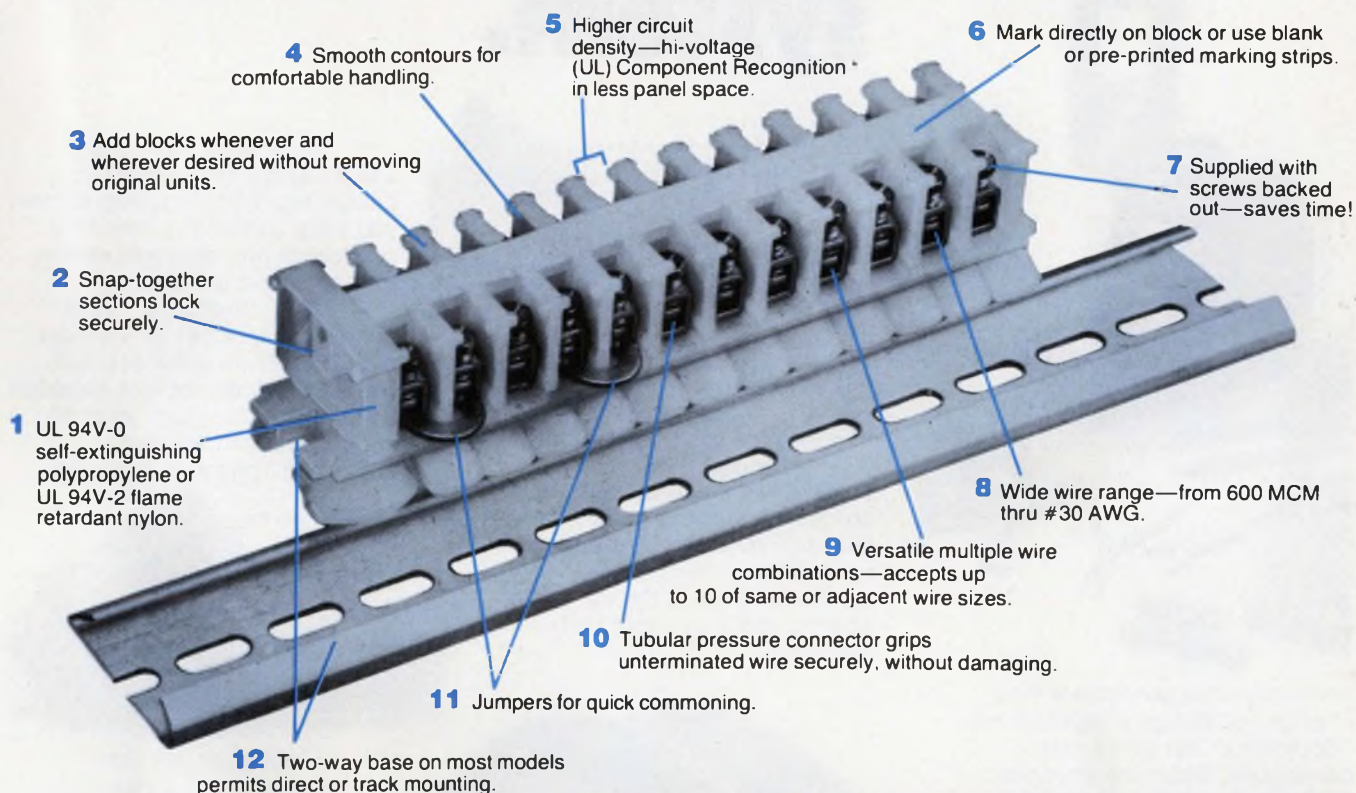

## AND—you can get 'em when you need 'em!

No matter how many advantages offered by a specific terminal block, you can't get the advantages if you can't get the block!

Which is why we make sure Buchanan blocks are stocked in ample quantities throughout the country. Buchanan has anywhere from twice to eight times as many stocking distributors as other manufacturers—so you can get the blocks you need *when* you need them.

And only Buchanan distributors can give you *all* the advantages shown above.

Copper tubular contacts that really grip . . . higher circuit density . . . ease of assembly and add-on . . . everything that works together to provide Lowest Total Applied Cost!

Next time you order terminal blocks, specify Buchanan and be sure of *all* the advantages, *plus* prompt delivery. In the meantime, send for our handy Selector Chart and Catalog. Use the Reader Service Card. (If you have a special application, call one of our Regional Offices shown below.)



**CONTROL PRODUCTS  
DIVISION**

Amerace Corporation  
Control Products Division  
2330 Vauxhall Road  
Union, N. J. 07083, U.S.A.  
Telex 138-978

16



# Design with the complete flat cable/connector system.

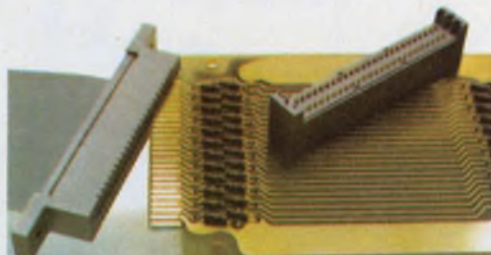

trimming the cable after assembly.

Connector units provide positive alignment with precisely spaced conductors in 3M's flat, flexible PVC cable. The connector contacts strip through the insulation, capture the conductor, and provide a gas-tight pressure connection.

With cable, connectors and assembly tools from one design and manufacturing source, you have added assurance the connection will be made surely, with no shorts or "opens."

And "Scotchflex" now offers you more design freedom than ever. From stock you can choose shielded and non-shielded 24-30 AWG cable with 10 to 50 conductors, and an ever-increasing variety of more than

The 3M DELTA pin and socket connector.



Assembly-cost savings are built in when you design a package with "Scotchflex" flat cable and connectors. But more important, 3M Company offers you the full reliability of a one-source system: cable *plus* connectors *plus* the inexpensive assembly aids that crimp the connections quickly and securely (with no special operator training required).

The fast, simple "Scotchflex" assembly sequence makes as many as 50 simultaneous multiple connections in seconds, without stripping, soldering or

100 connectors to interface with standard DIP sockets, wrap posts on standard grid patterns, printed circuit boards, or headers for de-pluggable applications. 3M's DELTA "D" type pin and socket connectors are now also available. For full information, write Dept. EAH-1, 3M Center, St. Paul, MN 55101.



## 3M's "Scotchflex" line.

See our catalog in EEM—Page 1056.

"Scotchflex" is a registered trademark of 3M Co.

CIRCLE NUMBER 39

ELECTRONIC DESIGN 22, October 25, 1976



# Power Amplifiers. The shape of things to come.



Using solid-state technology to replace bulky tube-type equipment, ENI's broadband amplifiers are tomorrow ideas available today. ENI's Class A power amplifiers already cover the frequency spectrum of 10 kHz to 1 GHz, with power outputs ranging from 300 milliwatts to over 4000 watts. And we're still climbing. Driven by any signal generator, frequency synthesizer or sweeper, ENI's compact portable amplifiers are completely broadband and untuned. Amplifying inputs of AM, FM, SSB, TV and pulse modulations with minimum distortion, these rugged units are versatile

power sources for general laboratory work, RFI/EMI testing, signal distribution, RF transmission, laser modulation, data transmission, NMR, ultrasonics and more. Designed to be unconditionally stable and failsafe (impervious to severe load conditions including open or short circuit loads), ENI power amplifiers will deliver their rated power to any load, regardless of match.

For information write: ENI, 3000 Winton Rd. So., Rochester, New York 14623. Call 716-473-6900. TELEX 97-8283 ENI ROC.

**ENI**

*World's Leader in Power Amplifiers*

ENI products available through ENI Power Systems, Ltd., 23 Old Park Road, Hitchin, Hertfordshire, England SG5 2JS, Tel: Hitchin 51711. TELEX 825153 ENI HITCHIN. And: UNITED KINGDOM: Dale Electronics, Ltd., Frimley Green, Camberley, Surrey, England, Tel: Deepcut (02516) 5094 AUSTRALIA: Elmeasco Instruments Pty. Ltd., 7 Chard Road, Brookvale, N.S.W. Australia, Tel: 939-7944 BENELUX COUNTRIES: Coimex, Hattem, Holland, Tel: 05206-1214 DENMARK: Tage Olsen A/S, 2100 Kobenhavn 0, Denmark, Tel: (01) 294800 FRANCE: Comsatec, 92300 LaVallois-Perret, France, Tel: 270 87 01 GERMANY, AUSTRIA: Kontron Elektronik GmbH, 8057 Eching/Munich, Oscar-von-Miller-Str. 1, Tel: 08165/77336 ITALY: Romagnoli Elettronica, 57100 Livorno, Italy, Tel: (0586) 407.301 JAPAN: Astech Corporation, Shinjuku-ku, Tokyo 160, Japan, Tel: Tokyo 343-0601 NORWAY: Solberg & Andersen A/S, Brynsvæien 5, Oslo 6, Norway, Tel: 47 2 19 1000 SOUTH AFRICA: Associated Electronics (Pty.), Ltd., Johannesburg, South Africa, Tel: 724-5396 SPAIN: Aupoca S.A., Madrid 16, Spain, Tel: 457-53-12 SWEDEN: Saven AB, S-185 00 Vaxholm, Tel: 07641315 80 SWITZERLAND: Kontron Electronic Limited, 8048 Zurich, Switzerland, Tel: 01 62 82 82

"ELECTRONICA HALL 20, BOOTH # 20221"



# We sell solutions.

When the man from Honeywell Test Instruments Division comes calling, you may have more and better reasons to see him than you ever realized.

You see, we sell solutions, not instruments. So if your problem can be solved best by a simple plug-in module, that's what he'll recommend.

But if your needs require sophisticated oscillographs, magnetic





tape recorders/reproducers or custom analog measuring and recording systems, he has the breadth of line and combinations of instrumentation to make exactly the right recommendation. With complete confidence because, in addition to his own expertise, he's backed by the best design, production, application and metrology experts in the instrumentation business.



**Honeywell Test Instruments Division — the top trouble-shooters. Call on them when you have any test instrumentation problem. And for a quick look at our complete line of test instruments, be sure to write for our FREE 20-page condensed catalog, Dept. 640, P.O. Box 5227, Denver, Colorado 80217.**



# Honeywell



# MOTOROLA introduces micromodules...

## Micromodule Family

### Monoboard Microcomputers

M68MM01 Monoboard Microcomputer 1  
M68MM01A Monoboard Microcomputer 1A

### Micromodule CPU

M68MM02 CPU Module

### Micromodule System Expanders

M68MM03 32/32 Input/Output Module  
M68MM04 8K/16K AROM/ROM Module  
M68MM05A 8-Channel Differential  
12-Bit A/D Module  
M68MM05B 16-Channel Single-  
Ended 12-Bit A/D Module  
M68MM05C Quad 12-Bit D/A Module  
M68MM06 2K RAM Module  
M68MM07 Priority CPU Module  
M68MM08 Microbug Module  
M68MM09 CMOS/RAM Battery Module  
M68MM10 Programmable Timer Module  
M68MM12 GPIB Module  
M68MM13 Ref State Detector Module

### Applicable EXORciser Modules

ACIA Module  
EROM/RAM Module  
8K RAM Module  
16K RAM Module  
Systems Analyzer

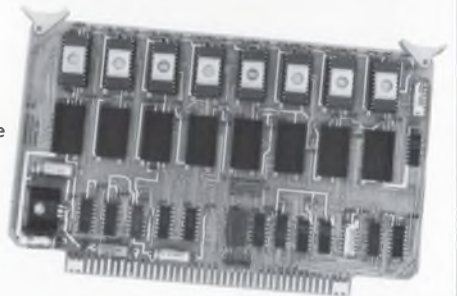
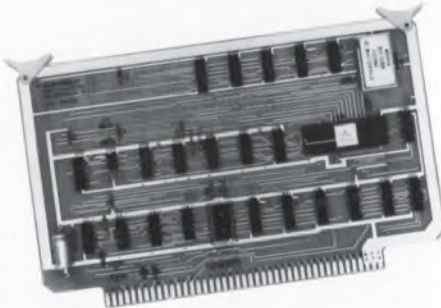
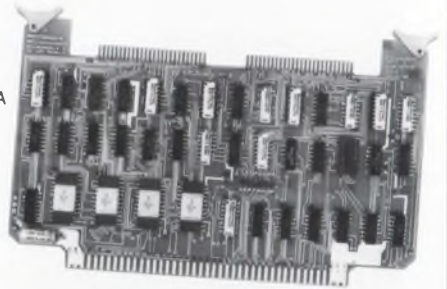
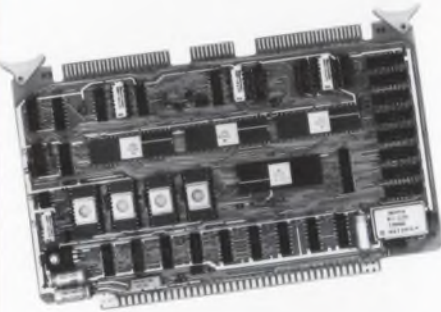

## the flexible M6800 microcomputer alternative

Looking for a fast, low cost, microcomputer hardware design? Trying to avoid the costs of designing and building your own microcomputer system for relatively low-use rates? Looking for ways to build a custom computer with standard boards without big working capital requirements, increased labor force, big inventories, and a drain on cash flow?

Motorola's new M6800-based Micromodule\* Family has the answers. You now have the choice you didn't have before. Take the single-board approach, or reach into our assortment of mix-'n-match module options and build your own customized system with standard boards.

Micromodules 1 and 1A are M6800-based 8-bit single-board microcomputers, Monoboard Microcomputers. MM 1 features all parallel I/O. MM 1A has both serial and parallel I/O.

Micromodule 2 is the M6800-based CPU module, the heart of the Micromodule Family's modular microcomputer concept. Use it with your choice of I/O, RAM, AROM/ROM, A/D, D/A, Programmable Timer and other Micromodule options.

Orders may be entered now for Micromodules 1, 1A, 2, 3 and 4, and ten additional Micromodules are already defined for this new microcomputer concept. As an example of the cost savings inherent in the concept, a single Micromodule 1, the M68MM01, sells for \$485.00, and drops to \$275.00 in 100 lots.

The total resources of Motorola's system development tools including the EXORciser\*, EXORdisk\*, and a full complement of software back up the Micromodule Family. The family also offers card cages, rack-mount chassis, and power supplies. Remember, too, that Micromodules and EXORciser modules are bus compatible.

\*Trademark of Motorola Inc.



## MOTOROLA Microsystems

— making it happen in microcomputers

Motorola Semiconductor Products Inc., P.O. Box 20912, Phoenix, AZ 85036

CIRCLE NUMBER 223



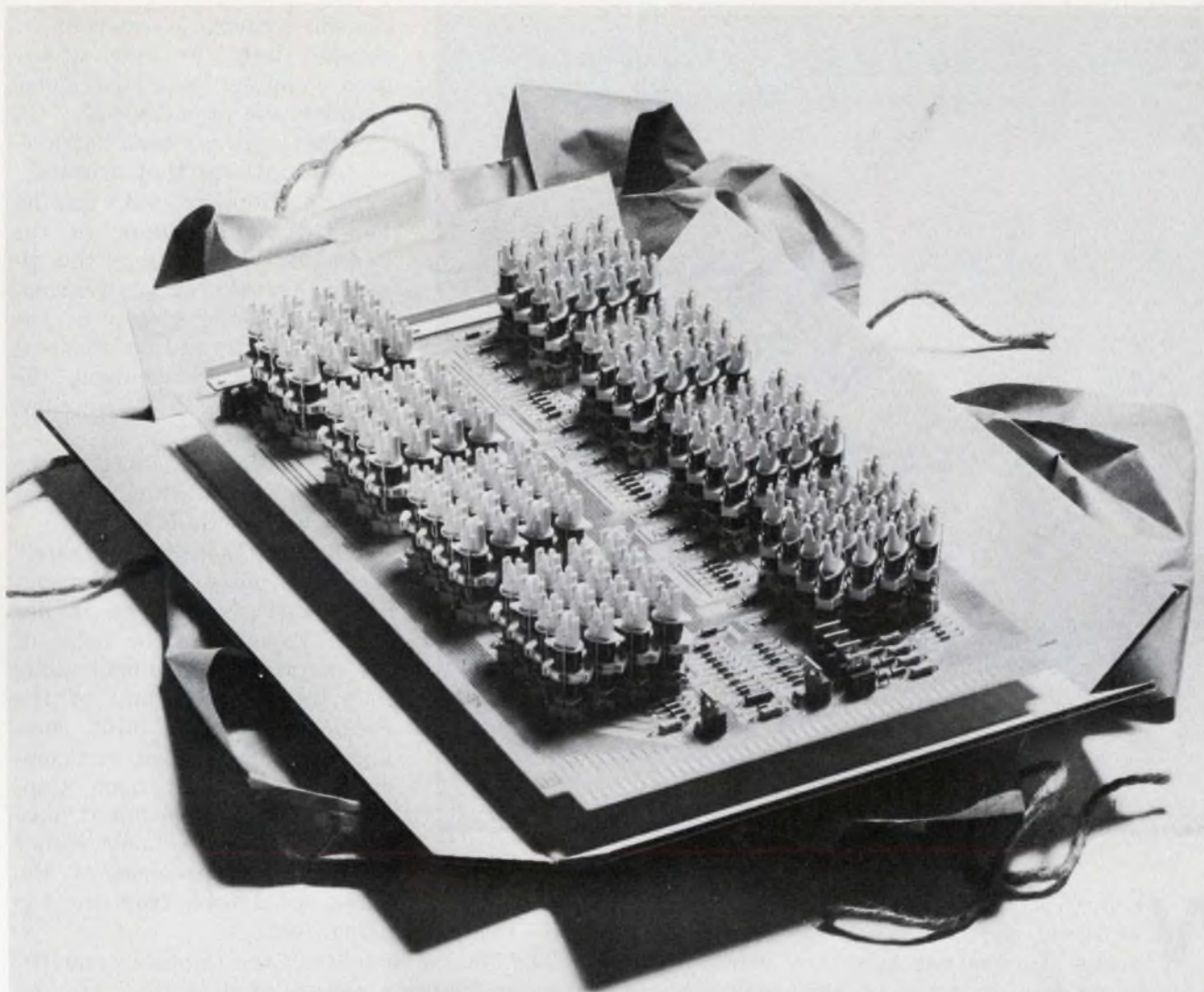

# Hot signal switching to go.

Here's a shortcut to your next state-of-the-art voice and data switching system. Our standard matrices and high-rise Correeds.

They help you design your system without long lead time or a big budget. And because they're standard items, you get the components you need fast.

Many matrix configurations are available, with either magnetically latched or electrically held crosspoints. You can create single- and multi-stage networks of any size by connecting two or more matrices together. Or, just buy our Correed crosspoints and build your own matrices, if you wish.

Correeds make the most of any matrix design. They give you high-density packaging. Millisecond switching speed. Very low insertion loss, noise and crosstalk. And millions of

trouble-free operations.

Why start from scratch? Start at THE SOURCE: GTE Automatic Electric.

For more information on matrices or Correeds, send the coupon below. Or call John Ashby at (312) 562-7100, ext. 250.



(Actual Size)

Please send more information on Correeds and matrices.

on \_\_\_\_\_ of \_\_\_\_\_  
(Quantity) (Product)

Name \_\_\_\_\_ Title \_\_\_\_\_

Company \_\_\_\_\_

Address \_\_\_\_\_

City \_\_\_\_\_ State \_\_\_\_\_ Zip \_\_\_\_\_

Telephone \_\_\_\_\_

Mail to: Mr. J.D. Ashby, B-4, GTE Automatic Electric, Northlake, Illinois 60164

**GTE AUTOMATIC ELECTRIC**



## Grand lady of software

# Grace Hopper: 'It's rewarding trying to do things in a new way.'

**W**hen Grace Murray Hopper was seven years old, she lived in a house with seven clocks. To find out how they worked—the alarm mechanism posed a particular challenge—she took one apart. Then, to put it together, she dismantled another. And on through the house, like a parable, to the seventh clock.

Dismantling things and putting them back together has remained a consuming interest for Grace Hopper. At seventy (in December) she is still doing it, and except for those clocks, whose restoration eventually required some kind of subcontract arrangement with a local repair shop—she has left a string of successes behind her of which anyone would be proud.

Hopper's most significant contribution to the computing profession has been her pioneering work in programming languages. Shortly after World War II, as a Senior Mathematician at the Eckert-Mauchly Computer Corp., the forerunner of the present Univac Division of Sperry Rand, she developed a concept of automatic programming with a compiling system which enabled the computer to write its own program from natural-language instructions. From this original concept, she created the first English-language compiler

system, Flowmatic, later incorporated into the now widely used computer language, Cobol—which she also devised.

"I have always been entranced by anything that worked," Captain Hopper said, leaning forward on her desk in the Pentagon where she is the director of the Navy Programming Language Group in the Office of Information Systems Planning and Development. "So when I met my first computer, I was fascinated."

She turned and looked at the shelves of books behind her that extend to the ceiling.

"It's up there somewhere," she said, putting out her cigarette and standing up in her chair. Except for the noise of the motorized messenger carts that ply the corridors of the Pentagon, and the faint, comforting, hum of two minicomputers in the next room, Captain Hopper's office might have been in someone's home rather than in the basement of the

Pentagon. She reached for a book from the top shelf—in her stocking feet.

"The Mark I computer," the Captain announced, after finding a picture of it in the book and climbing down from a perch that would have made many people half her age anxious, if not dizzy.

"The first automatically sequenced digital computer in the United States and the forerunner of the modern electronic computers," she went on, showing the picture of the Mark I, and lighting another cigarette. "It was 51 feet long, eight feet high and eight deep. It did three additions every second."

### Hopper discovers computers

Fate and World War II brought Grace Hopper and the Mark I together, thus introducing her to what would become her metier. "I'd never thought of going into computer work," she recalled, "because there weren't any computers to go into—except for the Mark I, which I didn't know anything about. In the 1940s, you know, you could have put all the computer people in the country into one small room."

But the Navy sent her to the Bureau of Ordnance Computation Project at Harvard where she was ushered at once into the Mark I computer room: "J. Presper Eckert, the director, said to





**Capt. Grace Murray Hopper** created the first English language compiler system, Flowmatic, and later the

widely used computer language, Cobol. Now, she would like to build an assembly-line computer.

me: 'Please compute the interpolation and coefficients of the arc tangent series.' And with the help of two ensigns, I did."

Hopper began programming right away. "We called it coding then," she recalled. "'Programming' was a British word that came over five or six years after we began 'coding' in the States. The American computer people finally adopted the term because, I think, it sounded elegant and they thought that 'programmers' would make more money than 'coders'."

She left active duty with the Navy reserve in 1946 after having been denied transfer into the Regular Navy because of her age. The limit was 38, and she was 40. So she taught mathematics at Harvard until 1949, then went to work for Eckert-Mauchly. She chose Eckert-Mauchly over other offers from young computer manufacturers because the company was on the verge of having a running computer. Eckert-Mauchly had completed Binac and was well on its way with the Univac I.

She stayed with Eckert-Mauchly (Univac) until 1967 when, despite having retired her from the Navy Reserve because she had reached 60, the Navy recalled her to active duty to standard-

ize its programming languages. She's been at the Pentagon ever since.

"We wrote a program for the Mark I," she explained, "because we wanted to try to make the system error-free."

Mark I, like computers today, could be programmed. It wasn't like the Illiac, the first of the electronic computers, which came out in 1946 and did not need to be programmed. "Illiac, you remember, was patch-boarded. You actually plugged wires from the end of this operation over to the end of that operation. It was made up of a whole bunch of adders and multipliers—all sorts of different components patch-boarded together," Hopper explained.

Mark I, on the other hand, required a sequential code from one location into another location to perform a certain operation. And it was easy to make errors. "You write a Delta," she continued, "and someone reads it as a 'four.' You write 'B,' and someone reads it as '13.' And sometimes you just make a mistake and write the wrong thing to begin with."

So while at Harvard, Hopper and her colleagues began collecting programs known to be correct: "When we got a correct subroutine, a





Grace Hopper checks out Flowmatic, the language from which Cobol evolved, on a Univac 2 in 1956.

piece of a program that had been checked out and debugged—one that we knew worked, we put it in a notebook.”

Eventually, the group acquired a library of routines—one doing the sine, one the cosine, one the arc tangent, and one integrating something. They all started at “0,” but to go into a sequential program, they had to be adjusted and have numbers added to them.

At Univac, Hopper put the programs on tape and gave them call numbers. “Then all I had to do was to write down a set of call numbers, let the computer find them on the tape, bring them over and do the additions. This was the first compiler,” she recalled.

Hopper realized very quickly, however, that she didn’t have to do all this: “We could start writing mathematical equations and let the computer do the work. The computer would call the pieces and put them together.”

### ‘People are scared to change’

Hopper’s next contribution was motivated by a plank in a personal platform that is responsible for many of her accomplishments. “Most people are scared to death of change,” she said, “and I’m not. Some of my most rewarding experiences have been in trying to do something in a new way.” (As a reminder that things don’t always have to operate along traditional lines, a clock on Captain Hopper’s wall runs counterclockwise. But since the numbers are backwards, too, you can tell time as easily on this clock as with a conventional one.)

“People wouldn’t believe my compiler worked. They said that computers could only do arithmetic, that they couldn’t do programming. So I got mad. I decided to show them that I could make a computer do anything I could define.” And since differential calculus could be completely defined, she programmed the computer to do dif-

ferential calculus. It took one year.

She quoted an observation made by a computer newsletter deploring the fact that major developments take so long to evolve. According to the editor, who cited 30 major developments as his example, it takes 10 years, or about 30,000 man years, to bring forth one new idea.

That isn’t really true, Captain Hopper said: “It only takes one year to develop an idea; the other nine years are needed to get people to believe it.”

Univac thought it was “marvelous” that she had made a computer do differential calculus, but what the customers really wanted, the company pointed out, was data processing. Please turn your attention to that, she was asked.

“Dealing with data ushered in a whole new world,” Hopper reflected. “We lost all our checking ability. We lost our language in mathematics—a well known, universal language, as easily understood here as in Tokyo or Berlin. We were dealing suddenly with words.”

So she set to work writing out typical programs. She wrote 500, identifying 30 verbs that would be common to all programs. Her next step was to recommend that data processing be written in English.

“I was told very quickly that I couldn’t do this because computers didn’t understand English.” And characteristic of people in a position to implement innovations, they took three years to recognize that the concept was workable.

“This was the first language in words developed for a computer,” she observed. Univac named it Flowmatic. Later, from Flowmatic, evolved Cobol, which eventually became the common business computer language.

Some people did not accept Cobol and are still writing assembly code, Hopper said. “We’re trying to stop them because the code can’t be transferred from one machine to another. Cobol, of course, can be moved.

“The real competition today is between Cobol and PL1. Cobol is sponsored by the American National Standards Institute and the Codasyl organization which is made up of users. PL1, which can only be used on IBM machines, is supported by IBM.

“IBM doesn’t like Cobol,” Hopper continued. “If a program is written for an IBM machine, and you can move it to another computer, then you can buy another computer. IBM doesn’t like this, so they invented PL1.”

Because of the high cost of software and converting from one language to another, the Navy has ruled that it will use either Cobol or Fortran. “If you want to use anything else, you must get permission two echelons above you, and no one wants to bother with that.”

Hopper recognized very early that program-



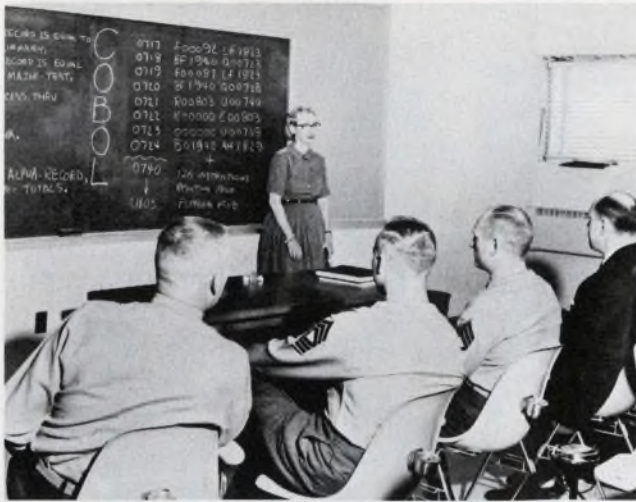

Army programmers at Fort Monmouth, NJ, learn about Cobol from Grace Hopper, who devised the language.

ming tools are an essential part of a computer package and should be included in any initial delivery to a user. At Univac, in 1957, she wrote a memo on the subject, which she entitled "Layette for a Computer." Responding in the same metaphorical vein, her boss commented that apparently she wasn't content to deliver just hardware, that she wanted to deliver "software" as well. Thus, a new term was born.

### Software on chips

Software is delivered now on tapes and cards, but that's going to change, Hopper predicted. "In the very near future, it's going to be delivered on chips and you won't be able to change the program once you get it."

Captain Hopper picked up a laminated paper-weight on her desk that contained a quarter-of-an-inch chip. "That's the new Data General computer," she said. "Isn't it beautiful? It adds, multiplies and divides. It's a central processing unit just as the Mark I was. It does the same thing the Mark I did, and it was 51 feet by eight by eight!"

Software is still a step-by-step procedure, Hopper cautioned. "You still have to write that linear series of instructions, get it on the computer, put test data through it and see if it works. Then you have to document it so you can give it to someone else to run and work with. And, of course, the tiny computer-on-a-chip requires a Cobol compiler just as an IBM 370 does."

Why do software costs continue to go up?

It's true that software costs. You might as well sell the software, these days, and throw the hardware in free.

One of the biggest costs, and a needless cost, Captain Hopper said, stems from people not being able to define, in the very beginning, what

they want the computer to do. A program may be written well, but if there's been poor communication between the programmer and the line manager of the company that bought the machine, then the result will be poor. All too often, the line manager isn't sure what he wants the computer to do, or how to define what he wants it to do. This happens in government, too, Hopper observed. An agency will buy more computer than it needs, because it doesn't know what it needs.

The traditional schism between the hardware designer and the programmer is drying up, in her view. "This used to be a big problem," she said. "Then the hardware designer realized that to build good hardware he needed to know how hardware was built. So they learned each other's jobs."

### What the future holds

Everything about computers is changing, Hopper said with enthusiasm. Size and cost are down dramatically. "These little chips," she said, glancing at her laminated chip, "are in clocks and ovens—they are all over the house and the office. And, in time, they're going to find application in even more appliances."

Look at the new computer stores, she pointed out. "You buy computers today like hi-fi equipment. You buy the components and put them together yourself. You can even pay for them with your credit card. Boy Scouts get merit badges for building computers. And you now find computer clubs in Junior High School. When the young people build these machines, their fathers, who are reluctant to try new things, often get interested and start using them themselves.

"All this means that young people are going to do things with computers we never dreamed of doing.

"We've got a new generation that's growing up with computers," Hopper continued. "They didn't learn about them after they grew up, as we did. They grew up regarding the computer as they did the telephone. And this attitude is going to make a difference.

"I've watched them at work," she said. "They are so related to the computer that they use high-level languages with no difficulty. They write it right the first time. They don't make the errors that we, who had to learn it after we were adults, make. It's like learning a foreign language. Young people do it better than the old."

What might they come up with?

Hopper reflected a moment. "Probably all the things we couldn't do. They'll probably come up with a computer that will really go after the weather problem—one that can handle a computer load of  $10^{15}$  operations.

*(continued on page 86)*



"Such a computer," she continued, "could also be used to study and predict economic trends. Most of our economic models are linear. We need second and third-order models to get at the relationship of our economy to the world economy. To solve these problems, you've got to get involved in second-order effects—quadratic equations."

What will the super computer be like?

"It will be a whole series of microcomputers. You don't need the big dinosaurs anymore that cost \$3 million. Our installation of micros and minis in the next room cost \$100 000."

What's the advantage of Amdahl's big computer?

"None. Except that people don't like change and still feel that big is best—that it's the safest way to go."

Hopper reflected further. "Of course, some outfits are buying micro networks now: the Bank of America, Ramada Inn, Citibank, Ford Motor Company. They're putting together DEC's, Data Generals, Hewlett-Packards.

"A lot of the big super computers contain micros inside their impressive cabinets. Even IBM's computers use them. They just don't broadcast it. Honeywell is the only one that's opened the door and said 'Look at all the micros we've got in here'."

There's an enormous, untouched market for computers, Hopper believes. "People don't realize," she said, "that only a little over 5% of American industry uses computers. The little businesses—which, of course, outnumber the giants—don't have computers yet. And with the increasing amounts of paper work the government is requiring they're going to need computational help.

"I can see the day when youngsters, like two we had working here this summer, will go back to their home towns and introduce microcomputers in whatever business they start up—whether it be a dairy, a dress shop or what."

### Grace Hopper looks to the future

Captain Hopper's computer career is far from finished even though she has over 30 years of contributions and over 50 published technical papers to her credit. She also has won many awards, including the Computer Science "Man-of-the-Year" award, given by the Data Processing Management Association.

Currently, she is building a Cobol compiler for a small shipboard computer. On the side, she's planning to get her family's genealogy chart off cards and into a computer. And, if she can bor-



Grace Hopper, with RCA programmers, demonstrates in 1960 that Cobol can be used on different computers—first an RCA and then (right) a Univac 2.

row a few micros, she would like to build her own assembly-line computer.

"The big difficulty with Illiac IV, Star, and the others, has been that to get more speed you use more adders, very high speed adders that have to work simultaneously. And if one of them drifts—and high speed adders do drift—you're dead.

"I think we could build a better and faster computer with these slower micros if we'd just use the assembly-line concept. I could move my data along, split up and in parallel, letting each micro handle one operation. For certain problems, like the weather, it would work. Eventually, I could beat the velocity of light by having work done in parallel."

So far, Hopper hasn't been able to persuade anyone to do this: "But," she added, "if I can get the micros somewhere, I'll do it myself. I'm hoping to borrow a Nova from Data General, or maybe a micro from Motorola. I've already got two computers in the next room—both borrowed. And if I get four strung together I think I can prove feasibility."

Hopper reiterated her faith in the young people she deals with. "They know so much more than we did. But they have no more maturity than we did. And they want leadership. More than motivation, they want to be told what to do. Guidelines. That's what they're looking for and that's what we must give them." ■■



# Magnecraft's line of 1200 stock relays just increased . . . by another series.

**WHY WAIT FOR SOLID STATE?** Our family of 24 solid state relays provides current ratings from 2.5 to 40 amps, with switching capacity up to 480 VAC. All models incorporate optoisolation between input and output, and zero-voltage switching. Screw type clamps and Faston "Quick-Connect" terminals are available on packages which are interchangeable with others.

Output switching reflects the latest state-of-the-art technology. Both the high-reliability dual SCR approach and the more economical triac approach are available.

Magnecraft is committed to providing design engineers with the best solution for their switching applications. It is with a complete understanding of the areas where solid state relays provide the most reliable and economical switching solution, that we've included this family in our line of stock relays.

For complete information and specifications, WRITE FOR OUR SOLID STATE RELAY PRODUCT BULLETIN. Magnecraft Electric Co., 5575 N. Lynch Ave., Chicago, IL 60630



**Magnecraft**  
ELECTRIC COMPANY

CIRCLE NUMBER 41



# STOP

## WAITING ON OUTPUT FROM YOUR $\mu$ P DEVELOPMENT SYSTEMS

You Are Wasting More In Program Development  
Costs Than This **LINE PRINTER** Sells For

**2400 LPM** – 80 COL.  
**MODEL 8210** – **\$3000\***

**1400 LPM** – 132 COL.  
**MODEL 8230** – **\$3785\***

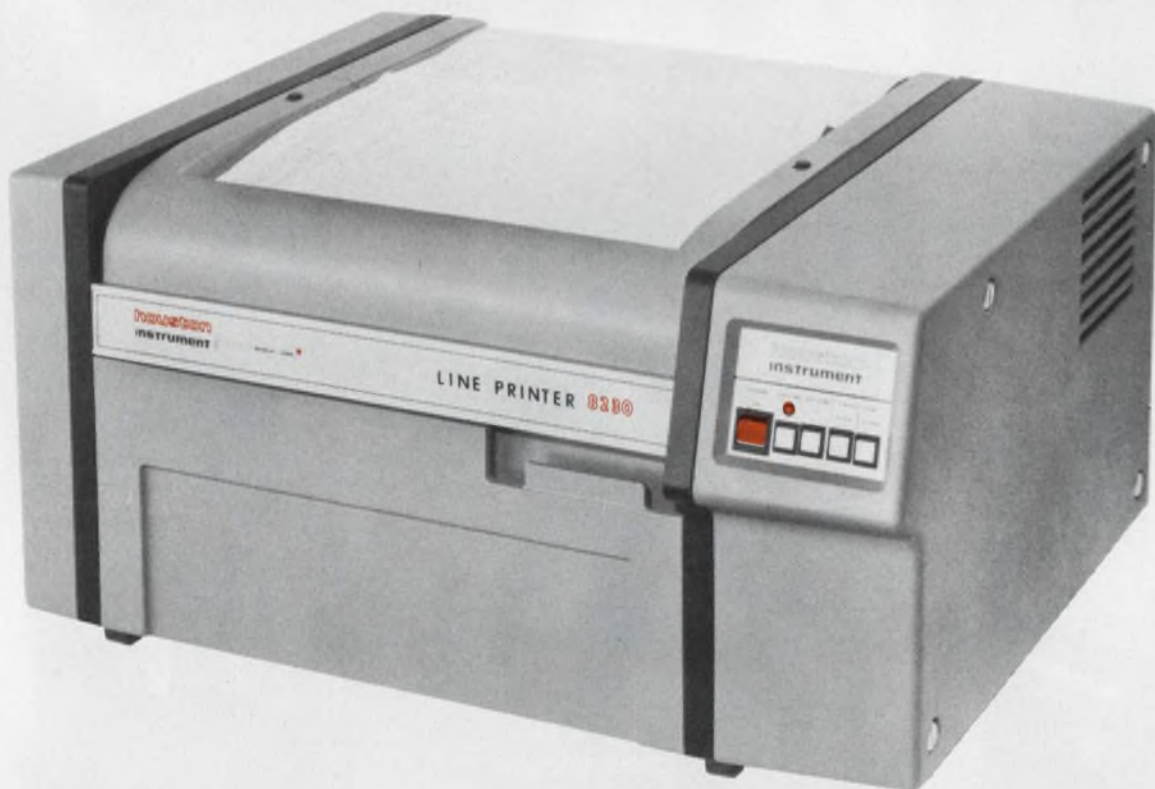

**POWERFUL** – A 65K byte dump  
may be done in 30 secs.

**QUIET** – The rustle of paper and  
the cooling motor hum are the  
loudest noises you'll hear.

FOR ORDERING  
INFORMATION  
CALL OR  
WRITE

**houston  
instrument**

DIVISION OF **BAUSCH & LOMB** 

ONE HOUSTON SQUARE (at 8500 Cameron Road) AUSTIN, TEXAS 78753  
(512) 837-2820 TWX 910-874-2022 cable HOINCO

EUROPEAN HEADQUARTERS Rochesterlaan 6 8240 Gistel Belgium  
Phone 059/277445 Telex Bausch 81399

\* Domestic USA Prices, Qty 1, End User

CIRCLE NUMBER 42



# Berg Quickie Connectors are the logical cable interface for Digital minicomputers

Berg Quickie™ Connectors rapidly, reliably terminate multi-lead, flat, round conductor cable—without pre-stripping. Quickie designs allow for visual inspection before and after assembly.

Digital Equipment Corporation likes the Quickie connector's ease of termination and how its askewed tines strip away insulation to assure positive electrical contact. They like the way Quickie Headers latch to maintain connection integrity through vibration and impact. Digital has found it can rely on Berg . . . to supply the products and the application

machines that precisely meet its demanding interconnection needs.

Berg is experienced. We read interconnection needs like Digital computers read data. We have the products, the background, and the back-up to do the job. Your job. Let's work on it, together. Berg Electronics, Division E. I. du Pont de Nemours & Co., New Cumberland, Pa. 17070—Phone (717) 938-6711.

 **BERG ELECTRONICS**

CIRCLE NUMBER 43

**We serve special interests—yours!**

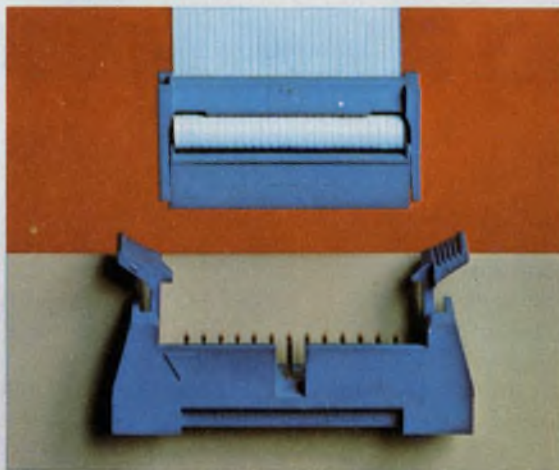

Visit our booth at  
Electronica '76  
Hall 7 Number 7300





# A lot of microprocessor users wish their analog interface problems would go away.

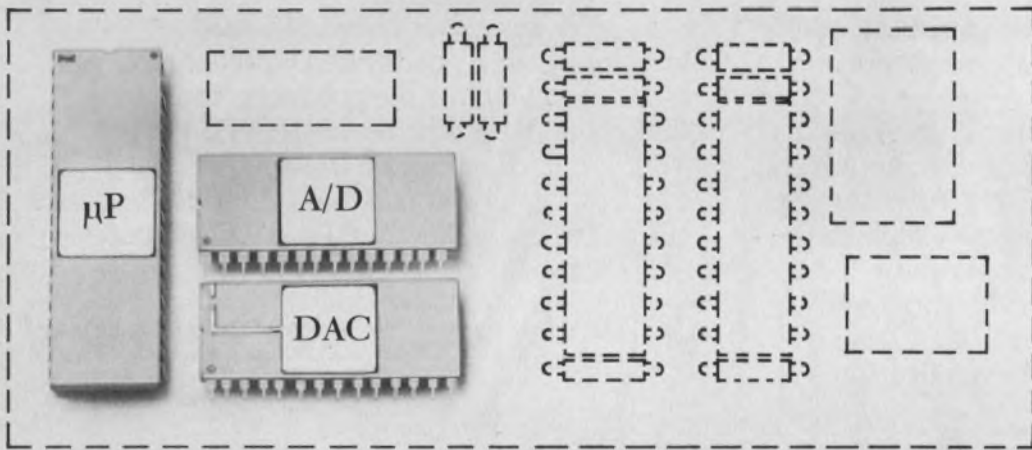

## We made them disappear.

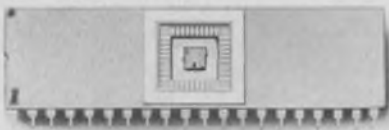

### With our monolithic CMOS converters.

10- and 13-bit A/D converters with tri-state output logic that gets you directly onto the microprocessor data bus. And our 10-bit D/A converter with double-buffered inputs direct from the microprocessor. And each communicates in two bytes: the 8 LSB's, and the remaining MSB's.

Our AD7550, industry's newest and most accurate monolithic CMOS A/D converter, uses a patented (Analog Devices U.S. Patent No. 3872466) "quad slope" conversion technique to provide 13-bit accuracy, 1 ppm/°C offset and gain drifts, and has its own amplifier, comparator, clock and digital logic.

Our AD7570 is a monolithic CMOS 10-bit successive approximation A/D converter with ratio-metric operation and only 20mW of dissipation. Parallel and serial outputs with 20μs conversion time provide excellent application flexibility.

Our AD7522 is a monolithic CMOS multiplying, 10-bit DAC. It's the only such device available with double buffered inputs that can be loaded in parallel or serial mode. Low dissipation, very low feedthrough and drifts of only 1 ppm/°C complement the interface handshaking routine for maximum flexibility and optimum performance.

These I/O peripherals, the AD7550, AD7570

and AD7522 data converters are your only real solutions for interfacing a microprocessor to the analog world.

And these are just three of a complete line of more than 20 IC converters that make a lot of your conversion problems disappear. For more information, write Analog Devices, the real company in precision measurement and control.

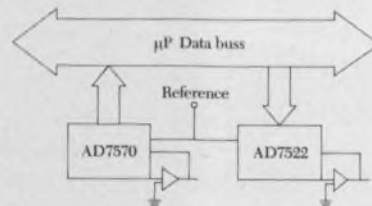

**ANALOG  
DEVICES**

The real IC Converter company.

Analog Devices, Inc., Norwood, Massachusetts 02062

East Coast: (617) 329-4700, Midwest: (312) 894-3300, West Coast: (213) 595-1783, Texas: (214) 231-5094, Belgium: 03 38 27 07, Denmark: 97 95 99, England: 01/94 10 46 6, France: 686-77 60, Germany: 089/53 03 19, Japan: 03/26 36 82 6, Netherlands: 076-122555 and representatives around the world.



# The 150 volt rectifier that performs like a low voltage Schottky.

If you want to design an efficient higher voltage switching power supply with the low forward voltage drop and fast recovery time you get with Schottky's in 5V supplies, you ought to take a look at our line of 50-100-150V industrial rectifiers.

Unlike the so-called fast-switching (250ns) rectifiers, Unitrode's rectifiers deliver real Schottky-like features:

1. Low forward voltage drop — typically .7V under maximum operation conditions.

2. Fast recovery times — reverse, typically 30ns;



forward, typically 15ns.

3. Low thermal resistance — less than 1.2°C per watt for our DO-4, .8°C for the TO-3, and .6°C for the DO-5.

4. High junction temperature of 175°C maximum.

5. Highest ratings — 25A for the DO-4, 30A

for the TO-3 and 70A for the DO-5.

Best of all, Unitrode's high voltage rectifiers are priced competitively with the less efficient high voltage types.

For complete specs plus an application note on the benefits of speed and low voltage drop for high voltage applications, just call or write: Unitrode Corporation, 580 Pleasant St., Watertown, MA 02172, 617-926-0404.

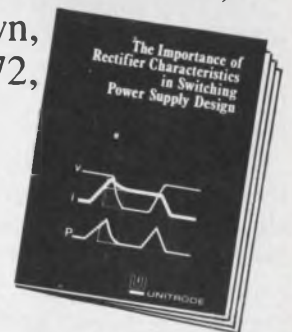

UNITRODE

CIRCLE NUMBER 45



# Electronica '76

## A panorama of products at the world's largest electronics show

**E**lectronica 76—the seventh international trade fair for electronic components and production—opens its 20 exhibition halls at the Munich, West Germany, Fair Grounds, from Nov. 25 to Dec. 1. The biannual Electronica is the largest electronics trade show by far.

Of the 73,000 who attended Electronica '74, over 30% came from 62 nations other than West Germany. Of the 1645 exhibitors, 770 were West German, and the rest came from 31 other countries.

Some 80,000 visitors are expected to flock to the 1600 stands representing more than 2500 electronics firms from 23 nations. Moreover, the Soviet Union, Poland and South Korea will be represented for the first time. Other combined stands will be set up by the United States, Great Britain, Canada, India, Israel and Japan.

The 7th International Congress on Microelectronics will also be held at the fair grounds from Nov. 29 to Dec. 1. The program will be strictly for users and will cover all aspects of semiconductors, solid-state circuits and integrated circuits as well as their practical application. In addition, seminars and courses will be offered

on such related topics as welding and soldering in the electronics field, reliability, quality control, programmable memories and the latest in solid-state microwave components and antennas.

### A diverse grouping of products

The products on display at Electronica 76 are grouped into the following categories:

- Diodes and active components.
- Passive components.
- Electrical assemblies (including IC types).
- Components and assemblies with mainly mechanical functions.
- Equipment and facilities for manufacturing printed circuit boards as well as assembly techniques.
- Equipment and facilities for manufacturing semiconductors and hybrid technology.
- Testing and sorting apparatus and special-purpose measuring instruments for manufacturing components and assemblies.

Here are just a few of the wide variety of products to look for at Electronica 76.

**An 8-bit CMOS microcontroller from Asea-**





Hafo, Sweden, and distributed by Hek- GmbH, Lubeck, West Germany, is designed to be used in communication interfaces, process control and random-logic replacement applications. The CMC8 metal-gate LSI device contains eight 8-bit, general-purpose registers. Every register may be used as a program counter, a subroutine or interrupt-nesting stack element or a working register. The CMOS controller features 43 instructions, including conditional branching, jump-to-subroutine indexed addressing, and bit and byte handling. Instructions are executed in 0.8 to 2.4  $\mu$ s, and the cycle time is 800 ns (Stand No. 14213).

A 12-V-dc, automotive instrument digital clock module from National Semiconductor GmbH, Furstenfeldbruck, West Germany, combines a monolithic MOS-LSI clock circuit; a 4-digit, 0.3 in., green vacuum fluorescent display, a 2.097-MHz crystal; and supporting components to form a complete digital clock for 12-V-dc applications. The MA 1003 module is protected against automotive transients and battery-reversal conditions, with timekeeping maintained even when the voltage drops as low as 5 V dc. (Stand No. 14509).

An "all-in-one" rf network analyzer from

Wiltron Co., Palo Alto, CA, distributed by Lang Electronik, Germering, West Germany, is capable of simultaneous transmission and reflection measurements. The model 640 consists of the mainframe with CRT display, a sweep generator plug-in that sweeps from 1 to 1500 GHz, a reflection plug-in unit and a transmission plug-in (Stand No. 16121).

A very low-mass/miniature piezoresistive strain gauge from J. P. B. Bois-D'arcy, France, is designed for model studies, flutter testing and other applications that require low-frequency response, minimum mass loading and high sensitivity. The model J212s range is  $\pm 25$  g to  $\pm 500$  g, weighs about 4 grams, and has a  $\pm 100$ -mV output for 10-V excitation.

The products described in the following section represent a tiny sampling of the components, systems and instruments on display at Electronica 76. Stand numbers that were available at press time have been included. ■■

*See p. 199 for more Electronica 76 products.*





## Programming matrix mounts on PC board

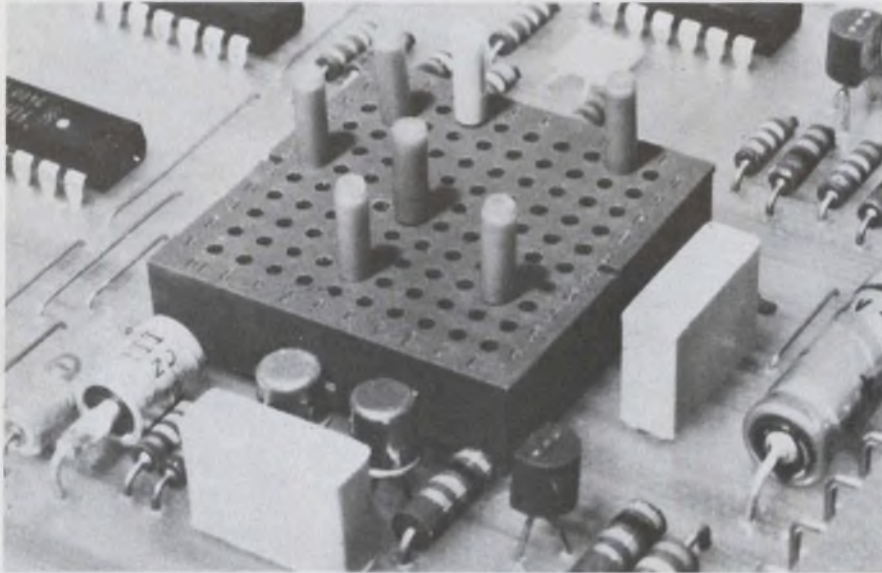

*Ghielmetti Ltd., 4500 Solothurn, Switzerland. 065/224341.*

The Compactmatrix is a 100-point programming matrix which mounts on a printed circuit board. Its 30 × 30 mm surface stands 8 mm high, with pin spaces 2.54 mm apart. The unit contains gold-plated, beryllium-copper bus bars. Contacts are rated at 50 V and 2 A, with 2 pF between two crossed bus bars and 3 pF between two parallel bus bars. Horizontal bus bars are labeled A through L, and vertical bus bars 1 through 10 to give each hole a unique designation. When multiple units are mounted butting one another there is no gap in the surface matrix.

**Stand No. 22421 Circle No. 436**

## Communication module operates at 74,000 bits/s

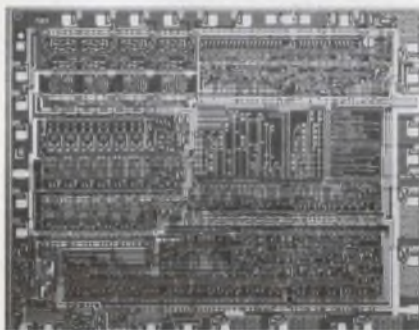

*E. F. C. I. S., BP. 85, Centre de Tri, 38041 Grenoble, Cedex, France. (76) 97 41 11*

A universal base-band receiver transmitter (UBRT) is a communication module that operates at up to 75,000 bit/s in full duplex mode. Modulation/demodulation is either differential bi-phase or split phase. Data are supplied in bit-series form and inputs/outputs are TTL compatible. Operating parameters are programmable by external strapping. Applications for the UBRT include short distance data-transmission, common-bus system—such as variable shift systems, traffic control and POS terminals—remote control and magnetic recording. The UBRT accepts and supplies NRZ data that are TTL compatible. In addition programming of the number of synchronization bits—8, 16, 32 or 64 on the transmission side and 4, 8, 16 or 32 on the reception side—is possible. Also the number of error bits that occur before synchronization is lost can also be programmed. The circuit is available in a 28-pin DIL package and is rated for a temperature range of 0 C to 70 C, with 5 V and -12-V supplies.

**Stand No.**

**Circle No. 437**

## Cassette tape drive meets DIN 45500

*Schoeller & Co., 6 Frankfurt A. M. 70, Postfach 701140. West Germany. (0611) 60 66-1.*

Type 1100 cassette-tape drive mechanism exceeds the requirements of HiFi Standard DIN 45500. The mechanism is indirectly driven by a controllable dc motor but its take-up clutch has its own belt. Seven keys provide the following functions: pause, stop,

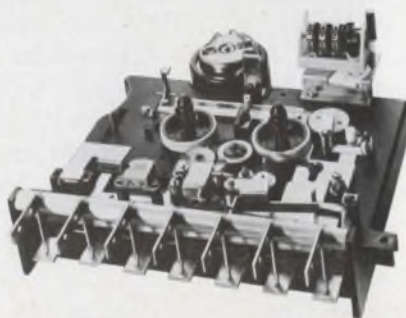

fast forward, start, fast rewind, record and eject. The cassette-tape drive normally mounts horizontally but can be modified for vertical operation. The mechanism drives the tape at 4.75 cm/s, has wow and flutter less than 0.2%, and speed accuracy of 1%. Time to rewind a C60 cassette is about 100 s. The starting current is 60 mA.

**Stand No. 12003 Circle No. 438**



# MINIATURIZED POWER SUPPLIES

## For Logic and Op Amps

With Screw Terminals

Nominal Output Voltage	Output Current Amps.	Regulation		Ripple mv RMS	Price	Model	Case Size
		Load $\pm\%$	Line $\pm\%$				
5	.500	.15	.05	1	\$ 55	5EB50	EB-10
5	1.0	.25	.05	1	75	5EB100	EB-13
5	1.5	.35	.1	1	105	5EB150	EB-13
5	2.0	.25	.05	1	115	5EB200	EB-20
5	2.5	.25	.05	1	130	5EB250	EB-20
$\pm 12$	.100	.05	.05	1	55	DB12-10	EB-10
$\pm 12$	.150	.05	.05	1	65	DB12-15	EB-10
$\pm 12$	.200	.05	.05	1	75	DB12-20	EB-10
$\pm 12$	.300	.05	.05	1	105	DB12-30	EB-13
$\pm 12$	.350	.05	.05	1	110	DB12-35	EB-13
$\pm 12$	.500	.1	.05	1	135	DB12-50	EB-20
$\pm 15$	.100	.05	.05	1	55	DB15-10	EB-10
$\pm 15$	.150	.05	.05	1	65	DB15-15	EB-10
$\pm 15$	.200	.05	.05	1	75	DB15-20	EB-10
$\pm 15$	.300	.05	.05	1	105	DB15-30	EB-13
$\pm 15$	.350	.05	.05	1	110	DB15-35	EB-13
$\pm 15$	.500	.1	.05	1	135	DB15-50	EB-20

PCB Mounting

Nominal Output Voltage	Output Current Amps.	Regulation		Ripple mv RMS	Price	Model	Case Size
		Load $\pm\%$	Line $\pm\%$				
5	.250	.05	.05	0.5	\$ 39	5E25	ES-10
5	.500	.1	.05	1	49	5E50A	EL-10
5	1.0	.2	.05	1	69	5E100	EL-13
5	1.5	.3	.1	1	98	5E150	EL-13
5	2.0	.15	.05	1	110	5E200	EL-20
5	2.5	.15	.05	1	125	5E250	EL-20
$\pm 12$	.025	.1	.05	1	24	D12-03	ES-10
$\pm 12$	.050	.1	.05	1	39	D12-05	ES-10
$\pm 12$	.100	.05	.05	1	49	D12-10A	EL-10
$\pm 12$	.150	.05	.05	1	59	D12-15A	EL-10
$\pm 12$	.200	.05	.05	1	69	D12-20	EL-10
$\pm 12$	.300	.05	.05	1	98	D12-30	EL-13
$\pm 12$	.350	.05	.05	1	105	D12-35	EL-13
$\pm 12$	.500	.1	.05	1	130	D12-50	EL-20
$\pm 15$	.025	.1	.05	1	24	D15-03	ES-10
$\pm 15$	.050	.1	.05	1	39	D15-05	ES-10
$\pm 15$	.100	.05	.05	1	49	D15-10A	EL-10
$\pm 15$	.150	.05	.05	1	59	D15-15A	EL-10
$\pm 15$	.200	.05	.05	1	69	D15-20	EL-10
$\pm 15$	.300	.05	.05	1	98	D15-30	EL-13
$\pm 15$	.350	.05	.05	1	105	D15-35	EL-13
$\pm 15$	.500	.1	.05	1	130	D15-50	EL-20

**Input Voltage:** 105-125 Vac, 47 to 420 Hz, single phase.

**Output Voltage Setting:** Single output models are factory preset to within  $\pm 2\%$  of nominal output voltage, and may be more precisely trimmed to the nominal voltage rating with an external trim resistor. Dual models are set to within  $\pm 1\%$  of their nominal ratings, and are not trimable.

**Polarity:** Either positive or negative terminal of a single output module may be grounded. Dual output modules have a positive/common/negative output terminal configuration.

**Ambient Operating Temperature:**  $-20$  to  $+71^\circ\text{C}$ . (Model 5E150 and 5EB150, 0 to  $+71^\circ\text{C}$ .) No derating required.

**Temperature Coefficient:** 5-volt models,  $.03\%/^\circ\text{C}$ ; dual output models,  $.015\%/^\circ\text{C}$ .

**Impedance:** 0.07 ohm at 1 kHz, 0.2 ohm at 10 kHz (approx.).

**Optional 230 Volt Input:** To order, add suffix "-230" to model number and \$10.00 to price.

**Case Sizes and Weight:**

- EB-10: 3.5" x 2.5" x 1.375" (1 lb)
- EB-13: 3.5" x 2.5" x 1.625" (1 lb 5 oz)
- EB-20: 3.5" x 2.5" x 2.375" (2 lb 1 oz)
- EL-10: 3.5" x 2.5" x 1" (15 oz)
- EL-13: 3.5" x 2.5" x 1.25" (1 lb 3 oz)
- EL-20: 3.5" x 2.5" x 2" (2 lb)
- ES-10: 2.3" x 1.8" x 1" (7 oz)

Other models available from 1 to 75 volts. Send for complete information.

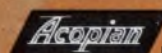

Corp., Easton, Pa. 18042 Tel: (215) 258-5441





## Cordless soldering iron charges-up quickly

*The Copper Group, 164 Innisfil St., Barrie, Ontario L4M 4V5, Canada. (705) 728-5564.*

A new cordless soldering iron has been developed that operates from long life nickel-cadmium batteries. The new Weller soldering iron uses special fast-charge batteries so that discharged batteries can be quickly recharged. Even though it is a battery operated unit, the iron has a fast heat-up time of only six seconds and an operating temperature of 700 F (420 C). To operate, the button is depressed and slid forward, however, to protect the batteries from being accidentally discharged or damaging surrounding objects, the button can be slid back into a safety lock position. To assist the soldering operation in poorly lit conditions, the iron is fitted with a focused lamp on the front of the housing. Four interchangeable tips are available for the iron, they are a regular tip, a fine point, long reach and miniature.

Stand No.

Circle No. 439

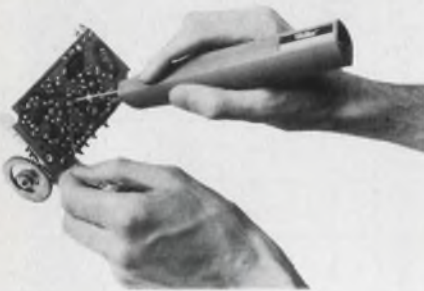

## Chart recorder has high resolution capability

*Gould, Mauerstrobe 3-5, D-6453 Seligenstadt, Germany. See text.*

Designed for a broad range of industrial, scientific and biophysical measurement applications, three new Gould 2600 Recorders are available with three, five, or six channels. Full scale signals recorded on the ultra-wide 100 mm channels reportedly have the greatest display resolution of any direct-writing recorder, making trace analysis easier and more accurate. A totally new high-stiffness servo



controlled penmotor is used in all channels and provides exceptional frequency response—30 Hz full scale at 100 mm, 50 Hz at 50 mm, and 100 Hz at 10 mm. Other features of the Gould 2600 include 99.65% linearity full scale, square

wave recording with less than 1% overshoot, and rectilinear trace presentation for true depiction of input waveshapes. A pressurized ink writing system ensures crisp, clear traces of uniform width at all pen velocities. Interchangeable plug-in signal conditioners for the Gould 2600 provide a wide measurement range from 0.25 mV full scale to 500 V full scale, with features such as calibrated zero suppression to expand desired portions of an input signal and low-pass filtering to reject high frequency noise or unwanted signal components. Prices start at \$4450 FOB.

Stand No.

Circle No. 440

## Small high-level relay gives high power gain

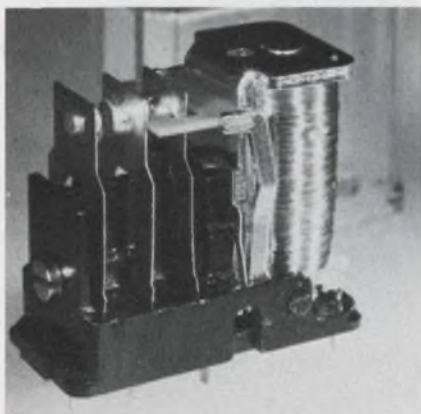

*Zettler International, Holzstr. 28-30, D-8000 Munich 2, West Germany. (089) 849056.*

The AZ 230 relay features a power gain of 8000 to 1 at up to 16-A ac in a 35.5 × 19 × 30.2-mm package. It can handle 3.5 kVA at 250-V ac. Energizing the coil takes 0.4 W. Winding to contact-testing voltage capability is 2500-V rms, in accordance with VDE 0435. Standard coils operate with 5 to 110 V.

Stand No.

Circle No. 441



# Optoisolators: More output configurations for more functions.

We offer you quite a choice. Transistors. Darlingtons. Transistors. SCR's. Logic gates. We also have slotted limit switches and reflective sensor switches. And there is immediate availability of most models.

Output Format	Package Types	Min. Current Transfer Ratio	Min. DC Isolation Voltage (V)
Transistor	6 Lead Plastic DIP	6%-100%	1500-3550
Transistor	8 Lead Plastic DIP (Dual Channel)	6%-20%	1500
Transistor	TO-18 Metal Can	15%	1000
Darlington	6 Lead Plastic DIP	100%-200%	1500

Output Format	Package Types	Forward Blocking Voltages (VFXM)	Min. DC Isolation Voltage (V)
SCR	6 Lead Plastic DIP	200V-400V	1500
2 SCR's (Connected Anode to Cathode)	8 Lead Plastic DIP	200V	1500-2500

Output Format	Package Types	Typical Bandwidth	Min. DC Isolation Voltage (V)
Logic Gate	8 Lead Plastic DIP	0.1MHz-1.0MHz	2000

Output Format	Package Types	Collector Current (IC) @ (IF, VCE)
Transistor	Slotted Limit Switch	50 $\mu$ A @ 20mA, 10V
Darlington	Slotted Limit Switch	200 $\mu$ A @ 20mA, 10V
Darlington	Reflective Sensor Switch	1.6mA @ 50mA, 1V
		2.0mA @ 16mA, 1V

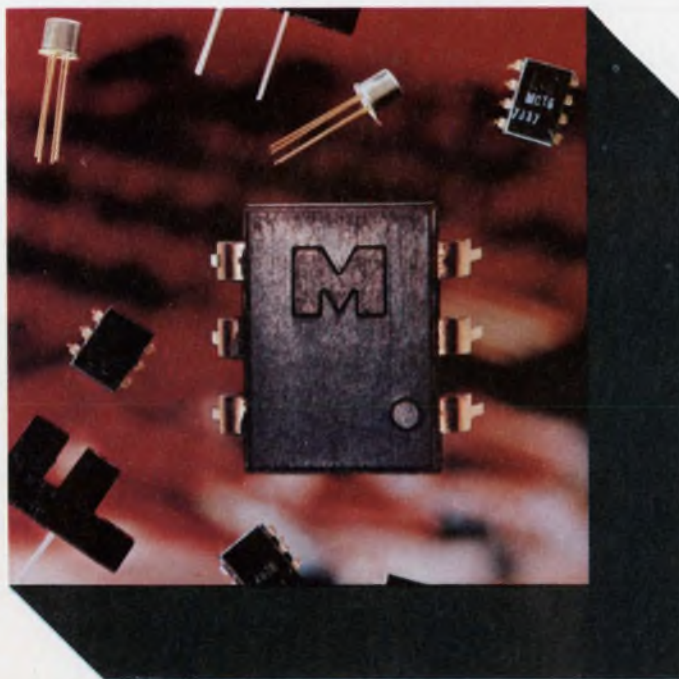

**Monsanto:**  
the science  
company.

IN EUROPE CONTACT: Monsanto Europe S.A.,  
Electronic Division, Avenue de Tervuren 270-272,  
B-1150, Brussels, Belgium

We'll send you a free copy of our internal QA Reliability Evaluation Report on our standard MCT2 device. It shows the requirements we place on our products before you even see them. It will prove that Monsanto means quality and reliability, which means cost savings and value to you. Just mail us the coupon.

That will also bring you up-to-date information on our optoisolator and LED products.

Or contact your Monsanto man or distributor for assistance or immediate delivery.

Please send me your free Reliability Reports and product information.

Name \_\_\_\_\_ Title \_\_\_\_\_

Company \_\_\_\_\_ Street \_\_\_\_\_

City \_\_\_\_\_ State \_\_\_\_\_ Zip \_\_\_\_\_

Mail to Monsanto Electronics Division,  
3400 Hillview Ave., Palo Alto, CA 94304.  
Phone (415) 493-3300.

ED-2





## PROM programmer handles eight devices simultaneously

Data I/O, Vondelstraat, 50-52, Amsterdam, Netherlands, 020-18-68-57.

A PROM programmer (the Mod-of VI) will automatically blank-check, program and verify up to eight PROMs at the same time. The PROMs can be mounted in an eight-way socket module or they can be programmed when in position on the user's own circuit board. Each PROM can be programmed with the same or a totally different truth table. Input to the programmer can be from a standard eight-track paper tape or from a master PROM and can be in hexadecimal, octal or binary format. A number of pushbut-



tons on the machine control operations that combine with interlock circuitry to ensure that the buttons cannot be inadvertently actuated at the wrong time. The status

of all important aspects of machine operation is displayed on a comprehensive set of front panel indicators. When programming MOS PROMs the machine's internal processor can monitor the amount of energy (number of program pulses) needed to successfully program each PROM address. This is known as the threshold value. The number of program pulses needed to reach the threshold value is then multiplied by a constant factor and applied as an "overprogramming" pulse train. In this way the highest possible programming speed conducive to reliable programming is achieved.

Stand No. Circle No. 442

## Plug-in analog I/O obeys microprocessor

Datelek Systems GmbH, Becker-Gundahlstrasse 1, 8 Munich 71, West Germany. (089) 78 4045. See text: 4 to 8 wk.

The four SineTrac 800 analog-interface cards mate into Intel's MDS 800 microprocessor rack and operate under the control of its CPU. Each of these cards can be accessed by the 8080 in either the program control, programmed interrupt or direct memory access mode. The a/d board, at \$845 for singles, accepts 32 single-ended or



16 differential analog inputs up to 10 V, either unipolar or bipolar. It converts each of these to 12-bit outputs in binary, offset-binary or two's-complement coding. The a/d X board, at \$295, expands the in-

put analog interface in increments of 32 single-ended channels per board up to a maximum of 256. The d/a board, at \$695 each, outputs eight analog channels from the digital input of the  $\mu$ P's data bus. The d/a X board, at \$595 each, expands the analog-output capacity up to 256 channels in eight-channel steps. System-analog accuracy of SineTrac 800 is within 0.025% of full scale at 25 C. Its tempo is 30 ppm of full scale over 0 to 70 C. Each card uses 5-V dc at 2 A, which each card gets from the micro's backplane power bus.

Stand No. 16014 Circle No. 443

## Sweep system offers dynamic range of 110 dB



Knott Elektronik GmbH, D-8021 Hohenschäftlarn, Benediktstraße 1, West Germany. (08178).

Polyskanner is a sweep measuring system with a dynamic range of 110 dB. The equipment consists of a generator, marker unit, rf-detector and display unit. Size is 443 x 276 x 395 mm and weight is only 18 kg with the display unit (28-cm screen). Two plug-in sweep

oscillators cover the frequency range of 10 kHz to 1200 MHz. The general-purpose generator covers the range of 1 to 1200 MHz. Both generators deliver a 0.5-V rms output signal into 50  $\Omega$  and have built-in precision attenuators. Center frequency is given by a numerical readout.

Stand No. Circle No. 444



# The Contortionist.

**A 5 volt, 50 amp, 250 watt switching power supply that will fit into places never before possible.**



Model  
9E5-50C-17

You asked for it . . . Powertec's new 9E SuperSwitcher™ in the package configuration most requested by power supply users.

An ultra low-profile switching regulated power supply with size, shape and power to meet modern requirements of computers, office equipment, and miniaturized instrumentation.

A true contortionist, the 9E stands thin in a rack . . . just 5" high, 2 1/4" wide, 15" long, and a weight of under 6 pounds. It flattens out alongside, above, below, or behind . . . mounts vertically, horizontally, or crosswise. A perfect fit for CRT display terminals (dumb or smart), CPU's, mini/microcomputers, printers, and card files.



Ideal for test and burn-in equipment because of low energy consumption. Perfect, too, for the office or lab environment. Thanks to its convection-cooled, 40-kHz operation, there is absolute zero noise to annoy personnel or interfere with "quiet zones." The 40-kHz switching rate helps make the 9E the most densely packaged off-the-shelf switching power supply available. Over 80% operating efficiency produces a remarkable 1.4 watts/inch<sup>3</sup>!

There's more, too. A.C. input is 115/230V with a +10/-20% line tolerance. This, coupled with a 20msec voltage carryover, allows smooth, continuous functioning even under abnormal line conditions. Five proprietary features\* guard against operating conditions that can shut down or possibly destroy other switchers. And there are all the standard features you could ever want, such as OVP, over current and temperature protection, remote sense, voltage programming and logic inhibit.

Priced at \$395 (lower for OEM's), the 9E fits tight budgets as well as tight places. So phone or write for complete 9E specs and delivery schedules.

\*Patent Pending

## **Powertec, Inc.**

9168 DeSoto Avenue, Chatsworth, CA 91311  
(213) 882-0004 • TWX 910-494-2092

# POWERTEC





## Memory mapping eases $\mu$ Ps I/O to analog

Burr-Brown, International Airport Industrial Pk., P.O. Box 11400, Tucson, AZ 85734. (602) 294-1431. \$695 (1-4); \$295 (100 up); 2 to 4 wk.

The MP8408 and MP8416 analog input and MP8304 analog output boards are accessed via memory mapping by Intel's  $\mu$ P-based MDS800 development station and SBC80/10 single-board computer. The memory mapping feature makes each of these boards look like an extension of memory to the  $\mu$ P, so it can acquire the channel's data as it would fetch a memory location—in one cycle. In many cases, this feature permits forego-

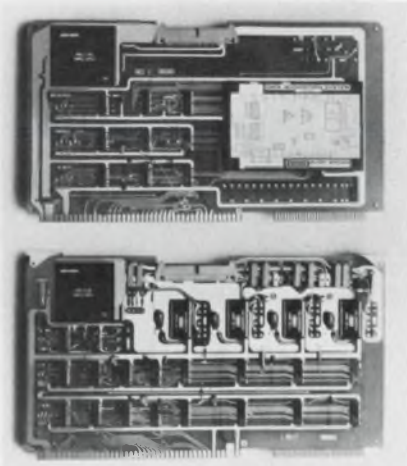

ing the use of interrupts for I/O operations. MP8408 (8-channel differential input) and MP8416 (16-channel single-ended input) have re-

sistor-programmable input ranges from 10 mV to 10 V. On the 10-V range, throughput accuracy is 0.025% of full scale, and conversion time is 33  $\mu$ s. On the 10-mV range, throughput accuracy is 0.1% of full scale, and conversion time is 100  $\mu$ s. The MP8304 (4-channel output) accepts 12 bits of input (one 8-bit word and 4 bits of a second word) from the data bus and converts these to an analog output with an accuracy of 0.0125% of full scale. Output ranges are strap selectable at  $\pm 10$ , 0 to 10,  $\pm 5$  and  $\pm 2.5$  V. Output-settling time is less than 10  $\mu$ s on all ranges. All three boards come with a flat cable and connector assembly.

Stand No. 14215 Circle No. 445

## High-voltage tester delivers to 35 kV

Haefely, Lehenmattstrasse 353 P.O. Box, CH-4028 Basel, Switzerland. 061 41 17 48.

Series P are light weight and compact high-voltage testers compatible with the typical set-ups of test stations for small components and appliances. Voltages up to 35,000 V are supplied from port-

able bench-top models or uniform 19-in. plug-ins. Units feature a built-in kilovoltmeter for impulse voltages. All testers of the series "P" are built to IEC-recommendations and many national standards. Six models for voltages ranging from 3000 to 35,000 C are available.

Stand No. 20112 Circle No. 446

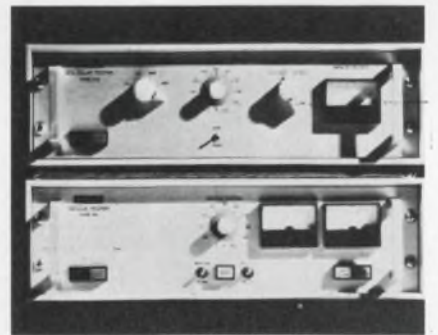

## Unit converts scope to a logic analyzer



Dolch GmbH, 6056 Heusenstamm, IndustriestraBe 48, Frankfurt, West Germany. 061104/30 55. \$395; stock.

Model SM 40 converts any general-purpose oscilloscope into a logic analyzer by expanding a single-scope channel into a parallel four-channel logic display. Alternate or chopped-display mode can be selected. The SM 40 is equipped

with a 5-bit combinatorial triggering: the four data channels, as well as a trigger externally fed into the SM 40, can be used to sync the scope to any previously selected bit-combination. The unit serves all logic families with a variable threshold ranging from -10 to +10 V. Frequency response is dc to 50 MHz.

Stand No. Circle No. 447



# SQUEEZE PLAY.

T10 relays by P&B let you mount your pc boards on 0.5" centers. They work in tight spots like a pro.

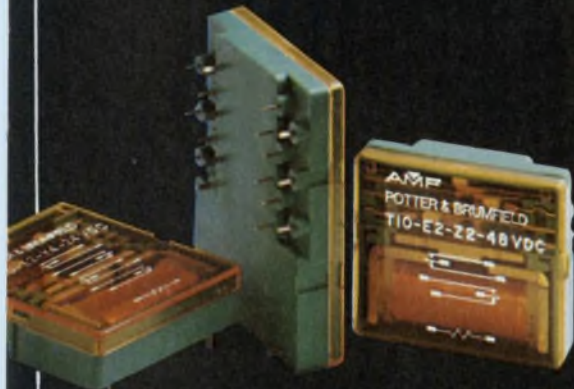
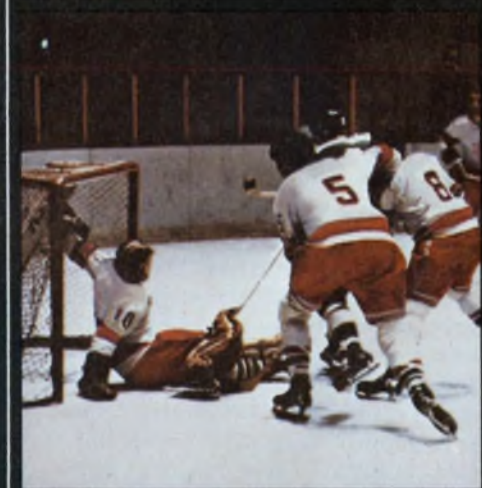
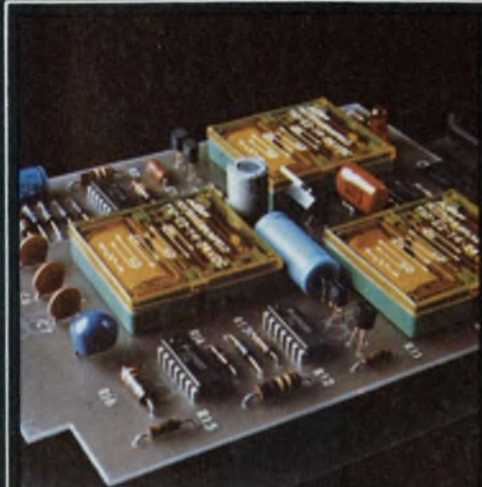

T10s are only 0.375" high. The lowest profile 3 amp relay in the Potter & Brumfield line.

They provide 0.1 to 3 amp switching @ 28V DC in 2, 4, and 6 pole models. Coil ratings are 6, 12, 24, and 48V DC. Permissive make, gold-flashed silver contacts are noted for low contact bounce, long operating life. Bifurcated contacts for low level switching are also available.

These relays are compatible with TTL and CMOS peripheral driver ICs, and TTL and CMOS buffers wired for current sharing. Ideal for telecommunications, copy and reproduction machines as well as computers and peripheral equipment.

Put a squeeze play on costs. Prices are as compact as the relays themselves.

For full information on the T10 series and all P&B relays, see your Potter & Brumfield sales representative or P&B Pro Shop distributor. Or, contact Potter & Brumfield Division AMF Incorporated, Princeton, Indiana 47671. Telephone: 812/385-5251.

European address: Electrical Products Group, AMF International Limited, AMF House, Whitby Road, Bristol B54 4AZ, England. Telephone: (0272) 778383, Telex: 449481, AMMAFOCO, BRSTL.

Go with the Pros and you can't go wrong.

**AMF**  
Potter & Brumfield





## Crystal oscillators are TTL and CMOS compatible

*Erie Elektronik GmbH, 85 Nurnburg, Kreuzsteinstrasse 1, West Germany. (0911) 66065. See text.*

Erie-crystal oscillators, series 547, use thick-film technology and are designed for TTL and CMOS logic. Applications include timing circuits, computers and transceivers. The hermetically sealed quartz oscillators span a frequency range of 1 through 25 MHz. Input voltage can range from 3 through 18 V. Rise and fall times are 10 ns (max), and a fan-out of 10 is specified. Output is 2.4 V minimum at nominal load. Operating temperature is  $-40\text{ C}$  to  $+100\text{ C}$  with stability specified as less than or equal to  $\pm 50$  ppm between the temperature limits of  $-30\text{ C}$  and  $+100\text{ C}$ . Tighter tolerances ( $\pm 10$  ppm) between 0 and 60 C are available upon request. Shipment time is four weeks or less. The price is \$10 each for quantities of 1000 or more.

Stand No. 9304

Circle No. 448

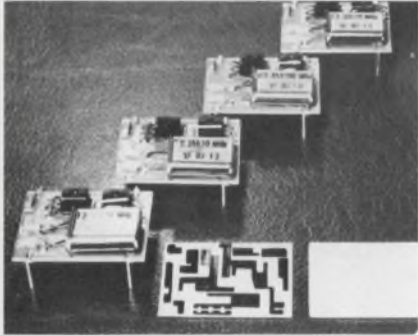

## Logic circuit models evaluated by simulator

*Membrain Ltd., 23 Cobham Rd., Wimborne, Dover, BH21 7PE, England. Ferndown (0202)893535. \$66,000.*

The Membrain MB7464 FLASH system—a dedicated, stand-alone programming station for logic simulation and fault finding—provides two essential functions. It enables the test program for a digital logic circuit to be developed and evaluated on a software model of the circuit and permits fault analysis to be undertaken on this software



model. The MB7464 is based on a minicomputer with 48-k store and includes a fast printer and a visual display unit (VDU) with keyboard. The test program and diagnostic data are produced on a single floppy disc and may be read directly by a Membrain MB2420 or MB-2460 test system. Optionally, the test program may be punched on paper tape for use with any Membrain automatic test system. The price quoted (station plus software) is f.o.b. Ferndown, U.K.

Stand No. 19321 Circle No. 449

## Hall-effect keyswitches give bounceless output

*RAFI-Raimund Finsterholz, Elektrotechnische Spezialfabrik, D-798 Ravensburg-Berg, Ravensburger Strasse 128-134, Postfach 2050, West Germany.*

A new switching technique for keyboard system RS 76 uses a Hall-effect IC to ensure that switching is bouncefree and reliable. Two-shot molded keys guarantee wear-



resistant legends. Complete keyboards or single keyswitches allow for the manufacture of standard or special configurations. Keyboard height is 15 mm. Operating strokes of 4 mm allow control of force-displacement characteristics of the keys to provide a particularly comfortable typewriting feel. The keyswitches are also available in a mechanical version, and both types can be illuminated or nonilluminated.

Stand No.

Circle No. 450



# To be precise about it, you need a wide choice of ultra precision resistors.



#### MAR Non-inductive Metal Film

Resistance range 20-1 meg $\Omega$  in 4 molded, axial lead sizes. All the advantages of evaporated metal film resistors with precision tolerances to .01% and temperature coefficients to 5 PPM/ $^{\circ}$ C.

The inherent low inductance and low capacitance of this design make it ideally suited to high-speed applications requiring a high degree of stability.



#### AR-90 High Range

Designed to satisfy critical design requirements where resistance values between 1 meg $\Omega$  and 10 meg $\Omega$  are required. Temperature coefficients to 5 PPM/ $^{\circ}$ C and tolerances to .05% are standard.

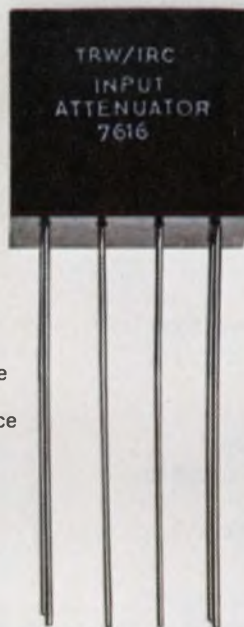

#### AR Resistor Networks

Provide the best performance and maximum flexibility where multiple, interdependent resistors are required. Resistance ranges from 20 $\Omega$  to 10 meg $\Omega$ . TC and tolerance matching to  $\pm 1$  PPM/ $^{\circ}$ C and  $\pm .01\%$  respectively.

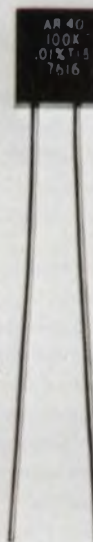

#### AR-40 Metal Film

Designed to satisfy critical design requirements where minimum T.C., stability and absolute accuracy are needed. Temperature coefficients as low as  $\pm 1$  PPM/ $^{\circ}$ C and purchase tolerances to .01% are standard.

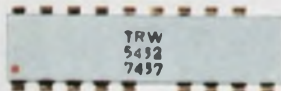

#### TaN Film Resistor Networks

These feature inherent passivation, ratio tolerances to .05% and TCR tracking to 3ppm. Standard packages are DIP sandwich from 4 pins to 20 pins and flatpack from 10 to 24 pins. Standard products include R-2R ladders in both package types, in R values from 2K $\Omega$  to 50K $\Omega$  and resolution from 8 Bits to 12 Bits. Other standard and custom networks also available.

For more technical information on these products call 319-754-8491. Or, for the broadest choice in resistors for all types of applications, write or call TRW/IRC Resistors, an Electronic Components Division of TRW Inc., 401 N. Broad St., Phila., Pa. 19108. Tel. 215-922-8900.

**TRW IRC RESISTORS**  
ANOTHER PRODUCT OF A COMPANY CALLED TRW



# Stretch your test instrument budget

Does a scope always have to be expensive to meet your needs? At B&K-PRECISION we don't think so. B&K-PRECISION offers a full line of scopes that give you the performance and features you need, at substantial cost savings...plus the advantage of immediate delivery and 10-day free trial through local distributors.

# B&K-PRECISION to high-priced

B&K-PRECISION has taken a no nonsense, cost-effective, approach to oscilloscope design. All our scopes will trigger at frequencies typically 50 to 100% beyond their rated band-width. They are rugged, dependable instruments, designed to match the features and performance of far more expensive scopes, without matching their high price. An important part of our approach is that you shouldn't have to buy more scope than you need to get the features you want. Before making your next purchase, compare the features and performance you require with what we have to offer. You'll discover that your budget is a lot bigger than you first thought!

## 30MHz Dual-Trace 5" Triggered Scope with Signal Delay

For the engineer who requires a full-feature 30MHz scope

- Built-in signal delay line permits viewing of high-frequency pulse risetimes
- Triggers on signals up to 50MHz
- Rise time 11.7nS
- 20 calibrated sweeps—0.2  $\mu$ S/cm-0.5S/cm
- Built-in high and low-pass filters
- 5mV/cm vertical sensitivity
- Illuminated graticule
- TTL compatible Intensity modulation
- X-Y capability using matched DC amplifiers
- P31 blue phosphor
- Internal .5Vp-p  $\pm$ 1% calibration source
- 5mV/cm horizontal sensitivity.

**Model 1474 \$820** (not including probes)

## 15MHz Dual-Trace 5" Triggered Scope

Premium features and performance in a 15MHz dual-trace scope

- Ultra—flat in-band response with smooth rolloff past 15MHz
- Triggers beyond 27MHz
- 24nS risetime
- 19 calibrated sweeps—0.5  $\mu$ S/cm-0.5S/cm
- 10mV/cm vertical sensitivity
- Algebraic addition and subtraction
- Illuminated graticule
- X-Y capability using matched DC amplifiers
- P31 blue phosphor
- Internal calibration source
- Built-in TV sync separator
- For fast setup, mode automatically shifts between CHOP and ALTERNATE as you change sweep times.

**Model 1472C \$630** (not including probes)





# without stretching your standards... has an alternative oscilloscopes

## 10MHz Dual-Trace 5" Triggered Scope

Our lowest-cost dual-trace scope more than fills the need in applications where extended bandwidth isn't required

- Triggers to 15MHz
- Mode automatically shifts between CHOP and ALTERNATE as sweep time is changed
- 18 calibrated sweeps— $1\ \mu\text{S}/\text{cm}$ - $0.5\text{S}/\text{cm}$
- 35nS risetime
- P31 phosphor
- X-Y capability using matched DC amplifiers
- Internal calibration source
- TTL compatible intensity modulation
- 10mV/cm vertical sensitivity

**Model 1471B \$495**  
(not including probes)

## 10MHz 5" Triggered-Sweep Scope

A 5" triggered scope with TTL compatible Z-axis

- 10mV/cm vertical sensitivity
- 35nS risetime
- 18 calibrated sweep ranges— $1\ \mu\text{S}/\text{cm}$ - $0.5\text{S}/\text{cm}$
- 5x magnification sweeps to  $.2\ \mu\text{S}/\text{cm}$
- Vectorscope capability
- Internal calibration source
- Internal TV sync separator
- P31 phosphor
- 11-position vertical attenuator, calibrated in convenient 1/2/5 step sequence
- Built-in calibration source.

**Model 1461 \$428**  
(not including probe)

## 10MHz 3" Triggered-Sweep Scope

Meets the demands for an uncompromising ultra-compact triggered-sweep scope

- 19 accurate sweep ranges
- Accurate 11-position vertical attenuator
- 10MV/div vertical sensitivity
- Front panel vectorscope capability
- Internal calibration source
- Only 5.75 x 7.9 x 12.9 • Weighs only 13 lbs
- Capable of writing speeds up to  $0.1\ \mu\text{S}/\text{div}$  with 5x magnification.

**Model 1431 \$399**  
(not including probe)

## 5MHz 3" Compact Scope

Ideal for many dedicated applications, freeing more expensive scopes from monitoring tasks

- 10mV/div vertical sensitivity
- Direct deflection terminals for waveform display to 450MHz
- Only 6 x 7.5 x 12" • Weighs just 8.5 lbs
- 600 Vp-p maximum input voltage
- Can be externally synced.

**Model 1403A \$209**  
(not including probe)



### Save up to 50% on probes!

B&K-PRECISION has engineered a full line of cost-effective probes to meet your needs. Our probes are designed for complete interchangeability with those of leading "ultra-sophisticated" brands, giving you compatible performance at about half the price.

FOR IMMEDIATE DELIVERY,  
or 10-day free trial, contact your local B&K-PRECISION distributor. Ask him for Catalog BK-77 with complete information on B&K-PRECISION oscilloscopes, probes and more than thirty other fine instruments, or contact us directly.

**B&K PRECISION**  
PRODUCTS OF DYNASCAN

6460 W. Cortland Avenue, Chicago, IL 60635 312/889-9087

CIRCLE NUMBER 51



## Bipolar controllers—they're fast, cheap and easy to use

A new type of bipolar integrated circuit has arrived on the design scene: the program controller. It is fast (10-MHz instruction rates are easy), it is cheap (\$12 to \$30 in 100s), and when combined with a ROM or PROM, it forms a complete stand-alone controller.

Program controllers go by many names, and their identity is usually hidden among the bipolar, bit-slice microcomputer-chip sets made by IC manufacturers, but they are worth investigating in their own regard.

The forefather, and simplest, of these devices is the 74161 or 9316 four-bit counter. This counter can be used as a programmable, next-address generator, and will output a number (address). When clocked, it will either increment the address (to address-plus-one) or load a new number (branch-to-new-address) that is present on the data input lines. The 74161 may also be initialized to address zero by pulsing the "clear" input.

If the outputs of the 74161 program counter are connected to a ROM, the outputs of the ROM not only can direct useful control functions but also can furnish the 74161 the necessary branch addresses and "load" commands to execute program branches and loops.

Conditional branches may be provided by connecting a gate between a ROM output and the 74161's load inputs. And multiple branches may be accomplished by placing a multiplexer on the 74161's data inputs.

The new program controllers can do all of this and more. Some of

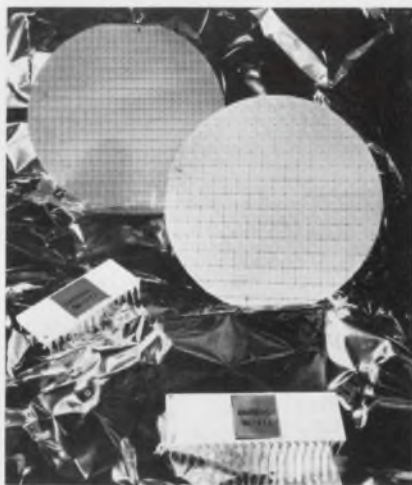

Expandability is a key feature of the 2909 controller from Raytheon. It is a 4-bit slice unit with no output latches.

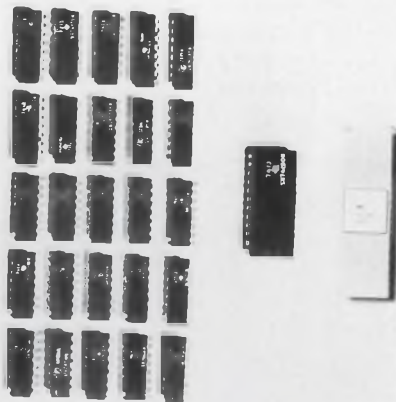

A 9-bit controller that replaces a lot of TTL is the 67110 from Monolithic Memories. It can address 512 words of memory.

them have on-chip, push-down stacks for subroutine programming, and others have on-chip loop counters for repeated program loops. They also have everything required for executing multiway

and conditional branches, as well as address-incrementing functions.

### Two choices are available

Two basic approaches to the program controller now exist: Those with a fixed number of memory locations within its addressing capability, and the expandable bit-slice units. The 67110 from Monolithic Memories and 3001 from Intel are in the former category, and can create a nine-bit address which can access 512 words of memory. So are the Signetics 8X02 and Fairchild 9408, which generate a 10-bit address to access 1024 words.

The 2909 and 2911 from Raytheon and 74S482 from Texas Instruments are 4-bit-slice program controllers. Two such 4-bit chips can access 256 words, three chips 4096 words, and so on.

Expansion of controller-addressing capability is important because controller memories are becoming larger all the time. Once, 256 words were sufficient to make a simple controller, but now 512 is common, with many at 1k, and a few in the 2-to-4k range. And even larger systems are now being designed.

Bit-slice controllers are best for expandability. Nonetheless, a little extra circuit design can make the fixed-address controllers expandable, too. Paging techniques extend their memory-access range.

The simplest approach is to add extra bits to each word of memory to select the next page of memory for the controller to access. This is easily done, for each word of memory has both a system-control and a next-address instruction field. The designer need only add a next-memory-page field to the



ROM, and a simple memory-page latch.

### Programming ease vs cost

In the design of any programmable system, a balance must be struck between two factors: the ease of programming and the size of the memory required to hold the final program. The ease of programming means a one-time cost to the manufacturer; but the size of the memory, in words  $\times$  bits

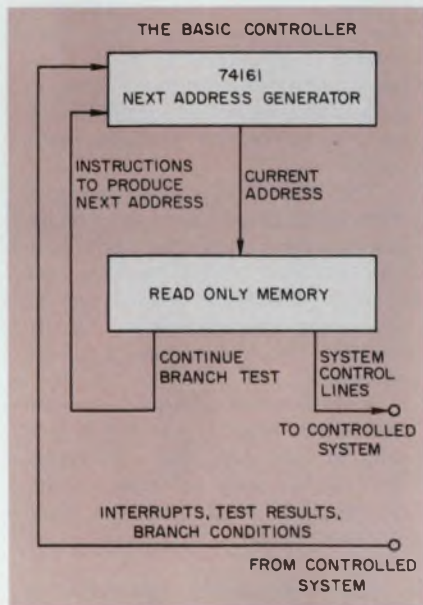

The forefather of today's programmable controllers is the 74161 four-bit counter from Texas Instruments.

per word, is a cost that recurs with each system built.

Three techniques have been developed to combat the recurring memory cost problem, and with varying restrictions on the ease of programming. The first technique is typified by the 9408, which has an inhibit output. This output allows the use of the same memory bits for generating branch-address locations, and controlling external devices.

The second technique is used in the 3001, where instructions and branch-address information share the same seven lines. The more detailed the branch-address information required, the smaller the number of bits in the instruction code.

The third technique is used in the 67110, where some rather sophisticated instructions allow

## Expandable control with the 74S482

Four bits of a multibit address are generated by the 74S482. Its operation can easily be understood by looking at its output, then working backwards through the logic.

The output from the 74S482, which drives the address lines of its control memory, is stored in a four-bit latch. This latch may be reset to all zeros by the chip reset input.

The output latch can load a new address on the rising edge of the clock, and this address may come from any one of three sources determined by two input pins.

In addition to the output latch's retaining its old address, a new branch address can be loaded into the latch from four input pins on the chip, from the output of a four-bit full adder, or from the top of a four-bit-wide, push-down stack.

The use of a full adder means that in addition to incrementing an address (by adding "one" either through the lowest-order input line, or through the low-order carry-in line), any number may be added to the current address. This capability allows addressing relative to the current instruction when programming.

The push-down stack is four levels deep and derives its input from the adder's output. The stack will push, pop, accept new information without pushing or remain unchanged on the next rising edge of the clock.

The 74S482 comes in a 20-pin package, and a full-Mil version is available as the 54S482. The 74S482 sells for \$6.30 in quantities of 100. From Texas Instruments, Dallas, TX.

CIRCLE NO. 430

## 67110 controller generates 9-bit address

The 67110 generates a 9-bit address for program-memory sequencing that offers the capability of addressing 512 words of memory. It uses eight control instructions and can test five inputs for conditional branching.

A number of special logic functions are provided on the 67110 chip for use in bit-slice minicomputer applications. These can be used to extend the memory-addressing capabilities of the device in nonbit-slice applications.

Notable among the instructions that the 67110 can execute is one which allows any group of up to 32 words of instruction code to be used as a subroutine, with no command necessary to return to the calling-program sequence.

The 67110 executes 16 flag control instructions. These per-

form two classes of operations involving the four flag inputs. First, various combinations of flag-control codes direct the flag multiplexer to steer either the instantaneous or stored values of any of the four flag bits to the least significant address bit.

The flag multiplexer also has an external input that can invert the output of the multiplexer, and so serve as a test input in its own right.

The second function of the flag control is to manipulate the four-bit flag latch.

The 67110 is available in a 40-pin package, and a full-Mil version known as the 57110 is available. The 67110 costs \$25.00 in quantities of 100. From Monolithic Memories, Sunnyvale, CA.

CIRCLE NO. 431

variable-length chunks of program code to be used repeatedly by other segments of the program. Thus, a two-instruction "returnless subroutine" may be used to "copy" up to a 32-instruction block of program from virtually anywhere in the rest of the program.

Another technique used in the 67110 for program shortening is

the inclusion of a loop counter, which is used to execute one or more instructions, or a subroutine, up to 32 times. Just two additional instructions are needed to do this.

The techniques used by the 9408 and the 3001 save memory by reducing the number of bits per word, while the technique used by the 67110 reduces the total number of



(continued from p. 107)

words. The techniques used by the 3001 and the 67110 employ more complex programming than the technique used by the 9408.

Some manufacturers, including Raytheon, Intel and Fairchild, have confronted the problem by programming complexity by generating assembler programs for their chips and making them available on commercial time-sharing networks.

### Controller speeds vary

The speed of these devices varies from about 35 ns to 100 ns and might well depend on a specific application in which outputs and inputs of each chip are used.

Rough cycle times for the various devices are: 44 ns for the 8X02; 50 ns for the 3001, 2909, 2911 and 74S482; and 100 ns for the 67110. And approximate times from clock-to-address output are: 27 ns for the 8X02; 30 ns for the 3001; 35 ns for the 67110; 105 ns for the 9408 with the output-address latch and 50 ns without it; 12 ns per chip for the 74S482; and 35 ns for the 2900 and 2911 and 10 ns per chip used. Manufacturers peg their maximum specs 25 to 35% higher.

Another question that has a bearing on the issue of speed is: How will the program controller be used? The normal use is with an address latch located on the controller's address outputs where they go to the ROM. This is not the fastest way to use the device because several sequential operations must be performed. The delay from clock-to-address output in the program controller is added to both the access time of the ROM and the reaction time of the controlled system. This delay is added to the setup time of the controller to give the minimum cycle time.

Faster still is the technique called "pipelining"—a combination of both cases—where latches are used at ROM inputs and outputs.

The pipeline technique requires considerable programming skill, but is also the method that allows the fastest possible operation of a system. The reason is that only the greater of the delays of the program controller, the ROM, or

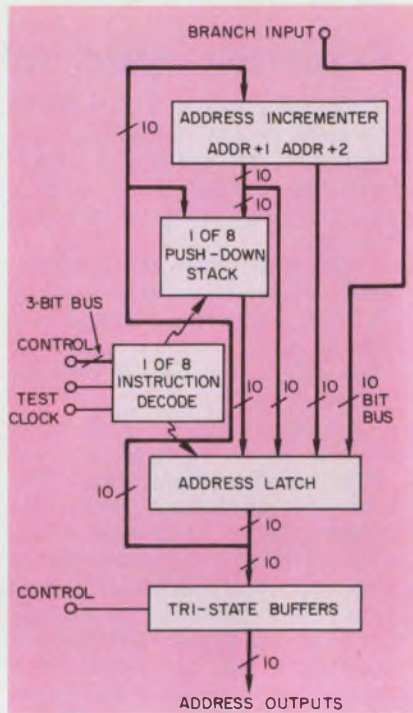

The 8X02 controller from Signetics is a 10-bit device that allows addressing of up to 1024 words of memory.

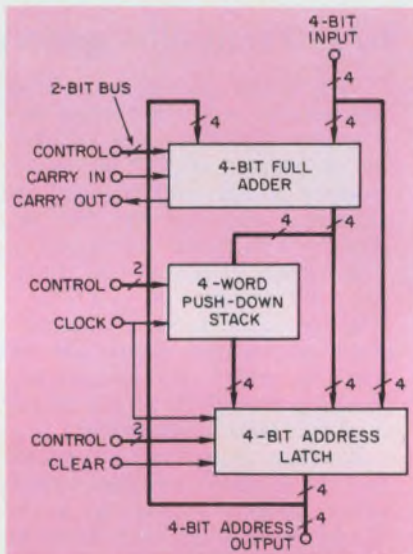

The 74S482 controller generates four bits of a multibit address. It contains a full four-bit adder.

controlled system determines the cycle time.

The 8X02, 67110, 3001, and 74S482 all have address-output latches on-chip, which forces the designer to use either the simplest approach or full pipelining.

The 2909 and 2911 have no address-output latch, which allows more flexibility, but requires the user to add his own latch. And the 9408 has an output latch that may

## Unusual addressing used in the 3001

The 3001, a 9-bit address generator, offers the capability of addressing 512 words of memory. It is the oldest of the devices in this category, and has an unusual approach to program-address specification. Instead of portraying the program memory as a linear array of words from 0 to 511, the memory is dealt with as a  $32 \times 16$  array of instruction locations laid out like a chessboard.

Like a rook on the chessboard, the 3001 may move from one square (instruction) to another by row-and-column jumps. There is no address-increment function on-chip; all moves are made by these jumps.

The 3001 has a 9-bit address latch which drives two sets of three-state buffers. The five most significant bits of the address are used to designate one of the 32 rows, and the four least significant bits to indicate one of the 16 columns.

In addition to a three-state control which affects all of the outputs in the chip, the row three-state buffer may be independently disabled, which allows a rudimentary external interrupt capability.

The chessboard approach to programming for the 3001 was intentionally chosen to minimize program memory costs. Since the same memory-output bits are shared by both instruction specification and branch address, the memory size is minimized.

The 3001 comes in a 40-pin package, and a full-Mil version is available. The 3001 costs \$22.30 in 100-piece quantities. From Intel, Santa Clara, CA, and Signetics, Sunnyvale, CA.

INTEL  
SIGNETICS

CIRCLE NO. 432  
CIRCLE NO. 433

be bypassed by the user by means of a "pipeline-select" input.

Three new program controllers, the 2910, 2930, and 2931 are in the works at Advanced Micro Devices, Sunnyvale, CA. The 2910 will be a 12-bit unit, and the 2930 and 2931 will be 4-bit slices. All are being readied for introduction at the beginning of next year.

While all of the program con-

(continued on page 109)



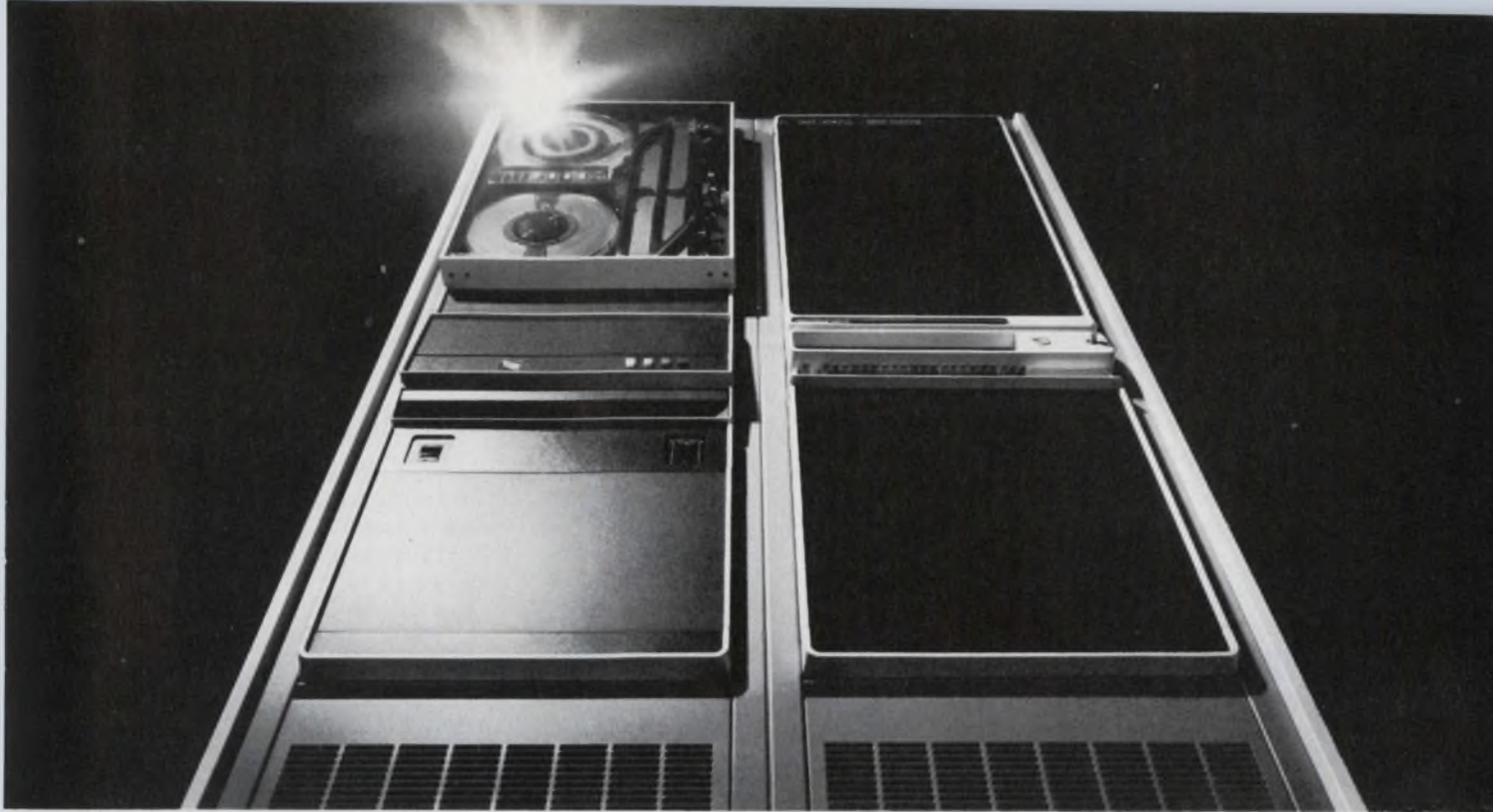

## Announcing a giant increase in the NOVA line.

Towering above is the new top of the NOVA<sup>®</sup> line. The NOVA 3/D.

It features a new Memory Management and Protection Unit that lets you do both on-line multitasking and batch operations. Concurrently. For instance, applications that need real-time multi-terminal software and on-going program development.

Plus, the NOVA 3/D features a new, economical, 32K-word MOS memory module. Which is something no other major minicomputer has.

All of which makes the NOVA 3/D more NOVA computer, at a lower price, than you've ever seen before.

What's more, the NOVA 3/D also has all the things that have made NOVA the most popular name in minicomputers.

Things like extended NOVA line instructions. Reliable high-speed MOS and economical 16K-word core memory modules.

The single-board CPU design concept Data General pioneered. The same concept that led to our removeable single-board power supply module.

Plus all the other things you've come to expect from a company like Data General.

Things like field-proven, real-time operating systems: our mapped Real-time Disc Operating System, diskette-based Disc Operating System, and our Real-Time Operating System. They're compatible with the entire NOVA line of computers.

Things like high-level FORTRAN IV and FORTRAN 5, as well as easy-to-work-with extended BASIC. Also fully NOVA-line compatible.

Things like the complete and completely-compatible line of Data General peripherals. All you could ever need to put together any system you could ever need. Including 10 to 90 megabyte discs, diskettes, and our new 30 and 60 cps terminal printers.

And when you do business with Data General, you get the kind of total systems support you can only get from a major computer manufacturer. Everything from sales and systems engineering to field service, training, and special systems design.

Write for information on the new NOVA 3/D. Or call your local sales office.

And see what the NOVA line is up to now.

### NOVA 3/D

# Data General

☛ Data General, Route 9, Southboro, Mass. 01772, (617) 485-9100. Data General (Canada) Ltd., Ontario. Data General Europe, 15 Rue Le Sueur, Paris 75116, France. Data General Australia, Melbourne (03) 82-1361

NOVA is a registered trademark of Data General Corp.



## an investment in capitol buys rugged switch design and long, trouble-free life

For Example!  
Our Extremely  
Dependable,  
Multiple-Position  
Push Button Strip  
Switches



Basic frames are anodized aluminum. Plungers are 5/32" square brass with a nylon actuator molded on them. Hence, they will not bend or warp.

Mechanical linking of all switch positions prevents operation of more than one position at a time. A released button will return to the "up" position before the next button can be actuated. These switches can be illuminated either by an external circuit or directly from the switch. Lamps do not travel when positions are engaged, eliminating shock to the bulb.

Capitol switches are tested with 2 to 3 million operations to assure life-long, trouble-free performance.

Our 28-page catalog will give you all the "specs" on CAPITOL's entire line of quality switches.



CAPITOL manufactures a complete, high-quality line of push button and lever switches — illuminated if desired — standard and custom designs to fit your every need.

# CAPITOL

The Capitol Machine and Switch Co.  
87 Newtown Road, Danbury, Conn. 06810  
Phone: 203-744-3300

CIRCLE NUMBER 53

(continued from page 108)

trollers currently available are termed Microprogram Controllers, the 2930 and 2931 are termed Macroprogram Controllers. They will have a 16-level, push-down stack, a full adder (like the 74S482) for relative-address pro-

gramming, and address incrementing.

The 2930 will come in a 20-pin package and will execute 16 instructions. The 2931 will come in a 28-pin package and will execute 32 instructions, 16 of which will be conditional. ■■

## Microprogram sequencing with the 9408

The 9408 program controller generates a 10-bit address for program memory sequencing and can address 1024 words of memory. It can execute conditional branches on either state of any one of four test inputs; and allows an unconditional eight-way branch.

Unlike other devices, the output of the 9408 comes from a multiplexer whose sole purpose is to avoid the latching function of the address latch, if desired. This multiplexer has a "pipeline-control" line that allows the chip to have either latched or unlatched outputs.

The 9408 has two "via" outputs which are used in conjunction with unconditional branch instructions. The intent of the manufacturer is that an external multiplexer's control lines may be attached to these pins. This capability would allow branching to

addresses originating from many sources (for example, the control memory that the 9408's address output drives, and external branch addresses.)

The via outputs may also be connected to the clock and the inputs of an up-down counter to enable memory paging beyond the 1k-word limit imposed by its 10-bit address register. For example, 2k-word addressing could be obtained by connecting one of the via outputs to a toggle flip-flop for paging, and the other via output would still be available for use with a branch-input multiplexer.

The 9408 is available in a ceramic 40-pin package at \$34.75 in 100-piece quantities, and a cheaper plastic packaged device is expected by the end of the year. From Fairchild Semiconductor, Mountain View, CA.

CIRCLE NO. 434

## The 8X02: A 10-bit control store sequencer

The 8X02 generates a 10-bit address for program-memory sequencing, which allows addressing of 1024 memory words. It responds to eight discrete instructions and can test for conditional instructions.

The 8X02 instructions include conditional skip next instruction; conditional branch to a subroutine, loop or externally applied branch address; push or pop the stack; initialize to address zero; and continue to the next instruction.

The block diagram shows that the current address is stored in the address-output latch, which has three-state output buffers for off-chip driving. The address latch may be loaded from any one of four next address sources or reset to zero on command of the instruction decoder. This occurs on the rising edge of the chip's clock

input.

The next-address sources for the latch can be the current-address-plus-one (or two), an externally applied, 10-bit branch input, or the output from the push-down stack.

The four-level push-down stack can push either the current address, the current-address-plus-one for looping or the branching to a subroutine. It can also pop with or without its output entering the address latch, under program control. The push-down-stack operates on the rising edge of the clock.

The 8X02 automatically resets to address zero on power-up. It comes in a 28-pin package. The 8X02 sells for \$31.50 in 100-piece quantities. From Signetics, Sunnyvale, CA.

CIRCLE NO. 435

CIRCLE NUMBER 54 ►



Protection that adds value . . .

# Presto!

## You've got a better product.

Your customers (and your boss) will love you for it. And all you did was design in a Heinemann circuit breaker instead of a fuse.

Clever indeed. Because a blown fuse means downtime. If the customer can't solve the problem himself, or can't find a spare, it means more downtime. And possibly even a service call. That costs you plenty—in reputation as well as money.

How good it is that an inexpensive Heinemann breaker, doubling as a power switch for your front panel, can turn that downtime into uptime . . . just one more way our products add value to your products.

Find out more in your free Protector Selector—a handy reference chart loaded with specs, capabilities, and even dimension drawings for twelve top-selling protector lines. Including electromechanical, solid-state, and hybrid devices to protect all manner of loads against shorts, overcurrent, overvoltage, and undervoltage—singly or in combination. Get it from your nearby Heinemann representative (listed in EEM) or Heinemann Electric Company, Trenton, NJ 08602. (609) 882-4800.

**another reason  
Heinemann is  
No. 1 in OEM circuit  
protection**



# HEINEMANN

**We keep you out of trouble.**

Factories in Trenton, Montreal, Dusseldorf,  
Johannesburg, and Melbourne.





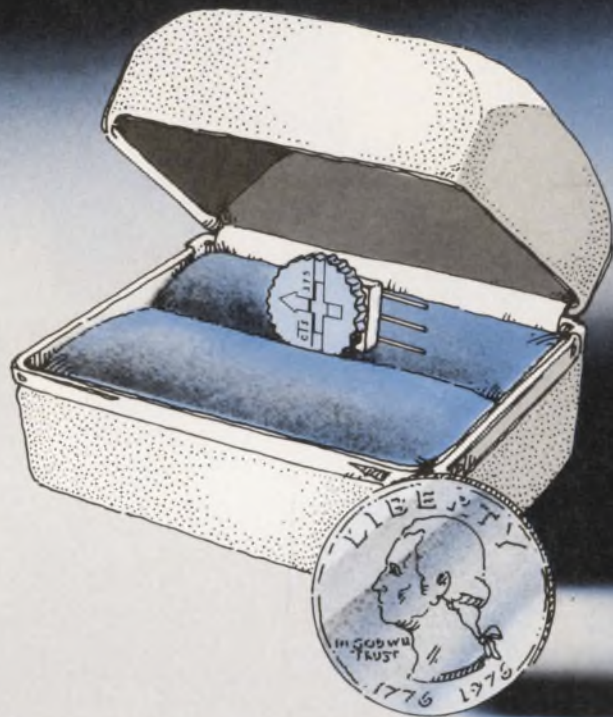

# Million-dollar performance for only a quarter.

Fantastic! Small size, great performance and CTS reliability are only three reasons you should use our NEW series 375 single turn cermet trimmers. The low 25¢ price tag is still another.

CTS 375's, in six popular terminal styles, feature a low  $\pm 100$  ppm/ $^{\circ}\text{C}$  standard temperature coefficient—throughout the resistance range. Power rating, 1 watt at  $40^{\circ}\text{C}$ ;  $\frac{1}{2}$  watt at  $70^{\circ}\text{C}$ . CRV of 2%. Settability of .03%.

And the serrated adjustment knob doubles as a dust cover to protect the element from dirt, oil and other contaminants.

It's a lot for so little. But you expect that from a company that's put millions into electronics for industry. For complete information, write **CTS OF BERNE, INC.**, Berne, Indiana 46711 or phone (219) 589-3111.

**CTS CORPORATION**  
ELKHART, INDIANA



A world leader in cermet and variable resistor technology

CIRCLE NUMBER 55



# The Ansley "D" Connector...



Our new series of male and female "D" connectors offer you a cost effective external mass termination cable and connector system second to none. Its uniqueness begins with a one-piece "D" connector package that meets industry standards for size, pin spacing, and contact reliability. With no loose parts to match up, positive cable-to-contact alignment is assured. Conductors are mass terminated in seconds with our standard BLUE MACS™ hand or bench tools. The results? Faster installation, higher reliability.

Contact pins are spaced on .0545" centers — a perfect fit for any standard inter-cabinet "D" type connector application. Our new "D" connectors are designed to mate with standard .050" pitch flat cable as well as our new, improved jacketed cable — the only flexible flat cable engineered specifically for out-of-cabinet use.

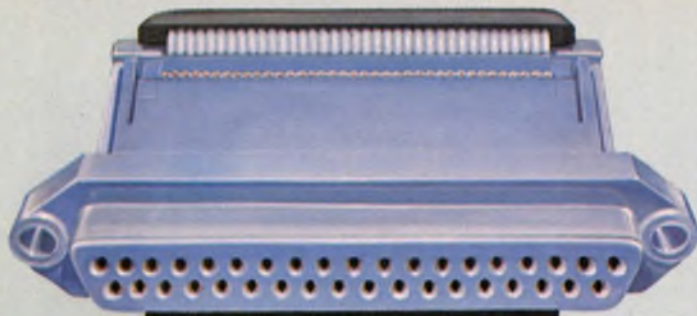

# a new meaning to cost effectiveness.

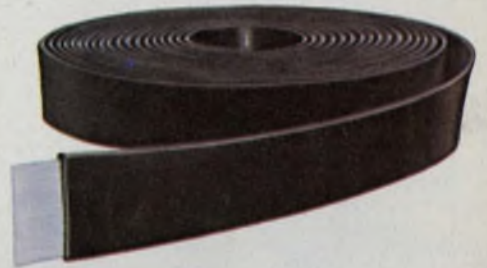

The Ansley BLUE MACS™ jacketed cable is U.L. listed for external interconnection of electronic equipment. Electrically, it outperforms standard jacketed twisted pairs in typical I/O applications. And there's no special zipper lock tubing required — reducing the need for an extra cable accessory. Installation is faster, easier. And like all Ansley connectors, you can daisy chain our "D" types anywhere in the cable — along with our DIP socket, card edge, or pc board connectors.

Cable alignment and high contact reliability is assured — because both cable and connector are grooved for absolute alignment. Our patented TULIP™ 4-point insulation-displacing contacts are permanently fixed and sealed-in to provide a reliable, gas-tight, corrosion-free mass termination.

For the full reliability/cost effectiveness story and technical data, call or write:

**T&B / Ansley**

The mass termination company.

**T&B/Ansley Corporation • Subsidiary  
of Thomas & Betts Corporation**  
3208 Humboldt St. • Los Angeles, CA  
90031 • Tel. (213) 223-2331 •  
TWX 910-321-3938

**Available through authorized  
Ansley distributors**

In Canada: T&B/Ansley, Ltd.  
700 Thomas Ave.,  
Industrial Park  
Iberville, P.Q.

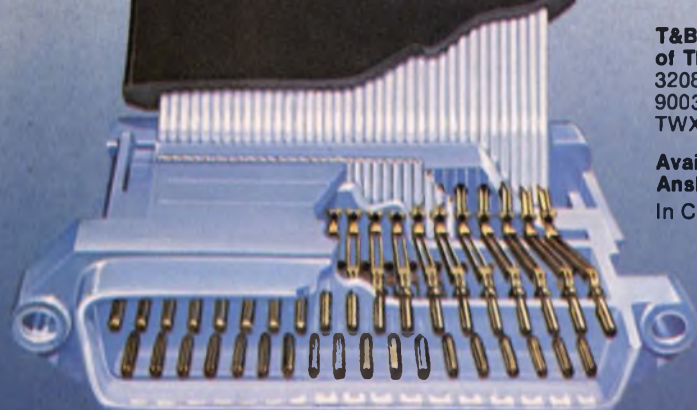



# There's so much good news about the Amphenol<sup>®</sup> SMA line, we almost ran out of ad.



But there's  
enough  
room to talk  
about our  
bigger-than-ever  
line. And our  
competitive prices.

What do you need in SMA's? Now you can get it in our expanded line of Amphenol stainless steel SMA's. And you'll get premium quality, too, at very competitive prices in all these configurations (shown above, left to right):

**Amphenol SMA cable assemblies:** For semi-rigid 0.141" and 0.085" diameter metal-jacketed cable and all flexible coaxial cables. Fitted with SMA or other RF connectors to your specs.

**Amphenol 'Spark Plug' SMA's:** For Microwave Integrated Circuit (MIC) packages. One-piece, screw-in, with hermetic seal. No gaskets, brazing, or soldering. Get a better seal for less cost. Superior RF performance, too.

**Amphenol phase-adjustable SMA's:** Just turn the nut to change phase up to 180° at 18 GHz and get phase-matched cable assemblies. No more repeated cable trimming operations are required to achieve precise electrical length. In-line adapters also available.

**Amphenol SMA connectors:** For all microwave frequencies up to 24 GHz. Comply with MIL-C-39012. All shell and body parts are gold-plated stainless steel. Dielectric is solid TFE. Amphenol SMA straight and angle plugs, jacks, receptacles, between-series adapters—the works.

**Something extra-special in SMA's?** We can help there, too. With unique designs that'll satisfy your needs. Just ask us.

**They're all easy to get—from your Amphenol Industrial Distributor.** He's in your neighborhood. For off-the-shelf service on our SMA line, give him a call. And phone or write us for more information. Amphenol Connector Systems, Bunker Ramo Corporation, 33 East Franklin Street, Danbury, Connecticut 06810. (203) 743-9272.

*When you can connect it  
and forget it...that's quality.*

Amphenol Connector Systems

**BUNKER  
RAMO**

CIRCLE NUMBER 57



# Microprocessor Design

## There is still a lot of guesswork attached to microprocessor testing

*As more and more products use  $\mu$ Ps, there is an increasing demand to make more reliable, functional tests on the devices. Chris Chrones, director of special products at the DCA Reliability Lab, presents his views on  $\mu$ P testing.*

The companies that come to us to test  $\mu$ Ps for their products are mainly commercial companies without too much  $\mu$ P-engineering expertise. They have a lot of difficulty in developing test procedures for the  $\mu$ Ps that they use, so they don't usually specify how to check them. All they want is good devices. We ask them to tell us what functional truth table and what instruction set they want us to test, and they reply, "We don't know."

Our only recourse is to devise what we think is a rational test procedure to weed out all the devices beforehand that might fail in their application.

We also test  $\mu$ Ps for aerospace companies. In the past, quite a bit of the standardized knowledge of how to test simpler ICs has emanated from aerospace programs, because the



subcontractors who use the devices can supply the funding to develop test procedures.

However, because the aerospace companies have not designed many instruments with  $\mu$ Ps,

*(continued on page 116)*

## A 61-k character serial data buffer gets smarter with a $\mu$ P

A smart data buffer, Nu Data's Model 1850-B, stores 61-k characters from a two-way serial data bus. With its  $\mu$ P brain, the buffer can be configured to selectively store and manipulate data, or transmit its status in response to computer interrogation. Serial data can transfer at rates from 50 to 4800 baud.

The buffer temporarily stores characters coming from a computer to a peripheral device or modem, and vice versa.

With the  $\mu$ P, the buffer will store data only when properly addressed over, for example, a phone line. The unit can also perform code conversion from, say, ASCII to BAUDOT. Or, the  $\mu$ P might split up the 61 k of total-character storage between incoming or outgoing channels.

Also, the 850-B can be programmed to acknowledge a received message, or tell a computer how much data it has stored.

The price of the unit varies with the amount of buffer memory and programming effort required, and the quantity of units ordered. For a single unit, with eight bits per character, the hardware will cost \$4250. Typical programming costs are \$600 extra.

*Nu Data Corp., 32 Fairview Ave., Little Silver, NJ 07739. (201) 842-5757.*



## MICROPROCESSOR DESIGN

*(continued from page 115)*

they have not had much need to test them. That is mainly why they are not taking the lead in generating the  $\mu$ P test procedures.

For many other IC products, a test philosophy has been established by the industry. For 4-k RAMs, for example, test methods that successfully weed out marginal and defective products are available. Symposia have dealt with the subject before, and experience has been gained by applying various types of testing patterns to the devices. This is true of many MOS-LSI devices that have one well defined memory, sequential, combinatorial or random logic pattern.

In contrast, a  $\mu$ P is a very complex device that has no single, well defined logic pattern. A typical  $\mu$ P might have 100 or more instructions.

The combination of these instructions and their sequence is an astronomically high number, so no one can even attempt to exhaustively test each device.

To generate a realistic test pattern for a  $\mu$ P, you must first select the instructions and their sequence that apply to your specific application. Then, a truth table must be made—a list of output-vs-input patterns for each of the 40 pins of the device.

If you use the  $\mu$ P in a data-communications instrument, for example, you will test the device's I/O capability. If you are making a calculator or a terminal, then you will check out the ALU in the  $\mu$ P thoroughly. Others will stress the memory elements and registers within the device.

Just as for other LSI devices, engineers will develop applications-oriented  $\mu$ P tests. Groups of instructions will be devised that will test  $\mu$ Ps under worst-case conditions.

---

## Seminar on $\mu$ Ps to be held at Fort Monmouth

Current and future applications of  $\mu$ Ps and  $\mu$ Cs will be discussed under the co-sponsorship of the Association for the US Army (AUSA) and the Small Business Administration.

The conference is not a detailed design workshop but is directed toward the businessman or engineering manager interested in putting  $\mu$ Ps and  $\mu$ Cs to work.

The conference will take place November 10, at Gibbs Hall in Fort Monmouth, NJ, from 8:30 a.m. to 5:30 p.m. Some of the subjects to be covered are military applications of  $\mu$ Ps, legal implications of their use, and the application of  $\mu$ Ps in diverse fields, such as consumer products.

For further details and registration information, contact AUSA, Crystal Brook Professional Bldg., Rte. 35, Eatontown, NJ 07724, or call (201) 741-7064.

---

## One card $\mu$ C features built-in video terminal



What do you get when you combine a 6502 microprocessor, 8-k bytes of RAM, a video interface and a regulated power supply, all on a single printed circuit card? You get the Apple-1, the latest entry into the low-cost microcomputer market.

Unlike low-cost microcomputers that often come in kit form, the Apple-1 comes fully assembled, tested and burned-in. The system's basic price is \$666.66 and includes 4-k bytes of RAM, the CPU, the video interface and ROM monitor. An additional \$195 buys another 4-k of memory and a cassette-tape interface.

The microcomputer's video interface connects directly to either a video monitor or a TV set via an rf modulator. The interface displays 24 lines of 40 characters at a display rate six times faster than a standard teletypewriter. It also features automatic scrolling.

The Apple-1 uses 16-pin, 4-k dynamic memory chips. But when the 16-k RAMs become

*(continued on page 118)*



# Just as you can count on Newton's law,



## you can count on Synchron<sup>®</sup> motors.

The synchronous motor you install in your product is likely to be the most important single component. So everything about that motor should be exactly right for your product. The speed, the torque, the price and the delivery, of course. The performance, the quality and the dependability. But, especially, its rightness for you.

What's exactly right for someone else may be exactly wrong for you. That's why it's almost impossible to find a ready-made synchronous motor



that meets your specs in every way. We custom-make every Synchron motor. At a competitive price. To fit your needs, not ours. Delivered on time. Designed and built right, to do the job right. That's the only way we do business.

Call or write for our specification sheets and the name and location of our representative in your area.

Choose from five principal styles of Synchron motors—60 or 50 Hz—from one revolution per week to 900 rpm—from 8 thru 98 oz-in torque at 1 rpm—from hundreds of different outputs.

**MALLORY**



**HANSEN MANUFACTURING CO.**  
a division of P. R. MALLORY & CO. INC.  
Princeton, Indiana 47870

We make every Synchron motor as if our name were on your product



## MICROPROCESSOR DESIGN

(continued from page 116)

available, some minor modifications to the Apple-1 board will make it possible to replace the 4-k chips with the larger memories, and provide a total on-board capacity of 32-k bytes, according to Steve Wozniak, Apple's director of engineering.

Apple Computer Co., 770 Welch Rd., Palo Alto, CA 94304. (415) 326-4248.

CIRCLE NO. 427

### Son of Altair offers many improvements



Positive customer feedback and technology advances have encouraged MITS, maker of the first microcomputer kit, to come out with a new version. Known as the Altair 8800b, the new microcomputer features several improvements over its predecessor, the popular 8080-based computer kit.

The new Altair's beefed-up power supply (8 V, 18 A) can handle a fully loaded machine without the add-on circuitry needed in the original model. A new interface

board that buffers all signals between the computer bus and the redesigned display/control board eliminates the front-panel logic loading problems that cropped up in the original microcomputer. The logic on the control board is totally synchronous.

The new model uses the improved 8080A CPU chip, which ensures better performance. In addition, the 8800b has five new front-panel-switch functions. One of them is a slow function that permits program execution at a rate of two machine cycles per second instead of the usual 500,000 cycles per second. The function is designed for debugging large programs that are even more time-consuming to single-step through. The other four functions display, load, input and output data to or from the accumulator.

The 8800b also incorporates mechanical improvements, including an 18-slot motherboard, a new dress panel and ribbon cables that replace the wiring harness in the original model.

All these improvements do come at a price. The Altair 8800b is \$400 more expensive than the original Altair and sells for \$840 in kit form and \$1100 assembled.

MITS, 2450 Alamo SE, Albuquerque, NM 87106. (505) 243-7821.

CIRCLE NO. 428

### LSI chip interfaces 16-pin 4-k RAMs with PPS micros

An LSI chip that interfaces NMOS 16-pin, 4-k RAMs with PPS-4 and -8 microprocessor systems without need for any supporting TTL circuitry has been introduced by the Microelectronic Device Division of Rockwell International, Anaheim, CA.

The RAM interface circuit, designated P/N 10929, fully buffers the PPS bus from dynamic RAM loading effects and provides all address multiplexing, system control and refresh functions. Memory refreshing is transparent to the PPS system so that conflicts between its use of memory and refresh operations are eliminated.

On-chip logic permits the interface to float its output to memory, allowing the configuration of shared-memory multiprocessing systems. Sharing is accomplished by stealing a clock phase used for refresh so that the transaction is completely unnoticed to the other processor.

In a high-speed block transfer mode, the new interface chip can be instructed to float the memory bus until control is returned to the PPS system. A typical application is the interlacing of CPU updates during direct refreshing of CRT displays.

Up to 32 NMOS 16 pin 4K RAMs can be controlled and directly addressed by a single pair of interfaces and additional chip pairs combined with bank switching techniques can be used to directly access up to 16 banks of 16-k bytes each (256-k-bytes total) in a single PPS-8 system.

The large standard memory options provided by the device are supported by the PPS-8 system's ability to move blocks of data at a rate of up to 4  $\mu$ s per byte.

Rockwell International, Microelectronic Div., P.O. Box 3669, Anaheim, CA 92803. (714) 632-8111.

CIRCLE NO. 429



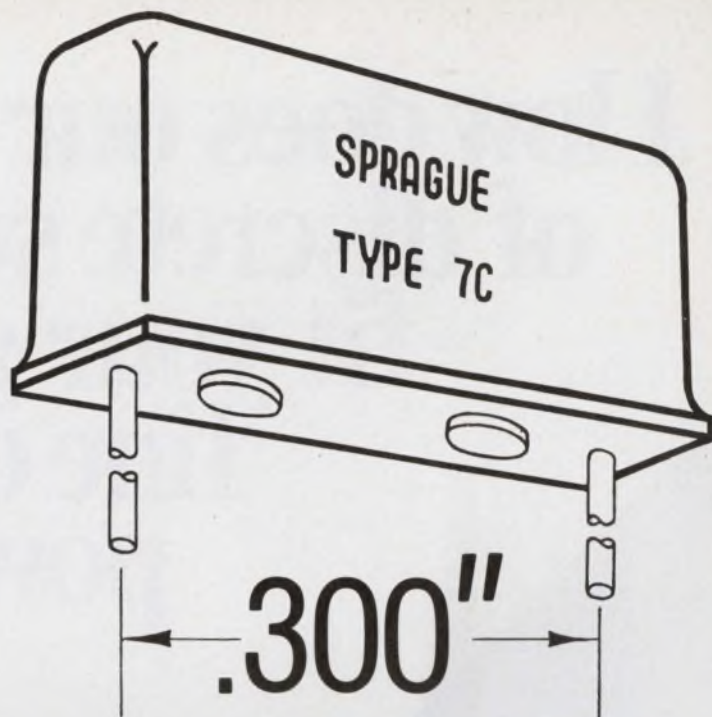
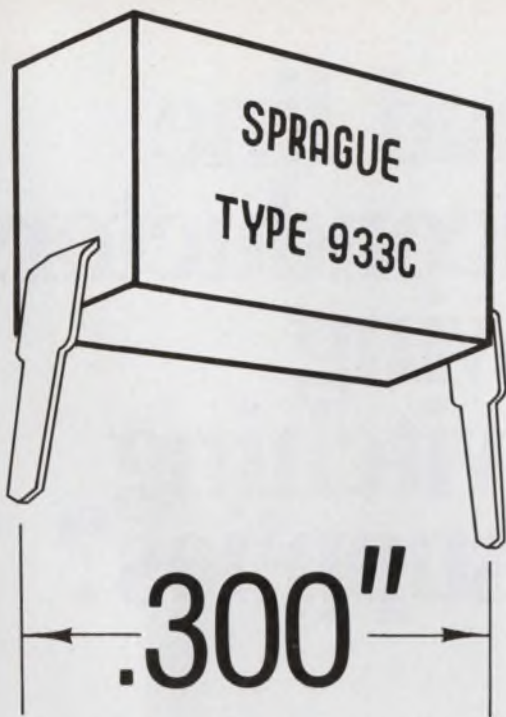

# COMPATIBILITY

**SPRAGUE GIVES YOU A CHOICE OF 2 MONOLYTHIC<sup>®</sup> CERAMIC CAPACITORS THAT GO HAND IN HAND WITH ALL TYPES OF STANDARD DIP COMPONENTS**

## **Type 933C DIP-Style\* Molded-Case**

Moisture-proof case offers excellent mechanical protection during hand or automatic insertion. Made by alternately depositing thin layers of metallic electrodes and ceramic dielectric until desired capacitance is obtained, then firing into a homogenous block. Capacitance range: 18 pF to .1  $\mu$ F @ 100 WVDC; to .22  $\mu$ F @ 50V; to .47  $\mu$ F @ 25V.

## **Type 7C Saddle-Base Resin-Coated**

Tough resin case, with outer epoxy varnish coating, protects against damage from handling as well as moisture. Phenolic base plate insures accurate lead spacing and eliminates resin run-down on leads. Capacitor sections made with proven layer-built construction. Capacitance range: 51 pF to 1  $\mu$ F. Voltage ratings: 50 and 100 WVDC.

For more information on these and other Monolythic<sup>®</sup> Ceramic Capacitors, write for Short-Form Catalog MC-108 to: Technical Literature Service, Sprague Electric Company, 347 Marshall Street, North Adams, Mass. 01247.

**\*Sprague puts more component families into dual in-line packages than any other manufacturer.**

CIRCLE NUMBER 59





# How does our broad line of discrete semiconductors fit your growing line of switching power supplies?



**IOR**  
**FAST RECOVERY RECTIFIERS**  
 8 SERIES  
 6-12 Amps  
 50-1000 Volts

**IOR**  
**RECTIFIERS**  
 28 SERIES  
 1-40 Amps  
 50-1000 Volts

**IOR**  
**ZENERS**  
 26 SERIES  
 250mW-50W  
 2.4-280 Volts

**IOR**  
**TEMP. COMP. VOLTAGE REFERENCES**  
 16 SERIES  
 250mW-1.6W  
 5.9-49.6 Volts

**IOR**  
**POWER SCHOTTKYS**  
 6 SERIES  
 20-50 Amps  
 10-50 Volts  
 150°C Junction Temp

**IOR**  
**INVERTER SCR's.**  
 4 SERIES  
 35 Amps (RMS)  
 20-400 Volts

**IOR**  
**SCR's**  
 22 SERIES  
 4-70 Amps (RMS)  
 15-1200 Volts

**IOR**  
**POWER TRANSISTORS**  
 34 High Gain Types  
 1-10 AMPS  
 15 Fast Switching Types  
 5-15 AMPS

**IOR**  
**HIGH VOLTAGE POWER DARLINGTONS**  
 25 High Gain Types  
 10-20 AMPS  
 9 Fast Switching Types  
 10-20 AMPS





# Beautifully.

When you're breaking new ground in switching power supplies you need a vendor who can solve most of your problems.

In discrete semiconductors, only a broad-line supplier like International Rectifier can help you in so many ways. Both in design and later in production.

**Design Tradeoffs.** Like your own circuits, each of our discrete semiconductors has its own limitations as well as advantages. If a part number you've previously specified doesn't seem to do the job, we can probably suggest one that will. We can also select standard devices with the special parameters you need, or start fresh with a new design.

If you need a capability trade-off between different types of discretes, no one has more knowledge to assist you with than IR.

**Applications Assistance.** We know it takes more than data sheets and application notes to keep your design and production running smoothly. No matter what your questions, if it has to do with discrete semiconductors we can help.

And we do help. Our application engineers will come when you call.

**High, and consistent quality.** For 28 years we have been specializing in discrete semiconductors. They have earned a reputation for consistently high quality, ruggedness, dependability, and good performance. Our manufacturing, test and QC procedures are sound, and painstakingly adhered to.

One source.

We save you design time.

We keep your production running smoothly.

We deliver the kind of performance that increases your sales.

For information, just give us a call. At the factory (213) 322-3331, at our 30 local sales offices, or at any of our nationwide distributors. Write to International Rectifier, 233 Kansas Street, El Segundo, CA 90245.

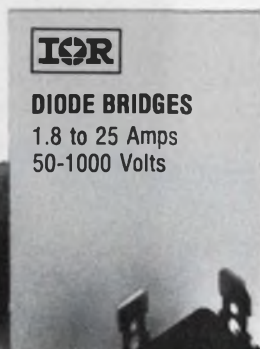
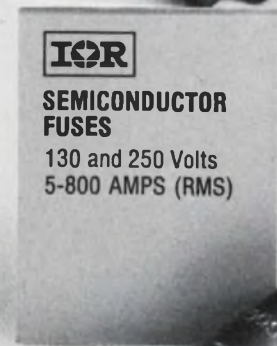

# International Rectifier

... the innovative semiconductor people



CIRCLE NUMBER 60



# FOCUS

## on Keyboards

If you're not now using a keyboard in your electronic system, chances are you soon will.

Expect a tough time when making a choice. You'll have mountains of claims to climb over as each manufacturer insists that his switching technique is best.

"But for 90% of the applications, it makes little difference which switching method is used," claims Harry Meyer, senior vice president and keyboard expert at Cherry Electric. Most methods, when well executed and properly interfaced, can probably do your job. Many manufacturers elect to go with a particular switching technique merely because it's different.

Only for very particular needs—extreme environmental conditions, exceptionally long life, very-high-speed operation, and situations requiring special keys, codes or functions, to name a few—are certain switching techniques possibly better than others.

Despite volumes of claims that tend to focus attention on switching techniques, the most important keyboard specification is reliability. Cost in most industrial, communications, military or other critical applications should be secondary, because a cheap switch that isn't reliable is useless.

### Reliability specs: Are they reliable?

With reliability such an important spec, you would be justified in assuming that keyboard vendors and users have developed some uniform, dependable way to measure and specify reliability. Not so!

Every manufacturer claims long life and high reliability for his product. But every manufac-

turer tends to run tests that make his product look good. And every manufacturer claims that he has the best cost-effectiveness ratios. For the design engineer, there are no hard standards even now, despite the lengthy existence of this industry. And even high cost doesn't guarantee good reliability.

An engineer can best protect himself by understanding the nature of keyboard reliability specs. Unfortunately, few manufacturers freely publish any "true" measure of reliability. What you usually get is a so-called life value in terms of the number of strokes each key (or the total keyboard—make sure which) can be expected to withstand.

But life figures are not true measures of reliability. Worse, life figures are not even very useful, unless the end-of-life criteria are also given. Too often, even when given, such criteria are vague.

Not every so-called failure means end of life.



Advanced solid-state switching techniques, such as used in these Hall-effect Micro Switch keyboards, solve the problems of contact wear, bounce and contamination by doing away with contacts. But, of course, the price for longevity is paid in circuitry and in the use of power.



Some switches are repairable, and the switch's life can continue for many failures. And some failures are merely temporary random "misses."

In a teletypewriter communications system, an occasional miss is not critical. But financial data keyed into a bank-record storage device could present very serious problems, if the data aren't error-free.

Accordingly, keyboard-life specifications in millions, even billions, of cycles are no criterion of reliability. One keyboard may last much longer than another, but may also generate an excessive number of misses. Or, during its lifetime, the keyboard may need a lot of servicing: application engineers of one manufacturer believe that a reliable keyboard should need less than one service call a year.

The construction of each keyboard must be carefully evaluated for serviceability. In some keyboards, individual keyswitches are easily replaced; in others, the entire keyboard must be replaced. Most of the low-cost, flat-keyboard units, as used in pocket calculators, are not repairable. Some manufacturers may even supply you with a measure of serviceability—MTTR (mean time to repair). But this is a figure dif-

ficult to standardize for comparison purposes and check out.

#### How many strokes in a lifetime?

Though stroke lifetime may not be a good measure of reliability, it still is a valuable specification, assuming the keyboard is adequately reliable for your needs.

What's a reasonable lifetime for a keyboard switch? It all depends upon the expected application.

Studies of English-language, keyboard-usage ratios show that the space bar is relatively heavily used. It is actuated about 17% of the time. If expected use is relatively heavy—say, 6 hr/day, 200 days/yr at an average rate of 30 words/min. (5-letter words)—then in one year about 1.84-million strokes will be accumulated on the space bar. Thus, a switch with a 10-million-stroke operating life could last for about 5 years.

Lifetimes of 50 or 100 million strokes probably wouldn't be worth much of a cost premium in today's fast moving technology—electronic-equipment half lives run closer to 3 to 5 years than to 30 to 50 years. But this is a value judg-



The popularity of metal-to-metal-contact keyswitches, as used in Cherry keyboards, results from being able to get

good reliability at low cost. Unless very long life is needed, contact switches can meet most needs.





Each of the many keyboard manufacturers tends to specialize in one or two different switching methods for its keyboards. All claim high reliability, and most manufacturers can deliver on their promises. But reliability results mostly from quality manufacturing procedures and processes: the switching method, generally, is secondary. As examples of the methods (from lower left, clockwise), Cortron uses a magnetic saturation method; Key Tronic's keyboard designed for Boeing's police-station data-entry system uses reed switches; GRT's Touch-Tone keyboard uses low-priced gold-contact switches; Maxi-Switch's Captron units use a capacitive switching method; and Collimation uses an optical-coding approach.



ment the engineer and his marketing department must make.

Pocket-calculator keyboards generally don't get anywhere near the use cited in the previous example. Thus, a life of 0.3 to 1-million actuations may be sufficient life expectancy. But for a desk-model calculator in a busy accounting department, a 10-million-stroke keyswitch life would be more reasonable.

### So what's reliability?

If a keyboard's lifetime is not a measure of reliability—what is?

Reliability is the probability that a device will perform its function under given conditions,

without failure, for a specific number of hours. It is usually specified as MTBF (mean time before failure) or in cycles as MCBF (mean cycles before failure).

In evaluating keyboards, you'll probably find a statement such as: "Minimum MTBF exceeds 25,000 hours."

That statement appears to be very definite and precise, but it really isn't.

In common with establishing lifetime values for a keyboard, to determine MTBF (or MCBF), the meaning of failure for this purpose also must be clearly defined. Obviously, the definitions of failure for measuring keyboard life and "failure" for measuring reliability are generally different. For MTBF, a single miss can be a "failure" in



some applications; in other cases, ten or more misses are allowed before a failure is indicated. Lifetime may end only when the unit is no longer repairable.

Other failure criteria might be based on arbitrary levels of contact resistance, contact bounce, mechanical force needed to depress a key and output voltage levels in coded units.

Perhaps the most meaningful definition of reliability for keyboards is the mean time before first failure (MTBFF)—the expected time between the installation of a new keyboard and its first failure. After the first repair, the mean time to the second failure is theoretically less than the initial MTBF because of the accumulated use of components that didn't fail the first time.

But no matter how you specify or define reliability, you should measure it under clearly defined test procedures and conditions. The methods should be standardized for "normal" conditions to allow easy comparison of different manufacturers. Environmental and operator hazards other than normal use should not be included in the standard procedure. For special applications, however, tests that include these hazards should be conducted to separate the effects and allow the engineer to decide if his application needs the extra ruggedness.

Most manufacturers publish bare reliability figures, or will supply them upon request. But the figures are generally interpretations of test results, not the real data. View such figures with caution: They may be totally irrelevant to your system. You may be forced to do your own reliability analysis and testing to obtain a meaningful evaluation.

### Keyboard layouts resist standardization

"Keyboards tend to be far more customized than is generally realized," reports a spokesman for Micro Switch. "The idea of an off-the-shelf keyboard is somewhat of a fallacy," he contends. "Standardization of board layout, key placement, key quantity or board shape is neither desirable nor feasible at this time," he concludes. Most users and manufacturers agree.

A prime reason for this, but seldom expressed, is that every manufacturer scrambles to corner a specific niche for his product with some distinctive design. Adding to this pressure for diversity, computer and peripheral-device OEMs also seek individuality in their equipment, with keyboard makers only too eager to comply—for a price, of course.

Nevertheless, your best interests are served by selecting a layout common to several keyboard makers, whenever possible. "The most serious mistake a design engineer can make is to finalize a system design before surveying the market to

find out what is available," application engineers at Stackpole point out. "By adapting designs to a manufacturer's "standard" keyboards, engineers not only can reduce the cost substantially, but in some cases can even allow second sourcing, although this is usually rare."

Almost every keyboard manufacturer urges a consultation early in the system design. This is good advice. At an early stage, you have the greatest flexibility to adapt and, therefore, not require a special design; perhaps you can use a so-called standard design and save money. If left to the last minute, your choice of vendors narrows, and then you must settle for what you can get.

Major keyboard manufacturers provide boilerplate specs to help guide your design. They also provide free advice for the selection of options to customize the unit to your needs. Of course, tight specs and overspecification are to be avoided—they only increase the price needlessly.

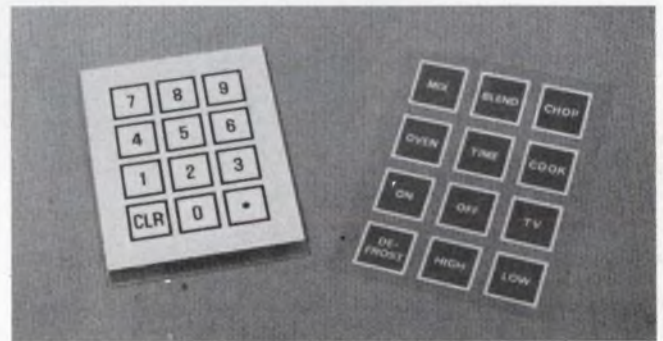

Flat, often waterproofed keyboards, with no cracks to collect contaminants, are easy to clean. Datanetics Series 700 units are now popular for both appliance and industrial-control applications.

If you expect to use a large number of keyboards, manufacturers will be most cooperative. Then you needn't worry when the "standard" model doesn't exactly fit your needs: Most manufacturers will bend over backwards to remodel a standard design—frequently at no extra cost. But get the manufacturer involved early.

Quantities over 1000 pieces drive those who make medium and high-priced keyboards ecstatic and ensure the fullest cooperation: 100-piece orders are the more usual quantities.

One area that is at least partially standardized is keyboard coding.

### Coded or uncoded—it's your choice

Some keyboards produce codes; some don't. The noncoded types often have a single common lead and a separate lead for each keyswitch. Another popular arrangement uses an XY matrix: Each key, when pressed, connects an X line to a Y line.

Noncoded keyboards may deliver either a logic



## Keyswitch techniques abound

When choosing a switching technique for your keyboard, consider your objective first, not the alleged reputation of a specific switching method. A technique is not necessarily reliable merely because it is a so-called solid-state method. Nor is the over-all result cheap, when you have to provide considerable electronic circuitry to make the switch work in your system. The switching technique you choose can often be the last item to consider. Nevertheless, consider it you must!

Here are thumbnail sketches of most of the popular switching methods:

**Mechanical contacts with open construction** are simple and low priced. Contacts can either be slow make or have snap action. But open construction is subject to contact contaminations. Also, bounce is an inherent problem; thus, direct coding is rarely provided. With "bounce-eliminator" circuits and a logic-encoder system, an effective and reliable system can be built. Cherry, for example, uses knife-edge keyswitch contacts made of gold alloy and experiences no difficulty handling any bounce problems. Life estimates of mechanical-contact keyswitches run from 5-to-10-million operations.

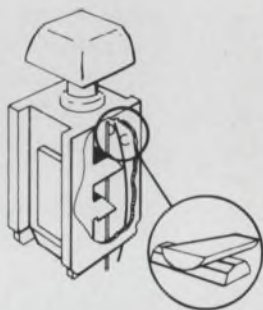

**Hall-effect keyswitches** move a magnet on a plunger assembly near a sensitive Hall transducer. In Micro Switch's design, the Hall unit provides two isolated outputs to reduce encoding-logic complexity. Though an oscillator or amplifiers are not required, the Hall transducer does require a substantial dc-current source that's always in a standby ON condition. Reliability is very good and lifetime to 100-million operations is reported.



**Reed switch contacts** in enclosed packages eliminate the problems of contact contamination. Also, the high resonant frequency of reeds produces short bounce times. Except for occasional misses, keyboards with reeds—a Key Tronic's specialty—offer high reliability with life estimates in the 50-to-100-million operation range.



level or a contact closure. If it's a contact closure with metal-to-metal contacts, question the bounce characteristics of the switch, and make sure your circuit design can handle the bounce. Bounce time on make may be quite different from break bounce time. Bounce may worsen as the contacts age. Such data are seldom volunteered, so be sure to ask.

For logic-level outputs, the keyboard's power requirements should be checked. Though seldom a problem in fixed installations, a portable application that works on batteries usually needs special attention to power demands. And, of course, the output-level tolerances and drive capabilities should be examined.

Coded keyboards may have special cycling, or timing, requirements. Study the keyboard's sequence carefully and make sure it can properly interface with your system.

**Saturable-core keyswitches** unsaturate a toroidal transformer by displacing permanent magnets when the key cap is pressed. When not saturated, a local hf oscillator can couple through the transformer and provide an output. This method, mainly used by Cortron, can provide good reliability with lifetimes in the 50-to-100-million operation range.

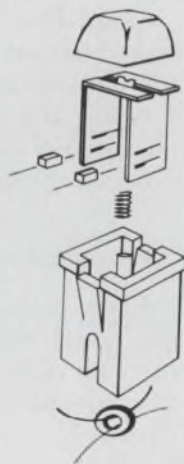

### Old codes persist

Although the ASCII code is used most frequently IBM's EBCDIC code has a good percentage of the market, and the old Baudot teletypewriter code is still very much alive. ASCII (American National Standard Code for Information Interchange) is a Federal standard, uses seven bits and separates the letters from the numerals and symbols on the keys. ASCII is also known as ANSI, or more correctly, USASCII.



**Elastomeric contact switching** is usually used in low-cost, low-profile keyboards, like those for pocket calculators. A "soft" contact eliminates problems of contact bounce. And the relatively high contact resistance is no problem with MOS circuits found in many calculator chips and  $\mu$ Ps.

**Capacitive keyswitches** are perhaps mechanically the simplest of all the methods. Movement of a plate couples a signal from an oscillator to an amplifier, whose output is then encoded. Electronic complexity is similar to that of the saturable-core approach. Companies such as Maxi-Switch and Key Tronic build capacitive keyboards. Reliability is high, and life over 100-million operations is claimed by most manufacturers.

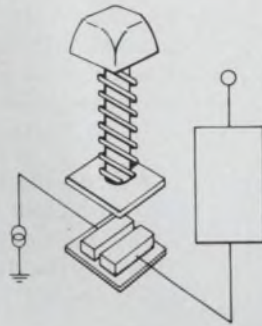

**Photo-optic coupled keyboards**, such as those made by Collimation, use an array of LEDs (or a single distributed light source) directed through a matrix of notched steel masks, that are controlled by the "keyswitches." The code in each notched mask selectively interrupts the light beams to provide a coded output for each key. Since there are no electrical contacts, contact bounce, wear and resistance are eliminated. But mechanical complexity takes their place. With a good design, reliability can be good. Lifetime values are difficult to estimate, but a 5-to-10-million operation range is reasonable to expect.

EBCDIC (Extended Binary Coded Decimal Interchange Code), the so-called data-separation keyboard widely used on IBM systems, uses eight bits (plus parity) and, unlike ASCII, assigns both numerals and symbols to alpha-character keys.

The keyboard industry would love to standardize on ASCII. With ASCII, lower-to-upper-case shifts are handled by inverting only one bit and the logical separation of numbers and letters

(and symbols) facilitates the processing of the data.

But the common use of a single key for two characters—or one character and a function, such as shift, unshift and various special controls—prevents any rigid code standards. Specialized codes will continue to be needed for a long time.

However, code standardization is an ongoing, if neglected, activity. The small degree of standardization found in today's keyboards can be traced back to the American National Standard—ANSI X4.14-1971—"Alphanumeric Keyboard Arrangements Accommodating the Character Sets of ASCII and ASCSOCR." Keypunch, key-to-disc, key-to-tape and other data-entry equipment codes are more or less standardized.

Many manufacturers would like to remove the burden of keyboard encoding from the keyboard. The manufacturers of calculator-type keyboards, in particular, argue that the advent of microprocessors makes letting the data system do the encoding more economical. However, those manufacturers whose designs inherently supply coded outputs (optical and some mechanical-matrix units) naturally insist that letting their keyboards do the encoding is still cheaper.

Keyboard manufacturers who advocate uncoded units point to the great flexibility a system designer achieves when only key-location or address codes are obtained from the keyboard. Then, with a ROM or logic circuit, the designer

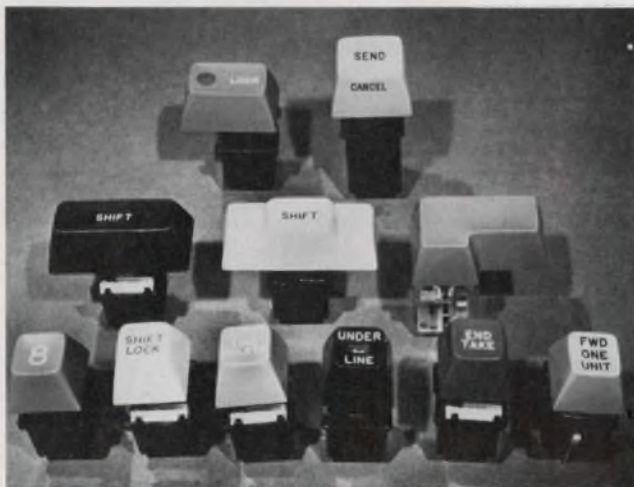

**Key caps can be obtained in many shapes and styles** as illustrated by this small selection from Cortron's repertoire. Some companies also offer a large selection of legends. The use of standards will save you money.



## Keyboard options fill every need

In addition to their "standard" keyboard assemblies, many manufacturers offer a list of options. Some of the more popular options—which need little explanation—include lighted indicators, lighted switches, selection of keyswitch operating forces and travel lengths, and tactile or nontactile feel. Also, various mechanical key-switch actions are available. They include alternate and shift-lock actions and switches with locks.

Other, more complex options, such as the choice of one of the many possible rollover versions and other electronic features need some explanation. Several of the available rollover variations include:

- **Second-key inhibit.** All keys must be released between keystrokes. The second key doesn't work on a rollover. This option is used mainly in calculators; point-of-sale devices and numerical controls, where single-finger operation is normal.

- **Two-key rollover.** Available in a number of forms—some with undesirable side effects—so this feature must be carefully examined. One popular form puts out the first code immediately, and the second code only when the first key is released. If properly designed, this approach can avoid the many undesirable characteristics some versions exhibit.

- **Two-key rollover, N-key lockout.** The keyboard locks out until only one key remains pressed. Only then is the pressed key's code put out.

- **N-key rollover.** A so-called true key-rollover version puts out a code as soon as a key is pressed, without regard to the release of any

other key. Some versions include a variety of provisions for simultaneously struck keys, such as a priority or other form of selectivity. Such a system, of course, must include a circuit that defines simultaneity. Key actuations occurring within a certain narrow time interval, are usually considered to be simultaneous.

- **Staggered N-key rollover.** For terminals that are slower than the operator, the first pressed key locks out the rest of the keyboard. After the terminal recognizes the first code, the keyboard puts out the code for the second key pressed, and so on, on a staggered basis. This is a less expensive approach than true-key rollover, which requires a large first-in/first-out buffer.

Other electronic options include:

- **Code inhibit.** Provides lockout of particular unwanted or nonmeaningful sets of codes, under such conditions as shift or external control. Or the inhibit can inactivate some keys, when desired, such as the Screen Erase.

- **Repeat key.** Allows repeat of the last character hit. But many versions are available, such as the alternate repeat of two or more keys with the repeat key pressed, or repeating characters only, such as for an upper-case X.

- **Special function keys.** Includes such functions as Scroll-up, Scroll-down, Cursor-control, Right-cursor keys, etc.

- **Multiple-function keys.** Combines such functions as carriage-return and line-feed keys.

And, of course, an endless variety of interface arrangements—TTL, MOS, special line drivers and serial or parallel outputs in many formats—are available.

can generate any code he wants for use inside his system. Some key-location addresses are determined by row/column contact-closure arrays. Many keyboards use a high-speed scanning circuit to spot the actuated key. Others use a diode matrix. And in still others, the switch itself provides an intermediate code to address a ROM.

The ASCII and EBCDIC codes both save keyboard space and cost by using each key to represent more than one character or function. This multilevel operation, as in the upper and lower-case modes, needs one or more additional shift keys to change the mode. For the usual dual-mode use, a single shift key with alternate action is often employed. For tri-mode, which allows even greater space saving, both a shift and control key are needed. For this case, a lighted shift key is almost a necessity to identify which shift level the keyboard is locked into.

But, of course, multilevel operation tends to slow data throughput and can cause confusion and errors. In addition, extra control logic is needed. Thus, some designers prefer a mono-mode operation—a single function for each key.

### Keyboard logic shows two-way trend

While some forces want to push electronics off the keyboard, other trends—multilevel operation, lighted keyswitches and readouts—tend to put electronics right back. In some cases, the keyboard even takes on such system functions as serial/parallel and parallel serial interfacing, handshake-sequencing logic, data storing and parity checking.

A keyboard usually only transmits data. However, sometimes it also receives data, for example, enable/inhibit control signals to modify the key-



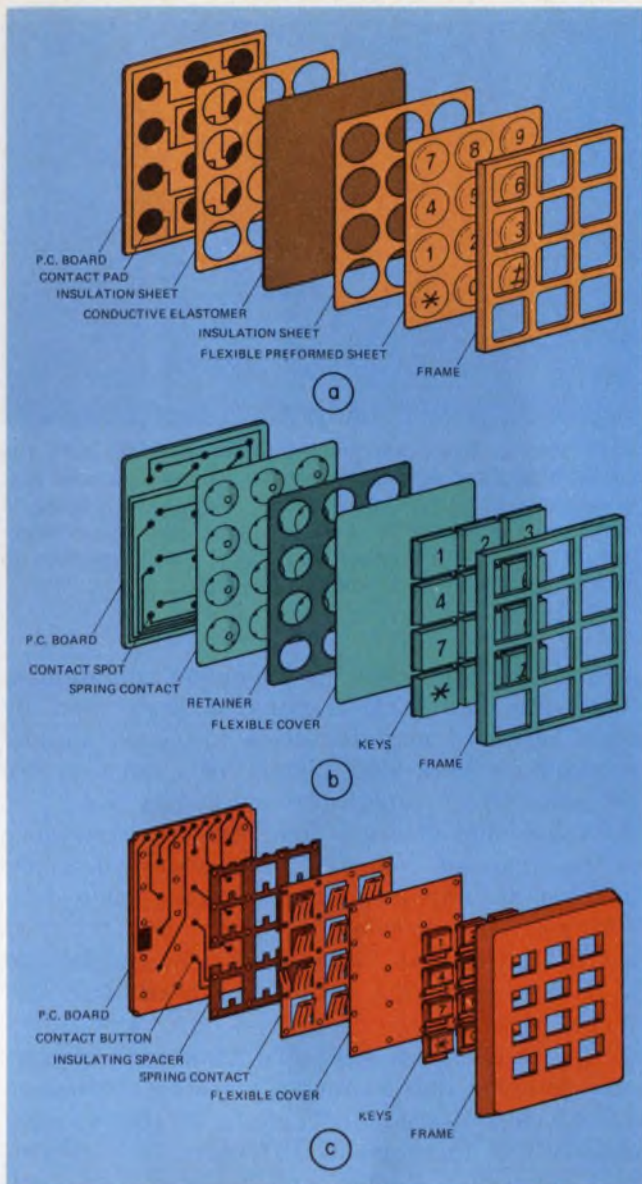

**Low-profile, calculator-type keyboards** frequently use one of these three methods of switching. Low-cost units, such as those offered by Chomerics and Flex-Key, use a conductive elastomeric sheet as the contacting medium (a). Domed-disc units (b) with an inherent snap-action are offered by Texas Instruments. Digitran prefers the flexible-design capability of its spring-type switch (c) for its keyboard (courtesy of Digitran).

board's performance, or shift signals to automatically change the keyboard from letters to numbers.

Also, interface circuits between keyswitches and data systems, such as three-state open-collector (wired-OR) drivers are often needed.

Other keyboard options also tend to pile electronics onto the keyboard. Thus the trend of electronics on the keyboard will probably go both ways: Electronic circuits will be added to the keyboard as frequently as circuits are removed.

The design engineer, in choosing between electronics on the keyboard and in his system, must base his decision on relative cost and his own special technical problems: There are no general



**Instruments now feature keyboards for function controls** rather than traditional knobs, buttons or switches. The only nonkeyboard switch on this Series 9000 microprocessing timer/counter made by Dana Laboratories is the power switch.

rules or trends to guide him.

One keyboard area—rollover—can require a large amount of on-board electronics.

#### On the rollover bandwagon?

Not all keyboards need N-key rollover. This option loads electronics onto the keyboard, adds cost and may increase equipment failure rate. Many engineers demand it merely because they've heard the word; they are victims of a name-dropping syndrome, according to some experts.

It's true that because MOS LSI circuits have allowed a substantial cost reduction in such keyboard options, opposition to N-key rollover has diminished.

High throughput applications—for example, typesetting, text editing, data communications and word processing—can very profitably use N-key rollover. The 10-to-15% higher cost over other rollover variations appears to be fully justified. For high-throughput work, studies show that about 30% fewer errors are made with N-key than with two-key rollover.

Two-key rollover is better, however, where one-handed operation is called for, as in high-speed desk calculators.

If you do choose a rollover option, be warned: Not all options work exactly alike, even if called by the same name. There are many versions of each type. Even a single company can offer several choices. Key Tronic offers a choice of three types of two-key and four N-key rollover. Although Key Tronic explains its versions, many companies don't.



For example, in a two-key rollover situation, say key A is pressed first, but key B is released first. Many outputs are possible. Will character A register first and then B, as probably desired? Or will you get B before A? A alone or B alone are also possible.

Some two-key rollover systems even have the deficiency of A coming out twice—or worse—character A coming out as many times as any second key is pressed and released, while A is held down.

Read spec sheets very carefully to determine which version is being offered. Then ask questions.

### It's human to disagree

Even more controversial than rollover are the questions of such human factors as tactile feel and audible or visible feedback from the keys. Naturally, the shape, arrangement, color and labeling of keys also are subjects of much discussion.

It's very difficult to separate prejudice and opinion from fact when studying the human factors of keyboards. Humans are creatures of habit, and thus tend to prefer what they are familiar with. But they also are adaptable—even though they may grumble a lot while they adapt. Therefore, objective test results of what is best are hard to obtain and even harder to interpret. The mere fact the people are being observed and measured influences the results.

Many electronic-keyboard input devices are operated by experienced typists. One theory holds, therefore, that such keyboards should simulate the feel and configuration of a standard typewriter to take the fullest advantage of the typists' skill. This simulation would also avoid confusing typists when they switch between typewriter and keyboard.

Other experts, however, claim that most typists can bring their throughput to normal standards on almost any electric keyboard in about 10 days, unless the keyboard has some clearly objectionable characteristics.

Bob Wilcox, engineering manager of Digitran, and a strong advocate of kinesthetic feedback, says: "An operator, in putting long lists of figures into a keyboard on a calculator, can work much faster if he can feel a definite movement of the individual keys, indicating that a digit has been entered. Looking back and forth from his list to the keyboard to verify the input by watching for an indicator light, or even watching his own fingers, eats up time and adds to potential inaccuracy. It's an inefficient method of data entry."

Other methods, such as introducing an audible click when a key is depressed—the Touch-Tone

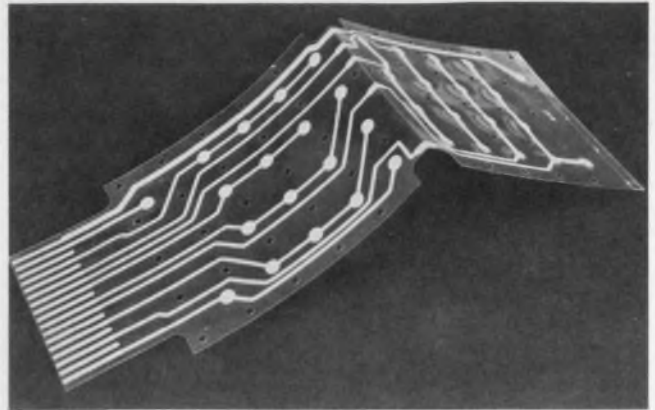

When folded, these screened bubbles provide both the contacts and spring mechanism for Chomeric's new flat-keyboard assembly. A piece of clear Mylar, with holes in the same pattern as the bubbles, separates the conductive members. The bubbles and ink contacts are said to withstand more than 10-million flexings.

audible feedback used in telephone communications—and the LED-illuminated keys used by some keyboard manufacturers are good supplementary feedback aids, Wilcox feels, but they are not satisfactory substitutes for tactile feel.

"A key that offers a firm, definite resistance to the fingertip, followed by an abrupt decrease in force, or snap, as contact is made, has a definite, positive psychological effect upon the keyboard user. He can feel contact being made, and is assured that his data have been entered," Wilcox observes.

Some studies by keyboard makers, however, seem to show that having a kinesthetic snap or audible click offers no advantage. Similarly, some experts feel there is no difference in performance between a stepped and a sloped keyboard. Of course, others disagree.

But everybody agrees that keys should not be so hard to push that the fingers soon tire. Neither should the touch be so light that bumping or vibrating the keyboard can easily actuate a switch.

Studies made by Honeywell show that the force needed to actuate a keyswitch fully should be between 0.9 and 5.3 oz, and full travel should be between 0.05 and 0.25 in. These values still allow a wide range of discretionary choice. Honeywell's recommended travel lengths, interestingly enough, appear to be smaller than those found in most mechanical typewriters and even in many electric typewriters.

Cortron (a division of Illinois Tool Works) says it can duplicate the "feel" of most electric typewriters: "Our tactile feedback switch can easily be tailored to match almost any specified force-displacement curve."

If you do decide to ask for a particular feel and tactile feedback, you will find it difficult to specify. Of course, a displacement-force curve



with tolerance limits is most definitive, and some manufacturers can meet such specs. Some can even supply different key groups on a single keyboard each with a different feel.

### Stick to standards

Special keycap requirements can add tremendously to cost, according to Meryl Miller, manager of engineering services of Datanetics. New legends requiring special tooling instead of standards and keycaps with mixed colors, odd shapes or sizes can be very expensive.

Keyboard envelope size, structural rigidity, weight and mounting can raise costs when requirements are off-beat. An extremely long keyboard obviously offers more of a challenge to obtain rigid mounting than a "normally" proportioned unit. Miller strongly advises that you should take maximum advantage of your housing to provide any needed support, and avoid expensive configurations.

Some manufacturers offer a wider choice of standards than others, so shopping around may get you what you want without a premium price.

Many standard keytop colors, finishes, shapes and orientations are offered. They include all the colors in the rainbow; gloss, semi-matte and matte finishes; square, rectangle, "L" and round shapes, among many others; and sloped, stepped and sculptured orientations. Keycaps often have a dished top for finger comfort. Deep-dish tops are available to allow an operator to feel a home position without looking.

Key Tronic says it has over 7000 hard-tooled legends available in nearly every human language.

The choices are many. Let good taste and economics decide. Human factor studies seem to provide too many conflicting answers to be helpful guides, so far.

### Low-profile keyboards—a high-volume market

The rapid spread of calculators has also expanded interest in low-profile keyboards for use in data-handling, communications equipment, instruments and consumer goods. A number of keyboard devices have appeared for specific use in this OEM market; however, most are designed with low cost rather than high quality in mind. Swift changes in the dynamic calculator market make these keyboards almost throwaway items, because the products are destined to be quickly superseded. Performance often receives only passing consideration.

Keyboards usually used in terminals, desktop calculators and similar equipment permit a long key travel and the incorporation of tactile feel. Low-profile keyboards, however, are denied the

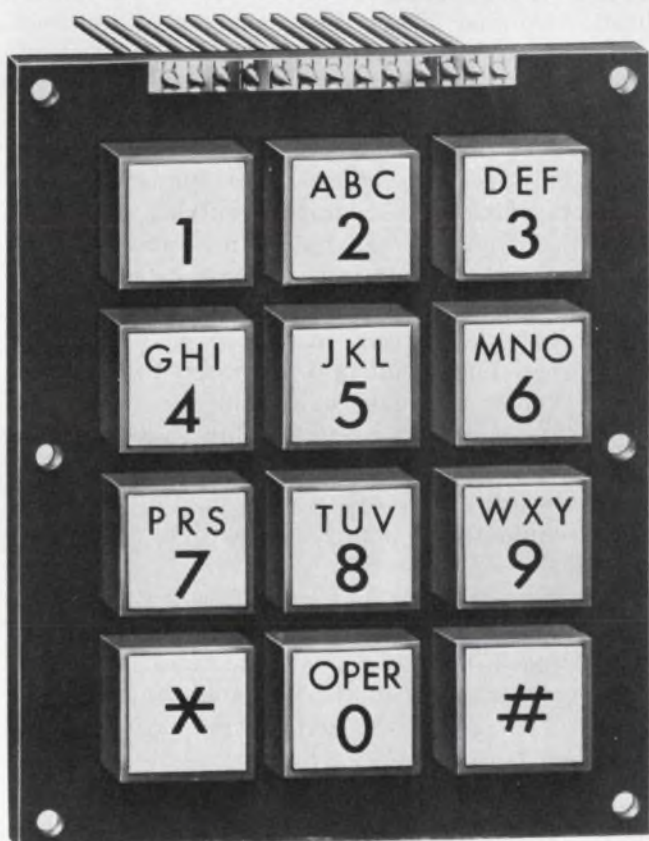
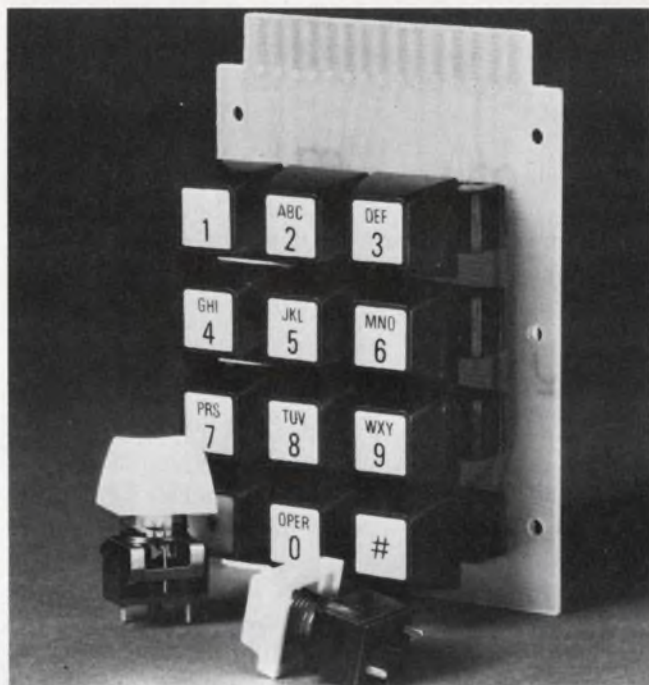

Telephone or scratchpad-type keyboards for phone or other control use are offered by Stackpole (top) and REFAC (bottom).

advantage of long key travel; limited space considerations restrict vertical key movement. A low-profile key must actuate in an average travel distance of about 0.07 in. This small travel offers a considerable challenge to the manufacturer wishing to provide a good tactile feel.

Currently, low-profile key designs fall into



three broad categories of contacts: elastomeric, domed-disc and spring contacts. Conductive-elastomer keyboards make electrical contact by pressing a portion of an electrically conductive "rubber" sheet through a hole cut into an insulating sheet. Contact is made with a metallic contact pad mounted on a PC board. The thin insulator spacers used between PC-board contact and elastomer dictate a very-short key travel—usually between 0.005 and 0.010 in.

### Introducing feedback raises cost

Because of an extremely soft contact mating with virtually no tactile feedback, some manufacturers (or users) of elastomeric keyboards provide visual feedback, often with a lighted LED. But such back-up indicator systems can add an appreciable cost that tends to nullify the advantages of the low-cost keyboard.

Other manufacturers simulate a tactile feedback with a plastic bubble on top of the metalized elastomer sheet that snaps when pressed.

There are other problems, too. Since the operator has almost no tactile indication that the bottom of the stroke has been reached, the tendency is to push harder than necessary. Such excessive pressure causes "scrubbing" of the contacts and possible multiple entries. Too light a touch, of course, can result in no data entry.

Moreover, the conductive coating, often carbon, on the back of the elastomer breaks down easily, especially from the abuse of heavy contact force. The result is a keyboard that is electrically noisy and eventually nonfunctional.

The elastomeric's normally high contact resistance—20 to 50  $\Omega$ —can be a problem, but today's MOS circuits work well with even 100-to-1000- $\Omega$  input contacts, so many applications are quite practical.

Another problem can result when interconnecting to the keyboard terminals. Metal terminals pressed into the elastomeric material are extremely heat sensitive. During soldering to other circuit elements, the terminal pins can become detached because of the heat.

Nevertheless, elastomeric boards are cheap and can do a good job when properly applied. For example, Chomeric's 35-cent price (100-k qty) for its new 17-key KCS assembly is hard to beat.

Another popular and inexpensive keyboard—such as the one made by Texas Instruments—uses a domed disc placed directly over a PC-board contact and separated by one or more insulation spacers. Pressing the keytop deflects the top of the disc downward through the spacer to make metal-to-metal contact with the PC-board contact pad. Nominal key travel on TI units is 0.01 in. and the standard actuating force is 6 oz. When deformed, the domed disc makes an inher-

ent clicking sound that serves as an audible feedback.

An overcenter-spring design, such as the one used in Digitran's KL keyboard, can also provide the snap action and nearly tease-proof contact of the domed disc, and perhaps even some greater degree of manufacturing flexibility, as claimed by Digitran. The design permits a sharply defined tactile feel, which can be customized for the user, and an audible secondary feedback, if desired.

Built-in overtravel and a preloaded spring allow electrical contact at about 70% of the full stroke; additional pressure on the keytop has no effect on the contact closure. A key travel longer than that of other low-profile key designs—

## Need more information?

The manufacturers of keyboards mentioned in the report are only a small sample of many more available. For further information, readers may wish to consult the manufacturers listed here by circling the appropriate number on the reader service card. More vendors and information may be found in ELECTRONIC DESIGN'S GOLD BOOK.

- Alco Elec Prods Inc., 1551 Osgood St., North Andover, MA 01845. (617) 685-4371. **Circle No. 451**
- AMP Inc., 449 Eisenhower Blvd., Harrisburg, PA 17105 (717) 564-0100. **Circle No. 452**
- Ann Arbor Terminals Inc., 6107 Jackson Rd., Ann Arbor, MI 48103. (313) 769-0926. **Circle No. 453**
- Artronix Inc., 1314 Hanley Ind Ct., St. Louis, MO 63144. (314) 968-4740. **Circle No. 454**
- Astronautics Corp. Amer., 907 S. 1 St., Milwaukee, WI 53204. (414) 671-5500. **Circle No. 455**
- Bowmar Instru Corp., 8000 Bluffton Rd., Fort Wayne, IN 46809. (219) 747-3121. **Circle No. 456**
- Capitol Machine & Switch Co., 87 Newtown Rd., Danbury, CT 06810. (203) 744-3300. **Circle No. 457**
- Centralab Elecs Div., Globe-Union Inc., 5757 N. Green Bay Ave., Milwaukee, WI 53201. (414) 228-1200. **Circle No. 458**
- Cherry Electrical Prods Corp., 3600 Sunset, Waukegan, IL 60085. (312) 689-7700. **Circle No. 459**
- Chicago Switch Inc., 2039 W. Wabansia Ave., Chicago, IL 60647. (312) 489-5500. **Circle No. 460**
- Chomeric Inc., 77 Dragon Ct., Woburn, MA 01801. (617) 935-4850. **Circle No. 461**
- Clare-Pendar Co., Box 785, Post Falls, ID 83854. (208) 773-4541. **Circle No. 462**
- Collimation Inc., 4206 Commercial Square, Austin, TX 78745. (512) 444-3191. **Circle No. 463**
- Computer Machinery Corp., 2500 Walnut Ave., Marina Del Rey, CA 90009 (213) 829-2926. **Circle No. 464**
- Controls Research Corp., 2100 S. Fairview St., Santa Ana, CA 92711. (714) 549-2990. **Circle No. 465**
- Cortron, Div. of Illinois Tool Works, Inc., 6601 W. Irving Park Rd., Chicago, IL 60634. (312) 282-4040. **Circle No. 466**
- Dacog Elecs, 86-046 Grand Ave., Elmhurst, NY 11373. (212) 779-3560. **Circle No. 467**
- Dana Laboratories, Inc., 2401 Campus Dr., Irvine, CA 92664. (714) 833-1234. **Circle No. 468**
- Datanetics Corp., 18065 Euclid St., Fountain Valley, CA 92708. (714) 549-1191. **Circle No. 469**
- Data 100, 6110 Blue Circle Dr., Minnetonka, MN 55343. (612) 941-6500. **Circle No. 470**
- Digitran Co., 855 S. Arroyo Pkwy., Pasadena, CA 91105. (213) 449-3110. **Circle No. 471**
- Dittmore-Freimuth Corp., 2517 E. Norwich St., Milwaukee, WI 53207. (414) 483-5100. **Circle No. 472**
- Elec-Trol Inc., 26477 N. Golden Valley Rd., Saugus, CA 91350. (805) 252-8330. **Circle No. 473**
- Electro Mech Components, 1826 N. Floradale, South El Monte, CA 91733. (213) 442-7180. **Circle No. 474**
- Flex Key Corp., 18 Sargent St., Gloucester, MA 01930. (617) 281-2040. **Circle No. 475**
- Fujitsu Ltd., 2-chome, 6-1, Chiyoda-ku, Tokyo, Japan. (03) 163211. **Circle No. 476**



typically from 0.050 to 0.095 in.—allows the tactile feel to correspond more closely in feeling with the long strokes of large desktop keyboards. And, according to Digitran, keying forces can be tailored to the user's needs.

Contact bounce is usually not a problem with elastomers; not so with metal-to-metal contact keyswitches, including the overcenter spring and domed disc. Bounce characteristics, especially after extended use, can become troublesome, as previously mentioned for long-stroke keyswitches. But to a man, metallic-contact keyboard makers say today's antibounce circuits readily eliminate this problem. Nevertheless the problem exists. It will not go away, unless the design engineer does something about it. ■■

- Futaba Elec Ind. Ltd., Super Bldg. 1-11-5 Sotokanda, Chiyoda-ku, Tokyo, Japan. (03) 55-5881. **Circle No. 477**
- General Control Co., 1200 Soldiers Fld Rd., Boston, MA 02134. (617) 782-7440. **Circle No. 478**
- General Electric, Data Com Prods, GE Dr., Waynesboro, VA 22980. (703) 942-8161. **Circle No. 479**
- Grayhill Inc., 565 Hillgrove Ave., LaGrange, IL 60525. (312) 354-1040. **Circle No. 480**
- GTE Sylvania Automatic Elec, 400 N. Wolf Rd., Northlake, IL 60164. (312) 562-7100. **Circle No. 481**
- IEE Inc., 7740 Lemona Ave., Van Nuys, CA 91405. (213) 787-0311. **Circle No. 482**
- IEE/Shadow Inc., 8081 Wallace Rd., Eden Prairie, MN 55343. (612) 944-1820. **Circle No. 483**
- Info-Lite Corp., 46-10 104 St., Corona, NY 11368. (212) 476-1287. **Circle No. 484**
- Jay-El Prods, 1859 W. 169, Gardena, CA 90427. (213) 321-3260. (I. K. Miller) **Circle No. 485**
- Key Tronic Corp., Bldg. 14, Spokane Ind Pk., Spokane, WA 99216. (509) 928-8000. **Circle No. 486**
- Korry Mfg. Co., 223 8 Ave., North Seattle, WA 98109. (206) 624-4066. **Circle No. 487**
- Ledex Inc., 123 Webster St., Dayton, OH 45401. (513) 224-9891. **Circle No. 488**
- Maxi-Switch Co., 9697 E. River Rd., Minneapolis, MN 55433. (612) 755-7660. (C. Stout) **Circle No. 489**
- Micro Switch, Div Honeywell, 11 W. Spring St., Freeport, IL 61032. (815) 232-1122. (J. S. Secker) **Circle No. 490**
- Mohawk Data Sciences, 781 3 Ave., King of Prussia, PA 19406. (215) 337-1910. **Circle No. 491**
- D. P. Mossman Inc., Box 265, Brewster, NY 10509. (914) 279-3725. **Circle No. 492**
- Oak Inds Inc., Switch Div., Crystal Lake, IL 60014. (815) 459-5000. **Circle No. 493**
- Preso-Matic Lock Co. Inc., 3048 Indl 33 St., Fort Pierce, FL 33450. (305) 465-7400. **Circle No. 494**
- REFAC Electronics Corp., P. O. Box 809, Winsted, CT 06098. (203) 379-2731. **Circle No. 495**
- Richey Elecs Inc., 10871 La Tuna Cyn Rd., Sun Valley, CA 91352. (213) 768-3800. **Circle No. 496**
- George Risk Ind. Inc., GRI Plaza, Kimball, NE 69145. (308) 235-4645. **Circle No. 497**
- Seacor Inc., 598 Broadway, Norwood, NJ 07648. (201) 768-6070. **Circle No. 498**
- Showa Musen Kogyo Co. Ltd., No. 5-5, 6-chome, Togoshi, Shinagawa-Ku, Japan. (037) **Circle No. 499**
- Southwest Tech Prods Corp., 219 W. Rhapsody, San Antonio, TX 78216. (512) 344-3140. **Circle No. 500**
- Stackpole Components Co., P. O. Box 14466, Raleigh, NC 27610. (919) 828-6201. **Circle No. 501**
- Staroswitch Inc., 1139 Baker St., Costa Mesa, CA 92626. (714) 549-3041. **Circle No. 502**
- Sweda Intl, OEM Prods Div., 34 Maple Ave., Pine Brook, NJ 07058. (201) 575-8100. **Circle No. 503**
- Symbolic Displays Inc., 1726 McGaw Ave., Irvine, CA 92705. (714) 546-0601. **Circle No. 504**
- TEC Inc., Components Div., 9802 N. Oracle Rd., Tucson, AZ 85705. (602) 297-1111. **Circle No. 505**
- Telenetics, Inc., 4120 Birch St., Newport Beach, CA 92660. (714) 752-6363. **Circle No. 506**
- Telemecanique Inc., 2525 S. Clearbrook Rd., Arlington Heights, IL 60005. (312) 437-1150. **Circle No. 507**
- Telesis Lab, 41-1/2 S. Paint St., Chillicothe, OH 45601. (614) 773-1414. **Circle No. 508**
- Texas Instruments Inc., 34 Forest St., Attleboro, MA 02703. (617) 222-2800. **Circle No. 509**
- Vector General Inc., 21300 Oxnard St., Woodland Hills, CA 91364. (213) 346-3410. **Circle No. 510**

# Short Story

## EMC's New Short Contact for Short Leads



IC's jarring loose? EMC's brand new short contact grabs and **holds** IC leads even less than .10" long! We designed it into our patented Nurl-Loc® terminal to provide the precise insertion and withdrawal forces you need. And Nurl-Loc® gives you 5 times the gripping surface to prevent twist and spread the stress to eliminate warping. Short contacts are available now in EMC's Wire-Wrap® Panels . . . and in our full line of DIP and Transistor Sockets. Call Allan Klepper (401) 769-3800 for the longer story, or write Electronic Molding Corp., 96 Mill Street, Woonsocket, R.I. 02895.

Wire-Wrap® Gardner-Deser Co.

  
Interconnection Specialists

CIRCLE NUMBER 61



# try and find more AM/FM function generator for \$795.

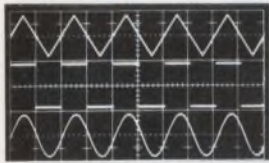

1. Precise Frequency Control with Kelvin-Varley divider that gives you 10-turn resolution and stability.

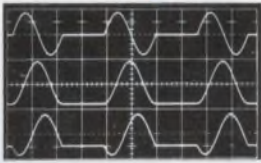

2. Variable Start/Stop control permits varying start/stop point 360 degrees in trigger, gate, pulse and burst modes.

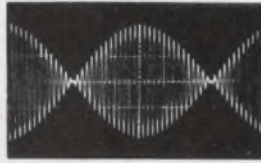

3. Amplitude Modulation from 0% through 100% on to double sideband suppressed carrier using AM Level and Carrier Level.

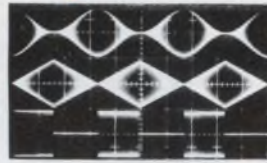

4. Multi-waveform AM/FM generator provides square, triangle, and sine AM. Modulating frequencies variable up to 1 MHz.

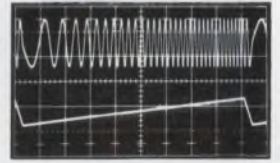

5. Variable Symmetry Control allows symmetry ratio adjustment from 1:1 to 10:1. Great for linear sweeping.

## more reasons why the Exact Model 519 is the most AM/FM function generator ever sold at \$795.

**TWO-IN-ONE.** The Model 519 is two completely separate generators in one box. Both are sine, square, triangle generators with the carrier generator having a frequency range of 1 Hz to 11 MHz and the AM/FM generator a range of 1 Hz to 1 MHz.

**WIDE BANDWIDTH.** The carrier can be frequency modulated by the internal modulation generator over a band of frequencies up to 3 decades around the center. It can also be swept over a range of 1000:1 manually or by use of an external or the internal ramp.

**INTERNAL AM/FM SOURCE.** The AM/FM generator can be used to frequency modulate, sweep, gate, trigger or amplitude modulate the carrier generator. It can also be used to amplitude modulate an external carrier. Percent of modulation is adjustable from 0% through 100% on to double sideband suppressed carrier.

**TRIGGER/GATE (Internal and External).** The carrier generator can be triggered (single cycle) or gated (burst or cycles) manually or with an external signal when GATE or TRIG mode is selected. The AM/FM generator is internally connected to the carrier generator to perform the gate and trigger functions when BURST or PULSE modes are selected.

**VARIABLE SYMMETRY.** The AM/FM generator is equipped with a variable symmetry control which allows the symmetry of the selected waveform to be varied up to a ratio of 10:1. When internally connected to the carrier, it provides for linear frequency sweeping at a rate ten times the retrace time.

**SIMULTANEOUS AM/FM.** The Model 519 provides increased flexibility by allowing simultaneous amplitude and frequency modulation. Examples are AM/frequency shift keying using square wave modulation source, linear AM/FM using triangle or ramp modulation source and sinusoidal AM/FM using sine modulation source.

**SEPARATE AM, FM AND CARRIER LEVELS.** The Model 519 has separate level controls for varying the FM width, the amplitude modulated carrier level, and the AM signal level to adjust percent of modulation. The output amplifier level can be attenuated from a maximum of 20V P-P open circuit or 10V P-P into a 50 ohm load down to 80db with a 60db attenuator in fixed 10db steps and a 20db variable amplitude control. Percent modulation is not effected by attenuator settings. Additional attenuation of approximately 40db can be achieved in the AM mode using the carrier level control.

**COMPACT.** The Model 519 measures 30.5 cm wide x 8.9 cm high x 37.5 cm deep and weighs 5.22 kg. A rackmount option allows the 519 to be mounted in a 3.5 inch high standard 19 inch RETMA rack.

**LOW COST.** Compare all of these features in the Model 519 with any other combination AM/FM function generator available today. Then compare the price of the Model 519 at \$795. FOB Hillsboro, Oregon. There is no contest.



**EXACT**  
electronics, inc.

P. O. BOX 160, HILLSBORO, OREGON 97123  
(503) 648-6661 TWX 910-460-8811



New from Centralab...

# CERBON™ TRIMMER RESISTORS

**Affordable Stability...**  
**300% More**  
**Stable Than Carbon...**  
**at a Carbon**  
**Trimmer Price!**



**Why pay more?** With Centralab's new CERBON trimmers you get stability approaching cermet and at carbon prices... As little as 28¢ in distributor 1,000 quantities; as low as 10¢ in high volume orders.

**The secret of CERBON superior performance?** A totally new thick film resistor element, which combines both potentiometer and conventional thick film technologies, plus a heat stable ceramic substrate, plus a dual-tine contact spring, plus "Fluxgard" protection from dust and wave soldering contaminants. In short, a totally balanced electromechanical system.

**Look at these benefits:**

- TCR less than  $-400$  ppm/°C.
- CRV less than 2% of maximum resistance.
- Rotational life exceeds 500 cycles.
- Adjustability (typical)  $-0.05\%$  of total voltage.
- High overload capability —

1 watt at 25°C ambient for 1,000 hours exhibits less than 2% cumulative resistance change. • Maximum stability in humid environment — Resistors exposed to an atmosphere of 40°C at 95% relative humidity for 300 hours return within four hours to  $+2.5\%$  of their initial readings.

CERBON trimmers are offered in a resistance range of 1 K ohm to 1 megohm with a choice of standard PC terminal configurations. They fit universally accepted circuit board mounting patterns. And they're ready now for fast delivery in any quantity.

Write for complete technical data on Centralab's new CERBON trimmer resistors. Or call (915) 779-3961 for a free evaluation sample. Move up to CERBON and save!



Knob colors available in white, blue, red and green for ease in assembly operations.



**CENTRALAB**

Electronics Division

GLOBE-UNION INC.

7158 MERCHANT AVENUE

EL PASO, TEXAS 79915

CIRCLE NUMBER 63

**AVAILABLE CIRCUIT OPTIONS**

Thanks to their ceramic substrate, Centralab CERBON trimmers permit a variety of screen printed circuit options. Here are three typical circuits:

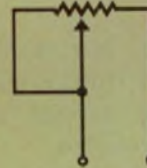

**TERMINAL SHORTING**

One of five electrical termination options available.

**OPERATIONAL AMPLIFIER NETWORK**

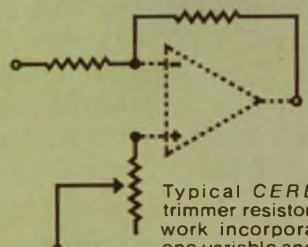

Typical CERBON trimmer resistor network incorporating one variable and two fixed resistors on dual substrate configuration.

**VOLTAGE DIVIDER**

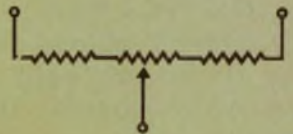

Fixed and variable resistors can be ratio matched for precise values and to insure temperature tracking. Eliminates need for costly discrete resistor selection.



### Getting to know the Cosmac

microprocessor is simple. Its single-byte instructions and CMOS structure make it easy to apply, simplifying  $\mu$ C design.

Unlike most other 8-bit microprocessors, which use multiple-byte instructions, the CDP1802 developed by RCA uses mostly single-byte commands. Only two instructions require two bytes. The  $\mu$ P is fabricated on a single chip with a self-aligned, silicon gate CMOS process. It can therefore operate over a 3-to-12-V supply range.

Because of its new, closed-CMOS structure, the 1802 offers many design advantages over n or p-channel devices:

- Wide operating temperature range. The  $\mu$ P can function over  $-55$  to  $125$  C.
- High speed. Instruction times of  $2.5$  to  $3.5$   $\mu$ s are possible when the 1802 is biased at  $10$  V. (All but two instructions require  $2.5$   $\mu$ s.)
- High noise immunity. The design permits an immunity margin equal to  $30\%$  of the supply voltage.
- Low power dissipation. Maximum dissipation ( $50$  mW with a  $10$ -V supply and a  $6.4$ -MHz clock) is about one tenth that of other  $\mu$ P families.
- Static operation. No minimum clock frequency or multiphase timing signals are needed. An on-chip oscillator circuit requires only an external crystal and resistor.

The 1802 contains all the logic necessary for fetching, interpreting, and executing instructions stored in memory. The 40-pin circuit minimizes the external I/O and memory-control circuitry (Fig. 1). Four directly testable input flags, an output flip-flop, an internal direct-memory access mode and flexible instructions all help reduce system complexity.

The 1802 contains all the logic necessary for fetching, interpreting, and executing instructions stored in memory. The 40-pin circuit minimizes the external I/O and memory-control circuitry (Fig. 1). Four directly testable input flags, an output flip-flop, an internal direct-memory access mode and flexible instructions all help reduce system complexity.

#### Get the most out of the 1802

For the 1802 to address its full 64-k word memory, two bytes must be sequentially loaded onto the memory address bus (pins 25 to 32), since the  $\mu$ P has only eight address lines. When the memory is addressed, the first byte, which represents the higher order part of the address,

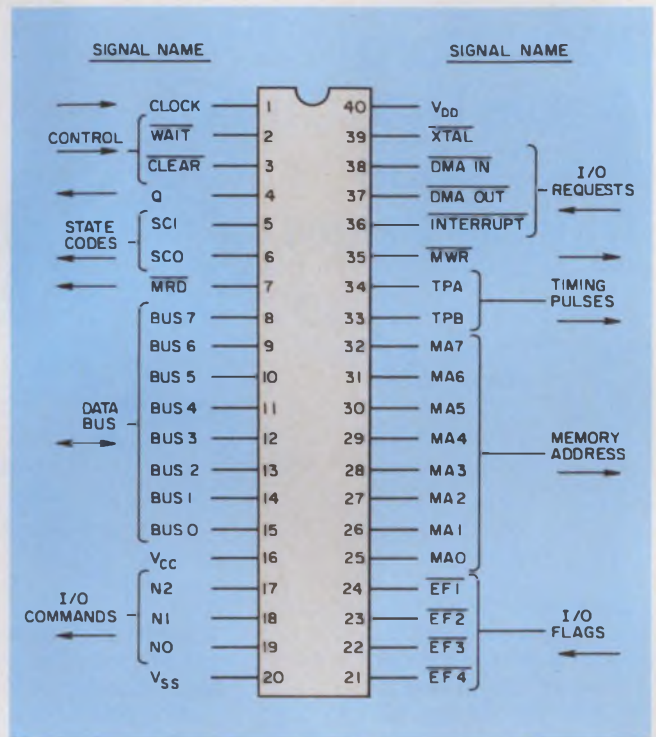

1. The CPD1802 microprocessor has an 8-bit data bus, an 8-bit address bus and 15 control lines. There are 91 instructions.

must be loaded into an external latch controlled by the TPA line of the 1802. After the data are latched, the second address byte is moved onto the bus and then the memory is enabled. If 1800-series, read-only memory circuits are used, no external latches are needed; the ROMs have the latches on the chip.

The MRD and MWR lines (pins 7 and 35) of the 1802 control the memory operation. For a memory-read function, MRD must be LOW and MWR must be high. A memory-write operation is just the reverse, and a nonmemory operation is indicated by both lines HIGH.

During normal operation, the CLEAR and WAIT lines (pins 3 and 2) are both HIGH. When the CLEAR line goes LOW, the 1802 resets and initializes itself. If both lines are LOW, the  $\mu$ P enters its Load mode, which permits input bytes to be sequentially loaded into memory start-

Alex Young, Manager,  $\mu$ P Design Engineering, RCA Solid State Div., Route 202, Somerville, NJ 08876.



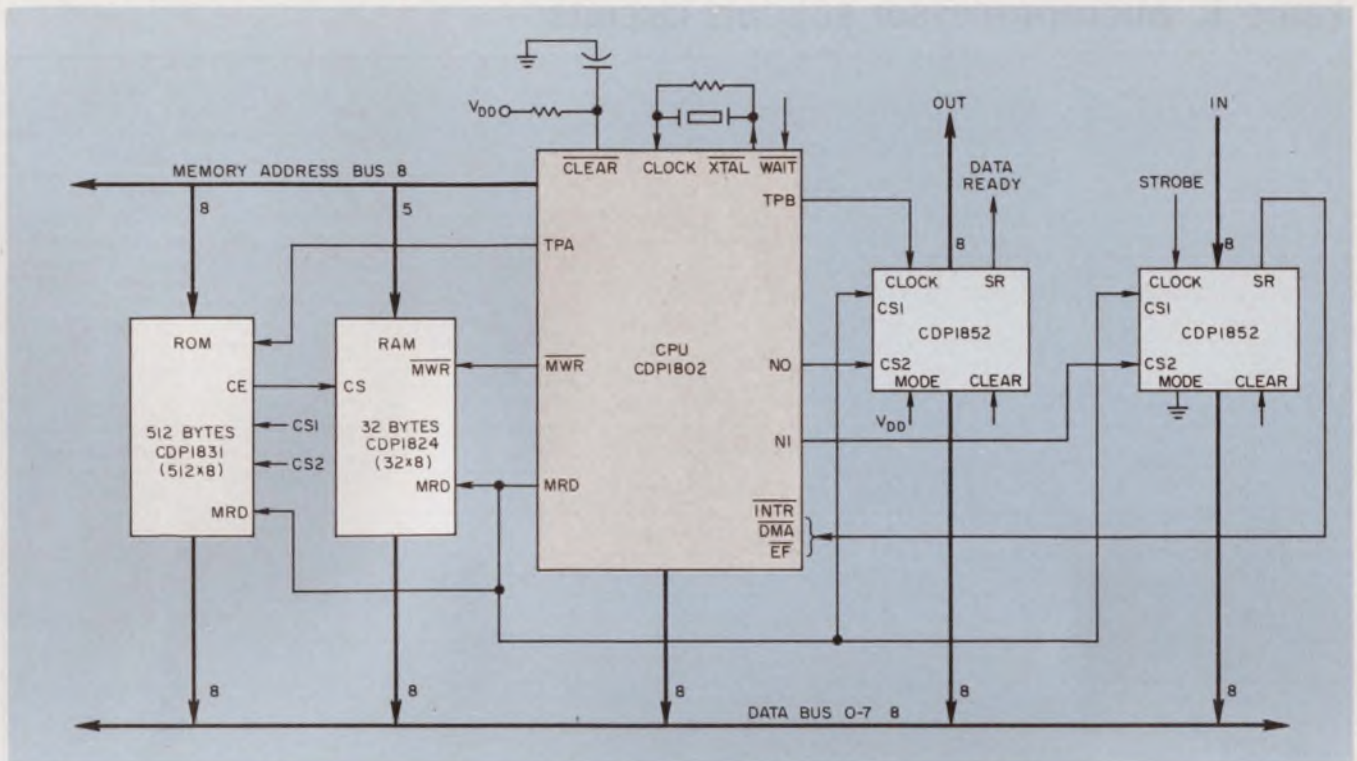

2. A minimal operating system for the 1802 includes an I/O port and a small amount of RAM or ROM. If a

large amount of memory is needed, an extra set of data latches must be used to deliver a 16-bit address.

ing at M(0000). This procedure permits direct program loading without the use of external "bootstrap" ROM programs.

When the WAIT line goes LOW (with the CLEAR line HIGH), the 1802 stops operation cleanly on the next negative transition of the clock. The 1802 resumes normal operation on the first negative transition of the clock after the WAIT line goes HIGH. The WAIT signal does not inhibit the on-chip clock, so all external timing is unaffected.

In the Run mode, when both the CLEAR and WAIT lines are HIGH, the 1802 can be in one of four processing states. The two state-code lines S0 and S1 (pins 5 and 6) indicate the processing mode: Instruction Fetch, Execute, DMA, or Interrupt. These lines can be used to display the mode on a front panel and to control a DMA or Interrupt operation.

### Use internal or external system timing

All the timing functions are controlled by the 1802's internal clock or by an external clock fed into the  $\mu P$  (pins 1 and 39). The high-frequency clock is internally divided into 16 periods. The first eight are used to control the fetch cycle, and the second eight control the execute cycle.

The TPA and TPB output lines (pins 34 and 35) are timing signals that can latch memory address bits, transfer data, and set or reset I/O controller flip-flops. The Q output line (pin 4),

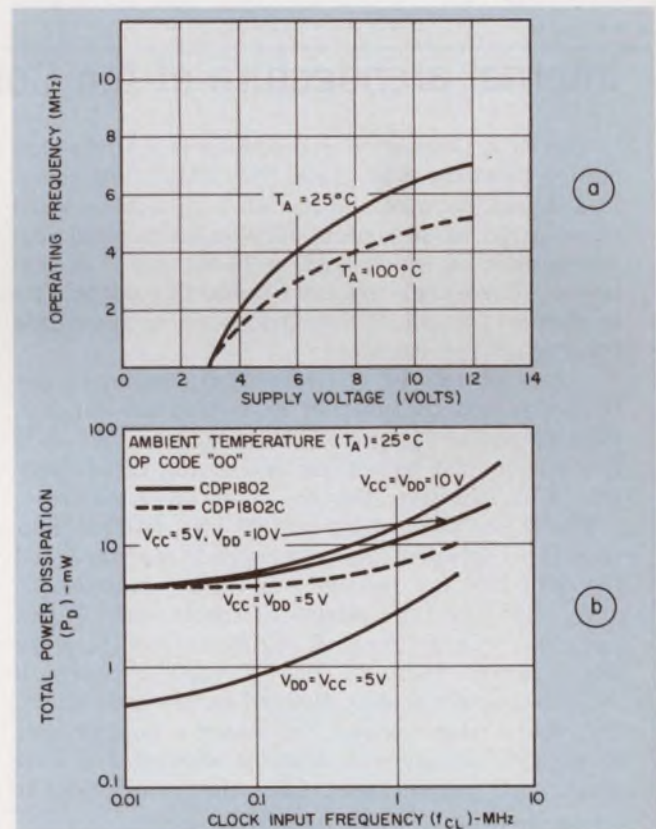

3. To calculate the maximum operating frequency of the microprocessor clock once you know the supply voltage, or vice-versa, you can locate one of the terms on its axis and find the other on the curve (a). Similarly, if you know the clock frequency or the power dissipation, you can find the other by using the family of supply-voltage curves developed at 25 C (b).



## Table 1. Microprocessor support circuits

CDP model number	Description	Approximate cost (100-up)
1802	8-bit static microprocessor	\$23.50
1821	1024 × 1 static RAM	\$21
1822	256 × 4 static RAM (2101 equiv.)	To be announced
1823	128 × 8 static RAM	To be announced
1824	32 × 8 static RAM	\$9.50
1831	512 × 8 ROM	Consult factory
1832	512 × 8 ROM (2407 compatible)	Consult factory
1851	Programmable I/O	To be announced
1852	Byte input/output port	\$8.35
1853	Gated 3-to-8 N-line decoder	\$6
1854	Asynchronous receiver/transmitter	\$18
1855	Multiply/divide unit	To be announced
1856	Memory-bus buffer/separator	\$6
1857	I/O-bus buffer	\$6
1858	Address latch decoder	\$6
1859	Address latch decoder	\$6

## Internal architecture of the Cosmac microprocessor

The RCA Cosmac microprocessor is a single-chip circuit handling 8-bit data. The CMOS  $\mu$ P comes in a 40-pin package and has an architecture based on an array of 16 general-purpose scratch-pad registers, each of which holds a 16-bit word (R registers). These registers can be used to point to data in memory, to point to programs, or to store data (two bytes per register).

Any of the 16 general-purpose registers can be designated to function as a program counter, memory-address register, data source, or data destination just by setting one of the three available 4-bit pointers, the N, P and X registers.

The D register, which holds 8 bits, buffers data transfers between the scratch-pad registers and the data bus and functions as an accumulator.

By changing the contents of the P register, you can point to a different R register (thus changing the program counter). The N register stores a variable pointer that is directed by the instruction. The other 4-bit register, X, stores a pointer that designates an address register during I/O and some ALU instructions. Like the P register, it can be loaded by a single instruction.

The use of the N, P and X registers to indirectly specify a 16-bit address is a key feature of the 1802  $\mu$ P. In addition to the register arrays, the 1802 contains a conventional arithmetic and logic unit that performs operations between data stored in the D register and in memory, with the result

stored in D. An overflow bit, DF, is also available and can be used for conditional branching.

Instruction cycles are divided into fetch and execute halves often referred to as machine cycles. During the fetch cycle, instructions are brought from the program memory, the four most-significant bits are placed in the I register, and the four least-significant bits are funneled into the N register. The I register designates a class of instructions, and the N register defines the specific processor operation.

The 15 lines of I/O interface offer some unique features:

- Four input flags, which can be tested by condition branch instructions.
- A serial output, which can be set and reset under program control and tested by conditional branch instructions.
- Programmed I/O data transfer, which uses the data in the N register as a device-select code, then transfers data between the selected device and memory.
- A maskable interrupt, which is activated by a single input. When an interrupt occurs, the old values of the P and X registers are automatically saved in a temporary register, T, and new values are jammed into the P and X registers.
- A DMA channel, which can be activated by either of two control lines, uses the R(0) register as a pointer. Each DMA request causes one ma-



combined with any of the four EF input lines (pins 21 to 24), forms a serial I/O interface. A software routine can interpret the logic levels and can assemble or disassemble the data into bytes or serial form.

Three I/O command lines, N0, N1 and N2 (pins 17 to 19) can be used, along with the MRD line, to directly select any of six possible ports. With a 3-to-8 decoder, up to seven input and seven output ports can be addressed. By using the 3-to-8 decoder, two CD4076s and an 8 to 256 decoder, any one of 1792 I/O ports can be selected.

Three I/O request lines (pins 36, 37 and 38) handle interrupts, DMA outputs and DMA inputs, respectively. A LOW condition on the Interrupt line initiates the interrupt. Inside the 1802 is a special Interrupt Enable (IE) register holding one bit. Normally it is kept in a ONE state; but when an interrupt command comes in, the IE register is set to ZERO and locks out any other interrupts. Software instructions can manipulate the IE register to control interrupt operation.

The only other lines on the 1802 are the 8-bit data bus (pins 8 to 15) and the power and

ground leads (pins 16, 20 and 40). The data bus is bidirectional, but pull-up resistors should be used on the bus outputs to put it in a known state if it is allowed to float during the Wait mode.

### Put a system together, simply

Designing a simple system based on the 1802 is straightforward. A parallel-I/O system can be built from only four ICs: the  $\mu$ P, two I/O ports and a RAM or ROM (Fig. 2). A family of ICs, designed for interface and memory use (Table 1), supports the 1802.

For a system requiring maximum performance, the operating speed must first be determined. The clock rate, in turn, fixes the instruction time at 16 clock periods for all commands except for long branch and long skips, which require 24 periods.

The maximum clock frequency is a function of supply voltage, and the graph of Fig. 3a can help determine one from the other. The frequency is also temperature dependent and must be decreased by 0.35%/°C from the calculated frequency at 25 C.

Power dissipation is composed of a frequency-

chine cycle to be stolen, generates appropriate memory address and control signals, and increments the pointer.

- Timing signals, which provide synchronization to assist in data transfers and general system

timing functions.

The 8-bit ALU performs all the arithmetic and logic operations. Operand bytes are pulled from the D register and from the memory (on the data bus).

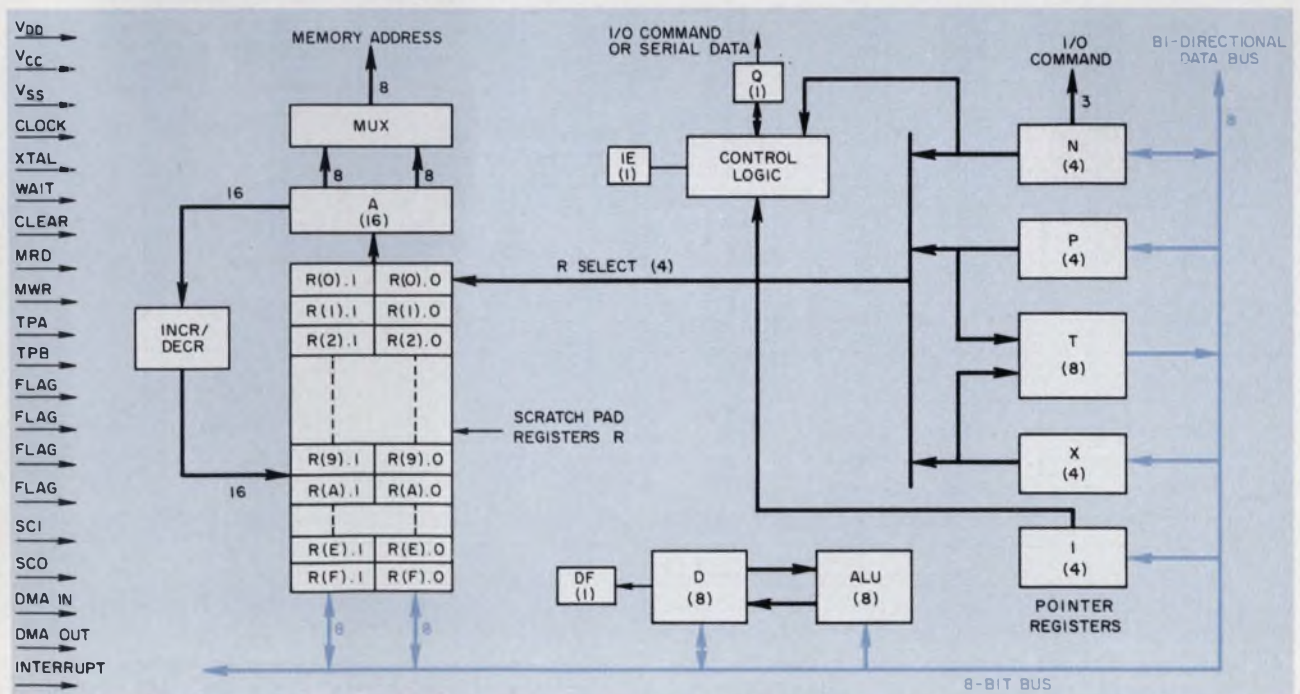







dependent dynamic term and a temperature-dependent quiescent term. The dynamic term can be calculated from the graph of Fig. 3b, and the quiescent term can be approximated by adding 20  $\mu\text{W}$  to the dynamic term for every degree C above 25 C.

Consider a simple system design for a micro-computer that must add two 8-bit bytes in 8  $\mu\text{s}$ , function over a 25-to-100-C range and operate from under 7 V. Since the processor must perform an ADD instruction,  $M(R(X))$  to D, one command can meet the 8- $\mu\text{s}$  time requirement.

For this system, the clock frequency can be determined by first dividing the instruction time by 16, then taking the reciprocal of the result:

$$(8 \mu\text{s}/16)^{-1} = 2 \text{ MHz.}$$

The  $\mu\text{P}$  must therefore be able to operate at 100 C—at a clock rate of 2 MHz. The curve of Fig. 3a can be used to find the minimum supply voltage: 4.8 V.

Assuming 5 V is used, the power dissipation can be read from Fig. 3b as 5 mW for the 1802D or as 9 mW for the 1802CD, at 25 C. At 100 C these values increase by 1.5 mW.

### It's easy for the system to remember

Almost any RAM or ROM circuit can be added to an 1802-based system. A small system with 32 bytes of RAM (CDP1824) and 512 bytes of ROM (CDP1831) requires no additional devices. You determine the address space for the memory when you write the program to be stored in ROM.

The 7-bit, user-specified sector address (the seven most significant bits of the 16-bit, multiplexed address bus) locates the ROM in one of the 128, 512-byte memory sectors. When the proper sector address is input to the ROM, the CEO output goes HIGH and disables the RAM. The RAM is enabled when the ROM is not selected.

Expanding the memory is simple. The circuit of Fig. 4a shows how to increase the ROM space from 512 bytes to 65-k bytes. The system needs no address decoding and is directly compatible with the 1802. A system with 4-k bytes of RAM uses the 1858 address latch/decoders and the 1822 RAMs (Fig. 4b). The 1824, 1822 and 1831 memories are directly compatible with the 1802, and the 1831 has the address latches built-in. If larger RAM or ROM circuits, made by other vendors, are used, the latches must be added externally.

The simplest way to bring data into the  $\mu\text{P}$  is through the four external flag inputs, EF1 to EF4. Each input can perform as an independent serial data link, under program control. Branch instructions can test the flag inputs and divert the program on the appropriate condition. Loops

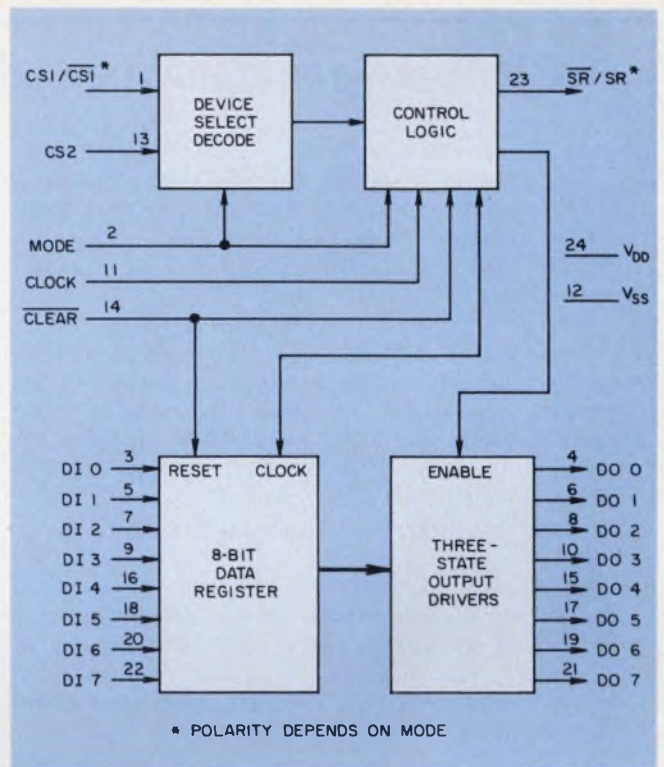

5. The byte input/output port handles data flowing into or out of the 1802  $\mu\text{P}$ . It can be hard-wired to do either, but it is not software programmable. When available, the 1851 I/O port provides software control of data flow.

can be constructed to continually test the flag lines and manipulate the data as required.

The Q output of the 1802 serves as a control port or serial output. The Q bit can be set, reset and tested by branch instructions, or it can be used either as a pulse-width-modulated output or a variable-frequency output.

Programmed I/O data transfers can be used to directly select any of three possible peripherals. The instructions use a hexadecimal format of 6X, where the three LSBs of the code for X digit are routed to the N0, N1 and N2 pins of the  $\mu\text{P}$  to activate a device.

Even more peripherals (up to 14) can be selected if an 1853 N-bit decoder is used. If a two-level decoding scheme is used, the number of external devices is unlimited.

### Memory selection isn't critical

RCA has designed several static RAMs and ROMs with the 1802 in mind. The smallest is the 1824, a 32  $\times$  8 CMOS RAM housed in an 18-pin DIP. It provides sufficient working space and stack storage for systems requiring minimal storage.

The 1822 and 1823 CMOS RAMs are organized as 256  $\times$  4 or 128  $\times$  8, respectively. The 1822 is pin-compatible with the common 22-pin 2101 RAM.

Access times for the RAMs are 350-ns typical



# CDP1802 programming methods and mnemonic definitions

The instruction set of the CDP1802 consists of 91 single-byte commands grouped into five basic types: register, memory and logic; arithmetic; branch, skip and control; and I/O byte transfer instructions.

Most instructions require two machine cycles (1 instruction period). The only exceptions are the long-branch and long-skip instructions, which require three cycles. Each machine cycle is internally divided into eight equal time intervals, T, so the instruction time is 16 T for two machine cycles and 24 T for three cycles.

There are four basic addressing modes of the Cosmac:

- **Register.** The operand's address is contained in the four lower-order bits of the instruction byte. This mode permits you to directly address any of the 16 scratch-pad registers so that you can count or move data in or out. Typical instructions might be Decrement (2N) and Get Low (8N).

- **Register-Indirect.** The address of the operand is stored in one of the 16-bit scratch pad registers. When you access one of the 16 registers it points to the location in memory where the operand is stored.

- **Immediate.** The operand is in the byte following the instruction. This mode permits you to extract data from the program stream without setting up special memory locations and pointers to them. Typical instructions include Add Immediate (FC) and Load Immediate (F8).

- **Stack.** One specific CPU register is implied as the pointer to memory. The stack is used as a last-in, first-out working area to store intermediate calculations and keep track of control transfers between parts of a program.

Each CPU instruction is fetched on the first machine cycle and executed during the second cycle, except for long-branch and long-skip instructions that require the first machine cycle to fetch the instruction on the second and third cycle to fetch the address (execute).

Each instruction is broken into two 4-bit hex digits, designated as I (the higher-order digit) and N (the lower-order digit). The I word specifies the instruction type, and the N word either designates the scratch-pad register to be used or acts as a special code.

Register operations include instructions that count or move data between internal 1802 registers. Memory reference commands provide directions to load or store a memory byte. Branching operations provide conditional and unconditional branch instructions that can either work in the current memory page or go to any location.

Arithmetic and Logic instructions provide many of the common operations: add, subtract, AND, OR, EX-OR and shift, while control and I/O com-

mands take care of all the timing and data-transfer operations. The control functions facilitate program interrupt, operand selection, branch and link operations and control the Q flip-flop. The I/O functions handle memory loading and all data transfer operations into and out of the 1802.

## Memory and logic instructions\*\*

Instruction	Mnemonic	Op Code
Increment reg N	INC	1N
Decrement reg N	DEC	2N
Increment reg X	IRX	60
Get low reg N	GLO	8N
Put low reg N	PLO	AN
Get high reg N	GHI	9N
Put high reg N	PHI	BN
Load via N	LDN	0N
Load advance	LDA	4N
Load via X	LDX	F0
Load via X and advance	LDXA	72
Load immediate	LDI	F8
Store via N	STR	5N
Store via X and decrement	STXD	73
OR	OR	F1
OR immediate	ORI	F9
Exclusive OR	XOR	F3
Exclusive OR immediate	XR	FB
AND	AND	F2
AND immediate	ANI	FA
Shift right	SHR	F6
Shift right with carry	SHRC	} 76*
Ring shift right	RSHR	
Shift left	SHL	FE
Shift left with carry	SHLC	} 7E*
Ring shift left	RSHL	

## Arithmetic instructions\*\*

Add	ADD	F4
Add immediate	ADI	FC
Add with carry	ADC	74
Add with carry immediate	ADCI	7C
Subtract D	SD	F5
Subtract D immediate	SDI	FD
Subtract D with borrow	SDB	75
Subtract D with borrow, immediate	SDBI	7D
Subtract memory	SM	F7
Subtract memory immediate	SMI	FF
Subtract memory with borrow	SMB	77
Subtract memory with borrow, immediate	SMBI	7F



### Branch instructions

Short branch	BR	30
No short branch (see SKP)	NBR	38*
Short branch if D = 0	BZ	32
Short branch if D not 0	BNZ	3A
Short branch if DF = 1	BDF	33*
Short branch if pos or zero	BPZ	
Short branch if equal or greater	BGE	3B*
Short branch if DF = 0	BNF	
Short branch if minus	BM	
Short branch if less	BL	
Short branch if Q = 1	BQ	31
Short branch if Q = 0	BNQ	39
Short branch if EF1 = 1	B1	34
Short branch if EF1 = 0	BN1	3C
Short branch if EF2 = 1	B2	35
Short branch if EF2 = 0	BN2	3D
Short branch if EF3 = 1	B3	36
Short branch if EF3 = 0	BN3	3E
Short branch if EF4 = 1	B4	37
Short branch if EF4 = 0	BN4	3F
Long branch	LBR	C0
No long branch (see LSKP)	NLBR	C8*
Long branch if D = 0	LBZ	C2
Long branch if D not 0	LBNZ	CA
Long branch if DF = 1	LBDF	C3
Long branch if DF = 0	LBNF	CB
Long branch if Q = 1	LBQ	C1
Long branch if Q = 0	LBNQ	C9

\*Note: This instruction is associated with more than one mnemonic. Each mnemonic is individually listed.

\*\*Note: The arithmetic and logic instructions are the only instructions that can alter the DF.

### Skip and control instructions

Short skip (see NBR)	SKP	38*
Long skip (see NLBR)	LSKP	C8*
Long skip if D = 0	LSZ	CE
Long skip if D not 0	LSNZ	C6
Long skip if DF = 1	LSDF	CF
Long skip if DF = 0	LSNF	C7
Long skip if Q = 1	LSQ	CD
Long skip if Q = 0	LSNQ	C5
Long skip if IE = 1	LSIE	CC
Idle	IDL	00
No operation	NOP	C4
Set P	SEP	DN
Set X	SEX	EN
Set Q	SEQ	7B
Reset Q	REQ	7A
Save	SAV	78
Push X,P to stack	MARK	79
Return	RET	70
Disable	DIS	71

### Input/output byte transfer instructions

Output 1	OUT 1	61
Output 2	OUT 2	62
Output 3	OUT 3	63
Output 4	OUT 4	64
Output 5	OUT 5	65
Output 6	OUT 6	66
Output 7	OUT 7	67
Input 1	INP 1	69
Input 2	INP 2	6A
Input 3	INP 3	6B
Input 4	INP 4	6C
Input 5	INP 5	6D
Input 6	INP 6	6E
Input 7	INP 7	6F



for the 1822 with a 5-V supply, and 400-ns typical for the 1824, also with a 5-V supply. Since the RAMs are CMOS, typical power dissipation is only 500  $\mu$ W for the 1824 and 8 mW for the 1822.

Available ROMs include the CDP1831 mask-programmable ROM, organized as  $512 \times 8$ . The ROM has a set of built-in data latches to hold the first word of the two-word address needed to locate a stored instruction. Because the latches are built-in, a ROM system of up to 64-k bytes can be designed and will require no extra decoding circuitry. Also included on the chip are three-state output buffers that are enabled by a combination of the three chip selects, CS1, CS2 and MRD. The signal polarities of these select lines are user-selectable during mask programming.

Similar to the 1831 is the 1832 mask-programmable ROM. Its pin-out, however, matches the popular 2704,  $512 \times 8$  erasable PROM's. The 1832 can be directly substituted into a 2704 socket without any circuit changes.

### Specialized circuits support the memory

In addition to the RAMs and ROMs developed for the 1802, four special support circuits simplify the over-all system design. The 1858 and 1859 address-latch/decoder circuits provide all the control necessary to interface the 1802 with up to 4-k bytes of RAM. The 1858 is designed to work with  $256 \times 4$  RAMs and the 1859 with  $1024 \times 1$  RAMs.

An 8-bit address latch, the 1852, and a memory-bus buffer/separator, the 1856, are also available. The latch contains three-state drivers that connect to the bus, and the buffer/separator can split the memory bus for large-memory applications.

Generalized I/O support circuits are also available, and there are a few others still being developed. The 1852, 8-bit I/O port; the 1853, 3-to-8-line decoder; and the 1857 (an I/O bus buffer) will be available this year. The 1851 programmable I/O port, the 1854 universal asynchronous receiver/transmitter and the 1855 multiply/divide unit will be available soon.

The 1852 (Fig. 5) simplifies parallel data transfers to and from the 1802. The I/O circuit is semi-dedicated because it can function, via mode control, either as an input port (mode = 0) or as an output port (mode = 1). When the circuit is used as an input port, and data are strobed into its 8-bit register by a HIGH level on the clock line, the HIGH-to-LOW transition of the clock latches the data and sets the SR (Service Request) output to ZERO. The three-state output drivers are enabled by  $CS1 \cdot CS2 = 1$ , and on the HIGH-to-LOW transition of  $CS1 \cdot CS2$ , SR is reset to ONE.

When used as an output port, data are strobed

**Table 2. Hardware and software support**

Model	Description
CDP18S011	Cosmac Microtutor: a low-cost free-standing microcomputer designed for users with no previous knowledge of microprocessors.
CDP18S020	Evaluation kit: a complete microcomputer kit based on the 1802 $\mu$ P. It contains 256 bytes of RAM, a utility program in ROM, built-in 20 mA TTY and RC232-C interfaces, and more—all on a $14 \times 9.17$ -in. PC board.
CDP18S004	Development system: a complete microcomputer with editor, assembler and debug programs. It is designed for hands-on use and complete software development. The system is housed in a $19 \times 11 \times 5.5$ -in. rack-mountable card cage and comes with its own power supply, front panel and 4 k words of RAM. A floppy-disc system is also available.
CSDP —	Cosmac software development package: an assembler and simulator/debugger program available on General Electric Information Services International network or can be purchased in a Fortran IV version for in-house installation. It is available on magnetic tape (CDP18S910) or as a card deck (CDP18S911). An Editor program is also available.

into the circuit at  $CS1 \cdot CS2 \cdot \text{Clock} = 1$ , and are immediately available at the outputs. A Data-Ready pulse is generated when  $CS1 \cdot CS2 = 1$  and is present (HIGH level) until the next HIGH-to-LOW clock transition. A built-in clear control resets the register and mode setting in the 1852.

The 1853 is a gated 3-to-8 N-line decoder that interfaces directly to the N0, N1 and N2 outputs of the 1802. It gates the decoded state with the interval between TPA and TPB pulses to select an I/O device during programmed data transfers. The 1857 buffers the data bus and can be used as a simple I/O port where data latching is not required.

### Support the hardware with software

In addition to the hardware circuits available, various support systems can be used for learning, evaluating, prototyping and programming the 1802 (Table 2). One of the newest units is the 18S011—the Cosmac Microtutor. This system is an inexpensive (\$349), free-standing



microcomputer designed for beginners.

Inputs are entered via eight toggle switches, and outputs are displayed on two LED hexadecimal displays. There are four auxiliary controls: Clear, Load, Start and Input. The Microtutor comes with 256 bytes of RAM and has an empty connector slot so that all processor signal lines can be examined. It also includes all the circuitry for clock and control signal generation, switch debouncing and general control.

The 18S020 evaluation kit, a more advanced microcomputer, contains the 1802  $\mu$ P, 256 bytes of memory (expandable to 4 k), I/O circuitry, a display, and clock and control circuitry. A comprehensive utility program stored in ROM is included to permit communication over built-in 20-mA TTY and RS232-C interfaces. It also has built-in controls for Reset, Run-Program, Run-Utility and Single-Step functions as well as a self-adjusting communications interface for terminal rates of 110 to 1200 baud.

The most advanced development system, the 18S004, is a full microcomputer with built-in Editor, Assembler and Debug programs for software development. The unit has its own power supply, 11 plug-in printed-circuit cards, room for 22 more cards, and a front panel for control and monitoring. It comes with paper tape, cassette, or floppy-disc versions of the Resident-Editor and Resident-Assembler programs. Only 4-k words of RAM come with the system, but they are sufficient to hold the Editor program and provide a working buffer.

The Editor program permits such commands as Move Pointer, Delete, Append, Insert, Save, Search and Substitute, Type, and Output. The assembler is a multipass program that can output the results to paper tape, cassette, or floppy-disc. The 18S004 also has a floppy-disc option, the 18S800, with an operating system to facilitate storage and retrieval of programs.

Software development programs are also available in Fortran IV for direct purchase, or lease on the GE timesharing network. Two versions of an Assembler program are available. Level I refers to each instruction by name, and each statement defines a single instruction. Level II provides a variety of shorthand symbols, some Fortran-like features and more flexibility.

A simulator/debugger program, available on time-sharing systems, is quite handy for program development. The simulator mimics the actions of the 1802 for all instructions. The Debug programs permit you to set breakpoints; set, read or write guards for any memory address; set interrupts; inspect and modify any memory address or register; save machine state at any point; restore machine state; single step through program executive; and more. It can also halt and give diagnostic messages for invalid instructions. ■■

# THIS MAKES 40,000 CASSETTE RECORDERS. WHEW!

When it comes to cassette recorders, who you buy them from is as important as what you buy.

And when you buy the Sycor Model 135, you're dealing with a company that already has 40,000 recorders in service worldwide.

The popularity of our cassette recorder isn't really surprising.

The Sycor 135 is the ANSI compatible cassette drive with record overwrite capacity that lets you edit a whole data block without disturbing so much as a character on adjacent records.

The recorder that reads/writes at a fast 12.5 ips with quick starts and stops for high throughput. With a dual-gap head for Read-After-Write verification.

The recorder that accesses data at a clip of 60 ips.

For more information on our Model 135, or for help on any design or application problem, give us a call.

A company that's made 40,000 cassette recorders ought to be pretty good at finding solutions.

## SYCOR

Contact Dick Conner, OEM Department, Sycor, Inc.,  
100 Phoenix Drive, Ann Arbor, Michigan 48104, Telephone: (313) 995-1381

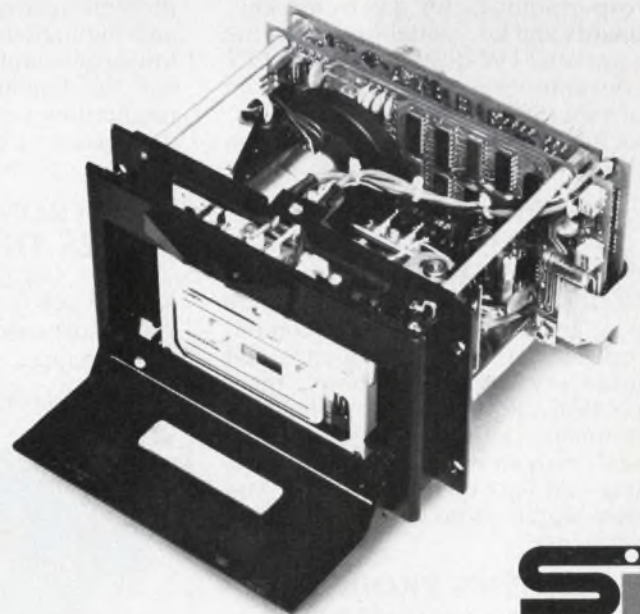

**SI**  
SYCOR INC

Sales offices in major metropolitan areas throughout the world.

CIRCLE NUMBER 64



# CORTRON IS WRITING THE SOLID STATE KEYBOARD SUCCESS STORY

A new name in keyboards, CORTRON actually has a history dating back to 1968, when Illinois Tool Works Inc. made news with the introduction of its first solid state keyboard through its Licon Division. ITW has emerged as a major producer of solid state keyboard products and has supplied thousands upon thousands of custom-designed keyboards to meet specific customer requirements.

## CORTRON DIVISION FORMED BY ITW

With a strong market demand and a promising future for keyboard products, ITW formed a new division, CORTRON, to handle full responsibilities for electronic keyboards and key switches. Following a proven ITW strategy, CORTRON concentrates a special division team of experienced Licon design, manufacturing and marketing people on this new major business opportunity.

## KEYBOARD MARKET DIVERSIFIED

Typical applications for CORTRON™ Keyboards include data and word processing, computerized accounting, production and inventory control systems, retail point-of-sale and remote banking terminals, airline reservation and seat assignment stations, typesetting and text editing systems. And new applications are continually surfacing.

## PROVEN PRODUCT RELIABILITY

The CORTRON Division offers proven keyboard products with an

established reputation for excellence and reliability. The

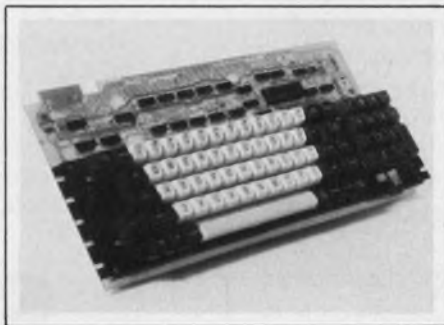

CORTRON Series 555 Solid State Keyboard is a sophisticated electronic device. Its high reliability protects against costly service calls and the hardship of downtime. The low profile alpha numeric keyboard has the human engineered "feel" required by your marketplace. This promotes speed, accuracy and greater operator productivity.

## CORTRON KEY SWITCH MAKES THE DIFFERENCE

The CORTRON Contactless Key Switch is the heart of the solid state keyboard. The CORTRON

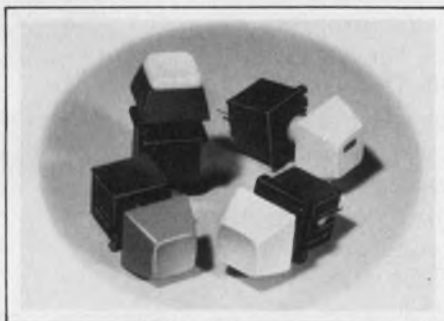

Key Switch is respected throughout the industry for its ultra reliable 100 million cycle life rating. Utilizing a ferrite core switching technology, the key switch is mechanically simple with only four basic parts.

## CORTRON RESPONDS TO CUSTOMER NEEDS

Since keyboard products are CORTRON's only business, the ITW Division is highly responsive to individual customer needs and requirements. CORTRON offers expert application engineering assistance, and has the high volume keyboard production capability so essential to large customer demands. Further, the division is backed by the resources of ITW, a worldwide corporation. Whether you want to buy keyboards or build them, CORTRON can supply the key elements necessary to success. For complete details, contact CORTRON, A Division of Illinois Tool Works Inc., 6601 West Irving Park Road, Chicago, Illinois 60634. Phone: (312) 282-4040. TWX: 910-221-0275.

CORTRON is writing the solid state keyboard success story.

TO BE CONTINUED...



**CORTRON**  
A DIVISION OF ILLINOIS TOOL WORKS INC.

**THE KEYBOARD  
PROFESSIONALS**



# 8080 Core

**non-volatile • high reliability**

Dataram introduces the industry's widest range of byte-designed single-board core systems for 8080 and other byte-oriented applications.

And when Dataram says "byte," we mean **true byte** systems — with 1K to 32K bytes, 8 to 10 bits/byte, not 16 or 18 bits/word systems that simulate byte systems.

What that means to you is less power and fewer components...and that means more for less. More reliability and more performance with smaller size... and lower product costs.

8080 Core. For people who think small.

Find out more about 8080 Core today. Return this coupon at once, or call us at 609-799-0071.

SYSTEM	CAPACITY	CYCLE/ACCESS	DIMENSIONS	VOLTAGES	TYPICAL POWER	COMPATIBILITY
DR-180	4K x 8 8K x 8	750/250 ns 750/250 ns	9.2" x 6.3" (233.4 mm x 160 mm)	+5V, +12V	30 Watts	8080 Microprocessor
DR-121	1K x 10 2K x 8 2K x 10	900/350 ns 900/350 ns 900/350 ns	11.7" x 11.5" (297 mm x 292 mm)	+5V, -12V	25 Watts	Cambridge Memories <sup>®</sup> 1K x 9 Unicore
DR-104	4K x 9 8K x 9 16K x 9 32K x 9	750/350 ns 750/350 ns 750/300 ns 800/300 ns	13.5" x 8.3" (343 mm x 211 mm)	+5V, -12V	32 Watts	National Semiconductors <sup>®</sup> MOSRAM 104

In addition to standard systems, Dataram offers impressive custom design capabilities.

- I'd like to learn more about 8080 Core.
- Please send information
- Please have a salesman contact me
- Please have a technical type call me.

Name \_\_\_\_\_

Title \_\_\_\_\_ Phone \_\_\_\_\_

Company \_\_\_\_\_

Address \_\_\_\_\_

City \_\_\_\_\_ State \_\_\_\_\_ Zip \_\_\_\_\_

- Please send me information about BULK CORE:  
256K byte memory system on a single board
- Please send me information about mini-memories for  
minicomputers



PRINCETON-HIGHTSTOWN ROAD  
CRANBURY, NEW JERSEY 08512  
TEL: 609-799-0071 TWX: 510-685-2542

Canada: Tracan Electronics Corporation, Ontario/Quebec/British Columbia • Belgium/Luxembourg/Netherlands: Synelec Information Systems, (02) 647-67-12 • France: YREL, 950-2224 • Italy: Telcom, s.r.l. 422-8646 • Sweden/Finland/Norway: Teleinstrument AB, 08-380370 • Spain: Apoca, 457-53-12 • Switzerland: Interest AG, 031-224481 • United Kingdom: GMT Electronic Systems Ltd., Epsom 20641 • West Germany/Austria: O E M Elektronik GmbH, 0711-478683 • India: Industrial Electronic Instruments, 79281 • Israel: K D M Electronics Ltd., 58232 • Japan: Matsushita Electric Trading Co. Ltd., (03) 435-4552 • Australia/New Zealand: Anderson Digital Electronics, (03) 543-2077

CIRCLE NUMBER 66



## Use $\mu$ P's in minicomputer systems.

The mini can test and code the  $\mu$ P. And the  $\mu$ P can relieve the mini of time-consuming simple tasks.

You can design a fast, powerful, yet inexpensive minicomputer-based system by including a microprocessor (Fig. 1). Let the  $\mu$ P replace much of the support hardware for the mini, and perform the simpler computer functions, while you reserve the mini itself for complex calculations, data taking and functions too slowly executed by the  $\mu$ P. Consequently, computation—the mini's most powerful capability—will be more readily available to the system. Also, you will avoid the mass of custom-designed interface logic usually needed. You will even be able to use the mini to compile the  $\mu$ P's programs.

All this can be done at a reasonable price. To keep costs down, you must select the right  $\mu$ P and its associated support circuitry. Also, you should use the mini wherever possible for programming, debugging and checking out the system's  $\mu$ P section.

Although the specific mini/micro system to be covered here is for nuclear-safeguards instrumentation, the features to be described are applicable to many mini-based systems—especially in real-time, on-line work. The following is a typical design example.

### Choosing a microprocessor

Select a suitable  $\mu$ P to link to the mini. The need for efficient programming, simple interrupt servicing, direct memory access (DMA) and compatibility with 16-bit minicomputers—such as Data General's Nova series—makes the 16-bit PACE by National Semiconductor a good choice. In this case, packaging considerations, over-all cost and system efficiency call for the use of chips rather than boards or complete systems.

The chips used in our example are:

- microprocessor (PACE).
- system timing element (STE).
- bidirectional transceiver element (BTE/8).
- address latch element (ALE/16).
- interface latch element (ILE/8).

---

David F. Jones, Senior Electronic Technician, and E. Ray Martin, Staff Physicist, Los Alamos Scientific Laboratory, Los Alamos, NM 87544.



1. The over-all system with PACE on the left, mini and display-scope in the center and terminal at right.

- random access memory (RAM  $256 \times 4$ ).
- programmable read-only memory (PROM  $512 \times 8$ ).

All except the PACE and the memories are available only in hybrid form, but, according to the manufacturer, they will soon be replaced by monolithic versions.

### Selecting memory size and structure

Next, examine our memory requirements. The semiconductor RAM storage of a  $\mu$ P system is volatile—programs are lost whenever power is shut down. Hence, ROMs or PROMs are used for permanent storage of instructions. The stored control program is called firmware.

Of course, when using a  $\mu$ P for the control and overhead support of a mini-based system, you don't want to use too much memory. A 4-k word memory is appropriate—using 16-bit words, of course. We can use 2-k of PROM, for firmware, at the bottom of the address space and 2-k of RAM contiguous to the PROM: Then input-output addressing can occupy the high end of the addressing space. And for input-output transfers, you can split page zero (that area which can be directly addressed) between the first 128-PROM



Mnemonic	Operation Code (octal)	Action
AISZ	074000	add immediate, skip if zero
LI	050000	load immediate
CAI	070000	complement and add immediate
JMP	014000	jump
JMP@	114000	jump indirect
JSR	120000	jump to subroutine
JSR@	112000	jump to subroutine indirect
SKG	116000	skip if greater
SKAZ	134000	skip if AND is zero
ISZ	106000	increment and skip if zero
DSZ	126000	decrement and skip if zero
LD@	120000	load indirect
ST@	130000	store indirect
LSEX	136000	load with sign extended
AND	124000	logical AND
OR	122000	logical OR
SUBB	110000	subtract with borrow
DECA	104000	decimal add
SKNE0	170000	skip if ac-0 not equal
SKNE1	172000	skip if ac-1 not equal
SKNE2	174000	skip if ac-2 not equal
SKNE3	176000	skip if ac-3 not equal
LDO	140000	load ac-0
LD1	142000	load ac-1
LD2	144000	load ac-2
LD3	146000	load ac-3
ST0	150000	store ac-0
ST1	152000	store ac-1
ST2	154000	store ac-2
ST3	156000	store ac-3
ADD0	160000	add to ac-0
ADD1	162000	add to ac-1
ADD2	164000	add to ac-2
ADD3	166000	add to ac-3
RTS	100000	return from subroutine
RTI	076000	return from interrupt
BOC0	040000	stack full
	040400	ac-0 = 0
	041000	ac-0 > 0
	041400	ac-0, bit 0 = 1
BOC1	042000	ac-0, bit 1 = 1
	042400	ac-0 ≠ 0
	043000	ac-0, bit 2 = 1
	043400	Contin = 1
BOC2	044000	Link = 1
	044400	IEN = 1
	045000	Carry = 1
	045400	ac-0 < 0
BOC3	046000	OVF = 1
	046400	JC-13 = 1
	047000	JC-14 = 1
	047400	JC-15 = 1
SHL	024000	shift-left
SHR	026000	shift-right
ROL	020000	roll-left
ROR	022000	roll-right

2. Memory-reference instructions for the PACE microprocessor showing octal operation codes and action descriptions.

locations and the upper 128 input-output locations.

### Letting the mini test and code the $\mu P$

Use the mini, since it is available, to check out, program and debug the system's microprocessor section. Then you won't have to invest in a  $\mu P$ -dedicated data terminal and an extensive control-panel.

It's a good idea to try rough programs in RAM before committing them into firmware. Temporarily substitute 3-k of RAM for the PROM-portion of memory. At start-up, the mini can now load test programs directly into this RAM via DMA. For large-block DMA transfers it is better to halt the PACE than to cycle-steal with the extend feature. After the software is debugged, the mini can punch out a bit-pattern tape for PROM programming.

### Easing $\mu P$ programming with an assembler

Most test routines are so simple that hand-loaded, machine-language instructions aren't too cumbersome. Of course, more substantial tasks will require the use of an assembly language. The resulting program, which converts mnemonic input into binary-bit machine code, is called an assembler. If code is produced by one machine for use on another, the control program for the host computer is called a cross-assembler.

The similarity in hardware of the PACE  $\mu P$  and Nova units—hence the similarity of many of their instructions—eases the job of generating a cross-assembler. Example: Both have four accumulators (with two available for index addressing) and essentially the same addressing modes.

Because of this similarity in addressing modes, the PACE instruction set can be separated conveniently into two parts. The larger part consists of Memory-Reference-type instructions which are the same or nearly the same as Nova's. The smaller part consists of Register-Reference and Miscellaneous-type instructions.

Memory-Reference instructions are the following:

- Register-Reference Immediate.
- Memory Reference Jump, Skip.
- Exchange Register Flags and Stacks.
- Branch.
- Return.
- Memory Data-Transfer.
- Memory Data-Operate.
- Shift and Rotate, slightly modified.

The PACE instruction SHR r, n, l specifies a shift right of n places in register r with the link set, if specified. If instead you use SHR r, n for a shift right of n/2 places in accumulator r and link only if n is odd, the cross-assembler is easier to write.



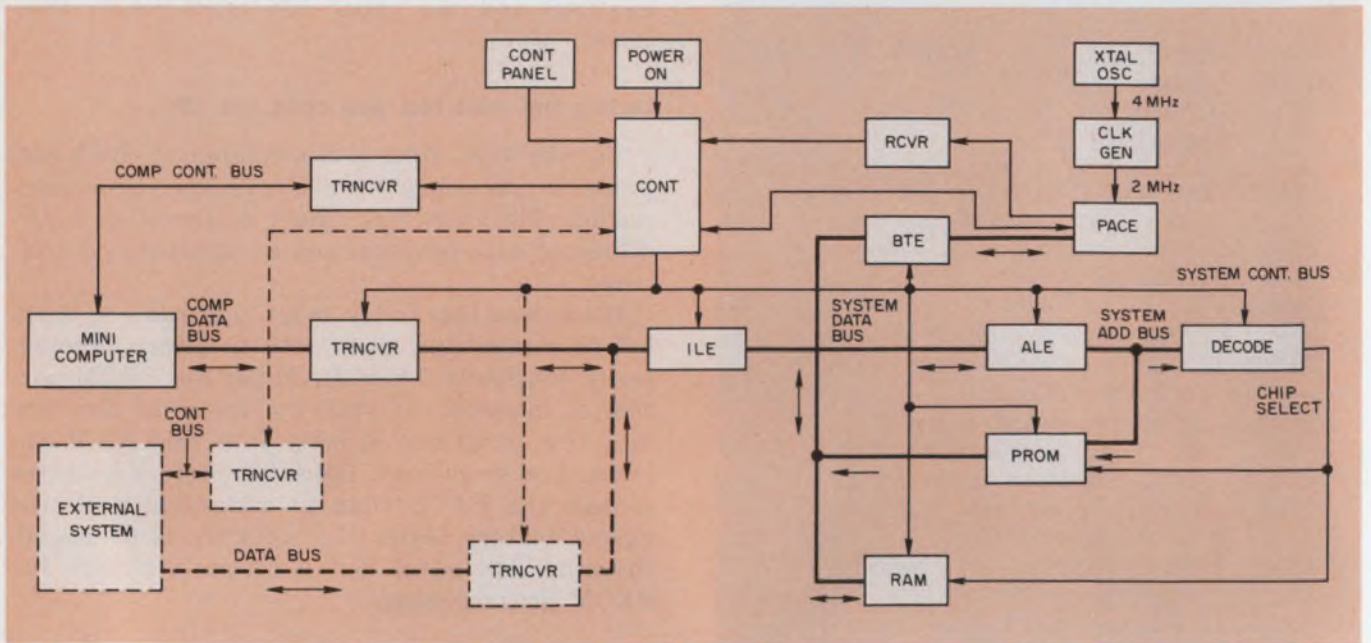

3. System block diagram shows data flow and control between mini and  $\mu P$ .

The format of the Memory-Reference-type instructions is:

15.....10	9 8	7.....0
operation	index	displacement

This bit format is described in detail on pages 3-2 and 3-3 of the User's Manual.

The Miscellaneous-type instructions are:

- Register to Register Data-Transfer.
- Register to Register Data-Operate (except for CA1).
- Miscellaneous—HALT, SFLG, PUSH F, PULL F.

The cross-assembler must provide separately for each instruction in this category.

The cross-assembler first determines the type of a particular instruction. For the Memory-Reference type, the cross-assembler assigns the proper index and displacement. They are the same as Nova's except for indexed addresses using the program counter, which are one address larger in the PACE.

For the Miscellaneous type, the cross-assembler identifies the particular instruction and the register(s) or flag involved. Then it generates the required code. The list of PACE Memory-Reference instructions shown in Fig. 2 illustrates the procedure.

The cross-assembler occupies approximately 2-k words of the Nova's core.

### Designing the logic

The relatively small amount of custom-designed logic needed to interface the PACE to the mini separates functionally as follows:

- *Data-transfer control.* Data passes from the

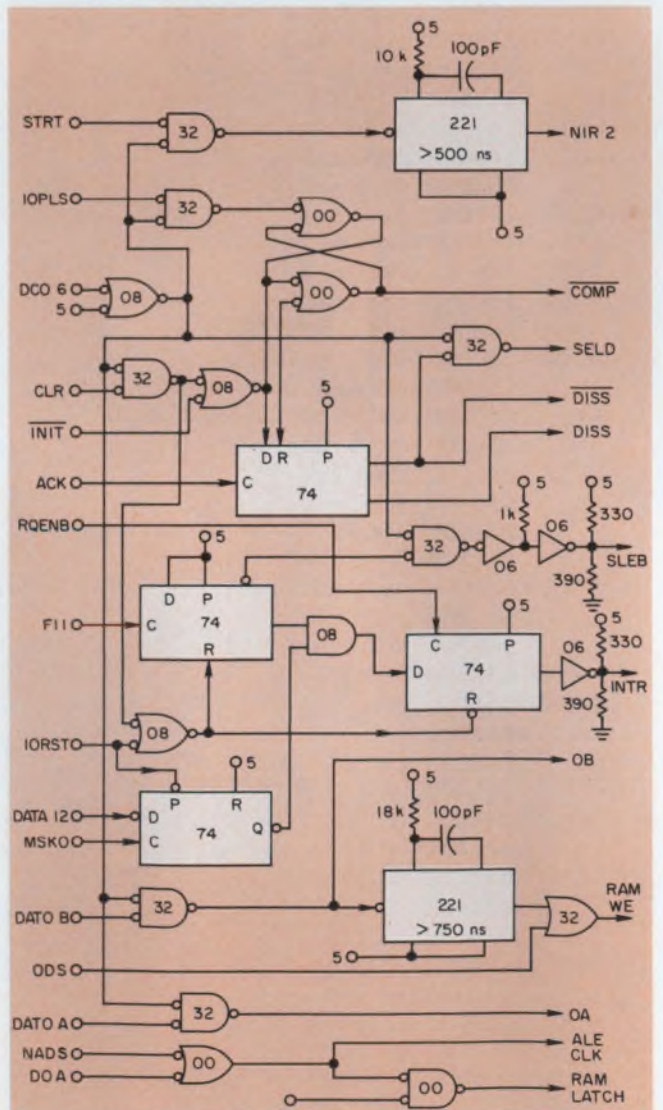

4. Interrupt circuitry for programmed transfer of data.



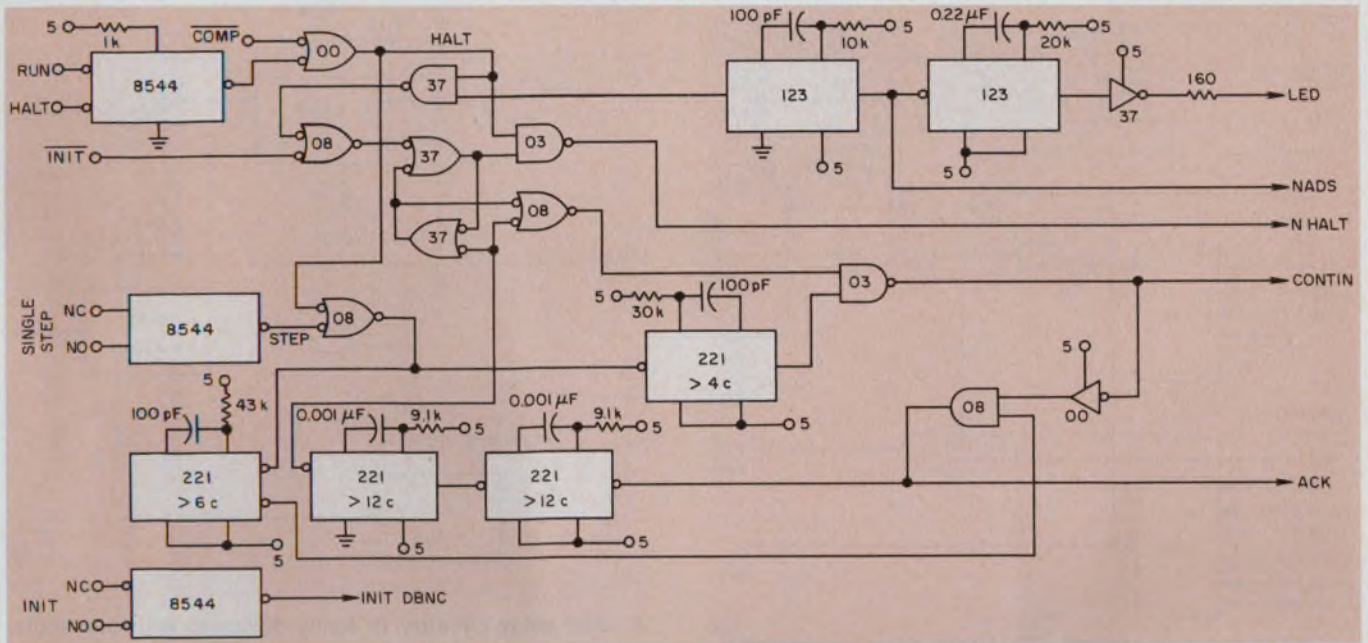

5. Halt/step control logic develops signals for starting, stopping and single-stepping PACE.

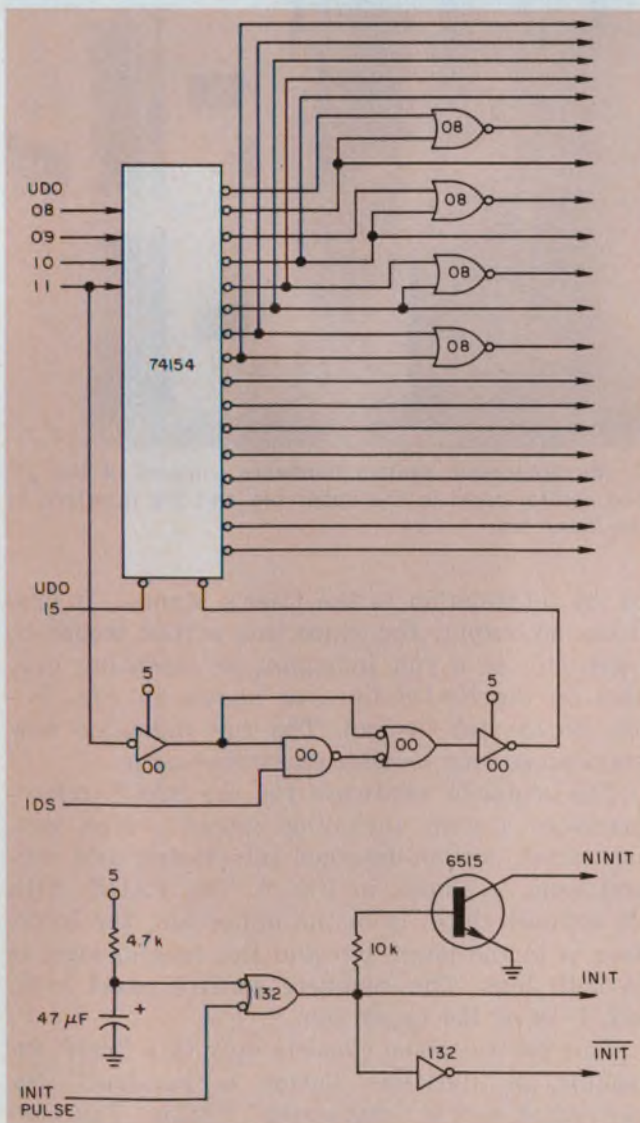

6. Memory address decoding for PROM and RAM.

mini to PACE via DMA, but passes bidirectionally between the  $\mu$ P and mini via programmed interrupts. Fig. 3 shows how the system and its busses handle the data. Fig. 4 describes the circuitry generating the required interrupts.

■ *Halt/Step circuitry.* The bidirectional NHALT and CONTIN lines are used to halt or single-step the PACE (see Fig. 5). Caution is needed, however, because these are multiplexed lines. On NHALT, whereas an input halts PACE, an output indicates that a halt has been executed. On CONTIN, whereas an input causes PACE to resume operation, an output acknowledges that PACE is halted. Four one-shots provide correct timing for NHALT and CONTIN.

■ *Memory-address decoding.* 2-k of PROM and 2-k of RAM are handled by the logic shown in Fig. 6. Circuitry to prevent writing into PROM is included, but must be disabled when you substitute RAM for PROM. Power-on initializing logic generates the INIT pulse, which resets the internal registers and starts the  $\mu$ P at memory-location ZERO.

■ *Device-decode circuitry.* The mini addresses PACE with device-code ZERO (Fig. 7); the PACE addresses the mini with device-code SEVEN. Seven additional device codes are spares in each direction.

■ *ILE control.* During a DMA transfer, two delays (see Fig. 7) allow data to pass through the ILE before latching into the ALE.

■ *BTE delay circuitry.* The BTE's three-state outputs are put into the open-circuit mode for 300 ns prior to a change in drive direction by the circuitry in Fig. 8. This circuitry eliminates a high-current race caused by internal switching



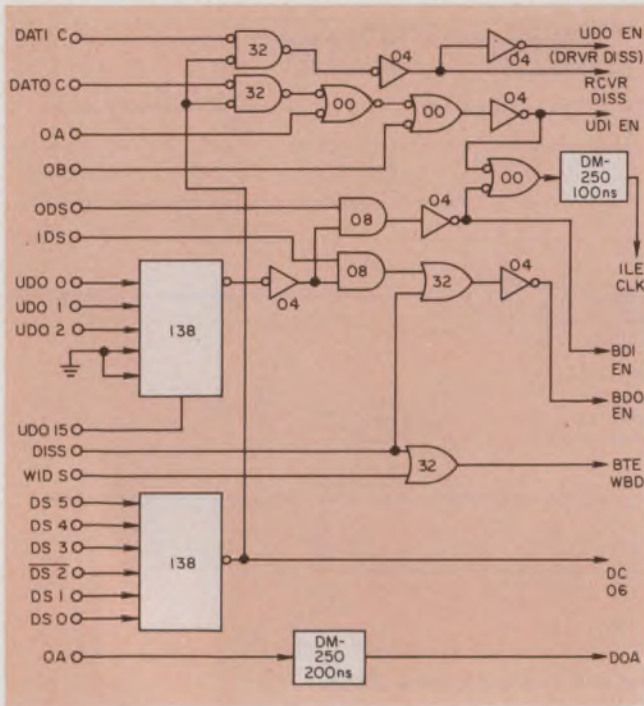

7. Device decode and ILE control logic.

between MOS and bipolar lines in the hybrids. The delay also allows the slow memory to release the bus before it is granted to the BTEs. The 3- $\mu$ s one-shot shortens the INIT signal.

The signal sequences during data transfers (Figs. 3, 4) merit closer examination. A DMA data transfer begins with a HALT from the mini. PACE then halts, after completing its current instruction, and outputs an acknowledge that causes the interface to give the mini access to the bus. The mini then sends an address through the ILE, and the address is latched into the ALE and RAM address latches. Next, the mini sends a data word through the ILE into RAM. After the data transfer, the mini sends a continue signal to the  $\mu$ P. Note that PACE has only one bus, which is multiplexed for both addresses and data.

A programmed-interrupt data transfer starts when the sender latches a word into the ILE, and transmits an interrupt (INTR from PACE) to the receiver. When the receiver becomes responsive to the interrupt, it reads the word in the ILE.

The data from the ILE must be identified for either receiver to process it. A two-word format is practical; the first word identifies the data, and the second specifies its value.

No hardware is needed to prevent ambiguous information from appearing in the ILE when both units try to write into it simultaneously. Use a one-bit check in the software—LSB = PACE to mini; MSB = mini to PACE. Consequently, information transfer is limited to 14 bits for the first word only.

A final note about the N HALT line: Contrary

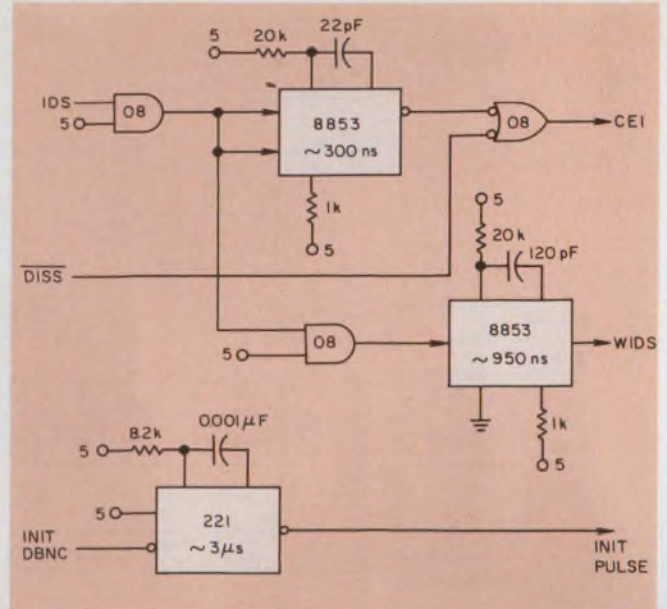

8. BTE delay circuitry is easily designed with one-shots.

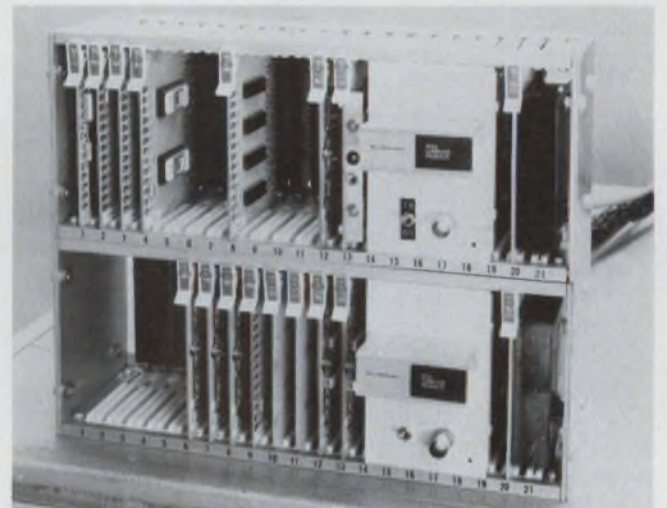

9. Microprocessor system hardware consists of the  $\mu$ P and control panel in the upper bin and the interface in the lower bin.

to the information in the User's Manual, it produces no output. But since this output would be used only as a run indicator, an updating one-shot on the NADS line—as shown in Fig. 5—can do the job instead. The run indicator now stays on so long as address strobes occur.

The complete hardware for the PACE microprocessor system, including support chips, control panel, custom-designed interfacing and control logic, is shown in Fig. 9. The PACE, with its support chips, is in the upper bin, the interface is in the lower bin and the custom logic is in both bins. The complete control panel is in slot P-13 of the upper bin.

This control panel consists only of a "run" indicator, an "initialize" button, a "run-halt" toggle switch and a "single-step" button. The control panel is used primarily for system-test. ■■



You can run back to the "home" of your minicomputer for more memory, or you can buy more memory from Ampex.

Buy it from Ampex. It'll cost less.

It'll also give you some solid advantages that you can't get from the original manufacturer. Like higher speed in some cases,

or fewer slots required in other cases, or wider environmental tolerance in still others. Or a combination of advantages.

Ampex minicomputer memories for Nova 2, Nova 1200 and PDP-11. Each one a better deal than you can get from the "home" of your CPU.

(Nova 2 and Nova 1200 are trademarks of Data General Corporation. PDP-11 is a trademark of Digital Equipment Corporation.)

**AMPEX**

Ampex Memory Products Division  
200 North Nash Street  
El Segundo, California 90245  
(213) 640-0150



# ADD-IN CORE MEMORY STOPS HOME RUN

CIRCLE NUMBER 67



# The MPU ANALYZER ARRIVES!

Motorola proudly presents  
the remarkable  
MPA-1.

It's here! The first digital diagnostic instrument created specifically for testing and debugging MPU hardware and software. Look at the features:

**Hexadecimal display.** The MPA-1 can capture any 32-word segment of program execution and display it in hexadecimal. Simple, direct comparison with written program instructions. No manual binary-to-hexadecimal translation. Each hex word displayed on the 9" CRT screen consists of 4 address characters and 2 characters of associated data bus information. Status information (from INTEL 8080 etc.) can be ignored, or captured and alternated with the corresponding data from 16 locations.

**Quick, easy connections.** The MPA-1 eliminates the slow and difficult individual-lead hookups. Individual probe buffers, with special quick-clip connectors, interface the unit directly with the Intel 8080 (A), AMD 9080, Texas Instruments TMS 8080, NEC uPD 8080A, Rockwell PPS-4, AMI S6800, MOS Technology 6500 Series, Synertek 6500 Series, plus the Motorola MC6800 and EXORcisor™.

**Attractive price.** The complete MPA-1 package, with 3 probe connectors, and the probe buffer of your choice, costs only \$2985 (slightly higher for international sales). Additional probe buffers are \$100 each.



Call or write today. Data sheets are available now. Just contact us at one of the addresses listed below. There's no need to wait . . . the MPU analyzer has arrived!

Try us out in Munich at ELECTRONICA 76



## MOTOROLA

Domestic Motorola Microsystems  
P.O. Box 20912  
Phoenix, Arizona 85036

International Please contact your local  
Motorola Semiconductor  
Sales Office.



# The Easy Reader

**FOR EFFECTIVE DISPLAY  
AND CONTROL**



model 4424  
0.55" display



model 4443  
1" display



## LARGE BRIGHT DISPLAY

LFE series 4400 DPM's are more readable than conventional LED displays. They provide a unique one inch display and uniform high intensity digits. Also, gaps between digit segments have been eliminated.



## LOW PRICE, HIGH VALUE

Use of the latest conversion techniques allows series 4400 to have fewer components and single board construction. Technological breakthrough provides proven LFE quality and reliability at a new low cost.

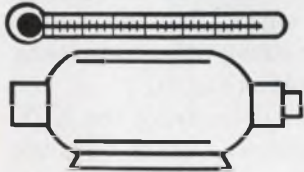

## RPM, °F, volts, AC, amps, °C, DC, ————

LFE series 4400 DPM's can accept optional second printed circuit board to provide for most signal conditioning conversions. Complete boards available for linearized thermocouple, RTD, AC motor speed, power line, and other special inputs.

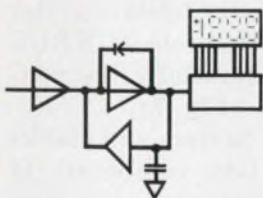

## ACCURATE DISPLAY, RELIABLE PERFORMANCE

FET high impedance input, multiplexed BCD output, high noise rejection, plug-in digits, auto polarity, flashing over-range, automatic zero, space saving design, and other features are standard. A lengthy burn-in and an exhaustive computer controlled checkout insure high reliability.

Nationwide network of modification/distribution centers provide local stocking, modification, and repair. Contact your local representative for applications assistance. For complete details on series 4400 DPM's write to LFE Corporation, Process Control Division, 1601 Trapelo Road, Waltham, MA, 02154, or telephone 617-890-2000.

**LFE**  
CORPORATION

CIRCLE NUMBER 69



## Let a $\mu\text{P}$ cut test time. With an LSI chip controlling programmable instruments, you can speed circuit measurements and improve accuracy, too.

Add a  $\mu\text{P}$  to programmable test equipment, and you can speed measurements while boosting accuracy. For example, you can automatically measure and plot the linearity of a voltage-controlled oscillator (VCO) in about five minutes—about six times faster than with manual methods. Because the procedure is automatic, you avoid mis-read meters or arithmetic tabulating errors.

To do the same tests manually, you adjust the reference voltage, read a power meter, read a frequency counter and record the readings for each of several reference voltages. All of this can be done without human intervention.

The  $\mu\text{P}$ —in this case, a Motorola 6800—steps the reference voltage through the VCO control range and prints and plots the results respectively on a teletypewriter and X/Y plotter (Fig. 1). Designing, constructing, programming and debugging such a  $\mu\text{P}$  test system should take about five weeks.

After the VCO is connected, operation starts with a teletypewriter command. The  $\mu\text{P}$  resets its own counters, prints a table heading on the teletypewriter and then begins a series of 40 VCO measurement cycles (Fig. 2).

### Three steps to linearity

The first step in each measurement cycle updates the reference generator supplying the control voltage to the VCO under test. The  $\mu\text{P}$  does this by sending the proper binary number to the voltage generator (Fig. 3).

The second step measures the VCO response. The  $\mu\text{P}$  reads the frequency counter in IEEE Standard 488 format and converts the received ASCII data to binary for further processing (Fig. 4).<sup>1</sup> It also reads the power meter and converts both the power data and the voltage generator data to ASCII for later printout at the teletypewriter.

The third step is to draw a curve segment on

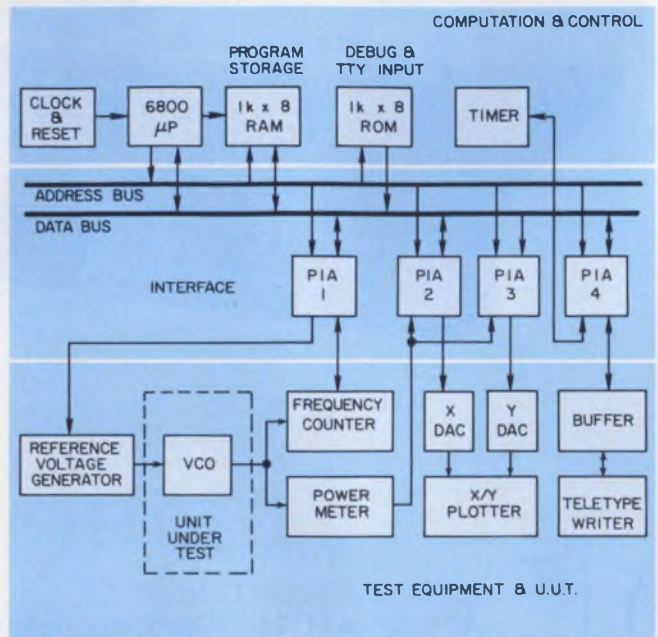

1. With a  $\mu\text{P}$  connected to programmable instruments through interface adapters, a VCO's linearity can be measured and plotted in only five minutes.

the X/Y plotter. The  $\mu\text{P}$  calculates a differential frequency value by subtracting the predetermined desired frequency from the measured frequency. The differential-frequency signal then goes to a Y-axis DAC, and simultaneously the reference voltage goes to an X-axis DAC (Fig. 5).

The analog outputs of the DACs drive the X/Y plotter to draw the line segment. Figure 6 shows a typical X/Y plotter curve.

Next, an entry is printed into the teletypewriter data table. The  $\mu\text{P}$  uses the Motorola MIKBUG interface routines to print sequentially the voltage, frequency and power data (Fig. 7).

Finally, the  $\mu\text{P}$  updates its counters and checks to see if the entire test has been completed. If testing is incomplete, the  $\mu\text{P}$  returns to the first step and begins another measurement cycle.

The  $\mu\text{P}$  communicates with the test equipment through a Peripheral Interface Adapter (PIA), a programmable IC that permits all handshake and data movements to be software controlled by the

Oliver Holt and Frederick Shirley, Members Technical Staff, Sanders Associates, Inc., 95 Canal St., Nashua, NH 03060.



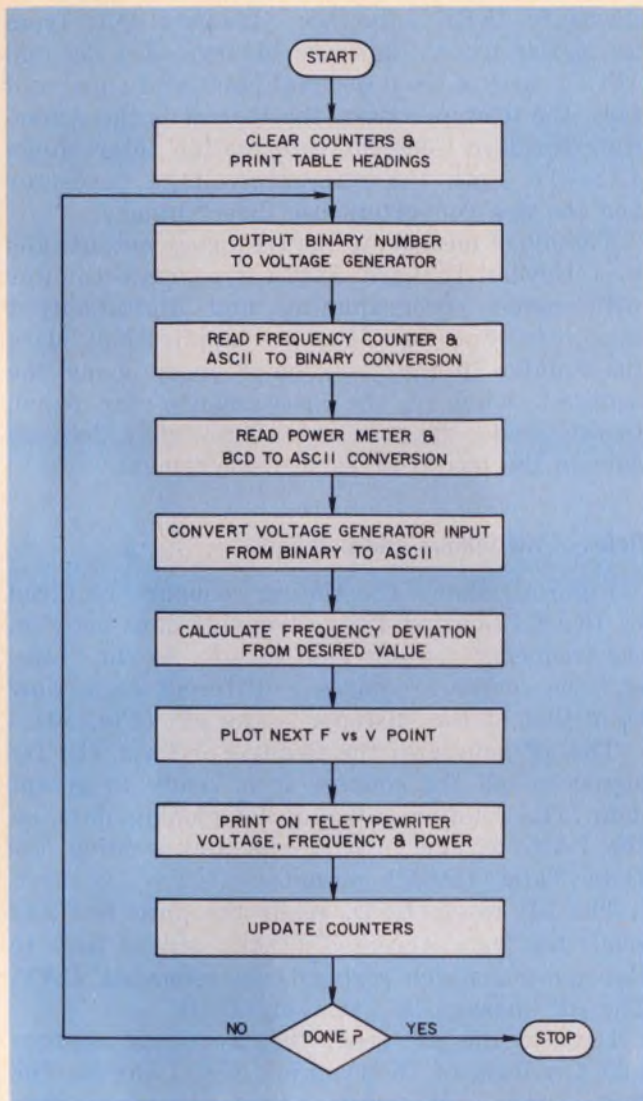

2. Operational sequence of the automatic test system starts with a teletypewriter command. The VCO is driven over its functional range of input voltages, and the corresponding output frequencies are read and recorded.

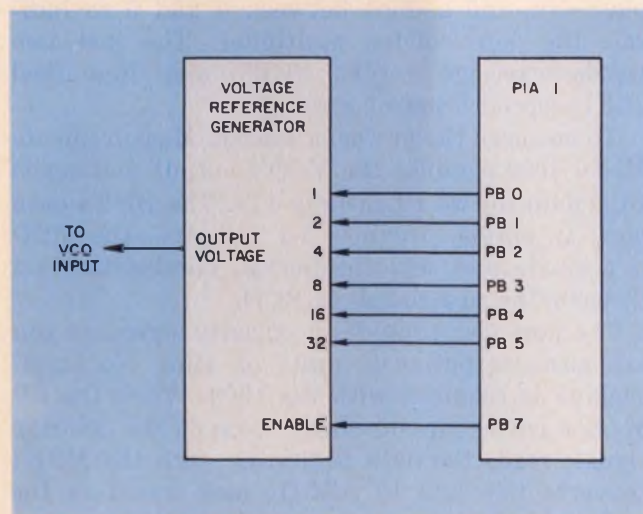

3. The reference-voltage generator receives its digital commands through a peripheral interface adapter (PIA). Six bits of binary code set the generator output level, which controls the VCO under test.

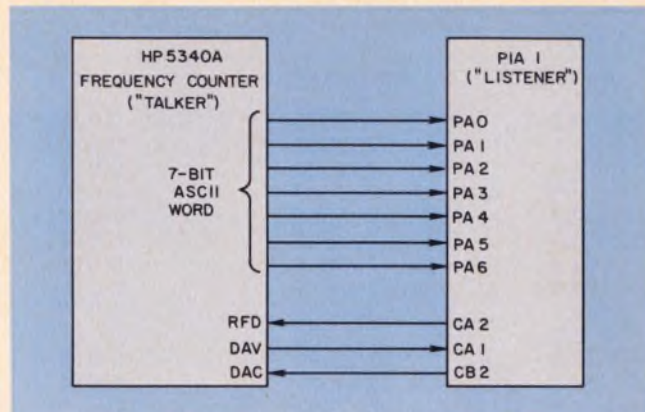

4. A PIA also interfaces the system counter to the  $\mu P$ . The counter works in a "talk" mode only and delivers the frequency automatically after each measurement.

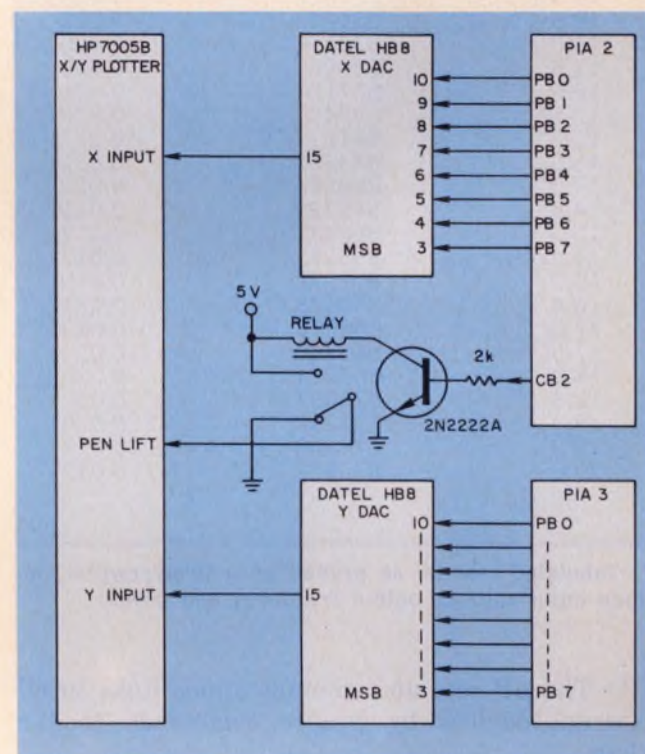

5. To draw test results on an X/Y plotter, both the frequency information and the reference voltage are put into analog form by d/a converters.

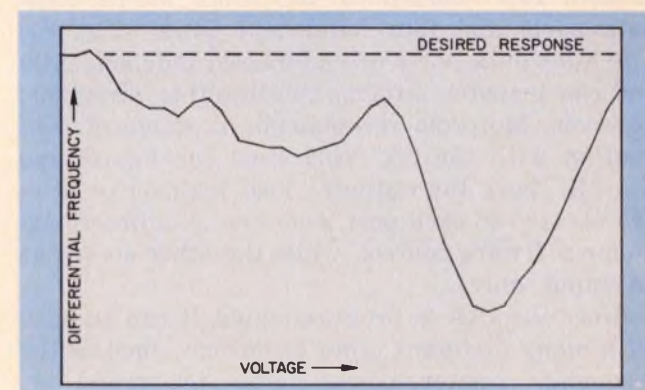

6. Typical test results: The VCO's linearity is plotted as differential frequency error vs. input level.



VOLTAGE	FREQUENCY	POWER
0.5	787579	0.023
1.0	789552	0.020
1.5	791501	0.019
2.0	793507	0.015
2.5	795593	0.019
3.0	797708	0.014
3.5	799838	0.011
4.0	801977	0.015
4.5	804139	0.019
5.0	806270	0.012
5.5	808382	0.013
6.0	810527	0.014
6.5	812752	0.016
7.0	814986	0.018
7.5	817234	0.022
8.0	819490	0.025
8.5	821769	0.028
9.0	824036	0.029
9.5	826293	0.027
10.0	828527	0.024
10.5	830715	0.022
11.0	832850	0.020
11.5	834965	0.020
12.0	837124	0.021
12.5	839407	0.022
13.0	841817	0.022
13.5	844355	0.022
14.0	846994	0.020
14.5	849729	0.019
15.0	852481	0.017
15.5	855212	0.017
16.0	857872	0.019
16.5	860473	0.021
17.0	863012	0.023
17.5	865462	0.024
18.0	867804	0.024
18.5	870057	0.022
19.0	872212	0.020
19.5	874300	0.017
20.0	876311	0.012

7. Tabulated results, as printed on a teletypewriter, include input voltage, output frequency and power.

$\mu$ P.<sup>2</sup> The  $\mu$ P sets up communications links to all external devices by proper commands to the PIAs.

### PIAs are the go-betweens

Each PIA consists of two 8-bit, bidirectional data ports and four handshake lines (Fig. 8). The 8-bit data ports are addressed independently and can transfer information in either direction; however, Motorola recommends a standard convention with the "A" port used for inputs and the "B" port for outputs. Two handshake lines are allotted to each port. One line is bidirectional under software control, while the other serves as an input only.

Since the PIA is programmable, it can be used with many different types of devices, such as the frequency counter, power meter, teletypewriter, reference-voltage generator and X/Y plotter.

Data format from the frequency counter con-

forms to IEEE Interface Standard 488; from the power meter, data are binary-coded decimal (BCD) with a fixed decimal point and sign; and from the teletypewriter, the format is the American Standard Code for Information Interchange (ASCII). Both the reference-voltage generator and the d/a converters use direct binary.

The job of measuring the frequency output falls to a Hewlett-Packard 5340A frequency counter with remote programming and digital-output capability. For the VCO test application, place the counter in the "talk only" mode using the external switch on the instrument's rear panel. In this mode, the counter automatically delivers data to the bus after each measurement.

### Roles of the talkers and listeners

Figure 9 shows the timing sequence required by IEEE Standard 488 to transfer data between the frequency counter and the  $\mu$ P. As the "talker," the counter requires a different logic flow from that of the "listener"—the  $\mu$ P (Fig. 10).

The  $\mu$ P generates the Ready-For-Data (RFD) signal to tell the counter it is ready to accept data. The counter responds by placing data on the 7-bit, parallel ASCII bus and sending the Data Valid (DAV) signal.

The  $\mu$ P resets RFD, reads the data bus and sends the Data Accepted (DAC) signal back to the counter, which responds by removing DAV. The  $\mu$ P answers by removing DAC.

Data to the  $\mu$ P from the frequency counter take the form of 16 seven-bit ASCII words. The first three 7-bit words are preliminary data that signal the counter's status. Words 4 through 11 give the frequency count, with the most significant digit (MSD) first and all blank digits represented by zeroes.

Words 12 to 14 represent the letter "E," a plus sign, and a digit between 0 and 6 to indicate the power-of-ten multiplier. The last two words—carriage return (CR) and line feed (LF)—specify end of message.

To measure the power, a Pacific Measurements Model 1009 samples the VCO's output and sends BCD data to two PIAs (Fig 11). The 1009's data port, an option, provides 3-1/2 digits—the MSD is a single line, and the tenths, hundredths and thousandths are coded in BCD.

The port also provides a polarity signal so you can measure power in units of dBm. No handshaking is required with the 1009. When the  $\mu$ P needs a power measurement, it reads the polarity signal; reads the data beginning with the MSD; converts the data to ASCII; and transfers the data for printing.

How the X/Y plotter interfaces to the  $\mu$ P PIAs is shown in Fig. 5. Two 8-bit d/a converters provide the analog form needed by the plotter. The



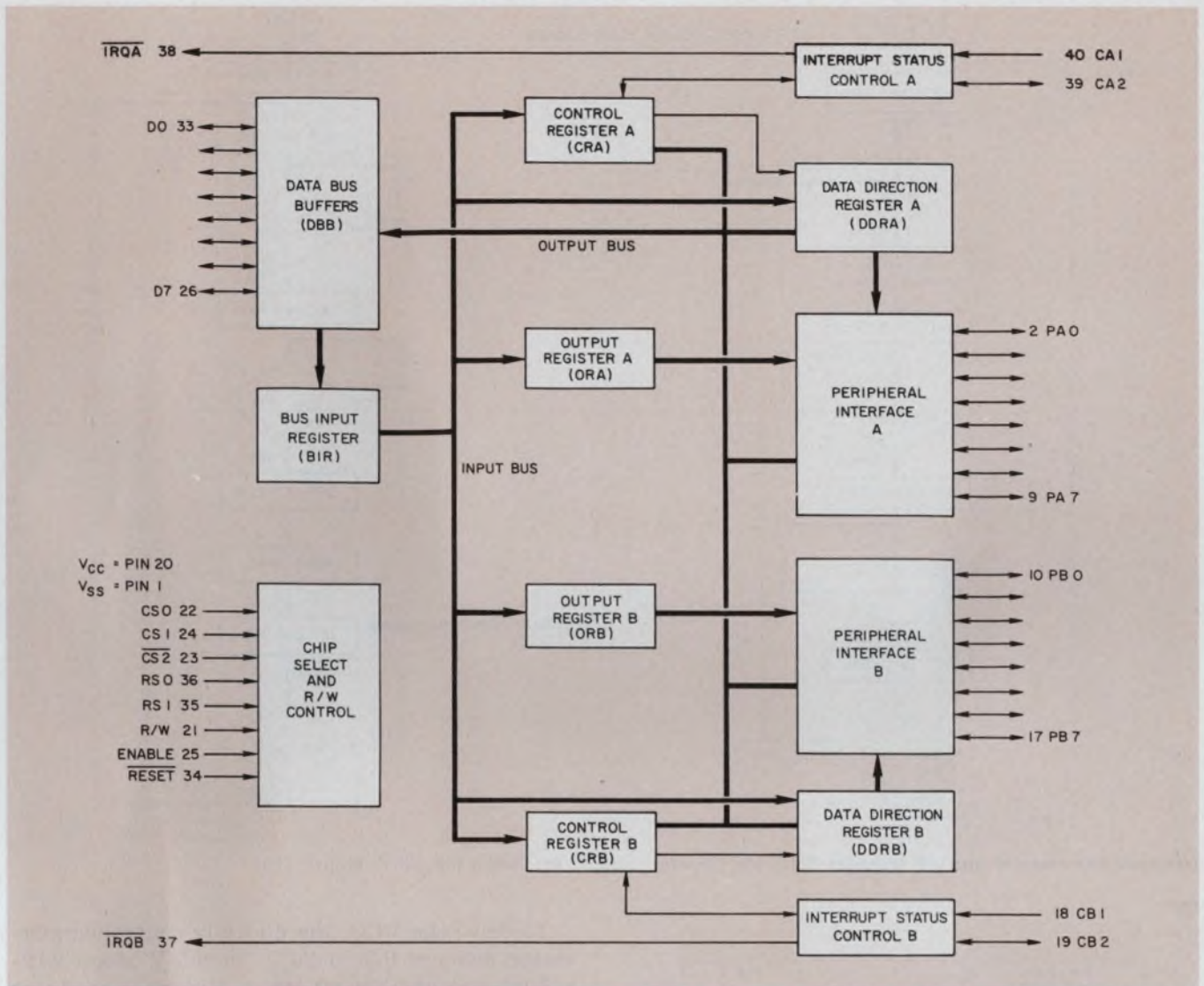

8. The PIAs used in the VCO tester provide two 8-bit data ports, over which information flows in either direc-

tion. Four handshake lines are also available. Usually port "A" is used for  $\mu$ P inputs, "B" to outputs.



9. Transfer of data between the  $\mu$ P and the counter conforms to IEEE 488, the recently adopted interface stand-

ard for programmable instrumentation. Shown here is the required timing sequence for the interface bus.

MSB on each converter (pin 3) connects to PB7 on each PIA. The only handshake signal required is the pen-position command, which lifts the pen between curves. This signal is applied to the plotter through a simple transistor drive and a relay.

Because of the high resolution required for the VCO test, the  $\mu$ P commands the X/Y plotter

to draw a curve of differential-frequency error vs. voltage. To do so, the desired response is typed into the  $\mu$ P, and the response is then normalized to a straight line across the center of the plotter.

The  $\mu$ P reads all frequency measurements and compares the results with the desired response to get the differential-error curve.



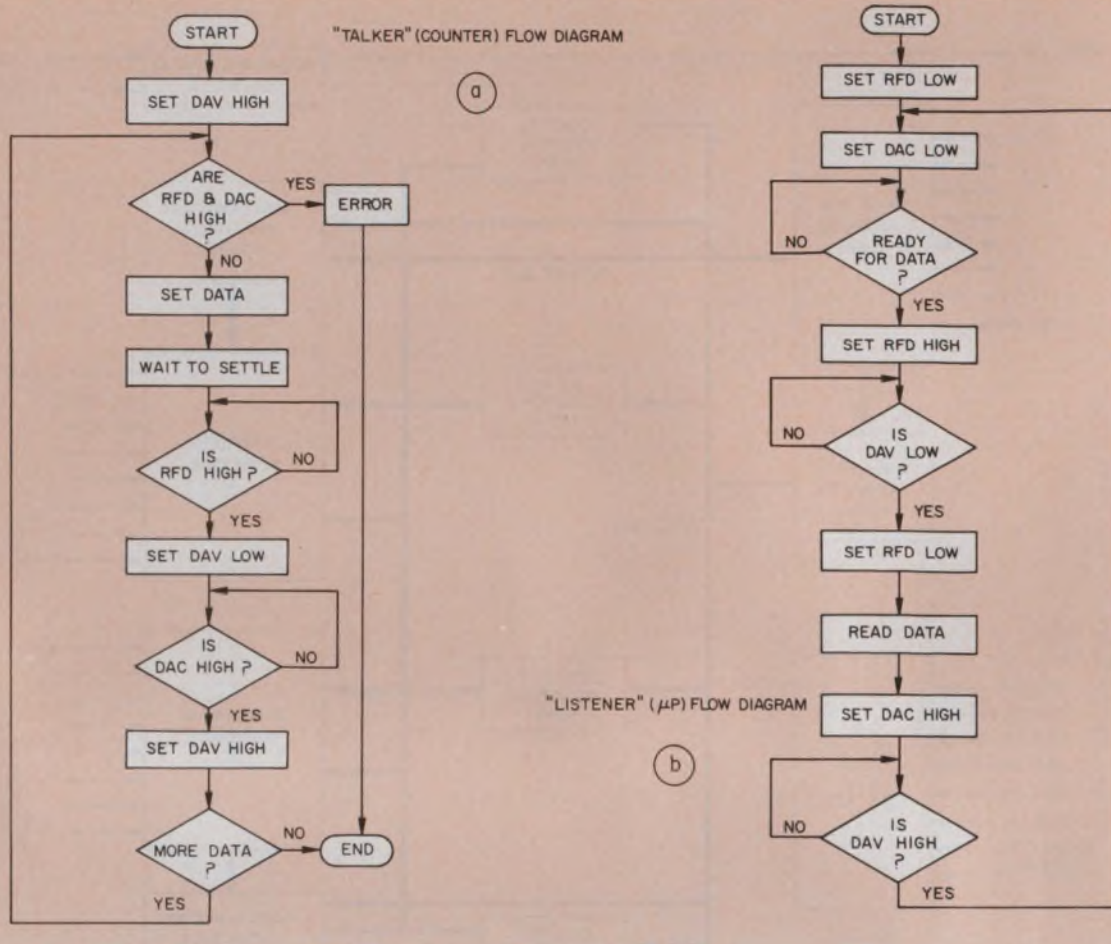

10. How the counter and  $\mu$ P transfer data: the counter "talks" (a), while the  $\mu$ P "listens" (b).

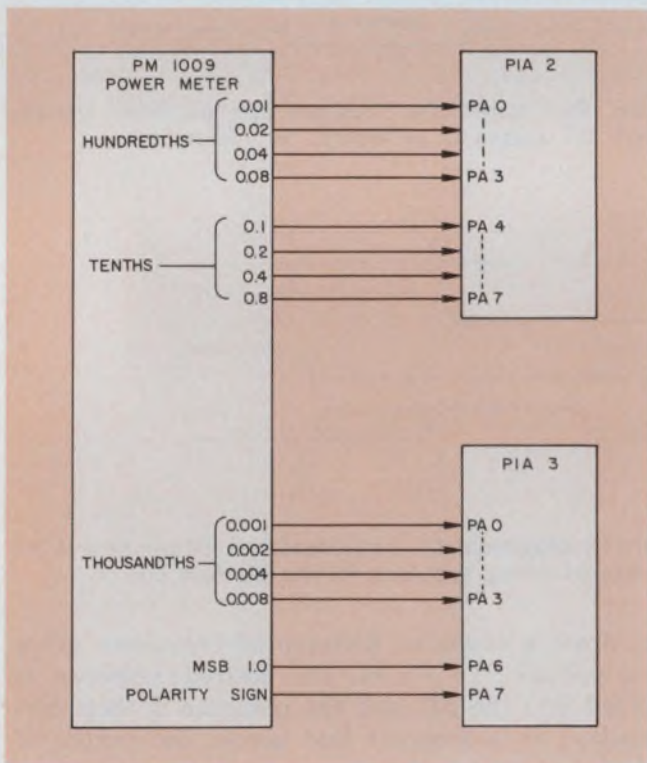

11. Power measurements are sent out on the system data bus with 3-1/2-digit resolution. No handshaking is necessary with the power meter.

To drive the VCO, the digitally controlled generator delivers 0.5 to 20 V in 0.5-V steps with a 6-bit straight binary input. Binary 0 produces the minimum level, binary 39 the maximum. The only handshake requirement is an enable signal, which switches the output from a high-impedance off state to the specified voltage at low impedance.

The interface between the teletypewriter and the  $\mu$ P is the standard 20-mA current-loop circuit recommended in the Motorola application manual. Input/output routines for the teletypewriter are provided in the MIKBUG firmware, a  $1\text{ k} \times 8$  ROM chip.

In the VCO test system, the teletypewriter serves as both an input device and a printer. You, the system operator, type in the voltage range for the VCO under test, the desired frequency-vs.-voltage curve and the VCO identification number. Then you get things moving with the teletypewriter which, shortly, becomes the system printer. ■■

#### References

1. *IEEE Standard Digital Interface for Programmable Instrumentation*, The Institute of Electrical and Electronic Engineers, Inc., New York, NY, 1975, IEEE Standard 488-1975.
2. *M6800 Microprocessor Applications Manual*, Motorola Inc., Phoenix, AZ, 1975.



# The Universal Counter.

**NOW go to 1300 MHz!**

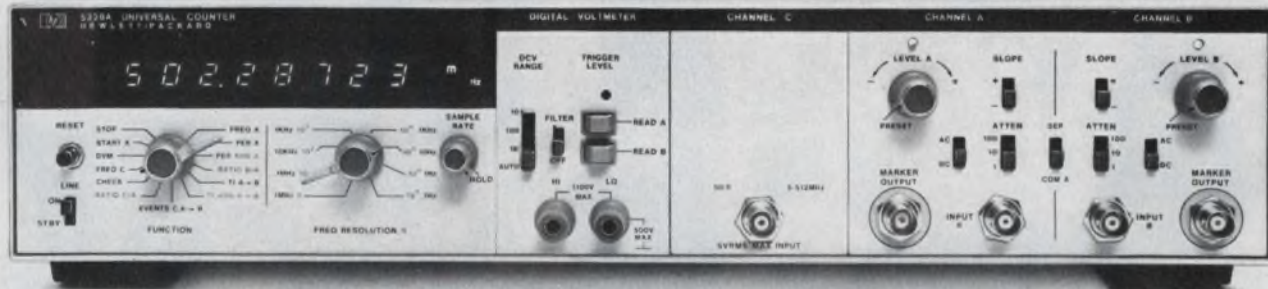

## Everything you're likely to need. The HP 5328A.

Here's a counter so versatile, it can really be called universal. You get high accuracy, operating ease and a low price tag of just \$1300\*. It's modular so you can buy the capability you need. Not more. Not less. Start with the basic 8-digit instrument with 100 MHz frequency range and 100ns single shot T.I. resolution. You also get period, 10 ps time interval averaging, ratio, scaling and totalizing. Then you can add more: 512 MHz with 9 digits and 15 mv sensitivity; time base aging  $< 5 \times 10^{-10}$ /day; and 10 ns single shot time interval with improved averaging. But look what else you get:

*\*Or now to 1300 MHz with 20 mV sensitivity!*

### UNIQUE TRIGGER LIGHTS

tell you what's happening. They're on when the input is greater than trigger level and vice versa. And they blink when the input channel is triggering from 0 to 100 MHz. Standard.

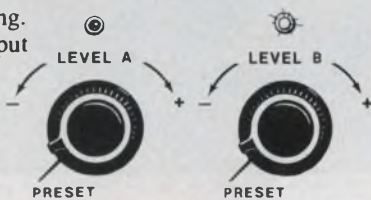

**UNIQUE BUILT-IN DVM** gives an instant accurate digital display of trigger levels.

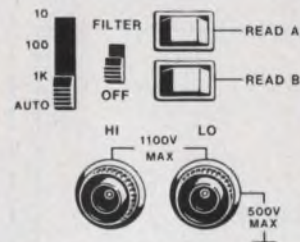

Or use this option to measure external voltages 10  $\mu$ V to 1100V auto-ranged, integrating, full floating, high common-mode rejection with switchable input filter. Optional.

### HIGH SPEED MARKERS

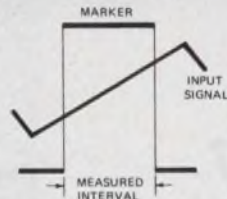

show just what your counter is doing with your input waveform. Use the markers on the second channel of your scope to see where the counter is triggering. Really useful thanks to the 5328A's 100 MHz ECL outputs. Standard.

### EASY SYSTEMS INTERFACE

with the HP Interface Bus simplifies integration of the counter into a system. You get this program-mability plus standard format data output with a single connector. Optional.



### ARMED MEASUREMENTS

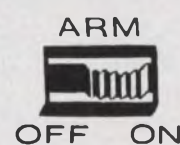

solve difficult dynamic measurement problems. The counter goes to work when your command tells it to. Ideal for burst frequency or sweep generator linearity measurements. Standard.

These are just a few things, of course. There are many more thoughtful engineering innovations that combine to give you everything you're likely to need in a general purpose, medium-priced counter for a long time to come. We talk about them in our 12 page booklet. Write for one or ask your nearby HP field engineer for a copy. We want you to find why we call this universal counter universal.

\*Domestic US Price only.

HEWLETT  PACKARD

Sales and service from 172 offices in 65 countries.  
1501 Page Mill Road, Palo Alto, California 94304

CIRCLE NUMBER 70



# The Right Time The Right Place The Right People



## **Electro77** **April 19-21, 1977** **New York Coliseum**

Now that the nation's economy and the electronics revolution are accelerating again, next April is an ideal time to display electronics products and services directly to the key domestic and international audiences who will attend **Electro77**.

The site is New York. Yes, New York, with its fresh outlook and renewed vitality. Within 500 miles of that metropolis more than 400,000 electronics specialists design, produce, and market a consistent 40 percent of the U.S. electronic volume.

Of course, people are **Electro77's** main ingredient. The right people. Technologists who design new equipment and new systems. Engineers in specifications, testing, manufacturing, quality control, and packaging. Specialists in purchasing and marketing, and end-users in industry, government and science.

**Electro77 New York** brings the right people to the right place at the right time. Make exhibit arrangements today.



**Electro77**  
999 North Sepulveda Blvd., El Segundo, California 90245  
Send Exhibit Information To: ED

(Attach Your Business Card Here)



# CRT YOKES FOR FLIGHT

Take a plane - military, commercial, or private. Chances are 9 out of 10 you'll find Syntronic Deflection Yokes and Focus Coils in critical cathode ray tube display equipment; weather radar, navigation, weapons systems, landing, monitoring, communicating. The U.S. Navy's/Lockheed S3A anti-submarine plane uses 14 Syntronic components in 7 critical displays.

Other aircraft display applications include the B52 Retrofit, F4 (D&E), F5E, A6, A7, F111, A10A, S3A, F14, F15, F16, AWACS, MCRA, Mirage, Viggen, 707, 727, 737, 747, DC-8, DC-9, DC-10, L1011 and many private aircraft. Call or write Syntronic Instruments, Inc. (312) 543-6444. Ask for Syntronic's Yoke Selection Guide to high-flying, high-performance yokes.



**syntronic  
instruments, inc.**

SYNTRONIC INSTRUMENTS, INC.  
100 Industrial Road • Addison, IL 60101  
(312) 543-6444



## For sequential control, FPLAs make sense.

Like computers, they can be programmed, but they are simpler to use and straightforward in application.

At first glance, the field-programmable logic array (FPLA) looks like it is only a combinatorial logic-function generator. However, it can also be used as part of a sequential system.

It's true, the FPLA accepts input variables, generates product terms and provides outputs that are programmable functions of inputs. Further, it does not provide internal storage, or even imply a state diagram for any of the logic functions it generates.

But you can turn the FPLA into a sequential-function generator by simply synchronizing its outputs and feeding some of them back. Then it can implement more complex sequential-logic functions than it could handle before. The savings in package count and engineering time, as well as the ease with which changes can be made, make the FPLA a very economical choice for these medium-complexity applications.

### FPLAs offer several advantages

For the designer of digital-control systems, the FPLA offers several advantages over conventional logic-design techniques. First, the FPLA reduces the number of SSI and MSI logic elements for a particular function. Design and debug time is saved because the translation from a logic-state diagram to FPLA code is a straight-forward rote process that is less error-prone than detailed logic design.

When design specifications change, the redesign can be much simpler than the "yellow wire" problem associated with hardwired logic; just reprogram the FPLA. A carefully thought-out design may be usable in a wide variety of unrelated control applications without changing the hardware; again, just reprogram the FPLA.

Often, using FPLAs to replace logic trees results in decreased delays because logic-path propagation delays are more nearly equal through the FPLA.

Extending the FPLA to sequential logic opens

**Gene Miles**, Engineer, Intersil, Inc., 10900 N. Tantau Ave., Cupertino, CA 95014, and **John Nichol**, Consulting Engineer, Logical Services, Inc., 711 Steirlin Rd., Mountain View, CA 94086.

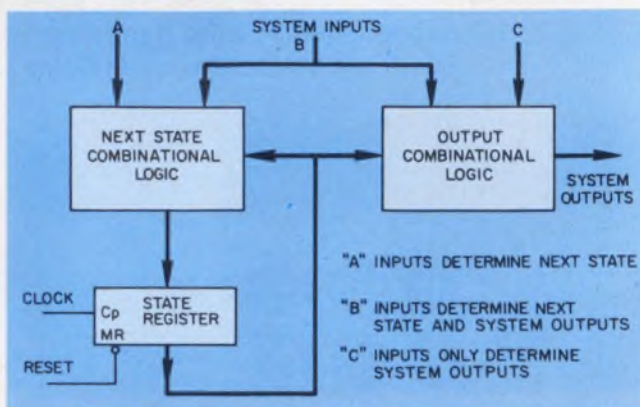

1. A generalized sequential controller steps from one state to another, based upon system inputs and its previous state.

new application possibilities that have particular appeal for designers in such areas as special-purpose industrial controllers, data acquisition systems, machine controllers, and data-plotting or display systems. Sequential controllers using the FPLA allow the designer to program a time sequence of operational steps and to maintain programmable combinations of input events to control output events.

### Controllers have three function blocks

A generalized sequential controller consists of two combinatorial logic blocks and a state register (Fig. 1). The "next-state" logic determines the next state of the machine and the "output logic" determines the controller's outputs. Both are functions of the present state of the controller's and some of the inputs to it. A clock input is provided to synchronize the controller, and a reset signal may be used to start the controller at a known state.

The definition of a sequential controller's operation usually takes the form of a state diagram in which each state is defined in three ways. First, each state is assigned an identification number which is usually obtained by ordering the contents of the state register as a binary number. Second, the outputs of each state are defined as a function of the inputs to that state.



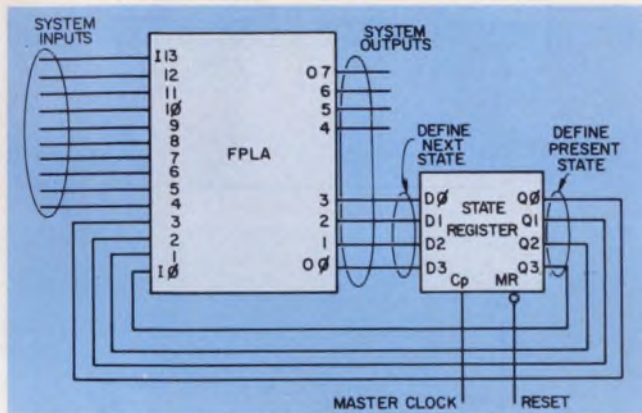

2. A simple sequential controller may contain as few as one FPLA and one quad flip-flop. This controller has 16 states and a maximum of 48 product terms.

Third, all transitions to the next state are defined as a function of the inputs to each state.

The state diagram is made up of a collection of blocks connected by lines. Each block represents a possible transition from one state to another. Each line has associated with it the condition of the inputs necessary for that transition to occur. Any number of lines may exit from each state, and any number of lines may enter each state.

### FPLAs are used for controller logic

FPLAs are a natural for implementing both the next-state logic and the output logic for a sequential controller. For relatively simple controllers, a single FPLA can perform both functions. For such a controller, the conversion from a state diagram to an FPLA design is a straightforward design procedure.

One example of a sequential controller is shown in Fig. 2. It uses an FPLA and 4-bit state register. The FPLA provides both the next-state and output logic, and a state register defines the present machine state.

An MSI quad-D flip-flop is used for the state register. Since it has 4 bits, the controller may have up to 16 states. The four state-register outputs are connected to FPLA inputs. The remaining FPLA inputs may be used to control the next

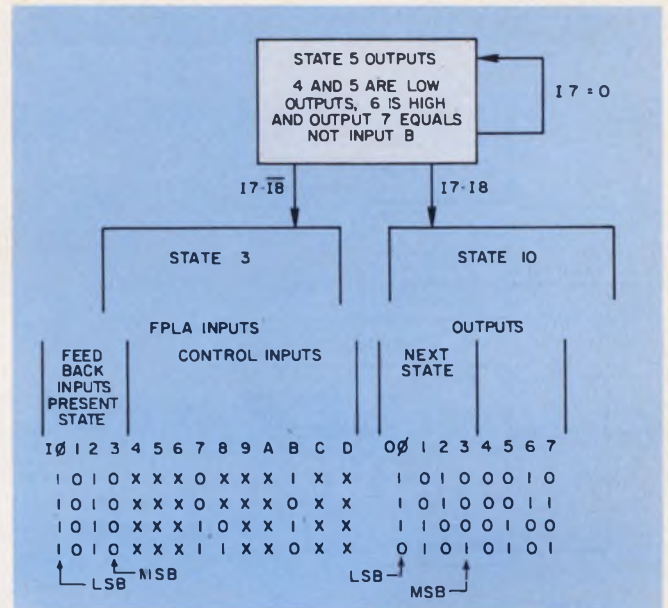

3. The state diagram defines the sequence of operations to be performed. The diagram then is used to generate the coding form for the FPLA.

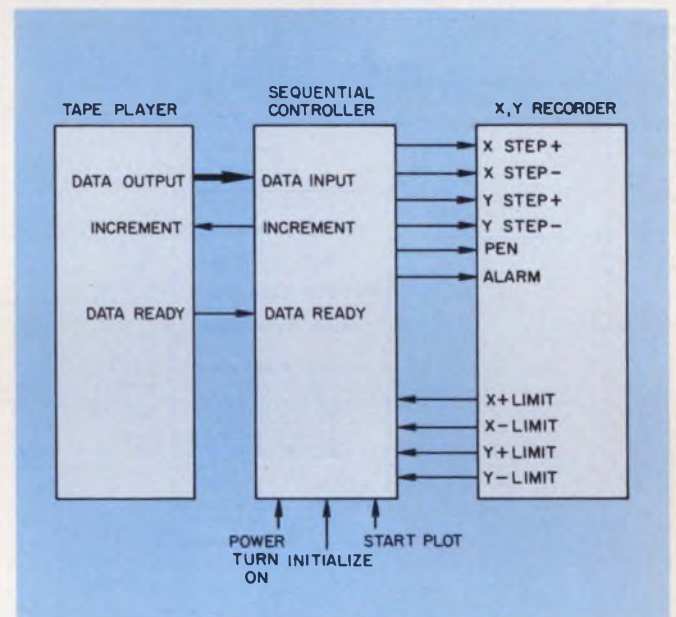

4. The block diagram for a tape to X-Y plotter-controller is generated from required inputs, outputs and additional control conditions.

state or remaining FPLA outputs.

The next machine state is generated by four FPLA outputs, which are also available as controller outputs. This next state is defined by the sum of product terms coded into the FPLA.

Each state used must have at least one product term. The number of product terms required for a given state depends upon the state diagram. For example, consider the partial state diagram in Fig. 3 and the corresponding product-term coding of the FPLA. Here we see that four prod-



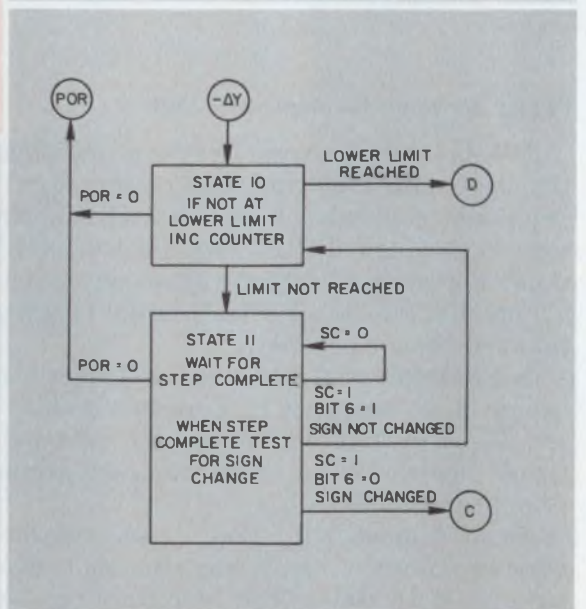
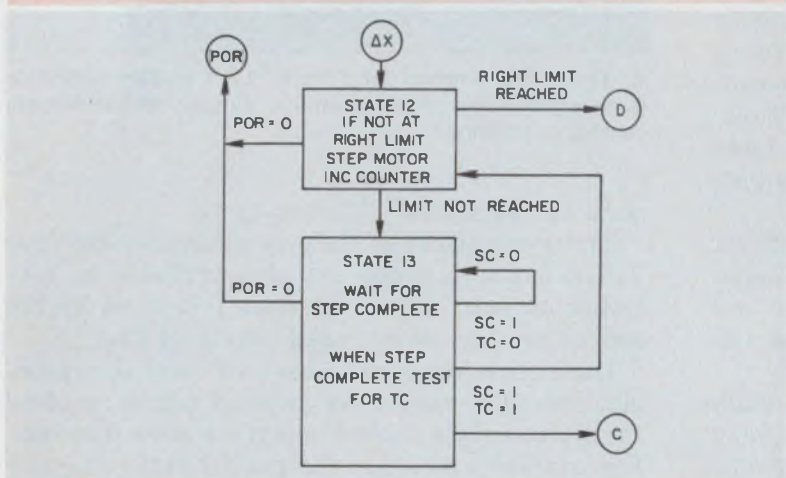
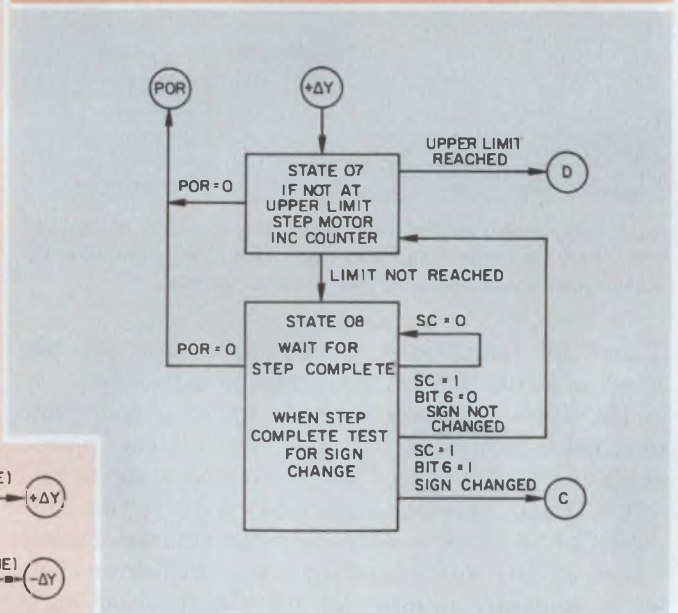
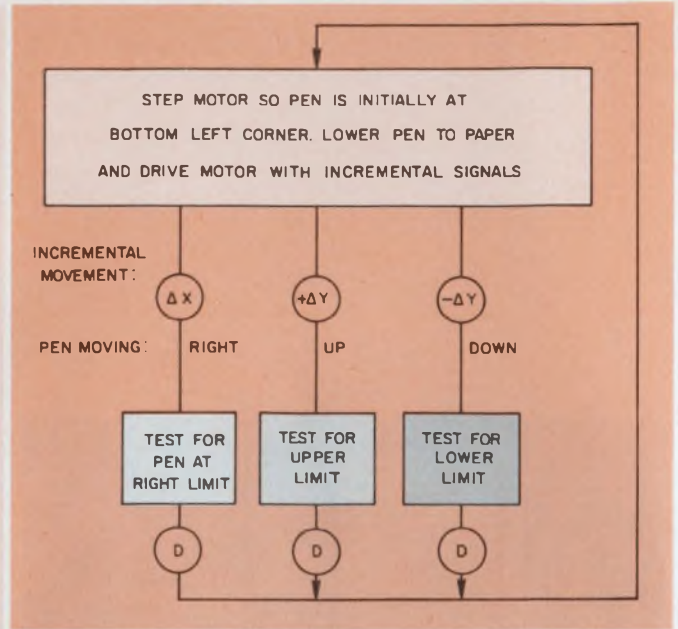
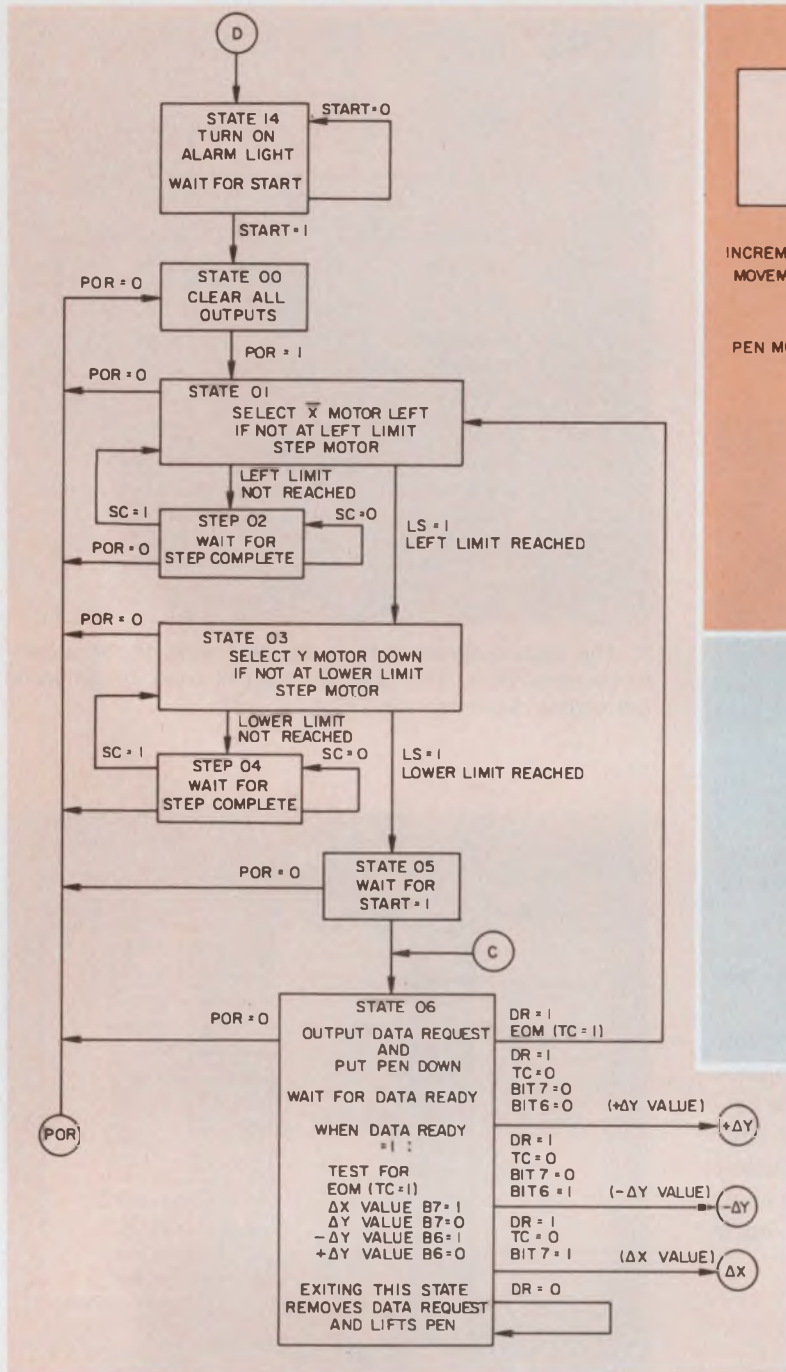

5. The controller must be initialized, acquire data from the tape recorder and control pen motion. At the same

time, it must sense the plotter's limit switches and stop the motor if it reaches the end of allowable travel.



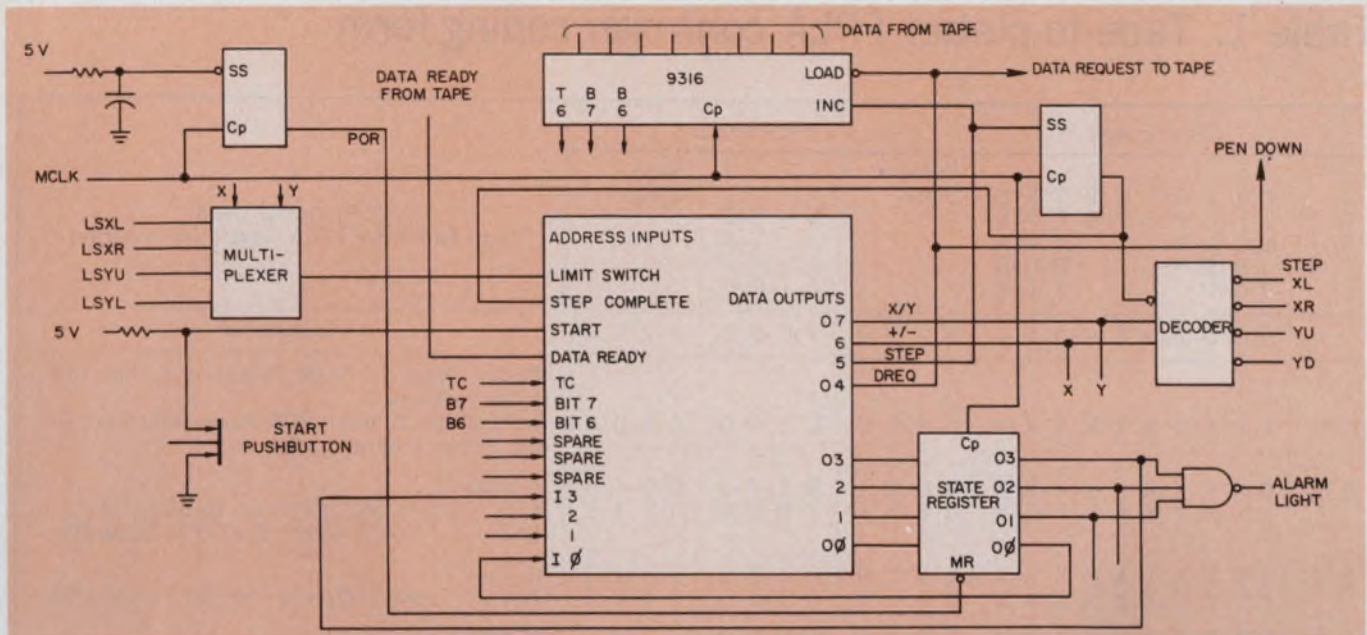

6. A detailed logic design of the system is made from the block diagram (Fig. 4). Additional switch inputs and

uct terms are required for state 5. The first two are identical except that output 7 is the complement of input B. The second two determine whether the next state is state 3 or state 10, based upon inputs 7 and 8 as shown. States can get as complicated as the required I/O logic, but an upper limit is established by the maximum product terms available in the PLA. The Intersil IM5200, for example, allows up to 48 product terms. If each state requires 4 product terms, then we are limited to 12 of the 16 available states (4 product terms per state  $\times$  12 states) unless we add another FPLA.

As each state is defined, the inputs and outputs of that state are taken from the state diagram and assigned to input or output variables in the FPLA coding form.

### Applying the design procedure

The following control problem (Fig. 4) illustrates more fully the capability of the FPLA as a sequential controller. In this example, data are available to the system in sequential bytes of eight parallel-binary lines. The data have been recorded on a digital tape recorder at some remote site and must now be read and displayed on an incremental X-Y plotter.

A system must be designed to control the incremental tape playback and to accept the data. This control system must also detect the type of data being read so that they may be displayed properly, and the system must recognize when it has reached the end of a data record on the tape. Certain operator commands and the actual information on the tape control the system, which in turn controls the tape reader.

limit switch inputs must also be included and assigned to the PLA.

The data consist of incremental changes in values of two related parameters, X and Y, or  $\Delta X$  and  $\Delta Y$ . The actual parameters could be temperature, pressure, displacement, angular rotation, velocity or other data requiring analysis. We wish to write these data in an X-Y plotter that accepts incremental motor-control signals to move a pen in an X or Y direction. The limits of pen travel are identified by the limit switches for +X, -Y, +Y, and -Y extremes.

The plotter's motor-drive signals will be supplied from our design, and the limit-switch outputs are to be sensed as inputs. The tape player will be stepped, the data read and the plotter controlled so that the data are plotted on an X vs. Y graph. The plot will be terminated either at the end of a record or upon reaching a limit on the plotter.

This hypothetical system seems specialized, at first, but it is typical of some industrial control problems. The system requires control of the acquisition and destination of the data, as well as conversion of the data itself. This kind of operation is found in all types of equipment from computer peripherals to automated assembly lines. The remote data acquisition and display application illustrated here may easily be tailored to an entirely different application, but the functions and techniques for sequential control using the FPLA will still be valid.

### Make the flow chart first

The first step in the design of our system is to draw a block diagram (Fig. 4)—to show the input and output requirements for the logic system—and a flow chart (Fig. 5) of the required



# Table 1. Tape-to-plotter FPLA controller coding form

S T A T E	FPLA inputs								FPLA outputs				33 Products Used Tape To Plotter FPLA Controller Program										
	L	S	D	T	B	B	S	S	S	Present State	X	+		S	D	Next State							
	I	T	T	R	C	7	6	P	P	P		/	/	T	R								
	M	E	A	D				A	A	A		Y	-	E	E								
	I	P	R	Y				R	R	R				P	Q								
	T	C	T					E	E	E													
	D	C	B	A	9	8	7	6	5	4	3	2	1	0	7	6	5	4	3	2	1	0	Comments
0 0	X	X	X	X	X	X	X	X	X	X	0	0	0	0	0	1	0	0	0	0	0	1	Master Reset To State Register, Forces Controller to State 0. Go To State 01 When POR Reset Goes Inactive And Select X Motor Left.
0 1	0	X	X	X	X	X	X	X	X	X	0	0	0	1	0	1	1	0	0	0	1	0	In State 01 If LS = 0 Step Motor And Go To State 02 If LS = 1 Select Y Down And Go To State 03
	1	X	X	X	X	X	X	X	X	X	0	0	0	1	1	0	0	0	0	0	1	1	
0 2	X	0	X	X	X	X	X	X	X	X	0	0	1	0	0	1	0	0	0	0	1	0	In State 02 Wait Until Step Complete Then Go To State 01
	X	1	X	X	X	X	X	X	X	X	0	0	1	0	0	1	0	0	0	0	0	1	
0 3	0	X	X	X	X	X	X	X	X	X	0	0	1	1	1	0	1	0	0	1	0	0	In State 03 If LS = 0 Step Motor And Go To State 04 If LS = 1 Go To State 05
	1	X	X	X	X	X	X	X	X	X	0	0	1	1	0	0	0	0	0	1	0	1	
0 4	X	0	X	X	X	X	X	X	X	X	0	1	0	0	1	0	0	0	0	1	0	0	In State 04 Wait Until Step Complete Then Go To State 03
	X	1	X	X	X	X	X	X	X	X	0	1	0	0	1	0	0	0	0	0	1	1	
0 5	X	X	0	X	X	X	X	X	X	X	0	1	0	1	0	0	0	0	0	1	0	1	In State 05 Wait For Start Then Go To State 06
	X	X	1	X	X	X	X	X	X	X	0	1	0	1	0	0	0	0	0	1	1	0	
0 6	X	X	X	0	X	X	X	X	X	X	0	1	1	0	0	0	0	1	0	1	1	0	In State 06 Turn On Data Request, Drop Pen, And Wait For Data Ready Signal
	X	X	X	1	1	X	X	X	X	X	0	1	1	0	0	0	0	0	0	0	0	1	
	X	X	X	1	0	1	X	X	X	X	0	1	1	0	1	1	0	0	1	1	0	0	
	X	X	X	1	0	0	1	X	X	X	0	1	1	0	1	1	0	0	1	0	1	0	
	X	X	X	1	0	0	0	X	X	X	0	1	1	0	1	0	0	0	0	1	1	1	
0 7	0	X	X	X	X	X	X	X	X	X	0	1	1	1	1	0	1	0	1	0	0	0	In State 07 If LS = 0 Step Motor And Go To State 08 If LS = 1 Alarm Go To State 14
	1	X	X	X	X	X	X	X	X	X	0	1	1	1	0	0	0	0	1	1	1	0	
0 8	X	0	X	X	X	X	X	X	X	X	1	0	0	0	1	0	0	0	1	0	0	0	In State 08 Wait Until Step Complete Then Test If Sign Has Changed: If B6 = 0 Go To State 07 Sign Has Not Changed If B6 = 1 Go To State 06 Get Next Data
	X	1	X	X	X	0	X	X	X	X	1	0	0	0	1	0	0	0	0	1	1	1	
	X	1	X	X	X	1	X	X	X	X	1	0	0	0	0	0	0	0	0	1	1	0	
1 0	0	X	X	X	X	X	X	X	X	X	1	0	1	0	1	1	1	0	1	0	1	1	In State 10 If LS = 0 Step Motor And Go To State 11 If LS = 1 Alarm Go To State 14
	1	X	X	X	X	X	X	X	X	X	1	0	1	0	0	0	0	0	1	1	1	0	
1 1	X	0	X	X	X	X	X	X	X	X	1	0	1	1	1	1	0	0	1	0	1	1	In State 11 Wait Until Step Complete - Then Test If Sign Has Changed If B6 = 0 Go To State 06 To Get Next Data Sign Has Changed If B6 = 1 Go To State 10 Step Motor Again
	X	1	X	X	X	0	X	X	X	X	1	0	1	1	0	0	0	0	0	1	1	0	
	X	1	X	X	X	1	X	X	X	X	1	0	1	1	1	1	0	0	1	0	1	0	
1 2	0	X	X	X	X	X	X	X	X	X	1	1	0	0	0	0	1	0	1	1	0	1	In State 12 If LS = 0 Step Motor And Go To State 13 If LS = 1 Alarm Go To State 14
	1	X	X	X	X	X	X	X	X	X	1	1	0	0	0	0	0	0	1	1	1	0	
1 3	1	X	0	X	X	X	X	X	X	X	1	1	0	1	0	0	0	0	1	1	0	1	In State 13 Wait Until Step Complete - Then Test For TC If TC = 0 Go To State 12 If TC = 1 Go To State 14
	1	X	1	X	X	0	X	X	X	X	1	1	0	1	0	0	0	0	1	1	0	0	
	1	X	1	X	X	1	X	X	X	X	1	1	0	1	0	0	0	0	0	1	1	0	
1 4	1	X	X	0	X	X	X	X	X	X	1	1	1	0	0	0	0	0	1	1	1	0	In State 14 (Alarm) Turn On Alarm Light And Wait For Start. When Start Received Go To Reset Start = 1 Go To State 00
	1	X	X	1	X	X	X	X	X	X	1	1	1	0	0	0	0	0	0	0	0	0	

When Data Ready Signal = 1 Test  
 If TC = 1 Go To State 01 (End Of Message Received)  
 If TC = 0 Test B7  
 If B7 = 1 Go To State 12 ΔX Value  
 If B7 = 0 ΔY Value Test B6 For Plus or Minus  
 If B6 = 1 Go To State 10 (-ΔY Value) Select Y Motor Down  
 If B6 = 0 Go To State 07 (+ΔY Value) Select Y Motor Up



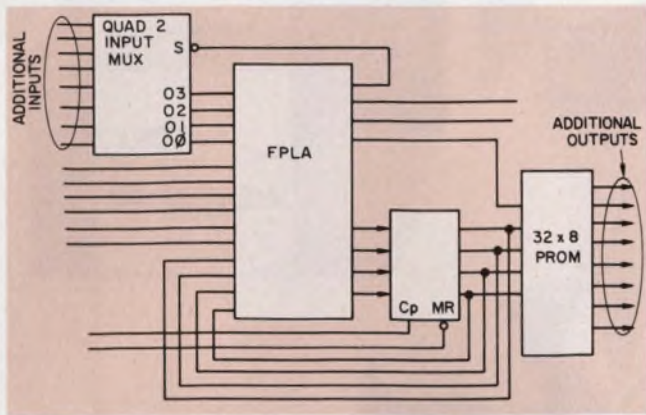

7. If more outputs are needed, a PROM controlled by the state register may be added. The FPLA and the PROM may each be reprogrammed if necessary.

sequence of operations. We have included the initialize, the power turn-on and the start-plot signals as additional inputs because we want to include a power-on reset, and to accept two push-button inputs from the operator.

We determine from the flow chart the states of the machines and the sequence of operations to be performed as a result of the inputs and feedback in the system. Then, we consider various methods for implementing the sequential controller.

For this class of application, the complexity is below that required for economical use of a computer, minicomputer, or microprocessor. Yet, it involves more than a simple PROM pattern and would need several handfuls of MSI/SSI packages and possibly multiple printed-circuit cards. The FPLA offers a way of minimizing the logic packages, while still providing the flexibility needed to allow rapid reprogramming when someone changes the tape format or wishes to add capability to the system.

Armed with the manufacturer's FPLA data sheet and programming matrix, as well as the block diagram (Fig. 4) and flow chart (Fig. 5), we assign inputs and outputs from the FPLA (Fig. 6). Once the FPLA is coded we check to assure that we have used no more than the allowable number of inputs, outputs, and product terms per device. If we need more, we can add FPLAs or use the technique illustrated in Fig. 7.

Finally, we add the interface logic diagram. The breadboard can be built while the FPLA is being programmed.

Now the inevitable debug process begins—but this time the changes are easier because most of them can be handled by changing only the program stored in the FPLA. ■■

#### References

1. IM5200 Preliminary Data Sheet, March, 1975.
2. Miles, Gene, "The Field Programmable Logic Array, A Second Generation LSI Element," Wescon, May 13, 1975.



## Small Wonder

\* It's PICOTEMP® thermal cutoff  
New from Micro Devices  
(Actual Size)

PICOTEMP® thermal cutoffs. Be-Fit tight spaces — and limited budgets. Same accuracy and similar capabilities as the widely used MICROTEMP® safety thermal cutoffs...but smaller in size. Weighs just 1/48th of an ounce. Installed costs are less, too.

Use PICOTEMP thermal cutoffs when installation or space restrictions rule out MICROTEMP. At present, motors and transformers are two leading applications.

But, wherever you use PICOTEMP thermal cutoffs, you're assured of positive, low cost protection against overheating caused by malfunctions in electrical circuits and components.

The PICOTEMP thermal cutoff is completely sealed

against atmosphere. Because of its unique design and construction, it won't derate. And it is unaffected by age or extended use.

Here are some other things you'll want to know:

- current capacity—to 5 amps. at 120 VAC. Will hold this rating up to and including 240 VAC.
- temperature tolerance +0° C.—3.3° C.
- temperature ratings—63° C.—150° C. (146° to 300° F.)
- leads are 26 gauge silver plated wire.

Recognized under the Component Program of Underwriters' Laboratories, Inc. UL File #E40667A. MITI approved.



# MICRO DEVICES



DIVISION OF EMERSON ELECTRIC CO.  
1881 SOUTHTOWN BLVD.  
DAYTON OH 45439 513-294-0581





**Here in Wabash, Indiana  
Jim Smith gets to meet them all...  
Xerox... 3M... Eastman Kodak... RCA... Zenith...**

They stop at the station for gas and directions when they come to talk to Wabash engineers about transformers and high voltage power supplies.

Wabash, you see is an outstanding source of transformers to a long list of blue chip customers who have come to rely on the custom engineering, sophisticated product, automated winding, high volume production capability and competitive pricing Wabash offers.

Jim doesn't own the Chippewa Service Station—

but the bait house next door. His buddy, Hal Roser, often goes mushroom hunting up in Michigan and that's when Jim gets a chance to meet all these people. And Jim is pretty happy about it—especially since word has gotten back that Xerox, RCA, Eastman Kodak, 3M and Zenith enjoyed meeting Jim.

And, that's just another thing Wabash offers that none of the hundreds of other transformer manufacturers can. A chance to meet Jim Smith.

*Coils, Relays & Transformers*  
**wabash**  
of  
**Wabash, Indiana**  
and Huntington, Indiana; Farmington, Missouri;  
Tipton, Iowa and South Boston, Virginia  
For information and quotes write or call:  
Wabash, Inc., Dept. TA-1, 810 N. Cass St., Wabash, Ind. 46992 Tel: 219/356-8300 TWX 810-333-1533  
CIRCLE NUMBER 74





E-Z-PROBES XP AND XPL ■ TEST LEADS AND JUMPERS ■ ADAPTORS

# OUR NEW MICRO TROUBLE SHOOTER SOLVES YOUR IC TESTING PROBLEMS

The XM Micro Hook is designed for difficult IC test connections. Light weight (less than 1 gram) and Finger-eze Hypo Action permit direct hookup to delicate wires where weight and leverage may damage component. Fully insulated to a single contact point for true readings.

**Construction:** One-Piece Beryllium Copper, Gold-Plated Conductor and Hook, made for connections over leads up to .025" diameter. Durable Heat and Chemical Resistant Nylon Body. Stainless Steel Spring. Available preconnected to a wide variety of interface connectors.

**Colors** Red, Black, Blue, Green, Orange, Yellow, White, Brown, Violet and Gray.

## EXCLUSIVE FIELD SERVICING FEATURE

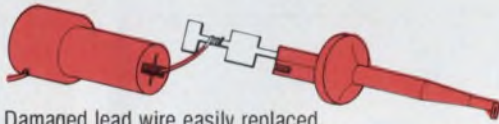

Damaged lead wire easily replaced.

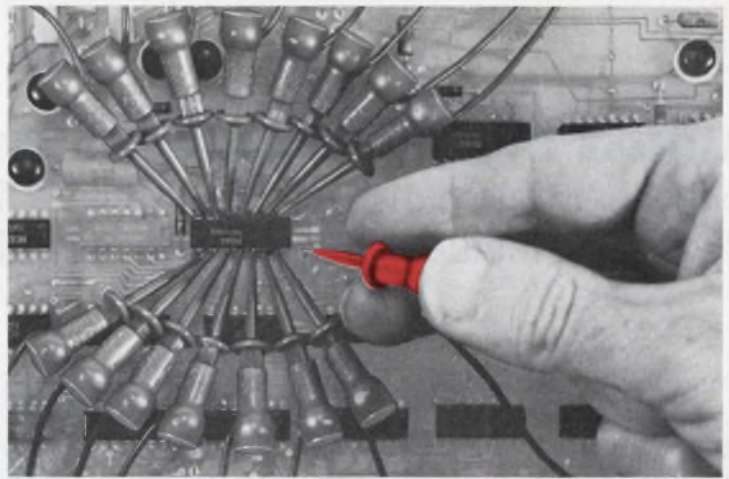

MODEL XM SHOWN ACTUAL SIZE WITH HOOK EXTENDED.

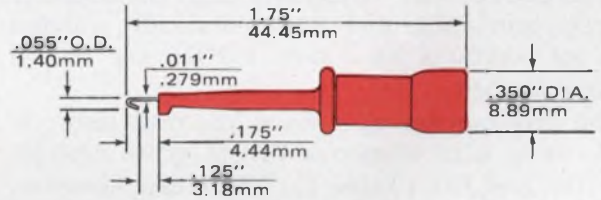

SEND FOR COMPLETE NEW CATALOG AND PRICE LIST

**EZ-HOOK**  
A DIVISION OF TEKTEST, INC.

114 EAST SAINT JOSEPH STREET  
ARCADIA, CALIFORNIA 91006  
(213) 446-6175 / TWX 910 582 1614

CIRCLE NUMBER 75

E-Z-PROBES XP AND XPL ■ TEST LEADS AND JUMPERS ■ ADAPTORS

# OUR PISTOL-GRIP PROBE IS RIGHT ON TARGET

Now, Mini-Hook convenience and size with provision for building in circuitry—combined in an easy to use Pistol-Grip Probe. Complete with amply sized Epoxy Glass Board, strain relief coaxial cable clamp and lead exit hole built into handle. Insulated to a single contact point to assure true readings.

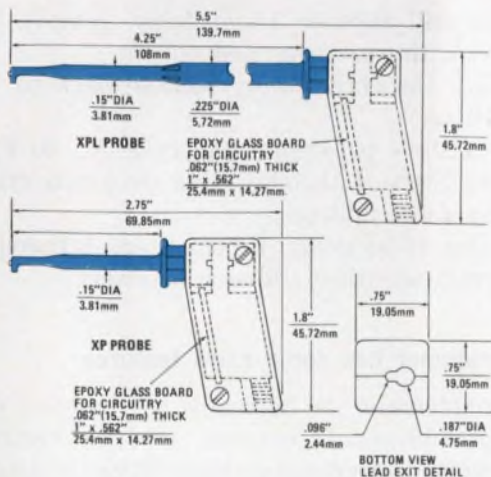

PISTOL-GRIP HANDLE SHOWN ACTUAL SIZE

**Construction:** One-Piece Beryllium Copper, Gold-Plated Conductor and Hook, Durable Heat and Chemical Resistant Nylon Body and Handle, Stainless Steel Spring.

**Colors:** Body-Red, Black, Blue, Green, Orange, Yellow, White, Brown, Violet and Gray. Specify color when ordering. Pistol-Grip—Black.

SEND FOR COMPLETE NEW CATALOG AND PRICE LIST

**EZ-HOOK**  
A DIVISION OF TEKTEST, INC.

114 EAST SAINT JOSEPH STREET  
ARCADIA, CALIFORNIA 91006  
(213) 446-6175 / TWX 910 582 1614

CIRCLE NUMBER 76

PATCH CORDS ■ COAXIAL JUMPERS ■ E-Z-HOOK CLIP 61-1 AND 61-2

PATCH CORDS ■ COAXIAL JUMPERS ■ E-Z-HOOK CLIP 61-1 AND 61-2



## Build a PROM programmer and program your own devices. An inexpensive instrument verifies unprogrammed PROMs and includes a seven-segment LED address display.

Using readily available components, you can build an inexpensive PROM programmer. This simple programmer has two features similar to commercial models: It includes LED displays for address and data, and it automatically verifies that all locations in a new PROM are indeed unprogrammed.

The programmer does have one drawback: It works only with Signetics PROM types 82S126, 129, 130 and 131 (Table 1). There are, however, good reasons why these PROM types were selected. They are completely TTL-compatible and require only a +5-V-dc power supply. Moreover, their size ( $256 \times 4$ ) seems ideal for many applications. More outputs would require a much more expensive 24-pin package.

Use of ultraviolet erasable ROMs (EPROMs) would have been impractical in TTL systems because EPROMs are expensive, and require an additional power supply ( $-12$  V) for operation. The remainder of a TTL system might use just +5 V.

### All you do is blow fuses

Inside the PROM, Ni-Cr links—alloys of nickel and chrome—"open" when a high current pulse is passed through, similar to blowing an ordinary fuse. Unprogrammed outputs are LOW (logic "0"). Once a link has been opened, that output is HIGH (logic "1") and cannot be changed. The links can be blown by the following steps (Fig. 1):

1. Terminate all device outputs with a 10-k $\Omega$  resistor to +5 V.
2. Select the address to be programmed.
3. Raise  $V_{cc}$  to  $V_{ccp} = 8.75$  V.
4. After a 10  $\mu$ s delay, apply  $V_{out} = +17$  V to the desired output. Program one output at a time.
5. After another 10  $\mu$ s delay, pulse both  $\overline{CE}$  inputs to logic "0" for 1 to 2 ms. The Ni-Cr links are actually blown at this time.

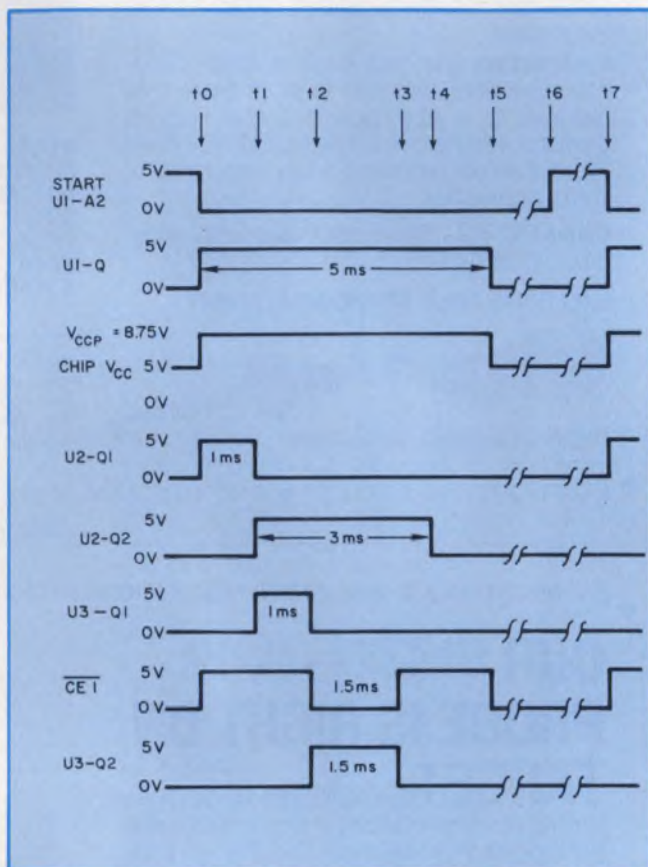

1. The programmer timing sequence follows the manufacturer's recommendations for the PROMs.

6. After still another 10- $\mu$ s delay, remove the +17 V from the programmed output.
7. Reduce the chip supply voltage back to +5 V after 10  $\mu$ s.
8. To continue programming, raise  $V_{cc}$  to  $V_{ccp}$ , and repeat Steps 4 through 7 to program other bits at the same address.
9. After a 10- $\mu$ s delay, repeat Steps 3 through 8 to program all other address locations.

### This programmer has some extra features

The programmer is basically a Signetics design, with additional features. It first verifies that a PROM is unprogrammed. Then it drives the various PROM inputs and outputs to code



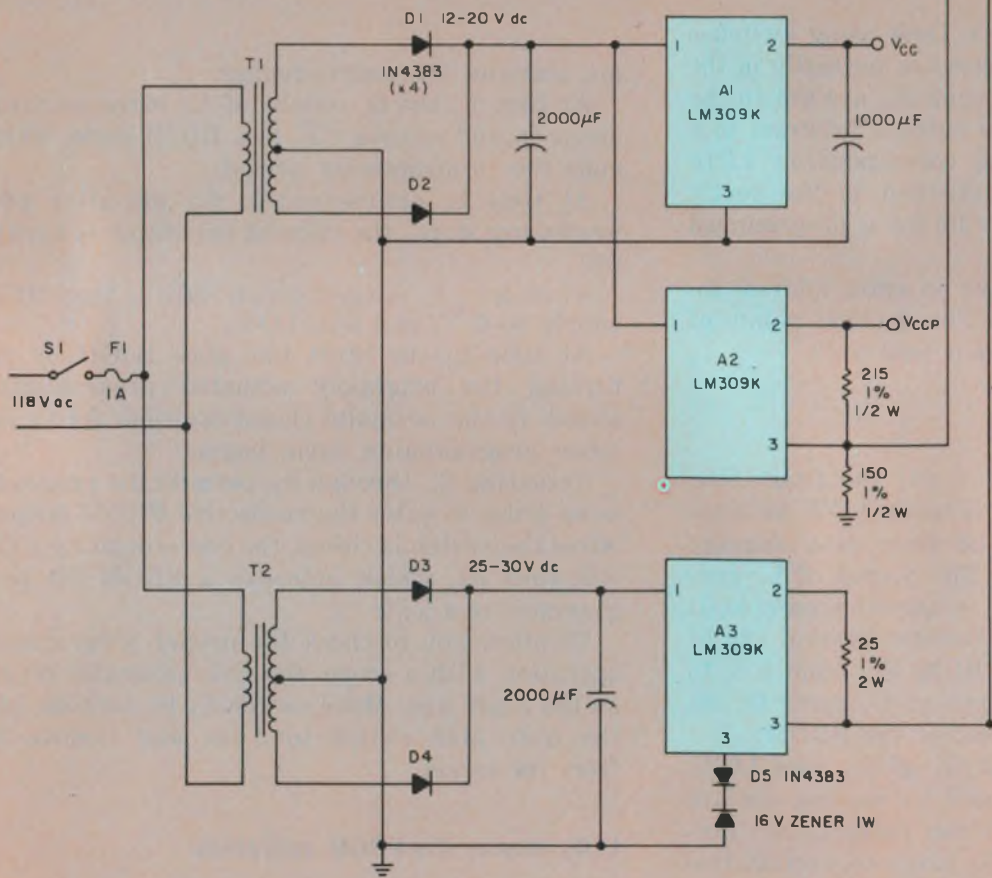
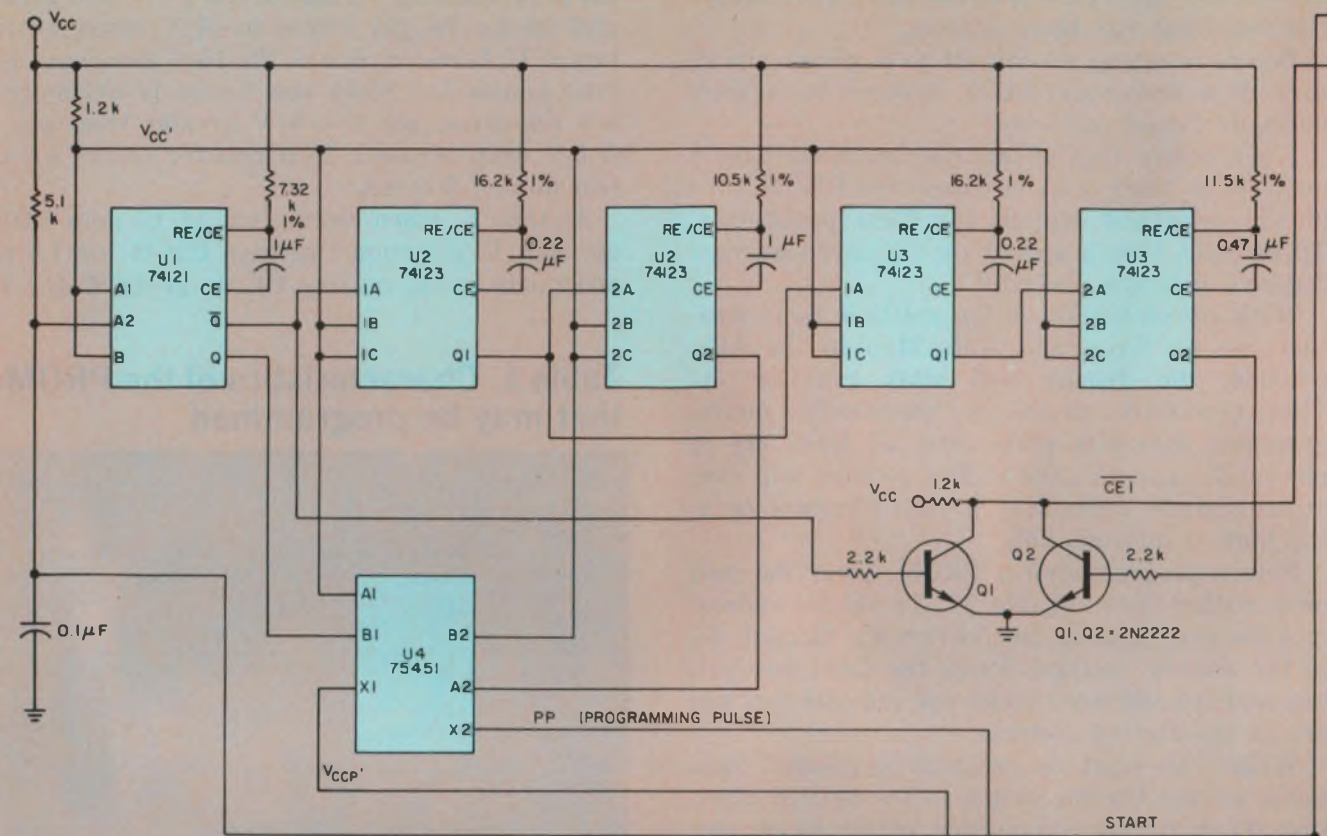

NOTES:  
 ALL RESISTOR VALUES ARE IN OHMS AND ARE 1/4 WATT, 5% TOLERANCE UNLESS OTHERWISE SPECIFIED  
 THE "LT" & "RB1" INPUTS TO U13, U14 AND U15 ARE TIED TOGETHER AND CONNECTED TO V<sub>CC</sub> THRU A 1.2k RESISTOR.

2. The programmer circuit is basically the manufacturer's recommended circuit, with additional features that allow verification of unprogrammed PROMs.



# The CROWN M-600 will drive shake tables, speaker coils, sonar transducers or servo motors.

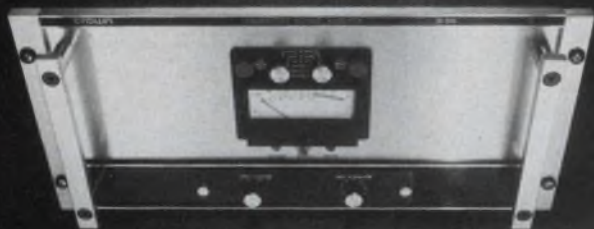

The Crown M-600 Amplifier is good at driving transducers, no matter what they're used for.

It's immune to damage from shorted, open or mismatched loads.

It operates continuously at full rated power.

It will give you up to 78 volts RMS. It will give you up to 1000 watts into 4 ohms, DC to 15 KHz. It works into any impedance. Compare the M-600 to any other amp in its frequency range, no matter what it's used for.

We're especially interested in helping you answer any application questions you might foresee for the M-600. Tell us your problem. We may already know a solution.



1718 W. Mishawaka Road, Elkhart, Indiana 46514

**219 / 294-5571**

CIRCLE NUMBER 77

Table 2. A typical PROM coding sheet

ADDRESS									OUTPUT			
A <sub>7</sub>	A <sub>6</sub>	A <sub>5</sub>	A <sub>4</sub>	A <sub>3</sub>	A <sub>2</sub>	A <sub>1</sub>	A <sub>0</sub>	Word	O <sub>1</sub>	O <sub>0</sub>	O <sub>2</sub>	O <sub>3</sub>
0	0	0	0	0	0	0	0	000				
0	0	0	0	0	0	0	1	001				
0	0	0	0	0	0	1	0	002				
0	0	0	0	0	0	1	1	003				
0	0	0	0	0	1	0	0	004				
↓	↓	↓	↓	↓	↓	↓	↓	↓				
1	1	1	1	1	0	1	1	251				
1	1	1	1	1	1	0	0	252				
1	1	1	1	1	1	0	1	253				
1	1	1	1	1	1	1	0	254				
1	1	1	1	1	1	1	1	255				

U<sub>12</sub>, convert the eight address lines to BCD.<sup>3</sup> The BCD-to-seven-segment decoders, U<sub>13</sub>, U<sub>14</sub> and U<sub>15</sub>, drive the seven-segment LED readouts displaying the decimal address.

Counters U<sub>6</sub> and U<sub>7</sub> are synchronous 4-bit up/down types that are cascaded to count to 255. The counter outputs drive the PROM address lines.

There are three ways to set a desired address on these lines:

1. Set the switches S<sub>A0</sub> through S<sub>A7</sub> to the desired combinations of "1's" and "0's," and push the Load pushbutton. These steps transfer the input data to the output.

2. Use the Single Step (S/S) switch, a spdt momentary pushbutton, to increment or decrement the address counters, depending upon the position of the Up/Dn switch.

3. Move the Auto/Manual (Auto/Man) switch to the Auto position, and the counter increments up or down at one of two rates. When moved to the Auto position, the nonretriggerable one-shot, U<sub>16</sub>, fires a 30-μs pulse to set the Auto/Man flip-flop, U<sub>17</sub>. Pin 4 of U<sub>18</sub> then goes HIGH and enables the 555 timer.

Resistor values shown will produce a free-running oscillator frequency of approximately 60 Hz in position one, 12 Hz in position two and 3 Hz in position three. The clock pulses go into U<sub>6</sub>, which will count either up or down depending on the position of switch Up/Dn.

The eight-input NAND-gate, U<sub>8</sub>, monitors the address lines so that when the address reaches word 255, the output will go LOW and reset the Auto/Man flip-flop. ■■

#### References

1. *Signetics Bipolar Memories*, data sheets for the 82S126 and 82S129, Signetics, Sunnyvale, CA, February, 1975.
2. *Signetics Data Book*, Copyright 1974, Signetics Corp.
3. *The TTL Data Book for Design Engineers*, First Edition, Copyright 1973, Texas Instruments, Inc., Dallas, TX.



# We're jumps ahead of any other flat cable/connector system.

## And we can save you up to 50%.

Now you can eliminate flat cable assembly with our new, pre-assembled Great Jumpers. Our new Great Jumpers come to you in one piece, assembled the way you tell us, as directly interchangeable replacements for the jumpers you're using now. And they come complete with integral, molded-on, strain-relieved connectors featuring amazingly accessible line-by-line probeability.





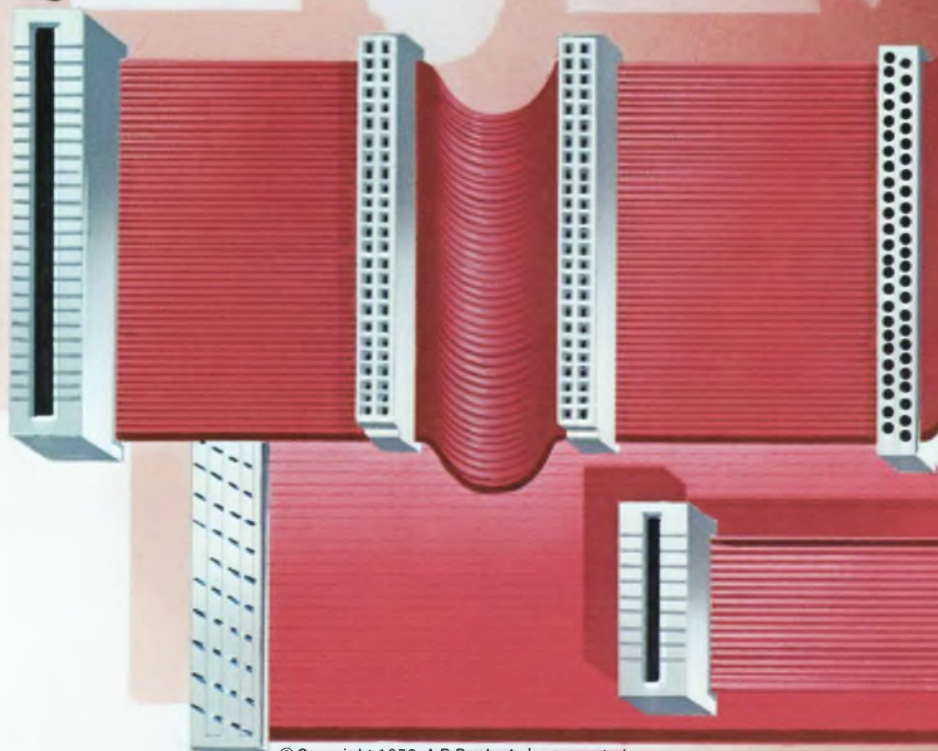
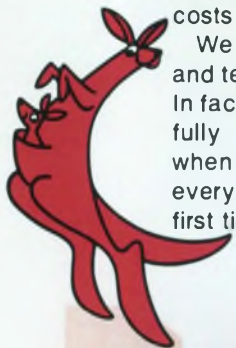



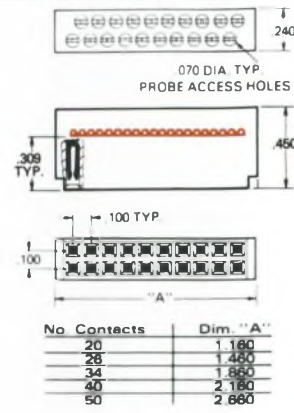

After all, when you pay for a jumper, why pay again to put it together? And why put up with caps that can fall off? Or connections that depend on a connector staking operation? Simplify with Great Jumpers. You'll avoid extra costs and extra problems.

We assemble our Great Jumpers ourselves and test them before they ever leave our factory. In fact, we're the only manufacturer who delivers fully assembled and pre-tested jumpers. So when you specify A P, you can be assured that every jumper you get does its job right the first time.

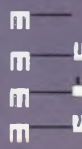

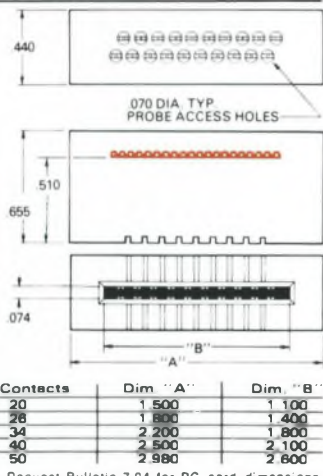
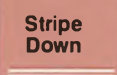
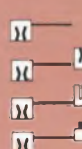

# Second, choose your connectors.

	Top View	Side View	Right Connector	Contacts		Style Code	
				Left	Right		
<b>Left Connector (Socket)</b> 	<b>Stripe Up</b> 		None	Down	N/A	922501	
			Socket	Down	Down	922521	
			PCB	Down	Down	922522	
			Card-Edge	Down	Down	922523	
			Socket	Down	Up	922531	
			PCB	Down	Up	922532	
			Card-Edge	Down	Up	922533	
	<b>Stripe Down</b> 		None	Down	N/A	922511	
			Socket	Down	Up	922541	
			PCB	Down	Up	922542	
			Card-Edge	Down	Up	922543	
			None	Down	N/A	922502	
			Socket	Down	Down	922526	
			PCB	Down	Down	922524	
Card-Edge	Down	Down	922525				
<b>Stripe Up</b> 		Socket	Down	Up	922536		
		PCB	Down	Up	922534		
		Card-Edge	Down	Up	922535		
		None	Down	N/A	922512		
		PCB	Down	Up	922544		
		Card-Edge	Down	Up	922545		
		Socket	Down	Up	922546		
<b>Left Connector (Card-Edge)</b> 	<b>Stripe Up</b> 		None	Down	N/A	922503	
			Socket	Down	Down	922528	
			PCB	Down	Down	922529	
			Card-Edge	Down	Down	922527	
			Socket	Down	Up	922538	
			PCB	Down	Up	922539	
			Card-Edge	Down	Up	922537	
	<b>Stripe Down</b> 		None	Down	N/A	922513	
			Card-Edge	Down	Up	922547	
			Socket	Down	Up	922548	
			PCB	Down	Up	922549	
			None	Down	N/A	922504	
			Socket	Down	Down	922527	
			PCB	Down	Down	922525	

Dielectric: UL recognized glass-filled polyester. Non-corrosive contacts: Socket connector and card-edge connector, alloy 770; PCB connector, alloy 725. All dimensions in inches.

## Now you're ready to order.

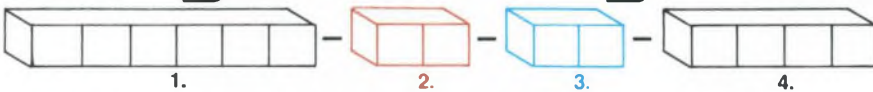

- Enter 6-digit style code (see chart)
- Indicate whether 20, 26, 34, 40 or 50 contacts in connector
- Enter "01" for Electric pink solid conductor cable.  
Enter "02" for Electric pink stranded conductor cable.  
Enter "99" for rainbow stranded conductor cable. (Available on single-ended jumpers only)
- Enter tip to tip length in inches.  
± 1/8 inch tolerance for jumpers up to 12"  
± 1/4 inch for jumpers over 12" and under 36"  
± 1/2 inch if longer than 36"





# Get your first Great Jumper free from your A P Products rep.

He'll have you hopping happy when you hear how little your next ones will cost.

Remember . . . fully assembled and tested AP Great Jumpers can cost just about half as much as competitive jumpers. In fact, if you allow for the cost of assembling and testing other jumpers, Great Jumpers can cost you even less.

So look up your local A P rep. And connect with him. For happier endings. By leaps and bounds.

## ARIZONA

Piper-Goyne, Incorporated  
P.O. Box 1648  
4261 North Brown Avenue  
Scottsdale, AR 85252  
Phone: (602) 946-4437  
(602) 949-8424  
TWX: 910-950-0083

## CALIFORNIA

Brooks Technical Group  
2465 East Bayshore, Suite 345  
Palo Alto, CA 94303  
Phone: (415) 328-3232  
TWX: 910-373-1198

Daniels & Doty Sales Co.  
5575 Magnatron Blvd. Suite B  
San Diego, CA 92111  
Phone: (714) 560-6266

Mission Marketing Group  
2182 Dupont, Suit 209  
P.O. Box 17477  
Irvine, CA 92713  
Phone: (714) 833-1802

## COLORADO

Piper-Goyne, Incorporated  
8041 West I-70  
North Frontage Rd.  
Denver, CO 80002  
Phone: (303) 420-4646  
TWX: 910-938-0755

## CONNECTICUT

Tri-Com Associates  
Wykeham Road  
Washington, CT 06793  
Phone: (203) 868-7748

## FLORIDA and S. EAST

Gra-Mar, Inc.  
3165 McCrory Place  
Orlando, FL 32814  
Phone: (305) 894-3351  
TWX: 810-850-0125

## ILLINOIS

Coombs Associates, Inc.  
1001 East Touhy  
Des Plaines, IL 60018  
Phone: (312) 298-4830  
TWX: 910-233-5980

## INDIANA

Elliott Engineering Sales Co.  
5102 Roberta Drive  
Fort Wayne, IN 46806  
Phone: (219) 447-9623

## MARYLAND

Compar Chesapeake, Inc.  
7 Church Lane  
Baltimore, MD 21208  
Phone: (301) 484-5400  
TWX: 710-862-0860

## MASSACHUSETTS

Tri-Com Associates  
Box 172  
Burlington, MA 01803  
Phone: (617) 272-8163

## MICHIGAN

Norm Case Associates, Inc.  
P.O. Box 103  
Milford, MI 48042  
Phone: (313) 356-2161

## MINNESOTA

Charles E. Bohlig Associates  
P.O. Box 16183  
Minneapolis, MN 55104  
Phone: (612) 922-7011  
TWX: 910-576-3429

## MISSOURI

Beneke & McCaul, Inc.  
P.O. Box 24552  
226 Chamonix Court  
St. Louis, MO 63141  
Phone: (314) 434-6242  
(Also)  
12825 Bristol  
P.O. Box 144  
Grandview, MO 64030  
Phone: (816) 765-2998

## NEW JERSEY

Compar New York, Inc.  
404 Clifton Avenue  
Clifton, NJ 07011  
Phone: (201) 546-3660  
TWX: 710-989-7239

Sunday-O'Brien, Inc.  
15 Potter Street  
Haddonfield, NJ 08033  
Phone: NJ (609) 429-4013  
Phone: PA (215) 923-5195  
TWX: 710-896-0679

## NEW MEXICO

Piper-Goyne Incorporated  
11701 Manual NE  
P.O. Box 14894  
Albuquerque, NM 87111  
Phone: (505) 294-1436

## NEW YORK (Metro)

Compar New York, Inc.  
404 Clifton Avenue  
Clifton, NJ 07011  
Phone: (201) 546-3660  
TWX: 710-989-7239

## NEW YORK (Upstate)

Nycorn, Incorporated  
2002 Teall Avenue  
Syracuse, NY 03206  
Phone: (315) 437-8343  
TWX: 710-541-1506

## OHIO

Norm Case Associates, Inc.  
P.O. Box 4791  
Fairview Park, OH 44126  
Phone: (216) 333-4120  
TWX: 810-421-8396  
(Also)  
P.O. Box 217  
Centerville, OH 45459  
Phone: (513) 433-0966

## OREGON

Freed Associates  
2953 NW Imperial Terrace  
Portland, OR 97210  
Phone: (503) 223-3374

## TEXAS

Allied Components, Inc.  
Suite 730, Keystone Park  
13771 N. Central Expressway  
P.O. Box 31027  
Dallas, TX 75243  
Phone: (214) 238-0408  
TWX: 910-867-4783  
(Also)  
4615 North Freeway, Suite 305  
Houston, TX 77022  
Phone: (713) 691-3961  
TWX: 910-881-3741  
(Also)  
P.O. Box 14274  
Austin, TX 78761  
Phone: (512) 443-9687

## WASHINGTON

Freed Associates  
11031 118th Place NE  
Kirkland, WA 98033  
Phone: (206) 822-8223

## WISCONSIN

Coombs Associates, Inc.  
6663 Industrial Loop  
Greendale, WI 53129  
Phone: (414) 421-2300

## CANADA

Weber Electronics, Inc.  
1111 Finch Ave. W.  
Downsview, Ontario  
M3J2E5  
Phone: (416) 638-1322

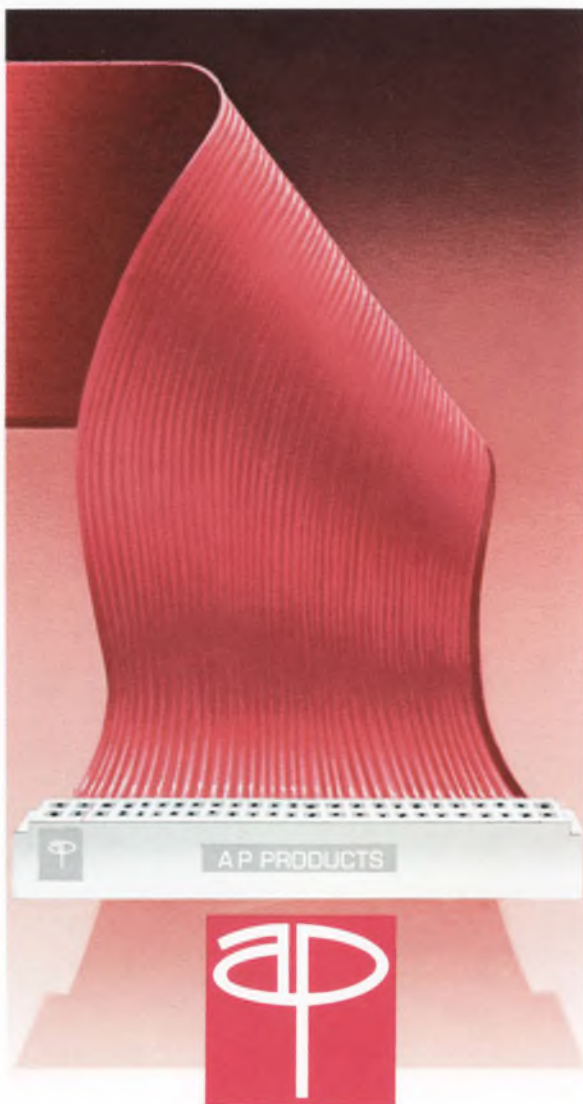

## A P PRODUCTS INCORPORATED

Box 110-Q • 72 Corwin Drive • Painesville, Ohio 44077

Tel: 216/354-2101 • Twx: 810-425-2250



# Let's talk about a way for you to save hours in microprocessor SOFTWARE DEBUGGING

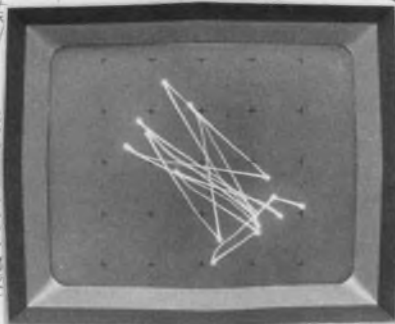
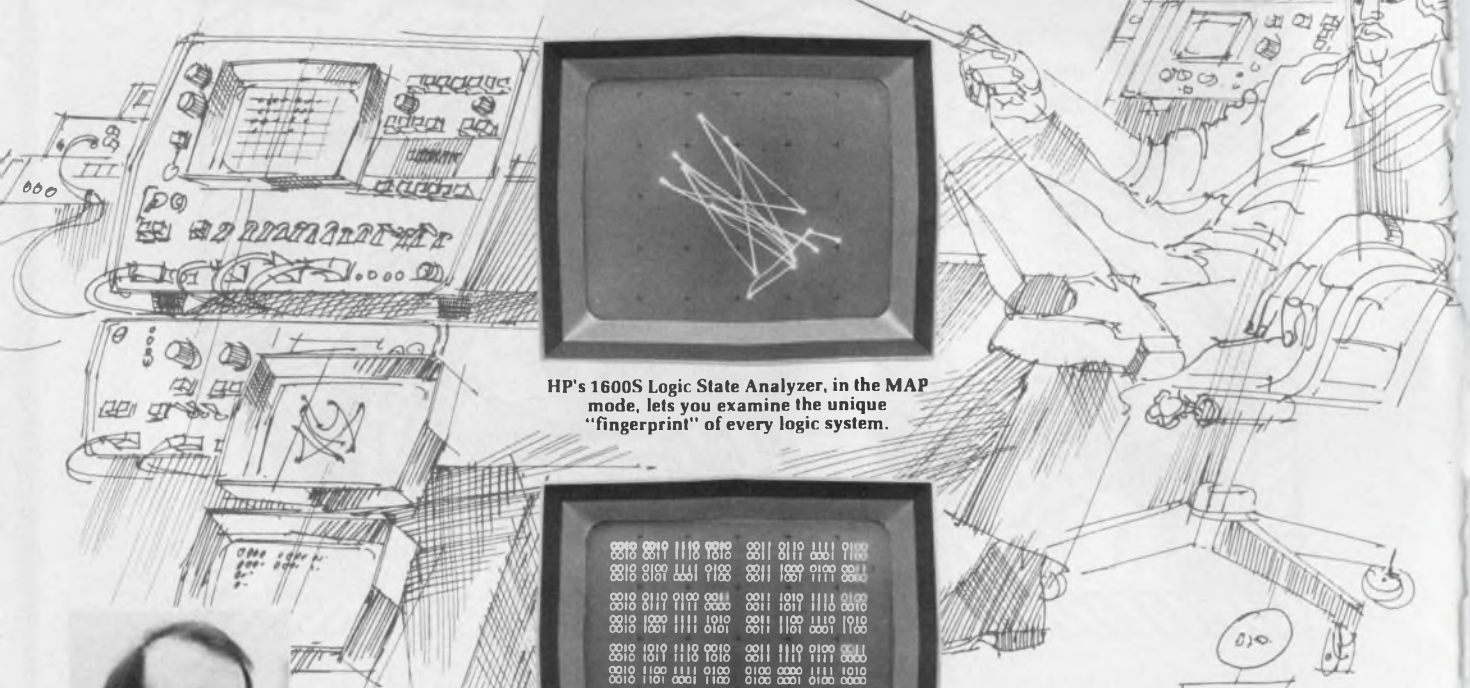

HP's 1600S Logic State Analyzer, in the MAP mode, lets you examine the unique "fingerprint" of every logic system.

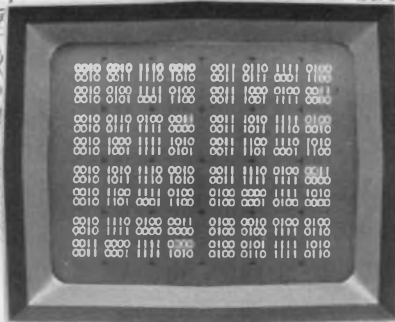

In the TABLE mode, the 1600S displays up to 16 lines of code, with their sequential relationships in familiar logic notation.



I mean many hours of savings if you've ever had this problem: You've just finished

your prototype microprocessor-based system, made the preliminary checks on the hardware, and loaded the program in RAM. You hit the start button. Everything's running smoothly, then wham! You're out of business. Things are out of sequence and the system is doing things you never intended. Now you could be in for hours—or even days—of troubleshooting.

But let me tell you about a much faster way to spot software problems... with HP's 1600S Logic State Analyzer. This instrument lets you look inside your operating circuit—right on the buses and qualifier lines—and see program implementation. That's the fastest way I know to locate software problems in operating circuits. Actually, the 1600S gives you two ways to view program flow:

**Mapping.** This is a dynamic view of your system's operation... a pattern of dots and lines that are unique for each program. Each dot is a specific data word. It's location indicates binary magnitude, and its brightness indicates relative frequency of occurrence.

You might call the map a personal fingerprint. It's different for every program. With a little practice, you can easily spot a suspicious pattern and locate the word or group of words that could be the trouble

source. Then you simply position a cursor over the word in question and push a front-panel switch to go to the Table display mode.

**Table.** The CRT now gives you a display of word flow using the word you selected as the trigger point. It displays up to sixteen 32-bit words at one time... in familiar One's and Zero's. You can look at events leading up to, surrounding, or following the trigger word. And even delay up to 99,999 clock cycles beyond the trigger point to view events anywhere in your program.

Suppose your problem is an erroneous data word that causes an unwanted jump. Mapping helps you spot the jump, and the Table mode lets you quickly compare each data word leading up to the jump with your written program.

That's just a simple example. HP's 1600S Logic State Analyzer, priced at \$7100\*, can speed more complex software debugging problems too. We'd like to tell you more. And HP has arranged a number of seminars to make that possible. Find out how to attend one in your area by calling your local HP field engineer. He can also supply you with complete spec sheets and application notes detailing the use of mapping

for troubleshooting minicomputer and microprocessor systems. You'll discover an exciting new concept in digital troubleshooting.

\*Domestic U.S.A. price only.



**HEWLETT  PACKARD**

Sales and service from 172 offices in 65 countries.  
1507 Page Mill Road, Palo Alto, California 94304



## A bidirectional pulse stretcher

has many uses. Superior to conventional stretchers, this dc-coupled circuit handles noisy signals and has Schmitt action.

Pulse-stretcher circuits are not exactly new tools for logic designers and control-system engineers. But the versatile pulse stretcher, shown in basic form in Fig. 1a, can provide such a large array of desirable properties that it is worthwhile for logic designers and control system engineers to examine its attributes closely and to learn how to fashion those attributes to their needs.

In a conventional, unidirectional pulse stretcher (Fig. 2), each positive-going input transition triggers a pulse generator to produce a logic-ONE output pulse whose width,  $T$ , is controlled by the generator. This generator pulse, when applied to an OR gate, effectively locks the system output into the ONE state for a period  $T$ . Input transitions are ignored during this period.

After  $T$  has elapsed, the input signal regains control of the output. If the input is now ZERO, the system output becomes ZERO (pulse 1, Fig. 2); if the input is still ONE, the output stays at ONE (pulse 2, Fig. 2).

Clearly, the difference between a pulse stretcher and a plain pulse generator is that a pulse stretcher can continue the output pulse after its internal pulse generator has timed out.

The positive-feedback, pulse-stretcher circuit, of course, provides this basic pulse-stretcher function, but it also:

- Handles bidirectional input transitions.
- Provides either symmetrical or selective responses to positive and negative-going transitions with a single RC-timing circuit.
- Dc couples the input and output.
- "Sharpens" and "cleans" fuzzy or poorly defined input transitions with regenerative trigger action.
- Allows a simple way of introducing hysteresis to give a bidirectional and polarity-selective Schmitt-trigger action.
- Operates with a wide range of supply voltage—from +5 to  $\pm 15$ -V.

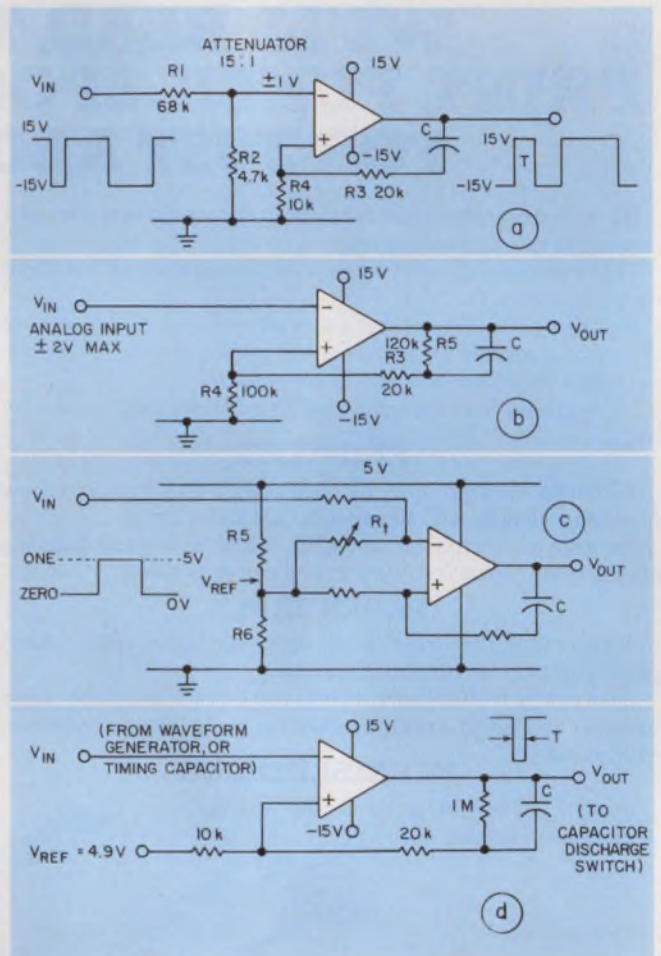

1. The versatile basic bidirectional pulse stretcher (a) can have symmetrical hysteresis (b), can operate on a single +5-V supply and have adjustable holding-time (c), or can detect a voltage reference level (d).

A conventional circuit, in general, can't provide all these variations or perform them as well as the new circuit.

### The stretcher uses a comparator

In the new pulse stretcher (Fig. 1a), the digital input signal directly couples to the inverting terminal of a comparator (or to an op amp used as a comparator). Regenerative ac feedback is applied between the output and the noninverting input terminal.



T are unaffected. Bidirectional pulse-stretching action is shown in Fig. 3f.

### Restoring waveforms

An important advantage of this positive-feedback, pulse-stretcher method over the usual triggered pulse generator is that the pulse-stretcher can handle poorly shaped input trigger pulses (Fig. 2g). The Fig. 1c circuit, for example, triggers when an input "pulse" first passes through  $V_{ref}$  potential, and all further variations are ignored. Of course, the trigger "pulse" must have disappeared before the time period T has elapsed.

With the usual pulse-generator circuit, a noisy trigger signal must first be smoothed and applied to a Schmitt-trigger stage before it is applied to

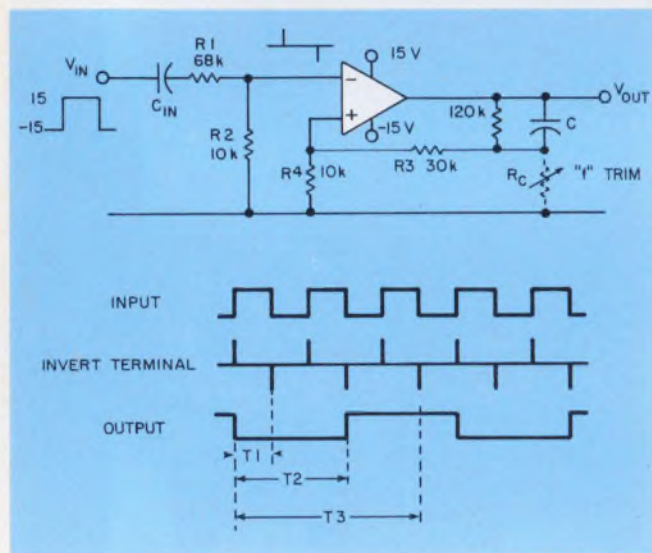

4. As a frequency divider, the pulse stretcher is particularly suitable for dividing by odd numbers.

the pulse generator. The positive-feedback circuits all give fast regenerative switching action, and hysteresis if desired, in one simple circuit.

Fig. 3h shows two types of signal distortion: multiple transitions on pulse edges and slow, noisy transitions between two levels. The positive-feedback pulse stretcher can produce "clean" output waveforms with such difficult-to-handle inputs. The usual RC filter followed by a Schmitt trigger for removing such transition noise, delays the output transitions. The pulse-stretcher circuit of Fig. 1 directly gives an output transition coinciding with an initial input transition that exceeds the circuit's threshold. The output is then locked for time T.

An important application of this capability controls the operation of a high-power electronic switch. Electrical noise, generated as the switch changes state, can interfere with low-power electronics and can cause false switching actions. In

a fast-acting control system, filter delays can't be tolerated. But the pulse-stretcher circuits can reject such noise without adding any delays to the system.

### Frequency division can be done, too

The pulse stretcher can be put to good use as a frequency divider—especially for division by an odd number. It has two important advantages over the usual capacitor-timed frequency divider. It can provide equal mark-to-space ratio outputs (50% duty cycle) because of its bidirectional nature. Also, it has a wide capture range for variations of input frequency.

The frequency capture range is increased by using a hysteresis version of the stretcher circuit with an input differentiator (Fig. 4). The circuit has symmetrical positive and negative trigger levels and holds either output state continuously in the absence of input trigger signals. The output holds, first, until time period T has elapsed and, second, until a trigger pulse of opposite polarity appears.

If  $T_1 < T < T_2$ , the circuit divides by 3. If  $T > T$ , simple inversion results—frequency division is unity. If  $T_2 < T < T_3$ , frequency division by 5 results.

Fig. 4 shows division by 3. Note that positive output transitions coincide with negative input transitions, and that the negative output transitions coincide with positive input transitions. This bidirectional property is not normally achieved in other odd-frequency dividers.

Because this circuit only divides by odd numbers, the absence of even division allows a wide capture range. When dividing by 3, input frequency variations of  $\pm 50\%$  (3:1 frequency range) can be tolerated. When dividing by 5, 7 or 9, input frequency variations of  $\pm 25\%$ ,  $\pm 16\%$ , and  $\pm 12\%$ , respectively, can be tolerated.

To trim the time T of the circuit, resistor  $R_c$  (shown dotted in Fig. 4) is used. A trim control in this location has the least effect on the input and feedback arrangement.

### Stretcher makes a good test probe

A dc-coupled, bidirectional pulse stretcher is ideal for building a logic test probe. A probe must energize, de-energize, or flash a visual indicator in response to a logic ONE, logic ZERO, or pulsating input, respectively. The pulse-stretcher circuit (Fig. 3a) can be used with any supply voltage from 5 to 20 V. The probe tip requires very little drive current from the monitored logic signal.

For use with a 5-V supply, the monitored logic terminal must supply  $30 \mu A$  in the ONE state and sink  $20 \mu A$  in the ZERO state. Note the



# A reducing plan for microprocessors.

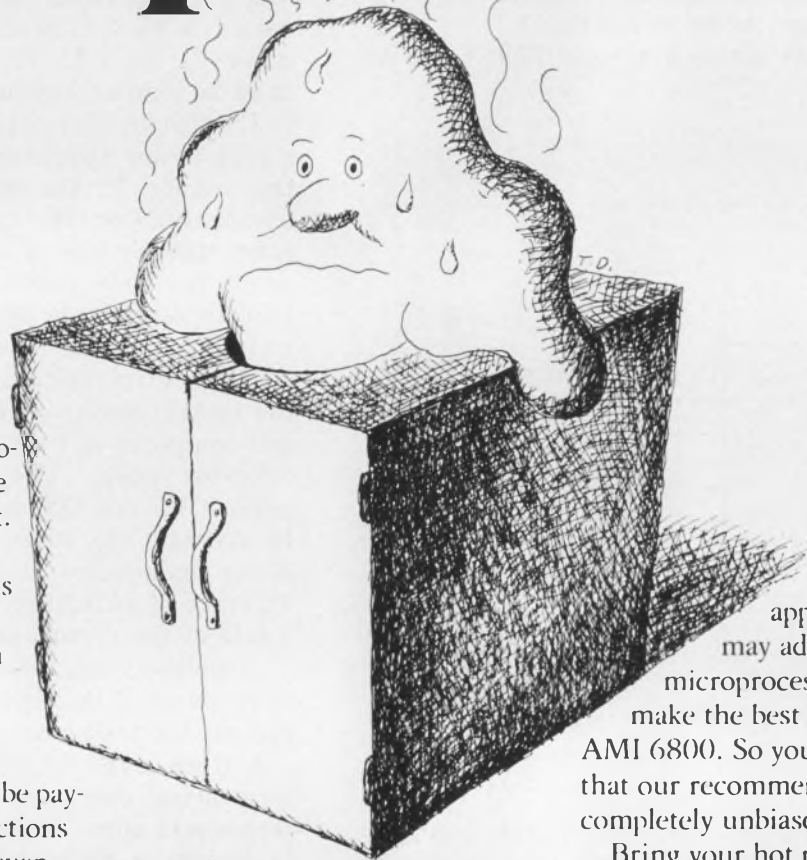

Here's a way to get a micro-computer that's *exactly* the right size for your product.

It's a custom microprocessor. We've made millions of them since 1966. And we're selling more of them today than ever.

The reason is simple. When you buy a standard microprocessor, you could be paying for a lot of built-in functions that you don't need. And, even though the standard part is cheaper going in, you can tell by the chart that custom comes out ahead in high volume runs.

If you're not sure which way to

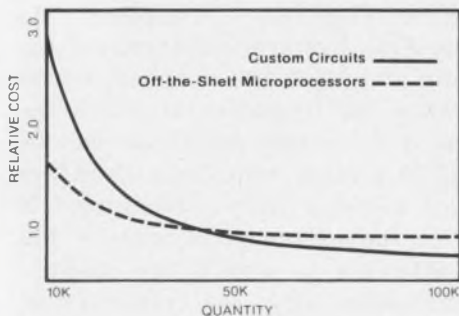

go, come to us. Nobody can match our experience in custom MOS, with our full-time staff of engineers, technicians and marketing specialists. We've recently developed a totally new method of design that cuts about 25 percent off the development cycle time. And our production lines in Santa Clara and Pocatello are geared to produce all the CMOS, N-Channel or P-Channel circuits you want.

After we've assessed your

application, we may advise a standard microprocessor—ours! We make the best one going, the AMI 6800. So you can be sure that our recommendation will be completely unbiased.

Bring your hot new idea to your nearest AMI sales office. Or write for our brochure on Custom MOS to: AMI, 3800 Homestead Road, Santa Clara CA 95051. One way or another, we'll help you cut out the fat.

Long Beach CA (213) 595-4768 • San Jose CA (408) 249-4550 • Altamonte Springs FL (305) 830-8889 • Elk Grove Village IL (312) 437-6496 • Norwood MA (617) 762-0726 • Livonia MI (313) 478-9339 • Minneapolis MN (612) 559-9004 • Monsey NY (914) 352-5333 • Cleveland OH (216) 292-6850 • Ampler PA (215) 643-0217 • Richardson TX (214) 231-5721

After we've assessed your **tailor-made MOS from AMI**

AMERICAN MICROSYSTEMS, INC.

CIRCLE NUMBER 81



## AM detector deflutters analog-signal tape outputs with only three IC packages

When amplitude modulation is recovered from an analog tape recorder, tape-transport flutter introduces both phase and amplitude distortion. Although electromechanical feedback frequently is used to remove low-frequency, tape-speed variations (wow), the short-term (flutter) variations of a mechanical tape drive system must usually be removed electronically. In critical applications, if the AM envelope lies within or near the flutter passband, some method of defluttering the recovered modulation is imperative.

The circuit in Fig. 1 provides both a defluttered and AM-detected signal with the help of only three ICs: a Reticon 128-V serial analog memory (SAM), an NE565 phase-lock loop (PLL), and an LM324 quad op amp. The SAM provides time-base error correction and also functions as an AM detector.

The system uses two carrier-frequency band-pass active filters, made with LM324 sections,  $Z_1$  and  $Z_2$ . Filter  $Z_1$  should have sufficient bandwidth to permit envelope recovery, and  $Z_2$  should be narrow enough to prefilter the signal for the

PLL. The output of  $Z_1$  is applied to the analog input of the SAM.

The SAM-input shift register is clocked by the negative-going edges of the PLL voltage-controlled multivibrator output,  $CP_1$ . Since the PLL is locked  $90^\circ$  out of phase with the output of  $Z_1$ , the peaks of the carrier waveform are sequentially stored in the SAM (Fig. 2). A stable clock signal,  $CP_0$ , is then used to clock the output shift register of the SAM at the carrier frequency.

As in all time-base modification schemes, the input and output time bases should be equated on a long-term average. Obviously, time-base expansion or contraction could be implemented by appropriate changes in the output shift-register clock rate,  $CP_0$ .

The resulting output of the SAM is a defluttered, time-sampled reproduction of the input-signal envelope. A low-pass filter,  $Z_3$ , is then used to smooth the output samples.

Although some additional logic may be required, depending upon the application, the basic circuit can be realized with only three IC packages.

*K. Russell Peterman, Radio Sciences Div., Applied Research Lab, The University of Texas at Austin, Austin, TX 78712. CIRCLE NO. 311*

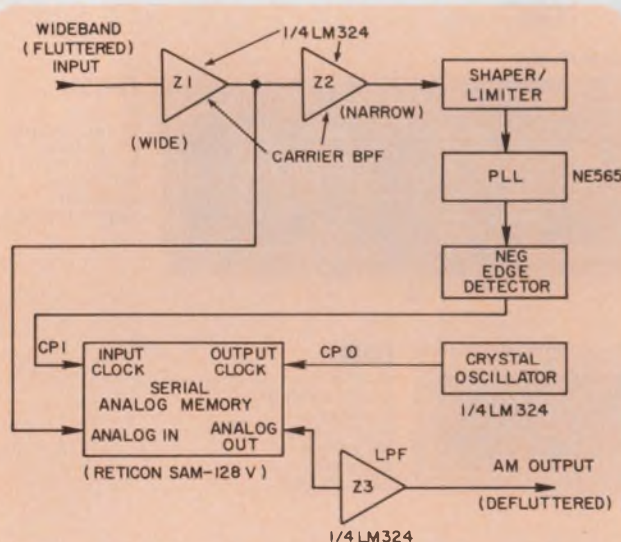

1. The block diagram of a basic tape-signal AM demodulator and deflutterer shows the use of only three ICs. But some applications may need additional logic.

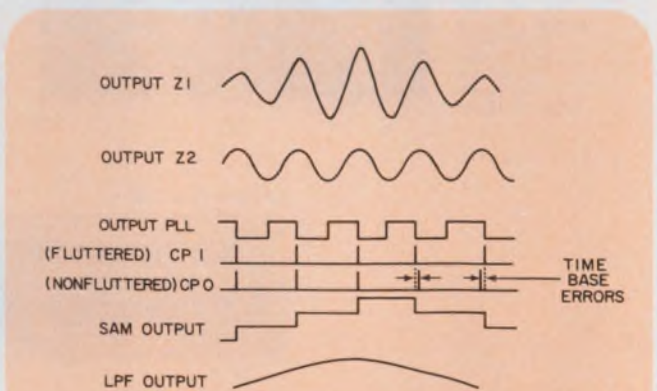

2. The timing diagram of the demodulator/deflutterer starts with a fluttering, AM-modulated signal and ends with a time-sampled reproduction of the input-signal's envelope.



# Battery monitor operates on only a few microamperes

If you need to "remember" that a battery-supported circuit died; want to protect a nickel-cadmium battery from polarity reversal during discharge; or wish to cut off a battery as soon as it reaches some minimum voltage, here's a circuit that performs with a snap. It steals only 4 to 5  $\mu\text{A}$  from a 3.6-V battery.

The RCA CA3078 op amp that is used has an input for the control of its quiescent current and can operate on as low as 1.5 V. A 1N816 forward-reference diode, with only a few microamps flowing through it, provides a clean threshold voltage.

Although the op amp consumes less than a microamp, it temporarily supplies milliamperes of output when, as a comparator, it flips to the ON state. This easily drives  $Q_1$ , which latches a magnetic reed relay in the OFF state until the reed relay is reset.

When the relay cuts the battery off from all loads, the op-amp circuit also is shut off. Most reed relays have enough momentum to flip reliably to the lock-out state, even if no storage capacitor,  $C_1$ , is provided. Larger relays, however, would probably need such coulomb storage.

Caution: Protect the reed from switching directly into capacitors when the circuit is reset. Even small capacitors can draw peak currents

capable of welding reeds. Use a small limit resistor such as  $R_1$  in series with any such capacitor.

*Maynard J. Kuljian, Product Manager, Applied Materials, 3050 Bowers Ave., Santa Clara, CA 95051.*

CIRCLE No. 312

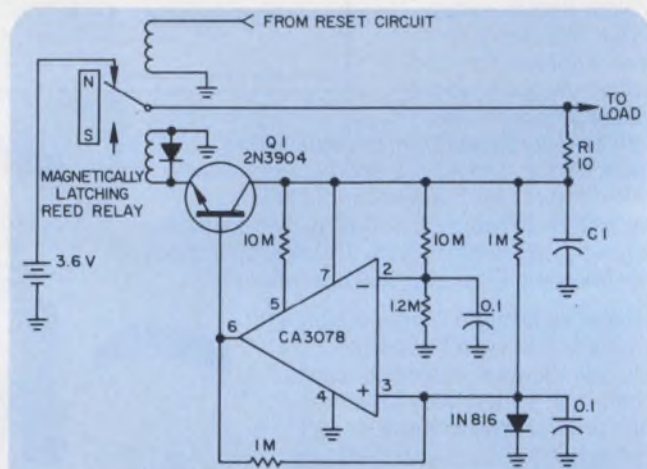

$C_1$ : (LOW-LEAKAGE, SIZE  $\approx 0.1 \mu\text{F}$ , OR AS REQUIRED)  
Although the battery monitor uses only microamperes in the monitoring state, when triggered into the ON state, it temporarily supplies milliamperes to operate the cut-off reed relay.

# Display-blanking circuit saves power, improves readability

Two circuits can suppress unwanted zeroes in a 4-1/2-decade display that uses the 5082-7300 series of Hewlett-Packard indicators (Figs. 1a and 1b). Since each indicator consumes about 94 mA at 5 V, substantial power is saved by selective blanking. Also, the display is easier to read.

Each indicator consists of a  $4 \times 7$ -dot LED matrix and also an on-chip decoder/driver with holding memory. The chips operate on BCD inputs. Types 7300/7302 have left and right-hand decimal points; type 7340 has a display-blanking facility instead of the decimal points.

When the first four decades of the display use 7300/7302 indicators, their ON state is controlled by transistor switches ( $Q_1$  to  $Q_4$ ) connected in series with  $V_{cc}$  and pin 7 of each device (Fig. 1a). Four decades of a ripple counter ( $IC_1$  to  $IC_4$ ) supply the numerical input codes. A conventional

LED,  $LD_1$ , shows overflow ( $1 \times 10^4$ ). This overflow LED is controlled by a single J-K or D latch.

A simplified truth table for four representative stored counts 00000 (reset), 10000, 01010 and 00001 is helpful in understanding the circuit's operation and the results obtained.

Gates  $IC_1$ ,  $IC_2$ , and  $IC_3$  may be CMOS types—CD4002 or CD4011, for example. But if a CMOS type is used for  $IC_1$ , then it's likely that Darlington transistor switches will be required to operate on the limited base drive available and supply the high 94 mA demanded by the indicators. However,  $IC_1$  could be a low-power TTL type such as SN74L00N that can interface with the CMOS gates and drive the single-transistor switches.

(continued on page 190)



## IDEAS FOR DESIGN (continued)

The circuit for the 7340 (Fig. 1b) is almost identical to that of the 7300/7302 types; however, no switching transistors are needed. The blanking signals are applied directly to pin 4 of the indicator chips. The gates of IC<sub>6</sub> must be capable of supplying the required maximum 2-mA ON control current at about 3.5 V. The OFF current is only 200  $\mu$ A. If a TTL gate is used for IC<sub>6</sub>, then a 3.3-k $\Omega$  pull-up resistor should be used at each blanking terminal.

Blanking is not as efficient with 7340s as with the 7300/7302 types, because it reduces the supply current from 94 mA to only about 45 mA. On the other hand, the 7340 allows you to multiplex the display without sacrificing use of its memory facility. In the first method, the total supply cur-

rent of each indicator is interrupted, which wipes out its memory.

*H. A. Cole, Electronics & Applied Physics Div., AERE Harwell, Oxfordshire, OX11 0RA, England.*

CIRCLE No. 313

## Blanking-circuit truth table

Stored Count	Points in the circuit										Display condition				
	A	B	C	D	E	F	G	H	I	J	10 <sup>0</sup>	10 <sup>1</sup>	10 <sup>2</sup>	10 <sup>3</sup>	10 <sup>4</sup>
00000	1	1	0	1	1	0	1	1	0	1	✓	X	X	X	X
10000	0	1	1	0	1	1	0	1	1	0	✓	✓	✓	✓	✓
01010	1	0	1	0	1	1	0	0	1	0	✓	✓	✓	✓	X
00001	1	1	0	1	1	0	1	1	0	1	✓	X	X	X	X

(Note: 1 = V<sub>cc</sub>; 0 = 0V; ✓ = display enabled; X = display inhibited)

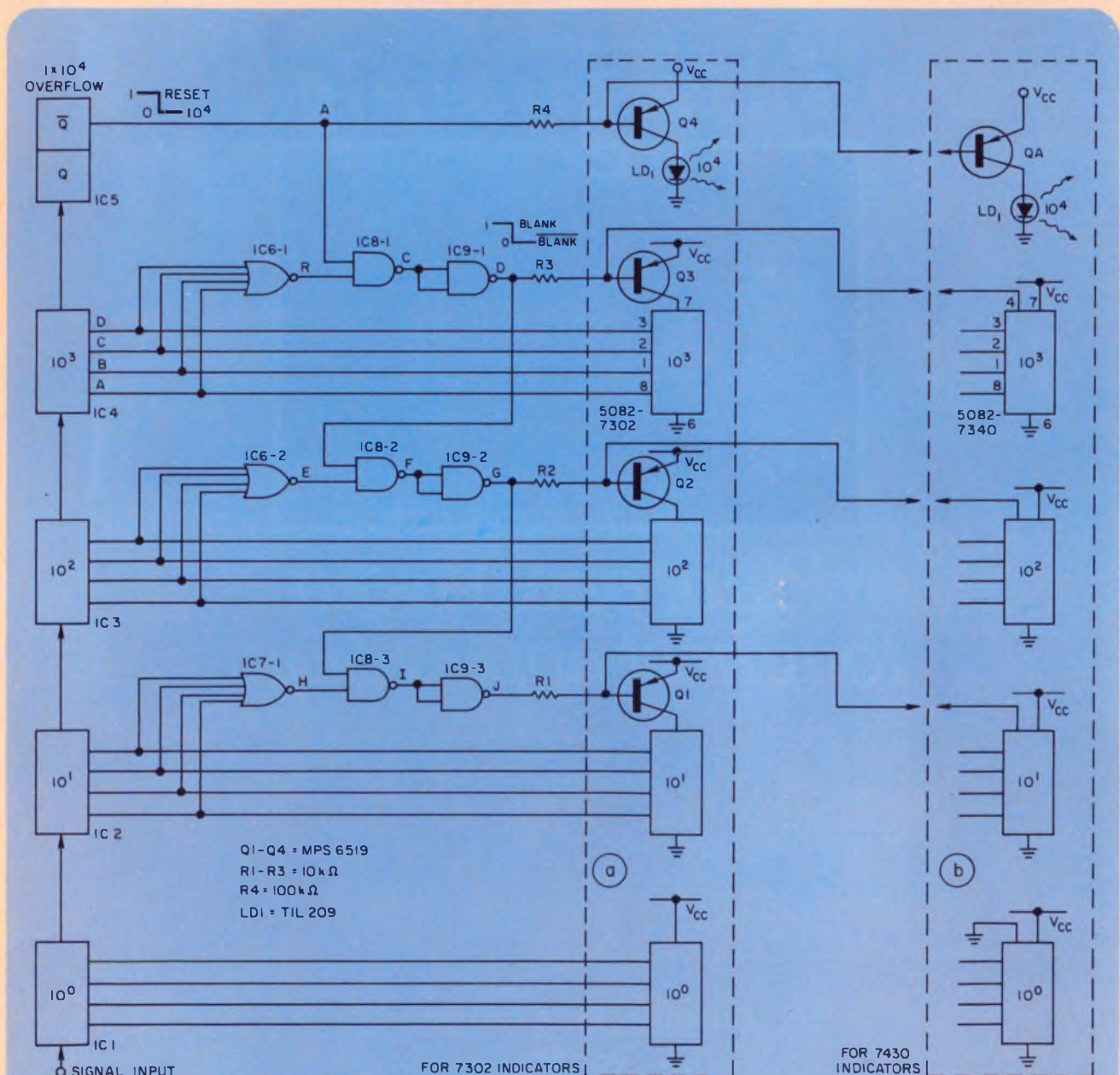

1. A LED-display blanking circuit (a) provides high-efficiency operation. But a second circuit (b),

though much less efficient, retains the use of the memory function and allows multiplexing.



# Simple circuit detects data edges; advanced circuit provides complex outputs

Need to detect the edges of asynchronous data pulses? Use the basic edge-detector circuit shown in Fig. 1. The data can be any digital signal. The clock rate, of course, depends on the application, but it will usually be much greater than the transition rate of the data.

The clock propagates the data edges (both leading and trailing) through a two-bit shift register as shown by waveforms A and B. The delay between a transition in A and a transition in B is exactly one-clock period,  $T$ . Therefore, the Exclusive-OR gate,  $G_1$ , produces an output pulse of duration  $T$  immediately following a transition in the data (waveform C).

Although this circuit design allows the input data to be asynchronous, it still provides an output that is synchronous with the clock. However, the output, corresponding to a detected edge, may be delayed by as much as one clock period with respect to the input.

If the data are synchronous, FF<sub>1</sub> can be eliminated and the output, or detected edge, will, of course, synchronize with the input data edge. If only leading edges or lagging edges are desired, the data signal or its complement, respectively, can be gated with the output pulse. Longer output pulses can be produced by increasing the length of the shift register.

An extension of this basic edge-detector circuit allows the generation of precise pulse sequences. Fig. 2 shows a generalized sequencing circuit. This circuit can provide numerous output pulses of various widths and delays (waveforms 1, 2, and 3). Also, the pulses can be made to overlap. The only restriction is that the time between data transitions must be greater than the duration of the desired output pulse sequence. The clock rate, of course, depends on the specific application.

The basic detector circuit (Fig. 1) finds applications in designs calling for the "differentiation" of data signals; the sequencing circuit (Fig. 2) can be used to control a sequence of events that must occur after a transition. Such a sequence is often needed in a/d and d/a converters, sample-and-hold circuits and resettable-integrator circuits.

Leland Langston, Project Engineer, Texas Instruments, P.O. Box 6015 Dallas, TX 75222.

CIRCLE No. 314

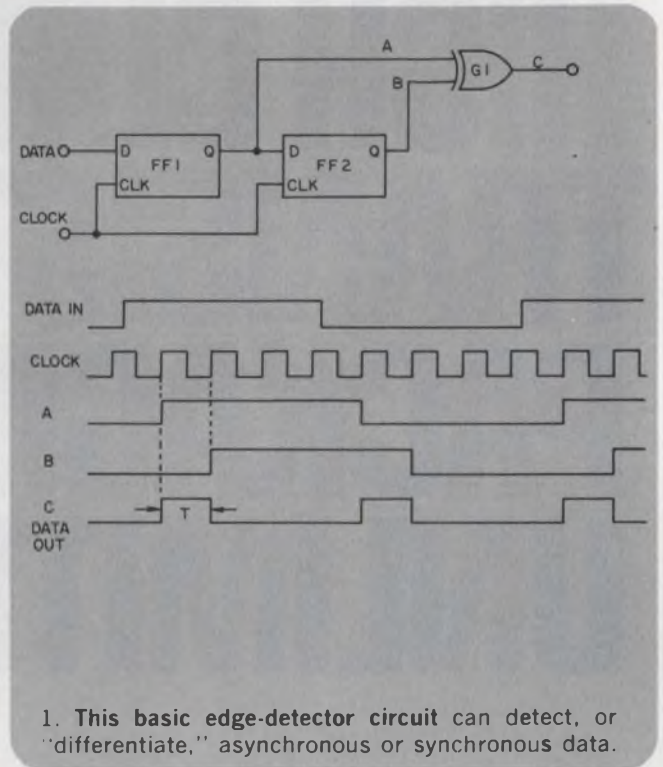

1. This basic edge-detector circuit can detect, or "differentiate," asynchronous or synchronous data.

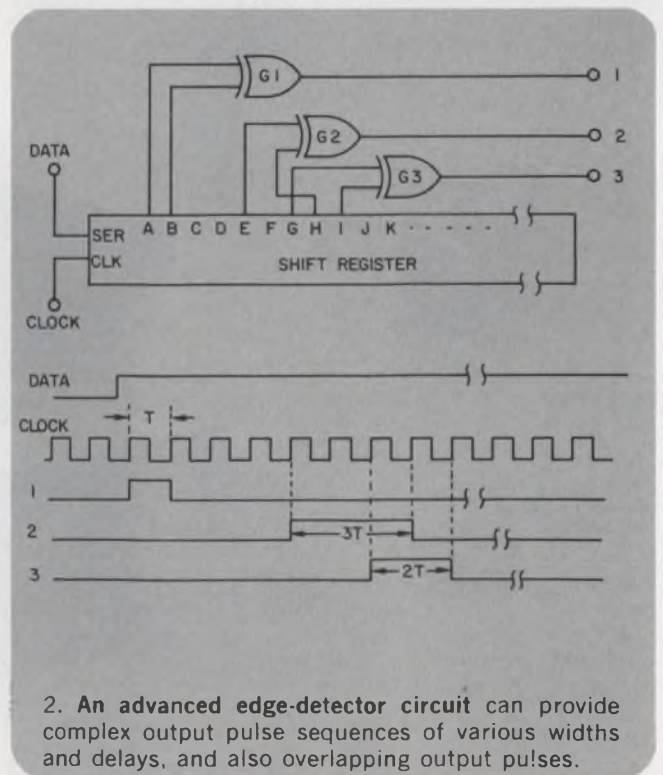

2. An advanced edge-detector circuit can provide complex output pulse sequences of various widths and delays, and also overlapping output pulses.



# Circuit monitors blinking phone lights and provides soft but commanding tone

For the phone extension that has no bell, this "phone-lite" monitor watches the flashing buttons of a two-line phone extension and provides an audible tone (Fig. 1).

A 2N5777 photo-Darlington cell picks up blinking light from the transparent plastic buttons. The cell mounts to the phone with black adhesive tape and is connected to a tiny circuit board by a flexible cord that can be taken from a transistor-radio earphone.

Special features of this circuit include low cost, no electrical connection to the phone line and current consumption only when the light flashes. The power is switched ON and OFF by a hi-beta 2N3904 transistor. The circuit's 9-V battery can be left continuously connected. Less than a micro-ampere is drawn—even with normal, office ambient light and the phone lights not flashing.

Logarithmic action of a 2N4250 transistor produces easily detectable differences in the pitch and pattern of the output tones. The differences allow you to know whether two lines are ringing or one is on hold and the other ringing and so on. Differences result because the hold-light pattern is quicker than the ringing pattern.

Because of the circuit's ac coupling, the output tones are soft and gentle, but stirring enough to command notice. When a line is called, the speaker emits an initial high-pitched signal that subsides quickly to a lower, but still noticeable pitch. On hold, the tone continues to pulsate, thus serving as a good reminder for a secretary that someone is still waiting on the line. The tone subsides completely when a line is answered or used for calling, since the light then remains on continuously.

For noisy locations, the tone can be made louder with an output transformer (ratio of 250:8) or

a 100- $\Omega$  speaker that replaces the 22- $\Omega$  resistor in the output.

*Hugh Macdonald, Hypnosis Research, Psychology Dept., Standard University, Stanford, CA 94305.*

CIRCLE No. 315

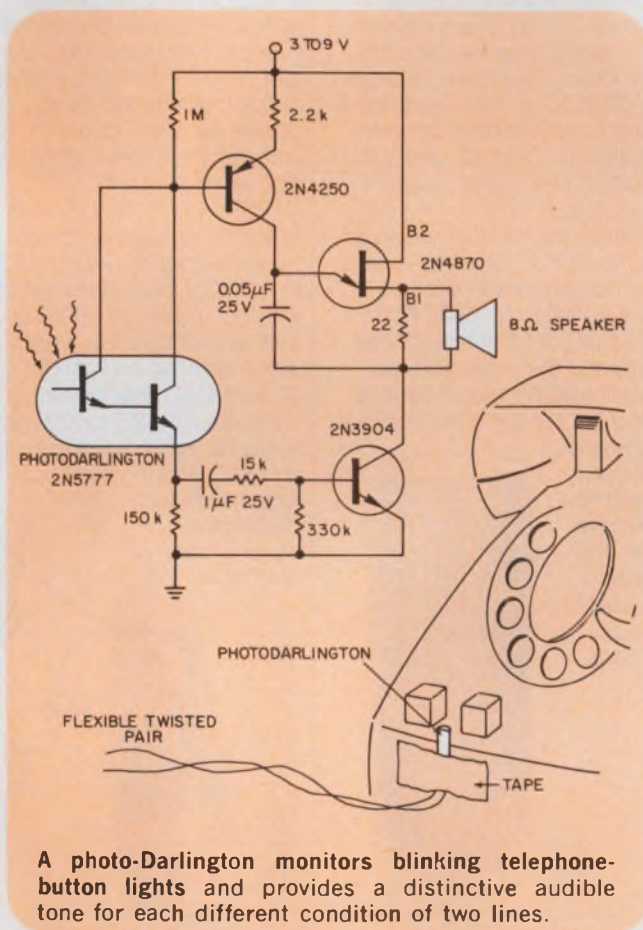

## IFD Winner of June 21, 1976

**James Nash**, 1518 S. Wenonah Ave., Berwyn, IL 60402. His idea "Improve Conventional Ignition Systems With a Transistor-Assisted Approach" has been voted the Most Valuable of Issue Award.

**Vote for the Best Idea in this issue** by circling the number of your selection on the Reader Service Card at the back of this issue.

**SEND US YOUR IDEAS FOR DESIGN.** You may win a grand total of \$1050 (cash)! Here's how. Submit your IFD describing a new or important circuit or design technique, the clever use of a new component or test equipment, packaging tips, cost-saving ideas to our Ideas for Design editor. Ideas can only be considered for publication if they are submitted exclusively to ELECTRONIC DESIGN. You will receive \$20 for each published idea, \$30 more if it is voted best of issue by our readers. The best-of-issue winners become eligible for the Idea of the Year award of \$1000.



## 'Fail-proof' network uses six close-coupled minis

The "close-coupled network," a new concept in distributed processing systems that uses six PDP-11/45 minicomputers, has been developed by Infonet BV in Amsterdam.

The network is virtually fail-proof and offers big computer performance at less than half the comparable cost, 100% data availability and easy modular expansion up to 16 CPUs, according to Infonet.

The close-coupled network differs substantially in concept from the four other commonly used networks:

- **The hierarchical network.** It normally has three levels. At the lowest level, various minicomputers carry out on-line functions. At the intermediate level, a dedicated computer system supports the minis. And at the highest level, a general-service, large-scale computer provides batch and interactive services.

- **The ring network.** It is flex-

ible in that it does not depend on the operation of any one component. When one node issues a service request, the other systems bid on providing that service.

- **The local network.** In this, no processor is the master, but the kernel of an operating system resides somewhere within it.

- **The virtual-channel network.** Here, simple hardware interfaces take the place of software.

The kernel of Infonet's system resides in each machine rather than in one, as with a local network. There is no hierarchy, no master and no slave. The resident operating program sits in each machine with the application program. The first two minis cope with teleprocessing, the next two handle processing and the last two do the file management.

If one of the minis fails, the system continues to function. If two machines fail on the same level, some functions are lost, but the system itself continues.

these conditions, one set of plates polarizes and is covered with an insulating layer of hydrogen bubbles. If a high voltage appears across the potassium-hydroxide cell, the cell breaks down the bubbles and discharges the excessive voltage to the ground.

## New microprocessor for switching applications

ITT's Standard Telecommunication Laboratories, Hallow, England, has developed what it calls a Boolean processor, a microprocessor aimed particularly at switching applications. The device is based on a one-bit bus, and its logic unit performs the standard operations—or combinations—of Boolean algebra, hence, the processor's name.

Logic signals are manipulated via the bus, which collects data from 11 data inputs and from internal storage elements. After serial processing in the logic unit, the new data are routed either to the 11 data outputs or back to the storage elements.

The processor is controlled by a series of 8-bit words stored in a memory that is addressed in a fixed cyclic sequence by means of a binary counter. Its programs are nonbranching to ensure inherent real-time reference. Internal delay elements and input-key debouncing are also included.

## Polarization cell guards against high voltage

Steel structures and pipelines subject to cathodic protection are electrically isolated from normal grounds by the use of insulated flanges or couplings. If lightning strikes part of the structure or if the high-tension cables fail, very high voltages can appear at these flanges. The result is dangerous to both man and plant, especially gas and petrochemical plants.

A new kind of polarization cell, developed by Metal and Pipeline Endurance Limited to protect against this problem, can be fitted

across the insulated flange to provide a safe bypass for grounding the dangerous voltages. The cell consists of two sets of stainless steel plates, mounted parallel to each other like those in a lead-acid battery, and immersed in a potassium-hydroxide electrolyte.

One set of plates is connected to the insulated side of the insulation flange and the other set is connected to the ground.

In normal operation, the voltage difference between each side of the flange does not exceed 1 V. Under

## Temperature converter is very stable

A highly stable electronic temperature converter that conditions signal outputs from temperature sensing elements or thermocouples has been introduced by Philips, Eindhoven, the Netherlands. Output stability is  $\pm 0.1\%/V$  supply voltage variations,  $\pm 0.05\%/^{\circ}K$  temperature difference and  $\pm 0.1\%/24$  hours. The temperature measuring range is adjustable in nine steps from  $-100$  to  $1200$  C.



# Arrow-M Amber Relays

## An important communication for the telecommunications industry.

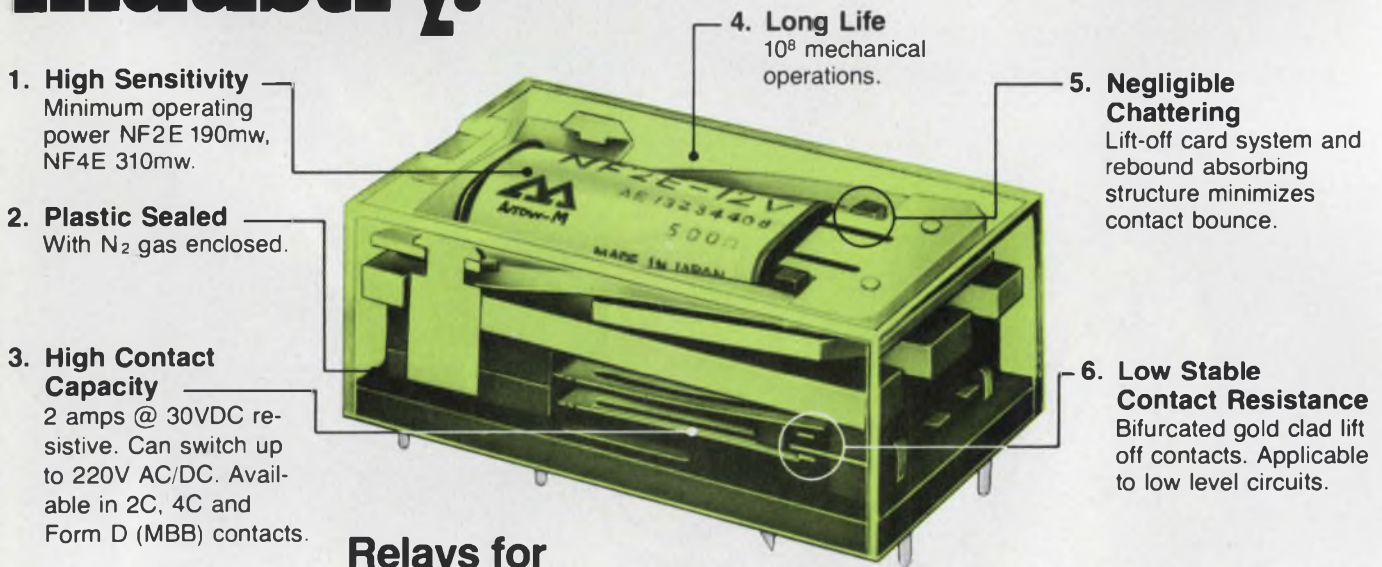

### Relays for advanced technology.

Arrow-M NFE Amber relays give you high sensitivity with half the power drain... N<sub>2</sub> gas-filled plastic sealed for automatic wave soldering and ultrasonic cleaning.

The low power requirements of most telecommunications computer installations demand critical sensitivity and reliability in the relay systems.

Arrow-M Flatpack NFE relays offer maximum reliability and sensitivity using half the power of ordinary relays. The Flatpack design, only .425 inches high, is ideal for high density PC board packaging. The unique automated modular assembly insures extra long life and total reliability. And the gas-filled plastic sealed construction allows for economical automatic wave soldering and ultrasonic cleaning.

For NFE relays providing maximum sensitivity and reliability with minimum power drain, look to Arrow-M, the Company with over 50 years of meeting and advancing needs of modern technology.

For more information on exact specifications, write or call your nearest Arrow-M office.

**Arrow-M Corporation**  
250 Sheffield St.  
Mountainside, N.J. 07092  
(201) 232-4260

*Western Office:*  
22010 South Wilmington Ave.  
Suites 300 & 301  
Carson, California 90745  
(213) 775-3512



**Arrow-M**

Member of Matsushita Group





# ALONE AGAIN

in low cost 1-watt Zener Diodes

## SCHAUER

"Z" SERIES ZENERS

DO-41 epoxy molded case

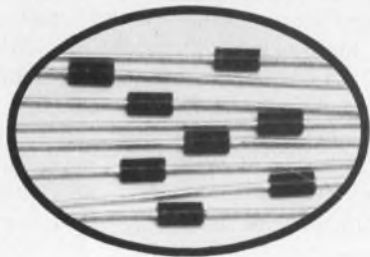

### ANY VOLTAGE

· 2.6 to 34.0

### ANY TOLERANCE

1% 2% 5% 10%

### At Any Test Current

Compare These Prices  
On 1% Tolerance Diodes

Quantity	Price each
1-99	91¢
100-499	83¢
500-999	77¢
1000 up	73¢

### LARGE STOCK GOOD DELIVERIES

Send for complete rating data and other tolerance prices.

Semiconductor Division

## SCHAUER

MANUFACTURING CORP.

4511 Alpine Ave., Cincinnati, OH 45242  
Telephone 513-791-3030 Telex 21-4576

### Preset up/down counter features very small size

*Non Linear Systems, Box N, Del Mar, CA 92014. (714) 755-1134.*

Combining MOS/LSI technology and miniature preset switches has resulted in a very small preset up/down counter the PR-5. The 57 × 82 × 100 mm device has a counting rate that varies between 0 and 300 Hz for contact closure and maximum 500 kHz with an electronic pulse. On the front panel there is one pushbutton to reset the counter and five preset switches. One for each digit. These functions can also be controlled externally. Additional control inputs and signal outputs such as counter preset, register preset, counter inhibit, display hold, display blank, leading zero blank, up/down input, BCD output (bit parallel, character serial), coincidence signal, coincidence signal latched, zero signal make the PR-5 very flexible. The power supply is single +12 V. When a stand-by power is required the PR-5B can be used which has additional buffer batteries to supply the counter for one hr.

Stand No.                      Circle No. 309

### Rectangular connector fastened by screwdriver

*Amphenol-Tuchel Electronics GmbH, 8024 Deisenhofen bei München, West Germany. (089) 6132001.*

Amphenol industrial connector series C146E provides screwdriver-tightened connections for small-lot industrial production. These rectangular connectors come with 6, 10, 16 and 24 contacts and have contours identical with Amphenol-Tuchel crimp wiper shaft units. They are insertable in all C146, D, E, and HvE-series Amphenol-Tuchel pressure-cast housing. The connecting screws have a head diameter of 4.5 mm, which makes it unnecessary to use specially small, watch-maker type tools.

Stand No. 1211              Circle No. 310

### Scanner measures static electricity

*Scientific Enterprises Inc., Static Control Div., P.O. Box 220, 2801 Industrial Lane, Broomfield, CO 80020. (303) 466-6611.*

The Scientific Enterprises' field scanner can measure the charge on a part as small as an IC chip and even the static associated with large industrial machines. It features autoranging, and will measure from 10 to 9,990 V in 10-V steps and from 10,000 to 99,990 V in 100-V steps. This device does not use radio-active material in its sensing head; therefore, a major component of error and lack of sensitivity is eliminated.

Stand No. 2240G              Circle No. 320

### 3 PROM programmers offer variety of I/Os

*CCIP, 7104 Obersulm-Willsbach Schillerstrasse 2, West Germany. (07134) 3014. See text.*

Three different types of PROM programmers are offered by CCIP: Models PRO-2000 VLC, PRO-2001 and PRO-2002. The PRO-2000 VLC (very low cost) is used for programming only the type 1702A PROM. Information is inputted via switches and is displayed on LEDs. The other two programmers are  $\mu$ P-controlled and accept the PROM types 1702A, 2704, and 2708. A hexadecimal keyboard provides input data to the PRO-2001, and the data are presented, in hexadecimal format, on a LED display. Optionally, a teletypewriter or paper-tape reader can be connected to this programmer. The PRO-2002 unit must be connected to a teletypewriter. Supported by this teletypewriter, the PROMs can be programmed through the keyboard as well as through the paper-tape reader. The PROM printout occurs via the printer or teletypewriter punch. Prices of the three programmers range from \$423 to \$2116 without teletypewriter and paper-tape reader.

Stand No. 14201              Circle No. 321



# MEET OUR family of dip clips

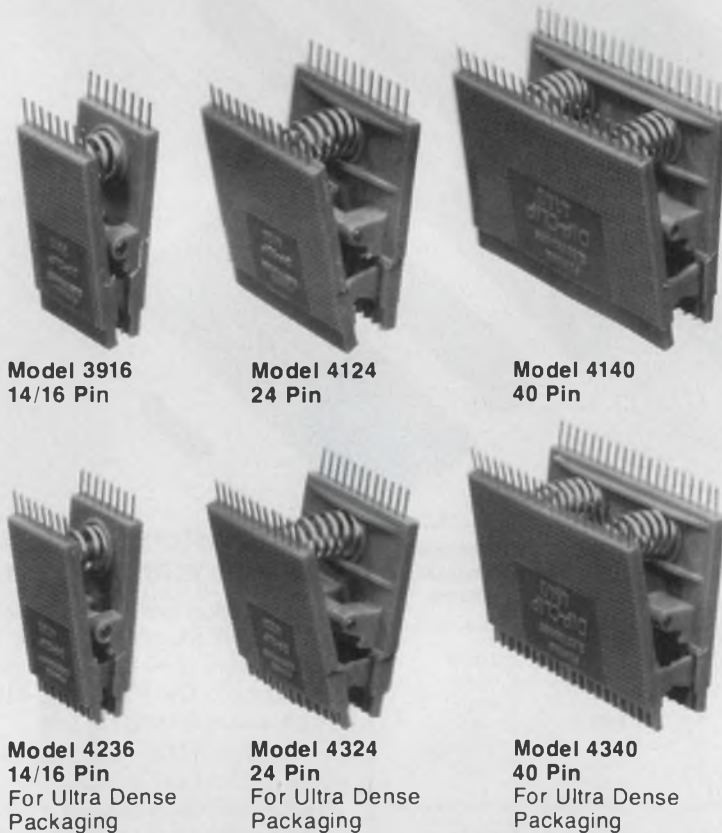

**Model 3916**  
14/16 Pin

**Model 4124**  
24 Pin

**Model 4140**  
40 Pin

**Model 4236**  
14/16 Pin  
For Ultra Dense  
Packaging

**Model 4324**  
24 Pin  
For Ultra Dense  
Packaging

**Model 4340**  
40 Pin  
For Ultra Dense  
Packaging

**Count on Pomona Electronics** to keep pace with the industry's trend toward higher density Dual In-Line packaging. We introduced the first Model 3916 in 1972. Now there are six improved models, including three designed for ultra dense packaging.

**DIP CLIPS** are designed for hands-free testing of integrated circuit packages. Lower contacts are .050 wide for improved surface contact with I.C. packages. Test contacts are .025 square, and are serrated for improved connection of test clips. Molded barrier between contacts minimizes accidental shorting. Can also be used as insertion and removal tool for DIPs.

**Available Through Your Favorite Electronic Parts Distributor**

## ITT POMONA ELECTRONICS

1500 East Ninth St., Pomona, Calif. 91766  
Telephone (714) 623-3463. TWX: 910-581-3822



CIRCLE NUMBER 92

## electronica 76

### Soldering-iron sets have thermal controls

*Fleet Communication Services, Ludgate House, 107 Fleet St., London EC4A 2AQ.*

Satellite soldering and desoldering units are designed as plug-in replacements for use with existing 24-V soldering stations. The units use the Invader system in their thermally controlled bits, which operate at a temperature of 410 C. A pencil handle can slip into a spring holder fitted to the majority of existing soldering stations. The units are available in two models: a 1/16 or a 1/8-in. Adiron long-life soldering bit. A special shim device eliminates bit seizure in the collet. A Bulgín 430 plug and 1-1/2-m of burnproof siliconized rubber cable connects the unit to the power source.

Stand No.

Circle No. 322

### Mini controlled system tests discretes and ICs

*Lorlin Industries, Inc., Precision Rd., Danbury, CT 06810. (203) 744-0096. \$28,750; 60 days.*

A new computer-controlled test system for discrete semiconductors and linear ICs is modular and has a wide range of hardware and software options. Called IMPACT II, it is custom assembled to fit a particular customer's requirements. Later, if the user's needs change, the system can be easily reconfigured. Depending upon the options chosen, the system can be assembled for wafer testing, engineering evaluation, production testing, incoming inspection, or high reliability testing and sorting. The versatility of the IMPACT II allows it to replace three previously manufactured ATE systems with a single product. All of the popular discrete devices can be tested on the new system. In addition, options are available for new devices such as power FETs, 4-layer diodes, DIACS, PUTs, and opto isolators. IMPACT II employs a PDP 11 central processor. I/O chores are handled via cassette tape; floppy-disc, tape-cartridge and paper-tape units are available as options.

Stand No.

Circle No. 323



# AMPERITE

## Thermostatic RELAYS

-LONG DELAY-

240 & 300 Seconds



New! For applications requiring long delays. Hermetically sealed — not affected by altitude, moisture, or climate changes... SPST only — normally open or normally closed... Compensated for ambient temperature changes from -55° to +80°C... Rugged, explosion-proof, long-lived... Standard radio octal base only.

Price, under \$6.00 ea.

Write for Bulletin No. LD-73.

### DELAYS:

2 to 180 SECONDS\*

Same rugged construction, hermetic sealing and stability as the long Delay Relays described above... For standard radio octal and 9-pin miniatures.

Price, standard or min., under \$4.00 ea.

\*Miniatures delays: 2 to 120 seconds.

PROBLEM? Send for Bulletin No. TR-81.

All Amperite Delay Relays are recognized under component program of Underwriters' Laboratories, Inc. for all voltages up to and including 115V.

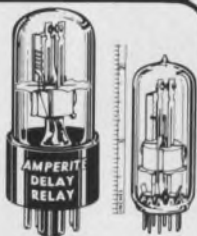

## DIFFERENTIAL RELAYS

For automatic overload, over-voltage or under-voltage protection... Made only to specifications for 70V, 80V, 90V and 100V.

Price, under \$6.00 ea.

## AMPERITE BALLAST REGULATORS

Automatically keeps current and voltage at a definite value. For AC or DC... Hermetically sealed, rugged, vibration-resistant, compact, most inexpensive.

Price, under \$3.00 ea.

Write for 4-p. Bulletin No. AB-51.



# AMPERITE

600 PALISADE AVE., UNION CITY, N.J. 07087

Telephone: 201 UNION 4-9503

In Canada: Atlas Electronics, Ltd.,  
50 Wingold Ave., Toronto 19

OUR COMPLETE PRODUCT LINE CAN BE FOUND IN ELECTRONIC DESIGN'S GOLD BOOK.

CIRCLE NUMBER 94



electronica 76

## Laser cuts and drills complicated shapes

Garching Instrumente GmbH, D8046 Garching, Freisinger Landstrasse, 25, West Germany. (0811) 3291855. See text.

A materials-processing laser (available in three models) can be used for drilling or cutting hard materials into complicated shapes. An Nd:YAG model (wavelength = 1.06  $\mu\text{m}$ ) can be operated either in cw mode or in relaxed mode with an acousto-optical Q-switch. Also available are CO<sub>2</sub> units operating at a wavelength of 10.6  $\mu\text{m}$ . All systems include focusing optics and either a microscope or TV for viewing the sample. Modular design allows the extension of the three models from manual control and sample positioning to fully automatic, computer-controlled systems. Power output of the Nd:YAG 1.06- $\mu\text{m}$  laser is 50 W. Export prices for the Models YL23, 24 and 25 are 69,300, 126,500, and 73,700 DM, respectively.

Stand No. 16223 Circle No. 326

## Ion implanter handles wafers automatically

High Voltage Engineering Europa B.V., Amsterdamseweg 61, P.O. Box 99, Amersfoort, the Netherlands. 033-19741.

This 350 keV ion implantation system features compact design, a high-temperature, hollow-cathode ion source and good mass separation by use of a 90-degree mass analyzing magnet placed immediately after the ion source. Gold implantations can be made with no more effort than for the implantation of boron, phosphorus or arsenic. The system is suited for implantation doses up to 10<sup>14</sup> particles/cm<sup>2</sup> (50  $\mu\text{A}$  B, 80 P, 50 As, 20 Au). The fully automatic wafer handling system can handle up to 300 wafers/hour with implantation times of 10 seconds.

Stand No. 22412 Circle No. 327

## Wires stripped and cut under electronic control

Terima Steiner and Co., Kriesbachstr. 5, CH-8304 Wallisellen, Switzerland. (01)8306100.

The ASM-770, a new automatic wire cutting and stripping machine, is electronically controlled. No relays or switches are used. A photocell and built-in magneto-brake guarantee precise length measurements. Lengths are displayed on a digital counter. Total length for one side crimping is 70 to 10,000 mm. For crimping on both sides, the length span is 70 to 200 mm. Production capability of the machine is 5000 pieces per hour.

Stand No. 22407 Circle No. 328

## Slo-Syn drivers range from 1 to 5 k steps/s

Superior Electric GmbH, Bermer Str. 18, Niedereschbach, Frankfurt, West Germany. (0611) 50 72 067. See text.

Translator boards to drive Slo-Syn stepping motors in three speed ranges are available from Superior Electric. The STM101 drives bidirectionally at up to 1000 steps/s. It can operate from its internal oscillator or from external pulses. STM 101 sells for 260 DM without a power supply. A supply for this unit sells for 440 DM. The STM 103 board drives at up to 3000 full, 1.8° or 6000 half steps/s and costs 410 DM without a power supply. The supply for STM 103 sells for 590 DM. The TBM 105 translator operates at 5000 full or 10,000 half steps/s. This unit sells for 1950 DM, including its power supply. The external-trigger input on all three translator boards is TTL-compatible. A preset-indexing module, PIM 151, provides a preset number of pulses to any of the translator boards. The number of pulses is controlled by BCD-coded logic switches. This unit has indexed start, run and jog functions.

Stand No. 16205 Circle No. 329



## Linearizing amp aids temp measurement

*Paskovsky-Messelektronik GmbH, 6456 Langenselbold, Vogelsberstrasse 6, Germany. 06/84/2859.*

The linearizing amplifier LK-2674 is a direct current amplifier for exact temperature measurements with thermocouple elements. It is available in many configura-

tions and can be delivered in the form of a European card, a 19 in. wide drawer, a table stand or a wall housing. An interchangeable construction element is used for amplifying and linearizing of the thermoelectric voltage. The installed reference spot permits temperature measurements even for much fluctuating ambient temperatures. The linearized output voltage amounts to 1 mV/°C for all execu-

Stand No.

Circle No. 330

## Breadboard mounts ease circuit design

*Wainwright Instruments & Co., Widdersberger Strasse 14, D8036 Frieding, West Germany.*

A breadboarding system, designated Mini-Mounts, solves experimental circuit problems and offers security against mistakes and unpredictable effects. A circuit built with this system performs similarly to one built on a PC. Mini-Mounts use a copper-clad and tinned groundplane, together with 23 different small printed-circuit elements with pressure-sensitive adhesive on one side and an etched pattern of solder pads on the other. The PC elements can mount practically any electronic component. The components—soldered to the PC elements—are positioned on the groundplane, after removing an adhesive covering paper exposing a MIL-spec adhesive. Stray capacitance to ground is very small and can be compared with a PC. Inductance is minimized, because of the short distance to ground.

Stand No. 16539 Circle No. 331

## Benchtop IC tester is very easily programmed

*3H Electronics, 830-B E. Evelyn, Sunnyvale, CA 94086. (408) 733-0780.*

A family of small dedicated benchtop IC testers can be programmed with an ordinary lead pencil and IBM-type card. The card list names, range, management units and three columns of digits for value entry in ordinary numerical notation. The program can also be stored with a standard PROM-device. The parameters which can be measured include positive and negative supply current, input-offset-voltage, input-bias current, input-offset current, positive and negative output swing, open-loop gain, common-mode rejection ratio, power-supply rejection ratio, gain-bandwidth product, slew rate, input-offset-voltage adjust, oscillation indicator, quiescent current, output voltage, drop-out voltage, line regulation and ripple rejection. Three basic models (3H201, 3H202 and 3H203) are available and they can be interfaced with digital printers, probers, temperature chambers and handlers.

Stand No.

Circle No. 332



# Rack up Sales

Right from the beginning of a sale to its very end, no rack works harder for you than an Optima.

For the introduction of your product, distinctive styling and colors get you out in front, instantly. Set you apart from all the rest.

Rugged aluminum construction and durable finishes help promote your product's long range dependability.

Accessories like easy-sliding chassis and drawers, convenient doors and shelves give you still more selling points. And your customer more confidence.

We think Optima racks are silent salesmen. Once you see how they get your product going, so will you. For size information, color selection, options and accessories, call 404-939-6340 or write...

# OPTIMA

Optima® Enclosures a division of Scientific-Atlanta, Inc.  
2166 Mountain Industrial Blvd., Tucker, Georgia 30084



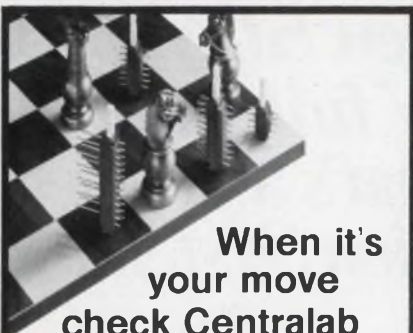

When it's  
your move  
check Centralab

## Visual display

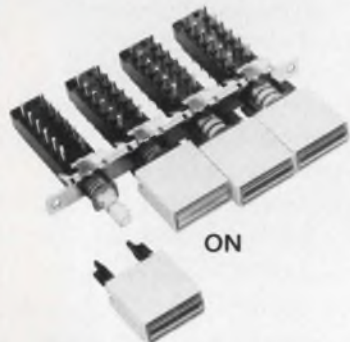

## in a non-lighted pushbutton switch

Now you can add visual display to Centralab non-lighted pushbutton switches. Our new status indicator button with a unique fluorescent reflective surface operates with ambient light to indicate switch status when activated. No power is required. There are no lamps to burn out.

Other features include:

- Choice of 6 display colors, 3 lens options and 5 button colors.
- Available with push-push or interlocking action.
- 140° peripheral viewing angle.
- Vertical or horizontal button mounting.

See your Centralab Pushbutton Distributor or send inquiry card for complete specifications.

Isostat Licensed

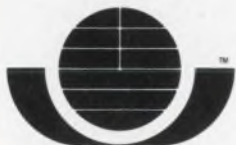

**CENTRALAB**

Electronics Division

GLOBE-UNION INC.

P.O. BOX 858

FORT DODGE, IOWA 50501

CIRCLE NUMBER 98

## New Products

# Cost cuts in flat-keyboards encourage new applications

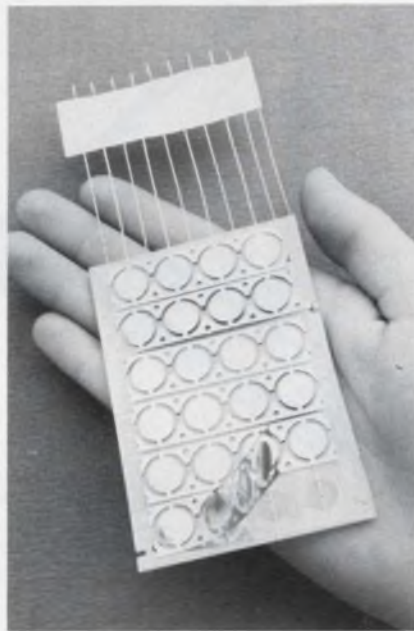

*Texas Instruments, Inc., Control Products Div., Attleboro, MA 02703. (617) 222-2800. See text.*

A low-profile keyboard from Texas Instruments that uses an X-Y matrix will sell for only 4¢ per switch position at 100,000 pieces and even less for higher volumes. Developed originally for TI's 1200 and 1250 calculators, the keyboard has been in high-volume production for these and other low-cost calculators for about 14 months. It is now offered to designers for noncalculator applications.

Possible uses include credit-card verifiers, telephone data-handling equipment, electronic games and other consumer products with digital control.

According to TI, the keyboard's low cost results from its simple design and few parts. No soldering is required in its manufacture.

Moreover, connector leads are integral and eliminate the need for a separate keyboard connector. Finally, it is manufactured on an

automated, high-volume assembly line.

TI reports that minimum cycle life is 500,000. The keyboard has successfully endured environmental testing in humidity, high and low-temperature storage, and temperature cycling. Test reports are available.

The new keyboard is currently offered in 20, 24, 28 and 40-position standard versions with 0.500 × 0.562-in. key spacing. Over-all size is 2.4 × 2.95 in. for a 20-position board and 2.4 × 3.512 in. for a 24-position board. TI advises that it can be cheaper to accept a standard 20 or 24-position board and simply mask any unwanted key positions than to require a special design. This approach is used in some calculator applications. Furthermore, the user's electrical circuitry must be able to accept the X-Y-matrix configuration.

The keyboard comes ready-made with a lead frame or a wire umbilical—part of the keyboard and not an extra-cost item. The leads are standard 0.07-in. cross-section wire, all arranged in a row at the top of the keyboard. The user can insert the lead wires directly into a motherboard and solder them along with circuit components.

Snap-acting discs, part of the switches, come in strips, and each disc functions independently. The carrying frame serves as an electrical common for the switches in any row (X direction). Individual wires are laid under each switch column from the Y-direction circuit element. Another set of wires is located between switch columns and electrically connected to the disc strips. As a result, all circuit elements emerge at the top of the keyboard to automatically form an integral lead frame. The supporting board is a sheet of engineering-grade structural thermoplastic.

CIRCLE NO. 301



## COMPONENTS

### Thermal head prints graphic or alphanumeric

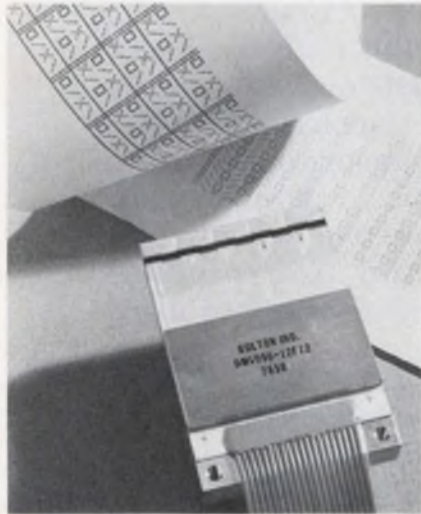

Gulton Industries Inc., 212 Durham Ave., Metuchen, NJ 08840. (201) 548-2800. \$90 (100-249); stock to 4 wks.

A dot-matrix thermal printhead, the DM1096, is capable of analog, graphic and alphanumeric data printout onto thermally sensitive paper. The unit contains a single row of 99 dots on a pitch of 24 dots per cm. The closely spaced, square-shaped dots produce a high-density printout. Dots are organized into 10 groups for multiplexed operation. Complete diode isolation and an integral heat sink are incorporated. The printhead is designed to allow multiple operation for trace-width expansion. Gird patterns may be thermally printed to eliminate chart tracking problems and permit complete scale flexibility in real time.

CIRCLE NO. 335

### 0.7-in. clock display visible from 40 ft

Cherry Electrical Products Corp., 3600 Sunset Ave., Waukegan, IL 60085. (312) 689-7702. \$6.10 (2000 up).

A new seven-segment, 0.70-in. high, 4-digit clock display in the Plasma-Lux gas-discharge display line, W04-0001, features digits for hours, minutes, a colon and AM/PM designators. Over-all size of the display panel is  $3.65 \times 1.4$  in. with 0.7-in. high digits that can be easily read up to 40 ft away.

CIRCLE NO. 336

### Unit replaces cams and limit switches



Theta Instrument, 24 Dwight Pl., Fairfield, NJ 07006. (201) 227-1700. Starts at \$1000; 4-6 weeks.

Camtrol is a direct electronic replacement for mechanical cams and limit switches. With it you can adjust dwell setting remotely with an accuracy of up to  $0.01^\circ$ . Its modular solid-state electronics are housed in a heavy-duty NEMA enclosure with a clear front panel for constant viewing of both position readout and dwell setting. Its plug-in thumbwheel control-modules have a capacity of one dwell position, i.e., one high-limit and one low-limit. The capacity of a control center is from 1-to-20-dwell-setting modules. The control centers can be cascaded to provide an unlimited number of dwell modules. A LED in each module lights when its relay is energized. A seven-segment three-digit LED-readout displays the transducer position. Resolution ranges are available from 1 to  $0.01^\circ$  (angular) and from 0.1 to 0.001% of full travel (linear). The input can be either parallel binary-coded decimal at DTL/TTL levels or one of the company's shaft encoders. Camtrol is claimed immune to electrical noise and power outages. Its parallel electronic format, eliminates time-delays typical of sampling or time-sharing methods. Each module's output is one DPDT 10-A plug-in relay per dwell. The relay is energized when the position set by the thumbwheels is within the range of the high and low limits. Power requirement is 115 V, 60 Hz. Operating temperature is 0 to 60 C.

CIRCLE NO. 337

### Miniature Xformers fit studio-grade uses



Microtran Co., Inc., 145 E. Mineola Ave., P.O. Box 236, Valley Stream, NY 11582. (516) 561-6050. \$8.50 to \$13 (100 up); stock.

Studio-grade mike/transducer input transformers, the S100 series, are miniature units designed for use in professional sound-studio applications and for low-level transducer input amplifiers. A broad frequency response of 30 Hz to 20 kHz  $\pm 1$  dB results from their special gapless laminations. Hum pick-up is negligible because of the use of nested Mu-metal shields and a unique gapless core. Available in turns ratios from 1:1 through 1:20, typical impedance ratios are 200:45 k $\Omega$ , 600:600  $\Omega$ , 10k:10k $\Omega$ . All units have electrostatic shielding. With unloaded terminations they provide an additional 6-dB voltage gain. Power levels range up to +0 dBm.

CIRCLE NO. 338

### Capacitor standards come in 32-unit kit

Arco Electronics, Inc., Community Dr., Great Neck, NY 11022. (516) 487-0500. See text.

A new series of capacitor standards provides 37 units with values from 0.0001 to 1  $\mu$ F and an accuracy of  $\pm 0.1\%$  +0.5 pF at 1000 Hz and 25 C. The units are much smaller and lighter than other designs of comparable accuracy. High capacitance units with ratings of 2, 5 and 10  $\mu$ F are also available. They have the same tolerance plus NBS traceability. A precision standards kit of 32 units (0.0001 to 0.5  $\mu$ F) and a four-position adapter jig in a case is priced at \$750. The adapter enables obtaining capacitance values to four significant figures with an accuracy of  $\pm 0.1\%$ .

CIRCLE NO. 339



# JOIN THE REVOLUTION AGAINST CUSTOM POWER SUPPLIES



Now is the time to put an end to high cost custom power supplies . . . and the long lead times they require. Join the Arnold Magnetics "Design-As-You-Order" revolution. Choose from over 1200 miniaturized off-the-shelf input and output submodules to meet your specific needs. Save time, save space, save money . . . and get outstanding performance.

- Single or dual inputs:  
115-220 VAC, 47-500 Hz,  
12, 18, 48, 115, 150 VDC.
- Multiple isolated and regulated DC outputs  
from 4.2 to 300 VDC.
- Line & load regulation to 0.1%.
- Up to 800 watts per output.
- Efficiencies to 85%.
- Completed units provided in tested and  
encapsulated, conduction cooled packages.

Phone or write for your "Declaration Of Non-Dependence" (our new Catalog and Specification Form) on custom power supplies . . . join the revolution today!



## ARNOLD MAGNETICS CORPORATION

11520 W. Jefferson Blvd.  
Culver City, Ca. 90230 ● (213) 870-7014

CIRCLE NUMBER 102

## COMPONENTS

### Ceramic trimmer caps said to be 50% smaller

*Johanson Manufacturing Corp.,  
400 Rockaway Valley Rd., Boonton,  
NJ 07005. (201) 334-2676. \$0.75  
(1000); stock.*

The 9371 series of ceramic trimmer capacitors is 50% smaller than most other trimmers of this type, but still provide high capacitance values. They are available in four capacitance ranges from 1.5 to 4, 3.0 to 10, 3.5 to 18 and 5.0 to 25 pF with  $Q_s > 300$  at 10 MHz. All units meet or exceed MIL-C-81. They have an over-all diameter of 0.225 in. with a 0.215-in. above-board height.

CIRCLE NO. 340

### Shaft actuates thumbwheel-type switch

*Cherry Electrical Products Corp.,  
3600 Sunset Ave., Waukegan, IL  
60085. (312) 689-7702. \$2.60 per  
deck (1000 up).*

Rotocode switches combine the coded electrical output of a conventional thumbwheel switch with the shaft actuation of a rotary switch. The switch is designed to be soldered directly to a host PC board by means of pins located at the bottom on 0.1-in. centers. Rotation is precisely determined by a low-backlash detent mechanism available with up to 50 angular positions. Output codes can be custom designed to meet specific application requirements. The output codes may be customized in two ways: In the basic version, a conventional rotary shaft drives one or more housed PC discs, whose concentric traces rotate past stationary wipers. Maximum bit count is seven, plus a common for each side of each disc. In its simplest form, one disc in this basic version can replace a multi-deck rotary switch. In an expanded version, a stationary PC board is added ahead of the first disc. Rotating wipers act on it in thumbwheel-switch fashion. This expanded board is designed to meet customer's specifications, and can contain electronic components. Rotocode can replace multideck rotary switches, thus saving space and much deck-to-deck wiring.

CIRCLE NO. 341

### Small potentiometer features metric sizes

*Allen-Bradley Co., 201 S. Second  
St., Milwaukee, WI 53204. (414)  
671-2000.*

A completely metric panel potentiometer has a 7-mm-long bushing and 3-mm-diameter shaft. The 10-mm<sup>3</sup> component is A-B's smallest pot available with a switch. This new Minimetric panel pot, designated Type M, has a plastic case, shaft and bushing for electrical isolation. Because it is so small, the Type M is very suitable for hand-held and other portable equipment. IEC resistance values are standard—100, 220, 470  $\Omega$  to 1 M $\Omega$ . The resistance element is conductive plastic. Independent linearity is specified with a maximum deviation of 5% in the range of 100  $\Omega$  to 100 k $\Omega$ . Power ratings are 0.1 W on the panel section and 0.05 W on the rear section at 40 C. Temperature range is -25 to 100 C. The pot is available with one or two resistor sections, or with a resistor section and a SPDT rotary switch with a detent at either end of rotation, clockwise or counterclockwise. In addition, the single or dual pots can include a detent only (no switch at either end of rotation).

CIRCLE NO. 342

### 60-Hz synchro resolver in 400-Hz case size

*Magnético, Inc., 182 Morris Ave.,  
Holtsville, NY 11742. (516) 654-  
1166. \$14 (5000 up); 4 wks.*

Synchro-to-resolver converter, part number 52448, converts 60-Hz 90-V line-to-line synchro information to 6-V sine-and-cosine information. This is the smallest available 60-Hz synchro-to-resolver converter, according to Magnético. Its nominal dimensions are 1  $\times$  1-5/8  $\times$  11/16 in. with 0.04-in.-dia pins for mounting. This same size was formerly used for 400-Hz units. Basic accuracy is 1 arc minute. Accuracy is not achieved by adjustment, but by an accurate magnetic transformation ratio. Accuracy is independent of temperature or age. Isolation from high common-mode bus voltages and transients is provided, therefore no synchro bus grounding is required.

CIRCLE NO. 343



## PACKAGING & MATERIALS

### Tool inserts a DIP into a PC board in 5 s

Unitool Corp., 1333 Lawrence Expressway, Suite 421, Santa Clara, CA 95051. (408) 249-7724. \$89.50 (1-4); stock.

The Dipshot insertion tool positions and inserts 14 or 16-pin DIPs

into a PC board at a rate of one every five seconds. Gravitational feed furnishes ICs, one at a time, to a loading platform. Pulling a trigger to its first detent rotates one IC into position with pins projecting 1/16 in. below the tool. Pulling the trigger to its second detent discharges the positioned IC with a preset force into the PC board.

CIRCLE NO. 344

### Low-cost enclosure is available in two sizes

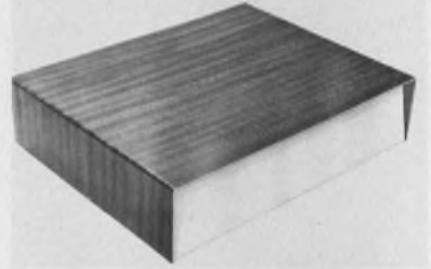

Vector Electronic Co., Inc., 12460 Gladstone Ave., Sylmar, CA 91342. (213) 365-9661. \$12.95 to \$19.70.

A new line of economical enclosures is available in two sizes and numerous attractive colors and finishes. Designated Cono-Cases the WA series enclosures incorporate a 10-degree sloped front panel and an optional smoked-plastic facing for behind-panel indicators. A recessed rear panel protects input/output connectors. The enclosures are assembled from two interlinked channels and allow easy access to circuits, accessories and wiring. The lower section forms a chassis integrated with front and rear panels. Elongated holes in the bottom and rear panel provide superior convection cooling. The upper section serves as top and side panels. The WA1 enclosures are 11 in. wide by 8 in. deep by 4 in. high, giving 307 cubic inches of circuit space. The WA2 enclosures are 14 in. wide by 11 in. deep by 4 in. high, providing 560 cubic inch working volume. Cono-Cases are available with clear anodize satin finish, or with blue or walnut grained vinyl on the cover. Other colors available in anodize, vinyl or paint on request. The WA Series enclosures are priced from \$12.95 to \$19.70, depending on model.

CIRCLE NO. 302

You know our Capacitors,  
but have you seen our...

## ALUMINUM FOIL TRANSFORMERS



If you're looking for an isolation or autotransformer with...

- Single or multiphase
- Reduced size and weight
- Higher temperature operation
- Improved thermal efficiency
- Higher electrical efficiency, and better regulation

...then our aluminum foil transformer line could be your answer. Units are available in 50/60 Hz, 400 Hz and higher frequencies, in sealed, shell and open-frame versions, with ratings to 5000 VA and outputs through 500 volts. Or send us your requirements for a design and price proposal. Send for our transformer data sheet and technical bulletin today to Electrocube, 1710 So. Del Mar Ave., San Gabriel, CA 91776; (213) 573-3300.



electrocube®

CIRCLE NUMBER 104

### Silicone-rubber sheet has high conductivity

Emerson & Cuming, Inc., Microwave Products Div., Canton, MA 02021. (617) 828-3300. 0.030 in.: \$49.50 (1-100).

Eccoshield SV-R is a conductive silicone-rubber-based sheet stock. It exhibits a volume resistivity of less than 0.001  $\Omega$ -cm. It is usable continuously at 400 F and may be cut, sheared or stamped.

CIRCLE NO. 345



# NOW!

## LINISTORS™

sensitive linear  
negative temperature  
coefficient thermistor  
assemblies

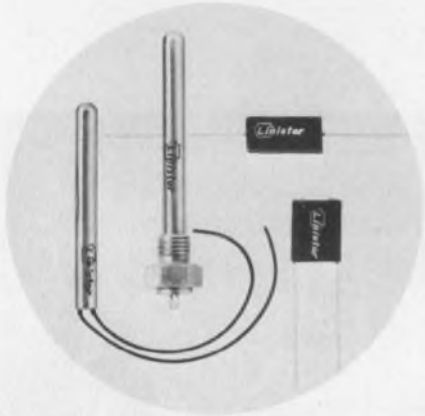

Linistor assemblies will provide you with an accurate straight line resistance/temperature plot from 0°C to 100°C.

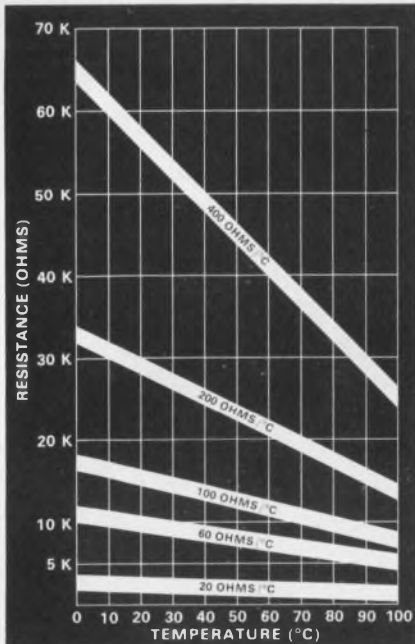

Linistors are ideal for temperature sensing and temperature compensating devices. They are now available in four standard encasements to satisfy most design applications. Write for Data Bulletin L-601.

### Keystone

CARBON COMPANY

Thermistor Division  
St. Marys, PA 15857  
814/781-1591 • Telex 91-4517

CIRCLE NUMBER 106

## PACKAGING & MATERIALS

### Latches operate without a door handle

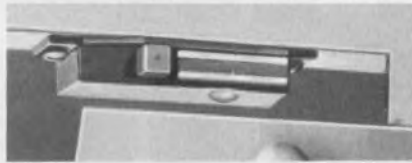

Southco Inc., Brinton Lake Rd., Concordville, PA 19331. (215) 459-4000. 500-A4: \$1.53; 500-B2: \$1.22 (100-up).

Two invisible door latches, the 500 series, are said to give cabinets a clean, uncluttered look. Since the latches open the door when they are pressed, no handle is required. The latches provide a choice between magnetic or mechanical operation. The 500-B2 push-release latch holds the door shut magnetically. A press activates a spring mechanism that releases the magnet, pushes the door open, and returns the magnet to a latching position. The 500-A4 push release latch operates mechanically. As the door is pressed shut, the latch pushes against the keeper and a spring loaded cam rotates 90 degrees to lock behind the keeper. Another press rotates the cam again and the door pops open.

CIRCLE NO. 346

### Kit makes a wide range of flat-cable assemblies



Alpha Wire Corp., 711 Lidgerwood Ave., Elizabeth, NJ 07207. (201) 925-8000. \$925.

A kit, Model FCT-80, makes a wide range of flat-cable assemblies. The kit consists of 57 connector styles, a reel of flat cable, and a bench press with universal adapter. There are a total of 248 connectors, including DIP, PC board, female-socket and header types. The reel consists of 100 ft of 50 conductor cable. The kit connectors come packed in a storage cabinet made with a gray baked enamel finish, a welded steel frame, and molded styrene drawers.

CIRCLE NO. 347

### DIP receptacle uses tin-alloy contacts

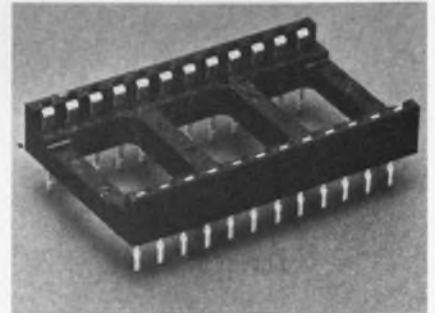

Burndy Elektro GmbH, Postfach 1247, 7022 Leinfelden-Echterdingen, West Germany.

The Burndy dual in-line receptacle uses tin-alloy base-metal plated contacts instead of gold plate. And the socket accepts packages with nonprecious metal lead frames, for a substantial cost savings over gold-plated systems. And yet the system performs as well as gold-plated systems, according to Burndy. Special contact geometry makes highly reliable gas-tight connections. Maximum over-all contact resistance is 20 mΩ at initial contact and only 50 mΩ after environmental testing. The receptacle design prevents wicking during soldering. The receptacle also features a ventilated molding to allow easy cleaning of the completed PC board assembly. IC packages are easy to insert into the dual in-line receptacle.

CIRCLE NO. 348

### 40-pin DIP clip features low cost

Continental Specialties Corp., 44 Kendall St., P.O. Box 1942, New Haven, CT 06509. (203) 624-3103. \$13.75; stock.

The Proto-Clip PC-40 test clip is claimed to have the lowest price of any 40-pin clip in the industry. The PC-40 sells for \$13.75 in single qty. It fits on DIPs having 0.6-in. spacing. This unit has a narrow throat to connect to IC leads on high-density printed-circuit boards. Scope probes and test leads lock onto the test clip's contact teeth. Noncorrosive nickel/silver contacts provide a wiping action, for a low resistance connection to IC leads. The plastic construction eliminates springs and pivots. A molded web provides the spring force to grip the IC.

CIRCLE NO. 349



## PACKAGING & MATERIALS

### DIP sockets rise 0.156 in. above the PC board

Cambion, 445 Concord Ave., Cambridge, MA 02138. (617) 491-5400. 14 pin: \$0.25, 16 pin: \$0.27 (both 100-up); 2 to 4 wks.

A series of low-profile sockets protrudes 0.156 in. above the PC board. Model numbers are 703-

4014-01-04-12 for the 14-pin type, and 703-4016-01-04-12 for the 16-pin type. The sockets have a closed-entry design that protects the contact springs. A molded lead-in funnel guides the DIP and protects against contact damage. The contacts apply pressure to the flat sides of the DIP lead. Standard contact finish is bright tin plating. The housings are molded glass-reinforced nylon.

CIRCLE NO. 350

### PC-board kits transfer artwork two ways

Vector Electronic Co., 12460 Gladstone Ave., Sylmar, CA 91342. (213) 365-9661. 32XA-1: \$28, 32X-1: \$11.50; stock.

Two kits make PC boards by directly applying artwork to the copper surface, or by phototransferring the artwork. The kits, Model No. 32X-1 and 32XA-1, contain positive-resist-coated circuit boards, bare copper-clad boards, and all other necessary materials. For direct processing, circuit patterns are applied directly on bare copper laminated circuit boards, using the acid-resistant, rub-transfer artwork sheets and other art materials contained in the kits. The sheets have patterns for 40, 24 and 16 pin DIPs and flat packs. They also have lines in five widths, pads in seven diameters, edge contacts in two sizes, alphabetic and numeric markings, and many miscellaneous coupling pad configurations. The rub-transfer patterns also may be used for making one-to-one size custom positives on the clear Mylar film supplied. The positive film is placed on the board, and exposed to a full or partial-ultraviolet light source. The exposed and developed boards are etched in the ferric chloride solution and the supplied chemical tray. The developing and etching process takes about 20 min. Following washing, the board is ready for use. The Vector 32XA-1 kit will make seven PC boards, and the 32X-1 makes two boards.

CIRCLE NO. 351

## Need answers on rechargeable power sources?



Call the guys who've been there  
**800-433-2684**  
in Texas 800-792-8767

Call our Hot Idea-Hotline toll-free and we'll help you design a nickel-cadmium sealed cell power package to fit your specific needs. In addition, we'll give you hard facts on sizes, ampere hours, configurations, prices, delivery. Chances are, all the applications we've done on hand tools, appliances, calculators, toys, and communication equipment will provide some short cuts for you. Call us. We'll deliver. Marathon Battery Company, P.O. Box 8233, Waco, Texas 76710. A division of Marathon Manufacturing Company.

marathon battery company 

CIRCLE NUMBER 108

### Adjustable caddy holds up to 19 PC boards

Vee Enterprises, Inc., 3186 D Airway Ave., Costa Mesa, CA 92626. (714) 979-7021. \$39.95; 2 wk.

An adjustable rack, called the Board Caddy, holds finished PC-board assemblies, work in process, or bare boards. It will hold up to 19 boards stacked on 1-in. centers. The rack is made of redwood with eight carriage bolts and wing nuts. By loosening the bolts, the Board Caddy expands or contracts to accommodate boards with 2 x 20-in. to 16 x 20-in. dimensions.

CIRCLE NO. 352



# NEW US INSTRUMENT RENTALS



A RENTAL GUIDE  
FOR INSTRUMENTATION  
USERS

- Why **US**?
- Rental Concept & Applications
- Complete New Equipment Index

Your Complimentary  
Copy is Waiting.  
Circle the Bingo or  
Call Any of the 14  
USIR Regional Offices.

Headquarters  
951 Industrial Road  
San Carlos, CA 94070  
(415) 592-9225  
CIRCLE NUMBER 110

## INSTRUMENTATION

### 60-MHz counter gives 1-kHz tone output



*Viz Mfg., 335 E. Price St., Philadelphia, PA 19144. (215) 844-2626. \$255.*

The WD-752A counter, for frequency measurements between 10 Hz and 60 MHz, features a 1-kHz audible side tone with separate on-off volume control. The 1-kHz tone is useful in modulating single-sideband transceivers for carrier-frequency measurement. The counter has a selectable input sensitivity of either 10 or 100 mV—use the lower sensitivity to eliminate noise. The counter uses a 10,000-MHz crystal time base to ensure the accuracy of its 10, 100 and 1000-ms gate signals and logic controls. It boasts a bright readout made up of six 0.3-in. seven-segment LEDs. The frequency, decimal point, and range (either MHz or kHz) are all displayed automatically. A signal lamp indicates when the signal is sufficiently strong to be counted and indicates when the higher-sensitivity input is required. An overflow lamp indicates a signal that exceeds 1 MHz when using the 1-s fixed gate. The unit's BNC input is compatible with most standard broadband oscilloscope probes. When making measurements of transmitter or transceiver AM frequencies, the counter is positioned near the transmitter and a one-meter cable, attached to the input, serves as a pickup antenna. The counter can also be attached directly to a transmitter or transceiver with a directional coupler and dummy load. The unit operates from 115 ±10 V, 50/60 Hz. It measures 2.7 × 5.75 × 9.25 in. and weighs 4 lb.

CIRCLE NO. 353

### Unit stores commands, controls generators



*Wavetek, 9045 Balboa Ave., San Diego, CA 92123. (714) 279-2200. \$795; 30 days.*

Model 583 is an erasable read-only memory (EROM) storage autoprogrammer for use with the company's programmable generators. The instrument will store, on interchangeable EROM cartridges, a sequence of programming commands which automatically control the generator output. The instrument is particularly useful in small systems applications involving repetitive tests. A sequence of up to 99 separate tests can be stored on each EROM cartridge and each can be called up as required. Test cycling can be either automatic or manual.

CIRCLE NO. 354

### Unit reads scope time intervals



*Tektronix, P.O. Box 500, Beaverton, OR 97077. (503) 644-0161. \$410; 4 wks.*

Direct numerical readout of displayed time intervals with 1% accuracy is provided by the DM44, as well as frequency measurement with 2% accuracy. The DM44 is an option for the company's 464, 465, 466, and 475 and 475A portable oscilloscopes. Other features include: 3-1/2-digit display; dc voltage measurement with 0.1% accuracy; resistance measurement with 0.25% accuracy; and temperature measurement from -55 to +150 C.

CIRCLE NO. 355



## INSTRUMENTATION

### Economical wattmeter offers four ranges

Bird Electronic Corp., 30303 Aurora Rd., Cleveland, OH 44139. (216) 248-1200. \$249; stock-6 wks.

Model 6156 four-range absorption wattmeter covers two-way communications frequencies from 25 to 512 MHz from as low as 5 W

full scale through 15, 50 and 150 W. This direct-reading unit offers  $\pm 5\%$  accuracy and an integral 150-W rf termination within the specified bands. The meter has squared scales for downscale reading, and its housing can be detached from the load. Model 6156 weighs 8 lb. Maximum VSWR is 1.1 at its 50- $\Omega$  female N input connector.

CIRCLE NO. 356

### Meter combines digital and analog in one



Tekelec-Airtronic, Cite des Bruyeres, Rue Carle Vernet B.P. N°2, 92 310 Sevres, France.

TE 358 is a 3-1/2 digit (2000 points) digital multimeter and an analog multimeter featuring nine functions, which provides the analog display, has a dB scale, a center-zero scale and a left-zero scale. The five standard functions of the unit are: dc voltmeter from 100  $\mu$ V to 1000 V in five ranges; ac voltmeter from 100  $\mu$ V rms to 750 V rms in five ranges; dc ammeter from 100 nA to 2 A in five ranges; ac ammeter from 100 nA to 2 A in five ranges; ohmmeter from 0.1  $\Omega$  to 20 M $\Omega$  in six ranges.

CIRCLE NO. 357

## TOUCHBOARD™ THE KEYLESS KEYBOARD



### KEYLESS KEYBOARDS.

Activated by the slightest touch. Reliable and inexpensive so you can use them where you never could before. An idea so simple, you wonder why nobody ever thought of it.

WHO NEEDS KEYS? Keys cost money. And they're the source of most of the reliability and cleaning problems of ordinary keyboards. So, we threw them out. Instead, we came up with Touchboard... a thin, one-piece, completely sealed circuit sandwich. The Touchboard is at home in any environment. Spilled liquids, contaminants, even acids wipe clean.

UNLIMITED ENGINEERING FLEXIBILITY. Use photos,

screening, just about any method for your legend. In any size, any color. With or without tactile feedback. There's no limit to the applications.

JUST TOUCHING THE SURFACE. We're so excited about Touchboard, we can't wait to share our own ideas with you. Give us a call. We'll show you how to put more function into your products at far less cost than ordinary keyboards.

TOUCHBOARDS.  
KEYBOARDS  
WITHOUT KEYS.

## Datanetics

18065 EUCLID STREET, FOUNTAIN VALLEY, CA 92708  
(714) 549-1191 TWX: 910-596-1301

CIRCLE NUMBER 112

### Compact attenuator aims at audio applications



Telecommunications Techniques Corp., 112 Frederick Ave., Rockville, MD 20850. (301) 340-8443. \$179; 4 wks.

Model TA-63 600- $\Omega$  balanced attenuator is tailored to audio-frequency applications. Input and output are each 600- $\Omega$  balanced ports with both tip-ring-sleeve, and binding-post connectors. Attenuation is selectable in 1-dB steps from 0 to 63 dB with a tolerance (dB) of  $\pm 1\%$ . Maximum power capacity is 100 mW and frequency response is flat to 750 kHz.

CIRCLE NO. 358



NOW AVAILABLE!

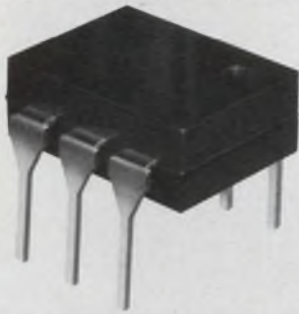

### 5KV OPTICAL ISOLATORS IN 6-PIN DIPS

Industry's first 5KV isolators to be offered in the popular 6-pin dual in-line package are available now! They are directly interchangeable with standard industrial 6-pin isolators... **UL approved**... No. E58979. Circle R.S. No. 205.



### STANDARD OPTICAL SWITCHES

Six, low-cost off-the-shelf optical switches are available as direct replacements for such popular devices as the H13A1, A2; H13B1, B2; MCA 8, 81 and MCT 8, 81. Both phototransistor and photodarlington versions are available from factory stocks. Circle R.S. No. 206.



### LOW-COST PHOTODETECTORS & LEDs

Spectronics provides industry's largest selection of standard off-the-shelf detectors and LEDs. Direct replacements for such popular industrial types as: LED55CF, BF, B, C; SSL315, 15, 35; TIL31, 81, 23, 24; and TIL601-616 Series. Call today for prices and deliveries. Circle R.S. No. 207.

Call Spectronics for everything you need in opto. We make optoelectronics work... for you!



# Spectronics

INCORPORATED

830 E. Arapaho, Rd.  
Richardson, Texas 75080  
(214) 234-4271

## INSTRUMENTATION

### Let new probe solve your logic problems



AVR Electronics, P.O. Box 45167, San Diego, CA 92145. (714) 566-1570. \$24.95.

The new Catch-a-Pulse logic probe is compatible with RTL, DTL, TTL, CMOS, MOS and  $\mu$ Ps which use a 3.5-to-15-V power supply. Thresholds within the probe are automatically programmed for multilogic family operation. The unit features an automatic resetting memory for single or multi-pulse detection. No adjustments are required. The instrument gives visual indications of logic levels, using LEDs to show hi, lo, bad logic, open-circuit logic or pulses. The shirt-pocket portable unit is supplied with a protective cap over its tip and a removable coiled cord.

CIRCLE NO. 359

### Portable scope displays alternate timebase



Philips Test & Measuring Instruments, 400 Crossways Park Dr., Woodbury, NY 11797. (516) 921-8880. \$2750.

PM3265E, a 150-MHz dual-trace portable scope, features on-screen display of both main and delayed timebase in the alternate mode. This feature enables both the main timebase with the intensified zone and the delayed timebase expansion of both traces to be viewed on the screen at the same time. Front-panel trace-separation controls allow easy alignment of the resulting four-trace display for convenient viewing. The PM3265E also features 5-mV sensitivity to the full bandwidth and a maximum sweep speed of 2 ns per div.

CIRCLE NO. 360

### Spectrum analyzer offers IEEE-488 interface



Rockland Systems, 230 W. Nyack Rd., West Nyack, NY 10994. (914) 623-6666. \$8900; 60 days.

Model FFT 512/S-15 real-time spectrum analyzer offers the IEEE-488/1975 digital interface, which enables the analyzer to be controlled by a minicomputer, terminal or other programmer/controller. The interface allows the external device to read and write into any location in the memory of the FFT 512/S. Since all data and control functions of the new spectrum analyzer are stored in the memory, access to it permits programming and/or sensing by the external source. The interface operates in a byte-serial, bit-parallel data-transfer mode, which makes it compatible with microprocessor-based equipment, as well.

CIRCLE NO. 361

### Two-channel filter matches phase to 2°



Precision Filters Inc., 303 W. Lincoln St., Ithaca, NY 14850. (607) 277-3550. \$2850.

Model 602 dual anti-alias filter consists of a pair of elliptic low-pass filters covering the frequency range from 10 Hz to 150 kHz in unit steps from 1 to 15 in each decade range. Independently programmable gain and overload detectors are provided in each channel. The 602 employs precisely controlled 6-pole, 6-zero, elliptic low-pass filters with 0.1-dB pk-pk pass-band ripple and 80-dB min stop-band attenuation. Yet, the 602 provides 2° phase match between channels up to the cut-off frequency.

CIRCLE NO. 362



# AIRPAX

## THE CIRCUIT BREAKERS THAT PUT THE PRO IN PROTECTION

It takes a real pro to produce circuit breakers with the built-in quality, service, and reliability of Airpax breakers. That's why they are the acknowledged standards in the protection of computer systems, military, industrial, and consumer electronic equipment.

Unaffected by temperature extremes (as is the case with fuses and thermal breakers), Airpax electromechanical circuit breakers are available in a wide variety of sizes, styles, voltage and current ratings to suit nearly any OEM application.



Get the full story of these pros of the protection field. Send today for the Airpax Short Form Catalog 2013.

# AIRPAX™

AIRPAX ELECTRONICS  
CAMBRIDGE DIVISION  
Cambridge, Maryland 21613  
Circuit Breakers, Switches,  
Glass/Ceramic-to-Metal Seals

In Europe:  
Airpax S.A.R.L.  
3 Rue de la Haise  
78370 Plaisir, France  
Phone: 055 8084

CIRCLE NUMBER 116

## INSTRUMENTATION

### Meters offer no-tamper adjustment

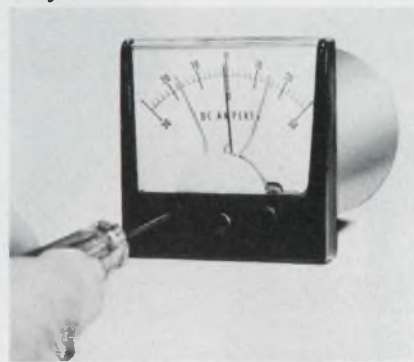

Larson Instrument, Greenbush Rd., Orangeburg, NY 10962. (201) 391-4400.

New tamper-proof control point adjustment for its line of contactless meter relays and controllers is now offered by Larson. The new control-point adjustments are set by inserting a hexagonal key through a special self-sealing collar. Once the adjustment has been made, the key is withdrawn, making it impossible for unauthorized personnel to change the setting. The self-sealing collar prevents entry of dust or dirt and makes the unit essentially splash-proof. The new adjustments can be supplied on 2.5, 3.5 or 4.5 in. wide-view units.

CIRCLE NO. 363

### Get best resolution with FET preamp

Ortec, 203 Midland Rd., Oak Ridge, TN 37830. (615) 482-4411. \$995; 60 days.

The Model 140 is a remote-FET-preamplifier system, which is claimed to have the best timing and energy performance, for charged particle spectroscopy, available in any commercial unit. The 140 preamplifier accommodates most standard surface barriers; its rise time is less than 3 ns for detectors with up to 600-pF capacitance. The detector and the preamp-FET-front-end are housed in a remote assembly that operates inside the vacuum chamber and feeds through to the preamp chassis, thus eliminating cable capacitance. This front-end housing also eases changing the detector.

CIRCLE NO. 364

### Small thermometer costs less

Noromix Ltd., 8 Thomas St., London SE18 6HR. 01-854-9185. \$250.

A low-cost, portable, digital thermometer for industrial use in the -55 to 999 C (-68 to 1830 F) range is offered at half the cost of comparable models, its producers claim. NTD 15L Minitemp comes in a metal-lined leather case, uses CMOS circuitry, has automatic cold-junction and linearizing circuits and is reported to be exceptionally sturdy. You read temperature, to a resolution of 1°C, by pressing a button, which illuminates an 8.2-mm (0.32-in.) high LED display. The unit will work with a wide range of NiCr-NiAl thermocouples. Variations in thermocouple length and diameter cause no error. To avoid possible errors, a chromel-alumel plug is provided to mate with the chromel-alumel socket in the instrument's base. The thermometer is accurate to  $\pm 0.2\%$  of reading  $\pm 1$  digit. It measures  $5.3 \times 3 \times 1.2$  in. and weighs 10.2 oz including battery.

CIRCLE NO. 365

### Record analog and print in margin



Gulton Industries, East Greenwich, RI 02818. (401) 884-6800. \$675; 90 days.

MED-110 OEM oscillographic recorder module simultaneously records analog signals and prints alphanumeric data. Its frequency response is 100 Hz (-3 dB) and chart speed is 25 mm/s. Analog recording is done by a thermal stylus on rectilinear chart paper. Alphanumeric data are printed in the lower chart margin by a thermal print head. The slide-mounted unit has a horizontal transport and internal chart rewind. Amplifier, power supply and transformer must be supplied by the user. Out-of-paper switch contacts are provided.

CIRCLE NO. 366



# BRUT!

The barriers that bend without breaking.

The interconnection company that innovates to serve you better.

# BEAU



Beau Products Division  
Vernitron  
Electrical Components

P.O. Box 10, Laconia, N.H. 03248 / N.H. tel.: 524-5101  
CALL TOLL FREE: (800)258-0370

CIRCLE NUMBER 118

# SAFE!

Pre-grounding plugs and sockets—only from Beau.



The interconnection company that innovates to serve you better.

# BEAU



Beau Products Division  
Vernitron  
Electrical Components

P.O. Box 10, Laconia, N.H. 03248 / N.H. tel.: 524-5101  
CALL TOLL FREE: (800)258-0370

CIRCLE NUMBER 119

## INSTRUMENTATION

### Measure laser power without a window



EG&G Inc., *Electro-Optics Div.*, 35 Congress St., Salem, MA 01970. (617) 745-3200. \$995; 2 wk.

The Model-460 laser power meter uses a windowless detector, thereby eliminating errors due to multiple reflections in parallel optics. The unit's silicon photovoltaic detector has low noise, uniform response over its surface, ultra-stable performance and a spectral range from 200 nm (in the UV region) to 1100 nm (in the near IR). The meter is direct reading in terms of watts for average power of CW or repetitively-pulsed lasers. Optionally available accessories measure integrated energy (joules), peak power and pulse shapes of pulsed lasers. The unit's full-scale range for average power is from  $1.999 \times 10^{-6}$  to  $1.999 \times 10^2$  W; its energy range is from  $1.999 \times 10^{-9}$  to 1.999 joules.

CIRCLE NO. 367

### Remote chopper ups radiometer specs

Molelectron Corp., 177 N. Wolfe Rd., Sunnyvale, CA 94086. (408) 738-2661. \$576; stock.

A new remote chopper accessory, the PC-294, has been announced by Molelectron to extend the sensitivity and dynamic range of its PR-200 pyroelectric radiometer for remote thermal, solar, and laser measurement applications. The unit is a fixed frequency device which plugs into the standard radiometer. It features an electronically adjustable phase reference.

CIRCLE NO. 368

### Pocket counter spans 1-to-10-MHz range

Logic Technology, 1950 Colony St., Mountain View, CA 94043. (415) 967-1007. \$189 (unit qty); stock to 30 days.

The Pocket Counter III has a seven-digit, seven-segment-LED readout plus a frequency-overrange indication. It has a measurement range of 1 Hz to 10 MHz, with 1-Hz resolution over the entire range. Its sensitivity is better than 250 V from  $-20$  to  $+55$  C and it has an accuracy of 0.001%  $\pm 1$  count at nominal battery voltage and room temperature. Input impedance is 100 k $\Omega$  shunted by 51 pF, with a maximum input of 200 V at 10 kHz, derated to 10 V at 10 MHz. A single "push-to-read" pushbutton is its only operating control. The unit is powered by four size AA rechargeable NiCd batteries (supplied) and will operate for more than 8 hr at 30% duty cycle when fully charged. An optional plug-in converter/charger, which fully recharges the batteries in less than 12 hr, and a heavy duty carrying case are also available. It has an aluminum case that is 7.8  $\times$  4.0  $\times$  1.7 in. and weighs 21 oz. Various OEM configurations (without case, without batteries, etc.) are also available on special order.

CIRCLE NO. 369

### CB counter uses 12-V auto power



Lectrotech, 5810 N. Western Ave., Chicago, IL 60659. (312) 769-6262. \$199.50; stock.

The Model FC-50 is a 50-MHz frequency counter intended primarily for testing CB radios. It operates from 12-V-dc (car battery) power permitting easy field use. The unit's 8-digit display provides a resolution of 1 Hz at frequencies of 50 MHz and can be viewed from up to 20 ft away. The counter uses LSI chips to reduce its component count and improve reliability. A line of optional accessories is available for testing CB equipment.

CIRCLE NO. 370



## DATA PROCESSING

### Light pen features two TTL-compatible outputs

HEI, Inc., Jonathan Industrial Center, Chaska, MN 55318. (612) 448-3510. \$85; 4-6 wk.

A light pen, the 120-1, offers two TTL-compatible outputs. The solid-state assembly uses optoelectronic

and hybrid circuitry to provide both light-pen-switch and light-pen-hit outputs. A light-pen-switch signal is generated when the tip of the pen is pressed against the CRT faceplate. A light-pen-hit signal occurs when an unblanked spot on the faceplate is under the pen tip. The signals are transmitted through the light pen cable to the external control logic. The 120-1 is IBM compatible.

CIRCLE NO. 371

# A keyboard is only as strong as its weakest switch.

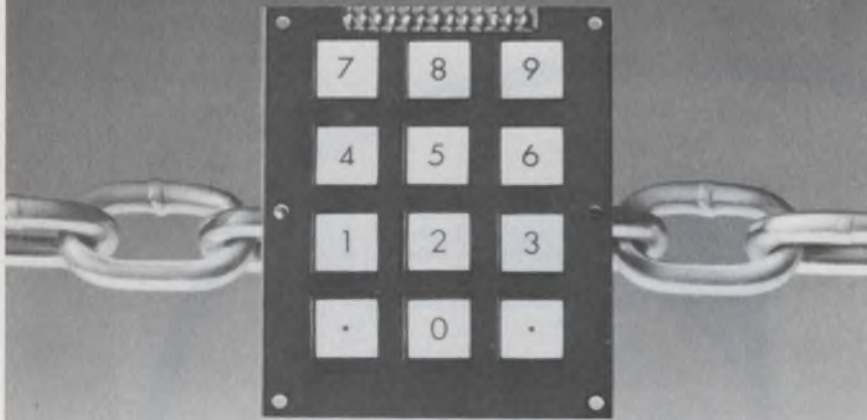

That's why we build Wild Rover® keyboards with a switch designed for over 10,000,000 cycles. Multiple contact points distribute circuit energy, provide more positive switching action and reduce contact wear. Our PCK switch has excellent noise characteristics, too. Less than 5 milliseconds bounce on leading and trailing edge.

REFAC offers standard 12 and 16 key keyboards. We'll also build custom keyboards to your specification with special legends or encoding. Or, if you prefer, we can supply our PCK switch as a component for your own keyboard assembly operations.

For more information on our keyboards and PCK switches, give us a call. We can have literature in the mail today.



**REFAC electronics corporation**

P.O. BOX 809 • WINSTED, CONN. 06098 • 203-379-2731

CIRCLE NUMBER 121

## Terminal printers feature modular design

Data General Corp., Southboro, MA 01772. (617) 485-9100. See text; 90 days.

A family of terminal printers includes the first 60 char/s terminal printer claimed to be manufactured by a minicomputer company. The printers feature modular electromechanical design. Four models comprise the new line; the 30 and the 60 char/s terminals are each available in keyboard or receive-only versions. All models print 132-column lines. The Model 6040 (60 char/s, keyboard) costs \$2650; 6041 (60 char/s, receive only) is \$2450; 6042 (30 char/s, keyboard) is \$2400; and 6043 (30 char/s, receive only) is \$2200. The keyboard models can be used off-line as typewriters. Form widths from 4 to 15 in. can be accommodated, and both left and right paper feed tractors adjust to allow placement of the form anywhere on the carriage. A viewing feature allows the typist to read the last character entered. They can be interfaced to a 20 mA current loop and to EIA RS232-C devices. Several character sets may be used; the standard set is 128-character upper and lower-case ASCII characters. European and Asian 96-character sets are optional and up to 29 function codes can also be added. Users can field-select an upper and lower-case format, or all upper-case format.

CIRCLE NO. 372

## Computer comes with dual or quad discs

DTC, 1190 Dell Ave., Campbell, CA 95008. (408) 378-1112. MK II: \$4295, MK IV: \$6750; 30-45 days.

The MK II and MK IV are stand-alone computers that have disc drives for either dual or quad discs. On-line capacity for the MK II is 600-k characters; the MK IV holds 1.2-M characters. Each have two RS-232 serial I/O ports. One port handles a data terminal and the other handles data communications. Both ports run at rates from 110 to 9600 baud. A software operating system provides file management and utilities for data transmission and reception.

CIRCLE NO. 373



# NEW

## ULTRA WIDEBAND AMPLIFIER



Model 1W1000

## 1 to 1000 MHz 1 Watt Linear

Here's a unique, all-solid-state amplifier that delivers 1 watt of swept power output from 1 to 1000 MHz instantaneously. It's the Model 1W1000 from Amplifier Research. A reliable, unconditionally stable unit, the new Model 1W1000 provides 1 watt of linear power over three decades of bandwidth.

Its performance is matched only by its versatility. For example, Model 1W1000 can be used with high-level sweepers, VSWR measuring systems and network analyzers. It's also used to increase the sensitivity of spectrum analyzers, oscilloscopes and wideband detector systems. It has all the bandwidth you'll ever need. For complete information, write or call:

Amplifier Research  
160 School House Road  
Souderton, PA 18964  
215-723-8181



Your Best source for RF Power Amplifiers

CIRCLE NUMBER 123

## DATA PROCESSING

### Ultraviolet lamps erase PROMs in under 10 min.

*Ultra-Violet Products, Inc., 5100 Walnut Grove Ave., San Gabriel, CA 91778. (213) 285-3123. S-52T: \$209; UVS-54T: \$99 (both 115 V ac).*

Two ultraviolet lamps erase programmable read-only memories. Both have a timer that may be set up to 30 min. The S-52T has a holding tray that will erase up to 16 chips in about 7 min. The UVS-54T will erase up to eight chips in about 14 min. Both are housed in plastic and are available in 115-V or 220-V versions.

CIRCLE NO. 374

### Hand-held terminal dials phone numbers



*Executive Devices, 740 S. Logan, Fresno, CA 93727. (209) 255-6977. PDT-700, \$49.95; PDT-1000, \$89.95.*

Two hand-held terminals generate dual-tone audio frequencies. The models, PDT-1000 and PDT-700, can dial telephone numbers and enter computer data over AT&T's Touch-Tone compatible lines. The data are entered via an acoustic coupler mounted on the rear of the unit. Both models have a 16-button keypad. The PDT-1000 additionally has a seven-digit diode memory matrix, allowing the operator to generate a local telephone number by pushing one control button. Once the desired party is reached, the terminal may send out dual-tone frequencies that are then converted to data to be entered into a computer. The terminal measures 2.1 x 4.5 x .88 in., and weighs 5.5 oz.

CIRCLE NO. 375

## Data-line monitor simulates and tests



*Digitech Data Industries, Inc., 66 Grove St., Ridgefield, CT 06877. (203) 438-3731. \$7500; 120 days.*

The Pacer-103 simulates and monitors RS-232 data lines, displaying the results in a 32-character alphanumeric window and a two character hexadecimal display. The unit also analyzes communication problems by simulating the signals DCE and DTE in a polling/response environment. In the monitor mode, it captures and stores 1024 characters (expandable in 2 k increments) either transmitted or received on full or half-duplex lines. The unit is compatible with IBM's bi-sync, SDLC and other line protocols. It will handle ASCII, BCD/EBCD, and EBCDIC codes at speeds up to 19.2 kbit/s. In the simulate mode, the unit will generate a variable test message that imitates a terminal or a modem signal. It can be used for analysis of modems or of the terminal's handshaking routines. When simulating a modem, the Pacer-103 allows the user to look at polling/selecting functions, and handshaking routines.

CIRCLE NO. 376

## 16 column, two-color printers are low cost

*Master Digital Corp., 457 Promontory Dr. W., Newport Beach, CA 92660. (714) 675-9674. \$89 (100 up).*

The 388 series Precisa printers produce up to 16 columns in two colors on a 2.25-in.-wide paper roll. The reliability of the design permits printing 5-million lines before servicing is required. The 388 Series has a printing speed of 3 line/s.

CIRCLE NO. 377



## The greatest invention since the thumb and the wheel:



### C&K's miniature Thumbwheel Switch!

Available in either front or rear-mounting models, C&K's miniature Thumbwheel is uniquely adaptable: each section is a switch by itself, or the sections can be easily stacked together—three, five, ten, or whatever—to handle the most complex switching requirement! Front-mounting model is only .315" (8.00 mm) wide and rear-mounting is .350" (8.9 mm) wide. Each section has a 10-position switch wheel with digits or optional symbols in your choice of 6 designer coordinated mix-and-match colors—black, gray, yellow, red, white or blue. The switch body is either matte black or gray. An 11-position switch including "off" is also available. For all the colorful details, make contact with C&K today!

Free Engineering Samples on Request

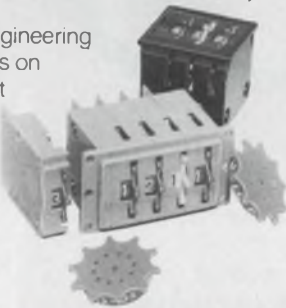

### C&K Components, Inc.

103 Morse Street, Watertown, MA 02172, U.S.A. Tel: (617) 926-0800

TWX: 710 327 0460 TELEX: 92 2546

IN EUROPE:

#### BELGIUM

C&K Benelux  
Schuttersvest 44, Mechelen  
Tel: 015-419868

#### FRANCE

C&K Composants S.A.  
60 Rue Du Dessous Des Berges  
75013 Paris  
Tel: 5832454 Telex: 204317

#### GERMANY WEST

C&K Germany GMBH  
8021 Neuried Munchen Gautlinger Str. 2  
Tel: 089 7557171 Telex: 5213068

#### ITALY

C&K Components S.P.A.  
Via Frapolli 21, 20133 Milano  
PH: (02) 719371-7386165

#### NETHERLANDS

C&K Benelux  
Arnhemsebouwenweg 40, Driebergen  
Tel: (03438) 2332 Telex: 40519

CIRCLE NUMBER 125

## DATA PROCESSING

### Data logger takes little power and space

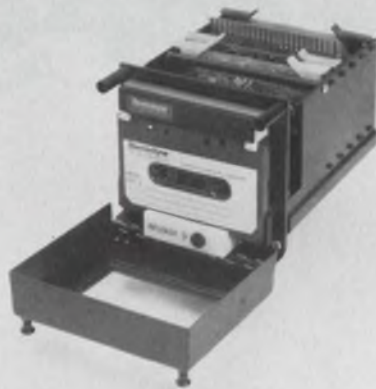

Memodyne Corp., 385 Elliot St., Newton Upper Falls, MA 02164. (617) 527-6600. \$1375.

The Model 221 data logger is small: it has dimensions of 3.8 × 4.5 × 7.0 in. and weighs 3 lbs. It features an incremental method of recording data on standard Philips cassettes. One to 16 channels of analog information at a 0-to-10-V level may be multiplexed, converted to digital data, buffered and clocked onto a cassette tape at rates up to 100 bit/s. The recording format is complementary-nonreturn-to-zero with a recording density of 615 bit/in. The total capacity of a 300-ft cassette is over 2 Mbits. The unit uses CMOS circuitry throughout and requires only 85 mA of current when recording. On standby, the power requirement is 25  $\mu$ A.

CIRCLE NO. 378

### System transfers keyed data onto cassette tape

Edmac Associates, Inc., 333 W. Commercial St., East Rochester, NY 14445. (716) 385-1440. \$990 (1-up); stock.

The Edmac key-to-tape system enables direct keyboard data entry onto a cassette drive. The system consists of a keyboard terminal with a display, and a cassette recording unit. Data are recorded on cassettes in ASCII format. Up to 90-k characters can be recorded on each cassette. Up to 11 characters may be entered at one time. The system can be powered by 115 or 230 V ac, or a 9-V battery.

CIRCLE NO. 379

### A cassette unit talks on three I/O channels

Datum, Inc., 1363 S. State College Rd., Anaheim, CA 92806. (714) 533-6333. See text, 30-45 days.

A cassette transport provides HP 9830 calculator users with 300-k character storage. The Model 4000 Universal Recorder contains three separate I/O channels for RS-232-compatible data terminals and data sets at switch-selectable data rates to 9600 bit/s, plus an eight-bit parallel I/O that transfers up to 1500 eight-bit char/s. The transport also has dual 4-k bit buffers which alternately accept data from the I/O ports and transfer it to the cassette tape. The recorder is a two-track read-after-write unit with 30 in./s read/write speed and 120 in./s rewind speed. Recording density is 800 bit/in, using the NRZ format. Weight is 40 lbs. Power required is 100 W at 115 V, 60 Hz. Unit price for the single-transport unit is \$2825; \$3725 for the dual unit.

CIRCLE NO. 380

### Programming panel runs controller circuits



Modicon Corp., P. O. Box 83, Shawsheen Village Sta., Andover, MA 01810. (617) 475-4700. \$7500 (1-up); 30 days.

A CRT display panel edits programmable-controller programs while the programs are running. Designated the UPP, Model P145, it is said to be the first CRT programming panel that does circuit editing while the programmable controllers run existing programs. Once all changes are made to the circuit on the screen, pressing a button updates the controller program. The UPP programs circuits directly from relay ladder diagrams. The CRT screen displays from one to seven lines of logic. Each line contains up to 10 contacts.

CIRCLE NO. 381



## DATA PROCESSING

### System provides remote on-off control

TeleMation, Inc., P.O. Box 15068, Salt Lake City, UT 84115. (801) 972-8000. \$1095 (TCT-150), \$995 (TCR-150).

A remote-control system consists of a TCT-150 control transmitter that controls up to eight TCR-150 control receivers. The system provides on/off or normal/alternate remote control of up to 15 functions at each receiver location. The TCT-150 transmitter will accept either front-panel switch commands or TTL and contact closure inputs. The transmitter connects to the receivers via a two-conductor cable or, through an optional modem, to a dedicated voice-grade telephone circuit. The TCR-150s connect to the equipment under control. The modem for the TCT-150 costs \$325, and the modem for the receiver costs \$450.

CIRCLE NO. 382

### Kit adds phone modem to DEC's LA36 terminal



Ven-Tel, 2360 Walsh Ave., Santa Clara, CA 95050. (408) 984-2727. \$325 (1-up); stock.

A data-communications interface adds phone-transmission capability to the DECwriter LA36. Called the Model 120, it adds four interface functions to the LA36's 20 mA current-loop interface. The four additional switch-selectable transmission modes include EIA (RS232-C) acoustic coupler, manual DAA (Bell 113A) and leased line (Bell 103F). The transmission rate goes from 0 to 300 baud, in a full or half duplex mode. The Model 120 installs without physical modification of the LA36 terminal.

CIRCLE NO. 383

### Data terminal feels like a typewriter



Multiterm Corp., 2612 Artesia Blvd., Redondo Beach, CA 90278. (213) 376-6975. \$2875.

A data terminal, the Model T-3000, has a keyboard that looks like an IBM Selectric typewriter to the operator. The T-3000 is controlled by an internal 8080  $\mu$ P. The unit prints error codes for noise pulses, failure in the communications link or operator-keyed entry errors. The terminal uses Diablo's printer mechanism. It communicates with a computer over an RS-232C interface in ASCII code.

CIRCLE NO. 384

## Behind every good designer is a new Cambion catalog.

Our new giant 747-A general catalog has a 56-page section just on new products introduced since our last big catalog. That's in addition to our familiar products like solder terminals, terminal boards, insulated terminals, coil forms, coils, RF Chokes, connectors, capacitors, IC accessories, hardware and thermo-electrics. You can get one behind you free just by writing: Cambridge Thermionic Corporation, 401 Concord Ave., Cambridge, MA 02138.



Standardize on

# CAMBION®

The Guaranteed Electronic Components

CIRCLE NUMBER 127

## Behind every good designer is a new metric Cambion catalog.

Our new giant M747-A general catalog has a 56-page section just on new products introduced since our last big catalog. That's in addition to our familiar products like solder terminals, terminal boards, insulated terminals, coil forms, coils, RF Chokes, connectors, capacitors, IC accessories, hardware and thermo-electrics. You can get one behind you free just by writing: Cambridge Thermionic Corporation, 445 Concord Ave., Cambridge, MA 02138.



Standardize on

# CAMBION®

The Guaranteed Electronic Components

CIRCLE NUMBER 128

ELECTRONIC DESIGN 22, October 25, 1976





### TAKE A MONOLITHIC TO LUNCH

Every day, thousands of people, in countries around the world, take our monolithic filters to lunch, or maybe home to dinner (in paging receivers which can call them to a fire, an emergency operation, or a poker game). Size, ruggedness, and low cost are important in this application. Our standard 10.7 and 21.4 MHz monolithics offer all three. Many paging receivers operate in urban, dense signal areas, and there our VHF monolithic filters can simplify front-end design and reduce intermodulation. If you're thinking about paging, or any other production application of monolithic filters, call for PTI — the standard in monolithic crystal filters.

### STRAIGHT STORY...

... about linear phase (constant group delay) monolithic filters. Three new four-pole models in our low-priced Comline® series offer a delay variation of 10  $\mu$ s. max. over the specified 3 dB. bandwidth ( $\pm 6$  kHz.) for land mobile radio applications requiring data transmission or improved impulse response. Center frequency is 10.7 MHz. Spec sheet available. Just ask for models 5182, 5261, and 5262.

**What's your application? Whether it's one of the above or something brand-new we'll be glad to work with you. Just give us a call, or a brief note outlining your requirements. We'll take it from there.**

Piezo Technology Inc.

2525 Shader Road Orlando, FL 32804  
(305) 298-2000

The Standard in monolithic crystal filters.

CIRCLE NUMBER 130

## DATA PROCESSING

### Unit reads cards and badges optically

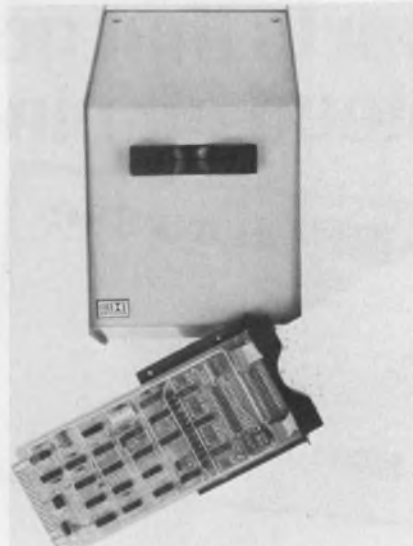

*Decicom Systems, Inc., 250 Adams Blvd., Farmingdale, NY 11735. (516) 293-2970. \$400 (large qty).*

An optical, rather than electro-mechanical, unit reads alphanumeric-coded cards and badges. The Model P12 has no moving parts and it will not damage the cards and badges. The unit contains all electronics for reading up to 22 columns of alphanumeric information. Plastic or paper cards may be interchanged without adjustments to the reader. All cards are read horizontally, using a corner cut to ensure correct positioning. The P12 checks its sensor, light sources or card each time one is read. The unit provides independent read and transmit clock rates and a data strobe.

CIRCLE NO. 385

### Calculator shrinks to matchbook size

*Casio, Inc., 15 Gardner Rd., Fairfield, NJ 07006. (201) 575-7400. \$29.95.*

The Micro-Mini is claimed to be the world's smallest electronic calculator. The unit measures 1.675  $\times$  2.375  $\times$  0.5 in.—about the size of a matchbook. The calculator weighs 1.2 oz, including the silver-oxide battery. The unit can add, subtract, multiply and divide and has a constant for multiplication and division. It has an eight-digit liquid-crystal display.

CIRCLE NO. 386

## Disc-based computer emulates the 8080 $\mu$ P

*EM&M, 12621 Chadron Ave., Hawthorne, CA 90250. (213) 644-9881. \$9450; 60-90 days.*

A disc-based microcomputer emulates the 8080  $\mu$ P. The system, called the S/80-DSK, also contains a 5 Mbyte disc drive. The disc drive uses one fixed and one removable disc. The drive/controller combination transfers data at 200-k byte/s. The S/80-DSK has a software package, which features file management on a named-file basis, and a disc-resident editor and assembler. The S/80-DEX provides I/O drivers as well as a symbolic debug capability. The S/80-DSK includes CPU, chassis and power supply, disc controller, 5 Mbyte disc and 32-k bytes of static semiconductor memory.

CIRCLE NO. 387

## Digital-scanner system monitors 11 data points



*QEI, Inc., 60 Fadem Rd., Springfield, NJ 07081. (201) 379-7400. QSR-1130: \$350, QST-1130: \$320 (1-up).*

A digital-scanner system monitors 11 data points. The system consists of a QST-1130 transmitter and QSR-1130 receiver. Optional units include a QSD-1130 status-display and a QSK-1130 relay output. A combination QSKD-1130 relay and status display unit is also available. The system uses time and frequency-division multiplexing to transmit at a 30 bit/s rate using a three-state return-to-zero code. The QST-1130 transmitter contains an FSK-tone-transmitter, and an 11-point scanner. All inputs are optically isolated. The QSR-1130 receiver contains an FSK tone receiver, and scanner. High-power-output circuits drive 35 V dc at 100 mA on all data outputs. A scan-fail circuit operates when the receiver fails to receive a valid scan for 10 s.

CIRCLE NO. 388



# Premier Electronic Cabinets and Cases

- ESTHETICS KEYED TO MODERN SYSTEMS
  - RUGGED-FUNCTIONAL CONSTRUCTION
  - ECONOMICAL PRICING
- PROMPT SERVICE & AVAILABILITY

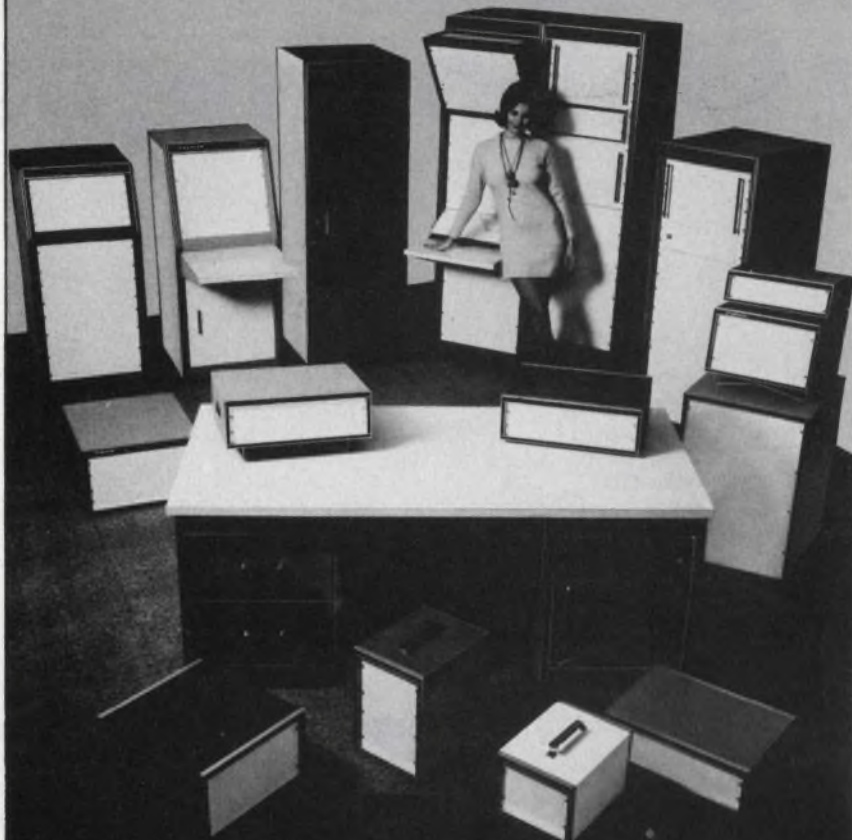

INSTRUMENT CASES - TIC SERIES

TVA Series Vertical Assembly—  
Construction Details  
(1 Frame, 2 End Panels, Rear Door)

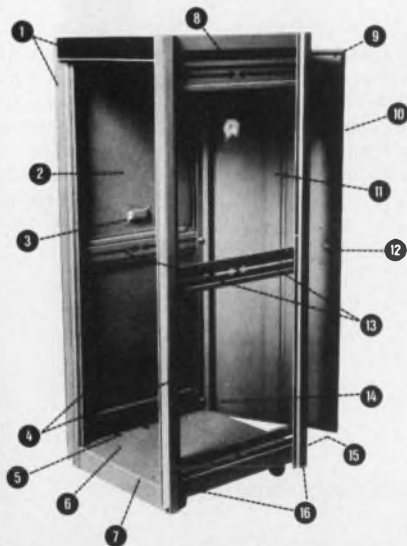

1. Trim: extruded anodized aluminum with textured vinyl inlays
  2. Outside removable flush end panels (16 ga.)
  3. Recessed hand grip for panel removal
  4. 2 pr. panel mounting angles, fully adjustable front to rear with tapped 10-32 holes on EIA & WE Standards spacing (12 ga.)
  5. 1" dia. holes for cable entry beneath base
  6. Recessed caster mounting holes
  7. 1 piece formed steel base provides for heavy equipment mounting area and concealed caster mounting (14 ga.)
  8. 1 piece solid top for extra rigidity and squareness (14 ga.)
  9. Foam gasketing (3 sides)
  10. Magnetic closure gasket
  11. Door stiffener channel
  12. Keyed latch and brushed aluminum pull handle
  13. Horizontal cross-brace and panel mounting angle supports
  14. Quick release, spring loaded door hinges (top and bottom)
  15. 1 1/8" dia. knock-outs for rear cable entry underneath rear door
  16. Formed steel uprights (14 ga.) provide 1/2" recess to panel mounting angles
- All features shown are standard in the Trimline TVA Series  
Welded, formed steel construction

Complete catalog and prices on request



**PREMIER METAL PRODUCTS COMPANY**  
381 Canal Place, Bronx, N.Y. 10451/(212) 993-9200

CIRCLE NUMBER 129

## DISCRETE SEMICONDUCTORS

### Alphanumeric matrix displays four characters

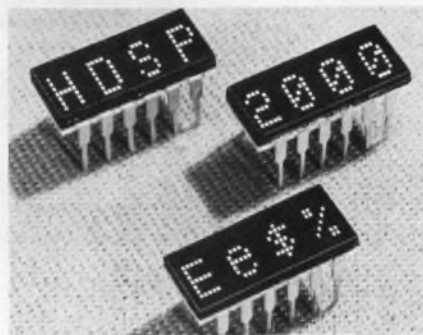

Hewlett-Packard, 1501 Page Mill Rd., Palo Alto, CA 94304. (415) 493-1501. See text.

HP's new HDSP-2000 LED alphanumeric displays with 0.15-in. high characters are packaged in standard DIPs and contain four characters in each package. Individual packages can be end-stacked for long multicharacter displays. Shift registers and externally programmable constant-current drivers are incorporated into each package, so associated circuitry is simplified.

Part count for a typical 32-character system has been reduced by a factor of 36 to 1, when compared with earlier displays. It takes only 12 pins to address each four-character set. The display is TTL-compatible and readily microprocessor-controlled.

Applications include interactive point-of-sale devices, compact mobile communications sets, smart microprocessor-based instruments or control mechanisms, medical instruments, and portable business terminals.

The package can operate at temperatures from -20 to 70 C, and it can be used in hostile industrial environments and many military situations.

Each HDSP-2000 character is formed with a 5 x 7 dot matrix. The full ASCII character set—lower-case as well as upper-case letters and punctuation marks, and mathematical and other symbols—can be formed. Each package measures 0.699-in. long by 0.290-in. high.

Priced at \$47 per 4-digit cluster in quantities of 125 clusters, small quantities are available from stock at authorized distributors.

CIRCLE NO. 389





now you have  
a choice!

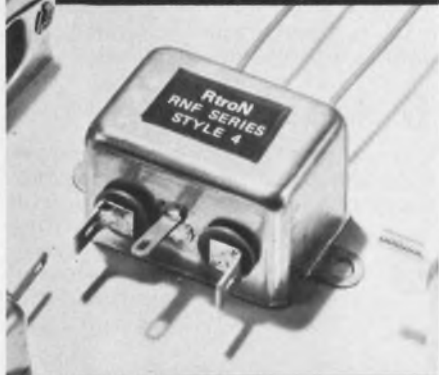

## RFI/EMI FILTERS

For Data Processing,  
Industrial Control and  
Instrument Application

Rtron's RNF Type Filters represent three series of the most widely used, low cost filters available. Over 100 combinations of current and case style to choose from "L" Series - low cost for general applications to combat line to ground noise. "P" Series - for suppression of line to line as well as line to ground interference. "T" Series - most effective for low impedance load applications. All types are U.L. Recognized and meet C.S.A. requirements. Rated at 115/250 VAC. Low leakage current insures safety.

For complete catalog and  
details, write:

**Rtron** corporation

P.O. Box 743, Skokie, Illinois 60076  
(312) 679-7180

CIRCLE NUMBER 134

## DISCRETE SEMICONDUCTORS

### Improved LED lamps have wide viewing angle

Chicago Miniature Lamp, 4433 N. Ravenswood Ave., Chicago, IL 60640. (312) 784-1020. \$1.75: standard LED, \$2; Hi-bright colors (1000 up).

CM4-9000 telephone-style LED indicator lamps offer high efficiency and an improved viewing angle of 65°. Intensity covers a range of 0.9 to 6.8 mcd, depending upon color and style. Clear indicators with a viewing angle of 24° and intensities to 80 mcd are also available. A standard style is offered, along with a short and a colored design. Previously, LEDs produced an average 1.2-mcd intensity. Current-limiting resistors are built-in and protection diodes withstand 75-V reverse polarity.

CIRCLE NO. 392

### MOSFET power Xistors claimed industry first

Siliconix, 2201 Laurelwood Rd., Santa Clara, CA 95054. (408) 246-8000. \$3.60 to \$8.10 (100-999).

Claimed to be the industry's first series of MOS power transistors, six new MOSPower FETs (field-effect enhancement-mode MOSFETs) are fabricated with Siliconix' recently developed VMOS (vertical MOS) technology. The VMP 1 (previously announced) 11 and 21 are 25-W, general-purpose power transistors in TO-3 packages. The VMP 2, 12, and 22 are 4-W devices in TO-39 packages. Key specifications include operation without secondary breakdown, thermal runaway or minority carrier charge storage time; direct compatibility with CMOS, microprocessors and other low-power ICs; maximum continuous drain current of 2 A (VMP 1 series); typical switching speed of 4 ns at 1 A drain current; typical input leakage current of less than 1 nA; highly linear transfer functions; and zener protected gates. Individual devices in the series have breakdown voltages from 35 to 90 V and maximum drain-source resistances of 1.8 to 4.5 Ω at 1 A.

CIRCLE NO. 393

### Optical coupler isolates 1500 V dc

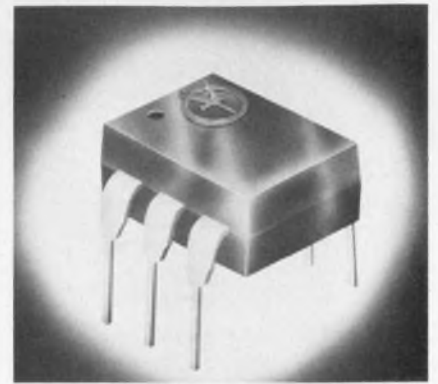

Optron, Inc., 1201 Tappan Circle, Carrollton, TX 75006. (214) 242-6571. \$1.25 (1000 up); stock.

The OP16000 in a 6-pin plastic DIP features 1500-V-dc input-to-output isolation with an output capability of 300-V-dc breakdown. It consists of a GaAs infrared LED and a high-voltage npn phototransistor. Guaranteed maximum output leakage current is 100 nA with a collector-emitter voltage of 200 V. Saturation voltage for the output transistor is 0.4 V maximum with an input current of 10 mA and output of 0.5 mA. Current transfer from input to output is 20% minimum with 10-mA input and 5 V on the output transistor.

CIRCLE NO. 394

### Power transistors rated at 1000 V and 50 W

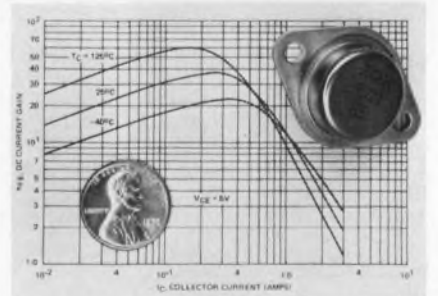

International Rectifier, 233 Kansas St., El Segundo, CA 90245. (213) 322-3331. \$6.10 (100-999); stock.

Npn power transistors with ratings to 1000 V and 50 W, designated IR721, handle a continuous collector current of 3 A. Their maximum dc-current gain is 60 at 150 mA and 5 V. All the new units are glass passivated to provide stability at high junction temperatures. Triple-diffused processing ensures a high-voltage and wide safe operating area.

CIRCLE NO. 395



from Electronic Measurements . . .

# SCR 1 $\phi$ & 3 $\phi$ DC Power Supplies

We are pleased to report that we now produce the industry's largest selection of SCR phase-controlled power supplies.

How did we do it?

Slowly.

We didn't acquire the largest selection without selling a lot of power supplies along the way. Our way, for 35 years, has been giving the user what he wants; and in a watts/dollar ratio that gives him no choice but E/M.



Type	SINGLE PHASE				THREE PHASE			
Watts	500	800	1600	2400	2500	5000	10 KW	To 60 KW
Volts	0 to 7.5 V up to 600 V DC							
Amperes	0 to 0.75 A up to 3000 A DC							
Height (in.)	3.50	3.50	5.25	7.00	7.00	8.75	12.25	To 4'
Price (\$)	450	575	800	1000	1200	1500	2300	To
	to	to	to	to	to	to	to	9500
	500	650	895	1100	1600	2300	2900	

Over 100 standard models. Thousands of optional combinations.

To order, or for any technical information, call  
TOLL FREE (800) 631-4298



**ELECTRONIC MEASUREMENTS INC.**

405 Essex Road, Neptune, N.J. 07753  
Phone (New Jersey) 201-922-9300 (Toll free) 800-631-4298

Specialists in Power Conversion Equipment

## INTEGRATED CIRCUITS

### Monolithic ADCs come in 8, 10 or 12 bits

Hybrid Systems, Crosby Dr., Bedford, MA 01730. (617) 275-1570. From \$19 (1 to 9); 2 to 4 wks.

The integrating a/d converters in the ADC586 series of 8, 10 and 12-bit units are housed in 24-pin hermetically sealed, ceramic DIPs. Conversion times of the monolithic units are 24, 6 and 1.8 ms for the 12, 10 and 8-bit units, respectively. The total dissipation is less than 20 mW for any converter and operation is from  $\pm 5$ -V power supplies. Other specifications include an input range of 0 to +10 V, a 5-ppm/ $^{\circ}$ C linearity drift (for the 12-bit units), and a scale factor error of less than 40 ppm/ $^{\circ}$ C. The offset vs temperature is 5 ppm/ $^{\circ}$ C. All units are complete, except for an external integrating capacitor.

CIRCLE NO. 396

### Standard multiplexers now come in CMOS

National Semiconductor, 2900 Semiconductor Dr., Santa Clara, CA 95051. (408) 732-5000. From \$3.80 (100-up); stock.

The MM74C150 and the MM82C19 are CMOS versions of the DM74150 and 8219 16-line-to-1-line multiplexers. A 4-bit address code determines which of the particular 16 inputs is routed to the output. The data is inverted from input to output on both devices. A strobe pin, which overrides the input data, places the output of the MM74C150 in the logic "1" state, and the output of the MM82C19 in a high impedance state. Both the MM74C150 and the three-state MM82C19 have clamp diodes on all inputs, a guaranteed noise margin of 1 V, a noise immunity of 0.45  $V_{CC}$  and an operating supply range of from 3 to 15 V. The circuits are designed for operation from -40 to +85 C and are available in either a 24-pin epoxy B package or a 24-pin ceramic DIP. Both are also available for operation over the -55 to +125 C range in either a 24-pin ceramic DIP or a 24-lead flat pack (the MM54C150 and MM72C19, respectively).

CIRCLE NO. 397

CIRCLE NUMBER 136



# 1 Relay Miss every 2-Billion Cycles



Series E Relay  
(actual size)

We tested 129 of our new Series E Relays at loads from dry circuits to 3 Amps. After 35-billion operations, only 10 single-cycle misses were monitored.

#### Series E Relays offer:

- Indefinite life
- No contact bounce
- Operation in all positions
- Contacts stable to  $\pm 0.015$  ohms over life
- Reliability at dry circuit or power loads
- Self-healing contacts
- Hermetically sealed contacts
- 1250V rms contact breakdown
- Low cost

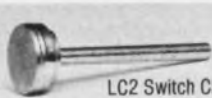

LC2 Switch Capsule  
(actual size)

Series E Relay uses a rugged LC2 welded capsule rather than a fragile glass reed switch. This patented design holds a film of mercury securely to the metal walls of the capsule. With every operation, the mercury film renews the switch contacts. You get the reliability of mercury relays, but with complete freedom of mounting orientation. LC2 welded capsule reliability is proven by hundreds-of-thousands of units in the field, as well as billions of cycles under stringent laboratory conditions.

Send for a FREE SAMPLE of the LC2 welded capsule on your letterhead. Circle the reader service card number for Series E Relay information.



### Fifth Dimension, Inc.

P.O. Box 483  
Princeton, N.J. 08540  
Tel: (609) 452-1200

CIRCLE NUMBER 138

## INTEGRATED CIRCUITS

### Analog gates handle up to $\pm 10$ -V inputs

*Teledyne Crystalonics, 147 Sherman St., Cambridge, MA 02140. (617) 491-1670. From \$39 (1 to 49); stock.*

The CAG50D and 50T general-purpose, quad FET analog gates can switch up to  $\pm 10$ -V signals directly from DTL or TTL. They have a logic noise immunity of typically 1 V and can turn off faster than they turn on, allowing multiplexing without shorting.

CIRCLE NO. 404

### Micro-controller forms stand-alone processor

*Western Digital, 3128 Red Hill Ave., P.O. Box 2180, Newport Beach, CA 92663. (714) 557-3550. See text.*

The WD/40, micro-controller chip is intended for use in smart instruments and office machines, special-purpose calculators, vending machines, cash registers, and computer peripherals. It is a stand-alone, 40-pin device that requires few support circuits. The chip contains its own register file, mask-programmable control ROM and output PLA. It also has an internal oscillator and power-up clear circuitry. The chip requires only a single, 12-V power supply and is TTL compatible. An editor, an assembler, and a simulator are available to set up programs. To check out the WD/40 in real applications a 64-pin version with the internal ROM inputs and outputs available for direct connection to PROMs is available. A development board containing the 64-pin WD/40 and PROMs is also available. The WD/40 can directly address up to 64 signals for input information and has two programmable interrupts and one wait input. It also has 16 static outputs and a scanned output which can drive an eight-digit numeric display. The cost of the programming mask is \$1500, and includes 10 chips for customer evaluation plus the opportunity to change the program mask two times. For quantities of 1000 or more, the chip costs \$8.95.

CIRCLE NO. 405

## LED digit drivers use saturating-output logic

*National Semiconductor, 2900 Semiconductor Dr., Santa Clara, CA 95051. (408) 732-5000. From \$1.40 (100-up); stock.*

The DS8871 series of saturating-output display drivers are designed to interface MOS calculator chips with common-cathode LED displays. The saturating output permits operation with lower supply voltages than Darlington-output display drivers, and also results in lower power dissipation in the LED driver. The series of drivers consists of the DS8871, an 8-digit driver; the DC8872, a 9-digit driver; the DS8873, a 9-digit driver with a low-battery indicator; and the DS8977, a 7-digit driver with a low-battery indicator. The 8871 and 8877 are housed in 18-pin DIPs and the 8872 and 8873 are housed in 22-pin DIPs. They can operate in calculator systems with a supply voltage range of 4.5 to 9 V. In a 9-V system, the low-battery feature of the DS8873 and 8977 can be set to turn the ninth-digit decimal point when the supply voltage falls below a typical value of 6.5 V. The series is functionally, and pin-for-pin equivalent to the SD8855, DC8864, DS-8865 and DS8866 family of LED display drivers.

CIRCLE NO. 406

## Dual line drivers meet RS-232C requirements

*Fairchild Camera and Instrument, 464 Ellis St., Mountain View, CA 94042. (415) 962-3816. From \$1.67 (100-up); stock.*

The 75150 dual line driver permits data transmission at rates of 2000 bits/s with a full 2500-pF load. They satisfy the interface requirements between data-terminal and data-communication equipment as defined by EIA Standard RS-232C. The logic input is compatible with most TTL and DTL families. Operation is from  $\pm 12$ -V power supplies. The 75150 is a pin-for-pin replacement for the SN75150, and it is available in ceramic (75150DC) or plastic (75150PC) DIPs and ceramic (75150RC) or plastic (75150TC) mini-DIPs.

CIRCLE NO. 407



## Baud-rate generator has 16 possible outputs

SMC Microsystems, 35 Marcus Blvd., Hauppauge, NY 11787. (516) 231-5151. \$6 (100-up); stock.

The COM 5026, a single baud-rate generator, provides any one of 16 program or switch selectable output frequencies. This device is compatible with dual baud-rate generator, the COM 5016. The 5026 offers: 16 asynchronous/synchronous baud rates (selectable via a 4-bit code); direct UART/USRT compatibility, a reprogrammable ROM for generating other frequencies; TTL and MOS compatibility; on-chip input pull-up resistors accuracy to within 0.01%; and a 50% duty cycle. With the addition of a 5.0688 MHz crystal, it provides an output of any of 16 externally-selectable "standard" frequencies from 50 to 19,200 baud. The device, housed on a 14-pin ceramic DIP operates from 0 to 70 C.

CIRCLE NO. 408

## 1-k static RAMs come with choice of speed

Texas Instruments, P.O. Box 5012, Dallas, TX 75222. (214) 238-2011. From \$3 (100-up); stock.

Three static RAMs, all organized as 256 words  $\times$  4 bits, are each available in three speed ranges; 1000, 650 and 450 ns maximum access and read/write cycle times. The TMS 4039/2101 comes in a 22-pin DIP, has separate input and output lines, a separate output enable and two chip enables. The TMS4042/2111, housed in an 18-pin DIP has a bus-oriented common I/O, an output enable and two chip enables. Lastly, the TMS 4043/2112, in a 16-pin DIP, offers common I/O lines and a chip enable. All units operate from a +5-V supply and are TTL compatible. A three-state output and chip enable makes memory expansion simple. Typical power dissipation is 175 mW. All the RAMs have fully-decoded direct addressing and are available in plastic or ceramic DIPs rated over a range of 0 to 70 C.

CIRCLE NO. 409

## A New High in Stability

Centre Engineering has met the challenge of providing ultra-high reliable sub-miniature ceramic capacitors for the space programs. Now, design engineers in the tele-communications, computer and instrumentation industries can have ceramic capacitors in high volume for low cost applications, using the same processes and manufacturing techniques from Centre Engineering.

Ceramic capacitors are available in 40 various formulations with a capacity range of 1pf to 10mfd. For applications requiring large volume, low cost ceramic capacitors consider Centre Engineering. Catalog available upon request.

**CENTRE ENGINEERING**

2820 E. COLLEGE AVE., STATE COLLEGE, PA. 16801  
814-237-0321 ■ TWX 510-670-3517

CIRCLE NUMBER 140

## Use it for its connections, or use it for its pull.

A P Super-Grip™ IC Test Clips grip dips without slips or shorting between the pins. Our patented "contact comb" prevents shorting while our superior gold-plated phosphor bronze terminals make contact. And our top-side pins make the perfect hanger for probes to simplify "hands-free" in-circuit testing. And this gutsy little clip has the right kind of pull for unequalled ease in pulling ICs, too. Some of its best friends are dips.

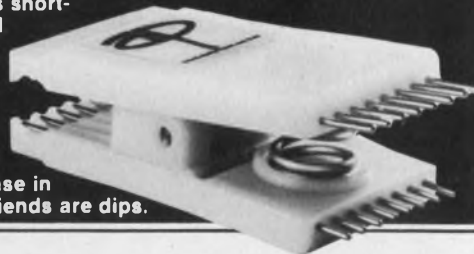

A P has a Super-Grip™ Clip for any DIP.

MODEL	ROW-TO-ROW DIMENSION	PART NUMBER	PRICE
TC-8	.3 in.	923695	\$ 7.35
TC-14	.3 in.	923698	\$ 4.50
TC-16	.3 in.	923700	\$ 4.75
TC-16LSI	.5/.6 in.	923702	\$ 8.95
TC-18	.3 in.	923703	\$10.00
TC-20	.3 in.	923704	\$11.55
TC-22	.4 in.	923705	\$11.55
TC-24	.5/.6 in.	923714	\$13.85
TC-28	.5/.6 in.	923718	\$15.25
TC-36	.5/.6 in.	923720	\$19.95
TC-40	.5/.6 in.	923722	\$21.00

Ohio and California Residents Add Sales Tax. All orders subject to acceptance at factory.

Write us for the full line A P Products catalog.



**A P PRODUCTS INCORPORATED**

Box 110-F Painesville, OH 44077 (216) 354-2101

For quick phone service, call the A P distributor nearest you:

(201) 224-8032	(513) 236-9900
(206) 682-5025	(516) 483-9200
(213) 768-3800	(516) 883-0999
(213) 875-2862	(914) 664-0088
(215) 698-4000	(602) 277-7661
(216) 441-3000	(612) 488-0201
(216) 587-3600	(617) 273-1860
(312) 298-8580	(617) 879-0860
(313) 525-1800	(713) 350-6771
(314) 863-7800	(713) 777-1666
(412) 782-2300	(714) 549-8611
(415) 326-5432	(714) 560-0515
(415) 969-9240	(803) 253-5333

Our Distributor List is growing daily. If none in your area call toll Free 800-321-9668.

CIRCLE NUMBER 141



# Amilon's cassette transports are compatible to more standards:

- \*A.N.S.I.
- \*E.C.M.A.
- \*I.S.O.
- \*N.A.B.

\*Recognized under Component Program of Underwriters Laboratories.

Amilon pioneered U.S. made quality cassette tape transports with flexibility in mind.

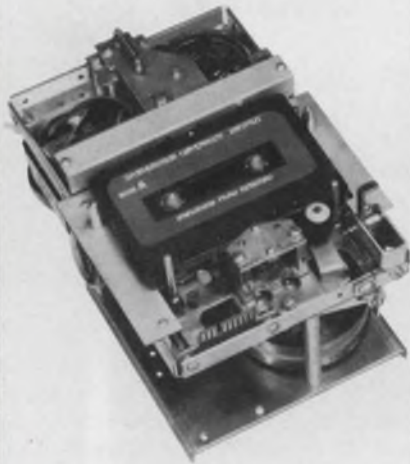

## HERE'S PROOF:

Long term speed accuracy: better than 1%

Jitter: less than 1%, peak-to-peak

Flutter & wow: less than 0.1%

Search speed: 50 ips

Read/write speed: 1.875 to 12 ips

Get all these advantages in one cassette transport with versatile applications for about \$100 in OEM quantities. True modular construction allows the addition or deletion of many options, tailoring the transport exactly for each application without the cost of unneeded features.



**AMILON CORP.**

49-12 30th Avenue Woodside, NY 11377  
(212) 274-1794

CIRCLE NUMBER 143

## INTEGRATED CIRCUITS

### IC zener diodes operate over 0.5 to 15 mA range

National Semiconductor, 2900 Semiconductor Dr., Santa Clara, CA 95051. (408) 732-5000. From \$0.79 (100-up); stock.

The LM129 IC zener reference operates over a 0.5 to 15 mA current range. A subsurface breakdown zener is the heart of the IC. Long term stability is typically 20 ppm while noise is guaranteed to be less than 20  $\mu$ V. Active circuitry around the zener buffers external current changes to give a 1- $\Omega$  dynamic impedance. The reference is available in selected temperature coefficients from 0.001%/°C to 0.01%/°C for use over 0 to 70 C or -55 to +125 C. The LM129 comes housed in either a TO-46 hermetic transistor package or a plastic TO-92 package.

CIRCLE NO. 412

### Five MIL qualified ICs are fully characterized

Signetics, 811 E. Arques Ave., Sunnyvale, CA 94086. (408) 739-7700. From \$5.53 (100-up); stock.

Five analog ICs, fully characterized to military specifications, are now available as part of the high reliability product line. The new devices include two dual operational amplifiers; a differential amplifier; a dual line receiver and a dual differential line driver. They are available processed in accordance with MIL-STD-883, class A, B, or C. The LM158, a single-supply (3 to 30 V) dual op amp, is available in an eight-pin TO-99 package with industry standard MC1558 pinout. The SE532, a dual amp, has single or dual supply operation (3 to 30 V) and is also available in 8-pin TO-99 packages with the MC1558 pinout. The SE-515 differential amplifier comes in a 14-pin Cerdip or 10-pin, TO-5 package. The DM7820, a dual line receiver, operates from a single 5-V supply and is housed in a 14-pin Cerdip. Lastly, the DM7830, dual differential line driver, is designed for 5-V supply operation and has transient protection circuitry. It too is available in a 14-pin Cerdip.

CIRCLE NO. 413

### Custom I<sup>2</sup>L arrays can come in only 4 weeks

Stewart-Warner Microcircuits, 730 E. Evelyn Ave., Sunnyvale, CA 94086. (408) 245-9200. See text.

The "SWAP"—Stewart-Warner Array Programming—provides semi-custom I<sup>2</sup>L circuits with a four-week delivery of first prototypes for as low as \$1800. It is based on the master-chip concept whereby a standard LSI circuit may be specially interconnected. Two different versions are available: A 16-pin device with 208 gates and 14 interfaces, and a 24-pin device with 408 gates and 22 interfaces. To get started on the SWAP program, it is necessary to have a SWAP Custom Design Kit, which costs \$25. The kit includes the SWAP design manual (complete with vellum work sheets) and 15 sample devices. The 15 samples include seven gates, five D flip-flops, one input interface, one output interface and one combination circuit that has two oscillators, two pulse shapers, a Schmitt trigger and a monostable multivibrator.

CIRCLE NO. 414

### TTL decade sequencers are glitchless

Fairchild Digital Products, 464 Ellis St., Mountain View, CA 94042. (415) 962-3816. \$1.21 (100-up); stock.

Two TTL decade-sequencer circuits using a decoded Johnson counter technique provide glitch-free operation. They are useful as multiphase-clock generators in variable-modulo sequencing, dead-end counting, bar-graph generation and switchable dividers. The circuits, the 9319 and 9320, can sequence through 10 states at a guaranteed clock rate of 35 MHz. Sequencing can be truncated synchronously or expanded to any number. The 9319 has standard TTL outputs that drive up to 10 TTL unit loads. The 9320 has DTL level (resistor pull-up) outputs to facilitate interfacing with MOS or CMOS logic, and can provide multiple-width output pulses if outputs are tied together. Both types are available in 16-pin plastic or ceramic DIPs in both military and commercial temperature ranges.

CIRCLE NO. 415



## DC to HV with PC mounting

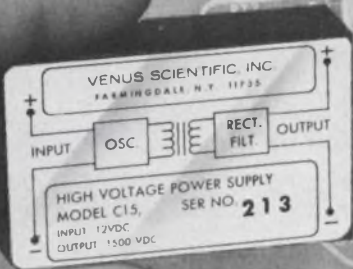

Model C-15

Model C-30

Output to 1500VDC @ 1ma / Output to 3000VDC @ 500ua

- Small, Flat, Lightweight • Low Cost • Input/Output Floating
- Short Circuit and Reverse Polarity Protected
- Output Proportional to Input • Operates on Only 12V DC
- Mounts on Printed Boards • MTBF 105,000 Hours



**VENUS SCIENTIFIC INC**

399 Smith Street, Farmingdale, N. Y. 11735  
Telephone (516) 293-4100 • TWX 510-224-6492

CIRCLE NUMBER 146

## AUTHOR'S GUIDE

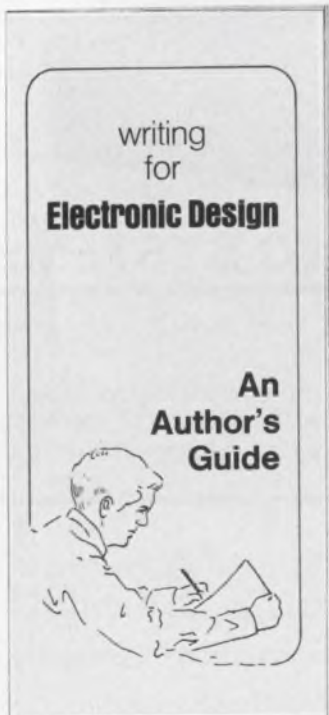

If you've solved a tricky design problem, if you have developed special expertise in a specific area, if you have information that will aid the design process... share it with your fellow engineer-readers of *Electronic Design*.

Articles you have authored not only raise your own professional status, but help build your company image as well. The readers benefit, your company benefits.

To help you prepare material that meets *Electronic Design's* high editorial standards, our editors have prepared a special author's guide entitled "Writing for *Electronic Design*." It covers criteria for acceptability, form, length, writing tips, illustrations, and payment for articles published. It's available without cost.

It's easy to write for *Electronic Design*, but it's often hard to get started. Send for your copy of our Author's Guide today.

**Circle No.  
250**

## MODULES & SUBASSEMBLIES

### Alphanumeric display has 20 characters



Digital Electronics Corp., 415 Peterson St., Oakland, CA 94601. (415) 532-2920. \$250 (sample qty.); 30 days.

The DE/200 random-access alphanumeric display comes complete with interface, drive and refresh electronics. It has 20 alphanumeric characters and each character is directly addressable. To display a message, simply write the ASCII character code at the input and select the character position. Display changes are instantaneous, with no line shift effect. A period or comma can be inserted after each character. The display tube uses fluorescent technology and has a 14-segment starburst character design. Each character measures 0.35 x 0.2 in. Power requirements are 5 V dc at 1 A, 45 V dc at 20 mA and 8.5 V ac at 70 mA. Interface connections include five for address, three for strobe, eight for data and six for power. The display measures 2.3 x 8.2 x 0.8 in.

CIRCLE NO. 416

### Pretrimmed VFCs resolve 13 bits

*Dynamic Measurements*, 6 Lowell Ave., Winchester, MA 01890. (617) 729-7870. From \$30 (unit qty); stock.

Factory pretrimmed within 0.2% F.S. (0.4% for 100-kHz models) and operating from a single +15-V supply, these new 800 general-purpose VFCs offer 13-bit resolution in three frequency ranges (100, 20 and 10 kHz). Maximum offset and gain TCs are 20  $\mu\text{V}/^\circ\text{C}$  and 50 ppm/ $^\circ\text{C}$ , respectively. Linearity is within 0.025% of full scale. The output is a string of fixed-width logic-compatible pulses, whose rate is proportional to the analog input. In many applications this pulse-train output is more useful than the parallel or serial binary-coded output of a standard ADC.

CIRCLE NO. 417



# Little Red Reed Relays

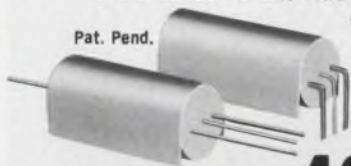

Pat. Pend.

In Quantities as low as **49¢**

- ★ Red Flame Retardant Shell
- ★ Instrument Grade Contacts
- ★ Coto's High Reliability Testing
- ★ Premium Grade Catalogued Switches
- ★ Epoxy Encapsulated
- ★ Low Water Absorption
- ★ ... and Much More!

Write or Call for Bulletin MR 12.1



**COTO-COIL COMPANY, INC.**  
59 Pavilion Ave.  
Providence, R. I. 02905  
Tel: (401) 467-4777

CIRCLE NUMBER 149



## CURRENT READING

OF ANY CONDUCTOR OR ION BEAM

- A Current Transformer used with an Oscilloscope for Fast Pulsed Current (nsec to millisecond)
- Sensitivities from 1 V/A to .01 V/A
- No Physical Connection Required
- Readings without Ground Loops
- BNC or Triax Connector
- Accurate      ■ Fast Delivery
- Low Cost      ■ Specials Upon Request



**ION PHYSICS CORPORATION**  
A SUBSIDIARY OF HIGH VOLTAGE ENGINEERING CORPORATION

BURLINGTON MASSACHUSETTS 01803 617-272-2800

CIRCLE NUMBER 150

## MODULES & SUBASSEMBLIES

### Single PC board contains four 12-bit DACs

ADAC Corp., 15 Cummings Park, Woburn, MA 01801. (617) 935-6668. \$850 (unit qty); 30 to 45 days.

Model 600-LSI-11D digital-to-analog system is compatible with the DEC LSI-11 and PDP-11/03 microcomputers. The system is contained on a single PC board measuring 5 × 8-1/2 in. and includes a bus interface, dc/dc power converter, scope control and either 1, 2, 3 or 4 12-bit digital-to-analog converters. Cable and documentation is also included in the basic system.

CIRCLE NO. 420

### Temperature controllers span -102 to +850 C



Thermalogic, 241 Crescent St., Waltham, MA 02154. (617) 891-9496. From \$29; stock.

Both "ON-OFF" temperature controllers (Series 3000) and "proportional" controllers (Series 4000) are available for use with RTD sensors. The temperature control modules are available in 17 different temperature ranges that cover -102 to +850 C. The high visibility calibrated temperature dial can be located remotely up to 100 feet from the controller. Typical sensitivity of the Series 3000 is ±0.3 C with a stability of 0.005 C/°C ambient. Typical bandwidth (adjustable) of the Series 4000 is 1 to 20 C. The circuitry is "fail-safe" to sensor lead breaks.

CIRCLE NO. 421

### Modular f/v converters accept 10 to 100 kHz

Analog Devices, P.O. Box 280, Rte. 1 Industrial Park, Norwood, MA 02062. (617) 329-4700. From \$39 (1 to 9); stock.

The 10-kHz Model 451 and 100-kHz Model 453 frequency-to-voltage converters permit programmable input thresholds, adjustable gain, and variable output offset voltages. They accept TTL, HiNIL, CMOS, sine wave, square wave, pulse, and triangle wave inputs. No external components are required to achieve rated performance, which includes 80 ppm maximum nonlinearity and 20 mA of output current. The two f/v converters are pin compatible with several popular competitive models. The 451 and 453 are each available in three versions of nonlinearity and gain drift performance. The Models 451J and 453J have a 0.03% maximum nonlinearity and a 100 ppm/°C maximum gain drift. The K versions offer a 0.015% maximum nonlinearity and a 50 ppm/°C maximum gain drift. Lastly, the L versions guarantee a 0.008% maximum nonlinearity and a 50 ppm/°C maximum gain drift. All units come in 1.5 × 1.5 × 0.4 in. (38 × 38 × 10.2 mm) modules and are specified from 0 to 70 C.

CIRCLE NO. 422

### Power op amp delivers over 1 A at up to 15 kHz

Beckman Instruments, 2500 Harbor Blvd., Fullerton, CA 92634. (714) 871-4848. From \$13 (100-up); stock.

The 833-21 series of power operational amplifiers delivers over 1 A of output current. The hermetically sealed, eight-pin TO-3 package handles more than 20 W when properly heat sunk. Features include a power bandwidth of 15 kHz, a quiescent power of 100 mW at ±15-V bias, an input offset voltage of 1 mV, an input offset current of 20 nA, a slew rate of 3 V/μs and an open loop gain of 100 dB. Two models are available: the 833-21 with an operating range of -55 to +125 C, and the 833-21C with a range of -25 to +85 C. Both units are pin-and-performance compatible with National Semiconductor's Models LH0021 and LH-0021C.

CIRCLE NO. 423



# COME ON UP TO OUR NEW PAD...



"SIL-PADS" are solid-state heat-sink insulators. . . easy to handle, completely flexible, with no breakage. High dielectric strength, superior tear strength, resistant to cut through. Save lots of production time and quality control problems. Regular "SIL-PADS" are manufactured from thermally conductive silicone rubber.

**NEW "SIL-PADS 400"** are a lamination of silicone rubber and fiberglass for particularly difficult cut-through problems. Other characteristics are the same as original "SIL-PADS" but "400s" are superior for some applications.

Many standard configurations; also custom capability.

**FREE SAMPLES,  
TECHNICAL DATA,  
and LITERATURE!**

## BERGQUIST CO.

4450 W. 78th  
Minneapolis, MN 55435  
Phone (612) 835-2322

CIRCLE NUMBER 154

## MICROWAVES & LASERS

### X-band rotary joint features two channels

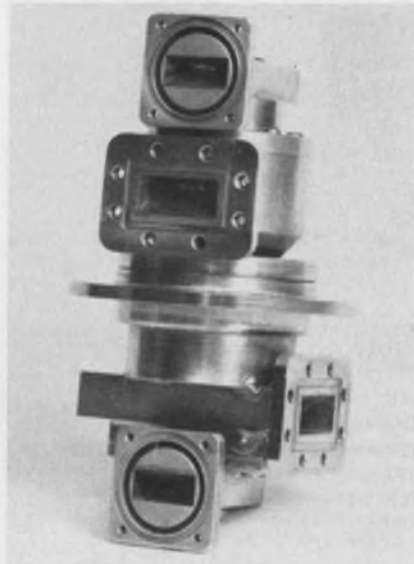

*Eastern Microwave Corp., 4 Gill St., Woburn, MA 01801. (617) 935-8600. \$3500; 60 days.*

A dual-channel X-band rotary joint operates over the frequency bands of 7.25 to 7.75 and 7.9 to 8.4 GHz. Channel 1 has a maximum VSWR of 1.15:1, maximum insertion loss of 0.15 dB, and a maximum variation in VSWR due to rotation (wow) of 1.05:1. Channel 2 is designed to carry 12.5 kW CS when pressurized at 30 psig. It has a maximum VSWR of 1.10:1.

CIRCLE NO. 424

### Impatt diode delivers 200 mW in Ka band

*Thomson-CSF, 750 Bloomfield Ave., Clifton, NJ 07015. (201) 779-1004. \$1425 (10-up); 3 mo. A.R.O.*

Standout of an extensive line of solid-state sources is the TH 5110, which delivers at least 200 mW of output power at its present Ka-band operating frequency, without the need for frequency multiplication. Performance characteristics of the TH 5110 include: preset frequency ( $F_0$ ) of 32 to 40 GHz; output power, min. of 200 mW; frequency stability less than 1 MHz/ $^{\circ}$ C. Mechanical tuning range covers 250 MHz on both sides of the factory-preset operating frequency.

CIRCLE NO. 425

### 1-GHz switch can replace relays

*Microwave Associates, South Ave., Burlington, MA 01803. (617) 272-3000. \$9.50 (large quantities).*

Usable from 20 to 1000 MHz, the solid-state MA-8334 SP2T switch replaces electromechanical switching relays in communications equipment. The circuit comes in a JEDEC power-transistor package. Typical switch specifications at 450 MHz are: isolation of 28 dB, insertion loss of 0.2 dB, input VSWR of 1.2, cw input power of 50 W, and pulsed power (.001 duty, 10  $\mu$ s pulses) of 1 kW.

CIRCLE NO. 511

### Use GaAs FETs for TWT drivers



*Plessey Microsystems, 1674 McGaw Ave., Irvine, CA 92714. (714) 540-9945. See text.*

Two new medium-powered n-channel GaAs FETs, Models PGAT-100 and PGAT-200, are designed to replace TWT drivers for higher powered devices or for medium-powered oscillators and amplifiers up to X-band. The PGAT-100 has a typical output of 100 mW with an associated gain of 6 dB at 5 GHz, and 64 mW with 5 dB gain at 8 GHz. The PGAT-200 has a typical output of 200 mW with an associated gain of 6 dB at 5 GHz, 100 mW out and 5 dB gain at 8 GHz. Both devices use a Schottky-barrier contact as the gate electrode and are fabricated using the same methods and materials as are used in other FETs, which have passed space qualification selection procedures. PGAT-100 devices are available as chips or in a space-qualified hermetic package. The 100-piece price of the PGAT-100 chip is \$99. PGAT-200 devices are at present only available in P130 packages at a 100-piece price of \$225.

CIRCLE NO. 512



# HOW DO YOU IMPROVE ON THE MOST ADVANCED EMI/RFI SHIELDING GASKET?

Armored Xecon® moves the state-of-the-art in conductive elastomer gasketing into a new dimension with pre-formed configurations that bend, twist and roll. Result: extra strength to withstand severe stress, shock, vibration and flexure, even at temperatures up to 200°C.

*The news:* we've integrated a backbone of strong, flexible knitted wire mesh into a sheet of our Xecon® conductive elastomer to produce a rugged, versatile shielding/pressure gasket material with high-tensile strength. Even under high flexure-stress, Armored Xecon retains maximum EMI/RFI shielding up to 18 GHz or higher, and a uniform pressure seal to above 100 psi. Another way Metex makes Xecon adaptable.

For full data, samples and application engineering consultation on Xecon and other composite shielding/pressure seal solutions, call or write: Metex Corporation, Edison, N. J. 08817, (201) 287-0800; or Cal-Metex Corp., Inglewood, CA, 90301, (213) 641-8000.

## BY MAKING IT FLEXIBLE



# METEX

ELECTRONIC SHIELDING GROUP

"Visit our booth at Electronica American Section, Hall 16"

CIRCLE NUMBER 165

## MICROWAVES & LASERS

### Variable attenuators handle 5 W



Weinschel Engineering, Gaithersburg, MD 20760. (301) 948-3434. -60, \$400; -114, \$555; stock to 45 days.

Models 940-60 and 940-114 are continuously variable attenuators for precision control of signal levels over a broad power range. Model 940-60 has a 0 to 60-dB incremental attenuation range from dc to 4.0 GHz. Model 940-114 has a 0 to 114-dB incremental attenuation range from dc to 2.0 GHz. Both models have a rated life of 10,000 cycles of operation without degradation of specifications. (A cycle is defined as a sweep from minimum to maximum and back to minimum.

CIRCLE NO. 513

### Diode switch offers super fast rise time

Hewlett-Packard, 1501 Page Mill Rd., Palo Alto, CA 94304. (415) 493-1501. Start at \$65; stock-6 wks.

With a guaranteed speed of 5-ns rise time and 7-ns fall time, this new series of microwave switches is said to be the fastest available. The 33140/33640 series switches are specified for operation from 0.1 to 18 GHz. Models 33640 series are discrete hermetically sealed modules using fast p-i-n diodes in shunt across a 50-Ω transmission line. Models 33140 series are complete switches with rf connectors, bias circuit and built-in dc return. Both series are available with either two or four diodes.

CIRCLE NO. 514

### Coax crystal detectors work to 12.4 GHz



Micronetics Inc., 36 Oak St., Norwood, NJ 07648. (201) 767-1320. \$145; 4-6 wks.

These coaxial crystal detectors cover a frequency range of 0.01 to 12.4 GHz with a frequency response within  $\pm 0.5$ -dB absolute. Relative matching, excluding bias sensitivity, is within  $\pm 0.2$  dB. Other specs include: output impedance below 15  $\Omega$  shunted by 10 pF; output polarity negative (positive optional); rf input, type N, male connectors; maximum power of 100 mW, peak or average.

CIRCLE NO. 515

### Small attenuators work at low VSWRs

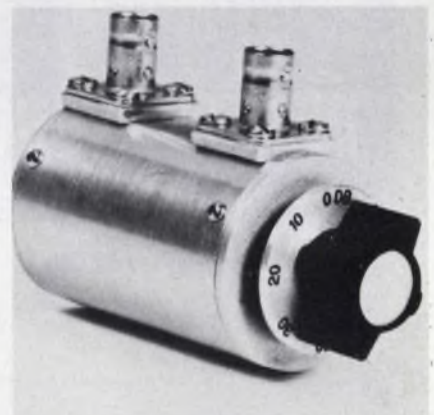

Kay Elemetrics Corp., 12 Maple Ave., Pine Brook, NJ 07058. (201) 227-2000. \$99; 15 days.

Subminiature rotary attenuators provide VSWR's of less than 1.3:1 and insertion loss of less than 0.5 dB over the 2-GHz frequency range. Printed-circuit techniques and self-cleaning rotary switch action provide positive repeatability over prolonged periods of time. The entire unit occupies only 2-1/2-in. of panel depth and weighs in at less than 10 oz. Various attenuations and steps are available.

CIRCLE NO. 516



# MOPS\* for your MPU

Trio Labs Model 674/675 \*Multi-Output (Switching Regulator) Power Supplies will provide all your MPU power needs in one box for less than you could do it yourself!

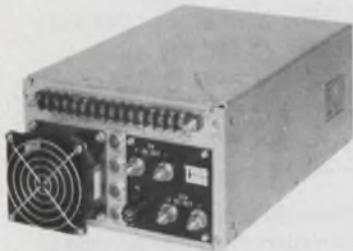

Up to 4 outputs — 475 watts. A main 2 or 5 VDC rail @ 50 or 70 amps. A second rail @ up to 10 amps. Two additional outputs @ up to 4 amps ea.

Internal Cooling — Overvoltage, Overload and Overtemperature Protection, Remote Sense—Independent V adj.—U.L. rec.—just some of the features of Trio's 674/675.

And single unit prices begin @ only \$635.

So go with the leader — Call or write:

**TRIO LABS** THE®  
Switcher Source  
80 Dupont St. Plainview NY (516) 681-0400

CIRCLE NUMBER 161

# Circuit Savers

## NEW SIGNAL/DATA/TELEPHONE PROTECTION



The SLP protectors were expressly designed to protect signal/data/telephone lines from transient overvoltages caused by lightning, heavy machinery, elevator motors, generators, etc. The SLP interfaces between the signal lines and the sensitive circuit to provide a sophisticated blend of high speed (nanoseconds) voltage limiting and brute force protection. The SLP's recover automatically to standby when the need for protection has passed.

Output Clamp Voltage Level  $\pm 5V$  to  $\pm 200V$   
Input Voltage Level (max) to  $\pm 35KV$  (10 US)  
Energy Handling to 50 joules and higher

CATALOG 801

Full line of protection modules for every hi-lo voltage/current requirement. Write or call for data.

279 Skidmore Rd., Deer Park, N.Y. 11729  
Telephone: 516-586-5125

# MCG Electronics

CIRCLE NUMBER 162

## MICROWAVES & LASERS

### Attenuators handle up to 25 W

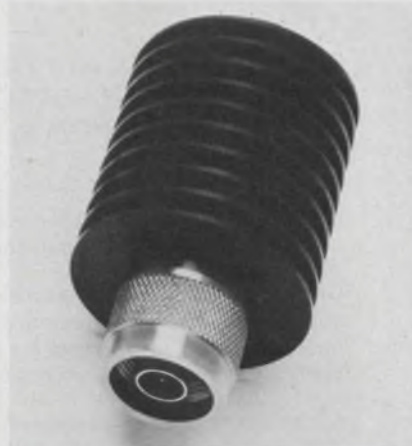

Telonic Altair, P.O. Box 277, 2825 Laguna Canyon Rd., Laguna Beach, CA 92652. (714) 494-9401. \$65.

The 8212 series of fixed-value attenuators can handle 15 through 25 W. The units operate from dc to 4 GHz, have a 50- $\Omega$  impedance, and are available in eight standard attenuation values: 3, 6, 10, 20, 30, 40, 50, and 60 dB. The 3-dB unit is rated at 25 W; the 6 and 10 dB at 20 W; and the balance at 15 W. Tubular in shape, the attenuators measure only 3-in. long and are 1-1/2 in. in diameter. Weight is 5.25 ounces.

CIRCLE NO. 517

### Miniature mixers work up to 9 GHz

Watkins-Johnson, 3333 Hillview Ave., Palo Alto, CA 94304. (415) 93-4141. WJ-M21, \$298; WJ-M22, \$315.

The company's line of dual-quad (eight-diode), high-level microwave mixers includes two new models, WJ-M21 and M22. These miniature mixers cover a frequency range of 2.5 to 5 GHz and 4 to 9 GHz, respectively, and measure only 0.6  $\times$  0.65  $\times$  0.2 in. They operate equally well as up or down converters and feature a high intercept point and wideband (5 MHz to 3 GHz) i-f response. WJ-M21 and M22 are designed for good two-tone performance and low noise figure, typically 6.0 dB. With +13-dBm LO drive level, these mixers have a typical +20-dBm input third-order intercept point.

CIRCLE NO. 516

### Mixers and preamps have lowered noise

RHG Electronics, 161 E. Industry Court, Deer Park, NY 11729. (516) 242-1100. See text.

RHG has improved the noise performance of a line of octave and multi-octave double-balanced microwave-mixers and mixer-preamplifiers. Although unit sizes and prices remain the same, reductions of up to 1.5 dB in noise-figures are now standard on all models. The units cover carrier ranges from 1 to 18 GHz and i-f ranges of dc to 2 GHz. As a typical example, the noise figure of the Model DM8-12 (still priced at \$350) has been reduced from 9.5 dB to 8.0 dB. All units feature a double-balanced configuration which offers high LO-to-rf isolation coupled with low intermodulation products. The improved noise performance can enhance system sensitivity and range in ECM, surveillance, radar and wideband communications systems where these devices are used.

CIRCLE NO. 519

### Small switch modules offer internal drivers

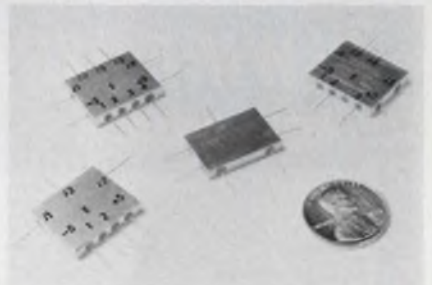

Crown Microwave, Inc., 6 Executive Park Dr., North Billerica, MA 01862. (617) 667-4165. \$100 to \$600; 30 days.

These diode switch modules have integrated TTL-compatible drivers and rf bias networks. They are hermetically encapsulated in a copper package 0.625  $\times$  0.750  $\times$  0.136 in. Depending on customer requirements, the tiny switches will operate over one, two or three plus octaves between 0.1 and 18.0 GHz. Designated CDM series Dri-Mod™ switch modules, these units are said to have over twice the MTBF of similar coaxial switches on the market. Standard units are offered in SPST, SPDT, SP3T and SP4T configurations with 5 and 6 throw available on request.

CIRCLE NO. 520



# DUAL OUTPUT REGULATED

## $\pm 15v$ DC power sources

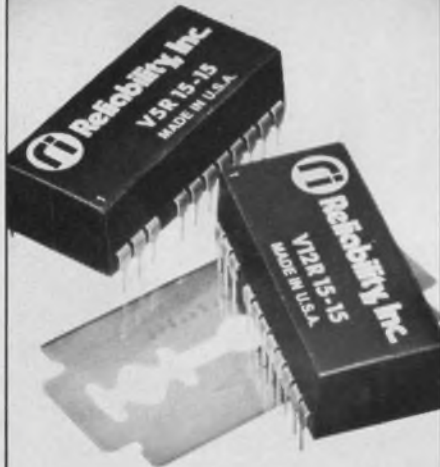

For...

- Operational amplifiers
- Comparators
- D-A Converters

**ONE WATT OUTPUT · COMPACT  
DIP PACKAGE · LOW NOISE  
ISOLATED · LOW PRICE**

Ultra compact "V-PAC" \*DC-DC power sources use 5v or 12v input, provide  $\pm 15v$  regulated low noise output, which can be balanced.

Output Voltage	$\pm 15v$
Output tolerance	$\pm 5\%$
Output ripple	30 mv, P-P max.
Line regulation	3%
Load regulation	3%
Operating temp	0° to 70°C
Isolation	10 M $\Omega$ @ 50v
Price	\$25.25 (100 pcs)



## Reliability, Inc.

5325 Glenmont/Houston, Texas 77036  
713-566-3261/TWX: 910-881-1739

International: Reliability Nederland, B. V.  
Summerhill, Nenagh, Co. Tipperary, Ireland

\*Trademark, Reliability, Inc.  
Price subject to change without notice

CIRCLE NUMBER 166

## POWER SOURCES

### Single unit outputs 3 CRT voltages from 28 V



Emco High Voltage, 2444 Old Middlefield Way, Mountain View, CA 94043. (415) 969-3056. \$395 (1-9); 3 to 4 wk.

The Model 431 CRT power supply gives you three separate output voltages from a +28-V input. Its 15-kV anode output supplies up to 200  $\mu$ A with 0.01% line and 0.1% load regulation and 0.01% pk-pk ripple. The +300-V output supplies 5 mA with 0.1% line and 2% load regulation, and 0.1% pk-pk ripple. The 3-to-5-kV focus voltage provides 250  $\mu$ A with 0.01% line and 0.2% load regulation, 0.05% pk-pk ripple, and has provision for adding 0 to 300 V for dynamic focusing. The unit switches at 25 kHz, is protected from reverse-input to 50 V and operates from -10 to +65 C. It is 2 x 5 x 8 in.

CIRCLE NO. 522

### Program 5 to 500 mA of constant current

Calex Mfg., 3305 Vincent Rd., Pleasant Hill, CA 94523. (415) 932-3911. \$49; stock to 2 wk.

The Model 930 is a programmable, constant-current source with an output of 5 to 50 mA (or 5 to 500 mA, using the MK296HP mounting kit). Output current of the 1.5 x 1.5 x 0.5-in. module can be set by means of an external potentiometer or by a dc voltage. A regulator and reference circuit make the output current independent of power supply variations. The input voltage range is +12 to +32 V dc. Compliance voltage (maximum output voltage for highest load impedance) is 5 V less than the supply voltage. Output current regulation is  $\pm 0.005\%$  over the full operating range.

CIRCLE NO. 523

### Three-output switcher passes 375 W

LH Research, Inc., 1821 Langley Ave., Irvine, CA 92714. (213) 843-8465. \$530; 8-9 wk.

Primary dc output of a standard Model MM-230 is 5 V at up to 75 A; the two secondary outputs can be any one of the following: 12 V at up to 8 A, 15 V at up to 8 A, and 18 V at up to 6 A. Maximum total for all three outputs is 375 W. This switching regulator is up to 80% efficient and features: ripple and noise on the output of 1% or 50 mV pk-pk; line regulation of 0.5% over the entire input range; load regulation of 0.4% from no-load to full-load; and response time of 200  $\mu$ s to 1% after a 25% load change. The unit contains a fan which permits operation from 0 to 70 C, with full rating to 40 C and derated to 60% at 70 C. This supply is designed to meet UL 478, measures 3.9 x 5 x 15.25 in. and weighs 10 lb.

CIRCLE NO. 524

### Anchor line voltage for line-load variations



Frequency Technology, Box 365, Whitcomb Ave., Littleton, MA 01460. (617) 456-3374. \$2000 to \$12,000; 6 wk.

The Stabilac series of completely magnetic ac line-voltage stabilizers spans the power range of 9 to 150 kVA. Operating from three-phase lines, they hold the variation of their three-phase output-voltages to  $\pm 4\%$ —even when a change in current demand from no-load to full-load occurs simultaneously with a line-voltage variation of -20 to +10%. These units hold to  $\pm 1.5\%$  for similar changes, in either line or load, occurring separately. Standard inputs and outputs are 208, 240 and 480 V for 60-Hz models, while the 50-Hz versions deliver 380 V, from 220/380-V inputs.

CIRCLE NO. 525



# Right on the button!

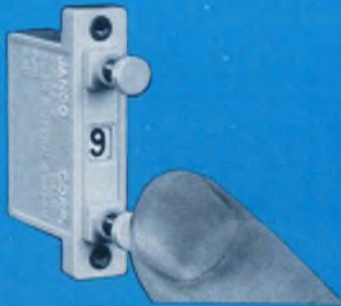

## Janco

### PUSH BUTTON ROTARY SWITCHES

Unique by virtue of their simplicity, Janco Push Button Rotary Switches function accurately and quickly in the most adverse environmental conditions and are "right on the button" for high density packaging.

Available in Bi-directional and Uni-directional models in 8, 10, 12 and 16 positions in all standard coded outputs with a wide variety of custom features. Qualified to MIL-S-22710.

Janco . . . the name for quality . . . since 1947.

**Janco**  
CORPORATION

3111 WINONA AVE., BURBANK, CALIF. 91504  
PHONE 213-845-7473 • TWX 910-498-2701

CIRCLE NUMBER 174

# MICROPAC

LOW-COST OFF-THE-SHELF

## HYBRID VOLTAGE REGULATORS



4 TO 10 amp  
output current

- 5 to 36 fixed voltage range
- Positive & Negative voltages
- 120 Watts power dissipation
- Internal short circuit protection
- External components not required
- Standard TO-3 Package
- Available from stock
- Economically priced

**CUSTOM PRODUCTS ALSO AVAILABLE  
WRITE FOR OUR FREE FACILITIES BROCHURE**

***Mii***

**MICROPAC INDUSTRIES, INC.**

905 E. WALNUT ST. GARLAND, TEXAS 75040 Tel. 214-272-3571  
TWX 910-860-5186

CIRCLE NUMBER 176

# NEW RECTIFIER BRIDGES

FREE  
FREE



FREE  
FREE

**NEW 12 AMP, .250 QUICK CONNECT  
LOW COST, SMALL SIZE**

Just tell us your OEM application for these great, new, low cost, small size, 12 ampere, single phase, full-wave bridges and we will send you free samples for evaluation. 50, 100, 200, 400, 600 and 800 PRV. Heat sink or chassis mounting. If you would rather have samples of some of the many other items in our extensive bridge and diode lines let us know. We will try to get them to you. Company letterhead, please.

Buy from the specialist.

**edi** **electronic devices inc.**  
21 GRAY OAKS AVE., YONKERS, N.Y. 10710  
(914) 965-4400. TWX 710 560-0021

CIRCLE NUMBER 175

- DPDT Snap action gold contact.
- Alternate or Momentary action.
- High reliable T-1 3/4 Bi-Pin Lamp.

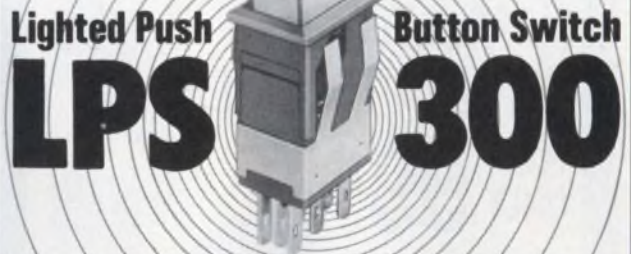

- LPS-300T ... DPDT, Momentary action
- LPS-300B ... DPDT, Alternate action
- LPS-301T ... SPDT, Momentary action
- LPS-301B ... SPDT, Alternate action

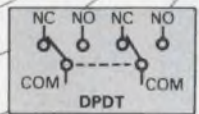

• For more information, please contact to:

**WAMCO Technical Sales, Inc.**

705 W. 16th Street, Costa Mesa, California 92627  
TEL: (714) 833-9361 TELEX: 678459

**OSHINO ELECTRIC LAMP WORKS, LTD.**  
TOKYO, JAPAN

CIRCLE NUMBER 177

ELECTRONIC DESIGN 22, October 25, 1976



# USC's UMI most compact ULTRA MINIATURE CONNECTORS

7 UMI Series -- Standard &  
Closed-Entry  
MIL-C-28748/7, 8 and others.

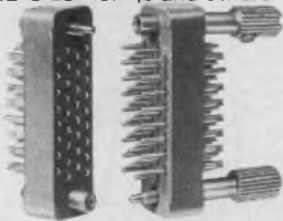

Highest reliability -- proved in Gemini/Apollo flights! 1 of over 20,000 types of connectors. Write or phone for UMI Series catalog -- today!

**U.S. COMPONENTS, INC.**

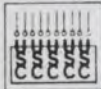

Leader in advanced engineering & design  
1320 Zerega Avenue, Bronx, N.Y. 10462  
(212) 824-1600 TWX: 710-593-2141  
Cable: COMPONENTS, NYK

CIRCLE NUMBER 179

## KEEP

Electronic Design's

# GOLD BOOK

HANDY



## When You Call

Save time when you contact suppliers. Check their catalog pages first in *Electronic Design's* GOLD BOOK. Maybe the information you need is right at your fingertips.

# New Literature

Texas Instruments  
Total Microprocessor Capability

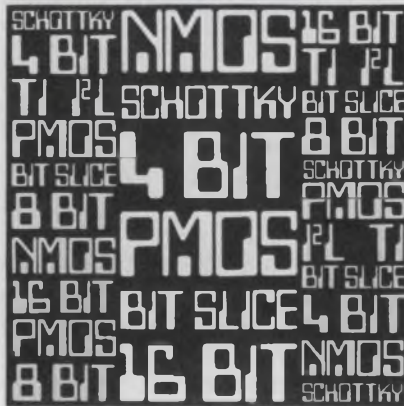

## Microprocessors

An eight-page brochure describes the firm's total microprocessor capability. Included are microprocessor CPUs, software, support hardware and memory components. Texas Instruments, Dallas, TX

CIRCLE NO. 530

## Illuminated switches

Low-cost, computer-grade illuminated switches are described in a 12-page catalog. Specifications, application data, mounting and ordering information are included. Dialight, Brooklyn, NY

CIRCLE NO. 531

## Latch connectors

Nearly 100 items in the company's latch connector series are described in a 16-page catalog. Also described in the catalog are card-edge connectors in 20 through 60-position sizes. AMP, Harrisburg, PA

CIRCLE NO. 532

## Component mounts, spacers

Component mounts, spacers and spreaders for ICs, semiconductors and discrete components are described in a 16-page packaging digest. Bivar, Santa Ana, CA

CIRCLE NO. 533

## Digital logic analyzers

Features of digital logic analyzers along with concise explanations on the applications and use of these features are given in a catalog. Included are photographs illustrating timing diagram display outputs for different operational modes. Biomation, Cupertino, CA

CIRCLE NO. 534

## Testing capabilities

Methods and equipment are described and illustrated for dynamics testing, environmental simulation and reliability demonstration in an eight-page brochure. Associated Testing Laboratories, Wayne, NJ

CIRCLE NO. 535

## Semiconductors

Transistors, rectifiers, diodes and other semiconductors are featured in a catalog. The 52-page catalog lists the type number, package and technical data for more than 5000 semiconductors in an easy-to-read format. Semiconductors, Freeport, NY

CIRCLE NO. 536

## Minicomputers

The microNova family of minicomputers is covered in a 16-page brochure. The brochure includes data on the 16-bit, NMOS microNova CPU and chip sets, board computers, fully packaged minicomputers and flexible-disc-based development systems. Data General, Southboro, MA

CIRCLE NO. 537

## Ignition systems

Electronic ignition systems are described in an eight-page illustrated booklet. Delta Products, Grand Junction, CO

CIRCLE NO. 538

## Zener diodes

A 146-page catalog contains cross-reference lists, diode specifications and application notes on zener diodes. Copies of the catalog are available upon request on company letterhead. Siemens, Components Group, 186 Wood Ave. S, Iselin, NJ 08830.

INQUIRE DIRECT



## NEW CATALOG! POWER ROTARY SWITCHES



- Complete line of switches for Industrial Control Applications
- 17 basic switch models
- Ratings from 10A to 200A . . . from 240V to 600V
- Up to 75 poles! up to 16 positions!
- Myriad of standard & optional features

Request Catalog E-4

**ELECTRO SWITCH**  
Weymouth, Massachusetts 02188

Telephone: 617/335/5200 • TWX: 710/388/0377

CIRCLE NUMBER 188

## SWITCHES FOR KEYBOARDS

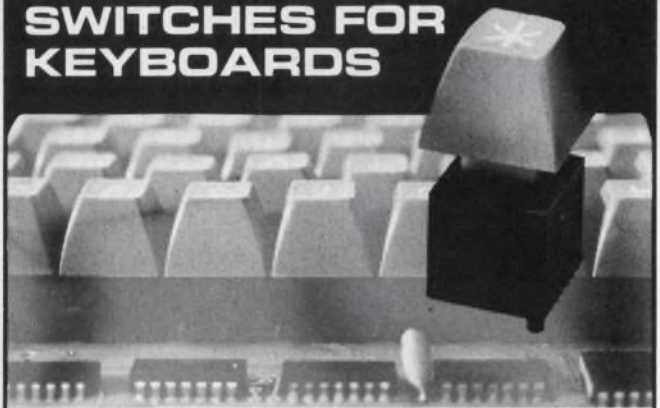

We offer the following for OEM's producing their own keyboards.

- Keyswitch sizes for 5/8" or 3/4" centers
- Gold Bar mechanical contacts or sealed contacts
- Front panel relampable lighted models
- Single and double pole contacts including NC
- Alternate action models
- Doubleshot molded keytops for 3/4" or 5/8" mounting
- Easy change legend systems
- 100,000 pc. quantity prices as low as \$0.19 each

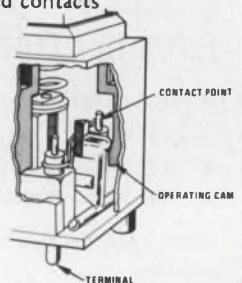

Letterhead request or phone call brings free sample switch w/keytop.



**MECHANICAL ENTERPRISES, INC.**

8000 Forbes Place Springfield, Virginia 22151  
(703) 321-8282 TWX 710-832-0942

In Germany · NEUMÜLLER GMBH, MUNICH  
In U.K. · TEKDATA Ltd., STOKE-ON-TRENT

CIRCLE NUMBER 189

# new from Hayden!

*"... well-organized, extremely well written . . . highly recommended for practicing engineers..."*

IEEE Transactions

## DIGITAL SIGNAL ANALYSIS

Samuel D. Stearns

This is an ideal master handbook on today's signal processing procedures and systems, containing recent advances, new design material, and a comparison between continual and digital systems that's extremely helpful to newcomers to the field. Featuring a foreword by Richard Hamming, the book contains a review of linear analysis; sample-data systems; analog-to-digital and digital-to-analog conversion, the discrete Fourier transform and the fast Fourier transform algorithm; spectral computations; non-recursive and recursive digital systems; computer simulation of continual systems; analog and digital filter designs, and more. 288 pages.

*"Jacobi's book is great . . . a new, original, readable, usable book on writing for business and professional people. . . ."*

Jim Lufkin, Mgr. Professional Publications, Honeywell.

## WRITING AT WORK: Dos, Dont's, and How Tos

Ernst Jacobi, Xerox Corporation.

This guide to better writing follows its own principles by being lively, informative, and easy to read. More than a collection of pat rules and formulas, the book is a storehouse of practical advice for business and professional people to make their writing sharper, more interesting, and more informative. It shows you how to overcome procrastination and change your entire attitude toward writing, making it easier and more enjoyable for you! 208 pages.



**HAYDEN BOOK COMPANY, INC.**  
50 Essex Street, Rochelle Park, New Jersey 07662

## Order today—15-day examination!

Please send me the following book(s) to read and use FREE for 15 days. At the end of that time, I'll either send the amount indicated, plus postage and handling, or return the book(s) with no obligation.

- DIGITAL SIGNAL ANALYSIS, #5828-4, \$19.95  
 WRITING AT WORK, #5730-X, \$10.95

Name \_\_\_\_\_

Company/Institution \_\_\_\_\_

Address \_\_\_\_\_

City/State/Zip \_\_\_\_\_

**SAVE MONEY! Payment Enclosed.** Publisher will pay all shipping and handling charges. Same 15-day return privilege and full refund if not satisfied.



# Circuit Savers

NEW

## AC POWER LINE PROTECTOR



Protects  
110, 220, 380,  
440 VAC line  
1 $\phi$ , 3 $\phi$  - 50/60/400 Hz

The Series P operates rapidly to prevent damage to equipment operating on the AC power lines, by switching rapidly to a clamping state whenever a transient exceeds the clamping threshold. The units operate on overvoltages of either polarity, on 1 $\phi$  and 3 $\phi$  lines and recover automatically when the transient expires. Severe transient conditions cause the protector to switch to a crowbar mode and cause an external fuse or circuit breaker to operate.

### CATALOG 801

Full line of protection modules for every hi-lo voltage/current requirement. Write or call for data.

279 Skidmore Rd., Deer Park, N.Y. 11729  
Telephone: 516-586-5125

# MCG Electronics

CIRCLE NUMBER 186

## Build a Microcomputer System With This \$7.95 Handbook.

At last, a practical, step-by-step approach to building an operational microcomputer for a bargain price. The **Iasis Microcomputer Applications Handbook** will guide you through all phases of actual design of a working 8080 microcomputer system including writing a system monitor program. Both development and OEM systems are covered in detail.

Microcomputer  
Applications  
Handbook

P.S. If the Microcomputer Applications Handbook isn't everything we say it is, return it within 15 days for a full refund.

ORDER BEFORE NOV. 24, 1976 AND WE'LL SHIP YOUR HANDBOOK POST-PAID.

- Here's my check or money order for \$7.95. Add \$ 50 for postage and handling if ordered after Nov. 24, 1976. (California residents please add \$ 49 state sales tax.) Overseas shipments will be made surface unless \$5.00 shipping is added.
- Charge to the credit card number below:

BankAmericard No. \_\_\_\_\_

Master Charge No. \_\_\_\_\_

For Master Charge, add 4-digit number from right above name. It is: \_\_\_\_\_

Here's my Signature \_\_\_\_\_

Credit card expiration date \_\_\_\_\_

FIRM \_\_\_\_\_

NAME \_\_\_\_\_

ADDRESS \_\_\_\_\_

CITY \_\_\_\_\_

STATE/ZIP \_\_\_\_\_

MAIL YOUR ORDER TO IASIS, INC.  
815 W. MAUDE AVE., SUITE 12  
SUNNYVALE, CA 94086

## NEW LITERATURE



### Alphanumeric displays

Cost, design and performance features of the second-generation SELF-SCAN II equipment compared with CRT displays is described in a six-page brochure. Burroughs, Plainfield, NJ

CIRCLE NO. 551

### Data-link control network

A set of four data sheets detail hardware and software aspects of a synchronous data-link control network for distributed computing. The SDLC 1578 and 1579 plus the 1575 multiplexer, are described. General Automation, Anaheim, CA

CIRCLE NO. 552

### OCR applications

A 24-page OCR applications sketchbook is available to aid system planners in the economic application of OCR machines to their systems. The 23-page booklet is not highly technical, but discusses applications in layman's terms. Context Corp., Burlington, MA

CIRCLE NO. 553

### Test equipment

Component test equipment—including bridges, comparators, capacitors, and high-voltage insulation testers—from A/S Danbridge, Denmark, is described in a booklet from their new U.S. distributor. General Resistance, Mt. Vernon, NY

CIRCLE NO. 554

### Ac motor starters

Solid-state ac motor starters that use power SCRs are discussed in a 12-page bulletin. Vectrol, Rockville, MD

CIRCLE NO. 555

### Barrier terminal blocks

A newly-expanded line of barrier terminal blocks for PC board and panel mount feed-through termination, featuring standard and patented right-angle mounting styles, are described in a 16-page catalog. Reed Devices, Glen Ellyn, IL

CIRCLE NO. 556

### Thermistors

Matched thermistor pairs designed for use in thermal-conductivity instrumentation and adaptable as prime transducers in the field of ecology instrumentation are described in a pamphlet. Fenwal Electronics, Framingham, MA

CIRCLE NO. 557

### Timing, control elements

An illustrated 16-page product guide contains condensed specs and data on a full line of timing and control components. North American Philips, Cheshire, CT

CIRCLE NO. 558

### UL/OSHA cables

UL-listed, CSA-certified, OSHA-acceptable cables are described in a 28-page 2-color catalog. Alpha Wire Co., Elizabeth, NJ

CIRCLE NO. 559

### Industrial relays

Application data and specifications on Class 67 miniature industrial relays are provided in a 12-page catalog. Magnecraft Electric, Chicago, IL

CIRCLE NO. 560

### Line-voltage regulation

Line-voltage regulation—problems and solutions—are detailed in a 16-page catalog covering both theory and design of regulators including 40 different applications. Sola Electric, Elk Grove Village, IL

CIRCLE NO. 561



# Have you read Electronic Design's ACCURACY POLICY?



We have been printing it in every issue of *Electronic Design* for the past 24 years and adhering to it every business day of the year.

The accuracy policy of *Electronic Design* is:

- To make diligent efforts to ensure the accuracy of editorial matter.
- To publish prompt corrections whenever inaccuracies are brought to our attention. Corrections appear in "Across the Desk."
- To encourage our readers as responsible members of our business community to report to us misleading or fraudulent advertising.
- To refuse any advertisement deemed to be misleading or fraudulent.

## Electronic Design

50 Essex Street, Rochelle Park, NJ 07662

## Bulletin Board

Control Data Corp. has introduced electromagnetic transients and power network analysis (EM-TRAN) software for use by electric utilities via CDC's CYBER-NET data services network.

CIRCLE NO. 562

Intersil is second-sourcing the Siliconix LD110/111/114 analog and digital a/d processors.

CIRCLE NO. 563

Computer Automation has introduced an assembly language specifically designed to function with very small computers such as the LSI-3/05 Millicomputers. The Omega 3/05 program is an assembler/editor and requires 4-k/16-bit words of memory.

CIRCLE NO. 564

Teledyne Semiconductor has introduced an 8-bit monolithic a/d converter in a plastic package for use over the 0-to-70-C range.

CIRCLE NO. 565

GenRad has reduced the price of its GR 1730 automatic linear circuit tester from \$7595 to \$6835.

CIRCLE NO. 566

Signetics has added five analog ICs to its military-qualified product line. They are the LM158, a single-supply (3-to-30-V) dual op amp; the SE532, a dual op amp; the SE515, a differential amp; the DM7820, a dual line receiver, and the DM7830, a dual differential line driver.

CIRCLE NO. 567

"Cooling of Electronic Equipment" is a training course consisting of six one-hour sessions. It is available in three formats: videotape (\$1500); slide/audiotape (\$595); and audiotape (\$150). For additional information, contact Cooling Courses, P.O. Box 11534, Palo Alto, CA 94036.

INQUIRE DIRECT

## Vendors Report

Annual and interim reports can provide much more than financial position information. They often include the first public disclosure of new products, new techniques and new directions of our vendors and customers. Further, they often contain superb analyses of segments of industry that a company serves.

Selected companies with recent reports are listed here with their main electronic products or services. For a copy, circle the indicated number.

**Honeywell.** Control systems and information systems.

CIRCLE NO. 568

**Sierracin.** Heating devices, temperature sensors, servo motors and hydraulic equipment.

CIRCLE NO. 569

**Philip Morris Industrial.** Packaging, paper and chemicals.

CIRCLE NO. 570

**EG&G.** Scientific instruments, components, environmental and biomedical services.

CIRCLE NO. 571

**Fairchild.** Semiconductors, consumer products, instrumentation systems, Federal systems, and industrial products.

CIRCLE NO. 572

**Pfizer.** Materials science products, chemicals and pharmaceuticals.

CIRCLE NO. 573

**Thomas & Betts.** Electrical/electronic connectors, terminals, fittings and accessories and application tooling.

CIRCLE NO. 574

**Vitramon.** Inorganic monolithic capacitors.

CIRCLE NO. 575

**Conrac.** Avionics, industrial products, information systems and machinery.

CIRCLE NO. 576

**Electronic Associates,** Analog/hybrid computers.

CIRCLE NO. 577



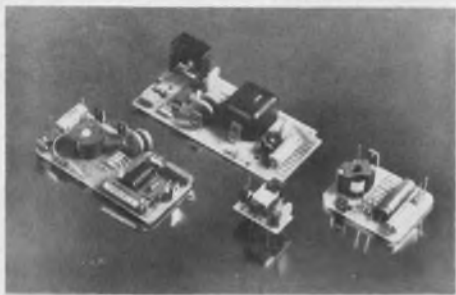

**Activate gas discharge readouts!** Custom designed and produced DC-to-DC power supplies to activate gas discharge displays, or for other applications. Regulation I/O options, packaging (encapsulated, aluminum shell or open frame), size and configuration, heat dissipation, mounting (PC board pins, edge connectors), etc., can be tailored to meet individual specifications. Price and delivery discussed after specifications are submitted. Endicott Coil Co., Inc., 31 Charlotte Street, Binghamton, N.Y. 13905 (607) 797-1263.

CUSTOM DESIGNED POWER SUPPLIES 260



36  
MONTH  
WARRANTY

1200  
MODEM

The TELCON TM-1200 is a quality FSK data Modem designed for asynchronous operation up to 1800 PBS. The Modem is available as a low profile desk top unit, in rack mount or in basic card configuration for OEM applications. All units comply with EIA standard RS-232 and are compatible with existing WE-202D models. Active integrated filter networks are used with excellent long term stability. All units are 100% burned-in. Price 1-9 \$365.00. Telcon Industries, Fort Lauderdale, Florida 305-971-2250.

MODEM 263

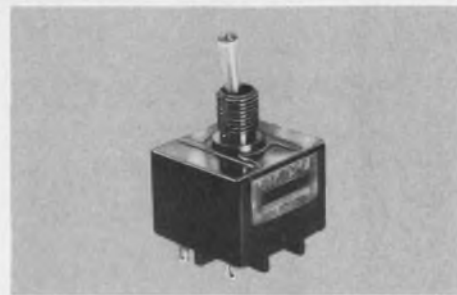

**Model 9201 Power Switch**, miniature DPDT toggle is designed to meet international dimensional/electrical specs. Electric life: 25,000 make-and-break cycles at full load. Contact rating: 6 amps with resistive load @ 120 VAC or 28 VDC. Free Engineering Sample on request. C&K Components, Inc., 103 Morse St., Watertown, MA 02172, (617) 962-0800.

POWER SWITCH 266

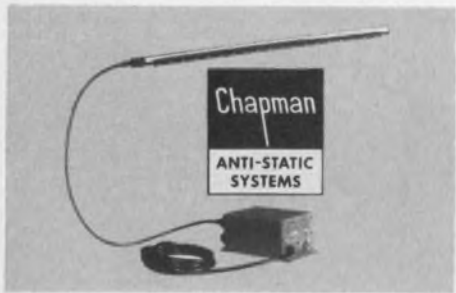

Chapman  
ANTI-STATIC  
SYSTEMS

**ANTI-STATIC SYSTEMS FOR PRINTERS, OCR COM and other machines.** Static causes rapidly moving paper and film to jam. . . cause arc tracks on undeveloped film. . . attract and hold dust to photographic negatives causing imperfections on printed circuit boards. Numerous products, of interest to both OEM and user, are detailed in new 32 page catalog to solve these problems quickly, reliably and economically. Chapman Anti-Static Div., Portland Co., 58 Fore St., Bx 427, Portland, ME 04112. (207) 773-4726

ANTI-STATIC SYSTEMS 261



**PRACTICAL DESIGN FOR ELECTROMAGNETIC COMPATIBILITY**, ed. by R. Ficchi. A complete guide to elec. compatibility for electronic systems and equipment, including semiconductor, microelectronic, and digital computer equipment. Numerous charts, graphs, and nomographs. #5685-0, 272 pages, \$17.20. Circle the Info Retrieval Number to order 15-day exam copy. When billed, remit or return book with no obligation. Hayden Book Co., 50 Essex Street, Rochelle Park, N.J. 07662.

DESIGN GUIDE 264



**MODULAR DC/DC CONVERTERS** offer 5 and 10 W dual output and 15 W single output with eff. from 55 to 68%. Regulation is 5 mv. Dual units allow rated power from one output. L/C filtering on both input and output for low noise. (1-9) from \$78.60. B. H. INDUSTRIES, 5784 Venice Bl., Los Angeles, CA 90019 (213) 937-4763.

MODULAR DC/DC CONVERTERS 267



**Free New '76 catalog** contains over 34,500 quality power supplies from the world's largest manufacturer, Power/Mate Corp. Power Supplies for every application including submodulars, open frame, variorated, encapsulated, laboratory & system. All units UL approved and meet most military and commercial specs for industrial and computer uses. Power/Mate Corp., 514 S. River St., Hackensack, NJ 07601 (201) 343-6294

POWER SUPPLIES 262

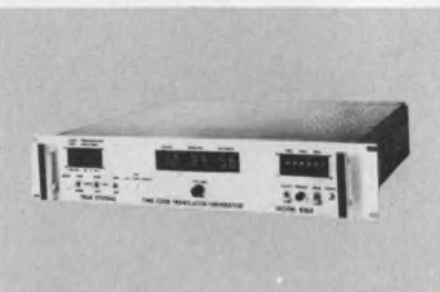

**MODEL 8363 TIME CODE TRANSLATOR/GENERATOR** operates on external 1 MHz standard or optional 1 MHz internal standard. Automatic WWV synchronization included. Time of day on six 0.6-inch planar displays. Code input formats include IRIG A, B, G, NASA 36, XR3, and 2137. Time generation continues with loss of input code. Numerous options and formats available. TRAK Systems, 4722 Eisenhower Blvd., Tampa, FL 33614. 813-884-1411. Telex 52-827.

TRANSLATOR/GENERATOR 265

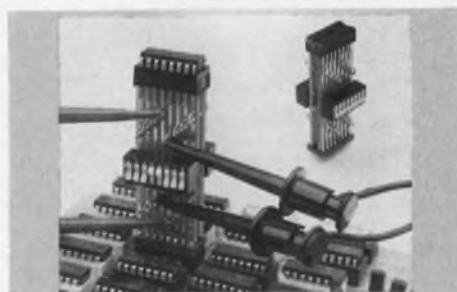

**Dual-in-Line circuit TEST/MODIFICATION fixture** for plug in IC's provides a means of non destructive testing or circuit modification. Switches provide isolation of each circuit lead, test points are provided on each side of the switches for testing or circuit modification. 14 pin \$21.95, 16 pin \$22.95, other sizes and prices on request. Pat. applied for. EMD Co., 7891 Camp Chaffee Road, Ventura, CA 93001 805-649-1513

TEST/MODIFICATION FIXTURE 268



# Advertiser's Index

Advertiser	Page	Advertiser	Page	Advertiser	Page
A P Products Incorporated	176A—F, 248	Caddock Electronics	241	Duncan Electronics, Subsidiary of Systron-Donner	189
AMP, Incorporated	10, 11	Cambridge Thermionic Corporation	236, 273	EECO	27
AVX Ceramics Corporation	18, 19	Centralab. The Electronics Division of Globe-Union, Inc.	135, 208	EMD Co.	274
Acopian Corp.	95	Centre Engineering	248	EMR Telemetry, Weston Instruments, Inc.	269
Advanced Micro Devices	8, 9	Cherry Electrical Products Corp.	28, 29	E-Z Hook, A Division of Tektest, Inc.	171
Ailtech, A Cutler-Hammer Company	253	Computer Automation, Inc.	16A—H	Efratom California, Inc.	261
Airpax Electronics, Cambridge Division	226	Computer Conversions Corp.	273	Elco Corporation	49
Alco Electronic Products, Inc.	267	Computer Operations, Inc.	261	Electro/77	162
Allen Bradley Co.	48B, C	Continental Specialties Corporation	229	Electro Space Fabricators, Inc.	275
American Microsystems, Inc.	184	Control Data Corporation	231	Electro Switch Corp.	268
Amilon Corporation	250	Control Products Division, Amerace Corporation	79	Electro-Craft Corporation	48
Amperite Co., Inc.	204	Cortron A Division of Illinois Tool Works Inc.	146	Electrocube Corp.	214
Ampex Memory Products	153	Coto Coil Company, Inc.	254	Electronic Design	33, *96J, 252
Amplifier Research Corporation	232	Crown Industrial	176	Electronic Devices, Inc.	264
Analog Devices, Inc.	90	Crystek Crystals Corporation	267	Electronic Measurements, Inc.	244
Arnold Magnetics Corp.	212	Dale Electronics, Inc.	*112A—L, 205	Electronic Molding Corporation	133
Arrow-M Corp.	198	Damon Electronics Division	*112 A—L, 205	Electronic Navigation Industries	80A
B & H Industries	274	Data Display Products	34	Elmwood Sensors, Inc.	257
B & K Products of Dynascan	104, 105	Data General Corporation	109	Endicott Coil Co., Inc.	274
Belden Corporation	31	Data I/O Corporation	17	Engineered Components Company	275
Berg Electronics	89	Data Precision Corporation	13	Exact Electronics, Inc.	134
Biomation	72, 73	Datak Corporation, The	257	Facit-Addo, Inc.	179
Bishop Graphics, Inc.	255	Datanetics	222	Fifth Dimension, Inc.	246
Bodine Electric Company	253	Dataram Corp.	147	GTE Automatic Electric	81
Bourns, Inc., Trimpot Products Division	Cover II	Datel Systems, Inc.	46	*Germanium Power Devices Corp.	96H
Bergquist Co.	256	Decitek	275	Gold Book, The	266, 271
Bunker Ramo, Amphenol Connector Division	114	Deltron, Inc.	265	Gulton Industries, Inc.	203
Burr-Brown	207	Dialight, A North American Philips Company	187	Hansen Manufacturing Co.	117
C & K Components, Inc.	234, 274	Digital Computer Controls, Inc.	239	Harwil Co.	273
CTS Corporation	112	Digital Equipment Corporation	14, 15	Hayden Book Company, Inc.	177, 268, 271, 273, 274, 275
Capitol Machine and Switch Co., Inc.	110			Heinemann Electric Company	111

## Design Data from Manufacturers

Advertisements of booklets, brochures, catalogs and data sheets. To order use Reader-Service Card (Advertisement)

### Low-Noise High-Gain Preamplification



Complete specifications of a variable-bandwidth high-gain preamplifier are contained in the Model 113 data sheet, T-224. Included are typical noise figure contours illustrating the amplifier's exceptionally low noise, which is as low as .05 dB at mid frequencies with a 1 megohm source. Other illustrations include typical plots of the equivalent input noise and common mode rejection, which exceeds 100 dB at 60 Hz at all gain settings. The data contained in the specification sheet will be of interest to all engineers and researchers looking for a preamplifier with calibrated gain and rolloffs from dc to 300 kHz.

CIRCLE NO. 200

**Princeton Applied Research Corporation**

Box 2565, Princeton, New Jersey 08540 - (609) 452-2111

See us at Electronica Show Hall 20 Booth 20308 2nd Flr

## classified ad

### CASH FOR YOUR SCRAP

We buy scrap P.C. boards, connectors, modules, fingers, cutoffs and all other material containing gold, silver and platinum.

No waiting for your money. We pay the freight. Send sample for quote and indicate number of pounds for sale.

ZONE INDUSTRIES  
719 North 12th St — P.O. Box 371  
St. Charles, Illinois 60174

**Protect Your Heart  
HAVE REGULAR MEDICAL  
CHECK UPS**



Give Heart Fund









# Q

WHICH OF THE  
ANNUALS DO  
ELECTRONICS ENGINEERS  
CONSULT MOST?

# A

Electronic Design's  
**GOLD BOOK**

# 83%

OF THE ENGINEERS WHO RESPONDED TO  
A TECHNICAL TRENDS ANALYSTS SURVEY SAY  
THEY CONSULTED THE GOLD BOOK  
WITHIN THE PAST MONTH

(Survey date: February, 1976)

*IF IT'S ELECTRONIC... IT'S IN THE*  
**GOLD BOOK**

(91,000 copies of the 1976/77 edition are now off the presses  
and are being used throughout the U.S.A. and overseas!)



Program it or modulate it ...

# RCA presents the variable op amp. As easy to use as a transistor.

The CA3080 variable op amp is the first differential-voltage input, current output op amp. Like a transistor it has a control input—one that lets you vary not just voltage but also power, bandwidth, slew rate, input current and output current. It can be programmed and/or signal modulated to select the optimum gain, speed, bandwidth and power. And the output can sink or source current.

#### It puts the designer in complete charge.

This wide range of operation gives you unusual design flexibility. You can create simplified versions of present designs ... or take unique approaches to new designs. You have linear gain over a 6-decade range to work with. A 50V/ $\mu$ s slew rate. Power levels adjustable from below 1  $\mu$ W up to 30 mW. And if you need more than 1 mA output, the CA3094 has integral Darlington's to provide 300 mA peak output.

In short, you can "shape" the variable op amp to fit the job—and create big circuit savings.

How much does all this flexibility cost? Amazingly little: 55¢ for the 3080E and 65¢ for the 3094E, at the 1K level.

For data sheets and application notes on these op amps, contact your local RCA representative. Or RCA.

Write: RCA Solid State, Box 3200, Somerville, N.J. 08876; Sunbury-on-Thames, Middlesex TW16 7HW, England; Ste. Anne de Bellevue H9X 3L3, Canada; Fuji Building, Tokyo, Japan.

# RCA



plex Voltage follower Multiplier  
range oscillator Analog timer L  
mple and hold Multiplex Voltage  
ply Wide-frequency-range osc  
voltage tunable filter Sample and  
ual-tracking power supply Wid  
erator Gain control Voltage tunable filter Sample and hold Multiplex Voltage

ge protector Dual-trackin  
n systems Ramp generator G  
multiplier Comparator Over-voltage  
analog timer Level detector Alarm syste  
Multiplex Voltage follower Multiplier C  
frequency-range oscillator Analog timer Le

## RCA. Full house in Linear ICs.