

Electronic Design[®] 15

VOL. 24 NO.

FOR ENGINEERS AND ENGINEERING MANAGERS

JULY 19, 1976

Custom LSI or microprocessor?

Which way? Each has its place, but the choice depends on many factors. These include: leadtime, performance specs, reliability,

software, production volume and, of course, price. There are a number of sign posts that can help guide the engineer. This special report starts on p. 26.



RENEW NOW

See card inside cover

THE FIRST INTEGRAL PUSHBUTTON POTENTIOMETER



If you're designing panels with precision data entry or set-point controls, consider the BOURNS Model 3680 KNOBPOT® Digital Potentiometer . . . another innovative idea from Bourns. The 3680 integrates a precision incremental decade potentiometer with an easy-to-read digital display, AND a speedy pushbutton control action. It is handsome, extremely accurate, and a "snap" to install. Everything is INSIDE the Model 3680 . . . no resistors or mini-PC boards are required . . . nothing clutters the back of the unit to steal precious space.

PUSHBUTTON ACTION



Simple, fast, precise. Push the PLUS button to increase; the MINUS to decrease. Rated life is 100,000 operations per decade.

IN-LINE DIGITAL READOUT

Large, easy-to-read numbers enable fast, "squint-free" data entry and information readout.

ACCURATE

You get what you set with the 3680 . . . every time. The unique Bourns design integrates precision laser-trimmed cermet resistor technology with a positive pushbutton detent action. The result is resolution of output of 1 part in 1000 discrete steps, and dependable repeatability of $\pm 0.1\%$.

COSTS LESS TO INSTALL

Snap-in mounting cuts installation time, eliminates mounting hardware. Integral bezel covers irregular panel cut outs and minor edge blemishes. Terminals match the AMP Series 110 receptacle . . . or can be soldered in the standard fashion.

FEATURES AND SPECIFICATIONS

- stable built-in cermet resistance elements
- 100 PPM/°C tempo • 2 watts power rating
- standard resistance range (3 decade unit) 5K ohms to 1 megohm • $\pm 1.0\%$ resistance tolerance • resolution 0.1%.

COMPACT SIZE

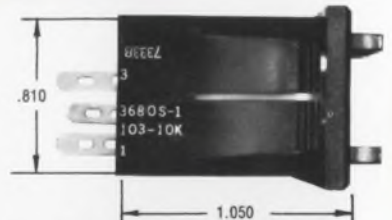

For more information, write or phone the "Panel Power People," TRIMPOT PRODUCTS DIVISION, BOURNS, INC., 1200 Columbia Avenue, Riverside, CA 92507. TWX 910 332-1252. Telephone: 714 781-5610. CIRCLE NUMBER 252



SURPRISE!



High Speed, High Reliability, High Gain Isolators from Hewlett-Packard!

Hewlett-Packard now offers you a broad family of high-performance optically-coupled isolators. These devices are ideal for telephone, computer, medical, press control and instrumentation applications. Our high-speed isolators can handle data at a rate of up to 10 Mbits per second. The high-reliability isolator is a dual-channel unit, hermetically sealed. Our high-gain, low-input isolator requires 0.5 mA of input. And, best of all, they are all in stock at any of our franchised distributors.

In the U.S., contact Hall-Mark, Schweber, Wilshire or the Wyle Distribution Group (Liberty/Elmar) for immediate delivery. In Canada, contact Bowtek Electronics Co., Ltd., Schweber Electronics or Zentronics, Ltd.

It's time to get to know Hewlett-Packard's family of high-performance isolators.

HEWLETT  **PACKARD**

Sales and service from 172 offices in 85 countries.
1507 Page Mill Road, Palo Alto, California 94304

Microprocessors take control with Teledyne I/O converters

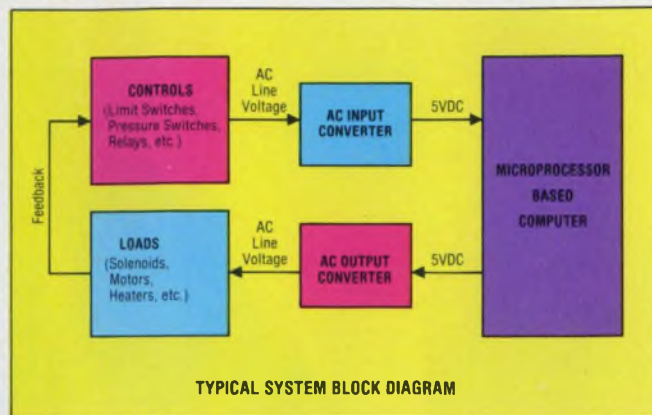

Modular packaging of input/output interface circuitry. That's what Teledyne I/O Converter Modules provide microprocessor based industrial controls for maximum I/O flexibility and expandibility. This single circuit modular concept features all-solid-state circuitry, 1500V optical isolation, and high noise immunity. Our 671 Series modules plug directly into a low cost custom-designed mounting panel, which physically isolates

service wiring from logic connections. For pc boards, we offer the same circuitry in our 675 Series low profile package. Both series include ac and dc input/output converters.

So for the best in I/O interface circuitry for microprocessor based industrial controls, contact the people who know the "ins and outs" of this business — Teledyne Relays.

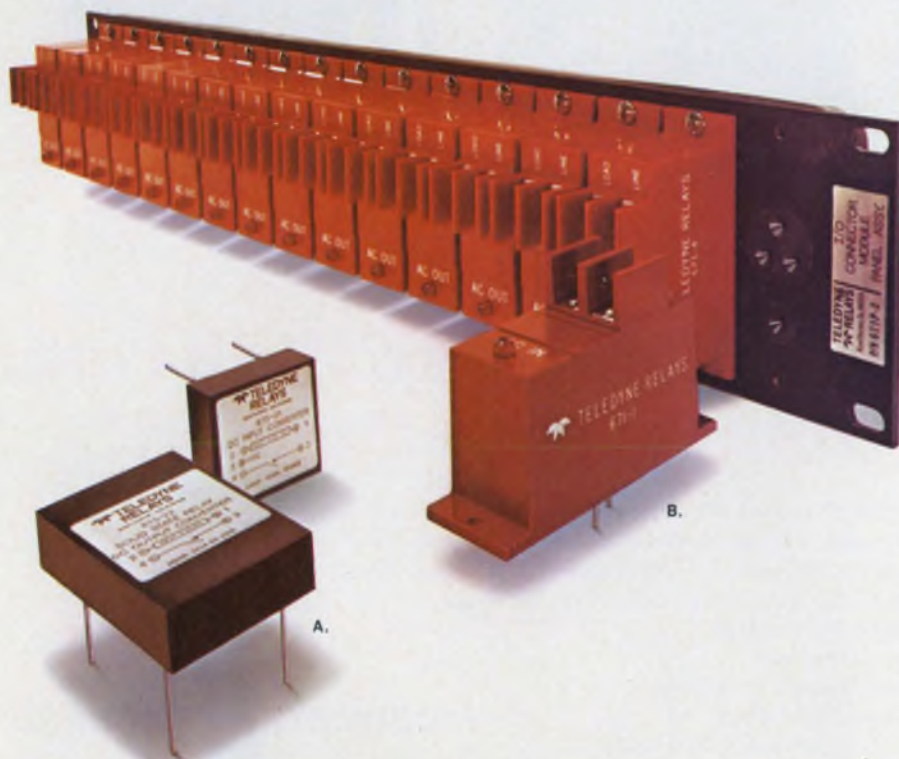

C.

- A. 675 Series — Low profile I/O converter modules for pc board mounting
- B. 671 Series — Panel mounted I/O converter modules (with integral LED status indicators)
- C. 671P Series — Custom-designed mounting panel

 **TELEDYNE RELAYS**

3155 West El Segundo Boulevard, Hawthorne, California 90250
Telephone (213) 973-4545

CIRCLE NUMBER 3

ELECTRONIC DESIGN 15, July 19, 1976

-
- 21 **News Scope**
 - 26 **To use custom LSI or microprocessors**, that is often the question . . . An Electronic Design special report.
 - 34 **Progress in gigabit logic design** is reported for super-fast switching applications.
 - 42 **Superconducting diode mixer** gives paramp noise figure.
 - 47 **Washington Report**
-

TECHNOLOGY

53 MICROPROCESSOR DESIGN

- 67 **Put together a complete microcomputer** with a 6800 μ P and only two or three support circuits. Programmable interface circuits offer maximum flexibility.
 - 80 **Bring your μ P up "bit-by-bit."** With a systematic, section-by-section approach you can test both hardware and software in less time.
 - 88 **Get simultaneous analog outputs** from your microprocessor-based system. Sequential addressing delays can be eliminated if you add extra data latches.
 - 98 **Programmable logic arrays** make simple controllers and decoders. They approach the versatility of microprocessors, yet they program like ROMs.
 - 104 **Reduce circuit manufacturing costs:** Monte Carlo computer simulation finds a cost-effective mix of tight component tolerances vs individual calibration.
 - 110 **The drive motor of a servo** or start/stop system largely determines the system's dynamic response. Low inertia/inductance motors provide high performance.
 - 116 **Ideas for Design:**
Voltage-to-current converter built with few components . . . Power-down circuits allow three-state operation with some CMOS drivers . . . A simple battery charger for gel cells detects full charge and switches to float.
 - 124 **International Technology**
-

PRODUCTS

- 144 **Lab power supply** adjusts itself for constant power.
 - 161 **Fastest pulse generator** blazes at 1-GHz rep rate.
 - 127 Discrete Semiconductors
 - 131 Components
 - 135 Integrated Circuits
 - 137 Data Processing
 - 139 Microwaves & Lasers
 - 144 Power Sources
 - 148 Modules & Subassemblies
 - 157 Packaging & Materials
 - 161 Instruments
-

DEPARTMENTS

- 61 **Editorial:** Plan Ahead
- 7 Across the Desk
- 164 Application Notes
- 164 Bulletin Board
- 166 Evaluation Samples
- 167 New Literature
- 174 Advertisers' Index
- 176 Product Index
- 176 Information Retrieval Card

Cover: Design by Art Director Bill Kelly, photo courtesy of Fairchild Semiconductor.

The Adventures of Digital Don.

Once there was an engineer named Digital Don who was into gates and flops and stuff like that. Don was... well... he was consistent.



He wasn't like the guys down the hall who were into micro-programming—the ones with lots of technicians, three-piece suits, fancy new equipment and slicky secretaries.



GOSH, YOU'RE NEAT.

WAIT'LL YOU SEE MY PIPELINE REGISTER.

SIGH.

Don didn't know much about micro-programming. There was never an easy way to get into it. And besides, he always did things the way he always did them, so why should he change now?

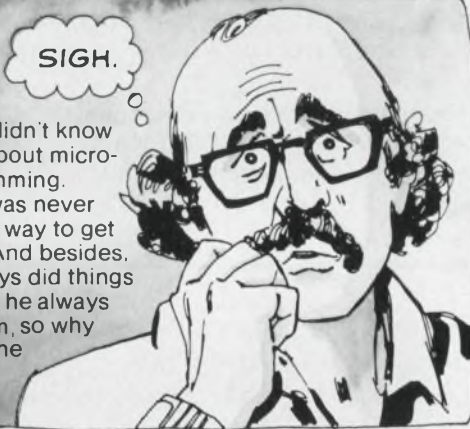

I'M REALLY WORRIED ABOUT HIM, GEORGE.



The Advanced Micro Devices' Learning and Evaluation Kit can teach Don how to configure a microprogrammed architecture using the industry standard Am2900 family. He'll be able to write and execute micro-instructions that will completely control an Am2901 microprocessor slice and Am2909 microprogram sequencer—just like a high-performance CPU.

GOLLY! FOR ME?!?!





The Am2900K1 Learning and Evaluation Kit.

It's terrific. For only \$289.00 you can master the basic theory and application of microprogramming. Here's what you get:

A read/write memory storing up to 16 microinstructions driving a pipeline register. From the pipeline register, the microinstructions control: an Am2901; circuits for logical and arithmetic shift and rotation; and the Am2909 sequencer that selects the next microinstruction address. Sixteen sequence control functions are built in, including conditional branch, loop, jump to subroutine and return. Built-in display logic

makes nearly every point in the system available at an LED display.

The Kit includes forty IC's, LED's, switches, resistors, decoupling capacitors, PC board and a really comprehensive manual covering assembly instructions, theory and experiments. The only thing you need to add is a 5-volt power supply.

Throw away your gates and flops. Get the Advanced Micro Devices Learning and Evaluation Kit from your AMD distributor. And become one of the really popular guys.



Advanced Microprocessors



Advanced Micro Devices • 901 Thompson Place, Sunnyvale, California 94086 • Telephone (408) 732-2400 • Distributed nationally by Hamilton/Avnet, Cramer and Schweber Electronics.



Save 5 Ways with Abbott's New 77% Efficient Power Supplies!

Abbott has a Hi-Efficiency series of power modules that can save 5 ways in your system. The Model "VN" series converts 47-440 Hz AC lines to regulated DC power and uses a new approach in switching technology that provides a highly reliable line or sixty-three high efficiency power modules.

The Model "VN" series saves in the following 5 ways:

- 1 SAVES POWER** – High frequency pulse width modulation and C/MOS digital IC control circuitry allow efficiencies of up to 77% in the Model "VN" series. This high efficiency realizes almost twice the output power per input watt than dissipative regulators.
- 2 SAVES SIZE** – Off line techniques and IC technology combine for packages of 70% less volume compared to dissipative regulators.
- 3 SAVES WEIGHT** – High efficiency means less power dissipated and less heat generated, thereby reducing or eliminating the need for bulky heat-sinking and forced air cooling. This translates into less total weight and smaller system size.
- 4 SAVES TIME** – You can quickly get the power supply you need because we have an extensive line of models to choose from. Outputs of 25, 50 and 100 watts are available at any voltage between 4.7 and 50.0 VDC. With popular voltages in stock, chances are the unit you need is available immediately.
- 5 SAVES MONEY** – At only \$299 for 25w, \$339 for 50w, and \$359 for 110w in small quantities, the "VN's" are among the lowest priced Hi-efficiency units on the market.

Abbott also manufactures 3,500 other models of power supplies with output voltages from 2.7 to 740 VDC and output currents from 4 milliamperes to 20 amps. They are all listed, with prices, in the new Abbott Catalog. Included are:

60 A to DC
 400 A to DC
 28 VDC to DC
 28 VDC to 400 A
 12-38 VDC to 60 A

Please see pages 1037-1056 Volume 1 of your 1975-76 EEM (ELECTRONIC ENGINEERS MASTER Catalog) or pages 612-620 Volume 2 of your 1975-76 GOLD BOOK for complete information on Abbott Modules.

Send for our new 60 page FREE catalog.

abbott transistor

LABORATORIES, INCORPORATED
 general offices eastern office

5200 W. Jefferson Blvd./Los Angeles 90016
 (213) 936-8185 Telex: 69-1398

1224 Anderson Ave./Fort Lee, N.J. 07024
 (201) 224-6900 Telex: 13-5332

"SEE US AT WESCON/76 SHOW IN LOS ANGELES, BOOTH NO. 1057"

CIRCLE NUMBER 6

Sr. Vice President, Publisher
 Peter Coley

Editors

Editorial Offices
 50 Essex St.
 Rochelle Park, NJ 07662
 (201) 843-0550
 TWX: 710-990-5071
 Cable: Haydenpubs Rochellepark

Editor-in-Chief George Rostky

Managing Editors:

Ralph Dobriner
 Michael Elphick

Associate Editors:

Dave Bursky
 Samuel Derman
 Morris Grossman
 John F. Mason
 Stanley Runyon
 Michael Shunfenthal

Contributing Editors:

Peter N. Budzilovich, John Kessler
 Alberto Socolovsky, Nathan Sussman

Editorial Field Offices

East

Jim McDermott, Eastern Editor
 P.O. Box 272
 Easthampton, MA 01027
 (413) 527-3632

West

David N. Kaye, Senior Western Editor
 8939 S. Sepulveda Blvd., Suite 510
 Los Angeles, CA 90045
 (213) 641-6544
 TWX: 1-910-328-7240

Jim Gold, Western Editor

1537 Shasta Ave.
 San Jose, CA 95128
 (408) 279-8588

Editorial Production

Marjorie A. Duffy, Production Editor
 Tom Collins, Copy Editor

Art

Art Director, William Kelly
 Richard Luce, Anthony J. Fischetto

Production

Manager, Dollie S. Viebig
 Helen De Polo, Anne Molfetas

Circulation

Manager, Barbara Freundlich
 Trish Edelmann, Gene M. Corrado

Information Retrieval

Peggy Long

Advertising Promotion

Paul K. Hogue

Across the Desk

Home power usage is less than stated

In his generally excellent article on major solar-cell programs (ED No. 6, March 15, 1976, p. 24), Associate Editor Samuel Derman mentions that the average single family house is estimated to require 500 kWh/day. I think this figure must be incorrect.

My home here in New Jersey is all electric. Power consumption in the last three years has been as follows:

	Total	
Year	Consumption	Daily Av.
1973	53,520 kWh	146.6 kWh
1974	43,374 kWh	118.8 kWh
1975	40,806 kWh	117.8 kWh

Since a very large part, say, 1/3 to 1/2 of the above energy is for heating, and since most homes use gas, or oil, I imagine, the correct figure for typical home electrical energy consumption must be more on the order of 50 kWh per day. At the time my house was built I was told that on a very cold day, 10 F, the heating load for my house would be about 20 kW. Thus, on an unusually cold day total power consumption might be about 500 kWh for an electrically heated house like mine.

John Pittman

3 Old Farm Rd.
Warren, NJ 07060

Ed Note: Yes, the published figures for electric usage should have been per month rather than per day. Consolidated Edison, New York City, provides the following data for average home use in New York City:

For a private home, approximate-

ly 500 kWh are used per month.

For each apartment in an apartment house, approximately 250 kWh are used per month.

According to the Edison Electric Institute, a national electric-utility organization, the average residential use of electricity in 1975, nationally, was 8176 kWh for the year, or 681.3 kWh per month.

Solar-cell inventor was unappreciated

As I scanned Samuel Derman's fine article on "Major Solar-Cell Programs" (ED No. 6, March 15, 1976, p. 24), I was constantly reminded that the inventor of the solar cell lives just six miles south of here: Anthony H. Lamb, 726 S. Fowler Ave., Newbury Park, CA 91320. (805) 498-5860.

I've seen the original prototype. It still works.

Back in 1931 he was threatened with dismissal if he persisted in promoting it. So he turned it into the Weston light meter.

When retired he was in charge of 1400 creative engineers. He holds Federal citations in such arts as night flying, and guided missiles, and at 72 he took out his 200th patent.

All through the years, Tony has bucked the interests. Today when we need his ideas more than ever, nobody seems to give him a tumble. Now he's 73, and naturally frustrated, but active in other fields.

Maybe his name should appear in your closing list, titled "Need More Information?" Personally I

(continued on page 11)

Electronic Design welcomes the opinions of its readers on the issues raised in the magazine's editorial columns. Address letters to Managing Editor, Electronic Design, 50 Essex St. Rochelle Park, N.J. 07662. Try to keep letters under 200 words. Letters must be signed. Names will be withheld on request.



OPTRON REFLECTIVE TRANSDUCERS

NEW OPB 704 OFFERS
MAXIMUM RELIABILITY
IN A SINGLE
HERMETIC PACKAGE

OPTRON's new, low cost OPB 704 reflective transducer assures maximum reliability by combining a high efficiency solution grown LED with a silicon phototransistor in a single miniature hermetic package.

The hermetically sealed glass-metal-ceramic package offers extremely high reliability and stable performance at a cost competitive with that of plastic encapsulated devices. And, the OPB 704 has a usable continuous operating life of more than five years when operated at an average LED device current of 20 mA.

The OPB 704's phototransistor senses radiation from the LED only when a reflective object is within its field of view. With an LED input current of 50 mA, the output of the phototransistor is typically 0.5 mA when the unit is positioned 0.100 inch from a 90% reflective surface. With no reflective surface within the phototransistor's field of view, maximum output is 10 μ A with a LED input of 50 mA and V_{CE} of 5 volts.

Ideal applications for the OPB 704 reflective transducer include EOT/BOT sensing, mark sensing, detection of edge of paper or cards and proximity detection.

The OPB 704 and other low cost, high reliability OPTRON reflective transducers are immediately available. Custom designed versions for special applications are available on request.

Detailed information on the OPB 704 reflective transducer and other OPTRON optoelectronic products... chips, discrete components, limit switches, isolators and interrupter assemblies... is available from your nearest OPTRON sales representative or the factory direct.



OPTRON, INC.

1201 Tappan Circle
Carrollton, Texas 75006, USA
TWX-910-860-5958
214/242-6571

What our bottom-of-the-line

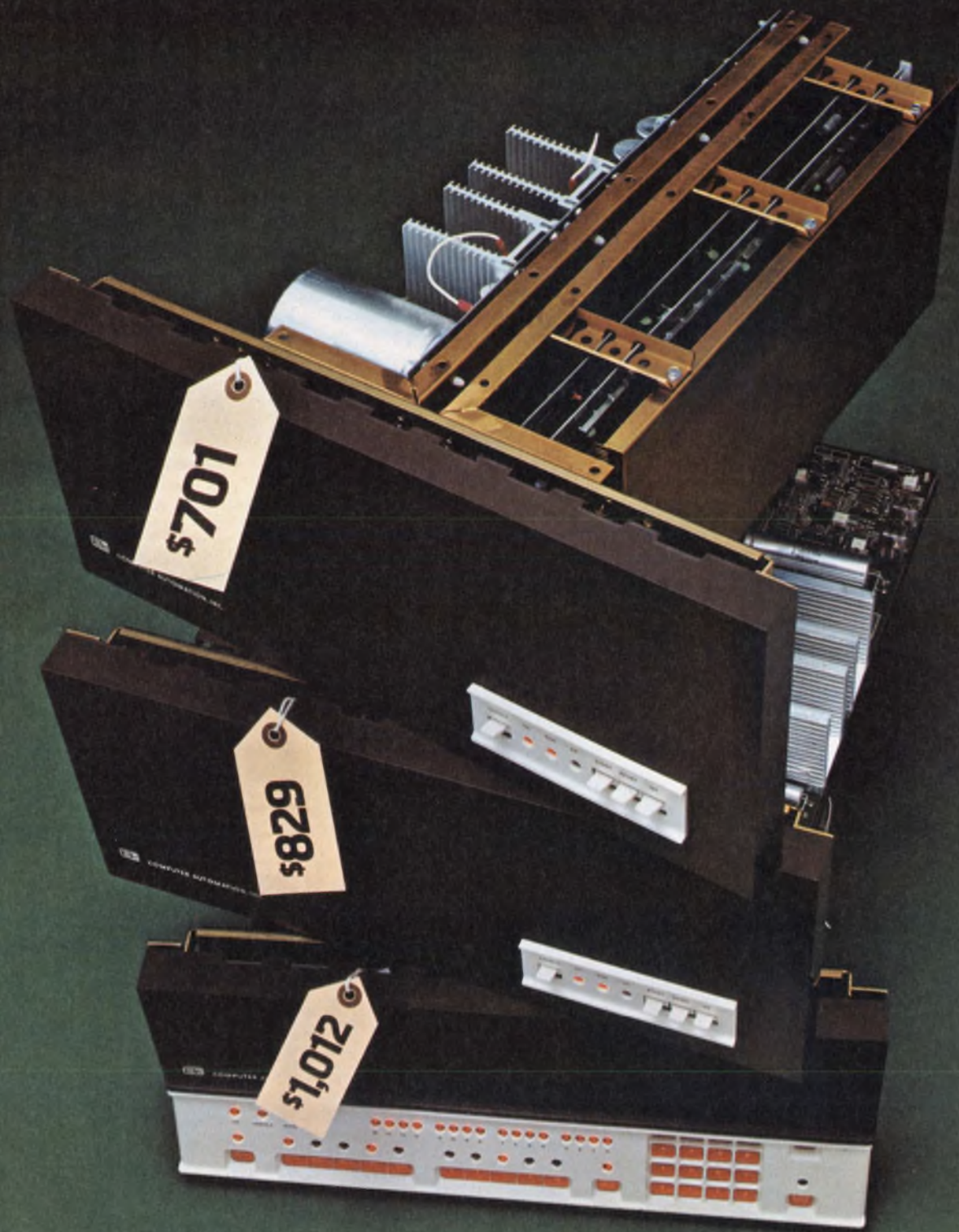

The ALPHA™ LSI-3/05 Series:
ComputerAutomation's low-cost line of 16-bit, full-scale,
fully compatible computers.

can do for your bottom line.

Stack the ALPHA LSI-3/05 millicomputer up against any other low-end computer.

Preferably while you're sitting down, because on price alone, you're bound to be astounded.

Ready? \$701 total packaged price. And that's complete with 256 words of MOS RAM, and a CPU that offers a really powerful instruction set, Power Fail Restart, Real-Time Clock and Autoload capability.

Try to buy an equivalent computer at twice the price.

Have it your way.

You also get the capability to configure your computer pretty well the way you want it. A choice of packaging, of course, that includes either the Operator's or the Programmer's Console, power supplies and so on.

A choice of two standard I/O options.

And a choice of optional memory configurations that

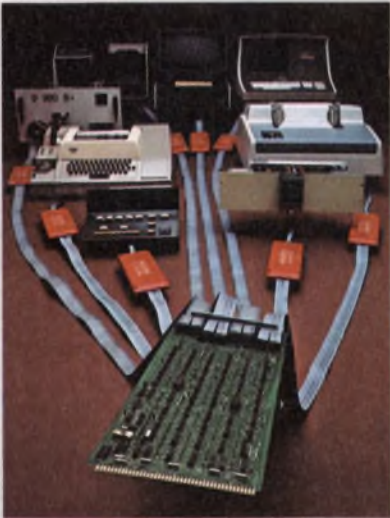

Maxi-Bus compatible ALPHA LSI-3/05 achieves unprecedented cost-effectiveness with ComputerAutomation's new Distributed I/O System.

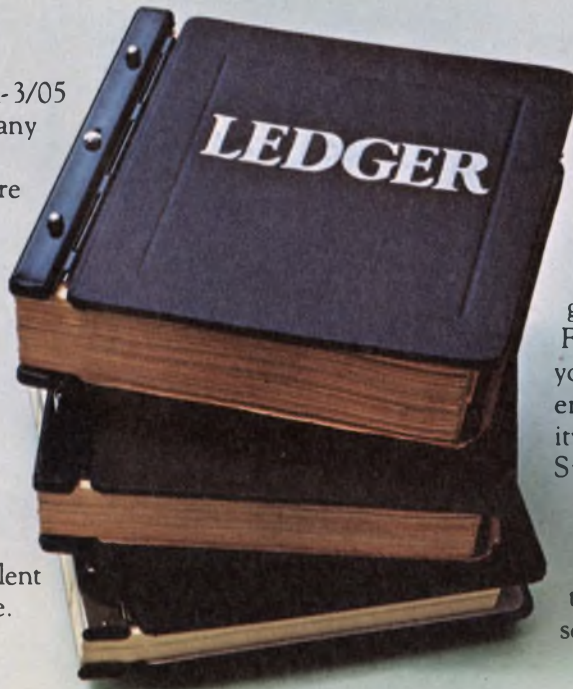

include RAM/ROM, RAM/EPROM and RAM-only in sizes from 256 words all the way up to 32K words. Totally addressable.

Family connections save you still more money.

So far, what we've been talking about could easily add another five or six figures to the bottom line of your ledger.

But there's more. Really big savings on off-the-shelf software, peripheral controllers and I/O interfaces.

The reason is that the ALPHA LSI-3/05 millicomputer is a full-fledged member of ComputerAutomation's LSI Family... Maxi-Bus compatibility and the whole works. So, every piece of Family hardware we've ever developed will work like it was made for the ALPHA LSI-3/05. Including ComputerAutomation's exclusive new Distributed I/O System... just like you see it in the picture.

With this versatile interface system, you can interface virtually any kind or combination of peripherals. Parallel or serial. Just by plugging them in.

Your cost? Probably less than \$200 per interface.

The pros know.

Computer-wise OEM's will tell you that product requirements sooner or later get ahead of the hardware. For instance, the computer you buy today may not have enough I/O or memory capacity for tomorrow's Mark II Super Widget.

Then you'll have to scrap all your software and your interface designs, because they're not about to work on some other machine.

You lose.

Of course, with our LSI Family of compatible computers you don't.

You can switch to a different CPU or a different memory anytime. Faster, slower, bigger, smaller. The electrical interface will still be the same; the original programming will still work.

You win.

From the people who brought you the NAKED MINI®

And the NAKED™ MILLI. And the Distributed I/O System. And the PICOPROCESSOR.

And now the ALPHA LSI-3/05 millicomputer.

One cost breakthrough after another. Breakthroughs that didn't just happen... a lot of profits got plowed back into R&D.

But then, that's the price of leadership.

 **ComputerAutomation**
NAKED MINI Division

U.S.A. 18651 Von Karman, Irvine, CA 92713
(714) 833-8830

EUROPE 31/35 Clarendon Road, Watford,
Hertfordshire WD1.11A England (0923) 39627

FOR FURTHER INFORMATION, CIRCLE 241
PLEASE HAVE A SALESMAN CALL, CIRCLE 242

HUGHES

HUGHES AIRCRAFT COMPANY
CONNECTING DEVICES DIV.

Today we
supply the spark
for America's
defense.

Connections were much simpler 200 years ago. Torch the fuse and the cannon fired.

Supplying the vital spark that makes a modern weapon system do its job is a lot more complicated.

That's where we come in. For many years, primes and OEMs for military and aerospace products have depended on us to provide the vital links in their electronic systems—flat cable, etched circuitry, connectors, and total interconnection systems.

Our high-rel connections have to be the best. They're used in systems like Phoenix, Maverick, Lance, Minuteman, AWACS, F-14, F-15, Space Shuttle, Viking, Sonobuoy, F-4, A-7, Condor, Standard Missile, F-18, AAH, Cruise Missile, F-8, Trident, Hobo, Sprint and many more.

To learn how we can serve your interconnection needs, contact Jack Maranto or Dave Cianciulli: Hughes Connecting Devices, 17150 Von Karman Ave., Irvine, CA 92714.

Or call (714) 549-5701.



**Hughes
Connecting Devices**

CIRCLE NUMBER 9

ACROSS THE DESK

(continued from page 7)

am convinced there are few men in the nation who could be more likely to steer us to simpler, less costly solar collectors.

A.S. Eves
Business Consultant

1668 Regent St.
Camarillo, CA 93010

Photovoltaic studies gain increased support

Thank you very much for your recent correspondence and the article by ELECTRONIC DESIGN on solar-cell technology. I have referred this material to my Subcommittee for further review.

I would like to point out that the Subcommittee has actually increased funding for photovoltaic research and development, over ERDA's FY1977 request, bringing the total to \$37,800,000—an increase of \$5 million. Additionally, the Materials Sciences portion of the ERDA budget will provide substantial funds for photovoltaic studies.

Thank you again for sharing with me your ideas on the development of solar cell technology as a potential large-scale source of electricity.

Mike McCormack, Chairman
Subcommittee on Energy

U.S. House of Representatives
Suite 2321 Rayburn House Office
Bldg.
Washington, DC 20515

New squelch circuit has multiple functions

Let me tell you about the new IC I have designed, which may be useful in implementing your latest "Thou shalt not sin . . . except in the interests of business."

It's a new squelch circuit that disables the transmitter whenever an audio signal occurs, and permits only the broadcasting of silence. It can also be used to implement the old dictum, "No news is good news," when applied to communications circuits. Best yet, this IC can be used in receivers as well as

in transmitters, so as to excise any sounds that unenlightened souls may foolishly broadcast. Bob Dobkin says this is the best invention since the Darkness-Emitting (Arsenide) Diode. Oughta sell millions . . . Keep up the good work.

Robert Pease
Staff Scientist

National Semiconductor Corp.
2900 Semiconductor Dr.
Santa Clara, CA 95051

What is this? Why, it's the Fruit of the Loom



No human ever painted this self-portrait.

The loom in the background is the "artist." It wove the picture in silk according to instructions on punched cards. Each of the ten million thread intersections was coded by hand on graph paper; the cards were then produced from the graph.

The year, by the way, was 1844—50 years before Herman Hollerith "invented" the punched card. Designer of the loom was the Frenchman, Joseph Marie Jacquard.

Short HP-25 program does combinations faster

I read with interest Mr. Schaffer's letter (ED No. 7, March 29, 1976, p. 7) about an improved HP-25 program for computing factorials. I also wrote programs for computing such important functions as permutations and combinations (binomial coefficients) which are much shorter than the

(continued on page 15)

For high-density CMOS/LSI circuits

Call Hughes
(714) 548-0671



1,021-channel Digital Frequency Synthesizer. 5V supply, 5 MHz input. (HCTR 0320)



Decade Counter/Latch/Decoder/Driver. Up/down, 2 MHz, 5V operation, 7-segment output (HCTR 0200)
4 Decade Counter. Up/down, 2 MHz, BCD outputs (HCTR 4010)



4-Decade Counter. 1 MHz, BCD outputs. (HCTR 6010)

Custom MOS designs. Use our experience in MOS/LSI circuits to meet unusual requirements like wide supply variations, high speed, ultra low power, differential amplifier input, RC oscillator and crystal oscillator. (Ask for custom MOS brochure).

Call number above or write to 500 Superior Ave., Newport Beach, CA 92663.



HUGHES

HUGHES AIRCRAFT COMPANY

Solid State Products Division

New ideas from a new source for flat cable and connectors

There are a lot of reasons why you should consider the newest source of flat cable connectors. To begin with, the newest source is one of the most experienced full line wire and cable manufacturers. So we know a lot about cable and how to connect it.

Let's start with our cable. It's compatible. Matches all flat-cable con-

nectors designed for 0.050 in. (1.27mm) conductor spacing. Excellent teardown characteristics make it easy to cleanly separate the conductors—essential when cable has to be routed to more than one location. It can be folded back on itself without damage to conductors or insulation—ideal for intricate cable routing. Another

bright idea: an exclusive footage indicator on the reel shows how much cable is left. And it's UL listed (style 2651). Complies with requirements of FR-1 flame test. The connectors, (57 of them) are an integral part of our flat cable connection system. They also offer some bright new ideas as you can see:

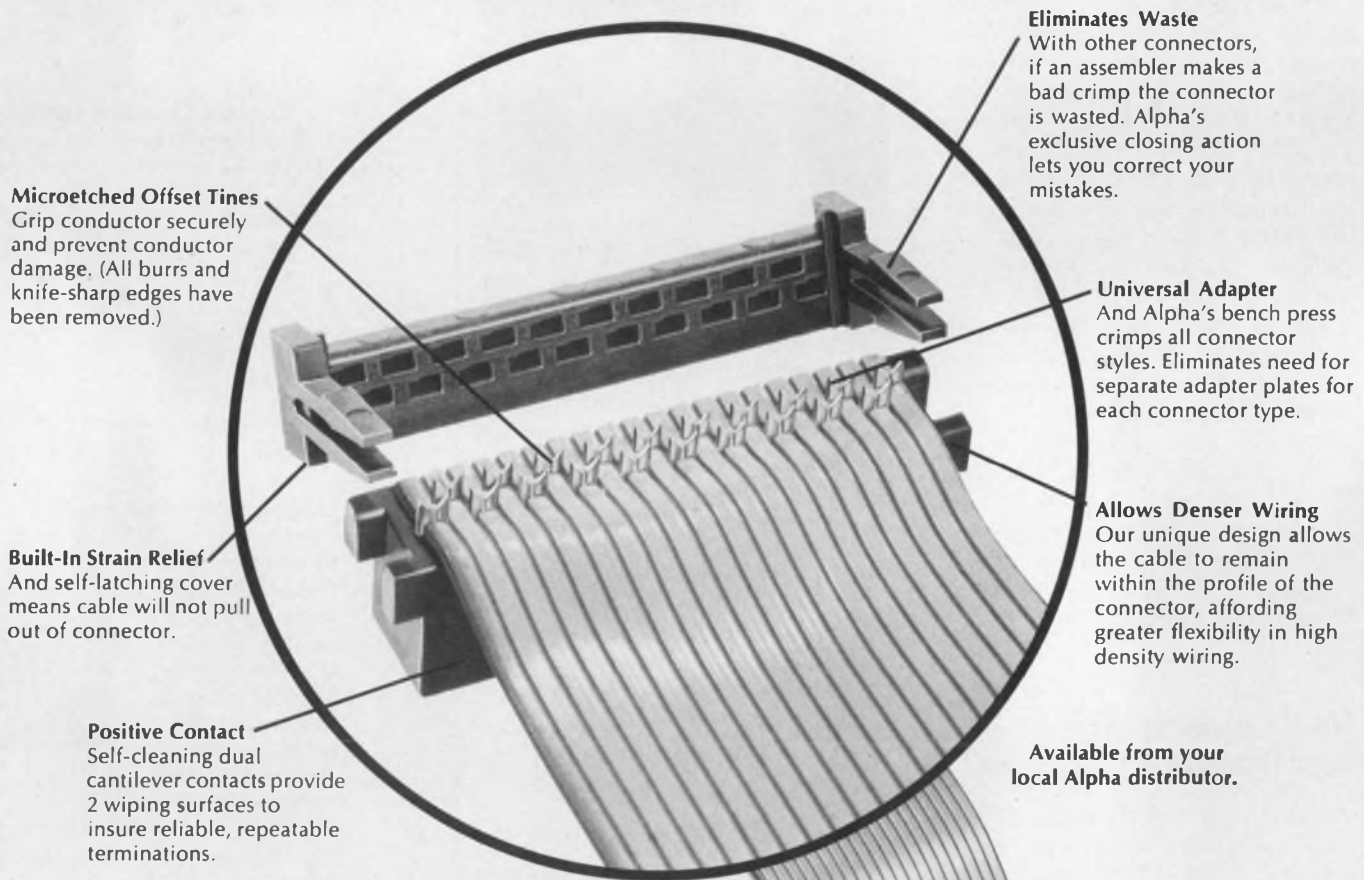

Microetched Offset Tines
Grip conductor securely and prevent conductor damage. (All burrs and knife-sharp edges have been removed.)

Built-In Strain Relief
And self-latching cover means cable will not pull out of connector.

Positive Contact
Self-cleaning dual cantilever contacts provide 2 wiping surfaces to insure reliable, repeatable terminations.

Eliminates Waste
With other connectors, if an assembler makes a bad crimp the connector is wasted. Alpha's exclusive closing action lets you correct your mistakes.

Universal Adapter
And Alpha's bench press crimps all connector styles. Eliminates need for separate adapter plates for each connector type.

Allows Denser Wiring
Our unique design allows the cable to remain within the profile of the connector, affording greater flexibility in high density wiring.

Available from your local Alpha distributor.

Complete Line
Female socket connectors
Headers
DIP connectors
PCB connectors.



Alpha Wire Corp., 711 Lidgerwood Ave., Elizabeth, N.J. 07207 (201) 925-8000

SORENSEN IS THE SOURCE: FOR RELIABLE OPEN- FRAME POWER SUPPLIES.

SOC, our new line of open-frame power supplies:

- Standard voltage and package sizes
- 115/208/230 Vac input standard
- Made in U.S.A. with quality components
- No overshoot with turn-on, turn-off or power failure
- Stocked for immediate delivery
- Conservatively designed and rated
- Low heat dissipation, high temperature stability
- One-year warranty, backed by a worldwide service organization

Model No.	Series	Voltage**	Output Current (A dc)*			Price
			@ 40°C	@ 50°C	@ 60°C	
SOC 2-3	A	2V	3.0	2.4	1.8	\$32
SOC 2-6	B	2V	6.0	4.9	3.8	54
SOC 2-10	C	2V	10.0	8.0	6.5	67
SOC 5-3	A	5V	3.0	2.4	1.8	32
SOC 5-6	B	5V	6.0	4.9	3.8	54
SOC 5-10	C	5V	10.0	8.0	6.5	67
SOC 12-1.6	A	12V	1.6	1.3	1.0	32
SOC 12-4.0	B	12V	4.0	3.0	2.5	54
SOC 12-6.0	C	12V	6.0	5.0	4.2	67
SOC 15-1.5	A	15V	1.5	1.2	1.0	32
SOC 15-3.0	B	15V	3.0	2.6	2.2	54
SOC 15-5.0	C	15V	5.0	4.2	3.5	67
SOC 24-1.0	A	24V	1.0	.75	.55	32
SOC 24-2.2	B	24V	2.2	1.9	1.6	54
SOC 24-3.5	C	24V	3.5	2.9	2.4	67
SOC 28-0.8	A	28V	0.8	.64	.45	32
SOC 28-2.0	B	28V	2.0	1.7	1.4	54
SOC 28-3.1	C	28V	3.1	2.6	2.0	67

Common Specifications:

AC Input Power: Vac 105-125 (190-226). (210 to 250 available by using taps on transformer.)

Frequency 50 to 63Hz. (Derate 10% at 50Hz.)

Voltage Regulation (comb. line and load): $\pm 0.15\% + 6\text{mV}$ for 105 to 125 Vac and 100% load change.

Voltage Ripple and Noise: 1.5mVrms, 5mVpp.

Temperature Coefficient: 0.03%/°C.

Drift (24 hours): 0.2% after 1-hour warm-up.

Remote Sensing: 100mV maximum drop in each leg.

Operating Temperature: 0°C to 60°C.

Storage Temperature: -20°C to +85°C.

Overvoltage Protection: Available on all models except 2 volt. Specify by adding "VP" suffix to model number and add \$8 to unit price.

Current Foldback: Automatic, factory-set to 140% of rated (40°C) output current.

Cooling: Convection.

Finish: Black anodize.

* Free-air rating — no external heatsink.

** $\pm 5\%$ adjustable.

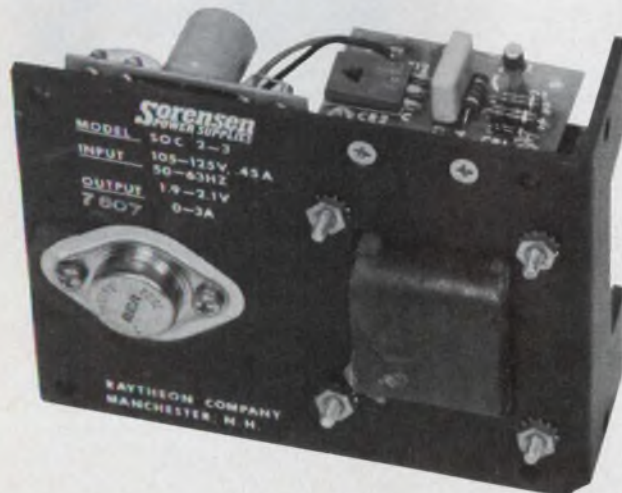

Call us for OEM discounts:

(603) 668-4500.

Sorensen

676 Island Pond Rd.,

Manchester, N.H. 03103.

SORENSEN
POWER SUPPLIES

A Raytheon Company

CIRCLE NUMBER 11

Let's talk about the easy way for you to spot microprocessor **HARDWARE PROBLEMS**

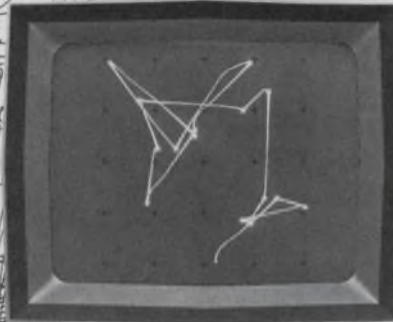
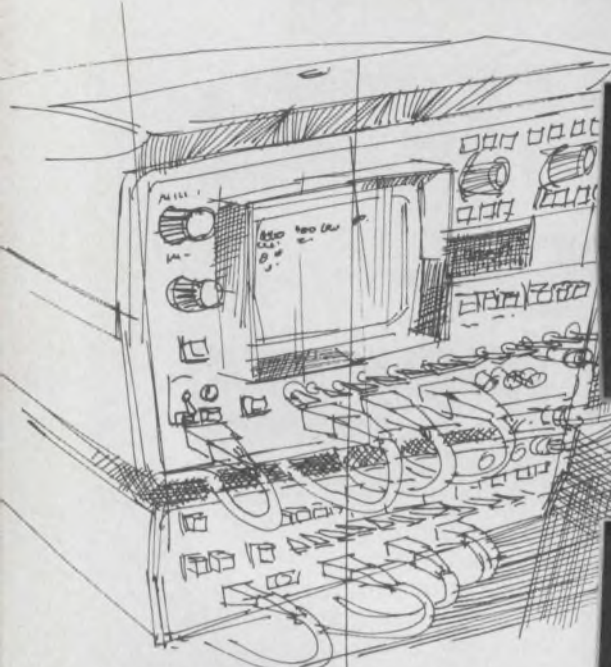

HP's 1600S Logic State Analyzer, in the MAP mode, lets you examine the unique "fingerprint" of every logic system.

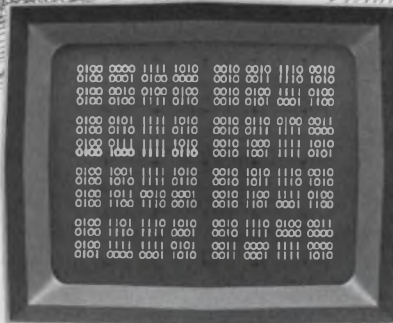

In the TABLE mode, the 1600S displays up to 16 32-bit words. These words could be combinations of addresses, instructions or states of the control lines.



We've probably both spent hours at the simulator to prove we had good software and then discovered

the hardware won't play — what do we do? You know the traditional answer. Dig out the scope, get out the program printout, and brace yourself for hours of grinding, point-by-point checks. But I can tell you that doesn't have to be the case. Especially now that HP has introduced some new tools that can really cut down your troubleshooting time.

HP's Logic State Analyzers can really take a lot of pain out of your troubleshooting procedures. You'll find wiring errors, defective components, and even solder splashes; and you'll find them a lot more quickly than ever before.

Let me give you an example. We had an eight-bit microprocessor system with start-up problems. The clocks were running and phased right, and the address lines toggled, but the machine didn't function. So, we

set up an HP 1600S Logic State Analyzer to look at both the Address and Data buses. It was then we noticed that only "zeros" were being fetched from memory. Knowing the ROM was good, we then added several control lines to the display and the problem showed up immediately. The "Enable" line never went high. A quick look at the "Enable" driver showed the input was ok, but no output. Obviously, the gate was defective.

I don't know how long it would have taken to find that one without HP's Logic State Analyzers, but I know it would have taken us a lot longer.

Call your local HP field engineer. He'll give you all the details on the 1600S (priced at \$7100*) including spec sheets and application notes detailing the use of mapping for troubleshooting minicomputer and microprocessor systems. He'll tell

you about the seminars that HP has arranged around the country and tell you when one will be held in your area and how you can attend. You ought to go to one, because you'll discover an exciting new concept in digital troubleshooting.

*Domestic U.S.A. price only.



HEWLETT  PACKARD

Sales and service from 172 offices in 65 countries.
1507 Page Mill Road, Palo Alto, California 94304

CIRCLE NUMBER 12

ACROSS THE DESK

(continued from page 11)

programs provided by HP. My programs require only 19 steps for P(m,n) and 17 steps for C(m,n) as compared to 42 and 30 steps, respectively, in the HP-25 application manual.

Being able to squeeze these functions into fewer steps allows writing many statistical programs within the pocket calculator capacity than would otherwise be possible. To keep the story short, I am presenting here only the binomial coefficient program:

```

STO 2
CLX
1
STO 3
+
STO 1
RCL 1
RCL      17 steps
X = 0
GTO 17
÷
1
STO - 2
—
STO × 3
—
GTO 07
RCL 3
    
```

To compute C(m,n), initial m{n}, f PRGM, R/S

Cass R. Lewart
System Development Corp.
185 Monmouth Pkwy.
West Long Branch, NJ 07764

Misplaced Caption Dept.



Another over-40 engineer thrown to the lions.

Sorry. That's Henri Rousseau's "The Sleeping Gypsy," which hangs in the Modern Museum of Art in New York City.



Our Micro-J[®] capacitors exceeded even our own expectations.

Not long after we introduced our sub-miniature ceramic disc trimmers, some customers began calling our attention to an error we made. It seems our Micro-J Capacitors actually perform better than we said they would.

The Quality Factor is typically greater than 1000 at 1 MHz. And the temperature coefficient of capacitance is typically better than ± 150 PPM/ $^{\circ}$ C over the entire

operating range from -55° to 125° C. This has prompted a number of people to call our Micro-J the best ceramic disc trimmer available at any price. And one customer even suggested that we could probably start charging more for it.

We must admit we were tempted. But we decided to continue selling Micro-J's at the original price.

We don't think you'll mind.

E. F. Johnson Company/ Dept. E.D., Waseca, MN 56093

I'd like more information about your Micro-J's.

Please send me your specifications.

I desire test samples. Please call me at _____.

Name _____

Title _____

Firm _____

Address _____

City _____

State _____ Zip _____



JOHNSON[®]

For fast service, contact your local Johnson Distributor.

Must you always obtain new application tooling when you develop a new design?

Not always. You can use AMP Multimate.

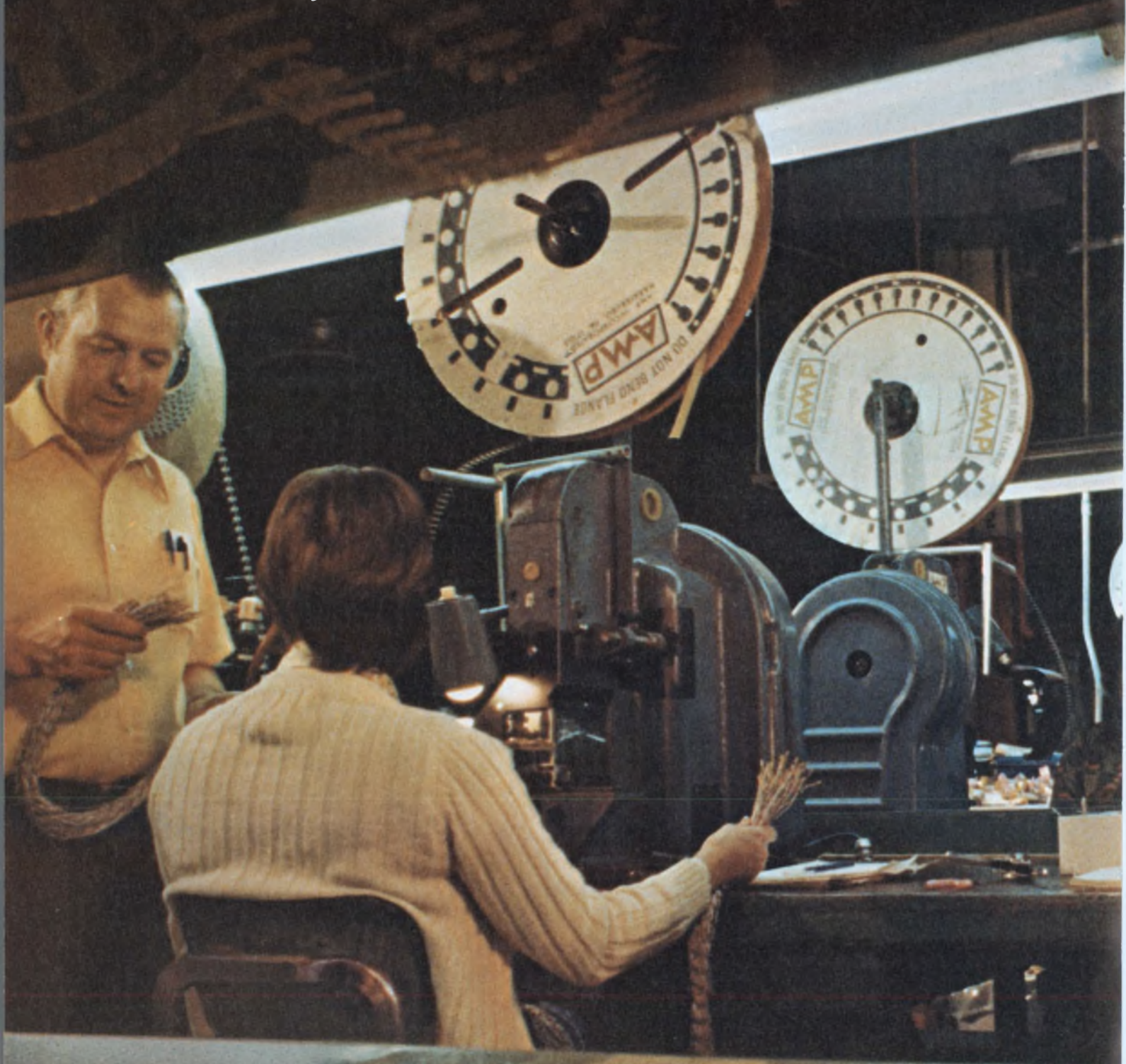

You asked for a way to produce new I/O cable or internal harness designs without always having to obtain new connector application tooling.

AMP answers with the Multimate concept.

For example.

A choice of three, size 16 contacts. A screw machine contact, and 1 or 2-piece precision formed contacts. All interchangeable and intermateable plus AMP Subminiature Coaxial contacts fit in the same cavities when needed.

Then specify AMP Connector housings from many proven styles and sizes.

The rugged, economical Circular Plastic Connector, or those versatile M Series connectors widely used for commercial and military applications; or the AMP MI Connectors, designed to international standards. Additionally there is a cast shell rack and panel range as well as metal-shelled modular connectors.

If you have AMP application tooling for the Multimate contacts, you can produce these connector assemblies. And that can save inventory and allows for larger piece part volume purchases. Further savings can be made in the field because fewer service tools are needed.

Here at AMP, answering your problems is our business.

So when you work with Multimate, you can expect the kind of service and backup for which AMP is famous.

We have district sales offices around the country; they are there for one purpose only. To serve you.

With Multimate, you not only get real contact-connector flexibility, you have AMP behind your design innovations.

For information on Multimate, write or call AMP Incorporated, Harrisburg, PA 17105. (717) 564-0100.



AMP
INCORPORATED

CIRCLE NUMBER 16

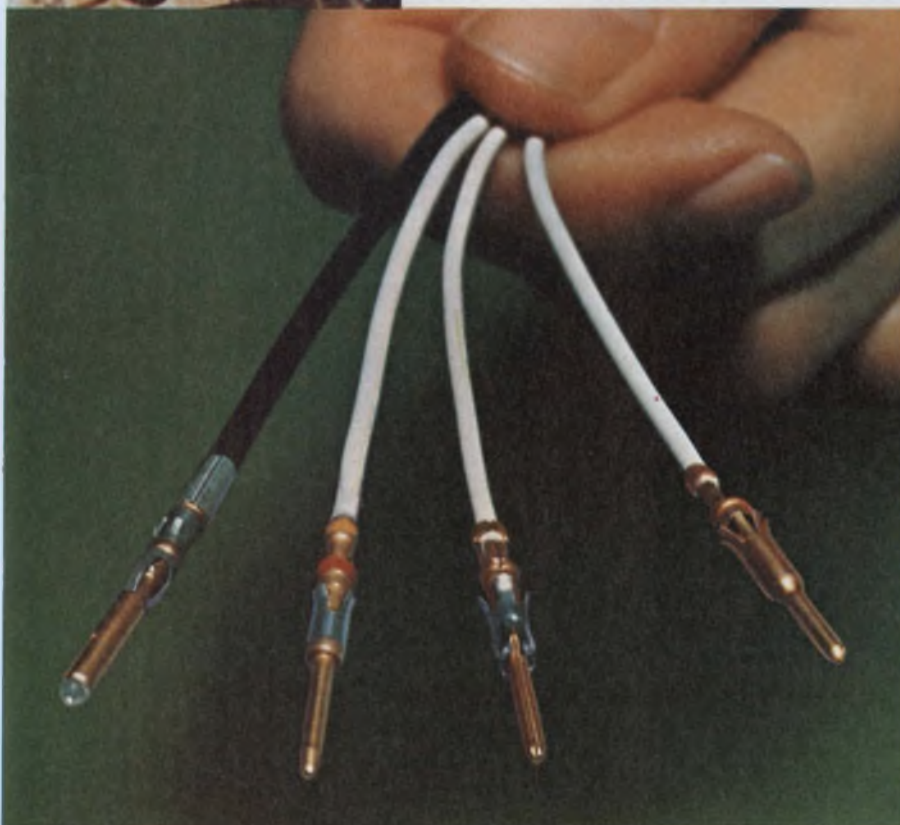

Design with the complete flat cable/connector system.

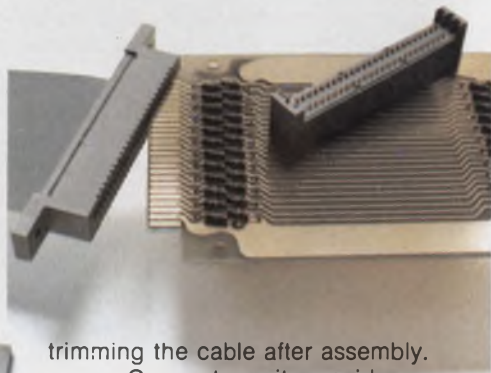

trimming the cable after assembly.

Connector units provide positive alignment with precisely spaced conductors in 3M's flat, flexible PVC cable. The connector contacts strip through the insulation, capture the conductor, and provide a gas-tight pressure connection.

With cable, connectors and assembly tools from one design and manufacturing source, you have added assurance the connection will be made surely, with no shorts or "opens."

And "Scotchflex" now offers you more design freedom than ever. From stock you can choose shielded and non-shielded 24-30 AWG cable with 10 to 50 conductors, and an ever-increasing variety of more than

The 3M DELTA pin and socket connector.



Assembly-cost savings are built in when you design a package with "Scotchflex" flat cable and connectors. But more important, 3M Company offers you the full reliability of a one-source system: cable *plus* connectors *plus* the inexpensive assembly aids that crimp the connections quickly and securely (with no special operator training required).

The fast, simple "Scotchflex" assembly sequence makes as many as 50 simultaneous multiple connections in seconds, without stripping, soldering or

100 connectors to interface with standard DIP sockets, wrap posts on standard grid patterns, printed circuit boards, or headers for de-pluggable applications. 3M's DELTA "D" type pin and socket connectors are now also available. For full information, write Dept. EAH-1, 3M Center, St. Paul, MN 55101.



3M
COMPANY

3M's "Scotchflex" line.

See our catalog in EEM 2-1034.

"Scotchflex" is a registered trademark of 3M Co.

CIRCLE NUMBER 14

NOW! SINGLE IN-LINE RESISTOR NETWORKS WITH IMPROVED PERFORMANCE

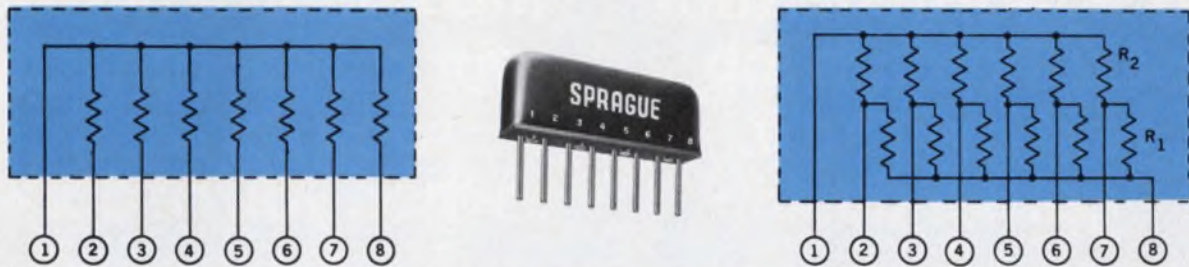

BOARDABLE AND AFFORDABLE

Low Cost and **High Density Configuration** are only two of the features of Sprague Type 216C Metanet® Resistor Networks. Now, you can also enjoy the benefits of improved power dissipation, better temperature coefficient of resistance, and closer standard resistance tolerance.

Save Board Space. Single in-line design permits vertical installation, which allows more units to be seated in less space. This mounting style also results in improved high-frequency performance and significant in-place cost reduction.

Better TCR. Typical temperature coefficient of resistance is within ± 200 ppm/°C, cutting previous allowable limit almost in half.

Up-graded Power Dissipation. Individual terminating, pull-up/pull-down, and interface networks are capable of dissipating 250 mW per resistor at 70°C, an increase of 100% over previous designs.

Closer Resistance Tolerance. Standard resistance tolerance for each resistor is $\pm 2\%$, with other tolerances between $\pm 1\%$ and $\pm 5\%$ available on special order.

Proven Product Line. Sprague has more than fifteen years of experience in the development and manufacture of precision thick-film resistor networks, which include individual terminating, pull-up/pull-down, interface, and dual terminating designs.

For complete technical data, write for Engineering Bulletin 7041A to:
Technical Literature Service, Sprague Electric Co.,
347 Marshall Street, North Adams, Mass. 01247.

45Z-9124R1

SPRAGUE®

THE MARK OF RELIABILITY

THE BROAD-LINE PRODUCER OF ELECTRONIC PARTS

CIRCLE NUMBER 15

**You can buy
this signal generator
for a 3-month job,
and then let it
gather dust.**

**You can rent
this signal generator
for a 3-month job,
and return it
when you're done.**



When you buy electronic test equipment for a short-term project, you're stuck with the equipment after the project is completed. Maybe it'll sit around gathering dust and costing you money. Or maybe you could sell it at a loss.

Or maybe, you should have rented it from REI.

When you rent equipment from us, you keep it only as long as you need it. When you're through with it, you send it back. Since you pay only for the time you have your instruments, you never have to spend your money on idle equipment. Short-term needs are just one reason for renting. Immediate delivery is another. Because we maintain over \$10 million in inventory in fully stocked instant inventory centers around the country, you can get delivery within hours.

REI stocks over 8,000 fully checked-out test instruments. And they're ready whenever you are. For the full story on renting as well as our low prices, send in the coupon for prompt delivery of our free illustrated catalog. Or call us now for your immediate requirements.

Rental Electronics, Inc.,
99 Hartwell Avenue, Lexington, Mass. 02173.
Please send me your free instrument rental catalog:

Name _____ Title _____

Company _____

Address _____

City _____ State _____ Zip _____

Tel. Number _____

Rental Electronics, Inc. 

A PEPSICO LEASING COMPANY

Burlington, MA (617) 273-2770 • Gaithersburg, MD (301) 948-0620 • Oakland, NJ (201) 337-3757 • Ft. Lauderdale, FL (305) 771-3500
Des Plaines, IL (312) 827-6670 • Dallas, TX (214) 661-8082 • Mountain View, CA (415) 968-8845 • Anaheim, CA (714) 879-0561
Rexdale, Ontario (PLC Leasing Ltd.) (416) 677-7513

Consumer electronics show highlights television games

Semiconductor manufacturers are pursuing the latest consumer electronics market—video games—with the same zeal that accompanied the introduction of calculators and digital watches in previous years.

This was evident at the recent Consumer Electronics Show in Chicago, where no less than 30 manufacturers displayed the latest video games. Their products ranged from low-cost, single-chip games without sound or color, to single or multiple-chip games with both sound and color.

At the most expensive end, interactive entertainment, and education centers using microprocessor systems under local program control were unveiled.

Of the 30 or so games, some 20 used General Instrument's single-chip game IC, the AY-3-8500. The chip was designed with n-channel devices, and uses dedicated microprocessor logic.

Both black-and-white and color games in single-chip form are programmed on the chip. These games include tennis, hockey or soccer, squash, practice skeet and random-target rifle shooting. Discrete supporting circuits are required for interfacing with the TV.

National Semiconductor is marketing its own "Adversary" game, which is a full-color system that has three game options: tennis, hockey and handball. The National system has one game chip and two supporting interface chips.

Other manufacturers producing game chips include Texas Instruments, American Microsystems and MOS Technology. More firms are expected to join the video-game bandwagon.

The arrival of the long-heralded home computer terminal may be hastened by the development of

microprocessor systems with programs that can be interchanged by the user. One such system is Videospond by Rockwell International. The Videospond uses the Rockwell PPS-8, a programmed tape cassette, keyboard, and a color TV for display.

Programs demonstrated included those for math calculations, interactive child or adult teaching programs, and a variety of games. The system is not being marketed as yet.

Universal Research (Des Plaines, IL) demonstrated an interactive game and educational system using a video-tape cartridge to provide question-and-answer formats as well as to display recipes and perform other interactive chores.

Universal already has several cartridges available and is working with software houses and book publishers to develop a library of information.

Fairchild's "Video Entertainment System" was also introduced at the show. The system incorporates the F-8 microprocessor, and allows the user to plug in a plastic cartridge that contains 8-k-bit programmed ROMs. Use of the ROM—rather than tape—to contain the programs prevents the software from being copied, such as can easily be done with magnetic-tape cassettes.

National Semiconductor is also using semiconductor-memory cartridges, rather than cassettes or other tape media in programmable systems now under development.

Marines test ground-unit concept before buying

The Pentagon's practice of flying an aircraft before deciding whether to buy it or not, has now

been extended to ground equipment.

A command-and-control system is being built for the Marines that the Corps will evaluate, not only for its performance but also for the feasibility of the initial concept: did they ask for more automation than they need? too little? in what specific areas?

Called the Marine Tactical Command-and-Control Systems, the test version for the program will serve as the basis for a family of closely-related systems. They will all use integrated data-processing equipment to automatically receive, process, display and distribute the tactical information that Marines need to plan and control both amphibious landings and the ground operations that follow.

The system—which is being built by the Ground Systems Div. of Hughes Aircraft, Fullerton, CA—is designed around a Control Data CDC-3500 computer with 20 megabytes of memory. It also contains both graphic and text-only CRT displays. The text-only displays are controlled by a Digital Equipment PDP-8 minicomputer.

"With the computers, displays and communications equipment available in this test-bed, the Marines can evaluate various approaches to automating their future command-and-control needs," says Robert Sandell, project manager at Hughes.

All of the equipment used on the test-bed is commercially available and off-the-shelf, rather than custom-designed to MIL specs.

Three μ Ps share memory and drive machine tools

For the first time, three microprocessors are working together to control the various functions of a numerically-controlled machine tool.

The system, developed by Actron of Monrovia, CA, assigns the functions of input/output controller, path calculator and servo control to individual μ Ps and provides a single memory that they all share.

Custom-designed 16-bit NMOS μ Ps were designed for Actron by Nitron, Cupertino, CA. Both Actron and Nitron are divisions of McDonnell Douglas Corp.

The most important advantage presented by the μP system is the increased reliability that it offers compared to other systems now available, according to S. G. Froyd, engineering manager at Actron. "The projected MTBF (mean-time-between-failures) of the Actron systems is 2500 hours as compared to 536 hours for a hard-wired NC system and 984 hours for a mini-computer-controlled NC system," he says.

He also notes that: "The majority of NC workpiece rejections result from servo problems. To overcome these problems, one of the microcomputers has resources available to compare the NC output (velocity reference) to actual machine speed (from the position feedback transducer).

"Further, it can take into account gain, transport lag, etc., and continuously monitor the performance of the machine axes—providing warning and fault signals before the part is miscut. This function is analogous to having an NC maintenance technician permanently installed on each axis, continuously rechecking the following error."

If the equipment fails, pushbutton-actuated, board-level self-test circuits are resident in the system. LEDs are used as readouts of self-test results.

The controller can be used with any NC machine tool.

Everest climbers to carry medical data sensors

An expedition to scale Mount Everest next spring is expected to provide new medical data on the operation of the heart and lungs under conditions of limited oxygen and extreme stress.

Such conditions are similar to those that exist in advanced coronary and pulmonary cases, where the lungs fail to oxygenate the blood properly and the oxygen level in the arteries falls to low levels.

Ten experienced mountain climbers will carry with them an array of electronic physiological monitoring equipment designed to measure heart and respiratory functions under the severe temperature and atmosphere conditions found atop the world's highest peak.

The lightweight equipment will

be strapped to the climbers' bodies. It includes a four-channel tape recorder with sensing attachments, to record electrocardiograms (ECG), respiratory frequency, and respiratory volume. A fourth channel on the recorder is used for timing.

Studying the results on a round-the-clock basis will be an international team of medical experts led by Dr. Michael Ward of the University of London, who was a member of the 1953 expedition—the first group to reach the summit of the 29,000-ft peak.

The medical team will climb to a camp at the 20,000-ft level, with the professional climbers continuing to the summit.

The recording and monitoring equipment built by Ambulatory Monitoring Co., Inc., Ardsley, NY, is designed to record continuously for 24 hours, on a single magnetic tape cartridge. High-speed playback equipment built by the same company allows the entire recorded tape to be analyzed or visually displayed in less than one-half hour. The operator can set limits on such recorded parameters as heart rate. When the playback device senses that these limits have been exceeded, it alerts the operator.

Expedition plans include transmitting the ECGs, by radio, from climbers at the summit to the medical group at the base camp. The transmitter presently available has a relatively short range, on the order of 2 to 3 miles, reports Dr. John West of the University of California Medical School, La Jolla, CA.

To increase the range, the transmitter's output stage will be modified to deliver more power, and a high-gain antenna will be added to the receiver, he says.

New process advances uniformity of thermistor

One of the problems in manufacturing thermally sensitive resistors (thermistors) is the difficulty in obtaining uniform electrical characteristics. Now, engineers at Victory Engineering Corp., Springfield, NJ report that they have developed a new thick-film process that results in chip thermistors that are not only more homogeneous but weigh less and are smaller

than equivalent pressed-disc types.

The new process used to make the so-called Sensichips makes use of a slurry of metal oxides in which each grain of oxide is uniformly coated and deposited through a screen . . . as a "slab."

The green 2 by 2 in. slab is then fired, metallized (thick-film deposited) top and bottom, and fired to effect an intimate metallurgical bond. A high-speed, multiple-blade diamond saw is used to cut the slab to the required size. Conformal coatings can be applied so that the final product approaches hermeticity.

"Since the chips from any given slab or mixture are in a uniform slurry," a Victory spokesman says. "The resulting chips from any given slab or mixture are quite homogeneous in terms of electrical characteristics.

"Further, thermal response times are typically 4 seconds, as opposed to 9 seconds for competitive devices."

Sensichips are available in 0.020 in. to 0.300 in. on a side; thicknesses from 0.005 in. to 0.070 in. and resistances from 5 K Ω to 1 M Ω .

Prices of the thermistor will range between 25¢ and 50¢ in modest volume.

CIRCLE NO. 310

Biggest Wescon show since 1970 is expected

Wescon's silver anniversary, to be celebrated in the Los Angeles Convention Center from Sept. 14 to 17, will be the largest Western Electronic Show and Convention since 1970, according to Wescon officials.

Approximately 400 companies will occupy 725 exhibit units on the convention floor, to be seen by 30,000 to 35,000 visitors.

A program of 35 half-day sessions will be held—five sessions at a time, with full-manuscript preprints available for most of the papers, and audio tapes of the discussions.

The exhibits will be presented in product-interest categories: components and microelectronics; instruments and instrumentation, production and packaging equipment, and computers, peripherals and communications.

Intro- ducing the amaz- ing EECO

machine: in one end you put your raw, un-annotated logic diagram, and out of the other comes your fully wire wrapped socket board/frame/drawer system—your choice. Together with a *Final Exception Report*, a *Final String List*,

an IC Location List, *lists for IC Type and Socket Size*, *a Wire Loop List*, *a Pin Assignment List*, *an Unused Circuit Elements and Pins List*, *a Pin by Pin Wire List*, and your diagram back, fully annotated.

This machine uses a computer, and people, and hardware all under the same roof, and gives you a chance to correct or change your circuitry before we go to hardware. We deliver in as little as two weeks, including time for you to review. We've been doing this for more than five years, almost in secret. Now we're telling you and the world because it's about time. Write or phone the keeper of the EECO machine, Dick Hunter.



EEECO

PACKAGING/SWITCHES/READERS

1441 East Chestnut Avenue, Santa Ana, California 92701
Phone 714/835-6000

CIRCLE NUMBER 18

Your next digital logic analyzer.

Biomation's new 851-D
8-channel, 50 MHz logic analyzer.



Digital logic analyzers are revolutionizing the solutions of design and trouble-shooting problems. Biomation, building on our early waveform recording technology, has created the tools you need for your fast new digital world. We offer the most complete line of logic analyzers anywhere. And our thousand-plus customers have helped us develop the most useful features for real-world problems of digital system design and test. Our new 851-D catches, records and displays 8 channels of high speed logic. It is the slickest handling, most cost-effective logic analyzer we've seen yet. But don't take our word for it. Check over the features for yourself.

- Ideal companion for your 2-trace portable scope
- Portable and self-contained
- 8 channel
- 50 MHz
- Digital delay for precise



- trigger control
- Accepts synchronous clock input (0° or 180° phase)
- Provides internal clocking
- Catches glitches as narrow as 5 ns
- Pre-trigger recording
- 512 bit per channel memory
- Captures 512 words before, after, or around the trigger
- Expanded and mixed display
- Constant brightness expand to X20
- Combinational "true" trigger
- "Any-change" trigger
- Built-in delay (4 digit)
- Latch mode (catches single pulses)
- Adjustable threshold levels for channels 1-4 and 5-8
- Step-and-wait cursor control
- Steps through data one bit at a time
- Price: \$3575
- Delivery: 30 days A.R.O.



What next?

If you want to see a demo, right now, of our new 851-D or any of our digital logic analyzers (we have both less expensive and more powerful models), pick up the phone and call (408) 255-9500. Ask for Roy Tottingham at ext. 851.D. Or circle the reader service number and we'll send data. Biomation, 10411 Bubb Road, Cupertino, CA 95014.

(851-D shown actual size.)

Biomation
Creating tools for technology



Sounds great, but I don't know what all of the features actually do. Please send more information.

Send information on your complete digital logic analyzer line.

Name

Title

Company

Street Address

City State

Zip

Biomation
10411 Bubb Road, Cupertino, CA 95014. (408) 255-9500.
TWX 910-338-0226

To use custom LSI or μ Ps? That is often the question...

Today's design engineer faces a problem: Should he design a new project in-house using a microprocessor, or should he buy a custom LSI circuit from an outside vendor?

Most of the time, the decision isn't easy. The engineer must consider both circuit-development cost and time. These must be balanced against production costs and future design changes.

Sometimes the nature of the product itself may dictate the use of either a custom LSI or a μ P. The size of the final product may freeze the choice. It would be nearly impossible to make a μ P-based wristwatch and still have it fit on a wrist, and the power consumption would also rule against a watch application. Similarly, most μ Ps are not fast enough to handle numerous I/O operations on a real-time basis, nor are they structured for a "soft-fail" application such as an automotive controller.

"Engineers are continually forcing μ Ps into applications where μ Ps are not suited—high volume applications, where system cost and the limitations of having extra flexibility show up," says John Hall of MicroPower Systems, Santa Clara, CA. "You can mechanize a clock with a μ P, but it wouldn't be cost effective."

Ben Anixter of Advanced Micro Devices, Sunnyvale, CA, carries this thought one step further: "Historically, custom circuits always cost more than standard products, although in specific systems standard circuits can represent an overkill or underkill solution."

And that's really the point. How

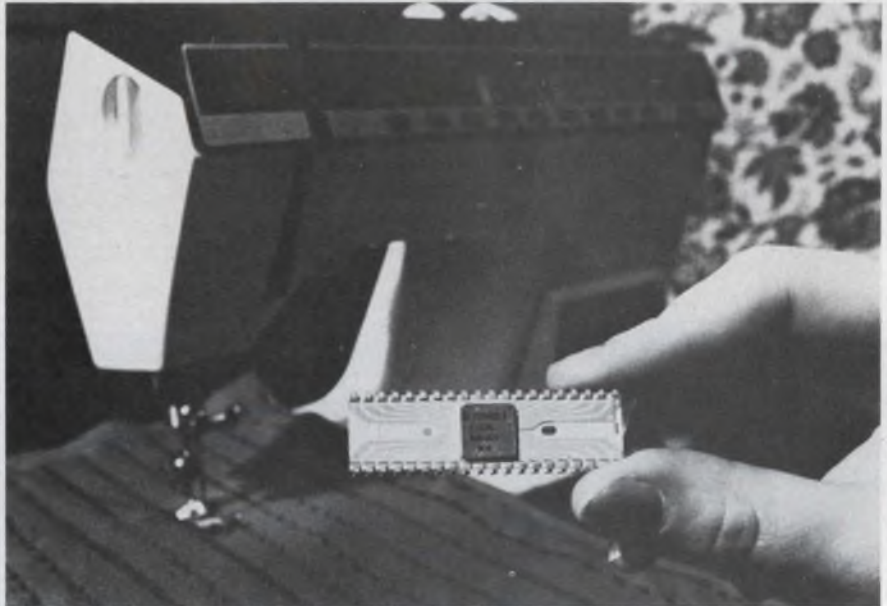

Sewing machine control chip replaces 350 mechanical parts. AMI made the custom LSI circuit to Singer's specifications.

does the designer tell which approach is better in his particular situation?

He looks at the number of systems he must build, and he looks at the time it will take to build them . . . and at the manpower and assembly requirements.

He looks at the final product's performance and its required flexibility . . . and at the money required for start-up and at the reliability of custom parts vendors.

Finally, he looks at his crystal ball and projects the project's future. With all this in mind, he sets the project's course and proceeds to implement his decision.

How many systems? When?

"Custom LSI can be attractive to us at the ten thousand pieces per year level," claims Bill Sanderson, custom MOS manager at National Semiconductor, Santa Clara, CA.

But most other IC houses require a minimum order commitment of 30,000 to 100,000 parts to do business. Generally, the larger the volume of circuits required, the more desirable the custom LSI business becomes for both vendor and customer.

This point is illustrated by the video games market. Home video games sell in large quantities for a low average selling price, and thus are a prime candidate for custom LSI (and, in fact, they are predominantly custom LSI.)

Coin operated arcade-type video games sell in smaller quantities, have more diverse functional requirements, and command a higher selling price. These are generally μ P controlled.

Appliance controllers, keyboard encoders, automotive controllers, and electronic organ circuits all are being made today using custom LSI. The television industry is



Buy our boards now if you want to stop buying them later.

If you're thinking of making your own micro-computer boards sometime in the future, ours are the only boards to buy right now.

Because the chips on our microNOVA boards are the same ones you can buy in the microNOVA chip set.

Which means you can switch from microNOVA boards to our microNOVA chips anytime you want.

The microNOVA board is a full 4K micro-computer. With a number of standard features. Like power-fail/auto-restart. Real-time clock. NOVA instruction set with hardware stack. Hardware multiply/divide. Data channel logic.

Yet all the above computer costs only \$589, in OEM quantities of 100*.

Which is a lot of computer for a little money.

Because it's a NOVA computer, the microNOVA board comes with powerful run-time software. Like

RTOS, our NOVA-compatible, field proven realtime executive. And it runs both Assembler and FORTRAN.

And because the microNOVA board comes from Data General, it comes with the manuals, technical publications, services, training courses and seminars you'd expect from a large minicomputer company.

Yet the microNOVA 4K board is only one member of an entire family. Besides the board (and all the supporting boards), you can get complete development systems. Or you can get completely packaged MOS minicomputers. Or chip sets that include the mN601 CPU, plus all the supporting chips.

So if you want to end up in the chips, call our toll free number, 800-225-9497. (Unless you're in Massachusetts. In which case, call 1-617-485-9100, EXT. 2509.)

microNOVA:

A giant reduction in the NOVA line.

DataGeneral

Data General, Route 9, Southboro, Mass. 01772 (617) 485-9100. Data General (Canada) Ltd., Ontario.
Data General Europe, 15 Rue Le Sueur, Paris 75116, France. Data General Australia, Melbourne (03) 82-1361

*Prices quoted are FOB Southboro and apply to the U.S. Taxes excluded. NOVA is a registered trademark of Data General Corporation.

heavily into custom LSI due to the industry's high-volume, very cost-conscious posture.

But there is a practical limit that is reached as the cost of the electronics becomes a smaller and smaller portion of the cost of the finished product, and other factors override volume considerations. Factors such as time.

The time required to produce prototype quantities of custom LSI circuits is an important issue for the designer. Generally six to nine months is a realistic figure, but various manufacturers are developing techniques for reducing it.

American Microsystems, Inc. (AMI) of Santa Clara, CA, is developing a computer-aided layout and artwork generation system, and Signetics has a standard building-block Composite Cell Logic for use on custom circuits. The Signetics approach reduces to about 20 weeks the time needed to prototype quantities at the 300 to 400-gate level of complexity.

"Custom chips in ten weeks for \$10,000 are not far off," with improved design and layout aids, according to Jim Meyer of Silicon Systems in Santa Ana, CA.

Time is an important concern in using custom LSI, because in many instances there is a real risk that someone will beat you to the marketplace.

"Future shock is on us in spades," emphasized Bob Lloyd, National Semiconductor's group director for MOS/LSI systems. "The useful manufacturing life of equipment is getting shorter, and sometimes response time in getting to market is more important than manufacturing cost."

Prototype first-generation systems frequently are designed with μ Ps in them, so they can get into the marketplace quickly, while custom circuits are developed to replace the μ Ps to lower costs later. "Microprocessor-based systems get to market sooner than hard-wired systems, achieve a greater market share, exhibit longer usage lifetimes, and are more profitable," stated Bill Baker, group director for μ Ps at National Semiconductor.

The custom LSI vendor is quick to point out that substantial savings can be achieved using their approach in not having to hire hard-

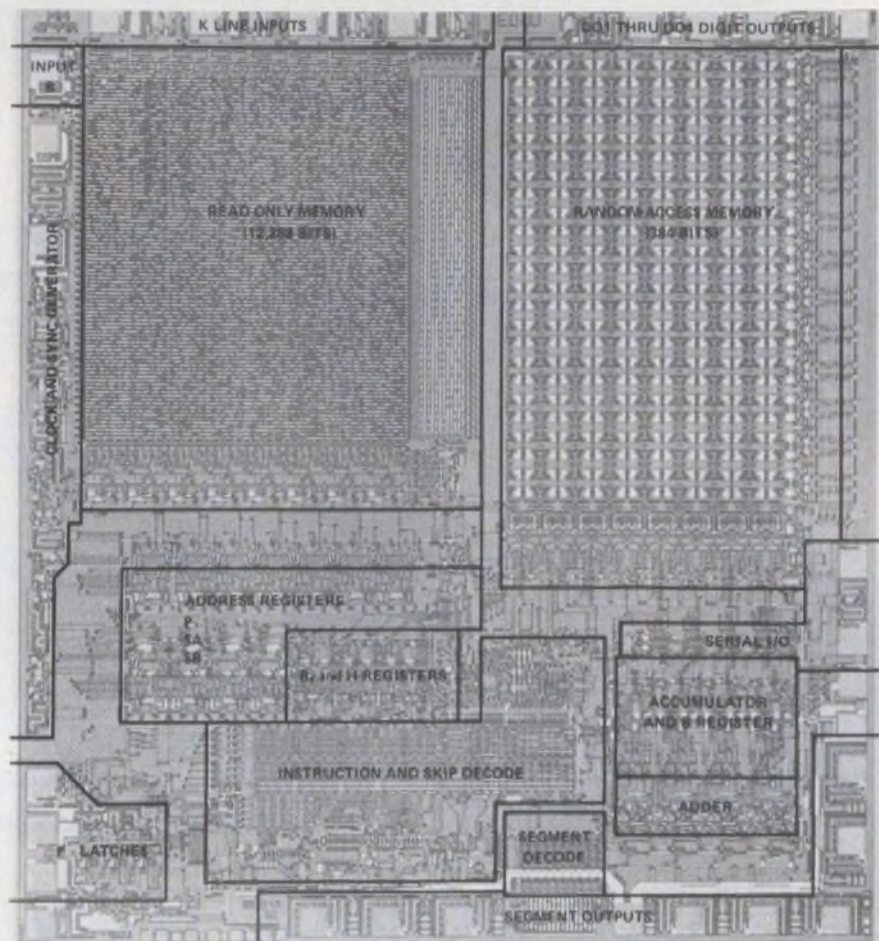

Programmable calculator chip from National Semiconductor processes 4-bit data words and 8-bit instruction words. It contains all system-timing, arithmetic and logic, RAM, and control-ROM functions.

ware, software, and interface engineers to support a μ P development project. (This engineers team must also be charged with selecting the correct μ P to do the job). In addition, software documentation is not required for the custom LSI part, unless it is programmable.

It is true too, that a number of the standard μ P manufacturers have spent significant amounts of money on μ P-support hardware and software. Some μ Ps, such as PACE and SC/MP from National Semiconductor, are grouped into "families" so that understanding of one greatly facilitates learning the other.

Already some μ Ps are departing from the scene, and the designer who chooses the wrong μ P for his system may have to redesign if his chosen one is discontinued. Custom circuits, on the other hand, are contracted for on an individual basis and cannot, with impunity, be discontinued.

System assembly costs are also reduced by using custom LSI. There are fewer parts in inventory since one custom chip usually replaces a μ P plus support chips. There are fewer leads to solder, and thus higher reliability and lower assembly costs.

Smaller, cheaper power supplies can be used with custom LSI designs generally, too.

Performance and flexibility

Microprocessors tend to have only digital inputs and outputs, but custom LSI may have any type of communication with the outside world that the user is willing to pay for. Custom ICs can be designed with specific I/O functions on-chip—for example, triac drivers, or special automotive-sensor interfaces.

Where the particular application is input/output intensive, the implementation leans toward a custom

Motorola Sets The B-Series CMOS Data Book STANDARD.

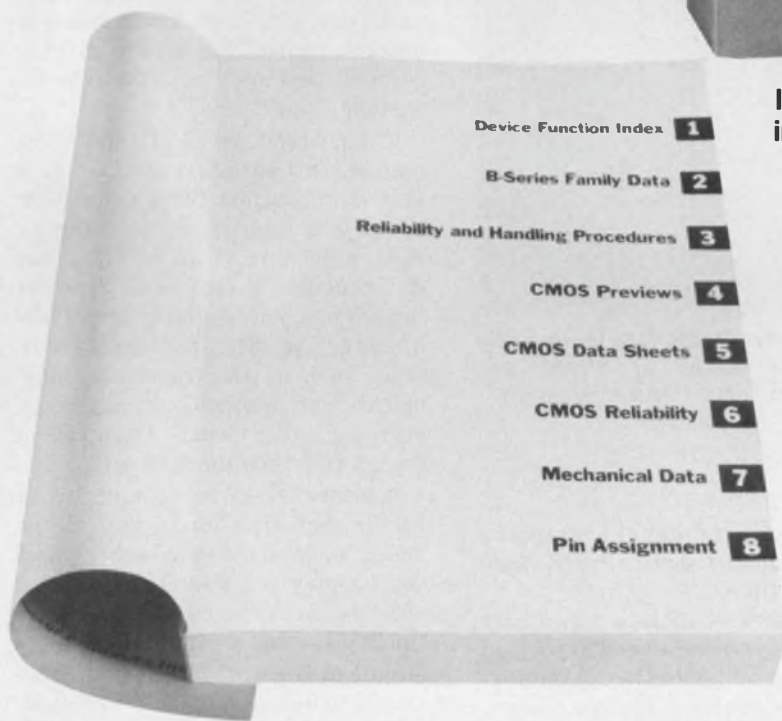
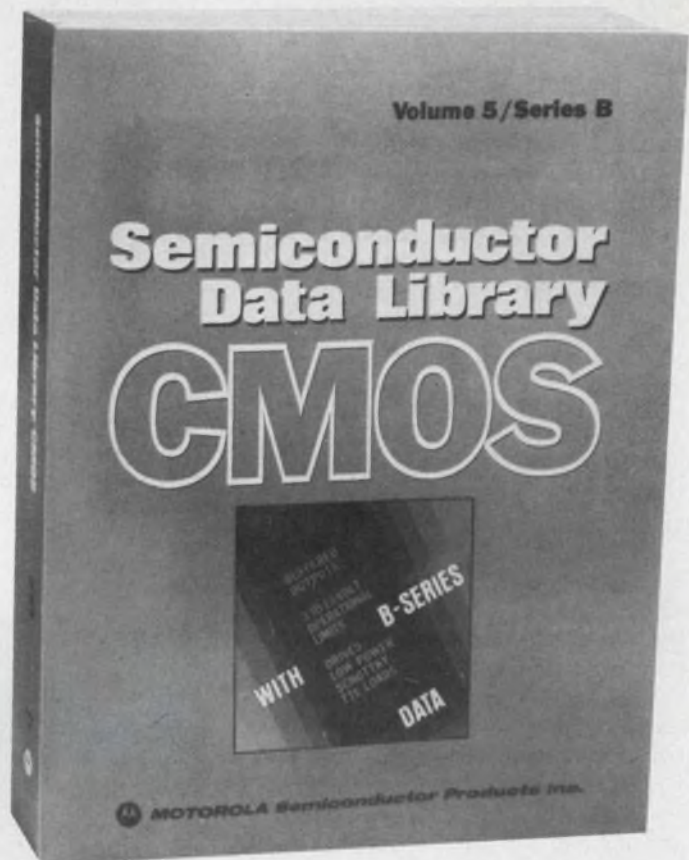

Industry B-Specs in Brand New All-CMOS 575-Page Volume

Written with the very latest industry-wide B-Series CMOS specifications formulated under JEDEC cognizance, and in easiest-to-use format, this is destined to overnight become *the* authoritative data book on CMOS integrated circuits.

The book covers over 100 parts in the new Motorola B Series, representing the broadest line of presently available B Series CMOS in SSI, MSI and LSI complexities. It also features CMOS LSI circuits.

That's design flexibility. And it's all yours in one easy-to-use reference work.

The book has just come off the presses, so your authorized Motorola distributor will have initial stock within 10 days. Call him now to reserve your \$2.50 copy for immediate delivery, or send your check to: Motorola Semiconductor Products Inc., P.O. Box 20912, Phoenix, AZ 85036. We'll have a copy in the mail to you within 24 hours of availability.



MOTOROLA Semiconductors
— CMOS reliability at its best

chip. But on the other hand, where it is computation intensive, the μ P would gain an edge. If the I/O intensive application could be structured into a bus-oriented design, the bus-oriented μ P, of course, would be preferred.

Alternatively, applications requiring much floating-point arithmetic might demand either a sophisticated μ P or even a minicomputer. The μ P is a general-purpose device, and in the absence of other considerations, unless sufficient use is made of its generality, a custom circuit may be a better choice.

A μ P is ideally suited for applications in self-diagnostic systems, or systems that can be field-modified to upgrade performance.

In fact, the advent of the μ P allows the manufacturer of many similar products to take advantage of the benefits of mass production. He may initially make all of the products identical, and then customize them by providing individual control ROMs for the μ Ps. For example, one generalized traffic-light controller may be mass-produced, and customized for each street installation by ROM coding.

The μ P approach allows simple modification of the circuit operation with software changes, where the custom circuit has only the flexibility it was designed with. This is significant. For example, a recent seatbelt interlock design had to go through over five iterations of functional design before it was acceptable. It used custom-LSI circuitry, for a μ P-based design, on the other hand, only the ROM would have had to be changed.

Flexibility may also be needed to respond to competitors' moves in the marketplace.

Start-up costs and risks

"The custom-LSI producer has to get his development money in advance, otherwise there's always the risk that the customer will cancel halfway through the development process," states Clement Lee, LSI product manager for Signetics.

The figures on start-up charges vary from company to company, but they generally range from \$25,000 to \$60,000, with \$35,000 as a good average.

But the dollar-commitment includes more than the initial start-up costs. Custom LSI vendors also generally require a commitment to

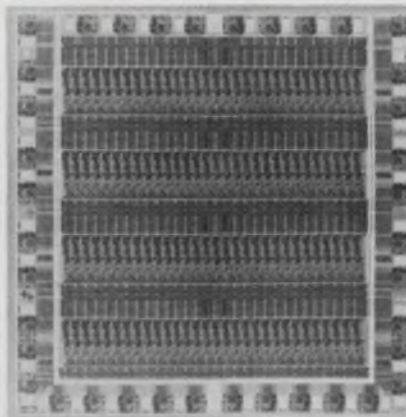

158 TTL NAND gates await connections to become a custom circuit. TRW Systems uses this approach to provide six-week turnaround to working parts.



High-density CMOS CB-frequency synthesizer made by MicroPower Systems to Fanon/Courier's design.

buy a certain minimum quantity of parts at preset prices over some period of time.

The larger IC houses frequently require a guarantee of \$250,000 to \$1-million in profitable sales revenues to institute a custom project. Smaller vendors require correspondingly fewer guaranteed sales.

And there are always some risks in buying custom LSI. One risk is the problem of second-sourcing. It does little good to be able to point to a contract in court when your custom LSI house has trouble delivering parts. Second-sources for custom parts can be as important as for standard ones.

"I don't want to do custom busi-

ness with you if you don't own the mask set, according to Ron Hammer, CMOS product manager for Intersil in Cupertino, CA. "I've never worked for a semiconductor company that didn't have problems occasionally producing products. It's not fair to the customer, nor to the company to sole-source custom products."

But only just recently have custom LSI vendors started cooperating on sharing the process parameters needed to allow use of the same photomasks on two vendors' wafer-fabrication lines. Many processes are still not second-sourced, so the danger of process problems affecting deliveries still exists.

Many IC houses do not like being used merely to process wafers using customers' masks, and Advanced Micro Devices is one.

"Some customers see the vendor as a foundry, remarks Ben Anixter. "Just processing wafers to someone else's masks is not cost effective. The only time to do that is when the industry is in a slump. There just isn't sufficient value-added to make a profit. Capitalism is risk-reward, that's very foreign to the custom circuit guy."

The custom circuit offers the potential user security, in that it is almost impossible for a competitor to copy it exactly in less than a year, according to an LSI feasibility study by MicroPower Systems. Security is particularly important in feature-sensitive consumer industries, such as the television, automotive, and appliance arenas. However, a custom circuit often can be copied functionally by a μ P.

Another risk in using custom LSI is that after an IC is designed based upon a breadboard circuit, the IC may not function the same way the breadboard did. Propagation delays on a single integrated circuit are faster than in communicating between chips. Circuit loading is different, and power dissipations change.

Some of these problems can be sidestepped if you use techniques for avoiding race conditions, and employ totally clocked systems. These risks of device nonfunction can be minimized by consultation with custom-LSI vendors.

"The high-volume user is taking us to a more custom product. As a result, we have to take the fat out

Point by point, line by line:

See why our lowest-cost Graphics package has no competition.

Our 1024 X by 780 Y viewable points separate Graphics from mere graphing. The price has never been lower. But Tektronix' new 4006-1 provides the same superior information capacity that has made us the company for all your graphics needs.

We'll throw you a curve. Tektronix will graph circles around the competition. Now, thanks to our new low priced 4006-1, we're in the same ballgame with mere alphanumeric terminals.

Graphics to gain. Nothing to lose. Add the graphics extra at an everyday price: \$2995 or \$150 a month on a two year lease. Alphanumerics? Up to 2590 on screen characters. Plus a spectacular package that includes confirmed compatibility with most mainframes through proven interfaces and time-tested software packages. And expert maintenance that follows you all over the world.

Plug-in peripherals standing by. Like our 4631 Hard Copy Unit for up to four 4006-1's with 8½"x11" copies, or

4923 Digital Cartridge Tape Recorder for low-cost, off-line storage.

Why wait for graphics? Let graphics wait on you. See what our fine-line, full-line graphics can mean for your applications. Check out the whole story and all the prices right now with your local Tektronix Sales Engineer. Or write:

Tektronix, Inc.
Information Display Group
P.O. Box 500
Beaverton, Oregon 97077



CIRCLE NUMBER 22



Graphics \$2995

of our processors," explains Joe Mingione, director of custom products at AMI. "Dedicated processors make a lot of sense—the automotive area comes to mind."

The markets for video games, microwave ovens, whitegoods timers, television, sewing machines, and telecommunications are also fields where custom μ Ps are now being used.

"If the customer needs the I/O-control-oriented functions of the F-8, there's no way that custom circuits can compete in function. And this holds for the TMS-1000 and 8048, too, claims Don Winstead of Fairchild Micro Systems, San Jose, CA. "We expect to see prices in the \$3 to \$5 range in 100k quantities on these."

These parts and the new PPS-4/1 introduced by Rockwell International in Anaheim, CA, are true μ Ps, but with customer-specified ROM and RAM on-chip. The F-8 is typical, with a \$1500 charge for masking the ROM and six week delivery on custom-masked parts.

Calculator-oriented μ Ps

The requirement for families of hand-held calculator products with ever-increasing repertoires of instructions led to small, cheap, simple calculator-oriented processors whose initial hallmarks were keyboard entry and LED-display outputs. These have been expanded in function to BCD output as well, and are well suited to the minimum-system, dumb-controller market. Uses in parking meters and appliance timers, or as computation blocks for μ P-based systems, are naturals for this kind of product.

The calculator-oriented processor also, when it does not have all of its ROM and RAM on-chip, may be structured using separate instruction and data busses to simplify programming and optimize memory requirements.

The cost of modifying a calculator-oriented processor (COP) for a custom application is in the \$5000 to \$10,000 range, and about three months are required, according to Bob Lloyd.

"We're seeing a trend toward general-purpose architectures, and general-purpose designs," he explained, "but not a general-purpose chip. We're seeing designs where

Doing it in custom LSI

The first thing the designer must do is define all of the circuit's characteristics as well as possible. That means identifying input and output functions and electrical parameters, and outlining the timing relationships between inputs and outputs. It also means specifying power-supply voltage ranges and operating temperature range.

A schematic or block diagram should be generated to accomplish the required function, and it should be analyzed for freedom from race conditions, and susceptibility to malfunctions due to illegal input state conditions. Breadboard and computer

simulation may well be advised in analyzing the schematic before committing it to silicon.

Then vendors of custom LSI should be contacted to determine the best process and company to manufacture the parts. The complexity of the circuit may play a part in determining the company chosen. While the state of the art in producing commercially feasible LSI is now in the 5000-gate complexity range, many companies are limited to the 500 to 1000-gate custom business.

Having chosen a vendor, the next steps are to negotiate a contract, pay your money, and receive your parts.

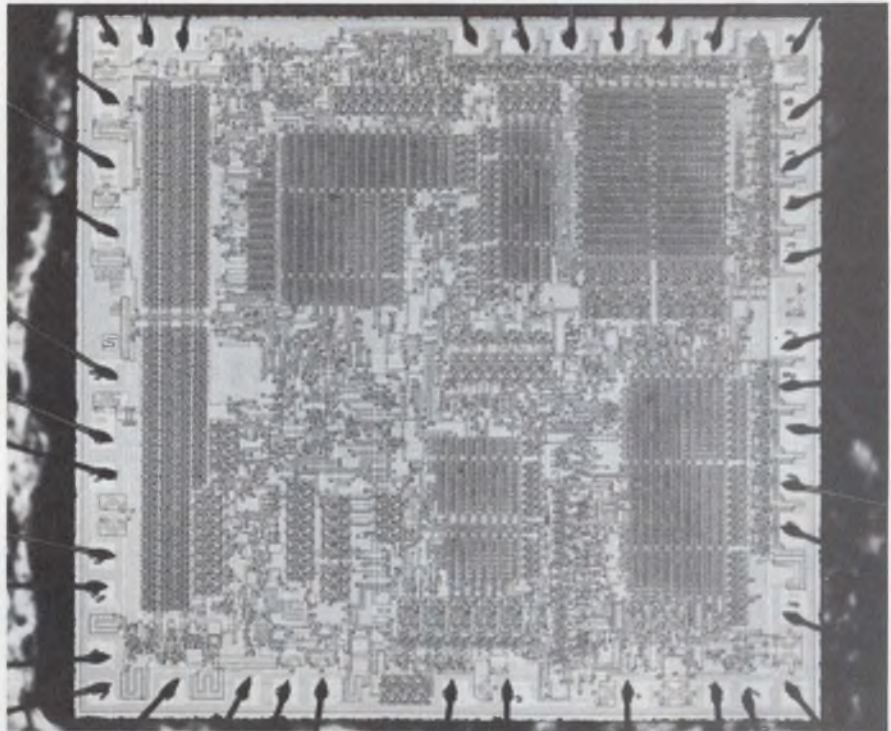

Automatic telephone dialer, a custom LSI circuit that uses μ P techniques by Synertek, Santa Clara, CA.

we can change either the digit length or PLA terms, for specific applications or to make a specific product."

The easy way out

Finally, for the lucky few designers whose requirements are for small circuits, there is the do-it-yourself approach to custom LSI, in which a standard IC with many unconnected transistors, gates, and other components is produced in

large quantities by an IC manufacturer. Then only a customer-specified metal interconnect is required to produce a custom circuit.

In this technique, frequently the designer himself specifies where the metal runs. The only problems are: Does the chip have enough parts, and can they be connected to do the job? But fifty parts delivered in three weeks for \$1800 is an attractive incentive for exploring this route. ■■

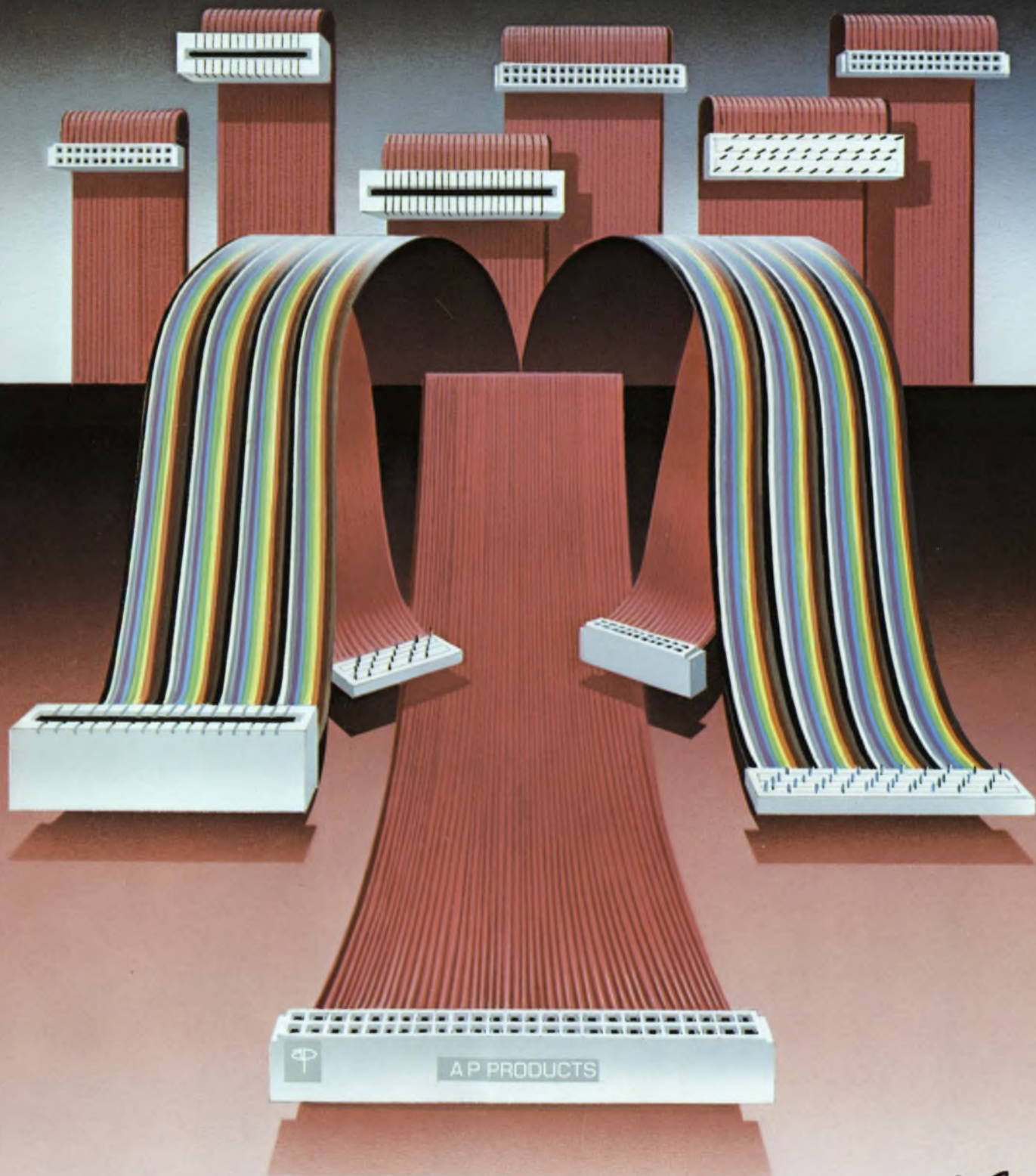

**Put yourself in the pink with
new Great Jumpers™ from A P.**



We're jumps ahead of any other flat cable/connector system.

And we can save you up to 50%.

Now you can eliminate flat cable assembly with our new, pre-assembled Great Jumpers. Our new Great Jumpers come to you in one piece, assembled the way you tell us, as directly interchangeable replacements for the jumpers you're using now. And they come complete with integral, molded-on, strain-relieved connectors featuring amazingly accessible line-by-line probeability.

After all, when you pay for a jumper, why pay again to put it together? And why put up with caps that can fall off? Or connections that depend on a connector staking operation? Simplify with Great Jumpers. You'll avoid extra costs and extra problems.

We assemble our Great Jumpers ourselves and test them before they ever leave our factory. In fact, we're the only manufacturer who delivers fully assembled and pre-tested jumpers. So when you specify A P, you can be assured that every jumper you get does its job right the first time.

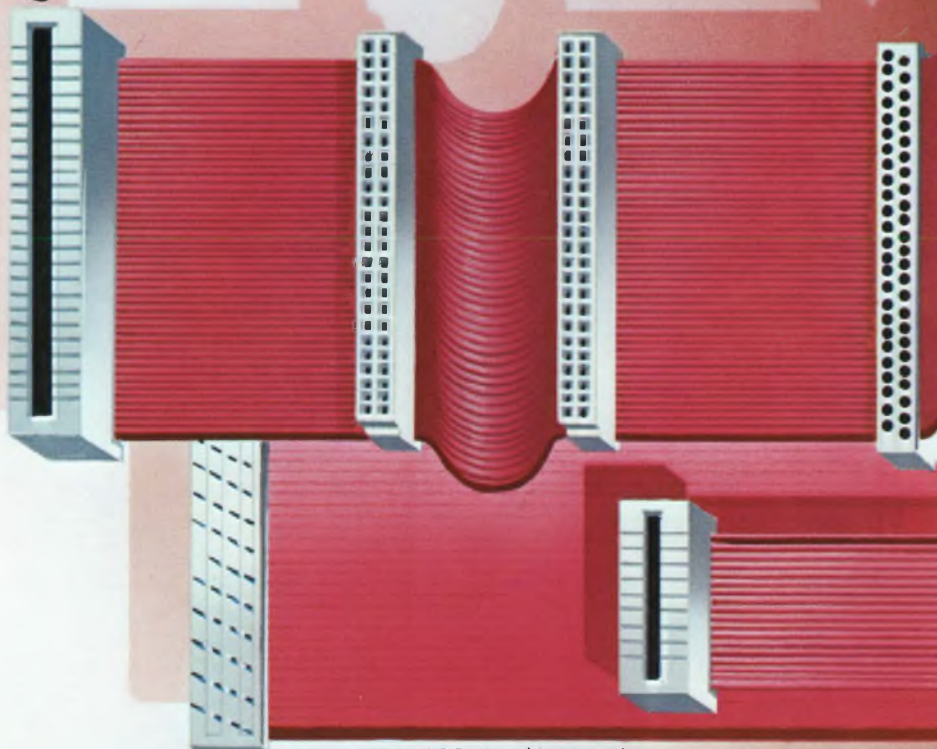
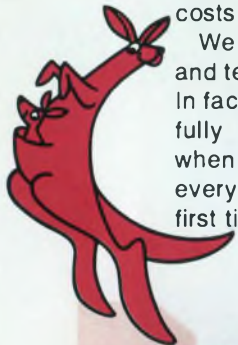

Second, choose your connectors.

	Top View	Side View	Right Connector	Contacts Left	Contacts Right	Style Code	
	Stripe Up 		None	Down	N/A	922501	
			Socket	Down	Down	922521	
			PCB	Down	Down	922522	
			Card-Edge	Down	Down	922523	
			Socket	Down	Up	922531	
			PCB	Down	Up	922532	
	Card-Edge	Down	Up	922533			
	Stripe Down 		None	Down	N/A	922511	
			Socket	Down	Up	922541	
			PCB	Down	Up	922542	
Card-Edge			Down	Up	922543		
	Stripe Up 		None	Down	N/A	922502	
			Socket	Down	Down	922526	
			PCB	Down	Down	922524	
			Card-Edge	Down	Down	922525	
			Socket	Down	Up	922536	
			PCB	Down	Up	922534	
	Card-Edge	Down	Up	922535			
	Stripe Down 		None	Down	N/A	922512	
			PCB	Down	Up	922544	
			Card-Edge	Down	Up	922545	
Socket			Down	Up	922546		
	Stripe Up 		None	Down	N/A	922503	
			Socket	Down	Down	922528	
			PCB	Down	Down	922529	
			Card-Edge	Down	Down	922527	
			Socket	Down	Up	922538	
			PCB	Down	Up	922539	
	Card-Edge	Down	Up	922537			
	Stripe Down 		None	Down	N/A	922513	
			Card-Edge	Down	Up	922547	
			Socket	Down	Up	922548	
PCB			Down	Up	922549		

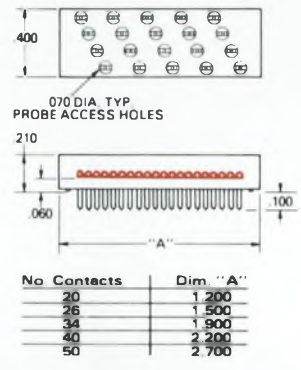
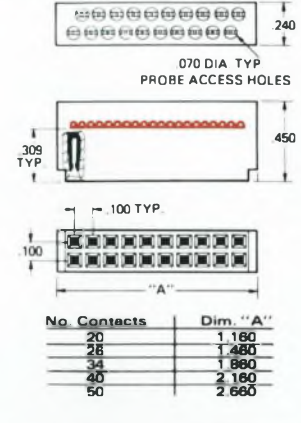

Request Bulletin 7.04 for PC board drill patterns.

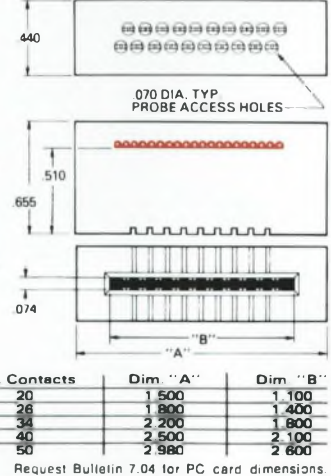

Request Bulletin 7.04 for PC card dimensions

Dielectric: UL recognized glass-filled polyester. Non-corrosive contacts: Socket connector and card-edge connector, alloy 770; PCB connector, alloy 725. All dimensions in inches.

Now you're ready to order.

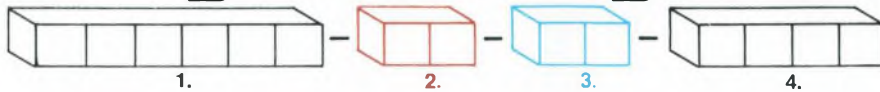

- Enter 6-digit style code (see chart)
- Indicate whether 20, 26, 34, 40 or 50 contacts in connector
- Enter "01" for Electric pink solid conductor cable.
Enter "02" for Electric pink stranded conductor cable.
Enter "99" for rainbow stranded conductor cable. (Available on single-ended jumpers only)
- Enter tip to tip length in inches.
± 1/8 inch tolerance for jumpers up to 12"
± 1/4 inch for jumpers over 12" and under 36"
± 1/2 inch if longer than 36"



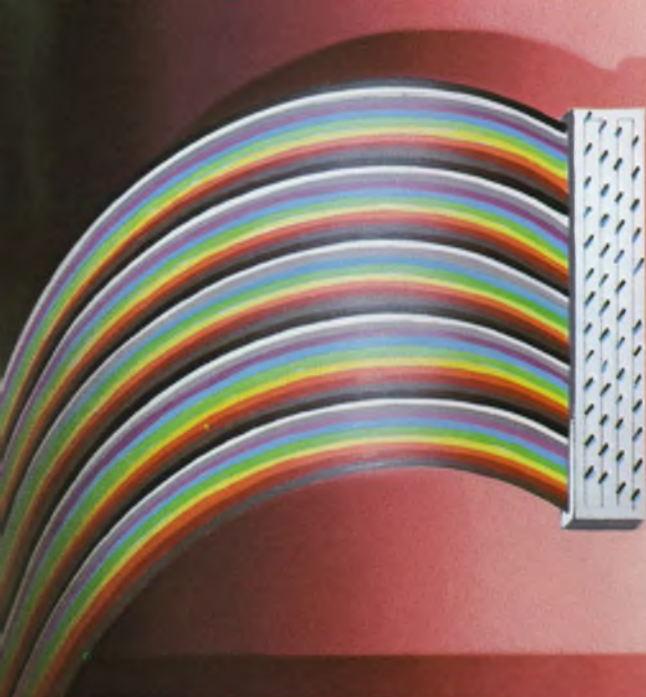

**We can
make any jump
in any of
360 ways.**

**And there are more
ways to come soon.**

Our Great Jumpers are available with three basic end terminations: Socket connectors, printed circuit board connectors, or card-edge connectors. Each of these termination types is available with any of the five most used flat cable widths: 20, 26, 34, 40 and 50 conductor. And Great Jumpers are available single-ended, or double-ended to your requirements, using any mix of end termination types and sizes.

Tell us about the Great Jumpers you need and watch us hop to it.

**We make Great
Daisy Jumpers,™ too.**

Design any kind of daisy chain arrangement you can think of around our Great Jumpers and we can deliver it fully assembled, tested and ready-to-use. Contact your A P rep for details. And there's more.

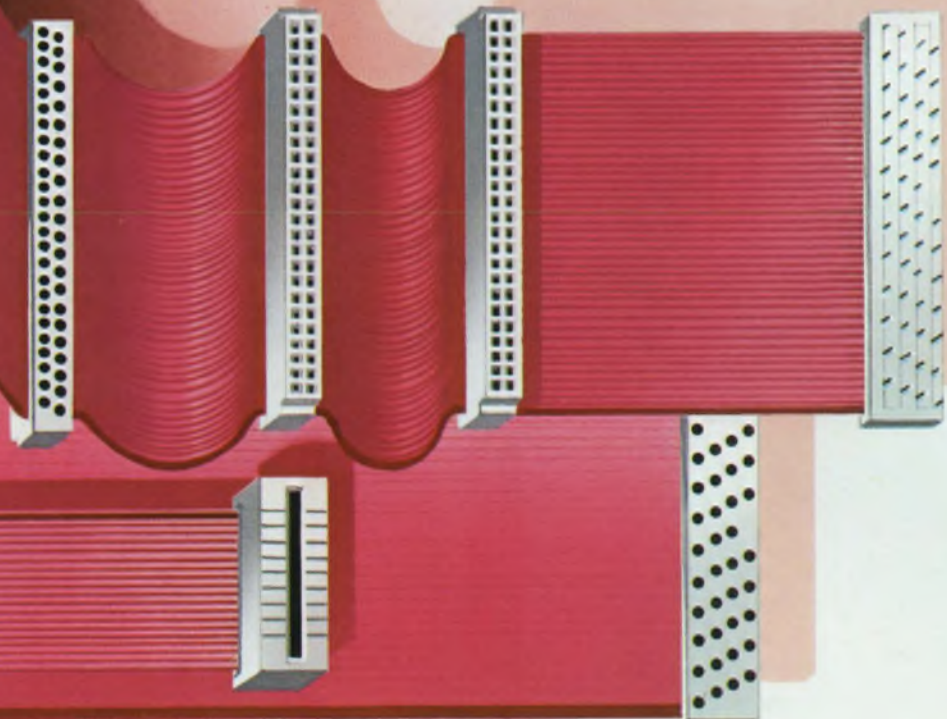

Your first Great Jumper is free. Just tell us which.



Most offers end with "Here's how to order." But that's where ours is just getting off the ground.

Your local A P Products factory rep (he's listed on the back page) will deliver an evaluation sample of one of our new Great Jumpers free. Made to order, just the way you tell us you want it. Just follow these charts, make your choices and give him a call.

The sooner you tell us how you want your free jumper, the sooner we can get hopping.



First, decide on a ribbon.

Great Jumpers feature laminated PVC insulated ribbon cable that's made to take its lumps as it makes its jumps. The rigors of real-world system performance are met and exceeded in our design. Conductors are No. 28 AWG. The insulation and lamination are designed for quick, easy tear-down and separation without need for a cutting tool. And they're available three ways.



ELECTRIC PINK SOLID CONDUCTOR RIBBON CABLE.

Our most economical. A solid edge stripe helps identify cable orientation.

ELECTRIC PINK STRANDED CONDUCTOR RIBBON CABLE.

Perfect for applications demanding repeated flexing. And cable orientation is identified with an edge stripe.



OPTIONAL RAINBOW CABLE WITH STANDARD COLOR CODING.

Available only on single-ended jumpers, designed for applications where each conductor must be discretely connected. Conductors are No. 28 AWG stranded with standard color coded insulation. And groups of ten conductors are color stripe coded on the back of each cable for easy identification of wire number and wire group.

Listed by UL under subject 758, style 2480 or 2651.

A P GREAT JUMPERS FLAT RIBBON CABLES ALWAYS COME FULLY ASSEMBLED, TESTED AND READY-TO-USE.

Get your first Great Jumper free from your A P Products rep.

He'll have you hopping happy when you hear how little your next ones will cost.

Remember . . . fully assembled and tested AP Great Jumpers can cost just about half as much as competitive jumpers. In fact, if you allow for the cost of assembling and testing other jumpers, Great Jumpers can cost you even less.

So look up your local A P rep. And connect with him. For happier endings. By leaps and bounds.

ARIZONA

Piper-Goyne, Incorporated
P.O. Box 1648
4261 North Brown Avenue
Scottsdale, AR 85252
Phone: (602) 946-4437
(602) 949-8424
TWX: 910-950-0083

CALIFORNIA

Brooks Technical Group
2465 East Bayshore, Suite 345
Palo Alto, CA 94303
Phone: (415) 328-3232
TWX: 910-373-1198

Daniels & Doty Sales Co.
5575 Magnatron Blvd. Suite B
San Diego, CA 92111
Phone: (714) 560-6266

Mission Marketing Group
2182 Dupont, Suit 209
P.O. Box 17477
Irvine, CA 92713
Phone: (714) 833-1802

COLORADO

Piper-Goyne, Incorporated
8041 West I-70
North Frontage Rd.
Denver, CO 80002
Phone: (303) 420-4646
TWX: 910-938-0755

CONNECTICUT

Tri-Com Associates
Wykeham Road
Washington, CT 06793
Phone: (203) 868-7748

FLORIDA and S. EAST

Gra-Mar, Inc.
3165 McCrory Place
Orlando, FL 32814
Phone: (305) 894-3351
TWX: 810-850-0125

ILLINOIS

Coombs Associates, Inc.
1001 East Touhy
Des Plaines, IL 60018
Phone: (312) 298-4830
TWX: 910-233-5980

INDIANA

Elliott Engineering Sales Co.
5102 Roberta Drive
Fort Wayne, IN 46806
Phone: (219) 447-9623

MARYLAND

Compar Chesapeake, Inc.
7 Church Lane
Baltimore, MD 21208
Phone: (301) 484-5400
TWX: 710-862-0860

MASSACHUSETTS

Tri-Com Associates
Box 172
Burlington, MA 01803
Phone: (617) 272-8163

MICHIGAN

Norm Case Associates, Inc.
P.O. Box 103
Milford, MI 48042
Phone: (313) 356-2161

MINNESOTA

Charles E. Bohlig Associates
P.O. Box 16183
Minneapolis, MN 55104
Phone: (612) 922-7011
TWX: 910-576-3429

MISSOURI

Beneke & McCaul, Inc.
P.O. Box 24552
226 Chamonix Court
St. Louis, MO 63141
Phone: (314) 434-6242
(Also)
12825 Bristol
P.O. Box 144
Grandview, MO 64030
Phone: (816) 765-2998

NEW JERSEY

Compar New York, Inc.
404 Clifton Avenue
Clifton, NJ 07011
Phone: (201) 546-3660
TWX: 710-989-7239

Sunday-O'Brien, Inc.
15 Potter Street
Haddonfield, NJ 08033
Phone: NJ (609) 429-4013
Phone: PA (215) 923-5195
TWX: 710-896-0679

NEW MEXICO

Piper-Goyne Incorporated
11701 Manual NE
P.O. Box 14894
Albuquerque, NM 87111
Phone: (505) 294-1436

NEW YORK (Metro)

Compar New York, Inc.
404 Clifton Avenue
Clifton, NJ 07011
Phone: (201) 546-3660
TWX: 710-989-7239

NEW YORK (Upstate)

Nycom, Incorporated
2002 Teall Avenue
Syracuse, NY 03206
Phone: (315) 437-8343
TWX: 710-541-1506

OHIO

Norm Case Associates, Inc.
P.O. Box 4791
Fairview Park, OH 44126
Phone: (216) 333-4120
TWX: 810-421-8396
(Also)
P.O. Box 217
Centerville, OH 45459
Phone: (513) 433-0966

OREGON

Freed Associates
2953 NW Imperial Terrace
Portland, OR 97210
Phone: (503) 223-3374

TEXAS

Allied Components, Inc.
Suite 730, Keystone Park
13771 N. Central Expressway
P.O. Box 31027
Dallas, TX 75243
Phone: (214) 238-0408
TWX: 910-867-4783
(Also)
4615 North Freeway, Suite 305
Houston, TX 77022
Phone: (713) 691-3961
TWX: 910-881-3741
(Also)
P.O. Box 14274
Austin, TX 78761
Phone: (512) 443-9687

WASHINGTON

Freed Associates
11031 118th Place NE
Kirkland, WA 98033
Phone: (206) 822-8223

WISCONSIN

Coombs Associates, Inc.
6663 Industrial Loop
Greendale, WI 53129
Phone: (414) 421-2300

CANADA

Weber Electronics, Inc.
1111 Finch Ave. W.
Downsview, Ontario
M3J2E5
Phone: (416) 638-1322

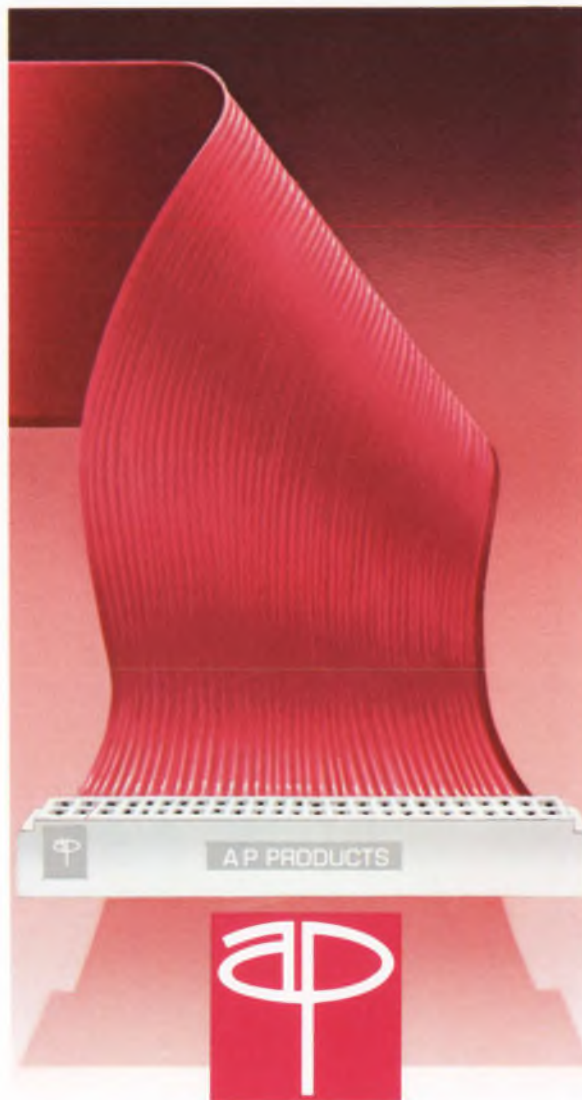

AP PRODUCTS INCORPORATED

Box 110-Q • 72 Corwin Drive • Painesville, Ohio 44077

Tel: 216/354-2101 • Twx: 810-425-2250

What's new in solid state . . .

Announcing the 1-chip COSMAC CPU and the 4-chip CMOS system.

Now, a CMOS system that really delivers the promise of the microprocessor. It's the expanded RCA 1800 family with CDP1802, our new one-chip COSMAC CPU. And it gives you an unsurpassed combination of flexibility, performance and cost effectiveness.

This cost effectiveness starts with price: \$23.50 for the CDP1802CD in 100-piece quantities. But there's more to it.

Simple COSMAC architecture lowers memory costs because of 1-byte instructions and internal address pointers. It also reduces I/O costs. Plus design and learning costs.

Then you have the familiar CMOS savings. Single power supply. Single-phase clock. Less cooling and other equipment, thanks to low power and high tolerances.

For all these reasons, we believe no other microprocessor matches the RCA 1800 for system cost effectiveness. What's more, you can get the whole system from us: CPU, ROM, RAM, I/O. Everything you need including complete design support. From the first house in CMOS.

For more information, contact your local RCA Solid State distributor. Or RCA.

Write: RCA Solid State, Box 3200, Somerville, NJ 08876; Ste. Anne de Bellevue H9X 3L3, Canada; Sunbury-on-Thames, U.K.; Fuji Bldg., Tokyo, Japan.

- COSMAC ARCHITECTURE
- DESIGN AIDS
- SUPPORT CIRCUITS
- CMOS FEATURES
- DESIGN EASE
- HIGH SPEED
- LOW PRICE

RCA

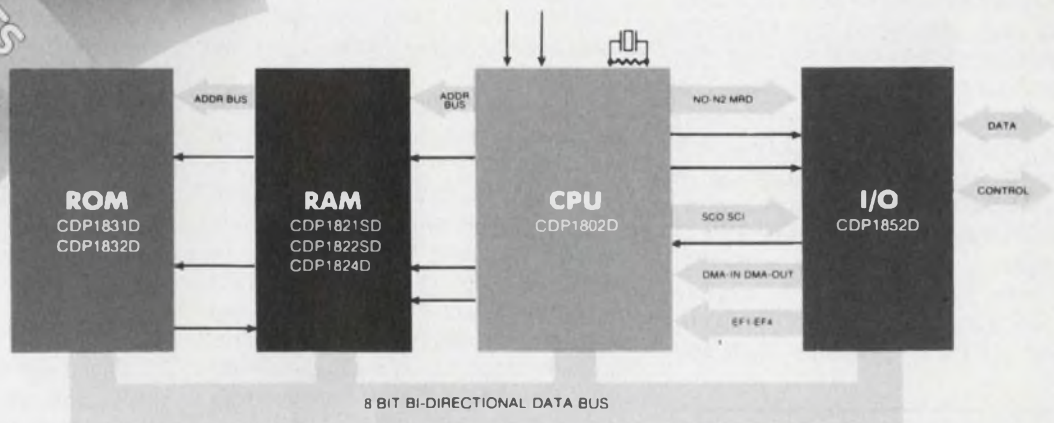

RCA 1800. The full spectrum in one low cost system.

Progress in gigabit logic reported for super-fast switching uses

Interest and activity in gigabit logic (10^9 b/sec) is increasing. Current work is aimed at developing discrete logic circuits, testing already-built discrete circuits, and implementing high-density integrated circuits.

For the first time, the annual IEEE MTT International Microwave Symposium (held last month in Cherry Hill, PA) devoted a full session to progress in gigabit logic, with speakers from the United States, Germany and Japan reporting progress in a variety of areas.

One of the many applications that await development of gigabit technology is a fast analog to digital (a/d) converter for today's sophisticated high-speed radars. Another area of potential benefit is in improving radar signal correlation techniques.

Although the words "gigabit logic" may conjure up images of ultra-fast computers gobbling up data at speeds of more than a thousand megabits per second, development of such machines is still a long way in the future.

Picosecond switching

A recently developed solid-state device of extremely fast switching time was described by Chainulu Upadhyayula of RCA Sarnoff Research Laboratories, Princeton, NJ.

Known as a Transferred Electron Logic Device (TELD), this element operates basically as a Gunn-Effect diode, but with one essential distinction. . . . the TELD contains a third element, a Schottky gate. This control gate, similar to the gate in a field-effect transistor (FET), provides isolation

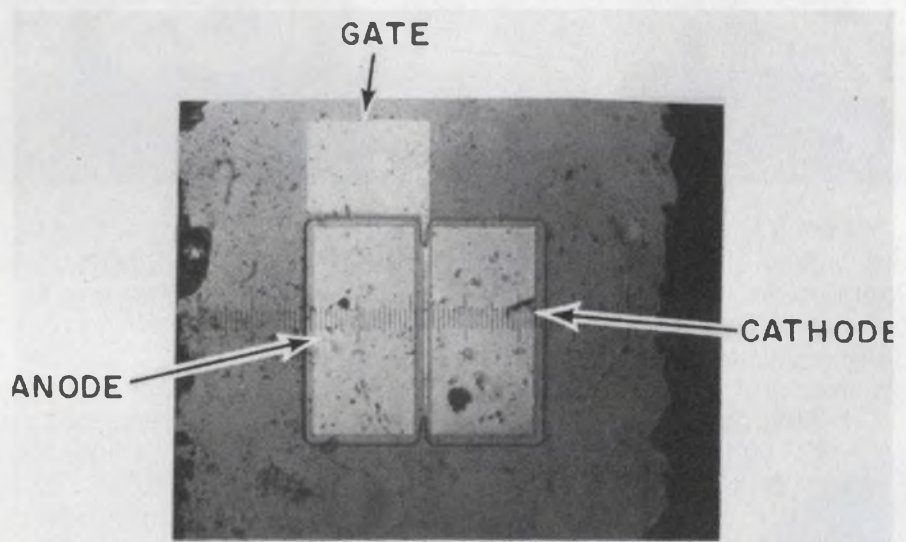

Multi-level mesa-type TELD can switch signals in picoseconds. Gate length = 2μ . Cathode to anode spacing = 12μ . Cathode-to-gate distance = 1 to 2μ . Average width of channel between cathode and anode = 150μ .

between input and output, and also ensures unidirectionality of the signal.

At a certain threshold voltage (approximately a few volts) the volt-ampere characteristic of the TELD exhibits a negative slope. Because of this negative resistance characteristic, extremely fast transition times are possible. Switching times of 20 to 50 ps (10^{-12} s) have been reported, and even shorter times (5 to 15 ps) are possible.

Present-day FETs are capable of extremely fast switching too, on the order of 100 ps or less. But for FETs the cutoff frequency—and hence the rise time—is determined by the geometry of the device, in particular by the source-to-drain spacing. In general, the closer the spacing, the higher the cutoff frequency. Present technology is limited however in how narrow this spacing can be made.

In the case of TELDs the switching time (actually the do-

main formation time) is a function of the properties of the material rather than the geometry. Thus the switching time limitation imposed by the source-to-drain spacing is eliminated. The result is a higher cutoff frequency and a faster rise time.

In his paper, "Transferred electron logic devices (TELDs) for gigabit-logic-rate signal processing," Upadhyayula reports that these devices are not only available, but are already being tested in specific circuits, such as (for example) threshold logic circuits and two-input AND gates.

One unit has been successfully tested at 1.25 GHz, "but that is certainly not the upper limit," he says.

On the practical side

There are a number of practical uses for gigabit logic circuits. These include: fast-Fourier transform calculators, a/d and d/a converters, and time of arrival sys-

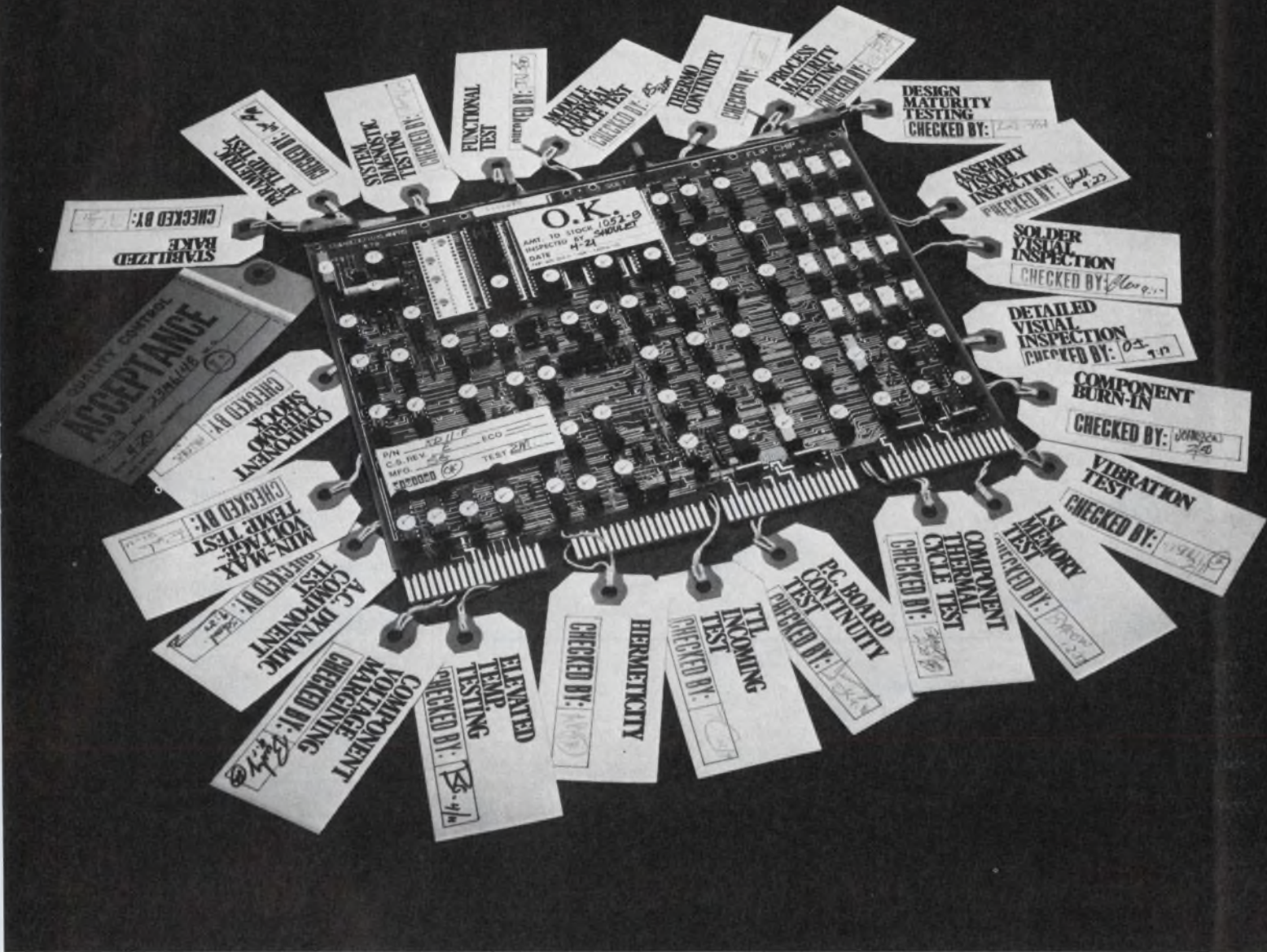

No other micro can make this claim.

The LSI-11.

No other micro goes through so much testing. So no other micro can ensure you of so much reliability.

We started with a Design Maturity Test that showed zero failures in 384,000 unit-hours for the 4K MOS RAMs, and only one failure in 20,000 unit-hours for the microprocessor chips.

We make each LSI-11 under our

special Manufacturing Quality Plan. This begins with 100% testing of incoming components and continues with computer-controlled monitoring at strategic points in the production flow.

And we run a thermal cycle on every LSI-11 that comes off the line.

What it all adds up to is a worst-case MTBF of over 35,000 hours. And that's from data in the field.

LSI-11. The \$634* 4K microcom-

puter on an 8½" x 10" board.

LSI-11. The one micro that's really been put to the test.

For more info, call 800-225-9480 (Mass. 617-481-7400 ext. 6819 or 6817). Or write: Components Group, Digital Equipment Corp., One Iron Way, Marlborough, MA 01752. Canada: Digital Equipment of Canada, Ltd. Europe: 81 Route de l'Aire, 1211 Geneva 26, Tel. 42 79 50. *In 100's. Prices apply to USA only.

digital
COMPONENTS
GROUP

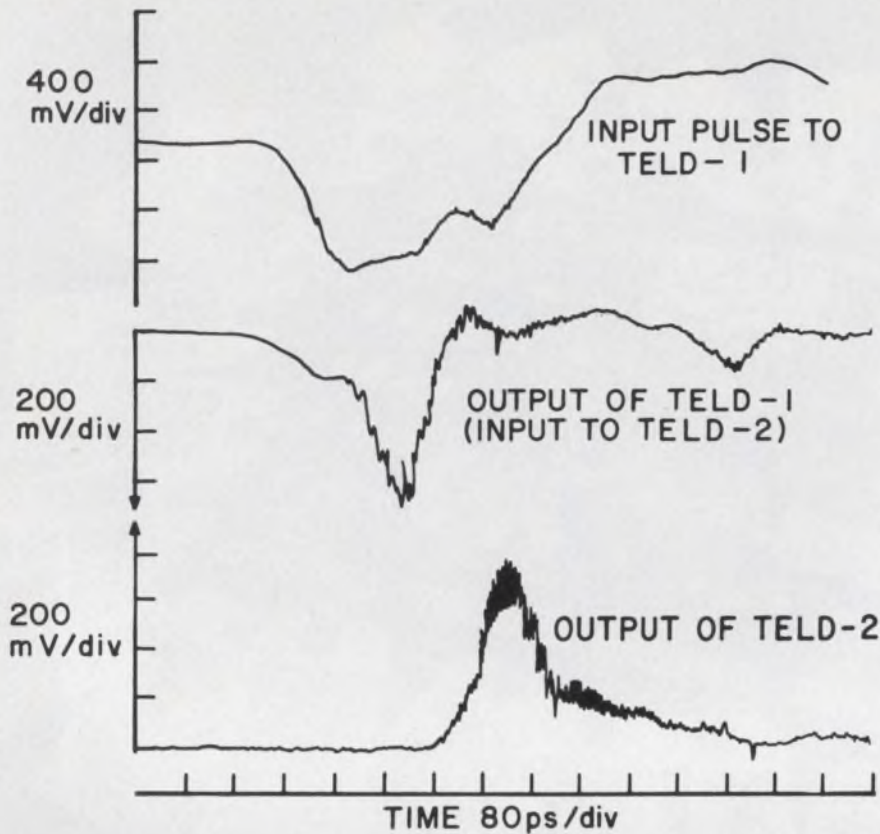

A cascade of two TELD threshold circuits delivers an output pulse of about 1 V and less than 100 ps-width at half-height.

tems. The last is used for distinguishing two events very closely spaced in time.

The lack of speed of currently available a/d converters is one of the limitations of present day high speed radars, declares Max Yoder of the Office of Naval Research, Washington, DC, and chairman of the gigabit-logic session. "The next major thrust in radar-system design will probably come about when a/d converters of much higher speed are developed" he says.

In pointing out comparisons between TELD devices and more conventional high-speed circuit elements, Upadhyayula notes that TELDs consume about twice as much power as emitter-coupled logic (ECL) devices. But the speed of processing is ten times faster than for the fastest ECL.

"Applications exist for transfer-electron logic devices where processing time is very important and where only a handful of these devices is needed," Upadhyayula says.

"Applications for high-speed computers however, are many years away because computers generally need thousands of similar devices, all of proven reliability. Present

Technology in TELDs is not yet at that stage," he points out.

Other materials, such as Indium gallium antimonide, consume only one-fourth the power of present gallium arsenide devices. Therefore, they may be more suitable for gigabit integrated circuits, he adds. But these newer, exotic materials are not yet easily available, although they are already being produced in Japan.

Very fast bipolar ICs

In the field of analog signal processing, development of a very fast silicon bipolar integrated-circuit technology is reported by Dave Breuer, manager of the high-speed bipolar department at TRW Systems, Redondo Beach, CA. This technology achieves operating speeds in the 1 to 2 GHz range, and has the capability of being fabricated into as many as 5000 devices per die.

Such high-speed, high-density circuits are possible through a new technology called OAT (Oxide Aligned Transistor) technology, described in a paper entitled, "A silicon monolithic technology for 1 to

Properties of OAT bipolar technology

OAT bipolar transistor—physical dimensions

Emitter width (also emitter contact width)	3 μ or 4 μ
Base contact width	4 μ
Metal overlap over contact	2 μ each side
Metal to metal spacing	2 μ
Minimum size transistor (to isolation centerlines)	44 μ \times 55 μ

OAT bipolar transistor—electrical characteristics

f_T	≥ 3.5 to 5 GHz
C_{co}	≈ 0.14 pF at $V_{ce} = 0$ volts
C_{eo}	≈ 0.08 pF at $V_{eb} = 0$ volts
C_{cs}	≈ 0.16 pF at $V_{cs} = -3$ volts
I_c	≈ 2 mA
r_c	≈ 60 ohms

Costas demodulator multiplier measured performance

Operating frequency	dc to > 2 GHz
Input level	≈ 40 mvpp
Differential mode gain	24.6 db
Common-mode gain	-32 db
Dynamic range	41 db
Power supply rejection	85 db
DC power	± 9 volts @ 7.3 ma

2-GHz analog signal processing," by TRW's Breuer, Dale Claxton, and Albert Cosand.

Advantages of the OAT technology are the following:

- Smaller device dimensions and lower junction capacitance. Thick-field oxide provides low parasitic capacitance.

- Smaller device dimensions for a given mask and alignment capability. One mask pre-aligns a number of subsequent diffusions. This offers the promise of high-complexity, large-scale integration.

- Improved resistance to radiation due to the reduced PN junction area.

Development of OAT technology results in integrated circuit (IC) transistors with high frequency cutoff (f_t) values in the 3.5 to 5-GHz range. Typical dimensions and electrical characteristics of such transistors are shown in the table.

The TRW process also enables fabrication of IC resistors that match to better than 1%, and that have parasitic capacitances to the substrate as low as 0.02 pf per

SELECTIVE MIXTURE.



It's time to toast the 54C/74C and 4000 series logic families. Because while they've always been electrically compatible, now many of the functions are pin-for-pin compatible.

So here's to a selective mixing of them in your system. You'll find that mixing these two CMOS families gives you more available functions from which to choose.

So your chances of finding the right ones are better. And it minimizes the amount of CMOS devices you need to implement the logic.

In addition, you can take advantage of each family's vintage features for better overall performance.

Features such as higher guaranteed noise margin, greater output drive, and the higher speed of the 54C/74C series.

When you're ready to set up these CMOS families in your system, your Harris distributor can mix in the right ingredients.

We're not only a qualified supplier of both CMOS series devices, but also your number one source.

For more information on how we can help you have a more efficient CMOS system, just call our CMOS Application Information Hot Line at 800-327-8934.



HARRIS
SEMICONDUCTOR
A DIVISION OF HARRIS CORPORATION

P.O. Box 883, Melbourne, Florida 32901 (305) 724-7412

WHERE TO BUY THEM: OEM SALES OFFICES: CALIFORNIA: Long Beach (213) 426-7687; Palo Alto (415) 964-6443; **FLORIDA:** Fort Lauderdale (305) 971-3200; Melbourne (305) 724-7430; **ILLINOIS:** Hinsdale (312) 325-4242; **MASSACHUSETTS:** Wellesley Hills (617) 237-5430; **MINNESOTA:** Minneapolis (612) 835-2505; **NEW YORK:** Endwell (607) 754-5464; Melville L.I. (516) 249-4500; **OHIO:** Dayton (513) 226-0636; **PENNSYLVANIA:** Wayne (215) 687-6680; **TEXAS:** Richardson (214) 231-9031.

SALES REPRESENTATIVES: ARIZONA: Scottsdale (602) 948-5590; **CALIFORNIA:** Los Angeles (213) 870-9191; Mountain View (415) 961-8121; San Diego (714) 565-9444; **COLORADO:** Denver (303) 773-0666; **CONNECTICUT:** East Norwalk (203) 838-1493; **FLORIDA:** Boca Raton (305) 395-6108; Oviedo (305) 365-3282; Tampa (813) 933-3183; **ILLINOIS:** Elk Grove Village (312) 640-1850; **INDIANA:** Indianapolis (317) 849-6454; **IOWA:** Cedar Rapids (319) 393-5652; **KANSAS:** Wichita (316) 943-6221; **MARYLAND:** Randallstown (301) 922-1248; **MASSACHUSETTS:** Burlington (617) 273-1313; **MICHIGAN:** Farmington (313) 476-2446; **MISSOURI:** Hazelwood (314) 731-5799; Kansas City (816) 761-6543; **NEW JERSEY:** Keasbey (516) 567-5900; West Caldwell (516) 567-5900; **NEW MEXICO:** Albuquerque (505) 265-5655; **NEW YORK:** Albany (518) 489-7408 or 4777; Huntington Station (516) 567-5900; **OHIO:** Cleveland (216) 831-8292; Dayton (513) 890-2150; **OREGON:** Beaverton (503) 643-1644; **PENNSYLVANIA:** Allison Park (412) 487-4300; King of Prussia (215) 265-0634; **TEXAS:** Dallas (214) 691-4592; Houston (713) 661-3007; **VIRGINIA:** Falls Church (703) 534-7200; Lynchburg (804) 237-4740; **WASHINGTON:** Bellevue (206) 454-0300; **CANADA:** Montreal (514) 626-6723; Ottawa (613) 749-0740; Toronto (416) 676-1042.

NATIONAL DISTRIBUTORS: Hamilton/Avnet, The Harvey Group, Inc., Schreiber Electronics, R.V. Weatherford Company

CIRCLE NUMBER 25

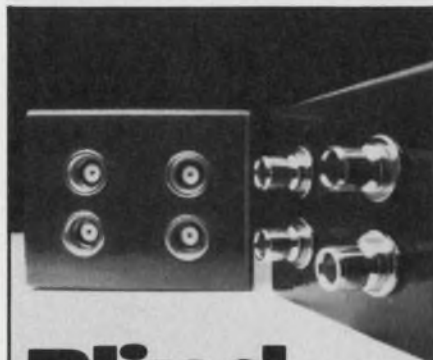

Blind coaxial mating made easy.

Blind coaxial mating used to pose a real problem. Now, standard connectors in Omni Spectra's OMQ[®] miniature and OSQ[®] subminiature series make it easy. Units in both series allow you to construct a virtually endless variety of multiple coupling configurations.

And electrical performance is outstanding. Pulse rise times of 30 picoseconds are passed without discernible degradation. Typical VSWR is 1.15 at 5 GHz.

OMQ and OSQ series also offer units for optional access to bulkhead connectors via flexible or semi-rigid cable. This includes quick connect/disconnect units that can be used with or without positive locking.

Send for complete catalog.

Omni

Spectra, Inc. OSM DIVISION

21 Continental Boulevard, Merrimack, N.H. 03054
Tel. (603) 424-4111, TWX 710-366-0674

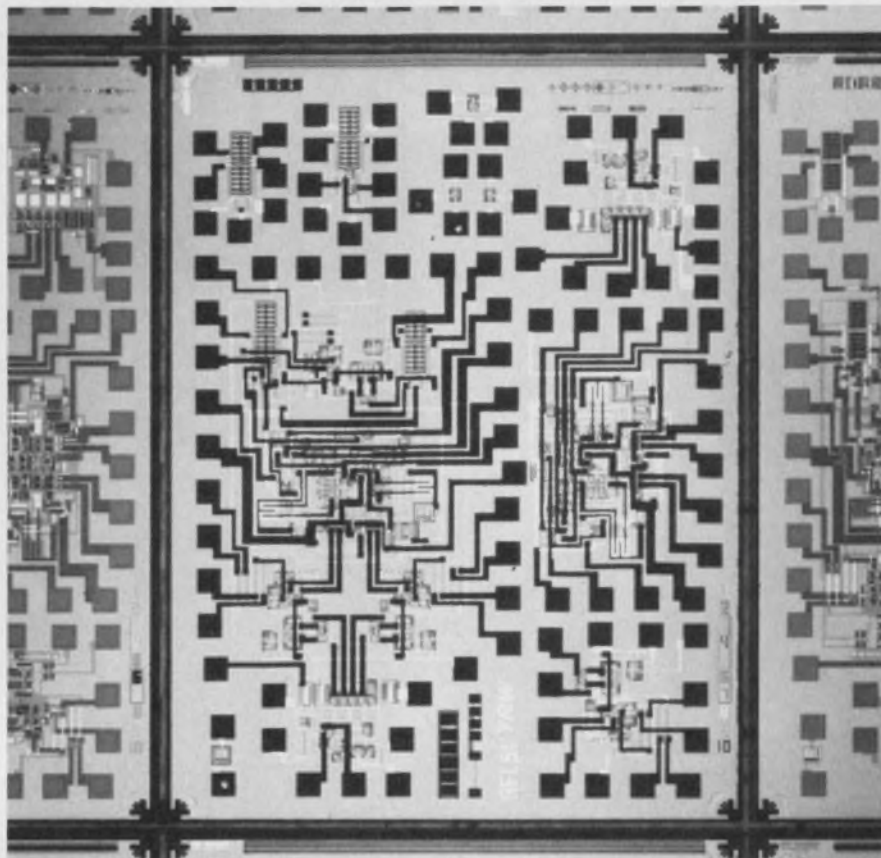

TRW's OAT technology offers promise of high-speed, high-density integrated circuits for analog signal processing.

mil². Such low stray capacitance permits, for example, the fabrication of a 200- Ω resistor with a substrate capacity of only 0.01 pf. This is in contrast to the figure of 0.05 pf for conventional diffused resistors of this type.

The first experimental application of the OAT process in a high-frequency analog circuit is as a multiplier for a Costas demodulator, a two-phase demodulator used for receivers.

Although the demodulator was designed to operate at 500 MHz, the phase detector was reported to give the correct transfer characteristics up to frequencies as high as 4 GHz.

The table lists the measured performance characteristics of the multiplier.

In still another paper, experiments with gallium-arsenide (GaAs) MESFETS for regeneration and amplification of very fast pulses were described by a team of West German scientists from the Technical University of Aachen. Pulses with speeds up to 5 Gbits/s, they reported, could be used for pulse-code modulation (PCM) of a laser in an optical communication system.

Pulse-sharpening factors of approximately three, could be achieved, they found. The sharpening factor is defined as the ratio of input-to-output pulse rise-time. A voltage amplification of 2, at 50 ohms, for output pulses of 100 ma, is attainable with pulse rise times as short as 53 ps at the output, the authors say.

Further work in high-speed regeneration of high bit rate PCM signals was described by B. Bosch, U. Barabas, U. Wellens, and U. Langmann of Ruhr University, Federal Republic of Germany. Two experimental hybrid integrated circuits using step-recovery diodes were tested at 300 Mbits/s and 1 Gbit/s, they report.

Progress in multiplexing and demultiplexing techniques in the Gbit range—with an experimentally measured bit rate of 1.8 Gbits/s—was reported by Klaus Mause of the German Post Office Research Institute.

From Japan, a group of scientists at Tokyo University described the successful modulation of a semiconductor laser at 500 M bits/s using TELDs. They also report using TELDs in high-speed logic systems. ■■

**Some companies
call two IC Converters
a complete line.**

**Now if they only had
the one you wanted.**

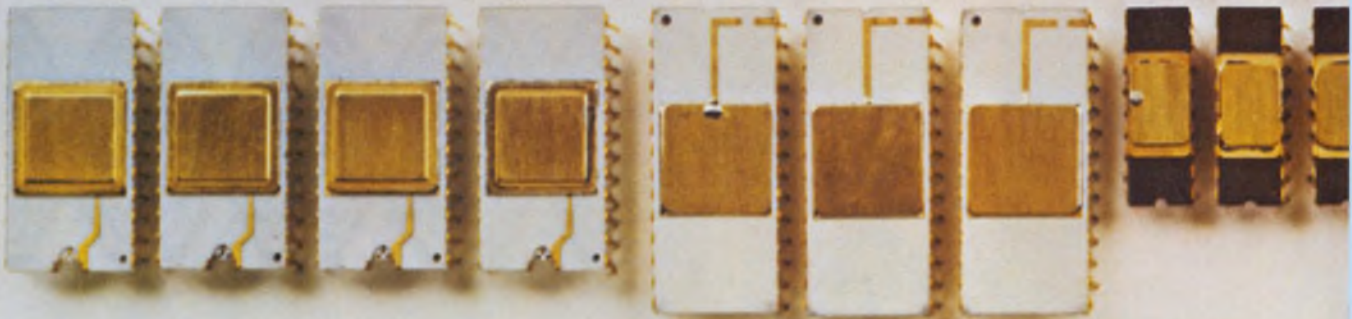
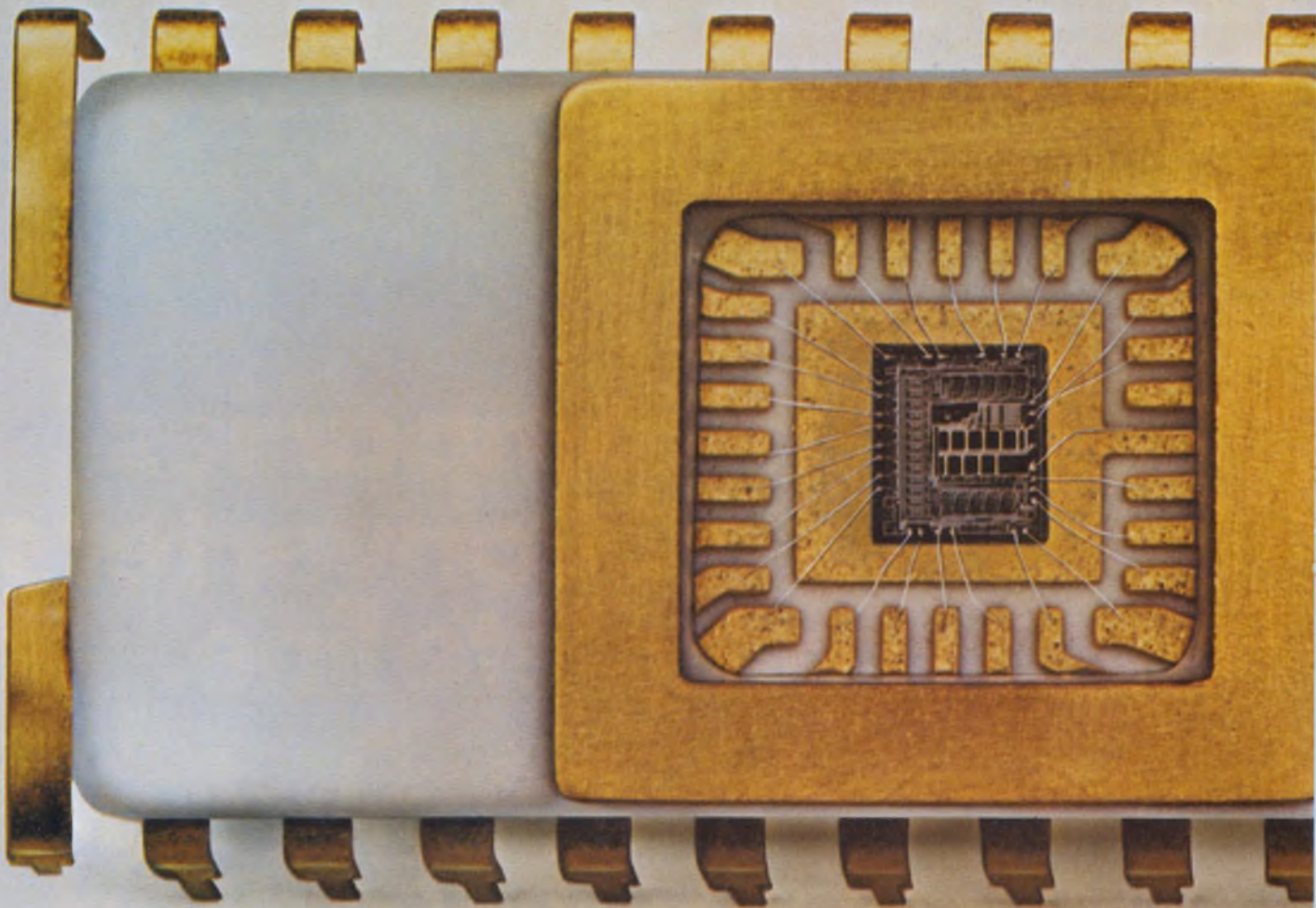

Analog Devices. We're for real.

It's hard to tell what's real and what's make believe nowadays. With all the claims and counterclaims about IC Converter capability.

We want to set the record straight.

The Analog Devices IC Converter expertise is more than talk. More than product. More than potential.

It's our ten years experience in data converter technology. It's the support and characterization of our family of IC Converters. It's the assessment of market needs, the implementation to meet those needs. It's the reality of a worldwide technical sales force that knows the IC Converter business from design through application. It's helping our customers solve their problems more efficiently.

The real world. Real products are the first measure of leadership. We have more than twenty bona fide IC Converters for immediate delivery in quantity.

A dozen or so more are in the wings which boast the advantages of low power CMOS and high stability bi-polar construction. Analog Devices IC Converters

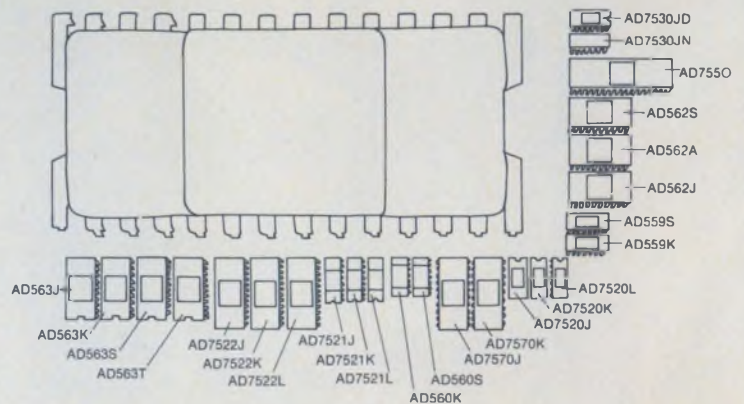

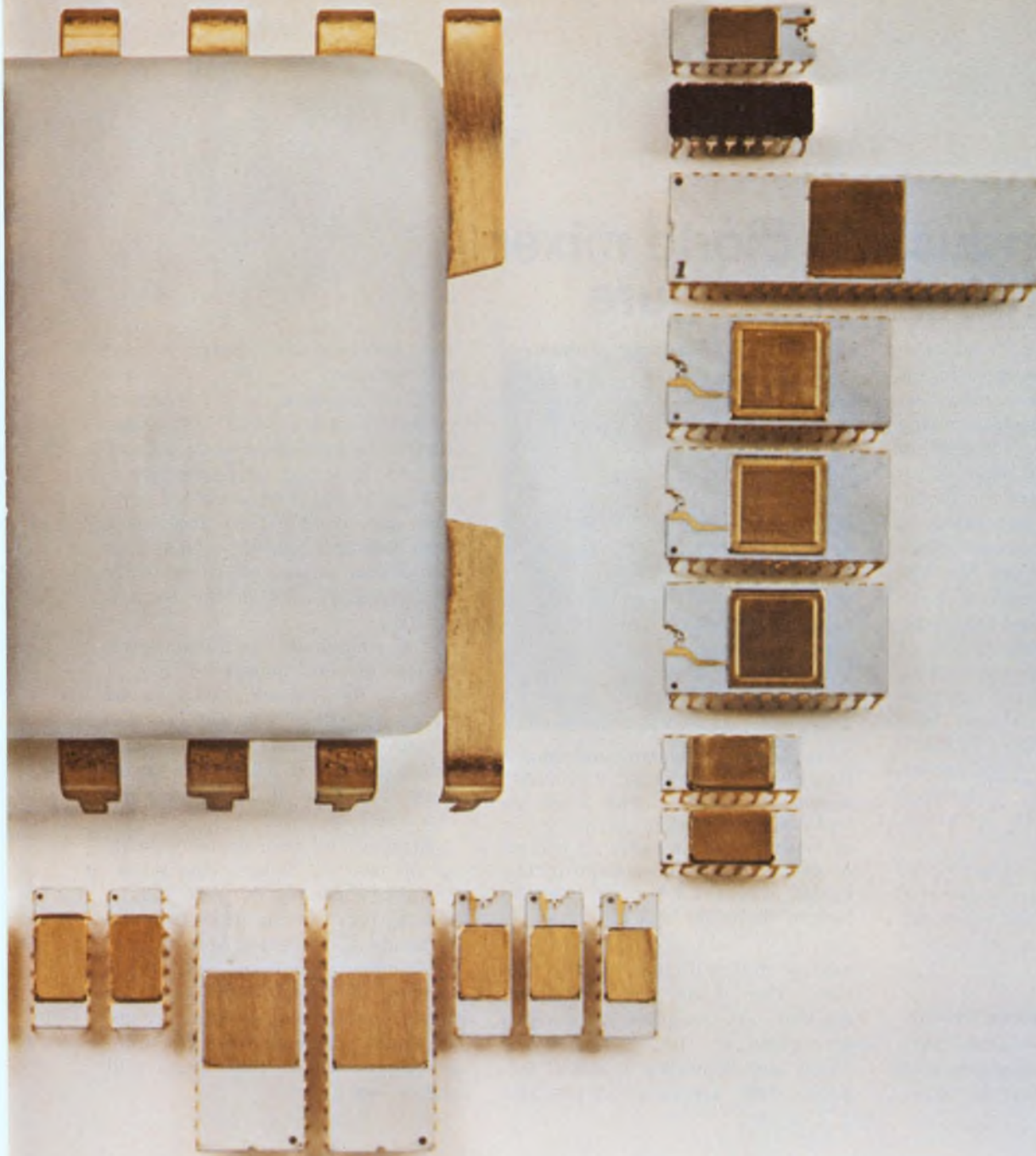

give you the solution to the very real problems of cost, reliability and performance.

From the 10-bit CMOS DAC, AD7520, to the 12-bit laser trimmed DAC's, the AD562 and AD563, and the microprocessor compatible 13-bit CMOS A/D Converter, AD7550, you'll find the right IC Converter to meet your specific needs. They're all available in a variety of performance and package options.

Making it real. IC production technology at Analog Devices is what separates us from our competition. Carefully controlled processes ensure the highest possible yield even on the most difficult chips. Add the fact that our IC Converters are true IC Converters specifically designed to maximize the advantages of bi-polar and CMOS technology with a minimum number of chips. Plus our exclusive laser trimming to guarantee IC Converter performance and our policy of 100% testing for complete stable final

characterization of each device make us your best source of IC Converters. We're the real company in precision measurement and control.



The real IC Converter company.

Analog Devices, Inc., Norwood, Massachusetts 02062
East Coast: (617) 329-4700, Midwest: (312) 894-3300, West Coast: (213) 595-1783, Texas: (214) 231-5094, Belgium: 03 38 27 07, Denmark: 97 95 99, England: 01/94 10 46 6, France: 686-77 60, Germany: 089/53 03 19, Japan: 03/26 36 82 6, Netherlands: 076-122555 and representatives around the world.

CIRCLE NUMBER 27

Superconducting diode mixer gives paramp noise figure

Noise temperatures previously possible only with parametric amplifiers or masers have now been achieved with a resistive mixer. The best results ever achieved by that device have been reported by Dr. Arnold Silver, director of the Electronics Research Laboratory at Aerospace Corp., El Segundo, CA.

At X-band, the mixer has 7.5-dB conversion loss and a 1.1-K diode noise temperature which results in a noise temperature of only 6.2 K. The superconducting Schottky diodes used have gallium arsenide structures and lead metalization. (See "Superconducting Diode Promises Tenfold Decrease in Mixer Noise," *ELECTRONIC DESIGN* No. 10, May 10, 1974, p. 30.)

The diodes will superconduct when the temperature is lowered below 7.23 K. The best performance reported so far is for a diode cooled to 1.1 K.

Diode in ridge-waveguide mount

The mixer mount consists of a 90- Ω X-band ridge-waveguide with an adjustable back short for mini-

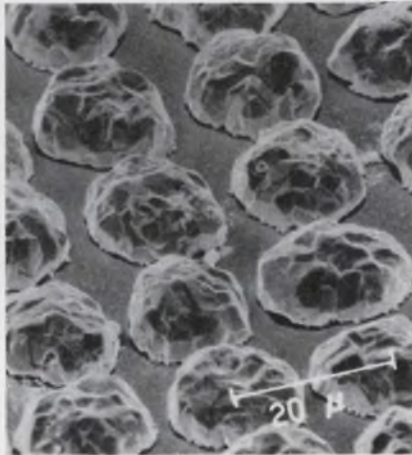

This scanning-electron-microscope view of several super-Schottky diodes shows the lead plating over the GaAs diode. Electrical contact to one or more dots is made with a contact whisker. These superconducting diodes have a 1.1-K noise temperature when cooled to 1.1 K.

mizing the coefficient of rf reflection. The diode and contacting whisker are mounted across the waveguide in the center of the ridge, and connected to a 50- Ω terminal. This arrangement provides

the intermediate-frequency port and dc bias.

The microwave input is connected through a broadband step transformer to a 30-dB directional coupler for local oscillator insertion.

Measurements of noise temperature are made with a local-oscillator power level of -46.4 dBm and a bias voltage of 0.6 mV. The rf frequency used in the tests is 10 GHz.

The same diode has a remarkable noise-equivalent power of 5.4×10^{-16} W/Hz^{1/2}, when used as a detector instead of a mixer. That is measured at a bias level of 1 mV, and is orders of magnitude better than any other diode detector yet reported.

Although all measurements made so far are at X-band, the super-Schottky diode should work just as well up into the mm-wave frequency bands, Silver says. Aerospace is investigating indium antimonide instead of gallium arsenide for millimeter-wave super-Schottky applications, although some researchers there believe that GaAs will suffice. ■■

RPVs get millimeter-wave radar

The Army's remotely-piloted vehicles (RPVs) will carry millimeter-wave radars for their battlefield surveillance work because of the high resolution the extremely high-frequency equipment provides in proportion to its small antenna size.

To get the same resolution at lower frequencies, a much larger antenna would be needed.

The disadvantage of millimeter

waves—that they are attenuated by fog and rain—is not an obstacle because the RPV will be flying close enough to its target to "brute force" through any precipitation.

RPVs, the small, unmanned aircraft being developed for missions where aircraft are highly vulnerable, will be launched and recovered by ground units near a battlefield. They will send their radar data back by telemetry.

The radar is being built for the Army by the Norden Div. of United Technologies, Norwalk, CT.

"We feel that millimeter-wave technology is ready to move out of the laboratory and into flight vehicles," says Norden's president Peter L. Scott.

The initial experimental flight model will be flown and evaluated by the Army in an Army aircraft. ■■

Program the all-new 8620C sweeper

and make your next sweeper a precision signal source for many microwave measurement systems.

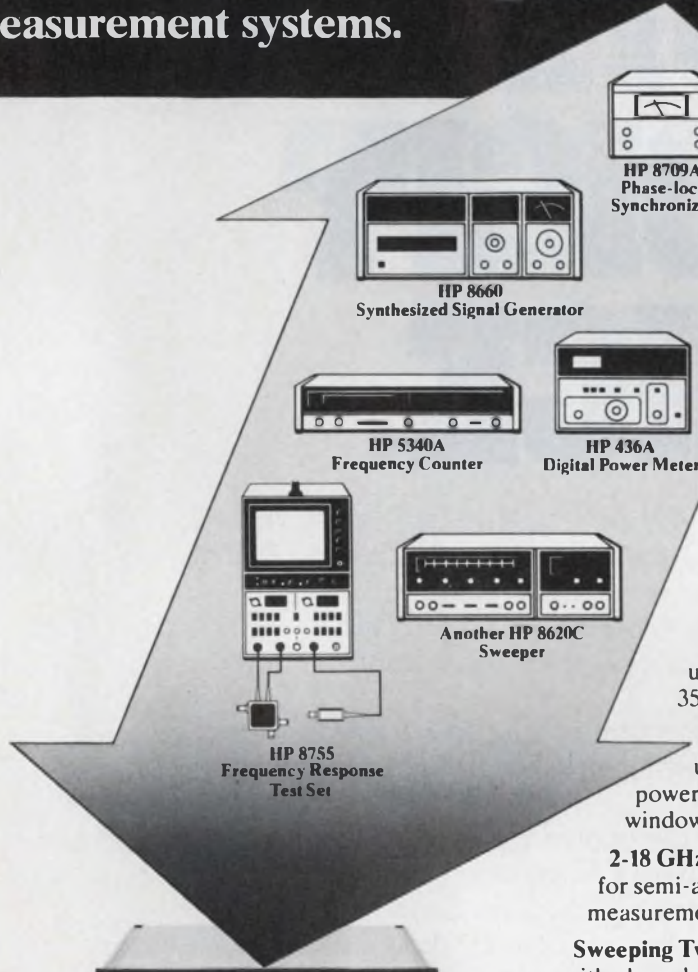
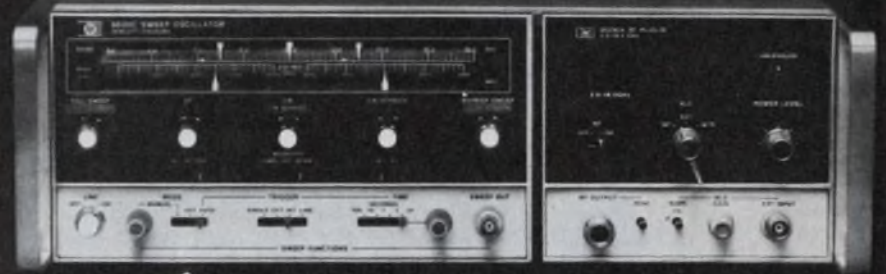

Combine the HP 8620C Sweeper Mainframe with optional HP-IB* programming interface and an HP Programmable Calculator such as the HP 9830A. Together they'll let you digitally select frequencies between 10 MHz and 18 GHz with a resolution of 10,000 points per band.  Then by adding other HP-IB compatible instruments, you can configure a variety of practical test systems.

FOR EXAMPLE:

2-18 GHz Phase-locked Synthesizer with 15 Hz resolution and 3×10^{-9} stability. Extendable down to 1 MHz.

Digital Frequency Control Loop using microwave counter to achieve 350 kHz frequency accuracy to 18 GHz.

Precision Power Control Loop using digital power meter to control output power with 0.02 dB resolution in a 10 dB window over a 120 dB range.

2-18 GHz Frequency Response Test System for semi-automatic simultaneous measurement of transmission and reflection.

Sweeping Two-tone Test Source with phase-locked IF offset for wideband front-end component tests.

These are described in our application notes — yours for the asking.

*HP-IB is Hewlett-Packard's implementation of IEEE Standard 488 and identical ANSI Standard MC1.1. *Digital interface for programmable instrumentation!

The 8620C Mainframe gives you the sweep modes you need for both wide and narrow scans. Plus markers to pinpoint frequencies of interest. You have several methods for RF coverage and all give you the high performance you need: Two multi-octave plug-ins span 10 MHz to 2.4 GHz or 2 to 18 GHz; six economical singleband plug-ins collectively cover from 10 MHz to 18 GHz; or you can configure your own multiband with up to three RF modules in a plug-in drawer (five modules from 0.1 to 12.4 GHz are offered). In short, you'll get all the features you're ever likely to need in a sweeper — features you'll use for years to come.

Can
any other
sweeper do
as well



Sales and service from 172 offices in 65 countries.
1507 Page Mill Road, Palo Alto, California 94304

5½ DIGIT ACCURACY. 4½ DIGIT PRICE.

The 4600 is our brand new 4½ digit multimeter. It gives you the accuracy and resolution of typical 5½ digit multimeters. At half the cost.

And the 4600 stays accurate longer than other DVM's. DC accuracy stays within 0.01% ± one digit for six months at a time. We guarantee it.

80dB normal mode noise rejection produces a 10,000:1 reduction of excess noise. A full decade better than the 1,000:1 reduction of comparable instruments.

Loading errors are virtually eliminated by the 4600's 10,000M Ω input impedance on the two lowest DC voltage ranges.

There's a lot more. Send for a free catalog on our new 4½ digit 4600 multimeter. And find out how to get 5½ digit accuracy without paying for it.

Dana Laboratories, Inc., 2401 Campus Dr., Irvine, CA 92715. 714/833-1234.



DANA

Others measure by us.

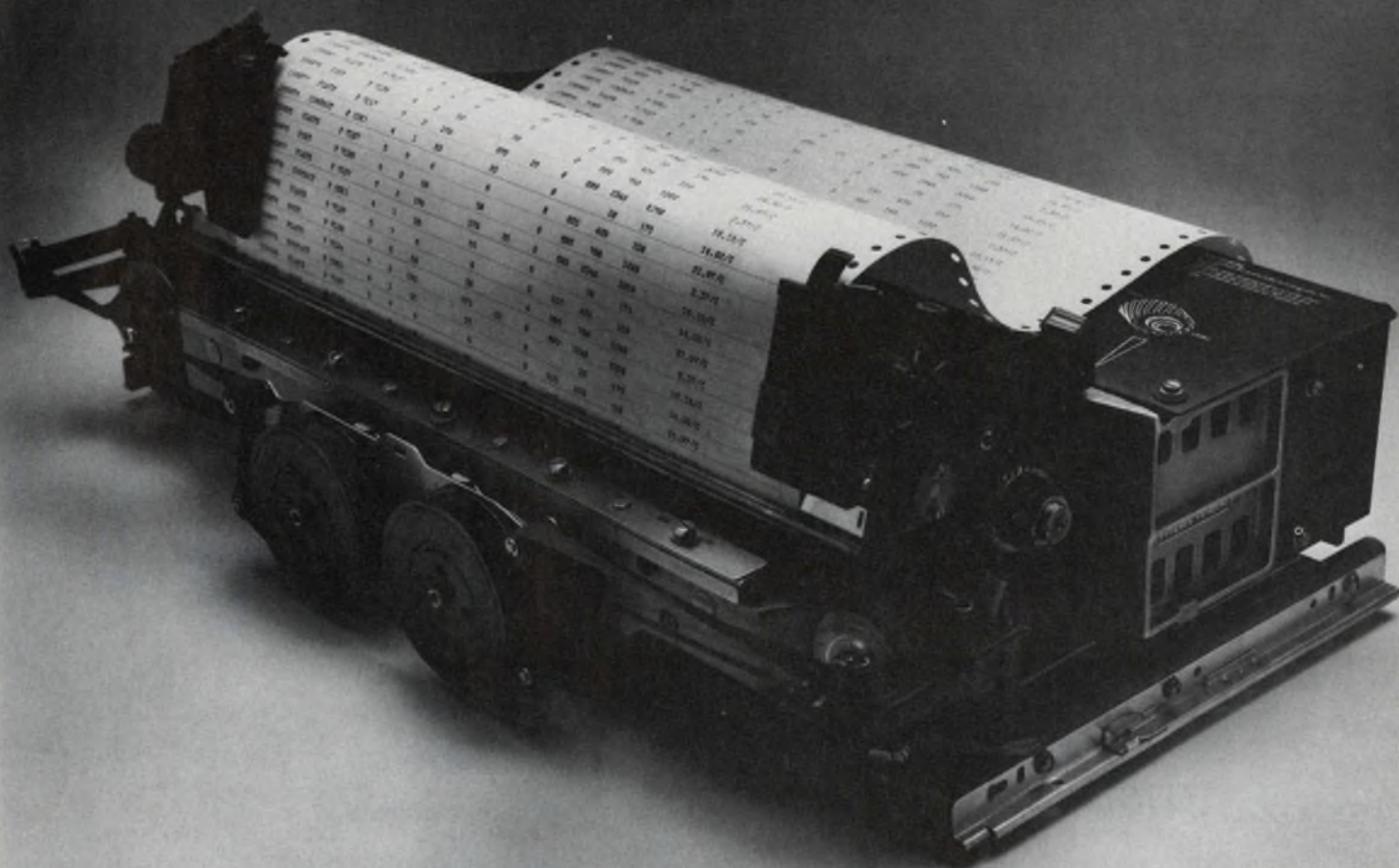

132 columns. Over 300 lines per minute. Under \$2000*.

In printers, it's not just a question of how much they cost, but one of how much you get for your money. And on a price/performance basis, nothing even comes close to the Teletype® model 40 OEM printer.

Besides getting a 132-column, heavy-duty impact printer that delivers over 300 lpm for less than \$2000, you also get a printer with outstanding flexibility and reliability.

The big reason behind the model 40's price/performance advantage over the competition is our unique design. Even though it operates at speeds over 300 lpm, wear and tear is less than you'd find in a conventional printer operating at a much slower speed. Fewer moving parts and solid-state components add up to increased reliability and reduced maintenance.

We'd be ahead if we just stopped there, but the model 40 also offers you a number of other features. Like a choice of character sets, operator-adjustable form width and form length, parity error indication, and a built-in self-test feature, just to name a few.

For complete information, please contact our Sales Headquarters at: 5555 Touhy Ave., Skokie, Ill. 60076. Or call Terminal Central at: (312) 982-2000.



**The Teletype model 40 OEM printer.
Nothing even comes close.**

an announcement of importance
from **KEPCO** and **TDK**

switching power supplies

3-groups of modular style voltage stabilizers: 50 watts, 100 watts and 150 watts; 5V models to 24V models.

These stabilizers are produced by TDK Electronics Co. Ltd., of Japan, an acknowledged leader in ferrite manufacturing technology, and are sold and serviced in the U.S.A. by Kepco Inc., a 30-year veteran of the power supply industry.



the new **RMK** power modules feature

- Small size
- High efficiency
- No derating to +50° C
- Overvoltage protection
- Logic level on/off control
- Soft start
- High frequency switching

50 WATT MODELS:

MODEL	d-c OUTPUT VOLTS	RANGE AMPS	PRICE
RMK 05-10	4.5-5.5	0-10	\$210.00
RMK 09-06	8.0-10.0	0-6	210.00
RMK 12-05	10.0-13.5	0-5	210.00
RMK 15-04	13.5-16.5	0-4	210.00
RMK 24-02	21.5-26.5	0-2	210.00

100 WATT MODELS:

RMK 05-20	4.5-5.5	0-20	299.00
RMK 09-10	8.0-10.0	0-10	299.00
RMK 12-08	10.0-13.5	0-8	299.00
RMK 15-07	13.5-16.5	0-7	299.00
RMK 24-04	21.5-26.5	0-4	299.00

150 WATT MODELS:

RMK 05-30	4.5-5.5	0-30	399.00
RMK 09-16	8.0-10.0	0-16	399.00
RMK 12-12	10.0-13.5	0-12	399.00
RMK 15-10	13.5-16.5	0-10	399.00
RMK 24-06	21.5-26.5	0-6	399.00

50 W size: $\approx 2 \frac{1}{8}$ " H x $5 \frac{1}{8}$ " W x $7 \frac{1}{2}$ " D

100 W size: $\approx 3 \frac{1}{4}$ " H x $5 \frac{1}{8}$ " W x $8 \frac{3}{4}$ " D

150 W size: $\approx 4 \frac{1}{6}$ " H x $5 \frac{1}{8}$ " W x $8 \frac{3}{4}$ " D



For complete specifications, write Dept. FL-05

KEPCO® 131-38 SANFORD AVENUE • FLUSHING, N.Y. 11352 U.S.A. • (212) 461-7000 • TWX # 710-582-2631 • Cable: KEPCOPOWER NEWYORK

CIRCLE NUMBER 31

Washington Report

Technology export policies contested

The Pentagon is resisting efforts by high-technology industries—particularly electronics—to liberalize policies governing export of U.S. technology.

The issue is currently before the House International Relations Committee, where Peter F. McCloskey, president of the Computer and Business Equipment Manufacturers Assn., testified that the Secretary of Defense should be able to deny an export license only if he could prove the technology would aid the recipient country's military capability. Under the current Export Administration Act, which expires Sept. 30, the Defense Secretary has broad powers to withhold technology if it "possibly" enhances such a capability. McCloskey spoke for a group that also includes the Electronic Industries Assn., WEMA and the Aerospace Industries Assn.

Dr. George H. Heilmeyer, director of the Defense Advanced Research Projects Agency, responded later in a speech before a labor group that the U.S. should be cautious about what it sells overseas and should be sure to get a fair price. He noted that in the past U.S. companies were content to sell technology cheaply because they had already recovered their basic costs, including market development, in the domestic market. "The days of such generosity are over," Heilmeyer said. "The time for hard-nosed dealings, even with our allies, is upon us."

Also urging caution in technology exchange was Dr. Fred C. Ikle, director of the Arms Control & Disarmament Agency, which is an independent government agency. Ikle warned that it is hard to determine end use of the technology. "The equipment for producing circuits used in pocket calculators may also be used for guidance computers of missiles," he said.

Foreign military sales bill goes to conference

House and Senate conferees will try to reconcile differences in the arms-control bills passed by their respective chambers following Senate passage of a more liberal measure than the one that cleared the House.

The Senate voted to give Congress a veto power over any weapons sale of \$25 million or more regardless of whether it was handled by the U.S. government or an individual company, but rejected the House-passed ceiling of \$9 billion in arms sales per year. Both bills would require the Defense Dept. to notify Congress of a proposed sale, and Congress would have 20 calendar days to overrule it.

In the midst of the debate the General Accounting Office released a

study showing that foreign military sales handled by the U.S. government had risen from less than \$1 billion in 1970 to \$10.8 billion in 1974, but have since dropped to \$9.5 billion in 1975 and are expected to drop further to \$8.2 billion this year. Unfilled orders have risen dramatically, however, from about \$5 billion in 1971 to \$24 billion last year.

Navy seeking family of CCDs

The Naval Electronic Systems Command, which has sponsored exploratory development of charge-coupled devices (CCDs) since 1972, is planning a new program to create an entire family of CCD sensors for advanced camera systems.

The objective is to have a set of modules that could be configured to meet future Navy electro-optical requirements. Under Navy funding (mostly with Fairchild Camera & Instrument Corp.) the CCD program has already yielded linear image-sensors (1×500 and 1×1000) and two low-light-level area image-sensors (244×190 and 488×380) plus a 1×1728 linear imaging-chip and a 128×128 time-delay and integration-imaging chip in development.

NASA seeks to put industrial facilities in space

Two firms will receive study contracts this fall from the National Aeronautics and Space Administration to investigate possibilities for "space industrialization"—the use of space stations for industrial purposes. The awards are part of NASA's on-going search for new missions for the Space Shuttle.

Internal studies by NASA have already identified electrical power generation as one promising application. And because of the weightless conditions that prevail in space, semiconductor materials might be profitably manufactured as well as certain medicines.

The new studies will last 16 months and concentrate on determining how space facilities could be used in the 1980-2010 period. First operational mission of the Space Shuttle is scheduled for 1980, but that vehicle is limited to 30-day orbital missions.

Earlier, NASA awarded parallel contracts of about \$700,000 each to Grumman Aerospace and McDonnell Douglas Aeronautics to define space stations that could be orbited after 1985.

Capital Capsules: The Navy, this month, will begin using the UHF channels for ship communications on the Marisat satellite launched by Comsat General Corp. June 9 from Cape Canaveral. The satellite will provide another 550 kHz of bandwidth over the Pacific in addition to the identical Marisat launched over the Atlantic Feb. 19. A third Marisat will give the same coverage over the Indian Ocean before the Navy launches its own communications satellite late next year. . . . **The Electronic Industries Assn. is claiming a victory in the recent International Electro-technical Commission Council decision to establish an international voluntary certification system for electronic components.** Each participating country will establish a national supervising inspectorate to examine companies' production, organization and quality-control procedures. EIA expects the system to be operational on an international basis within 12 to 18 months.

SQUEEZE PLAY.

T10 relays by P&B let you mount your pc boards on 0.5" centers. They work in tight spots like a pro.



T10s are only 0.375" high. The lowest profile 3 amp relay in the Potter & Brumfield line.

They provide 0.1 to 3 amp switching @ 28V DC in 2, 4, and 6 pole models. Coil ratings are 6, 12, 24, and 48V DC. Permissive make, gold-flashed silver contacts are noted for low contact bounce, long operating life. Bifurcated contacts for low level switching are also available.

These relays are compatible with TTL and CMOS peripheral driver ICs, and TTL and CMOS buffers wired for current sharing. Ideal for telecommunications, copy and reproduction machines as well as computers and peripheral equipment.

Put a squeeze play on costs. Prices are as compact as the relays themselves.

For full information on the T10 series and all P&B relays, see your Potter & Brumfield sales representative or P&B Pro Shop distributor. Or, contact Potter & Brumfield Division AMF Incorporated, Princeton, Indiana 47671. Telephone: 812/385-5251.

European address: Electrical Products Group, AMF International Limited, AMF House, Whitby Road, Bristol B54 4AZ, England. Telephone: (0272) 778383, Telex: 449481, AMMAFOCO, BRSTL.



Go with the Pros and you can't go wrong.

AMF
Potter & Brumfield

MICROMINIATURES FLEXIBLE INTERCONNECTIONS SYSTEMS CAPABILITY

We put it all together for you! Your single source for complete systems capability in flexible interconnections and microminiature connectors is Cannon. We offer you a complete system, 100% electrically and mechanically checked out, ready to plug into your assembly.

The best feature of this total capability? **It lowers your total installed cost.** And that's your real cost!

We can custom manufacture your flexible circuitry and assemble your complete interconnection system. Shielded wire, coaxial cable can be assembled with the



most reliable microminiature connectors available. Other pluses to think about: You can cut system costs as much as 50%, reduce weight and space up to 80% and eliminate point-to-point wiring, bundling and lacing. Solve those difficult density problems.

Cannon microminiature custom cable terminations can help you trim the costs inherent in your in-house hard wiring or harnessing—expensive engineering time, assembler training, quality assurance setup, inventorying, materials scrap and wastage.

There's much, much more you should know about Cannon's interconnection innovations and how they can lower your installed costs.

Send for our "Cannon Cost Cutters" brochure. ITT Cannon Electric, 666 East Dyer Road, Santa Ana, CA 92702. Toll-free, 24-hr. 800-854-3573; in California, 800-432-7063.

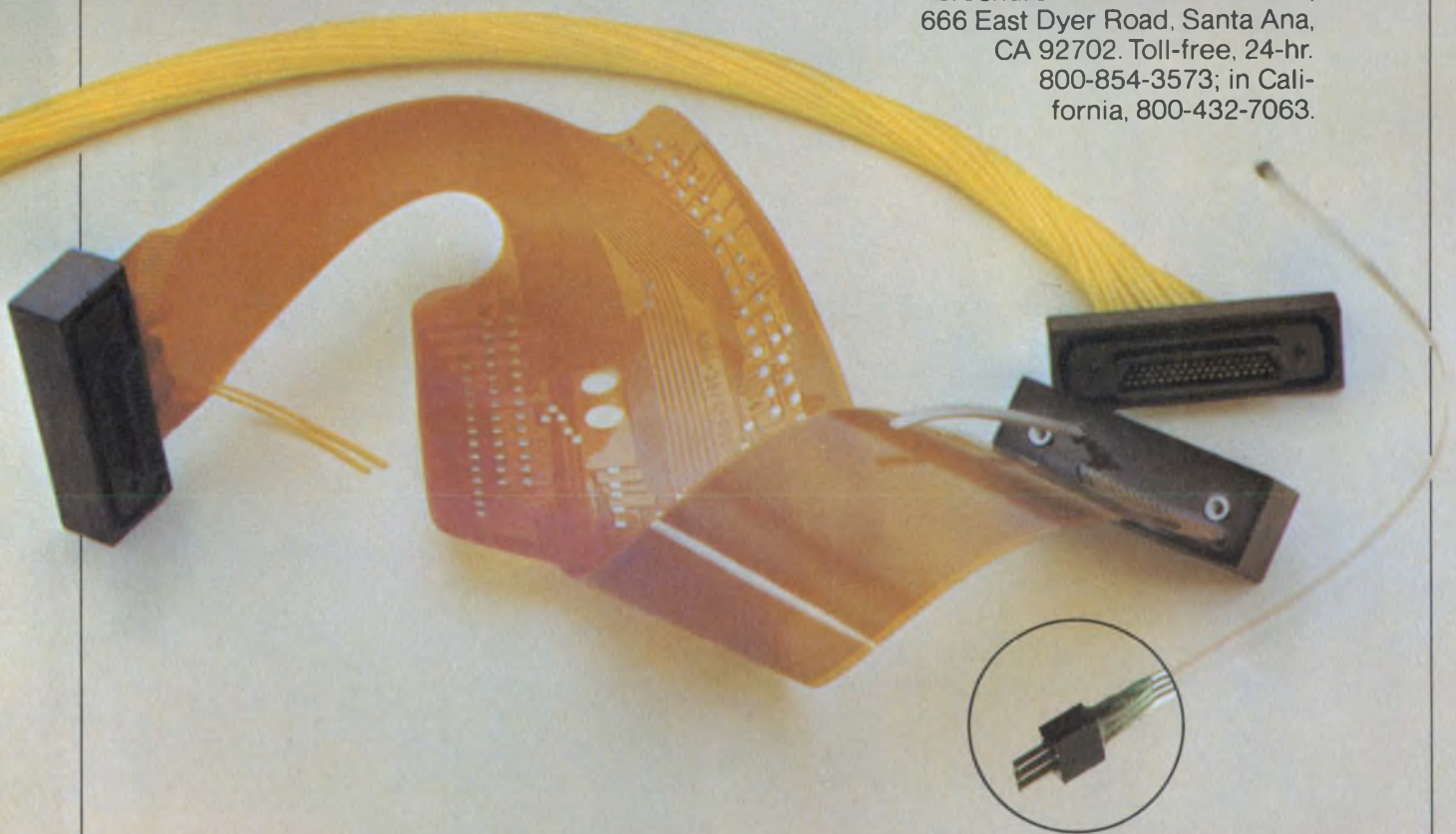

Six decades on the leading edge of interconnect technology.

CANNON ITT



If practically anyone can build a programmer for these proms who needs Data I/O?

Practically anyone who understands semiconductor memory can make a box to program a PROM, or maybe two different PROMs. That may be fine today, but the way things are, you could be programming ten or twenty different PROMs tomorrow.

Only a Data I/O PROM Programmer will program them all — 165 at last count.



Our Programmer V lets you enter data in a variety of input modes (keyboard, master ROM, paper tape,

computer, etc.), review the data, and then select from a variety of output modes.

Our MOS Memory Module Programmer can program eight MOS PROMs simultaneously, with eight different programs, in less than 30 seconds!



We also make a portable programmer, FPLA programmer and the Romulator.™ The Romulator allows you to emulate/simulate PROM operation — in your circuit — without PROMs.

PROM data is easily altered and updated on the Romulator keyboard, all prior to PROM programming.

Data I/O programmer calibration

standards let you calibrate to each PROM manufacturer's specs before you program, insuring maximum yields and reliability.

Data I/O total three point service.

1. Every Data I/O customer receives a quarterly update on currently available PROMs.

2. Through our direct (computerized) mailing program, Data I/O customers are kept constantly up-to-date on PROM specification changes and technological innovations.

3. Nine field offices in the U.S.A. and 22 distributors worldwide provide our customers with direct sales support, installation, operator training and service.

Get the facts

If you would like to know more about our products, or want copies of our quarterly PROM Comparison Chart and PROMBiTS (our periodic technical bulletin on PROM applications and innovations), mail this coupon or call one of our offices. Data I/O Corporation, P.O. Box 308, Issaquah, Washington 98027.

Name _____

Title _____

Company _____

Address _____ M/S _____

City/State/Zip _____



Data I/O

CIRCLE NUMBER 34

Opening new frontiers with electro optics

High resolution CRTs: 1 to 2 mil line widths. Fine choices for photorecording.

Get the most from your COM, photocomposition or medical imaging system with RCA CRTs. Clear, sharp photographic records result from our special combination of electron gun design, phosphor material synthesis and fine-grain phosphor deposition. And you can count on us to meet your volume needs. The 5" dia. 4869 or 4870, with 1-2 mil line widths, have optically flat faceplates, magnetic deflection and electrostatic or magnetic focusing. Special needs? See us — we have others to suggest.

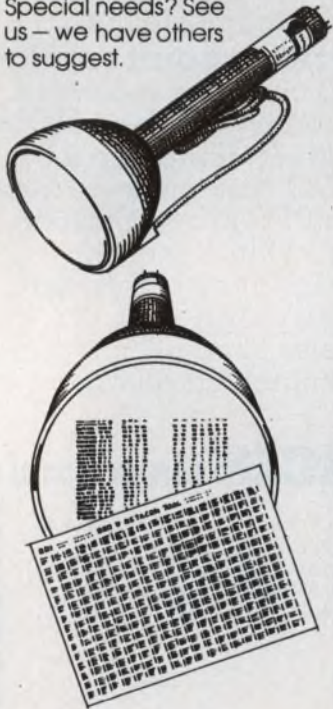

Circle 291

See more with the most sensitive RCA photomultiplier tube.

Astronomers and spectroscopists, RCA has 2" dia., 11-stage PMTs with the characteristics you need. For critical photon counting applications, the GaAs C31034A has the highest known photocathode responsivity over its entire 200-930 nm spectral range, plus dark noise of only 100 cps max. at -20°C . You can also get lower dark count rates, to 12 cps max. With InGaAs types you get extended spectral ranges, to 1030 nm. These are just a few of RCA's wide line of PMTs for all types of low-light-level detection systems.

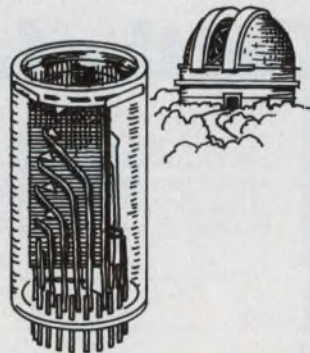
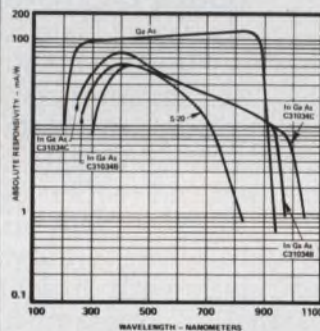

Circle 292

Projection kinescopes for clear, bright large-screen TV.

From our 3-in. dia. tubes for small meeting rooms to the big 7-in. dia. size for theaters and other larger viewing areas: RCA gives you one of the broadest lines to choose from. We offer electrostatic and magnetic focus types for Schmidt and dioptric systems, for color and monochrome. All with the power needed for bright, clear images. If you have unusual system requirements, we can help.



Circle 293

How to make your CCTV camera so sensitive it can see by starlight.

Apollo astronauts used cameras with RCA Silicon Intensifier Tubes to take TV pictures even within the moon's dark shadows. These tubes may be ideal for your new CCTV camera, too...whether it's for surveillance, astronomy or other uses where scene light levels can range down to 1×10^{-4} fc. Our line, the industry's broadest, includes 16, 25 and 40 mm types. 16 mm tubes are available with a new target that minimizes blooming effects. In fact, no matter how unusual your application, chances are we have the camera tube for it.

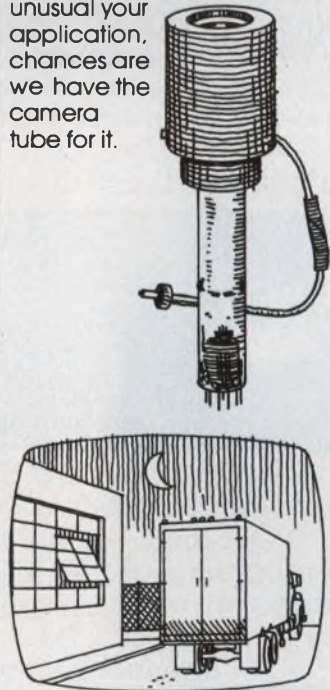

Circle 294

If electro optics can solve your problem, remember: EO and RCA are practically synonymous. No one offers a broader product spectrum. Or more success in meeting special needs. Call on us for design help or product information. RCA Electro Optics, Lancaster, PA 17604. Phone 717-397-7661.

RCA

Microprocessor Design

How about CMOS microprocessors for temperature and noise immunity?

CMOS μ Ps, while far less popular than those made of NMOS, have a number of advantages. Alex Young, manager of Microprocessor Engineering at RCA, speaks on the use of the CMOS technology for manufacturing microprocessors.

CMOS microprocessors are more rugged and more easy to use than μ Ps made by other technologies because the process is inherently more resistant to variations in temperature, power-supply voltage and noise interference.

First, all of our devices are designed to operate over a temperature range of -55 to 125 C. Dynamic NMOS microprocessors, in contrast, use circuit techniques that make it difficult to extend operation past the 70 or 80 -C area.

In dynamic NMOS devices, operation of logic elements depends upon stored charge held by the internal capacitive nodes. As temperature rises, there is an increase in leakage from these nodes, which imposes a severe limitation



on dynamic operation at high temperatures. In addition, static NMOS logic uses a passive pullup transistor as the load for the switching transistor. The operating characteristics of both transistors degrade with high temperature

(continued on page 54)

Evaluation board helps users assess 6800 components

The latest microcomputer on a board—the M6800B Evaluation Module II from Motorola (P.O. Box 20294, Phoenix, AZ 85036. 602-244-3465)—offers a quick and easy way to assess the capabilities of the 6800 family.

Measuring only $9.75 \times 5.75 \times 0.062$ in., the module includes the following components: 8-bit μ P, 128×8 -bit RAM, 1024×8 -bit ROM, PIA (peripheral-interface adapter), ACIA (asynchronous communications-interface adapter), clock oscillator and bit-rate generator.

The mask-programmed ROM contains a diagnostic/debug program known as Minibug II. Two of the RAMs provide 256 bytes for user programs; the remaining RAM is used as a scratch pad by Minibug II. The PIA provides two 8-bit bidirectional I/O ports, and the ACIAs serve as serial I/O interfaces. The module will operate with either a TTY terminal at a baud rate of 110 or an RS232C-type terminal at 300 baud.

Available sockets on the module accommodate 512×8 or 1024×8 -bit PROMs containing user-generated programs. Also resident editor and assembler programs, which require 8-k bytes of memory can be used. Module II requires supplies of 5, 12 and -12 V.

The new board costs \$795. Delivery is from stock.

CIRCLE NO. 501

MICROPROCESSOR DESIGN

(continued from page 53)

so the logic levels also vary radically.

Temperature affects static CMOS microprocessors less severely, however. Operation is static, and so is not determined by capacitive charge holding. Instead, data are stored in flip-flops. Further, HIGH and LOW states are determined by two active transistors connected in series. For each logic state, one transistor is switched off and the other is switched on. As temperature varies, the changes in characteristics of one transistor are largely cancelled out by those of the other.

Generally, the operating power dissipation of CMOS μ Ps is an order of magnitude less than for other microprocessors. CMOS μ Ps typically dissipate 10 mW with a supply voltage

of 5 V and with a 3.2-MHz clock. (NMOS units typically dissipate 350 to 1000 mW under similar conditions.) Peripheral-buffer, interface, and memory circuitry can also be CMOS, so an entire system can be run on low power. Quiescent power dissipation is three orders of magnitude less than for NMOS microprocessors.

CMOS microprocessors also have non critical power-supply requirements. Our CDP-1802, for example, is specified to operate over a range of 3 to 12 V with a maximum voltage of 15 V. Most other μ Ps require several positive and negative power supplies, or one supply regulated within 10 %.

When external digital signals drive CMOS, greater voltage noise on the line may be tolerated than when bipolar or NMOS devices are being driven. CMOS inputs have a 30%-of-supply-voltage noise immunity by design, and they are tested to that spec. Most other types have much less immunity.

Microprogrammable processor boosts Nova mini's performance

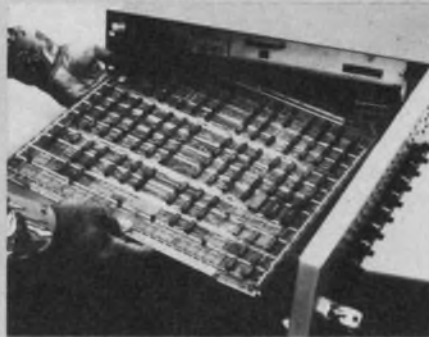

You can turn a Nova minicomputer into a parallel, multiprocessing system by plugging in some Micro-N microprogrammable processors. The Micro-N, developed by Educational Data Systems (17981 Sky Park Circle, Irvine, CA 92707. 714-556-4242), enhances the computing power of any Nova minicomputer by implementing user-defined, procedure-oriented macro-instructions.

Microprograms of the Micro-N can run in parallel with normal processing of the Nova CPU and at much higher speeds. Applications include floating point arithmetic, either binary or decimal, character string processing,

graphics control, matrix operations, sorting, and control of special devices.

The Micro-N occupies a board slot in the computer chassis and includes a high-speed microprograms from either the Nova's memory or from its own PROM.

The Micro-N occupies a board slot in the computer chassis and includes a high-speed processor with four accumulators, up to 4 kilowords of PROM to hold microprograms, and up to 64 words of RAM for temporary scratch-pad storage. The processor is driven by a 20-MHz clock, and most operations take only 100 ns, including instruction-fetch and execution.

A floating-point decimal arithmetic version of the Micro-N (Model 400-Pl-R) is also available. The microprogrammable Micro-N Model 400 with 64 words of RAM costs \$1850 in single quantity. The floating-point decimal arithmetic version, 400-Pl-R, with 64 words of RAM, costs \$2250.

CIRCLE NO. 502

Low cost printer connects to a 6800 μ P system

A 40 column printer complete with drive electronics, 6800 microprocessor interface, power supply and hardwood and plastic cabinet sells for \$450,000 (single qty). It can print at a 100 char/s rate, in either direction. Delivery is from stock.

Electronic Products Associates, Inc., 1157 Vega St., San Diego, CA 92110, (714) 276-8911.

CIRCLE NO. 503

Timing and state displays in one logic analyzer from Tektronix



FORMATTABLE MEMORY.
16 channels x 256 bits at 20 MHz
8 channels x 512 bits at 50 MHz
4 channels x 1024 bits at 100 MHz asynchronously; 50 MHz synchronous sampling.

CURSOR. For easy visual interpretation and timing comparisons. Converts selected word from timing to binary format.

DIGITAL DELAY. Use the 7D10 to delay by 99,999 events or words to access virtually any location in a data stream.

PRE-TRIGGER. For viewing faults before the trigger. Also offers center-trigger and post-trigger modes.

16-CHANNEL WORD RECOGNITION. Two additional qualifiers provide 18-bit parallel pattern recognition.

The 7D01 gives you both logic timing and state information in the same display. And many other features you'll probably need in a logic analyzer. The display is large and easy to read, as you can see from the photograph. It's easy to interpret, too: the trigger marker identifies the pre, center, or post-trigger point; the cursor you position yourself for binary readout of a particular word. You also get some other important logic analysis capabilities. Formattable 16-channel data acquisition plus a formattable 4k memory: acquire 4, 8, or 16 channels and store 1024, 512, or 256 bits at a time. Asynchronous timing resolution to 15 ns, synchronous operation with external clock rates to 50 MHz. Built-in word or pattern recognition. Active 1 M Ω /5 pF

probes that won't load down the circuit under test.

One possible logic analysis system, the 7D01, the 7603 mainframe, and the 7D10 delay-by-events units, allows you to delay by up to 99,999 events (or words) and lets you access virtually any point in a data stream.

The 7D01 operates in any 7000-Series mainframe. If you already own a 7000-Series lab oscilloscope, you're that much closer to moving into high-performance logic analysis. For example, in a 4 compartment mainframe you can have a logic analyzer and a real-time oscilloscope in the same instrument mainframe. Either way, you benefit from the ongoing expansion of the 7000-Series line, both in the analog world and the digital domain.

Buy the 7D01 Logic Analyzer for \$3,195 and the 7603 Oscilloscope mainframe for \$1,850. Add digital delay with the 7D10 for \$925.

Send for the technical details in our brochure, "Tektronix Logic Analyzers." Call or write Tektronix, Inc., P. O. Box 500, Beaverton, OR 97077.

U.S. sales prices F.O.B. Beaverton, OR. The 7D01 Logic Analyzer is currently available only in the U.S.A.

The 7000 Series
more than an oscilloscope



FOR TECHNICAL DATA CIRCLE #273
FOR DEMONSTRATION CIRCLE #274

Prototype system for 12-bit micros uses PDP-8 software



Take the problems out of prototyping 12-bit microprocessor systems by using Intercept—a benchtop development tool. Developed by Intersil (10900 N. Tantau Ave., Cupertino, CA 95014. 408-996-5000), it duplicates all functions and timing of the IM6100 μ P and related devices.

Intercept provides access for I/O devices through a built-in typewriter interface, and has a built-in control panel, and space for additional memory. The system can also operate with many PDP-8/E paper-tape programs from Digital Equipment Corp.

The machine can be split into three parts: the 6902, CPU and TTY interface; the 6901-M4KX12, 4 k \times 12 static RAM; and the 6900-CONTRL control panel. Intercept costs \$2850; delivery time is four weeks.

CIRCLE NO. 504

Floating-point firmware available for Intel MSC-80

Floating-point numbers can be manipulated on the Intel MCS-80, 8080 development system using the program in PROMS. The programs are being sold by Recognition Systems, who had previously written programs for 8008-based systems. The floating-point numbers have a 16-bit mantissa and 7-bit characteristic, both in two's complement form.

The programs are accessed as subroutines in the user's main program. The subroutines include multiply, divide, add, subtract, square root and conversion to fixed-point numbers. Execution times run to 7.5 ms for the first four subroutines mentioned above, to 30 ms for square root, and up to 1.5 ms for conversions.

Recognition Systems, Inc., 15531 Cabrito Rd., Van Nuys, CA 91406. Price: \$495, stock.

CIRCLE NO. 506

Basic language compiling package designed for 8080 system

You can now write an applications program for the 8080 μ P in Basic, then compile and debug your program on an Intel MDS prototyping system containing 32-k bytes of memory. The Micro Basic I, a Basic language compiling system, consists of text editor, compiler, debugger and object-code support subsystems. Other available high level languages have several drawbacks. They are generally adaptations of IBM's PL/M—Intel's PL/1, for example—and can run only on a large computer where there may be continual charges for use.

The compiling system was developed by the Ryan-McFarland Corp. and is available from Hamilton/Avnet Electronics. It costs \$325 delivered on fanfold paper tape with all applications literature. The literature is available separately for \$10.

The text editor, compiler and debug subsystems in Micro Basic I are used for applications-program development. When all parts of the program have been corrected and compiled into object code, only the object's code-support subsystem needs to be included in your product.

That subsystem comes in two versions. The simpler one includes only the routines necessary to execute the compiled applications program—arithmetic, string-handling, I/O and control routines. The more complex version includes all of that, plus a loader that links together and relocates one or more compiled programs. Either subsystem is available in PROMs for installation in your product.

Ryan McFarland Corp. 608 Silver Spur Rd., Rolling Hills Estates, CA 92274. (213) 377-2353.

CIRCLE NO. 507

The portable logic analyzer



16-CHANNEL WORD RECOGNITION. Event digital delay to 99,999; delay by words or clock pulses.

FORMATTABLE MEMORY.
 16 channels x 256 bits at 20 MHz
 8 channels x 512 bits at 50 MHz
 4 channels x 1024 bits at 100 MHz asynchronously; 50 MHz synchronous sampling.

SC 502 DUAL-CHANNEL OSCILLOSCOPE, one of many displays for the LA 501W Logic Analyzer.

QUALIFIER INPUT. Extend word recognizer to 17 bits, and/or selectively store data into memory.

CHANNEL POSITION CONTROL. Enables you to superimpose any two channels for easy timing comparisons.

AS PORTABLE AS CARRY-ON LUGGAGE. Shown in the TM 515 Traveler Mainframe.

Choose the TM 515 Traveler Mainframe with the LA 501W Logic Analyzer and the SC 502 Oscilloscope, and you have a complete logic analysis system in a suitcase. The Traveler Mainframe is as attractive as carry-on luggage and so compact that it can be stowed under an airplane seat or packed in the trunk of your car.

Choose the TM 506 power module/mainframe with the LA 501W, and you can set your logic analysis system up on the bench or rackmount it.

Whichever way, the LA 501W is a lab-quality logic analyzer you can use with virtually any oscilloscope or X-Y monitor.

The LA 501W acquires 4, 8, or 16 channels and stores 1024, 512, or 256 bits at a time. As much as 90% of the memory can be used to store pretrigger data.

Data is displayed for easy interpretation: biphase timing tick marks help you read the timing diagram, and the channel position control allows you to make comparisons easily between any two channels.



The LA 501W also features active 1 M Ω /5 pF probes that won't load down the circuit under test. Independent probe thresholds—TTL, ECL, and Variable (± 10 V)—that make the instrument compatible with virtually all logic families. Event digital delay, by words or clock pulses, to 99,999.

Prices for the system shown above are: LA 501W Logic Analyzer \$4450, SC 502 Oscilloscope \$1,200, and TM 515 Instrument Mainframe \$325.

For more information on the LA 501W, contact the Tektronix Field Engineer near you for a demonstration. Or send for your copy of our brochure, "Tektronix Logic Analyzers," by writing Tektronix, Inc., P.O. Box 500, Beaverton, OR 97077.

U.S. sales prices are F.O.B. Beaverton, OR.



TEKTRONIX®

committed to
technical excellence

FOR TECHNICAL DATA CIRCLE #271
 FOR DEMONSTRATION CIRCLE #272



Down to earth economy from CTS

Overall cermet resistor network economy is what CTS has been putting into modern systems for well over a decade. For example, Series 760 DIP cermet networks, purchased in quantity, can cost less than 30¢ each.

And on the PC board, they offer still more economy by saving valuable space. Quick, automatic installation lets you cut handling costs and inspection time. You eliminate many separate components. And CTS production methods assure not only the highest quality product, but the fastest delivery, too.

Where one of our more than 210 standard off-the-shelf 14-pin and 16-pin DIP cermet resistor networks won't meet your circuit requirements, we'll custom design the network you need in either

8, 14, 16 or 18 pin package configuration.

CTS Series 760 DIPs' stability and reliability are remarkable. Over 900 million hours of test data on CTS cermet resistor networks prove CTS reliability with an established failure rate of only 0.00051% per 1000 hours @ 95% confidence level — considerably superior to military failure level S of established reliability specs. With failure so low, you enjoy the ultimate in long-range system economy.

See for yourself the many ways CTS reliable, economical DIPs can benefit you. Write for your copy of our reliability report and complete 12-page cermet resistor network catalog. **CTS OF BERNE, INC.**, 406 Parr Road, Berne, Indiana 46711. Phone (219) 589-3111.

CTS CORPORATION

Elkhart, Indiana

A world leader in cermet and variable resistor technology.



CIRCLE NUMBER 33

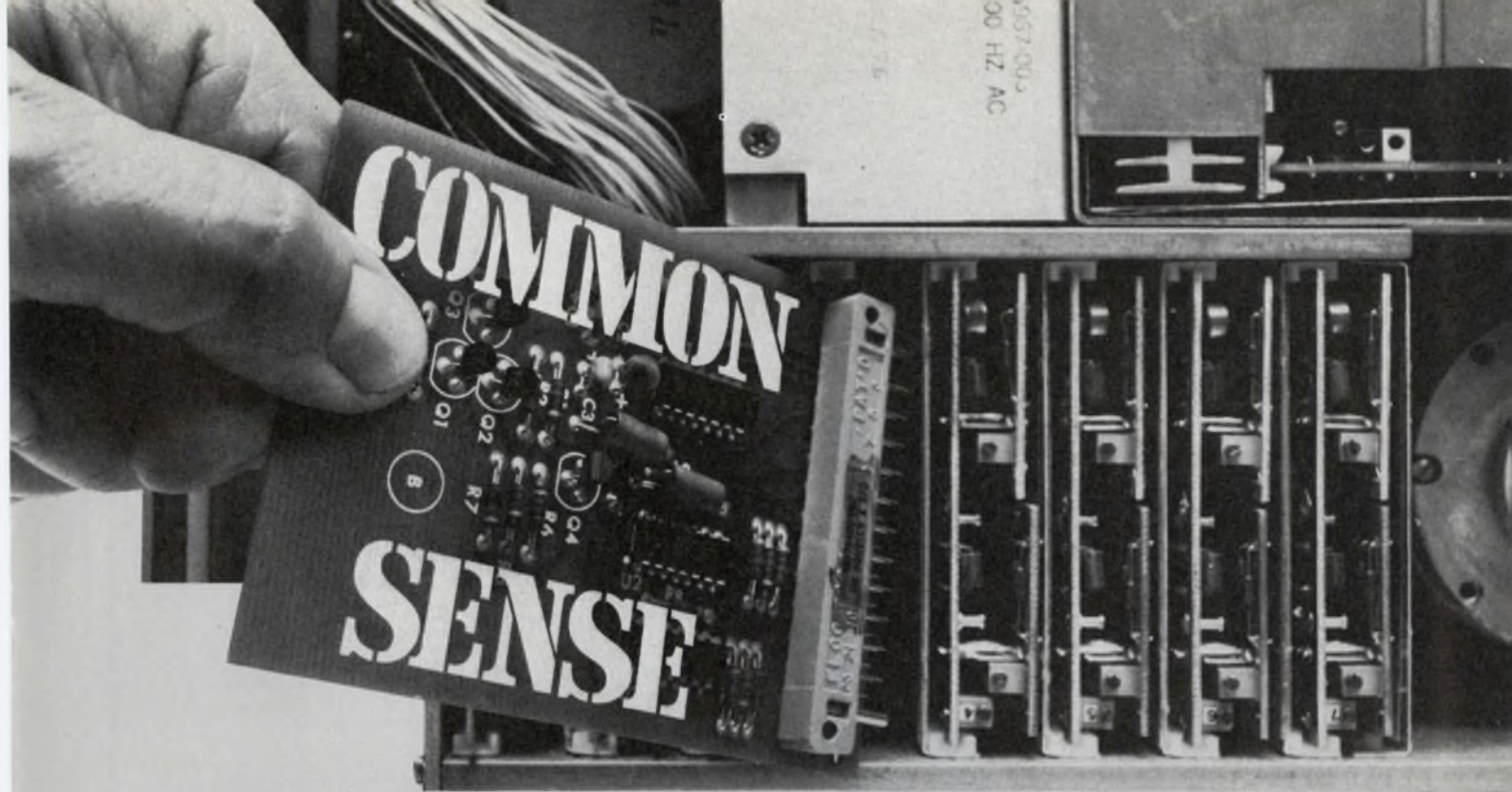

The most important part of every Honeywell tape system.

Common sense is basic to the Honeywell tape engineering philosophy. When we innovate for one tape product, we believe it's only common sense to apply that technology to other tape products in our broad line . . . lab, portables, high environmental and airborne recorders. The result is almost always a solution exactly right for your recording needs.

But if it's not, common sense dictates that we provide you with a custom tape system. Our consistent success with custom tape applications is common knowledge in the industry.

For more information and a catalog of our high-performance common-sense tape solutions, write or call Chuck Miller at Honeywell Test Instruments Division, P. O. Box 5227, Denver, Colorado 80217. (303) 771-4700.

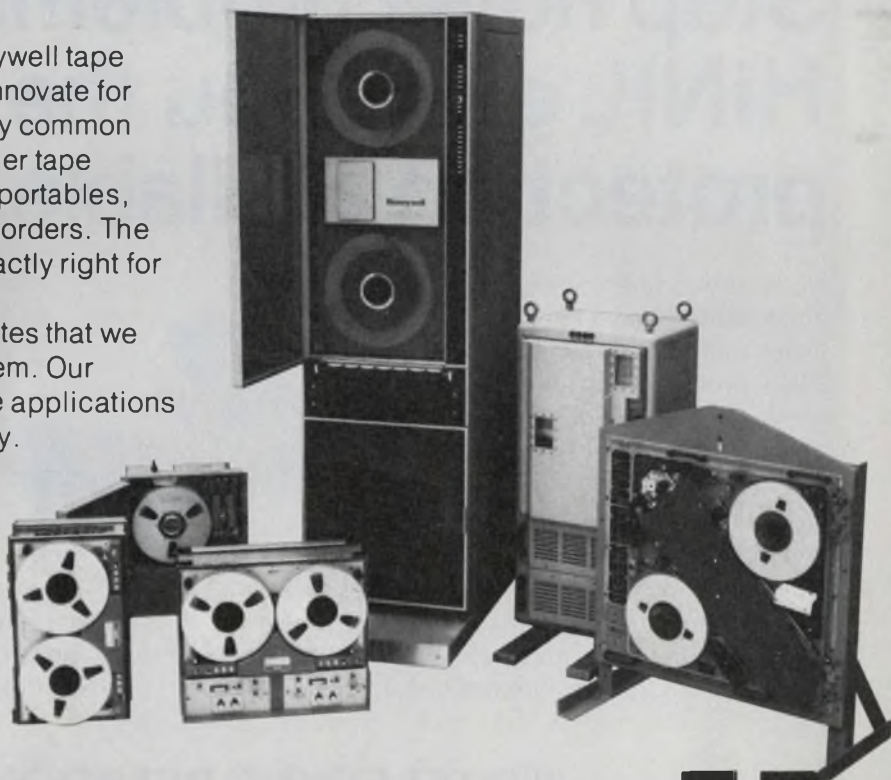

Honeywell



Stop noise problems. HiNIL gives you the best protection available. Bar none.

Noisy environments simply cease to be a problem when you design with High Noise Immunity Logic from Teledyne. HiNIL provides high immunity to any and all types of electrical noise, without the cost and inconvenience of special filtering or shielding.

Use HiNIL in place of your conventional I/O logic. It interfaces easily with TTL, DTL, MOS and CMOS. It will protect your CMOS inputs against static charge damage and SCR latchup. And it gives you a guaranteed dc noise margin of 3.5 V (as compared to 1.0 V for CMOS

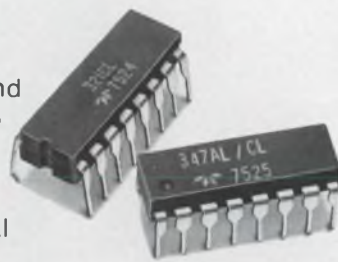

and 0.4 V for TTL) without added filter circuits or tight supply regulation.

Or design entirely with HiNIL. You will get even better noise protection and a simpler design, and you can use a low cost, loosely regulated power supply. The complete HiNIL family includes more than 40 devices, with more being added all the time. They're available in ceramic or molded plastic DIPs.

Get complete details on the full family of HiNIL logic circuits from your local Teledyne Rep or Distributor. Or contact us at the address below.

TELEDYNE SEMICONDUCTOR

1300 Terra Bella Avenue, Mountain View, California 94043 Tel: (415) 968-9241 TWX: 910-379-6494 Telex: 34-8416
SALES OFFICES:
DOMESTIC: Salem, N.H. (603) 893-9551; Stony Brook, N.Y. (516) 751-5640; Des Plaines, IL (312) 299-6196;
Los Angeles, CA (213) 826-6639; Mountain View, CA (415) 968-9241 • INTERNATIONAL: Hounslow
Middlesex, England (44) 01-897-2503; Tiengen, West Germany 7741-5066; Kowloon, Hong Kong 3-240122;
Tokyo, Japan 03-405-5738

CIRCLE NUMBER 38

Editorial

Plan ahead

Charlie and Joe run small instrument companies that they started at about the same time. But Charlie's company isn't quite so small anymore, and it's still growing fast.

That's strange because Joe's the guy who knows management techniques and, above all, he knows about planning. He keeps his senior people busy writing detailed plans and reports, so they know exactly what products they'll make five years from now. Charlie doesn't operate that way. He keeps his people busy developing products rather than plans. He doesn't give them much time to write plans and reports.

Charlie and Joe are ardent competitors. If you could listen to them, you'd know that Joe was the better manager. He's the one with the five-year plan. He's the one with reams of reports, most of which, unfortunately, he hasn't had time to read. He knows the products his company will be developing five years from now. Charlie, on the other hand, feels he's not smart enough to worry about 1981. In fact, he says, it's tough to figure what to do tomorrow—a problem Joe solved back in 1971.

It's not surprising that Joe feels contemptuous of Charlie since, in his ignorance, Charlie sees little use for paper. He sees it merely as a necessary evil. He concedes the need for some reports and plans but insists that his people condense them to a page or two. Joe, on the other hand, feels that the world is built on paper. His executives are doing a terrific job, he feels, when they deliver a 76-page report, complete with charts and other illustrations.

Unfortunately, the customers aren't buying paper. They're buying Charlie's instruments, which were designed a few months ago. They aren't buying Joe's instruments, whose design began five years ago.

If only they could read the books that Joe has read and attend the management conferences that prove you can't succeed without lots of plans. And paper.



RECOGNIZED BY
AMERICAN REVOLUTION
BICENTENNIAL
ADMINISTRATION

ELECTRONIC DESIGN is deeply honored to have received official recognition as a participant in the American Revolution Bicentennial Celebration, with authority to display the Bicentennial Symbol.

GEORGE ROSTKY
Editor-in-Chief

JOIN THE PROFESSIONALS

Advance Your Career With A Leader

We are growing, and we're seeking talented people to grow with us. Exciting opportunities exist at all of our 13 divisions located across the country. Here is just a sample of typical openings —

TERMINAL SYSTEMS DIVISION- MILLSBORO Millsboro, Delaware

SENIOR DESIGN ENGINEERS

SOFTWARE DEVELOPMENT PROGRAMMERS

Software and Firmware

- Key contributors of software aimed at advancing state-of-the art
- Knowledge of microprocessor systems and assembly level language programming a plus
- Will involve both application and peripheral control programming

Hardware

- Should be knowledgeable of microprocessor systems interfacing with peripherals and specifying functional capabilities to include hardware/software tradeouts
- Will write system and functional specifications to include proposals
- Prefer a BS in EE or CS and 2-5 years experience

DATA PROCESSING DIVISION-WICHITA Wichita, Kansas

MINICOMPUTER ENGINEERS

- For product development involving next generation mini-computer development

NETWORK DESIGN ENGINEERS

- Node Control
- Terminal Handling
- Computer Communications
- Distributed File Management

DIGITAL DESIGN ENGINEERS

- I/O Controller Design

SYSTEMS DESIGN ENGINEERS

- Minicomputer Systems Design
- Computing Systems Design
- Special Systems Design
- Diagnostic Systems Design

SYSTEMS SOFTWARE PROGRAMMERS

- Communications
- File Management
- Minicomputer Operating Systems
- Firmware Development

TERMINAL SYSTEMS DIVISION- CAMBRIDGE Cambridge, Ohio

OPERATIONAL SYSTEMS ENGINEER- RETAIL POS SYSTEMS

- Assist describing operational requirements of man/machine interfaces for retail systems
- Manage the documentation involved
- Should have 5 years experience in Systems Engineering involving man/machine interfaces with computer peripherals
- Experience in Program MIS and familiarity with computer industry nomenclature a plus

DIGITAL LOGIC DESIGN ENGINEERS

To design complex state-of-the-art logic circuits Point-of-Sale including initial design, prototype construction, initial check-out and manufacturing follow-up. Applicants should be experienced in one or both of the following specific areas:

1. Logic design involving microprocessors, and associated LSI devices.
2. Logic design of memory systems involving NMOS RAMS.

Many other opportunities exist for engineers or engineering programmers. If you are experienced in electronic business systems, write! We may have just what you want. Send your resume, salary requirements and geographical preference to:

Mrs. Marjorie L. Jones, Director
Corporate Executive
& Professional Recruitment
NCR Worldwide Headquarters, Dept. ED-719
Dayton, Ohio 45479
An Equal Opportunity Employer

The NCR logo consists of the letters 'N', 'C', and 'R' in a bold, sans-serif font, each contained within a separate black square.

Don't cheat yourself on trimmer performance.

Compare element size
and see why Dale gives
you better value!

Low profile doesn't have to mean low performance. The larger cermet element in Dale Low Profile Trimmers gives you extra value for your money. Extra assurance of trouble-free performance. You get: **More Power** 1 watt at 70°C lets you derate for assured long-term stability. **Better Adjustability** — $\pm 0.10\%$ output resistance, $\pm 0.05\%$ output voltage ratio. **Low Noise** 1% Contact Resistance Variation standard. **Low T.C.** ± 100 PPM standard.

Immediate delivery
from stock...

Cermet Models
(781, 783, 784)

Wirewound Models
(721, 723, 724)

Phone 402-564-3131
today for complete details.

DALE ELECTRONICS, INC., 1300 28th Ave., Columbus, Nebr. 68601
In Canada: Dale Electronics Canada Ltd.
In Europe: Dale Electronics GmbH
8 Munchen 60, Falkweg 51, West Germany
A subsidiary of The Lionel Corporation



DALE
780
Low
Profile



Brand H



Brand B



Brand I

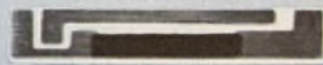

Brand E

CIRCLE NUMBER 41

Our complete product line can be found in *Electronic Design's GOLD BOOK.*

One of the most overworked words in the printed circuit board business is "quality." At Kalmus & Associates, we don't talk much about quality, we just build it into every one of our precision printed circuit boards. ■ If you're a user of PCB's, give us a try. We'll produce circuit boards that meet your specifications to the letter; that are delivered on schedule; that will reduce your production problems to a minimum. ■ For more information on the "quality house" in PCB's, send for our new catalog.

The House That Quality Built

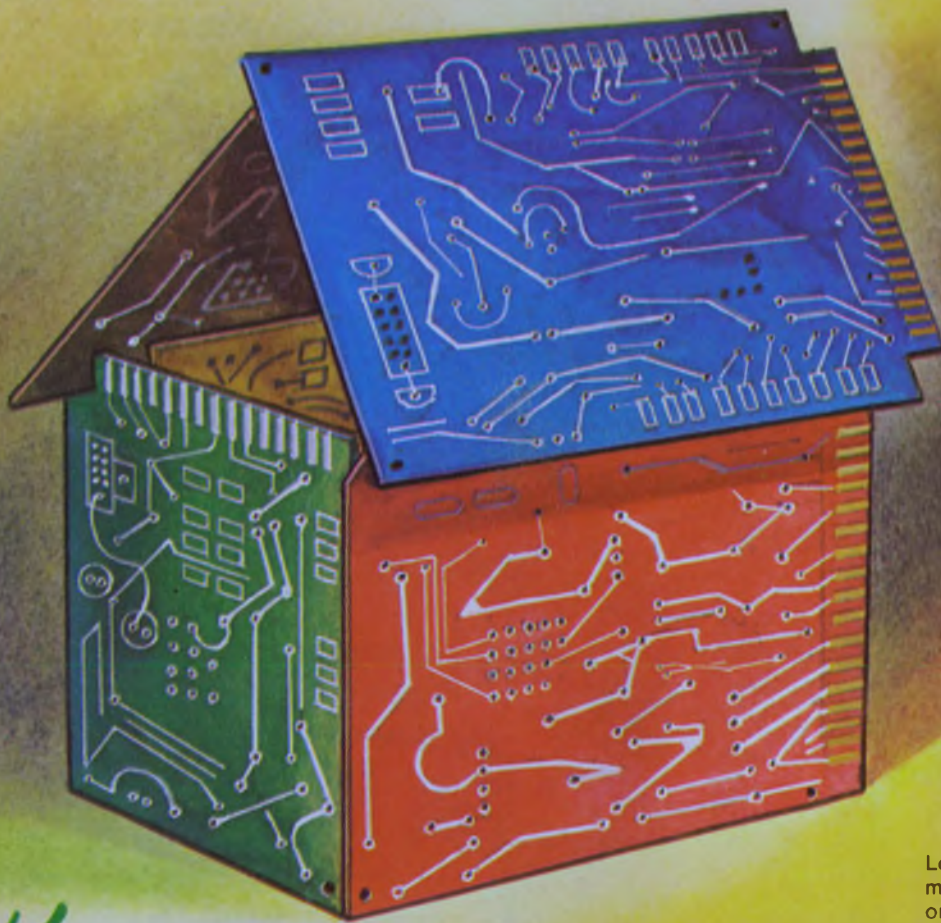

Look for this
mark of quality
on Kalmus circuitry

KALMUS & ASSOCIATES, INC.

2424 South 25th Avenue, Broadview, Illinois 60153 ■ Phone: 312-343-7004

CIRCLE NUMBER 43

Coming through...



with wire, cable and cord
that delivers quality,
performance, economy...

Belden has it: a total service capability. Extensive design and application know-how. What it takes to deliver complex cable configurations, special harnesses, cords, lead wires, and even special packages to fit your requirements.

Our specialists and engineers will meet with your people at your plant to discuss problems in processing, assembly, installation, ordering, human engineering, color coordination, physical and electrical parameters, opportunities for cost reduction. And when we can't help you using standard products, we'll innovate a solution to your problem.

Talk to a Belden specialist about your new applications, product ideas, processing problems—all your wire, cable and cord needs. He has thousands of standard items to draw from. And standard or special, he'll come through with the best wire buy around. For answers right now, phone:

317-966-6661 Electronic Div. or mark No. 400 on reader service card
312-986-1600 Electrical Div. or mark No. 401 on reader service card
312-887-1800 Transportation Div. or mark No. 402 on reader service card,
or write Belden Corporation, 2000 S. Batavia Ave., Geneva, IL 60134.



Coming through...

with new ideas for moving electrical energy .

Put together a complete microcomputer with a 6800 μ P and only two or three support circuits. Programmable interface circuits offer maximum flexibility.

When the single-chip MC6800 microprocessor was introduced in 1974 by Motorola, it offered designers three advantages over competing 8-bit units. It offered a dual bus structure for data and address lines and software-controllable interface elements. Further, it could operate from a single, 5-V supply. Several other companies have since introduced μ Ps with similar features, but so far few have equalled the flexibility of the interface circuits and the wide range of circuits available.

The software-programmable input/output elements—the peripheral interface adapter (PIA), the asynchronous-communications interface adapter (ACIA) and the synchronous serial data adapter (SSDA)—provide standard hardware interfaces, but can be switched under software control to act as either an input or output port. The single-supply operation of the μ P, its associated I/O circuits and its memory circuits, permit full compatibility with TTL-level signals and power supplies.

Systems go together simply

Only five circuits are needed to form a minimum microcomputer system: an MC6800 μ P, an MC6820 PIA or 6850 ACIA, a RAM or ROM for program storage, an MC6870 system clock, and, of course, a power supply (Fig. 1). The components are linked together by an 8-bit data bus and a 16-bit address bus.

The current family of M6800 circuits is listed in Table 1. The newest device in the family is the XC6852—a synchronous serial-data adapter (SSDA). This circuit is used to synchronously transfer blocks of data to and from the system data bus. The 6800 can address up to 65,535 memory bytes. Since each I/O device is treated as a location in memory, the system can theoretically handle as many I/O ports as there are memory locations.

All the timing functions are controlled by the two-phase system clock, which can be set for any

frequency from 100 kHz to 1 MHz. The clock modules are thick-film hybrid circuits that contain a crystal oscillator and waveshapers, as well as TTL and NMOS level drivers.

The other support circuits listed in Table 1 are NMOS, except for the bus transceiver, extender and buffers, and clock buffer, which are bipolar. And all circuits operate from a 5-V source—with the exception of the MCM6832, 68708, 6604 and 6605 memories. The four excep-

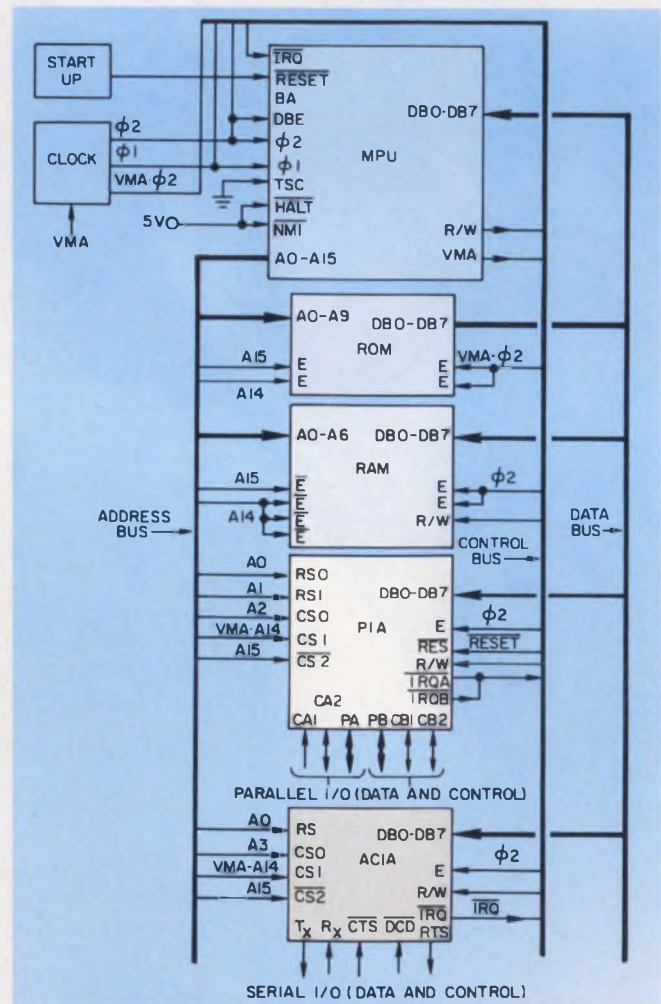

1. The simplest microprocessor-based computer can be built with only three or four chips, a clock and a power supply. All communication takes place over an 8-bit data bus and a 16-bit address bus.

Tom Mazur, Supervisor, Technical Communications, Motorola Semiconductor Products Inc., Phoenix, AZ 85008.

tions require additional +12 and -5 V sources. On the 6800, address and data-bus lines are buffered by three-state drivers for added interfacing ease.

The PIA permits a data interface to instruments and other sources of parallel digital data (Fig. 2a). It has two 8-bit bidirectional busses and four interrupt control lines. One of the output busses is CMOS compatible and the other is TTL-compatible.

For serial-data interfaces, the ACIA can provide serial-to-parallel data conversion (Fig. 2b). It can simplify the interface requirements between the μ P and such serial devices as modems, typewriter terminals and printers. The SSDA performs a similar function as the ACIA, but for synchronous serial data (Fig. 2c). This unit is useful for transferring large blocks of data, as found in disc or tape memory systems.

Also available is a low-speed modem that can serially transmit data at rates of up to 600 bits/s over voice-grade telephone lines (Fig. 2d). It translates TTL-level data to and from FSK (frequency-shift keyed) signals. Available memory circuits are in industry-standard pinouts to simplify interconnections and component selection.

Using the MC6800

To control the 6800 μ P, there are only six registers within the IC that have to be accessed (Fig. 3). With these six registers you can control the external memory and peripheral devices. Memory can be added in any sized block, up to 64-k. All peripheral circuits connect to the data and address busses, and to the μ P's control lines.

The assembly listing of a program that adds four numbers is shown in Fig. 4. Addition is set to take place in accumulator A, although accumulator B could have been selected just as easily. The assembler recognizes some special symbols in the operand field to indicate mathematical notation: a # means that the immediate address mode is to be used; a \$ indicates that a hexadecimal value will follow; a % indicates that a binary number will follow; and no symbol indicates that the number is in decimal notation.

An assembler directive, ORG (origin) assigns an initial address to the program counter (PC). The RMB (reserve memory bytes) directive reserves a temporary location in memory for the results of the addition. A randomly selected label, TEMP, represents the address chosen for the temporary storage location. The mnemonic operators LDA (load accumulator) and ADD (add) represent two-byte, two-cycle instructions that will be executed in the immediate address mode. The operator STA (store accumulator) is a 2-byte, 4-cycle instruction that will be executed in

the direct address mode if the address of the operand is within the lowest 256 bytes of memory space. Finally, the directive MON (return to console) indicates that the end of the source file has been reached.

Let's step through this program to see how the μ P actually carries out the commands. Lines 00100 and 00110 just identify the program and tell the μ P to set the PC to 000A. The next line sets up a temporary storage location called TEMP. When phase 1 of the clock goes low the PC is incremented to 000B. The next time phase 1 goes high, 000B is gated onto the address bus, and when phase 1 goes low again the PC increments to 000C.

When phase 2 goes high the contents of location 000B are put onto the data bus and when the phase 2 clock goes low the data on the data bus are gated into the instruction register where the internal ROM can decode the instruction. The contents of 000B are 86 (hex)—the op code for an LDA A (load accumulator A in the immediate mode) instruction.

Phase 1 again goes high and the contents of the PC are gated onto the address bus. When phase 1 goes low, the PC increases to 000D. When phase 2 goes high the contents of 000C, which are 19 (hex), are put on the data bus and after phase 2 goes low, the contents of location 000C

Table 1. 6800 System components

Model	Description	Price
MC6800	Microprocessing Unit (MPU)	\$29.95 (50-99)
MC6820	Peripheral Interface Adapter (PIA)	\$12.00 (100-999)
MC6850	Asynchronous Communications Interface Adapter (ACIA)	\$12.00 (100-999)
XC6852	Synchronous Serial Data Adapter (SSDA)	\$15.00 (100-999)
MC6860	0-600 bps Digital Modem	\$14.00 (100-999)
MC6862	2400 bps Modulator	\$21.00 (100-999)
MC6870A MC6871A MC6871B	Two-Phase Microprocessor Clocks	\$18.40 \$20.00 \$20.00 (50-99)
MC6880/ MC8T26L	Quad Three-State Bus Transceiver	\$ 3.95 (100-999)
XC6881/ MC3449P	Bi-Directional Bus Extender/ Switch	\$ 3.50 (100-999)
XC6885-88/P XC8T95-98P	Hex Three-State Buffers/Inverters	\$ 1.65 (100-999)
MCM6810L	128 \times 8-Bit Static RAM	\$ 7.00 (100-999)
MCM6830L	1024 \times 8-Bit Read-Only Memory	\$13.80 (100-999)
MCM6832L	2048 \times 8-Bit Read-Only Memory	\$18.40 (100-999)
MCM68308 MCM68317 MCM68708	1024 \times 8-Bit Read-Only Memory 2048 \times 8-Bit Read-Only Memory 1024 \times 8 Bit Alterable ROM	Consult Factory
MCM6604L	4096-Bit Dynamic RAM	\$13.95 (100-999)
MCM6605L	4096-Bit Dynamic RAM	\$20.50 (100-999)
MPQ6842	MPU Clock Buffer	\$ 2.75 (100-999)

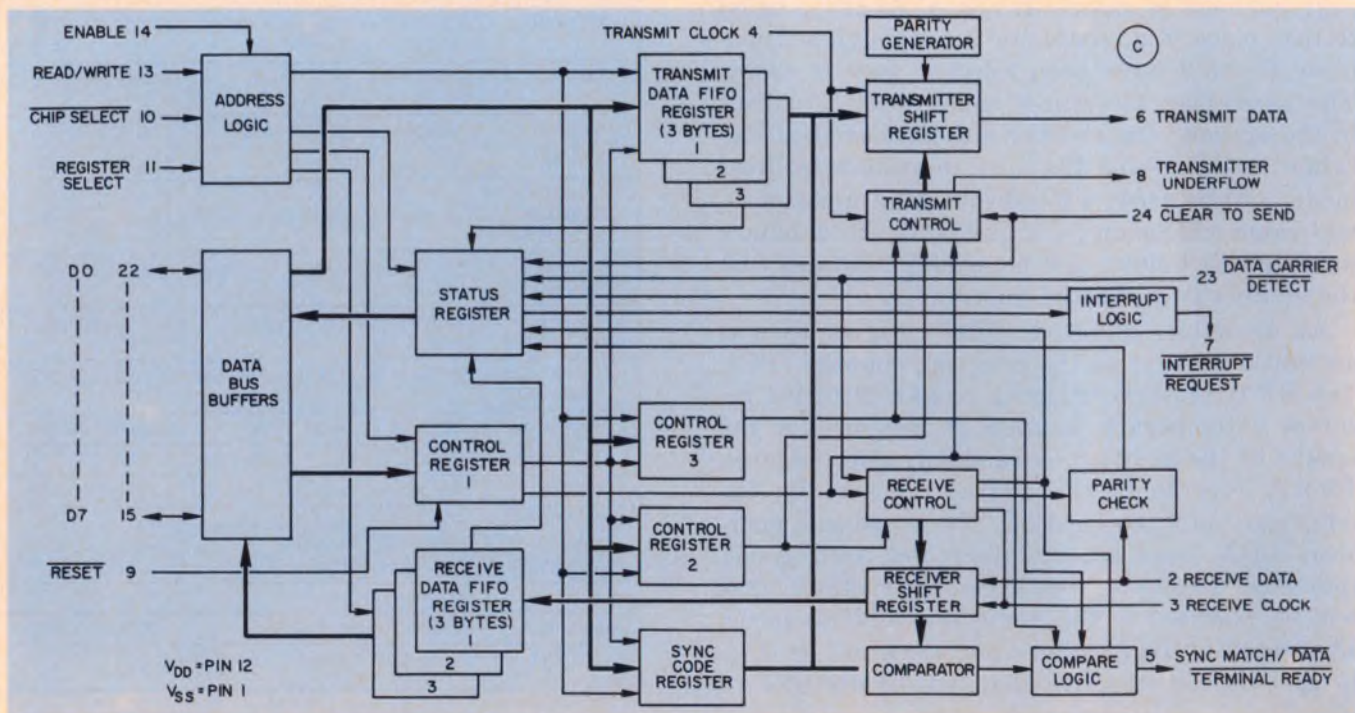
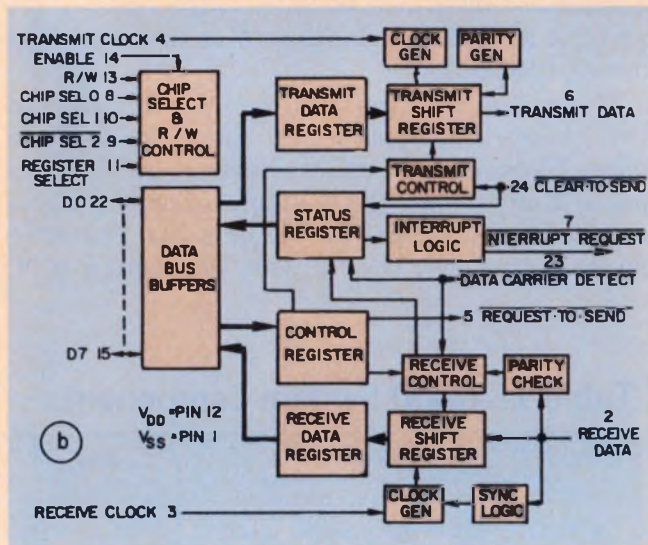
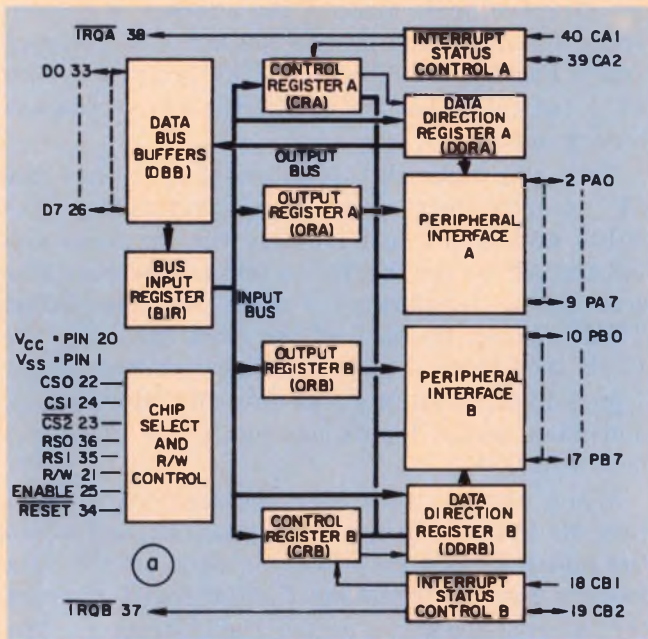

are loaded into accumulator A. At this point the decimal number 25 is in the accumulator.

The next three instructions follow the same routine, adding the numbers 35 (decimal), 32 (hexadecimal) and 10001 (binary) to the accumulator. The PC has now been increased to 0013, and that value appears on the address bus.

The byte from location 0013 is fetched and interpreted to be an STA A, direct instruction.

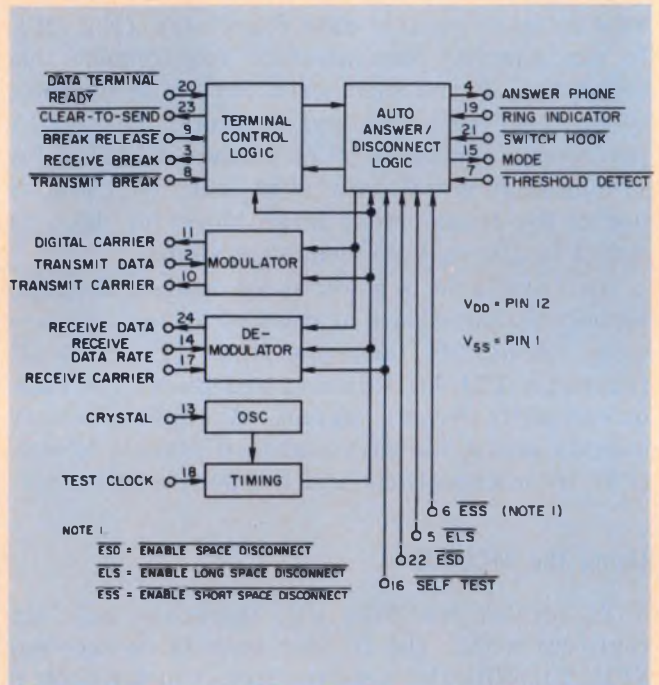

2. The four most often used peripheral devices, the peripheral interface adapter (a), the asynchronous communications interface adapter (b), the synchronous serial interface adapter (c) and the modem (d), help the 6800 communicate with the outside world. All units operate from a single supply and are TTL compatible.

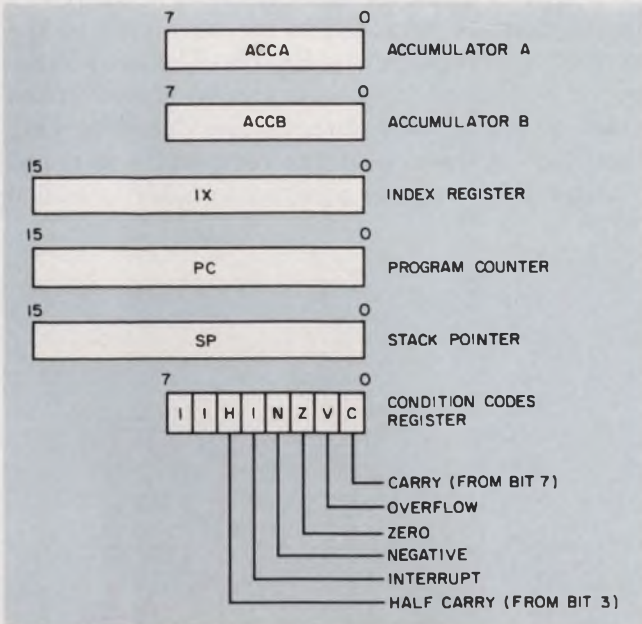

3. When you program the 6800, you will find there are only six user-accessible registers that must be controlled to get the microprocessor to function.

When phase 1 goes low the PC is incremented to 0014 and then when phase 2 goes high 0014 is loaded onto the address bus. After phase 2 goes low, the contents of location 0014 are transferred to the address bus. The next clock cycle gates the contents of the accumulator into the location specified by the address bus.

Many of the instructions, such as the ones used in this example, affect the status of the Condition-Code-Register (CCR) bits. Each bit may be set or cleared as a result of an instruction. For diagnostic purposes, the status of the six active bits of the CCR may be displayed after each instruction execution.

Internally, the 6800 operates in a synchronous mode, processing data-bus information at a rate determined by the clock. There are, though, many applications that require asynchronous data-handling capabilities. The M6800 system can handle these applications by delegating many of the routine peripheral-control tasks to the I/O interface devices. Each peripheral can be treated as a memory location and then addressed only when it requests an interrupt.

Interrupts divert the processor

The 6800 has three hardware interrupts—the Reset (\overline{RES}), Non-Maskable Interrupt (\overline{NMI}) and Interrupt Request (\overline{IRQ}). Software-based interrupts such as the SWI (software interrupt—initiates action) and the WAI (wait for interrupt) can be incorporated into a program. Except for the \overline{RES} input, all interrupts cause the 6800 to store the current contents of the user-

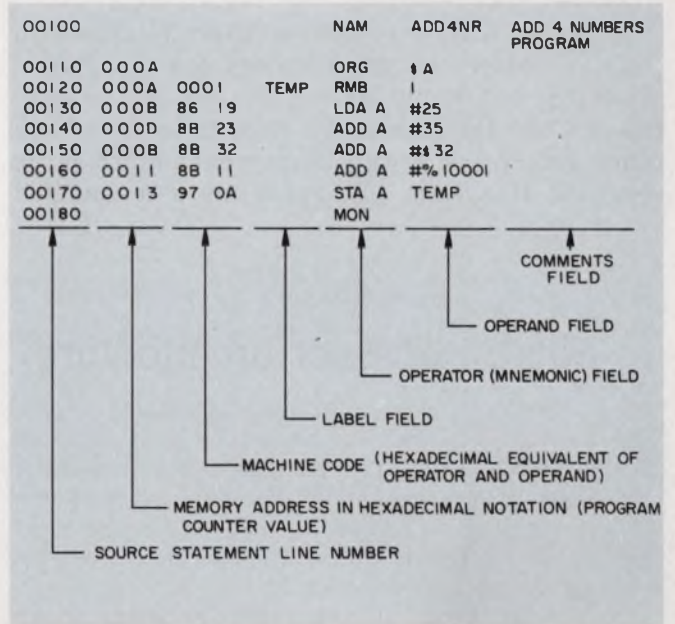

4. You can break apart the assembly listing of any program into its different fields for easy deciphering and debugging.

accessible registers (accumulators A and B, index register, program counter, and condition-code register) in read/write memory locations known as the stack—a last-in first-out memory space. A stack-pointer register assigns the contents of the stack to seven sequential locations and is used to retrieve the contents of the registers after the

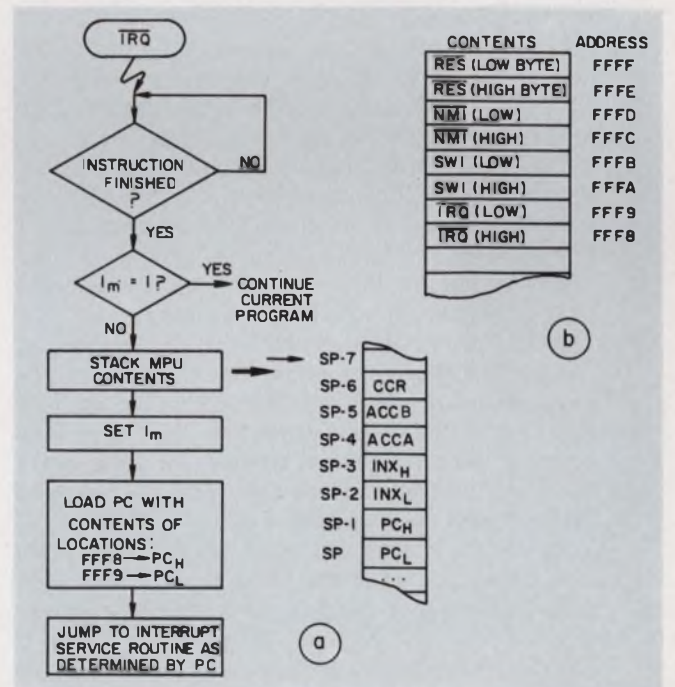

5. After an \overline{IRQ} interrupt request is given, the μP finishes its current instruction, dumps the contents of its user-accessible registers into the stack and services the interrupt (a). Permanent memory assignments for the interrupt service requests are placed in the last few memory addresses (b).

interrupt is serviced.

A typical \overline{IRQ} service-flow chart is shown in Fig. 5a. After the μP registers are put into a stack, the Interrupt Mask (IM) bit of the Condition Code Register is set high to lock out any other interrupts until the current interrupt is serviced. If system interrupts must be handled

on a priority basis, a Clear Interrupt Mask (CLI) instruction can be added to the beginning of the current interrupt-service routine. Then any number of additional interrupts can be nested in the stack awaiting their turn for service. The only limitation is the size of the read/write memory.

After IM is set, the program counter is loaded

Microprocessor architecture

The MC6800 microprocessor is a single-chip, 8-bit parallel processor housed in a 40-pin dual in-line package. The μP has a variable-length stack, maskable interrupt vectoring, direct memory addressing capability and six internal registers, as well as 72 variable-length instructions and seven addressing modes.

Inside the μP are three 16-bit registers, which form the Stack Pointer, Program Counter and Index Register. There are also three 8-bit registers that are known as the condition-code register and accumulators A and B. Since the address register is 16 bits wide, up to 64-k words can be directly addressed.

The stack pointer contains a 2-byte register that holds the address of the next available location in an external push-down/pop-up stack (usually part of the external RAM). The stack is usually used to store the contents of the program counter, accumulators, index register, and other information necessary for the μP to resume operation after an interrupt is serviced.

The arithmetic and logic section of the μP (the ALU) does all the bit manipulation under instruction-set control. In conjunction with the ALU, the two accumulators hold the data that go into and come out of the logic array.

The instruction register, along with the on-chip decoder and control-logic array, manage the internal operations of the μP . Combinations of commands and addressing modes produce a total of 197 executable instructions that are assembled in one, two or three bytes of machine code.

A two-phase clock controls all the timing of the μP . On the first phase the contents of the program counter are transferred to the address bus. The Valid-Memory-Address line then goes high to indicate a valid address is on the bus. On the negative transition of the clock, the program counter gets incremented.

When phase 2 of the clock goes HIGH, data are put on the data bus. (The direction of data flow—to or from the μP —is determined by the Read/Write control line.) Then, when phase 2 goes LOW, data are latched into either the μP or the memory. This sequence occurs every time the μP addresses a location and transfers a data word.

Incoming commands go into the instruction register and are then decoded by the Instruction

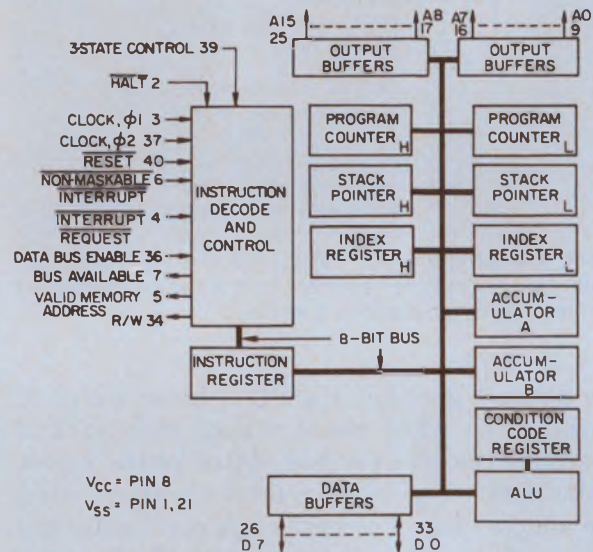

Decode and Control array, which in turn controls the ALU. All the registers and input and output buffers are interconnected on an 8-bit-wide data bus.

The nine control lines available on the MC-6800 package permit various machine operations or provide special control functions. The Go/Halt line permits you to stop all μP operation when put into the Halt position (LOW). The Three-State Control line permits you to cause the Read/Write line and all the address lines to go into the OFF (high impedance) state. You can then use the address bus for DMA applications.

The Read/Write line tells the peripheral devices whether the μP is in the read (HIGH) or write (LOW) state. When the Three-State Control line goes HIGH, it forces the R/W line OFF (high impedance). A Valid Memory Address line tells the memory and peripheral devices that the information on the address bus is a valid address.

For control of the data bus, two lines are available—the Data Bus Enable, which enables the bus drivers when it is placed in the HIGH state, and the Bus Available which, when brought HIGH, indicates that the μP has stopped and that the address bus is available.

with the contents of two memory locations that are permanently assigned to the \overline{IRQ} interrupt (Fig. 5b). The addresses, listed in hexadecimal, are the uppermost locations of the available address space. These locations should contain the addresses of the first instruction of each interrupt routine. Once the interrupt is serviced, a Return from Interrupt instruction (RTI), placed at the end of the routine restores IM and the μP returns to whatever it was doing prior to the interrupt.

The \overline{NMI} interrupt is similar, except that it only waits until the current instruction is finished before storing the registers in the stack, instead of waiting until the \overline{IRQ} line is reset by the current program. In effect, the \overline{NMI} request has a higher priority than \overline{IRQ} , and is often used with a power-failure sensing circuit or with a peripheral unit that must be immediately serviced.

The \overline{RES} interrupt differs from the other two in that it immediately sets IM, loads the program counter with the contents of the location assigned to \overline{RES} and jumps to a service routine. This interrupt is normally used following power-on to begin a program that sets the initial conditions of the μP and the bus.

Hardware interrupts usually occur at random intervals, but software interrupts are usually planned and occur at predetermined points on a program to aid in debugging.

Interfacing to the system bus

Various peripheral circuits used to interface to the outside world can be controlled by software. Each of the units must be connected to both the data, address and control busses.

The PIA provides two 8-bit bidirectional data busses through pins PA0 to PA7 and PB0 to PB7 and four interrupt/control lines—CA1, CA2, CB1 and CB2 (Fig. 6a). The peripherals on side A are 5 V, CMOS compatible. The ones on side B are TTL compatible. The data flow occurs between the PIA and μP over eight bidirectional lines, DB0 to DB7. Five additional lines connect to the system's address bus.

A peripheral can signal the μP for service via the \overline{IRQA} and/or \overline{IRQB} lines. If necessary, the μP can acknowledge the request via the CA2 and CB2 lines. Since data transfers on the 6800 data bus usually take place on the phase-2 portion of the clock cycle, the phase-2 signal is used by the PIA as a timing reference. It is connected to the enable pulse input of the PIA. Direction of data flow is controlled by the μP R/W line, which is connected to the matching line on the PIA.

The ACIA serial-to-parallel interface circuit can be configured under software control to handle any of eight preset serial codes (Fig. 7a).

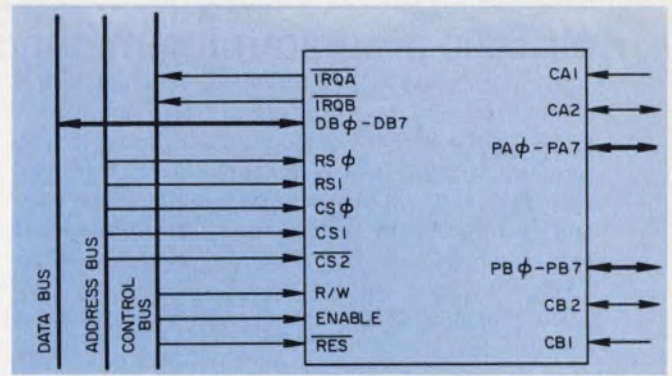

(a)

RS1	RS0	Control register bit		Location selected
		CRA-2	CRB-2	
0	0	1	x	Peripheral register A
0	0	0	x	Data direction register A
0	1	x	x	Control register A
1	0	x	1	Peripheral register B
1	0	x	0	Data direction register B
1	1	x	x	Control register B

x = Don't care

(b)

	7	6	5	4	3	2	1	0
CRA	IRQA1	IRQA2	CA2 control		DDRA access	CA1 control		
CRB	IRQB1	IRQB2	CB2 control		DDRB access	CB1 control		

(c)

6. The PIA connects into the 6800 system with eight bidirectional data lines, five address lines and another five control lines (a). Register selection for the output port and for the flow direction can easily be done under software control (b and c).

It connects to the data, control and address busses in the same way the PIA does (Fig. 7b).

Separate inputs are available on the ACIA to permit clocking of transmitted or received data, at frequencies of 1, 16 or 64 times the data rates. Counters in the ACIA can be programmed by the μP to divide external clock signals by 1, 16 or 64. Received-data synchronization is accomplished internally in the $\div 16$ and 64 modes. There are also three control lines that permit limited control of a peripheral such as a modem.

There is also an extra safety feature on the ACIA. As power is applied to the adapter, an internal circuit detects the power-line transition and holds the registers in a reset condition to prevent spurious outputs from affecting a peripheral that might already be operating.

The SSDA interface circuit appears as two

MC6800 programming methods and mnemonic definitions

To get a good look at the basic instruction set of the MC6800, you can divide it into accumulator and memory, index register and stack, jump-and-branch and condition-code instructions (see table). Each instruction requires one byte and is followed by either one or two additional bytes—of an address location, data or even another instruction.

The MC6800 offers seven different ways to address data:

(1.) Inherent. This mode lets you use the operand as the address for the data to be manipulated. The operand may be either one or two bytes long.

(2.) Accumulator. Although similar to inherent addressing, in this mode the operator defines the location being addressed.

(3.) Immediate. In this mode, the byte following the instruction is used as the operand of the instruction. No reference to the memory need be made.

(4.) Direct. For direct addressing, the μP can only reach locations 0 to 255 because only a single-byte operand is used. After an instruction

is encountered in this mode, the μP looks at the program counter's contents, adds one and uses that number as the location of the data word.

(5.) Extended. This mode is similar to the Direct mode except that a 2-byte operand is used, thus permitting the μP to reach the remaining memory locations, 256 to 65,535. After an instruction is encountered, the μP looks at the contents of the program counter, adds one and uses that number as the first half of the memory address. This repeats and the original value of the program counter plus two becomes the second half of the memory address.

(6.) Relative. You can specify a memory location whose address, relative to the value in the program counter, can be up to 125 locations below that value or up to 129 locations above the value. To go further than the 129 locations requires an unconditional jump, jump to subroutine or return from subroutine.

(7.) Indexed. The numerical address is not fixed, but depends on the contents of the index register.

Addressing-mode selection is made when the

Nomenclature

ACCA	Accumulator A	IXL	IX, lower order 8 bits
ACCB	Accumulator B	PC	Program counter, 16 bits
ACCX	Accumulator ACCA or ACCB	PCH	PC, higher order 8 bits
CC	Condition code register	PCL	PC, lower order 8 bits
C	Carry bit of CC	SP	Stack pointer, 16 bits
V	Two's complement overflow indicator bit of CC	SPH	SP, higher order 8 bits
Z	Zero indicator bit of CC	SPL	SP, lower order, 8 bits
N	Negative indicator bit of CC	M	A memory location (one byte)
I	Interrupt mask bit of CC	M+1	The byte of memory at location 0001 plus the address of the location indicated by M
H	Half carry bit of CC	REL	Relative address
IX	Index register, 16 bits		
IXH	IX, higher order 8 bits		

Accumulator and memory instructions

Operation	Mnemonic	Description
Add	ADDA ADDB	Adds contents of ACCX and contents of M; places results in ACCX.
Add accumulators	ABA	Adds contents of ACCB to contents of ACCA; places results in ACCA.
Add with carry	ADCA ADCB	Adds contents of C bit to the sum of the contents of ACCX and M; places results in ACCX.
Logical AND	ANDA ANDB	Performs logical AND between the contents of ACCX and contents of M; places results in ACCX.
Bit test	BITA BITB	Performs logical AND comparison of contents of ACCX and M and modifies N, Z and V bits of CC. Contents of ACCX and M are not changed.
Clear	CLR CLRA CLRB	The contents of M or the contents of ACCX are replaced with zeros.
Compare	CMPA CMPB	Compares the contents of ACCX and M and modifies the N, Z, V and C bits of CC. Contents of ACCX and M are not changed.
Complement, 1s	COM COMA COMB	Replaces each bit of the contents of ACCX or M with its one's complement.

programs are written. If you manually translate the program into machine code, the addressing mode is inherent in the operation code.

Several different methods of generating the machine-level codes are available to the programmer. For in-house development you can use an assembly program available either from time-sharing services or from the EXORciser development system. Time-sharing services also offer a high-level language called MPL (a subset of PL/1) that is especially handy for applications that involve mathematical computations of data.

The compiler program of MPL translates source statements into M6800 assembly-level programs. Already written assembly-level instructions can be embedded in the compiled program to permit optimization when programs are already available. An assembler program then takes the assembly-level program and makes two passes in the first, it assigns numerical values to source-statement labels, then checks syntax and lists errors. On the second pass, undefined symbols from pass one are defined and an assembled listing is provided. The assembler has

12 directives, which can be used to assign data values, allocate memory and control the sequencing and formatting of programs.

Also available are an interactive simulator program that duplicates, on a host computer, the exact execution of the assembled machine-language program. Another useful program is the Build Virtual Machine, which permits you to reorganize the software you have under development. This program helps to determine and minimize memory requirements.

For development systems such as the EXORciser, a macroassembler is available. Macroinstructions represent a sequence of assembly-level instructions. The macros simplify program development, when instruction sequences must be repeated, by providing the programmer with a shorthand notation of the sequences.

In the EXORciser, the Evaluation Module II and in the Design Evaluation Kit, available firmware includes EXbug, MINIBug and MIKbug, respectively. These programs contain routines for loading user programs, for debugging them and for providing interactive control of the prototype system.

Complement, 2s (negate)	NEG NEGA NEGB	Replaces each bit of the contents of ACCX or M with its two's complement.
Decimal adjust, A	DAA	Adjusts contents of ACCA and C bit to represent correct BCD sum and carry after an ABA, ADD or ADC operation on a BCD operand.
Decrement	DEC DECA DECB	Subtracts one from the contents of M or ACCX.
Exclusive OR	EORA EORB	Performs logical Exclusive OR between contents of ACCX and M; places results in ACCX.
Increment	INC INCA INCB	Adds one to the contents of M or ACCX.
Load Accumulator	LDA LDAB	Loads contents of M into ACCX.
OR, Inclusive	ORA ORAB	Performs logical OR between contents of ACCX and M; places results in ACCX.
Push data	PSHA PSHB	Contents of ACCX stored on stack at the address contained in SP; SP then decremented by one.
Pull data	PULA PULB	SP incremented by one; ACCX loaded from stack, from the address contained in SP.
Rotate left	ROL ROLA ROLB	All bits of ACCX or M shifted left by one bit. Bit 0 of the byte loaded with the initial C bit. C bit loaded with the initial MSB of ACCX or M.
Rotate right	ROR RORA RORB	All bits of ACCX or M shifted right by one bit. Bit 7 of the byte loaded with the initial C bit. C bit loaded with the initial LSB of ACCX or M.
Shift left, arithmetic	ASL ASLA ASLB	All bits of ACCX or M shifted left by one bit. Bit 0 of the byte loaded with zero. C bit loaded with the initial MSB of ACCX or M.
Shift right, arithmetic	ASR ASRA ASRB	All bits of ACCX or M shifted right by one bit. Bit 7 of the byte loaded with a zero. C bit loaded with the initial LSB of ACCX or M.

Operation	Mnemonic	Description
Shift right, logic	LSR LSRA LSRB	All bits of ACCX or M shifted right by one bit. Bit 7 of the byte held constant. C bit loaded with the initial LSB or ACCX or M.
Store accumulator	STAA STAB	Store the contents of ACCX at M; the contents of ACCX remains unchanged.
Subtract	SUBA SUBB	Subtract the contents of M from ACCX; place the results in ACCX.
Subtract accumulators	SBA	Subtracts the contents of ACCB from ACCA; places results in ACCA. Contents of ACCB not affected.
Subtract with carry	SBCA SBCB	Subtracts the contents of M and C from ACCX; places results in ACCX.
Transfer accumulators	TAB TBA	Moves contents of ACCA to ACCB (TAB) or vice versa (TBA). The contents of the transferred accumulator are not changed; the contents of the receiving accumulator are changed.
Test, zero or minus	TST TSTA TSTB	If MSB of ACCX or M is one, then the N bit of CC is set to one. If the contents of ACCX or M are all zeroes, then the Z bit is set to one.
Index register and stack manipulation instructions		
Compare index register	CPX	The contents of IXH and IXL are compared to M and M + 1, respectively. The N,Z and V bits of CC are affected.
Decrement index register	DEX	Subtracts one from the index register. Z bit of CC is affected.
Decrement stack pointer	DES	Subtracts one from the stack pointer. CC not affected.
Increment index register	INX	Adds one to the index register. Z bit of CC is affected.
Increment stack pointer	INS	Adds one to the stack pointer. CC not affected.
Load index register	LDX	Loads IXH and IXL with contents of M and M + 1, respectively. The N,Z and V bits of CC are affected.
Load stack pointer	LDS	Loads SPH and SPL with the contents of M and M + 1, respectively. The N,Z and V bits of CC are affected.
Store index register	STX	Stores IXH and IXL at locations M and M + 1, respectively. The N,Z and V bits of CC are affected.
Store stack pointer	STS	Stores SPH and SPL at locations M and M + 1, respectively. The N,Z and V bits of CC are affected.
Transfer from IX to SP	TXS	Loads SP with contents of IX minus one. Contents of IX unchanged.
Transfer from SP to IX	TSX	Loads IX with contents of SP, plus one. Contents of SP unchanged.
Jump and brand instructions		
Branch always	BRA	Branch to the address equal to PC + 0002 + REL.
Branch if carry clear	BCC	Branch to the address equal to PC + 0002 + REL, if the C bit = 0.
Branch if carry set	BCS	Branch to the address equal to PC + 0002 + REL, if the C bit = 1.
Branch if equal to zero	BEQ	Branch to the address equal to PC + 0002 + REL, if the Z bit = 1.
Branch if \geq zero	BGE	Branch to the address equal to PC + 0002 + REL, if the logical Exclusive OR of N and V bits = 0.
Branch if $>$ zero	BGT	Branch to the address equal to PC + 0002 + REL, if the contents of $Z + [N + V] = 0$.
Branch if higher	BHI	Branch to the address equal to PC + 0002 + REL, if the logical AND of C and Z bits = 0.
Branch if \leq zero	BLE	Branch to the address equal to PC + 0002 + REL, if the contents of $Z + N + V = 1$.
Branch if lower or same	BLS	Branch to the address equal to PC + 0002 + REL, if the contents of $C + Z = 1$.

Branch if < zero	BLT	Branch to the address equal to PC+0002+REL, if the contents of N + V = 1.
Branch if minus	BMI	Branch to the address equal to PC+0002+REL, if the contents of N = 1.
Branch if \neq zero	BNE	Branch to the address equal to PC+0002+REL, if the contents of Z = 0.
Branch if overflow clear	BVC	Branch to the address equal to PC+0002+REL, if the contents of V = 0.
Branch if overflow set	BVS	Branch to the address equal to PC+0002+REL, if the contents of V = 1.
Branch if plus	BPL	Branch to the address equal to PC+0002+REL, if the contents of N = 0.
Branch to subroutine	BSR	Branch to the address equal to PC+0002+REL. PC+0002 stored in the stack.
Jump	JMP	PC loaded with a numerical address; a jump to that location occurs.
Jump to subroutine	JSR	PC incremented by 0002 (indexed address mode) or 0003 (extended address mode), then stored in the stack. PC loaded with a numerical address; a jump to that location then occurs.
No operation	NOP	Advances PC; no other registers affected.
Return from interrupt	RTI	CC, ACCX, IX and PC restored in the states that were saved in the stack.
Return from subroutine	RTS	SP incremented by one; PCH loaded with the contents of the location specified by SP. Again, SP is incremented by one; PCL loaded with the contents of the location specified by SP.
Software interrupt	SWI	PC incremented by one; then PC, IX, ACCX and CC stored in the stack. SP decremented by one after each byte is stored. I bit then set and PC then loaded with the address specified by the software.
Wait for interrupt	WAI	Registers operated on and saved as in SWI instruction, except I bit is not set. Program execution suspended until interrupt occurs on IRQ line. When IRQ goes low, and provided that the I bit is clear, program execution proceeds as in SWI.
Condition code register manipulation instructions		
Clear carry	CLC	Carry bit reset to zero.
Clear interrupt mask	CLI	Interrupt bit reset to zero.
Clear overflow	CLV	Overflow bit reset to zero
Set carry	SEC	Carry bit set to one.
Set interrupt mask	SEI	Interrupt bit set to one.
Set overflow	SEV	Overflow bit set to one.
Transfer from ACCA to CC	TAP	Transfers the contents of bit 0 through 5 of ACCA to the corresponding bit positions of CC. Contents of ACCA not changed.
Transfer from CC to ACCA	TPA	Transfers the contents of bit 0 through 5 of CC to the corresponding bit positions of ACCA. Bits 6 and 7 of ACCA are set to one. Contents of CC not changed.

memory locations to the μ P. Internally there are actually seven registers. Data transferred to and from a peripheral must be accompanied by clock signals that are synchronized to the data. Transfer rates of up to 600 kilobits/second are possible. A power-on protect feature, similar to one in the ACIA, is also included.

To speed data flow over a telephone line, the low-speed modem circuit can operate in full-

duplex, half-duplex or simplex modes. It can also be used in the answer or originate mode and can respond to a hang-up request. When the circuit is used to originate a call, the output will be a 1070-Hz signal for a space (ZERO) and a 1270-Hz signal for a mark (ONE). When the modem answers a call its modulator output will be 2025 Hz for a space and 2225 Hz for a mark.

A wide range of memory types and sizes is

Table 2. Support software and hardware

Support software	Available versions for:		
	Time-sharing systems	In-house computer systems	Design instrumentation
MPL compiler	GE International System; UCS	Sigma 9, Honeywell 6000, IBM *360/370 CDC6000	
Assembler	GE; UCS; Dentsu; Honeywell-Bull	Sigma 9, HP2100 IBM 360/370, NOVA, Honeywell 6000, CDC6000, PDP11	Resident editor/assembler versions for EXORciser and evaluation modules
Simulator	Same as assembler	Same as assembler	
Build virtual machine	Same as assembler		
HELP	Same as assembler		
Macro assembler			Resident version
EXBUG			EXORciser firmware
MINIBUG II			Evaluation Module II firmware
MIKBUG			Design evaluation kit firmware
Support hardware	Description		
EXORciser	Basic EXORciser consists of an MPU module, debug module, baud rate module, power supply and chassis.		
EXORciser optional modules	input/output, ACIA, PROM programmer, wrapped wire and extender modules. 2k x 8 static RAM, 8k x 8 dynamic RAM, 16k x 8 dynamic RAM, EROM/RAM,		
System analyzer	Used to monitor and modify programs; contains 4k-bytes of RAM plus hex display and I/O control logic. The SA can be installed in the EXORciser or used as an independent, portable test instrument.		
User system evaluator	For prototypes developed or transferred outside of the EXORciser chassis, and for production level testing, USE can be employed for test and debugging purposes. Operating with a single, shared-processor, the USE/prototype interface can be changed at will, allowing elements of the prototype to be tested and debugged in real time.		
Component tester	Functionally tests the M6800 MPU, PIA, ACIA, ROM and RAM. Up to eight test heads can be connected to a single EXORciser for volume testing.		
EXORdisk	A twin-drive floppy disk peripheral for the EXORciser that provides a low-cost-per-bit storage medium. Included with the EXORdisk is a disk operating system called EDOS.		
EXORTape	A high speed papertape reader for the EXORciser. Data can be loaded at rates of up to 250 characters per second.		
Evaluation Module II	A microcomputer on a single board; contains an MPU, 3 RAMs, 2 ACIAs, a PIA, an MC6871A clock oscillator, an MC14411 bit rate gen., data, address and control bus and peripheral interface buffers. A ROM contains the MINIBUG II loader/diagnostic program. Two of the RAMs provide 256 bytes of storage for users' programs. A 24-pin socket on the board will accommodate 2704 or 2708 type PROMs that contain user-generated firmware. The module interfaces with a TTY or RS232C data terminal.		
Design evaluation kit	A low-cost microcomputer kit; contains an MPU, 2 PIAs, an ACIA, 2 RAMs, and a ROM that holds the MIKBUG loader/diagnostic program. One of the RAMs provides 128 bytes of storage for users' programs. The kit interfaces with a TTY or RC232C data terminal.		

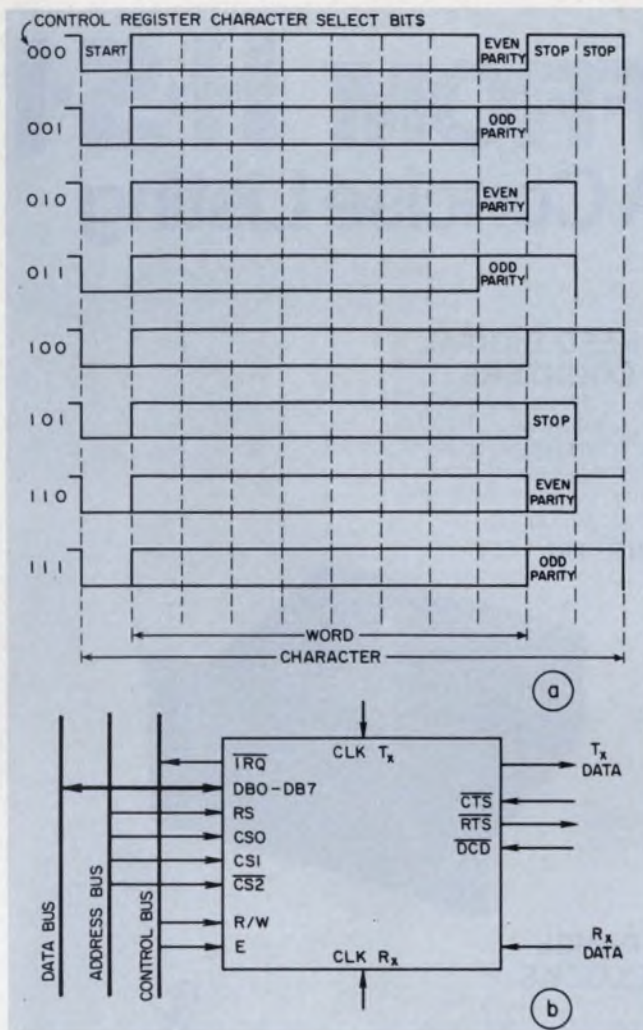

7. A three-bit input to the control register of the ACIA can set any of eight serial word formats (a). The ACIA connects easily to the general system bus (b). The eight bidirectional data lines are still needed. Only four address lines and three control lines are necessary.

available for use with the 6800 μ P. Some typical sizes include the 128×8 , byte-oriented RAM and the 1024×8 , byte-oriented ROM. The RAM is a static unit and requires no refresh. It has TTL-compatible inputs, a bidirectional, three-state I/O bus and four negative and two positive chip-enable lines.

The 8-k ROM is mask programmable and has four enable lines. The enable lines are defined by the customer, when the mask is designed, to be either positive or negative. Input lines are TTL-compatible and there are three-state outputs.

Access time of the RAM can be as short as 350 ns to as long as 1 μ s for the read function, depending upon the model selected. The ROM has an access time of 500 ns.

Other sizes of RAMs and ROMs are also available, along with clock buffers, alterable ROMs, dynamic RAMs, bus extenders and three-state buffers.

When the M6800 system runs at full speed (that is, at a clock rate of 1 MHz) memory components must have access times of 575 ns or less.

Of course for cost tradeoffs slower memories can be used if the clock rate is decreased, or if you switch to dynamic memories that can be accessed faster but which require extra refresh circuitry.

The MC6800 uses two nonoverlapping clocks that time the execution of a program. Dynamic RAMs place an additional constraint on the clock: the output phases can be held in one state no longer than 5 μ s without affecting the contents of the dynamic RAM.

Development aids fill most needs

A comprehensive array of support software and system-development tools is available from Motorola and other companies. The most powerful of these tools is the EXORciser. It contains a complete M6800 operating system, and built-in firmware to help design and debug prototype systems. The basic EXORciser consists of three plug-in boards, a power supply and a chassis. The three modules are the μ P card, the debug card and a baud-rate module. The μ P and debug cards each require one of the 14 card slots in the EXORciser chassis. The other 12 slots are available for custom-designed interfaces and circuits.

On the μ P card is the μ P, a clock, bus control logic, and clock-control circuit and three-state buffers.

The debug module contains ROMs, RAMs, a PIA, an ACIA, a PROM and an assortment of logic, buffers and opto-isolators for bus control and for data-terminal interfaces. Firmware on the board consists of the EXbug loader/diagnostic program.

On the baud-rate module is a crystal-controlled bit-rate generator that permits data rates of 110 to 9600 baud. The chassis power supply provides 5 V at 15 A, 12 V at 2.5 A and -12 V at 1.5 A to handle almost any circuit requirements.

For smaller design applications, the MEK-6800D1 Design Evaluation Kit or the M6800B Evaluation Module II are available. The MEK kit consists of a printed-circuit board and M6800 family ICs. Also included is a ROM that contains MIKbug, a debugging routine.

The Evaluation Module II is a self-contained microcomputer on a single board, similar to the Design Evaluation Kit, except that it comes completely assembled. It contains a μ P, three RAMs, two ACIAs, a PIA, a ROM, a clock oscillator and a bit-rate generator. Also included are the data, address and control-bus buffers. ■■

The first article in this series appeared in the April 26 issue. Part 2 covered the 8080 and appeared in the May 10 issue. Part 3 discussed the F8 and appeared in the June 7 issue. The next article in this series will appear in the August 2 issue.

PRODUCTS FROM H·S·I

... A Concise Listing



HIGH SPEED DIGITAL PULSE COUNTERS

with 4, 6, 8 digits; 12, 24 VDC, 115 VAC, 60 Hz; response rates of 0-100 pps; 2 or 3 wire stepper or synchronous motor. Extremely long life and extraordinary reliability. Available with BCD readout capability.

CIRCLE NO. 161

HIGH SPEED DIGITAL STOP CLOCKS

with 4, 6, 8 digits; 12, 20, 115 VAC, 50 or 60 Hz; 1.5 watt max.; readout in sec., min. or hrs.; increments of 1/10 or 1/100 of a sec. or a min. or an hour; manual or electric reset. Quiet, dependable and accurate. Available with BCD readout capability.

CIRCLE NO. 162



DIGITAL PANEL MOUNT CLOCKS

with readout in 12 or 24 hours, mins., 1/10 min. or 0-55 sec.; calendar (Gregorian month/day/hour/min./sec. or Julian 1-366 day/hour/min./sec.); 12, 20, 115 VAC, 50 or 60 Hz, driven by BIG INCH synchronous motors. Rapid transfer, reliable, long life, extremely accurate. Available with BCD readout capability.

CIRCLE NO. 163

PRECISION SWITCHES

Resilient or hermetic seal, high and low temperature switches and switch assemblies for applications where optimum performance is the criteria. SPST, SPDT, DPDT, etc. Push button, plunger, roller, toggle actuated. Many types, styles, sizes.

CIRCLE NO. 164



BIG INCH® PRECISION MINI-MOTORS

One watt synchronous, 2-wire and 3-wire stepper, step-servo, brushless DC; uni-directional, bi-directional; 1-1/16" dia.; instant (1/100 sec.) stop/start/reverse; integral gear train. Powerful, efficient, dependable.

CIRCLE NO. 165



HAYDON SWITCH & INSTRUMENT, INC.

1500 Meriden Road, Waterbury, Conn. 06705
(203) 756-7441

SEND FOR LITERATURE ON ANY OF THE ABOVE PRODUCTS.

automate your noise loading...

The **mi Model 2090C** automatically produces noise loading curves... fast without compromise to accuracy, printing data for each test channel within seconds ... runs either signal-to-noise or NPR curves... optional control unit provides local or remote control... computer compatible... utilizes existing filters...

gives immediate saving where repetitive measurements are needed... for full details call: MARCONI INSTRUMENTS, The Noise Loading Experts, Northvale, N.J. 07647, (201) 767-7250.



mi
MARCONI
INSTRUMENTS

DIVISION OF MARCONI ELECTRONICS INC.

CIRCLE NUMBER 46 751

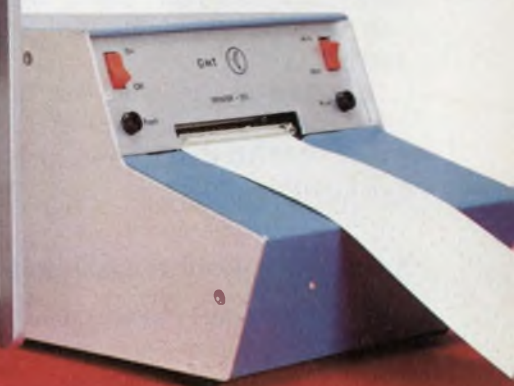

Bring up your μP "bit-by-bit."

With a systematic, section-by-section approach you can test both hardware and software in less time.

Unless you enjoy spending weeks or months in unraveling complex puzzles, take a systematic approach when you develop μP -based systems.

Two basic procedures underpin the approach: turn the system on one piece at a time, and debug software and hardware together. The tool that allows all this is the logic-state analyzer.

With the analyzer, you can develop a μP system with the same technique you usually use to develop a cascaded amplifier. That is, you usually turn on and check out the amplifier one section at a time by injecting a signal into the input and measuring the output of each section with a voltmeter, spectrum analyzer or oscilloscope. In turning on μP systems, analyzers offer a similar approach, and so ease the development process.

In operation, analyzers measure information transfer—program addresses, program instructions or any data that appear on any of the busses or ports within the μP system.

One analyzer can display sixteen 16-bit data words at one time, or sixteen 32-bit words with a companion analyzer. These words are displayed as ONEs and ZEROs and are selected with a pattern trigger and digital delay (Fig. 1).

The pattern, or data word, is selected by setting the 32 pattern-trigger switches to high, low, or off. The delay can be such that the display starts anywhere from 15 words before the pattern trigger, to 99,999 words after the trigger. Since the analyzer has a digital memory, data can be captured single-shot and displayed indefinitely.

Another useful analyzer feature is an output that can trigger a scope at any byte in a digital process. With the trigger, you can examine waveforms in detail.

Sequential operations cause problems

In developing a systematic process for turning on a μP system, remember that it's the data transactions on the various busses that determine



1. A functional display of ONEs and ZEROs gives designers an overview of the operation of a digital system. Words are captured in the analyzer's memory.

a system's function. Consider the μP system of Fig. 2. If all of the elements in this system are wired up, plugged in and turned on, chaos will almost surely result. Any small wiring mistake or logic error can cause the system to run amok.

Such alarming behavior results because the entire system is one giant digital-feedback loop. The next value of the program counter depends on the current instruction, but the latter depends on the current value of the program counter.

Interchanging two address lines causes the instructions to be executed in an entirely random sequence. A small logic error, which allows two ROMs to respond simultaneously to an address, will cause the outputs of the ROMs to be wire-ANDed, again putting entirely random instructions on the data bus.

Similarly, data stored in memory—to be read back later for conditional branches—are determined by instructions executed long ago, and the instructions to be executed in the future depend upon those stored values. Current or past values of the I/O ports also participate in decisions that affect future operation.

The only reasonable approach to turning on such a system is to break the feedback network

W. A. Farnbach, Engineering Section Manager, Hewlett-Packard, 1900 Garden of The Gods Road, Colorado Springs, CO 80907.

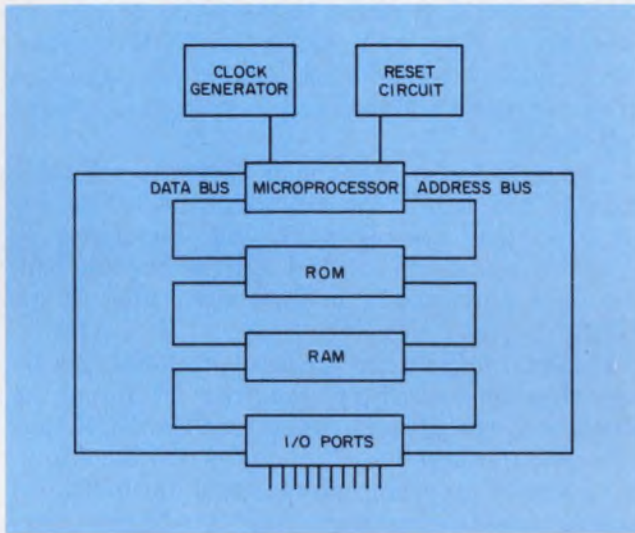

2. **Generalized microprocessor system** contains fixed programs in ROMs and data in RAMs. Interaction between the memory and μP appears like a feedback loop.

into pieces, so that each piece can be turned on independently.

The first candidates for turn on are the clock generator and reset circuits. These relatively simple timing circuits are best tested with a scope for proper timing and waveshape. Once these circuits are within specs, the next step is to check the interaction between the μP and the ROM.

A crucial path: μP to ROM

The linkage between the ROM (or RAM) and the μP is the first to be established because with this link, the processor can be programmed to serve as a signal generator for testing the remaining blocks. The linkage is tested in three steps:

First, you must establish that the NOP (no operation) instruction is being transmitted correctly to the processor. Second, establish that the program addresses are transmitted correctly to the ROM. Finally, determine that the ROM interprets the program addresses correctly.

To perform the first step, plug in only the μP and put the NOP code on the data bus (Fig. 3a).

In forcing the data bus to NOP, realize that many μP s will try to put data onto the bus during an operating cycle. If the data bus is simply wired to the NOP state, then the data-output buffers in the μP can be destroyed. You can avoid this problem in two ways.

Since the μP data inputs are usually high impedance, the data bus can be forced safely to NOP with large resistors. Or, it can be forced to NOP through a set of three-state gates. Connect the three-state control to the processor read/write line so that the gates are active only when the processor reads data.

This set-up will cause the program counter in the processor to increment. That is, the processor will execute a NOP, increment the program counter, execute the next NOP, and so on. You can easily measure the counting sequence on the address bus with the analyzer. Simply connect the 16 data inputs to the address bus at the ROM socket, and connect the clock input to the data-transfer processor clock.

The count sequence also can be easily verified. Just trigger the analyzer on 0000_{16} , increment the delay generator through several values, and compare the count displayed on the state analyzer with the delay setting. Obviously, the count (in decimal) and the delay value will be equal if the ROM receives correct addresses.

In this way, you verify that the processor is executing NOPs and that the addresses are correctly transmitted to the ROM. If the addresses do not form a counting sequence, then an examination of the address pattern should quickly reveal if address lines are interchanged or are inactive, or the processor is executing an unexpected branch instruction.

If you suspect that the processor is not executing NOPs during the instruction read phase, then connect the state analyzer to the data bus directly at the processor.

Check waveforms at each change

At this point, it is also important to examine the waveforms on the busses and the control lines. Any incorrect timing, marginal voltage levels, noise or crosstalk should be eliminated be-

fore proceeding. In fact, you must do this every time you add a new block to the system. Any input or output hung onto a common line can cause a problem.

The analyzer's scope-trigger output is very useful, especially as more blocks are added. For example, to examine the waveforms on the data bus when the bus is driven by the RAM outputs, you need only trigger the analyzer on the RAM read address or on the address of the RAM read instruction, then trigger the scope with the analyzer's pattern-trigger output.

Although such testing may seem needlessly repetitive, it takes very little time if there is no problem, and saves a great deal of time, if there is one by pinpointing the troublesome block.

Next, plug in some ROMs with known stored information and connect only the address lines and chip-select logic (Fig. 3b). Since the instructions returning to the processor are still NOPs,

the program counter will continue a simple count. This time, however, the ROMs will cycle through all possible addresses so that you can measure the ROM outputs with eight data inputs to the analyzer.

Keep 16 data inputs connected to the address bus, if possible. It isn't necessary to measure all possible values of ROM output, but you should check sufficiently to verify that the correct ROM is selected and that every ROM is addressed correctly.

Since not all 65-k addresses are ordinarily allocated to ROM, it might be necessary to connect temporarily some pull-ups to the ROM outputs. With pull-ups, an address outside the allocated ROM addresses will generate a known data word (all highs).

You should also check some addresses outside those of the ROM to verify that the ROMs are off when they are not addressed. Remember to check the waveforms on the address bus and central lines, particularly on the control lines of the ROMs.

Finally, complete the processor-to-ROM link by removing any circuitry required to force the NOPs onto the μP and connecting the ROM outputs onto the data bus (Fig. 3c). A ROM containing a simple program, with several unconditional jumps, should be installed (Fig. 4). Verify operation of this program by monitoring the address bus with the analyzer.

The program includes RAM access and I/O instructions so that the RAM and I/O control cycles can be checked before the RAM and I/O devices are installed. The timing of these cycles is easily checked. Just use the analyzer to trigger a scope at the beginning of each RAM or I/O instruction.

It isn't necessary to monitor the data bus—unless there is a problem—because the sequence of program addresses is ample to verify proper execution of the program. Although only a very simple program is required to test the μP -to-ROM data link and the RAM and I/O control cycles, a more elaborate program can be used if desired.

Debugging RAM and I/O

In no case, however, should any branches on RAM or I/O instructions be used at this point, as the RAM and I/O blocks have not yet been turned on and debugged. If enough ROMs are available, the test ROM, and any others used in the turn-on procedure, should be saved for future units.

The checkout of the μP -to-ROM data link is by far the most tedious. The reason is that this link must always be a feedback process. That is, each instruction depends on the address, and each ad-

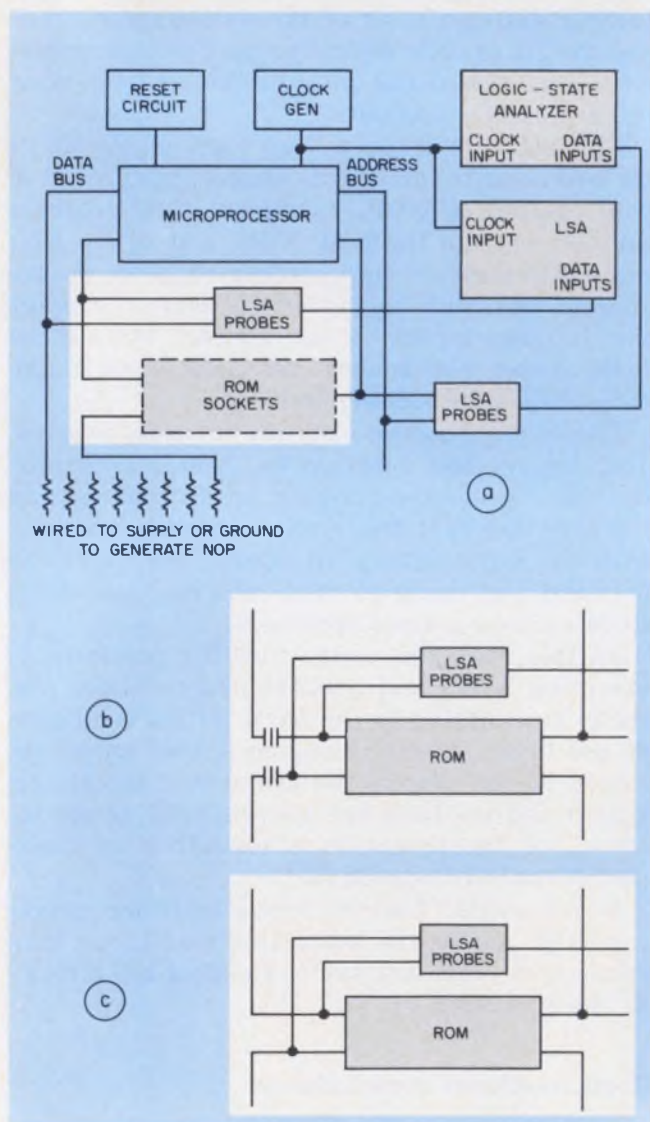

3. To check transactions between the μP and ROM requires three steps. The first step verifies NOP transmission (a), the second checks ROM addressing (b) and the last step tests the completed link (c).

dress depends on the previous instruction.

The RAM and I/O blocks can be turned on much more directly, and in any order. If you choose the RAM first, you can connect it to the system in one operation.

With the RAM connected, run the ROM test program briefly to verify operation. Pay particular attention to the timing of the RAM control signals during the RAM read and write instructions. The usual cause of failure at this point is a shorted address or data line, two lines shorted together, or an unwanted RAM response.

Again, the analyzer will reveal quickly the location of the problem, and a scope triggered from the analyzer will show the nature of the problem. With the ROM program verified, now run a RAM test.

A RAM test program should write to every location in memory, then read each location back and verify the data. With an eight-bit-wide memory, watch out for a pitfall:

The eight bits of memory represent only 256 states. Conventional memories are usually much longer. This means that each possible data pattern must be written several times to fill the memory. If the same data are written into each block of 256 words, an error in any of the higher order addresses can be masked.

An extreme example of such masking is the case where all address lines (A8 to A15) are disconnected. Any simple perturbation of the 256-word pattern—such as shifting the pattern one word location in each block—will reveal the problem (Fig. 5).

For example, if you count from 0 to 255 in the first block, you should count from 1 to 255,

then go back to ZERO in the next block; next, count 2 to 255, and go back to ZERO and ONE in the next block, and so on. The flowchart of an effective RAM-module test program is shown in Fig. 6. Remember, this test verifies that the memory system is working correctly—it does not check each cell of each memory location.

Again, if you design the program so that all locations are written and then read back, the analyzer quickly shows whether the data are correct. An oscilloscope triggered by an analyzer shows whether the waveforms are correct.

Although the I/O block is relatively easy to turn on, the discussion here is somewhat general since I/O structures vary more than other blocks from one μ P system to another. The main point is to test the I/O ports before connection to peripheral devices, such as keyboards, displays, or circuits to be controlled. The first step is to put the ROM test program back in, and verify that the control timing is correct with the ports connected during the I/O instructions.

You can check the output ports easily with a simple program that first sets all the ports to ZERO, then sets each port in turn to ONE, and finally sets each port back to ZERO one at a time. When testing the output ports, connect the analyzer to one block at a time.

If sufficient data channels are available on the analyzer, connect these to the address bus as well (Fig. 7). The object of this exercise is to see if the output ports are connected in the proper order and can be set both high and low.

The input ports are similarly tested. The program should check for each input high, then for each input low.

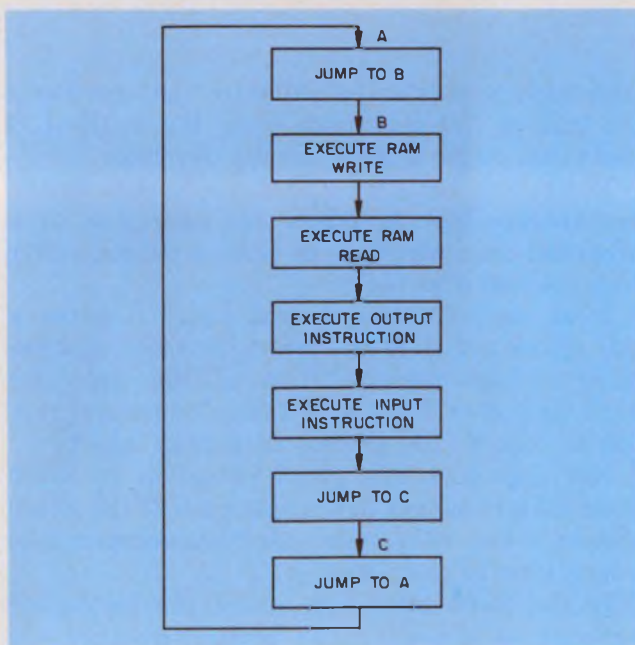

4. Verification program checks out the ROM-to-processor data link. Also checked are I/O control cycles.

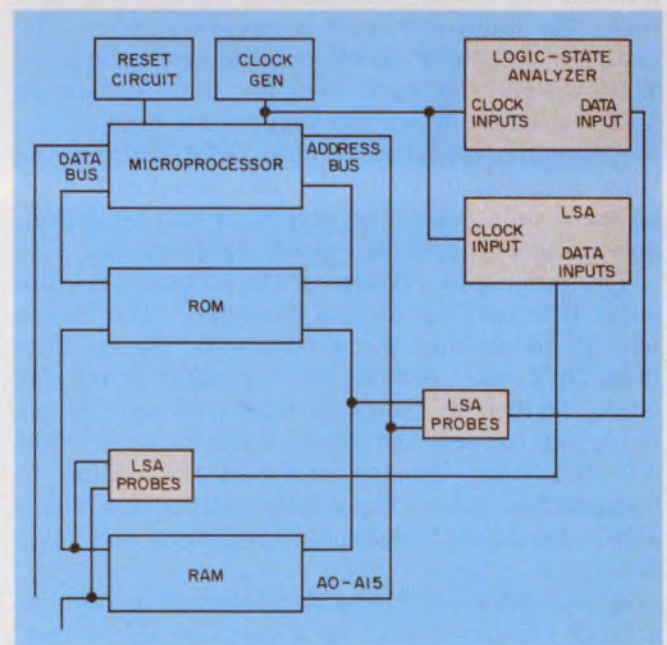

5. Test set-up to turn on the system RAM verifies the writing and reading of each location in memory.

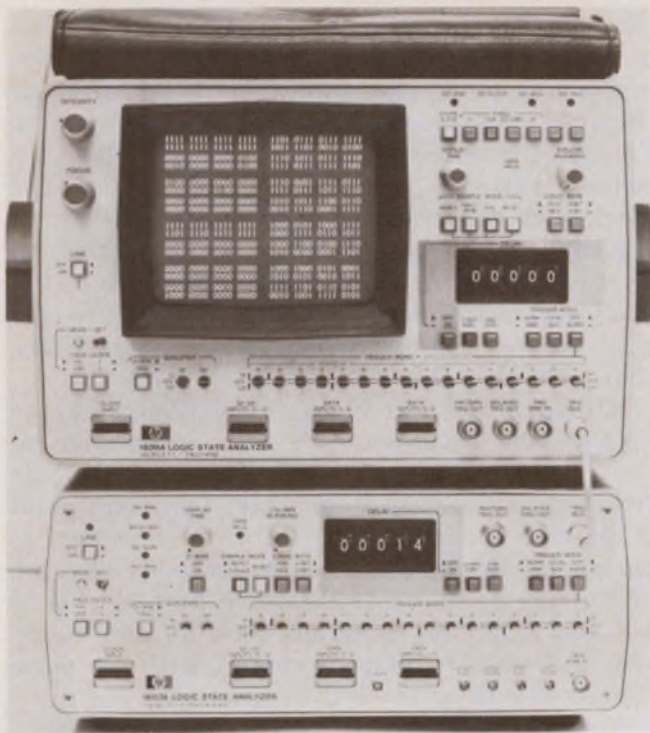

Logic state analyzer shows up to sixteen 32-bit words at a time. Data are put into memory when the instrument recognizes a selected word or are captured after a set delay.

The test, of course, is performed by a program that loops until the input under test is forced to the desired state, then jumps to another loop (Fig. 8). A simple approach is to pull all of the inputs either high or low, whichever is easier, through a resistor.

Assuming you selected the "high" approach, write a program that has two loops: the first to test for a specific input low and the second for that input high. While the analyzer monitors the address bus and at least the one input under test, force the input low with a grounded wire. The analyzer will show which loop the processor is in, exactly when the input went low and—usually in a second pass—when the input went high.

Although this process may seem tedious, the time required to write the test programs must be spent only once. The programs will be invaluable at every phase of system development.

The process of developing the software is quite a bit like turning on the hardware. The major idea is to develop the software in pieces. This idea isn't new. Nobody in his right mind sits down, writes six-thousand words of code, plugs it in, and expects the whole thing to work right off. You must develop and test the coding in manageable bytes. Three alternatives are available: simulators, breakpoint registers and logic analyzers.

A simulator—either a development system or a large computer—can be a valuable aid in testing such complex algorithms as sorting routines or mathematical functions. But it is difficult to

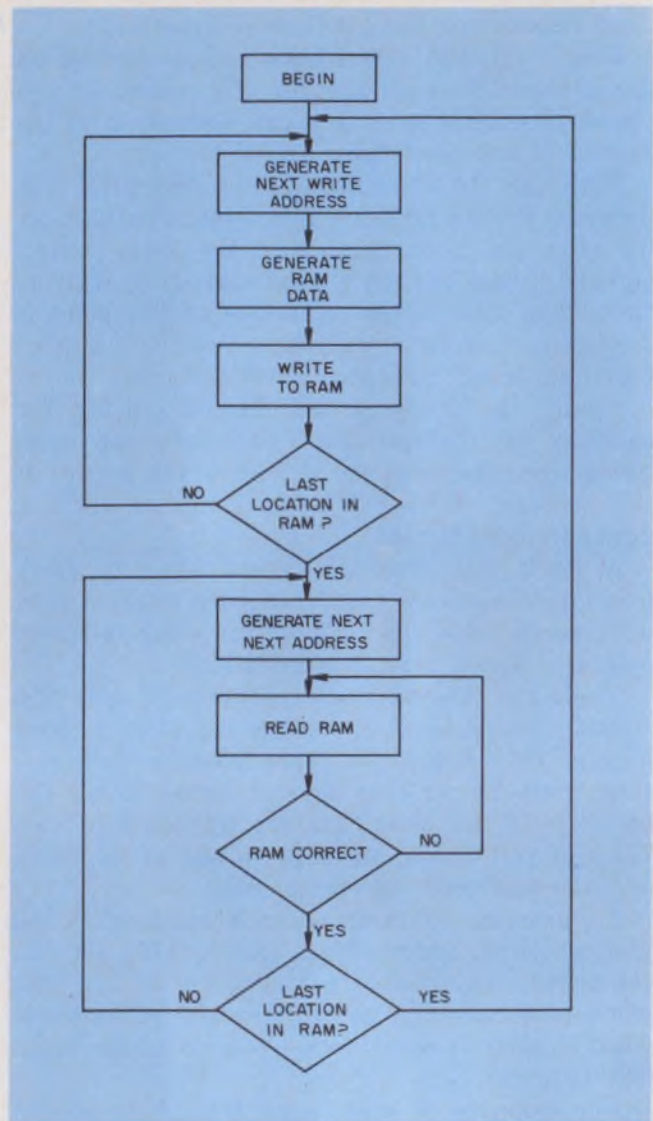

6. RAM-module test program wrings out memory system operation, as monitored by the logic analyzer.

adequately simulate the software that performs the bulk of I/O operations—and it's at the I/O ports that major trouble usually develops.

Breakpoint registers and a single-step button are another way to follow the operation of a program. Such registers, or control panels, suffer from several drawbacks:

First, to build the control panel requires a fair amount of time and effort. Second—and far more serious—the operation of the processor must be slowed down by a factor of several million to observe the process at human speeds.

Not only does this great reduction in speed cause major changes in the operation of the whole system, it can make even a simple algorithm take a long time to complete.

In the third technique, using the logic-state analyzer, it doesn't really matter whether the software has been simulated beforehand or not. (Although, as mentioned before, if a simulator

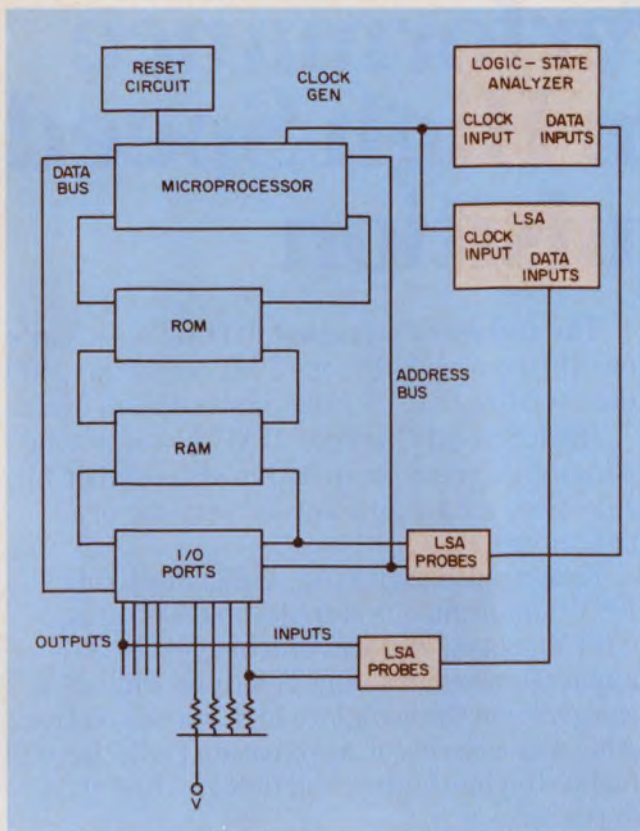

7. Test the I/O ports before you connect the system's peripherals. First, verify control timing.

is available, it can be a help in developing some parts of the software.) One clear advantage of the analyzer approach is that the hardware and the software are debugged in parallel instead of in series. Another is that the analyzer can monitor the program flow in real time.

In debugging software, you use the analyzer in the same way as when debugging hardware. In fact, most of the hardware debugging techniques are simply a matter of monitoring the flow of a simple program, then fixing the hardware when the program does not work.

The process of debugging software, as it usually arises, is really more a problem of identifying a problem, deciding how the software and hardware contribute to the problem, then doing the fix.

In pinpointing whether software or hardware is the culprit, the logic analyzer excels. Once the hardware is checked out—from the lock and reset generators, to the I/O ports—the software can be loaded in small blocks and tried out.

Although you can debug the software in any order, several rules may be helpful. It is usually best to turn on the keyboard or other entry device first, then any display or output device. Next, turn on the hardware and software together.

Note that the logic-state analyzer can serve as a breakpoint register. Connect its trigger output to a flip-flop and use the flip-flop output as the break signal (Fig. 9). ■■

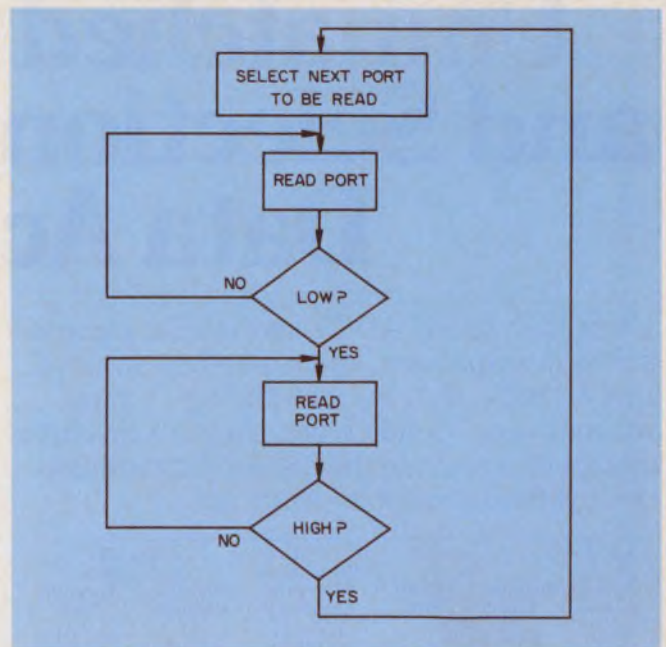

8. Input-port test program loops around to force the desired state, then jumps to another loop.

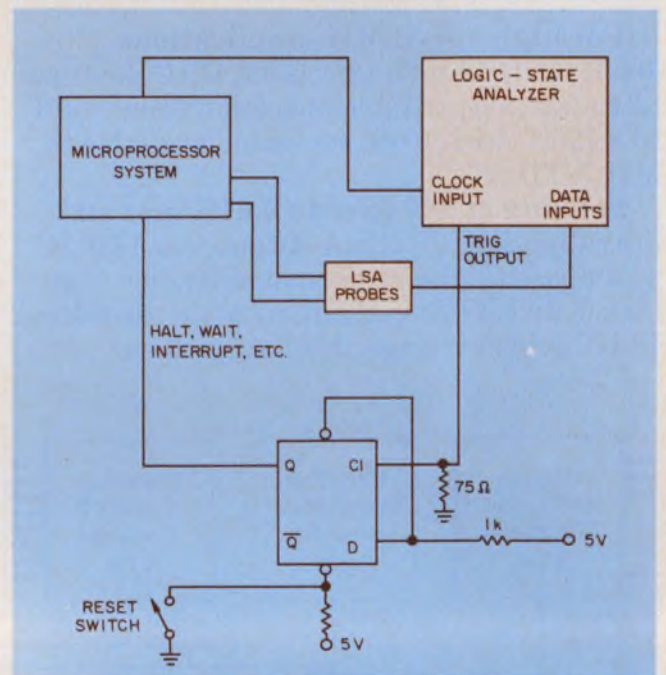

9. Connect the analyzer's trigger output to a flip-flop, and the instrument can halt or interrupt μP action.

Bibliography

Farnbach, W. A., "Logic State Analyzers—a New Instrument for Analyzing Sequential Digital Processes," *IEEE Transactions on Instrumentation and Measurement*, Vol. IM 24, No. 4, December, 1975, pp. 353-356.

Farnbach, W. A., "Troubleshooting in the Data Domain Is Simplified by Logic Analyzers," *Electronics*, May 15, 1975, pp. 103-105.

House, C. H., "Engineering in the Data Domain Calls for a New Kind of Digital Instrument," *Electronics*, May 1, 1975, pp. 75-81.

Small, C. T. and Morrill, J. S. Jr., "The Logic State Analyzer, A Viewing Port for the Data Domain," *Hewlett-Packard Journal*, August, 1975, pp. 2-10.

Unmatched Performance and Selection in High Speed Data Acquisition

Ultra-high speed ADC's and DAC's, sample-holds, multiplexers, and super-fast op amps. Individually, they're outstanding — many without peer. Collectively, they are carefully matched to provide the fastest data acquisition systems available. Anywhere.

Ultra-High Speed ADC's	Resolution	Conv Time	Gtd Throughput Rate with 4855S/H*	Add a 4550 Multiplexer Time per Channel	Throughput
4130	8-bits	0.75 μ s	1.25 MHz	1.10 μ s	909 kHz
4131	10-bits	1.00 μ s	940 kHz	2.12 μ s	471 kHz
4133	12-bits	2.50 μ s	377 kHz	3.30 μ s	303 kHz

*Model 4855 features 250 nsec acquisition time to 0.01% and an aperture time of 2 nsec max.

For high speed MIL-applications, our 4058, a true 12-bit microcircuit DAC, features ultra-fast, ultra-stable operation from -55°C to $+125^{\circ}\text{C}$ with 100% screening available to MIL-STD-883.

Settling at 200 nsec to 0.01% max and providing 10 V @ 50mA output, our 1430 IC op amp is still the performance leader. Combine it with 4058: without question the fastest 12-bit hybrid voltage DAC. Anywhere.

The industry's fastest MDAC's — that's our 4070 series. 8, 10, or 12-bit resolution, 500 nsec settling to 0.1%, and inputs up to 7 MHz.

High Speed Current DAC's — our 4060 series give you a competitive and compatible selection, with a guaranteed settling of 85 nsec to $\pm 0.1\%$.

Radar pulse digitizing, video digitizing, FFT, simultaneous sample-hold systems, CRT displays, and waveform synthesis — applications where only Teledyne Philbrick can give you the complete high speed solution. And, a new series of Application Bulletins will facilitate your high speed design. Just write for them.

Teledyne Philbrick, Allied Drive, Dedham, MA 02026 — Telephone (617) 329-1600. In Europe, Telephone 673.99.88, Telex 25881, or write 181 Chaussee De La Hulpe, 1170 Brussels.

TELEDYNE PHILBRICK

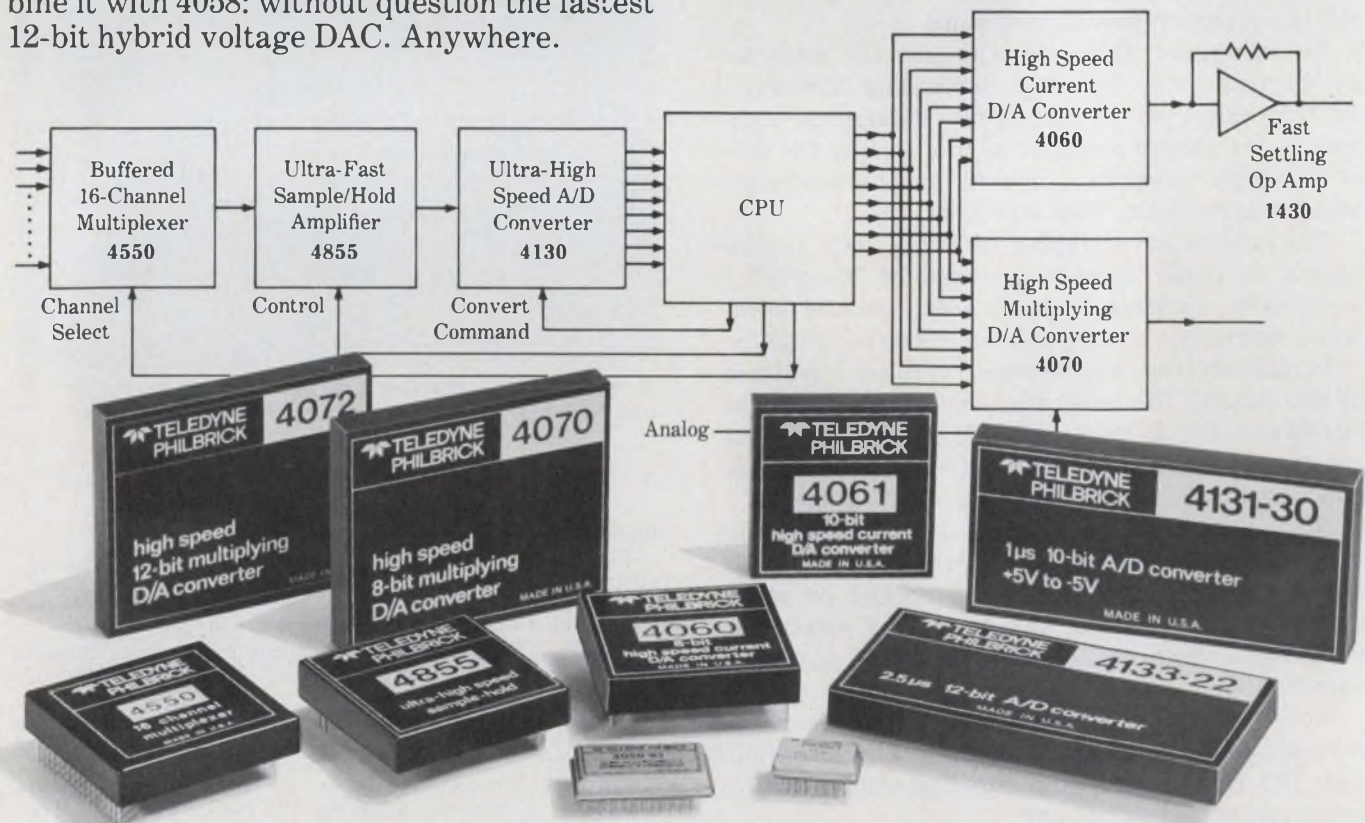

The Ansley "D" Connector...



Our new series of male and female "D" connectors offer you a cost effective external mass termination cable and connector system second to none. Its uniqueness begins with a one-piece "D" connector package that meets industry standards for size, pin spacing, and contact reliability. With no loose parts to match up, positive cable-to-contact alignment is assured. Conductors are mass terminated in seconds with our standard BLUE MACS™ hand or bench tools. The results? Faster installation, higher reliability.

Contact pins are spaced on .054" centers — a perfect fit for any standard inter-cabinet "D" type connector application. Our new "D" connectors are designed to mate with standard 50 mil pitch flat cable as well as our new, improved jacketed cable — the only flexible flat cable engineered specifically for out-of-cabinet use.

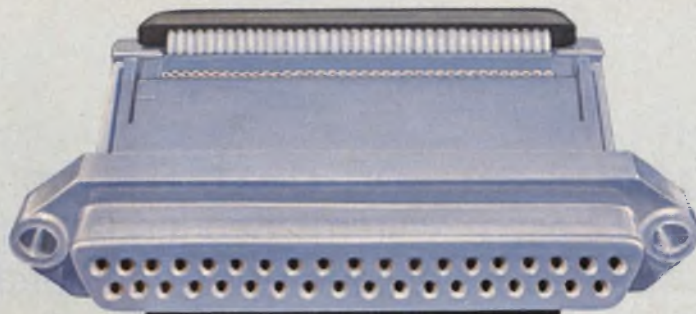

a new meaning to cost effectiveness.



The Ansley BLUE MACS™ jacketed cable is U.L. listed for external interconnection of electronic equipment. Electrically, it outperforms standard jacketed twisted pairs in typical I/O applications. And there's no special zipper lock tubing required — reducing the need for an extra cable accessory. Installation is faster, easier. And like all Ansley connectors, you can daisy chain our "D" types anywhere in the cable — along with our DIP socket, card edge, or pc board connectors.

Cable alignment and high contact reliability is assured — because both cable and connector are grooved for absolute alignment. Our patented TULIP™ 4-point insulation-displacing contacts are permanently fixed and sealed-in to provide a reliable, gas-tight, corrosion-free mass termination.

For the full reliability/cost effectiveness story and technical data, call or write:

T&B / Ansley

The mass termination company.

**T&B/Ansley Corporation • Subsidiary
of Thomas & Betts Corporation**
3208 Humboldt St. • Los Angeles, CA
90031 • Tel. (213) 223-2331 •
TWX 910-321-3938

**Available through authorized
Ansley distributors**

In Canada: T&B/Ansley, Ltd.
700 Thomas Ave.,
Industrial Park
Iverville, P.Q.



Get simultaneous analog outputs from your microprocessor-based system. Sequential addressing delays can be eliminated if you add extra data latches.

Interfacing digital-to-analog converters to a microprocessor is a straightforward job. Just connect them to the output bus and assign them channel numbers. Each converter will then deliver its analog output when addressed. But this isn't sufficient if you need several simultaneous output changes because individual addressing creates time delays between adjacent channel outputs.

You can avoid the time delays by first having the data for all channels stored in an array of buffer latches and then, after all channels are loaded, strobing the d/a converters so they all get the data at the same time.

A typical sequential system for multiple analog outputs has data transferred from the processor to the Channel-1 data latches using software commands and external control logic (Fig. 1). As soon as the data are latched, d/a conversion for Channel 1 begins.

The computer then generates a second set of software instructions that transfer data to Channel 2's data latches. When the new data are latched, conversion on Channel 2 begins. This process repeats until all data-output channels are accounted for.

For a given computer or microprocessor, the time interval between the beginning of the d/a conversion on one channel and that of the next channel can be calculated. All you need to assume is that all output data are already stored in the computer memory so that all transfer times are the same.

Let's use the National Semiconductor (Santa Clara, CA) IMP-16 microprocessor as a specific example of how the two data-output methods compare.

With conventional sequential addressing, to send data to an output channel requires three instructions for the first channel and two instructions for each additional channel. The first channel needs an instruction that identifies that

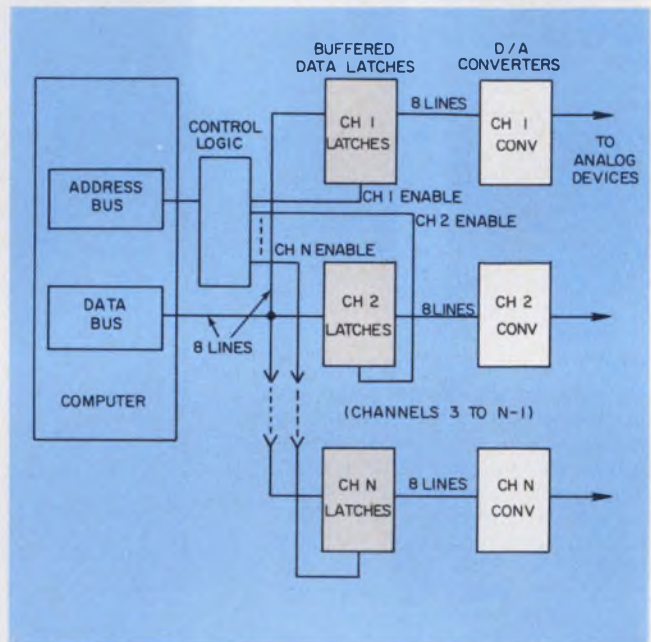

1. A sequential-output d/a-converter interface can delay the signals by approximately 20 μ s for each channel fed by the computer.

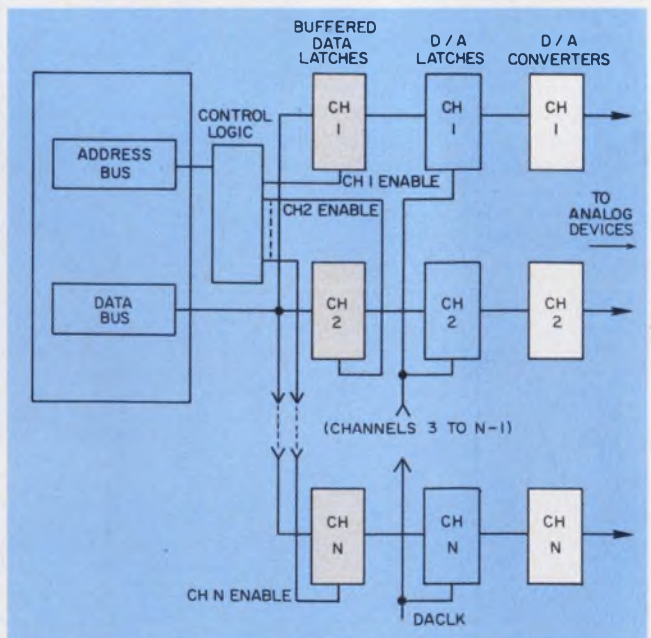

2. To obtain simultaneous analog outputs from a multi-channel d/a converter system, use an extra set of latches to hold the digital words.

John Connors, Senior Technical Staff, Henry Bell, Senior Technician, Bernard Nordmann, Senior Technical Staff and David Wainland, Senior Technical Staff, Naval Surface Weapons Center, White Oak, MD 20910.

channel's address. For all subsequent channels, the new address can be entered as part of the output instruction.

The two main instructions required include the LD command, which takes the stored data and sends them to a location from which they can be transferred to the output channel selected. The other command, ROUT, transfers the data from the computer to the output channel. A simple output program for this sequence is shown in Table 1.

Execution time of the two instructions on the IMP-16 requires a little less than 20 μ s. Therefore the time interval between the beginning of d/a conversion on one channel and on the next is 20 μ s. Also, if there are N channels, the d/a conversion on the Nth channel would begin (N-1) \times 20 μ s after the first channel—a considerable delay if you need simultaneous changes.

Extra latches eliminate the delay

There is an alternative (Fig. 2) for applications where time delays like the one just described are intolerable. An additional set of data latches for each channel can be added to hold data before strobing the d/a converters. Data are transferred from the computer to the extra latches in the same way they were transferred to the converters, as explained earlier. However, the d/a converter latches are disabled. After data have been transferred to all N channels, a pulse from the computer or generated externally enables the d/a converter latches and transfers data to all converters simultaneously so that all converter outputs will change at the same time.

Let's see how this simultaneous interface circuit goes together for a dual-output system. Data transfer from the computer is accomplished by use of software instructions, a decoding circuit and the d/a converter interface. The software routine needed is shown in Table 2 and the decoding circuit and d/a interface are shown in Figs. 3 and 4, respectively.

The software places data on the computer's buffered 16-bit data-out bus (BDO), loads the correct address on the 16-bit address bus (ADX) and supplies the decoder and interface circuits with pulses to control the latches. Data that go to the BDO bus must originate in the IMP's accumulator 0 (AC0).

The first instruction shown in Table 2 (line 100) loads data into AC0 from wherever they are currently being stored. The address sent to the ADX bus is the sum of the contents of accumulator 3 (AC3) and the seven-bit channel address specified in the output instruction, ROUT N.

You have the option of how to allocate the word for the address bus. In the system shown, bits 3

Table 1. Sequential output program

Program address	Label	Command	Comments
50	DATA1:	.WORD 75A6	
51	DATA2:	.WORD 6847	
52	DATA3:	.WORD FF83	
53	DATA4:	.WORD 8000	
100	WAIT:	BOC 00, WAIT	; Program is halted ; at line 100 until signal ; is received on condition ; bit "00" indicating it ; is time for computer ; to output data.
101		LI 3, 18	; Places device address 3 ; + channel address 0 in ; accumulator 3.
102		LD 0, DATA1	; Place contents of ; DATA1 in AC0
103		ROUT 0	; Data are output to ; channel 0 of device 3
104		LD 0, DATA2	; Contents of DATA2 ; are placed in AC0
105		ROUT 1	; Data are output to ; CM1 approx. 20 μ s ; after data were output ; to CM0
106		LD 0, DATA3	
107		ROUT 2	; Data are output to ; CH2 approx. 40 μ s ; after data were output ; to CH0
108		LD 0, DATA4	
109		ROUT 3	; Data are output to ; CH2 approx. 60 μ s ; after data were ; output to CH0

Table 2. Simultaneous output program

Program address	Label	Command	Comments
50	DATA1:	.WORD 0125	; DATA1 & DATA2 are memory
51	DATA2:	.WORD 0672	; locations containing stored ; data
100		LD 0, DATA1	; Load AC0 with contents of ; DATA1
101		LI 3, 18	; Load AC3 with 18 hexadecimal
102		ROUT 0	; Add 0 to AC3 and send the ; sum to ADX BUS, send con- ; tents of AC0 to BDO BUS, ; pulse WRP and WRPA lines.
103		LD 0, DATA2	; Load AC0 with contents of ; DATA2
104		ROUT 1	; Add 1 to AC3 and send sum ; to ADX BUS, send contents ; of AC0 to BDO BUS, pulse ; WRP and WRPA lines.

to 6 identify an interface device and permit up to 16 peripheral units. The three remaining bits, 0 through 2, correspond to the channel code for a particular device. This lets each device handle up to eight channels. The nine bits remaining can be used for further system expansion should the need arise.

The address for the first channel is given on lines 101 and 102 of Table 2. The sum specifies channel 0 of device 3 (the d/a interface). Execution of line 102 transfers this address to the

ADX bus, sends the contents of AC0 to the BDO bus and provides two latching pulses, WRP and WRPA.

Program lines 103 and 104 repeat the process for Channel 1. Line 103 loads the new data into AC0 and line 104 updates the address, sends the address and data to their respective busses and supplies the two latching pulses.

When the device and channel numbers are transferred to the ADX bus, they also appear on the input lines of the 74175 latches in the decoder circuit of Fig. 3. The WRP pulse latches the address, then the two 74154 decoders can enable the proper device-number and channel-number lines. A selected decoder line is LOW, while all unselected lines are HIGH. Decoder timing relationships are shown in Fig. 5a.

When data are transferred to the BDO bus they also appear at the input lines to the buffered

data latches of each channel. Latching the data to the proper channel's latches is the job of the control logic circuit of Fig. 4. This circuit prevents Channel 1 from receiving Channel 0 data, and vice-versa.

Inputs to the control-logic circuit include the device-3 decoder line, Channel-0 and Channel-1 decoder lines and the WRPA line. All the decoder lines are inverted and then the inverted lines for device 3 and Channel 0 are NANDed with WRPA to provide an enabling pulse to lock Channel-0 data into the latches. Similarly, the inverted Channel-3 line and the Channel-1 line are NANDed to enable the Channel-1 latches.

The timing sequence for latching in the data is shown in Fig. 5. When the inverted device and channel numbers and WRPA are all HIGH (starting at t_1), the NAND output goes LOW. About 100 ns later, at t_2 , the WRPA line goes

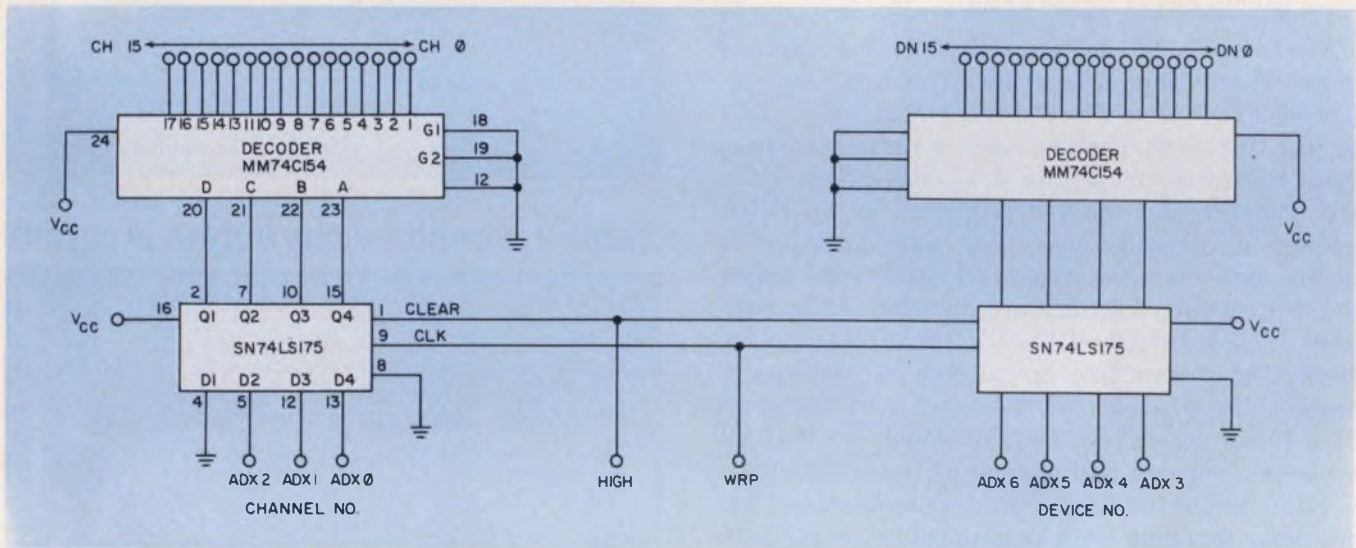

3. The channel and device number can be decoded by using a latch and a one-of-16 decoder. This system can

be expanded for as many channels as you need, just by adding extra latches and decoders.

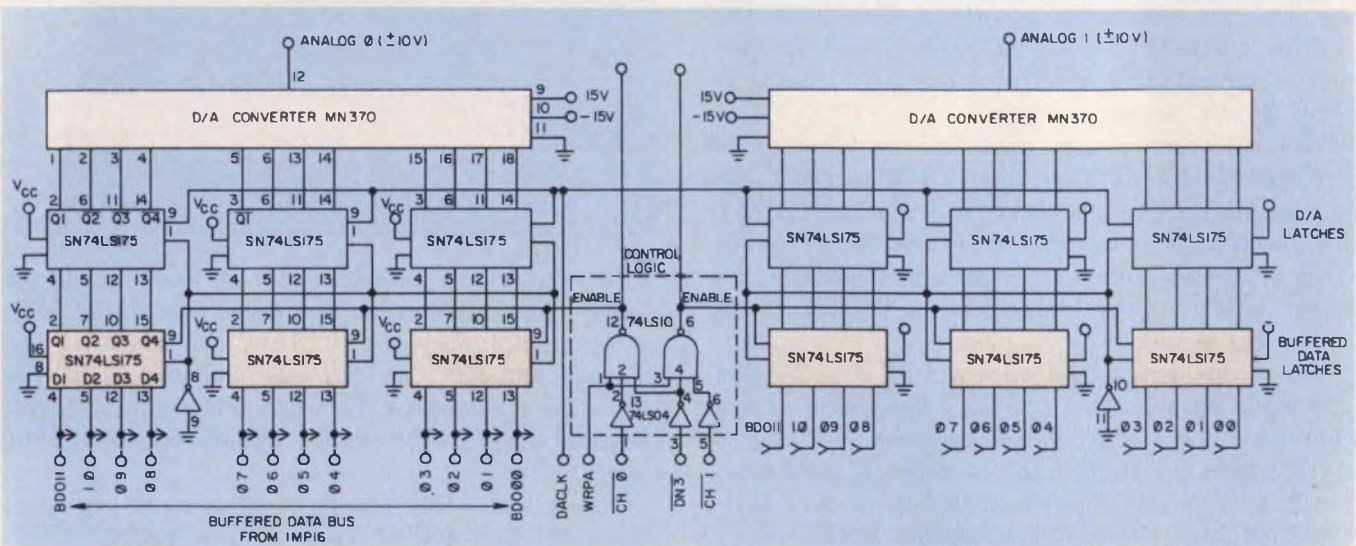

4. The d/a-converter interface circuit uses an extra set of data latches to buffer the computer data and store

the data until all channels are loaded. A common strobe signal starts all the converters.

LOW and returns the NAND gate to a HIGH output. At the same time data on the BDO bus are latched into the data buffers.

Once all the data latches are loaded, the data can be transferred to the d/a converters by a pulse on the data clock line (DACLK). Since the data appear simultaneously (barring propagation delays) on all the converter inputs, all outputs will change simultaneously. All the d/a converter-latch outputs are inverted except for the most significant bit. This was done to convert the two's-complement format used in the IMP to the type of binary code required by the d/a converter selected, in this case a Micro Networks (Worcester, MA) MN370.

Since the circuit uses low-power, Schottky TTL, bypass capacitors should be included to eliminate any chance of faulty operation due to current spikes at the clock frequency. A 0.01- μ F capaci-

tor should be used across each package's supply leads and a 10- μ F capacitor should be connected across the supply leads where they enter the circuit board.

The two-channel interface can easily be expanded to handle more channels. For instance, if eight channels are needed the following modifications must be made: For each new channel, connect up additional latches and d/a converters as shown for the two channels (in Fig. 4). Then, connect the NAND-gate inputs to the inverted decoder output of device 3, to WRPA and to a previously unused channel-decoder output, between 2 and 7.

There is an alternative to the additional data latches used for each converter (Fig. 6). Try using multiple sample-and-hold amplifiers to hold the analog signals. Since there are no latches, the d/a conversions all take place at different times. When the DACLK line is pulsed, data from d/a converters get locked into the amplifiers.

The costs of the s/h circuits are still higher than that of the extra latches, so this method really isn't economically feasible. Also, voltage offsets, drifts and decay are error sources for the s/h circuits.

Table 3. System self-test program

Program address	Label	Command	Comments
1	LOOP:	.WORD 0FFF	;12 bit counter to cycle
2	START:	.WORD 07FF	; through all possible codes.
3		LI 3, 018	; Represents positive full
4	LP1:	LD 2, LOOP	; scale
5		LD 0, START	; Select Device 3, CH 0.
6	LP2:	ROUT 0	; Dev. 3, CH 0.
7		ROUT 1	; Dev 3, CH 1.
8		PFLG 0	; Gate data into d/a.
9		AISZ 0, -1	; Decr d/a code.
10		RCPY 1, 1	
11		AISZ 2, -1	; Decr loop counter.
12		JMP LP2	
13		JMP LP1	
	.END		

Let the system check itself

Once you have the system up and running, every so often you can run a self-check to make sure the system is still operating properly. Table 3 lists a program that will test the operation of the d/a-converter interface. Each complete loop through the program provides a staircase output from each d/a converter. The range of each unit will vary from +10 to -10 V and if you continuously loop through the program you can see the converter outputs on an oscilloscope.

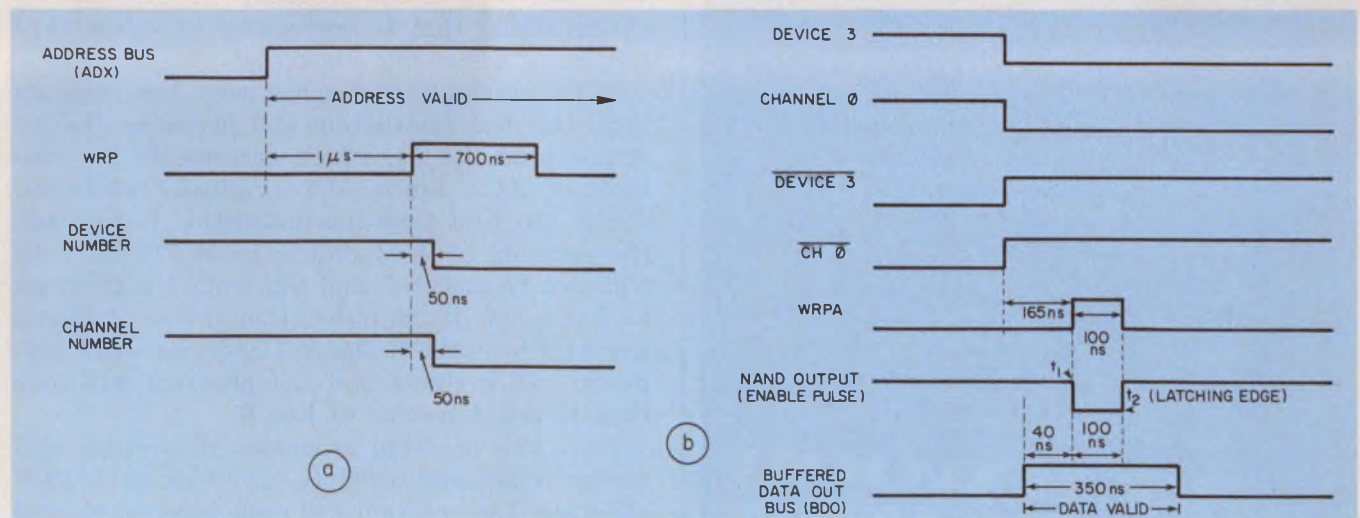

5. Timing relationships for the decoder circuit (a), and the d/a interface circuit (b), have no critical conditions.

After the device is selected, the enable pulse transfers data from the buffers to the converters.

New Hi-Temp Thermostat

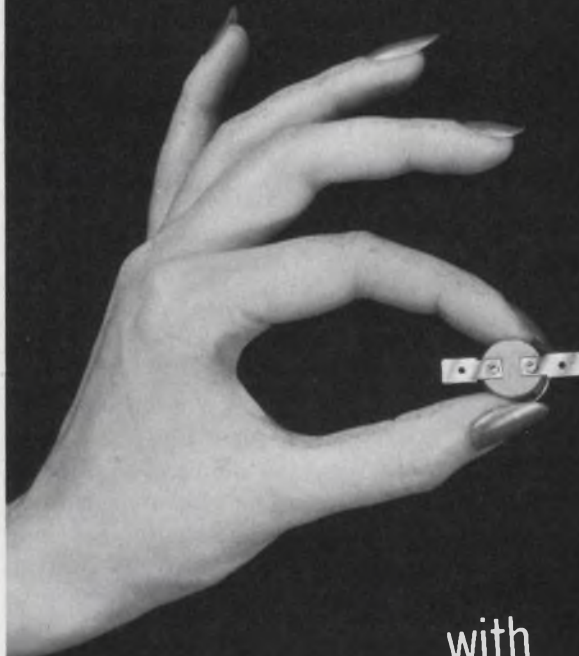

...with
European Acceptance

Ideal for a variety of high temperature applications! Elmwood's new snap-action RC thermostats include a glass-bonded mica (ceramo-plastic) base that allows set points to 550°F (290°C). The patented metal sleeve insert and rivet construction permit listings by European agencies as well as U.L. and C.S.A. The RC's are SPST, pre-set, tamperproof, and available with mountings, terminals and brackets to suit. Want more? Call or write Elmwood Sensors, Inc., 1659 Elmwood Ave., Cranston, R. I. 02907. Phone 401/781-6500. European Div., Elmwood Sensors Ltd., North Shields, Tyne and Wear, England.

ELMWOOD SENSORS

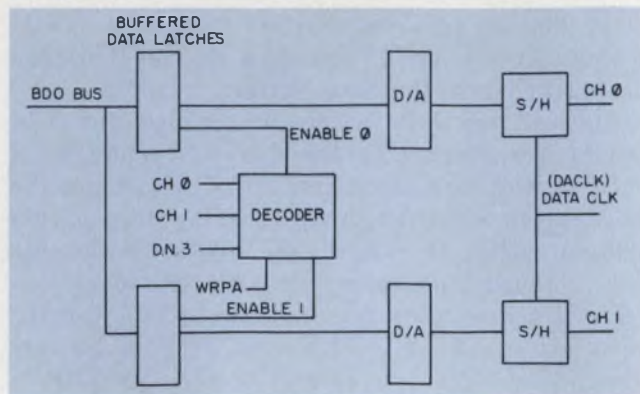

6. An alternative to the extra data latches uses multiple sample-and-hold amplifiers to store the analog outputs of the d/a converters.

Line 1 of the program is a memory location that contains the data word $\text{\$FFF}$ which will be used to count the number of program cycles. (All numerical values in Table 3 are in hexadecimal notation.) Line 2 defines another location that contains the data word $\text{\$7FF}$, which corresponds to the positive full-scale value of the d/a converter. The next program line (line 3) loads the code for device 3 and Channel 0 into AC3. Hex value 18 corresponds to device 3, Channel 0. Line 4 loads the contents of LOOP (data word $\text{\$FFF}$) into accumulator 2 while the next line loads the contents of START ($\text{\$7FF}$) into AC0.

Lines 6 and 7 output the contents of AC0 into Channels 0 and 1, respectively. After these two instructions each channel's buffered latches contain the binary equivalent to 7FF. Line 8 pulses a computer flag that is connected to the DACLK line for test purposes. When the flag is pulsed, the 7FF data are transferred to the d/a converters and conversion begins.

The instruction given on line 9—add immediate, skip if zero (AISZ)—adds -1 to the contents of AC0 thus decrementing it by 1. In this way each cycle of the program will generate an analog signal that is decreasing in value, thus forming a descending staircase.

If the accumulator reaches zero, the program skips the next instruction and performs the instruction on line 11, which decrements the contents of AC2. Since AC2 originally contained $\text{\$FFF}$, the first time the instruction is followed the contents of AC2 reduce to $\text{\$FFE}$. Line 12 will then be executed, and this loops the program back to line 6. If the instruction of line 11 causes the AC2 to reach 0, the d/a converter will output a -10-V signal and the program will loop back to line 4 instead of line 6.

Thus, this program generates all possible converter codes and produces a $+10$ to -10-V staircase. The program will cycle indefinitely and can only be stopped by pressing the Halt or Initialize switch on the computer front panel. ■■

STANDARD DIP NETWORKS

14 and 16 pin... hundreds
of values... stock items:
22 ohms to 100k.

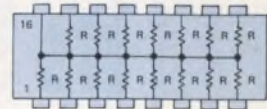
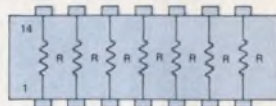

THICK FILM RESISTOR

DIP'S

CUSTOM DIP NETWORKS

Our computer controlled laser has solved thou-
sands of custom designed dip and sip networks
... use it to solve your's!

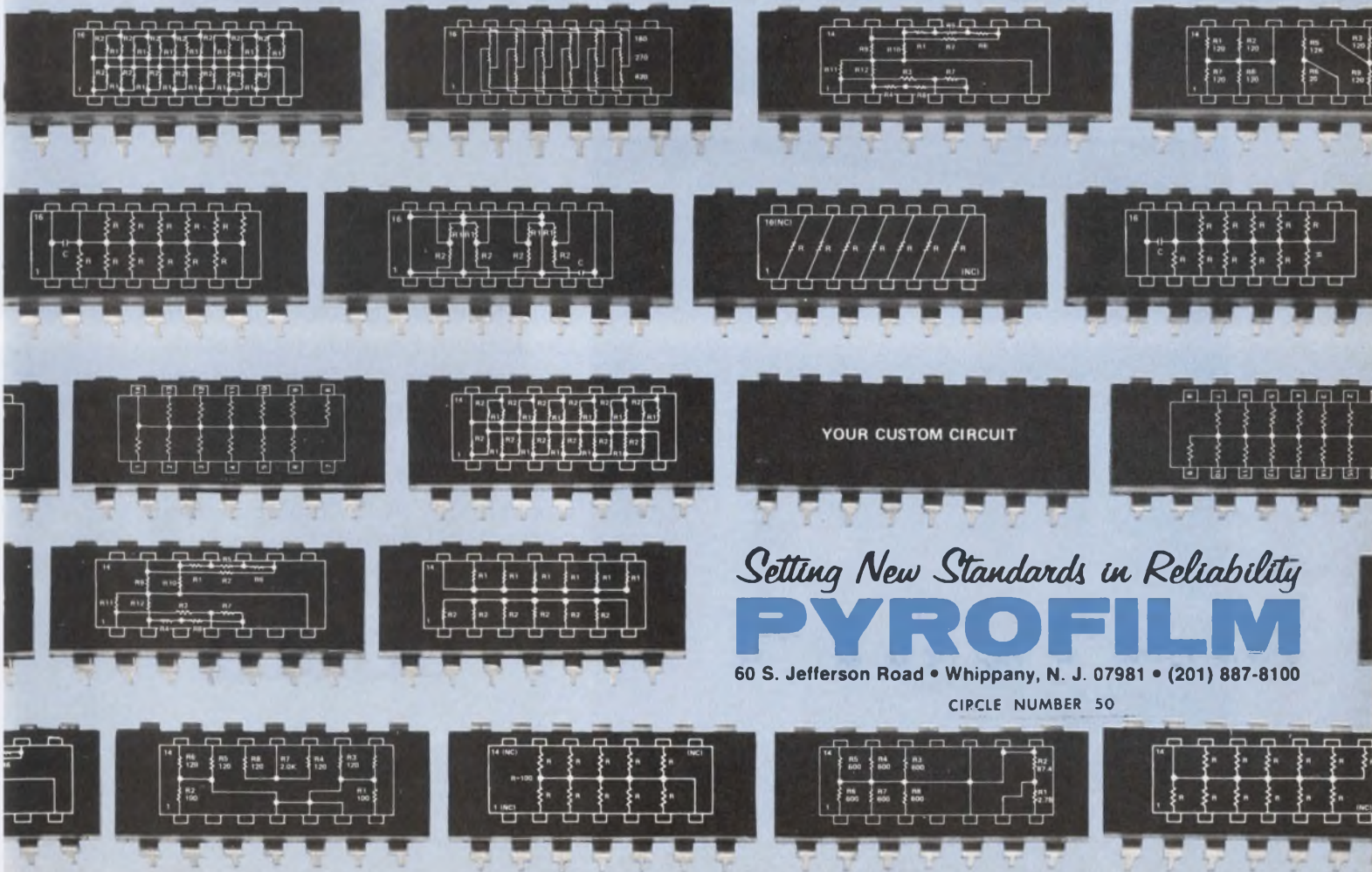

YOUR CUSTOM CIRCUIT

Setting New Standards in Reliability
PYROFILM

60 S. Jefferson Road • Whippany, N. J. 07981 • (201) 887-8100

CIRCLE NUMBER 50

**If it weren't for its frequency response
of 30 Hz at 100 mm,
its 99.65% linearity,
its pressure-ink writing,
its highest quality traces,
its full range of plug-in conditioners,
its 12 chart speeds, and
its wide channels,
the GOULD/Brush 2400 would be like
most any other direct writing recorder.**

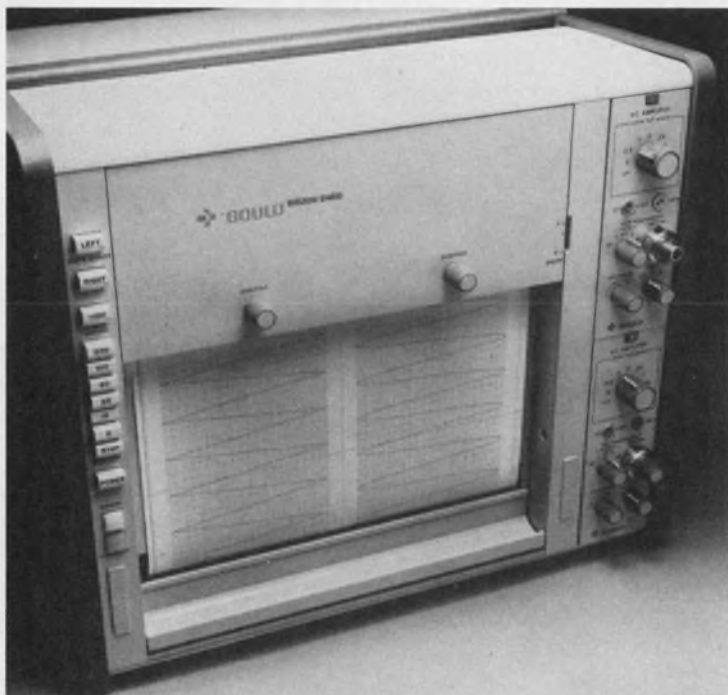

But because of all this, it's the best performing direct writing recorder on the market today. When you see it, you'll believe it. So call your nearest Gould Sales Engineer today for a demonstration. Or, for more details, write Gould Inc., Instrument Systems Division, 3631 Perkins Avenue, Cleveland, Ohio 44114. Or Gould Allco S.A., 57 rue St. Sauveur, 91160 Ballainvilliers, France.

 **GOULD**

PHONE TOLL FREE TODAY FOR TECHNICAL BROCHURE (800) 648-4990.

CIRCLE NUMBER 45



TOGGLE TERRITORY.

It's anywhere you are in the whole land.

It's anywhere you have to put your hands on exactly the right toggle switch to complete your design.

Especially if you need extraordinary design flexibility, distinctive appearance and proved performance in your toggle switches.

Cutler-Hammer not only provides the broadest line of toggle switches available, but offers you the greatest selection of ratings, terminations,

hardware, toggle shapes, materials and colors.

AC-rated. AC/DC. Low energy. Dry-circuit capability, or up to 25 amps. One, two and four poles. Select Cutler-Hammer Designer Line, miniature, slow-make/slow-break or hesitation switches from the complete Cutler-Hammer line. We have thousands of varieties ready for delivery. And if the toggle you need isn't among those thousands, we'll work with you to build exactly what you want.

You needn't look very far to get the finest quality in toggle switches. Wherever you are in the U.S.A., get the toggle you want. Because we cover Toggle Territory best. With

more distributors than anyone else. Call your Cutler-Hammer Sales Office or Stocking Distributor. Or write for full-line catalog LD-110A.



Switch
to No.1

More than just switches;
prompt availability,
field help, innovation,
quality assurance, too.



CUTLER-HAMMER
SPECIALTY PRODUCTS DIVISION, Milwaukee, Wis. 53201

CIRCLE NUMBER 52

Announcing...the new Electronic Design®

Book Club

(The new NO OBLIGATION book club*!)

*As an *Electronic Design* subscriber, you're already a member.

NO OBLIGATION TO BUY...UP TO 25% DISCOUNT ON ALL BOOKS...GREAT BUYS ON THE BEST BOOKS FOR ENGINEERS FROM LEADING PUBLISHERS.

Membership in a book club usually means you're obligated to buy a certain number of books a year. Not with us. As a subscriber to *Electronic Design*, you're already a member in good standing of the "Electronic Design Book Club." And, you're entitled to all club discounts.

Because you subscribe to *Electronic Design*, we know you belong to a select group of professionals who are always on the lookout for new publications to keep up on the latest developments in the field.

Why should we pressure you with rules and regulations? So, rest easy. Here, there are no membership forms to obligate you. *Only great buys on the best and most popular books for engineers from leading publishers!*

Sound like a good deal? It is. Just watch the pages of *Electronic Design* for all club announcements and take advantage of great discounts—on every single book we list.

Every step of amplifier design now faster and easier with this concise, on-the-job handbook...



High-Frequency Amplifiers

Ralph S. Carson

Actually reduces high-frequency amp design to systematic formulas and techniques, taking the sweat and error out of calculating transistor parameters; stability; power gains; tunability; bandwidths; every step of amp design! Uses Smith Chart on transmission lines, matching and microstrip networks, parameter variations. Includes scattering parameters. Wiley list price: \$14.95

Subscriber's club price: \$11.95
Order #S123

"... a dazzling array of products and possibilities..."
—Alvin Toffler

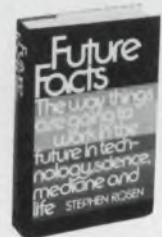

Future Facts: The Way Things are Going to Work in the Future in Technology, Science, Medicine and Life

Stephen Rosen

Delicious reading for any technical person — more provocative than the wildest science fiction — it presents forecasts based on present technology — synthetic blood; chemical light; from N.Y. to L.A. in 21 minutes; enzymes to stay young; geothermal power; moving sidewalks; flying trains; memory expansion; many other fantastic future facts! Simon & Schuster list price: \$14.95

Subscriber's club price: \$11.95
Order #S124

The Psychology of Computer Programming

Gerald M. Weinberg

"The best book about programming yet to be published..." — *Datamation*. This fascinating book reveals the human factor in programming. Explores the behavior and thought processes of programmers in their daily work. Here is must reading for every computer professional. Van Nostrand list price: \$9.50.

Subscriber's club price: \$8.50
Order #S102



Power Semiconductor Circuits

S. B. Dewan & A. Straughen

Complete coverage of the design of converter power circuits, including the specification of required thyristors and diodes. Treats various kinds of converters chapter by chapter. All methods have been applied to the design of industrial equipment. Wiley list price: \$26.50

Subscriber's club price: \$19.95
Order #S122



Assembly Level Programming for Small Computers

Walter J. Weller

Gradually builds your skills in every aspect of assembly level programming applicable to a wide range of minicomputers. Improves your problem-solving abilities with practical problems in real time control, monitoring, and data acquisition. Lexington Books list price: \$14.95

Subscriber's club price: \$12.70
Order #S101



Modern Data Communication: Concepts, Language, and Media

William P. Davenport

An on-the-job handbook mapping out the latest techniques, systems, and services for the most efficient data transmission. Includes simplified coding techniques; ways of dealing with distortion, distraction, interference; efficiency and control techniques; modulating and multiplexing methods; and good advice on system costs. Hayden list price: \$10.30

Subscriber's club price: \$9.25
Order #S111



Game Playing with Computers, Second Edition

Donald D. Spencer

Now you can match your wits against a digital computer! Here are over 70 games, puzzles, and mathematical recreations, along with more than 25 complete programs in FORTRAN or BASIC. Binary games, casino and board games, unusual gambling games and many others. Hayden list price: \$14.95

Subscriber's club price: \$12.70
Order #S112



Microprocessors: New Directions for Designers

Edward Tarrero

Here's two years of a wealth of information on microprocessors from *Electronic Design*. It's packed with data and advice on selecting micros, and operating and improving them to your best advantage. It's the "last word" in micros. Hayden list price: \$8.95

Subscriber's club price: \$7.95
Order #S100



Fundamentals and Applications of Digital Logic Circuits

Sol Libes

Includes everything from basic theory to the most advanced applications—circuitry of calculators, voltmeters, frequency counters, and the latest computer applications. Explores the applications of RTL, DTL, TTL, and other gating circuits. Hayden list price: \$8.98

Subscriber's club price: \$7.20
Order #S121



Just published!

The first authoritative study of the computer's great potential for crime, by "the leading expert on the history of computer crime."—*Fortune*

Crime by Computer

Donn B. Parker

Fascinating case histories reveal startling new kinds of million-dollar fraud, theft, larceny, and embezzlement. Who's doing it, why, how, and how to stop them. Explores invasion of personal privacy, computer intimidation, and the future of white-collar crime. "Must reading for those involved in electronic data processing..."—*Publisher's Weekly*. Scribner's list price: \$10.95

Subscriber's club price: \$9.30
Order #S117



Digital Signal Analysis

Samuel D. Stearns

"Highly recommended for practicing engineers"—*IEEE Transactions*. Featuring a Foreword by Richard Hamming, this ideal master handbook on signal processing contains recent advances, new design material, and a comparison between continuous and digital systems extremely helpful to newcomers. Hayden list price: \$18.95

Subscriber's club price: \$15.20
Order #S120

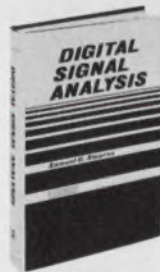

Assembler Language Programming: The IBM/360 and 370 Second Edition

George W. Struble

This guide offers a double value, enabling you to gain command of the structure and operation of the System/360 and 370, as you master the system's versatile assembler language. This new edition contains additional problems and examples to strengthen your working knowledge. Addison-Wesley list price: \$14.95
Subscriber's club price: \$12.70
Order #S103



Mathematical Foundations of Systems Analysis

R. H. Kupperman and Harvey Smith

A high-powered refresher course for analysts who want to bolster their mathematical abilities and handle all their system work with more expertise. Filled with problems and examples to improve your problem-solving skills—particularly in the areas of optimization. Addison-Wesley list price: \$13.95

Subscriber's club price: \$10.50
Order #S110



ELECTRONIC DESIGN BOOK CLUB

50 Essex Street
Rochelle Park, New Jersey 07662

Order Form

Your new NO OBLIGATION book club is a great idea! Please send the following book(s) on 10-day examination. At the end of that time, I will send payment plus postage and handling (and state sales tax where applicable) or return the book(s) and owe nothing.

As a Subscriber to *Electronic Design*, I understand that I am under no obligation to buy a specific number of books to continue to take advantage of your discounts

FILL IN BOOK ORDER NO. AND TITLE BELOW:

Order #	Title	PRICE

Sales tax: N.J.—5%, Ca.—6%, Fla.—4%
Outside USA, add \$2.00 shipping & handling

Sales Tax _____
Total _____

SHIP TO:

Name _____

Firm/Institution _____

Address _____

City/State _____ Zip _____

To take advantage of our subscriber's club price, you must fill in your *Electronic Design* subscription number (the long number over your name at the top of your address label on the front of this issue).

(Yes... We need all 29 numbers and letters)

CREDIT CARDS ACCEPTED—Customer pays postage and handling

CHECK ONE: Master Charge BankAmericard

Acct. No. _____

Expiration Date _____

InterBank No. _____ (Master Charge ONLY)

Signature _____

Payment (check or money order) enclosed.

This order card good only until November 30, 1976.

ED 7/19/76

Programmable logic arrays make simple controllers and decoders. They approach the versatility of microprocessors, yet are as simple to program as ROMs.

There is a large gap in flexibility, complexity and cost between the read-only memory (ROM) and microprocessor-based logic. Programmable logic arrays (PLAs) can help bridge the gap by offering the complexity of microprocessor functions along with the flexibility of a ROM.

PLAs are most useful where speed requirements are not stringent but power consumption and space are important. PLAs increase reliability many times over that of conventional logic while reducing costs by a third.

The sequential PLA, a new type of PLA which incorporates internal flip flops, is now being considered by manufacturers. This type has the advantage that it can be used in clocked systems to generate sequence-dependent outputs.

PLA performance is getting better

In the past, slow speed and high cost have kept PLAs from widespread use. Recent advances in technology, however, have produced units with propagation times of 65 ns¹, for \$25 in quantities of 100 and up.

Field-programmable logic arrays (FPLAs) have also been developed, further easing program development. The FPLA's ability to set desired information in the chip after the chip has been manufactured and put in a package distinguishes it from the conventional PLA. Now that it is no longer necessary to commit large sums of money for mask charges on units that may be logically incorrect, PLA use should increase. The added interest is similar to the popularity boost experienced for ROMs when programmable ROMs (PROMs) were introduced.

In most applications, PLAs and FPLAs are interchangeable in the same manner as ROMs and PROMs. Once the final pattern has been determined by successive programming of FPLAs (or PROMs), a dedicated PLA (or ROM) is used in production.²

PLAs are best suited for designs that use only

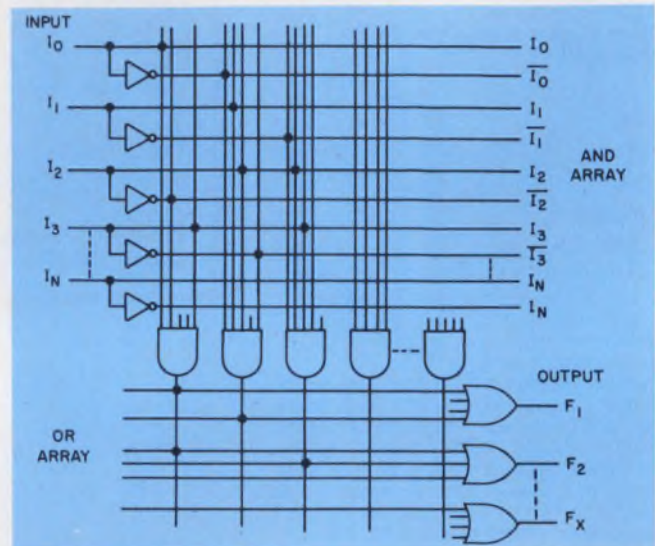

1. The PLA is internally structured as a set of inverters, an AND array plus an OR array with many separately programmable nodes.

a small subset of the total number of possible logic states. In general, PLAs have more input lines available than do ROMs. There are 14 inputs on the typical PLA, compared to ten inputs on a 1024-bit ROM.

To increase the PLA's size, it is not necessary to double the array size, the way you do for a ROM, every time an input bit is added.

On the other hand, a ROM with 14 input lines has the capability of recognizing 16,384 combinations of inputs; a PLA with the same number of input lines can recognize—generate a unique output for—only a small subset of the 16,384 possible input combinations. A PLA can be used instead of a ROM when there are a large number of inputs and when only a small number of the combinations are required.

Specifying the truth table

To specify the bit pattern desired for a PLA, you must understand its internal structure (Fig. 1). Each AND gate and input buffer/inverter of the PLA generates a signal called a minterm. A minterm is the logical product of any number of

Thomas W. Mitchell, Electrical Engineer, Northern Communications Area/EPEXR, Griffiss AFB, NY 13441.

COMPANY _____				DATE _____		PAGE _____ OF _____		TRUTH TABLE							
ADDRESS _____				CUSTOMER PO No _____											
PHONE _____				CUSTOMER PRINT OR I.D. No _____											

ACTIVE LEVEL DATA	H- HIGH ACTIVE LEVEL	PRODUCT TERM INPUT DATA	H- ACTIVE HIGH INPUT	SUMMING DATA	A- PRODUCT TERM IS SUMMED BY THE OUTPUT BLANK- PRODUCT TERM IS NOT SUMMED BY THE OUTPUT	ACTIVE LEVEL DATA												
	L- LOW ACTIVE LEVEL		L- ACTIVE LOW INPUT BLANK- DON'T CARE INPUT			F ₇	F ₆	F ₅	F ₄	F ₃	F ₂	F ₁	F ₀					
											H	H						

	PRODUCT TERM INPUT DATA														SUMMING DATA							
	I ₁₃	I ₁₂	I ₁₁	I ₁₀	I ₉	I ₈	I ₇	I ₆	I ₅	I ₄	I ₃	I ₂	I ₁	I ₀	F ₇	F ₆	F ₅	F ₄	F ₃	F ₂	F ₁	F ₀
	PIN 11	PIN 10	PIN 9	PIN 8	PIN 7	PIN 6	PIN 5	PIN 4	PIN 3	PIN 2	PIN 1	PIN 23	PIN 22	PIN 21	PIN 20	PIN 19	PIN 18	PIN 17	PIN 16	PIN 15	PIN 14	PIN 13
0											H	L		H								A
1											L	H	H	L							A	A
2											H	H	L								A	
3																						
47																						

2. A programming form defines the internal connections of a PLA. This one is for the IM5200 from Intersil.

inputs, either true or inverted. (The logical expression $A \cdot B \cdot C$ is an example of a minterm.) The maximum number of minterms varies from chip to chip, with 48 to 96 being common. Inputs to the AND gates are specified by the connections in the AND matrix.

The AND gate output is fed to OR gates. Connections to the OR gates are specified in the OR Matrix. In addition, some manufacturers allow programming of an inverted output.

To further understand the translation of logic into PLA hardware, refer to the coding form in Fig. 2. Each horizontal line represents one of the available gates in the AND matrix. The information entered in the product term's input-data column identifies the inputs to be connected to each AND gate as specified by an H (active high input), an L (active low input) or an X (don't care input). The summing-data section of

the programming form specifies minterm connections to the OR gate inputs.

A typical truth table with given inputs and outputs might look like this:

INPUTS				OUTPUTS	
A	B	C	D	F ₁	F ₂
H	X	L	H	H	L
L	H	H	L	H	H
X	L	H	H	L	H

The Boolean expressions for F₁ and F₂ are as follows:

$$F_1 = A\bar{C}D + \bar{A}BC\bar{D}$$

$$F_2 = \bar{A}BC\bar{D} + \bar{B}CD$$

The expressions for F₁ and F₂ are implemented in a PLA as shown in Fig. 2. (A, B, C and D are I₀, I₁, I₂ and I₃ respectively. An X in the truth table is represented by a blank in the coding form).

If a ROM were used as the decoding circuit to

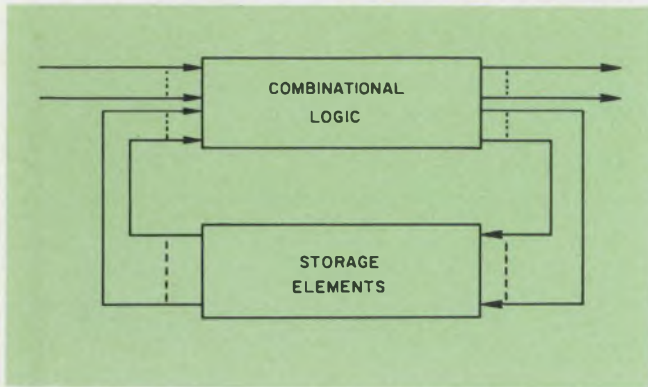

3. External flip-flops may be used as storage elements in a sequential PLA.

implement F_1 and F_2 in the above example, a memory size of 16 words would be required to decode all four input bits. Each of these 16 words would have to be programmed with the proper output state. In contrast, a PLA requires only programming of the input condition that yields a true output state. The result is a reduction in programming effort and in the number of required chips.

We needed only two output lines for F_1 and F_2 in the above example. If there were a requirement for more output lines than available on a single chip, the input lines of two or more PLA chips would be tied in parallel. Since there is an output from the PLA only when a programmed address is presented, there is no need for a separate chip select input.

For applications requiring more minterms than are available on a single chip, the inputs and outputs of the PLA are tied in parallel. In that case, a true output is represented by a high level, which permits wired-OR operation.^{1,4}

PLAs have many applications

The PLA can also serve as an alternative to a ROM in a truth table—for code conversion from Hollerith code to ASCII code, for example. ROMs are generally used instead of random logic for such code conversion because a logical correspondence between input and output codes may not exist.

The Hollerith code is a 12-bit code. Of the possible 4096 combinations, only 96 are used for graphic characters. If a ROM is used for the code conversion, 4096 words are necessary even though only 96 of the words would contain useful information. It's clear that a PLA could perform that code conversion easily and efficiently. Each AND gate would decode the input lines to produce an output for each of the 96 possible input states. Therefore, there would be 96 minterms in the PLA solution. Each minterm would excite the proper output lines to provide the output

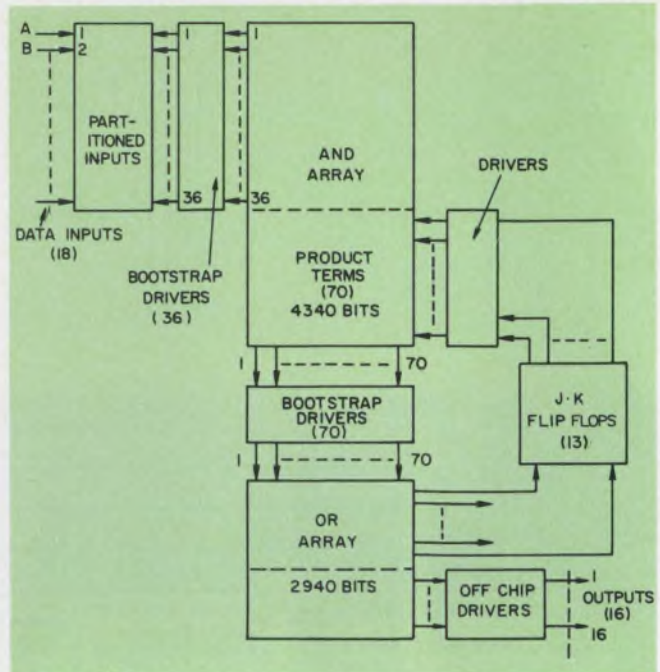

4. Internal flip-flops, integrated onto the chip, produce a sequential PLA.

code. The complete code conversion can be accomplished with a single PLA such as National Semiconductor's DM7575 PLA, which has 14 input lines, 8 output lines and total of 96 minterms.

Because PLAs can easily cope with special address conditions more easily than do ROM's, PLAs have been used to perform the table look-up procedure in microprogrammed processors. In cases where there are unprogrammed addresses or multiple addresses for single words, the PLA will outperform the ROM.

The ROM must be programmed to produce an all-zero output word for each unused address. A PLA output automatically stays at an unexcited level for unprogrammed addresses.

Multiple addresses for single words in a ROM require that each individual location be programmed with the desired output word. Such extra programming work is not necessary when a PLA is used. The "don't care" input condition can be specified, thereby eliminating that term from the address.

With the addition of storage elements in a feedback path a standard sequential-logic circuit can be realized (Fig. 3).

PLAs with internal flip-flops

If 13 JK flip-flops were used as storage elements in the feedback path of a PLA, and these flip-flops were included on the same chip as the PLA, then the usefulness of the device would be greatly magnified. In such an arrangement, device inputs would not only affect the output but also the next state.

A functional block diagram of the proposed device is shown in Fig. 4.⁶ To avoid race conditions from the feedback loop, a four-phase clock is used to cycle the data through the PLA. With this architecture, the PLA can be used to replace microprocessor-based logic and other types of sequential or control logic.

The PLA can be used as a sequential machine. For example, when an input of "01" is applied to the PLA, it will output BCD number 215 in sequence on the three output lines available.

An extension of the truth table presented earlier, can be used to program a PLA to solve the above problem. Identify inputs to the feedback flip-flops in the same manner that output connections were identified. Treat outputs of the flip-flops as inputs into the AND array.

To define which connections are made to the input of the flip-flops, you have several options. You can specify an S that will cause the flip-flops to be set, an R that will cause a reset of the flip-flop, or a T that will toggle the flip-flop if the line is activated. As with the normal output lines, a blank represents no connection. The flip-flop output connections to the AND array are specified in the same way as the other input lines.

An example of sequential operation appears in Fig. 5. Notice that the PLA will be in a waiting mode until an input condition of 01 appears on the input lines I₁ and I₂. Flip-flops FF₂ and FF₃ are used as a program counter, and controlled by lines 2, 3 and 4. While FF₁ is set, the counter cycles from 00 to 11 and then resets FF₁, thereby producing four time frames that can be used by the rest of the PLA.

When the PLA receives the input 01, FF₁ is set. All flip-flops must be low to prevent the PLA from receiving a second 01 code and trying to perform the instruction again before it has finished doing so the first time.

When FF₁ is set, the program counter is activated. As the program counter passes through each of its states, they are decoded by lines 5 through 7 and BCD number 215 is presented on the output lines.

Because not all of the available inputs and outputs are being used, it is possible for the PLA to operate in a parallel mode, that is, to perform two distinct functions at the same time.

Sequential logic PLAs have advantages

IBM has investigated using a PLA with a feedback feature to replace TTL logic in computer-terminal control units. A comparison between the dual-in-line-package TTL logic (DIP-TTL) and the PLA reveals the following:⁷

(1.) DIP-TTL versions require 6 1/2 (3 in. × 4 in.) printed circuit boards. The PLA version requires only 3-1/2 circuit boards.

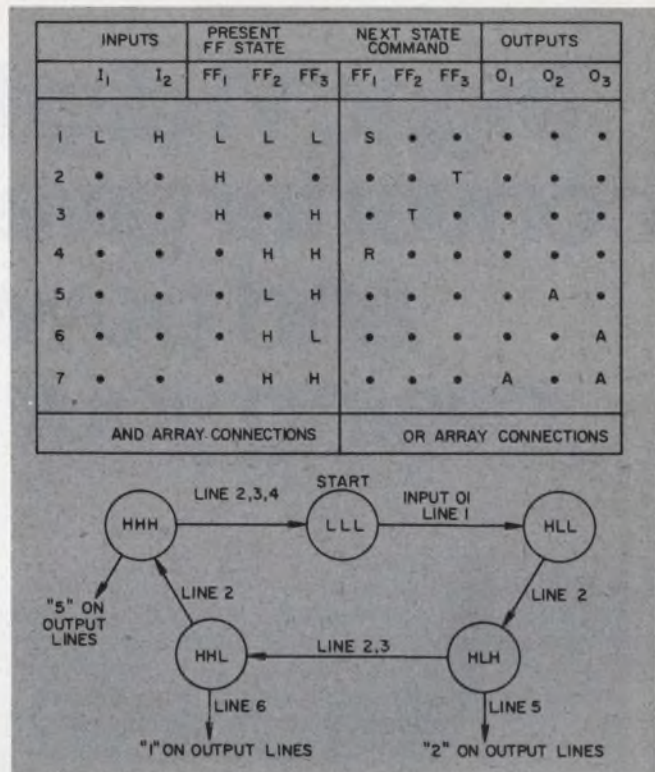

5. In this example of sequential operations, the numbers "two," then "one" then "five" appear on output lines O₁, O₂ and O₃.

(2.) Seven PLAs replaced 1,731 logic circuits, approximately 250 logic circuits per PLA.

Despite this very convincing comparison, several disadvantages are present with the device. The IBM PLA has serious speed limitations. The minimum cycle time for the PLA is 500 ns. In the test circuit speed is not a limiting factor because the unit operates at 135 bits per section. At higher speeds, however, the PLA may not be able to do the job.

References

1. Miles, G., "Field Programmable Logic Arrays for Next Generation Design," 1975 Western Electronic Show and Convention, San Francisco, CA, September, 1975.
2. Cavlan, N. and Cline, R., "Field-PLAs Simplify Logic Design," *Electronic Design*, Vol. 23, No. 18, Sept. 1, 1975.
3. Frankenberg, R. J., "Programmable Logic: A User's Viewpoint," 1975 Western Electronics Show and Convention, San Francisco, CA, September, 1975.
4. Mrazek, D., "The Programmable Logic Array As a Design Tool," 1973 Western Electronics Show and Convention, Los Angeles, CA, Vol. 17, Session 16.
5. Reyling, G., "PLAs Enhance Digital Processor Speed and Cut Component Count," *Electronics*, Vol. 47, No. 16, Aug. 8, 1974.
6. Wood, R. A., "High-Speed Dynamic Programmable Logic Array Chip," *IBM Journal of Research and Development*, Vol. 19, No. 4, July, 1975.
7. Logue, J. C.; Brickman, N. F.; Howley, F.; Jones, J. W.; and Wu, W. W., "Hardware Implementation of a Small System in Programmable Logic Arrays," *IBM Journal of Research and Development*, Vol. 19, No. 2, March, 1975.
8. Fleisher, H., Maissel, L. I., "An Introduction to Array Logic," *IBM Journal of Research and Development*, Vol. 19, No. 2, March, 1975.

Trigac VI digital-to-synchro converter gives you accuracy and power without raising your temperature.

The closest thing yet to a Solid State Synchro, Kearfott's Trigac VI Modular Digital-to-Synchro/Resolver Converters provide the accuracy and power you need, with a bonus. In addition to standard 4 arc minutes of accuracy at 1 volt ampere, the transformation ratio remains constant within $\pm .25\%$. We also have units constant within $\pm 0.1\%$. That can make the difference between delivering power or just throwing it away.

Let us help you be cost effective. Standard options range from industrial grades thru hi-reliability units, from accuracies of ± 20 arc minutes to ± 1 arc minute and, in addition, special designs and packaging as you require.

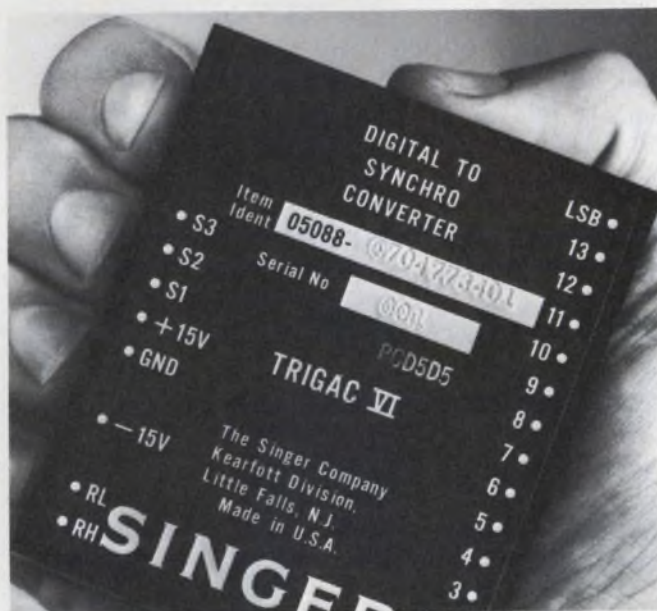

Need more power? Try our line of compatible synchro amplifiers.

Our 3185 Series is designed to perform the synchro power buffering or resolver to synchro (Scott-T) function. They provide matched power amplifier channels and transformer coupled outputs capable of driving torque repeaters or multiple control transformers up to 5 va. These fully potted units feature overload protection, low-quiescent currents and transformer-isolated outputs. Models available range from industrial to full MIL-SPEC high-reliability grades.

NEED ADDITIONAL POWER? We have units available with power outputs to 50 va, 60 or 400 Hz operation, and options of built in digital converters and/or power supplies.

For details on our converters and amplifiers, contact The Singer Company, Kearfott Division, 1150 McBride Avenue, Little Falls, New Jersey 07424.

SINGER
AEROSPACE & MARINE SYSTEMS

Dialight sees a need:

(Need: A switch for all reasons.)

Reason 1: Dialight offers three switch configurations to meet all your needs—*snap-action switches with silver contacts* for moderate-level applications, *snap-action switches with gold contacts* for intermediate-level applications, and *wiping-action switches with gold contacts* for low-level applications. Each of these ranges is served by two switching actions—momentary (life: 600,000 operations) and alternate (life: 250,000 operations).

Reason 2: Dialight's snap-action and wiping-action switches come in a new modular design concept . . . a common switch body for either high or low current operation. All 554 series switches and matching indicators have the same rear-panel projection dimensions.

The snap-action switching mechanism guarantees a fast closing and opening rate. This insures that contact force and contact resistance

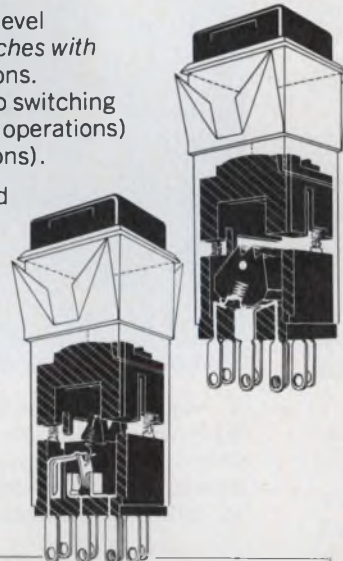
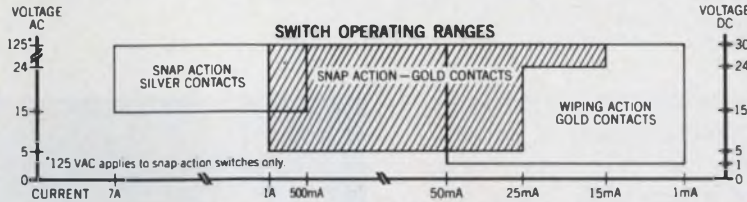

types. There are over 240 switch variations to choose from.

The 554 illuminated switch, designed for front of panel lamp replacement, gives you a choice of five different bezel sizes . . . $\frac{3}{4}$ " x 1", $\frac{5}{8}$ " x $\frac{3}{4}$ ", $\frac{3}{4}$ " square, $\frac{5}{8}$ " square, and $\frac{1}{2}$ " square. The first four sizes are also available with barriers. You also get a choice of six cap colors . . . white, blue, amber, red, green, and light yellow . . . four different underlying filter colors . . . red, green, amber, and blue and a variety of engraved or hot-stamped legends . . . over 300 cap styles . . . over 100,000 combinations.

There is also a variety of terminal connections . . . solder blade, quick connect, and for PC board insertions.

Reason 4: Dialight's 554 series is designed as a low cost switch with computer-grade quality.

Reason 3: Dialight offers a wide variety of panel and snap-in bezel mounting switches with momentary and alternate action configurations in SPDT and DPDT

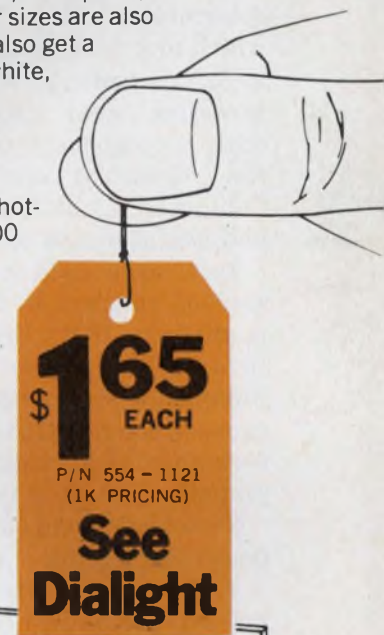

PRODUCT SELECTOR GUIDE						
SWITCHING ACTIONS	Snap-Silver contacts		Snap-Gold contacts		Wiping-Gold contacts	
	SPDT	DPDT	SPDT	DPDT	SPDT	DPDT
MOMENTARY	○	○	○	○	○	○
ALTERNATE	○	○	○	○	○	○
OPTIONS						
	PUSH BUTTON CAP SIZES					
	$\frac{1}{2}$ " Sq.	$\frac{5}{8}$ " Sq.	$\frac{3}{8}$ " x $\frac{3}{4}$ "	$\frac{3}{4}$ " Sq.	$\frac{3}{4}$ " x 1"	
BEZEL MOUNTING TO ACCOMMODATE	○	○	○	○	○	
BEZEL MOUNTING WITH BARRIERS TO ACCOMMODATE		○	○	○	○	
PANEL MOUNTING TO ACCOMMODATE	○	○	○	○	○	
MATCHING INDICATORS	○	○	○	○	○	

are independent of the switch's actuation speed.

In the wiping-action switch, the contacts are under constant pressure (A unique Dialight design). This insures long life with a minimum build-up of contact resistance.

Both switch types are tease-proof.

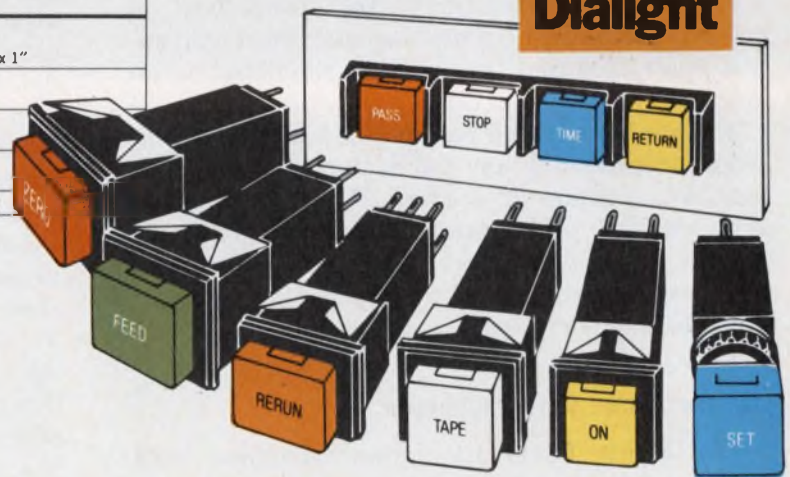

DIALIGHT

A North American Philips Company
203 Harrison Place, Brooklyn, N.Y. 11237
(212) 497-7600

Reduce circuit manufacturing costs:

Monte Carlo computer simulation finds a cost-effective mix of tight component tolerances vs individual calibration.

Computer simulation provides an inexpensive way of solving the traditional problem of achieving specified performance at minimum cost. Obviously, component cost drops with looser tolerance. Unfortunately, using inexpensive components often results in excessive labor costs to calibrate during the manufacturing process and perhaps even later on in the field.

But there is a reliable way of inexpensively determining the "break-even" point—beyond which any further use of inexpensive, loose-tolerance components will result in the penalty of excessive labor costs. Somewhere between excessive component costs and high labor costs is the region of optimum manufacturing costs. Computer simulation is an increasingly popular and useful means of finding that region.

In a large-scale system only the theoretical design of subcircuits that may require calibration is analyzed. With this selective approach the savings in time, labor and money are significant. Simulation shows not only how a combination of over-all component tolerances may affect the performance of a large number of systems. It also pinpoints actual or potential design problems.

Two basic compromises further reduce the expense of running a simulation program:

1. The entire circuitry of the "black box" is not simulated. The circuit that may need calibration is isolated and that portion simulated as an independent entity.

2. There is no need for special "canned" simulation programs or any particular computer system. Any version of Fortran IV with a reasonably efficient pseudorandom number generator will do, and may be used on the many computers that have Fortran compilers—and on a variety of time-sharing services.

Use the Monte Carlo technique

The Monte Carlo simulation technique used isn't new. It is well known in engineering, and

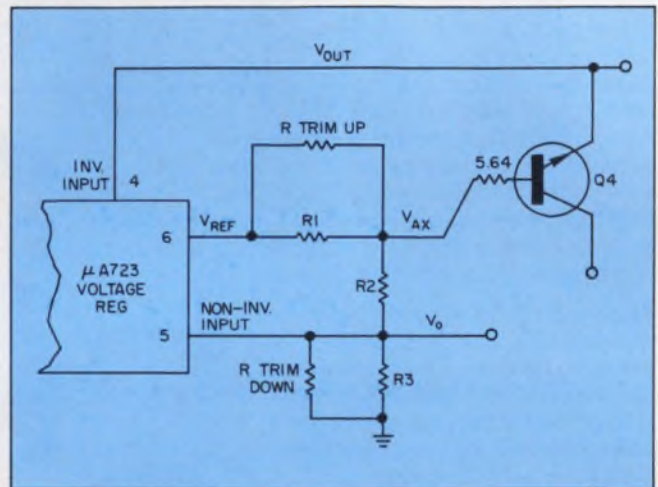

1. Voltage regulator develops +5 V output and an auxiliary voltage, V_{ax} , for undervoltage protection. A Monte Carlo computer simulation finds the best cost tradeoff between increased component tolerances and the need for individual calibration.

in other disciplines as well, but surprisingly, not much has been done in the area of manufacturing, where the pay-off for simulation can be very high.

In order to simulate, the relevant and realistic parameter distribution of the circuit components must be known. Unfortunately, manufacturers' data sheets don't give complete and detailed density functions, so the user must collect his own data and generate the required density distributions. With these inputs, and with a pseudorandom number generator, a Monte Carlo program can be run.

Let's illustrate the selective simulation approach with the portion of a voltage regulator shown in Fig. 1. The circuit has two outputs: V_{out} , the +5 V supply, and V_{ax} , and auxiliary voltage to control undervoltage protection circuitry. Our objective is to select resistor values and tolerance so that the majority of the circuits will yield V_{out} within $+5 \pm 0.06$ V. At the same time, we want a V_{ax} high enough to turn on Q_4 , and trigger undervoltage protection when V_{out} falls below 4.35 V. And, we want to do this without trimming every circuit individually.

Eli A. Sheffer, Supervisory Engineer, Hazeltine Corp., Greenlawn, NY 11740.

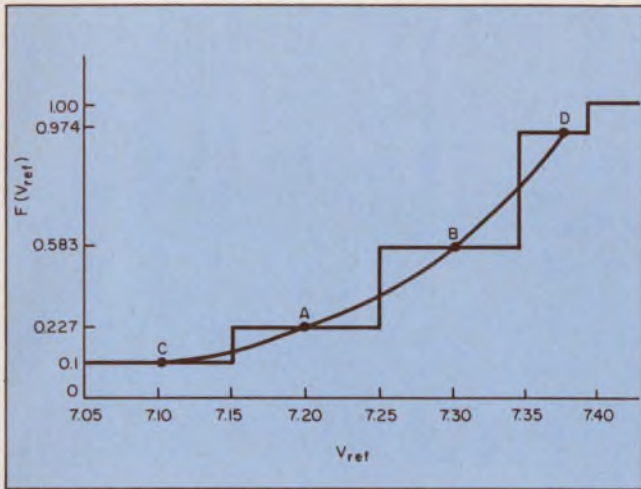

2. Cumulative probability distribution curve of the value of the reference voltage output from a large sample of μA 723 regulators.

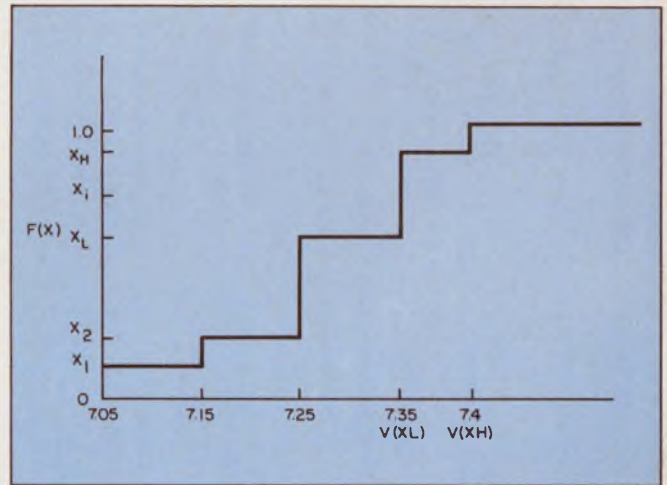

3. A random number, $F(X)$, determines the corresponding value of the reference voltage, V_{REF} , used in a simulation run.

In Fig. 1, a divider across the reference voltage from the voltage regulator, $\mu A723$, determines both outputs:

$$V_{out} = V_{REF} \cdot \frac{R_2}{R_1 + R_2 + R_3}$$

$$V_{ax} = V_{REF} \cdot \frac{R_2 + R_3}{R_1 + R_2 + R_3} \quad (1)$$

Also, the base-emitter drop, V_{BE} , of Q_1 , determines the value of V_{ax} at which the transistor conducts.

Specify parameter distributions

The next step is to specify the distributions of the three resistors and the two voltages, V_{REF} , from the IC, and the transistor V_{BE} . R_1 and R_3 are nominally 1%, R_2 5%, and we assume a uniform distribution throughout the tolerance range. The V_{BE} distribution is bell-shaped, with a mean value of 0.57 V and a standard deviation of 0.05 V. The V_{REF} distribution was derived from measurements on a statistically valid system of $\mu A723$ ICs and is discussed further below.

The Monte Carlo technique allows selection of nominal component and voltage values such that actual values will fall in the portion of the cumulative distribution curve where suitable values have a high probability. In Fig. 2 the cumulative distribution curve of V_{REF} is plotted against the probability function, $F(V_{REF})$. The slope from A to B is steeper than from C to A, indicating the probability of a higher concentration in the range from 7.2 to 7.3 than from 7.1 to 7.2 V. Thus, in simulation more values will be picked randomly in the first interval.

The cumulative distribution is constructed from sample measurements and consequently is noncontinuous. To find the V_{REF} corresponding to the random number generated, a linear inter-

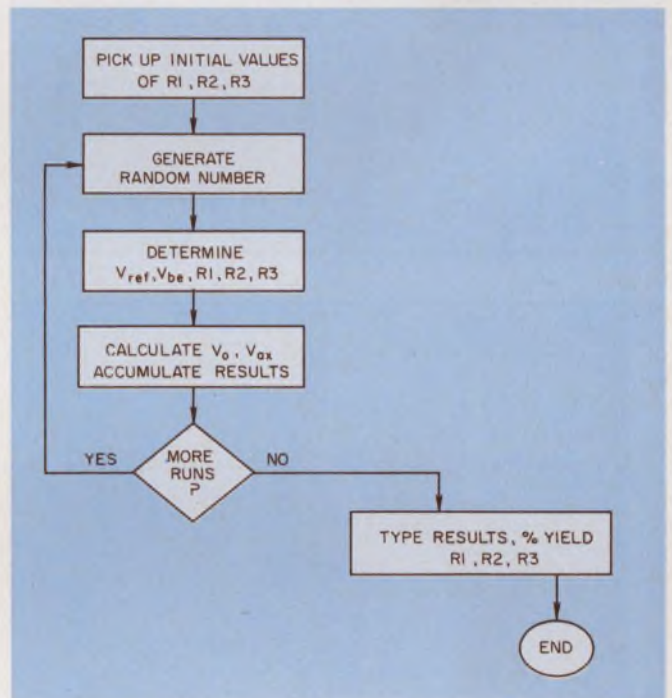

4. Flow chart of the computer program for the Monte Carlo simulation of a voltage regulator subcircuit.

```

INSERT NO. OF ITERATION REQUIRED
1000
INSERT R 1 VALUE.
887.
INSERT R 2 VALUE.
25.
INSERT R 3 VALUE.
2000.
INSERT TOLERANCE FOR R 1 (IN %)
1
INSERT TOLERANCE FOR R 2 (IN %)
10
INSERT TOLERANCE FOR R 3 (IN %)
1
  
```

5. Typical user entries of resistor values and tolerances for a voltage regulator subcircuit simulation run.

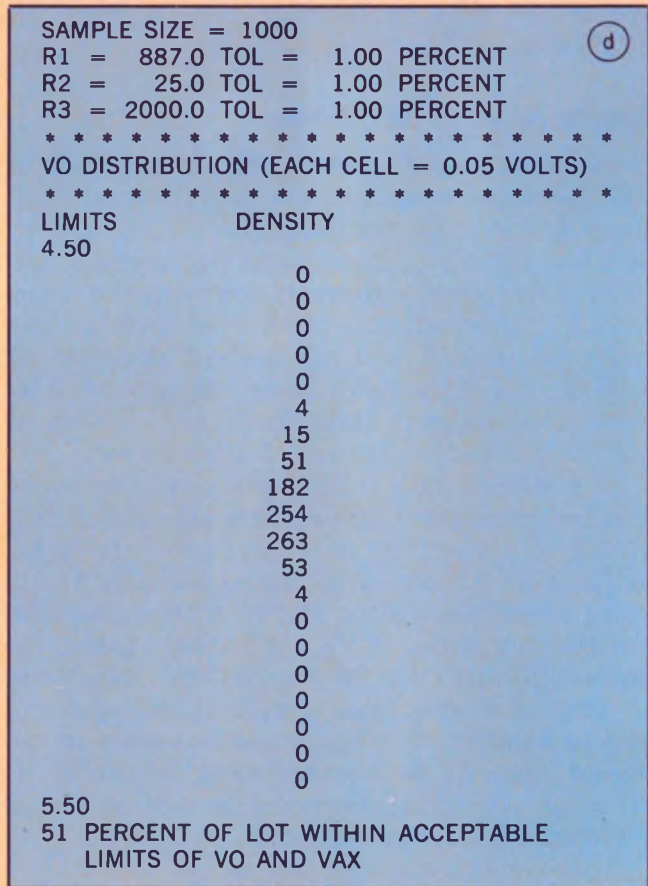
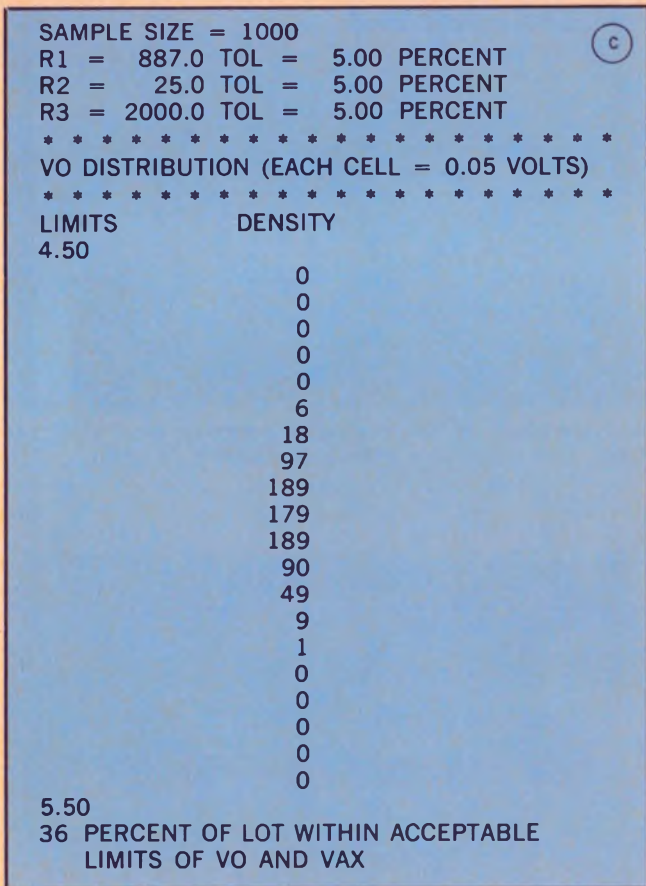
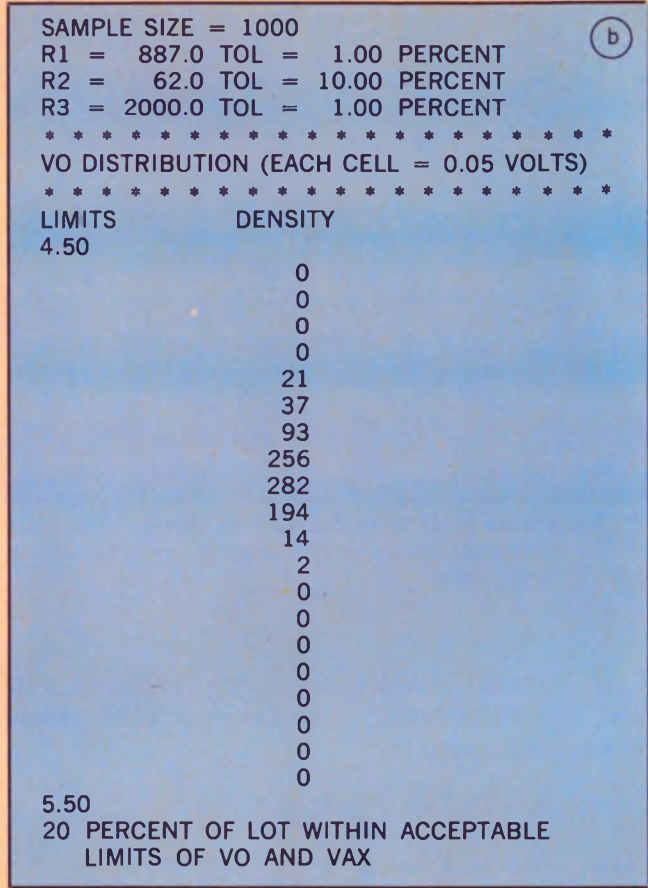
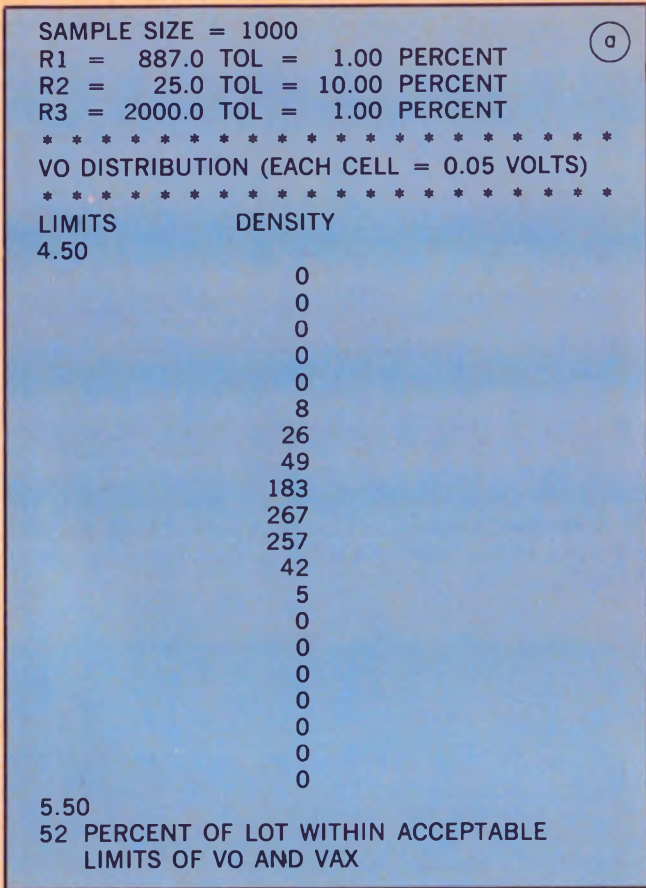

6. The results of four simulation runs on the voltage regulator. 52% of the production run, at best, will be in tolerance without calibration (a). Changing the value

of R₂ reduces yield by 32% (b). Looser tolerances for R₁ and R₃ show an expected reduction in yield (c). A tighter tolerance for R₂ shows no improvement (d).

Typical program for simulation of voltage regulator

```

SAMP-F4
C ***PROGRAM FOR THE SIMULATION OF VOLTAGE REGULATOR ***
C *** AS OF AUG. 1,1975 ***
C ***
C ***
C *** ARA)-CONTAIN VALUE OF VREF DIST. (DISCRETE STEPS) ***
C *** ANOMI- " " " R1,R2,R3 NOMINAL VALUES ***
C *** ALIM- " CUMULATIVE PROBABILITY DIST. POINTS FOR VREF ***
C *** AVBE- " " " " " " VBE ***
C *** VBE- CONTAIN VALUE OF VBE DIST.(DISCRETE STEPS) ***
      DIMENSION ANOMI(3),R(3),IRSLT(20),ARAY(6),ALIM(6),TOL(3)
      DIMENSION VBE(7),AVBE(7)
      DATA (ARAY(I),I=1,6)/6.95,7.05,7.15,7.25,7.35,7.4/
      DATA (ALIM(I),I=1,6)/0.0,0.1,0.227,0.583,0.974,1.0/
      DATA (VBE(I),I=1,7)/0.37,0.42,0.52,0.57,0.62,0.67,0.72/
      DATA (AVBE(I),I=1,7)/0.0,0.023,0.159,0.5,0.841,0.977,1.0/
C *** INITIALIZATION ***
2 DO 4 JJ=1,20
4 IRSLT(JJ)=0
C *** ACCEPT USER NOMINAL AND TOL. OF PARAMETERS & NO. OF ITERATIONS ***
      TYPE 60
      ACCEPT 50,N
      DO 30 IN=1,3
      TYPE 40,IN
30 ACCEPT 51,ANOMI(IN)
      DO 31 IN=1,3
      TYPE 70,IN
31 ACCEPT 51,TOL(IN)
C *** RUN SIMULATION FOR N ITERATION ***
      DO 1 II=1,N
C *** GENERATE TRIPLET (R1,R2,R3) ***
      DO 19 KK=1,3
      RNDOM=RAN(5)
      HILI=ANOMI(KK)+(ANOMI(KK)*TOL(KK)/100.)
      ALOLI=ANOMI(KK)-(ANOMI(KK)*TOL(KK)/100.)
19 R(KK)=RNDOM*(HILI-ALOLI)+ALOLI
      RNDOM=RAN(5)
C *** DETERMINE INTERVAL I FOR VREF ***
      DO 13 I=1,6
      IF(RNDOM .LT. ALIM(I)) GO TO 11
      CONTINUE
C *** THROUGH LINEAR INTERPOLATION DETERMINE VREF ***
11 VREF=ARAY(I-1)+0.1*(RNDOM-ALIM(I-1))/(ALIM(I)-ALIM(I-1))
C *** CALCULATE VO & VAX FOR THIS ITERATION ***
      VO=(VREF*(R(3)))/(R(1)+R(2)+R(3))
      VAX= VREF*(R(2)+R(3))/(R(1)+R(2)+R(3))
C *** VO DETERMINES CELL NO. ***
      CELL=(VO-4.50)/0.05
      K=INT(CELL)+1
      IF(K .GT. 20 .OR. K .LT. 1) GO TO 3
C *** ARRAY IRSLT CONTAIN DISTRIBUTION OF VO VALUES ***
C *** DETERMINE INTERVAL NU FOR VBE ***
      RNDOM=RAN(5)
      DO 32 NU=1,7
      IF(RNDOM .LT. AVBE(NU)) GO TO 33
      CONTINUE
C *** THROUGH LINEAR INTERPOLATION DETERMINE VBE ***
33 VBEX=VBE(NU-1)+0.05*(RNDOM-AVBE(NU-1))/(AVBE(NU)-AVBE(NU-1))
      IF(VAX .LT. (4.35+VBEX)) GO TO 1
      IRSLT(K)=IRSLT(K)+1
1 CONTINUE
C *** ACCUMULATE TOTAL COUNT OF VO IN THE REQUESTED RANGE ***
C *** CALCULATE PERCENTAGE OF VO FALLING INSIDE RANGE **
      ITOT=100*(IRSLT(10)+IRSLT(11))/N
C *** DISPLAY DIST. OF VO ***
      TYPE 100,N,(ANOMI(J),TOL(J),J=1,3)
      DO 9 L=1,20
9 TYPE 5,IRSLT(L)
      TYPE 41
      TYPE 14,ITOT
      TYPE 80
      ACCEPT 73,USER
      IF(USER .EQ. 'YES') GO TO 2
      GO TO 6
3 PAUSE'VO OUT OF RANGE OF INTEREST'
5 FORMAT(13X,I6)
14 FORMAT(//2X,I6,2X,'PERCENT OF LOT WITHIN ACCEPTABLE LIMITS
1 OF VO AND VAX'//)
40 FORMAT(//2X,'INSERT R',I2,' VALUE.')
41 FORMAT(2X,'5.50'//)
50 FORMAT(I6)
51 FORMAT(F9.0)
60 FORMAT(/2X,'INSERT NO. OF ITERATION REQUIRED')
70 FORMAT(/2X,'INSERT TOLERANCE FOR R',I2,'(IN %)')
73 FORMAT(A5)
80 FORMAT(//2X,'IF YOU WANT ANOTHER RUN ,TYPE "YES",OTHERWISE <CR>')
100 FORMAT(/2X,'SAMPLE SIZE=',I6//2X,'R1=',F7.1,2X,'TOL='
1,F9.2,2X,'PERCENT'/2X,'R2=',F7.1,2X,'TOL=',F9.2,2X,'PERCENT'/
22X,'R3=',F7.1,2X,'TOL=',F9.2,2X,'PERCENT'/
32X,43('*')/2X,'VO DISTRIBUTION',2X,'(EACH CELL=0.05',2X,
4'VOLTS)/2X,43('*')/2X,'LIMITS',5X,'DENSITY'/2X,'4.50')
6 CALL EXIT
      END

```

Want A Safer Product And Lower Manufacturing Costs Too?

On the one hand choose the **MICROTEMP®** thermal cutoff



On the other hand, don't overlook the new **PICOTEMP** thermal cutoff



A reliable, accurate easy to install, "one shot" thermal limiter.

- temperature tolerance— $\pm 1.7^{\circ}\text{C}$.
- temperature ratings— 58° to 242°C . (136° to 468°F .)
- current capacity—up to 30 amps at 240 VAC.
- compact—diameter, .157"; length, .457" (exclusive of leads).
- economical
- easy to install—assorted terminations, mounting packages and insulations available.
- Recognized under the Component Program of Underwriters' Laboratories, Inc. UL File #E40667A. CSA approved. BSI Certificate #5041 approved. Recognized by MITI and VDE. Military approval.

Used where installation or space restrictions rule out MICROTEMP® thermal cutoffs.

- temperature tolerance— $+0^{\circ}\text{C}$.— -3.3°C .
- temperature ratings— 63° to 150°C . (146° to 300°F .)
- current capacity—to 5 amps. at 120 VAC. Will hold this rating up to and including 240 VAC.
- compact—.236" x .389" x .087/.104" (exclusive of leads).
- economical
- Package is completely insulated, leads are 26 gauge silver plated wire.
- Recognized under the Component Program of Underwriters' Laboratories, Inc. UL File #40667A. MITI approved. CSA approved.

Both devices are completely sealed against the atmosphere. Because of their unique design and construction, they won't derate. And they're unaffected by age or extended use. You not only get positive, yet low cost protection against malfunctions in circuits and components caused by equipment failure or user abuse, but you eliminate costly and unnecessary service calls caused by nuisance tripping.

PICOTEMP or MICROTEMP? Which is best? Depends on your needs. Tell us about them.



MICRO DEVICES

 DIVISION OF EMERSON ELECTRIC CO.
1881 SOUTHTOWN BLVD.
DAYTON OH 45439 513-294-0581

CIRCLE NUMBER 56

polation is performed, which slightly reduces the over-all accuracy of the simulation.

The random number generator is the mechanism determining the value of the parameter from a given distribution, generating numbers in the range .00 to 1.0 in pseudorandom fashion. Any time a random number is generated, the corresponding value of V_{REF} may be determined from Fig. 3. Random numbers correspond to the vertical axis. A horizontal line is drawn at the number generated to the cumulative distribution curve, picking up the relevant interval of V_{REF} . Thus, in Fig. 3, the random number X_i falls between X_{Li} and X_{Hi} , corresponding to the interval between 7.25 and 7.35 V. The value of V_{REF} corresponding to the random number drawn, X_i for example, is:

$$V_{REF} = V(X_{Li}) + (0.1) \frac{X_i - X_{Li}}{X_{Hi} - X_{Li}}, \quad (2)$$

where X_{Li} = Lowest value of $F(X)$ in the interval I.

X_{Hi} = Highest value of $F(X)$ in the interval I.

X_i = Value picked by the random number generator.

V_{BE} and the resistors can be picked from their corresponding distributions in the same way. The values of V_{REF} , R_1 , R_2 and R_3 are inserted in Eq. 1, and V_{out} and V_{ax} are calculated. For a successful trial, $V_{out} = 5.0 \pm 0.06$ V and $V_{ax} - V_{BE}$ is greater than 4.35 V. This process may be repeated as often as desired. V_{out} and V_{ax} distribution plots will be the indication of the over-all subcircuit performance. In this example simulation, by selecting the optimum nominal values for the triplet of R_1 , R_2 and R_3 , reduced the number of units requiring calibration from 80% to 48%.

Fig. 4 shows a flow chart for an interactive Fortran IV program on a DEC-10 machine for iteration of values for the resistor set. In practice, the designer interacts with the program and has the option of changing the values and/or the tolerances of the circuit parameters. Fig. 5 shows how the user enters the input parameters and tolerances.

The results of four sample printouts for V_{out} are shown in Fig. 6. In (a), with the resistor values and tolerances used, 52% of the circuits—at best—will pass the test without calibration. In (b), R_2 has been increased from 25 to 62 ohms, and the yield has decreased from 52% to 20%. In (c) the tolerance on R_1 and R_3 has been changed from 1% to 5%; on R_2 from 10% to 5%. The yield, as expected, drops to 36%. But, tightening the tolerance on R_2 to 1% does not increase the yield.

The Fortran IV program shown was written specifically for the circuit discussed. With some modification, it can also be used to simulate a variety of other circuits. ■■

OK, you Power Schottkys, the heat's on. Talk!

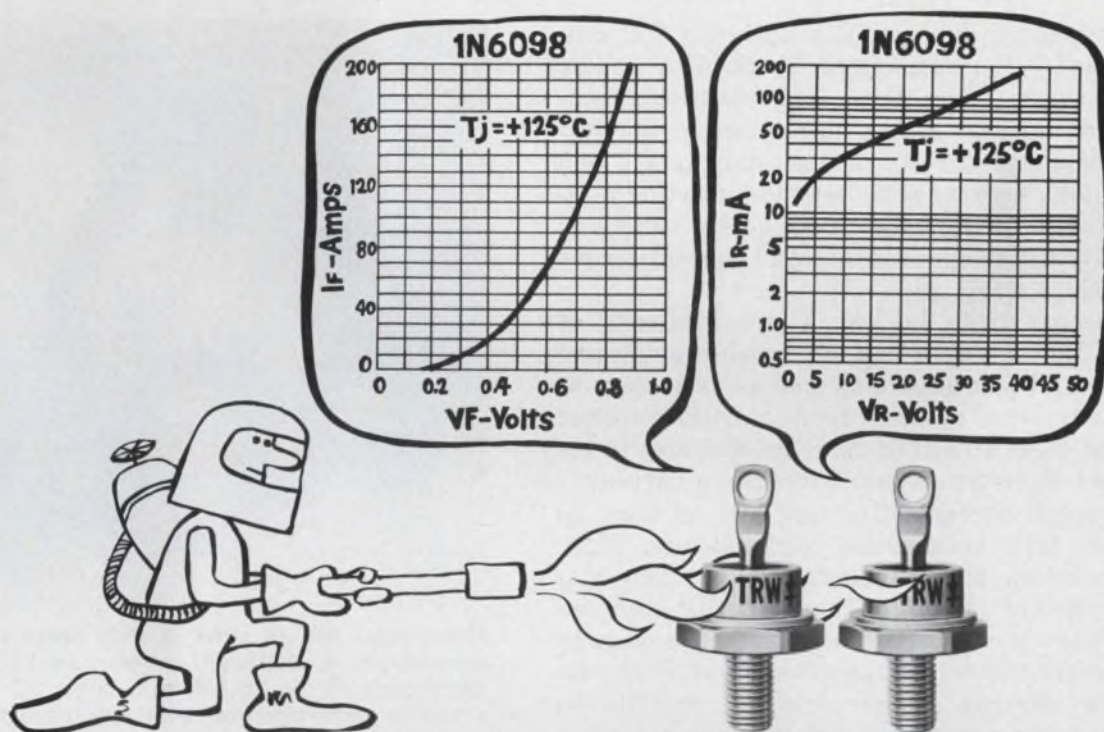

These new TRW Power Schottkys have quite a story to tell and it starts with the fact that they're JEDEC registered. Then they'll tell you that they let you maintain 50 Amps—typically 0.55 Volt forward drop at a T_j of 125° C. The highest operating junction temperatures, lowest reverse leakage typically less than 200mA @ 40V, 125° C, and highest voltages on the market today. (Yet, for all that, they're competitively priced.)

Yes, TRW's Schottky Diodes are now 1N registered. And they're about to be JAN and JANTX qualified.

Let these new Power Schottkys take your heat, try one in your present circuit or in the circuit you're working on, you'll find out they're not just talk.

1N6095	25 AMP	30V	DO-4
1N6096	25 AMP	40V	DO-4
1N6097	50 AMP	30V	DO-5
1N6098	50 AMP	40V	DO-5

If you'd like to hear more about how TRW's Power Schottkys can help you in the design of low-voltage, high-current power supplies, call John Power at (213) 679-4561. Or use the coupon. (These components are available from stock from our distributors.)

TRW Power Semiconductors

An Electronic Components Division of TRW, Inc.,
14520 Aviation Boulevard, Lawndale, California 90260

- Please send me data sheets on TRW's Power Schottky Diodes
- Have a salesman get in touch with me

Name _____

Company Name _____

Position _____

Address _____

City _____

State _____

Zip _____

TRW POWER SEMICONDUCTORS

ANOTHER PRODUCT OF A COMPANY CALLED TRW

The drive motor of a servo or start/stop system determines to a great extent the system's dynamic response. Low inertia/inductance motors allow high-performance designs.

Many motors are specially designed for constant-speed operation—record players, audio tape recorders, chart drives and electromechanical timing devices. But a large class of applications, including servo systems, must start and stop rapidly, operate with very low starting voltages, provide a high torque-to-inertia ratio and preferably linear speed-torque and current-torque relationships (Fig. 1).

The linear plots in Fig. 1 are idealized, of course. They ignore a motor's brush-bearing-and-windage—friction losses, as well as armature reaction. Armature reaction tends to reduce torque output at high armature currents and also to reduce the torque-per-ampere increase in current.

High-speed incrementing systems as used in computer tape transports, card readers, high-speed printers and numerically controlled machines, require motors with good start-stop dynamic characteristics. Of particular advantage in such use are the dc, permanent-magnet field, hollow-rotor designs.¹ Their special construction provides low rotor inertia and thus the desirably high torque-to-inertia ratio needed for rapid acceleration and deceleration.

A hollow-shelled armature winding forms a self-supporting cylindrical shell, or basket that contains no iron, but rotates about a stationary iron core. Such a shell design results in an armature inertia that is 10 times lower than so-called low-inertia disc designs and 100 times lower than traditional iron-core designs. Also, the armature inductance is 1000 times lower than in iron-core motors.

This type of motor is particularly suited for high-gain, wide-bandwidth servo systems, and cases where motors must be directly coupled to the load. Acceleration from dead stop to 3900 rpm in less than one millisecond and within only 5 degrees of shaft rotation is not unusual, because of the very high torque-to-inertia ratios that are possible. There is no cogging, and motor size is less than in ordinary wound-rotor motors

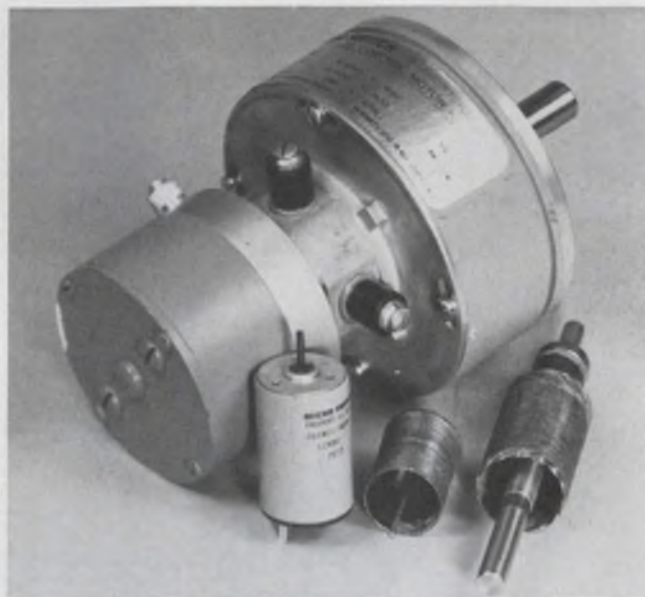

Hollow-rotor motors cover a wide range of styles and sizes—from a flashlight-battery-sized cassette drive motor such as the 26 EM, to a larger 33 VM unit with a built-in tachometer to drive speed-servo capstans in computer magnetic-tape units.

of the same output.

In Fig. 1, current-curve B, which originates at zero, represents an idealized condition that neglects static friction, i.e. the torque needed to start the motor. Curve A, the more practical case, when extended to the torque axis intersects the axis at a value equal to this static-friction loss.

Defining motor characteristics curves

The speed curve for a given terminal voltage, V_T , intersects the speed axis at the no-load speed of the motor; extending the curve to intersect the loss-torque line provides a higher speed value close to the theoretical no-load speed, if no friction is present. At this speed the back emf of the motor equals the input-terminal voltage.

At zero speed the motor provides the stalled-torque output, T_{stall} , and the motor draws a stalled current that is limited only by its terminal resistance, R_T , where

$$I_s = V_T / R_T.$$

John Mazurkiewicz, Applications Engineer, Micro-Switch Div. of Honeywell, Freeport, IL 61032.

A linear relationship between torque and armature current is approximately true for the motors under consideration. A torque constant, K_T , can then be defined as

$$K_T \cong \frac{\Delta T}{\Delta I} \cong \frac{T_{stall} + T_{loss}}{I_s} \quad (1)$$

In terms of a motor's construction and physical characteristics, the electrical equation for stall torque is

$$T_{stall} = N\phi I_s \frac{BpK}{A}; \quad (2)$$

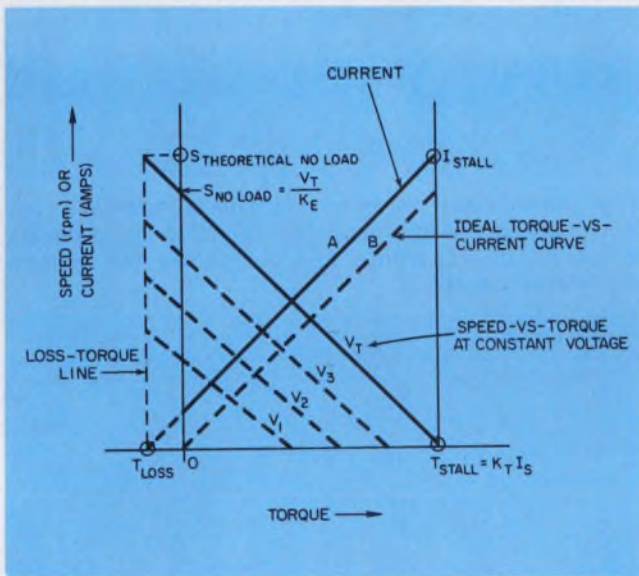

1. The speed-torque and current-torque characteristics curves of hollow-rotor motors are only approximately linear. These relationships are idealized into straight lines to simplify calculations and allow easy solution of the dynamic-response equations.

where N = number of turns per coil

ϕ = flux per pole

I_s = stalled current

B = number of commutator bars

P = number of poles

A = number of armature paths

K = constant for unit conversion.

For simplicity, let us assume that $T_{loss} = 5\% T_{stall}$; therefore

$$K_T \cong \frac{1.05 T_{stall}}{I_s}. \quad (3)$$

Combining Eqs. 2 and 3 and neglecting the 5% loss factor, we obtain

$$K_T = \frac{N\phi BpK}{A}. \quad (4)$$

Since a motor's armature turns in a magnetic field, it also generates a back emf,

$$V = \frac{SN\phi pB}{A}, \quad (5)$$

from which a voltage constant can be defined as

$$K_E = \frac{\Delta V}{\Delta S}, \quad (6)$$

where S is the speed of the rotor in krpm. When we combine Eqs. 4, 5 and 6, K_T and K_E are related as follows:

$$K_E \text{ (V/krpm)} = 0.74 K_T \text{ (oz-in/A)}.$$

Thus, K_T automatically determines K_E , or vice versa. And in Fig. 1

$$S_{no\ load} = \frac{V_T}{K_E}. \quad (7)$$

In general, the type of motors we are considering—dc motors with fixed-field permanent-magnet excitation—can be represented by the electrical equivalent diagram Fig. 2. From the diagram, we can derive the simple differential equation,

$$V_T = K_E S + I_a R_T + L \frac{dI_a}{dt}, \quad (8)$$

where I_a is the armature current. Because of the hollow-rotor motor's extremely low inductance, Eq. 8 can be reduced to

$$V_T = K_E S + I_a R_T \quad (9)$$

and

$$S = [V_T - I_a R_T] / K_E \quad (10)$$

Note that the slopes of the speed-torque lines can be expressed by

$$\frac{R_T}{K_E K_T} = \frac{S_{no\ load}}{T_{stall}}, \quad (11)$$

which is constant for all applied terminal voltages; thus a series of parallel straight-line speed torque curves for different terminal voltages, together with the single torque-current curve (Fig. 1) can fully describe the steady-state characteristics of the low-inductance, low-inertia motor.

Analyzing transient behavior

The transient performance of a motor may be analyzed in terms of motor speed and acceleration. However, the analysis undertaken for a system is dependent on whether a constant voltage or a constant current supply is applied to the motor.

When a constant voltage is applied to a motor, as the motor's speed increases, the back emf generated by the motor increases also and opposes the applied voltage to reduce the motor's current. The result is reduced acceleration as the motor speeds up. This can be precisely seen by solving the equation

$$T = J\alpha + K_D S + T_F + T_L, \quad (12)$$

where T = output torque (oz-in)

J = system inertia (oz-in-s²)

α = shaft acceleration (rad/s²)

K_D = viscous damping (oz-in/krpm)

S = speed (krpm)

T_F = friction torque (oz-in)

T_L = load torque (oz-in)

From Eq. 11 and Fig. 1

$$S = S_{no\ load} - \frac{TR_T}{K_E K_T}, \quad (13)$$

$$= \frac{V_T}{K_E} - \frac{TR_T}{K_E K_T},$$

and

$$T = \left[\frac{V_T}{K_E} - S \right] \frac{K_E K_T}{R_T}, \quad (14)$$

Then Eq. 12, which is a differential equation, since $\alpha = d^2\theta/dt$ and $S = d\theta/dt$, can be written as

$$\left[\frac{J R_T}{K_E K_T} \right] \alpha + S = \frac{V_T}{K_E}, \quad (15)$$

where θ is shaft angular displacement. Also, T_F and K_D are assumed to be negligible, and there is no load on the motor so only the motor's inertia is included in J .

A solution in terms of the motor constants yields

$$S = \frac{V_T}{K_E} \left(1 - e^{-\frac{K_T K_E}{J R_T} t} \right) \quad (16)$$

The exponent in Eq. 16 contains the motor's mechanical time constant $\tau_m = J R_T / K_T K_E$, used by servo designers use for determining the responsiveness of a system. A more precise transient analysis would include also the electrical time constant of the motor $\tau_e = L / R_T$, but for the high-performance motors under discussion, $\tau_m \gg \tau_e$; the electrical time constant is considered negligible.

Note that when time, t , in Eq. 16 becomes large, S approaches the steady-state, no-load-speed value, V_T / K_E , calculated in Eq. 7. In one mechanical time constant equal to $J R_T / K_T K_E$, the motor accelerates to 63.2% of its final speed (Fig. 3), after the application of a fixed voltage.

Substitute Eq. 14 into Eq. 12, but this time, consider the motor to be loaded with a load, T_L ; thus $J = J_m + J_L$). Also retain the terms T_F and K_D . The result is

$$K_T \frac{V_T}{R_T} - \left[K_D + \frac{K_T K_E}{R_T} \right] S - T_F - T_L = J \alpha. \quad (17)$$

Now solve this differential equation for speed and obtain

$$S = \frac{K_T \frac{V_T}{R_T} - T_F - T_L}{K_D + \frac{K_T K_E}{R_T}} \left[1 - e^{-\frac{-R_T K_D - K_T K_E}{R_T J} t} \right] \quad (18)$$

The denominator term $K_D + K_T K_E / R_T$ consists of two parts. The first term a damping constant—accounts for all friction losses that are velocity-dependent, such as losses that result from short-circuited conductors undergoing commutation in a leakage magnetic field, and losses from the friction of grease in the bearings. The second term results from damping caused by the back emf of the motor. However, in practical cases the relative magnitudes of these terms are such that

$$K_D \ll \frac{K_T K_E}{R_T}. \quad (19)$$

As a result, the speed approaches

$$S = \left(\frac{V_T}{K_E} - \frac{(T_F + T_L) R_T}{K_T K_E} \right) \left[1 - e^{-\frac{K_T K_E}{J R_T} t} \right] \quad (20)$$

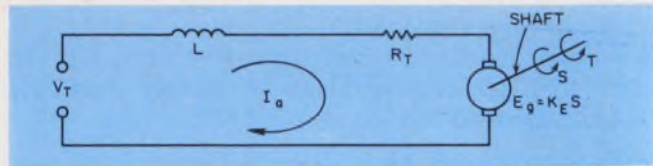

2. An equivalent electrical circuit of a motor helps in setting up and solving the dynamic-response characteristics of servo systems.

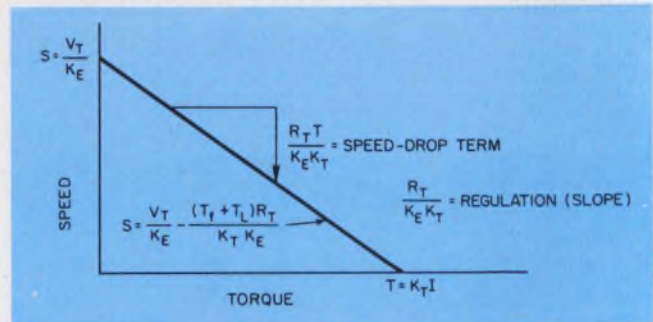

3. A hollow-rotor motor's mechanical inertia, even though comparatively small, still overshadows the effects of the rotor's inductance and determines the motor's acceleration capability.

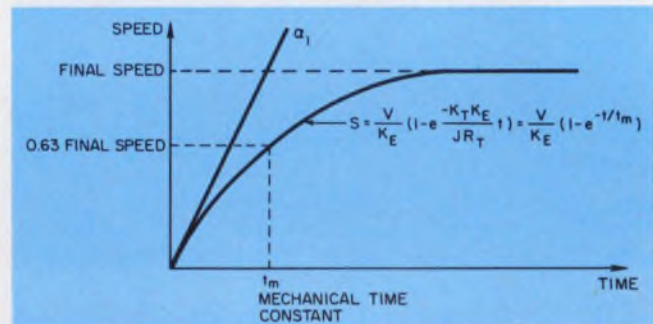

4. The slope of the speed-torque line is determined by the motor's torque/current constant, K_T ; its voltage/speed constant, K_E , and its terminal resistance, R_T .

Note that the first term, V_T / K_E , yields the approximate steady-state speed at no load (Eq 16). The second term is known as the "speed-drop" term, and the coefficient, $R_T / K_T K_E$ is motor regulation (Fig. 4).

To solve for acceleration, differentiate Eq. 18 and obtain the result

$$\alpha = \frac{-K_T V_T - T_F R_T - T_L R_T}{J R_T} \left[e^{-\frac{-R_T K_D - K_T K_E}{J R_T} t} \right] \quad (21)$$

If the motor is driven from a constant-current source with current I_a , a solution of Eq. 12, is

$$S = \frac{K_T I_a - T_F - T_L}{K_D} \left[e^{-\frac{-K_D}{J} t} \right], \quad (22)$$

and the acceleration is

$$\alpha = \frac{K_T I_a - T_F - T_L}{J} \left[e^{-\frac{-K_D}{J} t} \right] \quad (23)$$

A typical hollow-rotor motor system might have the following specifications:

$$K_T = 6 \text{ oz-in/A,}$$

$$K_D = 0.01 \text{ oz-in-s/rad,}$$

$$K_E = 0.0424 \text{ V-s/rad,}$$

$$R_T = 0.8 \Omega$$

$$J (\text{total}) = 0.0008 \text{ oz-in-s}^2.$$

To simplify a comparison of constant-voltage vs constant-current operation, assume T_F and T_L are negligible.

Then if $V_T = 16 \text{ V}$, from Eq. 21, the acceleration when a constant voltage is applied to a motor becomes

$$\alpha_i = 150 \times 10^3 e^{-400t}, \quad (24)$$

and Eq. 23 for constant current with $I_a = 20 \text{ A}$ during acceleration, becomes

$$\alpha_i = 150 \times 10^3 e^{12.5t}. \quad (25)$$

A short tabulation of numerical solutions of the exponents of Eqs. 24 and 25—

t (sec)	e^{-400t}	$e^{-12.5t}$
0.001	0.660	0.99
0.01	0.016	0.89
0.1	4.2×10^{-18}	0.30

—reveals clearly that acceleration in the constant-voltage case drops very rapidly—even as little as 0.01 s after starting. However, in the constant-current case, acceleration remains substantially constant during the critical first few milliseconds after start.

Therefore, the initial acceleration for constant-current operation, with negligible T_F and T_L , can be written as

$$\alpha_i = \frac{K_T I_a}{J}. \quad (26)$$

Note that acceleration is directly proportional to current for small time intervals. Also, motor resistance is absent from the speed formula, Eq. 22; thus speed is independent of motor resistance. A system that uses a constant-current driving source eliminates the effects of changes in motor resistance. Motor resistance changes can result from temperature variations and brush and commutator wear.

Pulse-width control is unsuitable

Pulse-width-modulated drive systems are often used to control motor speed and acceleration. Because the drive transistors operate in a saturated mode in pulse-width systems, the transistors dissipate less power for a given output and the system can operate at high efficiencies. However, with responsive low-inertia motors, the pulsed power may produce a ripple in the motor's output. And in a velocity servo system, the ripple is made worse, since it tends to be amplified.

Of course, a servo with a narrow amplifier bandwidth or with ripple filtering would reduce this undesirable condition, but it would also reduce the rapid-response capability of the servo system and defeat the high-response capability desired with low-inertia motors.

In addition, such undesirable speed variations cause excess motor heating and make precise

speed control difficult. Speed ripple would create ripple in the tachometer output of a servo. This ripple looks like speed errors in the system and would cause a large amount of current switching when the system attempts to correct. Audible noise, excessive heating and even burn-out of the amplifier, motor or power supply could result.

Negative feedback in a servo system, if allowed to form torsional-resonance loops, will cause instability. As a signal flows around a servo-system loop, it encounters delays caused by motor inertia, filters, amplifier response, inductance, shaft wind-up, etc. If at any given frequency these delays result in a phase shift of 180 degrees and a net loop power gain exists, the system will become unstable and tend to oscillate.

The solution to this problem lies in identification of the delay elements and control of the over-all-system frequency response to that gain is much less than unity at 180-degree phase-shift frequencies.

In any mechanical system, torsional resonance can occur when two or more masses are connected by a common shaft. A high-performance motor, its associated tachometer and a load can be represented by three inertial masses connected by shafts. The shaft's inertia is generally considered negligible, but they supply the spring-constant of the resonant system.

To solve the high-order differential equation of even a simplified equivalent-circuit of such a mechanical system is a difficult task. Thus, experimental methods are often used to determine resonance frequencies and instability conditions.

In practice, the conditions can be very complex. The inertias of the loads, motor rotor and tachometer; their relative location; the length, diameter and material of the connecting shafts, couplers and gears; and the friction and backlash in a system—all affect stability and are difficult to include in a mathematical model.

A resonant frequency can be damped in several ways. A notch filter can be tuned to reduce the amplifier's gain in the region of the frequency. Or, the rate of change of feedback can be limited to reduce the over-all system frequency below that of the resonant frequency. This later approach can severely compromise a system's response.

But no matter what type of system stabilization is used, high-performance, low-power drive applications can be more easily achieved with low-inertia, low-inductance motors such as hollow-rotor motors. And whether the system is a simple open-loop drive or a complex servo system, low-inertia and low-inductance motors allow the attainment of a higher level of rapid-response performance than most other motor types. ■■

Reference

1. Mazurkiewicz, J., "Consider Hollow-Rotor Motors," *Electronic Design*, May 24, 1975, pp. 76-79.

MOSTEK

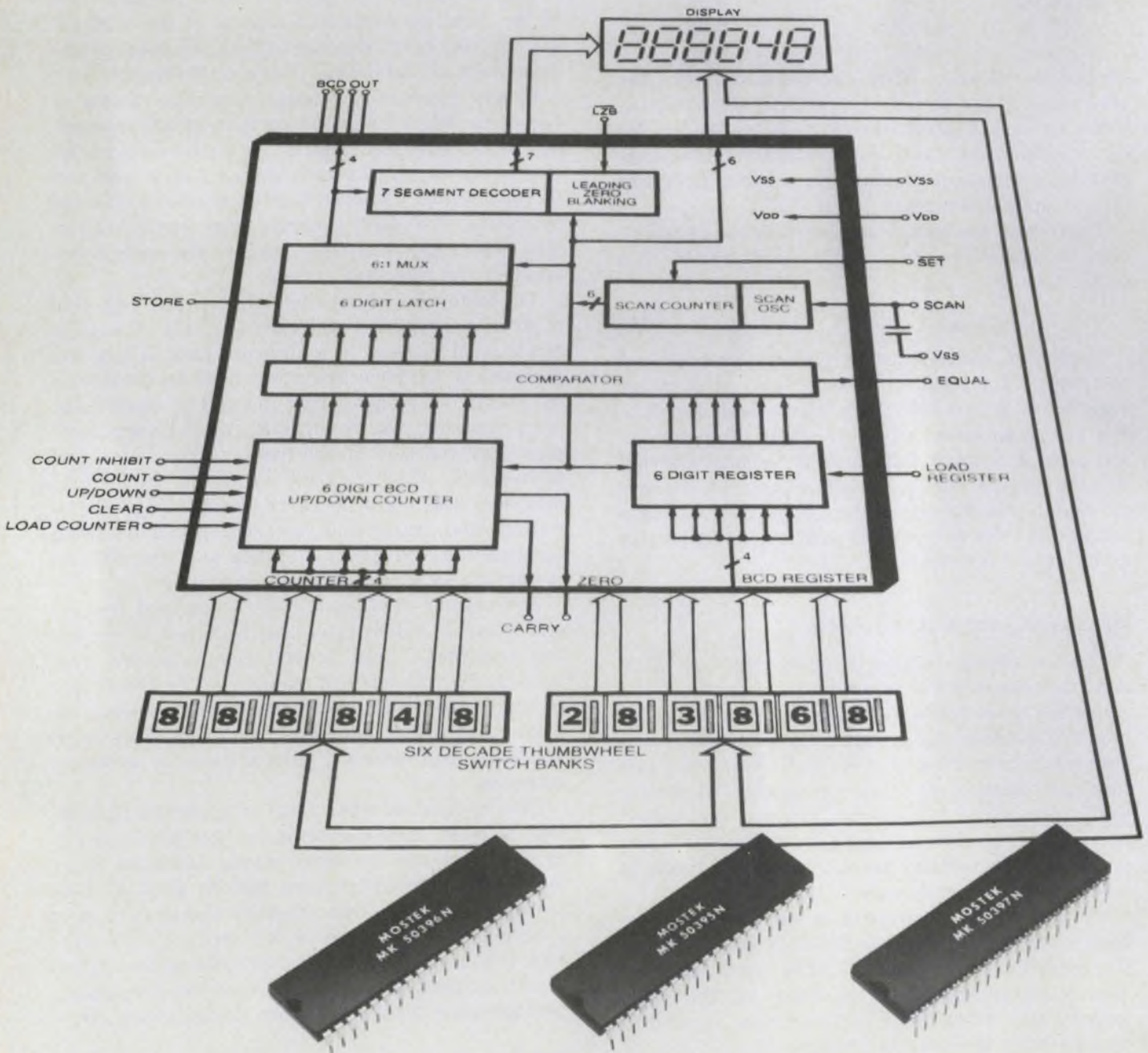

COUNTERS

Application ideas are proving their versatility.

From a Continuous Rate-Indicating Thermometer to a Robot Parking Attendant the wide range of applications submitted in our "I Need Help Counting" contest revealed a hint of the versatility we designed into our MK 50395 counter circuit. We received so many quality designs, in fact, we awarded more prizes than anticipated. Here's a sampling of the innovative designs entered:

- Digital Pulse Generator
- Digital Delayed Oscilloscope Trigger
- Simulated Counting at Frequencies above 100 MHz
- Phase Angle Detector with Revolution Counter
- Automobile Anti-Skid and Speedometer
- Batch Control System with Preset Load/Unload
- Tape Logging System
- Optical Position Controller
- Hand Portable Magnetometer for Surveying
- Digital FM Tuning Indicator

Now, there's a family of versatile counters to choose from.

MOSTEK has expanded its counter series to include two new circuits which count various increments of time, the MK 50396 and MK 50397.

Circuit Count Capability

MK 50395	Counts to 999999
MK 50396	Counts time to 99 hrs., 59 min., 59 sec.
MK 50397	Counts time to 59 min., 59 sec., 99/100 sec.

Whether you're developing a new system or making improvements, MOSTEK's counter series can offer significant cost savings and improved efficiency.

Never has one circuit had so much counting capability.

MOSTEK's new counter family provides six-decade synchronous up/down counter, display driver capability with compare register and storage latches. Plus, you'll find many features never before seen together on a single counter circuit.

- **Presettable Counter/Register.** The counter as well as the register can be independently loaded, digit-by-digit, with BCD data, and has an asynchronous clear function.
- **Comparator Function.** The six-decade register is constantly compared to the state of the six-decade counter and when the register and the counter have the same content, an EQUAL signal is generated.
- **Leading Zero Blanking.** The seven-segment decoder incorporates a leading-zero blanking circuit which can be disabled by an external signal.
- **BCD and Seven-Segment Output.** BCD and seven-segment data output provided. The MK 50395, 6 and 7 interface directly with standard CMOS logic and features single power supply operation, Schmitt-trigger on the count input, look-ahead carry or borrow and direct segment drive.

Count on your MOSTEK distributor. MOSTEK's new family of counters are now on distributors' shelves. Give them a call today for complete specifications.

DISTRIBUTORS ARROW ELECTRONICS

Baltimore, MD
Cleveland, OH
Dayton, OH
Farmingdale, NY
Hamden, CT
Moorestown, NJ
Saddlebrook, NJ

BELL INDUSTRIES

Skokie, IL

CRAMER ELECTRONICS

Albuquerque, NM
Atlanta, GA
Cherry Hill, NJ
Cleveland, OH
Dallas, TX
Denver, CO
Downsview, Ont.,
Canada

East Syracuse, NY Edina, MN

Gaithersburg, MD
Hanover, MD
Hauppauge, Long
Island, NY
Hollywood, FL
Irvine, CA

Moonachie, NJ Mt. Prospect, IL

Newton, MA
North Haven, CT
Orlando, FL
Phoenix, AZ
Rochester, NY
San Diego, CA
Salt Lake City, UT
Seattle, WA
Sunnyvale, CA
Winston-Salem, NC

DIPLOMAT/ALTA ELECTRONICS

Salt Lake City, UT

DIPLOMAT/ SOUTHLAND, INC.

Clearwater, FL

GRAHAM ELECTRONICS

Anderson, IN
Ft. Wayne, IN
Indianapolis, IN
Lafayette, IN
Muncie, IN

KIERULFF ELECTRONICS

Bierlerica, MA
Denver, CO
Los Angeles, CA
Palo Alto, CA
Phoenix, AZ
San Diego, CA
Seattle, WA

OLIVE INDUSTRIAL ELECTRONICS

St. Louis, MO

PRELCO ELECTRONICS

Montreal, Canada

SEMICONDUCTOR SPECIALISTS

Dayton, OH
Elmhurst, IL
Farmington, MI
Hazlewood, MO
Indianapolis, IN
Kansas City, MO
Milwaukee, WI
Minneapolis, MN
Pittsburg, PA

STARK ELECTRONICS

Minneapolis, MN

MOSTEK

1215 W. Crosby Rd., Carrollton, Texas 75006
214/242-0444

In Europe, contact:

MOSTEK GmbH, TALSTR. 172, 7024 Filderstadt-1, West Germany
Telephone: (0711) 701096

Voltage-to-current converter built with few components

With a minimum component count (two op amps and five resistors), the circuit in Fig. 1 converts voltage signals in the range of 0 to 10 V to a current output in the range of 4 to 20 mA.

To understand the operation of the circuit, first consider the Off/Set switch open. The noninverting input of the 72558 op amp, because it is strapped to the output terminal, forces the summing junction, S, to follow the output voltage, V_L . Therefore,

$$I_L = -\frac{V_i(R_2R_3)}{R_1(R_1R_3)} + \frac{V_L(R_2R_3)}{R_3(R_1R_3)} - 1 \quad (1)$$

The circuit becomes a perfect voltage-controlled current source, if the load current depends only on the input voltage, V_i , and not also on the load voltage, V_L . Make the coefficient of V_L in Eq. 1 equal to zero by setting

$$R_2R_3 = R_1R_3$$

Then the load current is given by the simple expression

$$I_L = -V_i/R_3$$

The load-current offset of 4 mA is obtained by closing the Off/Set switch to resistance R_0 . The expression for load current then becomes

$$I_L = -\frac{R_2}{R_1} \left(\frac{V_0}{R_0} + \frac{V_i}{R_1} \right) + \frac{V_L}{R_3} \left[\frac{R_2R_3}{R_1} \left(\frac{1}{R_0} + \frac{1}{R_1} \right) - 1 \right] \quad (2)$$

Now if

$$R_2R_3 = R_1 \frac{R_0R_1}{R_0 + R_1} \quad (3)$$

the expression for the load current reduces to

$$I_L = \frac{1}{R_3} \left(\frac{V_0R_1}{R_0 + R_1} + \frac{V_iR_0}{R_0 + R_1} \right) \quad (4)$$

If we set $(R_0 + R_1)/R_1 = 5$ to correspond to the ratio 20 mA/4 mA when $V_i = 10$ V and 0 V, respectively, then $R_3 = 500 \Omega$. The resistance R_1 should be high (100 k Ω) to ensure a high input impedance and R_4 should be low (47 Ω) to limit

the voltage excursions of point V_a . Finally, R_2 is determined from the balance condition of Eq. 3.

D. G. van Niekerk and G. J. Kühn, Automation Div., National Electrical Engineering Research Institute, P.O. Box 395, Pretoria 0001, South Africa.

CIRCLE NO. 311

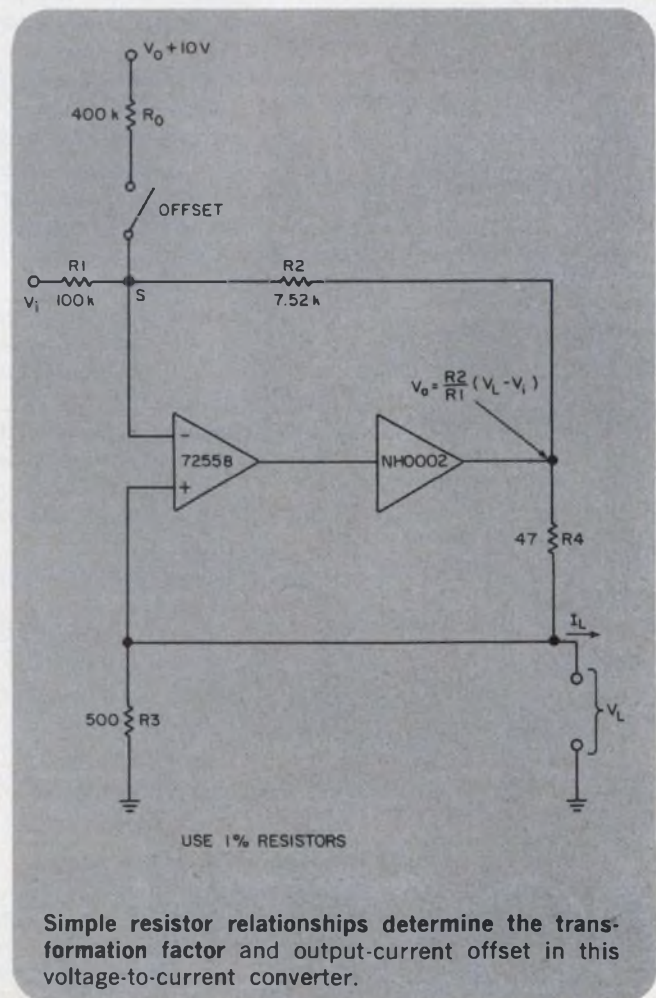

If you need
a tester
with **special**
scales, ranges,
accessories
or any
combination...

Buy a
Triplett tester
custom-designed
for you

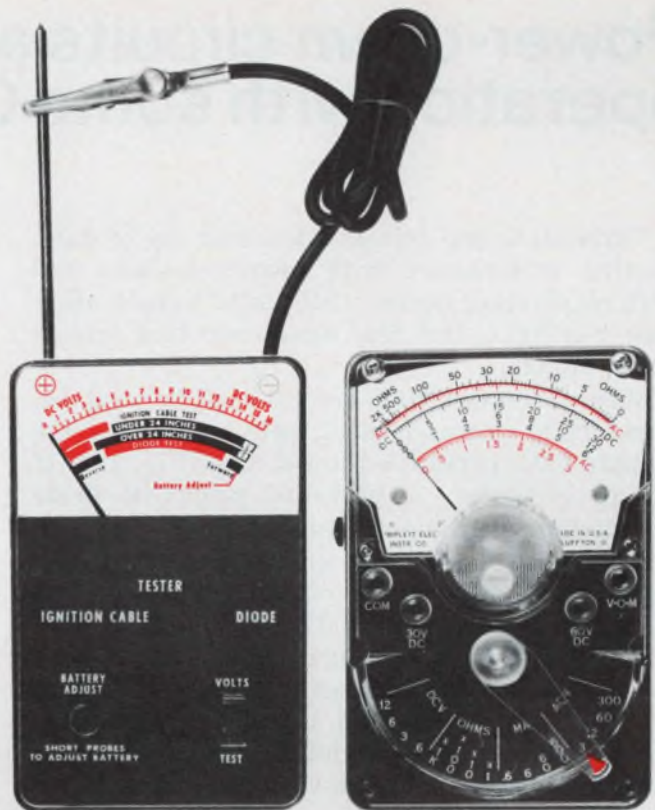

A

B



C

Triplett, manufacturer of the World's most complete line of V-O-M's, is ready, willing and able to design and manufacture special testers of virtually any size, style or type to meet your specifications.

Tester A (above) was designed to give auto mechanics a simple, rugged tester for "go/no go" tests that would otherwise be measured in electrical units unfamiliar to them.

Tester B is a modification of a

standard Triplett tester incorporating only the specific ranges needed by the field service engineers for whom it was designed.

Tester C has special ranges and special input connectors and cables to permit a single-point connection for trouble-shooting and servicing all the circuits of a complex business machine.

Several other buyers of standard Triplett test equipment request their company name on the dial to personalize their testers.

If you think a custom tester may solve some problems for you, contact your Triplett representative. He'll put you in touch with the Tester Designers and Engineers at Triplett who'll help you analyze the problem and suggest the optimum cost/result solution. Triplett Corporation, Bluffton, Ohio 45817

TRIPLETT
BLUFFTON, OHIO 45817
*Manufacturers of the World's
most complete line of V-O-M's*

CIRCLE NUMBER 60

Power-down circuits allow three-state operation with some CMOS drivers

Three-state line drivers allow easy use of databussing architecture with microprocessors and with many other devices that "talk" to each other over bus lines. But few three-state line drivers are available.

Most ordinary CMOS drivers can't be used, because diode clamps protect their inputs, and the outputs have parasitic drain diodes (Fig. 1a). If V_{cc} is grounded, a parasitic p-channel diode would clamp any input signal to 0.6 V. greater than 0.6 V; the input protection diode would clamp any input signal to 0.6 V.

However, with types MM78C29 and MM78C30 CMOS line drivers, the inputs and outputs both go to high-impedance states when powered down (their V_{cc} terminals are brought to ground). These drivers have modified input protective diodes, and they use a high-voltage npn transistor

in the output complementing circuit (Fig. 1b). With over 30-V breakdown limits, these CMOS drivers are amply protected in TTL circuits.

In the ON state, it's important to keep resistance between the line-driver circuit and the supply line as low as possible to minimize voltage variations at the driver's supply pin as its current varies. This minimizes cross-talk problems. A push-pull switch such as in Fig. 2a can be used to power down the line driver. Another version uses a CMOS inverter to replace the npn transistor (Fig. 2b). A single-ended configuration (Fig. 2c) is simpler and still effective; but it dissipates dc power.

Gerald Buurma, Design Engineer, National Semiconductor Corp., 2900 Semiconductor Dr., Santa Clara, CA 95051. CIRCLE No. 312

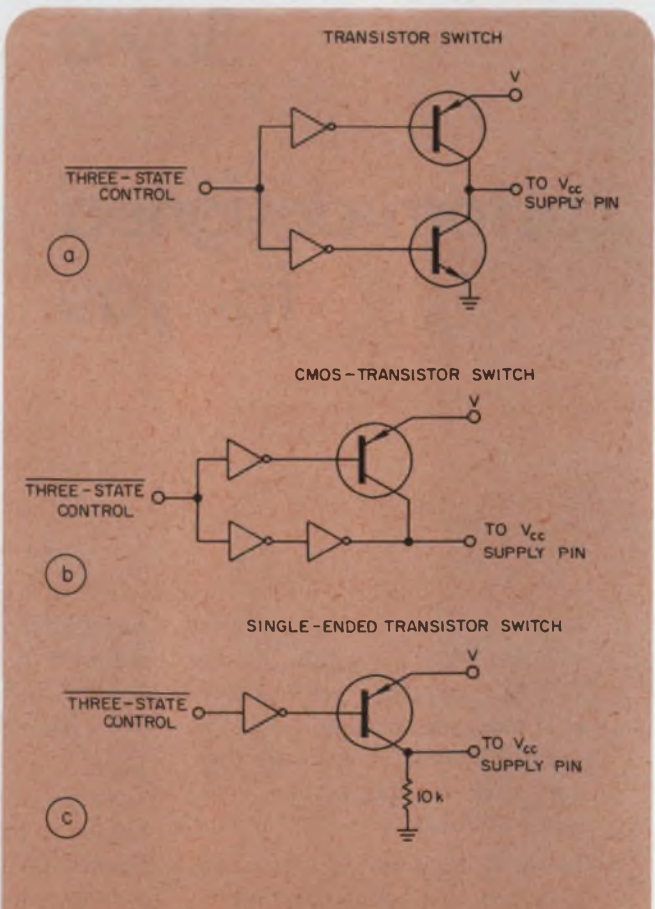
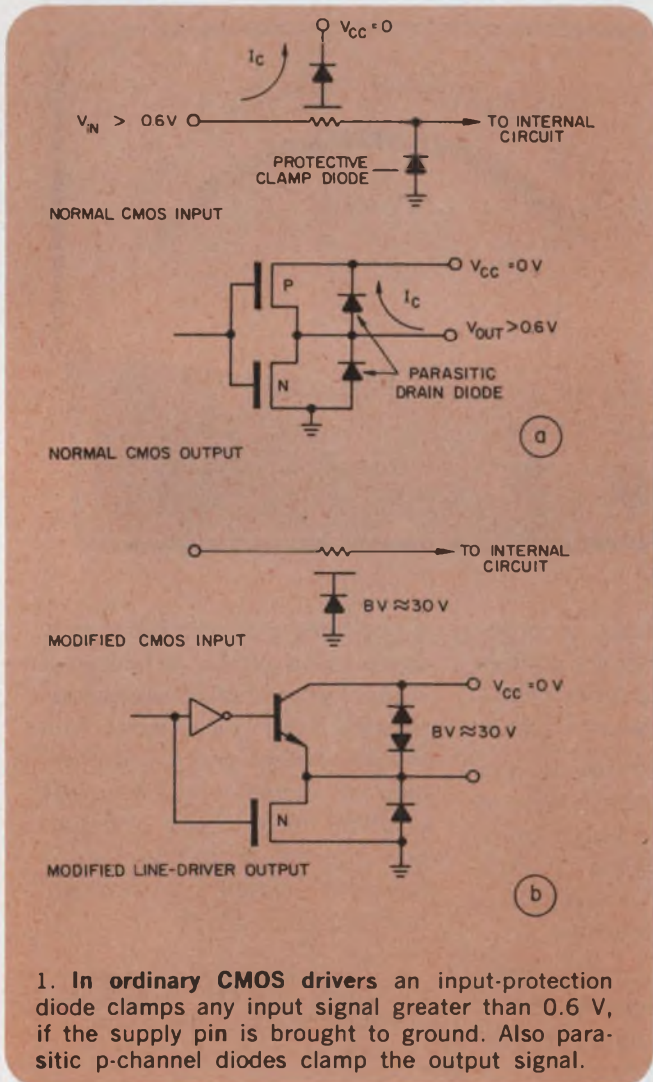

2. Low ON resistance to the positive supply is desirable to minimize channel cross-talk in line drivers. Saturated transistor switches power-up CMOS line drivers for normal operation or power-down for the high-impedance third state.

PMI-The μ P DAC Store.

When you go shopping for D/A Converters, please swing by PMI. Ever since we opened our doors six years ago, we've been working hard to spice up our shelves with the widest line of μ P-compatible monolithic DACs in the industry. 6-, 7-, 8-, 9-, and 10-bit DACs. Current or voltage outputs. Internal or external references. Routine MIL-STD 883A Level B processing, with Level A available. Guaranteed specs over full MIL Temp range. PMI pioneered monolithic DACs. It's only natural to find more here than anywhere.

And if DACs are new to you, lean on PMI's experience. We've helped designers and project managers put dependable PMI monolithic DACs to work in the most unusual spots. How can we help you with your microprocessor?

Also, our price list, DAC data sheets and App. Notes are yours for the asking. Ask your distributor or call your local rep.



Precision Monolithics Incorporated
1500 Space Park Drive, Santa Clara, CA 95050
(408) 246-9222. TWX 910-338-0528.
Cable MONO.

CIRCLE NUMBER 61



WORLD'S BEST
6 BIT DAC

10 BITS Vout
INTERNAL/EXTERNAL
REF. FROM

6 BITS Vout
INTERNAL REF.
from \$9.25

\$10.00

8 BITS Vout
INTERNAL/EXTERNAL
REF
from \$10.00

8 BITS Iout
EXTERNAL REF.
from \$3.95

8 BITS
I OUT
INTERNAL REF.
FROM
\$9.95

more
SOLD!
MORE MONOLITHIC
DAC'S SOLD THAN
BIG MAC'S (almost)



DAC-02's from \$15.00

8 BITS

7 BITS

9 BITS

10 BITS

A simple battery charger for gel cells detects full charge and switches to float

A gel-cell battery charger can be built with a 555 timer at a considerable parts saving over similar circuits. A cell should be charged at a current not exceeding 20% of its rated capacity until a specified terminal voltage is reached. The charging current must then be reduced to approximately 1% of the rated capacity of the battery to maintain the battery in a float condition.

The circuit in the figure meets these charging conditions for a 6-V, 1.2-Ah system. For this battery, the charge current should be equal to or less than 240 mA and the float-charge current should be approximately 12 mA. When the battery is fully charged it exhibits a terminal voltage of 7.2 V and a float voltage of 6.8 V.

The two comparators in the 555 detect both the need for charging and the fully charged condition. The timer's internal flip/flop and npn discharging transistor drive an external transistor, Q₁. Transistor Q₁ switches the charge current from its maximum value (limited by R₁) to the float value (limited by R₁ + R₃). Resistors R₄ and R₆ set the trip point for detecting a fully charged battery; resistors R₅ and R₇ set the trip points for detecting a partially discharged battery. Diode D₁ disconnects the charging circuit from the battery when the 10-V regulated-input source is removed.

Paul Kranz, Products Manager, and John Seger, Associate Engineer, Dytron Inc., 241 Crescent St., Waltham, MA 02154.

CIRCLE NO. 313

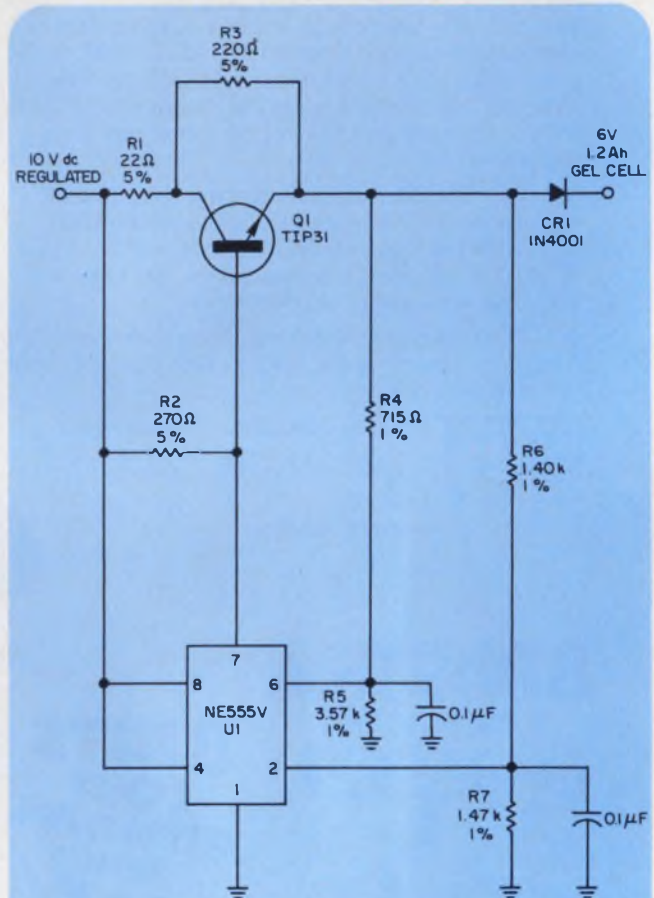

This battery charger for a 6-V gel cell automatically detects the full-charge state and switches to a float-charge condition—from 240 mA to 12 mA.

IFD Winner of March 15, 1976

John Okolowicz, Senior Electrical Engineer, Honeywell Inc., 1100 Virginia Dr., Fort Washington, PA 19034. His idea "Automotive charging regulator gives overvoltage and undervoltage warnings" has been voted the Most Valuable of Issue Award.

Vote for the Best Idea in this issue by circling the number for your selection on the information Retrieval Card at the back of this issue.

SEND US YOUR IDEAS FOR DESIGN. You may win a grand total of \$1050 (cash)! Here's how. Submit your IFD describing a new or important circuit or design technique, the clever use of a new component or test equipment, packaging tips, cost-saving ideas to our Ideas for Design editor. Ideas can only be considered for publication if they are submitted exclusively to ELECTRONIC DESIGN. You will receive \$20 for each published idea, \$30 more if it is voted best of issue by our readers. The best-of-issue winners become eligible for the Idea of the Year award of \$1000.

ELECTRONIC DESIGN cannot assume responsibility for circuits shown nor represent freedom from patent infringement.

RM 9000.

The totally modular graphics and imagery system from Ramtek.

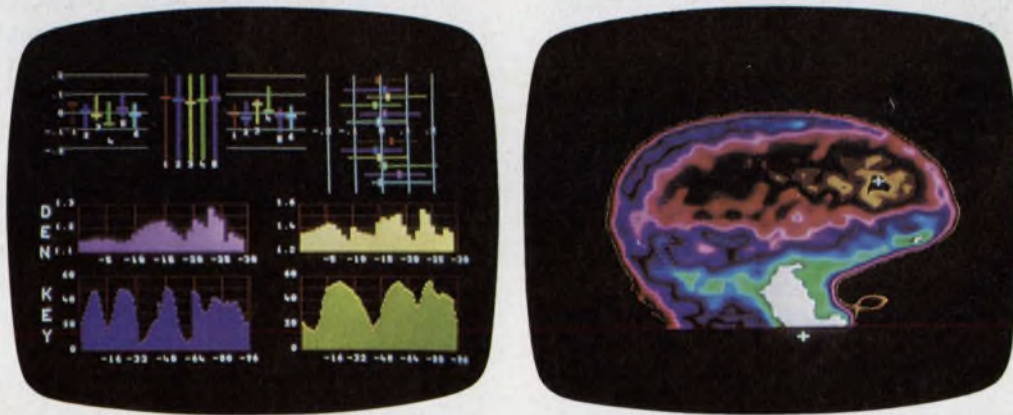

You decide the performance.

One of the major benefits of the Ramtek RM 9000 series is its modularity. Specifically, it means that you can select the precise amount of performance you need to satisfy the requirements of your particular application. The savings benefit is obvious. You pay only for the performance you need and nothing more.

The RM 9000's modular design provides long-range benefits as well. As your applications change or grow, so can your Ramtek Imager. A comprehensive list of options, such as grey-scale, color, and graphics generation, are simple plug-in modules. This enhances the cost effectiveness of the RM 9000 by permitting the addition of specific options as needed.

Functional, reliable, maintainable.

The RM 9000 series is the first raster scan graphics and imagery system to be totally micro-processor controlled. Implementation of a higher-

order user language minimizes programming costs without sacrificing system throughput. Reliability is the direct result of intensive testing of components and systems prior to shipment as well as the exclusive use of solid-state components and printed circuit construction throughout the systems. As a result, no special preventive maintenance measures are required. In fact, your Ramtek Imager can be pre-programmed with a self-diagnostic capability.

You need to know more.

To fully appreciate the RM 9000's capability, you need more details. Call or write Ramtek Corporation, 585 N. Mary Ave., Sunnyvale, CA 94086. (408) 735-8400

**The experienced leader
in computer displays.**

Super-high g_m input stage sums currents to make precision modular instrumentation amp

A novel design of a modular instrumentation amplifier, developed by Datel Systems of Canton, MA, permits the construction of small, bipolar-input, discrete-component modules that rival the performance of more costly rack-mounted amplifiers.

The desired specifications—such as input offset current drift of $20 \text{ pA}/^\circ\text{C}$, offset voltage drifts of only $0.25 \text{ } \mu\text{V}/^\circ\text{C}$, gains from 1 to 1000 and CMRRs of 114 dB that are flat to 700 Hz—ruled out many of the conventional methods, such as the triple op-amp scheme of Fig. 1.

The approach chosen by Datel lets the CMRR and gain be determined by a wideband bipolar input stage that makes use of a "super-high" matched g_m instead of critical resistor matching (Fig. 2). The output stage also operates in a wideband mode and produces no common-mode error voltage due to resistor mismatch, but only an offset that can be calibrated.

The input stage of Datel's circuit contains a differential gain block, represented simply by Q_{1a} and Q_{1b} . These transistors have a transconductance of 50 mhos, and they represent a tightly matched, high-gain differential circuit. The cur-

rent output of this stage drives an op amp that is connected as a differential current-to-voltage converter. When operated with 100% feedback, the amplifier has the desirable features of unity drift gain (unlike A_1 of Fig. 1 which has a minimum drift gain of 2) and maximum available bandwidth.

Only two nominally equal resistances, R_1 and $R_1(1 + \Delta)$, are required. Any mismatch between them produces an output offset—not a common-mode error—and can be nulled out. The extremely high transconductance of the input stage provides three important advantages:

1. It permits the ratio of two passive components (R_1/R_2) to define accurately the differential gain equation, and it eliminates changing transistor parameters as possible error sources.
2. It permits close control of the static and dynamic behavior of the amplifier.
3. It lets you use standard value resistors to set gain values externally.

All the capability formerly available in many rack-mounted units can now be put into $1.5 \times 1.5 \times 0.375$ -in. modules at a fraction of the cost—less than \$100 for the best unit.

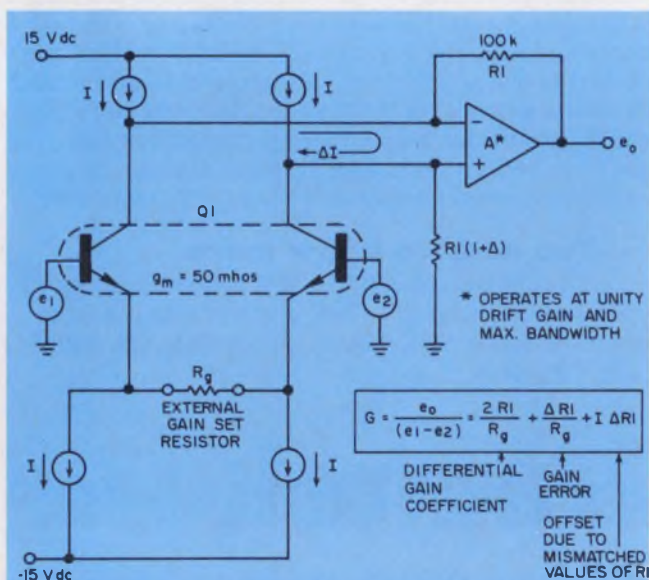

1. The CMRR of the common three op-amp instrumentation amplifier circuit relies on resistor and op-amp matching. A unity differential-gain setting is impossible.

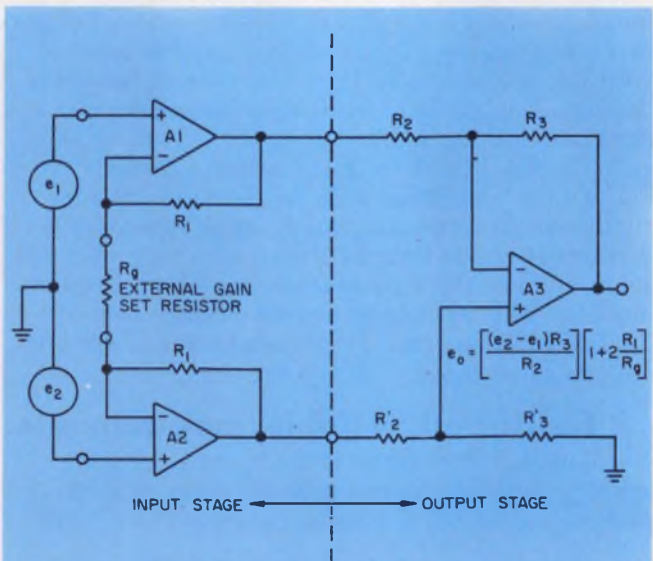

2. The high differential transconductance input stage converts resistor mismatch effects into an offset. This permits differential gains of less than one to be used.

**The other place in town to get the Am2900
from the first supplier with software to support it.**

Now there's another place in town for the 2900 Family of microcomputer components. Raytheon has immediately available the Am2901 4-bit Microprocessor Slice and the Am2909 Microprogram Sequencer.

The 2901 is the fastest, most powerful LS microprocessor in the world. With its cycle-saving two-address architecture, the Am2901's speed can't be touched. The 2909 can branch anywhere in memory, perform sub-routines, then return with up to four levels of sub-routine nesting. Together, the 2901 and 2909 are the most in-demand components in the Series. And the start of our big 2900 Family. Bus transceivers, look-ahead carry generators, registers, PROM's and RAM's are soon to come from Raytheon.

The story doesn't stop there. We also are the place in the world for you to get software support for your high-speed microprogrammed 2900 Series design. Raytheon has **RAYASM**, the general purpose Microassembler for the 2900 Family. It is available now on the National CSS computer network. The program will organize your microprogram, check errors, and punch PROM programming tapes automatically. And the manual is yours free for the asking.

For complete details, contact your local distributor or Raytheon Company, Semiconductor Division, Dept. 2900, 350 Ellis Street, Mountain View, CA 94042; (415) 968-9211.

**Am2900
SOLD & SUPPORTED
HERE**



SEMICONDUCTOR DIVISION

CIRCLE NUMBER 63

Novel display chips use magneto-optics

A novel display combines the storage properties of magnetic bubbles with magneto-optic effects produced using polarized filters.

Prototype display chips developed by Mullard Research Laboratories have a 10×10 bubble matrix. These chips have displayed alphanumeric characters using a 7×5 matrix format of $10 \mu\text{m}$ bubbles.

The display chip is similar to the conventional bubble memory. The chip has a thin layer of magnetic material overlaid with a pattern of permalloy elements that control the generation, propagation and annihilation of bubbles. The display chip is illuminated from behind with linearly polarized light. The light after passing through the chip, goes through a second polarized filter that has a different polarization axis.

Because the light passing through

magnetized areas of the chip undergoes Faraday rotation, a color contrast between the bubbles and the space around them is produced. The contrast obtained is higher than that of other two-color displays, and the colors are varied by changing the polarized filters.

The display, like the bubble memory, is non-volatile. Also, it is current-driven at low voltage. Another advantage is that only two connections to the chip are required for display of any size.

A major limitation of the display is its tiny size. It must be viewed through a magnifying eyepiece.

Further work is aimed at developing a 100×100 matrix chip that operates at 10 kHz, takes 1 s to build up a picture. The chip would be only about 4-mm^2 in area; but Mullard claims data written on the chip would be clearly visible using a $\times 10$ eyepiece.

New technique plots carrier concentration

A technique to obtain a continuous automatic plot of carrier concentration versus depth in a semiconductor, has been developed at the Research Laboratories of the British Post Office.

The key to the method is the formation of a Schottky barrier between the semiconductor and an electrolyte. A depletion layer is formed within the semiconductor. Then the capacitance-voltage behavior of the layer is used to determine the carrier concentration. Integrating the electrolyte's dissolution current yields the depth at which the carrier concentration is being measured.

The concentrated electrolyte is conductive enough to behave like a metal, thus giving rise to a Schottky barrier such as is formed at the metal/semiconductor interface. When the junction is reverse-biased a depletion layer is formed. Its width is obtained by measuring the junction capacitance.

If the barrier potential is modulated, the junction capacitance and depletion layer width are also modulated; and the ionized impurity concentration can be found from the relationship $N_D - N_A = KdV$. Here, K is a material constant and $N_D - N_A$, the difference between the donor and acceptor concentrations, is the required carrier concentration (assuming an n-type material).

A potential-barrier height of 1.5 V is maintained across the depletion region and a 100 mV, 30 Hz modulation is superimposed on the 1.5 V. The junction capacitance is measured using a 50 mV, 3 kHz test signal.

Analog processing of the modulation signal yields W_D and $\log(N_D - N_A)$. The depth of material removed by anodic dissolution is equated to the integrated dissolution current plus W_D .

Graphics device allows wide range of operations

The use of both light-pen and cursor controls allows a wide range of interactive-graphics operations to be carried out on a computer-controlled graphics device developed at the Science Research Council's Rutherford Laboratory at Didcot, Oxford, England.

The graphics system, called ASPECT, has stored graphics data. This enables pictures to be scaled, moved linearly or rotated in two and three dimensions in real time. A picture processor gives immediate

response to operator signals.

The scaling, lateral movement, and rotation capabilities work directly from the digitally-stored file of coordinates describing a three-dimensional structure. An operator, using tracker-ball input devices, can zoom in on any portion of the display.

Other features of ASPECT include an alphanumeric character generator and a vector generator for supplying lines between any two specified points.

Our New DAC90 Costs Less Than Modular DAC's And Outperforms the IC's

Any way you compare, DAC90 offers value. Our new DAC90 gives you lower drift and better linearity than other 8-bit IC's with a lower price and a smaller package than 8-bit modules.

Price? From just \$8.50.*
Performance? Settling time to $\pm 0.2\%$ is less than 200 nanoseconds!
Non-linearities are guaranteed less than $\pm 0.2\%$ for all models, over their entire temperature range. And of course monotonicity is guaranteed, too.
And all versions of the DAC90 are fully TTL compatible.

Package? All of that performance comes in a hermetic 16-pin ceramic DIP. Reference and feedback resistors are built in so it's easy to use.

We have solutions for your other conversion problems, too. We make A/D's, sample/holds, multiplexers, V/F's comparators and peak detectors.

Contact Burr-Brown, International Airport Industrial Park, Tucson, Arizona 85734
Telephone (602) 294-1431

*Unit price, model DAC90BG (-25 to +85C) in orders of 100 or more.



BURR-BROWN
BB

*Fifty-three
conversion choices*

CIRCLE NUMBER 64

This is what multifunction counters are supposed to be all about.

Model 5740, 7-digit, 100 MHz Multifunction Counter/Timer. \$295*

Quality you can count on. Data Precision's Model 5740 is a 7-digit, 100 MHz Timer/Counter; a superb laboratory quality instrument.

Data Precision built the 5740 to be exceptionally versatile. It measures frequency, period, period average, elapsed time and total events with the kind of accuracy, sensitivity, and upper frequency capability generally found only in higher priced units.

Consider: 10 mV RMS sine-wave to 20 MHz. 50 mV RMS at 100 MHz. That's excellent sensitivity in anyone's book. And this

15843.76

sensitivity is a minimum specification (not a typical) allowing lock-in measurements from even extremely weak signals. The 100 MHz bandwidth means the 5740 handles everything from sub-audio to VHF. Seven, not six digit resolution, means 0.1 Hertz resolution at 1 MHz, 1 part in 10 million in period measurements, with the decimal point always automatically correct.

Want even more? A low-cost optional BCD output provides printer and/or computer/system compatibility while providing

counter status timing and control signals as well as reading and decimal-point data. And an optional remote start/stop control makes this a most flexible elapsed time indicator.

The 5740 Multifunction Counter/Timer. Its quality, versatility and value are unmistakable. And it comes with something no one else gives you: Data Precision dependability.

For complete information or a demonstration contact your local Data Precision representative or Data Precision Corporation, Audubon Road, Wakefield, MA 01880, USA, (617) 246-1600. TELEX (0650) 949341.

*Price U.S.A.

DATA PRECISION[®]
...years ahead



New Products

Infrared LED light bars read tapes and cards

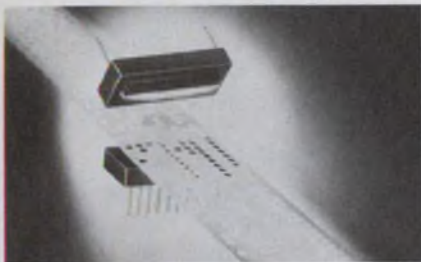

Opto Technology Inc., 1001 E. Touhy Ave., Des Plaines, IL 60018. (312) 724-2800.

An infrared LED Light Bar is a packaged array of solid-state LEDs. A reverse-voltage blocking diode is included. The Bars are complete and ready to use. Minimum to maximum light level is externally adjusted by user. The units are available in standard 1-in. nine-channel-reader packages. Custom lengths are available to user specifications.

CIRCLE NO. 320

Power Darlington rated for a 200-C junction temp

Lambda Electronics, 515 Broad Hollow Rd., Melville, NY 11746. (516) 694-4200. \$2.42 to \$4.60 (100 up); stock.

Power-Darlington assemblies in three new power levels—100, 150 and 225 W—allow power supply designers to use fewer components, to increase reliability, to save 40% on material costs and to reduce assembly labor, according to Lambda. These transistors are the only 200-C operating-junction-temperature Darlington power transistors in the industry. They all are true-hermetic sealed. The 100 and 150-W versions are resistance-welded units; the 225-W units are solder constructed. All are continuous-duty rated, have a low thermal resistance (0.67 C/W) and are 100% tested for second-breakdown current and leakage-current stability at a 200-C junction temperature. Current gain is 1000 at a collector current of 4, through 10 A.

CIRCLE NO. 321

Avalanche photodiodes have diverse properties

RCA Solid State Div., Route 202, Somerville, NJ 08876. (201) 685-6423. \$159: C30817; \$200: C30872, \$40: C30884, \$97: C30895 (unit qty).

Three new silicon avalanche photodiodes, the C30817, C30884 and C30895, are supplied in low-profile TO-5 packages and have useful photosensitive areas of about 0.5 mm². A fourth—the C30872—is a large-area photodiode; its useful photosensitive area is about 7 mm². This diode is supplied in a low-profile TO-8 package. The C30817 and C30872 are intended for use in general-purpose applications. They have a useful spectral range extending from about 400 to 1100 nm and rise and fall times of typically 2 ns. The C30884 has very high modulation capability, up to 400 MHz, and typical rise and fall times of 1 ns. Its spectral range is from 400 to 1100 nm. The C30895 is optimized for high responsivity and low noise at 1060 nm. Its spectral range extends from about 700 to 1100 nm. Rise and fall times are typically 2 ns. This device is designed for use in adverse environments.

CIRCLE NO. 322

Green LED chips brighten watch displays

Xciton Corp., Shaker Park, 5 Hemlock St., Latham, NY 12110. (518) 783-7726. \$2 (1000 up); stock to 2 wks.

Xciton's green monolithic watch chips, designated CXC-120G, used in numeric watch displays are two-to-five times brighter than previously available green digits. The displays are constructed with nine chip segments and each chip is a 0.097 × 0.060-in. bar. A companion chip, the CXC-121G, measures 0.088 × 0.045 in. Both are optimized for unmagnified viewing and rated at 100-mcd output with a 10-mA drive. The peak output wavelength is 565 nm and typical forward voltage is 1.9 V at 10 mA.

CIRCLE NO. 323

Rf silicon transistor provides low noise

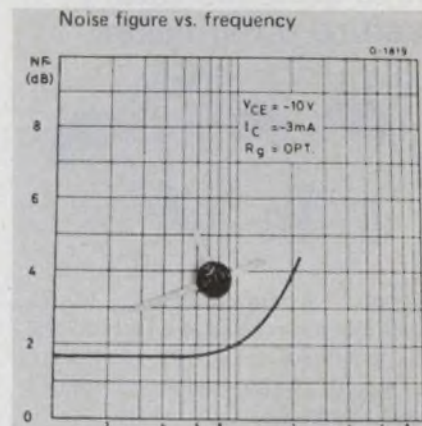

SGS-ATES Semiconductor Corp., 435 Newtonville Ave., Newtonville, MA 02160. (617) 969-1610. \$6 (1-9); stock.

BFT95 is a new 5-GHz silicon pnp transistor with extremely low noise (2 dB at 1 GHz) intended for high-volume rf applications such as antenna amplifiers, cable TV and up-converter tuners. The device is constructed with Planox silicon-nitride technology to minimize parasitic capacitances in a common-emitter configuration. It's mounted in the SGS-ATES T-plastic package, which uses a copper-alloy frame to withstand high current and thus achieve a better cross-modulation level. Forward-transmission gain is 10 dB at 1 GHz and the intermodulation intercept point with optimum biasing is +23 dBm.

CIRCLE NO. 324

Monolithic duals receive MIL approval

Teledyne Semiconductor, 1300 Terra Bella Ave., Mountain View, CA 94043. (415) 968-9241.

Military qualification for the monolithic 2N2919 and 2N2920 dual npn bipolar transistors are believed to be the first granted for these devices, according to Teledyne. Single-chip monolithic construction significantly improves matching and tracking when compared with two-chip units. Manufacturing economies also allow lower prices (not given), especially on the types requiring extra processing (JTX and JTXV), says Teledyne.

CIRCLE NO. 325

DISCRETE SEMICONDUCTORS

Solid-state indicators feature three colors



Chicago Miniature Lamp Works, 4433 N. Ravenswood Ave., Chicago, IL 60640. (312) 784-1020. \$1.15 to \$1.40: 6340; \$0.60 to \$0.80: 6080 (1000 up).

The new Ultralite series of solid-state indicators is available in red, amber and green in attractive chromed housings. The series is available in two sizes: a large 6340 series, featuring a 0.4-dia spot, and an economical 6080 series, featuring a 0.2-dia spot. The units provide up to 13 mcd (red, 6340 series) output. Power ratings include 5-V, 40-mA resistored and 2-V nonresistored styles as standards with 6-in. wire leads or solder/faston terminals.

CIRCLE NO. 326

Caseless SCRs and triacs 40% lower in cost

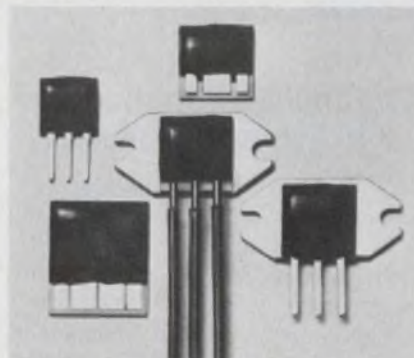

Unitrode Corp., 580 Pleasant St., Watertown, MA 02172. (617) 926-0404. \$0.52 to \$10 (1000 up); 3 to 4 wks.

Unitrode's ChipStrate line of SCRs and triacs now include ratings to 800 V and a wide range of new packaging options. The basic line covers 3-to-55 A ratings and consists of glassivated solderable power chips mounted on alumina or beryllia ceramic substrates having solderable terminal pads. The substrate package is smaller and up to 40% lower in cost than conventional stud or pressfit devices.

CIRCLE NO. 327

Switching power-supply transistors go plastic

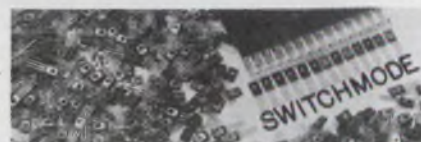

Motorola Semiconductor Products, Inc., P.O. Box 20294, Phoenix, AZ 85036. (602) 244-3465. \$0.75: MJE13002, \$0.95: MJE13003 (250-999).

Motorola introduces its switch-mode power transistor in plastic TO-126 packages. First in this planned series of plastic-packaged introductions are the MJE13002 and MJE13003 devices rated 1.5 A with a 600/700-V blocking voltage. The devices in the plastic packages are significantly lower in price than equivalent metal-packaged devices. For circuits requiring very fast turn-off time, at 100-C operation, critical parameters include a complete inductive-load switching matrix for collector currents ranging from 0.5 to 1.5 A, and a reverse-biased SOA for various turn-off voltages.

CIRCLE NO. 328

Problem:

No one makes a standard enclosure that'll house your system design.

Solution:

Contact Bud and tell us your problem. We'll solve it.

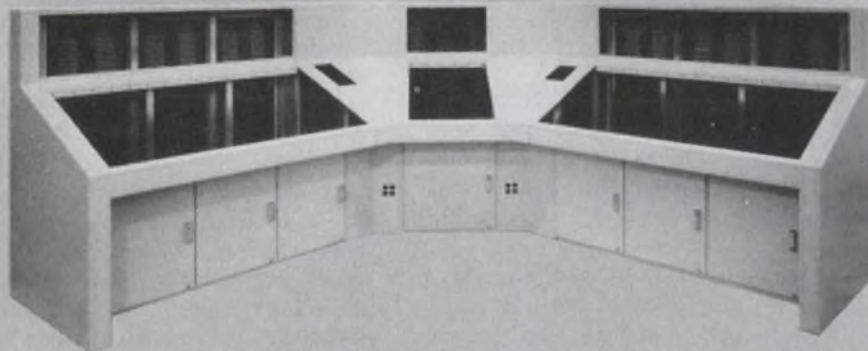

This is a special enclosure Bud helped design, then we built and delivered it on time. Special fabrication is a big part of our business; we know what we're doing — and we do it one of three ways: Adapting a standard product that'll fit a system; creating an entirely new enclosure; using the Imlok system, one that's ideal for short runs or prototypes. **YOUR PROBLEM IS SOLVED!**

Call toll free:

(800) 321-1764 for more facts. In Ohio, (800) 362-2265.

BUD

BUD RADIO, INC.
Willoughby, Ohio 44094

Who provides the industry's broadest line of electronic packaging hardware ... including IC Sockets?

SAE does! And in most cases, we'll deliver right off the shelf, because SAE makes all kinds of IC sockets to satisfy a wide variety of applications.

You can choose side or edge wipe styles; dual-in-lines or single-row strips. Standard or low-profile configurations (.150" high). One, two or three-level wrap terminals; dip-solder types in 8 through 40 pin sizes, all on .100" contact centers. Or if you prefer, select individual contacts or carrier strips; and even discrete assemblies.

Plating thicknesses range from 10 to 50 mils gold; and all the low-profile components have an anti-wicking feature that eliminates solder wicking entirely. So for your next requirement ... whether prototype or by the thousands ... give us a call. We'll deliver! Our new 128 page packaging handbook gives complete details, and also describes our entire line of electronic packaging and interconnection hardware.

For an immediate reply, call the following toll-free "ZIP QUOTE" number at the factory ... 800-538-6843.



SAE Stanford Applied Engineering, Inc.

340 Martin Ave., Santa Clara, CA 95050
(408) 243-9200 TWX 910-338-0132

CIRCLE NUMBER 67

Power Darlington's give greater power gain

Motorola Semiconductor Products Inc., P.O. Box 20294, Phoenix, AZ 85036. (602) 244-3465. \$6.25: MJ-10000. \$7.75: MJ10001 (250-999).

MJ10000/MJ10001—first in a series of switchmode power Dar-

lington transistors—are part of a high-voltage, high-speed series for use in switching power supplies and other inductive circuits where fall time is critical. The Darlington's provide up to 10 times the power gain of conventional, single-transistor, switchmode devices, according to Motorola.

CIRCLE NO. 329

High-efficiency diodes protect transistors

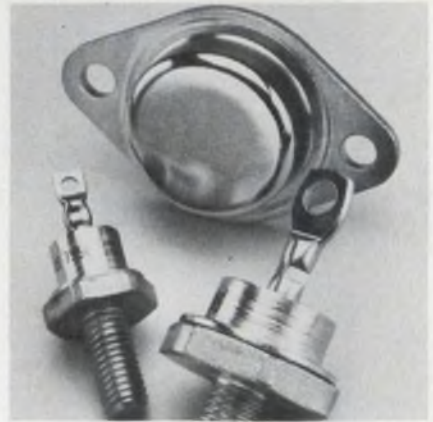

Unitrode Corp., 580 Pleasant St., Watertown, MA 02172, (617) 926-0404. \$1.10: 50-V leaded units, \$14.55: 500-V, DO-5 (1000 up); Stock.

High-efficiency industrial power rectifiers for use as commutating or "catch" diodes in switching regulators protect transistors from excessive switching losses, second breakdown and voltage stress. Their low V_f (typically 0.7 V under maximum operating conditions) and fast t_{rr} (typically 30 ns) make them equally suitable for high-frequency power supplies, telecommunications systems, dc motors and high-current off-line switching circuits. They are available in fused-in-glass axial-leaded bodies and DO-4, DO-5 and TO-3 packages with output current from 2 to 70 A and voltages to 500 V. The thermal resistances of the DO-4, DO-5 and TO-3 are typically 1.6, 0.6, and 0.8 °C/W, respectively.

CIRCLE NO. 330

Reliable AC line filters

Advanced engineering of inductors combined with the unique ceramic capacitor technology acquired from Allen-Bradley offers the reliability your equipment demands. Spectrum power line filters are designed for:

125 240VAC at 125°C 0-400 HERTZ

Proven Reliability

Controlled thermal characteristics

Limited AC voltage rise

Volumetric efficiency

Available in C, Pi, L, T

Mil-F-15733

TYPICAL PARTS	I Amps	Volts AC	Insertion Loss—Db		
			150KHz	10MHz	1GHz
54-367-006	15	125	12	53	65
51-353-112	3	125	13	70	70
51-320-023	1	240	24	70	70

For other ratings—see EEM 1-576 to 1-583

AVAILABLE from stocking distributors

HALL-Mark ELECTRONICS 215-355-7300 MOLTRONICS 213-773-6521
METUCHEN CAPACITOR 201-442-0500 ROSE ELECTRONICS 415-697-0224

ELECTRO 76 Boston Booths 2624/2626
IEEE EMC Symposium Wash. D.C. Booths 31/32



SPECTRUM CONTROL INC.
152 EAST MAIN ST · FAIRVIEW, PENNSYLVANIA 16415



SPECIALISTS IN ELECTRO-MAGNETIC COMPATABILITY

For a complete EMC solution let us test and analyze your equipment.

Darlington array operates with C/PMOS

Sprague Electric Co., 347 Marshall St., North Adams, MA 01267. (413) 664-4411.

A new high-current, high-voltage Darlington array, Type ULN-2004A, has been designed with series input resistors chosen to allow operation directly from CMOS or PMOS outputs that use supply voltages of 6 to 15 V. The input current is less than that of the Type ULN-2003A, while the input voltage is less than that required by the ULN-2002A.

CIRCLE NO. 331

COMPONENTS

Miniature relay features low profile

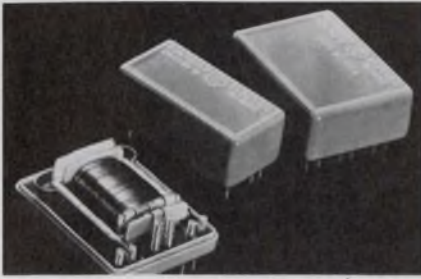

Guardian Electric Manufacturing Co., 1550 W. Carroll Ave., Chicago, IL 60607. (312) 243-1100.

A low-profile miniature relay, Series 1475 DC, with a choice of either an SPDT or DPDT contact assembly features contacts with multiple-convoluted contacting surfaces. The contacts are rated from dry-circuit to 10-A ac-resistive loads depending on voltage. For use on PC boards with 0.6-in. spacing between boards, the relay's terminals have a standard 0.1-in. grid spacing. The unit's sealed housing allows wave or hand soldering to 650 F without contact contamination or other damage. The case made of a glass-filled thermostet polyester is highly resistant to flux solvents.

CIRCLE NO. 332

Cermet trimmer offered with bushing mounting

Spectrol Electronics Corp., 17070 E. Gale Ave., City of Industry, CA 91745. (213) 964-6565. \$1.70 (100 up).

The new bushing-mount option to Spectrol's 3/4-in., Model 43, multiturn cermet-trimmer line is available in any of the common three-pin configurations. All units in this 20-turn trimmer line feature a T-slider block design and brush contacts that provide improved settability and stability as well as improved CRV and RT tolerance, according to Spectrol. The rectangular units have a low profile and stand only 1/4-in. above the board. They are resistant to shock and vibration per MIL-R-22097 and come in a sealed case that permits board washing.

CIRCLE NO. 333

Transient protectors handle 1-joule surges



Dale Electronics Inc., P.O. Box 609, Columbus, NE 68601. (605) 665-9301.

An expanded series of PCB-mounted transient protectors for low-voltage dc circuits, the LVP Series, now provides 10 standard models with preset clamping voltages from 6.2 to 51 V dc. The units have a shunt capacity of 15 μ F, nanosecond reaction times and operate over a temperature range of -55 to 85 C. These 1-joule units withstand power surges from 5000 W peak for a duration of 0.1 μ s to 40 W peak for a pulse duration of 10 ms. Physical size is 5/8-in. high with case diameters ranging from 0.651 to 0.932 in.

CIRCLE NO. 334

Small dc motors provide tach output

Siemens Corp., 186 Wood Ave. South Iselin, NJ 08830. (201) 494-1000. \$30 (1000 up).

A subfractional-horsepower motor, the 1AD4002, is supplied with a commutator circuit on a PC board that has two inputs for dc power and one tachometer signal output that allows speed regulation within 1%. Also speed is controllable externally. Available windings can meet customer requirements over a range of 4.4 to 30 V dc up to 10,000 rpm and for a stall torque of 2.9 oz-in. and continuous-running torque of 1 oz-in. The motor can be used either for gradual speed-change applications or accurate repeatable steps.

CIRCLE NO. 335

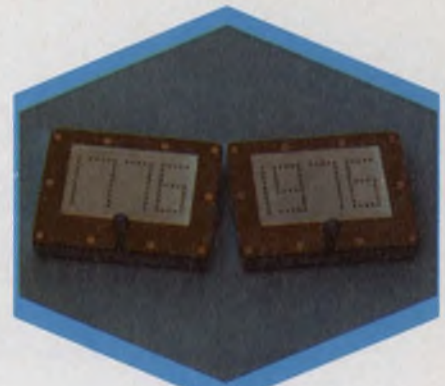

TEXTTOOL GRID ZIP SOCKETS

Versatile Standard Series
Accepts Most Devices . . .
Even "Bicentennial" Versions!

Even "Bicentennial" lead patterns offer no real challenge to the unique flexibility of TEXTTOOL's standard GRID ZIP socket series.

The GRID ZIP socket is capable of testing almost any plug-in device fitting within its 14 x 21 grid (.100 mil). You get optimum versatility without extra tooling costs. And, since only those positions actually required are available to the operator (294 maximum), the possibility of incorrect lead positioning is eliminated.

Simple mechanical action, characteristic of all TEXTTOOL zero insertion pressure sockets, allows a user to literally "drop" a device into the GRID ZIP's funnel entries which guide the leads to socket contacts. Then, simply flip a lever to test or age. Another flip of the lever allows extraction of the device with zero contact pressure, thus virtually eliminating mechanical rejects caused by bent or distorted device leads.

Regardless of device configurations — TO's, DIP's, platform and even "Bicentennial" — the versatile GRID ZIP socket accepts them all! If desired, several devices may be mounted in a single GRID ZIP for burn-in, or a single device may be inserted for hand test.

Detailed information on these and other products from TEXTTOOL . . . IC, MSI and LSI sockets and carriers, power semiconductor test sockets, and custom versions . . . is available from

your nearest TEXTTOOL sales representative or the factory direct.

TEXTTOOL's new
Condensed Catalog
describes them all.
Send for it today.



PRODUCTS, INC.

1410 W. Pioneer Drive • Irving, Texas 75061
214/259-2676

CIRCLE NUMBER 69

Our carry-in recorder/reproducer will carry on for 32.8 hours!

The 70-lb. Sabre VI: It's a giant leap beyond any other small, high performance IRIG analog tape recorder/reproducer. Records at 8 electrically selectable speeds: 120 ips through 15/16 ips; reproduces at any 3 electrically selectable speeds; records from 15.3 minutes at the highest speed to 32.8 hours at the slowest on 14" reels. Remote speed selection and LED footage counter. LED bar data monitor. Let us give you full details.



SANGAMO RECORDERS

THE INNOVATORS IN TAPE INSTRUMENTATION

Sangamo Electric Company

Data Systems

P.O. Box 3347 • Springfield, Illinois 62714

(217) 544-6411

CIRCLE NUMBER 70

COMPONENTS

Low-profile switch set by thumb or screwdriver

EECO, 1441 E. Chestnut Ave. Santa Ana, CA 92701. (714) 835-6000. \$2; BCD (1000 up); 4 wks.

A low-profile stripswitch, the 2500 series, features a 0.3-in.-high design that enables mounting on PC cards racked at 0.5-in. intervals. The switch can be mounted by hand, wave or flow soldering; vertically or horizontally; and on both sides of a board. No mounting hardware is required. Single modules snap together to form a multi-station switch of any desired length. This feature allows the mixing of different codes within one unit. Snaps may be cut off when switches are used in a single-station application. Available models offer thumbwheel or screwdriver setting, and legends on the top or side. Stops are available. Codes include 10-position BCD, BCD complement only, BCD with complement, decimal, + and -, not-true bits.

CIRCLE NO. 336

Photoelectric control resists interference

Micro Switch, Div. of Honeywell, 11 W. Spring St., Freeport, IL 61032. (815) 232-1122. \$210; (unit qty).

A photoelectric control penetrates dust, frost, rain, paper or canvas and is immune to high ambient light. The MLS5A can scan 250 ft in clear air and is highly resistant to shock and vibration, according to the Honeywell division. The twin-unit is solid-state controlled and uses high-intensity LED pulsing. Because the emitter transmits a specific pulsed frequency and color, to which the receiver is specially "tuned," the unit is largely unaffected by interfering signals. Indicators at the rear of the emitter and receiving units instantly indicate proper operation and alignment. The units are only 3.25-in. high. The control can provide 20 operations/second and requires 12 to 18 V dc. A 24-V-dc model also is available.

CIRCLE NO. 337

Scott-T Xformer comes in small package



Magnetics, Inc., 182 Morris Ave., Holtsville, NY 11742. (516) 654-1166. \$18 (100 up); stock to 4 wks.

A new driver Scott-T transformer, Part Number 12945, offers a low profile to allow close board-to-board spacing and small size to allow dense board packaging. Size is only $3/4 \times 1-1/2 \times 7/16$ in. With a 400-Hz resolver and input at 6 V rms, the output will drive an 11.8-V line-to-line synchro, equivalent to a 300- Ω load. Accuracy, stability and ground isolation are provided for the life of the system. Other features include an input impedance of 500 Ω , an angular accuracy of 5 arc-minutes. Operation is over the temperature range -55 to 125 C.

CIRCLE NO. 338

Automobile fuses receive new look



Littelfuse, Inc., 800 E. Northwest Highway, Des Plaines, IL 60016. (312) 824-1188.

The first major change in American automotive fuses in six decades provides a marked upgrading in the reliability of electrical-circuit protection for car owners, according to Littelfuse. The new Autofuse line replaces traditional glass-cartridge fuses in 1977 GM full-sized Buick, Cadillac, Chevrolet Oldsmobile and Pontiac cars. The fuses are small plug-in units made of only two components, an element/terminal combination protected by a tough plastic housing. Glass fuses, however, contain as many as six different piece parts. Autofuses provide large easy-to-read amperage numerals on top of each fuse for easy servicing.

CIRCLE NO. 339

Trigger transformers isolate SCRs



Dale Electronics, Inc., East Highway 50, Yankton, SD 57078. (605) 665-9301. From \$0.88; (100 up).

Low-cost, low-profile SCR isolation trigger transformers, designated PT50, have an above-board height of only 0.625 in., but have pin-spacing and performance that make them interchangeable with Sprague 11Z and Dale PT20 models. Other dimensions are a 0.75-in. length and .625-in. width. The unit is designed to transfer high-amplitude or long-duration pulses without saturation. Models are available with primary inductance values from 200 to 500 μ H with turns ratios of 1:1, 2:1 and 5:1. The transformer is designed to operate at 240 V ac, 60 Hz over a temperature range of -55 to 105 C.

CIRCLE NO. 340



FREE Fiber Optics Catalog

Features the complete AO line of fiber optics products—from Inspection Fiberscopes and Light Guides to Illuminators, Image Conduits, Faceplates and Custom Components. Includes the four newest remote inspection fiberscopes now available.

Describes the principle, technology and techniques used to make flexible light and image transmissions a proven, practical fact. Write today for your FREE copy of the AO Fiber Optics catalog to American Optical Corporation, Fiber Optics Division, Southbridge, Mass. 01550.

AO
American
Optical

CIRCLE NUMBER 71

ELECTRONIC DESIGN 15, July 19, 1976

ONE-CHIP SYSTEM LOGIC #1.

NEW AM/FM FREQUENCY SYNTHESIZER. ONE-CHIP ELECTRONIC TUNING.

Now a single LSI chip that performs all digital control functions for generating AM/FM/CB radio freqs. Uses PLL techniques. Up to 2000 AM/FM channels possible. Simply order from stock: #8X08.

Send book titled *One-Chip System Logic*. Clip coupon to letterhead.

Name Title

Tel. M.S.

811 E. ARQUES, SUNNYVALE, CA. 94086

**THINK
signotics**

a subsidiary of U.S. Philips Corporation

©1976

CIRCLE NUMBER 72

133

COMPONENTS

PM hysterises clutch repeats torque to 1%

Vernitech, 300 Marcus Blvd., Deer Park, NY 11729. (516) 586-5100. 6 to 8 wks.

A new industrial permanent-magnet hysterises clutch, the PMC series, has been designed for repeatable torque and long life. These units can make equipment comply

with OSHA safety regulations; as a fail-safe device it can protect other expensive components. In the 1.5-in.-dia frame size, torque is factory adjustable up to 8.5 oz-in., which can be held within 10% from unit to unit for speeds up to 10,000 rpm. Torque repeatability of a unit can be maintained within $\pm 1\%$. The operating temperature range is -65 to 260 F.

CIRCLE NO. 341

Proximity switch senses industrial objects



Eldec Corp., 16700 13th Ave. W., Lynnwood, WA 98036. (206) 743-1313. \$125 (small qty); 30 days.

A new industrial long-range proximity switch, the Model 8-275, senses steel targets up to 1 in. away. The unit features a LED that indicates each time the target is sensed. The sensing range for nonferrous metals is 0.50 in. Equipped with a steel-conduit fitting for easy installation, the self-contained sensor operates on 115 V ac or 15 to 24 V dc, and it interfaces directly to control logic or relays. Specifications include a 2500 cpm switching rate, approximately 2-ms response time, no warm-up time, momentary short-circuit protection, a 40-to-180-F operating-temperature range and an environmentally sealed aluminum case. The unit weighs 0.39 lb.

CIRCLE NO. 342

HP's Small Wonders

The 33311B OEM Microwave Switch

- DC to 18 GHz with 1.4 SWR, 0.8 dB loss and useable to 24 GHz.
- 90 dB isolation, $\pm .03$ dB repeatability at 10^6 switchings. ungated port terminated in 50 ohms.
- 30 ms switching time, zero-power magnetic latch. 5V or 24V coils.
- Small, rugged with a compact design that fits easily into microwave equipment. SMA connectors. Price is \$395* with quantity discounts available.

These and more than 300 other microwave measurement items are described in our 80 page coaxial and waveguide catalog. You can get a copy from your nearby HP field office, or write. *Domestic US prices only.

HEWLETT  PACKARD

Sales and service from 172 offices in 65 countries.
1507 Page Mill Road, Palo Alto, California 94304



04607

For assistance call: Washington (301) 948-6370, Chicago (312) 677-0400, Atlanta (404) 434-4000, Los Angeles (213) 877-1282, Toronto (416) 678-9430

CIRCLE NUMBER 73

Mushroom switch for emergency operation

Alco Electronic Products, Inc., 1551 Osgood St., North Andover, MA 01845. (617) 685-4371. \$18 to \$21.85 (1-9).

A series of "mushroom" switches for use in security and emergency applications features an exceptionally large button that measures 3-1/2-in. diameter, colored in red to act as an alert. Two operative modes are provided—momentary push and side to side wobble. Each switch comes mounted in a gray polyester box, which contains a choice of either a NO, NO/NC or dual NO/NC contact block, all rated at 10 A, 300 V ac.

CIRCLE NO. 343

INTEGRATED CIRCUITS

Multiplying CMOS d/a has 12-bit resolution



Analog Devices, P.O. Box 280, Route 1 Industrial Park, Norwood, MA 02062. (617) 329-4700. From \$8 (100-up); stock.

A CMOS multiplying d/a converter, the AD7531, has 12-bit resolution and 8, 9, or 10-bit linearity. The unit operates from a single, 5-to-15-V supply and dissipates only 20 mW, including the ladder network. The differential-nonlinearity tempo of 2 ppm of FSR/°C, maximum, and gain-error tempo of 10 ppm of FSR/°C, maximum, provide excellent stability over the 0-to-75-C operating range. The output-current settling time of the unit is 500 ns to 0.05%, worst case. The AD7531 is housed in either a plastic or ceramic 18-pin DIP.

CIRCLE NO. 344

DVM on a chip delivers multiplexed BCD outputs

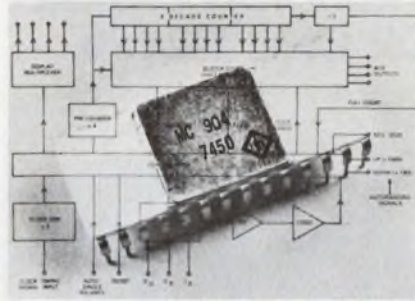

Integrated Photomatrix Inc., 1101 Bristol Rd., Mountainside, NJ 07092. (201) 233-7700. \$16 (100-up); stock.

The MC904 DVM IC can drastically reduce the number of components needed to build a meter. It contains both analog and digital functions on a single MOS chip. The IC contains automatic clamping for a stable zero point, has a cycle time of 100 ms for a full count and 300 ms per conversion, and input ranges from ±199.9 mV to ±199.9 V. The circuit delivers a multiplexed BCD signal so that the user can optimize the display driver.

CIRCLE NO. 345

Two resistors program shunt regulator

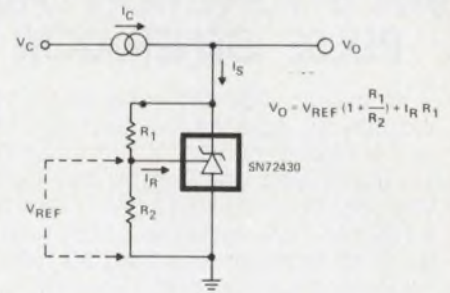

Texas Instruments, P.O. Box 5012, MS/84, Dallas, TX 75222. (214) 238-3527. See text; stock.

The SN72430, a three-terminal shunt regulator, can be set to any output voltage between 3 and 30 V with two resistors. The programmable regulator is temperature compensated and can handle shunt currents of 100 mA, maximum. It can work with input currents as low as 500 μA and its temperature coefficient is ±50 ppm/°C. The SN72430 is available in a TO-92 plastic package and costs \$0.73 in 100-piece lots, or in eight-pin ceramic DIPs at \$1.81 in the same quantities.

CIRCLE NO. 346

Low cost, high performance 3A SPDT relay really saves PC board space

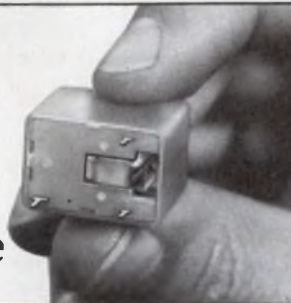

Mounts on .69" centers... satisfies thousands of application needs

Where size and space are important, the Series 27 relay can be just the low cost answer you've been looking for. It provides 3 amps of switching in a 0.526" cube and mounts on .69" centers, assuring high density PC board mounting. The cost is \$1.05 each in 1,000 piece lots for 3, 6 and 12V dc units ...slightly higher for 24V dc.

You'll find the Series 27 relay suitable for hundreds of control applications. For instance: timing controls; gas pilot light controls; anti-theft devices for CB radios; automotive controls; emergency lighting equipment; and medical equipment, to name a few.

The relay has a 450 mW pick-up sensitivity (180 mW available). Contact rating is 3A res @ 28V dc. 120V ac. Contact resistance is 0.10 ohm.

Write for information today!

NORTH AMERICAN PHILIPS CONTROLS CORP.

Frederick, Md. 21701 • (301) 663-5141

CIRCLE NUMBER 74

ONE-CHIP SYSTEM LOGIC #2.
NEW DESKEW FIFO. ONE-CHIP PARALLEL DATA DESKEWING.

Breakthrough. Synchronize parallel data with 1 new LSI chip per track. 2 inputs for each track, 16 bits each input, all commonly clocked. 2 versions: #8X03 10V CMOS compatible; #8X04 TTL compatible. Both reduce costs in high performance peripheral controllers.



I want to read your book on One-Chip System Logic. Coupon's clipped to letterhead.

Name _____ Title _____
Tel. _____ M.S. _____
811 E. ARQUES, SUNNYVALE, CA. 94088

THINK

signetics

a subsidiary of U.S. Philips Corporation

©1976

CIRCLE NUMBER 75

CSC'S NEW DESIGN-MATE 4. AN 8-FUNCTION LAB-PRECISION DIGITAL PULSE GENERATOR FOR ONLY \$124.95.

Wherever you need crisp, clean, fast output pulses compatible with virtually all logic families and discrete circuits, Design-Mate™ 4 is the logical choice. It produces symmetrical and unsymmetrical pulses ranging from 0.5Hz to 5MHz. And has a 100mV–10V variable output, with rise/fall times of less than 30 nanoseconds plus TTL sink output for up to 40 loads. Pulse width and spacing are independently-controllable from 100 nanoseconds to 1 second (10⁷:1 duty cycle) in seven overlapping ranges. And with the DM-4 you can select continuous operation, manual one-shot or external triggering to 10MHz with synchronous output gating. And a lot more. Which adds up to a high quality clock source, delayed pulse generator, synchronous clock source, manual system stepper, pulse stretcher, etcetera, etcetera, etcetera . . . minus the 'high quality' price tag.



For more information, see your CSC dealer. Or write for our catalog and distributor list.

CONTINENTAL SPECIALTIES CORPORATION



EASY DOES IT

44 Kendall Street Box 1942
New Haven, CT 06509 • 203-624-3103 TWX: 710-465-1227
West Coast office: Box 7809, San Francisco, CA
94119 • 415-421-8872 TWX: 910-372-7992
Canada: Len Finkler Ltd. Ontario
CIRCLE NUMBER 76

© Continental Specialties Corp. 1976

Balco

DIVISION

- Capacitors for Time Circuits
- Delay Lines
- R. C. Oscillators
- Integrators
- Smallest Size
- Exceptional Performance
- Low Cost
- Fast Delivery
- Long Term Stability

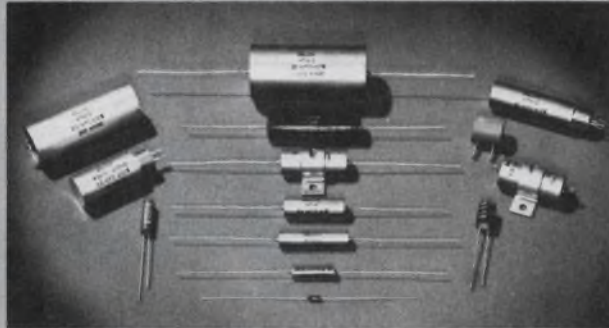

	Extended Foil (RTWGX)	Metalized Film (RTWGMX)
Capacitance Range (μ F)	0.0005 to 2.0	0.05 to 4.0
Working Voltage (Vdc)	50 to 600	50 to 600
Temperature Coefficient	$\pm 1.5\%$	-90 PPM/ $^{\circ}$ C ± 40
DF at 25 $^{\circ}$ C and 1 kHz (%)	0.05	0.1
Operating Temperature Range ($^{\circ}$ C)	-55 to $+175$	-55 to $+175$
Dielectric Absorption (%)	< 0.05	< 0.05
IR (Ohms)	$> 1 \times 10^{12}$	$> 1 \times 10^{11}$

Contact Custom for capacitors to suit your applications. Write for Brochure



CUSTOM ELECTRONICS, Inc.
Balco Division
4 Browne Street, Oneonta, N.Y. 13820
Ph: 607-432-3880 TWX: 510-241-8292

CIRCLE NUMBER 77

INTEGRATED CIRCUITS

Multiply 16-bit numbers in 300 ns

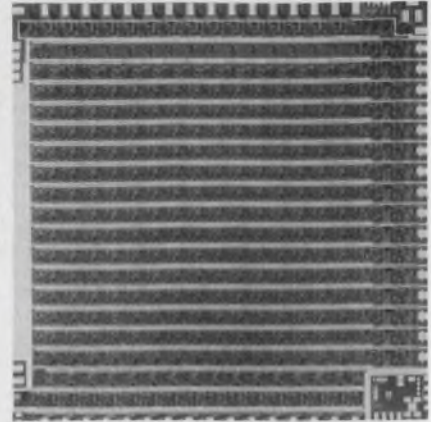

TRW, One Space Park, Redondo Beach, CA 90278. (213) 536-1500. \$250; end of year.

A single-chip 16-bit bipolar multiplier can generate a 32-bit data word every 300 ns. Inputs and outputs are fully TTL compatible, and the outputs have three-state control. A single 5-V power supply is used. Emitter-follower logic (EFL) is employed internally. Total power consumption is 5.1 W. The multiplier comes in a 64-pin hermetic flat package and operates over a case temperature range from -40 to $+100$ C.

INQUIRE DIRECT

See the Microprocessor Design section for microprocessors and related products.

Telephone-tone encoder uses simple keyboard

Intersil, 10900 N. Tantau Ave., Cupertino, CA 95014. (408) 996-5000. \$4.10 (100-up); stock.

The ICM7206, 2 of 8 sine-wave tone encoder, delivers dual-tone signals and uses a single-contact-per-key keyboard. The circuit uses a 3.579545-MHz crystal as the base frequency and can operate from 3-to-6-V supplies. Tone drive levels are approximately -3 dBV into a 900- Ω termination. Skew between high and low tone groups is typically 2.5 dB without low-pass filtering. The circuit is housed in a 16-pin DIP.

CIRCLE NO. 348

DATA PROCESSING

Mini-on-a-board rivals speed of other μ Cs

Hewlett-Packard, 1501 Page Mill Rd., Palo Alto, CA 94304. (415) 493-1501. \$1475; 2 wks.

The Model 2108K processor board runs as much as five times faster than LSI based microcomputers, according to the company. The board is identical to the one inside the HP 21MX series of minicomputers, and will execute 210 microinstructions. Connecting an optional ROM board (\$350 in single qty.) to the 2108K enables the full instruction set of the 21MX to be emulated. Additionally, user generated programs may be stored in ROM and unique instruction sets may be generated. Because of its high speed the 2108K can control complex functions, such as handle array processing or be incorporated into a distributed computing network. The unit adds two 16-bit numbers in its internal registers in one 325-ns machine cycle.

CIRCLE NO. 349

Three low-cost desk calculators print

Unitrex of America, Inc., 689 Fifth Ave., New York, NY 10022. (212) 688-3400. 10PPM: \$99.95; 12PPMR: \$129.95; 14PPMD: \$179.95.

Three desktop printing calculators, Models 10PPM, 12PPMR and 14PPMD, feature an impact printing head. All three units measure 9-1/2 x 11-1/4 x 3-1/2 in. and weigh 6 lb each. Other common characteristics include the ability to do chain or mixed calculations, reciprocal calculation, squaring and raising numbers to a power. In addition, they also share four addressable memory registers, an item count key, two-color ribbon, automatic percentage keys and a buffered keyboard. Model 10PPM has a 10-digit capacity and a non-add key. Model 12PPMR has 12-digit capacity, and an automatic square-root key. The combination printer, with display, Model 14PPMD, features 12-digit capacity, separate zero and triple zero keys and a selectable decimal point.

CIRCLE NO. 350

Digital data processor calculates equations

Aiken Industries, California Instruments Div., 5150 Convoy St., San Diego, CA 92111. (714) 279-8620. \$1500; 30-60 days.

Called the CP70A, this unit accepts digital data from up to three separate sources and operates on this data according to equations stored in a plug-in EPROM. Each equation may include data derived from any one or all of the external sources as well as one or more constants stored in RAM. Front panel thumbwheel switches allow the user to select either from a standard or optional series of equations. The value of the constants may be changed via a front panel keyboard. Results of calculations are displayed on an 8-digit display containing both polarity and decimal. The readout may also show the value of constants programmed from the keyboard. The basic CP70A comes with up to eight standard equations, including such functions as addition, subtraction, multiplication, ratios, deviations.

CIRCLE NO. 351

Rose enclosures. New. Beautiful. Quality. Standards.



Rose Enclosures, made specifically for electronic use, culminate years of design, engineering and production experience. Extra high quality, precision-finished units provide functional protection, easy access, excellent esthetics. Available materials: Lexan, Aluminum, Polyester and ABS. Clear plastic covers with Lexan and ABS. A competitively-priced stock of Rose Enclosures is maintained in Belding, Mich. for immediate shipment. Contact us at (616) 794-0700.

STAHLIN
BROTHERS, INC.
Belding, Michigan 48809

CIRCLE NUMBER 78

ONE-CHIP SYSTEM LOGIC #3 NEW CRC GENERATOR/CHECKER. ONE-CHIP ERROR-CHECKING.

Eight polynomials in one chip.
Detects serial digital data
errors including SDLC type.
I²L with on-chip TTL inter-
face. Order #8X01.

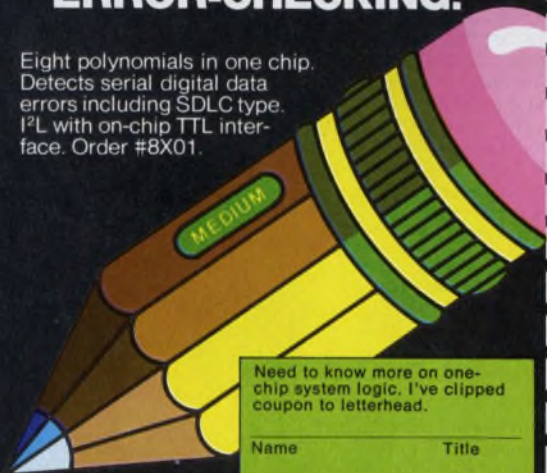

Need to know more on one-chip system logic. I've clipped coupon to letterhead.

Name _____ Title _____

Tel. _____ M.S. _____

811 E. ARQUES, SUNNYVALE, CA. 94086

THINK
Signoties

a subsidiary of U.S. Philips Corporation

©1976.

CIRCLE NUMBER 79

More disk storage available for System/3

IBM, General Systems Division, P.O. Box 2150, Atlanta, GA 30301. (404) 256-6797. \$7845, \$310 per mo; March, 1977.

The 5448 disk storage drive can be installed on IBM's System/3, Models 8 and 10. Added to an exist-

ing system already using the 5444 disk storage drive, this 9.8 Mbyte disk drive will provide total System-3 capacities of 14.7, 17.15 or 19.6 Mbyte. The 5448 has four fixed disks with eight recording surfaces. Access times average 126 ms at 1,500 rev/min. The 5448 transfers data at an effective rate of 199,000 bytes/s.

CIRCLE NO. 358

Sensor I/O subsystem controlled by computer

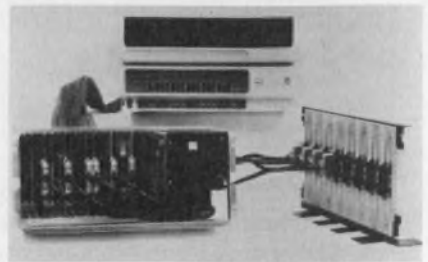

Data General, Southboro, MA 01772. (617) 485-9100. \$5200; 64 lines.

An I/O subsystem called DG/DAC ties Data General computers to a wide variety of sensors, laboratory apparatus instruments and industrial control devices. The DG/DAC includes a wide selection of analog and digital I/O function modules, circuitry for dual computer configurations and an optional line controller. Modular design simplifies installation and subsequent alterations. Software support for the DG/DAC subsystem is provided by Data General's real-time operating systems. Thirteen types of printed-circuit I/O control cards handle a wide variety of analog and digital signals. Included in the selection is a series of high-speed analog-to-digital converters for accurate low-level analog inputs. Any combination of analog and digital signal lines can be mixed in the same subsystem chassis. Software support for the subsystem is provided by a library of device handlers and subroutines that control I/O transfers between user programs and sensor hardware or instrumentation.

CIRCLE NO. 359

Plotter Controller connects to IBM's 5100

Houston Instrument, One Houston Sq., Austin, TX 78753. (512) 837-2820.

The Complot PTC-5 plotter controller allows the IBM 5100 portable computer to generate plots. The PTC-5 interfaces to the firm's DP-1, DP-3 or DP-7 digital plotters. A complete graphics system from IBM supports the PTC-5 with software similar to that used on IBM 370 computers.

CIRCLE NO. 360

BAUSCH & LOMB

StereoZoom[®] 5

microscope

Meet the new **MORE** and **LESS** microscope

MORE in optics . . .
MORE in mechanics . . .
LESS in price.

This new StereoZoom 5 completes the world-leading family of world-leading Bausch & Lomb Stereo-microscopes. Fills a need in electronics for a middle zoom range of 0.8X-4.0X (5:1 ratio) for bonders, welders, assembly, and quality control.

More in optics. Higher resolution . . . 200 lines/mm at 4X. Better color correction. Less distortion. Flatter fields . . . no refocusing to see detail at edge of wide field. Zooming is fast with image continuously in focus through full range, while maintaining full working distance of 4". Workers see more, faster, easier, more accurately.

More in mechanics. Tighter precision tolerances for better alignment, smoother operation. Eye-pieces can be locked in to prevent theft or tampering, but are still rotatable. StereoZoom 5 is directly interchangeable with other Bausch & Lomb pods, and can be used with many of the existing StereoZoom modules and accessories. Attractive new modern styling and professional black and white finish.

Less in price. Priced lower than other stereo-microscopes with equivalent features.

More . . . There's more to the new StereoZoom 5 story. Discover this exciting new instrument by arranging for a free, no-obligation demonstration. Catalog 31-2436 is also just for the asking.

Bausch & Lomb, Scientific Optical Products Division, 91507 N. Goodman St., Rochester, N.Y. 14602
In Canada: Bausch & Lomb, Scientific Optical Products Division, 2001 Leslie St., Don Mills, Ont. M3B 2M3

CIRCLE NUMBER 81

200-MHz linear amp generates 200 W

Amplifier Research, 16 School House Rd., Souderton, PA 18964. (215) 723-8181. \$7400; 45 days.

Model 200L broadband amplifier delivers 200 W of cw power at less than 1.0 dB-gain compression, from 1 to 200 MHz. A minimum 300 W of pulsed power is available at a 50% duty cycle with up to 500 W available at a 10% duty cycle. No special signal sources are required. The Model 200L can be driven to full output by any standard sweep generator or signal source capable of providing a 1-mW signal. An input attenuator allows the operator to vary the power output through a continuously adjustable 20-dB range. Flatness is ± 1.5 dB over the entire frequency range. Harmonic distortion at 300 W is not less than 12 dB down for frequencies below 110 MHz and 25 dB down for frequencies above 110 MHz.

CIRCLE NO. 361

Antenna-position differences displayed



Trak Systems, 4722 Eisenhower Blvd., Tampa, FL 33614. (813) 884-1411. \$3975; 120 days.

Model 6500-3 difference display provides visual indication of the differences between true position and designated antenna positions. Two pointers display azimuth and elevation differences from zero to $\pm 10^\circ$. Also, correction of the angular error is enhanced; an on-target indicator displays the status of an on-target input line to alert the operator of any antenna-position error. The Model 6500-3 uses plug-in digital and analog circuits and nearly all of the intraconnections are wire-wrapped. A self-contained power supply system has overvoltage protection, short-circuit protection, and RFI line filtering.

CIRCLE NO. 362

Coax attenuators meet MIL spec

Weinschel Engineering, Gaithersburg, MD 20760. (301) 948-3434. \$17 to \$25; stock to 60 days.

The Model HF and L series of film-resistor coaxial attenuators achieve rated specifications under conditions defined by MIL-A-3933. The Model L units operate at dc to 2 GHz and are available with Type N, BNC, or TNC connectors (one male and one female). The Model HF attenuator operates at 2 to 10 GHz and is available only with Type N connectors. The Model L features attenuation values of 1 to 20 dB with maximum deviations of ± 0.2 dB to 0.5 GHz, ± 0.5 dB to 1.0 GHz, and ± 0.75 dB to 2.0 GHz. Maximum VSWR is 1.20 with Type N connectors, and 1.25 with BNC and TNC connectors. Power rating is 1 W average. The Model HF attenuators are available in values of 3 to 20 dB with maximum deviations of $\pm 10\%$. Maximum VSWR is 1.35 to 1.4, and power is rated as 5 W average. All units operate over the -20-to-70-C temperature range.

CIRCLE NO. 363

NOW—A FAIL-SAFE SOLID-STATE RELAY

A unique combination of dv/dt snubber, fusible-link protection, and an oversized triac makes the new optically-coupled Heinemann SSRs fail-safe. Now, the worst thing that can happen to your system in the event of relay failure is the simple need to replace the relay. That's a lot better than having to reprogram your entire control sequence, isn't it?

We make our new SSRs for either zero-voltage or non-zero-voltage switching, and both types are rated for maximum ac load currents of 5A or 10A. Any control voltage from 3Vdc to 32Vdc, all models compatible with TTL, DTL, and CMOS logic.

And you have a choice of solder-pin, quick-on, and screw terminals.

Talk with Bob Kusek (609-882-4800) or write for further information. Heinemann Electric Company, Brunswick Pike, Trenton, NJ 08602.

HEINEMANN

We keep you out of trouble.

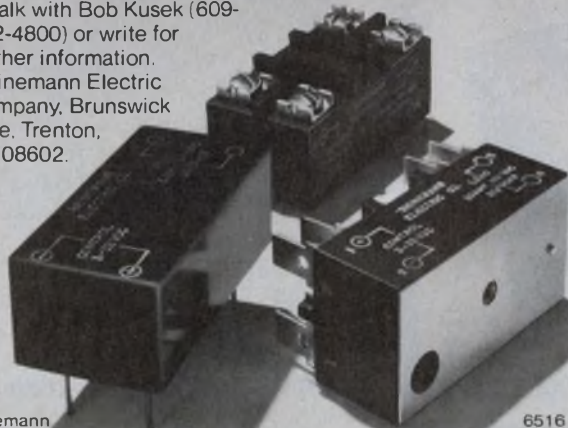

Heinemann

6516

CIRCLE NUMBER 82

ONE-CHIP SYSTEM LOGIC #4
NEW CONTROL STORE SEQUENCER. ONE-CHIP MICROINSTRUCTION SEQUENCING.



8 microfunctions —TSK, POP, RST, etc. in 52ns. All essential sequencing functions. 1K addressability, 4 level stack. Low power Schottky/LSI technology. Order #8X02.

Clip coupon to letterhead for book on this and all one-chip system logic products.

Name _____ Title _____

Tel. _____ M.S. _____

811 E. ARQUES, SUNNYVALE, CA. 94086

THINK
Signetics

a subsidiary of U.S. Philips Corporation

©1976

CIRCLE NUMBER 83

Scanbe-gram

RE: STANDARD PRICES FOR CUSTOM P.C. CARD FILES
 SCANBE ORIGINATED P.C. PACKAGING SYSTEMS...THE
 OPTIMUM SOLUTION TO YOUR SPECIAL CARD
 MOUNTING PROBLEMS.

18 YEARS EXPERIENCE...WIDEST LINE OF CARD
 PACKAGING HARDWARE IN INDUSTRY...VIRTUALLY
 UNLIMITED CONFIGURATIONS...NO COSTLY TOOLING.

FROM INITIAL SYSTEM DESIGN TO FINAL PRODUCTION...
 PLUS ANY STAGE ALONG THE WAY. WE DO IT ALL.

CALL SCANBE CARD FILE EXPERTS.
 YOUR GUARANTEE IS RESULTS...NOT REGRETS.

SEND FOR SCANBE'S P.C. CARD PACKAGING CATALOG.



"Imitated... never duplicated."

SCANBE
 CANOGA INDUSTRIES

Scanbe Manufacturing Corp.
 3445 Fletcher Ave., El Monte, CA 91731
 Tel: (213) 579-2300 • TWX: 910-587-3437

CIRCLE NUMBER 84

GENERATE CORRECT AND CONTROL AMPLITUDE FREQUENCY PHASE



WITH **Invertron**® THE MOST RESPECTED
 NAME IN AC POWER

- AC Power Supplies • Frequency Changers • AC Line Correctors
- Frequency Stabilizers • AC Converters • Programmable Power
- Power Amplifiers

Solid-State Invertron® has the answers to your AC Power requirements. Send for Free Selection Guide. 5150 Convoy St., San Diego, CA 92111, (714) 279-8620

CALIFORNIA INSTRUMENTS
 a division of
 AIKEN INDUSTRIES, INC.

See EEM Pages
 626-629, 1164, 1165

CIRCLE NUMBER 85

MICROWAVES & LASERS

Attenuators are remotely programmable

Kay Elemetrics, 12 Maple Ave., Pine Brook, NJ 07058. (201) 227-2000. \$250; 2-4 wks.

Two models of controlled, continuously variable and programmable attenuators are suitable for remote operation and have no moving parts. Model 2000 and 2100 can be used as an rf switch with high turnoff ratio or as control elements in a leveler to produce flat output for signal sources. Specs include a frequency range of 2 to 500 MHz, attenuation range of 0 to above 76 dB and insertion loss of 6 dB max.

CIRCLE NO. 364

Interference filters speed measurements

Melles Griot, 3006 Enterprise St., Costa Mesa, CA 92626. (714) 556-8200. \$450 to \$795 per set; stock.

Interference-filter sets allow rapid measurement of spectral irradiance distribution and spectral response. Each filter comes with its spectrophotometer curve. Ten different filter sets consist of 7-to-13 elements each. Seven are equally spaced bandpass and variable bandpass sets. Bandpasses of 10, 40 and 80 nm are available in the visible spectrum. Also, three color-process sets may be used in television, photography, printing and for inspection.

CIRCLE NO. 365

Amp modules handle 800 mW

TRW RF Semiconductors, 14520 Aviation Blvd., Lawndale, CA 90260. (213) 678-4561. \$35 to \$55.

Hybrid amplifier modules for general-purpose use feature rise times of 5 to 10 ns and have power ratings to 800 mW. Three lines are available: CA 2800, for 10 to 400 MHz with 17-dB gain; CA 2810, for 10 to 350 MHz with 33-dB gain; and CA 2818, for 5 to 150 MHz and 18-dB gain. The new amplifiers use thin-film techniques.

CIRCLE NO. 366

MICROWAVES & LASERS

Miniature PIN switches operate in 15 ns

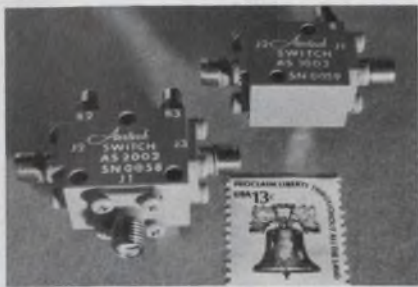

Aertech Industries, 825 Stewart Dr., Sunnyvale, CA 94086. (408) 732-0880. AS1002, \$135; AS2002, \$240; 30-45 days.

PIN diode switches offer 15-ns switching speed over the complete 2-to-18-GHz frequency range. Model AS2002 single pole, double throw provides 2.7-dB maximum insertion loss with 55-dB minimum isolation at 18 GHz. It occupies only 1/3 in³. Model AS1002 single pole, single throw provides 2.0-dB maximum insertion loss and 45-dB minimum isolation at 18 GHz. It occupies only 1/4 in³.

CIRCLE NO. 367

Uhf bandpass filter has 1.5% BW



Frequency Engineering Laboratories, Farmingdale, NJ 07727. (201) 938-9221. \$1245 (5-9); 6 wks.

A two-channel uhf bandpass filter for space or airborne environments uses WR51-size equivalents in each of the five-pole sections of the filter. The result is a flat 1.5% bandwidth at 560 MHz, maximum insertion loss of 4.0 dB, and VSWR of 1.3 max. Rejection bandwidth is 25 MHz at -30 dB, with the first spurious response occurring above 20 GHz. The 1-lb. unit has been assigned P/N 10EE185900. Other units having bandwidths as great as 40%, with up to 15 sections, and covering ranges from low rf to X-band, are included in this evanescent-mode filter series.

CIRCLE NO. 368

Coax attenuator handles 5 kW peak

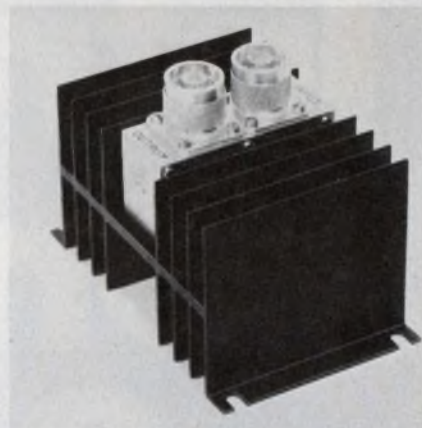

Sage Laboratories, 3 Huron Dr., Natick, MA 01760. (617) 653-0844. \$150; 45 days.

FA2015 coaxial attenuator covers dc to 2 GHz and features small size and high power handling capability. Attenuation is 10 ±0.5 dB, and is flat within ±0.1 dB. Power handling capability is 5 kW peak and 50 W average. VSWR is 1.2:1 max. Model FA2015 measures only 2-5/8 × 1-1/4 × 1 in., excluding the connectors.

CIRCLE NO. 369

New Transducer modules

measure electric power

NEW!



These new power transducers compute instantaneous ac electrical power. Simple design and high quality yield excellent reliability at an **unprecedented price**. New capabilities meet the needs of hundreds of previously difficult or uneconomical applications. These include, ±0.50% accuracy, 50 Hz to 10 kHz frequency range, one and three phase operation, accurate operation with non-sinusoidal waveforms, better than ±0.25% power factor influence and a 100µs response time.

Each transducer is encased in a small, tough nylon case for easy installation. Use the inquiry card to get complete technical data.

4949 Freeway Drive E
Columbus, Oh 43229
614/888-7501
TWX: 810-337-2851

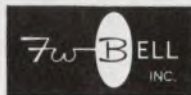

A subsidiary of The Arnold Engineering Company

CIRCLE NUMBER 86

ELECTRONIC DESIGN 15, July 19, 1976

ONE-CHIP SYSTEM LOGIC #5
NEW
8-BIT INTERPRETER.
ONE-CHIP
CONTROLLER.

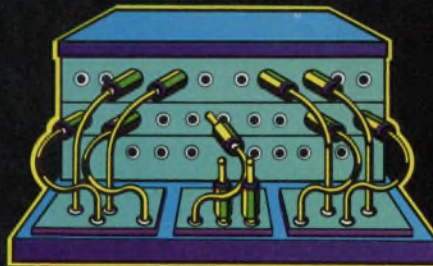

Finally, bipolar fixed instruction microcontroller on a single chip. Eliminates up to 150 SSI and MSI packages. Advanced Schottky LSI technology. 250 nano-seconds instruction cycle time. 8 powerful instructions. Order #8X300.

Coupon attached to my letterhead for One-Chip System Logic book.

Name _____ Title _____
Tel. _____ M.S. _____
811 E. ARQUES, SUNNYVALE, CA. 94086

THINK
Signoties

a subsidiary of U.S. Philips Corporation

©1976

CIRCLE NUMBER 87

Introducing One-Chip System Logic.

You get one-chip solutions to multiple-function problems!

Until now, when you wanted high-performance, you had to pay the high price. When you wanted low price, your performance options were limited.

That's exactly why Signetics has developed its line of "One-Chip System Logic" LSI products. To give you the best of both worlds. You get multiple functions on one chip. Great to build your own designs around. Great to upgrade from TTL and Schottky SSI and MSI. Great to save you time, hassle, board space, and reduce associated logic for overall lower systems cost.

"One-Chip System Logic" incorporated high-performance I²L and LS technologies and interfaces with TTL. The key is Signetics ¼ inch die capability which allows design and production of sophisticated LS building blocks.

System logic is one of the many LSI product families offered by Signetics including the MOS 2650 and bipolar 3000 series microprocessor.

Now, here are Signetics stock products

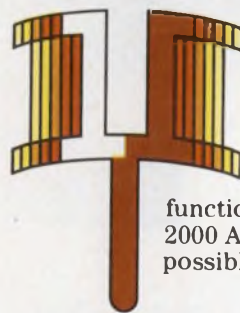

1 One-chip electronic tuning

(#8X08 AM / FM Frequency Synthesizer).

Do away with mechanical tuning and frequency generation forever.

It performs all digital control

functions and gives you up to 2000 AM / FM / CB channels possible.

2 One-chip parallel data deskewing

(#8X03 & 8X04 Deskew FIFO).

Now, one chip synchronizes parallel data on a per-track basis and offers lowest system cost. It's easy to design with and solves a lot of multiple circuit problems while you're at it.

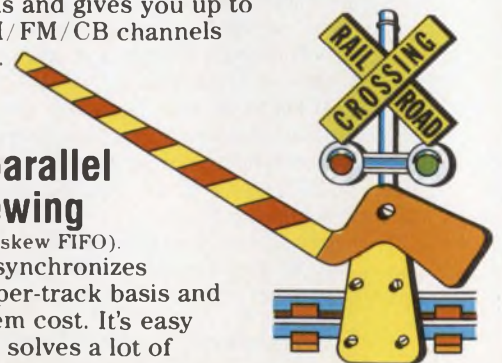

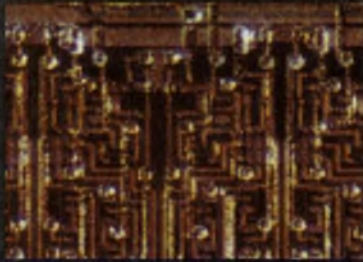

1. New AM/FM Frequency Synthesizer. 8X08

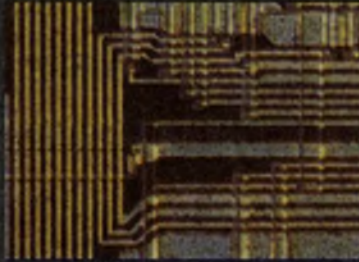

2. New Deskew FIFO. 8X03/04



3. New CRC Generator/Checker. 8X01

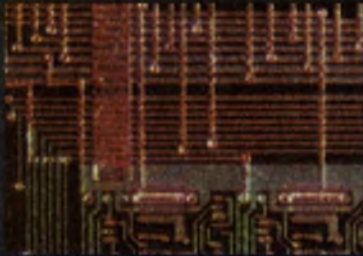

4. New Control Store Sequencer. 8X02

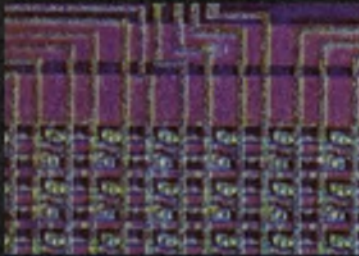

5. New 8 Bit Interpreter. 8X300



6. Your 1977 Solutions.

The only logical way to improve performance and save on systems cost.

③ One-chip error-checking

(#8X01 CRC Generator/Checker).

Eight polynomials for error detection of serial digital data. Detects SDLC type remainder. Easy-to-work with at an easier-to-live-with lower systems cost.



④ One-chip microinstruction sequencing

(#8X02 Control Store Sequencer).

You get 8 functions — everything you need for most efficient microprogramming. With low power Schottky LSI technology, 28 pin DIP with 1024 word addressability, and more.



⑤ One-chip central controlling

(#8X300 8 Bit Interpreter)

Control oriented bipolar fixed instruction microprocessor on one LSI chip. Eliminates up to 150 discrete SSI/MSI chips. You get easy programming and fast processing — 250ns instruction cycle time.

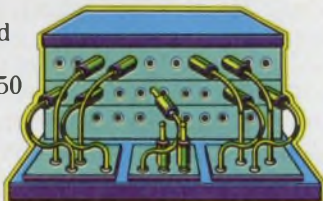

⑥ One-chip to solve your future needs.

Signetics has written a whole book detailing all of the instock standard products with a future products preview of "One-Chip System Logic." It shows you how Signetics is more responsive to your exact mixture of requirements. It includes a function/requirement questionnaire: tell us what you want us to develop as standard product in the system logic family for your next application. Read the book and send us the card.



Attach this to your letterhead for fast response.

- Send me the whole book titled "One-Chip System Logic — Multiple Functions on One-Chip Now and in the Future."
- I have lots of questions. Please call me.
- Have a Field Applications Engineer make an appointment soon.

My application is _____

Name _____ Title _____

Telephone _____ Mail Stop _____

THINK **Signetics**

811 E. Arques Ave., Sunnyvale, Ca. 94086

© 1976

a subsidiary of U.S. Philips Corporation



LEADER IN IMAGING DEVICES

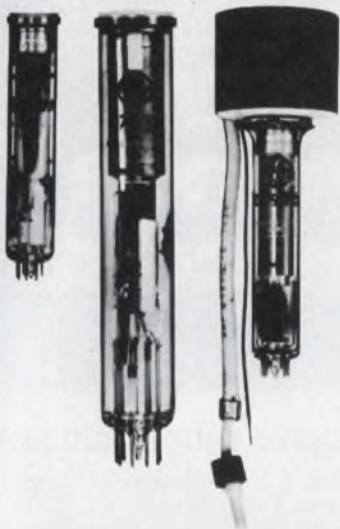

General Electric offers you a wide selection of high-quality imaging devices for a wide variety of surveillance, monitoring and display applications.

These GE imaging devices also offer:

- The right resolution and sensitivity for your specific needs!
- Prices lower than you normally expect!
- Ease of application combined with traditional GE expertise, quality and economy!
- Rugged construction!

For more detailed information, circle the Reader Service Card number below or contact: General Electric Company, Imaging Devices Operation (360-22), Room 301, Building 7, Electronics Park, Syracuse, N. Y. 13201 (phone 315-456-3300).

GENERAL  ELECTRIC

CIRCLE NUMBER 90

POWER SOURCES

Lab power supply adjusts itself for constant power



Hewlett-Packard, 1501 Page Mill Rd., Palo Alto, CA 94304. (415) 493-1501. See text.

Sandwiched between the constant-current and constant-voltage modes in Hewlett-Packard's new laboratory power supply is another, more unusual mode—one that can be termed constant wattage or power.

HP calls the Model 6002A an extended-range supply, however, rather than a constant-power unit, because the 6002 delivers a full 200 W over a 20 to 50-V output.

The output voltage is continuously adjustable from zero, and the maximum current is automatically controlled to stay within the power boundary. Or you can turn up the output current, from zero to 10 A, and the supply adjusts the voltage level accordingly.

If you'd like your calculator, computer or other controller to do the adjusting digitally, an option makes the HP 6002 one of the first supplies to offer the new standard interface bus (variously called the HP-IB, IEEE-488, ANSI MC1.1, universal bus or interface).

Switches included with the bus option allow either HP-IB or local front-panel control of voltage or current. When you operate the sup-

ply below 10 V, a programmable range improves resolution by a factor of ten.

Perhaps the only other supply on the market that offers an "extended" range (using an entirely different method than the HP) is the Uniply "universal" power source, from Power Designs, Westbury, NY. The patented Uniply has been around for many years, apparently without competition in its operating principle.

In operation, the Power Designs' source automatically ranges, or selects—from a number of internal unregulated sources, power transistors and control circuits—the combination that satisfies both the panel settings and the load demand, with minimum losses.

The highest-power unit in the Uniply series is the Model 6150, a \$350 lab supply that can deliver 0 to 6 V at 15 A or 0 to 15 V at 7.5 A, and so on, to a top level of 60 V at 2 A.

Price of the HP 6002A—which also offers a number of other features, status indicators and protection capabilities—is \$800. The HP-IB option costs another \$350. Delivery is stock to 30 days.

For Hewlett-Packard **CIRCLE NO. 370**
For Power Designs **CIRCLE NO. 357**



**COMING ATTRACTIONS
4K STATIC RAMS
DOWN TO 100NS.**

They're gonna make you a star.

In just a very short while, we'll be giving static RAM users the same thing we've already given dynamic RAM users.

The fastest MOS device on the market.

Using the same super technology that gave you the world's first 150ns 4K dynamic RAM, we'll soon be giving you the μ PD410 series of 4K static RAMs with speeds down to 100ns.

So right now you can start

designing products where that kind of speed at that kind of density can really help make you a star.

For your present applications, we'll also have slower versions you'll want to use right away.

In addition to access times down to 100ns, our n-channel silicon gate 4K x 1 static RAMs will also feature cycle times down to 200ns, 12 μ W/bit maximum standby power, three-state output, proven cross-coupled Flip-

Flop storage cell structure to eliminate soft errors and the need for refresh circuitry.

And they'll be pin compatible with the industry standard 22-pin dynamic part.

The μ PD410 series of 4K static RAMs.

For people into terminals, add-on memories, mainframes, and minis, it's quite a coming attraction.

NEC Microcomputers, Inc.,
Five Militia Drive, Lexington,
MA 02173. 617-862-6410.

NEC microcomputers, inc.

(Data sheets now at reps and distributors.)

REPS: East—C & D Sales 301-296-4306, Contact Sales 617-273-1520, Trionic Assoc. 516-466-2300; South—Merino Sales 214-233-6002, Perrott Assoc. 305-792-2211, 305-275-1132, 813-585-3327, Wolfs Sales Serv. 919-781-0164; Midwest—K-MAR Eng. & Sales 816-763-5385, McFadden Sales 614-221-3363, R.C. Nordstrom 313-559-7373, 616-429-8560, R.F. Specialists 312-698-2044; West—Mike Duffy Assoc. 303-934-7392, Electronic Component Marketing 714-524-9899, 714-295-6122, 213-340-1745, Summit Sales 602-994-4587, Trident Assoc. 408-734-5900, Tri-Tronix 505-265-8409, 206-454-0940; Canada—R.F.Q. Ltd. 416-626-1445, 514-626-8324 DISTRIBUTORS: Century Electronics, Diplomat (Chicopee Falls, Woodbury, Mount Laurel, Little Falls, Newport Beach, Clearwater, Dayton, Elk Grove Village, Farmington, Minneapolis, St. Louis, Salt Lake City, Sunnyvale), G.S. Marshall (Sunnyvale), Harvey Electronics (Lexington, Norwalk, Woodbury, Fairfield), Intermark (Santa Ana, San Diego, Sunnyvale, Seattle), Lionex Corporation, Mirco Electronics, R-M Electronics, Semiconductor Specialists, Technico.

Our 4K RAM
our 4K RAM

is faster than

Our fast 4K RAM.

Model No.	Access Time	Read/Write Cycle Time	Read/Modify/Write Cycle Time
MM5270 (18-pin)	200 ns	400 ns	580 ns
MM5271* (18-pin)	250 ns	400 ns	560 ns
MM5280 (22-pin)	200 ns	400 ns	520 ns
MM5281* (22-pin)	250 ns	400 ns	510 ns

*Chip enable is TTL compatible.

Our faster 4K RAM.

Model No.	Access Time	Read/Write Cycle Time	Read/Modify/Write Cycle Time
MM5270A (18-pin)	150 ns	300 ns	400 ns
MM5271A* (18-pin)	200 ns	300 ns	400 ns
MM5280A (22-pin)	150 ns	300 ns	370 ns
MM5281A* (22-pin)	200 ns	300 ns	370 ns

*Chip enable is TTL compatible.

ED719

National Semiconductor Corporation,
2900 Semiconductor Drive, Santa Clara, CA 95051

Gentlemen:
Kindly rush data sheets on your fast, and faster, 4K RAMs.

Name _____ Title _____

Company _____

Address _____

City _____ State _____ Zip _____

 **National Semiconductor**

Checkmated by
high pushbutton
switch cost?

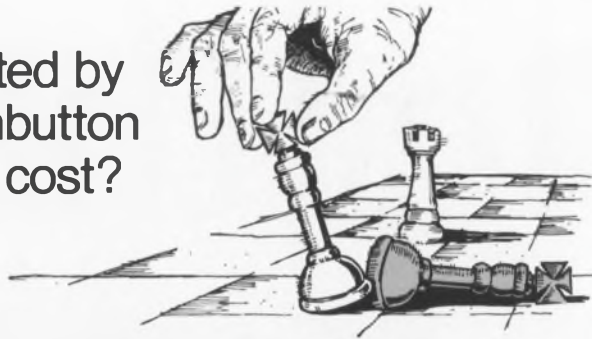

Check These Centralab Distributors For Three New Ways To Cut Switch Costs

The three new Centralab Pushbutton Switch products shown below are now available from Centralab Pushbutton Switch Distributors. They're low-cost money savers, and yet they offer the same high-quality features of all Centralab switches.

You can get these new products,

custom assembled to your specifications, from our factory trained Distributor Switch Specialists.

Contact your Centralab Distributor, listed at the right, for complete details. Ask for a copy of Centralab's New Pushbutton Switch Catalog, Series No. 301.

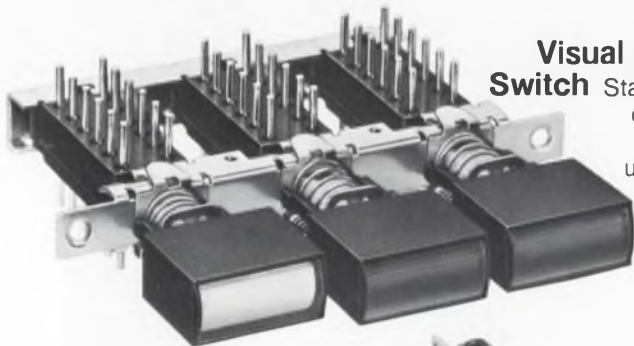

Visual Display in a Non-Lighted Switch Status indicator button adds visual display to non-lighted Centralab switches. The button, with a unique fluorescent display, uses reflected ambient light to indicate switch status. 6 display colors. Black or chrome plated buttons. 140° peripheral viewing angle.



5-amp Pushbutton Line Switch

UL listed for TV-5 rating: 120V, 5A, 78A peak inrush current. Accepts all Centralab button options.



Low-cost Lighted Pushbutton Switch

T-1 $\frac{3}{4}$, wedge base lamp brings cost down. New options increase harmonized panel aesthetics. Flat or recessed lenses. 8 lens colors. 15mm or 20mm spacing. Switch assemblies to 13 stations.

DISTRIBUTOR PRODUCTS



CENTRALAB
Electronics Division
GLOBE-UNION INC.

5757 NORTH GREEN BAY AVENUE
MILWAUKEE, WISCONSIN 53201

**FOR LOW-COST
PUSHBUTTON SWITCHES
CHECK YOUR CENTRALAB
DISTRIBUTOR.**

CALIFORNIA

Kierulff Electronics, Inc.
Los Angeles
213/685-5511

Kierulff Electronics, Inc.
Palo Alto
415/968-6292

Kierulff Electronics, Inc.
San Diego
714/278-2112

COLORADO

Kierulff Electronics, Inc.
Denver
303/371-6500

FLORIDA

Hammond Electronics
Orlando
305/849-6060

INDIANA

Radio Distributing
Co., Inc.
South Bend
219/287-2911

MASSACHUSETTS

Sterling Electronics
Watertown
617/926-9720

MINNESOTA

Gopher Electronics Co.
St. Paul
612/645-0241

NEBRASKA

Radio Equipment Co.
Omaha
402/341-7700

NEW YORK

Electronic Equipment
Co., Inc.
Hempstead
516/538-5510

Peerless Radio Corp.
Lynbrook, L.I.
516/593-2121

Summit Distributors, Inc.
Buffalo
716/884-3450

NORTH CAROLINA

Kirkman Electronics, Inc.
Winston-Salem
919/724-0541

OHIO

ESCO Incorporated
Dayton
513/226-1133

Pioneer-Standard
Electronics, Inc.
Cleveland
216/587-3600

PENNSYLVANIA

Cam/RPC Industrial
Electronics
Pittsburgh
412/288-2600

Herbach & Rademan, Inc.
Philadelphia
215/426-1700

Pyttronic Industries, Inc.
Montgomeryville
215/643-2850

TEXAS

Southwest Electronics Inc.
Stafford
713/494-6021

WASHINGTON

Almac/Stroom Electronics
Seattle
206/763-2300

ISOSTAT LICENSED

The one variable the world can standardize on.

Our new Type M conductive plastic variable resistor is hard metric. A 10 mm cube that's tiny, flexible and rugged. The MINI-METRIC is the smallest dual pot available today. Manufactured in the United States, it's dimensioned the way the rest of the world thinks. Allen-Bradley has what you need; or, it can be ordered through our distributors. Ask for Publication 5239.

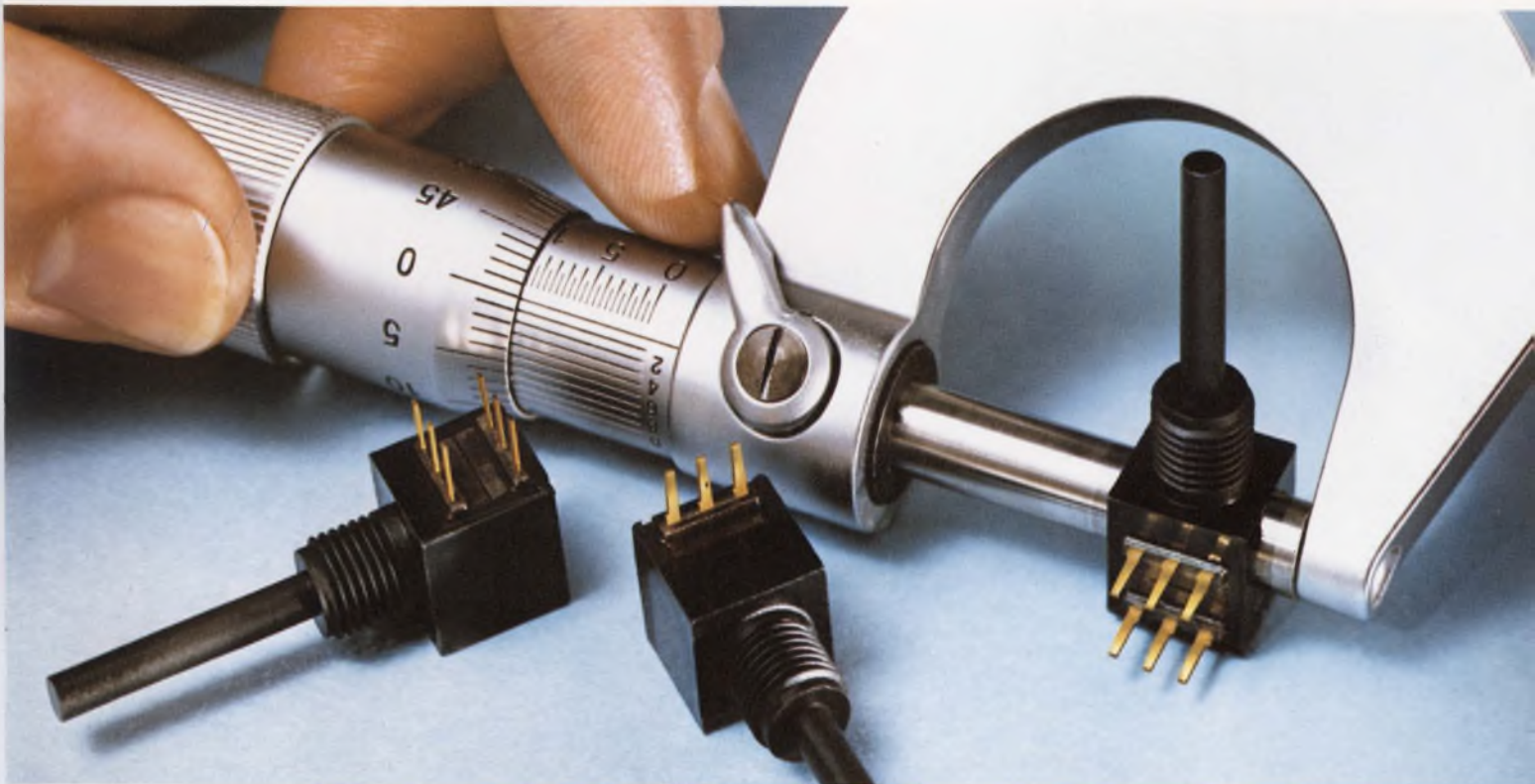
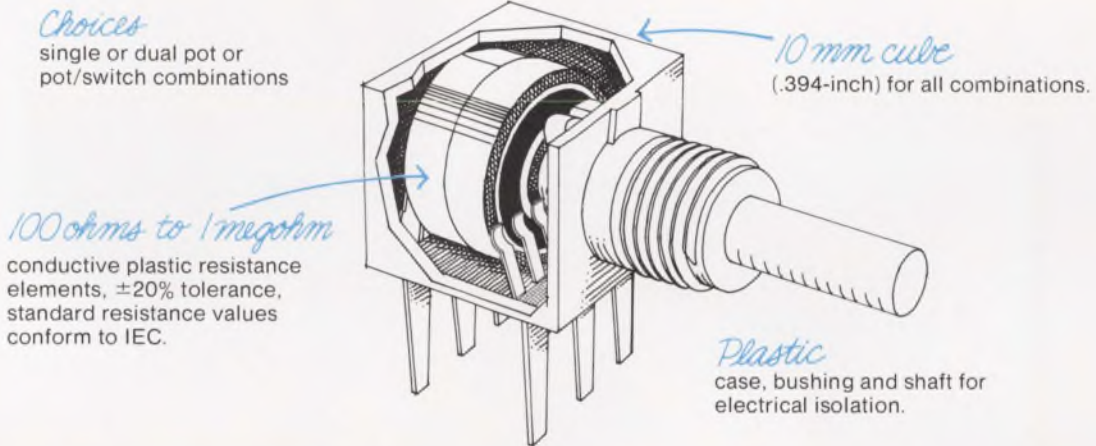

Quality in the best tradition.



ALLEN-BRADLEY
Milwaukee, Wisconsin 53204

CIRCLE NUMBER 152

EC131

Omron, 43 years old, and still building a family of relays, switches, and timers for every need.

Mind you, the control component *you* need may not be in the photograph. That's because this picture shows less than 5 percent of the components in our line. But it's more than likely that the "unique" device you're looking for is one which we've

been making for a long time, and which we carry in stock.

Omron hasn't achieved a position of international leadership by sitting still. Since we began making control components in 1933, we've been carving out a reputation for excellence in engineering, manufacturing, and—above all—in serving you, the Omron customer. We're still adding new products all the



**Welcome
to the family,
little fella**

time, and we're providing faster delivery than ever thanks to our expanded distributor network.

To find out what Omron can do for you, contact your nearest Omron distributor or call us at (312) 885-9500. We think you'll want to welcome us as your components supplier... because no matter what little fella you're looking for, we can probably help you give him a home.



*a world leader
in electronics
since 1933*

Omron Corporation of America
Corporate Headquarters
Sears Tower, Chicago, Illinois

Sales and Service
1051 State Parkway
Schaumburg, Illinois 60172
Phone: (312) 885-9500



CIRCLE NUMBER 153

New from Centralab...

CERBON™ TRIMMER RESISTORS

Affordable Stability...
300% More
Stable Than Carbon...
at a Carbon
Trimmer Price!



Why pay more? With Centralab's new CERBON trimmers you get stability approaching cermet and at carbon prices... As little as 28¢ in distributor 1,000 quantities; as low as 10¢ in high volume orders.

The secret of CERBON superior performance? A totally new thick film resistor element, which combines both potentiometer and conventional thick film technologies, *plus* a heat stable ceramic substrate, *plus* a dual-tine contact spring, *plus* "Fluxgard" protection from dust and wave soldering contaminants. In short, a totally balanced electromechanical system.

Look at these benefits:

- TCR less than -400 ppm/°C.
- CRV less than 2% of maximum resistance.
- Rotational life exceeds 500 cycles.
- Adjustability (typical) -0.05% of total voltage.
- High overload capability —

1 watt at 25°C ambient for 1,000 hours exhibits less than 2% cumulative resistance change. • Maximum stability in humid environment — Resistors exposed to an atmosphere of 40°C at 95% relative humidity for 300 hours return within four hours to $+2.5\%$ of their initial readings.

CERBON trimmers are offered in a resistance range of 1 K ohm to 1 megohm with a choice of standard PC terminal configurations. They fit universally accepted circuit board mounting patterns. And they're ready now for fast delivery in any quantity.

Write for complete technical data on Centralab's new CERBON trimmer resistors. Or call (915) 779-3961 for a free evaluation sample. Move up to CERBON and save!

AVAILABLE CIRCUIT OPTIONS

Thanks to their ceramic substrate, Centralab CERBON trimmers permit a variety of screen printed circuit options. Here are three typical circuits:

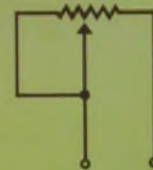

TERMINAL SHORTING

One of five electrical termination options available.

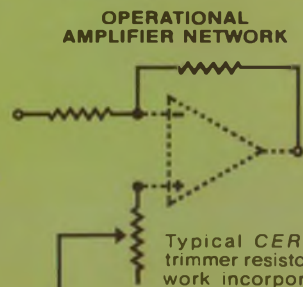

OPERATIONAL AMPLIFIER NETWORK

Typical CERBON trimmer resistor network incorporating one variable and two fixed resistors on dual substrate configuration.

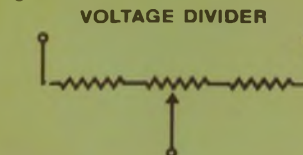

VOLTAGE DIVIDER

Fixed and variable resistors can be ratio matched for precise values and to insure temperature tracking. Eliminates need for costly discrete resistor selection.



ACTUAL SIZE

Knob colors available in white, blue, red and green for ease in assembly operations.



CENTRALAB

Electronics Division

GLOBE-UNION INC.

7158 MERCHANT AVENUE

EL PASO, TEXAS 79915

CIRCLE NUMBER 154

Modular supplies offer adjustable outputs

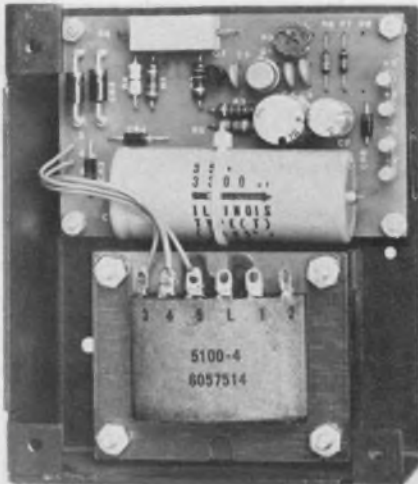

Century Electronics, 2688 S. La Cienega Blvd., Los Angeles, CA 90034. (213) 870-1083. Start at \$23 (100); stock.

SA series is composed of 12 standard models of wide-range single-output modular dc power supplies. Designed with open-frame construction, the units are available in popular OEM voltages with up to 12-A load current. These standard units are offered in four continuously adjustable output voltage ranges for low, medium and high-current applications from 4.5 to 30 V dc. OVP and ac line fusing are optional. Specs include regulation of $\pm 0.1\%$ and output ripple of 0.01% rms typically.

CIRCLE NO. 371

Supplies "trained" for combat duty

ERA Transpac, 311 K East Park St., Dept. 1209, Moonachie, NJ 07074. (201) 641-3650. \$385 to \$890; stock-10 wks.

MS series are off-the-shelf MIL spec dc modular power supplies. Transformers are per MIL-T-27A, semiconductors are MIL-STD-701 or MIL-S-19500 preferred types. Tantalum foil capacitors per MIL-C-3965 are used throughout except in the filter sections of higher current types where MIL-C-62 military grade electrolytic capacitors are used. These units have been fully tested to meet the component, workmanship, and environmental requirements of MIL-E-4158, MIL-E-5400, MIL-E-16400, MIL-E-5272, MIL-T-21200.

CIRCLE NO. 372

CHECK DIGITAL IC'S FASTER THAN A SCOPE, SAFER THAN A VOLTMETER

You're looking at the most convenient and efficient way developed to check digital IC's: CSC's Logic Monitor. It speeds digital design and testing by accurately and automatically displaying static and dynamic logic states of DTL, TTL, HTL and CMOS DIP IC's. All in a compact, self-contained 16-pin circuit-powered unit

Use it to effortlessly trace signals through counters, shift registers, gating networks, flip-flops, decoders... even entire systems made up of mixed logic families. It's a great way to cut minutes, even hours all along the line from design through debugging

Nothing could be simpler: just clip it over any DIP IC up to 16 pins, and the Logic Monitor does the rest. Precision plastic guides and unique flexible web insure positive connections between non-corrosive nickel-silver contacts and IC leads. Each contact connects to a single "bit" detector with high-intensity LED readout, activated when the applied voltage exceeds a fixed 2V threshold. Logic "1" (high voltage) turns LED on; Logic "0" (low voltage or open circuit) keeps LED off. A power-seeking gate network automatically locates supply leads and feeds them

to the Logic Monitor's internal circuitry.

Very clever. Very portable. Very effective. And very reasonable, at \$84.95*. See the Logic Monitor at your CSC dealer, or write for our catalog and distributor list



CONTINENTAL SPECIALTIES CORPORATION



EASY DOES IT

44 Kendall Street, Box 1942
New Haven, CT 06509 • 203-624-3103 TWX 710-465-1227
West Coast office: Box 7809, San Francisco, CA
94119 • 415-421-8872 TWX 910-372-7992
Canada: Len Finkler Ltd., Ontario

© 1976, Continental Specialties Corp

*Manufacturer's suggested price. Prices and specifications subject to change without notice.

CIRCLE NUMBER 91

POWER SOURCES

Dial-a-load makes testing easier

Transistor Devices, 85 Horsehill Rd., Cedar Knolls, NJ 07927. (201) 267-1900. \$279; stock.

The DAL 50-15-100 electronic Dial-A-Load can handle 3 to 50 V at 0 to 15 A, with a maximum power rating of 100 W. Load cur-

rent regulation is less than 0.05%/V, temperature coefficient is less than 0.03%/°C. Other maximums: line regulation 1%, ripple 0.1% rms. Overcurrent and over-power protection are standard. Turn-on time is approximately 20 ms and temperature rise is 35 C max.

CIRCLE NO. 373

Switcher offers four outputs to 750 W



LH Research Inc., 1821 Langley Ave., Irvine, CA 92714. (714) 546-5279. \$745; 4 wks.

A new switching regulated power supply offers up to four outputs totaling 750 W from a package that measures only 5.1 x 7 x 12.75 in. Primary output of the Model MM-440 is 5 V at 150 A. The second output can be any one of the following: 2 V at 12 A; 5 V at 12 A; 12 V at 10 A; 15 V at 10 A; 18 V at 8 A and 24 V at 5 A. Third and fourth voltage outputs can be one of a number of combinations.

CIRCLE NO. 374

HV supply adjusts continuously

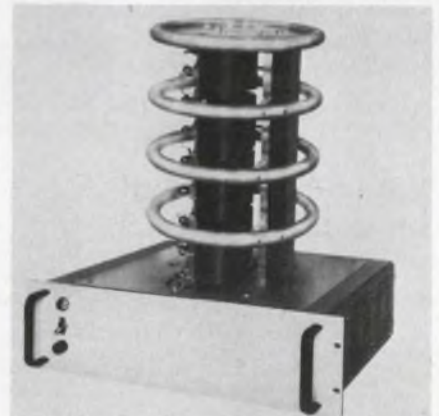

Spellman High-Voltage Electronics, 1930 Adee Ave., Bronx, NY 10469. (212) 671-0300. \$7300; 8-12 wks.

Model UHR160P640 regulated dc power supply delivers a continuously adjustable output of 160 kV at 4 mA. The unit is fully protected from arc-over, short circuit and overload. Line regulation is 1% for a $\pm 10\%$ change in line voltage. Load regulation is 1% for a no-load to full-load variation. Ripple is 0.5% pk-pk. Input requirements are 208-V ac, 3 phase, 4 wire.

CIRCLE NO. 375

Anatomy of Value in a Voltage-Tuned Oscillator

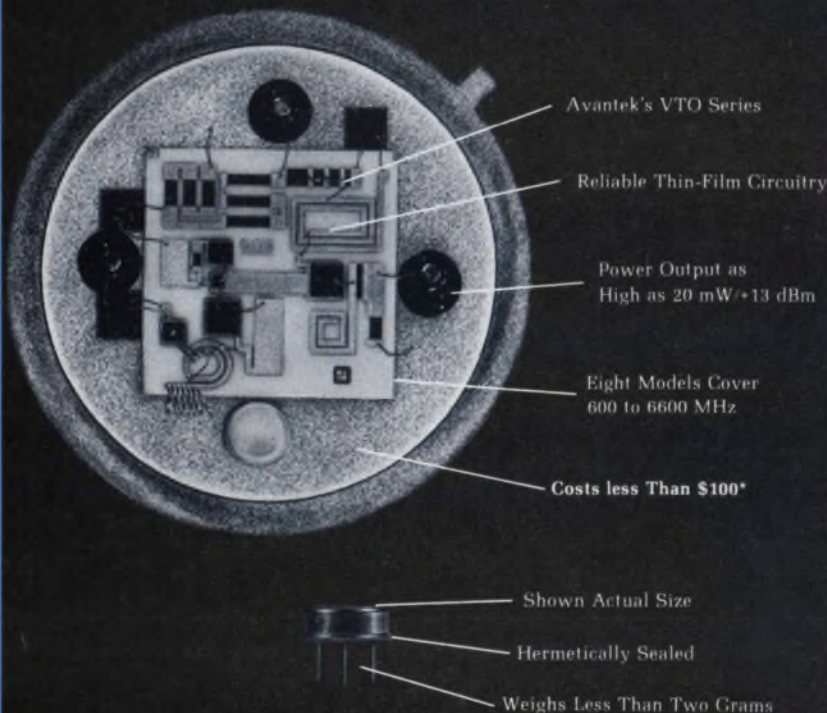

Avantek's VTO Series

Reliable Thin-Film Circuitry

Power Output as High as 20 mW ± 13 dBm

Eight Models Cover 600 to 8600 MHz

Costs less Than \$100*

Shown Actual Size

Hermetically Sealed

Weighs Less Than Two Grams

*in breadboard quantities

If you're designing a synthesizer or other instrument, why worry about designing voltage-tuned oscillators? Avantek VTO's represent an outstanding value as a cost-effective alternative to in-house discrete designs. Contact Avantek for an applications brochure describing the VTO Series in detail.

Avantek

3175 Bowers Ave., Santa Clara CA 95051 Phone (408) 249-0700

CIRCLE NUMBER 92

5-Volt, 10-AMP Power Supply

The Model HE237 Power Supply offers the design engineer, for the first time, a low cost, highly efficient alternative to the size, weight, and heat generation problems normally associated with series-pass regulated supplies. Using state-of-the-art switching techniques and CMOS logic, the HE237 achieves 75% efficiency, at a full load of 10 amps.

The HE237 has the "footprint" and mounting dimensions of the Lambda package size "B" supplies—a feature that allows the engineer to experiment with high efficiency techniques in exist-

ing designs. In new designs, the engineer can take advantage of the HE237's small size (6½" x 4½" x 1½") and light weight, (1.7 lbs).

The highly reliable HE237 Power Supply is short-circuit proof, contains over-voltage protection, and is backed by a full two year warranty.

Finally, the HE237 offers the design engineer considerable savings. It is available in both 115 and 230 VAC input models for just \$195...quantity, one.



Computer Products, inc.

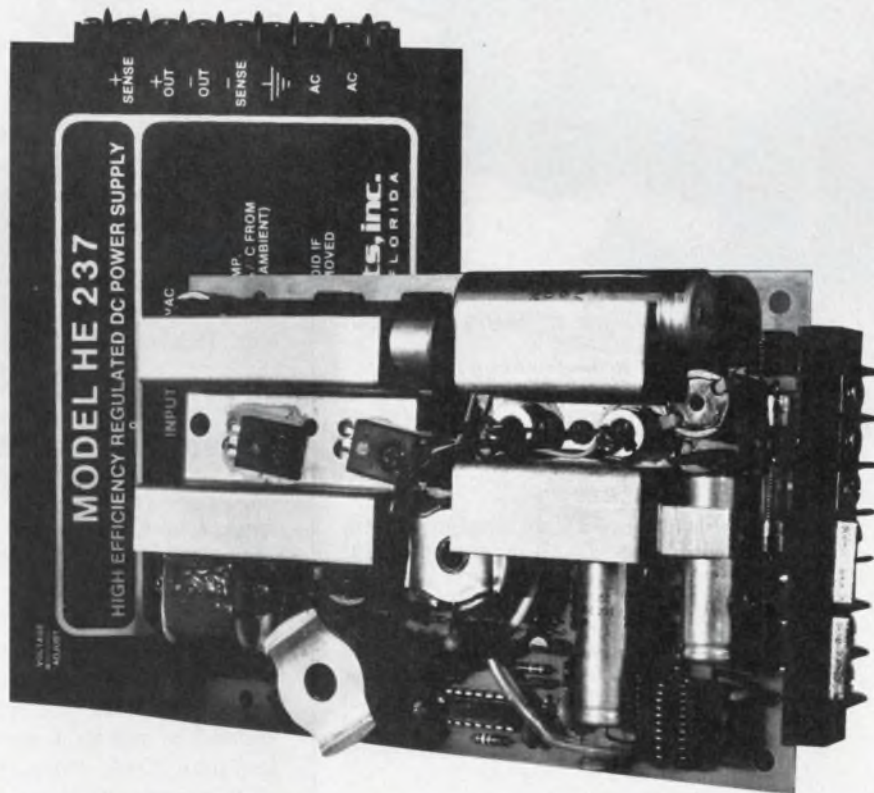

1400 NW 70 Street, Fort Lauderdale, Florida 33309 • (305) 974-5500, TWX (510) 956-9895.

Distributors: Los Angeles 213-877-5518 / Albuquerque 505-255-2440

CIRCLE NUMBER 93

High Efficiency

MODULES & SUBASSEMBLIES

Tiny atomic oscillator boasts high stability

Efratom California, 3303 Harbor Blvd., Suite EL, Costa Mesa, CA 92626. (714) 556-1620. \$5340 (unit qty.); stock.

The FRK-HTO atomic oscillator operates from -54 to $+65$ C. Its 10-MHz sine-wave output maintains a longterm frequency stabil-

ity of typically 1×10^{-11} per month and a short-term stability of better than 1×10^{-12} for 100 seconds averaging time. The FRK-HTO weighs 1.3 kilograms and measures $4 \times 4 \times 4.5$ in. The unit's ruggedized design complies to MIL-STD-810C, procedure 1, for shock and vibration and MIL-T-5422F for 95% humidity operation.

CIRCLE NO. 376

Triple low-pass filter available in four models



Fogg Systems Company, P.O. Box 22226, Denver, CO 80222. (303) 758-2979. See text.

The Model 126 programmable low-pass filter is three identical, unity-gain, differential-input filters. Each channel consists of an active two-pole Butterworth filter whose high-frequency 3-dB point is user programmed via a DIP switch on the $5.4 \times 4.55 \times 0.7$ in. card. Four standard versions provide frequency ranges of 1 to 16 Hz, 10 to 160 Hz, 100 Hz to 1.6 kHz, and 500 Hz to 8 kHz. The high-frequency 3-dB point is easily set at any one of 16 frequencies within the range. Roll-off is 40 dB/decade for all units. Power supplies or batteries from ± 2.7 to ± 15 V dc can be used to power the Model 126. The full-scale input and output range is ± 10 V with a ± 15 -V supply. The filter card costs \$196 for the 10-to-160-Hz and 100-Hz-to-1.6-kHz models, \$215 for the 500-Hz-to-8-kHz model and \$225 for the 1-to-16-Hz version. Up to 17 cards can be packaged in a 7×19 -in. card cage. Two metal enclosures are available. One provides BNC signal connectors and an MS power connector for \$65. The other, priced at \$20, provides a printed-circuit connector. Up to three of these enclosures can be mounted in a $1\text{-}3/4 \times 19$ -in. panel slot. Delivery is 30 days.

CIRCLE NO. 377

Crystal oscillators span 1 Hz to 5 MHz

Accutronics, 628 North St., Geneva, IL 60134. (312) 232-2600. From \$19.25; 6 wks.

The Series 162 crystal oscillator delivers a CMOS-compatible output at any fixed frequency from 1 Hz to 5 MHz. Typical operating current of the modular oscillator is less than 2 mA. Frequency stability of the output is $\pm 0.001\%$ over the standard 0-to-50-C operating range. Wider operating ranges are also available.

CIRCLE NO. 378

You know our Capacitors,
but have you seen our...

ALUMINUM FOIL TRANSFORMERS



If you're looking for an isolation or autotransformer with...

- Single or multiphase
- Reduced size and weight
- Higher temperature operation
- Improved thermal efficiency
- Higher electrical efficiency, and better regulation

...then our aluminum foil transformer line could be your answer. Units are available in 50/60 Hz, 400 Hz and higher frequencies, in sealed, shell and open-frame versions, with ratings to 5000 VA and outputs through 500 volts. Or send us your requirements for a design and price proposal. Send for our transformer data sheet and technical bulletin today to Electrocube, 1710 So. Del Mar Ave., San Gabriel, CA 91776; (213) 573-3300.

 **electrocube**

CIRCLE NUMBER 94

these two Panel Meters . . .
can become 93 different measuring instruments . . .

count'em.

DC and AC Volts	23 models
DC and AC Current	20 models
DC Autoranging	2 models
True rms	8 models
Thermocouple C or F	16 models
RTD C or F	4 models
Thermistor C or F	8 models
Offset and Scaled	4 models
Process Monitors	8 models

and the best part is . . .

You can change to any one of these models anytime. It is as simple as reprogramming the rear connector or adding one of DigiTec's exclusive adapters. Call or write for complete specifications.

These instruments are available under GSA Contract, GS-00S-27741.

DigiTec: Precision Measurements to count on

DigiTec.

**UNITED
SYSTEMS
CORPORATION**

918 Woodley Road, Dayton, Ohio 45403
(513) 254-6251, TWX (810) 459-1728



INFORMATION ONLY, CIRCLE 281

DEMONSTRATION ONLY, CIRCLE 282

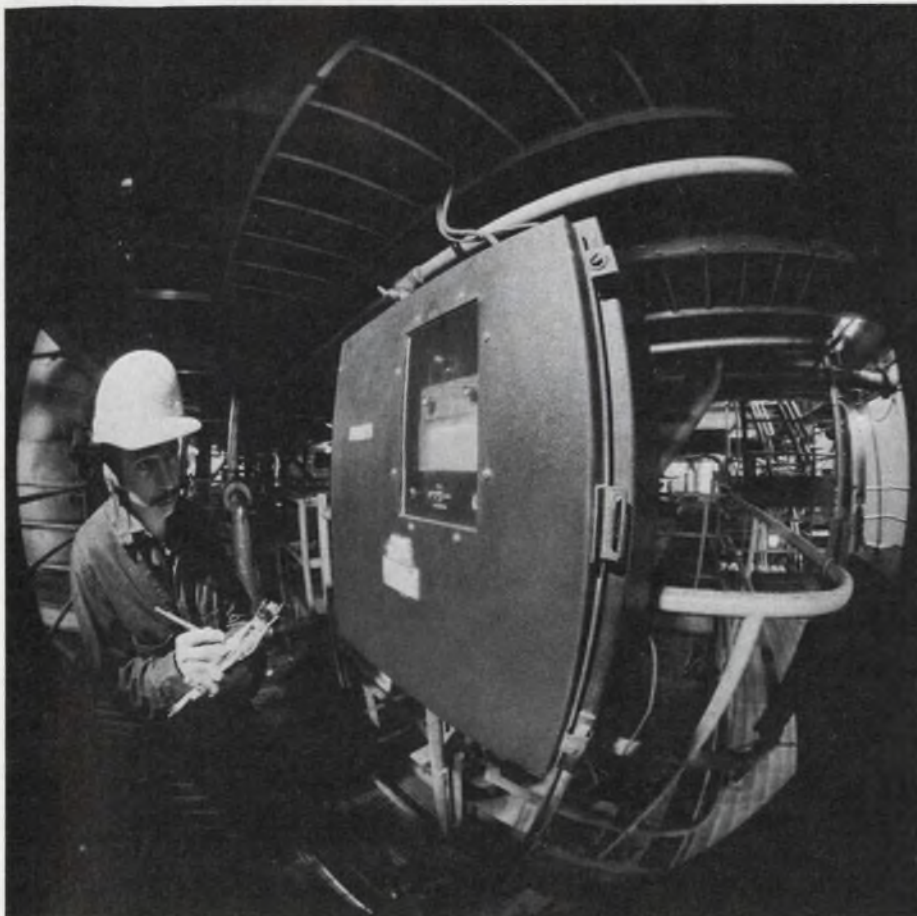

There's a Hoffman enclosure for almost every electronic application you can think of.

One company uses our NEMA 12 enclosures to house water-testing instrumentation. Whatever your electronic application, Hoffman probably offers an enclosure to match it, whether it's for servo controls or sensitive instruments.

Hoffman electronic rack enclosures, consoles, instrument boxes, and a full range of NEMA types are just some of the components in a broad-spectrum 1700-product line. All are quality-built in the materials, finishes, and sizes your application requires.

There's a Hoffman enclosure for almost every electronic application you can think of. Check with your Hoffman distributor, or write directly for specifications — we'll match our enclosures with your thinking any time you like.

For complete data write:
HOFFMAN ENGINEERING COMPANY
Division of Federal Cartridge Corporation
DEPT. ED671, ANOKA, MN 55303

Hoffman[®]
ELECTRICAL ENCLOSURES

CIRCLE NUMBER 95

DIRECT FROM STOCK

5V15A

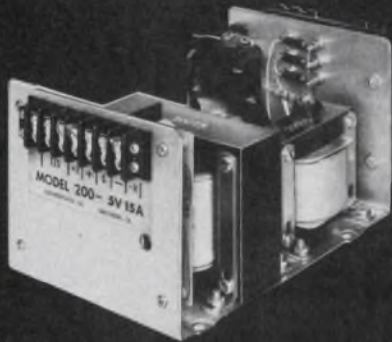

SINGLE \$99

\$84.00 - 100 pieces

**Singles and duals
up to 200 Watts,
3 to 50 Volts.**

SPECIFICATIONS

Size: 5 x 5.5 x 10.75 overall
 Input: 105-125V, 47-420 Hz
 Output: Any DC voltage 3 to 50
 Regulation: Line — 0.005%
 Load — 0.05%
 Ripple: Less than 250 Microvolts
 Temp: Operative —40 to +71°C
 Storage —65 to +85°C
 Coefficient —0.01%/°C Max.
 Current Limiting: Fixed Foldback Type
 Overvoltage: Optional

MODEL	VOLTS	AMPS
200-5	4.5-5.5	15.0
200-12	11.5-12.5	10.0
200-15	14.5-15.5	9.0
200-24	23.5-24.5	7.5
200-28	27.5-28.5	7.0
200-48	47.5-48.5	4.0
200-0505	± 4.5-5.5	7.0
200-1212	± 11.5-12.5	5.0
200-1515	± 14.5-15.5	4.5
200-2424	± 23.5-24.5	3.5
200-2828	± 27.5-28.5	3.5

ORDERING INFORMATION

SINGLE			DUAL		
Qty	Price	w/O.V.	Qty	Price	w/O.V.
1-9	\$99	\$114	1-9	\$119	\$129
10-24	94	107	10-24	113	122
25-99	90	102	25-99	104	112

CALL (714) 279-1414 FOR DELIVERY

Electrostatics, inc.

7718 CLAIREMONT MESA BLVD. • SAN DIEGO, CA 92111

CIRCLE NUMBER 97

MODULES & SUBASSEMBLIES

S/d converter series tracks at 5760°/s

Computer Conversions Corp., 6 Dunton Ct., East Northport, NY 11731. (516) 261-3300. Less than \$350 (prod. qty.); 4 wks.

The SDC410 series of synchro-to-digital converters can track input rates of up to 5760°/s with no added error. The modules convert synchro or resolver inputs of 11.8 or 90 V, 400 Hz, or 90 V, 60 Hz, into 10-bit, parallel-binary outputs that represent the angle with an accuracy of ±30 min. of arc. There is no accuracy degradation over the unit's operating temperature range, for ±10% amplitude and frequency variations and for ±5% power-supply variations. All units in the series measure 2.6 x 3.1 x 0.82 in. Typical operating requirements include a reference input of 26 or 115 V ac and supplies of +15 V at 65 mA, -15 V at 40 mA, and +5 V at 275 mA. Two operating temperature ranges are available: 0 to 70 or -55 to +85 C.

CIRCLE NO. 379

Two-tone decoder spans 832 to 2704 Hz

Solid-State Communications, 21060 Corsair Blvd., Hayward, CA 94545. (415) 785-4610. Under \$90; stock.

The Model 221 two-tone sequential decoder is intended for mobile selective calling systems. The decoder accepts signal formats of 100 ms to 1 s per tone over frequency range of 832 to 2704 Hz. Operating frequencies can be changed in the field without special tools or instruments. Both latched and timed relay outputs are available to control the radio speaker, vehicle horn, or other external functions. The unit operates from a power source of 10 to 15 V dc and draws a 10-mA standby current over a temperature range of -30 to +75 C. The decoder comes in two configurations: The V221 self-contained dash-mount control head with a lighted reset switch and a call-horn-monitor switch or a board-only version, the Model 221-A.

CIRCLE NO. 380

Narrow-band notch filter has 50-dB attenuation

Frequency Devices, 25 Locust St., Haverhill, MA 01830. (617) 374-0761. \$85 (1 to 9); stock.

The 585 series of narrowband notch filters have -3 dB and -50-dB bandwidths that conform with Bell System specifications. The units are three-pole-pair, stagger-tuned, band-reject active filters. They are packaged in plug-in modules that measure only 2 x 2 x 0.4 in. (50.8 x 50.8 x 10.1 mm). All models exhibit a passband gain of 0 ±0.3 dB, a constant input impedance of 20 kΩ, an offset voltage of less than ±5 mV, and an offset tempo of 50 μV/°C over their full operating temperature range of 0 to 70 C. All models provide rated specifications with ±15-V-dc power supplies but can be operated from power supplies ranging from ±5 to ±18 V dc. Output characteristics include a full power response to ±10 V at ±5 mA from dc to 10 kHz, and less than 50 μV of noise in a dc to 50 kHz bandwidth. Two standard models are available. Model 585-1 has 50 dB of attenuation from 995 to 1025 Hz to eliminate test tones, 1004-Hz holding tones and 1020-Hz tones that are often used for phase jitter measurements. Model 585-2 has 50 dB of attenuation from 2785 to 2815 Hz to eliminate the 2800-Hz holding tone that is commonly used in telephone system for line noise measurements.

CIRCLE NO. 381

High resolution v/f's deliver 100 kHz

SGR Corp., Neponset Valley Industrial Park, P.O. Box 391, Canton, MA 02021 (617) 828-7773. From \$39 (unit qty.); stock.

The 500 series of 100-kHz voltage-to-frequency converters offers resolution of better than 16 bits. Six models are available, with overall accuracies from 11 to 13 bits. Full-scale errors range from a loose ±150 ppm/°C to a tight ±15 ppm/°C.

CIRCLE NO. 382

E-Z-MICRO HOOK ■ E-Z-MINI HOOK X100W AND XL1 ■ E-Z-MACRO HOOK XH AND XHL ■ E-Z-NAILCLIPS
 E-Z-PROBES XP AND XPL ■ TEST LEADS AND JUMPERS ■ ADAPTORS
 PATCH CORDS ■ COAXIAL JUMPERS ■ E-Z-HOOK CLIP 61-1 AND 61-2

OUR NEW MICRO TROUBLE SHOOTER SOLVES YOUR IC TESTING PROBLEMS

The XM Micro Hook is designed for difficult IC test connections. Light weight (less than 1 gram) and Finger-eze Hypo Action permit direct hookup to delicate wires where weight and leverage may damage component. Fully insulated to a single contact point for true readings.

Construction: One-Piece Beryllium Copper, Gold-Plated Conductor and Hook, made for connections over leads up to .025" diameter. Durable Heat and Chemical Resistant Nylon Body. Stainless Steel Spring. Available preconnected to a wide variety of interface connectors.

Colors Red, Black, Blue, Green, Orange, Yellow, White, Brown, Violet and Gray.

EXCLUSIVE FIELD SERVICING FEATURE

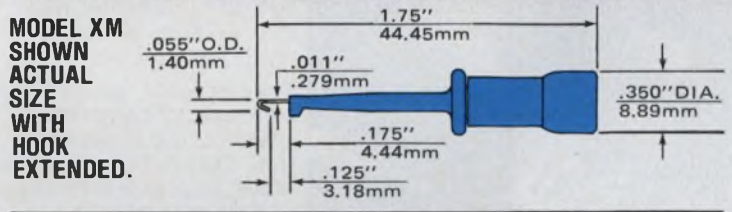
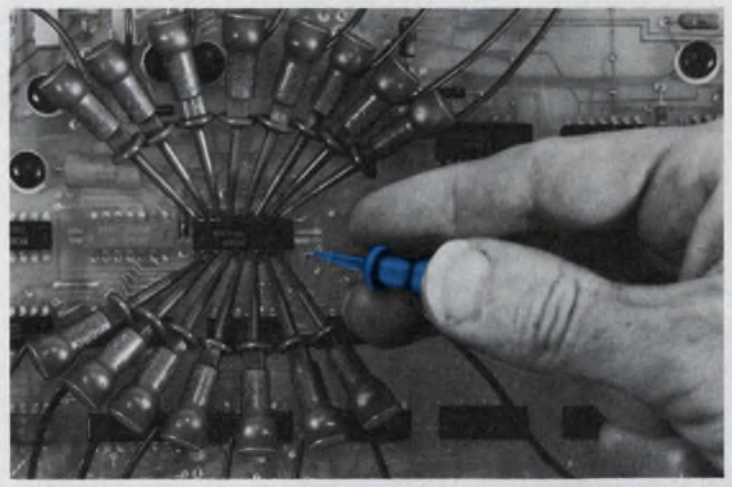
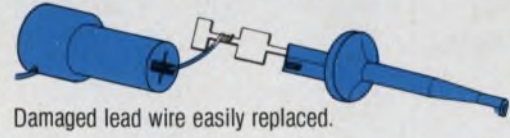

SEND FOR COMPLETE NEW CATALOG AND PRICE LIST
E-Z-HOOK
 A DIVISION OF TEKTEST, INC. | 114 EAST SAINT JOSEPH STREET
 ARCADIA, CALIFORNIA 91006
 (213) 446-6175 / TWX 910 582 1614

E-Z-PROBES 52 AND 54-1 ■ BNC, UHF, SMA AND STACKING DOUBLE BANANA COAXIAL TEST CABLES
 CIRCLE NUMBER 98

WE'RE NUMBER ONE FOR CUSTOM MOS

NUMBER ONE for experience. Our MOS experience dates back to 1964 and our company has been producing Custom Mos since its' founding in 1969.

NUMBER ONE for making the economics of Custom MOS right for you, whether your production quantities are 1,000 or 1,000,000. (We have no production minimum or maximum.)

NUMBER ONE for quality. Reliability is built into every MOS/LSI circuit we manufacture, whether packaged in plastic or ceramic.

NUMBER ONE for protecting the proprietary nature of your product. Your competition will not know about your product design and we will not become your competition.

NUMBER ONE for flexibility. We offer you PMOS, CMOS, and NMOS (we help select the right process for your requirement) and the assurance that multisourcing is available when needed.

LSI computer systems, inc.

22 Cain Drive, Plainview, NY 11803 (516) 293-3850

CIRCLE NUMBER 99

Stay current with small lamp data from General Electric. It's free.

**Check these 6 halogen cycle lamps
GE has added to its low-voltage line.**

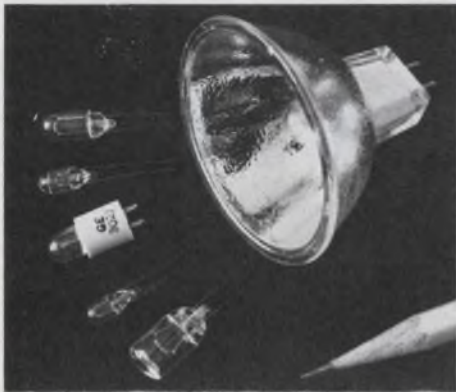

General Electric now offers over 27 halogen cycle lamps that pack high light output in small packages. (In addition, GE offers 8 sealed beam halogen lamps primarily for aircraft applications.) Bulb diameters range from $\frac{3}{8}$ " to $\frac{1}{2}$ ". Lengths from .520" to 2.25". Voltages from 3.5 to 28. O.V. And candlepower from 2.15 cd up to 250 cd.

They're ideal for you if you're designing applications such as optical systems, instrumentation, illuminators, fiber optics, card readers, displays and aircraft navigation. A variety of terminals are offered.

For updated technical information circle the number below or write GE for Bulletin #3-5357.

**These GE wedge base miniature lamps offer
you savings in time, money and space.**

These lamps are ideal for applications such as indicators, markers and general illumination where space is at a premium. Their wedge-based construction makes them easy to insert and remove. They don't require bulky, complicated sockets. And because the filament is always positioned the same in relation to the base, you get consistent illumination from lamp to lamp.

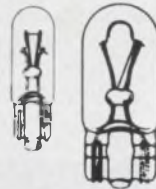

You can choose from over 25 types of GE wedge base lamps. Voltages range from 6.3 V to 28 V. Candlepower from 0.03 to 12 cd. Bulb sizes range from subminiature at 6mm to a heavy-duty bulb at 15mm.

To send for updated wedge base lamp technical information, circle number below or write GE for Bulletin #3-5259.

**These three free GE catalogs include
important data changes that could affect
your present design. Send for yours today.**



#3-5169

June '75 Miniature lamp catalog features 40 pages and 500 data changes for complete 500-lamp line.



#3-6252R1

Feb. '75 Sub-miniature lamp catalog features 24 pages and 91 changes for more than 210 lamps.



#3-6254R

Dec. '74 Glow Lamp catalog features 8 pages and 50 changes for 83 Glow Lamp Indicator and Circuit Component lamps.

For up-to-date technical information on any of these items write: General Electric Company, Miniature Lamp Products Department #3382-L, Nela Park, Cleveland, Ohio 44112.

GENERAL  ELECTRIC

CIRCLE NUMBER 101

MODULES & SUBASSEMBLIES

**Signal digitizer works
with most transducers**



Automated Industrial Measurements, P.O. Box 125, Wayland, MA 01778. (617) 653-8602. \$325 (1 to 9); stock.

A general-purpose transducer digitizer and transmitter—the 1001—includes the interface circuitry for most transducers. The input circuitry is programmable for both gain and offset, as well as being fully isolated from ground. Common-mode signals of up to 2500 V can be handled. Specifications include a nonlinearity of 0.01%, a gain temperature coefficient of ± 10 ppm/ $^{\circ}\text{C}$ and a zero offset of ± 1.5 $\mu\text{V}/^{\circ}\text{C}$. Floating ± 15 -V power supplies are built into the digitizer so that additional signal conditioning circuits could be powered. The 1001 transmits the digitized signal over a twisted pair of wires (which are also the 24-V power supply leads) at a frequency that ranges from 0 to 1 MHz.

CIRCLE NO. 383

**Power amps intended for
digital resolver systems**

Natel Engineering, 8954 Mason Ave., Canoga Park, CA 91306. (213) 882-9620. From \$250 (prod qty); 4 wks.

Two solid-state power amplifiers, the PS-56 and PA-13, provide 56 and 13-W outputs, respectively. Both units have current-limiting and thermal-shutdown protection. The amplifiers are intended for operation with the company's DSC 5012 digital-to-resolver or r/d converters. The accuracy of the DSC 5012 converter is within four minutes and with either the PA-56 or PA-13 added, the accuracy is within 15 minutes under load. Both the converter and the amplifier are designed to MIL-E-5276C and E-5400.

CIRCLE NO. 384

Reliability test results:

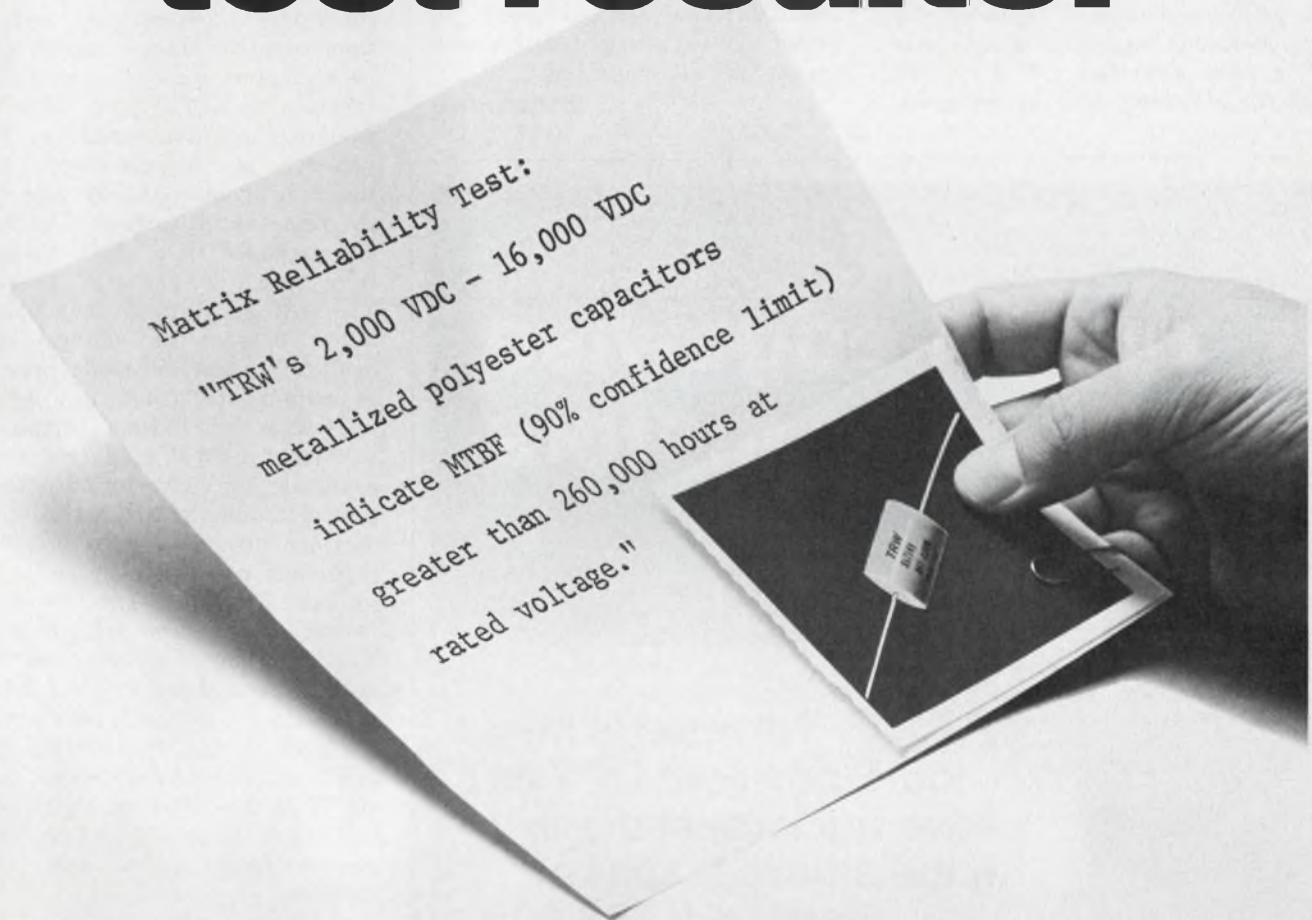

TRW's X675HV series is designed to meet the requirements of voltage multipliers and high voltage filters in high density, high voltage power supplies, instrumentation, data displays, pulse modulators and copiers.

They're smaller, lighter, self-healing and eliminate wet components which can bleed, crack and wreck a board.

The standard design is metallized polyester with axial leads, tape wrap and epoxy endfill case. Insulation resistance is 30,000 megohms x MFD and the dissipation factor is less than 1% at 1000 Hz.

The X675HV series can replace traditional dielectrics in many applications with substantial savings in size at comparable lower costs. *On quantity orders, modifications can be made to your specifications.*

Want to know more? Use the coupon for complete specs on the X675HV series — or information on any dielectric you require.

TRW Capacitors

An Electronic Components Division of TRW, Inc.
301 West "O" Street,
Ogallala, Nebraska 69153.

- Please send me specs on your new X675HV capacitors.
- I'd also like a copy of the matrix test results.
- Please have someone contact me.

Name

Firm Name

Address

City

State

Zip

TRW CAPACITORS

ANOTHER PRODUCT OF A COMPANY CALLED TRW

CIRCLE NUMBER 100

Phase-locking oscillator allows ± 30 ppm range

Vectron, 121 Water St., Norwalk, CT 06854. (203) 853-4433. From \$74 (100-up); 60 days.

The CO-233V voltage-controlled, crystal oscillator is intended for applications requiring phase locking. The deviation of ± 30 ppm allows self-correcting to the speci-

fied center frequency without adjustment for a period of five years. The oscillator has a 0-to-50-C operating range and is available at any frequency in the 4-to-200-MHz range. An output of +7 dBm into 50 Ω is available. The oscillator can be purchased for either printed circuit-board mounting or chassis mounting.

CIRCLE NO. 385

Hybrid 12-bit DACs 2nd-source Burr-Brown

Micro Networks, 324 Clark St., Worcester, MA 01606. (617) 852-5400. 100-up prices: \$18.50 (current outputs); \$19.50 (voltage output); stock to 3 wks.

The DAC-80 series of 12-bit d/a converters is completely self-contained and includes internal reference supplies and output amplifiers (voltage models). The units are available in either binary or BCD versions, are pin-compatible with the Burr-Brown DAC-80 and meet the same specifications. The units are packaged in a glass, hermetically sealed 24-pin DIP package. The DAC-80 units are available in either current or voltage-output modes. The current-mode provides an output of 0 to 2 mA or ± 1 mA with an output compliance voltage of ± 2.5 V, max. In the voltage mode, the converter outputs are user selectable by external pin connections providing 0 to +5, 0 to +10, ± 5 , or ± 10 -V outputs. The voltage models, DAC-80-CBI-V (binary coded) and DAC-80-CCD-V (BCD coded), have a slew rate of 20 V/ μ s and settle to $\pm 1/2$ LSB in 3 μ s for a full scale change. For a 1-LSB change, the settling time is 1.5 μ s. The current output models, DAC-80-CBI-I and DAC-80-CCD-I, settle in 300 ns. All units operate from ± 15 -V and +5-V supplies.

CIRCLE NO. 386

A/d converter series offers 3-state output

SGR Corp., Neponset Valley Industrial Park, P.O. Box 391, Canton, MA 02021. (617) 828-7773. From \$69 (unit qty); stock to 30 days.

A series of microprocessor-compatible a/d converter modules has three-state outputs, 13-bit resolution and up to 13-bit accuracy. The 6100 series units use a multi-slope integration technique and also provide for automatic zero correction, have an overrange flag line and have internal references. The converters are housed in 2 \times 3 \times 0.4-in. encapsulated modules. The units accept bipolar input signals, provide two's-complement, binary outputs, and require +5 and ± 15 -V supplies.

CIRCLE NO. 387

digital edgewise meters

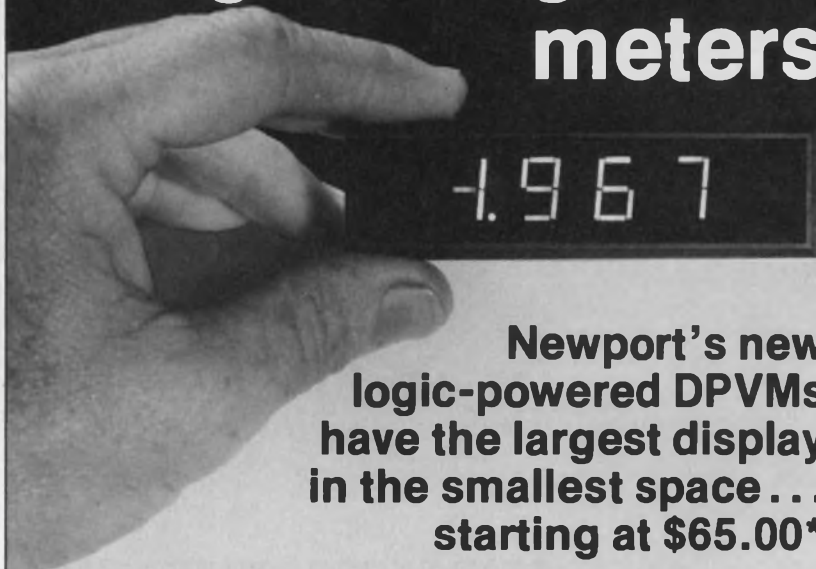

Newport's new logic-powered DPVMs have the largest display in the smallest space... starting at \$65.00*

The models 213 and 216 offer 2000 and 6000 count capacity respectively. Four ranges of voltage are available for each unit. The DIN standard case and cut-out permits mounting without occupying precious front panel space. The depth, including the connector, is 71 mm.

Newport's DPVMs will replace your edgewise analog meter with bright 13mm (1/2 inch) LED digits easily read from a distance.

Low power consumption and low parts count, plus Newport's ten years experience, add up to real reliability you can count on.

*OEM quantities

OTHER OUTSTANDING FEATURES:

- Differential input • Common mode voltage isolation • Bias current <1nA • One watt power consumption • Dual slope average value • DIN standard case • Bipolar ranges • Automatic zero
- High 50/60Hz NMR • 3-wire ratio standard • 4-wire ratio (optional) • Character serial BCD output (optional)

NEWPORT LABS—
630 East Young Street
Santa Ana, California 92705
Phone: (714) 540-4686

CIRCLE NUMBER 102

WE'RE WARNING YOU...

... it's easy to design instrument panel warning systems with these NEW solid state audio indicators. Six models . . . with .250" (6.4mm) quick-disconnect tabs. Pleasing continuous or pulsing tone . . . 85 dbA at 800 Hz . . . 5 to 50 vdc. Fits 1.125mm) opening; adapter ring optional for larger openings. Ask for new free catalog.



Series
AI-330

Actual Size

Model AI-301
Adapter Ring
(optional)

WHERE TO BUY

an audio indicator
for every need . . .

- CALIFORNIA, COSTA MESA
MarVac Electronics
- MASSACHUSETTS, SHARON
Adcour
- MICHIGAN, FARMINGTON
CMP Distributor Co
- NEW YORK, ROCHESTER
Ossmann Components
- OHIO, CLEVELAND
CMP Distributor Co.
- OHIO, CINCINNATI
COLUMBUS
Hughes Peters, Inc.
- TEXAS, DALLAS
K. A. Electronics
- UTAH, SALT LAKE
Newark Electronics
- WASHINGTON, SEATTLE
Frank Jackson & Associates
- WISCONSIN, MILWAUKEE
Taylor Electric
- ONTARIO, WILLOWDALE
Electro Sonic, Inc.
- B. C., VANCOUVER
Deskin Sales Corp.



projects[®]
unlimited

Selected distributorships available.

3680 Wyse Road, Dayton, Ohio 45414
Tel. (513) 890-1918, TWX 810-450-2523

CIRCLE NUMBER 103

Do-it-yourself dc motor with Pancake armature.

No coupling. No bearings. No shaft. No front housing.

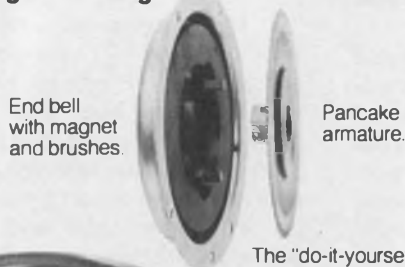

End bell
with magnet
and brushes

Pancake
armature.

The "do-it-yourself" motor provides you with the minimum key components to make a permanent magnet dc motor an integral part of your product. You save the cost of couplings, motor shaft and bearings, mounting plate and motor enclosure parts, while reducing assembly and alignment costs.

We supply the unique Pancake armature to mount on your shaft and an end bell with magnet and brushes. Your load bearings serve as motor bearings. Your housing can be the flux return path. These motors are thinner than any other, so you can design more compactly than before.

Pulse torque capability is very high, typically 10 times continuous-duty ratings. With low armature inertia, response is extremely fast with smooth torque at speeds ranging from 0 to over 3000 rpm. Brush life up to 10,000 hours. Ratings: 1/25, 1/13 and 1/8 hp.

PMI offers dc motors up to 4 hp as prime movers, gear-motors and high-performance servos. For information call PMI Customer Service at (516) 448-1234. Or write us.

PMI Division

Kollmorgen Corporation, Glen Cove, New York 11542

CIRCLE NUMBER 104

ELECTRONIC DESIGN 15, July 19, 1976

Free!

Power advantage . . . economic advantage. Get full details on the energy future . . . new Gates rechargeable, sealed lead-acid batteries. Send today for our free, informative brochure containing exclusive battery features, application information, ratings and specifications. Find out what this new third-generation energy cell could mean to your design work.



Yes! I would like to know more about these new energy cells. Please send free information.

Name _____

Title _____

Company _____

Address _____

City, State, Zip _____

Mail to: George Sahl,
Gates Energy Products, Inc.
1050 S. Broadway, Denver CO 80217



ED 36

Where the energy future is now

CIRCLE NUMBER 105

3-D

DISPLAY SYSTEM

FROM



Add 3-D to any X-Y display or oscilloscope for only \$147.00 (basic DC-500 KHz system). The 6100 Series of 3-D Modules come with bandwidths from DC-500 KHz up to 5 MHz. The modules generate aerial and geometric perspective, 360° rotation, interposition, depth of focus, and binocular (stereo) depth cues.

The entire image is described by $\pm 10V$ full-scale analog voltages.

Since the 6100 Series of 3-D Modules are analog by nature, it provides full compatibility with analog systems. When used with digital systems, the 6100 Series is placed at the CRT, X, Y inputs.

COMPLETE SPECIFICATIONS ON REQUEST

Optical Electronics, Inc., manufactures a complete line of OP AMPS, analog function modules, 3-D displays, and ultrasonic imaging systems.

OEI

OPTICAL ELECTRONICS INC.

P. O. BOX 11140 • Tucson, Arizona 85734
PH. (602) 624-8358 • TWX (910) 952-1283

CIRCLE NUMBER 106

MODULES & SUBASSEMBLIES

Digital clock module just needs transformer

National Semiconductor, 2900 Semiconductor Dr., Santa Clara, CA 95051. (408) 732-500. From \$10 (100-up); stock.

A miniaturized electronic digital clock movement is available with 0.5-in. high digits. The MA1002 series clock modules combine a MOS IC, a four-digit LED display, a power supply and associated components on a single PC board. Just add a transformer and switches to construct a pretested digital clock. Timekeeping may be done from inputs of either 50 or 60 Hz, depending on the model selected. Display formats of 12 or 24 hours are available. Direct, non-multiplexed drive for the LED display eliminates any possible rf interference.

CIRCLE NO. 388

Fast a/d converters have 8, 10 & 12-bit models

Teledyne Philbrick, Allied Dr. at Route 128, Dedham, MA 02026. (617) 329-1600. Unit qty prices: \$256, \$281, \$264, \$309 for models 4130, 31, 32 and 33, resp.; stock to 6 wks.

The 4130 family of 8, 10, and 12-bit binary output a/d converters has a maximum nonlinearity of $\pm 1/2$ LSB for 8 bits and ± 1 LSB for 10 and 12 bits. Conversion rates of 1.33 MHz for 8 bits (Model 4130), 1 MHz for 10 bits (Model 4131), and 0.285 MHz (Model 4132) or 0.4 MHz (Model 4133) for 12 bits are guaranteed. Monotonic operation from 0 to +70 C is guaranteed for 8 and 10-bit units. The 12-bit devices are monotonic from 1 to 49 C. Stability over the full operating-temperature range results from a ± 20 ppm/°C maximum full scale temperature coefficient, with offset stability a low ± 15 ppm/°C for 8 and 10-bit units and ± 10 ppm/°C maximum for 12 bits. In addition, the nonlinearity temperature coefficient is guaranteed to be ± 10 ppm/°C maximum for up to 10 bits and ± 5 ppm/°C maximum for 12 bits.

CIRCLE NO. 389

Temperature controller handles 4-A loads

Oven Industries, P.O. Box 229, Silver Spring Industrial Pk., Mechanicsburg, PA 17055. (717) 766-0721. From \$29.50; stock.

Two series of 4-A temperature controllers—the 5C1 and 5CX—provide proportional control for heating elements. Both 120 and 230-V-ac models are available. The zero-voltage firing, proportional control circuitry is completely solid state to ensure maximum controller and heater life. An operating ambient temperature range of 0 to 50 C is compatible with most industrial applications. The TX and TP series sensors provide control temperature ranges from -65 to +550 C (-85 to +1000 F). Coarse and fine set temperature adjustments permit precise control of temperature settings.

CIRCLE NO. 390

Line integrity monitor can shut off equipment

Potter & Brumfield, Div. of AMF Inc., 1200 E. Broadway, Princeton, IN 47671. (812) 385-5251. \$16 large qty.; 10 to 12 wks.

The CZS-01 ground line integrity monitor automatically disconnects electrical equipment from the line if an excessive potential difference develops between neutral and ground. If ground line resistance becomes high and sufficient fault current exists to develop an 8 to 15 V rms potential between neutral and ground, an internal relay will de-energize and open the power line. Likewise, if the ground line opens (resistance rises to approximately 1 M Ω or higher) the relay will de-energize. When the relay de-energizes, it will remain so even if proper ground-line conditions are restored. The CZS-01 must be reset by removing and reapplying power. Operating temperature range of the unit is 0 to +55 C, and termination is by 0.187-in. quick-connect solder lugs. The relay comes with DPDT contacts rated either 10 or 15 A at 120/240 V ac, 50/60 Hz. The unit measures 3.25 \times 1.75 \times 1.5 in. (the 240-V model has a maximum length of 3.35 in.).

CIRCLE NO. 391

Wire-wrapping kit eases breadboarding



Cambridge Thermionic Corp., 445 Concord Ave., Cambridge, MA 02138. (617) 491-5400. \$14.95 (unit qty).

A wire-wrapping kit, Pt. No. 601-2542, contains all of the tools necessary to produce wrapped-wire breadboards. The package contains an 80-pin socket, a 16-pin discrete component adapter, an IC insertion/extraction tool, a wrapping tool and 30-gauge wire. The 80-pin socket accepts up to five 0.300-in.-wide packages and has a removable cover for easy pin replacement.

CIRCLE NO. 392

Fiberglass shelter protects equipment

Porta House, Portatronic Div., 717 Kevin Court, Oakland, CA 94621. (415) 638-0100. See text.

Portatronic fiberglass shelters protect electronic equipment in temperatures from -30 to $+130^{\circ}$ F. The prefabricated shelters are supplied with power distribution panels and fluorescent lighting. Louvers, fans, air conditioners, heaters, wireways and specialized equipment are optional extras. The insulating and support material consists of polyurethane foam 1.5 in. thick. One model weighs 2112 lb. and costs \$3800 without optional equipment.

CIRCLE NO. 393

EMC's New Computerized IC Panel Design Service

In a hurry? EMC can shorten your need time with a computer-aided Design/Drafting Package for your new Wire-Wrap® IC Panel . . . Often within a week! And you're getting the unequalled NURL-LOC® terminal with 5 times the gripping surface that prevents twist and keeps your panel from warping. For fast action phone (401) 769-3800 or write Electronic Molding Corp., 96 Mill Street, Woonsocket, R.I. 02895.



Interconnection Specialists

for "need-it-now" requirements

Wire-Wrap® Gardner-Deser Co.

CIRCLE NUMBER 107

Autoranging Frequency Counting to 60 MHz with 1 Hz Resolution



B&K-PRECISION MODEL 1801 \$240

- For laboratory, production line or maintenance applications
- Automatic ranging, 20 Hz to 40 MHz is guaranteed...readout to 60 MHz is typical
- TTL circuitry updates the six-digit display five times per second
- Resolution to 1 Hz obtained by suppressing digits above 1 MHz when switching to 1 SEC mode

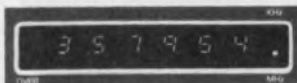

MHz display of
3.579548 MHz input (AUTO mode)



KHz display of overflow of
3.579548 MHz input (1SEC mode)

- Available for immediate delivery, from local B&K-PRECISION distributors
- 10-day free trial offer

B&K PRECISION
PRODUCTS OF DYNASCAN

6460 West Cortland Avenue
Chicago, Illinois 60635 • 312/889-9087
In Canada: Atlas Electronics, Toronto

CIRCLE NUMBER 109

PACKAGING & MATERIALS

Potting compound conducts heat well

Aremco Products, Inc., P.O. Box 429, Ossining, NY 10562. (914) 762-0685. \$27.50 qt. (single qty).

Ceramacast 510 is a high-thermal-conductivity potting compound for encapsulating electronic components. The compound's high alumina content gives it a thermal conductivity of 25 BTU/hr/ft²/in./°F. The material is inert (neither basic or acidic) and does not attack electrical windings. Ceramacast 510 has 7500-psi compressive strength, 1500-psi modulus of rupture, and a dielectric strength of 50 V/mil. The compound comes in powder form, and water must be added. The mixture is then poured in place and cured at 200 F.

CIRCLE NO. 541

Fiber optic cables are useful up to 6600 ft

Galileo Electro-Optics Corp., Galileo Park, Sturbridge, MA 01518. (617) 347-9191. See text; stock to 90 days.

A line of five optical communication fibers, Galite Models 1000, 2000, 3000, 4000 and 5000, has been introduced. Each model is produced by a different process for optimum efficiency when used in specific lengths. Galite 1000 is recommended for use in applications of from 1 to 150 ft; Galite 2000, 150 to 250 ft; Galite 3000, 250 to 1100 ft; Galite 4000, 1100 to 3300 ft; and Galite 5000, 3300 to 6600 ft. The fibers may be sheathed in different jackets, depending on the intended use of the cable. All come jacketed in polyvinyl chloride or Tefzel, a special material produced by Du Pont. Types 3000, 4000 and 5000 also are available in a specially strengthened jacket. Standard cables have one or two strands, or bundles of 7 or 19 strands. Prices are per ft, in lengths of 1000 ft, with seven strands and a polyvinyl chloride jacket. Outside diameter for all types is 1.37 mm. Type 1000 costs 14¢; 2000, 28¢; 3000, 74¢; 4000, \$1.05; and 5000, \$2.10.

CIRCLE NO. 542

DIP power bus can be cut to length

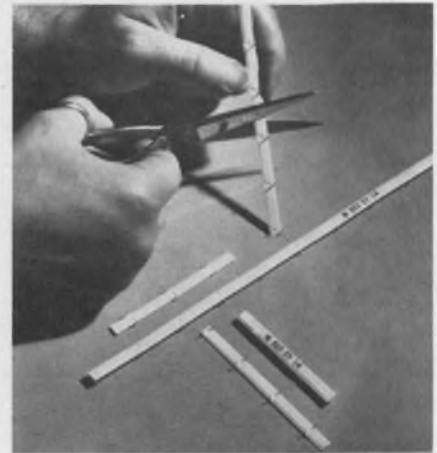

Rogers Corp., Chandler, AZ 85224. (602) 963-4584. \$1.25 (100 up).

The Model M-822 EY-14 Mini-Bus strip can be trimmed to length by the user. The bus strip is mounted underneath 14 or 16-pin DIPs for power and ground distribution. Construction of the 9-in. bar permits cutting with a scissors to the required length.

CIRCLE NO. 543

Wrapped-wire socket board made for ECL ICs

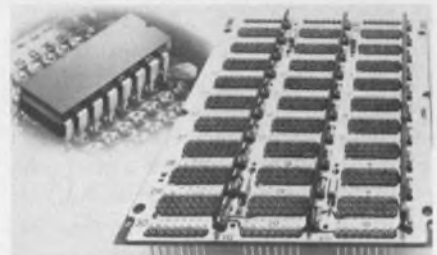

EECO, 1441 E. Chestnut Ave., Santa Ana, CA 92701. (714) 835-6000. \$100 (single qty) stock to 4 wks.

The Model 2D-ECL202 socket board will reduce noise problems that occur in some emitter-coupled logic applications. The board features four tantalum and 18 ceramic bypass capacitors, and has provision for mounting 12 additional capacitors. Three bus bars are used in the power distribution system. Power is prewired to all socket positions. The 2D-ECL202 can hold up to 30 16-pin, dual-in-line and 27 eight-pin, single-in-line packages. The board has dimensions of 5.06 × 4.14 in., and contains 0.370 in.-long posts for two-level wrapped-wire connections.

CIRCLE NO. 544

If you need a few custom ICs and can't afford them, call us.

When others quote you high prices for a few custom ICs, its because they treat them as a sideline. At Silicon Systems, custom ICs are our bread and butter. Especially modest quantity orders. Priced to compete with catalogue ICs.

One reason for our low prices is our proprietary design system. Developed in our own computer lab, this system helps us solve design problems in any technology—TTL, Schottky, ECL, Linear, PMOS, NMOS, CMOS, I²L—whatever is best for you. Designs that are fully protected because they can't be copied.

Over the years, we've become expert at satisfying all kinds of special design requirements. With ICs that replace entire groups of catalogue ICs, saving you board area, power, cooling, testing, spares—money and grief.

So when you think you can't afford custom ICs, write us. Silicon Systems, Inc., 2913 Daimler Street, Santa Ana, CA 92705. Better yet, call:

(714) 979-0941

**Silicon Systems
The One-of-a-Kind IC Company**

CIRCLE NUMBER 110

MINIATURE TOGGLES

MTA-PC
SERIES



MTF
SERIES

Compare these premium features. MOLDED-IN TERMINALS eliminate epoxy seal. SOLID SILVER contacts with gold flash to retard oxidation. Anti-Push-In toggle. High torque bushing and many other features most suited for your needs. Rated 3A @ 250 VAC or 6A @ 125 VAC. Compare and find ALCOSWITCH your best buy!

CIRCLE NUMBER 111

BI-DIRECTIONAL PUSHBUTTON



SMC
SERIES

Smallest size ever with large easy-to-read numerals. Occupies only 0.3 sq. in. of panel space, impractical with thumbwheels. Heavy gold plated contacts. Available in a variety of coded outputs (includes decimal) and mating accessories. Matte black finish. Detailed information on this and larger mating types available upon request.

CIRCLE NUMBER 112

ALCO ELECTRONIC PRODUCTS, INC.
NO. ANDOVER, MASS. 01845 U.S.A.

Tel: 1617/ 685-4371

TWx: 710-342-0552

A SUBSIDIARY OF AUGAT INC.

MICROPAC

LOW-COST OFF-THE-SHELF
HYBRID VOLTAGE
REGULATORS



4 TO 10 amp
output current

- 5 to 36 fixed voltage range
- Positive & Negative voltages
- 120 Watts power dissipation
- Internal short circuit protection
- External components not required
- Standard TO-3 Package
- Available from stock
- Economically priced

CUSTOM PRODUCTS ALSO AVAILABLE
WRITE FOR OUR FREE FACILITIES BROCHURE

mii

MICROPAC INDUSTRIES, INC.

905 E. WALNUT ST. GARLAND, TEXAS 75040 Tel. 214-272-3571
TWX 910-860-5186

CIRCLE NUMBER 113

MILITARY
APPLICATIONS

A/D CONVERTERS

by

MSK

Accuracy

Speed

Size

Repairability

Military

Temp. Range
-55°C to +125°C



- 4 Bit/50 nSec; Low Cost
- Ideal for Radar Scan Converters
- Holds Absolute Accuracy Over Temperatures
- Tracks a 10 MHz Analog Input



- 9 Bit/200 nSec.
- < 2 Bit Drift Over Temperature
- Insensitive to Clock Frequency

For Further Information Call or Write
M.S. Kennedy Corp.
Pickard Drive, Syracuse, New York 13211
Tel. 315-455-7077

CIRCLE NUMBER 114

PACKAGING & MATERIALS

Microcomputer controls wafer dicing saw

Micro Automation Inc., 3170 Coronado Dr., Santa Clara, CA 95051. (415) 988-2180.

Perhaps anticipating the era when computers will be self-reproducing, a new semiconductor-wafer dicing saw is controlled by a microcomputer. The Model 1000 programmed dicing saw cuts silicon wafers that have diameters of up to 5.25 in. The operator control panel has a 10-key numeric input keyboard, a program input group and an operating control group. To program for a particular wafer, the operator pushes the "program" key and enters the horizontal and vertical die dimensions in English or metric units. These are digitally displayed and entered into the machine. An internal microcomputer does the necessary calculations to profile the circular wafer. The operator mounts each wafer on a vacuum chuck and aligns it while observing through a microscope. When the wafer is properly aligned, the Cut pushbutton initializes dicing. The Model 1000 then completely saws the wafer at speeds up to 6 in./s. As the system will cut entirely through the wafer without causing microcracks or heat damage to the dice, no "breaking" is required after sawing.

CIRCLE NO. 546

Cable withstands high temperatures

Belden Corp., Electronic Div., 2000 S. Batavia Ave., Geneva, IL 60134. (312) 232-8900. 83¢/ft (1000 up).

The RV-1290 cable withstands 200 C temperatures indefinitely, and higher temperatures for short intervals. It is intended for fire alarm circuit wiring in buildings. Two 22-gauge solid copper conductors are insulated with teflon, wrapped in a high-temperature tape barrier and covered with a double outer jacket. The jacket is clear teflon placed over a red teflon underlayer. The RD-1290 is imprinted "Fire Alarm Service," spiralled between the jackets, making the cable quickly identifiable.

CIRCLE NO. 547

Free Sample! CARD EDGE CONNECTORS

from

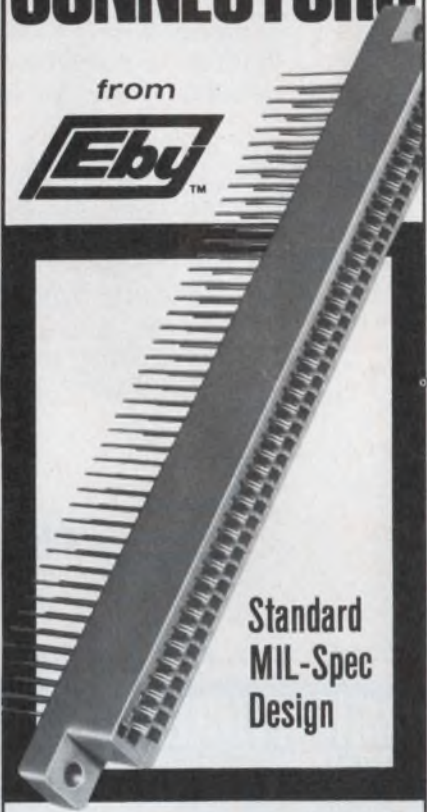

Standard
MIL-Spec
Design

Here's a whole family of connectors . . . immediate availability . . . in a number of different terminations including wire wrap, solder hole and printed circuit. Other sizes and variations available upon request.

.100 CENTERS . . . in wire wrap and printed circuit . . . with single or dual readout as follows:

15/30	43/86
22/44	50/100
36/72	

.156 CENTERS . . . in printed circuit and solder hole . . . with single or dual readout as follows:

10/20	22/44
15/30	36/72
18/36	43/86

SEND FOR A FREE SAMPLE
ON YOUR COMPANY LETTERHEAD!



HUGH H. EBY CO.

4701 GERMANTOWN AVENUE
PHILADELPHIA, PA. 19144
(215) 842-3000

a division of REDM Corp.

E 108

CIRCLE NUMBER 115

Fastest pulse generator blazes at 1-GHz rep rate



Hewlett-Packard, 1501 Page Mill Rd., Palo Alto, CA 94304. (415) 493-1501. See text.

After the HP 8080 system hangs up its hat as the world's fastest pulse generator, don't be surprised if it shows up later in an entirely different guise. The modular system can be configured as a 1-GHz pulse generator or as a 300-MHz word generator.

Functional blocks build up a complete instrument in the 8080 system. For example, combine the 8091A repetition-rate generator with the delay-generator/frequency divider module (8092A) provides modules, and you've got a two-channel pulser with 1-GHz rep rate, 300-ps transition times and ± 1.2 -V output into 50 Ω .

The delay-generator/frequency-divider module (8092A) provides some interesting capabilities. With it, you can delay one channel with respect to the other. Or you can chop the rep rate of one channel in half, leaving the second channel alone.

The full and half-frequency outputs contain each of the four possible digital combinations of two bits. This means you can test dual-input logic without two separate, synchronized generators.

Delays can be set in 100-ps steps over a ± 9.9 -ns range, with LEDs showing you the selected separation.

Still another rep-rate generator, the 8081A, works up to 300 MHz. Either generator can act as the source for the 8080 system. But for word generation, 300 MHz is the maximum rate.

Frequencies are adjusted on the generators with an eight-position range switch and a three-turn pot for fine control.

To put together a word generator, use the 8084A half-width module, together with the 300-MHz source and output-amplifier module. The 8084A generates a 16, 32 or 64-bit serial word in RZ or NRZ format.

You load the pattern you want
(continued on page 162)

Break your analyzer bottleneck

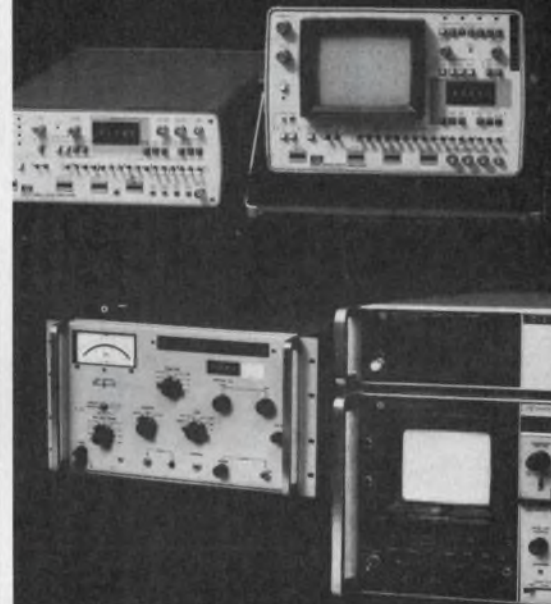

Today's best may be second-best tomorrow! If you're pushing the state-of-the-art and need the latest in speed, range and accuracy call the "Instrument Professionals". We can deliver the best available and replace it immediately when a better one comes along.

Write or call for data on our other specialties: Instrument Leasing • Computer Peripherals • Equipment Sales • Instrument Service.

Call  Get our FREE Catalog

Continental Rentals

Div. Continental Leasing Co., Inc.
175 Middlesex Turnpike, Bedford, MA, 01730 (617) 275-0850

Metuchen, NJ (201) 549-8500;
Galtersburg, MD (301) 948-4310; TX (214) 357-1779; Elk Grove, IL (312) 439-4700; Costa Mesa, CA (714) 540-6566; Santa Clara, CA (408) 735-8300; Los Angeles, CA (213) 477-7521



Data Display: YOUR Way

Ann Arbor makes over 1000 standard RO and KSR display terminal models. Alphanumerics. Graphics. Or both.

We also thrive on *tough* CRT display applications. Unique character sets. Unusual graphics. Difficult interfacing. Custom keyboards. Special packaging. You name it.

Standard or custom, *every* terminal produced is based on a field-proven Ann Arbor engineering concept. DESIGN III desktop terminals to complement any office decor. Compact, rugged Series 200 modular terminals that defy industrial environments. Or barebones board sets for OEMs who prefer to roll their own.

Many companies sell CRT terminals. But Ann Arbor sells creative solutions to CRT display problems, as well.

Probably at lower cost than anyone else in the business.

Contact us at 6107 Jackson Road, Ann Arbor, MI 48103. Tel: 313-769-0926 or TWX: 810-223-6033. Or see our catalog in EEM, Volume One.

ANN ARBOR
TERMINALS, INC

... creating new ways to communicate

CIRCLE NUMBER 117

Use it for its connections, or use it for its pull.

A P Super-Grip™ IC Test Clips grip dips without slips or shorting between the pins. Our patented "contact comb" prevents shorting while our superior gold-plated phosphor bronze terminals make contact. And our top-side pins make the perfect hanger for probes to simplify "hands-free" in-circuit testing. And this gutsy little clip has the right kind of pull for unequalled ease in pulling ICs, too. Some of its best friends are dips.

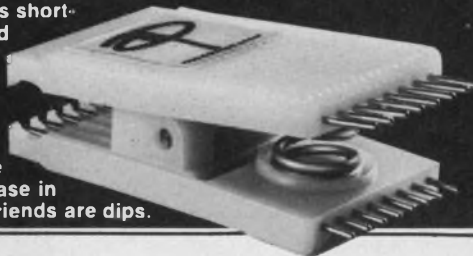

A P has a Super-Grip™ Clip for any DIP.

MODEL	ROW-TO-ROW DIMENSION	ORDER NUMBER	PRICE
TC-8	.3 in.	923695	\$ 7.35
TC-14	.3 in.	923698	\$ 4.50
TC-16	.3 in.	923700	\$ 4.75
TC-16LSI	.5/6 in.	923702	\$ 8.95
TC-18	.3 in.	923703	\$10.00
TC-20	.3 in.	923704	\$11.55
TC-22	.4 in.	923705	\$11.55
TC-24	.5/6 in.	923714	\$13.85
TC-28	.5/6 in.	923718	\$15.25
TC-36	.5/6 in.	923720	\$19.95
TC-40	.5/6 in.	923722	\$21.00

Ohio and California Residents Add Sales Tax. All orders subject to acceptance at factory.

For quick phone service, call the A P distributor nearest you:

(201) 224-8032	(513) 236-9900
(206) 682-5025	(516) 483-9200
(213) 768-3800	(516) 883-0999
(215) 698-4000	(612) 488-0201
(216) 587-3600	(617) 237-6340
(312) 298-8580	(617) 273-1860
(313) 525-1800	(617) 879-0860
(314) 863-7800	(713) 350-6771
(412) 782-2300	(713) 777-1666
(415) 326-5432	(803) 253-5333
(415) 969-9240	(914) 664-0088

(If no distributors in your area, call factory)

Write us for the full line A P Products catalog.



A P PRODUCTS INCORPORATED

Box 110-F Painesville, OH 44077 (216) 354-2101

CIRCLE NUMBER 118

(continued from page 161)

into the 8084A's memory with pushbuttons, and you can display the contents on LEDs, 16 bits at a time, with a "fetch" pushbutton.

Both the pulse and word generators deliver outputs in various selectable modes. In the gating mode, you can produce a pulse burst; in the gated-cycle mode, an external or manual command starts and stops the data.

Other modes let you choose continuous recycling or single-word outputs, synchronization to an external source, and more.

Signals from the pulse or word generator (or delay unit) go to one or more output amplifiers before reaching the outside world. The amplifiers condition the waveforms for 50-Ω operation, let you adjust output amplitudes and offsets for ECL, TTL or other logic, and perform other tasks.

In the two-channel system, independent controls provide individual adjustment of each channel for amplitude and offset.

How much does all this cost? The 1-GHz pulser with delay and two output channels sells for \$9615, the 300-MHz word generator for \$4920. Delivery takes 6 weeks.

CIRCLE NO. 548

New line debuts: counters, timers, more

Data Tech, 2700 S. Fairview Rd., Santa Ana, CA 92704. (714) 546-7160. \$675 to \$1225.

Included in a new series of instruments are digital universal counter timers, digital frequency counters and an automatic AM/FM modulation meter. The outstanding advantage offered by these instruments is a new LSI device containing the equivalent of 5000 components on a single chip. Standard features include RFI shielding enclosures, LED readout, 10-mV sensitivity, automatic gain control input circuitry, $\pm 3 \times 10^{-7}$ /month crystal stability.

CIRCLE NO. 549

Logic monitor clips on DIPs



Continental Specialties, 44 Kendall St., Box 1942, New Haven, CT 06509. (203) 624-3103. \$125.

Logic Monitor 2 digital test instrument offers a fully isolated power supply and selectable trigger threshold that matches the precise characteristics of the logic family under test. The LM-2 consists of two units: a connector/display unit, which clips over the IC and a power-supply module. The unit checks out the static and dynamic states of DIP ICs of up to 16 pins.

CIRCLE NO. 550

Unit lets you set delays in 10-ns steps

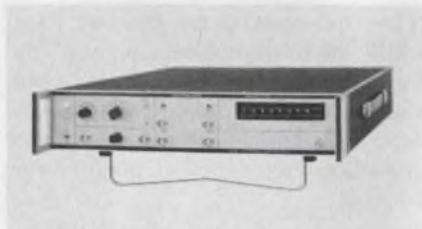

Eldorado Instruments, 2495 Estand Way, Pleasant Hill, CA 94523. (415) 682-2100. \$1950; 90 days.

Model 670 10-ns time delay generator provides 10-ns resolution delay steps with 100-ps accuracy, over a range from 10 to 999,999,990 ns. A unique feature is a "period mode" in which the pulse repetition rate is determined by the selected delay and is therefore highly accurate. Since a dual-channel option is available, it is possible to have both the pulse rate and a delayed pulse digitally selected (in 10-ns steps) with 100-ps accuracy.

CIRCLE NO. 551

MEET OUR family of ELECTRONIC TEST ACCESSORIES

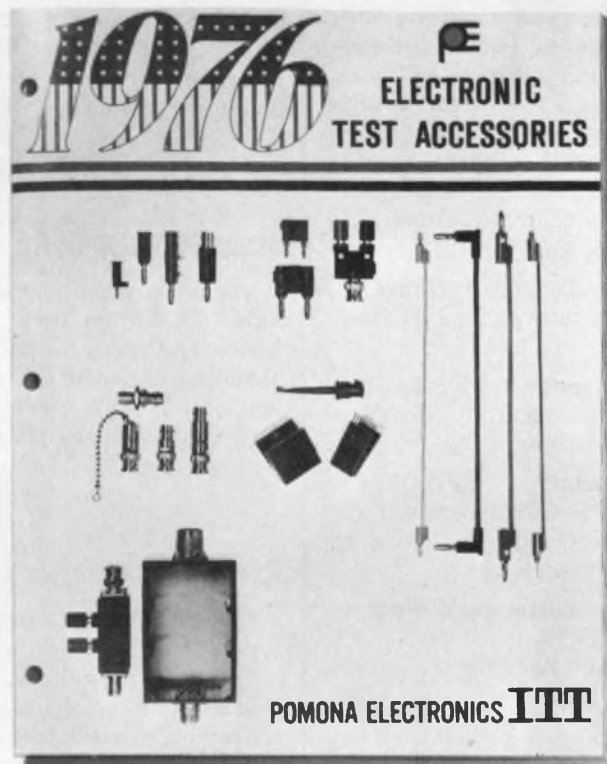

This new General Catalog is our latest family portrait. In the past twenty-five years (1976 is our Silver Anniversary year) it has grown from a handful of items to almost 500 products for the electronics industry.

Our catalog has grown to 76 pages for 1976, and we are introducing 65 new items this year. It describes and illustrates every member of our family. You're bound to find the solution to your testing problem with one or more of these quality products.

For your free copy, circle the reader service number listed below, or write:

ITT POMONA ELECTRONICS

1500 East Ninth St., Pomona, Calif. 91766
Telephone (714) 623-3463. TWX: 910-581-3822



CIRCLE NUMBER 119

Keystone

VERSATILE THERMISTOR PROBES



Get quick response for sensing temperatures of gases, liquids and surfaces with 23 thermistor probe styles and configurations. Probes with stainless steel tips can be ordered in lengths from 1" to 4", giving you an extra dimension to customize certain standard probes. Other features include:

Sensitivity . . . highly sensitive to minute temperature changes . . . fast response.

Temperature range . . . can withstand temperatures from -50°C to 260°C .

Resistance values . . . from 1K to 1 meg at 25°C . . . also miniature discs and rods of 100 ohms to 1 meg at 25°C are available.

Tolerance on resistance . . . $\pm 20\%$ at 25°C is standard; $\pm 10\%$ and $\pm 5\%$ or tighter tolerances if desired.

Low-cost series . . . three inexpensive probes to answer many requirements.

Catalog TP-739
... gives details on 23 probe styles and ordering information. Circle reader service card.



Keystone
CARBON COMPANY
Thermistor Division
St. Marys, PA 15857
814/781-1591 • Telex 91-4517

CIRCLE NUMBER 121

Application Notes

Contrast techniques

"Contrast Enhancement of Glow Discharge Displays" describes several alternative methods of contrast enhancement. Charts and drawings are included. Burroughs, Plainfield, NJ

CIRCLE NO. 552

Remote multiplexing

Written for designers of data-acquisition systems, a six-page application note, "Remote Multiplexing," points out the advantages of multiplexing and digital transmission over, both direct wiring and analog transmission. Burr-Brown, Tucson, AZ.

CIRCLE NO. 553

Magnetic shielding

Complete magnetic and physical data, application notes and fabrication methods of a new magnetic shielding material are given in an application note. Perfection Mica, Magnetic Shield Div., Bensenville, IL

CIRCLE NO. 554

Ceramic capacitors

"The ABC's of Ceramic Capacitors" describes the various types of ceramic capacitors, shows the construction of the most popular types and discusses their applications. Sprague Electric, North Adams, MA

CIRCLE NO. 555

Calculator interfaces

Two application summaries describe a pair of interface systems for the HP 9825 desktop programmable calculator. Included in the summary are descriptions of HP 9825/IB operation, additional capabilities through the General and Extended I/O ROMs, the interrupt device and a list of 25 HP-IB compatible instruments. Hewlett-Packard, Palo Alto, CA

CIRCLE NO. 556

Bulletin Board

RCA Electro-Optics and Devices has increased prices from 2 to 50% on many of its phototubes, imaging devices, display devices and tube sockets.

CIRCLE NO. 557

Mostek has lowered prices for its F8 μC evaluation package (Survival Kit) to \$147 from \$197 un-assembled (MK 79001) and to \$185 from \$250 assembled (MK 79002).

CIRCLE NO. 558

Diablo has begun shipping serial printers Models 1345, 1355 and the 1355 WP word processing unit. The company has reduced the price of the 1345 model to \$1300, and the 1355, a 55-cps printer is \$1230 (100). Basic price of the 1355 WP is \$1500.

CIRCLE NO. 559

Dionics has developed a line of low-cost multivalued MOS capacitor chips designed specifically for manufacturers of LED and LCD digital watches.

CIRCLE NO. 560

The Optoelectronics Div. of Fairchild has announced a new development in optical coupler technology that doubles the guaranteed minimum isolation voltage for all device types at no increase in cost.

CIRCLE NO. 561

Crydom Div. of International Rectifier has cut prices averaging 30% for its line of 120 and 240-V miniature solid-state relays.

CIRCLE NO. 562

Honeywell's Materials Requirements Planning (MRP) software package operates on a "net-change" processing basis for reduced computer run time and current information. It is intended for use with Honeywell's Level 66 large-scale computer system.

CIRCLE NO. 563



for design
engineers

new fhp motor ...and control catalog

Just published! An expanded catalog covering more than 325 stock Bodine fractional horsepower motors, gearmotors, plus controls. Helps you select and match the right motor and control for your application.

Twenty pages, 75 illustrations, tables and drawings (all drawings decimalized). Includes 14 new gearmotors, adjustable speed/torque drive systems. Optional and accessory parts for motor controls fully tabulated. Also a performance chart on K-2 motors . . . covers normal slip, high slip and synchronous motors. Ask for Catalog S-5.



Bodine Electric Co., 2500 West Bradley Pl., Chicago, Ill. 60618

CIRCLE NUMBER 122

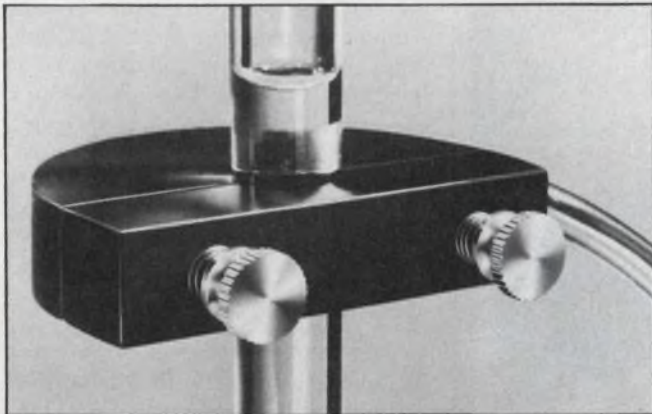

Liquid Level Detection from the outside looking in

This new Sight Glass Skanner will detect the level of virtually any liquid including water. It senses the capillary edge of the liquid with a positioning accuracy of $\pm .003$ inch. The unit easily clamps around the outside of a sight glass by means of tension springs for easy repositioning. The skanner's photoelectric sensor is compatible with the full range of standard Skan-A-Matic amplifiers and controls. 3 day shipment. **SEND FOR MORE INFORMATION**

SKAN-A-MATIC®
CORP.

P.O. Box S, Elbridge, N.Y. 13060 Phone: (315) 689-3961

CIRCLE NUMBER 123

ELECTRONIC DESIGN 15, July 19, 1976



HP 9830* users... your floppy disk is here! \$3895.

- The FD-30 runs on cassette commands... that means *no software changes!* Because it runs on your existing programs.
- The FD-30 finds files *50 times faster* than either the 9830 or the 9865 cassette drive.
- The FD-30 stores 5 cassettes of data at the cost of one cassette.
- The FD-30 stores a 6,000 word array in *4 seconds* via a simple STORE DATA — the HP 9880 mass memory takes 11 seconds to do the same job.
- The FD-30 sells for *less than a third* of the 9880B

Infotek's FD-30 provides 305K bytes of user area. Or 5 to 7 cassettes of data on-line, retrievable *50 times faster* than your present system.

No installation!

You can fit the FD-30 neatly between the calculator and printer. Just plug-in the I/O connector and power cord. And its color design perfectly matches the 9830.

Latest Technology

We're using the latest technology microprocessor for the controller/formatter and the finest floppy disk system.

All for \$3895.

Plus you get quality comparable to the 9830.

Call us collect at (213) 966-7431. Or write Infotek Systems, 733 E. Edna Place, Covina, Ca. 91723. Ask about other 9830 compatible products.

*a product of the Hewlett-Packard Company



Infotek Systems

CIRCLE NUMBER 124

BROWNOUT PROBLEMS?

Solve them with 98% efficient AC LINE REGULATORS

TOPAZ AC Line Regulators solve brownout problems once and for all. Whether your application is a large computer system or a small instrument, TOPAZ regulators are the best available solution.

Here are some reasons why:

- **HIGH EFFICIENCY** reduces heat losses and feeder costs.
- **FAST RESPONSE** prevents problems caused by rapid short term voltage fluctuations.
- **NO DISTORTION** is added to the output wave form.
- **SMALL SIZE AND WEIGHT** ease handling and reduce space requirements.
- **LOW AUDIBLE NOISE** permits use in office areas without the annoying noise common to constant voltage transformers.
- **OUTPUT VOLTAGE** is unaffected by input frequency variations.

All this plus TOPAZ noise suppression and quality at a price lower than you'd pay for regulators without these features. So, if you have a brownout problem, write for our brochure or give us a call—we know we can help.

TOPAZ
ELECTRONICS
SOLUTIONS TO
POWER PROBLEMS

3855 Ruffin Road, San Diego, California 92123—(714) 279-0831—TWX (910) 335-1526



500 VA to 100 KVA
Priced from
\$190.

CIRCLE NUMBER 125

The Low Priced AM-FM Signal Generator 1.5 MHz to 80 MHz.

Model 950A presents a direct 5 digit frequency display. Provides precise FM with calibrated deviation to ± 30 kHz and full AM capability with a direct reading calibrated meter. RF output is adjustable from $0.1 \mu\text{V}$ to 3 volts, automatically leveled to within $\pm 1/2$ dB. Frequency accuracy is 0.005%.

Write or call today for pricing, delivery and complete specifications.



LogiMetrics

121-03 Dupont Street, Plainview, New York, 11803, (516) 681-4700/TWX, 510-221-1833
RF Signal Generators, Frequency Synthesizers, Traveling Wave Tube Amplifiers

CIRCLE NUMBER 126

Evaluation Samples

Snap-acting PB switches

Model 8225 momentary snap-acting pushbutton switch is a double-pole version of the company's 8125. The 8225 offers a contact rating of 0.4 VA max at 20-V max (ac or dc), contact resistance of 50 m Ω max, insulation strength of 1000 M Ω min, dielectric strength of 1000 V rms minimum at sea level, electrical life of 60,000 cycles minimum at full load and a mechanical life of 100,000 make-and-break cycles minimum. C&K Components.

CIRCLE NO. 564

Adapters

Standard coaxial cable connectors, normally used for RG 58 cable, can be quickly and easily converted to coaxitube rigid cable connectors. The user simply replaces the braid clamp of the standard connector with the company's coaxitube adapter. The adapters come in two sizes—Models A-19-22-2 for 0.085-in. coaxitube and A-51-05-11 for 0.140-in. coaxitube. Kings Electronics.

CIRCLE NO. 565

Self-tapping screws

Self-tapping screws are color matched to blend with surfaces of panels and equipment. The fasteners feature one-piece assembly and their coating withstands solvents, abrasion and chipping. Stake Fastener.

CIRCLE NO. 566

Polycarbonate capacitors

Series CMK capacitors use a metallized-polycarbonate dielectric and are epoxy encapsulated in a flame-resistant molded case. Capacitance values of 0.0027 to 6.8 μF , come in standard tolerances of $\pm 20\%$, 10% and 2.5%. Closer tolerance units are available. Seacor.

CIRCLE NO. 567

BIG POWER SUPPLIES



IN LITTLE PACKAGES

**AC-DC and DC-DC
miniaturized power converters
that deliver 3.9 watts
per cubic inch.**

- AC inputs: 115-220 VAC, 47-500 Hz.
- DC inputs: 12, 28, 48, 115 & 150 VDC.
- 1 to 6 isolated and regulated DC outputs from 4.2 to 300 VDC.
- Line and load regulation to 0.1%.
- Up to 800 watts per output.
- Efficiencies to 85%.
- Design-As-You-Order construction from standard sub-modules . . . over 1200 possible configurations.
- Completed converters provided in tested and encapsulated, conduction cooled packages in just days.

See for yourself how we've packed the power and performance in . . . request our actual size "little black box" punch out kit and catalog today!

Call us collect . . . ask for Jim Dunn.



ARNOLD MAGNETICS CORPORATION

11520 W. Jefferson Blvd.
Culver City, Ca. 90230 • (213) 870-7014

CIRCLE NUMBER 127

ELECTRONIC DESIGN 15, July 19, 1976

New Literature

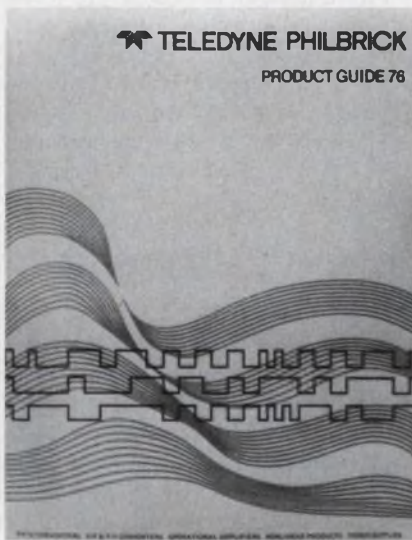

TELEDYNE PHILBRICK

PRODUCT GUIDE 76

Microcircuits, modules

Presented in data-sheet format, a 192-page catalog contains specifications, hook-up, packaging and applications for hundreds of electronic microcircuits and modules. Teledyne Philbrick, Dedham, MA

CIRCLE NO. 568

PM speed/torque systems

PM drive systems and accessories are featured in a 20-page catalog. Bodine Electric, Chicago, IL

CIRCLE NO. 569

Adhesives

Silicone and epoxy adhesives for electronic and industrial applications are covered in a 13-page catalog. Transene, Rowley, MA

CIRCLE NO. 570

8-bit microprocessor

"Using an 8-bit Microprocessor" is a comprehensive 170-page examination of the Intel 8080. Flowcharting and programming techniques are explained by solving typical problems. It is written from the viewpoint of the noncomputer oriented professional. No previous μ P or computer experience is assumed. Cost: \$13.95 including postage and handling. Technitrol, 1952 E. Allegheny Ave., Philadelphia, PA 19134.

INQUIRE DIRECT

CIRCLE NUMBER 128 ►

EMR Model 1172
Digital Frequency
Response Analyzer
(Transfer Function
Analyzer)

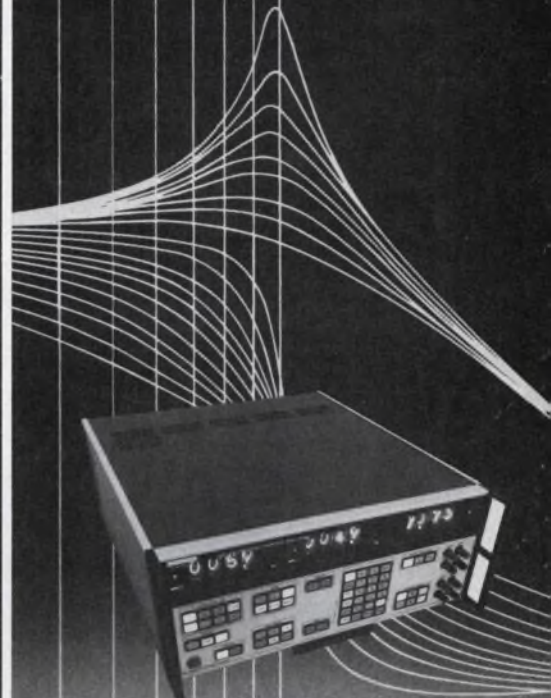

**0.1 phase
accuracy**

**0.1 dB amplitude
accuracy**

**140 dB dynamic
range**

2 channels

The ultimate in frequency response measurement, the EMR 1172 uses all-digital signal processing to provide the highest-ever accuracy and operational flexibility. Consisting of a synthesizer sweep generator and two independent fully floating measurement channels, the 1172 offers full frequency coverage from 0.0001 Hz to 9.999 kHz. Analysis results can be displayed as Bode, Nyquist or Nicholls plots. In addition to servo system analysis, the 1172 is ideal for applications including mechanical impedance measurement, hydraulic actuator dynamic response measurement, material testing, and environmental testing. For more details, write or call: EMR-Telemetry, Weston Instruments, Inc., Box 3041, Sarasota, Florida 33578; (813) 371-0811.

EMR Schlumberger

NOW AVAILABLE!

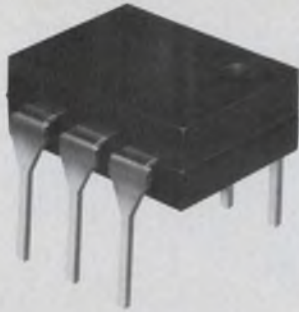

5KV OPTICAL ISOLATORS IN 6-PIN DIPS

Industry's first 5KV isolators to be offered in the popular 6-pin dual in-line package are available now! They are directly interchangeable with standard industrial 6-pin isolators . . . **UL approved . . . No. E58979.** Circle R.S. No. 286.



STANDARD OPTICAL SWITCHES

Six, low-cost off-the-shelf optical switches are available as direct replacements for such popular devices as the H13A1, A2; H13B1, B2; MCA 8, 81 and MCT 8, 81. Both phototransistor and photodarlington versions are available from factory stocks. Circle R.S. No. 287.

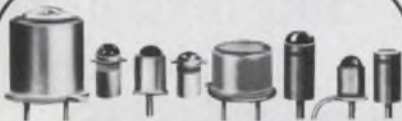

LOW-COST PHOTODETECTORS & LEDs

Spectronics provides industry's largest selection of standard off-the-shelf detectors and LEDs. Direct replacements for such popular industrial types as: LED55CF, BF, B, C; SSL315, 15, 35; TIL31, 81, 23, 24; and TIL601-616 Series. Call today for prices and deliveries. Circle R.S. No. 288.

Call Spectronics for everything you need in opto. We make optoelectronics work . . . for you!



Spectronics
INCORPORATED

830 E. Arapaho, Rd.
Richardson, Texas 75080
(214) 234-4271

CIRCLE NUMBER 289

NEW LITERATURE

Tone signalling products

Specifications of miniature audible and sub-audible tone encoders, tone decoders, multifrequency tone control packages and two-tone sequential selective calling devices are given in a 36-page catalog. Alpha Electronic Services, Stanton, CA

CIRCLE NO. 571

DMMs

A 16-page brochure describes 3-1/2 and 4-1/2-digit multimeters. A color-coded specification chart provides finger-tip access to equipment characteristics and comparative information. Dana Laboratories, Irvine, CA

CIRCLE NO. 572

Electronic kits

Descriptions of over 400 electronic kits—from build-it-yourself color TV and hi-fi equipment to amateur radio gear—are given in a catalog. Heath, Benton Harbor, MI

CIRCLE NO. 573

SCRs

Nearly 100 listings of the most commonly used SCRs and triacs are given in an eight-page brochure. A cross-reference of obsolete part numbers to new part numbers is included. International Rectifier, Semiconductor Div., El Segundo, CA

CIRCLE NO. 574

Bridges, rectifiers

"Devices for Use in Power Supply Applications," an eight-page guide, features silicon bridges and standard rectifiers. N.A.E., Semiconductors, West Lynn, MA

CIRCLE NO. 575

OEM power supplies

How to select standard single and triple-output switching-regulated power supplies in the 110-to-600-W range is covered in a 20-page catalog. Hewlett-Packard Rockaway NJ Div., Palo Alto, CA

CIRCLE NO. 576

Capacitors

Pictures, prints and full dimensions of film capacitors are presented in a 28-page catalog. Paktron Div., Illinois Tool Works, Vienna, VA

CIRCLE NO. 577

Resistors

Precision and power wire-wound resistors are covered in a 44-page catalog. All dimensions are shown in both inches and millimeters. RCL Electronics, Manchester, NH

CIRCLE NO. 578

Motor starter

Technical data and performance curves of Posistor solid-state motor starters are given in a two-page data sheet. Murata, Rockmart, GA

CIRCLE NO. 579

Instrumentation

The top articles in the latest edition of "News from Rohde & Schwarz" deal with diplomatic radio networks, rotatable lightweight log-periodic antennas for shortwave working and the latest plug-ins for the insertion-signal generator SPZF. Rohde & Schwarz, D-8000 Munchen 80.

CIRCLE NO. 580

Coax connectors

Application information, assembly instructions, and dimensional information on uhf, N, C, SC, HN, twin and triaxial coaxial connectors are provided in a 64-page catalog. Electrical, environmental and mechanical specifications are included. For a copy, contact Bunker Ramo RF Div., 33 E. Franklin St., Danbury, CT 06810.

INQUIRE DIRECT

Analog IC applications

A 245-page soft-cover book includes both entertainment and industrial applications involving i-f amplifiers, switching amplifiers, LED drivers, op amps, transistor arrays, etc. Text features circuit diagrams, specification drawings, graphs and descriptions. Send company letterhead request to Siemens, 186 Wood Ave. S., Iselin, NJ 08830.

INQUIRE DIRECT

FUJI SM SERIES STEPPER MOTOR



LOW COST

APPLICATIONS
MEASURING INSTRUMENT
INPUT-OUTPUT MACHINE FOR COMPUTER
REMOTE CONTROL DEVICE
PRINTER AND TYPEWRITER

HIGH TORQUE
HIGH EFFICIENCY

MODEL NO.	ONE STEP ANGLE	MAX. OUTPUT TORQUE
SM20 2003	18°	12g·cm
SM30 2001	18	18
SM35 2001	18	115
SM40 2001	18	165
SM40 2401	15	195
SM40 3601	10	195
SM40 4801	7.5	200
SM40 4803DD	7.5	420
SM50 4801	7.5	250
SM50 4801DD	7.5	450

FUJI has developed a new series of compact stepper motors incorporating a strong ferrite magnet with magnetic anisotropy in radial direction. The stepper motor fitted with this new magnet is proud of its superb efficiency. That's to say, its torque is more than 50% greater than that of similar models by other manufacturers. In addition, a single hybrid integrated circuit is prepared as a driving circuit. Our large inventory assures off the shelf delivery.

FUJI ELECTROCHEMICAL CO., LTD.

Head Office :

No. 36-11, 5-chome, Shinbashi, Minato-ku, Tokyo, Japan Tel: 03-434-1271
Los Angeles Office: Tel: 213-323-1134 Düsseldorf Office: Tel: 211-3881

CIRCLE NUMBER 130

FARATRON

open frame OEM Series
power supplies run 50% cooler...
and cost less than LAMBDA
and Powertec!

If you can prove otherwise we'll give you a 5V/3A OEM Module **FREE!**

If you've been looking at those other guy's open frames...take a good look at ours. 36 cooler OEM models, 5 package sizes, single, dual, and triple outputs. 5VDC to 28VDC, 0.8 amps to 30 amps. Prices start at \$22.00 in quantities of 250... So why pay more and have a hot potato on your hands.



Call or write for complete specifications today!
Ask for helpful Vic Plessner.

FARATRON 280 Green St., So. Hackensack, N.J. 07606
TWX 710-990-5022 Phone 201-488-1440
The COOLEST Power Supply People in the World!

CIRCLE NUMBER 131

ELECTRONIC DESIGN 15, July 19, 1976

19¢* ea.

An integrated
bridge rectifier in a
miniature
dual in-line package

DIB

DUAL IN-LINE BRIDGE

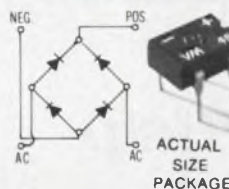

- 4-pin, low-profile DIP
- Leads on standard .10" (2,54 mm) grid
- Compatible with automatic testing, handling and inserting
- 1 Amp at 40°C (I_o)
- 25V to 1000V (V_{RRM})
- 25A Peak One-Half Cycle Surge (I_{FSM})
- Two devices will fit into standard 14-pin DIP socket
- Moisture resistant epoxy package
- Call Lee Miller 214/272-4551, Ext. 206 for more information.

* 100V; 100,000 qty.



Design us in... we'll stay there
VARO SEMICONDUCTOR, INC.

P.O. BOX 676, 1000 N. SHILOH, GARLAND, TEX. 75040
(214) 272-4551 TWX 910-860-5178

EUROPEAN OFFICE: UK: VARO SEMICONDUCTOR INTERNATIONAL, INC.
Deepdene House, Bellegrove Road, Welling, Kent, England DA163PY, 01-304-6519/0

CIRCLE NUMBER 132

169

Circuit Savers

NEW
SIGNAL/DATA/TELEPHONE
PROTECTION



The SLP protectors were expressly designed to protect signal/data/telephone lines from transient overvoltages caused by lightning, heavy machinery, elevator motors, generators, etc. The SLP interfaces between the signal lines and the sensitive circuit to provide a sophisticated blend of high speed (nanoseconds) voltage limiting and brute force protection. The SLP's recover automatically to standby when the need for protection has passed.

Output Clamp Voltage Level $\pm 5V$ to $\pm 200V$
Input Voltage Level (max) to $\pm 35KV$ (10 US)
Energy Handling to 50 joules
and higher

BULLETIN 301

Full line of protection modules for every hi-lo voltage/current requirement. Write or call for data.

279 Skidmore Rd., Deer Park, N.Y. 11729
Telephone: 516-586-5125

MCG Electronics

CIRCLE NUMBER 133

Please Help Children Live

Research is our only weapon against childhood cancer.

St. Jude Children's Research Hospital, which is non-sectarian, is the largest childhood cancer research center in the world.

Please join in the fight against childhood cancer.

Send your special gift now.



ST. JUDE CHILDREN'S RESEARCH HOSPITAL

Danny Thomas, Founder

Send contributions to:
MEMPHIS, TENN. 38101

This space donated by publication

Electronic Design

ELECTRONIC DESIGN's function is:

- To aid progress in the electronics manufacturing industry by promoting good design.
- To give the electronic design engineer concepts and ideas that make his job easier and more productive.
- To provide a central source of timely electronics information.
- To promote communication among members of the electronics engineering community.

Want a subscription? ELECTRONIC DESIGN is sent free to qualified engineers and engineering managers doing design work, supervising design or setting standards in the United States and Western Europe. For a free subscription, use the application form bound in the magazine. If none is included, write to us direct for an application form.

If you do not qualify, paid subscription rates are as follows: \$30.00 per year (26 issues) U.S., \$40.00 per year (26 issues) all other countries. Single copies are \$2.00 U.S., \$3.00 all other countries. The Gold Book (27th issue) may be purchased for \$30.00 U.S. and \$40.00 all other countries.

If you change your address, send us an old mailing label and your new address; there is generally a postcard for this bound in the magazine. You will have to requalify to continue receiving ELECTRONIC DESIGN free.

The accuracy policy of ELECTRONIC DESIGN is:

- To make diligent efforts to ensure the accuracy of editorial matter.
- To publish prompt corrections whenever inaccuracies are brought to our attention. Corrections appear in "Across the Desk."
- To encourage our readers as responsible members of our business community to report to us misleading or fraudulent advertising.
- To refuse any advertisement deemed to be misleading or fraudulent.

Microfilm copies are available of complete volumes of ELECTRONIC DESIGN at \$19 per volume, beginning with Volume 1, 1952 through Volume 20. Reprints of individual articles may be obtained for \$3.00 each, prepaid (\$.50 for each additional copy of the same article) no matter how long the article. For further details and to place orders, contact the Customer Services Department, University Microfilms, 300 North Zeeb Road, Ann Arbor, Michigan 48106 telephone (313) 761-4700.

Want to contact us? If you have any comments or wish to submit a manuscript or article outline, address your correspondence to:

Editor
ELECTRONIC DESIGN
50 Essex Street
Rochelle Park, N.J. 07662

classified ad

ELECTRONIC DESIGN SR. PROJECT ENGINEER/PROJECT ENGINEER — extensive experience in switching, analog, and digital circuitry design for high speed machine controls. Bachelors degree in electronics required. Masters degree and/or additional courses preferred. Some experience in engineering management. Leadership quality prerequisite. Send resume in strict confidence to: Mary Barina, Personnel, R & D Center, Levi Strauss & Co., 900 N. Dorothy Dr., Richardson, TX 75081.

WYOMING RANCH LAND

Wild horses, antelope, deer, elk. 10 acres \$30 down, \$30 month. FREE maps - photos - info. Owner - Dr. Michael Gauthier, 9550N Gallatin Rd, Downey, CA. 90240

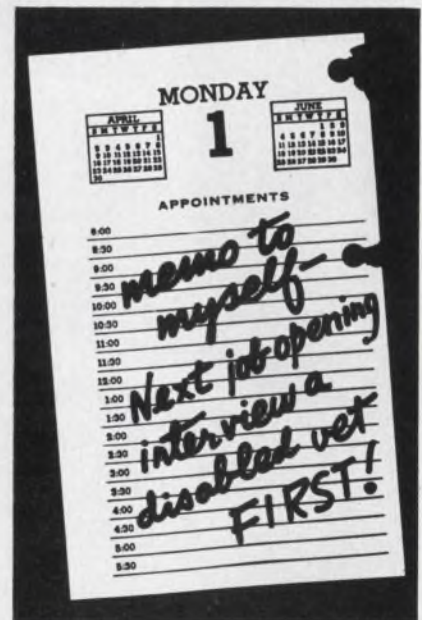

The President's Committee
on Employment of the Handicapped
Washington, D.C. 20210

Electronic Design

Advertising Sales Staff

Tom W. Carr, Sales Director
Jean Bunfield, Sales Coordinator

Rochelle Park, NJ 07662

Robert W. Gascoigne
Daniel J. Rowland
Thomas P. Barth
Stan Tessler
50 Essex St.
(201) 843-0550
TWX: 710-990-5071

Philadelphia

Thomas P. Barth
(201) 843-0550

Boston 02178

Gene Pritchard
P.O. Box 379
Belmont, MA 02178
(617) 489-2340

Chicago 60611

Thomas P. Kavooras
Berry Conner, Jr.
200 East Ontario
(312) 337-0588

Cleveland

Thomas P. Kavooras
(312) 337-0588

Los Angeles 90045

Stanley I. Ehrenclou
Burt Underwood
Neil Canavin
8939 Sepulveda Blvd.
(213) 641-6544

Texas

Burt Underwood
(213) 641-6544

San Francisco

Robert A. Lukas
3579 Cambridge Lane
Mountain View, CA 94040
(415) 965-2636

London

Constance McKinley
50 Essex St.
Rochelle Park, N.J. 07662
Phone: (201) 843-0550

Amsterdam, Tokyo, Seoul

Sanders, B. V.
Raadhuisstraat 24
Graft-De Ryp, Holland
Phone: 02997-1303
Telegrams: Euradteam-Amsterdam

Haruki Hirayama
Electronic Media Service
5th Floor, Lila Bldg.,
4-9-8 Roppongi
Minato-ku, Tokyo, Japan
Phone: 402-4556
Cable: Electronicmedia, Tokyo

Mr. O-kyu Park, President
Dongbo Intl Corp.—
World Marketing
C.P.O. Box 4010
Seoul, Korea
Tel. 76-3910/3911
Cable: DONGBO SEOUL
Telex: EBKOREA K27286

NEW! INSTANT FREQUENCY DIFFERENCE!



Tracor Model 527A measures frequency difference instantly, precisely. For precisely \$2,950. Front-panel meter reads directly to parts per 10¹¹. Allows adjustment of two oscillators to the same frequency, adjustment to a specific offset, determination of offset — all instantly. Plus both short-term and long-term stability analysis. Internal oscilloscope extends precision to 1 x 10⁻¹². Reference and signal frequencies need not be the same. Write or call for full technical and application information.

Tracor

Industrial Instruments

6500 Tracor Lane • Austin, Texas 78721 • AC 512/926-2800

CIRCLE NUMBER 134

New "MM" Series Switchers pack up to 2.26 watts per cubic inch; cost less than 60¢ per watt!

- 21 models — one, two, three, four, five and six outputs.
- Most watts/in.³ — more than 2 times denser than competitive switchers.
- Up to 80% efficient.
- Smallest sizes — 750 watt model measures only 5" x 5" x 12.75".
- Lightest weight — up to 62 watts/lb.
- Most reliable — all models carry 2-year guarantee.
- All models designed to meet UL 478.
- DC inputs and other options available.
- Almost 20,000 LH high power switchers now in use.

Write for 8-page catalog.

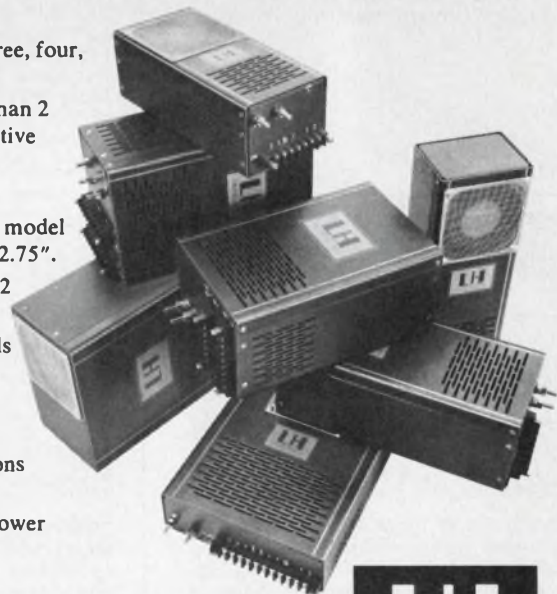

LH Research, Inc. • 1821 Langley Avenue, Irvine, CA 92714 • 714/546-5279

ABP

BPA



MINIATURE LOW INDUCTANCE CAPACITORS, 50% more capacity in the same size is now available in these Johanson extended range capacitors. Beautiful for microwave, VHF and UHF applications, they offer fine tuning, ultra high Q, low temperature coefficients and "sizes" for hybrid and microcircuit as well as standard applications. Featured are capacitance range .5 to 5.0 pf, $Q > 10,000$ @ 100 MHz, and extra fine tuning. Johanson Manufacturing Corporation, Rockaway Valley Road, Boonton, NJ 07005 (201) 334-2676.

MINIATURE CAPACITORS

181

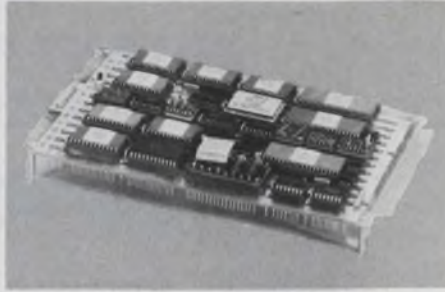

MICROPROCESSOR BOARD FOR MOTOROLA M6800 EVALUATION CHIP SET. \$197.50 from CAMBION distributors. Pre-wired board saves hours interconnecting M6800 evaluation kit. Wire-Wrap® tool and pre-cut wires for circuit changes included plus circuitry and components to interface with teletype machine, pre-wired sockets for three more MC6810L, connections for 12 more IC's, instructions and hardware. Cambridge Thermionic Corp., 445 Concord Ave., Cambridge, MA 02138.

MICROPROCESSOR BOARD

184

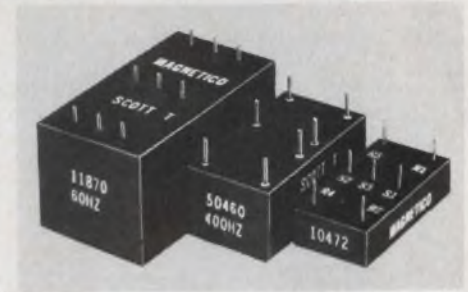

Scott T Transformer. 11870: 60HZ, 90v, L-L in. 1.1x2.1x1.1. 50460: 400 HZ, 90v, L-L in. 7/8x1-5/8x11/16. 50642: 400HZ, 11.8v, L-L in. 7/8x5/8-11/16. 10472: 400-HZ, 11.8v, L-L in. 3/4x1-1/2x3/8. All with 6v RMS sine & cosine output MAGNETICO, INC., 182 Morris Ave., Holtsville, N.Y. 11742 516-654-1166.

TRANSFORMER

187

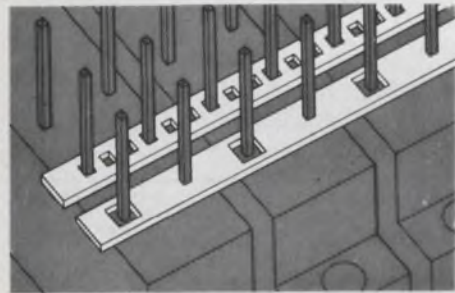

STRIP/BUS BY ROGERS. Low Cost Bussing Systems; easy installation, reliable solder joints; greater pin exposure. Write or call for details. Rogers Corporation, Rogers, CT 06263. Phone (203) 774-9605. (EUROPE: Mektron NV, Ghent, Belgium; Japan: Nippon Mektron, Tokyo)

STRIP/BUS

182



CMOS DIGITAL TIMERS by General Time. Low prices enable their use in lieu of both low and high accuracy analog timers and many electromechanical timers. $\pm 0.5\%$ typical repeat accuracy. On-delay, off-delay, and interval modes available in four different packages; AC and DC. Short reset, recycle and abort times; fast startup. From the industrial control specialists at Industrial Controls Division, General Time, Main Street, Thomaston, CT. 06787. Tel. (203) 283-5881. Telex 96-2445. Helpful literature available on request.

CMOS DIGITAL TIMERS

185



Basic Electricity & Basic Electronics by Van Valkenburgh, Nooger & Neville, Inc. Derived from the COMMON-CORE Training Program initially developed for the U.S. Navy. Thorough, comprehensive coverage. Available in separate paperbacks or cloth volume. Write for FREE brochure. Hayden Book Co., Inc., 50 Essex St., Rochelle Pk, N.J. 07662 (201) 843-0550.

TRAINING TEXT

188

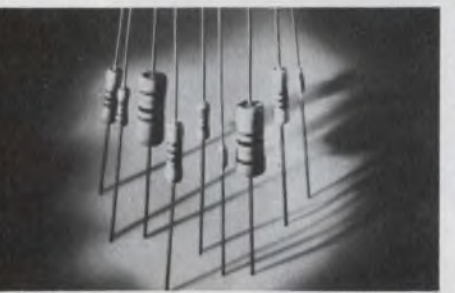

RCA FLAMEPROOF FILM RESISTORS. Design engineers prefer them because they won't flame or short under the most severe conditions. These resistors have a 2% tolerance, and are available in 1/4 watt, 1/2 watt, 1 watt, and 2 watt ratings. Resistance values range from 10 Ohms to 1.5 Megohms, depending on wattage rating. 475 film resistors to choose from. RCA Distributor & Special Products Division, Sales Promotion Services, Cherry Hill, N. J. 08101.

FILM RESISTORS

183

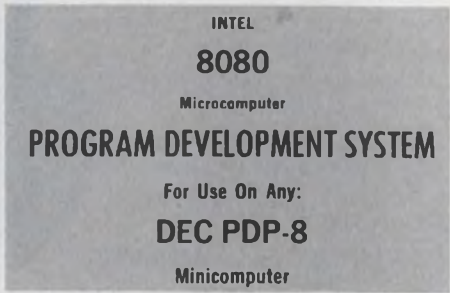

COMPLETE 8080 PROGRAM DEVELOPMENT SYSTEM FOR PDP-8: CAL-80 Cross Assembler produces BNPF object tape and formatted program listing from standard 8080 instruction mnemonics. SIM-80 Interactive Simulator reads BNPF tape and keyboard entries to provide a fully equipped program debugging facility. SIM/CAL-80 runs on any 4K PDP-8 with high or low speed paper tape equipment. FBE Research Company, PO Box 68234, Seattle, Washington 98168

ASSEMBLER SIMULATOR

186



'LYTIC CAPACITORS WITH AN OPTION. Type 32D Compulytic® Aluminum Electrolytic Capacitors, designed for power supply applications, give you the option of securing more capacitance in a given case size with the Type 32DX version or of obtaining lower ESR and higher ripple current capability in Type 32DR. Sprague Electric Co., 347 Marshall St., No. Adams Ma. 01247 (413) 664-4411.

CYLINDRICAL 'LYTIC CAPACITORS

189

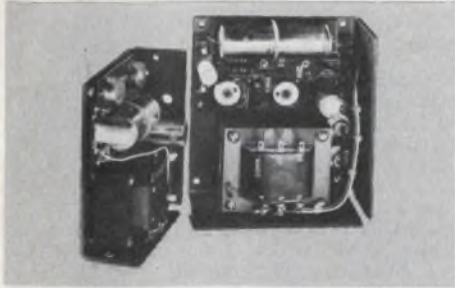

New "Slim Line" Industry Standard DC Supplies offer narrow silhouette interchangeability with other makes. Competitively priced, the SPS 32/42 are fully rated from 47 to 440Hz, 115/230Vac $\pm 10\%$ inputs. Nom. outputs are 5, 12, 15 and 24/28Vdc at 3.0, 1.8, 1.6 and 1.2/0.9A(max) for the SPS 32; and, 6.0, 3.5, 3.0 and 2.3/1.8A(max) for the SPS 42. Vdc adj. to $\pm 10\%$. For data, prices and local distr: Standard Power, Inc., 1400 So Village Way, Santa Ana, CA 92705 (714) 558-8512, or in east: (516) 420-0944.

DC POWER SUPPLIES

190



3M DATA CARTRIDGE RECORDER. 23 million bit storage - ANSI compatible - Read after write check, - 1 or 4-track - Parallel and RS-232/TTY Interfaces - Up to 9600 baud - Dual I/O ports - 8080 μ P controlled - Dual 128 character buffer - Line and record edit - Complete search capabilities - Auto answer - Compact/low cost. Various OEM and end user configurations available from \$695 to \$1995 in single quantities. Columbia Data Products, Inc., 6655 Amberton Dr., Baltimore, Md. 21227. 301-796-2300.

3M DATA CARTRIDGE RECORDER

193

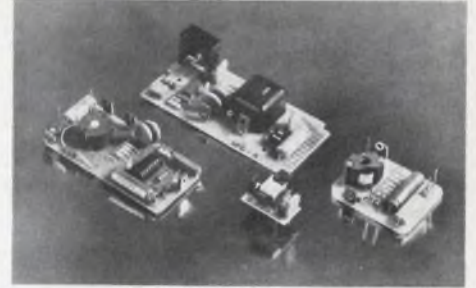

Activate gas discharge readouts! Custom designed and produced DC-to-DC power supplies to activate gas discharge displays, or for other applications. Regulation I/O options, packaging (encapsulated, aluminum shell or open frame), size and configuration, heat dissipation, mounting (PC board pins, edge connectors), etc., can be tailored to meet individual specifications. Price and delivery discussed after specifications are submitted. Endicott Coil Co., Inc., 31 Charlotte Street, Binghamton, N.Y. 13905 (607) 797-1263.

CUSTOM DESIGNED POWER SUPPLIES 196



SURPLUS ELECTRONICS AND OPTICS . . . in a free 104 page catalog featuring these bargains: — Color 'TV' Chassis for \$29.50; Microprocessor for \$595.00; Computer Data Phones for \$24.50 each; Teletypes - ASR33 for \$690.00; ASC II Keyboards for \$35.00 each; AM/FM Stereo Receivers for \$24.50; Transformers for \$0.40; Cal Key Boards only \$1.00; KLH Speaker Enclosures Cabinets for \$20.00 each; Electronic Organs; etc. B & F Enterprises, 119 Foster Street, Peabody, MA 01960 (617) 531-5774.

ELECTRONIC SURPLUS CATALOG

191



The **PMK04** is a portable off-line terminal tester. It can be used with your system up to exercise serial ASCII terminals such as Digital's VT50/52 CRT's, LA 30/36 terminals and other teleprinters and CRT's using 20 MA current loop or EIA interfaces. Priced at a low of \$1425 per unit with discounts available. Digital Equipment Corporation, Customer Spares, Parker Street, Maynard, MA 01754

TERMINAL TESTER

194

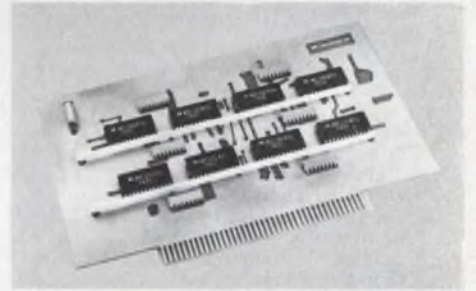

EASIER ECL VOLTAGE AND GROUND DISTRIBUTION SYSTEMS—Reduced system noise, high packaging density and less design time for PC boards with ECL circuits are yours with Mini/Bus[®], the Rogers way to eliminate the cost of multi-layer boards by off-board voltage and ground distribution. Rogers Corp., Chandler, AZ 85224 (602) 963-4584. (EUROPE: Mektron NV, Ghent, Belgium; JAPAN: Nippon Mektron, Tokyo)

MINI/BUS

197

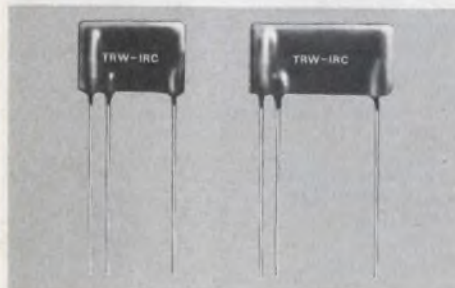

Thick-Film High Voltage Dividers are the latest line of high-voltage resistors from TRW. Each device consists of a high-voltage thick-film resistor circuit deposited on a high alumina ceramic substrate. The circuit can be encapsulated in a high-temperature epoxy coating with printed circuit leads or it can be made as a substrate for customer assembly into an integral high-voltage function. Available in various sizes and configurations. TRW/IRC Resistors, 401 N. Broad St., Phila, Pa. 19108. (215) 922-8900.

HIGH VOLTAGE RESISTORS

192



RECORDS ACCELERATION AND SHOCK Low cost, sensitive Accelograph[™] simultaneously monitors and permanently records acceleration and low frequency shock in all directions within a given plane. No power or electronics needed. Stylus traces acceleration on replaceable recording disc that can be resurfaced in field. Ranges of 1-50G. Ideal for shipping containers to record abuse in transit, monitor dynamic vehicle tests. Humphrey, Inc., 9212 Balboa Ave., San Diego, CA 92123. (714) 565-6631

SHOCK RECORDER

195



Overcurrent Protector, manual reset eliminates fuse replacement. Convenient panel mounting. 19 fractional ratings from 0.1 to 5 amp. Other models up to 400 amp. Trip-free and fool-proof, UL and CSA approved. High quality, low cost \$1.33 ea. in 1000 lots. E-T-A Products Co. of America, 7400 N. Croname Rd., Chicago, Ill. 60648. Tel: (312) 647-8303. Telex: 253780.

CIRCUIT BREAKER

198

Advertiser's Index

Advertiser	Page	Advertiser	Page	Advertiser	Page
AMP, Incorporated	16, 17	Gates Energy Products, Inc.	155	Omni Spectra, Inc.	38
AP Products Incorporated	32A-F, 162	General Electric Company, Imaging Devices Operation	144	Omron Corporation of America	144F-G
Abbott Transistor Laboratories, Inc.	6	General Electric Company, Miniature Lamp Products Department	152	Optical Electronics, Inc.	156
Advanced Micro Devices	4, 5	Gold Book, The	175	Optron, Inc.	7
Alco Electronic Products, Inc.	159	Gould Inc., Instrument Systems Division	94		
Allen Bradley Co.	144E			*Philips Electronic Components and Materials	144A
Alpha Wire Corp.	12			Potter & Brumfield, Division of AMF Incorporated	49
American Optical Corporation	133	Harris Semiconductor, A Division of Harris Corporation	37	Precision Monolithics, Incorporated	119
Analog Devices, Inc.	39, 40, 41	Hayden Book Company, Inc.	96, 96A-B, 97, 172	Projects Unlimited	155
Ann Arbor Terminals, Inc.	162	Hayden Switch & Instrument, Inc.	78	Pyrofilm Corporation	93
Ansley Electronics Corp.	87	Heinemann Electric Company	139		
Arnold Magnetics Corporation	167	Hewlett-Packard	1, 14, 43, 134	RCA Distributor & Special Products Division	172
Avantek, Inc.	146	Hoffman Engineering Company	149	RCA Electro Optics	52
		Honeywell Test Instruments Division	59	RCA Solid State	33, Cover IV
B & F Enterprises	173	Hughes Aircraft Company, Connecting Devices	10	Ramtek Corporation	121
B & K Products of Dynascan	158	Hughes Aircraft Company, Solid State Products Division	11	*Ranco Industries	144B
Bausch & Lomb, Scientific Optical Products Division	138	Humphrey, Inc.	173	Raytheon Semiconductor	123
Belden Corporation	65			Rental Electronics, Inc.	20
Bell, Inc., F. W.	141			Rogers Corporation	172, 173
Biomation	24, 25				
Bodine Electric Co.	165	ITT Cannon Electric	50	*SGS Ates Semiconductor Corporation	20
Bourns, Inc., Trimpot Products Division	Cover II	ITT Pomona Electronics	163	Sangamo Electric Company	132
Bud Radio, Inc.	128	Industrial Controls Division		Scanbe Manufacturing Corp.	140
Burr-Brown	125	General Time	172	*Schoeller & Co.	144B
		Infotek Systems	165	Signetics Corporation	133, 135, 137, 139, 141, 142, 143
CTS Corporation	58			Silicon Systems, Inc.	159
California Instruments	140	JS&A National Sales Group	Cover III	Singer Company, Inc., Kearfott Division	102
Cambridge Thermionic Corporation	172	Johanson Manufacturing Corp.	172	Skand-A-Matic Corp.	165
Centralab, The Electronics Division of Globe-Union, Inc.	144D, 144H	Johnson Company, E.F.	15	Sorensen, A Raytheon Company	13
Columbia Data Products Inc.	173			Spectrum Control Inc.	130
Computer Automation, Inc.	8, 9			Spectronics, Incorporated	168
Computer Products, Inc.	147	Kalmus Associates, Inc.	64	Sprague Electric Company	19, 172
Continental Rentals, Div. Continental Leasing Co., Inc.	161	Kennedy Corp., M.S.	160	Stahlin Brothers, Inc.	137
Continental Specialties Corporation	136, 145	Kepeco, Inc.	46	Standard Power, Inc.	173
Custom Electronics, Inc.	136	Keystone Carbon Company	164	Stanford Applied Engineering, Inc.	129
Cutler-Hammer, Specialty Products Division	95	Kollmorgen, PMI Division	155		
				TRW Capacitors, an Electronic Components Division of TRW, Inc.	153
Dale Electronics, Inc.	63			TRW/IRC Resistors, an Electronic Components Division of TRW, Inc.	173
Dana Laboratories, Inc.	44	LH Research, Inc.	171	TRW Power Semiconductors, an Electronic Components Division of TRW, Inc.	109
Data General Corporation	27	LSI Computer Systems, Inc.	151	Tektronix, Inc.	31, 55, 57
Data I/O Corporation	51	LogiMetrics	166	Teledyne Philbrick	86
Data Precision Corporation	126			Teledyne Relays, A Teledyne Company	2
Dialight, A North American Philips Company	103	3M Company	18	Teledyne Semiconductor	60
Digital Equipment Corporation	35, 173	MCG Electronics	170	Teletype Corporation	45
		Magneto, Inc.	172	Textool Products, Inc.	131
EECO	23	Marconi Instruments, Division of English Electric Company	79	Topaz Electronics	166
EMR Telemetry, Weston Instruments, Inc.	167	Micro Devices Corp.	108	Tracor, Inc.	171
E-T-A Products Co. of America	173	Micropac Industries, Inc.	159	Triplett Corporation	117
E-Z Hook, A Division of Tektest, Inc.	151	Mostek Corporation	114, 115		
Eby Co., Hugh H.	160	Motorola Semiconductor Products, Inc.	29		
Electrocube	148			United Systems Corporation	149
Electronic Molding Corp.	157	NCR Corporation	62		
Electrostatics, Inc.	150	NEC Microcomputers Inc.	144A	Varo Semiconductor, Inc.	169
Elmwood Sensors, Inc.	92	National Semiconductor Corporation	144B-C		
Endicott Coil Co., Inc.	173	Newport Labs	154		
		North American Philips Controls Corp.	135		
FBE Research Company	172				
Farotron	169				
Fuji Electrochemical Co., Ltd.	169				

*Advertisers in non-U.S. edition

TWO-MINUTE QUIZ.

There are two major electronics directories to assist engineer/specifiers in doing their jobs. How do they rate in a head-to-head editorial comparison?

1. "Which provides the greater number of product headings in its Product Category?"
GOLD BOOK has 5182. EEM has 3335.
2. "Which furnishes the greater number of pages in its Product Directory?"
GOLD BOOK has 542. EEM has 255.
3. "Which provides more pages in the Trade Name Directory?"
GOLD BOOK has 33. EEM has 24.
4. "Which supplies the greater number of pages in the Manufacturers Directory?"
GOLD BOOK has 397. EEM has 338.
5. "Which furnishes the larger number of manufacturers?"
GOLD BOOK has 6771. EEM has 3300.

What more need be said, except to ask one additional question:

6. "Which leads in circulation in the increasingly important foreign market?"
GOLD BOOK has 13,000. EEM has zero.

On top of all this, GOLD BOOK rates are lower than EEM rates by far!

**ELECTRONIC DESIGN'S GOLD BOOK
WORKS WORLDWIDE!**



Hayden Publishing Company, Inc. • 50 Essex Street, Rochelle Park, N.J. 07662 • (201) 843-0550

Product Index

Information Retrieval Service. New Products, Evaluation Samples (ES), Design Aids (DA), Application Notes (AN), and New Literature (NL) in this issue are listed here with page and Information Retrieval numbers. Reader requests will be promptly processed by computer and mailed to the manufacturer within three days.

Category	Page	IRN	Category	Page	IRN	Category	Page	IRN
Components			pulse generator	136	76	connectors	12	10
capacitors	136	77	pulse generator	161	400	connectors	160	114
catalog	165	122	recorder/reproducer	132	70	dicing saw, wafer	160	398
clutch, PM hysteresis	134	341	sweeper	1	2	enclosures	137	78
detectors, liquid level	165	123	time-delay generator	63	403	optical cable	158	395
fuses, automobile	133	339				potting compound	158	394
indicators	155	103	Integrated Circuits			shelter, fiberglass	151	393
lamps, miniature	153	101	analog IC applications			socket board	158	397
line filters	130	68	(NL)	168	423	sockets	131	69
motors	131	335	chip, DVM	135	345	test accessories	163	119
motors	155	104	converter, d/a	135	344	test clips	162	118
photoelectric control	132	337	encoder, tone	136	348	wrapped wire kit	157	392
potentiometers	11	252	multiplier	136	347			
probes, thermistor	164	121	regulator, shunt	135	346			
proximity sensor	134	342				Powered Sources		
relay	135	74				electronic load	146	373
relays	131	332	Microprocessor Design			HV unit	146	375
Scott-T Xformer	133	338	evaluation board	53	501	lab supply	144	370
solid-state relay	139	82	printer low-cost	54	503	mil-spec supplies	145	372
switch	132	336	processor, uprogram-			modular supplies	145	371
switch, mushroom-head	134	343	mable	54	502	OEM power supplies		
toggles	159	111	software, μ P	56	506	(NL)	168	418
transformers	148	94	software compiler,			power supplies	140	85
transformers, trigger	133	340	system	56	507	power supplies	167	127
transient protectors	131	334	system, prototyping	56	504	power supply	147	93
trimmer, resistance	131	333				power supply	150	97
			Microwaves & Lasers			regulators	166	125
Data Processing			amp, linear	139	361	switcher	146	374
calculators	137	350	amp, modules	140	366			
data acquisition system	138	359	attenuators	139	363			
data processor	137	357	attenuators	140	364			
disk drive	138	358	bandpass filter	141	368			
display, graphic	31	22	catalog	133	71			
microcomputer	137	349	coax attenuator	141	369			
minicomputer	9	8	difference display	139	362			
plotter controller	138	360	filters	140	365			
			microwave switch	134	73			
			switches	141	367			
Discrete Semiconductors						new literature		
Darlington array	130	331	Modules & Subassemblies			analog IC applications	168	423
Darlington, power	127	321	amplifiers, power	153	384	bridges, rectifiers	168	417
diodes, power	130	330	controller, temperature	156	390	capacitors	168	419
LED chips, green	127	323	converter, d/a	154	386	ceramic capacitors	164	407
LED indicators	128	326	converters, a/d	154	387	DMMs	168	414
LED light bars	127	320	converters, a/d	156	389	electronic kits	169	415
opto detectors	168	289	converters, I/O	2	3	instrumentation	168	422
photodiodes	127	322	converters, s/d	150	379	motor starter	168	421
power Darlington	130	329	converters, v/f	150	382	OEM power supplies	168	418
rf transistor	127	324	decoder, two-tone	150	380	resistors	168	420
rectifier	169	132	digitizer, transducer	153	383	silicon controlled		
SCRs and triacs	128	327	filter, active	148	377	rectifiers	168	416
silicon controlled			filters, notch	150	381			
rectifiers	168	416	module, clock	156	388			
transistors, dual	127	325	monitor, line integrity	156	391			
transistors, switching	128	328	oscillator, atomic	148	376			
			oscillator, crystal	148	378			
Instrumentation			oscillator, phase-lock	154	385			
counters	162	401	tone signalling products					
DMMs (NL)	168	414	(NL)	168	413			
generator	166	126				application notes		
generators	20	17	Packaging & Materials			calculator interfaces	164	408
instrumentation (NL)	168	422	bus strip	158	396	contrast techniques	164	404
logic monitor	145	91	cable, high temp	160	399	magnetic shielding	164	406
logic monitor	163	402	cables	151	98	multiplexing	164	405
meters	149	281	card file	140	84			
meters	154	102	circuit panels	157	107			
microscope	138	81				evaluation samples		
						adapters	166	410
						polycarbonate capacitors	166	412
						self-tapping screws	166	411
						snap-acting PB switch	166	409

Laser Beam Digital Watch

Never press another button, day or night, with America's first digital watch that glows in the dark.



Announcing Sensor's new Laser 220—the first really new innovation in digital watch technology.



Would you do this with your solid-state watch? Of course not. Most solid-state watches require care and pampering but not the Sensor. You can dunk it, drop it and abuse it without fear during its unprecedented five-year parts and labor warranty.

It's ingenious, it's simple and it makes every other digital watch obsolete. Scientists have perfected a digital watch with a self-contained automatic light source—a major scientific breakthrough.

SELF-CONTAINED LIGHT SOURCE

The Laser 220 uses laser beams and advanced display technology in its manufacture. A glass ampoule charged with tritium and phosphor is hermetically sealed by a laser beam. The ampoule is then placed behind the new Sensor CDR (crystal diffusion reflection) display.

The high-contrast CDR display shows the time constantly—in sunlight or normal room light. But, when the room lights dim, the self-contained tritium light source automatically compensates for the absence of light, glows brightly, and illuminates the display.

No matter when you wear your watch—day or night—just a glance will give you the correct time. There's no button to press, no special viewing angle required, and most important, you don't need two hands to read the time.



Replace the battery yourself by just opening the battery compartment with a penny. Free batteries are provided whenever you need them during the five-year warranty.

A WORRY-FREE WATCH

Solid-state watches pose their own problems. They're fragile, they must be pampered, and they require frequent service. Not the Laser 220. Here are just five common solid-state watch problems you can forget about with this advanced space-age timepiece:

1. Forget about batteries The Laser 220 is powered by a single EverReady battery that will actually last years without replacement—even if you keep the 220 in complete darkness. In fact, JS&A will supply you with the few batteries you need, free of charge, during the next five years. To change the battery, you simply unscrew the battery compartment at the back with a penny and replace the battery yourself.

2. Forget about water Take a shower or go swimming. The Laser 220 is so water-resistant that it withstands depths of up to 100 feet.

3. Forget about shocks A three-foot drop onto a solid hardwood floor or a sudden jar. Sensor's solid case construction, dual-strata crystal, and cushioned quartz timing circuit make it one of the most rugged solid-state quartz watches ever produced.

4. Forget about service The Laser 220 has an unprecedented five-year parts and labor

warranty. Each watch goes through weeks of aging, testing and quality control before assembly and final inspection. Service should never be required. Even the laser-sealed light source should last more than 25 years with normal use. But if it should require service anytime during the five year warranty period, we will pick up your Sensor, at your door, and send you a loaner watch while yours is repaired—all at our expense.

5. Forget about changing technology The Sensor Laser 220 is so far ahead of every other watch in durability and technology that the watch you buy today, will still be years ahead of all others.

THE ULTIMATE ACHIEVEMENT

Other manufacturers have devised unique ways to produce a watch you can read at a glance. The new \$300 LED Pulsar requires a snap of the wrist to turn on the display, but the Pulsar cannot be read in sunlight. The new \$400 Longine's Gemini combines both an LED and liquid crystal display. (Press a button at night for the LED display, and view it easily in sunlight with the liquid crystal display.) But you must still press a button to read the time. All these applications of existing technology still fail to produce the ultimate digital watch: one you can read under all light conditions without using two hands. Until the introduction of the Sensor.

PLENTY OF ADVANCED FUNCTIONS

Sensor's five time functions give you everything you really need in a solid-state watch. Your watch displays the hours and minutes constantly, with no button to press. But depress the function button and the month and the date appear. Depress the button again and the seconds appear. To quickly set the time, insert a ball-point pen into the recessed time-control switch on the side. It's just that easy.

Sensor's accuracy is unparalleled. All solid-state digitals use a quartz crystal. So does the Sensor. But crystals change frequency from aging and shock. And to reset them, the watch case must be opened and an airtight seal broken which may affect the performance. In the Sensor, the crystal is first aged before it is installed, and secondly, it is actually cushioned in the case to absorb tremendous shock. The quartz crystal can also be adjusted through the battery compart-



The new exclusive laser-sealed tritium and phosphor light source is a thin solid-state tube that automatically illuminates the display when the lights dim.

ment without opening the case. In short, your watch should be accurate to within 5 seconds per month and maintain that accuracy for years without adjustment and without ever opening the watch case.

STANDING BEHIND A PRODUCT

JS&A is America's largest single source of digital watches and other space-age products. We have selected the Sensor Laser 220 as the most advanced American-made, solid-state timepiece ever produced. And we put our company and its full resources behind that selection. JS&A will warranty the Sensor (even the batteries) for five full years. We'll even send you a loaner watch to use while your watch is being repaired should it ever require repair. And Sensor's advanced technology guarantees that your digital watch will be years ahead of any other watch at any price.

Wear the Laser 220 for one full month. If you are not convinced that it is the most rugged, precise, dependable and the finest quality solid-state digital watch in the world, return it for a prompt and courteous refund. We're just that proud of it.

To order your Sensor, credit card buyers may simply call our toll-free number below or mail us a check in the amount indicated below plus \$2.50 for postage, insurance and handling. (Illinois residents add 5% sales tax.) We urge you, however, to act promptly and reserve your Laser 220 today.

Stainless steel w/leather strap \$129.95
(Add \$10 for matching metal band)
Gold plated w/leather strap. \$149.95
(Add \$10 for matching metal band)

JS&A NATIONAL SALES GROUP

Dept. ED JS&A Plaza
Northbrook, Illinois 60062
CALL TOLL-FREE . . 800 323-6400
In Illinois call . . . (312) 498-6900

©JS&A Group, Inc., 1976

RCA power transistors: More Value per Penny.

Socket for socket, penny for penny, RCA direct replacement types give you all these reliability extras:

- Thermal Cycling Characterization, to help you predict in-service reliability.



- Real Time Thermal Process Control, to help insure that every transistor you get has the reliability you expect.
- Safe Operating Area Characterization, so you can determine performance under virtually any operating condition.
- Clip Lead Construction, for extreme ruggedness.
- Steel Headers, for even greater reliability.

RCA replacements for TIP and DTS types

TIP 29	RCA 29	TIP 31	RCA 31	TIP 41	RCA 41	DTS 410	RCA 410
TIP 29A	RCA 29A	TIP 31A	RCA 31A	TIP 41A	RCA 41A	DTS 411	RCA 411
TIP 29B	RCA 29B	TIP 31B	RCA 31B	TIP 41B	RCA 41B	DTS 413	RCA 413
TIP 29C	RCA 29C	TIP 31C	RCA 31C	TIP 41C	RCA 41C	DTS 423	RCA 423
TIP 30	RCA 30	TIP 32	RCA 32	TIP 42	RCA 42	DTS 431	RCA 431
TIP 30A	RCA 30A	TIP 32A	RCA 32A	TIP 42A	RCA 42A		
TIP 30B	RCA 30B	TIP 32B	RCA 32B	TIP 42B	RCA 42B		
TIP 30C	RCA 30C	TIP 32C	RCA 32C	TIP 42C	RCA 42C		

More Value per Penny in over 500 types.

RCA has a broad line of power transistors — the table shows only our replacements for TIP and DTS types. And all are known for quality, performance and manufacturing innovations. Choose from high speed switching types. High voltage types. Rugged commodity types.

Hometaxial and epitaxial constructions. In both hermetic and plastic packages. All have the RCA reliability extras. All give you More Value per Penny.

Your guide to More Value per Penny in RCA power transistors.

Get the RCA Transistor Interchangeability Guide. You'll see hundreds

more replacements. All with More Value per Penny.

Your RCA Solid State distributor has these Interchangeability Guides now. Or write RCA Solid State, Box 3200, Somerville, N.J. 08876; Ste. Anne de Bellevue H9X 3L3, Canada; Sunbury-on-Thames, U.K.; Fuji Bldg., Tokyo, Japan.

RCA. Powerhouse in Transistors