

Electronic Design[®] 23

VOL. 23 NO.

FOR ENGINEERS AND ENGINEERING MANAGERS

NOV. 8, 1975

See network behavior in more detail. A powerful new analyzer boosts frequency range: up to 1.3 GHz and down to 0.5 MHz — the widest yet attained. And the

displayed dynamic range of 100 dB is the best around. You also get direct counting to 1.3 GHz, digital display of magnitude and phase and group delay. P. 113.



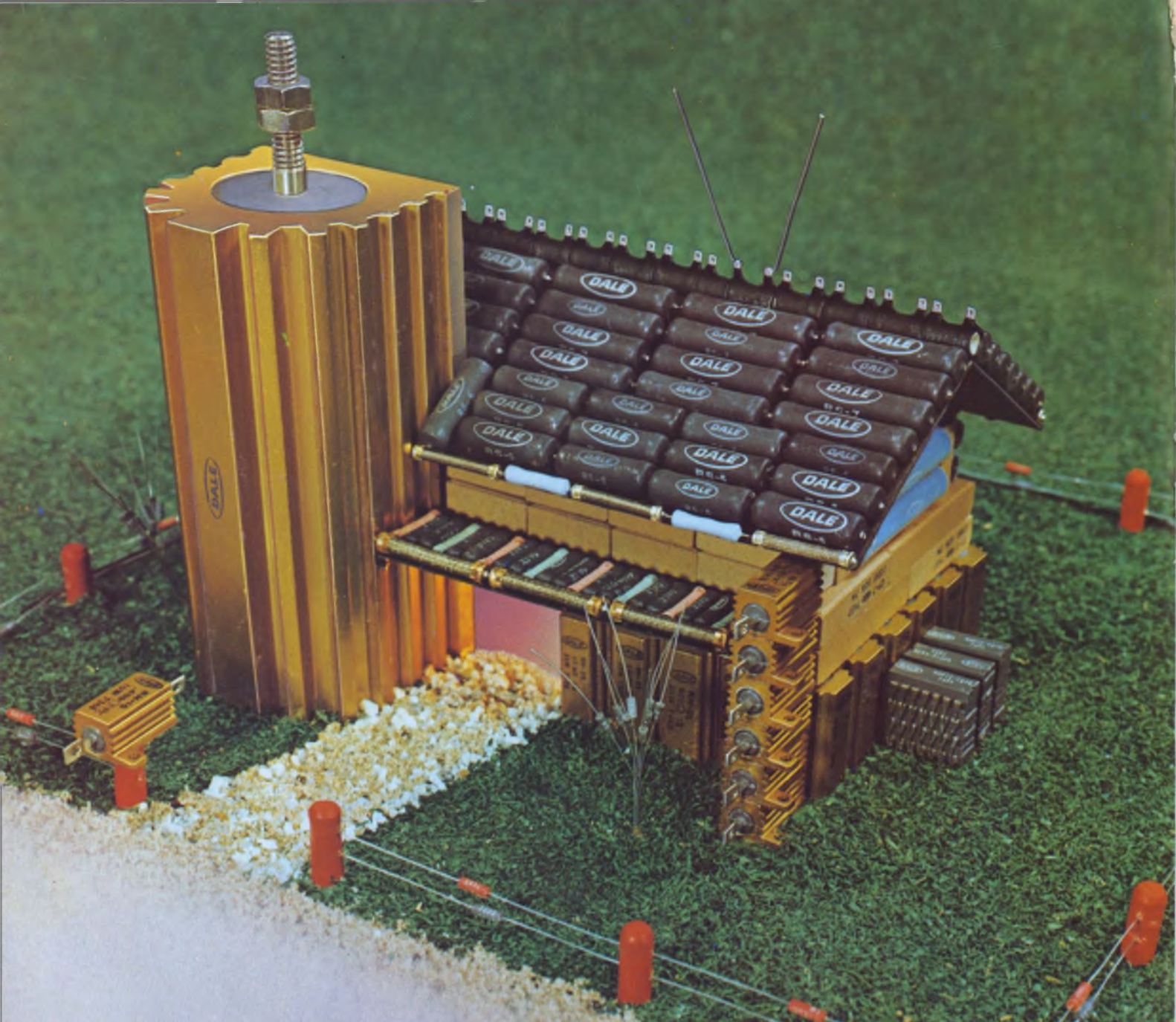

Powerhouse.

Dale makes more power wirewounds... E-Rel, precision, industrial, commercial... has more QPL's... more ways to meet your special housing and performance requirements... and just plain works harder to make sure you're satisfied.

Here are four ways to prove it:

- For Complete Cross Reference Guide, Circle 351
- For Comprehensive Wirewound Resistor Wall Chart, Circle 352
- For Guide to Non-Standard Wirewound Resistors, Circle 353
- Call 402-564-3131 for immediate information.

DALE ELECTRONICS, INC., 1300 28th Avenue, Columbus, Nebr. 68601
In Canada: Dale Electronics Canada Ltd.
In Europe: Dale Electronics GmbH, 8 Munchen 60, Falkweg 51, West Germany
A subsidiary of The Lionel Corporation



Our complete product line can be found in Electronic Design's GOLD BOOK.

SURPRISE!

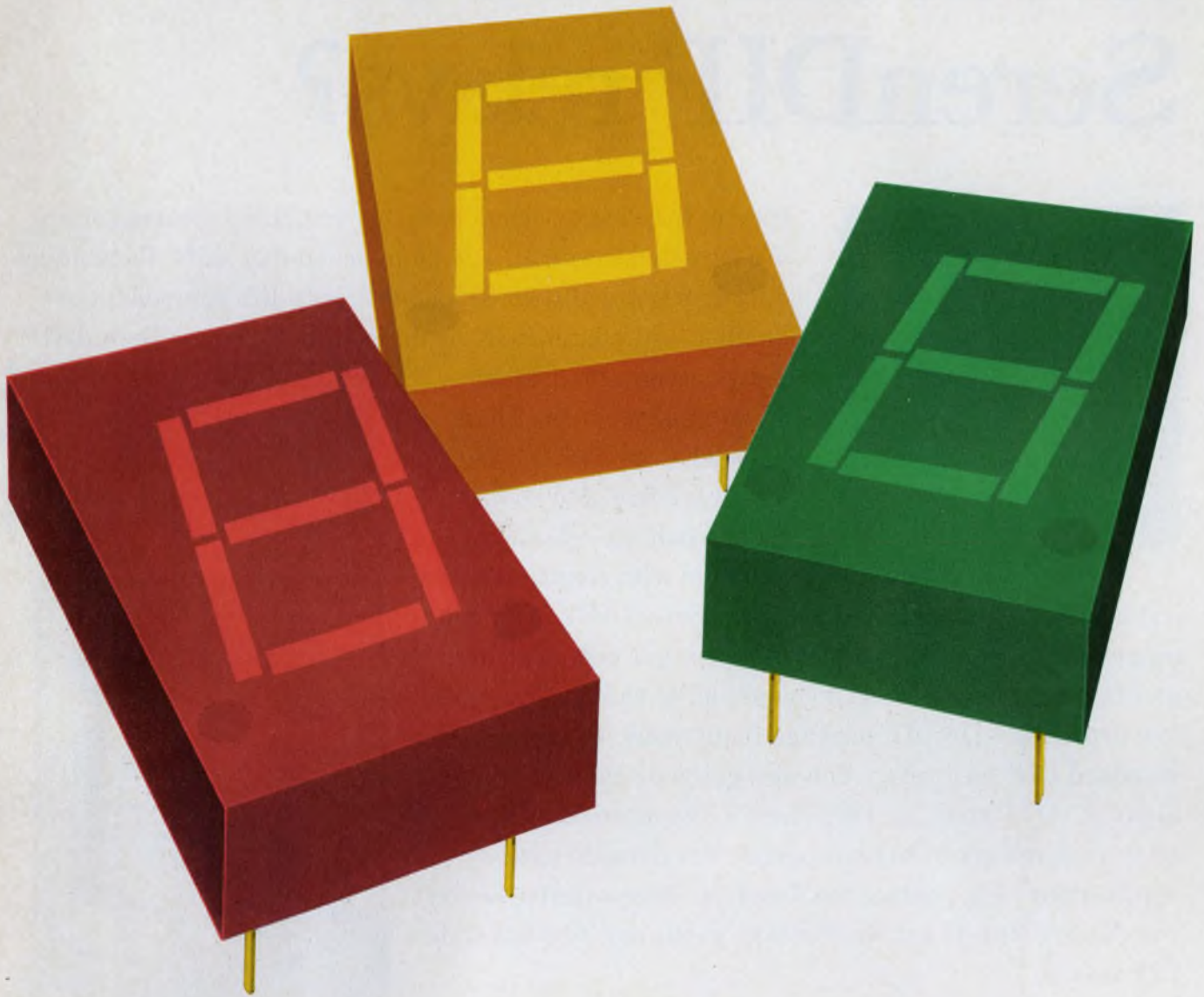

HP's 5 times brighter display!

At 20mA our new High-Efficiency red display is 5 times brighter than our standard red displays. Just 3mA per segment gives you all the brightness you need and makes it ideal for battery powered applications. These large .43" displays are offered in High Efficiency Red, Yellow, or Green and are readable up to 20 feet. The 5082-7650 (High-Efficiency Red), -7660 (Yellow),

-7670 (Green) are available in standard DIP packages with left-hand d.p. and common anode configuration. Just \$3.95* each in quantities of 100.

Contact Hall-Mark, Schweber, Wilshire or the Wyle Distribution Group (Liberty/Elmar) for immediate delivery, or write us for more information and our new application note on contrast enhancement.

01503

*Domestic USA price only.

HEWLETT  PACKARD

Sales and service from 172 offices in 65 countries.
1501 Page Mill Road, Palo Alto, California 94304

INFORMATION RETRIEVAL NUMBER 2

Did you get the message about our solid state SerenDIP relays?



International telex communication switching systems often are expected to run on a 24-hour, seven-day shift. Continuous duty like that calls for dependable, long-life component reliability — the kind RCA requires from Teledyne SerenDIP® relays used in their trunk terminator modules. These all-solid-state DIP relays provide wear-free and bounce-free switching — features you don't get with electro-mechanical or reed relays.

What's more, our SerenDIP's offer high input/output isolation, low level logic input compatibility, and fast response time. And you get all of this in a low cost, low-profile TO-116 DIP package ready-made to replace any standard DIP reed relay. You also get your choice of output: bi-polar, AC (triac), or DC. There's lots more to a SerenDIP relay that you ought to know about. For detailed specs or applications help, contact the Teledyne Relays people nearest you. You're sure to get the message about our all-solid-state DIP relays.

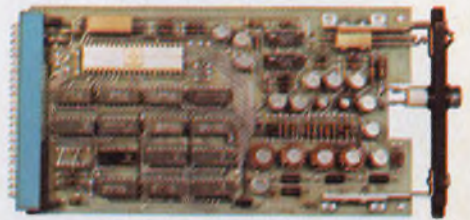

RCA Trunk Terminator Module



RCA CCT-3 Series
Telex Switching System
(Courtesy of RCA/Camden, N.J.)

 **TELEDYNE RELAYS**

3155 West El Segundo Boulevard, Hawthorne, California 90250
Telephone (213) 973-4545

NEWS

- 19 **News Scope**
- 26 **Smaller, cheaper passive chips spurring** hybrid-circuit advances.
- 53 **Optical reader scans coded copy** at 40 characters per second.
- 61 **Washington Report**

TECHNOLOGY

- 70 **Increase microcomputer efficiency** with interrupt and DMA capabilities. A microprogrammed μ P needs only seven extra ICs and six new instructions.
- 78 **Speed microprocessor responses** without interrupt or DMA techniques. Let the processor's Ready line do the job, and build a simple floppy-disc interface.
- 86 **Design for fault isolation:** Increasingly, the man who creates the circuit must ensure that it can be easily tested. Here are some techniques to do just that.
- 92 **Complacent about resistor reliability?** There are at least 18 ways these components can cause circuit problems. Here are tests to ensure reliability.
- 100 **Choosing the best enclosure:** Here are do's and don'ts for putting equipment in a sturdy, eye-catching, low-cost package.
- 104 **Ideas for Design:**
Wrapping and unwrapping wiring tools are easily made from tubing.
Programmable sawtooth generator settable at high and low output levels.
Power-failure alarm operates a long time on a single 1.5-V cell.
- 110 **International Technology**

PRODUCTS

- 113 **Instrumentation:** Analyzer brings new power to network-behavior measurement.
- 116 **Data Processing:** Computer series offers low cost, high performance.
- 120 **Components:** Mini resistor chips offer the tops in accuracy and stability.
- 124 **Modules & Subassemblies:** Multiplying d/a converters meet MIL specs at low cost.
- 122 Discrete Semiconductors
- 126 Integrated Circuits
- 128 Packaging & Materials
- 129 Power Sources

Departments

- 67 **Editorial:** Ignorance and apathy
- 7 Across the Desk
- 130 New Literature
- 135 Bulletin Board
- 138 Advertisers' Index
- 140 Product Index
- 140 Information Retrieval Card

Cover: Photo by Russell Illig, courtesy of Hewlett-Packard, Santa Rosa, CA.

JOIN OUR BME™ CAPACITOR SAVINGS PLAN

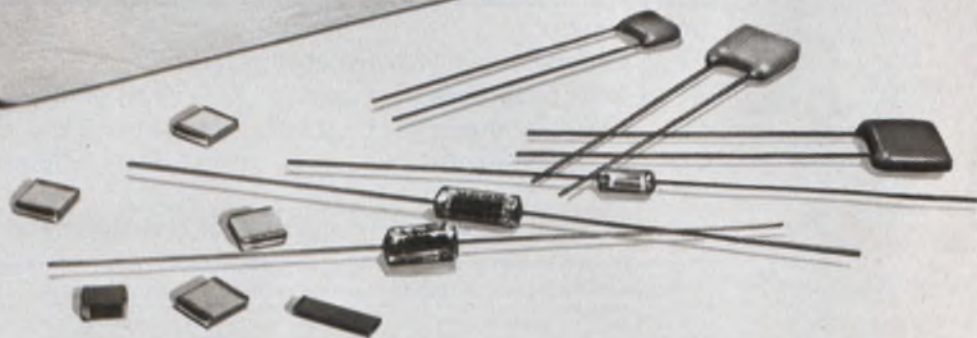

**SAVE 30% TO 50%
ON THE COST OF MONOLITHIC
CERAMIC CAPACITORS**



This major cost saving is the result of our new BME™ capacitor technology. We've eliminated precious metals entirely from the electrodes and terminations of our BME™ capacitors. No precious metals means lower cost. So now we offer you our complete line of monolithic ceramic capacitors — BME Chips™, BME Radials™ and BME Axials™ — at a genuine savings of 30% to 50%.

This significant reduction is not based on a momentary drop in precious metal prices. This is a long-term solution due to the replacement of precious metals by non-noble metals which are not subject to the same dramatic cost spirals.

SAVE WITH RELIABILITY

Our BME™ capacitors have not sacrificed the inherent electrical and mechanical Ceramolitic® quality. Their reliability can be demonstrated by the extensive test procedures to which they have been subjected. Write to our Applications Engineering Department for complete test reports.

**SAVE WITH DESIGN
FLEXIBILITY**

Now you can seriously consider monolithics to replace micas and tantalums. Our BME™ capacitors feature non-polarity, a wide range of

**TYPICAL SELLING PRICES PER UNIT FOR
USCC'S BME-KAPS™ ON
QUANTITIES OF 5000 OR MORE**

BME™ "J" DIELECTRIC (COG)	BME-Chip™	BME-Axial™	BME-Radial™
1 thru 100 pF, 5%, 50WVDC	5.1¢	6.8¢	7.5¢
1000 pF, 5%, 50WVDC	12¢	16¢	16¢

BME™ "S" DIELECTRIC (X7R)	BME-Chip™	BME-Axial™	BME-Radial™
.01 µF, 20%, 50WVDC	3.5¢	5.8¢	5.8¢
.1 µF, 20%, 25WVDC	9¢	16¢	14¢
1.0 µF, 20%, 25WVDC	52¢	—	73¢

BME™ "R" DIELECTRIC (Z5U)	BME-Chip™	BME-Axial™	BME-Radial™
.1 µF, +80 -20%, 25WVDC	5.7¢	8.8¢	8.8¢
.47 µF, +80 -20%, 25WVDC	13¢	16.5¢	16.5¢
1.0 µF, +80 -20%, 25WVDC	19¢	27¢	25¢
2.2 µF, +80 -20%, 25WVDC	35¢	—	49¢

capacitance value, low leakage, high volumetric efficiency, availability in chip, radial and axial packages at prices competitive with mica below 1000pF and tantalum up to 2.2µF.

SAVE ON DELIVERY TIME

Elimination of precious metal material costs have permitted us to stockpile chips. We now have five to ten million units in over 40 popular values ready for two-week delivery in chip style or four-week delivery in leaded configurations.

**JOIN THE USCC/CENTRALAB
BME™ CAPACITOR
SAVINGS PLAN**

Get all the details today. Write on your company letterhead for your

concise Savings Plan Price list — your pass book to the lowest monolithic ceramic capacitor prices available. Compare it with anyone else's price list and see.

Remember, USCC/Centralab—
Quality, Volume, Savings.



USCC/Centralab

Electronics Division • Globe-Union Inc.

4561 Colorado Boulevard ■ Los Angeles, Ca. 90039

(213) 240-4880

INFORMATION RETRIEVAL NUMBER 4



A Smart Way to Beat Your Power Supply Size Problem



1½" thin, 2¾" narrow, 2¾" short

yet this converter produces 1000 volts DC, regulated, from a battery input of 28 VDC! It weighs less than 15 ounces. This is only one of our wide variety of many small light weight converters, inverters and power supplies — there are over 3000 models listed in our newest catalog, including size, weight and prices. If you have a size problem, why not send for an Abbott catalog?

MIL SPEC ENVIRONMENT — All of the hermetically sealed power modules listed in our new catalog have been designed to meet the severe environmental conditions required by modern aerospace systems, including MIL-STD-810B. They are hermetically sealed and encapsulated in heavy steel containers. New high performance units can meet MIL-STD-461A.

Please see pages 1037-1056 Volume 1 of your 1975-76 EEM (ELECTRONIC ENGINEERS MASTER Catalog) or pages 612-620 Volume 2 of your 1975-76 GOLD BOOK for complete information on Abbott Modules.

Send for our new 60 page FREE catalog.

RELIABLE — Highest quality components are used in Abbott power modules to yield the high MTBF (mean time between failure) as calculated in the MIL-HDBK-217 handbook. Typical power modules have over 100,000 hours MTBF — proving that the quality was built in from the beginning.

WIDE RANGE OF OUTPUTS — Any voltage from 5 volts DC to 740 VDC is available by selecting the correct model you need from our catalog with any of a variety of inputs including:

- 60 \sim to DC
- 400 \sim to DC
- 28 VDC to DC
- 28 VDC to 400 \sim
- 12-38 VDC to 60 \sim

Sr. Vice President, Publisher
Peter Coley

Editors

Editorial Offices
50 Essex St.
Rochelle Park, NJ 07662
(201) 843-0550
TWX: 710-990 5071
Cable: Haydenpubs Rochellepark

Editor-in-Chief George Rostky

Managing Editors:

Ralph Dobriner
Michael Elphick

Associate Editors:

Dave Bursky
Jules H. Gilder
Morris Grossman
John F. Mason
Stanley Runyon
Edward A. Torrero

Contributing Editors:

Peter N. Budzilovich
Alberto Socolovsky
Nathan Sussman

Editorial Field Offices

East

Jim McDermott, Eastern Editor
P.O. Box 272
Easthampton, MA 01027
(413) 527-3632

West

David N. Kaye, Senior Western Editor
8939 S. Sepulveda Blvd.,
Suite 510
Los Angeles, CA 90045
(213) 641-6544
TWX: 1-910-328-7240

Editorial Production

Marjorie A. Duffy

Art

Art Director, William Kelly
Richard Luce
Anthony J. Fischetto

Production

Manager, Dollie S. Viebig
Helen De Polo
Anne Molfetas

Circulation

Manager, Evan Phoutrides

Information Retrieval

Peggy Long

Promotion, Creative Layouts

Manager, Albert B. Stempel
Maxine Correal
Nancy Gordon (Reprints)

abbott transistor

LABORATORIES, INCORPORATED
general offices eastern office

5200 W. Jefferson Blvd./Los Angeles 90016
(213) 936-8185 Telex: 69-1398

1224 Anderson Ave./Fort Lee, N.J. 07024
(201) 224-6900 Telex: 13-5332

INFORMATION RETRIEVAL NUMBER 5

Across the Desk

Chicken about progress

In this age of super small components and sophisticated electronics, one industry is still relying on old-fashioned electromechanical gadgetry.

Most of those fried chickens you purchase at the hundreds of fast-food chicken outlets around the country are so crisp and brown and thoroughly delicious because of an old-fashioned synchronous motor driven reset timer manufactured by Gulf & Western's Eagle Signal Div., Davenport, Iowa. The frying is done under pressure in large quantities and as fast as possible, says Joseph A. Carlin, marketing manager for industrial controls. "A half a minute or even several seconds can make the difference between a good batch and a ruined batch," he notes. To duplicate the timing control, electronically, Carlin says, would, of course, be possible—but at two to three times the price of the electromechanical units. And then it wouldn't necessarily be an improvement.

Power Hybrids sets the record straight

We appreciate the coverage given to Power Hybrids, Inc., in the Sept. 1 issue and thought the survey was complete and informative ("Rf and Microwave Semis Rising in Power and Declining in Noise," ED No. 23, p. 34). For the record:

The photo of the TAC-250 circuit was supplied courtesy of Elliot Ressler of the Naval Air Development Center, Warminster, PA.

In addition we detected an error in the caption under the photo. The

frequency range should have been 960 to 1215 MHz instead of 960 to 121.5 MHz, but I'm sure the readers instinctively knew the correct range.

Wayne E. Schaub

Vice President Marketing

Power Hybrids Inc.
1742 Crenshaw Blvd.
Torrence, CA 90501

Exact's generator costs less than it seems

We were very happy to see the notice of the Exact Model 7059 Pulse/Sweep/Function Generator on p. 93 of the Aug. 16 issue. May we point out, however, that in your copy you indicated a price of \$1895 for this instrument. This is \$1000 higher than the actual price of the Model 7059.

Joe Foster

U.S. Sales Manager

Exact Electronics Inc.
455 S.E. Second Ave.
Hillsboro, OR 97123

Misplaced captions



"The focus circuit needs a bit of work."

Sorry. That's Diego Velasquez' "The Toilet of Venus," which hangs in The National Gallery in London.

Electronic Design welcomes the opinions of its readers on the issues raised in the magazine's editorial columns. Address letters to Managing Editor, Electronic Design, 50 Essex St. Rochelle Park, N.J. 07662. Try to keep letters under 200 words. Letters must be signed. Names will be withheld on request.

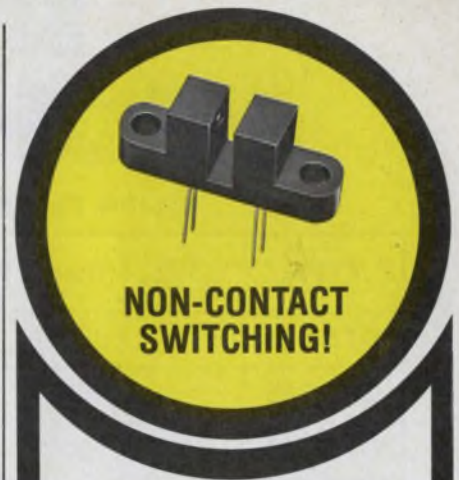

OPTICALLY COUPLED INTERRUPTER MODULES

OPTRON OFFERS IMMEDIATE DELIVERY OF NEW, LOW COST SERIES

OPTRON's new, low cost optically coupled interrupter module series combines non-contact switching and solid state reliability for applications requiring sensing of position or motion of an opaque object such as motion limit, paper edge or shaft encoding.

The new OPB 800 and OPB 803 consist of a gallium arsenide infrared LED coupled with a silicon photosensor in a plastic housing. The OPB 800 with a phototransistor sensor has a typical unblocked output of greater than 0.75 mA with a LED input of 20 mA. Typical output of the OPB 803 with a photodarlington sensor is 3 mA at an input of 10 mA.

Both devices are available from stock and offer design flexibility with the following options:

- High resolution aperture for shaft encoder or strobe bar applications
- Infrared transmitting filter for applications in high ambient light applications
- Alternate pin separation to fit standard DIP socket

New OPTRON optically coupled interrupter modules are interchangeable with similar products as follows:

OPTRON	GE	Monsanto
OPB 800	H13A1	—
OPB 800	H13A2	—
OPB 803	H13B1	MCA 8
OPB 803	H13B2	MCA 81

Detailed technical information on these and other OPTRON standard interrupter and reflective modules, as well as versions for specific applications is available on request.



OPTRON, INC.

1201 Tappan Circle
Carrollton, Texas 75006, U.S.A.
214/242-6571 • TELEX-73-0701
TWX-910-860-5958

DELCO'S NEW FAS HIGH-GAIN TRANSISIS

MAJOR PARAMETER LIMITS

TYPE	h_{FE} @ 10A	V_{CBO}	V_{CEO} (sus)	V_{CE} (sat) @ 7A	t_f (typical) @ 5A)
DTS 515	3.5	300V	250V	5.0V	0.25 μ sec
DTS 516	4	400V	250V	1.9V	0.25 μ sec
DTS 517	5	500V	250V	1.6V	0.25 μ sec
DTS 518	5	600V	275V	1.4V	0.25 μ sec
DTS 519	5	700V	300V	1.4V	0.25 μ sec
2N6573	5	500V	250V	1.6V	0.25 μ sec
2N6574	5	600V	275V	1.4V	0.25 μ sec
2N6575	5	700V	300V	1.4V	0.25 μ sec

NPN triple diffused silicon transistors. Packaged in solid copper cases conforming to JEDEC TO-3 (TO-204MA) outline dimensions.



Our newest high-energy silicon power transistors have increased capabilities over our earlier types in current ratings, gain and switching speeds. These improvements were achieved without sacrificing the useful peak power handling capacity that is characteristic of Delco's transistors.

Fall time of these transistors is typically 0.25 microseconds. Their biggest advantage, however, is their high current gain as shown on the accompanying beta curves.

A new characterization feature offered with the DTS-515 series is a graph of capabilities for reverse bias clamped inductive switching. Parameter variables, dealt with in the graph, are voltage, collector current, temperature, and forward and reverse base current. As can be seen in the

" $V_{BE}(\text{reverse}) \geq 5V$ " notation, emitter diode avalanche is recommended under certain conditions.

And, of course, these high-energy silicon power transistors come in Delco's solid copper TO-3 packages to ensure low thermal resistance.

The accompanying curves, charts and circuits tell part of the story. Prices, applications literature and electrical data from your nearest Delco sales office or Delco distributor can supply another part.

But the most important part of the story is how well these new transistors function in your applications.

You can order them today; they're in stock at your Delco distributor's.

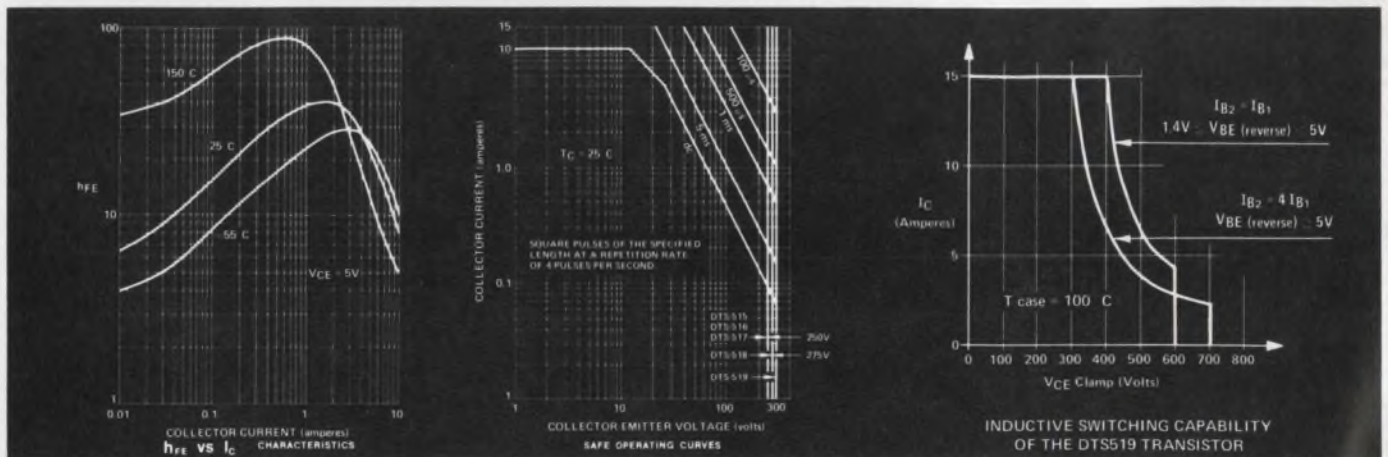

TER SWITCHING, TORS NOW IN STOCK.

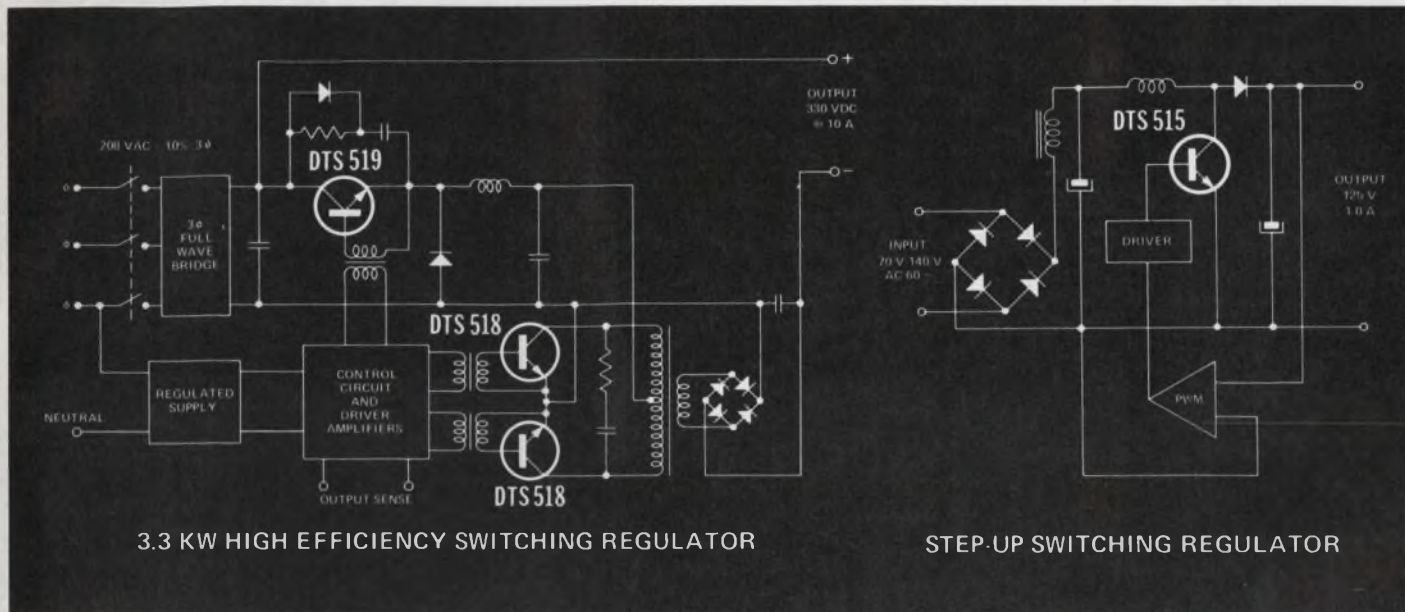

NOW AVAILABLE FROM THESE DISTRIBUTORS IN PRODUCTION QUANTITIES.

ALABAMA, Birmingham
Forbes Distributing Co., Inc.
(205) 251-4104

ALABAMA, Huntsville
Powell Electronics
(205) 539-2731

ARIZONA, Phoenix
Sterling Electronics, Inc.
(602) 258-4531

CALIFORNIA, Gardena
Bell Industries
Electronics Distributors Div.
(213) 321-5802

CALIFORNIA, Goleta
R.P.S. Electronics, Inc.
(805) 964-6823

CALIFORNIA, Los Angeles
Kierulff Electronics, Inc.
(213) 685-5511

CALIFORNIA, Los Angeles
R.P.S. Electronics, Inc.
(213) 748-1271

CALIFORNIA, Palo Alto
Kierulff Electronics, Inc.
(415) 968-6292

CALIFORNIA, San Diego
Kierulff Electronics, Inc.
(714) 278-2112

CALIFORNIA, San Diego
R.P.S. Electronics, Inc.
(714) 292-5611

CALIFORNIA, Sunnyvale
Bell Industries
(408) 734-8570

COLORADO, Denver
Kierulff Electronics, Inc.
(303) 371-6500

CONNECTICUT, Norwalk
Harvey Electronics
(203) 853-1515

FLORIDA, Clearwater
Diplomat/Southland
(813) 443-4514

FLORIDA, Miami Springs
Powell Electronics/Florida
(305) 592-3260

ILLINOIS, Elk Grove Village
Kierulff Electronics, Inc.
(312) 640-0200

ILLINOIS, Skokie
Bell Industries
Electronics Distributors Div.
(312) 282-5400

INDIANA, Indianapolis
Graham Electronics Supply, Inc.
(317) 634-8202

MARYLAND, Baltimore
Radio Electric Service Co.
(301) 823-0070

MASSACHUSETTS, Billerica
Kierulff Electronics, Inc.
(617) 935-5134
(617) 667-8331

MASSACHUSETTS, Newton
The Greene-Shaw Co., Inc.
(617) 969-8900

MICHIGAN, Livonia
Pioneer/Michigan
(313) 525-1800

MINNESOTA, Minneapolis
Stark Electronics Supply Co.
(612) 332-1325

MISSOURI, Kansas City
Walters Radio Supply, Inc.
(816) 531-7015

MISSOURI, St. Louis
LCOMP-St. Louis
(314) 647-5505

NEW JERSEY, Cinnaminson
Wilshire Electronics/Philadelphia
(609) 786-8990 (215) 627-1920

NEW JERSEY, Clifton
Wilshire Electronics/New Jersey
(201) 365-2600 (212) 244-8930

NEW MEXICO, Albuquerque
Sterling Electronics
(505) 345-6601

NEW YORK, Binghamton
Harvey Electronics
(607) 748-8211

NEW YORK, Buffalo
Summit Distributors, Inc.
(716) 884-3450

NEW YORK, Farmingdale
Wilshire Electronics/Long Island
(516) 293-5775

NEW YORK, Woodbury
Harvey Electronics
(516) 921-8700 (212) 895-9260

OHIO, Cincinnati
United Radio, Inc.
(513) 761-4030

OHIO, Cleveland
Pattison Supply Co.
Industrial Electronics Division
(216) 441-3000

OHIO, Dayton
Pioneer/Dayton
(513) 236-9900

PENNSYLVANIA, Philadelphia
Almo Electronics
(215) 698-4000

PENNSYLVANIA, Pittsburgh
Cameradio Electronics
(412) 288-2600

SOUTH CAROLINA, Columbia
Dixie Radio Supply Co., Inc.
(803) 253-5333

TEXAS, Dallas
Sterling Electronics
(214) 357-9131

TEXAS, Houston
Harrison Equipment Co., Inc.
(713) 652-4700

TEXAS, Houston
Sterling Electronics
(713) 627-9800

WASHINGTON, Seattle
Kierulff Electronics, Inc.
(206) 763-1550

IN CANADA: ONTARIO, Scarborough
Lake Engineering Co., Ltd.
(416) 751-5980

OVERSEAS: EUROPEAN INQUIRIES:
European Parts & Accessories
Marketing Group
General Motors Continental
Plant 2, Noorderlaan, Postbus 9
B-2030 Antwerp, Belgium

ALL OTHER OVERSEAS INQUIRIES:
General Motors Overseas
Operations
767 Fifth Avenue
New York, N.Y. 10022

Delco Electronics Regional Sales Offices
Union, New Jersey 07083
Box 1018 Chestnut Station
(201) 687-3770

Van Nuys, California 91404
Box 2968
(213) 988-7550

General Sales Office
700 E. Firmin, Kokomo, Ind. 46901
(317) 459-2175

Delco Electronics



Division of General Motors



We think our data terminal system is so good nothing even comes close.

In fact, we believe the Teletype® model 40 system is so good it'll change the way business looks at data. We're that sure it's that good.

Here's why:

It's a complete, versatile, reliable terminal system delivering maximum efficiency in a wide range of applications. From message communications to computer input/output on switched network or private-line systems. Right now, the model 40 system is being used by airlines, news services, brokerage firms, manufacturers, law enforcement agencies and time-sharing services.

Significant features of the system are speed, ease of data preparation and editing, compactness and extremely low maintenance. And since the model 40 is completely modular, you can forget about obsolescence.

It's designed to grow as your needs grow.

Data is presented with extreme clarity on the big, 13-inch screen. Characters are 35 percent larger than standard print size and are formed on a 7 x 9 dot matrix. Screen capacity is 24 lines of 80 characters each for a total of 1,920.

Teletype's exclusive solid-state design makes the model 40's fast (up to 2400 wpm), heavy-duty impact printer the most cost-effective unit on the market. Its simplicity of design makes it one of the most reliable printers we've ever made. And after more than 60 years experience building printers that set the standards for reliability, that's saying something.

It took a total corporate commitment to come up with something as good as the model 40. For example, we had to develop and manufacture our own MOS. It didn't come easy, but we think it's worth it. Because the solid-state components throughout the system deliver exceptionally high reliability.

And the self-diagnostic circuitry and design modularity significantly reduce downtime and maintenance costs.

Operator comfort and efficiency are increased by human-engineering efforts like a brightness control and screen tilt, plus a glare-reducing display tube and an easy to operate keyboard.

The Teletype model 40 data terminal system.

It's every bit as good as you've heard. And probably even better.

For complete technical data, please contact our Sales Headquarters at

5555 Touhy Avenue, Skokie, Illinois 60076.

Or call TERMINAL CENTRAL at (312) 982-2000.

Teletype is a trademark registered in the United States Patent Office



The Teletype model 40 system.

Save Space. Save Weight. Increase Reliability.

Paralleling transistors doesn't pay —not when an inherently rugged single device can do the job far more reliably, using much less space, weight, and at lower total system cost. That's why PowerTech's unique single-chip NPN silicon high-power transistor is the one way to go.

Used alone, our space-saving single-chip device eliminates multiple failure sources while reducing the environmental testing costs inherent in parallel arrays. Because of their simplicity they're available off-the-shelf—pre-rated, pre-tested and inventoried to meet virtually any hi-rel JAN and JAN-TX hi-current requirements without custom prices and long

custom waits. For information, application assistance, and free design guide call Sales Engineering, PowerTech, Inc., 9 Baker Court, Clifton, N.J. 07011; (201) 478-6205.

Type #	(pk.) I_c	V_{ce0}	($h_{fe} = 10$) $V_{ce} \text{ (sat) @ } I_c$
JAN-TX 2N5926	90A	120V	0.6V @ 50A
PT-7511	90A	200V	0.6V @ 50A
JAN-TX 2N5927	120A	120V	0.6V @ 70A
PT-6502	200A	80V	0.7V @ 100A
PT-9502*	500A	80V	0.5V @ 300A

350 Watt Power Rating
*625 Watt Power Rating
Guaranteed SOAR

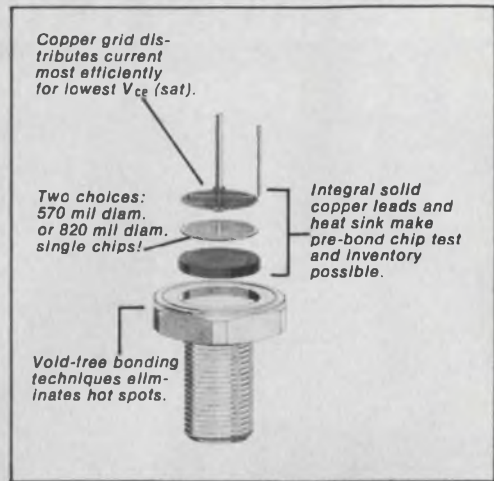

TO UNPARALLEL IS TO SAVE:

Silicon transistors
to 500 amps with
lowest $V_{ce} \text{ (sat)}$



PowerTech, Inc.
"BIG IDEAS IN
BIG POWER"

Everything you need to know about electronics to be called:

“THE MAN WITH THE ANSWERS”

Win a reputation for accuracy and reliability! Have the right answers fast. Each volume is a library in itself . . . each helps you work quickly, confidently, more efficiently! And each is yours to examine free!



SAVE MONEY—ORDER IN ADVANCE OF PUBLICATION...



- Over 1,200 pages
- Nearly 1,400 illustrations
- Large, easy-to-read type
- Over 40 pages of index

REFERENCE DATA FOR RADIO ENGINEERS

The favorite reference for electronics engineers and teachers of many nations. Over 450,000 copies have been sold. Now, an updated and expanded 6th edition has been prepared — the most complete of its kind. Order your copy today and save \$5.

With this volume, you'll save time and trouble, too. Features major new additions on *semiconductors & transistors, micro-miniature electronics, radio noise and interference, navigation, filters, optoelectronics, optical communications, electro-acoustics, and more.*

Regular price \$30 — now yours for only \$25! (\$5 savings)

RADIO HANDBOOK

It's the standard reference of the radio world: the leading independent authority on amateur radio hf and vhf communication. Use it to look up facts — set up circuits — or design and build the latest types of equipment.

Completely updated, this 20th edition covers *every* phase of radio operation and construction. Features *semiconductor and IC-circuit design, amateur television, moon-bounce and satellite communication.* Some new construction projects are a high-performance solid-state receiver and linear amplifier using the new ceramic power triodes.

Regular price \$19.50. Now just \$17.50! (\$2 savings)



- Over 1,000 pages
- Hundreds of drawings and photographs
- Large, easy-to-read type
- Thoroughly indexed

MODERN DICTIONARY OF ELECTRONICS

Your key to 18,500 terms and symbols. With this complete reference, no electronics book should baffle you. Also features terms in communications, microelectronics, fiberoptics, semiconductors, reliability, computers, and medical electronics. 688 pages. \$15.50

HANDBOOK OF ELECTRONIC TABLES & FORMULAS

This is one book everyone involved in electronics should own. Here are all the charts, tables, formulas, symbols, and standards used in electronics. Includes a colorful foldout chart showing FCC radio and TV frequencies. 264 pages. \$7.95

AUDIO CYCLOPEDIA

The world's most comprehensive audio reference — ranging from *Basic Principles of Sound to Installation Techniques.*

Question-and-answer format helps you understand concepts, equipment, and the latest solid-state and IC audio technology. Find answers in seconds. 1,760 pages. \$34.00

IC OP-AMP COOKBOOK

The new, comprehensive guide to IC OP-AMPS. Covers not only the basic theory in great detail, but also includes over 250 practical applications. An all-encompassing “cookbook” of useful circuits. 592 pages. \$12.95



Howard W. Sams & Co., Inc.

MAIL TODAY FOR 15-DAY FREE TRIAL

YES—send me the book(s) checked below to examine for 15 days *free*. If not completely satisfied, I may return my order and owe absolutely nothing. Otherwise, for the amount shown, plus shipping and handling (and sales tax if applicable), it's mine to keep and use permanently.

- | | |
|---|--|
| <input type="checkbox"/> REFERENCE DATA FOR RADIO ENGINEERS 21218 \$25.00 (\$5 savings) | <input type="checkbox"/> RADIO HANDBOOK 24032 \$17.50 (\$2 savings) |
| <input type="checkbox"/> AUDIO CYCLOPEDIA 20675 \$34.00 | <input type="checkbox"/> HANDBOOK OF ELECTRONIC TABLES & FORMULAS 20982 \$7.95 |
| <input type="checkbox"/> MODERN DICTIONARY OF ELECTRONICS 20852 \$15.50 | <input type="checkbox"/> IC OP-AMP COOKBOOK 20969 \$12.95 |

NAME _____ (please print)

COMPANY _____

ADDRESS _____

CITY _____ STATE _____ ZIP _____

BILL MY COMPANY BILL ME

MAIL TO: Howard W. Sams & Co., Inc./4300 West 62nd Street/ TH11A
Indianapolis, Indiana 46206.

(Pre-publication offer expires December 31, 1975)

INFORMATION RETRIEVAL NUMBER 10

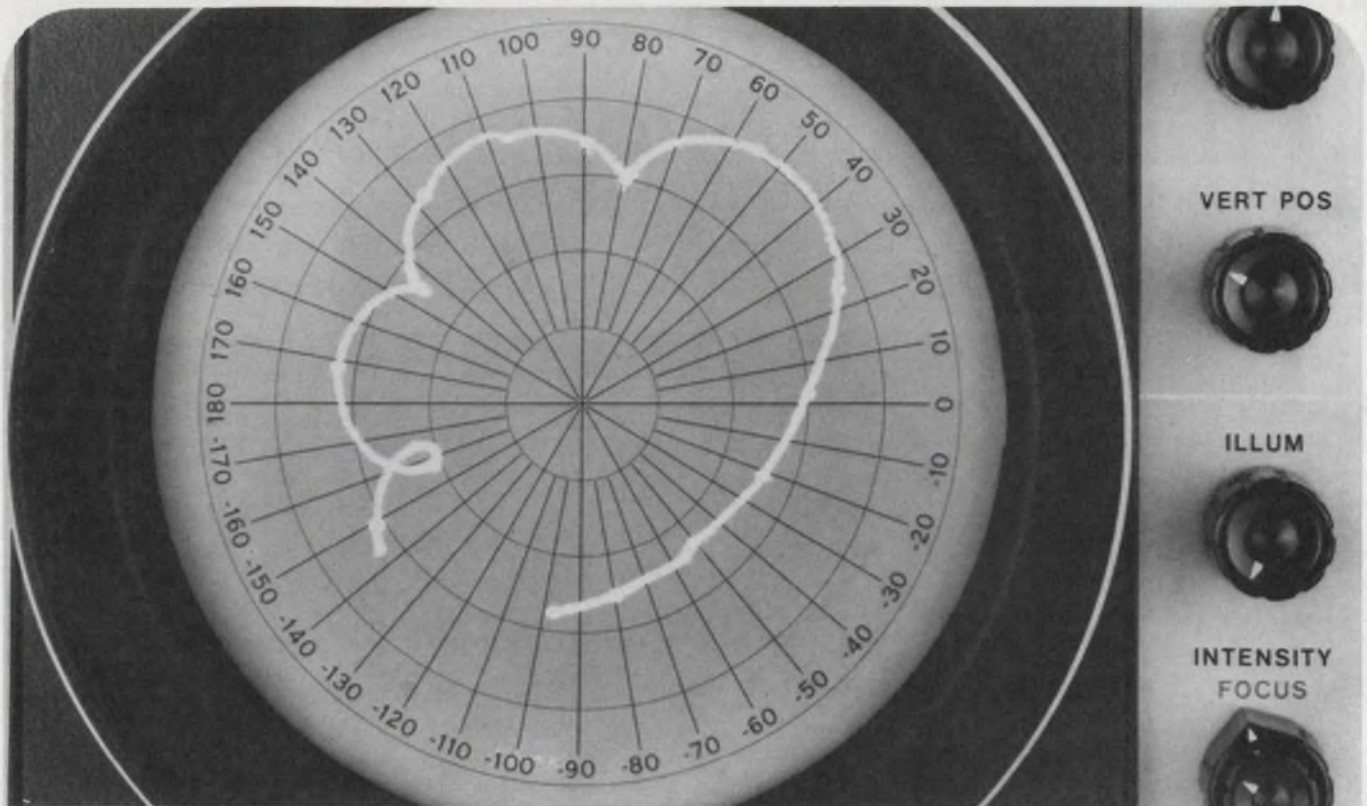

Reflection (s_{11}) of broadband transformer, 200-1000 MHz, with 50 MHz frequency markers.

Here's the way to make multi-octave RF and microwave vector measurements.

A total system that now lets you make broadband swept measurements of magnitude and phase from 100 to 2400 MHz or from 2 to 18 GHz in one continuous sweep.



The familiar HP 8410 Network Analyzer now has automatic tuning to track the wide sweeps of the HP 8620A sweeper with its new broadband plug-ins.

Sweep 2-18 GHz with the HP 86290A plug-in and 100-2400 MHz with the new HP 86222A/B. The HP 86222B adds unique digitally-processed birdie markers for precise frequency identification.

Why not find out more about this complete high-frequency vector system? All the details are yours by calling your nearby HP field engineer, or writing.

HEWLETT  PACKARD

Sales and service from 172 offices in 65 countries.
1501 Page Mill Road, Palo Alto, California 94304

A new low for on-board programming.

AMP introduced the DIP switch to solid-state electronics. Now we've gone still further. AMP's new *low-profile* DIP switches are as low as you can get. You can use them to program ICS right-on-the-board without remote wiring. And sandwich boards in less space, to cut packaging costs.

With our new, low-profile DIP switches, cleaning boards is easier than ever. Simply place our protective covers or pieces of tape on the switches and you can clean complete boards without damage.

We're the people who developed and perfected DIP switches—a whole family of them—including our innovative, pluggable Hexadecimal Rotary Switch. Our experience is broader and deeper than anyone's. At AMP we'll have the right answers for your applications.

Bright new lights.

Unique LED DIP switches are available in SPST "on" or "off" as well as momentary-contact types. They permit rapid, visual circuit test, fault indication and programing verification. Plus, for the first time, they permit DIP packaging of LEDs.

Rockers are detented to avoid accidental actuation. Switch leads and LED leads are terminated independently for circuit connection versatility.

There's nothing quite like new AMP LED DIP switches. For more details on them, or the new AMP low-profile DIP switches, call (717) 564-0100. Or write AMP Incorporated, Harrisburg, PA 17105.

AMP is a trademark of AMP Incorporated.

AMP

INCORPORATED

Intel is the way to

You can go into production of higher density memory systems confidently now that Intel's new 2104 16-pin, 4096-bit dynamic RAM is in stock at Intel distributors, and readily available in OEM quantities.

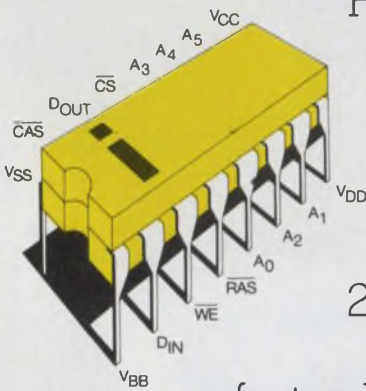

We are mass producing the 2104 on the same fabrication lines and with the same silicon gate n-channel MOS process as the industry standard 2107B 22-pin 4K RAM.

Intel's 16-pin RAM assures you fast, reliable parts as well as delivery in

volume. The Intel 2104 is based on the proven single-transistor cell design of the Intel 2107B, the highest performance 22-pin 4K MOS RAM. Like the 2107B, the 2104 chip is much smaller than other 4K RAM chips produced today.

The fastest available 16-pin 4K RAMs are also in the 2104 series. Our 2104-2 guarantees an access time of only 250 nanoseconds and a cycle time of 375 nanoseconds over the full

INTEL'S STANDARD 4K RAM FAMILY				
Part Number	Pins	Max. Access Time (ns), 0-70°C	Min. Cycle Time (ns), 0-70°C	
			Read or write	Read modify write
D2104-2	16	250	375	515
D2104-4	16	300	425	595
D2104	16	350	500	700
2107B	22	200	400	520
2107B-2	22	220	470	680
2107B-4	22	270	470	590
2107B-6	22	350	800	960

0 to 70°C operating temperature range.

To keep system costs low, the 2104 operates on standard -5, +5 and +12V power supplies, and TTL I/O levels. All inputs including clock

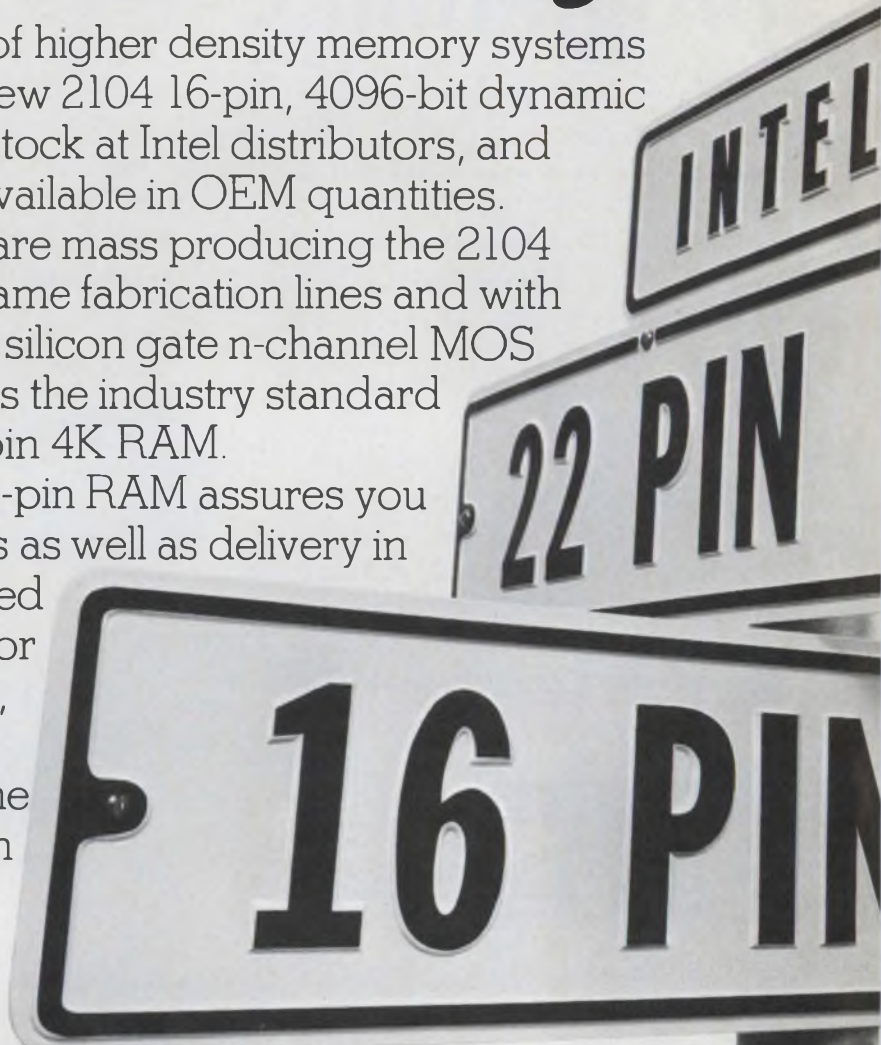

go for 4K RAMs.

inputs are fully TTL compatible.

Overall system advantages of the 2104 are detailed in a new application brief, "Which Way for 4K... 16, 18, or 22 Pin?" It explains why the 16-pin 2104 is best for very compact systems such as minicomputers, microcomputers, terminals, business equipment, scientific calculators and anywhere high density is needed.

Moreover, we show how the 16-pin standard is compatible with the next generation of even higher density memories. The application brief also tells why the 2107B's simple, straightforward 22-pin design has become an industry standard for computer main memories and many other applications.

Now the industry has two standard configurations—16 pins with multiplexed addresses and 22 pins with parallel addresses. Which-ever way you go, you'll find Intel ready to support both in volume production. For delivery of the 2104 or 2107B contact our franchised distributors: Almac/Stroum, Component Specialties, Cramer, Elmar, Hamilton/Avnet, Industrial Components, Liberty, Pioneer, Sheridan or L.A. Varah.

For your copy of "Which Way for 4K..." or data sheets on any of our 4K RAMs write: Intel Corporation, 3065 Bowers Avenue, Santa Clara, California 95051.

intel® delivers.

INFORMATION RETRIEVAL NUMBER 13

Tomorrow ideas today.



Using solid-state technology to replace bulky tube-type equipment, ENI's broadband amplifiers are tomorrow ideas available today.

ENI's Class A power amplifiers already cover the frequency spectrum of 10 kHz to 1 GHz, with power outputs ranging from 300 milliwatts to over 4000 watts. And we're still climbing.

Driven by any signal generator, frequency synthesizer or sweeper, ENI's compact portable amplifiers are completely broadband and untuned. Amplifying inputs of AM, FM, SSB, TV and pulse modulations with minimum distortion, these rugged units are

versatile power sources for general laboratory work, RFI/EMI testing, signal distribution, RF transmission, laser modulation, data transmission, NMR, ultrasonics and more.

Designed to be unconditionally stable and failsafe (impervious to severe load conditions including open or short circuit loads), ENI power amplifiers will deliver their rated power to any load, regardless of match.

For information write: ENI, 3000 Winton Rd. So., Rochester, New York 14623. Call 716-473-6900. TELEX 97-8283 ENI ROC.

ENI

World's Leader in Solid State Power Amplifiers

INFORMATION RETRIEVAL NUMBER 14

NOVEMBER 8, 1975

Microcomputers giving rise to new medical instruments

A new class of mass-producible, intelligent medical diagnostic instrumentation incorporating microcomputers will be developed at the Massachusetts Institute of Technology to overcome the limitations of computer-based medical research systems now used.

Expected advantages of the new approach include the following:

- Substantially lower cost.
- Much smaller instrument sizes, suitable for use in a clinical setting rather than only in a research laboratory.
- Simplified operation, with the microprocessor taking over the monitoring of medical diagnostic tests and routines.
- Data processing in real time and with simplified presentation, so that highly skilled medical researchers or computer personnel are not needed to interpret the results.

The work at MIT will be performed in the Core Microprocessor Engineering Laboratory as part of a new program administered by the Biomedical Engineering Center for Clinical Instrumentation. The center is being established by the joint Harvard-MIT Program in Health Sciences and Technology with the help of a Federal grant of \$1,016,439.

The center's first research projects will be the design, development and testing of four basic types of instruments: (1) A computerized monitor for detection of irregular heartbeats; (2) Equipment and techniques for the diagnosis of causes of dizziness and disequilibrium; (3) Instrumentation for collecting and processing respiratory-function data for the study of dynamic events found in asthma victims; and (4) A probe for the measurement of blood flow through tissues to monitor patients during surgery.

The center will be under the direction of Roger G. Mark, M.D., Ph.D., associate professor of electrical engineering in the MIT Dept. of Electrical Engineering and Computer Science. He also is assistant professor of medicine at the Harvard Medical School and director of the Biomedical Engineering Dept. at Beth Israel Hospital in Boston.

Dr. Mark will direct the work of developing a wearable, computerized device that can monitor, identify and evaluate heartbeat irregularities in ambulatory patients. If the beat indicates failure, the device will give a warning.

Dr. Laurence R. Young, professor of aeronautics and astronautics at MIT, heads the project on instrumentation for diagnosing dizziness and vestibular instability. He sums up his approach, which is representative of the over-all program this way:

"The problem is that current methods of diagnosis are clumsy, difficult for the doctor, uncomfortable for the patient, and require specialized equipment that is usually not available in a clinic.

"Our objective is to take a number of test conditions that are used to evaluate dizziness—this requires measurement and analysis of nystagmus, which is an arhythmic movement of the eyes when a subject is rotated or if his balance is upset—and put the instrumentation into a single, usable package for the clinician.

"The next step will be to take computer programs for analysis of this nystagmus and reduce them to the level of hard-wired programs on a microprocessor."

The advantages of reducing this system to a μ P-based instrument are lower cost and smaller size. In addition, Young says, you'll have a dedicated machine that a medical

technician can use and that does not require a knowledge of software and programming.

Hand-held control unit to monitor artillery

A new hand-held control system that will automatically monitor artillery and ultimately provide correction data for a target is under development at the Army's Picatinny Arsenal in Dover, NJ.

The new device, still in the development stage, will look like a hand-held calculator and will contain a radio to receive firing data transmitted by transducers on a piece of artillery.

According to Dan Ramer, an engineer at the arsenal, the prototype is being built with a MOS Technology two-chip calculator set. The final product, however, will probably use a CMOS microprocessor, he says. The unit, Ramer explains, will use Schottky logic to provide a 100-MHz capability, while all the rest of the circuitry will be CMOS.

To achieve maximum battery life, circuitry that is not in use is automatically disconnected. The unit contains a ROM that holds 256 program steps. This eliminates the need for any sort of programming by the user. Specific calculated data as to shell velocity and acceleration, recoil velocity of the artillery and orientation with respect to gravity are read out on a digital display when the appropriate button is pressed.

The initial unit will only read out these individual parameters, but Ramer says there is no reason why a little extra programming can't be done to have the device read out corrected coordinates for a target.

The transducers for this system, Ramer reports, will be mounted in a removable collar that can be quickly attached to any piece of artillery. The telemetry equipment will be self-powered.

Ramer notes that either the heat, pressure or physical movement of the weapon when fired will be used to generate electricity to power the transducers and transmitter. Final units should go into production in about a year, he says.

Laser-TV bomb sight likely to raise accuracy

Day and night bombing accuracy by Marine Corps aircraft is expected to improve significantly with a new angular-rate bombing system being built at Hughes Aircraft, Canoga Park, CA. Unlike most current bombing systems, neither measurement of range to the target nor inertial quality platform inputs are required.

The bombing unit uses a combination laser and TV system that automatically acquires the ground target and immediately begins to track on the aircraft's first pass over the target.

According to Richard Furtaw, program manager at Hughes: "The unit is basically a simple angular-rate system. The tracker, after locking on a target, provides the aircraft-to-target line-of-sight angle and angle rate to the weapon-delivery computer. This information, combined with the true airspeed and altitude, is processed by the computer yielding the weapon delivery solution."

Target position, weapon release and azimuth-steering information are displayed to the pilot on a head-up display.

Furtaw notes that the dual-mode laser-TV tracker is the heart of the system. A television tracker shares a common optical system with a laser spot tracker. A dichroic filter behind the optics separates the laser energy from the visible light for sensing by a four-quadrant laser detector.

A portable radar set to survey battlefields

A hand-held battlefield surveillance radar being developed for the Marine Corps to detect both personnel and vehicles is so light (10 pounds) and inexpensive (a tenth the cost of existing units) that it's also being considered for other military and civilian applications.

Under development for about four years by the Naval Electronics Laboratory Center, San Diego, the X-band, solid-state transceiver was developed by Rockwell International's Autonetics Div. and the antenna by the company's Missile Systems Div. both in Anaheim.

The reason for the cost reduction, the Navy says, is that it does not require the diode or ferrite phase shifter for each array element that existing radars do.

The unit is designed to use an electronic scan antenna with 26 elements and two ferrite analog circuits to provide ± 45 -degree coverage. The antenna provides a six-by-six degree beamwidth at 9 GHz, with sidelobes down to 18 to 20 dB. It will weigh about two pounds and will have a beam control power of about 0.5 W.

The X-band transmitter signal is derived from an S-band source, quadrupled and biphase-coded. The resulting signal is applied to an Impatt diode.

The main purpose of using this technique, Navy Laboratory engineers say, is to achieve a more efficient power source and to increase the power output. They predict a transmitter efficiency of 8%—an increase of an order of magnitude over present battlefield surveillance radars. The average power, they estimate, will be 2.5 W, which represents a 20-dB gain over that of conventional units.

The primary advantages of using fiber optics for remote control capability are low weight, RFI/EMI immunity, and wide bandwidth capability. The predicted weight for 50 m of a four-channel fiber optics cable is about one pound.

Hitachi cites advance in optical IC work

Continuous-wave, room-temperature operation of a new distributed feedback semiconductor laser—reported by Hitachi in Japan—promises to bring a practical optical IC system a step closer.

Room-temperature operation eliminates the need for cooling and simplifies substantially the interface between the distributed feedback gallium-arsenide-phosphide devices and OIC elements. Also, it is possible to integrate several of these distributed feedback lasers—each with a different wavelength—in one element. As a result, a number of independently modulated laser beams can be easily generated and sent through a single optical fiber.

With the distributed feedback device, the optical resonation necessary for lasing action is obtained by use of an internal grating structure instead of the mirror surfaces found in regular semiconductor lasers.

This grating structure, according to M. Nakamura, K. Aiki and J. Umeda, researchers at Hitachi's Central Research Laboratory in Tokyo, produces radiation of substantially purer spectral quality and better modal control than that of the conventional lasers.

Data General builds its own MOS chip

Overshadowing Data General's recent introduction of its Nova 3 OEM minicomputer family was the announcement that the machine's memory module would contain a dynamic n-channel, 4096-bit MOS RAM chip manufactured by Data General in Sunnyvale, CA.

It's believed to be the first time a small computer firm has extended in-house manufacture of computer parts down to the level of complex MOS devices.

"The use of in-house manufactured chips," says Donald McDougall, Nova 3 marketing manager, "allowed the chip to be designed with close interaction between our semiconductor specialists and Nova 3 system engineers. This resulted in the best over-all RAM/memory design that could be developed for these computers."

An alternate memory board will be available using MOS parts supplied by Texas Instruments.

The four-slot Nova 3/4 and 12-slot Nova 3/12 are available with core memory in 8-k and 16-k-word increments, or MOS semiconductor memory in 4-k, 8-k or 16-k-word increments.

The new computers feature main memory expansion up to 128-k words, an extended data channel and 16-level priority interrupt structure.

Memory cycle speeds are 700 ns for MOS memory, 800 ns for 8-k word core and 1000 ns for 16-k core.

McDougall notes that at the low end of the OEM market, the Nova 3 challenges microcomputers in a number of applications.

.05 MHz
to
3 GHz
(+17dBm LO)

HIGH-LEVEL

Double Balanced Mixers

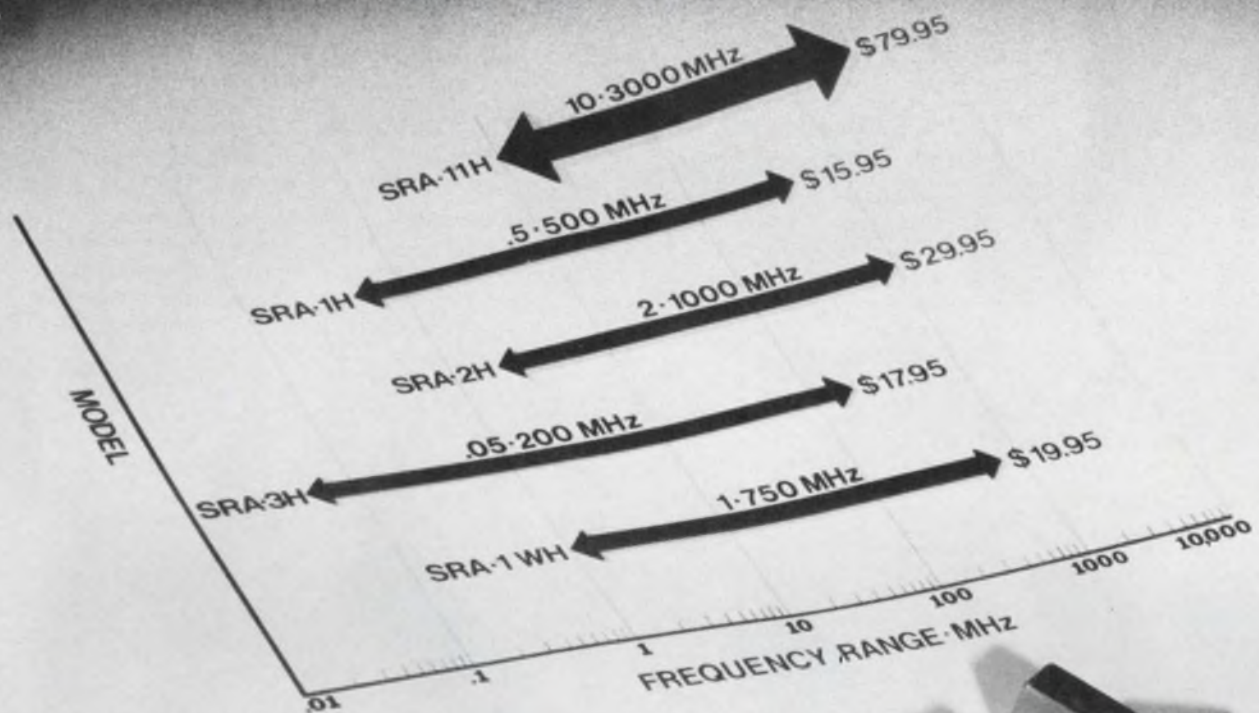

Model	Frequency Range (MHz)	Conversion loss (dB) Total Range	Isolation, dB						Price Quant.
			Lower band edge to one decade higher		Mid range		Upper band edge to one octave lower		
			LO-RF	LO-IF	LO-RF	LO-IF	LO-RF	LO-IF	
SRA-11H	RF, LO-10-3000 IF - DC-1000	9.5 typ. 12 max.	27 typ. 20 min.	27 typ. 20 min.	25 typ. 18 min.	25 typ. 18 min.	23 typ. 16 min.	23 typ. 16 min.	\$79.95 (1-24)
SRA-1H	RF, LO-5-500 IF - DC-500	6.5 typ. 8.5 max.	55 typ. 45 min.	45 typ. 35 min.	45 typ. 30 min.	40 typ. 30 min.	35 typ. 25 min.	30 typ. 20 min.	\$15.95 (5-24)
SRA-2H	RF, LO-2-1000 IF - DC-1000	7.5 typ. 9.5 max.	50 typ. 40 min.	45 typ. 35 min.	45 typ. 25 min.	40 typ. 25 min.	35 typ. 25 min.	25 typ. 20 min.	\$29.95 (4-24)
SRA-3H	RF, LO-.05-200 IF - DC-200	5.5 typ. 7.5 max.	55 typ. 45 min.	45 typ. 35 min.	45 typ. 30 min.	40 typ. 30 min.	35 typ. 25 min.	30 typ. 20 min.	\$17.95 (5-24)
SRA-1WH	RF, LO-1-750 IF - DC-750	5.5 typ. 7.5 max.	50 typ. 40 min.	45 typ. 35 min.	45 typ. 25 min.	40 typ. 25 min.	35 typ. 25 min.	30 typ. 20 min.	\$19.95 (5-24)

Conversion compression: 1 dB at +10 dBm rf input

World's largest supplier of double balanced mixers

Mini-Circuits Laboratory
A Division Scientific Components Corp

837-843 Utica Avenue, Brooklyn, NY 11203

(212) 342-2500 Int'l Telex 620156 Domestic Telex 125460

International Representatives: AUSTRALIA General Electronic Services, 99 Alexander Street, New South Wales, Australia 2065; ENGLAND Dale Electronics, Dale House, Wharf Road, Frimley Green, Camberley Surrey; FRANCE S. C. I. E. - D. I. M. E. S., 31 Rue George - Sand, 91120 Palaiseau, France; GERMANY, AUSTRIA, SWITZERLAND Industrial Electronics GMBH, Klüberstrasse 14, 6000 Frankfurt/Main, Germany; ISRAEL Vectronics, Ltd., 69 Gordon Street, Tel-Aviv, Israel; JAPAN Denso Kaisha, Ltd., Eguchi Building, 8-1-1 Chome Hamamatsucho Minato-ku, Tokyo; EASTERN CANADA B. D. Hummel, 2224 Maynard Avenue, Utica, NY 13502 (315) 736-7821; NETHERLANDS, BELGIUM, LUXEMBOURG: Coimex, Velweg 11, Hattem, Holland.

US Distributors: NORTHERN CALIFORNIA Cain-White & Co., Foothill Office Center, 105 Fremont Avenue, Los Altos, CA 94022 (415) 948-6533; SOUTHERN CALIFORNIA, ARIZONA Crown Electronics, 11440 Collins Street, No. Hollywood, CA 91601 (213) 877-3550

INFORMATION RETRIEVAL NUMBER 15

Good news from Hughes
for circuit designers
bogged down in SSI/MSI:

Now you can get these popular high-density CMOS/LSI circuits off the shelf.

4-Decade Counters

Three CMOS units to choose from:

- 2 MHz, up/down, BCD outputs (HCTR4010)
- 1 MHz, BCD outputs, 16-pin package (HCTR6010)
- 5 MHz, presettable, 7-segment outputs (HCTR0154)



Reader Service No. 271

CMOS Decade Counter/ Latch/Decoder/Driver

(HCTR0200)

- Up/down, 2 MHz, 5V operation
- 7-segment output compatible with LED and LCD
- Units may be cascaded



Reader Service No. 272

CMOS Programmable Logic Array

(HPLA0174)

- 1 MHz with 5V supply
- 19 inputs, 16 outputs
- 12 on-chip DFFs,
- 70 product terms



Reader Service No. 273

CMOS LED/LCD Watch Chips

- 32 KHz crystal oscillator
- Hours, minutes, seconds, date
- Low power, AM indicator
- De-bounced set inputs



Reader Service No. 274

Our business is making advanced MOS/LSI devices. Mostly they're custom circuits, but we also produce designs that have wide-spread application as standard parts.

We're now offering some of our standard devices to circuit designers still burdened with SSI and MSI circuits — to save space, power, cost and time, and a lot of headaches.

Look over these proved-and-packaged circuits and let us know which ones fit your particular needs. We'll send you specs, prices and delivery information.

Need custom MOS designs? We've developed a systematic design procedure for handling any custom MOS project, from simple logic to large scale systems. And we have the comprehensive manufacturing and automated testing facilities to complete the production cycle. (Our new brochure offered



Reader Service No. 275

here tells how it works.) Use our extensive experience in MOS/LSI circuits to meet unusual requirements such as wide supply variations, high speed, ultra low power, differential amplifier input, RC oscillator and crystal oscillator.

For more information, use the handy reader service number shown under each product group, or contact Hughes Microelectronic Products Division, 500 Superior Avenue, Newport Beach, California 92663. (714) 548-0671, Ext. 346.

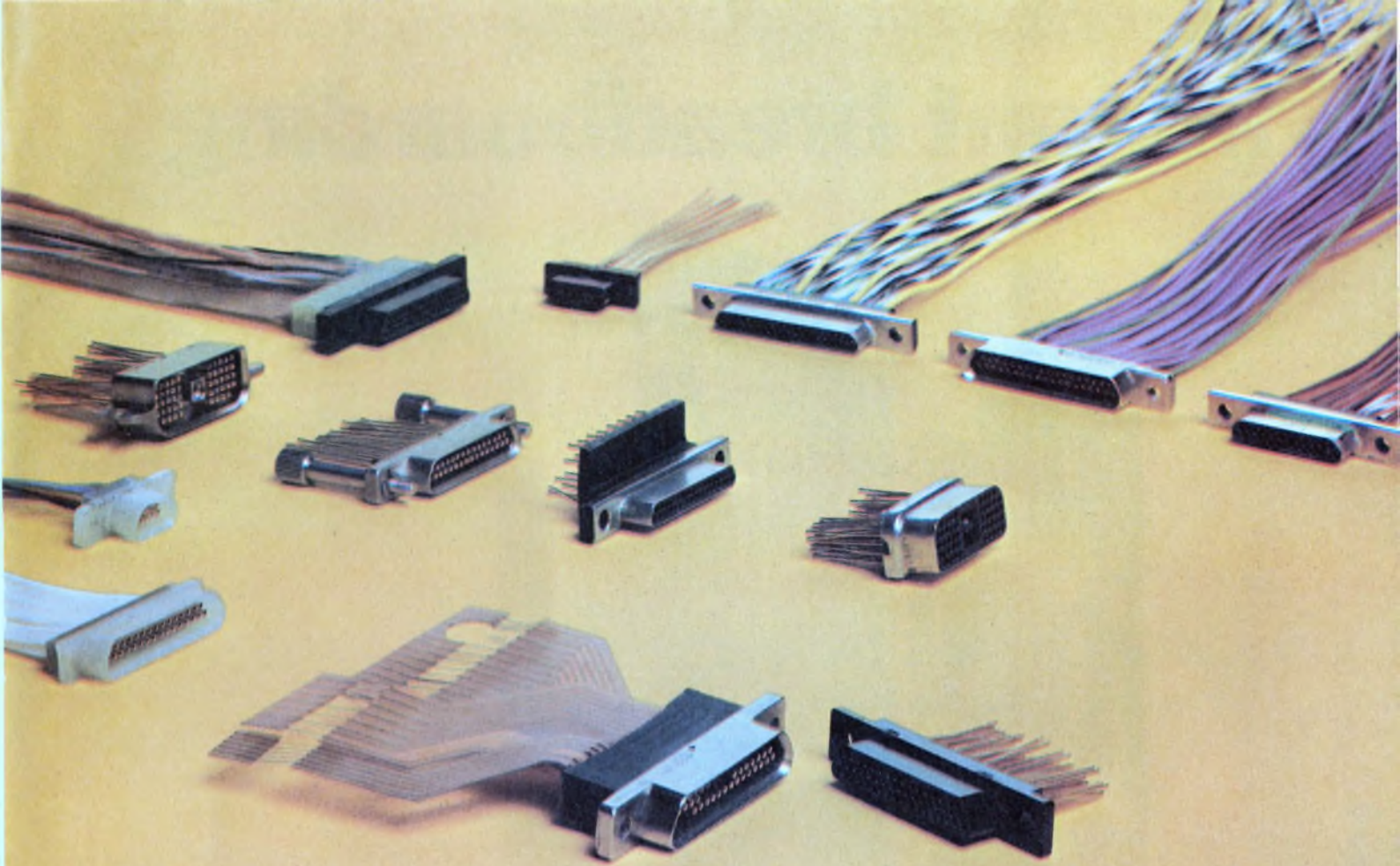

Malco Rectangulars... they'll help you out in a tight spot.

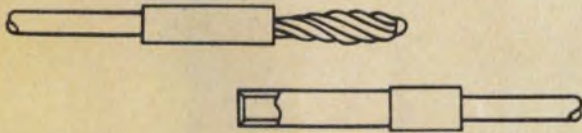

Twist/Con™ 22/24 pins and sockets. In the Twist/Con system, the male contact is constructed of seven strands of spring copper alloy wire wound helically around an inner core of three copper alloy strands. This creates a breathing helical spring so that contact is made at many points around the periphery of the pin bundle instead of a few discrete points as in conventional design.

- Material: Copper Alloy
- Plating: .000050" Gold over Copper Flash per MIL-G-45204, Type II
- Rating: 5 amps for 22 pins, 3 amps for 24 pins.
- Contact Resistance: .008 ohms max.

If you've never looked at Malco, look now. Malco offers a complete line of rectangulars including some of the smallest high-density connectors available . . . to help meet your tightest packaging requirements. Like our MCDM 1 Micromate.™ Only Malco gives you a metal shell connector like this one with as many as 184 straight-through connections, centers as small as .050" and very little weight.

Whether you're designing with conventional wire, coax, flat cable or ribbon-cable, Malco has the rectangulars you can plug into your circuitry—all with the Twist/Con™ high reliability contact system. And if you ever need help getting out of a tight squeeze, you can depend on Malco for a custom engineered rescue operation. Malco—the only contact you need for all your connectors. Write today: 12 Progress Drive, Montgomeryville, Pennsylvania 18936 or call our South Pasadena facility (213) 682-3351 for price and delivery.



Instant breadboarding



Takes the tedium from microcomputer systems design

"Donkey Work" in microcomputer systems development seems endless. It doesn't have to be! With Motorola's M6800 Family and an EXORciser*, that wasteful tedium is no longer necessary.

EXORciser configuration as a prototype of a unique M6800 system is fast and simple using standard production board options. That's instant breadboarding. It's in the M6800 tradition of simplifying and accelerating the design job. But, instant breadboarding is only one of the key functions of this triple-threat design development tool.

The EXORciser also is used to edit and assemble source programs, and its very name is derived from the functions of debugging, exorcising, and evaluating M6800 system designs in real-time.

It's both the complete system emulation tool and the debug system, too. Two systems in one. Emulation of the user system within the EXORciser chassis is achieved with the use of optional memory and I/O modules. With an external system, connect its bus as

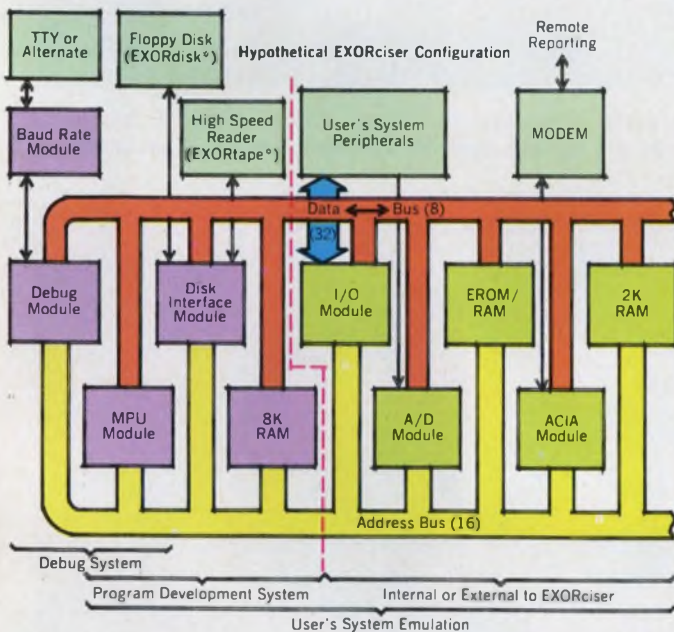

an extension of the EXORciser bus, and timeshare the EXORciser's MPU.

The basic machine consists of MPU, Debug and Baud Rate Modules, with chassis and power supply. Flexibility is enhanced by options for altering memory and I/O, the 2K Static RAM, 8K Dynamic RAM, Input/Output and ACIA modules. EXORciser options also include extender and wirewrap modules, flat ribbon interconnect cable, and battery backup.

There's a full range of M6800 support software and hardware

Support Software. M6800 software meets nearly any need. It's available on commercial timesharing from G.E.,



U.C.S. and Motorola Time-sharing.

Custom and host computer software are available, and so is a full complement of M6800 Resident Software.

Evaluation Modules. Certainly the EXORciser is the ultimate M6800 system development tool, but many designers may prefer to first evaluate the operating characteristics of the various M6800 Family devices with one of several evaluation module options. These include a bare board, a completely assembled and tested module, and the same version with an 8K Dynamic RAM module plus resident software.

Support Peripherals. Other systems development tools supplement EXORciser capabilities. The EXORdisk* floppy disk unit and EXORTape* high speed tape reader are available. More items are being added.

For complete story on Motorola's M6800 support hardware and software, use the reader service number or write to Motorola Semiconductor Products Inc., P.O. Box 20912, Phoenix, AZ 85036. Any Motorola sales office or authorized Motorola distributor can handle your questions and your order.

*Trademarks of Motorola Inc.



MOTOROLA M6800
Benchmark family for microcomputer systems.

Smaller, cheaper passive chips spurring hybrid-circuit advances

As hybrid circuit manufacturers reach for more complexity in their designs, impressive advances in individual chip components are turning their ideas into reality.

Capacitors, inductors and resistors are getting smaller and smaller. Component costs also are dropping. And—how lucky can you get?—ranges are being extended.

Chip capacitors are now available with values from 1 pF to well over 200 μ F in chip sizes from 30 mils square by 5 mils thick to 250 mils square by 100 mils thick.

Inductors are being offered with values from 1 nH to over 10 mH in both fixed and variable types, while sizes start at 50 \times 80 \times 25 mils and increase to over 250 \times 250 \times 200 mils.

Chip resistors and resistor networks come with values from 1 Ω to 10^{12} Ω , while tracking capabilities are to within 1 ppm/ $^{\circ}$ C.

There are now three major families of chip capacitors: monolithic ceramic, tantalum and MOS. Inductors can be broken down into two families: deposited and wound. And for resistors, there are thin-film and thick-film types.

Within each of these areas, manufacturers are developing new ways to lower costs, extend the value range and shrink the size. For instance:

- New materials and processes for monolithic ceramics promise to cut costs up to 50% by eliminating the use of precious metals and replacing them with base metals.

- Thinner dielectrics will permit a fourfold increase of capacitance per unit volume.

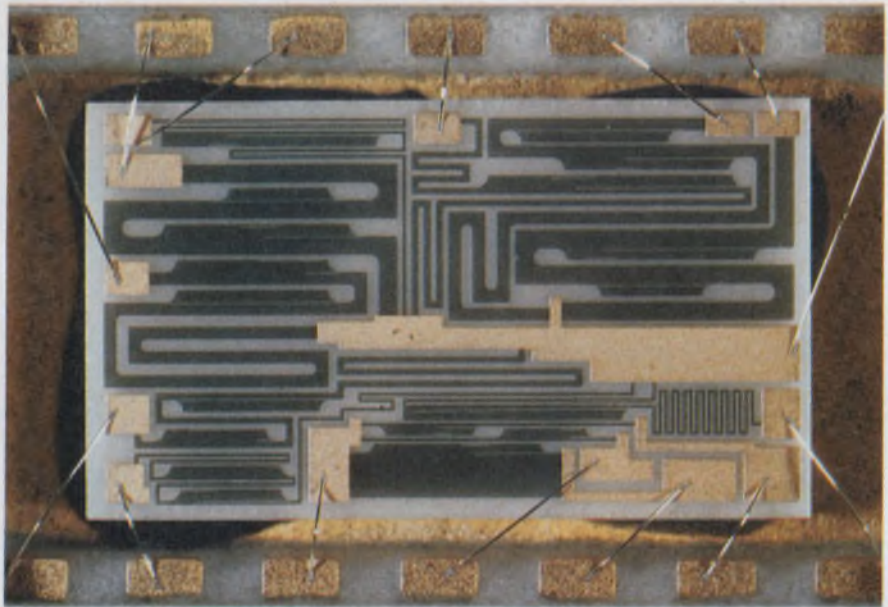

Thin-film resistor networks, deposited on either silicon chips or ceramics, made by Analog Devices are coming down in cost when used in high volumes.



Ceramic chip capacitors in various sizes, including these from USCC/Centrolab, range in value from 0.1pF to over 200 μ F. Ratings are from 4 to 200 V.

Dave Bursky
Associate Editor

- Better packages for tantalum capacitors promise to eliminate reliability problems of the T-bar construction.

- New mounting methods are permitting low-cost thermal compression bonding instead of reflow soldering or conductive epoxy.

- More use of machine operations is expected to cut the cost of chip inductors by up to 75%.

- Increasing use of laser trimming in thin-film networks is making possible tight-tolerance applications.

- Automated processing is expected to cut the cost of thin films by over 50% in the next few years.

Base-metal cuts ceramic costs

Ceramic chip manufacturers have had problems with the rising cost of precious metals. USCC/Centralab, though, has done something about it. The company has developed monolithic ceramic capacitors that use a base metal compound for the electrodes. This makes them 30 to 50% cheaper than ceramic types that use precious metals. In 5000-piece lots for a 0.1- μ F capacitor, the new capacitors sell for less than 10 cents each.

USCC/Centralab, Union Carbide, AVX, Sprague, Centre Engineering and other companies predict that new and thinner dielectric materials will permit higher capacitance per unit volume. More capacitance without an increase in package size will be a reality within the next year.

Ceramic chip manufacturers offer various termination styles designed for reflow soldering or conductive epoxy attach techniques. However, AVX claims to have found a better way with its Planar series of foil-tab leaded chips, intended for low-cost thermal compression bonding. Prices start at \$3 to \$10 in single quantities, and the values range from 1 pF to 1 μ F. Four different dielectrics are available, along with 12 chip sizes.

Monolithic ceramic capacitors are the most widely used chip family, but within the family many different dielectric types are available. Three of the most common are the NPO, X7R and Z5U. The temperature characteristics and prices of monolithic capacitors

with these materials differ widely.

The NPOs are ideal for high-stability circuits, have tempcos of about ± 30 ppm/ $^{\circ}$ C and are typically available with values from 5 pF to 0.02 μ F. X7Rs are good for bypassing applications, have tempcos of about 50 ppm/ $^{\circ}$ C and can range in value up to about 0.1 μ F. The Z5Us offer the widest range of applications, have tempcos of about 100 ppm/ $^{\circ}$ C and are available with values of over 2 μ F.

The lower-cost chips are the

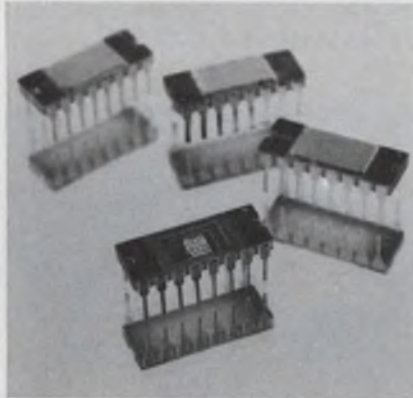

Thin-film resistor networks are often housed in DIPs for easy use. Shown is one from Hybrid Systems.

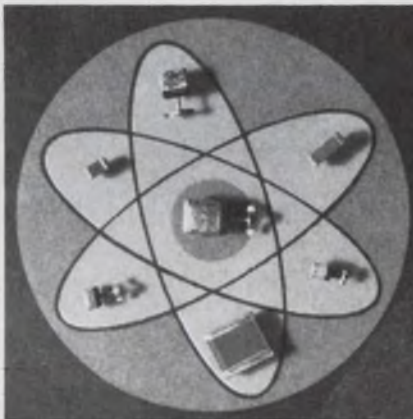

Tantalum capacitors use T-shaped terminations for mounting onto ceramic substrates. These are from Union Carbide.

NPOs and X7Rs; prices are down around 15 to 20 cents each in 5000-piece lots. The Z5Us cost between 25 and 40 cents for similar lots.

Chip sizes start at about 50 mils square by 20 mils thick and range to about 250 mils square by 100 mils thick.

Capacitors that use a material with a high dielectric constant, K

—such as the Z5U—have properties that are similar to those of tantalum capacitors, although the values are limited to about 2 or 3 μ F when the K is more than 1000.

Medium-K dielectrics, such as the X7R formulations (K between 100 and 1000) can equal the performance of Mylar and polycarbonate types. The low-K types, like NPOs (K less than 100), have characteristics similar to those of mica and polystyrene capacitors.

You need a scorecard

Telling different valued chips apart can be troublesome, since many values are available in the same package size. Marking the values on the tiny chips is an art. Some companies have even resorted to laser marking to get the values ingrained permanently. Coding is done either by letters, dots, numbers or combinations thereof.

If you don't know the value you need, several companies offer adjustable chip capacitors that let you add or subtract capacitance within a limited range. Vitramon has its Vee-Cal series of chip capacitors with an NPO dielectric that permits up to 12 incremental adjustments. Base values start at 10 pF and go up to 680 pF in 24 models. Adjustment increments vary from 1 pF for the small-value units to 20 pF for the larger values.

Each of the Vitramon chips has adjustment contacts on two sides—one set for the coarse adjustment and the other for the fine. A maximum of six adjustments can be made on each side. All that's needed to adjust the value is a lead pencil and an eraser. The chip sizes are all identical—0.18 \times 0.05 \times 0.05 in.

Semtech offers a different method with its SC6000 series. The company will sell you slabs of monolithic capacitors made from barium titanate ceramic. The slabs are about 1.8 \times 1.8 in., which you can then cut to the value you need with a diamond saw. Result: instant custom capacitors.

The Semtech slabs have capacitance values up to 23,000 pF and are available in voltage ratings of 2 to 20 kV. Slabs are also available with custom voltage ratings of up to 70 kV. Prices start at 66 cents

and rise to \$10 a slab in 1 to 10 quantities.

Tantalums pack it in

To get even more capacitance in a small space, users now have tantalum-based capacitors. These can have values from about 0.1 μF to over 200 μF , while taking up no more room than the large ceramic chips. Typical sizes range from 50 \times 100 \times 50 mils up to 150 \times 285 \times 110 mils.

There are, though, several different termination variations for the chips. For instance, National Components Industries offers end-terminated Blue-Chips, with wide area mounting terminals that are similar to those on ceramic chips. Other companies, like Union Carbide and Corning, have the T-bar structure, which uses the chip itself for one terminal and a lead shaped like a T for the other.

The T-bar has a tendency to break, however, if the chips are not handled with extreme care, says Robert Gress, tantalum capacitor product manager for Corning.

Prices for the tantalum capacitors start at about 20 cents for a low value and increase to about \$2 and more for larger values or higher voltage ratings. Ray Irion, marketing manager for Union Carbide, says that tantalum chips cost less than ceramics with the same value. And they provide the user with a more stable temperature characteristic, he notes.

Capacitors get transistorized

Metal-oxide semiconductor technology is being used for capacitors of low value. But so far only a handful of companies—Texas Instruments, Dionics and Micro Networks, among them—are offering MOS chip capacitors. The values range from fractions of a picofarad to about 150 pF.

The advantages of these chips include their low height from the circuit substrate—typical thicknesses are only 5 mils against the 20-to-50-mil thicknesses of ceramic types.

Larger values than the 150-pF upper limit are possible, note George Seaton, marketing manager for Dionics, and Robert Jay, president of Micro Networks. But

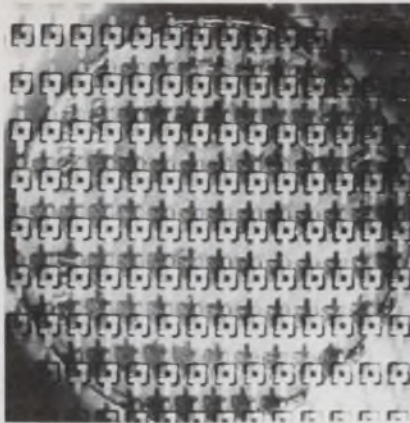

Inductors made by deposits of metal on glass are the specialty of Thinco. Values range up to 120 nH.

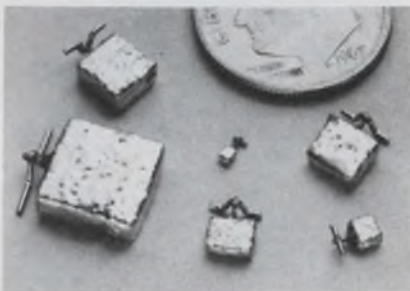

Tantalum chip capacitors range in size from 100 to over 250 mils square. A sampling from Corning is displayed.



Monolithic ceramic chip capacitors made by American Technical Ceramics vary in size from 50 to 250 mils square.

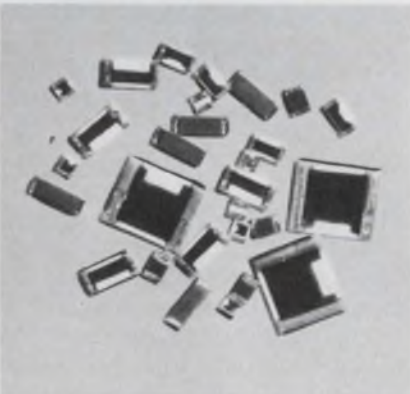

Thick-film chip resistors, like these made by KDI Pyrofilm, are available in values from 1 Ω to 10 M Ω .

as low cost becomes the dominant consideration in design, ceramic tends to prevail. However, MOS capacitors can be attached with the same equipment used for semiconductor die mounting and conventional wire bonding.

Typical chip prices in 10,000-piece lots range from 13 cents for low-value units to about 75 cents for high-value. Since the capacitors are deposited on a silicon substrate, many different values can be placed on a single silicon chip.

Dionics, for example, has its Models C-700 and C-1248, which contain capacitors that range from 1 to 39 pF on a 50 \times 35 \times 5-mil chip. The C-700 contains a total of 94 pF, while the C-1248 has a total of 15 pF—but on a chip about half the size.

Chip inductors: Limited choice

Miniature inductors in chip form have been available from only a few manufacturers because they are both hard to make and the very-high-volume demand for them just isn't there. The companies that do offer them have both fixed and variable types, with values from 1 nH all the way up to 10 mH. The variable types are usually available with a tunable range of about half a decade.

"Prices are starting to drop as more of the expensive hand labor needed for wound inductors is eliminated," says Bill Parker, vice president of technical and special components for Airco Speer.

However, the assembly of variable wound inductors is a very delicate operation, and their prices are still in the \$3 to \$5 range for small quantities—still cheap compared with the \$15 to \$20 of several years ago.

The cost of fixed units has also continued to decline as production techniques have improved or new methods have been found. Fixed inductors can be bought for as little as 29 cents each in large quantities.

Inductor size is perhaps the most critical factor, after the inductance value. Ultra-small deposited fixed units, such as the L-30 inductors made by Thinco, span a range of 1 to 120 nH and have a chip size of only 50 \times 80 \times 25 mils. These units are made by

Transient Voltage Suppressors! Zeners - Voltage Regulators!



**Maximum Power
in a Mini Package!**

Semtech technology once again sets the standard for semiconductors! Now, a new generation of Voltage Regulators and Transient Suppressors for protection of delicate logic circuits and sophisticated power supplies, providing protection against voltage transients in airborne-equipment as well as suppression of relay coil and contact noise.

The smallest package in the industry and with power ratings up to 1500 watts is available now thanks to a breakthrough in junction technology, combined with the proven metoxilite (metal-oxide) coating and superior non-cavity monolithic high temperature bonded construction!

LOW DYNAMIC IMPEDANCE VOLTAGE REGULATORS "ZENERS"

These new devices offer significantly lower dynamic impedance. Lower impedance means improvement in regulation ripple reduction and transient protection.

1 watt

1N5559A,B thru 1N5589A,B
Nominal Voltage: 6.8 to 120 V ($\pm 5\%$)
Low Reverse Leakage
Dimensions (max.): Body .070"D x .165"L
Leads .031"D x 1.25"L

5 watt

1N4954 thru 1N4984
Nominal Voltage: 6.8 to 120 V ($\pm 5\%$)
Low Reverse Leakage
Dimensions (max.): Body .140"D x .165"L
Lead .038"D x 1.10"L

3 & 5 watt

SX6.8 thru 120
Nominal Voltage: 6.8 to 120 V ($\pm 5\%$)
Low Reverse Leakage
Dimensions (max.): Body .140"D x .165"L
Lead .040"D x 1.10"L

10 watt

SY6.8 thru 120
Nominal Voltage: 6.8 to 120 V ($\pm 5\%$)
Low Reverse Leakage
Dimensions (max.): Body .165"D x .165"L
Lead .040"D x 1.10"L

BI-POLARITY TRANSIENT SUPPRESSORS

At last, a single chip device providing symmetrical transient voltage protection. Voltage matching to 5% in either direction. Protection for A.C. and D.C. circuits.

500 watt Peak Pulse Power

L 10A, 20A, 30A, 39A, 51A, 60A, 82A, 100A and 110A.
Nominal Voltage: 10 to 110 V
Dynamic Impedance (max.): 1.5 to 70 Ohms
Dimensions (max.): Body .140"D x .165"L
Lead .031"D x 1.25"L

1500 watt Peak Pulse Power

TS 10A, 20A, 30A, 39A, 57A, 60A, 82A, 100A and 110A.
Nominal Voltage: 10 to 110 V
Dynamic Impedance (max.): 0.7 to 35 Ohms
Dimensions (max.): Body .165"D x .165"L
Lead .040"D x 1.10"L

1975 NATIONAL SBA SUBCONTRACTOR OF THE YEAR



652 Mitchell Road, Newbury Park, California 91320
(805) 498-2111, (213) 628-5392 / TWX: 910-336-1264

CHICAGO: (312) 352-3227
DALLAS: (214) 387-3551
FLORIDA: (305) 644-5404
MARYLAND: (301) 424-6663
NEW JERSEY: (201) 654-4884
SAN FRANCISCO: (415) 494-0113
EUROPEAN SALES HOO: Bourns AG Zug,
Switzerland (042) 232-242

Contact factory for complete specifications.

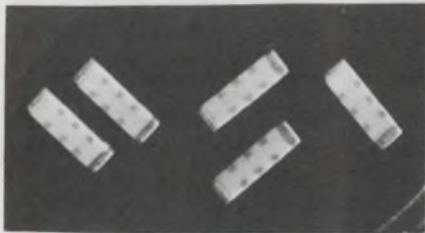

Variable chip capacitors, newcomers to the hybrid scene, are made by Vitramon for easy breadboarding.



Tantalum capacitors in rectangular chip form are the specialty of National Components Industries.



Miniature variable and fixed inductors from Airco Electronics are available with values up to 10 mH.



Pellet resistors by CTS Microelectronics are designed to fit into holes drilled through the substrate.



High-value thick-film resistor chips made by Eltec are so small that stamp perforations dwarf them.

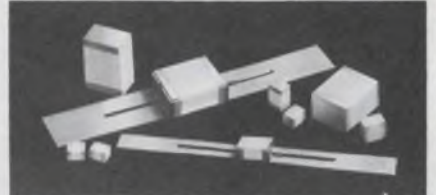

Chip capacitors designed for microwave ICs use beam leads. These are from Johanson Monolithics.

vacuum-depositing sequential layers of insulation and metal so they form a square, flat coil. Larger inductor chips, made by Delevan, Nytronics, Vanguard and others, use wound coils of very fine wire that are epoxy-sealed in brick or cylindrical form. They come in sizes up to 250 mils square by 100 mils high.

Inductor manufacturers have had problems in maintaining the coil Q while providing the most inductance in the smallest space. The tradeoff is usually the lower Q, which for these small units is usually under 100, although the L-30 fixed units from Thinco are reported to have Qs as high as 260 at 400 MHz.

Most companies that offer chip inductors also make tuned circuits to custom requirements, since all they have to do is add a tap, or several resistors and a capacitor.

Resistance comes in many forms

Whether you need a high-value resistance or a low one, you have a choice of thick or thin films. Thick films tend to offer the lower cost but lack the temperature stability of thin-films.

Prices for thick-film resistor chips start at about 10 cents each in 10-k lots; thin-film resistors still cost about double that. Manufacturers of thin-film networks, like



Beam-lead capacitors from AVX are designed for thermal compression bonding with foil tabs.

Analog Devices, Hybrid Systems, LRC Microelectronics and National Semiconductor, all feel that as volume applications for thin-film networks increase, prices will drop to compete with those for thick-film circuits.

Thick-film networks are usually not available in chip form; usually they are part of the circuit substrate. Thin films, however, can be built with IC technology, which permits the networks to be treated the same as active chips.

The accuracies of thick-film resistors range from a poor 20% to a fairly tight 1%, with some 0.5% tolerances available on special orders. However, for most applications, trimming thick films to 0.5%

is not the answer if tight tolerances are needed. This is because the temperature drift of thick films (depending upon formulation) can be as bad as 200 ppm/°C or as good as 50 ppm/°C.

Thin films have high stability

Thin-film networks, on the other hand, have typical stabilities of 25 ppm/°C and can be formulated down to about 5 ppm/°C. The ratio accuracies of the networks can be trimmed down to 0.001% with computer-controlled laser machines—quite a bit tighter than the accuracies of thick films.

Typical thick-film resistance values range from about 1 Ω to well over 10 M Ω . Mini-Systems offers thick-film chips that range in value up to 1000 M Ω and can handle up to 0.5 W. Their prices start at about 13 cents in 10-k lots, with the chip sizes ranging from 35 \times 35 to over 100 \times 100 mils.

Other companies—like Airco-Speer, KDI Pyrofilm, Dale, Eltec and CTS Microelectronics—offer chip resistors that are designed for power handling, isolation and special circuit designs.

For instance, CTS manufactures the Ceradot series of cermet pellet resistors. The pellets range in size from 50 mils in diameter and 30 mils thick up to 100 mils diameter and 62 mils thick. Values go from 10 Ω to 1 M Ω . A typical application

The new package from the leader:

Precision Graphics at an alphanumeric price.

Not just graphing. Graphics from the graphics specialist. The key is information capacity. Tektronix' new 4006-1 offers far and away the highest output density of any terminal in its price range: 1024 X by 780 Y viewable points; 2590 alphanumeric on screen characters.

It's all you'd expect from the company serving all your graphic needs . . . priced competitively with most alphanumerics.

Immediately compatible with most mainframes. Thanks to proven interfaces. Time-tested software. Great new usable software packages. And expert maintenance anywhere in the world.

And rely on Tektronix to do it right. The 4006-1 is our biggest breakthrough towards making the power of graphics affordable for everyone. Just \$2995

for openers. Lease price \$150 per month on a two year lease, includes maintenance. Plus peripheral options like our 4631 Hard Copy Unit for up to four 4006-1's, with 8½"x11" copies, and 4923 Digital Cartridge Tape Recorder. And as fine a package of technical support as you'll find for any terminal anywhere.

Check it out: we're graphic leaders for some mighty good reasons. Your local Tektronix Sales Engineer can give you the whole story. Or write:

Tektronix, Inc.
Information Display Group
P.O. Box 500
Beaverton, Oregon 97077



Graphics \$150/mo

might be to mount the pellets in holes drilled in the circuit substrate and make contact to the top and bottom.

Tolerances for the Ceradots can be as close as 1%, while the temperature drift of the resistance is about 300 ppm/°C. CTS also has rectangular resistor chips that cover a 200-Ω to 350-kΩ range.

If you need high resistance values, try the Eltec. It has thick-film resistor chips with resistances up to 10¹² Ω. Prices start at about 45 cents each in 10-k lots and accuracies at 30%, narrowing to 5%.

Bulk-Metal for high efficiency

If your circuit needs call for high accuracy and high-stability resistors, thin films are the only way to go. Vishay has just entered the super-precision chip market with its Micro Chip series of 0.01

and 0.001% absolute accuracy Bulk-Metal film chip resistors. Temperature coefficients are down to 5 ppm/°C over a -55 to +150 C operating range. Resistance values at present are limited to 1 Ω to 10 kΩ, but higher values will be available shortly. Prices for these precision chips will be about \$3 for 100-piece lots.

Analog Devices offers a thin-film custom service to buyers who fill out a form in the company's catalog. Prices for user-designed networks with 0.1% ratio accuracy typically cost \$5 in 1000 quantities.

National Semiconductor has introduced thin-film networks that cost only 35 cents each in 100,000-piece lots. This is for 1% tolerance.

Typical thin-film resistance values range from 10 Ω to about 10 MΩ. Most networks are built on silicon that has a sheet resistivity of about 250 Ω/square. However, Jay of Micro Networks says that

materials with sheet resistivities of 1000 Ω/square are "just around the corner." This increased resistivity, he says, is needed to build the low-power circuits required.

Prototype kits—a mixed bag

Did you ever try to calculate the resistance value that you need for a circuit? Or the inductance or capacitance? The law of averages says that you won't have that value available to plug in.

To counteract this breadboard problem, just about every chip company offers a designer's kit of chips. This could range from as few as five chips to several hundred, depending upon what you want to pay and your need. Typical kit prices range from \$10 to \$700. The kits are usually a great bargain, since they offer a wide selection of component values at a greatly reduced price. ■■

Need more information?

The following companies contributed inputs for this report. The list is far from complete, but it does contain most of the chip component manufacturers. Additional listings can be found in ELECTRONIC DESIGN's GOLD BOOK. The code letters after each company define the various product lines: thick-film resistors (A), thin-film resistors (B), inductors (C), ceramic or porcelain capacitors (D), tantalum capacitors (E), and MOS capacitors (F).

- AVX Ceramics, P.O. Box 867, Myrtle Beach, SC 29577. (803) 448-9411. (D) **Circle No. 401**
- Airco Electronics, P.O. Box 547, Bradford, PA 16701. (814) 362-5536. (A, B, C) **Circle No. 402**
- Alpha Industries, Sylvan Rd., Woburn, MA 01801. (617) 935-5150. (D) **Circle No. 403**
- American Technical Ceramics, 1 Norden Lane, Huntington Station, NY 11746. (516) 271-9600. (D) **Circle No. 404**
- Analog Devices Inc., P.O. Box 280, Norwood, MA 02062. (617) 329-4700. (B) **Circle No. 405**
- Burr-Brown, International Airport Industrial Park, Tucson, AZ 85706. (602) 294-1431. (A, F) **Circle No. 406**
- CTS Microelectronics Inc., Box 1278, Lafayette, IN 47902. (317) 463-2565. (A) **Circle No. 407**
- Centre Engineering, 307 Benner Pike, State College, PA 16801. (814) 237-0321. (D) **Circle No. 408**
- Corning Glass Works, Electronic Products Div., Corning, NY 14830. (607) 974-8237. (D, E) **Circle No. 409**
- Dale Electronics, 1376 28 Ave., Columbus, NE 68601. (402) 564-3131. (A) **Circle No. 410**

- Delevan Div., American Precision Ind., 271 Quaker Rd., East Aurora, NY 14052. (716) 652-3600. (C) **Circle No. 411**
- Dionics Inc., 65 Rushmore St., Westbury, NY 11590. (516) 997-7474. (F) **Circle No. 412**
- Eltec Instruments Inc., Central Industrial Park, Daytona Beach, FL 32014. (904) 252-0411. (A) **Circle No. 413**
- Emcon Div., Illinois Tool Works Inc., 11620 Sorrento Valley Rd., San Diego, CA 92138. (714) 459-4355. (D) **Circle No. 414**
- Gowanda Electronics, 179 Broadway Rd., Gowanda, NY 14070. (716) 532-2236. (C) **Circle No. 415**
- Hybrid Systems Corp., 87A 2 Ave., Burlington, MA 01803. (617) 272-1522. (B) **Circle No. 416**
- Hy Comp Inc., 146 Main St., Maynard, MA 01754. (617) 897-4578. (B) **Circle No. 417**
- Johanson Manufacturing Corp., 400 Rockaway Valley, Boonton, NJ 07005. (201) 334-2676. (D) **Circle No. 418**
- Johanson, Monolithic Dielectrics Div., P.O. Box 6456, Burbank, CA 91505. (213) 848-4465. (D) **Circle No. 419**
- KDI Pyrofilm Corp., 60 S. Jefferson Rd., Whippany, NJ 07981. (201) 887-8107. (A) **Circle No. 420**
- LRC Inc., 101 Digital Dr., Hudson, NH 02051. (603) 883-8001. (B) **Circle No. 421**
- Mepeco/Electra Inc., Columbia Rd., Morristown, NJ 07960. (201) 539-2000. (D) **Circle No. 422**
- Micro Networks Corp., 324 Clark St., Worcester, MA 01606. (617) 852-5400. (B, F) **Circle No. 423**
- Mini-Systems Inc., 20 David Rd., North Attleboro, MA 02761. (617) 695-0206. (A) **Circle No. 424**
- MuRata Corp. of America, Rockmart, GA 30153. (404) 684-7143. (D) **Circle No. 425**
- National Components Ind., Inc., 5902 Australian Ave., West Palm Beach, FL 33407. (305) 842-3201. (E) **Circle No. 426**
- National Semiconductor Corp., 2900 Semiconductor Dr., Santa Clara, CA 95051. (408) 732-5000. (B) **Circle No. 427**
- Nytronics Components Group Inc., Orange St., Darlington, SC 29532. (803) 393-5421. (C) **Circle No. 428**

- Philips Research Press Dept., Eindhoven, the Netherlands. (B) **Circle No. 429**
- Piconics Inc., Cummings Rd., Tyngsboro, MA 01879. (617) 649-7501. (C) **Circle No. 430**
- Precision Monolithics, 1500 Space Park Dr., Santa Clara, CA 95050. (408) 246-9222. (B) **Circle No. 431**
- RCL Electronics Div., AMF Inc., 700 S. 21 St., Irvington, NJ 07111. (201) 374-3311. (B) **Circle No. 432**
- Republic Electronics Corp., 176 E. 7 St., Paterson, NJ 07524. (201) 279-0300. (D) **Circle No. 433**
- San Fernando Electronic Mfg., 1501 First St., San Fernando, CA 91341. (213) 365-9411. (D) **Circle No. 447**
- Semi-Films Div., National Micronetics Inc., Box 188, West Hurley, NY 12491. (914) 338-7714. (B, F) **Circle No. 434**
- Semtech Ltd., 652 Mitchell Rd., Newbury Park, CA 91320. (805) 498-2111. (D) **Circle No. 435**
- Sprague Electric Co., 645 Marshall St., North Adams, MA 01247. (413) 664-4411. (D, E) **Circle No. 436**
- Stackpole Carbon, Carbon Div., Stackpole St., St. Marys, PA 15857. (814) 781-1234. (A) **Circle No. 437**
- Tensor Electronics Inc., 11404 Sorrento Valley Rd., Bldg. 120, San Diego, CA 92121. (714) 453-7262. (D) **Circle No. 438**
- Texas Instruments, P.O. Box 5012, Mail Station 84, Dallas, TX 75222. (214) 238-3914. (F) **Circle No. 439**
- Thinco Inc., Hatboro, PA 19040. (215) 675-5000. (C) **Circle No. 440**
- USCC/Centralab, 2151 N. Lincoln St., Burbank, CA 91504. (213) 843-4222. (D) **Circle No. 441**
- Union Carbide/Components, Box 5928, Greenville, SC 29606. (803) 963-7421. (D, E) **Circle No. 442**
- Vanguard Electronics Co., 930 W. Hyde Park Blvd., Inglewood, CA 90302. (213) 678-7161. (C) **Circle No. 443**
- Varadyne, 1547 18 St., Santa Monica, CA 90404. (213) 829-2991. (D) **Circle No. 444**
- Vishay Resistive Products, 63 Lincoln Hwy., Malvern, PA 19355. (215) 644-1300. (B) **Circle No. 445**
- Vitramon Inc., P.O. Box 544, Bridgeport, CT 06601. (203) 268-6261. (D) **Circle No. 446**

When you've got a new product that excites 1,235 people at Wescon, you've got what they want. Bud has it!

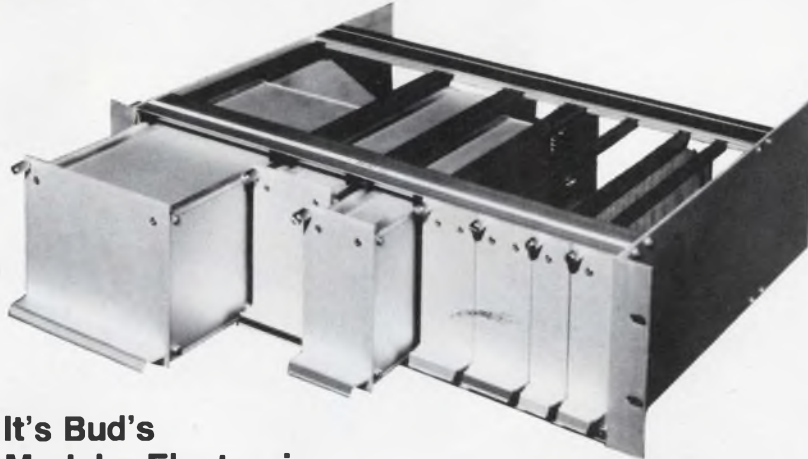

It's Bud's Modular Electronic Packaging System.

And 1,235 people were stopped in their tracks at the Bud booth during the Wescon show to see it, talk about it. Here's what they saw. Talked about.

Accurate alignment.

Highly stable, one-piece, full length guides provide accurate alignment of circuit boards and edge connectors. The edge connectors are mounted directly to the end of the guides, thereby eliminating the need for separate mounting rails and spacers. Glass-loaded polycarbonate guides rest on the horizontal cross rails of the sub-racks. Since guides do not carry the weight of boards or sub-units, there is no guide distortion.

Variable guide spacing.

Plug-in guides can be spaced instantly on any pitch that is a multiple of 0.200". Basic pitch of 0.200" with a normal card pitch of 0.600" provides 0.200" on the wiring side and 0.400" on the component side of the circuit board. When guides are plugged in at an 0.400" pitch, 42 circuit boards can be housed.

Easy insertion.

Guides are flush with the front of the sub-rack. Circuit boards and sub-units can, therefore, be inserted into the sub-rack even when the sub-rack is located above or below eye level.

No profiling of boards.

A specially designed connector end foot provides lead-in for each board and, also, allows the edge connector to be the full height of the board. Board profiling is eliminated.

Simple and rugged construction.

The system has been uniquely designed with a minimum number of components to assemble. Rugged aluminum extrusions and heavy gauge aluminum panels provide extreme rigidity. The front panels are brush finished and anodized while all other aluminum parts are etched and anodized.

And it's flexible.

One of the major advantages of the Bud System is that the componentry comes in a range of sizes. In sum, the System adapts to your application. Sub-rack frames are available in standard 19" width, four E.I.A. panel heights and two depths. Eight sub-racks, 30 sub-units, six printed board units come in individual easily assembled kits. Eight standard circuit boards and 16 standard edge connectors are also available. Special Connector Mounting Rails can be ordered to accommodate other types and sizes of connectors.

See it. Talk about it.

Your Bud Representative has complete data on the new Modular Electronic Packaging System. He also has a demonstration model. See it. Work with it. Then you'll realize here's a highly functional system that adapts to your ideas, your imagination, your system.

BUD

BUD RADIO, INC.
4605 East 355 Street Dept. 11A
Willoughby, Ohio 44094

Phone your nearest Bud Representative.

JACK BERMAN CO., INC.
(*Ariz., S. Calif., S. Nev.*)
Inglewood, Calif.
213-649-6111

CARTWRIGHT & BEAN COMPANY
(*Ala., Ark., Fla., Ga., La., Miss., N.C., S.C., Tenn.*)
Huntsville, Ala.
205-533-3508

Orlando, Fla.
305-422-4531
Plantation, Fla.
305-791-3989

Atlanta, Ga.
404-255-5262
Chalmette, La.
504-279-4598

Jackson, Miss.
601-981-1368
Charlotte, N.C.
704-333-6457

Raleigh, N.C.
919-832-7128
Knoxville, Tenn.
615-693-7450

Memphis, Tenn.
901-276-4442
EARL & BROWN CO., INC.
(*No. Ida., Mont., Ore., Wash. Alas.*)

Seattle, Wash.
206-284-1121
Portland, Ore.
503-245-2283

INDUSTRIAL REPRESENTATIVES, INC.
(*N. Ill., E. Wis.*)
Chicago, Ill.
312-647-7755

THE CLARK R. GIBB CO.
(*Minn., N. Dak., S. Dak., W. Wis.*)
Minneapolis, Minn.
612-377-1200

LINDBERG COMPANY
(*Cal., Ut., Wyo., S. Ida., E. Mont., N.M., El Paso, Tex.*)
Denver, Col.
303-758-9033

Albuquerque, N.M.
505-881-1006
Salt Lake City, Ut.
801-534-1500

LUND & COMPANY INC.
(*Okl., Tex.*)
Dallas, Tex.
214-387-4634

MARLOW ASSOCIATES, INC.
(*Oh., W. Pa., W. Va.*)
Cleveland, Oh.
216-932-0900
Xenia, Oh.
513-426-6270

MARSEY SALES, INC.
(*Upper New York*)
Rochester, N.Y.
716-442-9700

MULLIN TECHNICAL SALES, INC.
(*Ma., N.H., Vt., Mass., R.I., Conn.*)
Needham, Mass.
617-444-4780

PALATINE ENGINEERING SALES, INC.
(*S. Ill., Kan., Mo., Neb., Ia.*)
Cedar Rapids, Ia.
319-365-8071

Andover, Kan.
316-683-7512
Lenexa, Kan.
913-492-7020

St. Louis, Mo.
314-426-7055
DAVID H. ROSS COMPANY
(*N. Calif., N. Nev.*)

San Carlos, Calif.
415-591-4411
SOUTHERN SALES CORP.
(*Ind., Ky.*)

Indianapolis, Ind.
317-257-7575
JACK M. THORPE CO.
(*Mich.*)

St. Clair Shores, Mich.
313-779-6363
TRINKLE SALES, INC.
(*E. Pa., S. N.J., Dela., Md., D.C., Va.*)

Cherry Hill, N.J.
609-795-4200
215-922-2080 (Phila.)

WILLGOLD ELECTRONIC SALES CORP.
(*N. N.J., Metro N.Y.C., Long Isl., Westchester Cty.*)
Rockville Centre, N.Y.
516-764-4022

What our bottom-of-the-line

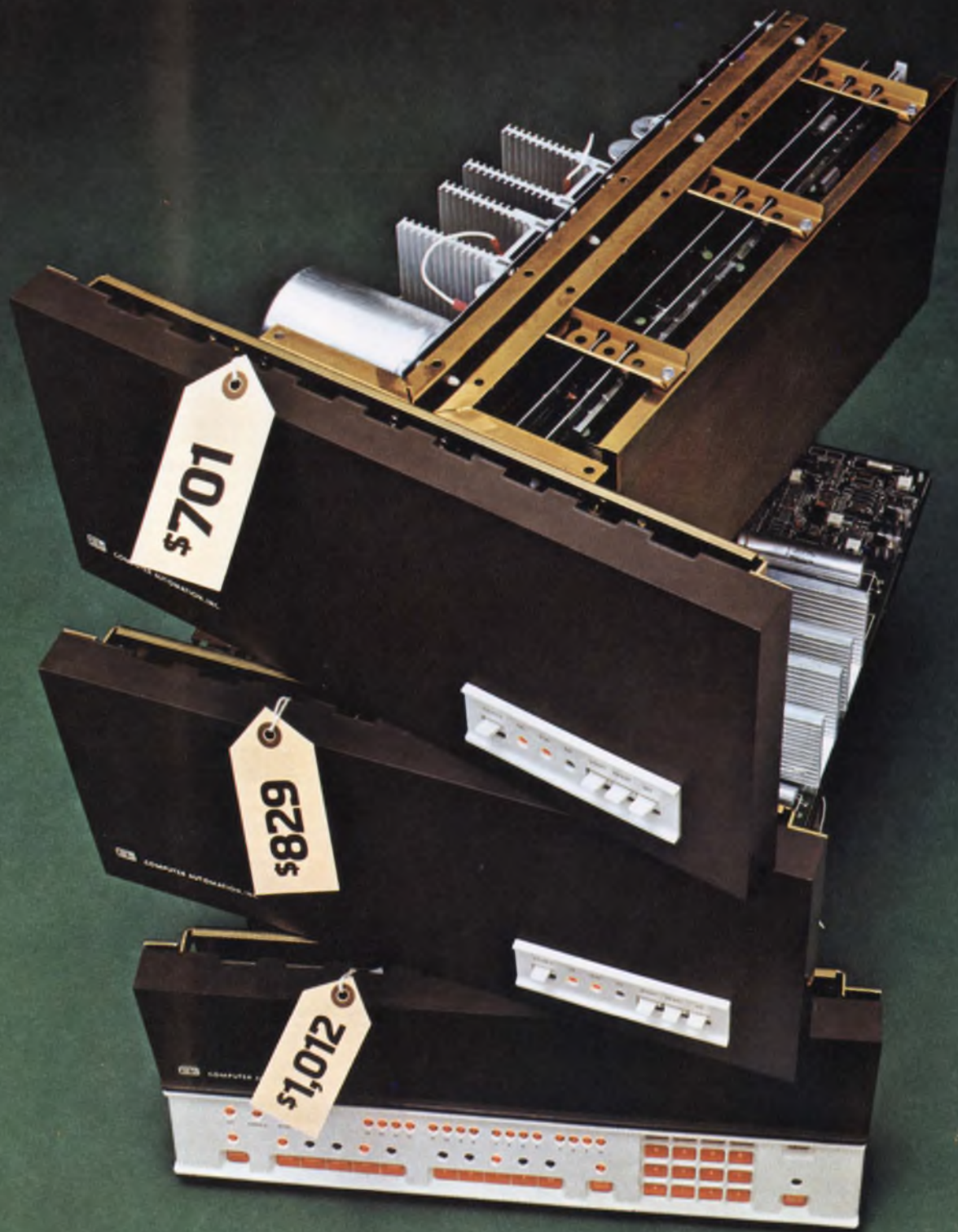

The New ALPHA™ LSI-3/05

Introducing the lowest priced, 16-bit, full-scale, fully compatible, packaged computers in the world.

can do for your bottom line.

Stack the new ALPHA LSI-3/05 millicomputer up against any other low-end computer.

Preferably while you're sitting down, because on price alone, you're bound to be astounded.

Ready? \$701 total packaged price. And that's complete with 256 words of MOS RAM, and a CPU that offers a really powerful instruction set, Power Fail Restart, Real-Time Clock and Autoload capability.

Try to buy an equivalent computer at twice the price.

Have it your way.

You also get the capability to configure your computer pretty well the way you want it. A choice of packaging, of course, that includes either the Operator's or the Programmer's Console, power supplies and so on.

A choice of two standard I/O options.

And a choice of optional memory configurations that

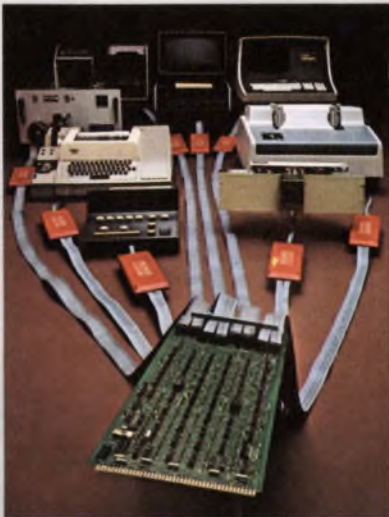

Maxi-Bus compatible ALPHA LSI-3/05 achieves unprecedented cost-effectiveness with ComputerAutomation's new Distributed I/O System.

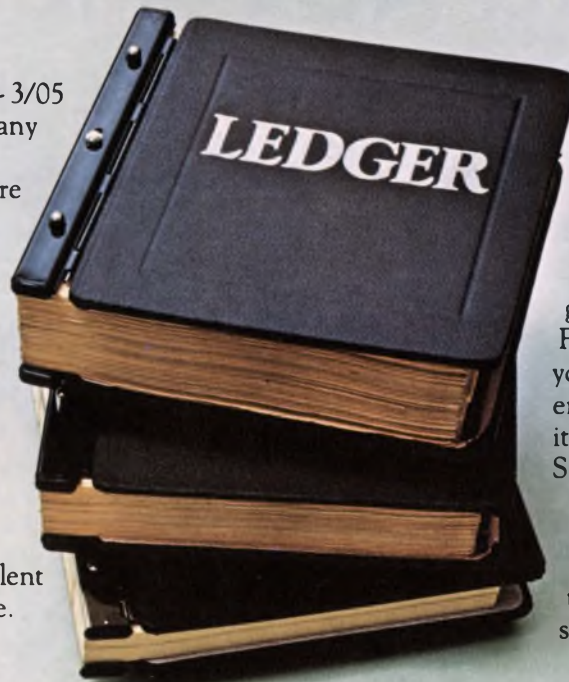

include RAM/ROM, RAM/EPROM and RAM-only in sizes from 256 words all the way up to 32K words. Totally addressable.

Family connections save you still more money.

So far, what we've been talking about could easily add another five or six figures to the bottom line of your ledger.

But there's more. Really big savings on off-the-shelf software, peripheral controllers and I/O interfaces.

The reason is that the ALPHA LSI-3/05 millicomputer is a full-fledged member of ComputerAutomation's LSI Family... Maxi-Bus compatibility and the whole works. So, every piece of Family hardware we've ever developed will work like it was made for the ALPHA LSI-3/05. Including ComputerAutomation's exclusive new Distributed I/O System... just like you see it in the picture.

With this versatile interface system, you can interface virtually any kind or combination of peripherals. Parallel or serial. Just by plugging them in.

Your cost? Probably less than \$200 per interface.

The pros know.

Computer-wise OEM's will tell you that product requirements sooner or later get ahead of the hardware. For instance, the computer you buy today may not have enough I/O or memory capacity for tomorrow's Mark II Super Widget.

Then you'll have to scrap all your software and your interface designs, because they're not about to work on some other machine.

You lose.

Of course, with our LSI Family of compatible computers you don't.

You can switch to a different CPU or a different memory anytime. Faster, slower, bigger, smaller. The electrical interface will still be the same; the original programming will still work.

You win.

From the people who brought you the NAKED MINI®

And the NAKED™ MILLI. And the Distributed I/O System. And the PICOPROCESSOR.

And now the ALPHA LSI-3/05 millicomputer.

One cost breakthrough after another. Breakthroughs that didn't just happen... a lot of profits got plowed back into R&D.

But then, that's the price of leadership.

 **ComputerAutomation**
NAKED MINI Division

U.S.A. 18651 Von Karman, Irvine, CA 92664
(714) 833-8830

EUROPE 31/35 Clarendon Road, Warford,
Hertfordshire, WD1. IJA England (0923) 39627

COMING NOVEMBER 22

A MAJOR NEW EDITORIAL SECTION

IN EVERY ISSUE OF

Electronic Design

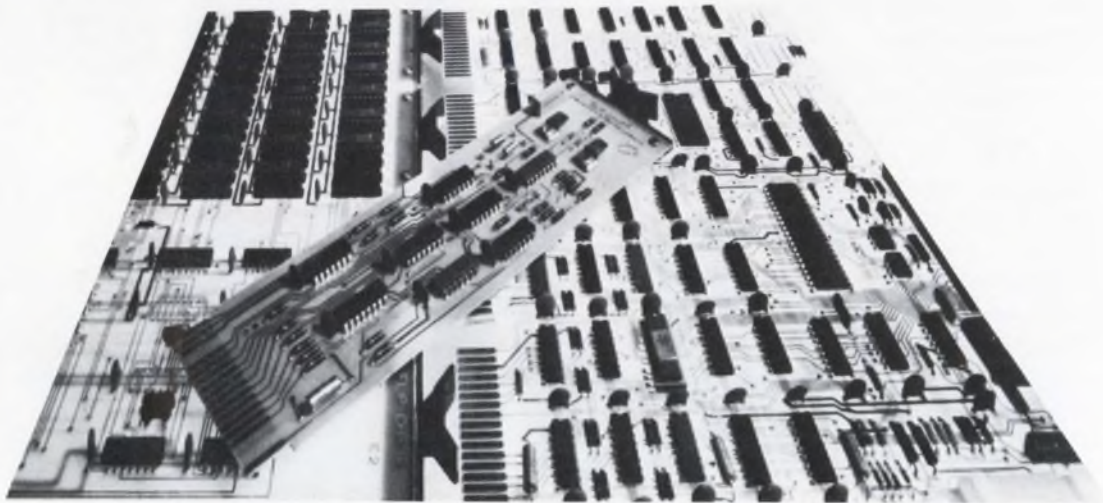

“MICROPROCESSOR DESIGN”

Microprocessors are hot...and they're going to get even hotter. That's why we've been giving microprocessors extensive coverage ever since their first commercial availability three years ago.

Now we're going to do even more. A major new section of the magazine, MICROPROCESSOR DESIGN, will begin November 22 and will continue in every subsequent issue.

The new section will cover all important developments that relate to designing with microprocessors. In addition to several major reports devoted exclusively to microprocessors in 1976, tech articles, news, new product data, new lit, new books, announcements of meetings and seminars and interviews with industry experts will be consolidated in this section.

Microprocessors don't stand alone. Our approach will be to help our readers not only to specify the microprocessor, but also to deal with everything that will surround the microprocessor and everything that will help him to design with a microprocessor.

So if microprocessors figure in your future...watch for MICROPROCESSOR DESIGN...another service to the reader from *Electronic Design*.

Optical reader scans coded copy at 400 characters per second

A new low-cost optical page reader scans typewritten copy with a throughput rate equivalent to that of 20 to 30 computer keyboard operators.

The reader, which uses special typewritten copy that contains a bar code under each character, can scan a densely typewritten page in 10 seconds—400 characters per second—according to Gordon Baty, president of Taplin Business Machines, Burlington, MA, the system developer. The company recently changed its name to Context Corp.

The machine reads out data in an 8-bit ASCII format and also in the RS232C serial code at 4800 or 9600 baud. With modifications, other codes can be used.

Called the Model 101, the machine was developed for use as a minicomputer peripheral. Baty says. Typists use a special \$30 ball for an IBM Selectric or Remington SE-100 typewriter.

The key to the system is a continuously rotating three-lens barrel that scans the copy and focuses the 0.024-in.-high code bars onto a fixed linear array of nine photo-cells. These cells are electronically gated to give an effective array of six four-bar cells. The electronics controlling this selection, according to Baty, provide the following advantages:

- The typewriter letters are rejected and only the bar codes are read.

- The proprietary bar code, which consists of four narrow or wide vertical bars and three narrow or wide spaces between the bars, reduces errors. It has a built-in parity check that prevents the

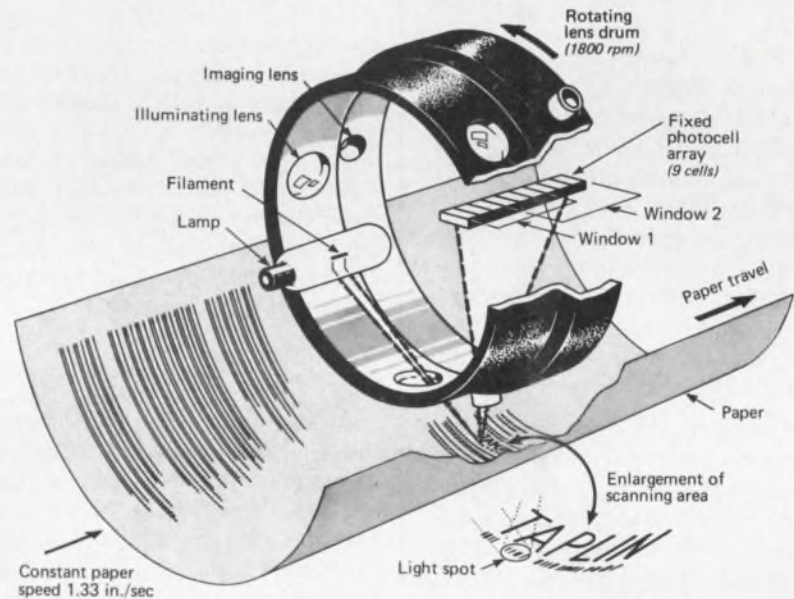
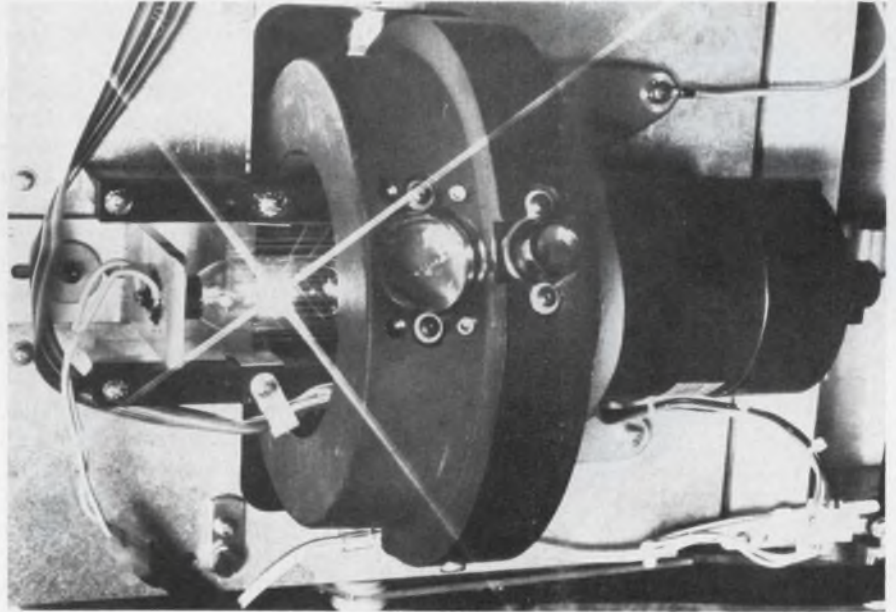

The optical drum is the only moving part in the Model 101 reading mechanism. The drum rotates at 1800 rpm, scanning the typed line at 1000 inches per sec.

reading of spots of dust or dirt.

- If error-free typewritten copy is used, the accuracy of the reader is better than 1 character in 25,000.

- The machine can read "free form" typing—numerical data, lines and corrections typed anywhere on the page—so long as the lines are within the system's skew

Jim McDermott
Eastern Editor

Thin-Trim[®] capacitors



Tucked in the corner of this Pulsar Watch is a miniature capacitor which is used to trim the crystal. This Thin-Trim capacitor is one of our 9410 series, has an adjustment range of 7 to 45 pf., and is .200" x .200" x .050" thick. The Thin-Trim concept provides a variable device to replace fixed tuning techniques and cut-and-try methods of adjustment. Thin-Trim capacitors are available in a variety of lead configurations making them very easy to mount.

A smaller version of the 9410 is the 9402 series with a maximum capacitance value of 25 pf. These are perfect for applications in sub-miniature circuits such as ladies electronic wrist watches and phased array MIC's.

Johanson Manufacturing Corporation, Rockaway Valley Road., Boonton, N.J. 07005. Phone (201) 334-2676, TWX 710-987-8367.

MANUFACTURING CORPORATION

tolerance of ± 0.070 -in.

The Model 101 code, says Leland J. Hanchett, manager of advanced product development for Context, was chosen over previous codes for several reasons. The code corresponds to four bars and three spaces. Both the bars and the spaces are wide for a digital ONE, Hanchett explains, or narrow for a digital ZERO.

The basic code provides a seven-element array with 128 possibilities, but because the typewriter prints only 88 characters, the most easily recognized sets of 88 bars were chosen.

Use of the four-bar code aids in holding down reading errors, Hanchett notes. In contrast with other optical bar codes, he says, dust specks and other sources of optical noise, instead of making the system believe it is exposed to a false character, tend to make the bar code unreadable. The machine then provides an indication of unreadability.

For example, Hanchett explains, the dust speck is more likely to obscure the space between bars, producing three bars instead of four. The dirt may add another bar, making a total of five. The system electronics rejects such false readings.

Further, Hanchett points out, if the bar and space widths fall substantially outside the specified dimensions, it will be diagnosed as a "can't read."

On the other hand, Hanchett notes, with bar codes that follow the Teletype or ASCII format, the addition of a speck of dirt can add the equivalent of a bar and cause an error.

No timing errors

In the electronics for interpreting the bar codes, the Model 101 detection system starts a clock count at the beginning of every bar and every space, and it stops counting at the end of every bar and space.

In this way, Hanchett says, the system is free from the cumulative timing errors of ASCII coding methods. ASCII-coded systems use the timing circuits to generate a strobe, which samples whether a bar is present at predetermined intervals.

Another limitation of the ASCII



Special type ball imprints bar codes for character recognition beneath each of the typewritten characters.

method, Hanchett asserts, is that samples of the horizontal bars in the typed letters can be misconstrued as a code bar. For this reason, ASCII bar readers require that the first typed line coincide with a preprinted marker and that the paper be stepped in precise line increments. As a result, free-form typing cannot generally be used.

In the new reader a sheet is inserted, and it progresses beneath the rotating optical head at a uniform rate of 1.33 in/s. This head design was chosen, Hanchett says, to eliminate the drawbacks of scanning with mirrors, as well as those of mechanical systems that scan back and forth across the page.

The role of the rotating lens assembly is to illuminate the characters to be read and to focus the typewritten elements onto the nine-element photocell array.

The paper is drawn by a vacuum into a semicylinder shape as it travels under the reading head, Hanchett explains. Thus the lenses view the entire line at constant focal length.

The optical drum rotates at 1800 rev/min or 30 rev/s, sweeping a beam of light across each line of typed characters. At the 30 rev/s drum speed, the light spot travels across the width of the page at about 1000 in/s.

Since the characters are typed at 10 per inch, each character in a line is illuminated for about 100 μ s. This provides an instantaneous reading rate for a single lens of 10,000 characters per second.

However, because the rotating drum houses three pairs of illuminating and imaging lenses, the typed line is swept three times by a light spot per revolution. ■■

Our years of working directly with design engineers on hybrid circuits for high-reliability military applications have given us the experience to eliminate your uncertainties in hybrid circuit planning and packaging. We can ease you through a smooth transition from your basic electronics to hybridization, or help you consolidate a preferred circuit, taking advantage of the space, handling, stock and inventory economies of the hybrid package.

With hybrids, the only limitation is imagination. You'll be surprised by the variety and number of parts we can put in a package. Our unique facility can supply thick film or thin film hybrid microcircuits ranging from simple multiple chip to complex multi-layer assemblies, all built and maxi-tested to meet the most stringent military standard, 883 Level A.

In addition, our experience has led us through an evolution of top quality hybrid analog gates and D-to-A switching circuits. We make an array of standard hybrids from which you might easily choose the one to answer your special design problem, at a cost much lower than you expected.

No matter what your hybrid requirement—small quantities of custom circuits or large quantities of our standard hybrids—Crystalonics is unbeatable on size, reliability and turn-around time. You can send for our microcircuits catalog today. Or for immediate design assistance, stop wrestling and call Jack Senoski, Art Pauk or Richard Antalik of our hybrid applications engineering squad.

**Stop wrestling
over
hybridization**

We're at your elbow to ease your design.
Crystalonics. We listen.

 **TELEDYNE
CRYSTALONICS**

147 Sherman Street, Cambridge, Mass. 02140
Tel: (617) 491-1670 • TWX: 710-320-1196

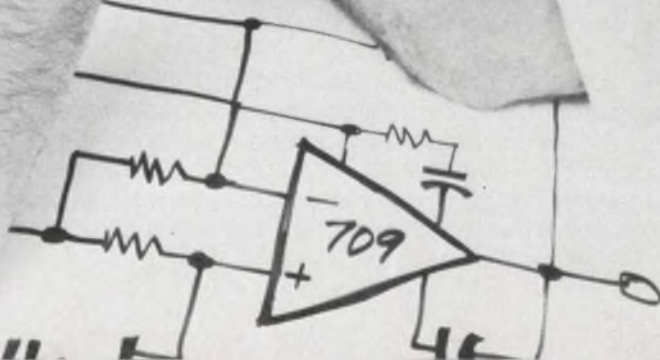

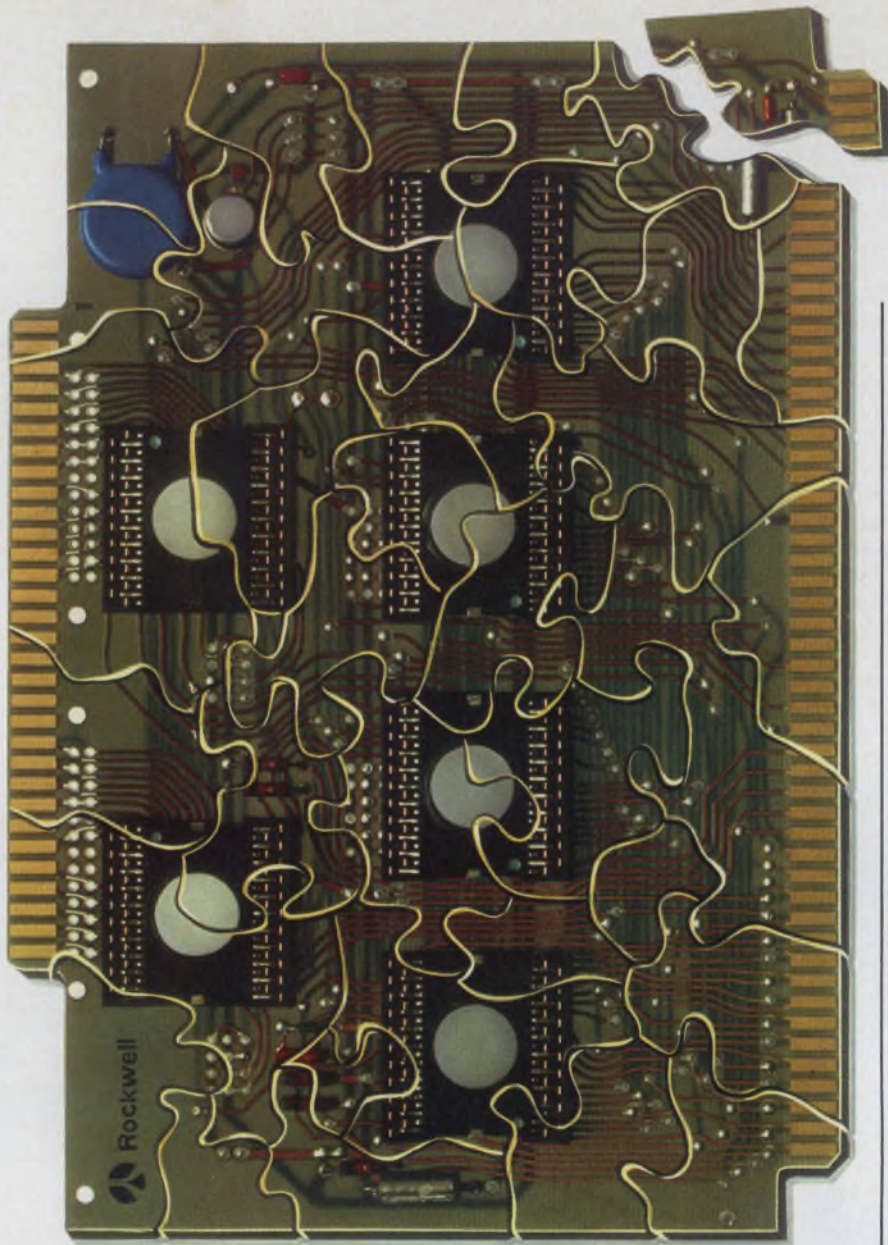

Rockwell a system

Intelligent I/O's do the CPU's busywork.

We've identified many common tasks performed by micro-processing systems and designed intelligent LSI I/O's to control them — independent of the CPU. The CPU is thus able to delegate mundane chores such as running the peripherals, while concentrating on the serious thinking it does best.

The spreading of intelligence among the I/O's also reduces the amount and cost of program memory in your system. And because the CPU is no longer responsible for monitoring a multiplicity of functions all over the lot, programming becomes simpler, faster, and more flexible. You simply plug in or remove a chip with minor, not total, software changes to add or subtract functions.



DMAC:

**Another burden
lifted from the CPU.**

Our 8 channel Direct Memory Access Control (DMAC) gives priority to data flow between the I/O's and the system's memory. Once again, the CPU is freed from a routine, time-consuming chore.

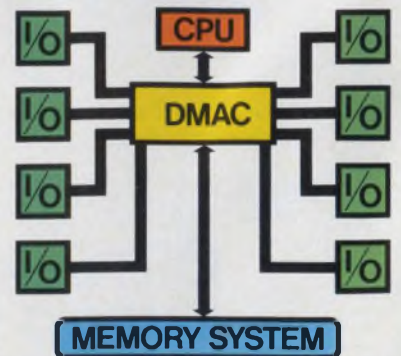

is there with approach to microprocessing.

PARALLEL PROCESSING: HIGH SPEED RESULTS FROM LOW COST TECHNOLOGY

With so much independent intelligence spread through our system, many tasks can be executed at virtually the same time. With our parallel processing system (PPS) you can now perform tasks with MOS micro-processing that would otherwise require higher cost technologies.

A THRILLING CASE HISTORY

A fellow designed a new cash register whose I/O's sprawled over three PC boards and cost about \$250. He felt there was a better way and went to a large microprocessing house, but one which sold chips, rather than systems. They reduced him to one large and two small PC boards, with a cost of about \$160. Finally, he came to Rockwell, where we applied

our LSI system approach to his problem. He walked out with his entire system in LSI on one PC board at a cost of about \$85.



MILLIONS OF DOLLARS SAY WE'RE SERIOUS ABOUT ALL THIS

We've spent millions of dollars to develop more than 40 LSI microprocessor circuits to offer you LSI options for most of

your electronic needs. As well as a worldwide sales and field service organization. Add to that a production capacity of tens of millions of circuits per year and you get the picture: giant Rockwell is very serious about tiny micro-processors. Don't let anyone tell you otherwise.

**Help is never more than
ten digits away:**

714. 632-3729

Just call us at any hour and tap into a wealth of Rockwell customer support: detailed literature, software libraries, assembler - simulators and other design aids. Programming and board development assistance. And training programs at our facilities or yours. Some of this help is free; some costs. Take as much or as little as you need. What's important is that it's there. Right now.

Stop trying to solve micro-processor problems by bits and pieces. Instead, see how Rockwell's LSI system approach can help you. Call Bill Roland at (714) 632-3729 or write to:

Department 1 C 1108
Microelectronic Device Div.
Rockwell International
P.O. Box 3669
Anaheim, California 92803



Rockwell International

...where science gets down to business

Now, a Hewlett-Packard 21MX for OEM's who think big.

The M/30 processor.



Now Hewlett-Packard brings 4K RAM semiconductor technology to OEM's with large memory needs. Compatible with all previous 21MX minicomputers, the new M/30 offers the same modularity, the same flexible user microprogrammability.

Not only does 4K RAM technology bring you more reliability, you also benefit from our recent February 30% price reduction on memories. (Send for your free copy of our recent "Engineering Evaluation Report." It proves the 4K RAM based 21MX minicomputer series is 50% more reliable than our previous "core" based machines.)

And take a hard look at what HP offers you in I/O. We give you more: 14 I/O slots in the M/30. But equally important they're all fully powered with vectored interrupts.

Plus Dynamic Mapping with addressability to 1 megawords.

Choose the 21MX that fits your thinking: M/10, M/20 or M/30. Ideal solutions for OEM's from 8K to 256K.

For complete data, write or phone your nearest Hewlett-Packard sales office.

HEWLETT-PACKARD'S 21MX FAMILY

21MX PROCESSOR	TYPICAL 21MX SYSTEM		I/O EXPANSION FULLY POWERED I/O CHANNELS		RACK HEIGHT
	4K RAM MEMORY	PRICE (QTY. 50)	WITHIN MAINFRAME	WITH TWO EXTENDERS	
M/30	64K WORDS	\$13,629*	14	46	12¼"
	↑ Only \$594* more	↑ Double the memory	↑ 50% more I/O slots	↑ Only 3½" more rack space	
M/20	32K WORDS	\$ 7,788*	9	41	8¾"
M/10	16K WORDS	\$ 5,049*	4	36	5¼"

*Domestic USA OEM prices quantity 50.

HP Minicomputers. They work for a living.



Sales and service from 172 offices in 65 countries.
1501 Page Mill Road, Palo Alto, California 94304

Straight talk about IC sockets.

Integrated-circuit sockets are becoming such a household item, people are starting to forget something.

They're not all alike. And the differences can have a major impact on the performance and profitability of the products they're used in.

That's why we've decided to go over a few socket basics.

THE REASONS... AND THE RISKS.

All sockets serve basically the same purpose: they allow you to replace ICs without damaging either the IC or the PC board. In so doing, they make both design changes and field service economically feasible for you and your customer.

There's only one problem. When a socket fails, troubleshooting can be a nightmare — to a point where you'd have been better off without sockets in the first place. So it pays to be sure that the sockets you buy are right for your application.

CHOOSING THE RIGHT SOCKET.

Buying the right socket is much more than a matter of profile and price. It's matching the right one to the demands of your application.

For low-cost, high-volume products where the risk and consequences of socket failure are minimal — and where repeated IC insertion and high retention aren't required — buy the cheapest sockets that will do the job properly.

But for high-shock and vibration environments, or other situations where performance is critical, by all means get the best sockets money can buy.

At Augat, we understand these

differences. That's why we make sockets for both needs, in the widest range of sizes and specifications in the industry — from 6 to 40 contacts, on .300", .400", and .600" centers. These include low-profile, LED, and test sockets, socket carrier assemblies, and more — with PC, wire-wrapping, and solder pocket terminations.

And thanks to high-volume, automated production economies, these sockets are priced competitively despite many features you can't get elsewhere.

SMALL POINTS MAKE A BIG DIFFERENCE.

It's amazing how the finer points of socket construction can affect reliability.

Take the material the contacts are made of. For repeated IC insertion and good retention no other material can match the beryllium copper used in all Augat PC sockets. Cost alone leads other producers to use other materials.

Designs vary, too. Among low-priced sockets, Augat's new low-profile series grip the IC lead along *both* flat sides, rather than by the edge, for best contact. And they'll take the full range of lead sizes, too.

Among premium sockets, Augat's Series 500 and 700 are the only ones in the world to include the two-piece machined contact assembly designed and perfected by Augat. While stamped "equivalents" abound, their looser tolerances have given



rise to a series of pitfalls avoided by the Augat design:

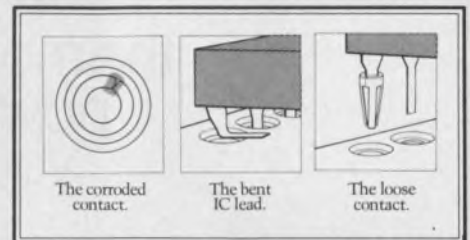

In the important matter of flow soldering, both series again provide a decisive edge. The closed-end construction completely eliminates the possibility of flux or solder wicking.

These distinctions may seem small. But taken together, they're a good indication of how well the sockets you buy will stand up under long-term use. And in a market flooded with lookalikes, they're something to shop for.

A SUPPLIER YOU CAN COUNT ON.

As the pioneer and leader in the IC interconnection industry, Augat has always been the world's prime supplier of IC sockets.

Now, after completing a multi-million dollar program of vertical integration, we're better equipped than ever to maintain that position — by providing the best sockets, the best service, and the finest distributor network in the world.

For all the facts, send today for our new brochure. We're convinced that the more you know, the more you'll come to Augat for all your IC interconnection needs.

YOU ONLY GET IT ALL FROM AUGAT.

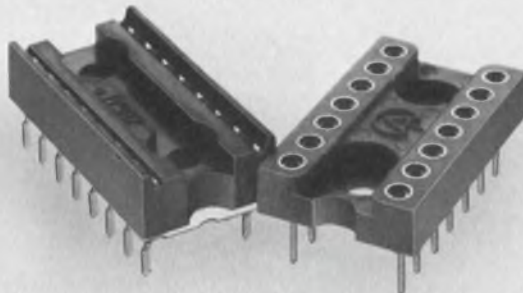

AUGAT[®]

Augat Inc., 33 Perry Avenue, P.O. Box 779, Attleboro, Massachusetts 02703. Tel. (617) 222-2202.

Europe — Augat N.V., Boulevard A. Reyers, 103, 1040 Brussels, Belgium. Tel. (02) 7369399.

Japan — Kyokuto Boeki Kaisha Ltd., New Otemachi Bldg., 2-1, 2-Chome Otemachi, Chiyoda-Ku, Tokyo 100-91, Japan. Tel. (03) 244-3788.

Canada — A.C. Simmonds & Sons Ltd., 285 Yorkland Blvd., Willowdale, Ont. M2J1S8, Tel. (416) 491-1010.



KEPCO

PRM

180 watts of
the most reliable
power supply
you can buy

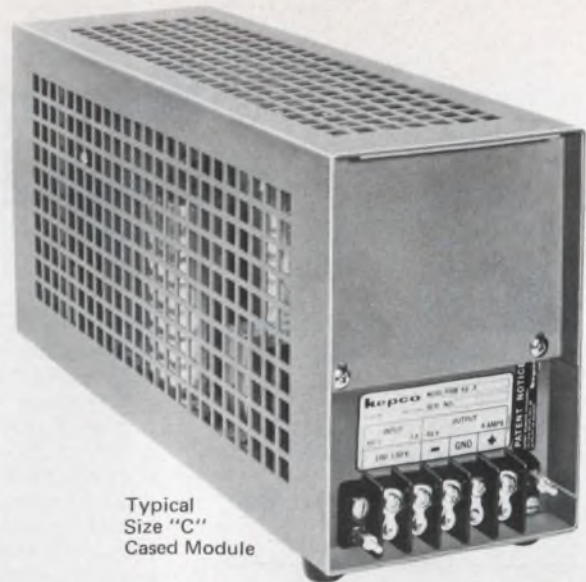

Typical
Size "C"
Cased Module

Recognized by Underwriters' Lab under their component recognition program, UL478 and UL114.

180 watts of the most reliable power supply you can buy. We really mean it. Reliability bears a simple inverse relationship to the number of parts likely to fail. Kepco's Size "A" PRM design uses *exactly 10 components*: 4 diodes, 2 capacitors, 1 transformer, 1 resistor, 1 terminal strip, and 1 chassis. . . . That's it, period.

Compare parts population to some of the competitive SCR-regulators, high-frequency switching supplies and transistor feedback stabilizers. But, the PRM isn't an unstabilized brute; it's a rather elegant power supply with a number of attractive features:

1. Automatic (inherent) overcurrent limiting—at approximately 150% of rated current.
2. Automatic (inherent) overvoltage protection. There's no crowbar—there's no need for one.
3. Good source isolation, a 100–130V a-c line change brings less than 2% output effect. Line noise is attenuated by more than -120 dB at 1 MHz.
4. Low output impedance for minimal load effect, typically less than 0.1 ohm.
5. Ripple on the order of 30–300 millivolts (depending on model) and as little as 3 millivolts for the double filter models.
6. Operation in environments up to +55°C with no derating whatever.
7. A choice of several power ratings for the standard output voltages: 5.2V, 6.3V, 12V, 18V, 24V, 38V, 36V, 48V, 60V, and 120V. The size "D" models offer 85 different volt/ampere combinations from 4.2 volts at 12 amperes to 260 volts at 0.23 amperes.
8. Custom volt/ampere combinations available to your order.

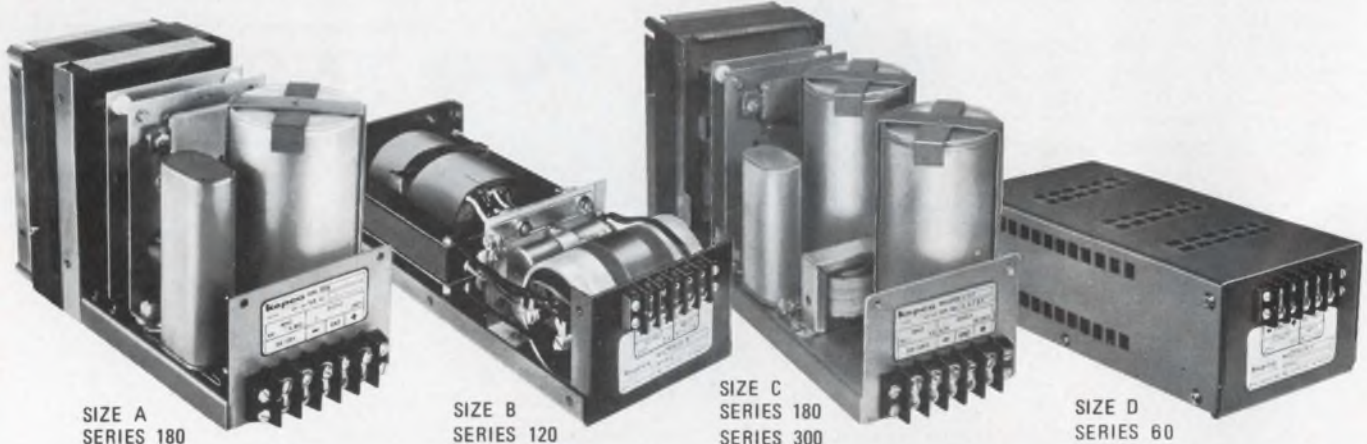

SIZE A
SERIES 180

SIZE B
SERIES 120

SIZE C
SERIES 180
SERIES 300

SIZE D
SERIES 60

For complete specifications,
write Dept. O-05

KEPCO

KEPCO, INC. • 131-38 SANFORD AVENUE • FLUSHING, N.Y. 11352 • (212) 461-7000
TWX 710-582-2631 • Cable: KEPCOPOWER NEWYORK

Washington Report

An independent FAA sought

The Federal Aviation Administration may regain its old place in government life through a father and son act. Sen. Barry Goldwater (R-AZ) and his son, Rep. Barry Goldwater Jr. (R-CA), have introduced bills in their respective chambers on Capitol Hill that would take the FAA out from under the Dept. of Transportation and once again make it an independent agency.

In 1967 the then independent Federal Aviation Agency ran its own show, but management experts argued—and won—the debate that resulted in all forms of transportation being lumped into one department. By stacking bureaucracies on top of one another Senator Goldwater contends, the Government has introduced some obvious shortcomings—such as adding 18 months or more to the FAA's procurement process. Both father and son argue that independence will permit the agency to act more quickly to update its services and improve air safety.

Better distribution of NSF grants urged

Contending that there is a pattern of administrative abuses and mismanagement in the National Science Foundation, Sen. Jesse A. Helms (R-NC) has introduced a bill to provide a peer review and management system for awarding grants. A similar bill in the House has been introduced by Rep. John B. Conlan (R-AZ). Both bills are aimed at obtaining better nationwide distribution of grants and the blocking of projects of questionable value.

At present, there is no single decision process in the foundation. On all but the larger grants, the program officer has formidable power. The bills to amend the National Science Foundation Act of 1950 would, among other things, require a review of applications by a peer group of no less than five qualified individuals in a particular field. The NSF program officer could select half of the group from an approved list, the applicant could name 20% and the remaining 30%, chosen randomly.

Recent statistics, says Rep. Conlan, "show that NSF funding is restricted primarily to a small group of preferred institutions within a few states, with special preference to an elite corps of academic institutions heavily represented on the foundation's advisory committees."

Defense budget backers arm for new battles

The war over the Defense budget goes on with the Senate Armed Services Committee victorious over the Senate Budget Committee and the House of Representatives in the first engagement. But more battles lie ahead.

Just prior to the August recess, the Senate, at the urging of its new Budget Committee, refused to approve the conference report on the authorization bill, which was a stinging defeat for Sen. John Stennis (D-MS), chairman of the Armed Services Committee. Although the more liberal Senators wanted billions sliced from the bill, Senator Stennis and the other conferees reported back with a bill that was further trimmed by only \$250-million. The Senate has now passed this version almost placidly, with the defense budget-cutters reserving their next attack for the appropriations bill passed by the House on Oct. 2.

The authorization for the coming 15 months now amounts to \$30.9-billion. The conferees cut \$60-million for a nuclear strike cruiser. The AWACS program still calls for six aircraft, but \$60-million was cut from the program and spares. The Air Force F-15 program was reduced \$22.3-million on all spares, in addition to AWACS, \$22.7-million. The Navy's patrol frigate program was cut from 10 to nine vessels, saving \$85-million.

With the "shopping list" bill out of the way, the Senate began considering a \$112-billion appropriation bill, which would cut some \$4.5-billion from the sum the Defense Dept. now plans to spend this year. A spirited fight is expected in the Senate, for example, over the AWACS program. The House, which reluctantly agreed to a six-plane program, voted money for only two planes.

According to the Senate Budget Committee, the House appropriation bill exceeds the Senate committee's guidelines by \$700-million. A replay of the donnybrook on the authorization bill is assured, because this will be the last chance to cut defense spending during the next 15-month period that began on July 1.

California leads in defense contracts

When it comes to winning the defense dollar, California still reigns supreme, capturing one-sixth of the total procurement in the fiscal year that ended last June. According to the Defense Dept. Comptroller, the total value of military procurement for the year came to \$43.3-billion; California contractors got nearly \$8-billion of that.

New York State was second with \$3.7-billion, followed by Connecticut, \$2.3-billion, and Texas, slightly over \$2-billion. States with more than \$1-billion in contracts were Massachusetts, Washington, Missouri, Virginia, Pennsylvania, Florida and Ohio. Montana, with \$5.1 million, received the smallest slice of the pie.

Capital Capsules: The Air Force has developed a Voice Input Code Identifier that enables a computer to recognize spoken digits and certain command words, say Air Force engineers, who tested it with a variety of regional accents. The identifier will be used with the Automated Speaker verification system for controlling entry to restricted areas. . . . The Army's Safeguard ballistic missile defense system became operational Oct. 1. It will not be deployed, however, due to terms of the U.S.-Soviet detente. . . . **Libya is looking for \$30-million worth of air control training equipment**, including air traffic control, search and rescue and computer systems. . . . The Army's selection of the French-German air defense system, Roland II, over an American system is described by the Defense Dept. as "a major step forward in defense cooperation among NATO allies." . . . **The Army is giving a longer reach to chaff dispensers by sending the jamming material via rocket.** The projectile dispensers are powered by 2.75-inch rocket motors.

It makes audio communications measure- ments too...

Tektronix TM 500

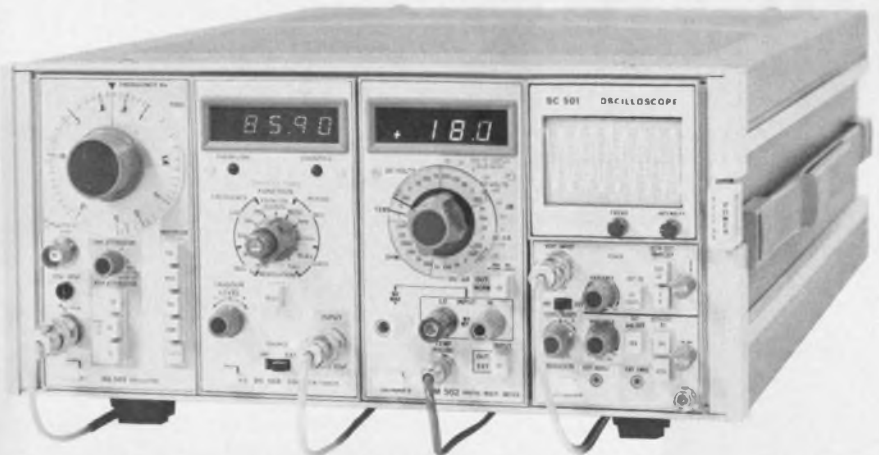

- digital multimeters
- counters
- generators
- amplifiers
- power supplies
- oscilloscopes
- a blank plug-in for your own circuitry
- and more

The TEKTRONIX modular Audio Frequency Instrumentation group provides the test and measurement instruments you most frequently need . . . for only \$1970* These compact light weight instruments work together as a system or independently within a TM 504 power module/mainframe.

The above TM 500 configuration features a dB reading DM 502 Digital Multimeter with 3½ digit display and optional (\$125)*temperature measurement capability (a function that has proven valuable in identifying active solid-state device circuit problems); the SG 502 Audio Oscillator provides 5 Hz to 500 kHz sine and square waves, 600Ω output, and low distortion (0.035% from 20 Hz to 50 kHz); the DC 504 Digital Counter offers 5-digit LED display of frequency to 80 MHz and period resolution to 1 μs; and the SC 501 Oscillo-

scope is a single-channel, dc-to-5 MHz modular instrument with triggered sweep and vertical sensitivity to 10 mV/division.

All TM 500 plug-ins are readily interchangeable within the entire TM 500 line. Plus there's a blank plug-in kit, which allows you to add your own special circuits to a TM 500 system. The plug-ins can work together synergistically through the common interface circuit board of the power module/mainframes. So you can tailor a system of instrumentation exactly to your needs . . . a system that's only 6" x 11" x 20" and weighs less than 30 lbs. . . and a system that offers you benefits difficult to duplicate with "monolithic" instruments.

TM 500 is a growing, compatible family of 29 plug-in modular instruments, accessories, and one, three, four, and six-compartment power module/mainframes. Package configurations can be selected for work in high-speed logic circuitry, medical instrumentation, instrumentation calibration, industrial equipment, and more. All may be hand carried, all go on the bench, and there are rack-mounting and SCOPE-MOBILE® configurations as well. You can select from general-purpose instruments, such as the DM 501 Digital Multimeter, or highly specialized instruments, such as the AF 501 Tunable Bandpass Filter or AM 502 high-gain amplifier with calibrated gain to 100 dB and switch-selectable high and low-pass filters. If your work requires the measurement of electrical phenomena in the audio frequency range, Tektronix TM 500 offers substantial benefits to you.

Find out what TM 500 can do for you. Get the TM 500 Catalog A-3072 with full specifications and applications information. Or contact your local Tektronix Field Engineer for a demonstration of how TM 500 offers a better solution to your needs. Write to Tektronix, Inc., P.O. Box 500, Beaverton, Oregon 97077. In Europe, write Tektronix Limited, P.O. Box 36, St. Peter Port, Guernsey, Channel Islands.



* U.S. Sales Prices FOB Beaverton, Oregon

New snap-in rockers with Cutler-Hammer reliability.

Here's a completely new line of snap-ins, each engineered with the kind of solid dependability you expect in Cutler-Hammer Rockette® switches. Bright metal bezels, illuminated and non-illuminated, A-c and D-c capabilities up to 20 amps.

Sub-panel rockers in a variety of colors, rocker or paddle designs in standard, special, or proprietary models.

Switches snap in and stay in permanently. Speed up assembly time, cut costs.

Flush-mounted rockers in the same wide range of designer-oriented colors and styles. One- and two-pole models.

Illuminated single-pole rockers. Choice of red, green, amber, white, or clear. Hot-stamped legends indicate switch functions.

For more information, call your Cutler-Hammer Sales Office or Switch Distributor.

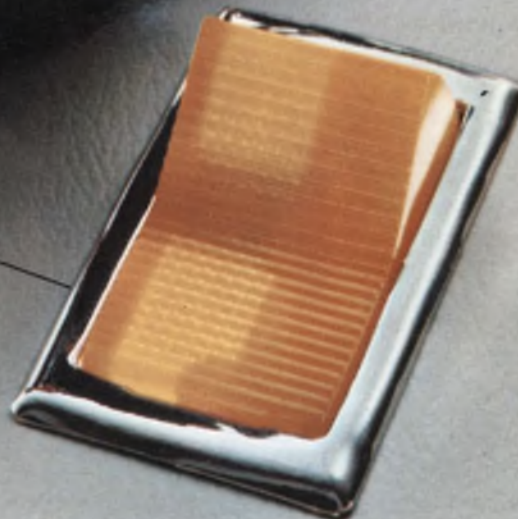

CUTLER-HAMMER
SPECIALTY PRODUCTS DIVISION, Milwaukee, Wis. 53201



Announcing..... A New Portable from Tektronix

The TEKTRONIX 455

- 50 MHz bandwidth. ● Dual trace. ● Delayed sweep. ● Sweep rates to 50 ns/div with 2% accuracy (5 ns/div with 3% accuracy.)
- Vertical deflection factors to 5 mV/div with 3% accuracy.
- Large 8 x 10 cm CRT display ● \$1695.

And that's not all. The 455 offers this performance combined with more convenience features to speed measurements and reduce human error. All at a budget-conscious price. Measurements are made easier and faster with trigger view; trigger hold-off; lighted deflection factor indicators; and a functionally laid out, easily understood control panel.

Servicing the 455 is faster and less expensive. Although monolithic in design, the instrument contains easily removable vertical amplifier and time-base modules for ready access to all components. That means quicker repairs and less down time. And the entire unit is housed in a shock-resistant, reinforced plastic case to withstand rough handling in factory or field environments.

Optional battery pack provides operation at remote sites and eliminates noise due to line transients. The 455 will operate up to 4 hours without a battery recharge. When AC power is available, the battery pack can be detached to reduce weight.

For specialized applications, the 455 can be equipped with emi protection or tv sync separator.

The 455 is the latest entry in the Tektronix 400 Series of Portable Oscilloscopes. Other dual channel delayed sweep units offer:

- 5 mV/div sensitivity at 100 MHz (the 465)
- 2 mV/div sensitivity at 200 MHz (the 475)
- 5 mV/div sensitivity at 350 MHz with simultaneous displays of intensified and delayed waveforms (the 485)
- Unique single-shot storage to 100 MHz (the 466)

For complete information on how the 455 Portable Oscilloscope delivers the performance, versatility, and cost-saving effectiveness you need, contact your local Tektronix Field Engineer. Or write: Tektronix, Inc., Beaverton, Oregon 97077, for the new 455 applications and specifications brochure. In Europe, write Tektronix Limited, P.O. Box 36, St. Peter Port, Guernsey, Channel Islands.

U.S. Sales Price FOB Beaverton, Oregon



TEKTRONIX®

committed to
technical excellence

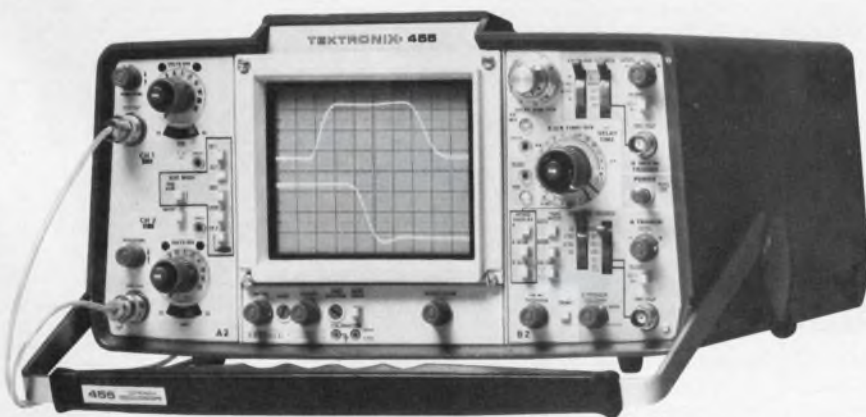

FOR TECHNICAL DATA CIRCLE #243

FOR DEMONSTRATION CIRCLE #244



HiNIL Interface

Keeping the bugs out of microprocessor systems with high noise immunity logic.

An MOS microprocessor system can be troubled by disastrous bugs unless it is protected against noise transients generated by switches, electromechanical peripherals and other nearby noise sources, such as lamps and machinery. But filters and shielding, the traditional cures, are often difficult to add to a microprocessor because of size and cost constraints.

These problems can be avoided by substituting HiNIL interface devices for conventional I/O logic. HiNIL—Teledyne's bipolar High Noise Immunity Logic—has a guaranteed DC noise immunity about 10 times that of TTL, for example (3.5 vs. 0.4V). Also, HiNIL blocks AC transients large enough to cause TTL malfunctions. Two additional advantages are superior output drive and, in low power systems, protection of CMOS memory and random logic inputs.

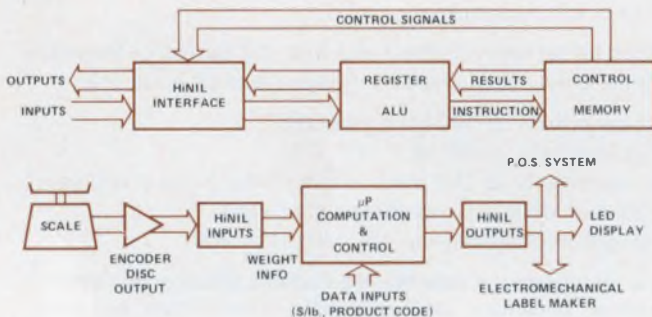

Figure 1. Use of HiNIL interfaces in POS systems with electronic scale. Top diagram shows basic microprocessor configuration.

One manufacturer of microprocessor-controlled electronic scales decided to use the configuration in Figure 1 because he was concerned about the consequences of incorrect weights and prices. The probability of errors resulting from noise transients was high because the scale would be used in a supermarket POS system, where the environment includes refrigerators, fluorescent lamps, meat grinders and electromechanical label makers.

In the system, the microprocessor receives weight codes from an encoder disc in the scale and operates a cash register interface, LED display, and relays of a receipt printer or label maker. The system designers put HiNIL interface logic on the microprocessor board to handle the I/O functions, suppress noise transients picked up along the transmission lines, and drive the peripheral devices. HiNIL output interfaces can drive long lines, relays, displays and lamps without additional components since they sink up to

65 mA and source up to 12 mA. (The new 390 buffer series will sink up to 250 mA.)

Manufacturers of systems requiring random logic are finding that HiNIL and CMOS are an ideal combination. They maximize system noise immunity and assure an excellent system function/power product. HiNIL and 54C/74C CMOS interface directly at V_{CC} voltages from 10 to 16 volts, the power supply range of HiNIL. Moreover, HiNIL protects CMOS inputs from destruction by static electricity and from harmful DC input levels that can exist before CMOS circuits are powered up.

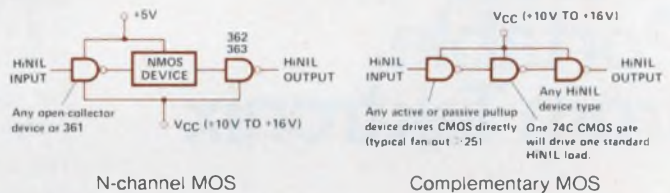

Figure 2. Typical HiNIL/MOS and HiNIL/CMOS interfaces

The rules for using HiNIL with MOS or with CMOS operating at lower voltages are simple. The pullup resistor of an open collector HiNIL device is connected to the desired high logic level voltage (see Figure 2). To use HiNIL with other bipolar logic, just plug in a Teledyne dual or quad interface circuit (see table). HiNIL is also compatible with most analog devices.

Examples of HiNIL Interface Devices

301 Dual 5-Input Power Gate	65mA relay or lamp driver
302 Quad Power NAND Gate (OC)	
323 Quad NAND Gate (OC)	Input noise protection plus open-collector pullup to other logic levels
332 Hex Inverter (OC)	
334 Strobed Hex Inverter (OC)	
350 8-Bit Multiplexer	Drive longer lines than TTL with 10X noise immunity ($I_{OH} = 12mA$)
351 Dual 4-Bit Multiplexer	
361 Dual Input Interface	361 directly connects HiNIL to DTL/RTL/TTL
362 Dual Output Interface	362 and 363 connect DTL/RTL/TTL to HiNIL
363 Quad Output Interface	
367 Quad Schmitt Trigger	Suppress 100V/1 μ s spikes, protect CMOS, decode switches, etc.
368 Quad Schmitt Trigger (OC)	
380 BCD to Decade Decoder	
381 BCD to Decade Decoder (OC)	Provide decoder/drive for lamps, LEDs, gas discharge displays, etc.
382 BCD to Decade Decoder	
383 BCD to 7-Segment Decoder	
390 Interface Buffer Series	250mA HiNIL driver series will be available soon

If you need a simple, inexpensive solution to a difficult noise problem, write or call Teledyne Semiconductor for a copy of application notes and specifications on Teledyne's High Noise Immunity Logic family.

TELEDYNE SEMICONDUCTOR

1300 Terra Bella Avenue, Mountain View, California 94043 Tel: (415) 968-9241 TWX: 910-379-6494 Telex: 34-8416

ENGLAND: Heathrow House, Cranford, Hounslow, Middlesex, Tel: (44) 01-897-2503 Telex: 851-935008

FRANCE: 90, Avenue Des Champs Elysees, 75008 Paris, Tel: 2563069 Telex: 842-29642

WEST GERMANY: Albert Gebhardtstrasse 32, 7897 Tiengen, Tel: 7741-5066 Telex: 841-792-1462

JAPAN: Nihon Seimei-Akasaka Bldg (3F), 1-19, Akasaka 8-chome, Minato-ku, Tokyo 107, Tel: 03-405-5738 TWX: 781-2424241

Additional offices in West Germany, Hong Kong and the United States. Representatives and distributors worldwide.

Ignorance and apathy

Dan, an old buddy, telephoned the other day to relate a conversation. He was sipping some lemonade at the Wagon Wheel, a local culture center in California's Silicon Gulch, when he overheard two semiconductor executives.

"What's wrong with this industry," Will was philosophizing, "all boils down to two factors—ignorance and apathy." Jerry stirred his drink, steeped his hands, looked at the ceiling, then replied, "I don't know. And I don't give a hoot."

Jerry may have been kidding. But the story, even if apochryphal, is more sad than funny. It's sad on two counts. First, far too many of us don't know and don't care. And second, far too many of us don't know and don't care that we don't know and don't care.

We adjust too readily. When we see our own companies turning out shoddy products or engaging in practices that might be less than admirable, we close our eyes. We see nothing and want to see nothing. Maybe the social and economic setup makes us insecure and fearful. Or maybe we're too comfortable. And maybe our comfort is too easily shaken by our seeing things and giving voice to our consciences. Maybe our blinders help us drug our consciences. Unfortunately, conscience can't be buried. So there's one tragedy.

The second may be a blessing rather than a tragedy. Most of us can't see what we can't see—even when we are shown.

Tell one fellow that there's too much bigotry in the world. And he might agree, if he cares to agree, while denouncing Jews, or blacks, or women, or red-headed men, or Easterners or Westerners, or whomever. Tell a man there's too much conceit in the world and he might agree while hailing his own virtues. Tell an engineer there's too much equipment around that fails too readily and he might agree, while condemning those who don't use his designs with the utmost caution.

Maybe it's fortunate that most of us have a built-in mechanism to protect us from seeing some of our ugliness. But wouldn't it be better if we were secure enough and strong enough to see and care?



A handwritten signature in dark ink, which appears to read "George Rostky". The signature is fluid and cursive, written in a professional style.

GEORGE ROSTKY
Editor-in-Chief

IT'S WORKING FOR ME

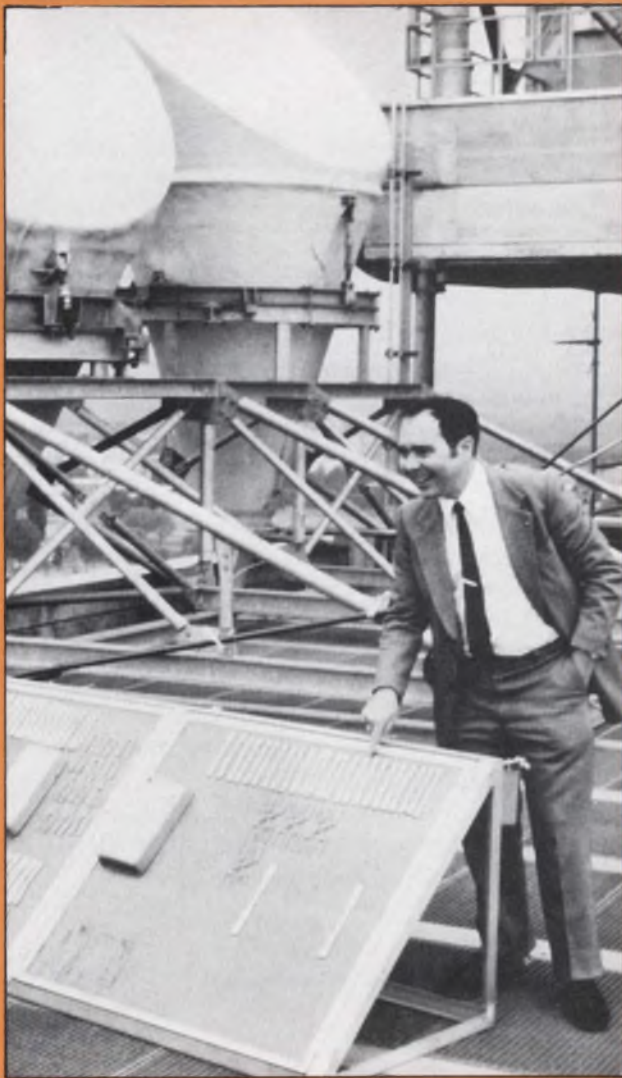

"THE GOLD BOOK IS A VERY RICH SOURCE FOR INFORMATION ON U.S. PRODUCTS"

Mr. Peter Kartaschoff is Head, General Radio Technology Section, R&D Center, of the Schweizerische Post-, Telephon- und Telegraphenbetriebe (Swiss Postal Enterprise) in Bern, Switzerland.

The Post Office in Switzerland, as in most of Europe, is also responsible for communications, telephone and telegraph. The R&D Center is very important; what it specifies will be bought later in quantities. Mr. Kartaschoff told *Electronic Design's* Associate Editor, John Mason:

"We buy a wide range of special components for development work. We have a relatively good network of suppliers in Switzerland where we usually can get small quantities. But in the last few years we have sometimes had trouble in finding large quantities.

"Your GOLD BOOK is a very rich source of information on U.S. electronic products.

"If a piece or system can be bought on the market we tell our people, listen there it is. We'll buy it. We're not going to develop it ourselves because it's always cheaper to buy something than to develop it."

This is the *Electronic Design* audience at work. The GOLD BOOK sells the best of both worlds, brings you in-depth coverage of U.S. engineer/specifiers plus key engineers in major markets overseas.

Electronic Design's GOLD BOOK is working. It's working for users and it's working for advertisers, too.

NEW SIMPSON SERIES 2850 DIGITAL PANEL METER



NOW... at the right price...
a single DPM for popular
domestic and IEC/DIN cutouts



STANDARD CUTOUT
1.682" x 3.622"
(42.72 mm x 92 mm)



IEC/DIN CUTOUT
1.77" x 3.622"
(45 mm x 92 mm)



OTHER DOMESTIC CUTOUT
1.682" x 3.92"
(42.72 mm x 99.57 mm)

- 3½ digit readout
- Automatic zero and polarity
- 0.1% of reading accuracy
- BCD output is standard
- Input/output edge connector included
- Highly reliable LSI circuitry
- Choice of 120/240 VAC, 50-400 Hz or 5 VDC operation
- OEM quantity prices available upon request.

ORDER FROM YOUR ELECTRONICS DISTRIBUTOR

Model 2850 120/240 VAC input; 0.55" planar gas discharge display complete with panel mounting clips, edge connector and manual. **\$138**

Model 2851 5 VDC input, 0.55" planar gas discharge display complete with panel mounting clips, edge connector and manual. **\$138**

Model 2852 120/240 VAC input, 0.43" LED display complete with panel mounting clips, edge connector and manual. **\$138**

Model 2853 5 VDC input, 0.43" LED display complete with panel mounting clips, edge connector and manual. **\$138**

STOCK DC CURRENT RANGES: 20 & 200 μ A; 2, 20 & 200 mA
STOCK DC VOLTAGE RANGES: 200 mV; 2, 20 & 200 V
OTHER RANGES ON SPECIAL ORDER



SIMPSON ELECTRIC COMPANY

853 Dundee Avenue, Elgin, Illinois 60120 • (312) 697-2260

CABLE: SIMELCO • Telex: 72-2416

IN CANADA: Bach-Simpson, Ltd., London, Ontario

IN ENGLAND: Bach-Simpson (U.K.) Ltd., Wadebridge, Cornwall

IN INDIA: Ruttonsha-Simpson Private, Ltd., Vikhroli, Bombay

KATY INDUSTRIES



INDUSTRIAL
EQUIPMENT
GROUP

INFORMATION RETRIEVAL NUMBER 30

Increase microcomputer efficiency with interrupt and DMA capabilities. A microprogrammed μ P needs only seven extra ICs and six new instructions.

Two common features of large computers—program interrupt and direct memory access (DMA)—can be readily applied to microcomputers. These features give micros a vast increase in processing efficiency.

Program interrupt allows external hardware to initiate program operations without continuous program monitoring. It also makes more time available for program operations by reducing time spent waiting for I/O devices to complete operations (see box).

The DMA feature provides controls for high-speed direct transfer of data between an I/O device and memory. No program intervention is required during the transfer. Data can be transferred at rates up to the maximum speed of the memory—much faster than would be possible under program control. And the DMA feature allows attachment to the microcomputer of high-transfer-rate devices, such as magnetic tape and disc units.

Moreover program interrupt and DMA can be simple to build into a microprocessor. A microprogrammed processor,¹ in particular, requires only seven additional ICs, six new instructions and nine extra control-ROM bits (Fig. 1).

Making decisions

Both interrupt and DMA operations occur between instructions. Thus these operations affect normal instruction fetch and execute sequences. At the end of each instruction the microprocessor must select the next sequence to be performed—execution of an interrupt, one of two DMA operations or the fetch and execution of a normal instruction.

This decision-making begins with the ROM address register (RAR) of Fig. 1. It clears to zero at the end of each instruction, so that ROM-address zero starts the next instruction fetch portion of the microprogram. A memory called the

End-Op ROM decodes the status of the following lines: Interrupt Request ($\overline{\text{INTR}}$), Interrupt Enable Flip-Flop ($\overline{\text{INTEN}}$), DMA Request ($\overline{\text{DMAR}}$), and DMA Write ($\overline{\text{DMAW}}$). The decoding produces an address that is loaded into the RAR at the end of instruction execution.

If no interrupt or DMA requests are present, the ROM emits an address of zero, and RAR sets to the start of the next instruction-fetch sequence. If an Interrupt or DMA request is present—indicated by activation of the $\overline{\text{INTR}}$ and/or the $\overline{\text{DMAR}}$ lines—the RAR loads with the starting address of the appropriate Interrupt, DMA Read or DMA Write sequence. The End-Op ROM is so coded that DMA operations have priority over interrupt operations. Also both $\overline{\text{INTEN}}$ and $\overline{\text{INTR}}$ lines must be active before the interrupt sequence can be selected. A flow chart of these operations appears in Fig. 2.

Once an interrupt request has been received and the execute sequence has been entered, the interrupt request must be disabled. Otherwise the hardware will continue to loop through the interrupt execute sequence. The End-Op ROM, enabled at the end of the interrupt sequence, continues to generate the sequence start address as long as $\overline{\text{INTR}}$ is active.

The $\overline{\text{INTEN}}$ flip-flop overcomes this problem. It disables the interrupt request ($\overline{\text{INTR}}$). And the $\overline{\text{INTEN}}$ flip-flop clears during the interrupt sequence, and may be set—or cleared—under program control by new instructions.

The $\overline{\text{INTEN}}$ flip-flop is loaded from the I/O bus and by bit 15 (least-significant bit). The circuit is set or cleared when the 6701s emit all ONEs or all ZEROs as data, respectively. Also the flip-flop must be clocked with an additional control-ROM bit.

The right time for requests

Interrupt and DMA requests can come at any time. However any request must be made available before the end of the microstep that enables the End-Op ROM.

Specifically these signals must be stable for one ROM access time plus a counter-load setup

David C. Wyland, Microprocessor Design Manager, Monolithic Memories, 1165 E. Arques Ave., Sunnyvale, CA 94086.

Interrupt and DMA: μ P time savers

Both program interrupt and direct-memory access capabilities conserve valuable microprocessor time. They allow a computer to devote most of its time to a long program, while simultaneously providing immediate response for shorter, more urgent functions.

The program-interrupt function provides what its name implies: the ability to suspend a running program to perform a higher-priority one. When the latter program is completed, the original one resumes.

One example of interrupt is printer buffering. Serial printers are often slow—about 10 characters per second. To print a line of characters without interrupt, the CPU transfers a character to the printer, waits 100 ms until that character is printed and then transfers the next character. This procedure repeats until all the characters in the line are printed. However, only a few microseconds are needed to transfer a character. So the microprocessor spends most of its time waiting for the completion of print operations.

The program-interrupt feature eliminates this waiting time. Now the printer causes a program interrupt when it has completed a character. And while the printer is busy, the microprocessor begins or continues the execution of a program.

When the printer interrupts current program operation, the microprocessor is forced to begin execution of a special interrupt-service routine. The interrupt-service program gets the next character to be printed, sends it to the printer and re-enables the interrupt. If the last character has been printed, no commands are sent to the printer. The microprocessor can return to the original program (usually called the background program) and continue operating. Processor time is required only for a few microseconds every 100 ms.

The direct-memory access (DMA) feature allows

the high-speed transfer of data directly between the memory and an I/O device. Memory cycles are "stolen" from the processor for use by the I/O device that is transferring data.

Typically the DMA feature is used to transfer blocks of words to a list in memory. The I/O device supplies the memory address and data for each word to be transferred. It also contains the logic to increment the address to the next word on the list, count the number of words transferred and determine when the transfer is complete.

Direct-memory access must be used when data-transfer rates exceed those that are possible with program-controlled transfers. For example, a disc-file unit may require a byte of data every 3.2 μ s. This can easily be too short for a program. Within the required interval, the program must do the following: detect the transfer request, get a byte from a list, transfer it to the disc unit, increment the list address counter, decrement the word counter and test the word counter for a zero result. But with DMA, the I/O device usually contains all the logic necessary to perform data transfer in one memory cycle—typically 1 μ s.

DMA is also useful for low-speed block transfers, such as in the serial-printer example. And DMA can be used simply to make more processor time available. However, it is particularly useful for medium-speed devices with transfer rates of 1000 to 10,000 bytes per second.

If a device transfers data at 100 μ s per byte (10,000 bytes/sec) and the interrupt service program requires 60 μ s to run each interrupt, only 40% of the processor's time is available for the background program during the transfer. But if DMA transfer is used, only one 1- μ s memory cycle will be "stolen" from the processor every 100 μ s. Thus 99% of the microprocessor's time can be applied to the background program.

time and before the trailing edge of counter-load RAR clock. These signals are synchronized through clocking into flip-flops earlier in the microprogram, providing the settling time.

In our system a synchronizing flip-flop in each device requests an interrupt and/or DMA operation (Fig. 3). The flip-flops are clocked at the end of State 0, and they are clocked at appropriate points in the DMA and interrupt microprograms to ensure sufficient settling time. Timing diagrams for the DMA and interrupt operations appear in Fig. 4.

A microcomputer may have more than one DMA device, and more than one device may simultaneously request service. Thus a priority scheme is required to determine which gets serviced first. It also specifies whether a read or write

operation is to be performed.

This priority selection is performed by the logic in Fig. 3. The DMA Request flip-flop sets at the end of State 0 of the microprogram, ensuring that at least one microprogram state exists before the End-Op ROM is enabled. It also ensures that at least two microprogram state times minus a ROM access time and counter set-up time exist before all lines must be stable. During this period if any DMA Request flip-flops sets, the $\overline{\text{DMAR}}$ line (an open-collector OR bus) activates.

The priority of simultaneous requests is resolved in serial, "daisy chain" fashion: Each set of DMA request logic has a priority enable input, $\overline{\text{DMAP IN}}$. If this input is low and the DMA Request flip-flop is set, I/O device logic is enabled

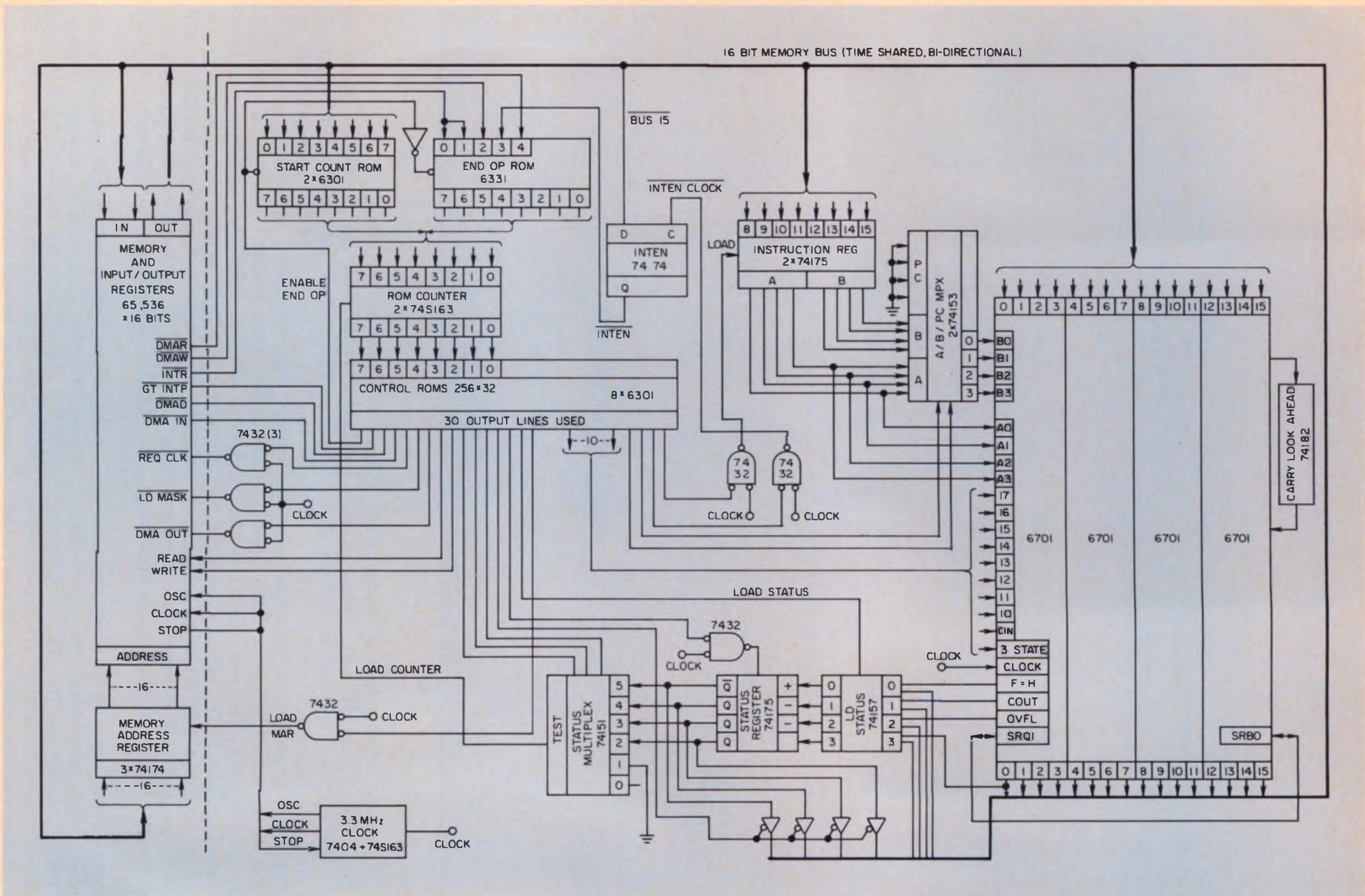

1. A microcomputer employing bipolar processor slices (the 6701s) uses just seven additional ICs, six new instructions and nine extra control-ROM bits to obtain

interrupt and direct-memory-access capabilities. This relatively simple implementation is possible because the 6701s are microprogrammable.

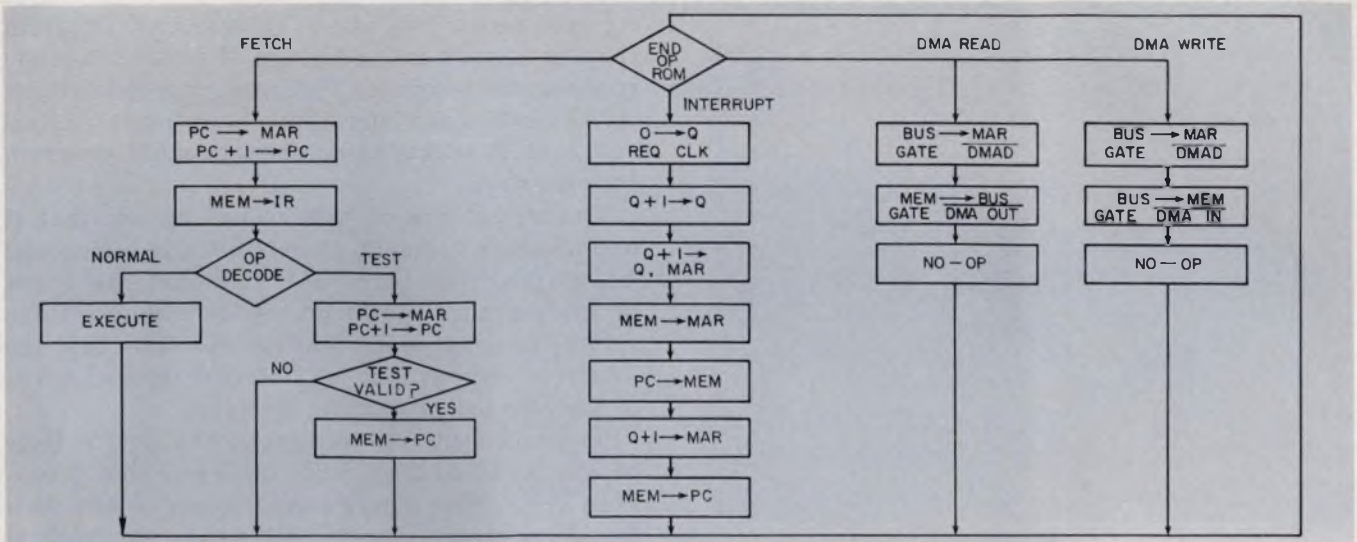

2. Decisions affecting interrupt and DMA requests focus on the End Op ROM. It determines whether the proc-

essor will perform a DMA operation, an interrupt sequence or a normal instruction fetch and execution.

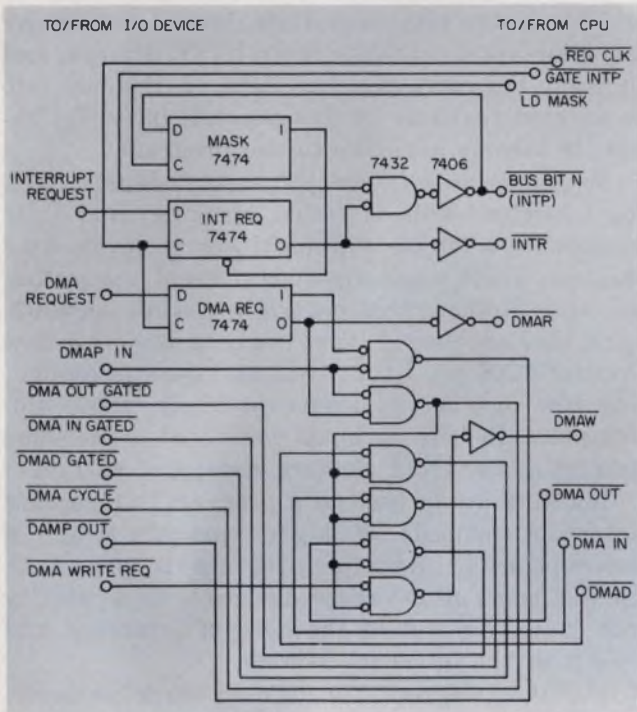

3. Each I/O device contains all the logic needed to initiate interrupt and DMA transfers.

to receive the next DMA cycle, and to drive the DMAW line, which controls read/write selection.

The DMAP IN line is permanently enabled, or grounded, for the highest priority device. Each set of logic generates a priority output signal, DMAP OUT, that goes to the DMAP IN input of the next lower priority device. This signal is normally low, unless the DMAP IN line is high or the DMA Request flip-flop is on. Either of these forces DMAP OUT high.

(continued on page 74)

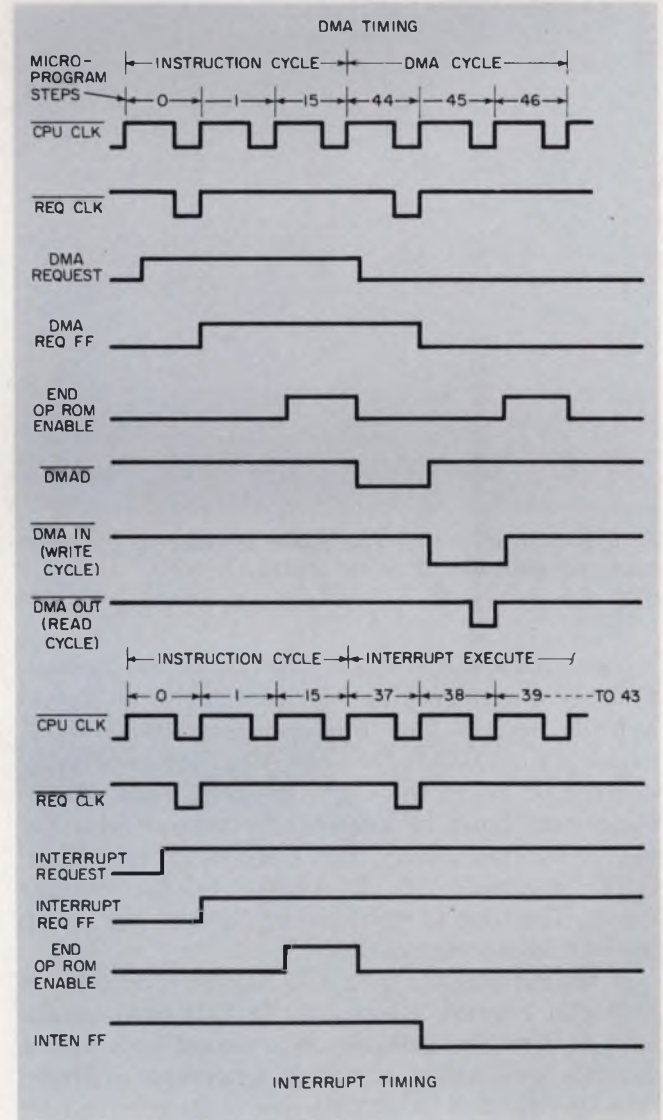

4. Both interrupt and DMA operations require special timing. The timing diagrams are segmented by micro-program steps defined in Fig. 6.

NEW INSTRUCTIONS		
Op Code	A	B
Op Code	Instruction	Operation
19	Interrupt Enable	Sets Interrupt Enable flip-flop
20	Interrupt Disable	Clears " " " "
21	Load Interrupt Status	Interrupt Status — Register B
22	Set Interrupt Mask	Register B — Mask flip-flops
23	Save Status	Status bits — Register B
24	Restore Status	Register B — Status flip-flops

NEW CONTROL-ROM BITS	
Name	Function
INTEN CLK	Clock to INTEN flip-flop
REQ CLK	Clock to all request flip-flops
GATE INTP	Gates device INTP signals to bus
LD MASK	Clock to Mask flip-flops
GATE STAT	Gates Status bits to bus
LD STAT	Gates bus to Status flip-flop inputs
DMAD	Gates device DMA address to bus
DMA IN	Gates device DMA data to bus
DMA OUT	Clock to DMA device data register

5. Data transfer for interrupt and DMA entails the use of these new instructions and additional control-ROM bits.

ROM ADDRESS	OPERATION	COMMENTS
0	PC → MAR, PC + 1 → PC REQ CLOCK MEM → IR DECODE AND LOAD START COUNT	INSTRUCTION FETCH UPDATE REQ FFs
1		
5	B + A → B, END GATE END OP ROM	OP = 7, ADD END OF EXECUTE
37	Q → Q REQ CLOCK INTEN CLOCK	BEGIN INTERRUPT EXECUTE UPDATE REQ FFs CLEAR INTEN FF
38	Q + 1 → Q	1 → Q
39	Q + 1 → Q, MAR	2 → Q, MAR
40	MEM → MAR	GET PC STORE ADDRESS
41	PC → MEM	STORE PC
42	Q + 1 → Q, MAR	3 → Q, MAR
43	MEM → PC GATE END OP ROM	GET NEW PC VALUE END OF EXECUTE
44	BUS → MAR DMAD GATE REQ CLK	BEGIN DMA READ EXECUTE DMA ADDRESS → MAR UPDATE REQ FFs
45	MEM → BUS DMA OUT GATE	OUTPUT DMA WORD STROBE DEVICE REG
46	Q → Q (NO OP) GATE END OP ROM	END OF EXECUTE
47	BUS → MAR DMAD GATE REQ CLK	BEGIN DMA WRITE EXECUTE DMA ADDRESS → MAR UPDATE REQ FFs
48	BUS → MEM DMA IN GATE	DMA DATA → MEMORY GATE DMA DATA → BUS
49	Q → Q (NO OP) GATE END OP ROM	END OF EXECUTE
50	NOT USED	
254	NOT USED	
255	0 → PC, END	OP = X, ILLEGAL OP (RESTART @ 0)

6. A portion of the microprogram is reserved for interrupt and DMA execution sequences.

Thus the DMA Request flip-flop of the highest-priority device seeking service disables all lower-priority devices. The flip-flop raises DMAP OUT, causing the DMAP IN lines of all lower-priority devices to go to the high, disabled state. Sufficient time must be allowed for this priority decision to ripple from the DMAP IN to DMAP OUT terminals of all devices in the request chain. The time is provided by the two microstep periods mentioned earlier.

A microcomputer may also have several devices that can request interrupts. In this case resolution of simultaneous requests transforms into a priority resolution of which interrupt program will be executed. And this can be determined by another program.

In our system, all interrupting devices activate a common interrupt-request line, INTR. The in-

terrupt-execute sequence causes the program counter to be set to the address of a common interrupt-service program. This program determines which devices are currently requesting an interrupt, and it selects the highest-priority program for execution.

The advantages of this technique are that it minimizes the amount of hardware required and allows priorities to be set and modified under program control. However, the technique requires several program steps between the time that the interrupt request is generated and the beginning of the selected program's execution.

To implement the technique, the device logic of Fig. 3 has an open-collector driver that generates INTP. The driver's connection to the data bus determines priority; bit 0 has the highest priority, while bit 15 has the lowest. The driver is activated by a new control-ROM bit, GATE INTP (Fig. 5). The ROM bit, in turn, activates during execution of a new instruction, Load Interrupt Status (LIS).

This instruction causes all devices requesting an interrupt to activate their INTP drivers, and it loads the corresponding data on the bus into a selected register. In this way all interrupt requests become available to the program.

In some cases interrupt-request signals must be inhibited. This is called masking, and it is done with a simple flip-flop in each device (see Fig. 3). These mask flip-flops prevent the setting of other flip-flops that control interrupt requests. And they are loaded from the data bus by a new control-ROM bit, LD MASK, and the corresponding new instruction, Interrupt Mask. Mask flip-flops have their data inputs connected to the same bus bit as the INTP drivers mentioned earlier.

Masking can be used by a program to recognize interrupt requests of higher priority while a lower-priority interrupt program is processed. Simply mask all interrupt devices with a priority not exceeding that of the current interrupt and re-enable the interrupt system.

For the interrupt function to work properly, it must be possible to save all previous data and to restore it after the interrupt has been serviced. This is easily done for CPU registers and the program counter. However, we also must be able to save and restore the status indicators.

Two new Control ROM bits are required: GATE STAT, to place the status bits on the data bus for save operations, and LD STAT, to load the status bits from the bus for restore operations. Two new instructions—Save Status and Restore Status—are also required.

Three other control-ROM bits are required for DMA: DMAD, which causes the requesting DMA device to gate its address onto the data bus; DMAIN, which causes the DMA device to gate data onto the bus for write operations; and

Interrupt

METHOD: SINGLE HARDWARE INTERRUPT
SOFTWARE PRIORITY DETERMINATION
HARDWARE FOR INTERRUPT STATUS SENSE
INTERRUPT LATENCY: 2.4 μ s (8 MICROCYCLES)
MASKABLE INTERRUPT: 16

DMA

METHOD: SYNCHRONIZED REQUESTS
HARDWARE PRIORITY DETERMINATION—DAISY CHAIN
DMA LATENCY: 1.5 μ s (5 MICROCYCLES)
DMA TRANSFER RATE: 1.11 MEGAWORDS/SEC (3 MICROCYCLE LOOP)

7. A performance summary reveals latencies of only 2.4 μ s for interrupts and 1.5 μ s for DMA.

DMAOUT, which strobes DMA memory data.

The execution sequences for interrupt and DMA operations appear in Fig. 6. The interrupt sequence causes the old program counter to be stored at the memory location defined by the contents of location 2. The program counter is then loaded with the contents of location 3—the location of the interrupt-service routine. The DMA execute sequences have an extra, dummy step that ensures a minimum of two steps between the request clock and the enable of the End-Op ROM.

Interrupt and DMA performance is measured by the maximum delay—or latency—between the submission of a request and the start of the corresponding execution sequence. Other important specs are the transfer rate for continuous DMA requests and the number of different maskable interrupt requests that the processor can recognize (Fig. 7).

DMA latency time equals the execution time of the longest instruction, assuming that the Request Enable clock came just after a request was submitted. Interrupt latency equals DMA latency plus one DMA cycle. This definition assumes that both an interrupt and DMA request were submitted simultaneously just after the Request clock and before execution of the longest instruction. The DMA transfer rate is equal to the inverse of the time required to pass once through the DMA sequence.

The interrupt and DMA implementations described have been kept simple in order to illustrate the problems and their solutions. However, many improvements can easily be added because of the microprogram control.

For example, the interrupt capability could be extended by the use of one 6701 as a last-in, first-out stack pointer for program-counter storage, and use of microcode to implement priority determination and program selection. Likewise the DMA sequences can be expanded to include such features as the use of memory locations as indirect DMA address and word counters. ■■

References

1. Wyland, David C., "Design Your Own Microcomputer," *Electronic Design* No. 20, Sept. 27, 1975, pp. 72-78.



Small Wonder

*It's PICOTEMP thermal cutoff
New from Micro Devices
(Actual Size)

PICOTEMP thermal cutoffs. against atmosphere. Be-Fit tight spaces — and limited budgets. Same accuracy and similar capabilities as the widely used MICROTEMP® safety thermal cutoffs...but smaller in size. Weighs just 1/48th of an ounce. Installed costs are less, too.

Use PICOTEMP thermal cutoffs when installation or space restrictions rule out MICROTEMP. At present, motors and transformers are two leading applications.

But, wherever you use PICOTEMP thermal cutoffs, you're assured of positive, low cost protection against overheating caused by malfunctions in electrical circuits and components.

The PICOTEMP thermal cutoff is completely sealed

Here are some other things you'll want to know:

- current capacity—to 5 amps. at 120 VAC. Will hold this rating up to and including 240 VAC.

- temperature tolerance $\pm 3^\circ\text{F}$ (1.7°C).

- temperature ratings—136° to 300° F (58°-150° C).

- leads are 26 gauge silver plated wire.

- facilitates approval to UL 506, UL 544, UL 547, UL 697, UL 492 and UL 859, signed to comply to UL 1020. Currently being tested by UL for yellow card recognition.

For more information, check the reader service card, or call or write.



MICRO DEVICES CORP.

1881 Southtown Blvd., Dayton, Ohio 45439
Ph: (513) 294-0581 Telex: 28-8087



Charles Fair, Electronics Buyer, North Electric.

**“NORTH
ELECTRIC
demands
high-rel CMOS.”**

**SOLID
STATE
SCIENTIFIC
QUALIFIES.”**

“North Electric is making some pretty sophisticated telephone equipment. Like our NX-IE and ETS-4 computer-controlled switching systems. So we have to be sure what goes into them are *really* reliable. That’s why we asked Solid State Scientific to supply a special grade of CMOS for us.”

North Electric’s reliability specs are so tough we developed a prescreening and burn-in program, for the 4000 Series Cerdip CMOS devices we supply for North’s advanced electronic switches.

We call this program Solid Plus. It’s the first complete

high-rel screening program for commercial CMOS. It pays off in exceptionally high delivered quality level, and in extremely low failure rates during equipment burn-in and in field operation.

We like tough specs. Because we know we can meet them, with one of the most modern and most experienced processing and testing facilities in the CMOS business. And we can do it at the most attractive pricing you’ll find. Just ask us to quote on your next order. We’ll prove what we claim. Meanwhile, call or write for our Solid Plus booklet.



SOLID STATE SCIENTIFIC INC.
Montgomeryville, Pa. 18936 / (215) 855-8400 / TWX 510-661-7267

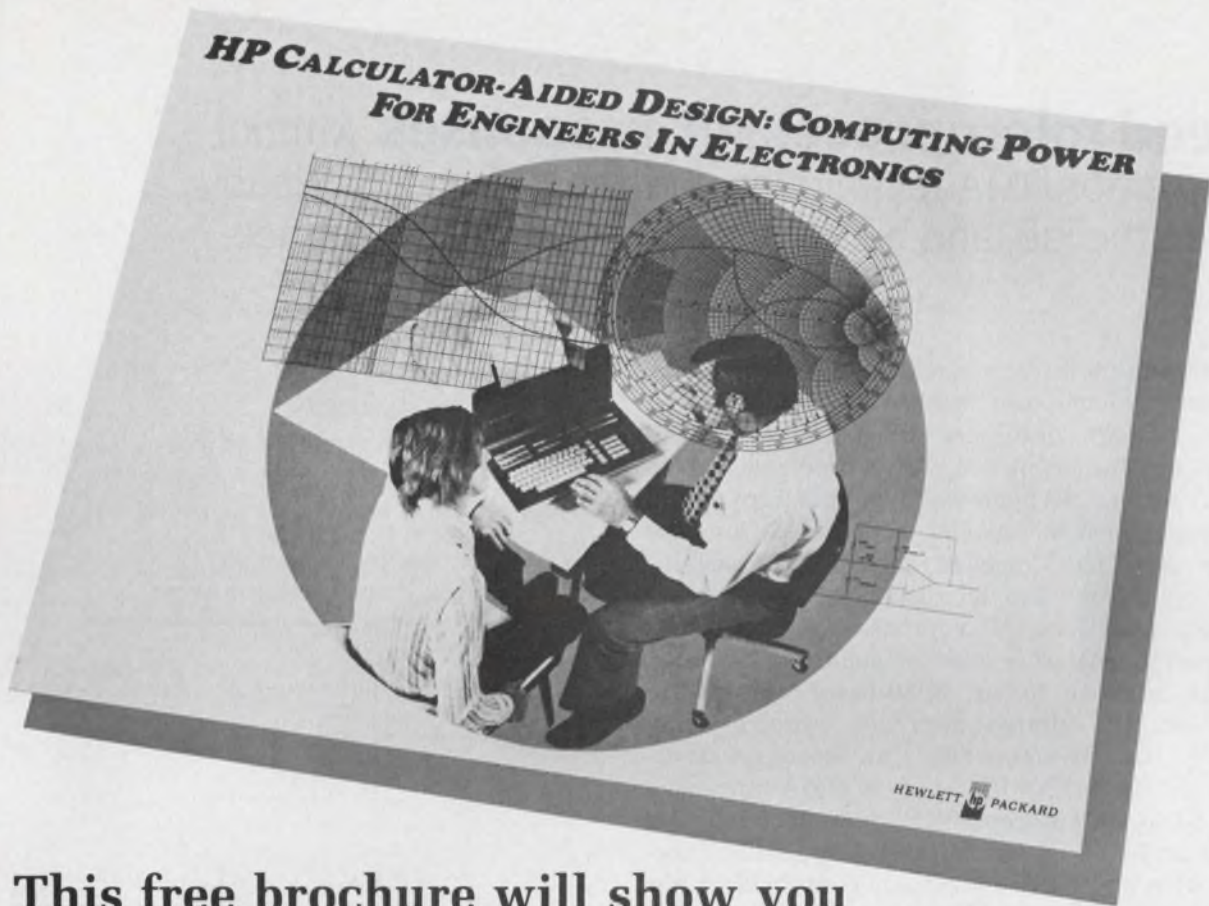

This free brochure will show you fresh new approaches to electronic design.

Network analysis, control systems, logic simulation, magnetics, microwave... whatever your engineering problem, our calculator-aided design brochure will show you how to slash days—perhaps weeks—from your design schedule. It describes fully-proven combinations of computing calculators and engineering software that can give you fast, accurate solutions to your most complex problems—perhaps to the very design problems that confront you now.

From electronic super slide rules to the most powerful calculator-aided design system, there's a combination that fits your needs... and your budget. HP puts the computing power where you need it—right at your fingertips. Get out from under tedious number crunching and back to creative engineering design. We'd like to show you rather than tell you, so call your local HP Sales Office. Or send for our 12-page, illustrated brochure... it's free.



Sales and service from 172 offices in 65 countries.
P.O. Box 301, Loveland, Colorado 80537



O.K., I'd like to see how HP computing calculators can help solve my design problems. Please send me your free brochure.

Name _____
Title _____
Company _____
Address _____
City/State _____ Zip _____
Phone _____

HP-Calc. Inq.
P.O. Box 301, Loveland, Colorado 80537

860A

Speed microprocessor responses without interrupt or DMA techniques. Let the processor's Ready line do the job, and build a simple floppy-disc interface.

Microcomputer designs don't require techniques based on minicomputer hardware to achieve high speeds. Though designers often employ speed-enhancing interrupt or direct-memory-access (DMA) techniques borrowed from the mini world, the same improvements can be obtained far more simply. All that's needed is a microprocessor whose operations can be suspended readily during data transfers. Microprocessors like Intel's 8080 permit just this kind of solution.

When applied to an 8080-based floppy-disc controller, the simple approach requires only about 20 ICs. By comparison, an interrupt structure uses 40 to 80 ICs, and a DMA approach needs 80 to 100. Moreover the 8080 exercises full format and timing control over floppy-disc functions, with all of the algorithms contained in less than 512 words of ROM.

The alternatives

Interrupt structures often require hardware that is external to the microprocessor, as well as special programming (Fig. 1). Further, high-speed applications can easily require all of the microprocessor's real-time capability. For this reason, other interrupt sources usually must be disabled during the execution of the high-speed routine. Also, it may be necessary to save—in advance—sensitive registers to increase the speed of the interrupt service routine.

After an interrupt in the application program, a series of vectors (either hardware or software) transfer program control to the interrupt-service routine. This routine is the actual program that performs the synchronized I/O transfer. After the servicing of the interrupt, control returns to the application program to prepare again for the next high-speed interrupt service. As many as 100 bytes of code may be needed to handle the high-speed interrupt. This doesn't include the code for standard I/O that would be required without interrupt synchronization.

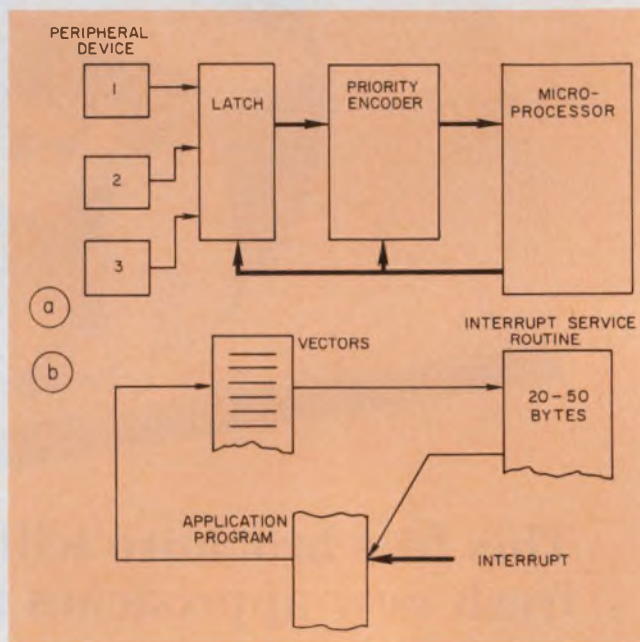

1. Interrupt techniques may entail the addition of such external circuits as storage latches and priority encoders (a). Typical response time is 32 μ s. However, the major portion of an interrupt structure resides in software (b). Interrupt techniques can achieve typical data rates of about 31-k bytes per second.

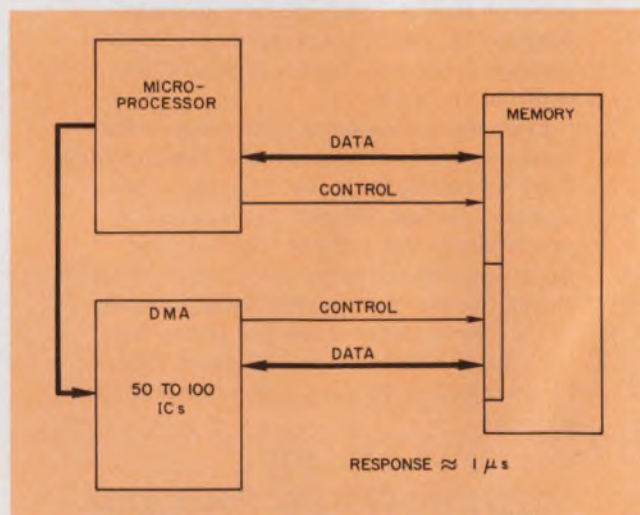

2. Direct-memory access, or DMA, requires a separate, external controller that communicates directly with memory. When built with standard ICs, the controller can use up to 100 circuits.

Eugene Fisher, Design Engineer, Lawrence Livermore Laboratory, Livermore, CA 94550.

Debugging of this interrupt service is extremely difficult, since it cannot be effectively simulated on a separate computer. In fact, debugging is a very time-consuming effort, requiring the use of all of the system's hardware or a trial-and-error method using oscilloscopes and other external hardware. This difficulty alone has discouraged designers. The typical speed for an interrupt interface is approximately 31,000 bytes per second.

Unlike the interface for a high-speed interrupt, the direct-memory-access interface isn't really part of a microprocessor or microcomputer system. It actually is a separate hardware controller that communicates directly with the computer memory (Fig. 2). The only function a microprocessor has in these cases is to initialize the data channel.

Once DMA has begun, the microprocessor must be able to disconnect itself from the associated memory, so as not to inhibit the transfer. Thus debugging focuses on the hardware, because the only software functions employed are those needed for DMA-channel controls. The typical data-transfer rates are limited primarily by the memory. For example, memories for most single-chip MOS processors operate at 415 ns to 1 μ s. So the data rate can be in excess of 100-k bytes per second.

A simple solution

An alternative approach—one that requires the μ P to halt for each transfer—takes full advantage of the processor. The technique can be applied to any microprocessor that has Ready-line synchronization or otherwise allows the stopping of the processor for data transfers. The hardware to implement this synchronization appears in Fig. 3. The block diagram shows that a simple, external flip-flop can synchronize the microprocessor.

The circuit operates as follows: An I/O instruction—in this case an output from the microprocessor—clears the flip-flop, halting the processor with the I/O data available on the microprocessor's data bus. The external device takes the data presented by the microprocessor and then returns a signal. Called DONE, the signal is used by the synchronizing flip-flop to raise the Ready line, letting the microprocessor continue. The microprocessor responds to an external input within one cycle—500 ns in our case.

Not only is this interface simple, but the microprocessor worst-case response is 1 μ s. This response time is comparable to a DMA transfer, but with none of the associated hardware complexity. And the software is extremely simple; no difficult timing loops are required.

The output instruction actually stops the proc-

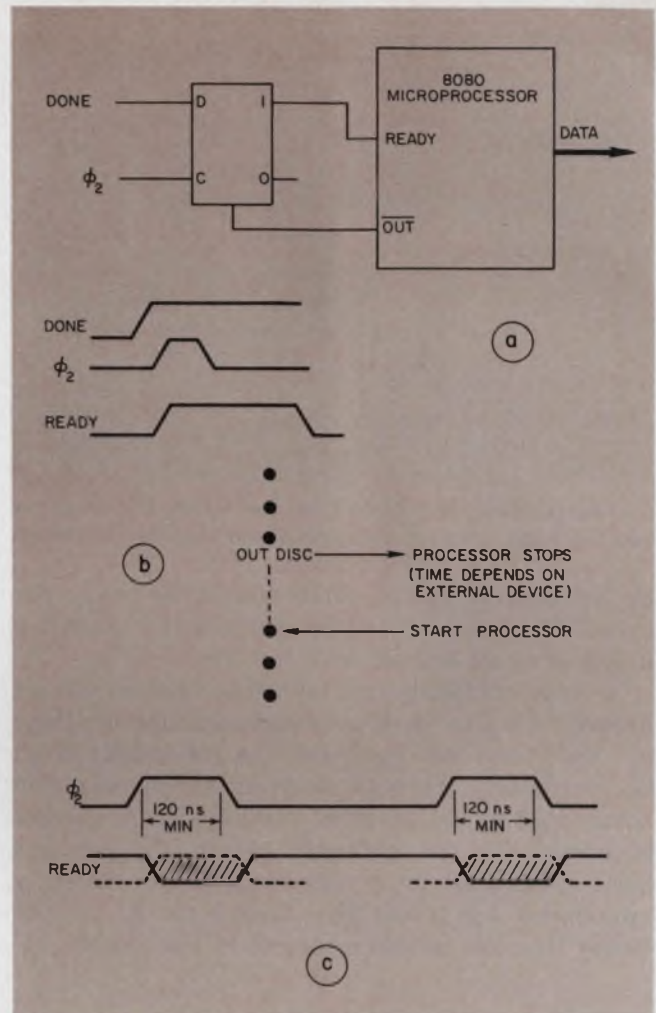

3. The alternative to DMA and interrupt techniques employs a microprocessor's Ready line (a) to suspend the processor's operation during data transfers (b). The Ready line is sensed by the microprocessor during phase two of state T_2 or T_w , the Wait state (c). This straightforward approach has a response time of 1 μ s, and it yields data rates of 62-k bytes per second.

essor for a time that depends on the external device. If the microprocessor is already running at 100% utilization, there isn't time for other operations anyway. Thus the time lost by halting the processor is of no real consequence. And now software for the output or input is merely a standard I/O operation, with synchronization and data timing taken care of automatically. The data rate is 62-k bytes per second—a program-execution limitation.

Employing the Ready line

The Ready line on the 8080 processor was designed primarily to interface the processor to a slow memory or a slow I/O operation. But while the processor is stopped, the data bus is present on the processor's data lines. On an input instruction, the processor takes the data within 500 ns after starting or after the assertion of the Ready Signal. After the Ready line is raised,

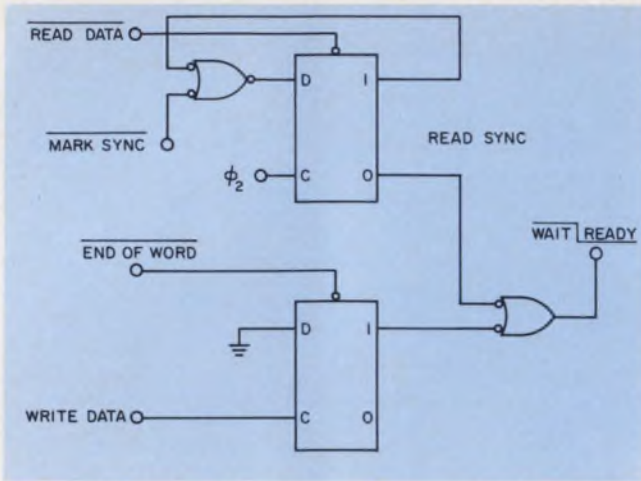

4. The synchronizing circuit for the Ready line employs two flip-flops, one for the output and one for the input.

the microprocessor responds within the next clock cycle. Thus over-all response is about 1 μ s when a 500-ns clock is used with the 8080.

A typical Ready-line synchronization circuit appears in Fig. 4. Two synchronizing flip-flops are used, one for input and one for output from the peripheral. In both cases all synchronization is handled by an external flip-flop. Even the requirement for an external D-type flip-flop has been eliminated by a new clock driver recently announced by Intel. The synchronizing of the Ready line can be taken care of by the new IC.

Programming constraints

The program must be able, of course, to accept synchronization by the external hardware. In the sample program (Fig. 5) the timing of each instruction in a critical loop has been calculated. This is necessary to ensure that the next I/O instruction is asserted in time. The routine allows the maximum data-transfer rate for the 8080 by employing the processor's stack pointer.

By adding the two halves of the loop, we see

that the maximum time between instructions is 16 μ s. Also the response to an external stimulus is 1 μ s. And the data rate for this interface is twice that possible in any equivalent interrupt-driven interface.

Specifying the interface

Our floppy-disc application employs the IBM format (Fig. 6). Note the different types of sector information. Each has a unique indicator—a Mark—for Index, Data, Deleted Data and Address. A Mark doesn't contain a full set of clock pulses, and the missing clocks and Mark words, form synchronizing elements. Another critical item is the cycle redundancy check (CRC) character. This appears at the end of each data sector. It must be read to determine if there has been an error in reading or writing.

The data rate in this format is 4 μ s per data bit, with the clock pulses coming between each data pulse (Fig. 7). The data rate of the standard floppy disc is 4 \times 8 bits/byte, or 32 μ s per 8-bit byte. However, to eliminate any possibility of timing problems, the interface is designed for twice that rate, or 16 μ s per 8-bit byte—an effective transfer rate of 62-k bytes per second. And to eliminate the need for double buffering, the previously collected data word is read before the next clock pulse occurs. This results in the 2- μ s interval at our double speed.

Solving interface problems

The "missing"—but implied—clock signal is detected by a retriggerable, monostable multivibrator. With the aid of a separate clock signal from the floppy disc (Fig. 7b), the detected signal is then used to synchronize an 8-bit register and to generate an end-of-word signal.

A 4-bit counter (Fig. 8) regenerates the missing pulses. The microprocessor's crystal clock

005161	333 011	ROVR:	IN DATAR	:READ ONE WORD—5.5
005163	157		MOV L · A	:SAVE —2.5
005164	015		DCR C	:BUMP CNTR —2.5
005165	345		PUSH H	:STORE TWO WORDS —5.5
005166	333 011	DATCOL:	IN DATAR	:NEXT—AND CRC WORD 1 —5.5
005170	147		MOV H · A	:SET UP WORD—2.5
005171	302 161 012		JNZ ROVR	:AGAIN—5
005174	333 011		IN DATAR	:CRC WORD 2
005176	333 011		IN DATAR	:CRC DELAY WORD
005200	333 007		IN STAT	:CHECK STATUS
005202	027		RAL	:SET UP FLAG
005203	052 301 014		LHLD TEMP	:GET THE STACK POINTER
005206	371		SPHL	:RESTORE SP
005207	332 217 012		JC CRER	:CRC ERROR
005212	311		RET	:WE MADE IT

5. The time of each instruction in a critical loop must be calculated to ensure that I/O instructions are as-

serted soon enough. A portion of the read routine lists these times in microseconds.

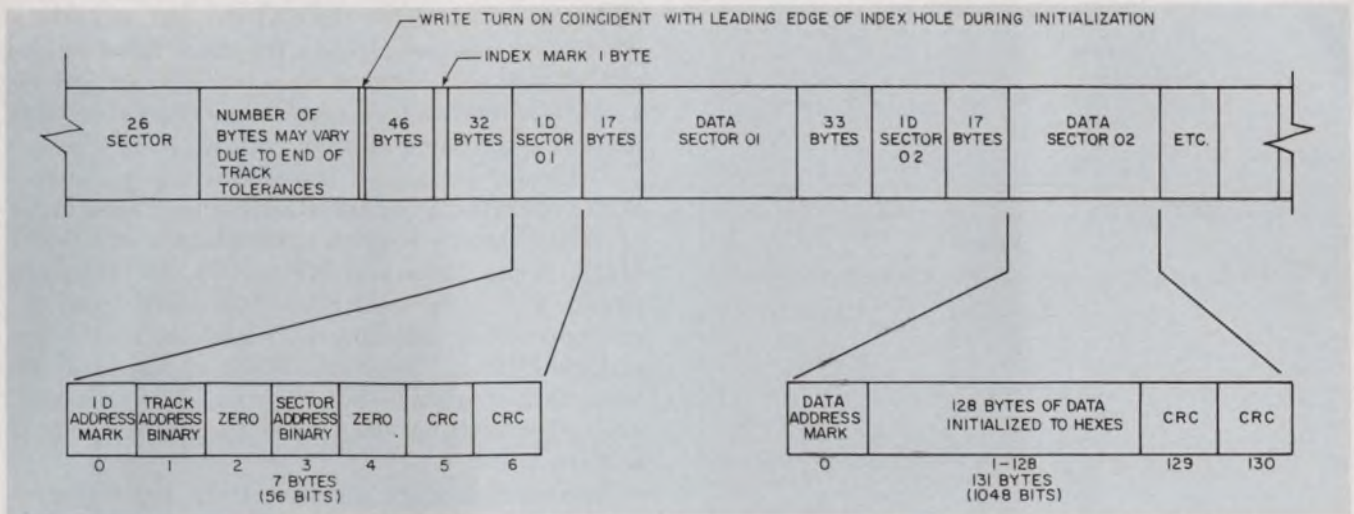

6. An IBM data format applies to our floppy-disc example. Different sectors of information use an indicator

known as a Mark. It relies on a series of implied—but not present—clock pulses for synchronization.

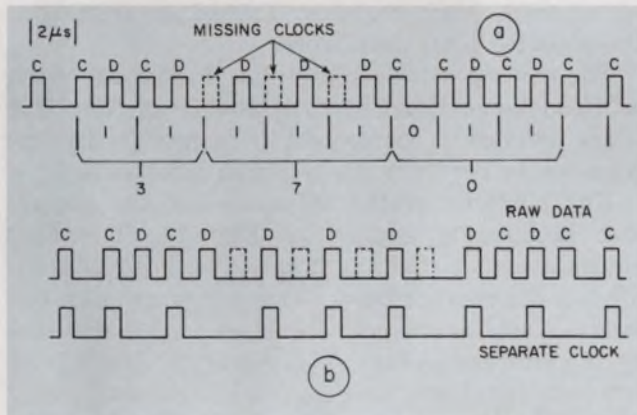

7. The Data Mark has a transfer rate of $2 \mu\text{s}$ per bit (a), or twice that of the usual format. This eliminates possible errors and the need for double buffering. The missing clock pulses are generated with the aid of a separate clock signal (b) from the floppy disc.

provides the time base for the counter and thus, the floppy disc.

The counter is synchronized with the data received from the floppy disc, thereby providing a clock signal that doesn't have missing pulses. This counter and the crystal clock also generate the accurate timing pulses required for the Write operation to the floppy disc.

A single IC—the 8-bit register—handles both the serialization and deserialization of the signal from the floppy disc to the microcomputer (Fig. 9). This register has a common I/O; the same eight pins are used for parallel data input and output. Three-state data lines are compatible with the 8080 microprocessor data bus.

The Ready-line synchronizer for our application appears in Fig. 10. To detect a Mark word, the microprocessor sends the input signal called READ MARK. This signal sets the flip-flop called Mark Sync, which suspends microprocessor operation until a “missing” clock signal occurs. When missing pulses are detected, the synchronizing flip-flop resets, allowing the processor to read the Mark word collected.

At this time the microprocessor verifies that the correct Mark word has been read. If it is not the correct word, the microprocessor loops back, sending out the READ MARK signal. Again, the processor stops until the next Mark word is received. The timing diagram shows an input Mark signal being sent two times. The first time it detects the address sector and the second time a data sector.

After the Mark word has been read, the succeeding data words must be read to verify the data format, the data transfer or the address sector. Therefore a second input signal called READ DATA is sent in a manner similar to that of the Mark operation just described. However, the input-data synchronizer resets at the end of

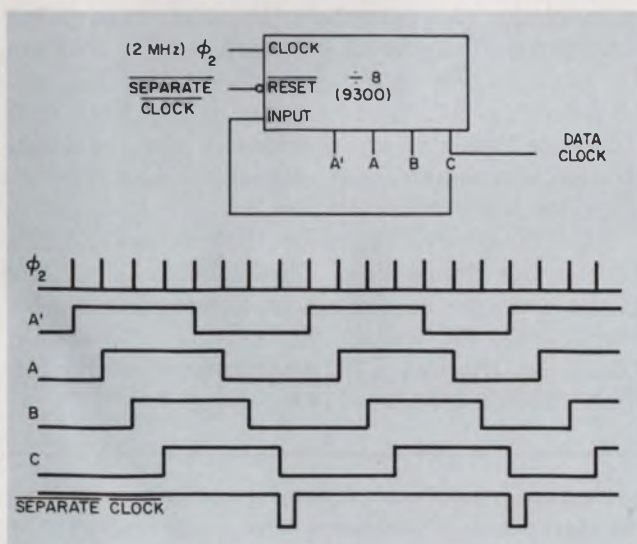

8. A simple 4-bit counter, synchronized to each separate-clock pulse from the floppy disc, regenerates the missing clocks.

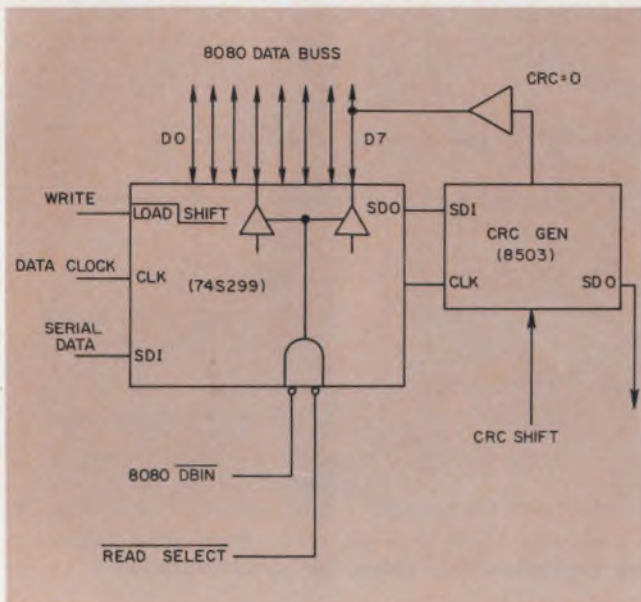

9. An 8-bit shift register, synchronized by the "missing" clocks, provides the parallel-to-serial conversion of the signal from the floppy disc. The second IC generates the cycle-redundancy-check character.

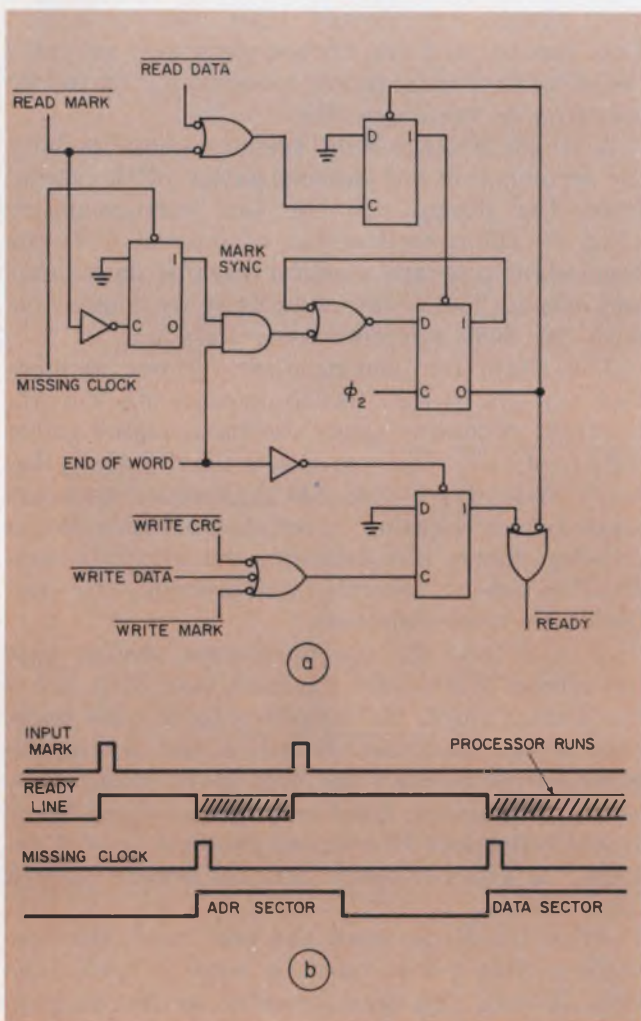

10. The Ready-line synchronizer for the floppy-disc application employs only four flip-flops and a few gates (a). The input Mark signal is sent twice (b) to detect address and data sectors.

each data word rather than at the end of a Mark word. The processor reads the data word at the end of each serial string in less than $1 \mu\text{s}$, giving a 100% safety factor even for a floppy disc having twice the usual storage capacity.

The lower portion of the synchronizer controls Write operations for the Ready line. Three types of Write signals require synchronization: Write Mark, Write Data and Write CRC. Write Data simply writes the next 8-bit data word from the microprocessor into the shift register at the appropriate time. The Write Mark signal loads an 8-bit shift register (not shown), and this generates the missing clock lines for the writing of a Mark word.

Also on this shift register, Data Bit 6 is provided for one of the inputs, thereby allowing the software to create any of the three missing clock words required. The Write CRC command converts the CRC generator from a coded mode to a 16-bit serial shift register. The latter shifts out the collected CRC data word.

The control of the floppy disc functions—such as Head Load, Head Step In and Head Step Out—are handled in the usual I/O fashion, with flip-flops set to perform the required functions.

Key portions of the software for the floppy-disc application appear in Fig. 11. The first routine verifies that the floppy-disc head is actually on the correct track. The sequence is as follows: Wait for an address Mark; read the rest of the address sector; save the critical words of interest, the track and sector addresses; verify that there are no errors; then drop into a routine that steps the head to the desired track. Note that no critical timing loops are required. The only requirement is that the program return within $16 \mu\text{s}$, so it can read the next data block.

Fig. 11b shows the code used to read a data block from the floppy disc and to store it in memory at the maximum transfer rate. This routine uses the processor's stack pointer to store 16 bits or two bytes per operation (thereby transferring data at $16 \mu\text{s}$ per byte). Note that this code lists timing intervals in the comment, so the programmer can actually count the instruction times that will result.

Fig. 11c shows the code that writes a data file on the floppy disc. This routine is similar to the previous one. However, a preamble of zero words must be written before the actual data file. Also, the last CRC character must be followed with a zero word. ■■

11. Excerpts from the program, compiled by an 8080 macroassembler, illustrate the three major routines. The first, a search routine, checks to see that the disc head is properly positioned (a). The next routine reads a block of data in the disc and stores it in memory (b). The third routine writes data into the floppy disc (c).

004403	365	STRT:	PUSH PSW	:SAVE A REG	
004404	323 012		OUT HDDN	:LOWER HEAD	
004406	315 222 011		CALL LDDLY	:WAIT FOR HEAD	
004411	176		MOV A - M	:TRK ADR	
004412	376 112		CPI 112Q	:TEST FOR TOO LARGE ADR	
004414	322 147 011		JNC NOADER	:ADR ERROR—TOO LARGE	
004417	315 242 011		CALL SEEK	:STEP TO TRK	
004422	315 222 011		CALL LDDLY	:WAIT TO SETTLE	
004425	333 010		IN RDMRK	:SYNC AFTER STEP	
004427	333 010	TSTRD:	IN RDMRK	:READ MARKS	
004431	376 376		CPI 376Q	:WAIT FOR ADR	
004433	302 027 011		JNZ TSTRD	:LOOP	
004436	333 011		IN DATAR	:TRK ADR	
004440	107		MOV B - A	:SAVE TRK ADR	
004441	333 011		IN DATAR	:ZEROS	
004443	333 011		IN DATAR	:SECTOR ADR	
004445	333 011		IN DATAR	:ZEROS	
004447	333 011		IN DATAR	:CRC	
004451	333 011		IN DATAR	:CRC	
004453	333 011		IN DATAR	:CRC DELAY WORD	
004455	333 007		IN STAT	:CHECK CRC	
004457	027		RAL	:SET UP FLAG	
004460	332 165 011		JC ERROR	:CRC ERROR	
004463	072 300 014		LDA ADR	:GET EXISTING ADR	(a)
:ROUTINE TO READ A DATA SECTOR					
005064	333 010	READ:	IN RDMRK	:ENTER SECTOR ADR IN B	
005066	376 376		CPI 376Q	:LOOK FOR ADR MARK	
005070	302 064 012		JNZ READ	:LOOP BACK	
005073	333 011		IN DATAR	:SKIP TRK ADR	
005075	333 011		IN DATAR	:SKIP ZERO WORD	
005077	333 011		IN DATAR	:READ SECTOR ADR	
005101	270		CMP B	:TEST SECTOR	
005102	302 064 012		JNZ READ	:WRONG SECTOR—LOOP	
005105	333 011		IN DATAR	:ZEROS	
005107	333 011		IN DATAR	:CRC	
005111	333 011		IN DATAR	:CRC	
005113	016 013		MVI C . 13Q	:SET UP JUNK-IN-GAP COUNTER	
005115	333 011		IN DATAR	:CRC DONE GAP WORD #1	
005117	333 007		IN STAT	:CHECK CRC	
005121	027		RAL	:SET UP FLAG	
005122	332 217 012		JC CRER	:CRC ERROR	
005125	333 011	CRAPLP:	IN DATAR	:SKIP THE JUNK-IN-THE-GAP -13 WORDS	
005127	015		DCR C	:DONE? -2.5	
005130	302 125 012		JNZ CRAPLP	:NOPE LOOP BACK -5	
005133	041 000 000		LXI H - 0	:CLR H AND L	
005136	071		DAD SP	:ADD STACK POINTER	
005137	042 301 014		SHLD TEMP	:SAVE SP	
005142	016 100		MVI C - 1000	:SET DATA CNTR	
005144	061 000 014		LXI SP - BUFF	:POINT TO BUFFER	
005147	333 010		IN RDMRK	:WAIT FOR DATA	
005151	376 373		CPI 373Q	:TEST FOR DATA MARK -3.5	
005153	302 213 012		JNZ CRERX	:NOT A CRC ERROR BUT GET OUT FOR NOW -5	
005156	333 011		IN DATAR	:FIRST WORD -5.5	
005160	147		MOV H - A	:SET UP -2.5	
005161	333 011	ROVR:	IN DATAR	:READ ONE WORD—5.5	
005163	157		MOV L - A	:SAVE -2.5	
005164	015		DCR C	:BUMP CNTR -2.5	
005165	345		PUSH H	:STORE TWO WORDS -5.5	
005166	333 011	DATCOL:	IN DATAR	:NEXT—AND CRC WORD 1 -5.5	
005170	147		MOV H - A	:SET UP WORD—2.5	
005171	302 161 012		JNZ ROVR	:AGAIN—5	
005174	333 011		IN DATAR	:CRC WORD 2	
005176	333 011		IN DATAR	:CRC DELAY WORD	
005200	333 007		IN STAT	:CHECK STATUS	
005202	027		RAL	:SET UP FLAG	
005203	052 301 014		LHLD TEMP	:GET THE STACK POINTER	
005206	371		SPHL	:RESTORE SP	
005207	332 217 012		JC CRER	:CRC ERROR	
005212	311		RET	:WE MADE IT	(b)
005213	052 301 014	CRERX:	LHLD TEMP	:GET THE STACK POINTER	
005216	371		SPHL	:RESTORE SP	
005024	174	OVR:	MOV A - H	:SET UP NEXT WORD -2.5	
005025	323 014		OUT DATAW	:WAIT FOR DISC—5.5	
005027	341	DATWT:	POP H	:GET TWO WORDS -5	
005030	175		MOV A - L	:NEXT WORD -2.5	
005031	323 014		OUT DATAW	:WAIT FOR DISC—5.5	
005033	015		DCR C	:BUMP CNTR—2.5	
005034	302 024 012		JNZ OVR	:OVERS—5	
005037	174		MOV A - H	:SET UP LAST WORD	
005040	323 014		OUT DATAW	:OUT LAST WORD	
005042	323 016		OUT CRC	:SHIFT OUT CRC	
005044	323 016		OUT CRC	:IBID	
005046	257		XRA A	:CLEAR THE A	
005047	323 014		OUT DATAW	:WRITE OFF —LAST WORD IS ZEROS	
005051	052 301 014		LHLD TEMP	:GET SP	
005054	371		SPHL	:RESTORE SP	(c)
005055	311		RET	:FAREWELL	

**YOUR
HYBRID
CIRCUITS**

**DESERVE THE
BEST SOLDERING
INSTRUMENTS
AVAILABLE...**



**MODEL RR-4
ROTARY REFLOW
SYSTEM**

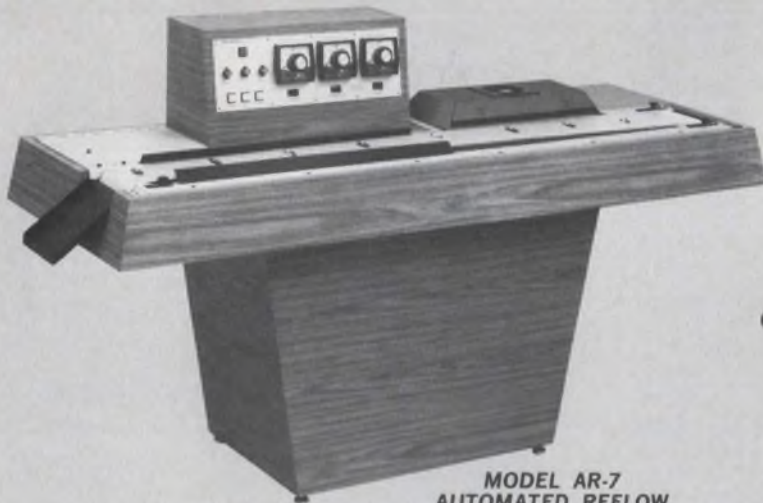

**MODEL AR-7
AUTOMATED REFLOW
SYSTEM**



**MODEL CM-2
MICRO REFLOW
SYSTEM**



**MODEL CC-1
SPOT REFLOW
SYSTEM**



**MODEL SR-3
SONIC REFLOW
SYSTEM**



**MODEL LR-6
LINEAR REFLOW
SYSTEM**

**... . INTRODUCING
A COMPLETE LINE OF
REVOLUTIONARY HIGH
SPEED LABORATORY AND
PRODUCTION SOLDERING
SYSTEMS ...**

**BROWNE
CORPORATION
203 CHAPALA STREET
SANTA BARBARA, CALIF. 93101
PHONE (805) 963-0371**

SIEMENS

Low profile relays Space savings in a proven design.

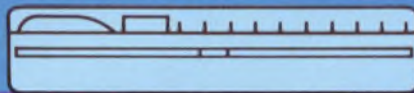
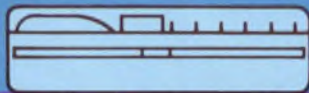
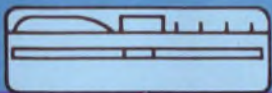

Siemens low profile relays permit nearly double the PC board mounting density compared to standard height relays. And only the Siemens design covers the full range—1, 2, 4 and 6 PDT contacts, with a uniform height of only 0.4 inches. Space savings that add up to greater dollar savings through better cabinet utilization.

Bifurcated contacts (standard) of fail-safe design assure maximum reliability over a long electrical life. Millions in use over the past four years confirm this proven design. Typical applications include communications systems, data processing and automatic control systems.

Delivery is assured as Siemens-designed low profile relays are available from more than one source.

Siemens low profile relays. Space savings in a proven design. Write for detailed literature.

Siemens Corporation
Special Components Division

186 Wood Avenue South, Iselin, New Jersey 08830 (201) 494-1000



RIGHT ON TARGET AGAIN



Correct your deflect effect!

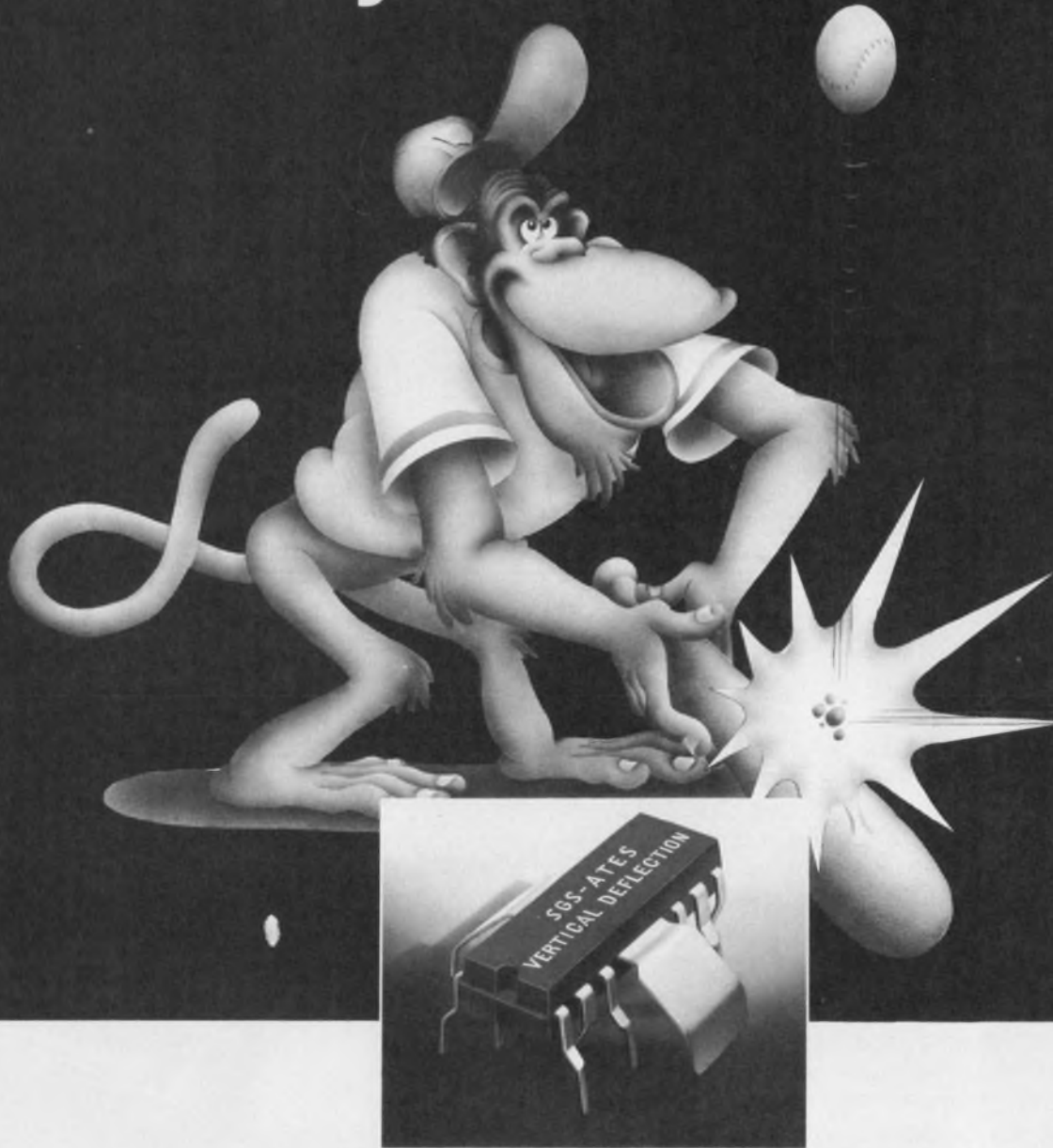

TDA 1170/1270 vertical deflection systems

The TDA 1170 and TDA 1270 are integrated vertical deflection systems for B & W and colour TV sets.

Both are mounted in a FIN DIP package and integrate the functions of oscillator, voltage ramp generator and high gain power amplifier with 1.5 A output current.

Their main features are:

- independent frequency, linearity and height controls
- few external components
- very low oscillator and ramp generator bias current

- high frequency stability
- positive or negative sync input

The TDA 1270 is for colour sets. When its own output current is inadequate the addition of a low-cost complementary transistor stage will solve the problem.

The supply voltage can be up to 40V.

The TDA 1170 incorporates the flyback generator and provides the complete vertical deflection section for B & W sets. Maximum supply voltage is 27 V and the peak flyback voltage is 58 V.

SGS-ATES Semiconductor Corporation - Newtonville, Mass. 02160 - 435 Newtonville Avenue - Tel: 617-9691610 - Telex: 922482
ILL. (312) 298-8580 - Energy Electronic Products, Los Angeles, CA. (213) 670-7880 - Esco Inc., Dayton, OHIO. (513) 226-1133 - KA Electronic Sales, Dallas TX. (214) 634-7870
Radar Electric Co., Seattle, WA. (206) 282-2511 - Re-Coil Electronics Inc., Santa Clara, CA. (408) 984-0400 - Rosyl Electronics, Bayshore, NY. (516) 586-1800 - Wilshire Electronics,
Burlington, MASS. (617) 272-8200 - Zeus Components Inc., Elmsford, NY. (914) 592-4120 - Burlington, MA. (617) 273-0750 - Pompano Beach, FLA. (305) 942-4312
Prelco Electronics Ltd., Montreal 357, Quebec. (514) 389-8051

General Electric... No. 1 manufacturer of silicon tubes that...



Got a "blooming" problem? General Electric's new Reduced-blooming Silicon Epicon® Vidicon can provide the solution without degradation of performance.

Available in 2/3-inch, 1-inch & 1 1/4-inch sizes, GE's Reduced-blooming Epicons offer significant reduction of blooming caused by high light glints, point sources of light, lamps, and auto head lights. And you still get the high sensitivity, high resolution and low lag that you paid for!

For more information contact Microwave and Imaging Devices Products Section, (315) 456-3231, Room 301, Building 7, Electronics Park, Syracuse, N.Y. 13201. Or circle the number below on the Reader Service Card.

substantially reduce "blooming"!



GENERAL  ELECTRIC

Interested in network variety? Select from a spectrum of 347 standards.

Allen-Bradley has the popular configurations you need. Pull-ups, Pull-downs. Line Terminators. Networks to complement Core Memory Sense Amplifiers. TTL to ECL Translators. O-Pad Attenuators. All styles available from your Allen-Bradley *Electronic Distributor*. Call for specs or check your EEM Catalog. If you need specials, contact your local Allen-Bradley district office for fast turn-around. Ask for Publication 5840. A-B is an experienced twin-film manufacturer, i.e. precision thin film and thick film.

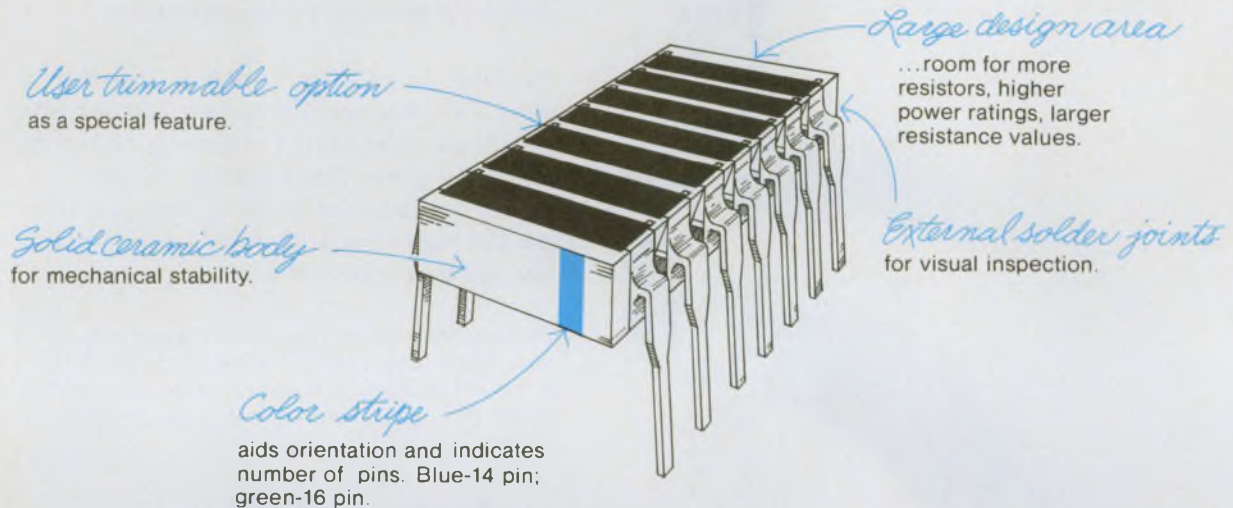

0347



Quality in the best tradition.



ALLEN-BRADLEY

Electronics Division
Milwaukee, Wisconsin 53204

Broad range of I-DIP standards

PULL-UP/PULL-DOWN

Two basic configurations (314A-14 pin; 316A-16 pin). Each available in 81 resistance values for unused TTL gates, parallel high speed circuitry, wired OR circuits, TTL-MOS interfacing and pulse squaring.

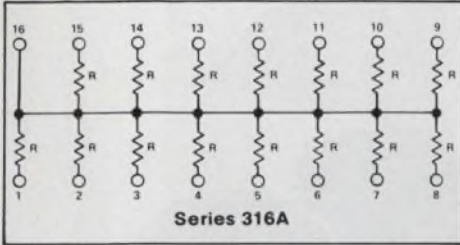

LINE TERMINATION

Two basic configurations (314B-14 pin; 316B-16 pin). Each available in 81 resistance values for transmission line termination, power gate pull-up, current limiting and logic level translation.

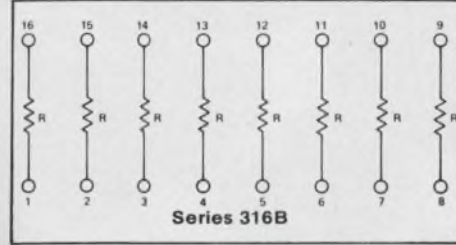

PARALLEL TERMINATION

Two basic configurations (314E-14 pin; 316E-16 pin). Each available in eight R1/R2 combinations for a wide range of impedance values.

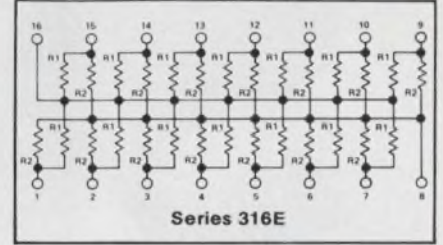

Standard Resistance Values R (Ohms), $\pm 2\%$ Tolerance

22	43	82	160	330	620	1200	2400	4700	8200	16K	33K
24	47	91	180	360	680	1300	2700	5100	9100	18K	47K
27	51	100	200	390	750	1500	3000	5600	10K	20K	68K
30	56	110	220	430	820	1600	3300	6000	11K	22K	100K
33	62	120	240	470	910	1800	3600	6200	12K	24K	
36	68	130	270	510	1000	2000	3900	6800	13K	27K	
39	75	150	300	560	1100	2200	4300	7500	15K	30K	

Characteristic Impedance Z_0

R1/R2	Z_0	R1/R2	Z_0
81/130	50	160/260	100
120/200	75	180/390	123
90/660	80	220/330	132
130/210	80	330/680	222

SENSE AMP TERMINATOR

Three basic configurations complement the 7520 series of core memory sense amps.

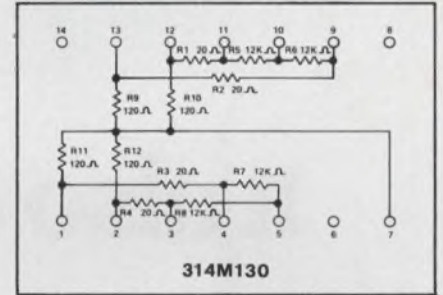
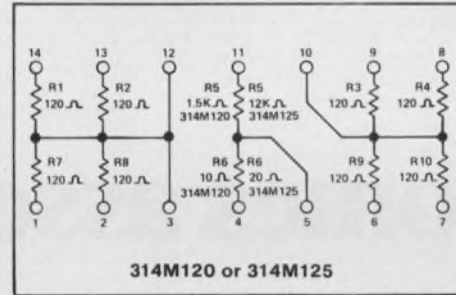
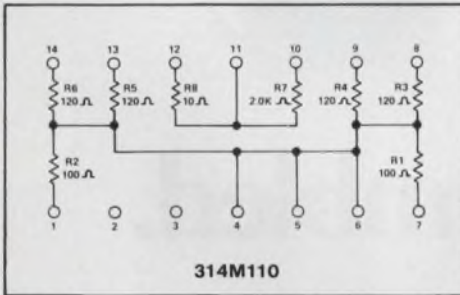

SENSE AMP TERMINATOR

For sense line applications with two 711 dual voltage comparators.

O-PAD ATTENUATOR

Two basic circuits for fixed voltage attenuation with impedance matching.

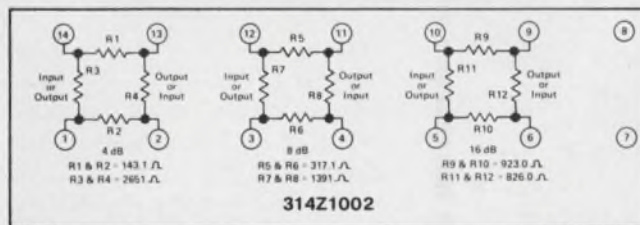
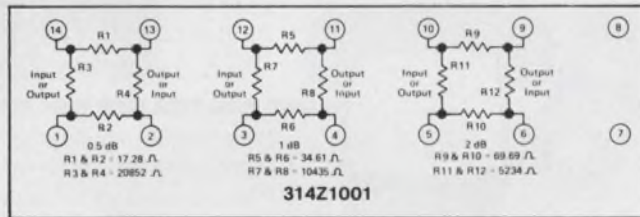

TTL to ECL TRANSLATOR

Contains six TTL to ECL translators.

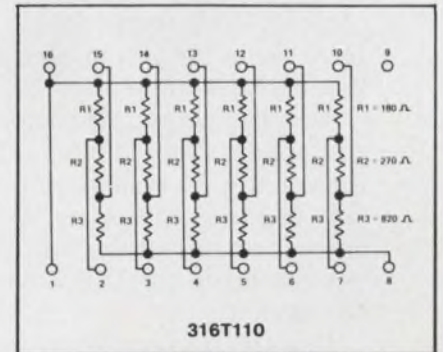

ALLEN-BRADLEY

Electronics Division
Milwaukee, Wisconsin 53204



It also comes assembled.

If you need dials, we have dials. If you need handsets, we have handsets. If you need Touch Calling keysets, we've got 'em by the thousands. Ringers and hook-switches, too. Or, if you need complete telephones, we have them for you in all the latest styles and colors.

You get communications components faster from GTE Automatic Electric because, outside of the Bell System, we're the largest manufacturer of telephone equipment in the U.S. If you need it, we have it.

Use the coupon below for a complete

catalog. Or if you're in a real hurry, call John Ashby at (312) 562-7100, extension 250.

When it comes to quality components, call THE SOURCE: GTE Automatic Electric.



- Please send your catalog of communications components.
- Please send more information and prices on _____ of _____
(Quantity) (Product)

Name _____ Title _____
 Company _____
 Address _____
 City _____ State _____ Zip _____
 Telephone _____

Mail to: Mr. J. D. Ashby, B-4, GTE Automatic Electric, Northlake, Illinois 60164.

GTE AUTOMATIC ELECTRIC

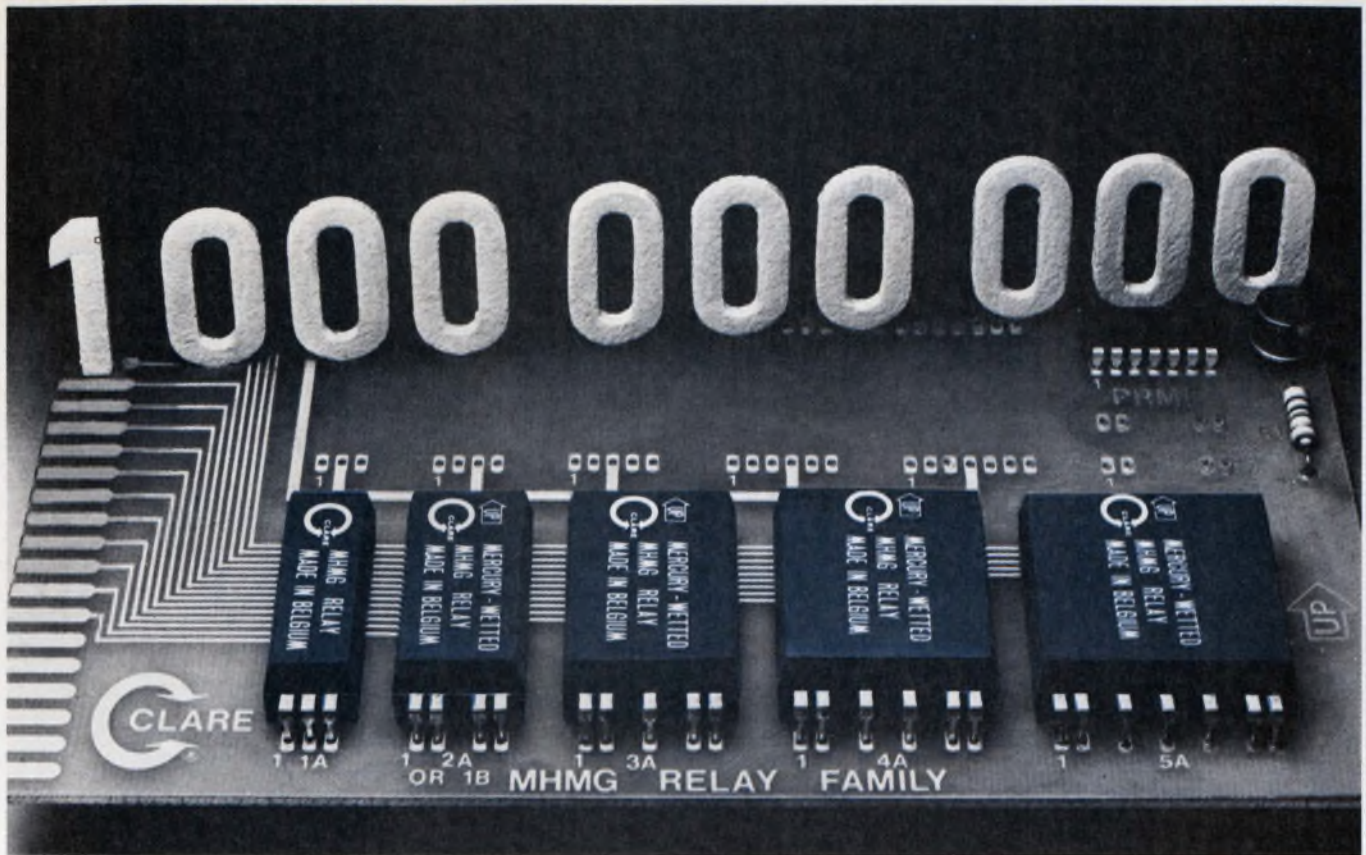

**BILLIONS OF SWITCHING OPERATIONS
AT A PRICE YOU CAN AFFORD**

CLARE 851 SERIES MHMG RELAYS

A new family of epoxy molded mercury-wetted reed relays.

The 851 Series MHMG relays offer billion (10⁹) operations. Bounce free mercury-wetted switching performance and load handling capability from signal-level to 50 VA. Multiple flexibility from one to five contacts, epoxy molded packaging for PCB mounting, and at a cost approaching dry reed relays.

Like all Clare mercury-wetted relays, the heart of these relays is a Clare manufactured hermetically sealed glass capsule. Contact switching is mercury-to-mercury. So there's no contact wear, no contact bounce, constant ON and OFF impedances—every operation. Maximum switching ratings are 350 Vdc, 1 ampere.

The 851 Series MHMG family are high quality components for telecommunications, business machines, industrial data logging and control, and other electronic instrument applications.

For more information contact: C. P. Clare & Co., 3101 W. Pratt Ave., Chicago, Ill. 60645. Phone (312) 262-7700. Telex: 25-3775.

C. P. CLARE & COMPANY a subsidiary of
GENERAL INSTRUMENT CORPORATION



FREE SAMPLE OFFER

Send today for your free sample of new 851 Series relays. Sorry, only one sample per customer. Offer ends Dec. 31, 1975. Just mark your selection below:

852A05B1A 1 form A 5 Vdc

851A12B1A 1 form A 12 Vdc

851A05B2A 2 form A 5 Vdc

851A12B2A 2 form A 12 Vdc

Name _____

Function _____

Company _____

Address _____

City _____ State _____

Zip _____ Phone _____

Send to: C. P. Clare & Co., 3101 W. Pratt Ave., Chicago, Ill. 60645.

INFORMATION RETRIEVAL NUMBER 156

Limited by
the color
restrictions of
standard neon
indicators?

swing to the blues

or greens. Littelfuse
now offers them both
in our Littelite line of
neon cartridge lamps
(901 series) and
Snap-Mount Plastic
Lites. Add these to our
indicators with
standard neon lamps
and you have the
widest selection on the
market today . . . full
color for greater
design flexibility.

For more information
and free samples, write
or call Littelfuse or
your Littelfuse
representative today.



LITTELFUSE

Subsidiary of Tracor

800 E. Northwest Highway • (312) 824-1188 • Des Plaines, Illinois 60016



A Public Service of
This Magazine &
The Advertising Council



Let us send you 33 proven ways to conserve energy in your business

Frederick B. Dent
Secretary of Commerce

You will find that these 33 ways to
save energy will also save you money.
And if you send for this free booklet,
we will also send you another: "How
to Start An Energy Management
Program."

The energy crisis is now a serious
reality. But it is something that we all
can do something about. One of the
best ways to start is to send for these
two booklets now.

**To: U.S. Department
of Commerce
Office of Energy Programs
Washington, D.C. 20230**

Please send me your two free booklets
on "33 Ways to Conserve Energy" and
"How to Start An Energy Management
Program."

Name _____

Title _____

Company _____

Address _____

City _____ State _____ ZIP _____

Type of Business _____

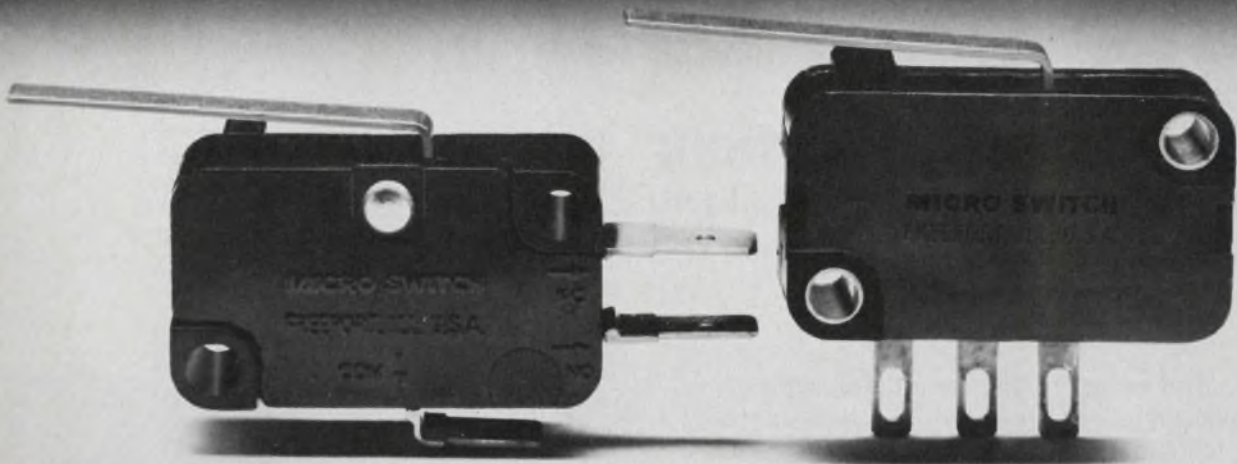

One of these is a new solid state switch. It's important that you can't tell which one.

The switch on the left is the V3. A mechanically-actuated snap-action switch the size of a postage stamp. It was an industry first when MICRO SWITCH introduced it in 1943. And it's gone on to become the industry standard, with hundreds of millions in use worldwide.

The switch on the right looks like the V3. Mounts like the V3. It's even actuated like the V3. And that's exactly where the similarities end. Because it's all solid state inside.

Designed around a Hall-effect integrated circuit perfected by MICRO SWITCH, the XL has been made to provide every benefit of true solid state design without the necessity of getting out of mechanical control.

Because the XL is all solid state, there are no contacts to bounce or become contaminated. And the Hall-effect integrated circuit has been performance tested through over 12 billion operations without a single failure. Unlike

standard mechanical switch designs, the XL can also interface directly with other solid state components. Its 20MA output eliminates the need for amplifiers, in most applications. And you can order it with either current sinking or current sourcing outputs.

It needs very little force for actuation—down to 10 grams. Even less with a lever. And the choice of actuator styles is the same as for the V3: over 500 different actuators in all. Including simple pin plunger, straight lever, simulated roller or roller lever.

Power supply requirements are also flexible. 5 VDC or 6 to 16 VDC with built-in regulator, over a temperature range of -40°C to $+100^{\circ}\text{C}$.

So the XL obviously offers some unique advantages. It's just one of a wide range of MICRO SWITCH solid state designs that do. Including a complete range of magnetically operated solid state position sensors, like the ones pictured here.

If you'd like more information on the XL, or any of the other MICRO SWITCH solid state switches, call your nearest MICRO SWITCH Branch Office or Authorized Distributor. Or write for literature.

We'll tell you the advantages of solid state design in your particular application.

And about a switch that looks very familiar. But works like nothing you've ever seen.



Products shown are actual size.

MICRO SWITCH
 FREEMPORT, ILLINOIS 61032
 A DIVISION OF HONEYWELL

MICRO SWITCH products are available worldwide through Honeywell International.

CIRCLE 231 FOR DATA
 CIRCLE 232 FOR SALESMAN CALL

Design for fault isolation: Increasingly, the man who creates the circuit must ensure that it can be easily tested. Here are some techniques to do just that.

Largely overlooked in the search for solutions to the problem of fault isolation has been the designer who creates the circuits to be tested and diagnosed.

Fortunately, this situation is now changing. The realization is growing that the designer not only has a responsibility in this area, but also has available a number of rather simple-to-implement techniques that can significantly reduce the cost and complexity of fault isolation.

These techniques permit the subsequent fault-isolation test system to observe and control specific elements within a circuit so that meaningful tests can be made.

The difficulty and cost of fault isolation has risen in direct proportion to the density and complexity of today's circuitry. Dozens of IC devices of a circuit board can be the equivalent of hundreds of thousands of individual components and circuit connections. Moreover, most of the problem points are out of reach, and the effect of individual faults can be masked by intermittent failures, fanouts, and errors that occur only when a particular logic sequence is performed.

For the production department, fault isolation has long been a growing and frustrating problem. Go/no-go testing becomes a meaningless exercise when the percentage of no-go assemblies exceeds the half-way mark. Skilled personnel are siphoned into rework activities, and production-labor costs continue to climb in an industry that depends on IC technology for its future profits.

Fault isolation and computers

Similar frustrations are being encountered in the field at repair centers and service depots. A 25¢ device may be the only item that needs replacement, but the cost to locate the faulty IC package often exceeds the value of the complete circuit board or assembly. And, again, there is the problem to find and train the skilled personnel needed to do the work. Not surprisingly, then,

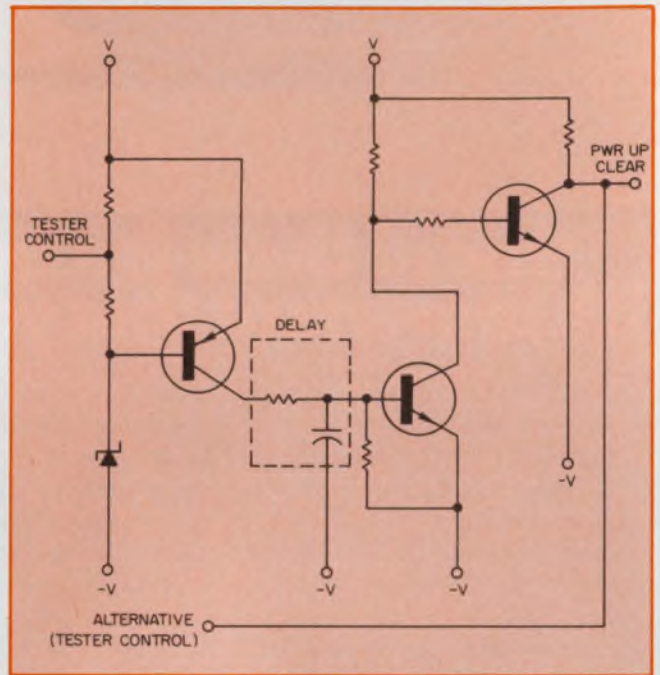

1. In circuits that turn on in an arbitrary state, a power-up clear can be provided to set a desired initial condition. Test-control signals can be designed to check both the circuit and clear.

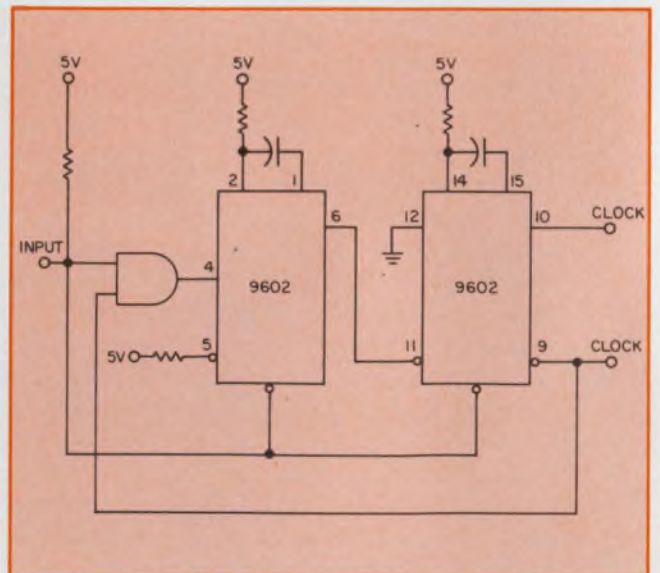

2. To test asynchronous circuits, control lines can enable or disable the clock circuit.

Jai Hun Jhu, formerly with Technology Marketing, now General Manager, μ P Div., Plessey Memories, 1674 McGaw Ave., Santa Ana, CA 92705.

a great deal of attention is now being applied to the technology of fault isolation.

Theoretical work, much of it performed at the university level, finds expression in computer-controlled diagnostic schemes. Do-it-yourself test systems are being replaced with more sophisticated equipment from companies who specialize in this field. Larger manufacturers are developing staffs, strictly for fault isolation, composed of experts in the theory and implementation of diagnostic techniques.

But the net effect of much of this activity has been to replace one cost problem with another. Computer software and programming can make the cure as expensive as the disease. New fault-isolation systems, with computer-like logic but without the need for computer programming, are now becoming available. At best, however, the new systems will just hold the line in the face of increasing circuit complexity.

All of these difficulties can be largely overcome, if the designer—with the support of production, service and management—recognizes the interplay between design and fault isolation, and takes advantage of the cost-savings opportunities at his disposal.

The designer may, for example, increase the size of an edgeboard connector to accommodate test points for factory-level tests. The extra cost will probably be insignificant compared with the easing of the fault-isolation problem.

In general, fault-isolation testing consists of the creation of a particular set of conditions or sequence of conditions that permit the designer to observe whether the circuit performs as intended.

To do this is not necessarily a simple matter, especially when the objective is to narrow the test to a particular component or device. The de-

signer is primarily interested in the over-all performance of the circuit assembly, but the fault-isolator must have a way to control specific elements within the circuit to apply meaningful tests to individual devices or groups of components.

The first task of the designer, therefore, is to add to the controllability of his circuit.

His second requirement is to increase the observability of the circuitry under test. Usually only a small fraction of the internal-circuit nodes are brought out for functional purposes. Obviously, it would be impossible to bring out all the nodes just for test purposes. The answer lies in a careful selection of extra test lines and a physical design that lends itself to easy probing with IC clips, oscilloscope leads, and other test-equipment connections.

Controllability and observability are separate, yet interrelated, functions, and the circuit designer can contribute importantly to both. A number of examples show how.

Designing for controllability

On power-up, flip-flops or any memory holding device can come up in any state. A long shift register will therefore require a long series of input pulses to flush out the unknowns. This extends the test time and a larger test-system memory may be required. The solution is to use a master-reset line, even if there is no need for the line in the circuit function. Bring the master reset line out to a pin for accessibility.

Some circuits include a power-up clear to provide the initial condition. This circuit is active only when the power is initially applied to the board. Figure 1 shows two alternative ways to

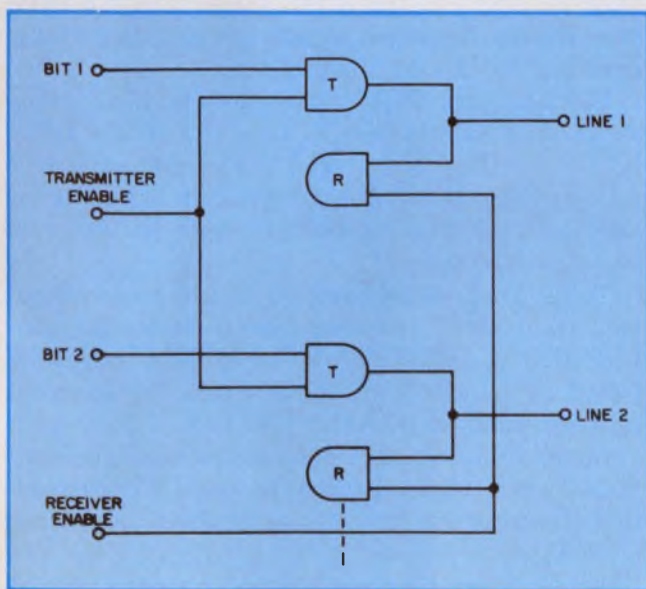

3. Test-system lines (1 and 2) are assigned to check receivers and transmitters that share a bidirectional line.

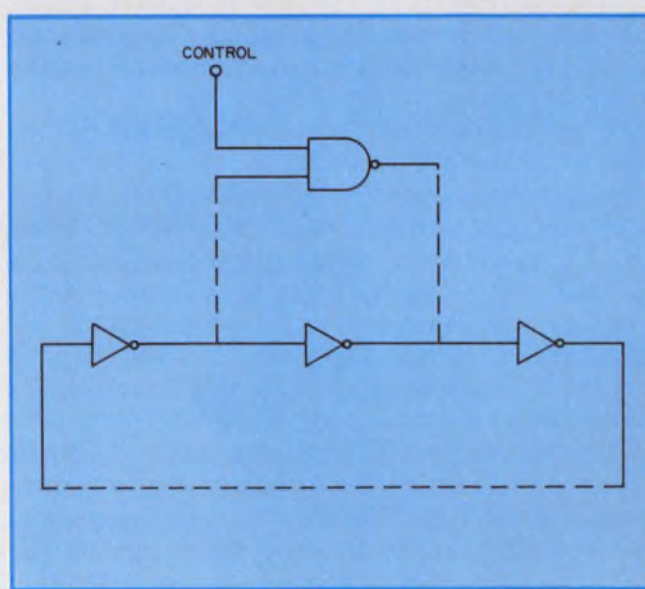

4. Feedback loops are hard to test. A control line can be used to stop errors at a gate during test.

provide external control signals to test both the power-up clear circuits and the reset line of the internal flip-flops.

Astable multivibrators that run asynchronously can make testing very difficult because there is no time reference with which to make consistent tests. The solution here is to design control lines to the clock circuit to enable or disable the clock, or to let one clock pulse go out at a time.

The control lines will let the fault-isolation system exercise the circuit one clock at a time, and thus process the data at the system's own speed. One typical clock circuit is shown in Fig. 2. The input, when LOW, disables the clock. When HIGH or left open, the input enables the clock. An alternative solution is to provide a port for an external clock, as well as a clock disable.

With dynamic MOS circuits, provision must be made to synchronize the test system and the

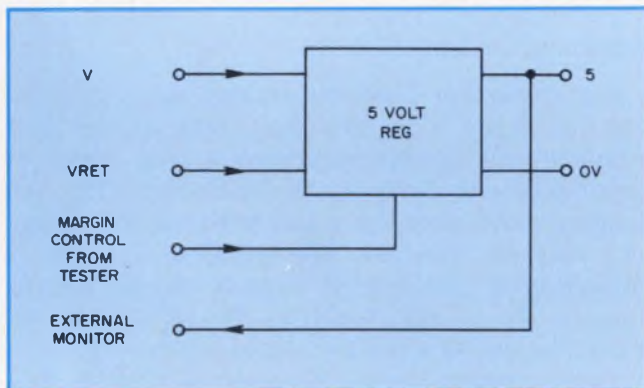

5. 5-V regulators often fail under marginal conditions so that provision should be made for limit tests.

device under test. In the case of built-in clocks, provide either alternate inputs for external clocks or some method to synchronize to the internal one.

With bidirectional lines—where the line is shared by both a receiver and a transmitter—testing becomes complicated unless there is prior knowledge as to which circuit is active. It is advisable, therefore, to bring out the enable terms so that the system can test or troubleshoot the receiver and transmitter independently. To do this, assign test-system lines one and two as output (response) pins and test transmitters (Fig. 3).

Troubleshooting of circuits with feedback loops can be very difficult because errors tend to propagate and feed back to the origin (or seemingly to the origin). To provide a method for fault isolation, the designer can use control points without the sacrifice of circuit performance or addition of parts. For instance, one of the

inverters could be an AND gate that provides an external control within the loop so that the loop can be broken in the middle by an input signal (Fig. 4).

In Fig. 4, with the control line disabled during troubleshooting, errors will not propagate beyond the gate. (The control line is permanently enabled during normal operation.)

Regulators, ROMs and RAMs

It is common practice to place a +5-V regulator on a printed circuit board. However, designers often neglect to bring out a test point to check the regulator. Malfunctions in the V_{cc} regulator will cause massive errors or—worse—unpredictable, intermittent errors, commonly known as ghosts. It is therefore imperative to check the V_{cc} regulator on the board before diagnostic attempts are made.

It is also advisable to provide some control for voltage margin. Many circuit malfunctions occur at voltage margins. To eliminate “weak sisters” and thus enhance the reliability of the equipment, circuits should be exercised at marginal conditions before installation (Fig. 5).

Circuits that use ROMs to replace hard-wired logic tend to have many feedback loops. In many cases, technicians troubleshoot the ROMs along with the rest of the circuit—a practice that can lead to confusion. Therefore, it is best to install sockets for the ROMs so that the memories can be checked prior to installation on the board. This not only simplifies the test but also provides a breakpoint in the loops.

The sockets can also be used to connect to the test equipment during checkout. Thus the test system can be directed to generate ROM patterns while the system monitors the results coming back as inputs to the ROM. (Inputs to the ROM for address lines are usually a function of the previous ROM address pattern.)

Circuits with ROMs also tend to have many jumps and subroutines so that it is often difficult to verify whether the instruction sequence follows the right course. Single-step capability is easy to implement at points where an external break is advisable.

To test large RAM systems requires specialized test equipment. However small memories embedded in a large circuit board may be easily tested by provision of some access for external controls, such as READ or WRITE.

In the usual circuit implementation, a memory READ cycle forms a subcycle of a CPU instruction. Therefore, it may not be possible to exercise a READ cycle without going through all the motions. If it can be done without unbearable cost and long delay in the development cycle, provide pins for external READ and WRITE commands

(data input and output can be monitored by means of an IC clip).

For dynamic MOS RAMs, refresh requirements present some degree of difficulty. The strategy here is to first thoroughly check out the refresh logic, then test the memory.

One shots, ghosts and fanouts

Verification of the pulse width of a one-shot circuit can be easily handled by test systems with programmable sample clocks. However, most test systems have a fixed resolution and a minimum sampling time period, which makes it easier to check a long than a very short pulse width. If possible, therefore, make the pulse width at least

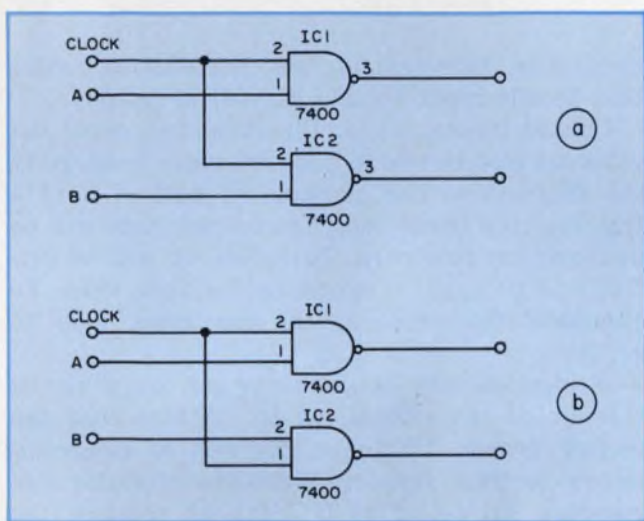

6. Two gates are laid out on a PC card so that each uses the same test routine (a). This can't be done with setup in "b."

1 μ s, or greater.

A common occurrence is for errors to disappear when a scope probe is placed in an IC pin. This can be traced to changes in dynamic and static loading characteristics. The problem can become worse if the test system is directly interfaced with the internal circuit outputs.

For instance, standard TTL fanouts are usually limited to 10. If the tester receiver(s) is connected directly to an output node with the maximum fanout, circuit behavior may become erratic. A CMOS buffer can prevent loading but this can increase the cost of the test system (CMOS chips are also very slow). The design engineer can resolve this problem by limiting the number of fanouts to one less than the nominal maximum.

Designing for observability

It may not always be possible to design circuit boards with identical edge connectors. However,

as a general rule, boards should have a minimum number of connector varieties. Avoid connectors on more than one side of the board, multiple-connector types and connectors in the middle of the board.

Provision for extra test points is very important. However, the points must be easily accessible if they are to be of value. Use of extra edge-connector pins to bring out the test points can minimize test time and simplify the test fixture design.

More thought should be given as to what constitutes a good test point: Each test point should be an internal circuit node that can give the test system an important clue to the nature of possible failures (Fig. 6).

Most test-systems use IC clips to monitor circuit operations during troubleshooting. Often, the ICs are so close that it is impossible to use the clip. Sometimes discrete components get in the way or ICs are inserted in more than one direction. These problems must be avoided during the layout stage. At this stage, component locations should be numbered and the numbers should be easily visible on the board.

Jumper options can be tested most easily if all the jumping is done on the edge connector. However, if the board is not designed in this fashion, a set of parallel access lines should be provided, at the least, so that the tester automatically can exercise all the possible jumper configurations. Unused jumper options and their verification are often overlooked, and circuit malfunctions traceable to the jumper options are sometimes hard to diagnose.

It is common for a printed-circuit-board assembly to go through engineering changes after it has been put into production. Some of the changes will be temporary fixes. The manner in which these changes are incorporated will affect the tests. If an IC clip is to be used during testing, it is advisable to avoid the "dead-bug" method. If a "bed-of-nails" fixture is to be used, consideration must be given to accessibility before jumpers are added.

Design for simplicity

To ease diagnosis and test-program generation on an automatic tester, circuits can be laid out to use a common test routine. For example, in Fig. 6a an automatic card tester with an IC-clip probe is used for diagnostics. The two 7400 gates are laid out on the printed-circuit board in such a way that a test routine for one chip can also be used for the other (the clock is connected to pin 2 on both chips).

By contrast, the circuit in Fig. 6b has the clocks connected to pin 2 of one chip and pin 1 of the other so that a common test routine is

Dialight sees a need:

(Need: The widest choice for your every application.)

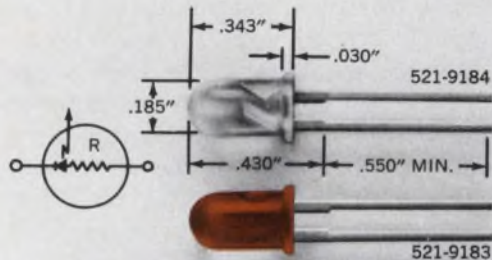

Available in red or clear LED packages with or without a built-in current limiting resistor. Red LED is also made without resistor. Suitable for circuit status indication, alpha-numeric displays and visual indicators. Features long wire-wrappable leads. IC compatible with solid state reliability. High luminous intensity, low power consumption, low cost.

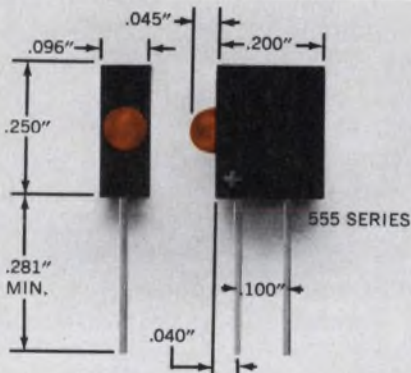

LED logic state fault indicators available in 14 models with voltage ratings from 1.7 to 14. Suitable for dense packaging on printed circuit boards—up to 10 units to the inch—IC compatible. With built-in series resistor. Polarity identified. Low power consumption.



Dialight, the company with the widest choice in switches, LEDs, indicator lights and readouts, looks for needs . . . your needs . . . and then they develop solutions for your every application. No other company offers you one-stop shopping in all these product areas. And no other company has more experience in the visual display field. Dialight helps you do more

with these products than any other company in the business, because we are specialists that have done more with them. Talk to the specialists at Dialight first. You won't have to talk to anyone else. Send for your free new copy of Dialight's current catalog.

DIALIGHT

Dialight, A North American Philips Company
203 Harrison Place, Brooklyn, N. Y. 11237
(212) 497-7600

See Dialight.

INFORMATION RETRIEVAL NUMBER 35

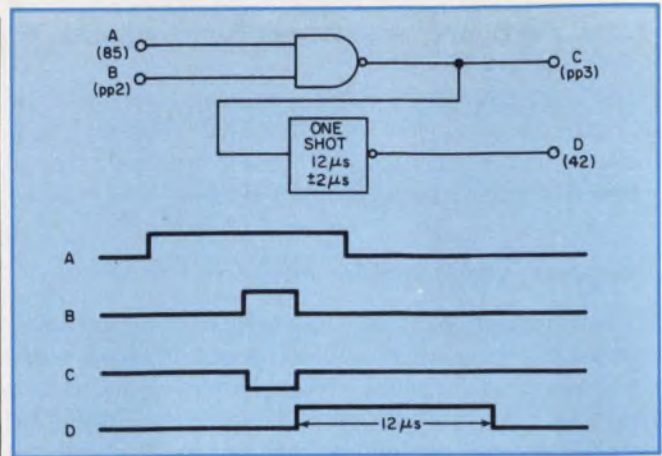

7. Schematics are as important as tests. Shown are all vital internal nodes, sources, destinations, and important circuit data, such as a one-shot's timing.

impossible. This example also pertains to testers that handle input signals as well as output.

Unused inputs, gates, flip-flops and other devices can also be tied to a known state to simplify the diagnostics. For example, if half of a 7474 flip-flop chip is not used, the output state will be unknown on power-up. Therefore, it will be difficult to program diagnostics for that chip. To eliminate the problem, tie the reset side to ground.

If identical pin assignments can be achieved throughout the system, as in systems that use mother boards, fixturing (as well as programming) becomes simpler. Since the stimulus and response pin definition is identical, most of the test-routine for one board can be used for the rest.

In any event, the designer should make an effort to simplify the connection scheme by assigning common power connections. Since most computer-controlled testers have the capability to change the input and output definition, the same interface fixture can be used for a number of different cards, as long as the cards have the same power connection.

Aside from test specifications and test procedures, a well-designed schematic can be a great help to test personnel. Schematics must be not just easy to follow, but should also provide test information as well. Such information can include a timing diagram, IC types and pin-out chart, a notation for I/O pins that is different from the internal connections, and the pulse width of one shots.

Figure 7 shows that "A" and "D" are edge-connections and that their pin numbers are 85 and 42, respectively; while "B" and "C" are internal connections and their source and designations are on page two and three, respectively. Also shown is a one-shot with its time-out classified as 12 μ s with ± 2 - μ s tolerance. ■■

Announcing the biggest thing to ever hit the OEM market.

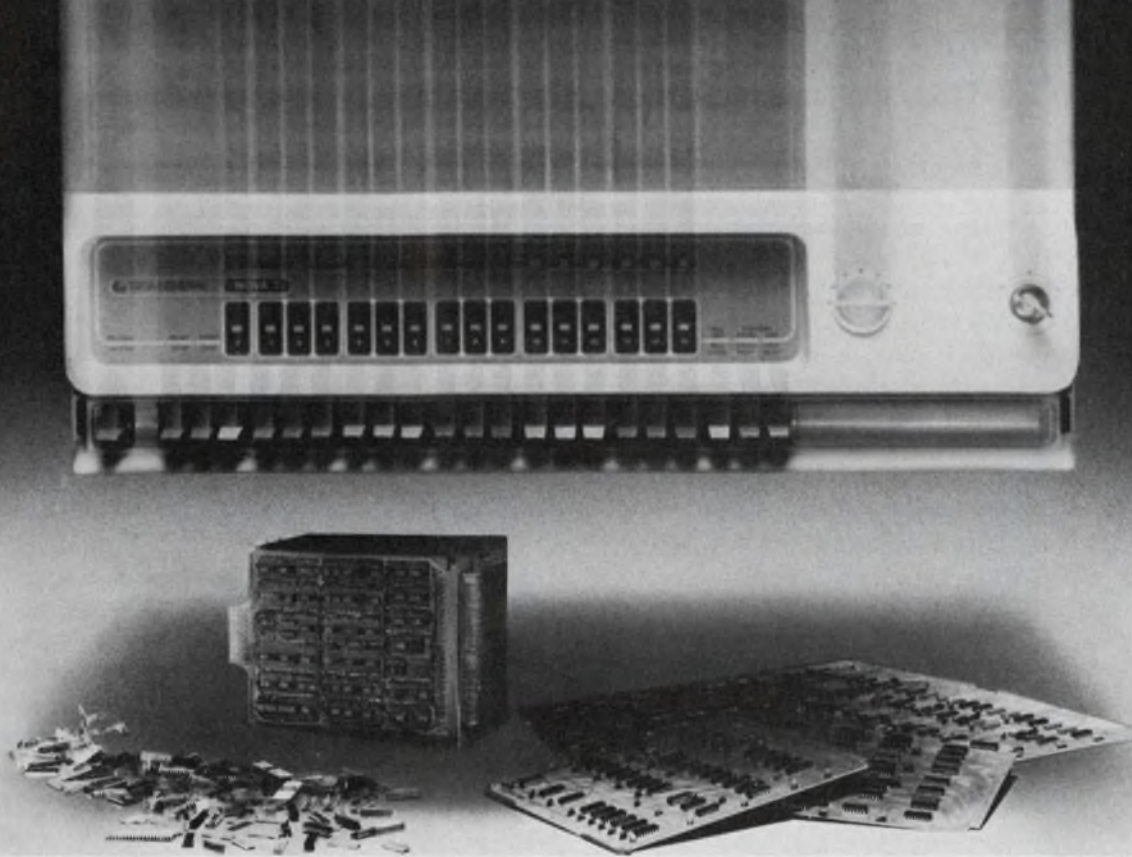

Here comes the biggest OEM computer you've ever seen. At some of the lowest prices you've ever seen.

The new Nova 3 from Data General.

Nova 3 has a big price edge over any competitive minicomputer. You can get a single 4K MOS Nova 3 for only \$2600. (And that's before the OEM and quantity discounts get figured in.)

Nova 3 has the biggest performance of any OEM mini. It can execute instructions in 700 nanoseconds with MOS memory. And its sophisticated architecture lets you use every bit of 128K words with the optional Memory Management Unit.

And Nova 3 has the broadest range of configurations you can get in an OEM mini-computer line. There's a 4 slot Nova 3. A 12 slot Nova 3. (It has an optional expansion chassis

that gives you 12 more slots of I/O.) And you can configure multiple processor Nova 3 systems.

Nova 3 also has the latest, state-of-the-art MOS memory. And the MOS chips are manufactured at our Sunnyvale, California facility. The biggest MOS RAM manufacturing capability of any minicomputer company in the world. (In fact, the only one.)

Nova 3 has the biggest array of peripherals and software. Because its hardware and software are compatible with previous Novas. The most successful 16-bit computers ever made.

And Nova 3 comes with a comprehensive OEM support package. Also available are Field engineers. Systems engineers. Our hardware and software subscription service. And a Data General User's Group.

Write or call for the Nova 3 brochure.

This has to be big news for every OEM.

DataGeneral

Data General, Dept. J4, Route 9, Southboro, Mass. 01772 (617) 485-9100. Data General (Canada) Ltd., Ontario.
Data General Europe, 15 Rue Le Sueur, Paris 75116. France. Data General Australia, Melbourne (03) 82-1361/Sydney (02) 908-1366.

Complacent about resistor reliability?

There are at least 18 ways these components can cause circuit problems. Here are tests to ensure reliability.

Fixed resistors of the molded-composition and film types generally have such a good reputation for reliability that many design engineers seldom question it—until it's too late. Their reputation, usually well-deserved, is kept that way because the leading manufacturers subject their resistors to stringent inspection and testing. Laxity in any phase of resistor testing can easily result in poor circuit performance when a completed assembly is put through environmental tests.

To ensure reliability, resistors must undergo at least 18 tests. Here they are:

Group 1

- Visual and mechanical inspection.
- Resistance value and tolerance.

Group 2

- Resistance-temperature characteristics.
- Resistance-voltage coefficient.
- Dielectric withstanding voltage.
- Insulation resistance.

Group 3

- Low-temperature operation.
- Temperature cycling.
- Steady-state humidity.
- Short-time overload.

Group 4

- Load life.

Group 5

- Terminal strength.
- Effect of solder heat temperature.

Group 6

- Solderability.

Group 7

- Shock and vibration.

Group 8

- Pulse applications.

Group 9

- Resistance to effects of solvents.

Group 10

- Temp/humidity cycling.

Because of the impracticality of testing every one of a large batch of resistors, select samples

at random. For each test sequence, except the first group, pick 10 resistors of each type and resistance value.

The tests in Group 1—visual and mechanical inspection and resistance tolerance—are applied to all of the specimens. And within each group the tests should be made in the sequence shown. Some tests, such as groups 4, 6, 7, 8, 9 and 10, may damage or render the resistors unfit for further tests, thus they include only a single test.

In testing to compare the products of several manufacturers, use resistor samples with the narrowest standard tolerances. The resistance values should include the manufacturer's lowest and highest standard values as well as the "critical."

The critical resistance value is defined as the highest standard value that can safely dissipate full-rated wattage at 70 C when a maximum-rated, continuous-working voltage (RCWV) is applied. The maximum RCWV for dc or rms voltages is supplied by the manufacturers. Table 1 lists RCWV values for common hot-molded fixed resistors.

All resistors, except those that are truly hermetically sealed, absorb moisture. Since this can affect resistance values, you must remove the moisture. This operation on test samples, often called conditioning, is done by exposing the resistors to warm, dry air from a ventilated oven in an air-conditioned space. For the resistors in Table 1, apply dry 100-C air for the conditioning time listed. Longer drying may be required if the resistors have been stored for long periods under unusually high relative humidity.

Resistance to resistance change

Of course, a resistor's ohmic value and its tolerance range are the most important specifications. The ohmic values should be within the specified tolerance when measured at 25 C. And because composition and some film resistors exhibit a voltage coefficient, measure the resistance with standardized voltage levels, so the measurement error doesn't exceed one-tenth the allowable resistance tolerance.

The use of specific dc test voltages, as in Table

Don Bugalski, Manager Fixed Resistors, and Jack Polakowski, Fixed Resistor Applications Engineer, Allen-Bradley Co., Electronics Div., Milwaukee, WI 53205

Table 1. Test limits for hot-molded fixed resistors

Maximum continuous power rating at 70 C ambient watts	Maximum rated continuous working voltage (RCWV) dc or rms volts	Dielectric withstanding voltage volts		Insulation resistance test voltage volts ±10%	Short-time overload voltage limit volts	Recom- mended conditioning time at 100 C +5 -0 C hours	Critical resistance value megohms
		at 30" Hg sea level	at 3.4" Hg 50,000 ft.				
1/8	150	300	200	100	200	25	0.18
1/4	250	500	325	100	400	50	0.27
1/2	350	700	450	500	700	75	0.27
1	500	1000	625	500	1000	120	0.27
2	750	1500	625	500	1000	130	0.30
3	500	1000	625	500	1000	120	0.091
4	750	1500	625	500	1000	130	0.15

Table 2. Recommended resistance measurement voltages

Nominal resistance range	Test voltages (dc volts)
1.0 to 9.1 ohms	0.3
10 to 91 ohms	1.0
100 to 910 ohms	3.0
1K to 9.1K ohms	10.0
10K to 91K ohms	30.0
0.1 Meg. and Higher	100.0

Table 3. Temperature characteristic test sequence

Sequence	Ambient temperature °C
A	105
B	85
C	55
D	25
E	0
F	- 25
G	- 55

2, is recommended for all performance tests. Apply these voltages for the shortest possible time to avoid heating. Wherever practical, use the same instrument and the same temperature (within ±2 C) in all tests. Wheatstone-bridge test equipment is preferred.

To evaluate resistance-temperature characteristics, maintain the resistors within ±1 C at each of the ambient temperatures in Table 3 and in the sequence shown. The use of forced circulating air is recommended to assure temperature stability and uniformity. Make the resistance measurements 15 minutes after the air temperature has stabilized at each specified temperature. The percent difference in resistance, referred to the resistance at +25 C, is computed by the equation

$$\frac{(R - r) \times 100}{r}$$

where R is the resistance at the test temperature and r is the resistance at +25 C.

The resistance-voltage coefficient—often called instantaneous voltage coefficient—is normally important only in testing; it allows accurate com-

parison of the results. Measure the resistance values for calculating the voltage coefficient at one-tenth RCWV and full RCWV. And remember to apply the voltages for a short time to minimize heating. The voltage coefficient is calculated from

$$\text{Voltage coefficient} = \frac{(R - r) \times 100}{R \times 0.9 (\text{RCWV})}$$

where R is the resistance at full RCWV and r is the resistance at one-tenth RCWV.

The next test is to check the resistors' dielectric withstanding voltage. Clamp the resistors in the trough of a metallic 90-degree V-block. The resistor body should not extend beyond the ends of the trough, and the resistor leads should be parallel to the sides of the V-block.

Apply sine-wave voltage at commercial-line frequency and at the levels specified for the resistors under test (Table 1). The voltage should be applied between the V-block and both resistor terminals, with the terminals connected together. Raise the voltage at 100 V/s and hold it for 5 s.

Note that Table 1 provides two sets of test voltages. One is for a sea-level pressure of about

30 in. of mercury, and the other is for atmospheric testing at about 3.4 in., which corresponds to an altitude of 50,000 ft.

A companion test to withstanding voltage is insulation resistance. Clamp the resistors between a round nonconducting rod, placed at right angles to the resistor body, and a resilient conductive material about 0.075-in. thick, bonded to a rigid metal strap (Fig. 1). Apply sufficient pressure to embed the resistor color bands in the resilient material and to provide intimate electrical contact along the entire axial length of the resistor body.

The metal strap and resilient conductive material should be as wide as the length of the resistor body, and the resistor should be placed in the center of the strap. The resistivity of the resilient conducting material must be less than 1000 Ω -cm.

Avoid excessive resistor handling to minimize the effects of perspiration or other contaminants. Connect the lead wires of the resistor together and measure the resistance between these leads and the metal strap. Use the manufacturer's specified dc test voltage. Table 1 provides test voltages for hot-molded resistors. Check the values obtained against the manufacturer's limits.

Testing for performance at extremes

To test for the effects of very low temperature, mount the resistors by their leads so there is at least 1 in. of free air space around each resistor, with no appreciable obstruction to the flow of air.

Measure the initial resistance. Then expose the resistors to an air stream of -65 C for 1 h, with no voltage applied. Follow this with 45 min of exposure, but with the RCWV applied. Allow the resistors to return to room temperature and to remain there for 24 h, then make a final measurement of resistance. Note any deviation from the manufacturer's spec.

Temperature cycling is an even more severe test of a resistor's ability to withstand temperature extremes without permanent change of resistance. Again, measure initial resistance with the resistors mounted for low-temperature evaluation. The temperature-cycling sequence in Table 4 is frequently used by manufacturers. It shows four steps. The temperatures in steps 1 and 3 are obtained by forced-air circulation. The heat source should push the air temperature within 2 min to the temperatures specified in the table. Measure the final resistance about 1 h after completion of the last cycle.

Moisture also can permanently change a resistor's value. Though the results of humidity tests are hard to reproduce and compare, the fol-

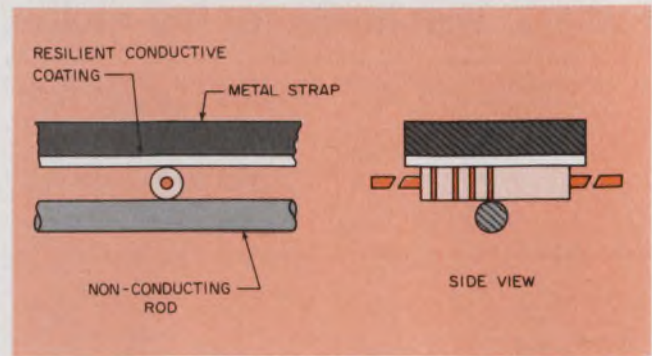

1. To check insulation resistance, the resistor should be clamped tightly against a resilient conductive surface to obtain a large-area contact with the resistor's body.

lowing procedure has proved effective as a steady-state test:

Measure the initial resistance values, avoiding excessive handling. Place the resistors in a chamber with relative humidity of 90 to 95% at an ambient temperature of 40 C for 240 h. Then remove the resistors from the chamber and allow them to dry at room ambient for 4 h. This removes only surface moisture. Final resistance measurements can then be made.

To determine if any resistance changes are permanent, the resistors may be conditioned, as described previously, and the values checked again.

A more realistic approach to humidity testing is sequential exposures of high temperature followed by high humidity. After measurement of the initial resistance, put the resistors in a dry oven at 130 C for 240 h. Immediately after this exposure, place the resistors in an atmosphere of 66 C and 100% relative humidity for 125 h. Then take final resistance measurements and observe for erratic behavior. This cycle may be repeated, depending on the severity of the intended application.

Testing under load

The testing thus far still does not assure long-life stability under load conditions. An actual load-life test is needed.

Do this test at an ambient temperature of 70 C, with the resistor leads soldered to lightweight terminals. Bolt the clamps of metal-clad resistors to 4-in.-square steel plates, 0.05 in. thick, one plate for each resistor. The length of each lead should be about 1 in.

Arrange the resistors so heat from any one resistor doesn't influence the temperature of any other. And allow only the natural convection circulation of air to cool the resistors. Use RCWV.

Expose the resistors to the 70-C ambient temperature without load for 2 h, then make the initial resistance measurements. Apply dc RCWV

Table 4. Temperature cycling test sequence

Step	Temperature °C	Time minutes
1	-55 ⁺⁰ / ₋₃	30
2	+25 ±5	10
3	+85 ⁺³ / ₋₀	30
4	+25 ±5	10

intermittently—1-1/2 h ON and 1/2 h OFF—for a total of 1000 h. Take resistance measurements near the end of OFF periods after 50, 100, 250, 500, 750 and 1000 h. Keep the resistor ambient temperature at 70 C throughout.

For intermittent short-time overload testing, apply for 5 s a well-regulated dc or sine-wave voltage that is 2.5 times the RCWV but does not exceed the limit values in Table 1. Measure the resistance before and about 30 min after application of the test voltage.

For circuit applications that experience repeated pulses with peak values in excess of steady-state ratings, design special tests. These should last ideally for at least 1000 h under conditions that accurately represent the peak value, pulse waveform, repetition rate and environmental conditions that must be met. Even more severe conditions than expected are recommended to establish safety factors.

However, a good way to test easily for pulse capabilities is to use a capacitor-discharge technique for the stress signals. Charge a noninductive capacitor at successively higher voltages and discharge it through the resistor. The circuit should have a minimum and consistent inductance value. Make resistance measurements initially and after each capacitor discharge.

Some recommended test levels are listed in Table 5. Resistors are subjected to a single energy pulse from a capacitor discharge. The resistor samples should have a nominal resistance of at least 150 Ω. A change in resistance of more than 4% is considered excessive. The actual applied voltage can be computed from the equation

$$V = \sqrt{\frac{2E}{C}}$$

where C = capacitance in farads and E = energy in watt-seconds (Table 5).

A resistor may be accurate, stable, resist moisture and take the stress of overloads, but if its leads break off easily or its resistance changes when the leads are stressed, the component is

Table 5. Capacitor energy-pulse test limits

Rated wattage	Energy watt-seconds	Approx applied dc volts	Capacitance μF
1/8	0.45	670	2
1/4	1.8	600	10
1/2	6.4	630	32
1	16.0	1000	32
2	44.0	1650	32

obviously too unreliable to be put to use.

To test lead strength, measure the initial resistance and then hold the resistor by one lead and gradually apply a pulling force of 5 lb to the other lead along the longitudinal axis of the resistor. Maintain the force for 5 s. For 1/8-W resistors, use only 2 lb. The leads, of course, should not come off.

Follow this pull test with a bend test. Bend the leads 90 degrees at a point 1/4 in. from the resistor body in a radius of about 1/32 in. (Fig. 2a). Then clamp the free end of the lead up to 3/64-in. from the bend (Fig. 2b).

Now rotate the resistor body 360 degrees about its longitudinal axis in alternating directions three times. Each rotation should be done in about 5 s. After the last rotation, measure the resistance—assuming, of course, that the lead has not broken off. The resistance should not have changed appreciably.

Solder heat is another stress that resistors must withstand. Measure initial resistance, then immerse the resistor leads, one at a time, for about 3 s each in molten solder at 350 C (250 C for 1/8-W resistors). Immerse to a distance of 1/8 to 3/16 in. from the resistor body. Now measure the final resistance about 24 h after the immersions; it should not exceed the manufacturer's specified limits.

Leads must be solderable

To evaluate solderability, use either a heated still pot or a recirculating-flow soldering machine, both capable of maintaining the solder at a uniform temperature of 232 C. If a still pot is used, the stirring-paddle and skimmer material should not contaminate the solder.

The flux must consist of a minimum of 35% by weight of waterwhite rosin dissolved in 99% isopropyl alcohol. The solder should be 60% tin and 40% lead.

Test both leads of each resistor "as received," with normal care taken to prevent contamina-

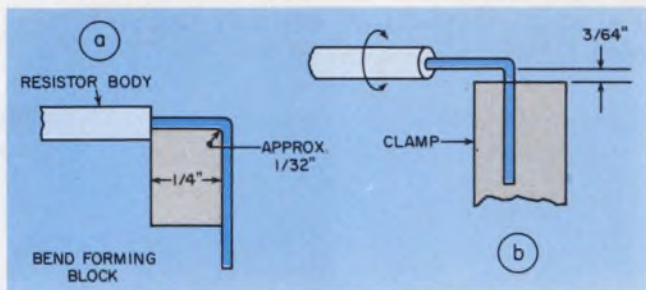

2. To test the twist strength of the terminal leads, first bend the leads (a), and then twist slowly three times for 360 degrees in alternate directions (b).

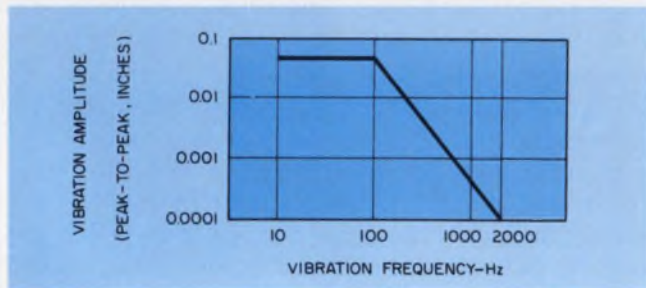

3. The resistors should be subjected to a vibration test over the frequency range and vibration amplitudes as shown in this graph.

tion that might influence test results. The leads should be immersed first in flux for 5 to 10 s at room temperature. Skim off any scum or dross accumulation on the solder surface.

If the solder isn't circulating, stir it with the paddle to keep its temperature uniform. Then dip the fluxed leads into the solder only once to the same depth they were immersed in flux. The rate of immersing into the molten solder should be about 1 in./s with a dwell time of 5 s.

After this soldering operation, allow the leads to cool in air. Remove residual flux from the leads by bathing in clean isopropyl alcohol and, if necessary, wiping with a soft cloth. Examine the surface of each lead for uniform coverage with a 10-power optical magnification system.

Shock and vibration testing

In addition to pull and bend stresses, resistors must contend with vibration and shock. To test for shock effects, mount them on rigid holding fixtures. Resistor leads should be supported 1/4 in. from the resistor body. Test leads to the resistors must be 22 AWG or smaller. Apply a sawtooth shock with a peak value of 100 g and duration of 6 ms. The actual velocity change must be within 10% of the ideal change of 9.7 ft/s.

Measure the initial resistance. Then subject the mounted resistors to 10 impacts in two directions: parallel and perpendicular to the longi-

tudinal axis of the resistor. Provide electrical monitoring during the test to detect resistor discontinuities of 0.1 ms or greater. After the shock cycle make final measurements and examine for mechanical failures.

To evaluate vibration characteristics, the test fixtures with the resistors mounted on them must be free of mechanical resonances over the frequency range of 10 to 2000 Hz.

After measuring the initial resistance, subject the mounted resistors to the vibration amplitude and frequency range shown in Fig. 3. The vibration waveform should be a simpler harmonic motion with an amplitude that provides 20 g of peak acceleration but does not exceed 0.06-in. peak-to-peak displacement.

Vary the frequency approximately logarithmically between 10 and 2000 Hz with a return sweep to 10 Hz. The entire sweep cycle should be traversed in approximately 20 min. Continue this sweep cycle for 6 h in two directions—parallel and perpendicular to the longitudinal axis of the resistor. Test interruptions are permitted, provided the requirements for rate of change and total test duration are met.

Here again, provide electrical monitoring to detect resistor discontinuities of 0.1 ms or greater. Make the final measurements and examinations for mechanical failures after the tests.

Resistors must resist solvents

To test for the actions of common solvents, inspect the resistors visually first for color coding. This is so comparison can be with after-test results should the solvents remove the codes. In addition measure the initial resistance values at ambient room temperature. Then heat the resistors in an oven at 120 C for 4 h.

Immediately thereafter immerse the resistors completely in ultrasonically (25 kHz) agitated liquids at approximately 40 C, one solution at a time, in this order:

1. Methyl chloroform 10 min.
2. A 50-50 mixture of isopropyl alcohol and freon alcohol 5 min.
3. Toluene or xylene 30 min.
4. Trichloroethylene 30 min.
5. Tap water 30 min.

Avoid mechanical abrasion during the tests. At the conclusion of the immersions, allow the resistors to dry for 4 h. Then measure resistance values and examine the color code for changes.

Because of the popularity of Freon TMC, many manufacturers test resistors with a one minute immersion in this solvent. However a separate test group of resistors should be used for this or any other special solvents the resistors may be subjected to. ■■

VACTEC brings you BLUE



Unlike our little Japanese friend, photodetectors have always been insensitive to blue. Until now.

Vactec's latest development is a new Blue Enhanced Silicon (BES) photodiode with exceptionally low dark current for efficient response in the blue region (200 - 400 nm). Made in Missouri, U.S.A., it performs equally well in an expensive Japanese SLR camera or in an American-made colorimetric analyzer as well. And you'll like the price, which could be as big a breakthrough as blue sensitivity. Vactec also introduces a new line of PIN photodiodes that operate at high voltages, low noise levels, and fast rise times, with about half the blue sensitivity of the BES photodiode. For larger areas, Vactec offers a complete range of Blue Enhanced Silicon photovoltaic cells up to 1 1/8" diameter.

Vactec now supplies the broadest line of photodetectors in the industry, including:

- silicon solar cells
- hi-speed / low-leakage silicon cells
- NPN phototransistors
- NPN photodarlington
- CdS & CdSe photoconductors
- CMOS & bi-polar custom ICs
- opto-couplers
 - a) LED / photoconductor
 - b) LED / phototransistor or darlington
 - c) lamp / photoconductor
- selenium photovoltaic cells

Call or write today:



Vactec, Inc.

**2423 Northline Industrial Blvd.
Maryland Heights, Mo. 63043
(314) 872-8300**



Design with the complete flat cable/connector system.

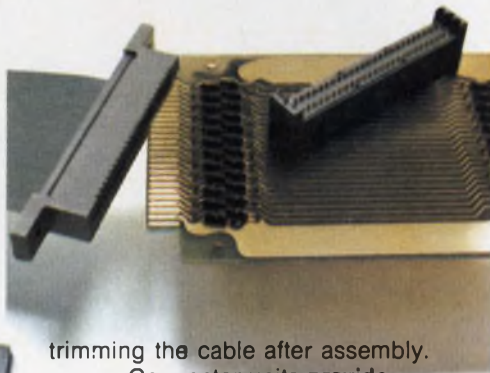

trimming the cable after assembly.

Connector units provide positive alignment with precisely spaced conductors in 3M's flat, flexible PVC cable. The connector contacts strip through the insulation, capture the conductor, and provide a gas-tight pressure connection.

Assembly-cost savings are built in when you design a package with "Scotchflex" flat cable and connectors. But more important, 3M Company offers you the full reliability of a one-source system: cable *plus* connectors *plus* the inexpensive assembly aids that crimp the connections quickly and securely (with no special operator training required).

The fast, simple "Scotchflex" assembly sequence makes as many as 50 simultaneous multiple connections in seconds, without stripping, soldering or

With cable, connectors and assembly tools from one design and manufacturing source, you have added assurance the connection will be made surely, with no shorts or "opens."

And "Scotchflex" now offers you more design freedom than ever. From stock you can choose shielded and non-shielded 24-30 AWG cable with 10 to 50 conductors, and an ever-increasing variety of more than

The 3M DELTA pin and socket connector.



100 connectors to interface with standard DIP sockets, wrap posts on standard grid patterns, printed circuit boards, or headers for de-pluggable applications. 3M's DELTA "D" type pin and socket connectors are now also available. For full information, write Dept. EAH-1, 3M Center, St. Paul, MN 55101.

3M
COMPANY

3M's "Scotchflex" line.

"Scotchflex" is a registered trademark of 3M Co.

INFORMATION RETRIEVAL NUMBER 85

Consider all the ins and outs of your new circuit design. Then consider Curtis® Terminal Blocks.

Tangled, twisted, and loose wires can snarl up even the best circuit design. So don't tangle with trouble. Curtis offers 19 electronic and electrical terminal blocks with hundreds of model variations available to straighten out almost any wiring layout problem.

Here are just a few of the features offered---

- capacities ranging from 5 amps/300 volts to 250 amps/600 volts
- modular, channel-formed, closed-back, feed-thru and fully insulated feed-thru designs offered
- choice of tab, screw, clamp, PC pin or taper pin termination
- heavy duty lug and tubular, high pressure solderless types available for high current applications
- full mechanical thread system incorporated in many units

Specify Curtis electronic and electrical terminal blocks and you'll have the best line in the industry to work with. Specify anything less and you may be tangling with trouble.



CURTIS INDUSTRIES, INC.

8000 West Tower Avenue, Milwaukee, Wisconsin 53223

Call (414) 354-1500 for the name of a representative or distributor near you.

In Canada: A.C. Simmonds & Sons, LTD, Willowdale, Ontario.

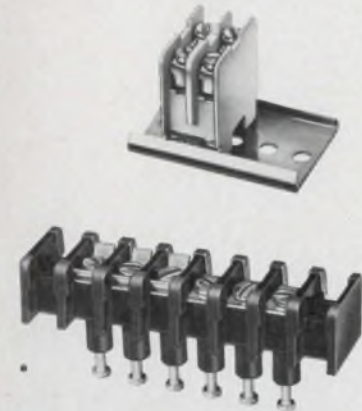

INFORMATION RETRIEVAL NUMBER 38

You don't have to buy a new car to get an electronic ignition.



Most of you know the evaluation of automotive electrical systems . . . an evaluation characterized only occasionally by efficiency and performance. I know that, and that's why I use the Delta Mark Ten B CDI on all my cars, new and old. And believe me, you don't have to have a new car to appreciate the best electronic ignition available today. Study these features and you'll know what I mean.

1. Mark Ten and Mark Ten B Capacitive Discharge Ignition Systems are manufactured by Delta Products, Inc., a company with a conscience, and with a proven record of reliability both in product and in customer relations.
2. The Mark Ten CDI's really do save money by eliminating the need for 2 out of 3 tune-ups. Figure it out for yourself. The first tune-up or two saved pays for the unit, the rest is money in your pocket. No bunk!
3. Because the Mark Ten CDI's keep your car in better tune, you actually can save on expensive gasoline.
4. With a Mark Ten, spark plugs stay clean and last longer . . . fouling is virtually eliminated.



No matter what kind of car you drive, it too can use a Delta quality lift.

I want to know more about Mark Ten B CDI's. Send me complete no-nonsense information on how they can improve the performance of my car.

Name _____
 Address _____
 City _____ State _____ Zip _____



DELTA PRODUCTS, INC.

P. O. Box 1147, Dept. ED, Grand Junction, Colo. 81501
 303-242-9000

Mark Ten B, assembled	\$64 95 ppd	Standard Mark Ten, assembled	\$49 95 ppd
Mark Ten B, kit	\$49 95 ppd	Deltakit®	\$34 95 ppd

INFORMATION RETRIEVAL NUMBER 120

Choosing the best enclosure: Here are do's and don'ts for putting equipment in a sturdy, eye-catching, low-cost package.

Selecting the right cabinet or rack for an instrument or circuit calls for a dual personality—well, almost. To do the job right, you must be both design engineer and purchasing agent. You must analyze the cabinet or rack construction from the standpoints of size, material, eye appeal and cost.

As a design engineer, you want the enclosure that best fits the equipment while providing good user efficiency. On the other hand, as a pur-

chasing agent, you must watch out for expensive custom options; you want the best unit for the lowest possible cost.

If you can't find an enclosure that fits the equipment, consider minor equipment changes instead of custom cases. Depending on the number of enclosures needed, it might pay to redesign a portion of the circuit rather than buy a custom case.

Here are some do's and don'ts that can help minimize cost and simplify selection of the right enclosure. The list contains many often-overlooked design details. After checking these, you'll probably come up with several more of your own.

Allen Hehs, Technical Director, Bud Radio, Inc., 4605 E. 355th St., Willoughby, OH 44094.

Eye appeal

Do's

1. Consult with the vendor when it comes to finishing or coloring the enclosure. It's important to know the environment the equipment will be operated in so the proper primer can be chosen to resist corrosion. For color selection, use Federal Color Chart No. 595. The lowest-cost colorings are "self-texturing" enamels, in which the resins are ground into the vehicle. To cut costs, use the vendor's standard paint whenever possible.

2. Decide how much "sophistication" you want in cabinet or rack styling. If you know the final location of the product—executive office, showroom, computer room, laboratory, production area, etc.—consider that factor.

3. Look through vendors' catalogs to see what is available from stock. Nearly every stock unit can be modified, for a price.

Don'ts

1. Try not to specify paint by brand name, unless the vendor can't supply an equivalent covering. Remember, air-dry paints (except lacquers) require dust-free rooms. Also, baking cycles change, depending upon oven type

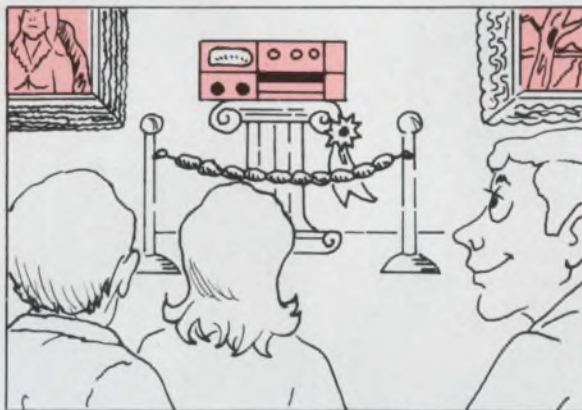

- and paint formula. If you order a specific paint, you'll be responsible for the results—good or bad. Don't order a textured paint and then use silk-screening for lettering; the resulting resolution is very poor.

2. Avoid loading up the enclosure with fancy trim, two-tone paint, odd shapes, etc. You pay extra for these.

3. Don't purchase a completely painted unit and then modify it by punching holes, drilling, etc. Any operations like these will probably destroy the finish.

Mechanical extras

Do's

1. If slides are needed, tell the vendor the load to be moved, distance of travel and whether a tilting or disconnect feature is required. G forces should also be indicated for internal components.

2. Indicate panel size and the amount of air to be moved per minute if you plan to cool equipment with a blower. For casters, indicate load. Other accessories, such as drawers, handles, shelves, brackets, etc., are usually available in company catalogs.

3. For large room-like enclosures, try using aluminum extrusions with corner connectors. The engineering and fabricating costs are less than for similar steel structures, and the weight is up to 65% less, too.

Don'ts

1. Don't specify the slide loosely. If you aren't sure what type to use, explain the conditions and constraints to the vendor's applications engineering staff. Let the vendor help you select the slide.

2. Avoid constraining the vendor unnecessarily with tight noise-level and motor-shielding specifics. Check with the vendor for his specs on acoustic noise and his standard for shielded blowers and fans—he might be able to do the job at lower cost.

3. Minimize the use of aluminum extrusions, unless the vendor is extremely familiar with this construction method. The extrusions are trickier to use than steel, and they won't bear as much weight.

The inside specs

Do's

1. Allow an internal radius equal to the thickness of the material used.

2. Understand that sheared edges are not perfect but are generally accepted "as is" for materials up to 3/16-in. thick. Indicate areas where additional finishing is needed.

3. Allow for burrs on cut edges, unless special dies and punches are used for each metal thickness.

4. Specify in detail the amount of visible welding you can accept. Use such phrases as (a) "Remove weld marks completely;" (b) "Weld marks to be not over ± 0.005 -in. deep," and (c) "Weld marks not to be visible from 36-in. distance."

5. Make your smoothness requirements as minimal as possible. A 30-to-60-microinch finish is usually adequate.

6. Outline the requirements for mechanical loads, g forces, environment, etc. If heavy loads are expected, show their distribution.

Don'ts

1. Avoid specifying formed radii, unless they are actually needed.

2. Don't use the phrase "sheared edges not acceptable," unless this is absolutely necessary. And then use the wording only for material thicker than 1/8 in.

3. Try not to demand a general requirement like "deburr all over," since this involves finishing both sides and is expensive.

4. Avoid MIL specs and certified welding, unless they are true requirements, since these procedures add substantially to the cost. Omit general terms like "no visible weld marks are permitted."

5. Try not to make rigid demands for surface "roughness," since textured finishes usually cover blemishes.

6. Don't forget to indicate which loading factors are important. Anti-tilt devices or provisions for bolting the unit to a floor or rack may be required.

(continued on page 102)

The outside specs

Do's

1. Outline in general terms the purpose of the enclosure and the approximate quantity needed.

2. Make a simple sketch to indicate physical dimensions (allow a tolerance of ± 2 in. on height, width and depth, so you can use a low-cost standard case).

3. Indicate the placement of brackets, holes, cutouts, louvers, etc., together with acceptable tolerances.

4. Specify the material as loosely as possible and the range of gauges for various sections of the enclosure. Have the vendor indicate the alloys he intends to use, subject to your final approval. Specify exact alloys only if stresses, strains or other considerations require their use.

5. Use fractional tolerances when expressing dimensions, especially when measured from a formed edge.

Don'ts

1. Try not to make the enclosure design too elaborate or detailed, until you are familiar with the production capability of the vendor.

2. Avoid specifications that are so tight that they make it difficult for the vendor to quote on a standard product. The savings of standard vs custom designs can often be 10:1.

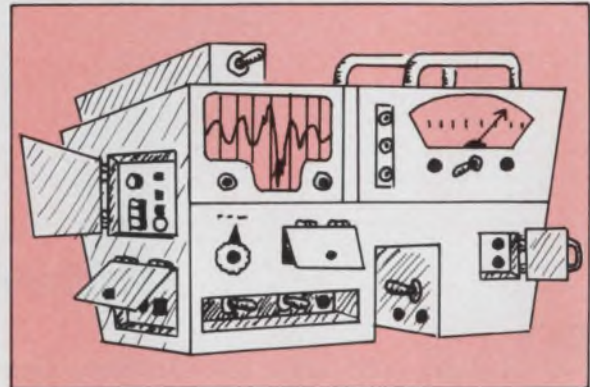

3. Don't specify hole tolerances for fasteners or louvers, unless absolutely necessary. Remember, practical tolerances vary with the thickness of the materials used.

4. Minimize the use of specific aluminum alloys. Vendors usually have thousands of pounds of material that they have purchased in volume at low prices. A small-quantity purchase of a specific alloy can increase cost substantially.

5. Try not to use two or three-place decimal dimensions from formed edges or between spot welds or tack welds. And don't make the tolerances from hole to hole tighter than the tolerance for the hole sizes themselves.

Available standards

Do's

1. Use EIA* specs, like RS-310-B, for racks, panels and other enclosures. These specs are for metric as well as English units. For large-quantity orders, it's less expensive to use tapped screw holes than threaded-screw receptacles.

2. Minimize the use of NEMA** standards. They apply more to electrical than electronic equipment.

Don'ts

1. Avoid the use of tolerances other than those listed in EIA standards, unless you are prepared to pay extra. The EIA standards have replaced RETMA[†] standards and Western Electric spacing.^{††}

2. Don't confuse the different NEMA en-

closure specifications. There are many different types and tradeoffs. For instance, don't use an expensive NEMA Type 4 case to meet the hose-test requirements in definition IC-1-2.68; all you really might need is the lower-cost Type 1 enclosure.

*EIA: Electronic Industries Association, 2001 Eye St., Washington, DC 20006.

**NEMA: National Electrical Manufacturers Association, 155 E. 44th St., New York, NY 10017.

[†]Radio Electronics and Television Manufacturers Association (original name of EIA).

^{††}Western Electric spacing is the same as the EIA "Wide Mounting-Hole Spacing for Racks and Cabinets" specification.

Amphenol wants to break up your marriage.



You and your
SMA supplier —
maybe you've
been a twosome
long enough.

Now there's an alternative — Amphenol. You can't get better SMA connectors than Amphenol's. Ours operate at all microwave frequencies up to 25 GHz. RF performance and mechanical integrity comply with MIL-C-39012. They're easy to assemble with either crimp or solder connections. And our quality will give you a change of heart: all shell and body parts are gold-plated stainless steel. The center contact is gold-plated beryllium-copper. The dielectric is solid TFE, making Amphenol SMA's completely interchangeable with your present source.

Our price will make you want to change partners. When you hear our price, you'll know our SMA's are the best value around. So ask for a quote.

There's a big selection of popular types. Including styles for cable mounting, flange and bulkhead mounting, and stripline mounting. We also offer between-series adapters.

And our SMA's are available. Wherever you are. Your Amphenol Industrial Distributor can fix you up with the SMA connectors you need, by giving you fast off-the-shelf service. He's close to you (there are over sixty Amphenol Industrial Distributors — nationwide). Give him a ring (on the phone, not the finger). Or for more information, write or call us: Amphenol RF Division, 33 East Franklin Street, Danbury, Connecticut 06810. (203) 743-9272.



**BUNKER
RAMO**

*When you can connect it
and forget it...that's quality.*

AMPHENOL

Wrapping and unwrapping wiring tools are easily made from tubing

Inexpensive manual wire-wrapping and unwrapping tools that do a professional job can be constructed from small-diameter nickel, aluminum or brass tubing available at most hobby shops. The tubing costs approximately 25 cents for a 12-in. length. Tubing with ODs of 1/16, 3/32, 1/8, 5/32 and 3/16 in., cut into 2-in. lengths, is used. Epoxy the 1/8 tubing inside the 5/32 tubing, and then fasten both inside the 3/16 tubing to form a handle. Make two such handles.

To form the wire-wrapping stem, apply epoxy to a length of 1/16 tubing, insert it into 3/32 tubing and carefully crimp one end of only the 3/32 tubing until there is a noticeable gap between the two tubes. Make the crimp about 3/16-in. long. Select a drill bit about the size of the wire you intend to wrap—a 0.020-in. drill is suitable for 30-AWG wire.

First, drill a hole through only the 3/32 tubing at right angles to the stem at the back of the crimp, and then drill a hole through the gap toward the previously drilled hole (see figure). With a file, shape the tubing at the drilled back of the crimp so a wire inserted from the front slides easily out the back. Finally epoxy 1 in. of the stem inside the handle and allow sufficient curing time before use.

The unwrapping tool is made to remove right-handed wire wrapping. One end of 1/16 tubing is filed to approximately a 45-degree slope. Position the tube with the slope to your right and face it upwards. On the side of the tubing closest to you, at mid-point of the slope and perpendicular to it, file a notch half way through the slope and form a counterclockwise groove that winds part way around the tubing. The groove depth should cut partially through the tubing at the start and taper off as it lengthens.

Epoxy 1-1/2 in. of the square end of this 1/16

tubing into 3/32 tubing and 1-1/2 in. of the 3/32 tubing into the handle, and allow sufficient curing time before use.

With constant use, the tools wear. However, the faces of the tool can be reformed—about five minutes' work with a file. At least for the 1/16 and 3/32-in. tubing, nickel should be used, because it is harder than brass or aluminum.

David L. Holmes, Systems Engineer, Communications Electronics Div/DOKS, Hq. Strategic Air Command, Offutt AFB, NE 68113.

CIRCLE No. 311

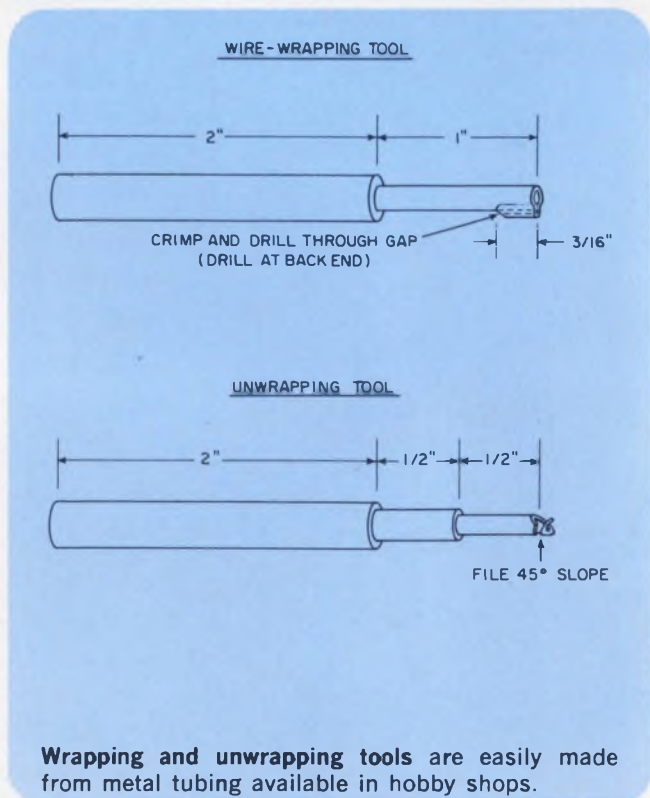

Gates introduces the future in energy cells.



There's now a new energy source that's a superb alternative: Rechargeable, sealed lead-acid batteries from Gates.

We call these batteries the future in energy cells. And for good reason.

They have all the product advantages you need plus economic advantages that may well give a new dimension to your product pricing.

Advantages: Gates Energy Cells are as compact as nickel cadmium or gelled type cells. And they are completely sealed, so that no acid vapor can leak out (they also include a self-sealing vent for extra safety). Gates Energy Cells provide low internal impedance for high discharge rates (more than 100 amps from the D cell and 200 amps from our X cell for short periods of time). And can be operated or stored in any position.

Gates Energy Cells offer great packag-

ing flexibility. In fact, our individual cell availability allows you to choose your own specific voltage (in 2-volt increments) and current, as well as configuration.

Just as important as what Gates Energy Cells have to offer is what they don't have to offer. Like outgassing problems. Or cell reversal. Or "memory" problems.

Because Gates Energy Cells are made from low-cost materials that are readily available, they're very high in watt-hr. per dollar value. Which means that if you specify them, you'll probably save your company more than a few dollars. And make yourself into something of a hero in the bargain.

To find out more about the future in energy cells, circle our reader service number or write us. We'll send you *free* literature containing features, application information, ratings and specifications. George Sahl, Gates Energy Products, Inc., 1050 S. Broadway, Denver, CO 80217.



Energy Products

*Where the
energy future is now*

Programmable sawtooth generator settable at high and low output levels

Many circuits can generate sawtooth waves, but seldom can they be programmed easily to provide a wave that oscillates between two desired voltages— V_U , the higher voltage, and V_L , the lower voltage.

The circuit in Fig. 1 is programmed by voltages V_{R1} and V_{R2} . It consists of an integrator, IC₁; a comparator, IC₂; and inverter, IC₃, and a switch, IC₄, where $V_U = V_{R2} + V_{D3}$ and $V_L = V_{R1} - V_{D2}$.

Pin 3 of IC₂ is at V_U during the rising portion of the waveform. Since pin 2 is at a much lower voltage than V_U , the output of IC₂ is $\approx V_{CC}$ (Fig. 2). This output is applied to pin 2 of IC₃. And with only V_{R1} on pin 3, the IC₃ output is approximately zero, which holds the switch, IC₄, open.

When the integrator output reaches V_U , the output of IC₂ changes to near 0 V, and its pin 3 drops to V_L . Then IC₃'s output goes to V_{CC} , which turns on the IC₄ switch to discharge C_1 . When the integrator output falls to V_L , pin 6 of IC₂ goes back to approximately V_{CC} , the switch opens and the ramp part of the waveform is again generated.

The ramp rise time is given by

$$t_1 = \frac{R_1 C_1 (V_U - V_L)}{V_{R1} - V_{D1}}$$

The fall time, t_2 , is determined by the slower of either the time constant of C_1 and the IC₄ switch resistance or the slewing-rate limit of IC₁, IC₂ or IC₃.

Since the IC₂ and IC₃ outputs are pulses with amplitudes that range from near zero to the pow-

er-supply voltage, these ICs should be fast. Thus 531s are used. Because in the author's application the maximum required sawtooth excursion was only 1 V, the slower 741 was used for the integrator. In this circuit the fall time is about 2 μ s.

The circuit can be synchronized with negative pulses to pin 2 of IC₃.

Jack E. Holzschuh, Project Engineer, Dept. of the Navy, Naval Undersea Center, Hawaii Laboratory, P.O. Box 997, Kailua, Hawaii 96734.

CIRCLE NO. 312

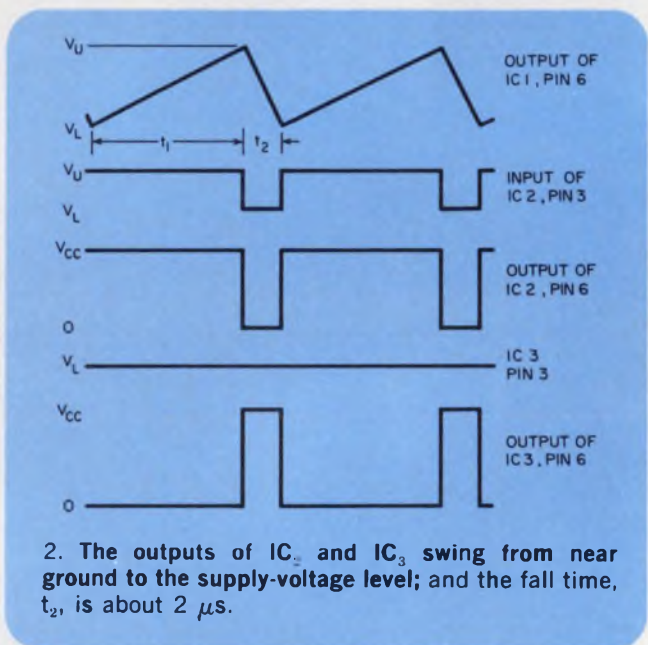

2. The outputs of IC₂ and IC₃ swing from near ground to the supply-voltage level; and the fall time, t_2 , is about 2 μ s.

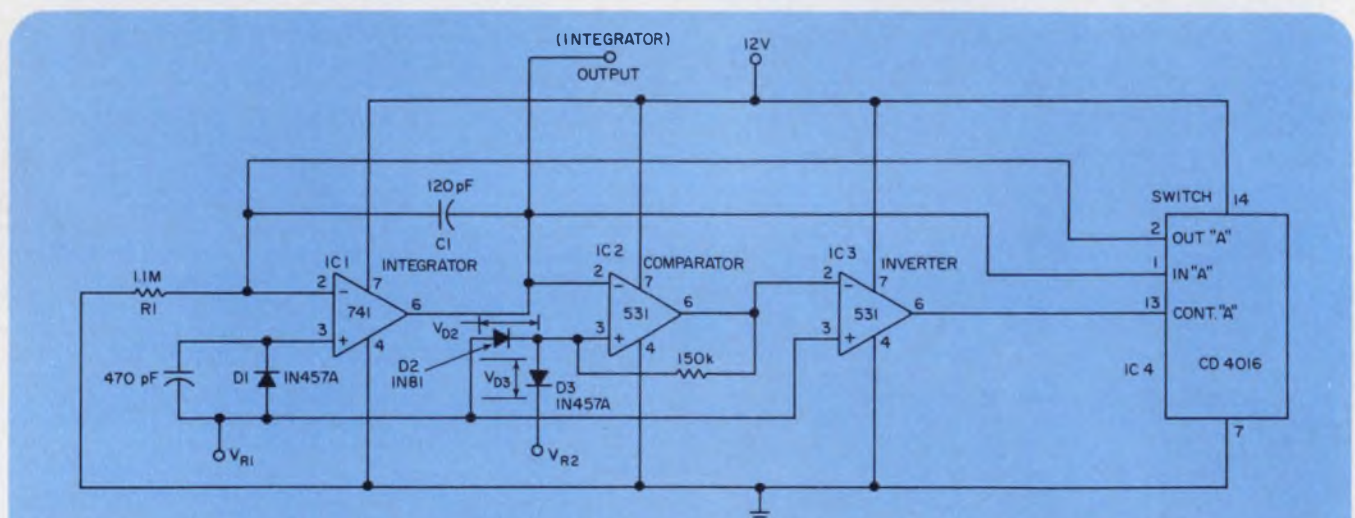

1. A sawtooth voltage-generator can be programmed to provide an output between selected high

and low voltage levels. The ramp rise time depends on $R_1 C_1$ and the upper and lower voltage levels.

Signal has the answer...



The 241 Series.

Cuts transformer weight, size and cost almost in half!



Special "split" bobbin (secondary wound alongside primary rather than over it) effectively isolates primary and secondary and reduces inter-winding capacitance. An electro-static shield

is not required in all but the most sensitive applications. Hipot rating of 2500V RMS is standard. Bobbin winding technique affords a 40-50% savings in winding space over conventional layer winding. "Split" bobbin eliminates the need for inter-winding insulation and cross-over of primary and secondary leads.

Grain-oriented steel core is used at higher saturation flux densities and results in about a 40% reduction in turns required. Although the cost per lb. of grain-oriented steel is higher than that

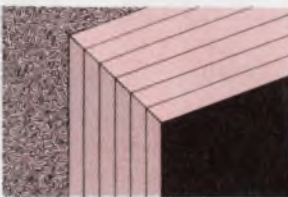

for ordinary silicon steels, the net cost is less, since less core weight is required and a significant reduction is made in copper weight.

Terminals, which are wedged into the bobbin wall, are designed so that they can be used as solder lugs or as 0.187" quick-connect types. Lead slots are incorporated in the bobbin wall leading to the terminals. It is not necessary to tape the start lead since it comes to the top of the coil through the slot and is thus separated from the winding. Separate lead wires or terminal boards and the extra assembly time to use them are eliminated.

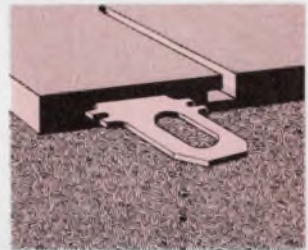

Fresh thinking in engineering design and material selection has reduced material and labor cost and results in a series of small power transformers which cut weight, size, and cost almost in half. Therefore, we named them the "2-for-1" series...



signal transformer co., inc.

1 Junius Street, Brooklyn, N.Y. 11212
Tel: (212) 498-5111 • Telex 12-5709

-and Signal has it in Stock!

Power-failure alarm operates a long time on a single 1.5-V cell

A power-failure alert is often a vital need, especially in hospitals and laboratories. The warning circuit shown drains only about 50 μA from a single-cell battery when the ac power is normal. This low drain allows more than three-year life from many battery types.

Capacitor C_1 and resistor R_2 form a positive-feedback loop to make an LM3909 oscillate. However, with ac line power, charge accumulates on C_1 to keep pin 8 slightly more positive than pin 2. This cuts off the input transistor of the LM3909 and the complementary, direct-coupled circuit of the IC almost completely turns off.

When line power fails long enough to allow the charge on C_1 to disappear and reverse its polarity somewhat, the IC oscillates. The very small reverse voltage on C_1 and the short time

that it is reversed cause no damage to C_1 , even if it is electrolytic.

Current from the line charges only the capacitor and produces very little flow in the 1.5-V cell. The circuit is safe to leave plugged-in for years.

The alarm tends to oscillate at the speaker's self-resonant frequency. A louder and clearer tone results if the speaker enclosure is built to augment the speaker resonance. This can be done by adjustment of the enclosure size with baffles and ports.

Peter Lefferts, Design Engineer, MS 220, National Semiconductor Corp., 2900 Semiconductor Dr., Santa Clara, CA 95051.

CIRCLE NO. 313

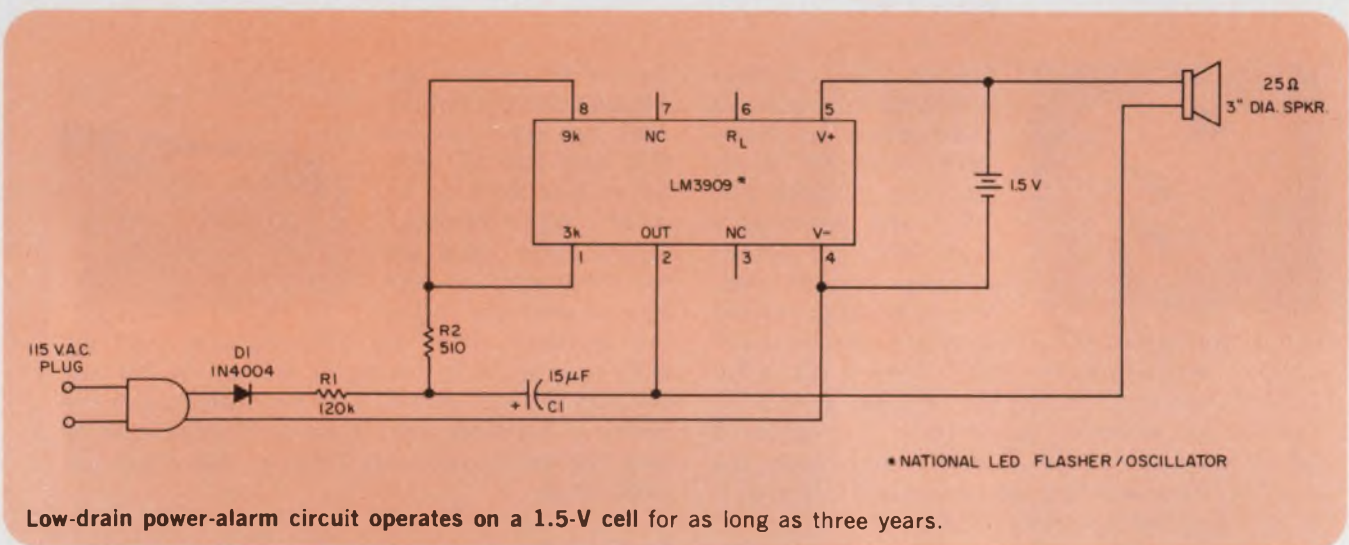

IFD Winner of July 5, 1975

Robert W. Hilsher, Assistant Engineer, Dept. 487, Bendix Communications Div., E. Joppa Rd., Baltimore, MD 21204. His idea "Constant Period with Variable Duty Cycle Obtained from 555 Timer with Single Control" has been voted the Most Valuable of Issue Award.

Vote for the Best Idea in this issue by circling the number for your selection on the Information Retrieval Card at the back of this issue.

SEND US YOUR IDEAS FOR DESIGN. You may win a grand total of \$1050 (cash)! Here's how. Submit your IFD describing a new or important circuit or design technique, the clever use of a new component or test equipment, packaging tips, cost-saving ideas to our Ideas for Design editor. Ideas can only be considered for publication if they are submitted exclusively to ELECTRONIC DESIGN. You will receive \$20 for each published idea, \$30 more if it is voted best of issue by our readers. The best-of-issue winners become eligible for the Idea of the Year award of \$1000.

ELECTRONIC DESIGN cannot assume responsibility for circuits shown nor represent freedom from patent infringement.

HYBRID MANUFACTURERS:



*Let Solitron
Put You In The Chips!*

We're in the hybrid chip business in a big way. We have an immediate supply of semiconductor chips for power transistors, planar diodes and field effect transistors. You can order individually tested silicon chips with or without gold backing. Complete wafers. Power chips on molytab or Beo substrates with or without ultrasonic bonded aluminum leads. Just about everything you need to build your own hybrids.

Solitron offers epitaxial planar, triple-diffused planar and single-diffused mesa dice, including a full line of NPN/PNP complementary devices, and planar power Darlington transistors. Our capabilities can meet design requirements up to currents of 200 amps, gains of 10,000 and reverse breakdown voltages up to 2,000 volts.

The very latest state-of-the-art technology combined with exhaustive qualification testing guarantees the quality and reliability of Solitron chips. For example, our dice are 100% tested to meet the rating of the die either in chip or wafer form. Dice can be packaged for shipment either in bulk form or in cavity packs. Flat packs are used for complete wafers. Shipments in hermetically sealed containers may be requested.

With more than ten years of experience, we can offer application assistance. Solitron engineers are always available to work with you on hybrid circuit designs and assembly techniques.

Today, contact us and we'll send you a free copy of Solitron's newest Semiconductor Chip Catalog.

Solitron
DEVICES, INC.

1177 BLUE HERON BLVD./ RIVIERA BEACH, FLORIDA 33404
(305) 848-4311 / TWX: (510) 952-7610

PLANTS IN: CALIFORNIA • FLORIDA • NEW YORK • ENGLAND • HONG KONG • MEXICO

INFORMATION RETRIEVAL NUMBER 42

Ratio ratemeter has high accuracy

A ratio ratemeter that is accurate to better than 1% with regularly distributed input pulses and 2% with statistically averaged pulses has been designed by the Radiation Centre, University of Birmingham, England. The output of the circuit (see figure) is proportional to N_1/N_2 , where N_1 and N_2 are average rates of the applied input pulse trains.

The ratemeter consists of a logic circuit and an integrator. The logic circuit converts the two input trains into a single train whose pulse rate is equal to N_1 . The pulse width is equal to the time intervals between two adjacent pulses in the N_2 train.

Operation of the ratio ratemeter is satisfactory as long as at least two N_2 pulses appear for every time interval, or the gap between

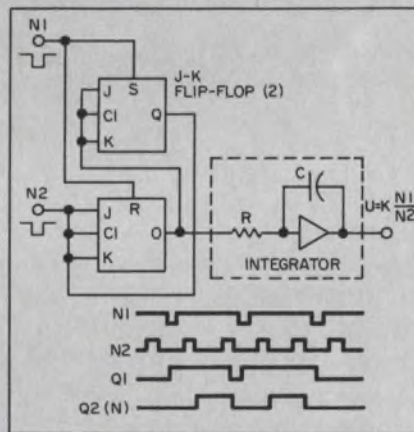

two successive pulses N_1 . For regularly distributed input pulses, it is sufficient to satisfy the following conditions: $2N_1 < N_2$. For random pulse trains, $2N$ should be much less than N_2 .

much greater electrical activity of the ventricle from confusing the pacemaker.

Cambridge Instruments, Cambridge, England, is currently building five nonimplantable commercial models for further hospital trials. The research team at Sussex is miniaturizing the electronic package and battery so it can be implanted.

Road-guidance system directs by minicomputer

An automatic highway guidance system, known as ALI, provides information on directions, weather ahead and traffic. Developed by Blaupunkte Werke GmbH of West Germany, the system also indicates the best speed to make the fastest time.

Each car in the system has a radio transceiver with a 20-cm ferrite antenna. An indicator panel conveys information to the driver, who keys in a four-character code that represents his destination. The first character defines one of 16 zones in Germany; the second, one of 16 areas within each zone; and the remaining two, an area about three square miles. Resolution is sufficient to direct the driver to within 1.5 miles of 65,000 destinations.

Messages from the system's minicomputers are preceded by a series of rapid flags to draw the driver's attention. An analog scale indicates changes of direction. Communication to roadside beacons is performed by buried inductance loops.

Heartbeat drives pacemaker signal

A pacemaker that uses a delayed, amplified signal generated by the patient's own heartbeat—conventional pacemakers are driven by a pulse generator—has been developed at the Royal County Hospital in Brighton and Sussex University's Medical Research Centre, England.

The new device picks up an electrical pulse produced when the atrium—the chamber above a ventricle—contracts to fill the ventricle prior to its contraction. The unit delays the atrial pulse for the proper fraction of a second and

uses this signal, amplified, as the stimulus for the ventricle. If the ventricular beat fails, a fail-safe pulse generator takes over.

This technique has two advantages. First, the ventricle contracts at the correct time after the atrium has filled it. And, second, because the atrial beat adjusts to the body's needs, the pacemaker is physiologically compatible.

The pacemaker's catheter, which picks up the signals from the atrium, also picks up a signal from the ventricle but electronically screens this out, preventing the

There's a reason we make so many types of precision resistors.

You need them.



Established Reliability Metal Glaze. Per MIL-R-39017, 55182 and program specifications.



Precision Metal Glaze™. Rugged performance at low cost. An industry standard for semiprecision and precision film resistor applications.



Precision Metal Film. Excellent high stability performance in a wide variety of sizes and specs. S level MIL-R-55182.

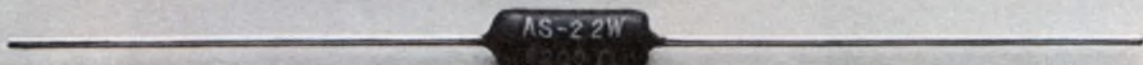

Precision Power Wirewound. Best available power-to-size ratio from 1/2-10W. Tolerances to 0.1%, TC < 20ppm.



Precision High Voltage, High Resistance Metal Film. Excellent high voltage load stability; 1.5-20KV, to 500 Megohms \pm 1%.



Ultra-Precision MAR™. Bulk property metal film. Rugged molded construction. Broad resistance range, high frequency response with TC's and tolerances to 2ppm and .01%.



Precision Power Metal Glaze. 3W rating in a molded RW69 size. Runs cooler than wirewound. Has excellent frequency characteristics.

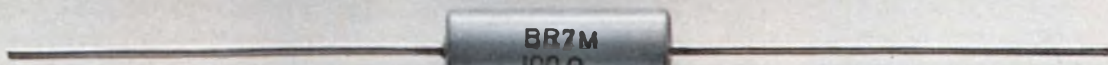

Precision Power Metal Film. Excellent power-to-size ratio, 1-5W ratings. High frequency response. Tolerances and TC's to 0.1%, 25ppm.

Precision Film Resistor Networks. 7, 8, 10 and 12 bit R2R ladders replace up to 27 discretes. Other precision TaN-Film™ networks available.



Most types available from your local distributor. Or, for the broadest choice in resistors for all types of applications, write or call TRW/IRC Resistors, an Electronic Components Division of TRW, Inc., 401 N. Broad St., Phila., Pa. 19108. Tel. 215-922-8900.

TRW[®] IRC RESISTORS
We give you a choice.

INFORMATION RETRIEVAL NUMBER 43

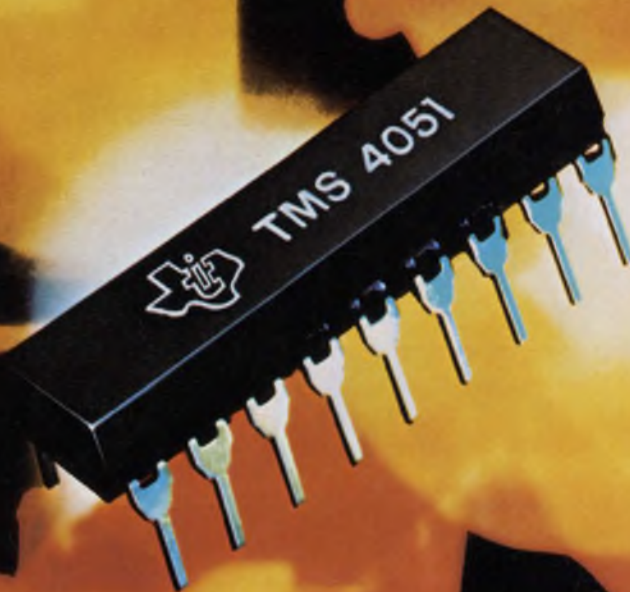

MOS memories

TI's New TMS 4051

The fully TTL compatible 4K RAM in the 18-pin space saver package

Available now in the 18-pin space-saver package: A fully TTL compatible 4K RAM. In addition to the high board density achievable with the compact 18-pin package, board space is also minimized because the TMS 4051 is fully TTL compatible and fewer parts are necessary. Fewer parts, less wiring, and a smaller PC board mean the TMS 4051 will save you money.

Easiest 4K dynamic RAM to use.

The TMS 4051 is fully compatible and will plug directly into your Series 74 TTL system. No longer is a high voltage clock driver needed to interface from TTL to MOS. All TMS 4051 inputs (including the single clock) and output interface directly with TTL.

Reduce parts. Save PC board space.
In addition to eliminating the need

TI's 18-PIN 4K RAM FAMILY			
		ACCESS TIME (MAX)	READ OR WRITE CYCLE (MIN)
TMS 4051	TTL CLOCK	300 ns	470 ns
TMS 4051-1	TTL CLOCK	250 ns	430 ns
TMS 4050	HI-LEVEL CLOCK	300 ns	470 ns
TMS 4050-1	HI-LEVEL CLOCK	250 ns	430 ns
TMS 4050-2	HI-LEVEL CLOCK	200 ns	400 ns

for clock driver ICs, the TMS 4051 requires no external address multiplexers or address registers. The on-chip address registers provide full direct addressing eliminating system timing headaches. The TMS 4051's common data I/O eliminates the need for an external I/O multiplexer making it ideal for bus-oriented and microprocessor based systems. And the space saver package alone yields as much as 30% board savings over 22-pin 4K RAMs.

Availability is now.

TMS 4051 adds to TI's pioneering experience and volume production of 4K RAMs. TMS 4051 uses the same proven single transistor cell design as TI's popular TMS 4030 and 4060. Result: High density. High yield. Lower cost to you. The TMS 4051 is available in 300 mil wide 18-pin plastic and ceramic packages.

Proven reliability.

The TMS 4051 uses TI's reliable N-channel silicon gate process, the same as TI's other RAMs. And TI has proven field reliability.

For a 24-page reliability report of TI's 4K RAM family or a data sheet, write on your letterhead to: Texas Instruments Incorporated P.O. Box 5012, M/S 308, Dallas, Texas 75222.

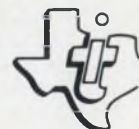

TEXAS INSTRUMENTS
INCORPORATED

Analyzer brings new power to network-behavior measurement

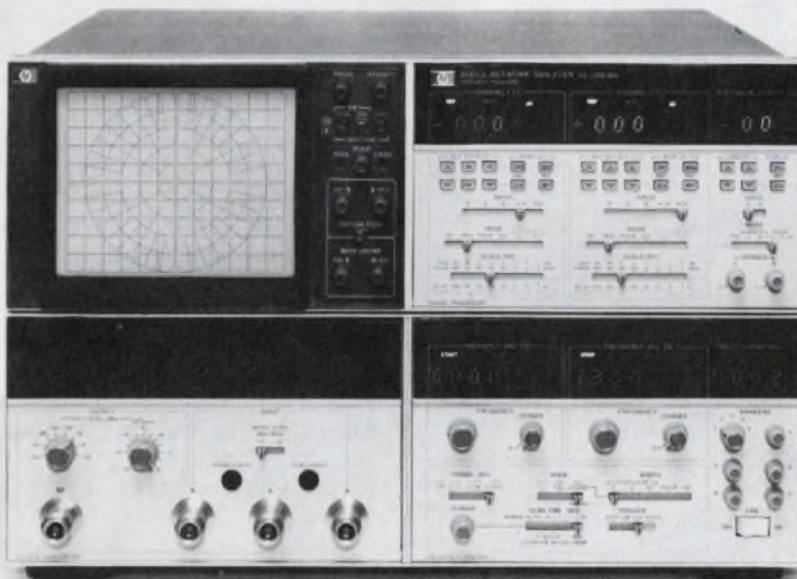

Hewlett-Packard, 1501 Page Mill Rd., Palo Alto, CA 94304. (415) 493-1501. See text.

With the broadest frequency coverage, widest displayed dynamic range and a line-up of performance features hitherto unavailable, Hewlett-Packard's Model 8505A brings new measurement power to network analysis.

The HP unit measures magnitude and phase—from 500 kHz to 1.3 GHz—of the transmission and reflection properties of active and passive networks. And you can also use the analyzer to measure group delay and deviation from linear phase.

Three channels (two independent and one reference input)—each with 100-dB of dynamic range—let you display on a CRT, two parameters simultaneously, and you can see ratios over the full dynamic range without switching.

Either of two coordinate systems, rectilinear or polar, can be selected to view the input parameter as

a function of frequency. Or you can display one parameter in rectilinear and the other in polar format.

Fully integrated, the 8505A contains a swept source, which can operate in several modes, a built-in counter for direct readout of frequency to the top frequency, and various digital displays of the measurement parameters.

Internal RAMs let you select independent operating conditions for the sweep, so that two, independent start-stop sweeps can be programmed. You can also set any of five independent markers, and the counter will measure the marker frequency while the unit is sweeping.

Other digital displays read magnitude, phase or delay at the marker setting with resolutions of 0.01 dB, 0.1° and 0.1 ns, respectively. The group delay and linear-phase deviation features are also fully calibrated and direct reading—no calculation is needed. Pushbuttons

for each digit of display provide calibrated offsets (up or down) of the reference in steps as fine as the specified resolutions.

Linear phase is measured with an electronic line stretcher built into the HP analyzer (no cable lengths to jockey) and settable with pushbuttons up to almost five wavelengths.

Noteworthy is the ability to use the 8505A as a calculator based automatic network analyzer. In this application, the system (called the 8507A) offers an "accuracy enhancement program" which measures and stores system errors, then applies the information to the measured data to boost accuracy.

Another notable feature of the automatic system is a "learn" mode: Each 8505A control setting is read by the calculator and put into memory. Consequently, you don't need to know any programming language—you "write" the program by just twirling the analyzer's dials and storing the settings.

Other popular analyzers cover a smaller frequency and dynamic range compared with the HP unit. And few analyzers include the sweep generator and frequency-marker capability in the same box. These are usually separate, add-on units. Included are HP's own 8407A, the General Radio 1710 and the Rohde & Schwarz ZWD swept diagraph.

Price of the basic 8505A is \$22,500. Another \$2950 buys programmability through the HP-IB interface bus. Options include an S-parameter test set, a three-way power splitter, a transmission/reflection bridge and various calibration kits. Delivery of the Hewlett-Packard 8505A starts in January.

CIRCLE NO. 304

AIRPAX™ miniature TOGGLE, ROCKER, AND LEVER HANDLE Switches



AIRPAX
QUALITY

AIRPAX
PERFORMANCE

AIRPAX
SERVICE

American made. Competitively priced. Airpax miniature switches are the product of years of experience in the design and manufacture of electromechanical devices.

Single and two pole models. Maintaining or momentary switching actions. A wide range of options for appliances, industrial, military, and consumer applications.

You can choose the exact combination required from the selection of basic switching functions, contact ratings, terminations, handle types, and hardware.

Airpax miniature switches assure you of the superior quality, performance, and service that has been synonymous with Airpax products throughout the years.

Send for catalog.

AIRPAX™

Other Airpax Divisions:
CONTROLS DIVISION, Ft. Lauderdale, Florida - Instruments for Industry
AMERICAN DATA, Huntsville, Alabama - TV Products

AIRPAX ELECTRONICS
CAMBRIDGE DIVISION
Cambridge, Maryland 21613
Switches, Circuit Breakers,
Glass-to-Metal Seals

INSTRUMENTATION

Unit automatically makes white-noise tests

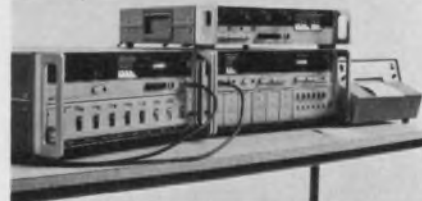

Marconi Instruments, 100 Stonehurst Ct., Northvale, NJ 07647. (201) 767-7250. \$6900; 60 days.

Model 2090C white-noise test set provides an automatic measurement capability for all noise loading tests. The unit retains the accuracy of the company's manually operated 2090B and, in addition, has the automatic, programmable mode of operation and a digital readout. It conforms to the CCIR and Intelsat recommendations for white-noise testing, as well as current DCA and Bell standards. The 2-1/2-digit readout is presented as a front-panel display and shows the unit of the selected measurement function alongside its value. Outputs are also provided in both BCD and analog form for recording purposes.

CIRCLE NO. 306

Cassette recorder accepts four channels



Dallas Instruments, P.O. Box 38189, Dallas, TX 75238. (214) 341-2990. \$3600; 4-6 wks.

Model T-5 portable magnetic tape recording system provides four channels of FM and direct signal record and playback. The system uses a tape cassette in the convenient Philips format and provides up to one-hour recording time. The deck has a digital tape counter and is pushbutton operated. The system has both record and reproduce electronics and covers the frequency range of dc to 1000 Hz in FM mode and 100 to 10,000 Hz in the direct mode of operation.

CIRCLE NO. 307

Smart timer/counter brings new benefits



Dana Laboratories, 2401 Campus Dr., Irvine, CA 92664. (714) 833-1234. 9015, \$2995; 9035, \$3495; 90 days.

Series 9000 microprocessing timer/counter is a standard timer/counter, a reciprocating counter and a calculator all in one package. Two models handle frequencies to 100 and 512 MHz, respectively. The instruments feature a calculator-type keyboard for function control, rather than traditional knobs, buttons or switches. The keyboard is located in a front-panel drawer and disappears from view when not in use. An 11-digit, 0.43-in. yellow LED display provides numeric information while LED lamps are used as status indicators. Interface options include a general purpose interface bus (GPIB) system, a parallel BCD format, a serial ASCII and a "do-it-yourself" high speed option. With another option, the 9000 calculates rise and fall times and pulse widths. Standard is automatic trigger. Or you can key in trigger levels for unusual waveforms. Stability is 3×10^{-7} per month. Higher stability is optional.

CIRCLE NO. 308

Test system checks microprocessors

Instrumentation Engineering, 769 Susquehanna Ave., Franklin Lakes, NJ 07417. (201) 891-9300.

Model 103/system 390-series computer-controlled test system performs high-speed functional tests and fault diagnostics on microprocessors and other complex digital logic circuits on printed circuit boards. The system uses a two-family digital word general/receiver (DWG/R) that enables the user to test as many as four different levels of logic simultaneously. The DWG/R contains bidirectional pins so that it can test bidirectional busses on microprocessor PCBs in real time.

CIRCLE NO. 309

SLIM-MOX

**NOW VICTOREEN
QUALITY COSTS LESS
THAN A DOLLAR.**

Victoreen announces SLIM-MOX, our new, thick-film, flat substrate resistor.

Compact in design, it carries with it all the quality and dependable performance you have come to expect from Victoreen.

SLIM-MOX, right now, is available from stock in a wide range of standard resistance values. More important, SLIM-MOX will deliver the same proven performance in high-voltage applications that you find in more expensive resistors with more bulk.

Specify SLIM-MOX in any standard resistance value and your unit cost will be less than one dollar in OEM quantities.

Truly a major cost breakthrough for resistors designed for miniaturized

electronic networks and equipment, or other critical applications that demand stability and reliability.

Standard tolerance is $\pm 15\%$ for all standard resistance values which include 1, 2,

5, 10, 20, 50, 100, 200, 500, 1000, 2000, and 5000 megohm. All in stock. With a voltage coefficient of better than 5 ppm/volt, full-load drift typically less than 0.5% in 1000 hr at 70° C, and 250 ppm TCR or less to 5000 megohm, SLIM-MOX is a little, big performer. For less than a buck.

From a name you know you can count on. Victoreen.

Victoreen Instrument Division,
Sheller-Globe Corporation,



SHELLER-GLOBE CORPORATION

10101
Woodland
Avenue,
Cleveland,
Ohio 44104

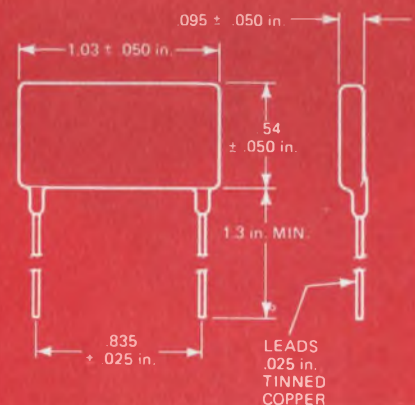

SLIM-MOX SPECIFICATIONS

Resistance Range	1M-5,000M
Power Rating @ 70°C	2W
Maximum Operating Volts	
(Applicable above critical resistance)	10,000V
Available Tolerance	15%
Critical Resistance	50M
Max. Service Temperature	150°C

1
AMERICAN MADE
Tolerance
SCHAUER
1-Watt
ZENERS

**Immediate Shipment
Low Prices**

ANY voltage from 2.0 to 16.0

Quantity	Price each
1-99	\$1.07
100-499	.97
500-999	.91
1000-4999	.86
5000 up	.82

All welded and
brazed assembly

No fragile
nail heads

Gold
plated
leads

Write for complete
rating data and other
tolerance prices.

**Buy the kit—
Save
a lot**



Kit contains a 51-piece assortment of SCHAUER 1% tolerance 1-watt zeners covering the voltage range of 2.7 to 16.0. Three diodes of each voltage packaged in reusable poly bags. Stored in a handy file box. Contact your distributor or order direct.

A \$54.57 value for
ONLY \$24⁵⁰

Semiconductor Division

SCHAUER
Manufacturing Corp.

4511 Alpine Ave. Cincinnati, Ohio 45242
Telephone: 513/791-3030

DATA PROCESSING

**Computer series offers
low cost, high performance**

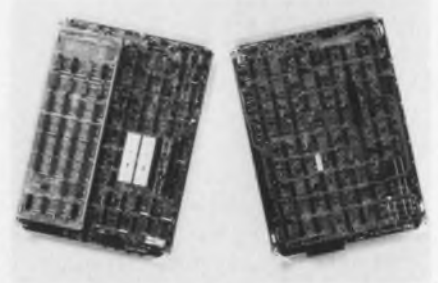
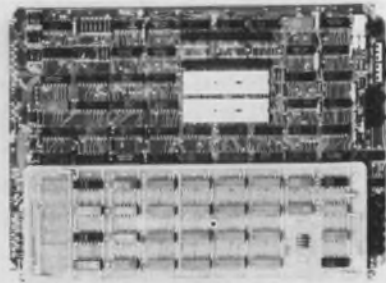

General Automation, 1055 S. East St., Anaheim, CA 92805. (714) 778-4800. P&A: See text.

A series of four micro and mini-computers offers full 16-bit operation with the speed of MSI TTL processors but at the cost of 8-bit PMOS microprocessors. The General Automation GA-16 series provides an instruction execution time of less than 2 μ s.

There are four units—the 110, 220, 330 and 440. The 110 and 220 are single and dual-board micro-computers that come with 1-k of solid-state RAM as standard. The board size is only 7.75 x 11 in., and the computers cost \$531 and \$765, respectively.

Capabilities of the 110 include 91 basic microprogrammed instructions, 16 general-purpose registers, memory expansion to 64-k words, 11 addressing modes. A complete set of arithmetic and logic instructions and auto restart capability are just some of the features.

The Model 220 includes all this and more—a microconsole ROM, TTY controller and serial I/O port and DMA capability of the larger SPC-16 series of minicomputers.

The other two units in the series, the 330 and 440, are housed in 5.25 x 19 x 21.25-in. and 8.75 x 19 x 21.25-in. rack-mounting

cabinets, respectively. The 330 comes with 4-k of core memory and costs \$1950, while the 440 equipped with 16-k costs \$5370.

The 330 has no operator controls, save for the on-off switch, while the 440 has a full operator's console with keyboard and displays. Both computers can directly address 1 million words of memory, and they have a memory cycle time of 720 ns.

All of the software and I/O devices for General Automation's SPC-16 minicomputer line are directly compatible with the GA-16 series. This will save considerable time and effort in designing systems and getting them on-line. Prices for the GA-16 series machines are given for maximum-discount quantity purchases. Single unit prices are about 40% higher.

All four computers are based on a two-chip NMOS LSI processor developed by General Automation and a subsidiary, Synertek. The processor chips consist of a 16-bit register arithmetic and logic chip and a control read-only memory. Together they have a complexity of about 20,000 components.

CIRCLE NO. 305

8-bit microcomputer fits on one board

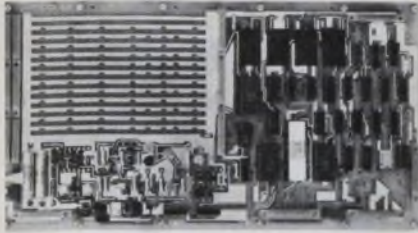

Monolithic Systems Corp., 14 Inverness Drive East, Englewood, CO 80110. (308) 770-7400. \$820 (unit qty); 4 wks.

A new 8-bit microcomputer, the MSC8080, includes a general-purpose wire-wrappable section, which simplifies the task of interfacing the computer to a particular system. This single-board unit uses an Intel 8080 microprocessor and includes interfaces for input, output, optional memory and control panel. Room is provided for 1 k × 8 of PROM, and a number of pre-programmed PROMs are available as options. A power inverter on the board supplies all necessary processor voltage levels from a single +5-V input.

CIRCLE NO. 320

Microcomputer system comes with software

Mostek Corp., 13300 Branch View Lane, Dallas, TX 75234. (214) 620-2454. \$995.

Mostek's new general-evaluation microprocessor system, GEMS-8, consists of a processor board designed around the MK 5065, 8-bit microprocessor, a programmer-aid-routine ROM and a 12-k × 8 memory board with direct interface to the processor board. Software support includes a resident assembler, which can generate object tapes from source tapes, a dump-to-dump memory in ASCII format and a text editor that allows users to generate and modify the source text prior to assembly. The processor needs a power-supply of +5 and ±12 V. The available 51 basic instructions have a typical execution time of 7 μs. The processor can address 32-k × 8 memory spaces with a 1-k RAM located on the board. Triple-level architecture allows rapid interrupt servicing.

CIRCLE NO. 321

INTERFACE



For High-Voltage, High-Current Interface with PMOS, CMOS, TTL, DTL... Sprague Darlington Transistor Arrays Have No Equal

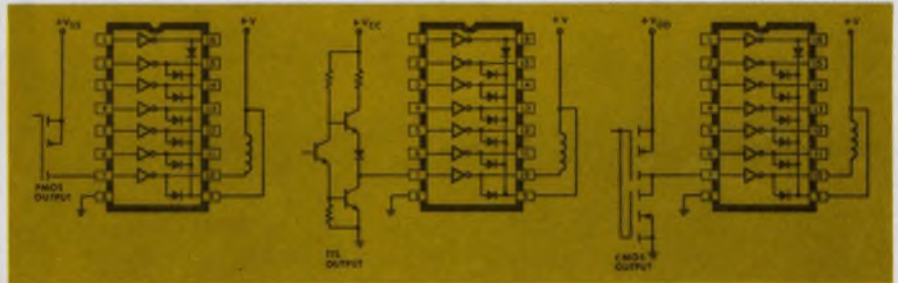

A new exclusive Sprague development, Series 2000 Transistor Arrays are high-voltage, high-current integrated circuits comprised of seven silicon NPN Darlington pairs on a common monolithic substrate. They feature open collector outputs and integral suppression diodes for inductive loads.

Supplied in 16-pin dual in-line plastic, these devices greatly reduce the number of discrete components used to interface between digital logic and high-voltage and/or high-current loads. In some applications, all discrete components can be replaced by a single

DIP, resulting in substantial space and cost reduction.

With broad commercial/industrial application, these unique arrays are an excellent choice for interfacing to LEDs, solenoids, relays, lamps, and small stepping motors in printing calculators, cash registers, and control equipment.

Type ULN-2001A is a general-purpose array, pinned with inputs opposite outputs to facilitate circuit board layout. Type ULN-2002A is designed for use with 14 to 25 V PMOS inputs. Type ULN-2003A interfaces with TTL or CMOS operating at a 5 V supply voltage.

For more information, write or call Chuck Scott, Semiconductor Division, Sprague Electric Co., 115 Northeast Cutoff, Worcester, Mass. 01606. Tel. 617/853-5000.

For Engineering Bulletin 29304, write to Technical Literature Service, Sprague Electric Co., 347 Marshall St., North Adams, Mass. 01247.

For the name of your nearest Sprague Semiconductor Distributor, write or call Roger Lemere, Sprague Products Company, North Adams, Mass. 01247. Tel. 413/664-4481.

455-9101

SPRAGUE

THE MARK OF RELIABILITY

THE BROAD-LINE PRODUCER OF ELECTRONIC PARTS

INFORMATION RETRIEVAL NUMBER 47

Deltron

Custom Power Supplies have what you need



Deltron's continuing R&D programs insure that your customs will be made using the latest technology, components, and manufacturing techniques. Our modern facilities include a U.L. printed circuit department. In-plant magnetics department. And a graphics and technical writing department.

Next time get what you need! Try Deltron. Call collect or write Deltron, Inc., Wissahickon Avenue, North Wales, Pa. 19454, Telephone: 215-699-9261, TWX 510-661-8061.

Deltron inc.

DATA PROCESSING

Interface converts printer to data terminal

Bedford Computer Systems, Inc., Three Preston Court, Bedford, MA 01730. (612) 275-0870. \$1125 (unit qty).

The Model 1200 printer control converts the Qume Q-30 or Diablo HyType-I printer mechanisms into low-cost receive-only data terminals. Options can augment the basic terminal into a stand-alone interactive keyboard-entry work station. The basic package includes a power supply with sufficient power for the printer; an interface module, which is contained in the power-supply assembly; and all required interface cables. The printer control operates in ASCII code over an asynchronous serial RS-232 interface.

CIRCLE NO. 322

Microprocessor system uses 16-bit chips

General Instrument Corp., 600 W. John St., Hicksville, NY 11802. (516) 733-3000.

The Series 1600 microprocessor system is based on a 16-bit microprocessor chip and built with GI's n-channel ion-implant Giant II process. The processor design uses eight 16-bit general-purpose registers. All registers are program accessible and can be used as accumulators or address registers. Six of the registers can be used by the running program, one is used as the memory stack pointer and the eighth is used as the program counter. The memory stack pointer provides last-in, first-out storage in the main memory. The general registers and high-speed pipelined ALU and its status register form the data-processing logic for all series 1600 microprocessors. Compatible assembler/simulator software is available for popular minicomputer systems and large time-sharing machines. Comprehensive subroutine libraries, diagnostics, utility programs and an on-line debug program for direct program checkout of the 1600 system are also available.

CIRCLE NO. 323

Low-cost CRT terminal offers full features

KKM Corp., Micro Application Systems Div., Box 213, Grand Forks, ND 58201. (701) 772-5944. See text; 60 day.

The MAS/T1 CRT terminal is designed as a low-cost teletypewriter replacement. It costs only \$649 in singles and can perform in many minicomputer applications where intelligence and other features are an unnecessary luxury. Standard features include full cursor control, character and line insertion/deletion, tab control, selectable speeds to 9600 baud, and solid/blinking underline cursor. The MAS/T1 display uses a 5 x 7 dot matrix and has a 12-line-by-80-character capacity on a 9-in. video display (24 by 80 capacity and 12-in. display are available options). RS-232 compatible output is standard. Other outputs or the ability to add on I/O devices (cassette, floppy disc, or printer) are available as options. The terminal can do a self-test, functioning in either on-line or local modes to indicate whether it is operational.

CIRCLE NO. 324

UV PROM eraser handles five devices at a time

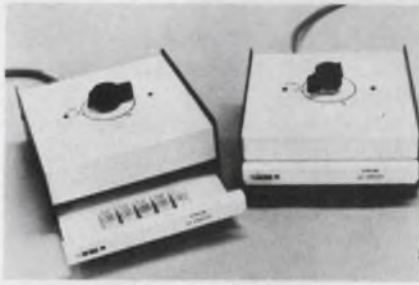

Prometrics Inc., 5345 N. Kedzie Ave., Chicago, IL 60625. (312) 539-3373.

Up to five UV-erasable PROMs are erased in 5 to 10 min with complete safety to devices and personnel. An adjustable timer shuts off the UV source when the set-in time has elapsed. And the unit's housing is designed to prevent UV leakage. An interlock shuts off the UV when unit is opened. Devices rated at 6 W-s/cm² integrated erasure dose, such as the 1702A/4702A, require less than 5 min for complete erasure; 10-W-s/cm² devices, such as the 2704 and 2708, erase in less than 10 min.

CIRCLE NO. 325

STABILITY YOU CAN COUNT ON...

MURATA'S
TEMPERATURE COMPENSATING
CERAMIC CAPACITORS.

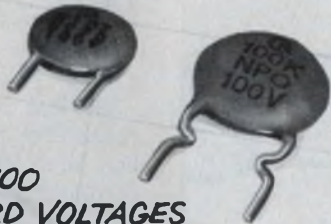

- NPO TO N4700
- ALL STANDARD VOLTAGES
- FAST DELIVERIES
- RELIABILITY BACKED BY 30 YEARS OF EXPERIENCE

muRata

CORPORATION OF AMERICA
Rockmart Industrial Park, Rockmart, Georgia 30153
Phone: 404-684-7143 Telex: 54-2999

INFORMATION RETRIEVAL NUMBER 49

MINI-ROTARY SWITCHES

New ROTARY SWITCHES feature adjustable stops & are only 6/10" in diameter. Molded-in terminals prevent contamination. For PC or hand wired use. Available in one through 4 poles with 360° detent; waterproof types too! 10,000 operations @ rated .5 amps, 125 VAC load.

Call (617) 685-4371 for more detailed information.



MRC
SERIES

INFORMATION RETRIEVAL NUMBER 50

PUSHBUTTON SWITCHES

Light touch MOMENTARY PUSHBUTTON switches designed for electronic test equipment, data entry, etc.

Upwards to 10 million life cycle. A unique magnetic action eliminates springs. Contains glass encapsulated reeds and shielded to avoid interaction.

Call (617) 685-4371 for other technical data and pricing.



MSPM
SERIES

INFORMATION RETRIEVAL NUMBER 51

ALCO ELECTRONIC PRODUCTS, INC.
NO. ANDOVER, MASS. 01846 U.S.A.

Tel: (617) 685-4371 Telex: 710 392 0922

A SUBSIDIARY OF AUGAT, INC.

Price/ Performance Breakthrough

Actual Size



8 bit A/D's
now only
\$59⁰⁰

Micro Networks MN5120 Series of successive approximation 8 Bit A/D converters is now less than half the cost of the previously available Dip A/D converters.

The outstanding features include:

- Completely Adjustment Free... no external components or trim pots required, just plug in.
- Linearity... $\pm 1/2$ LSB from 0 to 70C, no TC specs needed.
- High Speed... 6 μ sec setting time.
- Low Power... 680mw typical — a savings of 30 to 50% over modular units.
- Hermetic Sealed Dip... for long term stability.

The MN5120 Series of A/D converters with its high performance and low cost makes it ideal for commercial and industrial applications, typical of which are: medical instrumentation, process control, computer peripherals, and interface circuits. All units are 100% electrically tested at 0, 25, and 70C for linearity and accuracy.

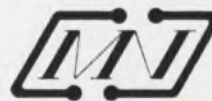

For complete data write or call —
Jerry Flynn: Tel: 617 852-5400.

MICRO NETWORKS
CORPORATION

324 Clark Street, Worcester, MA. 01606
INFORMATION RETRIEVAL NUMBER 52

Mini resistor chips offer the tops in accuracy and stability

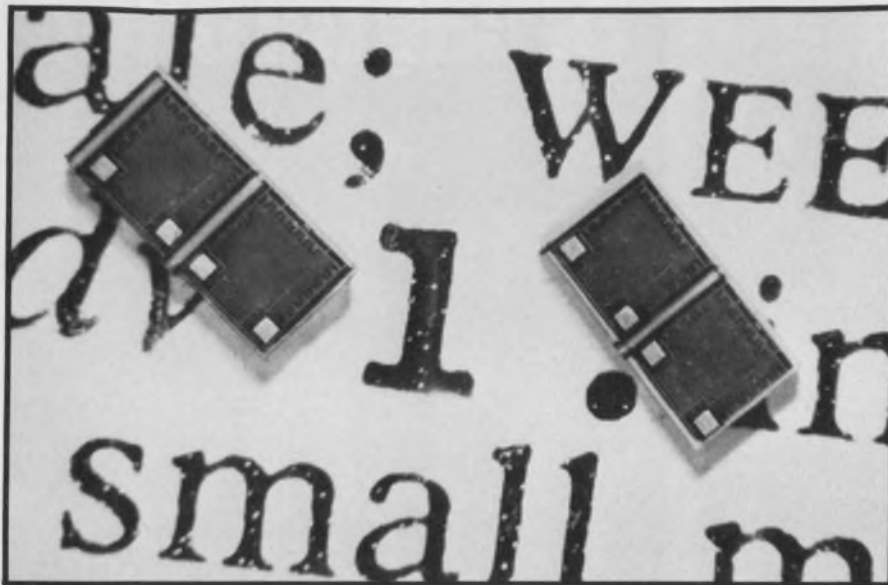

Vishay Resistor Products, 63 Lincoln Hwy., Malvern, PA 19355. (215) 644-1300. See text.

Buy a chip resistor today and try to get another exactly like it next year. Vishay says you can do the improbable with its V50X50 Series of Microchip precision resistors.

These resistor chips are built with Vishay's proprietary Bulk-Metal process that is said to permit accuracies and repeatabilities to within 0.01% and stabilities of 5 ppm/°C over the -55 to +150 C range. The chips measure only 50 × 50 × 15 mils and conform to or exceed all the requirements of MIL-R-55342A.

Resistance values ranging from 500 Ω to 5 kΩ are available, and chips with values from 1 Ω to 10 kΩ will be offered shortly. Power ratings for the chip start at 0.05 W at 70 C, when it is bonded to the ceramic substrate, and are de-rated to zero at 150 C.

Tracking of resistance values is to within 3 ppm over the full operating temperature range. End terminations of the resistor chips consist of gold plating over copper bonding pads and measure 6 × 6 mils. Each resistor chip has a mois-

ture resistance of 0.5% ΔR, which improves to 0.005% ΔR under hermetic seal packaging conditions. Resistance shelf life is very long, with aging down to only 50 ppm/year.

Suggested termination for the chip is by thermal pulse welding of a 1-mil-diameter gold wire to the pads. The proprietary process used to form the resistors provides a form of stress control that counterbalances the temperature coefficient of the resistor element—thus keeping the value almost constant.

Two versions of the chip are available: a fully calibrated, finished chip made to exact user specifications and an uncalibrated chip for the user who can trim the chip to exact value before insertion or who must do active trimming after bonding. Fixtures and work stations will be available in the near future.

Prices for these tight-tolerance units start at \$3 each in 100-piece lots for 1-to-2-kΩ values and \$3.30 for 2-to-5-kΩ values. V50X50 resistor chips are available from 8 to 12 weeks for evaluation orders and 12 to 16 weeks for volume production.

CIRCLE NO. 301

Chip capacitors resonant free to 10 GHz

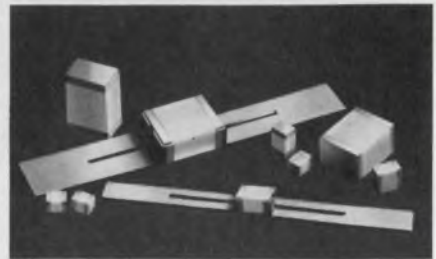

Johanson, Monolithic Dielectrics Div., Box 6456, Burbank, CA 91505. (213) 848-4465. \$0.76 to \$2.95 (1000 up); stock to 6 wks.

High-Q microwave ceramic chip capacitors with easy-to-mount ribbon leads offer resonance-free performance to 10 GHz. Chip sizes available are from 0.055 × 0.055 × 0.050-in. to 0.11 × 0.11 × 0.10-in. with a maximum capacity of 100 pF in the smallest size to 1000 pF in the largest.

CIRCLE NO. 326

Pushbutton switches are illuminated

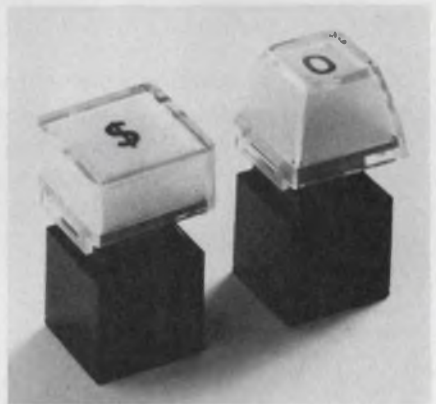

Mechanical Enterprises, Inc., 8000 Forbes Pl., Springfield, VA 22151. (703) 321-8282. \$0.60; T-5 (10,000 up)

Self-contained lights indicate keyboard switch action on sealed mercury M-5 and gold-plated contact T-5 pushbutton switch series. Clear plastic keytops, either box-shaped or truncated, contain a light diffuser made of thin polyester film that holds the switch legend. In large quantities, the legends are printed on the diffuser; for short runs, press-types can be used. The operator's fingertips never contact the legends. Switches mount on 3/4-in. centers. T-1 bi-pin incandescent lamps are used to illuminate the switches. The plastic keytops snap off for bulb replacement.

CIRCLE NO. 327

Cermet film resistors meet MIL-R-39017

Allen-Bradley Co., 1201 S. Second St., Milwaukee, WI 53204. (414) 671-2000. See text.

Allen-Bradley's Type CC cermet film fixed resistor MIL-Style RLR-07 has now been approved to MIL-R-39017 standards for resistance values from 10 Ω through 1 M Ω . No other has been approved beyond 470 k Ω , A-B indicated. Six-week delivery time is being quoted for these resistors, compared with six to 13 weeks generally required for similar types. The resistors are offered in both 2% and 5% tolerances with a temperature coefficient of ± 100 ppm/ $^{\circ}$ C. The 1/4-W resistor measures 0.25-L \times 0.09-D in. and is priced at 16 cents each in 1000-piece quantities. It is expected to be offered through A-B appointed electronic distributor locations this fall.

CIRCLE NO. 328

Chip capacitors meet MIL marking standard



American Technical Ceramics, One Norden Lane, Huntington Station, NY 11746. (516) 271-9600.

A new method of marking chip capacitors enables ATC to fully identify even its smallest micro-miniature rf chip capacitors—the ATC Case A, 55-mil cube—with the manufacturer's identification, capacity and tolerance code. Marking meets MIL-STD-202, Method 215 and is unaffected by all commonly used solvents and temperatures to 1500 F. ATC says it is the only capacitor manufacturer with such a marking capability. These marked rf chip capacitors are available in 40 different design values. Four kits contain Case A and Case B (110-mil cube) sizes with values ranging from 0.1 to 220 pF.

CIRCLE NO. 329

If it's a thick film resistor network...

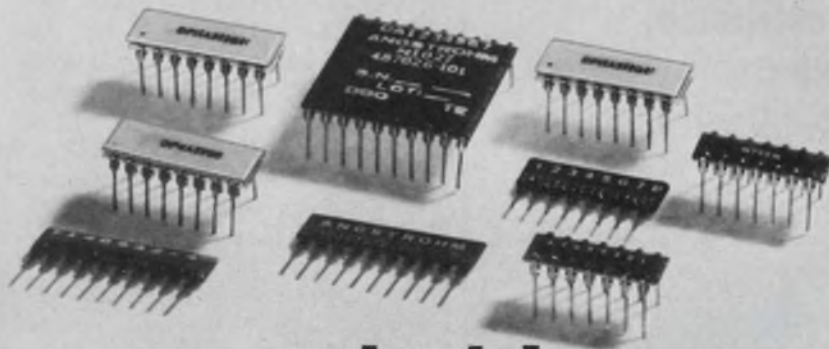

we make it!

SIPs, DIPs, Binary Ladders, all manufactured to meet the most critical specifications. SIPs and DIPs are offered in tolerances up to $\pm 1\%$, Binary Ladders to $\pm \frac{1}{2}$ LSB. What's more, we can provide custom resistor networks in almost any configuration to the very tightest tolerances possible. Write for complete technical details today.



angstrom precision, inc.

one precision place/hagerstown, maryland 21740
telephone: 301-739-8722 twx: 710-853-6834

INFORMATION RETRIEVAL NUMBER 53

SWITCH TO CONTROL SWITCH



UNIFORM-PANEL APPEARANCE PUSHBUTTONS

They look alike even though they have different ratings, actions, and circuits!



TWO-CIRCUIT MINIATURE PCB SWITCHES

Toggle or Push Button. No mounting hardware required! Ideal for sub-chassis check out.



TOGGLES

Hundreds of types in all configurations.

SEND FOR FREE TECHNICAL BULLETINS



PUSHBUTTONS
 Circle #87



PCB SWITCHES
 Circle #88



TOGGLES
 Circle #89



CONTROL SWITCH

A CUTLER-HAMMER COMPANY

1420 DELMAR DRIVE, FOLCROFT, PA. 19032 215/586-7500

Representatives and Stocking Distributors Throughout the United States, Canada, and Europe

"off the shelf"

a rugged, well constructed, high quality switch from Capitol it has the same solid reputation as our custom ordered switches

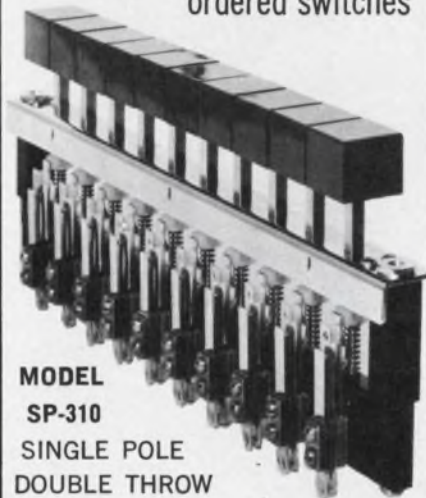

**MODEL
SP-310
SINGLE POLE
DOUBLE THROW
CONTACT
SQUARE BUTTON,
NON-ILLUMINATED**

Contacts: Palladium
rated at 3 amp, 110VAC, non-inductive

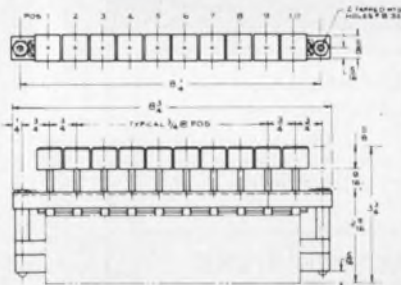

NOTES: 1. CONTACTS: 1 FORM C EACH POS. SEC. 1
2. MECHANICAL ACTION: INTERLOCKING WITH POSITIVE LOCKOUT BETWEEN POS.
3. BUTTONS: 22-32 3/16

We manufacture top quality push button and lever circuit selector switches single switches or banked assemblies. Write for our catalog.

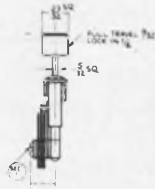

Representatives in principal cities.

CAPITOL SWITCHES

THE CAPITOL MACHINE & SWITCH CO.
87 NEWTOWN RD. DANBURY, CONN. 06810
(203) 744-3300

DISCRETE SEMICONDUCTORS

MOSFET analog switches made for ± 5 and ± 10 V

Signetics, 811 E. Arques Ave., Sunnyvale, CA 94086. (408) 739-7700. From \$0.90 (100-up); stock.

Four D-MOS FET analog switches handle ± 5 or ± 10 -V applications. The SD212 and SD213 are characterized for ± 5 -V analog switching or sample-and-hold. The SD214 and SD215 cover the same applications for ± 10 -V signals. The SD212 and SD214 do not have zener diode protection on the gates while the SD213 and SD215 do. All devices have an on-resistance of 35 Ω , typical. Input capacitance is 2 pF typically, output capacitance is 0.5 pF and feedback capacitance only 0.2 pF. Isolation from input to output is -120 dB typical at 3 kHz.

CIRCLE NO. 330

Power Darlingtons made for inductive loads

Semicoa, 333 McCormick Ave., Costa Mesa, CA 92626. (714) 979-1900. From \$18 (100-up); stock.

The SCA108 series of 10-A Darlingtons is designed for driving inductive loads. The transistors have a V_{CE0} of 100 V, a secondary breakdown of 5 A at 70 C (at rated BV_{ec0}), an f_t of 60 MHz and leakage currents of less than 10 nA at 25 C. The Darlingtons have betas from 10,000 to 70,000 minimum. An SCA0108 will drive 20 mH at 2 A or 50 mH at 1 A. The SCA0108 is available in an isolated or nonisolated TO-5 package for 25-W dissipation at 75 C, or in TO-3, TO-66 and TO-59 packages.

CIRCLE NO. 331

N-channel JFET has on resistance of 2.5 Ω

Teledyne Crystalonics, 147 Sherman St., Cambridge, MA 02140. (617) 491-1670. \$13.40 (100-up); stock.

The 2N6568 silicon n-channel junction FET is designed for an ultra-low R_{on} . The FET ON resistance is specified as 2.5 Ω R_{DS} . It also has extremely high isolation resistance of greater than 5 G Ω .

CIRCLE NO. 332

JAN power transistors handle up to 10 A

Solid Power, 440 Eastern Pkwy., Farmingdale, NY 11735. (516) 694-2883. From \$8.36; 2 to 8 wk.

The JAN, JANTX and JANTSV-2N3715 silicon power transistors handle collector currents of up to 10 A. The transistors have collector voltage ratings of up to 80 V and are housed in TO-3 packages.

CIRCLE NO. 333

Epoxy transistors have 125-MHz gain-bandwidth

Sprague Electric, 347 Marshall St., North Adams, MA 01247. (413) 664-4411. \$0.17 (large qty.); stock.

The NPSA20 Econoline transistor is housed in a TO-92 one-piece molded epoxy package. It has straight, in-line leads with an emitter-base-collector configuration. Power dissipation for the transistor is 360 mW. The collector-to-emitter voltage is 40 V maximum and the gain-bandwidth product is 125 MHz. Maximum collector current at 25 C is 100 mA. The maximum collector-emitter saturation voltage is only 0.25 V at a collector current of 10 mA.

CIRCLE NO. 334

Reverse switching diodes handle pulses to 1200 A

Westinghouse Electric, Youngwood, PA 15697. (412) 925-7272. Sample prices for 600 V, 2000 A/ μ s unit: \$83 (100 up).

The T40R reverse switching rectifier is optimized for short, high rate-of-rise pulse switching. The two-terminal switching units are available with peak pulse current ratings up to 1200 A, current rate-of-rise ratings up to 2000 A/ μ s and blocking voltage range up to 1000 V at 125 C. A typical value of turn-off time is 100 μ s at 25 C. The reverse switching rectifiers are available with repetitive peak forward blocking voltage ratings of 600, 800 or 1000 V. Maximum pulse trigger voltage—the off-state threshold voltage where turn-on begins when a 500-V/ μ s trigger pulse is applied—is 1500 V. The units are available in a DO-5 type stud-mounted package.

CIRCLE NO. 335



FREE Fiber Optics Catalog

Features the complete AO line of fiber optics products—from Inspection Fiberscopes and Light Guides to Illuminators, Image Conduits, Faceplates and Custom Components. Includes the four newest remote inspection fiberscopes now available.

Describes the principle, technology and techniques used to make flexible light and image transmissions a proven, practical fact. Write today for your FREE copy of the AO Fiber Optics catalog to American Optical Corporation, Fiber Optics Division, Southbridge, Mass. 01550.

AO
American
Optical

INFORMATION RETRIEVAL NUMBER 56



PRECISION MINI-PINS

For use in connectors, IC's, relays, modules, potted assemblies, headers, etc.

Ultra-miniature, precision machined pins to your most exacting requirements. Available in diameters from .005" to .093" and in lengths up to 1". Fabricated from free-cutting brass (QQB-626, Comp.22). Choose from a wide selection of plating options. Send for a copy of our catalog of standard mini-pins to...



PRECISION METAL PRODUCTS CO.

41 ELM ST., STONEHAM, MASS. 02180
Telephone: (Area Code 617) 438-3650

INFORMATION RETRIEVAL NUMBER 57

ELECTRONIC DESIGN 23, November 8, 1975

Mini-Jump™... .025" disconnect jumper for bussing and programming.

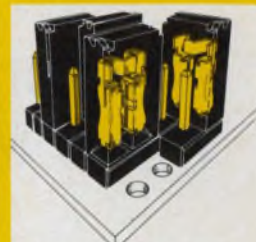
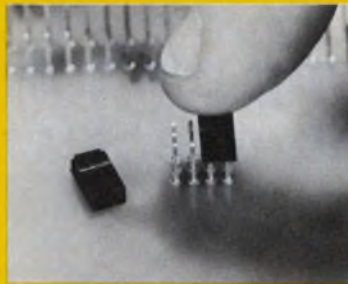

Cutaway showing
PV receptacles

Berg's MINI-JUMP provides flexibility in the circuit programming of mini-computers, card readers, printers, modems, point-of-sale equipment and test instruments. It is designed for high-density packaging and is stackable in both directions on .100" centers and up. Low-profile design allows for tight packaging in the vertical plane. MINI-JUMP mates with industry standard .025" square or .028" round pins. (Note—.125, .150, .200 and .250 center versions will be available in the near future.) Write for Bulletin 144.



**BERG
ELECTRONICS**
Division E-1 of DuPont de Nemours & Co. (Inc.)

New Cumberland, Pa. 17070 Phone: (717) 938-6711

INFORMATION RETRIEVAL NUMBER 58

Quickie™ Connector... reliably terminates flat, flexible, round conductor cable...in about 10 seconds.



Berg's Quickie Connector simultaneously terminates multi-lead, flexible round conductor cable without pre-stripping. The askewed tines of the contact affect a stripping action which terminates virtually any insulation material in about 10 seconds. Design assures redundant electrical contact and allows for visual inspection before assembly. Connector can be supplied with either closed or open end-covers for Daisy Chain usage. The Right-Angle Quickie Header has a positive latch to assure continuous mating with low-contact resistance through vibration and impact. Quickie can be used to interface cable on .050" centers to .025" sq. wire-wrapping pins on .100" sq. grid. Write for Catalog 131.



**BERG
ELECTRONICS**
Division E-1 of DuPont de Nemours & Co. (Inc.)

New Cumberland, Pa. 17070 Phone: (717) 938-6711

INFORMATION RETRIEVAL NUMBER 59

123

Multiplying d/a converters meet MIL specs at low cost

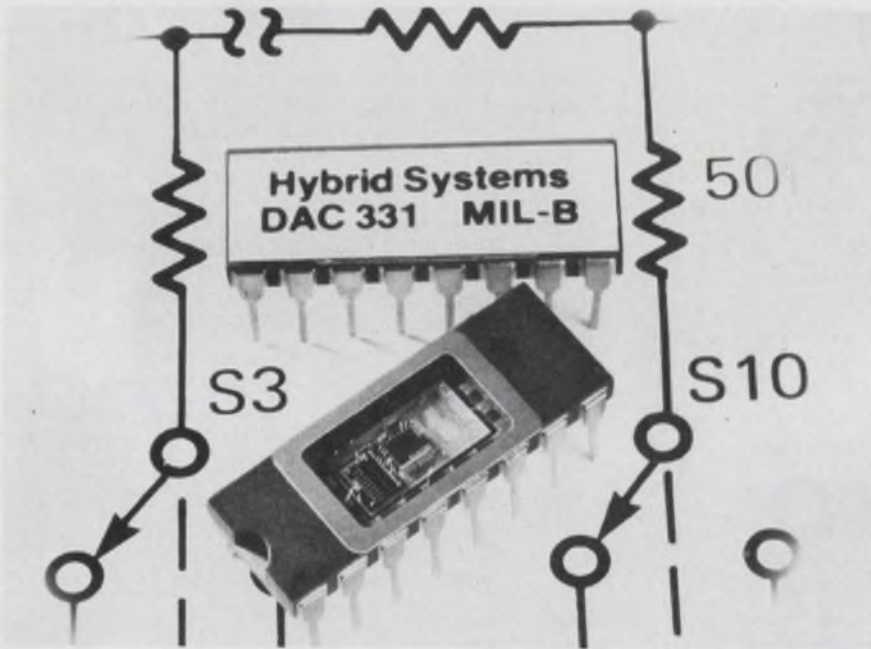

Hybrid Systems, 87 Second Ave., Northwest Park, Burlington, MA 01803. (617) 272-1522. P&A: See text.

You can pay \$200 or more for a multiplying digital-to-analog converter that meets military specs. But now there's a lower cost alternative. The DAC-331, a 10-bit current-output hybrid microelectronic unit made by Hybrid Systems, costs only \$49 in single quantities and is processed to MIL-

STD-883, Level C, requirements.

The converter is designed to maintain accuracy over the entire military temperature range of -55 to +125 C and is pin-compatible with the AD7520 made by Analog Devices (Norwood, MA).

There are two versions of the DAC-331, both with 10-bit resolution. The 331-8 has full-scale accuracy of $\pm 0.3\%$ over -25 to +85 C, or $\pm 0.5\%$ over the full MIL range. The 331-10 has an accuracy

of $\pm 0.2\%$ over -25 to +85 C and $\pm 0.4\%$ over the full range. Either version can be processed to Level B or Level C of MIL-STD-883.

Analog output scaling is a nominal $40 \mu\text{A/V}$. The reference input voltage can span a $\pm 10\text{-V}$ range, and there is a feedthrough of 0.1% at 5 kHz, minimum. For a full-scale digital input change, the converters require only $2 \mu\text{s}$ to settle to within 0.05%.

Accuracy and stability errors are combined into a total spec. For the 331-8, these errors reach 0.2% of full-scale, while for the 331-10, they are only 0.1%. The output impedance is 25 k Ω .

The converters require only a single 3-to-10-V supply for operation and typically draw only 2.5 mA when operated at 5 V. Hermetically sealed ceramic 16-pin DIPs house the converters. These packages measure $0.75 \times 0.3 \times 0.1$ in.

The AD7520, by comparison, is a monolithic CMOS multiplying d/a converter that costs \$87 for a unit with 10-bit accuracy. Prices drop, though, to \$42 if only 8-bit accuracy is needed. Both prices are for the MIL versions in unit qty. The gain tempo is 10 ppm/ $^{\circ}\text{C}$.

(continued on page 125)

ANA & LOG

I WILL NOW TURN ANA INTO A BUNNY... ER RABBIT. ABBRA-DABBRA

YIPES! DABBRA-ABBRA!

WHEE! SIGH...

ANALOGY

A-TO-D OR D-TO-A. THERES AN INTECH CONVERTER MODULE WITH HIGH ACCURACY AT BIG COST SAVINGS. WE STOCK 20 DIFFERENT TYPES WITH BINARY RESOLUTIONS FROM 8 TO 16 BITS FROM 4 TO 5 1/2 BCD DIGITS. LINEARITIES TO BETTER THAN $\pm 0.0025\%$. EVEN OUR LOWEST COST DACS REMAIN MONOTONIC THROUGHOUT TEMP RANGE WITH CONVERSION TIMES TO 800 NS.

intech/FMI
282 BROOKAW RD. SANTA CLARA, CA 95050 (408) 244-0500

Single unit prices for the DAC-331 series of converters start at \$39 for the 331-8-MIL-C, 8-bit unit processed to 883 Level C and \$49 for the 331-10-MIL-C, 10-bit converter also processed to Level C. Both converters are also available processed to 883 Level B with a price increase of approximately \$15, depending upon test requirements. All units are available from stock to two weeks.

Hybrid Systems CIRCLE NO. 302
Analog Devices CIRCLE NO. 303

Rf amplifier in TO-8 covers 5 to 500 MHz

Aydin Vector, P.O. Box 328, Newtown, PA 18940. (215) 968-4371. \$90 (1 to 9); stock to 2 wk.

The Model MHT-250 hybrid amplifier is housed in a 4-pin TO-8 package. It covers the frequency range of 5 to 500 MHz, has a noise figure of 2.5 dB, max, a power output of -2 dBm min., an input/output VSWR of 2:1 max and requires +15 V dc at 10 mA.

CIRCLE NO. 336

Counter/controller can retain count for 10 days

Square D, Dept. SA, Milwaukee, WI 53201. (414) 332-2000. \$395; stock.

The Class 8854, Type PC-42 storage counter/controller runs from 120 V ac, 50 to 60 Hz. It consumes 15 VA and uses a rechargeable battery (charger included) to prevent loss of count. The battery will permit the unit to retain the count for 10 days if necessary. The unit uses CMOS circuitry, has an up/down reversible counter that counts between 0 and 15, an anticoincident circuit to allow simultaneous up and down counts and has a binary readout consisting of four LEDs in a 1248 code. The 10-A output relay switches when the chosen count is reached—de-energizing on count-up, energizing on count-down. The controller also has manual buttons to adjust the count up or down. The PC-42 is designed for heavy duty industrial applications and has a high electrical noise immunity. The PC-42 measures 8 × 9.5 × 4 in. and is panel-mountable.

CIRCLE NO. 337

CUSTOM HYBRID MICROCIRCUITS

For Military/Aerospace Applications

CIRCUIT TECHNOLOGY INCORPORATED

160 Smith Street, Farmingdale, N.Y. 11735
Phone (516) 293-8686 • (213) 374-7446

INFORMATION RETRIEVAL NUMBER 61

SAM IS THE LOWEST PRICED READER YOU CAN BUY. BUT YOU DON'T GET SHORT CHANGED.



You could spend a lot more for a tape reader and still not get all of SAM'S quality features. SAM clips along at 300 cps, has our sure-footed dual sprocket drive and our state-of-the-art fiber optic light source and photo transistor read head. We can make SAM do all this *and* save you money because we do things differently.



This is the plain, brown wrapper SAM comes in.

The more you know about punched tape equipment, the better you read us.

DECITEK

250 CHANDLER STREET, WORCESTER, MASSACHUSETTS 01602. U.S.A. (617) 798-8731

INFORMATION RETRIEVAL NUMBER 62

Thirty years of designing and manufacturing cord sets, wire and cable has given us the kind of experience which can solve your problems. Whether you are stumped by a complex design requirement or a sticky cost situation, our engineering and production staffs can come up with the right answers. In fact, many of our now standard designs were created as solutions to specific customer problems. And, our reputation for ingenuity is equalled

only by our reputation for quality.

Test us with your special requirements. You'll discover why Victor has become the standard of quality in cord sets and other wire specialty items.

Victor Electric Wire & Cable Corp.
618 Main St., West Warwick, R.I. 02893
Telephone: 401-821-1700
TWX: 710-382-1534



There is no limit to our capability in cord sets or wire & cable!

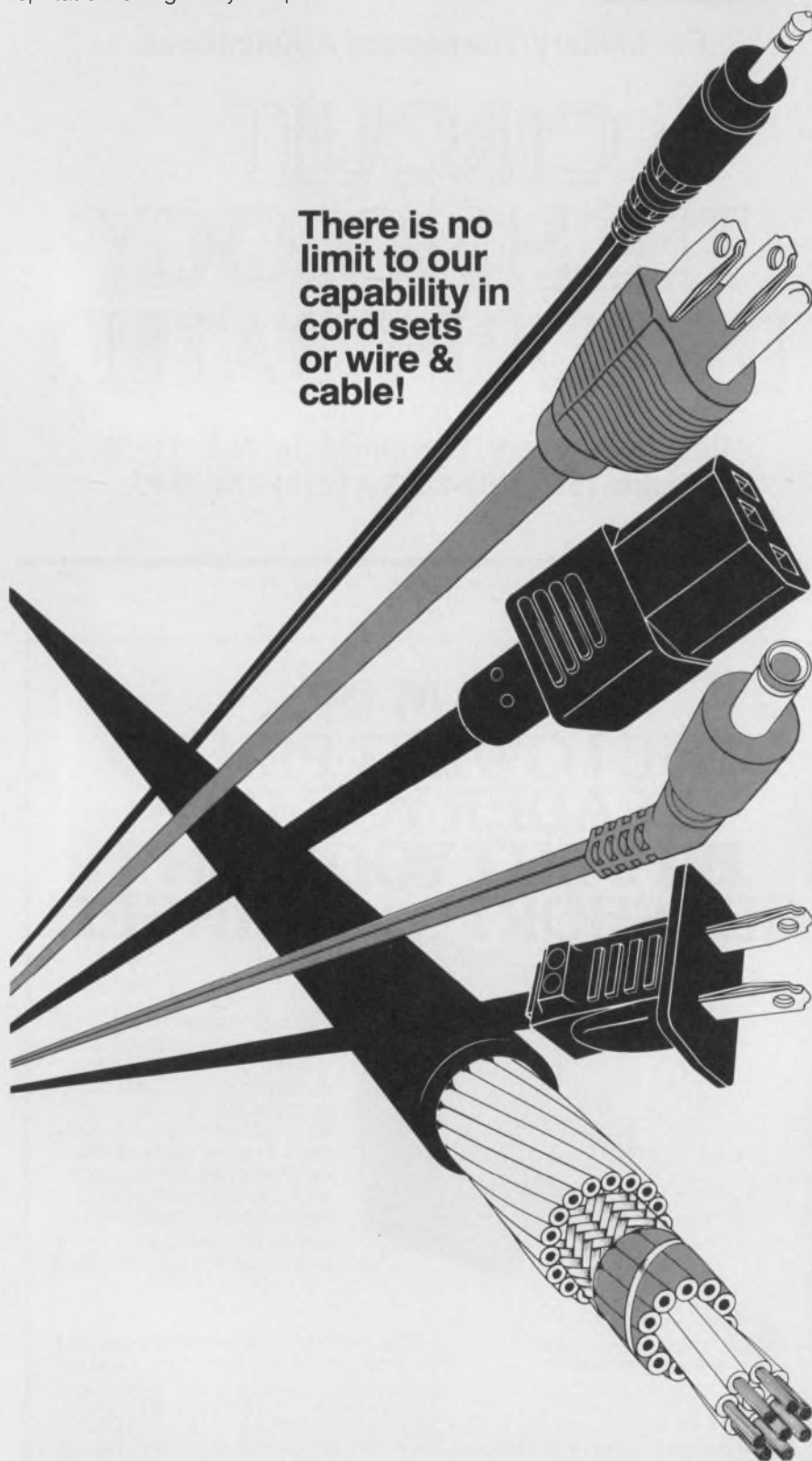

INTEGRATED CIRCUITS

Preamp operates from 4-to-20-V supply

SGS-ATES Semiconductor, 435 Newtonville Ave., Newtonville, MA 02160. (617) 969-1610. \$1.60 (100-999); stock.

The TDA1054 preamp, packaged in a 16-pin DIP, operates from supply levels ranging from 4 to 20 V. The IC has a 0.5-dB noise figure, 110-dB open-loop gain and 0.1% distortion. Supply ripple rejection is 30 dB and automatic level-control range is 54 dB.

CIRCLE NO. 338

Voltage reference holds drift to 1 ppm/°C



National Semiconductor, 2900 Semiconductor Dr., Santa Clara, CA 95051. (408) 732-5000. \$3.25 to \$35.00 (100); stock.

A monolithic temperature-stabilized voltage-reference IC outperforms standard zener diodes by a factor of 20. Called the LM199, the linear IC provides a 6.9-V reference and guarantees drift to be less than 1 ppm/°C. Long-term stability is better than 0.002%—the accuracy limit of the manufacturer's test system. Low-frequency noise is less than 10 μ V, and the circuit requires only 300 mW at 25 C.

CIRCLE NO. 339

14-pin DIP holds wideband op amp

Optical Electronics Inc., P.O. Box 11140, Tucson, AZ 85734. (602) 624-8358. \$36.50 (10-29); stock.

The Model 9916 op amp, packaged in a 14-pin DIP, features 150-MHz minimum guaranteed gain-bandwidth product, and 6-dB per octave uniform roll-off rate for high-frequency stability. It also has 60-dB open-loop gain at dc and ± 300 -V/ μ s minimum slew rate.

CIRCLE NO. 340

4-k 'CMOS' RAM accesses in 70 ns

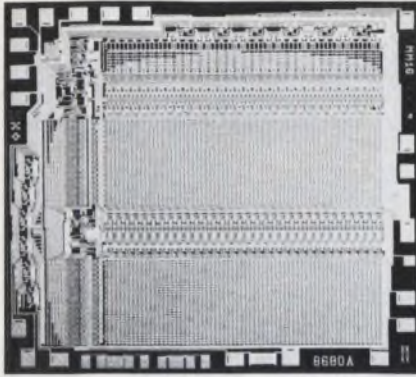

Toko, 1-17, 2-Chome, Higashi-Yuki-gaya, Ohta-ku, Tokyo, 145 Japan. P&A: See text.

The first 4096-bit RAM to employ both n and p-channel MOS devices—Toko's KM 8680—sets the pace for access and cycle times. The new silicon-gate dynamic RAM specs access at 70 ns typical and 100 ns maximum. Cycle time is 160 ns typical and 200 ns maximum.

Existing 4-k dynamic RAMs employ NMOS, and they have top access and cycle times of 200 and 400 ns, respectively.

The new "CMOS" memory employs n-channel single-transistor cells for the storage matrix, and it includes p-channel devices in the peripheral circuitry. Transistor gate lengths of $6\ \mu$ have been achieved, and the entire chip measures just 3.5×3.9 mm.

The new RAM has a maximum, total power dissipation of only 350 mW, compared with a watt or so for some NMOS versions. In the standby mode, the KM 8680 needs only 3 mW. Refresh is required every 2 ms.

The 4096×1 -bit KM 8680 comes in a 22-pin ceramic DIP, with Intel and TI 4-k-RAM pin-outs. It uses ± 5 and 12-V supplies. However the 12-V supply can drop to as low as 5 V or rise as high as 16 V. So it's possible to have the memory operate, in fact, from just two supplies, +5 and -5 V.

Except for the chip-enable input, all input and output lines are TTL compatible.

Production quantities will be available in December. In sample quantities, the KM 8680 costs 6000 yen, or about \$20. In quantities of 5000, unit prices drop to less than \$14.

CIRCLE NO. 341

CMOS IC counts units or frequencies

Intersil, Inc., 10900 N. Tantau Ave., Cupertino, CA 95014. (408) 257-5450. \$15.05 (100-999).

The ICM7208 CMOS circuit, a fully integrated counter-decoder-driver, can count units, frequencies or time intervals. It can directly drive a seven-decade multiplexed common-cathode LED display. The ICM7208 operates over a supply voltage range of 2 to 6 V. Its operating power dissipation is less than 10 mW; its quiescent power dissipation, less than 5 mW.

CIRCLE NO. 342

Interface inductive loads to TTL, MOS

Plessey Semiconductors, 1674 McGaw, Santa Ana, CA 92705. (714) 540-9979. \$5.94 (100); stock.

Two bipolar devices provide a power interface between MOS and TTL devices and heavily resistive or inductive loads. The SP761B allows a direct 12-V MOS interface, while the SP762B permits a direct 5-V TTL interface. Both contain five current amplifiers, two of which include a common strobe input to control a high-current parallel output. The 12-V circuit delivers up to 150 mA with input current of approximately 3 mA. The 5-V circuit provides up to 200 mA with approximately 1 mA of input current. Both circuits can operate at speeds up to 1 MHz.

CIRCLE NO. 343

Multiply 16×16 -bit numbers in $1\ \mu$ s

Advanced Micro Devices, 901 Thompson Pl., Sunnyvale, CA 94086. (408) 732-2400. \$23.25 (100).

With two Am25LS14 multipliers, a 16-bit by 16-bit multiplication can be accomplished in $1\ \mu$ s. The new 8-bit circuit uses low-power Schottky techniques. The device takes an 8-bit multiplicand at its parallel X inputs and multiplies it by the multiplier that is clocked serially into the Y input. A two's-complement product is available at the serial output.

CIRCLE NO. 344

LASER MARKED UHF/MICROWAVE CHIP CAPACITOR KITS

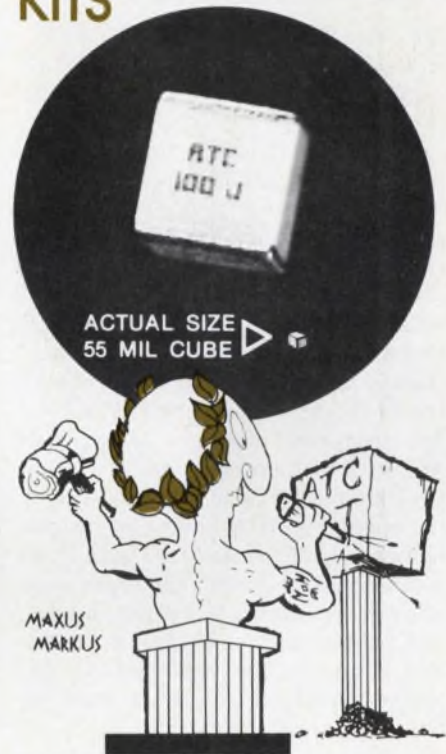

DESIGN VALUE KITS:

40 MARKED POPULAR VALUES IMMEDIATELY AVAILABLE IN KITS OR SEPARATELY.

BUY ANY DESIGN VALUE KIT OF 100 ATC 100 LOW LOSS PORCELAIN CHIP CAPACITORS FOR \$77.00.



Just circle the number below for more information on ATC's new laser marked chip capacitor kits.

american technical ceramics

ONE NORDEN LANE,
HUNTINGTON STATION, N.Y. 11746
(516) 271-9600 • TWX 510-226-6993

INFORMATION RETRIEVAL NUMBER 64

Microwave substrate has high dielectric constant

3M Co., P.O. Box 33600, St. Paul, MN 55133. (612) 733-1725. For a 0.025-in.-thick sheet, \$81 (1 to 4 sheets); stock.

The "Epsilam-10" microwave substrate, a high dielectric constant laminate for stripline or microstrip use has a dielectric constant of 10.3 ± 0.5 . The copper-clad, ceramic-filled Teflon compound combines the flexible mechanical properties of a plastic with electrical properties similar to alumina. Its high dielectric constant allows for reduced package size and weight and increased circuit density. Epsilam-10 is supplied in 9×9 in. sheets with a choice of thicknesses—0.025 or 0.05 in. with 1-oz copper on two sides. The sheet size allows for multiple circuit layout and processing using typical resists and etchants. The material can be easily machined, drilled, routed or cut with shears or knife.

CIRCLE NO. 350

Pawl latch locks out noise, dust & vibration



Rexnord Inc., Specialty Fastener Div., P.O. Box 98, Paramus, NJ 07652. (201) 845-6900. From \$1.20 (1000-up); stock.

The Camloc 65L series pawl latch is designed to exert increasing pressure to hold gaskets to panels and access doors. One quarter turn locks the door and each additional turn pulls the door closer to the frame to apply the amount of latching pressure you need. The latch seals tight to lock out noise, dust and vibration. Each latch fits many frame requirements of varying thicknesses with a grip range that compensates for wear and aging gaskets.

CIRCLE NO. 354

Processor hardware kit just needs the ICs

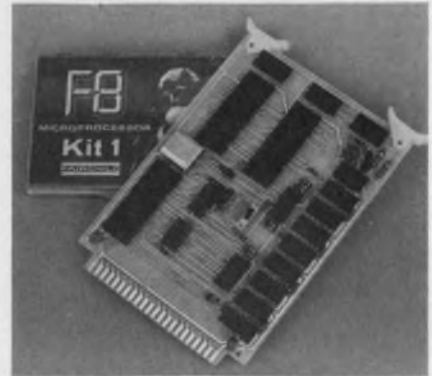

Pronetics Corp., P.O. Box 28582, Dallas, TX 75228. (214) 276-1968. \$65 (1 to 99); 2 wks.

The PS-710 F-8 kit module is a fully assembled printed-circuit card with sockets to accept the F-8 microprocessor kit ICs. It can be used for prototype and development systems or as a standard hardware module for production systems. All necessary functions are available on a standard edge connector to permit memory expansion.

CIRCLE NO. 355

NEED A COMPETITIVE EDGE?
CHECK OUT WESTON POTS
 FOR COST DELIVERY • PERFORMANCE

EXAMPLE:

Model #830P

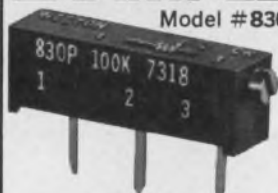

WESTON RECTILINEAR 3/4" CERMET TRIMMER

PRICE (1000 Piece Orders) **\$.91 EA.**

Comparable prices — all sizes — Square
 • Round • Cermet • Wirewound

WESTON

Schlumberger

WESTON COMPONENTS
 ARCHBALD, PENNSYLVANIA 18403
 TEL. (717) 876-1500
 TWX 510 656-2902
 TELEX 83-7443

INFORMATION RETRIEVAL NUMBER 82

**NEW LOW COST REED RELAY
 ROCK HARD EPOXY COATED**

\$1.85 to 49¢

Depending on coil voltage, contact level and volume.

Blue Boy Reed Relays offer:

- Protection from handling, solvents, tough environments
- 1 pole normally open contacts up to 10 watts
- General purpose or logic level contacts
- Coil voltages 5 through 48 VDC; .35" H x 1" L

Available from distributors.

26477 Golden Valley Road • Saugus, California 91350
 (805) 252-8330 • (213) 788-7292 • TWX 910-336-1556

ELEC-TROL, INC.



INFORMATION RETRIEVAL NUMBER 83

POWER SOURCES

Isolated supplies meet UL 544 specs

Calex Mfg. Co., 3305 Vincent Rd., Pleasant Hill, CA 94523. (415) 932-3911. 7009, \$69; 7010, \$79; stock-2 wks.

Two new power supply modules are UL approved for use in medical and dental instruments. Listed as a recognized component under UL 544, Model 7009 is rated at +5 V, 1000 mA and Model 7010 is rated at ± 15 V, ± 200 mA. Special bobbins and winding techniques provide complete physical isolation between primary and secondary windings. Ac hot and neutral connections may be interchanged without any degradation of isolation. Isolation is specified as 10 pF of capacitance, 0.1- μ A maximum leakage from input to output and a minimum voltage isolation rating of 5000 V.

CIRCLE NO. 356

Submodular supplies: 42 models, 7 packages

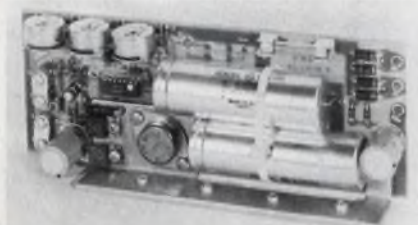

Power/Mate Corp., 514 S. River St., Hackensack, NJ 07601. (201) 343-6294. Start at \$35.

By breaking a power supply into its submodular elements and then standardizing these elements, the company can offer custom power supplies economically and rapidly. The new SMS Series of submodular supplies consists of 42 different models in seven different package sizes. These provide a wide variety of voltages from 0 to 20.0 V and currents from 0 to 36.0 A. The series features built-in overvoltage protection, current limiting overload protection, and adjustable controls for voltage and other protective functions. Line and load regulation is better than 0.075% and the output ripple is better than 1 mV rms.

CIRCLE NO. 357

Open-frame source claims midget title

Power-One, 531 Dawson Dr., Camarillo, CA 93010. (805) 484-2806. \$49.95; stock.

Said to be the world's smallest triple-output open-frame power supply, Model HTAA-16W provides 5 V at 2 A with OVP and ± 9 to 15 V at 0.2 A. Total isolation between the 5 and ± 9 to 15-V out-

puts allows the user to arrange polarities to suit his specific application. Size is 6.5 \times 4 \times 2.12 in. and weight is 2 lb. Standard features include 115/230 V ac $\pm 10\%$ input; $\pm 0.05\%$ line and load regulation, and full protection against short-circuit and overload. Maximum output ripple is 10 mV pk-pk while the full load operating temperature specifications are 0 to 50 C, derated to 71 C.

CIRCLE NO. 358

65 watts of reliable power in frequencies of 10 to 2500 MHz.



And here's what we built into our new 15122.

- solid state circuitry
- short and open circuit protection
- frequency stability $\pm .001\%$
- external pulse or AM modulation
- internal square wave modulation
- low tube cost/operating hour
- qualified to MIL-STD-461 and 810

It has six different plug-in heads

Model	Freq. (MHz)	Pwr. (MIN)
6047	10-50	65
6048	50-200	65
6049	200-500	65
6050	400-1000	65
6051	1000-2000	40
6052	2000-2500	35

You have now ended your search for a stable, reliable 65 watt oscillator. Just call or write for detailed engineering data. Or ask for a demonstration

MCL, INC.,
10 North Beach Avenue,
LaGrange, Illinois, 60525.
(312) 354-4350



INFORMATION RETRIEVAL NUMBER 65

New Literature



Digital multimeters

Portable, 3-1/2-digit multimeters are highlighted in a four-page bulletin. United Systems, Dayton, OH

CIRCLE NO. 359

Solid-state current sensor

Features, applications, absolute maximum ratings, electrical characteristics, mounting dimensions and operating characteristics of solid-state current sensors are listed in a four-page bulletin. Micro Switch, Freeport, IL

CIRCLE NO. 360

Structural foam

"The Handbook of Engineering Structural Foam," 62-pages, describes and documents state-of-the-art design, materials and processing information. General Electric, Structural Foam Resins, Plastics Div., Pittsfield, MA

CIRCLE NO. 361

Chips and wafers

Specifications and data on wafer and chip processing, power ratings, testing, quality-assurance criteria, bonding and handling are given in a brochure. A guide cross-references standard packaged devices to chip types. Unitrode, Watertown, MA

CIRCLE NO. 362

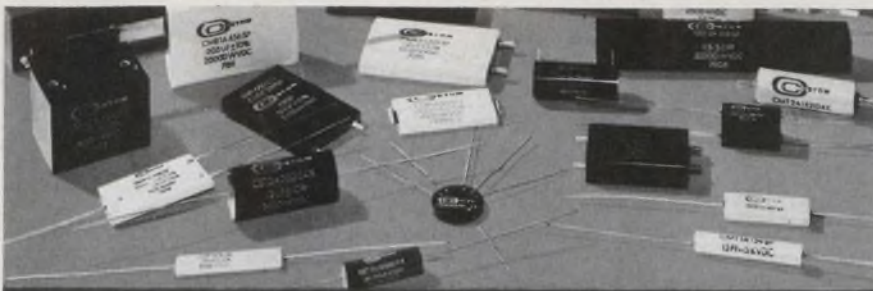

Long on Reliability BUT Short on Delivery

Mica Capacitors by Custom Electronics

Custom can meet your capacitor needs better, because each process in our capacitor production begins and ends with quality control to avoid failure in the field. Let us show you how we can fill your requirements. Write for FREE descriptive TechniTip, includes sample of mica dielectric.



Send for FREE Product Brochures
CUSTOM ELECTRONICS, INC.
4 Browne Street Oneonta, N.Y. 13820
PH: (607) 432-3880 TWX: 510-241-8292

Check these specifications on typical units —

CMR — Wrap & Fill Type				Typical
Cap & Tol	WVDC	L x W x T		1-10 ea
0.1 μ F \pm 10%	3000	2.562" x 1.620" x 0.270"		\$ 9.25
CER — Epoxy Housed Type				Typical
Cap & Tol	WVDC	L x W x T		1-10 ea
02 μ F \pm 10%	8000	2.812" x 2.0" x 0.469"		\$11.85
CEM — Epoxy Molded Type				Typical
Cap & Tol	WVDC	L x W x T		1-10 ea
05 μ F \pm 10%	2000	2.0" x 0.812" x 0.562"		\$14.00

INFORMATION RETRIEVAL NUMBER 66

Three Cheers for **FERRITES** from the Permag Team

1. With Permag supplying application-rated Indiana General Corp. Ferramics, you'll always get exactly what you need.
2. Complete fabricating facilities. Prototype quantities available. Plus engineering assistance, field testing.
3. Prompt 24-hour delivery. Extensive stock of ferrite parts at all locations. New catalog available. Yea Team!

FERRAMICS™ FROM PERMAG

Consult your Yellow Pages for address and telephone number of Permag near you
Cable Address: MAGNETS NEWYORK

YOUR NO. 1 SOURCE FOR ALL MAGNETIC MATERIALS

PERMAG

San Francisco Dallas Boston
Los Angeles Chicago New York
Atlanta

ALL ACROSS THE COUNTRY

INFORMATION RETRIEVAL NUMBER 67

GE's June, 1975 miniature catalog has over 500 data changes that could affect your current design. Send for it. It's free.



(3-5169)

NEW. June '75 Miniature Lamps:

40 pages. 500 changes. Data covers over 500 miniature lamps ranging up to 20,000 hours rated average life. With a design voltage range of from 1.2 to 55, and candle-power range from .02 to 250. Diameter range from $1\frac{1}{32}$ " to $2\frac{1}{16}$ ".

Circle Product Card # 251



(3-6252R1)

NEW. Feb. '75 Sub-Miniature Lamps:

24 pages. 91 changes. Data covers over 210 sub-miniature lamps. Diameters $\frac{1}{4}$ " and smaller. Rated voltage 1.3 to 60. Candle-power range from .006 to 15. Rated average lamp life up to 60,000 hours.

Circle Product Card # 252

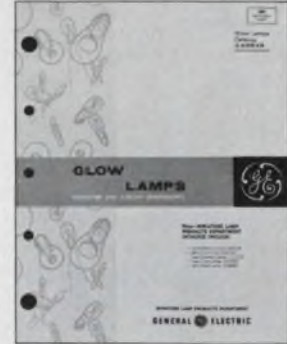

(3-6254R)

NEW. Dec '74 Glow Lamps:

8 pages. 50 changes. Data covers 83 Neon Glow Indicator and Circuit Component lamps. Diameters ranging from $\frac{1}{4}$ " to $1\frac{3}{4}$ ". Wire terminal lengths $\frac{1}{2}$ ", $\frac{5}{8}$ ", $\frac{3}{4}$ " and $1\frac{1}{8}$ ".

Circle Product Card # 253

To get the catalogs you need, free of charge, circle the product card number shown under each catalog, or write General Electric, Miniature Lamp Products Department, 3382-L, Nela Park, Cleveland, Ohio 44112.

GENERAL  ELECTRIC

Low cost tool for design and trouble-shooting

Pocket Size
Slide-Switch
Resistance
Substitution Unit
still only **\$58**

- Over 11 million step range
- 1% accuracy resistors
- Unique in convenient size
- Rugged construction



Small enough to take anywhere in your pocket, this aluminum-housed unit delivers a very broad range of resistance steps. Excellent for both development and repair work.

Half-watt 1% tolerance resistors give an accurate range from 1 to 11,111,110 ohms, in one-ohm steps. Has three binding posts, one to ground case.

Available now from stock. Catalog No. 7092-236. Cash savings available, see coupon. Write, or call (804) 264-2858. Phipps & Bird, Inc.

- Please send _____ Units @ \$58 each. (Check enclosed less 5% cash discount)
- Send _____ Units @ \$58 each C.O.D. (Phipps & Bird will pay C.O.D. charges)

Name _____
Firm _____
Address _____
City, State _____ Zip _____

Ask your dealer, or contact:



PHIPPS & BIRD, INC.

Manufacturers of Scientific Instruments

P.O. Box 27324 • Richmond, Virginia 23261 • Phone: 804/264-2858

INFORMATION RETRIEVAL NUMBER 69

ELECTRONIC DESIGN 23, November 8, 1975

PHOTO ETCH PRINTED CIRCUIT KIT

Makes circuits **THREE WAYS**

- 1 FULL SCALE ARTWORK MASTER
- 2 MAGAZINE ART ILLUSTRATION → FILM POSITIVE → NEGATIVE → DEVELOPED PHOTO RESIST IMAGE ON COPPER CLAD CIRCUIT BOARD → ETCHED CIRCUIT BOARD
- 3 DIRECT ETCH DRY TRANSFERS APPLIED TO COPPER CLAD BOARD

NO CAMERA DARKROOM FILM CUTTING TRACING

USES DATAK'S POS-NEG PROCESS
The revolutionary photographic way that makes **PERFECT** printed circuits from original art or a printed page.

KIT CONTAINS: 5" x 6" steel printing frame, 4 sheets 5" x 6" photocopy film, yellow liter, chemicals for 1 pint film developer and 1 pint film fixer, 5" x 6" copper clad board, 3" x 4" copper clad board, spray can of photo etch resist, 1 pint resist developer, 2 sheets 8 1/2" x 11" layout film, 1 roll 1/16" printed circuit tape, 1 roll 1/32" printed circuit tape, 8 sheets dry transfer direct etch PC patterns including gates, transistors, round can and flat pack ICs, DIP-ICs, edge card connectors, lines, circles, jogs, etc. 1/2 lb. to anhydrous ferric chloride to make 1 pint etchant - instructions.

- ER-4 COMPLETE PHOTO ETCH SET \$24.95
- ER-2 PC patterns and tapes—refill 3.39
- ER-3 1/4 pound dry etchant—refill 1.25
- ER-5 6 sheets photocopy film—refill 3.39
- ER-6 Film process chemicals—refill 1.79
- ER-7 Photo resist spray, 2.5 oz.—refill 2.95
- ER-8 Resist developer, 16 oz. can—refill 2.95

AT YOUR DISTRIBUTOR OR DIRECT

the **DATAK** corp.
65 71st St. • Guttenberg, N. J. 07093

INFORMATION RETRIEVAL NUMBER 70

think small . . . with sub-miniature ceramic capacitors



Thick film hybrid design engineers can choose sub-miniature single and multi-layer ceramic chip capacitors with the widest range in capacitances, sizes, temperature characteristics and terminations in the industry from Centre Engineering.

In frequency critical areas requiring accuracy and stability, consider Centre Engineering's NPO type chip capacitors. Applications

requiring less stringent specifications Centre Engineering W5R and Z5U chip capacitors are economy savers.

Single layer and multi-layer ceramic chip capacitors, as small as .080 x .050 x .55T up to .460 x .420 x .65T with extremely high capacitance to volume ratios are ultra-reliable.

If you are thinking small . . . write for our catalogue.



CENTRE ENGINEERING

2820 E. COLLEGE AVE., STATE COLLEGE, PA 16801
814-237-0321 • TWX 510-891-2834

INFORMATION RETRIEVAL NUMBER 71

Thin Film Center Tapped Chip Resistors

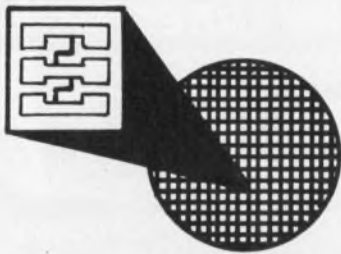

STANDARD SPECIFICATIONS:

- 4.7 ohms to 560K ohms
- 0.03 x 0.03 x .007 Silicon
- 0.005 inch x 0.005 inch, Bonding Pad Aluminum.
- $\pm .1, 1, 5, 10$ and 20% standard. Custom tolerances from 0.01%.
- TCR, ± 50 ppm/ $^{\circ}\text{C}$, from -55°C to $\pm 150^{\circ}\text{C}$. Custom ± 10 ppm/ $^{\circ}\text{C}$.
- 250 mw.

For additional information write or call:



1001 Digital Drive, Hudson, N.H. 03051
Tel. 603-883-9351 TWX 710-228-1377

INFORMATION RETRIEVAL NUMBER 72

Plug Us In



Turn Us On



Quietly

Measuring low level signals is tough enough without adding noise—so our preamplifiers are quiet. To find out more about our wide range of quiet preamps, write or call for our handy full color wall chart; it will help you in selecting the best preamp for your application. Princeton Applied Research Corporation, P.O. Box 2565 Princeton, New Jersey 08540, 609/452-2111. In Europe, contact Princeton Applied Research GmbH, D8034 Unterpfaffenhofen, Waldstrasse 2, West Germany.



286

INFORMATION RETRIEVAL NUMBER 73

NEW LITERATURE

Incandescent lamps

Specifications on nearly 300 industry standard and special sub-miniature incandescent lamps, sizes T-7/8 to T-3-1/4, are given in a 16-page catalog. IEE, Van Nuys, CA

CIRCLE NO. 363

Power supplies

Switching regulated power supplies are highlighted in a six-page foldout. Deltron, North Wales, PA

CIRCLE NO. 364

IC logic panels

A 20-page catalog covers IC logic panels. Interdyne, Van Nuys, CA

CIRCLE NO. 365

Resistors

Thin-film resistor networks including general-purpose networks, precision ladder networks, network starter kits and user designed chip and packaged network specifications are covered in a 16-page guide. Analog Devices, Norwood, MA

CIRCLE NO. 366

Microcomputer kits

Specification sheets cover six different ready-to-assemble microcomputer kits. Cramer Electronics, Newton, MA

CIRCLE NO. 367

Thick-film materials

Conductor cermet pastes, high temperature metalizing, dielectrics, resistor compositions, solder creams and protective coatings are covered in a 35-page catalog. Transene Co., Rowley, MA

CIRCLE NO. 368

Mini and microcomputers

The U-Series minicomputer and L-16A 16-bit microcomputer are covered in two separate catalogs. Background information on Panafacom is supplied in another catalog. Panafacom, Ltd., Jiygaoka, Meguro-ku, Tokyo, Japan.

CIRCLE NO. 369

Q. what's new from the specialists in waveform analysis?

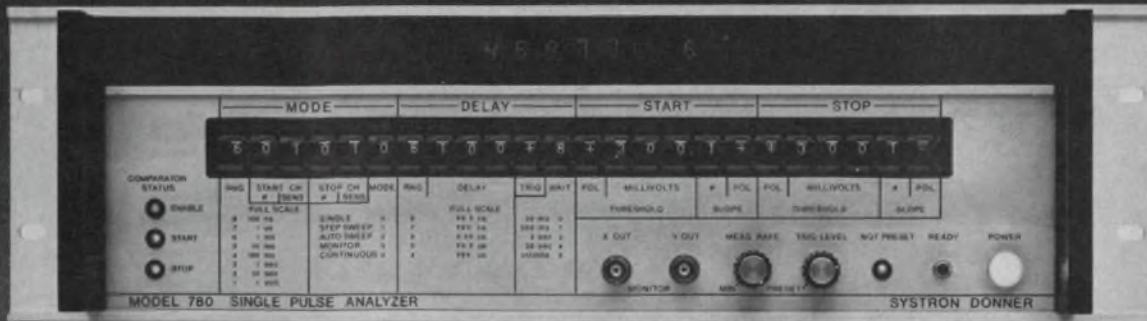

A. a systems measurement center that makes 20,000 measurements/sec!

Model 780 measures single transient to 100 MHz signals • Measures time from 0.1 ns to 10 s
Measures voltage with bandwidth from D.C. to 300 MHz • Calculator or computer compatible • ASCII buss programming.

For information on Systron-Donner waveform analysis instruments call your Scientific Devices office or Systron-Donner at 1 Systron Drive, Concord, CA 94518. Phone (415) 676-5000.



INFORMATION RETRIEVAL NUMBER 74

8844,
7262A, 7735A,
8134, 8507, 8541,
8573, 25PE12, 8480, N513,
N736, N747, N156, N214, N603,
N400, N177, N371.

QUALITY VIDICONS

2/3, 1, 1 1/2 inch visible, infra-red, silicon target, UV, x-ray. For replacement, upgrading, or OEM. If quality is important request our catalog today.

FREE CATALOG
on complete vidicon
line including over
30 different types
call or write

**HAMAMATSU
CORP.**
120 Wood Avenue
Middlesex, New Jersey 08846
201/468-6640

Introducing . . .



Custom Devices

DIVISION OF CONTINENTAL TESTING LABORATORIES INC

We assemble --

- HI REL HYBRIDS
- SEMICONDUCTOR SPECIALS
- ON-SHORE ASSEMBLY (Orlando)
- COMPLETE MIL-STD-883 and 750 TESTING

*we'll
do it
your way!*

Ph. 305/834-3340

763 U.S. Hwy. 17-92, Fern Park, Florida 32730

INFORMATION RETRIEVAL NUMBER 75

ELECTRONIC DESIGN 23, November 8, 1975

INFORMATION RETRIEVAL NUMBER 76

133



Thin-Trim variable capacitors provide a reliable means of adjusting capacitance without abrasive trimming or interchange of fixed capacitors. Series 9401 has high Q's and a range of capacitance values from 0.2-0.6 pf to 3.0-12.0 pf and 250 WVDC working voltage. Johanson Manufacturing Corporation, Boonton, New Jersey (201) 334-2676.

THIN-TRIM CAPACITORS 601

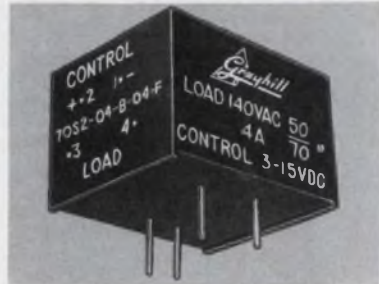

SPACE-SAVING 4 AMP SOLID STATE RELAY occupies only 1 cubic inch, is logic compatible, with switching capability from 0.1 to 4 amps, rated @25°C. Optically coupled; zero voltage turn-on. Offers inductive load switching, excellent transient protection. PC mountable. Prototype quantities from stock. Grayhill, Inc., (312) 354-1040.

SOLID STATE RELAY 604



48 pages of data on circuits for commutation, analog and D.C. switching, gating, multiplexing, chopping, D-to-A conversion, sample and hold, modulation, demodulation, solid state relays, lamp/relay driving, TTL to MOS level shifting. Teledyne Crystalonics, 147 Sherman Street, Cambridge, MA. 02140 (617) 491-1670

MICROCIRCUITS CATALOG 607



Free catalog of 34,500 power supplies from the worlds largest manufacturer of quality Power Supplies. New '74 catalog covers over 34,500 D.C. Power Supplies for every application. All units are UL approved, and meet most military and commercial specs for industrial and computer uses. Power Mate Corp. (201) 343-6294.

POWER SUPPLY 602

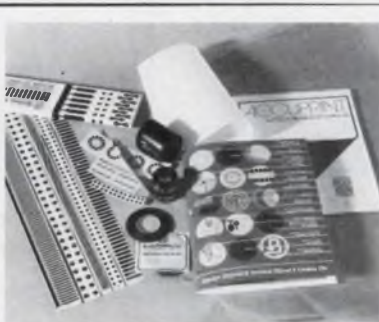

Free 84-page Printed Circuit Drafting Aids Technical Manual & Catalog contains hundreds of time & money-saving tips, plus details on over 15,000 component symbols & tapes, film, vellum, grids. Bishop Graphics, Inc., 20450 Plummer St., Chatsworth, California, 91311, (213) 993-1000.

FREE CATALOG 605

INTEL 8080

Microcomputer

SYMBOLIC CROSS ASSEMBLER

For Use On Any:

DEC PDP-8

Minicomputer

CAL-80 CROSS ASSEMBLER. INPUT: ASCII source tape using standard Intel 8080 mnemonics. OUTPUTS: BNPF Prom Programmer tape and an assembled program listing. Runs on 4K Digital Equipment Corporation PDP-8 series minicomputer. Stores up to 400 symbols. FBE Research Company, P.O. Box 68234, Seattle, Washington 98168

ASSEMBLER 608

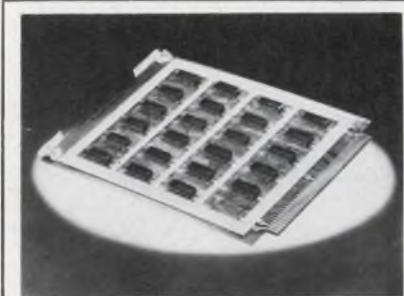

T2L Power Distribution—Noise attenuation and highest packaging density for P.C. boards with T2L logic are yours with Mini/Bus®, the Rogers way to eliminate the cost of multilayer boards by off-board power distribution. Rogers Corporation, Chandler, AZ 85224. Phone (602) 963-4584.

PC POWER DISTRIBUTION 603



1. LOCATE COMPONENTS. 2. DRILL MILL INSULATED PADS

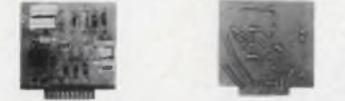

DRILL/MILL tools allow fabrication of small quantity and experimental circuit boards from full-size artwork without etching. Isolated-pad technique allows duplication of any etched board layout, even for breadboards. \$27.50 set of 3 (.20", .15", .10"). Saves builders time, money. AFS Precision Tools, Bx 354, Cupertino, CA 95014 (408) 252-4219

DRILL/MILL 606

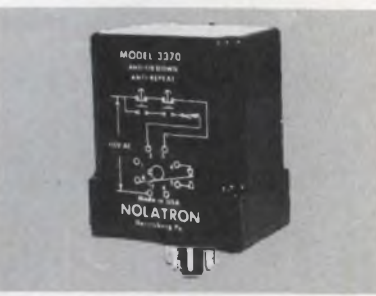

SOLID STATE ANTI-TIEDOWN ANTI-REPEAT CONTROL fail-safe solid state two hand machine control. Small, competitively priced, is easily plugged in. Contains all circuitry necessary to meet requirements of OSHA. Provides reliability and operator safety. Nolatron Inc., 3809 Paxton Street, Harrisburg, Pa. 17111 (717) 564-3398.

SOLID STATE CONTROL 609

Bulletin Board



FLEXIBLE CIRCUITS BY ROGERS. We have the people, experience, plant, equipment—and know-how! Write for information—or call Herman Gordon for action. ROGERS CORPORATION, P.O. Box 700, Chandler, Arizona 85224. Phone (602) 963-4584.

FLEXIBLE CIRCUITS

610

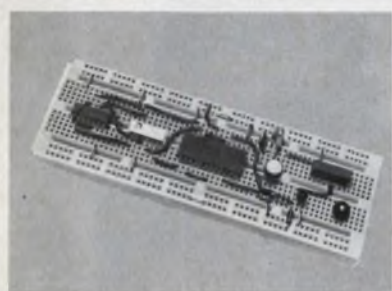

AP Super-Strip. High-performance breadboarding element has 840 solderless, plug-in tie points, holds up to nine 14-pin DIP's, has 8 integral distribution buses. For all DIP sizes, TO-5's and other components with leads up to .032" dia. Patch with any solid wire up to 20-ga. AP PRODUCTS INC., Box 110-D, Painesville, OH 44077 (216) 354-2101.

SUPER-STRIP

611



Low Cost Model 5800A; sine, square and triangle waveforms from 0.2Hz to 2 MHz. 15V p-p outputs, 50 Ohm output. Distortion typ. less than .3%. 1000:1 tuning dial covers audio range on one band. Aux. output sq. wave. Price \$245. Stock delivery. Krohn-Hite Corp. Avon Ind. Park, Avon MA. 02322 (617) 580-1660; TWX 710-345-0831.

FUNCTION GENERATOR

612

Motorola Component Products is offering microprocessor clock oscillators. Models MC6870A, MC6871A and MC6871B are designed to drive Motorola's M6800 μ P; Model K1117A is recommended for Intel's 8080 CPU. Prices for the MC6870A have been reduced from \$68.13 to \$33 (1-4) and from \$33.51 to \$18.40 (50-99). The MC6871A and B are lowered from \$70.88 to \$36 (1-4) and from \$34.85 to \$20 (50-99). The prices for the K1117A are the same as the MC6870A.

CIRCLE NO. 370

Siliconix has dropped prices by nearly one-third on its 3-1/2-digit LD110/LD111 a/d converter IC chip set and LD111/LD114 multiple-option a/d converter IC pair.

CIRCLE NO. 371

The Monroe 324 scientific micro-computer has been reduced to \$495.

CIRCLE NO. 372

Signetics has announced that it will manufacture two device types selected from the Intel 3000 series as part of a bipolar microprocessor system set.

CIRCLE NO. 376

New Band-Selectable Fourier Analysis (BSFA) software is now included in Hewlett-Packard's Model 5451B Fourier analyzer system.

CIRCLE NO. 373

National Semiconductor's Memory Systems group has begun volume production shipments of its MOS-RAM 410, featuring the MM2102 1k static memory chip.

CIRCLE NO. 374

Siltek is offering 68 types of CMOS 4000B and 4500B series products. All types are interchangeable with Motorola's 14500 series.

CIRCLE NO. 375

Only with an EMR Real-Time Spectrum Analyzer...

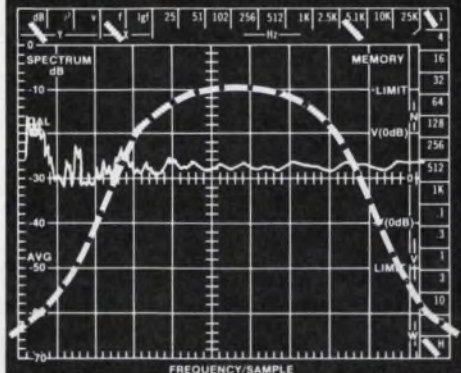

A Rectangular Window for Transient and Order Analysis

EMR Real-Time Spectrum Analyzers are not restricted by a single window function. Our rectangular window allows accurate analysis of transient data type signals... without the restriction imposed by arbitrarily shaped windows. Competitive equipments utilize a window function analogous to the dashed line superimposed on the CRT display shown above. All data above the dashed line would have been severely restricted. Why lose vital data!

That's not all... other features include 60dB dynamic range, LED readout, computer interface, CRT status display, and much more!

Only From EMR!



EMR Schlumberger

EMR Telemetry
Weston Instruments, Inc.
Box 3041, Sarasota, Florida 33578
813-371-0811

Design Data from Manufacturers

Advertisements of booklets, brochures, catalogs and data sheets. To order use Reader-Service Card (Advertisement)

Dual Hi-Speed FFT Processor Easy to Operate



Conceived from the point of view of the operating engineer rather than the computer programmer, the new Omniferous™ FFT Analyzer operates like an instrument, calculates like a computer. This Series OF-400 Analyzer is a universal digital signal analysis system for real-time viewing of changing functions, a complete instrument with all signal conditioning and display calibration built-in. For the first time an operator can observe transfer function, cross-spectra or coherence as the signal is changing without waiting for the analyzer to perform successive laborious calculations.

Features include high speed of 68,000 samples/sec throughput, and high resolution with a 2048 transform size and extra-sharp input anti-aliasing filtering. Calculates FFT, IFFT, power spectra, auto-correlation, cross correlation, and signal enhancement (time averaging), as well as the averaging of any calculated function in sum, peak or exponential mode.

The system excels in high dynamic range, ease of use, display flexibility with two simultaneous display outputs, frequency coverage to 100 kHz, and reasonable cost. Designed by the originators of the famous Ubiquitous® family of real-time spectrum analyzers.

Nicolet Scientific Corp. (formerly Federal Scientific Corp.)

245 Livingston St., Northvale, New Jersey 07647
(201) 767-7100. TWX: 710-991-9619

IMMEDIATE, CIRCLE NO. 170
ROUTINE, CIRCLE NO. 171

GIANT FREE CATALOG



New 164-page catalog! Packed with 1,000's of hard-to-find buys in Optics, Science, Electronics. Loaded with optical, scientific, electronic equipment available from stock. Rare surplus buys. Many "one-of-a-kinds". Ingenious scientific tools. Components galore: lenses, prisms, wedges, mirrors, mounts, accessories. 100's of instruments: pollution test equipment, lasers, comparators, magnifiers, microscopes, projectors, telescopes, binoculars, photo attachments, alternate energy sources. Shop, save by mail! Request free Catalog "DA".

CIRCLE NO. 172

Edmund Scientific Co.

America's Largest Science-Optics-Electronics Mart
300 Edscorp Bldg., Barrington, New Jersey 08007 (609) 547-3488

CERAMIC CHIP CAPACITOR CATALOG



New 24 page chip capacitor catalog is the most comprehensive and easy to use available and insures proper chip selection. The catalog features 7 basic product sections which cover a complete variety of dielectric materials and special designs. Included are NPO-COG, BX-X7R, HI-K and High Q dielectrics and high voltage and single layer types. Each section contains suggested application data for the particular dielectric material, technical information on all characteristics much of which is in graphic form. A unique bar-chart arrangement illustrates each chip in its actual size and the various capacitance values available for that size. Also included is simplified "how to order" information. Other parts of the catalog are devoted to chip capacitor theory, feed-thru capacitors, prototyping kits, chip capacitor modules and temperature compensating dielectrics.

CIRCLE NO. 173

Johanson Dielectrics, Inc.

Box 6456, Burbank, California 91510
(213) 848-4465

Electronic Design

ELECTRONIC DESIGN's function is:

- To aid progress in the electronics manufacturing industry by promoting good design.
- To give the electronic design engineer concepts and ideas that make his job easier and more productive.
- To provide a central source of timely electronics information.
- To promote communication among members of the electronics engineering community.

Want a subscription? ELECTRONIC DESIGN is sent free to qualified engineers and engineering managers doing design work, supervising design or setting standards in the United States and Western Europe. For a free subscription, use the application form bound in the magazine. If none is included, write to us direct for an application form.

If you do not qualify, you may take out a paid subscription for \$30 a year in the U.S.A., \$40 a year elsewhere. Single copies are \$1.50 each.

If you change your address, send us an old mailing label and your new address; there is generally a postcard for this bound in the magazine. You will have to requalify to continue receiving ELECTRONIC DESIGN free.

The accuracy policy of ELECTRONIC DESIGN is:

- To make diligent efforts to ensure the accuracy of editorial matter.
- To publish prompt corrections whenever inaccuracies are brought to our attention. Corrections appear in "Across the Desk."
- To encourage our readers as responsible members of our business community to report to us misleading or fraudulent advertising.
- To refuse any advertisement deemed to be misleading or fraudulent.

Microfilm copies are available of complete volumes of ELECTRONIC DESIGN at \$19 per volume, beginning with Volume 1, 1952 through Volume 20. Reprints of individual articles may be obtained for \$3.00 each, prepaid (\$.50 for each additional copy of the same article) no matter how long the article. For further details and to place orders, contact the Customer Services Department, University Microfilms, 300 North Zeeb Road, Ann Arbor, Michigan 48106 telephone (313) 761-4700.

Want to contact us? If you have any comments or wish to submit a manuscript or article outline, address your correspondence to:

Editor
ELECTRONIC DESIGN
50 Essex Street
Rochelle Park, N.J. 07662

recruitment and classified ads

CRAMOLIN—CONTACT CLEANER

"The less you use—the better it works!"
Cleaner, Lubricant, and Corrosive for use on metal electrical contacts. Reduce contact resistance. Will bring back electronic system performance. Protects against corrosive atmospheres. Safe. Liquid or Spray. Free Data. Sample available.
CAIG LABORATORIES, INC.
P.O. 64, Escondido, CA. 92025

CIRCLE NO. 201

FREE ALARM CATALOG

Huge selection of burglar & fire systems, supplies. Motion detectors, infrared beams, controls, door switches, bells, sirens 500 items. 99 pp packed with technical details, notes.

(Outside U.S., send \$1.00.)



mountain west alarm

4215 n. 16th st., phoenix, az. 85016

CIRCLE NO. 202

INFRA-RED TUNNEL OVENS

Free Catalog Describing Complete Line of Bench and Floor Models.

IR Radiant Energy, the newest stage of Product Heating Evolution. Ovens tuned to the matching absorptive wave length character of product chemistry. Produces clean, fast, dry heat. Has replaced batch Hot Air types. Every Lab must have one. Many sizes.

OAL ASSOCIATES, INC.
P.O. 64, Escondido, CA. 92025

CIRCLE NO. 203

RADAR SYSTEMS

TRACKING ANTENNA SYSTEMS

Nike Hercules, Nike Ajax, M-33, MPS-9, SCR-584, TPS-1E, TPS-20, FPS-6, FPS-14, FPS-18, FPS-75, UPX-6, MPO-10A, IBM 705 Computers, HUNDREDS MORE. LARGEST INVENTORY OF RADAR AND MICROWAVE EQUIPMENT IN THE WORLD.



RADIO RESEARCH INSTRUMENT CO.
3 QUINCY ST., NORWALK, CONN.
(203) 853-2600

Protect Your Heart HAVE REGULAR MEDICAL CHECK UPS



Give Heart Fund

Electronic Design

Advertising Sales Staff

Tom W. Carr, Sales Director

Rochelle Park, NJ 07662

Robert W. Gascoigne
Daniel J. Rowland
50 Essex Street
(201) 843-0550
TWX: 710-9990-5071

Philadelphia

Thomas P. Barth
50 Essex Street
Rochelle Park, NJ 07662
(201) 843-0550

Boston 02178

Gene Pritchard
P.O. Box 379
Belmont, MA 02178

Chicago 60611

Thomas P. Kavooras
Berry Conner, Jr.
200 East Ontario
(312) 337-5088

Cleveland

Thomas P. Kavooras
(Chicago)
(312) 337-5088

Los Angeles 90045

Stanley I. Ehrenclou
Burt Underwood
8939 Sepulveda Boulevard
Los Angeles, CA
(213) 641-6544

Texas/Oklahoma

Burt Underwood
(Los Angeles)
(213) 641-6544

San Francisco 94040

Robert A. Lukas
3579 Cambridge Lane
Mountain View, CA 94040
(415) 965-2636

London, Amsterdam, Tokyo, Seoul

John Ashcraft
12, Bear St.
Leicester Square
London WC2H 7AS England
Phone: 01-930-0525

W. J. M. Sanders
John Ashcraft & Co.
Herengracht 365
Amsterdam C., Holland
Phone: 020-24-09-08

Haruki Hirayama
Electronic Media Service
5th Floor, Lila Bldg.,
4-9-8 Roppongi
Minato-ku, Tokyo, Japan
Phone: 402-4556
Cable: Electronicmedia, Tokyo

Mr. O-kyu Park, President
Dongbo Int'l Corp.—
World Marketing
C.P.O. Box 4010
Seoul, Korea
Tel. 76-3910/3911
Cable: DONGBO SEOUL
Telex: EBKOREA K27286

ABP

BPA

Circuit Savers

DC **95¢** 1000 pcs.

TRANSIENT SUPPRESSOR

See GOLD BOOK Vol. 2 pg. 320-322

The TSD-1.5 Series are ideal for protection of long signal lines from damage from induced lightning etc. Reaction time is in nanoseconds.

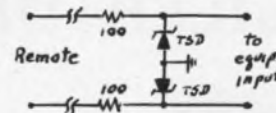

2 units (back to back) will protect sensitive components from a 5KV, 1ms duration transient. Clamp voltages from 5V to 200V. Call Mike Coyle for applications assistance. Full line of protection modules for every hi-lo voltage/current requirement. Write or call for Catalog 749,

279 Skidmore Road
Deer Park, New York 11729
Telephone: 516-586-5125

MCG Electronics

See Gold Book Vol 2, p. 320-322
INFORMATION RETRIEVAL NUMBER 79

Revolutionary Lithium Primary Batteries



For lighter, more compact, higher performance, and longer-lived portable electric and electronic equipment.

- 2.8 volts-per-cell nominal operating voltage—double ordinary batteries
- highest energy per unit weight and volume
- outstanding shelf life—5 years and more
- remarkable low-temperature performance, down to -65F
- continuous storage to +160F
- rugged, MIL spec qualified

Available in 10 standard cell sizes. Including standard 9-volt transistor size, "AA", "C", and "D". Designs for custom applications, too.

Write or phone for full specs on Eternacell® lithium batteries.

Power Conversion, Inc.
70 MacQueten Parkway South
Mount Vernon, N.Y. 10550 Telephone: 914-699-7333

INFORMATION RETRIEVAL NUMBER 80

CONNOR-WINFIELD's

NEW LOW PROFILE DIP CRYSTAL OSCILLATOR



Actual Size

MODEL S14R-2

FREQUENCY TOLERANCE:

±.01% from -25°C to +75°C

FREQUENCY RANGE: Available

4 MHz to 20 MHz

OUTPUT WAVEFORM:

Squarewave

85% of supply voltage

into a 10k Ω load

Duty Cycle 30/70 or better

SUPPLY CURRENT: 1 ma to 5 ma

TERMINATION: 14 pin DIP socket
pin diameter .02"

SUPPLY VOLTAGE: 5Vdc to 15Vdc

DIMENSIONS:

0.3" H x 0.5" W x 0.8" L

* SMALL SIZE

* LOW COST

* HIGH FREQUENCY

CONNOR-WINFIELD CORP



West Chicago,

Illinois 60185

Phone: (312) 231-5270

INFORMATION RETRIEVAL NUMBER 84

Advertiser's Index

Advertiser	Page	Advertiser	Page
A P Products, Inc.	135	Littelfuse, Subsidiary of Tracor	84H
AFS Precision Tools	134	LRC, Inc.	132
AMP, Incorporated	15	3M Company	98
Abbott Transistor Laboratories, Inc.	6	MCG Electronics	137
Airpax Electronics, Cambridge Division	114	MCL, Inc.	129
Alco Electronic Products, Inc.	119	Malco, A Microdot Company	23
Allen Bradley Co.	84D-E	Micro Devices Corp.	75
American Optical Corporation	123	Micro Networks Corporation	119
American Technical Ceramics	127	Microswitch, A Division of Honeywell	85
Amphenol RF Division, The Bunker-Ramo Coporation	103	Mini-Circuits Laboratory, A Division of Scientific Components Corp.	21
Angstrom Precision, Inc.	121	Motorola Semiconductor Products, Inc.	24, 25
Augat, Inc.	59	MuRata Corporation of America	119
Berg Electronics, Inc.	123	Nicolet Scientific Corp.	136
Bishop Graphics, Inc.	134	Nolatron Inc.	134
Browne Corporation	84	Optron, Inc.	7
Bud Radio, Inc.	32A	*Oscilloquartz SA	84H
Capitol Machine & Switch Co., Inc.	122	Permag	130
Centre Engineering	132	*Philips Industries, Electronic Components and Materials Division	84A
Circuit Technology, Inc.	125	*Philips Industries, Test and Measuring Instruments Dept.	84D-E
Clare & Co., C. P.	84G	Pilips & Bird, Inc.	131
Computer Automation, Inc.	32B-C	Power Conversion, Inc.	137
Conner-Winfield Corp.	138	Power/Mate Corp.	134
Continental Specialties Corporation	33 thru 52	Power Tech, Inc.	12
Control Switch, A Cutler-Hammer Company	121	Premier Metal Products Company	123
Curtis Industries, Inc.	99	Princeton Applied Research Corp.	132
Custom Devices	133	RCA Solid State	Cover IV
Custom Electronics, Inc.	130	Reader Service Card	140A-B
Cutler-Hammer, Specialty Products Division	64	Research Inc.	140
Dalc Electronics, Inc.	Cover II	Rockwell Microelectronic Device Division	56, 57
Data General Corporation	91	Rogers Corporation	134, 135
Datak Corporation, The	131	SGS Ates Semiconductor Corporation	84B
Decitek, A Division of Jamesbury Corp.	125	Sams & Co., Inc., Howard W.	13
Delco Electronics, Division of General Motors Corporation	8, 9	Schauer Manufacturing Corp.	116
Delta Products, Inc.	99	Semtech Corporation	29
Deltron, Inc.	118	Siemens Corporation, Special Components Division	84A
Dialight, A North American Philips Company	90	Signal Transformer Co., Inc.	107
EMR Telemetry, Weston Instruments, Inc.	135	Simpson Electric Company	69
Edmund Scientific Company	136	Sodeco	84B
Elec-Trol, Inc.	128	Solid State Scientific, Inc.	76
Electronic Design	13*, 32D	Solitron Devices, Inc.	109
Electronic Navigation Industries	18	Sprague Electric Company	117
FBE Research Company	134	Systron-Donner	133
GTE Automatic Electric	84F	TRW/IRC Resistors, an Electronic Components Division of TRW, Inc.	111
Gates Energy Products, Inc.	105	Tektronix, Inc.	31, 63, 65
General Electric Company, Miniature Lamp Products Department	131	Teledyne Crystalonics	55, 134
General Electric Company, Tube Products Department	84C	Teledyne Relays, A Teledyne Company	2
Gold Book, The	68, 139	Teledyne Semiconductor	66
Grayhill, Inc.	134	Teletype Corporation	10, 11
Hamamatsu Corp.	133	Texas Instruments, Incorporated	112
*Hayden Book Company, Inc.	84F-G	*Thomson CSF	84C
Hewlett-Packard	1, 14, 58, 77	USCC/Centralab Electronics Division, Globe-Union, Inc.	4, 5
Hughes Aircraft Company, Micro-Electronic Products Division	22	United States Department of Commerce	84H
Intech, Incorporated	124	Vactec, Inc.	97
Intel Corporation	16, 17	Victoreen Instrument Division, Shellar-Globe Corporation	115
Johanson Manufacturing Corp.	54, 134	Victor Electric Wire & Cable Corp.	126
Johanson/Dielectric, Inc.	136	Weston Components	128
Johnson Company, E. F.	Cover III		
Kepeco, Inc.	60		
Krohn-Hite Corp.	135		

*Advertisers in non-U.S. edition

IT'S WORKING FOR US



James F. Freeman

**'I know the
GOLD BOOK
gets to engineers
in Europe
... I was there'**

James F. Freeman is Marketing Director for Sylvan Ginsbury, Ltd., exporters and importers of electronic components and instruments.

Back from a recent business trip to Scandinavia, Europe and the Middle East, Mr. Freeman reports:

"Your GOLD BOOK is sure finding its way around the world. I saw it in Finland, Sweden, Denmark, France, Germany, Italy and Israel. I didn't expect to see it in technical and engineering offices. Technical people are referring to it. It gets around."

Sylvan Ginsbury, based in Teaneck, N.J., handles overseas sales for a string of American electronics companies, including Arnold Engineering, Clairex Electronics, KMS Optical Systems, Quan Tech, Solar Systems, Electro Corp., Stackpole Carbon Co. and Thomas Electronics.

Electronic Design's GOLD BOOK offers the largest circulation among European engineer/specifiers of any U.S. electronics publication and it's the only U.S. directory to go overseas in quantity—more than 13,000 copies in 1975. Another 78,000 copies went to engineers, engineering managers, distributors and purchasing agents throughout the USA. This is *Electronic Design's* audience at work!

**THE GOLD BOOK IS WORKING FOR
SYLVAN GINSBURY, LTD.
... IT CAN WORK FOR YOU!**

***Electronic Design's* GOLD BOOK is working. It's working for users and
it's working for advertisers, too.**

Here's all you need for computer/process interface!

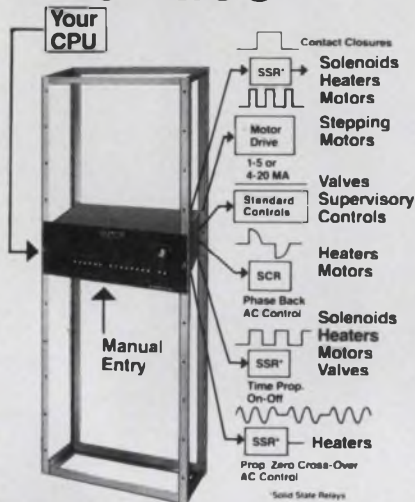

UNI-DRIVER, the one *stand-alone* interface between your computer and *all* commonly used final control elements. It maintains process control at the last command level, even with the computer shut down, and provides "back up" manual control.

Mix or match any combination of control cards to drive contactors, heaters, motors, pumps, power controllers, valves, set points, motor speeds, solenoids, shutters, louvers, fans, lamps, stepping motors, you call the shots. Up to 64 proportional outputs or 512 on-off outputs per Uni-Driver.

Eliminate a rack full of "black boxes!" Call collect (612) 941-3300 and ask for UNI-DRIVER! Also, ask about ANA-PLEXER. That's our combination Mux & A/D converter for sampling process control signals of almost any analog transducer or sensor. Directly interfaces with your CPU without external I/O.

184
 Direct Digital Control Division
RESEARCH INC
 BOX 24084 MINNEAPOLIS MINNESOTA USA 55424
 PHONE (612) 941-3300

Product Index

Information Retrieval Service. New Products, Evaluation Samples (ES), Design Aids (DA), Application Notes (AN), and New Literature (NL) in this issue are listed here with page and Information Retrieval numbers. Reader requests will be promptly processed by computer and mailed to the manufacturer within three days.

Category	Page	IRN	Category	Page	IRN
Components			preamplifiers	132	73
capacitor kits	137	80	pulse analyzer	133	74
capacitors	119	49	recorder	114	307
capacitors, ceramic	132	71	resistance substitution		
capacitors, chip	120	326	box	131	69
capacitors, chip	121	329	spectrum-analyzer,		
capacitors, mica	130	66	real time	135	77
indicators	90	35	timer/counter	115	308
miniature lamp catalog	131	251	white noise tester	114	306
photodetectors	97	37			
potentiometers	138	82	Integrated Circuits		
relays, reed	138	81	binary converter	127	345
resistor networks	121	53	CMOS, high-rel	76	32
resistors	115	45	counter, CMOS	126	342
resistors	11	351	crosspoint switch	127	346
resistors, cermet-film	121	328	HiNIL/microprocessor	66	28
resistors, precision	111	43	interface chip	126	343
switch, solid-state	85	231	microprocessing	57	23
switches	114	44	multiplier	126	344
switches	122	55	op amp	126	340
switches, DIP	15	12	preamp	126	338
switches, mini-rotary	119	50	RAM, 4-k CMOS	126	341
switches, pushbutton	119	51	RAMs, 4-k	17	13
switches, rocker	67	27	voltage reference	126	339
thermal cutoffs	75	31			
trimmers	111	247	Microwaves & Lasers		
vidicons	133	75	fiber optics catalog	123	56
Data Processing			Modules & Subassemblies		
computer/process			amplifier, rf	125	336
interface	118	48	controller, counter	125	337
computers	116	305	converter, d/a	124	302
computing calculators	59	25	converters, a/d	119	52
microcomputer	117	321	converters, a/d & d/a	124	60
microcomputer board	117	320	crowbars	137	79
microprocessor	118	323	electronic ignition	99	86
minicomputers	14	11	hybrid circuits	55	22
PROM eraser	118	325	hybrid microcircuits	125	61
printer control	118	322			
tape reader	125	62	Packaging & Materials		
terminal, CRT	118	324	assemblers, circuit	133	76
			breadboarding	32	220
Discrete Semiconductors			cable, flat	107	41
Darlingtons, power	122	331	connectors	103	39
FET, n-channel	122	332	connectors	123	59
hybrid chips	109	42	cord sets, wire & cable	127	63
interrupter modules	7	6	ferrites	130	67
rectifiers, reverse-switch	122	335	jumper, disconnect	123	58
suppressors, voltage	29	19	kit, processor	128	355
switches, MOSFET	122	330	latches, panel	128	354
transistor arrays	117	47	PC kit	131	70
transistors, epoxy	122	334	pins	123	57
transistors, high-gain	9	7	pins and sockets	23	17
transistors, power	122	333	sockets, IC	58	24
transistors, silicon	22	16	substrate, microwave	128	350
zeners	116	46	terminal blocks	99	38
Instrumentation			Power Sources		
amplifiers, broadband	18	14	batteries	105	40
audio freq			batteries	137	78
instrumentation	63	241	medical supplies	129	356
digital panel meters	69	30	open-frame source	129	358
electronics books	12	9	power generator	129	65
network analyzer	113	304	power modules	129	357
network analyzers	77	33	power supplies	6	5
oscilloscopes	65	243	power supplies	140	83
PC-board tester	115	309			



A whole new crop of trimmers to pick from.

Mature, fully developed, and at their peak. It's our family of ceramic trimmers.

All of them offer good stability, a variety of capacitance ranges, ceramic stators, linear tuning, and a precision rotor.

Our Micro-J Capacitor is the Cadillac of the group, and features high performance, monolithic design, and horizontal and vertical PC and stripline mounts.

Our Micro-K Capacitor is the newest member of the family. Tiny enough for quartz watches. And it has a precision lapped titanate stator and finely machined brass rotor.

Our 10mm model is low cost and mounts interchangeably with similar ceramic disc trimmers.

The 5mm type is even less expensive and can be used in the same applications as monolithic types where maximum stability isn't required.

Just send in the coupon for more information about our newest crop of trimmers. We think they're ripe for the times.

E. F. Johnson Co./ED 9/Waseca, MN 56093

Please send me technical information.

I desire test samples. Please call me at

()

Area Code

Name _____

Title _____

Firm _____

Address _____

City _____ State _____ Zip _____



E. F. JOHNSON COMPANY
WASECA, MINNESOTA 56093

What's new in solid state...

RCA high-voltage power transistors made our special way.



You already know RCA transistors for reliability and performance. But maybe you didn't know about our high-voltage, high-current, fast switching 2N6513, 2N6308 and 2N6251 families. Available off-the-

shelf, they're made with the special brand of advanced technology, process controls, device characterization and circuit performance you expect from RCA. Inventors of the workhorse 2N3055.

Our special way

These transistors have multiple epitaxial base structure and 4-layer pi-nu construction, for high voltage and energy-handling capabilities. Rugged clip-lead connections for reliability and high current-

handling. Plus a thermal cycling rating that helps you design for optimum reliability vs. cost. All of which makes these devices excellent choices for 20 kHz switching regulators and inverters. Motor switches. TV monitors. Hammer, solenoid and relay drivers. Electronic ignition.

Check the specs and competitive prices below. Contact your local RCA Solid State distributor. Or RCA. Write: RCA Solid State, Box 3200, Somerville, New Jersey 08876; Ste. Anne de Bellevue 810, Canada; Sunbury-on-Thames, U.K.; Fuji Bldg., Tokyo, Japan.

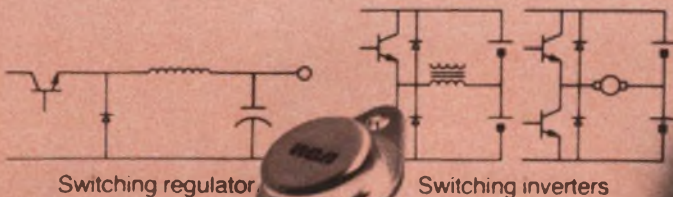

Coming soon.
A Super Switch.
 $t_r < 200$ nsec@6 amps.

	I_C amps	V_{CEr} volts	V_{CBO} volts	V_{CEO} (sus) volts	P_T watts	V_{CE} (sat) volts	t_r nsec	t_s μ sec	t_f nsec	100+ price
2N6513	7	400	400	350	120	1.5@4A	700@4A	3@4A	500@4A	\$4.44
2N6308	8	450	700	350	175	1.5@3A	600@3A	1.6@3A	400@3A	\$5.09
2N6251	10	375	450	350	175	1.5@10A	800@10A	1.8@10A	500@10A	\$6.84

RCA. Powerhouse in Transistors.