

Electronic Design.22

VOL. 23 NO.

FOR ENGINEERS AND ENGINEERING MANAGERS

OCT. 25, 1975

Big computers and mass storage systems continue to evolve. Today's large central processors and megabit cartridge memories contain much of the technology

and architecture that will appear in tomorrow's mainframe systems. Microprocessors will play a major role in these hardware designs. For the latest trends, see P. 34.



So good ... you can actually feel the difference!



BOURNS announces an ADVANCED building-block potentiometer...

... with a velvety smooth control feel that will enhance the quality image of your equipment. It's BOURNS® new Model 80 Building-Block potentiometer.

The Model 80 incorporates a unique new shaft torque control device which enables us to produce an advanced modular potentiometer with a smooth, consistent high quality "feel" ... regardless of the number of modules ganged on a single shaft (shaft torque only .3 to 2.0 oz.-in.).

MODULAR VERSATILITY, FACTORY ASSEMBLY

Bourns modular concept combines the design versatility of advanced building-

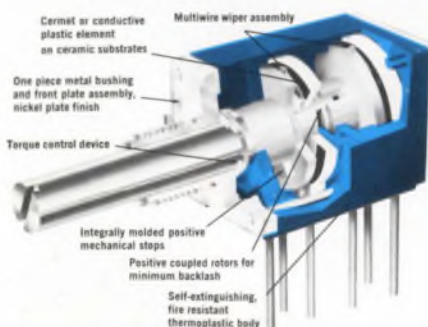

block construction ... with factory assembled reliability and quality control. All Model 80 potentiometers are built to your "prescription" by full-time production personnel, under the supervision and control of the industry's most respected quality assurance organization. High-volume assembly techniques, plus mass-produced modular components stock means fast delivery ... at competitive prices.

CERMET OR CONDUCTIVE PLASTIC

Bourns Model 80 is available with either cermet or conductive plastic elements in virtually all linear and non-linear tapers. Element types may be mixed in multiple section units. **INDEPENDENT LINEARITY IS $\pm 5\%$** ... offering more precise phasing of potentiometer output to panel calibration.

SUPER SETABILITY

A multifinger wiper and precise resistive ink formulations provide tight 1% CRV in both cermet and conductive plastic elements. This - combined with a smooth, no backlash feel - makes for easy, accurate operator settings.

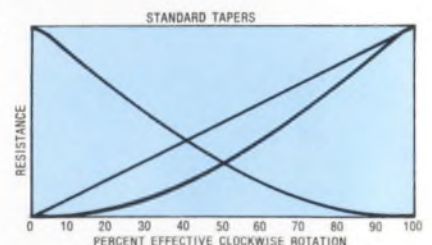

NO SHARP KNEE ON TAPERS

Model 80 audio tapers provide a smooth "knee", which allows improved setability within the crossover area on both cermet and conductive plastic.



FREE SAMPLES

Write on your company letterhead and tell us about your application. We'll send you the Model 80 that best suits your needs.



TRIMPOT PRODUCTS DIVISION

1200 COLUMBIA AVENUE, RIVERSIDE, CALIFORNIA 92507
 PHONE 714 684-1700 TWX 910 332-1252 CABLE BOURNSINC

The most accurate word in function generators is XCG.

When we introduced the first of the 180 Series last month, we said we hadn't told you everything. What we didn't tell you about is XCG.

Now it can be told [or XCG revealed]

XCG stands for xtal-controlled-generator — which stands for a degree of accuracy never before found in any function generator. In both the Models 181 and 183, generator output is locked to a crystal at up to 25 discrete points on the frequency dial. This means they will produce waveform frequencies with synthesizer accuracy of 0.01% of dial setting. When you dial a frequency, you know it's precise, and you don't need a counter to prove it.

The Model 181 XCG/Sweep Generator \$495

Besides being the most accurate function generator ever, the 181 is also a full sweeper — from 0.1 Hz to 2 MHz, with internal 1000 to 1 sweep. It provides sine, square, and triangle wave outputs (20V output p-p), as well as dc voltage, dc offset, and separate TTL output. And with full



More 180s from Wavetek.

attenuation, you get ultra-clean signals down to -50dB. The only way you can come close to this performance is to buy the Model 180, which gives you everything but XCG for only \$275.

The Model 183 5 MHz XCG/Sweep Generator \$695

As you can see, the Model 183 is a couple of hundred bucks more than the 181. Here's what that buys you: The 183 has a top frequency of 5 MHz, and provides continuous, triggered, and gated operation. For precise adjustment of continuous sweep, there's a control to individually set start and stop points. There's also a variable symmetry control and another for amplitude — down to -60 dB. All of this, plus XCG, add up to the most versatile and accurate function generator ever produced.

Our Conclusion

Now that you know something about the Wavetek 180s, you'll want to know more. So for complete specs or demonstration, just contact Wavetek, P.O. Box 651, San Diego, CA 92112. Or call (714) 279-2200.

WAVETEK[®]
INFORMATION RETRIEVAL NUMBER 2

Mini-Circuits' answer to holding down your costs of Double Balanced Mixers

Specify our model SRA-1...

1971 - \$7.95

SRA-1 (in 500 quantities)



1972 - \$7.95

SRA-1 (in 500 quantities)



1973 - \$7.95

SRA-1 (in 500 quantities)



Mini-Circuits Laboratory, now the world's largest supplier of double-balanced mixers, guarantees to maintain its famed low-price structure throughout 1975 and 1976. \$7.95 (model SRA-1, 500 quantity). You, the design engineer, have made this offer possible. Your large volume orders, from over 500 companies throughout the world, have enabled us to purchase our components and packages at lowest possible costs with guaranteed delivery schedules from our vendors. And we think it's appropriate to pass these savings to you. Need fast delivery? One week or better is routine; for your emergency needs, 24-hour turnaround is possible.

Our history of quality and performance is unmatched. All our units are unconditionally guaranteed for 1 year. Every Mini-Circuits employee, from the president to the final test operator, is committed to excellence in performance and quality for every unit produced. For reliability, performance and quality more and more systems engineers are specifying Mini-Circuits mixers as the industry standard.

1974 - \$7.95

SRA-1 (in 500 quantities)



1975 - \$7.95

SRA-1 (in 500 quantities)



STILL ONLY \$7.95 IN 1976

SRA-1 (in 500 quantities)



*\$9.95 (1-49)

SRA Series

Frequency Range (MHz)	Conversion Loss (dB) Total Range	Isolation (dB)						Price (Quantity)
		Lower band edge to one decade higher		Mid range		Upper band edge to one octave lower		
		LO-RF	LO-IF	LO-RF	LO-IF	LO-RF	LO-IF	
SRA-1 LO-0.5-500 RF-0.5-500 IF-DC-500	6.5 typ. 8.5 max.	50 typ. 35 min.	45 typ. 30 min.	45 typ. 30 min.	40 typ. 25 min.	35 typ. 25 min.	30 typ. 20 min.	\$9.95 (1-49)
SRA1-1 LO-0.1-500 RF-0.1-500 IF-DC-500	6.5 typ. 8.5 max.	50 typ. 45 min.	45 typ. 30 min.	45 typ. 30 min.	40 typ. 25 min.	35 typ. 25 min.	30 typ. 20 min.	\$11.95 (6-49)
SRA-1W LO-1-750 RF-1-750 IF-DC-750	6.5 typ. 8.5 max.	50 typ. 45 min.	45 typ. 30 min.	45 typ. 30 min.	40 typ. 25 min.	35 typ. 25 min.	30 typ. 20 min.	\$14.95 (6-49)
SRA-2 LO-1-1000 RF-1-1000 IF-0.5-500	6.5 typ. 8.5 max.	45 typ. 30 min.	45 typ. 30 min.	35 typ. 20 min.	35 typ. 20 min.	30 typ. 20 min.	30 typ. 20 min.	\$24.95 (1-24)

Frequency Range (MHz)	Conversion Loss (dB) Total Range	Isolation (dB)						Price (Quantity)
		Lower band edge to one decade higher		Mid range		Upper band edge to one octave lower		
		LO-RF	LO-IF	LO-RF	LO-IF	LO-RF	LO-IF	
SRA-4 LO-5-1250 RF-5-1250 IF-0.5-500	6.5 typ. 8.5 max.	60 typ. 40 min.	50 typ. 40 min.	40 typ. 20 min.	40 typ. 20 min.	30 typ. 20 min.	30 typ. 20 min.	\$26.95 (1-24)
SRA-3 LO-0.025-200 RF-0.025-200 IF-DC-200	6.5 typ. 8.5 max.	60 typ. 50 min.	45 typ. 35 min.	45 typ. 35 min.	40 typ. 30 min.	35 typ. 25 min.	30 typ. 20 min.	\$12.95 (6-49)
SRA-6 LO-0.003-100 RF-0.003-100 IF-DC-100	6.5 typ. 8.5 max.	60 typ. 50 min.	60 typ. 45 min.	45 typ. 30 min.	40 typ. 25 min.	35 typ. 25 min.	30 typ. 20 min.	\$19.95 (5-24)
SRA-8 LO-0.005-10 RF-0.005-10 IF-DC-10	6.5 typ. 8.5 max.	60 typ. 50 min.	60 typ. 50 min.	50 typ. 40 min.	50 typ. 40 min.	45 typ. 35 min.	45 typ. 35 min.	\$24.95 (5-24)

Common specifications for all models:
Signal: 1 dB compression level: 1 dBm
Impedance: all ports 50 ohms
Phase detection: DC offset: 1 mV typical
DC polarity: negative

For complete product specifications and U.S. Rep. listing see MicroWaves' "Product Data Directory," Electronic Design's "Gold Book" or Electronic Engineers Master "EEM"

Mini-Circuits Laboratory
A Division Scientific Components Corp

837-843 Utica Avenue, Brooklyn, NY 11203
(212) 342-2500 Int'l Telex 620156 Domestic Telex 125460

Foreign Sales Representatives: AUSTRALIA General Electronic Services, 99 Alexander Street, New South Wales, Australia 2065; ENGLAND Dale Electronics, Dale House, Wharf Road, Frimley Green, Camberley Surrey; FRANCE S. C. I. E. - D. I. M. E. S., 31 Rue George - Sand, 91120 Palaiseau, France; GERMANY, AUSTRIA, SWITZERLAND Industrial Electronics GMBH, Klüberstrasse 14, 6000 Frankfurt/Main, Germany; ISRAEL Vectronics, Ltd., 69 Gordon Street, Tel-Aviv, Israel; JAPAN Denso Kaisha, Ltd., Eguchi Building, 8-1 Chome Hamamatsucho Minato-ku, Tokyo; EASTERN CANADA B. D. Hummel, 2224 Maynard Avenue, Utica, NY 13502 (315) 736-7821; NETHERLANDS, BELGIUM, LUXEMBOURG: Coimex, Veldweg II, Hattem, Holland

US Distributors: NORTHERN CALIFORNIA Cain-White & Co., Foothill Office Center, 105 Fremont Avenue, Los Altos, CA 94022 (415) 948-6533; SOUTHERN CALIFORNIA, ARIZONA Crown Electronics, 11440 Collins Street, No. Hollywood, CA 91601 (213) 877-3550

For complete U.S. Rep listing and product line see MicroWaves' Product Data Directory

NEWS

- 21 **News Scope**
- 34 **Computer special issue**, featuring current trends in computer technology. Topics covered include: The radical changes that are taking place which will determine tomorrow's large computer systems; mass-memory storage systems that are capable of storing several billion bytes at high speed and relatively low cost; the increasing use of floppy discs, cartridges and fixed hard discs; the upsurge in medium-speed printers and the emphasis on various hardware/software aids used in microprocessor design.
- 29 **Washington Report**
-

TECHNOLOGY

- 86 **FOCUS on CRT terminals**: It is all too easy to misspecify a CRT display terminal. Clear up the confusion and select the right terminal for your computer.
- 96 **Microprocessors simplify industrial control systems**. Examples show how the LSI chips can lower costs and increase flexibility of process controllers.
- 102 **Checking microprocessors?** A lack of standards and equipment makes the μ P as hard to test as it is to choose. Look into four test methods to get started.
- 108 **Agc extends the range of a/d converters**. Use the computational power of a minicomputer and save a great amount of hardware in implementing the agc.
- 114 **Use autoranging amplifiers** to boost the accuracy of computerized data-acquisition systems. Four comparators and some CMOS switches are all that's needed.
- 120 **How long a wait for computer response?** Nomographs of queuing equations provide transaction time or the allowable number of terminals for a given response time.
- 126 **Ideas for Design**:
Voltage-to-frequency converter preserves polarity of input.
MOS alarm-clock chip drives gas-discharge display directly.
Inverter uses ferrite transformer to eliminate cross-conduction.
Linear bar graph constructed with sequentially lighted LEDs.
- 134 **International Technology**
-

PRODUCTS

- 137 **Data Processing**: Processor family debuts: 16-bit μ P to full-blown mini, with software support.
- 142 **Modules & Subassemblies**: Modular v/f converter series offers choice of six models.
- 146 **Modules & Subassemblies**: Phase-control power modules handle 25 A at up to 240 V rms.
- 164 **Integrated Circuits**: Monolithic v/f converters deliver signals with 0.05% linearity.
- 172 **Power Sources**: Miniature HV supply gives full regulation.
- | | |
|-----------------------------|-------------------------|
| 154 Discrete Semiconductors | 182 Components |
| 176 Instrumentation | 186 Microwaves & Lasers |
| 178 Packaging & Materials | |
-

DEPARTMENTS

- 83 **Editorial**: Suddenly, the rest of the world died.
- | | |
|--------------------|--------------------------------|
| 7 Across the Desk | 196 Advertisers' Index |
| 187 New Literature | 198 Product Index |
| 190 Design Aids | 200 Information Retrieval Card |
| 191 Vendors Report | |

Cover: Photo courtesy of IBM.

The 6011A Time

Try setting frequencies and amplitudes fast and accurately with your oscillator/counter/level meter set-up. Now try it with the new Fluke 6011A Signal Generator. We called up nine different frequency and amplitude combinations in just four seconds.



Clock Challenge:

Spend more time testing, less time turning knobs.
Dial 800-426-0361 toll-free or circle #274 for
a fast demo.

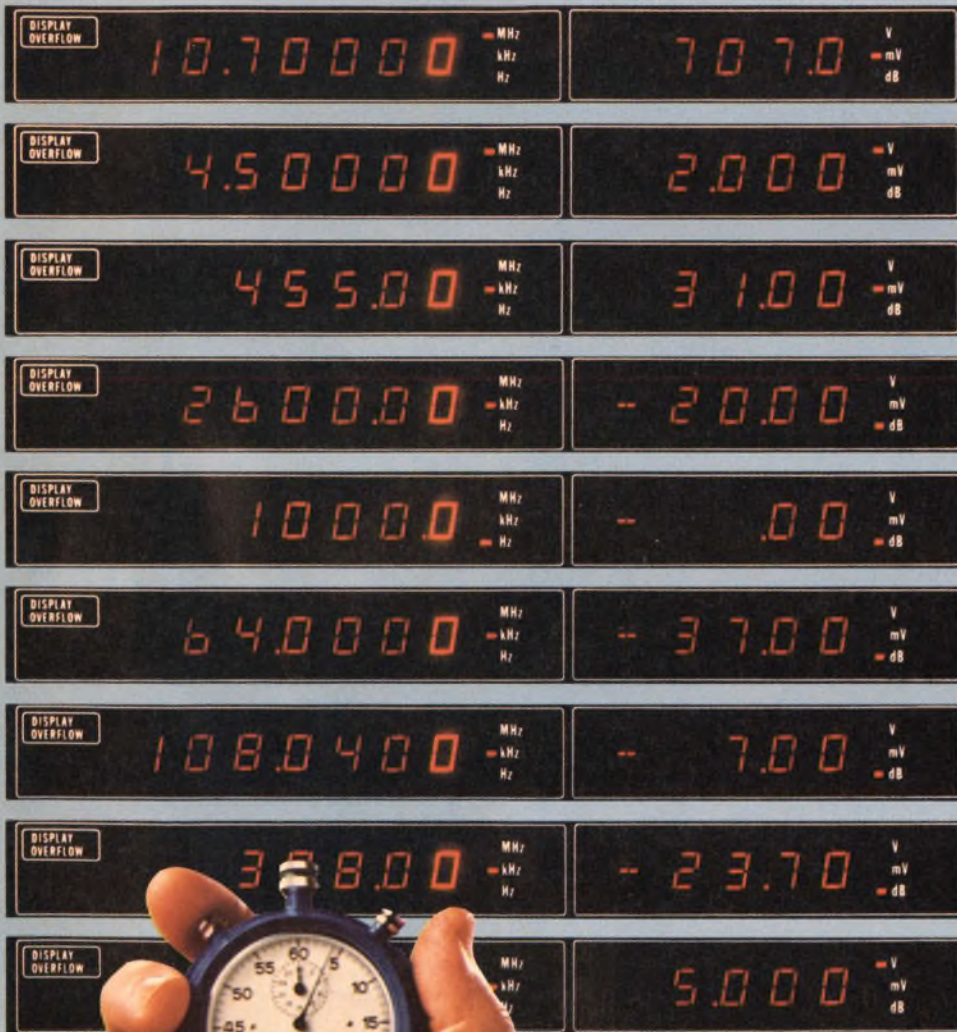

And that's just the beginning. Not only does the 6011A store and recall up to nine different frequencies and levels, but the output can be edited, limited and modulated. You can program voltage and frequency deviations about any desired reference.

Give the 6011A a try. You'll find more signal generator power, performance and flexibility at your fingertips than ever before.

Take yourself out of the loop.

The 6011A stores up to nine different frequencies and associated amplitudes (voltages or dBm). You call them back via keyboard control. Use the EDIT CONTROL to tune level and frequency just like on a conventional generator. Set frequencies to 3 ppm, levels to ± 0.05 dB. Range is 10 Hz to 11 MHz. Maximum open circuit output voltage is 28.28 volts peak-to-peak. Frequency response is flat to within ± 0.025 dB from 100 Hz to 5 MHz.

Yes, it has a microprocessor. The microprocessor means the 6011A economically listens to IEEE 488, RS-232-C or Fluke defined parallel ASCII interfaces.

The price is \$3,995.* That's a good 40% less than anything remotely comparable.

For a "hands on" demo soon, dial 800-426-0361 toll-free today. Or if more convenient, write us or use the reader service card. For a demo circle #274
For literature #275

* U.S. price

FLUKE

John Fluke Mfg. Co., Inc.
P.O. Box 43210
Mountlake Terrace, WA 98043



Johnson fills the price-performance gap with connectors in 3 sizes.

Between the high-cost MIL spec connectors and low-cost, low-performance types, you'll find Johnson miniature rectangular connectors. And now, you'll also find 3 models in 36, 23 and 14 contact sizes.

Johnson connectors are superbly and simply designed for high performance applications such as communications, instrumentation and industrial control. Contacts are nickel silver, available with either solder or crimp type terminals, recessed in the housing to provide proper mating and protection. Contacts may be removed with a simple tool. Available with or without jackscrews to provide maximum vibration resistance. A nylon hood gives positive cable strain relief. U. L. recognized.

We think our connector line nicely fills the price-quality gap. Like to see if it will fill the bill in your application? Just send in the coupon for more information.

E. F. Johnson Company
3005 Tenth Ave. S.W./Waseca, Minnesota 56093 ED 10

Please send me technical information on your rectangular connectors.

I want test samples. Please call me at _____

Name _____

Title _____

Firm _____

Address _____

City _____ State _____ Zip _____



E. F. JOHNSON COMPANY
WASECA, MINNESOTA 56093

Sr. Vice President, Publisher

Peter Coley

Editors

Editorial Offices
50 Essex St.
Rochelle Park, NJ 07662
(201) 843-0550
TWX: 710-990 5071
Cable: Haydenpubs Rochellepark

Editor-in-Chief George Rostky

Managing Editors:

Ralph Dobriner
Michael Elphick

Associate Editors:

Dave Bursky
Jules H. Gilder
Morris Grossman
John F. Mason
Stanley Runyon
Edward A. Torrero

Contributing Editors:

Peter N. Budzilovich
Alberto Socolovsky
Nathan Sussman

Editorial Field Offices

East

Jim McDermott, Eastern Editor
P.O. Box 272
Easthampton, MA 01027
(413) 527-3632

West

David N. Kaye, Senior Western Editor
8939 S. Sepulveda Blvd.,
Suite 510
Los Angeles, CA 90045
(213) 641-6544
TWX: 1-910-328-7240

Editorial Production

Marjorie A. Duffy

Art

Art Director, William Kelly
Richard Luce
Anthony J. Fischetto

Production

Manager, Dollie S. Viebig
Helen De Polo
Anne Molfetas

Circulation

Manager, Evan Phoutrides

Information Retrieval

Peggy Long

Promotion, Creative Layouts

Manager, Albert B. Stempel
Maxine Correal
Nancy Gordon (Reprints)

Across the Desk

Management training by experts defended

Re: John Fluke's article, "Training Engineering Managers," (ED No. 11, May 24, 1975, p. 88). In general, I am very much in agreement with what he has to say, including his tree-climbing analogy of the Peter Principle. However, I do have some critical comments.

First of all, there are some assessment centers around the country that have been highly successful in predicting managerial performance in individuals. Secondly, schools are beginning to teach management to undergraduate engineering students. A. S. Gilmour Jr. of the State University of New York at Buffalo discussed this at Intercon 75 in a session entitled "The Engineer in Transition to Management."

Thirdly, Mr. Fluke's seemingly haphazard approach to management training is probably a waste of time. If he is having trouble developing managers, he should consider hiring an Organizational Development specialist. OD is a very new field, but its successful efforts are numerous. A good example of what it can do is seen in the many case studies written about TRW Systems.

George S. Pristach, P.E.
87-56 Francis Lewis Blvd.
Queens Village, NY 11427

The author replies

In answer to Mr. Pristach, I don't believe I ruled out identification of management potential in young engineers, because it can be very useful indeed. However, I think some of my thoughts are more

basic than Mr. Pristach gleaned from my remarks. Perhaps I can make my point this way:

Soon after graduation, a great many young engineers will be called on to manage technicians or other engineers—perhaps at the outset, only one or two technicians or engineers. They will also have to interrelate with other support people in the engineering process, and the training I am seeking will help these young engineers relate with such people. Without such training, they may not be able to use an otherwise excellent technical education.

I am by no means suggesting that management training be instituted in engineering schools to prepare students to become general executives or chief executives. However, in later years, the foundation I suggest could be helpful toward preparation for management.

John M. Fluke
Chairman

John Fluke Mfg. Co., Inc.
Mountlake Terrace, WA 98043

An 'excellent' guide to miniature relays

How true your relay article "Focus on Miniature Relays" is (ED No. 11, May 24, 1975, pp. 56-64) in stating there is widespread confusion in relay terminology. An excellent guide to relay selection and application that you failed to mention is MIL-STD-1346, "Relay Selection and Application," available for the asking from the Naval Supply Depot, 5801 Tabor Ave., Philadelphia, PA 15120.

(continued on page 10)

Electronic Design welcomes the opinions of its readers on the issues raised in the magazine's editorial columns. Address letters to Managing Editor, Electronic Design, 50 Essex St. Rochelle Park, N.J. 07662. Try to keep letters under 200 words. Letters must be signed. Names will be withheld on request.

Thin-Trim[®] capacitors



Tucked in the corner of this Pulsar Watch is a miniature capacitor which is used to trim the crystal. This Thin-Trim capacitor is one of our 9410 series, has an adjustment range of 7 to 45 pf., and is .200" x .200" x .050" thick. The Thin-Trim concept provides a variable device to replace fixed tuning techniques and cut-and-try methods of adjustment. Thin-Trim capacitors are available in a variety of lead configurations making them very easy to mount.

A smaller version of the 9410 is the 9402 series with a maximum capacitance value of 25 pf. These are perfect for applications in sub-miniature circuits such as ladies electronic wrist watches and phased array MIC's.

Johanson Manufacturing Corporation,
Rockaway Valley Road., Boonton, N.J.
07005. Phone (201) 334-2676, TWX 710-987-8367.

Johanson

Keep up with solid-state



Upgrade isolation with 5,000 V couplers



The next step up in isolation protection of small signal/logic circuitry is here — and what a state-of-the-art step it is!

The new MOC1005/1006 optical couplers offer 5,000 V *minimum* isolation in applications where spikes and high energy transients from the

power side can zap control and logic parts.

That's 2,500 V more than usually available.

And, the protection of isolation doesn't degrade or disappear over time. Revolutionary new construction techniques make that a certainty.

Much larger light pipe periphery . . . new, improved molding compounds . . . matched thermal expansion coefficients and long voltage creepage paths combine to form an inherently reliable package unaffected by ionization, voids, cracking, etc., that degrade performance to a fraction of spec over long term.

Isolation testing proves that out.*

We've tested samples at 5,000 V dc for 1,000 hours. No failures.

We've tested samples at 1,500 V peak ac for 1,000 hours.

No failures.

We're even pushing samples through an entire matrix of life and environmental testing that will soon document what we've been telling you all along

— MOC1005/1006 couplers ensure voltage isolation to levels and lifetimes never before attained . . . with no failures.

Keep your logic clean, pure and protected with the patent-applied-for MOC1005/1006 optical isolators. Shut down transients before they start between CMOS, MPU, small signal discrete or T²L and ac, dc or motors at a price of just \$2.00, 100-up.

And watch for the same state-of-the-art upgrade in all Motorola couplers. Now it's the only way to go.

*Isolation ratings on couplers are transient protection ratings . . . milliseconds, microseconds or, at most, a few seconds. We've stressed these couplers much beyond recommended operating conditions, only to prove the integrity of the new 5,000 V units — with outstanding results!

Circle No. 251

from Motorola,

What?! Another '3055 replacement...??

Yeah, but THIS one's a DARINGTON! And, it's got 2,000 min GAIN at 4 A!! And, it costs LESS than both 2N3055 and 2N3054 driver!

The industry's got a lot of '3055 drop-in replacements floating around, some with better specs, some with worse, some with price advantages and little else . . . but none with all that's going for the 2N6576-78 Epi-Base* Darlingtons.

Costing just \$1.05, 50-up, or about 50% less than the standard '3055 and '3054 driver, the 60-120 V family offers complete switching specs, including all max t_n parameters at a 10 A, 2% duty cycle — 4 MHz f_T (opposed to 0.8 MHz for the '3055) — excellent SOA — and the inherent desirable capability of being directly driven off low level logic.

To gain economical command in milliampere-to-ampere audio, regulator and switching circuits where the call for minimum space/heat sinking, assembly time and components is heard, you need the 2N6576-78s. We'll send data sheets that answer. Understand, we're not saying the 2N3055 is dead. But the day is near...

*Trademark of Motorola Inc.

Circle No. 254

Thermowatt thyristors take total charge

The really exciting thing about plastic Thermowatt* SCRs isn't broadened capability to handle 12 and 16 A . . . or expanded flexibility for applications to 800 V . . . or inclusion of 100, 300, 500 and 700 V "in between" ratings so you don't over- or under-buy . . . or even the fact you can send thousands of watts through them in control designs.

What's exciting is reliability. Reliability head and shoulders above others. Reliability promising to headline a new direction in plastic thyristor fabrication. Reliability that's spelled GLASSIVATION on all Motorola plastic thyristors.

We've taken a total look at integrated die and package, hammered samples through power cycling



CMOS takes the "dial" out of pulse dialing

A pair of new McMOS MSI subsystems will soon take the "dial" out of telephone pulse dialing. The MC14419 Keypad-to-Binary Converter and the MC14409 Binary-to-Pulse Converter, scheduled for October introduction, team up in keypad pulse dialing systems.

The MC14419 interfaces directly with a 2-of-8 keypad and generates the binary number equivalent of the number activated. The 4-bit binary code is converted to a pulse train for conventional telephone equipment by the MC14409.

Each finds other applications in its own right . . . the MC14419 as a keypad encoder and the MC14409 for computer automatic dialing. MC14409 capabilities allow pulsing of 16-digit numbers and number redialing.

Prices are right, too: MC14419 is just \$3.00 in plastic, \$3.90 in ceramic. The MC14409 will be introduced under \$7.50 and \$9.50 in the same 16-pin packages.

Circle No. 253

CMOS 0-600 bps MODEM ties directly to phone line

Because there are no handshaking or telephone signalling interface requirements, Motorola's McMOS MC14412 MODEM is ideal for a direct tie to the telephone line in dedicated private line applications.

The MC14412 is a low cost, universal, low speed, low power, single supply MODEM in a space saving 16-pin package. It has a complete frequency-shift keying modulator and demodulator compatible with both U.S. and International (C.C.I.T.T.) communication networks. Selectable data rates are 0-200, 0-300 and 0-600 bps.

An on-chip oscillator reduces external components and the Self Test Mode simplifies evaluation and incoming inspection. The MODEM has originate and answer modes, and simplex, half-duplex and full duplex operation.

Low 100-999 prices are \$19.99 for the 4.75-15V FL version and just \$15.00 for the 4.75-6V VL type.

Circle No. 255



and 9 other electrical, mechanical and thermal tests and documented results in "Thyristor Reliability for Consumer and Industrial Equipment." Our leadership in plastic thyristor reliability is now undeniable. We'll send a copy plus new "Guide to Thyristors" when you . . .

Circle No. 252

dynamic
the semiconductor source.



**HI-YO,
SILVER,
AWAY!**

Now! Type 135D Tantalum-Cased Wet-Anode Tantalum Capacitors for Space Age Reliability

Sintered-anode capacitors with tantalum instead of conventional silver cases! The new Sprague Type 135D Tantalex® Capacitor is a breakthrough in the art of manufacturing gelled-electrolyte, sintered-anode, hermetically-sealed tantalum capacitors.

This unique construction feature eliminates the problem of possible silver migration caused by reverse voltages or excessive ripple currents that result in ultimate short-circuits from silver case to anode.

With a 3-volt reversal capability, Type 135D Tantalex® Capacitors also withstand high ripple

currents and high vacuum conditions without any degradation in function or appearance.

The Sprague-perfected true glass-to-tantalum hermetic seal is welded to the case rather than being soldered in the conventional manner, another feature which contributes to a shelf life in excess of ten years.

This all-tantalum capacitor was developed by Sprague under partial sponsorship of NASA, providing space age reliability that cannot be matched . . . Sprague's military equivalent, Style CLR79, is the only capacitor approved to meet MIL-C-39006/22A.

For complete technical data, write for Engineering Bulletin 3760 to: Technical Literature Service, Sprague Electric Co., 347 Marshall St., North Adams, Mass. 01247.



THE BROAD-LINE PRODUCER OF ELECTRONIC PARTS

INFORMATION RETRIEVAL NUMBER 8

ACROSS THE DESK

(continued from page 7)

In Fig. 2 on p. 61 of the Focus report, where relay coil arc suppression methods are shown, the polarity marks should be deleted for both the shorted bifilar winding method and the back-to-back zener diode method. The text states the latter is not polarity-sensitive. A word of caution should be added that a straight diode across the coil of a relay not only increases the release time, as you stated, but can also materially decrease the life of the contacts.

Incidentally, the proper designation for a diode is CR and not D (see ANSI Y32.16, which superseded MIL-STD-16).

E. U. Thomas

Chairman SAE A-2R

Society of Automotive Engineers, Inc.

Grumman Aerospace Corp.
Bethpage, NY 11714

Misplaced captions



"Sure we can get to The Velvet Turtle and back before the break is over."

Sorry. That's Pierre Cot's "The Storm," which hangs in The Metropolitan Museum of Art in New York City.

(continued on page 14)

Amphenol's **MERLIN™**
 is lighter, shorter, and
 more reliable than most
 other MIL-C-26482/0026482/83723
 connectors.

That takes guts:

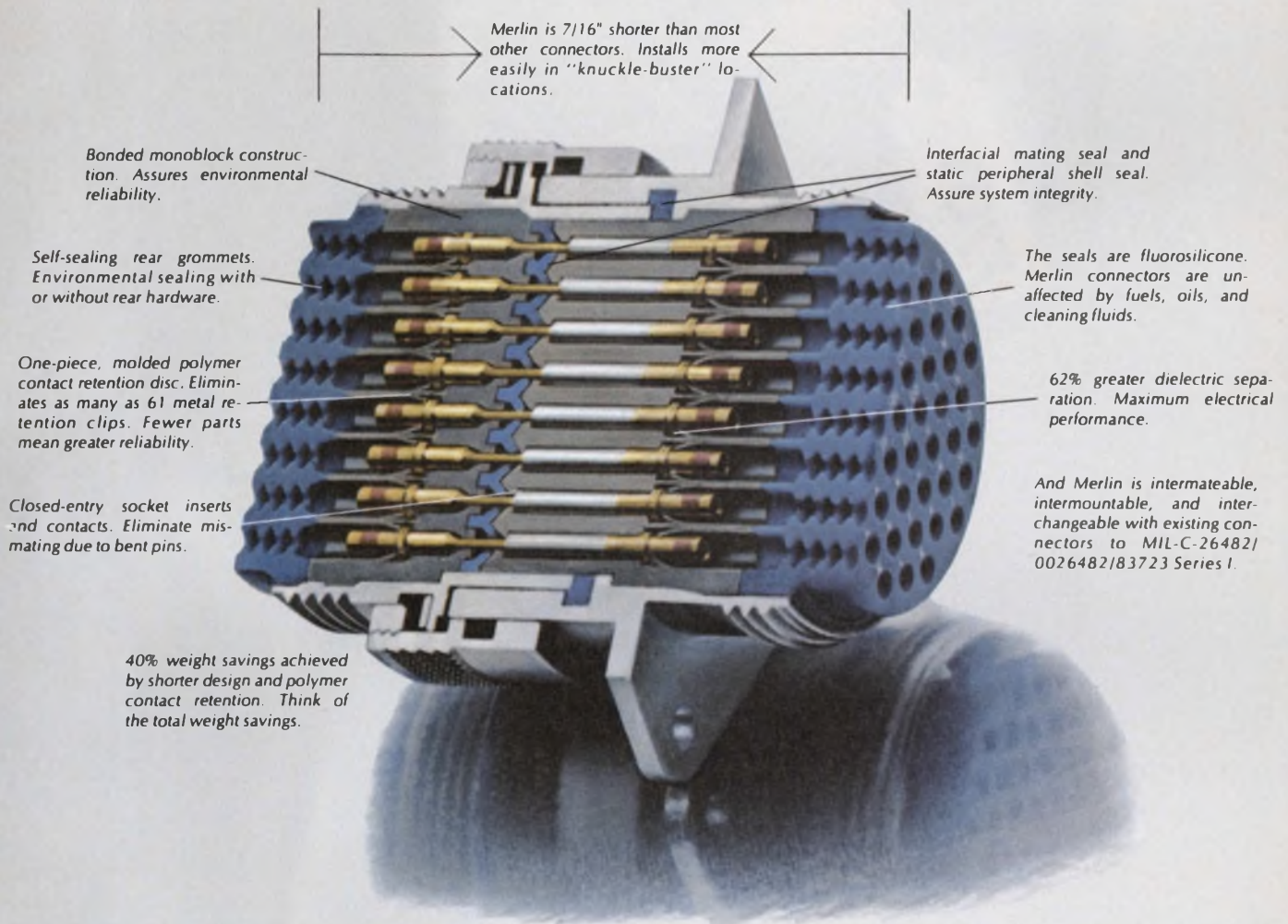

Merlin — a quality connector you can connect and forget. At a competitive price. Ask for a quotation. Most sizes and styles are available, off-the-shelf, from your Amphenol Industrial Distributor. Or call or write: Wayne Zimmerman, Amphenol Connector Division, 2801 South 25th Avenue, Broadview, Illinois 60153. Phone: (312) 345-9000.



*When you can connect it
 and forget it... that's quality.*

AMPHENOL

What our bottom-of-the-line

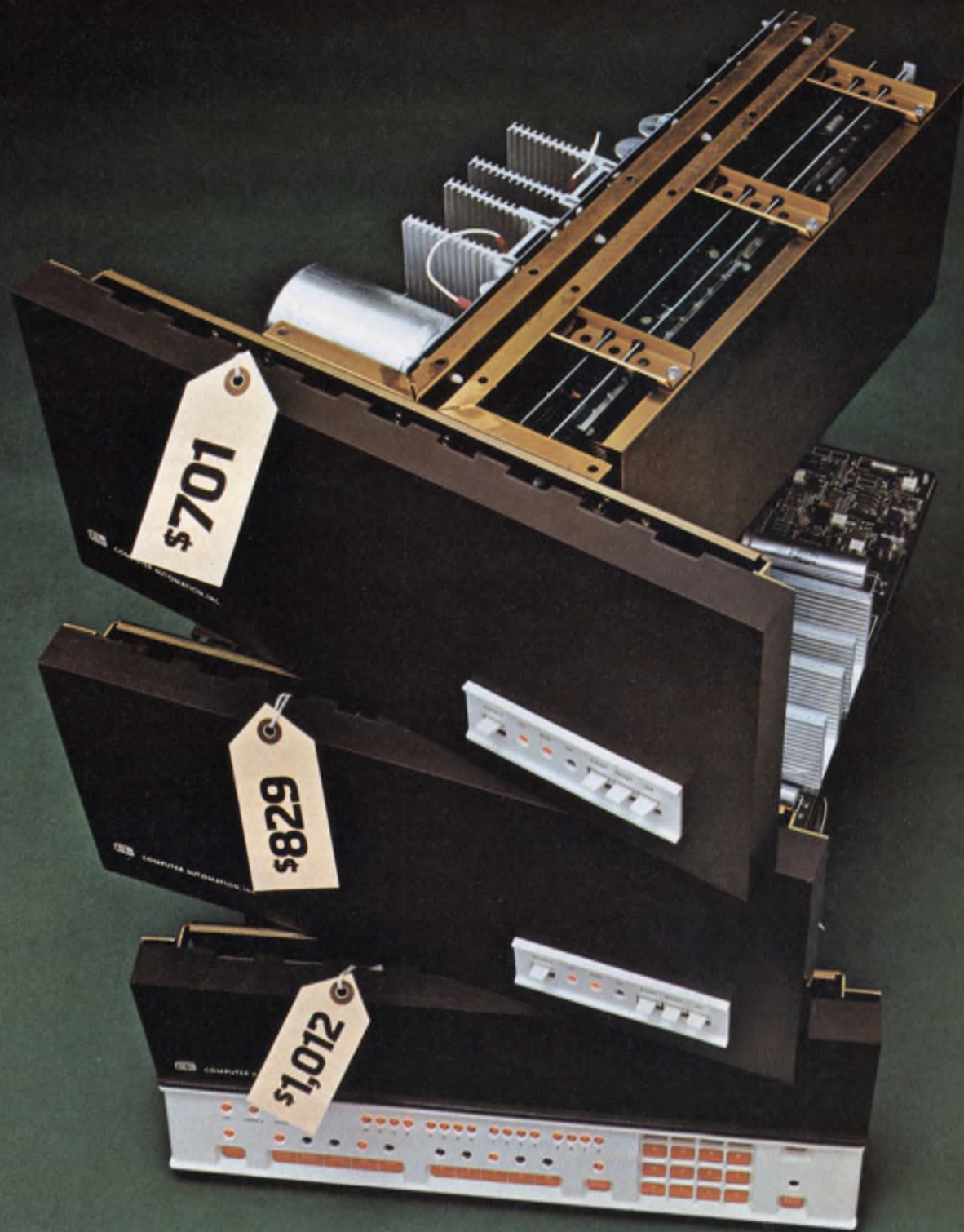

The New ALPHA™ LSI-3/05

Introducing the lowest priced, 16-bit, full-scale, fully compatible, packaged computers in the world.

can do for your bottom line.

Stack the new ALPHA LSI-3/05 millicomputer up against any other low-end computer.

Preferably while you're sitting down, because on price alone, you're bound to be astounded.

Ready? \$701 total packaged price. And that's complete with 256 words of MOS RAM, and a CPU that offers a really powerful instruction set, Power Fail Restart, Real-Time Clock and Autoload capability.

Try to buy an equivalent computer at twice the price.

Have it your way.

You also get the capability to configure your computer pretty well the way you want it. A choice of packaging, of course, that includes either the Operator's or the Programmer's Console, power supplies and so on.

A choice of two standard I/O options.

And a choice of optional memory configurations that



Maxi-Bus compatible ALPHA LSI-3/05 achieves unprecedented cost-effectiveness with ComputerAutomation's new Distributed I/O System.

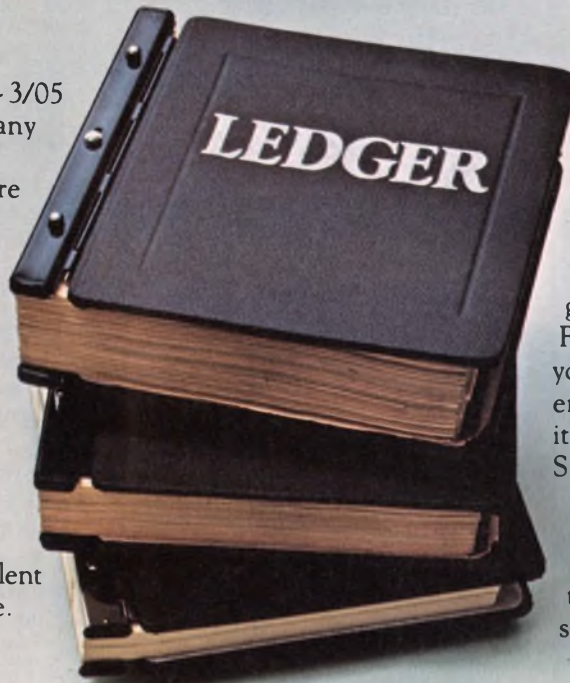

include RAM/ROM, RAM/EPROM and RAM-only in sizes from 256 words all the way up to 32K words. Totally addressable.

Family connections save you still more money.

So far, what we've been talking about could easily add another five or six figures to the bottom line of your ledger.

But there's more. Really big savings on off-the-shelf software, peripheral controllers and I/O interfaces.

The reason is that the ALPHA LSI-3/05 millicomputer is a full-fledged member of ComputerAutomation's LSI Family... Maxi-Bus compatibility and the whole works. So, every piece of Family hardware we've ever developed will work like it was made for the ALPHA LSI-3/05. Including ComputerAutomation's exclusive new Distributed I/O System... just like you see it in the picture.

With this versatile interface system, you can interface virtually any kind or combination of peripherals. Parallel or serial. Just by plugging them in.

Your cost? Probably less than \$200 per interface.

The pros know.

Computer-wise OEM's will tell you that product requirements sooner or later get ahead of the hardware. For instance, the computer you buy today may not have enough I/O or memory capacity for tomorrow's Mark II Super Widget.

Then you'll have to scrap all your software and your interface designs, because they're not about to work on some other machine.

You lose.

Of course, with our LSI Family of compatible computers you don't.

You can switch to a different CPU or a different memory anytime. Faster, slower, bigger, smaller. The electrical interface will still be the same; the original programming will still work.

You win.

From the people who brought you the NAKED MINI®

And the NAKED™ MILLI. And the Distributed I/O System. And the PICOPROCESSOR.

And now the ALPHA LSI-3/05 millicomputer.

One cost breakthrough after another. Breakthroughs that didn't just happen... a lot of profits got plowed back into R&D.

But then, that's the price of leadership.

 **ComputerAutomation**
NAKED MINI Division

U.S.A. 18651 Von Karman, Irvine, CA 92664
(714) 833-8830

EUROPE 31/35 Clarendon Road, Watford,
Hertfordshire, WD1. IJA England (0923) 39627

MORE
COMPANIES
BUY
WIRE-WOUND
RESISTORS
FROM
RCL
THAN
FROM
ANYONE
ELSE
ON
EARTH

Write for
catalog



Call our hotline for prompt
service and delivery.

(603) 627-3831

AMF

RCL Electronics

195 McGregor St.

Manchester, N.H. 03102

ACROSS THE DESK

(continued from page 10)

The ultra-ultimate: Ugaritic snobbery

If you're going to flaunt your knowledge in an editorial ("The Foreign Engineer," ED No. 4, Feb. 15, 1975, p. 45), please be advised that quoting de Maupassant in Sanskrit is the ultimate among cultural snobs. Or perhaps translating Proust into Ugaritic?*

Jack Heller

General Electric Co.

Nela Park

Cleveland, OH 44112

*Ugaritic—The Semitic language of ancient Ugarit, closely related to Phoenician and Hebrew.

Another thermometer with digital readout

The article "Hand-Held IR Thermometer Has Digital and Analog Displays" (ED No. 14, July 5, 1975, p. 77) indicates that the closest competing unit is the Heat Spy from Wahl and that it is the only other hand-held digital-readout IR thermometer on the market. Williamson Corp. also manufactures noncontact temperature-measuring instruments and has a unit with digital readout—the Williamson ViewTemp 2000 Series.

W.R. Barron

Vice President, Marketing

Williamson Corp.

1152 Main St.

Concord, MA 01742

Who'll tell the boss he's lost his buttons?

Re: "My Secretary's Pants," (ED 18, Sept. 1, 1975, p. 47).

You came close to a problem I have. My boss has a different conception of what constitutes a problem. When biz gets slow, he invents problems for all to solve. No one has enough guts to call him psychotic and to refuse to do his bidding, for fear that as his boss is also psychotic, we might all be fired. Seems to me that too many bosses who have to justify their own existence are part of the U.S.

blight. Keep swinging.

P.S. Wish my secretary would shed her pants so easily.

Ed note: For obvious reasons, this man prefers to remain anonymous.

And yet another bipolar processor

I have just read your article in the Aug. 16 issue on new logic circuits ("Semi Firms Speed Up Drive to Develop New Logic Circuits," ED No. 17, p. 24). Your otherwise excellent article neglected to mention the SMS MicroController, a single-chip, 8-bit bipolar microprocessor (not a slice). The chip has been available since January in our MicroController systems and since July as a component in a 48-lead DIP.

Further information may be obtained from Tal Hurant, (415) 964-5700.

William J. Price

Manager IC Engineering

Scientific Micro Systems, Inc.

520 Clyde Ave.

Mountain View, CA 94043

Datran clarifies 'certain errors'

In regard to an article in the June 21 issue relating to changing patterns in telecommunications ("Designers Adapt as Traffic Begins to Shift to a Mix of Speech and Data," ED No. 13, June 21, 1975, pp. 44-50), I would like to call certain errors to your attention as they relate to Datran and the services it is providing.

The radios we are using in the Datran system were manufactured for us by Nippon Electric Co., not Fujitsu, as your article stated. The 3-sec response time to which the article referred is the 95% probability level in the busy hour. The mean busy-hour response is less than 1 sec. On the Datran all-digital backbone presently operating between Houston and Chicago, we guarantee short-term performance of 99.95% error-free seconds, not 99.5%, as reported.

Ned Farinholt, Manager
Market Planning

Data Transmission Co.

8130 Boone Blvd.

Vienna, VA 22180

CELCO makes "Above-Average" YOKES for "Above-Average" CRT Displays

Need a deflected CRT spot as small as 0.00065"?

The CELCO HDQ High-Resolution Deflectron for Satellite Photography Read-out was the choice of one of our customers for their "Above-Average" display requirements.

You can get performance like that with a CELCO YOKE optimized on your CRT for your "Above-Average" display. (measured with a CELCO CRT Spot Analyzer.)

Or YOUR "Above-Average" display may require fast Zero-approach settling time, as required in a Fingerprint Scanning job where CELCO HDN Deflectrons are specified to recover to 0.01% in 25 μ s.

Precision Linearity on the final film plane or work surface, in Integrated Circuit Mask-Generator Displays enables producers of LSI technology to make low-cost computers for all of us. CELCO Special Deflectrons and Linearity Correctors LC123 are being used by several equipment builders for their "Above-Average" displays.

For PEPR, a system for reading Bubble Chamber photographs, developed by a few individuals at MIT and refined and expanded by others at leading universities throughout the world, CELCO was asked to provide special Low Residual Yokes for their project. CELCO produced their HD Deflectron with special 0.003% residual, and GFJ irrotational Focus Coils to help achieve the performance of these "Above-Average" displays. CELCO DAPP2N-7 Amplifiers drive the Dynamic Focus Coil; a CELCO DAPP2N-5 Amplifier was selected by another PEPR group to drive the CELCO B1700 Di-Quadrupole which produced the rotating high-resolution scanning line!

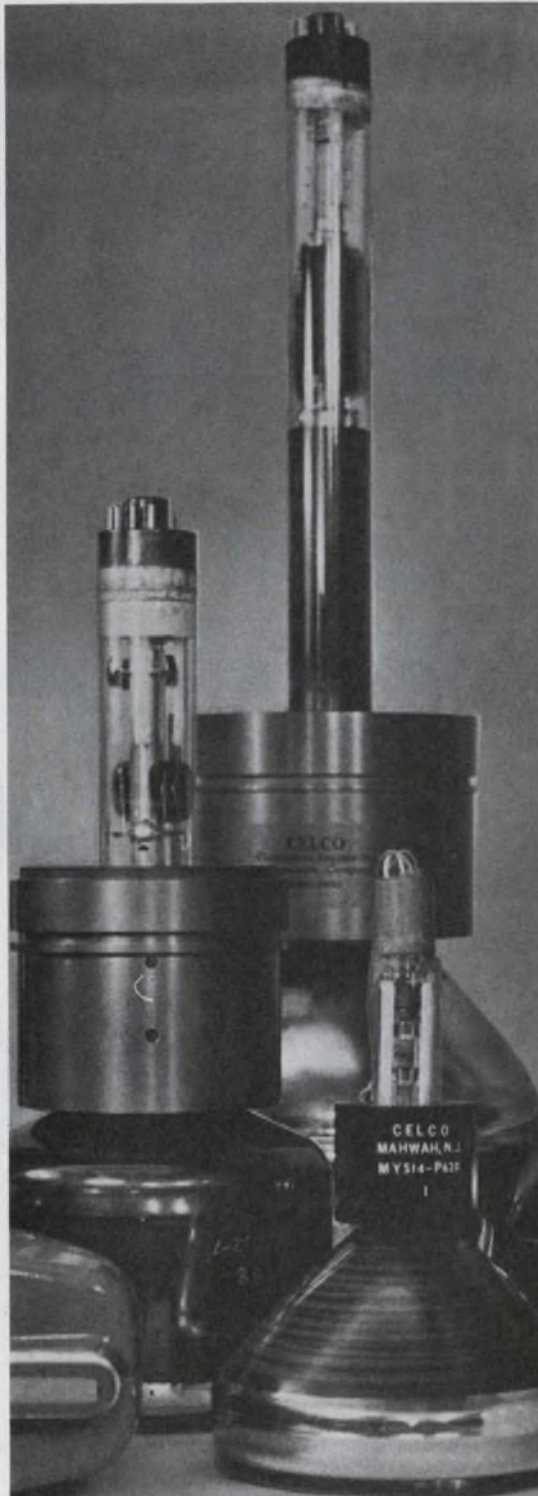

"Above-Average" Recording Storage Tube displays with 1 $\frac{1}{16}$ " neck scan converters and storage tubes need CELCO QY and QD Recording Storage Tube Yokes.

CELCO electronics and magnetics were integrated into a CELCO "DS" Special Display System for Oil Exploration and Data Reduction where "Above-Average" Linearity, Spot Growth, Zero-approach, Bandwidth, and Residual performances were required. Our customer decided to use CELCO's unique display experience to achieve his "Above-Average" display.

CELCO "Above-Average" deflection yokes, focus coils, beam-centering and aligners, astigmatic correctors, and pincushion correctors applied to your specific requirement will help you produce YOUR "Above-Average" Direct-View Display.

REMEMBER CELCO YOKES, whether you want to send a man to the moon, a probe to Jupiter or Mars, investigate chromosomes or trophoblast for cancer research, or build a large format scanner to generate type-setting masters, X-Ray enhancement, or data digitization.

- CELCO CRT Mounts, coil positioners, holders and magnetic shields will enable you to get everything together to achieve your "Above-Average" display.
- Write for CELCO YOKE BROCHURE and your FREE CELCO CRT Display Computer Slide Rule to compute the CELCO YOKE you need for your "Above-Average" CRT Display.

UPLAND CA 714-982-0215
MAHWAH NJ 201-327-1123

(average is so . . . ho-hum to us.)

"Above-Average" YOKES for "Above-Average" CRT Displays.

CONSTANTINE ENGINEERING LABORATORIES COMPANY
1150 E. Eighth Street, Upland, CA 91786

70 Constantine Drive, Mahwah, N J 07430



INFORMATION RETRIEVAL NUMBER 12

THE SOURCE...

for Digital Instrument Printers!

Need a hard copy printer that is readable, reliable, flexible and maintainable?

With DigiTec's instrument printers you get a model to fulfill your exact specifications.

Want a printer that lasts with use and is easily repaired after abuse?

DigiTec's instrument printers have rugged, high-styled enclosures and state-of-the-art circuitry with plug-in components for serviceability.

Require integral time recording, batch or event counting, up to 21 data columns, red or black print out, TTL or RTL interface, and integration into an existing product or system?

Selected DigiTec models offer these features in combination with many others.

Look first to the "SOURCE" for your digital instrument printers and ask about our generous OEM quantity discounts!



6100 Series
digital printers for
production, laboratory
and OEM applications.
Starts at

\$549.

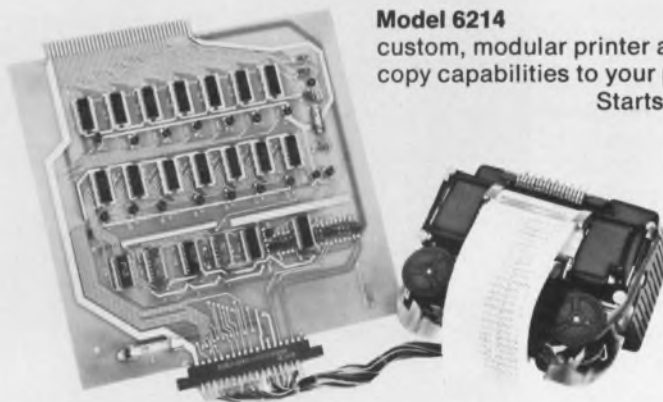

Model 6214
custom, modular printer adds hard
copy capabilities to your product.

Starts at

\$350.



Model 691
systems printer for
maximum flexibility in
data acquisition systems.
Starts at

\$725.

Call your nearest United Systems representative for complete specifications.

DigiTec

UNITED SYSTEMS CORPORATION

918 Woodley Road • Dayton, Ohio 45403 • Ph: (513) 254-8251 • TWX: (810) 459-1728

These instruments available under GSA Contract GS-OOS-27741

TAKE THE LEAD WITH THE 2ND NEW 4K STATIC RAM FROM EMM

TTL-COMPATIBLE; FULLY STATIC.

The new SEMI 4200 is fully static like the 4402 we recently introduced. But in addition it is TTL-compatible, output as well as input. Thus you can not only forget about refresh and charge pump circuitry when designing high performance MOS memory systems, you can also forget about drive amplifiers.



225 NANOSECOND ACCESS. The SEMI 4200 4K static RAM has a worst case access time of 225 nsec, and a worst case cycle time of 400 nsec. *It is the fastest TTL-compatible 4K static RAM in production.*

LOW POWER. The SEMI 4200 requires 450 mw operating power. And, just as with the 4402, power conservation is achieved by the Chip Select Input, which causes the 4200 to enter a low power standby state whenever it is unselected. Normal V_{DD} is 12Vdc, but V_{DD} can be reduced to 4 volts without risking loss of stored data, thus permitting the design of effectively non-volatile systems. Power consumption in this mode is less than $2\mu W/\text{bit}$.

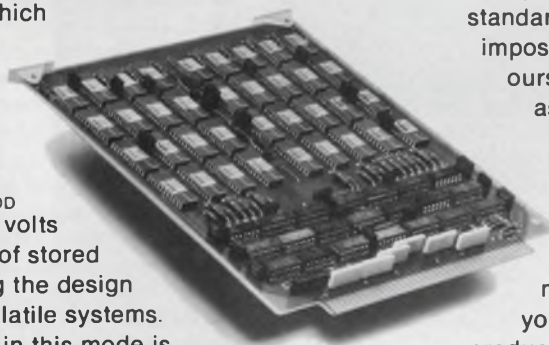

MICRORAM 1240.
16K x 8/9 using
SEMI-4200 4K Static RAM
Ideal for
microprocessor applications.

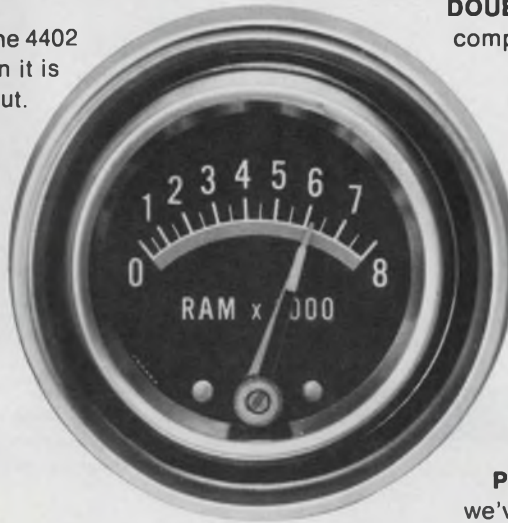

DOUBLE TESTED. Like all SEMI NMOS components, the 4200 TTL-compatible 4K static RAM must meet our own tough test standards, since we use it in our memory systems. In fact, our normal procedure requires 100% ac and dc testing of all components twice — at wafer and again in the package.

MODEL SELECTION. EMM SEMI offers you a growing line of static RAM and ROM components to help you take the design lead.

Pick out the one that best meets your needs from the adjacent chart.

PROVEN TRACK RECORD. At EMM we've been making memory components

and systems since 1961. Unlike memory suppliers who market components only, all EMM components are performance proven in our own systems. When you buy from EMM, you get the benefit of the unusually high acceptance standards we impose on ourselves, as well as our years of experience in

Part No.	Bit Org.	Access Time
RAMS		
SEMI-4200	4096 x 1	225 nsec
SEMI-4402	4096 x 1	200 nsec
SEMI-1801	1024 x 1	90 nsec
SEMI-1802	1024 x 1	70 nsec
SEMI RA-3-4256	256 x 4	1 usec
SEMI RA-3-4256B	256 x 4	1 usec
ROMS		
SEMI RO-3-4096	512 x 8	500 nsec
SEMI RO-3-5120	512 x 10	500 nsec
SEMI RO-3-16384	4096 x 4	1 usec
SEMI RO-3-8316A	2048 x 8	850 nsec

More new products to come... additional 4K static RAMs, ROMs.

meeting the needs of the memory marketplace. If you'd like further information about any of the products featured here, or any other EMM components or systems, contact your local EMM office today.

EMM SEMI

A subsidiary of Electronic Memories & Magnetics Corporation
3883 North 28th Avenue, Phoenix, Arizona 85017
Telephone (602) 263-0202

INFORMATION RETRIEVAL NUMBER 14



Dual-Delayed Sweep.

A new advance that speeds timing measurements

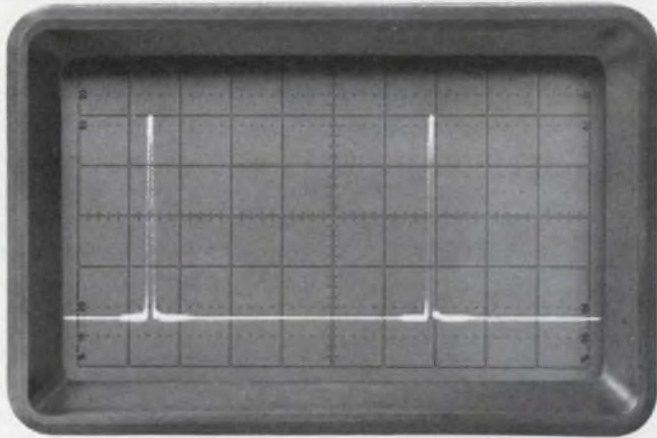

Main-Sweep Mode

Set start point/Set stop point
Read the time interval between
dots directly.

2.735 -6

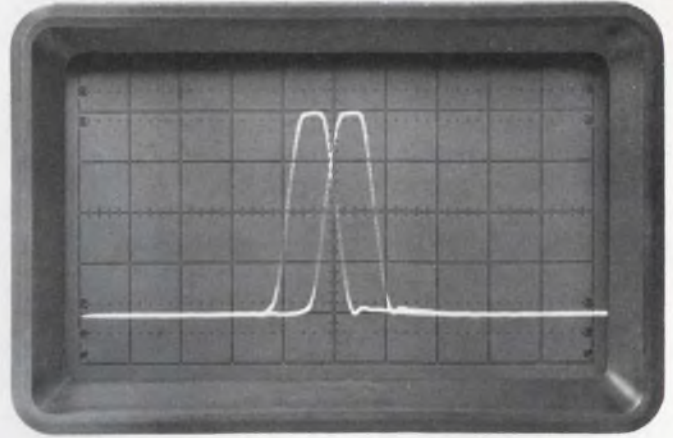

Delayed-Sweep Mode

Start point/Stop point
Start and stop events viewed together
—overlap them for maximum accuracy.

2.735 -6

HP's Dual-Delayed Sweep makes timing measurements just this simple: set two markers on your scope trace and read the time interval between them on a built-in LED display or a separate DVM.

Testing is faster because your setup is easier...there's no graticule counting...no mental calculations either. Accuracy is improved because drift, nonlinearities, and many sources of human error are eliminated.

In the Main Sweep Mode, you simply set the start point with one marker (first dot) and the stop point with the second marker. HP's 1722A oscilloscope with microprocessor automatically gives you a direct time-interval readout on the built-in LED display. With our 1712A oscilloscope, you get direct readings by connecting a DVM to the Time-Interval output. For increased resolution and accuracy, the Dual-Delayed Sweep lets you overlap (null) two traces using the scope controls and again gives you a direct time-interval reading.

If you've had to give up the 1% accuracy achievable with single delayed sweep because you couldn't afford the test time. Dual-Delayed Sweep could be the answer. Since it lets you see both start and stop events simultaneously, you can follow adjustments in your system—even if they're interactive—until you're right on. This can give you as much as a factor of 4 reduction in adjustment time.

Repeatability—so important in critical timing adjustments—is improved as much as 10 times compared to conventional scopes without digital readout.

Whether you're doing single-trace measurements—such as risetimes, pulse durations, and periods—or dual trace measurements—such as propagation delays, dual-clock phasing, and other measurements from one waveform to another—Dual-Delayed Sweep lets you work to new standards of speed and accuracy.

At HP, we made comparative tests using a conventional (single-delay) scope, a single-delay scope with digital read-out, and a scope with Dual-Delayed Sweep (DDS). Twelve people made one time-interval measurement each. Based on these tests, we at HP found that Dual-Delayed Sweep (DDS) is about three times faster than a single-delay scope with a turn-counting dial and about the same as a single-delay scope with digital readout. In repeatability, DDS is about five times more repeatable than a conventional scope with digital readout and ten times more repeatable than a conventional scope with a turn-counting dial.

With the 1722A, you can also measure frequency, voltage, and percent with the same ease...and have a direct 4-digit readout on the built-in LED display.

Dual-Delayed Sweep is a standard feature in HP's 1712A 200 MHz scope (time-interval via external DVM—\$2950) and in our 275 MHz 1722A (with LED's built-in—\$4750). Contact your local HP field engineer and find out how Dual-Delayed Sweep can speed your timing measurements while improving their accuracy. Or, write for our application note AN-186.



HEWLETT  PACKARD

Sales and service from 172 offices in 65 countries.
1501 Page Mill Road, Palo Alto, California 94304

FOR TECHNICAL INFORMATION CIRCLE #261

FOR IMMEDIATE APPLICATIONS ASSISTANCE CIRCLE #262

ELECTRONIC DESIGN 22, October 25, 1975

New snap-in rockers with Cutler-Hammer reliability.

Here's a completely new line of snap-ins, each engineered with the kind of solid dependability you expect in Cutler-Hammer Rockette® switches. Bright metal bezels, illuminated and non-illuminated, A-c and D-c capabilities up to 20 amps.

Sub-panel rockers in a variety of colors, rocker or paddle designs in standard, special, or proprietary models.

Switches snap in and stay in permanently. Speed up assembly time, cut costs.

Flush-mounted rockers in the same wide range of designer-oriented colors and styles. One- and two-pole models.

Illuminated single-pole rockers. Choice of red, green, amber, white, or clear. Hot-stamped legends indicate switch functions.

For more information, call your Cutler-Hammer Sales Office or Switch Distributor.

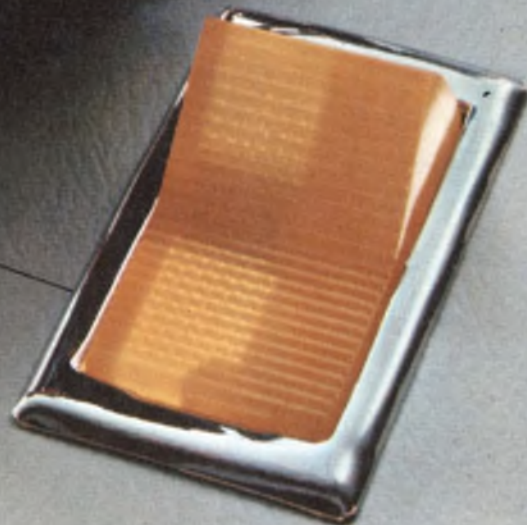

CUTLER-HAMMER
SPECIALTY PRODUCTS DIVISION, Milwaukee, Wis. 53201



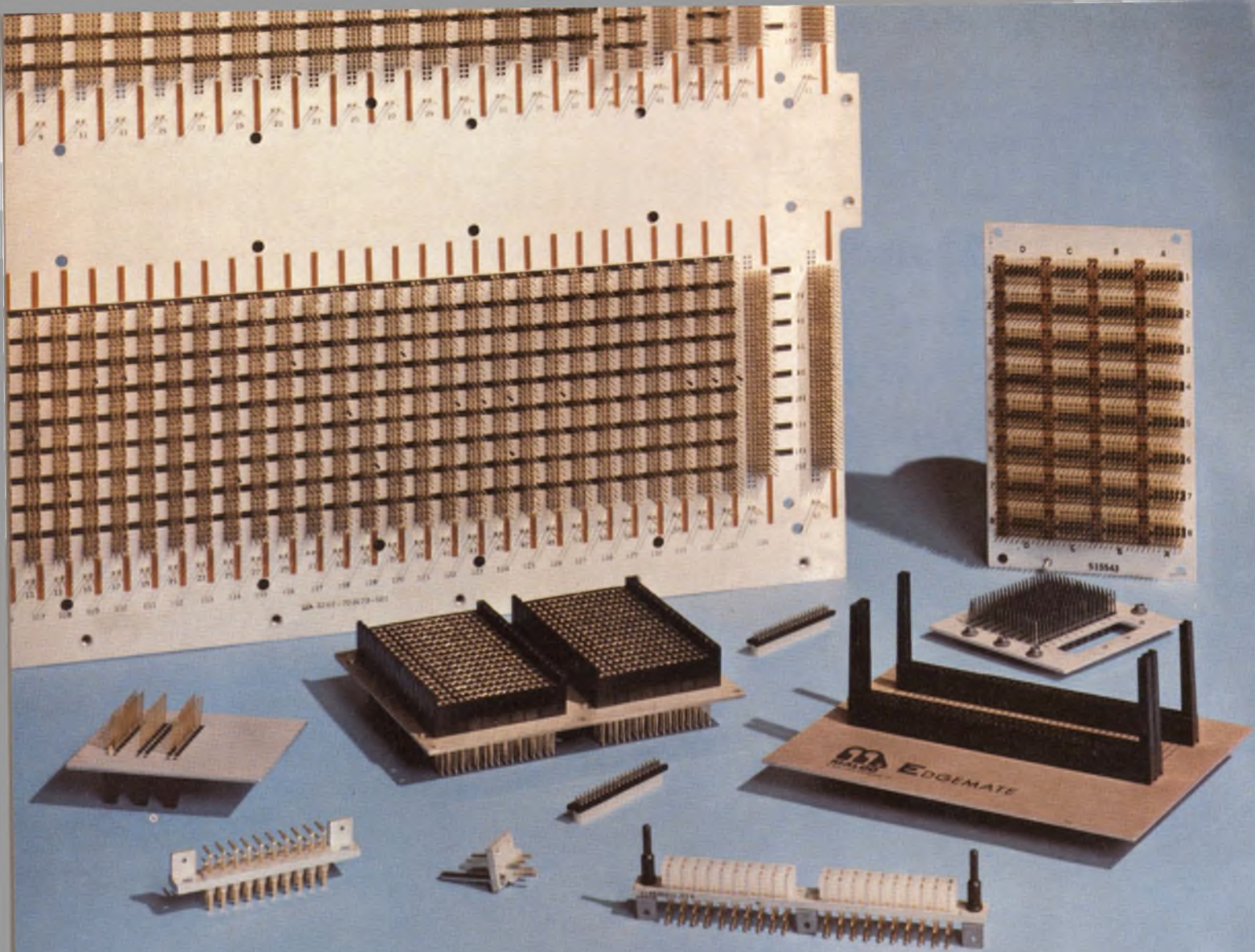

**One contact
with Malco
gets you all the
contacts you need.**

Malco, the originators of the metal back plane gives you as many as 50,000 individual contacts on one 24" x 24" plate. That's up to 100 contacts per square inch—whether you choose our blade and tuning fork WASP and MINI-WASP systems or our low-cost, card edge Edgemate and Edgemate II systems. Yet, even with that kind of density, each contact is precisely positioned to permit use with automatic wire wrapping machines. Naturally your back planes will be made to your exact design specifications with contacts arranged to suit your individual configuration requirements.

For even greater flexibility you can add a variety of Malco headers. Get the quality back planes you need for computers, data processing equipment, automatic test systems, missile control and guidance and communications systems.

Malco also has a complete line of card edge connectors and inter-connector systems ready for automatic wrapping. Make that first contact with Malco and get all the contacts you need. Write Malco, 12 Progress Drive, Montgomeryville, Pennsylvania 18936 or call . . . (215) 628-9800.



MALCO
A Microdot Company
Helping industry put things together.™

OCTOBER 25, 1975

8-k RAM, due out in 1976, to defy 'rule of four' trend

Defying Gordon Moore's "rule of four," which states that memory advances come in multiples of four, semiconductor designers at Advanced Memory Systems are planning to offer an 8-k RAM during the first half of 1976 that will be only two times larger than the memory chips now available.

According to Millard H. Phelps, vice president of the Sunnyvale, CA, company, the device will be pin-compatible with existing 22-pin, 4-k memories. Known as the 7008, it not only will have more density than all high-performance RAMs, Phelps says, but it will also be faster and cheaper per bit on a system level.

Commenting on the 7008's compatibility with current 22-pin, 4-k RAMs, Phelps notes that the latter have an unused pin on the package that can be used to accommodate the extra address line required by 8-k devices.

The 8-k RAM, Phelps says, gives system designers a smooth way to upgrade a product as semiconductor technology progresses and the 4-k RAMs become obsolete.

Another advantage of the 8-k RAM, he continues, is that it can be applied by simple extension of today's 4-k circuit designs; no circuit changes are required. And because of this, the 8-k devices enjoy the same reliability as 4-k RAMs, he adds.

Moreover, since more power per function is available at the 8-k level than at the 16-k, it is reasonable to expect higher performance from the 8-k device, Phelps contends.

The cost savings for system designers using the 8-k RAM can be significant, Phelps says. He reports possible savings of 25 to 40% if the 8-k memory is used as a bridge between 4-k and 16-k devices. The savings come from a reduction in printed-circuit boards,

connectors, cables and use of cabinets, he notes.

With the industry advancing at its current rate, 1978 appears to be the earliest that mature 16-k RAMs will be available, Phelps says. That would mean that 8-k devices have two years in which the only competition will be from smaller 4-k RAMs.

Acoustic radar helping FAA study wind shear

To prevent air crashes caused by wind shear—a phenomenon in which the wind speed or direction varies with changes in altitude—the Federal Aviation Administration has instituted a program to collect data on the characteristics of wind shear on the approaches to runways at the John F. Kennedy International Airport in New York and Boston's Logan Airport.

The investigation of low-level wind shear—believed responsible for a recent fatal airplane crash at Kennedy—is using acoustic radar equipment with capability that is expected to measure winds up to 1000 feet above the surface.

The equipment, according to Larry Langwell, manager of the FAA Wind Shear and Wake Vortex Programs, has demonstrated in preliminary tests that it can detect wind speeds up to 600 feet.

The equipment was developed for the FAA as an acoustic doppler system for detection of wake vortices.

The vortex system, produced by Avco in Wilmington, MA, can detect wind changes at various altitudes. Operating between 2 and 4 kHz, the equipment transmits an acoustic pulse with 50 W of sonic energy.

"To date," says Langwell, "the system has been used in a test pro-

gram to track wake vortices and display their location on a CRT on a real-time basis."

Both the display and the transmitting transducers are being modified, Langwell points out, because while the wake vortex system looks up at about a 150° angle, wind-shear measurements require that the transducers be pointed straight upward to probe the atmosphere.

In addition, Langwell notes, the software of the PDP-11 computer, which is a part of the system, will be modified.

An installation of sonic radar—by Aerovironment, Pasadena, CA—has been made at Logan Airport, Langwell says, to determine the feasibility of using a lower-cost system. It would cost about \$20,000 as contrasted with about \$100,000 for the Avco system.

The Aerovironment system was designed for mapping inversion layers in air-pollution studies. The height of the layer, Langwell points out, is identified by backscatter from the inversion interface.

A special acoustic wind-shear system measuring up to 1000 feet and higher is also under development for the FAA by the National Oceanic and Atmospheric Administration. It is to be installed at Dulles International Airport, outside of Washington, DC, early next year.

Minicomputer speed at microprocessor cost

Taking advantage of NMOS LSI circuitry, General Automation of Anaheim, CA, has introduced a series of 16-bit micro and minicomputers that it describes as offering the speed and versatility of larger systems at prices equivalent to the slower, low-cost 8-bit microprocessor-based machines.

The GA-16 series of computers has typical instruction execution times of 2 μ s, and prices start at \$531 (in quantity) for a 16-bit machine with 1 k of memory. All machines offer software and I/O compatibility with the company's existing SPC-16 series of minicomputers. This saves considerable time and money when it comes to picking a system and preparing the software.

There are four units in the series—GA-16/110, 220, 330 and 440. All of the units are based on a two-chip custom LSI processor. Models 110 and 220 are microcomputers and include 1 k words of solid-state memory.

The 110 is built on a single 7.75 × 11-in. circuit board, costs \$531, has 91 basic microprogrammed instructions, memory expansion capability to 64 k and 16 general-purpose registers for openers.

The 220 includes all of the 110's features and has an additional 7.75 × 11-in. board that houses a microconsole ROM, TTL controller and serial I/O port. It costs \$765 in quantity.

Two larger systems are also available—the 330 and 440. These computers are housed in 5.25 × 19 × 22 and 8.75 × 19 × 22-in. cases, respectively. Both machines can directly address 1 million words of memory. The 330 comes with 4 k of core memory while the 440 is equipped with 16 k. They cost \$1950 and \$5370, respectively.

Instruction sets for the mini-computers include full-word, byte and bit manipulation in memory and an extended instruction set for the 330. The 440 includes all that plus even higher speed, since it uses Schottky MSI circuits in addition to the LSI processor. The 440 has a complete front panel, while the 330 comes with just the basic control switches.

CIRCLE NO. 319

CAD speeds matching of antenna networks

A jaw-busting computer program—called NETXMTCH—intended to let engineers optimize rapidly the design of broadband matching networks for given impedances, has been developed by the Naval Research Laboratory in Washington, DC.

According to Monroe Y. McGown, principal investigator for the project, the program is designed to use transmission-line cable and/or discrete element characteristics in the design of the matching network.

The design of broadband matching networks, generally a tedious task, is required for shipboard antennas, McGown observes. Most

shipboard transmitting antennas need compensating matching devices to transform the antenna impedances to values that will keep the voltage standing wave ratio (VSWR) at 3-to-1 or less.

NETXMTCH can be used to determine the VSWR, relative to any terminating resistance, for given antenna impedances. This reduces design time and effort.

Although it was specifically designed for antenna matching, it can be used for other broadband impedance-matching problems as well, McGown says.

The program is written in Fortran for the CDC 3800 computer.

Next computer era: A gradual shift seen

Unlike the dramatic entrance of IBM's 360 series—which ushered in the third-generation computer era—fourth-generation machines will make their debut without fanfare, says Joseph Ferreira, vice president of the Diebold Research Program in New York City.

The management research official asserts that “the fourth-generation computers will require no significant advances in hardware technology, such as was evident in the 360 series.” Instead, he continues, there will be a gradual shift—probably no earlier than the 1980s—spurred largely by new developments in software.

“We've got the hardware,” Ferreira says, “but enormous problems with software remain. It's the major bottleneck in the use of large systems.”

The architecture of fourth-generation computers will be determined by product needs rather than by technological development, he says, with the major characteristic functional, specialized processor modules collected in multiprocessor configurations.

Other trends expected as the next generation unfolds, according to the Diebold official, include these:

- Virtual machine program execution.
- Very large main storage—millions of bytes of memory representing a substantial proportion of system cost.
- Intelligent controllers for peripheral devices.

Navy system pinpoints computer transients

High-voltage transients on primary ac power lines for computers can introduce errors in the data. To identify the transient sources, as well as their polarities, on computer power lines, the Navy has developed a portable monitoring device at its Civil Engineering Laboratory, Port Hueneme, CA.

“We needed to determine where the transients were coming from so we could trace and eliminate them,” explains M. N. Smith, electronic designer with the laboratory's Electrical System Div.

The transient direction-finding circuit can be used with single, two and three-phase lines, Smith points out. The transient instrument has a voltage probe, a current probe and TTL logic.

The voltage probe is connected between one side of the line under test and neutral. The current probe is a split-core unit that clamps over the line.

The leading edge of the first transient to occur triggers the circuit, Smith explains. And with the voltage measured by the probe as a reference, comparison is made to the polarity of the current-probe output.

If the transient source is the computer or some other load, the polarity of the current flow will be the opposite of that of a disturbance coming in from the line, Smith notes, adding:

“The logic circuitry compares the outputs of the probes and lights corresponding LED indicators marked ‘source,’ ‘load,’ ‘positive’ and ‘negative.’”

The transient-finder unit is being used in conjunction with a portable power line monitor that prints out the LED indications and also resets the LEDs to OFF to wait for the next transient.

The power-monitor unit also monitors line frequency, overvoltage and undervoltage, together with a clock printout that gives the time of any of the line disturbances.

Two of these transient locators and associated power-monitor systems are now in use at Navy supply installations that have large computer complexes—at the Oakland (CA) Naval Supply Depot and at Mechanicsburg, PA.

"WANT TO SEE SOMETHING **SUPER?**"



SUPERE

NOT JUST A BETTER RECTIFIER... BUT A WHOLE



CTIFIER™

NEW CONCEPT IN RECTIFIER TECHNOLOGY



No other 1 to 3 Amp rectifier of any kind—plastic, glass, or metal—can match (or even approach) SUPERECTIFIER's combination of features... the result of General Instrument's unique glass-plastic construction:

- Brazed at greater than 600°C at both leads and cell—eliminates all soft solders
- Exclusive UL recognized *flame-retardant epoxy* molding compound rated 94V-0, the highest available
- Patented glass passivation
- Reliability proved equal to military requirements
- Hermetically sealed construction
- And all this at plastic prices

General Instrument's SUPERECTIFIER is exactly that... a super rectifier. There is nothing else in the world like it.

In cell construction, most other rectifiers rated up to 3 Amps are soft soldered or are only pressure contacted. SUPERECTIFIER is made into an entirely solid unit with its leads and cell brazed at temperatures greater than 600°C. All other rectifiers fail at half that temperature.

In cell protection, conventional plastic rectifiers use either varnish, silicone rubber or a thin film of silicon oxide to protect the junction. SUPERECTIFIER uses a patented glass passivation to seal its junction hermetically.

In device encapsulation, again SUPERECTIFIER is the only one that won't go down in flames. It is the only rectifier using an exclusive flame-RETARDANT molding compound, rated UL 94V-0, the highest rating available. All other plastic rectifiers use flame-ENHANCING compounds. Here again, SUPERECTIFIER's superiority is manifest. In fact, it is the only plastic rectifier that exceeds environmental standards of MIL-STD-19500/228.

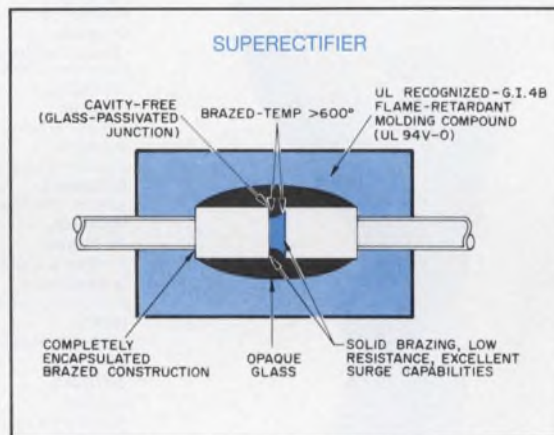

In summary, SUPERECTIFIER is the world's only rectifier with totally brazed construction, with a patented glass passivated junction, and with flame-retardant molding encapsulation.

And the topper... SUPERECTIFIER sells at super-low plastic prices.

SUPERECTIFIER? ... You bet it is!

If you want to know more call us at 516-733-3355 or write, General Instrument Corporation, Semiconductor Components Division, 600 W. John St., Hicksville, N.Y. 11802.

P.S. If you have a Super Girl around, we have a Super Girl T-shirt for her. You can get yours from any participating General Instrument distributor (listed on the next page).

**GENERAL INSTRUMENT CORPORATION
SEMICONDUCTOR COMPONENTS**



SUPERECTIFIER

Here's where you get it!
(your Super Girl T-shirt, too)

PARTICIPATING GENERAL INSTRUMENT DISTRIBUTORS



- ALABAMA,**
Huntsville
Cramer Electronics (205) 539-5722
- ARIZONA,**
Phoenix
Mirco Electronic Dist. (602) 944-2281
- CALIFORNIA,**
Newport Beach
Semicomp Sales (714) 833-3070
Santa Ana
Intermark Electronics (714) 540-1322
San Diego
Intermark Electronics (714) 279-5200
Sunnyvale
Intermark Electronics (408) 339-9312
Woodland Hills
Semiconductor Concepts . (213) 884-4560
- COLORADO,**
Denver
Integrated Electronics (303) 534-6121
Wheatridge
Century Electronics (303) 424-1985
- CONNECTICUT,**
Bethel
Pioneer (203) 792-1182
Norwalk
Harvey Conn. (203) 853-1515
- FLORIDA,**
Ft. Lauderdale
N.R.C. (305) 792-2600
Hollywood
Cramer Electronics (305) 923-8181
Orlando
Cramer Electronics (305) 894-1511
Hammond Electronics (305) 849-6060
- ILLINOIS,**
Chicago
Newark Electronics (312) 638-4411
Elmhurst
Semiconductor Specialists (312) 279-1000
Rosemont
Advent Electronics (312) 298-4210
- INDIANA,**
Ft. Wayne
Ft. Wayne Electronics (219) 423-3422
Indianapolis
Semiconductor Specialists (312) 279-1000
- IOWA,**
Cedar Rapids
Deeco Inc. (319) 365-7551
- KANSAS,**
Lenexa
Hall-Mark Electronics (913) 888-4747-8-9
Wichita
Radio Supply Co. (316) 267-5214
- MARYLAND-WASHINGTON, D.C.,**
Gaitersburgh
Cramer Electronics (301) 948-0110
Savage
Pyttronic Industries
Baltimore—(301) 792-7000
Washington—(301) 953-3000
- MASSACHUSETTS,**
Newton
Greene-Shaw Co. (617) 969-8900
- MICHIGAN,**
Framington
Semiconductor Specialists (313) 478-2700
Grand Rapids
Stotts-Friedman Co. (616) 459-0216
- MINNESOTA,**
Minneapolis
Hall-Mark Electronics (612) 935-3118
Semiconductor Specialists (612) 854-8841
The Berquist Co. Inc. (612) 835-2322
St. Louis Park
Park Electronics (612) 935-3118
- MISSOURI,**
Hazelwood
Semiconductor Specialists (314) 731-2400
St. Louis
Olive Electronics (314) 863-7800
- NEBRASKA,**
Lincoln
Scott Electronics Supply ... (402) 464-8308
- NEW MEXICO,**
Albuquerque
Century Electronics (505) 292-2700
- NEW YORK (Metropolitan),**
Bay Shore
Rosyl Electronics (516) 586-1800
Elmsford
Zeus Components (914) 592-4120
Hauppauge
Semiconductor Concepts . (516) 273-1234
New Hyde Park
Lafayette (516) 488-6600
Syosset
Nasco (516) 822-9450
Woodbury
Diplomat Electronics (516) 921-9373
- NEW YORK STATE,**
Buffalo
Summit Distributors (716) 884-3450
Johnson City
Wilshire Electronics (607) 797-1236
- NORTH CAROLINA,**
Raleigh
Pyttronic Industries (919) 782-6370
Winston-Salem
Cramer Electronics (919) 725-8711
- OHIO,**
Cincinnati
Newark Electronics (513) 874-5115
Dayton
Semiconductor Specialists (513) 278-9455
Stotts-Friedman Co. (513) 224-1111
Solon
Repco (216) 248-8900
- PENNSYLVANIA,**
Cinnaminson
Wilshire Electronics (215) 627-1920
- Erie**
Advacom (814) 455-8110
Harrisburg
Pyttronic Industries (717) 233-6591
Horsham
Pioneer Electronics (215) 674-5710
Huntington Valley
Hallmark (215) 355-7300
Montgomeryville
Pyttronic Industries (215) 643-2850
Philadelphia
Philadelphia Electronics Inc.
Pa.—(215) 568-7400
N.J.—(609) 365-6704
- Pittsburgh**
Semiconductor Specialists (412) 781-8120
- TEXAS,**
Dallas
Component Specialties ... (214) 357-4576
K.A. Electronics Sales ... (214) 634-7870
Semiconductor Specialists (214) 358-5211
Houston
Component Specialties Inc. (713) 771-7237
Lenert Company (713) 225-1465
- UTAH,**
Salt Lake City
Alta Electronics (801) 486-7227
Century Electronics Inc . (801) 487-8551
- WASHINGTON-OREGON,**
Seattle
Intermark Electronics (206) 767-3160
- WISCONSIN,**
Mequon
Taylor Electric (414) 241-4321
Milwaukee
Semiconductor Specialists (414) 257-1330

GENERAL INSTRUMENT CORPORATION
SEMICONDUCTOR COMPONENTS



UNIVERSAL MODEMS



Universal makes modems any way you want them — as OEM cards, rack-mountable units or free-standing packages. In a word, we combine the latest in modem technology with the ultimate in personalized service and personalized applications engineering.

For example, using CMOS technology, we've put a whole 201 modem on a single card in less than 50 square inches. Of course we also offer many choices of 103s and 202s.

Our custom design capability offers you the performance options you need, as well as complete compatibility with your mechanical layout. Besides cards, rack-mounted or free-standing units, Universal also provides multi-channel packages, with modems in any frequency mix up to 2400 bps.

In addition to our products, we're extremely proud of our customer service. Check us out: Call us on the telephone. You'll like what you hear.



universal data systems

4900 Bradford Drive • Huntsville, Alabama 35805 • Telephone (205) 837-8100 • TWX 810-726-2100

Created by Hall & McKenzie Advertising, Winter Park, Florida

INFORMATION RETRIEVAL NUMBER 20

SURPRISE! \$9.95

DIRECTIONAL COUPLERS

- Frequency 10 KHz - 1000 MHz
- High directivity to 35 dB
- Wide selection of coupling
- From \$9.95
- Low main line loss from 0.1 dB
- One week delivery

Mini-Circuits ships thousands of signal processing components each week to more than 500 companies throughout the world. These units are included in over 300 critical military programs as well as communications, medical, CATV, telephone transmission and instrumentation applications.

Our years of experience in high-volume production result in high reliability units with guaranteed repeatability of performance at lowest cost. That's why more and more systems engineers are specifying Mini-Circuits' directional couplers, mixers and power splitter/combiners as the industry's standard.

For complete specs, performance curves and application notes, see MicroWaves 1974 Product Data Directory (p. 187-311) or circle Reader Service No. for your 132-page catalog.

Model	Coupling, dB	Freq. MHz	Price	Qty.
PDC 10-1	11.5 ± 0.5	0.5- 500	\$11.95	(5-49)
ZDC 10-1			\$26.95	(4-24)
ZMDC 10-1			\$36.95	(4-24)
PDC 10-2	10 ± 0.5	250-1000	\$15.95	(5-49)
ZDC 10-2			\$30.95	(4-24)
ZMDC 10-2			\$40.95	(4-24)
PDC 15-6	15 ± 0.5	0.01- 35	\$19.95	(5-49)
ZDC 15-6			\$34.95	(4-24)
ZMDC 15-6			\$44.95	(4-24)
PDC 20-3	19.5 ± 0.5	0.2- 250	\$11.95	(5-49)
ZDC 20-3			\$26.95	(4-24)
ZMDC 20-3			\$36.95	(4-24)
PDC 20-1	21 ± 0.5	25- 400	\$19.95	(5-49)
ZDC 20-1			\$34.95	(4-24)
ZMDC 20-1			\$44.95	(4-24)
*PDC 10-1B	11.5 ± 0.5	1- 400	\$ 9.95	(6-49)
*PDC 20-1B	19.2 ± 0.5	0.5- 200	\$14.95	(5-49)

*Bidirectional

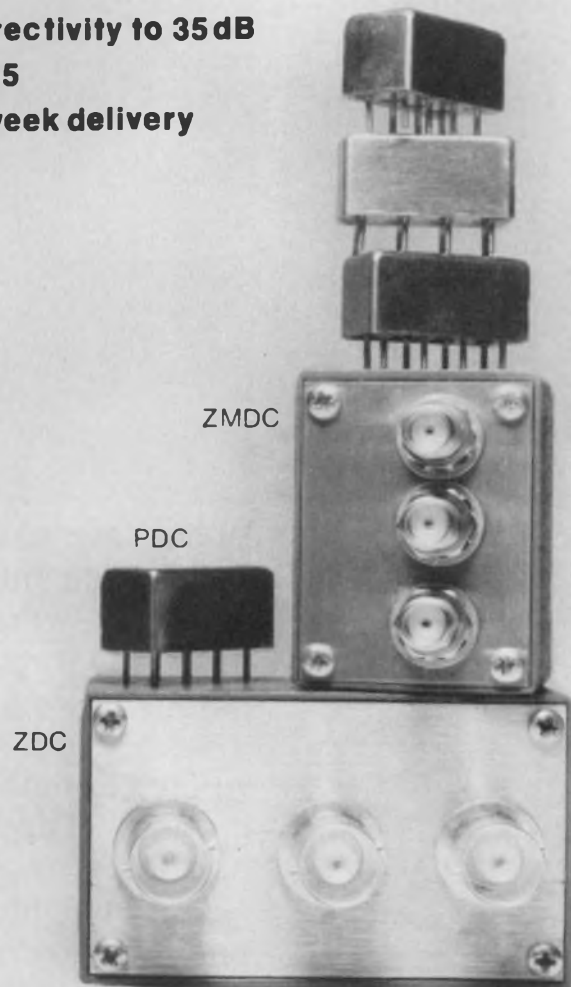

For complete product specifications and U.S. Rep. listing see MicroWaves' "Product Data Directory," Electronic Designs' "Gold Book" or Electronic Engineers Master "EEM"

Mini-Circuits Laboratory ^{MCL} 837-843 Utica Avenue, Brooklyn, NY 11203
 A Division Scientific Components Corp (212) 342-2500 Int'l Telex 620156 Domestic Telex 125460

Foreign Sales Representatives: AUSTRALIA General Electronic Services, 99 Alexander Street, New South Wales, Australia 2065; ENGLAND Dale Electronics, Dale House, Wharf Road, Frimley Green, Camberley Surrey; FRANCE S.C.I.E.-D.I.M.E.S., 31 Rue George - Sand, 91120 Palaiseau, France; GERMANY, AUSTRIA, SWITZERLAND Industrial Electronics GMBH, Klüberstrasse 14, 6000 Frankfurt/Main, Germany; ISRAEL Vectronics Ltd., 69 Gordon Street, Tel-Aviv, Israel; JAPAN Densho Kaisha Ltd., Eguchi Building, 8-1-1 Chome Hamamatsucho Minato-ku, Tokyo; EASTERN CANADA B. D. Hummel, 2224 Maynard Avenue, Utica, NY 13502 (315) 736-7821; NETHERLANDS, BELGIUM, LUXEMBOURG: Coimex, Veldweg 11, Hattem, Holland

US Distributors: NORTHERN CALIFORNIA Cain-White & Co., Foothill Office Center, 105 Fremont Avenue, Los Altos, CA 94022 (415) 948-6533; SOUTHERN CALIFORNIA, ARIZONA Crown Electronics, 11440 Collins Street, No. Hollywood, CA 91601 (213) 877-3550

Washington Report

Senator seeks cross-pollination of defense technology

With the objective of easing the transfer of technology from the Dept. of Defense to other Federal agencies and state and local governments, Sen. Joseph M. Montoya (D-NM) has introduced a bill to create an Agency for Technology Transfer. Basically, he says, the agency would disseminate existing ideas and knowledge to the public and private sectors. In addition it would assess the secondary applications of technology and provide for research. Funding for this purpose would be separate from the defense budget.

The bill would create a declassification board to review and evaluate technology. Serving on the board would be two members from the private sector, two from the Defense Dept. and two from other Federal agencies. Senator Montoya, when introducing his proposal, said: "We must promote the advances in science and technology to remain first in the world in technology, but it is also time for us to stop wasting these technologies and scientific advancements by limiting their use to one area and retarding their possible development in other fields."

To determine the feasibility of transferring technology, the bill also calls for a 12-member Congressional commission composed of six Senators and six Representatives to study the situation over a two-year period and to report back to the full Congress.

Joint procurement cutting costs of satellites

The Air Force and the National Aeronautics and Space Administration have pretty conclusive proof that things are cheaper by the dozen. In this case, it's advanced meteorological satellites. By jointly procuring a new spacecraft identified as Block 5D, the two spacecraft operators contend they will save the taxpayers \$37-million.

The new satellites, to be built by RCA Corp.'s Astro Electronic Div. will replace those now in 450-mile, sun-synchronous orbits. Nine of the satellites will be for NASA, three for the Air Force.

Although sensors and scan systems used by the two agencies differ, the vehicles will be able to accommodate the payloads. The saving comes through NASA's not having to spend \$33-million for development, plus an additional \$4-million in economies in material and assembly costs.

U.S. to analyze effects of material shortages

The Federal Energy Research and Development Administration, which has marked its first nine months of existence with a flurry of study contracts in an effort to get a grip on future energy problems, now wants to

know the probable impact of shortages of materials used in the manufacture of electrical products. Westinghouse Research Laboratories in Pittsburgh has a 14-month, \$163,000 contract to evaluate the effects of shortages over the next 25 years in conductor materials, wood, steel and petrochemicals. The study will also identify possible substitutes for these materials, draft recommendations for further R&D and suggest national policies to attempt to stave off materials shortages.

Better ways to locate lost aircraft envisioned

In the annual marshalling of forces to fight budget cuts, the Dept. of Defense has top officials on the speaking trail. A key area being stressed is the value of R&D to both national defense and the civilian sector. Noting that the military services annually spend some \$200-million to locate lost aircraft and ships, Deputy Secretary of Defense William P. Clements Jr. recently told the Survival and Flight Equipment Association of new electronic developments that could speed such rescues of aircraft and thus save money.

Using subminiaturized electronics components, he says, it's possible to build a system that a plane could carry and that, in a crash, would transmit the craft's exact position via satellite to a central search and rescue facility. Rescue teams could then be sent directly to the scene, thus eliminating prolonged searches. He names the Navstar Global Positioning System as ideal for navigation position updates.

Clements also notes that the Air Force has developed to the breadboard stage a new rescue beacon for wartime use.

Capital Capsules: TRAM, a new avionics system designed to give the Navy A7-E fighter attack aircraft eyes in the night, is undergoing tests by LTV Aerospace Corp. The system, which uses forward-looking infrared sensors, has the long name of Target Recognition and Attack Multi-Sensor. . . . Aetna Life and Casualty has announced plans to join Comsat General and IBM in establishing a domestic satellite communication system. The three would share equally in the total investment of \$165-million. . . . The Air Force's Aeronautical Systems Div. reports the start of a program to design, fabricate and test an infrared warning receiver for slow-flying and low-flying aircraft. It would be used in cargo, helicopter and fighter aircraft. . . . The Electronic Industries Association reports the dollar value of new orders for electronic parts in the first seven months of 1975 was down 28.25% over the same period a year ago. . . . The Air Force plans to look at the latest equipment in remote writing for use by weather forecasters at mobile tactical air bases. Among its requirements: The units must be available in transmitter, transceiver and receiver combinations, and they must use exchangeable, highly reliable solid-state electronics. . . . WEMA has announced the start of an industrywide statistical service to collect and distribute data on monthly bookings and shipments of semiconductor devices. Monthly reports are slated to start next January. . . . The National Association of Broadcasters, the Institute of Electrical and Electronic Engineers and the Electronic Industries Association are studying the feasibility of using AM for radio stereophonic broadcast systems. At the request of the Federal Communications Commission, the three have formed a National AM Stereophonic Committee to test and evaluate all proposed broadcast and receiver systems and report the results back to the FCC.

Ampex just added a 300 megabyte drive to the common-interface DM-9000 family.

Ampex common-interface disk capacity now extends all the way from 40 to 300 megabytes—the industry's broadest range of mix-and-match disk drives.

Newest addition to the Ampex line is the DM-9300, a self-standing, compact unit that incorporates the same disk medium used on the DM-9200 (IBM 3336 or equivalent) with the high-density signal electronics of the DM-980 drive. The DM-9300 packs 6060 bits of data per inch of track, has 800 data cylinders and 19 surfaces, and delivers a full 300 megabytes of storage in a single spindle unit.

Ampex disk drives are field-upgradable. If you now have a DM-940, you can increase storage capacity from 40 to 80 megabytes with a field conversion. In a similar manner, you can begin with a DM-9100 and grow in increments of 100 megabytes all the way to the DM-9300.

And since all disk drives in the Ampex DM-9000 series are designed to operate with a single controller, once you've installed your first drive, you'll be able to add units of **any** capacity.

Easily available disk media, common controller, and a full range of capacity ratings from 40 to 300 megabytes: good reasons to get together with the Ampex Disk Drive Family before you build your next high performance system.



AMPEX

Ampex Corporation
Data Products Division
401 Broadway, Redwood City,
California 94063, (415) 367-4105

DO YOU MEASURE DYNAMIC OR TRANSIENT PHENOMENA?

If you view slowly changing waveforms or fast single-shot events (up to $1.3 \mu\text{s}$), variable persistence storage offers you an easy, accurate way to evaluate them.

The variable persistence oscilloscope stores a bright, high-contrast display of new information as the old information fades from the crt. Variable persistence is available in both portable and laboratory oscilloscopes.



But there's a lot more to be said. Variable persistence storage has applications in spectrum analysis, mechanics, biophysics, and many other areas. Just fill out the coupon and we'll send you our guide, "Variable Persistence Storage Applications," or, if you prefer, arrange for a demonstration.

DO YOU NEED TO RETAIN SIGNALS ON A CRT FOR LONG PERIODS OF TIME?

If you do, bistable storage offers you an easy, inexpensive way to store information for an hour or longer.

A bistable storage oscilloscope makes it easy to store nonrepetitive signals and low-rep-rate waveforms with rise times as fast as 20 ns.

You can get bistable storage in portable and labo-



ratory oscilloscopes. With the split-screen feature, you can store a reference waveform on one half of the crt screen and compare it with incoming signals on the other half.

If you aren't familiar with bistable storage, we'd like to help. Send for our guide, "Bistable Storage Applications," or request a demonstration.

DO YOU CAPTURE, RECORD, AND ANALYZE VERY FAST EVENTS?

If you do, FAST storage allows you to record rise times as fast as 3.5 ns and to store information at full bandwidth—100 MHz. Only our mesh-to-mesh transfer technique makes it possible to store at such fast writing speeds.

This technique also makes it possible to combine different kinds of storage in a single instrument. Variable persistence and FAST variable persistence are available together in our portable scopes. Bistable, variable persistence, FAST bistable, and FAST variable persistence

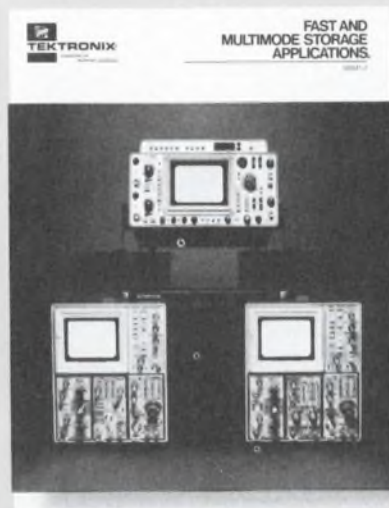

are combined in our laboratory oscilloscopes with multimode storage.

To find out more about FAST storage, write for our guide, "FAST and Multimode Storage Applications," or request a demonstration.

To request a demonstration of our storage oscilloscopes, contact your Tektronix Field Engineer or write us at Tektronix, Inc., P.O. Box 500, Beaverton, Oregon 97077. In Europe, write Tektronix Limited, P.O. Box 36, St. Peter Port, Guernsey, Channel Islands.

ONLY TEKTRONIX OFFERS ALL THREE KINDS OF STORAGE. FIND OUT ABOUT THE ONE THAT'S RIGHT FOR YOU.



TEKTRONIX®

committed to
technical excellence

Computer Special

The macro machines:



Despite the increasing attention being paid to microprocessors these days, there's still a whole world of "macro" hardware out there.

Large-scale computer systems—IBM's 370 series and the newer Amdahl 470, as well as such super machines as Staran and Illiac—are alive and kicking. Their designs are having a powerful impact on the big, stand-alone mainframe and processor field. But is this the end of the line? Have these monolithic systems—like the dinosaur—reached the end of the evolutionary trail?

Not by any means, experts say. A decade from now there will be large computer systems, but they'll be as different from today's machines as the Concorde is from the Boeing 707 jetliner.

On the drawing boards are large systems that will be a lot easier to use, simpler to maintain

and yet be a lot more intelligent. Their architectures will be based largely upon distributed system concepts, with extensive use of parallel processing. These machines will essentially monitor and run themselves automatically.

Major factors spurring these radical changes are the continued decrease in the cost of hardware and—would you believe—the advent of the microprocessor. These tiny devices will play a major role in converting today's architectures into distributed function systems.

Like the large computers, large mass memories are also thriving. Magnetic disc and tape memories are in wide use. But computer users are demanding larger, cheaper and faster memories. And manufacturers are beginning to comply. IBM and Control Data have introduced magnetic

Survival of the big



cartridge mass-memory systems that can store several billion bytes of information at a tenth the cost of magnetic-disc storage.

Both IBM and California Computer Products have recently announced two new disc memories that have doubled the storage density of current disc systems. Finally the development of electron-beam memories by General Electric and Micro-Bit and holographic memories by Sperry Univac and Harris promise even higher storage densities and speed.

Like their large brothers, the small magnetic memories are also in demand, particularly with the move toward microcomputers and low-cost minis. Floppy discs, fixed-hard discs and cartridges can now be bought for less than \$2000. Probably the biggest growth area to watch in

Contents

Tomorrow's large computer systems are taking shape today and the changes are going to be radical.....	36
Mass-memory storage pushes to several billion bytes, while speeds rise and costs drop.....	46
Floppy discs, cartridges and fixed-hard discs are rising in use at savings to you.....	54
Medium-speed printers are on the way up—but the 'ideal' hasn't arrived yet.....	62
Microprocessor emphasis swings from specifications for chips to aids for designers.....	74

1976 will be floppy discs. They've been slow getting off the ground, but experts estimate that the number of floppy disc drives to be shipped next year will double over the 1975 figure of less than 3000 drives a month.

Another area of change is the computer printer. Until recently the choice of printer was limited to either expensive high-speed units or low-speed machines used in the teleprinter field. Coming into vogue are medium-speed printers—those that can put out 100 to 160 lines a minute. Their development has been spurred by the advance of minicomputers, remote batch printing and small-business machine applications.

For an inside view of the dramatic changes occurring in computer technology, turn the pages of this special section.

Tomorrow's big computers are taking shape today; the changes are radical

What the large "super" computers of tomorrow will be like is a multi-million-dollar forecasting game. A multitude of predictions have been made, but there is agreement among most experts on one point: The big, stand-alone mainframe and processor of today will, within the next 10 years, be as outdated as the Model A Ford.

Replacing these monolithic systems will be newer architectures based upon a variety of distributed system concepts. And the newer systems will be more intelligent and easier to use, according to a consensus of experts.

Spurring the development of the new machines are a number of strong influences already at work. They include the following:

- The continuing downslide in the cost of LSI hardware, including logic, microprocessors and memories.
- The increase in the number of devices per chip and in the functions on a chip.
- The ballooning cost of software.
- The high cost of data transmission.
- The energy and material shortage.

Under these influences, these radical changes are expected in the organization and programming of the large machines:

- The cost of programming, which can be more than the cost of the system, will decline. More software functions will be incorporated in hardware than is now done.
- Large computers will be easier to use. They will require less software, and what software is

used will work directly in newer, higher-level languages—higher than Fortran, for example. Also, types of data processing that tend to reduce software requirements, like associative processing, will be incorporated into architectures.

- Large computer systems will become decentralized through use of distributed computing networks with multiple processors.

- Microprocessors—almost universally identified as a component of microcomputers and minicomputers—will be used in the large systems and will aid substantially in recasting present architectures into distributed function systems. Intelligence will be incorporated in all system elements and peripherals, instead of being principally in the mainframe. Loads will be shared between the newer mainframes and terminals.

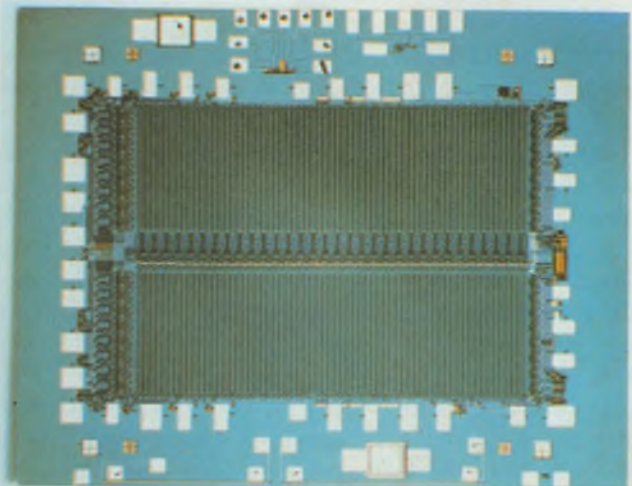

Increasing chip densities, like the 5-million bits per square inch on this experimental IBM 8192-bit FET memory will change future machine architectures.

- The use of data communications will grow, both for internal system communications and external communications.

- Super machines will be independently built and independently controlled, with the elements tied together in a network of mainframes.

- More extensive parallel processing—multiple processing going on simultaneously—will be incorporated in both the large and super machines to increase throughput.

- Architectures with dynamic allocation of functions will appear. These machines will be able to monitor and run themselves automatically.

- The limitation on throughput imposed by the speed of the logic will be overcome by use of the newer, distributed architectures.

- The speed of solid-state logic will continue to increase, reaching 500 ps within five years.

Large systems will be easier to use

“New systems, in general, are going to be driven by the need to reduce the complexity of software and the cost of maintaining it,” says R. C. Phillips, vice president of system engineering at Sperry Univac, Blue Bell, PA. “We’re concentrating on architectures that will make more use of higher-order languages. The key objective here is to make the systems easier for our customers to use.

“We’ve also been spending a lot more time and

effort in the area of maintainability and reliability—in self-checking and error checking and in the integrity of the data. Some of the improvements will be in the ability to manage and control the system. We’re trying to make it ‘fail-soft,’ so that the user does not lose his data or the integrity of the system.”

The demand for higher hardware speeds and throughput is greater than ever. There is general agreement that the speed of computers will increase gradually and not jump by orders of magnitude.

Seymour Cray, president of Cray Research, Chippewa Falls, WI, and designer of the new Cray I, says that the performance of machines he has developed has improved fourfold or fivefold every three or four years.

“I don’t see much change in this pattern,” Cray says. “Neither do I see any revolutionary breakthroughs. The Cray I has a performance factor of four or five over that of the Control Data 7600, which is the last machine I did. I imagine that Cray II, in three or four years, will have about the same performance improvement over the Cray I.”

While the increase in semiconductor logic speeds will have some impact, the experts see a limit beyond which faster speeds will be achieved only by improved machine architecture. Today gate speeds are on the order of 10 to 20 ns.

“The gate speeds we’ll see in the next five



Through development of higher software language and by putting more of the software into the hardware, fu-

ture generations of large scale computer systems like this Sperry Univac 1100/40 will be easier to use.



Together with multiple processing elements, this Staran S-1000 has a memory organized so that it can be ac-

cessed either by word or by association. Words can be selected based upon a commonality of meaning.

years will be on the order of 500 ps, or 0.5 ns," says Neil Lincoln, senior design consultant at Control Data Corp., Minneapolis, who is concerned with architectures for extremely high-performance computers like the Star 7600. "Some day we'll get down to 200 ps, but I don't think we'll ever push the technology beyond that, and that's a long time away."

The big speed improvements are expected in the new architectures rather than the semiconductors.

"The future architecture has to go to some form of parallelism to get higher performance," Lincoln points out. "And high-bandpass peripherals will be needed to move large masses of data fast. For example, the present STAR station that does file processing has an I/O bandwidth in excess of 100 Mbits to move the data to and from the mainframe. But we're now working on one that will have 900-Mbit bandwidth."

The computer experts agree that the architecture of the future will be that of the distributed system. But just how the elements will be distributed is subject to interpretation.

Phillips of Univac says: "There are about seven different definitions of these distributed systems. You'll see architectures that will accommodate the functional distribution of the various system elements. You'll also see more and more networks of systems. The new architecture will be 'software driven.' Software complexity will be reduced by giving the hardware more software functions."

A major influence in implementing the distributed function concept will be the decreasing

cost of hardware. This type of architecture has a number of dedicated processors within the system.

"Because the cost of the hardware is getting so cheap, you can afford to keep these resources idle a major part of the time just to have it available when you need it," notes Ragnar Nilsen, senior staff engineer of Hughes Aircraft, Culver City, CA. For example, you don't use your car more than two hours a day, yet you're paying for the fact that it's there when you want it to go somewhere. And the same thing is happening in the computer world.

"I also think you'll see a trend away from scientific computing and number crunching. What we really need in this country is to distribute information and not people. The way we distribute information now, because we have so many cars, is by moving people from place to place.

"Most of the people who drive to work don't have to if they can convey their information. It's not unrealistic in the next 10 years for me to pick up the phone and call the library and have them pipe over a book that I want and display it on my TV set. With that type of information transfer, we wouldn't have the oil crisis.

"Data communication is also going to be a focal point of the next generation of computers. You're not going to have the big central processors that you've had in the past. Instead you're going to have a federated system with a sophisticated communication interface. So you dial up what you need and where you need it."

Oscar Rothenbeucher, senior staff member of

A. D. Little's Information Systems Section, observes:

"IBM and other manufacturers have already shown in their architecture the tendency to distribute functions within the system rather than leave them centralized and assigned to one single processor. For example, the architecture of IBM's 370/115 and 370/125 has distributed processors—I/O processors, an arithmetic logic processor and a diagnostic processor. In the next generation of hardware we expect to see this carried further.

"There will be a number of processors to which the various functions are assigned via microprogramming. These microprograms will be loaded once and sit there, unchanged by the customer.

"An advantage of multiprocessors in the system is that if one goes out of service, it can be removed and the work assigned to another, with the work still going on in the degraded mode. The user, however, cannot do that reassignment today because the microprogramming is now done by the manufacturer. To make the change dynamically requires software of an exceptionally high level of competency.

"We expect this dynamic software to be out at the end of the decade. And in that case you'll have what is termed master software plus the operating software which would handle the dynamic allocation of functions to these boxes. The boxes, once told what they are, remain the same."

Systems monitor own workload

Rothenbeucher sees dynamic systems emerging that will monitor their own workload at all times. As an example, he points to a system that has five dynamically assignable processors: three file processors and two I/O units.

"If one has a low workload in file management but a high I/O requirement, the system would reconfigure itself." Rothenbeucher explains, "making one of the file processors an I/O processor. In this case the system would operate with three I/O's and two file units."

But Rothenbeucher cautions that "the type of software that would be needed for this system has been much more difficult to design than everybody, including ourselves, anticipated."

Earl Joseph, staff scientist at Sperry Univac, St. Paul, MN, predicts that "steps will be taken to automate the programming task" in the 1980s.

"One of the major influences here is the fact that it's becoming less costly to wire in a line of code in the hardware than to do it in software," Joseph says. "For example, back in 1965 a line of code wired in as an instruction cost about \$10,000 to the computer users. This cost has been tumbling by a factor of 10 every five years. We're now at the point where it's in the neighbor-



Programming tasks are made easier in this CDC Star-100 through the use of virtual memory and a very high-level instruction set. APL language is used.

hood of \$50 per line of code, and before 1980 it will be less than \$10.

"As a result, you will see much of the system support software—and what we would call application primitives—moving into the hardware, where the primitives look almost like the total application.

"For a large, general-purpose computer, one of the most likely architectures will be one which will have dedicated processing functions in the form of microprocessors. Each microprocessor will have its own local memory plus a hard program for doing that dedicated function. Then you integrate the processors to form the system, using what can be called a 'universal interface module.'"

In considering the cost of a component in 1980, Joseph says that the number of gates or logic functions—10, 10 k or 100 k—will not be the major cost. The price will be determined by how many ICs are produced. As a result, the designer can put in as much circuitry as he wants in these interface modules.

With that assumption, all of the bit-handling and field-handling capability that will be needed for 1, 2, 3, 4 and 5-bit operations, can be put into the interface module. In addition the character-handling capability for 6, 7, 8, 9 and 10-bit characters, and word-handling capabilities for 8, 12, 16, 24, 30, 32, 36 and 48-bit words can be put into modules.

"We might as well put in all of the protocols for getting outside of the system for real-time operation—the standard IBM, Univac, DEC interfaces and so on," Joseph says. "And we might also include the various security functions you need, as well as the various ways of getting to

memory—direct address, indirect, index, page, virtual and so forth.

"In addition we could put in the interface module the various arithmetic operations, such as one's complement, two's complement, the absolute value sign, the arithmetic capability and so on.

"And finally we might as well put onto that module provisions for connecting to 5, 15 and 25-V systems.

"For this dedicated module, there would be a wide range of use," Joseph indicates, "but for any one application only 5% of the logic would be needed. The cost to the computer user would be very little because the development would be spread out over many modules."

The dedicated microprocessor would then be integrated with an interface module to form the system. Because of the low cost of these modules—say \$100 to \$1000—there will be little motive to keep the system busy, Joseph notes.

"As a result, about three-fourths to seven-eighths of the executive program disappears," he continues. "And what you're left with is data and flow control.

"In the calculation process today, we compile programs to memory, because we do it in software form. But if most of the programs are going to be in hard form, we have an entirely different type of compilation process. Instead of having to compile and run, as now, what we have is 'compile while running.'

"And we're telling the chip what pins it is connected to internally and what chips are connected in to make the architecture. But that's a dynamic process, microsecond to microsecond, fitting the specific application needs.

"So what we have then is a compiled-architecture machine in which you're dynamically compiling the architecture, which is an evolutionary result of putting more and more of the programs in the hardware.

"We'd call these things intelligent adjuncts rather than computers because we can attach them to existing processors, memories, communication channels or whatever. And with these adjuncts we can grow into the next generation. We have an architecture that is piecemeal updatable and a distributed system as well."

Memories will grow in size

Future large systems will have much larger memories than present systems, says Gene Amdahl, president of Amdahl Corp., Sunnyvale, CA. He looks for memory hierarchies and, possibly, for uniform addressing systems between the CPU internal storage and the complete archival store.

"I would expect that there would be some distributed processing with the large system for

management, as well as some of the functions," Amdahl says. "This would remove them from being serial with respect to the execution of the main programs of the system."

Bubble memories still are not commercially feasible, Amdahl comments.

"Whether or not this will come within the next 10 years I think is in considerable doubt," he says. "Also, whether or not there is any advantage in having fully electronically accessible information at all levels of storage is rather doubtful."

The reason for this doubt, Amdahl points out, is that "the transaction rate on a lot of data files is infrequent.

"And when it does occur," he continues, "it is often clustered in time. I don't think that there is any medium right now that could compete with tape for shop storage."

Jack Bremer, director of the North American Operations Program for Honeywell Information Systems, Waltham, MA, agrees with Amdahl about exotic memories.

"While charge-coupled devices or magnetic bubbles may come into use by 1980," he says, "they will be used only in special cases, where their unique characteristics are especially valuable. I don't think we'll see electronic disc technology replacing rotating magnetic devices for storage in the 80s, because the discs themselves will continue to improve.

"But I do see a trend towards the use of the diskette as a user-removable medium for local information storage—as opposed to cards—and for program development and for terminal storage."

Rothenbeucher at A.D. Little, turning to another aspect of memory development notes:

"The main problem the commercial user of large machines has is handling large masses of data. It's a problem of file of data-base management and the mixing of sequential orders in file with random-access requirements.

"The solution, and the faster way of handling data, is a joint development of both hardware and software—for example, the IBM 3850 mass-storage system. The 3850 is seen by many as a tape-replacement system; I look at it as a disc-expansion system. What we have there is a virtual disc system.

Rise in batch processing seen

David Hodges, a professor in the Dept. of Electrical Engineering and Computer Science at the University of California, Berkeley, says he "wouldn't be surprised if there is a trend away from interactive time sharing with the large, remote computer, despite opinions to the contrary.

"Rather," he continues, "I expect to see the

VACTEC optoelectronics



New High Speed Silicon Photovoltaic Cells

Ten times faster with excellent linearity, high temperature stability, and high low-light sensitivity.

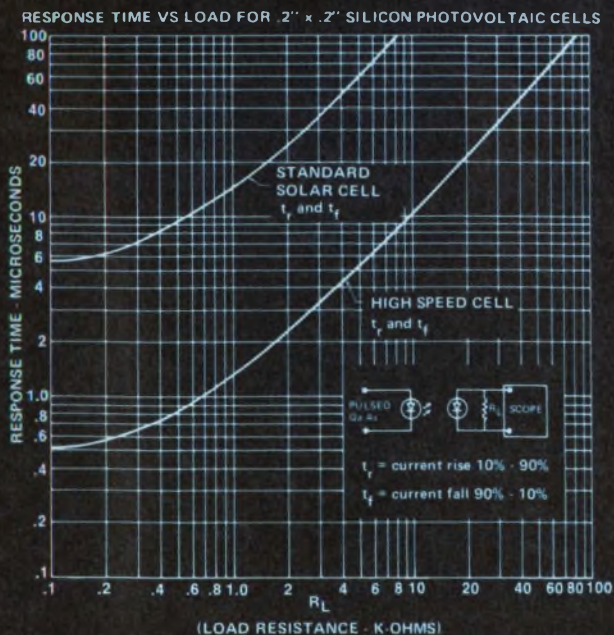

THE INDUSTRY'S BROADEST LINE:

- A. Standard and high speed silicon photovoltaic cells.
- B. Phototransistor and photodarlington.
- C. Opto-Couplers (three types).
LED/Photoconductor
LED/Phototransistor
Lamp/Photoconductor
- D. Selenium photovoltaic cells.
- E. C-MOS and Bi-polar custom I-C's.
- F. CdS and CdSe Photoconductors.

Write today for more details.



Vactec, Inc.
2423 Northline Industrial Blvd.
Maryland Heights, Mo. 63043
Phone (314) 872-8300

data entry and editing done on a small terminal with some kind of local processing and storage, such as a microcomputer and a memory or floppy disc. When the user is satisfied with the data he has prepared, it can then be remote-batch-processed.

"I also don't believe the cost of communications is coming down. For example, even if you make the long lines between the terminal and mainframe free, the local loop from the user to the telephone office is going to get more expensive. And the cost of that loop puts a floor on communications of about 60 cents an hour."

Future designs in the supercomputers like Staran, the Star and Illiac are expected to be strongly influenced by their current designs.

"Over the next few years," says James Feldman, Staran project engineer for Goodyear Aerospace, Akron, OH, "we expect that the basic architecture of the Staran will remain the same.



Distributed processing is found in the architecture of this IBM 370/125. Functions are assigned to I/O, arithmetic, and diagnostic processors.

However, it will have a number of enhanced capabilities. The amount of memory that is directly available to each processing element will be increased, speeds of the processing elements will be raised and the manner in which the processing elements are used will be expanded.

"This will probably make available bit-by-bit processing with the Staran. Now the arithmetic operations are serial-by-bit. The end result will be more throughput, in particular in the long-word-length arithmetic and floating point operations.

"The Staran now has bipolar LSI memory arrays, and the logical extrapolation to the next generation is that the bulk memory will be ICs and the mass stores may go from rotating systems to some sort of solid-state memory.

A "coordinated amalgam" of functional elements—a mainframe network—is what Lincoln at Control Data sees for the very large or super-computer machines.

"In this type of system" he notes, "all of the functional units will have access to all of the available memory, with an extremely high bandwidth for the transfer of data between the units in the memory. But the memory units and functional units will be fairly stand-alone and intelligent—which will make fabrication and checkout of a machine of this size much easier than in the past.

"But the reason that will be possible is that we will be getting much higher logic densities in the future MSI and LSI circuitry. Because we can afford to put more intelligence and independence in these functional units, we no longer need to have a giant slave and a giant CPU."

How will throughput be improved in future super machines?

"One obvious answer," Lincoln says, "is the use of parallelism—you perform two or three or four add operations simultaneously. One type of parallel architecture is that of the Illiac IV, which can be considered a two-dimensional processor. Multiple additions are obtained in the same clock cycle."

Another approach, Lincoln points out, is a multiprocessor, with four independent processors working on four independent instruction streams.

A five-year program of studies leading to a more powerful Illiac in the 1980s is reported by Loren Bright, director of research support at the NASA Ames Research Center, Moffet Field, CA.

"Experience over the last three or four years," he says, "has demonstrated that Illiac IV has insufficient computing power for Ames requirements. We need to have about 1000 times the computing power we have today—something on the order of 10^{10} operations per second—before we can substitute computer flow solutions for wind-tunnel experiments."

Daniel Slotnick, professor of computer science at the University of Illinois and a principal designer of the original Illiac, cites improvements that he would make in the machine.

"I wouldn't distribute control," Slotnick says. "I'd keep it central, because I still don't think we have the programming technology to deal with such a large system—a system where each node requires a substantial amount of individual control.

"But I'd greatly increase the number of processing elements, for two reasons. One is simply to increase the processing capacity. The other is to obtain an order or two of magnitude increase in reliability and availability. The present Illiac is very memory-limited, so I'd lay on the memory like there's no tomorrow."

But, in general, Slotnick feels that the redesign of the supercomputers that were funded by the Government is several years off. ■■

Analyze your spectrum— The S-D way.



The scenery's great from our point of view . . . and so is S-D's new Model 4808 UHF Spectrum Analyzer (10 KHz to 1.8 GHz). Interchangeable plug-ins plus "bolt-on" units you can add right on the scene make this one analyzer that won't see a final sunset. 100 Hz to 1 Mhz bw, absolute amplitude calibration, sensitivity 115 dBm, and skirt selectivity of better than 11:1 go along with a price that's right. Give us a call . . . we'll brighten your day.

In the U.S. give your local Scientific Devices office a call. Or contact us at 14844 Oxnard Street, Van Nuys, CA 91409. Phone (213) 786-1760. Abroad, contact Systron-Donner GmbH, Munich; Systron-Donner Ltd., Leamington Spa, U.K.; Systron-Donner S.A., Paris (Le Port Marly); Systron-Donner Pty. Ltd., Melbourne.

Specialists in Frequency Domain Instrumentation

SYSTRON  DONNER

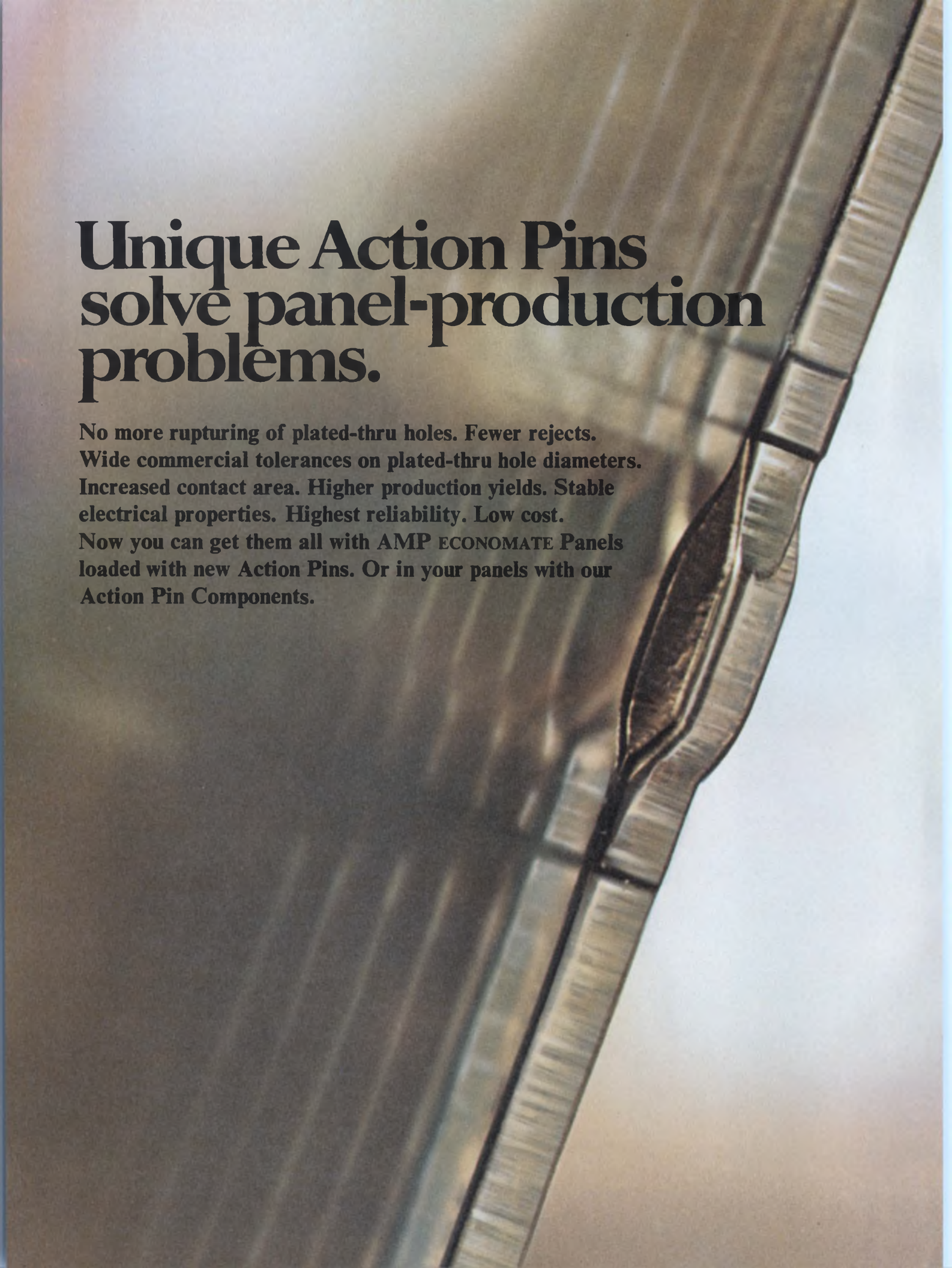

Unique Action Pins solve panel-production problems.

No more rupturing of plated-thru holes. Fewer rejects.
Wide commercial tolerances on plated-thru hole diameters.
Increased contact area. Higher production yields. Stable
electrical properties. Highest reliability. Low cost.
Now you can get them all with AMP ECONOMATE Panels
loaded with new Action Pins. Or in your panels with our
Action Pin Components.

HOW ACTION PINS WORK. AMP Action Pins incorporate a spring section to give a higher degree of compliance than ever before possible. The diagonal measurement of the spring section—before insertion—is larger than the hole diameter (Fig. 1). When the Action Pin is inserted, the two opposing spring members readily compress, and after insertion, exert a force sufficient to effect a gas-tight interface with the plated-thru hole walls (Fig. 2). Yet their rounded corners prevent rupture of the plated-thru hole. They come with a variety of configurations: card-edge contacts, .025² feed-to and feed-thru posts, and SEM (NAFI-style) two-piece receptacle-and-blade contacts. All are compatible with wrap-type terminations or I/O connections.



Fig. 1



Fig. 2

AMP ECONOMATE panels are made to your specifications and consist of two elements: the pc board—either two-sided or multi-layer with plated-thru holes—and the AMP ECONOMATE Action Pin contacts.

ECONOMATE I card-edge contacts, and ECONOMATE II two-piece receptacle-and-blade, SEM (NAFI-style), contacts both feature snap-on housings for maximum maintainability of panels. Posted panels feature .025² feed-to and feed-thru posts for automatic, semi-automatic, or manual point-to-point wiring. All types hold costs to a minimum through AMP's high-speed automated assembly process.



MAKE OR BUY. AMP can supply all your panel requirements. Or, you can make them yourself using our reliable Action Pin components. Contacts come in strip for high-speed, low-cost gang insertion at rates up to 10,000 an hour with our high-productivity assembly tools.

Action Pins solve the problems that bother you most. They won't broach, rupture, tear, distort or damage the plated-thru hole—giving you the ultimate in reliability.

When it comes to panels, AMP is where the action is. Get the whole story. Call (717) 564-0100 or write AMP Incorporated, Harrisburg, PA 17105.

AMP and ECONOMATE are trademarks of AMP Incorporated.

AMP
INCORPORATED
INFORMATION RETRIEVAL NUMBER 25



Mass memories raising speed, dropping cost and storing billions of bytes

Prodded by the demands of computer users for larger, cheaper and faster memories, manufacturers have stepped up their efforts to produce mass-memory storage systems. As a result of this increased activity, several advances in memory technology have taken place. Among them are:

- The introduction by both IBM and Control Data of mass-memory systems that are capable of storing several billion bytes of information.
- The announcement by California Computer Products, IBM and Storage Technology of larger and cheaper disc memories.
- The development by General Electric and Micro-Bit of electron-beam memories that promise high storage densities, high speed and low cost.

The most dramatic of these advances may be the introduction by IBM of the 3850 mass-storage system. This system uses a new storage component, called a data cartridge, that combines the random-access characteristic of disc devices with the economy of tape drives.

Housed in honeycomb storage compartments, these fist-sized data cartridges can each hold up to 50 million bytes of information. Data in the 2-by-4-in. plastic cartridges are stored on 770 inches of 3-in.-wide magnetic tape. The information is organized on the tape spool into cylinders, in much the same way it is recorded on magnetic discs, giving the tape medium the random-access characteristic of disc storage.

Each cylinder accommodates 19 tracks, and

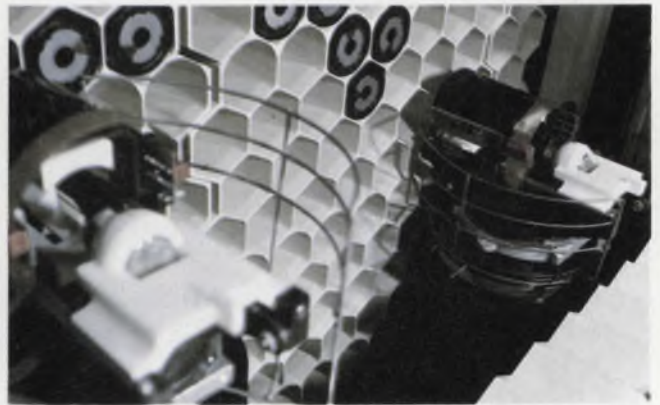

Small data cartridges stored in a honeycomb array form the heart of IBM's new 3850 mass memory system. The new system extends the virtual storage concept to magnetic disc memories.

each track can hold up to 13,030 bytes of data. Since there are 202 cylinders in a cartridge, the total storage capacity of each cartridge is 50 million bytes. Thus only two of these small units are needed to store all the information stored on a 3336 disc pack.

Whenever information from a cartridge is needed by the computer, a mechanical mechanism selects the desired cartridge and transports it to one of eight reading stations. There the data are read out and transferred to disc drives through a process known as "staging."

It's a virtual disc system

An interesting feature of the 3850 is that it extends the virtual-storage concept to magnetic disc devices. By combining the 3850 with a standard 3330-type disc system, the new memory sys-

Jules H. Gilder
Associate Editor

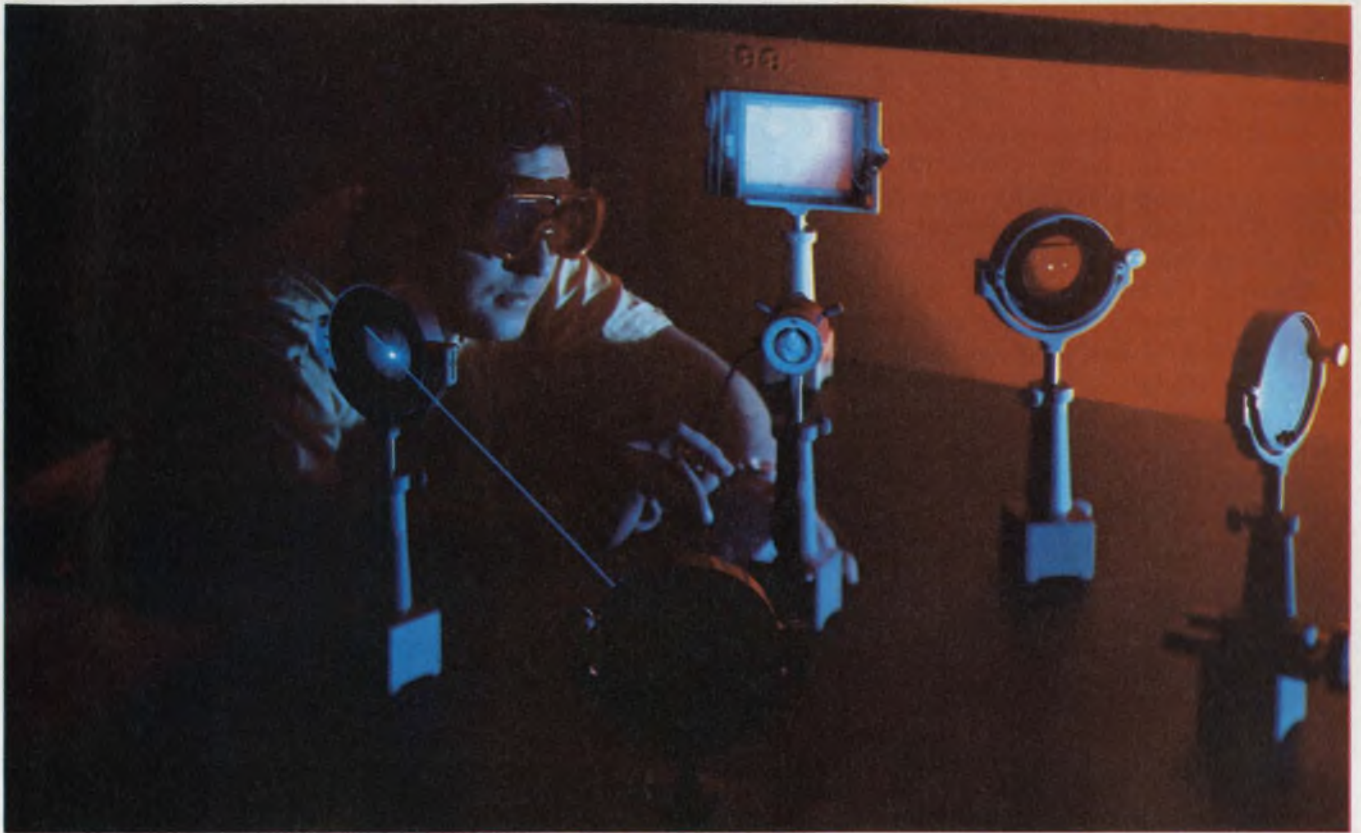

An experimental holographic memory that has a storage density of 10^6 bits/sq. cm has been developed by Sperry

Univac. Optical memories promise a storage density of 10^8 bits/sq. cm.

tem makes the computer "think" that there are many more discs available than there actually are. This is done by using the same area on a disc pack to hold different data files at different times.

The basic 3850 system starts with a storage capacity of 35 billion bytes and is expandable in increments of 67 billion bytes to 472 billion. IBM claims that, with the 3850, users with a large number of data files can make all of their information available to the computer at about one-tenth the cost of magnetic-disc storage.

Enter, the CDC 38500

Only months after IBM announced its 3850, Control Data introduced its version of a mass-storage system and dubbed it the 38500. The CDC unit offers IBM 370 users a smaller alternative to the 3850 at lower cost. While IBM's minimum 35-billion-byte configuration costs about \$477,000, the 16-billion-byte minimum configuration from CDC costs \$326,335.

As with the 3850, data in the 38500 are stored in small cylindrical cartridges. But unlike the cartridges in its predecessor, each cartridge in the 38500 contains only 150 in. of 2.75-in.-wide magnetic tape. Data are recorded on 100 inches of tape on 18 tracks. The CDC data cartridge can store only 8 megabytes of data, while the IBM cartridge holds 50 megabytes. But the smaller

CDC cartridges have an advantage: They are more flexible and allow for faster access times.

Many marketing specialists in the industry say that since the CDC system is not compatible with the IBM unit, it will have a difficult time being accepted by users. But CDC's hopes for the 38500 are based not on parity but on what it says are tangible advantages over the 3850. These include:

- Faster average access time to data.
- Faster data transfer rate.
- Plug compatibility with IBM hardware.

Up to 2000 data cartridges can be stored in a honeycomb structure that is similar to the one used by IBM. CDC claims that the average access time to any byte of data is only 7 seconds, while IBM says its system needs an average of 15 seconds to access data.

When data-transfer-rate figures for the IBM and CDC units are compared, CDC comes out ahead, though it may not appear that way at first glance. On the surface, IBM's transfer rate of 874 kilobytes per second looks quite a bit faster than Control Data's 806-kilobyte rate. But because IBM has borrowed from video technology and used helical scanning, rather than the longitudinal recording of the 38500, the system must perform considerable error correction.

Error correction slows down the IBM system so that the actual transfer rate of data is about 200 kilobytes per second.

By using longitudinal recording, designers at CDC have avoided this problem; the 806-kilobyte transfer rate is the actual speed at which data are moved.

Another interesting feature of the CDC 38500 is that it is plug-compatible with existing IBM hardware. It can plug right into a 3832 controller. The IBM mass memory cannot; it requires a special new controller—the 3830.

There are other differences between the IBM and CDC systems that may make the CDC unit more attractive. In the 38500, data from the tape cartridge can be read directly into the computer or staged onto a disc. Thus the system can be used either for virtual memory or with any other IBM operating system. The IBM 3850 can be used only in the virtual mode.

Also, the CDC mass memory will work with

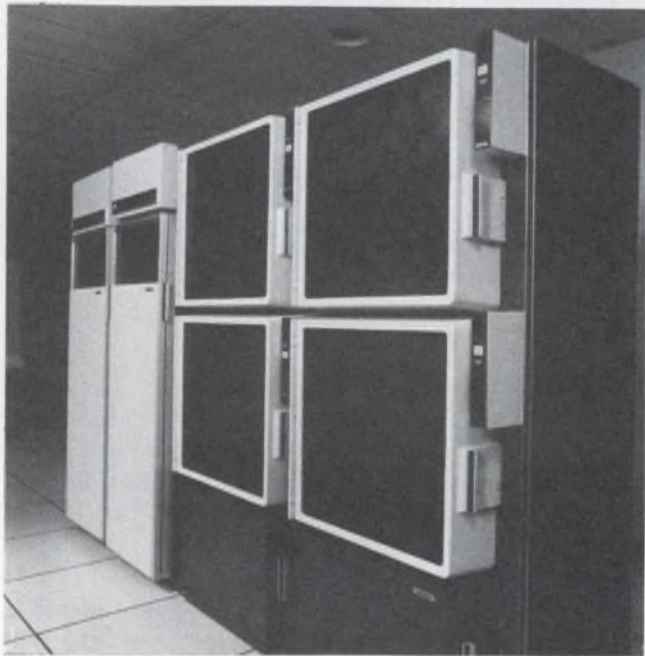

The Terabit Memory from Ampex is capable of storing up to 358 billion bytes of data on 2-in. wide video tape. The access time is 15 sec. Data move at 1.2 million bytes/sec.

any disc memory system, while IBM's works only with 3330-type discs.

A potentially serious problem with the CDC device, however, is that it uses only one tape-cartridge selection unit. If that device fails, 2000 cartridges, or 16 billion bytes of data, are out of commission. You can't easily move 2000 cartridges to another selection box; recovery from such a failure is very difficult. IBM avoids the problem by having two selection mechanisms for each system, so there is always a spare.

Terabit memory hangs in there

While both the 3850 and the 38500 appear to be attractive possibilities for mass storage, neith-

er of these systems has been installed yet, and thus there is no user experience to back them up. IBM systems should be installed by the end of this year, but CDC doesn't expect to ship until the fourth quarter of 1976 at the earliest.

This lack of user experience, notes Erik Salbu, Ampex's marketing manager for advanced systems, is a good reason why customers should consider a system that has been in use for a few years and has had the bugs worked out of it. Ampex's Terabit memory (TBM) is such a system, he argues; it has been around since 1972.

That's not to say that Salbu doesn't hope IBM will be successful. He does. Ever since the computer giant announced an entry into the mass-memory market, the projected \$20-million potential market has jumped to somewhere between \$500-million and \$1-billion; Ampex expects to get a slice of this larger market.

Salbu notes that the TBM is more modular than the IBM system, and he says it can outperform it. He points out that a minimum IBM system contains 35 billion bytes, while the TBM has a minimum configuration of 11 billion bytes.

As far as efficiency is concerned, Salbu vigorously opposes the widely held view that sequential media, such as large tapes, are inefficient in a random-access mode. There isn't much truth to that, he asserts, because the TBM system searches tapes at 1000 inches per second. Access time for the TBM in a random mode is about 15 seconds. In the same mode, the CDC system requires about 10 seconds, while the IBM unit needs 20 to 25 seconds, he reports.

And if some simple techniques—such as re-writing at the end of the tape data that haven't been used in the last 30 days—are employed, access time can improve by a factor of 2.

In its maximum configuration of 358 billion bytes, the TBM can store the same amount of data that normally would be found on 3500 IBM 3336 disc packs or on 160,000 tape sets. This enormous capacity makes it possible to put an entire tape library on-line.

While the TBM is basically the same system that was introduced three years ago, some improvements have been made, particularly in interfacing, Salbu says. One improvement has been the addition of a disc-staging capability that allows data to be entered onto discs directly.

Research on further improvements is still going on, the Ampex manager reports. For example, efforts are under way to increase the recording density of the system. And good results are being achieved, Salbu says. For the last two years, Ampex has been testing a TBM system that has 10 times the packing density of the presently available unit. That means that the system has a bit density of 15 million bits per square inch.

Another approach to the mass-memory problem—one that is a lot more palatable to many users with a large investment in standard computer tape—is the 7100 Automated Tape Library from California Computer Products (CalComp).

The most attractive thing about this system is that it does not require a user to convert his standard computer tapes to another format. All he has to do is install the hardware, place his tapes in the bins and turn on the equipment.

The system can handle between 700 and 7200 reels of tape. In operation, a selector mechanism moves along a rail, and when it reaches the site of the tape it wants, it pneumatically grabs it, mounts it on an automated tape drive and afterward puts it back.

Disc density doubled in new units

Recently IBM announced two new disc memories that set records for storage density. The two units, the 3350 and the 3344, have doubled the storage density of discs, resulting in the packing of 3 million bits of data into one square inch of area. The previous storage density record was also held by IBM, with its 3340 Winchester disc.

According to Richard Whitney, manager of storage products at IBM in San Jose, CA, the increased density resulted from improvements in both the track density and the linear bit density. But just what the new limits on these parameters are he will not say. However, he does note that each spindle in the new system—it has two—can accommodate 317.5 megabytes of data.

The major difference between the 3350 and the 3344 is that the 3350 has a transfer rate of 1.2 megabytes per second, compared with only 885 kilobytes per second in the 3344.

Like the 3340, which preceded them, the new disc systems use Winchester technology—that is, they incorporate sealed disc packs. But unlike the earlier memory system, the new ones have the media, or discs, fixed into the unit. By bolting the disc pack to the system, IBM has shut the door to independent disc pack manufacturers.

The industry is already reacting to the IBM announcement. California Computer Products has already announced an 800-megabyte disc memory. CalComp's 800 MB 235-IV is expected to be on the market by the second or third quarter of 1976.

Although other manufacturers already have 800 megabyte units on the market, the CalComp unit is said to be a real advance in the technology in that it uses IBM 3330-type discs in which the track density has been doubled from 370 tracks/in. to 740 tracks/in.

Three other new products that are designed to compete directly with the new 3350 from IBM

come from Storage Technology of Louisville, CO. They are known as the 8850, 8450 and 8350.

The 8850 is an upgraded version of the company's Super Disk, and it has a storage capacity of 1270 megabytes, which is achieved with 238 tracks/in. and 6425 bits/in. It is compatible with the IBM 3350 and it looks to the computer like four of those units.

The 8850 has an access time of 27 ms compared with 25 ms for the smaller 3350. It will cost half the price of the 3350 and will be available during the last quarter of 1976.

A scaled down version of the 8850 is the 8450. This unit stores up to 635 megabytes of data and looks like two 3350s. It has the same bit and track densities as the 8850. Both the 8850 and the 8450 can run in a 3330 mode and be con-



Data cartridges in CDC's 38500 mass memory system are read at a read/write station where the tape inside is automatically unwound into vacuum columns. Information is transferred at 806,000 bytes/sec.

verted to a 3350 mode when desired. The final entry from Storage Technology is the 8350, which looks identical to the 3350.

Holographic memories being pursued

Development of holographic memories is under way at several companies. Among them are Sperry Univac and Harris.

To date, Sperry has fabricated an experimental read-only holographic memory with partially populated pages. The storage medium is a photographic plate on which data are recorded in both amplitude and phase modes.

In Minneapolis, researchers at Sperry are at-

Comparison of mass memory systems

	Ampex Terabit Memory	CalComp Automated Tape Library	Control Data 38500	IBM 3850
Capacity	Minimum: 11 billion bytes Maximum: 358 billion bytes	Minimum: 600 standard computer tapes Maximum: 6000 standard computer tapes	Minimum: 16 billion bytes	Minimum: 35 billion bytes Maximum: 472 billion bytes
Access time	15 sec	20.5 sec	7 sec	15 sec
Data rate	1.2 million bytes/sec	1.2 million bytes/sec	806,000 bytes/sec	874,000 bytes/sec
Media	5620 megabyte, 2-in. TV tape on 10.5-in. reels.	0.5-in. wide magnetic tape on 10.5-in. reels	8 megabyte cartridges containing 150 in. of 2.75-in. wide magnetic tape	50 megabyte cartridges containing 770 in. of 3-in. wide magnetic tape
Recording technique	Transverse video tape recording	Longitudinal	Longitudinal	Helical scan
Throughput	220 files/hour	150 reels/hour	200 files/hour	100 files/hour
Cost	\$375,200 to \$461,000 for minimum system	\$75,000 for minimum system	\$326,000 for minimum system	\$477,000 for minimum system

tacking some of the critical problems that still stand in the way of commercially feasible holographic memories. These include the recording material, the light deflector and the page composer, which converts electrical data into optical data.

Engineers at Harris' Electro Optics Operation in Melbourne, FL, seem to be progressing faster. They have already delivered a preliminary model of a holographic system to the Air Force and have a contract to deliver preproduction models by the spring of 1976.

The Harris approach uses 4-by-6-in. microfiche cards to store information. The system is unusual in that it accommodates a special human-readable/machine-readable format. The concept consists of 60 images arranged in five rows of 12 that contain human-readable data plus a 6.4-mm-wide strip of one-dimensional holograms recorded along an unused portion of the title block. This strip contains 2.5 megabits of data, the encoded equivalent of the 60 pages.

The memory can also operate in a machine-read-only mode. In this case the storage capacity jumps to 37 megabits.

Electron beams increase speed and density

For applications that require high speed, as well as high density, electron-beam memories developed by Micro-Bit and General Electric look promising.

Basically an electron-beam memory is one that uses a high-resolution electron beam to store and read information on a target by some reversible reaction. In practice, the target is made of silicon dioxide, and the data are stored as electrostatic charges.

According to Dennis Speliotis, manager of advanced systems for Micro-Bit in Lexington, MA, a prototype system consisting of nine storage tubes, each with a capacity of 128 kilobits, has already been delivered to Control Data for evaluation. It is being used with a Star 1B computer, a scaled-down version of the giant Star computer.

Speliotis says that he hopes to introduce a commercial electron-beam memory by the end of the year. The product would be known as the System 7000 and would consist of 18 parallel storage tubes, each with a capacity of 4 million bits. The access time of this memory would be 5 μ s to a block of data. Once at the correct block, the system requires only 0.5 μ s/bit to read out data.

The OEM price for a plug-compatible system, Speliotis indicates, would be only 0.04 cent/bit.

Dampening this cost claim is William C. Hughes, program manager for electron-beam memories at General Electric's Research and Development Center, Schenectady, NY. He says that the cost for storage on a systems level will be 0.02 cent/bit.

GE, says Hughes, has developed an electron-beam memory that is similar in many ways to Micro-Bit's. Known as Beamos, the GE memory is capable of storing 32 million bits per tube. That's 256 times more capacity than the tubes delivered in Micro-Bit's prototype and eight times more than its proposed product entry. Because it is larger, the GE memory has a higher access time—typically 30 μ s.

While the 32-megabit memory module has been successfully constructed and tested for the military, it is not yet commercially available. Hughes indicates that it will take at least another year to put together a commercial product. ■■

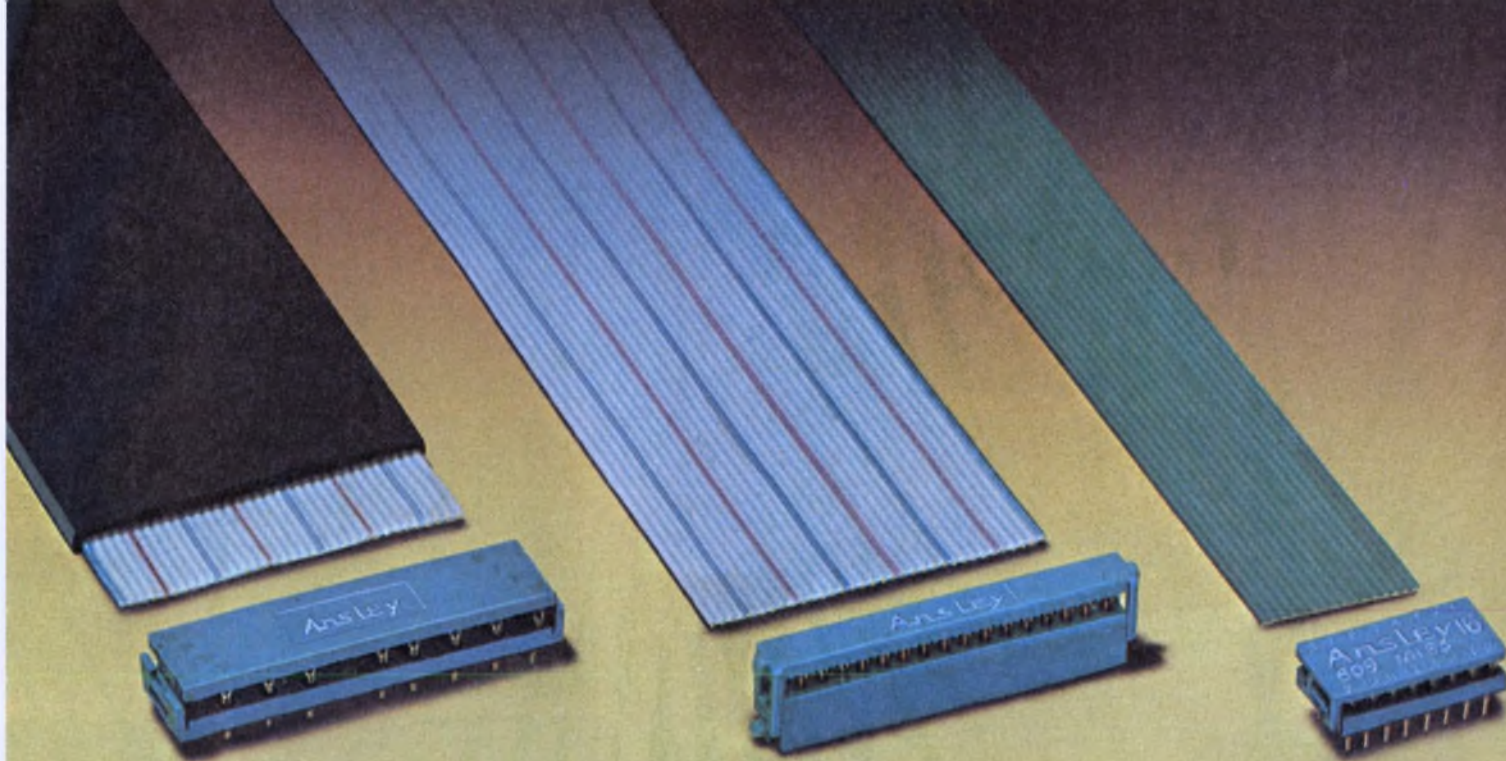

BLUE MACS™...the lower installed cost mass termination system.

The new Ansley BLUE MACS cable/connector system employs a unique mass termination technique that achieves both lower installed cost and maximum reliability.



Cross section of TULIP™ contact termination.

With our specially designed one-piece connector *there is no pre-assembly*. Which means you can simultaneously mass terminate up to 50 conductors — in seconds — with our BLUE MACS round or flat

conductor cables. And because both the cable and the connector are made to fit together like a glove, absolute electrical contact reliability is assured.

Before, during and after crimping, precision mechanical side latches hold the one-piece BLUE MACS connector together. The self-aligning connector grooves automatically position *each* conductor over a 4-point TULIP-shaped contact for positive termination. And finally, the one-step crimp cycle does the rest — all without pre-stripping.

The same cost-efficiency and reliability benefits of our mass termination technique apply to our SHURE STAKE® hand and bench tools. Our entire series of one-piece connectors, UL-listed jacketed and high-flex flat and round conductor cables all use the same, simplified tooling.

In short, our one-source BLUE MACS termination technique offers built-in design compatibility to pro-

vide you with the most reliable and complete mass-assembled-connector-system in the industry. After all, who else would know more about mass termination techniques than T&B/Ansley . . . the company that's been doing it since 1958.



Pre-set compression cycle assures connection reliability.

To prove our point, a free demonstration is yours for the asking. Call or write:

T&B/Ansley
The mass termination company.

Ansley Electronics Corp. • Subsidiary of Thomas & Betts Corporation
3208 Humboldt St. • Los Angeles, CA 90031 • Tel. (213) 223-2331 • TWX 910-321-3938

In Canada: Ansley Electronics Ltd., P.Q.

The BLUE MACS system is stocked and sold through authorized T&B/Ansley distributors worldwide.

EASIEST-TO-USE

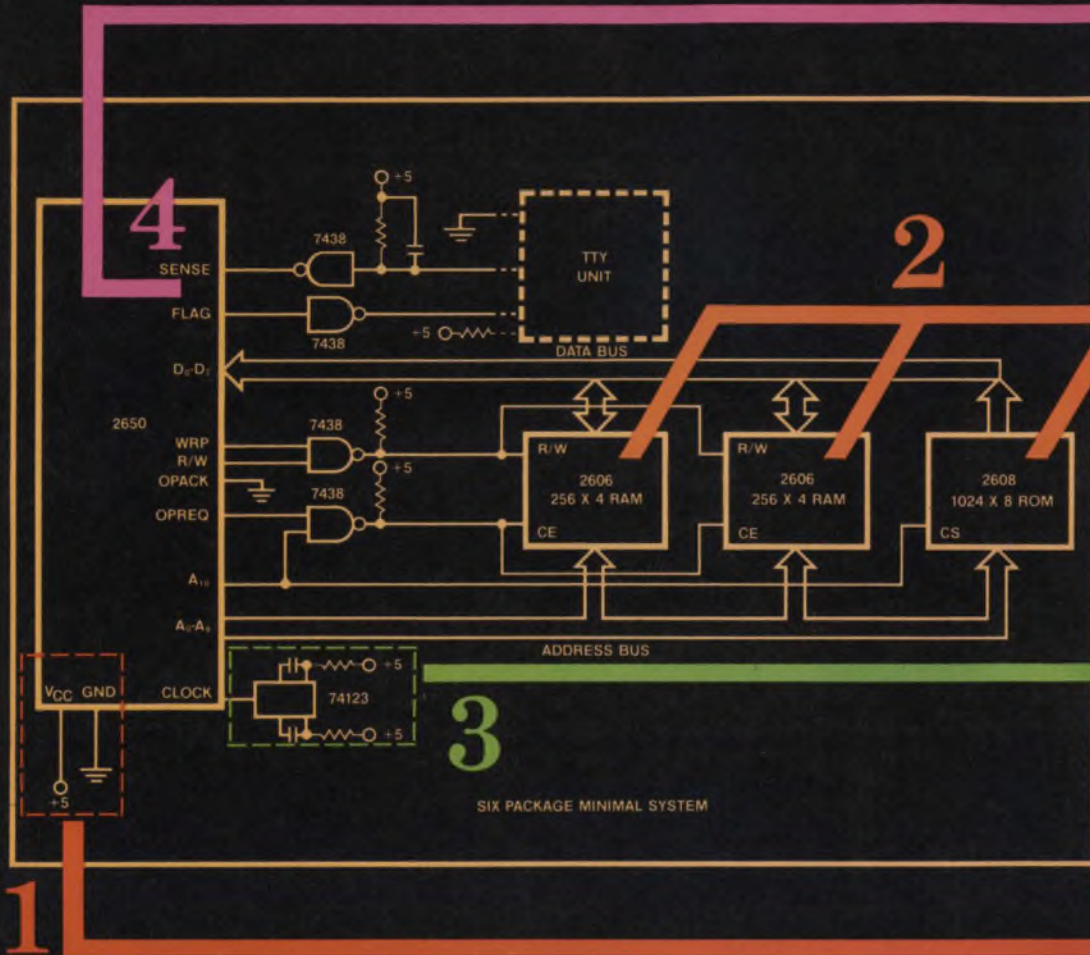

The 2650—static, 5V, TTL compatible, 8-bit μ P

Conceptual simplicity is the key to the 2650's ease of design. This μ P is static, not dynamic. Its multiple addressing modes mean fewer instructions. Even the instruction set is extra powerful, to increase coding efficiency. Features that add up to less memory required, less design time. Less parts cost and assembly time. More value.

Illustrated: Parts for 6-package system. Can be purchased for under \$100 in quantities of 1.

How much less than \$100? In large quantities, the parts could go below \$50. But what's most important is that if you build a larger system—perhaps with 5 or 10 times the memory, plus more I/O—you'll do it with the greatest of ease, and increase your savings still further. Because the 2650 won't need the special (and expensive) memory and LSI I/O chips required in other microcomputer systems. What's an outstanding value in small systems becomes an unbeatable value as the systems get

larger. Convince yourself by looking at this beautifully simple Teletype system, a typical example.

1 Only one +5V power supply drives everything in the system; and this microprocessor is really low power: just 525mW max.

2 Standard, low-cost memories—your choice. This 6-package system with TTY interface uses only 3 ICs to give you 1024 bytes of standard ROM, 256 bytes of standard RAM. ROM can contain bootstrap loader and I/O driver programs for the TTY, plus operating programs for the system. Other programs plus data can also be in the ROM or written into the RAM by the TTY. Or use a PROM instead of a ROM for maximum flexibility.

3 Single-phase, TTL-compatible clock input eliminates the nest of transistors, crystal and extra ICs some other microprocessors require. Simple. Cheap. Works better.

MICROPROCESSOR.

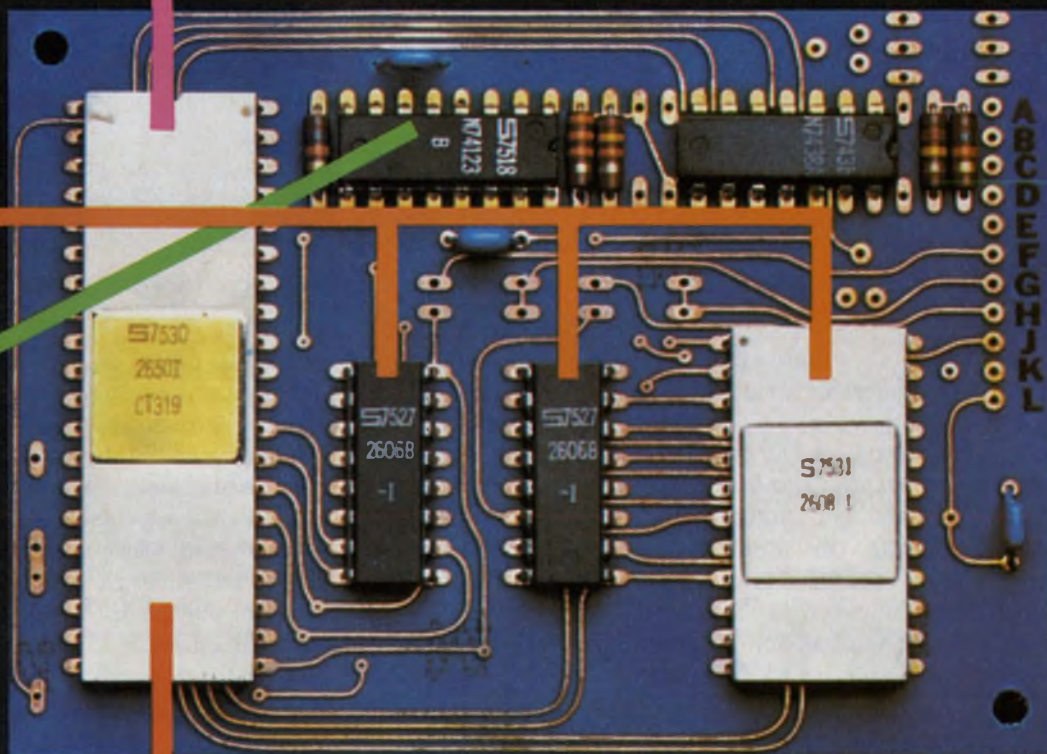

Photo approximately twice actual size.

4 On-chip serial interface eliminates a 24-pin IC. And its cost. And its space. And its connections.

5 Where are the special interface chips? There aren't any in this sample system. And not much in any other system you might design with the 2650. With much of the I/O built into the 2650, you can interface the I/O devices with simple, low-cost, industry-standard 74LS, 7400 and 8T circuits.

For instance, get both input and output with the 8T31 Bidirectional I/O Port. Or take the 8T26 Quad Bus Driver as another example. Signetics offers fifty 8T types and nearly everything in 74LS and 7400—all low cost, all industry standards. Lower parts cost means much greater value.

Software and people to back the 2650 are here now.

Cross assemblers and simulators are available in batch and on timeshare. (The assemblers come in both 32- and 16-bit formats because we realize that not everyone has a 32-bit machine.) And there's a prototyping card (CPU, RAM, ROM) with debug firmware. Documentation, manuals, application notes. Plus training seminars and

on-the-spot Field Applications Engineer assistance.

You get more computer with fewer parts at less cost with the 2650. That's high-technology value. Send now for complete details and prove it to yourself.

Attach this to your letterhead for fast response

- Send me full specs & abridged manual, free.
- Send me the complete 2650 manual with update service (additions, corrections, application notes, etc.). Bill me \$40.
- Call me to answer questions I have.
- Have a Field Applications Engineer make an appointment with me soon.

NAME _____

TITLE _____

TEL. _____

Signetics

811 E. Arques Ave., Sunnyvale, CA 94086

Floppy discs, cartridges and fixed-hard discs rise in use at savings to you

Two years ago there were buoyant predictions that floppy-disc manufacturers would be shipping tens of thousands of their drives for a multitude of applications by the middle of this year. It hasn't happened yet. But hang in there.

Floppy discs, fixed-hard (nonfloppy) discs and cartridges are all heading for much wider use. All can be bought today for less than \$2000, and with the move toward microcomputers and low-cost minicomputers, it has become increasingly important to get such low-cost peripherals.

Floppies are taking off

A buzzword in the industry; the floppy is a round disc of coated Mylar, about the size of a 45-rpm phonograph record, that sits in a plastic envelope with a large hole in the middle. More effort has been expended toward producing reliable, low-cost floppy disc drives than any other low-cost magnetic peripheral.

Experts now estimate that by mid-1975, the entire floppy-disc industry was shipping less than 3000 drives a month. But that figure is expected to rise to 5000 a month by the end of this year. And from then on, the experts say, production should increase steadily. These estimates do not include output by IBM, which produces many thousands of floppy-disc drives for its own use.

William E. Walker, director of marketing at Remex, Santa Ana, CA, notes: "Floppies have divided into two basic types. When media inter-

changeability (use of discs on different floppy disc drives) is necessary, there is a class of drives that call themselves IBM-compatible. These drives are compatible both in media and in format with the diskettes used on the IBM 3740 terminal. They use biphase recording, with 26 soft sectors, and can store about 1.9 Mb of usable data. The other class of drives is broadly defined as non-IBM-compatible. This covers a broad variation in features."

The main feature that most floppy-disc manufacturers have added is double density. By



Kennedy's 331 is a drive for the standard 3M data cartridges. Maximum capacity is 2.875 Mbytes. The drive sells for \$350 to \$400 with a formatter.

switching to modified frequency-modulation (MFM) coding, they have increased the 3268-bpi inner track density to over 6000 bpi. The usable capacity of the disc increases to around 4 Mb. Through other coding tricks, some manufacturers have increased the capacity to about 5 Mb.

Another feature that many manufacturers offer is hard sectoring. This marks the boundaries of data "bins" on the disc surface. Hard sectoring is usually done with either holes punched into the disc and sensed by the drive or—in the case of Orbis Systems, Costa Mesa, CA, and Remex—with a strobe wheel on the drive shaft. Holes in the strobe wheel are sensed and counted. The number of sectors is determined by the number of holes counted per sector. Memorex of Santa Clara, CA, was the first to use holes in the disc for hard sectoring.

Leading manufacturers of floppy-disc drives—such as Control Data, Hawthorne, CA; Memorex; Shugart Associates, Sunnyvale, CA; Century Data Systems, Anaheim, CA, and Pertec, Chatsworth, CA—offer both IBM-compatible and non-compatible drives. But is this necessary?

"I don't think that IBM compatibility will continue to be important in floppies," says Frank Madren, marketing manager for instrumentation and control at Data General in Southboro, MA. He believes that media interchangeability is important in only a very limited number of applications. When it's not necessary, Madren thinks that customers will want all of the additional features that can be offered, including higher capacity at not much increase in price.

Michael Shebanow, vice president of engineering at Pertec, feels differently. "Certainly some customers will want double density and a variety of other features," he says. "That's why Pertec and others offer those features. But IBM compatibility is a comfortable standard for floppy-disc users to specify. It is a safe buy, and a predictable level of performance will be obtained no matter who the vendor is. IBM-compatible floppies are certainly the leader now, and I believe that they are here to stay."

Two-sided recording expected

One feature that most floppy vendors are working on is two-sided recording. It requires that media be available with oxide on both sides and slots cut into the envelope for the recording heads to come through. Discs suitable for two-sided recording will soon be available from a variety of media vendors. Shebanow of Pertec does not believe that two-sided recording is cost-effective at present. Walker of Remex expects two-sided drives within the next two years.

A survey of vendors indicates that the industry is almost evenly split on the question. Most seem to think that two-sided recording will eventually come, but not in a big way, within the next couple of years.

Another area of floppy-disc controversy involves the best way to handle multiple drives. Companies such as Shugart, Memorex and Sycor in Ann Arbor, MI, have used a single ac-drive motor and have driven more than one disc on a single spindle. This, they contend, increases the



The 2644A Data Terminal from Hewlett-Packard uses a tiny version of the 3M data cartridge. On one track the cartridge can record over 100,000 bytes.

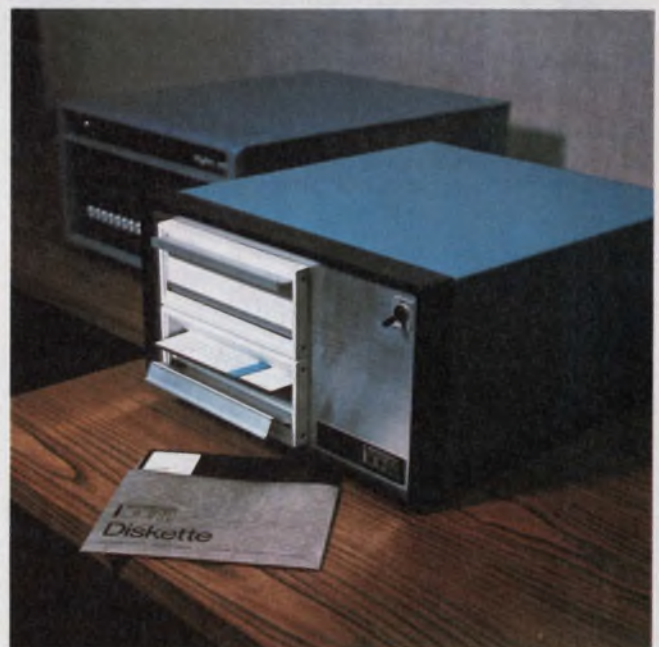

iCOM's FD360 dual floppy-disc drive system interfaces to the Intellec MDS-800 microcomputer system from Intel, as well as other microcomputers.

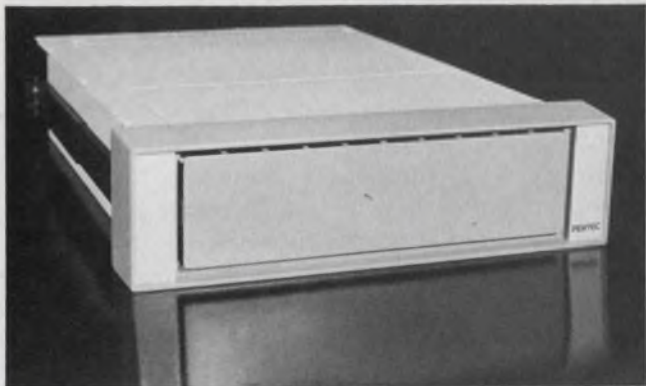

Fixed disc drives are a lower-cost alternative to removable disc packs. The D1400 from Pertec can store 6 Mbytes with an average seek time of 70 ms.

capacity of the system with a minimum increase in mechanical parts. Generally these drives also share a single controller, and sometimes they also share a single head positioner.

Most other manufacturers seem to feel that it is more reliable to use a separate motor for each drive. This, they argue, allows the system to stay up even if a motor fails. In addition it allows seek overlay—that is, when one drive is reading, another can be seeking a new track.

Among the other features predicted for the next year or two:

- Higher operating temperature capability for the media. The present plastic envelope does not remain stable much above 100 F. Better plastics will improve this.

- Wide use of ceramic recording heads. This will give five times longer lifetime than steel heads.

- Faster head positioners. These should come into wide use, yielding a small improvement in average access time.

The middle ground: Fixed drives

When floppies are not fast enough or have too little capacity, and removable media cartridge disc drives are too expensive, a middle ground must be sought. It has come into wide use in the last few months in the form of a fixed hard disc drive. Leading minicomputer disc drive companies—such as the Diablo Systems Div. of Xerox in Hayward, CA, Pertec and the Caelus Div. of EM&M, San Jose, CA—now offer this type of drive. These are moving-head, voice-coil-positioned, flying-head drives with capacities on the order of 5 and 10 Mbytes. They sell for under \$2000.

“I see a major move to fixed media drives,” says Taz Pettebone, product manager at Diablo. “I believe that the next couple of years will bring whole families of fixed media drives with ever larger capacities. Recent IBM developments

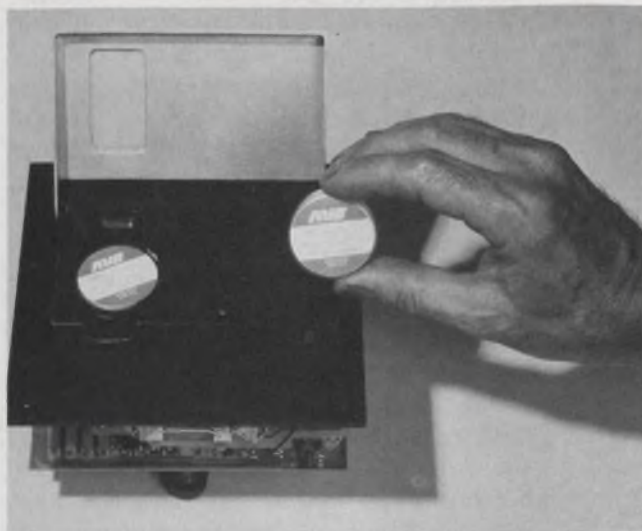

American Videonetics offers the MDR 212 with fully automatic loading of small tape reelettes. The reelette can store 1.5 Mb at a storage density of 800 bpi.

have also indicated that fixed media drives will be used in many IBM systems. This stamp of approval is sure to accelerate the sales of these drives.”

Robert Rottmayer, manager of disc components and technology at Digital Equipment Corp., Maynard, MA, says: “Fixed media drives have a couple of major advantages over removable media drives. They are 30 to 40% cheaper for the same capacity, and they are more resistant to harsh environments. Since they are fairly well sealed, the disc is protected against particulate contaminants.”

Virtually all manufacturers are moving in the same general direction with these drives. The next major advance is likely to be a combination of fixed heads and moving heads on the same disc surface. Avi Brand, disc engineering manager at Pertec, points out: “The inside tracks on the disc will have fixed heads, and the outside tracks will be accessed by a moving head. Thus we will have the cost advantages of a moving head drive combined with the much faster access time of a fixed head-per-track drive.”

Higher bit and track densities

Another main avenue of development is toward higher bit and track densities. Existing drives have about 2000 bits per inch and either 100 or 200 tpi. New drives will be coming with over 4000 bpi and up to 600 tpi.

On most disc drives the head is positioned by means of a mechanism mounted on the drive chassis. This is not accurate enough when the track density gets too high. It then becomes necessary to position the head through the use of positioning data recorded on the disc itself. This technique is called servo following.

Whereas large multisurface disc drives use a servo surface for this function, small drivers will place the servo information in the record gaps on a data surface. This technique is called imbedded servo-track following. So far it has been best demonstrated on a floppy-disc drive produced by Dynastor in Denver. Dynastor has been shipping drives with this feature for several years.

Brand of Pertec also expects fixed media drives to share a common interface and controller with floppy-disc drives. The floppy disc allows for some media removability. You can place another disc into the same drive.

Some controllers for both floppies and fixed-media drives are using microprocessors. For the high transfer rates of hard-disc drives, bipolar microprocessors will probably be necessary. For floppies, MOS microprocessors will do the job.

Cartridges are expanding

Of all the tape cartridges that have been introduced so far, the one that seems destined for widest acceptance is the 3M Data Cartridge. About a dozen manufacturers are now making drives for it, and BASF of Germany and Information Terminals of Mountain View, CA, are also making compatible versions of the cartridge.

Most cartridges are still having difficulty making it in real-time operating systems. Russ Bartholomew, vice president of marketing for the Kennedy Co., Altadena, CA, says: "We're just starting to see the 3M cartridge drives finding their way into real-time operating systems. So far most of the sales for this application have been overseas. Most cartridges still go into such things as point-of-sale terminals and program loaders."

Bartholomew notes that 3M cartridge drives are now in the \$200-to-\$400 price range in large quantities. Kennedy, he points out, sells the Model 331 drive for \$350 to \$400 in large quantities, with a formatter.

The 3M cartridge uses a single point drive with all of the tape alignment done in the cartridge. A single four-track cartridge can store about 2.9 Mbytes with a read/write speed of 25 to 40 ips and a search speed of 90 ips.

A new mini version of the 3M cartridge has been designed by 3M in conjunction with Hewlett-Packard, Cupertino, CA. The cartridge measures only $3 \times 2\frac{1}{2} \times \frac{1}{2}$ in. and contains 140 ft of tape 0.15-in. wide. It can store more than 100,000 bytes on each of two tracks. Tom Anderson, product manager at HP notes:

"We use a 10 ips read/write and 60 ips search mode. The drive is constructed of DuPont Lexan. HP is using a pair of the drives in the new 2644A Data Terminal."



ICP's 3321 Termicette is a cassette peripheral that offers data rates of 110, 150 and 300 baud and has a gap-stop feature that provides automatic stop in a file separation gap without the use of special codes.

The cartridge that is in widest use at present is the Tri-Data. The Mountain View, CA, company has an endless loop cartridge with 150 ft of 1/4-in. tape. The cartridge can store up to 312,000 bytes and be read and written at 10 ips.

A pair of new cartridges show promise. American Videonetics, Sunnyvale, CA, makes the MDR 212. The drive uses a small, sealed cartridge called a reelette. It is 1-1/2-in. diameter by 3/8-in. thick, and it can store 750,000 bits. The read/write speed is 10 ips.

Emerson Electric, Santa Ana, CA, has the R-522, which uses a special cartridge with 600 ft of 1/2-in. tape. It has 30 ips read/write and 240 ips search. The capacity of the cartridge is 180 Mb, and the price for the basic drive will be about \$900. Ron Carroll, marketing manager at Emerson, says that the drive is comparable in performance to 7-in. reel-to-reel drives.

Dale A. Spencer, director of engineering at Cipher Data Products, San Diego, feels that the next big breakthrough in low-cost tape will be a 1/2-in. reel-to-reel drive with IBM compatibility for less than \$1000. He sees it coming within the next year or two.

Finally, mention must be made of Digital Equipment's DEC Tape or the equivalent from Computer Operations, Beltsville, MD, LINC Tape. A total of 336,000 bytes of data are stored on a single reel with a read/write speed of 60 ips. Although the technology has been around for a long time, Stephen Silverman, president of Computer Operations, notes that the drives used to cost over \$4000 but are now under \$2000. ■■



IBM announces the new 5100 Portable Computer

A compact problem-solving aid for engineers,
statisticians, scientists and financial and business analysts.

Now you can have a computer right on your desk. Exactly where you need it. When you need it.

The new IBM 5100 Portable Computer incorporates the latest in semi-conductor technology. It features a typewriter-like keyboard and numeric key-pad for simplified data entry, a 1024 character display screen, an integrated magnetic tape drive, and 16K characters of memory.

Options available with the 5100 include a bi-directional 80-characters per second printer, a second magnetic tape drive, and additional memory up to a maximum of 64K characters. Also available is a communications feature which allows the 5100 to be used as a terminal.

The IBM 5100 comes with either APL or BASIC language or both.

Over 100 often-used analytical routines in mathematical, statistical and financial calculations are available for such functions as forecasting, modeling, matrix arithmetic, engineering and design calculations, regression and correlation analysis, return on investment and cash flow analysis.

In addition, the 5100 features a self-study training package that makes it easy to learn and easy to use without taking any classes or relying on specially trained experts.

If you'd like to find out more about IBM's new 5100 Portable Computer and arrange for a demonstration right at your desk, call your IBM General Systems Division office or fill out this coupon

IBM	IBM General Systems Division P.O. Box 2068, Atlanta, Georgia 30301	ED
<input type="checkbox"/> I would like more information about IBM's new 5100.		
<input type="checkbox"/> I would like a demonstration of IBM's new 5100.		
My major area of interest is:		
<input type="checkbox"/> Engineering/Scientific <input type="checkbox"/> Statistical Analysis		
<input type="checkbox"/> Business/Financial Analysis		
Name _____		
Title _____		
Company _____		
Address _____		
City _____ State _____ Zip _____		
Phone _____		

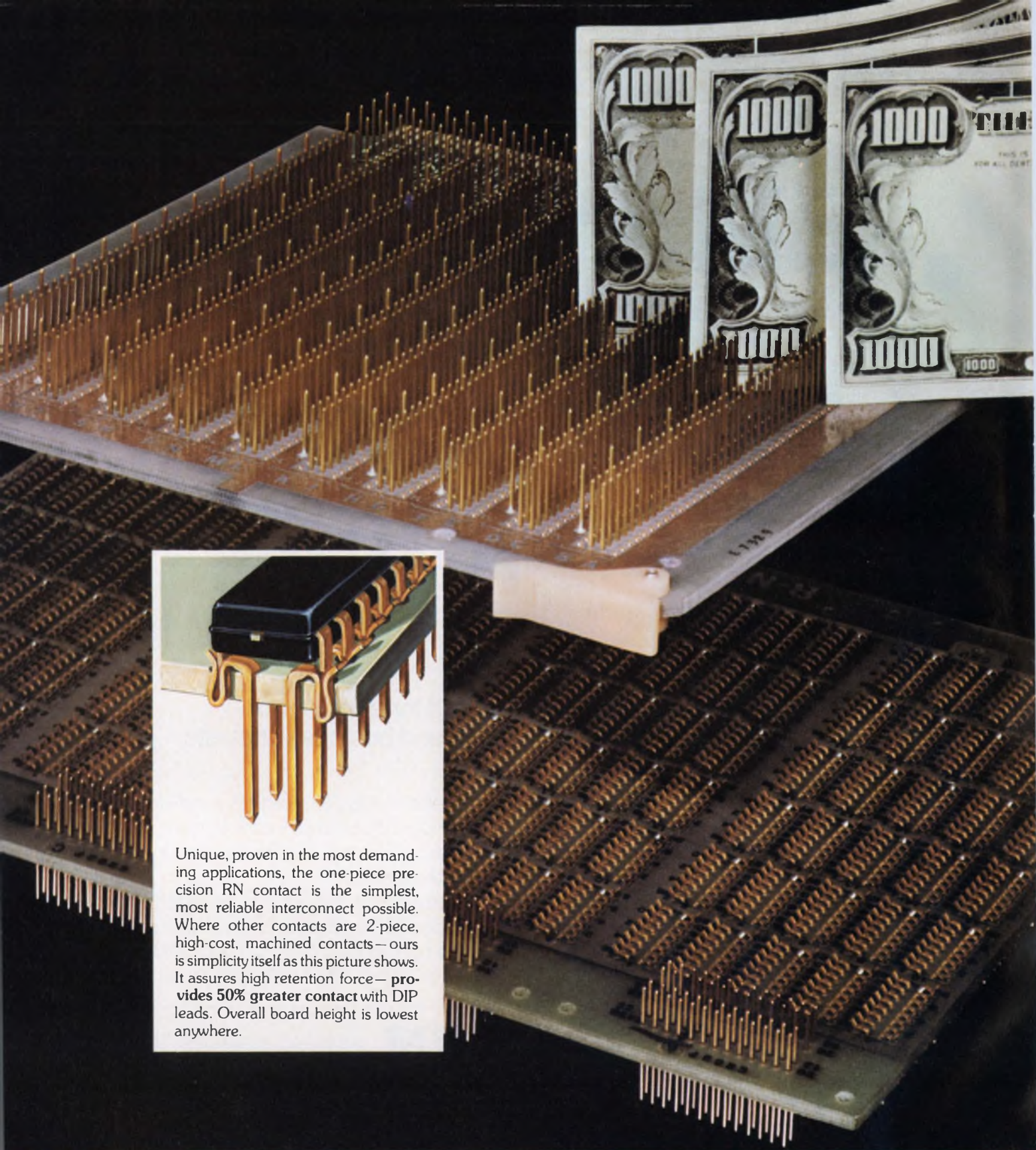

Unique, proven in the most demanding applications, the one-piece precision RN contact is the simplest, most reliable interconnect possible. Where other contacts are 2-piece, high-cost, machined contacts—ours is simplicity itself as this picture shows. It assures high retention force—**provides 50% greater contact** with DIP leads. Overall board height is lowest anywhere.

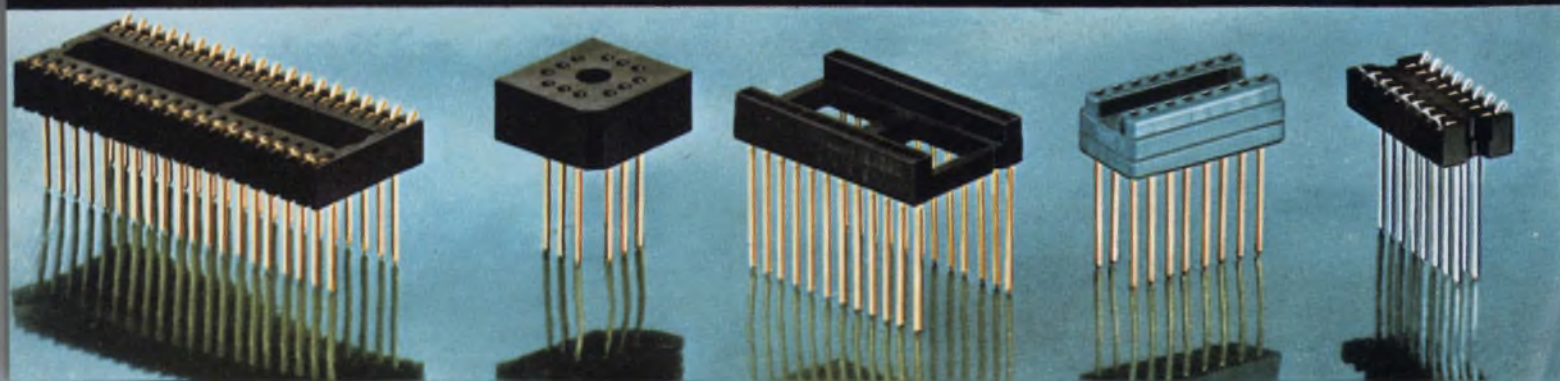

Save \$3,000... get 10-day delivery

Switch to Robinson-Nugent Wire-wrap* Socket Boards

Save 30%! By specifying RN high reliability Wire-wrap Socket Boards—your \$10,000 production order will cost only \$7,000! Sound impossible? More and more quality, cost-conscious firms are discovering that the same simple RN one-piece contact construction that reduces the cost by 30%—also brings added reliability, higher contact retention. Many say that RN Wire-wrap Socket Boards provide the most reliable, rugged solderless interconnect system available.

“Environmental Test Program” done by independent test lab reveals RN Wire-wrap Socket Boards meet or surpass the toughest MIL-specs. Summary of tests in latest RN catalog. Write for it today.

On production-size orders we'll pay for the reprogramming of your Wire-wrap tapes. What could be easier than switching to RN?

These cost-conscious firms are saving with RN high reliability Wire-wrap Socket Boards

Texas Instruments	Bendix Aerospace
Motorola	Hughes Aircraft
NCR	RCA
Airborne Instruments	Sandia Labs
Lockheed Electronics	General Dynamics



Send today for catalog with full details and specifications. Start now to save 30% on your Wire-wrap Socket Boards.

RN ROBINSON NUGENT, INC.

800 East Eighth Street • New Albany, Indiana 47150 • Phone: (812) 945-0211

INFORMATION RETRIEVAL NUMBER 28

*Trademark of Gardener-Denver Co.

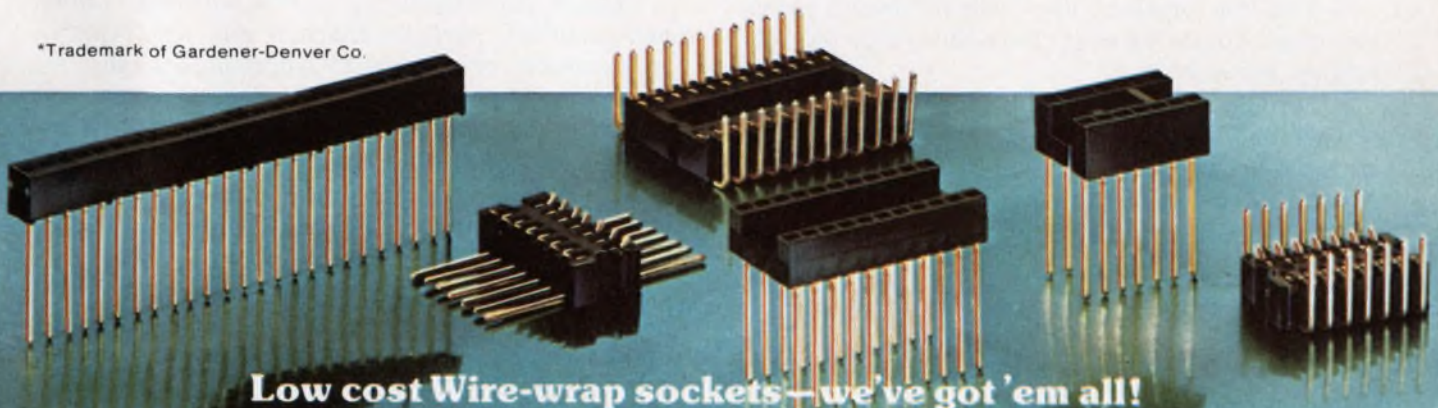

Low cost Wire-wrap sockets—we've got 'em all!

Medium-speed printers are on the way up—but the 'ideal' isn't here yet

The medium-speed printer—one that can put out about 100 to 600 lines a minute—is coming into vogue, sparked by the strong advance of minicomputers, remote batchprinting and small business-machine applications.

Formerly the choice of a printer was limited to either expensive high-speed units, designed primarily for giant computers, or low-speed clunkers recruited from the teleprinter field.

The "ideal" mid-speed machine isn't available yet. When it comes, it will be a low-cost, compact unit that provides both upper and lower-case print and a full set of ASCII symbols. It will produce copies cheaply, require no maintenance and will operate silently.

With the latest improvements, some of the present impact line and quasi-line printers come pretty close.

Almost all categories of printers claim some new features. Among impact types, the evolutionary improvements include the following:

- Quasi-line printers can now go over 600 lines/min on 132-column data. And built-in microprocessors control overshoot and misregistration of characters.
- Full-line printers have edged toward printing speed limits of over 2000 lines/min on 132-column formats.
- Serial printers with full-faced characters of typewriter quality can now print 100 char/s, where formerly they were limited to about 30.
- Serial printers with matrix-formed characters have been accepted for low-cost applications

Morris Grossman
Associate Editor

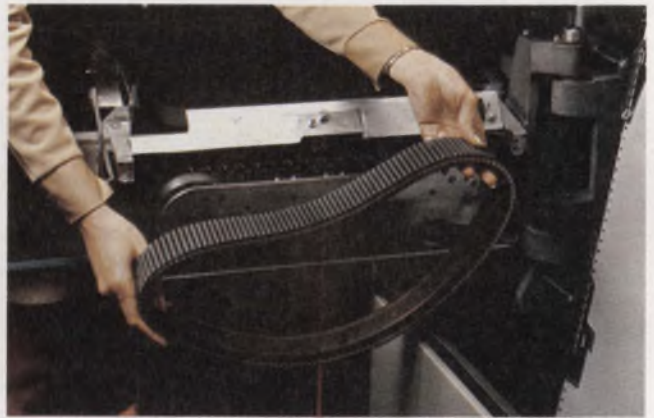

An important advantage of band printers, as in this Dataproducts 2550 Charaband unit, is that a line of print is at least straight.

and can achieve 200-char/s speed. For a given speed, matrix printers generally cost less than full-character units. Often multiple heads are used to double and triple the data throughput.

Nonimpact printers are promising

Though manufacturers of conventional nonimpact printers, such as thermal and electrostatic types, report only modest improvements, the potential for super-speed printing at low cost still lies with nonimpact methods. Consider IBM's recently announced laser-imaging printer that can spew out data at 13,360 lines/min. Another new nonimpact printer comes from Universal Technology (Verona, NJ), which offers a hot-air jet printer that scorches characters onto ordinary paper in a 7 x 9-dot matrix. One model can print up to 1100 lines/min, and it even provides copies.



Electrostatic printers such as the Gould 4800 can print 3600 lines/min or draw complex diagrams and charts; and do it silently. The Gould 5200 has 200 styli/in. and

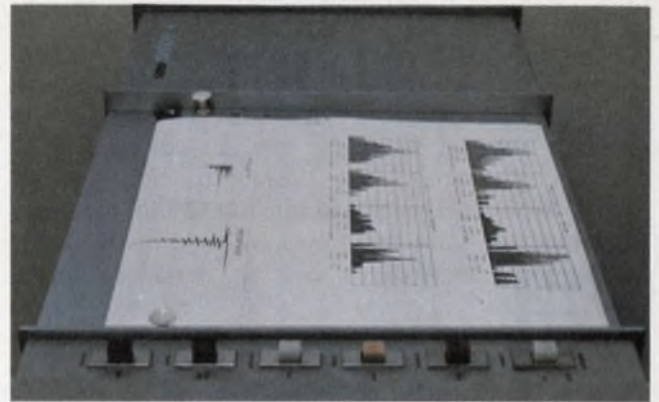

can provide accurate, high-definition plots and even camera-ready art. However, a considerable amount of software and memory is needed.

Some of the reported improvements in conventional nonimpact printers include the following:

- In thermal serial printers, quiet operation, low cost and improved reliability provide stiff competition for 10-to-100-char/s impact printers, especially in office use for teletypewriter and data-terminal applications. Also, list or strip printers for data-logging, miniterminals and instrument recording now frequently use thermal print heads. They print mainly numbers, but some also have limited alphabet or other symbol capabilities.

- In electrostatic printers, definition has been raised to 200 styli/in., which allows the production of fine-quality drawings or even camera-ready art. And printing speeds of 3600 lines/min are offered. Some units have built-in microprogrammed controllers to take some of the software and memory-capacity burden from the computers they serve.

The price is right

In spite of inflation, the prices of both impact and nonimpact printers have tended to remain stable. In some cases they have even dropped. Renn Zaphiropoulos, president of Versatec (Cupertino, CA), reports:

"Rising production has allowed a cut from \$9700 to \$8400 in our biggest seller—the high-resolution dual-array 200 dot/in. D1200A electrostatic printer/plotter. This price is even less than that of our original 72.5-dot/in. units of five years ago."

Except for the noise they make, some line impact printers have most of the desirable characteristics sought in the "ideal" medium-speed printer. And even the noise can be substantially controlled with acoustically insulated enclosures supplied by some manufacturers.

One class of line printers—quasi-line—achieves a low price by time sharing some mechanical com-

ponents, thus requiring fewer parts than other line printers. Of course, this sharing means that the parts are used more frequently; they have shorter lives. In addition the maximum speeds are lower—about 100 to 600 lines/min—where full-line printers can go well over 2000 lines/min.

Dataproducts (Woodland Hills, CA) puts out a quasi-line printer, the 2230. It uses one-half the number of hammers of a full-line printer and achieves print speeds of 300 lines/min on a 136-column format. The character print sets are carried on a drum. Odd columns print during one drum revolution and the even columns on another. Hammers fire as selected characters move into position on the printing line. Thus the drum needs two revolutions per line of print.

However, the Dataproduct 2260, which uses a full complement of hammer actuators—one per column of print—prints at 600 lines/min. It is a true line printer. Other Dataproduct full-line printers, such as 2470, can operate as high as 2400 lines/min. Generally print quality suffers at such high speeds.

The case for band printers

Another class of line printers uses a horizontally moving band, chain or belt to carry the characters. Timed hammers fire as characters align with column positions. As with drum printers, band printers also can share parts.

For example, IBM, in its 5023 chain printer, moves the print hammer to four positions. The printer needs only one-fourth the hammers of a full-line printer. It operates at speeds of 100 to 200 lines/min.

And IBM's steel-band 3770 printer, used primarily in data terminals, operates with one hammer for two columns and runs at 50 to 150 lines/min. On the other hand, Control Data Corp. (Minneapolis, MN), in its 200 lines/min printer, moves the paper to three positions and thus needs

only one-third the hammer mechanisms.

Band printers can have only two or three sets of characters per band, at most, whereas drum printers have at least one set per column. Thus the band characters are subject to more impact and wear than the characters on drum printers. But in most band machines, individual fonts or short character groups can be easily replaced. The fonts in Dataproducts' 2550 Charaband ma-

chines are carried on a steel-belted polyurethane band. Individual steel font slugs are easily removed and new ones quickly snapped into place. The 2550 operates to 1500 lines/min with a 132-column format.

An important advantage of band printers over drum printers is that horizontal misregistration of printed characters is less noticeable to the eye than even a small amount of vertical dis-

No printer fits all applications

The all-purpose, all-applications printer will probably never be built.

Giant computers need printers that can keep pace with their high-speed outputs. Speeds can run to over 5000 lines per minute with some of the nonimpact printers, and printer costs to over \$100,000.

At the other extreme are hard-copy devices for data terminals and keyboard printers, where speeds are geared to a human operator. The costs must be low to match the relatively low cost of the rest of the equipment. Characters usually are printed in serial fashion at 10 to 55 char/s, and prices run in the \$1000-to-\$3000 range.

And then there is a vast middle ground—printers for minicomputers and remote-batch outputs—with speeds of 100 to 600 lines/min and prices to match—\$2000 to \$20,000. This is the fastest expanding portion of the printer market, judging by development and marketing activity.

In choosing a printer, consider the following:

- Are full-faced characters and special fonts needed?
- Can dot-matrix-generated characters meet your print-quality requirements?
- Do you need multiple copies?
- Can ordinary paper be used?
- Is printer noise a serious problem?
- What are the periodic maintenance requirements?
- Should the printer be able also to plot curves or draw complex diagrams?
- What are the interfacing problems?

No matter what you buy, expect undesirable features along with the good. For example, the need for multiple copies usually dictates use of an impact printer. It will be noisy.

If use of ordinary paper is a must, some type of inking is needed for the original and carbon paper for the copies. Ribbons require frequent changing and liquid inking mechanisms need maintenance. With multipart forms, the carbon inserts must be removed after printing.

Some impact printers allow use of the new pressure-sensitive paper. No inking or carbons

are required. But special paper costs more.

And don't forget that a printer needs a proper interface to its data source. Though many printers can handle either serial or parallel inputs, some need buffers to convert serial to parallel, or vice versa.

In addition to a data interface, printer control signals of appropriate timing and levels are also usually needed. It can be very expensive to force a match to a printer that is incompatible with the data source.

Don't get fooled by the printing speeds in manufacturer specs. All the conditions that can affect throughput are not always clearly spelled out. Four major variables generally affect throughput:

1. Time to print a line. Serial printers, usually rated in char/s, sometimes have multiple print heads to speed throughput. Line printers, rated in lines/min, often time share hammers and other components, which reduces throughput.
2. Width of the line—72, 80 and 132 columns are common. For a given line/min rate, more columns means more throughput.
3. Time to index the paper between lines, including carriage-return time in serial printers—400 ms is typical.
4. Size and nature of the character set—48, 64 and 96 characters are common.

The stated line print rate might be for only an 80-column form. A 132-column form needs 30% more time to print a line. And if both upper and lower case characters are printed, it may take as much as 50% more time. Manufacturers often supply a table to cover all the variables and resultant speeds.

For example, the speed of IBM's popular 132-column 1403 line printer depends upon the character subset size. The 1403's total character set is 240, and it can be divided into many subset combinations and groups. The smaller the subset, the faster the machine can print. A 48-character subset prints at about 550 lines/min, but a 14-character subset attains 1385 lines/min. Many other combinations of subsets and speeds also are available.

placement. The horizontal band motion at least ensures a straight line of data, and variations in spacing between characters are less obvious than those in a wavy printed line.

Other band printers are promised soon by Data-100 (Minneapolis, MN). Its 5540 and 5560 use steel-character bands and operate at 400 and 600 lines/min with 132 hammers. They will sell for \$8195 and \$8998 in small OEM quantities when they become available next January. The printers feature a microprocessor, which controls the registration of the characters, monitors the ribbons and directs the skew of the drive shaft to compensate for irregular tracking.

Often a line printer operates in a quasi-line, or near-serial, mode because the electronics constrains the system to accept and print only one character at a time. The 80-column Teletype 40 ROP is such a machine. It operates at about 200 lines/min when a 94-character ASCII set is used. But its speed increases to 300 lines/min, when a 63-character, upper-case-only set is used. The Teletype 40 sells at an OEM price of \$2732.

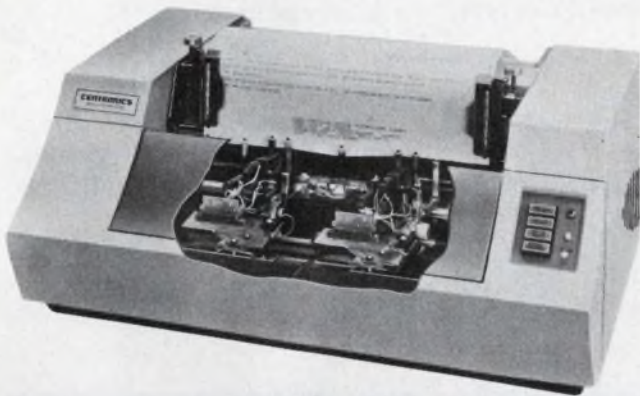

Some serial printers use multiple print heads. The Centronics 102A printer has two heads with 9×7 dot matrices and prints 132-columns at 125 lines/min.

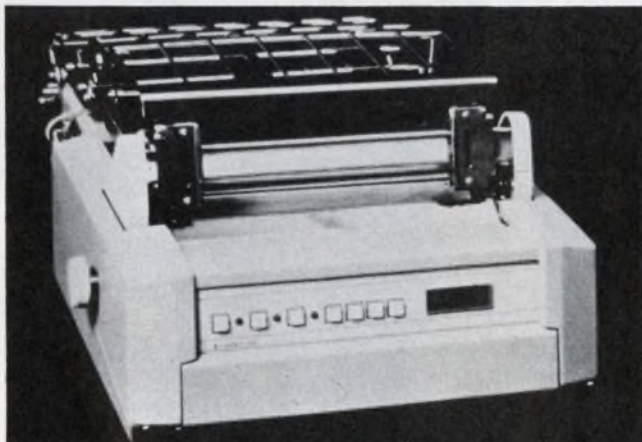

General Electric's TermiNet 120 uses a belt technique to print 120 lines/min at 240 char/s on 120-column paper. Models for 80 columns are also available.

GE (Waynesboro, VA) makes the TermiNet 120, which operates at 120 lines/min with a set of 94 ASCII characters and up to 180 lines/min on a 64-character upper-case-only set. Both models are available with either 80 or 120-column line lengths. The 80-column printer sells for about \$2917 in small quantities.

The position of the print head in true serial printers determines where a character is printed. But in quasi-line machines, the position of the printed character is determined by electronic instructions that cause a hammer to strike at a particular time. Also, functions such as tabbing, line feed and the equivalent of carriage return are all electronically controlled. And as in many models of serial machines, some quasi-line units come with keyboards and complete electronics for send/receive time-shared data terminals or for direct interfacing with minicomputer systems.

Serial printers have typewriter quality

Diablo (Hayward, CA) offers the Hytype I, a 30-char/s serial printer, and the new Qume Corp. (Hayward, CA) the Sprint 45 and 55 printers, which operate at 45 and 55 char/s. The latter are significant advances in speed over the traditionally Teletype 33 and IBM Selectric printers. The Teletype units, which carry their characters on a cylinder, and the Selectrics on a ball mechanism, operate at only 10 to 15 char/s.

The Qume and Diablo units use a plastic daisy-

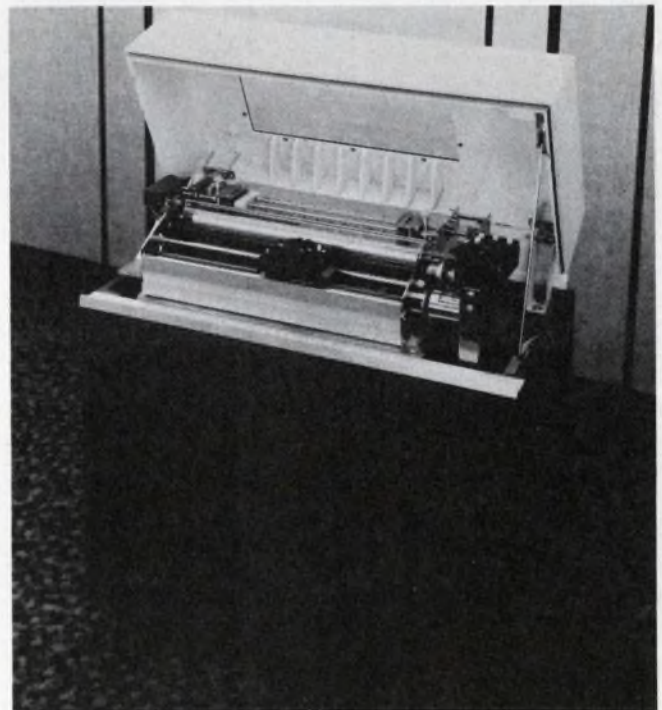

Singer's MPS-300 series of matrix serial printers operate to 150 char/s and use a 9×7 dot matrix to print the full 128 character ASCII set.

wheel font carrier, which is cheap and easy to replace when a different character set is desired or when worn, according to David Lee, vice president of marketing at Qume.

"Daisy wheels last for a long time, and because the Sprint has fewer moving parts than other printers—less than one-fifth of those in a typical typewriter—reliability is high and servicing easy," he explains.

For still higher speeds, the family of Printec serial machines, made by Printer Technology (Woburn, MA), carries the print fonts on a continuously rotating steel print wheel. A timed hammer drives the paper against a selected character. Print speeds to 100 char/s, or 35 lines/min, are attained on 132-column paper. An ink roller, rather than a ribbon, keeps the print wheel coated with a thin film of ink. The Teletype, Selectric, Diablo and Qume serial printers use ribbons.

One advantage of this roller and liquid inking arrangement is that magnetic ink can be used. Thus the Printec can print documents with both magnetic and ordinary characters. And with two sets of fonts on a single print wheel, both types of characters can be printed in a single pass. Other printing setups often require two passes using two different machines.

The Printec 100M, with a special font set for magnetic-ink printing, operates at only 35 char/s, but the Printec 100A can do 70 char/s with a 96-character ASCII font set. The Printec 100 can reach 100 char/s, but with only a 64-character set. The price you pay depends upon interface requirements and other features; it can vary from \$2750 to about \$4150.

Dot matrix for low cost

The principal advantage of impact dot-matrix printers is low cost. They are more reliable than some of the slow-speed machines, such as the Teletype 33, but they are not as reliable as most line printers, according to Irving L. Wieselmann, vice president of product programs at Data-products Corp. Individual matrix pins get a lot more use than the full-formed font characters on a line printer. But then the matrix head is mechanically simpler than many of the serial-printer mechanisms.

Though they have font limitations, dot-matrix impact techniques are widely used for the low-to-medium-speed printers—from 30 to approximately 200 char/s for a single-head serial machine. Dot matrix printers tend to sell for less than shaped-character printers.

For example, the Model LA36, a 132-column matrix printer made by Digital Equipment (Maynard, MA), sells for \$1250 in OEM quantities, but it operates at only 30 char/s. GE's

Terminet 30 printer, also a 30 char/s machine, is being offered for about \$1200. Both units come with keyboards. They compete with Teletype 33 units and operate three times faster than the 33.

However, the 132-column Model 104 matrix serial machine, made by Centronics Data Computer (Hudson, NH), operates at 200 char/s. It uses a print head that consists of a vertical column of pins, selectively pushed against an inked ribbon to create either a 7×5 or 9×7 dot matrix. Machines that print both upper and lower-case characters need the 9×7 matrix to obtain greater definition.

Often serial printers, both full-character and matrix, increase their throughput capability by using two, or even three, print heads. For example, the Centronics 102A has two print heads, with double the throughput at 330 char/s that the company's single-head 101A has. The SV Alphanumeric printer, made by Sweda International (Pine Brook, NJ), offers three independently controlled heads, but it uses a different kind of head—a seven-segment matrix instead of a dot.

Nonimpact types are quiet and fast

If quiet operation is of prime importance, a nonimpact printer is your choice. The super-speed printers are found in this category. However, nonimpact printers generally can't produce multiple copies, and except for xerographic and ink-jet types, they require special paper.

Thermal printers are relatively inexpensive. Serial units operate to about 30 char/s and usually print with a 5×7 matrix. Such units include

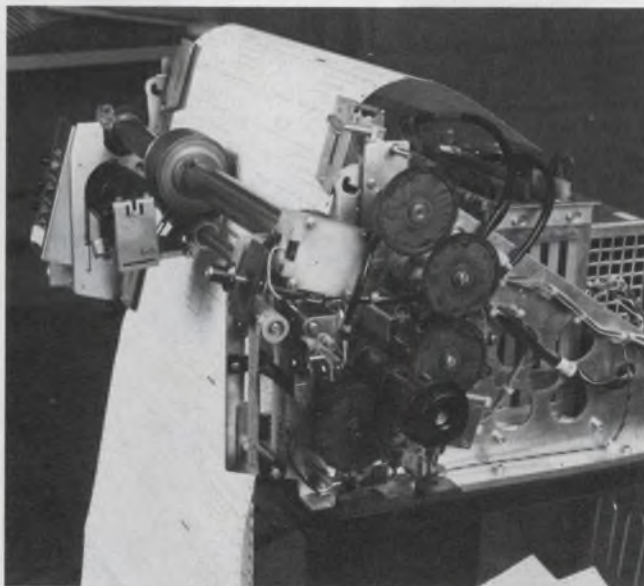

To print magnetically detectable characters the Printec 100M, made by Printer Technology, uses a roller to apply ink to its print wheel.



Where other data terminal systems grow old, this one is designed to simply grow.

The Teletype® model 40 is the data terminal system to start with because it's completely modular, and is designed to grow as your needs grow.

The display, operator console, printer and controller modules form the heart of the model 40 system and permit a variety of configurations to suit your application.

There's a wide range of options, too, such as expandable memory with scrolling; half/full duplex modes; fixed and variable field transmission; protected formats; a variety of on-line controls; current loop and EIA (RS232) interfaces; and speeds from 110 to 4800 bps. Printer options include 80 column friction and adjustable tractor feed units.

And don't worry about obsolescence. Since the model 40 design consists of separate modules, you can select only those capabilities you need now—and add others later.

Add it all up. The model 40 system offers outstanding reliability, versatility and economy. And delivery is sooner than you may expect. No wonder you can't beat the model 40 on a price/performance basis. To start with. Or to grow with.

For complete information, please contact our Sales Headquarters at: 5555 Touhy Ave., Skokie, Ill. 60076. Or call Terminal Central at: 312/982-2000.

Teletype is a trademark and service mark registered in the United States Patent and Trademark Office.



**The Teletype model 40 system.
Nothing even comes close.**

the Model 700 from Texas Instruments (Houston) and the Model 260 from NCR (Dayton, OH). And Computer Devices (Burlington, MA), with its 930 Teletherm, and Computer Transceiver Systems (Upper Saddle River, NJ), with the Execuport 300, provide both receive and transmit capability similar to that of a standard teletypewriter. But the special paper for their thermal printers costs about twice as much as ordinary paper does.

Where the number of columns printed is limited to, say, 12—as the TP-10 thermal digital printer made by PPM (Bedford, OH), print speeds can be as high as 600 lines/min for bursts of 1000 impressions with parallel input BCD data. The TP-10 forms its characters with a seven-segment matrix.

Gulton Industries (Metuchen, NJ) makes thermal print heads for data-collection systems and

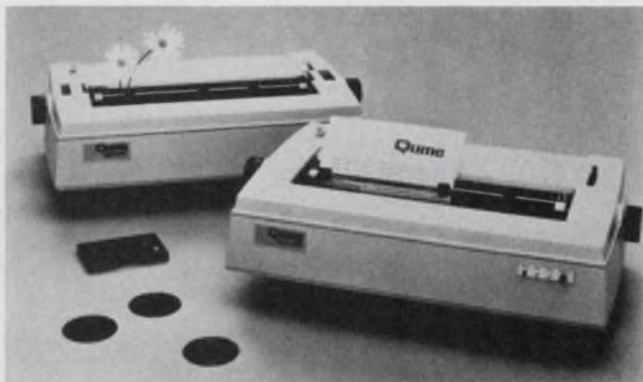

Daisy wheels, which carry character fonts, as in these Qume Sprint 45 and 55 units, are low cost and easy to replace.



Speeds to 120 char/s are attainable on Tally's Series 1000 matrix serial printers. Form widths from 4 to 15 in. can be handled.

panel printers, such as the DPP-7 units made by Datel Systems (Canton, MA).

Electrostatic printers, manufactured by Varian Data Machines (Irvine, CA), Versatec (Cupertino, CA), Gould (Cleveland) and others, use a dielectric-coated paper. The paper is electrostatically charged by a row of styli—80 to 100 styli/in. is common—as the paper advances, usually in a step motion. The charged spots become visible and fixed when the paper passes through a liquid toner. Since only the paper moves, electrostatic printers are mechanically simple. And print speeds as high as 5000 lines/min have been reported. The Gould 4800 can print 3600 lines/min with a paper speed of 7.5 in/s. And at a paper speed of 2.75 in/s Varian's Statos 4122 can print 1200 lines/min.

Also, electrostatic printers can plot curves and print complex diagrams. Varian says it can supply units with up to 200 styli/in., and Gould's Model 5200 has 200 styli/in. However, an electrostatic printer needs considerable memory and software to interface a computer. The Statos 4122 uses a microprogrammed controller to help reduce this burden on the computer.

Printers that work on the xerographic principle, using standard paper and operating at 4000 to 9000 lines/min, are available from Xerox (Los Angeles). They can reproduce multiple copies of 132 columns on 8-1/2 × 11-in. paper.

And IBM has just announced a new laser-imaging printer, the Model 3800, that operates at up to 13,360 lines/min. A low-power laser forms characters on the photoconductor surface of a rotating drum. A dry powder adheres to the images only and then transfers to the paper in a way that is similar to xerography. The usual 132-column data format is printed on the more economical 8-1/2 × 11-in. paper instead of large computer paper. Delivery of the machine is promised for the fall of 1976 for \$310,000 or a monthly rental of \$6250 to \$7344.

Another of the nonimpact printers uses a jet to squirt electrostatically deflected ink particles. The particles are directed, much as an oscilloscope directs and focuses an electron beam, to form characters on standard paper. For years, the A. B. Dick Co. of Chicago made a series of ink-jet printers that could print 250 to 750 char/s with a single jet; however, they have been withdrawn from the market because of lack of demand. Now A. B. Dick is using its jet printers in industrial applications, such as point-of-sale code labeling and the printing of variable data on form documents.

Teletype's ink-jet units, introduced a few years ago, have also been discontinued. But Casio Computer Co. (Tokyo) is marketing a new unit for about \$1000 in OEM quantities. ■■

Just as you can count on Newton's law,



you can count on Synchron[®] motors.

The synchronous motor you install in your product is likely to be the most important single component. So everything about that motor should be exactly right for your product. The speed, the torque, the price and the delivery, of course. The performance, the quality and the dependability. But, especially, its rightness for you.

What's exactly right for someone else may be exactly wrong for you. That's why it's almost impossible to find a ready-made synchronous motor



that meets your specs in every way.

We custom-make every Synchron motor. At a competitive price. To fit your needs, not ours. Delivered on time. Designed and built right, to do the job right. That's the only way we do business.

Call or write for our specification sheets and the name and location of our representative in your area.

Choose from five principal styles of Synchron motors—60 or 50 Hz—from one revolution per week to 900 rpm—from 8 thru 98 oz-in torque at 1 rpm—from hundreds of different outputs.

MALLORY



HANSEN MANUFACTURING CO.
a division of P. R. MALLORY & CO. INC.
Princeton, Indiana 47870

We make every Synchron motor as if our name were on your product

**Developing this new pushbutton was
a little like coming up with a Ferrari that gets 32 mpg,
holds 12 people and costs less than a Pinto.**



Until now, there have been some good-looking lighted pushbuttons and indicators.

And there have been others with varied electrical capabilities. But there's never been a line that gave you harmonious panel design, electrical flexibility, and low cost. All at the same time. Until now.

Introducing the MICRO SWITCH Advanced Manual Line—AML.

The most sophisticated line of pushbuttons and indicators ever designed. And you can see a few of the reasons why right here. The AML button height, bezel size and visual compatibility of the square and rectangular sizes "harmonizes" your panel. To give you a panel with a clean, good-looking geometric face. And a panel with increased efficiency, because it doesn't distract. The low-profile square and

rectangular buttons are available in five colors: white, red, yellow, green, and blue. Display capabilities include split screen, hidden color, and a unique three segment lens cap indicator. Illumination can be transmitted or projected. But what you can't see here is what helps to make these the most advanced line of lighted pushbuttons and indicators available: their extreme electrical flexibility.

Solid state operates at 5V or 6-16V with a built-in regulator, sink (TTL) and source (CMOS).

Electronic control is capable of handling low energy circuits and has a maximum rating of 3 amps, 120 VAC,

with single or double pole double throw.

And power control, DPST, with a rating of 10 amps at 120 VAC.

The AML has snap-in mounting from the front of panel and can also be subpanel mounted. There's a choice of individual or strip mounting.

All devices are the same shallow depth behind the panel to provide a unique single level termination system. The result is ease of wiring and neat appearance.

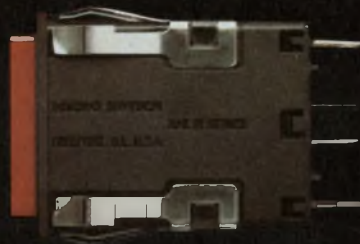

There are 5 types of terminals available: solder, quick-connect, wire-wrap, push-on or p.c. board mount.

Relamping is

accomplished from the front of the panel. And it's done without a tool. With a choice of lamps including a T-1 $\frac{3}{4}$ wedge base lamp, neon and LED. To provide international acceptance, every AML device has been designed to comply with essential IEC, CEE24, UL and CSA standards.

For more information on the AML, call your nearest MICRO SWITCH Branch Office. Or write for our literature.

What you'll see is a line of lighted pushbuttons and indicators that give you a completely harmonious panel design in the front.

And the utmost in electrical flexibility behind the panel.

All products shown on this page are actual size.

MICRO SWITCH

FREEPORT, ILLINOIS 61032

A DIVISION OF HONEYWELL

We unknot wire problems

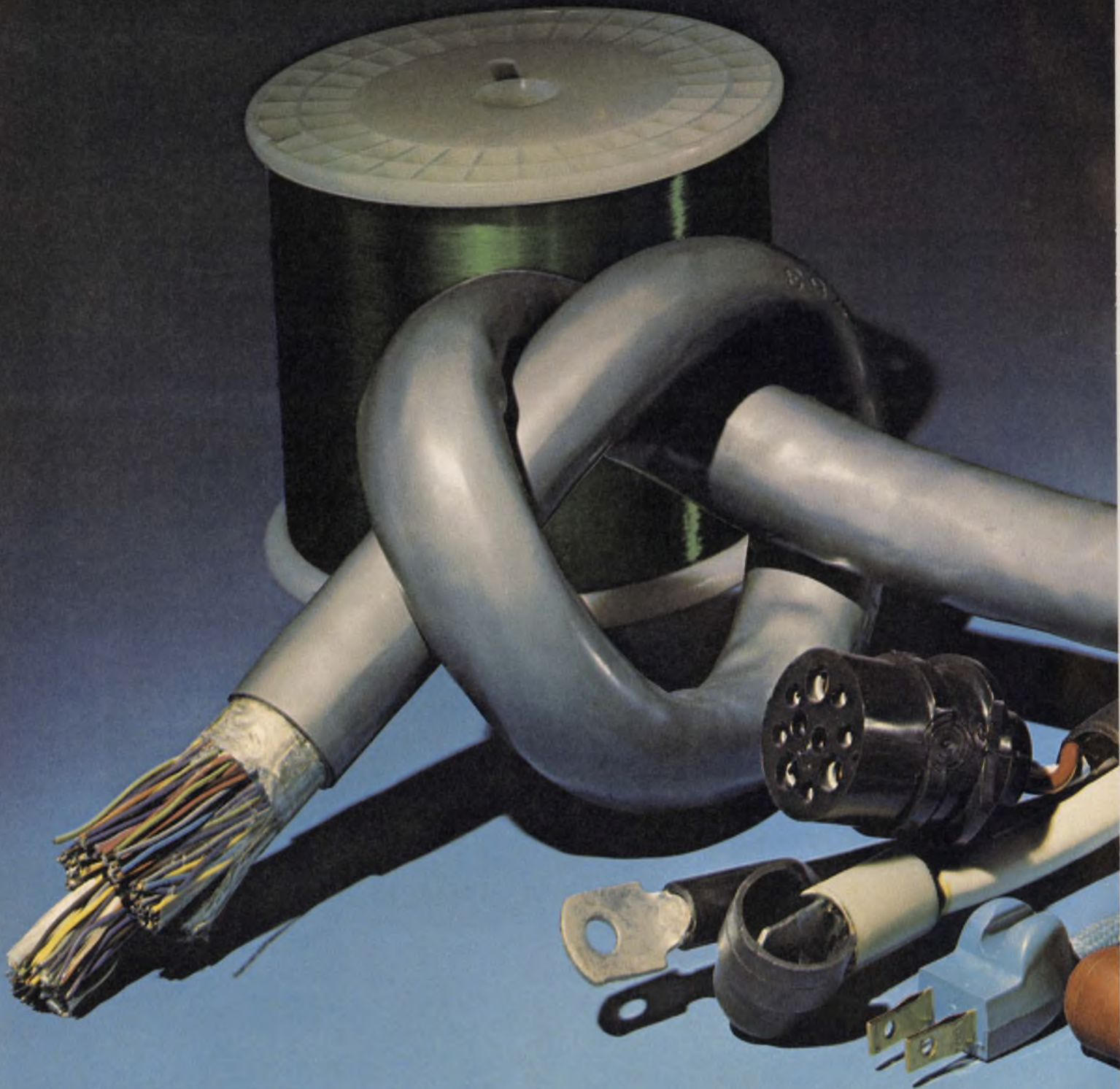

BELDEN 

...new ideas for moving electrical energy

Knotty problems in wire, cable, and cords can pop up at any stage of a project. Hopefully, they arise early in design. Oftentimes, they surface later. This can put an unexpected crimp in your product's profit or performance.

We're ready to offer backup help in performance, design, processing, assembly, installations, and ordering. Whatever wire and cable application idea you put on paper, Belden can help put life into it! Our total engineering approach to your problems can identify and analyze the "knots" before they tie up a major project.

If you have problems involving electrical parameters, space, compatibility, human

engineering, color coordination, precision, materials, fabrication, processing, put-ups, installation, Belden has the ability to engineer reliability and ease of assembly into wire, cable, and cords without letting costs run wild due to over-engineering.

When we can't get out the "kinks" using standards, we'll innovate a solution for your problem. We're here with service and multi-plant facilities that can meet your demands. Need answers? Phone:

(312) 681-8920, Electrical Division

(317) 966-6681, Electronic Division

(312) 887-1800, Transportation Division

Or, write Belden Corporation, 2000 South Batavia Ave., Geneva, Illinois 60134.

H-4-4



Microprocessor emphasis swings from chip specs to aids for designers

In the hotly contested microprocessor race, the spotlight has shifted from basic μ P-chip performance to the various hardware/software design aids that simplify system development. Microcomputer manufacturers have shown they can make high-performance microprocessors—and deliver them in volume. Now vendors are trying to convince skeptical designers that the processors can be easy to work with.

The most advanced design aids are a far cry from the ones first available. Early designers had a two-way problem. First, software had to be

developed with computer-aided-design techniques. This involved the use of assembler and simulator programs on computer services. Simultaneously a hardware prototype had to be built. And this entailed the construction of test and control circuitry, as well as the interconnection of the several chips that make up a microcomputer.

A designer could spend much effort getting both the hardware and software to function properly, only to discover they didn't work together in the final product.

Edward A. Torrero
Associate Editor



A resident compiler will be added to National Semiconductor's development systems. Already disc-operating systems are available for use with the company's 16-bit multichip processor. And the disc system will shortly be available for the PACE processor.

Design-aid advances

Now microcomputer development systems combine both hardware and software design tools. They constitute complete microcomputers with the capability to interface with a host of peripherals that speed development. Like minis, newer prototype "boxes" can interface with disc-operating systems and high-speed readers and printers. They have extended debug capabilities, being able to check internal μ P registers and memory locations and exercise a system one or several steps at a time. And they now allow in-circuit emulation, permitting the very early isolation of trouble spots in an end product.

Significantly microcomputer manufacturers say present development systems won't become obsolete when future microprocessors become available. These systems will be "universal" design centers. They will accommodate a company's existing and future products and, possibly, competing vendor's microprocessors.

In essence, the universal design aids are multiprocessor systems. One microprocessor, residing in the prototype box, generates the code and per-

forms basic software-development chores, like editing and assembly. The other processor, part of an add-on unit, tailors the box to a specific microprocessor and replaces the system processor. It monitors and controls the system, tracking down errors and simplifying diagnostic tests.

The next advance might well come on the software front. Efforts are under way to tackle one of the biggest design headaches: The need to have a working knowledge of different assembly languages to use different microprocessors. One approach seeks to circumvent the problem at the assembler level by establishing an industry-standard compiler that would accept a subset of IBM's PL/1. Intel has pioneered such a compiler with its PL/M; however, many competing vendors say they would prefer a different version.

Another, more ambitious, approach seeks to create a kind of cross-compiler. It would accept a popular assembly language for one processor and output code for another μ P. Initial versions of the cross-compiler would translate assembly languages, but later versions might handle higher-level languages.

Another aspect of the growing design-aid field is the increasing presence of organizations that don't make ICs. Recent entries include distributors. Cramer, for example, offers kits containing a popular microprocessor, peripheral-support circuitry and memory. The kits also have software packages and instruction manuals. These kits provide a lower-cost alternative to the micro maker's more extensive prototype boxes, which range in price from about \$4000 to \$8000.

Similarly other companies are concentrating on the "low-end" of the design-aid spectrum. Pro-Log, for example, sells small micros and con-

ducts courses showing hardware-oriented designers how to assemble programs by hand. This approach minimizes the amount of software expertise needed, though its usefulness tends to be limited to small systems.

In-circuit emulation speeds designs

An advanced feature of new prototype systems is in-circuit emulation (ICE). It is found on Intel's latest unit, the Intellec MDS (for micro-computer development system). The ICE capability leads directly to reduced development time.

"We believe that between 25 and 40% can be saved over our earlier prototype system, the Intellec 8," estimates Jim Lally, Intel's manager for system products.

With ICE, the resources of MDS can be applied to an end product at an early design stage. As soon as the bus structure is defined—often the first step—the ICE module can be plugged into an actual system prototype in place of the microprocessor. Then various trouble spots may be checked out by a "transparent" mapping from the prototype to the MDS.

For example, a problem may arise from either a malfunctioning memory module or software errors. The MDS solution disconnects the module and replaces it with an internal memory; the system doesn't know the difference. The program is then executed. If the system works, the hardware is at fault; if not, software must be checked.

The Intel system also includes enhanced debug tools. One allows hardware "breakpoints" to be set up within the ICE module for the 8080. These breakpoints suspend the execution of the



In-circuit emulation is offered in Intel's latest development system, the MDS. The capability permits early fault and error isolation in actual system prototypes.

MDS can accommodate the company's 8080 MOS processor, as well as the 3001 bipolar processor slice. MDS includes floppy-disc storage and CRT terminals.

processor and permit examination of bus activity during the previous 40 machine cycles. Further, the breakpoints can be set "symbolically" rather than at specific locations.

Accommodating future products

Besides the 8080 MOS processor, the MDS can accommodate Intel's Model 3001 microprocessor, a bipolar bit-slice unit that requires microprogramming techniques. For this product, a different ICE module must be used along with a ROM simulator to develop the processor's instructions. For future Intel microprocessors, the company plans to use the same MDS mainframe but to offer ICE modules designed for those products.

Going one step further, Klaus Haferkorn, product marketing manager at Motorola, asserts: "Eventually I am sure development tools will also accommodate competitive products." He believes that his company's Exorciser prototyping system might be doing so within a year.

Present efforts, though, are aimed at enhancing Exorciser development capabilities for Motorola's 6800 MOS processor. For example, the company will shortly add a component tester for the 6800 family. External to the Exorciser, the LSI tester would plug into the development system and could perform incoming inspection on all microcomputer ICs, including memory.

Also scheduled is a system analyzer for detailed checks of faults and errors. For each step of the program, the analyzer would permit tests of internal microprocessor registers and each memory position up to 65-k words. And by year's end, Motorola will add PROM programmer modules for UV-erasable ROMs. These additions will permit Exorciser program development in PROMs. Present programs are developed in the system's RAMs, which may be switched into a read-only mode when programs are firm.

A recent addition to National Semiconductor's prototype box, the IMP-16P, is a disc-operating system (DOS). It can now be used to design systems involving the company's 16-bit multichip MOS processor, and it will shortly be available for use with PACE (a single-chip version).

"By putting everything on disc, we can do in 30 minutes what used to take a day," observes Bernie Kute, National's application manager.

Unlike most competitors, National emphasizes resident software (run on the microcomputer rather than a larger, host computer) to the point that simulators aren't available on computer networks.

"You can't simulate I/O operations, and most micros stress them," observes Kute, "so you eventually have to go to the hardware, anyway."

The next step for National will be a compiler accepting a PL/1 subset. In keeping with the

hardware emphasis, the compiler will be resident.

However, National does provide a microassembler on computer networks. It enables designers to microprogram the company's multichip processor. The manufacturer also provides preprogrammed control ROMs that provide enhanced data-movement capabilities and various arithmetic functions. Replacement or modification of these control ROMs (or CROMs)—key elements in the multichip set—represent another technique whereby instruction sets can be altered.

Future development systems may entail radically different software techniques. "Assemblers and compilers as we presently know them," says Gerry Madea, a product marketing manager at National, "will become obsolete within the next three years."

Madea believes a new and better alternative to existing microcomputer languages is possible, one that he prefers to call a translator. It would com-

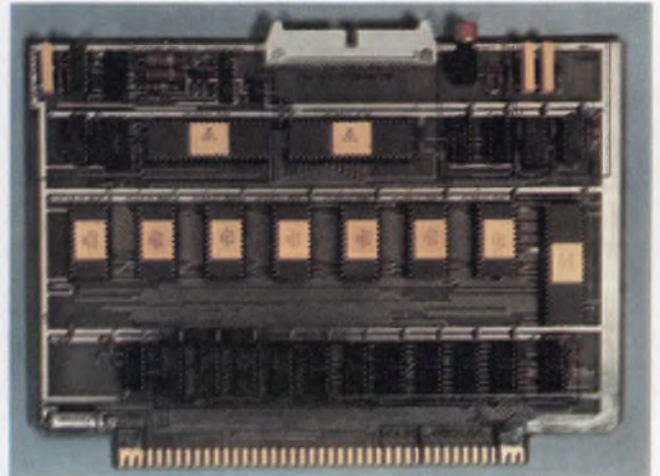

Evaluation boards like this one from Motorola come with sufficient aids to build small microcomputer systems. They serve two purposes: They allow designers with little microprocessor experience to get "on board," and they allow experienced hands to simplify designs.

bine some of the best features of both assemblers and compilers, and it would have an input language that would be completely machine independent. However several problems remain to be solved before the translator becomes a practical reality. A key one is how primitive operations would be implemented in different machines.

The rapid pace of design-aid developments raises the ante for micro manufacturers entering the field. Fairchild—a recent entry—believes its aids must match those of most competitors. "We believe our aids are the absolute minimum needed to support our F8 microprocessor," asserts Bruce Threewitt, manager of MOS applications.

The "minimum" includes a microcomputer on a board (the F8S). It requires a power supply but allows memory expansion in 4-k byte incre-

SIEMENS

S.V.P.[®] SURGE VOLTAGE PROTECTORS



Low-cost protection against damaging voltage transients.

Electronic equipment—especially solid state—needs protection from sudden surges in voltage that can lead to costly maintenance, long operational down-time or even loss of equipment.

Siemens Surge Voltage Protectors provide this protection. If you are now using or contemplating the need for gas tubes or spark gaps, check out Siemens SVP's on performance, price and delivery.

Highly reliable and of proven design, Siemens SVP's offer:

- High current capability.
- Accurate breakdown voltage.
- Low capacitance.

- High insulation resistance.
- Ability to withstand extreme environmental and operational extremes.
- A broad line: power, fail safe and 3-electrode types.

Beyond typical telephone and communications uses, Siemens SVP's have a variety of non-protective "switching" applications. Strobe/flash warning lights, photography, ignition or almost anywhere a voltage sensitive switch is required.

To learn more about Siemens SVP's, write for literature, free samples or applications engineering data. Immediate delivery is available from current stock.

Siemens Corporation
Special Components Division

186 Wood Avenue South, Iselin, New Jersey 08830 (201) 494-1000

ments, and it can support a resident assembler, which occupies only 1-k bytes of storage. Also offered is a prototyping system in a box, the F8C formulator, which provides the tools for both hardware and software development. An expanded version of this box is expected next year. Called the F8T, it will accommodate both a floppy-disc system and a video terminal.

Time sharing: a design alternative

Micro makers often promote their development systems by saying that the major alternative—time-sharing services—can be very expensive. The cost for their full-time use over an extended period can easily exceed that of a hardware/software system, which has a one-time, fixed price. However, the computer-service approach does have advantages.

With time sharing, a designer pays as he goes; there isn't any fixed overhead. Also, several computer services now offer programs for a number of popular microprocessors. So designers can check out different units without committing themselves to a specific one. Moreover a designer has at his disposal the full resources of a fast, large computer. Storage space isn't limited to that of a floppy disc or other storage media used by smaller systems. And outputs can be obtained in various forms without the purchase of peripheral equipment.

The major drawback, though, is an inability to fully simulate real-time processes.

"We offer microprocessor, not microcomputer, software," notes Paul Newton, marketing manager of electronic products at University Computing Co. "We can simulate a stream of I/O bits to and from, say, a disc or large external RAM and see the effect on the microprocessor. But we can't see the effect on the peripheral at the same time."

However, designs can proceed up to the simulation phase and then be applied to a hardware prototype.

One proponent of time sharing over development systems is Matt Biewer, vice president of engineering at Pro-Log. "If a system involves more than 1000 words of coding, go to a computer service, which has the power needed," he advises. However, most microcomputer jobs aren't that large, according to Biewer, and these can best be done with hand-assembly techniques.

Pro-Log emphasizes the use of assembly language, although individual instructions are manually programmed, one at a time, in their hexadecimal form. The technique is simple, and it doesn't require software expertise. A designer begins by assembling the program on paper. Then portions of the program are developed and stored in PROMs. And the initial prototype can

be made to look as close to the final product as possible.

"Hardware people really relate to this," says Biewer. "It's the way they're accustomed to working."

Designing with bipolar μ Ps

The design of systems using bipolar μ Ps can pose problems in addition to those of MOS processors. Most bipolar units are actually microprocessor slices. They don't come with fixed instruction sets, so designers must first develop these, storing the instructions in a special microprogram memory. Further, various peripheral and interface circuits—as well as additional memory—must be connected to the processor slices to form a working microcomputer. Then a design can proceed as it does with most MOS units; application programs are developed and stored in the microcomputer's memory.

Hardware testing can bring other problems if the prototype system doesn't run at the high speeds of bipolar units. Typically bipolar processors can operate many times faster than MOS versions can. The microprogram need not be checked out at the high operating speeds, but the complete system generally requires real-time tests.

One exception to the general rule is presented by Scientific Micro Systems. The company offers the Model 300, an 8-bit bipolar microprocessor—not just a slice. It comes with its own instruction set, so microprogramming isn't needed. Also, the company offers a multiprocessor prototyping system, called MCSIM, which allows in-circuit tests in real time.

MCSIM (for microcontroller simulator) comes complete with power supply, and it doesn't require a CRT terminal or teletypewriter. Instead the mainframe can be entered from a paper-tape reader or through octal switches on the front panel.

"And the next generation of design aids will handle several companies' microprocessors," says Steve Drucker, product manager at Scientific Micro Systems. However, several hurdles must first be overcome. One is how to handle the different software needs of different micros. Another is grappling with the widely diverse architecture of today's micros.

Meanwhile manufacturers of bipolar micro slices are seeking other ways to simplify designs. Monolithic Memories, for example, will shortly introduce a kit that will eliminate the need for microprogramming. Preprogrammed memories in the kit will provide a fixed-instruction set. Other chips will include the company's 6701 micro slice, as well as the additional ICs needed for a complete micro. ■■

New from Potter & Brumfield

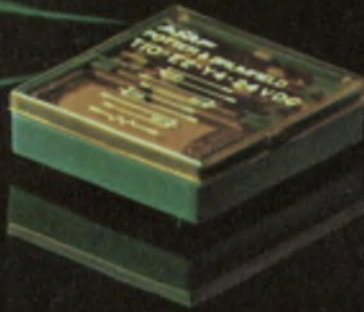

The lowest profile 3 amp relay we've ever offered!

The P&B T10 Series relay is lower than many other circuit board components. Only 0.375" high, it's ideal for high-density applications. Permits pc boards to be mounted on 0.5" centers!

T10 relays provide 0.1 to 3 ampere switching @ 30VDC. Coil ratings are 6, 12, 24, and 48VDC. Permissive make, gold-flashed silver contacts are noted for low contact bounce, long operating life. Bifurcated contacts for low level switching are available on special order.

Designed for low cost general purpose applications, the T10 is ideal for use in tele-communications, copy and reproduction machines, computer and peripheral equipment.

For additional information, contact the Potter & Brumfield sales representative or authorized distributor nearest you, or write Potter & Brumfield Division AMF Incorporated, Princeton, Indiana 47671. Telephone 812 385 5251.

Potter & Brumfield



Solving switching problems is what we're all about.

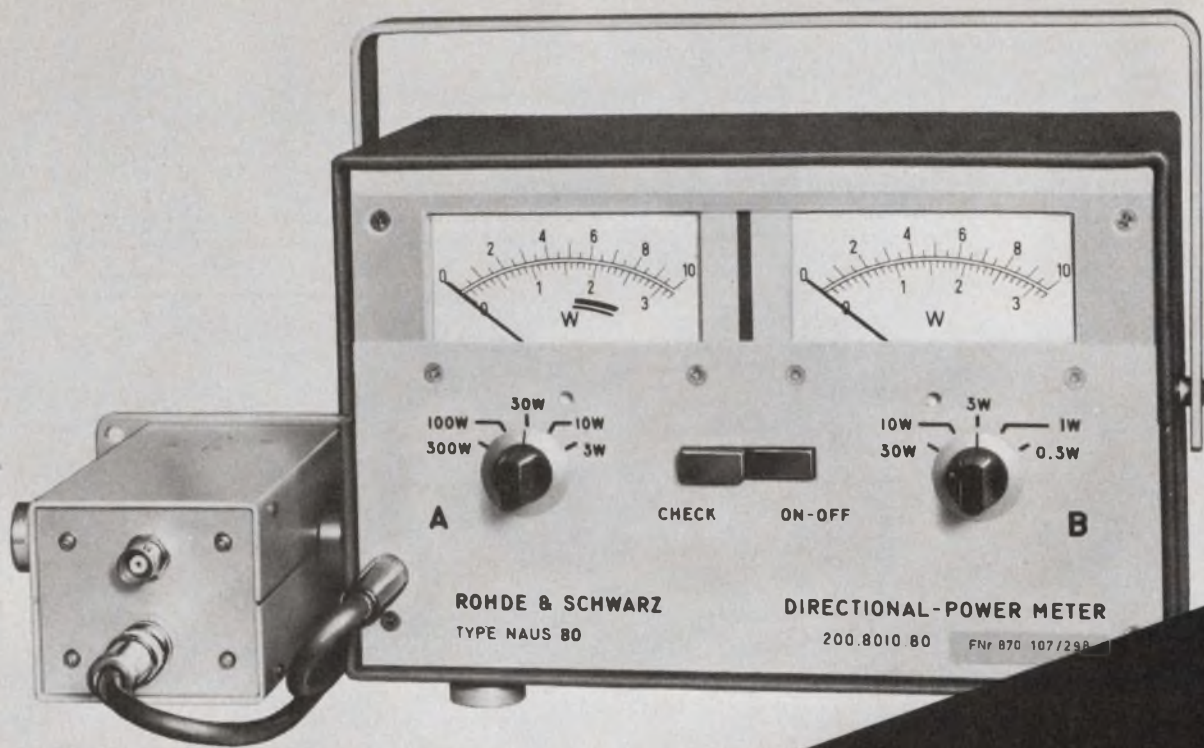

The Perfect Power Meter

You get what you want when you want it.

The Rohde & Schwarz Model NAUS-80 Power Meter Family was designed with you and your budget in mind and it's stocked in depth to give you quick delivery when you need it.

Just check the items and compare them to your present or planned meter . . . You'll see the R&S NAUS-80's are superior in every way . . . it is the PERFECT POWER METER!

Prove it to yourself . . . send for our complete literature and/or request a demonstration.

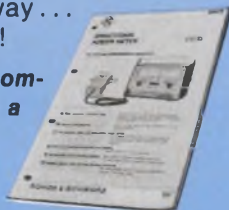

- One head for ALL ranges — 25-1000 MHz; 20 mW-320 W (NO PLUG-IN ELEMENTS NEEDED).
- Two meters for simultaneous incident and reflected power readings (VSWR) — Only this method allows tuning optimization.
- High Resolution (linear scale).
- High Accuracy (4% of reading $\pm 1\%$ F.S.).
- 1 kW overload protection (no burnouts).
- One low price for the *complete* instrument — (NO ADD-ONS NECESSARY).
- Five-year warranty on Parts and Labor (no exceptions).
- OFF THE SHELF DELIVERY.



ROHDE & SCHWARZ

14 Gloria Lane, Fairfield, N.J. 07006 ■ (201) 575-0750 ■ Telex 133310

INFORMATION RETRIEVAL NUMBER 35

NI 2001 Programmable Calculating Oscilloscope



Turn your waveforms into more useful data...quickly!

**Just key in
conversion factors...
read out
engineering units**

If you have used the NI 2001, or seen it demonstrated, you know that there is no easier way to acquire, process and manipulate electrical data without interfacing with a mini-computer or programmable calculator. All of its convenience and versatility is contained in a single mainframe that combines the capability of a digital oscilloscope and a microprocessor.

Whether you're performing a simple calculation or programming complex sequences, the 81-key interactive keyboard of the NI 2001 combines function and convenience never before attainable. Eight groups of color-coded controls put required commands at your fingertips. Consider, for example, what you can do using just the group of 14 keys of the NUMERIC ENTRY section of the keyboard, shown above. This group of keys eliminates the need for a separate calculating unit. In conjunction with other keyboard controls they give the NI 2001 complete calculating power to let you perform any arithmetic function. It operates on entire arrays of data as well as individual numbers.



More than a simple calculator, the NUMERIC ENTRY keys let you convert waveform measurements (or constructed waveforms) into any desired units to make processed data immediately useable. You can instantly convert waveform data to units of power, current, energy, acceleration, velocity, displacement, torsion, temperature or any other engineering, scientific or biological units to meet your needs. You can even convert instantly to metric units. You just key in the conversion factors and the results are displayed on the CRT in desired units. This group of keys is also used in searching for voltage levels or horizontal positions.

See how you can increase your productivity with the simplified signal analysis and accuracy of the NI 2001. Send the reader service card or write Norland Instruments, Department F-2.

Want a demonstration? Call us, today.



NORLAND INSTRUMENTS
A Subsidiary of Cordis Corporation

Norland Drive
Fort Atkinson, Wisconsin 53538
Tel. (414) 563-8456 U.S.A.

The Am9080A: Microprocessing for the masses.

The Am9080A, a pin-for-pin plug-in replacement for the C8080/8080A is priced at \$29.95 in 100-piece quantities now. Less Later.

Something is going on. Something big and important. A revolution. The Microprocessor revolution.

In the second half of this decade, microprocessors of various configurations, complexities and technologies will be sold and used in systems. But, only one will be used by the millions: The Am9080A/C8080A.

Since Intel's introduction of the 8080 and its successor — the 8080A — hundreds, perhaps thousands of designs have been committed to this general-purpose, 8-bit instruction set microprocessor. Design aids, software development systems, adequate debugging equipment, independent computerized programming systems, assemblers, compilers, cross-assemblers and systems applications materials are abundant.

The principal reason for using microprocessor-based systems is cost reduction. Unchallenged in the marketplace and hampered by an aging process technology, price decreases on the competitors' 8080 have been lagging. Until now. The Am9080A, a superior performance pin-for-pin functional replacement for the C8080/8080A, is built with an advanced ion-implanted, n-channel, silicon gate process that has enabled Advanced Micro Devices to build a chip with superior speed characteristics only two-thirds the size of the competition!

This independently developed CPU is guaranteed interchangeable in your system — or your money back. It is just like their 8080A — only better.

Like all Advanced Micro Devices' products, it is manufactured to the requirements of MIL-STD-883 at no extra charge. The \$29.95 price is the unbundled price. You don't have to buy our RAM's, our ROM's or our other support circuits if you don't want to. We think you'll want to.

Advanced Micro Devices offers the broadest line

of alternate plug-in replacement kit parts for your 8080-based system featuring high-speed and high-performance memories designed to take full advantage of the microprocessor's speed. We present the opportunity to optimize your microprocessor system, not compromise it.

The same engineering excellence that has made Advanced Micro Devices the price/performance leader in n-channel static RAM's is at work for you in the Am9080A microprocessor family.

Design a microprocessor-based system around the third generation *de facto* standard, the Am9080A/C8080A — the only independently multiple-sourced microprocessor from proven suppliers of high-volume n-channel silicon gate products.

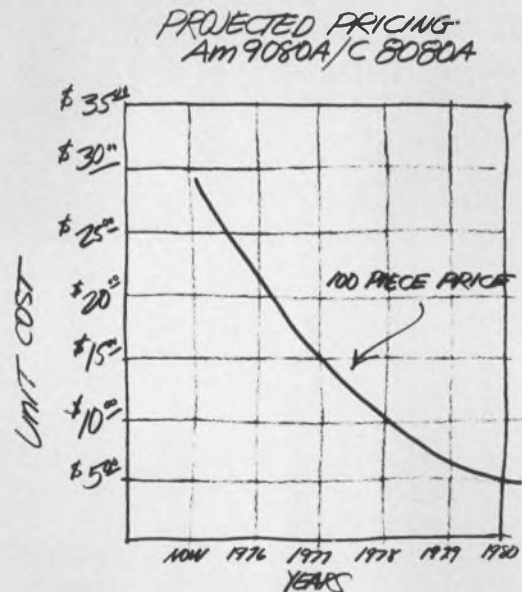

Buy the microprocessor that will be sold by the millions. By the way the million-piece price is \$6.00. F.O.B. Sunnyvale.

Am 9080A System Circuits

AMD Part Number	Description	Availability	8000 Series Plug-In Replacement	AMD Part Number	Description	Availability	8000 Series Plug-In Replacement
CPU				Dynamic Read/Write Random Access Memories			
Am9080ADC	0-70°C 480 nsec clock period	In Dist. Stock	C8080/C8080A	Am9060C	4K x 1, 300 ns, 22 pins	Samples Now	8107A
Am9080A-2DC	0-70°C 375 nsec clock period	In Dist. Stock	C8080A-2	Am9060D	4K x 1, 250 ns, 22 pins	Samples Now	8107A
Am9080A-1DC	0-70°C 325 nsec clock period	In Dist. Stock	C8080A-1	Am9060E	4K x 1, 200 ns, 22 pins	Samples Now	8107A
Am9080ADM	-55°C to +125°C 480 nsec clock period	In Dist. Stock	M8080A	Am9050C	4K x 1, 300 ns, 18 pins	Samples Now	N.A.
Am9080A-2DM	-55°C to +125°C 375 nsec clock period	In Dist. Stock	N.A.	Am9050D	4K x 1, 250 ns, 18 pins	Samples Now	N.A.
Static Read/Write Random Access Memories				Serial Memories			
Am9101A/Am91L01A	256 x 4, 500 ns, 22 pins/low power	In Dist. Stock	8101	Am2812	32 x 8 FIFO	In Dist. Stock	N.A.
Am9101B/Am91L01B	256 x 4, 400 ns, 22 pins/low power	In Dist. Stock	N.A.	Am2813	32 x 9 FIFO	In Dist. Stock	N.A.
Am9101C/Am91L01C	256 x 4, 300 ns, 22 pins/low power	In Dist. Stock	N.A.	Am2841	64 x 4 FIFO	In Dist. Stock	N.A.
Am9101D	256 x 4, 250 ns, 22 pins	In Dist. Stock	N.A.	Am2847	4 x 80 static shift register	In Dist. Stock	N.A.
Am9102/Am91L02	1K x 1, 650 ns, 16 pins/low power	In Dist. Stock	8102/8102-2	Am2896	4 x 96 static shift register	In Dist. Stock	N.A.
Am9102A/Am91L02A	1K x 1, 500 ns, 16 pins/low power	In Dist. Stock	N.A.	Mask Programmable Read-Only Memories			
Am9102B/Am91L02B	1K x 1, 400 ns, 16 pins/low power	In Dist. Stock	8102A-4	Am9208B/C	1K x 8 mask programmed, 400 ns/300 ns	Now	8308
Am9102C/Am91L02C	1K x 1, 300 ns, 16 pins/low power	In Dist. Stock	N.A.	Am9214	512 x 8 mask programmed, 500 ns	Now	N.A.
Am9102D	1K x 1, 250 ns, 16 pins	In Dist. Stock	N.A.	Am9216B	2K x 8 mask programmed, 400 ns	Oct. 1975	8316*
Am9111A/Am91L11A	256 x 4, 500 ns, 18 pins/low power	In Dist. Stock	8111	Erasable Read-Only Memories			
Am9111B/Am91L11B	256 x 4, 400 ns, 18 pins/low power	In Dist. Stock	N.A.	Am9702	256 x 8, 1.0 μsec	In Dist. Stock	N.A.
Am9111C/Am91L11C	256 x 4, 300 ns, 18 pins/low power	In Dist. Stock	N.A.	Am1702A	256 x 8, 1.0 μsec	In Dist. Stock	8702A
Am9111D	256 x 4, 250 ns, 18 pins	In Dist. Stock	N.A.	Am2708	1024 x 8, 450 nsec	2nd Q 1976	8708
Am9112A/Am91L12A	256 x 4, 500 ns, 16 pins/low power	In Dist. Stock	N.A.	Processor System Support Circuits			
Am9112B/Am91L12B	256 x 4, 400 ns, 16 pins/low power	In Dist. Stock	N.A.	Am8212	8-bit I/O port	1st Q 1976	8212
Am9112C/Am91L12C	256 x 4, 300 ns, 16 pins/low power	In Dist. Stock	N.A.	Am8224	Clock Generator	1st Q 1976	8224
Am9112D	256 x 4, 250 ns, 16 pins	In Dist. Stock	N.A.	Am8228	System Controller	1st Q 1976	8228
Am9130A	1024 x 4, 500 nsec	1st Q 1976	N.A.	Am8T26	Bus Transceiver	In Dist. Stock	8216**
Am9130B	1024 x 4, 400 nsec	1st Q 1976	N.A.	Am25LS138	1 of 8 Decoder	In Dist. Stock	8205**
Am9130C	1024 x 4, 300 nsec	1st Q 1976	N.A.	Am25LS14	8-bit Serial/Parallel Multiplier	Samples Now	N.A.
Am9130E	1024 x 4, 200 nsec	1st Q 1976	N.A.	Am2905/6/7	2-Port LSI Bus Transceiver/Registers	Samples Now	N.A.
Am9140A	4096 x 1, 500 nsec	1st Q 1976	N.A.	Am9555	Programmable Peripheral Interface	1st Q 1976	8255
Am9140B	4096 x 1, 400 nsec	1st Q 1976	N.A.	Am9551	Serial Communications Interface	2nd Q 1976	8251
Am9140C	4096 x 1, 300 nsec	1st Q 1976	N.A.	*Functional replacement only			
Am9140E	4096 x 1, 200 nsec	1st Q 1976	N.A.	**Pin-for-pin replacement only. Some parameters vary.			

Advanced MOS/LSI



In stock **now** at Hamilton/Avnet, Cramer and Schwebel Electronics.

Advanced Micro Devices • 901 Thompson Place, Sunnyvale, California 94086 • Telephone (408) 732-2400 •

INFORMATION RETRIEVAL NUMBER 167

Evaluate complicated functions.
Calculate transcendental functions.

Find the roots of: $F(x) = 0$.

Find numerical solutions to ordinary differential equations.

Invert and multiply matrices.

Solve simultaneous algebraic equations.

Integrate a function between arbitrary limits.

Determine best-fit values for statistical samples.

Now you can set up calculations like these just once. Record them. Then use them for years.



SR-52
Handheld
programming
power

\$395.00

Suggested Retail

Texas Instruments SR-52.
224 program locations.
Twice the user-defined keys.
Twice the memory registers.
But half the cost
of the only other programmable in its class.*

Complex repetitive problems or lengthy calculations that once took hours can now be solved in seconds. And the chances of entry error are dramatically reduced.

The SR-52 allows you to record up to 224 keystrokes to perform your calculations—your way. Programming is simple and straightforward. What's more, preprogrammed cards are available which can be integrated into your problem solving routines.

Easy Left-to-Right Algebraic Entry. Enter calculations *exactly* as you write them. The SR-52 combines a 3-level algebraic hierarchy with 9 levels of parentheses. This lets you enter problems containing up to 10 pending operations (three times the capability of the only other machine in its class). This means you don't have to presolve the problem or search for the most appropriate, efficient order of execution. The SR-52 does this automatically.

Learn Mode. Teach the SR-52 your personal approach to problem solving. Simply key-in your problem left-to-right as you would in calculate mode, using the following options for precise control:

- Preprogrammed "if" Statements (8). Makes a decision based on the condition of the display.
- Decrement and Skip on Zero. Lets a segment of code be repeated a specified number of times.
- User-defined Flags (5). Determines the condition under which

- a program transfer is made.
- Program Levels (3). A main program can call up to two levels of subroutines.
- Labels (72). Name program segments.
- Indirect Addressing (2 modes). Extends versatility of all memory-reference and branching instructions.

Trial-run your program. Editing and "debugging" are easy. Move through problems a step at a time, forward or backward. Add more steps. Delete. Or write over steps. Then record.

Run Mode. Load a magnetic card. This puts the card's contents in memory. Insert the card above the 5 user-defined keys representing 10 functions.

Enter numbers directly into the

program. Or into one or more of the 20 addressable memory registers. Or both.

Execution is completely automatic. A program runs until it encounters a halt, which may be part of a program or a keyed-in interruption.

Repeat a program as often as needed. Change values of your variables. Solve for different unknowns. The stored program is unaffected.

With the SR-52 comes a Basic Library Program Manual and preprogrammed cards: Factors of an integer. Complex arithmetic. Reconcile checking account. Ordinary annuity. Permutations and combinations. Means and moments. Random number generator. Hi-pass active filter. Low-

pass active filter. Dead reckoning. Hyperbolic functions. Trend line analysis. Solution of quadratic equations. Conversions. Game.

Additional Libraries may be purchased separately: Statistics. Math. Electrical Engineering. Finance. And more are on the way.

Calculate Mode. Operated manually, the SR-52 is one of the most powerful calculators available today.

For more information. See your TI calculator retailer. Or send for new brochure. Write Texas Instruments, M/S 358, Box 22013, Dallas, Texas 75222.



Complete software... and soon, an optional printer.

Accompanying an SR-52: Operating guide. Comprehensive owners manual. Basic library of prerecorded programs, diagnostic cards and head cleaner in carrying case. Basic library manual. User instruction & coding forms. Blank magnetic cards. Fast-charge battery pack. AC adapter/charger. Sturdy vinyl carrying case.

SR-52 lock-in printer.
(available early 1976)

- Print out an entire program.
- Print calculate mode results.
- Print instructions or results without halting program execution.
- Trace program execution step by step for error detection.

*Based on suggested retail prices current at time of this printing.

If you need HYBRIDS...

TELEPHONE HIGH BAND ACTIVE FILTER

1000pF NPO CERAMIC CHIP CAPACITOR

MULTILAYER CONDUCTORS

μ A741 OP AMP IC

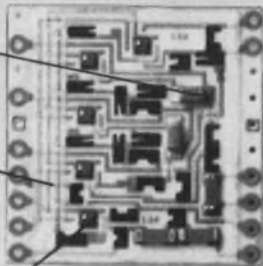

AUDIO FREQUENCY MODULATOR

1.0 μ F TANTALUM CHIP CAPACITOR

6.8 MEGOHM THICK FILM RESISTOR

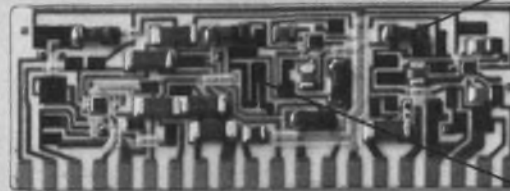

13-BIT MULTIPLYING DAC

13-BIT THIN FILM R-2R BINARY LADDER NETWORK

CUSTOM MOS IC

DIELECTRICALLY ISOLATED HIGH SLEW RATE OP AMP

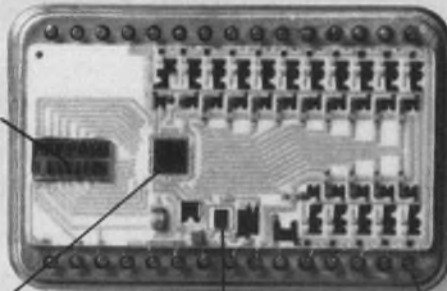

PROJECTION WELD SEAL HERMETIC PACKAGE

MULTICHANNEL TIME DELAY

4.7 μ F TANTALUM CHIP CAPACITOR

SOLDERABLE TERMINAL PAD

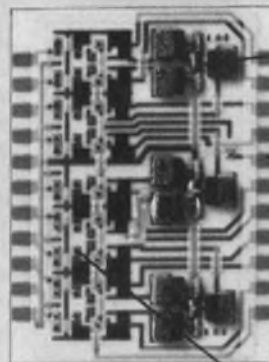

2N2907A SILICON CHIP TRANSISTOR

you should know about BECKMAN!

We offer *expert* application assistance and *quality products* at *competitive prices*.

Beckman Hybrids can solve your system packaging problems in:

- Active Filters and Telephone Tone Filter/Modem products
- DACs and ADCs from Industrial to Military standards
- Power Linears from Amplifiers to Voltage Regulators
- Complex Customs from Passive Substrates to Multilayer Digital hybrids

For fast response, call (714) 871-4848, Ext. 1776

Beckman[®]

HELIPOT DIVISION

INFORMATION RETRIEVAL NUMBER 166

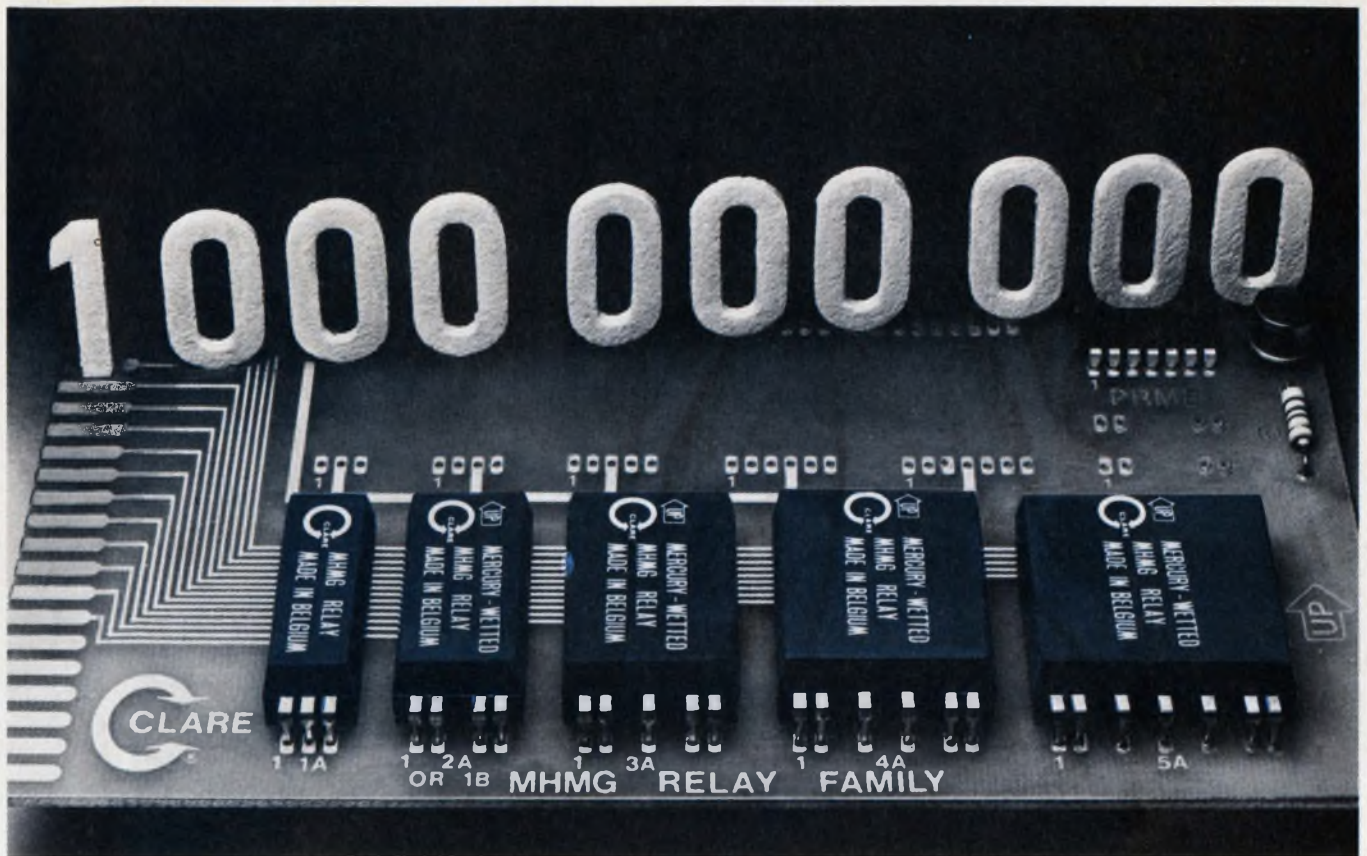

**BILLIONS OF SWITCHING OPERATIONS
AT A PRICE YOU CAN AFFORD**

CLARE 851 SERIES MHMG RELAYS

A new family of epoxy molded mercury-wetted reed relays.

The 851 Series MHMG relays offer billion (10^9) operations. Bounce free mercury-wetted switching performance and load handling capability from signal-level to 50 VA. Multi-pole flexibility from one to five contacts, epoxy molded packaging for PCB mounting, and at a cost approaching dry reed relays.

Like all Clare mercury-wetted relays, the heart of these relays is a Clare manufactured hermetically sealed glass capsule. Contact switching is mercury-to-mercury. So there's no contact wear, no contact bounce, constant ON and OFF impedances—every operation. Maximum switching ratings are 350 Vdc, 1 ampere.

The 851 Series MHMG family are high quality components for telecommunications, business machines, industrial data logging and control, and other electronic instrument applications.

For more information contact: C. P. Clare & Co., 3101 W. Pratt Ave., Chicago, Ill. 60645. Phone (312) 262-7700. Telex: 25-3775.

C. P. CLARE & COMPANY a subsidiary of
GENERAL INSTRUMENT CORPORATION



FREE SAMPLE OFFER

Send today for your free sample of new 851 Series relays. Sorry, only one sample per customer. Offer ends Dec. 31, 1975. Just mark your selection below:

- 852A05B1A 1 form A 5 Vdc
- 851A12B1A 1 form A 12 Vdc
- 851A05B2A 2 form A 5 Vdc
- 851A12B2A 2 form A 12 Vdc

Name _____

Function _____

Company _____

Address _____

City _____ State _____

Zip _____ Phone _____

Send to: C. P. Clare & Co., 3101 W. Pratt Ave., Chicago, Ill. 60645.

INFORMATION RETRIEVAL NUMBER 168



Your Guardian Angel presents an all-new relay that's **Low slung... and ready to turn on.**



This new "flat-pack" relay for high density packaging switches currents that could weld contacts on other small relays . . . and reeds. And it comes in your choice of SPDT or DPDT.

Guardian's new Series 1475 low profile relay is specifically engineered for use on printed circuit boards. Or, where usable output load to be controlled is inductive or of higher value than practical for reed relays or even solid state controls. This compact little relay switches low to intermediate currents by handling up to 3 amps at 120VAC resistive or correspondingly higher currents at lower voltages.

All this action inside a sealed thermoset housing and cover that lets you wave or hand solder at up to 650°F without contact contamination or damage during normal soldering time. Mechanical life of this little miracle? 10^7 operations. (What else would you expect from your Guardian Angel?!!)



**SEND FOR THE BOOK
THAT TELLS IT ALL:**

Guardian's 48 page relays catalog. Full of facts and specs to make selecting a relay a snap. Yours free for the asking.



CIRCLE NO. 164



GUARDIAN®

GUARDIAN ELECTRIC MANUFACTURING CO. • 1572 West Carroll Ave., Chicago, Illinois 60607

SOLID-STATE? YOU BET!

For compatible solid state
switching products call
Guardian . . . or circle 165

Two years of a wealth of incredible information on MICROPROCESSORS brought right up to date by Electronic Design

We sifted through the last two years of ED and found an incredible amount of practical information and advice on selecting micros . . . using them to your best advantage . . . improving them for better speed and broader application. We compiled it all into one

convenient handbook — **MICROPROCESSORS: New Directions for Designers**. If you'd like to see a copy, circle the information retrieval number below and we'll send you one to read and use FREE for 15 days. At the end of time, just send in a check for \$8.95, or return the book.

Hayden Book Company, Inc.

50 Essex Street
Rochelle Park, N.J. 07662
(201) 843-0550

INFORMATION RETRIEVAL NUMBER 95



±15 VOLT POWER MINI'S FOR OP AMPS

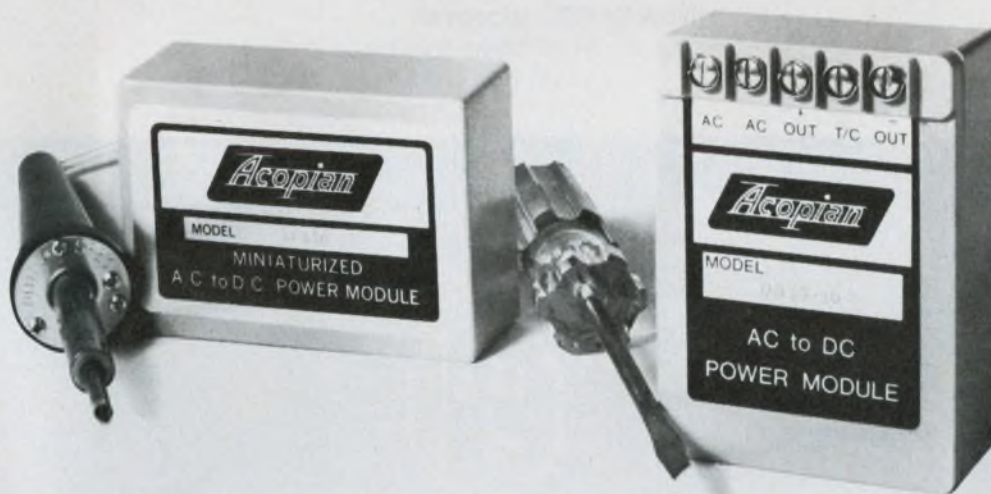

ALL MODELS U.L. RECOGNIZED

PC-BOARD MOUNTING

OUTPUT CURRENT MA	SIZE INCHES	PRICE	MODEL
25	2.3 x 1.8 x 1.00	\$24	D15-03
50	2.3 x 1.8 x 1.00	39	D15-05
100	3.5 x 2.5 x 1.00	49	D15-10A
200	3.5 x 2.5 x 1.00	69	D15-20
300	3.5 x 2.5 x 1.25	105	D15-30
500	3.5 x 2.5 x 2.00	130	D15-50

CHASSIS MOUNTING

OUTPUT CURRENT MA	SIZE INCHES	PRICE	MODEL
100	3.5 x 2.5 x 1.38	\$55	DB15-10
150	3.5 x 2.5 x 1.38	65	DB15-15
200	3.5 x 2.5 x 1.38	75	DB15-20
300	3.5 x 2.5 x 1.63	105	DB15-30
350	3.5 x 2.5 x 1.63	110	DB15-35
500	3.5 x 2.5 x 2.38	135	DB15-50

Line/load regulation, $\pm 0.1\%$ or better; ripple, 1 mv; input, 105-125 VAC. Other single and multiple output models from 1 to 75 volts, to 2.5 amps. Liberal quantity discounts. Three-day shipment guaranteed.

Complete details on these plus a comprehensive line of other power supplies and systems are included in the Acopian 74-75 catalog. Request a copy.



Corp., Easton, Pa. 18042. Telephone (215) 258-5441.

INFORMATION RETRIEVAL NUMBER 169

This one resistor can shrink your inventory costs

TYPE CC RN55D

- 10 ohms to 10 megs (1/4w size)
- high stability cermet film
- multiple wattage ratings
 - 1/8w at 125°C
 - 1/4w size 1/4w at 70°C
 - 1/2w at 70°C (max 250 v)
- tolerance 1%
- dual resistance marking
- available now, off-the-shelf
- **Now RLR07 approved**
 - 10 ohms to 1 meg
 - tolerance 2%



Quality in the best tradition.



ALLEN-BRADLEY

Electronics Division
Milwaukee, Wisconsin 53204

INFORMATION RETRIEVAL NUMBER 170

EC119C

Heath sets a new performance level for laboratory recorders

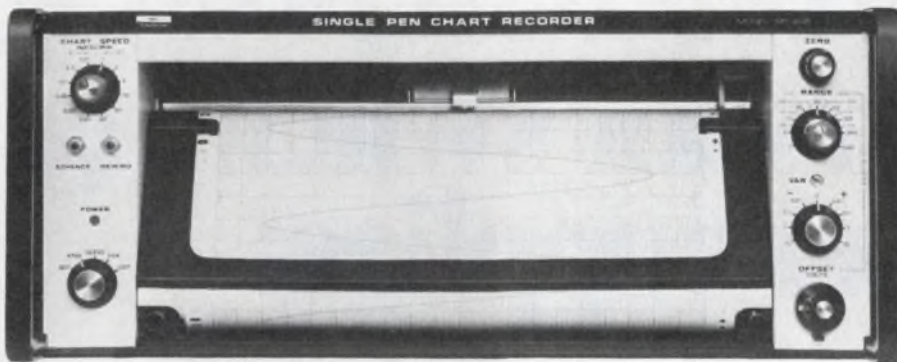

Our new single-pen SR-205 has many standard features that are available only as extra-cost options with other manufacturers. Like front panel zero controls for pen placement anywhere with zero input...full scale input ranges of 1, 2, 5, 10, 20, 50, 100, 200 & 500 mV or volts...calibrated positive & negative offset for input signal suppression...pushbutton chart advance and rewind...12 chart speeds from 50 in/min to 0.01 in/min in a 1-2-5 sequence...remote control capability for all functions. Balance time is only 250 msec for accurate response to fast-changing signals. Maximum error is $\pm 0.2\%$ of full scale. A great recorder value—only \$995*.

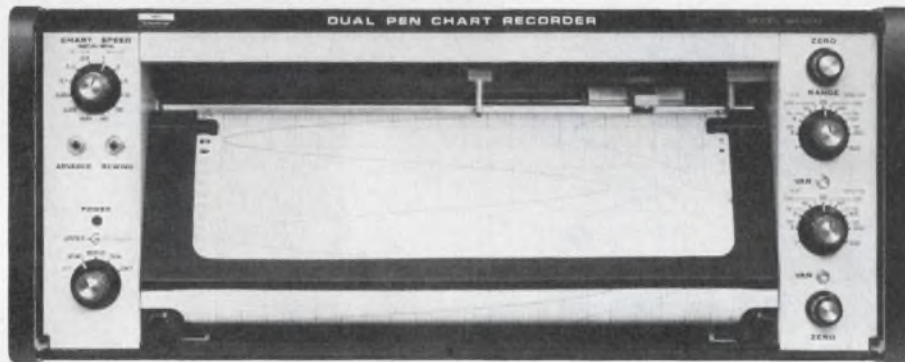

The new SR-206 brings dual-pen recording to the Heath/Schlumberger recorder line. Both channels offer the same capability as the SR-205 above, except for calibrated offset...both inputs provide 18 calibrated ranges from 1 mV to 500 V full scale...pens are separated by one large division on the chart for easy comparison...remote control includes separate pen lift and events marker for each channel...disposable, nylon-tipped pens for sharp, distinct traces at any chart speed. The SR-206 is the most complete recording system in its price class. Only \$1395*.

Heath/Schlumberger has engineered precision and performance into two new strip chart recorders that are probably all the lab recorder you will ever need. Each recorder is a complete system — there are no extras to buy. The price even includes events markers, electric pen lift, necessary hardware for rack mount and easy conversion to metric operation. Chart drive is quartz crystal controlled for stable chart operation regardless of line frequency. Front panel pushbuttons provide two-speed chart advance and rewind. Remote control by TTL-level signals for pen

lift, chart drive, events marker and servo mute is possible through a connector on the rear panel (mating connector supplied). An enclosed conductive plastic slideware is used for long life without periodic cleaning. Pen motor current limiting circuitry allows the pen to be driven continuously off scale with no audible noise and no possibility of damage to the recorder.

The precision and versatility of the SR-205 & SR-206 will make them the most-used instruments in your lab.

Research-quality performance on a low budget... the SR-204 only \$395*

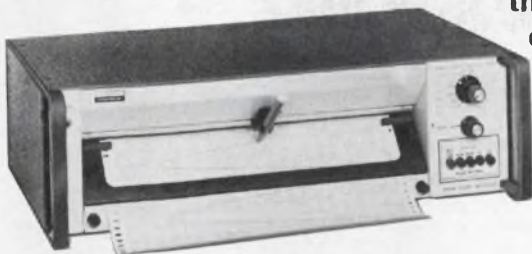

The SR-204 is our best recorder value. It offers a full 10-inch chart width...pushbutton selection of 10 mV, 100 mV, 1 V and 10 V full scale spans with variable control for expansion to 100 V full scale...10 digitally-derived chart speeds from 10 to 0.01 in/min with accuracy to 0.5% or better...balance time is only 1/2 second...floating input with better than 10^7 megohms input impedance to minimize source loading...complete remote control capability for all functions. Only \$395*, including rack mount & metric conversion.

Send for your free Heath/Schlumberger Catalog

The latest Heath/Schlumberger Assembled Instruments Catalog has complete specs and descriptions for all of the above recorders — along with many other high performance, low cost instruments for industrial, research and educational applications. Send for your free copy today.



Please send my free copy of the latest Heath/Schlumberger Assembled Instruments Catalog.

HEATH/SCHLUMBERGER INSTRUMENTS
Dept. 511-100
Benton Harbor, Michigan 49022

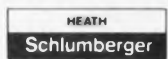

NAME _____		
TITLE _____		
COMPANY/INSTITUTION _____		
ADDRESS _____		
CITY _____	STATE _____	ZIP _____
<small>• MAIL ORDER PRICES F.O.B. FACTORY. PRICES AND SPECIFICATIONS SUBJECT TO CHANGE WITHOUT NOTICE.</small>		
		EK-462A

The first packaging breakthrough in power transistors for switching power supplies:

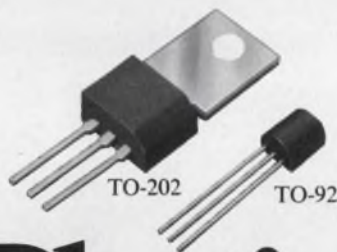

Plastic.

Introducing the Unitrode Plastic Power Switching Transistors.

The first series of power transistors in plastic designed and characterized for maximum efficiency at 20KHz and above in switching power supplies up to 300W.

This means that now, for the first time, you can get high-

priced power switching performance in a low-cost package.

For complete specs on the

whole line, simply circle the reader service number, drop us a line, or call Ed Rodriguez at 617-926-0404.

And find out how to get everything you want in a power switching transistor.

For less than you're willing to pay.

Unitrode Corporation, 580 Pleasant Street, Watertown, Mass. 02172.

PERFORMANCE

SERIES	UPTD	UPTC	UPTF	UPTA	UPTB
PACKAGE	*	*	*	**	**
BV_{CEO}	60-100V	60-100V	100-300V	100-300V	200-500V
I_c	5A	2A	2A	.5A	.1A
$t_f(\mu s)$ typical	.2	.2	.5	.2	1.0
$t_s(\mu s)$ typical	.3	.2	.5	.2	.25

*TO-202

** TO-202 OR TO-92



UNITRODE

Suddenly, the rest of the world died

A fellow came up to our office the other day to tell us about a dramatic new product his company had developed. I couldn't understand why he seemed sheepish and apologetic about it until he broke down and admitted that the product did not include a microprocessor and had nothing to do with microprocessors. He feared that we might not publish anything that didn't give us an opening for headlining the word microprocessor.

That really threw me. I certainly appreciate the importance of microprocessors. They are the most dramatic and far-reaching products of this decade. But they are not the only ones. There are lots of other products around and we're going to have to use them.

Since their first commercial availability three years ago, *ELECTRONIC DESIGN* has published dozens of articles on microprocessors and we expect that, before the world ends, we will have published quite a few more. In fact, in the November 22nd issue, we're starting a new section, "Microprocessor Design." But please don't think that this increased emphasis is going to throw us. We are not going to ignore other products. We are not going to lose our perspective.

After the transistor was introduced in 1948, some engineers acted as if all other products were dead. The transistor was such a dramatic development that people were almost ashamed to use old, garden-variety resistors and capacitors and pots in their transistor circuitry. We had the same phenomenon after 1959 when the IC was introduced. Again, nothing was important unless it *was* an IC, *included* an IC, or *worked* with an IC. And now we're seeing it again.

If somebody introduces a digital-to-analog converter today, you can be sure he'll say it can be used with a microprocessor. If somebody has a new DVM, it is, of course, suitable for measuring microprocessor supply voltage. Even resistors and capacitors will be "suitable for use with microprocessors." The word microprocessor will be strewn all over the place.

People will lose sight of the fact that a microprocessor mounts on a PC board, which often goes to a connector, which often goes to some plain-vanilla cable. The PC board is likely to be mounted in a cabinet, whose front panel supports switches, knobs, meters and, maybe, paint. And the microprocessor, powered by a power supply, is likely to be surrounded by resistors and capacitors as well as old-fashioned transistors and ICs.

If we keep these things in perspective, we're not likely to lose our balance.



GEORGE ROSTKY
Editor-in-Chief

The Qualified Supplier Offers

OEM PLUG

COMPATIBILITY

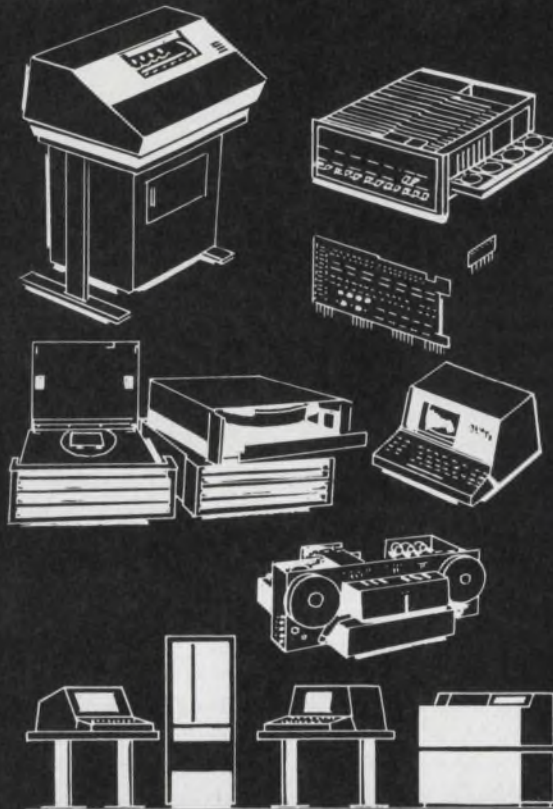

Complete customer satisfaction comes first at DATA 100. That's why we are being called the OEM's OEM—we understand how important your customer is to you. Call a DATA 100 OEM sales office for information about these highly reliable, proven in use products:

Line Printers	62.5, 125, 210, 225, 250, 300, 400 and 600 LPM
Card Equipment	Readers and Punches
Micro Programmable Mini Computers	Basic Hardware and Complete Systems
Plug Compatible Memories	PDP-11 8K and 16K, Connectors, Mounting Units and Memory Address Extenders
Disk Drives	Front Loaders, Top Loaders, 6 to 12 Megabytes Capacity
Paper Tape Products	Readers, Handlers and Punches
Communications Equipment	Throughput Enhancers, Line Testers

OEM products are backed up from over 200 field service locations throughout North America.

We care more about our customers because we are one.

DATA 100

C O R P O R A T I O N

Boston (617) 848-6100 • Minneapolis (612) 941-6500

• San Francisco (415) 574-1812

Take a big byte out of data requirements with conography.



TM—Conographic is a trademark of Hughes Aircraft Company

What's conography? It's a new space-age technology which uses conic curves to digitize and store graphic and symbolic information.

Conography not only reduces data requirements, it produces a better image. (It's like using a french curve instead of a straight-edge to draw contours and curved images — a lot easier and with smoother results.) The computation of these special curves is so fast that a mini-computer can interactively change curved images in real time.

The Conographic™-12 advanced display terminal uses a standard video format, so you can receive, transmit and process information by video data transmission. It has complete graphic and alphanumeric capability, high resolution video (1029-line), selective erasure and extensive line texturing capability.

Since it requires less data to operate, the Conographic-12 system needs less support

hardware, simpler software, and less computer time for most applications.

In other words, conography can save you a lot of time and money.

Write for our brochure, "Image Processing with Conography." Hughes Conographic Products: 6855 El Camino Real, Carlsbad, CA 92008, (714) 729-9191. Or 1284 North Broad Street, Hillside, New Jersey 07205, (201) 289-7770.



Creative Image Processing

INFORMATION RETRIEVAL NUMBER 39

on CRT terminals

Cathode-ray tube computer terminals come in all shapes and sizes. Not only that, but they have widely varying IQs.

They range from dumb to smart and on to intelligent, with many degrees in between. You almost need to be a psychologist to buy one.

Some offer only alphanumeric characters. Others have some graphics capability. And some have enough graphics to draw three-dimensional pictures, with a choice of 64 levels of gray scale. Most system designers tend to buy more capability than they need. This is like asking for a 150-mph auto speedometer, even though the legal speed limit is 55.

Perhaps the most serious problem in specifying a CRT terminal is to ensure that it will interface with your computer. Standard interfaces don't always mate, and line protocols are almost never specified by the vendor. Just because you can buy a PDP-11 interface for the terminal doesn't necessarily mean that the terminal will work with a PDP-11 computer and the interface alone. You often need a bit more.

Just how smart is it?

Most common of all the specsmanship games that manufacturers play is that of characterizing the terminal's IQ. Only a few manufacturers are brave enough to call their terminals dumb. Rather they tend to pitch the least-intelligent CRT terminals as improved low-cost terminals—as “glass teletypewriters.” These terminals usually have ASCII 96-character keyboards (sometimes only 64 characters), and they transmit data asynchronously (character-by-character as they are typed) at a rate of at least 110 baud.

David N. Kaye
Senior Western Editor

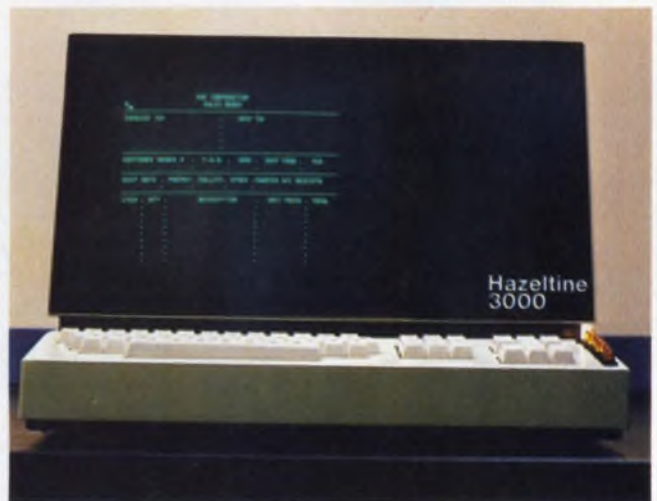

Hazeltine's 3000 is a smart terminal with a programmable communications interface. The interface provides the polling discipline compatible with the communication network.

Anything more than a dumb terminal is generally referred to as “smart.” But how smart is it? That depends on who the terminal's mother is. One proud manufacturer has described his line of terminals as smart, smarter and smartest. The “brains” of smart terminals are sometimes hard-wired logic and sometimes an internal microprocessor programmed with firmware.

The first smart feature usually added is editing capability. Most manufacturers point to “full editing capability.” Depending upon who is talking, that can mean anything from character delete and insert, to line delete and insert, to field delete and insert, to page delete and insert, to clear line (clear to end of line from cursor location), to clear page (clear to end of page from

cursor location except for protected fields), to clear memory (clear all refresh memory including protected fields), to automatic justification of text, or any combination of these. However, the specific editing functions you need in your system will largely determine which terminal you buy. Certainly, by looking at editing capabilities, you can considerably narrow the field of suitable vendors.

Beyond editing, smart terminals often offer selectable baud rates. These allow transmission from below 110 baud up to 19.2 kbaud. And many terminals have buffer memory, so that blocks of data may be transmitted synchronously as well as asynchronously. Once memory is added, many terminals also offer a feature known as "scrolling." But this means different things to different people. If only enough scroll memory is available to store the information that appears on the screen, the scrolling control will move the entire display either up or down one line at a



An Intel 8080 microprocessor is the heart of the Control Data 92451 Display Terminal. Control of the basic terminal is performed by semiconductor read-only memories mounted on PC boards within the terminal.

time, saving the line that disappears at the top or bottom in the scroll memory. Then, if you scroll in the opposite direction, the lines will reappear on the screen.

If more than one page of scrolling memory is available, it is usually four pages. With four pages of scrolling memory, you can save one page above the page on the screen and one page below the page on the screen. Thus, as you scroll the page of characters on the screen up, the lower page appears out of memory and the upper page moves from one memory location to another. As you scroll down, the reverse happens.

Another feature that's possible if the terminal has memory is called "protected fields." Normally if a character is on the CRT screen and you



A compact 5-in. CRT and unusual styling with a keyboard in a drawer make this terminal from Informer unique in its field.



The 2644A Data Terminal from Hewlett-Packard is a smart terminal with a character generator that can draw line segments and a pair of built-in data cartridge drives that accept a new, small 3M data cartridge. The cartridges can be used on-line as well as off-line.



Research's Teleray 3900 is a terminal that provides APL as well as ASCII characters. A 15-in. CRT is used, and high readability is achieved.

strike a new character over the existing character location, the old character goes away and the new character appears. But, sometimes you put information on the screen that you don't want to lose. A protect key handles this situation. When this key is depressed, the character marked by a cursor on the screen is protected from strike-over. Until the character is unprotected, it cannot be removed from the screen if another key in its position is struck. Protected fields are very useful when forms are set up on the screen and labeled. The forms and the labels are usually protected, so that when the form is filled in, the form is not accidentally erased.

Once a protected field is set up, it is often desirable to give it special prominence on the screen for ease of identification. Or it may be desirable to highlight information other than protected fields. Terminals offer a variety of ways of doing this. Multiple intensity, blinking, reversing and underlining are popular methods. Most terminals offer one or more of these techniques and some offer several that can be used in any combination with each other. Most common of the multiple intensity features is dual intensity. Usually the second intensity is half the normal intensity. Sometimes double brightness is also offered. In more advanced graphic terminals, up to 64 levels of brightness are available.

Blinking is also very common. In this mode the protected field, or any desired character or combination of characters, can be instructed to blink from one intensity level to another.

Reversing means creating a dark character on a white field or drawing horizontal and vertical broad white stripes on the CRT. Underlining is also offered sometimes. In combination, these techniques can give many different items on the



Sycor's 350 intelligent terminal contains a pair of built-in floppy-disc drives and a range of interfaces for other peripherals.

screen special identity.

And if these visual techniques aren't sufficient, audible alarms are available—sounds like ping, bong, buzz or click. These can tell when you have finished entering a record of prescribed length on the screen, or they can tell you that a block of data has been transmitted from the terminal. On some terminals the alarm can be programmed to indicate almost anything the user desires. If an audible alarm is available, make sure it has a volume control. Some don't.

All terminals have a cursor of some sort. On the smarter terminals, the cursor can be moved around freely, but usually the movements are more restricted. Typical cursors include a line under the character at hand, a nondestructive blinking white block and a white block on which an existing character on the screen is reversed.

Typical cursor keyboard commands are up, down, left, right, home and return left to next line on new line command. With the up, down, left and right keys, there is usually a repeating feature for rapid long-distance cursor movement. When cursor control keys are not enough, other interactive control devices are sometimes available as options. These include a joystick, a light pen, a track ball and a set of thumbwheel controls. These techniques are most useful on graphic terminals.

Another technique for quick cursor movement when tabular data are being entered on the display is a tab key. This works just like the tab key on a regular typewriter and comes complete with "set" and "clear" keys.

Smart terminals frequently offer special function keys. These can be set through firmware to transmit any code the user desires. When the code is received at the computer, it is interpreted

through software. Since the software can be changed, the function keys can be reprogrammed at the computer rather than at the terminal.

Some smart terminals can also do internal error checking under microprocessor control. In addition widely expanded character sets are often features of smart terminals. These may be foreign letters or graphic elements. Blanking is also offered sometimes. In this mode a private code can be typed into the terminal without being displayed on the screen.

When is it intelligent?

Although this point is disputed (primarily by some manufacturers who would call smart terminals intelligent), users tend to agree that a terminal must be user-programmable at the keyboard before it is truly intelligent. Of course, it must have a processor and random-access memory in it as well.

Generally, an intelligent terminal can also be interfaced to other peripherals under program control. These may be other terminals, floppy-disc drives and other forms of add-on memory. Sometimes paper tape or card readers are also used. Printers and copiers are quite common.

There is one big area of dispute in the definition of intelligence. What about the terminal that can be reprogrammed when the manufacturer plugs a new ROM control store into the terminal? Most manufacturers and users would classify this type of terminal as not quite intelligent but very, very smart.

Intelligent terminals come close to minicomputers in their capabilities—in some cases, they're more powerful. The dividing line is becoming blurred. For example, a terminal may include a minicomputer-like programming console for aid in debugging programs. Therefore some manufacturers call their terminals minicomputers when the customer seems to want it that way.

The human interface

Nothing is as difficult to specify for the manufacturer as the human interface. Key elements include the size of the screen; the number, shape and size of the characters on the screen; the color and appearance of the screen; the arrangement of the keyboard; and the sound of the keyboard.

The most common screen sizes are 12 in. diagonal for alphanumeric displays and 21 in. diagonal for graphic displays. A circumference of 22 in. is also quite common in graphic terminals. However, alphanumeric terminals come as small as 5 in. diagonal and as large as 19 in. The most common alphanumeric format is 24 lines by 80 columns (1920 characters). But other formats



The Model 455 from TEC, Inc., is a smart terminal with a large character set and a full range of editing functions and cursor controls.

are often used as well. They include 24×40 , 12×80 , 12×40 and 6×80 .

Characters are most often formed by 5×7 dot matrices, with 7×9 coming in a distant second, though the 7×9 is far more readable and also allows better shaping of the characters. Character sizes vary from as small as $1/8$ in. to as large as about $3/8$. Some terminals even offer variable height characters. When inspecting a terminal, watch for uniform character definition and shape, regardless of the position of the character on the screen. Check for out-of-focus sections on the screen.

Different manufacturers have gone to different phosphors for their CRTs. Some terminals have white characters on a gray screen, some green characters and some blue. Some screens are also glare-resistant. A rarely found feature, but useful, is a screen whose intensity is automatically varied as the ambient light in the room changes.

The most common keyboard feature purchased is a 10-key numeric pad. Aside from this, the keyboards are laid out differently but constrained by general guidelines. Special-function keys are usually across the top or on the right side.

Some people prefer an audible click when a key is depressed; others like silent keys. Both are available. Although the click can be annoying, some terminal operators work faster and more accurately if they can hear an audible acknowledgement.

Many terminals are available with separate keyboards and displays connected only by a cable. This is becoming a very common way of ordering terminals, as it allows flexibility in system design.

Interfacing is aggravating

Usually listed under interfaces on the terminal spec sheet are comments such as "RS-232-C," "current loop," "20-mA current loop," "60-mA



A microprocessor-controlled terminal with flexible data-communications protocol is the Pertec 7100.



The Intecolor 8000 is the only single package, eight-color intelligent terminal available. The terminal comes with either the Intel 8008 or 8080 microprocessors and up to 24 k of RAM.

current loop," or a variety of computer names. Rarely is there any more detail. But you need to know a lot more about the interface than you are told.

For example, if your computer has an RS-232-C interface port and the terminal an RS-232-C interface, the two devices still may not work together. RS-232-C specifies a 25-pin connector, of which only 13 pins are assigned definite functions. The 12 others are used, in whole or in part, by different terminal manufacturers for different functions. Also, RS-232-C doesn't provide timing specifications.

In the case of current loops, a 20-mA is the most common. Whereas RS-232-C interfaces are generally used only for cable runs of up to 50 ft, current-loop interfaces with appropriate cables can be used for cable runs of over 1000 ft. But since a current loop depends upon a constant-current source, the terminal manufacturer should tell you whether he provides the current source

or whether you must provide it.

Common practice is to have the terminal provide the current source when it is transmitting and the computer the source when it is transmitting. However, don't count on this. Everyone handles the interface in his own way. When the interface is specified by computer name, make sure that it is specified for the current computer of that model name. Some manufacturers have changed the hand-shaking line protocol for their computers as models have been revised.

Which brings up another touchy point. Rarely, if ever, does the terminal manufacturer tell you anything about the word structure or line protocol that his terminals work with. For example, each character in a message is usually defined by a start bit, 7 bits (generally ASCII code), one or two stop bits and sometimes a parity bit. Occasionally a protect bit will also be included between the character code and the stop bits. When specifying a terminal, you must find out if your word configuration is compatible with the terminal. Since most terminals use an even parity bit (the addition of a 0 or a 1 so that the character has an even number of ones), it is very important to consider if you plan to use odd parity or no parity.

If your terminal is to work with a printer, you must not only specify the printer type but also the baud rate, word structure and whether the printer will be under internal or external control. With internal control, the terminal must wait after each carriage return/line feed for the mechanical operation to occur. External control allows the printer to stop and start the data from the terminal, as required, to fill its buffer or to return the carriage and move the paper.

Line protocols vary all over the lot. How do you plan to handle the various hand-shaking routines? How much external remote control over the terminal do you require? Are you using a modem? What kind? If you are connecting directly to a computer, how long are your cable lengths? (Pulses get distorted by the capacitance of the cable. If you plan long cable runs, ask for a plot of cable length vs baud rate for your type of cable.)

Do you plan to run half duplex or full duplex? In the half-duplex mode, the same line is used to transmit and to receive; you must wait for an acknowledgement from the receiving end before sending more data. In full duplex, separate lines are used for transmit and receive, so both can be done simultaneously. Most terminals use half-duplex transmission.

How many terminals?

If you plan to have many terminals hooked to the same computer, you must decide how you're

going to do it and whether the terminal will allow your technique.

You now come into contact with words like addressable, pollable, multidrop and daisy-chain.

When a terminal is addressable, it has its own unique identifier. All data sent to the terminal must be preceded by their addresses.

Pollable means that the terminal responds to status inquiries from the computer. Each terminal in the system is queried by the computer in succession. The ability of the terminal to respond to the poll and to identify itself makes it pollable.

Multidrop refers to when it is possible to have a number of modems, with associated terminals, share or drop off one telephone line. This is distinct from multipoint, where each modem has its own data link with the central computer.

Daisy-chaining is the same as multidropping, except that no modems are used; however, the terminals share the same data link. The data link comes from the computer, goes to the first terminal, comes out of the first terminal and on to the second terminal, etc. All terminals share the same data link and the same computer port.

It is important to know in advance the maximum number of terminals that you will ever cluster on a single line.

A choice of graphics

Although some alphanumeric terminals have limited graphic capabilities (bar charts, dot graphs, forms generation), picture drawing generally calls for a graphics terminal. These range from medium-performance storage-tube displays at less than \$3000 to high-performance, direct-writing refresh terminals at \$25,000 to \$150,000. Some of these terminals are controlled by a local minicomputer and are extremely intelligent. They can be programmed in a high-level language, such as Fortran, and have large chunks of internal memory. Others share a number of functions between hardware and software and are not quite as versatile.

Among the hardware features on some terminals are image transformations in two or three dimensions; zooming and windowing on selected parts of the screen; function, vector and character generators (circles, ellipses, rectangles, etc.); depth cueing (change in line intensity with depth); and perspective (nonparallel planes define the viewing space).

Graphic terminals are often sold with the option of a color CRT.

All graphics terminals have high levels of interaction built in. In addition to the usual interaction devices, digitizing data tablets are now turning up along with the so-called "mouse." The type of device that you specify for interaction is very application-dependent. For example,



Omron's 8025 is a powerful intelligent terminal that is offered with an external programmer's console that facilitates debugging.



Tektronix makes a large selection of low-cost graphics terminals. Left to right are the 4010-1, 4014 and 4012. The 4014 has a 19-in. screen.

light pens are excellent for selecting items from a displayed list, but data tablets are better for entering pictures.

Writing speed is subject to specsmanship. It is not a simple matter to take the spec and translate it into the time that it takes to draw a picture on the screen. To start with, the processing time for vector generation may vary greatly. How efficient is the software? How much of your picture is made up of alphanumeric characters? Where are the characters in the drawing? What are the time and memory requirements for drawing the picture? Does the terminal just draw straight lines, or can it directly generate curves? All affect speed. It is possible that a terminal with a slower writing speed will draw your picture faster.

It is highly recommended, therefore, that you ask the vendor to do a benchmark test with a



Conographics is the name given by Hughes to its technique of directly drawing curves for graphics rather than just straight vectors. This color display is from the Conographic-12 system.



Lundy's 32/200 is an interactive graphics terminal in which the display is fully buffered and requires no overhead in the computer for refreshing the CRT.



The **Series-3 display terminal** from **Vector General** provides hardware modularity and three-dimensional graphics. This terminal can also be obtained with a different CRT that provides a color display.

picture that is typical of your application. Ask him to give you the time and memory requirements for that picture. Then ask other vendors to run the same benchmark.

Difficult as it is to specify the interface with alphanumeric terminals, it is even more so with graphic terminals. Connectors are not standard. The interface boards supplied by vendors are often not optimum designs. And the boards may not match the latest version of the computer you're using. It is often best to let the graphics-terminal vendor handle the interfacing for you.

Other specs that may be important when you're selecting a graphics terminal are spot size, linearity and distortion. They are not always specified. On linearity, you are never told what the plane of reference is. Is it the face of the tube or the plane at the front of the terminal? Rarely, too, are you ever told anything about resolution, which can be a problem if you plan to make a hard copy of the picture on the tube through a direct CRT copier or a camera.

Check out the reliability

Many terminals have features that make them easy to service. These include self-testing and diagnostic circuitry, modular construction and hinged surfaces. If you can't afford down-time on your terminal, it is always worth noting the reputation and track record of the manufacturer. Can he provide service at the plant where you are installing the terminals? Can he deliver on time? Is he perhaps so large that your small order will not get the attention it deserves?

Terminals are getting cheaper. And more features are being added all the time. But because of the ultra-competitive nature of this business, there is a very high mortality rate among termi-

nal manufacturers. When buying terminals from a manufacturer that you're not totally familiar with, the dictum is definitely, "Let the buyer beware." ■■

Need more information?

In this report, terminals have been discussed only in general terms. We haven't attempted to describe specific units. For additional information on specific product lines, circle the appropriate information-retrieval numbers. For data sheets on many terminals, consult ELECTRONIC DESIGN's GOLD BOOK.

Adage, 1079 Commonwealth Ave., Boston, MA 02215. (617) 783-1100. (David Cooper). **Circle No. 401**

Algorex Data, 6901 Jericho Turnpike, Syosset, NY 11791. (516) 921-7600. (Jeff Waxweiler). **Circle No. 402**

Amperex Elec. Corp., Providence Pike, Slatersville, RI 02876. (401) 762-9000. (Ron Goga). **Circle No. 403**

Ann Arbor Terminals, Inc., 6107 Jackson Rd., Ann Arbor, MI 48103. (313) 769-0926. (Barbara Evans). **Circle No. 404**

Applied Digital Data Systems, 100 Marcus Blvd., Hauppauge, NY 11787. (516) 231-5400. (Richard Kaufman). **Circle No. 405**

Astronautics Corp. of America, 907 S. First St., Milwaukee, WI 53204. (414) 671-5500. (R. D. Seinfeld). **Circle No. 406**

Aydin Controls, 414 Commerce Dr., Fort Washington, PA 19034. (215) 542-7800. (Jack Adair). **Circle No. 407**

Beehive Terminals, 870 W. 2600, S., Salt Lake City, UT 84120. (801) 487-0741. (Carl Rasmussen). **Circle No. 408**

Bunker Ramo, Information Systems Div., Trumbull Industrial Park, Trumbull, CT 06609. (203) 377-4141. (Walter Clark). **Circle No. 409**

Burroughs Corp., Burroughs Place, Detroit, MI 48232. (313) 972-7200. (Terminal Systems Product Mgr.). **Circle No. 410**

Comptek, 143 Albany St., Cambridge, MA 02139. (617) 864-5140. (Marvin Lewis). **Circle No. 411**

Computer Optics, Berkshire Industrial Park, Bethel, CT 06801. (203) 744-6720. (William Taren). **Circle No. 412**

Conrac Corp., Conrac Div., 600 N. Rimsdale Ave., Covina, CA 91722. (213) 966-3511. (Elton Sherman). **Circle No. 413**

Control Data Corp., 2401 N. Fairview Ave., Roseville, MN 55113. (612) 633-0371. (M. O. Arman). **Circle No. 414**

Courier Terminal Systems, 2202 E. University Dr., Phoenix, AZ 85034. (602) 244-1392. (Richard Nosky). **Circle No. 415**

CPS, 722 E. Evelyn Ave., Sunnyvale, CA 94086. (408) 738-0530. (John North). **Circle No. 416**

Data General, Southboro, MA 01772. (617) 485-9100. (Ed Geithner). **Circle No. 417**

Datamedia, 7300 N. Crescent Blvd., Pennsauken, NJ 08110. (609) 665-2382. (Kenneth Asquith). **Circle No. 418**

Datapoint Corp., 9725 Datapoint Dr., San Antonio, TX 78284. (512) 690-7000. (Gerry Cullen). **Circle No. 419**

Data 100, 7725 Washington Ave., S., Minneapolis, MN 55435. (612) 941-6500. (Paul Kraska). **Circle No. 420**

Delta Data Corp., Woodhaven Industrial Park, Cornwells Heights, PA 19020. (215) 639-9400. (Robert Fuller). **Circle No. 421**

Digi-Log Systems, Babylon Rd., Horsham, PA 19044. (215) 672-0800. (Ronald Mayer). **Circle No. 422**

Digital Computer Controls, Inc., 12 Industrial Rd., Fairfield, NJ 07006. (201) 575-9100. (Vince Choffo). **Circle No. 423**

Digital Equipment Corp., Maynard, MA 01754. (617) 897-5111. (Ed Canty). **Circle No. 424**

Electronic Associates, Inc., West Long Branch, NJ 07764. (201) 229-1100. (Ray Moran). **Circle No. 425**

Entrex, 168 Middlesex Turnpike, Burlington, MA 01803. (617) 273-0480. (Harry Bickers). **Circle No. 426**

Evans & Sutherland Computer Corp., 3 Research Rd., Salt Lake City, UT 84112. (801) 582-5847. (D. Freeze). **Circle No. 427**

Four-Phase Systems, 19333 Vallco Parkway, Cupertino, CA 95014. (408) 255-0900. (Marketing Services). **Circle No. 428**

Fujitsu Ltd., 2-Chome 6-1 Chiyoda-ku, Tokyo, Japan 100 03 21 63211. (H. Seimiya). **Circle No. 429**

Genesis One Computer Corp., 300 E. 44 St., New York, NY 10017. (212) 557-3500. (Dan Kail). **Circle No. 430**

GTE Information Systems, Inc., E. Park Dr., Mount Laurel, NJ 08057. (609) 235-7300. (Bud Barnes). **Circle No. 431**

Hazeltine, Greenlawn, NY 11740. (516) 261-7000. (Thomas R. Foley). **Circle No. 432**

Hewlett-Packard, Data Systems Div., 11000 Wolfe Rd., Cupertino, CA 95014. (408) 257-7000. (Ed Hayes). **Circle No. 433**

Hughes Aircraft Co., Industrial Products Div., 2020 Ocean-side Blvd., Oceanside, CA 92054. (714) 757-1200. (Robert Curry). **Circle No. 434**

IBM, 1133 Westchester Ave., White Plains, NY 10604. (914) 696-1900. (Data Processing Div.). **Circle No. 435**

Imlac, 150 A St., Needham, MA 02194. (617) 449-4600. (Hiram French). **Circle No. 436**

Incoterm, 6 Strathmore Rd., Natick, MA 01760. (617) 655-6100. (Edward Nevielle). **Circle No. 437**

Information Displays, 150 Clearbrook Rd., Elmsford, NY 10523. (914) 592-2025. (C. Machover). **Circle No. 438**

Informar, Inc., 2218 Cotner Ave., Los Angeles, CA 90064. (213) 477-4216. (Phil Friedman). **Circle No. 439**

Infoton, Inc., Second Ave., Burlington, MA 01803. (617) 272-6660. (Ed McCormack). **Circle No. 440**

Intelligent Systems, 2405 Pine Forrest Dr., Norcross, GA 30071. (404) 449-5961. (Charles Muench). **Circle No. 441**

International Communications, 8600 N.W. 41 St., Miami, FL 33166. (305) 592-7654. (Brent Barkley). **Circle No. 442**

ITT, Data Equipment and Systems Div., E. Union Ave., East Rutherford, NJ 07073. (201) 935-3900. (Ken Whitehouse). **Circle No. 443**

Lear Siegler, Inc., Data Products, 714 N. Brookhurst, Anaheim, CA 92803. (714) 774-1010. (Tom Viggers). **Circle No. 444**

Linolex Systems, Subsidiary of 3M, 5 Esquire Rd., North Billerica, MA 01862. (617) 667-4151. (Ms. Kelly Dvareckas). **Circle No. 445**

Lundy Electronics & Systems, Inc., Glen Head, NY 11545. (516) 671-9000. (G. Albanese). **Circle No. 446**

Megadata Computer & Communications Corp., 35 Orville Dr., Bohemia, NY 11716. (516) 589-6800. (J. A. Hill). **Circle No. 447**

Mohawk Data Sciences, P. O. Box 16, Frankfort, NY 13340. (315) 792-2202. (Walter Sexton). **Circle No. 448**

Motorola Display Products, 455 E. North Ave., Carol Stream, IL 60187. (312) 690-1400. (Bob Gatza). **Circle No. 449**

Nuclide Corp., 642 E. College Ave., State College PA 16801. (814) 238-0541. (J. Kalasky). **Circle No. 450**

Olivetti Corp. of America, 500 Park Ave., New York, NY 10022. (212) 371-5500. (James Parker). **Circle No. 451**

Omron Systems, 432 Toyama Dr., Sunnyvale, CA 94086. (408) 734-8400. (E. E. Faber). **Circle No. 452**

Ontel, 3 Fairchild Court, Plainview, NY 11803. (516) 822-7800. (Frank A. Kirby). **Circle No. 453**

Optimation, Inc., 9259 Independence Ave., Chatsworth, CA 91311. (213) 882-6490. (Henry O. Wolcott). **Circle No. 454**

Pertec Business Systems Div., 17112 Armstrong Ave., Santa Ana, CA 92705. (714) 540-8340. (Peter Craig). **Circle No. 455**

Plantronics, Inc., 385 Reed St., Santa Clara, CA 95050. (408) 249-1160. (Wayne Thalls). **Circle No. 456**

Princeton Electronic Products, P.O. Box 101, North Brunswick, NJ 08902. (201) 297-4448. (W. Herbener). **Circle No. 457**

Raytheon Data Systems, 1415 Boston-Providence Parkway, Norwood, MA 02062. (617) 762-6700. (Ken Backer). **Circle No. 458**

Research, Inc., P.O. Box 24064, Minneapolis, MN 55424. (612) 941-3300. (Dick Deegan). **Circle No. 459**

Sanders Data Systems, Daniel Webster Hwy. S., Nashua, NH 03060. (603) 885-3727. (Richard Gorton). **Circle No. 460**

SC Electronics, Inc., 530 Fifth Ave., NW, Brighton, MN 55112. (612) 633-3131. (Roy Thomas). **Circle No. 461**

Shindengem Electric Mfg. Co., Ltd., New-Ohtemachi Bldg. 2-1 2-Chome Ohtemachi Chiyoda-ku, Tokyo, Japan, 03 27 94431. (H. Akihama). **Circle No. 462**

Silver Glo Picture Tubes, Ltd., 12418 66 St., Edmonton, Alberta, Canada. (403) 475-7922. (W. Plath). **Circle No. 463**

Sperry Univac, P.O. Box 500, Blue Bell, PA 19422. (215) 542-4011. (Frank B. Holst). **Circle No. 464**

Stereotronics TV, 13720 Riverside, Sherman Oaks, CA 91403. (213) 783-7770. (Don Whitney). **Circle No. 465**

Sycor, 100 Phoenix Dr., Ann Arbor, MI 48104. (313) 971-0900. (Gerry Hendein). **Circle No. 466**

TEC Inc., 2727 N. Fairview Ave., Tucson, AZ 85705. (602) 792-2230. (Ron Owens). **Circle No. 467**

Tektronix, Inc., P.O. Box 500, Beaverton, OR 97005. (503) 644-0161. (Larry Mayhew). **Circle No. 468**

Terminal Communications, Inc., 3301 Terminal Dr., Raleigh, NC 27611. (919) 834-5251. (William Rein, Jr.). **Circle No. 469**

Texas Instruments, Digital Systems Div., Mail Station 2107, P.O. Box 2909, Austin, TX 78767. (512) 258-5121, Ext. 2539. (Computer Mkt.). **Circle No. 470**

Trivex, 3180 Red Hill Ave., Costa Mesa, CA 92626. (714) 546-7781. (Woody Thompson). **Circle No. 471**

Vector General, Inc., 21300 Oxnard St., Woodland Hills, CA 91364. (213) 346-3410. (C. M. Ceranowski). **Circle No. 472**

Wang Laboratories, 836 North St., Tewksbury, MA 01876. (617) 851-4111. (Arnold Kraft). **Circle No. 473**

Western Development Labs Div., Aeroneutronic-Ford Corp., 3939 Fabian Way, Palo Alto, CA 94303. (415) 494-7400. (Bernard Marcus). **Circle No. 474**

Zentec, 2390 Walsh Ave., Santa Clara, CA 95050. (408) 246-7662. (Dennis Daniels). **Circle No. 475**

International Rectifier

New 10 Amp device makes one-stop shopping easy for fast-switching power transistors.

Now, IR is your source for a wide variety of 3, 5 and 10 Amp JEDEC fast-switching power transistors, to simplify your buying. These hard-glass passivated devices are the ones to use for better reliability and lower costs in line operated power supplies, whether you're chopping line voltages at 20 KHz or inverting and stepping down at high frequency.

Fast Switching Speed—Cooler Operation . . . the oscillographs show typical fall times in the one-micro-second and lower range. Gives extremely low switching losses for cooler operation and higher reliability.

Lower Leakage — High Temperature Stability . . . with ICEO in the micro-amp range, IR devices are about one-tenth the accepted leakage rates of others. Provides the higher stability important for high performance at elevated temperatures.

High Second Breakdown — High Reliability . . . high second breakdown helps provide a broad safe-operating area for an extra margin of safety.

Glass Passivation — Long Term Reliability . . . high reliability and long term stability is achieved by hard glass passivation. Also, if you're using chips to make your own circuits,

IR's glass passivation gives you the most stable, easy to assemble chips you can start with, making your yields higher.

If you are paralleling devices, the tight gain, switching time and saturation voltage control of these transistors make the job easier. And through 100% testing of key parameters we can provide even closer matching if necessary.

JEDEC types listed are immediately available, so contact your local IR salesman, rep or distributor today.

International Rectifier, 233 Kansas Street, El Segundo, California 90245. (213) 678-8261.

New International Rectifier Fast Switching Power Transistors

IR Part No.	V _{CEO} (sus) (Max V)	I _C Peak (A)	h _{FE} (min, max)	@ I _C (A)	V _{CE} (sat) (Max V)	@ I _C (A)	P _d (W)	t _r /t _f (μs)
2N6306	250	16	15/75	3.0	0.8	3.0	125	.6/4
2N6307	300	16	15/75	3.0	1.0	3.0	125	.6/4
2N6308	350	16	12/60	3.0	1.5	3.0	125	.6/4
2N6542	300	10	7/35	3.0	1.0	3.0	100	.7/8
2N6543	400	10	7/35	3.0	1.0	3.0	100	.7/8
2N6544	300	16	7/35	5.0	1.5	5.0	125	1/1
2N6545	400	16	7/35	5.0	1.5	5.0	125	1/1
2N6249	200	30	10/50	10.0	1.5	10.0	175	2/1
2N6250	275	30	8/50	10.0	1.5	10.0	175	2/1
2N6251	350	30	6/50	10.0	1.5	10.0	175	2/1

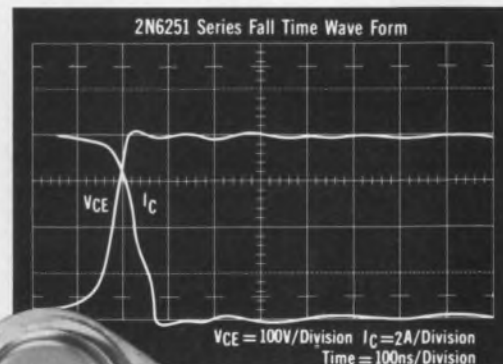
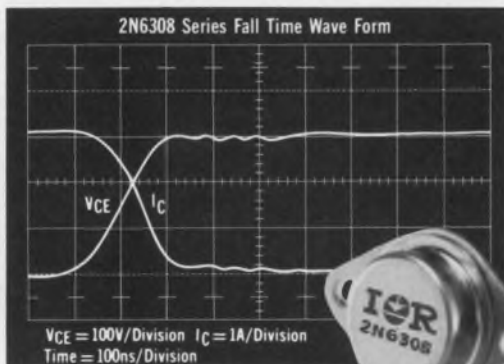

INTERNATIONAL RECTIFIER
the innovative power people



SEMICONDUCTOR DIVISION, 233 KANSAS STREET, EL SEGUNDO, CALIFORNIA 90245, PHONE (213) 678-6281

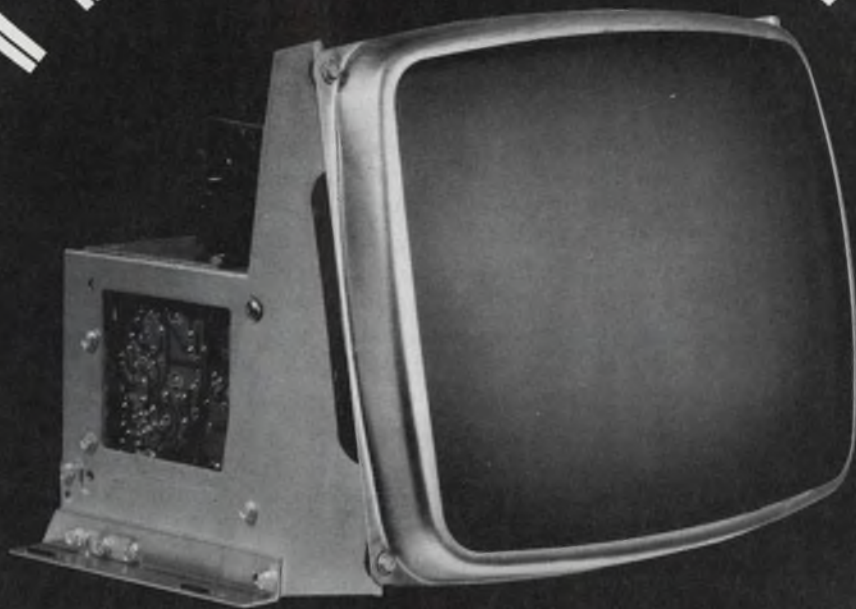

Motorola CRT modules

FOR THAT IMPORTANT FIRST IMPRESSION

The CRT in your terminal tells a lot about the system design. It's the first impression your customer has of terminal quality, and you want it to be good.

Naturally, it makes sense to use a display that enhances your design expertise. One that leaves a first, and lasting, impression of quality and performance. Motorola, of course.

Motorola delivers alphanumeric display modules optimized for terminal applications and manufactured in a tradition of innovation, quality and customer support.

Isn't it time you found out for yourself why so many leading terminal manufacturers buy Motorola?



MOTOROLA *Display Products*

Domestic 455 East North Avenue
Carol Stream, ILL. 60187 312-690-1400

International Airport Center 4250 Veterans Memorial Hwy.
Holbrook, L.I., NY 11741, U.S.A. 516-588-4700 TWX: 510-228-1096

Microprocessors simplify industrial control systems. Examples show how the LSI chips can lower costs and increase flexibility of process controllers.

An increasingly popular use for LSI microprocessors is in industrial-control applications. The computer chips are cheaper than minicomputers, they're smaller and some are even more flexible.

Already, microprocessors have found their way into warehouse equipment, numerical and process controllers, and manufacturing machines. And future systems might well have microprocessors distributed throughout a plant. Individual processor-chip operations would be coordinated by a centralized minicomputer to form an integrated computer network.

Some of the hurdles

But the use of microprocessors in industrial equipment can entail special design techniques. The rigors of an industrial environment, for example, present several design hurdles. These include noise, physical distance between sources of variables, power consumption and dissipation, I/O interfacing, and future expansion plans.

Ambient electrical noise and line transients that typically occur in plant environments often require special circuitry and components to ensure reliable system operation. CMOS or high-threshold interface logic may be used to obtain adequate power-supply tolerance and noise immunity.

Further, opto-couplers can be employed to transform voltage signals originating in high-noise systems to light waves. These are transmitted through a fiber-optic "pipe" and then converted back to electrical signals. A phototransistor at the receiver detects the presence or absence of light. This simple detection and reconstruction scheme provides complete electrical isolation between the noisy industrial environment, subject to electromechanical radiation, and a noise-sensitive processor. Also, the light wave doesn't require a reference ground, as do elec-

trical signals, which are susceptible to ground loops.

Distributed power supplies offer additional system benefits. Smaller supplies are easy to use and provide a reliability advantage over a centrally located supply. If one supply fails, the system won't shut down. Distributed supplies come in the form of voltage regulators or ferro-resonant supplies.

Cabling costs and noise pickup are high when the process variables are far from the processor. For this reason the variables should be "clustered" around the processor whenever possible. For one or two isolated variables—distances greater than 50 ft.—a two-wire transmitter can be used to convert the voltage to a current and send it along a twisted-pair cable. The same twisted-pair carries the required supply voltage from the processor to the two-wire transmitter. The current is converted back to an input voltage by the use of a precision resistor at the input.

MOS processors coupled with CMOS or low-power TTL logic minimize power consumption, dissipation and cooling requirements. This is an important consideration when physical size is limited or battery back-up operation is needed.

Interface logic and signal-conditioning circuitry are necessary for analog and digital I/O, control, timing, event counting, condition sensing and communication. Analog-scaling circuitry is usually needed to convert the output from a transducer, thermocouple or strain gauge to one that is compatible with an a/d converter. Low-level or high-level analog multiplexers may be required depending on the a/d input-voltage ranges. Voltage inputs or outputs must be converted to ONE and ZERO levels for the selected processor. In many cases, control can be simplified by the use of strobe or timing signals generated by the processor. Control-flag outputs provided on the microprocessor can be used, for example, to turn on a valve actuator, turbine, generator, pump, or to stop a motor via program control.

External event counters, interval timers and real-time clocks can be used to keep track of events and inform the processor when service is required. The processor can directly sense vari-

Alan J. Weissberger, Applications Engineer, National Semiconductor, 2900 Semiconductor Dr., Santa Clara, CA 95051.

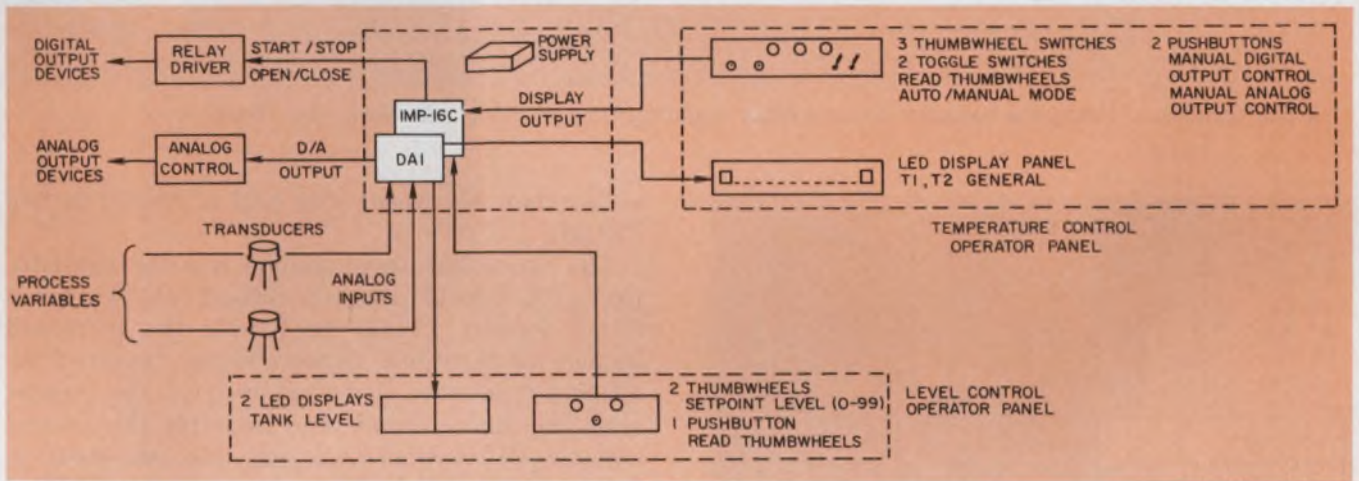

1. A data-acquisition system consists of two 8-1/2 × 11-in. PC boards: one for the IMP-16C microprocessor

and the other for data-acquisition interface circuitry (DAI). The system uses two 256-word PROMs.

ous conditions by using branch-condition inputs. The status of a process loop and the completion of an a/d conversion are examples. A conditional branch or test-and-skip instruction checks the condition and specifies a memory location to branch to if the condition is true.

Communication requirements can be met with line drivers, line receivers, modems (when distance is over 10,000 ft.) or more elaborate communication controllers.

In the design of a microprocessor-based control system, distributed-task partitioning and software modularity are of paramount importance. If control points are added or removed homogeneously from a modularly designed system the impact on software will be minimal; the same routines and algorithms still apply. However if the data load exceeds the processor's capability or different control points or process variables are added, the problem becomes more complicated. One approach expands the number of microprocessors and redistributes control points and functions. Software complexity is then minimized along with system program and debug time.

A modular data-acquisition system can be built

on two 8-1/2 × 11-in. PC boards (Fig. 1). A data-acquisition-interface (DAI) board contains analog and digital circuitry, and it simplifies the exchange of data and control signals to and from the microprocessor board (National Semiconductor's IMP-16C, a 16-bit unit). The microprocessor couples to pressure and temperature IC transducers.

Sensing the process variables

Process variables are sensed by the transducers and sent to the DAI board either directly or by means of two-wire transmitters, such as the LH0045. The DAI multiplexes the analog input signals and converts them to digital data which go to the microprocessor. The DAI also converts digital control signals from the processor to analog signals and sends them to the analog control points.

Changes in temperature and fluid level are two independent processes. The microprocessor receives the digitally encoded variables from the DAI and monitors the process via a program stored in PROMs on the microprocessor card. The temperature can be controlled either by this firmware program (auto mode) or by operator

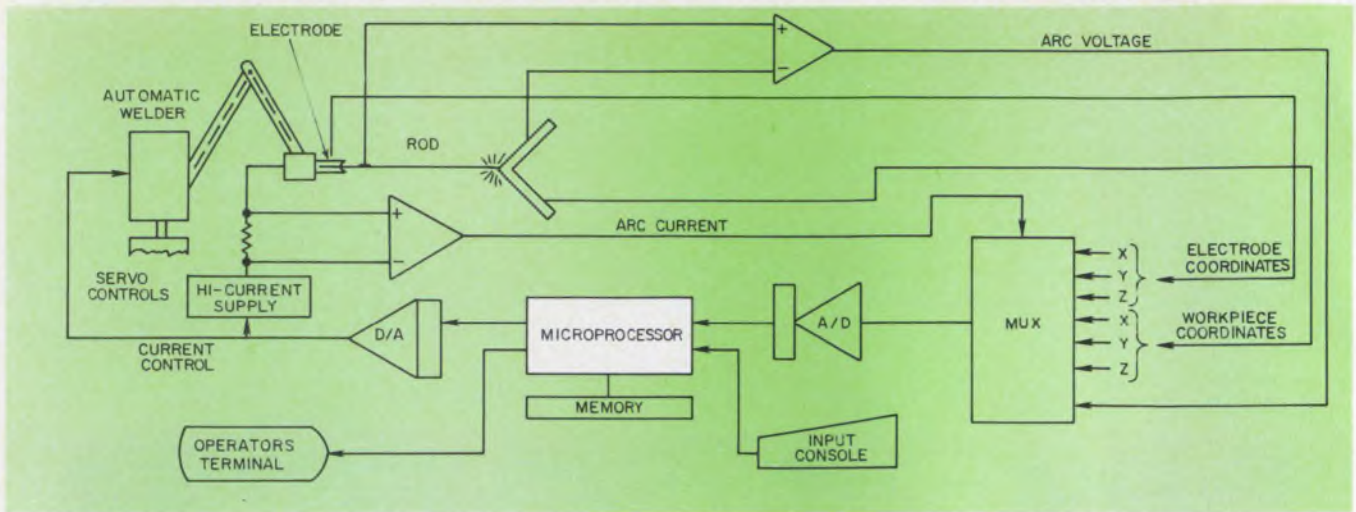

2. A microprocessor forms the basis for an automated manufacturing machine that welds and rivets.

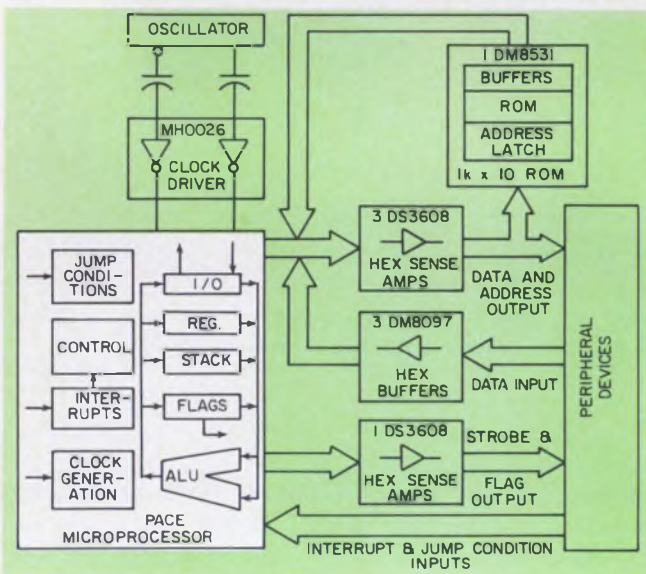

3. Single-chip 16-bit microprocessors, such as National's PACE chip, allow systems to be built with a minimal number of components.

intervention through a local operator panel (manual mode). Tank-fluid level is controlled by operator entry of a setpoint level at a remote operator panel. The program then regulates pumps to achieve the entered setpoint.

Both operator panels consist of thumbwheel switches, pushbuttons, and LED displays. They are connected directly to the DAI and are serviced through CPU interrupts or by the testing of status conditions in the program. The CPU activates on/off and analog control points through relay drivers or power transistors.

Originally the system performed only temperature regulation. The incorporation of level sensing and pump control illustrates the minimal changes and fast redesign possible with a microprocessor. The firmware program was revised to acquire, process, and display the tank-fluid level and to control the pumps. The complete program

is less than 256 words long and it resides in two PROMs.

The major hardware change was the substitution of a 4-to-16 decoder (Model 74154) for a 3-to-8 decoder (7442) to handle the increased number of functions. Other changes involved additional transistor circuitry to drive the pumps, scale the analog input, and decouple the control signals. All revisions took only one man-week to design, build and check. An equivalent hardwired control system would have taken many weeks to dismantle, rebuild and rewire.

Many relatively expensive analog components can be eliminated by the use of digital techniques. For example, RAM memory locations or registers internal to the microprocessor are used as programmable timers in the data-acquisition system described previously. Each analog variable to be scanned is assigned a memory location. These timer locations are initially set to a value proportional to the variable's response time.

At periodic intervals, an external oscillator interrupts the microprocessor. As a result, each timer is decremented and tested for zero (DSZ instruction) to determine if it is time to scan the variable. If it is, the corresponding subroutine is executed. The interrupt timer hardware consists of a D-type flip-flop (Model 7474) that saves the interrupt request from the oscillator. This prevents loss of the timer interrupt when the CPU is busy servicing another interrupt. The oscillator and flip-flop can be used to regulate any number of timers by use of DSZ instruction for each RAM timer.

Automatic welding and riveting

Another plant application employs a microprocessor in an automatic welder and riveter (Fig. 2). Both these systems require precise knowledge of the X, Y, and Z coordinates of both

the workpiece and the rod or rivet tip. In the welding operation, the rod must be maintained at a precisely controlled distance from the weld surface: if the rod is too close, it sticks; if it is too far away, an open weld (or no weld at all) results.

By monitoring the current through the arc and voltage between the rod and workpiece, the microprocessor maintains precise, real-time, distance control. Similarly, the riveter head should exert the correct pressure on the workpiece, to prevent the rivet from being too loose or breaking during the fastening process. By monitoring the riveter head pressure against the work surface, the processor maintains it in the proper position at all times.

For process-control applications requiring a minimum number of component parts, new single-chip 16-bit microprocessors can be used. For example, National's Processing and Control Element (PACE) provides 16-bit instructions that can operate on 8 or 16-bit data length words (Fig. 3.). The benefits of this approach are lowered costs and decreased system size and dissipation.

A minimum microprocessor system could be installed at unmanned sites, such as a natural gas pipeline, water or power-distribution system, or an environmental or weather-monitoring station. In each case, information would be sensed, collected and processed locally before being sent to a central computer or recorded on a cassette. Local control and preprocessing reduces data transmission costs and improves system security because only tested and verified data are sent. These systems could also run calibration and diagnostic tests of the remote instrumentation.

Plant security monitor

Single-chip 16-bit microprocessors can also replace a minicomputer or multiple dedicated microprocessors in complex control and data-processing applications. One example is a plant security monitoring system (Fig. 4) that monitors and, in some instances, controls an entire plant's operation.

One CPU chip acts as a data-acquisition/alarm scanner, while another CPU forms a central control/acknowledgement terminal. The functions monitored are plant power (peak demand, total consumption and output) and environmental quality (air contaminants, temperature and air flow). Various transducers, thermocouples and sensing devices measure the required analog variables and provide inputs to an analog multiplexer. The CPU scans these input points at pre-selected time intervals by supplying an address to the analog-multiplexer and starting the a/d conversions.

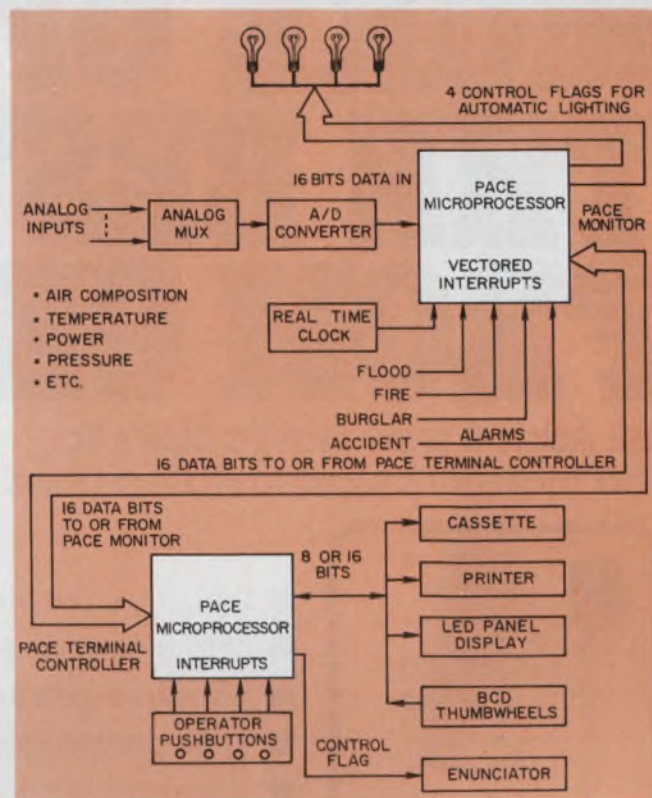

4. A plant-security monitor employs two PACE chips. The one at the top acquires data, while the other performs terminal operations.

When the conversion is completed, data are read, processed, and checked against alarm limits. Critical deviations from normal operating conditions are detected and alarms are sent to the control/acknowledgement terminal. The CPU at the terminal formats and routes the alarm data to an operator's display panel. The operator on duty observes the detected alarm and takes the necessary steps to correct the problem.

Alarms corresponding to "crisis" situations, can be detected directly by limit switches, circuit-continuity breaks or by the manual depression of a button. Examples include floods, fire, burglary or accidents. These conditions require immediate attention and would therefore be assigned as priority vector interrupts in the CPU monitor. The sounding of an annunciator horn at the control terminal guarantees immediate operator notification.

In addition to monitoring chores, one or more simple control functions could be provided. For automatic light control, a real-time clock generates interrupt signals at fixed, preset, intervals. The processor recognizes the time of each interrupt, and it can dim the lights or turn them off to conserve electricity. Light-control commands employ flag bits provided by the CPU chip. Another function might be the temperature control of the building through the regulation of heaters and air conditioners. ■ ■

MORE OF THE BEST FROM GE

GE Adds 3 New Plastic SCR's To The Industry's Most-Imitated Lines



C103 .8 Amp
up to 200V

- Sensitive gate (typ 50 μ A I_{GT})
- Passivated pellet offers outstanding ac blocking stability and low failure rate
- TO-18 pkg

Only 29¢*

- Industry's broadest line of plastic SCR's
- .8 to 8 Amp; up to 600 volt
- Sensitive gate and high-surge types
- Field-proven reliability
- Competitive pricing

NEW



C203 .8 Amp
up to 200V

- C103 in TO-92 pkg
- Exact replacement for 2N5060-64 series

Only 29¢*



C106 4 Amp
Now up to 600V

- Introduced by GE in 1963 — now industry's most-imitated SCR
- Power Glas™ passivated for stability and reliability
- Silicone encapsulated TO-202 pkg. available in 8 optional lead configurations

Only 31¢*

NEW



C108 5 Amp
up to 600V

- 5 Amp version of C106
- Highest surge rating (30A) of any sensitive-gate SCR
- Power Glas™ passivated pellet

Only 37¢*

NEW



C116 8 Amp
up to 600V

- Combines high surge (90A) with low-cost C106 pkg
- Power Glas™ passivated pellet
- Silicone encapsulated TO-202 pkg

Only 52¢*



C122 8 Amp
up to 600V

- 90 amp surge current rating
- Power Glas™ passivated pellet in silicone-encapsulated TO-202 pkg. for outstanding reliability
- Unique construction yields thermal fatigue-free capability

Only 60¢*



C123 8 Amp
up to 600V

- Isolated lab version of C122
- Eliminates need for optional mica isolating kit

Only 71¢*

FREE SAMPLE — GE SCR (for qualified OEM users)

Test a GE SCR in your circuit — free. Watch it outperform the competitive SCR you may be using. Just indicate on this coupon what type you'd like. clip it to your firm's letterhead and mail it. We'll rush your free SCR sample to you.

	Voltage									
	15	30	50	100	150	200	300	400	500	600
C103 .8A										
C203 .8A										
C106 4A										
C108 5A										
C116 8A										
C122 8A										
C123 8A										

(place an X in the box which corresponds to desired rating.)

Send a free GE plastic SCR to:

NAME _____ TITLE _____

FIRM _____

STREET _____

CITY _____ STATE _____ ZIP _____

General Electric Company
Semiconductor Products Dept.
Electronics Park, 7-49, Syracuse, New York 13201

ED

GENERAL  ELECTRIC

*in 10K lots

Display Tubes for Computer Terminals

We offer a variety of tubes in sizes and designs to meet diversified computer terminal applications. Tubes can be provided with laminated implosion panels for maximum safety which can be etched and/or coated to improve contrast and minimize objectionable reflections. In addition, tubes can be supplied with mounting ears, brackets, or custom bezels.

All phosphor screens are available, including a number of multi-color and dual persistence types. Special formulations for light pen applications, multi-mode radar displays and other custom applications can be provided.

Send for our **FREE Short Form Catalog** today.

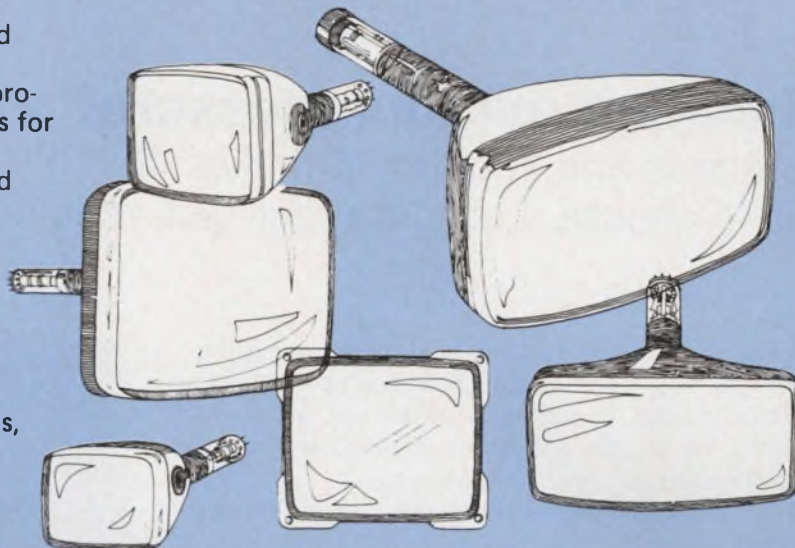

THOMAS ELECTRONICS, INC.

100 RIVERVIEW DRIVE, WAYNE, N. J. 07470 / Telephone: 201 - 696-5200 / TWX: 710-988-5836 / Cable: TOMTRONICS

INFORMATION RETRIEVAL NUMBER 42

MEET OUR family

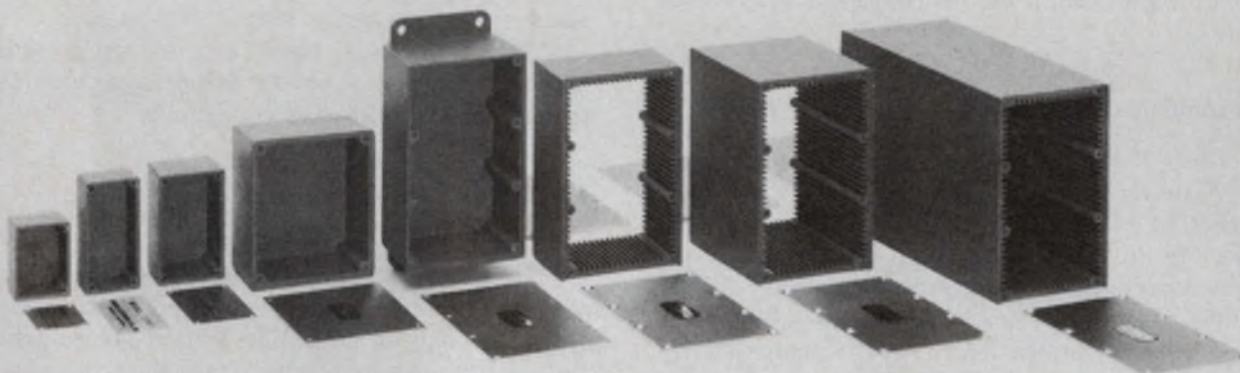

of shielded "black boxes"

Almost 10 years ago (1966 to be exact) we introduced our first two series of shielded electronic enclosures. They became an overnight success. Since then the demand for different sizes, shapes and applications has increased our family to eight series of models, each with a noise rejection greater than 70db.

Sizes range from 1.50" x 1.13" x 0.88" to 4.13" x 2.68" x 6.0"; in blank versions or with a complete choice of coaxial connectors; painted or unpainted; with or without printed circuit card guides; with mounting flanges or bottom mounting plates. All models supplied with aluminum covers and screws.



POMONA ELECTRONICS ITT

1500 East Ninth St., Pomona, California 91766 Tel: (714) 623-3463

INFORMATION RETRIEVAL NUMBER 43

Checking microprocessors? A lack of standards and equipment makes the CPU as hard to test as it is to choose. Look into four test methods to get started.

When it comes to testing LSI microprocessors, about the only thing engineers agree upon is that worst-case and benchmark tests are a must. Which tests to run and what constitutes "worst case" depends on whom you talk to.

Why is microprocessor testing so difficult? Because every microprocessor is different. Variations occur in architecture, chip layout, the random logic of the CPU, the fabrication processes and the instruction languages. Add to these the variations in I/O capabilities and pin count (18 to 48), the various bit sizes (4, 8, 12 and 16 bits) and the different bus organizations, and you can see the problem.

There is no one way to test all units. And, in fact, no one—neither the manufacturer nor the user—knows how to test a microprocessor fully. At best, testing is a trial-and-error situation.

At present four major test categories are available to the engineer: the self-diagnostic method, the comparison method, algorithmic pattern generation and stored-response testing (Table 1).

The economical way to test

In the self-diagnostic method, you use a ROM to load into CPU memory (RAM) a worst-case sequence of instructions. The CPU chip is placed within its intended operating environment, including interrupts from peripherals. The instruction set terminates at some identifiable error location. Error indication, usually identified by an instruction routine, shows if the unit fails or passes.

Most small users of CPU chips test with self-diagnosis, because it can be implemented easily with laboratory equipment or with hardware and assistance from the chip manufacturer. But there are shortcomings to this apparently economical technique, including the following:

- Multiple errors may negate each other and be undetected.

Eugene R. Hnatek, DCA Reliability Laboratory, 645 Clyde Ave., Mountain View, CA 94040.

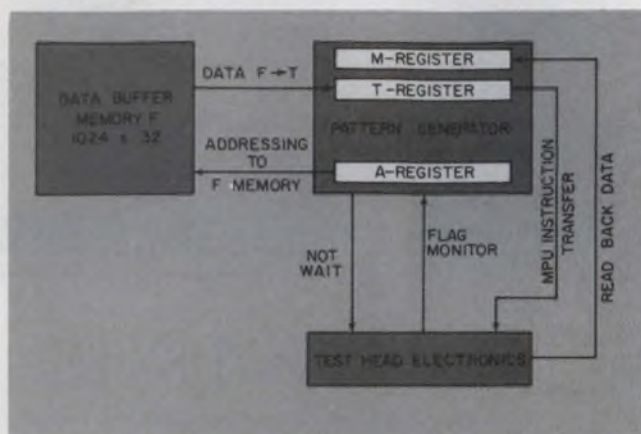

1. **Low-cost CPU tester** uses algorithmic pattern generation to verify a microprocessor's instruction set. The method can also be used to check memories.

- The actual cause of a failure may not be diagnosed.
- Long diagnostics may have to run to completion, even if an early failure occurs. This results in unnecessarily long test times.
- Without special hardware, external environment conditions, such as interrupts, cannot be tested under worst-case conditions.

The comparison approach

Another widely used test method compares the CPU with a known good device. With both devices mounted close to each other, input data are sent simultaneously to both, but with separate drivers. Output data are monitored from both devices and are considered valid when data coincidence occurs.

The method, which lends itself to production testing, has many inherent benefits. Real-time-cycle response testing is possible. Implementation is not difficult, chiefly because output data need not be stored in a memory for comparison. But, again, there are also drawbacks.

First, dependence on a known good device for comparison imposes the task of defining such a device. Second, dependence on a designer to specify the test pattern tends to limit the flexibility to changes or modifications in the input test pat-

Table 1. Basic microprocessor test methods

Test Method	Application			Devices Tested			Summary of Characteristics	Available Test Equivalent
	*	**	†	Memory	Logic	CPU		
Self-Diagnostic	✓					✓	Tests • Limited diagnostic (Functional only) Limitations: 1) Error Negation 2) Timing Varies	None Commercially Available
Comparison		✓			✓	✓	Tests: • Functional Only • No Parametric Measurements Limitations: 1) Dependence on Known Good Device 2) Identical Faults Between Known & Unknown Device Undetected 3) Inflexibility to Change Input Test Pattern 4) Synchronization Between Good CPU & DUT	None Commercially Available
Algorithmic Pattern Generation	✓				✓	✓	Tests: • Functional Only • Flexible programming Limitations: 1) Partial Outputs 2) Personality Board 3) Requires That Test Engr Understand CPU Architecture & Application	Macrodata MD-104 Micro Control M-10 Data Test DT-400
Stored Response	✓	✓	✓	✓	✓	✓	Tests: • Functional Parametric & Dynamic • Extensive Engrg & Evaluation Modes • Multiplexed Operation • Emulation 1) Easy To Implement 2) Uses Reference Device • Simulation 1) Harder To Implement 2) Minimal Programming Effort 3) Flexibility To Change Program 4) High Hardware Cost For Super Buffer & Added PROMs & Pattern Generator 5) Depends On Known Good Device	Fairchild Systems Technology S-610 Macrodata MD-154 MD-501 Tektronix S-3260

* Incoming Inspection

** Production

† Engineering Evaluation/QC

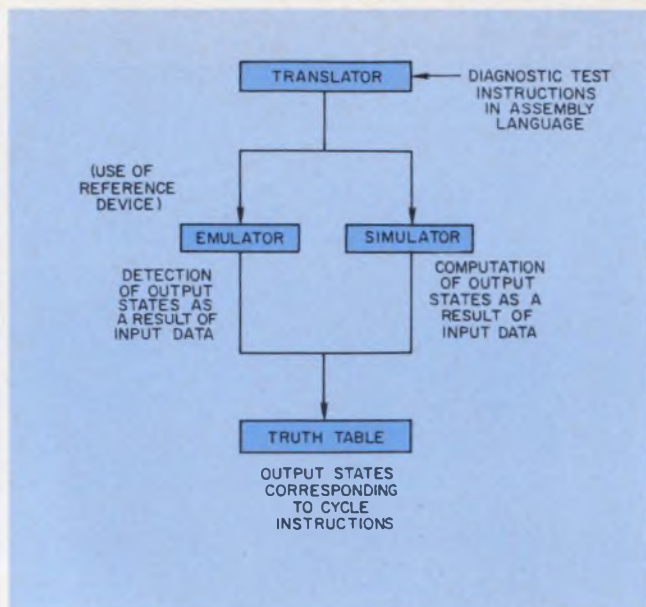

2. Steps in emulation and simulation testing: Both methods store user-written diagnostics in bulk memory.

tern, making the degree of test completeness somewhat questionable. Another problem can be encountered when you attempt to synchronize the known good CPU and the one under test. Finally, limitations in functional testing under dynamic conditions and lack of parametric measurements are severe drawbacks.

Algorithmic pattern generation

Still another test method—one that keeps cost down and can be used to test memories as well—is algorithmic pattern generation (Fig. 1). A CPU usually contains an instruction set that specifies an operation in conjunction with an operand. Each instruction is well-defined, in the sense that an exact result can be expected after execution of an instruction over its existing operand. However, it is not always feasible to monitor the executed output of a single instruction. Instead, it may be necessary to execute a series of instructions before you can monitor the output.

Since you are especially interested in your own set of instructions, user-oriented testing of any CPU can be reduced to verification of all instructions. But because you may have your own instruction-verification sequence, the ability to readily change the instruction sequence becomes a most desirable feature.

With the pattern-generation technique, you store all instructions (op codes) in a high-speed, local-buffer memory. Depending on the complexity of the expected output, some instructions will go into the local buffer, while the rest are generated by the high-speed pattern generator. All instructions—when addressed in local buffer memory and sent to the CPU—are verified in the

proper sequence. By proper sequence is meant the order of execution of each instruction—arranged at your discretion. This gives you complete control over the device program and permits you, in principle, to attain any needed information about the CPU.

Note that this method is limited to partial functional testing and excludes parametric or dynamic tests. Cost is low, since you need only an optimized data buffer memory. And the method provides flexibility: You can generate your own instruction verification program to take full control of the test program or to change or modify the existing program. Also, the technique lets you diagnose multiple faults.

One note of caution: Because you take control of the test problem, you must be thoroughly familiar with the CPU—from the device architecture to the function of each instruction, arrangement of instruction execution order, and the allocation of local-data buffer memory and expected result generation.

Stored-response testing

The final test category—stored-response testing—encompasses two test development methods and two pattern-generation techniques. Each method stores and executes user-written diagnostics quite differently. With stored-response, you keep an emulation or a simulation program in bulk memory (usually a disc) and then apply the program to the CPU under test to generate output data response.

The emulation process consists of the following steps (Fig. 2): (1) The diagnostic program (in assembly language) is loaded into the test system, translated to machine language (1's and 0's) and then applied to a reference device; (2) During a learning mode, the reference device is tested on a cycle basis with a comprehensive set of diagnostic instructions; (3) The output states of the reference device are recorded in memory; (4) The entire truth table of the device is developed into user language, as well as machine language invisible to the user; (5) The test sequence so derived is then used to test the CPU.

You can simulate the sequence of operation of a CPU in conjunction with all peripheral devices, such as RAMs and ROMs. To do this requires a large RAM or PROM to store a predefined sequence of instructions associated with the appropriate data set. Simulated outputs can be sampled and their logic states identified at a defined sampling period.

In this way, an output pattern can be identified with its corresponding input pattern. This information can be stored in an appropriate buffer memory and, finally, transferred to disc or magnetic tape for permanent storage. To execute

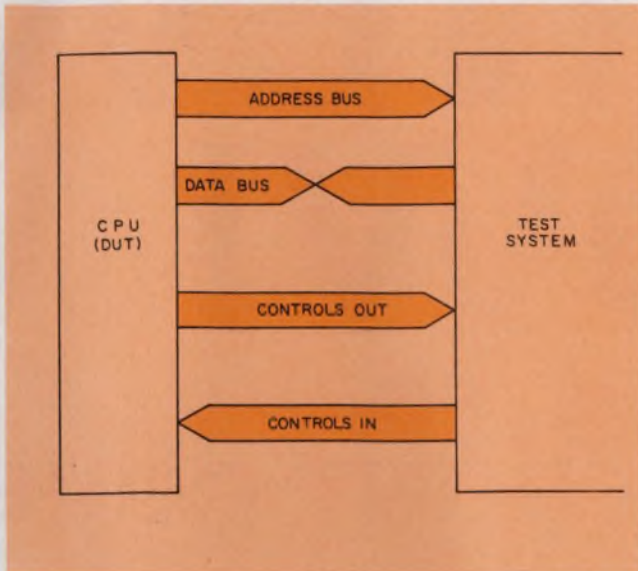

3. The test system provides all necessary stimuli and then senses the microprocessor's response. In most cases the data bus is a two-way street.

the test, the stored pattern is transferred from disc or magnetic tape back to the buffer memory and then to the device under test.

Two independent steps are involved in the technique: pattern identification and test execution. The first step is a one-time operation. Unless program modification is necessary, the generated pattern will be stored permanently on the disc. The second step is a typical procedure that executes the test in a burst mode.

Advantages offered by simulation include easy programming of the test system and flexibility to change the program so that device characterization is easily implemented. But there are trade-offs. Hardware cost is significantly increased by the need for a "super" buffer; additional PROMs are required for each modification of the program, since the simulator is usually generated by the PROM; and the cost of the pattern simulator and its maintenance—which may require substantial support—must be added to the cost of the test system. In addition simulation depends on a known good device.

Diagnostic emulation, which tests the CPU with its operating instructions, points to the fact that microprocessors are instruction-sensitive. One such problem is related to the jump, interrupt and scratch-pad memory instructions. In MOS LSI, these effects certainly seem to be a way of life. However, simple instructions apparently cause no problem.

Both emulation and simulation have advantages and drawbacks. The emulation method is easier to implement but uses a reference device. The simulation process is more difficult to achieve without extensive knowledge of intrinsic device characteristics, and it requires a high-level

Table 2. CPU test system requirements

Computer with 16 to 64K bytes of memory.
Disc storage: Approximately 1 million words.
I/O peripherals: CRT, magnetic tape, line printer.

Software: High-level language, foreground and background operations, production and engineering evaluation modes.

Functional tests: 10-MHz data rate—MOS and bipolar levels.

Parametric tests: Several digitally programmable sources, voltage, current, stress, continuity power dissipation and MOS and bipolar levels.

Dynamic tests: Digitally programmable timing channels.

Pin electronics: Flexible pin electronic modules, 60-to-64-pin capability, separate drivers and detectors per pin with force, compare, inhibit and mask modes at data rates.

Local memory: Each DUT pin has local memory capable of 10-MHz data rates. Chaining or nesting capabilities exist.

language. Some engineers find that their test system computer or software is limited and resort to offline simulation. Note that most CPU suppliers use a variation of the stored-response method to verify the integrity of their devices.

What about test equipment? Of necessity, that required for microprocessor testing is complex and costly. Fig. 3 shows the interface between a microprocessor and its test system. The system must supply stimuli on the clock, control and data-input lines and must sense responses on control, address and data-output lines. Since most microprocessors use a bidirectional data bus, the tester must enable and disable the drivers at high speeds.

For characterization testing, you need a system that can gather and manipulate vast amounts of data, then reduce the information to a meaningful display. One example: The Tektronix S3260 test system. For larger CPUs (12 and 16-bit), you need very large bus and data-handling capabilities that can operate at high speeds (20 MHz) and handle variable instruction sets.

The test system should be able to modify the test program rapidly through an iterative CRT. However, test systems of this caliber are very expensive (\$250,000 and up) and not justifiable, unless large quantities of CPUs are to be tested or continuous characterization programs will be performed on a regular basis. For incoming inspection tests, low-cost (\$10,000 to \$30,000) dedicated testers will provide the desired confidence level (Table 2). ■■

Bibliography:

Christos Chrones, "Testing Microprocessor Chips: A Large Scale Challenge," *Electronic Packaging and Production*, April, 1975.

RENEW NOW!

GO BACK TO
INSIDE FRONT COVER



KEEP
**Electronic
Design**
COMING YOUR
WAY IN '76

NOTE

If you have sent us your renewal since August 16, 1975, ignore this notice. ALL OTHERS MUST RENEW AT THIS TIME (regardless of when your subscription started).

Your FREE subscription to Electronic Design has expired. Once you're off our list it takes months to get back on. All you have to do is fill in and mail the FREE RENEWAL APPLICATION FORM bound inside the front cover of this issue. If you DO IT NOW your subscription to Electronic Design will continue without interruption throughout 1976.

Think Large.

Think Small.

Think Ise *itron*[®]

Think our three jolly green giants for desk-top electronics. Our two pint-size pigmies for carry-in-the-pocket display designs. But don't stop there. Think low operating voltages, low power consumption, glass encapsulation all around, and wafer-thin thickness and dip clip pins for fast efficient mounting.

FG-159A2

ec = eb = 35Vp-p
ic = 4.5mA-p-p
ib = 3.5mA-p-p

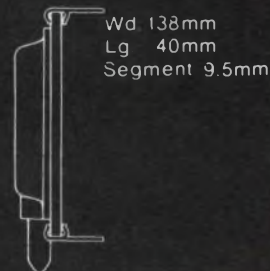

FG-139A2

ec = eb = 30Vp-p
ic = 3.6mA-p-p
ib = 2.8mA-p-p

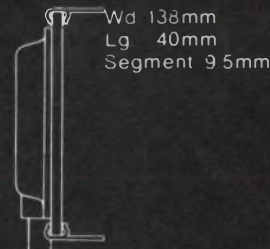

Our jolly green giants

FG-99A2

ec = eb = 24Vp-p
ic = 3.5mA-p-p
ib = 2.5mA-p-p



FG-125A2

ec = eb = 24Vp-p
ic = 2.0mA-p-p
ib = 2.0mA-p-p



Our pint-size pigmies

FG-95A

ec = eb = 24Vp-p
ic = 2.0mA-p-p
ib = 1.5mA-p-p

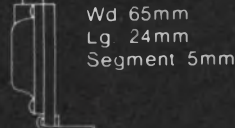

Something else to think about

Think Ise for digital readouts for instruments, clocks and other products, too

The Brighter Side of Electronics

ISE ELECTRONICS CORP.

Main Office:

P.O. Box 46 Ise City, Mie Pref., Japan
Tel. (05963) 5 2121 to 4, Telex 4969523

Tokyo Office:

2-7-7 Shigashi, Shinbashi, Minato-ku, Tokyo, Japan
Tel. (03) 433 6616 to 9, Telex J26546

Noritake Electronics Office:

22410 Hawthorne Blvd., Torrance, California 90505, U.S.A.
Tel. (213) 373 6704, Telex 230674910

Agc extends the range of a/d converters.

Use the computational power of a minicomputer and save a great amount of hardware in implementing the agc.

In many signal-processing applications, the dynamic range of the input signals is too large to be accommodated by practical analog-to-digital (a/d) converters. Solution: Place automatic gain control (agc) ahead of the a/d converter. This will reduce the dynamic range needed for long-term signal variations if the short-term signal variations are within the range of the a/d converter.

A multiplying d/a converter (MDAC) is used in an agc loop to form a digitally controlled attenuator (Fig. 1). The output of the attenuator, after conversion to digital samples, enters a minicomputer. Feedback from the computer determines the level of attenuation.

The minicomputer saves much circuit design and hardware in implementing the system. The system uses software to exploit the computational power of a minicomputer for real-time signal processing.

The digital samples from the a/d converter are related to the analog signal input by the equation

$$Y(n) = x(nT) / A(n - 1), \quad (1)$$

where

$Y(n)$ = n^{th} data-input sample,

$A(n)$ = n^{th} attenuation-gain-control sample,

$x(nT)$ = value of analog input signal at time nT (in which T is the sample period).

An algorithm controls the gain

The algorithm of the control sequence for the MDAC attenuator circuit can be described by the equation

$$A(n+1) = A(n) [1 + k(|Y(n+1)| - R)], \quad (2)$$

where the desired loop-gain constant is k , and R is a reference-level constant. Both constants are stored in the computer memory.

If the magnitude of the input sample Y is larger than the reference level R , the next attenuation gain-control sample, $A(n+1)$, is increased, as determined by the product of the

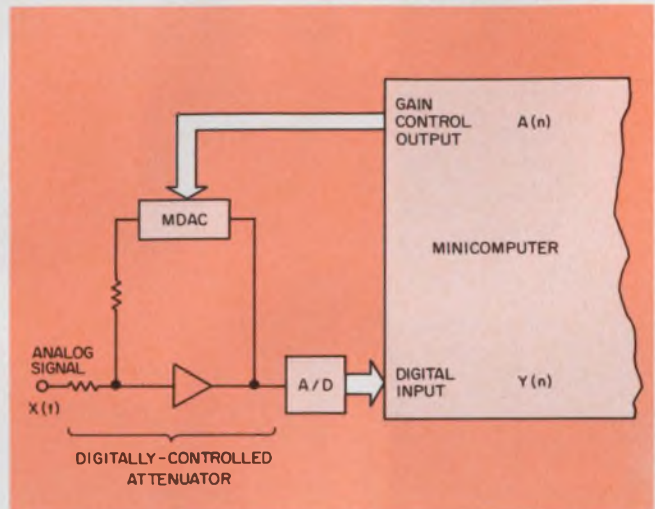

1. An a/d converter can use the real-time computing power of a minicomputer to provide agc and broaden the converter's dynamic range.

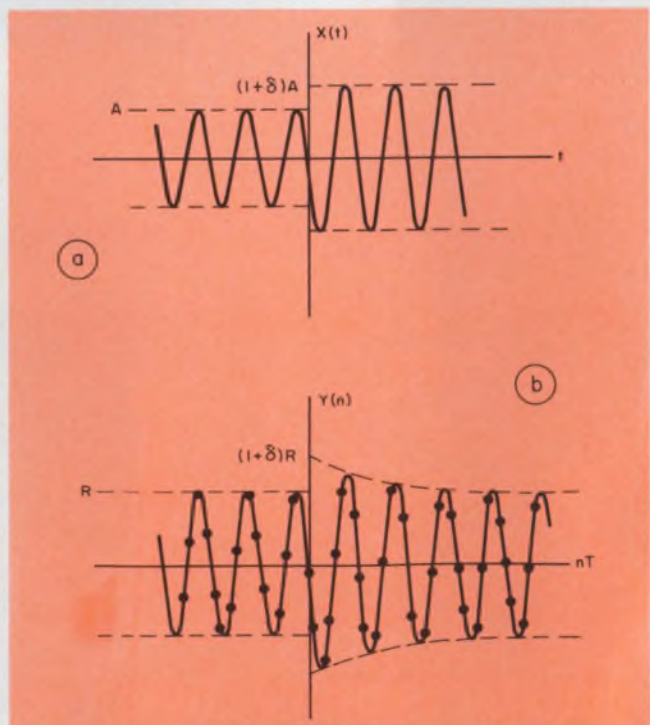

2. The system's response to a small step input (a) damps out (b) with a time constant independent of the absolute input levels, unlike other agc systems.

Dennis R. Morgan, Senior Engineer, Electromagnetics and Acoustics, General Electric Co., Electronics Laboratory, Syracuse, NY 13201.

error term $|Y| - R$ and the gain factor k . This correction then reduces the magnitude of the next data sample and thereby reduces the error. Of course, an input smaller than the reference decreases the attenuation. Successive samples and corrections tend to produce an average error of zero.

The correction steps for a constant error level generate a geometric attenuation sequence. Hence the algorithm is called geometric feedback.

Time constant independent of level

The response to small-signal envelopes of the geometric feedback algorithm is characterized by a time constant,

$$\tau = T \ln(1 + Rk). \quad (3)$$

The time constant of the algorithm does not depend on the average level of the analog input signal, as it does in other agc systems.

To illustrate this behavior, consider a sinusoidal input signal with a step change in input level (Fig. 2a):

$$x(t) = \begin{cases} A \cos \omega t, & t < 0 \\ (1 + \delta) A \cos \omega t, & t \geq 0, \end{cases} \quad (4)$$

where $\delta \ll 1$. This step input produces a data-input response to the minicomputer (Fig. 2b):

$$Y(n) \cong \begin{cases} R \cos n\omega T, & n < 0 \\ R(1 + \delta e^{-nT/\tau}) \cos n\omega T, & n \geq 0. \end{cases} \quad (5)$$

The envelope of the digital input samples undergoes an exponential transient with the time con-

stant given in Eq. 3. Though a sinusoidal analog input signal is used in the example, the response to the envelope of any arbitrary signal would be similar (Figs. 3a and 3b). The fine detail of a signal is irrelevant to this analysis. Thus only signal envelopes are considered, and they are denoted by overbars as follows:

$$\overline{x(t)} = \begin{cases} A, & t < 0 \\ (1 + \delta) A, & t \geq 0 \end{cases} \quad (6)$$

$$\overline{Y(n)} \cong \begin{cases} R, & n < 0 \\ R(1 + \delta e^{-nT/\tau}), & n \geq 0, \delta \ll 1. \end{cases}$$

The response to envelopes of small signals does not depend on the absolute value of the input level, but large signals do affect the response somewhat. Nevertheless, the attenuation, $A(n)$, for the geometric feedback algorithm can always be described by a simple exponential impulse response. Hence for a step-input envelope

$$\overline{x(t)} = \begin{cases} A, & t < 0 \\ B, & t \geq 0, \end{cases} \quad (7)$$

the normalized attenuation is given by

$$R A(n) = \begin{cases} A, & n < 0 \\ B - (B - A)e^{-nT/\tau}, & n \geq 0, \end{cases} \quad (8)$$

and the output envelope is then determined by a combination of Eqs. 1, 7, and 8 to give

$$\overline{Y(n)} = \begin{cases} R, & n < 0 \\ \frac{R}{1 - (1 - A/B)e^{-nT/\tau}}, & n \geq 0. \end{cases} \quad (9)$$

This response is plotted in Fig. 4 for several values of the ratio B/A . Note that the time con-

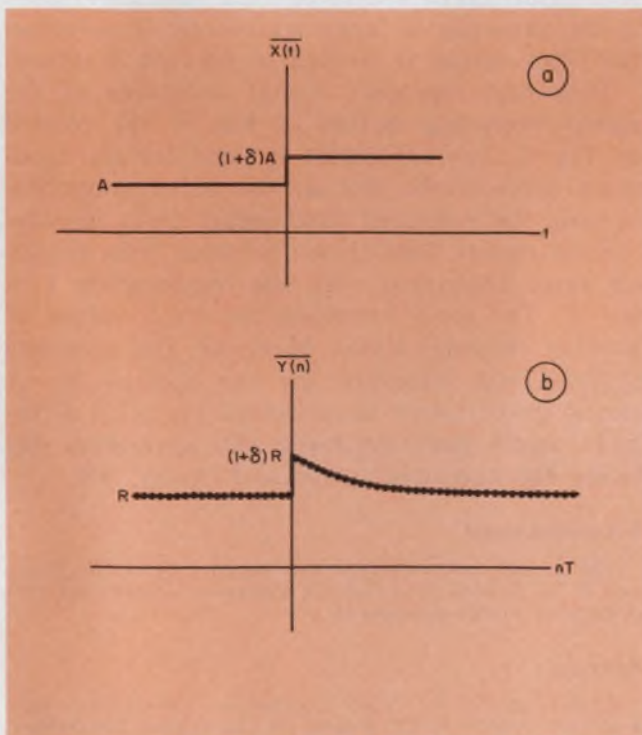

3. Only the envelope of the input signal (a) need be considered to determine the system's response (b). The fine detail is unimportant to the analysis.

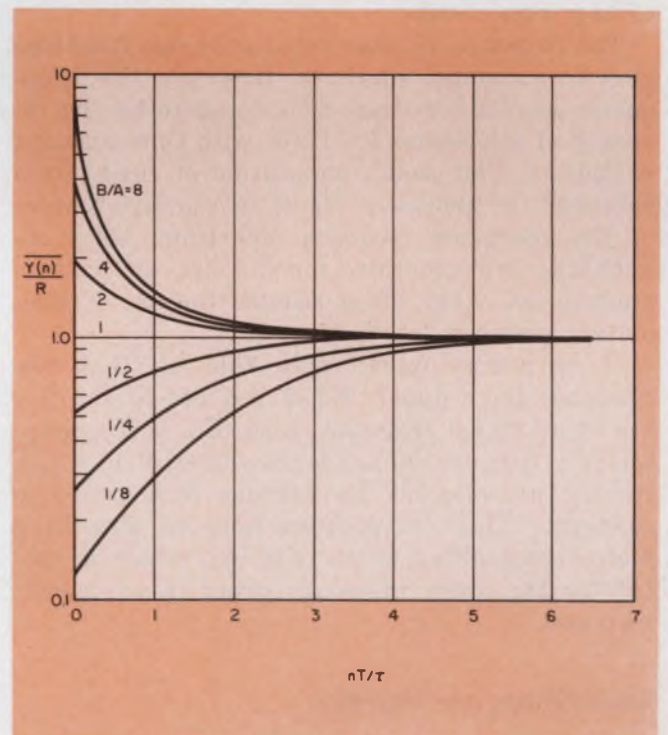

4. The response of the geometric-feedback agc amplifier to a step input is a function of the envelope-amplitude ratio, B/A and independent of absolute input level.

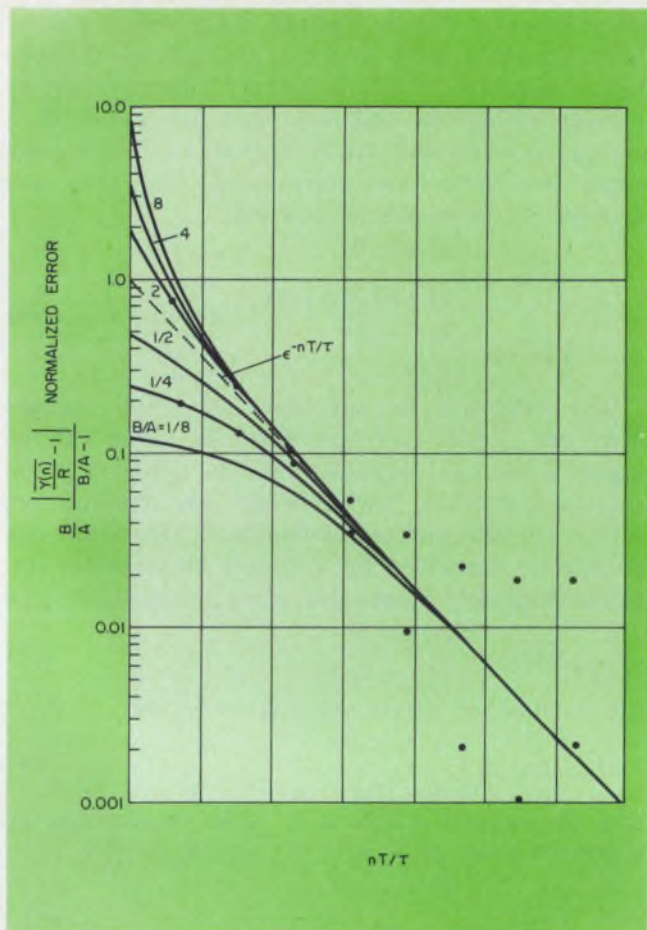

5. The normalized error response converges for large values of n data samples.

stant is still independent of the absolute value of the input level.

The response of other input envelope functions may be computed similarly. However, the attenuation envelope is then considered to be the response of a low-pass RC filter with time-constant τ (Eq. 3). This easy computation of closed-form solutions for arbitrary inputs is a unique feature of the geometric feedback algorithm; other algorithms are generally much more difficult to analyze, and they often require the use of simulation methods to solve.²

It is interesting to note that as B/A approaches the value 1, Eq. 9 reduces to Eq. 6—the small-signal response. Also, Eq. 9 is asymptotically exponential for large values of n , which causes the solutions for various B/A ratios to converge. This convergence appears also in a plot of normalized error (Fig. 5), which is useful for the study of small errors in equipment response.

Implementing the algorithm

Fig. 6 is the block diagram of a geometric-feedback agc signal-processing system built by the author. The resistors in the MDAC feedback

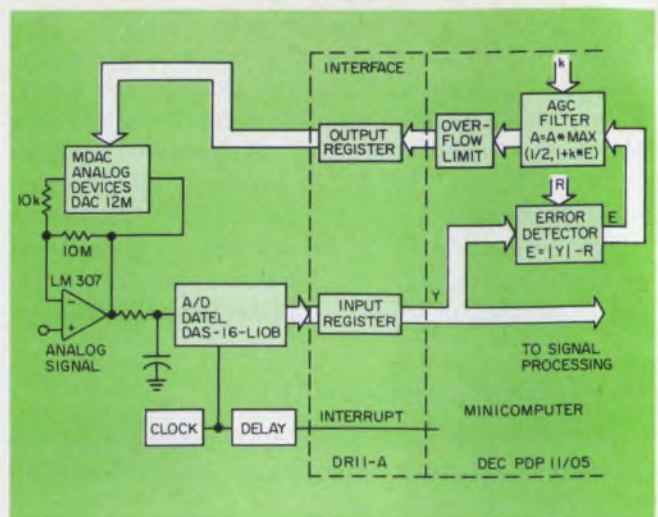

6. Block diagram of a complete signal-processing system shows the minicomputer's input and output registers, used as interfaces for the external a/d and agc loop.

loop limit the gain of this stage to 1000. An RC filter at the input to the a/d converter removes switching transients from the MDAC. A/d conversion is activated by an external clock, which also interrupts the minicomputer to allow read-in of the successive data samples. The interface circuit of input and output buffer registers is part of the minicomputer.

A subroutine of the minicomputer's main program computes the attenuation sequence in accordance with Eq. 2 and feeds the MDAC via the output register.

The gain multiplier in the agc filter is limited to a minimum of $1/2$ to prevent negative values in the presence of large transients. In addition the filter output is limited to prevent overflow.

Data that represent output sequences of the signal-processing system of Fig. 6 are plotted on Fig. 5. The agreement is good for the moderate error levels. But as the error converges to zero, the measured data depart from the theoretical curves. This disparity stems from round-off error associated with the computation $1 + k * E$. The error increases for small values of k —long response times. However, the accuracy attained was adequate for the application. A simple modification using double-precision arithmetic could have improved the agreement between the measured points and theory. ■■

Acknowledgement

The author acknowledges the support of S. E. Craig and D. L. Roberts who did the electronic design and programming of the equipment.

References

1. Morgan, D. R., "A/D Conversion Using Geometric Feedback AGC," *IEEE Trans. on Computers*, September, 1975.
2. Morgan, D. R., "On Discrete-Time AGC Amplifiers," *IEEE Trans. Circuits and Systems*, February, 1975, pp. 135-146.

End Microprocessor Power Supply Problems...

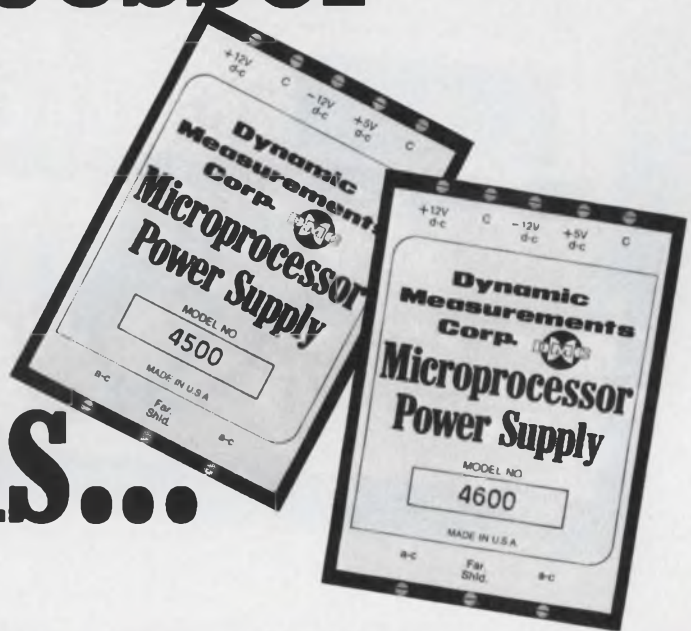

If you are working with microprocessors, you know that supplying and controlling properly-characterized power is a critical element in the accuracy, reliability, and protection of your entire system.

So it pays to get a power supply specifically designed for your microprocessor system — especially when that power supply is less expensive and more effective than anything else you can build or buy.

We're talking about the new Series 4500/4600 from DMC. These specialized power supplies are designed from the microprocessor system designer's viewpoint. They control not only voltage selection, but turn-on waveform characteristics which critically affect accuracy and reliability, especially in processor initializing routines. They minimize power supply noise and overshoot that can create havoc in costly microprocessor

systems. Output voltage and current levels accurately interface with such typical microprocessor circuitry as RS232 Interface, ASR current loops, and 8T26 Tri-state bus drivers/receivers. Unique void-free encapsulation provides a rugged, reliable package with high thermal conductivity — there's no need to derate this SuperCool performer. And Series 4500/4600 comes in single, dual, and triple output models specifically tailored to work with today's microprocessors.*

For complete facts on how to select the power supply best matched to your microprocessor system, write DMC, the microprocessor power supply people. **Or call toll free at (800) 225-1151.**

*Designed for use with Motorola M6800, Intel 3001, Intel 8008, Intel 8080, NEC Microcomputer 8080, Texas Instruments 8080, Advanced Micro Devices 8080, Texas Instruments SB P 0400, Fairchild F8 Family, Intersil IM6100, Mostek MK5065P, National PACE, Monolithic Memories 5701/6701, MOS Technology 6501 and RCA COSMAC. Custom configurations are also available.



Dynamic Measurements Corp.

6 Lowell Avenue, Winchester, Mass. 01890 • (617) 729-7870 • Cable: DYMECO, TWX (710) 348-6596

INFORMATION RETRIEVAL NUMBER 45

NEW

PRICE/PERFORMANCE BREAKTHROUGH



SIMPSON

MODEL 464

Digital Multimeter

USE IT EVERYWHERE:
In Field or Factory
Production Line Testing,
Laboratory, R & D, and for
General Electronic Servicing.

- 3½ Digit, 0.43" LED Readout
- Highly Reliable LSI Circuitry
- Bi-Polar Operation and Automatic Zero
- Full Pushbutton Selection of Ranges and Functions
- 28 Ranges: 6 AC current ranges to 10 amps
6 DC current ranges to 10 amps
6 resistance ranges to 20 megohms
5 AC voltage ranges to 600 volts
5 DC voltage ranges to 1000 volts

- Choice of Battery/AC Line Combination or AC Line Operation Only
- High Impact Shock-Resistant Case with Tilt-View, Adjustable Handle
- Conforms to Applicable ANSI C39.5 Requirements

Model 464A line operation **\$210.00**

Model 464D line and battery operation .. **\$235.00**

ORDER FROM YOUR ELECTRONICS DISTRIBUTOR



SIMPSON ELECTRIC COMPANY

853 Dundee Avenue, Elgin, Illinois 60120 • (312) 697-2260

CABLE: SIMELCO • Telex: 72-2416

IN CANADA: Bach-Simpson, Ltd., London, Ontario

IN ENGLAND: Bach-Simpson (U.K.) Ltd., Wadebridge, Cornwall

IN INDIA: Ruttonsha-Simpson Private, Ltd., Vikhroli, Bombay

INFORMATION RETRIEVAL NUMBER 46

KATY INDUSTRIES



INDUSTRIAL
EQUIPMENT
GROUP

INFORMATION RETRIEVAL NUMBER 47 ►

At last— low prices on Interdata memories.

Plessey Microsystems, the leading independent supplier of minicomputer add-ons, can expand your Interdata memory without putting the bite on your budget; with the PM-716 plug-in memory card.

The PM-716 is offered in 8k and 16k capacity and is fully compatible with all Interdata minicomputers. It is available off-the-shelf for much, much less than the Interdata equivalent.

It's another example of the Plessey practice of giving your mini a great deal more capacity and flexibility for a great deal less.

The PM-716 augments our line of miniperipherals, which includes DEC and NOVA add-on memories, dual disc drives and controllers at big savings, and high performance photo-electric paper tape equipment, as well as a powerful 16-bit microprocessor (MIPROC 16).

Contact us today for details or a demonstration. Whatever you need, you're going to be impressed by what we can do for your minicomputer system.

And love what we can do for your budgets.



**PLESSEY
MICROSYSTEMS**

(714) 540-9945

THE MINI EXPANDERS

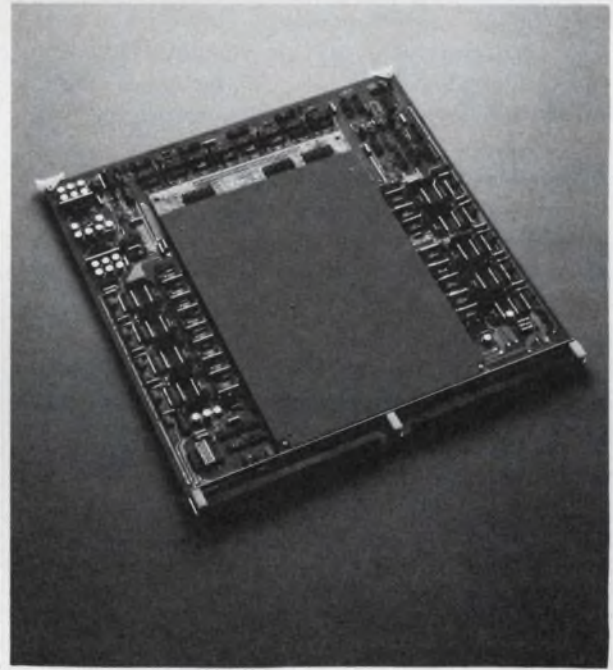

THE PLESSEY PM-716

Use autoranging amplifiers to boost the accuracy of computerized data-acquisition systems. Four comparators and some CMOS switches are all that's needed.

Adjust the input range of data-acquisition systems to match the input-signal amplitude, and you can improve over-all system accuracy and provide better signal resolution.

To get higher accuracy for small signals, obviously you should boost the signal to make best use of the analog-to-digital converter's full dynamic range. However, since you can't be sure when you'll need the extra gain, the system must change the amplification factor when it samples the input signal.

If the over-all system operates slowly, you can use a fast a/d converter and do repeated conversions of the analog input. A computer or logic section can digitally alter the input gain until the best resolution is found. You can, though, automatically select the gain without programming and with simpler electronics by using multiple analog comparators.

The circuit in Fig. 1 uses four comparators to switch between three gain ranges. The system is designed for a 12-bit a/d converter and a ± 5 V input range. As a bonus, the autoranging amplifier has continuous offset compensation to eliminate trims.

Building the automatic gain control

Input signals to the data-acquisition system go first through a multi-input analog multiplexer that is controlled by a multiple-bit digital code. From the multiplexer, the selected signal is fed to a follower with a differential input and then to an amplifier whose gain is controlled by the comparators and three analog switches. Depending upon the input-signal amplitude, one of the switches—A, B or C—is ON, thus closing the feedback loop and setting the gain. For the circuit described, the gains are 1, 10 and 100, respectively.

Fig. 2 shows the circuit of the complete autoranging amplifier. The circuit automatically compensates for amplifier offsets,¹ nulling them to zero. The amplifier cycles between the ampli-

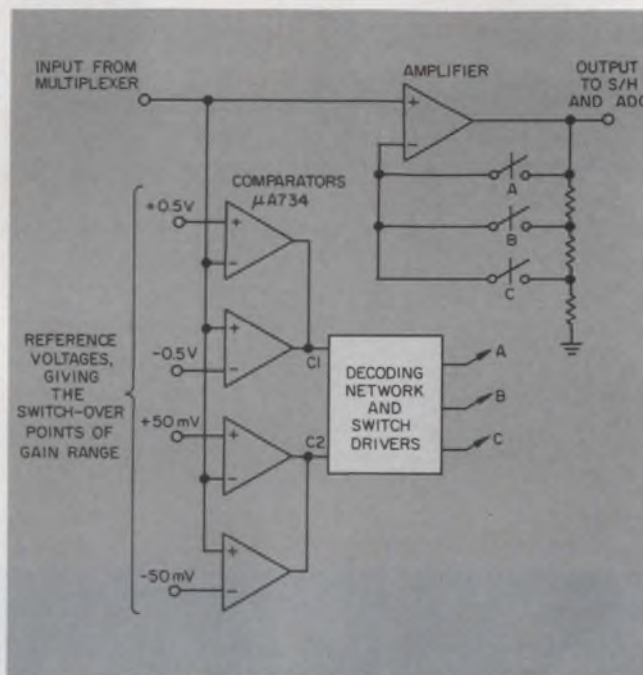

1. Simplified block diagram of the autoranging amplifier uses four comparators and a FET-input op amp to provide gains of 1, 10 and 100.

cation and offset compensation modes. A computer command on the start line initiates operation by triggering monostable M_1 . The monostable places the entire amplifier in the amplification mode, latches the D flip-flops (74175) and lets the amplifier settle for a total time of $50 \mu\text{s}$. After the $50\text{-}\mu\text{s}$ period has elapsed, M_1 places the sample-and-hold circuit in the hold mode, initiates the a/d converter and turns on monostable M_2 , which, in turn, re-zeros the amplifier for a period of $150 \mu\text{s}$ (Fig. 3).

The settling and offset compensation times are based on a combination of amplifier settling time and RC time constant. The highest gain range has the slowest response and has a basic RC time constant of $6 \mu\text{s}$. For the amplifier output voltage to settle to within 0.1% of its final value, seven time constants are needed. Thus $50 \mu\text{s}$ is suitable.

The time needed to do accurate offset compensation can be found from the time constant of the offset-hold network (capacitors C_4 , C_5 , the ampli-

Erik Ljung, Fil. kand, University of Lund, Solvegatan 14, S-223 62 Lund, Sweden.

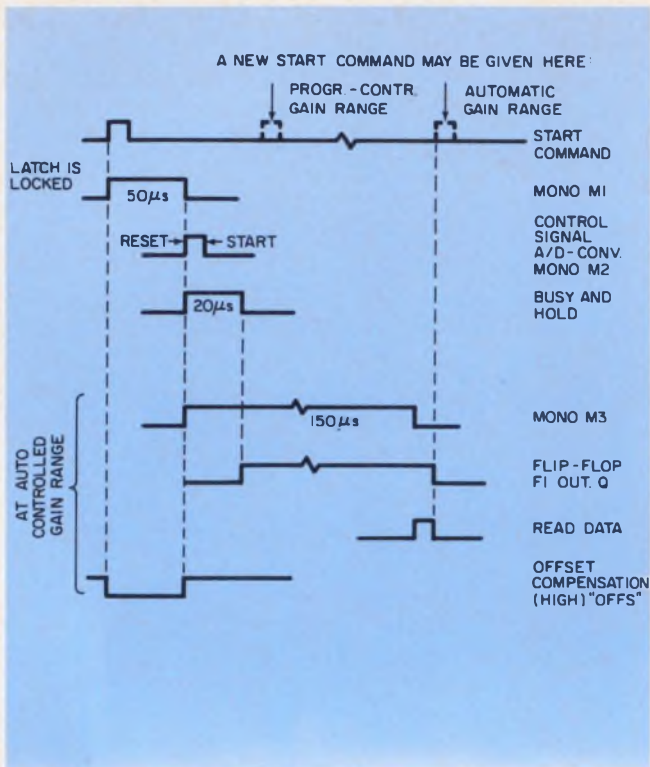

3. The timing waveforms of the autoranging amplifier control the amplifier after initiation from a single input pulse sent by the computer.

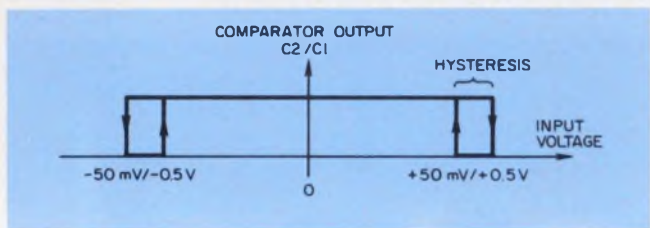

4. Hysteresis in the comparators permits adjustment of the trigger level for both positive and negative inputs.

fier output impedance, the electronic switch resistance and the 100- Ω resistor in series with C_4). Since the offset-hold circuit is part of the amplifier feedback loop, the gain and slew rate of the amplifier must be included when you find the compensation time.

When switched from the gain to offset-compensation modes, the amplifier output approximates a two-pole response. If you approximate the initial overshoot at 15%, you can find² that the time for at least five peaks must be allowed for the output to reach 0.1%. The settling peaks occur at about 5- μ s intervals, and the amplifier thus requires a minimum of 25 μ s for offset compensation. However, this is only a rough approximation, and in the actual circuit shown, 150 μ s has proved more realistic.

The a/d converter delivers its 12-bit output 20 μ s after initialization by monostable M_2 . When conversion is complete, the "busy" signal from

the a/d converter goes low, sets flip-flop F_1 , thus signaling the computer that the data are ready. However, the signal doesn't reach the computer until the offset-compensation is complete.

Since the autoranging data-acquisition system operates under some form of computer control, the program should be written so that a new multiplexer channel is selected during the 20- μ s converter-busy period. This way the multiplexer and comparators have a settling time of more than 100 μ s.

The computer can also override the comparator gain selection, if desired. Thus faster measurements are possible if you know ahead of time that, say, the signals vary over a limited range. Once one of the gain control lines (G_1 , G_{10} or G_{100} of Fig. 2) is activated, the amplifier stays in the amplification mode.

You can obtain even more speed from the autoranging system, while still making use of the range selection, by modification of the control logic. The modification should keep the unit in the amplification mode, and only upon digital command will the amplifier switch into the offset-compensation mode. Faster amplifiers or converters can also be used, but these would, of course, increase cost.

Almost any parts can be melded for this system. Dozens of 12-bit a/d converters are available. For the system assembled, the a/d converter has a ± 5 -V input range and an offset-binary-coded digital output. The most-significant bit represents the sign of the number, and the other bits represent the number. If you assume a maximum relative error of ± 1 LSB, the relative error for an input signal of ± 250 mV approaches $\pm 1\%$. Thus with gains of 1, 10 or 100, the error remains at 1% for inputs of ± 250 , ± 25 or ± 2.5 mV, respectively.

To maintain the $\pm 1\%$ relative accuracy over a range of ± 5 mV to ± 5 V, gain ranges should switch at ± 50 mV and ± 0.5 V. With the resistor values used in Fig. 2, the hysteresis of the comparators is 3 mV for the ± 50 mV comparators and 8 mV for the ± 0.5 V comparators (Fig. 4).

A μ A740 FET-input op amp functions as the controlled amplifier. At high gains, though, the 740 requires more than 50 μ s to settle (Fig. 5). To get around the long settling times, a positive-feedback capacitor, C_3 , can speed the amplifier. If you drive the 740 with a low-impedance voltage follower any tendency of the 740 to self-oscillate will be eliminated.

When the amplifier operates under digital control, leakage currents in the offset-hold path must be kept low since no offset compensation is done in this mode. CMOS switches are used for the autorange switching, but a Signetics D-MOS transistor (Q_1), which has a lower drain-source leakage current than CMOS switches, is used as

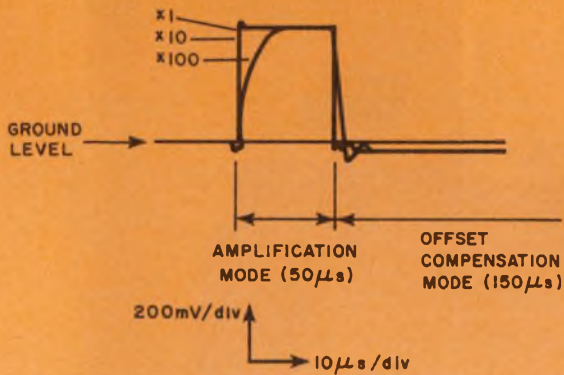
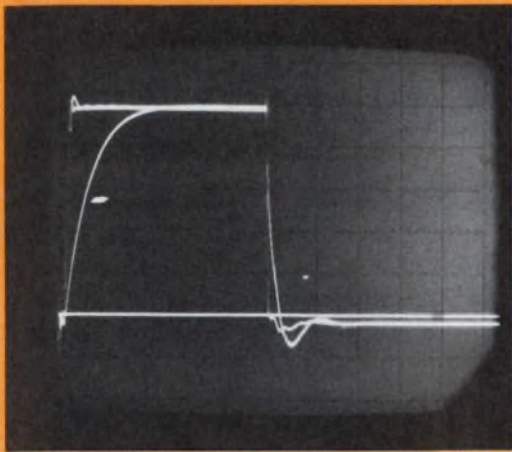

5. When the amplifier operates in the automatic ranging mode, the settling time is affected by the gain range that the amplifier picks.

the switch in the offset-hold path. This minimizes drift due to recharging of the offset-hold capacitor C_4 .

By placing another D-MOS switch, Q_2 , in series with Q_1 , you can reduce the drain-source voltage of Q_1 to less than 100 mV. Thus you limit the drain-source voltage, which is dependent upon the leakage current through Q_1 . The drift in the circuit is substantially reduced, from an experimentally measured 5 mV/s to 0.05 mV/s, referred to the amplifier input.

During the time required for switches Q_1 and Q_2 to go from the closed to open state, the amplifier output switches to a new level. To prevent feedthrough from the amplifier output to C_4 , the voltage at the point between switches is kept fixed by C_5 during switching. ■■

References

1. Jaeger, R., and Hellwarth, G., "Dynamic Zero Correction Method Suppresses Offset Error in Op Amps," *Electronics*, Vol. 45, No. 25, Dec. 4, 1972, pp. 109-110.
2. Tobey, Graeme and Huelsman, "Operational Amplifiers," McGraw Hill, New York, 1971, p. 193.

Acknowledgement

The amplifier described in this article forms part of a data-acquisition system developed at Anker Lassfolk AB in Stockholm, Sweden.

floating-point, 167 nanosecond multiply-add



is a
reality
for your
operating system.

The AP-120B programmable floating-point array processor compliments your computer, giving direct access to real compute power . . . **12,000,000** floating-point calculations per second!

"Computational power comparable to a CDC 7600...", that's how our customers describe their AP-120B's.

What can the AP-120B do for you?

For information
CALL TOLL FREE
800-547-1885

Delivery is 90 days
or ask about our
simulation package.

**floating
point
systems**
incorporated

- Leaders in floating-point hardware and array processors.
- Installations world wide.
- We service what we make.

10520 S.W. Cascade Blvd., Portland, Oregon 97223
Phone: (503) 620-1980 TELEX: 360470 FloatPoint PI

INFORMATION RETRIEVAL NUMBER 48

Through a miracle of modern technology, Facit can now offer you less for your money.

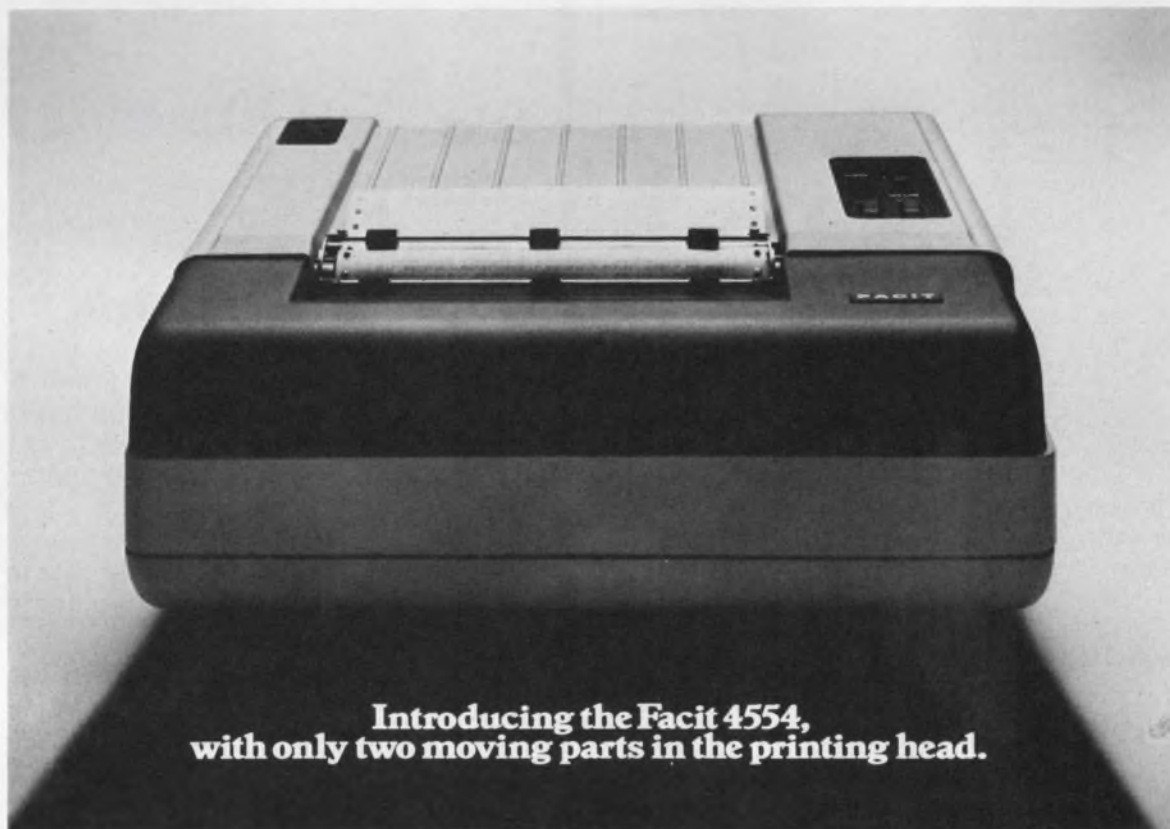

**Introducing the Facit 4554,
with only two moving parts in the printing head.**

The rationale: fewer parts moving around means fewer parts wearing out.

But we didn't stop there.

We also gave considerable thought as to how well our page printer should produce a print-out.

So, unlike most page printers, our 4554 uses a character by character (asynchronous) print-out and an automatic ribbon

control to give you big, easy-to-read characters at 6 or 60 characters per second.

And whether you need one, two or even three copies, your print-out will always come out crystal clear.

Our 4554 is even less trouble to hook up than most page printers. That's because we give you several interface versions. Among them are: The Facit SPI interface for bit parallel data transfer, and the EIA, RS 232C.

All things considered, the Facit 4554 page printer is one of those rare instances where less for your money is really more for your money.

Facit-OEM Division,
66 Field Point Road,
Greenwich, Connecticut
06830.

 **FACIT**
Dedicated to Efficiency

In Canada: Facit-OEM Division,
2270 Speers Road, Oakville, Ontario,
L6J-SK2 Canada.

INFORMATION RETRIEVAL NUMBER 49



Meet the "Green Goddess"

The ultimate capacitor — with automatic insertion equipment, the cost of the "Green Goddess" is lower than disc capacitors!

Varadyne's "Green Goddess" Ceramic Capacitors are sealed in glass, the time proven package that offers superior: hermeticity, reliability, volumetric efficiency and lead "pull" strength.

"Green Goddess" capacitances range from 10 pF to 1.0 mFd and meet the requirements of MIL-C-11015 and MIL-C-39014.

Three formulations are offered: Type BN (Ultra Stable)

NPO, Type BR (Stable) X7R and Type GM (General Purpose) Z5U/Y5V.

Three standard case sizes are offered with maximum dimensions of .160 x .100, .260 x .100 and .400 x .155. Leads are tin plated, copper clad steel with a .020 diameter, 1¼" minimum length.

"Green Goddess" capacitors are available for immediate delivery!

FREE: Your own .01 mFd "Green Goddess" axial leaded ceramic capacitor. Call, write or circle our "Bingo" number and the "Green Goddess" is yours!

We're
out to
WIN



VARADYNE

Varadyne Industries, Inc.
1520 Cloverfield Blvd.
Santa Monica, California 90404
(213)829-2984 • TWX(910) 343-6856

How long a wait for computer response?

Nomographs of queuing equations provide transaction time or the allowable number of terminals for a given response time.

The increasing use of data terminals in networks with central computers means that the waiting time to get access to the computer is also increasing. In the design of such a system, the engineer needs a quick method to estimate waiting time. An easy approach is to use nomographs.

A commonly used network configuration is the communication loop in Fig. 1. Each terminal is assumed able to receive input messages that occur at random intervals and to provide output messages. The independence of input and output messages is a good approximation, especially where there are many terminals on the loop.¹

The lengths of input and output messages are assumed constant, but not necessarily equal. And the average arrival rates of input and output messages are equal. In addition controller delay—the time from an input message's arrival at the controller until a response is ready—also is assumed constant.

The queuing analysis is based upon a single server model having random arrival and general service-time distribution. The Khintchine-Pollaczek equations² are simplified and the nomographs are constructed³ to determine mean loop response time as functions of message lengths, arrival rates, loop speeds and an over-all loop use factor called utilization.

Mean time provided

The nomograph in Fig. 2 determines the mean waiting time of transactions contending for the loop. The loop's mean response time equals the sum of the waiting time, T_w , the service time, T_s , and the controller delay, T_c .

Fig. 3 is a nomograph to determine the standard deviation of waiting time and percentile response time. Percentile response time is the time, T , in seconds that is not exceeded by a given percentage of all transactions. For example, percentile response time can answer the

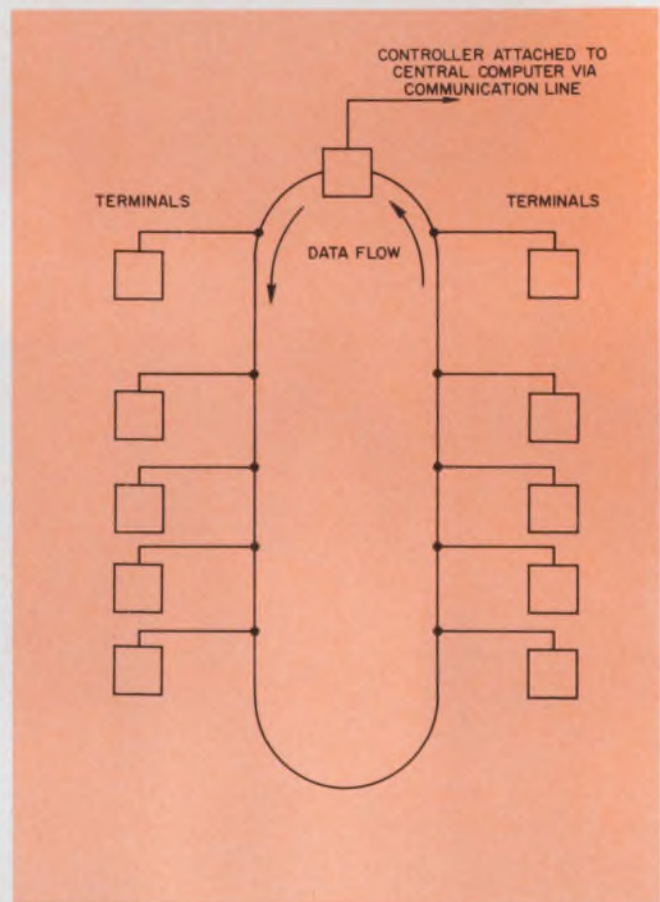

1. Data terminals are commonly connected in a loop configuration.

question of whether 90% of the transactions have response times of, say, 3 s or less.

As an example of the use of the nomographs, assume that 24 terminals are connected to a loop and that complete transactions are generated by each terminal at random intervals with a mean time between them of 24 s. Therefore the mean arrival rate at the controller from all terminals totals one transaction per second.

Further, if the transmission speed of the loop is 9600 bits per second and each terminal has an inquiry format of 45 characters and a response message of 315 characters, the total number of characters for a complete transaction equals 360 characters, and the service time is about 0.3 s.

T. Thananitayudom, IBM System Development Div., Kingston, NY 12401.

MULTIPLY T_w BY K IF MSG LENGTHS ARE NOT EQUAL ($N =$ LENGTH RATIO)

N	1	2	3	4	5	7	10	15	20	∞
K	1	1.11	1.25	1.36	1.44	1.56	1.67	1.76	1.82	2.0

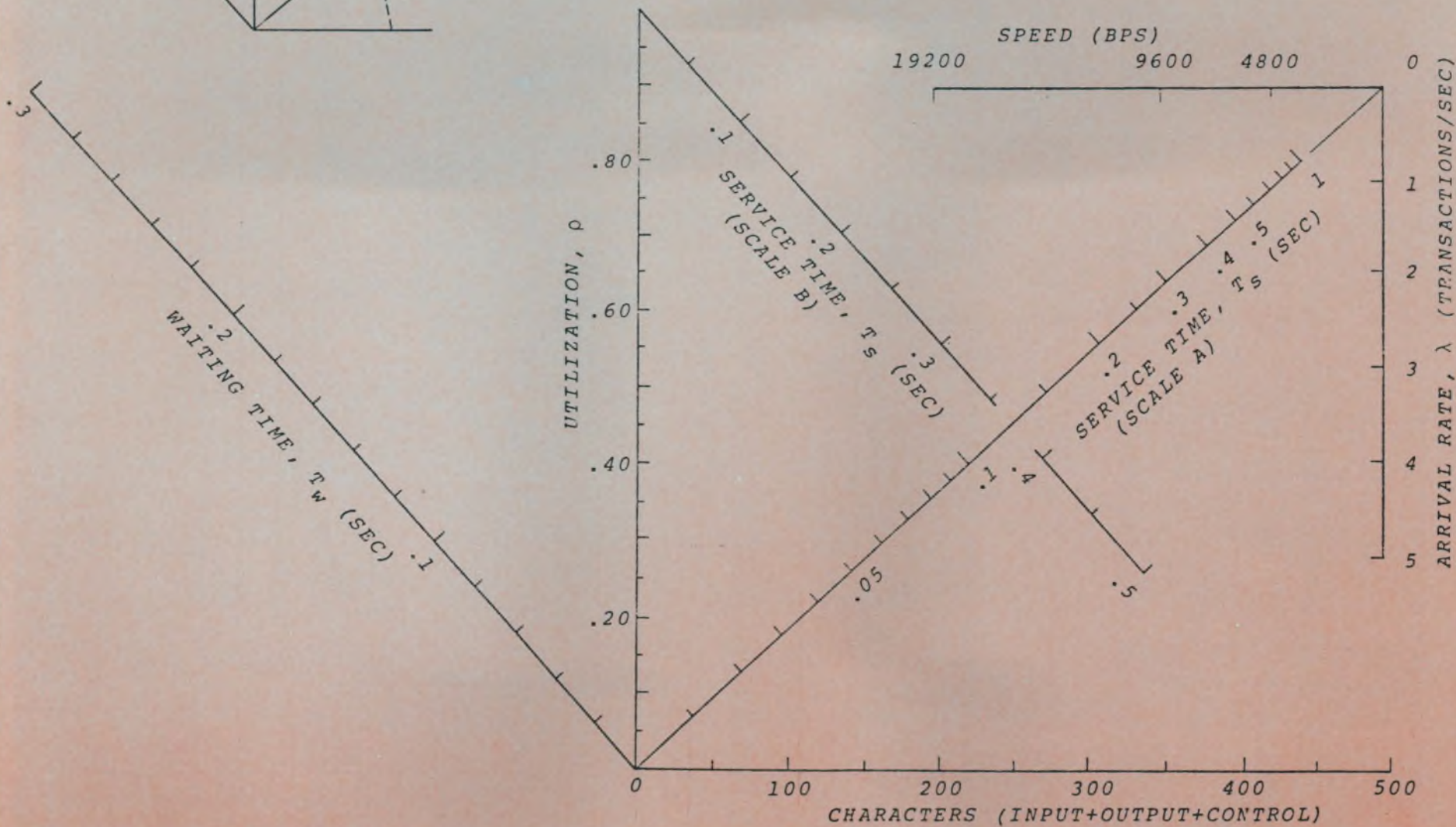
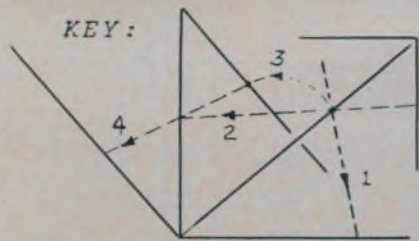

2. Nomograph for mean waiting time. The loop's response time equals the sum of the waiting time, service time and controller delay.

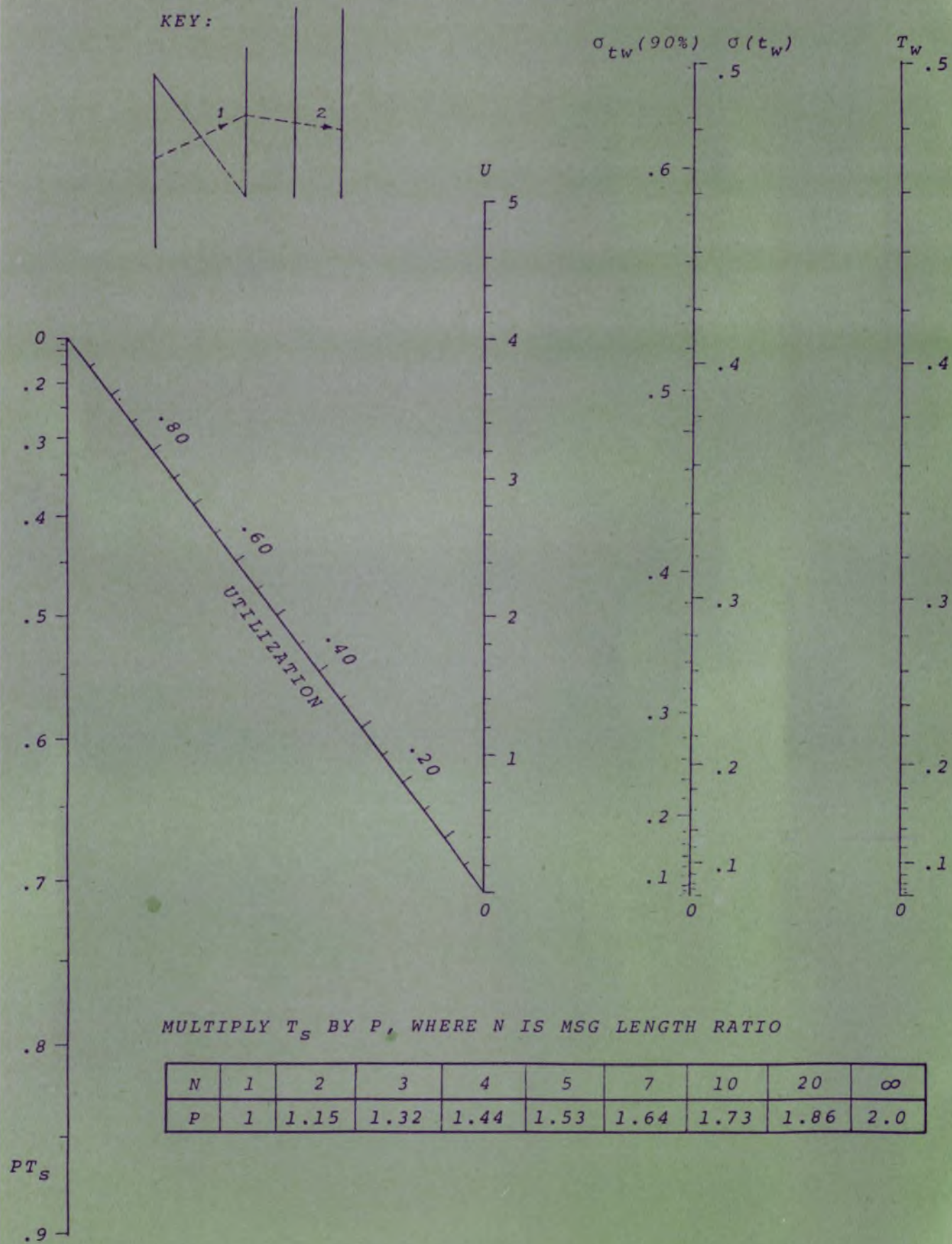

3. Nomograph for standard deviation $\sigma(t_w)$ and 90th percentile waiting time.

The service time, T_s , is obtained from a line drawn between the speed and characters scales through T_s on scale A (Fig. 2).

This means that the loop utilization corresponding to one transaction per second is 30% ($\rho = 0.3$). A line from T_s on scale B ($T_s = 0.3$ s) through utilization scale at $\rho = 0.3$ provides the value of T_w . It is 0.064 s.

Note that since the message length ratio, N , on the table in Fig. 2 is $7 = 315/45$, the value of K is 1.56. Multiply 1.56 times T_w , the mean waiting time, and the result is about 0.1 s. The over-all mean response time is the sum of the service time, the mean waiting time and the controller delay. For a controller delay of 0.2 s, the mean response time is

$$T_s + T_w + T_c = 0.3 + 0.1 + 0.2 = 0.6 \text{ s}$$

Fig. 3 provides the 90th percentile response time. From the table, $P = 1.64$ for $N = 7$ and $PT_s = (1.64 \times 0.3) = 0.492$ s. This value of PT_s , when taken with a utilization of 0.3, provides a value for U of approximately 0.8. A line from the U scale to 0.1 s on the T_w scale intersects the σ_{T_w} scale, the standard deviation of waiting time, at 0.15 s. The corresponding point on the $\sigma_{T_w}(90\%)$ scale reads 0.19 s. This value when added to the mean response time becomes the 90th-percentile estimate of response time as follows:

$$0.6 + 0.19 = 0.79 \text{ s.}$$

Conversely, an engineer might seek the loop configuration that would satisfy a specific response time. The previous procedure, used in reverse, provides the answer.

For example, for a response time of 0.7 s and combined service time and controller delay of 0.5 s, the mean waiting-time component can't exceed 0.2. In Fig. 2, the utilization that corresponds to $T_w = 0.128$ and $T_s = 0.3$ s is 0.46, because $0.2/K = 1.56$ when $N = 7$.

The transaction arrival rate that corresponds to this utilization is then 1.53 transactions per second. Thus, for a 24-s mean transaction time, the number of terminals that can be serviced by the loop is increased to 36. From Fig. 3, the corresponding value of $\sigma_{T_w}(90\%)$ is 0.3 s and the 90th-percentile response time estimate is 1 s, or $0.3 + 0.7$. ■■

For a copy of the author's analysis and a description of the nomograph construction method, write to Ronald K. Freeman, IBM Corp., Dept. 65Q, Bldg. 202-4, Kingston, NY 12401.

References

1. Walsh, A. P., and Li, T. J., "Simulation and Analysis of a Loop Communication System," the Seventh Annual Simulation Symposium, Tampa, FL, March, 1974.
2. Martin, J., "System Analysis for Data Transmission," Prentice-Hall, 1972.
3. Levens, A. S. "Nomography," Second Edition, John Wiley & Sons, 1959.

One good turn...

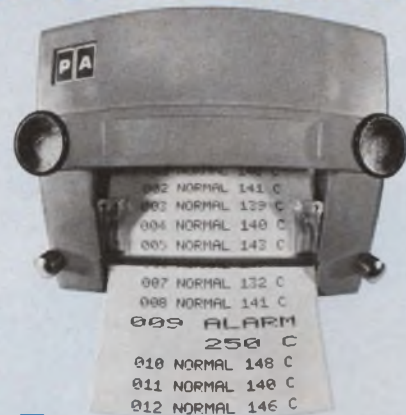

deserves another.



You flipped over our Matri-Dot alphanumeric mini for "first line down" data printing; now we've flipped our design to give you "first line up" text print format, too. So you're ahead, whatever your point of view. Because no one else makes printers as small as 3"H x 3½"W x 7"D. No one else sells them as low as \$140 (in quantities of 100). And no one else offers our features. Instead of a drum, our unique print head purrs along at 38 lines per minute for 18 data columns, even faster for fewer columns. Instead of messy ribbons, our exclusive drop-in ink platen lasts for 75,000 lines and replaces from the front panel. And instead of engraved drum limitations, our 7 x 5 dot matrix characters provide full alphanumeric with a complete ASCII 63 character set. Enhanced characters are also available... 8, 10, 12, or 14 characters per inch. All this, plus multiple-copying capabilities and plug-in panel mounting. No matter how you look at Matri-Dot, it's a turn for the better.



**PRACTICAL
AUTOMATION,
INC.**

Trap Falls Road • Shelton, Connecticut 06484
Tel: (203) 929-5381

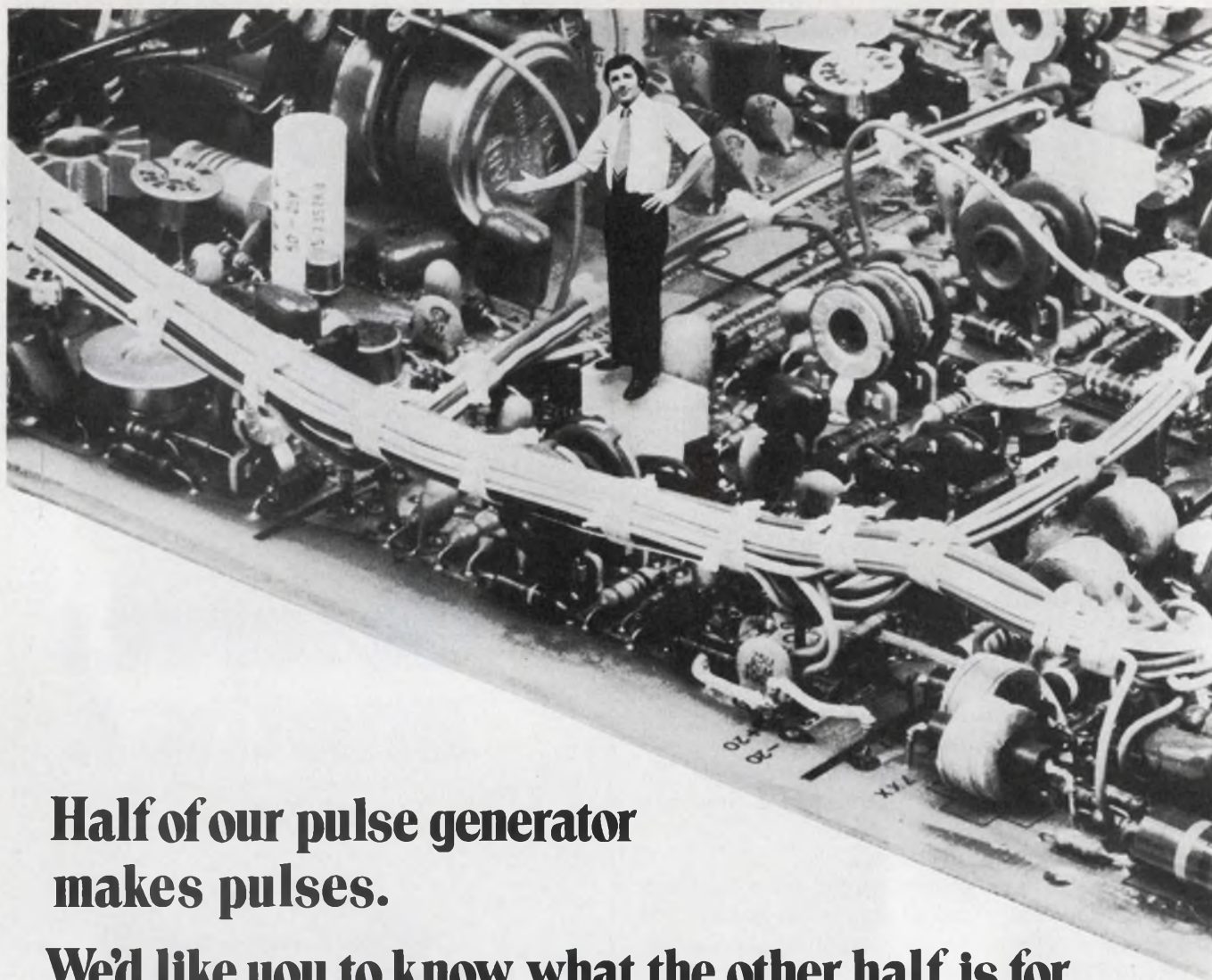

**Half of our pulse generator
makes pulses.**

We'd like you to know what the other half is for.



Pulse generators make pulses — everybody knows that. The half everybody **doesn't** know about is that today's general-purpose pulse generators (like Interstate's SERIES 20) can:

- 1) **Make your life easier.** With Interstate's constant duty cycle mode, for example, you don't have to reset width and pulse period every time you change the frequency when testing a differential amplifier or an analog computing circuit over a wide range of frequencies. The width-to-period ratio remains constant as you change the frequency. Much easier.
- 2) **Give you an infinitely more versatile pulse.** Clock and sync outputs on Interstate's SERIES 20 Pulse Generators are squarewaves, instead of those other skinny, 10-nanosecond trigger pulses. So when you're testing low-speed stuff, like electromechanical machines or reed relays, or even some of the new microprocessors, you won't have to keep switching the scope over to high speed to make sure the trigger is there. Interstate's sync pulse is readily visible — and immediately usable.
- 3) **Allow you to use the pulse generator for other jobs.** SERIES 20's pulse amplifier mode can restore levels and transition times in MECL testing, for instance, so you can avoid having to jerry-rig some complex kluge of equipment.

Put the other half of your pulse generator to work. Interstate has just produced "Today's General-Purpose Pulse Generator Report" in which our SERIES 20 Pulse Generators, together with the major pulse generator models in the 50 MHz, 3.5 ns rise/fall time, 10 V output (into 50 ohms) category, are detailed and cross-compared, and application notes reveal methods and techniques for practical pulse problem-solving. For your free copy, write to:



INTERSTATE
ELECTRONICS CORPORATION
Subsidiary of **A-T-O Inc.**

P.O. Box 3117, Anaheim, California 92803 • (714) 549-8282 • TWX U.S.A. 910-591-1197 TELEX 655443 & 655419

INFORMATION RETRIEVAL NUMBER 52

UP-FRONT SIMPLICITY: LEVER-LITE III

Rugged modular construction gives you a reliable lighted lever switch that provides front-of-panel convenience on the assembly line or in the field.

Our new "Lever-Lite" III switches were designed to simplify installation and servicing of lighted lever switches on computers, telecommunications systems, industrial control equipment, intercoms, broadcast consoles and scientific or test instruments of all kinds.

SIMPLE to mount and terminate. "Lever-Lite" III switches are installed from the front. In a single hole. The lever assembly (lever-actuator, lamp and socket, and color filters) simply

slips into its housing. An escutcheon that "snaps-in" place secures the lever assembly and "trims" the mounted switch. Switching and lamp terminals are solder lug type but also accept standard quick connect-disconnect receptacles.

SIMPLE to relamp. Front-of-panel relamping or changing of color filters can be done easily by removing the escutcheon and lever assembly with your fingertips.

SIMPLE to find what you need. "Lever-Lite" III switches are available in 2- and 3-position types. With locking, non-locking and talk-listen functions. You can order multi-color (different colors in each position), mono-color (one color in all positions) or non-illuminated "Lever-Lite" III switches. And they can be specified with SPST to 8PDT switching.

SIMPLE to get. Contact your local Switchcraft distributor, sales representative, or write us direct. Switchcraft, Inc., 5541 N. Elston Avenue, Chicago, Illinois 60630.

SWITCHCRAFT
INC.

INFORMATION RETRIEVAL NUMBER 53



Voltage-to-frequency converter preserves polarity of input

A single op-amp circuit not only converts voltage to frequency; it also preserves the polarity of the input signal. The input voltage, V_i , causes C_1 to charge and produce a ramp voltage at the output of the 741 op amp.

Diodes D_1 and D_2 are four-layer devices. When the voltage across C_1 reaches the breakover voltage of either diode, the diode conducts to discharge C_1 rapidly, and the op-amp output goes abruptly to zero. This rapid discharge action applies a narrow pulse to G_1 and G_2 , whereas the relatively slow ramp rise doesn't couple through C_2 . Positive discharge pulses produced by a positive V_i are coupled to the output only through G_1 , while negative pulses are coupled only through G_2 .

The voltage-to-frequency conversion ratio can be scaled with counters fed from these G_1 and G_2 outputs. And the ratio can be changed to a limited extent by a change in the values of C_1 and R_1 . However, because of the forward breakover current of diodes D_1 and D_2 , the circuit won't operate below a minimum input voltage. An increase of R_1 increases this minimum voltage and reduces the circuit's dynamic range. The minimum input voltage with $R_1 = 1 \text{ k}\Omega$ is in the range of 10 to 50 mV.

This input dead zone, when input signal V_i is near zero is desirable in applications that require a signal to exceed a certain level before an output is generated. The original application of this circuit in a proportional temperature controller made use of this hysteresis feature to help stabilize the system. And the output-signal polarity determined whether the controller cooled or heated the system.

Stephen D. Anderson, *Electrical Engineer*,
1341 W. Maynard Dr., St. Paul, MN 55101.

CIRCLE NO. 311

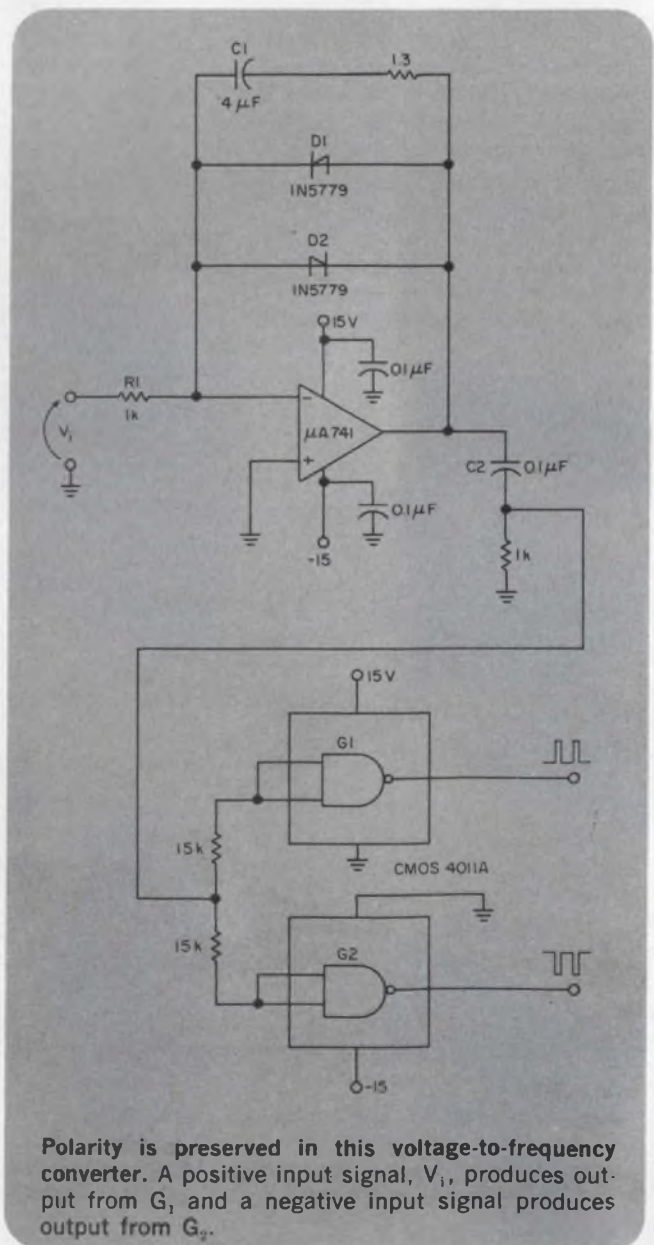

Next time you need custom power supplies, talk to Deltron. The nation's leader. Because Deltron gives you more.

More Experience. We're not just another maker of standard power supplies who occasionally build custom units. We've been making custom power supplies since 1952. It's our business. We've accumulated an enormous library of circuit designs and established methods, while making the highest quality power supplies in the business.

More Feedback. Talk to Deltron. And Deltron talks back. With technical assistance, good documentation and follow-up. We take your specifications and expertly build supplies to meet them. To make them work better. And longer. And at lower cost.

More Facilities. Deltron's continuing R&D programs insure that your customs will be made using the latest technology, components, and manufacturing tech-

niques. Our modern facilities include a U.L. printed circuit department. In-plant magnetics department. And a graphics and technical writing department.

More Technology. Deltron was the first to provide precision cut back for short circuits. First to develop the power steering circuit. First with an IC regulation system. Our U.L. expertise includes 544, 478, PC boards and transformers to 180°C.

More Service. Quotes in three days. Delivery in eight weeks. Call collect. Ask for our Custom Applications Department. Or send for literature. It includes our instant quotation form. A convenient guide to specify your custom power supply requirements.

Next time get what you need . . .

Write or call collect to Deltron, Inc.,
Wissahickon Avenue, North Wales, Pa.
19454, 215-699-9261, TWX 510-661-8061.

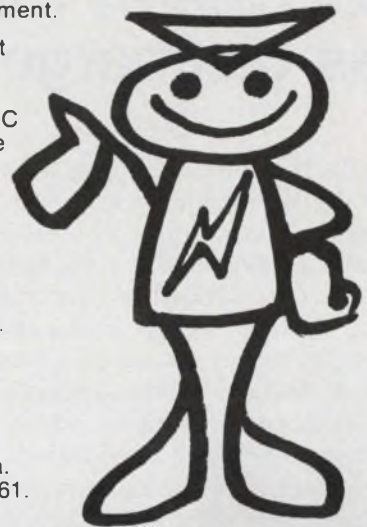

Deltron Custom Power Supplies have what you need...

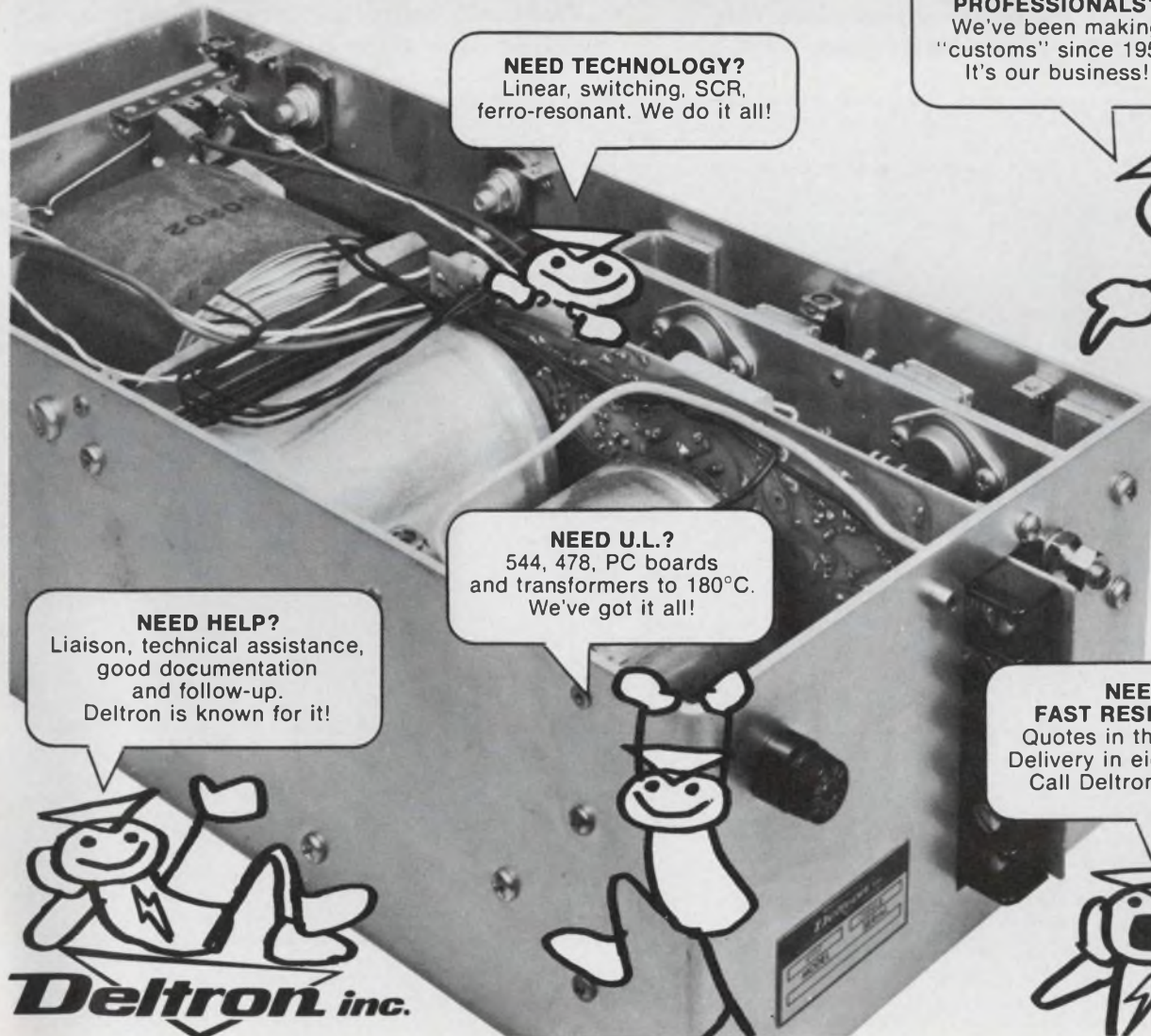

NEED TECHNOLOGY?
Linear, switching, SCR,
ferro-resonant. We do it all!

NEED EXPERIENCED PROFESSIONALS?
We've been making "customs" since 1952. It's our business!



NEED U.L.?
544, 478, PC boards
and transformers to 180°C.
We've got it all!

NEED HELP?
Liaison, technical assistance,
good documentation
and follow-up.
Deltron is known for it!

NEED FAST RESPONSE?
Quotes in three days.
Delivery in eight weeks.
Call Deltron collect!

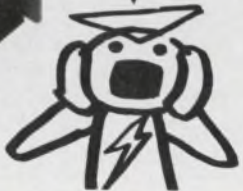

MOS alarm-clock chip drives gas-discharge display directly

With the proper power supply, a standard MOS digital alarm-clock circuit can drive a gas-discharge display directly (Fig. 1). Each display segment is driven by a dedicated driver within the chip. One advantage over single driver, multiplexed systems is the elimination of the multiplexer frequency as an RFI source. Another important feature is the circuit's transformerless regulated power supply, which uses few parts and has low-power dissipation.

The display draws no segment current up to an anode-cathode potential of 120 V. A 20-V increase above 120 illuminates the segment to approximately 200 ft-lamberts. Therefore the driver circuit need only be capable of providing a low-voltage swing above a 120-V bias to illuminate the segment brightly. And the low-voltage breakdown MOS transistor in the clock chip can safely control the gas-discharge display.

The V_{SS} terminal of the digital clock chip is connected to the circuit's high-voltage point, and

its V_{DD} terminal is connected to -27 V with respect to V_{SS} . The clock circuit's output common-source terminal (pin 23) is jumpered to V_{DD} .

The circuit derives its power and timing from a 50 or 60-Hz ac line of 105 to 130 V. The power input is half-wave rectified by D_1 and filtered by C_1 . Components VR_1 , Q_1 , and R_2 form a constant-current generator to control series-voltage regulator Q_2 . Resistor R_1 prevents thermal runaway of Q_2 , which can result from leakages in Q_1 .

At start-up, R_1 is a current path to VR_1 via R_3 . Though the power-supply circuit regulates the output voltage for input line variation only from 105 to 130 V, the arrangement allows power to be applied to the MOS clock chip with as little as 25-V-ac input, which can still maintain the timekeeping function. Power dissipation for the entire circuit at an input voltage of 130 V is less than 5 W.

Resistor R_5 limits the current to the frequency time-base input of the MOS chip, and C_2 together

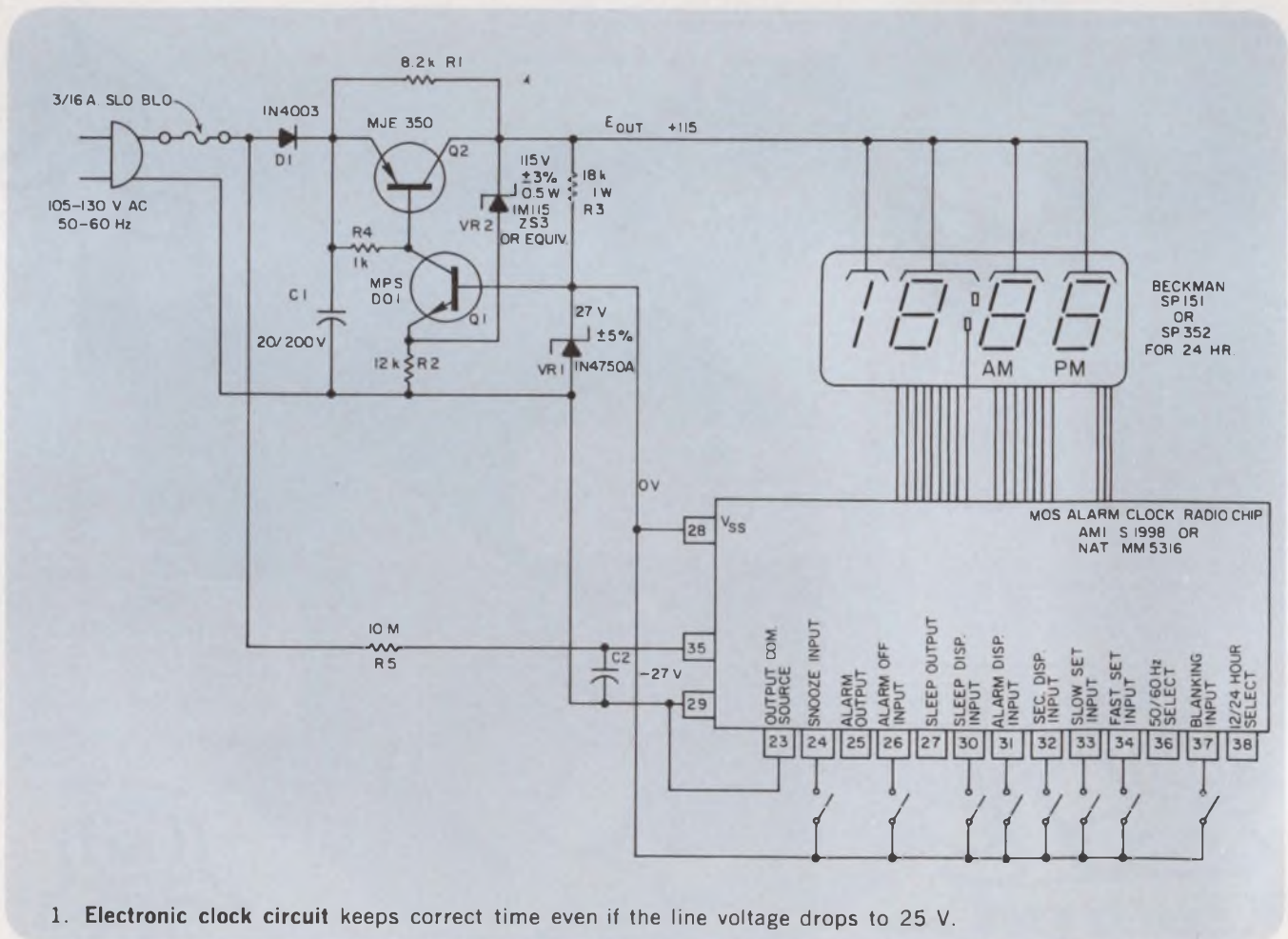

1. Electronic clock circuit keeps correct time even if the line voltage drops to 25 V.

NEW 5V/30A SWITCHER FROM ACDC

VOLTS	AMPS	MODEL NO.	PRICE*
5	30	JP5N30	\$265
5	60	JP5N60	\$436
5	100	JP5N100	\$535
5	150	JP5N150	\$765
5/±12	50/5	JT301	\$491
5/±15	50/4	JT302	\$491

*100 piece quantity

This mini-switcher is the newest addition to ACDC's 5 volt power supply line. It operates from a selectable input of 115/230 VAC, 47-63 Hz or 48-60 VDC. Like most power supplies, it's rated for full output at 40°C, but will also deliver over 83% of rated output at 50°C without internal fans or forced air cooling.

THE MOST DEPENDABLE SWITCHERS ON THE MARKET. AND YOU CAN PROVE IT

Just ask for an evaluation unit and put it through its paces...at your plant...under your own supervised test conditions. ACDC switchers will work better, longer and more dependably than any other switcher you can buy.

HOW CAN WE BE SO SURE?

Switchers are complicated devices...tricky, temperamental and tough to build, but we've been building them for over six years and have eliminated all the major problems.

We start with a proven electrical design, proper derating of quality domestic components and rigid, comprehensive, in-process controls. All semiconductors, the most common cause of switcher

failure, are thermally shocked for three cycles from 0°C to 100°C, followed by a 48-hour bake at 150°C. A thorough electrical test eliminates marginal devices and isolates potential failures due to thermal stress and infant mortality.

A second phase of testing occurs after final assembly. Each power supply is subjected to a no load/full load burn-in at elevated temperatures for a minimum of 24 hours, then put through another test cycle before it gets an inspector's stamp of approval.

ACDC switchers are designed to work when you get them and built to last so you can depend on them.

A WIDE RANGE OF POWER SUPPLIES SOLD AND SERVICED INTERNATIONALLY

In addition to these 5 volt switchers, ACDC also offers 12, 15, 20 and 24 volt switchers rated at 150, 300, and 500 watts. These switchers and 200 other conventional power supplies are available from stock and serviced at eighteen service centers throughout the world. The complete line is detailed in our new 72-page catalog. Write for it. It's free.

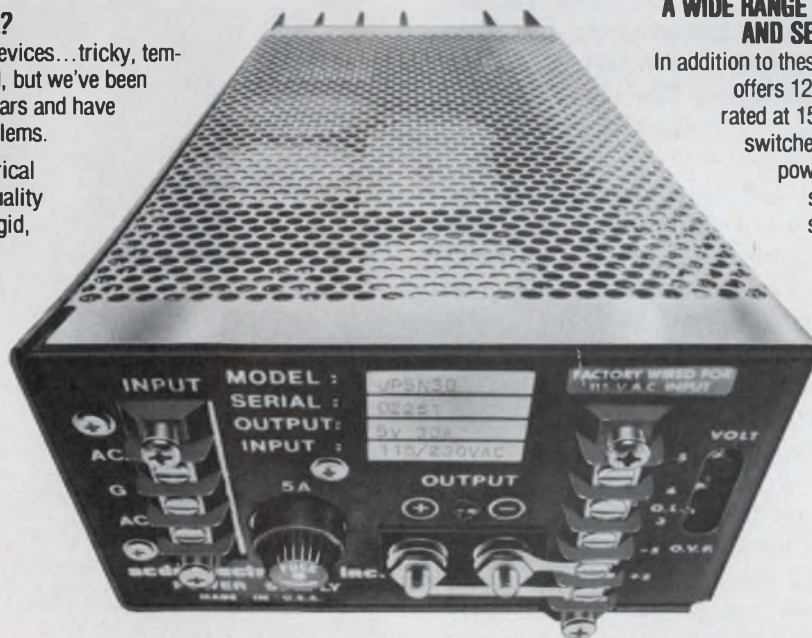

acdc electronics

401 Jones Road Oceanside, California 92054 (714) 757-1800

INFORMATION RETRIEVAL NUMBER 55

IDEAS FOR DESIGN

with R_3 form a low-pass filter to reduce noise inputs to the clock.

Dimming of the display may be a desirable feature. If the blanking input of the clock chip is connected to the ac line, 50% dimming is achieved. For continuous dimming control, the blanking input is used as a summing junction

(Fig. 2). The ac input is summed with variable dc. Because the blanking input behaves as a Schmitt trigger, the varying dc changes the duty cycle of the display to control its illumination. The keep-alive connection to the display minimizes the re-ionization time.

Eugene Y. K. Lew, Project Engineer, Beckman Instruments, Inc., P.O. Box 3579, Scottsdale, AZ 85257.
CIRCLE No. 312

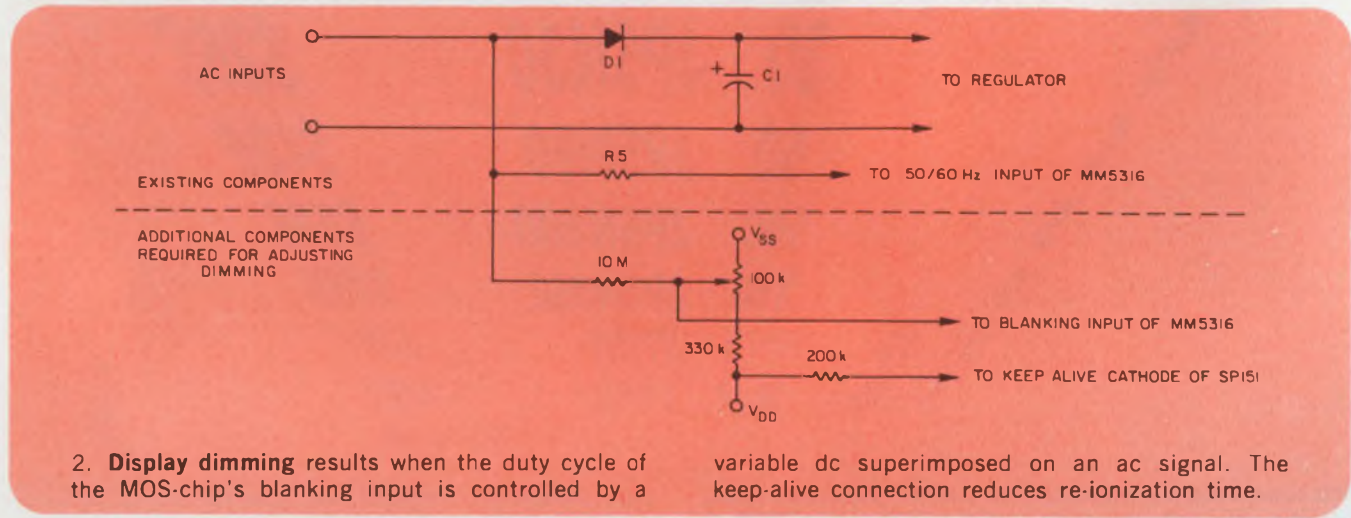

Inverter uses ferrite transformer to eliminate cross-conduction

A bipolar inverter usually requires several components to provide pulse-polarity reversal and the necessary delays to prevent cross-conduction of the power transistors. The circuit in the figure uses a single ferrite pulse transformer to provide both these functions.

The inverter uses a 555 timer operating at 25 kHz to drive the circuit. During the rising half of each timer output cycle, C_2 charges and turns on Q_1 . And each time the output of the 555 goes low, C_2 discharges through diode D_1 and the primary of the ferrite transformer, T_1 . The polarity of the T_1 windings are arranged to generate a positive current to turn on Q_2 during this C_2 discharge portion of each cycle.

The inductance of T_1 delays current flow so transistor Q_2 doesn't conduct until Q_1 is off, thus cross-conduction is eliminated. And then the fly-back action of T_1 aids the turn-off of Q_2 , when the timer voltage rises again. The circuit thus provides a uniform bipolar drive to power transformer T_2 , as required for maximum inverter efficiency.

Paul Domiciano, Application Engineer, Indiana General, Keasbey, NJ 08832. CIRCLE No. 313

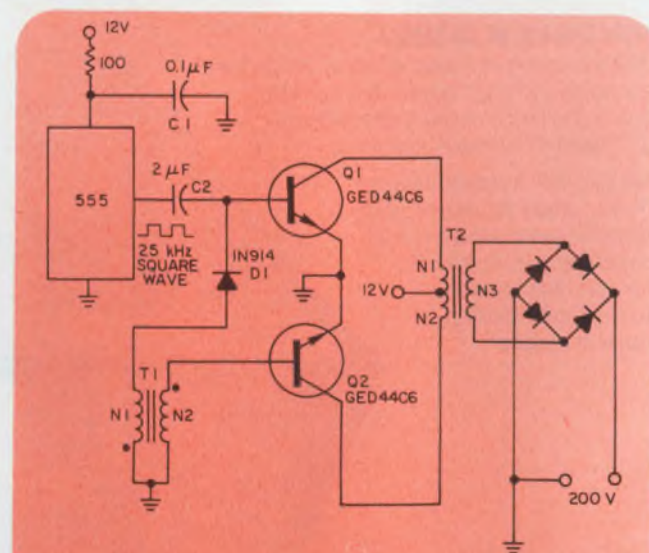

T1 F62S-9-06 TOROID N1=20 N2=10
T2 IR8112 E CORE N1=N2=30 N3=500
BOTH FROM INDIANA GENERAL

The inverter has uniform bipolar drive, because a ferrite transformer provides pulse-polarity reversal and eliminates transistor cross-conduction.

CANNON® COST CUTTERS: ADAPTA-CON INTERCONNECTION SYSTEM



IT LOWERS YOUR TOTAL INSTALLED COST.

Adapta-Con solves one big problem: it meets the ever increasing demand for more versatile, high- or low-force, post-and-receptacle interconnections at less cost per termination. Now you can design your product around the Adapta-Con system and lower your total installed cost—your *real* cost.

Description: Adapta-Con is a versatile approach to printed circuit board, backplane, and I/O interconnection systems.

They're available as box-type PC connectors (single and double row UBS) with 0.100, 0.125, and 0.150 centers. Other styles are box-type, crimp insertable contacts (UBC bulk and reel types) for use in UBC receptacles (single and double row) that mate with 0.025 square posts in UBP assemblies (metal plates and PC boards). There is also a broad line of special assemblies, as well as hand tools and semi-automatic machines. Material is copper alloy, finished in gold over nickel or 90/10 electro-deposited tin lead.

Applications: EDP and computer peripheral equipment; commercial, military, and consumer electronics; indeed, it's so universal, it's used wherever electronic packaging is required.

For the first time, Adapta-Con is available locally from the Cannon nationwide distributor network. Send for the "Cannon Cost Cutters" brochure, ITT Cannon Electric, 666 E. Dyer Rd., Santa Ana, CA 92702, (714) 557-4700, and find out how

**CANNON
ENGINEERING
LOWERS YOUR COSTS.**

CANNON ITT

Linear bar graph constructed with sequentially lighted LEDs

A simple way to make a bar-graph display is to arrange a number of LEDs in a linear array and illuminate them in a sequence that is proportional to an input voltage (Fig. 1).

With an input voltage, V_c , of about 3 V, resistors R_1 to R_5 supply sufficient base current to saturate transistors Q_1 to Q_5 . This ensures that all the LEDs are extinguished. When V_c decreases, a point is reached where the current in R_1 diverts through D_5 instead of D_1 . Then transistor Q_1 turns off and LED₁ lights. If V_c is further reduced, D_7 becomes forward-biased and the current from the Q_2 base is diverted to enable LED₂ to light. Further V_c reduction, successively turns off each transistor and lights the

corresponding LED.

Diodes D_1 to D_5 protect the transistors from reverse V_{be} . Transistor Q_6 provides a constant current to the LED chain.

Though Fig. 1 shows only five LEDs, the circuit may be extended to operate any reasonable number, if a sufficiently high supply voltage is available. Fig. 2 shows the linear response and the values of V_c obtained with a 10-LED display. Each LED lights fully before the succeeding one starts to light.

J. R. Ball, 7, Moorfield Rd., Woodbridge, Suffolk, IP12 4JN, England.

CIRCLE NO. 314

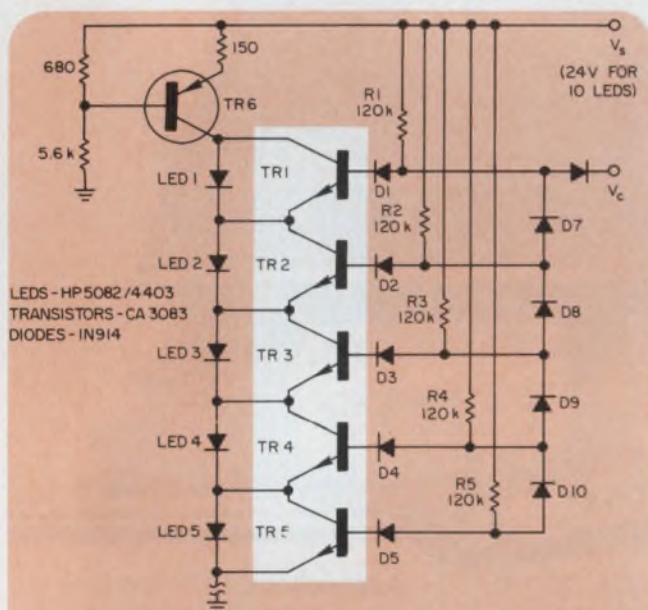

1. A bar-graph circuit provides a linear display for positive or negative control voltages.

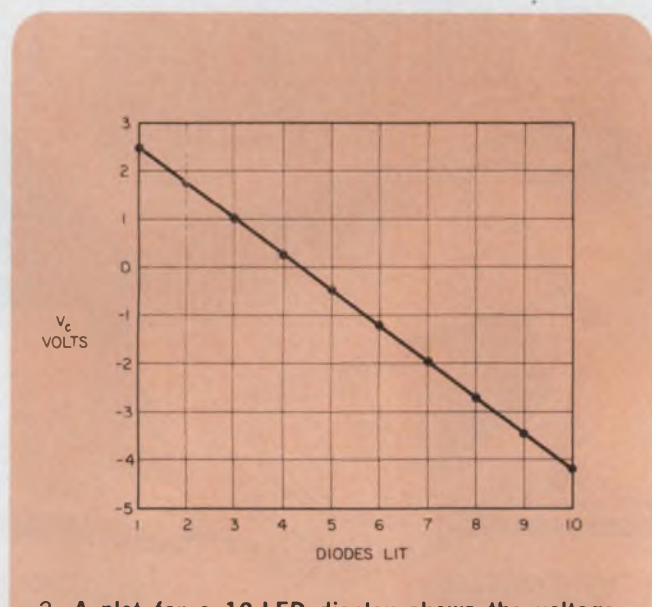

2. A plot for a 10-LED display shows the voltage range the circuit can handle and the values of V_c needed to light the LEDs.

IFD Winner of June 21, 1975

J. L. Huertas, Associate Professor of Electronics, and A. Civit, Professor of Electricity, Facultad de Ciencias, Universidad de Sevilla, Spain. Their idea "Square-Wave Frequency Divider Provides Symmetrical Output for Odd Divisors" has been voted the Most Valuable of Issue Award.

Vote for the Best Idea in this issue by circling the number for your selection on the Information Retrieval Card at the back of this issue.

SEND US YOUR IDEAS FOR DESIGN. You may win a grand total of \$1050 (cash)! Here's how. Submit your IFD describing a new or important circuit or design technique, the clever use of a new component or test equipment, packaging tips, cost-saving ideas to our Ideas for Design editor. Ideas can only be considered for publication if they are submitted exclusively to ELECTRONIC DESIGN. You will receive \$20 for each published idea, \$30 more if it is voted best of issue by our readers. The best-of-issue winners become eligible for the Idea of the Year award of \$1000.

ELECTRONIC DESIGN cannot assume responsibility for circuits shown nor represent freedom from patent infringement.

4K GENERIC PROM- new addition to the family.

With the introduction of the Harris family of GENERIC PROMs, stand alone PROM design is fast becoming obsolete. Diverse requirements for density, modularity, and performance within a system can be totally satisfied by this one generic family.

And now there's a brand new addition to the family. The 512x8 (4K) PROM device. Like the 256x4 (1K), the 512x4 (2K), and the 32x8 (256) devices, it is now in volume production. And can help upgrade your system's performance as well as lower your costs.

The advantages of the Harris GENERIC PROM family over ordinary PROMs are many. For instance, each device within a series features identical DC electrical specifications plus common programming requirements, permitting easy use of other family elements.

GENERIC PROMs have fast programming speeds. Equivalent I/O characteristics for easy upgrading. Faster access time. Guaranteed AC and DC performance over full temperature and voltage ranges. And improved testability.

For Harris, the addition of the 4K

PROM device marks another step in the continual development of the GENERIC PROM concept. A concept that only Harris offers.

So if you're considering PROM devices, consider the Harris GENERIC family. For details see your Harris distributor or representative.

Device #	No. of Bits	Organi- zation	No. of Pins	Max. Access Time*		Price 100 up.	
				Comm	Mil.	Comm.	Mil.
HM-7602 (open coll)	256	32 x 8	16	40ns	50ns	\$2.95	\$5.95
HM-7603 (three-state)	256	32 x 8	16	40ns	50ns	\$2.95	\$5.95
HM-7610 (open coll)	1024	256 x 4	16	60ns	75ns	\$4.95	\$9.95
HM-7611 (three-state)	1024	256 x 4	16	60ns	75ns	\$4.95	\$9.95
HM-7620 (open coll)	2048	512 x 4	16	70ns	85ns	\$9.95	\$19.95
HM-7621 (three-state)	2048	512 x 4	16	70ns	85ns	\$9.95	\$19.95
HM-7640 (open coll)	4096	512 x 8	24	70	85ns	\$19.95	\$39.95
HM-7641 (three-state)	4096	512 x 8	24	70	85ns	\$19.95	\$39.95
HM-7642 (open coll)	4096	1024 x 4	18	70	85ns	Available January '76	
HM-7643 (three-state)	4096	1024 x 4	18	70	85ns		
HM-7644 (active pullup)	4096	1024 x 4	16	70	85ns		

*Access time guaranteed over full temperature and voltage range.
Industrial ($T_A = 0^\circ\text{C}$ to 70°C , $V_{CC} \pm 5\%$)

Military ($T_A = 55^\circ\text{C}$ to 125°C , $V_{CC} \pm 10\%$)



HARRIS
SEMICONDUCTOR
A DIVISION OF HARRIS CORPORATION

P.O. Box 883, Melbourne, Florida 32901 (305) 724-7412

WHERE TO BUY THEM: OEM SALES OFFICES: CALIFORNIA: Long Beach, (213) 426-7687; Palo Alto, (415) 964-6443 FLORIDA: Melbourne, (305) 724-7430 ILLINOIS: Hinsdale, (312) 325-4242 MASSACHUSETTS: Wellesley Hills, (617) 237-5430 MINNESOTA: Minneapolis, (612) 835-2505 NEW YORK: Endwell, (607) 754-5464; Melville, L.I., (516) 249-4500 OHIO: Dayton, (513) 226-0636 PENNSYLVANIA: Wayne, (215) 687-6680 TEXAS: Richardson, (214) 231-9031
SALES REPRESENTATIVES: ARIZONA: Scottsdale, (602) 948-5590 CALIFORNIA: Los Angeles, (213) 870-9191; Mountain View, (415) 961-8121; San Diego, (714) 565-9444 COLORADO: Denver, (303) 771-4920 FLORIDA: Boca Raton, (305) 395-6108; Oviedo, (305) 365-3283; Tampa, (813) 933-3183 ILLINOIS: Elk Grove Village, (312) 640-1850 KANSAS: Wichita, (316) 943-6221 MARYLAND: Randallstown, (301) 922-1248 MASSACHUSETTS: Lawrence, (617) 685-7973 MISSOURI: Hazelwood, (314) 731-5799; Kansas City, (816) 761-6543 NEW JERSEY: Middletown, (516) 549-4283 NEW YORK: Albany, (518) 489-7408 or 4777; Huntington Station, (516) 567-5900 NORTH CAROLINA: Raleigh, (919) 828-0575 OHIO: Cleveland, (216) 831-8292; Dayton, (513) 890-2150 OREGON: Beaverton, (503) 643-1644 PENNSYLVANIA: Allison Park, (412) 487-4300; King of Prussia, (215) 265-0634 TENNESSEE: Shelbyville, (615) 684-4544 TEXAS: Dallas, (214) 691-4592; Houston, (713) 661-3007 VIRGINIA: Falls Church, (703) 534-1673; Lynchburg, (804) 237-4140; Troutville, (703) 345-3283; Virginia Beach, (804) 481-7200 WASHINGTON: Bellevue, (206) 454-0300

TV channel numbers displayed on screen

A circuit for displaying TV channel identification numbers on the tube has been developed by N V Cobar Barco Electronic of Kortrijk in Belgium.

The program numbers appear in white figures, 35 mm high, on a black background in the upper left-hand corner of the screen. The figures appear each time the channel is changed or the recall button is pushed. They remain in view for about five seconds.

The numbers, as many as there are channels, are made up of eight segments (A.....G + Z) overlapping each other at the corners (see figure). Pulses from the eight-segment generators are connected to an AND gate, to which is also fed an input to verify whether or not a segment is required for a particular digit. This information is generated by preselection ICs via a diode matrix. The segment pulses at the output of the AND gates are brought together in an OR gate and are clamped into the video signal.

In this video signal the background pulses, which are directly

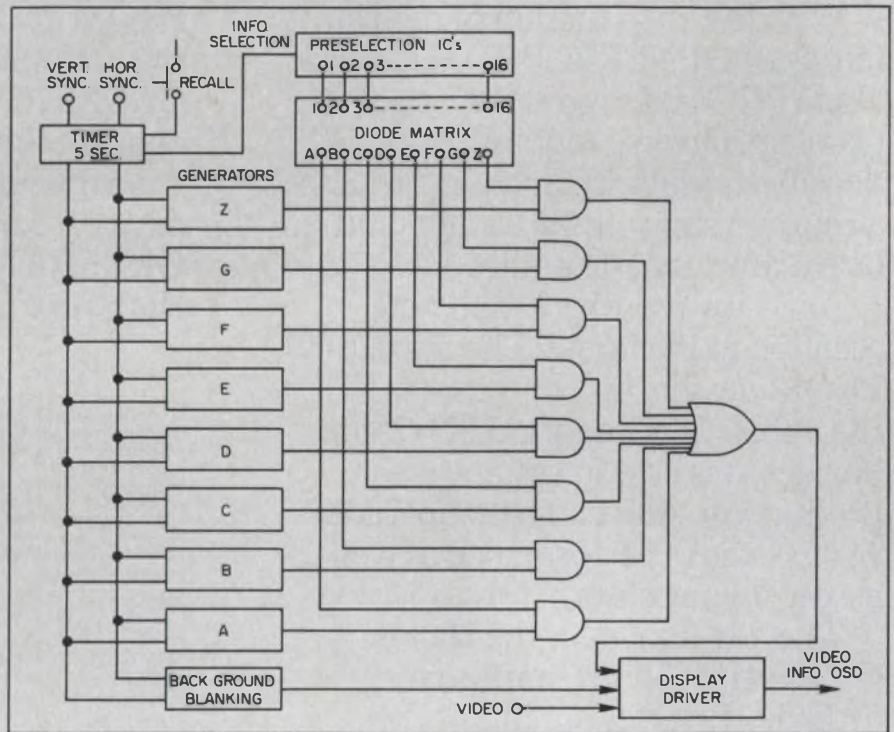

obtained from a ninth generator, are also clamped. The generators (a combination of monostable mul-

tivibrators) are triggered by line and feedback pulses, which are interrupted after five seconds.

Ultrasonics helps infants to 'see'

The ultrasonic walking stick, popular with blind adults, has been redesigned to provide babies with "binocular" information, an important ingredient in normal development. An experimental device developed by a Scottish researcher at Stanford University, England, has been fitted to a baby born last September with a congenital retina disorder.

Operation of the ultrasonic unit is relatively simple. The child wears a transducer about the size of a half-dollar piece strapped to

its forehead. This emits an 80° cone of sound.

Echoes are converted by two receivers on the headset into audible sound. The closer an object, the lower the frequency of the sound heard. The larger the object, the louder the signal. It is also possible to tell the difference between hard and soft surfaces.

TV sound picked up without need for wiring

A device for picking up sound signals from television receivers, without a wired connection, has

been produced by Dinosaur Electronics Ltd., London.

In the British television signal, the sound and vision carriers are separated by 6 MHz. The system employs an antenna or coil probe, placed in the region of the TV i-f strip, to pick up stray radiation of a signal that is the difference between the sound and video signal carriers. This sound signal is 6 MHz FM.

The 6 MHz is fed, via an amplifier and limiter, to a frequency discriminator, which recovers the sound. The sound signal can be fed into an amplifier, such as a hi-fi, for quality reproduction.

THERMAL PRINTER AND POWER SOURCE NOW, TOGETHER FROM NCR.



Now you can offer your customers a "receive only" Thermal Printer that contains its own power source. No extra box. No extra cable. Just one handsome cabinet.

With the new EM-T33 (parallel) or the EM-T44 (serial) unit from NCR you can provide distinct advantages over other terminals.

Quiet ... almost completely electronic, the only sound

comes from the movement of paper and a non-impact printing head.

Fast ... Up to 30 characters per second is the printing speed—2 to 3 times faster than terminals with conventional impact printers.

Accurate ... Hard copies of every message means no slips of memory; no mistakes in transcribing which are possible with some units.

Compact ... One single, light, easy-to-carry unit contains both

the thermal printer and the power source in a single attractive cabinet.

Here's a way for you to increase the benefits you offer in the communications system you sell ... and increase your sales and profits by doing so.

For more information on this and other components for your communication systems, please contact us today.

NCR

Terminal Systems Division - Ithaca

Director of Marketing
P.O. Box 490, Ithaca, N.Y. 14850 607-273-5310

**EXTRA!
EXTRA!**

**Free Demos
Arranged!**

★★★★★

Compatible Memory News

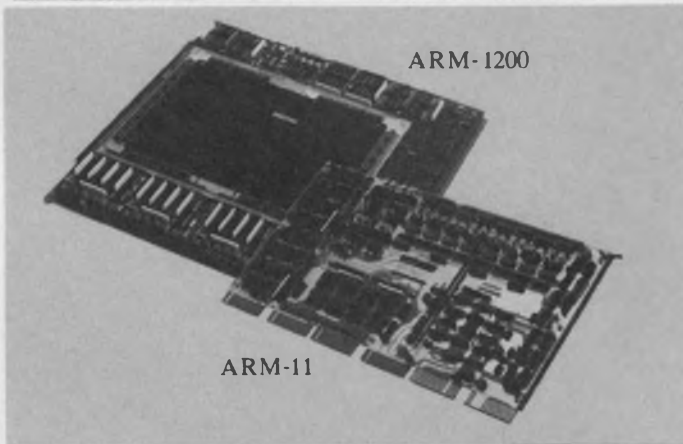

EXTRA SAVINGS

Ampex add-in memory modules save hundreds of dollars (20% or more) over the original mainframe manufacturer's list price.

EXTRA CAPACITY

Ampex add-in modules give you 16K capacity per unit, and use only two slots in PDP-11, and use only one slot in Nova 1200 computers.

EXTRA RELIABILITY

Ampex add-in memories offer better margins, lower noise, and more conservative design overall than any competitive product you can buy.

EXTRA AVAILABILITY

Ampex ARM-11 and ARM-1200 memory add-in modules are available immediately from stock.

DEC AND NOVA* USERS SAVE \$\$\$

Now Ampex representatives have immediate stock of add-in memories for PDP-11 and Nova 1200 series computers.

Call your closest Ampex Memory Man today and tell him to bring out an Ampex add-in so you can see how well it works, how easy it is to expand your capacity, and how much money you can save.

TEST ONE TODAY. CALL AMPEX

(201) 489-7400	(312) 593-6000
(212) 736-6116	(412) 371-6050
(213) 240-5000	(415) 367-3861
(214) 637-5100	(516) 822-9110
(215) 887-7650	(617) 890-2040
(301) 530-8800	(713) 774-8714
(305) 783-1811	

*TM. Data General Corporation

AMPEX

Ampex Memory Products Division
13031 West Jefferson Blvd.
Marina Del Rey, CA 90291

FOR ARM-11, CIRCLE #282
ELECTRONIC DESIGN 22, October 25, 1975

FOR ARM-1200, CIRCLE #281
136

Processor family debuts: 16 bit μ P to full blown mini, with software support

Texas Instruments, P.O. Box 1444, Mail Station 784, Houston, TX 77001. (512) 258-5121. See text.

Though microprocessors have proliferated lately like so many unchecked rabbits, no vendor has gone to the lengths that Texas Instruments has in developing a new product. The recently unwrapped 990 is not just another microprocessor, but a family of computers built around a 16-bit single-chip μ P.

This is the "big gun" that, TI hopes, will blast the company to the forefront of the marketplace. Whether TI's heavy artillery has enough range remains to be seen. Nevertheless the weapon appears formidable. Three members make up the family now, with more models to follow; the three are: the TMS 9900 μ P, the 990/4 microcomputer on a card and the 990/10 minicomputer—a TTL implementation of the 990's architecture and the most powerful member of the family.

All 990 members are upward compatible in software and share a host of standard, prominent features. Included are independent bit, byte and word addressing of memory and I/O; 16 vectored interrupts; hardware context switching, which lets the computer handle multiple jobs; hardware multiply and divide; and 16 extended operation instructions (XOP), which allow the computer to go to a software subroutine if a specific hardware module (such as floating point) isn't present.

With the 990's addressing capability, you can handle I/O operations at the interface (called the Communications Register Unit, or CRU) at the bit level or in groups of up to 16 parallel bits. This can simplify and lower costs of periph-

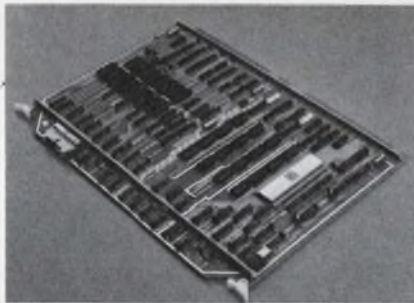
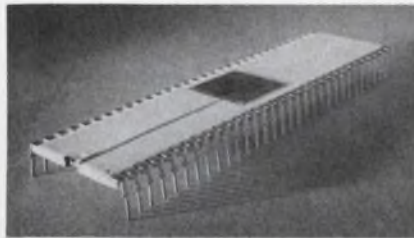

peripheral interfacing—usually a tedious, expensive task. And independent busses for memory and I/O keep information flowing with minimum delay.

In the 990/10, a feature called TILINE by TI is actually a direct memory access composed of a 16-bit parallel data bus that links the CPU, memory and high-speed peripherals. Since the bus is asynchronous, it can accommodate both slow and fast memory. And device synchronization worries are eliminated.

One of the more salient capabilities of the 990 is rapid context switching, made possible by programmable 16-word workspaces located in memory and said to be ten

times faster than competing units. When a program is interrupted, the contents of three registers—the program counter, workspace pointer and status register—are stored automatically in the workspace. When the program resumes, the contents are reloaded automatically.

Attributes of the μ P—an n-channel, silicon-gate MOS chip—include separate 16-bit data and 15-bit address busses, a repertoire of 69 instructions, and register-to-register addition in 3.5 μ s. Just one instruction is needed to multiply or divide. Support circuits and software complement the chip.

Using the MOS chip as the central processor, the 990/4 PC card also carries up to 8 kbytes of dynamic RAM and up to 2 kbytes of static RAM or PROM/ROM. Also on the card is a real-time clock (120 Hz) input, vectored interrupts, a front-panel interface, the CRU port and a high-speed bus interface (memory expansion).

You can get the 990/4 in a low-cost OEM chassis or in either of two rack-mount chassis, 7 in. or 12-1/4 in. Or a table-top version is available. The chassis options provide for a programmer's front panel and I/O slots. With a chassis, you can expand memory up to 128 kbytes (12-1/4 in.) and opt for any of several power-supply choices.

At the top of the new TI line, at present, is the 990/10—the TTL version of the family. Composed of three cards in its basic configuration, one of which contains 16 kbytes of memory, the 990/10 supports memory expansion to two-million bytes with a memory mapping option. Chassis options of the 990/10 are the same as those of the 990/4.

from Grayhill

the different DIP Switch



- Exclusive sliding ball contact system for positive wiping action



- Life tested to 50,000 mechanical operations, with commensurate electrical life

- Available in 9 sizes, even a hard-to-find 2 rocker version, on up to 10 rockers

- All SPST, each switch independent, rocker actuated

Of course, the different DIP Switch—Grayhill's Series 76—also offers the standard DIP benefits of easy PC board mounting, compact high density design and a multitude of cost savings. Get the full story, including detailed specifications and prices, in Grayhill Engineering Bulletin #247 available free on request.



561 Hillgrove Avenue • La Grange, Illinois 60525
Phone (312) 354-1040

DATA PROCESSING

Many options are available for the 990, including parity, memory expansion, power fail/auto restart, battery pack and standby power, ROM loaders, and the like. And, of course, you can choose from TI's wide line of peripherals.

Under development for release in 1975 is a cross-support package consisting of assembler, linking loader, and simulator available on National CSS, Tymshare and GE time-sharing networks.

A wide range of software packages is planned for release early next year. Included are: a prototyping system for development of custom firmware modules for the TMS 9900; software development systems for development of appli-

cations programs for the 990/9900 family; disc operating system, editor, assembler, debug monitor and many others.

In addition, such high-level languages as COBOL, FORTRAN IV and BASIC will be available early next year.

Prices of the TI 990 family stack up as follows: For the 990/4 with 512 bytes of memory, \$368 (50). For the 990/4 in the OEM chassis and 8 kbytes, \$624 (50). For the 990/10 with 16 kbytes, \$1264 (50). Price of the TMS 9900 μ P was not available at press time.

Deliveries of the new computers, software development systems and the prototyping system will begin in March, 1976. The TMS 9900 will be available in the first quarter of 1976.

CIRCLE NO. 310

μ processor calculator offers new capabilities



Hewlett-Packard, 1501 Page Mill Rd., Palo Alto, CA 94304. (415) 493-1501. 9815A, \$2900; 9817A, under \$4000; 10 wks.

Model 9815A programmable desktop calculator is said to be smaller, faster and have greater interface capability than any in its price class. Another unit, the 9817A, is a rugged output printer with plotting and tabulating capabilities.

The 13-lb 9815 has a built-in tape drive that uses a new, fast bidirectional cartridge that has greater information packaging density than any similarly sized cartridge currently on the market. New memory chips, a new built-in alphanumeric thermal printer and programming enhancements are also standard.

A library of prerecorded pro-

grams on cartridges is available in the areas of statistics, engineering, research, the life sciences, and surveying. Reverse Polish Notation (RPN) is used, and the calculator's buffered keyboard is arranged in convenient blocks to further simplify computation. One block contains 24 preprogrammed scientific functions, another contains memory stack manipulation and simple arithmetic function keys. The third block contains program control keys and 15 user definable keys for single keystroke execution of programs.

An AUTO START feature automatically loads the first file from the cartridge into the calculator and executes the program when the 9815 is turned on.

In addition to a four-memory input stack, the 9815 has 472 steps of program memory and 10 data storage registers. An option is available to expand the calculator's internal memory to 2008 program steps. Program steps can be exchanged internally for memory registers at the rate of eight steps per register.

The dual-track data cartridge stores 96,000 bytes of information (approximately equal to 45 2008-step programs). It has a search speed of 60 ips and a read-write speed of 10 ips. Information transfer rate is 8000 bits per second, and packing density is 800 bpi.

CIRCLE NO. 324

When Honeywell engineers designed the Model Ninety-Six, they had just two objectives: make it the leader and stay on top.

Becoming the leader in its introductory year was an almost unheard-of accomplishment in the field of lab quality magnetic tape recorders/reproducers. It could have been a real temptation for the designers of the Model Ninety-Six to sit back and relax, watching the competition play catch-up.

But they weren't — and aren't — that kind of engineers. From the day the first Model Ninety-Six was shipped more than two years ago, they've never slowed their efforts to make the new leader even more outstanding. Changes have been made to improve reliability and ease of operation. Here are a few of the features that keep the Ninety-Six out ahead of the pack:

- Solid ferrite heads deliver stable, rock-solid data and they're warranted for 3,000 hours at 120 ips.
- A space-saver combination: In 3½ inches of rack space, 14 omniband record amplifiers, 14 record/reproduce monitors, 14 record level amplifier/attenuators and 14 reproduce output level amplifier/attenuators — all front-panel controlled!

- Accepts ¼-inch tapes on 7-inch plastic reels. You don't have to dub your field recorder data before processing.
- High slew rate servomotor gives super spectral purity.

- Selective track record.

Normally, when "record" is selected, all record heads are energized with bias, whether or not data is present. The Model Ninety-Six permits selective energizing of each record track to improve tape utilization.

- Nine bidirectional tape speeds, adjustable fast and search speeds, all solid-state footage counter; super all-electronic shuttle system, E.O.T. sensing without optics, 16-inch reel capacity for the most usable and easy-to-use transport system around.

- Gentlest tape handling. Only the heads touch the tape oxide. No adjustments in tape path. No adjustments when changing reel sizes. 15-minute width change. No pinch rollers; no fixed guides. Low balanced tension is easy on tape and heads.

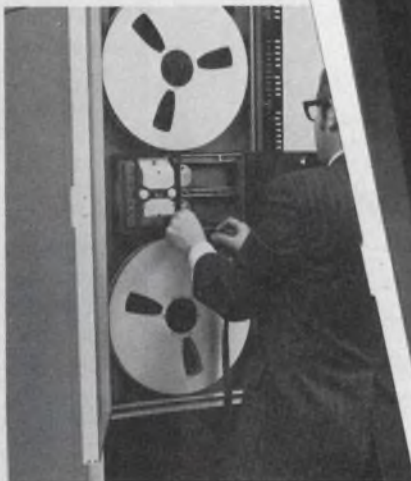

Want complete, up-to-date specifications? Call or write a reel expert: Ed Haines, (303) 771-4700, Honeywell Test Instruments Division, P.O. Box 5227, Denver, Colorado 80217.

FOR LITERATURE CIRCLE 279

**TEST
INSTRUMENTS
DIVISION**

Honeywell

FOR DEMONSTRATION CIRCLE 280

CRT terminal allows voice entry of data

Threshold Technology, Inc., 1829 Underwood Blvd., Delran, NJ 08075. (609) 829-8900. \$10,500 (unit qty).

Threshold 500 replaces or complements intelligent CRT stations by enabling the user to enter data by voice. The output of each Threshold 500 terminal is in the same format and code as that of a standard keyboard terminal. Voice input is especially valuable to personnel whose hands and eyes are already occupied in their normal work. The data are displayed for verification by the operator before entry.

CIRCLE NO. 325

Calculator programmed with magnetic cards

Texas Instruments Inc., 13500 N. Central Expressway, Dallas, TX 75222. (214) 238-2011. \$395.

A magnetic-card programmable handheld calculator, the SR-52, offers twice the programming and memory power of comparable models at half the price, according to TI. It executes programs prerecorded on 2-7/8 × 5/8-in. magnetic cards and can learn original programs written by the user. True algebraic entry allows problems to be entered exactly the way they are normally written. This is accomplished with a three-level hierarchy and nine levels of parentheses. The unit can store up to 224 program steps and numbers on a single magnetic card. Twenty independent addressable memory registers permit addition, subtraction, multiplication and division of any displayed quantity with any memory register without affecting the keyboard calculation in progress. And trig and logs, powers and roots, factorials, reciprocals, three conversions and pi can be directly executed from the keyboard. Ten decision instructions and five user-set flags allow the user to program repetitive decision and branch-program segments automatically.

CIRCLE NO. 326

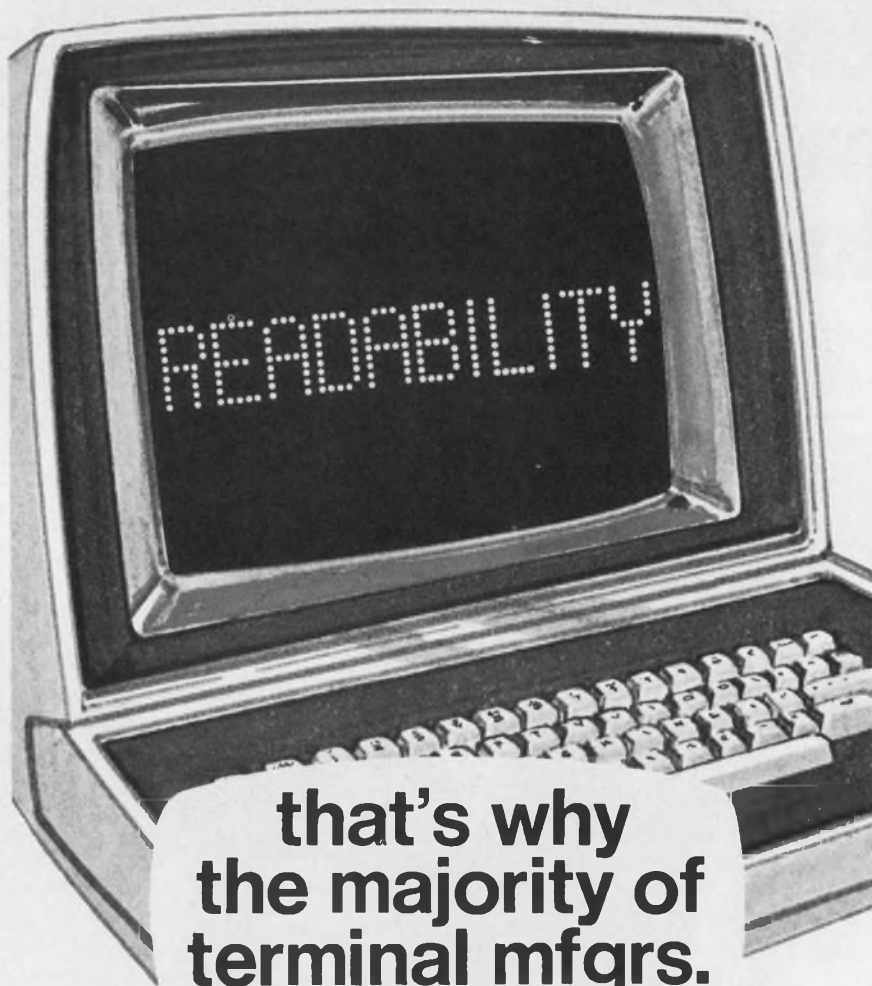

that's why
the majority of
terminal mfgs.
use

CLINTON CRT'S in their products

CLINTON...
the ANSWER people in CRT'S.



**CLINTON
ELECTRONICS
CORPORATION**

6701 Clinton Rd., Loves Park, Rockford, Ill. 61111 or phone 815-633-1444

The HC4D is a 4PDT relay that can switch 100 μ A, 10 VDC over one contact set and 3 A, 250 VAC or 30 VDC on another contact set. Save a relay. Save bucks. The secret's in bifurcated, gold-clad, silver-nickel moving and stationary contacts. HC4D's are super-reliable and have a $> 2 \times 10^5$

electrical life. They're small too: 1.079" L x .827" W x 1.280" H. Other great design features: arc barriers, debris wells, one-piece molded contact blocks, and hermetic sealing in plastic. There are no other relays like them. Send for detailed description and specs.

THE RELAY CIRCUIT SHRINKER.



Relays for advanced technology.



Arrow-M Corp. 250 Sheffield St., Mountainside, N.J. 07092 U.S.A.
Telephone: 201 232 4260

INFORMATION RETRIEVAL NUMBER 63

PRE-PUNCHED, PERFORATED, EXPERIMENTER or PROTOTYPE Boards.

VARIETY OF MATERIALS

GLASS EPOXY
PAPER PHENOLIC
COPPER CLAD
PAPER EPOXY

CHOICE OF THICKNESS

1/32, 3/64, 1/16, 3/32

WE CAN ALSO FABRICATE AND ASSEMBLE TO YOUR SPECIFICATION.

IN STOCK

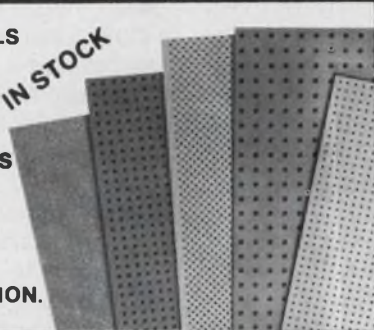

Whatever you call them... We make them!!!

SELECTION OF TERMINALS & HARDWARE

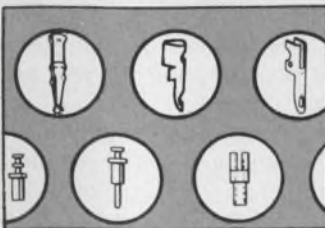

ASSORTED PATTERNS

Pattern	Centers	Hole Dia.
"A"	.265 x .265	.093
"B"	.187 x .187	.062
"E"	.250 x .250	.100
"F"	.200 x .200	.062
"G"	.100 x .200	.062
"H"	.375 x .375	.120
"P"	.100 x .100	.042

Send for new catalog.



KEYSTONE
ELECTRONICS CORPORATION

49 BLEECKER STREET • NEW YORK, N.Y. 10012 • (212) 475-4600

INFORMATION RETRIEVAL NUMBER 64

ELECTRONIC DESIGN 22, October 25, 1975

TWO HEADS ARE BETTER THAN ONE.

Especially when they save you money.

Our unique Sycor 145 Dual Diskette Recorder costs considerably less than two ordinary IBM compatible single-head models.

But price isn't the only reason our recorder is head and diskette above the crowd.

Take storage. With the Sycor 145, you have four times the storage capacity of the usual single head recorder. Because its two heads have the capability of writing on either side of the diskette.

And when it comes time to access that data, our recorder is even more impressive.

Being 3740-compatible, the Sycor 145 handles the same 77-track diskette as other recorders, but its track to track access time of 2.5 msec is the fastest in the industry.

Four times faster than the others.

But don't just take our word for it. Check out the competition. Then look at the Sycor Model 145. We think you'll prefer ours.

Now that there's two sides to the story.

SYCOR

Contact OEM Department, Sycor, Inc.,
Ann Arbor, Michigan 48104. Telephone (313) 971-0900.

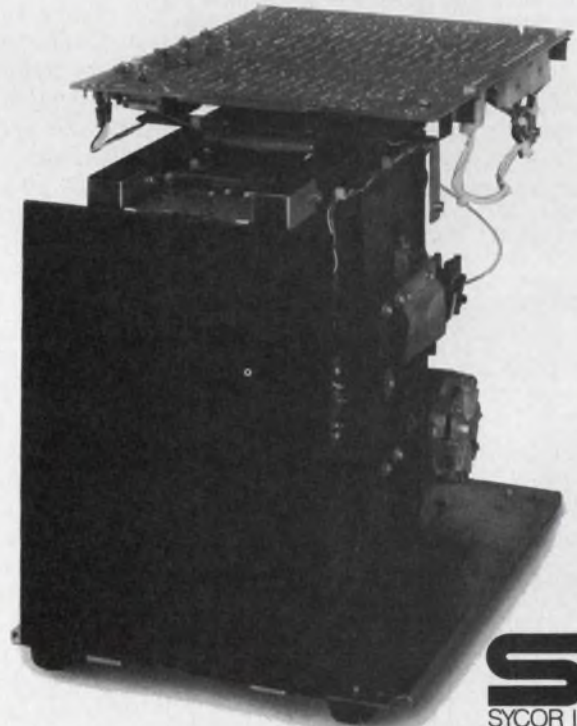

SI
SYCOR INC

Internationally represented by
Munzig International in London, Paris, and Geneva;
by CORE, GmbH, in Copenhagen, Hamburg, and Frankfurt;
by Mitsui & Co., Industrial Machinery Dept., Tokyo;
and by STG International in Tel Aviv.

INFORMATION RETRIEVAL NUMBER 65

mini-computer data acquisition family

Adac Data Acquisition Systems give the user a superior alternative to expensive external systems and the time-consuming task of assembling a system.

Adac systems are available for most popular minicomputers. They offer superior performance at savings up to \$4000 over other approaches.

Advantages:

- Lowest cost
- Up to 64 channel multiplexer
- Direct interface to bus
- Software control programmable gain
- High speed 12 bit A/D converter (100 KHz)
- Up to 4 DAC's
- Plugs directly into computer mainframe

Compatible with the following computers

PDP-8E, F, M, N
PDP-11 series

Nova, Eclipse, 800 and 1200 series

Consult factory for other minicomputers not listed.

GET THE FACTS.

A critique comparing the price and performance of our systems against alternate approaches is available for the asking.

For additional information contact our representatives or Adac Corporation, 118 Cummings Park, Woburn, MA 01801. Phone (617) 935-6668.

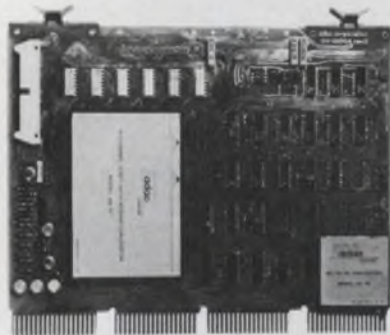

GSA CONTRACT GROUP 66

adac

corporation

INFORMATION RETRIEVAL NUMBER 66

MODULES & SUBASSEMBLIES

Modular v/f converter series offers choice of six models



Analog Devices, P.O. Box 280, Route 1 Industrial Park, Norwood, MA 02062. (617) 329-4700. P&A: See text.

High-accuracy converters, low-cost converters or low-drift, voltage-to-frequency converters—Analog Devices has all in its entry into the v/f user market with the 450 series.

The 10-kHz converters range from an economy model that costs only \$25 (in hundreds) to high-accuracy units ($\pm 0.005\%$) at \$42. Two of the converters handle voltage or current inputs and the other four handle only voltage inputs. All units, though, use a charge-balancing technique to provide linear conversion over an 80-dB input signal range.

The high-performance units, Models 450J and 450K, offer a choice of nonlinearity and drift specs. The 450K has maximum nonlinearity of $\pm 0.005\%$, a tempco of ± 25 ppm/ $^{\circ}$ C and an offset voltage drift of ± 20 μ V/ $^{\circ}$ C, max. The 450J has a max nonlinearity of $\pm 0.01\%$, a ± 50 ppm/ $^{\circ}$ C tempco and a ± 50 μ V/ $^{\circ}$ C input offset drift.

The 456J economy units, design-

ed for 10-bit accuracy, are guaranteed to have nonlinearity that is no worse than 0.03% over a 1-mV-to-15-V input range. Full-scale drift is 120 ppm/ $^{\circ}$ C. The 456K, though, has nonlinearity of 0.02% and a full-scale drift of only 80 ppm/ $^{\circ}$ C. Both the 456J and K have an input offset drift of less than 100 μ V/ $^{\circ}$ C.

The 454J and K can accept either voltage or current inputs, but are otherwise identical in performance to the 450J and K. The input signal range for the 454 converters spans 0 to 10 V or 0 to 0.33 mA, and the signal produces a max output frequency of 10 kHz.

Each of the six modules is housed in a 1.5 \times 1.5 \times 0.4-in. epoxy case and is specified for operation over 0 to 70 C. The power required is +15 V at 15 mA and -15 V at -9 mA.

There are, of course, many other modular converters that these units are designed to compete with. Included are the VFC-12 and 15 from Burr-Brown (Tucson, AZ), the VFV-10k from Datel (Canton, MA), the 801A, B and C and the 851 from Dynamic Measurements

(continued on page 144)

NOW! PM and SHUNT-WOUND adjustable speed drive systems



CDC-PM describes PM systems, 1/12-1/4 Hp. 12 pages, 32 drawings, photos and tables.



CDC-SH describes shunt-wound systems, 1/50-1/4 Hp. 16 pages, 51 photos, drawings and tables.

... from Bodine and Bodine Distributors

Designed and built by Bodine to give you *perfectly matched* speed/torque control characteristics—provide reliability and performance you might expect only from far more costly and complex systems.

**BODINE
ELECTRIC
COMPANY**
BODINE MOTORS
GEAR MOTORS
SPEED CONTROLS

Send for catalogs today.

Bodine Electric Company, 2528 W. Bradley Place, Chicago, IL 60618

INFORMATION RETRIEVAL NUMBER 67

PHOTO ETCH™ PRINTED CIRCUIT KIT Makes circuits **THREE WAYS**

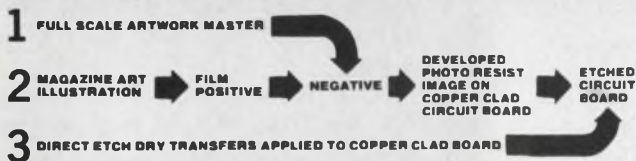

NO CAMERA DARKROOM FILM CUTTING TRACING

USES DATAK'S POS-NEG PROCESS
The revolutionary photographic way that makes **PERFECT** printed circuits from original art or a printed page.

KIT CONTAINS: 5" x 6" steel printing frame; 4 sheets 5" x 8" photocopy film; yellow liter; chemicals for 1 pint film developer and 1 pint film fixer; 5" x 8" copper clad board; 3" x 4 1/2" copper clad board; spray can of photo etch resist; 1 pint resist developer; 2 sheets 8 1/2" x 11" layout film; 1 roll 1/8" dia. photo circuit tape; 1 roll 1/32" printed circuit tape; 8 sheets dry transfer direct etch PC patterns including pads, transistors, round and flat pack ICs, DIP ICs, edge card connectors, lines, circles, logs, etc.; 1 lb. anhydrous ferric chloride to make 1 pint etchant; instructions.

ER-4 COMPLETE PHOTO ETCH SET	\$24.95
ER-2 PC patterns and tapes — refill	3.39
ER-3 1/4 pound dry etchant — refill	1.25
ER-5 6 sheets photocopy film — refill	3.39
ER-6 Film process chemicals — refill	1.79
ER-7 Photo resist spray, 2.5 oz. — refill	2.95
ER-8 Resist developer, 16 oz. can — refill	2.95

AT YOUR DISTRIBUTOR OR DIRECT

the **DATAK** corp.
65 71st St. • Guttenberg, N. J. 07093

INFORMATION RETRIEVAL NUMBER 68

ELECTRONIC DESIGN 22, October 25, 1975

THIS MAKES 40,000 CASSETTE RECORDERS. WHEW!

When it comes to cassette recorders, who you buy them from is as important as what you buy.

And when you buy the Sycor Model 135, you're dealing with a company that already has 40,000 recorders in service worldwide.

The popularity of our cassette recorder isn't really surprising.

The Sycor 135 is the ANSI compatible cassette drive with record overwrite capacity that lets you edit a whole data block without disturbing so much as a character on adjacent records.

The recorder that reads/writes at a fast 12.5 ips with quick starts and stops for high throughput. With a dual-gap head for Read-After-Write verification.

The recorder that accesses data at a clip of 60 ips.

For more information on our Model 135, or for help on any design or application problem, give us a call.

A company that's made 40,000 cassette recorders ought to be pretty good at finding solutions.

SYCOR

Contact OEM Department, Sycor, Inc.,
Ann Arbor, Michigan 48104. Telephone (313) 971-0900.

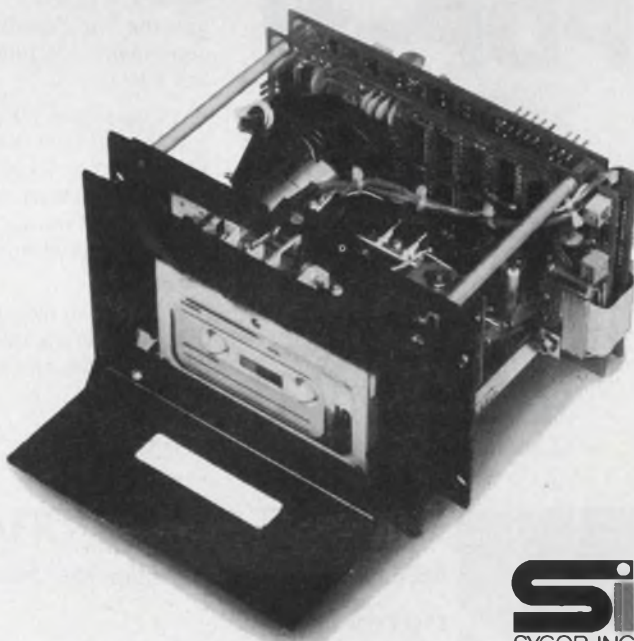

SI
SYCOR INC

Internationally represented by
Munzig International in London, Paris, Munich, Tokyo, and Geneva;
and by STG International in Tel Aviv.

INFORMATION RETRIEVAL NUMBER 69

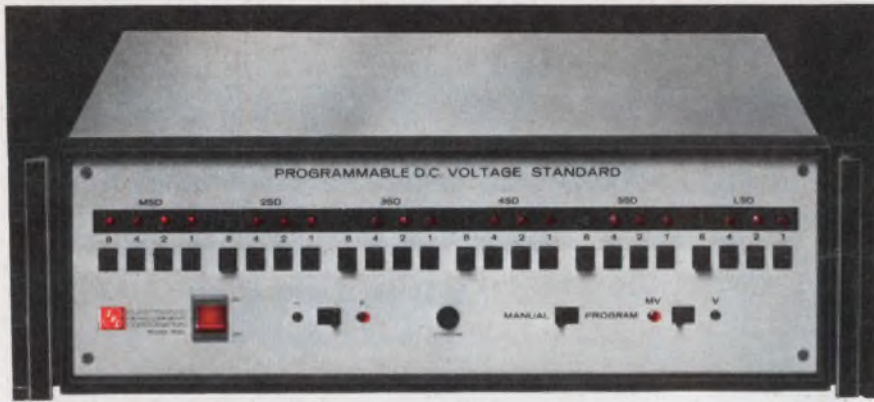

programmable microvolts for \$1,485

The EDC third generation 501 H has:

Speed: 50 μ s switching and settling time
Ranges: 100 mV, 10 V, 100 V, 200 V DC
Resolution: 1 ppm to steps of 0.1 μ V
Accuracy: \pm 0.005% of programmed value
Programming: TTL, BCD 8-4-2-1; other codes available including binary and ASCII
Options: Added resolution, ranging, CMOS compatibility
Accessories (field installable, plug-in): Serial-to-parallel converter, memory register, opto-isolators, ranging amplifier

For complete specs and prices on the 501 H and other EDC calibrators and standards, circle reader service number. To evaluate the 501 H in your application call Bob Ross at 617-268-9696.



"standards of excellence since 1958"
ELECTRONIC DEVELOPMENT CORPORATION
 11 Hamlin St., Boston, MA 02127

INFORMATION RETRIEVAL NUMBER 70

MAG TAPE FOR PDP-11



SEE THE REEL EXPERTS FOR YOUR MAG TAPE NEEDS NOW.

A great minicomputer deserves a great mag tape transport! Don't hang second-rate peripherals on your top-notch PDP-11. Digi-Data offers you the finest quality tape-handling equipment available anywhere at any cost.

Phase-encoded, NRZI, or both together, and tape speeds to 45 ips. Prices start at \$5,050 for complete systems which are thoroughly checked-out on our own PDP-11's and supplied with diagnostic software.

Digi-Data also manufactures mag tape systems for Hewlett-Packard's HP2100 series and Data General's NOVA series.



DIGI-DATA CORPORATION

8580 Dorsey Run Road, Jessup, Md. 20794 (301) 498-0200

Digi-Data Europe

Fluestrasse 632 5313 Klingnau Switzerland TELEX: 845-58555

INFORMATION RETRIEVAL NUMBER 71

MODULES & SUBASSEMBLIES

(continued from page 142)

(Winchester, MA), the A-846 and 847 from Intech (Santa Clara, CA), and the 4701, 4713 and 4721 from Teledyne-Philbrick (Dedham, MA).

These converters range in single-unit price from \$29 for the Dynamic Measurements 851, to \$49 for the 0.005%-linear VFV-10k from Datel and \$73 for the low-drift, 5 ppm/ $^{\circ}$ C Model 801C from Dynamic Measurements.

The Analog Devices converters are priced at \$49 and \$59 for the 450J, K; \$53 and \$62 for the 454J, K, and \$34 and \$42 for the 456J, K, respectively, for 1 to 9 pieces. All are available from stock.

Analog Devices	CIRCLE NO. 301
Burr-Brown	CIRCLE NO. 302
Datel	CIRCLE NO. 303
Dynamic Measurements	
	CIRCLE NO. 304
Intech	CIRCLE NO. 305
Teledyne-Philbrick	CIRCLE NO. 306

Window comparator uses two reference levels



ILC Data Device Corp., Airport International Plaza, Bohemia, NY 11716. (516) 567-5600. \$95; 6 to 8 wk.

A differential window comparator, the DWC-66B, is packaged in a PC-mountable module and measures 1.5 x 2.7 x 0.5 in. The unit compares the difference between two input signals and two set-point levels. An output relay driver is energized when the relationship between the input signals A and B, and set point levels I and II becomes I A-B and II B-A. High impedance input buffers have input bias currents of 100 nA and a 0.5-mV differential sensitivity. The relay driver output can handle up to 55 V and 80 mA. The DWC-668 is available for operation over 0 to 70 C and wider ranges can be provided on special order.

CIRCLE NO. 327

Voltage-output DAC has drift of only 7 ppm/°C

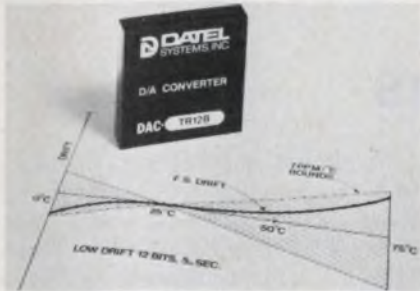

Datel Systems, 1020 Turnpike St., Canton, MA 02021. (617) 828-8000. \$179 (1 to 9); stock to 4 wk.

The DAC-TR12B voltage output 12-bit d/a converter has a low temperature coefficient of 7 ppm/°C for scale factor drift, 10 $\mu\text{V}/^\circ\text{C}$ for unipolar offset drift and 20 $\mu\text{V}/^\circ\text{C}$ for bipolar offset drift. The converter is available with either binary or BCD coding in complementary form. The voltage output of the DAC settles in 5 μs . There are five output voltage ranges that are pin-programmable by the user: 0 to +5, 0 to +10, -2.5 to +2.5, -5 to +5, and -10 to +10 V. The DAC output current capability is ± 5 mA or 0 to +10 mA and the output impedance is 0.02 Ω and is short-circuit proof. The converter is housed in a 2 x 2 x 0.375 in. module with DIP compatible 0.1 in. pin spacing. Power required by the converter is ± 15 V dc at 40 mA and +5 V dc at 30 mA.

CIRCLE NO. 328

High level alarm has single or dual channels

Bell & Howell, Control Products Div., 706 Bostwick Ave., Bridgeport, CT 06605. (203) 368-6751. \$80-single, \$120-dual; stock.

The 18-132 high-level alarm is available in two models: a single-channel and a dual-channel unit. The 18-132 accepts all standard process inputs (1 to 5, 4 to 20, 10 to 50 or 0 to 5 mA), as well as various dc voltage inputs (0 to 1, 0 to 2, 0 to 5 or 0 to 10 V). The alarm includes an integral power supply (optional 24-V operation), repeatability of 0.1% and adjustable hysteresis. Options include: LED alarm indicators, remote-set trip-point adjustment and latching alarm (includes LEDs).

CIRCLE NO. 329

Instrumentation amp has 1-kHz bandwidth

Calex Manufacturing Co., Inc., 3305 Vincent Rd., Pleasant Hill, CA 94523. (415) 932-3911. From \$29; 2 to 4 wk; stock.

The Model 176 differential-input instrumentation amplifier uses a single external resistor to adjust gain between 10 and 1000. The amplifier is encapsulated in a 1.5 x

1.5 x 0.5-in. module and is rated for a temperature range of 0 to 70 C. Amplifier bandwidth is 1 kHz at a gain of 1000, and the differential input impedance is 10 M Ω . The Model 176 can handle a source as high as 10 k Ω with almost no effect on CMR. Two versions of the 176 are available: the 176J with a drift of ± 3 $\mu\text{V}/^\circ\text{C}$, and the 176K with a drift of ± 1 $\mu\text{V}/^\circ\text{C}$.

CIRCLE NO. 330

Put your money where your reputation is.

If your equipment breaks down because of a cheap case, you're not saving money.

Because you can't afford the wrong case, buy Zero Centurion.TM

It makes good economic sense. Extra strength, quality and reliability built into Zero Centurion aluminum carrying cases mean the difference between equipment success or failure.

The anodized silver "Elite" line and the textured blue "Valuline" are available in 59 standard sizes for two week delivery A.R.O.

Zero Centurion. Because your reputation depends on it.

Send for your free catalog today.



The Final Touch



ZERO MANUFACTURING CO.

Burbank, CA 213/846 4191 · Monson, MA 413/267 5561 · Clearwater, FL 813/531-8991

FOR IMMEDIATE NEED CIRCLE #241

FOR LITERATURE CIRCLE #242

Phase-control power modules handle 25 A at up to 240 V rms

General Electric, Semiconductor Div., Electronics Park, Syracuse, NY 13201. (315) 253-7321. P&A: See text.

Medium-power phase-control circuits are often built from separately packaged SCRs and diodes that must be heat sunk and isolated from other components. Several companies offer a solution to the headaches involved with stocking and assembling these circuits. General Electric, with the introduction of its Power Module series, offers over three dozen variations of diode-bridge assemblies.

The Power Modules are designed to operate with steady-state currents of 25 A max, at line voltages of 120 or 240 V rms. Each module contains individual semiconductor pellets that are housed in an electrically isolated, epoxy-encapsulated package. The maximum current of 25 A is guaranteed at base plate temperatures of 85 C.

The metal base plate used by the

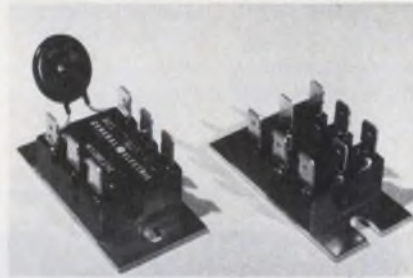

modules as a heat sink and mounting plate measures 2.5 x 1.25 in. and attaches with only two screws.

There are eight basic versions of the modules available. Many of these can be supplied equipped with either an MOV transient suppressor across the input, a free-wheeling diode on the output, or both.

Electrical isolation between the diodes, SCRs and the base plate is a high 2500 V. The peak one-cycle surge capability for a 60-Hz input is 300 A, while the peak gate power dissipation can reach 5 W for a 10-μs period.

Maximum current for fusing—total device burnout—is given by the I²t rating. This is 370 A²s for pulses 8.3 ms apart, and it drops to 260 A²s for 1-ms period pulses.

Competing control circuits such as the Pace/Pak are available from International Rectifier (El Segundo, CA), the VCB series from Varo Semiconductor (Garland, TX) and the 2500 series from Gentron (Milwaukee, WI). These companies have bridge assemblies that don't quite match the performance of the GE units.

The prices for the GE assemblies start at \$11.60 for the W2DA25C and go up to \$45.80 for the WV2-BH25E. These prices are for 100-up lots. All units are available from stock.

- General Electric CIRCLE NO. 320
- Gentron CIRCLE NO. 321
- International Rectifier CIRCLE NO. 322
- Varo Semiconductor CIRCLE NO. 323

CIRCUIT FAMILY	BE		BJ		BA		BH		AA		CA		DA		DC	
BASIC CIRCUIT SCHEMATIC																
AVERAGE OUTPUT CURRENT @ T _{BP} 85°C (AMPS)	25		25		25		25		50(A _{avg})		25		T		T	
VOLTAGE INPUT (V _{AC}) RMS	120	240	120	240	120	240	120	240	120	240	120	240	120	240	120	240
CIRCUIT TYPES	WV2BE25C WV2BE25E		WV2BJ25C WV2BJ25E		WV2BA25C WV2BA25E		WV2BH25C WV2BH25E		WV2AA50C WV2AA50E		WV2CA25C WV2CA25E		WV2DA_C WV2DA_E		WV2DC_C WV2DC_E	
	W2BE25C W2BE25E		W2BJ25C W2BJ25E		W2BA25C W2BA25E		W2BH25C W2BH25E		W2AA50C W2AA50E		W2CA25C W2CA25E		W2DA_C W2DA_E		W2DC_C W2DC_E	
	W2BE25C W2BE25E		W2BJ25C W2BJ25E		W2BA25C W2BA25E		W2BH25C W2BH25E		W2AA50C W2AA50E		W2CA25C W2CA25E		W2DA_C W2DA_E		W2DC_C W2DC_E	
TERMINAL POSITION																

*OTHER CIRCUIT TYPES AVAILABLE. CONTACT FACTORY
†CONTACT FACTORY FOR CURRENT RATINGS FOR APPLICABLE CIRCUIT.



ANALOGY
FEED TRANSDUCER DATA FROM TOUGH ENVIRONMENTS TO REMOTE MINIS THROUGH THE FIRST CRYSTAL CONTROLLED VOLTAGE-TO-FREQUENCY CONVERTER MODULES WITH TOTAL ISOLATION AND 15-BIT ADC PERFORMANCE. INTECH'S NEW A-841 HAS BUILT-IN OPTICAL ISOLATOR. A-842 DRIVES 2000 FT. OF CABLE THROUGH ITS PULSE TRANSFORMER, BOTH AT TTL LEVELS. WE ALSO SUPPLY BETTER ADC, DAC, SEH, OP AMP AND MATH MODULES AT PRICES THAT SAVE.

intech/FMI
282 BROKAW RD. SANTA CLARA, CA 95050 (408) 244-0500

Our Super Switcher is three years old.

Should we call it new?

We're not sure. We noticed our competitors are calling their switching regulated power supplies "new". And why shouldn't they? After all, switching technology itself is new, isn't it?

Or is it?

To them, maybe. Not to Powertec.

Ours have been around about 3 years now. Over 2500 of them. You might even call them *field proven* (now, there's a phrase the other boys have studiously avoided. We wonder why.) Still, we've got to admit that with 24 new models, up to 24V, up to 200A output, our 9N Series *is new. All new.*

Only there's a difference.

Our *new* is based on experience, unique design innovations, and the best craftsmanship in the industry. Their "new"? Well, their new is just plain old new.

So take a look. Here are just a few 9N features.

OUTPUT RATING CHART

MODEL*	DC OUTPUT		PRICE
	VOLTAGE NOMINAL	CURRENT @ +40°C	
9N2-200	2.0V	200A	\$695
9N5-150	5.0V	150A	\$695
9N5-120	5.0V	120A	\$625
9N6-100	6.0V	100A	\$625
9N12-50	12.0V	50A	\$625
9N15-50	15.0V	50A	\$625
9N17-42	17.0V	42A	\$625
9N20-40	20.0V	40A	\$625
9N24-33	24.0V	33A	\$625
9N28-28	28.0V	28A	\$625

* Add dash number for desired input:
115VAC, -01; 208VAC, -03; 220VAC, -04

- Up to 80% efficiency
- 24 hour elevated temperature "burn-in" with cyclic testing
- Logic inhibit
- Programmable
- Most second-sourced package
- Modular construction by function for maximum reliability
- "Motherboard" design eliminates internal cabling
- Master/slave adapter for paralleling up to 4 units (equal load sharing)
- 30 ms energy storage
- Long-life fan and dust screen
- Immediate delivery

Call us for an evaluation unit. Or, if you're still not convinced, we'll send you a Switcher Evaluation Guide.

POWERTEC

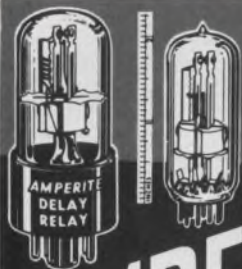

AMPERITE

THERMOSTATIC
DELAY RELAYS

For **LOW COST,**
LONG LIFE,
Maximum Stability

Delays: 2 to 180 Sec.*

Hermetically sealed — not affected by altitude, moisture, or climate changes... **SPST only** — normally open or normally closed... Compensated for ambient temperature changes from -55° to +80°C... **Rugged, explosion-proof, long-lived**... Standard radio octal and 9-pin miniatures.

Price, standard or min., under \$4.00 ea.

*Miniatures delays: 2 to 120 seconds.

PROBLEM? Send for Bulletin No. TR-81.

New! LONG DELAYS

240 & 300 Sec.

Same rugged construction, hermetic sealing and stability as the shorter Delay Relays described above... For delays beyond 300 seconds, these Relays may be used in series.

Price, under \$6.00 ea.

Write for Bulletin No. LD-73.



DIFFERENTIAL RELAYS

For automatic overload, over-voltage or under-voltage protection... Made only to specifications for 70V, 80V, 90V and 100V.

Price, under \$6.00 ea.

AMPERITE BALLAST REGULATORS

Automatically keeps current and voltage at a definite value. For AC or DC... Hermetically sealed, rugged, vibration-resistant, compact, most inexpensive.

Price, under \$3.00 ea.

Write for 4-p. Bulletin No. AB-51.



AMPERITE

600 PALISADE AVE., UNION CITY, N.J. 07087

Telephone: 201 UNION 4-9503

In Canada: Atlas Electronics, Ltd.,

50 Wingold Ave., Toronto 19

OUR COMPLETE PRODUCT LINE CAN BE FOUND IN ELECTRONIC DESIGN'S GOLD BOOK.

INFORMATION RETRIEVAL NUMBER 75

MODULES & SUBASSEMBLIES

Rf power amplifier spans 10 to 400 MHz

Optimax Inc., P.O. Box 105, Advance Lane, Colmar, PA 18915. (215) 822-1311. \$120; stock to 60 day.

The AH-4072 two-stage thick-film broadband amplifier is housed in a TO-3 package. The amplifier frequency range spans 10 to 400 MHz and the gain is 22 dB with a flatness of ± 0.5 dB. Maximum noise figure is 7 dB while the reverse isolation is a minimum of 30 dB. VSWR is 2:1 maximum and the amplifier operates from a 28 V floating dc supply.

CIRCLE NO. 331

4-quadrant multipliers trimmable to 0.03%

Analog Devices, Rte. 1 Industrial Park, P.O. Box 280, Norwood, MA 02062. (617) 329-4700. 1 to 9 prices: \$145 (435K); \$98 (435J); stock.

The Model 435 four-quadrant multiplier has a $\pm 0.1\%$ untrimmed accuracy and externally is trimmable to $\pm 0.03\%$. This accuracy combines the maximum offset drift of $0.002\%/^{\circ}\text{C}$, maximum total-error drift of $0.01\%/^{\circ}\text{C}$, maximum nonlinearity of 0.05% and noise in a 5-Hz-to-10-kHz bandwidth of $250 \mu\text{V rms}$. With a 20-V input step applied, the Model 435 settles to 0.1% in $20 \mu\text{s}$, slewing at $2 \text{ V}/\mu\text{s}$. Its 30-kHz full power bandwidth is sufficient to meet all low frequency requirements and still achieve rated accuracy. At 2 kHz, the Model 435 shows about a 1% vector error, but its nonlinearity error is below $\pm 0.05\%$ and feedthrough is $\pm 0.1\%$ maximum. The multiplier is housed in a $1.65 \times 3.07 \times 0.65$ in. ($41.91 \times 77.97 \times 16.51$ mm) module and is specified from 0 to 70 C. It is available in two accuracy versions: the Model 435K with the specs already listed and the Model 435J which differs only in untrimmed accuracy ($\pm 0.1\%$ maximum, drift ($\pm 0.03\%/^{\circ}\text{C}$ maximum), and feedthrough ($\pm 0.2\%$ maximum).

CIRCLE NO. 332

New MMI 1K x 4 PROM

Sales Offices:

EASTERN AREA SALES OFFICE: (617) 655-7070 • NEW ENGLAND REGION: (617) 475-8883 • MID-ATLANTIC REGION: (215) 643-0883 • CENTRAL AREA SALES OFFICE: (815) 385-8767 • MINNEAPOLIS REGION: (612) 884-2686 • SOUTH CENTRAL AREA SALES OFFICE: (214) 369-7952 • SOUTHERN CALIFORNIA AREA SALES OFFICE: (714) 557-1216 • WESTERN AREA SALES OFFICE: (415) 969-4061 • BAY AREA REGION: (408) 227-1472

Representatives:

ARIZONA: Phoenix (602) 264-7971 • CALIFORNIA: Mountain View (415) 965-9180; San Diego (714) 277-8044 • COLORADO: Wheatridge (303) 423-1020 • CONNECTICUT: North Haven (203) 239-9762 • FLORIDA: Clearwater (813) 441-4702; Ft. Lauderdale (305) 944-5031; Orlando (305) 299-5303 • ILLINOIS: Chicago (312) 774-9022; Rolling Meadows (312) 394-4900 • MARYLAND: Baltimore (301) 825-3330 • MASSACHUSETTS: Needham (617) 444-2484 • MICHIGAN: Gross Point (313) 499-0188 • MINNESOTA: Minneapolis (612) 884-7471 • NEW JERSEY: Teaneck (201) 692-0200 • OREGON: Beaverton (503) 643-5754 • PENNSYLVANIA: Horsham (215) 672-8300 • WASHINGTON: Seattle (206) 762-7664 • CANADA: Scarborough, Ontario (416) 751-5980; Ottawa, Ontario (613) 729-6090; Richmond, B.C. (604) 277-0414; Winnipeg, Manitoba (204) 889-7966.

Distributors:

ALABAMA: Huntsville, Hall-Mark (205) 837-8700 • ARIZONA: Phoenix, Kierulff (602) 273-7331; Phoenix, Sterling (602) 258-4531 • CALIFORNIA: Los Angeles, Kierulff (213) 685-5511; Los Angeles, Sterling (213) 767-5030; Palo Alto, Kierulff (415) 968-6292; San Carlos, Sterling (415) 592-2353; San Diego, Intermark (714) 279-5200; San Diego, Kierulff (714) 278-2112; Santa Ana, Intermark (213) 436-5275; Sunnyvale, Intermark (408) 738-1111 • COLORADO: Denver, Kierulff (303) 343-7090; Wheatridge, Century (303) 424-1985 • CONNECTICUT: Hamden, Arrow (203) 248-3801 • FLORIDA: Orlando, Hall-Mark (305) 855-4020 • ILLINOIS: Chicago, Hall-Mark (312) 437-8800 • INDIANA: Indianapolis, Pioneer/Indiana (317) 849-7300 • KANSAS: Lenexa, Hall-Mark (913) 888-4747 • MARYLAND: Baltimore, Arrow (202) 737-1700; Technico, Inc. (301) 828-6416; Gaithersburg, Kierulff (301) 948-0250 • MASSACHUSETTS: Billerica, Kierulff (617) 935-5314; Burlington, Arrow (617) 273-0100 • MINNESOTA: Bloomington, Arrow (612) 888-5522; Bloomington, Hall-Mark (612) 884-9056 • MICHIGAN: Livonia, Pioneer/Michigan (313) 525-1800 • MISSOURI: Earth City, Hall-Mark (314) 291-5350 • NEW JERSEY: Moorestown, Arrow (609) 235-1900; Saddlebrook, Arrow (201) 797-5800; Rutherford, Kierulff (201) 935-2120 • NEW MEXICO: Albuquerque, Century (505) 292-2700 • NEW YORK: Buffalo, Summit Distributors (716) 884-3450; Farmingdale, Arrow (516) 694-6800; Rochester, Summit Distributors (716) 334-8110 • NORTH CAROLINA: Raleigh, Hall-Mark (919) 832-4465 • OHIO: Cleveland, Arrow (216) 464-2000; Cleveland, Pioneer/Cleveland (216) 587-3600; Dayton, Arrow (513) 253-9176; Dayton, Pioneer/Dayton (513) 236-9900 • OKLAHOMA: Tulsa, Hall-Mark (918) 835-8458 • OREGON: Portland, Almac/Strom (503) 292-3534 • PENNSYLVANIA: Horsham, Pioneer/Delaware Valley (215) 674-5710; Pittsburgh, Pioneer/Pittsburgh (412) 782-2300 • TEXAS: Houston, Hall-Mark (713) 781-6100; Houston, Component Specialties (713) 771-7237; Dallas, Component Specialties (214) 357-4576; Dallas, Hall-Mark (214) 231-6111 • UTAH: Salt Lake City, Century (801) 487-8551 • WASHINGTON: Seattle, Almac/Strom (206) 763-2300; Seattle, Intermark (206) 767-3160 • WISCONSIN: West Allis, Hall-Mark (414) 476-1270 • CANADA: Montreal, Quebec (514) 735-5775; Toronto, Rexdale (416) 677-7820; Vancouver, B.C. (604) 261-1335.

“This is the year for the 60ns 1K x 4 PROM.”

MMI has always set the trends in bipolar memories. The first 1K, 2K and 512 x 8 4K PROMs had MMI stamped on them. Now we offer the designer another first: a 4K PROM configured 1K x 4, the way you've told us you want it.

We've drawn on our vast experience in making PROMs coupled with our proven Schottky process, and here it is: Speed is 60ns max. over temp and voltage ranges. Power dissipation is only 150 microwatts/bit. Reliability is improved, growback is nonexistent, and wait until you see the programmability — better than 90%. It's packaged in an 18-pin DIP for best board density, and priced at only \$30 in 100 quantities. Totally compatible ROMs are ready for your truth table now.

Our newest 4K PROM is only the latest in a series of leadership moves. MMI grew to be the largest

manufacturer of bipolar memories in the world by finding what the industry wanted and delivering better devices. Our new 1K x 4 PROM is better because its 18-pin package allows you four times the packing density of 1K PROMs. It's available in both commercial and mil spec versions. And it clearly offers you the opportunity of upgrading from 1K, 2K or even 512 x 8 PROMs.

One 6350/51 is worth a thousand words.

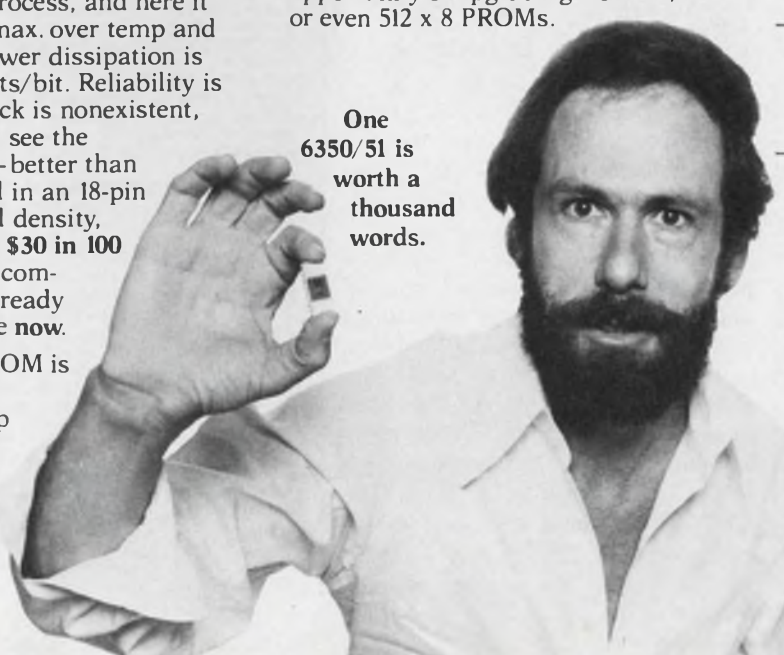

MMI 1K x 4 MMI PROMs

OC TS	COMMERCIAL	MIL SPEC
	6350J 6351J	5350D 5351D
TEMP. RANGE	0°C to 75°C	-55°C to +125°C
MAX. ACCESS TIME OVER TEMP. RANGE	60 nsec	75 nsec
PRICE (@ 100 QUAN.)	\$30	\$55
ROM COMPATIBLE PART NO.		
OC	6250J	5250D
TS	6251J	5251D

Availability is off the shelf. We'll be glad to ship you some. Call, TWX or write Ed Bohn (408) 739-3535 or any of MMI's sales offices, representatives or distributors. We are at your service. Monolithic Memories, Inc., 1165 East Arques Avenue, Sunnyvale, CA 94086. TWX 910 339 9229.

mmi
This is our year.

BIG POWER SUPPLIES



IN LITTLE PACKAGES

**AC-DC and DC-DC
miniaturized power converters
that deliver 3.9 watts
per cubic inch.**

- AC inputs: 115-220 VAC, 47-500 Hz.
- DC inputs: 12, 28, 48, 115 & 150 VDC.
- 1 to 6 isolated and regulated DC outputs from 4.2 to 300 VDC.
- Line and load regulation to 0.1%.
- Up to 800 watts per output.
- Efficiencies to 85%.
- Design-As-You-Order construction from standard sub-modules . . . over 1200 possible configurations.
- Completed converters provided in tested and encapsulated, conduction cooled packages in just days.

See for yourself how we've packed the power and performance in . . . request our actual size "little black box" punch out kit and catalog today!

Call us collect . . . ask for Jim Dunn.



ARNOLD MAGNETICS CORPORATION

11520 W. Jefferson Blvd.
Culver City, Ca. 90230 • (213) 870-7014

MODULES & SUBASSEMBLIES

Interface card for HP minis saves two slots

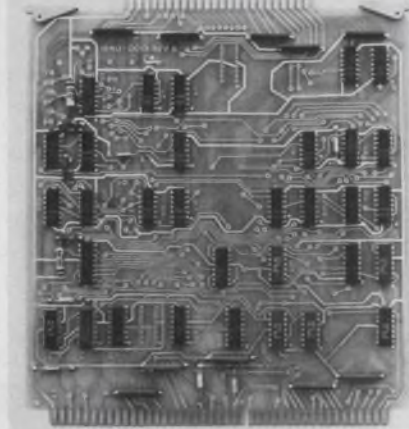

*Custer Research, P.O. Box 305,
Fleetwood, PA 19522. (215) 367-
6931. See text; 90 day.*

The S2530 three-way interface card for the Hewlett-Packard 21 MX or 2100 series computers can replace three separate interface cards. The S2530 card can replace a high speed tape input (HP 2748B), a high speed tape output (Facit 4070 Punch) and a high speed printer card (Centronics, Tally or Odec units). Not only does the card save two slots in the computer but it can save from 10 to 30% over the cost of individual I/O cards. Prices start at \$2500 for the card and interface kit.

CIRCLE NO. 333

Buffer amplifier boosts op amps to 200 mA

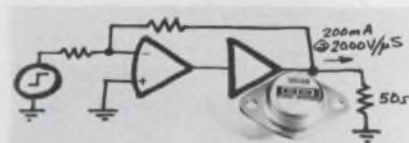

*Burr-Brown, International Airport
Industrial Park, Tucson, AZ 85734.
(602) 294-1431. \$25 (1 to 24);
stock.*

The 3553 unity-gain amplifier provides a power output for op amps or functions as a stand-alone buffer. The booster has a 200-MHz, -3-dB bandwidth and 2000-V/μs slew rate that helps preserve the dynamic performance of the operational amplifier, while delivering up to ±200 mA to a load. The 3553 can deliver ±10 V into a 50-Ω load.

CIRCLE NO. 334

New MMI 16K ROM

Sales Offices:

EASTERN AREA SALES OFFICE: (617) 655-7070 • NEW ENGLAND REGION: (617) 475-8883 • MID-ATLANTIC REGION: (215) 643-0883 • CENTRAL AREA SALES OFFICE: (815) 385-8767 • MINNEAPOLIS REGION: (612) 884-2686 • SOUTH CENTRAL AREA SALES OFFICE: (214) 369-7952 • SOUTHERN CALIFORNIA AREA SALES OFFICE: (714) 557-1216 • WESTERN AREA SALES OFFICE: (415) 969-4061 • BAY AREA REGION: (408) 227-1472

Representatives:

ARIZONA: Phoenix (602) 264-7971
• CALIFORNIA: Mountain View (415) 965-9180; San Diego (714) 277-8044
• COLORADO: Wheatridge (303) 423-1020
• CONNECTICUT: North Haven (203) 239-9762 • FLORIDA: Clearwater (813) 441-4702; Ft. Lauderdale (305) 944-5031; Orlando (305) 299-5303 • ILLINOIS: Chicago (312) 774-9022; Rolling Meadows (312) 394-4900 • MARYLAND: Baltimore (301) 825-3330 • MASSACHUSETTS: Needham (617) 444-2484 • MICHIGAN: Gross Point (313) 499-0188 • MINNESOTA: Minneapolis (612) 884-7471 • NEW JERSEY: Teaneck (201) 692-0200
• OREGON: Beaverton (503) 643-5754
• PENNSYLVANIA: Horsham (215) 672-8300 • WASHINGTON: Seattle (206) 762-7664 • CANADA: Scarborough, Ontario (416) 751-5980; Ottawa, Ontario (613) 729-6090; Richmond, B.C. (604) 277-0414; Winnipeg, Manitoba (204) 889-7966.

Distributors:

ALABAMA: Huntsville, Hall-Mark (205) 837-8700 • ARIZONA: Phoenix, Kierulff (602) 273-7331; Phoenix, Sterling (602) 258-4531 • CALIFORNIA: Los Angeles, Kierulff (213) 685-5511; Los Angeles, Sterling (213) 767-5030; Palo Alto, Kierulff (415) 968-6292; San Carlos, Sterling (415) 592-2353; San Diego, Intermark (714) 279-5200; San Diego, Kierulff (714) 278-2112; Santa Ana, Intermark (213) 436-5275; Sunnyvale, Intermark (408) 738-1111 • COLORADO: Denver, Kierulff (303) 343-7090; Wheatridge, Century (303) 424-1985 • CONNECTICUT: Hamden, Arrow (203) 248-3801 • FLORIDA: Orlando, Hall-Mark (305) 855-4020 • ILLINOIS: Chicago, Hall-Mark (312) 437-8800
• INDIANA: Indianapolis, Pioneer/Indiana (317) 849-7300 • KANSAS: Lenexa, Hall-Mark (913) 888-4747 • MARYLAND: Baltimore, Arrow (202) 737-1700; Technico, Inc. (301) 828-6416; Gaithersburg, Kierulff (301) 948-0250 • MASSACHUSETTS: Billerica, Kierulff (617) 935-5314; Burlington, Arrow (617) 273-0100
• MINNESOTA: Bloomington, Arrow (612) 888-5522; Bloomington, Hall-Mark (612) 884-9056 • MICHIGAN: Livonia, Pioneer/Michigan (313) 525-1800 • MISSOURI: Earth City, Hall-Mark (314) 291-5350
• NEW JERSEY: Moorestown, Arrow (609) 235-1900; Saddlebrook, Arrow (201) 797-5800; Rutherford, Kierulff (201) 935-2120 • NEW MEXICO: Albuquerque, Century (505) 292-2700 • NEW YORK: Buffalo, Summit Distributors (716) 884-3450; Farmingdale, Arrow (516) 694-6800; Rochester, Summit Distributors (716) 334-8110 • NORTH CAROLINA: Raleigh, Hall-Mark (919) 832-4465 • OHIO: Cleveland, Arrow (216) 464-2000; Cleveland, Pioneer/Cleveland (216) 587-3600; Dayton, Arrow (513) 253-9176; Dayton, Pioneer/Dayton (513) 236-9900 • OKLAHOMA: Tulsa, Hall-Mark (918) 835-8458
• OREGON: Portland, Almac/Stroum (503) 292-3534 • PENNSYLVANIA: Horsham, Pioneer/Delaware Valley (215) 674-5710; Pittsburgh, Pioneer/Pittsburgh (412) 782-2300 • TEXAS: Houston, Hall-Mark (713) 781-6100; Houston, Component Specialties (713) 771-7237; Dallas, Component Specialties (214) 357-4576; Dallas, Hall-Mark (214) 231-6111 • UTAH: Salt Lake City, Century (801) 487-8551
• WASHINGTON: Seattle, Almac/Stroum (206) 763-2300; Seattle, Intermark (206) 767-3160 • WISCONSIN: West Allis, Hall-Mark (414) 476-1270 • CANADA: Montreal, Quebec (514) 735-5775; Toronto, Rexdale (416) 677-7820; Vancouver, B.C. (604) 261-1335.

“This is the year for the 16K bipolar ROM.”

Yes, it's 16K bits, organized 2K x 8. Yes, it's bipolar. Not only did we make it bigger, we made it faster, with 110ns max. access time over temp and voltage; yet it consumes less than 55 μ w/bit.

If you're doing space-critical systems, you need the 16K's density. If you're doing speed-critical stuff, you need bipolar performance. In both cases, this is the ROM you'll want. It's available from Monolithic Memories in commercial and Mil Spec versions, open collector and three state. It's organized 2K x 8, and it's pin-compatible with our 1K x 8 bipolar ROM. Now you can upgrade your system without modification and enjoy the speed/power/density benefits of our new 16K ROM.

Remember, it's bipolar. Needs only one 5V power supply. Provides faster access time for microprocessors. Improves system reliability and it requires fewer peripheral circuits than MOS. The 16K ROM is a great way to store microcode and fixed programs. It's perfect for high resolution look-up tables or character generation of complex fonts. Lots of applications; what's yours?

MMI, the leader in bipolar memories, offers the most complete ROM line: 1K, 2K, 4K, 8K, 9K, 10K. And now 16K. Compare it to anything else on the market — in any technology — and see for yourself.

Need some parts? Call, TWX or write Russ Rottiers: (408) 739-3535. TWX 910 339 9229. Monolithic Memories, Inc., 1165 East Arques Ave., Sunnyvale, CA 94086. Or check with your local MMI sales office or rep. We're at your service worldwide.

LARGE CAPACITY BIPOLAR ROMS

PART NUMBER	OPERATING	MEMORY	MAX. POWER	MAX. ACCESS	PRICE	
OC TS	TEMP.	ORGANIZATION	DISSIPATION/BIT	TIME (nsec)	(@ 100 QUANTITY)	
6275J	6276J	0°C to 75°C	2048 x 8	55 μ w	110	\$ 67.50
5275D	5276D	-55°C to +125°C	2048 x 8	57 μ w	120	\$155.00
6255J		0°C to 75°C	1024 x 10	77 μ w	150	\$ 49.50
5255D		-55°C to +125°C	1024 x 10	81 μ w	150	\$ 99.00
6260J		0°C to 75°C	1024 x 9	85 μ w	150	\$ 45.00
5260D		-55°C to +125°C	1024 x 9	90 μ w	150	\$ 99.00
6280J	6281J	0°C to 75°C	1024 x 8	109 μ w	150	\$ 36.00
5280D	5281D	-55°C to +125°C	1024 x 8	114 μ w	175	\$ 70.00

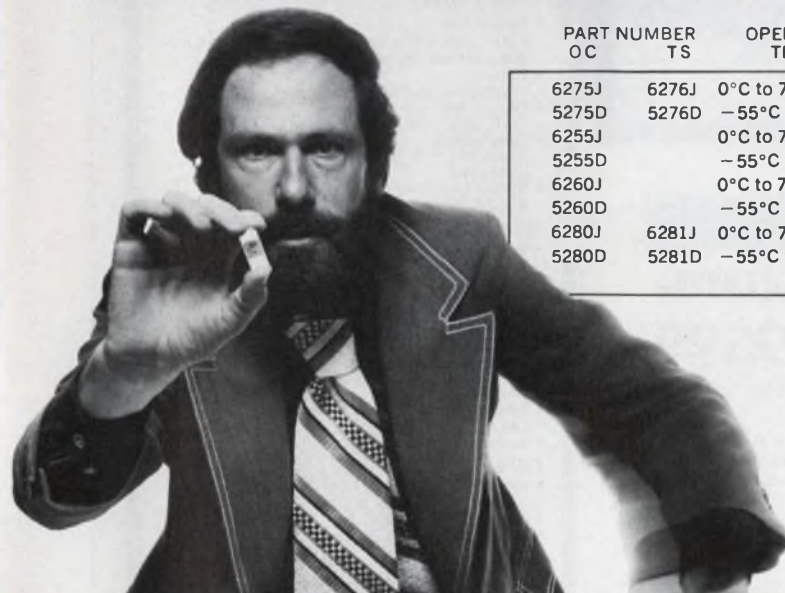

mmi
This is our year.

MODULES & SUBASSEMBLIES

Dc speed control has high and low adjust

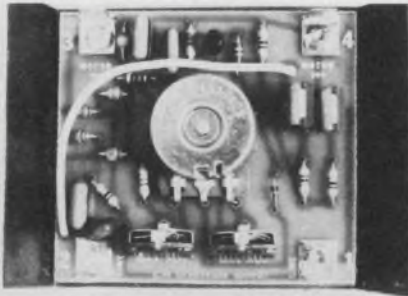

SSAC Precision Products Inc., P.O. Box 395, Liverpool, NY 13088. (315) 457-9610. \$11.95 (250-up); stock.

The SC120A-85 dc motor speed control operates fractional horsepower dc motors. Two trimmers allow calibration of both the high and low speeds. Built-in feedback ensures good regulation against load and line variations. Operating voltage is 120 V ac $\pm 15\%$, 50/60 Hz. The output range spans 0 to 85 V dc with high and low trim adjustments. Output is 1 A max, steady state, 10 A max, inrush.

CIRCLE NO. 335

Low bias modular amp has low drift, too

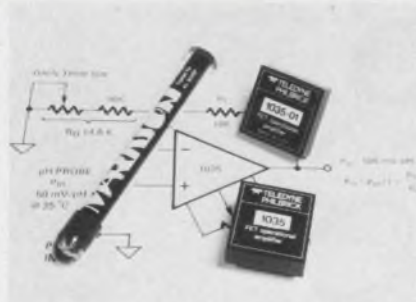

Teledyne Philbrick, Allied Dr. at Rte. 128, Dedham MA 02026. (617) 329-1600. From \$32 (1 to 9); stock.

The 1035 modular op amp has a bias current of less than 150 fA and an $E_{o,TC}$ of 25 $\mu V/^\circ C$. A premium version, the 1035-02 has a bias current of under 50 fA and a tempo of less than 15 $\mu V/^\circ C$. The 1035 has two additional features: Its 50-kHz guaranteed full power frequency (fp) permits high speed current measurements, and the guaranteed CMRR of 86 dB allows pH measurements and differential operation with high impedance bridge transducers.

CIRCLE NO. 336

Thick-film circuit handles 0.3 A at 30 V

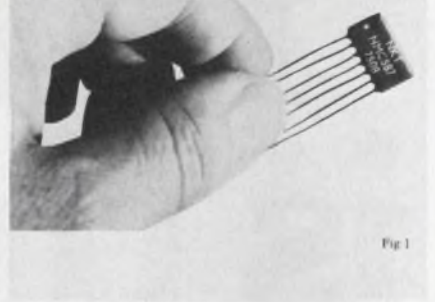

Newmarket Transistors Ltd., Newmarket, Suffolk, England.

The NMC587 thick-film hybrid circuit can switch 300 mA at 30 V. Special features of the device include the ability to accommodate any number of different inputs (each via an external diode) and a noise-immunity of 400 mV minimum. The NMC587 is basically a dual NAND gate with open collectors. The device is housed in an epoxy-dipped package capable of dissipating 500 mW. It measures 20 \times 12.5 \times 5 mm, and its seven in-line leads are spaced 2.54 mm apart.

CIRCLE NO. 337

Every dollar Counts.



Multifunction Counter • 7 Digits • 100 MHz

Data Precision's Model 5740 makes absolutely no compromise in the area of performance. Every element, every component has been "value-optimized" to keep its exceptional range, sensitivity, accuracy and resolution within your budget.

\$295⁰⁰

Contact your Data Precision representative or Data Precision directly. You may be surprised just how much more instrument you can buy, when you buy Data Precision.

DATA PRECISION®
..years ahead

FUNCTIONS:

- Sinewaves, Square Waves, Pulses, Pulse Pairs, Complex Waves
- Frequency
5 Hz to 100 MHz; resolution to 0.1 Hz; 10 ms/100 ms/1 sec./10 sec. gate times
- Period
½ microsecond to 0.2 sec.
- Period Average
1, 10, 100, and 1000 periods
- Total Events
0 to 9,999,999 (unlimited with "overflow" indicator)
- Elapsed Time
0 to 99,999.99 sec. (27.8 hrs.)

FEATURES:

- Sensitivity
10 mV from 5 Hz to 20 MHz rising linearly to a high frequency sensitivity of 50 mV RMS at 100 MHz
- 100 MHz Bandwidth
- 250 Volts RMS Input Protection
- Low Component Count
- Wide Signal Tolerances
- 0.43" high LED display
- Gate/Overflow Indicators
- Trigger Level
- Front Panel Adjustable
- x1 and x20 Attenuator

OPTIONS

- Remote Start/Stop
- 50 OHM Input Termination
- External Clock Input
- BCD Interface and Logic Control

Data Precision Corporation, Audubon Road, Wakefield, MA 01880 (617) 246-1600 TELEX (0650)949341



The Power of Systron-Donner

**Systron-Donner Power Supplies
offer it all!**

- Watts/Dollar
- Reliability
- Hi MTBF
- Remote Programmability
- Precision Regulation
- Hi-Current Capability
- Remote Sensing
- 5-Year Warranty

Here's how to get details on the industry's finest power supplies: In the United States, give your local Scientific Devices office a call, or contact us at 10 Systron Drive, Concord, CA 94518 • (415) 676-5000. Abroad, contact Systron-Donner GmbH, Munich; Systron-Donner Ltd., Leamington Spa, U.K.; Systron-Donner S.A., Paris (Le Port Marly); Systron-Donner Pty. Ltd., Melbourne.

SYSTRON  DONNER

DISCRETE SEMICONDUCTORS
P-channel JFETs switch
in 10 to 60 ns max

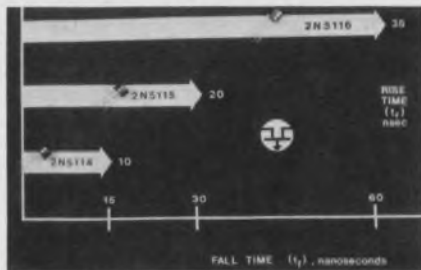

Teledyne Crystalonics, 147 Sherman St., Cambridge, MA 02140. (617) 491-1670. From \$3.40 (100-up); stock.

Three p-channel JFETs, the 2N5114, 5115 and 5116, have switching speeds in the 10-to-60-ns range. Fastest of the three is the 2N5114 with maximum rise and fall times of 10 and 15 ns, respectively. Next is the 2N5115 with rise and fall times of 20 and 30 ns. And, slowest of the group, the 2N5116 has rise and fall ratings of 35 and 60 ns. The JFETs are housed in TO-18 metal cases.

CIRCLE NO. 338

IR emitting LEDs supply
up to 60 mW



Hitachi Shibaden Corp. of America, 58-25 Brooklyn-Queens Expy., Woodside, NY 11377. (212) 898-1261. \$250 (sample quantity).

The Yaglex III series of infrared LEDs provides 60 mW (at 8100 Å) of optical output power at diode current of 300 mA. Most of the diodes have a spectral peak wave length of 8100 ± 50 Å and a half-width of 300 ± 50 Å. This radiation can be switched on or off in nanoseconds. The life test of several diodes carried out at room temperature and a current density of 1000 A/cm^2 showed no degradation after 17,000 hr. of operation. Yaglex-III diodes are packaged on plate-like headers that can be piled up and used as a light source array for pumping a solid-state laser.

CIRCLE NO. 339

Transient suppressors
protect MOS & bipolar

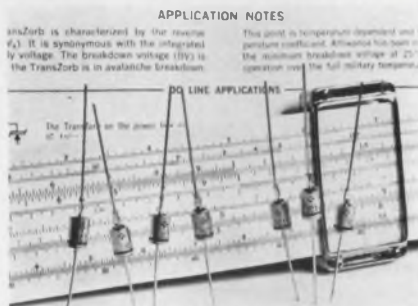

General Semiconductor Industries, 2001 W. 10th Pl., Tempe, AZ 85281. (602) 968-3101. \$3.05 (1000-up); stock.

The ICT series of TransZorb transient voltage suppressors is designed specifically to protect bipolar, MOS and Schottky ICs. Devices are available in nine voltages ranging from 5 to 45 V at standard power supply levels and are housed in the DO-13, glass-to-metal, hermetically sealed packages. The suppressors have sub-nanosecond response, high surge capabilities (15,000 W for 10 μs) and low clamping factors.

CIRCLE NO. 340

For the greatest CV density in Electrolytic
Capacitors for standard power supplies and...



for high reliability, you can now call on Mepco/Electra's computer-grade 91C Series.

This family of aluminum electrolytic capacitors offers an attainable capacity/voltage density to 1 farad at 6 volts. For example, 555,000 μF at 6 volts in a can measuring only 8-5/8" in height by 3" in diameter.

Other features of this series include: high ripple current, very low ESR, operating ranges from -40°C to +85°C (without derating) and protective sleeves able to withstand 3,000 volts (meet all applicable mil specs, heavier available).

If your business is building standard power supplies, our 91C Series is just what your designer needs. Get the facts by calling or writing:

MEPCO/ELECTRA, INC.

Morristown, N.J. 07960 (201) 539-2000

MEPCO/ELECTRA
THE ACTIVE COMPANY
FOR PASSIVE COMPONENTS



Microwave transistors designed for linear mode



TRW RF Semiconductors, 14520 Aviation Blvd., Laundale, CA 90260. (213) 679-4561. From \$34.43 (100-up); stock.

A line of microwave transistors, designed for ultralinear performance, has power outputs of up to 6 W. The units provide up to 6-dB linear gain at frequencies of 4 GHz. The microwave transistors, designated the 52000, 53000 and 54000 series, use a proprietary emitter ballasting technique and are available with six hermetic package options. The design also achieves protection from transients and load mismatches to infinite VSWR.

CIRCLE NO. 341

Dual monolithic JFETs have 0.1-pA leakage

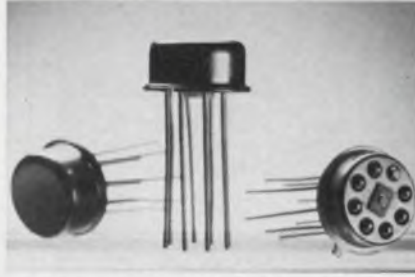

National Semiconductor, 2900 Semiconductor Dr., Santa Clara, CA 95051. (408) 732-5000. From \$2.85 (100-up); stock.

The 2N5902 series of dual n-channel JFETs has diode-isolated substrates. The physical structure keeps leakage current down to 0.1 pA over wide input swings (up to 20 V) during operation. Common-mode rejection is extremely high—typically better than 120 dB—which eliminates any chance of input error. The transistors can be matched within 5 mV, and drift can be matched within $5 \mu\text{V}/^\circ\text{C}$. There are eight models available in 8-pin TO-99 cans.

CIRCLE NO. 342

Power rf transistor delivers 7-dB gain



Motorola Semiconductor Products Div., Box 20924, Phoenix, AZ 85036. (602) 244-6900. \$34.50 (1 to 24); stock.

The MRF835 transistor is designed specifically for 12.5 V, large signal amplifier applications in the 900-MHz region. It provides a 15-W, 7-dB minimum gain with 50% efficiency at this frequency. A built-in matching network provides broadband performance.

CIRCLE NO. 343

The lowest ESR in high CV product Electrolytic Capacitors for switch mode power supplies...

is yours with the new MEPCO/ELECTRA 171C Series of capacitors featuring non-aqueous electrolytes. Utilizing new foil anodizing procedures, they optimize CV density, minimize ESR (starts at 5 milliohms) and significantly increase the parametric stability with time and temperature. Also, it's new internal geometry eliminates potting and permits direct thermal transmission between element and case.

In addition, a unique cover assembly, which is sealed by a silicone-rubber gasket, meets or exceeds applicable mil specs. At -55°C capacitor exhibits 85% of room temperature value.

If you're a designer and builder of switch mode power supplies, it will pay you to switch to the new MEPCO/ELECTRA Series 171C electrolytics. Get all the facts by calling or writing: MEPCO/ELECTRA, INC., Morristown, N.J. 07960 (201) 539-2000



MEPCO/ELECTRA
THE ACTIVE COMPANY
FOR PASSIVE COMPONENTS

INFORMATION RETRIEVAL NUMBER 82

You'll like what printer designers like about the 82900 logic stepper motor.



Schematic showing motor drive arrangement. A pinion mounted on the motor shaft engages a spur gear that drives the carriage platen.

Take low price...top quality...compactness and 23 oz-in torque as starters.

The new 82900 stepper motor is built to do yeoman's service not only in impact and non-impact printers, but in small X-Y plotters, chart drives and computer peripherals. Yes, even medical instrumentation, where its reliability really pays off. Compact size, efficiency, low cost and 23 oz-in torque @ 200 PPS all combine to offer design advantages unobtainable in larger, bulkier and more expensive steppers.

A case in point. A high-speed impact terminal printer. Initially a mechanical linkage, actuated by a solenoid, was used to advance the carriage platen and paper automatically on command. This design proved to be somewhat cumbersome in making adjustments during assembly and required excessive downtime during servicing. After careful investigation, the 82900 stepper was adopted as a more vi-

able alternative. In addition to meeting the load requirements of the application, the 82900 proved capable of providing the necessary torque output, the required step angle and a minimum of 5000 hours operating time. Equally important, the motor met price parameters.

Consider the 82900 stepper in your own design. It's bidirectional. It has a nominal power rating of 12.38 w @ 5 vdc. And it is efficient, operating at lower than average temperatures. Standard construction provides 2-phase operation (requiring simplified drive circuitry) a 7.5° step angle and roller bearings. A 15° step angle, 4-phase operation or sleeve bearings in any combination desired can also be provided as options.



Send for information now!

A. W. HAYDON CO. PRODUCTS

NORTH AMERICAN PHILIPS CONTROLS CORP.

Cheshire, Conn. 06410 • (203) 272-0301

INFORMATION RETRIEVAL NUMBER 83

DISCRETE SEMICONDUCTORS

0.3 in. high displays come in seven styles

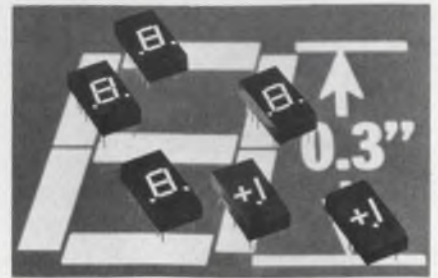

Texas Instruments, P.O. Box 5012, Dallas, TX 75222. (214) 238-3741. \$1.50 (1000-up); 4 to 6 wk.

Seven LED numeric displays have 0.3-in. character heights. Types TIL314 and 316 are available in green and amber, respectively, and are seven-segment displays with right and left decimals; types TIL315 and 317, in green and amber, respectively, are seven-segment displays with a right decimal only; and types TIL327, 328 and 329, in red, green and amber, respectively, are ± 1 displays with left decimal. These displays are direct electrical equivalents to many of the MAN, SLA, NDP, DL and PMO displays.

CIRCLE NO. 344

Power switching devices handle currents to 20 A

Solitron Devices, 1177 Blue Heron Blvd., Riviera Beach, FL 33404. (305) 848-4311. From \$10.50 (100-up); 2 wk.

Four high voltage power switching transistors, the 2N6560, 61, 62 and 63, can handle loads of up to 20-A peak or 450 V. The 2N6560 and 62 are both rated for a V_{CE0} of 450 V, a load of 15-A peak, a t_{on} of 600 ns, a t_s of 25 μ s and a t_f of 500 ns. The 2N6560 is housed in a TO-3 case and the 62 in a TO-61/I stud case with isolated collector. Similarly the 2N6561 and 6563 are rated for a V_{CE0} of 300 V, an I_c peak of 20 A, a t_{on} of 600 ns, a t_s of 1.2 μ s and a t_f of 500 ns. The 2N6561 is housed in a TO-3 case and the 63 in a TO-61/I case. The thermal resistance for the TO-3 devices is 0.8 C/W and 1 C/W for the TO-61/I version. All units have a rated f_T of 40 MHz and a $V_{CE(SAT)}$ of less than 1 V at 10 A.

CIRCLE NO. 345

If anybody can hand you the ready-made P/C connector you need,

we can.

That's because we have more of them on the shelf than anybody else we know. We have them from .050 contact centers through .156, from 6 to 210 contacts, with full bellows, semi-bellows and cantilever designs, with gold saving AuTAc™ plating, low insertion force contacts, in micro miniatures, dual and single read-outs . . . and on and on and on.

We've been at this 23 years. And — because we don't compromise on quality

when we make our connectors — we don't like to see your P/C designs compromised by a make-do connector. So, we have a lot of them.

They're all cataloged in our latest 44-page brochure. Send for your free copy so you'll have it when you need it.

Or, if you need help right now, just pick up your phone and call Customer Service. (213) 341-4330.

Ok. Send me: Details on your line of P/C connectors.
 and, come to think of it, your low cost circular connectors, too.

Name _____

Title _____

Company _____

Address _____

City _____

State _____

Zip _____

 **Viking**
CONNECTORS

Viking Industries, Inc./21001 Nordhoff St./Chatsworth, Calif. 91311



Somebody goofed!

The story of a calculator that doesn't do everything it was designed to do.

50,000 UNITS LATER

After 50,000 integrated circuits (the heart of the calculator) were manufactured by a world famous CHIP manufacturer, someone discovered an error in the algorithm program. This is the mathematical formulas electronically built into each integrated circuit. This error is ONLY apparent in calculating the arc cos of 0 however, and none of the other functions were affected. Rather than discarding these 50,000 chips, a quality calculator manufacturer, MELCOR, decided to take advantage of the situation. After all, not everyone needs the arc cos of 0. (By the way, NEW chips have since been made by this chip maker and are now available in calculators retailing for \$99.95.)

THE CHIP ERROR AND WHAT IT CAN DO FOR YOU

For a limited time, Chafitz is offering what is sure to be a first in the calculator field. A limited quantity of quality calculators with a CHIP ERROR. Due to this chip error the MELCOR 635 is not able to calculate the arc cos of 0 (which everyone knows is 90 degrees). But, at our unbelievable low price, who cares about the error. Just remember that the arc cos of 0 is 90 degrees and you've got a perfect calculator at the incredibly low price of only \$59.95.

LOOK AT WHAT YOU DO GET

A 40 key calculator with 23 functions • 8 digits with scientific notation • Two levels of parenthesis • Algebraic logic • e^x , \ln , 10^x , \log , SIN, COS, TAN, \sqrt{x} , x^2 , $1/x$, $n!$, y^x , π • Radian and degree calculations • Arc SIN, COS, TAN • 3 button accumulating memory • Register exchange • Sign change • Rechargeable, with NiCd batteries included • Plus much more •

Accessories included: A/C adapter/charger, leather case with belt loop, instructions. Also, one year parts and labor warranty.

For the scientist, student, mathematician, engineer, businessman!

LIMITED QUANTITIES!

Due to the amount of machines produced we will have to fill orders on a first come first serve basis. So hurry, you don't want to goof by not getting one of these incredible machines!

10 DAY NO RISK TRIAL

If you can't believe this offer, try the calculator for 10 days in your home or office. If you feel it doesn't do everything we say it does, return the complete package for a prompt refund.



Remember, you can't calculate the arc cos of 0. But at \$59.95 who cares!!!

WHEN YOU THINK CALCULATORS, THINK

Chafitz

856 Rockville Pike
Rockville, Maryland
20852

AMERICA'S CALCULATOR COUNSELORS™

MAIL ORDERS ACCEPTED
Add \$2 per unit when ordering
Maryland residents remit 4% sales tax.

ORDER NOW BY PHONE

800-638-8280

Maryland residents call: 301-340-0200
Operators on duty Mon. Sat. 10-5 EST

MAJOR CREDIT CARDS ACCEPTED

532

DISCRETE SEMICONDUCTORS

25-A SCR bridges have low thermal resistance



Gentron Corp., 6667 N. Sidney Pl., Milwaukee, WI 53209. (414) 351-1660. From \$7.50 (100-up); stock.

Powertherm 25-A bridge rectifier circuits have a low thermal resistance of 0.5 C/W. Circuits are available in the 2500 Series with 120, 230 and 460 V ratings. The heat-sink mounting plate is isolated between the base and terminals and thus eliminates elaborate isolation schemes. Bridge breakdown isolation exceeds 2000 V. Six circuit combinations are offered. Options such as voltage transient suppression, free-wheeling diode protection thermal limiters and current monitors are available.

CIRCLE NO. 346

Gate-turn-off thyristors handle up to 2.4 kW

Sabor Corp., 12597 Crenshaw Blvd., Hawthorne, CA 90250. (213) 644-8689. From \$5 (100-up).

The CA-A series of GTS gated thyristors handles power up to 2.4 kW and can be turned on by a positive gate pulse and turned off by a negative pulse. The series of thyristors includes standard sizes for current levels of 10, 15 and 30 A. They handle surges to 100-A forward current for 1 ms. Voltage levels of 100, 200, 400 and 800 V are available in the three current ranges, with transient peak voltage capacity up to 900 V dc. These devices have a fast response, with turn-on times of less than 4 μ s and turn-off times of 50 μ s. Reverse recovery time is 5 μ s.

CIRCLE NO. 347

Four-digit LED display has 1-in. digit height

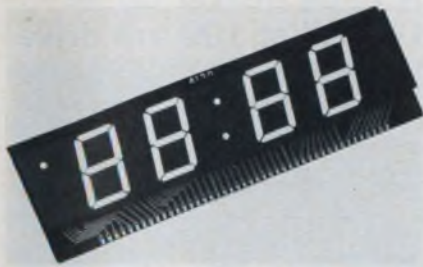

Litronix, Inc., 19000 Homestead Rd., Cupertino, CA 95014. (408) 257-7910. \$1.70/digit (1000-up); stock (prototype quantities).

The DL-4120 is a seven-segment LED digit display with a 1-in. character height. The digits are mounted on a circuit board and are legible from 60 ft or more. A colon and LED lamps to indicate AM, PM and "alarm set" are included.

CIRCLE NO. 348

Zener diodes get boost in power rating

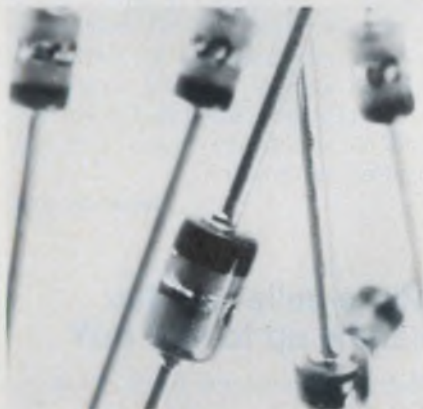

Teledyne Semiconductor, 1300 Terra Bella Ave., Mountain View, CA 94043. (408) 968-9241. From \$0.22 (100-up).

The 1N4728 to 1N4764 series of zener diodes are housed in hermetically sealed glass packages instead of the conventional plastic. The series is registered for a 1-W device power dissipation, but by use of the new PowerStud package, the devices can handle 1.5 W. Designed for voltage regulator and other applications demanding higher power handling capacity, the 37 new devices cover a zener voltage range from 3.3 to 100 V. Voltage tolerance is $\pm 5\%$ or $\pm 10\%$ depending upon device type. Optionally available are voltage ranges down to 2.4 V and tolerances as tight as $\pm 1\%$.

CIRCLE NO. 349

Laser diodes operate at room temperatures

Laser Diode, 205 Forrest St., Metuchen, NJ 08840. (201) 549-7700. Prices from \$180 (10-up); stock.

The LCW series of gallium-arsenide injection laser diodes can operate continuously at room temperature. Assembled in hermetic, dual-lead TO-5 packages, the laser diodes are designed to emit 5 to 20

mW of continuous power at a typical forward drive current of 350 mA. In addition, they can be modulated to frequencies in excess of 100 MHz. The LCW-5 laser diode provides a minimum average power output of 5 mW at 27°C and the LCW-10, 10 mW. Both units emit light at 850 nm, but devices can be selected to emit at wavelengths between 800 and 910 nm.

CIRCLE NO. 350

Six ways to a winning first impression.

At first glance, Zero's VIP 6-Way enclosure says quality. The second look reveals a unique versatility designed to delight your customer.

VIP 6-Way can be hard-mounted, slide-mounted, used as a table top or portable unit, tilted, stacked and racked. This inherent versatility, combined with unique modular design and a wide variety of options and accessories, lets you start with a basic chassis and go as far as you want toward specialization. Standardization keeps prices competitive and permits delivery of all 17 sizes within 2 weeks A.R.O.

With VIP 6-Way, your product's winning first impression lasts and lasts.

Write for your free catalog today.



The Final Touch



ZERO MANUFACTURING CO.
Burbank, CA 213/846-4191 • Monson, MA 413/267-5561 • Clearwater, FL 813/531-8991

FOR IMMEDIATE NEED CIRCLE #243

FOR LITERATURE CIRCLE #244

Premier Electronic Cabinets and Cases

- ESTHETICS KEYED TO MODERN SYSTEMS
 - RUGGED-FUNCTIONAL CONSTRUCTION
 - ECONOMICAL PRICING
- PROMPT SERVICE & AVAILABILITY**

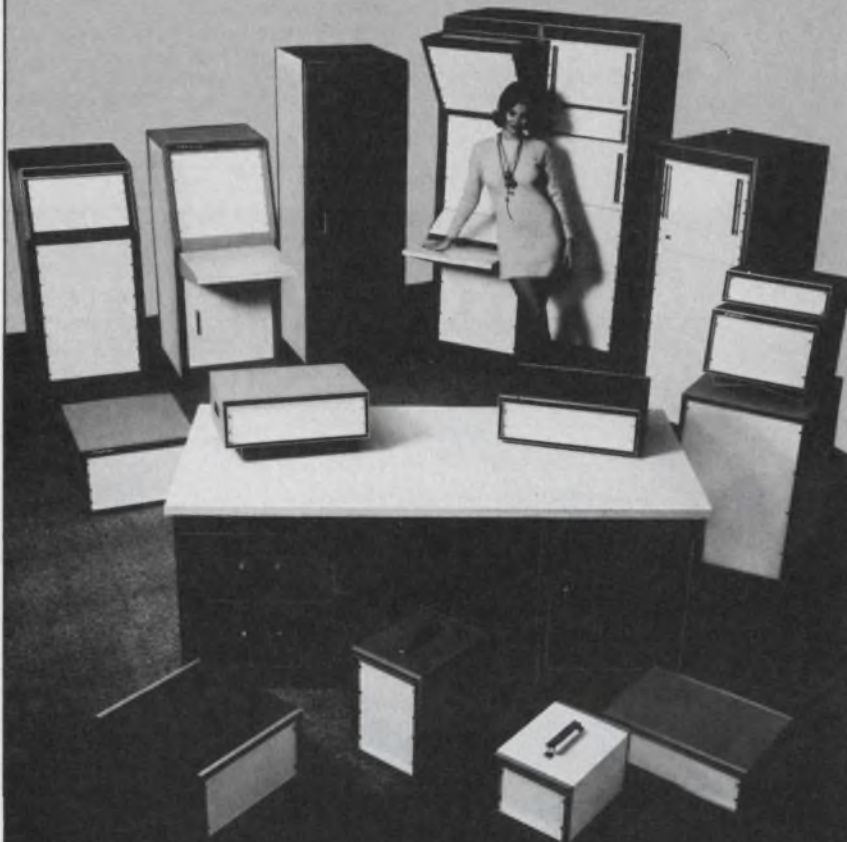

INSTRUMENT CASES - TIC SERIES

TVA Series Vertical Assembly—
Construction Details
(1 Frame, 2 End Panels, Rear Door)

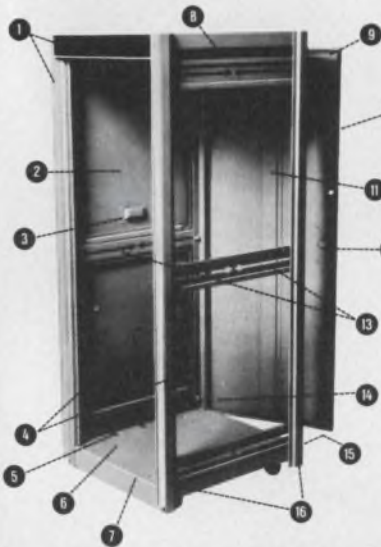

1. Trim: extruded anodized aluminum with textured vinyl inlays
2. Outside removable flush end panels (16 ga.)
3. Recessed hand grip for panel removal
4. 2 pr. panel mounting angles, fully adjustable front to rear with tapped 10-32 holes on EIA & WE Standards spacing (12 ga.)
5. 1" dia. holes for cable entry beneath base
6. Recessed caster mounting holes
7. 1 piece formed steel base provides for heavy equipment mounting area and concealed caster mounting (14 ga.)
8. 1 piece solid top for extra rigidity and squareness (14 ga.)
9. Foam gasketing (3 sides)
10. Magnetic closure gasket
11. Door stiffener channel
12. Keyed latch and brushed aluminum pull handle
13. Horizontal cross-brace and panel mounting angle supports
14. Quick release, spring loaded door hinges (top and bottom)
15. 1 1/8" dia. knock-outs for rear cable entry underneath rear door
16. Formed steel uprights (14 ga.) provide 1/2" recess to panel mounting angles

All features shown are standard in the Trimline TVA Series
Welded, formed steel construction

Complete catalog and prices on request



PREMIER METAL PRODUCTS COMPANY
337 Manida St., Bronx, N.Y. 10474/(212) 991-6600

DISCRETE SEMICONDUCTORS

IR LEDs deliver up to 5.4 mW at 100-mA drive

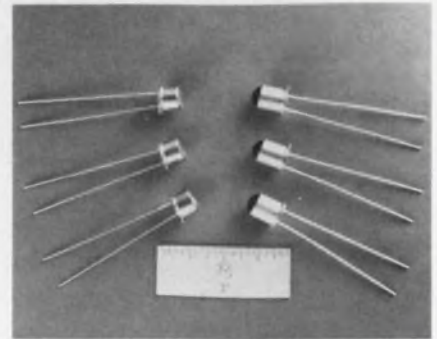

General Electric Semiconductor Product Dept., Electronics Park 7-78, Syracuse, NY 13201. (315) 456-2715. From \$1.56 (1000-up); stock.

The LED55 and LED56 series of infrared LEDs produce noncoherent infrared energy at 9400 Å. They are available in hermetically sealed packages with either flat or lens cap configurations. The LED55C series has a guaranteed power output of 5.4 mW minimum at 100 mA and 150 C. Both the LED55 and the LED56 series are exact replacements for the SSL55 and 56 series, previously supplied by General Electric.

CIRCLE NO. 351

Micro-pellet diodes handle up to 400 mW

Microsemiconductor Corp., 2830 S. Fairview St., Santa Ana, CA 92704. (714) 979-8220. From \$1.75 (100-up); stock at 4 wk.

A line of MicroPellet devices includes a full array of zeners, temperature compensated diodes, switching diodes, general-purpose diodes and rectifiers. The devices can dissipate 400 mW and are completely packaged and sealed. The zener family has breakdown voltages ranging from 6.8 to 200 V; the rectifiers exhibit PIVs from 100 to 400 V; switching diodes have a reverse recovery time of 4 ns and are electrically equivalent to the 1N4148; the TC diodes are 6.2-V devices and have temperature coefficients from 0.01 to 0.005%/°C (1N821-829 Series) and the general-purpose diodes are electrically equivalent to 1N486B, 1N5196 and 1N645-649.

CIRCLE NO. 352

Digital Counter Buyers' Guide



Simplify specification, batten down budgets. ENM guide provides descriptions, illustrations, dimensional diagrams . . . and prices in 7 quantities from 1 to 1000 . . . for 76 specific mechanical stroke and revolution counters, electric counters, and elapsed time indicators. A supermarket in print of reliable, value engineered counters for practically every application.

PHONE OR WRITE FOR FREE COPY



ENM COMPANY

5340 Northwest Highway, Chicago, Ill. 60630
PHONE: (312) 775-8400 TELEX: 25-4068

INFORMATION RETRIEVAL NUMBER 88

NEW FROM AUGAT.

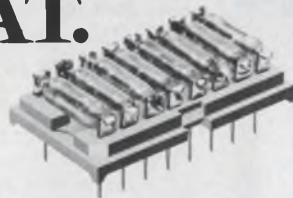

New adaptor plug assemblies make inexpensive circuit modules for plugging into Augat sockets or PC boards. Available as standard items in either 14- or 16-pin format, with gold- or tin-plated pins.

Available now from your Augat distributor.

AUGAT[®]

Augat Inc., 33 Perry Avenue, P.O. Box 779, Attleboro, Massachusetts 02703

Name _____
Title _____
Company _____
Address _____
City _____ State _____ Zip _____

INFORMATION RETRIEVAL NUMBER 89

ELECTRONIC DESIGN 22, October 25, 1975

Dialight sees a need:

(Need: The widest choice for your every application.)

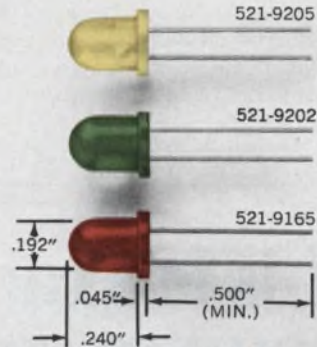

Now available in green, yellow and red. Mini-sized for maximum front panel density and easy panel mounting. High luminous intensity, low cost. Vibration/shock resistant. Solid state for long life. Wide viewing angles. Ideal for applications like panel lighting, film annotation and alpha-numeric displays.

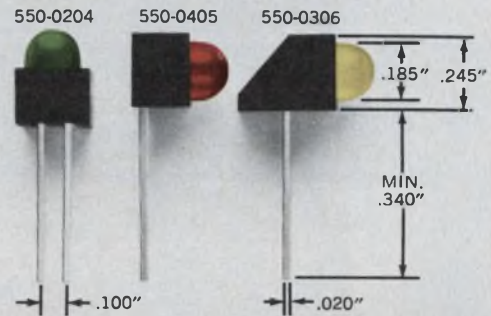

Mix 'em or match 'em. LED logic state fault indicators are available in red, yellow and green, in a variety of shapes, some with a built-in integral resistor. Can be driven from DTL and TTL logic. Designed for easy alignment on PC boards so that multiple functions can be displayed.



Dialight, the company with the widest choice in switches, LEDs, indicator lights and readouts, looks for needs . . . your needs . . . and then they develop solutions for your every application. No other company offers you one-stop shopping in all these product areas. And no other company has more experience in the visual display field. Dialight helps you do more

with these products than any other company in the business, because we are specialists that have done more with them. Talk to the specialists at Dialight first. You won't have to talk to anyone else. Send for your free new copy of Dialight's current catalog.

DIALIGHT

Dialight, A North American Philips Company
203 Harrison Place, Brooklyn, N. Y. 11237
(212) 497-7600

See Dialight.

INFORMATION RETRIEVAL NUMBER 90

DISCRETE SEMICONDUCTORS

Beam-lead p-i-n diodes have sturdy leads

Hewlett-Packard, 1501 Page Mill Rd., Palo Alto, CA 94304. (415) 493-1501. From \$8.50 (100-up); stock.

Each lead on the Model 5082-3900 microwave beam lead p-i-n diodes is guaranteed to survive a

2 gram pull. Breakdown voltage of the diode is 150 V, minimum, and 200 V typical. Capacitance (C_0) is a low 0.02 pF, which is claimed by the company to result in isolation equal or better than other presently available diodes. The diodes are designed for use in stripline or microstrip circuits and can be attached by welding, thermocompression or ultrasonic bonding techniques.

CIRCLE NO. 353

Avalanche photodiode has 24-MHz bandwidth

Electron Tube Div., EMI Electronics Ltd., 243 Blyth Rd., Hayes, Middlesex, England.

An epitaxial silicon avalanche photodiode, type S30512, is a light sensitive detector with an active area approximately 0.25 mm in diameter. The NEP of the S30512 is 3×10^{-12} W over a 24-MHz bandwidth, sensitivity at 900 nm is 24 A/W and spectral response is from 450 to 1100 nm. The fast component rise and fall times are less than 1 ns and the slow component decay time is less than 20 ns. The photodiode is housed in a TO-18 window can, and can be fitted with either a flat or lens window. A complete photodetector unit, the C535, uses the S30512. This contains a bias controller and pre and main amplifiers as well as a converter, which enables the unit to operate from a single 12-V, 40-mA supply. Stable operation over -40 to $+70$ C is possible and the gain can be adjusted by a built-in potentiometer. The C535 has a bandwidth from 300 Hz to 50 MHz. The detectivity (D^*) is 1.7×10^{11} cm W^{-1} Hz $^{1/2}$.

CIRCLE NO. 354

This is a rack-full of counter capability.



HP's new 75 MHz Timer/Counter is easily held in your hands. Take a look at the front panel: Never before has there been so much counting capability in such a small package at such a small price. Seven other modules snap on to convert to other instruments — including a DMM — or to connect to the HP Interface Bus.

Features include: 1 nsec time interval averaging • autoranging of frequency, frequency ratio, period average, time interval average • full complement of triggering controls, monitor LEDs • preset ECL and TTL thresholds • an astonishingly low price of only \$910* total for 5308A module with 5300B mainframe. *Domestic USA price only.

HEWLETT  PACKARD

Sales and service from 172 offices in 65 countries.
1501 Page Mill Road, Palo Alto, California 94304

02503

T-1-sized LEDs give you choice of brightness

Monsanto, 3400 Hillview Ave., Palo Alto, CA 94304. (415) 493-3300. From \$0.30 (1000-up); stock.

A series of red LEDs is in T-1 sized cases. There are two brightness levels and two lead length variations available. Also included is a low-profile lamp with the same lead variations. The MV5074B and the MV5074C have a brightness of 2 millicandelas (mc) typical with a drive current of 20 mA; the MV5075B and MV5075C have a 1 mc output at 20 mA. The B and C suffixes of these T-1 packaged lamps refer to a minimum lead length of 0.6-in. (15.2 mm) and 1-in. (25.4 mm), respectively. Viewing angle of these units is 70° (MV5074) or 90° (MV5075). The MV5077B and the MV5077C have a typical luminous intensity of 1.75 mc at 20 mA. The viewing angle of these low profile lamps is 110° when operated between the 50% power points.

CIRCLE NO. 355

3.5-GHz transistors made for vhf and uhf use



TRW Semiconductors, 14520 Aviation Blvd., Lawndale, CA 90260. (213) 678-4561. From \$1.30 (1000-up); stock.

The LT1001, LT2001 and LT3002 vhf and uhf linear transistors are designed for communications circuits. All devices feature a cut-off frequency of 3.5 GHz. The LT1001 is available in a TO-39 package, the LT2001 in a TO-117 package and the LT3002 in a 280 SOE package. The 280 SOE features lower parasitics and provides improved high frequency characteristics with lower emitter inductance than the other packages.

CIRCLE NO. 356

High power SCRs switch at rates up to 10 kHz

International Rectifier, 233 Kansas St., El Segundo, CA 90245. (213) 678-6281. From \$83.60 (10 to 99); stock.

The 500 PBQ series of high power SCRs offers what the company believes to be the fastest turn-on and turn-off time and the lowest switching losses and forward voltage drop of any commercially available unit. The SCRs operate at switching frequencies up to 10 kHz and have guaranteed turn-off times as low as 10 μ s. SCRs in the series are the 500 PBQ, 501 PBQ and 550 PBQ. They are rated for continuous operation to 1200 V and 500 A. Maximum peak one-cycle surge current is 7500 A for all units. Forward voltage drop for the units is about 1.3 V at 500 A, and the minimum dV/dt is 500 V/ μ s. The 500 PBQ units have voltage ratings from 500 to 1200 V with an 1100-A peak repetitive current rating at 5 kHz; 501 PBQ units are also rated from 500 to 1200 V but with a current of 840 A at 5 kHz; and 550 PBQ units are rated from 100 to 600 V, 1100 A at 5 kHz.

CIRCLE NO. 357

General Electric has some valuable new free lamp information for you.

GE ADDS BLUE to its line of color glow lamps.



Actual Size

With our new T2B blue glow lamp you can choose from a broad spectrum of colors for a wide range of indicator, panel illumination, and edge-lighting applications. Red, yellow, orange, green, blue and white are available with just three basic lamps (C2A, G2B, T2B) and the appropriate filters.

All three lamps are electrically and physically interchangeable for operation from a standard 120 V, ac, line in series with an appropriate current limiting resistor.

They offer rugged construction, long life for reliable performance and shock and vibration resistance for use in almost any environment.

Send for complete, updated technical information. Circle the number below or write GE for Bulletin #3-5258.

GE has added 6 halogen cycle lamps to its low-voltage line.

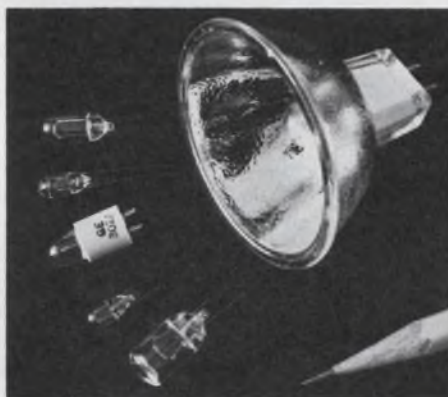

General Electric now offers over 27 halogen cycle lamps that pack high light output in small packages. (In addition, GE offers 8 sealed beam halogen lamps primarily for aircraft applications.) Bulb diameters range from $\frac{3}{16}$ " to $\frac{1}{2}$ ". Lengths from .520" to 2.25". Voltages from 3.5 to 28.0 V. And candlepower from 2.15 cd up to 250 cd.

They're ideal for applications such as optical systems, instrumentation, illuminators, fiber optics, card readers, displays and aircraft navigation. A variety of terminals are offered.

For complete, updated technical information circle the number below or write GE for Bulletin #3-5257.

GE wedge base miniature lamps can save you time, money and space.

These lamps are ideal for applications such as indicators, markers and general illumination where space is at a premium. Their wedge-based construction makes them easy to insert and remove. They don't require bulky, complicated sockets. And the filament, which is always positioned in the same relation to the base, offers consistent illumination from lamp to lamp.

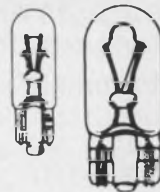

There are now more than 25 types of GE wedge base lamps available. Voltages range from 6.3 V to 28 V. Candlepower from 0.03 to 12 cd. Bulb sizes range from subminiature at 6 mm to a heavy-duty bulb at 15 mm.

Send for complete, updated technical information. Circle the number below or write GE for Bulletin #3-5259.

For the most up-to-date technical information on any or all of these lamps write: General Electric Company, Miniature Lamp Products Department #3382-L, Nela Park, Cleveland, Ohio 44112.

GENERAL  ELECTRIC

INFORMATION RETRIEVAL NUMBER 92

Here's all you need for computer/process interface!

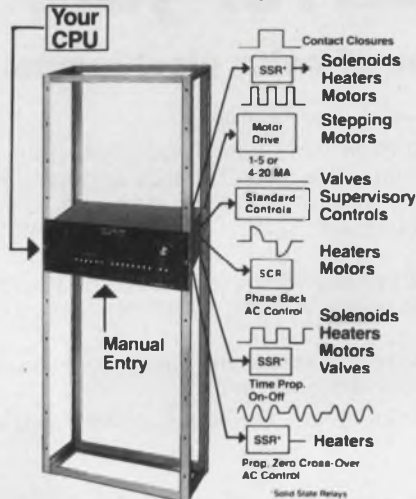

UNI-DRIVER, the one *stand-alone* interface between your computer and *all* commonly used final control elements. It maintains process control at the last command level, even with the computer shut down, and provides "back up" manual control.

Mix or match any combination of control cards to drive contactors, heaters, motors, pumps, power controllers, valves, set points, motor speeds, solenoids, shutters, louvers, fans, lamps, stepping motors, you call the shots. Up to 64 proportional outputs or 512 on-off outputs per Uni-Driver.

Eliminate a rack full of "black boxes!" Call collect (612) 941-3300 and ask for UNI-DRIVER! Also, ask about ANA-PLEXER. That's our combination Mux & A/D converter for sampling process control signals of almost any analog transducer or sensor. Directly interfaces with your CPU without external I/O.

184



Direct Digital Control Division
RESEARCH INC
 BOX 24084 MINNEAPOLIS, MINNESOTA USA 55424
 PHONE (612) 941-3300

INFORMATION RETRIEVAL NUMBER 101

INTEGRATED CIRCUITS

Monolithic v/f converters deliver 0.05% linear signals

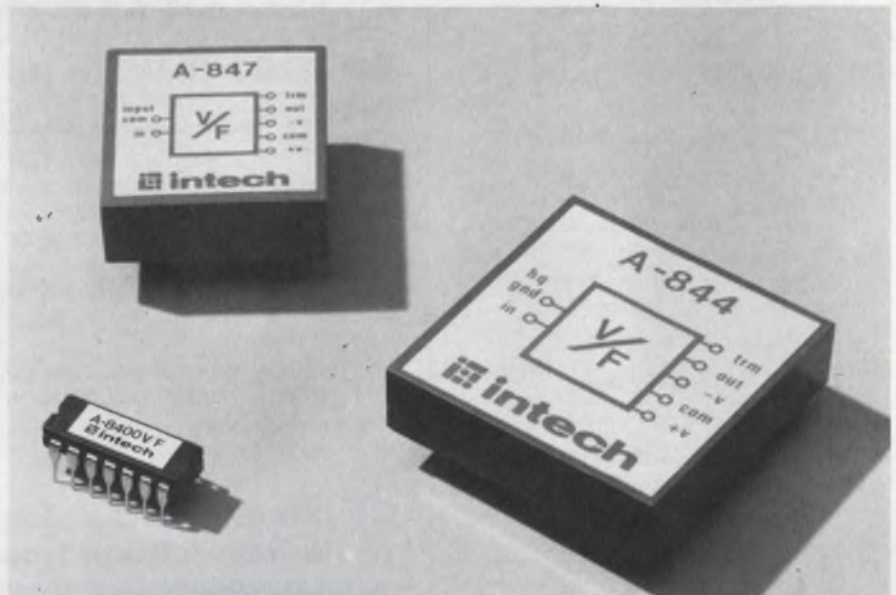

Intech/Function Modules, 282 Brokaw Rd., Santa Clara, CA 95050. (408) 244-0500. P&A: See text; stock.

Shrinking the size and cost of modules has been a goal of both IC and module manufacturers, and Intech/Function Modules has done just that with its voltage-to-frequency converters. The Model A-8400 monolithic v/f converter delivers a 0-to-100-kHz output signal with a linearity of 0.05% and costs only \$15 in singles.

Monolithic v/f converters, though, aren't new. Raytheon Semiconductor introduced its Model 4151 several months ago—but with linearity that is only 1% typical.

The A-8400 delivers a 10-kHz signal with 0.01% linearity or a 100-kHz signal with 0.05%. Raytheon expects to improve the linearity to 0.05% over a 10-kHz bandwidth by adding an external op amp and several passive components. Both units will also function as f/v converters—just reconnect the pins.

Although the A-8400 tops the 4151 in linearity, the Raytheon chip will cost only \$3 in 100 quantities, while the Intech/Function Modules converter costs \$12 for the same quantity. At the unit level, the 4151 costs \$3.75 and the

A-8400 \$15. Both of these products, though, are many times cheaper than the closest competitive modular v/f converter on the market.

Consider this when evaluating costs, however: The A-8400 does not need any active external components to achieve good linearity, while the 4151 does.

The A-8400 linearly converts a 0 to +10 V analog input signal to a near dc to 100-kHz digital output pulse train whose repetition rate is proportional to the analog input.

Output frequency scaling for the A-8400 is determined by an external RC time constant. And a single external resistor is required to terminate the uncommitted open-collector output to allow complete compatibility with all logic forms (TTL, CMOS, etc.).

Temperature coefficients for the A-8400 are a good ± 10 ppm/ $^{\circ}$ C for offset tempo and a fair ± 150 ppm/ $^{\circ}$ C for full-scale tempo.

The converter comes in a 14-pin plastic DIP and is rated over 0 to 70 C for the commercial version and -25 to +85 C for an extended-temperature-range version. The A-8400 requires a ± 15 -V supply.

Intech/Function Modules

CIRCLE NO. 307

Raytheon

CIRCLE NO. 308



DIGITAL "TIME-OF-DAY" CLOCKS

- Manual Thumbwheel Time Setting
- Input Power – 1 Watt Nominal

PLANETGEAR® Snap Action Transfer
and Large Digits Eliminates
Readout Errors



- Superior Accuracy
- Extremely Reliable
- Extraordinary Life
- Panel Mount

For more information, send for our Clock/Counter catalog or get in touch with one of our sales engineers. They are always ready to help.



HAYDON SWITCH & INSTRUMENT, INC.

1500 Meriden Road, Waterbury, Conn. 06705 (203) 756-7441

INFORMATION RETRIEVAL NUMBER 102

Touche!

Target: to eliminate the warp problem in space-saving 1/8" plug-in panels.

The winning combination: EMC's Wire-Wrap® Panels with Nurl-Loc® Terminals. EMC panels stay flat, without stiffeners, because Nurl-Loc's splined cylinder distributes stress evenly throughout board thickness, even on boards as large as 15" x 18" (shown). A flat panel means more accurate true positioning between pins for better wrapping. Nurl-Loc also permits easy pin removal without damage. And the four-finger contact holds any I.C. lead firmly, even as small as .011 dia. Call Allan Klepper (401) 769-3800 for your copy of the interesting and informative "Inside Story", or write Electronic Molding Corp., 96 Mill St., Woonsocket, Rhode Island 02895.

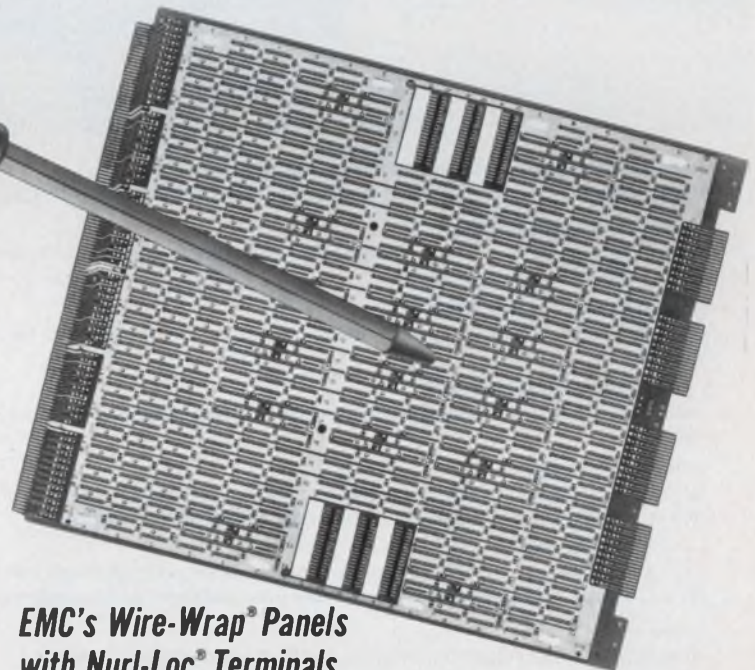

**EMC's Wire-Wrap® Panels
with Nurl-Loc® Terminals
... better performance by design!**



Interconnection Specialists

Wire-Wrap® Radnor-Denver Co.

INFORMATION RETRIEVAL NUMBER 103

INTEGRATED CIRCUITS

Improved 8080 and other ICs enhance μ Cs

Intel, 3065 Bowers Ave., Santa Clara, CA 95051. (408) 246-7501. 8080A: \$110 (25-99); stock.

Eight components extend the capabilities of the 8080-based MCS-80 microcomputer system. They include an upgraded version of the 8080 that is designated with a suffix A. It is available in four op-

tions. Three provide instruction cycle times of 1.3, 1.5 or 2.0 μ s, and the fourth operates at 2 μ s over the MIL-temperature range. Also, an LSI CPU group provides an 8080A option, the 8224 clock generator and the 8228 system controller. Other new circuits consist of five programmable I/O and peripheral devices. These devices include the 8251 communications interface, 8255 peripheral interface, 8253 interval timer, and the 8257 DMA controller.

CIRCLE NO. 360

10-bit CMOS DAC aims for μ P uses

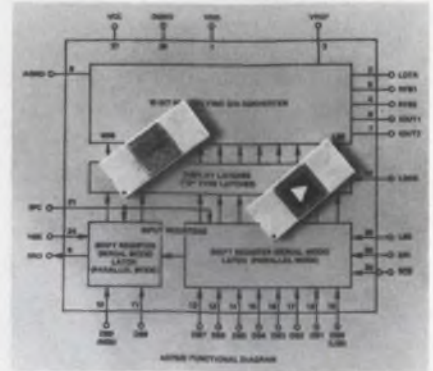

Analog Devices Inc., P.O. Box 280, Route 1 Industrial Park, Norwood, MA 02062. (617) 329-4700. \$19.50 to \$127.00 (1 to 49); stock.

A 10-bit CMOS bus-oriented d/a converter—the AD7522—can communicate directly with LSI microprocessors such as Intel's 8080. In addition, the double-buffered DAC can provide an analog output for a previous digital message, while the microprocessor is loading a new value into the AD7522's front buffer. Hence, the microprocessor may treat the DAC as an I/O peripheral. The CMOS DAC has a maximum quiescent supply current (I_{DD}) of 2 mA. It has linearities of 8, 9 or 10 bits. The circuit has a differential nonlinearity tempo of ± 2 ppm/ $^{\circ}$ C maximum; gain tempo is ± 10 ppm/ $^{\circ}$ C maximum. The AD7522 uses a 15-V power supply and a 5-to-15-V logic supply.

CIRCLE NO. 358

Bipolar bit-slice μ P offers 45-ns cycle

Signetics, 811 E. Arques Ave., Sunnyvale, CA 94086. (408) 739-7700. \$12 to \$22.50 (100-999); stock.

The N3001 microprogram control unit and N3002 2-bit central processing element are bipolar microprocessor slices that provide 30% faster clock-cycle time than competing devices. The new units' clock-cycle time is typically 45 ns, compared with 70 ns for competitors. As a supplement to the N3001 and N3002, the company offers both an 8-bit and 16-bit evaluation kit containing the chips, as well as a complete set of standard memory and interface circuits.

CIRCLE NO. 359



— enters both graphic and alphanumeric data automatically
simply trace a curve, circle a printed character or make a checkmark with a pen or cursor.

— not restricted to a "tablet"
Graf/Pen can be mounted on a drawing table, a blackboard, a projection screen, a CRT display or any other flat surface.

— permits human judgement
unlike automatic optical data entry systems, permits human judgement to intervene when needed.

— cuts graphic data entry time
users have experienced reduction of 90% compared with manual scaling and keyboard entry.

— widely applicable
currently used for such diverse purposes as planning radiographic treatment in medicine and as entering part numbers in order processing and inventory control.

— systems oriented
interfaces available to almost every kind of minicomputer, programmable calculator or RS-232 device. Complete off-line systems use punched paper or magnetic media.

— low cost
compared with other digitizers; compared with other data entry techniques.

No wonder Graf/Pen is the most widely used digitizer in the world!

For all the details, just ask Rolf Kates, vice president for marketing.

SAC SCIENCE
ACCESSORIES
CORPORATION
Kings Highway West
Southport, Connecticut 06490
(203) 255-1526

INTRODUCING SCANBE'S US-2TM ULTIMATE SOCKET

The Ultimate Socket That Completely Eliminates Solder Wicking and Intermittent Shorts Due to Flux Entrapment

And Low Profile, too!

Who says a low profile socket can't be exciting? Our US-2 is. In fact, revolutionary is a better word. Here's a socket designed for the world of LSI & microprocessors. The Ultimate Socket. For three prime reasons. And many more.

1. No Solder Wicking!

Our patented built-in anti-wicking design makes it impossible for solder to flow into the contact.

Yes, we said impossible! The offset pin construction absolutely prevents solder & flux capillary action.

2. No Flux Entrapment!

Our competitors have tried to lick the wicking problem with a wafer. It isn't a very good barrier. And it creates an even worse problem. Flux entrapment. Which can cause intermittent short circuits that may shift from contact to contact as the flux heats up. Think what this problem could cost in your finished product.

Our US-2 doesn't need a wafer since there's no wicking problem to begin with. Consequently, no flux entrapment. Ever.

3. The Fully Tested Contact!

The US-2 also has the Ultimate Contact, which accepts the full range of IC leads without over-stressing. The contacts are designed for ideal insertion and withdrawal forces, even after multiple insertions. Contact material

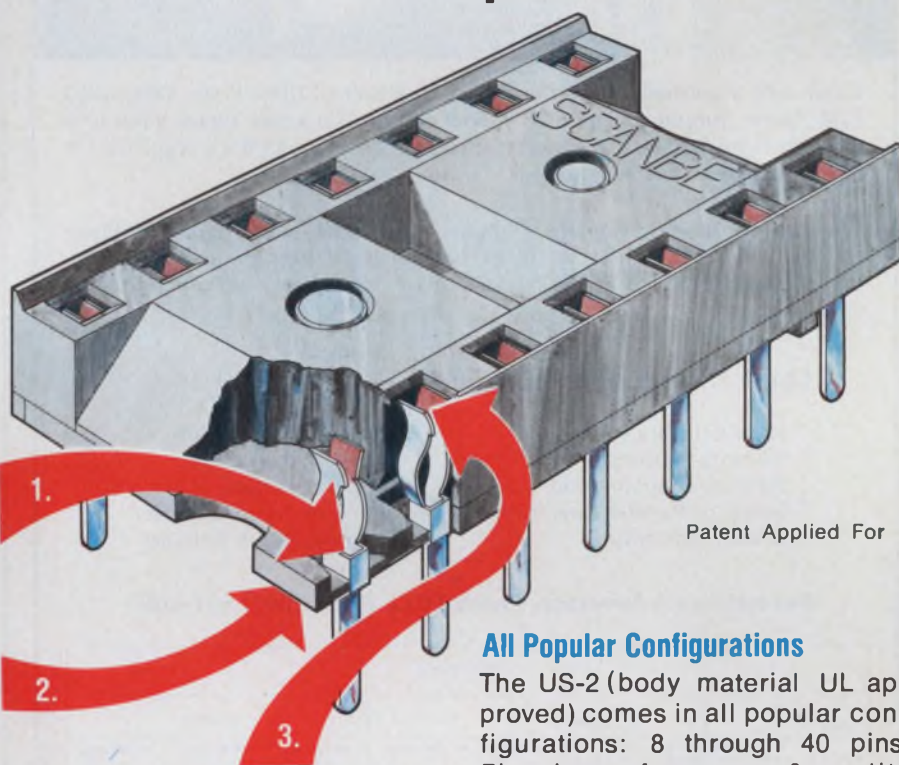

Patent Applied For

is copper alloy CA-770 with a 100 microinch gold inlay on the contact surfaces (and no gold adder). An independent test lab has proven the US-2 edge-wipe design to meet or exceed EIA RS-415 specs by a wide margin. Example — 195 gram insertion, 28 gram withdrawal & 14 milliohm contact resistance.

All Popular Configurations

The US-2 (body material UL approved) comes in all popular configurations: 8 through 40 pins. Plus the performance & quality of the Scanbe ME-2 socket. And it's priced competitive.

Scanbe Manufacturing Corporation

3445 Fletcher Ave., El Monte, Ca. 91731
(213) 579-2300

FREE US-2 SOCKET

Don't take our word for it. Send for your free 16 pin US-2 socket, test report & spec sheet. Just attach this coupon to your letterhead.

One question: The socket sizes you use most are _____

Scanbe Manufacturing Corporation
3445 Fletcher Ave., El Monte, Ca 91731
(213) 579-2300

 **SCANBE**
CANOGA INDUSTRIES

SCR POWER SUPPLIES YOU CAN RELATE TO



Enter into a permanent relationship with either of these Phase Controlled E/M Power Supplies. The SCR model on top is a single phase input unit offering from 500 to 2,400 watts of power and precise 0.1% regulation in both voltage and current modes.

The bottom unit is our three phase input SCR model boasting power ratings in the 2,500 through 10,000 watt range. It too features 0.1% regulation. Both types offer the highest power output per mechanical volume in the industry.

Check these superior benefits:

- * High Efficiency
- * Remote Sensing
- * Remote Programming
- * Series or Parallel Operation
- * 5 Year Warranty
- * Rack or Bench Mount
- * Overvoltage Protected
- * Constant voltage or current with automatic crossover
- * Optional Input Voltages

For technical information, Phone TOLL FREE (800) 631-4298

SCR MODELS														
VOLTS	1 ϕ INPUT								3 ϕ INPUT					
	500 Watts		800 Watts		1600 Watts		2400 Watts		2500 Watts		5000 Watts		10,000 Watts	
	A	S	A	S	A	S	A	S	A	S	A	S	A	S
0 - 6											600	2300		
0 - 7.5			100	650	180	850	250	1100	300	1600				
0 - 10	40	450	80	600	150	850	210	1100	250	1500	500	2300		
0 - 20	25	450	40	600	80	800	120	1000	125	1400	250	1900	500	2900
0 - 30									100	1400	200	1900		
0 - 40	13	425	20	500	40	750	60	900	60	1400	125	1800	250	2700
0 - 50													200	2900
0 - 60	9	450	13	500	26	850	40	1000						
0 - 80	6	450	10	500	20	850	30	1000	30	1400	60	1800		
0 - 100													100	2900
0 - 120									20	1400	40	1800		
0 - 150	3	425	5	500	10	850	15	1000						
0 - 160									15	1400	30	1800	60	2700
0 - 250									10	1400	20	1900	40	2900
0 - 300	1.5	475	3	550	5	850	8	1000						
25 - 500									5	1600	10	2300	20	2900
0 - 600	.75	500	1.5	650	3	850	4	1100						



ELECTRONIC MEASUREMENTS INC.
405 Essex Road, Neptune, N. J. 07753
Phone: (New Jersey) 201 - 922-9300 • (Toll-Free) 800 - 631-4298
Specialists in Power Conversion Equipment

INFORMATION RETRIEVAL NUMBER 106

INTEGRATED CIRCUITS

16-pin DIP holds 4-k dynamic RAM

Fairchild, Mountain View, CA 94042. (415) 962-3816. \$17.80 to \$23 (100-999); stock.

A 4096-bit n-channel dynamic RAM, packaged in a 16-pin DIP, is available in two speed versions. The Model 40963 has a 250-ns access, while the Model 40964 has 300 ns. Both units employ the company's Isoplanar techniques, and are fully TTL-compatible. Power dissipation is specified at 250 mW, and typical active access power is 120 mW.

CIRCLE NO. 361

High-speed video/i-f amp slews at 175 V/ μ s

Plessey Semiconductors, 1674 McGaw Ave., Santa Ana, CA 92705. (714) 540-9979. \$14.78 (100); stock.

The SL541C video/i-f amplifier combines a slew rate of 175 V/ μ s with a settling time to baseline of 50 ns. The high-speed unit features open-loop gain to 70 dB. Closed-loop bandwidth at 20-dB gain is dc to 100 MHz. The amplifier accommodates both inverting and noninverting inputs. The device comes in a TO-5 package and requires about 16 mA from a 12-V supply.

CIRCLE NO. 362

Bucket-bridge device offers second delays

Reticon Corp., 910 Benicia Ave., Sunnyvale, CA 94086. (408) 738-4266. Under 1 ϵ bit (large qty); stock.

The first n-channel bucket-bridge analog-delay device, the SAD-1024, contains two independent arrays of 512 storage elements within the same 16-lead ceramic DIP. Both sections may be independently clocked and inputted, or they may be connected in sequence to provide 1024 elements of delay. Delays in excess of 1 s can be obtained at room temperature. The unit has a dynamic range in excess of 75 dB, signal bandwidth of greater than 100 kHz, sampling frequency from 1 kHz to 2 MHz and less than 1% second harmonic distortion.

CIRCLE NO. 363

Op amps lower noise for 4-1/2 decades

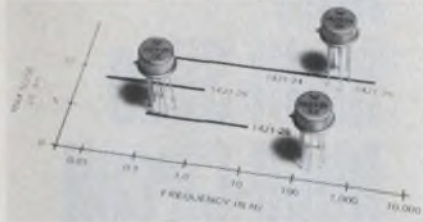

Teledyne Philbrick, Allied Dr. at Rt. 128, Dedham, MA 02026. (617) 329-1600. \$6.50 to \$12.00 (100); stock to 2 wks.

The 1421-24 and 1421-25 hybrid FET op amps guarantee a maximum flicker noise voltage (referred to the input) of 12 μ V pk-pk over a 4-1/2 decade band of frequencies. That range is 0.05 to 2000 Hz. At frequencies below 10 Hz, flicker noise is also guaranteed in two overlapping bands: 8 μ V pk-pk from 0.01 to 1 Hz, and 5 μ V pk-pk from 0.1 to 10 Hz. Other specs include 3-V/ μ s slew rate and 1-MHz unity-gain bandwidth. Offset is 15 mV and bias is 25 pA. The op amps output ± 10 V and ± 10 mA.

CIRCLE NO. 364

4-k bit ROM has 500-ns access

Advanced Micro Devices Inc., 901 Thompson Pl., Sunnyvale, CA 94086. (408) 732-2400. \$13 (100).

A 4096-bit factory-programmable ROM—the AM9214—offers guaranteed speeds of 500 ns. It requires only 250 mW from its single 5-V supply. The silicon-gate NMOS IC is organized 512 \times 8 bits, and it permits direct interface to TTL circuits.

CIRCLE NO. 365

4-k TTL PROMs read in 45 ns

Intersil, 10900 N. Tantau Ave., Cupertino, CA 95014. (408) 257-5450. \$26.70 (100-999).

Two 4096-bit TTL PROMs—the IM5605 and 5625—are organized 512 \times 8 bits and use the company's avalanche-induced-migration (AIM) technology for programming. The IM5605 has open collector outputs and the IM5625 has three-state. Typical read cycle time for both memories is 45 ns at 25 C.

CIRCLE NO. 366

Two-chip 4-bit μ P costs less than \$35

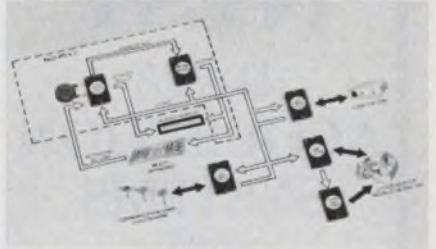

Rockwell, 3310 Miraloma Ave., P.O. Box 3669, Anaheim, CA 92803. (714) 632-1650.

A two-chip 4-bit microprocessor system costs less than \$35 in quantities of 1000. The high-speed PPS-4/2 consists of one chip with clock, CPU and 12 I/O lines, and a second chip with 2-k \times 8-bit ROM, 128 \times 4-bit RAM and 16 bidirectional I/O lines. Operating at a 5- μ s cycle time, the PPS-4/2 can add two 8-digit numbers in only 240 μ s. The PPS-4/2 is instruction and bus compatible with the Rockwell PPS-4 microprocessor so that all 17 input/output, memory, and peripheral controller chips now provided can be used with the 4/2.

CIRCLE NO. 367

Free!

Polyester Film Capacitor Catalogs

Request your choice of Polyester Film or Metallized Polyester Film catalogs today. For more than five decades the name Nichicon has been synonymous with outstanding quality and new developments in the international electronics field.

PRODUCTION ITEMS: Electrolytic Capacitors, Ceramic Capacitors, Film Capacitors, Oil Filled Capacitors—without P.C.B., Metallized Paper Capacitors, Wax Paper and Mica Capacitors, Hybrid IC's and P.T.C. Thermistors.

nichicon We help keep your world turned on.

NICHICON AMERICA CORPORATION
 Division of NICHICON CAPACITOR LTD., Kyoto, Japan
 6435 N. Proesel, Chicago, Ill. 60645 (312) 679-6530
 40 Orville Dr., Bohemia, N.Y. 11716 (516) 567-2994

MEMORY SERIES NO. 11

WHAT ARE 16 INPUT VARIABLES WORTH IN OUR FPLA'S?

Four times the address-scan capability of competitive Field Programmable Logic Arrays. As a bonus you get chip enable. Simplifies expansion of our 48 product terms and 16 input variables. Permits tristate application in bus organization. Provides logic inhibit, preconditional decoding. Got it? Get it now.

For specs & data on our unique chip-enable FPLAs #82S100 (Tristate) & #82S101 (Open Collector), attach coupon to letterhead

Name _____

Tel _____ Ext _____

Send pricing for sample parts

THINK **Signetics**

311 E. ARQUES SUNNYVALE CALIF 94086

NEW DATA ACQUISITION SYSTEMS

with

- Resolution to 15 bits
- Thruput accuracy to .01%
- Four customer-selected Gain Ranges from 0.1 to 10.0V
- Multiplexed thruput rates to 50 KHz
- Auto or Programmable Gain Ranging
- 8 to 128 channels in one chassis



Phoenix Data's new 7000 Series

Phoenix Data's new 7000 series offers a unique solution to high-speed A/D conversion where the input amplitude cannot be predicted in advance of the conversion. Using a high-speed, fast-settling, multi-range amplifier, the 7000 series can switch channels, determine the gain range, and perform a 14-bit conversion in less than 20 μ sec. In the Auto-ranging mode, a 14-bit data word is combined with 2 bits of range data for a 16-bit output word. Note the thruput rates in the models below.

MODEL 7115: 10 KHz
MODEL 7215: 20 KHz
MODEL 7315: 30 KHz
MODEL 7415: 40 KHz
MODEL 7515: 50 KHz

If it's stability, accuracy, speed, or all-around quality you need in Data Conversion, contact Ron Brunner, director of marketing, or the representative in your area.



PHOENIX DATA, INC.

3384 W. OSBORN RD. PHOENIX, AZ 85017
Ph. (602) 278-8528, TWX 910-951-1364

INFORMATION RETRIEVAL NUMBER 109

INTEGRATED CIRCUITS

256-bit CMOS/SOS RAM has 100-ns access

Solid State Scientific, Montgomeryville, PA 18936. (215) 855-8400. \$9 (1000).

A CMOS RAM using silicon-on-sapphire techniques, the SCM-5520S, has a 256-bit storage capacity. It features pin-compatibility with comparable bipolar and NMOS RAMs, and access time of less than 100 ns. Typical access values range from 50 to 80 ns. The RAM comes in a 16-pin ceramic package, and it dissipates 5 mW at 1 MHz. Only 2-V battery back-up is needed to store data.

CIRCLE NO. 368

Linear amp aims for radar uses

Plessey Semiconductors, 1674 McGaw Ave., Santa Ana, CA 92705. (714) 540-9979. \$18.12 (100); stock.

A linear amplifier for radar i-f and microwave instrumentation—the SL 550—features bandwidth of 200 MHz, a noise figure of 2.2 dB at 60 MHz, and an agc range of 21 dB. Typical voltage gain is 42. The agc circuit may be connected as a sensitivity time control permitting programmed gain over a range sweep. The full agc range is controlled by a voltage change of less than 700 mV.

CIRCLE NO. 369

Voltage comparators work to ± 18 V

Analog Devices, Route 1 Industrial Park, P.O. Box 280, Norwood, MA 02062. (617) 329-4700. \$2 to \$22 (100); stock.

A family of voltage comparators—AD111, 211 and 311—features 200 V/mV gain for low level signal detection and 50-mA or 35-V output drive capability. Units have 100-nA maximum input-bias current and 3-mV maximum input-off-set voltage. Supply levels range from ± 5 to ± 18 V dc, and differential input voltages up to these levels are permitted. Input common-mode range is ± 14 V.

CIRCLE NO. 370

New Multi-Slide Multi-Circuit DIP Switches



- Widest variety of switching combinations available anywhere
- One switch . . . many functions
Frequency Range Selection Select on Test
Test Point Monitoring Cross Point Switching
Program Addressing Attenuator Level Selection
- Choose from these popular models . . . and more
2 Poles, 4 Posit. 1 Pole, 8 Posit.
4 Poles, 2 Posit. 4 Poles, 2 Posit. (var.)
- True "make-before-break" action
- Spring-loaded double ball-bearing detenting for positive positioning
- Self-cleaning Gold/Nickel contact plating, wiping action for consistent switching performance
- Epoxy dust cover (clear optional), molded-in standoffs

Sudden Service on Small Quantities!

PROTOTYPES

available on phone or letterhead request

MINELCO Div. General Time

135 South Main St., Thomaston, Conn. 06787

Phone 203-283-8261

A  TALLEY INDUSTRIES COMPANY

...from **Minelco**

INFORMATION RETRIEVAL NUMBER 110
ELECTRONIC DESIGN 22, October 25, 1975

ICs aim for remote TV tuners

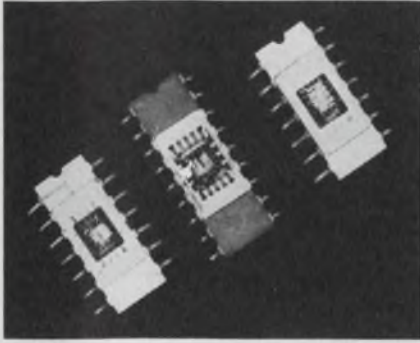

AEG-Telefunken Corp., 570 Sylvan Ave., Englewood Cliffs, NJ 07362. (201) 568-8570. About \$15 (large qty).

Three PMOS, ion-implanted ICs simplify remote-control TV tuners. The SAB 2000, designed for the transmitter, can handle up to 32 commands at two ultrasonic frequencies. The SAB 2010 and SAB 2020 are used in the receiver circuit.

CIRCLE NO. 371

Data-comm chip handles 1 Mbaud



Western Digital Corp., 3128 Red Hill Ave., Newport Beach, CA 92663. (714) 557-3550. \$20 (100); stock.

A single n-channel, silicon-gate IC—the UC1671B—interfaces serial data communication with parallel digital systems. Also called Astro, the circuit combines functions of two existing chips. The asynchronous/synchronous transmitter/receiver can handle full-duplex data rates up to 1 Mbaud. It also features "transparent" mode capability for minimum system interfacing. Five to eight-bit word lengths can be selected by either a control word or hard wiring to the Astro chip. Eight selectable clock rates are provided with up to a 40% distortion allowance.

CIRCLE NO. 372

A better LED

It's all in how you look at it. If you get even distribution of light over the entire lens area, that's better, isn't it? If you get a higher luminous intensity at lower current, that's better two ways, isn't it? If you can get three colors—green, red and yellow, that's important, too, right?

Let's put it this way. Try an Opcoa **SOLID-LITE**® lamp in your instrument panel or whatever. What have you got to gain? Plenty. You'll get all the benefits of advanced LED technology . . . Gallium Phosphide Technology—that's what we have been talking about; and you won't have to go around GaAsPing for brighter, longer lasting light.

And cost? We wouldn't dare charge you more. Phone us now for your sample lamp at 201-287-0355. For catalog and prices: Opcoa, Inc., 330 Talmadge Road, Edison, N. J. 08817.



A division of idsi



...clearly better.

INFORMATION RETRIEVAL NUMBER 111

our quiet one

Our low noise, punched tape I/O desktop unit, is designed to satisfy numerical control, graphic arts, data communications and computer peripheral applications.

It accommodates oiled paper, dry paper, metallized mylar, sandwich paper/mylar/paper and polyester . . . 5, 6, 7 or 8-level tapes. And, it's TTL/DTL compatible.

Asynchronous punching at up to 60 characters per second.
Photoelectric reading at up to 150 characters per second,
start/stop. Synchronous reading at up to 250 characters per second.
Via a highly reliable stepping motor tape transport. At OEM prices.

For full details, write or call us.



OEM PRODUCTS

SWEDA INTERNATIONAL

Litton 34 Maple Avenue, Pine Brook, N.J. 07058/(201) 575-8100

IN U.K. — ADLER BUS SYSTEMS/OEM PRODS. Airport House, Purley Way, Croyden, Surrey, England
IN FRANCE — SWEDA INTERNATIONAL/OEM, 103-107 Rue de Tocqueville, 75017 Paris, France

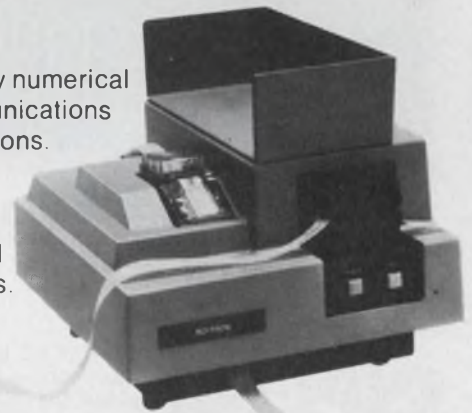

**ROYTRON
Model 1560 Reader/Punch**

High speed, compact, with integral electronics and power supply self-contained in a quietized housing



INFORMATION RETRIEVAL NUMBER 112

985 LOW COST VIDEO ALTERNATIVES FOR INDUSTRY

DESIGN III
Display
Terminals



BAREBONES
Display Terminal
PC Module Sets



SERIES 200
Display Controllers

Plus Keyboards, Video Monitors, & Accessories

APPLICATIONS: Data Entry/Retrieval • Data Readout/Display • Industrial Monitoring/Control • TV/Video Tape Titling • TTY Replacement • Printer Add-On • Multi-Drop.

TYPES: • RO(Read Only) • KSR(Keyboard Send/Receive) • ASR(Automatic Send/Receive).

DISPLAYS: 7 Formats, 256 to 3200 Characters.

AVAILABLE FEATURES: Alphanumerics, Graphics, Video Overlay • Selectable Data Rates to 9600 Baud • RS232-C, Current Loop, TTL Interfaces • I/O Multiplexing • Upper/Lower Case & Special Character Sets • Switchable Characters • Blinking, Dual Intensity, Reverse Video • New Line, Hold at EOL, Auto LF on CR • Protected Format, Compressed Transmission, Error Detection.

Styling to match every application, configuration, and budget requirement. Engineering assistance for the toughest application. And immediate availability.

ANN ARBOR
TERMINALS, INC.

See our listing in the 75/76 EEM,
Volume 1, Pages 134 through 140.
... creating new ways to communicate

6107 JACKSON RD. • ANN ARBOR, MICH. 48103 • TEL: 313-769-0926 • TWX: 810-223-6933
INFORMATION RETRIEVAL NUMBER 113

POWER SOURCES

Miniature HV supply gives full regulation

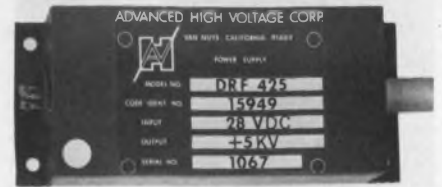

Advanced High Voltage, 14532 Arminta St., Van Nuys, CA 91402. (213) 997-7222. See text.

To pack a high-voltage power supply into a miniature enclosure is hard enough. Make the unit fully regulated and adjustable as well, and you've got something to crow about. That something is the DRF Series, from Advanced High Voltage Co.

Eleven different models comprise the series, which boasts a case size of 1.5 x 3 x 0.6 in., a weight of only 5 oz and a combined line/load regulation of 0.02%, no load to full load and ±10% line variation. Input is 28 V dc ±3 V and 300 mA at full load, and outputs range from 180 V to 5500 V (all at 3 W), depending on the model.

Operating temperature (case temperature) of the series ranges from -20 to 65 C with no derating necessary. Tempo of the 3, 4 and 5-kV units is 150 ppm and that of models with outputs of 2.5 kV or less is 100 ppm.

Ripple of the DRF is specified at 0.02% pk-pk for a bandwidth of 10 MHz. The ripple spec is reduced over previous models by an electrostatic shield which surrounds the high-voltage section of the supply. With separate high and low-voltage compartments—and with only the high-voltage section potted in clear epoxy—the units can be easily repaired if necessary.

Voltage adjustment of the Advanced High Voltage series is accomplished through a small hole in the case. The range of adjustment runs from -30% to +10%. A wider range is available as an option, as are hermetic sealing and remote programmability.

Prices of the series vary from \$240 for the DRF325—a 200-V, 15-mA model—to \$360 for the 425, which delivers 5 kV at 0.6 mA. Delivery is 3 to 4 weeks.

CIRCLE NO. 309

At last... circuit design answers

The PC boards shown above are just a few of the answers Douglas has for your design problems. Choose from a complete line of more than 50 off-the-shelf PC boards. Then select the card rack, case, and connectors that are best suited to your needs. Douglas has everything you'll need for prototype design and limited production. Singly or in quantities, you'll get total, off-the-shelf assistance. Next time you have a design problem, check with the people who have the answers. Write for your free copy of our catalog today.

DOUGLAS ELECTRONICS, INC.

718 Marina Boulevard, San Leandro, California 94577 (415) 483-8770

INFORMATION RETRIEVAL NUMBER 114

QUICK.... what number is this?



If you have to read your microcomputer like this--bit by bit, from rows of lights--the computer's making *you* do *its* work. And if you have to use rows of toggle switches to program it, you might wonder why they call the computer a labor-saving device!

Contrast the layout of a typical pocket calculator. A key for each number and function; six easy-to-read digits. Why not design microcomputers like that?



Here they are! The *modular micros* from Martin Research. The keyboard programs the computer, and the bright, fully-decoded digits display data and memory addresses. A Monitor program in a PROM makes program entry easy. And, even the smallest system comes with enough RAM memory to get started!

Both the *MIKE 2* system, with the popular 8008 processor, and the 8080-based *MIKE 3* rely on the *same* universal bus structure. This means that accessories--like our 450 ns 4K RAM--are compatible with these and other 8-bit CPUs. And, systems start at under \$300!

Still available from Martin Research--our innovative book, *Microcomputer Design*. An industry standard for the engineer designing with microprocessors.



- With 8080, \$200.
- With 8008-1, \$110.
- With 8008, \$100.
- Alone, \$75.
- School and quantity discounts.

Over 300 pages, dozens of schematics, worth its weight in microprocessors!

Martin Research / 3336 Commercial Ave. Northbrook, IL 60062 / (312) 498-5060

INFORMATION RETRIEVAL NUMBER 115
ELECTRONIC DESIGN 22, October 25, 1975

Compact switcher delivers 2 W/in.³

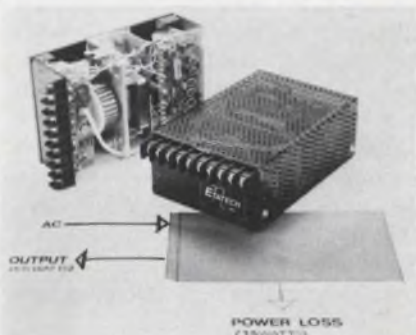

Etatech, Inc., 187-M W. Orange-thorpe, Placentia, CA 92670. (714) 996-0981. \$360 (Model A5R25S20); stock.

Series "A" 5.25-V fully regulated switching power supply provides 105 W from a 100-to-130-V-ac, 47-to-440-Hz line with only 35-W power loss. Power density is 2 W/in.³ (40 W/lb). Size of the conduction cooled module is 4 × 6 × 2-1/2 in. and weight is 2-1/2 lbs. Combined line and load regulation is ±10 mV from a 2-A minimum output current to full-load current of 20 A over full-line range. Output ripple is ±50 mV from all sources. Featured are automatic recovery for overload/short-circuit and input overvoltage protection.

CIRCLE NO. 373

Converters come in DIP-like package



Semiconductor Circuits, 306 River St., Haverhill, MA 01830. (617) 373-9104. \$26.95 to \$31.95; stock-3 wks.

UD5 series is a family of miniature dc/dc converters capable of powering up to 25 TTL or IC modules. Operating from an input of 5 V dc (+15%, -10%), the units feature operating efficiencies to 90%, input-to-output isolation of 300 V dc and output short-circuit protection. Package size is 1.245 × 0.795 × 0.375 in., with 0.21 × 0.02 in. dia. pins on 0.5-in. centers.

CIRCLE NO. 374

THE INSIDE STORY OF CHIP CAPACITORS

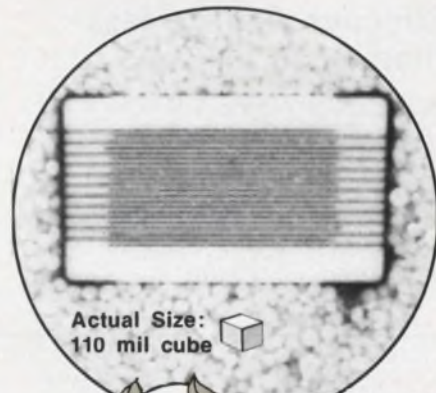

NOW HEAR THIS ...
If you're interested in the basics of monolithic chip capacitor construction, circle the reader service number below for your copy of "The Inside Story" and a sectioned ATC 100 chip capacitor.

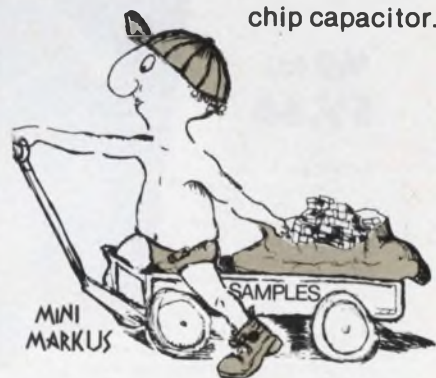

If you'd like samples of any other ATC UHF / Microwave Capacitors, call Ralph Wood at (516) 271-9600.

american technical ceramics

ONE NORDEN LANE,
HUNTINGTON STATION, N.Y. 11746
(516) 271-9600 • TWX 510-226-6993

INFORMATION RETRIEVAL NUMBER 116

POWER SOURCES

Supplies feature less than 4- μ A leakage

ACDC Electronics, 401 Jones Rd., Oceanside, CA 92504. (714) 757-1880. \$150 (10-24); 60 days.

A new line of power supplies, ME Series, meets the requirements of UL 544, type A. The units are designed specifically for use in

diagnostic, patient monitoring and therapeutic equipment and feature low leakage current (less than 4 μ A) and special shielding to limit the magnetic field strength. Thermal protection, overload protection and short-circuit protection are standard. Overvoltage protection is optional. There are five models in the new series: a single-output, two dual-output models and two triple-output models.

CIRCLE NO. 375

PLUG UGLY.™



\$49 (unit qty.)
5V, 6A

They're not much to look at.

Because instead of fancy front panels, we designed our standard open-frame dc power supplies to cover 90% of your OEM applications. And once you plug them into your computers, peripherals or instrumentation, they're so reliable that chances are you'll never see them again.

They're designed and built conservatively, so you get full rated power all the way up to +55°C. Regulation, ripple and noise are specified by the book. And with no expensive options, you can now get your dc power for as little as 69¢/W (unit qty.).

If you've looked at the competition, we know that has to be a sight for sore eyes.

For more info, use the bingo card or call 714/979-4440. Or call your local Cramer or Newark distributor and get UGLY today.

Elexon Power Systems

Get UGLY wherever you are: New England: Coakley, Boyd & Abben 617/444 5470 □ Upstate N.Y.: Ontec 716/464 8636 □ N.Y. Metro: New Jersey: Ed Glass Assoc. 201/592-0200 □ Penn. Del. So. N.J.: TOE Sales 215/348 2212 □ Va. Md. W. Va. Component Sales Inc. 301/484-3647 □ Kentucky Ohio Ind.: Frank J. Campisano Co. 513/662-1616 □ Michigan: VPI 313/271 4600 □ No. Carolina So. Carolina Fla. Georgia Ala. Miss. Tenn. W.A. Brown Components 205/539 4411 □ Ill. Wis. Iowa: Balhorn & Welch 312/889 5011 □ Minn. N. & S. Dakota: Lew Cahill & Assoc. 612/646 7217 □ Colo. Utah: J.S. Heaton Co. Inc. 303/758 5130 □ Texas La.: Hillman Enterprises 214/827 4790 □ Okla. Ark.: Hugh J. Daly Co. 918/627-4159 □ Wash. Ore.: Blum & Assoc. 206/285 2590 □ N. Calif.: J.S. Heaton Co. 415/369 4671 □ S. Calif.: RLS Assoc. 714/644 7497 □ Canada: Cantronics Ltd. 416/661 2494



ELPAC

© Copyright 1974 ELPAC, Inc.

INFORMATION RETRIEVAL NUMBER 117

Converters show high η at light loads

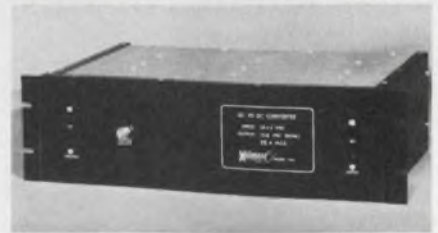

Wilmore Electronics, P.O. Box 2973, Durham, NC 27705. (919) 489-3318. \$470 (10); stock to 30 days.

Series 1265 dc/dc converters feature efficiencies of 80%. Models are available for input voltages of 48 V \pm 20% or 24 V \pm 20%. Standard models provide an output current of 0 to 30 A at an output voltage adjustable from 12 to 14 V. Though the series can deliver a full 420 W, no-load power requirement is only 5 W. Therefore, they are highly efficient at light or standby loads.

CIRCLE NO. 376

Switcher delivers 600 W at 75% efficiency.

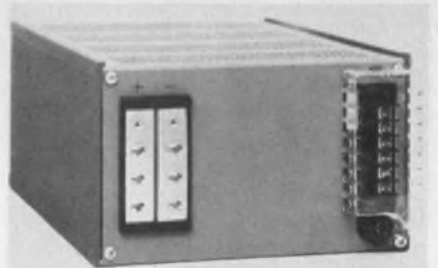

Hewlett-Packard, 1501 Page Mill Rd., Palo Alto, CA 94304. (415) 493-1501. \$546 (25); 6 wk.

A new 600-W switching-regulated power supply is 75% efficient. The HP 62615M has a single output of 15 V at 40 A. The unit features integral forced-air cooling that eliminates the need for conventional heat sinks and permits the unit to be packaged into half-rack width cases (5 \times 8 \times 11-1/2 in). Specs include 0.1% line and load regulation with ripple and noise of 15 mV rms, 65 mV pk-pk (20 Hz to 20 MHz) and 30- μ s transient response following a load change from 100% to 50% and 50% to 100%. Model 62615M delivers full-rated output from 0 to 40 C with derated operation to 24 A at 70 C.

CIRCLE NO. 377

COMING NOVEMBER 22

A MAJOR NEW EDITORIAL SECTION

IN EVERY ISSUE OF

Electronic Design



“MICROPROCESSOR DESIGN”

Microprocessors are hot... and they're going to get even hotter. That's why we've been giving microprocessors extensive coverage ever since their first commercial availability three years ago.

Now we're going to do even more. A major new section of the magazine, MICROPROCESSOR DESIGN, will begin November 22 and will continue in every subsequent issue.

The new section will cover all important developments that relate to designing with microprocessors. In addition to several major reports devoted exclusively to microprocessors in 1976, tech articles, news, new product data, new lit, new books, announcements of meetings and seminars and interviews with industry experts will be consolidated in this section.

Microprocessors don't stand alone. Our approach will be to help our readers not only to specify the microprocessor, but also to deal with everything that will surround the microprocessor and everything that will help him to design with a microprocessor.

So if microprocessors figure in your future... watch for MICROPROCESSOR DESIGN... another service to the reader from *Electronic Design*.

NEW!

Design unusual circuits fast . . . with built-in, regulated, metered POWER!

Now you can build/test electronic circuits WITHOUT SOLDER . . . using solid #22 AWG wire to interconnect discrete components . . . resistors, transistors, linear/digital ICs in TO5 or DIP packages (8-40 pins), and more. Plus, you get 5-15 VDC up to 600ma (9 watts) of variable regulated power, with a built-in 0-15V voltmeter to monitor internal power and/or external circuits. Compact (6.75" L x 7.5" W x 3.25" H), lightweight (only 2 lbs.), and priced very low. Order your DM-1 off-the-shelf from your local distributor or direct from CSC on Master Charge, BankAmericard, Amer. Express. Prices subject to change. Patent #235,554.

CSC

CONTINENTAL SPECIALTIES CORPORATION
Box 1942, New Haven, CT 06509 • 203/624-3103
W. Coast: Box 7809, S. Francisco, CA 94119
415/421-8872
Canada: Len Finkler Ltd., Ontario
© Copyright Continental Specialties Corp. 1975

DESIGN MATE 1



49⁹⁵

Add \$2.50 for shipping/handling

INFORMATION RETRIEVAL NUMBER 120

Built to work no matter how you use it.

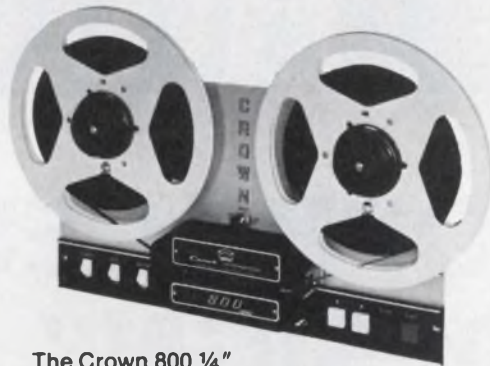

The Crown 800 1/4" mag tape transport is rugged¹, computerized², professional³ and adaptable⁴. It's designed, built and one-by-one tested by people who are good at their jobs. It will work exactly the way you expect. No glitches.

Good design and careful fabrication are the

reasons why the 800 transport works in many different systems. Audio record/playback systems. Data recording. Program origination.

If your latest project includes 1/4" mag tape capabilities, ask Crown to explain the 800 transport.



CROWN INTERNATIONAL

1718 W. MISHAWAKA ROAD ELKHART, INDIANA 46514 219-294-5571

1. 3/8" thick aluminum front plate. Anodized or plated metal parts. Only 10 moving parts. All sub-assemblies are plug-in.
2. Logic circuit automatically sequences transport, regardless of command sequence, to prevent tape spill or breakage. Remotable.

3. Three motor drive. DC braking. Automatic end-of-tape braking. 19" rack mount. Wow and flutter 0.09% @ 7 1/2 ips guaranteed maximum.
4. Heads independently mounted — can be easily changed. 4ch, 2ch or mono. Build your own electronics or order from Crown. Crown will customize. Variable speed drive available.

INFORMATION RETRIEVAL NUMBER 121

INSTRUMENTATION Software speeds in-circuit testing



Faultfinders, Inc., 15 Avis Dr., Latham, NY 12110. (518) 783-7786. Licensed at no charge to customers.

With Faults I, a typist enters data from engineering drawings into a terminal and the software program does the rest, creating a test program for an in-circuit test system, such as the company's FF101A. Programming time is said to be reduced by 75% over traditional techniques. For example, a PC board with 200 components can be programmed for in-circuit component testing in as little as 24 hours, including 16 hours of debug. The input process requires no knowledge of either the programming language of the test system or of computer programming languages in general.

CIRCLE NO. 378

Systems DPM fits standard panel cutout

Analogic, Audubon Rd., Wakefield, MA 01880. (617) 246-0300. \$139; stock-90 days.

The latest addition to the company's broad line of DPMS is the systems oriented AN2537. This new unit, with instrumentation type input circuitry, provides balanced differential inputs and buffered parallel BCD outputs as standard. In addition, the 3-1/2-digit instrument is available with a choice of either a 0.55-in. Beckman plasma display or 1/2-in. LED. Other features include a reading accuracy of better than 0.5% of reading ± 1 count, a deadband of less than 0.1 count and an over-all power consumption of only 2 W.

CIRCLE NO. 379

20,000-count DMM offers true rms



Systron-Donner, 10 Systron Dr., Concord, CA 94518. (415) 676-5000. \$699; 60 days.

Model 7224 20,000-count auto-ranging multimeter offers a choice of true rms or ac averaging capability. Both of these ac-voltage measuring modes are designed as plug-in PC boards, so you can add this function at any time in the field. The unit also includes an ACCU-OHM resistance measuring circuit, which allows the convenience of two-wire resistance measurements with accuracies usually equivalent to that of four-wire systems. Also, a 20- Ω range permits resistance measurements to 0.001- Ω resolution.

CIRCLE NO. 380

Digital phasemeter calibrates itself



Dranetz Engineering Laboratories, 2385 S. Clinton Ave., South Plainfield, NJ 07080. (201) 755-7080. \$2400 to \$4000.

Model 305/107 digital phase-angle meter features automatic calibration to assure $\pm 0.01^\circ$ repeatability and $\pm 0.03^\circ$ absolute accuracy in five-digit phase-angle measurements. The unit is a new version of the company's 305 family and offers precision measurement from 0.00° to $\pm 180.00^\circ$ and 0.00° to 360.00° . Operating over the range from 1 Hz to 11 MHz, this instrument accepts a variety of standard plug-in modules and optional features for specific functions and applications: high-frequency operation, auto-ranging, remote programmability, gain/phase measurements, network analysis, etc.

CIRCLE NO. 381

Tiny scope claims midget title



Lawtronics Ltd., 139 High St., Eden Bridge, Kent TN8 5AX, England.

Claimed to be smaller and lighter than any other portable oscilloscope, the Model A1010 measures only $2\frac{1}{4} \times 5\frac{1}{4} \times 7\frac{3}{4}$ in. and weighs just 3- $\frac{3}{4}$ lb. The unit features Z modulation—unusual on such a small instrument. The Y preamp output can be isolated and fed into the X amplifier to increase sensitivity, leaving direct access to the Y deflection amplifier. The scope is powered by rechargeable batteries, which offer up to 3 h of operating time and are automatically charged when the instrument is plugged into an electrical outlet. Bandwidth is 10 MHz and sensitivity is 10 mV.

CIRCLE NO. 382

SPEED PRODUCTION...
SAVE SPACE AND WEIGHT...
REDUCE ASSEMBLY COSTS...
WITH BUCKBEE-MEARS FLEXIBLE CIRCUITRY

BMC flexible circuitry offers significant advantages over conventional hand wiring of discrete circuits. It can simplify assembly, reduce costs, and greatly improve wiring accuracy and reliability.

Buckbee-Mears' Circuits Division also can provide as much—or as little—engineering assistance as you require . . . from preliminary drawings through testing to finished products. This team of flexible circuit specialists can help define your requirements, then work with you in developing the circuitry to fit your exact application. For information, write or call Ed Dugan.

FLEXIBLE CIRCUITRY DIVISION **BUCKBEE-MEARS COMPANY**
bmc
 245 EAST SIXTH STREET
 ST. PAUL, MINNESOTA 55101 612-228-0263

INFORMATION RETRIEVAL NUMBER 122

ELECTRONIC DESIGN 22, October 25, 1975

MEMORY SERIES NO. 12

HOW MUCH MORE CAN YOU GET OUT OF OUR FPLA'S?

Twice the speed (50ns vs. 100). Two extra inputs: 16 vs. 14, yielding a 4:1 address scan capability, compared to other Field Programmable Logic Arrays. And our bonus extra, chip enable, for expanding our 48 product terms.

Rush full info on FPLA's #82S100 (Tristate) & #82S101 (Open Collector)
 Please quote sample parts immediately.

Name _____
 Tel _____ Ext _____
 Attach coupon to letterhead.

THINK
Signetics
 811 E. ARQUES, SUNNYVALE, CALIF. 94086

INFORMATION RETRIEVAL NUMBER 123

177

MONOLITHIC
CRYSTAL FILTERS

the
State
of the
Art

BE PREPARED

Tomorrow's 900 MHz band is just around the corner. If you're scouting around to get ready, we've got the monolithic crystal filters you need — right now. And, a wide variety, too. Take a look.

45 MHz FIRST I.F.

Our newest additions, Model 4371F (4-pole performance in a single HC-18 envelope) and Model 2372F (economical 2-pole performance).

10.7 MHz SECOND I.F.

Our large selection of standard models. Two, four, six and eight poles. Prefer 21.4 MHz? The same choice is available.

FM DEMODULATOR

Our new Model 2283F, 10.7 MHz monolithic discriminator for use with IC quadrature detectors. At 21.4 MHz, ask for Model 2378F.

ALL THESE MODELS ARE AVAILABLE OFF-THE-SHELF.

If your conversion scheme calls for something special, give us a call. We'll tell you what can be done and what can't.



Piezo Technology Inc.

2400 Diversified Way Orlando, Fla. 32804
(305) 425-1574

The standard in
monolithic crystal filters.

PACKAGING & MATERIALS

**Photoresist primer
boosts resist adhesion**

Transene Co., Route 1, Rowley, MA 01969. (617) 948-2501. \$20/gal. (4 to 12 gallon).

Resist-Aid is a primer material designed to improve the adherence of photoresists on oxidized silicon surfaces. It is formulated as a reactive silane product readily chemisorbed on SiO₂ surfaces. The product contains functional groups which react with silanol structures on the surface of SiO₂. Additional functional groups behave to bond the photoresist to the substrate interface. Resist-Aid is a clear liquid that has a flash point of 84 F, a boiling point of 140 C, an operating temperature of 70 C and a shelf life of one year when kept dry.

CIRCLE NO. 383

**Multiple contact strips
space contacts 0.05 in.**



Tecknit, 129 Dermody St., Cranford, NJ 07016. (201) 272-5500. From \$1.15 (1000-up); 1 wk.

A multiple connector strip provides reliable electrical contact between two or more circuit elements. It consists of an array of conductive pads molded into insulating carriers of different thicknesses with contact center spacing of 0.05 or 0.1 in. The carrier frames also contain two end holes for easy mounting. For quick installation and accurate alignment, the multiple connector strips are available with adhesive foam backing. Just remove the protective release backing and place in position.

CIRCLE NO. 384

**Brightman & Rubin
Save the Image with
the Princeton 801**



The Princeton 801 is terrific too! Everything you need in a full-graphics CRT terminal plus gray scale graphics and analog video. It's the low cost terminal that stores a high-density image of gray scale computer graphics without refresh. Or store full tone output—Alpha numeric characters—for up to an hour.

Other features include:

- Low-cost
- 32-level gray scale
- 16X zoom
- High brightness and resolution (1,029 lines standard)
- Flicker-free viewing
- Selective erase and re-write (without disturbing the rest of the image)

We deliver in 60 days. Options include joy stick cursor control and zoom enlargement, hard copy print-out and more. Write or call...

© 1975



**PRINCETON
ELECTRONIC
PRODUCTS, INC.**

Box 101, North Brunswick, N.J. 08902
Phone: (201) 297-4448

PC breadboard holds analog & digital parts

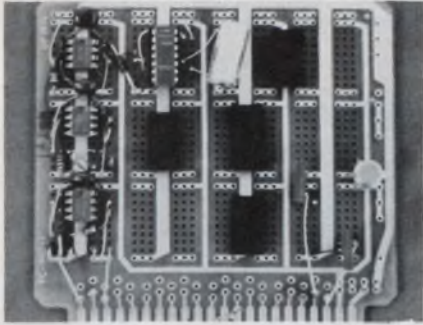

Midgard Electronics, 26 Walnut St., Watertown, MA 02172. (617) 924-9053. \$24; 3 wk.

The Model PCMIT-1 printed-circuit board permits you to mix analog integrated circuits with standard 14 or 16-pin logic integrated circuits on one standardized printed-circuit board. This epoxy-glass board has a two-sided pattern with plated-through holes. One side has the ground and -15-V power distribution and the other side has +5 and +15-V lines. The IC positions are arranged in a 4 x 3 matrix. Exterior connection is provided with a 22-finger edge on each side, compatible with the common Amphenol 225-22221-101 connector type.

CIRCLE NO. 385

ECL-SIP wrapped-wire boards hold 48 DIPs



Augat Inc., P.O. Box 779, 33 Perry Ave., Attleboro, MA 02703. (617) 222-2202. From \$60; 3 to 5 wk.

The 8136-ECL24 ECL/SIP (single-in-line package) series of IC panels accommodates up to 48 24-pin and 16-pin devices, with positions for 8-pin and 12-pin SIP resistor networks for parallel termination to a -2-V supply. Panels include provisions for mounting high frequency and electrolytic decoupling capacitors for -5 and -2-V busses. There are 12 boards in the series and are available in patterns of 32, 64, and 96 pins in either two or three-level wrapped-wire terminations.

CIRCLE NO. 386

LOW COST MASS STORAGE

COJ



CO-3000N LINC TAPE

\$1995
with
controller
(quantity one)

PDP*-11

- DECtape* Compatible
- RT-11 Driver for FORTRAN, BASIC, and MACRO Support
- Built-in ROM Bootstrap to Load Empty PDP-11
- Uses One SPC Slot

* Registered trademark of Digital Equipment Corporation.

NOVA†

- Full SOS, RTOS, RDOS Support
- 8400 Bytes/Second - 336K Bytes/Tape
- Data Channel I/O Option
- One I/O Slot - Direct Access to Any Block
- Full FORTRAN IV and Extended BASIC Support
- Named Files in SOS for Fast Program Development

† Registered trademark of Data General Corporation.

Computer Operations, Inc.

10774 TUCKER STREET
BELTSVILLE, MARYLAND 20705
(301) 937-5377 • TELEX 89-8327

INFORMATION RETRIEVAL NUMBER 126

IMC FAN FACTS

Our standard Boxer Fan is rugged and reliable

Here's a compact* whose whirlwind delivers 70 to 115 cubic feet of air per minute. The Boxer can convert to a variety of uses - has long life and saves time and money. Literature on request! For immediate service please call Fred Taylor, Sales Manager - 603/332-5300 or write:



50/60 HZ AIRMOVER



*4-11/16" square by 1-1/2" deep.

IMC MAGNETICS CORP.
NEW HAMPSHIRE DIVISION

ROUTE 168, ROCHESTER, NEW HAMPSHIRE 03867

INFORMATION RETRIEVAL NUMBER 127

If we're Number 1, it's your fault.

Computer Products, Inc., is the world's leading manufacturer of encapsulated power supplies. And we owe it all to you, for recognizing the value of:

- "Triple-testing" before delivery to insure reliable performance
- Internal short circuit protection
- 24 month warranty
- Flexibility... single and dual outputs from 3.6V to 28V with output currents from 65mA to 2,000mA.

- Low cost and fast delivery.

With 49 models to choose from, chances are we can fill your every need. Like to find out more? Just circle our number on the Reader Service Card, and we'll send you our new Power Supplies catalog. If you just can't wait, give Bill Ford a call at 305-974-5500. He can't wait to send it to you.

 **Computer Products, inc.**



Distributors: Indianapolis 317-899-2890/Dallas 214-341-8311/
Los Angeles 213-877-5518/Albuquerque 505-255-2440/Sunnyvale 408-735-9040.

1400 NW 70 Street, Fort Lauderdale, Florida 33309 (305) 974-5500. TWX (510) 956-9895.

INFORMATION RETRIEVAL NUMBER 128

Power Supplies

PACKAGING & MATERIALS

Subminiature connectors have removable contacts

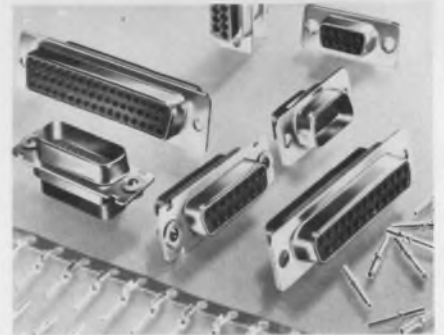

TRW, 1500 Morse Ave., Elk Grove Village, IL 60007. (312) 439-8800. From \$0.66; stock.

The style D-subminiature Mark IV connector has insertable/removable crimp contacts. It is intended for commercial, nonenvironmental applications with operating temperatures to 250 F, is fully interchangeable and intermountable with standard D types and is available in five sizes containing from 9 to 50 contacts. The rear release, size 20 crimp contacts are rated at 5 A and can accommodate #18 through #30 AWG stranded wire. The connector is supplied with either stamped or machined contacts. Both styles are available with the connector or separately on carrier strips for use with semi-automatic crimping machines.

CIRCLE NO. 387

Subminiature Toroidal Coils Available in Commercial and MIL Spec Grades

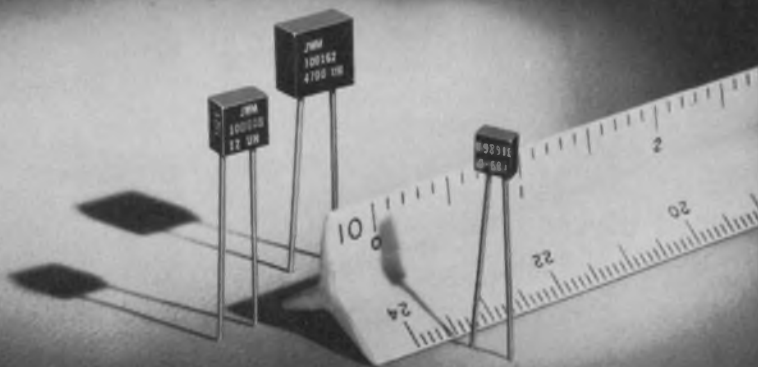

Write on your letterhead for full line catalog.

BELL INDUSTRIES / J. W. Miller Division
19070 REYES AVENUE • P.O. BOX 5825 • COMPTON, CALIFORNIA 90224

Humidity chamber has close tolerance settings

Tenney Engineering, 1090L Springfield Rd., Union, NJ 07083. (201) 686-7870. \$6000; 6 to 8 wk.

A close tolerance version of the Benchmaster BTH humidity chamber uses an electronic control system with a lithium chloride sensor. The chamber stabilizes the humidity to closer than $\pm 1\%$ RH. The chamber has a 5-cubic-foot capacity and both temperature and humidity are finely trimmed by solid-state time-proportioning instruments. Options are available for the type of temperature and humidity readout. Indication can be by meters, by two-pen round chart recorder or by strip-chart recorder. High and low out-of-tolerance alarms and automatic shut-down devices are also available.

CIRCLE NO. 388

INFORMATION RETRIEVAL NUMBER 129

Variable tension latches handle up to 500 lb

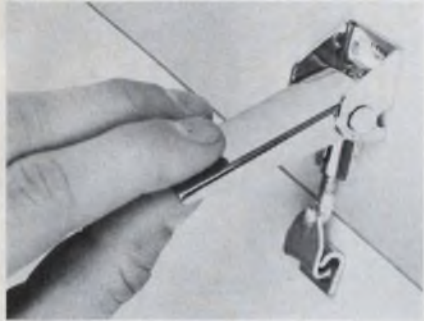

Rexnord Inc., Specialty Fastener Div., P.O. Box 98, Paramus, NJ 07652. (201) 845-6900. From \$0.53 (1000 piece lots); stock.

Choose your own latching pressure when using 51L series adjustable tension latches. Total adjustment through 0.3 in. with 0.02-in. steps (per drawhook rotation) is available. Designed with overcenter toggle geometry, which assures positive locking, the latches have a strength of 500 lb. Rivet and weld mount variations are available in carbon and stainless steel while finishes include cadmium, chrome, and zinc.

CIRCLE NO. 389

Ceramic fiber insulation uses no asbestos



Cotronics Corp., 5008 Ave. M, Brooklyn, NY 11234. (212) 531-9376. See text.

Type 370 asbestos free ceramic fiber insulation is made from high purity refractory fibers with a melting point of 3200 F. It can be cut with ordinary hand scissors and formed into complex shapes. The high efficiency insulation can reduce the temperature from 2000 to 300 F by use of a 1-in.-thick barrier. The type 370 ceramic fiber insulation is available in 3/16, 1/2, 1 and 1-1/2 in. thicknesses in 24-in.-wide rolls. A 50 ft² roll of 3/16 in. thick or 25 ft² roll of 1/2 in. thick material is available for \$40.50 for evaluation.

CIRCLE NO. 390

SIP adaptor plug holds seven components

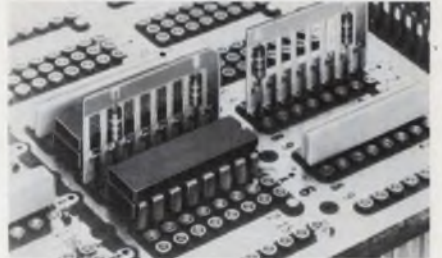

Augat Inc., P.O. Box 779, 33 Perry Ave., Attleboro, MA 02703. (617) 222-2202. From \$0.60; stock to 3 wk.

The 608-DG6 SIP (single-in-line package) adaptor eases the addition of discrete components while increasing board density. The SIP adaptor allows the user to solder in discrete resistors up to 1/8 W in size, or other similar size components, in seven different pin positions. The adaptor duplicates the form factor of SIP resistor networks and ties pin number one to a common bus. The glass epoxy plug, which has tin-plated leads, is 0.015 in. thick, 0.83 in. (± 0.01 in.) long and 0.415 in. (± 0.01 in.) high.

CIRCLE NO. 391



ALCOSWITCH OFFERS WORLD'S SMALLEST TOGGLE SWITCH

made SPECIFICALLY for PC APPLICATIONS

- 60% smaller in volume than existing miniatures.
- 3/8" Max. Height compatible with PC components.
- Terminals match 1/10" centers X-Y axis.
- Gold plated contacts and terminals for dry circuit.
- Available in 1 and 2 poles, On-On or Center-Off.
- Upright or Right Angle mounting.

Call (617) 685-4371 or write for additional info.

ALCO ELECTRONIC PRODUCTS, INC.
1551 OSGOOD STREET, NORTH ANDOVER, MA 01845 U.S.A.
TEL: (617) 685-4371 TWX: 710 342-0552 A SUBSIDIARY OF AUGAT INC.

INFORMATION RETRIEVAL NUMBER 130
ELECTRONIC DESIGN 22, October 25, 1975

MEMORY SERIES NO. 13 PICK ANY 48 WORDS FROM A 65,538 POOL

IN THE FIELD, WITH JUST ONE FPLA. And edit your program at will. In our Field Programmable Logic Arrays with 16 inputs to the decoder, product terms can be added (up to 48) or removed—or delete input variables from your terms. And outputs programmed active-high are reprogrammable to active-low.

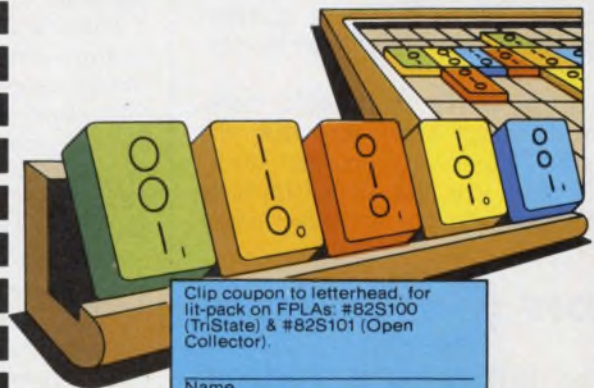

Clip coupon to letterhead, for lit-pack on FPLAs: #82S100 (TriState) & #82S101 (Open Collector).

Name _____

Tel _____

Ext _____

Call me with sample part quote.

THINK

Signetics

811 E. ARQUES, SUNNYVALE, CALIF. 94086

INFORMATION RETRIEVAL NUMBER 131

DIT-MCO WIRE/CIRCUIT ANALYSIS SYSTEMS ...THE ULTIMATE TEST!



Computer Controlled System 823 Tests Backplanes, Multilayer Boards, Cable Networks, Wired Racks . . .

And performs the tests accurately with a wide range of substantially superior test parameters. Distributed solid state switching eliminates adaptor cables. System 823 is pluggable directly to the product or fixture.

System 823: Computer Control, solid state switching, test speed, superior test parameters, testing at higher voltage, a complete standard software package, and a variety of standard and special hardware/software options.

CALL OR WRITE: A DIT-MCO representative can show you how the System 823 relates to your test needs. He'll show you how to perform tests faster, more simply, and save money too!



The Difference in Testing!

DIT-MCO INTERNATIONAL

A Division of Xebec Corporation
5612 Brighton Terrace, K. C., Mo. 64130
Telephone (816) 444-9700
Telex Number 42-6149

European Technical Representative, Radix House,
Central Trading Estate, Staines, Middlesex,
TW18-4-XA, England. Telephone (0784) 51444
Telex Number 935023

INFORMATION RETRIEVAL NUMBER 132

COMPONENTS

Rotary switch includes PB action through shaft



Standard Grigsby, Inc., 920 Rathbone Ave., Aurora, IL 60507. (312) 897-8417.

A combination rotary-pushbutton switch allows the use of all strut-screw assembled rotary switches. The pushbutton switch, available in 2, 4, 6 or 8-poles, is actuated via a dual concentric shaft, and may have a momentary or push-push action. The rear-mounted pushbutton switch is easily wired and, because of its modular design, may be easily assembled or disassembled. The switch has an expected minimum life of 25,000 cycles.

CIRCLE NO. 392

Delay lines feature single in-line mounting

Pulse Engineering Inc., P.O. Box 12235, San Diego, CA 92112. (714) 279-5900. \$7.85 (1 to 9); stock.

The new SIL series of delay lines features single-in line mounting in 10-tap epoxy-encapsulated modules that stand 0.25 in. off the board and are only 0.19-in. wide by 1.455-in. long. Ten models are available. They meet the environmental requirements of MIL-D-23859. Input impedances are 50, 100 or 200 Ω . Total delays range from 20 to 200 ns with delay-to-rise-time ratios of 4:1 minimum. Delay time per tap ranges from 2 to 20 ns. Maximum net rise time is from 4 to 37 ns. Maximum dc resistance is from 1 to 9 Ω , dependent on model selection. Maximum distortion at any tap is $\pm 15\%$. Attenuation varies from 2 to 10%.

CIRCLE NO. 393

MODELS 9906 & 9910 MINIDIPS

FROM



WIDEBAND BIPOLAR DIFFERENTIAL OP AMP & CURRENT BOOSTER AMPLIFIER



MODEL 9906 WIDEBAND OP AMP FEATURES:

100 MHz min. unity gain frequency.
300 MHz min. gain bandwidth
product at X100.
 ± 250 V/ μ S min. slewing rate.
 ± 10 volts swing.
 ± 4.5 mA output current.
150 nS 0.1% settling time.
Temperature operating range:
-65°C to +125°C.

MODEL 9910 CURRENT BOOSTER FEATURES:

0.97 typ. voltage gain.
 ± 12 V input voltage.
 ± 10 output voltage swing.
 ± 100 mA output current.
 ± 2000 V/ μ S slew rate.
DC to 60 MHz small signal bandwidth.
Temperature operating range:
-65°C to +125°C.

COMPLETE SPECIFICATIONS ON REQUEST

Note these low prices:

Model	Price	Model	Price
9906	9910		
\$18.00 1-2	\$26.00 1-2		
16.25 3-9	23.50 3-9		
14.75 10-29	21.00 10-29		

Optical Electronics, Inc., manufactures a complete line of OP AMPS, analog function modules, 3-D displays, and ultrasonic imaging systems.



OPTICAL ELECTRONICS INC.

P. O. BOX 11140 • Tucson, Arizona 85734
PH. (602) 624-8358 • TWX (910) 952-1283

Rf transformers cover 1.8 to 30 MHz

Communications Power Inc., 2407 Charleston Rd., Mountain View, CA 94943. (415) 965-2623. \$1.25 to \$2.25 (1000 up).

A line of wideband rf transformers for impedance matching of high-power solid-state amplifiers operates in the 1.8-to-30-MHz range. The transformers come in 25-to-150-W ratings. Turns ratios available are 1:3, 4, 5 or 6.

CIRCLE NO. 394

Timer/counter handles up to 99 hours



Eagle Signal Industrial Controls Div., 736 Federal St., Davenport, IA 52803. (312) 329-9292. \$250; 6 digits; stock.

A solid-state timer/counter with a six-digit LED readout, the new Series CT600, contains an LSI/MOS chip that handles up to 99 hours. Until now, 99 minutes was the maximum available, according to Eagle Signal. The chip also simultaneously can add and subtract. The unit can be programmed in the field via subminiature rocker switches to provide up-or-down timing, add-or-subtract counting, timed/counted-out totalizing, delayed-or-interval output sequence, time ranges form 0.01 s to 99 h and count ranges to 999,999,000. It operates on 50 or 60-Hz line frequency. The user has a choice of three outputs—a 1-A solid-state triac, a 25-VA reed switch or an open-collector transistor rated at 500 mA. The unit's totalizer gives an output when the unit times/counts out to a preselected thumb-wheel setting. But the readout continues to register additional time or counts until reset.

CIRCLE NO. 395

A WIDEBAND AMPLIFIER WITH WIDEBAND FEATURES

It's IFI's Model 5100. Exclusive features include automatic remote leveling and remote level control. Also prominent in its broad performance spectrum: auto pulse and auto limit to confine amplifier current to safe levels in pulsed operation...Operates into any load from open to short...Frequency range, 10 KHz to 250 MHz...Peak RF input, 1 V; 40 dB gain; output, 10 W...Model 5100 was designed primarily as a preamplifier for IFI and other high power wideband amplifiers. As such, it's a direct replacement for IFI's Model 5000—with all of that unit's proven performance AND the advanced features you will find only in Model 5100. Write for technical data.



instruments for industry, inc.

151 TOLEDO STREET • FARMINGDALE, N.Y. 11735

516-694-1414 Cable: Electronic Hallendale, Fla. Telex: 51-43-32

INFORMATION RETRIEVAL NUMBER 134

Power Supplier



For your high voltage switching circuits the 2N6251 series of STC Power Transistors features VCEO sus. to 350 Volts with 10 Amp. continuous current ratings.

Whatever your power transistor needs you can get the *RIGHT* one.

FROM



SILICON TRANSISTOR CORP. ... THE POWER SOURCE

KATRINA ROAD, CHELMSFORD, MA 01834 (617) 256-3321

Get complete data on these and other STC Power Transistors

INFORMATION RETRIEVAL NUMBER 135

WATERS OFFERS the best answer to your servo feedback problem

Designed with computer programmed correction, Waters conductive plastic pots and elements are the answer to your most difficult servo feedback application. They offer long rotational life, low output smoothness, low static noise, and infinite resolution in rotaries from 1/2" to 2" diameters with accuracy to 0.1% terminal linearity. Elements are built to your specifications from 1/2" to 40" in length to almost any resistance value.

Waters customer service team includes an engineering services group which processes every customer inquiry and will consult with you to review existing applications and provide assistance on new ones.

Call Bob Waters at 617-358-2777 or circle reader service card for complete catalog.

We're ready to serve you.

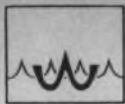

**WATERS
MANUFACTURING,
INC.**

Longfellow Center
Wayland, MA 01778 617-358-2777

INFORMATION RETRIEVAL NUMBER 136

NEW! DYNAMIC T²L DELAY MODULES

- For super high-speed T²L, standard T²L, and DTL.
- Fan out capability=10 loads per tap.
- Five compatible lines: 25-, 50-, 100-, 250- and 500-ns delays; can be cascaded without deterioration of rise time, any number, any combination.
- Rise time= ≤ 1 ns (25- and 50-ns delays); ≤ 2 ns (100-ns delay); ≤ 5 ns (250-ns delay); ≤ 9 ns (500-ns delay).
- MIL-SPEC (-55° to $+125^{\circ}$ C) models available.
- 14-pin DIP (8 pins used).

Call Bill Chamberlin at 215-426-9105. Or write for details.



TECHNITROL, INC. 1952 E. Allegheny Avenue, Philadelphia, PA 19134.
Specialists in pulse transformers and completely transfer molded, welded DIP delay lines under 3/16" high—to 250 ns.

INFORMATION RETRIEVAL NUMBER 139

COMPONENTS

Pushbutton switch operates in two steps



Otto Engineering Inc., 36 Main St., Carpentersville, IL 60110. (312) 428-1232. \$8.75. (100 up); stock to 4 wks.

A new pushbutton offers two stages of operation with a definite detent feel for each position. Designated the Otto Two-Step P2 Series, the pushbutton's first step operates a SPDT switch at 0.1-in. of travel and a second SPDT at 0.2 in. The contacts are rated at 5 A, 28 V dc or 115 V ac, and they are enclosed in a dust-tight, moisture-proof seal.

CIRCLE NO. 396

Ceramic chip capacitors packaged in kits

Johanson/Monolithic Dielectrics Div., Box 6456, Burbank, CA 91505. (213) 848-4465. S-900: \$65, S-905: \$65, Hi-Q-101: \$125; stock.

Three new ceramic chip capacitor prototyping kits comes in a special vinyl cover for easy shelf storage with each chip value individually packaged. The NPO dielectric kit, S-900, includes 12 chips, each of 24 different values from 1 pF to 4700 pF with tolerances from ± 0.25 pF to $\pm 10\%$ at 50 V dc. The BX and Z5U dielectric kit, S-905, includes 12 chips, each of 23 BX types with values from 560 pF to 0.22 μ F with tolerances of $\pm 10\%$ at 25 and 50 W dc and 13, Z5U types with values from 0.018 to 1.0 μ F with tolerances of ± 100 , -0% at 6 WV dc. The High-Q dielectric kit, Hi-Q-101, includes six chips, each of 48 different values from 0.3 pF to 1000 pF with tolerances from $+0.1$ pF to $\pm 5\%$ at 250 WV dc.

CIRCLE NO. 397

Hottest Darlington



Clairex[®] photodarlington offers extreme sensitivity – light currents of .6 ma minimum at .02 mw/cm².

- Hermetically sealed for longer life.
- Tested at two light levels.
- Available with lens or flat window.
- Six standard units, plus custom designs.

Come to the leader in opto-electronics.
Tell us the problem.
We'll develop the solution.

CLAIREX ELECTRONICS

560 South Third Ave., Mount Vernon, N.Y. 10550 (914) 664-6602

INFORMATION RETRIEVAL NUMBER 137

LOOKING FOR A DISTRIBUTOR NEAR YOU?

Electronic Design's GOLD BOOK lists 5,700 distributors with access both **alphabetic**, by distributor name, and **geographic** by location.

When you need
information . . .

**Electronic Design's
GOLD BOOK
IS THE PLACE
TO LOOK**

Design in Elmwood thermostats with world acceptance

Why eliminate world-wide sales with unlisted temperature controls? Many Elmwood snap-action thermostats are available to meet U.L., C.S.A. and European requirements for high limit or control. Choose wide or narrow differentials and tolerances to suit your application at minimum cost. Each is factory pre-set and tamperproof, 100% thermally and operationally tested and available with a variety of terminals, mounting brackets or custom packages. If your application requires exposures from -65° to +550°F, ask for suitable commercial or precision prototypes and prices to meet your needs. Elmwood Sensors, Inc., 1675 Elmwood Ave., Cranston, R. I. 02907. Phone 401/781-6500. European Div., Elmwood Sensors, Ltd. North Shields, England



ELMWOOD SENSORS

INFORMATION RETRIEVAL NUMBER 138

NEW SERIES

Schottky Barrier Rectifiers



- Five series: 1A, 3A, 5A, 15A & 30A (I_o) with 20V, 30V and 40V (V_{RRM}).
- Extremely fast recovery (t_r), very low forward voltages (V_F), high reliability and low cost.
- VSK 120, 130 & 140-1A series in DO-41 packages. 550 mV (V_F). 40A peak 1/2 cycle surge (I_{FSM}). 10 mA (I_R) at T_L = 100°C.
- VSK 320, 330 & 340-3A series. Epoxy package, axial leads. 475 mV (V_F). 150A surge. 30 mA (I_R) at T_L = 100°C.
- VSK 520, 530 & 540-5A series. Epoxy package; axial leads. 450 mV (V_F). 250A surge. 75 mA (I_R) at T_L = 100°C.
- VSK 1520, 1530 & 1540-15A series in DO-4 metal stud cases. 600 mV (V_F). 300A surge. 75 mA (I_R) at T_C = 100°C.
- VSK3020T, 3030T & 3040T-30A series. Center-tapped, common cathode, 15A per leg in TO-3 package. 630 mV (V_F). 300A surge. 75 mA (I_R) at T_C = 100°C.

All series have junction operating temperature range of -65°C to +150°C.

Call Mike Hawkins
214/272-4551 for more information



Design us in —
We'll stay there

VARO SEMICONDUCTOR, INC.

P.O. BOX 676, 1000 NORTH SHILOH,
GARLAND, TEXAS 75040
(214) 272-4551 TWX 910-860-5178

INFORMATION RETRIEVAL NUMBER 142

MICROWAVES & LASERS

Manual or computer control operates rcvr



Watkins-Johnson Co., 700 Quince Orchard Rd., Gaithersburg, MD 20760. (301) 948-7550.

The WJ-9023A receiver, which provides continuous frequency coverage from 50 MHz to 12.4 GHz, can be operated either manually, semi-automatically or under full computer control. The built-in I/O interface is compatible with a 16-bit computer. Other features include the following: synthesized local oscillators with 1 ppm stability from 0 to 50 C; variable-rate tuning with automatic band switching; and keyboard and six memory cells for selection and storage of scan and fixed frequencies.

CIRCLE NO. 480

Rf filters ease PC-board applications

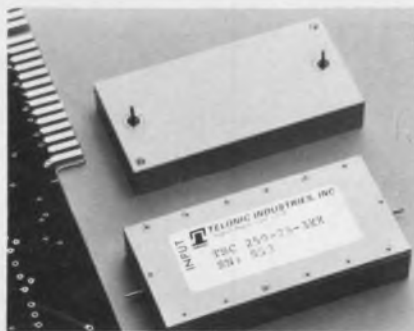

Telonic Altair, 21282 Laguna Canyon Rd., Box 277, Laguna Beach, CA 92652. (714) 494-9401. \$195 to \$300.

Designed for mounting on printed-circuit boards, a series of rf filters measures only 1/2-in. thick by 1-1/2-in. wide. The unit's length depends on the number of sections incorporated. The filters are 0.1-dB Chebyshev designs, fixed-frequency types with center frequencies from 40 to 500 MHz and bandwidths from 1 to 15%. Insertion loss is also a function of section quantity. A typical figure is 1.4 dB for a 10% bandwidth, four-section unit at 250 MHz.

CIRCLE NO. 481

TWT amp extends options



Hughes Electron Dynamics Div., 3100 W. Lomita Blvd., Torrance, CA 90509. (213) 534-2121.

Increased options for the company's instrumentation TWT amplifiers include local/remote operation up to 50 ft, 28-V-dc operation and logic circuitry. The new options are designed for the company's 1177H (10 W) and 1277H (20 W) 1-to-18-GHz amplifier lines and the new 1077H (1 W) 18-to-26-GHz units. Other options also include 220/240-V input, helix voltage regulator, rack mounting, 48-to-420-Hz operation and a minimum gain of 50 dB for selected frequency ranges.

CIRCLE NO. 482

Stripline couplers work to 18 GHz

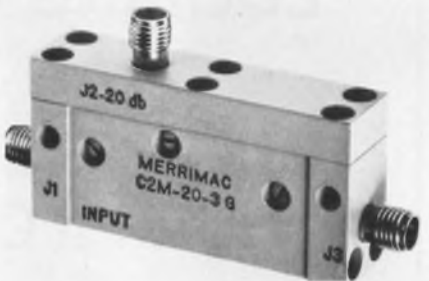

Merrimac Industries Inc., 41 Fairfield Pl., West Caldwell, NJ 07006. (201) 228-3890. \$120; 45 days.

A family of stripline microwave directional couplers covers the 1-to-18-GHz frequency range. The C2M-G series of octave bandwidth devices features nominal couplings of 6, 10, 20 and 30 dB with insertion loss (over coupling loss) from less than 0.25 dB to 0.4 dB, depending on frequency range. Other specs include coupling-frequency deviation of ±0.5 dB typical, directivities to more than 20 dB, VSWR of 1.2:1 to 1.45:1, forward power of 50-W average and reverse power from 1-to-50-W average. Peak power capability is 1 kW.

CIRCLE NO. 483

New Literature



Business computer

"DEC DATASYSTEM 30: A New Approach to Business Data Processing" tells about the stand-alone computer system. Digital Equipment, Maynard, MA

CIRCLE NO. 484

Measurement systems

Two booklets describe applications and prices of HP 9600MX automatic measurement and control systems. A 14-page survey includes an overview of analog and digital I/O subsystems, along with a description of distributed multiprogramming. A 50-page pricing guide features hardware, software and options for all five systems in the 9600MX series. Hewlett-Packard, Palo Alto, CA

CIRCLE NO. 485

Switches

Photos, line drawings, specifications and ordering information on over 300 switches are included in a 24-page catalog. Chicago Switch, Chicago, IL

CIRCLE NO. 486

Coaxial cable

Two bulletins cover commercial and MIL coaxial cable. Easy-to-use tables help you make the best selection for your application. Essex International, Stancor Products, Chicago, IL

CIRCLE NO. 487

Components

A 124-page catalog provides specifications, diagrams and illustrations of over 3700 components, all of which are individually coded and priced. R.S. Components Ltd., London. EC2P 2HA, England.

CIRCLE NO. 488

Subminiature lamps

Specs and drawings of 177 different lamps, tips on selecting the proper type, plus data on wedge-base and halogen cycle lamps can be found in a 24-page catalog. General Electric Inquiry Bureau, Cleveland, OH

CIRCLE NO. 489

A/d conversion systems

High and low-level solid-state multiplexers; fixed gain preamp per channel; digital gain controlled amplifier per channel; wide-range relay multiplexers, and a simultaneous s/h amplifier per channel systems are covered in a brochure. Tustin Electronics, Santa Ana, CA

CIRCLE NO. 490

Noise sensitivity problems go away—we guarantee it!

Topaz Ultra-Isolation Transformers provide an inexpensive and reliable way to supply clean, noise-free AC power to sensitive equipment such as computers, instrumentation, communication and process control equipment.

Ultra-Isolation Transformers offer the industry's best noise attenuation:

- Common-mode noise rejection greater than 145 dB.
- Transverse-mode noise rejection greater than 125 dB at 1 kHz.
- Standard models 125 VA to 45 kVA.
- Priced from \$64.



Our guarantee: A Topaz Ultra-Isolation Transformer will solve your noise sensitivity problems to your complete satisfaction or we'll take it back—no questions asked.

TOPAZ SOLUTIONS TO POWER PROBLEMS
ELECTRONICS

3855 RUFFIN ROAD, SAN DIEGO, CA. 92123 • (714)279-0831

MEMORY SERIES NO. 14 6 THINGS TO DO WITH OUR FPLA'S.

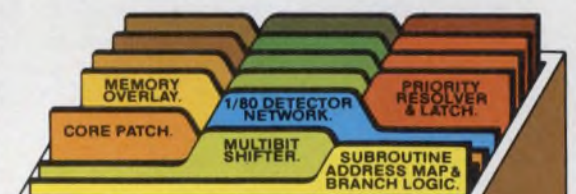

(BET YOU'LL THINK UP MORE.)

Just a few applications where the 16 inputs, 50ns speed, and optimized chip enable of our Field Programmable Logic Arrays provide major design/performance improvements.

Coupon clipped to letterhead gets you detailed applications data on FPLAs #82S100 (TriState) & #82S101 (Open Collector).

Name _____

Tel _____

Ext _____

Rush me sample parts quote.

THINK

Signetics

811 E. ARQUES, SUNNYVALE, CALIF 94086

INFORMATION RETRIEVAL NUMBER 140

ELECTRONIC DESIGN 22, October 25, 1975

INFORMATION RETRIEVAL NUMBER 141

RAPID SYN

... the broad
flexible line of

STEPPERS



Your special may be one of our standards

Computer Devices gives you more step angles, more sizes and more types of stepper motors. Make your choice from the broad, flexible line that the majors are switching to in ever-increasing numbers.

Standard RAPID-SYN steppers include 2, 3, 4, & 5 phase units, frame sizes of 3/4" and up with stepping angles of 1.8°, 2.25°, 5°, 7.5°, 11.25°, 45° and 90°—all designed to operate from a wide variety of solid state logics offered from stock.

RAPID-SYN Synchronous 72, 200, 300 & 450 RPM motors are also stock items. These low speed, high torque motors eliminate the need for gear reducers, clutches and brakes and are rated for 110 VAC, 60 HZ.

Chances are your special motor requirements and drivers are already in stock at Computer Devices. If not, you can be assured that your needs get extra-prompt attention.



Call or wire for free catalog



COMPUTER DEVICES OF CALIFORNIA
11901 Burke St., Santa Fe Springs, Calif. 90670
(213) 698-2595 • TELEX: 65-7478
For local offices see EEM 74-1

NEW LITERATURE

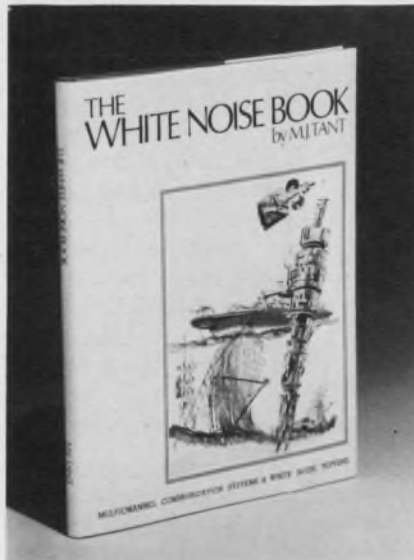

Communications testing

"The White Noise Book," a 104-page hard-cover illustrated text book, traces the development of multichannel communications and describes in detail how noise loading techniques provide the key to evaluating system performance. The price of the book, postpaid, is \$6. Marconi Instruments, 100 Stonehurst Ct., Northvale, NJ 07647

INQUIRE DIRECT

Regulator and signal diodes

A 576-page handbook on voltage regulator and signal diodes is printed in both English and French. Graphs, tables and illustrations are helpful additions to the text. Thomson-CSF, 75737 Paris, Cedex 15, France.

CIRCLE NO. 491

Test sets

Specifications and features on standard models of ac/dc dielectric and insulation test equipment, plus ac resonant test equipment are contained in a 16-page catalog. American HV Test Systems, Accident, MD

CIRCLE NO. 492

Video equipment

General-purpose, high-performance cameras and video products are covered in an eight-page product guide. RCA Closed Circuit Video Equipment, Lancaster, PA

CIRCLE NO. 493

Multiturn trimmers

Line drawings, specifications, standard resistance values, photos and ordering information on 3/8-in. multiturn square cermet trimmers are included in a data sheet. Spectrol Electronics, City of Industry, CA

CIRCLE NO. 494

Electromechanical systems

Hundreds of illustrations, detailed drawings and specifications of electromechanical systems can be found in a 700-page catalog. Minarik Electric, Los Angeles, CA

CIRCLE NO. 495

Multichannel analyzer

Optical multichannel analyzer detectors, including UV, visible and IR types, are described in a 16-page catalog. A short glossary and calibration wavelength table are included. Princeton Applied Research, Princeton, NJ

CIRCLE NO. 496

IC packaging assemblies

Wire-wrappable packaging boards, packaging sockets and individual terminals are featured in a 41-page catalog. Garry Manufacturing, New Brunswick, NJ

CIRCLE NO. 497

Power semiconductors

Electrical and mechanical characteristics on more than 10,000 power semiconductors, including high-speed switching transistors, zeners and transient voltage suppressors, are described in a 60-page catalog. General Semiconductor, Tempe, AZ

CIRCLE NO. 498

Nickel-cadmium batteries

An updated second edition of the "Nickel-Cadmium Battery Application Handbook" describes performance characteristics, specifications, capabilities and limitations of these batteries. Over 100 diagrams, charts and photos illustrate the data presented. A glossary of terms and an index are included. The handbook costs \$5. General Electric, Battery Business Dept., P.O. Box 992, Gainesville, FL 32602

INQUIRE DIRECT

CMOS circuits

A design guide describes the predesigned and preprocessed MasterMOS array. The guide defines the array cell and shows examples of CMOS devices laid out with the MasterMOS cell, plus examples of circuit applications solved with MasterMOS. International Microcircuits, Santa Clara, CA

CIRCLE NO. 499

Packaging products

Features and specifications for circuit boards, cages, card cases, sockets, terminals and tools are highlighted in a 16-page catalog. Vector Electronic, Sylmar, CA

CIRCLE NO. 500

Hand-held terminals

"Hand-Held News" provides an interchange of ideas and applications among the Termiflex hand-held terminal users. Termiflex, Nashua, NH

CIRCLE NO. 501

Feedthrough connector

Electrical performance data, specifications and a photograph of a high pressure feedthrough connector are contained in a two-page data sheet. Malco, South Pasadena, CA

CIRCLE NO. 502

Zeners

A technical bulletin covers 5-W zeners. TRW Capacitors, Ogallala, NE

CIRCLE NO. 503

Porcelain capacitors

Electrical, mechanical and environmental characteristics of low-loss porcelain capacitors are included in an eight page catalog, along with a chart on the terminations and dimensions. Graphs of Q, insertion loss, VSWR, reflected power loss and equivalent series resistance vs frequency and temperature are included. American Technical Ceramics, Huntington Station, NY

CIRCLE NO. 504

Desoldering method

Before and after photos in a four-page brochure illustrate the effectiveness of a desoldering method. Solder Removal, Covina, CA

CIRCLE NO. 505

NFPA catalog

Described, priced and illustrated in a 52-page "Publications and Visual Aids Catalog" are more than 600 titles—books and booklets, films, training courses, posters, speakers' aids and educational materials, as well as the current edition of each NFPA standard and code. NFPA Publication Sales Dept., Boston MA

CIRCLE NO. 506

Miniature switches

Miniature toggle and pushbutton switches are featured in a 52-page catalog. Dimensional drawings, specifications and prices are included. Alco Electronic Products, North Andover, MA

CIRCLE NO. 507

MICROPROCESSOR POWER

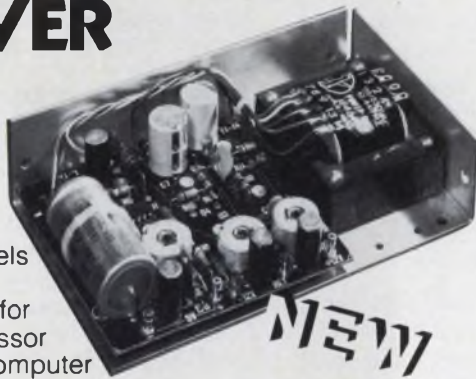

New dual and triple output models designed specifically for microprocessor and microcomputer applications.

MODELS

DUAL: HAA512, 5V @ 2A W/OVP	\$44.95
9 to 15V @ 0.5A	Single Quantities
TRIPLE: HTAA-16W, 5V @ 2A W/OVP	\$49.95
±9 to ±15V @ 0.2A	Single Quantities

FEATURES: 115/230 VAC Input • OVP on 5V Outputs • ±0.05% Regulation • I.C. Regulated • 1.5 mv Ripple • Foldback Current Limit • Full Rated to 50°C • 2 Hour Burn-in • 2 Year Warranty

See our complete product listing in EEM & GOLDBOOK

For a copy of our NEW 1976 D.C. POWER SUPPLIES CATALOG, contact Power-One or your local factory representative.

Visit us at WESCON, BOOTH 1558



531 Dawson Dr. Camarillo, Ca. 93010
Phone: 805/484-2806 TWX: 910-336-1297

POWER-ONE, INC.

INFORMATION RETRIEVAL NUMBER 144

ELECTRONIC DESIGN 22, October 25, 1975

MEMORY SERIES No. 1

THE DO-IT-YOURSELF 2K PROM

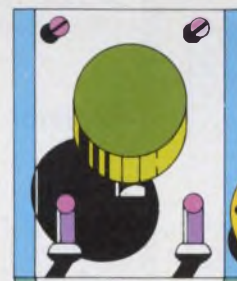

Program it on your own home ground. With our big, fast, Field Programmable 512x4 PROM #82S130/131. Twice the memory for your money: 2048 bits with same pins, same high performance rating as a 1K PROM.

Coupon clipped to letterhead gets you data sheet on #82S130/131—2K PROM.

Name _____

Tel. _____

Ext. _____

THINK

Signetics

311 E. ARQUES SUNNYVALE CALIF 94086

INFORMATION RETRIEVAL NUMBER 145

DIRECT FROM STOCK

SINGLES
72⁰⁰

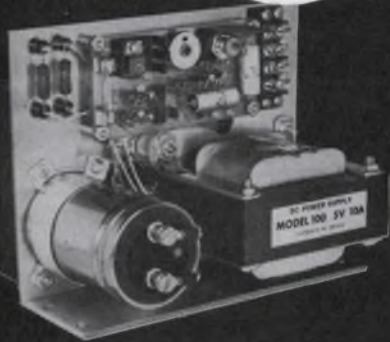

5V10A

SINGLES AND DUALS
FULL RATING AT 71°C

SPECIFICATIONS

Size: 7 x 5.5 x 5.5 overall
 Input: 105-125V, 47-420 Hz
 Output: Any DC voltage 3 to 30
 Regulation: Line — 0.005%
 Load — 0.05%
 Ripple: Less than 500 Microvolts
 Temp. Operative — 20 to +71°C
 Storage — 65 to +85°C
 Coefficient — 0.01%/°C Max.
 Current Limiting: Fixed Foldback Type
 Overvoltage: Optional

SINGLE OUTPUTS			DUAL OUTPUTS		
Model	Voltage	Amps	Model	Voltage	Amps
100-5	5.0	10.0	100-0505	5.0	5.0
				5.0	5.0
100-10	10.0	8.0	100-1212	12.0	3.5
				12.0	3.5
100-12	12.0	7.0	100-1515	15.0	3.0
				15.0	3.0
100-15	15.0	6.0	100-2424	24.0	2.0
				24.0	2.0
100-24	24.0	4.0	100-2828	28.0	2.0
				28.0	2.0

ORDERING INFORMATION

Quantity	Singles	With O.V.*	Duals	With O.V.*
1-9	\$72 ea	\$78 ea	\$85 ea	\$97 ea
10-14	68	73	81	91
25-49	62	67	73	83
50-99	57	61	67	76
100-	53	57	63	72

*O.V. = Overvoltage protection

CALL (714) 279-1414

Electrostatics, Inc.
 7718 CLAIREMONT MESA BLVD • SAN DIEGO, CA 92111

INFORMATION RETRIEVAL NUMBER 146

Design Aids

PC boards

Production steps and chemical processes involved in the manufacture of multilayer, conventional and semi-additive PC boards are shown in a guide. The Sel-Rex Co.

CIRCLE NO. 508

Adhesives

Specification and selection information on high-strength epoxy adhesives are given in a chart. The Dexter Corp., Hysol Div.

CIRCLE NO. 509

Dielectric materials

A dielectric materials chart shows the dielectric constant (k') and dissipation factor (D) or loss tangent ($\tan \delta$) of materials at microwave frequencies by position on a grid chart. Emerson & Cuming.

CIRCLE NO. 510

Thermal classification chart

A six-page electrical insulation thermal classification selector chart helps to select the proper composite insulation for virtually any thermal classification. Keene Corp., Chase-Foster Laminates Div.

CIRCLE NO. 511

Resistor networks

A cross-reference guide lists the most popular brands and types of standard resistor networks and indicates interchangeability of base part numbers. Bourns Data Distribution Center.

CIRCLE NO. 512

Algorithms

"Algorithms for Four-Function Electronic Calculators" helps users to evaluate mathematical functions with greater accuracy than that required for ordinary engineering applications. The book costs \$2. Mallmann Optics & Electronics, 836 S. 113 St., West Allis, WI 53214

INQUIRE DIRECT

Fiber Optic CRT's in Your New Designs?



Specify
DuMont for
Performance to Match Needs

Whatever your Fiber Optic application—

- Well logging oscillograms
- High speed computer output/COM
- Facsimile
- Oscilloscope/oscillograph recording
- Single-transient capture
- High efficiency optical coupling
- Photo typesetting

—DuMont has a solution for you. Sizes of available designs range from 1-inch-diameter faceplate to 15-inch line scan. Choice of all-electrostatic or hybrid tubes with high- or low-voltage focus, or fully-magnetic tubes. Many with line widths as fine as 0.0007 inch.

Faceplates can be ordered with fiber diameters from 5 to 10 microns and with clear or extramural dark cladding.

For performance specifications of representative fiber optic CRT's, send for Bulletin CRT-007. For instant response, call our Marketing Department—(201) 773-2000.

DuMont Electron Tubes & Devices Corporation

750 Bloomfield Avenue □ Clifton, New Jersey 07015

A Subsidiary of THOMSON-CSF

INFORMATION RETRIEVAL NUMBER 147
 ELECTRONIC DESIGN 22, October 25, 1975

Vendors Report

Annual and interim reports can provide much more than financial-position information. They often include the first public disclosure of new products, new techniques and new directions of our vendors and customers. Further, they often contain superb analyses of segments of industry that a company serves.

Selected companies with recent reports are listed here with their main electronic products or services. For a copy, circle the indicated number.

Tocom. Computer controlled communications systems and CATV.

CIRCLE NO. 513

The Aerospace Corp. Nonprofit scientific services to Air Force and Dept. of Defense agencies.

CIRCLE NO. 514

Omni Spectra. Microwave components, coaxial connectors and sub-assemblies, oscillators and microwave intrusion sensors.

CIRCLE NO. 515

Varian. Electronic devices, medical electronics, information systems and instrumentation.

CIRCLE NO. 516

General Automation. Computers and minicomputers.

CIRCLE NO. 517

Energy Conversion Devices. Semiconductor memories and imaging materials and systems.

CIRCLE NO. 518

Redactron. Word processing systems.

CIRCLE NO. 519

Dynascan. Electronic equipment, CB radios and radio remote control systems.

CIRCLE NO. 520

General Radio. Electronic equipment for measuring, testing and analysis of circuits and equipment for regulating and controlling line voltage.

CIRCLE NO. 521

Your source
for Electronic
Discharge
Printers

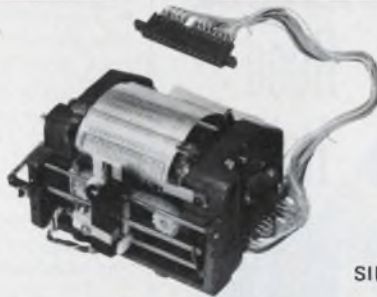

\$130
1606A
16 COLUMN

\$150
2106A
21 COLUMN

SINGLE QUANTITY PRICE
VOLUME DISCOUNTS

FAST 6 LINES PER SEC.

QUIET NON IMPACT PRINTER

SMALL 3.3" X 4.5" X 4.5"

LIGHT ONLY 1.5 POUNDS

LONG LIFE MTBF 5.5 MILLION LINES

HOOK UP WITH HYCOM. These quick, quiet and compact alphanumeric printers need no ribbons and have fewer moving parts . . . adding up to economy and reliability. Get them from the source . . .

HYCOM

16841 Armstrong Avenue, Irvine, California 92705, Telephone (714) 557-5252

Your source for Microelectronic Systems
Custom MOS/LSI • Communication Systems • Dedicated Calculators
INFORMATION RETRIEVAL NUMBER 148

When motion control is the problem, motomatic® is the answer.

Motomatic® is a complete line of DC motion control products including speed controls, digital position controls, phase lock velocity controls, servo amplifiers and motors ranging from 1/70 hp to 1-3/4 hp. If you need a motion control system, call Electro-Craft. We will take our standard "building blocks" and design a system tailored to your requirements. Within days, you'll receive a detailed proposal including inputs, outputs, dimensions, and performance specs. We may also suggest ways of optimizing your machine to reduce drive costs. This service is free, without obligation. We will guarantee our system to perform as specified. So if motion control is your problem, call us today. Electro-Craft Corporation, 1600 Second Street South, Hopkins, Minnesota 55343. (612) 935-8445.

INFORMATION RETRIEVAL NUMBER 149



Many Options for Most Applications

New CR-2000 Series utilizes the popular 1" x .100" grid pattern, with 1 to 6 poles and a variety of options and contact forms for almost any application. Reliable low-level switches may be conditioned by special run-in and dynamic testing. Models can be epoxy-encapsulated or simply encased for added economy. Ask for Bulletin MR 11.1 for full details.



COTO-COIL COMPANY, INC.
59 Pavilion Ave.
Providence, R. I. 02805
Tel: (401) 467-4777

INFORMATION RETRIEVAL NUMBER 151

Aerospace Optics make it Sunlight Readable

Patents in Process

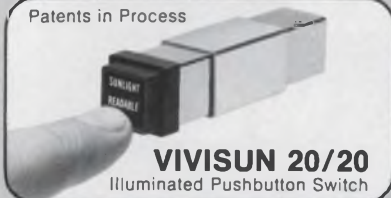

VIVISUN 20/20
Illuminated Pushbutton Switch

Only Vivisun 20/20 is sunlight readable in a light ambient of 10,000 foot-candles (sunlight)

Vivisun 20/20 pushbutton switches are designed in accordance with MIL-S-22885. Momentary or alternate push-button action available with SPDT, DPDT or 3 PDT switches. 1, 2, 3, or 4 separate messages. Messages available in green, yellow, red or white

AEROSPACE OPTICS INC.

7112 Burns St., Dept. 3, Fort Worth, Texas 76118
(817) 284-2293 (Ext. 3) • Telex 75-8461

INFORMATION RETRIEVAL NUMBER 152

Electronic Design

ELECTRONIC DESIGN's function is:

- To aid progress in the electronics manufacturing industry by promoting good design.
- To give the electronic design engineer concepts and ideas that make his job easier and more productive.
- To provide a central source of timely electronics information.
- To promote communication among members of the electronics engineering community.

Want a subscription? ELECTRONIC DESIGN is sent free to qualified engineers and engineering managers doing design work, supervising design or setting standards in the United States and Western Europe. For a free subscription, use the application form bound in the magazine. If none is included, write to us direct for an application form.

If you do not qualify, you may take out a paid subscription for \$30 a year in the U.S.A., \$40 a year elsewhere. Single copies are \$1.50 each.

If you change your address, send us an old mailing label and your new address: there is generally a postcard for this bound in the magazine. You will have to requalify to continue receiving ELECTRONIC DESIGN free.

The accuracy policy of ELECTRONIC DESIGN is:

- To make diligent efforts to ensure the accuracy of editorial matter.
- To publish prompt corrections whenever inaccuracies are brought to our attention. Corrections appear in "Across the Desk."
- To encourage our readers as responsible members of our business community to report to us misleading or fraudulent advertising.
- To refuse any advertisement deemed to be misleading or fraudulent.

Microfilm copies are available of complete volumes of ELECTRONIC DESIGN at \$19 per volume, beginning with Volume 1, 1952 through Volume 20. Reprints of individual articles may be obtained for \$3.00 each, prepaid (\$.50 for each additional copy of the same article) no matter how long the article. For further details and to place orders, contact the Customer Services Department, University Microfilms, 300 North Zeeb Road, Ann Arbor, Michigan 48106 telephone (313) 761-4700.

Want to contact us? If you have any comments or wish to submit a manuscript or article outline, address your correspondence to:

Editor
ELECTRONIC DESIGN
50 Essex Street
Rochelle Park, N.J. 07662

recruitment and classified ads

WE SHIP IN 1 DAY
FROM OUR 42000 SQ FT FACILITY

MINIS— DEC • DG • CAI
CASC • HP • HIS • IBM • INT
Lock • Micro • Sel • Tempo
Univac • Varian • XLO
PRINTERS

ODEC 1321	110LPM	\$2000
1322	200LPM	1500
MDS 4330	300LPM	2950
DP 2440	700LPM	7500
DP 4300	1333LPM	7500

CARD READERS
GDI M110 \$450
100 350

PAPER TAPE
Digitronics 2500 \$350
Chalco 5401 350
BRPE Punch 21 250

MAGNETIC TAPE
Pertec 7830 \$ 250
6840 1450
Wangco 1137 1450

617-261-1100
AMERICAN USED COMPUTER CORP
Box 68, Kenmore Sta., Boston, MA 02215
member COMPUTER DEALERS ASSOC.

CIRCLE NO. 269

FREE DISCOUNT BOOK CATALOG
ELECTRONICS—DATA PROCESSING—MATH
Our 1975 catalog describes over 1000 state-of-the-art, professional-level books, grouped in 31 technical interest categories, from 16 major publishers. All NEW books . . . not used or over-stock

TECHNI-BOOKS
P.O. Box 11665, Santa Ana, CA 92711
(714) 633-6015
A Mail Order Technical Book Service

CIRCLE NO. 270

Protect Your Heart HAVE REGULAR MEDICAL CHECK UPS



Give Heart Fund

Double up, America.



Two can ride cheaper than one.

When people carpool, companies benefit directly, because, obviously, fewer cars will make less demand on the parking spaces in the company lot. And some companies have attributed an increase in punctuality to the fact that more and more of their employees were carpooling.

Find out how you can help organize carpools. For your "Double up Kit," write to Double up, U.S. Department of Transportation, P.O. Box 1813, Washington, D.C. 20013.



A Public Service of The Magazine & The Advertising Council



Electronic Design

Advertising Sales Staff
Tom W. Carr, Sales Director

Rochelle Park, NJ 07662
Robert W. Gascoigne
Daniel J. Rowland
50 Essex Street
(201) 843-0550
TWX: 710-9990-5071

Philadelphia
Thomas P. Barth
50 Essex Street
Rochelle Park, NJ 07662
(201) 843-0550

Boston 02178
Gene Pritchard
P.O. Box 379
Belmont, MA 02178

Chicago 60611
Thomas P. Kavooras
Berry Conner, Jr.
200 East Ontario
(312) 337-5088

Cleveland
Thomas P. Kavooras
(Chicago)
(312) 337-5088

Los Angeles 90045
Stanley I. Ehrenclou
Burt Underwood
8939 Sepulveda Boulevard
Los Angeles, CA
(213) 641-6544

Texas/Oklahoma
Burt Underwood
(Los Angeles)
(213) 641-6544

San Francisco 94040
Robert A. Lukas
3579 Cambridge Lane
Mountain View, CA 94040
(415) 965-2636

London, Amsterdam, Tokyo, Seoul
John Ashcraft
12, Bear St.
Leicester Square
London WC2H 7AS England
Phone: 01-930-0525

W. J. M. Sanders
John Ashcraft & Co.
Herengracht 365
Amsterdam C., Holland
Phone: 020-24-09-08
Haruki Hirayama
Electronic Media Service
5th Floor, Lila Bldg.,
4-9-8 Roppongi
Minato-ku, Tokyo, Japan
Phone: 402-4556
Cable: Electronicmedia, Tokyo

Mr. O-kyu Park, President
Dongbo Int'l Corp.—
World Marketing
C.P.O. Box 4010
Seoul, Korea
Tel. 76-3910/3911
Cable: DONGBO SEOUL
Telex: EBKOREA K27286

ABP

BPA

Advertisement

DIELECTRIC MATERIALS CHART REVISED IN 1975



This colorful chart is a standard reference for electronic engineers. Shows Dielectric Constant (κ') and Loss Tangent ($\tan \delta$) for many E&C products and common materials plotted on 11" x 16½" graph. For notebook or wall mounting.

INFORMATION RETRIEVAL NUMBER 201

NEW CONVENIENCE IN RESIN SYSTEMS



Emerson & Cuming, Inc. one-part systems — epoxies, silicones, thermoplastics, solvent containing compounds, and others — eliminate weighing, metering, mixing, bring new convenience, speed, and accuracy to production processes involving coating, bonding, casting, molding, sealing, etc.

INFORMATION RETRIEVAL NUMBER 202

FLAME-RETARDANT EPOXIES & URETHANES

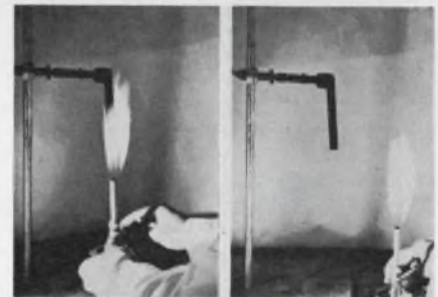

Stycast® Casting Resins and Eccocoat® Coatings, already spec'd in thousands of electrical/electronic applications, now offer an extra feature: **Flame Retardancy!** New E&C products, with the designation "FR", pass UL, Federal, and ASTM tests, including stringent UL 94 VE-O.

INFORMATION RETRIEVAL NUMBER 203

Emerson & Cuming, Inc.



CANTON, MASS.
GARDENA, CALIF.
NORTHBROOK, ILL.
Sales Offices
in Principal Cities

EMERSON & CUMING EUROPE N.V., Oevel, Belgium

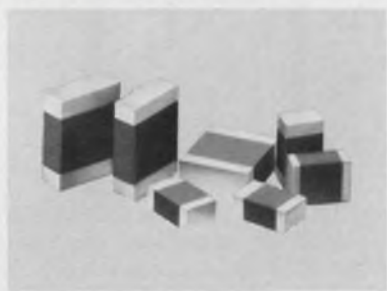

HIGH Q MULTILAYER CAPACITORS feature very high quality factors at microwave frequencies. Offered in three standard sizes: .050 x .040, .080 x .050, .125 x .095. Capacitance values from 0.1 pf to 1000 pf with close tolerance and voltages to 1000 VDCW. Johanson/Monolithic Dielectrics Div., Box 6456, Burbank, Ca. 91510, (213) 848-4465.

MULTILAYER CHIP CAPACITORS 601



Free 84-page Printed Circuit Drafting Aids Technical Manual & Catalog contains hundreds of time & money-saving tips, plus details on over 15,000 component symbols & tapes, film, vellum, grids. Bishop Graphics, Inc., 20450 Plummer St., Chatsworth, California, 91311, (213) 993-1000.

FREE CATALOG 604

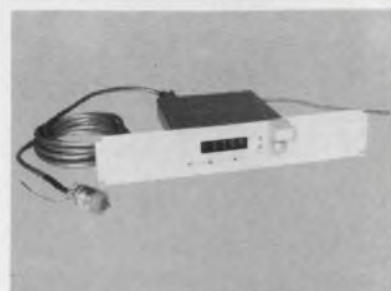

ABSOLUTE ENCODER— ± 1 Part In 3600 System Accuracy, Electro-Magnetic Transducer + LED Display + BCD, Binary, and DC Output—Infinitely Adjustable Scale Factor (0 to 9999)—Hi Noise Immunity—Zero Offset—Single and Multi-Channel Units From \$375/Axis (1 pc.) Computer Conversion Corporation, East Northport, NY 11731 516-261-3300

ENCODER 607



Model 5035A—easy, solderless breadboarding tool for complex TTL circuits. Has 6 bounceless HI-LO data switches, two clocks, & 4 LED indicators, allows easy design and checkout for circuits containing 16 DIPS on one removable breadboard. 1-amp supply can power several breadboards. Hewlett-Packard; 1501 Page Mill Rd.; Palo Alto, CA 94304

BREADBOARDING TOOL 602

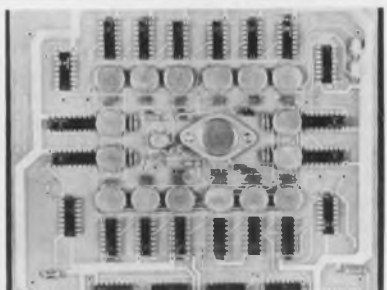

The 5 bit converter constructed on single printed circuit card. Total thrupt time 50 n sec, with 20 MHz update rate. Temperature stability over full mil range, -55°C to $+125^{\circ}\text{C}$ with drift less than ± 1 bit over entire range. M.S. Kennedy Corp; Pickard Dr, Syracuse, NY 13211 (315) 455-7077.

CONVERTER 605



MINIATURE WIDEBAND CURRENT PROBE. Low impedance Model 711 probe allows insertion in current path of high-speed circuits without affecting circuit operation. 8KHz-100MHz BW gives 3.5ns risetime and sensitivity of $1\text{V/A} \pm 2\%$. Use in all high speed current circuits. \$33.00. American Laser Systems, Inc. 106 James Fowler, Goleta, CA 93017

MINIATURE PROBE 608

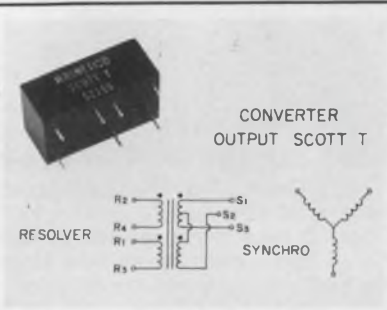

CONVERTER
OUTPUT SCOTT T

SCOTT T. TRANSFORMER: MAGNETICO Synchro driver is $7/8 \times 1-5/8 \times 11/16$ high, rated at 1 volt amp., 2 arc minutes accuracy. P.N. 52155 is 5.9 sine and cosine to 11.8 v. L-L Synchro. P.N. 52156 is 5.9 sine and cosine to 90 v. L-L Synchro. MAGNETICO, 182 Morris Avenue, Holtzville, N.Y. 11742—516-654-1166.

TRANSFORMER 603

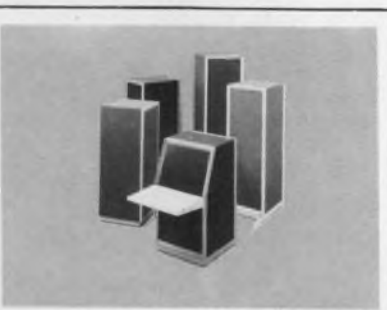

Optima Racks are set apart by a unique bezel construction—a rigid aluminum frame that protects your equipment and gives it a distinctive look. Vertical and sloped for 19" and 24" panels. Optima Div., Scientific-Atlanta, Inc. 2166 Mountain Industrial Blvd. Tucker, Ga. 30084. Ph. 404-939-6340

INSTRUMENT RACKS 606

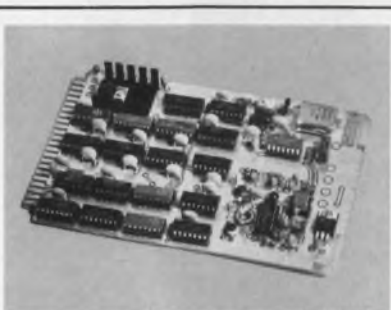

MODULE FREQUENCY SYNTHESIZER with a frequency range of 0.1Hz to 16MHz allows O.E.M. and systems people to have programmable frequency at a fraction of the cost of mounted synthesizers. AT \$295, in unit quantities, the SM-101 module is TTL programmable. Synstest Corp., 169 Millham St., Marlboro, MA 01752 (617) 481-7827.

FREQUENCY SYNTHESIZER 609

Power Supply Catalog



POWER MATE CORP.

Free catalog of 34,500 power supplies from the worlds largest manufacturer of quality Power Supplies. New '74 catalog covers over 34,500 D.C. Power Supplies for every application. All units are UL approved, and meet most military and commercial specs for industrial and computer uses. Power Mate Corp. (201) 343-6294.

POWER SUPPLY

610



"Timing Products Shortform Catalog" provides complete listing of standard Datametrics digital clocks, time code generators and readers, remote time display products. Includes operation theory of clocks and generators, application of time code for synchronization, calibration, indexing, distribution. Datametrics, 340 Fordham Rd., Wilmington, MA 01887

TIMING CATALOG

613

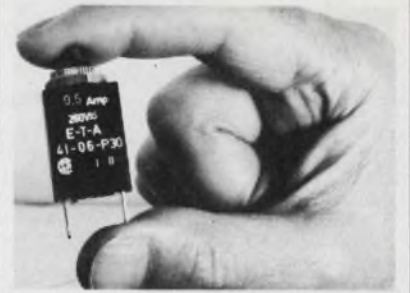

Overcurrent Protector, manual reset eliminates fuse replacement. Convenient panel mounting. 15 fractional ratings from 0.1 to 3 amp. Other models up to 400 amp. Trip-free and fool-proof, UL and CSA approved. High quality, low cost \$1.29 ea. in 1000 lots. E-T-A Products Co. of America, 7400 N. Crounse Rd., Chicago, Ill. 60648. Tel: (312) 647-8303. Telex: 253780.

CIRCUIT BREAKER

616



Cost Saving Unregulated DC Supplies are reliable alternatives for many applications where regulation is a "frill", like powering solenoids, lamps, relays, latches, etc. Featuring a floating output, they may be referenced to common ground or in series with another DC voltage. Standard Power, Inc., Santa Ana, CA 92705 (714) 558-8512

UNREGULATED BLACKLINE

611

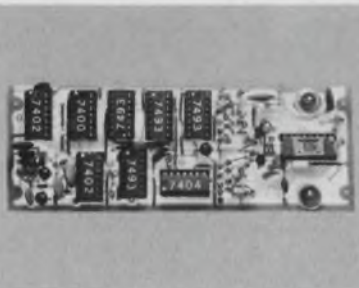

Low Cost Image Sensing Module contains a 1024 element (32-by-32) image sensor and all support circuitry on a single pc board. Digital video output may be displayed directly on an oscilloscope. Complete module (SE1024W) is \$150. Kit (SE1024K) is \$90. Cromemco, 26655 Laurel, Los Altos, CA 94022.

MODULE

614

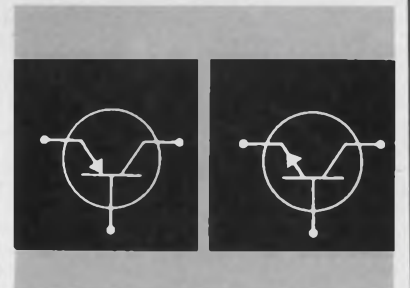

2 Ohms $r_{ec(sat)}$ switching transistors, used wherever low on resistance is critical. Complementary NPN/PNP, extremely low I_{cBC} and I_{eBO} , with 30V BV_{cBC} and BV_{eBO} . Unique, low priced. Samples available, 2N6566 2N6567. 1-99, \$8.00; 100-999, \$5.30. Teledyne Crystalonics, 147 Sherman St., Cambridge, MA 02140. Tel: (617) 491-1670.

2 OHMS SWITCHES

617

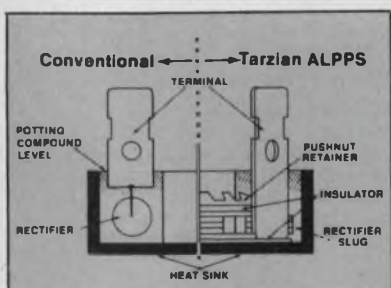

TARZIAN BRIDGE RECTIFIER ASSEMBLIES. Patented ALPPS design has faster, more consistent heat dissipation for high stability and conservative rating. 0.6" sq. 10A unit has 200A surge. 30A 1-1/4" round has 400A surge. ALPPS design available in custom units too. Sarkes Tarzian, Inc., 415 N. College, Bloomington, IN 47401 (812) 332-1435.

BRIDGE RECTIFIERS

612



High performance Type "T" subminiature machined-plate capacitors. Rotors and stators machined from solid brass extrusions provide excellent stability and uniformity. High Q, low temp. coefficient (plus 30 \pm ppm/ $^{\circ}$ C). Available in horizontal and vertical tuning for PC and strip-line mounts. E. F. Johnson Co., Waseca, MN., (507) 835-5222.

TYPE "T" CAPACITOR

615

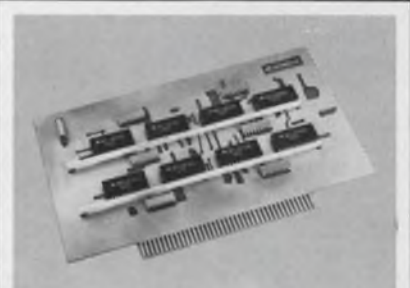

EASIER ECL VOLTAGE AND GROUND DISTRIBUTION SYSTEMS—Reduced system noise, high packaging density and less design time for PC boards with ECL circuits are yours with Mini/Bus[®], the Rogers way to eliminate the cost of multi-layer boards by off-board voltage and ground distribution. Rogers Corp., Chandler, AZ 85224 (602) 963-4584.

MINI/BUS

618

Advertiser's Index

Advertiser	Page	Advertiser	Page	Advertiser	Page
ACDC Electronics, Inc.	129	Electronic Design	106, 175, 197	NCR Corporation	135
AMP, Incorporated	44, 45	Electronic Development Corp.	144	Nichicon America Corporation	169
Acopian Corp.	80K	Electronic Measurements, Inc.	168	Norland Instruments, A Subsidiary of Cordis Corporation	80A
Adac Corporation	142	Electronic Molding Corporation	165	North American Philips Controls Corp.	156
Advance Micro Devices	80B-C	Electrostatics, Inc.	190	*Nucleotides	80B
Advertising Council	193	Elexon Power Systems	174	Opcoa, Inc.	171
Aerospace Optics Inc.	192	Elmwood Sensors, Inc.	185	Optical Electronics Inc.	182
Alco Electronic Products, Inc.	181	Emerson & Cuming, Inc.	193	*Oscilloquartz SA	80D
Allen Bradley Co.	80L	Facit-Addo, Inc.	118	*Philips Industries, Test and Measuring Instruments Division	80A
American Laser Systems	194	Floating Point Systems, Inc.	117	Phoenix Data, Inc.	170
American Technical Ceramics	173	Fluke Mfg. Co., Inc., John	4, 5	Piezo Technology, Inc.	178
Amperite Co., Inc.	148	General Electric Company, Miniature Lamp Products Department	163	Plessey Microsystems	113
Ampex Data Products Division	31	General Electric Company, Semiconductor Products Dept.	100	Pomona Electronics, A Division of ITT	101
Ampex Memory Products Division	136	General Instrument Corporation	23, 24, 25, 26	Potter & Brumfield, Division of AMF Incorporated	79
Amphenol Connector Division, Bunker-Ramo Corp.	11	*General Semiconductor Industries, Inc.	80C	Power/Mate Corp.	195
Ann Arbor Terminals, Inc.	172	Gold Book, The	185, 199	Power One, Inc.	189
Ansley Electronics Corp.	51	Grayhill, Inc.	138	Powertec, Inc.	147
Arnold Magnetics Corp.	150	Guardian Electric Manufacturing Company	80H-I	Practical Automation, Inc.	123
Arrow-M Corp.	141	Hansen Manufacturing Co., Inc.	69	Premier Metal Products Company	160
Augat, Inc.	161	Harris Semiconductor, A Division of Harris Corporation	133	Princeton Electronic Products, Inc.	178
Beckman Instruments, Inc., Helipot Division	80F	Hayden Book Company, Inc.	80J	RCA Solid State	Cover IV
Belden Corporation	72, 73	Haydon Switch & Instrument, Inc.	165	RCL Electronics, Inc.	14
Bell Industries, J. W. Miller Company	180	Heath/Schumberger Instruments	81	Reader Service Card	200A-B
Bishop Graphics, Inc.	194	Hewlett-Packard 18, 162, 194, Cover III	Cover III	Research, Inc.	164
Bodine Electric Company	143	Honeywell Test Instruments Division	139	Robinson Nugent, Incorporated	60, 61
Bourns, Inc., Trimplot Products Division	Cover II	Hughes Aircraft Company, Industrial Products Division	85	Rogers Corporation	195
Buckbec-Mears Company	177	Hycom	191	Rohde & Schwarz	80
CELCO (Constantine Engineering Laboratories Company)	15	IBM General Systems Division	58, 59	Sarkes-Tarzian, Inc.	195
Chafitz	158	IMC Magnetics Corporation	179	Scanbe Manufacturing Corp.	167
Clairex Electronics, A Division of Clairex Corporation	185	ISE Electronics Corporation	107	Science Accessories Corporation	166
Clare & Co., C. P.	80G	ITT Cannon Electric, International Telephone and Telegraph Corporation	131	Scientific Atlanta, Inc.	194
Clinton Electronics Corporation	140	Instruments for Industry, Inc.	183	Siemens Corporation, Special Components Division	77
Computer Automation, Inc.	12, 13	Intech, Incorporated	146	Signetics Corporation	52, 53, 169, 177, 181, 187, 189
Computer Conversions Corp.	194	International Rectifier	94	Silicon Transistor Corporation	183
Computer Devices of California	188	Interstate Electronics Corporation	124	Simpson Electric Company	112
Computer Operations, Inc.	179	Johanson Manufacturing Corp.	7	Sprague Electric Company	10
Computer Products, Inc.	180	Johanson/Monolithic Dielectrics Division	194	Standard Power, Inc.	194
Computer Survey Card	64A-B	Johnson Company, E. F.	6, 195	Sweda International	171
Constantine Engineering Laboratories Company (CELCO)	15	Kennedy Corp., M. S.	195	Switchcraft, Inc.	125
Continental Specialties Corporation	176	Keystone Electronics Corporation	141	Systron-Donner	43, 153
Coto Coil Company, Inc.	192	Magnecraft Electric Company	200	Sycor, Inc.	141, 143
Cromemco	195	Magnetico, Inc.	194	Syntest Corp.	194
Crown International, Industrial Products Division	176	Malco, A Microdot Company	20	Technitrol, Inc.	184
Cutler-Hammer, Specialty Products Division	19	Martin Research	173	Tektronix, Inc.	32, 32A-B, 33
Data 100 Corporation	84	Mepco/Electra, Inc.	154, 155	Teledyne Crystalonics	195
Data Precision Corporation	152	Microswitch, A Division of Honeywell	70, 71	Teletype Corporation	67
Datak Corporation, The	143	Minelco Division/General Time Corp.	170	Texas Instruments, Incorporated	80D-E
Datametrics	195	Mini-Circuits Laboratory, A Division of Scientific Components Corp.	2, 28	Thomas Electronics, Inc.	101
Deltron, Inc.	127	Monolithic Memories, Inc.	148, 149, 150, 151	Topaz Electronics	187
Dialight, A North American Philips Company	161	Monsanto, United Systems Corporation Subsidiary	16	*U. S. Department of Commerce	80D
Digi-Data Corporation	144	Motorola Display Products	95	United Systems Corporation	16
Dit Mco International	182	Motorola Semiconductor Products, Inc.	8, 9	Unitrode Corporation	82
Douglas Electronics, Inc.	172			Universal Data Systems	27
DuMont Electron Tubes & Devices Corporation	190			Vactec, Inc.	41
Dynamic Measurements Corporation	111			Varadyne Industries, Inc.	119
EMM Semi, A Division of Electronic Memories & Magnetics Corporation	17			Varo Semiconductor, Inc.	186
ENM Company	161			Viking Industries, Inc.	157
E-T-A Products Co. of America	194			Waters Manufacturing	184
Electro-Craft Corporation	191			Wavetek San Diego, Inc.	1
				Zero Manufacturing Co.	145, 159

*Advertisers in non-U.S. edition

YOUR FREE SUBSCRIPTION TO Electronic Design HAS EXPIRED

With business prospects brighter in '76 you won't want to miss a single issue of Electronic Design. Some of our readers have to pay as much as \$80 per year for this magazine and our GOLD BOOK. They're yours FREE if you qualify.

All you have to do is fill in the renewal application bound inside the front cover of this issue. In return for 3 minutes of your time we'll send you 26 issues packed with tech articles, news, design features and FOCUS reports. And we'll send you the 1976-77 GOLD BOOK too.

DON'T PUT IT OFF. Once you're off our list it takes months to get back on again.

RENEW NOW!

See inside front cover



NOTE

If you have sent us your renewal since August 16, 1975, ignore this notice.

ALL OTHERS MUST RENEW AT THIS TIME (regardless of when your subscription started).

Product Index

Information Retrieval Service. New Products, Evaluation Samples (ES), Design Aids (DA), Application Notes (AN), and New Literature (NL) in this issue are listed here with page and Information Retrieval numbers. Reader requests will be promptly processed by computer and mailed to the manufacturer within three days.

Category	Page	IRN	Category	Page	IRN	Category	Page	IRN
Components			page printer	118	49	Microwaves & Lasers		
CRTs	140	62	portable computer	59	27	couplers, directional	2	3
capacitor catalog	169	107	reader/punch	171	112	double-balanced mixers	28	21
capacitors	7	6	terminal systems	67	29			
capacitors	10	8	terminals	172	113	Modules & Subassemblies		
capacitors	119	50	Discrete Semiconductors			amplifier, low bias	152	336
capacitors, chip	184	397	Darlington	185	137	amplifier, power	150	334
coils, toroidal	180	129	diodes, beam-lead	162	353	converter, d/a	145	328
displays	107	44	diodes, zener	159	349	converters, v/f	142	301
drive systems	143	67	display, LED	159	348	delay modules	184	139
filters, crystal	178	124	displays, numeric	156	344	modules, power	146	320
lamps	163	92	indicators	161	90	motion control products	191	149
motors	69	30	JFETs, dual	155	342	multipliers, 4-quad	148	332
potentiometer	11	246	JFETs, p-channel	154	338	optical couplers	9	251
reed relays	192	151	LEDs	171	111	v/f converter	146	73
relay	141	63	LEDs, IR	160	351			
relay, 3-A	79	34	LEDs, T-1 sized	162	355	Packaging & Materials		
relays, delay	148	75	power transistors	82	37	adaptor, SIP	181	391
resistors	14	11	power transistors	94	40	adaptor plug assemblies	161	89
silicon photovoltaic cells	41	23	power transistors	183	135	black boxes	175	119
stepper motor	156	83	power transistors	IV	248	breadboard	176	120
steppers	188	143	rectifiers	25	19	cabinets and cases	160	87
surge voltage protectors	77	34	rectifiers	186	139	circuit boards	141	64
switch, DIP	138	60	SCR, high power	163	357	connectors	6	5
switch, PB	53	291	transistor, rf	155	343	connectors	11	9
switch, rocker	19	16	transistors, microwave	155	341	connectors, PC	157	84
switch, toggle	131	130	transistors, power	156	345	connectors, sub-		
switches	125	53	transistors, vhf & uhf	163	356	miniature	180	387
switches	165	102				contacts	20	17
switches, DIP	170	110	Instrumentation			dielectric materials	193	201
switches, PB	192	152	amplifier, wideband	183	134	enclosures	145	242
thermostats	185	138	chart recorders	81	36	enclosures	159	244
timer, counter	183	395	counters	167	105	fans	179	127
transformer, isolation	187	140	DMM	177	380	flexible circuitry	177	122
			DPM	176	379	latches, tension	181	389
			digital counters	161	88	PC kit	143	68
Data Processing			digital multimeter	112	46	panels	71	31
advance display terminal	85	39	dual-delayed sweep	18	261	panels and terminals	165	103
alphanumeric mini	123	51	function generator	1	2	panels, ECL	179	386
CRT displays	15	12	oscilloscopes	32A	298	socket boards	61	28
CRT modules	95	41	pulse generators	124	52	termination system	51	25
CRT terminal	178	125	recorders/reproducers	139	61	wire, cable and cord	73	234
calculator	138	324	signal generator	45	275			
calculator	140	326	wire/ckt analysis system	182	132	Power Sources		
calculator	158	85				dc/dc converter	172	309
cassette recorders	143	69	Integrated Circuits			dc/dc converters	173	374
computer interface	164	101	amplifier	170	369	medical supply	174	375
computers	137	310	comparators	170	370	microprocessor power		
data-acquisition system	142	66	converter, v/f	164	307	supply	111	45
data-acquisition systems	170	109	DAC	166	358	power supplies	43	24
data entry pen	162	91	microprocessor	166	359	power supplies	127	54
data processing	84	38	microprocessor	169	367	power supplies	147	74
digital instrument printer	16	271	microprocessors	166	360	power supplies	150	77
discharge printers	191	148	mini-DIPs	182	133	power supplies	153	80
dual diskette recorder	141	65	op amp	169	364	power supplies	155	82
mag tape	144	71	PROM, 4k generic	133	57	power supplies	168	106
mag tape transport	176	121	PROMs	169	366	power supplies	174	117
mass storage	179	126	PROMs, 1k x 4	149	76	power supplies	180	128
memories	136	281	RAM, 4-k	168	361	power supplies	190	146
minicomputer	13	10	RAM, 4k static	17	14	prog. voltage standard	144	70
minicomputer add-ons	113	47	ROM	169	365	switcher supply	174	377
minicomputers	173	115	ROM, 16-k	151	78	switchers, 5-V/30-A	129	55
modems	27	20						

IT'S WORKING FOR ME

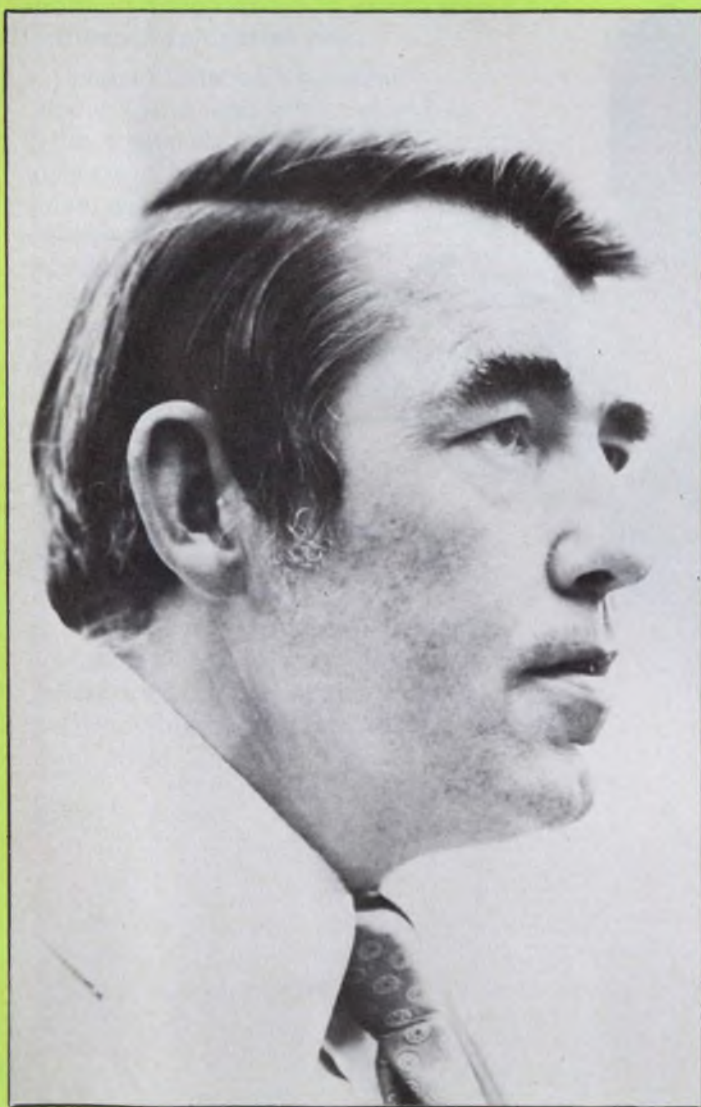

George A. O'Sullivan

"The GOLD BOOK is Producing Business For Us 75 to 1"

Back in January, George A. O'Sullivan, President, Abacus Controls, Inc. wrote:

"Our company booked its first \$30,000 for its new frequency converter line through our advertisement in the GOLD BOOK. Each contact was initially from a specifying engineer, who was asked where he learned about us. All of the orders came from territories in which we have neither a representative nor a distributor."

Now, six months later, Mr. O'Sullivan reports that "Business produced by the GOLD BOOK is running at a ratio of 75 to 1 for each dollar invested. And it's performing 3 to 1 better than EEM."

"We have a terribly complicated product. We've got to talk directly to engineers. Leads from the GOLD BOOK are almost always from engineers so we can swing right into our pitch. Often we are able to close orders as high as \$25,000 over the phone."

Mr. O'Sullivan adds, "We appreciate your ability to put the GOLD BOOK in the hands of engineers who make source selection decisions."

**THE GOLD BOOK IS WORKING . . .
IT'S WORKING FOR USERS, AND
IT'S WORKING FOR ADVERTISERS!**

ELECTRONIC DESIGN/GOLD BOOK
50 Essex Street, Rochelle Park, N.J.

Introducing, a New Design Spectrum* of Low Profile Relays.



Engineering excellence, a tradition at Magnecraft, is reflected in our new printed circuit relays. Three low cost classes are available in stock with performance specifications including absolute reliability, long mechanical life, and a wide choice of contact configurations and switching capabilities.

Packaging flexibility includes, a truly low profile dust proof design, with a minimum height above the P.C. board, and a vertically mounted space saving version. The relays feature industry standard .1 inch grid spacing for terminals, and high density center to center board spacing. Contact arrangements include SPDT, DPDT, 4PDT, and 6PDT rated from 1 to 8 amps. Bifurcated contacts are optional on certain configurations.

These compact relays are particularly suited for communication systems, data processing equipment, automatic control systems, process control, automotive and consumer electronics.

*Family of Relays



Free!
LOW PROFILE
RELAY BROCHURE

Specifications, photos, and line drawings are included in Magnecraft's latest 4 page bulletin, number 750. A 36 page stock relay catalog will accompany the bulletin for all your relay applications.

Find Magnecraft Relays in EEM and the Gold Book

Magnecraft[®] ELECTRIC COMPANY
5575 NORTH LYNCH AVENUE • CHICAGO, ILLINOIS 60630 • 312 • 282 5500 • TWX 910 221 5221

The right DMM decision means
 1 μ V sensitivity, 0.03% accuracy,
 and a \$425* price.

Introducing HP's 3465A DMM.

Now you have a five-function DMM with the needed accuracy, sensitivity, and low cost to solve your bench or field service requirements. See how HP's 3465A Digital Multimeter combines capability, convenience, and confidence with low cost to bring you to the right decision.

Capability: Take a look at the front panel. It has all the functions and ranges you'd expect, and more. You get ohms, ac/dc volts, and ac/dc current. Extra resolution is obtained with a full-scale readout of 19999. Accuracy is $\pm 0.02\%$ of reading $\pm 0.01\%$ of range on dc, meeting the needs for most field or bench applications. The 10 mV dc range and 100 mV ac range provide performance typically found only in more expensive $5\frac{1}{2}$ -digit multimeters.

Convenience: The 3465A's functional design means easy rack and stack with other instruments in the lab, while its compactness and low power consumption result in a handy field-service instrument. It will operate from four different sources of power: 1) Four standard D-cell** batteries. 2) The ac line using an HP hand-held calculator charger. 3) The ac line using its own internal power supply. 4) Rechargeable Nickel Cadmium batteries.

Confidence: Fewer components and higher reliability are achieved through the use of a newly developed Tantalum-Nitride on Sapphire thin-film resistor. Easy calibration and improved performance are obtained with a new dual-slope integrator that uses a single reference supply. All these design features, plus input protection, give you the performance you'd expect from HP.

Cost: The standard 3465A costs \$500* and is equipped with an internal power supply, a battery recharging circuit, and Nickel-Cadmium batteries. If you don't need the rechargeable batteries, order Option 001 for \$480* and save \$20* Order Option 002 for \$425* and save \$75* by powering the HP 3465A from dry-cell batteries. Also, Option 002 can operate from the ac line when using one of HP's Model 82002A chargers (supplied with most HP pocket calculators).

When you consider its capability, convenience, and cost, you can be confident that the 3465A is the right decision. Contact your local HP field sales engineer, or, write for more information.

*Domestic U.S.A. Price Only **U-2 Batteries in Europe

**HP DMM's...
 the right decision**



HEWLETT  PACKARD

Sales and service from 172 offices in 65 countries
 1501 Page Mill Road, Palo Alto, California 94304

INFORMATION RETRIEVAL NUMBER 247

What's new in solid state...

RCA delivers the promise of GTO SCRs in an 8.5A series.

You've heard the GTO promise: a dependable, cost-effective switch that requires only a short negative power pulse to the gate for turn-off. Now RCA makes that promise. And delivers it with product.

Right now, you can choose from 18 RCA 8.5-ampere GTO SCRs available from RCA or through your distributors. At prices ranging from \$4.13 to \$11.47 for 1 to 99 units, from \$2.50 to \$6.95 at 1K.

Marriage of technologies

RCA is in GTOs to stay. We're that confident of the combination that made them possible: high

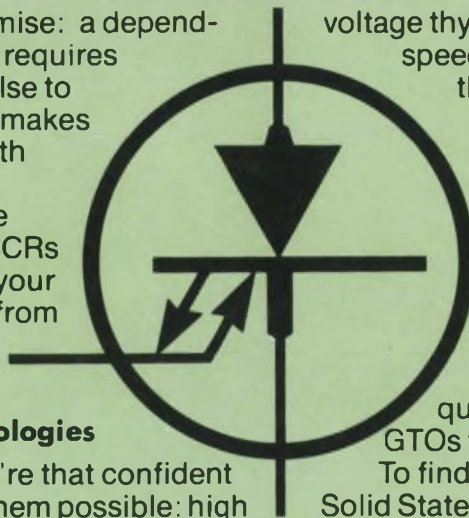

voltage thyristor technology combined with high speed transistor technology. You get everything a conventional 8.5-A SCR offers: normal inrush handling capability, pulse turn-on, operating range to 125°C. Gate turn-off capability is a bonus.

RCA GTOs come in the TO-3 package, in a choice of voltages: 100, 200, 300, 400, 500 and 600 V. They offer high peak-to-average current ratio, 20 kHz operating frequency. For the future, we're working on GTOs with higher current and higher speeds. To find out more, contact your local RCA Solid State distributor. Or RCA.

Write: RCA Solid State, Box 3200, Somerville, New Jersey 08876; Ste. Anne de Bellevue 810, Canada; Sunbury-on-Thames, U.K.; Fuji Bldg., Tokyo, Japan.



			SWITCHING CHARACTERISTICS		
			For high-, medium- & low-frequency applications.		
			G5001	G5002	G5003
V_{GTHM}			70 V	70 V	50 V
I_{TGQM}			15 A	15 A	15 A
t_{gq}	t_s		1 μ s	1.5 μ s	5 μ s
	t_f		1 μ s	2 μ s	5 μ s
t_{gt}	t_d		1 μ s	1 μ s	1 μ s
	t_r		1 μ s	2 μ s	2 μ s

INFORMATION RETRIEVAL NUMBER 248

RCA. Powerhouse in Thyristors