

Electronic Design. 16

VOL. 23 NO.

FOR ENGINEERS AND ENGINEERING MANAGERS

AUG. 2, 1975

Microcomputers? Minicomputers?
That really is not the question. Although some micros perform as fast as the best minis, both can complement each other. But the

decision whether to use a micro chip set, micro board, mini board, a full-scale minicomputer or a combination can be complex. A special report begins on p. 26.



A new low for on-board programming.

AMP introduced the DIP switch to solid-state electronics. Now we've gone still further. AMP's new *low-profile* DIP switches are as low as you can get. You can use them to program ICS right-on-the-board without remote wiring. And sandwich boards in less space, to cut packaging costs.

With our new, low-profile DIP switches, cleaning boards is easier than ever. Simply place our protective covers or pieces of tape on the switches and you can clean complete boards without damage.

We're the people who developed and perfected DIP switches—a whole family of them—including our innovative, pluggable Hexadecimal Rotary Switch. Our experience is broader and deeper than anyone's. At AMP we'll have the right answers for your applications.

Bright new lights.

Unique LED DIP switches are available in SPST "on" or "off" as well as momentary-contact types. They permit rapid, visual circuit test, fault indication and programing verification. Plus, for the first time, they permit DIP packaging of LEDs.

Rockers are detented to avoid accidental actuation. Switch leads and LED leads are terminated independently for circuit connection versatility.

There's nothing quite like new AMP LED DIP switches. For more details on them, or the new AMP low-profile DIP switches, call (717) 564-0100. Or write AMP Incorporated, Harrisburg, PA 17105.

AMP is a trademark of AMP Incorporated.

AMP
INCORPORATED

INFORMATION RETRIEVAL NUMBER 282



Starting now, the function generator market does a 180.

This is where Wavetek turns it around again. With three new high-performance, low-cost generators.

The Model 180 Sweep/ Function Generator \$275

Believe it or not, this is a full sweeper—from 0.01 Hz to 2 MHz—with internal 1000 to 1 sweep. The 180 has sine, square and triangle wave outputs (20v output p-p), plus dc voltage, dc offset, and a separate TTL output. It also has a full attenuator which means you get super-clean signals down to -50dB. If you measure price vs. performance, no other instrument even comes close.

The Model 184 Sweep Generator \$495

The 184 has all of the above, plus some other features that you wouldn't expect for the price. First of all, the 184 goes all the way up to 5 MHz, and provides continuous, triggered and gated operation. For precise adjustment of continuous sweep, there's a control to individually set start and stop points. There's also a variable symmetry control and another

The new 180 Series from Wavetek.



for amplitude—down to -60 dB. Like the rest of the instruments in this series, the 184 comes in a tough, light-weight package.

The Model 185 Lin/Log Sweep Generator \$595

As you can see, the 185 has two frequency dials, which give you the ultimate in precise sweep start/stop settability. Now you can sweep up or down the frequency range, which goes from 100 μ Hz to 5 MHz with continuous and triggered ramps or discrete steps. Like the 184, this model has continuous, triggered and gated operation. Of course, there are both linear and logarithmic modes, and log sweep width is an incredible 100,000 to 1.

We haven't told you everything.

There's a lot more to the 180 series than the three instruments described here. But that's another story.

When we let that out, the market may just do a 360.

For more information, contact Wavetek, P.O. Box 651, San Diego, California 92112. Phone (714) 279-2200. TWX 910-335-2007.

WAVETEK®

The largest selection of "OFF-THE-SHELF" POWER SPLITTERS/COMBINERS Available!

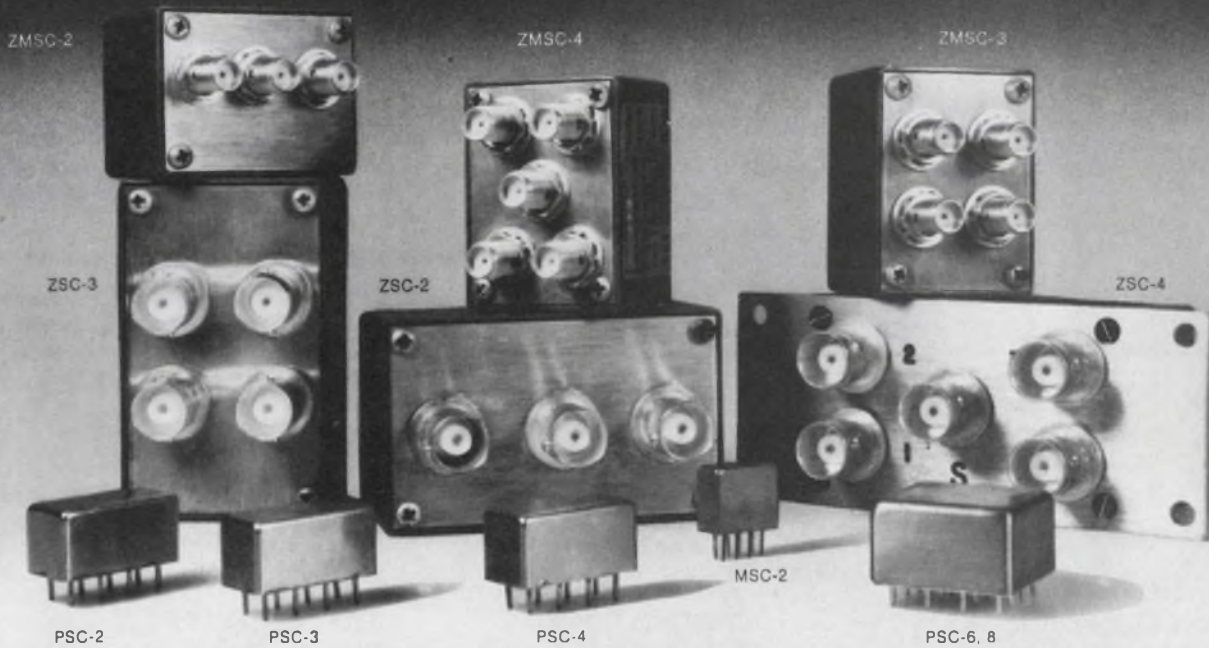

TWO-WAY, THREE-WAY, FOUR-WAY, SIX-WAY AND EIGHT-WAY POWER SPLITTER/COMBINERS

Model No.	Freq. range (MHz)	Isolation between outputs (dB) typical	Insertion loss (dB) (typical)	Unbalance		Price (Quantity)	Model No.	Freq. range (MHz)	Isolation between outputs (dB) typical	Insertion loss (dB) (typical)	Unbalance		Price (Quantity)
				ϕ (deg)	Amp (dB)						ϕ (deg)	Amp (dB)	
Two-way 0°							Three-way 0°						
PSC 2-1	0.1-400	25	0.4 above 3dB split	1	0.1	\$ 9.95 (6-49)	PSC 3-1	1-200	30	0.4 above 4.8 split	2	0.1	\$19.95 (6-49)
ZSC 2-1						\$24.95 (4-24)	ZSC 3-1						\$34.95 (4-24)
ZMSC 2-1						\$34.95 (4-24)	ZMSC 3-1						\$44.95 (4-24)
PSC 2-2	0.002-60	40	0.3 above 3dB split	1	0.1	\$19.95 (6-49)	PSC 3-2	0.01-30	40	0.25 above 4.8 split	2	0.1	\$29.95 (6-49)
ZSC 2-2						\$34.95 (4-24)	ZSC 3-2						\$44.95 (4-24)
ZMSC 2-2						\$44.95 (4-24)	ZMSC 3-2						\$54.95 (4-24)
Two-way 180°							Four-way 0°						
PSC 2-1W	1-650	25	0.5 above 3dB split	3	0.20	\$14.95 (6-49)	PSC 4-1	0.1-200	30	0.5 above 6dB split	2	0.1	\$26.95 (6-49)
ZSC 2-1W						\$29.95 (6-49)	ZSC 4-1						\$41.95 (4-24)
ZMSC 2-1W						\$139.95 (6-49)	ZMSC 4-1						\$51.95 (4-24)
PSC 2-1-75*	0.25-300	25	0.4 above 3dB split	1	0.05	\$ 9.95 (6-49)	ZSC 4-2	0.002-20	33	0.45 above 6dB split	2	0.1	\$64.95 (4-24)
ZSC 2-1-75*							ZMSC 4-2						\$74.95 (4-24)
MSC 2-1	0.1-450	30	0.4 above 3dB split	1	0.1	\$16.95 (6-24)	PSC 4-3	0.25-250	30	0.5 above 6dB split	2	0.1	\$23.95 (6-49)
							ZSC 4-3						\$38.95 (4-24)
							ZMSC 4-3						\$48.95 (4-24)
Two-way 90°							Six-way 0°						
PSCJ 2-1**	1-200	33	0.6 above 3dB split	2.5	15	\$19.95 (5-49)	PSC 6-1	1-175	30	0.75 above 7.8dB split	4	0.2	\$59.95 (1-5)
ZSCJ 2-1						\$34.95 (5-49)							
Two-way 90°							Eight-way 0°						
PSC Q 2-90	55-90	30	average of coupled outputs less 3dB 0.3	3	1.0	\$19.95 (5-49)	PSC 8-1	0.5-175	30	0.8 above 9dB split	3	0.2	\$59.95 (1-5)

COMMON SPECIFICATIONS FOR ALL MODELS: Impedance all ports, 50 ohms. *Except 75 suffix denotes 75 ohms VSWR:1.1-1.2 typical Nominal phase difference between output ports. 0° **Except J suffix denotes 180° Q denotes 90° Delivery from stock; One week max.

For complete product specifications and U.S. Rep. listing see MicroWaves' "Product Data Directory," Electronic Designs' "Gold Book" or Electronic Engineers Master "EEM"

Mini-Circuits Laboratory ^{MCL} 837-843 Utica Avenue, Brooklyn, NY 11203
 A Division Scientific Components Corp. (212) 342-2500 Int'l Telex 620156 Domestic Telex 125460

Foreign Sales Representatives: AUSTRALIA General Electronic Services, 99 Alexander Street, New South Wales, Australia 2065; ENGLAND Dale Electronics, Dale House, Wharf Road, Frimley Green, Camberley Surrey; FRANCE S.C.I.E.-D.I.M.E.S., 31 Rue George - Sand, 91120 Palaiseau, France; GERMANY, AUSTRIA, SWITZERLAND Industrial Electronics GMBH, Klüberstrasse 14, 6000 Frankfurt/Main, Germany; ISRAEL Vectronics, Ltd., 69 Gordon Street, Tel-Aviv, Israel; JAPAN Denso Kaisha, Ltd., Eguchi Building, 8-1-1 Chome Hamamatsucho Minato-ku, Tokyo; EASTERN CANADA B. D. Hummel, 2224 Maynard Avenue, Utica, NY 13502 (315) 736-7821; NETHERLANDS, BELGIUM, LUXEMBOURG: Coimex, Velweg 11, Hattem, Holland

US Distributors: NORTHERN CALIFORNIA Cain-White & Co., Foothill Office Center, 105 Fremont Avenue, Los Altos, CA 94022 (415) 948-6533; SOUTHERN CALIFORNIA, ARIZONA Crown Electronics, 11440 Collins Street, No Hollywood, CA 91601 (213) 877-3550
 For other Mini-Circuits Lab. Products see ad on Pg. 42

NEWS

- 21 **News Scope**
- 26 **Whether to select a micro or mini for a particular application still poses a problem for many designers. A decision plan can help.**
- 32 **Microprocessor-based digital voltmeters or multimeters are about to be announced by at least two major instrument manufacturers.**
- 43 **Washington Report**

TECHNOLOGY

- 50 **Consider MSI for tape controllers.** It's cheaper and more efficient than an LSI microprocessor when the programmable-logic needs are simple.
- 58 **Catch missing codes** in a/d converters, as well as nonmonotonic operation and other errors. Here's how to design a dynamic test circuit and jitterless display.
- 68 **The $\alpha\beta\gamma$'s of bioelectric measurements.** Pay attention to four crucial areas: the signal, the noise and the safety of both the patient and the instrumentation.
- 74 **Simplify acoustic surface-wave designs** by using concise guidelines for the calculation of key parameters. A delay-line example illustrates the procedure.
- 80 **Jerry Sanders of AMD** speaks on making your engineers profit conscious.
- 86 **Ideas for Design:**
Voltage-controlled attenuator provides linear variations in decibels.
Ultrasonic transmitter/receiver generates a 20-ft beam that detects objects.
Microvolt comparisons made with preamp and comparator.
- 94 **International Technology**

PRODUCTS

- 97 **Components:** Ferrites halve core loss in inverter applications.
- 102 **Modules & Subassemblies:** Ratiometric dual-slope a/d converters offered in 14-bit or 4-1/2-digit models.
- 106 Integrated Circuits
- 114 Instrumentation
- 116 Data Processing
- 118 Power Sources
- 122 Packaging & Materials

DEPARTMENTS

- 47 **Editorial:** Love
- 7 Across the Desk
- 126 New Literature
- 129 Design Aids
- 129 Vendors Report
- 134 Advertisers' Index
- 136 Product Index
- 136 Information Retrieval Card

Cover: Photo by Steve Grohe, on Polacolor type P2 land film, courtesy of Digital Equipment Corp., Maynard, MA

The ultimate solution to the micro/mini confusion

Just what you needed, right? Another computer to confuse things a bit more. And a millicomputer at that... whatever that is.

Well take heart, pilgrim. Because thanks to the whatever-it-is NAKED MILLI millicomputer, your hardware hardships are over.

Solution No.1

Start with your price problem: \$395 used to buy you a lot of grief in the form of

an 8- or 12-bit microprocessor. Which was still a bunch of bucks away from anything you could call a computer.

Now, \$395 buys you the NAKED MILLI LSI-3/05 with 256 16-bit words of RAM. A full-blown, full-scale computer with an amazingly powerful instruction set and two standard I/O systems including ComputerAutomation's new Distributed I/O System.™

Solution No.2

It also buys you membership in the NAKED MINI® LSI Family. Not just a casual relationship, but total hardware and software compatibility.

"Ah ha," you say, as you reach for a purchase order. "That means Maxi-Bus™ compatibility, too. Which means the NAKED MILLI is also compatible with ComputerAutomation's standard peripheral controllers and I/O interfaces. Which means..."

Yeah.
You're

going to save a fortune on interfaces. And software. And everything else. Because the NAKED MILLI really is a genuine, 100% full-fledged member of the LSI Family.

Solution No.3

Suppose, however, that you need more machine. Okay, how about a computer with 1K words of RAM for \$489? Or...

4K for \$616?

8K for \$914?

16K for \$1679?

And that's how it is. No matter where you buy in, the NAKED MILLI is positively the lowest-priced, low-end computer around.

From the people who brought you the NAKED MINI

When ComputerAutomation offered the first NAKED MINI LSI for \$990, folks figured that was it... the all-time rock bottom price.

And now we're introducing the NAKED MILLI at \$395. True, it's the smallest computer in the LSI Family. But here's something to think about: The NAKED MILLI is more powerful than our original Model 816 minicomputer!

In short, ComputerAutomation has done it again.

But then, that's what leadership is all about.

 **ComputerAutomation**
NAKED MINI® Division

18651 Von Karman, Irvine,
Calif. 92664 (714) 833-8830

INFORMATION RETRIEVAL NUMBER 4



Any design—Ribbon Cable, IC Interconnects, Custom Harnesses. Woven Electronics produces flat woven cable assemblies to your specs for conductors, spacing, insulation, color coding, marking, all requirements including special features such as breakouts, fold lines, tinning, connectors.

Don't accept cable compromises. Let us assist in design stages and get the exact interconnect your system needs.

WOVEN ELECTRONICS

P.O. Box 189/Mauldin, South Carolina 29662
(803) 963-5131

FLAT CABLE

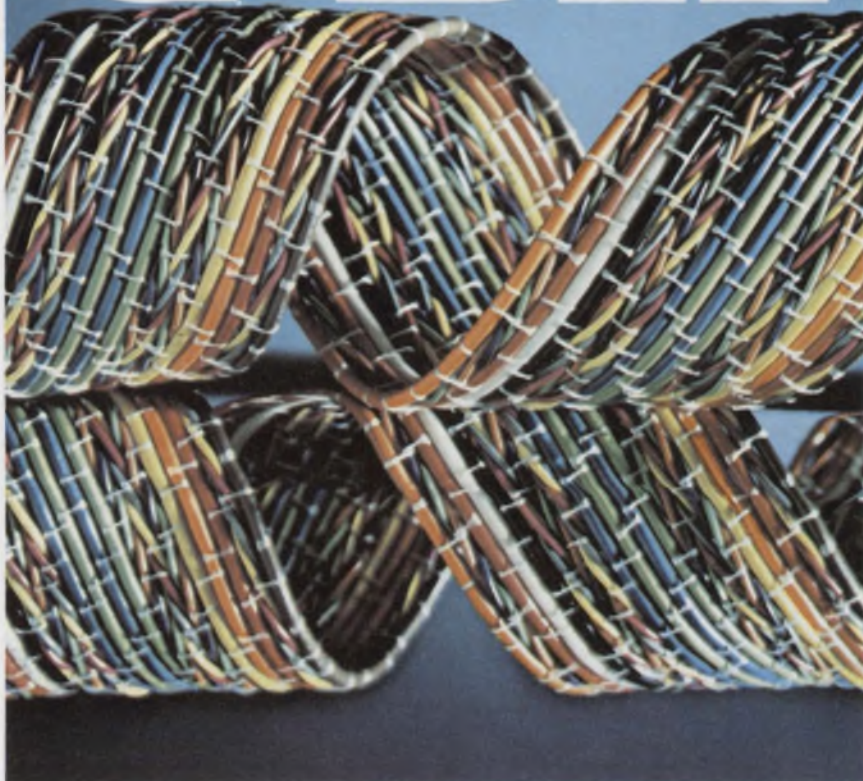

INFORMATION RETRIEVAL NUMBER 5

Sr. Vice President, Publisher

Peter Coley

Editors

Editorial Offices
50 Essex St.
Rochelle Park, NJ 07662
(201) 843-0550
TWX: 710-990 5071
Cable: Haydenpubs Rochellepark

Editor-in-Chief George Rostky

Managing Editors:

Ralph Dobriner
Michael Elphick

Associate Editors:

Dave Bursky
Jules H. Gilder
Morris Grossman
John F. Mason
Stanley Runyon
Edward A. Torrero

Contributing Editors:

Peter N. Budzilovich
Alberto Socolovsky
Nathan Sussman

Editorial Field Offices

East

Jim McDermott, Eastern Editor
P.O. Box 272
Easthampton, MA 01027
(413) 527-3632

West

David N. Kaye, Senior Western Editor
8939 S. Sepulveda Blvd.,
Suite 510
Los Angeles, CA 90045
(213) 641-6544
TWX: 1-910-328-7240

Editorial Production

Marjorie A. Duffy

Art

Art Director, William Kelly
Richard Luce
Anthony J. Fischetto

Production

Manager, Dollie S. Viebig
Helen De Polo
Anne Molfetas

Circulation

Manager, Evan Phoutrides

Information Retrieval

Peggy Long

Promotion

Karen Kerrigan (Reprints)

Creative Layout Services

Manager, Albert B. Stempel

Across the Desk

Two ways of looking at one TV program

With reference to the editorial "To the Rear, March!" (ED No. 9, April 26, 1975, p. 41):

Was I watching the same "Nova" program? I didn't hear Chicken Little clamoring for hasty retreat. I heard Dr. E. F. Schumacher suggest flanking the boggy slough dead ahead. To that end, he showed working examples of intermediate technology benefiting communities when "high" technology could not. I agree that one of our objectives now should be to conserve fuel, even at the expense of increased labor.

Are fossil fuels now the world's prime energizers and is the supply limited? Can we mark time waiting to develop blue-sky energy sources? Is the cost of energy therefore increasing? Need we provide for "social" costs, such as unemployment? Are we obliged to account for the environmental cost—the true cost—of our product?

A U.S. manufacturer made great advertising to-do about clean air after the company built the world's tallest smokestack. Now, instead of spreading the effluvia of its manufacture over the local valley, it's shot into world-circling stratospheric jet streams! This is the archtypical case of "blowin' smoke" to hide the true environmental cost.

If these premises are valid, I reach Dr. Schumacher's conclusion: that the economic, social, environmental and resource expenses of a product per unit can be lowered, with an attendant increase in labor. Our decision—whether or not to move in this new direction—is a moral judgment involving the

application rather than advancement of "technology."

Chris Johanson

Orion Research Inc.
11 Blackstone St.
Cambridge, MA 02139

I read your editorial "To the Rear, March!" with chagrin. How could you and I watch the same show and come away with two totally divergent opinions?

Dr. Schumacher argued not for a step back but a step forward. The step forward he advocated was for the developing nations. These people can ill afford the trap the "advanced" countries find themselves in of constantly requiring an energy "fix." He very coherently argued for a superior level of engineering to meet their needs, taking into account the realities of the situation as they apply to excess manpower, world inflation and forced allocation of energy reserves.

He also argued that if the engineering put into designs for the Third World had an application back home (in his case England) so much the better.

Hogwash! He didn't throw a shoe into a machine or proclaim the sky is falling; he talked about a better and cheaper egg carton (better for the people of Tanzania).

Hogwash! He didn't look back to a "benign past" with a faulty memory, only a factual one. He only argued that bigger is not always better. Look at the quality control coming out of Detroit for 10 years, and look at those prices.

You should try to catch a rerun of the program if it is aired, with your editorial in hand, and every-

(continued on page 8)

Thin-Trim[®] capacitors



Tucked in the corner of this Pulsar Watch is a miniature capacitor which is used to trim the crystal. This Thin-Trim capacitor is one of our 9410 series, has an adjustment range of 7 to 45 pf., and is .200" x .200" x .050" thick. The Thin-Trim concept provides a variable device to replace fixed tuning techniques and cut-and-try methods of adjustment. Thin-Trim capacitors are available in a variety of lead configurations making them very easy to mount.

A smaller version of the 9410 is the 9402 series with a maximum capacitance value of 25 pf. These are perfect for applications in sub-miniature circuits such as ladies electronic wrist watches and phased array MIC's.

Johanson Manufacturing Corporation,
Rockaway Valley Road., Boonton, N.J.
07005. Phone (201) 334-2676, TWX 710-987-8367.

Johanson

Electronic Design welcomes the opinions of its readers on the issues raised in the magazine's editorial columns. Address letters to Managing Editor, Electronic Design, 50 Essex St. Rochelle Park, N.J. 07662. Try to keep letters under 200 words. Letters must be signed. Names will be withheld on request.

ACROSS THE DESK

(continued from page 7)

time you think you've scored a point, mark it down. No cheating now!

George W. Bossers

42 Skyline Dr.
Brookfield, CT 07804.

Implicit in your misinterpretation of Dr. Schumacher's efforts is the assumption that the most advanced technology is always a blessing, and that where there is a conflict between social and political institutions and the introduction of the latest technology, the institutions must give way. Hogwash! We all like our comforts, but it has yet to be established that life without flush toilets is not worth living.

Dr. Schumacher does not advocate going back to the caves; he would introduce a level of technology appropriate to each society in terms of the educational level, skills, values, social relationships and physical resources of that society, and he does not preclude the introduction of more advanced technology where a fledgling local industrial base can benefit by it.

Isn't it time we stop viewing technology as an end in itself and recognize it as one of the means by which, used wisely, we may build a better and more humane world?

Tom Townsend
Consultant

AIL
Deer Park, NY 11729.

After reading your editorial contention with Dr. Schumacher, I wondered if we'd been watching the same program. I saw his comments as calling for a different use of technology rather than a diminution of technology. I felt challenged, not discarded.

Karl King
Chief Engineer

Great Lakes Instruments, Inc.
7552 N. Teutonia Ave.
Milwaukee, WI 53209

Thanks for expressing my thoughts so well! You certainly put it well when you explained to Dr. E. F. Schumacher that pushing technology backwards will not

make things better.

Goofheads who want to go back to the caveman days should forsake all the technological advances that they deplore. Let them give up their cars, bicycles, calculators, central heat, insulated houses, clothes. Let them go back to walking, figuring in their heads, living in unheated caves, wrapped in bearskins. They don't understand that their jobs are substitutes for berrypicking, hunting, fishing and primitive agriculture. Keep up the good work on your editorials.

David Michaellyer
President

Autocybernism Unlimited Systems
P.O. Box 72
Hughesville, MD 20637.

Misplaced Caption Dept.



"When the chief engineer told you to go back to the pool, he meant the typing pool."

Sorry. That's Pierre-Auguste Renoir's "The Bathers," which hangs in the collection of Carroll S. Tyson, Jr. in Philadelphia.

IC makers found stingy with samples

I read with interest Norman Schwarz' letter in the March 15 issue ("Samples Are Tough All Over," ED No. 6, p. 14). While I totally disagree with his sentiment about your exceptionally fine editorials (I often cut them out and mail them with signature to past employers), I have experienced the same nightmare in getting unit quantities or samples from the "busy" LSI firms, switch and control vendors, etc.

We are not primarily engaged in electronically oriented endeavors,

our primary product being individually designed and hand-crafted pipe-organs, although some electronic peripheral equipment is used. We also do some research and developmental work in which electronic material is used.

We are working on an instrument that we hope to market to our trade, and it is, of course, necessary for us to obtain samples or single-purchased parts to develop and construct the production prototype. I am convinced that the fact that we are not IBM or General Motors is the reason why I have difficulty getting applications assistance, samples or even the courtesy of a promised return telephone call.

Dozens of LSI-MOS firms will not even answer correspondence or phone calls. Some employ individuals in their sales departments who actually laugh at me when it becomes evident that our needs will not reach 100,000 pieces of a given chip.

Jan Rowland
Vice President

Visser-Rowland Associates, Inc.
2033 Johanna Suite A-2
Houston, TX 77055

Too many American firms are missing tremendous opportunities because they just will not take the time or make the slightest effort to learn something about doing business overseas.

Congratulations on an excellent piece.

Fred Krehbiel
Vice President

International Operations

Molex Inc.
5224 Katrine Ave.
Downers Grove, IL 60515

6 phases of a project

At the IEEE International Microwave Symposium in Palo Alto, CA, one speaker described the six phases of an engineering project, as viewed from years of experience. He said they were:

- Enthusiasm.
- Disillusionment.
- Panic.
- Search for the guilty.
- Punishment of the innocent.
- Praise for the guilty.



MEASUREMENT COMPUTATION

innovations from Hewlett-Packard

NEWS

AUGUST, 1975

in this issue

New 0.03% accurate
digital multimeter

New fully-ruggedized
signal generator
500 kHz to 1100 MHz

Ultra-fast disc in new
MX/65 DISComputer

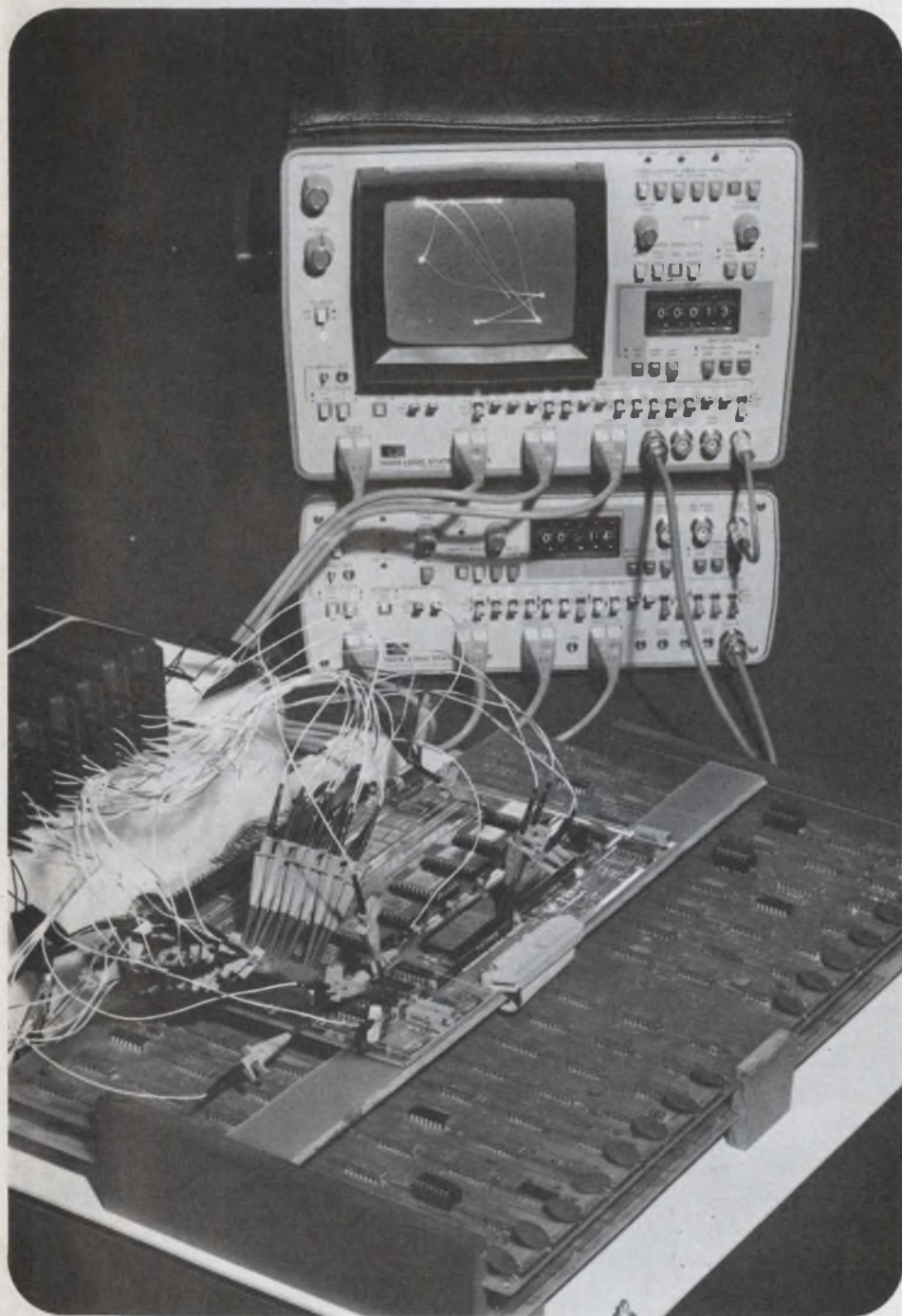

New logic state analyzer 'maps' the data domain

To properly troubleshoot complex digital circuits, you need a way to examine the system's functional behavior. That's where the HP 1600A Logic State Analyzer comes in.

It has the unique capability of being able to produce 'maps' of logic-circuit operation which graphically show each address or state as a discrete dot on a screen. The brightness of each dot reveals its frequency of occurrence and the lines between dots are vectors indicating the direction of the state flow.

After familiarization, the maps form recognizable logic patterns, with departures from the norm easily detected.

The HP 1600A also presents a functional picture, in word format (table display), triggered and indexed on digital words. A 16-channel word-format display is standard and this can be in-

(continued on third page)

New HP 2000 ACCESS system supports up to 32 terminals on-line with concurrent remote job entry

With the introduction of the HP 2000 Access System, networking has suddenly become affordable for a large group of applications.

While exercising all of their interactive, on-line processing functions, HP 2000 Access System terminals can operate concurrently as remote job entry stations for large IBM or CDC host computers. The HP system simulates either an IBM HASP-II Multi-leaving Workstation or CDC User 200 Terminal for synchronous intercommunication. Any of up to 32 terminals can initiate data transfers and other remote job entry (RJE) functions to and from the central system, and data can be processed on the HP 2000 System before transmission. Any user may execute applications that can access a paper tape reader, multiple card readers, line printers, magnetic tape drives and disc units.

The system is compatible with the

microprocessor-equipped HP 2640 CRT terminal. With the terminal in the system, a non-technical person can easily format the screen to resemble source documents, then enter data conversationally by filling in blanks. Data entered through all video key stations can be transmitted concurrently to the central host system.

Two versions of HP 2000 Access Systems are available, Model 30 and Model 40. Multiple access for up to 16 terminals is provided by the Model 30. The Model 40 increases the capability to as many as 32 terminals.

Disc storage for both systems can be expanded from the basic disc storage provided (5 megabytes in Model 30 and 15 megabytes in Model 40) to 120 megabytes.

For more information, check A on the HP Reply Card.



An optimum system for manufacturing operations including data collection, inventory control, financial planning and order entry.

New MX/65 DISComputer combines ultra-fast disc with 32K word processor for OEM's

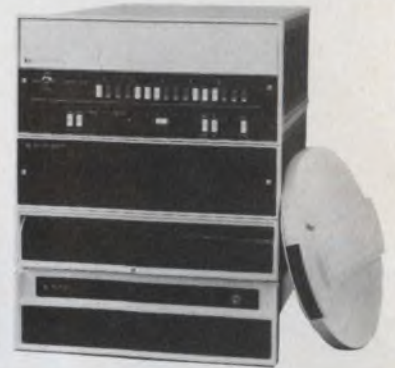

The fastest cartridge disc in the industry, and a versatile 21MX minicomputer combine to form the most powerful DISComputer available.

The new high performance MX/65 DISComputer is a powerful combination of two HP computer components. The unit combines a 15 MByte disc, the HP 12962A, and a 32K word computer, the HP 21MX, into a fully interfaced unit.

The package is available with options to fit nearly any need. Options allow the 12962A ultra fast (25 msec average access time) moving-head disc subsystem to be expanded to 118 MBytes in 15 MByte steps. The micro processor-equipped storage control unit gives the DISComputer automatic error detection and correction to enhance data reliability.

The 4K RAM-based 21MX minicomputer starts at 8K words of memory and can be expanded to 256K words in 4K steps.

The 21MX minicomputer is fully microprogrammable by the user. Its 650 ns semiconductor memory comes in plug-in modules; add memory economically at any time. The 128 instructions in the mini's base set include floating point and extended arithmetic. Memory parity, dual channel port controller (direct memory access) and power fail interrupt are standard features.

Nine powered I/O channels are available in the standard version; up to 36 additional channels can be added without reducing memory space.

To find out more about how to fit the MX/65 DISComputer into your system, check O on the HP Reply Card.

NOW, time interval measurements you couldn't make before

Here's a solution for major problems in high-speed time interval measurements, the 5363A Time Interval Probes. They'll remove some limitations in electronic counter measurements of rise time, propagation delay between 50% points, slew rates, etc.

Trigger point definition is simple and precise. Just dial the thumbwheels to any desired trigger voltage from ± 10 mV to ± 10 V and your counter gets fast rise time 50 Ω pulse when the input reaches the level set. Drift is very low and level calibration is automatic.

Dynamic range is ± 10 V compared to the ± 0.5 V to ± 1.0 V typical of counters. This, plus high sensitivity, lets you trigger close to the bottom and top of signals from most IC families. An ordinary 10:1 probe doesn't extend dynamic range for, while it lets you trigger close to the top of a 5V pulse, for example, it multiplies the counter's 50 to 100mV hysteresis by 10 so you can't trigger lower than 0.5 to 1.0V.

Circuit loading is low because impedance converters at the tips of these active probes provide 1M/10pF input.

Unequal time delays in stop and start channels are equalized by merely turning the Time Zero control.

For automatic system use, order Option 011, Interface Bus compatibility.

To receive data on solutions to time interval problems, check H on the HP Reply Card.



In production line testing the 5363A's high repeatability and pushbutton operation make it ideal for automated time interval measurement systems.

New RF sweeper plug-in emphasizes high performance



HP Model 86222B plug-in for 8620A sweeper, covering 10 MHz to 2.4 GHz, offers useful crystal markers.

For wideband RF sweep testing, Hewlett-Packard now offers an HP 8620A sweeper plug-in that covers 10 MHz to 2.4 GHz in a continuous sweep. The plug-in, models 86222A/B ("B" version adds precision crystal marker system), delivers calibrated RF output from 0 to +13 dBm with full range flatness of ± 0.25 dB. For each key performance characteristic—e.g., frequency accuracy, linearity, stability, residual FM, harmonics, spurious content—the 86222 matches or exceeds any other wide-range RF sweeper. And

no other sweeper can equal the overall performance specifications of the 86222. The 86222B's unique digitally-processed birdie markers (1, 10, 50 MHz) are fully compatible with the HP 8410B Network Analyzer and HP 8755 Frequency Response Test Set, permitting accurate frequency identification.

For a data sheet, check K on the HP Reply Card.

New logic state analyzer

(continued from first page)

creased to 32 channels with the addition of another logic state analyzer, the HP 1607A.

The system can be set to trigger on any unique word and to display the following 15 words for analysis. If, on the other hand, you are attempting to debug a microprocessor program error, you can just as easily display the 15 words immediately preceding the trigger word. Or, you can place the trigger

word anywhere in the 16-word window to reveal what happened both before and after the trigger word.

If your work involves digital circuits, this brochure is worthy of your reading time. For your copy, check C on the HP Reply Card.

New software for HP network and spectrum analyzers cuts linear circuit design time

OPNODE is a new software tool for the engineer with the responsibility for designing and optimizing linear circuits and systems.

With the 92817A OPNODE package on an HP 8542B Automatic Network Analyzer or an HP 8580B Automatic Spectrum Analyzer, you can design improved circuits in less time.

Design parameter inputs (constants, variables or complex equations) are entered via keyboard or cassette tape, and OPNODE outputs the data on the graphics console in the form that you need—tabular, log or linear rectangular plots, Smith chart or even polar plots. Substantial savings in both design and production are benefits derived from more reliable circuit designs. An additional benefit is control of recurring computer-aided design expenses.

OPNODE provides a wide range of capabilities including S-parameter analysis, sensitivity analysis, feedback analysis, optimization and worst case analysis. Up to 40 nodes and 200 components in a circuit can be analyzed in real time, with outputs (including plotting results) provided in from 0.1 to 3 seconds per frequency.

If you are presently using an HP 8542B or an 8580B, you can add OPNODE as a low-cost enhancement. When you consider purchasing either system, OPNODE will provide you additional capability and an even greater return on your investment.

To receive more information on OPNODE, circle P on the HP Reply Card.

Ruggedized RF signal generator offers laboratory performance



Providing AM, FM, or Pulsed RF modulation for a wide range of receiver test applications, the 8640M brings total signal generator performance to environments previously difficult for lab grade instruments.

Field and flight line receiver test applications requiring a precision RF generator now have a solution. HP's Model 8640M Signal Generator provides test signals from 500 kHz to 550 MHz. (1100 MHz; external doubler).

Model 8640M is a highly-ruggedized version of the well-known HP 8640B Signal Generator. It withstands the environmental requirements of MIL-T-21200J, Class II, including salt spray, avionic fuel hazards, and -40°C to $+71^{\circ}\text{C}$ operating temperatures.

Signal quality is intended for testing state-of-the-art receivers. A high-Q, cavity-tuned, solid-state oscillator yields excellent spectral purity with SSB noise >125 dB/Hz at 20 kHz offset. LED digital display resolution of 1 kHz at 500 MHz makes operation ideal for closely spaced channels.

After tuning, the cavity may be phase-locked to the frequency shown on the display. In this locked mode, long term stability is better than $5 \times 10^{-8}/\text{hr}$.

Output power is calibrated from a high level of +13 dBm for spurious response tests, down to -145 dBm for tests at $<0.03 \mu\text{V}$ on shielded receivers. A reverse power protection circuit protects against burnout caused by inadvertent keying of the test transceiver (up to 25 watts).

For more information on this reliable, all-solid-state, general purpose signal generator, check L on the HP Reply Card.

New RF generator with calibrated FM for mobile radio test

Calibrated and metered FM, over the full range 10 to 520 MHz, is featured by the newest (Model 8654B) Hewlett-Packard RF signal generator. Four FM peak deviation ranges are available—0 to 3 kHz, 10 kHz, and 30 kHz over the full 520 MHz range of the generator, and 0 to 100 kHz above 80 MHz. AM specs of the earlier 8654A are preserved.

Frequency settability has been improved with a fine frequency vernier. The instrument's solid-state oscillator drifts less than 1 kHz +20 ppm per 5 minutes after warmup.

Important to transceiver test personnel is a reverse-power protection module, available as option 003. This circuit detects reverse power and instantly isolates the generator output from burnout (up to 25 watts.)

The 8654B is small and portable at $26.7 \times 18 \times 30.5$ cm ($10\frac{1}{2}'' \times 7'' \times 12''$) weighing only 7.9 kg (17 lbs. 5 oz.).

Notice to Owners of 8640A/B RF Generators.

Reverse power protection is now available as Option 003 or retrofit kit (11699A) for HP 8640A/B RF generators.

For detailed technical information, check M on the HP Reply Card.



New compact, solid-state RF generator with calibrated FM is ideal for mobile radio test.

Universal counter plus options tailors to your precise needs

Modular design and a choice of easy-to-install options can be combined to give you a new 8-digit Model 5328A Universal Counter that comes close to meeting your unique needs at minimum cost. The simplest version with no options measures frequency to 100 MHz, single shot time intervals to 100 ns resolution, plus time interval averaging giving 10 ps resolution for repetitive events. The 5328A also measures period, period average, and frequency ratio, and will totalize and scale inputs. Frequency measurement sensitivity is 25 mV rms to 40 MHz and 50 mV to 100 MHz.

Arming capabilities of the basic 5328A allow precise control when a measurement starts—essential for starting time interval measurements on a selected pulse in a bit stream.

Six options are currently available to expand the capabilities of the 5328A:

- Opt 040 expands time interval capabilities and gives 10 ns resolution.
- Opt 030 extends range to 512 MHz with 15 MV rms sensitivity.
- Opt 011 gives full compatibility with the HP Interface Bus.
- Opt 010 increases accuracy and extends calibration intervals.
- Two DVM options measure external DC voltages or internal trigger level settings.

To receive your copy of a technical data sheet, check C on the HP Reply Card.



Option-packed counter comes close to meeting all high-precision frequency and time applications below microwave frequencies.

New triple-output OEM power supply gives brownout protection

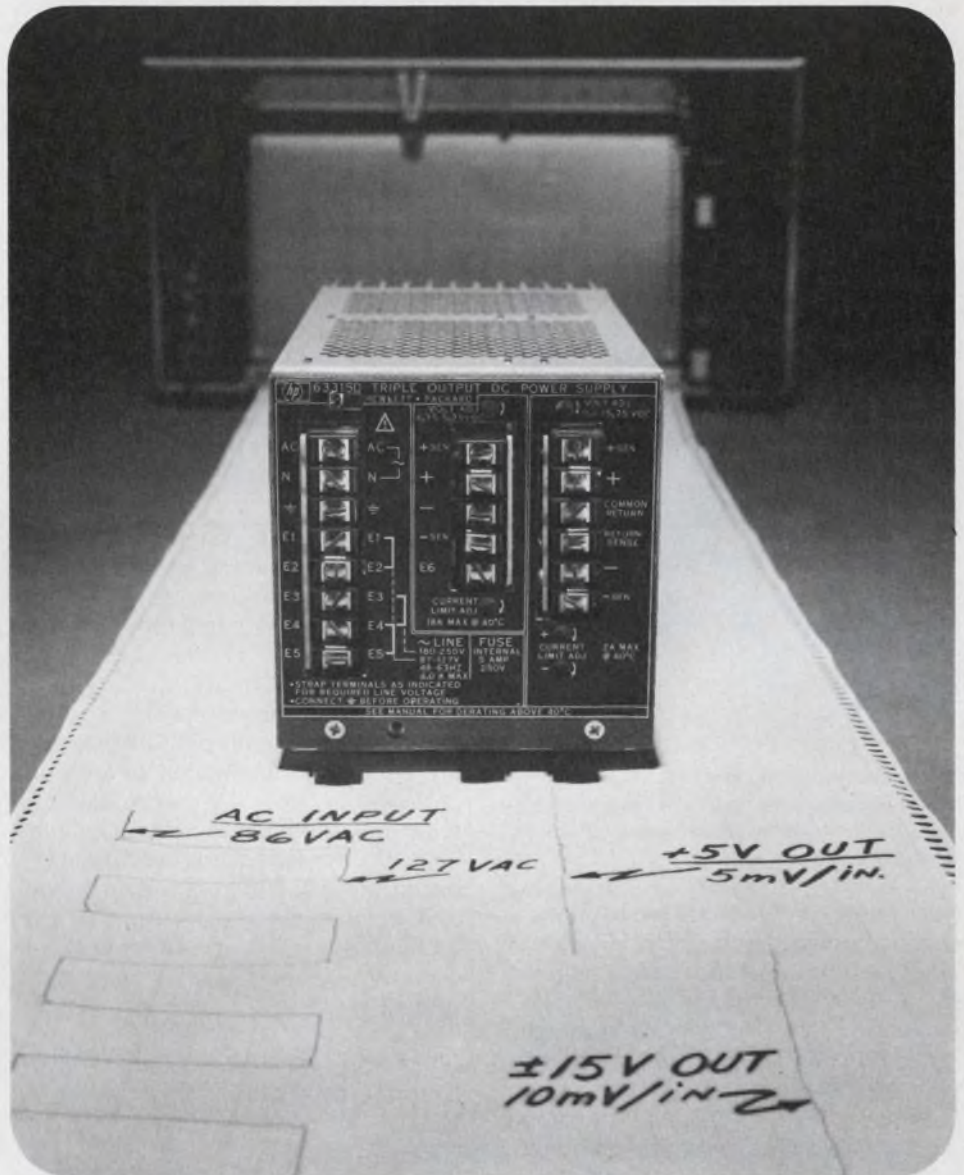

110 Watt Regulated Modular supply is designed for applications requiring the performance, compact size and high conversion efficiency of a switching supply.

Data terminals, mini-computers and other devices with volatile memories are susceptible to loss of data if their power supplies cannot regulate for wide variations or momentary loss of AC input voltage.

HP's new switching supply, Model 63315D, overcomes these problems by maintaining its 5V and $\pm 15V$ outputs "in-spec" for AC line "dips" to 20% and total AC power loss for periods up to 20 msec. The range of input voltages for normal operation is 87 to 127 Vac or 180 to 250 Vac. The unit is also

available for operation from a 48 Vdc input as a DC-DC Converter.

The supply is regulated to 0.12% on all outputs with ripple and noise of 5mV rms, 40mV p-p (20Hz to 20MHz). Outputs are adjustable in the range of 4.75V to 5.25V and 11.4V to 15.75V. Over-voltage, overcurrent, and overtemperature protection are standard.

For details, check I on the HP Reply Card.

NEW CRT subsystem for HP 9830 desktop programmable calculator



9882A subsystem (right) provides CRT and high speed data entry for 9830A calculator (left). Mass memory, below 9882A, has 4.8M bytes memory.

The new HP 9882A CRT subsystem, a special configuration of the HP 2640A intelligent terminal, has been designed to interface with the HP 9830 BASIC language calculator to provide a high speed entry system for users who work with business forms. It can be operated in either a block or character mode for sophisticated data entry applications.

The easy-to-read, 5 x 10 inch, inverse video (black on white) display is available with standard 128-character Roman font. The terminal generates characters with a high-resolution (7 x 9) dot matrix in a 9 x 15 dot character cell.

The microprocessor-controlled operating characteristics of the terminal, combined with its RAM semiconductor memory, provide a smart (dynamically allocated) memory that can store more than 200 lines of data that are viewable 24 lines at a time.

The 9882A comes with 3K bytes of memory, which can be expanded in a 2K byte step up to 5 bytes.

For more information, check N on the HP Reply Card.

New HP Application Note explains causes and measurement of intermodulation distortion in microwave radio systems

Hewlett-Packard's new Application Note 175-1 "Differential Phase and Gain at Work," discusses the causes and measurement of intermodulation distortion in wideband microwave radio systems.

Intermodulation distortion affects the quality of Frequency Division Multiplex (FDM), video and digital transmission signals being passed through the radio system. The various contributors to intermodulation distortion are explained, as well as the special test techniques required to properly display their presence. Nomograms and formulas are provided to allow the user to directly relate intermodulation noise magnitude in FDM/FM systems to specific radio distortion (e.g., differential gain, amplitude flatness) parameters. An extensive bibliography is also provided to assist even more extensive study into the subject.

Check Q on the HP Reply Card to obtain your free copy of Application Note 175-1.

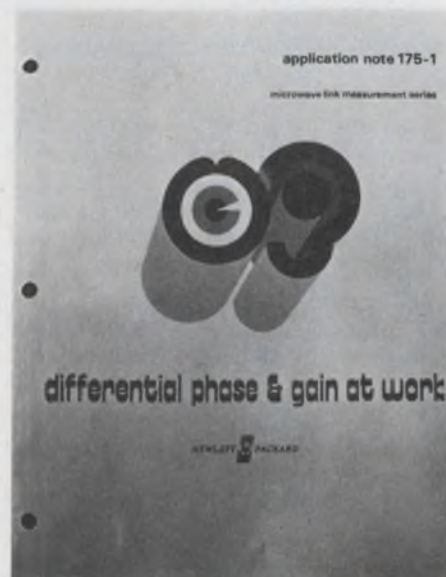

New Cesium Beam Frequency standard, precise and rugged, can take a beating

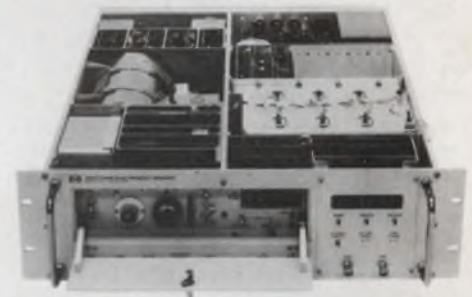

Remove the lid and you'll see the sturdy construction that enabled the 5062C Cesium Standard to pass the grueling 400-lb hammer blow test.

Now, there's a precision frequency source combining laboratory accuracy with compactness and ruggedness required by military hardware.

The new HP 5062C was designed to meet the specific needs of navigation, communication, guidance and other on-line systems where high performance is required under field environments.

The ruggedness of the 5062C was proven by passing the 400-pound hammer blow test (MIL-S-901) under operating conditions.

Its MTBF has been calculated to exceed 25,000 hours. It maintains 3×10^{-11} accuracy over a wide operating range and requires only 20 minutes of warm-up time even in a -28°C environment.

It is compact: 5 1/4" high (133 mm); fits standard 19" racks (482 mm); and weighs 50 lbs. (22.7 kg).

Major specifications of the 5062C:

Accuracy	$\pm 3 \times 10^{-11}$
(-28°C to $+65^{\circ}\text{C}$)	
Reproducibility	$\pm 1 \times 10^{-11}$
Stability	$\pm 2 \times 10^{-12}$
Long Term Stability	$\pm 1 \times 10^{-11}$
(for life of Cs tube)	
Short Term Stability	7×10^{-11}
(ave = 1 sec)	

Optional digital display clock and stand-by battery are available at additional cost.

To receive complete technical data, check F on the HP Reply Card.

Digital test simplified with 8 bit × 32 word generator and HP Interface Bus



High speed, high capacity, high timing stability and unrestricted bit pattern programmability available in highly flexible word generator.

To learn more, check J on the HP Reply Card.

Hewlett-Packard's Model 8016A word generator, now with the HP Interface Bus, is unmatched in its capability to produce complex multichannel data streams for digital design and troubleshooting applications. Using it, you can focus all the powers of both an 8 channel × 32 bit word generator plus a 50 MHz pulse generator on your testing problems.

You first set up the proper 1's and 0's pattern in the memory. Then, you can adjust the analog pulse parameters of the data waveforms to simulate varying

or worst case conditions. Pulse widths, logic levels, and channel-to-channel delays all are independently variable. Your testing becomes more thorough; it is both functional and parametric. Also, because all of it is accomplished with only a single stimulus instrument, it is thus simpler.

Additional features include strobe channel, RZ/NRZ operation channel serializer, and optional card reader to quickly load data patterns through the HP-IB further simplify your digital testing.

Portable instrumentation recorder gathers data that travels with you

When you have one chance to gather data in the field—data that you will work with later—you can now carry it out with you on the Hewlett-Packard 3960A Portable tape recorder.

When field recording situations are demanding, you need something extra going for you. This compact portable has the performance capability that you need, along with ruggedness.

Capable of operating on either AC or DC, it has a built-in calibration source and high accuracy AC or DC peak meter for input or output monitoring.

Options available allow you to customize your recorder for the kind of work you do. The choice includes voice annotation, DC-AC inverter, remote control, tape/tach servo and others.

Send for complete details on HP's high performance 3960A. Check E on the HP Reply Card.

Rugged recorder with superior tape drive assembly plus outstanding signal to noise ratio.



New portable digital multimeter delivers lab-grade quality and performance at an economical price

The new HP 3465A Digital Multimeter features performance and accuracy that qualify it for lab use. Its 10 mV dc range provides 1 μ V sensitivity. Its ease of operation, light weight, and battery power make it attractive for such cost sensitive applications as production test, service maintenance and education. With its dc/ac/ohms and current measurement capability, it is well suited for CATV, communications and appliance troubleshooting.

Take a look at the front panel. It has all the functions and ranges you'd expect, and more. You get ohms, ac/dc volts, and ac/dc current. The display is a large LED for easy viewing, and extra resolution is obtained with a full scale readout of 19999. Accuracy is $\pm 0.02\%$ of reading $\pm 0.01\%$ of range on dc, meeting the needs for most field or bench applications. The 10 mV dc range and 100 mV ac range provides performance typically found only on more expensive 5½ digit multimeters. The instrument can be powered by any one of four optional power sources: D-cell batteries, the hand-held calculator charger, Ni-cad batteries, ac line.

HP's 3465 uses IC and thin-film technology to combine high sensitivity and accuracy offering wide capability, measurement convenience and user confidence within a reasonable cost.

The standard 3465A is fully equipped with an internal power supply, a battery



New 4½ digit five-function DMM is accurate, sensitive and easy to use.

recharging circuit, and Ni-cad batteries. If you wish to power the HP 3465A from its furnished dry cell batteries, order Option 002. (Option 002 will operate from ac lines when using one of HP's 82002A chargers supplied with most

HP pocket calculators). For ac operation only, order Option 001.

To receive new data sheet on this multimeter, check C on the HP Reply Card.

HEWLETT  **PACKARD**

East-4 Choke Cherry Road, Rockville, MD 20850
Ph. (301) 948-6370.

South-P.O. Box 28234, Atlanta, GA 30328,
Ph. (404) 434-4000.

Midwest-5500 Howard Street, Skokie, IL 60076,
Ph. (312) 677-0400.

West-3939 Lankershim Blvd, North Hollywood, CA
91604, Ph. (213) 877-1282.

Europe-P.O. Box 349, CH-1217 Meyrin 1, Geneva,
Switzerland, Ph. (022) 41 54 00.

Canada-6877 Goreway Drive, Mississauga, Ontario,
L4V 1L9, Ph. (416) 678-9430.

Japan-Yokogawa-Hewlett-Packard Ltd., Ohashi
Bldg., 59-1 Yoyogi, 1-chome, Shibuya-ku,
Tokyo 151, Ph. 03-370-2281/92.

CMOS reliability should never cost extra

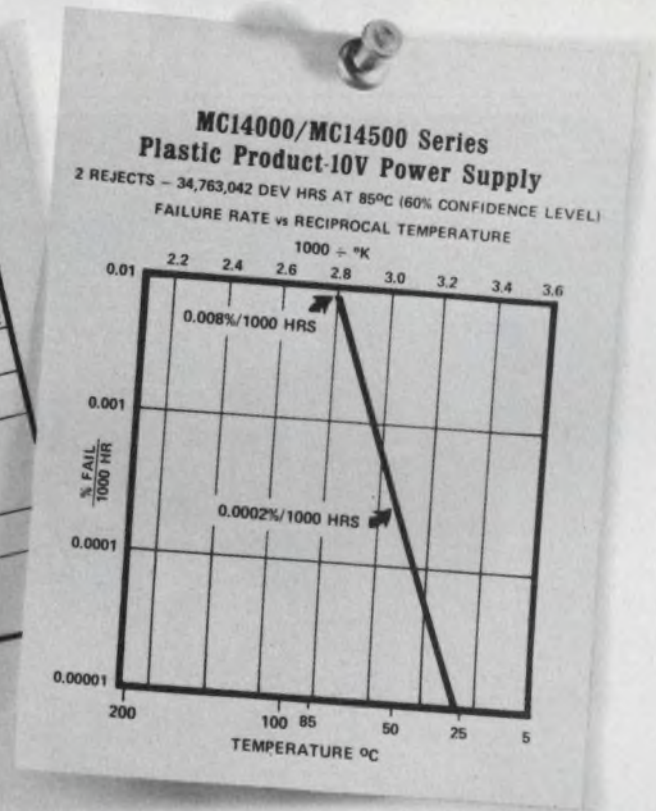
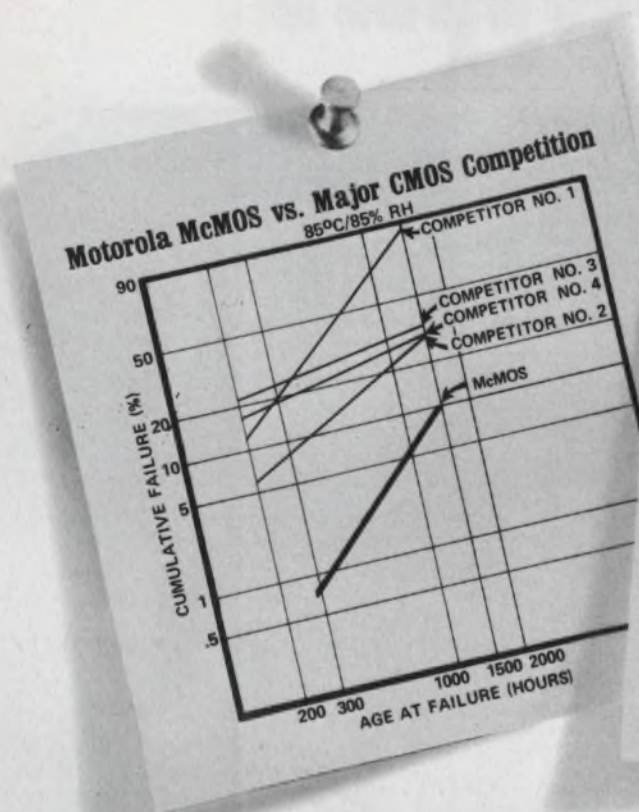

At Motorola, we believe that CMOS reliability should be built in, never a higher price add-on option. Motorola has introduced no gimmicky special programs which raise the price you pay for the reliability we build into our McMOS* family of CMOS logic functions and the MC14400 series of specialized MSI functions.

Conversely, extra cost CMOS reliability programs have proliferated in recent times. Apparently the suppliers believe these programs are needed, so they undoubtedly assure better CMOS reliability than is normally supplied by these vendors.

We're especially proud, therefore, that Motorola's McMOS has pioneered in bringing CMOS prices down into direct competition with TTL without making you pay extra for reliability.

One hundred percent functional ($V_{DD} = 3, 18$) testing and 100% parametric ($V_{DD} = 5, 10, 15$) testing are standard. Visual

*Trademark of Motorola Inc.

die inspection and pre-cap visual inspection are standard, and so is certified sampling. Temperature cycling and hermeticity testing for ceramic units are standard. Naturally burn-in isn't, but you'll find us happy to quote attractive rates when burn-in is truly required.

No matter what others do, we wouldn't let our standard McMOS product out the door unless we had done these things. As a result, over 83,000,000 life test hours at maximum product temperature ratings have demonstrated that with McMOS, reliability is inherent . . . as it should be. CMOS reliability should never cost extra.

To learn more about what happens when reliability is built in, circle the reader service number or write to Motorola Semiconductor Products Inc., P.O. Box 20912, Phoenix, Arizona 85036.



MOTOROLA McMOS

—complementary MOS for contemporary systems

LED Show Stoppers



Bright lights from a cast of thousands.

A great show of LED Panel and PCB lights from Data Display Products. Vivid colors . . . red, yellow, green and amber. Outstanding performance . . . brighter than many incandescents (50 MCD @ 20 mA — typical clear red). Direct replacements for incandescents. Immediately available at popular prices.

Subminiature Panel LED's (also suitable for PCB mounting) — available in hundreds of sizes, shapes and styles.

PCB LED's — horizontal or vertical viewing.

Bi-Pin (T1-3/4) LED's — direct replacements for incandescent types.

Midget Flanged (T1-3/4) LED's — direct replacements for incandescent types.

Send for our Catalog on the whole show: Data Display Products, 5428 W. 104th Street, Los Angeles, Ca. 90045, (213) 641-1232.

Produced by the Original "little light" people.



AUGUST 2, 1975

New entries heat up injection-logic race

The integrated injection-logic race is heating up with at least three major semiconductor manufacturers planning to introduce products during the first quarter of 1976.

Among the devices slated for announcement are an 8-bit multiplier, a direct memory access (DMA) controller and 4k RAMs. Looking ahead to the end of next year, semi manufacturers predict that several I²L microprocessors will make their debuts.

To date, the only I²L parts to be announced have been wristwatch circuits and a 4-bit slice microprocessor, both from Texas Instruments. The watch circuits, however, are the only I²L parts in commercial production.

Ever since the TI microprocessor was announced, rumors have persisted that TI will shortly come out with a 4k I²L RAM. Industry sources now indicate that announcement of such a device can be expected before the end of the year but that it could come from either TI or Fairchild, and will probably have an access time of under 100 ns.

In other microprocessor-related circuits, Motorola plans to come out with an 8 by 8 multiplier, a DMA controller and a programmable delay module.

The multiplier will provide the product of two 8-bit words. Multiplication will be accomplished in 2 to 4 μ s. This compares quite favorably with the currently used software routines that require between 200 and 300 μ s. The I²L multiplier IC, says Jim Loro, Motorola's bipolar-product planner, will be compatible with all bus-oriented microprocessors.

To provide direct memory access for its MC6800 microprocessor, Motorola is coming out with a DMA controller chip that will have

gate delays ranging from 5 to 15 ns. This will allow the microprocessor to take itself out of the circuit while a peripheral device and the random-access memory exchange data at high rates. Without the DMA, data transfer would be limited by the speed of the micro.

Motorola's third processor-related I²L part, which can also be used on a stand alone basis, is a programmable delay module that can be set for time periods of up to one hour.

Like most major semiconductor manufacturers, Motorola is working on an I²L microprocessor. No decision has yet been made about the form it will take, says Loro, but early indications are that it will use the same instructions and development tools as the MC6800 chip, although the architecture may be different.

The reason this is a good possibility, Loro explains, is that it costs just as much to develop the support material for a processor as for the chip. By using the support material generated for the MC6800, Motorola can effect substantial savings.

Loro notes that he is also considering a 4-bit slice-type processor as well as a 16-bit single-chip processor. The final decision will be made in the next few months, he says, and first units should be announced some time in 1976.

I²L technology has a lot going for it, says Loro, and he predicts that in a few years manufacturers of NMOS devices will switch to I²L to cut costs.

GE's aim: top producer of PC boards in 1 year

General Electric plans, within 12 months, to become "one of the world's largest quantity producers

of printed circuit boards." The production increase will be possible because of the development of "a rapid and inexpensive fabrication technique."

Millions of circuit boards have already been manufactured at GE using the new technique, and production is "scheduled to reach tens of millions of units annually." These boards are earmarked for GE's new "FlipFlash" array of eight flashbulbs.

The new technique uses an inexpensive, fast-drying, resin-based conductive ink that can be applied by a screen-printing process and dried in a matter of minutes. Conventional inks used for screen printing, GE says, are too expensive and are slow to dry, making it necessary to bake printed parts in ovens that consume large amounts of energy.

Total production time for GE's new circuit boards, from screen printing through curing, is only a few minutes, compared with up to 60 minutes for PC boards made by conventional techniques.

GE is also exploring other applications of the new printed circuit technology.

AF space computers to use bubble memories

In its first application of magnetic bubble technology to system applications, the Air Force Avionics Laboratory at Wright-Patterson Air Force Base in Ohio is developing bubble memories to provide mass storage for airborne and spaceborne computers and data processing, signal sorting and other digital systems.

According to Stewart Cummings, program manager of the project, current development plans call for it to last two and a half years. During the first year and a half, two breadboard systems will be developed. Texas Instruments will build two partially populated systems containing 2-million bits, which will be configured to serve as block-accessed memories or as digital recorders, says Cummins.

During the second phase of the project, four full-size systems will be built. Two will be designed for spaceborne recorder applications and will have a capacity of 100-mil-

lion bits each. The other two, to be used for airborne applications, will be block-oriented memories with a capacity of 15-million bits each.

Each chip to be used in the bubble memories will contain 150,000 bits. Currently, TI has submitted for Air Force evaluation 0.30 by 0.33-in. chips that contain 100,000 bits of storage, but Cummins notes that the final system will be built with the larger devices.

The decision to use bubble chips to replace magnetic drums, discs and small tape recorders was based on the fact that bubble memories offer nonvolatility, high-bit density, reliability and potentially low cost, says Cummins.

Other nonvolatile memories such as MNOS were considered, he says, but were rejected because they cannot achieve the high density required. Also, Cummins notes, under certain operating conditions MNOS memories have a limited lifetime.

New push-button switch called world's smallest

A simple compressed spring is the heart of a new switch made by Illuminated Products, Anaheim, CA, called the world's smallest lighted, alternate action push-button switch.

"The new Marcoflex mechanism means that an alternate action, double-throw, illuminated push-button switch can now be put in a 3/8-in. diameter package. Switches without lamps can be even smaller. We anticipate total space savings, compared with competing switches, of at least 50%," says Peter Van Benschoten, vice president of engineering.

Van Benschoten notes that the switch has some wiping action, multiple-point contact, true snap action, tactile feel and over 1.5 oz of contact force.

One end of the spring is the common contact on the switch. The compressed spring is normally buckled so that the middle presses against one side of the cavity that contains it. When the button is depressed, it contacts a small hat on top of the spring, forcing it to buckle in the opposite direction

and press against the other side of the cavity. One side of the cavity is the second contact, the other side the third. The spring is gold-plated beryllium copper.

Van Benschoten expects that the main use of the switch will be for logic-level switching. Under low-level switching, mechanical life in excess of 1-million cycles can be expected, he says. Terminal-to-terminal switch resistance is about 0.015 ohms, of which only about 0.003 ohms is due to the resistance of the contact spring.

The switch will also stand 1 A at 30 V dc or 1/4 A at 125 V ac. The first switch using the new mechanism will sell for \$1.30 a thousand and will accommodate either a LED or lamp.

Van Benschoten warns: "Because the Marcoflex involves both spring forces and mass, some contact bounce occurs on each actuation, typically for about 1 ms. While this is better than measured on most other switches, the designer must still consider the need for suitable de-bounce precautions."

CIRCLE NO. 315

Over-the-rainbow radar to aid weather forecast

Over-the-horizon radar, which is normally used to search for approaching missiles or aircraft, is being tested for its ability to examine sea state as far out as 2000 nautical miles.

Standing on the rocky shoreline of San Clemente Island, the radar, called Sea Echo, will study the North Pacific Ocean and Gulf of Alaska for the next 12 months. Sponsors of the project are the Naval Research Laboratory, the Commerce Dept.'s National Oceanic and Atmospheric Administration and the Institute of Telecommunications Sciences.

The information acquired from this area of severe and changeable weather will be helpful for meteorological predictions and for high wave warnings.

Resembling a monster radio station more than a typical radar, Sea Echo's antenna consists of a quarter-mile-long row of 150-foot towers and a spiderweb of wires. The web is 1200 feet long by 400 feet wide. The electronics and com-

puter are housed in trailers. Power is supplied by three diesel generators.

Unlike the familiar microwave radars operating with short wavelengths and dish antennas, Sea Echo uses very long wavelengths (20 to 30 MHz) which match the lengths of the actual waves in the sea. The radio signals are reflected by the ionosphere and back to the sea.

Some of the sea-scattered signals bounce back up to the ionosphere and are reflected back to the transceiver. A computer at San Clemente records the time delays for the echo return as well as the echo frequencies, and analyzes the way the returning echo has been scattered at the ocean surface. From this information the computer produces contour line maps showing differing wave heights, directions, and periods within the region scanned with as little as an hour and a half of echo observation.

Baggage X-ray system features real-time image

A new X-ray baggage inspection system for airports displays the image directly, in real time, rather than presenting it on a TV screen. Advantages of the new system, according to Robert Blanchard, vice president of Astrophysics Research Corp., systems developers, include the following:

- Substantially simplified system.
- Increased reliability.
- Reduced cost—as much as one-third less.
- Directly viewed, flicker-free images.

The key to the development by Astrophysics—a Harbor City, CA, firm—is a special image-intensifier tube with a 5-in. viewing screen. The image is optically magnified to give the machine operator a 10-in. presentation.

The direct-view system, Blanchard explains, consists of a four-stage electrostatic image amplifier—such as that used for military and police surveillance systems—plus the display tube at the output. The tube is manufactured by ITT Electro Optical Products Division, Roanoke, VA.

Sprague puts more passive component families into dual in-line packages than any other manufacturer.

Call Sprague First!

				HIGHER PACKAGING DENSITY
		LOWER PRODUCTION COSTS		

plus improved performance and compatibility with DIP microcircuits



**DIP
MULTIPLE
TANTALUM CAPACITORS**

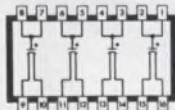

Solid-electrolyte tantalum capacitors with 2 or 4 sections per package. 8- or 16-pin configurations. Standard ratings are 6.8 μF @ 35V, 15 μF @ 20V, 22 μF @ 15V, 33 μF @ 10V. Capacitance tolerance, $\pm 20\%$. Operating temperature range, -55C to $+85\text{C}$. Write for Bulletin 3542 or circle 291 on reader service card.

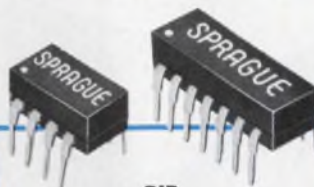

**DIP
MULTIPLE
CERAMIC CAPACITORS**



Monolithic[®] construction . . . alternate layers of ceramic dielectric material and metallic electrodes are fired into a solid homogenous block. 2, 4, 7, or 8 capacitor sections per package. Standard ratings, 18 pF to 0.1 μF @ 100V. Capacitance tolerance, $\pm 20\%$. Write for Bulletin 6242 or circle 292 on reader service card.



**DIP
TANTALUM/CERAMIC
CAPACITOR ASSEMBLIES**



Solid tantalum and Monolithic[®] ceramic alternating isolated sections. Choice of 4 or 8 sections per package. Standard tantalum ratings, 6.8 μF @ 35V, 15 μF @ 20V, 22 μF @ 15V, 33 μF @ 10V. Ceramic ratings .01, .047, .1 μF @ 100V. Cap. tol., $\pm 20\%$. Write for Engineering Bulletin 6642 or circle 293 on reader service card.



**DIP
RESISTOR/CAPACITOR
NETWORKS**

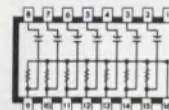

(1 of 3 designs)

Metanet[®] metal-film resistors and Monolithic[®] ceramic alternating bypassed pull-up, R-C coupling, speed-up, and active terminator networks. Resistor ratings, 100 to 6800 Ω with 125mW power dissipation. Capacitor ratings, 100 pF to .01 μF @ 100V. Write for Engineering Bulletin 6612 or circle 294 on reader service card.

**DIP
MULTIPLE
METAL-FILM RESISTORS**

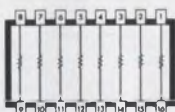

Noble metal film resistors encased in protective glass. Choice of 7 or 8 resistors per 14- or 16-pin package. Resistance values, 50 Ω to 100,000 Ω . Power dissipation, 125mW. Standard resistance tolerance, $\pm 5\%$. Operating temperature range, -55C to $+70\text{C}$. Write for Bulletin 7042 or circle 295 on reader service card.

**DIP
PRECISION RESISTOR
NETWORKS**

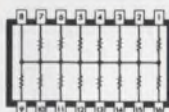

(1 of 5 designs)

Noble metal film resistors in pull-up, pull-down, interfacing, and terminating configurations, for applications requiring repetitive resistance patterns. 14- or 16-pins. Up to 28 resistors per package. Individual resistors from 50 to 100,000 Ω . Dissipation, 125 mW. Write for Bulletin 7042 or circle 296 on reader service card.

**DIP
MULTIPLE
PULSE TRANSFORMERS**

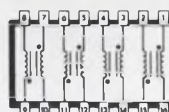

(1 of 2 designs)

Four transformers in 16-pin package. All cores have exclusive protective coating. Inductance values from 10 to 1000 μH . ET product values of 5 volt- μsec . Choice of four turns ratios . . . 1:1, 2:1, 3:1, 4:1. Operating temperature range, 0 C to $+70\text{C}$. Write for Engineering Bulletin 40400 or circle 297 on reader service card.

**DIP
TAPPED
DELAY LINES**

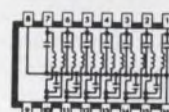

Lumped constant delay lines . . . ideal for timing and pulse synchronization circuits. 14- or 16-pin packages with delays of 50, 100, or 150 nanoseconds at a characteristic impedance of 100 Ω . Working voltage, 50 VDC. Operating temp. range, 0C to $+70\text{C}$. Write for Bulletin 45004 or circle 298 on reader service card.

Popular Types Now Available OFF-THE-SHELF From Your Sprague Industrial Distributor.

For complete technical data, write for any of the above-mentioned Engineering Bulletins to: Technical Literature Service, Sprague Electric Company, 347 Marshall Street, North Adams, Mass. 01247.

THE BROAD-LINE PRODUCER OF ELECTRONIC PARTS



New semiconductors for new designs



Sink heat problems with 2 watt Duowatt

Duowatt provides about $\frac{1}{4}$ W more P_D than comparables at 25°C — through the leads, through the plastic body, through the exposed tab — at less stress to the chip. In industrial applications, that's about 12% more in temperature-handling. Or, at equal P_D conditions, you're ensured cooler operation, longer life.

Drop Duowatt into existing power tab sockets. Increase reliability. Pay less for it. Watch it run . . . and run . . . and run . . . and run . . .

At 2 watts, of course.

When we say Duowatt, we mean Duowatt.

Circle No. 261



Push an ordinary power tab device to 2 watts in free air and you get high θ_{JA} , high stress levels and early demise.

Push a new Duowatt* the same way and you get — the lowest free-air θ_{JA} in the industry — 62.5°C/W . . . low stress levels . . . and a real edge in reliability and long life. Besides lower T_J , Duowatt offers second generation epoxy molding providing better impermeability to moisture, lower thermal resistance and higher mechanical strength than sili-

DUOWATT	V_{CE0} Min. V	h_{FE} @ I_C Min.	Price 100- 999	APPLICATIONS
2N6548/49	40	25,000/ 15,000 @ 200 mA	\$0.65/0.55	NPN Darlington Amplifier
2N6551/52/53	60/80/100	60 @ 250 mA	.45/.50/.55	NPN GP Amplifier and Driver
2N6554/55/56	60/80/100	60 @ 250 mA	.45/.50/.55	PNP GP Amplifier and Driver
2N6557/58/59	250/300/350	40 @ 30 mA	.50/.55/.70	NPN HV Amplifier, Low Sat, C_{cb}

cone†. Plus heavy-duty leads and 2-mil gold wire.

And Duowatt is offered with a device selection already proven reliable in the standard Uniwatt package including monolithic Darlington to 100 V.

* Trademark of Motorola Inc.

† Thermal shock tests on the package ($+150^\circ\text{C}$ to -55°C liquid-to-liquid transfer) over 600 cycles resulted in 0.5% failure rate for epoxy, 3.5% for silicone — a preliminary indication of significant improvement of bond integrity of the one material over the other.

from Motorola,

MHTL — more than just a pretty interface

If industrial systems raise your noise level, quiet down by pairing Motorola MHTL with McMOS. Complement your CMOS signals with bipolar IC's to provide signal conditioning. At the same time meet high-current load demands.

The MC691 Hex Inverter/Translator accepts McMOS inputs and provides high-level outputs.

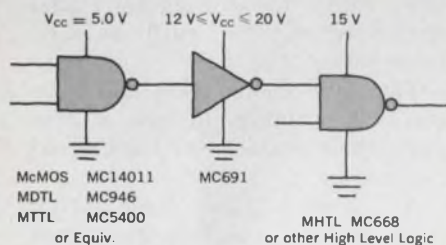

The MC696 Dual Interface Unit, Line Driver/Receiver offers flexible hysteresis capability for design variety. And has low output impedance of ≈ 20 ohms in LOW state.

The MC699 Dual Power "AND" Gate operates at 5 to 20 V supply and also features varying threshold. Its high-voltage, 0.5 A output is a natural for driving relays, lamps and discrete power devices.

MHTL — providing new interference solution to industrial noise problems. Remember — MHTL on the input/output blocks, McMOS in the middle. Result: savings in power dissipation, medium speed operation . . . and noise problems become whispers. Check for specs and a look at the entire MHTL family. We'll send it along — quietly.

Circle No. 262

MHTL, MDTL, M TTL and McMOS are Trademarks of Motorola Inc.

Number's up for tone-dialing kluges

Days of the telephone tone-dialing kluge are numbered. Countdown for cumbersome pot-coil/discrete combinations is activated by Motorola's new CMOS 2-of-8 Tone Encoder, the MC14410.

This space saving circuit synthesizes standard tone-dialing sinewave signals from digital 2-of-8 code inputs. It's a boon for the usual standard telephones, of course. And, because of the single compact IC package and its insensitivity to RF radiation, it opens completely new opportunities in the regular and hand-held mobile radio

telephones. Other potentials include process control, P-O-S terminals, and credit card verification.

A D/A converter generates sine-wave signals, and an on-chip precision 1 MHz crystal controlled oscillator handles master clocking. Pull-up resistors on row and column inputs are used for mechanical switch interface.

It's \$6.40 at 100-999 for the 16-pin plastic MC14410P, and \$8.32 for the MC14410L. Don't be the last one on the line to call for more information.

Circle No. 264

Quad buffer clicks in MPU clock circuit

MPU clock specs which constrain clock drivers the most are the 1 MHz rise and fall time requirements as well as logic level demands into the load capacitance within the overshoot restrictions.

One method — and a darned good one — of guaranteeing speed and sat voltage necessary to design clock circuits that meet MPU clock needs is the new MPQ quad transistor buffer. It meets them to a "t": 5 nanosecond minimum t_r and t_f with 40 nanosecond maximum t_{in} (overshoot) duration. 1ϕ and 2ϕ input high and input low voltage specs are, respectively, -0.3 V and $+0.3$ V.

The non-overlapping requirement of the clock signals can be met by the control logic design which drives the buffers.

Various methods of clock circuit driver design are described on the comprehensive data sheet, with circuit schematics, test conditions, waveforms and interfacing detailed. Also included is a section on interfacing MPU with dynamic and slow memories.

100-up price for the versatile MPQ-6842 is just \$3.35.

Circle No. 263

Readers! Digest the MPU!



An abridgement it's not — but the most complete, clear comprehensive applications coverage of MPU from organization to design and development.

714 pages of detailed info lead from basic understanding of MPU, its characteristics, organization and use through programming, I/O and family hardware techniques. Peripheral control, system design and development are covered, too. A Q&A section orients to a wide variety of needed supplements.

It guides the experienced, initiates the uninitiated, tells you what-it-is, how-to-do-it.

The best investment of the year for the serious MPU student is only \$25 by check or P.O. to Box 20912, Phoenix, AZ 85036.

total
the semiconductor source.

How to pick a microprocessor, a mini or anything in between

"No matter what else it contains, that new product you're developing must have a microprocessor in it. If it doesn't, marketing will scream."

Sound familiar? Microprocessors, minicomputers and systems in between are "in," and designers throughout the electronics industry are being ordered to incorporate them in products wherever possible. Is there a logical procedure for selecting the right processor for the job? Industry specialists say there is. It requires considerations of speed, cost, size, dissipation, instruction set and a

David N. Kaye
Senior Western Editor

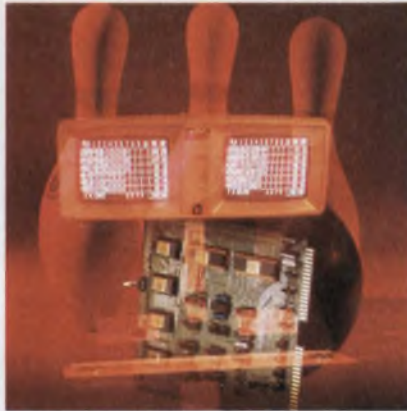

Automatic recording of bowling scores is done with the help of a Motorola M6800 microprocessor. Magic Score, by AMF, computes and displays individual and team scores and provides a hard copy printout at the end of a game.

variety of other factors.

Once a decision is made to incorporate some type of digital processor into the product design, the engineer needs to consider three factors: the I/O parameters (often referred to as the "goes into" and "comes out of"), how long it takes to get the data processed (also called the throughput) and special constraints, such as size, temperature and cost.

The first choice that must be made is whether to use a programmable processor or hard-wired random logic.

At present hard logic often costs less. But it suffers from large size (many ICs instead of a few), high power dissipation and very little flexibility.



Both **board-level microcomputers** and full scale **mini-computers** are produced by a few companies. Microdata shows the full-scale 3200 and the board-level Micro-One. The microprogrammable Micro-One can emulate any other microcomputer on the market.

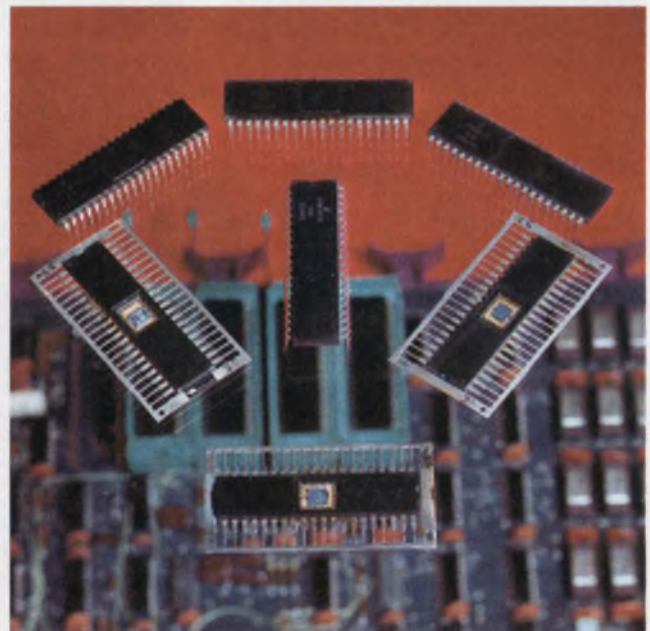

Western Digital produces a chip set that is used by Digital Equipment Corp. as the heart of the board-level microcomputer, the LSI/11. These chips allow Digital Equipment to market a 16-bit PDP-11 minicomputer on a board.

A programmable processor, on the other hand, accomplishes much through software and is easily changed. Thus the product is readily expandable; special features can be added to meet different applications. Let's assume a programmable processor is the choice.

A universe of processors

Many types are available and at many levels of integration. They range from MOS and bipolar microprocessor chip sets up through modular cards (containing microprocessor chips with some external circuitry, or I/O cards or memory cards) and on to microcomputers on a board, minicomputers on a board, microcomputer systems or minicomputer systems.

Most processors are used in four application areas: data acquisition and control; data communications; human interface equipment (terminals, point-of-sale, etc.); and computation. Each area stresses certain processor characteristics.

For data acquisition and control, the processor should offer: wide word length, number crunching ability, speed, ability to react in real time, interrupt capability and ease of interfacing to analog signal sources.

For data communications: high-speed data handling, good file search, error-code generation and checking and interfacing to serial data lines.

For human interface: low cost, small parts count, high reliability, BCD arithmetic capability, low speed, some user programmability and small word length.

For computation: large word length, number crunching, low cost, interface to mass storage, high speed and higher-level languages.

Evaluate the I/O

Start with an evaluation of the input and output requirements. How many bits wide are the data paths? What are the data rates? How many separate signals are there on the input to the processor? Are they serial or bit-parallel signals? How many peripheral devices must be connected to the processor, and must they be continually serviced by the processor during operation? Can the I/O be polled or are interrupts needed? Is

block-transfer DMA (direct memory access) needed?

From this analysis of I/O requirements, you can determine the bit length required for your data path, the amount of data processing required to service the I/O channels, the requirements for I/O driver software and the need for a number of I/O features available on some processors but not on others.

According to Ken McKenzie,

product manager on the 8080 at Intel, Santa Clara, CA: "I/O handling varies considerably from processor to processor, and an I/O analysis will sharply limit the potential processors for your application."

After an I/O analysis, says Dean McKay, president of AH Systems, Chatsworth, CA, "look at any special characteristics that your processor must have."

Special characteristics include

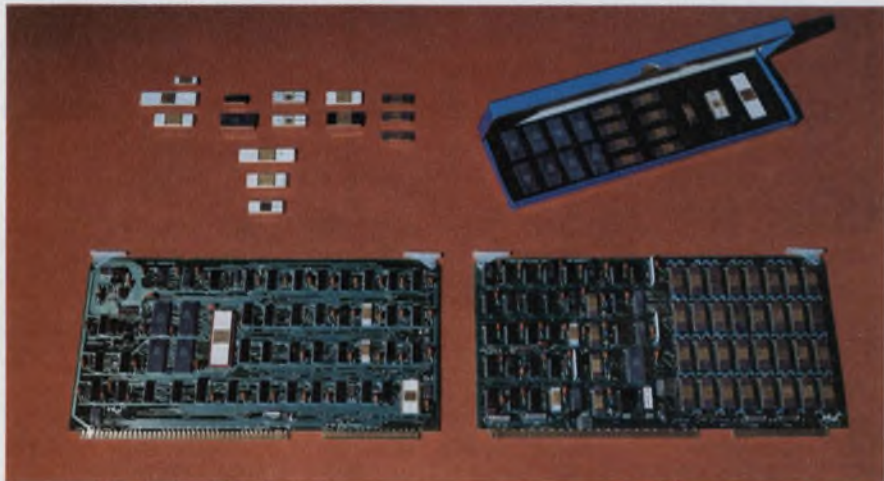

Intel's popular 8080, 8-bit n-channel MOS microprocessor can also be bought at many levels of integration. The chips are available to designers who choose to assemble their own boards. Or a small prototyping kit can be purchased. In addition larger boards are sold, with all the associated circuitry to make a complete CPU or add-on memory boards.

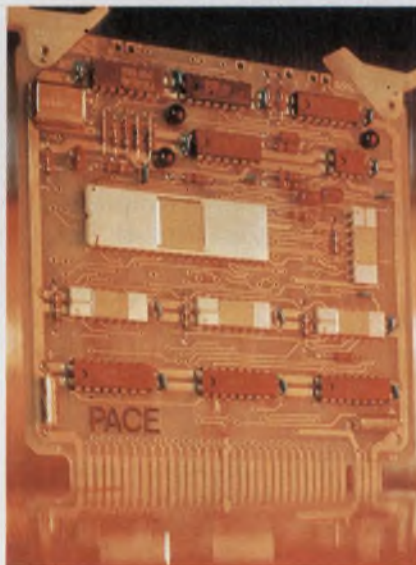

National Semiconductor's Pace microprocessor was the first 16-bit micro on a single chip. It comes in chip form, on a board with some memory (shown here) and also packaged into a prototyping system.

such things as working in a harsh environment, very small space or at a very low power.

"To that must be added weight, cost, speed and ease of use considerations," notes Philip Roybal, microprocessor product marketing manager at National Semiconductor, Santa Clara, CA.

David C. Wyland, manager of processor design at Monolithic Memories, Sunnyvale, CA, recommends that the designer structure the special characteristics in priority order."

"But," warns Robert Clarke, member of the Sorrento Valley Group, a software and hardware consulting organization in San Diego, CA, "there may be more than one set of priorities, depending upon the ultimate design approach."

Don't forget another special characteristic—time. Kenneth H. Harlan, manager of applications



Computer Automation was the first with board-level minicomputers. The latest in the series is the Naked Milli LSI-3/05, which sells for only \$295 as a CPU with no additional memory. Shown next to a full-scale Alpha LSI minicomputer, also made by Computer Automation, the Naked Milli is a bipolar minicomputer priced in the same range as board-level microcomputers.

engineering at Western Digital, Newport Beach, CA, points out: "What if you have to get a product out to market in 30 days. You won't have time to optimize your design now. You may have to buy a fully engineered minicomputer from someone now, to hold you over while you redesign the product and incorporate a more appropriate processor for long-term sales."

Block and flow

One or more design approaches must now be blocked out and a flow chart drawn to outline the required software. At this point the designer who is used to random logic design must think along different lines.

"A computer approaches a problem in a sequential way. Random logic is often a parallel solution," says Douglas Cassell, director of engineering at Control Logic, Natick, MA.

In fact, adds David Wyland of Monolithic Memories, "the processor is the most elegant solution to any problem in sequential logic."

But designers should also recognize the power of software to do a parallel job, as opposed to external hardware, says John Nichols, vice president of Logical Services, Mountain View, CA. He explains that "such things as

serial-parallel conversion and other housekeeping chores can easily be done with software."

Now it's important to evaluate the speed requirements of the processor. Roybal of National Semiconductor concedes that speed is the biggest area of specsmanship.

Phil Kaufman, director of corporate product planning at Computer Automation, Irvine, CA, notes: "The only speed that counts is the critical path speed." Nelson of AH Systems agrees saying:

"Now you must identify the critical paths in your system. Estimate the required critical path speeds and look for the processors that might do the job. Processing of critical paths, as a rule of thumb, should use no more than 20% of the time between samples on the input. Then you must write critical path benchmarks for the leading-candidate processors. It is only through these benchmarks that you will know the actual speed of a given processor in your application."

Karl Kulp, product manager at Fabri-Tek, Edina, MN, cautions that processor speed should be used very conservatively. He says: "It is much easier to use a processor whose performance is only 50% utilized than one that is 95% utilized. Software costs go through the sky as the computer approaches 100% utilization."

In addition, many specialists point out, if speed is used conservatively, memory can be used much more efficiently.

Word length and memory

Should you use 4, 8, 12, 16 or 32-bit processors? Most specialists agree that word length can be optimized for some applications but that most word lengths are fine no matter what your application is. If the application is BCD arithmetic, 4-bit processors are ideal. But if you need high precision or communication with a wide-word-length processor elsewhere in the system or lots of directly addressable memory and instructions, larger word lengths are better.

Certain memory decisions must now be made. The hardest is: How much do I need? Harlan of Western Digital cites a general range for some common applications.

"If the processor is a 4 or 8-bit machine and the application is control, you will probably need 1 to 4 k words of memory," he says. "For number crunching, 4 to 16 k may be needed. If the processor is a 16-bit machine, the memory size in words [though not in bits] is cut by a little more than half. The extra saving in memory comes from the fact that a 16-bit processor can use memory more efficiently."

Remember that memory must be broken down into program and data memory. Data memory is easy to estimate, but program memory can be determined for sure only after the program is written.

Memory allocation must also be considered. McKenzie of Intel notes that you may be able to use memory management techniques, such as memory mapping or interleaving.

Robert D. Wright, director of microprocessor products at the RCA Solid State Div., Somerville, NJ, suggests looking for the chance to use mass memory, such as disc or tape, when possible.

And don't forget ROMs for storing microprograms, adds Richard E. Vahlstrom, vice president and director of technical research at Microdata, Irvine, CA.

"Software development can account for up to 50% of the product's design cost," notes Wil-

New from Potter & Brumfield



The lowest profile 3 amp relay we've ever offered!

The P&B T10 Series relay is lower than many other circuit board components. Only 0.375" high, it's ideal for high-density applications. Permits pc boards to be mounted on 0.5" centers!

T10 relays provide 0.1 to 3 ampere switching @ 30VDC. Coil ratings are 6, 12, 24, and 48VDC. Permissive make, gold-flashed silver contacts are noted for low contact bounce, long operating life. Bifurcated contacts for low level switching are available on special order.

Designed for low cost general purpose applications, the T10 is ideal for use in tele-communications, copy and reproduction machines, computer and peripheral equipment.

For additional information, contact the Potter & Brumfield sales representative or authorized distributor nearest you, or write Potter & Brumfield Division AMF Incorporated, Princeton, Indiana 47671. Telephone 812 385 5251.

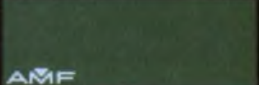
Potter & Brumfield



Solving switching problems is what we're all about.

liam A. Lucy, market research analyst at Scientific Micro Systems, Mountain View, CA. "Choosing a microcomputer with a first-rate software development system can greatly reduce both the cost of design and the time it takes to get your product to market."

This holds for any type of processor. In fact, many specialists think that 50% of the total development dollar is far too small a figure. At times the software can cost several times the hardware.

Here are rules of thumb for estimating software costs:

For commercial products—depending upon the experience of the programmer and the complexity of the system—a line of code will cost from \$10 to \$100.

For military products, a line of code will cost up to \$500.

Software expense varies considerably with the type of processor used. Fully packaged minicomputers come with high-level languages and a variety of software packages. Microprocessors come in two forms: microprogrammable and nonmicroprogrammable.

The microprogrammable microprocessors are usually bit-slice processors of either 2 or 4-bit word length. These can be coupled to build a CPU of any word length which is an integer-multiple of the basic word length.

These processors come with almost no software support. With the exception of the IMP from National, they all require that the user define his own instruction set before he can use them. With the IMP, a fixed instruction set is available.

Since very few engineers have the experience to design an instruction set, the microprogrammable chips are limited at present to the few designers who know how to use them. A major use of these chips, most of them bipolar and fast, will be in new minicomputers.

Several manufacturers of microprogrammable microprocessors note that future models will offer a fixed instruction set plus writable control store. This will allow the designer to microprogram a few special instructions without need to write a whole instruction set. Obviously the software cost is the highest if these microprogram-

mable processors are used.

Most nonmicroprogrammable microprocessors are also harder to program than minicomputers. Two types of languages are available. All can be programmed in assembly language. And a few can use a slightly higher-level language, such as Intel's PL/M or one of the sub or super sets of PL/M that other manufacturers will have available. Once again, while the software cost will be less than with a microprogrammable microprocessor, it will be higher than if a minicomputer is used.

With regard to software, an important factor in product selection is the level of experience of the company designing the system.

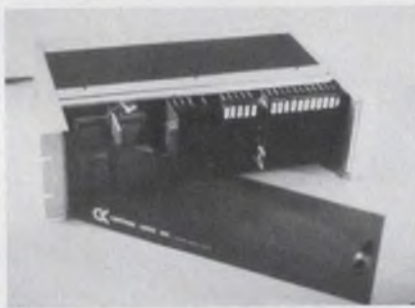

A modular microcomputer development system is available from Control Logic. The microcomputer chips and various I/O, memory and other support chips are each packaged on small PC boards. The boards can be housed in the Control Logic chassis and used together to form a microcomputer system.

"Remember," says William Senske, 21 MX product manager at Hewlett-Packard, Cupertino, CA, "software, as well as hardware requires service. So if you have a need for large-scale field service of your equipment, a major minicomputer manufacturer will probably be needed to help support your product."

The cost/volume tradeoff

Cost is a prime concern in the development of any product. Two kinds must be considered: recurring and nonrecurring.

Recurring costs are primarily hardware expense plus general administrative and overhead. Nonrecurring costs are primarily for product planning and hardware and software development.

Unfortunately software often

filters back in as a recurring cost as well. The higher the level of integration you start with in a processor, the lower the nonrecurring costs.

However, recurring costs are usually higher. Therefore a cost/volume tradeoff must be made. As a general rule, low volumes (10 or less) dictate system-level processors. From 10 to 100 board-level processors are often best. From 100 to 1000, cards are very effective. From 1000 to 10,000, processors should be assembled from chip sets on boards of your own design. And above 10,000, it often is worth custom LSI designs to satisfy your needs. But these guidelines are very iffy and subject to many qualifications.

In addition, as Donald McDougall, international marketing manager for Data General, Southboro, Ma., points out: "Volume must be looked at as now volume and future volume when deciding the proper level of integration." Future volume might entail a product modification requiring a different level of integration.

Selecting the company

At this point you have enough information to select the type of processor technology and the level of integration. It is time to select a manufacturer and a product. Your choice should already be narrowed to a group of products that will all do the job at the right price.

The selection criteria now become: What kind of applications assistance can you get? What kind of experience have you had with the companies in the past? Who can deliver to your time schedule? Who has the best software and hardware design system? Who has the best salesman? And so on.

If every last ounce of performance is going to be important, you may want to run elaborate benchmarks and do some instruction-set comparisons.

If one processor won't do the job, you may have to go to a multiprocessing or distributed computing network, with several parallel processors or even a hierarchy of processors. But designing these systems is a couple of orders of magnitude more difficult than designing a single processor. ■■

O.K., you guys, back to the old drawing board.

It's a whole new ball game. And just when you'd made all your panel lamp decisions, right? But Monsanto's patented nitrogen doping process for GaAsP on GaP substrates has improved the light-emitting efficiencies of our LED lamps so dramatically that every good designer will want to take another look.

Monsanto has T-1 and T-1 $\frac{3}{4}$ replacement lamps in standard red color (improved significantly over last year's red LEDs) and new bright red which is *unbelievably* bright. Red. Plus green, yellow, and a dazzling new orange. In two lens choices and two lead lengths. And all improved, as you can see on the chart.

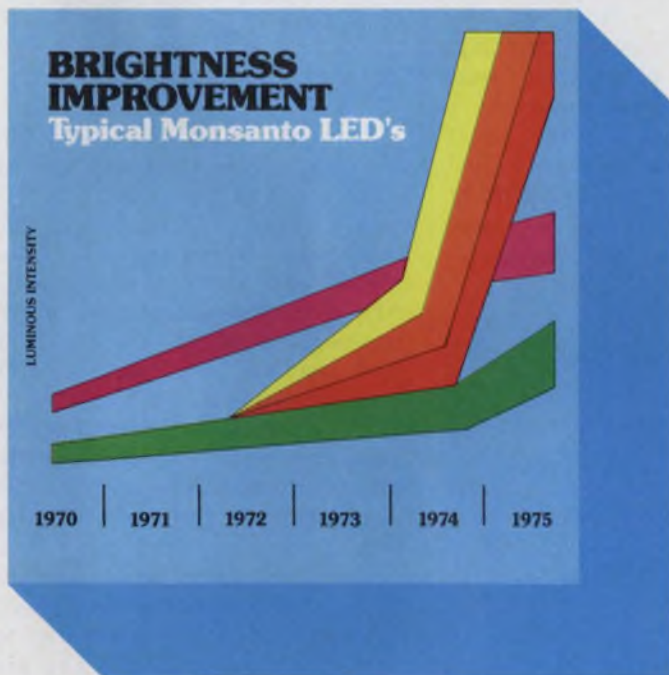

Model Number	Color	Size	Luminous Intensity	Viewing Angle
5174B*	Orange	T-1	5.0 mcd	90°
5274B*	Green	T-1	1.0 mcd	90°
5374B*	Yellow	T-1	4.0 mcd	90°
5774B*	Red	T-1	5.0 mcd	90°
5152**	Orange	T-1 $\frac{3}{4}$	40.0 mcd	28°
5252**	Green	T-1 $\frac{3}{4}$	15.0 mcd	28°
5352**	Yellow	T-1 $\frac{3}{4}$	45.0 mcd	28°
5752**	Red	T-1 $\frac{3}{4}$	40.0 mcd	28°

*Also available with 1" lead lengths, low profile (.138" high) lens, and 180° viewing angle.

**Also available with 24° and 65° viewing angles.

Last year there were some sockets that demanded filament lamps, despite their inherent failure-and-replacement problems. *Bright* was needed, and damn the torpedos.

This year you just might find the bright you need in a shake-rattle-and-roll-proof LED lamp. Come and see.

If you can take the time, you just might be able to add a lot of T to your MTBF.

So it's reset to zero, folks, if you want the best indicator lamps (and widest choice of functional differentiation colors) in your gear.

For product information, circle the service number or call your local Monsanto man. Or write Monsanto Electronics Division, 3400 Hillview Avenue, Palo Alto, CA 94304.

Putting innovation to work.

Monsanto:
the science
company.

Microprocessor DVMs, with new features, to hit the market shortly

At least two major instrument companies, and possibly a third, are on the verge of announcing microprocessor-based digital voltmeters or multimeters.

Both Systron-Donner, Concord, CA, and Dana Laboratories, Irvine, CA, are expected to unveil the instruments at next month's Wescon show in San Francisco. And John Fluke Manufacturing Co., Seattle, confirms that it isn't far behind with its own version.

Chuck Bishop, Systron's product manager for DVMs, says his company has designed a top-of-the-line autoranging, 5-1/2-digit unit in which the microprocessor, an Intel 4004, takes over all the jobs ordinarily performed by digital logic.

Thus to a user, the Systron box

(called the 7115) appears to measure dc volts—and, as an option, true rms, ohms and ratios—just as other DVMs do. But while it is measuring, the 7115 calibrates itself to an internal reference, zeros itself and diagnoses itself for internal problems.

By contrast, the Intel 4040 in the Dana unit doesn't get involved in the measurement process. Instead, the microprocessor handles all the interface functions in accordance with the new interface standard for instruments, IEE STD 488-1975.

"With the microprocessor," says Chris Everett, product-line manager for Dana, "we can satisfy a customer's special interface needs swiftly and save money by just dropping in the required PROM or other memory. We could have used the microprocessor in the measure-

ment process. But in a high-performance, 5-1/2-digit DVM—with accuracy already very high—how much more could the microprocessor have contributed?"

Everett continues: "Sure, a microprocessor DVM can be designed to crunch numbers or linearize inputs. A lot of customers ask for just that. But many system or automatic-test-equipment engineers already have computers for that purpose. Or they change tests so often they'd rather have the DVM stick to the measurement and feed data to the computer."

Contrasting designs

Systron-Donner has obviously decided to fulfill the needs of the first group of customers. The 7115 can linearize, normalize and store high and low readings for future recall. The unit can also multiply the displayed number by a programmed constant, average 10 or 100 readings and perform limit comparisons.

To linearize or normalize, the customer must tell Systron what curve he'd like. The company will then program the curve into the 7115's memory.

The remaining routines are built in but require an optional keyboard or a programming option. With the keyboard, the user can type in, say, two six-digit numbers and have the DVM compare for high and low limits a measured number with those typed in.

Or with the 7115's programming—either ASCII or parallel BCD—the user can implement the same routines with an existing terminal or computer.

Since speed is essential in automatic test equipment, Systron has taken special pains to see that the

Stanley Runyon
Associate Editor

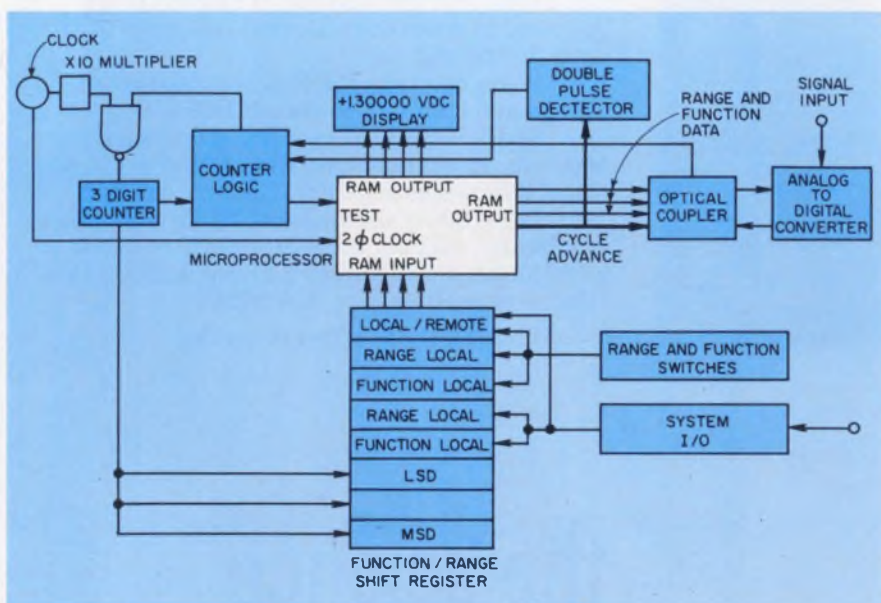

In the first LSI microprocessor-based digital voltmeter, from Systron Donner, the computer-on-a-chip, plus memory ICs, replace all the digital logic ordinarily used in such an instrument. Benefits include self-calibration.

Just as you can count on water to freeze at 32° F,



you can count on Synchron motors.

When you buy a motor for installation in your product, the last thing you want is a troublemaker. You want to install it and forget it.

Despite many similarities, all synchronous motors aren't the same. Not by a long shot. No matter what anyone may claim.

You can't judge performance and dependability by data sheets alone. Or by price. Or delivery. Or the flip of a coin. The big difference often is the brand name. And what's behind it. The integrity of the company that makes the motor. The expertise



of the designer and the people who put it together and test it.

We make Synchron motors as if our name were on your product. Total quality, total dependability. Designed right and built right, to do the job right. That's the only way we do business.

Call or write for our specification sheets and the name and location of our representative in your area.

Choose from five principal styles of Synchron motors—60 or 50 Hz—from one revolution per week to 900 rpm—from 8 thru 98 oz-in torque at 1 rpm—from hundreds of different outputs.

MALLORY



HANSEN MANUFACTURING CO.
a division of P. R. MALLORY & CO. INC.
Princeton, Indiana 47670

We make every Synchron motor as if our name were on your product

MIX 'n MATCH "Vise Grip" Collet Knobs & Accessories



EASY AS 1, 2, 3

1. SET KNOB
2. TIGHTEN SCREW
3. ADD CAP

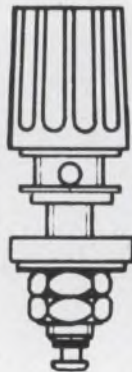

The largest selection of knobs and accessories for your panel components. Color coded, color pointed dial plates eliminate high cost of panel marking.

Choose the set-up you require. Color coded for safety . . . for convenience.

No set screw, yet provides firmer grip than conventional type knobs.

Call our hotline for prompt service and delivery.

(201) 374-3311

AMF

RCL Electronics

**General Sales Office:
700 So. 21st Street
Irvington, N. J. 07111**

NEWS

7115 is fast. The autoranging function makes one measurement, then immediately shoots over to the correct range. By contrast, most autorangers sequentially step through adjoining ranges until the right one is found. Thus, says Bishop, the 7115 measures up to three times faster in the autoranging mode than conventional designs do. A fast, four-digit mode in the Systron unit also speeds measurements. By dropping one digit, the 7115 can take 100 readings/sec.

Memory plays a key role in the Systron unit. To automatically zero itself, the 7115 first measures any drift or offset caused by temperature or aging (time-related drift). Then the voltmeter stores any measured error in memory. Finally, the unit subtracts the drift from subsequent measurements and displays the results. This cycle is repeated often enough to eliminate tempo and time errors.

To calibrate itself, the 7115 measures the value of an internal, precision source, then stores the number. When an unknown input is measured, the meter uses the stored number to normalize, or correct, the reading.

If during the autocalibration routine an out-of-limit measurement occurs, the Systron meter signals the condition with both a front-panel display and an output flag. Such signals signify that precision components may have drifted out of spec or that a circuit failure has occurred. The 7115's self-diagnostics then come into play.

To see what happened, all a user need do is open the 7115's top cover. One series of LEDs thus exposed will point to the problem. Another group of four LEDs indicates in binary code the number of any out-of-tolerance registers. If more than one register goes out, the user can increment the LED display with an internal switch.

Has the microprocessor boosted the accuracy of the digital voltmeter? The basic dc accuracy of the Systron-Donner unit is specified at $\pm 0.002\%$ of reading $\pm 0.001\%$ of full scale for three months at $23\text{ C} \pm 1\text{ C}$. This spec applies to the 1, 10, 100 and 1000-V ranges. Most 5-1/2-digit meters,

Thinking instruments: The list grows

DVMs that think join a ballooning list of smart instruments. Only about three short years after the microprocessor's debut, the list includes a calculating oscilloscope, the Hewlett-Packard 1722A, a programmable frequency synthesizer from John Fluke (the 6010A), a data acquisition system—developed by Doric Scientific, San Diego—and an automatic capacitance bridge, from Boonton Electronics, Parsippany, NJ. And these aren't all.

More equipment with intelligence is sure to follow as designers familiarize themselves with the microprocessor and what it can do. What are the benefits?

In general, and aside from the marketing advantages or appeal, the microprocessor can reduce the number of IC packages and thereby boost reliability. And, theoretically, it can reduce costs.

In performance, think of what it can mean to add a computer to an instrument—even one presently limited in software and speed. Accuracy, resolution, control, data manipulation, programmability, complicated analyses—all can enjoy the benefits of LSI microcomputers.

however, don't do better than about 0.01% of reading for the same time period and temperature.

Thus the 7115 appears to be about five times more accurate than most existing 5-1/2-digit boxes. One exception, though, is the 5900 series of voltmeters—coincidentally from Dana—with a basic dc accuracy of $\pm 0.001\%$ of reading $\pm 0.001\%$ of full scale. Super high accuracy such as this seems to support Everett's claim that upgraded accuracy isn't what a microprocessor can do best in a high-performance DVM.

With all this activity in "intelligent" DVMs, it's logical to ask: Will we see such a unit in the near future from Hewlett-Packard, the industry leader in DVMs? When asked just this question, a spokesman for HP said flatly: "No." ■■

Dana CIRCLE NO. 318
Systron-Donner CIRCLE NO. 319

RCA EXPANDS THE
COS/MOS UNIVERSE
THREE WAYS

Now RCA offers 3 galaxies of COS/MOS devices...

More standard "A" types

- 3-15 V rating
- 112 types
- New MSI functions

New high-voltage "B" types

- 3-20 V rating
- 76 types
- Standardized symmetrical outputs

Expanded High Rel program

- MIL-M-38510 types: 25 now
- RCA 883 series: 71 now
- Off-the-shelf delivery

Introducing a new level of COS/MOS cost effectiveness.

The RCA Extra Value Program. A new enhanced product. For applications where you need extra quality and reliability. At minimum additional cost.

The enhanced product of the Extra Value Program achieves AQL levels of 0.15% (functional) and 0.65% (parametric).

You get extra value because we add a product burn-in period to the comprehensive real-time controls and tests made on standard plastic and frit-seal devices.

	Plastic "EX" suffix	Ceramic "FX" suffix
Burn-in time	48 hours	168 hours
Temperature	125°	125°
Voltage	10 V	10 V

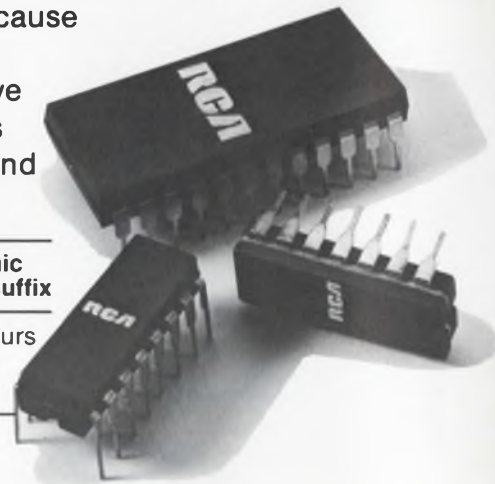

Send for RCA COS/MOS literature



Give us your name and address in the form of a mailing label and we'll send you a full-range package of COS/MOS literature. Including data sheets. Technical papers on reliability. A 24-page product guide including interchangeability data. Plus a great deal more.

For literature and other information, contact your local RCA Solid State distributor. Or RCA.

Write: RCA Solid State.
Box 3200, Somerville, N.J. 08876;
Ste. Anne de Bellevue 810, Canada;
Sunbury-on-Thames, U.K.;
Fuji Bldg., Tokyo, Japan.

RCA

Here is a designer's place high-volume, off-the-shelf

AVAILABLE NOW, OFF-THE-SHELF

A

Gates, Single-Level

CD4000A Dual 3-input NOR + inverter
 CD4001A Quad 2-input NOR
 CD4002A Dual 4-input NOR
 CD4011A Quad 2-input NAND
 CD4012A Dual 4-input NAND
 CD4023A Triple 3-input NAND
 CD4025A Triple 3-input NOR
 CD4068A 8-input NAND
 CD4078A 8-input NOR
 CD4071A Quad 2-input OR
 CD4072A Dual 4-input OR
 CD4073A Triple 3-input AND
 CD4075A Triple 3-input OR
 CD4081A Quad 2-input AND
 CD4082A Dual 4-input AND
 CD4007A Dual comp. pair + inverter
 CD4009A Hex buffer/converter (inverting)
 CD4010A Hex buffer/converter (non-inv.)
 CD4041A Quad true/complement buffer
 CD4049A Hex buffer/converter (inverting)
 CD4050A Hex buffer/converter (non-inv.)
 CD4069A Hex inverter

Gates, Multi-Level

CD4030A Quad exclusive-OR
 CD4070A Quad exclusive-OR
 CD4077A Quad exclusive-NOR

CD4037A Triple AND-OR bi-phase pairs
 CD4048A Expandable 8-input
 CD4085A Dual 2-wide 2-input (AOI)
 CD4086A Expandable 4-wide 2-input (AOI)
 CD4028A BCD-to-decimal decoder
 CD4514A 4-bit latch/4-to-16 line decoder
 CD4515A 4-bit latch/4-to-16 line decoder
 CD4532A 8-input priority encoder
 CD4555A Dual binary to 1-of-4 decoder/demultiplexer
 CD4556A Dual binary to 1-of-4 decoder/demultiplexer
 CD4093A Quad 2-input NAND Schmitt Trigger

Multivibrators

CD4013A Dual "D" flip-flop with set/reset
 CD4027A Dual J-K master-slave flip-flop
 CD4042A Quad clocked "D" latch
 CD4043A Quad 3-state NOR R/S latch
 CD4044A Quad 3-state NAND R/S latch
 CD4095A Gated J-K M-S flip-flop
 CD4096A Gated J-K M-S flip-flop
 CD4099A 8-bit addressable latch
 CD4047A Monostable/astable multivibrator

Registers

CD4006A 18-stage static shift
 CD4014A 8-stage static shift
 CD4015A Dual 4-stage static shift
 CD4021A 8-stage static shift

CD4031A 64-stage static shift
 CD4034A MSI 8-stage static shift
 CD4035A 4-stage parallel in/out shift
 CD4094A 8-stage shift-and-store bus
 CD4062A 200-stage dynamic shift
 CD4076A 4-bit D-Type w. 3-state outputs

Counters, Binary Ripple

CD4020A 14-stage
 CD4024A 7-stage
 CD4040A 12-stage
 CD4045A 21-stage
 CD4060A 14-stage w. oscillator

Counters, Synchronous

CD4017A Decade counter/divider
 CD4018A Presettable divide-by-N
 CD4022A Divide-by-8 counter/divider
 CD4029A Presettable up/down
 CD4059A Programmable divide-by-N
 CD4518A Dual BCD up counter
 CD4520A Dual binary up counter

Display Drivers

CD4026A Decade counter/divider
 CD4033A Decade counter/divider
 CD4054A 4-line for LCD
 CD4055A BCD-7-segment decoder/driver

B

Gates, Single-Level

CD4068B 8-input NAND
 CD4078B 8-input NOR
 CD4071B Quad 2-input OR
 CD4072B Dual 4-input OR
 CD4073B Triple 3-input AND
 CD4075B Triple 3-input OR
 CD4081B Quad 2-input AND
 CD4082B Dual 4-input AND
 CD4069B Hex inverter

Gates, Multi-Level

CD4070B Quad exclusive-OR
 CD4077B Quad exclusive-NOR
 CD4085B Dual 2-wide 2-input (AOI)
 CD4086B Expandable 4-wide 2-input (AOI)
 CD4514B 4-bit latch/4-to-16 line decoder
 CD4515B 4-bit latch/4-to-16 line decoder

CD4532B 8-input priority encoder
 CD4555B Dual binary to 1-of-4 decoder/demulti.
 CD4556B Dual binary to 1-of-4 decoder/demulti.
 CD4093B Quad 2-input NAND Schmitt Trigger

Multivibrators

CD4095B Gated J-K M-S flip-flop
 CD4096B Gated J-K M-S flip-flop
 CD4099B 8-bit addressable latch

Registers

CD4094B 8-stage shift-&-store bus
 CD4076B 4-bit D-Type register w. 3-state outputs

Counters

CD4518B Dual BCD up counter
 CD4520B Dual binary up counter

**High
Rel**

MIL-M-38510 types

CD4000A	CD4013A	CD4023A
CD4001A	CD4014A	CD4024A
CD4002A	CD4015A	CD4025A
CD4006A	CD4017A	CD4027A
CD4007A	CD4018A	CD4031A
CD4009A	CD4019A	CD4049A
CD4010A	CD4020A	CD4050A
CD4011A	CD4021A	
CD4012A	CD4022A	

MIL-STD-883 Slash (/) Series

CD4000A	CD4012A	CD4021A	CD4030A
CD4001A	CD4013A	CD4022A	CD4031A
CD4002A	CD4014A	CD4023A	CD4032A
CD4006A	CD4015A	CD4024A	CD4033A
CD4007A	CD4016A	CD4025A	CD4034A
CD4008A	CD4017A	CD4026A	CD4035A
CD4009A	CD4018A	CD4027A	CD4036A
CD4010A	CD4019A	CD4028A	CD4038A
CD4011A	CD4020A	CD4029A	CD4039A

Planning guide to help COS/MOS ICs.

OCT. 1975

CD4056A BCD-7-segment decoder/driver
CD4511A BCD to 7-segment latch decoder/driver

Multiplexers/Demultiplexers

CD4016A Quad bilateral switch
CD4019A Quad AND-OR select gate
CD4051A Single 8-channel multi
CD4052A Differential 4-chan. multi.
CD4053A Triple 2-chan. multi.
CD4066A Quad bilateral switch
CD4067A 16-chan. multi./demulti.
CD4097A Differential 8-chan. multi./demulti.
CD4046A Micropower phase-locked loop

Arithmetic Circuits

CD4008A 4-bit full adder w. parallel carry
CD4032A Triple serial adder (pos. logic)
CD4038A Triple serial adder (neg. logic)
CD4063A 4-bit magnitude comparator
CD4057A LSI 4-bit logic unit
CD4089A Binary rate multiplier

Memories

CD4036A 4-word x 8-bit RAM (binary addressing)
CD4039A 4-word x 8-bit RAM (word-line addressing)
CD4061A 256-word x 1-bit static RAM

TOTAL: 92 TYPES

Multiplexers/Demultiplexers

CD4016B Quad bilateral switch
CD4067B 16-chan. multi./demulti.
CD4097B Differential 8-chan. multi./demulti.
CD4063B 4-bit magnitude comparator
CD4089B Binary rate multiplier
CD4511B BCD to 7-segment latch decoder driver

TOTAL: 32 TYPES

CD4040A CD4049A CD4063B CD4081B
CD4041A CD4050A CD4066A CD4082B
CD4042A CD4051A CD4068B CD4085B
CD4043A CD4052A CD4069B CD4086B
CD4044A CD4053A CD4071B CD4514B
CD4045A CD4057A CD4072B CD4515B
CD4046A CD4060A CD4073B CD4518B
CD4047A CD4061A CD4075B CD4520B
CD4048A CD4062A CD4078B

TOTAL: 96 TYPES

Gates, Single-Level

CD4502A Strobed hex inverter/buffer
CD40107A Dual 2-input NAND buffer/driver
CD40109A Quad low-to-high voltage level shifter
CD4098A Dual monostable multivibrator
CD40104A 3-state 4-bit left/right static shift register
CD40194A 4-bit left/right static shift register
CD4510A 4-bit BCD up/down counter
CD4516A 4-bit binary up/down counter
CD40102A Presettable 8-bit BCD down counter
CD40103A Presettable 8-bit binary down counter
CD4527A BCD rate multiplier
CD40181A 4-bit arithmetic logic unit
CD40182A Look-ahead carry block
CD40101A 9-bit parity generator/checker

TOTAL: 106 TYPES

Gates

CD4001B Quad 2-input NOR gate
CD4011B Quad 2-input NAND gate
CD4009B Hex buffer/converter (inverting)
CD4010B Hex buffer/converter (non-inv.)
CD4049B Hex buffer/converter (inverting)
CD4050B Hex buffer/converter (non-inv.)
CD4502B Strobed hex inverter/buffer
CD40107B Dual 2-input NAND buffer/driver
CD40109B Quad low-to-high voltage level shifter
CD4098B Dual monostable multivibrator

Registers, Static Shift

CD40104B 3-state 4-bit left/right
CD40194B 4-bit left/right
CD40105B 16-word x 4-bit FIFO buffer

Counters

CD4510B 4-bit BCD up/down
CD4516B 4-bit binary up/down
CD40102B Presettable 8-bit BCD down
CD40103B Presettable 8-bit binary down

Display Drivers

CD4054B 4-line LCD driver
CD4055B BCD-7-segment decoder/driver
CD4056B BCD-7-segment decoder/driver

Multiplexers/Demultiplexers

CD4051B Single 8-channel multiplexer
CD4052B Differential 4-chan. multi.
CD4053B Triple 2-channel multiplexer

Arithmetic Circuits

CD4008B 4-bit full adder w. parallel carry
CD4527B BCD rate multiplier
CD40181B 4-bit arithmetic logic unit
CD40182B Look-ahead carry block

TOTAL: 58 TYPES

JAN. 1976

CD4508A Dual 4-bit latch
CD40100A 32-bit left/right static shift register
CD40192A 4-bit BCD up/down counter (dual clock)
CD40193A 4-bit binary up/down counter (dual clock)
CD40257A Quad AND-OR data selector w. 3-state outputs
CD40108A 4 x 4 multiport register

TOTAL: 112 TYPES

Gates

CD4000B Dual 3-input NOR + inverter
CD4002B Dual 4-input NOR
CD4012B Dual 4-input NAND
CD4023B Triple 3-input NAND
CD4025B Triple 3-input NOR
CD4041B Quad true/complement buffer

Multivibrators

CD4013B Dual 'D' flip-flop w. set/reset
CD4027B Dual J-K master-slave flip-flop
CD4042B Quad clocked 'D' latch
CD4043B Quad 3-state NOR R/S latch
CD4044B Quad 3-state NAND R/S latch
CD4508B Dual 4-bit latch

Registers

CD40100B 32-bit left/right static shift
CD40108B 4 x 4 multiport

Counters

CD40192B Synchronous 4-bit BCD up/down (dual clock)
CD40193B Synchronous 4-bit binary up/down (dual clock)
CD40257B Quad AND-OR data selector w. 3-state outputs
CD40101B Parity generator/checker

TOTAL: 76 TYPES

MIL-M-38510 types

CD4008A CD4016A
CD4042A CD4066A
CD4047A CD4051A
CD4030A CD4028A
CD4041A CD4061A
CD4029A CD4057A
CD4040A
CD4034A
CD4035A

MIL-STD-883 Series

CD4067B CD4095B
CD4070B CD4096B
CD4077B CD4099B
CD4089B CD4510B
CD4093B CD4516B
CD4094B CD4532B

TOTAL: 123 TYPES

with new performance features:

100% TESTED

to limit max.
quiescent current at
15 V (A types), 20 V (B types).

LOW LEAKAGE

1 μ A max. input
leakage at 15 V (A types),
20 V (B types)

HIGH NOISE MARGIN

1V noise margin
gives better protection
than TTL



If anybody can hand you the ready-made P/C connector you need,

we can.

That's because we have more of them on the shelf than anybody else we know. We have them from .050 contact centers through .156, from 6 to 210 contacts, with full bellows, semi-bellows and cantilever designs, with gold saving AuTac™ plating, low insertion force contacts, in micro miniatures, dual and single read-outs... and on and on and on.

We've been at this 23 years. And — because we don't compromise on quality

when we make our connectors — we don't like to see your P/C designs compromised by a make-do connector. So, we have a lot of them.

They're all cataloged in our latest 44-page brochure. Send for your free copy so you'll have it when you need it.

Or, if you need help right now, just pick up your phone and call Customer Service. (213) 341-4330.

Ok. Send me: Details on your line of P/C connectors.
 and, come to think of it, your low cost circular connectors, too.

Name _____

Title _____

Company _____

Address _____

City _____

State _____

Zip _____

 **Viking**
CONNECTORS

Viking Industries, Inc./21001 Nordhoff St./Chatsworth, Calif. 91311



Mini-Circuits' answer to holding down your costs of Double Balanced Mixers

Specify our model SRA-1...

1971 - \$7.95*

SRA-1 (in 500 quantities)



1972 - \$7.95*

SRA-1 (in 500 quantities)



1973 - \$7.95*

SRA-1 (in 500 quantities)



Mini-Circuits Laboratory, now the world's largest supplier of double-balanced mixers, guarantees to maintain its famed low-price structure throughout 1975 and 1976. \$7.95 (model SRA-1, 500 quantity). You, the design engineer, have made this offer possible. Your large volume orders, from over 500 companies throughout the world, have enabled us to purchase our components and packages at lowest possible costs with guaranteed delivery schedules from our vendors. And we think it's appropriate to pass these savings to you. Need fast delivery? One week or better is routine; for your emergency needs, 24-hour turnaround is possible.

Our history of quality and performance is unmatched. All our units are unconditionally guaranteed for 1 year. Every Mini-Circuits employee, from the president to the final test operator, is committed to excellence in performance and quality for every unit produced. For reliability, performance and quality more and more systems engineers are specifying Mini-Circuits mixers as the industry standard.

1974 - \$7.95*

SRA-1 (in 500 quantities)



1975 - \$7.95*

SRA-1 (in 500 quantities)



STILL ONLY \$7.95 IN 1976

SRA-1 (in 500 quantities)



*\$9.95 (1-49)

SRA Series

Frequency Range (MHz)	Conversion Loss (dB) Total Range	Isolation (dB)						Price (Quantity)
		Lower band edge to one decade higher		Mid range		Upper band edge to one octave lower		
		LO-RF	LO-IF	LO-RF	LO-IF	LO-RF	LO-IF	
SRA-1 LO-0.5-500 RF-0.5-500 IF-DC-500	6.5 typ. 8.5 max.	50 typ. 35 min.	45 typ. 30 min.	45 typ. 30 min.	40 typ. 25 min.	35 typ. 25 min.	30 typ. 20 min.	\$9.95 (1-49)
SRA1-1 LO-0.1-500 RF-0.1-500 IF-DC-500	6.5 typ. 8.5 max.	50 typ. 45 min.	45 typ. 30 min.	45 typ. 30 min.	40 typ. 25 min.	35 typ. 25 min.	30 typ. 20 min.	\$11.95 (6-49)
SRA-1W LO-1-750 RF-1-750 IF-DC-750	6.5 typ. 8.5 max.	50 typ. 45 min.	45 typ. 30 min.	45 typ. 30 min.	40 typ. 25 min.	35 typ. 25 min.	30 typ. 20 min.	\$14.95 (6-49)
SRA-2 LO-1-1000 RF-1-1000 IF-0.5-500	6.5 typ. 8.5 max.	45 typ. 30 min.	45 typ. 30 min.	35 typ. 20 min.	35 typ. 20 min.	30 typ. 20 min.	30 typ. 20 min.	\$24.95 (1-24)

Frequency Range (MHz)	Conversion Loss (dB) Total Range	Isolation (dB)						Price (Quantity)
		Lower band edge to one decade higher		Mid range		Upper band edge to one octave lower		
		LO-RF	LO-IF	LO-RF	LO-IF	LO-RF	LO-IF	
SRA-4 LO-5-1250 RF-5-1250 IF-0.5-500	6.5 typ. 8.5 max.	60 typ. 40 min.	50 typ. 40 min.	40 typ. 20 min.	40 typ. 20 min.	30 typ. 20 min.	30 typ. 20 min.	\$26.95 (1-24)
SRA-3 LO-0.025-200 RF-0.025-200 IF-DC-200	6.5 typ. 8.5 max.	60 typ. 50 min.	45 typ. 35 min.	45 typ. 35 min.	40 typ. 30 min.	35 typ. 25 min.	30 typ. 20 min.	\$12.90 (6-49)
SRA-6 LO-0.003-100 RF-0.003-100 IF-DC-100	6.5 typ. 8.5 max.	60 typ. 50 min.	60 typ. 45 min.	45 typ. 30 min.	40 typ. 25 min.	35 typ. 25 min.	30 typ. 20 min.	\$19.95 (5-24)
SRA-8 LO-0.005-10 RF-0.005-10 IF-DC-10	6.5 typ. 8.5 max.	60 typ. 50 min.	60 typ. 50 min.	50 typ. 40 min.	50 typ. 40 min.	45 typ. 35 min.	45 typ. 35 min.	\$24.95 (5-24)

Common specifications for all models

Signal: 1 dB compression level = 1 dBm

Impedance: all ports 50 Ohms

Phase detection DC offset = 1 mV typical

DC polarity = negative

For complete product specifications and U.S. Rep. listing see MicroWaves' "Product Data Directory," Electronic Design's "Gold Book" or Electronic Engineers Master "EEM"

Mini-Circuits Laboratory

A Division Scientific Components Corp.

837-843 Utica Avenue, Brooklyn, NY 11203

(212) 342-2500 Int'l Telex 620156 Domestic Telex 125460

Foreign Sales Representatives: AUSTRALIA General Electronic Services, 99 Alexander Street, New South Wales, Australia 2065; ENGLAND Dale Electronics, Dale House, Wharf Road, Frimley Green, Camberley Surrey; FRANCE S. C. I. E. - D. I. M. E. S., 31 Rue George - Sand, 91120 Palaiseau, France; GERMANY, AUSTRIA, SWITZERLAND Industrial Electronics GMBH, Klüberstrasse 14, 6000 Frankfurt/Main, Germany; ISRAEL Vectronics, Ltd., 69 Gordon Street, Tel-Aviv, Israel; JAPAN Densho Kaisha, Ltd., Eguchi Building, 8-1 1 Chome Hamamatsucho Minato-ku, Tokyo; EASTERN CANADA B. D. Hummel, 2224 Maynard Avenue, Utica, NY 13502 (315) 736-7821; NETHERLANDS, BELGIUM, LUXEMBOURG: Coimex, Veldweg II, Hattem, Holland.

US Distributors: NORTHERN CALIFORNIA Cain-White & Co., Foothill Office Center, 105 Fremont Avenue, Los Altos, CA 94022 (415) 948-6533; SOUTHERN CALIFORNIA, ARIZONA Crown Electronics, 11440 Collins Street, No. Hollywood, CA 91601 (213) 877-3550

For complete U.S. Rep listing and product line see MicroWaves' Product Data Directory

Washington Report

GAO questioning design-to-cost concept

The design-to-cost concept in the development of weapon systems is getting a hard look from the Government Accounting Office. For one thing, the GAO fears that too much attention to production costs could stifle engineering innovativeness, thus slowing breakthroughs.

Design-to-cost has been applied to 26 of 54 major weapon systems in the acquisition process, but none of these have been in production long enough to provide meaningful data for evaluation. In a recent progress review, the GAO asked such questions as whether the system acquisition costs had been reduced at the expense of higher operating and maintenance costs; whether design austerity, which could reduce a system's multimission and growth potential, would foster a proliferation of weapons to satisfy essentially similar needs; and whether the military services would attempt to reinstate through costly modification programs performance features discarded during development.

NASA planners reaching for the stars

Long-range planners at the National Aeronautics and Space Administration say that by the year 2000 or soon after, it may become possible to send a probe to a star. The study group made up of personnel from NASA centers and a representative from the Air Force, is consulting such organizations as the Electronic Industries Association for forecasts of technological capabilities and limitations. Although conclusions are still to come, the group's interim report says that while interstellar flight will require propulsion systems far beyond anything yet invented, a breakthrough shouldn't be discounted. One possibility is the creation and storage of antimatter.

Air Force aims to slash production costs

The Air Force is making a major effort to reduce production costs. Gen. Samuel C. Phillips, commander of the Air Force Systems Command, says his headquarters has been reorganized to focus on reducing plant overhead and eliminating unneeded production capability. The goal is to reduce the Air Force's overhead expenses by, first, 30% and eventually 50%. The Air Force is challenging industry to do the same.

Also planned is less dedication to the vertical approach to system acquisition, in which program managers are charged with responsibility for their programs from top to bottom.

"This is a very effective approach from the specific system standpoint,"

says General Phillips, "but it has brought a penalty: proliferation of equipment. We are going to reduce that penalty by placing more emphasis on 'across-systems standardization,' when it makes sense. This trend toward increased standardization will move us toward a matrix type management of the subsystem, training and support-equipment level."

In March, the Air Force Systems Command established an Avionics Advisory Board to advise program managers and the commander on avionics architecture and standardization. Yet to be named are similar boards for ground-support and aeronautical equipment.

Wider export of U.S. defense equipment sought

Legislation proposed by the Ford Administration would amend existing laws to permit the Defense Dept. to sell defense equipment to U.S. industry for assembly with other equipment and eventual foreign sales.

Leonard A. Alne, former director of foreign military sales for the department, recently told the Senate Subcommittee on Foreign Assistance that this authorization should be given to permit greater use of commercial channels. He cited the possible sale of 2000 F-16s overseas. Such purchases of the General Dynamics fighter, he noted, would create 900,000 jobs and generate tax receipts of over \$6-billion. The U.S. would recover about \$470-million spent on research and development and over \$9-billion in balance-of-payments receipts.

California finishes first in patent derby

California again leads the nation in patents granted to inventors. The Patent and Trademark Office has released the totals for 1974, and they show that Californians were awarded 7200 of the 80,839 patents issued. Residents of foreign countries received 26,514, with West Germans in the lead with 6243.

New York followed California, then Illinois, New Jersey, Pennsylvania and Ohio. After West Germany came Japan, Britain, France, Switzerland and Canada. On a per-capita basis, Delaware led with one patent for every 1095 residents; Mississippi was last, with one for every 24,232.

Capital Capsules: The National Science Foundation says that figures from 1970 and 1974 surveys of engineering employment show that the 1970-1974 period marked **one of the highest levels of unemployment for engineers and scientists in recent years.** The level in 1973 was close to that of the mid-sixties. . . . The Air Force says it is testing **a new infrared camera that promises to be a breakthrough in night-imaging technology.** Heart of the system is a silicon wafer the size of a 25-cent piece. A half-million sensing cells have been patterned in a two-dimensional mosaic on the wafer's surface. . . . **Research and development spending in the U.S. will be about \$34.3-billion this year,** says a recent National Science Foundation report. This would be some 7% above the total in 1974. Basic research will rise 2%, applied research 7% and development 8% under the projection. Basic research would account for 12% of the dollars; applied research, 23% and development, the remaining 65%. . . . The Air Force is **seeking a source to do environmental and power-stress tests at microwave frequencies** to determine the potential reliability and operating life of commercially available gallium-arsenide Schottky-barrier field-effect transistors.

Analog



Now they work together

The interaction of analog and digital in one Tektronix instrument package makes it all possible. This innovative concept gives you the best of both techniques and opens up new opportunities for measurements that wouldn't be feasible otherwise. The analog display allows you to interpret general trends and patterns and visually select points of interest. The digital capability quickly supplies you with precise values for the points you've chosen.

Here, for example, is a unique combination of oscilloscope, sample and hold dvm, counter/timer, and digital time and events delay in one interactive analog-digital measurement package. It's made up of the TEKTRONIX 7704A 250-MHz Oscilloscope, the 7D12M2 A/D Converter, the 7D15 225-MHz Counter Timer, the 7D11 Digital Delay Unit, and the 7B53A Dual Time Base.

With this instrument system, you can delay by the actual count of pulses to look at a desired logic train window without jitter or make selective interval measurements along asymmetric data trains. You can digitally measure pulse time delays, measure voltage amplitude at selected points, or count events in frequency burst patterns.

This instrument system is only one possible configuration of an oscilloscope mainframe and digital instrumentation. Many packages that combine analog and digital capabilities may be configured, from a selection of more than 30 instrumentation plug-ins, to suit specific applications.

The 7000 Series . . .
more than an oscilloscope.

Tektronix will be conducting seminars in several areas to acquaint you with the measurement potentials available with this analog-digital measurement technique. For a schedule of seminars in your area, contact your local Tektronix Field Engineer.

Tektronix, Inc., P.O. Box 500, Beaverton, Ore. 97077. In Europe, Tektronix Limited, P.O. Box 36, St. Peter Port, Guernsey, Channel Islands.



TEKTRONIX®
committed to
technical excellence

Now freedom from compromise is no big thing.

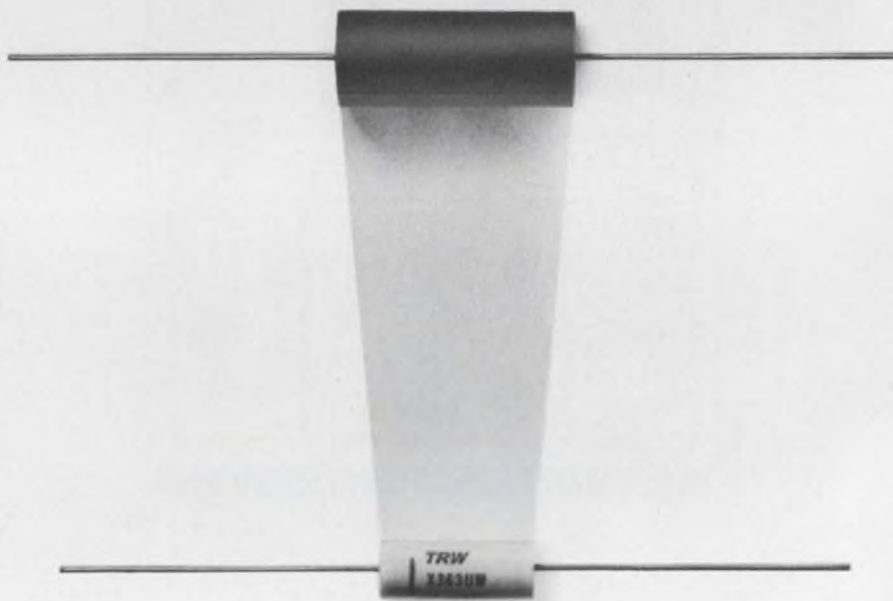

Introducing the metallized polypropylene
X363UW capacitor.

Now, circuit designers have a new freedom in applications where trade-offs were always necessary.

And, our new capacitor is no big thing. It's small where it should be, in physical size. But large in capabilities.

Capabilities such as low dielectric absorption (even better than polystyrene). Outstanding stability. High insulation resistance equal to polystyrene. And a low dissipation factor (High Q).

The result: the X363UW is an excellent all-purpose capacitor ideal for many applications including time base generators, integrators, filters and low level RF circuitry.

Tired of compromising? Tired of trade-offs? Write for complete specs. TRW Capacitors, an Electronic Components Division of TRW Inc., Box 1000, Ogallala, Neb. 69153.

TRW® CAPACITORS

Love

Of all the activities of man (and woman), love has got to rank right up at the top of the list for being one of the great things to do. In fact, if people spent more time in love and less time in some other activities, this might be a nicer planet. Now, I hope I've established the fact that I'm very much in favor of love. But not always.

Too many companies have taken terrible drubbings because somebody fell in love with a project that once looked beautiful. Though faithfulness to our loves may be a desirable quality in human affairs, it can be suicidal in business and engineering.

In the earlier days of our industry—before 1948—engineers used to design all their circuits around active devices called vacuum tubes, which were something like bottled field-effect transistors with filaments. Those things did just about everything a transistor could do. In those days there were engineers who were so much in love with the excellent vacuum-tube circuits they designed that they stuck with them, even when transistors were beginning to look pretty good. We don't see many of those circuits around today.

But that's ancient history. Nobody does anything like that today. No?

Surely not in your company, but in other companies you may find products that were designed several years ago that were going to have sensational futures that haven't happened yet. How many companies are still pumping money into products that simply don't sell? How many companies are still pumping engineering effort into products that people don't want? How many managers are still convinced that the only thing separating their failing products from spectacular success is a little further education of their potential customers? If only they could show the world how beautiful is their love.

Admirers of love stories can be deeply moved by people whose undying love remains ardent despite endless trial and tribulation. If I'm not mistaken, there may have been a few poems, operas, and novels written around this theme. In contrast, I don't think a single work of art has been inspired by the chap who ruthlessly cuts off a project when the payoff begins to look unlikely.

There is among us that type of man who will say: "I was wrong. This doesn't have the future I thought it would. If I allow it to continue it will drain away resources that could be used more profitably. It's no longer a beautiful idea. I'll kill it and cut my losses." That type of man will never earn a place in the ennobling works of art. But I'll put my money on him.



A handwritten signature in dark ink, which appears to read "George Rostky". The signature is written in a cursive, flowing style.

GEORGE ROSTKY
Editor-in-Chief

Bye bye, MSI.

Now there's a microprocessor that gives you the best of LSI. Without giving up any speed. Without having to fight your way around registers you can't get at and ALU functions that aren't there.

Introducing the Am2901.

The Am2901 is a microprogrammable four-bit central processor slice using Advanced Micro Devices' high-performance, low-power Schottky TTL process. It's the first and foremost member of the Am2900 Family, a series of large-scale, low-power Schottky circuits for computation, control, communication and storage in microprogrammed computers. The Am2900 Family combines the architectural and functional flexibility of MSI with the performance and cost advantages only possible with LSI. The circuits can be used to emulate existing hardware, so the software doesn't have to be changed; to build machines with specialized instruction sets; to construct high-performance processors with the entire program in efficient microcode.

Cycle-saving two-address architecture.

The Am2901 stores data in sixteen addressable working registers and an auxiliary register. The sixteen registers are arranged in a two-port RAM—two addresses are used to read data simultaneously from any two of the registers.

Two source operands for the arithmetic logic unit are selected from the two addressed registers, the auxiliary register, external data, or logic zero, providing a total of 203 unique pairs of source operands for every ALU function.

The most powerful bipolar microprocessor ever made.

The Am2901 includes a eight-function Arithmetic Logic Unit that performs addition, subtraction both ways and five logic functions on two source operands. It also does single operand functions like increment, complement and force zero. On every operation it provides all four status outputs—carry, overflow, zero and negative. The output of the ALU can be shifted left or right prior to storage; the auxiliary register can be shifted at the same time. In one cycle the Am2901 can perform this multiplication algorithm: Examine the LSB of the multiplier; if it's a 1, add the multiplicand to the partial product; shift the partial product down one place; shift the multiplier down one place.

The world's fastest TTL microprocessor.

The typical cycle time for a register-to-register read-modify-write is 100ns. No other microprocessor is close. And most other bipolar microprocessors only have single address architectures—that usually means two cycles to do what the Am2901 can do in one. (If you don't need speed, use an 8080; if

you do, then use the fastest microprocessor around—the Am2901.)

You can't afford to ignore it.

The Am2901 costs \$30 in quantities of 100. Now. And in case you've forgotten how prices go in the semiconductor industry, we've projected the Am2901 pricing over the next few years. But component cost isn't your only savings. Look at the additional benefits you get: fewer components and interconnections, smaller PC boards, less power consumption, and the improved reliability that goes with these. If MSI were free, the Am2901 would still be a bargain.

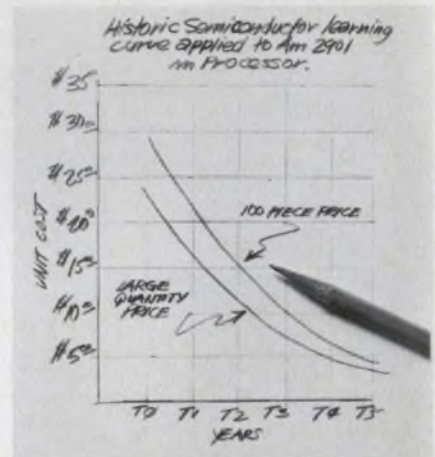

Write for more information.

The Am2901 is going to be the industry standard. It's too good to be anything else. Write, right now, for the whole story, and say bye bye to MSI.

Advanced Microprocessors



Advanced Micro Devices • 901 Thompson Place, Sunnyvale, California 94086 • Telephone (408) 732-2400 • Distributed nationally by Hamilton/Avnet, Cramer and Schweber Electronics.

INFORMATION RETRIEVAL NUMBER 22

9 instruction lines
- 512 instructions

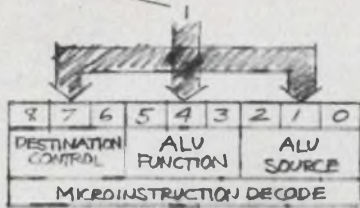

Left right shift independent of ALU

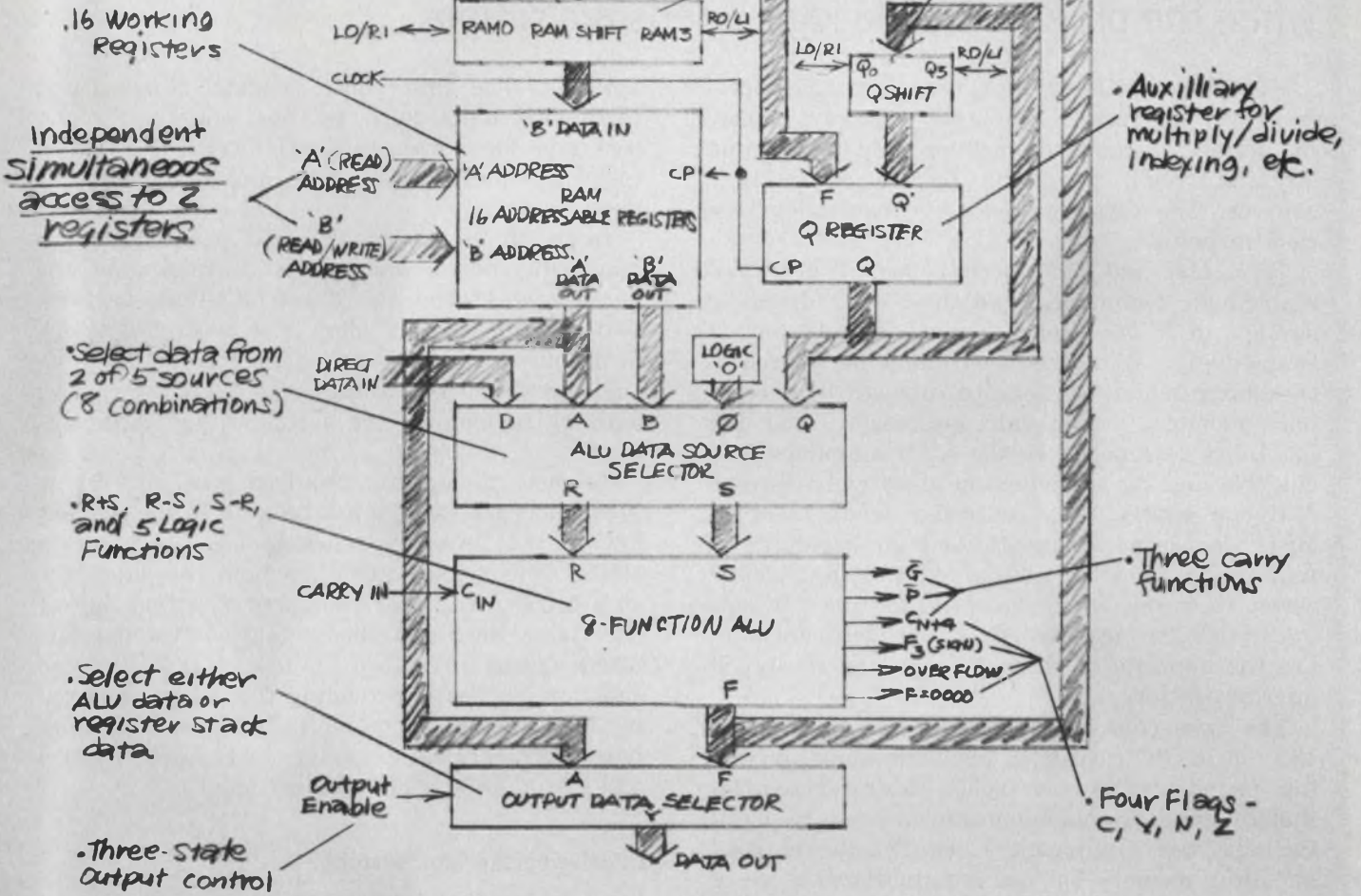

THE Am2901 4-BIT MICROPROCESSOR SLICE



Hello, LSI.

ED

Now that I've found you, I want to know everything about you. Send me The Am2900 Family data book.

Name _____

Company _____ Dept./MS _____

Address _____

City _____ State _____ Zip _____

Consider MSI for tape controllers. It's cheaper and more efficient than an LSI microprocessor when the programmable-logic needs are simple.

For some digital systems, use of an LSI microprocessor is overkill. You'll not only save money by going to standard medium-scale integration circuits; you'll have the benefit of multiple sources. The cassette-tape drive controller is a case in point.

Both LSI and MSI permit use of programmable-logic techniques, and these offer dramatic savings in IC costs when compared with conventional logic.¹ With the programmable approach, complex random logic can be replaced by a read-only memory and a microprocessor. And the flexibility obtained with the ROM simplifies field changes and the introduction of special features.

But a simple tape controller lends itself to MSI, because no arithmetic or logic capability is required beyond the ability to count and detect zeros. However, extensive status testing and output capability are needed. These characteristics are the opposite of those provided by most LSI microprocessors.

The tape controller can be built on a single 13 × 4-in. PC card with about 40 chips, including memory. (The controller design resembles that of the State Machine used in some Hewlett-Packard test equipment.²) The hardware cost, including memory but not the amortized price of the ROM mask, is just over \$65 for small quantities. The comparable cost for an LSI-microprocessor-based system would be over \$100.

Controllers cover a wide range

Programmable logic can be applied to a host of peripheral-device controllers. They may be as simple as a single interface with storage registers and a set of request-response lines. Or they can be highly sophisticated devices that perform complex sequences of operations and execute I/O programs with minimal CPU intervention.

In any case, the device controller consists basically of two logically distinct, but interacting, circuit blocks: a data network and a control

network. The first contains data storage and processing units, such as tape, counters, registers and logic operators. The control network physically positions the tape and supervises the data network.

Interaction between the two networks takes place via control and status terminals on the data network elements. These terminals perform two functions: They allow the control network to initiate operations—called microcommands—in the data network, and they also allow the control network to monitor the status of the data network.

To meet the control requirements, an LSI or MSI microprocessor must be able to do the following: (1) Assert or negate any combination of the control lines, and then hold this state for an arbitrary length of time, and (2) Test any of the status lines and choose one of two possible operations as a result of the test. A third, related function, is that of providing the delays required by the process being controlled. For minicomputer peripherals, the number of required control and status lines is manageably small.

Interfacing the tape system

In the tape system's block diagram, three motors control tape positioning (Fig. 1). The motors and associated servos drive the capstan, supply reel and take-up reel. The capstan servo moves tape past the read/write head in either direction at one of two constant speeds. And the reel servos provide the correct torques to maintain proper tension and prevent tape slackening or stretching.

The correct torques depend on the speed and direction of tape motion and on whether the motion is changing or in steady state. The requirements, however, are satisfied by a small number of discrete torque values that may be commanded digitally. In addition other commands accomplish the following: move tape at very high speed to clear leader at either end; move the read/write head into or out of contact with the tape; eject the cassette by opening a loader door.

The block labeled "read/write logic" transfers

Kenneth G. Bartlett, Senior Engineer, Advanced Technology Div., Ampex Corp., 1020 Kifer Rd., Sunnyvale, CA 94086.

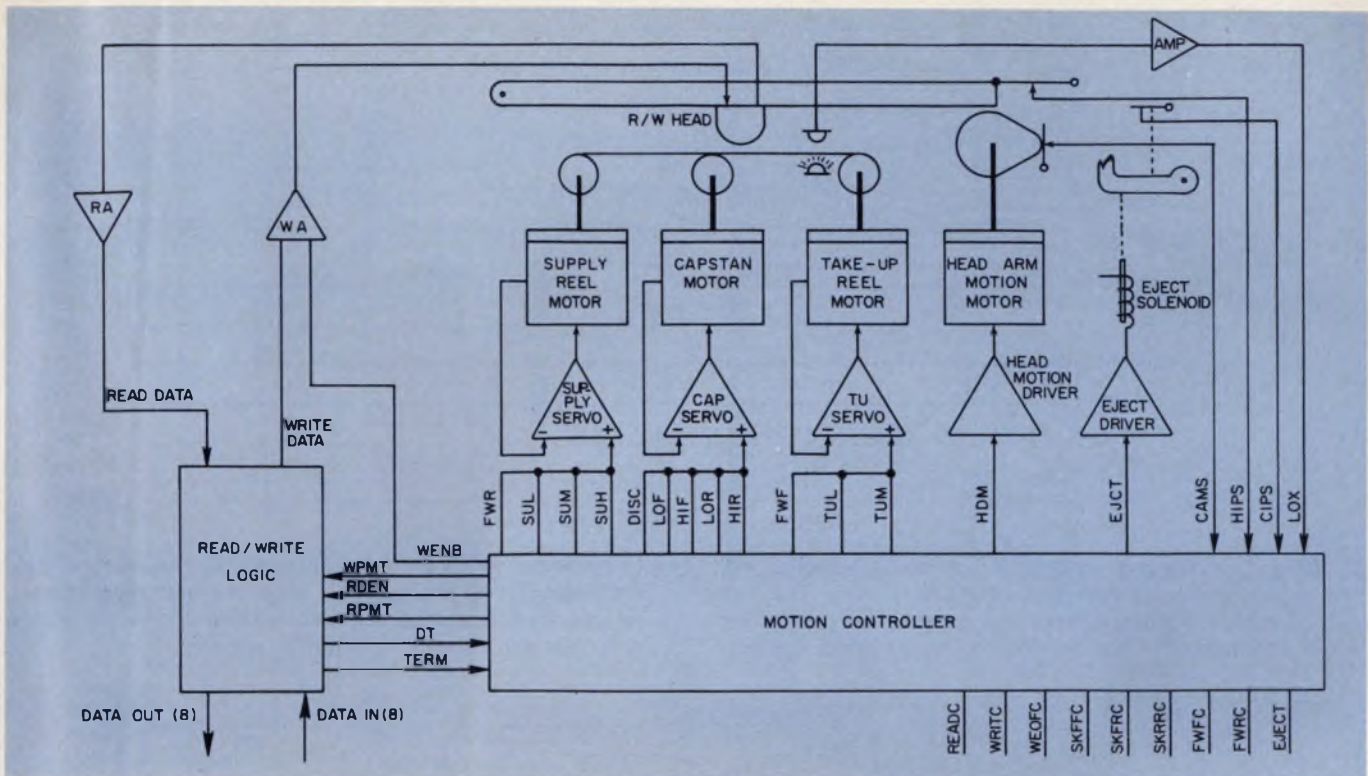

1. A cassette-tape drive system uses a programmable controller consisting of read-only memory and an MSI-

based microcontroller. Mnemonic codes shown on various lines are defined in Table 1.

Table 1. Command and status signals

COMMANDS	
Mnemonic	Signal Description
SUL	Supply Reel—Low Torque
SUM	Supply Reel—Medium Torque
SUH	Supply Reel—High Torque
TUL	Take-up Reel—Low Torque
TUM	Take-up Reel—Medium Torque
LOF	Capstan Drive—Low Speed Forward
HIF	Capstan Drive—High Speed Forward
LOR	Capstan Drive—Low Speed Reverse
HIR	Capstan Drive—High Speed Reverse
DISC	Disconnect Capstan Drive
FWF	Fastwind Forward
FWR	Fastwind Reverse
HDM	Move Head Arm
EJCT	Open Loader Door (Eject Cassette)
WENB	Write Enable (Current in Write Head)
WPMT	Write Permit (Transfer Data to Tape)
RDEN	Read Enable (Turn Read Amplifier On)
RBMT	Read Permit (Transfer Data to Tape)
STATUS LINES	
Mnemonic	Signal Description
READC	Read Command Latch
WRITC	Write Command Latch
WEOF	Write End-of-File Command Latch
SKFFC	Skip One File Forward Command Latch
SKFRC	Skip One File Reverse Command Latch
SKRRC	Skip One Record Reverse Command Latch
FWFC	Fastwind Forward Command Latch
REW	Rewind Command Latch
EJECT	Eject Command Latch
LOX	Leader Tape Sensor
CIPS	Cassette in Place Switch
HIPS	Head in Place Switch
CAMS	Head Arm Motion Cam Switch
DT	Data Being Read from Tape
TERM	Terminate Writing of Record
DTOX	DT or LOX
TZDT	DT or TIMER=0

data in either direction. In the write mode, 8-bit parallel characters, transferred from the computer to the tape unit, are converted to serial form and encoded for writing on a single track of the tape. In reading—the reverse operation—data are read serially off the tape, decoded and formed into 8-bit characters. These are then presented in parallel form to the computer.

The controller supervises read and write operations only broadly. A more detailed control would require the controller to have facilities for active storage, shifting and interrupt. And these would add significantly to the cost and complexity of the controller without a corresponding reduction in read/write logic.

For this reason, only two signals provide control for read or write operations. An Enable signal sets up the appropriate operation, while a Permit signal allows actual data transfer between tape unit and computer.

Table 1 lists all of the command lines that the controller can activate and the status lines that the controller can test. The computer can command the tape system to perform these eight operations:

1. Read One Record.
2. Write One Record.
3. Write End-of-File Marker.
4. Space Forward One File.
5. Space Backward One File.
6. Space Backward One Record.
7. Fast Wind Forward.
8. Fast Wind Reverse (Rewind).

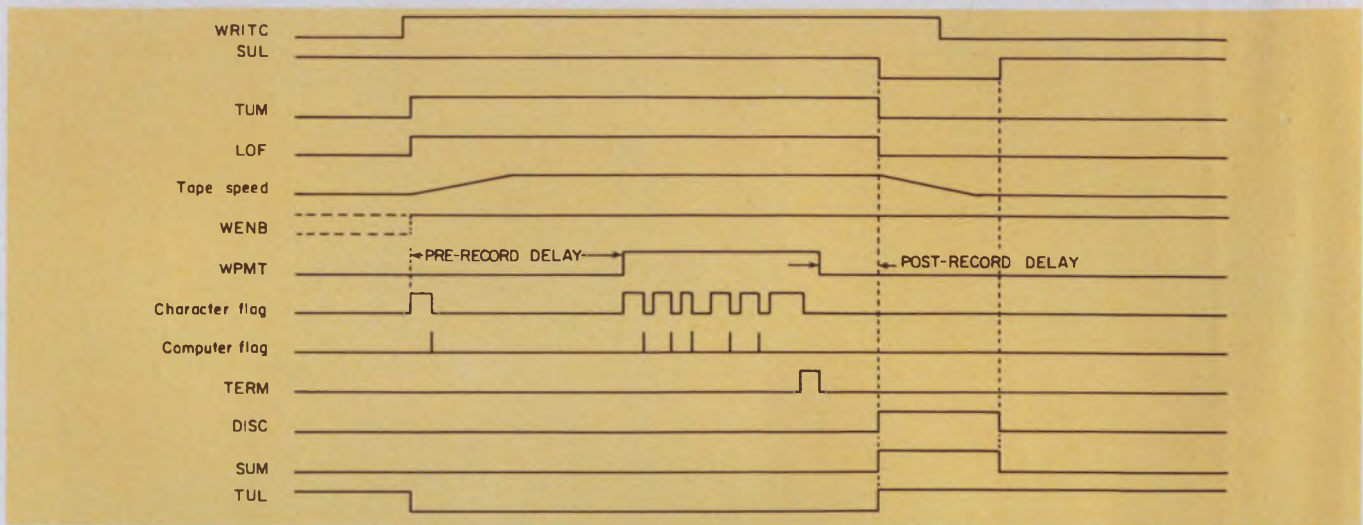

2. Write One Record—a typical command—begins with the tape initially at rest (tape torque is low). The first set of raised signals causes the tape to be moved forward and erased. This pre-record delay allows the tape

to come up to speed and generates an interrecord gap. With the raising of Computer Flag, the first data character transfers from the computer to the controller, where it is held temporarily in a buffer register.

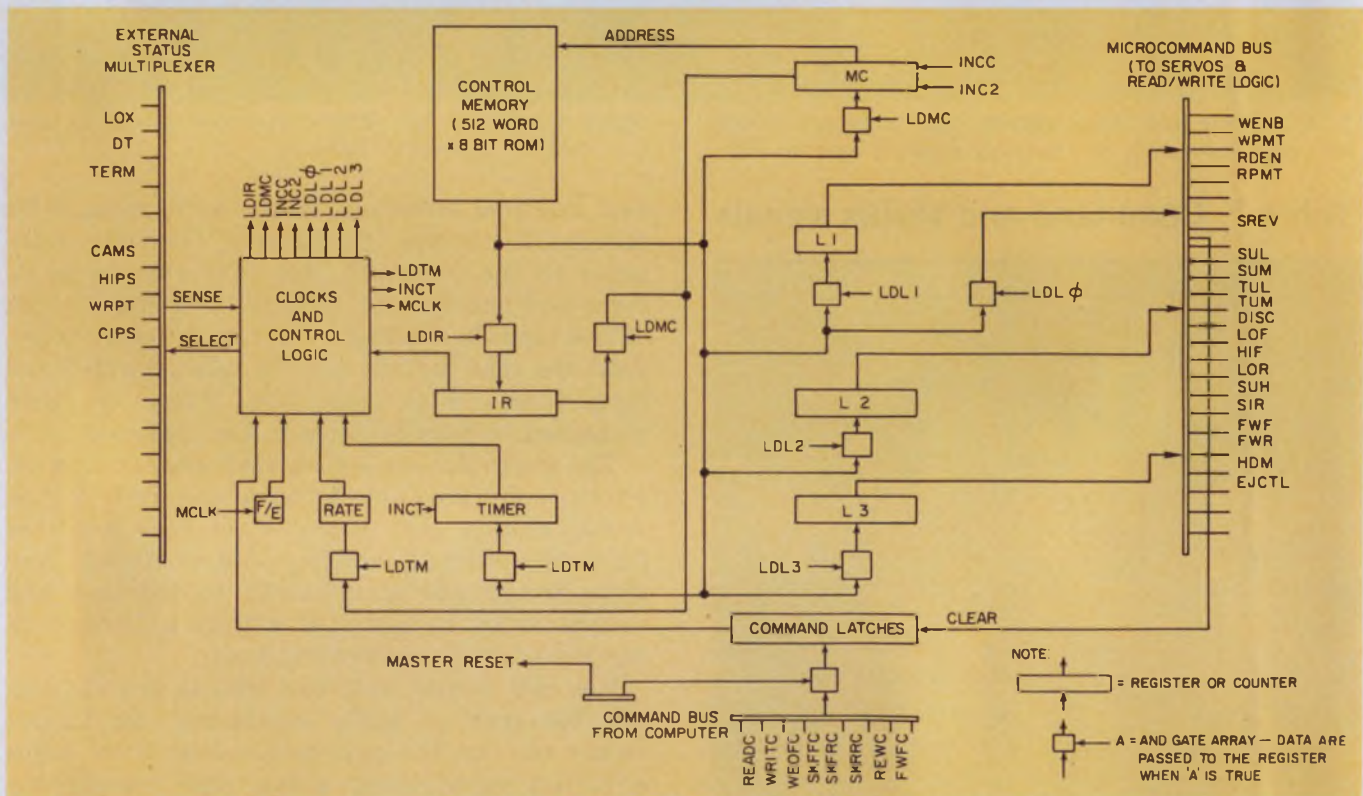

3. The major elements of the controller are a 512 × 8-bit memory, clock and control logic, and various counters

and registers. The latter are all 8 bits long, except for register L₁, which has a 4-bit length.

Fast wind operations 7 and 8 may cause the cassette to be ejected at the completion of the operation. And other operations, not listed, may be implemented by firmware changes. As defined by most magnetic-tape users, a *record* is a contiguous collection of characters terminated by an interrecord gap. And a *file* is a collection of records terminated by a longer gap and a file-mark character.

The timing diagram of one operation, Write

One Record, appears in Fig. 2.

The controller doesn't require complex architecture (Fig. 3). The control program memory, a 512 × 8-bit MOS ROM, is addressed by the 9-bit address counter, MC. Instructions fetched from memory are loaded into instruction register IR and then decoded and executed. Registers L₁, L₂ and L₃ latch the microcommands. Delays can be generated by the use of the 8-bit counter labeled Timer. One of three preset rates may be

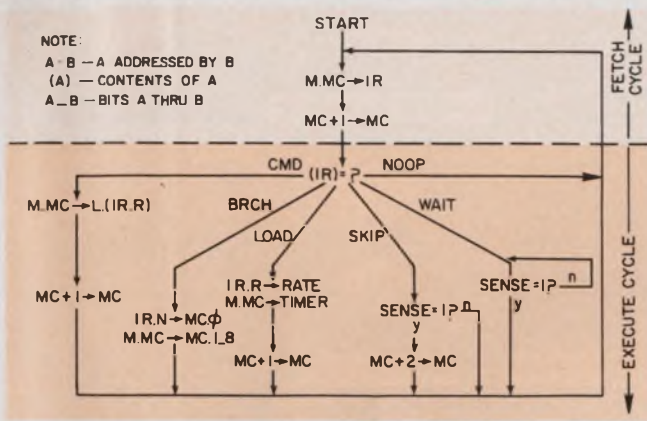

4. In the execution of an instruction, the contents of memory location M, addressed by counter MC, are loaded into instruction register IR. Then the register's contents are decoded, and the diagram branches according to instruction. All instructions are fetched in one clock time, and all except WAIT are executed in the next clock time.

selected when the appropriate code is set into the 2-bit register labeled Rate.

Executing instructions

Table 2 lists the instructions that the controller can execute, and Fig. 4 shows the processor state diagram,³ which indicates how the instructions are executed. There are only two basic states: (1) FETCH, in which the contents of the location currently addressed enter IR and MC increments to the next address, and (2) EXECUTE, in which the contents of IR are decoded and executed. Some instructions use the byte following the instruction as an argument. Then MC also increments during the execute state.

Table 2 also indicates the formats of the various commands, all of which have a tag, or parameter field, of from 1 to 6 bits. In operation, a CMD command loads the microcommand registers. The tag, consisting of 2 bits, indicates which of three 8-bit registers is to be loaded with the pattern in the next successive ROM address. If the tag is 00, no register is loaded, but pulses generated on command lines correspond to ONEs in the pattern byte.

The LOAD command, which affects the time-delay counter, has a 2-bit tag indicating the rate at which the timer is to be counted down. The next successive byte gives the number of counts needed to time the required interval. A value other than zero in the Rate register causes one of three oscillators to pulse the timer counter. When the value reaches zero, the last pulse clears the Rate register, thus removing the clock pulses and stopping the counter. The condition $TIMER = 0$ can then be sensed by another controller command.

The command BRCH changes the sequence in

Table 2. Summary of instructions

Mnemonic	IR								Instruction
	7	6	5	4	3	2	1	0	
NOP	0	0	0	0	0	0	0	0	No Operation
BRCH	0	0	0	1	x	x	x	N	Branch to (NEXT) ≠ N
LOAD	0	0	1	0	x	x	R	R	Load the TIMER with (NEXT) and begin counting it down at the rate specified by RR
	0	0	1	1	x	x	x	x	Not used
CMD	0	1	x	x	x	x	R	R	Load (NEXT) into the Command Register specified by RR
WAIT	1	0	S	C	C	C	C	C	Halt execution until the condition specified by CCCCC has the truth value specified by S
SKIP	1	1	S	C	C	C	C	C	Skip the next two successive bytes if the condition specified by CCCCC has the truth value specified by S

Note: NEXT
 ≠ Next successive memory location
 Concatenated with

which instructions are executed. The command has a 1-bit tag, which is the least-significant bit of the address to be branched to. The most significant eight bits of the address are contained in the next successive byte from the read-only memory.

Checking status

Status testing can be performed by either the SKIP or WAIT commands. If SKIP is executed and the specified condition is met, the next two bytes in the program memory are skipped. If WAIT is executed, operation of the controller is suspended until the specified condition is met. The command's 6-bit tag specifies this condition by selecting one of 32 status lines and indicating whether the line is to be at a high or low logic level.

In the cassette-tape drive controller, nine of the status lines test controller command latches. A tenth line tests the timer for a count of zero. Fifteen lines sense various tape conditions (as indicated in Table 1), and eight are unused. An unconditional skip or a halt may be implemented by specification of an unused status code with SKIP or WAIT, respectively.

Controller commands begin when one or more input lines and the strobe are activated. The strobe enters the state of the command lines into the command latches and resets address counter MC to zero. The program proceeds from there to test the command latches, and it branches to the routine that can execute the command.

Fig. 5 shows a flow chart of the initial scanning loop and another for the operation Write One Record. The latter flow chart assumes that the tape has a speed of 10 in. per sec.

The only software support really required is

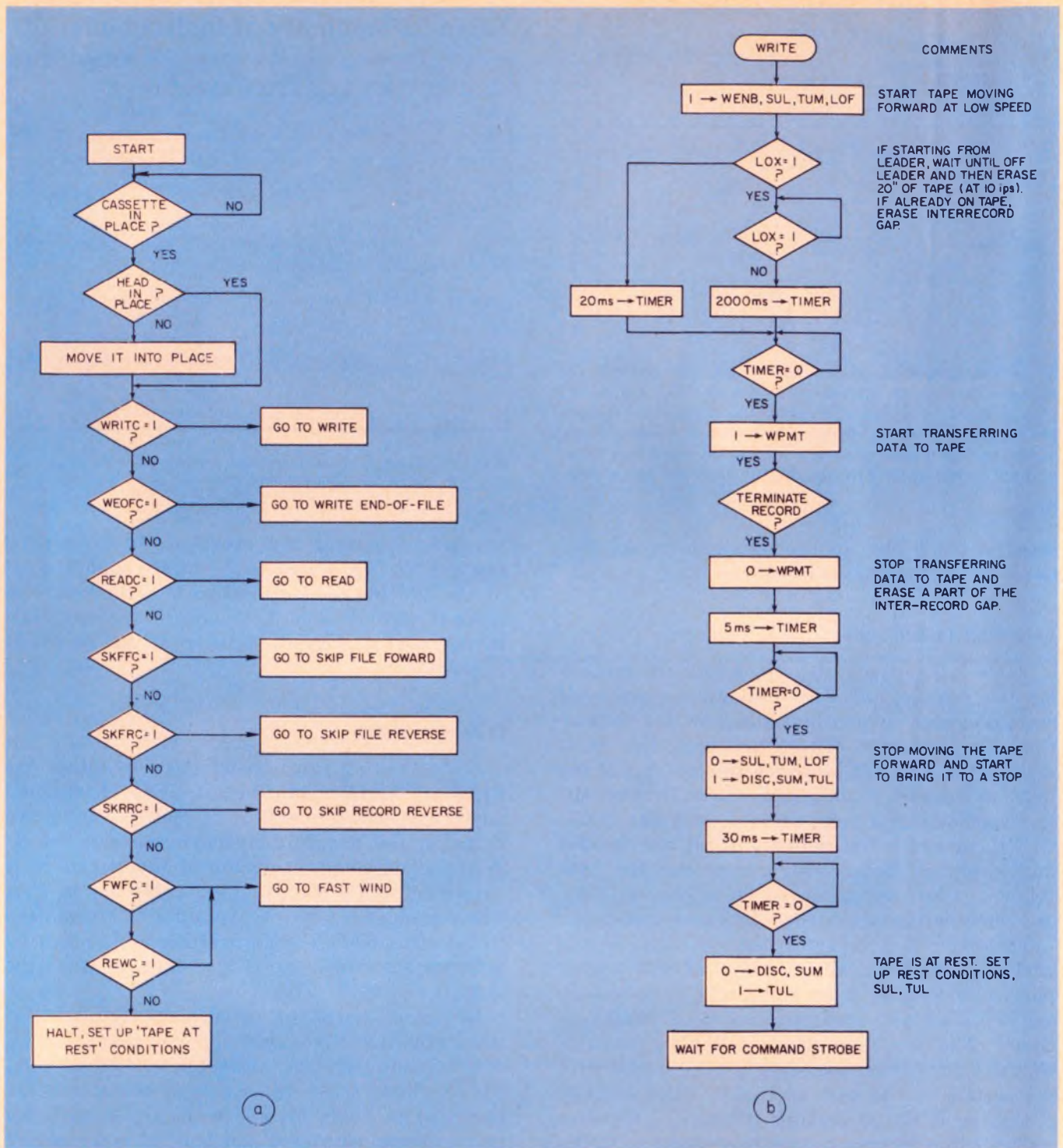

5. A command scanning routine determines which command to execute (a). It checks the conditions necessary to execute any command and then tests the command

latches. When one is found set, the routine performs the corresponding operation. The flow chart for Write One Record assumes a tape speed of 10 in. per sec. (b).

an assembler for control-memory contents. It must be able to generate input data for a PROM programmer, memory simulator or the ROM-mask generator.

The assembler for the tape controller was written in PL/1 and run on an IBM 370/158 at a local service bureau. It required about six weeks of part-time effort and cost about \$75 in computer time and related charges to develop.

Typically computer costs are about \$1.50 per run. ■■

References

1. "Design of Microprogrammable Systems," Signetics Memory Systems Application Note SMS 0052 AN, December, 1970.
2. Felsenstein, Roland E., "The 5345A Processor: An Example of State Machine Design," *Hewlett-Packard Journal*, June, 1974.
3. Bell, G. and Newell, A., "Computer Structures," McGraw-Hill, 1971, p. 28.

How to strike up an instant conversation with your favorite Microcomputer

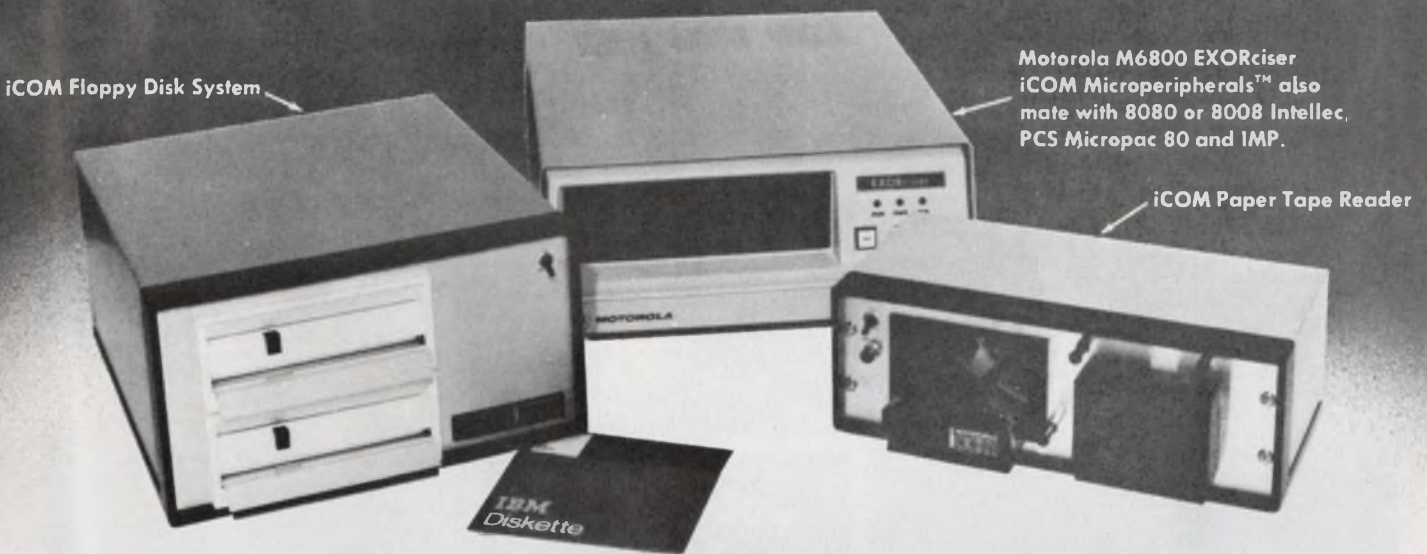

First

Unpack an iCOM Microperipheral™. Either the Floppy Disk System or Paper Tape Reader.

Second

Plug it into your 8080 or 8008 Intellec, M6800 EXORciser, PCS Micropac 80 or IMP.

Third

Start conversing!

A complete, ready to go system

Let's face it. A lot of peripheral makers are trying to jump on the microcomputer bandwagon by advertising floppy disks and tape readers. We say "customer beware!" Mostly, these are warmed-over products that might take you weeks to interface to your particular microcomputer.

Not so with iCOM. We've been delivering floppy disk systems for microcomputers since September, 1974. Our floppy disks and paper tape readers are 100% software & hardware compatible with 8080 or 8008 Intellec, M6800 EXORciser, PCS Micropac 80 and IMP. They're ready to go.

The minute you connect an iCOM floppy disk system to your microcomputer, you're conversant. Immediately, you can do disk to disk edits, disk to disk assemblies, program load and go, program merge, disk to paper tape, paper tape to disk, etc.

Floppy Disk. Just \$1840.*

Our floppy disk system speeds up microcomputer program development like an electronic calculator speeds up accounting. You can assemble a program in 30 seconds compared to 2½ hours on a teletype. Simple too. Our software — FDOS, Assembler and Editor is on an IBM Diskette so there's no media conversion to worry about.

People ask why we don't offer cassettes. We may eventually, but floppies are just as cheap, must faster and offer random access. We think it's the best approach to microcomputer programming.

**Small OEM quantities*

Paper Tape Reader. Only \$895.

If you don't need the speed of a floppy disk, our paper tape reader is the next best bet. Priced at only \$895, it operates at speeds up to 250 cps. Which means you can load programs 25 times faster than using a TTY.

Again, pin compatible interfaces for your microprocessor are standard.

Just plug in and run!

How About You?

Lots of people are buying our Microperipherals™. How about you? If you want to strike up an instant conversation with your microcomputer, give us a call. Or if you'd like to see literature first, just circle the reader card. Either way, you'll find out what iCOM Microperipherals™ can do for your microcomputer.

MICROPERIPHERALS™
iCOM

6741 VAREL AVENUE
CANOGA PARK, CALIFORNIA 91303
(213) 348-1391

Put 6 volts into a matchbox and get 10,000 out?



**It wasn't easy
(but we did it)**

We'll take on just about any power supply job. Especially the kind we can sink our teeth into. The tougher, the better — even jobs other companies don't want. Like building a matchbox-size power supply to convert a 6V input to a 10KV output.

From high-volume, low cost commercial to highly sophisticated, ultra-dependable military power supplies. From high-voltage to low-voltage, high power to low power.

Give us the specs for the supply you need and we'll design it, build it, test it; freeze it, heat it, test it; we'll shake it, kick it, test it... We'll build you the power supply you want, from start to finish. And it will work... and work... and work.

Our power supplies are matchless.



NCR

NCR Corporation

Scott Electronics Division 2525 Shader Road
P.O. Box 7637 Orlando, Florida 32804 (305) 295-5850

How to order a Card-Pak.



When we say we can ship Card-Pak instantly, you can see from our picture why. Each of those boxes contains a knocked down Card-Pak assembly, ready to go. And this is only one of our stockrooms for Card-Pak.

To order one or all of our Card-Paks, just dial (714) 835-6000 collect.

But why should you want what we've so obviously got so much of?

Because Card-Pak is the newest circuit card filing system on the market. And, we modestly think, the best.

It will take up to 56 cards in 19 inches of width. It will take any card between 2x4 and 8x9 inches. It will space those cards any way you like

And why.

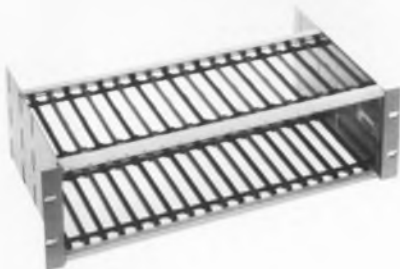

from 3/10 inch up (in .05 inch increments).

It offers a variety of tier arrangements and sizes. As well as versatile provision for connectors. And card handles, card ejectors, and an assortment of identification techniques.

Card-Pak is not cheaply made. It uses parts of precision-molded Noryl, anodized aluminum end plates, and extruded aluminum rails.

And last but not least you can put most Card-Paks together with eight screws. You furnish the screwdriver, we furnish the screws.

We alertly await your call.

EECO FOR PACKAGING

1441 East Chestnut Avenue, Santa Ana, California 92701
Phone 714/835-6000

Also available from G. S. Marshall nationwide.

Look who just tied the knot.

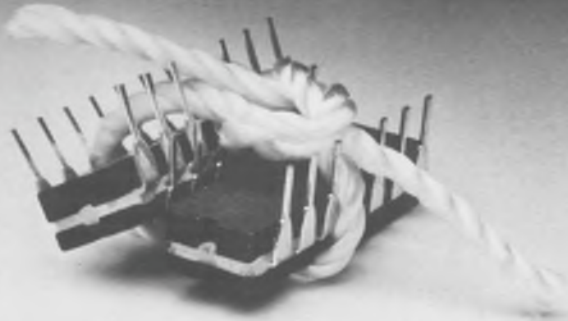

The 54C/74C and the 4000 series

Actually, it's no great surprise. The 54C/74C and the 4000 series logic families have always been electrically compatible and now many of the functions are even pin-compatible, so you can marry them in your very own system without worrying about a family feud. You'll find mixing these two CMOS series beneficial to you in many ways. First, you'll have more available functions to choose from. So your chances of finding the right one are better. This will minimize the number of CMOS devices you need to implement the logic. And second, you can take advantage of the best personality traits of each series to optimize your system's performance. Key

features such as higher guaranteed noise margin. Greater output drive. And higher speed of specific CMOS functions.

When you're ready to tie the CMOS knot in your system, Harris can help you perform the ceremony. Harris CMOS devices are fully compatible with others in the industry and will perform in your present system without modification. And you can get immediate delivery of both logic families from your Harris Distributor.

For more information on how we can make the CMOS marriage work for you, call our CMOS Application Hot Line at 800-327-8934. Your systems will live happily ever after.

DEVICE	OUTPUT SINK CURRENT	MINIMUM
4102A	$I_{OL}(V_{OL} = 0.5V)$	0.06 ma
4042A	$I_{DN}(V_{OL} = 0.5V)$	0.20 ma
4001A	$I_{OL}(V_{OL} = 0.4V)$	0.30 ma
All 54C/74C	$I_O(V_{OL} = 0.4V)$	0.36 ma
4071B	$I_{DN}(V_{OL} = 0.4V)$	0.40 ma

This illustrates some of the variations in output drive current specified in the 4000 series, and how the 54C/74C fits within the range.

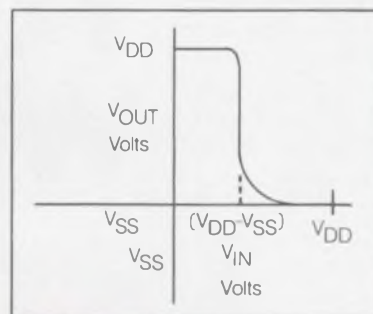

This CMOS transfer characteristic for single level gate functions is for all CMOS logic families. It is the commonality of this characteristic which is the basis of CMOS inter-family compatibility.



P.O. Box 883, Melbourne, Florida 32901 (305) 727-5430

WHERE TO BUY THEM: OEM SALES OFFICES: ARIZONA: Scottsdale, (602) 946-3556 CALIFORNIA: Long Beach, (213) 426-7687; Palo Alto, (415) 964-6443 FLORIDA: Melbourne, (305) 727-5826 ILLINOIS: Hinsdale, (312) 325-4242 MASSACHUSETTS: Wellesley Hills, (617) 237-5430 MINNESOTA: Minneapolis, (612) 835-2505 NEW YORK: Endwell, (607) 754-5464; Melville, L.I., (516) 249-4500 OHIO: Dayton, (513) 226-0636 PENNSYLVANIA: Wayne, (215) 687-6680 TEXAS: Richardson, (214) 231-9031.

SALES REPRESENTATIVES: CALIFORNIA: San Diego, (714) 565-9444 COLORADO: Denver, (303) 771-4920 FLORIDA: Oviedo, (305) 365-3283 KANSAS: Olathe, (913) 782-1177 MARYLAND: Randallstown, (301) 922-1248 MICHIGAN: Bloomfield Hills, (313) 642-0203 MISSOURI: Hazelwood, (314) 731-5200 NEW YORK: Albany, (518) 489-7408 or 4777 NORTH CAROLINA: Raleigh, (919) 828-0575 OREGON: Beaverton, (503) 643-1644 TENNESSEE: Shelbyville, (615) 684-4544 UTAH: Salt Lake City, (801) 268-3533 VIRGINIA: Falls Church, (703) 534-1673; Troutville, (703) 345-3283; Virginia Beach, (804) 481-7200 WASHINGTON: Bellevue, (206) 454-0300.

DELAY BY EVENTS, STABLE DISPLAYS, AND EASY-TO-USE CONTROLS: HOW DO YOU GET ALL THIS IN AN INEXPENSIVE LABORATORY OSCILLOSCOPE WITH DELAYING CAPABILITY?

The TEKTRONIX 5B31 Digitally Delaying Time Base has a delay-by-events mode in addition to delay by time (up to 99,999 μ s in 1- μ s increments). In the delay-by-events mode, you can synchronize the delay to a specific event and then trigger the sweep up to 99,999 events later.

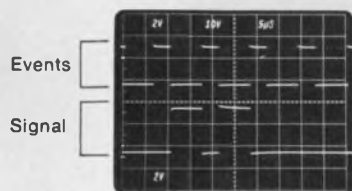

The 5B31 has a digital delay system—a crystal-controlled clock, a digital counter, and a circuit that eliminates 1-count ambiguity—that introduces no more than 20 ns of jitter at any sweep speed. So the 5B31 will have little effect on the stability of your display, even at very high sweep speeds.

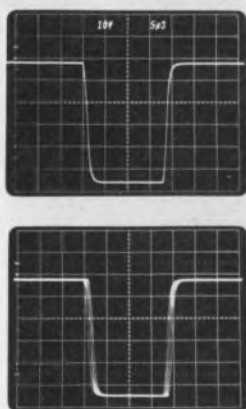

The 5B31 has easy-to-use controls: thumbwheels and pushbuttons instead of dials. You can set and read out the

delay from the 5-digit thumbwheel to the nearest μ s or event, select the delay mode by pushing the μ s or events button, and trigger at the beginning of the delay by pushing the DLY'D button.



Then you can study any portion of the waveform in detail by adjusting the thumbwheels and increasing the sweep speed.

You can choose a 5400-Series laboratory oscilloscope with this digital delaying capability for less than \$2000. This oscilloscope system gives you the basic performance and capability you need now and the potential to expand for your future measurement needs.



How can we offer you this flexibility? The 5400-Series, a comprehensive group of plug-ins and store and non-store mainframes, can be combined to make up just the right oscilloscope measurement system for you.

We'd like to help you select the right system for your needs. Let us send you all the technical details on the 5400-Series Oscilloscopes and the 5B31 Digitally Delaying Time Base. Write Tektronix, Inc., P.O. Box 500, Beaverton, Oregon 97077. In Europe write Tektronix Limited, P.O. Box 36, St. Peter Port, Guernsey, Channel Islands. For a demonstration, contact your nearest Tektronix Field Office. U.S. Sales Prices F.O.B. Beaverton, Oregon.

DIGITAL DELAY/ANOTHER 5000-SERIES SYSTEM.



TEKTRONIX®
committed to technical excellence

OUR NEW DIGITALLY DELAYING TIME BASE

INFORMATION RETRIEVAL NUMBER 25

FOR DEMONSTRATION, CIRCLE 202

Catch missing codes in a/d converters, as well as nonmonotonic operation and other errors. Here's how to design a dynamic test circuit and jitterless display.

How can the user of a/d converters measure the performance of a high-speed or high-resolution unit in an accurate, fast and inexpensive way? A good design combines both high-accuracy dc measurements and a jitter-free graphic display, while it operates in a fast dynamic mode.

And the unit can test and calibrate high-speed converters to exacting specifications, regardless of the input voltage range or the resolution of the converter.

As a user quickly learns, many converter manufacturers do not perform sufficiently detailed production and QA tests to ensure conformance to catalog specifications. The debugging of a system with one bad converter can cost the user more than the acceptance-testing of hundreds of units. With an n-bit converter, there are 2^n discrete points on the transfer characteristic to worry about—4096 points in a 12-bit unit. Measurement at every point is almost never practical.

Some of the larger converter manufacturers use highly automated techniques to spot-check and predict over-all performance from the limited data. But most automated methods are too expensive for a converter user. And automatic testers can miss important errors.

Automatic testers miss a/d errors

Thus even the most elaborate tester in use today can overlook such converter performance anomalies as narrow or wide code steps, jittery transitions caused by converter noise, points of alternation between codes, missing codes and nonmonotonicity—a reversal in the direction of the transfer characteristic. For some time, the practice has been to detect these errors with a graphic display. But conventional instrumentation to do this is awkward to set up and is often tailored for one voltage range or a limited converter resolution.

In a commonly used a/d test configuration, the

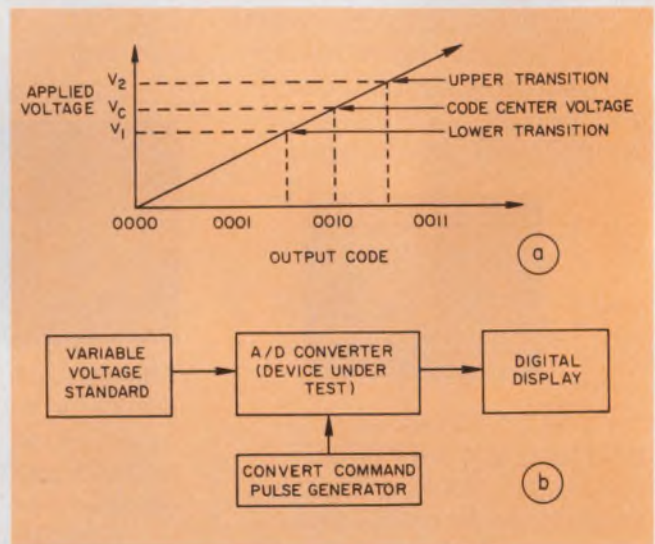

1. To check an a/d-converter's static transfer function—output codes vs input levels (a)—the user varies the input voltage and looks at the displayed code (b). Such a test provides limited performance data, however.

circuit verifies, bit-by-bit, the transfer-function parameters of a converter (Fig. 1a). To do this, the user dials in a voltage and checks that the right code is displayed. However, the information obtained is limited.

Thus the user sets a voltage, V , and gets a code, say 0010. But he doesn't know how close V is to V_1 or V_2 , the voltages at which transitions to adjacent codes occur (Fig. 1b). This corresponds to a full least-significant-bit uncertainty.

If the voltage standard is ultra-linear, has a secondary-standard absolute accuracy and is of higher resolution than the converter under test, it is possible to measure accurately V_1 and V_2 , the points of transition to adjacent codes. The average of V_1 and V_2 then can be computed as the code center for 0010 and compared with the theoretical value.

Some test personnel become quite proficient at measuring transition voltages. But, at best, such a test takes a long time and requires some mental calculation of the code centers—with the inherent possibility of errors and oversights. With a feed-

Robert Havener, Manufacturing Engineer, Analogic Corp., Audubon Rd., Wakefield, MA 01880.

back approach, however, the code centers can be measured directly (Fig. 2a).

Feedback gets exact centers

In the setup of Fig. 2, the input to the converter is supplied by an integrator. The converter output delivers one input, code A, to a digital comparator. A second input to the comparator, code B, is set to an arbitrary value with manual switches. The integrator ramps up or down, depending on the position of the solid-state switch, S_1 , which is driven by the comparator so the system operates closed-loop. To trace the feedback path, assume the following initial conditions:

1. Code B is set at 0010.
2. The integrator output, V_y , is less than V_1 , the converter input voltage at which a transition from code 0001 to 0010 occurs.
3. Code A is less than code B.

For these conditions, the switch connects V_x to a negative voltage, $-V$, and the integrator output ramps upward until V_y crosses and exceeds V_2 , the transition voltage from code 0010 to 0011. Code A now exceeds code B, S_1 switches to a positive voltage, $+V$, and the ramp direction reverses and moves downward. The ramp reverses once again when V_y crosses V_1 (Fig. 2b).

Thus the converter output cycles between codes 0001 and 0011, while the converter input, V_y , ranges between the lower and upper transitions, V_1 and V_2 for code 0010. Consequently the average value of V_y equals the center voltage corresponding to code 0010 and is read directly on an integrating digital voltmeter.

For high accuracy, the ramp speed is set so that the a/d makes at least 10 conversions during each ramp excursion, and the voltmeter conversion rate is set to sample over 100 ramp cycles. For a converter with 100- μ s conversion time, the ramp speed is less than 1 LSB voltage change/ per millisecond, and the voltmeter input sampling time is 100 ms.

The setup can handle just about any a/d converter, regardless of input range and regardless of the number of bits, however coded. One caution: The converter must be monotonic. The feed-

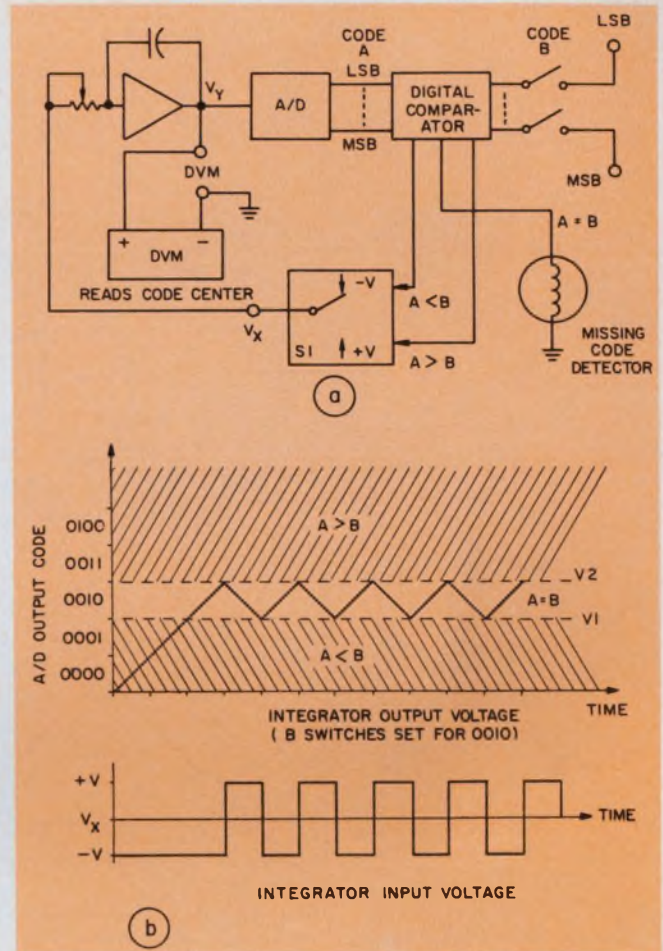

2. Code centers can be determined by use of a digital comparator and feedback to an integrator (a). The integrator's output ramps up or down, depending on where the comparator sets the solid-state switch (b). The manual switch is set by the user to an arbitrary code.

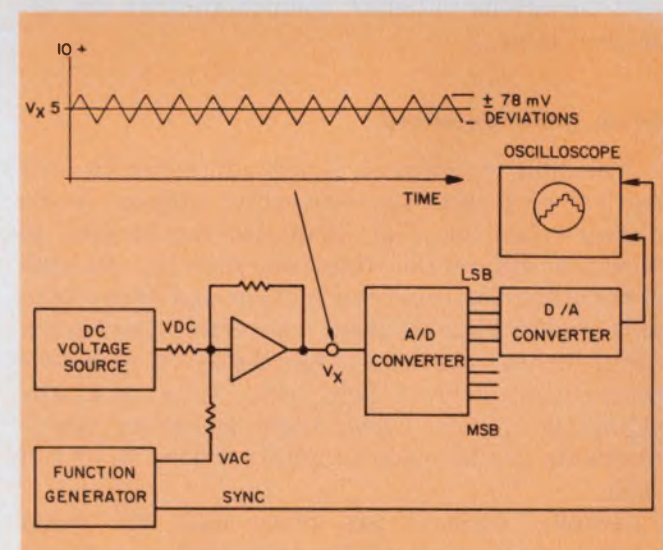

3. With a scope, you can observe and measure the switching points around a major bit, set by V_{dc} . A triangle, V_{ac} , is added to V_{dc} to exercise the LSBs around the set point. The d/a converter changes the information back to analog for display.

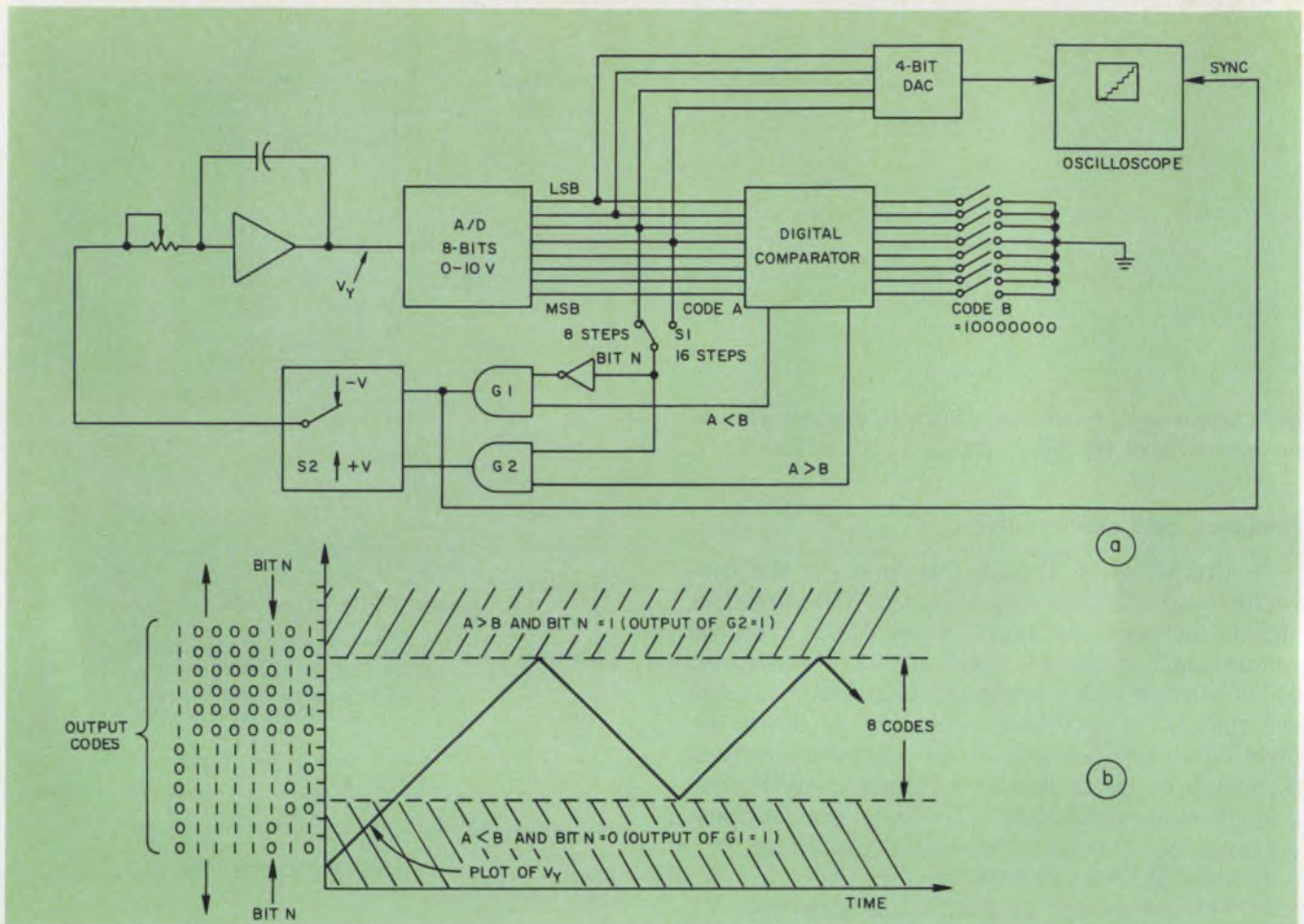

4. Local linearity can be displayed by modification of the feedback and comparator sections (a). With S_1 set to

eight steps, the integrator's output will ramp up and down over an eight-code range (b).

back system breaks down at voltage/code transition points of opposite direction—that is, during a switch to a lower code on a positive ramp. Circuit variations to detect nonmonotonicity are described later.

Setup gives few errors

The only significant source of error in this method of measuring code-center voltage is the digital voltmeter. The setup also can be used to measure differential linearity directly. In this application, the converter's offset and range trim pots (most high-accuracy converters have such adjustments) are set so that the DVM reads the theoretically correct code-center voltages at the calibration points. Under these conditions, measurements can be made to within $\pm 0.001\%$ of full scale.

Graphic displays are often used for rapid measurement of local linearity and for visual observations of code transitions (Fig. 3). In this system the dc voltage, V_{dc} , from an adjustable source, and a triangular wave, V_{ac} , are combined in an op amp to produce a voltage excursion at

the a/d's input. Level V_{dc} is set typically at a major bit transition point, and the amplitude of V_{ac} is set to exercise the LSBs around that point. The LSBs then are converted back to an analog variation (with a d/a) and are displayed on an oscilloscope.

Consider a 10-bit a/d with a range of 0 to 10 V. To explore local linearity around a major bit transition point, V_{dc} is set to the corresponding voltage—that is, 5 V for the MSB, 2.5 V for bit two, and so on. On a 10-bit converter, the four LSBs are 9.75, 19.5, 39 and 78 mV in value. For these four bits to go on and off, the peak ramp excursion should be adjusted to exceed the value of the fourth bit, or 78 mV. Adjusted to switch four LSBs around the MSB, the converter output will step between 1000000000 and 1000001000 on positive excursions, and on negative excursions from 1000000000 to 0111110111.

Display improves tester

While the system of Fig. 3 is useful to observe and calibrate the switching points around a major bit, the dc voltage must be adjusted for each

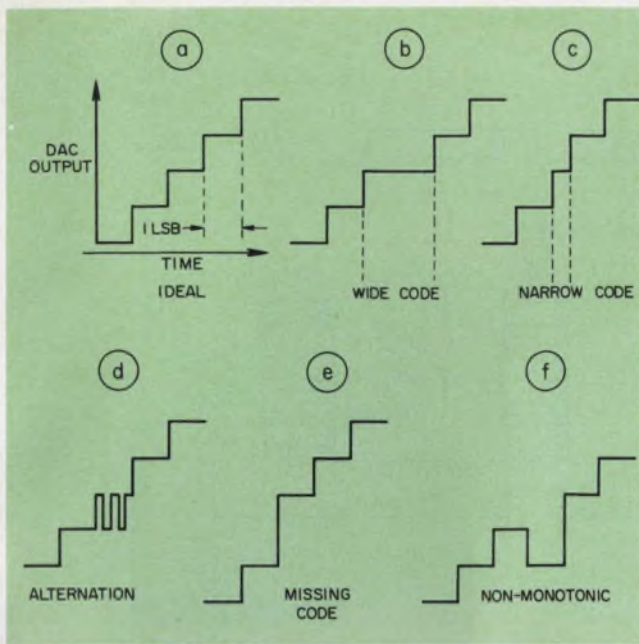

5. Various displays depict uniform excursions of an ideal a/d (a), wide and narrow codes (b and c), alternations (d), missing codes (e) and nonmonotonicity (f).

major bit selected, the dither amplitude must be varied to match the change in the LSBs selected, and the ramp slope must be adjusted to synchronize with the a/d. With so many adjustments, the system can easily go out of synchronism, causing the display to jitter. Also, it is difficult to keep track of the test conditions while the equipment is readjusted for each change in the operating region.

Visual testing can be substantially improved by a modification of the digital comparator to include a display of local linearity (Fig. 4a). In the figure, a d/a converter and display have been added and the feedback system modified with AND gates, planted between the integrator and the digital comparator.

Consider the situation when the system starts up. Assume (1) A 0-to-10-V, 8-bit converter; (2) That V_{in} , the a/d input, is zero; (3) That code A is less than code B (code B is set for a major bit transition, so that the $A < B$ output of the comparator is logic ONE; (4) That bit n, the bit selected by S_1 , is logic ZERO and that the inverter output is therefore at logic ONE. Also note that both inputs to the AND gate, G_1 , are HIGH and that the output of G_1 , correspondingly, is also HIGH.

Under these conditions, S_2 applies $-V$ to the integrator input, and a positive-going ramp results. Before S_2 will operate to reverse the ramp direction, the voltage must increase until code A exceeds code B and until bit n goes HIGH. Correspondingly, a negative-going ramp will reverse when code A decreases below code B and bit n

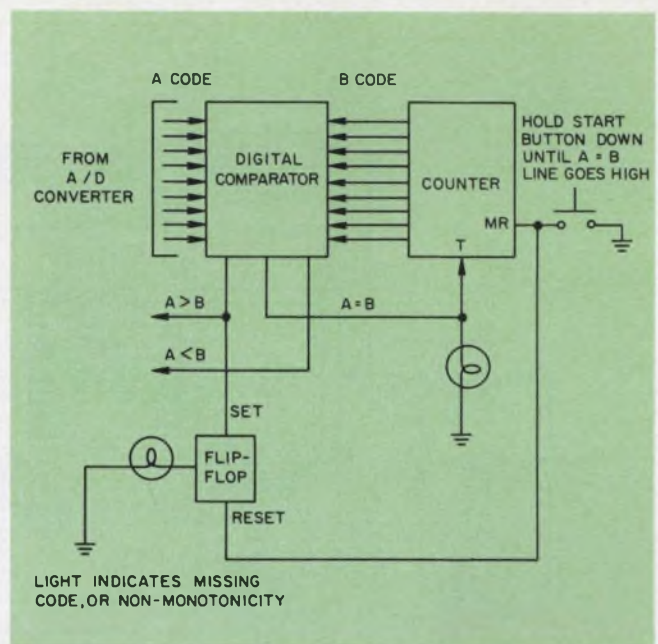

6. Missing codes are automatically searched out with a counter in place of the manual switches. Nonmonotonicity is also determined and indicated.

goes LOW. The integrator output will cycle between these extremes, and the intermediate LSB transitions can be examined on the scope.

Wide range is handled

Note that the voltage range and resolution of the a/d do not affect the operation of the circuit, which is very easy to set up. The display is synchronized with a single adjustment of ramp speed. Local transitions at any point of interest over the entire input range of the a/d may be selected and displayed with just two switches. The code display center is determined by the code B bit switches; the amplitude of excursion is determined by bit n, selected by S_1 .

Thus a wide or narrow region of operation centered at any point within the a/d range may be traversed and displayed. Consider a 10-V, 8-bit converter, to be examined around the major-bit transitions. To select the MSB transition with 5 V as the center of excursion, the B switches are set to code 10000000. If S_1 is set to the eight-step position, the operation in Fig. 4b will result.

The desired information can be secured quickly from the scope, whose controls can be adjusted to make accurate performance measurements (Fig. 5). With a uniform ramp from the integrator, the a/d's input voltage changes linearly with time, and the ramp speed can be set for a 1-LSB voltage change per box. The scope's vertical input from the d/a converter can be similarly set. Note that Fig. 5a shows ideal, uniform transitions.

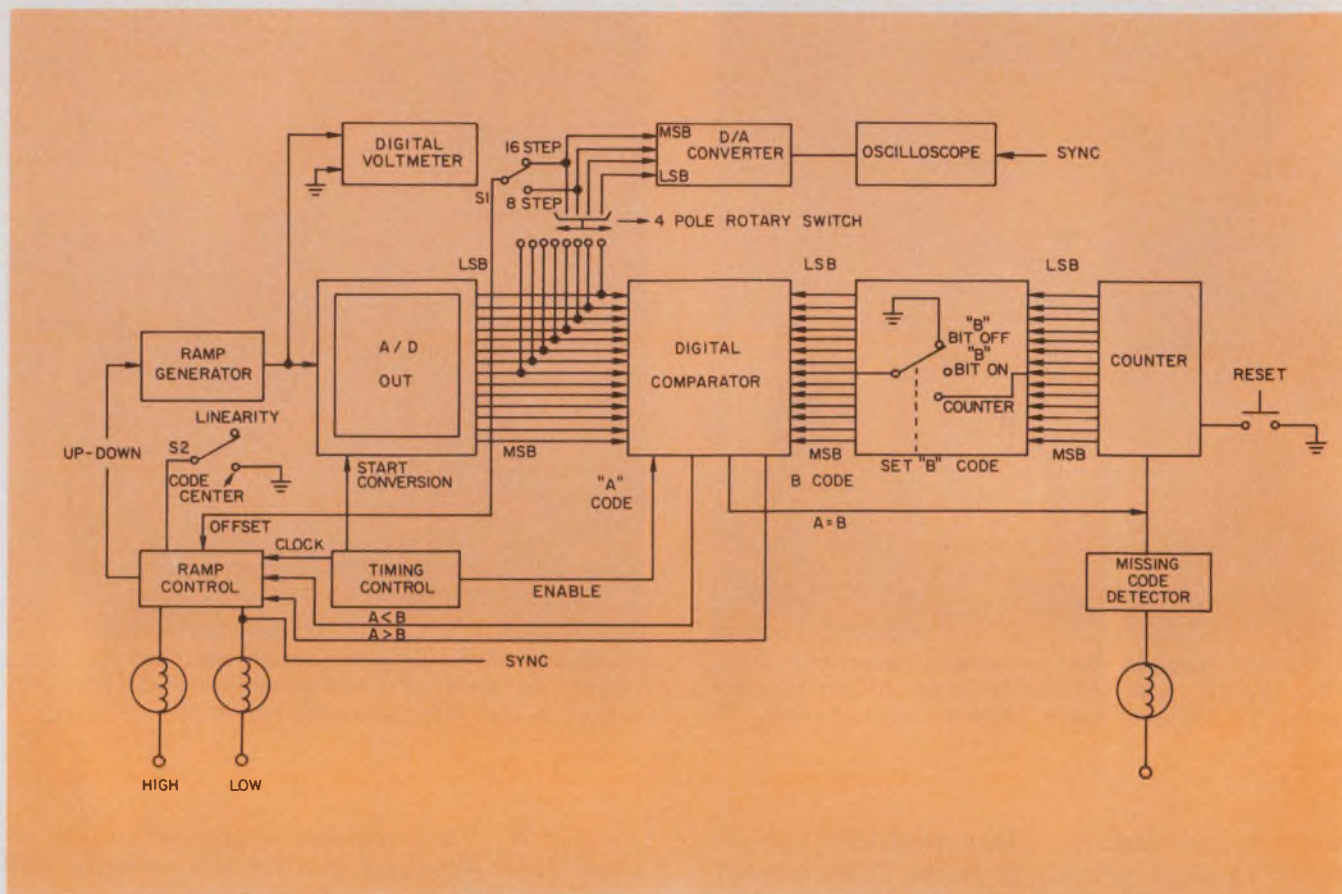

7. The complete a/d converter tester, with all additions and modifications, can determine converter errors in several ways. Code centers are measured with the digital

voltmeter, while the user observes local linearity on the scope. Missing codes are indicated by the flashing lamp. Or a total-range search can be performed.

In Fig. 5b, a 1-LSB code change requires more than a 1-LSB voltage change, and the length of the "wide" increment shows the size of the error. A "narrow" increment is illustrated in Fig. 5c. In Fig. 5d, the transition alternates and fluctuates rapidly between adjacent codes before settling down. The missing step in Fig. 5e shows a missing code. And, finally, a nonmonotonic a/d conversion in Fig. 5f is indicated by the output code's reversal and dropping back.

Missing codes searched out

Missing codes and monotonicity can be checked automatically and more efficiently if a digital counter replaces the code-B switches (Fig. 6). In this arrangement a search for missing codes is made automatically over the entire a/d range. With the integrator input to the converter at some arbitrary level, the start switch sets the counter to zero and initiates the search.

With code B thus set to zero, a downward ramp continues or begins. The ramp descends until the A code approaches—and then reaches—zero. At this point the following sequence occurs: The A=B line goes HIGH and advances

the counter one step. A is now less than B, the $A < B$ line goes HIGH, the ramp reverses and moves upward, the A-code output increases one step, $A=B$, and the counter advances. This process continues, with the counter advance "bootstrapping" the ramp.

However, if any code is missing from the a/d output, the comparator outputs will go from $A < B$ to $A > B$ and skip the $A=B$ stage; thus the search stops and the system hunts around the missing code. The search will resume when the counter is stepped ahead.

A nonmonotonic code sequence, however, will not cause the search to halt, unless it is followed by a skipped code. But nonmonotonicity can be readily observed—just monitor the lamp on the flip-flop output, or use the d/a converter and scope, as discussed.

The test time for a complete missing-code search is a minimum. A converter with a 100- μ s conversion time and a ramp speed set for 20 conversions per code step requires 2 ms per LSB step change. For a 14-bit converter, there are 16,384 steps; the entire search takes $2 \times 16,384$ ms, or less than 33 s.

Operation of the test circuit is not critical with

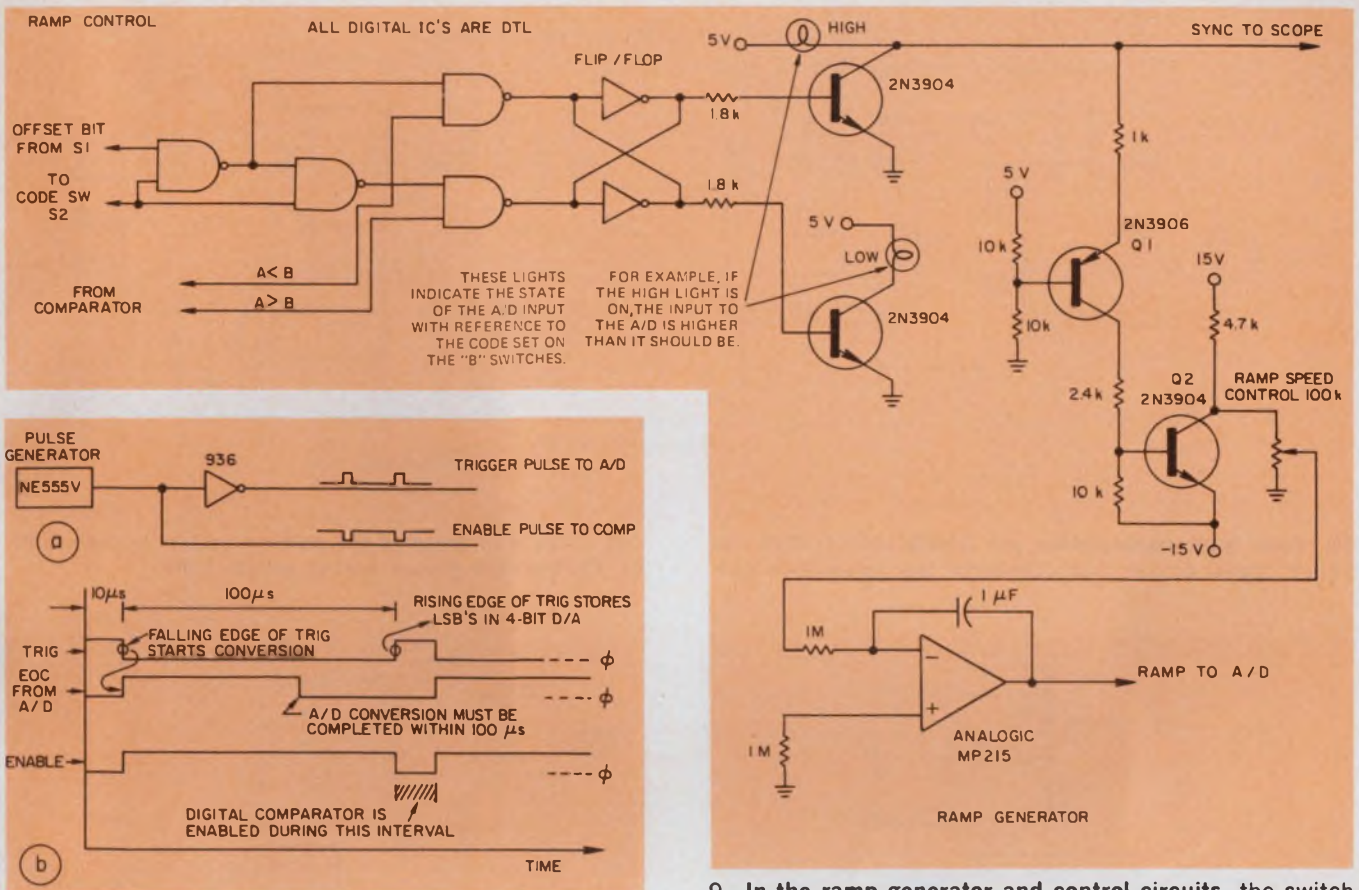

respect to power-supply voltage or ambient temperature, so the tester can be placed in an environmental test chamber along with the device under test. Only the DVM and some controls must be located externally. Hence qualification and environmental tests can be readily performed.

The complete tester (Fig. 7) is capable of several modes of operation:

- Code centers are measured on the digital voltmeter. In this mode, the appropriate major bit B switch is set ON and all others OFF. The mode switch, S₂, is set to the code-center position. The voltage input to the a/d converter cycles between the bit upper and lower transitions, and the voltmeter reads the average voltage as the code center.

- Local linearity is observed visually on an oscilloscope. The B switches are set to the desired center code, and S₁ selects eight or 16 steps. The four least-significant bits are viewed by connection of the bits to the d/a converter input. The mode switch is set for linearity.

- Missing codes can be detected in two ways. In mode 1, the code steps from code A < code B to code A > code B, and passes through code A = code B when code B is present in the a/d's out-

put. The digital-comparator A=B line goes HIGH when the two codes are equal. A missing-code-detector circuit generates a flashing lamp if the A=B line is not activated.

To perform a missing-code search over the entire a/d input range, switch the B inputs of the digital comparator to the counter. A missing code breaks off the search, and the ramp hunts around the missing code. System synchronization and timing relationships are given in Fig. 8.

Fig. 9 depicts the ramp generator and control. The polarity of the integrator is controlled by transistor switch Q₁ and Q₂. When the switch is on, the ramp moves upwards and integrates the -15-V line voltage at a rate controlled by the ramp speed pot. When the switch is off, the 4.7-kΩ resistor pulls the output to +15 V, and the ramp moves downwards. Thus the up and down slopes are approximately equal. The ramp speed is set for at least 10 conversions between each code step. For a 100-μs converter with a 10-mV LSB, ramp speed = $10 \times 10^{-3} / 10 \times 100 \times 10^{-6} = 10 \text{ V/s}$.

An inverter flip-flop controls the state of Q₁ and Q₂. Either the set or the reset input is activated from NAND gate outputs. The comple-

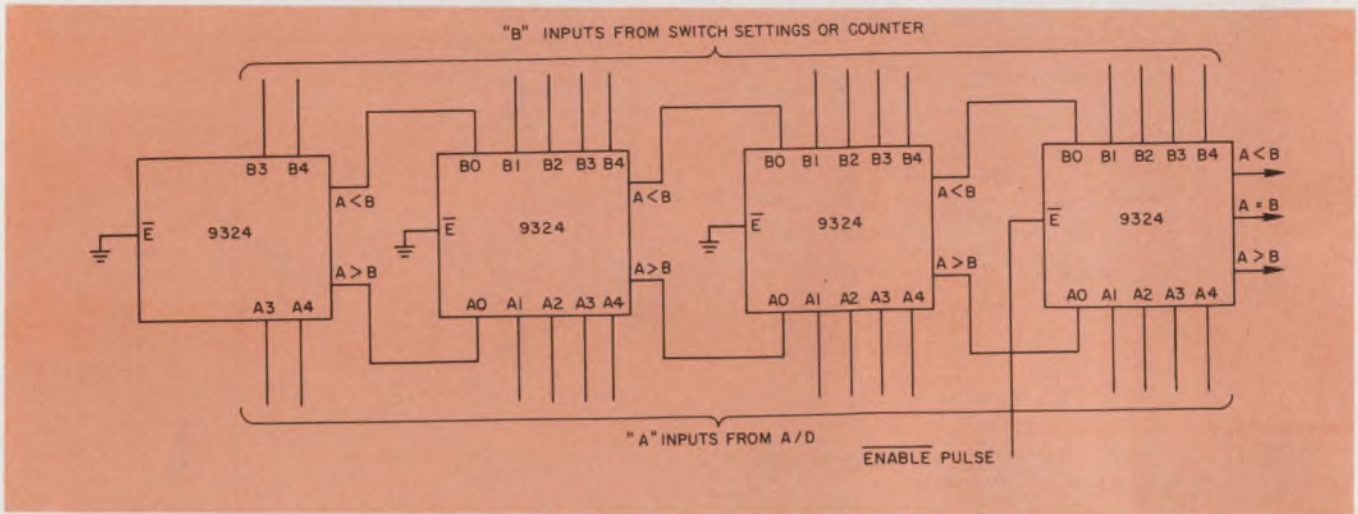

10. Four 5-bit comparators are connected to form the 14-bit digital circuit that compares the converter's out-

put codes with those of the manual switch or the counter. Comparison occurs during enable LOW.

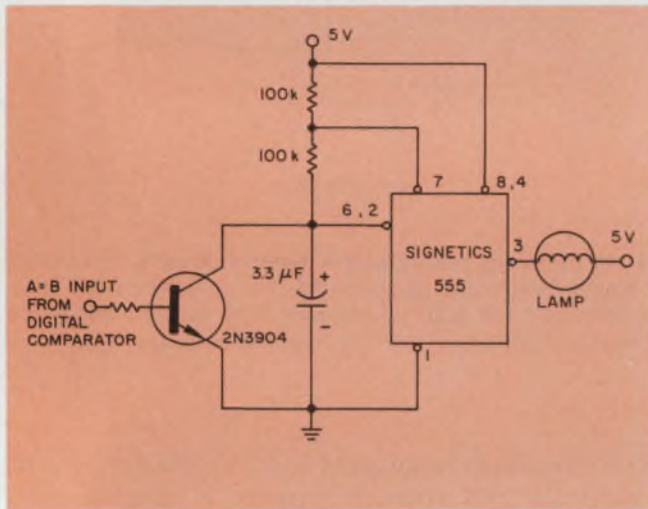

11. Missing codes are indicated when the 2N3904 is cut off and the 555 timer, acting as a multivibrator, blinks the lamp at about three flashes per second.

mentary outputs of the flip-flop cause either the HIGH or LOW lamp to light and thereby display the relationship between the a/d input voltage and the B code.

The digital comparator compares one input code from the a/d with a second input derived from either the B-code switch setting or from the counter. Only one of the three comparator output lines—A > B, A = B, A < B—is HIGH. The comparison is enabled during the LOW interval of the enable pulse. Four 9324 ICs, each a 5-bit digital comparator, are connected to form the expanded 14-bit comparator (Fig. 10).

In the configuration for the missing-code detector, a 555 chip operates as a multivibrator at a rate of about 3 pps, causing the lamp to blink at the same rate (Fig. 11). However, when the electronic switch (transistor 2N3904) goes on and shorts the capacitor, multivibrator action stops.

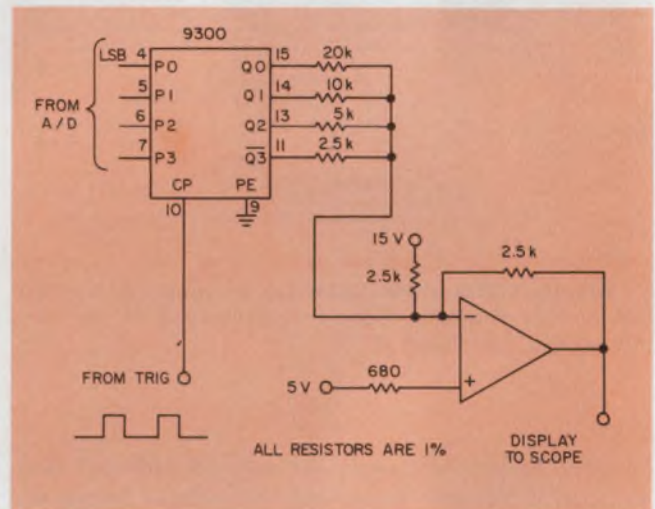

12. A two's complement, four-bit d/a converter provides ± 5 -V analog excursions for the scope display. The screen amplitude doesn't depend on the a/d under test.

The transistor switch operates when the A = B line from the comparator goes HIGH. This indicator is used to detect missing codes during the code-center measurement mode. In this mode the A-code output of the a/d cycles between A > B and A < B. When code A = B is missing, the lamp blinks uniformly. However, when—as in the normal case—the converter output steps through code A = B, the lamp goes off. Thus blinking indicates a missing code.

Note the simple 4-bit d/a converter used in the tester (Fig. 12). The trigger pulse latches the LSB states into the d/a after each conversion. The amplitude of the linearity display on the scope will be the same, regardless of the a/d under test.

The automatic test system, as described, is in daily use at Analogic Corp., and has proved capable of rapid and economical testing to the most exacting performance specifications. ■■

Signal has the answer...



The 241 Series.

Cuts transformer weight, size and cost almost in half!



Special "split" bobbin (secondary wound alongside primary rather than over it) effectively isolates primary and secondary and reduces inter-winding capacitance. An electro-static shield

is not required in all but the most sensitive applications. Hipot rating of 2500V RMS is standard. Bobbin winding technique affords a 40-50% savings in winding space over conventional layer winding. "Split" bobbin eliminates the need for inter-winding insulation and cross-over of primary and secondary leads.

Grain-oriented steel core is used at higher saturation flux densities and results in about a 40% reduction in turns required. Although the cost per lb. of grain-oriented steel is higher than that

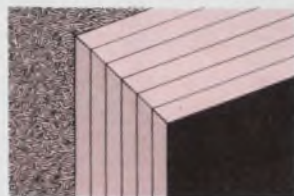

for ordinary silicon steels, the net cost is less, since less core weight is required and a significant reduction is made in copper weight.

Terminals, which are wedged into the bobbin wall, are designed so that they can be used as solder lugs or as 0.187" quick-connect types. Lead slots are incorporated in the bobbin wall leading to

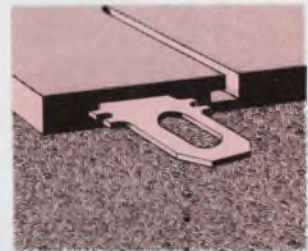

the terminals. It is not necessary to tape the start lead since it comes to the top of the coil through the slot and is thus separated from the winding. Separate lead wires or terminal boards and the extra assembly time to use them are eliminated.

Fresh thinking in engineering design and material selection has reduced material and labor cost and results in a series of small power transformers which cut weight, size, and cost almost in half. Therefore, we named them the "2-for-1" series...



signal transformer co., inc.

1 Junius Street, Brooklyn, N.Y. 11212
Tel: (212) 498-5111 • Telex 12-5709

-and Signal has it in Stock!

MOS 6501 Microprocessor BEATS -EM ALL

~~MOTOROLA 6800
Intel 8080
FAIRCHILD F8
Rockwell PPS8~~

Prove it for yourself!
You Can
Try It!



See Us At **WESCON75** Booth 1010
(If you can't make a copy of our documentation, \$10.00 more gets you your very own set!)

HEADQUARTERS—MOS Technology, Inc. 950 Rittenhouse Rd., Norristown, Pa. 19401 (215) 666-7950

EASTERN REGION—Mr. William Whitehead, MOS Technology, Inc., 410 Jericho Turnpike, Suite 312, Jericho, N.Y. 11753 (516) 822-4240

WESTERN REGION—MOS Technology, Inc., 2172 DuPont Dr., Suite 221, Patio Bldg., Newport Beach, Calif., 92660 (714) 833-1600

the first of a low cost high performance microprocessor family

the mcs6501

PRICE!

- LOWEST COST STARTER SET
- LOWEST COST DOCUMENTATION
- LOWEST COST SOFTWARE
- LOWEST COST PROCESSOR
- LOWEST COST I/O (M6800 Compatible)

PERFORMANCE!

- MORE USEFUL ADDRESSING CAPABILITY:
 - TWO REAL INDEX REGISTERS
 - TWO POWERFUL INDIRECTS
- HIGHEST PERFORMANCE (A-H SYSTEMS BENCHMARKS)
- SECOND SOURCE APPOINTED
- READY (RDY) FOR SLOW MEMORY OR DMA

EASE OF USE!

- EASIEST DOCUMENTATION TO USE
- SIMPLE, EASY-TO-FOLLOW INSTRUCTIONS (SIMILAR TO PDP-11)
- EASIEST TO USE DESIGN-IN SYSTEM

COMPATIBILITY!

- ONLY SOFTWARE COMPATIBLE MICROPROCESSOR FAMILY
- PLUG COMPATIBLE WITH M6800

AND THIS IS ONLY THE BEGINNING—
DON'T MISS **MOS** AT **WESCON75**!

Whether it's details, further documentation or actual parts, MOS Technology will be making it all readily available—be sure to see us!

MOS

MOS TECHNOLOGY, INC.
VALLEY FORGE CORPORATE CENTER, NORRISTOWN, PA. 19401 (215)666-7950

The $\alpha\beta\gamma$ s of bioelectric measurements.

Pay attention to four crucial areas: the signal, the noise and the safety of both the patient and the instrumentation.

Measuring and recording bioelectric signals produced by the human body is anything but simple. You've got to pull out a low-level voltage from high-level noise, build equipment to survive anything from liquid spills to high-voltage pulses and—most important—make sure the patient is protected from electrical hazard while you're about it.

Start by characterizing the signal. Will the signal be used for diagnostic purposes or simply for routine patient monitoring? What, exactly, do the medical people want to measure? Next identify the sources of noise. Then design your front end with the aim of boosting the signal, cutting the noise, protecting the equipment and keeping the patient alive.

The human heart signal

Bioelectric signals generally fall in the low millivolt region—that from the heart, for instance, runs about 1 mV. Since this level can be buried in about 10 V of noise, making an electrocardiogram (ECG) isn't easy.

The noise arises because of the capacitive coupling of the body to surrounding ac electrical sources—power lines, lighting, motors, X-ray machines, transformers and the like—and because of the body's similar coupling to power-line grounds.

Though the magnitude of the source-coupling capacitance varies widely, 0.2 pF is probably within an order of magnitude of the true value. The capacitance to ground tends to be about 10 times larger, since ground references are much more widespread than sources (Fig. 1).

The impedance of the human body beneath the outside layer of skin is less than a few hundred ohms. Consequently, from a circuit viewpoint, the patient sits at a potential of about 10 V with respect to ground. This is the voltage you see when you touch the input of a high-impedance oscilloscope. Since the coupling capacitances

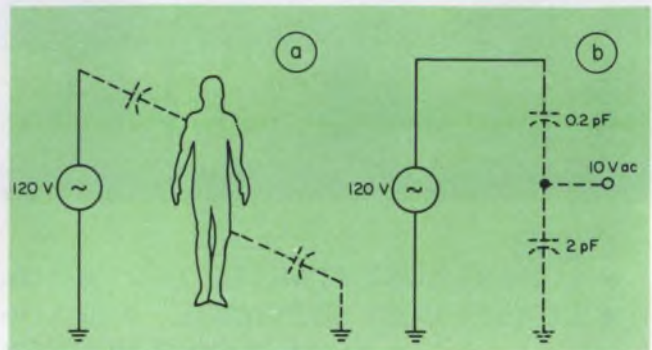

1. Capacitive coupling to surrounding power sources and grounds (a) causes the human body to appear electrically as a 60-Hz noise source (b).

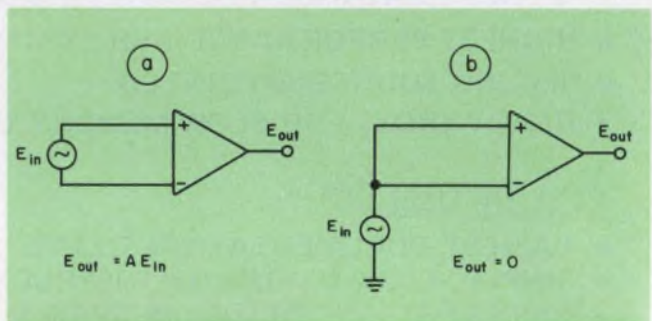

2. To extract minute biomedical signals and simultaneously discard the 60-Hz noise, the signal is first applied to a differential amplifier (a). An ideal differential amplifier shows no output when the same signal, called the common mode, is applied to both input terminals (b).

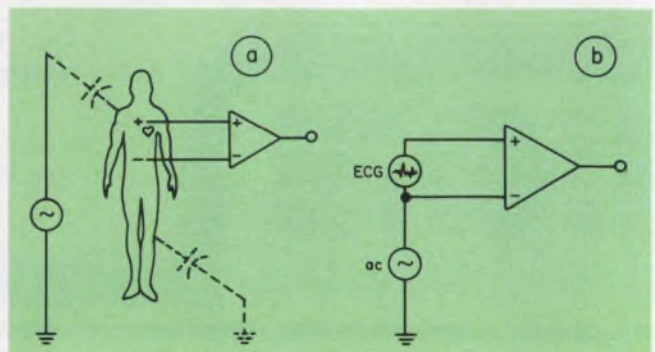

3. A biomedical signal, such as ECG, is differential (a), while the unwanted 60 Hz appears as common mode (b).

Paul Svez, Product Support Engineer, and Neil Duane, Senior Technical Writer, Hewlett-Packard, Medical Electronics Div., 175 Wyman St., Waltham, MA 02154.

show very high impedance at 60 Hz, very little current actually flows. Even so, the problem of extraction and amplification isn't easy.

The front end

Differential amplifiers are the key to digging out the wanted signal and discarding the 60 Hz. An ideal amplifier takes the difference between two input signals and multiplies this difference by its gain. If a signal—called the common-mode signal—appears at both inputs simultaneously, then the output of such an amplifier is zero (Fig. 2).

Practical amplifiers can't reject a common-mode signal entirely, and they are usually classified in terms of their ability to do so. One measure of this ability is called the common-mode rejection ratio (CMRR), the differential gain of the amplifier divided by its common-mode gain.

Fortunately the patient is a good conductor, and the noise magnitude remains constant regardless of where the electrodes are placed. Hence the noise is a common-mode signal, while, say, the heart signal (ECG) is mostly differential (Fig. 3).

If the ECG is amplified by a factor of 10^4 , the signal will equal the noise. If the noise is attenuated by 100, the 60 Hz will then be negligible. To get this attenuation, a CMRR of 10^6 , or 120 dB, is required. Modern amplifiers can exceed this figure; however, CMRRs above 10^7 are difficult to measure in practice.

Unfortunately, things are even more complex. Look at the ideal amplifier and apply a common-mode signal at the input in series with an impedance. If the impedance is unbalanced, different currents will flow into each leg (Fig. 4). The result: a differential voltage at the amplifier input. Phrased another way, because of the imbalance, a piece of the common-mode value is transformed into a differential signal, which then receives the full amplifier gain. Such an imbalance can result from unequal capacitances to ground in the input cables and also from unequal electrode impedances (Fig. 5).

The human electrode interface involves a complex exchange of ions between the electrode metal and electrolytes of the body. Electrode research aims for a reduction in both the contact impedance and the associated offset voltages. In the simplified model of Fig. 6, the resistances represent those of the fluid contact and the outer layer of the skin. Capacitance exists between the fluid and the low-impedance tissue below the horny outer layer of the skin.

You can largely reduce electrode imbalance by making the differential input impedance of the amplifier very high with respect to that of the electrode. However, since electrode impedance is

usually high to begin with, the increase is limited by circuit-board impedances, dust, humidity and other considerations. Detailed attention to electrode cleaning and application goes a long way to reduce 60-Hz noise. One tradeoff: Extremely high input impedances also increase the amplifier's susceptibility to capacitive coupling from outside sources.

High input impedance does little to reduce the imbalance caused by unequal capacitance to ground. You can reduce the effect by use of short, well-insulated cables and by equalizing the capacitance to each lead. To equalize capacitance, use leads that are molded together and tie a geometrically symmetrical shield to the voltage reference.

Molded leads also avoid loops that can magnetically couple stray fields and induce additional noise (Fig. 7). The induced voltage is differential and is amplified along with the ECG. Often the leads are twisted together to average out the area perpendicular to the field and so reduce the induced signals.

Before the advent of modern amplifiers with superior common-mode rejection, you avoided 60

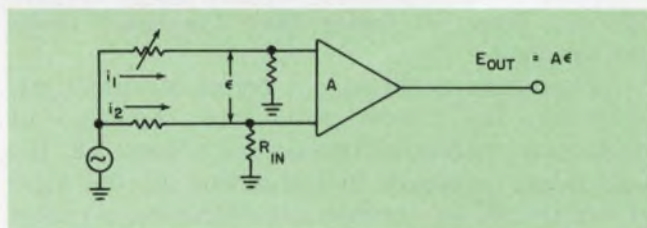

4. Unbalanced impedances in the two input legs of the amplifier cause unequal currents to flow into each leg. As a result, a portion of the common-mode noise is converted to a differential signal, which is then amplified and delivered at the output.

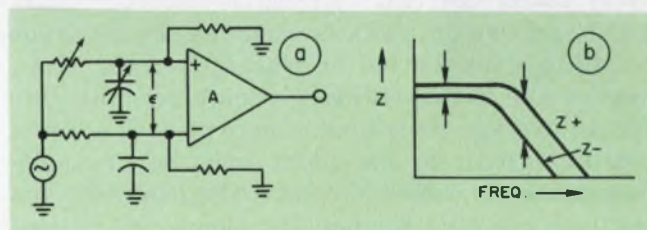

5. Input imbalance results from unequal electrode impedances or unequal capacitances to ground (a). The impedances are frequency-dependent, of course (b).

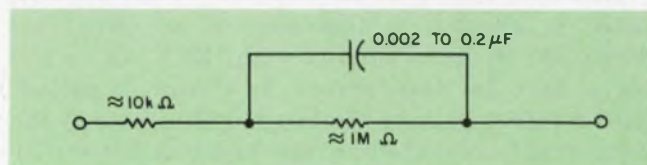

6. An equivalent circuit of the skin's contact impedance accounts for tissue and fluid resistance and capacitance.

Hz simply by grounding the right leg of the patient. This fixed the patient at ground potential, and common-mode voltages were eliminated at their source. Neat as this solution appears, it presents problems. If somehow the patient comes in contact with an ac source, dangerous currents can flow directly through him to ground. It's generally recognized that about 20 mA can be fatal, so in the early days of medical instrumentation design, it was common to insert a 5-mA fuse in series with the right leg lead.

The patient's survival

More recent additions to the physician's instrument arsenal have compounded the problem. Devices such as pacemakers, catheters, intracardiac thermistors, electrodes, and intracardiac microphones all provide direct electrical paths to the heart. Tiny currents through these paths can cause ventricular fibrillation—a usually fatal tremor of the cardiac muscle fibers that results in ineffectual pumping.

Fig. 8 shows the approximate relationship for dogs between frequency and the minimum current required for fibrillation. At high frequencies, the curve becomes very steep because the ac current changes direction faster than the heart tissue can respond.

As bad luck would have it (or as Murphy's law dictates), the lowest point—the condition of maximum susceptibility—occurs around 58 Hz. Laboratory evidence indicates that as the mass of an animal or cardiac size increases, so must the current to produce fibrillation. Extrapolation of such data for man gives an average minimum value of about $100 \mu\text{A}$. To play it safe, therefore, it's best use $10 \mu\text{A}$ as the design criterion.

Generally sources are isolated to protect people from 60-Hz currents. Wiring is carefully insulated and run in walls or conduits, high-voltage conductors are buried or placed on poles. However, while low-level voltages may be quite safe for an average individual, a patient with a direct electrical path to his heart may be unusually susceptible to small currents. Consequently you must go one step further and isolate the patient as well as the source.

Watch for ground faults

Isolation requires the removal of all current paths to ground, so that even if an individual does come in direct contact with 120 V, there will be no path for the current. In theory, a patient with a direct path to the heart will be safe if the instrument connected to the heart catheter (1) does not provide a source of more than $10 \mu\text{A}$, and (2) doesn't sink to ground more than 10

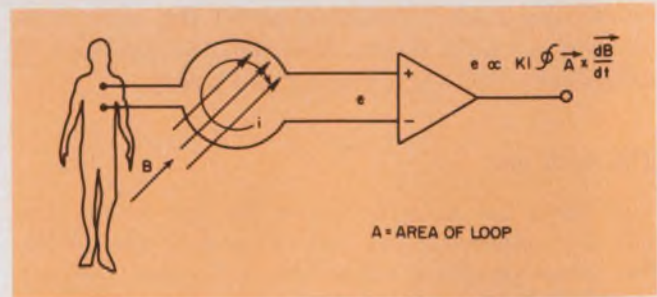

7. Loops in connecting leads should be avoided, since stray fields can couple and induce unwanted voltages into the input. Molded leads avoid the problem.

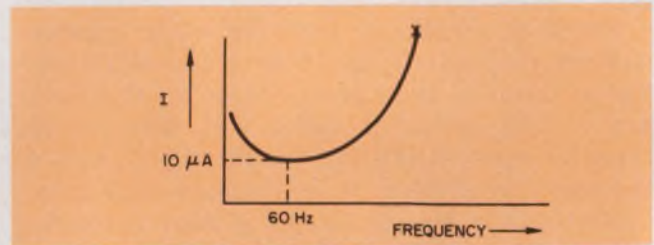

8. Minimum current vs frequency to produce heart fibrillation—muscle tremors—in dogs. Maximum susceptibility, unfortunately, occurs near 60 Hz. Data must be extrapolated for people.

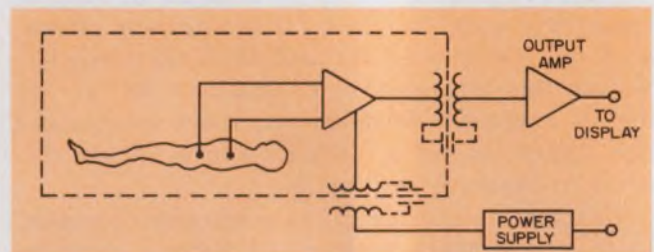

9. Present practice aims to isolate as much as possible the patient and instrument front-end from all external electrical sources. Thus input power and output signals are coupled with high-isolation devices.

μA if the patient comes in contact with an ac line.

Several schemes and devices are available to limit current, and they can be roughly divided into two categories: passive and active. Passive devices, those in series with monitoring leads, include nonlinear resistors and FETs, which pinch off whenever the current exceeds a given amount. In the active category are modulators, which couple an ECG or other signal through LEDs or high-frequency transformers.

Current-limiting devices are necessary in spite of the amplifier's high input impedance because signals above a few volts usually saturate the amplifier's input transistors. When that happens, the input impedance to ground is essentially the output impedance of the power supply—just a few milliohms.

Passive devices in series with the monitoring leads offer an excellent solution to isolation of

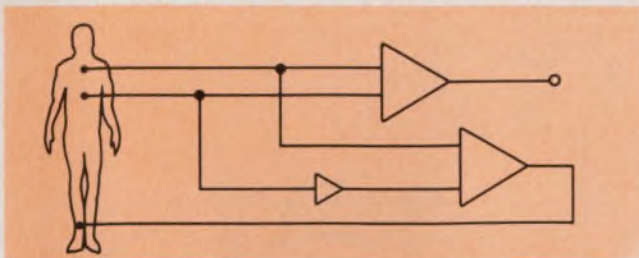

10. To cut common-mode noise, you can detect the unwanted signal, then vary a reference signal—usually derived from the right leg—at the same rate as the noise. The differential amplifier thus “sees” no common mode at its front end.

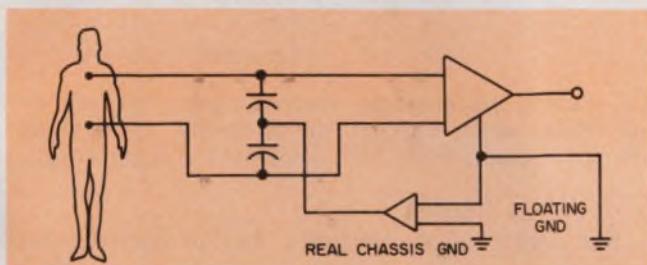

11. Still another way to discard a common-mode signal: Drive the junction of two capacitors with a signal 180-degrees out of phase with the noise.

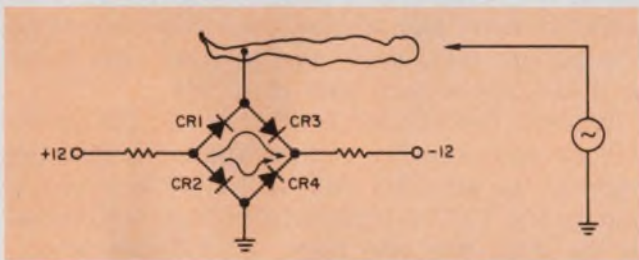

12. With a diode bridge, you can safely ground a patient to eliminate common-mode voltages. The bridge prevents a direct path to ground if the patient inadvertently touches a power supply.

instruments already in service. But these devices add considerable imbalance, are bulky and often can't tolerate European line voltages. Modulation schemes avoid these problems but at the cost of greater complexity, coupled with further problems affecting reliability, cost and service support. And modulation must be designed into an instrument from the start.

Ideally you would like to suspend a patient in a blanket of high-impedance foam and bring signals to the instrumentation with telemetry. This would certainly reduce electrical coupling to the outside world. Both the patient and front-end amplifier would be floating; the only link would be the coupling between antennas.

Present modulation techniques aim for this ideal isolation (Fig. 9). Here the patient and front-end amplifier are electrically isolated from the outside world. The dc supply voltages for the amplifier are chopped at a high frequency (10⁰

kHz), coupled across a transformer and then rectified and filtered to provide power to the input circuitry.

Because of the high frequencies, the transformers are small and offer very little coupling to 60 Hz—typically less than 3 pF. The ECG output is coupled the same way, resulting in an amplifier with very little leakage to the outside world.

Common-mode strikes again

With both the amplifier and patient floating, the right-leg ground has been eliminated and Murphy's law strikes again—you are once more faced with the common-mode problem. One way out is to detect the common-mode signal, then drive the reference electrode up and down 180 degrees out of phase with the common-mode signal. In effect, this fools the amplifier into thinking that no common-mode level exists (Fig. 10).

Since the current in the right-leg drive circuit is always less than that already flowing through the patient, it does not represent a hazard.

In another scheme to cut common-mode noise, you artificially load the input leads of the amplifier with two series capacitors. The 60-Hz signal between the real and floating grounds—that part of the common-mode signal that is left at the input of the amplifier and represents imbalance—is detected, and the junction of the two capacitors is driven by an equivalent signal 180 degrees out of phase (Fig. 11).

Unfortunately no effort is as effective in the removal of common modes as the grounding of the right leg, which removes the common-mode voltage at its source. The question then arises: Can you ground a patient for extremely low currents, yet protect him from lethal values? The answer is yes. There are several effective methods, and one of the best is a simple diode bridge (Fig. 12). In the figure, current ordinarily leaves the positive supply, goes through the diodes and enters the negative supply.

Bridge current is limited to approximately 1 μ A by the series resistors. Since all diodes are forward-biased, the impedance between the right leg and real ground is only several hundred thousand ohms—virtually a short when compared with the impedance between a patient and random ac sources. Thus the common-mode signal is drastically reduced.

If a patient comes in contact with a power line, the diodes prevent a direct connection to ground. During the positive half cycle, CR₁ and CR₂ are reverse-biased and current must flow through high impedance (20 M Ω) into a floating supply. During the negative half-cycle, CR₃ and CR₄ are reverse-biased and current must be provided by the positive supply—again, the current

NF RELAYS HALVE OPERATE POWER.

240-480 mW



150-300 mW

Now you can switch with half the power required by relays of this class. These low min-nom operate powers derive from a unique armature design that also yields ultra-long life: $3 \times 10^8/2\text{pdt}$, $10^8/4\text{pdt}$ mechanical operations. Bounce-controlled (1.5 msec) switching. PI/DO: 10/5 msec. Contact resistance: 25 milliohms (typ). Size: .886" L x .764" or .945" W x .402" H (mounts on 0.5" centers). Capacity: to 60 W @ 2 A. Available in plastic hermetic sealed models. There are no other flatpacks like them. Send for full NF relay specs. Or if you're in a hurry, call.

Relays for advanced technology.



Arrow-M Corp. 250 Sheffield St., Mountainside, N.J. 07092 U.S.A.

Telephone: 201 232 4260

INFORMATION RETRIEVAL NUMBER 29

From the people at Bodine and Bodine Distributors

New PM drive systems

BODINE
ELECTRIC
COMPANY



1/8 thru 1/2 HP systems

Type DPM permanent magnet SCR adjustable speed/torque drive systems, for demanding applications. Available from stock.

Built for rugged, long term use—controls feature circuitry with wide degree of flexibility for end-use convenience. Chassis-type controls adaptable to any type sub-system.

Our proven single source systems approach—Bodine designs and manufactures both the control and drive units. Results: Perfect matching of controls with motors or gearmotors. You get high performance—more reliability.

Get the facts on Bodine DPM Control Systems.

Bodine Electric Company, 2528 W. Bradley Place, Chicago, IL 60618

INFORMATION RETRIEVAL NUMBER 30

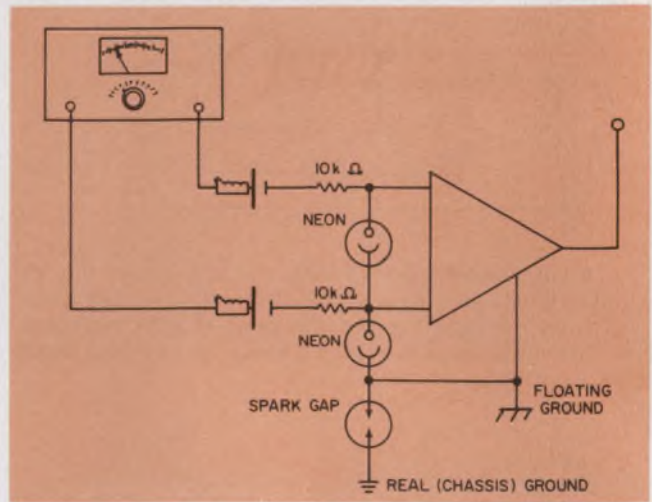

13. Hazards are posed by electrosurgery units and defibrillators, which work at kilovolt levels. Neon lamps and spark gaps protect both equipment and personnel.

is obviously limited.

Not only must patients be protected, but amplifiers must also be able to survive the rather vicious environment posed by defibrillators and electrosurgery units. Six-thousand-volt levels are not uncommon. It's best to limit these voltages before they enter the amplifier. To do so, use low-value (1 k Ω), high-dissipation resistors molded into patient cable heads and provide neon bulbs or diodes across each lead (Fig. 13).

When a defibrillator is discharged, the neons will conduct, and the voltage applied across the input of the amplifier will be limited to approximately 100 V. The remaining voltage is dropped in the lead; this also helps to eliminate breakdown in the cable itself.

A few older defibrillators are designed with one paddle, ground-referenced. The output appears as a common-mode signal rather than differential. This raises a serious problem, because a neon between floating and real ground is hazardous. Usual line voltages can turn the lamp on, virtually grounding the patient. To avoid the possibility, tie a calibrated spark gap, conducting at about 400 V, between the floating and the real ground.

These are just a few of the problems you can expect. More subtle, but equally important, obstacles exist. But these few give you an idea of what you're up against when you try to extract a bioelectric signal from a source as complex as the human body. ■■

Bibliography:

1. Berson, Alan S., Pepberger, Hubert V., MD, "Skin-Electrode Impedance Problems in Electrocardiography," *American Heart Journal*, Vol. 76, No. 4, pp. 514-525.
2. Bruner, John M. R., MD, "Hazards of Electrical Apparatus," *Anesthesiology*, Vol. 28, No. 2, March-April, 1967.
3. Whalen, R. E., Starmer, C. F., and McIntosh, H. D., "Electrical Hazards Associated With Cardiac Pacemaking," *Annals of New York Academy of Science*, Vol. 3, pp. 921-931.

Millions of bits for just a few bucks.

**Systems 60 & 90...a new generation
of low cost, fast access head-per-track
disc memories.**

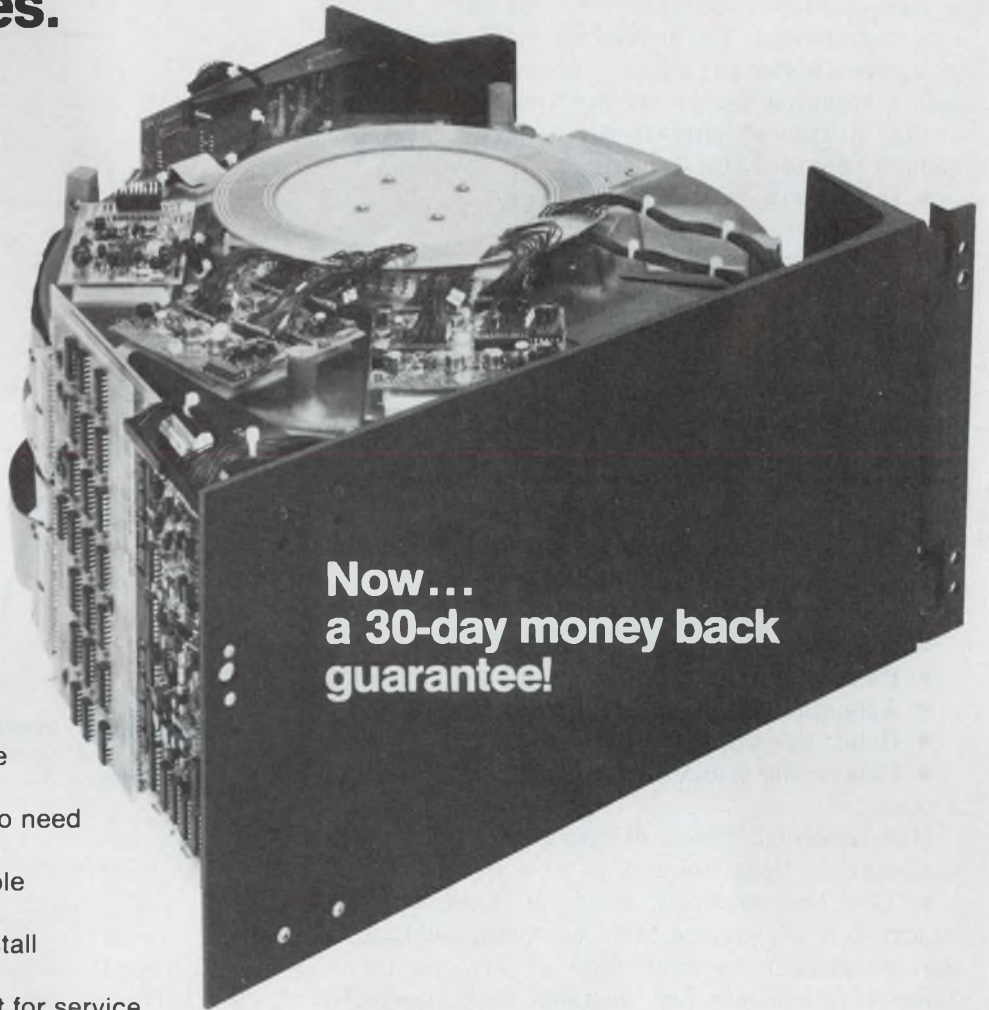

FEATURES:

- High capacity—**
up to 38 million bits per unit
- Fast access—**
8.5 or 17 milliseconds average
- Flexibility—**
capacity and format tailored to need
- Modular construction—**
field expandable and repairable
- Small size—**
light in weight and easy to install
- Front mounting—**
no slides required, swings out for service
- High performance and reliability—**
at minimum cost

DDC Systems 60 & 90 are self-contained head-per-track disc memory units, complete with all required read-write electronics. The disc units are plug compatible with existing interface controllers for DDC disc products. A highly reliable disc—the system ran the equivalent of 14 years of start-stop-start operation with no wear or reduction in reliability. Systems 60 & 90: high performance at a very attractive price.

**Now...
a 30-day money back
guarantee!**

DDC

**DIGITAL
DEVELOPMENT
CORPORATION**

8615 Balboa Avenue, San Diego, CA 92123
Phone: (714) 278-9920 / TELEX U.S. 69-54-30
Radix House, Staines, Middlesex, England
Phone: Staines 51444 / TELEX 93-50-23

INFORMATION RETRIEVAL NUMBER 31

Simplify acoustic surface-wave designs

by using concise guidelines for the calculation of key parameters. A delay-line example illustrates the procedure.

The design of acoustic surface-wave delay lines can be simplified significantly through the use of a step-by-step procedure that provides key device parameters. The procedure yields first-order, or approximate, parameter values so you can obtain a working design on the first cut.

For a typical surface-wave device, the procedure provides the following:

- Impedance of the transducer.
- Bandwidth of the transducer.
- Delay time.
- Interference generated within the device—or triple-transit reflections.

A design example illustrates the relationship between the first-order parameters and the piezoelectric crystal. Consider the case of a line having a delay of 10 μ s and a center frequency of 70 MHz. Assume further that the transducers have the impulse response shown in Fig. 1.

Initially a material must be selected—for our example, temperature-compensated quartz. Key material properties are as follows:

- Quartz crystal: ST cut, X propagation.
- Piezoelectric coupling constant: $k^2 = 0.16\%$.
- Acoustic velocity: 3.150×10^5 cm/sec.
- Delay per unit length: 3.17μ s/cm.
- Delay-time temperature coefficient: less than 2 ppm/ $^{\circ}$ C.

Now nominal layout dimensions can be determined from these four steps:

1. Use the specified delay to determine the length of line required from centerline of launching transducer to centerline of receive transducer (transducers are assumed to be perfectly aligned).

2. Calculate the center-to-center spacing between adjacent fingers.

3. Calculate the desired bandwidth of the launching and receive transducers.

4. Calculate aperture A as a function of the desired impedance.

Steps 1 and 2 can be performed readily. Since a delay of 10 μ s is specified, the distance be-

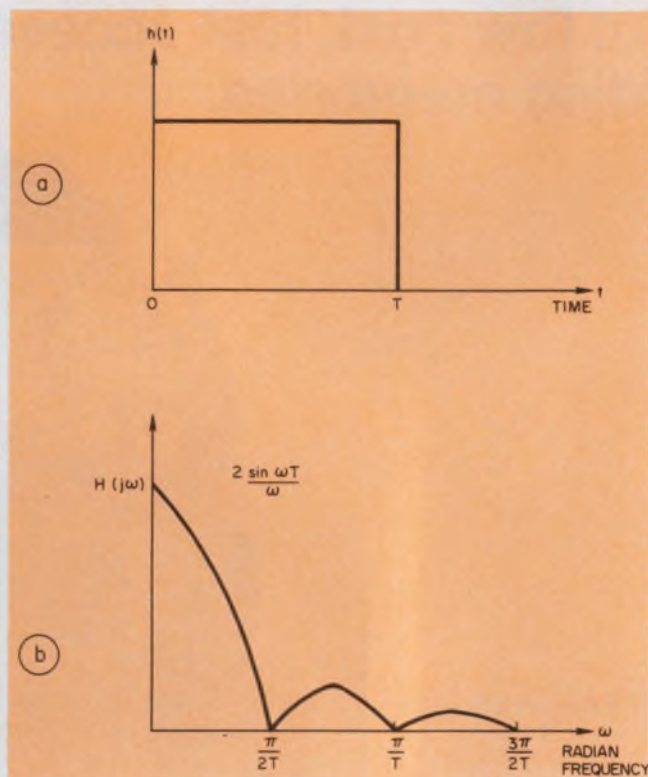

1. Assume each transducer has an impulse response (a). As a result, the corresponding spectrum has a $(\sin x)/x$ type of variation (b).

tween receive and transmit transducers is

$$\frac{\text{delay time}}{3.17 \times 10^{-6} \text{ sec/cm}} = 3.154 \text{ cm.}$$

And since the adjacent finger spacing is one-half the surface-wave wavelength at the center frequency, spacing D is

$$\begin{aligned} D &= \frac{\lambda}{2} = \frac{\text{surface-wave velocity}}{\text{frequency}} \\ &= \frac{3.15 \times 10^5 \text{ cm/sec}}{70 \text{ MHz}} \\ &= 2.25 \times 10^{-3} \text{ cm, or 0.886 mils.} \end{aligned}$$

Calculating bandwidth

Both transducers together represent a band-pass filter. The assumption of a uniform aperture along each transducer's length results in a spectrum with a $(\sin x)/x$ variation—the trans-

R. Stephen Gordy, Group Leader, Electronic Communications, Inc., 1501 72nd St. N., Box 12248, St. Petersburg, FL 33733.

How do acoustic surface-wave devices work?

An acoustic surface-wave device consists of an interdigital metalization deposited on a piezoelectric crystal substrate (Fig. a). When the metalization is subjected to an alternating voltage, a strain develops between the interdigital fingers and also at the frequency of excitation. This alternating strain on the crystal surface launches a Rayleigh surface-wave front that travels in both directions and that originates from the center of the transducer. The wave exists as an electro-acoustic vibration.

Since the wave has the properties of sound—slow travel—but retains the frequency of the source, a large number of wavelengths are accommodated on a short length of crystal. Hence a relatively large delay time is possible for a relatively small piece of device real estate. For example, an equivalent delay on quartz and coaxial cable would require 100,000 times more coaxial cable than quartz.

In a typical layout, two transducers are deposited on a crystal substrate (Fig. b). The application

to one transducer of a source with center frequency f_0 causes an acoustic wave front to be generated at the center of the launching transducer. The wave travels in both directions. An absorbing material placed on the crystal dampens the energy traveling to the left.

The wavefront traveling to the right traverses a distance L , corresponding to a certain delay, before it passes under the recovery transducer. As a result of this action the electric potential difference—a part of the surface wave—excites the recovery transducer. Thus energy transfers from the surface wave to the recovery transducer, which in turn drives the load.

The energy transfers occur because the center-to-center spacing of the transducer's fingers are spaced one-half wavelength apart at the transducer center frequency (Fig. c). Adjacent fingers are driven by opposite polarities. The associated charges of the resulting strain wave are generated by distortion of the piezoelectric dipoles on the crystal's surface.

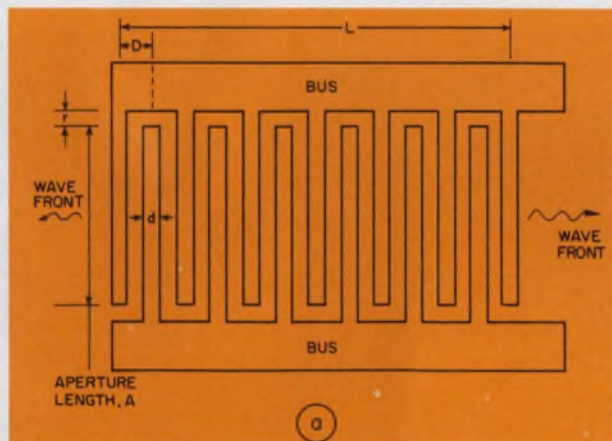

a. Excitation of the device's interdigital transducers generates acoustic surface waves that travel in two directions.

b. Absorbers on the crystal damp out surface waves that can't be used.

c. Half-wavelength finger spacings permit surface-wave energy transfers.

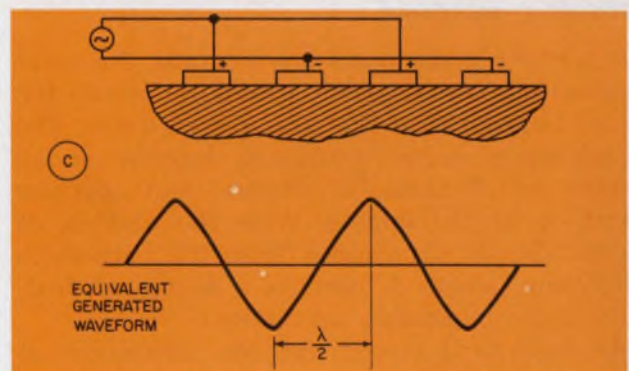
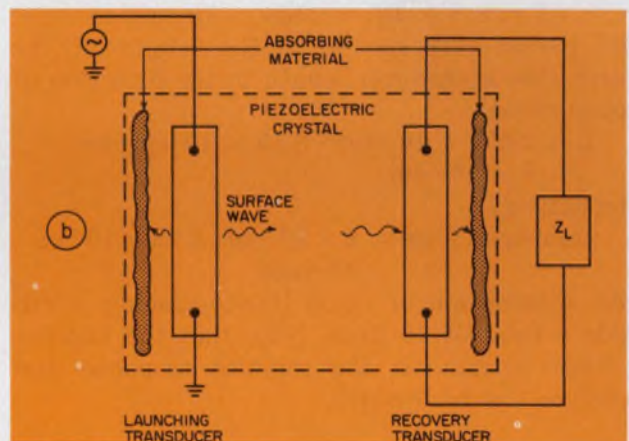

form of a uniform impulse response (Fig. 1a).

The over-all device can approximate the $(\sin x)/x$ impulse response if one of the transducers is designed to have a very small T —the duration of the impulse response—compared with the T of the other transducer. The transducer with the shorter impulse response then has a much larger bandwidth.

The total transfer function $H(j\omega)$ is

$$H(j\omega) = H_T(j\omega) \cdot H_R(j\omega),$$

where $H_T(j\omega)$ is the transfer function of the transmit transducer and $H_R(j\omega)$ is the transfer function of the receive transducer.

If the transmit-transducer bandwidth is very much larger than that of the receiver, then $H(j\omega) \approx H_R(j\omega)$. The result is a very narrow impulse response, which leads to a high input impedance.

For simplicity, let the two transducers have an identical transfer function. Then the total impulse response is that shown in Fig. 2a. The convolution of both impulse responses,

$$h_E(t) = h_T(t) * h_R(t),$$

appears in Fig. 2b. This spectrum is that of a phase-shift-keying matched filter—one that has a bit rate of $1/T$.

The first null bandwidth is equal to $1/T$ Hz, where T is the length of the impulse response. At a center frequency of 70 MHz, the null-to-null bandwidth equals $2/T$ (Fig. 3).

Let the first null bandwidth be chosen at 10% of the center frequency. Then

$$T = 2/7 \times 10^6 = 2.857 \times 10^{-7} \text{ sec.}$$

This period corresponds to the length of the quartz (the transducer length in the direction of propagation):

$$L = 2.857 \times 10^{-7} \text{ sec} \cdot 3.15 \times 10^5 \text{ cm/sec} \\ = 9 \times 10^{-2} \text{ cm.}$$

Alternatively,

$$\text{number of lines} = 9 \times 10^{-2} \text{ cm} / 2.25 \times 10^{-3} \text{ cm} \\ = 40 \text{ lines.}$$

An assumption of equal line-to-spacing width yields a total of 40 lines. Note that the number of lines determines the impulse response and therefore the bandwidth.

Calculating impedance

Since both transducers are identical, the input impedance of the transmit transducer equals the output impedance of the receive transducer. The impedance of either transducer depends on the number of elements, or fingers, and aperture length A of the fingers. With the number of fingers already determined from the bandwidth calculation, length A permits a degree of flexibility in the impedance calculations.

An equivalent circuit for the transducer at center frequency is shown in Fig. 4. The equivalent admittance is

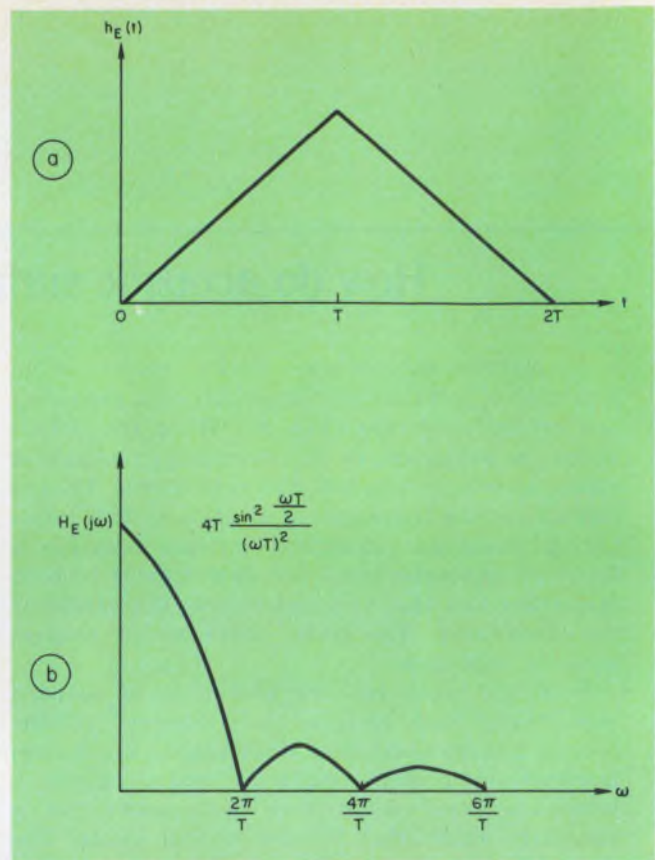

2. The over-all delay line has a triangular impulse response (a). The corresponding spectrum exhibits the characteristic of a matched filter with a $1/T$ bit rate.

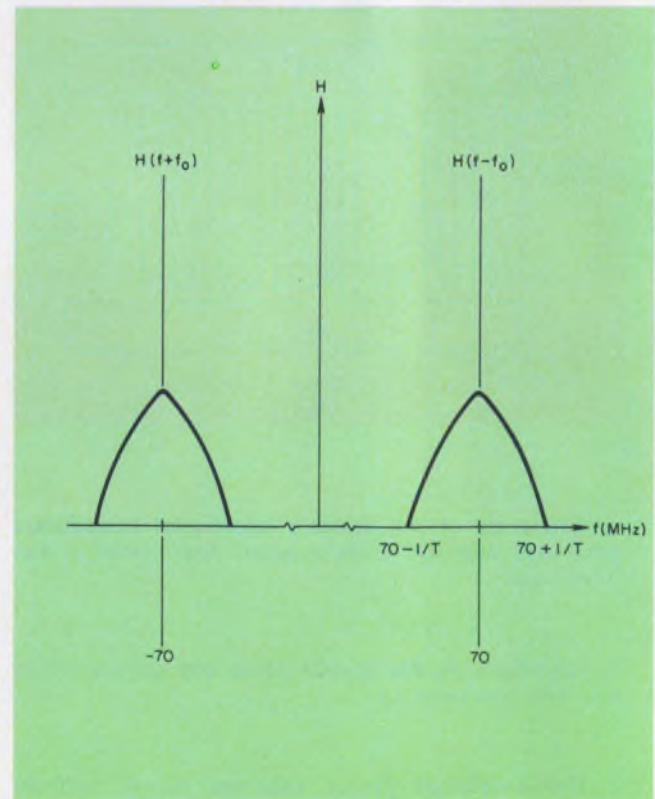

3. The first null-to-null bandwidth affects the length of the quartz and number of lines.

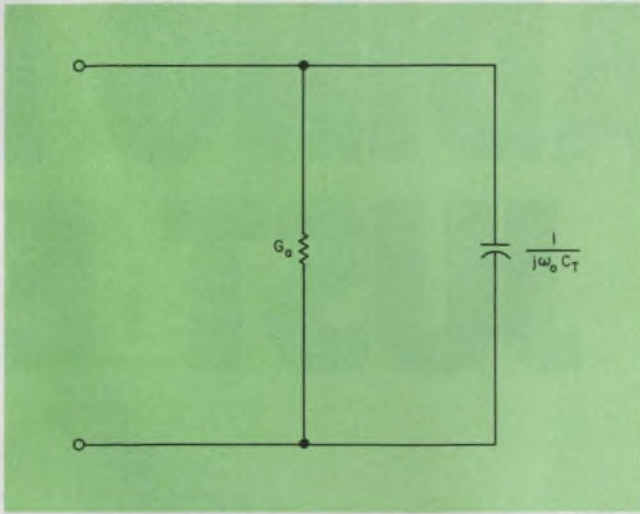

4. A surface-wave transducer can be represented by this equivalent circuit.

$$G_a = \frac{4}{\pi} k^2 (\omega_0 C_s) N^2,$$

where N is the number of finger pairs (20 in our case), C_s is the static capacitance of one element and ω_0 is the radian center frequency ($2\pi \times 70 \times 10^6$ rad/sec).

For equal finger-width-to-spacings, the static capacitance of one element becomes

$$C_s = \frac{A E_{11} E_{22}}{2},$$

where dielectric tensors E_{11} and $E_{22} = 39.21 \times 10^{-12}$ F/m for ST, x quartz. The static capacitance can be given by

$$C_s = A 1.9605 \times 10^{-11} \text{ F/m}$$

and the admittance by

$$G_a = 1.75661 \times 10^{-5} N^2 \text{ A.}$$

For the 20-line pair transducer,

$$G_a = 7.0264 \times 10^{-3} \text{ A.} \quad (1)$$

The admittance is then a function of the aperture A . The total static capacitance is

$$C_T = 2NC_s,$$

$$\text{or} \quad C_T = 7.842 \times 10^{-10} \text{ A} \quad (2)$$

Hence impedance depends on the overlap length of adjacent lines. When transducers are impedance-matched, the insertion loss exceeds 6 dB; 3 dB is lost by each transducer, since energy is transmitted in both directions and one of the wavefronts is absorbed by an acoustic absorber.

Triple transit reflections are generated by the receive transducer when the latter is illuminated by the acoustic wave. This sends a wavefront to the transmitter, where it generates a third wave that travels back to the receiver. This third wave represents an interference.

For every 3-dB loss, the throughput signal suffers and the triple-transit signal decreases by 6 dB. But if additional loss can be accepted through impedance mismatch or absorbing material on the crystal surface, the triple-transit effect can be reduced. ■■

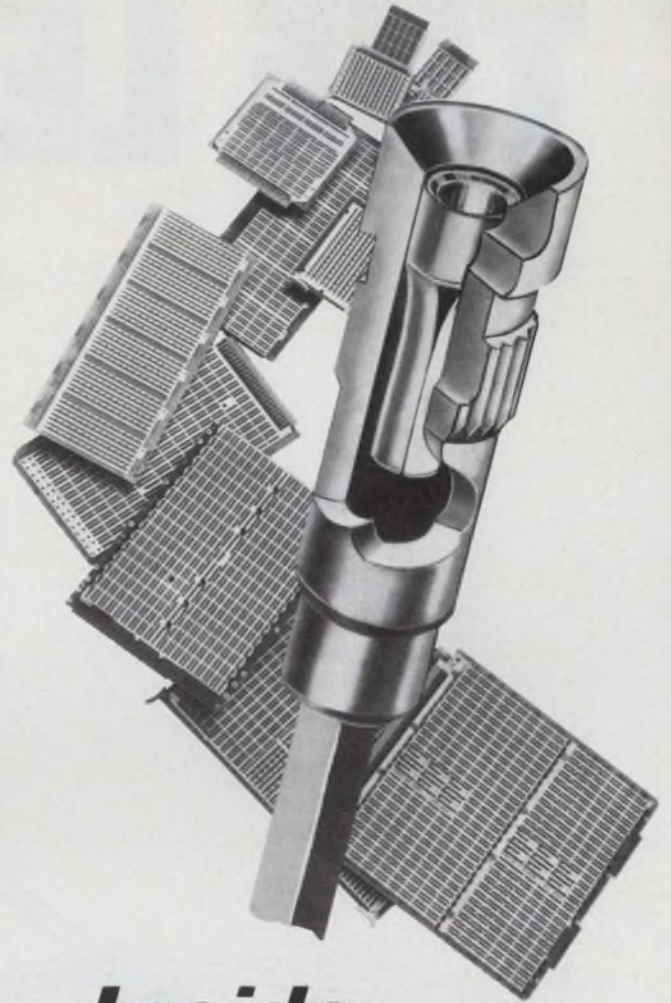

Inside Story

Beat the "bends". EMC's Nurl-Loc® Terminals spread the stress evenly throughout the panel, eliminating warp (and the need for stiffeners) . . . even on 1/8" boards. The straight male splined cylinder guides the terminal securely into a more accurate true position than a barbed ring. And the internal burr-free, four-finger contact grabs any IC lead firmly, even as small as .011 dia. Prototypes or production, call Allan Klepper (401) 769-3800 for a copy of our new, interesting "Inside Story" . . . or write Electronic Molding Corp., 96 Mill Street, Woonsocket, R. I. 02895.

**EMC's Wire-Wrap® Panels
with Nurl-Loc® Terminals
... better performance
by design!**



Wire-Wrap® Gardner-Desmar Co.

INFORMATION RETRIEVAL NUMBER 32

THE LEADING M JUST EX



INI EXPANDER PANDDED

Plessey Memories is now Plessey Microsystems

We're busting out all over: expanding our horizons, our product lines and even our name.

WIDER HORIZONS

We'll never forget the high quality, low-cost memories that made us the largest independent supplier of DEC and NOVA add-on memories. But now we've expanded our horizons to include a broad range of minicomputer products. You'll get the same high dedication to high quality and low prices—just more of it.

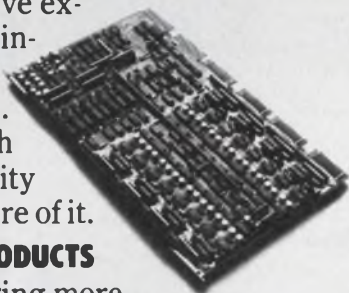

MORE PRODUCTS

And we're not just offering more products, but more for your money.

Our new non-volatile IC memory can be reprogrammed electrically in seconds, without removing it from your system.

Our new dual disc drives are fully compatible with minicomputer systems and provide twice the storage in half the space at a much lower cost than drives from the original minicomputer suppliers.

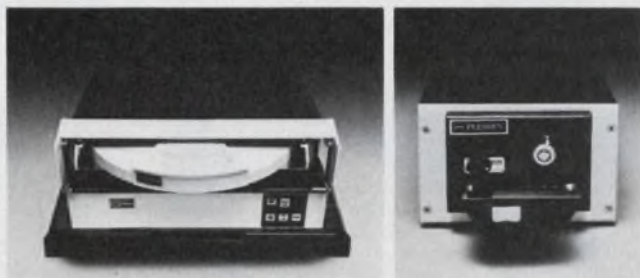

Our high-performance photoelectric tape readers, punches and combos are priced ideally for OEM and end-user applications and feature an ultra-reliable pinch roller/-capstan drive.

We're solidly into semiconductors from dc to daylight, with components, IC's and subsystems.

And we've even got a new microprocessor system—hardware, software and all the development aids you could ask for. Because you don't stay ahead unless you work at it.

A LONGER NAME

So our new name isn't just longer, it's more descriptive of what we have to offer. To see exactly what this can mean to your system designs and your budgets, contact us today for details or a demonstration.

We'll show you a lot more than a name change.



PLESSEY MICROSYSTEMS

Telephone (714) 540-9945

INFORMATION RETRIEVAL NUMBER 34

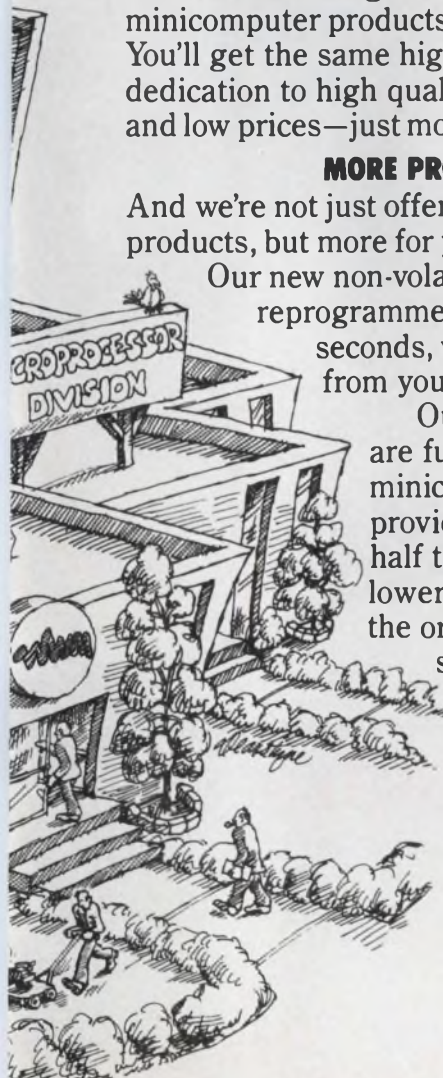

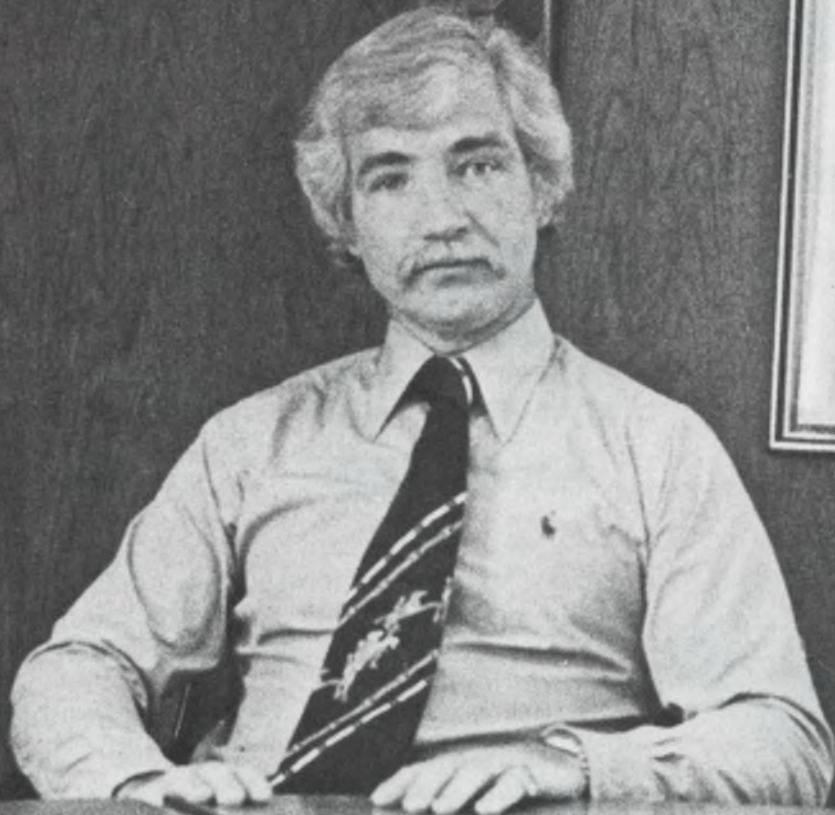

Yea,
though I walk
through the valley
of the shadow
of death
I shall fear no evil:
for I am the meanest
son-of-a-bitch
in the valley.

**Jerry Sanders of AMD
Speaks on
Making Your Engineers
Profit Conscious**

The only reason for a business to be in business is to make a profit. If you're running a business that depends heavily on engineers, you've got to get those engineers to think about profits. They've got to weigh every decision in terms of the bottom line of the profit-and-loss statement.

You can give your engineers all sorts of lectures and pompous speeches but, in my opinion, the only way to make them profit conscious is to make them feel the profits. They've got to feel—really feel it in their pocketbooks—that when the company makes money, they make money.

Some engineers think that the way to make money for the company is to invent the most dynamic product in the world. This isn't necessarily so.

When we started Advanced Micro Devices in mid-1969, we decided that our first responsibility was to survive. You have to survive before you can prosper. So I said that we're not going to come up with any unique or proprietary products initially. I didn't want to be tied into that cycle for new products—a gestation period of getting designed in, having prototypes built, then having equipment going into production before we can see any reasonable volume of orders for integrated circuits. I realized we weren't going to make any money unless we could get some volume orders.

The answer was to become a second source because there's an established market. But if you want to be a good second source, and by "good" I mean profitable, you have to bring something to the party. And what we were going to bring to the party was the best parts in the world.

Now here's a problem. How do you convince sharp engineers that goodness is not in megahertz, or picocoulombs or angstroms, but in dollars? How do you show them that a product is a good product only if it makes a profit, and is a great product if it makes a great profit?

When you're running an entrepreneurial firm, you start by attracting engineers with an appeal to their desire to acquire an estate. You have to create a structure that makes it easy for them to acquire an estate.

But first you have to convince an engineer that goodness is defined as returning a profit. And you have to be honest—with engineers or anybody else. So you have to admit that you can't make a great profit by being a second source. To make a great profit you have to offer something unique; you have to acquire leadership.

But before you get leadership and great profit,

you have to survive. Before you take on Muhammad Ali, you'd better make sure you're in good condition and know a bit about fighting. You've got to get through a few fights successfully before you start to duke it out with the best in the business.

So we decided that we would start by being a second source, but we were going to be the best second source in the world. Naturally, our parts were to be plug-in replacements for the other guys' parts. But we weren't going to just copy the circuits. We weren't going to make a microphotographic duplicate of the other guy's mask set. We weren't going to tailor our process to his.

First, I said, we're going to get a thorough understanding of the product from an engineering viewpoint. Since many of my people were the original developers of the products we were going to second source, this was easy. What we wanted to know was what the product did, how it did it, and why.

Then we had to learn what the problems were with the circuit. What did customers not like about it? Maybe the circuit had an anomaly.

It turns out, for example, that one popular circuit had an anomaly at high temperature. It wouldn't operate at maximum frequency at high temperature. Or take the 715, the highest speed op amp at the time. It didn't sell. Why? Under most conditions it oscillated. It was an excellent product, but you had to know how to use it. The customers liked its performance capability, but the part was virtually impossible to use.

Or take the 741, a fantastically popular op amp, and the first one with full compensation. Its compensating capacitor often broke down at low voltages.

So we redesigned the 715, and the 741, and the 9602, and the 9316 and a bunch of other popular integrated circuits. And they still fit into the old sockets. But ours worked better.

Now, if we're going to sell 715s and 741s and 9316s, what could we offer? Could we sell price? How could we compete on price with a giant? Could we sell delivery? That would have meant a large investment in inventory. We had to sell quality and reliability.

These are different, as you know. If a product has quality, it meets its specs at the beginning. It has fewer rejects at incoming inspection. Reliability is the ability of a product to continue to meet its specs with time. We decided that every part that went out the door at Advanced Micro Devices would be tested to MIL-STD-883.

And when our engineers found that specifications were inadequate, we would add specs, at

least for information. We gave fuller characterizations. We put our money into processing and into testing. Building a better part was a cornerstone to our strategy. If you build a better part, you can specify it better.

So the challenge we gave our engineers was that we could make money—and they could make money—if they could design parts with a discernible advantage. Our philosophy tended to mean that we would be selling at a higher price than our competition, so we tended to sell to the top-of-the-line user and to military customers. If customers were quality conscious, we could sell them. If they weren't, we didn't have a prayer.

Now there's something else we did. We gave our engineers direct communications with our sales organization and with our customers. We wanted them to hear what the customer likes about our products and what he doesn't like.

We don't lock them up in the back room. We keep them in touch, and that pays off. For example, our shift registers, like those of almost every supplier, used to drop bits. A shift register is not supposed to drop bits, you can say, and that's true. But just about every shift register on the market drops bits. Now, however, thanks to the fact that our engineers got out and learned of this problem from the customers, our shift registers don't drop bits.

Once we established ourselves as a producer of high-quality ICs—even if those ICs weren't exciting—and once we had reached an adequate sales and earnings level, we could start developing our own unique, proprietary products. We've begun to do that.

So we're now at the stage where an engineer can buy our plain-vanilla device, which will have a discernible difference from others on the market. Or he can buy a dramatic device that's substantially different from any other.

It's easy to inspire engineers to develop world beaters like the new products we're beginning to introduce. But it takes a different approach to get engineers to knock themselves out to develop a better 741.

How do you do that? When we put this company together, I wanted the best engineers because the heart of this business is excellent engineering. We put together a unique compensation package. We didn't give stock options to engineers. Everybody else did that. Instead we sold them stock at the founders' price—10 cents.

Our competitors never sold stock to their engineers at less than the price paid by outside investors. We sold common stock to our engi-

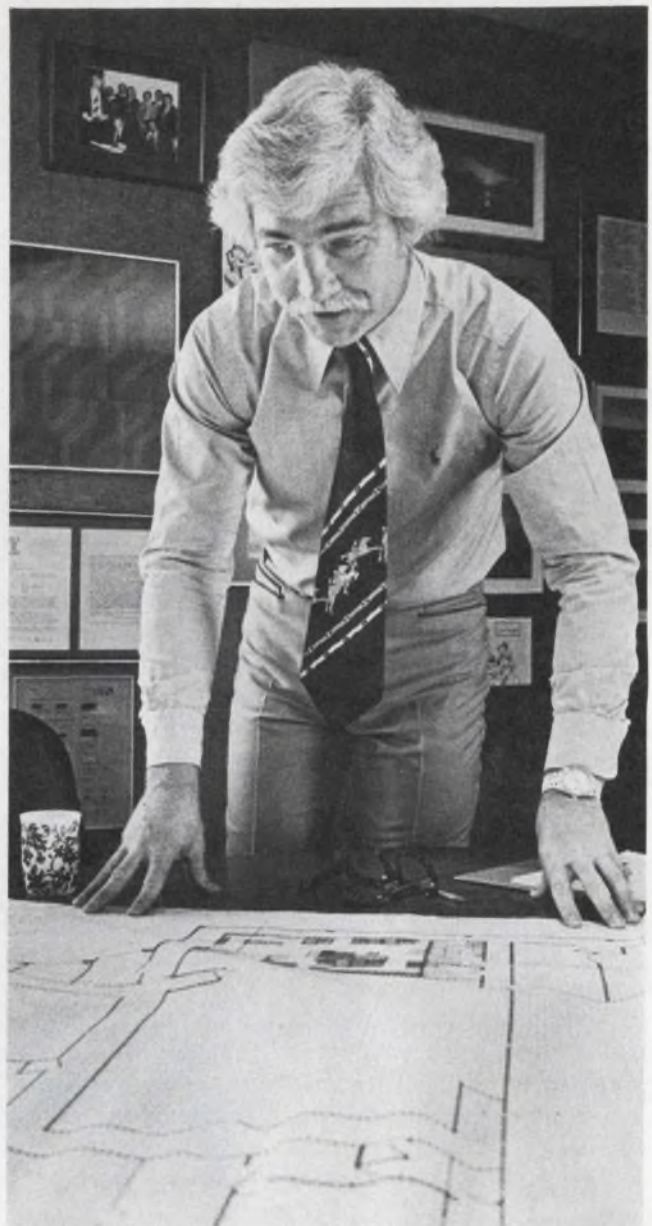

neers at a dime a share when outsiders were paying \$2 a share for preferred stock that was convertible, one-for-one, into the common.

The preferred stock, naturally, has first rights in a liquidation. But if we were successful, the engineers could make a lot of money. I don't mean just the "key" engineers or the founder engineers. I mean all the engineers. Every engineer at Advanced Micro Devices has an equity position. When the stock was selling at its peak in 1973, my average engineer could have made between \$25,000 and \$125,000. Now that the stock is lower—like everybody else's—they could still make a third of that. But it's still not insignificant. A lot of our guys are driving Mercedes Benz.

I really wanted my engineers to make money—not when they're 80 years old, but right away. I wanted them to feel that if Advanced Micro Devices made a lot of money, they would be able

Who is Jerry Sanders?

He first got excited about semiconductors on his first job after graduation with a BSEE from the University of Illinois in 1958. So he left Douglas Aircraft, where he had been designing the air-conditioning control system for the DC-8, and joined Motorola as an applications engineer. He stayed with Motorola from mid-1959 till April '61, when he joined Fairchild Semiconductor, which was just coming out with RTL integrated circuits.

One of Fairchild's customers, Hughes Aircraft, had a profound effect on Jerry Sanders. "I was really staggered," he says, "by the level of competence of the engineers there. They had a lot of pride and a great feeling that they built the best equipment in the world. I heard people say that they were there only to provide support for the engineers." And that was part of the philosophy that was to guide him many years later when he founded Advanced Micro Devices.

Sanders stayed at Fairchild through the last days of 1968, moving up in seven years through the positions of District Sales Manager, Regional Sales Manager, Area Sales Manager, Department Manager, U.S. Director of Marketing then, finally, Worldwide Director of Marketing.

Soon after he left Fairchild, he was sitting with his friend, Charlie Sporck, now president of National Semiconductor, at the Velvet Turtle, one of Northern California's popular culture centers. Sporck was the man who advised Sanders to start his own business. He did. He built the company, he says, "as an extension of my own pride. If I couldn't be terribly proud of Advanced Micro Devices," he says, "I couldn't work there. I don't think anybody should work where he's not proud."

AMD has not done badly. In the year ending March 1975, the company grossed \$26-million. But for Jerry Sanders, Chairman of the Board, President and Chief Executive Officer, the important thing is that he's still proud to work there. He spends six days a week at AMD and loves it. But his love for the company is exceeded by his love for his family.

At 38, Sanders feels there's nothing more wonderful than being with your family. Though he spends lots of time gardening and enjoys getting his hands in dirt, and though he likes to play tennis, he feels that the best part of life is spending time with his wife, Linda, and his three daughters—11-year-old Tracy, 7-year-old Lara (who was named after Lara in Dr. Zhivago) and 4-year-old Alison (who was named after Ali McGraw).

"My hobby," says Sanders, "is being with my kids. I love to be covered with kids. I love to have them climbing all over me."

to develop a large estate because they were actually owners of the stock.

Let's take an engineer who got 1500 shares for \$150. The other day those 1500 shares were worth about \$15,000. That's not a dream; it's real. And we make it easy for an engineer to sell his stock. We have an on-going S-1 registration statement with the Securities and Exchange Commission. We've arranged things so that when an engineer is ready to sell, he has fully registered, fully negotiable stock.

There's no stigma attached to selling stock. We make it easy for a fellow to sell his stock because I want to make profits real for him. My goal is to make everybody rich because that's going to make me rich. I don't know of any semiconductor company that has as large a percentage of its stock in the hands of its employees.

The obvious question now is how we keep a guy going after he sells his stock. What's the incentive then? After a fellow has built an estate—once—why should he continue to plug away to make the company even more successful?

And that's our second phase. The original engineers all got that stock jump and now they can sell at a profit. Now we have the same problem everybody else has. Now all we have to work with are options. But there's still a difference.

First you have to realize that a fellow has to be with the company four years before he has full control of his stock. He's entitled to 25% after the first year, 50% after the second year, and so on. During those first four years, nobody is going to look kindly on the idea of returning stock to the company at a dime when the market price is \$10 or so.

But when the fellow reaches his 42nd month, we give him stock options. That's an additional incentive for staying with the company. The exercise price of the option—the price he eventually must pay to buy the stock—is determined by the fair market value of the stock at the time we grant the option. Naturally, he won't exercise the options unless the market price of the stock is higher.

But we did something different. When the market started its slide and the options went under water—that is, the stock price on the open market was less than the option price—I persuaded the Board of Directors to rescind those options and issue new ones at a more favorable price. And when the stock market really collapsed, I went back to the Board again and got all these options replaced by new ones at \$1.94. We saw the bad market as a great opportunity to en-

hance our engineers' ability to acquire an estate.

What's important here is that the engineer can afford to exercise options for 400 or 1000 shares. Suppose an engineer is with a company where he has options for 500 shares at \$60 a share. How many engineers do you know with \$30,000 socked away?

Many other companies were delighted when their stock price dipped below the option price because they knew those options would not be exercised, so the shares could be returned to the company treasury. Others who reduced the option price also reduced the number of optioned shares, as well. We did not.

We genuinely tried to enrich our engineers and we're continuing to. The way to motivate people to be profit conscious is to let them share in the profits.

On top of everything else, we have a profit-sharing fund that gets 10% of our pre-tax profit. Every six months people can get half of their profit-sharing allotment, usually 7 to 15% of their salary, in cash. The other half goes into a long-term account that you have to wait 10 years to get.

Let me tell you, when profits vanished during the recession and there were no profit-sharing checks, everybody was very much attuned to the

problem. Everybody tried to figure out how to make the company more profitable.

This profit consciousness pervades everything the engineer does. He really thinks twice, for example, before he buys capital equipment he doesn't genuinely need. He recognizes the impact on profits because he has a stake in the company. Before he buys, he usually has a heart-to-heart talk with himself to see if he really needs the gear or if he can get along by sharing someone else's.

And yet he knows that we always back our engineers with the stuff they need, even in recessionary times. We're still buying groovy scopes and pulse generators. We're still committing several thousand dollars to test equipment. We just bought a scanning electron microscope because our engineers felt it would help them do a better job on surface studies. With all the bells and whistles, that's good for \$50,000. And if engineering wants different epi reactors or better sputtering equipment, that's it. We back our engineers.

Has our policy paid off? What I find particularly thrilling, but scary, is the intense recruitment effort that some of the big companies have mounted to get our guys. That's really flattering. It's like having a beautiful wife everybody wants to make love to. You don't want them to succeed, but it's still flattering. ■■

New Digital/Analog Power Supplies from Heath



Whichever you choose, Heath's 2700-Series power supplies set new standards for versatility and value. Choose from four DC models: .0-7.5V at 0-10A, 0-15V at 0-5A, 0-30V at 0-3A or 0-60V at 0-1.5A...digital or analog readout...constant voltage, constant current operation...remote voltage & current programming...precise load and line regulation...output protection...voltage sensing. They're available in easy-to-build kit form or completely assembled and calibrated — with prices as low as \$169.95*. Send for your free Heath catalogs and get complete details.



Send for your **FREE Heath catalogs**

Our '75 Heathkit Catalog describes the world's largest selection of electronic kits — including a full line of lab and service instruments. The latest Heath/Schlumberger Assembled Instruments Catalog features a complete line of high performance, low cost instruments for industrial and educational applications. Send for your free copies today!

HEATH COMPANY
Dept. 511-080
Benton Harbor, Michigan 49022

HEATH
Schlumberger

- Please send the 1975 Heathkit Catalog.
- Please send the latest Heath/Schlumberger Catalog.

NAME _____

TITLE _____

COMPANY/INSTITUTION _____

ADDRESS _____

CITY _____ STATE _____ ZIP _____

PRICES & SPECIFICATIONS SUBJECT TO CHANGE WITHOUT NOTICE.

*MAIL ORDER PRICES; F.O.B. FACTORY.

TE-325A

INFORMATION RETRIEVAL NUMBER 35

ELECTRONIC DESIGN 16, August 2, 1975

Think Large. Think Small. Think Ise

Think our three jolly green giants for desk-top electronics. Our two pint-size pigmies for carry-in-the-pocket display designs. But don't stop there. Think low operating voltages, low power consumption, glass encapsulation all around, and wafer-thin thickness and dip clip pins for fast efficient mounting.

itron[®]

FG-159A2

ec = eb = 35Vp-p
ic = 4.5mA-p-p
ib = 3.5mA-p-p

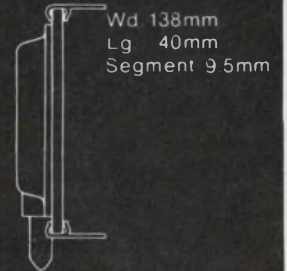

FG-139A2

ec = eb = 30Vp-p
ic = 3.6mA-p-p
ib = 2.8mA-p-p

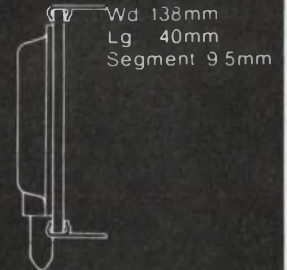

Our jolly
green giants

FG-99A2

ec = eb = 24Vp-p
ic = 3.5mA-p-p
ib = 2.5mA-p-p

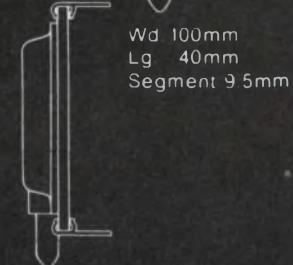

FG-125A2

ec = eb = 24Vp-p
ic = 2.0mA-p-p
ib = 2.0mA-p-p

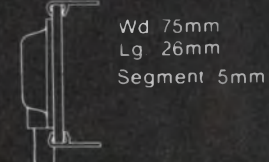

Our pint-size
pigmies

FG-95A

ec = eb = 24Vp-p
ic = 2.0mA-p-p
ib = 1.5mA-p-p

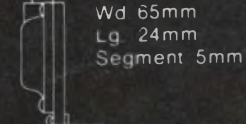

Something else to think about

Think Ise for digital readouts for instruments, clocks and other products, too

The Brighter Side of Electronics

ISE ELECTRONICS CORP.

Main Office:

P.O. Box 46 Ise City, Mie Pref., Japan
Tel: (05963) 5-2121 to 4. Telex: 4969523

Tokyo Office:

2-7-7 Shigashi Shinbashi, Minato-ku, Tokyo, Japan
Tel: (03) 433-6616 to 9. Telex: J26546

Noritake Electronics Office:

22410 Hawthorne Blvd., Torrance, California 90505, U.S.A.
Tel: (213) 373-6704. Telex: 230674910

Voltage-controlled attenuator provides linear variation in decibels

Use the approximately logarithmic relationship between the gate voltage and the drain-to-source resistance of a FET to build a voltage-controlled attenuator with linear variation in dB (Fig. 1a). A string of diodes provides a gate bias voltage to the FET that is a nonlinear function of control voltage V_c . This gate bias, combined with the FET resistance characteristic, produces a curve that shows a linear dB attenuation vs control voltage (Fig. 1b).

The circuit provides a slight gain at the minimum attenuation setting to position the transfer curve so the unity gain, or 0-dB attenuation point, is in the linear region. To calculate the minimum

and maximum attenuation for the circuit, you can use the following equations:

$$\text{Min: } E_{\text{out}}/E_{\text{in}} = R_3/(R_1 + R_2), \text{ for } V_c \geq 7 \text{ V;}$$

$$\text{Max: } E_{\text{out}}/E_{\text{in}} = (R_3/R_2) [R_{\text{ds on}}/(R_1 + R_{\text{ds on}})], \text{ for } V_c = 0 \text{ V.}$$

The operating frequency of the circuit has an upper limit that mainly depends on the low-pass filter formed by R_1 and the FET's capacitance. The worst-case cut-off frequency is 1.8 MHz. It occurs when the circuit is set at minimum attenuation.

David B. Millirou, Electrical Engineer, Naval Surface Weapons Center, Silver Spring, MD 20910.

CIRCLE NO. 311

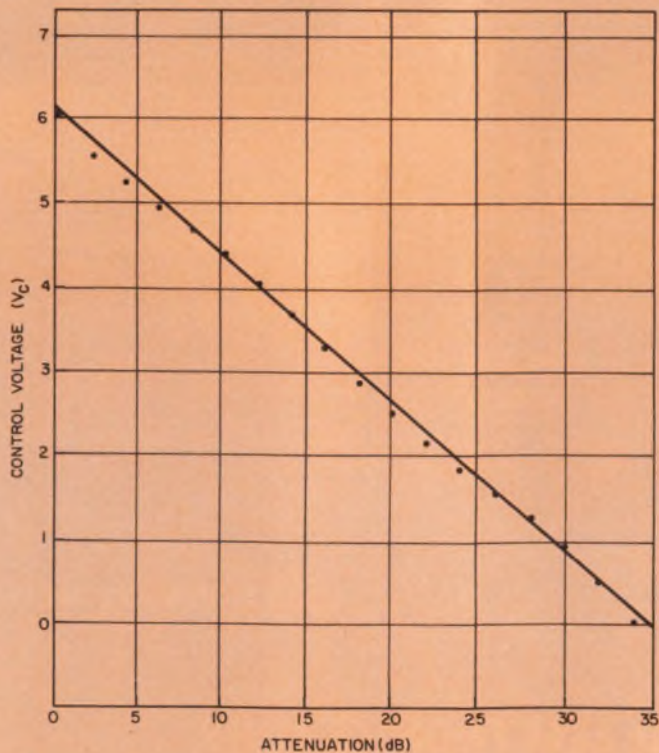
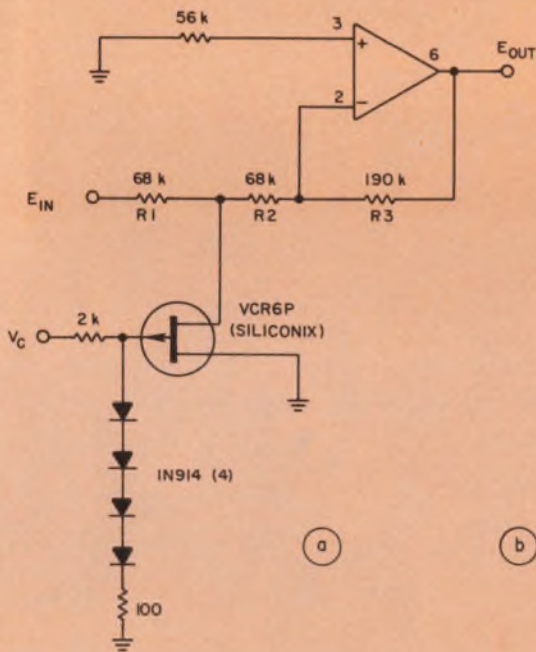

A voltage-controlled attenuator circuit (a) can provide linear dB variations (b) when the nonlinearity

of a diode bias source is combined with the resistance characteristics of a FET.

ANOTHER DIMENSION

has been added to the world famous family of

Simpson®
260 VOMS

the **SERIES 6XL**



FOR THE SPECIAL NEEDS OF THE SOLID STATE ELECTRONICS INDUSTRY

- Extra shock and drop-resistant construction, high impact, custom-molded panel and case
- Extra large viewing area with four-color (Red, Green, Blue and Black) scales, keyed to matching range panel
- 33 ranges with extra voltage, current, resistance and low-power ohms functions
- Plus — all the features of the time-honored, ever popular 260-6

260-6XL, Complete with batteries, test leads and manual **\$90.00**

260-6XLM, with mirror scale **\$93.00**

260-6XLP WITH CIRCUIT OVERLOAD-PROTECTION

Reset pushbutton releases when overload exists. Will not reset until overload condition is eliminated.

260-6XLP, complete with batteries, test leads and manual **\$125.00**

260-6XLPM, with mirror scale **\$128.00**



RANGES:

DC Volts	0-0.25; 0-1; 0-2.5; 0-10; 0-25; 0-100; 0-250; 0-500; 0-1000
AC Volts	0-2.5; 0-10; 0-25; 0-100; 0-250; 0-500; 0-1000;
DC Microamperes	0-50 (250 MV Drop)
DC Milliamperes	0-0.5; 0-5; 0-50; 0-500
DC Amperes	0-5 (250 MV Drop)
AC Amperes	6 ranges from 0-5 to 0-250 with optional Model 150 Amp-Clamp adapter.
DB Scale (1 MW 600 Ω Reference)	-20 to +10; -9 to +21; -1 to +29; +11 to +41; +19 to +49
Resistance (Standard Power)	Rx1 (6 Ω center scale), Rx100 (600Ω center scale), Rx1K (6000 Ω center scale), Rx10K (60,000 Ω center scale)
Resistance (Low Power)	Rx1 (20 Ω center scale) Rx10 (200 Ω center scale) Max. open circuit voltage only 100mV! Max. measuring power only 0.125 mW!
Size	5¼ x 7 x 3½" (133 x 178 x 79 mm)
Weight	2.5 lbs. (1.14 kg)

ACCESSORIES

Model 150 Amp-Clamp, Catalog No. 00532 complete with a No. 00533 test lead	\$29.50
30 kV DC Probe, Catalog No. 00509	\$22.00
Grip-Tip Extension Probe, Catalog No. 00118	\$ 4.75
Rigid Case, Catalog No. 00805	\$20.50
Sheath Case, Catalog No. 01818	\$16.75
5 kV DC Probe, Catalog No. 00506	\$ 5.25
5 kV AC Probe, Catalog No. 00505	\$ 5.25

Available Now at Leading Electronics and Electrical Equipment Distributors • Write for Complete Specifications



SIMPSON ELECTRIC COMPANY

853 Dundee Avenue, Elgin, Illinois 60120 • (312) 697-2260

CABLE: SIMELCO • Telex: 72-2416

IN CANADA: Bach-Simpson, Ltd., London, Ontario

IN ENGLAND: Bach-Simpson (U.K.) Ltd., Wadebridge, Cornwall

IN INDIA: Ruttonsha-Simpson Private, Ltd., Vikhroli, Bombay

INFORMATION RETRIEVAL NUMBER 37



Ultrasonic transmitter/receiver generates a 20-ft beam that detects objects

A signal from an ultrasonic transmitter, beamed to a transducer in a receiver unit up to 20 ft away, can be used as an invisible anti-intrusion device, an object sensor on industrial belt-conveyor systems, a person detector on automatic door openers and many other applications that can operate from a relay.

Most circuits for ultrasonic generation and detection are complex and need high-gain stages to amplify weak received signals, but the circuit in the figure is extremely simple. It uses only two ICs.

The transmitter has a 555 timer, which is connected in an astable mode to provide a square-wave output of approximately 50% duty cycle. The frequency is adjusted by R_5 for optimum sensitivity with the transducers used. The values shown are for operation at about 40 kHz.

In the receiver, the LM1808 IC (National Semiconductor) controls the relay directly. The LM1808 is equivalent to combining an LM3065 i-f amplifier with an LM380 power amplifier but in a single 18-pin DIP. The volume-control section of the LM1808 is not used in this application. And though the 1808 is designed for 24 V, in this application a 15-V supply is adequate.

The output from the 40-kHz receiver transducer enters pin 13 of the 1808, which is the input terminal of emitter-coupled, cascaded differential i-f amplifiers. Resistor R_2 maintains pin 13 at about the same potential as pin 12, and resistor R_1 reduces the potential at pin 6 to about 11 V, which is stabilized by the internal circuit.

The output from the i-f amplifier at pin 9 is a square wave when the input at pin 13 exceeds the threshold voltage. Diodes D_1 and D_2 are low forward-drop germanium diodes connected in a "diode-pump" circuit to supply a dc negative output when the receiver transducer picks up the 40-kHz beam.

A bias current via R_3 to the inverting input of the 1808 power stage at pin 16 results in a 2-V quiescent level at its pin-1 output. When a 40-kHz signal appears at pin 9, the output from the diode circuit causes the voltage at pin 1 to rise to about 13 V, and the relay closes. Diode D_3 suppresses the relay-coil's current turn-off surge voltage. The relay should de-energize when the coil voltage falls to about 2 V, unless a latching circuit is required. A relay with a lower release voltage may be used if a low-voltage zener diode or about three forward-biased silicon diodes in series are included in the pin-1 circuit to reduce the voltage across the relay coil.

In the author's application, the relay was out-fitted with 10-A DPDT contacts.

The transmitter's 40-kHz transducer has an impedance of about 200 Ω and the receiver a value of about 70 k Ω . In both units shown in the figure the capacitance is listed as 1400 pF $\pm 20\%$. The receiver unit is sharply resonant, but the 8.2-k Ω resistor across it reduces the Q so the transmitter frequency is not critical. Completely different transducer types, with the transmitter and receiver transducers both identical (400- Ω impedance, 1700 pF), provide very similar performance. Thus the choice of transducers is not critical.

J. Brian Dance, Physics Dept., The University of Birmingham, P.O. Box 363, Birmingham B15 2TT, England.

CIRCLE No. 312

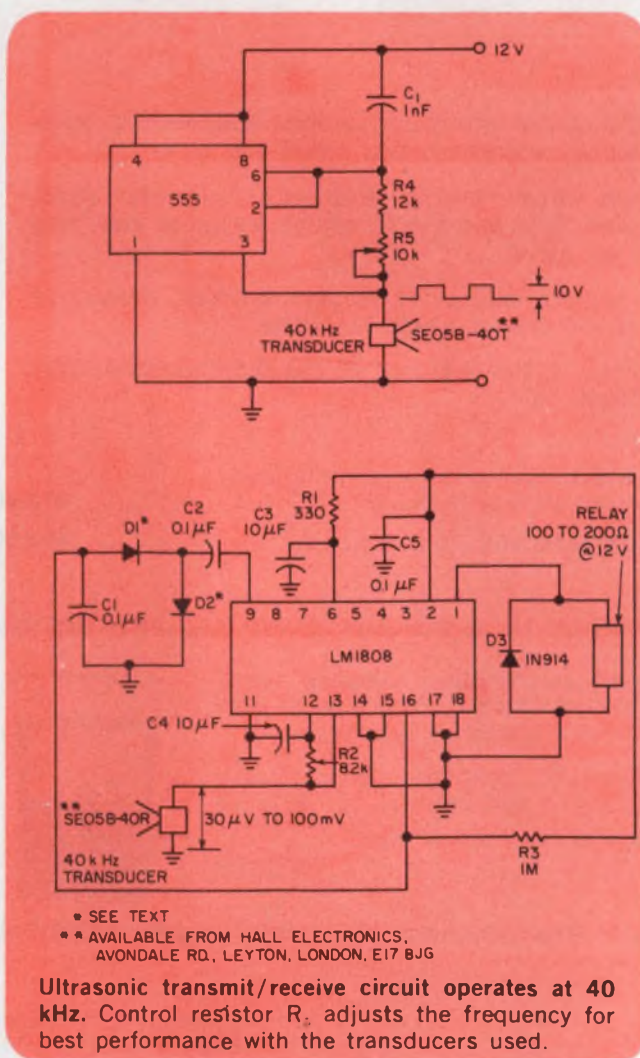

Uninterruptible Power Systems that do a lot more than just provide emergency power.

When a power failure or power brownout occurs, many operations using sensitive equipments are critically affected. Intensive care units in hospitals, process control systems, mimicomputers and programmable calculators using semiconductor memories are a few examples.

If you are planning the purchase of a back-up power system ask yourself these questions. Does the system always supply dependable, noise-free power... instantly? ...smoothly? How dependable? How noise-free?

Incoming AC power can fail, become noisy, or fluctuate widely in voltage level, but the output from a Topaz Uninterruptible Power System will always be there when needed... supplying continuous, dependable power.

Topaz systems incorporate our GW and GX inverters... units that have logged millions of hours of reliable service. We make systems rated 300 VA and larger with battery power furnished to meet the requirements of your application. And you can have various options including special monitors and alarms.

So write for our brochure or give us a call. We'll show you why we say... "We make the most reliable UPS in the business."

**Talk to us
about it today.
Tomorrow you
may wish you had
a good one.**

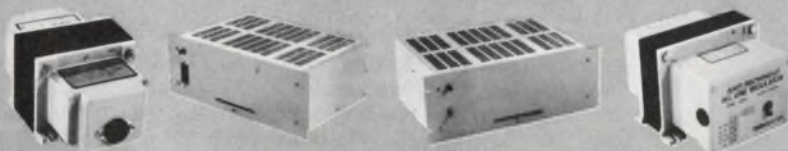

Other Products • Ultra-Isolation Transformers • Inverters • Frequency Changers • AC Line Regulators

Topaz is also a major supplier of **custom** power conversion equipment. Contact us.

TOPAZ

ELECTRONICS 3855 Ruffin Road, San Diego, California 92123 • Phone: (714) 279-0831. TWX (910) 335-1526

INFORMATION RETRIEVAL NUMBER 38

Microvolt comparisons made with preamp and comparator

Comparison of dc signal levels within microvolts can be achieved by use of an LM121A preamp and an LM111 comparator IC. After nulling, you get maximum offset drift of $0.2 \mu\text{V}/^\circ\text{C}$ from the 121A and almost nothing from the 111. Many operating conditions are possible for the circuit shown, since the signal characteristics can vary widely. The table lists some test results for $5\text{-}\mu\text{V}$ hysteresis.

For large-amplitude signals, C_s can be decreased and the hysteresis increased to make the speed greater. Conversely, to obtain hysteresis as low as $1 \mu\text{V}$, trim R_{H1} to about $300 \text{ k}\Omega$, use a C_s of 0.01 to $0.1 \mu\text{F}$ and a low-impedance signal source.

Great care must be taken when building the circuit, because the over-all gain is about 10 million. One source of trouble is the Kovar leads of the IC package. When soldered to copper pads, they generate a $3.5\text{-}\mu\text{V}$ offset for only a $0.1\text{-}^\circ\text{C}$ temperature difference. Compact layout and shielding against air currents can minimize this offset.

Common-mode voltages should be kept small, even though the 121A provides 120-dB rejection. Large common-mode swings can still generate several microvolts of offset. In addition large

common-mode dc voltages enable the generation of microphonic voltages, such as signals from capacity changes in a moving input cable. Therefore, the input cable should be short and stiff and have a low capacitance.

Imbalances in input-cable capacitance and in the source impedance can result in unbalanced noise pickup. Also, the unbalances tend to counteract the IC's common-mode rejection effect. An increase in the value of C_s and the amount of hysteresis is helpful to reduce noise problems. Of course, ground loops should be eliminated and low temperature-coefficient parts should be used throughout the input circuit.

Peter Lefferts, Design Engineer, Advanced Linear IC Engineering, National Semiconductor, 2900 Semiconductor Dr., Santa Clara, CA 95051.

CIRCLE NO. 313

Typical overdrive delays

HYST SET.	R_h	R_s	C_s	DELAYS WITH VARIOUS OVERDRIVES			
				25%	100%	1000%	100 mV
$5 \mu\text{V}$	$75 \text{ k}\Omega$	$10 \text{ k}\Omega$ MAX.	6800 pF	2 ms	1.8 ms	$600 \mu\text{s}$	$560 \mu\text{s}$

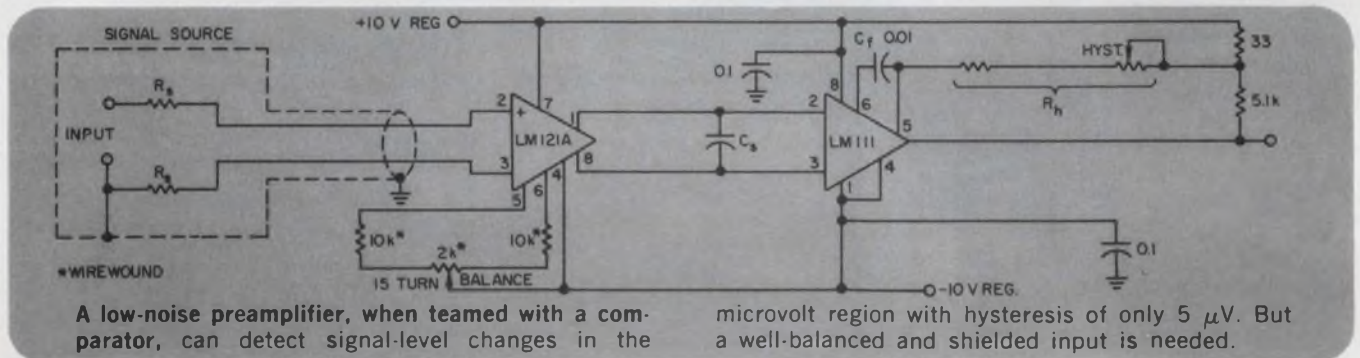

IFD Winner of April 1, 1975

William Hearn, Electronic Engineer, Lawrence Berkeley Laboratory, Bldg. 71, Berkeley, CA 94720. His idea "Complete Phase-Locked Loop Made from Part of a Quad EX-OR Gate" has been voted the Most Valuable of Issue Award.

Vote for the Best Idea in this issue by circling the number for your selection on the Information Retrieval Card at the back of this issue.

SEND US YOUR IDEAS FOR DESIGN. You may win a grand total of \$1050 (cash)! Here's how. Submit your IFD describing a new or important circuit or design technique, the clever use of a new component or test equipment, packaging tips, cost-saving ideas to our Ideas for Design editor. Ideas can only be considered for publication if they are submitted exclusively to ELECTRONIC DESIGN. You will receive \$20 for each published idea, \$30 more if it is voted best of issue by our readers. The best-of-issue winners become eligible for the Idea of the Year award of \$1000.

ELECTRONIC DESIGN cannot assume responsibility for circuits shown nor represent freedom from patent infringement.

RACK MOUNT POWER SUPPLIES ...TO 60 AMPS

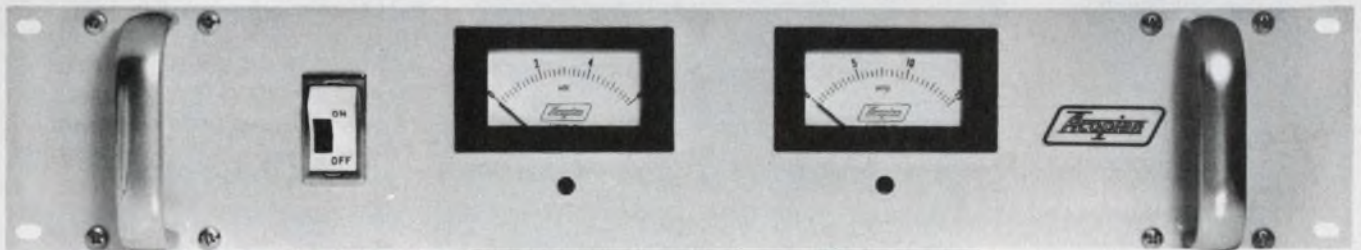

ALL MODELS U.L. RECOGNIZED

NOMINAL OUTPUT VOLTAGE	OUTPUT CURRENT AMPS	PRICE	MODEL	DIMENSIONS (INCHES)	
				HEIGHT	DEPTH
5	20	\$280	5PT20	3½	11
5	32	330	5PT32	5¼	12
5	60	525	5PT60	5¼	17
12	20	330	12PT20	5¼	12
12	45	550	12PT45	5¼	17
15	10	280	15PT10	3½	11
15	16	330	15PT16	5¼	12
15	31	590	15PT31	5¼	17

OPTIONS

Overvoltage protection—Add prefix "V" to model number and \$25.00 to price of models with output current rating of 20 amps or less, \$75.00 to price of other models.

Ammeter—Add suffix "A" to model number, \$15.00 to price.

Voltmeter—Add suffix "F" to model number, \$15.00 to price.

Handles—Add suffix "H" to

model number, \$10.00 to price.

Regulation, $\pm 0.05\%$ or better.
Ripple, 1 mv rms or better.
Many other models from 1 to 50 volts. Write for complete catalog.



Corp., Easton, Pa. 18042. Telephone: (215) 258-5441.

INFORMATION RETRIEVAL NUMBER 39

When it comes
to wire processing
we won't
leave you stranded

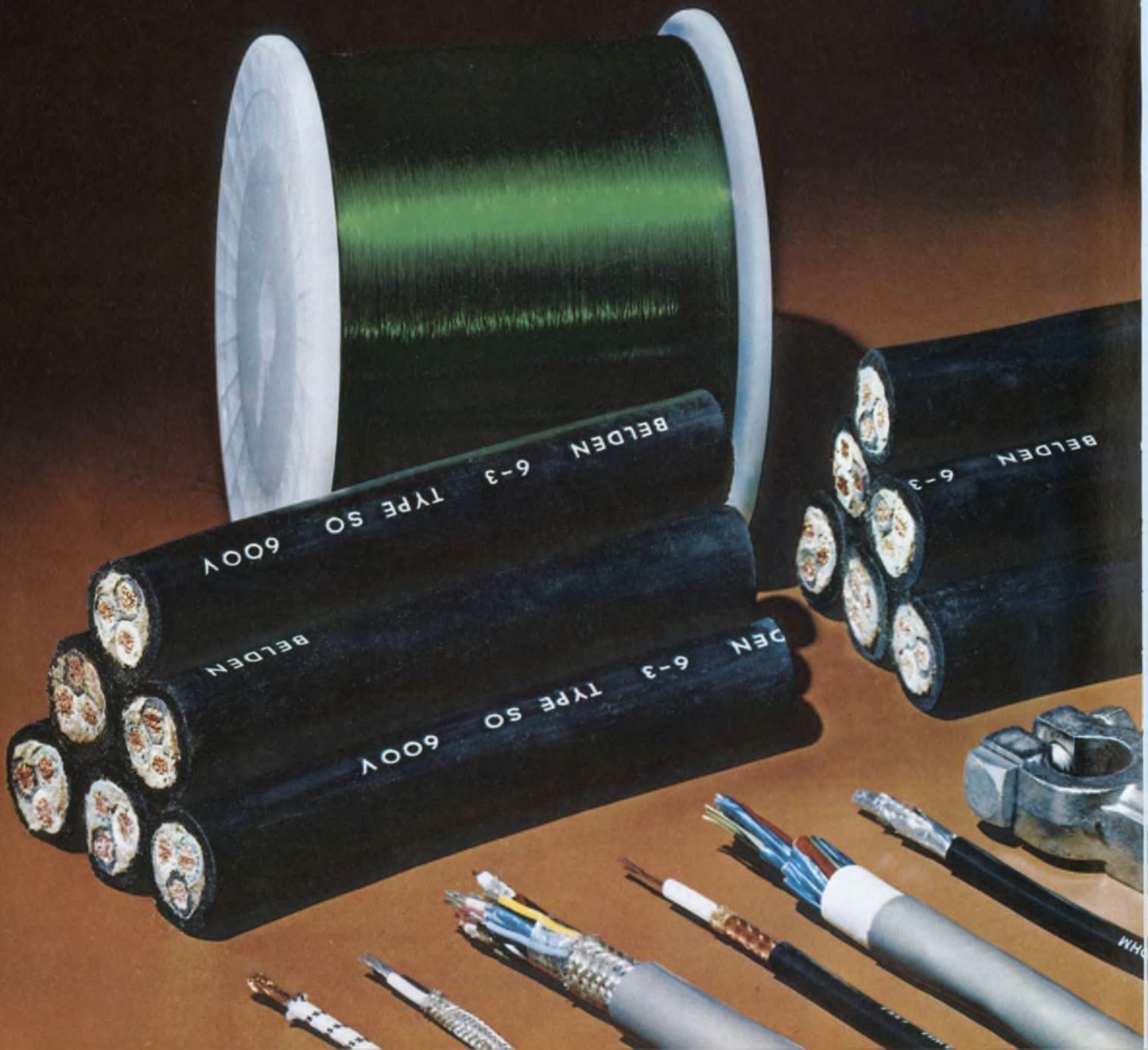

Your design is set. The components are on hand. The line is starting to roll. All of a sudden wham! That essential wire connection cannot be controlled. Your production schedule is "bottlenecked," and more importantly, your costs have skyrocketed.

While such situations are difficult to avoid completely, most wire processing problems can be foreseen if you take advantage of Belden's "total engineering view" to wire, cable, and cord applications.

Not only will it foresee a fabricating problem, for example, it can also uncover opportunities for cost reduction without hurting performance.

Consult Belden specialists when you get ready to look into the fine points of wire feeding, cutting, stripping, terminating, and

assembly. Our wire specialists and engineers will meet with your people, at your plant, to discuss a wire problem. Helping solve customer problems has always been our long suit. It still is.

We not only have the capability to provide standard techniques, we also have developed proprietary technology to anticipate your needs.

When we can't help you "get it all together" using standard procedures, we'll innovate a solution for your problem! For answers right now, phone:

(312) 887-1800, Transportation Division

(312) 681-8920, Electrical Division

(317) 966-6681, Electronic Division

Or write Belden Corporation, 2000 South Batavia Ave., Geneva, Illinois 60134.

BELDEN 

... new ideas for moving electrical energy

INFORMATION RETRIEVAL NUMBER 234

H-5-4



Researchers simplify Baritt diode design

A p^+n-p^+ Baritt diode that operates at 8 GHz with a power-output level of 85 mW and efficiency of 2.6% is reported of simpler design than previous devices. Heretofore only p^+n-v-p^+ structures have proved effective above 6.3 GHz.

Developed at the University of Munich in West Germany, the Baritt device uses as a starting material n epitaxial silicon ($\rho = 3 \Omega \text{ cm}$) on a p^+ substrate. A p^+ diffusion using a paint-on technique with boron glass was performed, so that the final thickness of the n layer was $8.7 \mu\text{m}$. This corresponds to a transit-time frequency of about 8 GHz.

Since the negative rf resistance of Baritt diodes is inherently small, special care was taken to reduce the series resistance of the device. To minimize this resist-

ance, the substrate was etched to a thickness of $6 \mu\text{m}$, maximum, and the contacts (Ti, Au) on both sides were evaporated at a substrate temperature of 280 C. Standard photoresist technology was used to obtain mesa-shaped diodes with a diameter of $240 \mu\text{m}$.

These diodes were mounted into microwave packages, with the substrate on the heat sink. The encapsulated diodes were incorporated in a conventional waveguide resonator.

To obtain the 8-GHz performance, the diodes were biased so that the top contact was the emitter. This gave steeper current rise and larger punchthrough voltage.

A voltage of 72 V was applied at 55 mA with use of an input power of 4 W. An rf output of 18 V was obtained from an oscillating diode.

1 mW of power pumps new type of laser

A new type of miniature laser that uses neodymium pentaphosphate as the active substance has been developed at the Max Planck Institute for Solid State Research in Stuttgart, West Germany. The laser requires only 1 mW of pump-

ing power to emit a continuous-wave signal at a wavelength of 1.05μ .

The unusual characteristic of the laser is that there is no ion-implantation of neodymium ions into an alien crystal matrix. The laser crystal is instead a homogeneous chemical compound that contains Nd as one of its components.

Echo pulses pinpoint optical-fiber flaws

The echo-pulse technique, used to locate discontinuities or imperfections in electrical cables, has been applied to optical fibers by experimenters at the AEG Tele-

funkun Research Institute, Ulm, West Germany. In place of electrical pulses used for cables, light pulses from a solid-state laser are employed.

A gallium-aluminum-arsenide laser, excited with short current pulses, is the light source. The

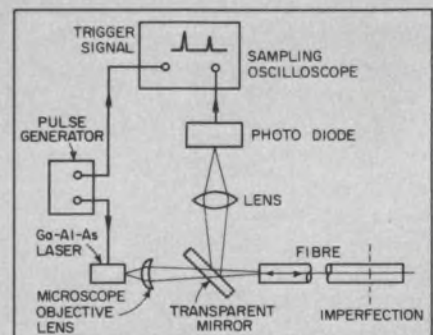

Telefunken researchers use a microscope objective to focus the laser light onto the end of the fiber under test. Between the microscope objective and the fiber, the front surface of a transparent mirror picks up light reflected from the fiber front face, from the fiber imperfection and from the far end of the fiber. This reflected light is focused onto an avalanche photodiode, and the detector output is displayed on a sampling oscilloscope.

The position of the break in the fiber can be determined from the time delay between the pulse reflected from the fiber front face and the pulse from the imperfection. The spatial resolution is higher for shorter light pulses. The limit of resolution is set by the pulse broadening occurring in the fiber.

The laser power into the fiber must be high, the researchers report, because the light reflected from a break is small. For a clean 90° break, the back-scattered power is only 4% if there is an air gap much greater than the wavelength of the light. However, the broken fiber end may not be normal to the fiber and therefore the fraction of reflected light power may be considerably smaller.

When RFI problems get sticky, try **stickn fingers**®

Attaches faster, shields better than anything else!

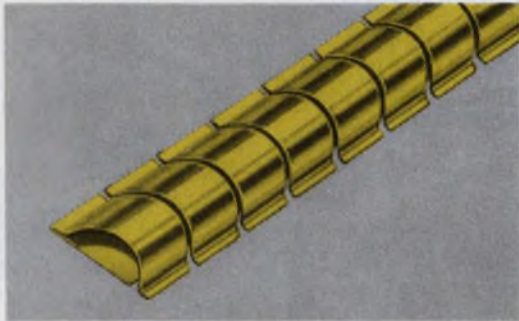

SERIES 97-500 The original Sticky Fingers with superior shielding effectiveness.

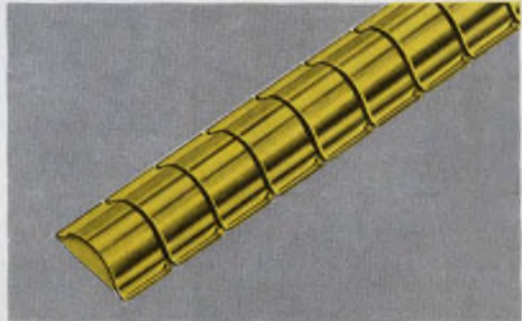

SERIES 97-520 A smaller size Sticky Fingers for high shielding effectiveness in less space.

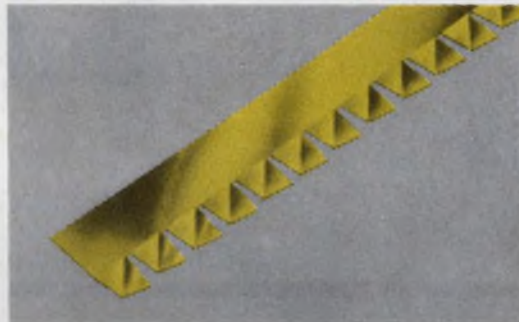

SERIES 97-555 New Single-Twist Series for use when space is at a premium. Measures a scant $\frac{3}{8}$ " wide.



SERIES 97-560 New $\frac{1}{2}$ " wide Double-Twist Series, ideal for panel divider bar cabinets.

Now you can specify the exact type beryllium copper gasket that solves just about every RFI/EMI problem. Perfect for quick, simple installation; ideal for retro-fitting. Self-adhesive eliminates need for special tools or fasteners. Write for free samples and catalog.



INSTRUMENT SPECIALTIES COMPANY, Dept. ED-65

Little Falls, N.J. 07424

Phone—201-256-3500 • TWX—710-988-5732

To measure lower distortion than ever before

-- just push a button

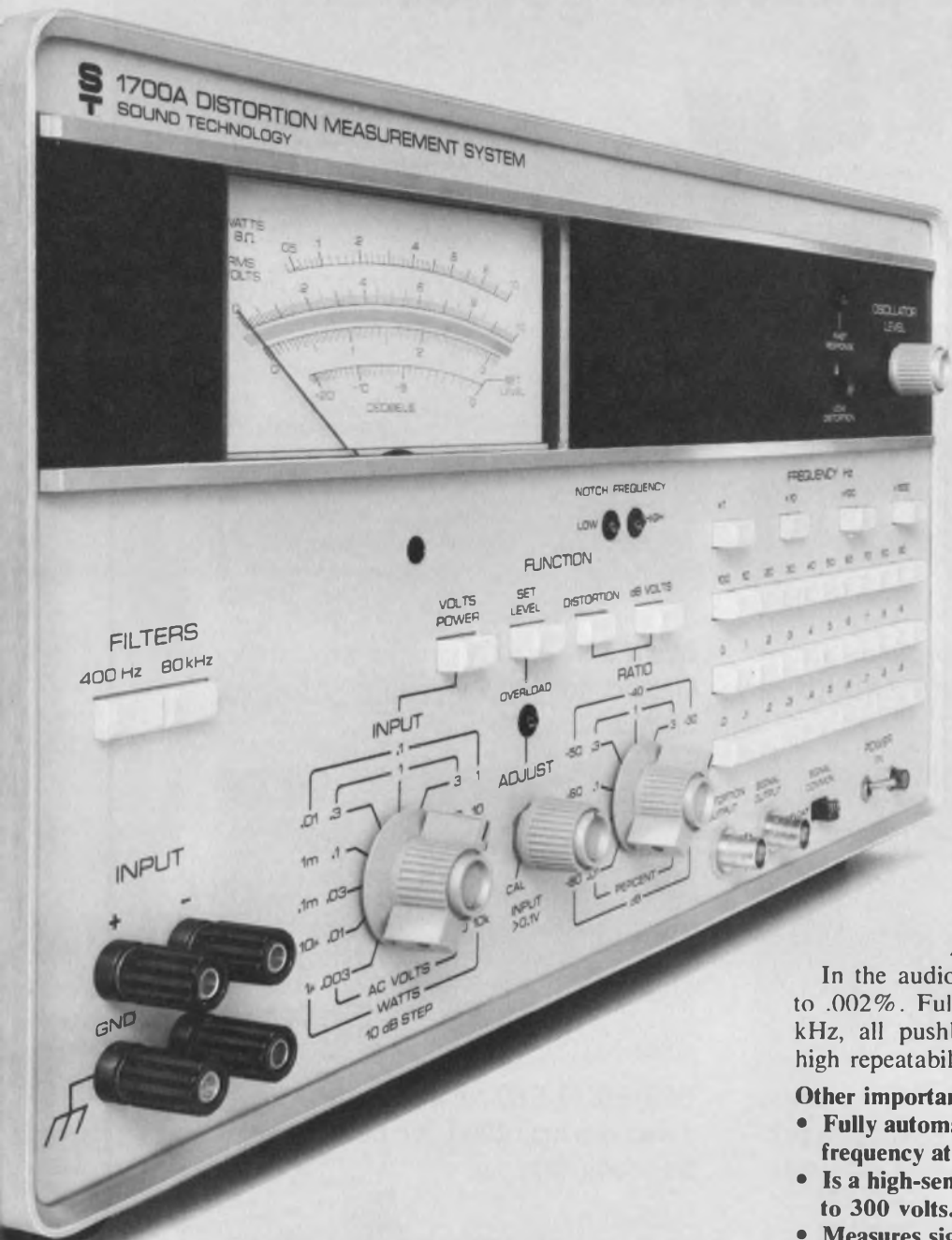

MEASURE DOWN TO .002%

Here is an important new system for measuring distortion.

This new Sound Tech 1700A is both an ultra-low-distortion signal source and a total harmonic distortion analyzer.

It's an instrument that's fast and easy to use. You can make a measurement in 5 seconds — because both source and measuring circuits are tuned by the same pushbuttons. Even non-technical production personnel can measure with it. And that can save a lot of test dollars in the plant and lab.

AUTOMATIC NULLING

In the audio range you can typically measure down to .002%. Full frequency range is from 10 Hz to 110 kHz, all pushbutton-controlled for fast selection and high repeatability.

Other important features:

- Fully automatic nulling — just push a button for frequency at which you want the measurement.
- Is a high-sensitivity AC voltmeter — 30 microvolts to 300 volts.
- Measures signal ratios up to 100 dB.
- Has differential input.
- Reads power in 8-ohm loads.

ECONOMICAL

The 1700A truly saves on initial outlay, too. It's only \$1625 (other models only \$1340). That's less than the cost of much lower performance oscillators and distortion analyzers.

MAKE PROFIT HAPPEN — CALL NOW

So don't get caught short. Make profit happen. Call Larry Maguire or Bob Andersen and get full performance data on this important new development.

**S
T**

SOUND TECHNOLOGY

1400 DELL AVENUE
CAMPBELL, CALIFORNIA 95008
(408) 378-6540

DEVELOPERS OF THE INDUSTRY-STANDARD 1000A STEREO ALIGNMENT GENERATOR AND 1400A ULTRA-LOW-DISTORTION OSCILLATOR
INFORMATION RETRIEVAL NUMBER 42

Ferrites halve core loss in inverter applications

Indiana General, 405 Elm St., Valparaiso, IN 46383. (219) 462-3131. 30 to 40 cents pair 1-in. E. core (10,000 up).

Core loss and heat generation are reduced up to 50% with Inverter-Rated IR-8100 ferrite components for inverters and power supplies. The improvement is based on a comparison with Ferramic 05, also developed by Indiana General. And, according to a company spokesman, the 05 was previously the lowest-loss power ferrite material available.

The higher efficiency of the new series extends operating time with

battery-powered equipment, reduces other component costs, because less drive current is required, and significantly lowers the cooling load. Reliability also is improved, because of less thermal stress on the transformer and adjacent components, and smaller parts can often be used.

The low-loss characteristics of IR-8100 components are optimized for 50 C, a temperature especially suited for solid-state devices. It is no longer necessary, as with 05 and similar power ferrites, to operate the transformer at high temperatures to achieve the highest efficiency.

The IR-8100 series is one of three Inverter-Rated component groups formulated to operate at maximum efficiency at a particular temperature. They are designed, tested and rated specifically for inverter operation rather than for generalized sine-wave performance. Instead of merely providing material characteristics, which are difficult to interpret, all Inverter-Rated components are guaranteed for minimum core loss under square-wave drive conditions.

Of the two other formulations, the IR-8000 series provides maximum efficiency at 75 C and the IR-8200 at 120 C. Efficient inverter operation at temperatures above 100 C has not been practical with conventional ferrites because of prohibitive core loss. The IR-8200 series meets these high temperature requirements.

A complete range of component shapes is available in all three temperature ranges—E cores, U cores, toroids, pot cores and cross cores—with identical mounting and packaging requirements.

Core loss at ± 1.6 k gauss with 16-kHz sine-wave excitation yields:
 IR-8100, 30 mW/c³ at 50 C
 IR-8000, 45 mW/c³ at 75 C
 IR-8200, 35 mW/c³ at 120 C.

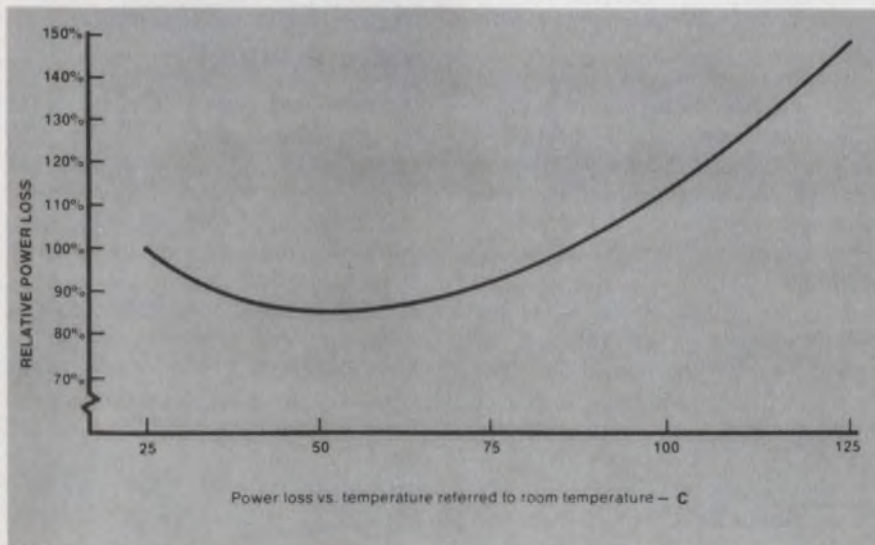
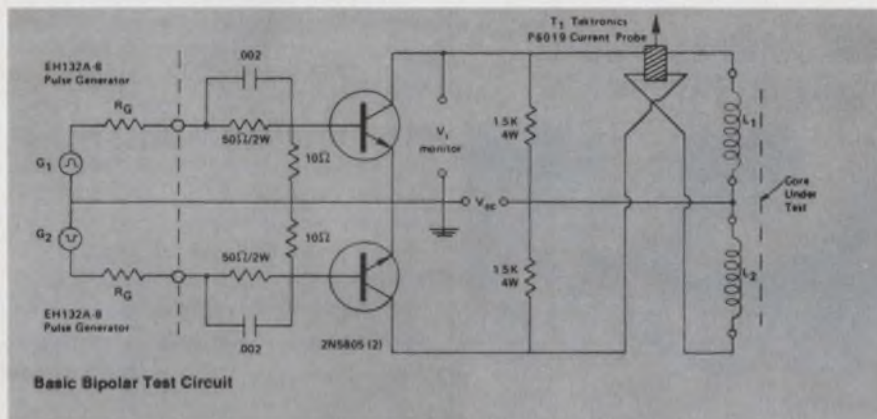

CIRCLE NO. 301

COMPONENTS

Precision resistors available to 100 M Ω



Caddock Electronics, Inc., 3127 Chicago Ave., Riverside, CA 92507. (714) 683-5361. \$2: 5 M Ω and up, \$0.50: 10 Ω to 5 M Ω (1000 up); 4 to 6 wks.

Caddock Electronics considers its extended-range MK, miniature, precision, film resistors to be a breakthrough in resistor technology. The resistors cover a wide range in values from 10 Ω to as high as 100 M Ω in a standard CK-06 case. These resistors were especially developed to meet the increasing need for high stability and precision in high-impedance circuits.

Resistance tolerance of $\pm 1\%$ is standard and tolerances as close as $\pm 0.1\%$ are available on special order. Power rating is 0.75 W at 125 C, and operating temperatures extend from -55 to 175 C. Temperature coefficients are only 50 ppm/ $^{\circ}$ C for values up to 10 M Ω and 80 ppm/ $^{\circ}$ C for values from 10 to 100 M Ω over a range from -15 to $+105$ C, when referenced to 25 C. The stability of the resistors is typically better than 0.05% per 1000 h and their maximum working voltage is 400 V.

Standard CK-06 package dimensions are only 0.3-in. square by 0.1-in. thick. The radial leads have a standard spacing of 0.2 in. for handling by automatic insertion equipment. When used in resistive divider networks, the MK resistors track to within 40 ppm/ $^{\circ}$ C. Special matched sets can be specified for TC tracking to within 5 ppm/ $^{\circ}$ C.

The resistors are constructed from Micronox resistance films, fired on a solid ceramic substrate. They are then encapsulated inside a transfer-molded case to protect against extreme environments. Lead wires are made of tinned 22-gauge copper.

CIRCLE NO. 303

Bar-graph display in circular format



Burroughs Corp., P.O. Box 1226, Plainfield, NJ 07061. (201) 757-3400. \$29 (1000 up); available second quarter 1975.

A third member of the Self-Scan bar-graph, analog-display family is in a circular, 120-element format with an elongated marker every fifth position. It displays a neon-orange glow, is flicker free and can be readily seen in bright environments. With internal scanning techniques, the display requires only nine connections to control the display. It can be provided in special configurations for custom applications.

CIRCLE NO. 304

DIP switches mount easily on PC boards

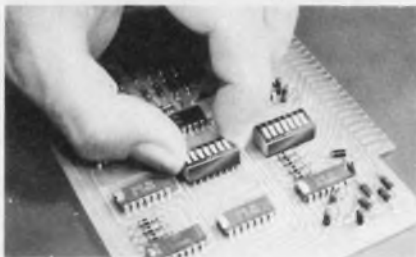

Grayhill, Inc., 561 Hillgrove Ave., La Grange, IL 60525. (312) 354-1040. \$4.30: 10 position; (unit qty.)

A new line of rocker-actuated DIP switches, Series 76, includes nine sizes, from 2 to 10 positions, each providing independent single-pole single-throw operation. The switches feature a low-profile above-board height of 0.305 in. minimum. They are rated to make and break 50 mA at 30 V dc for 35,000 operations or 125 mA at 30 V dc for 25,000 operations. The switches are available with red or black housings and with or without standoffs. Terminal length is variable, but a maximum of 0.125 in. is standard.

CIRCLE NO. 305

Mini stepping switch handles 400 mA dc

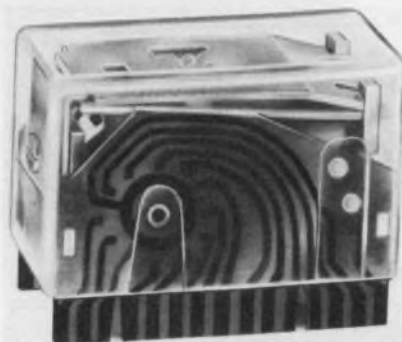

Schrack Electrical Sales Corp., S. Glassman Associates, 1140 Broadway, New York, NY 10001. (212) 683-0790. From \$11.75 to \$16 (unit qty.); stock.

A miniature relay stepping switch (approximately 1.5 \times 1 \times 0.75 in.) is available with coil voltages of 6, 12, 24, 48, 60 and 110 V dc. The switch comes in two poles, 10 or 12 positions and with or without homing contact. The switch runs on dc pulses until the desired contact point is reached. Homing to the initial position is achieved by half wave ac pulses (60 Hz). The contacts can handle loads of up to 400 mA dc resistive.

CIRCLE NO. 306

Metal-film resistors feature stability

International Importers, Inc., 2242 S. Western Ave., Chicago, IL 60608. (312) 254-4252. \$0.05: 1/4 W, \$0.14: 2 W (OEM qty.).

A new family of semiprecision, tantalum, metal-film resistors, Type RTL, with a resistance range of 10 Ω to 1.5 M Ω has tolerances of 1, 2 and 5%. They conform to MIL-R-22684B. Four sizes range from 1/4 to 2 W with dimensions from 6.4 to 17.5-mm long and 2.3 to 8-mm diameter. Temperature coefficients are 50, 100 and 200 ppm/ $^{\circ}$ C.

CIRCLE NO. 307

OEM buyers:

Ask Control Data

for STORAGE MODULE DRIVES:
a 40-80-150-300 megabyte family.

We have it.



40MB 9760 80MB 9762



150MB 9764 300MB 9766

40MB model 9760, 6038 bpi, 200 TPI
80MB model 9762, 6038 bpi, 400 TPI
150MB model 9764, 6038 bpi, 200 TPI
300MB model 9766, 6038 bpi, 400 TPI

Easy system integration

- common software
- common interface firmware

Removable media
Average access time: 30ms

21 OEM offices in 11 countries
specializing in service to the mini OEM.

Call (612) 830-5624 or return coupon.

Bruce Bergman, OEM Product Sales Manager
Control Data Corporation, Dept. ED-825
7801 Computer Ave. So., Minneapolis, MN 55435
Please send information on your Storage Module Drives.

NAME

TITLE

COMPANY

ADDRESS

CITY

STATE

ZIP

PHONE



**CONTROL DATA
CORPORATION**

The Total Services Company

INFORMATION RETRIEVAL NUMBER 44

Somebody goofed!

The story of a calculator that doesn't do everything it was designed to do.

50,000 UNITS LATER

After 50,000 intergrated circuits (the heart of the calculator) were manufactured by a world famous CHIP manufacturer, someone discovered an error in the algorithm program. This is the mathematical formulas electronically built into each intergrated circuit. This error is ONLY apparent in calculating the arc cos of 0 however, and **none of the other functions were affected**. Rather than discarding these 50,000 chips, a quality calculator manufacturer, MELCOR, decided to take advantage of the situation. After all, not everyone needs the arc cos of 0. (By the way, NEW chips have since been made by this chip maker and are now available in calculators retailing for \$99.95.)

THE CHIP ERROR AND WHAT IT CAN DO FOR YOU

For a limited time, Chafitz is offering what is sure to be a first in the calculator field. A limited quantity of quality calculators with a CHIP ERROR. Due to this chip error the MELCOR 635 is not able to calculate the arc cos of 0 (which everyone knows is 90 degrees). But, at our unbelievable low price, who cares about the error. Just remember that the arc cos of 0 is 90 degrees and you've got a perfect calculator at the incredibly low price of only \$59.95.

LOOK AT WHAT YOU DO GET

A 40 key calculator with 23 functions • 8 digits with scientific notation • Two levels of parenthesis • Algebraic logic • e^x , \ln , 10^x , \log , SIN, COS, TAN, \sqrt{x} , x^2 , $1/x$, $n!$, y^x , π • Radian and degree calculations • Arc SIN, COS, TAN • 3 button accumulating memory • Register exchange • Sign charge • Rechargeable, with NiCd batteries included • Plus much more •

Accessories included: A/C adapter/charger, leather case with belt loop, instructions. Also, one year parts and labor warranty.

For the scientist, student, mathematician, engineer, businessman!

LIMITED QUANTITIES!

Due to the amount of machines produced we will have to fill orders on a first come first serve basis. So hurry, you don't want to goof by not getting one of these incredible machines!

10 DAY NO RISK TRIAL

If you can't believe this offer, try the calculator for 10 days in your home or office. If you feel it doesn't do everything we say it does, return the complete package for a prompt refund.



Remember, you can't calculate the arc cos of 0. But at \$59.95 who cares!!!

WHEN YOU THINK CALCULATORS, THINK

Chafitz

856 Rockville Pike
Rockville, Maryland
20852

470

AMERICA'S CALCULATOR COUNSELORS™

MAIL ORDERS ACCEPTED

Add \$2 per unit when ordering
Maryland residents remit 4% sales tax.

ORDER NOW BY PHONE

800-638-2997

Maryland residents call: 301-340-0200
Operators on duty Mon. Sat. 10-5 EST

MAJOR CREDIT CARDS ACCEPTED

INFORMATION RETRIEVAL NUMBER 45

COMPONENTS

Cermet trimmer is immersion sealed

Allen-Bradley Co., 1201 S. Second St., Milwaukee, WI 53204. (414) 671-2000. Under \$0.50 (OEM qty); 2 to 6 wks.

Allen-Bradley's new single-turn cermet trimmer, Type E, is 3/8-in. square and comes in six different configurations. The trimmer covers the range of 10 Ω to 2 M Ω with $\pm 10\%$ tolerance. Its immersion-seal is tested in 85-C water. Power rating is 0.5 W at 70 C. The operating temperature range is -55 to 125 C with a temperature coefficient of 100 ppm/ $^{\circ}$ C for all values over the entire temperature range.

CIRCLE NO. 308

Thin-film resistors offered in starter kit

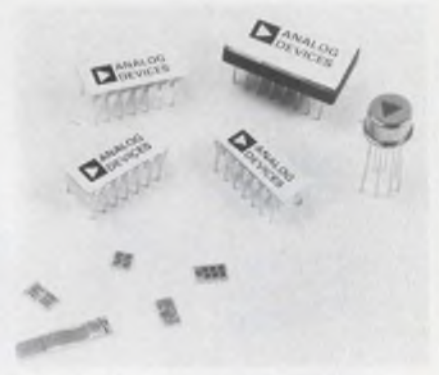

Analog Devices, Route 1 Industrial Park, P.O. Box 280, Norwood, MA 02062. (617) 329-4700. \$24.95: 0.1%, \$49.95: 0.01%.

AD1890 starter kits of thin-film resistor networks with either 0.1% or 0.01% ratio accuracy are packaged in DIPs, flatpaks or in chip form. The resistors feature temperature tracking to 0.5 ppm/ $^{\circ}$ C, ratio drifts to 50 ppm/year at 25 C and negligible voltage coefficients. Screening to MIL-STD-883B is available. Each kit includes one each of: eight equal resistors in two-element dividers; five-resistor decade dividers with ratios from 10,000:1 to 10:1; four equal independent resistors in a TO-99 can; a 10 binary-weighted resistor string from R/2 to R/1024; and seven independent 10-k Ω resistors.

CIRCLE NO. 309



It also comes assembled.

If you need dials, we have dials. If you need handsets, we have handsets. If you need Touch Calling keysets, we've got 'em by the thousands. Ringers and hookswitches, too. Or, if you need complete telephones, we have them for you in all the latest styles and colors.

You get communications components faster from GTE Automatic Electric because, outside of the Bell System, we're the largest manufacturer of telephone equipment in the U.S. If you need it, we have it.

Use the coupon below for a complete

catalog. Or if you're in a real hurry, call John Ashby at (312) 562-7100, extension 250.

When it comes to quality components, call **THE SOURCE:**
GTE Automatic Electric.



- Please send your catalog of communications components.
- Please send more information and prices on _____ of _____

Name _____ Title _____
 Company _____
 Address _____
 City _____ State _____ Zip _____
 Telephone _____

Mail to: Mr. J. D. Ashby, B-4, GTE Automatic Electric, Northlake, Illinois 60164.

GTE AUTOMATIC ELECTRIC

Ratiometric dual-slope a/d converters offered in 14-bit or 4-1/2-digit models

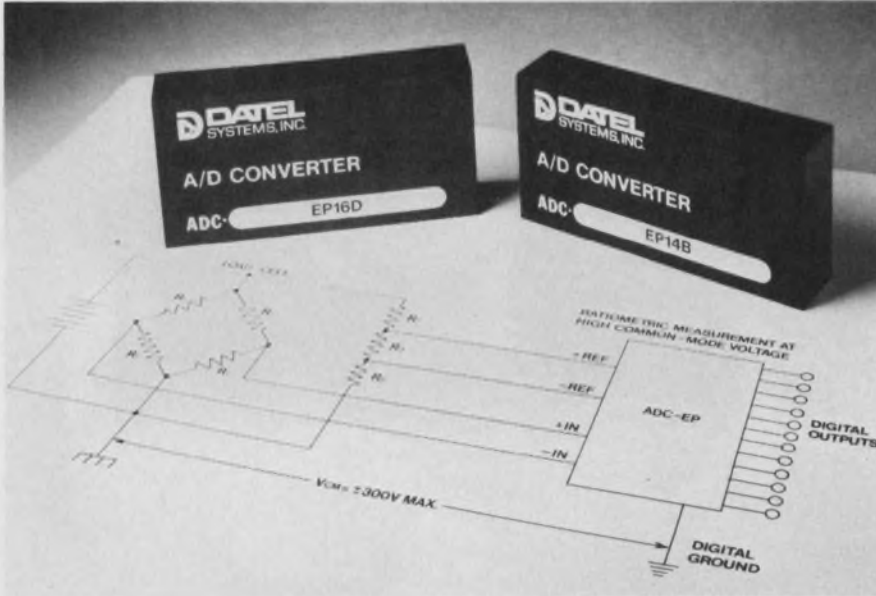

Datel Systems, Inc., 1020 Turnpike St., Canton, MA 02021. (617) 828-8000. P&A: See text.

Dual-slope a/d converters in Datel's ADC-EP series combine high precision with ratiometric-input capability. The modular 14-bit or 4-1/2-digit BCD analog-to-digital converters have a total error of only 0.01% of reading ± 1 count, and any of the four available models handles four-wire inputs.

All converters have isolated analog and digital power commons plus optical and transformer coupling of digital control signals to provide high isolation. When ref-

erenced to digital ground, the analog input withstands up to ± 300 V, common mode, and has a common-mode rejection of 100 dB, minimum, from dc to 60 Hz.

Each unit works with analog input signals up to ± 2 V, has a minimum input impedance of 100 M Ω and can withstand input overvoltages of up to ± 25 V. The buffered CMOS digital outputs are positive-true and can drive one TTL load or a host of CMOS gates over the full operating temperature range of 0 to 70 C. Aside from the digital output word, there is also a gated clock signal and a

reset pulse that permit synchronous data transmission to an external counter.

An internal crystal clock permits these converters to operate in the presence of either 50 or 60-Hz power-line noise while still maintaining a minimum normal-mode rejection of 60 dB.

The two reference inputs alternately share the charge of a "flying capacitor." This scheme permits the reference to operate at a ± 5 -V common-mode difference from analog ground. An externally applied reference can range from 0.5 to 2 V, while the internal reference of 1 V $\pm 0.1\%$ is available for nonratiometric applications.

Automatic zeroing holds the converter's zero drift to a low ± 1 $\mu\text{V}/^\circ\text{C}$, max. The basic ratiometric converter has a tempco of only ± 5 ppm/ $^\circ\text{C}$, but the internal reference has a drift of 8 ppm. Combined, the worst-case drift is still a low 13 ppm/ $^\circ\text{C}$ (after a 15-minute warm-up).

There are two 14-bit binary-output versions, the ADC-EP14B-5 and the EP-14B-6. The -5 version is optimized for 50-Hz normal-mode rejection and the -6 for 60 Hz. BCD output units also come in two versions—the ADC-EP16D-5 and EP-16D-6, optimized at 50 and 60 Hz, respectively.

(continued on p. 104)



ANALOGY

FEED TRANSDUCER DATA FROM TOUGH ENVIRONMENTS TO REMOTE MINIS THROUGH THE FIRST CRYSTAL CONTROLLED VOLTAGE-TO-FREQUENCY CONVERTER MODULES WITH TOTAL ISOLATION AND 15-BIT ADC PERFORMANCE. INTECH'S NEW A-841 HAS BUILT-IN OPTICAL ISOLATOR. A-842 DRIVES 2000 FT. OF CABLE THROUGH ITS PULSE TRANSFORMER, BOTH AT TTL LEVELS. WE ALSO SUPPLY BETTER ADC, DAC, SEH, OP AMP AND MATH MODULES AT PRICES THAT SAVE.

intech/FMI
282 BROOKAW RD. SANTA CLARA,
CA 95050 (408) 244-0500



We specialize in flat cable and flexible circuit problems nobody else can crack.

A lot of people make flat cable. A lot of people make flexible circuits. We're one of the few who make both.

But the big difference isn't only what we can manufacture, it's what we can design.

Hughes CONTOURTM Cable solved problems for the Viking Mars probe. We worked out solutions for the Minuteman missiles. We cracked tough packaging problems for shipboard and airborne systems, radar, sonar, high-speed computers.

And we can crack your tough ones, too.

Not wild-eyed, super-expensive,

forever-and-a-day solutions. Practical solutions. Maybe even less-expensive-in-the-long-run solutions.

And once we design it, we'll make it. In one of the industry's newest, most complete facilities.

Think of it this way. If it's simple and easy, anybody can do it, including us. But the tough nut is our specialty.

A tour? Or a consultation to discuss your design requirements? Just call (714) 549-5701 and ask for Dave Cianciulli.

Or write: 17150

Von Karman Avenue, Irvine,

California 92705.



HUGHES MICROELECTRONICS LTD.: BELGIAN BRANCH - Passage International 29, 1000 Bruxelles 1 Belgium. Telephone 2179172.
UNITED KINGDOM - Clive House, 12-18 Queens Road, Weybridge, Surrey, England. Telephone Weybridge 47262

INFORMATION RETRIEVAL NUMBER 48

Typical XFMR Transients (Peak currents to 20X nominal) results in . . .

Nuisance Trips!

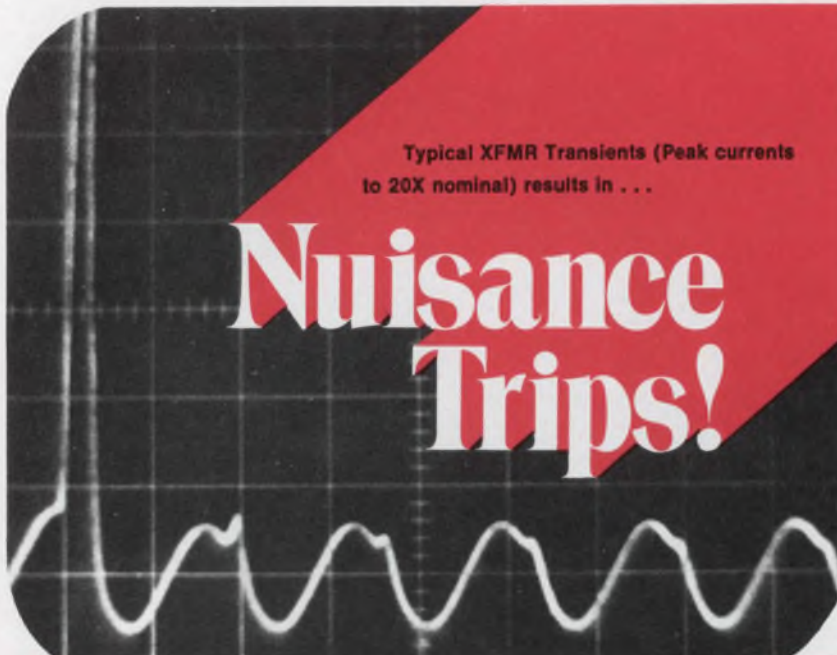

Eliminate them with Airpax Electromagnetic Circuit Protectors

with patented Inertial Delay

Many circuit protector applications involve a transformer turn-on, an incandescent lamp load, or a capacitor charge from a dc source. Each of these applications have one common factor: a steep wave front transient of very high current amplitude and short duration. This takes the form of a spike, or a single pulse, and is the cause of most nuisance tripping associated with circuit protectors.

Airpax circuit protectors, with patented inertial delay, assure positive protection without nuisance tripping by providing tolerance of short duration inrush currents without decreasing steady state protection. This does not affect standard delay curves and trip points.

Just another example of Airpax "application-oriented" engineering.

Get the full story on Airpax electromagnetic circuit protectors. Write for Short Form Catalog 2013.



AIRPAX

Airpax Electronics
CAMBRIDGE DIVISION
Cambridge, Maryland 21613
Phone (301) 228-4600

Other Airpax Divisions:
CONTROLS DIVISION, Ft. Lauderdale, Florida 33313, Instruments for Industry
AMERICAN DATA, Huntsville, Alabama 35805, TV Products

MODULES & SUBASSEMBLIES

(continued from p. 102)

Conversion time for the 50-Hz versions is 260 ns, while for the 60-Hz versions it falls to 230 ns. Both these conversion times include 80 ns for auto-zeroing.

All units measure $2 \times 4 \times 0.8$ in. ($50.8 \times 101.6 \times 20.3$ mm) and require +15 V dc at 45 mA, -15 V dc at 20 mA and +5 to +15 V dc at 6 mA. The price for any model is \$179 for 1 to 9 units. Delivery is from 4 to 6 weeks.

CIRCLE NO. 302

Monolithic Xtal filters made for bandpass use

AEG Telefunken, D 6000 Frankfurt 70, AEG Hochhaus, West Germany.

Monolithic, crystal, steep bandpass filters are available for the fundamental frequency range from approx. 4 to 40 MHz. This extends the product line to harmonic bandpass filters for approx. 300-MHz operation. Apart from the crystal filters for the center frequencies of 10.7 and 15.3 MHz, the company produces filters for 21.4 MHz. The bandwidth of this 21.4 MHz filter is 15 kHz and is compatible for 20 and 25-kHz channel spacing. Relative bandwidths of approx. 0.01 to 50% are obtainable at center frequencies in the range from 4 to 200 MHz.

CIRCLE NO. 404

Inverting op amps settle in under 150 ns to 0.1%

Intronics, 57 Chapel St., Newton, MA 02158. (617) 332-7350. From \$75; 2 to 4 wk.

The A503/504 inverting op amps have gain-bandwidth products of 100 MHz, slew rates of $100 \text{ V}/\mu\text{s}$ and output current capabilities of 50 mA. The A503 settles to within 0.1% in less than 150 ns and the A504 will settle to the same value within 80 ns. Input offset voltage vs temperature for the A503 is $20 \mu\text{V}/^\circ\text{C}$ and for the A504, $10 \mu\text{V}/^\circ\text{C}$. The maximum input bias current is a low 20 nA or 15 nA, respectively. The op amps are packaged in $1.8 \times 1.2 \times 0.6$ in. cases.

CIRCLE NO. 405



How to go on a precious metals diet without starving quality

If you're still barrel plating electronic contacts and parts, it's near certain that you're consuming about twice as much gold or other precious metals as you need to.

The SELECT-O-PLATE process is your most economical answer. SELECT-O-PLATE eliminates precious metals waste and saves you 40 to 60%, with no loss of quality or product reliability whatsoever (in fact, reliability often improves).

SELECT-O-PLATE deposits only the exact amount and kind of precious metal plating precisely where it's needed for function. On the tips of contacts, or the center of lead frames, or on continuous coil-stripe or spot. Plating thickness can range as low as .000005". Precision Plating Co. has one of the industry's most exacting systems of quality control assures you of parts that match your specifications exactly.

Our staff of plating technologists is anxious to help you reduce your precious metals plating costs. Call or write us and we'll send you full details about SELECT-O-PLATE. If you like, we can also give you a complete appraisal of the parts or components to be plated.



SELECT-O-PLATE

... Makes a little bit of gold go a long, long way.

PRECISION PLATING COMPANY, INC.



Precious metal plating since 1904
4123 West Peterson Avenue
Chicago, Illinois 60646
Tel: 312/583-3333

JOIN THE REVOLUTION AGAINST CUSTOM POWER SUPPLIES

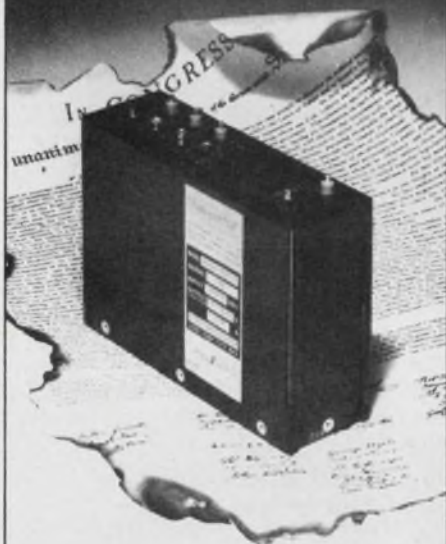

Now is the time to put an end to high cost custom power supplies . . . and the long lead times they require. Join the Arnold Magnetics "Design-As-You-Order" revolution. Choose from over 1200 miniaturized off-the-shelf input and output submodules to meet your specific needs. Save time, save space, save money . . . and get outstanding performance.

- Single or dual inputs:
115-220 VAC, 47-500 Hz.
12, 18, 48, 115, 150 VDC.
- Multiple isolated and regulated DC outputs from 4.2 to 300 VDC.
- Line & load regulation to 0.1%.
- Up to 800 watts per output.
- Efficiencies to 85%.
- Completed units provided in tested and encapsulated, conduction cooled packages.

Phone or write for your "Declaration Of Non-Dependence" (our new Catalog and Specification Form) on custom power supplies . . . join the revolution today!



ARNOLD MAGNETICS CORPORATION

11520 W. Jefferson Blvd.
Culver City, Ca. 90230 ● (213) 870-7014

INTEGRATED CIRCUITS

IC holds a/d converter

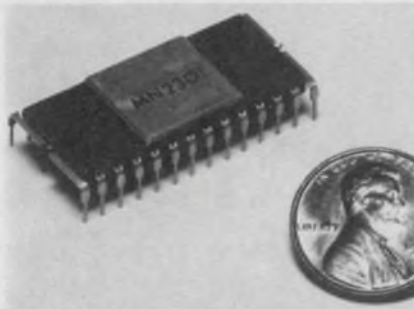

Analogic, Audubon Rd., Wakefield, MA 01880. (617) 246-0300. \$24 (100); 30 days.

A single-chip integrating analog-to-digital converter features autozeroed, true ratiometric, dual-slope conversion of bipolar analog-input signals. With clock and reference supplies, the MN2301 provides a multiplexed 3-1/2-digit BCD output. A PMOS IC in a 28-pin DIP, the new converter operates from standard ± 15 -V supplies and consumes less than 300 mW. The unit has a conversion accuracy of $\pm 0.05\% \pm 1/2$ count, autozeroed offset-voltage drift of $3 \mu\text{V}/^\circ\text{C}$ and input impedance of greater than 1000 M Ω . Bias current is typically 30 pA.

CIRCLE NO. 320

Op amps slew at 60 V/ μs



ILC Data Device Corp., Airport International Plaza, Bohemia, NY 11716. (516) 567-5600. \$10.20 to \$25.10; stock to 6 wks.

Series 1009 op amps feature 60 V/ μs slew rates, 1-MHz full power bandwidth and 12-MHz gain-bandwidth product. Devices are internally compensated for gains exceeding 10 and can be externally compensated for lower gains via an external lead connection. Settling time is 250 ns and rated output is 10 mA. Both commercial and MIL-temperature range versions are offered.

CIRCLE NO. 321

Reprogrammable ROM has 4-k-bit capacity

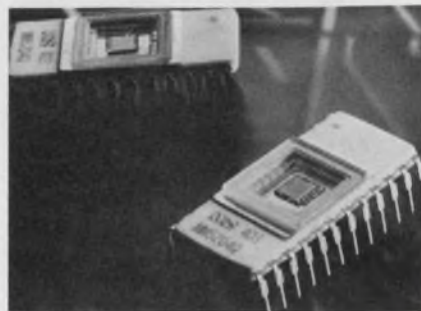

National Semiconductor Corp., 2900 Semiconductor Dr., Santa Clara, CA 95051. (408) 732-5000. \$50 (100); 4 wks.

A 4096-bit PROM can erase and reprogram repeatedly. Organized 512×8 bits, the new MM5204 employs floating-gate avalanche MOS technology. Access time is 750 ns, and complete programming takes about 30 ns. The PROM operates from standard sources of +5 and -12 V while drawing about 28 mA.

CIRCLE NO. 322

256 \times 4 CMOS static RAM makes debut

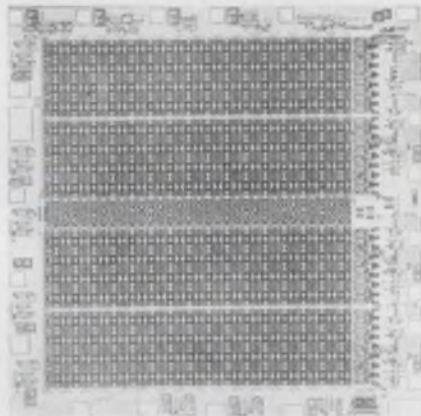

Intel Corp., 3065 Bowers Ave., Santa Clara, CA 95051. (408) 246-7501. \$29.40 to \$70.40.

The first 256 \times 4-bit CMOS static 1-k RAM—the 5101—has a worst-case standby current drain of 15 nA per bit at 70 C. Hence standby power is 75 nW per bit maximum. Worst case access time—and minimum cycle time—is 650 ns over the 0-to-70-C temperature range. A military version, the M5101, is also offered. At 125 C the M5101 has a maximum standby power of 1 μW per bit and worst case access time of 800 ns over the -55 to +125 C temperature range.

CIRCLE NO. 323

Latchproof CMOS Analog Switches

Latchproof CMOS analog switches—another reason why Siliconix, the analog switch leader, is the best source to fill your needs. Our exclusive new process (patent pending) eliminates latchup in CMOS analog switches by reducing parasitic PNP-NPN Beta to less than one!

Features:

- No latchup under any conditions—no external protection required.
- Full ± 15 V analog signal range—ideal for op amps.
- Low $r_{DS(ON)}$ for error-free operation.
- Full TTL and CMOS compatibility over the -55°C to $+125^{\circ}\text{C}$ temperature range without external components.
- Break-before-make switching action.
- New high-current capability—100mA pulse on DG200.

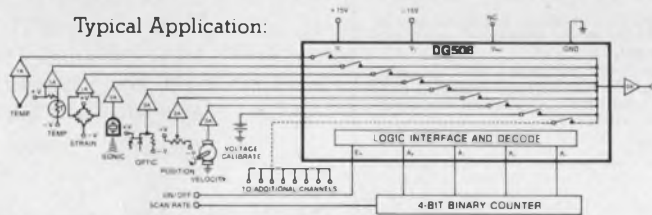

Sequential 16-Transducer Scanner (8 channels illustrated)

Siliconix latchproof CMOS analog switches are ideal for multiplexing, demultiplexing, computer interface, commutation, signal processing and many other applications. For further information or applications:

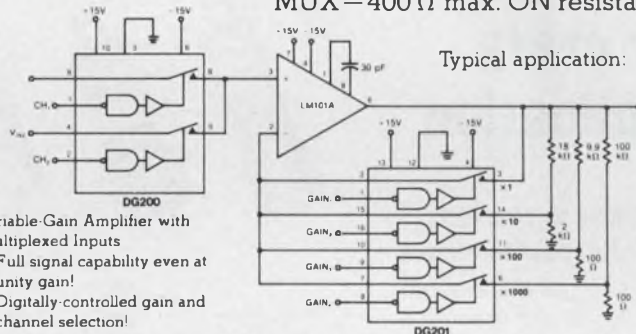

Variable-Gain Amplifier with Multiplexed Inputs

- Full signal capability even at unity gain!
- Digitally-controlled gain and channel selection!

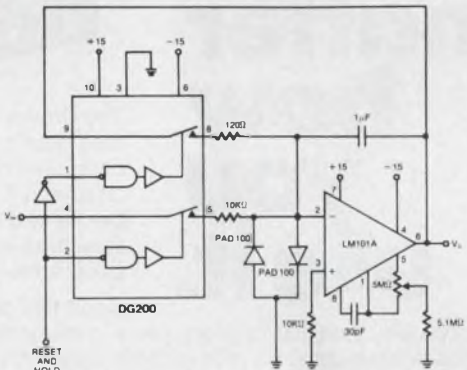

Typical Application: Integrator Reset & Hold

Take your choice from these CMOS switches:

- DG200—2-channel SPST—70 Ω max. ON resistance.
- DG201—4-channel SPST—175 Ω max. ON resistance.
- DG506—16-channel MUX—400 Ω max. ON resistance.
- DG507—8-channel differential MUX—400 Ω max. ON resistance.
- DG508—8-channel MUX—400 Ω max. ON resistance.
- DG509—4-channel differential MUX—400 Ω max. ON resistance.

write for data

Analog Switch Applications (408) 246-8000 x 120

Siliconix CMOS is now available from your local CRAMER, ELMAR or HAMILTON/AVNET distributor outlet.



Siliconix incorporated

2201 Laurelwood Road, Santa Clara, California 95054

INFORMATION RETRIEVAL NUMBER 52

Built to work no matter how you use it.



The Crown 800 1/4" mag tape transport is rugged¹, computerized², professional³ and adaptable⁴. It's designed, built and one-by-one tested by people who are good at their jobs. It will work exactly the way you expect. No glitches.

Good design and careful fabrication are the reasons why the 800 transport works in many different systems. Audio record/playback systems. Data recording. Program origination.

If your latest project includes 1/4" mag tape capabilities, ask Crown to explain the 800 transport.



CROWN INTERNATIONAL

1718 W. MISHAWAKA ROAD ELKHART, INDIANA 46514 219-294-5571

1. 3/4" thick aluminum front plate. Anodized or plated metal parts. Only 10 moving parts. All sub-assemblies are plug-in.

2. Logic circuit automatically sequences transport, regardless of command sequence, to prevent tape spill or breakage. Remotable.

3. Three motor drive. DC braking. Automatic end-of-tape braking. 19" rack mount. Wow and flutter 0.09% @ 7 1/2 ips guaranteed maximum.

4. Heads independently mounted — can be easily changed. 4ch, 2ch or mono. Build your own electronics or order from Crown. Crown will customize. Variable speed drive available.

INFORMATION RETRIEVAL NUMBER 53

RF detectors for every application

100 kHz to 18.5 GHz

Field replaceable diodes

You can get the detector suited to your needs from WILTRON's broad line.

And in all of these high-performance detectors the diodes are field replaceable.

Note, too, the variety of available connectors: BNC, N, APC and SMA (see table).

Discounts to 15% in quantity. Stock delivery.

Call Walt Baxter at WILTRON now for details.



Model	Range	Connectors In	Connectors Out	Flatness	Price \$
71B50	100 kHz-3 GHz	BNC Male	BNC Fem.	±0.5 dB	70
73N50	100 kHz-4 GHz	N Male	BNC Fem.	±0.2 dB	75
74N50	10 MHz-12.4 GHz	N Male	BNC Fem.	±0.5 dB	145
74S50	10 MHz-12.4 GHz	SMA Male	BNC Fem.	±0.5 dB	165
75A50	10 MHz-18.5 GHz	APC-7	BNC Fem.	±1 dB	190
75N50	10 MHz-18.5 GHz	N Male	BNC Fem.	±1 dB	170
75S50	10 MHz-18.5 GHz	SMA Male	BNC Fem.	±1 dB	170



930 E. Meadow Drive • Palo Alto, Ca. 94303 • (415) 494-6666 • TWX 910-373-1156

INFORMATION RETRIEVAL NUMBER 54

INTEGRATED CIRCUITS

512-bit static CMOS RAM uses 50 nW/bit

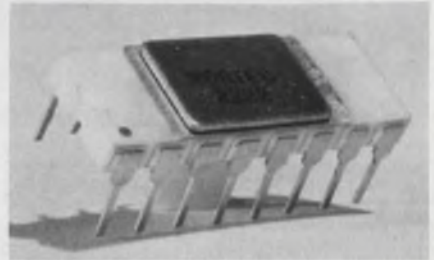

Nortec Electronics Corp., 3697 Tahoe Way, Santa Clara, CA 95051. (408) 732-2204. \$12.50 to \$20.00 (100-999).

The Model 2222 CMOS static RAM, organized 512 × 1-bit, uses less than 4 nW per bit in standby and less than 50 nW per bit when operating. The typical access time is 200 ns with a minimum cycle time of 470 ns. The circuit operates on a single power supply, and it is compatible with TTL as well as CMOS logic families. Housed in a 16-pin DIP, the 2222 will retain memory data with a 3.5-V supply.

CIRCLE NO. 324

Mult/div ICs need no external adjustments

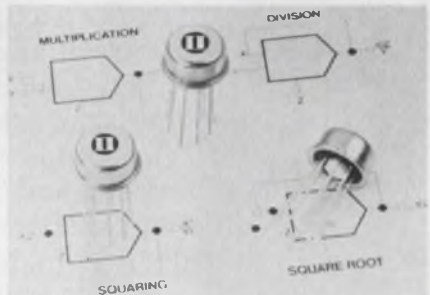

Intronics, Inc., 57 Chapel St., Newton, MA 02158. (617) 332-7350. \$26 to \$36 (1-9); 2-4 wks.

The M540 series of multiplier/dividers doesn't require external adjustments or output op amp. The M540J and M540K ICs can be used for four quadrant multiplication or two quadrant division, as well as squaring or square rooting. The M540J is specified for a maximum multiplying error of ±2%, and the M540K for 1%. Both units are rated for operation from 0 to 75 C. Small signal bandwidth is 1 MHz, with full power output to 750 kHz.

CIRCLE NO. 325

This one resistor can shrink your inventory costs

Type CC. It's a 1/4w size 1% cermet film resistor that far exceeds RN55D specs. Use it for your needs from 1/8w at 125° to 1/2w at 70°C (max. 250 V) and 10 ohms to 10 megs.

TCR is well below 100 PPM/°C. Now available from A-B distributors: 10 ohms to 10 megs off the shelf. Write for publication EC33.



Quality in the best tradition.



ALLEN-BRADLEY

Electronics Division
Milwaukee, Wisconsin 53204

INFORMATION RETRIEVAL NUMBER 55

EC112

INTEGRATED CIRCUITS

1103A-type RAM boosts speed

Rockwell Microelectronic Device Div., P.O. Box 3669, 3430 Miraloma Ave., Anaheim, CA 92803. (714) 632-3729. \$7.80 to \$9.80 (100); 5 days (evaluation quantities).

Pin and electrically compatible with 1103A-type memories, the company's new 1024-bit dynamic RAM reportedly can reduce system access times by as much as 30% over equivalent circuits. The Rockwell memory has 16-row refresh, 205-ns maximum access with no precharge requirement and low power drain—typically, 190 mW operating and 20 mW standby.

CIRCLE NO. 326

Gyrator emerges for impedance conversions

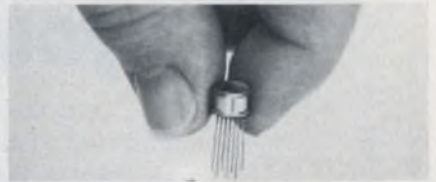

Amperex Electronic Corp., Slatersville, RI 02876. (401) 762-9000.

An IC gyrator, or impedance converter, for audio frequencies consists of dual monolithic differential amplifiers and four 0.1% film resistors. Packaged in a 10-lead TO-100 can, the Model ATF-431 gyrator has a film-resistor tempo that is equal and opposite to that of polystyrene capacitors. Hence, the combination is highly stable with temperature. And high-inductance values can be achieved in compact spaces. The ATF431 and a 0.1- μ F capacitor, for example, produces 5.625 H. A Q of over 500 can be obtained from such an inductor. Further, up to about 10 kHz, the achievable Q depends primarily on the capacitor.

CIRCLE NO. 327

The inside story of the amazing new \$31 Compact 1.

Take a close look.

Beneath the handsome exterior of Zero's new VIP Compact 1 you'll find a feature you've never found on a \$31* instrument enclosure before. Those rugged steel and aluminum panels are hiding a removable chassis. Which means you can now easily build up your equipment on the free chassis, and then simply re-assemble the enclosure around it.

A result of thorough design, Compact 1 delivers an amazing new level of quality, strength, efficiency and economy. If these are your requirements for a small instrument enclosure, you've found what you've been looking for. We're ready to ship any of the twelve standard sizes to you within two weeks.

Write for your free catalog today.

*From \$30.80 to \$38.65 in quantities of 50.



The Final Touch

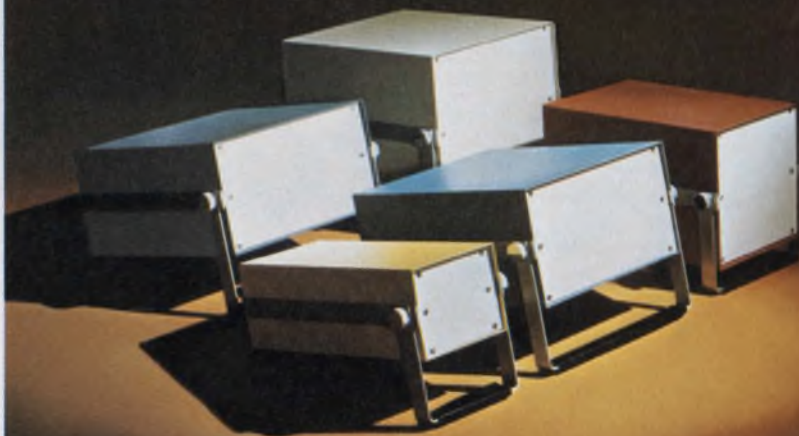

ZERO MANUFACTURING CO.
Burbank, CA 213/846-4191 • Monson, MA 413/267-5561 • Clearwater, FL 813/531-8991

Circle #286 for immediate need

Circle #287 for information only

CMOS IC provides datacomm frequencies

Motorola Semiconductor Products Inc., P.O. Box 20924, Phoenix, AZ 85036. (602) 244-3466. \$15.71 to \$20.43 (100 up).

The MC14411, a CMOS circuit, generates baud-rate clock frequencies that are required by data-communications systems. Sixteen clock frequencies are available simultaneously from low-power-TTL-compatible buffered outputs. The MC14411, which operates from a 5-V supply, contains a crystal oscillator circuit, a programmable rate-select circuit and divider chains. When controlled by a 1.8432-MHz crystal, and at a X1 rate factor, 14 frequencies in the range of 75 to 9600 Hz are produced at the outputs. Rate select logic can multiply these frequencies by 8, 16 or 64. Output waveforms have a 50% duty cycle. The oscillator frequency and a signal at half the crystal frequency provide the fifteenth and sixteenth buffered outputs.

CIRCLE NO. 328

MICRO-ONE. THE MAGNUM MICRO.

Now
\$607.50
in quantities
of 100.

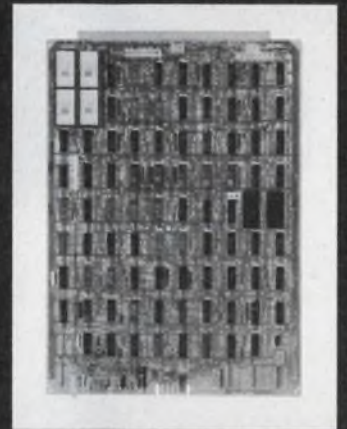

Microdata's Micro[®]-One is a lot of power on a little card—the micro computer with a whole library of proven, high-powered software to back it up.

The Micro-One is built with here-and-now technology—so you get reliable operation and immediate delivery. It's fast, flexible, modular in function, low in cost, and user-microprogrammable.

Designed specifically to outperform all competitors in dedicated volume applications, the Micro-One is the only serious choice for the smart system designer. It's dynamite.

If your requirements are for volume quantities of micro computers that get the job done, contact Microdata now. Ask for our brochure on Micro-One, The Magnum Micro.

We'll fire it off to you.

Microdata

17481 RED HILL AVENUE • IRVINE, CALIFORNIA 92705
TELEPHONE 714/540-6730 — TWX 910-595-1764

NOW OFF THE PRESS!

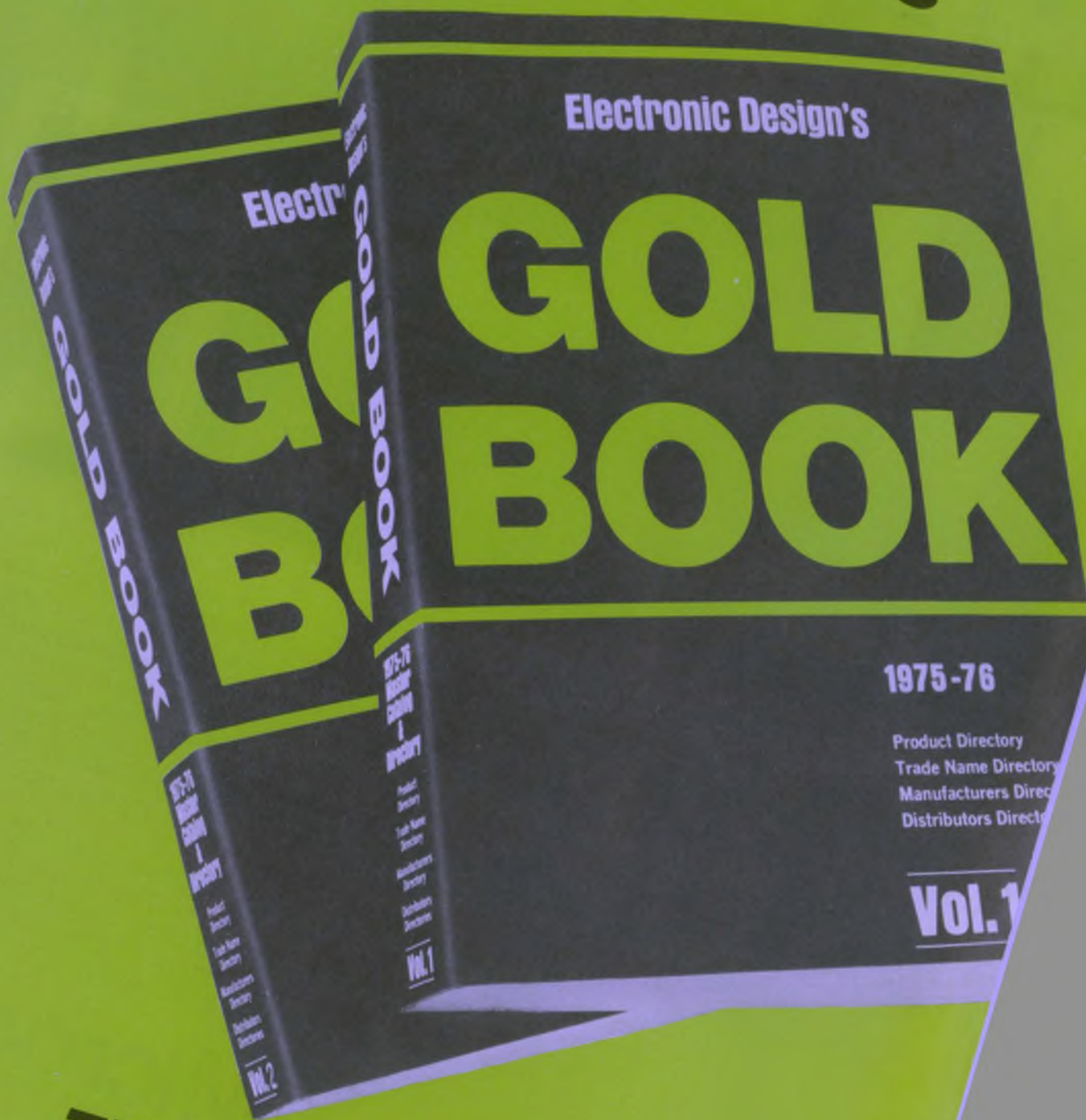

THE INDUSTRY'S BEST

Electronic Design's ALL NEW 1975-76 GOLD BOOK

POWER SUPPLIES, LOGIC 5V

American Power Sys Corp 51 G Jackson St Worcester MA 01608 Vol 3/903-905	(617)753-8103
Amphenol Sls Div, Components Group, Bunker Ramo Corp 2875G S 25 Av Broadview IL 60153 Vol 3/910,911	(312)345-4260
Computer Prods, Dept G, Box 23849 Ft Lauderdale FL 33307 Vol 3/918,919	(305)974-5500
Dynage Inc 1331G Blue Hills Av Bloomfield CT 06002 Vol 3/922	(203)243-0315
ELDEC Corp 16700G 13 Av W PO Box 100 Lynnwood WA 98036 Vol 3/930	(206)743-1313
Electrostatics Inc, Dept G, 7718A Clairemont Mesa Blv San Diego CA 92111 Vol 3/943	(714)279-1414
Elpac Inc/Elexon Power Svs. Dept G. 3131 S Standard Av Santa Ana	

If you were among the 99% of our surveyed readers who reported *Electronic Design's* 1974-75 GOLD BOOK equal or SUPERIOR to all other industry directories *here's good news*. The 1975-76 edition is even better.

It contains *more* product listings, *more* cross-references, *more* detailed information about companies — *more* sales outlets, reps, sales office, and distributor listings.

USE THE GOLD BOOK TO . . .

SPEED your first-step search for products.

SIMPLIFY your contact with companies or their reps or distributors.

FIND specific product information.

LOCATE *complete* company names, addresses, zip codes and phone numbers. You'll also often have access to TWX; TELEX; facsimile equipment (by make and call number); toll-free numbers; cable addresses; number of engineers; number of employees; key officials and financial data.

BUY what you need without necessarily having to see a salesman.

The GOLD BOOK puts the entire electronics industry at your fingertips. Reach for it *first*. Distribution began in mid-July — FREE to qualified *Electronic Design* subscribers. Others may order copies while they last for \$30 per set domestic or \$40 elsewhere.

DIRECTORY GETS EVEN BETTER

Memory tester works around microprocessor

Micro Control Co., 1601 37th Ave., NE, Minneapolis, MN 55421. (612) 788-3351. Start at \$36,000, 30-60 days.

The M-10A memory and LSI test system checks chips, boards and systems in production or engineering. Featured are: crystal-controlled digital timing with 1-ns resolution and a range of 0 to 65 μ s; an 8-bit microprocessor for completely automatic operation; 10-MHz operation; 16 address bits, expandable to 24 and 16 data bits expandable to 72 bits; complete panel controls including keyboard display and digital voltmeter; and tape cartridge storage of test programs.

CIRCLE NO. 329

Scope resolves time intervals to 100 ps



Hewlett-Packard, 1501 Page Mill Rd., Palo Alto, CA 94304. (415) 493-1501. \$310; 6-10 wks.

A new 200-MHz dual-channel scope, Model 1712A, can resolve time-interval measurements to 100 ps. A special output delivers a voltage so precisely proportional to the selected time interval that its measurement with a 4-1/2-digit DVM is justified. The bandwidth of the unit is maintained at both switch-selectable input modes, 50 Ω or 1 M Ω (shunted by 11 pF), over the entire 6 \times 10-cm display area, and within the whole 0-to-50-C temperature range; 10 mV/div deflection factor is attained across the full 200-MHz band (5 mV/div to 150 MHz), with 2% attenuator accuracy. Sweep speeds from 10 ns/div to 0.5 s/div are 3% accurate or better over the full specified temperature range.

CIRCLE NO. 330

Modular units hook to programmed calculator

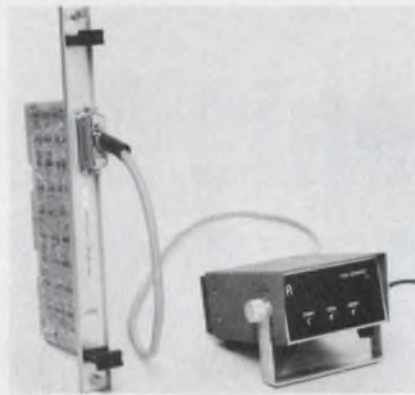

Fluidyne Instrumentation, 1631 San Pablo Ave., Oakland, CA 94612. (415) 444-2376. From \$500.

A series of modular digital voltmeters, counters, timers, and temperature indicators, 7200/2200, hooks up to Wang Laboratories' System 2200 basic programmable calculators. Analog voltage, time, frequency, rpm and temperature measurements may be processed by the calculator to provide small-scale automated test and data-acquisition systems. These plug-in instruments come with a 6-ft cable, which connects to the Wang 2252 parallel-data-input card in the calculator's central-processing-unit mainframe. Up to eight instruments can be used with an individual calculator.

CIRCLE NO. 331

200-MHz synthesizer resolves 1 μ Hz at 1 Hz



Syntest, 169 Millham St., Marlboro, MA 01752. (617) 481-7827. \$1650; stock-30 days.

Features of the Model SI-200 200-MHz vhf synthesizer include 100-Hz resolution at 200 MHz and 1 μ Hz at 1 Hz with 6-1/2 digits of thumbwheel programming. Frequency stability is \pm 1 ppm from 0 to 50 C. High-level ECL and Schottky TTL outputs are available at the rear panel, as well as attenuated outputs on the front panel.

CIRCLE NO. 332

Portable DMM costs just \$179.95



Heath Co., Benton Harbor, MI 49022. (616) 983-3961. \$179.95.

The IM-2202 portable DMM is the lowest-priced professional-grade unit the company has ever offered. Included are four rechargeable nickel-cadmium batteries and a built-in charging circuit. Up to 8 h of continuous operation can be obtained from each charge. The IM-2202 may also be operated from 110 or 220 V ac. Features include 26 ranges, 100% over-range, 3-1/2-digit display with automatic polarity and decimal point.

CIRCLE NO. 333

Transition counter finds logic faults



Tektronix, P.O. Box 500, Beaverton, OR 97005. (503) 644-0161. 465/719A, \$2525; 475/719A, \$3280; 12 wks.

Model 719A transition counter detects faults in logic networks and is available as an integral part of either a 465 (100 MHz) or 475 (200 MHz) dual-trace, delayed sweep, portable scope. Once the 719A has detected a fault the parent scope provides a versatile tool for detailed electrical analysis. For a given set of input sequential logic signals, the number of ONE to ZERO and ZERO to ONE transitions at an output is a known quantity. Any departure from this number indicates a fault.

CIRCLE NO. 334

New! Simple, low-cost way to monitor equipment usage time!

Install these new, low cost electrochemical elapsed time indicators in the equipment you design to measure use time of equipment and its components. They are small in size... the size of an ordinary automotive fuse... and easy to install. A snap-in type that fits a standard 3AG fuse clip—or a solder type—are available. They are inexpensive enough to be used in quantity on a single piece of equipment.

The indicator employs a simple coulometry principle. When a controlled DC current is applied across the indicator's terminals, there is a precise buildup of a copper column in the unit's glass tube. The tube, calibrated in hourly increments, provides a direct scale non-reversible readout. Models are available for 1000, 2000, 5000 and 10,000 hours.

Keeps accurate time records for warranty validation, preventive maintenance.

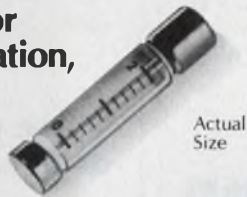

Send for information now!

A. W. HAYDON CO. PRODUCTS

NORTH AMERICAN PHILIPS CONTROLS CORP.

Cheshire, Conn. 06410 • (203) 272-0301

INFORMATION RETRIEVAL NUMBER 58

Ledex offers you an alternative

in economically priced solenoids



New, low priced, D-Frame solenoids are available from Ledex. Extra cost efficient solenoids in a full range of sizes from stock. AC or DC in standard industry voltages.

Send for this complete catalog of specifications, sizes, and details on how you can keep your products competitive.



LEDEX INC.
123 Webster St.
Dayton, Ohio 45401
(513) 224-9891

INFORMATION RETRIEVAL NUMBER 59

ELECTRONIC DESIGN 16, August 2, 1975

Dialight sees a need:

(Need: The widest choice for your every application.)

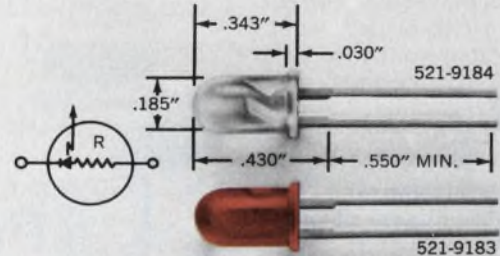

Available in red or clear LED packages with or without a built-in current limiting resistor. Red LED is also made without resistor. Suitable for circuit status indication, alpha-numeric displays and visual indicators. Features long wire-wrappable leads. IC compatible with solid state reliability. High luminous intensity, low power consumption, low cost.

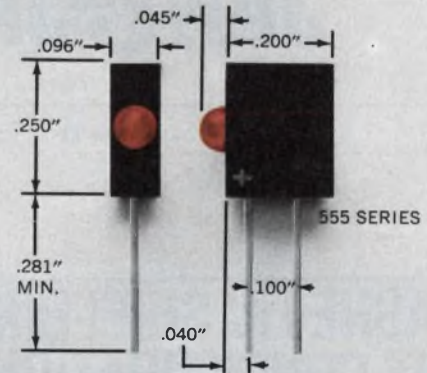

LED logic state fault indicators available in 14 models with voltage ratings from 1.7 to 14. Suitable for dense packaging on printed circuit boards—up to 10 units to the inch—IC compatible. With built-in series resistor. Polarity identified. Low power consumption.



Dialight, the company with the widest choice in switches, LEDs, indicator lights and readouts, looks for needs . . . your needs . . . and then they develop solutions for your every application. No other company offers you one-stop shopping in all these product areas. And no other company has more experience in the visual display field. Dialight helps you do more

with these products than any other company in the business, because we are specialists that have done more with them. Talk to the specialists at Dialight first.

You won't have to talk to anyone else. Send for your free new copy of Dialight's current catalog.

DIALIGHT

Dialight, A North American Philips Company
203 Harrison Place, Brooklyn, N. Y. 11237
(212) 497-7600

See Dialight.

INFORMATION RETRIEVAL NUMBER 60

Our single-chip concept:

Copper grid distributes current most efficiently for lowest $V_{CE(sat)}$.

Integral solid copper leads and heat sink make pre-bond chip test and inventory possible.

Meet stringent MIL requirements best with the NPN silicon transistor that's single-minded about performance.

The concept: a unique single-chip design that packs the highest current rating in its class... keeps saturation voltage low and eliminates second breakdown problems. $V_{CE(sat)}$ is .75V max. @ 70 Amps, and guaranteed at 120 Amps. $E_{S/b}$ is 6 joules. And because its very simplicity allows pre-rating

One bigger, beefier chip.

Void-free bonding techniques eliminates hot spots.

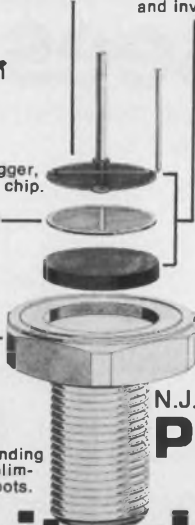

and pre-testing, you can order our JAN & JAN-TX-2N5927 device off-the-shelf for switching regulators, motor controls and other hi-rel power circuits. For tech. data and application assistance, write or call, PowerTech, Inc., 9 Baker Ct., Clifton, N.J. 07011; (201) 478-6205

PowerTech
BIG IDEAS IN
BIG POWER

Top of its class. 120v @ 120A transistor JAN & JAN-TX

INFORMATION RETRIEVAL NUMBER 61

DATA PROCESSING

Single PDP-11 interface card does the work of two

Applied Peripheral Systems, 1781 Barcelona St., Livermore, CA 94550. (415) 443-7077. \$150; stock to 4 wks.

A single-card replacement for the DEC M105 and M7820 modules offers address selection as well as interrupt control. The unit is said to require 30% less power and provide three times the drive fanout. Interrupt vector and device register addresses are jumper selectable; DIP switches are optional.

CIRCLE NO. 335

Three pulse sources designed for step motors

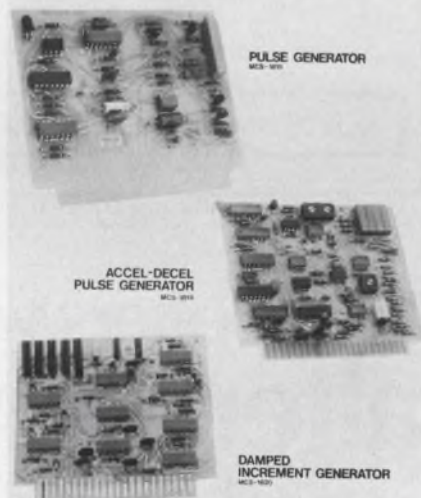

Warner Electric Brake & Clutch Co., 449 Gardner St., Beloit, WI 53511. (815) 389-3771. MCS-1815: under \$100; 1819, 1820: \$100, stock.

Three pulse-generator cards handle most stepper-motor applications. Each card generates pulse trains that are compatible with standard drivers. The MCS-1815 provides 5 to 5000 pulse/s in four ranges and can operate with a run/single-step switch. The MCS-1819 is capable of accelerating and decelerating a stepper motor in an open-loop slew mode. The MCS-1820 provides six steps of electronically damped motion. All three boards accept TTL/DTL level signals and are suitable for such products as computer peripherals and digital instrumentation.

CIRCLE NO. 336

MAGNETIC SHIELDING FOR ANY CONFIGURATION

Ad-Vance reduces your shield costs because it already owns tooling for most standard shields. Or, our Magnetic Shielding Specialists will custom fabricate shields to your exact specifications.

- Magnetic Shields for 312 Types of Photomultiplier Tubes.
- AD-MU Sheet Stock.
- AD-MU Tape Data Protectors assure full fidelity of valuable tapes.
- Unequaled engineering & design service.
- In-house quality control.
- Fast delivery, competitive pricing.



2 Modern Plants with complete facilities for quality shield manufacturing

Ad-Vance Magnetism, Inc., the Old Firm with the New Name, is the industry's largest, oldest and most experienced independent firm exclusively manufacturing magnetic shielding.



AD-MU Foils Cut, Wrap Easily & Quickly



Typical Custom Fabricated Shields For Components & Systems



Send for 16-page catalog

AD-VANCE MAGNETICS, INC.

226 E. SEVENTH ST., ROCHESTER, IND. 46975

(219) 223-3158 TWX 810 290 0294

The Magnetic Shielding Specialists

INFORMATION RETRIEVAL NUMBER 62

Science and statistics combined in calculator



Hewlett-Packard, 1501 Page Mill Rd., Palo Alto, CA 94304. (415) 493-1501. \$395; stock.

A 9-oz. calculator, the HP-55, provides 49 program steps plus a host of keyboard functions. Aside from standard trig, arithmetic and logs, the unit handles linear regression, and solves four simultaneous linear equations. Twenty addressable memory registers permit register arithmetic and simultaneous two-dimensional vector accumulation. The HP-55 displays up to 10 significant digits, a two-digit exponent and signs for both. Simple keyboard commands allow the user to write his own programs with any of the preprogrammed steps as program functions. Back-step and single-step keys ease debugging. A "go-to" command and two conditional tests provide branching.

CIRCLE NO. 337

Paper tape reader uses single 5-V supply

Teleterminal Corp., 12 Cambridge St., Burlington, MA 01803. (617) 272-8504. \$365.

The Fly Reader 30 digests paper tape at the rate of 300 char/s using a single 5-V, 2-A supply. The bidirectional reader, based on a stepper-motor drive, can stop on character and read eight-level, 1-in. tapes. The tape material can have transmissivities up to 60%. Reader outputs are at TTL levels. And the unit draws only 0.7 A in standby.

CIRCLE NO. 338

Disc storage for minis has 270 Mbyte capacity

Systems Industries, 535 Del Rey Ave., Sunnyvale, CA 94086. (408) 732-1650. \$15k to \$35k; 60 days.

Large-capacity disc storage systems, designated the Series 9500, provide up to 270 megabytes storage capacity at an average access time of 30 ms. The series, ready-to-use with most minicomputers, couples Control Data Storage Module Drives (9760/62) to a unique controller which handles many cumbersome software routines in hardware. For example, the controller can, with a single instruction sequence, execute the seek function; transfer multiple blocks of data; and verify the accuracy of the operation when complete. Moreover the controller automatically matches the performance of slow CPUs with the fast transfer rate of the Control Data drives. Each disc pack contains five discs. Data transfer rate is 1.2 Mbyte/s.

CIRCLE NO. 339

Graphics controller for mini fits on one card



Intermedia Systems, 20430 Town Center, Lane, Cupertino, CA 95014. (408) 996-0900. \$2750 (1 to 4); 60 days.

A single-card graphics system for HP-2000 series computers displays a 256 × 256 point matrix on standard television monitors. Color and/or grey scale displays may be generated by using the internal synchronizing feature of two or more of these graphic video generators. The local screen refresh memory is implemented with 4k RAMs, which permit a plotting rate in excess of 200,000 points per second. Software drivers are provided for HP operating systems, and additional support software is available for character and vector generation.

CIRCLE NO. 340

Advertisement

ELECTRONIC PACKAGING

Cabinet racks: upright, inclined, big, deep



Bud Radio, Inc., 4605 E. 355 St., Willoughby, O. 44094, (216) 946-3200. Shipped ready for use.

Series 2000 cabinet racks from Bud. Standard uprights, 16 sizes. Clear inside depths, 20½", 24". Eight extra-deep units have 29½" clear inside depth. Outside heights, 30½" to 88". Mounting rails adjusted horizontally. Six inclined units. Clear inside depths, 20½", 29½". Front panel, 20° off vertical. Compare value, shipping economies. For further information phone—

1-800-321-1764, TOLL FREE

IN OHIO, 1-800-362-2265, TOLL FREE

Special fabrication of electronic housings



Bud Radio, Inc., 4605 E. 355 St., Willoughby, O. 44094, (216) 946-3200. Get what you want for less.

Bud designs and fabricates racks, cabinets, enclosures for new or re-designed electronic instruments or systems. Standard Bud housings can be altered to fit many applications. Original housings can be designed and produced. In addition, Bud's Imlok system can be used for short runs, test or pilot models. For further information phone —

1-800-321-1764, TOLL FREE

IN OHIO, 1-800-362-2265, TOLL FREE

ELECTRONIC PACKAGING

Standard enclosures with custom features

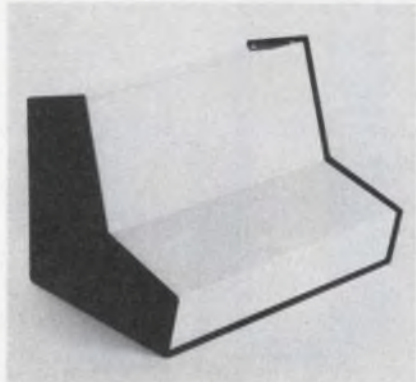

Bud Radio, Inc., 4605 E. 355 St., Willoughby, O. 44094, (216) 946-3200. Your Bud Distributor has it.

Compucab by Bud. Dual-slope, off-the-shelf enclosures with custom-designed configurations. Use for a range of instruments. Maximum visibility — no fasteners on panel area. All aluminum. Cover and back in smooth white enamel. Base and sides, black textured enamel. Knockouts in rear panel. Rubber feet furnished. Two styles. Shipping economies. For further information phone —

1-800-321-1764, TOLL FREE

IN OHIO, 1-800-362-2265, TOLL FREE

Compact enclosures, versatile, economical

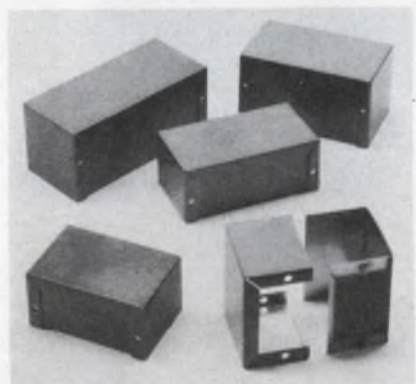

Bud Radio, Inc., 4605 E. 355 St., Willoughby, O. 44094, (216) 946-3200. Available in 18 sizes.

Miniboxes from Bud. Use as separate housings or as part of a larger assembly. Flanges give assured shielding. Projecting covers on cowl-type units minimize glare, protect controls, dials. .040 and .050 aluminum alloy. Immediately available. Shipping economies. One of nearly 3000 products from Bud Radio. For further information phone —

1-800-321-1764, TOLL FREE

IN OHIO, 1-800-362-2265, TOLL FREE

POWER SOURCES

High-voltage supplies like lofty levels

CPS, Inc., 722 E. Evelyn Ave., Sunnyvale, CA 94086. (408) 738-0530. \$700 to \$800; 90 days.

Two new high-voltage power supplies are designed specifically for airborne military applications. The new models are called CPS 1485 and CPS 1487. CPS 1485 features up to 10 kV at 0.1 mA with 0.05% load regulation and pk-pk ripple. The unit has a temperature range of -40 to 85 C and an altitude range to 75,000 ft. CPS 1487 is offered to 15 kV at $30 \mu\text{A}$ with 15-V pk-pk maximum ripple. Focus is 5 to 5.3 kV at $300 \mu\text{A}$. Temperature range is -54 to $+71$ C.

CIRCLE NO. 341

Dc/dc converter offers high I/O isolation

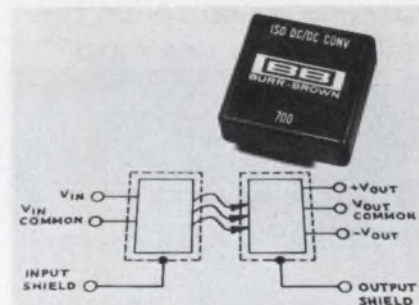

Burr-Brown, International Airport Industrial Park, Tucson, AZ 85734. (602) 294-1431. 700, \$25 (100s); 700M, \$27.

Model 700 dc/dc converter provides isolation of 1500 V dc, 1000 V rms minimum. The unit converts a 10-to-18-V-dc input voltage to dual, bipolar outputs of the same magnitude, delivering a total current of 60 mA. Packaged as a modular unit, the dimensions are just $1.13 \times 1.13 \times 0.4$ in. so it can be mounted right on a PC board. The Model 700 comes in two grades: The industrial version conforms to NEMA ICS 1-109 and is rated to 1000 V rms, 60 Hz, and 1500 V dc continuous. The unit is tested at 3000 V rms, 60 Hz for 5 s. The medical version, Model 700M, conforms to UL544.

CIRCLE NO. 342

Dc/dc converters aimed at industrial use

Aaron-Davis, 1720 22nd St., Santa Monica, CA 90404. (213) 829-1834. \$175.

A new line of industrial dc/dc converters, the G6-20 Series, operates from 24-V battery power. 28 and 48-V inputs are also available. Efficiencies of up to 65% minimize heat dissipation and prolong battery life. The 20-W supply measures $4 \times 4 \times 2$ in. Regulation is 0.1% for line and load. Ripple deviation is less than 0.1% of the output voltage. The converter is conduction cooled. Operating temperature is from -20 to $+71$ C at the mounting base. Output ranges from 5 to 28 V.

CIRCLE NO. 343

Switcher gives 100 A at 5 V

Power Dynamics, Inc., Box 965, Acton, MA 01720. (617) 263-9100. \$575; Stock to 2 wks.

Model PD1-502 is the first in a new line of switching-regulated power supplies intended for OEM use. The unit delivers 100 A at 5 V, with 0.2% regulation, overvoltage and short-circuit protection. Other features include 0.02%/°C tempco, remote sensing and inhibit and soft start.

CIRCLE NO. 344

Dc sources loosen specs and drop prices

Sola Electric, 1717 Busse Rd., Elk Grove Village, IL 60007. (312) 439-2800. \$119 to \$165.

This new line of class 82 IC-regulated dc power supplies, dubbed the "Premier," offers an economy-priced alternative for applications that permit less stringent regulation, ripple and tempco. Premier-line power supplies encompass nine models in two chassis configurations, with outputs ranging from 4.8 V/25 A to 50 V/3 A. However, combined line/load regulation is rated at 0.2% compared with 0.02% for the company's "Premium" line and ripple is rated at 0.1% V rms compared with the Premium line's 0.01%; tempco is 0.03%/°C, versus the Premium's 0.01%/°C.

CIRCLE NO. 345

Switcher series gives three outputs



LH Research, 2052 S. Grand Ave., Santa Ana, CA 92705. (714) 546-5279. \$600; 30 days.

Another addition to the company's line of switching regulated power supplies, a series with forced-air cooling, provides 600 W from up to three outputs and weighs less than 12 lb. The new switchers measure $5 \times 8 \times 10$ in. Primary output, which has 80% efficiency, is 5 V dc, 120 A. Second and third outputs, which have 75% efficiency, are ± 12 or ± 15 V at 8 A. All outputs are fully regulated and adjustable from the front panel.

CIRCLE NO. 346

Three units join miniature dc line



Tele-Dynamics, 525 Virginia Dr., Fort Washington, PA 19034. (215) 643-3900. \$89; stock.

Three new miniature dc power supplies feature high output currents. The units operate from 115 V ± 10 V ac, 50 to 400 Hz. The TW5-2000 is a single-output unit and provides 5 V, 2000 mA with $\pm 0.02\%$ line regulation and $\pm 0.05\%$ load regulation. The TWD12-400 and TWD15-350 are dual output units with $\pm 0.02\%$ line and load regulation. Model TWD12-400 is rated at ± 12 V, 400 mA, and Model TWD15-350 is rated at ± 15 V, 350 mA.

CIRCLE NO. 347

Dual-output switcher delivers 60 W



Abbott Transistor Labs, 5200 W. Jefferson Blvd., Los Angeles, CA 90016. (213) 936-8185. \$349; 5 wk.

A new member in the company's line of high-efficiency power supplies, Model ZZ, offers dual-output, switching-regulated ac-to-dc power. The unit converts low-frequency (47 to 440 Hz) ac lines (100-132 V rms) to 60 W of regulated power in a package measuring $4 \times 7\frac{1}{4} \times 2\frac{1}{2}$ in. and weighing 3 lbs. Model ZZ12T2.5 offers an adjustable output from 11.5 to 12.5 V and delivers 2.5 A per channel. Regulation is well within 0.15% for input voltage changes of 100 to 132 V rms and load changes of no load to full load, while the ripple is less than 5 mV rms or 100 mV pk-pk.

CIRCLE NO. 348

Ac line corrector shows 0.2% harmonics



California Instruments, 5150 Convoy St., San Diego, CA 92111. (714) 279-8620. \$1495; 30 days.

The 1200-VA Model LC-1201B ac line corrector delivers over 10 A at 115 V from a 57-to-63-Hz input source in the range of 93 to 143 V (tap selectable). Harmonic distortion of up to 10% at the input is reduced to 0.2% or less at the output. Input transients of as much as 500 V for periods up to 10 μ s are reduced by a factor of 1000:1. Common-mode isolation is 100 dB and the output may be floated to 300 V rms.

CIRCLE NO. 349

ATC 100 SERIES QPL CAPACITORS

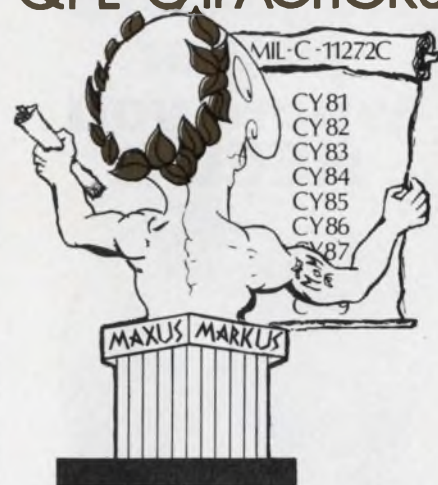

NOW HEAR THIS..

ATC 100 UHF/Microwave Capacitors have been QPL approved since June 1974 in the following types:

- CY81 -Case A chip
- CY82 -Case A pellet
- CY83 -Case B chip
- CY84 -Case B pellet
- CY85 -Case B microstrip
- CY86 -Case B axial ribbon
- CY87 -Case B radial wire
- CY88 -Case B radial ribbon
- CY89 -Case B axial wire



FOR INFORMATION...

just circle the number below.

For samples of any ATC 100 UHF/Microwave Capacitors, call Ralph Wood (516) 271-9600.

american technical ceramics

ONE NORDEN LANE,
HUNTINGTON STATION, N.Y. 11746
(516) 271-9600 • TWX 510-226-6993

INFORMATION RETRIEVAL NUMBER 65

Regulated power where you NEED it



...On the PC card!

Have 5 or 12v DC, and need power for RAMs, ROMs, UARTs, OpAmps, line drivers? Use new regulated V-PAC* DC-DC power sources. Isolated, protected against shorts and thermal overload, use them for either positive or negative voltage.

DC inputs: 5 or 12v
 DC outputs: 3 to 15v (see table)
 Output voltage tolerance: $\pm 5\%$
 Output ripple: 100 mv, P-P, max.
 Line regulation: $\pm 0.2\%$
 Load regulation: 150 mv, no load to full load
 Operating temperature range: 0 to 70°C
 Temperature coefficient: $\pm 3\text{mv}/^\circ\text{C}$
 Package: 24 pin DIP. .6 X 1.25 X .4 inches
 Price: \$33.25 in 1 to 9 quantities.

12v input Part type	5v input Part type	Output v DC	Output Ma
V12R 3	V5R 3	3	90
V12R 5	V5R 5	5	100
V12R 9	V5R 9	9	90
V12R 12	V5R 12	12	80
V12R 15	V5R 15	15	65



Reliability, Inc.

5325 Glenmont/Houston, Texas 77036
 713-666-3261/TWX: 910-881-1739

Facilities in Nenagh, Ireland

*Trademark, Reliability, Inc.

Price subject to change without notice

INFORMATION RETRIEVAL NUMBER 66

POWER SOURCES

Dc/dc converters work at 60% efficiency

B.H. Industries, 5784 Venice Blvd., Los Angeles, CA 90019. (213) 937-4763. \$78.60; 3 wks.

2065 Series of compact dc/dc converters offers dual 5-to-15-V tracking outputs and 5-W max output. Efficiency of the series is 60%, voltage accuracy is 100 mV and regulation is 5 mV for load and line changes. The 5-W can be taken from one output or it can be split between both outputs. Units are PCB mounted and epoxy encapsulated. Short-circuit and input reversal protection is provided. Input and both outputs include L/C filters for low noise. Size is 2.75 x 2.0 x 0.5 in.

CIRCLE NO. 350

Something for less \$? Yes, says this supply



Abbott Transistor Labs, 5200 W. Jefferson Blvd., Los Angeles, CA 90016. (213) 936-8185. \$86 to \$89; stock.

Model RNO.6 Series gives the same electrical performance and mechanical construction of the company's popular "R" series but at 20% less cost. The RNO.6 family provides 0.6 A at various voltages between 4.5 and 37 V dc. Line and load regulation are 0.1% and ripple is less than 0.02%. Standard features include short-circuit protection, input-transient protection and remote error sensing. Predicted mean time between failure (MTBF) is more than 100,000 h.

CIRCLE NO. 351

Card-mount supplies can be repaired



Adtech Power Inc., 1621 S. Sinclair St., Anaheim, CA 92806. (714) 997-0034. \$29.95 (1-4); stock.

DEPS Series is a new line of dual-output ± 12 and ± 15 V (100 mA) card-mounted dc power supplies that feature open construction. These models are available either as PC-board mounting types with plug-in, pin-type terminals or with solder terminals and inserts for chassis mounting. Regulation for all four models is $\pm 0.05\%$ for full line range of 105 to 125 V, 60 Hz, and $\pm 0.1\%$ for no load to full load. Ripple is 1 mV rms max. All units feature foldback current limiting.

CIRCLE NO. 352

Bipolar source programs with 12-bit word



Kepeco, Inc., 131-38 Sanford Ave., Flushing, NY 11352. (212) 461-7000. \$1611; stock.

12-bits of binary resolution control this bipolar unit over the range of -36 to $+36$ V linearly through zero with a settling time of better than 26 μs . The illustrated instrument is comprised of a Kepeco BOP 36-5M and SN-12 digital controller which offers up to 5 A dc output current at any programmed setting. The digital control is via 12 parallel lines (TTL compatible), strobed for noise immunity and fully deglitched with a 6- μs delay circuit. Storage registers hold the 12-bit program. The packaging occupies 5-1/2-in. of space in a 19-in. rack.

CIRCLE NO. 353

Chassis-mount sources provide 10 W



Computer Products, 1400 N. W. 70th St., P.O. Box 23849, Fort Lauderdale, FL 33307. (305) 974-5500. PM301, \$109; PM345, \$99; stock.

Two new ac-to-dc modular power supplies offer convenient chassis mounting, and each delivers 10 W. Model PM301 supplies ± 15 V dc at 350 mA, and Model PM345 supplies 5 V dc at 2000 mA. The units measure $2.7 \times 4.0 \times 2.0$ in. and contain threaded inserts for mounting and barrier-type, terminal-strip connections. Specs include line regulation of $\pm 0.05\%$ max. and load regulation of $\pm 0.05\%$ max (PM301).

CIRCLE NO. 401

6-kVA ac power system weighs just 275 lb

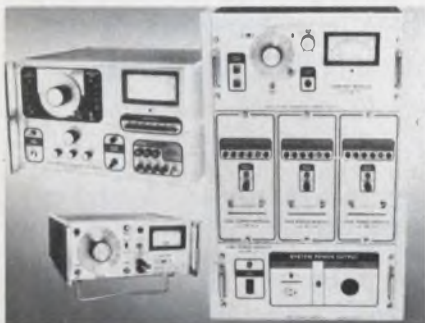

Pacific Electronics, 2643 N. San Gabriel Blvd., Rosemead, CA 91770. (213) 573-1686. \$695 (250-A), to \$1800 per kVA; stock.

A new line of compact, solid-state ac power sources features significant reductions in weight (said to be approximately five times lighter than competitive units) and use of a "self-healing" circuitry in multi-kVA units, which isolates and disconnects any failed output transistor, enabling continued, distortion-free power. All units are fully metered. Sizes range from $5\text{-}1/2 \times 12 \times 13$ in. (250 VA, single-phase) at 30 lbs. to $42 \times 19 \times 24$ in. (6 kVA, three phase) with a total weight of only 275 lbs.

CIRCLE NO. 402

Efficient dc/dc unit is only 0.375-in. high

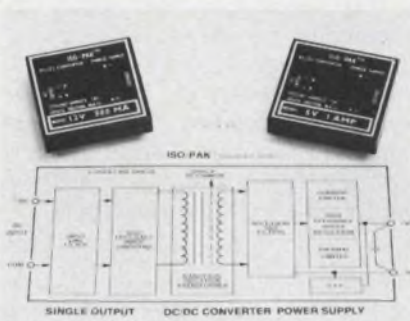

Stevens-Arnold, 7 Elkins St., South Boston, MA 02127. (617) 268-1170. \$89.

Series F Iso-Pak is an ultra-miniature, isolated 5-W dc/dc converter housed in a copper case $2 \times 2 \times 0.375$ in. The unit requires no adjustments, heat sinks or derating to meet its published specs. Input ranges from 5 to 48 V, while outputs vary from 3 to 15 V at 1 A to 0.35 A. Specs include 70% efficiency, $10^6\text{-}\Omega$ isolation and 0.02% regulation, no load to full load.

CIRCLE NO. 403

Bright? Brighter? Brightest?
We'll help you
spot the difference.

There's one sure way to consistently and objectively measure light: the Spectra SpotMeter. The key is a high sensitivity, built-in photomultiplier tube and an internal, ultrastable calibrating source providing NBS-traceable light readings.

The unique optical system lets you measure luminance (brightness) as close as $2\frac{1}{2}$ " — or to infinity — without using supplementary lenses or other extras. What's more, it provides an unobstructed light measuring path free of mirrors, beamsplitters or fiber optics. The result? Zero polarization error.

A full complement of optional accessories expands measurement capabilities over a wide range of lighting parameters.

For full data, write for brochure. Or call collect.

Spectra SpotMeter™



PHOTO RESEARCH
 A Division of Kollmorgen Corporation

3000 No. Hollywood Way, Burbank, CA 91505
 (213) 849-6017 • Telex 69-1427

The light measurement people

Clean copper PC boards with simple wash

Transene Co., Route One, Rowley, MA 01969. (617) 948-2501. \$4.50/gallon (15 gallons & up).

Bright copper cleaner removes tarnish from copper printed-circuit boards and simultaneously forms a thin, protective film highly resistant to corrosion. The cleaner is used at room temperature and should be followed by a water rinse. It produces a molecular-bonded physical barrier layer, stable to 280 C and has no adverse electrical effects on the copper.

CIRCLE NO. 354

Pad spacers help mount discrete components

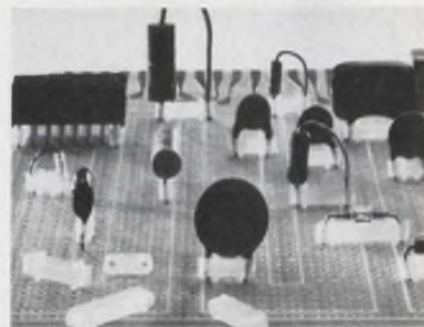

Bivar Inc., 1617 E. Edinger Ave., Santa Ana, CA 92705. (714) 547-5832. \$18.25 (10,000 up); stock.

Discrete components may be accurately assembled on PC boards with Perm-O-Pad mounts, molded from clear nylon per MIL-M-20693. Controlled positioning improves yield, reduces rework and inspection time and helps protect boards from component failures. Posts on tops and bottoms provide cleaning and probing ease as well as lead exposure for heat dissipation. Available spacings include: 0.2, 0.25, 0.3, 0.35, 0.4 and 0.5 in. Samples on request.

CIRCLE NO. 355

PLUG UGLY.™

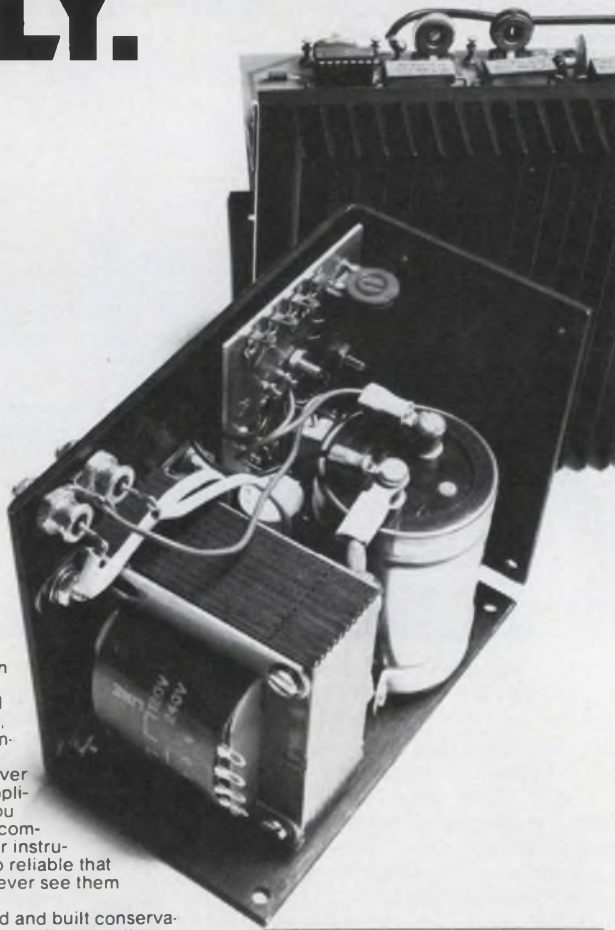

\$49 (unit)
5V, 6A

They're not much to look at

Because instead of fancy front panels, we designed our standard open-frame dc power supplies to cover 90% of your OEM applications. And once you plug them into your computers, peripherals or instrumentation, they're so reliable that chances are you'll never see them again.

They're designed and built conservatively, so you get full rated power all the way up to +55°C. Regulation, ripple and noise are specified by the book. And with no expensive options, you can now get your dc power for as little as 69¢/W (unit qty).

If you've looked at the competition, we know that has to be a sight for sore eyes.

For more info, use the bingo card or call 714/979-4440. Or call your local Cramer or Newark distributor and get UGLY today.

Elxon Power Systems

OPEN-FRAME OLV SERIES: 4-28 Vdc, 15-250 W

STANDARD FEATURES: Choice of 16 voltages, adjustable ±5% Current to 50A, no derating to +55°C, ±0.1% IC regulation, ±0.1% ripple and noise, Remote sensing/programming, Spike suppression, Foldback current limiting, 120/240 Vac, 50/60 Hz inputs

OPTIONS: OVP crowbar, PRICES: \$29.00 to \$219 (unit qty)

Get UGLY wherever you are: New England: Cuskey, Boyd & Abbott, 617/444-5470 □ Upstate N.Y.: Ontic, 716/464-8636 □ N.Y.: Metro, New Jersey: Ed Glass Assoc., 201/592-0200 □ Penn.: Del. So. N.J.: IOE Sales, 215/348-2212 □ Va.: Md.: W. Va.: Component Sales Inc., 301/484-3647 □ Kentucky: Ohio Ind.: Frank J. Campisano Co., 513/662-1616 □ Michigan: VPI, 313/271-4600 □ No. Carolina: So. Carolina: Fla.: Georgia: Ala.: Miss.: Tenn.: WA: Brown Components, 205/539-4411 □ Ill.: Wisc.: Iowa: Balhorn & Welch, 312/889-5011 □ Minn.: N. & S. Dakota: Lew. Cahill & Assoc., 612/646-7217 □ Colo.: Utah: J.S. Heaton Co. Inc., 303/758-5130 □ Texas: La.: Hillman Enterprises, 214/827-4790 □ Okla.: Ark.: Hugh J. Daly Co., 918/627-4159 □ Wash.: Ore.: Blum & Assoc., 206/285-2590 □ N. Calif.: J.S. Heaton Co., 415/369-4671 □ S. Calif.: RLS Assoc., 914/644-7497 □ Canada: Cantronics Ltd., 416/661-2494



ELPAC © Copyright 1974 Elpac, Inc.

Flame retardant epoxy is self-extinguishing

Emerson & Cuming, Canton, MA 02021. (617) 828-3300. \$2.50/lb.

Eccocoat VE-FR is a fire retardant, two-component, epoxide surface coating which has built-in toughness and adjustable flexibility. It can be brushed, sprayed or used as a dip coating. The coating is self-extinguishing per Federal Standard No. 2022 (ASTM D568-61). Eccocoat VE-FR can be used for coating electronic components, printed circuits and for generalized surface coating of plastics, metals and ceramics. Resultant coatings are usable from -70 to +275 F (-57 to +135 C). Under normal conditions, Eccocoat VE-FR cures tack-free after 6 hr at room temperature. Data taken on a 10-mil surface coating of Eccocoat VE-FR on metal include: Dielectric strength of 420 V/mil, a dielectric constant of less than 4 over -60 to 10¹⁰ Hz, a dissipation factor less than 0.03 over 60 to 10¹⁰ Hz and a volume resistivity of 10¹² Ω-cm.

CIRCLE NO. 356

Conductive-rubber sheet replaces metal contacts

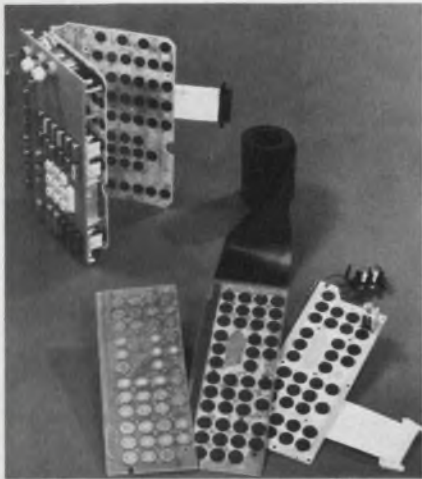

Du Pont Co., Wilmington, DE 19898. (302) 774-7148.

A new conductive, silicone-rubber sheet, Fairprene SS-0066, replaces metal-circuit contacts in keyboards. The conductive-sheet material has a surface resistivity of less than 100Ω , $\pm 20\%$, which is uniform on both sides of the material. Standard thickness is 32 ± 3 mils, but other thicknesses are available. The material, slit to a maximum width of 28 in., is supplied in 75-ft rolls. The new material is also proposed for nonelectronic keyboard uses as in rfi shielding, static bleed-off and flexible connectors.

CIRCLE NO. 357

Jumper family simplifies circuit programming



Augat Inc., 33 Perry Ave., Attleboro, MA 02703. (617) 222-2202. \$0.15 to \$0.60; stock to 4 wks.

A family of programming jumper-plug assemblies is available in units of one, three, four, seven, eight and nine positions with up to 18 contacts. Contact pins are either 0.3 or 0.1-in. spacings to mate with IC patterns, either on sockets or PC boards. Insulation is 94 V-0 glass-filled thermoplastic, and the pins are gold-plated. Special configurations and individual insulators and pins for user assembly are available.

CIRCLE NO. 358

Connector mates with flexible PC

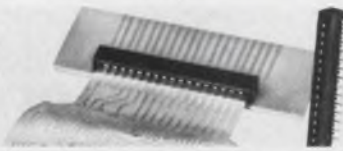

Burndy Corp., Richards Ave., Norwalk, CT 06852. (203) 838-4444.

Flexlok is directly pluggable to flexible printed circuitry and flat

cable. Thus it allows close packaging densities and easy installation. The design is based on Burndy's GTH, tin-alloy plated, gas-tight, high-pressure interconnections, which Burndy claims are as reliable as gold-plated systems. Flexlok can accommodate any finish—even unplated—if resistance requirements permit. Also, it can be wave-soldered.

CIRCLE NO. 359

MEAN AND UGLY.™



\$79 3 outputs

Our OEM dc supplies have always been stark, but now they're twice as ugly (also 3x).

Because instead of working up a new color scheme, we've combined two and three of them on a single chassis to make them an even better buy for your computers, peripherals and instruments.

We've taken out redundancies, but they still offer the widest range of voltages you can get in a modular dc supply. Still deliver all the power we promise across the full temperature range (even with 50 Hz inputs). And still include all the features you need as standards, not expensive options.

So that now if you check us out against the competition, they're liable to tell you that we're not just ugly.

We're downright mean.

For more info, use the bingo card or call 714/979-4440. Or call your local Cramer or Newark distributor and get UGLY today.

MULTIPLE OUTPUT DLV/TLV SERIES: 1st output: 5 V at 3-15 A. OVP standard. 2nd and/or 3rd outputs: each 4-28 V @ 1.5 W. OVP optional. All outputs isolated; may be used as positive or negative supplies.

STANDARD FEATURES: Choice of 16 voltages, adjustable $\pm 5\%$. Currents to 15 A, no derating to -55°C . $\pm 0.1\%$ regulation. $\pm 0.1\%$ ripple and noise. Remote sensing/programming. Spike suppression. Feedback current limiting. 100/240 Vac. 50/60 Hz inputs.

OPTIONS: Enclosure. **PRICES:** \$29 to \$151 (1-9)

Elxon Power Systems

Get UGLY wherever you are: New England: Coakley Boyd & Abbott 617/444-5470 Upstate N.Y.: Ontec 716/464-8636 N.Y. Metro: New Jersey: Ed Glass Assoc. 201/592-0200 Penn. Del.: So. N.J.: TOE Sales 215/348-2212 Va. Md.: W. Va. Component Sales Inc. 301/484-3647 Kentucky: Ohio: Ind.: Frank J. Campisano Co. 513/662-1616 Michigan: VPI 313/271-4600 No. Carolina: So. Carolina: Fla.: Georgia: Ala.: Miss.: Tenn.: WA: Brown Components 205/539-4411 Ill.: Wisc.: Iowa: Balhorn & Welch 312/889-5011 Minn.: N. & S. Dakota: Lew. Cahill & Assoc. 612/646-7217 Colo.: Utah: J.S. Heaton Co. Inc. 303/758-5130 Texas: La.: Hillman Enterprises 214/827-4790 Okla.: Ark.: Hugh J. Daly Co. 918/627-4159 Wash.: Ore.: Blum & Assoc. 206/285-2590 N. Calif.: J.S. Heaton Co. 415/369-4671 S. Calif.: RLS Assoc. 714/644-7497 Canada: Cantronics Ltd. 416/661-2494



ELPAC © Copyright 1974 Elpac, Inc.

INFORMATION RETRIEVAL NUMBER 71

TRIPLE DC SUPPLIES

DIRECT FROM STOCK



Model 300
5V 1.0A
±12 or 15V 0.25A
Size:
4.5" W x 4.5" L x 2.25" H
Price: With OV \$80

70⁰⁰
(1-9)



Model 301
5V 5.0A
±12 or 15V 1.0A
Size:
6.0" W x 3.38" H x 7.0" L
Price: With OV \$111

99⁰⁰
(1-9)



Model 302
5V 15.0A
±12 or 15V 2.0A
Size:
6.0" W x 4.0" H x 13.25" L
Price: With OV \$174

159⁰⁰
(1-9)

SPECIFICATIONS

Input: 105-125V, 47-420 Hz
Regulation: Line—0.005%
Load—0.05%
Ripple: Less than 250 Microvolts
Temp: Operative —20 to +71°C
Storage —65 to +85°C
Coefficient —0.01%/°C Max
Current Limiting: Fixed Foldback Type
Overvoltage: Optional

CALL (714) 279-1414
FOR DELIVERY AND
QUANTITY DISCOUNT

Electrostatics, Inc.
7718 CLAIREMONT MESA BLVD. SAN DIEGO, CA 92111

PACKAGING & MATERIALS

Eliminate lamp solder-in with low-cost holder

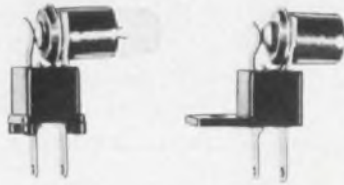

Chicago Switch Inc., 2035 Wabansia, Chicago, IL 60647. (312) 489-5500. \$0.12 (1000 up).

One of the most popular lamps is the T-1-3/4 midget flange base in the 6-to-28-V range. However, the unavailability of a simple inexpensive socket has been a handicap. Some users have soldered directly to the bulb. The Klip-socket is a solution. Spring action of nickel-silver contact and terminals maintains good electrical contact. Terminals are easily soldered or used with Amp 61005-1 quick connectors. Samples available. State application and annual requirements.

CIRCLE NO. 360

Glass for LCDs is precision cut



Corning Glass Works, Corning, NY 14830. (607) 974-9000.

Precisely cut microsheet glass for use in liquid crystal and electrochromic digital watches is available in a range of geometric configurations with typical shape dimensional tolerances of ±0.002 in. Microsheet is provided in thicknesses from 7 to 30 mils, with or without predrilled holes. Corning notes that the tight dimensional tolerances and thinness are essential for miniaturizing precision timepiece displays.

CIRCLE NO. 361

Temp-indicator coating cools to original color

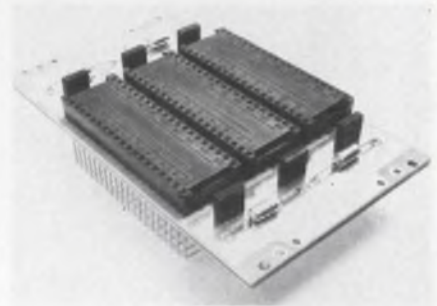

Tempil Div., Big Three Industries Inc., 2901 Hamilton Blvd., South Plainfield, NJ 07080. (201) 757-8300. See text.

Chromonitor, a temperature-indicator coating, is now available for immediate delivery in 2-oz jars at \$15 per jar. The coating can be used on polypropylene, Delrin, nylon, stainless steel and other substrates. It changes from a bright red to a deep maroon in the range of 150 to 160 F and then reverts to its original color upon cooling. Since it has the consistency of a thin lacquer, Chromonitor can be applied in several modes, which include brushing, spraying or via glass or stainless steel metering devices for more controlled application. For light production purposes or preliminary evaluations, an eye-dropper application is feasible.

CIRCLE NO. 362

Board mounts three 40-pin microprocessors

Electronic Engineering Company of California, 1441 E. Chestnut Ave., Santa Ana, CA 92701. (714) 835-6000. \$59 (unit qty); stock to 4 wks.

Up to three 40-pin microprocessors or I/O DIPs can be mounted on this new socket board. The board is 2.45 × 4.14 in. and can be mounted in any of 84 standard EECO wire-wrappable drawers, panels, swingouts, fixed-frames and large scale assemblies. Power is customer connected with convenient wire loops. Six ceramic and four tantalum capacitors provide power decoupling. V_{cc} and ground power planes are extra large for maximum reduction of power noise. The board for three-level wrap is part number H-2961-01 and two-level wrap, H-2961-02.

CIRCLE NO. 363

FOR THE UTMOST IN RELIABILITY



INTERVAL TIMERS Series PAB.

This is an automatic reset interval timer with an extremely accurate timing mechanism built to stand up under hard usage in modern manufacturing processes. Due to the simplicity and reliability of its special clutch we can offer it in a range of time intervals from 1 second (1/60" dial divisions) to 3 hours (3' dial divisions), twelve in all. It is also available in a panel mount model PAF.

All of our timers are made to give you service far beyond what you'd reasonably expect. Our line consists of 17 basic types, each avail-

able in various mountings, voltages, cycles, circuits and load ratings... and with whatever special wrinkles you may need.

Bulletin #403 tells all about our line of reliable Interval Timers. Write for it or a catalogue of the entire line. If you have an immediate timer requirement, send us your specifications. Or for fastest service, give us a ring at (201) 887-2200.



INDUSTRIAL TIMER

A UNIT OF ESTERLINE CORPORATION

Industrial Timer Corporation, U.S. Highway 287, Parsippany, N.J. 07054

INFORMATION RETRIEVAL NUMBER 73

If you need

DIGITAL CLOCKS

look to

Chrono-log

for

the features you need at off-the-shelf prices. LED, NIXIE® or BCD displays. Time ranges from milliseconds to years. Outputs can be parallel and or serial BCD, modulated carrier, level shift or video. DC, AC or internal battery operation. "Naked" cards for OEM's.

For Digital Clocks, Time Code Generators and Readers, write or call Chrono-log Corp., 2 West Park Road, Havertown, Pa. 19083 Phone: (215) 853-1130



CHRONO-LOG CORPORATION

INFORMATION RETRIEVAL NUMBER 74

ELECTRONIC DESIGN 16, August 2, 1975



Small Wonder

*It's PICOTEMP.
New from Micro Devices
(Actual Size)

PICOTEMP thermal cutoffs. Fit tight spaces — and limited budgets. Same accuracy and similar capabilities as the widely used MICROTEMP® safety thermal cutoffs...but smaller in size. Weighs just 1/48th of an ounce. Installed costs are less, too.

Use PICOTEMP when installation or space restrictions rule out MICROTEMP. At present, motors and transformers are two leading applications.

But, wherever you use PICOTEMP, you're assured of positive, low cost protection against overheating caused by malfunctions in electrical circuits and components.

PICOTEMP is completely sealed against atmosphere. Because of its patented

design and construction, it won't derate. And it is unaffected by age or extended use.

Here are some other things you'll want to know:

- current capacity—to 5 amps. at 120 VAC. Will hold this rating up to and including 240 VAC.
- temperature tolerance—+/-3°F. (1.7°C).
- temperature ratings —136° to 300° F. (58°-150° C).
- leads are 26 gauge silver plated wire.
- Facilitates approval to UL 506, UL 544, UL 547, UL 697, UL 492 and UL 859. Designed to comply to UL 1020. Currently being tested by UL for yellow card recognition.

For more information, check the reader service card, or call or write.



MICRO DEVICES CORP.

1881 Southtown Blvd., Dayton, Ohio 45439
Ph: (513) 294-0581 Telex: 28-8087

INFORMATION RETRIEVAL NUMBER 75

New Literature



TV, hi-fi, radio xformers

A 70-page "1975-1976 Replacement Catalog and Television Guide for Transformers" features several hundred replacement transformers. Triad Utrad Distributor Services, Huntington, IN

CIRCLE NO. 364

Microwave devices

A product library covers microwave devices and subsystems for terrestrial and satellite communications. Com Dev, Montreal, Canada

CIRCLE NO. 365

Fastener adhesives

Twenty-eight curves, charts and tables provide microencapsulated fastener adhesive performance data. 3M, Adhesives, Coatings and Sealers Div., St. Paul, MN

CIRCLE NO. 366

Instrumentation

Multimeters, voltmeters and DPMs; pulse and multipulse generators; telecommunication instruments; signal processing instruments; and others are covered in a 104-page catalog. Specifications, block diagrams, charts and photos are included. Tekelec Airtronics, 92310 Sevres, France

CIRCLE NO. 367

16-bit microprocessor

The Pace single-chip, 16-bit microprocessor is described in an easy-to-read illustrated 16-page brochure. A color-mapped photograph of the chip, complete with call-outs, is included along with a functional block diagram. National Semiconductor, Santa Clara, CA

CIRCLE NO. 368

32-bit minicomputers

A new hierarchy of microprogrammed computer systems, the SEL 32 series, is described in a 20-page catalog. Systems Engineering Laboratories, Fort Lauderdale, FL

CIRCLE NO. 369

Plastic parts

Specifications and prices for over 3000 plastic plugs, caps, protectors, finishing flanges, straps, nuts, bolts, washers, connectors and containers are included in a 54-page catalog. Niagara Plastics, Erie, PA

CIRCLE NO. 370

Rf power signal sources

Specifications and application data on rf power signal sources are provided in a 12-page brochure. Ailtech, City of Industry, CA

CIRCLE NO. 371

Electronic components

A 104-page engineering reference catalog covers more than 2000 electronic components. Herman H. Smith, Inc., Brooklyn, NY

CIRCLE NO. 372

Recorders

Direct-acting electrical recorders are described in a 44-page publication. A selection guide, options and prices are included. General Electric, Schenectady, NY

CIRCLE NO. 373

Generators

Thirty-six models including function generators, phase generators, pulse/sweep function generators, frequency synthesizers and complex waveform synthesizers are highlighted in an eight-page catalog. Dana Exact Electronics, Hillsboro, OR

CIRCLE NO. 374

Digital plotter

Specifications and operating instructions for the DP-3 digital plotter are included in a four-page brochure. Houston Instrument, Austin, TX

CIRCLE NO. 375

Software library

A software library that supports the NAKED MILLI, NAKED MINI and MegaByter minicomputers is described in a brochure. Computer Automation, Irvine, CA

CIRCLE NO. 376

Microprocessor update

"Microprocessor Field Survey and Data Book," a quarterly update, includes CPU data on 23 different products from 21 manufacturers. AH Systems, Chatsworth, CA

CIRCLE NO. 377

TWT amplifiers

Medium-power, low-noise, instrumentation and special types of TWTAs are described in an eight-page brochure. Thomson CSF, 75737 Paris, Cedex 15, France.

CIRCLE NO. 378

CMOS ICs

A 116-page data book includes updated specifications on CMOS ICs. Basic design, operating and handling information are covered. Solid State Scientific, Montgomeryville, PA

CIRCLE NO. 379

EMI filters

"Maxi-Brute General Purpose EMI Filters" incorporates newly added specifications on the international series EMI filters and plug-in interference filters suitable for retrofitting EMI field problems. The Potter Co., Wesson, MS

CIRCLE NO. 380

Power transistors

"Power Transistors Users Guide," 120-pages, includes practical user-oriented information on circuit application, handling and mounting and reliability prediction. General Electric Semiconductor, Syracuse, NY

CIRCLE NO. 381

We made them first. To last.

Available now from Singer: Size 8 and 11 Bu/weps synchros designed to meet the latest requirements of MIL-S-20708C specifications.



Kearfott, the first to design Bu/weps size 5, 8 and 11 synchros, has over the years constantly made them better. These units are used in fire control systems, radar, navigation, missile functions and other applications requiring a high level of precision, endurance and reliability.

These Kearfott synchros operate over the entire temperature range of -55°C to $+125^{\circ}\text{C}$. They are DOD qualified and listed in the QPL.

(They can also meet reasonable cost requirements in computers, electronics and other types of business equipment.)

You can get these synchros in the following Bu/weps types:

Size 8	Size 11
26V 08CX4c	26V 11CX4c
26V 08CDX4c	11CX4e
26V 08CT4c	26V 11TX4c
	26V 11CDX4c
	11CDX4b
	26V 11CT4d
	11CT4E

We'll be happy to send you drawings and technical details on request. Also for Kearfott Size 5 Bu/weps CX, CDX and CT units, and Size 11 and 15 resolvers. Units with the same characteristics but different Bu/weps shaft variations are also available. Write for information to the Singer Company, Kearfott Division, 1150 McBride Avenue, Little Falls, N.J. 07424.

SINGER
AEROSPACE & MARINE SYSTEMS

NEW LITERATURE



Switches

Subminiature and microminiature switches are featured in a 24-page catalog. C&K Components, Waertown, MA

CIRCLE NO. 382

Power supplies

Product data, application information and test procedures for line operated power supplies and dc/dc converters are covered in a 28-page guide. Semiconductor Circuits, Haverhill, MA

CIRCLE NO. 383

Clutches and brakes

The Bendix line of electric clutches and brakes for applications from business machines to control mechanisms on heavy machinery is featured in a 54-page catalog. Facet Enterprises, Motor Components Div., Elmira, NY

CIRCLE NO. 384

PC production systems

Assembly, wavesoldering, cleaning, component tinning and soldering and PC board coating systems are described in a 20-page catalog. Electrovert, Mount Vernon, NY

CIRCLE NO. 385

Data processing

Helpful ideas on the selection and use of systems from Allen-Bradley are highlighted in a quarterly newsletter. Allen-Bradley Systems Div., Highland Heights, OH

CIRCLE NO. 386

Everything in Fail-Proof Digital Printers.

Whatever your hard-copy need — alpha-numeric/digital print-out; multi-copy; multi-color; ordinary calculator paper/pressure-sensitive tape; card, label, fan-folded forms, sales slip, — one of our 12 basic field-proven impact printers will suit you perfectly.

Products of Shinshu-Seiki, world-famous for a decade of reliability. Choose up to 21 columns, up to 42 characters/column, 3.4 lines/sec printing speed. Lowest sample prices.

Phone Hans Weck, Sales Manager, or write . . .

C. Itoh Electronics, inc.
 SYSTEMS & COMPONENTS DIVISION
 280 Park Avenue, New York, N.Y. 10017
 (212) 573-9456. Telex: WUD 12-5059

INFORMATION RETRIEVAL NUMBER 79

Help college help you.

Businesses like yours gave over \$340,000,000 to higher education last year. It was good business to do so. Half of all college graduates who seek work go into business. The more graduates there are, and the better educated they are, the more college serves the business community.

Your money was vital to colleges. It relieved financial pressures, made planning more flexible, and contributed to the kind of basic and applied research that puts new knowledge and technology at the service of industry.

So that colleges can continue to help you, give to the college of your choice now. For information on ways to do it, please write on your letterhead to Council for Financial Aid to Education, Inc., 6 East 45th Street, New York, N.Y. 10017. Ask for the free booklet, "How Corporations Can Aid Colleges and Universities."

CF AE Council for Financial Aid to Education, Inc.
 Advertising contributed for the public good.

SUBSCRIBER SERVICE For prompt service include the addressed label when writing about your subscription.

CHANGE OF ADDRESS

NEW ADDRESS	
name	title
company	
division/department	
company address	
city	state
	zip

If you're moving, please let us know six weeks before changing your address. If you have a question, place your magazine address label here and clip this form to your letter.

MAIL TO: ELECTRONIC DESIGN Circulation Dept. Hayden Publishing Co., Inc., 50 Essex Street, Rochelle Park, NJ 07662

Design Aids

Computer program wallet

A 4-1/2 × 6-1/2-in. program wallet organizes up to 40 magnetic memory cards for instant user selection and easy access. The wallet opens to display all memory cards at a glance and folds to a thin packet that slips into a jacket or purse. Ticor.

CIRCLE NO. 387

Silicon rectifiers

A Semtech Corp. silicon rectifier guide covers single-phase and high-voltage rectifiers, single-phase and three-phase bridges, doublers and center tapped units. Compar New York.

CIRCLE NO. 388

Heat-shrinkable tubing

The right heat-shrinkable tubing to meet your specific applications can be found in a selection guide. Norelcom Electronics.

CIRCLE NO. 389

Thermocouple indicators

A "Quick Look Selection Guide" covers seven separate digital thermocouple indicator series for single or multipoint monitoring. Doric Scientific.

CIRCLE NO. 390

Zeners and tunnel diodes

A pocket reference guide cross-indexes 270 temperature-compensated reference diodes by tempo, zener voltage, test current and maximum dynamic resistance. Also listed are static characteristics for 37 tunnel diodes and 10 backward tunnel diodes. Microsemiconductor Corp.

CIRCLE NO. 391

Data guides

Four pocket-sized data guide slide rules—electronic, mechanical, structural and secretarial—are made of tough, durable, varnished stock. The price is \$2.95 each. Medcom, 92 Taxiera Rd., Stoughton, MA 02072

INQUIRE DIRECT

Vendors Report

Annual and interim reports can provide much more than financial-position information. They often include the first public disclosure of new products, new techniques and new directions of our vendors and customers. Further, they often contain superb analyses of segments of industry that a company serves.

Selected companies with recent reports are listed here with their main electronic products or services. For a copy, circle the indicated number.

Mohawk Data Sciences. Electronic data processing systems and equipment.

CIRCLE NO. 392

Western Digital. MOS/LSI chips and LSI test systems.

CIRCLE NO. 393

ITT. Telecommunications products and services, industrial, automotive and consumer products, defense-space programs and business and financial services.

CIRCLE NO. 394

Spartan. Sonobuoys, automobile electronics and telecommunications equipment.

CIRCLE NO. 395

Scientific-Atlanta. Communications equipment, electronic instrumentation and engineered mechanical products.

CIRCLE NO. 396

Wang. Calculating/computing products, word-processing systems and computer services.

CIRCLE NO. 397

Leeds & Northrup. Industrial instruments, recorders and controllers and automatic control systems.

CIRCLE NO. 398

Gould. Electrical and electronic products, batteries and industrial products.

CIRCLE NO. 399

National Semiconductor. Semiconductors, data systems and consumer electronics.

CIRCLE NO. 400

MEASURE THE 5 figure hand held digital new 1 SECOND! tachometer

NEW—MADE IN U.S.A.

Power Instruments, leader in portable tachometer equipment brings you the first high precision digital tachometer made in U.S.A.



Model 1704

- 5 (five) big 7/8" displays
- Easy push button operation
- Accuracy to 0.01%, ±1 RPM
- 100% solid state, built-in memory
- Range—up to 19,999 RPM
- Compact, 1 1/2" x 2 1/4" x 8", under 1 lb.
- Easy to read, red L.E.D. digits
- Carrying case, tips, batteries included
- Only \$175.00 FOB our plant
- Distributor inquiries invited

POWER INSTRUMENTS, INC.

7352 N. Lawndale Ave.

Skokie, IL 60076 • (312) 676-2300

INFORMATION RETRIEVAL NUMBER 80

Circuit Savers



Here's positive low cost protection for your IC's, transistors, power supplies and pc cards.

The LVC-1A crowbar switches to a short circuit whenever the voltage across it exceeds a specified level.

Any trip voltage level between 4.7V and 200V ± 10% can be selected. The unit will handle a peak current of 50 Amps (8ms) and 3A continuously. MIL Temperature range. Call Mike Coyle for applications assistance.

Full line of protection modules for every hi-lo voltage/current requirement. Write or call for Catalog 749.

279 Skidmore Road
Deer Park, New York 11729
Telephone: 516 - 586-5125

MCG Electronics

See Gold Book vol 2. p. 320-322

INFORMATION RETRIEVAL NUMBER 81

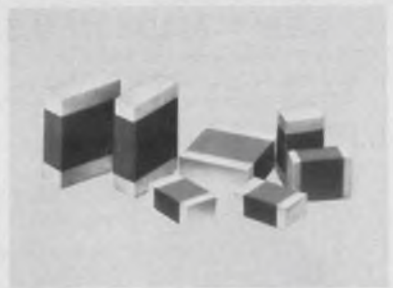

HIGH Q MULTILAYER CAPACITORS feature very high quality factors at microwave frequencies. Offered in three standard sizes: .050 x .040, .080 x .050, .125 x .095. Capacitance values from 0.1 pf to 1000 pf with close tolerance and voltages to 1000 VDCW. Johanson/Monolithic Dielectrics Div., Box 6456, Burbank, Ca. 91510, (213) 848-4465.

MULTILAYER CHIP CAPACITORS 601



Free 84-page Printed Circuit Drafting Aids Technical Manual & Catalog contains hundreds of time & money-saving tips, plus details on over 15,000 component symbols & tapes, film, vellum, grids. Bishop Graphics, Inc., 20450 Plummer St., Chatsworth, California, 91311, (213) 993-1000.

FREE CATALOG 604

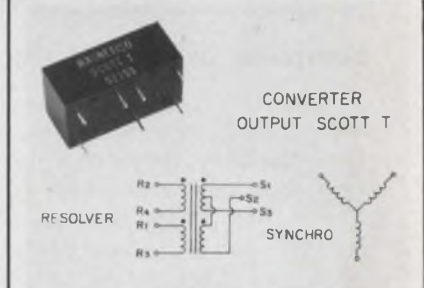

SCOTT T. TRANSFORMER: MAGNETICO Synchro driver is 7/8 x 1-5/8 x 11/16 high, rated at 1 volt amp., 2 arc minutes accuracy. P.N. 52155 is 5.9 sine and cosine to 11.8 v. L-L Synchro. P.N. 52156 is 5.9 sine and cosine to 90 v. L-L Synchro. MAGNETICO, 182 Morris Avenue, Holtsville, N.Y. 11742—516-654-1166.

TRANSFORMER 607

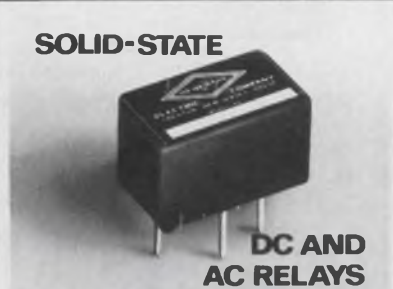

SOLID-STATE
DC AND AC RELAYS

For computer peripherals and other high-speed, high-reliability switching jobs, with either DC or AC loads up to 6 amp, these transformer-coupled Heinemann relays offer highest sensitivity and control-to-output pulse-shape conformity for TTL and other low-level control signals. Heinemann Electric Company Trenton, NJ 08602.

SOLID STATE RELAYS 602



Introduction To Defense Radar Systems Engineering. Excellent introduction and practical reference to radar systems design and applications. #9194, 260 pp., \$22.95. Circle the Info Retrieval No. to order 15-day exam copy. When billed, remit or return book with no obligation. Hayden Book Co. 50 Essex St. Rochelle Park, N.J. 07662

RADAR SYSTEMS 605



ELCON 80 DEVELOPMENT SYSTEM Emulation of 8080 expands design aids to simultaneous 8080 register display • Operation from dc to 2Mhz • Utilities in microcode • Breakpoint and I-C-E capability • TTY interface • High density Prototype boards and power supplies options • 15-30 days SANTEK SYSTEMS, 6645 Convoy Ct., San Diego, Ca. 92111 (714) 560-1101

DESIGN SYSTEMS 608

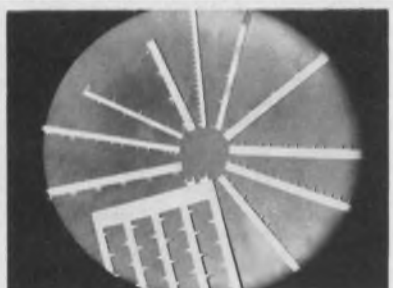

Mini/Bus® Evaluation Kit, \$25, in stock. Lets you try Rogers' low-cost, noise attenuating, high packaging density power distribution system for PC boards. Millions in use. Standard parts on 2 weeks delivery, or less! Customer parts 4 to 6 weeks delivery. Rogers Corporation, Chandler, Ariz. 85224. Phone (602) 963-4584

MINI BUS 603



High performance Type "T" sub-miniature machined-plate capacitors. Rotors and stators machined from solid brass extrusions provide excellent stability and uniformity. High Q, low temp. coefficient (plus 30 ± ppm/°C). Available in horizontal and vertical tuning for PC and stripline mounts. E. F. Johnson Co., Waseca, MN., (507) 835-5222.

TYPE "T" CAPACITOR 606



Surplus Electronics & Optics in free catalog featuring typical bargains: Computer caps 50¢, L.E.D. displays 50¢, ICs 10¢, power supplies \$1, ASC II key bds \$35, Cal Key Bds \$2, Ultra-Sonic XDUcers \$2, Xformers 40¢, card connectors 75¢, plus stereo radios, speaker enclosures, etc. B & F ENTERPRISES, 119 Foster St. Peabody, MA 01960 (617) 531-5774

ELECTRONIC SURPLUS CATALOG 609

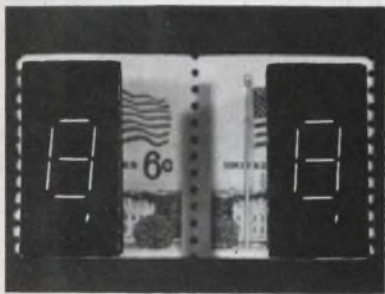

The Proven Incandescent Readout Standard 16 Pin DIP Flat Pack. All units 5 Volt 100,000 hrs. plus 3015F-BM 08ma/seg 700 ft/lam 3015F-BM10 10ma/seg 1700 ft/lam 3015F-BM15 15ma/seg 4500 ft/lam Field tested over 4 years in many applications. READOUTS, INC. P.O. Box 149, Del Mar, Ca. 92014 Tel. 714-755-2641 Telex 69-7992.

DISPLAY

610

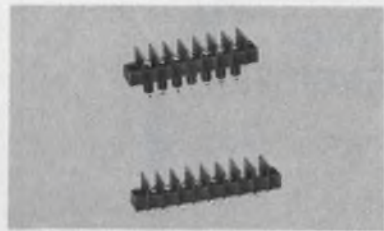

Compact Curtis Terminal Blocks of Unbreakable Thermo-Setting Plastic feature ultrasonically welded terminal inserts and full mechanical thread system. High-barrier CB/CFT blocks are rated 15 amp/300 volt with 5,500 volt breakdown. Feed-thru and surface-mount designs available. Curtis Industries, Inc., 8000 West Tower Avenue, Milwaukee, Wisconsin 53223, (414) 354-1500 or toll free (800) 645-9200 — New York call collect (516) 294-0990.

COMPACT TERMINAL BLOCK 613

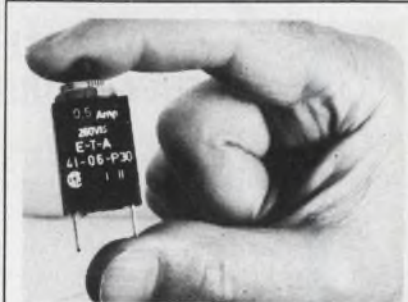

Overcurrent Protector, manual reset eliminates fuse replacement. Convenient panel mounting. 15 fractional ratings from 0.1 to 3 amp. Other models up to 400 amp. Trip-free and fool-proof, UL and CSA approved. High quality, low cost \$1.29 ea. in 1000 lots. E-T-A Products Co. of America, 7400 N. Croname Rd., Chicago, Ill. 60648. Tel: (312) 647-8303. Telex: 253780.

CIRCUIT BREAKER

616

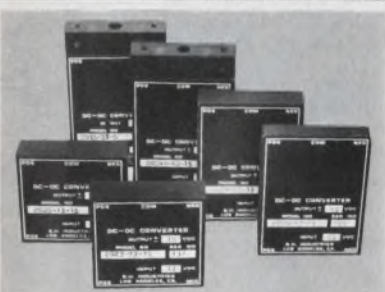

Modular DC/DC Converters. 1.5 W to 30 W. Miniature easy to use P.C.B. mtg. Hundreds of standard variations are available. All have low-noise filtered inputs and outputs. Inputs are reverse voltage protected. Regulated units have current limited outputs. (1 to 9) qty from \$37.25 B. H. INDUSTRIES, 5784 Venice Bl., Los Angeles, CA 90019, (213) 937-4763

DC-DC CONVERTER

611



Basic Electricity & Basic Electronics by Van Valkenburgh, Nooger & Neville, Inc. Derived from the COMMON-CORE Training Program initially developed for the U.S. Navy. Thorough, comprehensive coverage. Available in separate paperbacks or cloth volume. Write for FREE brochure. Hayden Book Co., Inc., 50 Essex St. Rochelle Pk, NJ 07662 (201) 843-0550

TRAINING TEXT

614



LABTRONICS' Multiple Restrike (M-R) Ignition produces high energy repetitive spark on each power stroke for effective ignition of air/fuel mix. Increase mileage up to 40%, longer points/plug life. Model VI \$79.95, VI-B \$59.95 1 yr warranty, 30 day guaranteed refund. Check, M.O. (postpd US) Labtronics, Inc 3635 Hillside, Ypsilanti MI 48197

M-R IGNITION

617

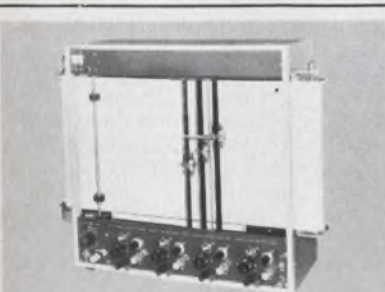

D-73BP Three pen X-Y, Y, Y, T Recorder features single X-axis common to 3 electrically independent Y axes. Use as a 3-channel recorder for accurate time correlation and greatly extended duration. Sensitivity: 2, 5, 10, 50, 100, 500mV, 1, 5, 10, 50 100V/full scale. Riken Denshi Co. Ltd. 5-5-2, Yutenji, Meguro-ku, Tokyo, Japan. tel (03) 711-6656.

RECORDER

612



Free catalog of 34,500 power supplies from the worlds largest manufacturer of quality Power Supplies. New '74 catalog covers over 34,500 D.C. Power Supplies for every application. All units are UL approved, and meet most military and commercial specs for industrial and computer uses. Power Mate Corp. (201) 343-6294.

POWER SUPPLY

615



OPCO MARKERS. Self contained. Designed to "write on anything." Dries in seconds, non-fading, non-etching, non-corrosive. Excellent adhesion on porous or non-porous surfaces. Writing is resistant to abrasion, water, gasoline, naphtha, oils, vapor degreasing, etc. Assorted colors. Send for free sample, Organic Products Co. Box 428, Irving, TX 75060.

OPCO MARKERS

618

COMPUTER AIDED MANUFACTURING ENGINEER

McDonnell Aircraft Company, St. Louis, Missouri has immediate requirements to support Direct Numerical Control Programs, and other automation on the Air Force F-15 Eagle Air Superiority Fighter, and the F-18 Navy Air Combat Fighter.

Requires EE degree and experience in digital electronic circuit design and mini computer applications, or Computer Science degree with experience in APT.

If you possess the above experience, please send your resume in confidence to:

Mr. J. H. Diller
Section Manager-Employment
P. O. Box 14308
Department ED-2A
St. Louis, Missouri 63178

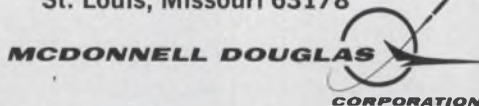

An equal opportunity employer m/f

STRETCH YOUR BUDGET!

Reconditioned Scopes, SS Power Supplies, Freq. Counters & Generators - Many others. Send for our: "Bargain Bulletin"

Lawrence Instruments, Sunbury PA

CIRCLE NO. 210

FREE ALARM CATALOG

Huge selection of burglar & fire systems, supplies. Motion detectors, infrared beams, controls, door switches, bells, sirens. 500 items, 99 pp. packed with technical details, notes.

(Outside U.S. send \$1.00)



mountain west alarm

4215 n. 16th st., phoenix, az. 85016

CIRCLE NO. 211

Help your
Heart...
Help your
Heart Fund

American Heart Association



Please Help Children Live

Research is our only weapon against childhood cancer.

St. Jude Children's Research Hospital, which is non-sectarian, is the largest childhood cancer research center in the world.

Please join in the fight against childhood cancer.

Send your special gift now.



**ST. JUDE
CHILDREN'S
RESEARCH
HOSPITAL**

Danny Thomas, Founder

Send contributions to:
MEMPHIS, TENN. 38101

This space donated by publication

Electronic Design

ELECTRONIC DESIGN's function is:

- To aid progress in the electronics manufacturing industry by promoting good design.
- To give the electronic design engineer concepts and ideas that make his job easier and more productive.
- To provide a central source of timely electronics information.
- To promote communication among members of the electronics engineering community.

Want a subscription? ELECTRONIC DESIGN is sent free to qualified engineers and engineering managers doing design work, supervising design or setting standards in the United States and Western Europe. For a free subscription, use the application form bound in the magazine. If none is included, write to us direct for an application form.

If you do not qualify, you may take out a paid subscription for \$30 a year in the U.S.A., \$40 a year elsewhere. Single copies are \$1.50 each.

If you change your address. send us an old mailing label and your new address; there is generally a postcard for this bound in the magazine. You will have to requalify to continue receiving ELECTRONIC DESIGN free.

The accuracy policy of ELECTRONIC DESIGN is:

- To make diligent efforts to ensure the accuracy of editorial matter.
- To publish prompt corrections whenever inaccuracies are brought to our attention. Corrections appear in "Across the Desk."
- To encourage our readers as responsible members of our business community to report to us misleading or fraudulent advertising.
- To refuse any advertisement deemed to be misleading or fraudulent.

Microfilm copies are available of complete volumes of ELECTRONIC DESIGN at \$19 per volume, beginning with Volume 1, 1952 through Volume 20. Reprints of individual articles may be obtained for \$3.00 each, prepaid (\$.50 for each additional copy of the same article) no matter how long the article. For further details and to place orders, contact the Customer Services Department, University Microfilms, 300 North Zeeb Road, Ann Arbor, Michigan 48106 telephone (313) 761-4700.

Want to contact us? If you have any comments or wish to submit a manuscript or article outline, address your correspondence to:

Editor
ELECTRONIC DESIGN
50 Essex Street
Rochelle Park, N.J. 07662

Advertisements of booklets, brochures, catalogs and data sheets. To order use Reader-Service Card (Advertisement)

Advertising Sales Staff

Tom W. Carr, Sales Director

Rochelle Park, NJ 07662

Robert W. Gascoigne

Daniel J. Rowland

(Recruitment, Quick Ads, Classified)

50 Essex Street

(201) 843-0550

TWX: 710-9990-5071

Philadelphia

Thomas P. Barth

50 Essex Street

Rochelle Park, NJ 07662

(201) 843-0550

Boston 02178

Gene Pritchard

P.O. Box 379

Belmont, MA 02178

(617) 489-2340

Chicago 60611

Thomas P. Kavooras

Berry Conner, Jr.

200 East Ontario

(312) 337-0588

Cleveland

Thomas P. Kavooras

(Chicago)

(312) 337-0588

Los Angeles 90045

Stanley I. Ehrenclou

Burt Underwood

8939 S. Sepulveda Boulevard

Suit 510

Los Angeles, CA

(213) 641-6544

San Francisco 94040

Robert A. Lukas

3519 Cambridge Lane

Mountain View, CA 94040

(415) 965-2636

London, Amsterdam, Tokyo, Seoul

John Ashcraft

12, Bear St.

Leicester Square

London WC2H 7AS England

Phone: 01-930-0525

W. J. M. Sanders

John Ashcraft & Co.

Herengracht 365

Amsterdam C., Holland

Phone: 020-24-09-08

Haruki Hirayama

Electronic Media Service

5th Floor, Lila Bldg.,

4-9-8 Roppongi

Minato-ku, Tokyo, Japan

Phone: 402-4556

Cable: Electronicmedia, Tokyo

Mr. O-kyu Park, President

Dongbo Int'l Corp.—

World Marketing

C.P.O. Box 4010

Seoul, Korea

Tel. 76-3910/3911

Cable: DONGBO SEOUL

Telex: EBKOREA K27286



NEW PORTABLE MINI-UBIQUITOUS[®] NEVER FORGETS!

For on-site instant diagnosis of noise/vibration, 440A real-time universal frequency analyzer/averager/waveform recorder always "remembers" to write test conditions and readings on its CRT—a Polaroid photo preserves them: perfect for inexperienced personnel.

Detects closely-spaced frequencies with 400-point resolution; senses small signals over a 60 dB (1000:1) dynamic range (greater with averaging). All-digital design means precision without recalibration. Includes digital reading of both frequency and amplitude at cursor. On-line real-time display of instantaneous frequency spectra and changing average; viewing and plotting of input time signal. Plug-in modules for special/future jobs. Annotated photos, X-Y plots, or digital recordings.

For machine analysis: reads frequency directly in RPM and Hz; harmonics are automatically identified. For noise reduction: subtracts factory background noise from a machine noise spectrum; log frequency scales available. For machine failure prediction: signature analysis of rotating machines in terms of orders; direct readout of differences between present and past spectra. For automatic systems: digital input or output, remote control/sensing. For transients: transient waveform can be held, viewed and plotted before analysis; spectrum of transient is undistorted because of true flat weighting.

DEMO, CIRCLE 170

LITERATURE, CIRCLE 171

Nicolet Scientific Corporation (formerly Federal Scientific Corp.)

245 Livingston St., Northvale, N.J. 07647, 201-767-7100 TWX: 710 991 9619

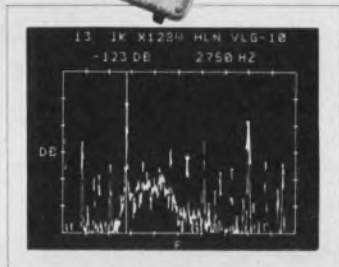

GIANT FREE CATALOG



New 180-page catalog! Packed with 1,000's of hard-to-find buys in Optics, Science, Electronics. Loaded with optical, scientific, electronic equipment available from stock. Rare surplus buys. Many "one-of-a-kinds". Ingenious scientific tools. Components galore: lenses, prisms, wedges, mirrors, mounts, accessories. 100's of instruments: pollution test equipment, lasers, comparators, magnifiers, microscopes, projectors, telescopes, binoculars, photo attachments, alternate energy sources. Shop, save by mail! Request free Catalog "DA".

CIRCLE NO. 172

Edmund Scientific Co.

America's Largest Science-Optics-Electronics Mart

300 Edscorp Bldg., Barrington, New Jersey 08007 (609) 547-3488

Are you using the #1 training courses in electricity & electronics?

BASIC ELECTRICITY and BASIC ELECTRONICS

By Van Valkenburgh, Nooger & Neville, Inc.



Derived from the COMMON-CORE Training Program initially developed for the U.S. Navy, these unique texts are now about to enter their third decade of use in schools, industries, and communication utilities. They continue to be exemplary training texts in their subjects. Carefully integrated illustrations comprise almost half the course material. These perform a remarkable job of visualizing complex theory and applications. Readers are able to grasp essential concepts right away without having to wade through pages of wordy explanation. Thorough, comprehensive coverage. Available in separate paperbacks or one cloth volume. Write for FREE brochure.

Hayden Book Company

50 Essex St. Rochelle Pk, N.J. 07662

CIRCLE NO. 173

NEW PROGRAMMABLE TIME DELAY RELAYS

For R&D, low volume & production requirements.

Featuring CMOS digital circuitry; DPDT contacts—10 amps resistive; no "false" operation on delay on make function; competitive pricing; low inventory requirements.



Model TDP-1: Each unit easily field selected for delay on make or break; for 24VDC, 24VAC, or 120VAC; and for delay ranges of 0.3 to 10, 3 to 80, or 10 to 300 seconds—adjustable to min/max of each range.

Low cost conventional, adjustable and fixed, single mode timers also available.



for further information contact
Hi-G, Inc./Windsor Locks, CT 06096
Area Code (203) 623-2481
see complete Hi-G line in EEM

INFORMATION RETRIEVAL NUMBER 82



MCLEAN RACK-MOUNTED PACKAGED COOLING

Airflows to 1000 CFM! QUIET! Pressurize consoles, computers, electronic systems with cool, filtered, unpolluted air. Dust free! EIA notching for quick mounting. No cutting or fitting needed. Over 100 models in any panel width. Heights from 3½" to 12¼". Stainless steel, or brushed aluminum grilles.

SEND FOR CATALOG

MCLEAN ENGINEERING LABORATORIES

P.O. BOX 127D PRINCETON JUNCTION NEW JERSEY 08550
PHONE 609-799-0100 • TELEX 84-3422

INFORMATION RETRIEVAL NUMBER 83

Do you train or retrain employees? Consider these famous courses...

BASIC ELECTRICITY

By Van Valkenburgh, Nooger & Neville, Inc.

This simplified illustrated course is the civilian version of the Basic Electricity course used for years by the U.S. Navy and requires no previous background in electricity and little mathematics. The step-by-step approach covers basic concepts from electromagnetism to AC and DC circuits and motors. Frequently only one new concept is introduced on each page and it is amplified by at least one illustration per page. Each topical section concludes with helpful review pages. In five volumes, 624 pages.

- Paperbound set, #0033-2, \$18.40
- Combined Cloth Edition, #0039-1, \$16.70



HAYDEN BOOK COMPANY, INC., 50 Essex St., Rochelle Park, N.J. 07662

Please send me the book(s) checked above on 15-day free examination. At the end of that time, I will remit payment, plus postage, or return the book(s) with no further obligation. **Save Money!** Payment enclosed. Publisher will pay all shipping and handling charges—same 15-day guarantee.

BASIC ELECTRONICS

By Van Valkenburgh, Nooger & Neville, Inc.

Any trainee with a basic knowledge of electricity (equivalent to *Basic Electricity* study) can master the fundamentals of electronics with this progressive course. *Basic Electronics* explains all vital concepts in a logical, step-by-step sequence — from power supply elements and circuits through amplifiers, transmitters, receivers and transistors. In six volumes, 680 pages.

- Paperbound, #0048-0, \$22.15
- Combined Cloth Edition, #0049-9, \$19.50

Tests (and answers) for both courses are available for group and self-study applications.

Prices subject to change without notice.

Name _____

Firm _____

Address _____

City/State/Zip _____

Product Index

Information Retrieval Service. New Products, Evaluation Samples (ES), Design Aids (DA), Application Notes (AN), and New Literature (NL) in this issue are listed here with page and Information Retrieval numbers. Reader requests will be promptly processed by computer and mailed to the manufacturer within three days.



use pressure sensitive
TEMP-R-TAPE of fiberglass
for quick relief.

Excellent electrical properties plus most anything else you want in fiberglass tapes like high tensile and tear strength, dimensional stability, good conformability, thermal endurance, abrasion resistance, non-corrosiveness, Temperature to 180°C. Available with several adhesive systems. Low unit cost.

Find your nearest Distributor in the Yellow Pages under "Tapes, Industrial" or in Industrial Directories or write for complete specification kit and sample offer. The Connecticut Hard Rubber Company, New Haven, Conn. 06509

CHR

an ARMCO company

Category	Page	IRN	Category	Page	IRN
Components			CMOS analog switch		
capacitors	23	291	datacomm, CMOS	110	328
capacitors	46	20	gyrator	110	327
capacitors	119	65	microcomputer	111	57
circuit protectors	104	49	multiplier/dividers	108	325
DIP switch	11	282	op amps	106	321
display, circular			PROM, 4-k	106	322
bar-graph	98	304	RAM	110	326
elapsed time indicators	115	58	RAM, CMOS	106	323
ferrite cores	97	301	RAM, CMOS	108	324
indicators	115	60	Modules & Subassemblies		
LED lamps	31	13	converters, a/d	102	302
LEDs	20	8	op amps, inverting	104	405
motors	33	14	optical system	110	56
relays	72	29	PM drive systems	72	30
relays	111	283	rf detectors	108	54
resistors	109	55	v/f converter modules	102	47
resistors, metal-film	98	307	Packaging & Materials		
resistors, precision	98	303	aluminum grilles	135	83
resistors, thin film	100	309	beryllium-copper gaskets	95	41
solenoids	115	59	cable	6	5
switch, stepping	98	306	cleaner, PC-board	122	354
switches, DIP	98	305	conductive rubber	123	357
synchros	127	77	connector, flexible PC	123	359
tachometer	129	81	epoxy, flame-retardant	122	356
time-delay relays	125	74	fiberglass tapes	136	86
timers	125	73	flat cable	103	48
transformers	65	26	glass, LCD	124	361
trimmer, cermet	100	308	jumpers, IC	123	358
Data Processing			knobs and accessories	34	15
calculator	117	337	magnetic shielding	116	62
calculators	100	45	metal plating	105	50
communications			PC connectors	41	17
components	101	46	socket, lamp	124	360
controller, graphics	117	340	sockets, microprocessor	124	363
digital clocks	135	82	spacers, mounting	122	355
disc drive	99	44	temp-indicator coating	124	362
disc memories	73	31	terminals	77	32
floppy-disc system	55	23	wire, cable and cord	93	234
interface, mini	116	335	Power Sources		
mag-tape transport	108	53	ac line corrector	119	349
memories	79	34	dc/dc converter	118	342
reader, paper-tape	117	338	dc/dc converter	118	343
stepper controls	116	336	dc/dc converter	120	350
storage, disc	117	339	dc/dc converter	120	352
Discrete Semiconductors			dc/dc power sources	120	66
npn silicon transistor	116	61	dc supplies	124	72
Instrumentation			HV supplies	118	341
DMM	114	333	miniature dc source	119	347
digitally delaying time			modular supply	120	351
base	57	25	power source	118	345
memory tester	114	329	power supplies	84	35
modular testers	114	331	power supplies	89	38
oscilloscope	45	19	power supplies	91	39
scope	114	330	power supplies	122	70
synthesizer	114	332	power supplies	123	71
transition counter	114	334	power supply	56	24
VOMs	87	37	programmed source	120	353
Integrated Circuits			switcher supply	118	344
a/d converter	106	320	switcher supply	119	348
			switchers	119	346

Just How Broad is the **MAGNECRAFT** Stock Relay Line?



**free
wall
chart!**

Magnecraft's stock relay line consists of 1200 versions derived from 17 categories - - - - that is the largest and broadest line in the industry.

Oh? Did I read that correctly?

Yes, Magnecraft Electric provides 1200 relay versions in stock through our nationwide distributor network. Those 17 categories include; low profile, general purpose, power, mercury displacement, sensitive, coaxial, telephone type, air dashpot time delay, solid state, latching types, high voltage, mercury wetted reeds, dry reeds, and dip reed relays.

Magnecraft can offer you the design engineer, a quality product, local distributors, and the broadest relay line in the industry to choose from. If we don't have the relay in stock we will custom design a relay to meet your requirements.

Full color 22"x 34" relay specification chart.



Magnecraft ELECTRIC COMPANY

5575 NORTH LYNCH AVENUE • CHICAGO, ILLINOIS 60630 • 312 • 282-5500 • TWX 910-221-5221

INFORMATION RETRIEVAL NUMBER 283

What's new in solid state...

RCA "Gold CHIP" LICs. Hermeticity in plastic at plastic prices.

Plastic LICs may have caused you some worries about field failures, actual or potential. But you didn't want to pay the price of ceramic or frit seal. Or, maybe the expensive hermetic packages you did use were damaged during insertion.

Now, the solution. RCA "Gold CHIP" linear integrated circuits. With gold metalization plus Chip Hermeticity In Plastic (CHIP). For reliability *plus* the economy and ruggedness of plastic.

Gold CHIP LICs have noncorroding gold metalization and leads. No aluminum with its potential problems. We make the chip itself hermetic. And put it in our advanced plastic package

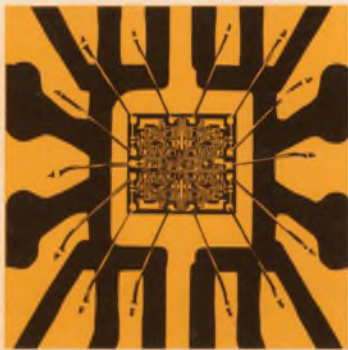

with proven outstanding reliability. Result: truly cost-effective hermetic LICs at the price of standard plastic LICs.

How reliable are they? We experienced zero failures in the following tests (data available): Temperature/Humidity/Bias, Operating Life, Thermal Fatigue, Pressure Cooker, Thermal Shock, Temperature Cycle.

Free Gold CHIP Sample

Evaluate them yourself! We'll send you one of the 6 off-the-shelf "G" standards listed here, free: CA741CG op amp; CA747G dual op amp; CA324G quad op amp; CA339G quad voltage comparator; CA3724G high voltage transistor array; CA3725G high voltage transistor array. Just specify which one, on a self-addressed label.

To find out more, contact your local RCA Solid State distributor. Or RCA.

Write: RCA Solid State, Box 3200, Somerville, New Jersey 08876; Ste. Anne de Bellevue 810, Canada; Sunbury-on-Thames, U.K.; Fuji Bldg., Tokyo, Japan.

RCA

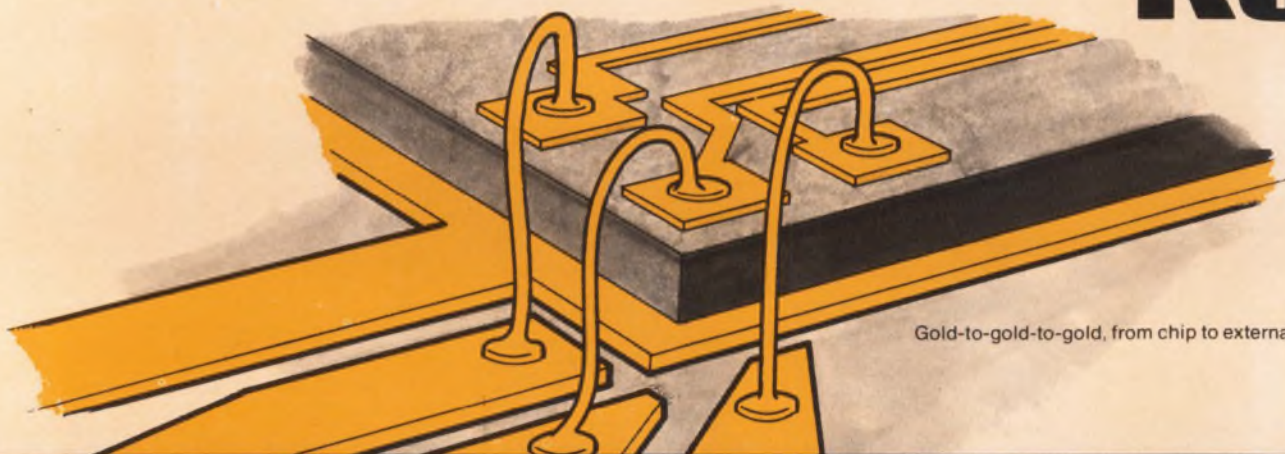

Gold-to-gold-to-gold, from chip to external world.

RCA. Full house in Linear ICs.