

# Electronic Design<sup>®</sup> 15

VOL. 23 NO.

FOR ENGINEERS AND ENGINEERING MANAGERS

JULY 19, 1975

**Hybrid technology progresses** as new equipments and materials solve tough design problems. Improved inks, better printers, advances in bonding methods

and functional circuit trimming raise hybrid yields and reliability and cut costs. Most packages are custom, though standards are emerging. See update on p. 24.

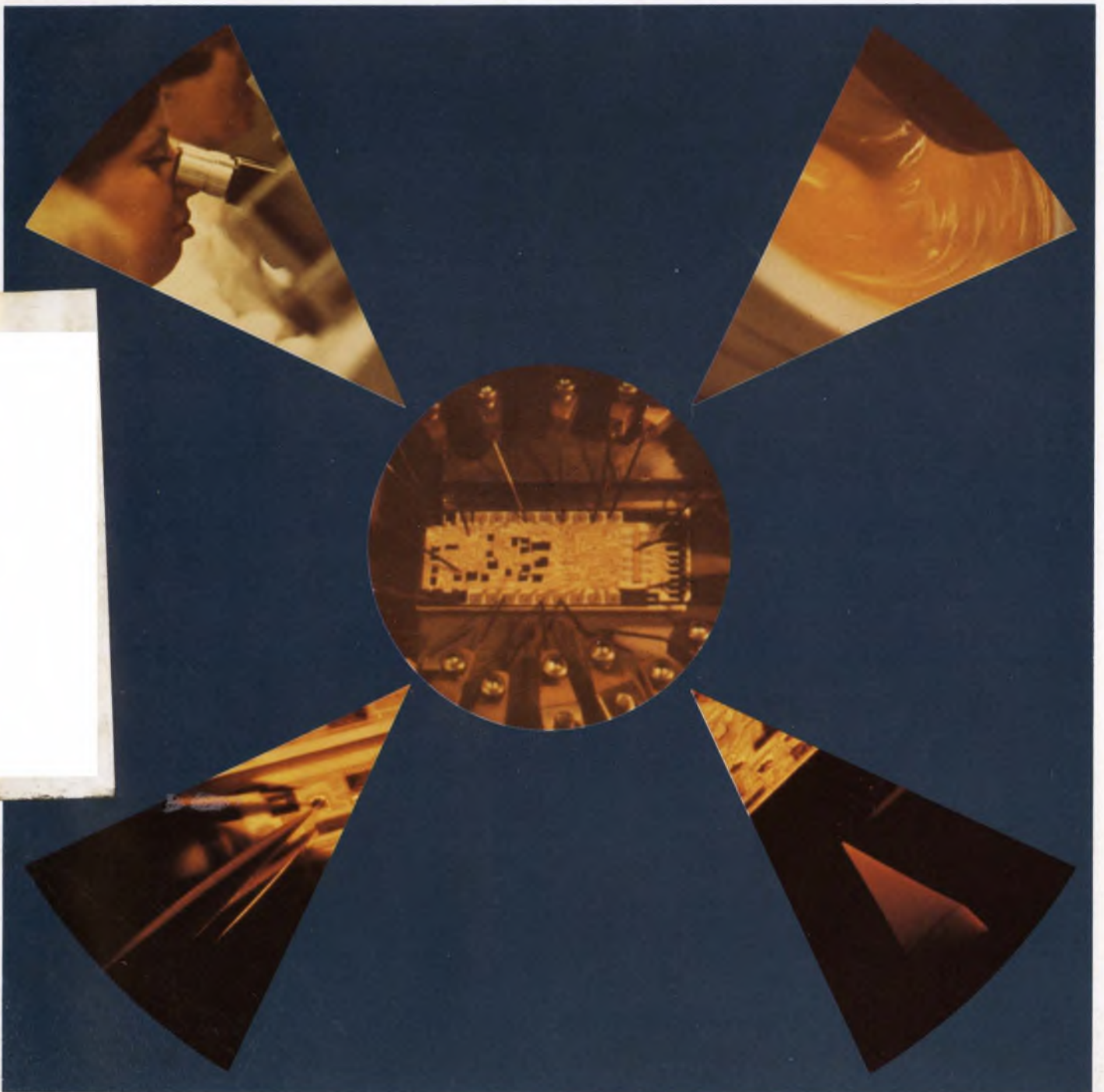

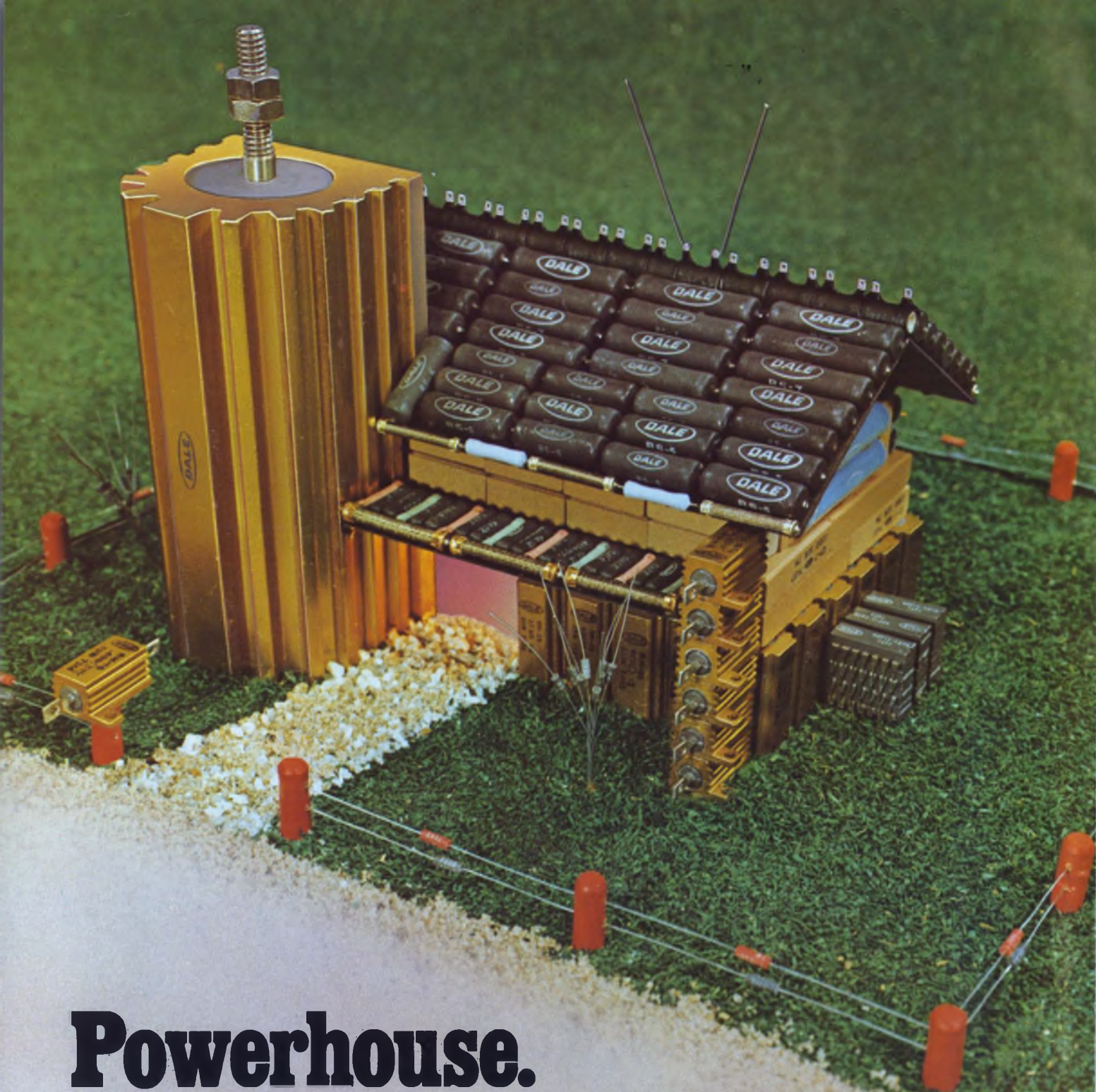

# Powerhouse.

Dale makes more power wirewounds... E-Rel, precision, industrial, commercial... has more QPL's... more ways to meet your special housing and performance requirements... and just plain works harder to make sure you're satisfied.

*Here are four ways to prove it:*

- For Complete Cross Reference Guide, Circle 251
- For Comprehensive Wirewound Resistor Wall Chart, Circle 252
- For Guide to Non-Standard Wirewound Resistors, Circle 253
- Call 402-564-3131 for immediate information.

DALE ELECTRONICS, INC., 1300 28th Avenue, Columbus, Nebr. 68601  
In Canada: Dale Electronics Canada Ltd.  
In Europe: Dale Electronics GmbH, 8 Munchen 60, Falkweg 51, West Germany  
A subsidiary of The Lionel Corporation



*Our complete product line can be found in Electronic Design's GOLD BOOK.*

# SURPRISE!



## The first 24 mcd LED lamp!

And that's 24 mcd at only 10 mA for our brightest red lamp. At 20 mA you can get over 48 mcd of light output.

	RED	YELLOW	GREEN
NARROW BEAM	4658	4558	4958
5082 -	4657	4557	4957
WIDE BEAM	4655	4555	4955
5082 -	4650	4550	4950

HP's new high efficiency material makes these new bright LED's possible. With our brightest yellow you get 16 mcd at 10 mA. Our brightest green offers 16 mcd at 20 mA.

Three colors, two beam angles, and two luminous intensity categories are available in the popular T 1-3/4 package. Twelve new LED's, one just right for your application.

All are available for immediate delivery, just \$0.89\* each or \$1.15\* each at the 100 piece level, depending on brightness category.

Contact Hall-Mark, Schweber, Wilshire or the Wyle Distribution Group (Liberty/Elmar) for immediate delivery. Or, write us for more details. They offer you new ways to apply solid-state technology in your products.

**HEWLETT  PACKARD**

Sales and service from 172 offices in 65 countries.  
1501 Page Mill Road, Palo Alto, California 94304

01502 \*Domestic USA Prices Only

INFORMATION RETRIEVAL NUMBER 2

ELECTRONIC DESIGN 15, July 19, 1975

# An extra margin of safety: our 611 Series AC solid state relays.



U.L. recognized

Life sustaining artificial kidney machines using sensitive low level IC logic to monitor temperature controls demand the utmost in safety and reliability. And that's just how the Teledyne 611 Series of solid state relays are made to perform.

What's more, we've broadened the line to include both ac and dc input ranges and load ratings of 10, 25, and 40 Amps. All versions provide high output transient immunity — 100 V/

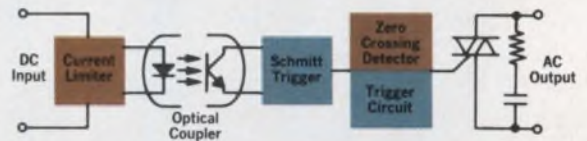

Typical Functional Diagram

$\mu\text{sec}$  guaranteed minimum  $\text{dv}/\text{dt}$  with  $200 \text{ V}/\mu\text{sec}$  typical. And we've added an optional 600-volt transient withstand capability for ultra-high immunity from false triggering caused by over-voltage transients.

All Teledyne 611s are optically isolated, and feature zero voltage turn-on to reduce RFI. For added safety, we've encased each relay in a rugged, high-impact package with recessed connections that include both quick-disconnect and screw terminals. And in case you haven't heard, we're not the only ones with this package configuration.

All in all, if it's true reliability you want, there's a Teledyne 611 ready to do the job ... in medical electronics, computers, machine tool or process controls. For technical assistance and fast delivery, call us.



Drake-Willock Dialysis System  
Photo courtesy of DWS, Inc.

## TELEDYNE RELAYS

3155 West El Segundo Boulevard, Hawthorne, California 90250  
Telephone (213) 973-4545

Burgstrasse 6-8, 62 Wiesbaden, West Germany  
Telephone: 06121-30231/2 Telex: 04-186851 (Trel-D)

Heathrow House, Bath Road, Cranford, Hounslow, Middlesex, U.K.  
Telephone: 01-8972501 Telex: 935008

## NEWS

- 21 **News Scope**
  - 24 **Report on hybrids**—Better materials and equipment are trimming costs and raising reliability.
  - 34 **A new class of micro-optic devices** are showing advantages over optical integrated circuits.
  - 37 **Washington Report**
- 

## TECHNOLOGY

- 46 **Solve your measurement problems** with v/f and f/v converters. These versatile circuits offer simple ways to send and receive data over two-wire links.
  - 52 **Are buffered CMOS gates right for you?** They are when you can trade off the dynamic performance of unbuffered CMOS for improved transfer characteristics.
  - 58 **Measure CRT spot size** to pack more information into high-speed graphic displays. You can do it accurately with the vernier line method.
  - 62 **Bill Walker of Tektronix** speaks on getting engineers to work harder and enjoy it more.
  - 68 **Ideas for Design:**  
A single potentiometer adjusts op-amp's gain over bipolar range.  
Combine multichart Karnaugh maps into single, easy-to-handle versions.  
Increase current-probe range up to 10 times for 15 $\mu$  with wire-and-lug assembly.
  - 74 **International Technology**
- 

## PRODUCTS

- 77 **Integrated Circuits:** 4-bit bipolar/LSI processor slice cuts microcycle time to 100 ns.
  - 84 **Power Sources:** Series-regulated supplies hurdle efficiency barrier.
  - 88 Modules & Subassemblies
  - 93 Instrumentation
  - 94 Discrete Semiconductors
  - 96 Data Processing
  - 97 Packaging & Materials
- 

## DEPARTMENTS

- 45 **Editorial:** The hard driver
- 7 Across the Desk
- 98 New Literature
- 101 Application Notes
- 101 Bulletin Board
- 107 Advertisers' Index
- 108 Product Index
- 108 Information Retrieval Card

**Cover:** Photos courtesy Beckman Instruments, Inc., Fullerton, CA

---

ELECTRONIC DESIGN is published biweekly by Hayden Publishing Company, Inc., 50 Essex St. Rochelle Park, NJ 07662. James S. Mulholland Jr., President. Printed at Brown Printing Co., Waseca, MN. Controlled circulation postage paid at Waseca, MN and New York, NY, postage pending Rochelle Park, NJ. Copyright © 1975, Hayden Publishing Company, Inc. All rights reserved. POSTMASTER: Please send form 3579 to ELECTRONIC DESIGN, P.O. Box 13803, Philadelphia, PA 19101.

**INTRODUCING THE WORLD'S FIRST**

# MEGA

**THE INTERDATA 8/32—UNMATCHED LEVELS OF PERFORMANCE IN A MINICOMPUTER SYSTEM.**

**MEGAMINI ARCHITECTURE: AN ABUNDANCE OF SHEER POWER.**

Interdata's new 8/32 Megamini has performance characteristics found only on large scale computers. Like direct addressing to one million bytes. Full 32-bit hardware with performance enhancers such as dual instruction

look-ahead stacks, multiple register sets, interleaved 32-bit memory, and fast floating-point hardware. What our 8/32 Megamini means to you is an unequalled combination of power, flexibility, and reliability in a compact package. All at a price that's fully competitive.

**MEGAMINI SOFTWARE: POWERFUL, FLEXIBLE, EASY-TO-USE.**

Today's hardware must be designed to ease your software effort. You shouldn't have to spend a lot of expensive programming time trying to figure out how to get around minicomputer hardware limitations. With the 8/32 Megamini you don't — because there are none.

For example. The direct addressing capability of the 8/32 Megamini allows you to build programs and data arrays in any size up to the amount of memory you have — no more 64K limits.

It also means we can give you versatile and powerful software to help lower the cost of building your system. Software with a multi-tasking operating system, OS/32MT, with unique multi-user

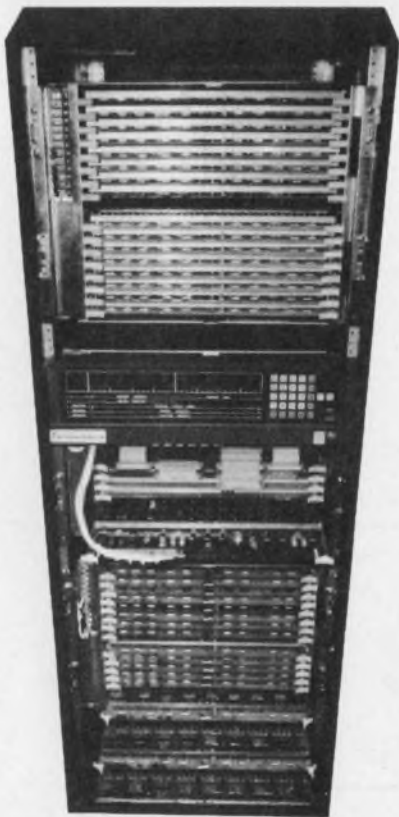

The 8/32 MEGAMINI — with a full Megabyte.

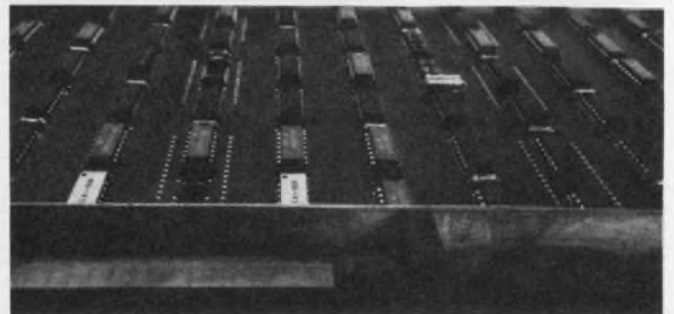

Multi-Wire Technology — a key to MEGAMINI performance.

# M I N I <sup>TM</sup>

**COMPARE: THE INTERDATA 8/32 MEGAMINI VS. THE-LESS-THAN-MEGAMINI COMPETITION.**

	<b>INTERDATA 8/32</b>	<b>XEROX 550</b>	<b>IBM 370/158</b>	<b>DEC 11/70</b>	<b>DG Eclipse</b>
<b>WORD LENGTH</b>	32 bits	32 bits	32 bits	16 bits	16 bits
<b>INSTRUCTION TIMES (Register to Memory)</b>					
Integer Add	1.25	1.8	.9	1.8	2.5
Multiply	3.54	6.2	2.0	3.9	8.8
Divide	5.8	14.4	9.9	8.3	11.2
Floating Point Add	2.3	6.1	2.4	8.25	5.5
Multiply	3.0	9.1	2.3	11.25	7.2
Divide	5.35	23.3	8.9	12.25	7.9
<b>HARDWARE I/O</b>	Yes	Yes	Yes	No	No
<b>MAX. DMA RATE/SECOND</b>	6MB	4MB	6.7MB	4MB	2MB
<b>DIRECT ADDRESSING RANGE</b>	1MB	1MB	16MB	64KB	64KB
<b>GENERAL PURPOSE REGISTERS</b>	2 stacks 16 each*	4 stacks 16 each	1 stack 16 each	2 stacks 8 each	1 stack 4 each
<b>PRICING (Basic Configuration)</b>					
CPU + 128KB Memory	\$51,900	\$128,700	N/A	\$54,600	\$32,500
CPU + 1048KB Memory	\$179,400	\$478,700	\$1,905,700	\$163,800	N/A

\*(6 Additional Stacks Optional)

All prices shown are U.S. list only.

program development capabilities. Software that has an optimizing macro assembler, MACRO CAL. And software with a sophisticated telecommunications access package, ITAM, that allows you to treat remote communications terminals and computers as if they were simply local devices.

Now, with all of this available, you can concentrate your efforts on the real problem at hand – your application.

**THE MEGAMINI: NOT JUST A COMPUTER – BUT A SYSTEM.**

The Interdata 8/32 Megamini gives you a full range of peripherals, software and advanced features to choose from in tailoring your system: 166MB disc systems, fast line printers, 1600 BPI tapes and graphic CRT's. Plus software modules like FORTRAN, BASIC, EDIT, AIDS and many more

**FOR MORE MEGADATA, CLIP AND MAIL.**

Interdata, Inc., Oceanport, N.J. 07757

- All that power sounds marvelous. Send me more information on the Interdata 8/32 Megamini.
- You may have hit on the solution to my megaproblem. Have a representative call me.

Name \_\_\_\_\_ Title \_\_\_\_\_

Company \_\_\_\_\_

Address \_\_\_\_\_

City \_\_\_\_\_ State \_\_\_\_\_ Zip \_\_\_\_\_

Telephone \_\_\_\_\_

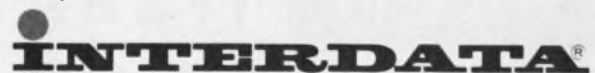

Subsidiary of Perkin-Elmer

ED-7-19-75

Oceanport, N.J. 07757. (201) 229-4040

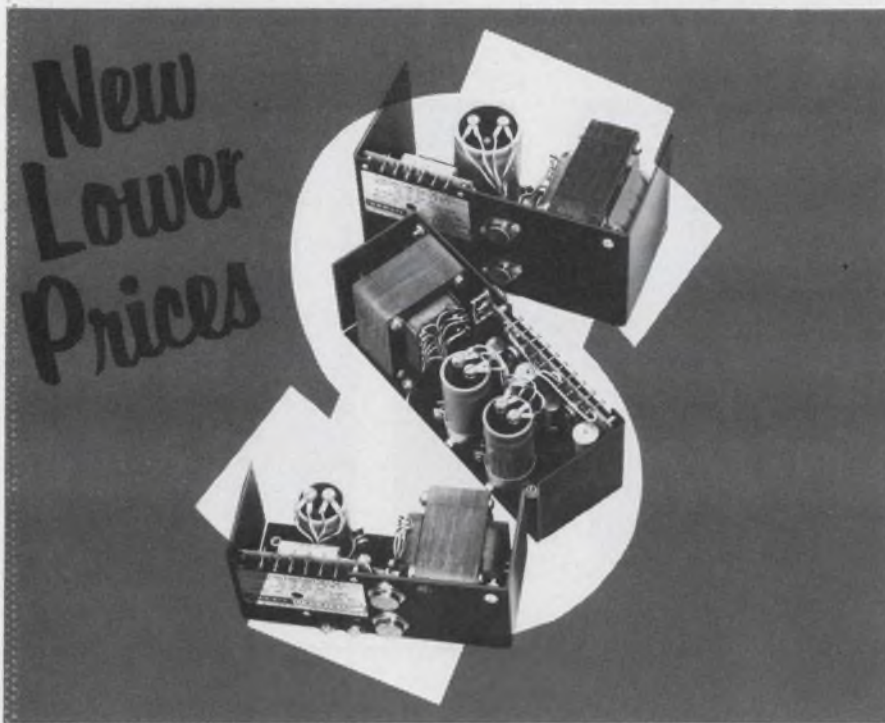

## Start Getting Your Money\$worth Out of Power Modules

Now, you can really start getting your moneysworth out of power modules with Abbott's new LOW COST series. Designed to give you 100,000 hours of trouble-free operation (that's 11½ years!), these reliable units meet the needs of OEM engineers. Their purchase price is about \$7 per year of service. The model LC series feature:

- 47-420 Hz Input Frequency
- 0.1% Regulation
- +50°C. Ambient Operation
- Single and Dual Outputs
- 1 Day Stock Delivery

These units provide more quality per dollar compared to similar items on the market. See table below for prices on some of our LC models. Many other LC models are listed in our catalog.

If analyzing the many similar power supplies on the market is confusing; if you are concerned about the long-term reliability of those units, then decide on an Abbott power supply for your system. Your best buy in OEM power modules is ABBOTT.

Abbott also manufactures 3,000 other models of power supplies with output voltages from 5 to 740 VDC and with output currents from 2 milliamps to 20 amps. They are all listed with prices in the new Abbott Catalog with various inputs:

60 to DC  
 400 to DC  
 28 VDC to DC  
 28 VDC to 400   
 12-38 VDC to 60

5V @ 6 Amps	5V @ 10 Amps	12V @ 10 Amps	15V @ 4 Amps	28V @ 1 Amp	±12V @ 1.2 Amps	±15V @ 4 Amps
LC5T6	LC5T10	LC12T10	LC15T4	LC28T1	LLC12T1.2	LLC15T4
\$62	\$73	\$99	\$73	\$62	\$87	\$119.00

Please see your 1975-76 EEM (ELECTRONIC ENGINEER'S MASTER Catalog) or your 1975-76 GOLD BOOK for complete information on Abbott Modules.

Send for our new 60 page FREE catalog.

**abbott transistor**

INDUSTRIAL PRODUCTS DIVISION  
 general offices eastern office

5176 W. Jefferson Blvd./Los Angeles 90016  
 (213) 930-1040

Telex: 69-1398

1224 Anderson Ave./Fort Lee, N.J. 07024  
 (201) 224-6900

Telex: 13-5332

INFORMATION RETRIEVAL NUMBER 5

**Sr. Vice President, Publisher**  
 Peter Coley

### Editors

Editorial Offices  
 50 Essex St.  
 Rochelle Park, NJ 07662  
 (201) 843-0550  
 TWX: 710-990 5071  
 Cable: Haydenpubs Rochellepark

**Editor-in-Chief** George Rostky

### Managing Editors:

Ralph Dobriner  
 Michael Elphick

### Associate Editors:

Dave Bursky  
 Jules H. Gilder  
 Morris Grossman  
 John F. Mason  
 Stanley Runyon  
 Edward A. Torrero

### Contributing Editors:

Peter N. Budzilovich  
 Alberto Socolovsky  
 Nathan Sussman

### Editorial Field Offices

#### East

Jim McDermott, Eastern Editor  
 P.O. Box 272  
 Easthampton, MA 01027  
 (413) 527-3632

#### West

David N. Kaye, Senior Western Editor  
 8939 S. Sepulveda Blvd.,  
 Suite 510  
 Los Angeles, CA 90045  
 (213) 641-6544  
 TWX: 1-910-328-7240

### Editorial Production

Marjorie A. Duffy

### Art

Art Director, William Kelly  
 Richard Luce  
 Anthony J. Fischetto

### Production

Manager, Dollie S. Viebig  
 Helen De Polo  
 Anne Molfetas  
 Maxine Correal

### Circulation

Manager, Evan Phoutrides

### Information Retrieval

Peggy Long

### Promotion

Karen Kerrigan (Reprints)

### Creative Layout Services

Manager, Albert B. Stempel



# Across the Desk

## Calculator evaluation found incomplete

John Ball's article "Reverse Polish or Algebraic" (ED No. 2, Jan. 18, 1975, pp. 50 and 51) didn't consider two important aspects of algebraic calculators. Since many algebraic systems include parentheses, this capability should be included in the analysis. Expressions such as  $(a \pm b) \times (c \pm d)$  can therefore be evaluated with fewer key strokes and without the use of intermediate storage.

In addition, the algebraic sequences used in the article did not make maximum use of chaining capabilities, because of the desire to eliminate intermediate equals operations. As an example, the expression  $a \div (b \pm c) * d$  was evaluated with the sequence  $b \pm c \times d = 1/x \times a =$ . Six key strokes were used. With chaining, it can be done in five with the sequence

$b \pm c \times d \div a = 1/x$ .

A review of all the sequences listed would undoubtedly show that the algebraic systems don't require substantially more key strokes than RPN.

*Dwight Jividen*

*Supervisor of ROM Programming  
CompuCorp  
12401 W. Olympic Blvd.  
Los Angeles, CA 90064*

## The author replies

The reason for leaving out algebraic entry systems with parentheses (call them AESP) is that more key strokes are usually needed with them than with just AES. Of course, an AESP calculator can work in AES—just avoid using  $($  and  $)$ . Con-

sider the example

$$(a \pm b) \times (c \pm d).$$

This was line 20 in Table 1 in my article. AES needs seven key strokes, AESH eight and RPN five. The straightforward approach, with closed parentheses, uses eight key strokes and works on any AESP calculator. But in the form

$$a \pm b \times (c \pm d =$$

the solution with five key strokes will work only on some.

You must read the fine print in the instruction book with each AESP calculator to determine exactly how it works. I therefore disagree with Mr. Jividen's statement that this expression "can therefore be evaluated with fewer key strokes" with use of AESP.

However, I concede that there are shorter algorithms that hadn't occurred to me for some of the entries in Table 1. Specifically, Mr. Jividen's suggestion cuts one key stroke from the AES algorithms in eight cases and from the AESH algorithm in one case, and it changes Table 2 to the following:

### Sum of number of wins $\times$ weights

RPN vs AESH	RPN 156	AESH 30	Ties 170
RPN vs AES	RPN 54	AES 0	Ties 302
AES vs AESH	AES 122	AESH 31	Ties 203

### Sum of key strokes $\times$ weights

AES	1528
AESH	1626
RPN	1484

(continued on page 10)

Electronic Design welcomes the opinions of its readers on the issues raised in the magazine's editorial columns. Address letters to Managing Editor, Electronic Design, 50 Essex St. Rochelle Park, N.J. 07662. Try to keep letters under 200 words. Letters must be signed. Names will be withheld on request.



## OPTICALLY COUPLED INTERRUPTER MODULES

OPTRON OFFERS IMMEDIATE DELIVERY OF NEW, LOW COST SERIES

OPTRON's new, low cost optically coupled interrupter module series combines non-contact switching and solid state reliability for applications requiring sensing of position or motion of an opaque object such as motion limit, paper edge or shaft encoding.

The new OPB 800 and OPB 803 consist of a gallium arsenide infrared LED coupled with a silicon photosensor in a plastic housing. The OPB 800 with a phototransistor sensor has a typical unblocked output of greater than 0.75 mA with a LED input of 20 mA. Typical output of the OPB 803 with a photodarlington sensor is 3 mA at an input of 10 mA.

Both devices are available from stock and offer design flexibility with the following options:

- High resolution aperture for shaft encoder or strobe bar applications
- Infrared transmitting filter for applications in high ambient light applications
- Alternate pin separation to fit standard DIP socket

New OPTRON optically coupled interrupter modules are interchangeable with similar products as follows:

OPTRON	GE	Monsanto
OPB 800	H13A1	—
OPB 800	H13A2	—
OPB 803	H13B1	MCA 8
OPB 803	H13B2	MCA 81

Detailed technical information on these and other OPTRON standard interrupter and reflective modules, as well as versions for specific applications is available on request.



**OPTRON, INC.**

1201 Tappan Circle  
Carrollton, Texas 75006, U.S.A.  
214/242-6571 • TELEX-73-0701  
TWX-910-860-5958

# Presenting the OEM branch of Digital.

It's a complete family of computer tools. And it's growing every day.

Nine CPU's — from our smallest, the LSI-11, to our biggest and newest, the PDP-11/70 — with virtually every meaningful price/performance choice available in between. Choose one of them, and a whole world of possibilities opens up.

Proven operating systems offer real time, time-sharing, and batch capabilities, so you can

choose the system that exactly fits your needs. Also you can hook up any of 60 different peripherals including your choice of 4 different disc drives, 5 terminals, 3 tape systems, 6 line printers — among a host of others.

What's more, you can join a special family called DECUS

(Digital Equipment Corporation Users' Society) and instantly put at your disposal a whole library comprised of thousands of applications software packages.



And then you can start to plan your future. Your next new product, your next PDP-11 or PDP-8 computer. And to help you along the way, our family includes 2400 field service experts

ready to lend a hand when and where you need it. And that means everything from operator training programs that get you quickly up to speed, to the new OEM Referral Program that helps you market your product.

When an OEM chooses a computer company, he makes a big decision with important long-term consequences. The OEM branch of Digital gives you a computer family you'll never outgrow.

To find out more, call or write Digital Equipment Corporation, Maynard, Massachusetts 01754. (617) 897-5111. European headquarters: 81 route de l'Aire, 1211 Geneva 26. Tel: 42 79 50. Digital Equipment of Canada, Ltd.

**digital**





## We can deliver the world's smallest 180° air variable capacitors. On time.

And since we're nice people, we don't even charge much for them. So if you have an application that calls for a sub-miniature capacitor that you can "tweak" to a specific frequency, these Johnson trimmers are ideal.

You can choose from either PC or stripline mount, either vertical or horizontal tuning. These Type "T" capacitors are about one-third the size of the familiar type "U" capacitors, so you can save space, cut costs and insure improved performance in the most compact electronic equipment.

Rotors and stators are precision-machined from solid brass extrusions, resulting in exceptional stability and uniformity. High Q—typically 2000 at 150 MHz. Temperature coefficient is a low plus  $30 \pm 15$  ppm/°C. High torque (1½ to 8 oz./inches) holds rotor securely under vibration. They're designed to meet or exceed EIA-RS 204 and MIL Standard 202C Methods 204A and 201A.

In short, these capacitors may be just what you've been looking for. It'll only cost you a stamp to get more information. And if you give us your phone number, we'll call you and send free samples after we have clarified your application.

E. F. JOHNSON COMPANY  
3305 Tenth Ave. S.W. / Waseca, MN. 56093

- Please send me technical information on the type T.  
 Also, include information on your entire line of variable capacitors.  
 I want test samples. Please call me at \_\_\_\_\_

NAME \_\_\_\_\_  
 TITLE \_\_\_\_\_  
 FIRM \_\_\_\_\_



ADDRESS \_\_\_\_\_  
 CITY \_\_\_\_\_ STATE \_\_\_\_\_ ZIP \_\_\_\_\_

**E. F. JOHNSON COMPANY**

## ACROSS THE DESK

(continued from page 7)

This does not change the conclusions of the article.

*John A. Ball*

Harvard College Observatory  
Harvard, MA 01451

## Misplaced Caption Dept.



"Boy, if TI finds out how we grow these crystals."

Sorry. That's Edouard Manet's "Lunch on the Grass," which hangs at the Louvre in Paris.

## Calculate while flying? It's up to the airlines

Washington Report, in the May 24 issue, stated that calculators had been banned for use aboard aircraft. Being a calculator manufacturer and not aware of this rule previously, we contacted the Federal Aviation Administration, which gave us the following information:

"At one time there was a proposal to prohibit electronic calculators aboard aircraft. However, this proposal has been dropped. The situation is the same now as it always has been. Electronic calculators are permitted for use aboard aircraft at the discretion and option of the operator."

We also contacted a few airlines, and in all cases they did allow the use of calculators aboard the aircraft.

*Robert Turner*

*Product Marketing Manager*  
Hewlett-Packard Co.  
Advanced Products Div.  
19310 Pruneridge Ave.  
Cupertino, CA 95014

*Ed. Note: Mr. Turner is correct.*

(continued on page 14)

# The Scot Pot™ Surprise.



*Amphenol designed a high-performance  
precision pot.*

*That's no surprise.*

*But that low, low price. Now that's a surprise.*

**Performance second to none.**

Scot Pot's total performance is better than or equal to any other 10-turn wire-wound miniature precision pot you can buy. One look at the Scot Pot spec sheet tells the story. (Be sure to ask for a copy.) Scot Pot has improved electrical, mechanical, and environmental characteristics. Its performance meets even the most demanding design requirements. All at that surprisingly low price.

**Save up to 25%.**

And the Scot Pot price-tag is a surprise. A very pleasant one. Because Scot Pot can replace what you're using now—in

form, fit, and function—and save you as much as one fourth the cost.

**Scot Pots are available — now.**

You can get immediate, off-the-shelf delivery on Scot Pots from your Amphenol Industrial Distributor. He's located close to you—so call him. Or for more information (and a copy of the Scot Pot spec sheet) contact: George Boyd, Amphenol Connector Division, Controls Operation, 2801 South 25th Avenue, Broadview, Ill. 60153. Phone: (312) 261-2000.

*When you can connect it  
and forget it...that's quality.*



# AMPHENOL

We unknot wire problems

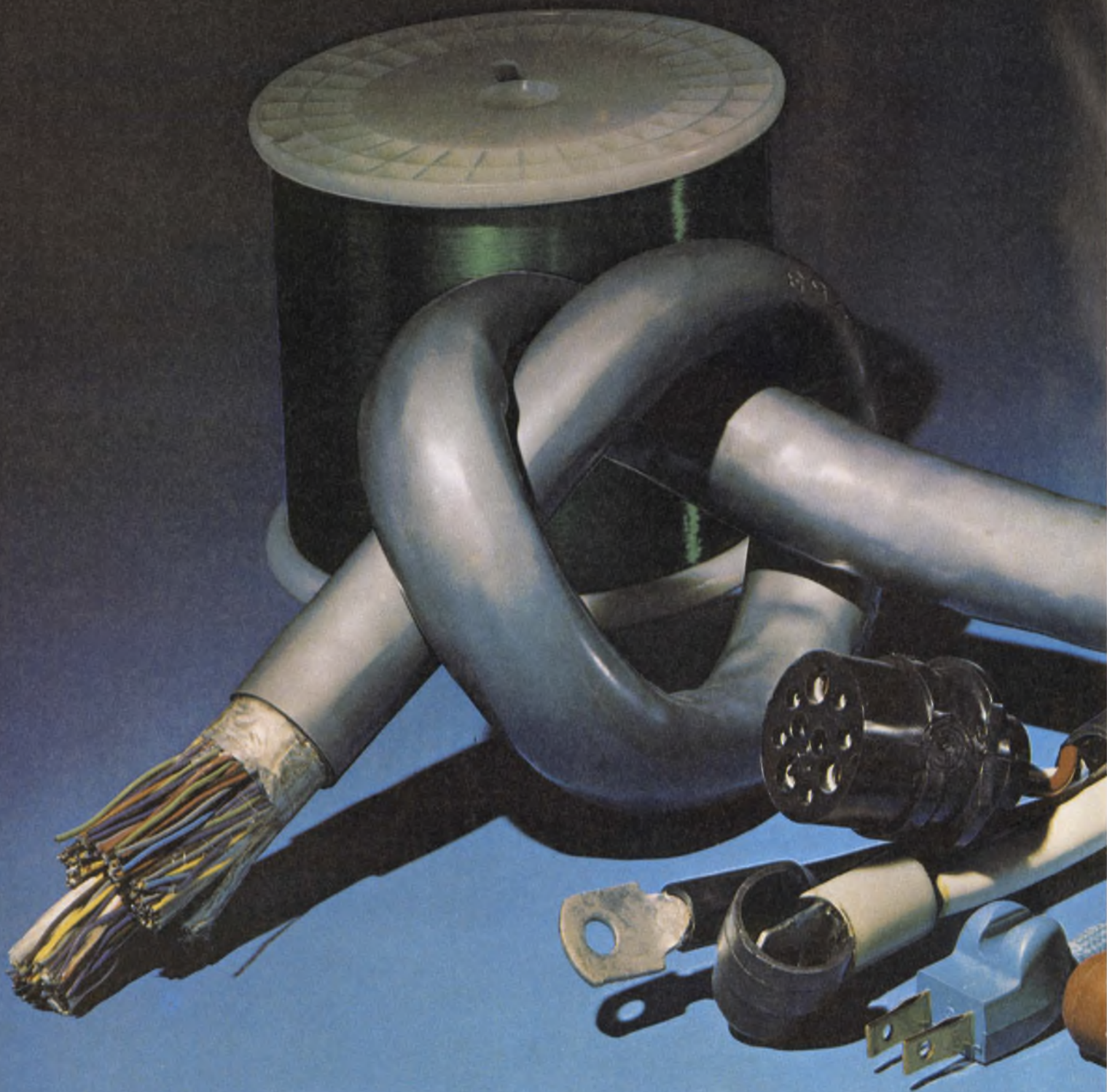

**BELDEN** 

*... new ideas for moving electrical energy*

Knotty problems in wire, cable, and cords can pop up at any stage of a project. Hopefully, they arise early in design. Oftentimes, they surface later. This can put an unexpected crimp in your product's profit or performance.

We're ready to offer backup help in performance, design, processing, assembly, installations, and ordering. Whatever wire and cable application idea you put on paper, Belden can help put life into it! Our total engineering approach to your problems can identify and analyze the "knots" before they tie up a major project.

If you have problems involving electrical parameters, space, compatibility, human

engineering, color coordination, precision, materials, fabrication, processing, put ups, installation, Belden has the ability to engineer reliability and ease of assembly into wire, cable, and cords without letting costs run wild due to over-engineering.

When we can't get out the "kinks" using standards, we'll innovate a solution for your problem. We're here with service and multi-plant facilities that can meet your demands. Need answers? Phone:

(312) 681-8920, Electrical Division

(317) 966-6681, Electronic Division

(312) 887-1800, Transportation Division

Or, write Belden Corporation, 2000 South Batavia Ave., Geneva, Illinois 60134.

H-4-4



## ACROSS THE DESK

(continued from page 10)

in that the airlines can allow the use of portable electronic calculators in flight. They do so on their own responsibility, and are in compliance with Federal Aviation regulations. In effect, the FAA is standing aloof. It will not give blanket approval to portable electronic calculators, nor will it of-

ficially ban them by name. ELECTRONIC DESIGN was misled by an FAA news release.

### Idea Killers

"It's against company policy."

"That's beyond our responsibility."

"That has already been tried in . . . ."

"No one would ever accept that."

"We're not quite ready for that."

"It was tried years ago and . . . ."

"But what would you do about . . . ."

"I considered that once myself, but . . . ."

"It's great but ahead of its time . . . ."

"But it may make our other products obsolete."

"Top management would never go for it."

"Has anyone else ever tried it?"

"It won't work in our industry."

"It's not feasible."

"It would be too expensive."

"I remember reading about something like that."

"It's not new, it reminds me of . . . ."

"It would be too impractical . . . ."

"That would never work because . . . ."

"Let's hold it in abeyance."

"We've never done it that way before."

In the U.S.: Put it down on one sheet of paper.

In Japan: Where are the case studies?

In Finland: Have they tried it yet in Sweden?

In England: Has ICI tried it yet?

The universal idea killer: . . . . Silence.

# The first impression is only the beginning.

Beneath the rugged good looks of Zero's Matrix IV electronic cabinets you'll find something more. You'll find outstanding design engineering that brings you more strength, versatility, and quality per dollar.

Zero combines standard pre-engineered all-steel components with an extensive list of accessories. So it's easy to tailor a home for your product that is distinctive, economical, and available.

A Matrix IV cabinet looks good. But it's that final built-in quality that makes the difference.

Write for your free catalog today.



The Final Touch



ZERO MANUFACTURING CO.

Burbank, CA 213/846-4191 · Monson, MA 413/267-5581 · Clearwater, FL 813/531-8991

FOR IMMEDIATE NEED CIRCLE 10  
FOR INFORMATION ONLY CIRCLE 214

## Logic design program corrected by author

Subroutine MINIM in the article "Bypass Multivariable Karnaugh Maps" (ED No. 21, Oct. 11, 1974, pp. 86-91), for use in both combinational and sequential logic-circuit synthesis, contains an error. As published on p. 90, the subroutine hangs in a loop if  $ID = 2$ . The following changes are needed to avoid this:

The statements after line 41 should be

```
41 FORMAT ('b', 35x,  
        '***NONE***')
```

```
42 IID1 = IID1-2  
   IF(IID1·EQ·ϕ) GO TO 2ϕ  
   RETURN  
   END
```

Note: b represents a blank.

Also, include the following statement just before  $N1J = N$ :

```
IIS1 = ID.
```

(continued on page 16)



# RELIABILITY:

When the highest capacitor reliability is required for critical filtering, by-pass and coupling circuits in medical equipment, space vehicles and undersea communications equipment, KEMET GR500 Series Graded Reliability Capacitors are specified.

Each GR500 Series Capacitor is thoroughly tested and precisely performance-graded. Your order is shipped with the actual test data documenting the failure rate — as low as 0.001% per 1,000 hours. They are available now for prompt delivery in six hermetically sealed case sizes in a CV range of 0.0047 to 1,000  $\mu\text{F}$ , 6 to 100 VDC for operation at  $-65^{\circ}\text{C}$  to  $+125^{\circ}\text{C}$ .

The performance characteristics and specifications for these capacitors are described in a new series of product catalogs. Write today for this latest information.

Components Department, Union Carbide Corporation, P.O. Box 5928, Greenville, SC 29606; phone (803) 963-6300, TWX: 810-287-2536, or Telex: 57-0496.



## KEMET OFFERS YOU MORE.



 **COMPONENTS DEPARTMENT**

KEMET is a registered trademark of Union Carbide Corporation.

In Europe: Union Carbide Europe, S.A. 5, Rue Pedro Meylan, Geneva 17, Switzerland. Phone: 022-47 4411 Telex: 845 2225.

# Only Sprague bantam 4-pin DIP capacitors can give you these advantages...



**guaranteed max. high frequency impedance**



**low inductance and low ESR...  
4-terminal connection mode option**



**preferred capacitance values to  
optimize performance when tantalum  
and ceramic capacitors are paralleled**



**automatic insertion capability**



**your choice of layer-built ceramic  
or solid-electrolyte tantalum**

## Type 935C MONOLYTHIC CERAMIC CAPACITORS

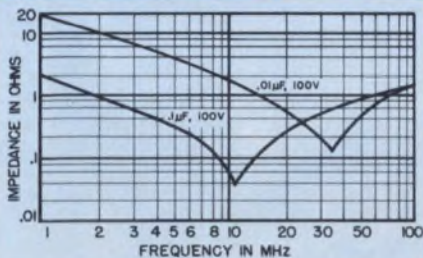

Proven multi-layer construction. COG(NPO) and X7R temperature characteristics. Preferred ratings are .01, .047, and .1  $\mu\text{F}$  @ 100 WVDC. Operating temperature range,  $-55^{\circ}\text{C}$  to  $+85^{\circ}\text{C}$ .

INFORMATION RETRIEVAL NUMBER 141

For complete technical data on Type 935C or 935D Capacitors, write for Engineering Bulletins 6242.3 or 3542.3, respectively, to: Technical Literature Service, Sprague Electric Company, 347 Marshall St., North Adams, Mass. 01247.

## Type 935D TANTALEX SOLID-TANTALUM CAPACITORS

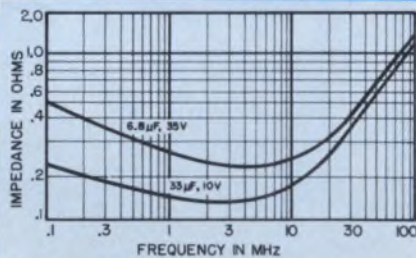

Dual in-line plastic package for mechanical protection and increased reliability. Preferred ratings are 6.8  $\mu\text{F}$  @ 35 V, 15  $\mu\text{F}$  @ 20 V, 22  $\mu\text{F}$  @ 15 V, and 33  $\mu\text{F}$  @ 10 V. Operating temperature range,  $-55^{\circ}\text{C}$  to  $+85^{\circ}\text{C}$ .

INFORMATION RETRIEVAL NUMBER 142

# SPRAGUE

THE MARK OF RELIABILITY

THE BROAD-LINE PRODUCER OF ELECTRONIC PARTS

## ACROSS THE DESK

(continued from page 14)

Subroutine MINIM in the article properly after these changes are made.

Eq. 10 on p. 89 contains a type-setting error. Correct it as follows:  $f(U, V, W, X, Y, Z) = 0-1-1 + --0-+ -1-11- + --1111.$

A prepunched card deck or magnetic tape copy may be purchased by sending \$60 to Troy Nagle, Electrical Engineering Dept., Auburn University, Auburn, AL 36830.

In the article "Reduce State Tables by Computer" (ED No. 22, Oct. 25, 1974, pp. 122-127), the unnamed program segment in the bottom right column of p. 125 is part of subroutine ISSM on p. 126. Take statements 15 through RETURN on p. 125 and place them just before statement 62 on p. 126 (after GO TO 7).

Troy Nagle  
Associate Professor

Auburn University  
Dept. of Electrical Engineering  
207 Dunstan Hall  
Auburn, AL 36830

## Analogic sets record straight!

A product feature in the March 1 issue presented erroneous information about Analogic's MP-2912A a/d converter ("A/D Converter Module Keeps Speed High but Cuts Costs by 50%," ED No. 5, p. 80). The unit price of the MP2912A is \$450, not \$595. The article also states that the Analog Devices ADC-1103 has the best gain tempo—only 10 ppm/ $^{\circ}\text{C}$  max. However, Analogic's MP-2912A has a 7 ppm/ $^{\circ}\text{C}$  max gain tempo.

Russ Hawkins  
Director, Marketing  
Communications

Analogic Corp.  
Audubon Rd.  
Wakefield, MA 01880

Ed. Note: Readers who want more information about the MP-2912A, please Circle No. 315.

# Get more for your money!

## Use This New 3/8" Square Cermet Trimmer From Allen-Bradley

Our new TYPE E trimmer is a high performer with a realistic price. It has some important advantages: • Immersion seal is tested in 85°C water (not 50° or 70°). • Temperature characteristic is 100 PPM/°C for stability. • Multifingered contact for excellent adjustability. • \$0.49 each—1000 piece price. For more information call your A-B distributor or write for Publication 5219.

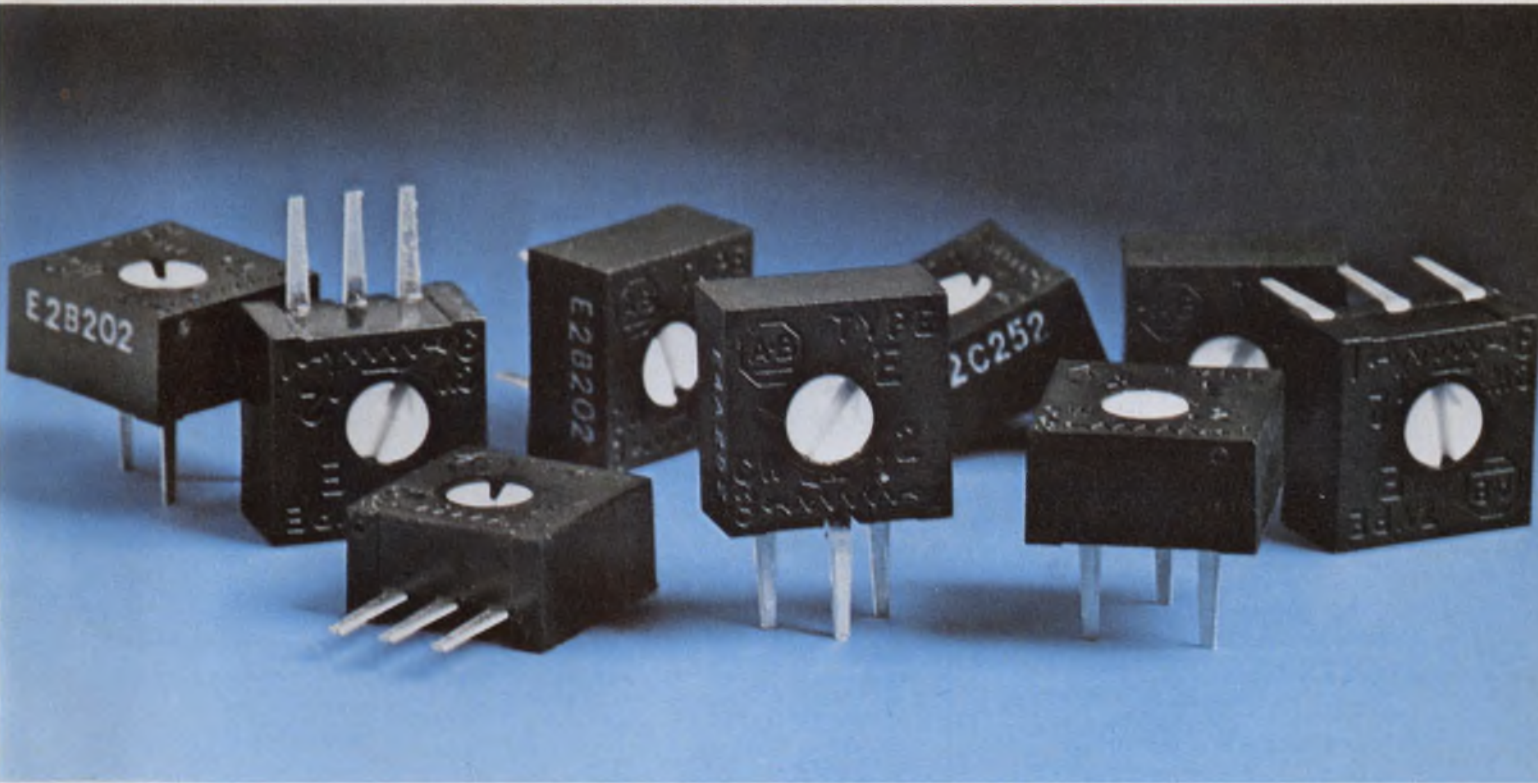
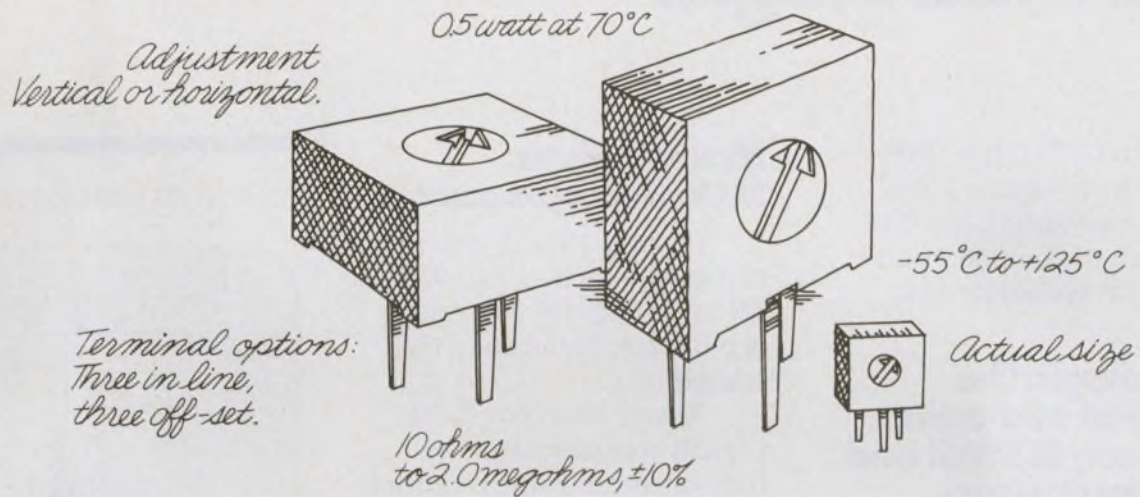

## Quality in the best tradition.



**ALLEN-BRADLEY**

Electronics Division  
Milwaukee, Wisconsin 53204

# How to go faster than MOS microprocessors and easier than SSI/MSI.

## New TTL Macrologic.™

Fairchild's latest 9400 Series Macrologic is a new kind of high-speed, low-cost approach to computer and peripheral system design.

### Macrologic. The practical mid-point between SSI/MSI and microprocessors.

We're introducing this family with seven new advanced Schottky TTL devices that offer some very distinct advantages.

Typical Macrologic complexity ranges from 150 to 250 gates per device.

Typical gate delays are just 4ns per on-chip gate, and 6ns per output buffer.

And the circuits are packaged in standard 14 and 18-pin packages—as well as in a slim new standardized 24-pin unit.

### Macrologic vs. SSI/MSI.

Compared with conventional SSI/MSI design, for example, Macrologic devices represent a significantly higher level of integration—up to 250 gates per device..

So fewer parts are required.

Less power is required.

Design is simpler.

Reliability is greater.

And the system cost is less.

### Macrologic vs. MOS microprocessors.

Compared with microprocessors such as Fairchild's own two-chip F8, Macrologic is more complementary than competitive.

Where economy is the critical consideration, the fully-integrated new F8 affords the most practical solution.

But where speed, performance and architectural flexibility are required, Macrologic is the answer.

Most important, Macrologic elements can be used with any bit length, instruction set or organization—without performance penalties, loss of flexibility or the need for custom development.

### TTL Memory

Check these Fairchild memories which may be used with Macrologic:

DEVICES	AVAILABILITY	
<b>TTL ROMs</b>		
93406	256 X 4	NOW
93431/93441	512 X 4	NOW
93432/93442	512 X 8	NOW
93454/93464	1024 X 8	3rd Q
<b>TTL PROMs</b>		
94316/93426	256 X 4	NOW
93417/93427	256 X 4	3rd Q
93436/93446	512 X 4	NOW
93438/93448	512 X 8	NOW
<b>TTL RAMs</b>		
93410/A	256 X 1	NOW
93411/93421	256 X 1	NOW
93L420/93L421	256 X 1	NOW
93412/93422	256 X 4	3rd Q
93415/93425	1024 X 1	NOW
93L415/93L425	1024 X 1	NOW

### DEDICATED SUBSYSTEMS

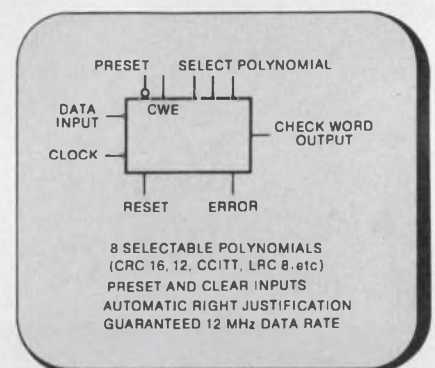

The 9401 Cyclic Redundancy Check Generator/Checker is an advanced tool for implementing the most widely used error-detection scheme in serial digital data handling systems. A 3-bit control input selects eight different generator polynomials, including CRC-16 and CRC-CCITT, as well as their reciprocals (reverse polynomials). Separate Clear and Preset inputs are provided.

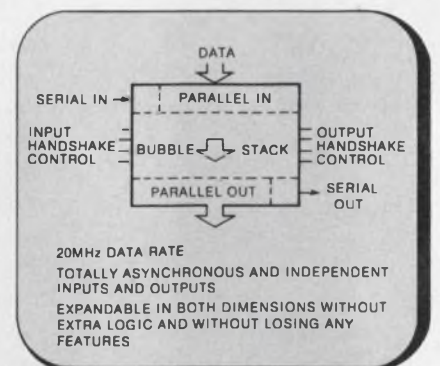

The 9403 FIFO Buffer Memory is a high-speed expandable fall-through type with totally independent and asynchronous inputs and outputs. Organized as a 4-bit wide by 16-word deep "bubble stack," it has four bits parallel and bit-serial data inputs and outputs. Complete "handshake" control signals are provided for unambiguous operation in asynchronous systems. It is intended for disk and high-speed communications applications with data rates of up to 20 MHz.

## FUNCTIONAL BUILDING BLOCKS

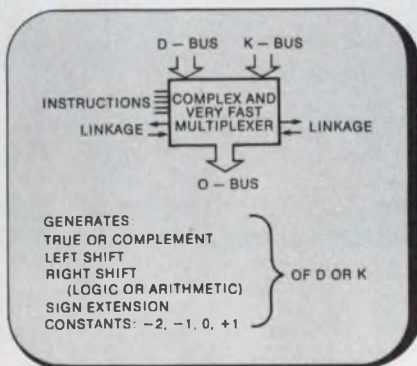

The 9404 Data Path Switch (DPS) is a very fast combinatorial array for closing data path loops around arithmetic logic networks (like the 9405 ALRS). A 5-bit instruction word selects one of the 32 instructions operating on two sets of 4-bit data inputs. Four linkage lines are available for expansion in 4-bit increments. The delay is less than 30ns over 16 bits. Samples available August.

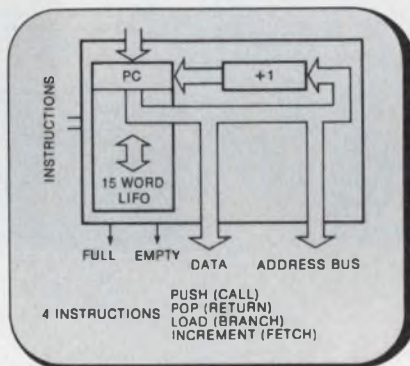

The 9406 16-word by 4-bit "Push Down-Pop Up" Program Stack stores program counter and return addresses for nested subroutines in programmable digital systems. It executes four instructions — Return, Branch, Call, and Fetch as specified by a 2-bit instruction. The 9406 may be expanded to any word length without additional logic and operates at a 10 MHz Microinstruction rate over 16 bits.

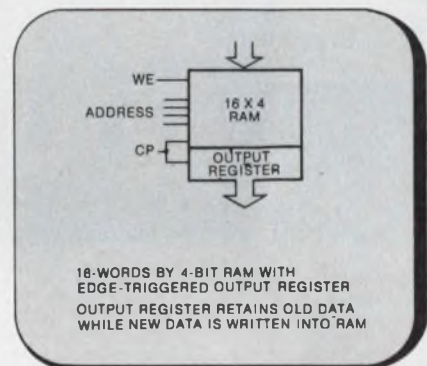

The 9410 64-bit Read/Write Memory is a register-oriented high-speed device organized as 16 words by four bits. An edge-triggered 4-bit output register allows new input data to be written while previous data is held. Three-state outputs are provided for maximum versatility. The 9410 operates at a 10 MHz Microinstruction rate.

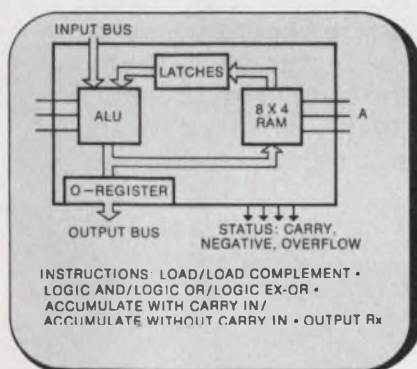

The 9405 Arithmetic Logic Register Stack contains a 4-bit arithmetic logic unit (ALU), an 8-word by 4-bit RAM, an edge-triggered output register, and associated control logic. The ALU implements eight different arithmetic or logic functions where one of the two 4-bit operands is supplied from the input data bus and the other is supplied from one of the eight registers selected by the Address inputs. The result of the operation is loaded back into the same register and is also loaded into the edge-triggered output register and becomes available on the 3-state output data bus. The 9405 operates at a 10 MHz microinstruction rate over 16 bits.

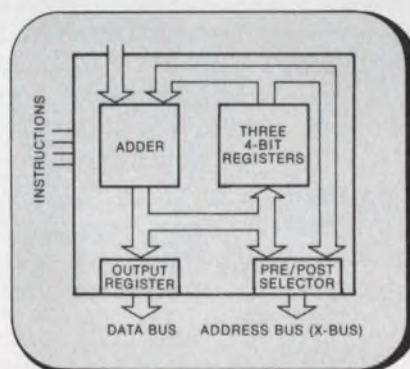

The 9407 Data Access Register (DAR) performs memory address arithmetic for RAM resident stack applications. It contains three 4-bit registers — program counter, stack pointer and operand address — a 4-bit adder, a 3-state address output buffer and a separate output register with 3-state buffers. The DAR performs 16 instructions, and operates at a 10 MHz Microinstruction rate. Samples available August.

## Information here.

Most devices are available for sampling immediately.

For more detailed information on Macrologic devices, write or call your Fairchild Sales Office, Distributor or Representative today.

Semiconductor Components Group, Fairchild Camera & Instrument Corp., 464 Ellis St., Mountain View, CA 94042. Tel: (415) 962-3333. TWX: 910-379-6435.

# FAIRCHILD

No.1 for logic and memory.

**You can buy  
this Spectrum Analyzer  
and take a big chunk  
out of your budget.**

**You can rent  
this Spectrum Analyzer  
and get more  
equipment out of  
your budget.**



Even the best equipment budget can only go so far. And at the price you pay for electronic test equipment nowadays, that's not very far at all.

Unless you rent your equipment from REI.

When you rent from us, there's no large cash outlay. You pay only for the time you have your instruments, and you return them when you're through. So you never have to spend your money on idle equipment.

Getting more for your money is just one reason for renting from REI. Immediate delivery is another. We have over \$10 million in inventory in fully stocked centers around the country. And, when you have short-term needs, you can rent equipment for just as long as you need it, and make it pay for itself.

REI stocks over 8,000 fully checked-out test instruments, and they're ready whenever you are. For the full story on renting, as well as our low prices, send in the coupon for prompt delivery of our free illustrated catalog... or call us now for your immediate requirements.

Rental Electronics, Inc.  
99 Hartwell Avenue, Lexington, Mass. 02173  
Please send me your free instrument rental catalog:

Name \_\_\_\_\_ Title \_\_\_\_\_

Company \_\_\_\_\_

Address \_\_\_\_\_

City \_\_\_\_\_ State \_\_\_\_\_ Zip \_\_\_\_\_

Tel. Number \_\_\_\_\_

**Rental Electronics, Inc.** 

A PEPSICO LEASING COMPANY

Burlington, MA (617) 273-2770 • Gaithersburg, MD (301) 948-0620 • Oakland, NJ (201) 337-3757 • Ft. Lauderdale, FL (305) 771-3500  
• Des Plaines, IL (312) 827-6670 • Dallas, TX (214) 661-8082 • Mountain View, CA (415) 968-8845 • Anaheim, CA (714) 879-0561  
• Rexdale, Ontario (PLC Leasing Ltd.) (416) 677-7513

INFORMATION RETRIEVAL NUMBER 14

JULY 19, 1975

## F-16: A multibillion bonanza for the makers of avionics

With only half the avionics of the ultra-sophisticated and super-expensive F-15, the new F-16 air combat fighter may be on its way to becoming the world's most popular military aircraft.

Eventual sales, the Air Force says, should reach \$15-billion for 3000 planes. At least 20% of this total, or \$3-billion, will go for electronic systems and components the Air Force estimates.

The Air Force has chosen the F-16 for its close-in, tactical fighter, as have four NATO countries—Belgium, Norway, the Netherlands and Denmark. The U.S. Air Force will buy 650 F-16s for a start, and the NATO countries, 306.

The whole concept of the F-16 differs markedly from that of its predecessor, the F-15.

"We designed the F-15 to be the ultimate," an Air Force spokesman says. "And it is. It has 'advanced' everything, and its cost \$14.4-million a copy. The program cost \$10-billion.

"The F-16, on the other hand, was designed as a simple, close-in fighter that could be easily maintained, that was highly maneuverable and would be cheap. And that's what it is." The total program cost for each fighter is \$6.3-million.

The F-16 will complement the F-15, not replace it. The new fighter lacks the independence of the F-15. It needs to be in contact with ground radar or with Awacs, the airborne warning and control systems aircraft, whereas the F-15 can operate alone.

The technology used in the design of the F-16 avionics is sophisticated. "Perhaps more so than the F-15," the Air Force spokesman says. "We just didn't equip it with as much avionics or ask the avionics to do as much."

For example, the F-16 will carry



half the avionics the F-15 does—750 pounds, half of which will be a look-down radar system being developed competitively by Hughes Aircraft and Westinghouse.

The F-16 radar, which is the only new avionics system being developed specifically for the plane, is based on the design of the F-15 radar. But it will have only half its predecessor's range. It will be coherent pulse doppler, like the F-15 radar. But it will be considerably less complex—it won't have to guide missiles as the F-15 radar does. And it will be cheaper, lighter and twice as reliable, the Air Force says.

The F-16 radar will have a look-

down detection range of at least 15 nautical miles, with 20 miles desired. A look-up range of 20 miles is required, with 25 miles desired. The radar will be able to detect targets five meters square at an azimuth of  $\pm 60$  deg. And its automatic acquisition range will be five miles.

Borrowing from the Apollo spacecraft, the F-16 will use fly-by-wire aerodynamic controls built with quad-redundant sensors and power and triplex integrated servo-actuators. Also from Apollo, there will be a side-stick control for the pilot, making it easier for him to maneuver the stick when he is pulled back in his seat by high-G forces. And the aircraft's flight-control computer will automatically shift the aircraft's center of gravity according to the maneuver the aircraft makes.

To keep the F-16 lean, it won't carry the radar-guided Sparrow missile. It will be equipped only with the shorter-range, infrared-seeking Sidewinder. The F-16, therefore, won't need a radar-target data processor.

The aircraft will carry free-fall and electro-optically guided bombs and dispensers. There will be a multiple air-to-air target display for the radar and electro-optical weapons systems. And for the Maverick air-to-surface, TV-guided missile and the Hobo guided bomb, there will be a video display.

Besides the flight-control computer, the F-16 will have a central air-data computer, fire-control computer, an inertial navigation system, a stores management set to keep tabs on the weapons supply, the usual navigation aids, penetrations aids (ECM), a radar-data processor, a head-up display, a radar head-down display and an instrument landing system.

### U.S. metric conversion is called 'disjointed'

It's not a question anymore of whether the United States should convert totally to the metric system. The argument is rapidly shifting from whether to how and from why to when, according to Senator Daniel Inouye (D-HI).

Addressing a seminar on metrification in New York City, the

Senator noted that "events are leading us almost inevitably on an uncoordinated and disjointed conversion program which is fast leaving Congress behind."

Despite Congressional foot-dragging major American businesses have been converting their operations to the metric system. Senator Inouye—co-sponsor of the Administration's new Senate metric bill (S1882)—cited such diverse concerns as General Motors, Caterpillar Tractor, IBM, Exxon and Otis Elevator. He observed that the conversions were having ripple effects throughout the economy, because smaller concerns that supply the big companies that have converted must also convert, to ensure their share of market.

International trade is an important spur to metric conversion, Senator Inouye observed, particularly since the European Economic Community has indicated that by 1978 it will accept products only if they are marketed with metric measurements.

"Our exports to the European Economic Community amounted to more than \$22-billion in 1974, and failure to adopt to these standards will have a vast impact on our trading community," the Hawaiian Senator noted.

The seminar was sponsored by Information Handling Services, Englewood, CO, which offers a "metric service" that supplies subscribers with microfilmed catalogs and data sheets on U.S. metric products and suppliers.

## GaAs cell produces 10 W from sunlight

Using gallium arsenide as the photoelectric conversion medium, researchers at Varian Associates in Palo Alto, CA, have produced a 1-cm-diam solar cell that can produce 10 W of electricity directly from the sun.

According to Joe Feinstein, vice president of research, other solar energy materials—such as silicon—require 1000 times as much surface area to produce the same amount of energy.

The dramatic increase in available power from solar cells, he notes, is primarily due to the fact that a concave reflector about 12



Gallium-arsenide solar cell only 1 cm in diameter can produce up to 10 W of electrical power.

in. in diameter collects the sunlight and focuses it on the solar cell, concentrating the light by a factor of 1000. The thing that makes it possible to use such highly concentrated light with the Varian solar cell is gallium arsenide's ability to work at high temperatures and with high current densities. Silicon cannot.

Gallium arsenide can operate effectively at temperatures as high as 300 C, Feinstein reports. Operation at such levels, however, does result in some degradation of performance. If the cell is operated at only 100 C, Feinstein continues, cooling can be easily accomplished by air convection.

Another factor that contributes to the high output power of the Varian device is its high efficiency. To date, experiments have shown that the cell can convert as much as 23% of light energy into electrical energy. But the future holds promise for even more efficient operation. Feinstein says that methods under investigation may make it possible to increase the efficiency to between 35 and 40%. This, however, is not expected for several years.

Plans are under way to build a rooftop array that will produce 1 kW of power. This is to be achieved by the use of 100 cells, each producing 1 V at 10 A. The array, Feinstein says, will be mounted on a rotating servo mechanism so it can follow the sun from sunrise to sunset and thereby use 40% more sunlight in a day than arrays that rely on incident sunlight.

A pilot production line could be set up within six months to produce devices for small rooftop units, Feinstein notes, with large-scale commercial applications requiring three to 5 years.

## Fiber-optic gyro called navigation-improvement

A low-cost, optical rate-sensing element—a fiber-optic ring interferometer—is the heart of a new kind of laser gyroscope.

Suitable for precision navigation systems, the fiber-optic ring provides the following advantages, according to one of its inventors, Dr. Richard Shorthill, director of the Geospace Sciences Laboratory at the University of Utah Research Institute, Salt Lake City.

- It theoretically can increase navigational accuracy by more than an order of magnitude over that of today's aircraft inertial navigation systems.

- Because of the ring element's simplicity, total system cost should be on the order of \$25,000, about one-fifth the cost of the best system available today.

- Three-axis system size may be reduced ultimately "to the order of a shoebox."

The ring interferometer element—developed by Shorthill and Dr. Victor Vali, a physicist at the Geospace Laboratory—consists of several thousand turns of an optical fiber, a few kilometers long, wound on a frame about a foot wide.

In operation, light from a laser is piped into both ends of the fiber, and, as a result, it passes through the fiber coil in opposite directions. A small optical path difference is deliberately inserted ahead of one of the entering laser beams, and a phase difference between the opposite-going light is produced.

As a result, when the laser outputs are taken from the ends of the fibers and optically compared, a fringe pattern is produced, like that of a conventional interferometer.

As the fiber optics ring is rotated in space about its axis, the velocity of rotation adds to the speed of laser light traveling in one direction and subtracts from that going in the opposite direction. This effect is multiplied by the number of turns to produce a relatively large additional phase shift, thus causing a change in the fringe pattern. This change can be interpreted as a rate of rotation.

Shorthill sees a single-axis interferometer gyro useful in a low-cost system for ships.



# Mini-Circuits' answer to holding down your costs of Double Balanced Mixers

## Specify our model SRA-1...

**1971 - \$7.95\***

SRA-1 (in 500 quantities)



**1972 - \$7.95\***

SRA-1 (in 500 quantities)



**1973 - \$7.95\***

SRA-1 (in 500 quantities)



Mini-Circuits Laboratory, now the world's largest supplier of double-balanced mixers, guarantees to maintain its famed low-price structure throughout 1975 and 1976. \$7.95 (model SRA-1, 500 quantity). You, the design engineer, have made this offer possible. Your large volume orders, from over 500 companies throughout the world, have enabled us to purchase our components and packages at lowest possible costs with guaranteed delivery schedules from our vendors. And we think it's appropriate to pass these savings to you. Need fast delivery? One week or better is routine; for your emergency needs, 24-hour turnaround is possible.

Our history of quality and performance is unmatched. All our units are unconditionally guaranteed for 1 year. Every Mini-Circuits employee, from the president to the final test operator, is committed to excellence in performance and quality for every unit produced. For reliability, performance and quality more and more systems engineers are specifying Mini-Circuits mixers as the industry standard.

**1974 - \$7.95\***

SRA-1 (in 500 quantities)



**1975 - \$7.95\***

SRA-1 (in 500 quantities)



**STILL ONLY \$7.95 IN 1976**

SRA-1 (in 500 quantities)



\*\$9.95 (1-49)

### SRA Series

Frequency Range (MHz)	Conversion Loss (dB) Total Range	Isolation (dB)						Price (Quantity)
		Lower band edge to one decade higher		Mid range		Upper band edge to one octave lower		
		LO-RF	LO-IF	LO-RF	LO-IF	LO-RF	LO-IF	
<b>SRA-1</b> LO-0.5-500 RF-0.5-500 IF-DC-500	6.5 typ. 8.5 max.	50 typ. 35 min.	45 typ. 30 min.	45 typ. 30 min.	40 typ. 25 min.	35 typ. 25 min.	30 typ. 20 min.	\$9.95 (1-49)
<b>SRA1-1</b> LO-0.1-500 RF-0.1-500 IF-DC-500	6.5 typ. 8.5 max.	50 typ. 45 min.	45 typ. 30 min.	45 typ. 30 min.	40 typ. 25 min.	35 typ. 25 min.	30 typ. 20 min.	\$11.95 (6-49)
<b>SRA-1W</b> LO-1-750 RF-1-750 IF-DC-750	6.5 typ. 8.5 max.	50 typ. 45 min.	45 typ. 30 min.	45 typ. 30 min.	40 typ. 25 min.	35 typ. 25 min.	30 typ. 20 min.	\$14.95 (6-49)
<b>SRA-2</b> LO-1-1000 RF-1-1000 IF-0.5-500	6.5 typ. 8.5 max.	45 typ. 30 min.	45 typ. 30 min.	35 typ. 20 min.	35 typ. 20 min.	30 typ. 20 min.	30 typ. 20 min.	\$24.95 (1-24)

Common specifications for all models  
Signal: 1 dB compression level = 1 dBm  
Impedance all ports 50 ohms

Phase detection - DC offset - 1 mV typical  
DC polarity - negative

Frequency Range (MHz)	Conversion Loss (dB) Total Range	Isolation (dB)						Price (Quantity)
		Lower band edge to one decade higher		Mid range		Upper band edge to one octave lower		
		LO-RF	LO-IF	LO-RF	LO-IF	LO-RF	LO-IF	
<b>SRA-4</b> LO-5-1250 RF-5-1250 IF-0.5-500	6.5 typ. 8.5 max.	50 typ. 40 min.	50 typ. 40 min.	40 typ. 20 min.	40 typ. 20 min.	30 typ. 20 min.	30 typ. 20 min.	\$26.95 (1-24)
<b>SRA-3</b> LO-0.025-200 RF-0.025-200 IF-DC-200	6.5 typ. 8.5 max.	60 typ. 50 min.	45 typ. 35 min.	45 typ. 35 min.	40 typ. 30 min.	35 typ. 25 min.	30 typ. 20 min.	\$12.95 (6-49)
<b>SRA-6</b> LO-0.003-100 RF-0.003-100 IF-DC-100	6.5 typ. 8.5 max.	60 typ. 50 min.	60 typ. 45 min.	45 typ. 30 min.	40 typ. 25 min.	35 typ. 25 min.	30 typ. 20 min.	\$19.95 (5-24)
<b>SRA-8</b> LO-0.005-10 RF-0.005-10 IF-DC-10	6.5 typ. 8.5 max.	60 typ. 50 min.	60 typ. 50 min.	50 typ. 40 min.	50 typ. 40 min.	45 typ. 35 min.	45 typ. 35 min.	\$24.95 (5-24)

For complete product specifications and U.S. Rep. listing see MicroWaves' "Product Data Directory," Electronic Design's "Gold Book" or Electronic Engineers Master "EEM"

**Mini-Circuits Laboratory**  
A Division Scientific Components Corp.

837-843 Utica Avenue, Brooklyn, NY 11203  
(212) 342-2500 Int'l Telex 620156 Domestic Telex 125460

**Foreign Sales Representatives:**  AUSTRALIA General Electronic Services, 99 Alexander Street, New South Wales, Australia 2065;  ENGLAND Dale Electronics, Dale House, Wharf Road, Frimley Green, Camberley Surrey;  FRANCE S.C.I.E.-D.I.M.E.S., 31 Rue George Sand, 91120 Palaiseau, France;  GERMANY, AUSTRIA, SWITZERLAND Industrial Electronics GmbH, Klüberstrasse 14, 6000 Frankfurt/Main, Germany;  ISRAEL Veconics, Ltd., 69 Gordon Street, Tel-Aviv, Israel;  JAPAN Denso Kaisha, Ltd., Eguchi Building, 8-1-1 Chome Hamamatsucho Minato-ku, Tokyo;  EASTERN CANADA B. D. Hummel, 2224 Maynard Avenue, Utica, NY 13502 (315) 736-7821;  NETHERLANDS, BELGIUM, LUXEMBOURG: Coimex, Veldweg II, Hattem, Holland.

**US Distributors:**  NORTHERN CALIFORNIA Cain-White & Co., Foothill Office Center, 105 Fremont Avenue, Los Altos, CA 94022 (415) 948-6533;  SOUTHERN CALIFORNIA, ARIZONA Crown Electronics, 11440 Collins Street, No. Hollywood, CA 91601 (213) 877-3550

For complete U.S. Rep listing and product line see MicroWaves' Product Data Directory

## REPORT ON HYBRIDS

# Better materials and equipment trim costs and raise reliability

Hybrids. They bridge the gap between tiny monolithic circuits on a chip and PC boards that use discrete components. They provide a technology that is most cost-effective at moderate volume—5000 to 100,000 units.

By comparison, hundreds of thousands of monolithics must be produced to justify the tooling costs, and above a few thousand units, PC boards don't provide much of a volume discount.

Formerly confined mostly to the military, hybrids are now used also in the data-handling and medical fields. And the automotive industry is considered a growth area in the next three to five years. New packaging materials and equipment are continually appearing to help solve tough design problems and to cut costs.

One area in which giant strides have been made is in thin-film technology. Thin films have the advantages of high stability, excellent as-deposited control and reproducibility and the ability to produce finer lines and smaller geometry components than thick films.<sup>1</sup>

Nevertheless the bulk of hybrid packaging is still done by thick-film methods; it is much less expensive and easier to set up a thick-film shop. And improvements in thick-film materials and equipment keep making it easier and cheaper to do a better job.

Advances in thick-film technology include the following:

- Improved thick-film printing machines and better screens. Routine production of 2 to 3-mil line



**Abrasive trimming** is frequently used to trim thick-film resistors at Raytheon's hybrid-facility, especially where stability is a prime concern.

definition is attainable, and even 1-mil is possible.

- An increased variety of inks—or pastes, really—to suit almost any need. Wider resistivity ranges, a wider selection of temperature coefficient, higher stability—especially after laser trimming—and better storage, handling and curing properties are evident. Also, as-fired resistor systems can now be held to closer tolerances.

- Improvements in component attachment materials, techniques and equipment. Epoxies have been improved for die attachment; both conductive and nonconductive materials are available.

- Higher power-handling capability. With substrates like beryllia, dissipation up to 50 W/in<sup>2</sup> can be obtained with proper heat-sinking.

- Functional trimming of hybrid circuits. Loose tolerances in hybrid circuit components can be accommodated by trimming strategic circuit components.

The kind of equipment used in building hybrids and the materials employed are strongly influenced by the number of units in a manufacturer's average batch of circuits. The bulk of the hybrid business consists of custom designs, though some suppliers have standard catalog product lines, some on the market for years.

A quantity of 100,000 hybrid units is a huge production run. But this is only small change, when compared with catalogued monolithic circuits like TTL logic. On the other hand, less than 5000 custom hybrid units a year is considered uneconomically by a company like National Semiconductor, Santa Clara, CA. However, a small hybrid job shop might consider a quantity of 1000 a profitable run. And in special cases, as with high-frequency hybrids, only hundreds or even tens of units are often considered cost-effective.

"In hybrids you don't often sell a circuit to more than one customer," explains Jerome Fischel, president of Circuit Technology, Farmingdale, NY. "Hybrid packaging is primarily a custom-design-oriented market, which generally commands only moderate quantities. This determines the character of the manufacturing methods and the equipment used by hybrid makers."

## Printer automation cuts costs

In spite of only moderate quantities, costs can be saved by automation, and some large hybrid producers—such as Beckman Instruments, Fullerton, CA—often design and build their own equipment. Beckman's screen and squeegee assembly prints resistors,

# Design with the complete flat cable/connector system.

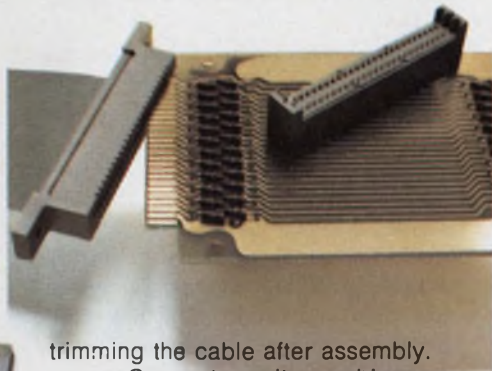

trimming the cable after assembly.

Connector units provide positive alignment with precisely spaced conductors in 3M's flat, flexible PVC cable. The connector contacts strip through the insulation, capture the conductor, and provide a gas-tight pressure connection.

Assembly-cost savings are built in when you design a package with "Scotchflex" flat cable and connectors. But more important, 3M Company offers you the full reliability of a one-source system: cable *plus* connectors *plus* the inexpensive assembly aids that crimp the connections quickly and securely (with no special operator training required).

The fast, simple "Scotchflex" assembly sequence makes as many as 50 simultaneous multiple connections in seconds, without stripping, soldering or

With cable, connectors and assembly tools from one design and manufacturing source, you have added assurance the connection will be made surely, with no shorts or "opens."

And "Scotchflex" now offers you more design freedom than ever. From stock you can choose shielded and non-shielded 24-30 AWG cable with 10 to 50 conductors, and an ever-increasing variety of more than

The 3M DELTA pin and socket connector.



100 connectors to interface with standard DIP sockets, wrap posts on standard grid patterns, printed circuit boards, or headers for de-pluggable applications. 3M's DELTA "D" type pin and socket connectors are now also available. For full information, write Dept. EAH-1, 3M Center, St. Paul, MN 55101.



# 3M's "Scotchflex" line.

"Scotchflex" is a registered trademark of 3M Co.

INFORMATION RETRIEVAL NUMBER 16



Probes are set up to test hybrid circuits at various stages in Raytheon's manufacturing cycle to detect defects before final encapsulation.

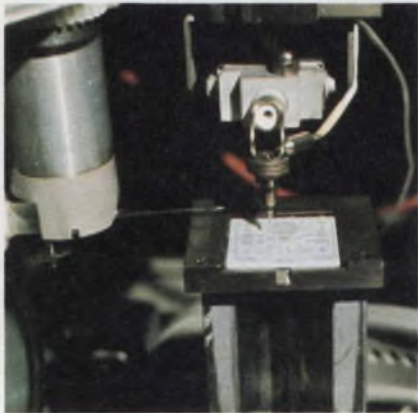

Wire bonding to platinum-silver thick-film conductors is easy, reliable and now also economical, according to Electro-Science Laboratories.

capacitors and conductors at rates up to 4000 units an hour. This is up to 10 times more efficient than the usual hand-loaded machine used by small job shops, according to Gene Markley, a hybrid-product expert at Beckman.

"Experience shows," he says, "that typical commercial printers can handle only 1000 to 2000 parts an hour but our requirements need the higher speed to cut cost."

Dan Saslow, chief engineer of Aremco Products, Ossining, NY, describes his company's Model 3100 screen printer as an "old workhorse" capable of repetitive accuracy to 0.0003 in. and suitable for both production and lab work. A 1975 version has reduced vibration, increased speed and provides

a squeegee pressure control option to allow light, 2-to-3-lb/in<sup>2</sup> pressure for special inks and out-of-chamber substrates. But the price is still \$3250.

Saslow explains that the printer must be very rugged to provide this degree of reproducibility. "In addition," he says, "to close control of the deposited ink thickness and pattern definition, the printer should facilitate easy setup. Hybrid volume runs can be quite low and frequent changes may be required."

During the printing process, the squeegee blade deflects the screen down onto the substrate. The seal that forms between the screen and substrate "sucks" the ink through the screen openings onto the substrate, as the screen snaps back to its original distance from the substrate. The squeegee's speed, pressure and angle of attack must be kept constant to assure a reproducible rate of deposition.

Though older printing machines usually allowed the accurate positioning of the substrate holder and screen height, the squeegee pressure and speed were generally not controllable. And the pressure and speed were not known. Today's printers, however, are equipped with squeegee pressure and speed controls and accurate pressure gauges—a 0-to-12-in/s control covers the maximum usable speed range, and 0.15 to 4.2 lb/in. of squeegee length is a good adjustable pressure range. A vernier readout of the squeegee's angle-of-attack setting is also desirable for good control.

To obtain controlled uniform ink deposits, in spite of variations in substrate height and multilayer work, the squeegee pressure must be kept constant. To help in this, some experts recommend large, soft squeegees that allow the wafer contour to be followed. But the mechanism used to maintain the squeegee pressure is probably most important, since it also influences the angle of attack on compliant squeegee blades. Manufacturers use various combinations of spring assemblies, dead weights and air cylinders to solve this problem.

The printing screen is one of the most critical items in thick-film technology. Screens are made

of synthetic fibers like nylon or polyester and also of stainless steel. Affiliated Manufacturing, Inc., Whitehouse, NJ, a screen manufacturer, favors stainless steel because it can take the constant stretching that results from the squeegee motion.

Al Sweet, a microcircuit engineer with Mini-Systems, North Attleboro, MA, agrees saying: "Nylon doesn't seem to stand up, though it is more pliable and gets into recesses and handles multi-layer work better than stainless steel."

However, Sweet adds, polyester screens are almost as pliant as nylon and wear better. Polyester has good properties for printing on irregular surfaces with crossovers and capacitors, he says. And polyester screens also permit the printing of heavier ink deposits than steel.

Microcircuit Engineering, Medford, NJ, supplies both synthetic-fiber and stainless-steel screens. It makes an improved 400-mesh stainless-steel screen with 0.0009-in.-diam wire. This allows very fine lines—to at least 2 mils—with its 41% open area. Also, 45° screen weaves are available, to eliminate the situation where a screen wire can run down the middle of a 3-mil printed line and block a good portion of it.

### To mask or to screen?

For really fine-line printing—perhaps to 1-mil definition—metal-etched masks are often used. An additional advantage is that the deposited ink conforms closely to the mask thickness. But masks have their drawbacks. They are three to six times more expensive than stainless-steel screens.

In addition masks lie directly in contact with the substrate; they don't have a screen's several mils of separation. Since a mask doesn't snap away from the substrate, as the screen does, the mask must be peeled off. In the process the mask retains some of the ink and the deposited lines have rounded sides. The screen's snap-off action is more desirable. This provides a sharp edge, which some experts feel results in better line control.

Further, a mask's lack of flexi-

Our years of working directly with design engineers on hybrid circuits for high-reliability military applications have given us the experience to eliminate your uncertainties in hybrid circuit planning and packaging. We can ease you through a smooth transition from your basic electronics to hybridization, or help you consolidate a preferred circuit, taking advantage of the space, handling, stock and inventory economies of the hybrid package.

With hybrids, the only limitation is imagination. You'll be surprised by the variety and number of parts we can put in a package. Our unique facility can supply thick film or thin film hybrid microcircuits ranging from simple multiple chip to complex multi-layer assemblies, all built and maxi-tested to meet the most stringent military standard, 883 Level A.

In addition, our experience has led us through an evolution of top quality hybrid analog gates and D-to-A switching circuits. We make an array of standard hybrids from which you might easily choose the one to answer your special design problem, at a cost much lower than you expected.

No matter what your hybrid requirement — small quantities of custom circuits or large quantities of our standard hybrids — Crystalonics is unbeatable on size, reliability and turn-around time. You can send for our microcircuits catalog today. Or for immediate design assistance, stop wrestling and call Jack Senoski, Art Pauk or Richard Antalik of our hybrid applications engineering squad.

**Stop wrestling  
over  
hybridization**

**We're at your elbow to ease your design.**  
Crystalonics. We listen.

 **TELEDYNE  
CRYSTALONICS**

147 Sherman Street, Cambridge, Mass. 02140  
Tel: (617) 491-1670 • TWX: 710-320-1196

INFORMATION RETRIEVAL NUMBER 17

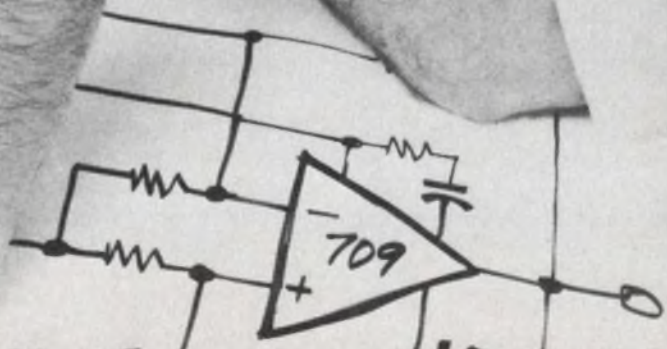



Beckman-designed machine-controlled laser trimmer can trim up to 20,000 resistors per hour. Laser trimmers are particularly effective in today's small geometry microcircuits.

bility prevents it from conforming to substrate surface variations and from use in multilayer work.

"In any event," says Aremco's Saslow, "many thick-film engineers believe that the ability to produce lines narrower than 2 or 3 mils is of little value, since the resistivity of the line becomes too high for many circuits and not many people ask for it."

### Ink is life blood of hybrids

A hybrid circuit can't be more reliable than the inks that the circuit's conductors, resistors and capacitors are made of. The ink is composed of powdered metals, metal oxides or semiconductors, often mixed with a glass-frit binder and all suspended in an organic vehicle. The type and quantity of metal, metal oxide or other material determines the ink's resistivity or dielectric constant. The frit helps bond the mixture to the substrate, and the organic vehicle determines the viscosity and how well the ink prints.

Metal powders are used for conductors, metal oxides for resistors and high dielectric glasses form capacitor dielectric layers. After the ink has been forced through the screen or mask onto the substrate, it is dried and then fired in a furnace at 750 to 950 C, where the organic vehicle burns off and the glass frit reflows and bonds to the substrate.

Separate patterns and screens or masks are needed for the conductor, crossover, dielectric, resistor and protective encapsulant materials. And careful sequencing is needed in the application and firing of the different materials.

For example, a conductor ink that fires at 850 C can't be applied after resistors on the substrate have been fired at 750 C. Successive applications should be separated by firings that are at least 50 C lower than previous ones.

Bill Liederbach, a thick-film expert at Plessey EMD, Melville, NY, explains: "Essential to consistent performance of thick-film materials is the reproducible quality, quantity and mixing of the powders and vehicles. The powders must be very fine and properly suspended, or you're not going to get the correct properties, even if the right thickness of ink is deposited."

Plessey offers a complete line of ink materials. Conductor materials include gold, silver and various combinations with platinum or palladium. Resistor materials include ruthenium and ruthenium/silver, and nonmetallic materials include vitreous dielectrics, solder pastes and conductive epoxies.

Adrian Rose, a technical service engineer with Electro-Science Laboratories, Pennsauken, NJ, emphasizes that ink-material costs have become a major selection factor, because of the steep rise in the price of noble metals.

"For years, palladium/silver was the standard low-cost thick-film conductor," he notes. "But recent price increases have narrowed the gap between palladium and platinum. Since a small amount of platinum has the same effect as a large amount of palladium in a silver alloy; platinum/silver pastes, such as Electro-Science's 9500 series, have become competitive. Also, platinum/silver is more resistant to oxidation and thus has better bonding qualities and solderability, especially when fired at temperatures that cause palladium to oxidize.

"But the next few years should see the development of completely base-metal systems for conductors and resistors that are fully compatible with each other and also possess most of the desirable qualities of noble-metal mixtures."

At least two dozen companies supply thick-film inks. If the number of announcements of new materials is any measure, Thick Film Systems of Santa Barbara, CA, the Sel-Rex Co. of Nutley, NJ, and

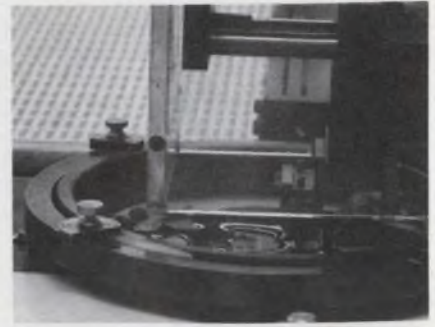

This screen and squeegee assembly of a Beckman-built high speed printer can handle up to 4000 units per hour versus up to 2000 per hour for commercial printers.



Motorized ultrasonic ball bonders, such as this Model 9700 unit offered by West Bond Equipment, provide the capability of presetting tool motions for repetitive action.

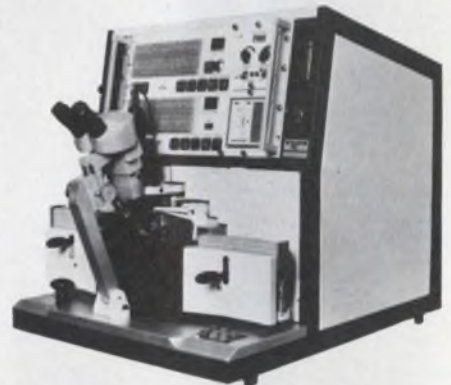

Teledyne's high-speed wire bonder can attach wires at 0.5 s/wire. Off-line programming is easily changed and repeatability is up to 0.0002 in.

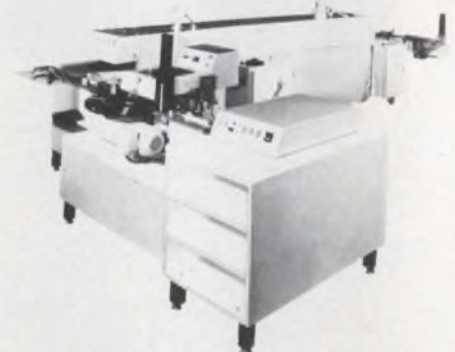

An automatic screen printer, such as Wells Electronics' Model 44-PS, handles 2100 substrates per hour.

A Price-Performance Benchmark!

# 3 $\frac{1}{2}$ Digit A/D Converter

Siliconix state-of-the-art concept in 2-chip 3 $\frac{1}{2}$ -digit A/D converters has established new industry standards. Consider these outstanding device characteristics:

## LD110/LD111

Price and performance are two of the many good reasons why the LD110/LD111 3 $\frac{1}{2}$ -digit A/D converter has become an industry benchmark for data display (DPMs and DVMs), data acquisition and logging systems. Exceptional performance and stability is achieved by a unique conversion technique which uses a single full-scale adjustment to produce a highly-accurate 3 $\frac{1}{2}$ -digit output of up to 3100 counts plus sign. The system characteristics include:

### Specifications

- Accuracy of 0.05% of reading,  $\pm 1$  count.
- $Z_{IN} > 1000 \text{ M}\Omega$ .
- 4 pA typical input bias current (25°C).
- 100  $\mu\text{V}$  resolution (200.0 mV range).
- 40 dB NMRR @ 60 Hz.

### Features

- Auto-zero minimizes effect of offset, drift and temperature.
- Auto-polarity.
- Sampling rates to 20 samples/sec.
- Two voltage ranges: 2.000V and 200.0 mV.
- TTL-compatible outputs.
- \$19.60 per set (100-unit price).

## LD114 Multiple-Option Processor

Greater system design flexibility is now offered by the recently-introduced LD114 digital processor. The LD114, combined with the LD111 analog

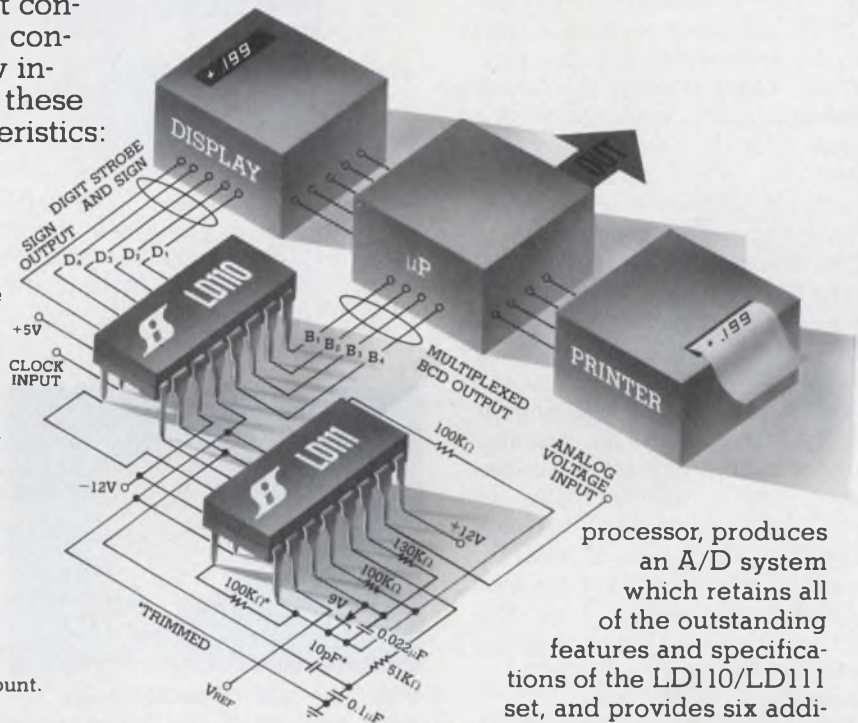

processor, produces an A/D system which retains all of the outstanding features and specifications of the LD110/LD111 set, and provides six additional features which reduce interface problems in many data acquisition applications.

### LD111/LD114 Features

- External latch inhibit control ("Hold" feature).
- Multiplexed parallel or serial BCD output.
- Active high or active low digit strobe outputs.
- Active high or active low data bit outputs.
- Sequential or interlaced digit scan.
- $\pm 512$  output available for phase locked loop clock.
- \$25.85 per set (100-unit price).

These features are offered as user-programmable options, with independent selection by means of separate pins on the 28-pin DIP LD114 package.

For further information:

**write for data**

(408) 246-8000, Ext. 120



**Siliconix incorporated**

2201 Laurelwood Road, Santa Clara, California 95054

INFORMATION RETRIEVAL NUMBER 18

Transene Co., Rowley, MA, are in the forefront in developing improved materials.

### Connecting the components

After inked components are fired, the hybrid's substrate is ready to receive additional chip components and then be connected to the outside world. Discrete chip capacitors, special resistors, multilead IC chips and other parts that can't be fabricated by the printing process are added during this stage. Microcircuit engineers agree that lead attachment gives rise to most failures in hybrid packaging. But they agree on little else when discussing component bonding.

The methods of attachment are many, the opinions expressed by the experts contradictory and the solutions offered apparently not ideal. At the 1975 Electronic Components Conference in Washington, DC, Jerome J. Mazenko, manager of the Hughes Aircraft Microelectronics Dept., Fullerton, CA, reported: "The promise of increased reliability and decreased cost for beam-lead attachment has not been realized in our tests of over 4000 beam-lead ICs for more than 2.5 million device hours of tests."<sup>1</sup>

According to Mazenko:

"The improved reliability claims for beam leads are based upon assumptions, such as beam leads allow the use of metallurgy that is less prone to migration problems; silicon-nitride sealed junctions are impervious to sodium-ion contamination, and the integral beam-lead configuration eliminates failure-prone wire bonds. Claims for reduced cost are based upon statements such as: beam-lead attachment is faster than chip-and-wire bonding; beam leads simplify functional testing of the chip before assembly in the hybrid, and beam leads eliminate the need for hermetic packaging—a simple polymer coating is sufficient protection."

However, beam-lead bonding is a complex operation and hence more expensive, Mazenko goes on. And it introduces failure modes that didn't exist before, he says, concluding: "Thus in solving one set of problems, new ones take over to produce a net negative result."

Beam-lead bonding was, however,



**Aremco's 1975 version of its 3100 screen printer provides new squeeze pressure controls, settable timers, vibration-free motion and 0.0003-in. repeatability.**



**Some discrete components are still hand soldered to the hybrid's substrate, especially in small quantity and prototype designs.**

staunchly defended by representatives of Bell Laboratories and Western Electric during a question and answer period at the Components Conference. Bell Laboratories is credited with the development of the beam-lead technique.

In another report at the conference ("A Second Look at Beam Leads—Are They Cost-Effective?"), Thomas B. Gillis of Raytheon Co., Quincy, MA, agreed with one of Mazenko's conclusions: that beam leads are expensive. He estimated them to be three to six times more costly than wire bonding. In Gillis' evaluation, however, beam-lead assemblies provided higher yields than equivalent wire-and-chip assemblies, which is contrary to Mazenko's findings.

Though many hybrid-packaging experts predict that the use of beam-lead devices will eventually increase, chip-and-wire bonding is

still the favored method. Wire bonding is an entrenched technology, and the inertia to change is considerable, the experts say.

Strengthening this entrenchment is the fact that significant advances have been made in wire-bonding technology. High-speed wire bonders, such as the new Tacmatic-1000 by Teledyne TAC, Woburn, MA, is said to need only about 0.5 sec per wire, where older manual machines needed 3 to 10 sec. The Tacmatic can compensate for a high degree of die-placement errors during operator alignment. Other features include off-line preparation of program panels, which can be quickly changed; positioning accuracy repeatable to 0.002 in.; variable ball size, and adjustable wedge and ball band pressure.

When combined with commercially available wire bonders, the L101 control system by General Automation, Anaheim, CA, is said to bond more than 2500 wires an hour at a cost of only 0.7 to 0.8 cents a wire. The cost with typical manual systems is put at 1 to 1.3 cents. The control can compensate for die-placement inaccuracies in the X and Y axis of up to  $\pm 1$  in. and rotational errors up to  $\pm 89$  degrees.

"Once programmed, the L101 allows less-skilled personnel to achieve expert results, since the system automatically corrects for inaccuracies and prevents table movement while a bond is being made," explains Allen G. Fiegehen, director of General Automation's Advanced Systems.

### Bonding the components

Many IC chips and some chip components are temperature-sensitive, but many new epoxies can be cured at low or even room temperatures. The conventional gold-silicon eutectic bond requires temperatures close to 400 C, which can damage some ICs. Thus epoxy bonding, with either insulating or conductive compounds, is being used increasingly.

In addition to low curing temperatures, some of the newer epoxies can be heated to at least 350 C for short periods after curing and still retain most of their strength on cooling. Earlier materials seriously degraded in bond strength



## New from Potter & Brumfield



### The lowest profile 3 amp relay we've ever offered!

The P&B T10 Series relay is lower than many other circuit board components. Only 0.375" high, it's ideal for high-density applications. Permits pc boards to be mounted on 0.5" centers!

T10 relays provide 0.1 to 3 ampere switching @ 30VDC. Coil ratings are 6, 12, 24, and 48VDC. Permissive make, gold-flashed silver contacts are noted for low contact bounce, long operating life. Bifurcated contacts for low level switching are available on special order.

Designed for low cost general purpose applications, the T10 is ideal for use in tele-communications, copy and reproduction machines, computer and peripheral equipment.

For additional information, contact the Potter & Brumfield sales representative or authorized distributor nearest you, or write Potter & Brumfield Division AMF Incorporated, Princeton, Indiana 47671. Telephone 812 385 5251.

**AMF**  
**Potter & Brumfield**



Solving switching problems is what we're all about.

after only a 200-C rise. On the other hand, to be repairable, a die adhesive should weaken between 200 and 250 C. to permit chip removal without substrate damage.

In operation, a small dispensing needle is used, whose diameter corresponds to the smallest die on the circuit. For large dice, several small dots of epoxy are dispensed. After all dots have been placed, the dice are aligned and placed upon the resin. Automatic and semi-automatic equipment is available.

For example, Tridak, Inc., of Danbury, CT, offers its Model 2805 metering/dispense system, which is said to "accurately dispense any flowable material in any shot size without any after-drip." A micrometer adjustment in the head allows selection of a shot size as small as 0.005-in. diam, or any larger size up to the entire contents of its reservoir.

Many other companies, such as West Bend, Inc., Orange, CA, and Kasper Instruments, Mountain View, CA, make metering and dispensing equipment for epoxy die-bonding. And dozens of resin manufacturers can supply the epoxy material to go into these bonding machines.

Epoxy Technology, Watertown, MA, offers the Epo-Tek H61, a medium-to-heavy flowable paste that is also screen-printable, easy to handle and will not dry out, because it is a solventless formulation. Its curing time is 60 min at 120 C or 30 min at 150 C, and it has a shelf life of six months at room temperature.

Other epoxy manufacturers include Sigma Plastronics, Dearborn, MI; Emerson & Cumings, Canton, MA, and Formulated Resins, Inc., Greenville, RI. Plessey EMD of Melville, NY, supplies a line of conductive epoxies with silver, gold and base-metal fillers. Curing temperatures range from 150 to 380 C, and the materials store well at room temperatures.

### Alumina substrate has rivals

Most hybrid substrates for thick films are made of 96% alumina. One problem with this material is its hardness, which makes it difficult to cut and drill. However, there are companies like Comco, Inc., of Sun Valley, CA, that can produce



**Bonders come in many sizes and forms.** This bonder performs ultrasonic aluminum-wire bonding.

96% or 99.5% alumina substrates with special shapes and hole locations, and even do it in small prototype quantities delivered in three weeks. The 99.5% alumina has an as-fired surface finish of less than 4 microinches; the 96% surface is less than 15 microinches.

But for high thermal conductivity, beryllia is the ceramic to choose, says Ceredyne, Inc., Chatsworth, CA. It produces a complete series of precision ground beryllium-oxide substrates with accuracies to better than 0.001 in. And National Beryllia Corp., Haskell, NJ, makes a substrate material called Berlox-Strates, which it says has 14 times the head conductivity of alumina. It is even 15% better than aluminum metal, the company says, and it has a thermal conductivity of 150 BTU/hft<sup>2</sup>-°F/ft at 25 C. Berlox-Strates is made from 99.2% beryllia and has a surface finish of 15 microinches. Stock sizes come in 1 × 1 to 2 × 2 in., all 0.025-in. thick.

Mica Corp., Culver City, CA, however, departs from the traditional ceramic substrate and offers its Micaply Ohmega system.

The key features:

- An epoxy-glass substrate that is much less expensive than ceramic.
- A more easily machined and fabricated material.
- A material that can be more readily multilayered than ceramic.

Among the drawbacks: Thermal-compression bonding can't be used, because the high temperature can damage the epoxy glass. And the surface is still too rough for microwave use, but Mica engineers are working on this.

### Functional trimming cuts costs

Thick-film resistors are typically within ±50%, as fired. To attain closer tolerances, they are trimmed to reduce cross-sectional area, thereby increasing their resistance. Trimming methods include laser, air-abrading, oxidizing and etching with chemicals.<sup>3</sup>

But trimming is a major cost consideration, especially when the components are handled individually. Many hybrid circuits are designed so that only one or two key components need be trimmed to attain circuit operation within desired tolerances. This is called functional trimming.

This operation can compensate for wide tolerances in active components, set trigger levels, adjust time constants, vary biases, etc.

More than half of Beckman Instruments circuits are functionally trimmed, according to Gene Markley, hybrid product manager. "Although we prefer laser trimming, because it's fast and subsequent cleaning processes are unnecessary, we do rely on air-abrasive trimming for very critical applications where resistor stability is imperative," Markley says. "However, in the tight layouts of the newer geometries—with up to 1/10 the former spacing—lasers are better and can handle 10,000 to 20,000 resistors per hour on a component basis and about 35,000 circuits a day of functional trimming."

With thick-film resistors, pre-trimming to 0.5% is often first done abrasively. Then, for functional trimming, a fine cut is performed with a laser, perhaps to as close as 50 parts per million. ■■

### References

1. King, J., "Thick or Thin-Film Resistors?" *Electronic Design*, Aug. 16, 1974, pp. 92-95.
2. Mazenko, J.J., "The Effects of MIL-STD-883 Screening and Stress Test Upon Beam Lead ICs," Proceedings of 25th Electronic Components Conference (1975), pp. 65-75.
3. Torrero, E.A., "Focus on Resistor Trimming Equipment," *Electronic Design*, Feb. 3, 1972, pp. 44-50.

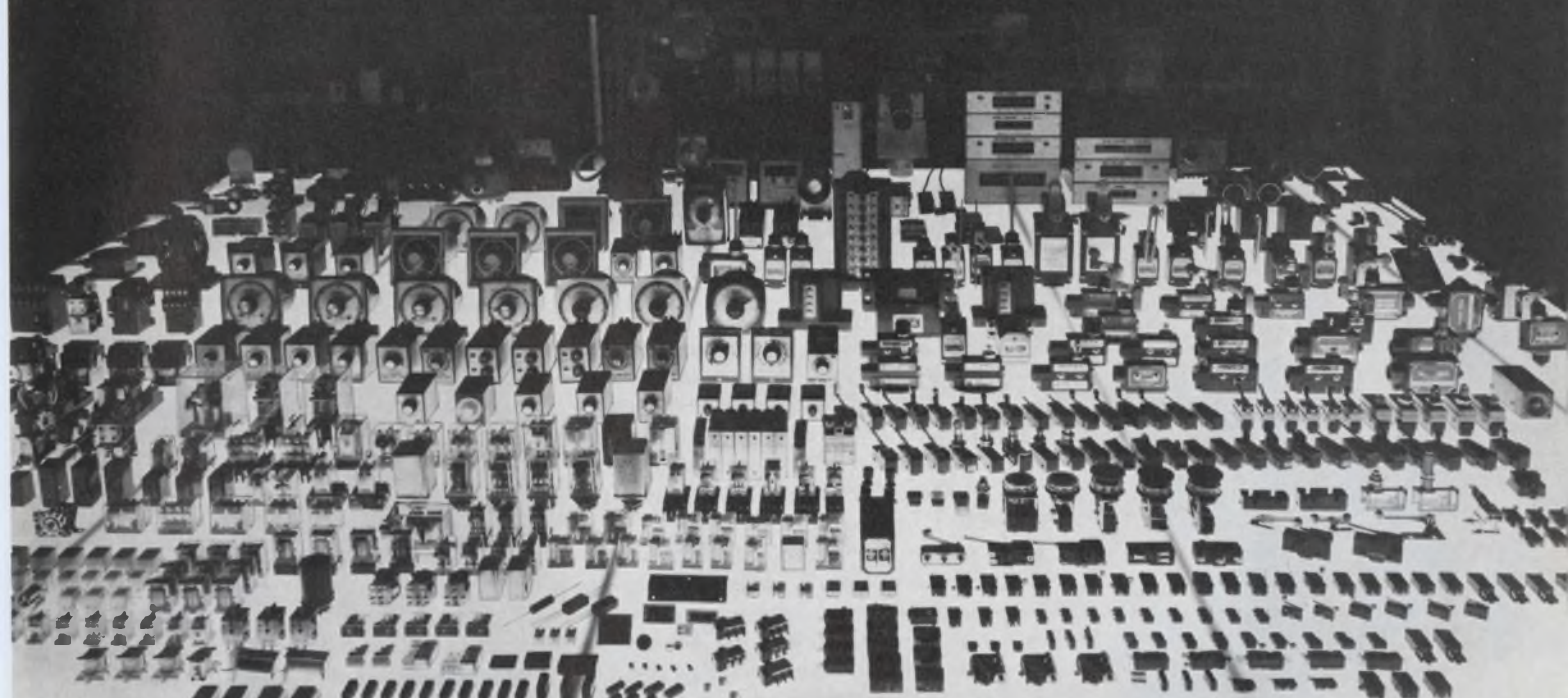

**Choose the one company  
that makes all this...**

**and win  
this calculator.**

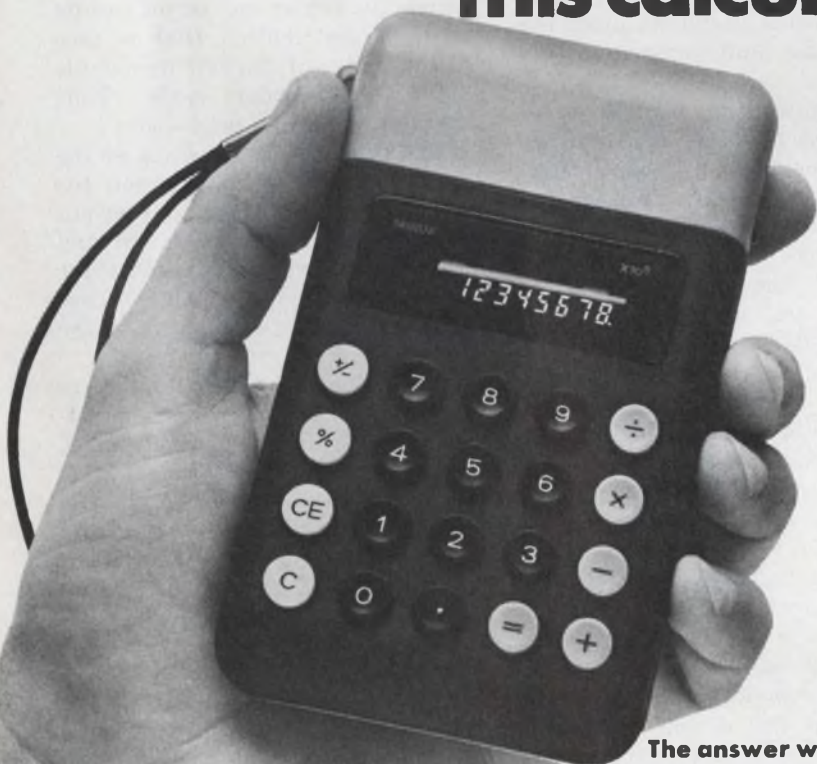

**The answer will  
appear on the inside  
cover of the August 7, 1975,  
Electronics magazine.**

If you can guess\* the name, and are among the first 500 to do so, we will send you a four-function calculator (retail value \$19.95) free. Hint: The company that made all the products in the photo also made the calculator.

Name the company in the coupon below that has this enormous breadth of line. If the coupon has been torn out, send your entry in any form to: Breadth of Line Contest, P.O. Box 4160, Merchandise Mart, Chicago, IL 60654. Calculators will be mailed to the winners—the first 500 correct entries, based on postmark—on August 1, 1975.

Breadth of Line Contest  
P.O. Box 4160, Merchandise Mart,  
Chicago, IL 60654

The company with this enormous breadth  
of line is: \_\_\_\_\_

\_\_\_\_\_  
Name

\_\_\_\_\_  
Title

\_\_\_\_\_  
Company

\_\_\_\_\_  
Address

\_\_\_\_\_  
City

\_\_\_\_\_  
State

\_\_\_\_\_  
Zip

\*Limit, one guess per entrant.

Void where prohibited by law or where taxed.

Employees of this company, of their advertising agency,  
and of their sales representative organization are not eligible.

# Thin-Trim<sup>®</sup> capacitors



 Tucked in the corner of this Pulsar Watch is a miniature capacitor which is used to trim the crystal. This Thin-Trim capacitor is one of our 9410 series, has an adjustment range of 7 to 45 pf., and is .200" x .200" x .050" thick. The Thin-Trim concept provides a variable device to replace fixed tuning techniques and cut-and-try methods of adjustment. Thin-Trim capacitors are available in a variety of lead configurations making them very easy to mount.

 A smaller version of the 9410 is the 9402 series with a maximum capacitance value of 25 pf. These are perfect for applications in sub-miniature circuits such as ladies electronic wrist watches and phased array MIC's.

Johanson Manufacturing Corporation, Rockaway Valley Road., Boonton, N.J. 07005. Phone (201) 334-2676, TWX 710-987-8367.

MANUFACTURING CORPORATION

## NEWS

# Micro-optic devices show advantages over optical ICs

A new class of micro-optic devices under development in the laboratory shows promise of having advantages over the optical IC technologies now being explored.

The micro-optic devices use the interference and reinforcement of coherent light in an interferometer-like waveguide arrangement to function as modulators and switches. The optical integrated circuits use the resonant coupling of two parallel waveguides for the same purpose.

Dr. William E. Martin, inventor of the microscopic elements at the Naval Electronics Laboratory Center in San Diego, says the micro-optics are easier to fabricate than optical ICs. And their dimensional tolerances are substantially broader than those of equivalent ICs, he adds.

The basic micro-optic building block is a single-mode waveguide interferometer patterned after the Mach-Zender interferometer (see figure).

The single-mode channel waveguides that form the active structure are roughly 2 by 2  $\mu\text{m}$  square, Martin reports. The waveguides are diffused into the surface of a zinc-selenide or lithium-niobate substrate. The device length is about 5 mm, and the substrate width about 20  $\mu\text{m}$ .

In operation, coherent laser light is piped into the lefthand end of the structure, where it splits into the two waveguide arms of the interferometer and then goes back into one at the output.

Electrodes on the substrate can be connected to provide an electrical field across both of the channel waveguides. This field changes the optical path length in each leg of the interferometer. With zero voltage across the device, the light from the two interferometer legs joins at the output and is reinforced at this junction.

Application of a differential volt-

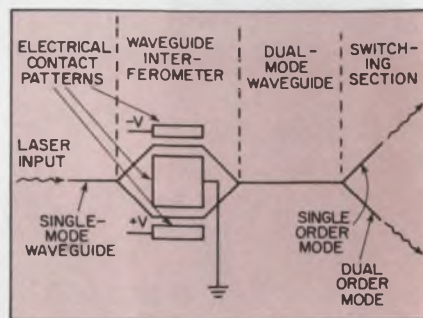

**Modulating and switching device,** which uses micro-optics, is said to be easier to fabricate than an equivalent optical IC.

age across the structure increases the propagation constant in one leg and decreases it in the other.

If a differential electric field is applied to the interferometer and it is high enough to cause a phase shift of 180° between the light passing through both arms, the recombination at the output results in light distribution that is zero at the center of the exit waveguide—the second-order mode. Thus modulation can be produced.

The propagation constant of the dual-mode waveguide between the interferometer element and output Y causes the light to follow and exit at the two end branches for the first-order mode. This occurs when no voltage is applied to the interferometer.

Application of a field to the interferometer changes the lowest-order mode to the second order, which has a different propagation constant—one designed to channel the light up the other branch of the Y. Thus an optical switch is obtained.

The first generation of zinc-selenide devices required 25 V for operation, Martin reports. With this substrate, a single-pole, double-throw optical waveguide switch was made that had an on-off ratio of 7:1. With use of lithium niobate and only 5 V, extinction ratios of better than 12 to 1 have been

achieved, Martin points out.

The upper frequency of operation—at present about 1 GHz—is limited only by the drive electronics, Martin points out. The device presents a capacitive load of about 1 pF. Depending upon the substrate material, from 5 to 20 V is required for its operation.

For increased input-output isolation, cascading of the devices is needed at the present state of the art, Martin notes. However, these micro-optic elements have among the highest on-off ratios of any of the optical IC switching devices so far proposed.

A present limitation of the micro-optic elements is high-level cross talk, Martin says. But he is confident of reducing these levels with improved understanding of the device and its fabrication. ■■

### The 2-in-1 watch



Combination digital timepiece and split-second stop watch contains a liquid-crystal display for the time and a LED for the chronograph. A button activates a lamp for reading the LCD at night. The digital watch sells for about \$400 and will be available from Heuer-Leonidas of Springfield, NJ, later this year. Integrated Display Systems of Montgomeryville, PA, supplies the electronics.

*Plain talk about  
power supply values from...  
TELE-DYNAMICS*



DPS Series  
open-chassis power supply  
Only \$23.80 (50-99)  
3 models from 5 to 24 Vdc

Why you should buy it. UL-listed. Easy mounting. Excellent regulation ( $\pm 0.25\%$  line & load). Output: 5-24 Vdc at 0.8-3.5 A. Input: 105-125 or 210-250 V, 47-63 Hz. This is the original open-chassis supply. It has fewer parts than competitive units, and has been field-proven reliable over many years of use. Over 100,000 sold.

**FAST**  
How you can get it. Off-the-shelf delivery from 110 stocking distributor locations in U.S. & Europe. For big-volume orders, ask rep for price & delivery quote -- you'll be pleasantly surprised. See EEM for distributor/rep addresses and additional product data.

Write for free 48-page designer's handbook.

||||| **TELE-DYNAMICS** DIVISION OF **AMBA**  
WANLASS POWER SUPPLIES AND  
LINE CONDITIONERS

525 Virginia Drive, Fort Washington, PA 19034 • (215) 643-3900  
An equal opportunity employer M/F

© Tele-Dynamics

6173



# KEPCO

## OPERATIONAL POWER SUPPLIES

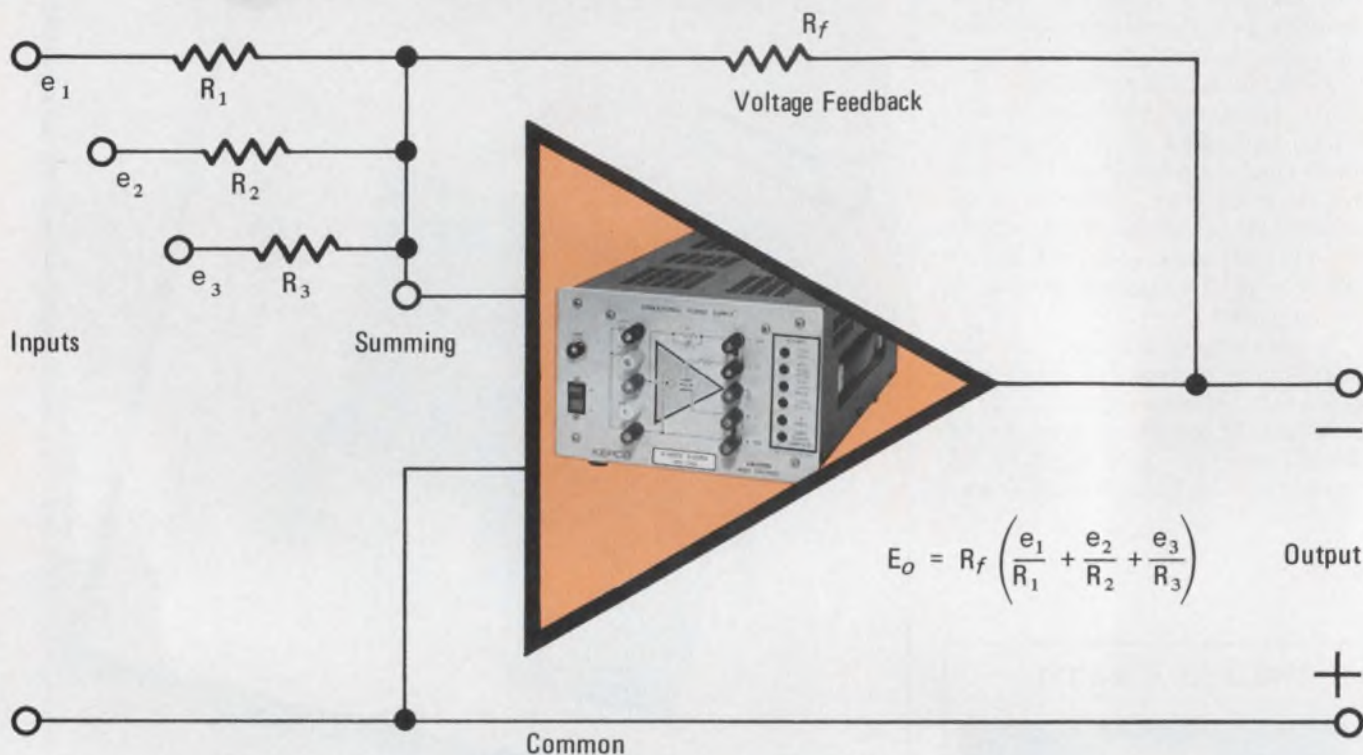

A Kepco Operational Power Supply is capable of producing more than mere voltage *stability* (though it does that admirably, too). An Operational Power Supply offers voltage *agility*. These unique power supplies allow you to exercise subtle, precise, rapid control, closed loop control, even digital control. They'll respond with better than 0.01% linearity to the most complex programming instructions, will slew to a new setting at speeds up to 1V/microsecond, and allow you to set zero with millivolt resolution. Kepco's Operational Power Supplies are most useful instrumentation for:

- **AUTOMATIC TEST EQUIPMENT (ATE)**, where the ability to rapidly settle at a programmed level, speeds your test cycle.
- **PROCESS CONTROL SYSTEMS**, where the Operational Power Supply's high gain and linear response permits you to close a variety of feedback loops.
- **THE STABILIZATION OF CURRENT**, where minimum offsets allow small currents to be effectively controlled and where *capacitorless* output circuits offer the dynamic compliance to track a varying load.
- **MEASUREMENTS**, where an Operational Power Supply's ability to sum, scale and integrate, permits the complex combination of inputs.
- **OPERATIONAL POWER SUPPLIES** are made *only* by KEPCO, INC.

Ask for your free copy of "Using Operational Power Supplies," our 32-page booklet that will open your eyes to what a power supply can do, besides producing a stable voltage.

Write Dept. EU-05

**KEPCO**®

KEPCO, INC. • 131-38 SANFORD AVENUE • FLUSHING, N.Y. 11352  
(212) 461-7000 • TWX = 710-582-2631 • Cable: KEPCOPOWER NEWYORK

INFORMATION RETRIEVAL NUMBER 23

ELECTRONIC DESIGN 15, July 19, 1975

# Washington Report

## **A Federal R&D corporation asked**

High-risk, high-technology research and development programs—the kind that most private companies can't afford to gamble on—would be financed by a national technology development corporation under a bill proposed by Rep. Thomas J. Downey (D-NY).

The corporation would be funded initially with \$1-billion, with which it would make investments and guarantee long-term loans. Patterned on the Depression days' Reconstruction Finance Corporation and the existing Export-Import Bank, the corporation would share in the profits of any development that might come from funded research.

Emphasis would be on energy, pollution, resource conservation, environmental problems and basic research. A scientific advisory panel would approve any loans or guarantees.

## **Polymer studied as copper substitute**

In this age of substitution, with fiber optics already bidding to replace copper in some communications areas, the National Science Foundation has announced another candidate—thin layers of electrically conducting polymeric sulphur nitride.

Working under a joint NSF and Advanced Research Projects Agency program, University of Pennsylvania scientists say they have demonstrated that the thin layers can be synthesized so the chains of molecules are aligned parallel to one another on the plastic surfaces. The fibers that make up the crystals and films are aligned parallel to one another, because electricity flows more easily along them than across them.

Researchers, who call the discovery "metallic polymer," say the new synthetic metals may one day replace ordinary metals. The polymer, first discovered in 1910, wasn't given serious consideration until 1973. With copper deemed exhaustive, the new synthetic may be a strong candidate in the future, since its basic ingredients, sulphur, chlorine and ammonia, are readily available and inexpensive.

## **A reorganized FCC proposed**

The Federal Communications Commission would be restructured if legislation recently introduced in the House by Rep. Torbet H. MacDonald (D-MA) becomes law. In it are 15 recommended changes that would scrap some procedures, allow the agency to be more independent of the White House and generally raise the veil of secrecy under which the FCC sometimes operates.

A major change would be to reduce the present number of commissioners from seven to five and to increase their terms from seven years to 10.

More staff help would be authorized for the commissioners. This is designed to give each a better grasp of problems, according to Rep. MacDonald, who is chairman of the House Subcommittee on Communications.

To give Congress greater oversight of operations, the bill would grant committees immediate access to FCC documents.

## **New radio propagation studies under way**

More studies on radio propagation activity at higher frequencies—10 GHz to 300 GHz—will be carried out by the Dept. of Commerce's Office of Telecommunications, according to Assistant Secretary of Commerce for Science and Technology Betsy Ancker-Johnson.

Among the programs is an investigation of the use of high-powered microwaves to "heat" a section of the ionosphere, which then reacts as a large reflector. Using the Department's transmitter near Platteville, CO, ionospheric irregularities 100-km in diameter have been created at F-region heights. Such a phenomenon is capable of bouncing communications signals for very long distances.

Besides research on propagation, the Telecommunications Office will also increase its search for new telecommunications applications.

**Capital Capsules:** The Electronic Industries Association has a seven-point export control program that it is pushing vigorously on Capitol Hill and in the State Dept. and Dept. of Commerce. The goal is to make U.S. manufacturers more competitive with those overseas. Problems that have to be solved include those arising from uneven application of export controls and excessive time to process licenses. . . . Apollo Soyuz astronauts are going to try to produce superior optical fibers in a small electric furnace. Lithium fluoride fibers made under weightless conditions are expected to have better continuity, regularity and orientation. . . . The Energy Research and Development Administration is drawing up a blueprint of work to be done by a Solar Energy Research Institute. Its creation is required by the Solar Energy Research and Development Act of 1974. The National Research Council of the National Academy of Sciences and the National Academy of Engineering favor a single center, which would be a contract-operated lab. The contractor would be a consortium of universities or a single university. . . . Sources are being sought by the Air Force for an exploratory development program to establish the feasibility of nonvolatile semiconductor memory chips. The USAF Avionics Laboratory says the element will be an MNOS transistor. The contractor must trade off the various technologies, such as aluminum vs silicon-gate. . . . A study of the chemical and structural influences of doped aluminum conductors on ICs is about to be launched by the Air Force. The effort will include building aluminum thin-film conductors doped with silicon. To be investigated through accelerated stress tests will be their chemical stability, resistance to electro-migration and interaction with other device features, such as deposited dielectric layers and silicon contacts. . . . The Office of Management and Budget is out to stop Federal agencies from awarding grants to an organization or company instead of a contract. A grant makes sure the agency assigns the work to the outfit it wants but it bypasses the competitive system. The office's proposed solution? To redefine the "vague" definitions of "contract, grant and cooperative agreement" to strengthen pending legislation.



# Tektronix TM 500

a line  
of 29 test  
instruments

that go  
six-in-a-rack  
including  
custom circuits.

- digital multimeters
- counters
- generators
- amplifiers
- power supplies
- oscilloscopes
- a blank plug-in for your own circuitry
- and more

TEKTRONIX modular instrumentation offers your QC, production test, or built-in test equipment a highly compact, extensive line of test instruments . . . TM 500. They are designed to work totally independently or as a system with each other. Blank plug-in kits make it easier for you to build in your own testing circuits compatible with TM 500. The RTM 506 rackmounting power module/mainframe (only 5¼" high) provides six compartments to accommodate TM 500 plug-in modular instruments and the plug-in kits. It is available for benchtop or portable use (TM 506), as well as for rackmounting (RTM 506).

A common interface circuit board within the mainframe permits the intercommunication of inputs, output, and various parameters among the plug-ins. Tektronix will supply you with data on voltages, currents, and pin connection diagrams, so you can determine the feasibility of assembling your special circuits in blank TM 500 plug-in kits.

The TM 500 family of instruments is designed to fulfill your test and system needs in such widely divergent areas as high-speed logic; dc, power line frequency, audio, and rf to 550 MHz; oscilloscope and other instrumentation calibration; and even medical instrumentation calibration. They represent Tektronix standards of quality in design, performance, and ease of opera-

tion. Included are pulse generators with features such as independent pulse top and bottom controls and repetition rate to 250 MHz. And the DC 505A Universal Counter/Timer features direct counting to 225 MHz and time interval averaging with resolution to 100 ps.

Here is a growing, compatible family of 29 plug-in modular instruments, accessories, and one, three, four, and six-compartment mainframes providing the common power supply. All mainframe/power modules may be hand-carried, all go on the bench, and there are SCOPE-MOBILE® configurations as well. Some instruments are general purpose, such as DMMs, some are highly specialized, such as those for oscilloscope calibration. They comprise test and measurement systems that are difficult to duplicate with monolithic instruments.

Send for the 56-page TM 500 catalog A-3072 with full specifications and suggested selections of instruments for typical applications. Or contact your local Tektronix Field Engineer for a demonstration of how TM 500 instruments can solve your needs. Write to Tektronix, Inc., P.O. Box 500, Beaverton, Oregon 97077.

In Europe write Tektronix Limited, P.O. Box 36, St. Peter Port Guernsey, Channel Islands.



**TEKTRONIX®**

committed to  
technical excellence

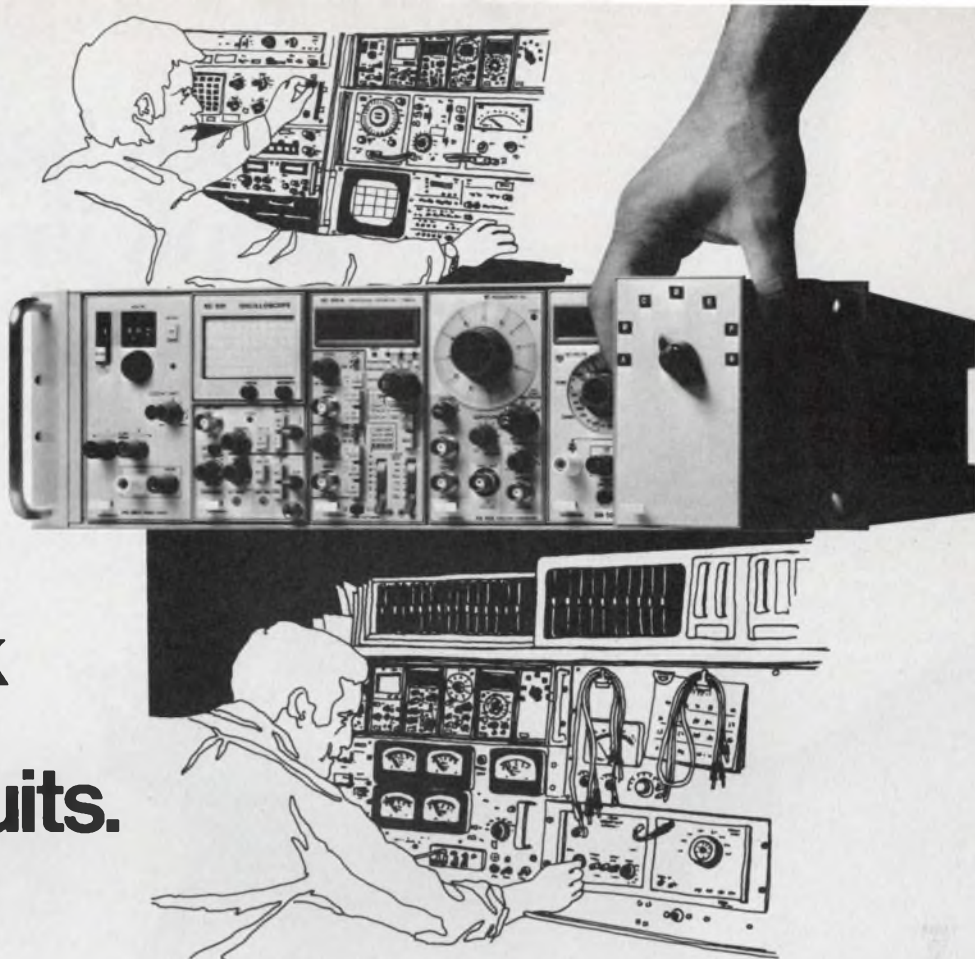

A black and white photograph showing a hand operating an AMP shuttle tool. The tool is a dark, heavy-duty metal device with a large cylindrical component on top. A multi-strand flat-cable is being inserted into a slot in the tool. The hand is positioned at the bottom left, holding the tool's handle. The background is plain white. The text is positioned in the upper right quadrant of the image.

# Nobody has an easier to apply line of no-strip, no-solder, round- conductor flat-cable connectors than AMP.

**Quick, easy terminating.** The new AMP shuttle-tool is designed for reliable and repeatable production. Loading is easy. The operator simply pulls out the shuttle to load the cable and housing, and then pushes the shuttle in, to terminate. Alignment is automatic and positive. Pneumatic tooling is also available.

AMP Latch connectors terminate 10 through 60 leads on multi-conductor flat cable. Simultaneously. They mate with two rows of .025 posts on .100-inch centers. Our 14- and 16-position AMP Latch connectors mate with standard DIP sockets. There's also a family of edge connectors in the line.

**Fail-safe.** Dual camming and latching ears on the unique AMP Latch folding contacts provide a four-point electrical contact and mechanical grip for each conductor—not just two points—to provide true redundancy. You can inspect the termination itself before the cover is applied. After termination, inspection ports in the connector cover allow visual checkout of each fork-type contact for proper locking and latching. The latching of individual contacts prevents bowing or parting of the covers. The connectors can also be probed under electrical load via the inspection ports. To insure integrity, the cover also locks to both ends of the connector housing with auxiliary latches.

**Connects three ways.** With AMP Latch, you can interconnect to pc board spring sockets, directly to the board itself, or to DIP sockets—anywhere you want to interface on high-density, .100-inch patterns.

Ask your AMP representative for an in-plant demonstration. Or write for AMP Latch connector literature. AMP Incorporated, Harrisburg, Pa. 17105.

AMP is a trademark of AMP Incorporated.

# AMP

## INCORPORATED

INFORMATION RETRIEVAL NUMBER 25

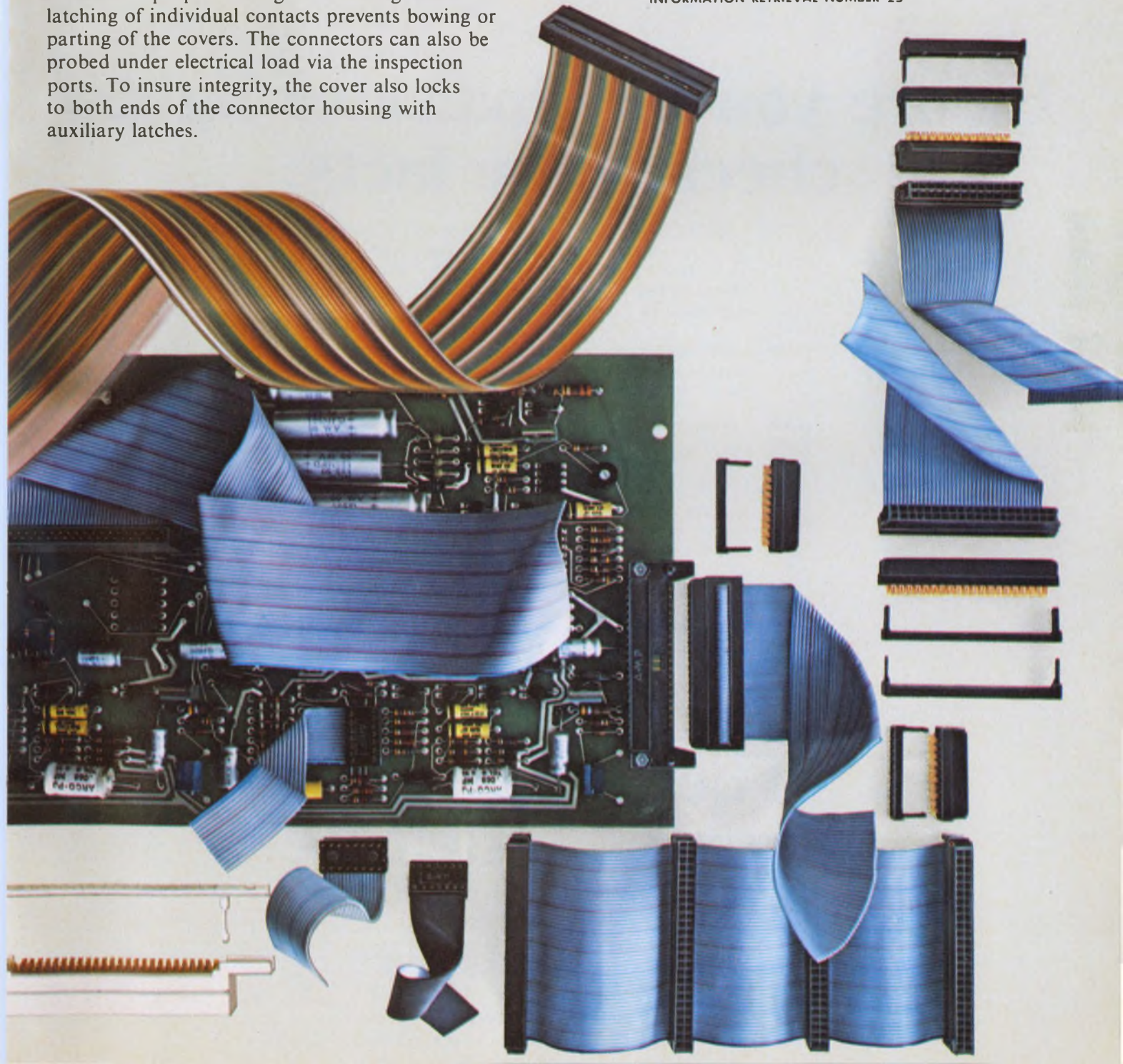



## Before you buy indicator lights, check these facts:

- LITTELITES** include Cartridge Lamps and Lampholders, Subminiature and Miniature Lampholders, and Snap-Mount Plastic Lites. We offer a wider selection among these four product groups than any other single manufacturer.
- LITTELITES** are made with all new tools and molds. This plus total in-house production capabilities make Littelites the finest quality lights on the market today.
- LITTELITES** are all U.L. Recognized or Listed and Certified by C.S.A.
- LITTELITES** Snap-Mount Plastic Lites feature unique flex arms to ensure positive retention and protection against shock and vibration. Absolutely no additional mounting hardware required.
- LITTELITES** are available off-the-shelf from a nationwide network of Littelites distributors. For large volume requirements, you can depend on a fast turn-around on orders.
- Our **LITTELITES** team of R & D and sales engineers is ready to assist you at any time with standard or special applications.

## Then check the source... Littelfuse

Send for your Littelites Product Guide today!

# LITTELFUSE

Subsidiary of Tracor

800 E. Northwest Highway • (312) 824-1188 • Des Plaines, Illinois 60016

INFORMATION RETRIEVAL NUMBER 26

# If you need HYBRIDS...

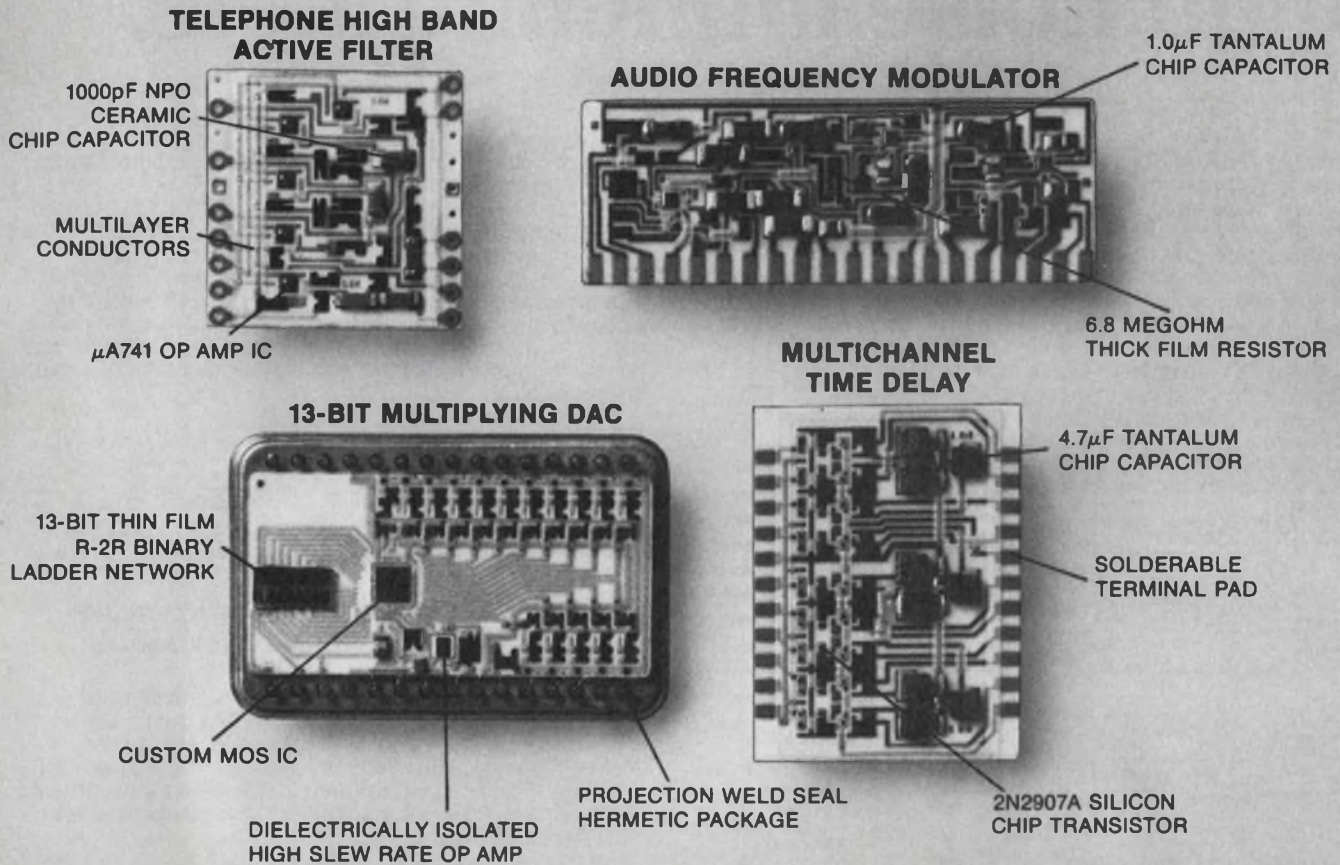

## you should know about **BECKMAN!**

We offer *expert* application assistance and *quality products* at *competitive prices*.

Beckman Hybrids can solve your system packaging problems in:

- Active Filters and Telephone Tone Filter/Modem products
- DACs and ADCs from Industrial to Military standards
- Power Linears from Amplifiers to Voltage Regulators
- Complex Customs from Passive Substrates to Multilayer Digital hybrids

For fast response, call (714) 871-4848, Ext. 1776

**Beckman**<sup>®</sup>

HELIPOT DIVISION

INFORMATION RETRIEVAL NUMBER 27

# HiNIL Interface

# Keeping the bugs out of microprocessor systems with high noise immunity logic.

An MOS microprocessor system can be troubled by disastrous bugs unless it is protected against noise transients generated by switches, electromechanical peripherals and other nearby noise sources, such as lamps and machinery. But filters and shielding, the traditional cures, are often difficult to add to a microprocessor because of size and cost constraints.

These problems can be avoided by substituting HiNIL interface devices for conventional I/O logic. HiNIL—Teledyne's bipolar High Noise Immunity Logic—has a guaranteed DC noise immunity about 10 times that of TTL, for example (3.5 vs. 0.4V). Also, HiNIL blocks AC transients large enough to cause TTL malfunctions. Two additional advantages are superior output drive and, in low power systems, protection of CMOS memory and random logic inputs.

65 mA and source up to 12 mA. (The new 390 buffer series will sink up to 250 mA.)

Manufacturers of systems requiring random logic are finding that HiNIL and CMOS are an ideal combination. They maximize system noise immunity and assure an excellent system function/power product. HiNIL and 54C/74C CMOS interface directly at  $V_{CC}$  voltages from 10 to 16 volts, the power supply range of HiNIL. Moreover, HiNIL protects CMOS inputs from destruction by static electricity and from harmful DC input levels that can exist before CMOS circuits are powered up.

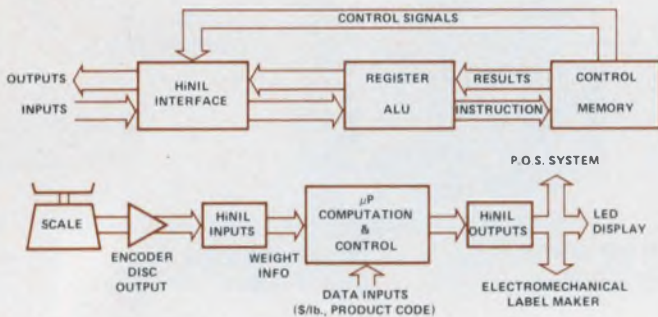

Figure 1. Use of HiNIL interfaces in POS systems with electronic scale. Top diagram shows basic microprocessor configuration.

One manufacturer of microprocessor-controlled electronic scales decided to use the configuration in Figure 1 because he was concerned about the consequences of incorrect weights and prices. The probability of errors resulting from noise transients was high because the scale would be used in a supermarket POS system, where the environment includes refrigerators, fluorescent lamps, meat grinders and electromechanical label makers.

In the system, the microprocessor receives weight codes from an encoder disc in the scale and operates a cash register interface, LED display, and relays of a receipt printer or label maker. The system designers put HiNIL interface logic on the microprocessor board to handle the I/O functions, suppress noise transients picked up along the transmission lines, and drive the peripheral devices. HiNIL output interfaces can drive long lines, relays, displays and lamps without additional components since they sink up to

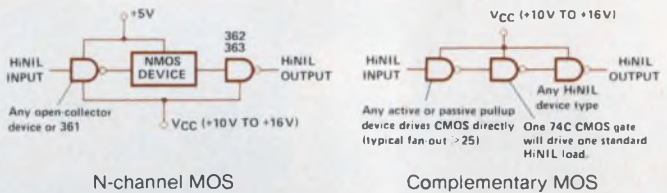

Figure 2. Typical HiNIL/MOS and HiNIL/CMOS interfaces

The rules for using HiNIL with MOS or with CMOS operating at lower voltages are simple. The pullup resistor of an open collector HiNIL device is connected to the desired high logic level voltage (see Figure 2). To use HiNIL with other bipolar logic, just plug in a Teledyne dual or quad interface circuit (see table). HiNIL is also compatible with most analog devices.

### Examples of HiNIL Interface Devices

301 Dual 5-Input Power Gate	65mA relay or lamp driver
302 Quad Power NAND Gate (OC)	
323 Quad NAND Gate (OC)	Input noise protection plus open-collector pullup to other logic levels
332 Hex Inverter (OC)	
334 Strobed Hex Inverter (OC)	
350 8-Bit Multiplexer	Drive longer lines than TTL with 10X noise immunity ( $I_{OH}=12mA$ )
351 Dual 4-Bit Multiplexer	
361 Dual Input Interface	361 directly connects HiNIL to DTL/RTL/TTL
362 Dual Output Interface	362 and 363 connect DTL/RTL/TTL to HiNIL
363 Quad Output Interface	
367 Quad Schmitt Trigger	Suppress 100V/1 $\mu$ s spikes, protect CMOS, decode switches, etc.
368 Quad Schmitt Trigger (OC)	
380 BCD to Decade Decoder	
381 BCD to Decade Decoder (OC)	Provide decode/drive for lamps, LEDs, gas discharge displays, etc.
382 BCD to Decade Decoder	
383 BCD to 7-Segment Decoder	
390 Interface Buffer Series	250mA HiNIL driver series will be available soon

If you need a simple, inexpensive solution to a difficult noise problem, write or call Teledyne Semiconductor for a copy of application notes and specifications on Teledyne's High Noise Immunity Logic family.

## TELEDYNE SEMICONDUCTOR

1300 Terra Bella Avenue, Mountain View, California 94043 Tel: (415) 968-9241 TWX: 910-379-6494 Telex: 34-8416

ENGLAND: Heathrow House, Cranford, Hounslow, Middlesex, Tel: (44) 01-897-2503 Telex: 851-935008

FRANCE: 90, Avenue Des Champs Elysees, 75008 Paris, Tel: 2563069 Telex: 842-29642

WEST GERMANY: Albert Gebhardtstrasse 32, 7897 Tiengen, Tel: 7741-5066 Telex: 841-792-1462

JAPAN: Nihon Seimei-Akasaka Bldg. (3F), 1-19, Akasaka 8-chome, Minato-ku, Tokyo 107, Tel: 03-405-5738 TWX: 781-2424241

Additional offices in West Germany, Hong Kong and the United States. Representatives and distributors worldwide.

## The hard driver

Larry can't get good engineers. He's willing to pay top dollar if the right people come along, he says, but nobody wants to work anymore. He admits that he drives his people pretty hard, but if he didn't do that, they would simply loaf. Everybody knows that people are lazy.

At least he's honest. Larry really tells his engineers what he thinks. He shows them that he knows what's going on. "You have to watch them like a hawk," he says, "or they'll try to get away with murder." In fact, it's amazing how many small mistakes he's caught, and how many times he's caught his engineers making judgments that differed from his.



Well, if constant criticism is nourishment for dedication and creativity, Larry should have the most dedicated, most creative engineers in the world. The fact that he doesn't is proof again that you can't find good people. Or, at least, Larry can't.

Strangely, one of his competitors, Steve, doesn't have that problem. It's not that Steve isn't tough on his engineers; he demands more than Larry does. He's always pushing them to do a better job—to cut power consumption, to improve stability, to broaden bandwidth, to cut costs—and they do. And everytime they do, he's all over them with honest praise and with other forms of appreciation—like money.

But Steve's a fool. If you don't believe it, ask Larry. Larry can tell you how many of his no-good engineers have gone to work for Steve. It seems that Larry loses bad engineers while Steve gains good ones, though they're the same people.

Larry gets bad engineers by tearing them down, discouraging them and letting them know how bad they are. He thinks he's whipping them into shape; he can't see that they're simply whipped. Steve gets good engineers by building them up, encouraging them and letting them know how good they are.

Larry poisons his engineers with disapproval. Steve nourishes his people with the ambrosia of encouragement and recognition. Larry creates losers. Steve breeds winners.

GEORGE ROSTKY  
Editor-in-Chief

## Solve your measurement problems with v/f and f/v converters. These versatile circuits offer simple ways to send and receive data over two-wire links.

Use v/f and f/v converters to help solve tough data-acquisition problems. These versatile subsystems can transmit data from analog sensors over simple two-wire links. Thus you can minimize the effects of electrical noise and transients on the transmitted signal.

By mating a voltage-to-frequency converter with a counting circuit, you can generate computer-compatible digital signals. By doing the reverse and feeding pulses to a frequency-to-voltage converter, you generate analog signals that can, in turn, control a process or instrument.

Modular v/f converters are available in versions to handle signals from millivolts to well over 100 V. And both v/f and f/v converters are available with various frequency ranges—from 1 kHz to well over 5 MHz, full scale (see table). Furthermore, these ranges can be modified—with external circuitry—to match specific applications.

Frank Goodenough, Product Marketing Engineer, Teledyne Philbrick, Allied Drive at Route 128, Dedham, MA 02026

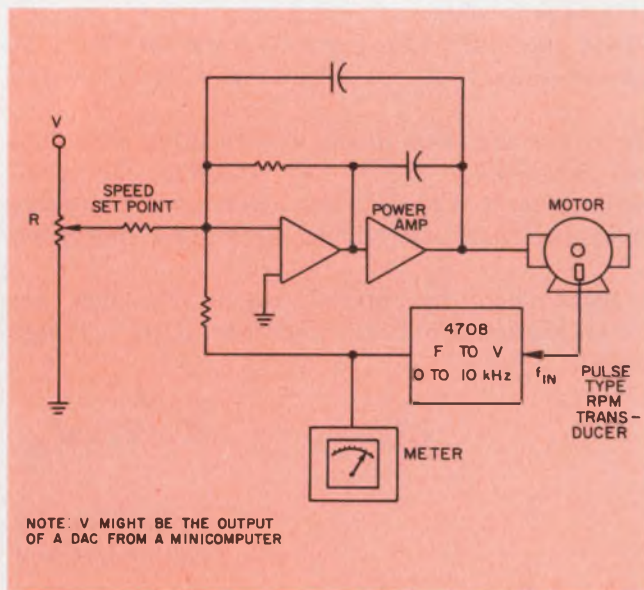

1. An f/v converter and a magnetic pickup are paired in a closed-loop control system to monitor and regulate the speed of a motor.

When you must monitor, say, the speed of a motor, you have a choice of many types of sensors. The transducer outputs are very often pulse trains whose frequencies are proportional to the speed at which the motor shaft rotates. In this form, the signals usually aren't too useful. Often you will need an analog output to drive a chart recorder, analog controller or panel meter to indicate the rotational speed.

### Measure rotational speed

Most transducers for rotation measurement fall into one of these categories:

- Mechanical: cam-driven switches and reed switches closed by magnets.
- Magnetic (no moving contacts): Frequency-sensitive (in which the output voltage is a function of rpm), variable-reluctance and variable-magnetic-field. Nonfrequency-sensitive: Hall-effect sensor and flux-gate pickup (saturated core).
- Capacitive.

### Typical v/f and f/v converter models

FUNCTION	Full scale frequency	MODEL Teledyne Philbrick	Non-Linearity		Dynamic range (decades)	Full-scale tempco ppm/°C	COST 1 to 9 pcs.
			% Full Scale	% Sig.			
V TO F	10 kHz	4701	0.05	...	3-1/2	100	\$ 53.50
		4721	0.2 (0.05 typ)	...	3-1/2	300	\$ 19.50 (1000 pcs)
	100 kHz	4709	0.005	0.02	6	44	\$ 79
		470903	0.005	0.02	6	6	\$ 114
	1 MHz	4705	0.001	0.05 (0.01 typ)	6	200	\$ 99
		470501	0.0005 (0.0002 typ.)	0.02	6	200 (44 typ.)	\$ 153
5 MHz	470702	0.01 (0.004 typ.)	0.05 (0.02 typ.)	5	40	\$ 195	
F TO V	10 kHz	4714	0.1 (0.03 typ)	...	4	150 (100 typ.)	\$ 39.50
		470803	0.005	0.01	4	6	\$ 114
	100 kHz	4704	0.05	...	4-1/2	150	\$ 69
		4710	0.007	0.013	5	44	\$ 79
	1 MHz	4706	0.008	0.02	6	150	\$ 125

(All specifications guaranteed unless marked typ.)



## The f/v and v/f converter

A typical f/v converter module (top) accepts many different waveforms. It conditions them with an op-amp type comparator, then converts the comparator pulses into voltage levels by use of a precision charge dispensing circuit. Two internal resistors and an external reference voltage set the comparator trip point. The comparator controlled charge dispensing network feeds constant amounts of charge into an integrator. The faster the charge feeds in, the higher the voltage out. The amplifier-integrator also forms a low-pass filter that smoothes any abrupt changes in voltage levels and then boosts the current to a usable level for analog indication or control circuitry.

V/f converter modules (bottom) handle varying voltage inputs. After the converter-condi-

tioning circuitry modifies the analog input voltage, it feeds the signal to transistor  $Q_1$ , which, combined with  $A_1$ , forms a precision current pump which charges capacitor  $C$ . The precision current is a direct linear function of the current that flows into the summing point of  $A_1$ . Thus  $C$  charges at a constant linear rate. When the charge reaches a precise, pre-set level, the Schmitt trigger/comparator trips and starts the one-shot multivibrator. The one-shot, in turn, controls  $Q_2$  and the charge dispensing circuit. Each time the one-shot triggers, the precision charge dispensing circuit resets  $C$  to the same initial voltage by the current pump but the rate of charge and thus the output pulse rate is a function of pump current.

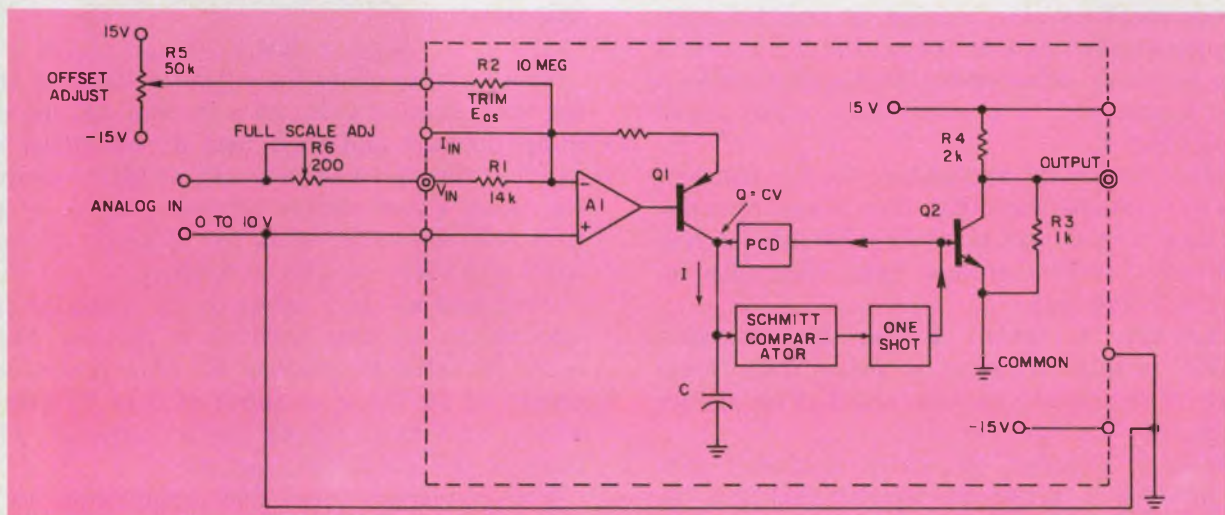
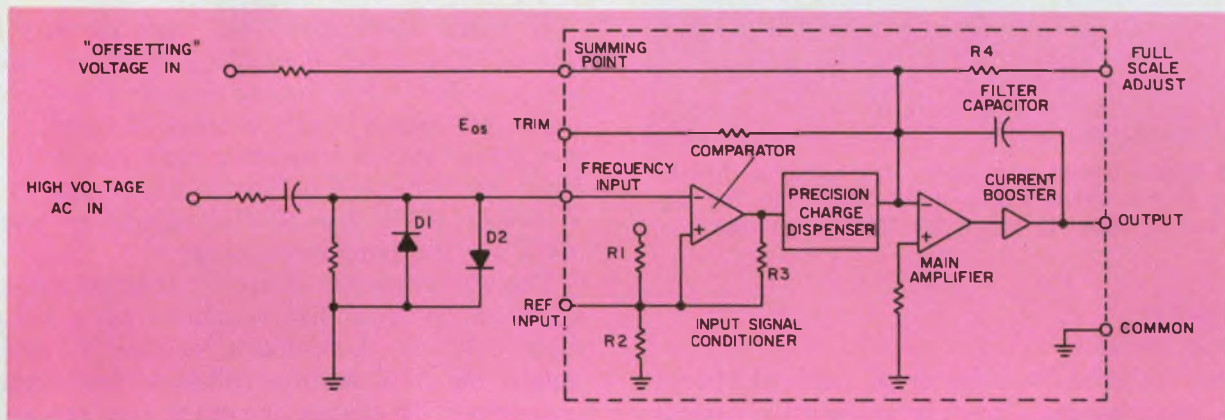

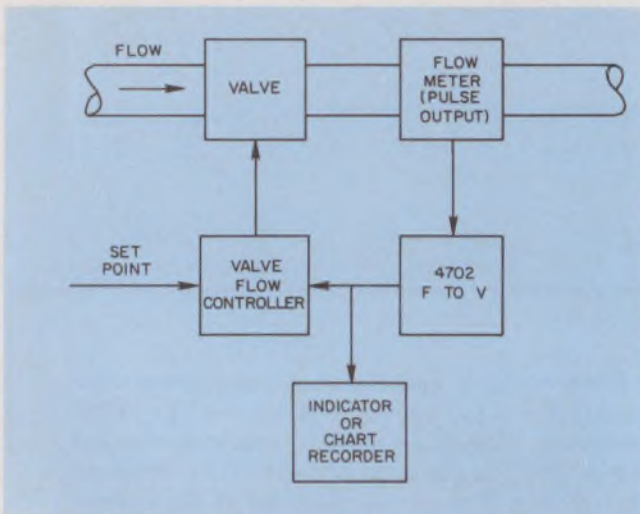

2. Different types of flow meters can be connected to f/v converters in liquid or gas-flow control systems.

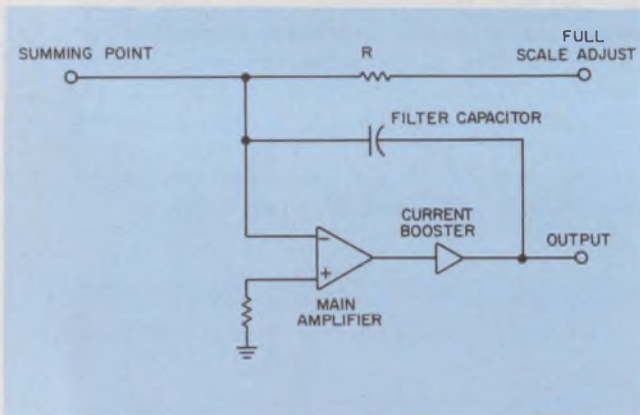

3. The output circuit of a typical f/v converter has an op amp that is connected as a low-pass filter. The amplifier can be offset to adjust the frequency range.

- Optical.
- Piezoelectric.

These transducers, with or without additional signal conditioning, provide compatible inputs for f/v converters. Whether the transducer output waveshape is sine, square, triangular, narrow-pulse or even random-noise, the f/v converter can be easily adapted to the requirements. A simple application is a closed-loop motor speed control (Fig. 1).

Another important application for f/v converters is in systems for fluid flow measurements. Many flow transducers provide pulse information as a linear function of flow rate. Examples include the following:

- Turbine, in which a variable-reluctance magnetic pickup produces a pulse train from moving vanes on the turbine shaft. This device is much like the rpm sensor.
- Acoustic doppler, in which electronic circuits produce a difference signal that can be handled easily by f/v converters. This tech-

nique often measures very low or very high flow rates without obstructing the flow path.

- Fluidic, which produces a frequency that is a function of mass flow and is said to be as accurate as differential pressure transducers.

- Vortex shedding, which produces a frequency output caused by a turbulent vortex that forms around a taut wire or other obstruction in the flow path. The signal created is usually sensed by a piezoelectric microphone transducer.

Many of the applications for sensing flow are process-control oriented and part of feedback systems. The circuit of Fig. 2 shows an f/v converter connected in such a closed-loop control system.

### Customize converters for applications

Because of the many measurements possible with f/v converters, the odds are that the range you need isn't available in an off-the-shelf design. In your application, the input to the converter may be a full-scale frequency of only 5000 or 100 pulses per second instead of the 10,000 (full-scale) specified on the data sheet of a moderate-precision f/v. You can, though, take full advantage of the full 0-to-10 V (or  $\pm 10$  V) converter output by offsetting or expanding the scale.

In many applications the rpm or flow only varies by a small percentage from a nominal value. A flow meter might produce 6000 to 8000 pulses per second over the range of interest. You can offset an f/v converter that has a 10-kHz input and 0-to-10-V output to produce a 0-to-10-V output for a 5-to-10-kHz input—or possibly  $\pm 5$  V for the same input range.

The output circuit of an f/v consists essentially of an op amp that functions as a low-pass filter (Fig. 3). A feedback resistor, R, sets the output for 10 V when a full-scale frequency, K, is inputted. To change the scale, just replace the resistor with a value that can be calculated from this equation:

$$R_{(new)} = KR_{(old)} / f_{(new)}$$

You can also offset the output voltage by treating the summing point as a normal op-amp summing junction and then feed an offsetting voltage to it through a series resistor. If, for example, the input signal varies between 5 and 10 kHz, first find the value of R for a 5-kHz full-scale input (10 kHz - 5 kHz = 5 kHz).

Next feed a -10 V offset to the summing junction of the op amp through a resistor that is equal in value to resistor R. This produces an output of 10 V for an input of 5 to 10 kHz. To obtain  $\pm 5$  V as an output, use an offset of -15 V through the summing junction.

F/v converters also find application in the audio field. They can produce a semi-log plot of

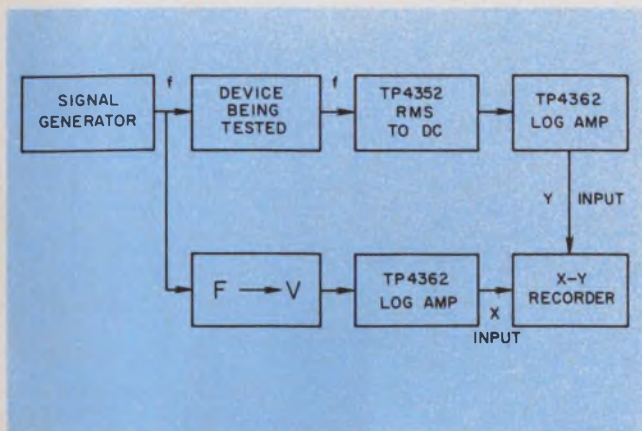

4. A simple test set can be built from an f/v converter and several log amps. Plots of output frequency vs voltage can be obtained.

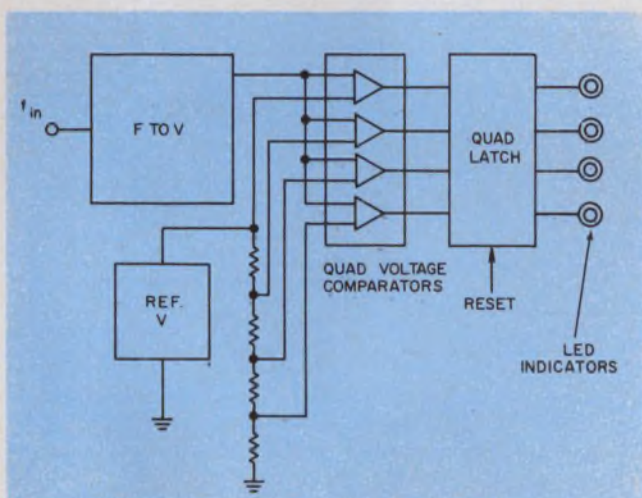

5. Building a multifrequency alarm system is simple when you use an f/v converter and a quad comparator. The comparator outputs can control indicators.

frequency vs amplitude for an amplifier or speaker (Fig. 4). An f/v and a log amp can be used over any frequency range from near dc to the converter's maximum. The same basic system of Fig. 4 can be used in vibrational analysis if a shaker stand and vibration pickup are used instead of a signal generator.

Wow and flutter measurements for high-quality magnetic tape recorders and turntables are also possible with the f/v. The converter can detect the change in frequency from a known, precise crystal source when the recording is played back. The converter output can be offset so that the recorded frequency provides a zero output and the maximum deviation expected becomes the full-scale output.

F/v converters also double as precision FM demodulators. They can be set to produce a zero output at the center frequency and to deliver a 10-V signal at the maximum deviation. A very similar application uses the f/v as a broadband

analog frequency meter or frequency monitor and alarm. The alarm could consist of several preset voltage comparators that drive logic circuits or indicators (Fig. 5).

#### Use v/f's to reverse the process

The v/f converter is just as versatile as its cousin the f/v. The simplest application is as a variable frequency pulse generator. All you need is the converter, a  $\pm 15$ -V power supply and a frequency-adjustment potentiometer (Fig. 6a).

The useful frequency range of this type of pulse generator depends upon the converter's characteristics and the resolution of the pot. Of course, you can use more precise converters and higher-frequency units to get more accurate outputs and wider dynamic range. By replacing the simple pot with a linear multiturn digital pot, and by adding a unity gain voltage follower between the pot and v/f, you can get three-decade settability, since many v/f's are more linear than the pots that control them.

Fig. 6b shows the full circuit with a precision voltage source and a vernier frequency adjustment that provides an extra two decades of frequency range. The vernier input, controlled by resistors  $R_1$  and  $R_2$ , feeds the current input of the v/f. The buffer amplifiers ensure that  $R_2$  and  $R_3$  are not loaded and thus don't degrade linearity.

Resistors  $R_1$  and  $R_2$  should be set to approximately 1000 times the value of the input resistance to the v/f. Trim  $R_1$  so that the same frequency appears at the output when the decade dials read 000 999 and 001 000 (for  $R_2$  and  $R_3$ , respectively). An extra three-decade divide-by-10 circuit enhances low-frequency resolution.

You can feed a ramp or sawtooth waveform into a v/f converter to get a swept-frequency signal generator. The input voltage waveform can easily be generated by analog or digital techniques.

For computer control of the v/f, just feed the digital signals into a digital-to-analog converter. The d/a, in turn, feeds its analog output into the v/f.

Long-time-constant integrators can be built if the output of the v/f is connected to a counter and the counter output is fed into a d/a converter (Fig. 7a). The resulting output is the integral of the input. This method is simple compared with the problems of designing and building a 1000 or 10,000-second integrator. To build such a circuit with linear op amps requires precision devices with ultra-low bias currents, ultra-low-leakage, low-soakage capacitors and very-high precision resistors. And all of these must have low temperature coefficients.

An outstanding feature of the digital inte-

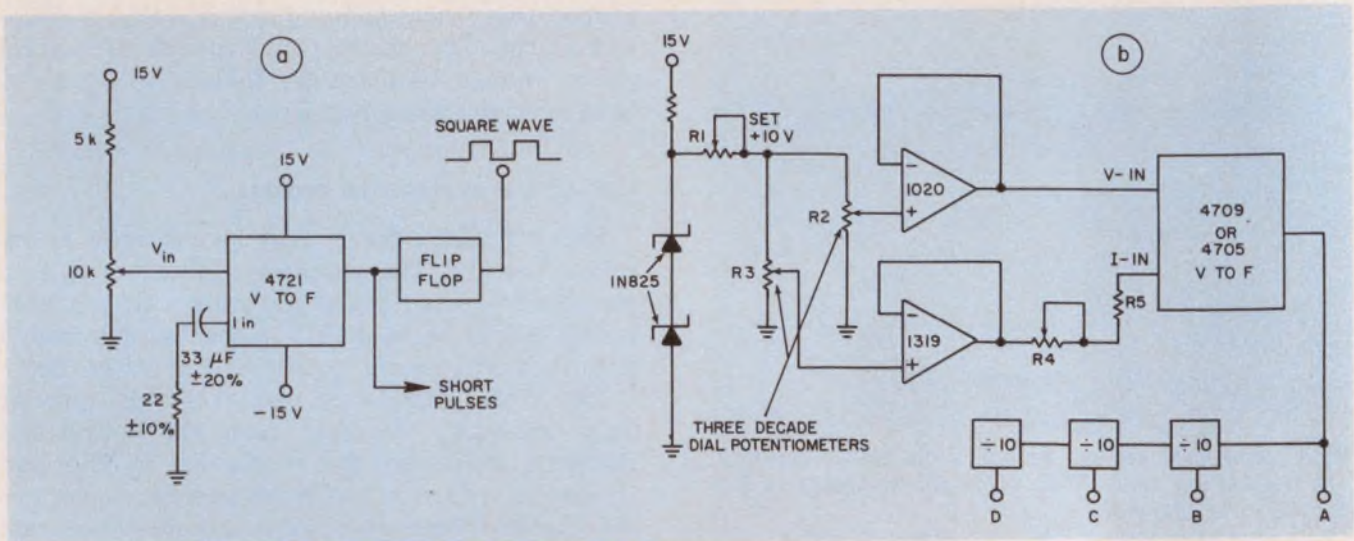

6. Build a simple variable-frequency pulse generator (a) that uses a v/f converter. By modifying the circuit and

using decade potentiometers, you can increase the resolution to six decades (b).

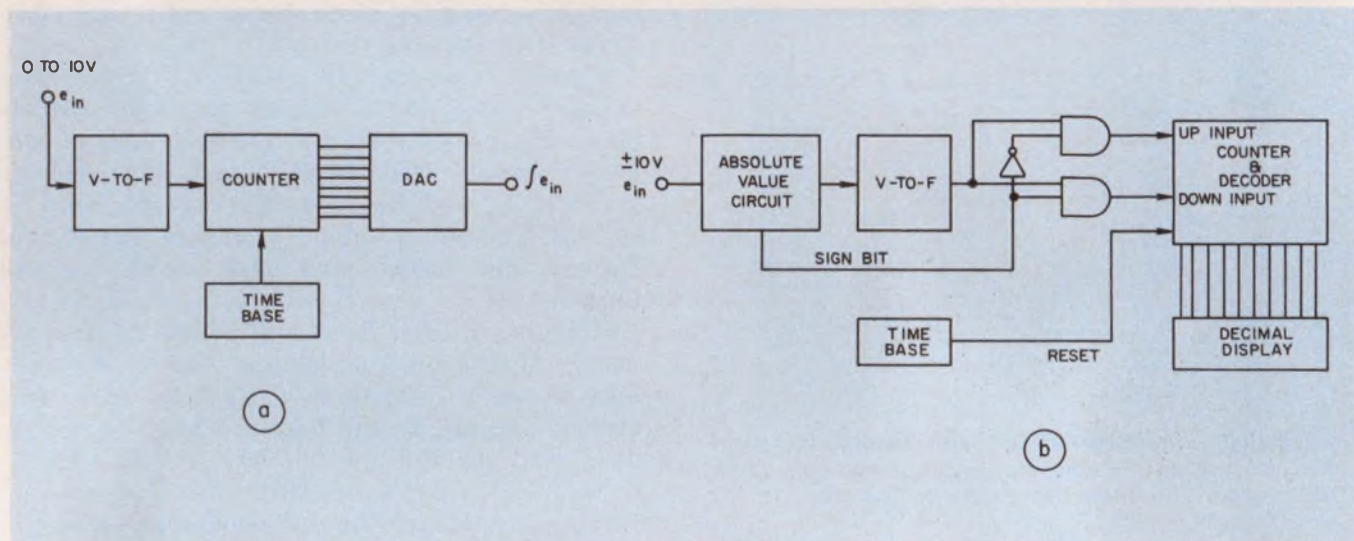

7. A v/f converter combined with a counter, time base and d/a converter makes a simple integrator (a). By

eliminating the d/a and using an up/down counter, you can build a simple integrating digital voltmeter (b).

grator method is its infinite-hold capability, which has no losses. Once the counter is stopped, the count remains stored until a reset pulse is sent. Linear circuits always have leakage paths that let the output vary with time.

Bipolar digital voltmeters can be built with a v/f converter, a time base and some counting logic (Fig. 7b). An absolute-value circuit can be placed in front of the v/f input to condition negative input signals and tell the counters whether to count up or down (up if the input is positive, down if negative).

This combination of v/f and counter forms an integrating digital voltmeter, especially if you use a binary-coded decimal display and BCD counters. This analog-to-digital conversion method can separate the counter and signal source over long distances, and it uses simple two con-

ductor wiring instead of 8, 10, 12 or higher conductor cable. Also, you can use optocouplers to provide high levels of circuit isolation and eliminate any ground potential problems between the converter and the processing circuit.

The simple cabling and the low cost of moderate-precision v/f converters (about \$20 in large quantities) make it economical to use a converter for each channel in a data acquisition system.

V/f converters have a unique overrange capability, which can range from 10 to 100%. With a chain of counters, any converter overrange causes the counters to overflow and to lose the most-significant bit. But all other bits remain accurate. Thus you can have a digital voltmeter with up to 100% overrange capability at no extra cost. ■■

# Think Large. Think Small. Think Ise

Think our three jolly green giants for desk-top electronics. Our two pint-size pigmies for carry-in-the-pocket display designs. But don't stop there. Think low operating voltages, low power consumption, glass encapsulation all around, and wafer-thin thickness and dip clip pins for fast efficient mounting.

# itron<sup>®</sup>

## FG-159A2

ec = eb = 35Vp-p  
ic = 4.5mA<sub>p-p</sub>  
ib = 3.5mA<sub>p-p</sub>

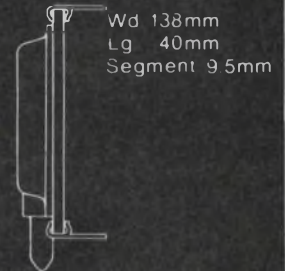

## FG-139A2

ec = eb = 30Vp-p  
ic = 3.6mA<sub>p-p</sub>  
ib = 2.8mA<sub>p-p</sub>

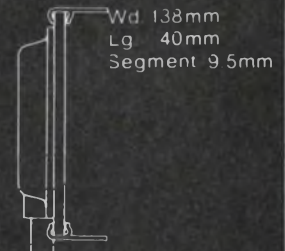

Our jolly  
green giants

## FG-99A2

ec = eb = 24Vp-p  
ic = 3.5mA<sub>p-p</sub>  
ib = 2.5mA<sub>p-p</sub>

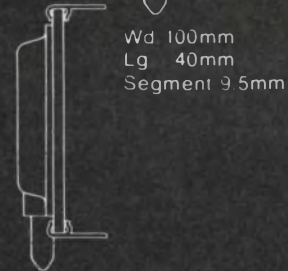

## FG-125A2

ec = eb = 24Vp-p  
ic = 2.0mA<sub>p-p</sub>  
ib = 2.0mA<sub>p-p</sub>



Our pint-size  
pigmies

## FG-95A

ec = eb = 24Vp-p  
ic = 2.0mA<sub>p-p</sub>  
ib = 1.5mA<sub>p-p</sub>

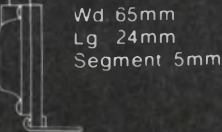

### Something else to think about

Think Ise for digital readouts for instruments, clocks and other products, too.

The Brighter Side of Electronics

## ISE ELECTRONICS CORP.

Main Office:

P.O. Box 46, Ise City, Mie Pref., Japan  
Tel: (05963) 5 2121 to 4 Telex: 4969523

Tokyo Office:

2-7-7 Shigashi, Shinbashi, Minato-ku, Tokyo, Japan  
Tel: (03) 433 6616 to 9 Telex: J26546

Noritake Electronics Office:

22410 Hawthorne Blvd., Torrance, California 90505, U.S.A.  
Tel: (213) 373 6704 Telex: 230674910

# Are buffered CMOS gates right for you?

They are when you can trade off the dynamic performance of unbuffered CMOS for improved transfer characteristics.

The best way to determine the relative advantage of newer buffered CMOS gates vs "traditional" unbuffered types is to compare ICs that use the same process and layout techniques. You'll then be able to judge the merits of each approach without being misled by supposed advantages that actually are due to differences in technology rather than circuit configuration.

This kind of comparison reveals that buffered gates are the preferred choice in applications requiring enhanced noise immunity, pulse-shaping and tolerance for slow input transitions. The costs for both circuit types are about the same, so either can be used for general-purpose CMOS logic. However unbuffered gates provide better over-all dynamic performance. Low-fanout propagation delays, for example, of less than 20 ns, can be obtained with a 10-V supply.

## Unbuffered gates use fewer devices

In the unbuffered CMOS approach, a minimum number of p and n-channel devices implement the logic function (Fig. 1). The size of individual transistors is increased to obtain the required output-current drive capability.

In the buffered method, recently adopted by several semiconductor manufacturers, a pair of inverters follow the basic gate structure and provide isolation between inputs and outputs. Only the output inverter sources and sinks output current.

The unbuffered gate circuit selected for comparison—the SIL4001BE quad two-input NOR gate—represents one of the basic circuits available from Siltek and other manufacturers of the widely available 4000-series CMOS family, which was originally introduced by RCA. The selected buffered gate is the SIL4901BE, a pin-compatible alternative for the SIL4001BE that uses a buffered, triple-inversion circuit. Although only one gate function is compared, the over-all results apply equally well to both NOR and NAND two,

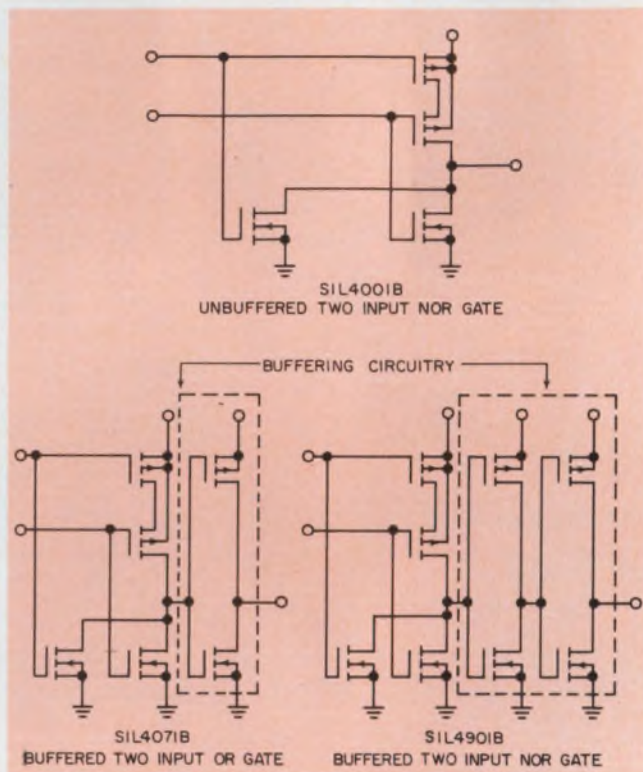

1. Buffered CMOS gates contain a pair of inverters that follow the basic circuit. The inverters isolate the input from the output and provide output drive.

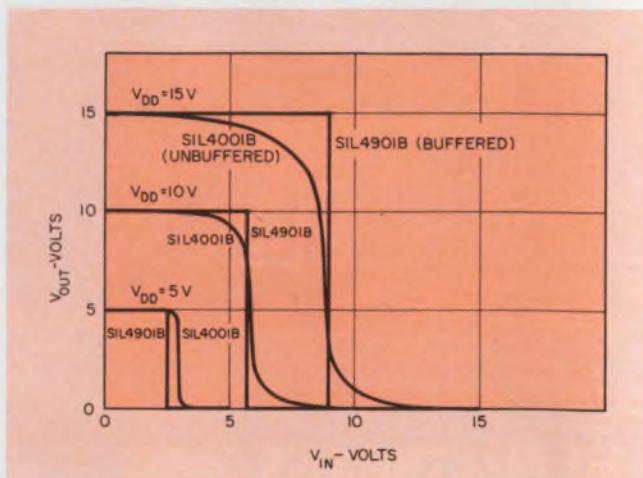

2. Nearly ideal transfer characteristics are offered by buffered gates. Hence they provide higher noise immunity than unbuffered circuits.

**Roger T. Griffin**, CMOS Applications Manager, Siltek International Ltd., Airport Industrial Park, Bromont, Quebec, Canada JOE 1L0.

three and four-input logic functions in the series.

The buffered circuit has a 7% smaller chip size, than the unbuffered unit. This small size difference results in minimal cost difference between packaged circuits. Material and labor costs associated with assembly and packaging are much larger than the cost of the chip itself—at least when the IC employs standard aluminum-gate diffused technology. Hence cost isn't a selection factor.

The static characteristics of the two circuit types also exhibit relatively little difference. Both specify the same leakage current of 5  $\mu\text{A}$  maximum with a supply of 10 V for commercial-grade units. And both circuits can source and sink the same output currents by suitable choice of channel-width-to-length ratio in each case.

### Noise immunity—a major difference

Only input-voltage noise immunity differs significantly. For a specified 3-V noise voltage at the inputs (with 10-V supply), the buffered-gate output has a guaranteed level of less than 1 V (logic ZERO) compared with 2.9 V for the unbuffered gate.

The buffered structure offers almost ideal transfer characteristics when compared with those for the unbuffered gate (Fig. 2). With increasing input voltage, the buffered-gate output remains at  $V_{DD}$  all the way to the switching threshold. Then the output switches rapidly to  $V_{SS}$ . Also, a buffered-gate structure inherently has a very high voltage gain.

The high gain improves output transition time when slow-transition signals are applied to the input (Fig. 3). For an input transition time of 10  $\mu\text{s}$ , the output transition of the buffered circuit exceeds that of the unbuffered gate by a factor of 30.

Moreover the buffered gate uses less power when input signals have slow transition times. The smaller input transistors of the buffered circuit permit less current to flow from  $V_{DD}$  to  $V_{SS}$  during the part of the input transition when both n and p-channel devices are conducting (Fig. 4). With input transitions of greater than 5  $\mu\text{s}$ , dissipation reduces by a factor of 5. With transitions of less than 100 ns, however, power dissipation remains essentially the same in both circuits.

### Delay—a minus for buffered gates

The extra stages in buffered gates increase propagation delay—the major disadvantage of these circuits. However, since the circuits are designed to meet a standard output-drive specification, output transition times are the same for both circuit types (Fig. 5).

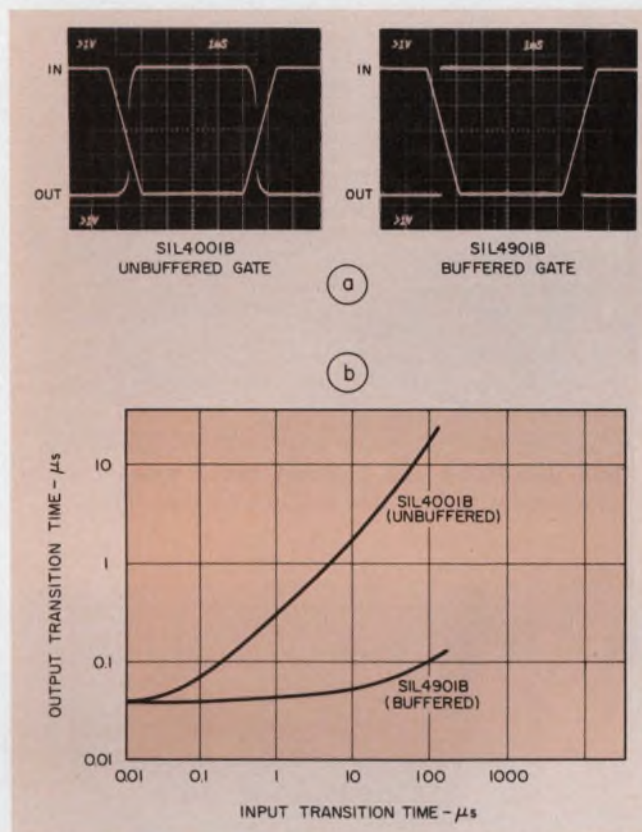

3. Buffered gates have the higher tolerance to slow input transitions (a). The improvement extends to input transitions that are shorter than 100 ns (b).

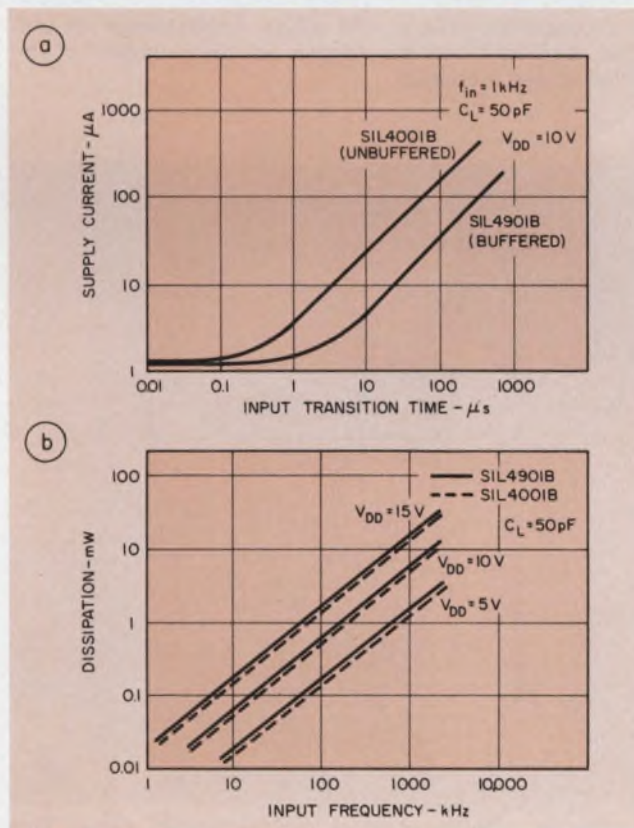

4. Power drain is less with buffered gates for a wide range of input transition times (a). However power dissipation with fast input edges is essentially the same (b).

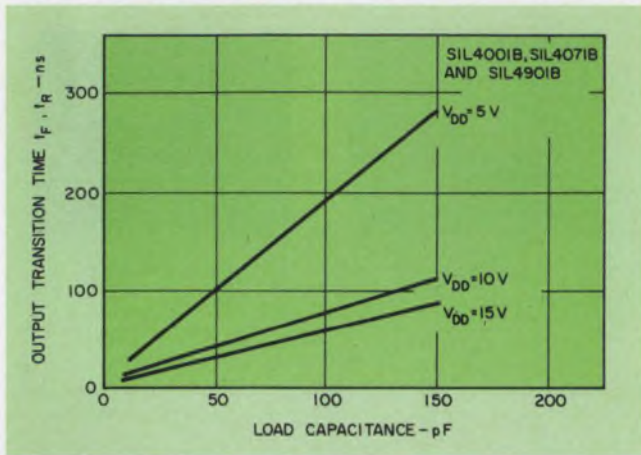

5. Both unbuffered and buffered circuit types can be manufactured with the same output transition times.

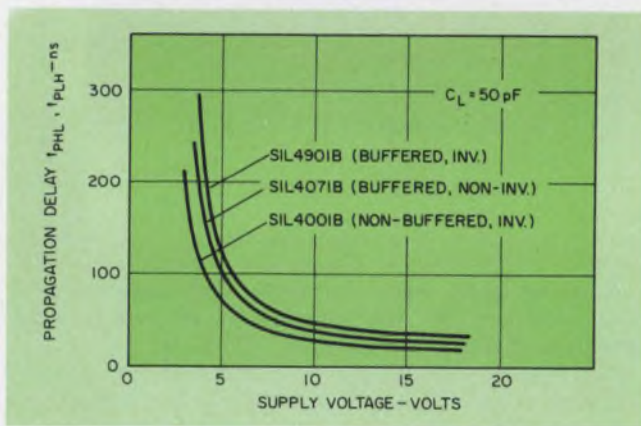

6. Propagation delays—the major disadvantage of buffered circuits—become longer as the number of inverter stages increases.

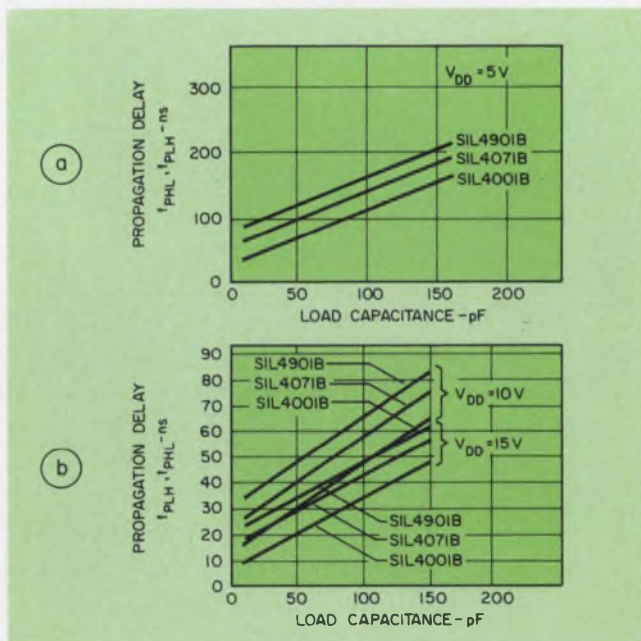

7. Though unbuffered gates exhibit smaller delays than buffered circuits do, the difference depends on supply voltage. At 5 V (a) the difference is much higher than at 10 and 15 V (b).

But propagation delay strongly depends on the number of inversions between input and output (Fig. 6). Propagation delay falls from about 120 ns for the triple-inversion SIL4901BE to 100 ns for the double-inversion SIL4071BE, and to 70 ns for the SIL4001BE at 5-V supply and with a 50-pF load. However, the delay difference at higher supply voltages is considerably less: 48, 40 and 30 ns, respectively, at 10 V; and 34, 28 and 20 ns, respectively, at 15 V. Similarly Fig. 7 illustrates the variation in propagation delay with load capacitance.

### Applying buffered gates

Like unbuffered CMOS gates, buffered types are offered in inverting and noninverting forms for a host of applications (Fig. 8).

An astable circuit, for example, depends for its operation on the fact that the capacitor charges via the resistor up to the threshold of the first gate (Fig. 8). Then the output switches to logic ONE. Thus the voltage at the resistor-capacitor junction increases rapidly until it is clamped by the input diode of the first gate. Subsequently the resistor-capacitor junction discharges until it again reaches the threshold of the first gate, so the output switches to ZERO.

Use of a buffered gate results in very fast transitions at the output, even if large values of resistance and capacitance produce very long input transition times. Hence the output can be used directly without need for additional gates to "square up" the output waveform. Power dissipation is also reduced considerably, especially when the circuit is designed to operate at low frequencies.

The monostable circuit functions on a similar principle (Fig. 8b). The negative edge of the output of the first gate causes the resistor-capacitor junction to swing below the threshold of the second gate. The output pulse width depends on the time it takes the capacitor to charge back to the threshold. Again, use of a buffered gate results in an output pulse with sharp transitions, so that no further pulse shaping is necessary and power dissipation is reduced.

Use of a noninverting gate yields a method of obtaining hysteresis in the transfer characteristic (Fig. 8c). This type of circuit depends on the fact that the input-resistor junction lags the input waveform until the threshold of the gate is reached. At that time the output changes state. Positive feedback via resistor R<sub>i</sub> then causes the input-resistor junction to lead the input waveform. Since only one noninverting gate is necessary, this technique provides an economical method of increasing noise immunity and of interfacing to a slowly varying and noisy input waveform.



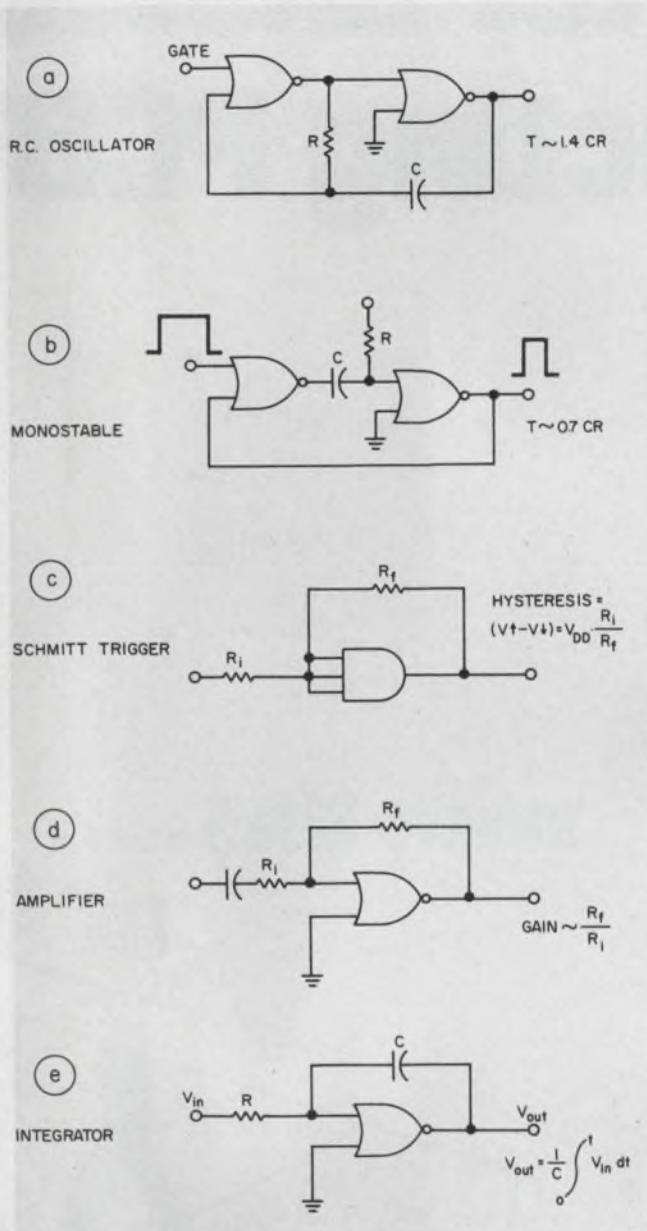

8. Buffered gates can be applied in most cases where unbuffered ICs are now used. In many applications, the use of buffered gates leads to lower power dissipations.

A simple voltage-amplifier circuit uses a buffered gate to obtain very high open-loop gain (Fig. 8d). The closed-loop gain then essentially equals the ratio of the resistors, so that the circuit can be used for such applications as a dc amplifier, summing amplifier or unity-gain buffer.

Care must be exercised to prevent oscillation caused by phase shift through the amplifier. Usually a stable circuit can be obtained by the addition of a capacitor between output and ground.

The integrating circuit (Fig. 8e) resembles that of the voltage amplifier. But it uses capacitive feedback to obtain an integrating function. Again, an external stabilizing capacitor is needed when a buffered gate is used. ■■

# TWO HEADS ARE BETTER THAN ONE.

Especially when they save you money.

Our unique Sycor 145 Dual Diskette Recorder costs considerably less than two ordinary IBM compatible single-head models.

But price isn't the only reason our recorder is head and diskette above the crowd.

Take storage. With the Sycor 145, you have four times the storage capacity of the usual single head recorder. Because its two heads have the capability of writing on either side of the diskette.

And when it comes time to access that data, our recorder is even more impressive.

Being 3740-compatible, the Sycor 145 handles the same 77-track diskette as other recorders, but its track to track access time of 2.5 msec is the fastest in the industry.

Four times faster than the others.

But don't just take our word for it. Check out the competition. Then look at the Sycor Model 145. We think you'll prefer ours.

Now that there's two sides to the story.

## SYCOR

Contact OEM Department, Sycor, Inc.,  
Ann Arbor, Michigan 48104. Telephone (313) 971-0900.

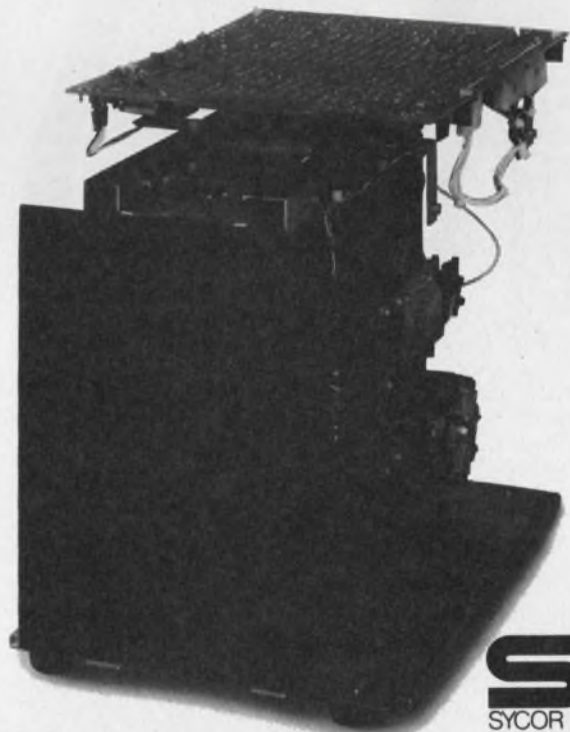

**SI**  
SYCOR INC

Internationally represented by  
Munzig International in London, Paris, and Geneva;  
by CORE, GmbH, in Copenhagen, Hamburg, and Frankfurt;  
by Mitsui & Co., Industrial Machinery Dept., Tokyo;  
and by STG International in Tel Aviv.

# Now! A better answer of connecting PCB's

replace this...

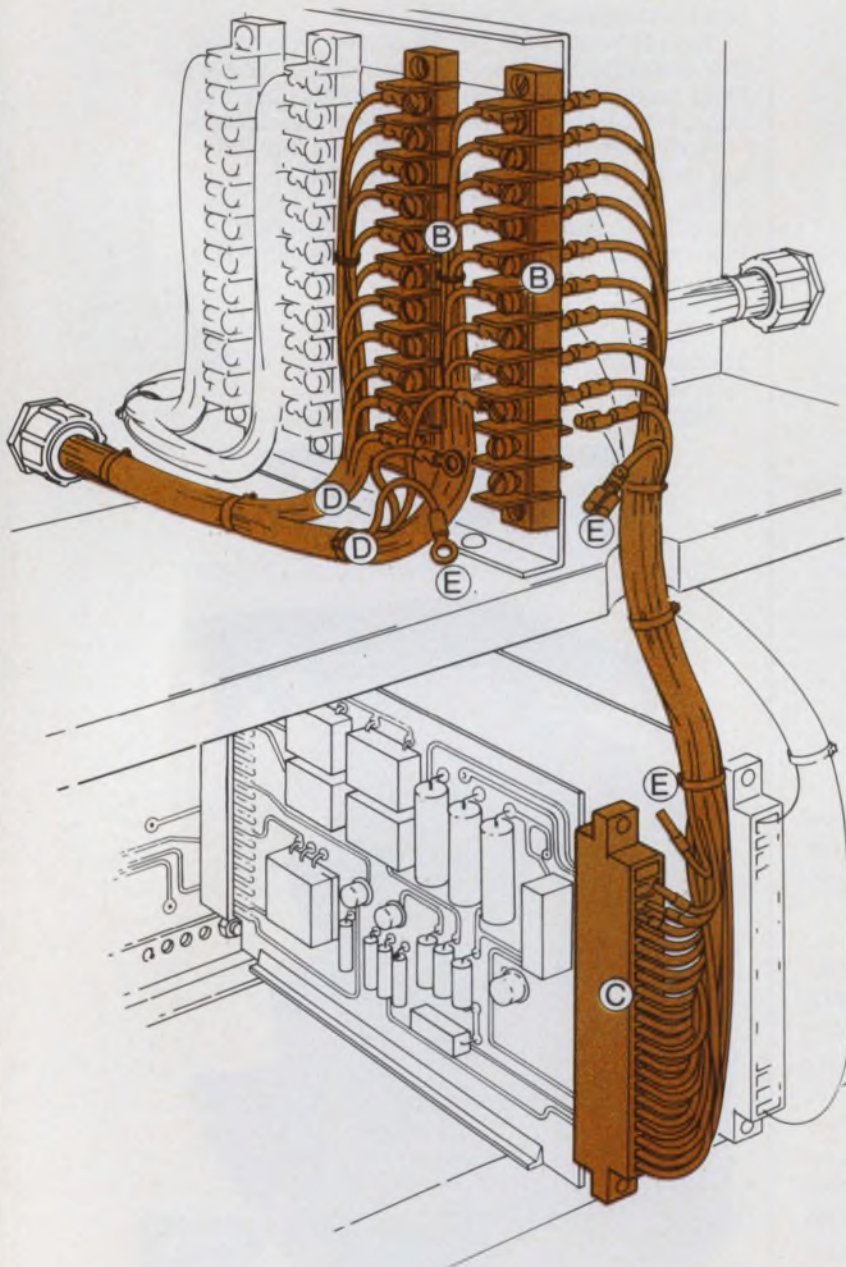

with this...

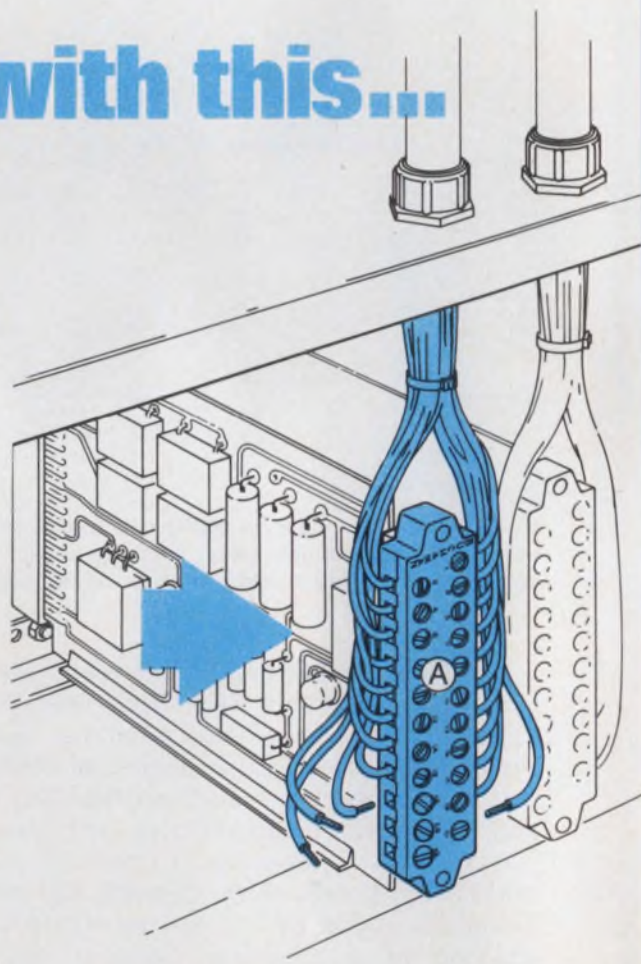

Just one Buchanan Printed Circuit Board Connector (A) replaces the two barrier strips (B), the edge card connector (C), the double wiring (D), and the 110 costly terminations (E) shown at left. Result: LTIC (Lower Total Installed Cost)!

# to the problem to the outside world!

## with **Buchanan**® PCB Connectors

- Accept unterminated wires from 12 through 30 AWG
- Save up to 5 connection points per circuit
- Eliminate barrier strips & terminal blocks
- Available for inside or through-the-panel wiring
- Save time, money and cabinet space

If you're building control panels or other electrical/electronic equipment that uses printed circuit boards, here's a new PCB connector that's sure to give you LTIC (Lower Total Installed Cost)!

The new Buchanan connector eliminates hybrid interfaces between electronic circuitry and electrical connections. It replaces terminal blocks and barrier strips and the costly wiring between them and internal electronics. Actually saves you up to 5 separate connection points per circuit!

The unique screw terminals accommodate unterminated solid or stranded wires, #30 through #12 AWG. Models are available with .156" or .200" (.508 cm) centerlines; for up to 43 10-Amp circuits; and for inside panel or through-the-panel mounting. Many carry UL component recognition for field wiring.

For complete engineering and ordering information, use the Reader Service Card. Or, call one of our Factory Regional Offices shown below. They'll also be happy to talk to you about special configurations.

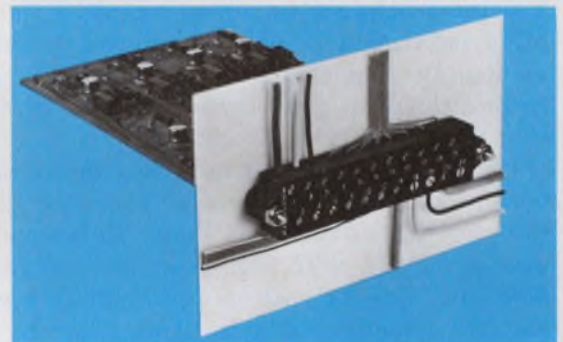

*Models available for surface or through-the-panel mounting, with or without card guides and keys.*



**CONTROL PRODUCTS  
DIVISION**

Amerace Corporation  
Control Products Division  
Union, New Jersey

# Measure CRT spot size to pack more information into high-speed graphic displays. You can do it accurately with the vernier line method.

Engineers who design systems using high-speed graphic displays need new, more accurate techniques to determine the information capacity of the displays. One such technique is the vernier-line method, which offers repeatability of 1.5%, compared with up to 30% for other methods. And most laboratories already have all of the required equipment. However, since vernier accuracy depends greatly on the concentration of the test engineer, the repeatability is gained at the cost of human fatigue.

Another thing a designer wants is the sharpest possible contrast for each character to minimize fuzzy edges. Ambient lighting, reflection shielding, the phosphor, trace sharpness—all affect contrast and make it tough to measure. So better methods are needed to measure this parameter, too.

High-speed graphic displays position a spot to a point on the screen, then “paint” a line to another point. The amount of information that can be legibly displayed in a given area is directly proportional to the observed width of the line that makes up each stroke.

Classical methods for measurement of spot size or line width do not perceive phosphor illumination as the human eye does. Historically spot size is defined with spot-scanning techniques at 50% of the brightness amplitude, and with shrinking-raster methods, at 60% of the brightness amplitude.<sup>1,2</sup> This gives an indication of information display capability, but it does not measure what the eye really sees—8% of the brightness amplitude. Thus a 100-foot-lambert line actually appears two times wider to the observer than the width given by spot-scanning or shrinking-raster methods.

## Flaws in classical methods

Classical techniques are also based on a gaussian distribution of the brightness of a spot, line, or raster. However, because of CRT lens aberrations,

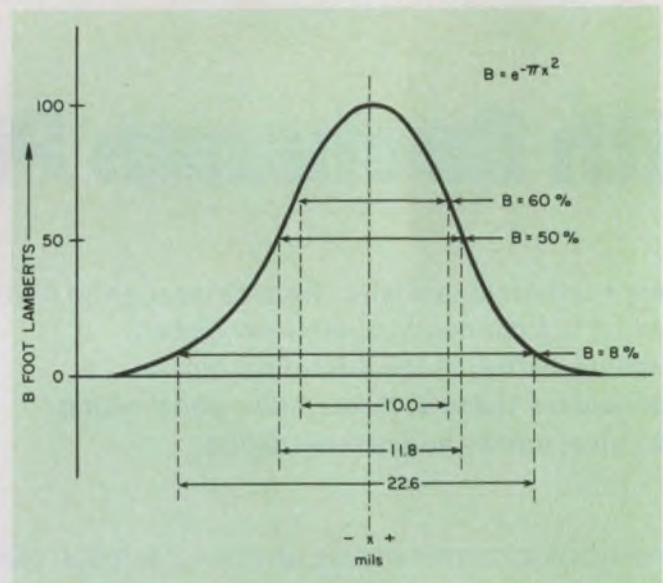

1. Brightness distribution across the width of a CRT spot or line: If the distribution is gaussian, the width at the 50%-brightness point will be 1.9 times less than the apparent, or perceived, width.

tions, the brightness distribution only approximates a gaussian function. The major flaw in the gaussian assumption occurs at the edges of a spot.

For a true gaussian distribution, the ratio of the width at the 50% point to the width at the base (or 8% point) must be constant. However, the aberrations in electrostatic lenses distort the distribution primarily at the skirts of the curve. The extension of these skirts has a minimal effect on spot-size measurements with shrinking-raster, spot-scanning, spatial-frequency, or modulation-transfer function techniques. But the eye will see the skirts of individual traces or of characters. Therefore, aberrations increase the observed spot size.

Since graphic-display users look at relatively widely spaced traces and characters, the display should be measured and designed around the observed spot size. Then, spot size must be determined at approximately 8%-of-the-brightness amplitude, not at the 50% specified with other techniques.

If the brightness distribution equals a gaussian

Bill Middlebrook, CRT Section Manager, Hewlett-Packard, Colorado Springs, CO 80907 and Mike Day, Engineer CRT Manufacturing, Sony Corp., San Diego Div., 16450 W. Bernardo Dr., San Diego, CA 92127.

function (Fig. 1) and has a peak brightness of 100 foot-lamberts (fL), the human eye will perceive a spot size 1.9 times greater than that measured at the 50% point, and 2.3 times greater than that measured with the shrinking-raster method (60% point). Measurement of the spot size at the 50% point gives an indication of information capability but does not measure what the eye really sees.

For example, with the spot size measured at the 50% amplitude point and the characters spaced accordingly, the viewer will see the lines run together. Brightness variations for lines positioned on the basis of the 50% point are illustrated in Fig. 2 and lines positioned by the 60% point are shown in Fig. 3.

Displays that use scanned TV rasters brighten or intensify certain areas in the formation of pictures. Each of the 525 picture elements per line and 525 line per frame overlaps into the adjacent element or line, resulting in the obscuration by the background illumination of brightness levels below the 50% point.

If a TV raster is merged with standard shrinking-raster techniques, the measured line width will be at 60% of the peak brightness if the brightness distribution is gaussian and the peak light output of an individual line is 100 fL. This can be traced to the ability of the human eye to resolve a difference in brightness of 3% at 100 fL.<sup>3</sup>

If the distribution becomes nongaussian, two points of mergence occur: one at the 60% point and another in the 80 to 85% region. The second mergence (80% point) will become more notice-

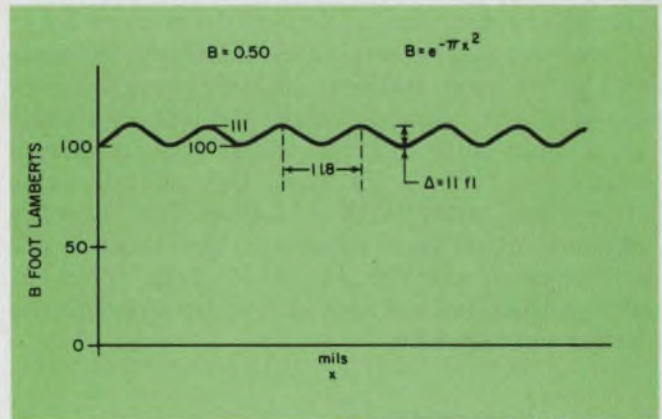

2. If characters, or lines, are spaced according to the width at the 50%-brightness point, the lines will appear to the eye to run together, or merge. Brightness variations for such spacing are shown as a function of width.

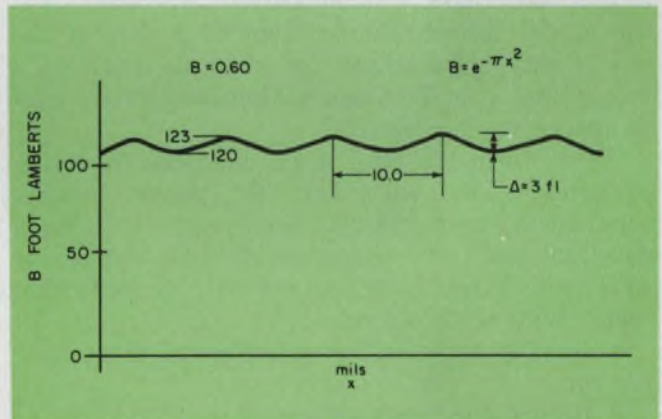

3. Brightness varies as shown when the 60% brightness points are used to define spot width.

## Other ways to measure CRT spot size

Existing methods to measure spot size include the traveling-microscope, the shrinking-raster and the modulation transfer-function techniques. These are in addition to the vernier-line technique.

The first technique maps the complete brightness distribution and the typical spot size is specified at the 50% point. To perform the test, position a fiber optic bundle at the focal point of a microscope and draw the bundle across the CRT screen. Light from the screen is amplified by a photomultiplier tube, amplified again, and then applied to a recording instrument.

The microscope technique is usually performed in the lab since

shifts in ac line power, movements on the measuring table and other variables can cause large errors— $\pm 20\%$  is not uncommon. Also, typical equipment costs are on the order of \$5000 to \$10,000.

In the shrinking-raster method, a raster of horizontal lines (50, 100, 250, etc.) is displayed on the CRT. With the desired number of lines displayed, adjust the vertical gain until individual lines can no longer be discerned. This mergence should occur at about the 60% amplitude point on the brightness distribution. If the brightness is nongaussian, a second mergence can occur at about the 85% amplitude point.

With the shrinking raster, it is

not always clear which is the correct mergence, and errors on the order of 30 to 40% are likely if the 85% point is picked. The technique, though satisfying TV-raster display requirements, does not allow measurements of severe beam aberrations on the skirts of the brightness distribution.

The third method—the modulation transfer function—is generally used in photographic work to measure lens aberrations. When used with a CRT display, this technique specifies the number of lines per inch at 50% of the brightness amplitude. To determine the 50% point, however, the raster generator or photometric technique is required.

able as the distribution departs from gaussian.

Spot size measurements should always be made under the same ambient lighting conditions as expected in the field. While ambient light acts as a bias and thereby offsets the measured brightness, it does not affect the absolute value of emitted light. With a darker than average ambient (100 foot candles), the human eye will observe a lower threshold light. This increases the observed spot size with respect to the darker environment.

### Simulate field conditions

In the vernier-line technique, the visual acuity of the human eye determines the width of a line painted on a CRT in its operating environment: under actual ambient lighting, with noise on input voltages, contrast filters, in place, phosphor effects, etc.<sup>4</sup> Spot size measured this way gives the actual information content of a display device. Fuzzy trace edges, for example, indicate a larger spot size. This means that characters must be spaced further apart.

To perform the test, you'll need the following equipment: dc voltmeter, dc power supply, square-wave generator, an oscilloscope with main gate and main sweep outputs, and an attenuator (Fig. 4). First, measure the display deflection factor with these steps:

- Display and position a horizontal trace near the top of the CRT.
- Record the input voltage.
- Position the trace near the bottom of the CRT and measure the distance the trace has moved.
- Record the input voltage.
- Determine the difference between the two input voltages and divide this voltage by the distance the trace moved. This gives the deflection factor in volts/cm or volts/inch.

Next, measure spot size:

- Apply a square wave to the Y-axis of the display and oscilloscope. The rise time should be about 1% of the horizontal sweep time.
- Adjust the horizontal gain of the display to position the square wave near center screen.
- Attenuate the pulse to position the top edge of the lower line and the bottom edge of the upper line as shown in Fig. 5. It may be necessary to cover the center of the display screen as shown in the figure, as the background brightness from one trace may blank out the skirt of the other.

Measure the pulse amplitude with the oscilloscope.

Divide the measured pulse amplitude in volts by the measured deflection factor of the display (V/in. or V/cm) to obtain the observed spot size.

Repeat this test a few times until the readings

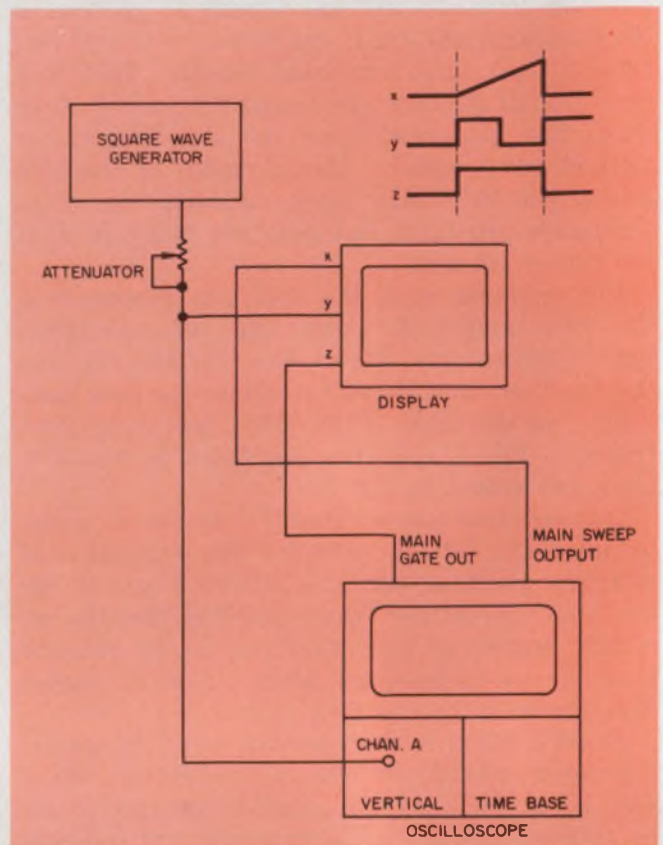

4. The vernier-line technique first measures the display deflection factor, then the pulse amplitude needed to bring two displayed lines colinear. Spot size is the ratio of amplitude to deflection factor.

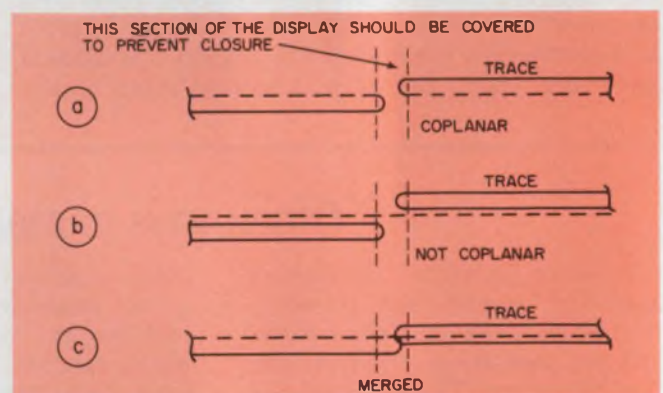

5. Traces must be properly aligned for accurate measurement. Correct position is shown in "a," while "b" and "c" show incorrect gapped and merged alignments.

can be repeated. A magnifying glass will improve the ability to resolve between proper and improper readings as shown in Fig. 5. ■■

### References

1. Sawtelle, Edward M., Gonyou, George W., "Dynamic CRT Spot Measurement Techniques," *Information Display*, July/August 1969, Barrington Publications, Inc.
2. Constantine, John M., "Two Slit Spot Analyzer," *Proceedings 7th National Symposium on Information Display*, Society for Information Display.
3. "IES Lighting Handbook," Fifth Edition 1972, Illuminating Engineering Society, New York.
4. Sherr, Sol, "Display System Design," Wiley-Interscience, New York, 1970.

# What Would You Call an Easy-to-Use, Low Cost, Portable, Flexible, Time-Saving, Four Channel Test Instrument?

Most people would call it unbelievable.

We call it the Bell & Howell® Datagraph Model 5-144, probably the most convenient test instrument you'll ever use.

With a frequency response of up to 10,000 Hz, the Model 5-144 records both analog and digital data with equal ease.

Four channels are available for viewing simultaneous events, such as timing sequences or multiple, inter-related functions.

The Model 5-144 contains all electronics needed to record information. There's no need to make special cables or calculate complicated damping networks. Just plug in your scope probes and record your data.

And after you've captured that data, the Model 5-144 provides a hard-copy for further examination.

In fact, think of it as a scope with a screen 200 feet wide.

Other user features include trace polarity reversal, ac or dc coupling, and three selectable timing reference line spacings.

Two choices of gridlines and ten recording speeds are also available.

Total weight for all of this capability is only 34 pounds.

For more information or a demonstration, circle the appropriate reader service number below or write the CEC Division of Bell & Howell.

The Datagraph Model 5-144 will make a believer out of you.

## CEC DIVISION

360 Sierra Madre Villa, Pasadena, California 91109

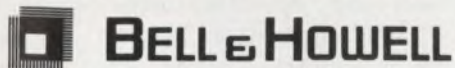

(In Canada: 125 Norfinch Drive, Downsview, Ontario M3M 3B5)

CEC is a registered trademark of Bell & Howell.

© Bell & Howell 1975

INFORMATION RETRIEVAL NUMBER 32



# Bill Walker of Tektronix Speaks on Getting Engineers to Work Harder and Enjoy it More



What makes engineers work harder or do better work? No monetary incentive, no bonus system, no profit-sharing plan, no stock option plan is effective in itself in getting people to work harder and do better engineering.

But if there is sufficient creative challenge, if engineers realize that they're carrying a vital load and can make a significant achievement for the company; then they'll show amazing performance. And they'll enjoy it.

**What motivates engineers to work hard is operating in a team context that sets difficult, but meaningful challenges.**

For engineers to realize their greatest potential, they must have goals that are meaningful and real in today's market, yet truly challenging to their creative and intellectual capacities.

Engineers tend to be conservative. When an engineer expresses certainty, you can pretty well rely on it, but you must also know when to ask for more. There are times when someone needs to say, "We can do a lot better than that," or "Here's what I think we can do." The motivation begins there. But you need to know what you're doing and where you're going. One of the problems we have is that the electronics business is not a place for the "professional" manager. The engineering manager has to be competent technically. He doesn't have to be more skilled in every facet than any person he manages. But he must be skillful enough to lead with imagina-

tion, as opposed simply to keeping the house in order.

The manager supplies that leadership when he talks with an engineer about his hopes for higher performance. It is he who must supply the belief that far-out objectives can really be achieved. If the manager does not have insight into what might be achieved, he has no basis from which to ask for extra achievement on the part of the engineer.

**This whole business is the challenge of making engineering exciting. That's the real motivation.**

Excitement will cause engineers to produce more by a factor of two or three than they would otherwise. The manager must help them with the idea—and the reality—that they are doing something vitally important.

I remember our 500-MHz oscilloscope, the 7904. One of our competitors was at WESCON in 1969 with a 250-MHz scope. That was 100 MHz faster than anything we had at the time. Well, we felt a little disconcerted about that. We had been busy with our 7000 Series. We were all



...tied up working on the four-hole plug-in concept, on new ICs that had to be developed and on a new CRT.

When we got back from WESCON, we sat down with some of our senior engineers. The essence of what was said was, "OK, our competition has us beat in bandwidth. What can we do? We could go up to 250 MHz and match them, or we could move a bit ahead to, say, 275 MHz. But we need to do a lot better than that. Can we do it?" We talked for many long hours.

We finally convinced ourselves that we should shoot for a 600-MHz scope in the 7000 Series. We decided that 600 MHz should be our target—with no holds barred. We knew our IC group was just getting off the ground and had never done anything with  $f_T$ s of this order. We didn't have the kind of traveling-wave CRT structure that would be needed. And at that time, we didn't have people with that kind of high-speed experience.

But we had the basic resources. And we sure had the engineers who knew about the problems you can run into with oscilloscopes as you approach that kind of speed. Oliver Dalton (presently manager of Laboratory Oscilloscopes Engineering), who always seems to get things right, warned that it would not come out that high, but we ought to shoot for 600 MHz anyway.

So we put together a high speed team that was absolutely first class. We had Val Garuts, who came out of our low speed, 500-kHz scope line. And we had Thor Hallen, who did an impressive job on the vertical, though he was a relative newcomer at the time, just out of college. Wim Velsink, who is now vice-president in charge of Tek Labs, took a major interest in the CRT design. The CRT group developed the smoothest helical deflection structure I've seen.

Dalton, who had plenty of experience, put the team together and made sure there were no major holes in the program as we went along. In a year and a half, at the 1971 IEEE Show, we announced the 7904, a 500-MHz bandwidth, 10-mV/div scope with 1-GHz direct access. That's not a bad compromise with the 600 MHz we originally shot for.

**The key here was inspiration. The engineers felt the need and challenge of new vistas; they wanted to achieve something beyond what had ever been done.**

We couldn't have done the job without such a turned-on crew. I know that Thor Hallen spent long periods at a time never leaving this place. He'd go three or four days with almost no rest. He's very intense about his work, anyway, but that's real dedication.

## Who is Bill Walker?



"I was destined to work for Tektronix," says Bill Walker. It started in the Air Force one day, when a dozen newly arrived Tektronix 511s generated a great deal of excitement. Walker found the staff people taking the sides off the scopes and admiring the workmanship.

"Boy, wouldn't it be something to work for a company like that," he said. It was after his wife's folks moved to Oregon that he learned that Tektronix was located there, so he needed no further confirmation that Tektronix was, indeed, his destiny.

He tried, but failed, to get summer work at Tektronix during his junior and senior years at the University of Missouri at Rolla, where he took his BSEE. He tried again after graduation, and didn't make it. So he took a job at Boeing in Seattle which, he felt, was pretty close to Portland. Within five months, in November, 1958, he got a job as an engineer with Tektronix. He's been there ever since, moving up the engineering ladder till, in 1969, he was appointed Vice-President, Engineering.

Walker has two main hobbies—tennis and flying. He owns a Cessna 172 and has been a Sunday flier for about eight years.

His son, Scott, is graduating from high school this year, and his daughter, Janice, is married and "back home" in Missouri. He's too young to have grandchildren, he says, though his wife, Lula Fay, points out that they're from the Ozarks, where folks marry when they're 13.

All the fellows, in fact, were determined that we weren't going to give up our leadership. They knew that if they didn't do the job, it would probably never get done, and that if they missed with this effort, or if they did it badly, our leadership could well be lost, and, with it, a significant piece of our marketplace. They took it as a personal mission.

From a management viewpoint, it then became a matter of making sure that the engineers had the necessary resources. We had to make sure, for example, that the integrated-circuits people understood the size of the bet we were making and would uphold their piece of it. They did and were a key factor in the success of the project. We had to be certain that other development people knew that this was a top-priority thing and that they were involved, too.

I helped select the people who were needed and talked with them about the importance of the project to us. How do you find them? Engineers tend to build reputations for themselves. We have more than 700 engineers, but word gets around about who the really hot ones are. I get to know the strong individuals. That's part of my job. All managers need to watch for the bright young engineers and not let them go unnoticed.

Our managers spend a lot of time talking to each other, too. We kick around what can be done by one manager who has the people another manager needs. You do run into problems where a manager doesn't want to give up his strong people for someone else's project. Everybody wants to build a strong team.

But we've evolved a culture in which managers talk about these things. We really encourage them to talk about their good people.

**Another problem you face when you try to inspire people to higher levels of performance is that you still have to maintain interest in your bread-and-butter lines. Unfortunately, they're usually not nearly as sexy as the more advanced technological products are.**

Bread-and-butter products keep you in business; they provide the money so you can work on the dramatic products for the future. So you need to maintain enthusiasm among the people working on them.

It helps sometimes to bring in new people to revitalize an old line. Let me give you an example. Back around 1965, we had an older series of low-frequency scopes, the 503/504 Series. A competitor brought out a nice, solid-state series. It wasn't a huge business—a few million dollars—but we didn't want to give it up.

Well, we had brought out the 5030 Series in

1968 and though these scopes were excellent, they were not cost competitive. Howard Vollum (Tektronix' founder and Chairman of the Board) agreed. He saw the need for a new low-cost line and visualized what it could be.

Rather than give the project to an existing group, we decided to put together a new group to achieve what we wanted. After much conversation between Jerry Shannon, Howard Vollum and me, we put together a plan and Jerry said, "A year from now we'll introduce the series." Shannon gathered several engineers and started working with the manufacturing people. The concept of the 5000 Series began to emerge. They developed a complete line of instruments that included plug-in versatility at nonplug-in prices. Within nine months it was obvious that Shannon and his group were going to make the goal.

I was talking to Howard about this later, and he commented that it was a miracle. In just over a year, Jerry introduced four mainframes and 13 plug-ins. I think that's kind of neat. Shannon's success came from one of the most inspired groups I've seen. Everyone from the people wiring and assembling the hardware to the design engineers felt they were part of an important team making a major contribution to the company. And they were.

**The ultimate question here is how to keep engineering people excited. We have to realize that an engineering project can extend from many months to several years—a long time to maintain any kind of effective motivation.**

You can't keep people going on the pep talk you might use with a football team that has to play for a few hours. The key is that you have to have something real.

It used to be a great game when the engineers working on the low-cost 5000 Series would go over to their counterparts on the 7000 Series, pick up some good ideas, then put them together in cheaper form. They'd joke with the 7000-Series people and show them how much less expensive the new 5000 Series time base was going to be, for example. So the competitiveness is part of the fun and part of the inspiration, too.

In every way, that spirit has to be kept going. Keep the competitiveness and the fun and the excitement alive and make the projects worthwhile to the people involved.

**Far more is accomplished when people are enjoying themselves than when management is leaning on them.**



Managers get together for a beer or coffee and rib each other about their projects. They talk about new achievements—how sharp a trace they have, or how little noise there is in this vertical amplifier compared with another. They needle each other all the time. We like that pride and *esprit de corps*.

You need to keep reminding your engineers that they are the best in the world. I keep putting it to our people that we are the ones who set the mark on the wall for our industry. Performance, price, appearance, weight, ease of use. These are the challenges that I like to keep in front of everyone. If we can't provide this leadership, someone else will. And if no one else will, then the whole world will slow down a little bit. So our role is very important and all the engineers are aware of it.

There's another thing we have to watch constantly. The environment won't sit still so I can't keep my organization stable. We continually have programs spilling over into another market area or another technology area. So I have to be willing to abandon an organizational structure. We must create environments in which we can change without a lot of insecurity.

An engineer does get concerned about status or position, and when you start switching organizations around, he will be nervous. He gets concerned about losing some prerogatives. When he gets a good team of people working for him, he hates to see some of them move off into someone else's group.

A certain amount of insecurity always goes

with organizational change. You have to nurture an environment that decreases people's insecurity about this kind of thing. Managers need to know that they'll be recognized not just for their own achievements, but for having developed strong engineers who move on to other areas.

You have to reward people not just for their own accomplishments, but for the potential they develop in others. You also have to remember who was responsible for which part of a project's development. Inevitably, when a product moves from one group to another, the second group begins to get the spotlight. Its people may take the product to its final form; then it's easy to forget who made the original contribution and who deserves additional recognition.

You have to make sure that people understand that you remember these things. There's still another aspect to this reorganizing aside from an engineer being deprived of due recognition. People tend to fall in love with a project. If you're doing everything else right, the engineer is really convinced that it's a very important project. If a project is taken away after a person has worked on it a couple of years, it's like separating a mother from her baby. The engineer needs to be told the overriding reasons and his manager must put forth the next new challenge.

Don't forget: engineers get emotionally involved in what they do, like you and me and everybody. Giving direction to these emotions and providing the challenge to existing aspirations are the keys to better management and more creative engineering. ■■

# Two for your budget.

Affordable spectrum analyzers that typically will make over 90% of your everyday frequency domain measurements. Easily. Accurately.

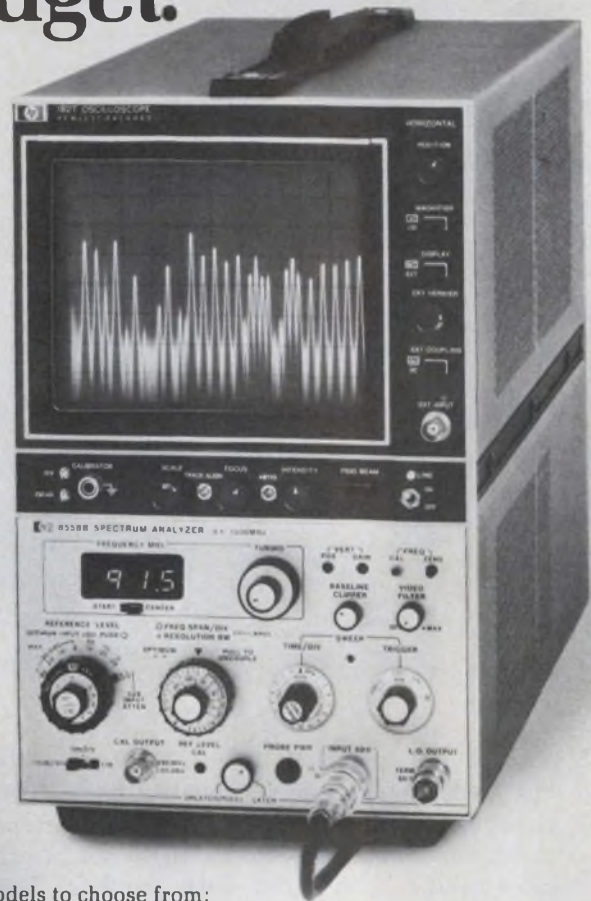
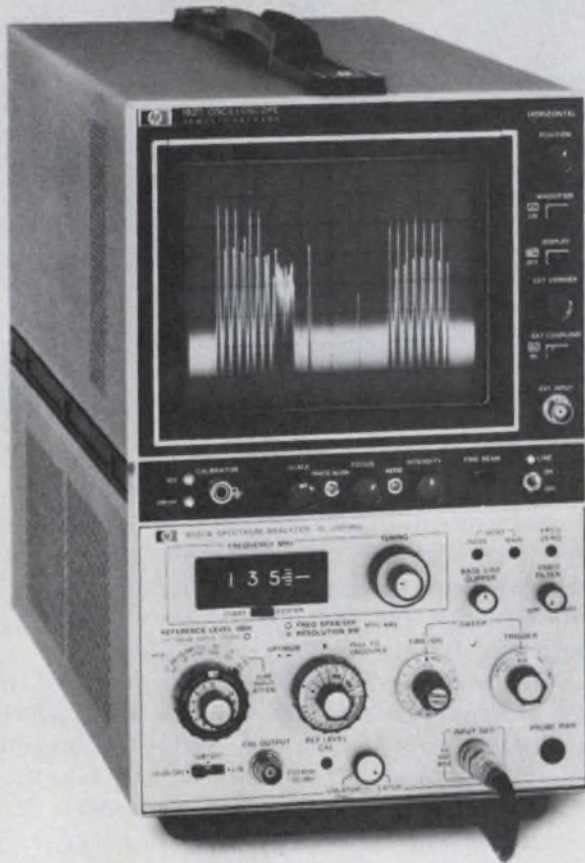

Two models to choose from; they're plug-ins for HP's versatile 180 Series Scopes.

Performance:	HP 8557A	HP 8558B
Frequency Range	10 kHz — 350 MHz	100 kHz — 1500 MHz
Amplitude Range	-117 dBm — +20 dBm	-115 dBm — +30 dBm
Frequency Response	±0.75 dB	±1.0 dB
Distortion-free Dynamic Range	>70 dB	>70 dB
Frequency Span Range	50 kHz — 350 MHz	50 kHz — 1000 MHz
Resolution Bandwidths	1 kHz — 3 MHz	1 kHz — 3 MHz
Price (Plug-in)	\$3450	\$4300

(HP 182T Large Screen Display Unit, \$1400.) Domestic USA prices.

Ease of use is another important feature of these HP Spectrum Analyzers. For most measurements you use just three controls:

1. Tune to the signal. Frequency is displayed on a digital readout.
2. Set the Frequency Span. View a wide spectrum then zoom in on your signal — resolution, sweep time, video filtering are all set automatically for optimum signal presentation.
3. Measure Amplitude Level. Read it directly from Reference Level control and CRT.

To help minimize chances for erroneous measurements, panel markings show optimum signal levels, and there's out-of-range blanking or limiting.

Economical for use on every bench, these analyzers provide the performance for over 90% of your everyday applications. This means they can relieve the need to use the more expensive high-resolution analyzer for routine measurement, with equivalent amplitude and frequency accuracy.

Want more information? Just call your nearest HP field office, or write.



Sales and service from 172 offices in 65 countries.  
1501 Page Mill Road, Palo Alto, California 94304

45506B

# Straight talk about IC sockets.

**I**ntegrated-circuit sockets are becoming such a household item, people are starting to forget something.

They're not all alike. And the differences can have a major impact on the performance and profitability of the products they're used in.

That's why we've decided to go over a few socket basics.

---

## THE REASONS... AND THE RISKS.

---

All sockets serve basically the same purpose: they allow you to replace ICs without damaging either the IC or the PC board. In so doing, they make both design changes and field service economically feasible for you and your customer.

There's only one problem. When a socket fails, troubleshooting can be a nightmare — to a point where you'd have been better off without sockets in the first place. So it pays to be sure that the sockets you buy are right for your application.

---

## CHOOSING THE RIGHT SOCKET.

---

Buying the right socket is much more than a matter of profile and price. It's matching the right one to the demands of your application.

For low-cost, high-volume products where the risk and consequences of socket failure are minimal — and where repeated IC insertion and high retention aren't required — buy the cheapest sockets that will do the job properly.

But for high-shock and vibration environments, or other situations where performance is critical, by all means get the best sockets money can buy.

At Augat, we understand these

differences. That's why we make sockets for both needs, in the widest range of sizes and specifications in the industry — from 6 to 40 contacts, on .300", .400", and .600" centers. These include low-profile, LED, and test sockets, socket carrier assemblies, and more — with PC, wire-wrapping, and solder pocket terminations.

And thanks to high-volume, automated production economies, these sockets are priced competitively despite many features you can't get elsewhere.

---

## SMALL POINTS MAKE A BIG DIFFERENCE.

---

It's amazing how the finer points of socket construction can affect reliability.

Take the material the contacts are made of. For repeated IC insertion and good retention no other material can match the beryllium copper used in all Augat PC sockets. Cost alone leads other producers to use other materials.

Designs vary, too. Among low-priced sockets, Augat's new low-profile series grip the IC lead along *both* flat sides, rather than by the edge, for best contact. And they'll take the full range of lead sizes, too.

Among premium sockets, Augat's Series 500 and 700 are the only ones in the world to include the two-piece machined contact assembly designed and perfected by Augat. While stamped "equivalents" abound, their looser tolerances have given

rise to a series of pitfalls avoided by the Augat design:

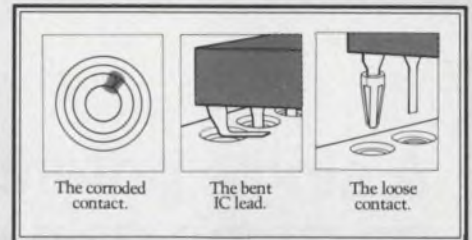

In the important matter of flow soldering, both series again provide a decisive edge. The closed-end construction completely eliminates the possibility of flux or solder wicking.

These distinctions may seem small. But taken together, they're a good indication of how well the sockets you buy will stand up under long-term use. And in a market flooded with lookalikes, they're something to shop for.

---

## A SUPPLIER YOU CAN COUNT ON.

---

As the pioneer and leader in the IC interconnection industry, Augat has always been the world's prime supplier of IC sockets.

Now, after completing a multi-million dollar program of vertical integration, we're better equipped than ever to maintain that position — by providing the best sockets, the best service, and the finest distributor network in the world.

For all the facts, send today for our new brochure. We're convinced that the more you know, the more you'll come to Augat for all your IC interconnection needs.

---

## YOU ONLY GET IT ALL FROM AUGAT.

---

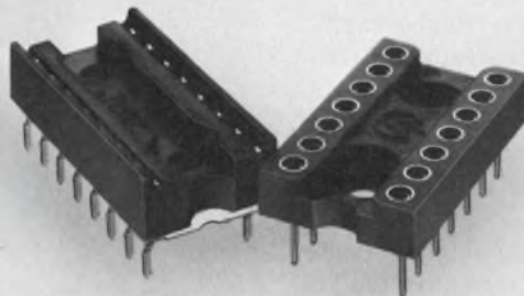

# AUGAT®

Augat Inc., 33 Perry Avenue, P.O. Box 779, Attleboro, Massachusetts 02703. Tel. (617) 222-2202.

Europe — Augat N.V., Boulevard A. Reyers, 103, 1040 Brussels, Belgium, Tel. (02) 7369399.

Japan — Kyokuto Boeki Kaisha Ltd., New Otemachi Bldg., 2-1, 2-Chome Otemachi, Chiyoda-Ku, Tokyo 100-91, Japan, Tel. (03) 244-3788.

Canada — A.C. Simmonds & Sons Ltd., 285 Yorkland Blvd., Willowdale, Ont. M2J1S8, Tel. (416) 491-1010.

## A single potentiometer adjusts op-amp's gain over bipolar range

An op-amp's gain level must often be adjusted over its full inverting and noninverting gain range. The simple circuit shown can provide bipolar gain control, and it uses only a single potentiometer. And the gain adjustment is linear—as linear as the pot used.

Pot  $R_3$  varies the signal applied to both the inverting and noninverting amplifier inputs. When the wiper position (denoted by  $x$ ) equals zero, the noninverting amplifier input is grounded. This also holds the voltage across  $R_2$  at zero, so  $R_2$  has no effect on operation. Now only  $R_1$  and  $R$  carry feedback current, and the amplifier operates at a gain of  $-n$ .

At the other pot extreme, where  $x = 1$ , the input signal is connected directly to the noninverting input. Since feedback maintains a near-zero voltage between the amplifier inputs, the amplifier's inverting input will also be near the input signal level. Thus little voltage is across  $R_1$ . Also now the gain is  $+n$ .

However, the amplifier input resistance varies with the pot setting, as does the feedback current drawn by  $R_1$ . This variation can produce a source loading error that looks like a nonlinear gain function. The amplifier should be driven from a low-impedance source to minimize this effect.

Trouble can also come from input offset voltages, since the inverting and noninverting amplifier inputs both boost any offset to double that of the conventionally connected amplifier. Thus the circuit should be used with low-offset op-amps.

*Jerald Graeme, Manager of Monolithic Engineering, Burr-Brown, International Airport Industrial Park, Tucson, AZ 85734.*

CIRCLE NO. 311

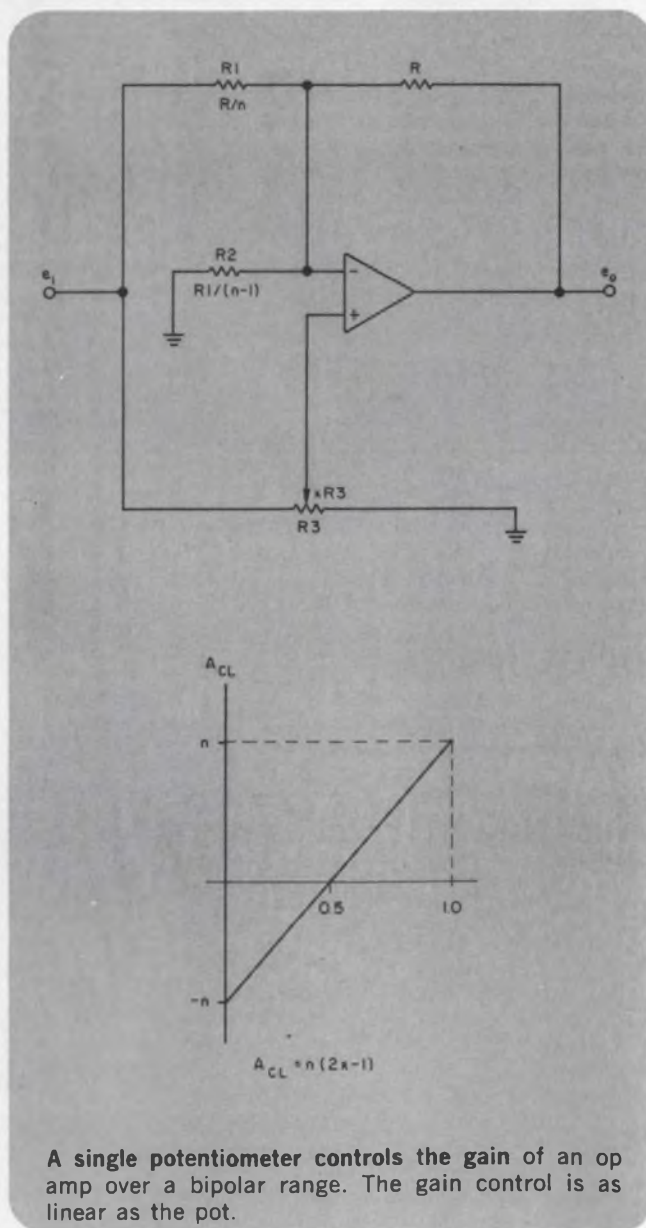

A single potentiometer controls the gain of an op amp over a bipolar range. The gain control is as linear as the pot.

# A new 310-Type 3. Made to take a fall.

The rugged new "drop-resistant," hand size Triplet Model 310, Type 3 is priced at just \$49.

The latest addition to the rugged Triplet 310, general purpose, multi-range V-O-M family—the Model 310, Type 3—has impressive new features. Its case and clear front are made of high impact-resistant plastic.

The low Ohms range Rx1 has been fused to protect against damaging overloads. These two improvements should eliminate over half of all repair requirements resulting from field use damage.

But that's not all. The case of the new Triplet 310, Type 3 sports an elegant new non-slip "finger-tread" surface finish. The meter movement brackets and pointer feature a new rugged design as well as newly designed lead jacks and Model 10 jack. Added to this, the front range and tester dial markings are changed to read easier when used with Triplet's Model 10 Clamp-on-Ammeter.

#### Outstanding features:

1. Drop-resistant, hand size V-O-M with high impact thermoplastic case.
2. 20,000 Ohms per Volt DC and 5,000 Ohms per Volt AC; diode overload protection with fused Rx1 Ohms range.

3. Single range switch; direct reading AC Amp range to facilitate clamp-on AC Ammeter usage.

The durable new 310, Type 3, self-shielded for checking in strong magnetic fields is an extra-rugged, high-torque, bar-ring instrument with spring back jewels. Interchangeable test prod fits into the top of the tester, making it a common probe and freeing one hand. All this for only \$49.

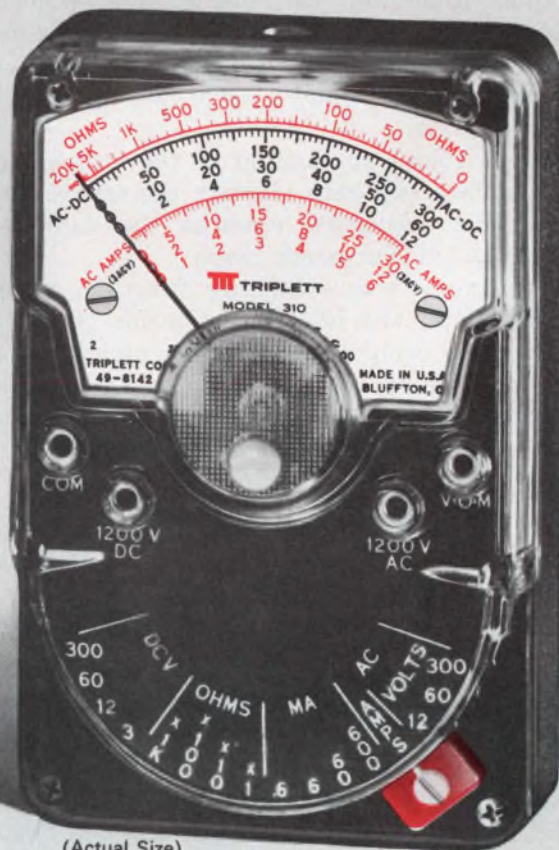

(Actual Size)

See for yourself. Try the new Model 310, type 3 V-O-M. Have your Triplet distributor or sales representative give you a free demonstration of this new tester. You'll be glad you did. So, do it today. Triplet Corporation, Bluffton, Ohio 45817.

**TRIPLET**  
ALL YOU'LL EVER NEED IN V-O-M's.

## Triplet. The easy readers.

INFORMATION RETRIEVAL NUMBER 35

# Combine multichart Karnaugh maps into single, easy-to-handle versions

Traditionally two separate Karnaugh maps are employed to minimize a five-variable switching function, VWXYZ (Fig. 1a). To provide a simpler and less error-prone approach, the two maps can be combined into a single map (Fig. 1b). Place corresponding values of WXYZ into sub-cells created by the diagonal division of the square cells.

In this so-called embedded Karnaugh map, the upper half of each square corresponds to the false value of the fifth variable, V, and the lower half to the true value. Logically adjacent terms are now also physically adjacent in the corresponding upper and lower-half sub-cells (Fig. 2).

Different colors or shading of the two halves of each square can help identify the terms. The minimization procedure remains the same as with traditional Karnaugh maps.

For a six-variable switching function, a cell is divided diagonally into four sub-cells (Fig. 3). Otherwise you would need four Karnaugh maps, which are difficult to work with. Logically adjacent terms, formerly scattered among four maps, are now located in neighboring sub-cells within a single square of the new map.

*Om Vikas, Senior Research Assistant, Dept. of Electrical Engineering, Indian Institute of Technology Kanpur, Kanpur-208016, India.*

CIRCLE No. 312

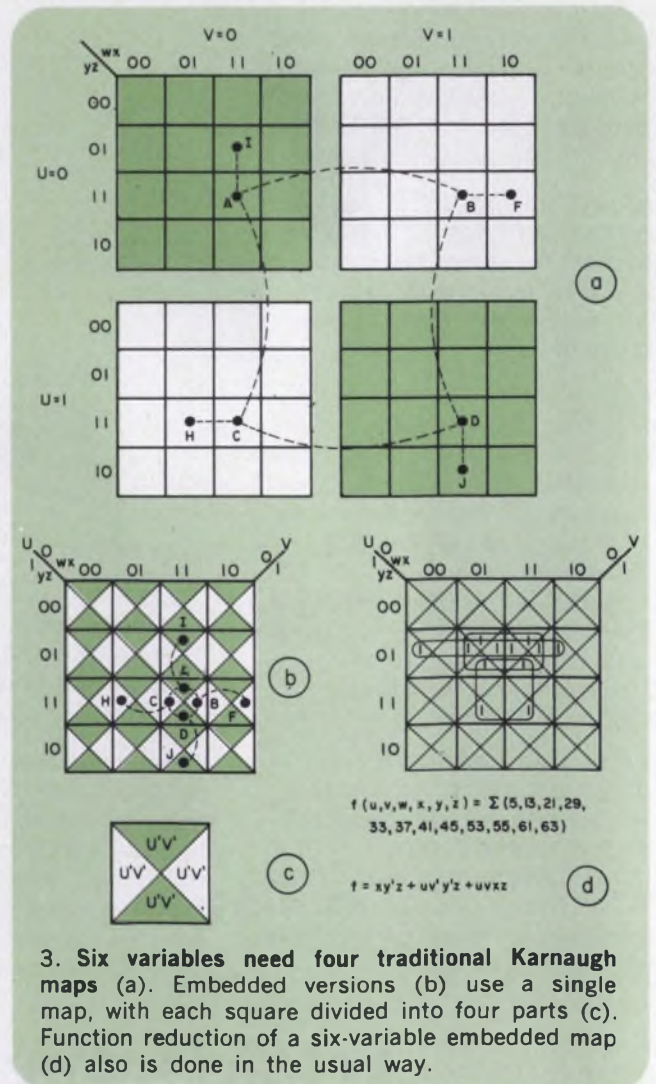
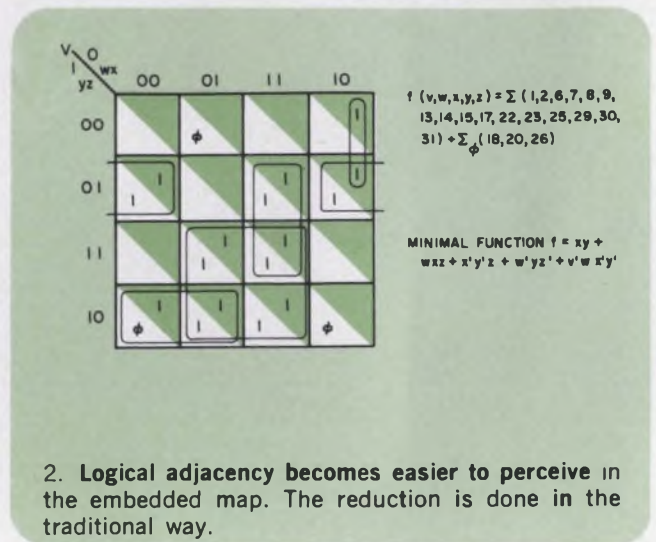
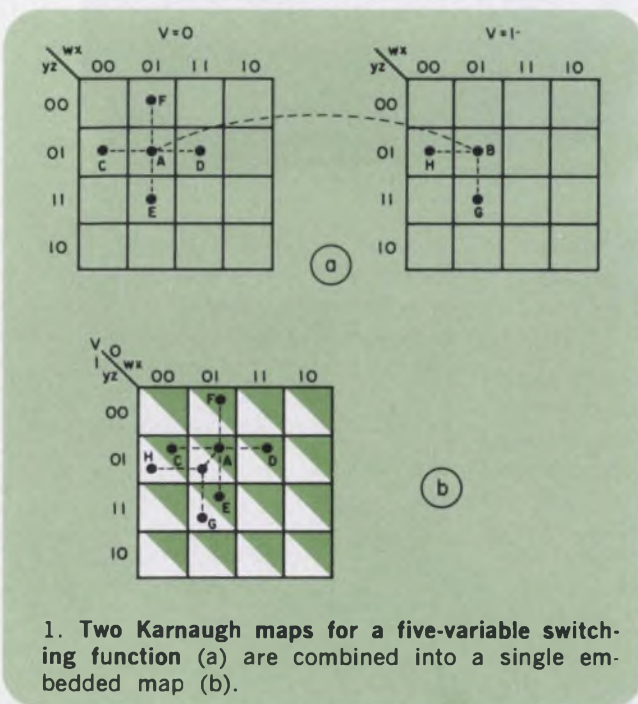



# New Resistor LED's from Xciton!

Lucky you! Now Xciton offers a real choice of 24 different resistor LED's. It's the world's widest resistor LED selection with the same high performance in all colors. Red, green, orange or yellow.

Choose direct drive from 5 volt or 12 volt logic supplies with a typical output of 1.6 mcd at 16 mA.

Xciton resistor LED's are available in three lens package styles, with diameters of .125 and .200 inch at these popular prices: 50¢ for Red, 60¢ for all other colors in quantities over 1000.

Please order by correct part number. Each part number is formed by choosing a lens style (XC209, XC5053 or XC22), followed by the voltage (5V or 12V) and ending with the color code (no symbol for red, A for orange, Y for yellow or G for green). Example XC209-5VY.

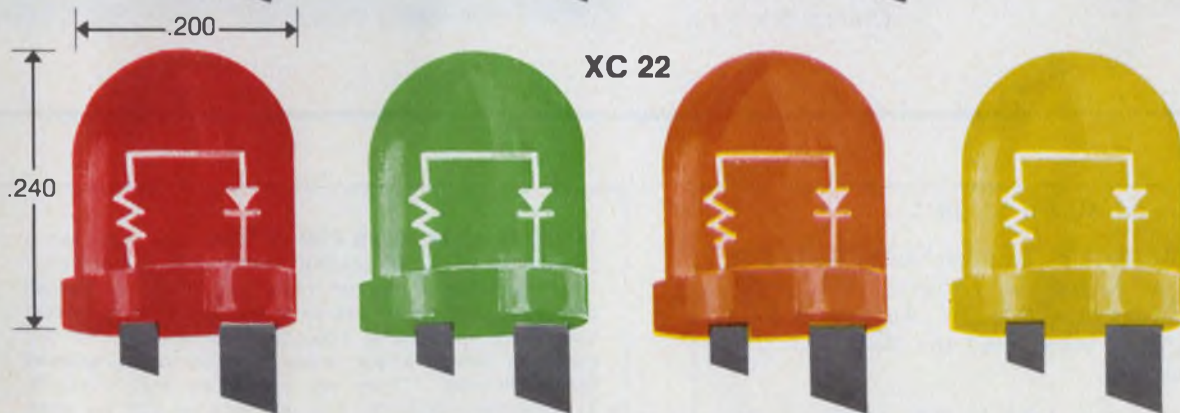
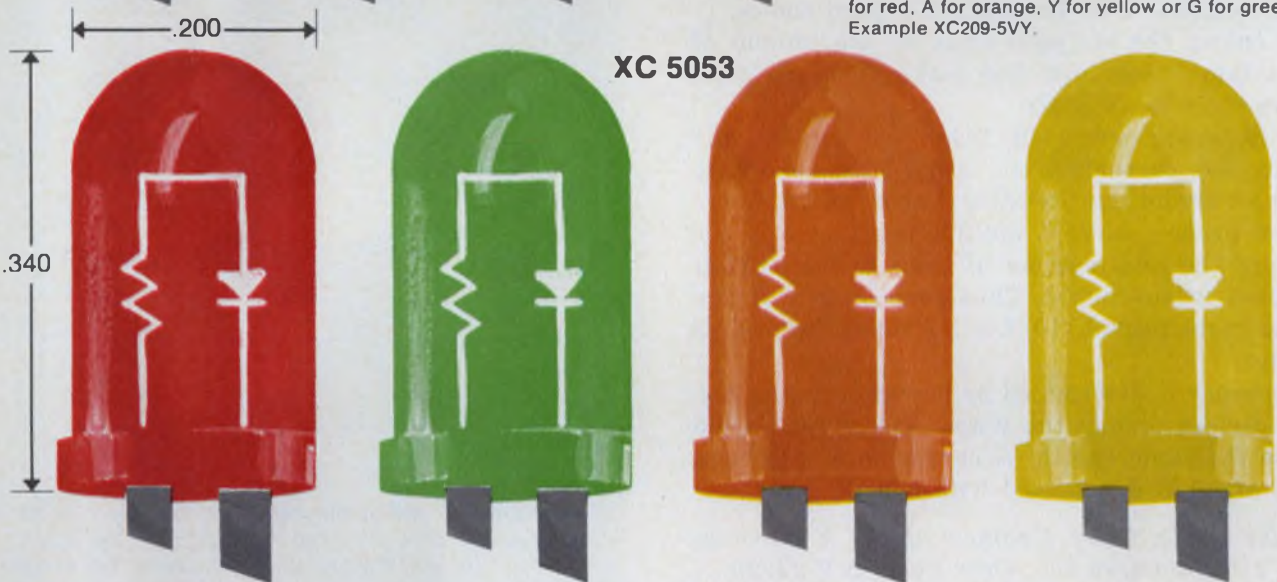
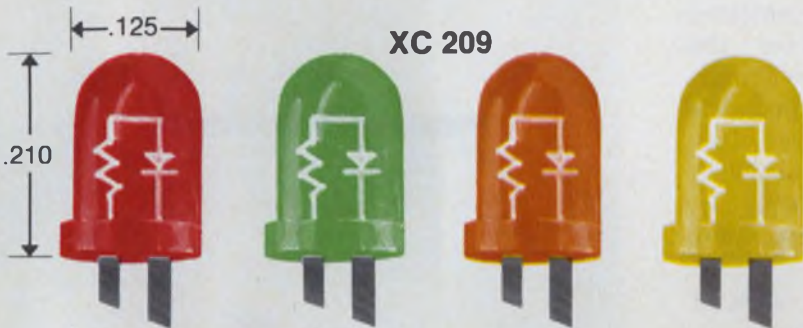

**cramer/ Xciton**

Cramer: See adjacent list for the Cramer location nearest you.  
Xciton Corp., 5 Hemlock St., Latham, N.Y., 12110, Tel. (518) 783-7726, TWX: 710-444-4962

INFORMATION RETRIEVAL NUMBER 36

# Increase current-probe range up to 10 times for 15¢ with wire-and-lug assembly

A simple way to increase a current probe's range can be assembled in five minutes from a few lengths of wire and two lugs.

Pulse measurements with a conventional scope's current probe sometimes exceed the probe's rating and provide erroneous readings. For example, the HP 1110A current probe is rated at 50-A max, peak to peak, but pulses often exceed this value. A circuit may generate 500-A pulses, which are 10 times the probe rating.

To handle currents like these, follow these three steps:

1. Cut 10 pieces of No. 22 insulated wire of equal lengths—2-in. lengths are a good choice.

2. Insert the stripped ends of the bundle of leads into spade lugs and make good electrical connections to all leads.

3. Separate one lead from the bundle and clamp the current probe around this lead, to yield a current-multiplication factor of 10.

The probe's current multiplying factor is the ratio of the total number of leads to the number enclosed in the probe. Thus four leads clamped in the probe provide  $10/4 = 2.5$  times the probe's rating.

Accuracy is determined by how equally the current divides among the wires. The wires should all be the same length. Accuracy to 5% is common, and 1% is achieved with a little care.

*Mike Coyle, Chief Engineer, MCG Electronics Inc., 279 Skidmore Rd., Deer Park, NY 11729.*

CIRCLE NO. 313

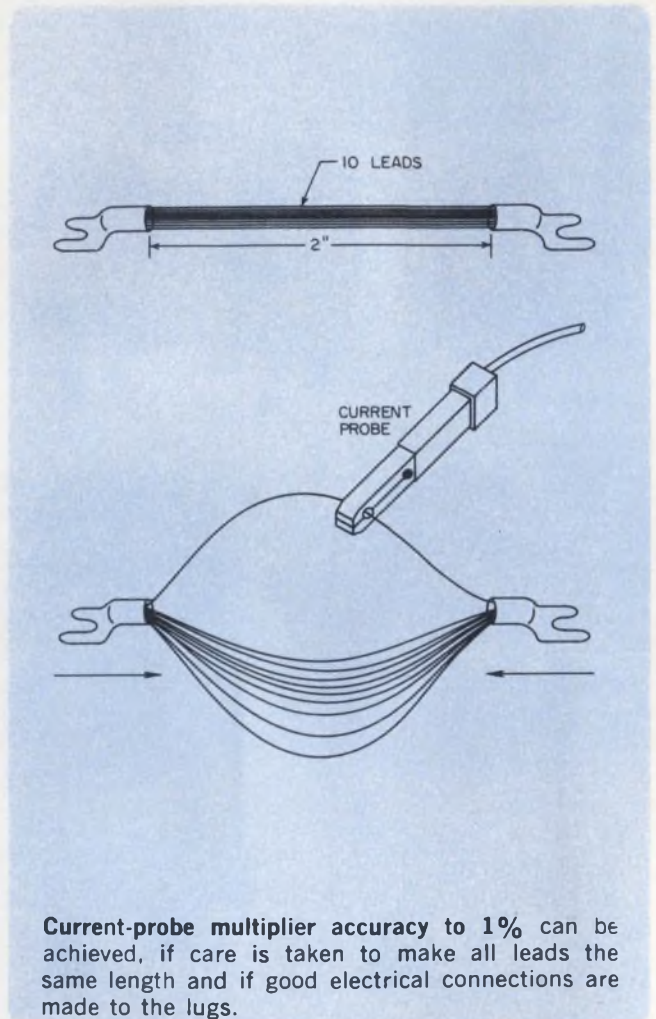

Current-probe multiplier accuracy to 1% can be achieved, if care is taken to make all leads the same length and if good electrical connections are made to the lugs.

## IFD Winner of March 15, 1975

**Marshall K. Kessie**, Bechtel Corp., P.O. Box 60860, Term. Annex, Los Angeles, CA 90060. His idea "Flat, Flexible TV Antenna Offers High Gain" has been voted the Most Valuable of Issue Award.

Vote for the Best Idea in this issue by circling the number of your selection on the Information Retrieval Card at the back of this issue.

**SEND US YOUR IDEAS FOR DESIGN.** You may win a grand total of \$1050 (cash)! Here's how. Submit your IFD describing a new or important circuit or design technique, the clever use of a new component or test equipment, packaging tips, cost-saving ideas to our Ideas for Design editor. Ideas can only be considered for publication if they are submitted exclusively to ELECTRONIC DESIGN. You will receive \$20 for each published idea, \$30 more if it is voted best of issue by our readers. The best-of-issue winners become eligible for the Idea of the Year award of \$1000.

ELECTRONIC DESIGN cannot assume responsibility for circuits shown nor represent freedom from patent infringement.

# think small



... with TRW metallized film capacitors. For example, metallized polycarbonate ultra-miniatures (Type X463). Real problem solvers in precision circuitry where stability with small size is essential. Capacitances: .001 to 10.0 mfd in 50, 100, 200, 400 VDC. High IR, low DF, fully rated from  $-55$  to  $+125^{\circ}\text{C}$ —with less than  $1\frac{1}{2}\%$  capacitance change. Rugged, plastic film case. For similar performance in a metal enclosed unit, ask about Type X482. And for real space savings in a rigid pre-molded case, check the X440.

And then there are X601PE subminiatures in metallized Mylar\* construction with dipped epoxy coating. Capacitances: .01 to 10.0 mfd—in 100 and 200 VDC. Temp.:  $-55$  to  $+100^{\circ}\text{C}$  (to  $125^{\circ}\text{C}$  with derating). Tough, self-healing. Great for high-density PC's, humid environ-

ments, precision applications. (Metallized Mylar units also available tape-wrapped or metal enclosed.)

One other thing. We figure you can't make quality capacitors and me-too capacitors under the same roof. Because sooner or later, one operation will goof the other one up. So we take the quality route. Count on it.

Write for catalog or application engineering assistance. TRW Capacitors, an Electronic Components Division of TRW, Inc. Box 1000, Ogallala, Nebraska 69153. (308) 284-3611.

\*Du Pont T.M. for Polyester Film

## TRW<sup>®</sup> CAPACITORS

INFORMATION RETRIEVAL NUMBER 37

## Large meteorology net to be installed in Zaire

A nationwide meteorological network will be installed in Zaire to provide information for agriculture and aviation in the African republic. There will be seven regional weather-data stations, according to Omera-Segiel of Paris, the builder, with outlying observation stations that employ SSB or CW hf radio links transmitting information to the regional terminals.

The main station, near Kinshasa/Binza, will be connected to the regional centers by hf radio. This center will also receive data from other stations in Africa via facsimile and Teletype. And the center will also be equipped with an automatic picture-transmission

receiver to obtain meteorological data from outside Africa via satellite.

Equipment to be supplied to the main Zairan Meteorological Office will monitor the following weather parameters:

- Precipitation within a 400 km radius from each station.
- Weather at various altitudes. Radiosonde balloons will measure air pressure, temperature and humidity. The balloons will be tracked by radar to determine the wind speeds at various altitudes.
- Visibility near the threshold of the longest runway at the country's main airport.
- The altitude of the cloud base at the airport.

## 10-W gain reported for a GaAs FET

The highest known rf power gain for a gallium-arsenide FET—10 W at 18 GHz—has been reported by the Institut für Halbleitertechnik in Aachen, West Germany. By minimizing parasitic series resistances, the institute has fabricated a GaAs FET with a 1- $\mu\text{m}$  gate length.

A new fabrication process combining dc sputter etch and chemical etch was developed. The process improves control of the spacing of the thin layer between the gate stripe and the ohmic contacts, which limits the series resistance to a low value. To minimize the resistance of the gate stripe—which with its capacity, causes an input delay—silver was used for

gate metallization.

To maximize the transconductance and saturation characteristics, which depend on the carrier concentration, doping and mobility profile, and the presence of trapping centers, an undoped buffer layer or qualified substrates were used. These elements retain their semi-insulating character near the surface when the epitaxial layer is grown on top of it.

The gallium-arsenide device developed is a single-gate FET with 1.0- $\mu\text{m}$  gate length, a 200- $\mu\text{m}$  gate width and 3.0  $\mu\text{m}$  source-to-drain contact spacing. A pinch-off voltage of 1.3 V was obtained. This value includes the built-in voltage of the gate diode. The diode was fabricated on a 0.4- $\mu\text{m}$ -thick layer, with doping near the surface on  $n \approx 1 \times 10^{17} \text{ cm}^{-3}$ .

## Surface-wave oscillator can be programmed

An acoustic surface-wave oscillator that can be programmed to operate at 10 frequencies between 121 and 130 MHz has been produced by Thomson-CSF in Domaine de Corbeville, Orsay, France.

The oscillator, which is expected to find application in telecommunication systems, consists of a filter bank, an amplifier and diode output switches. The bank of 10 channels is etched on a 50-mm-long and 10-mm-wide quartz substrate to obtain maximum frequency stability.

The device has a single input transducer that operates in a beam-steering mode. This transducer has 200 point sources, and the direction in which the beam is launched is a function of frequency. The output transducers are positioned to intercept the 10 beams, each beam corresponding to one of the spot frequencies.

The angle between the X axis of the substrate and the line joining the input transducer sources is  $41^{\circ}58'$ , and the 10 output transducers lie at angles that vary with respect to the X axis from  $-2^{\circ}8'$  to  $2^{\circ}23'$ . The output elements with the largest off-axis angles are deposited closest to the input array to reduce any anisotropy effect.

The frequency response of the individual channels is a sin X/X curve, while the 3-dB bandwidth of the filters is about 0.8 MHz. The frequency of the oscillator is controlled by a number of diode switches, two of which are used for each output.

# THE FASTEST, MOST DEPENDABLE, MOST VERSATILE STRIP CHART RECORDER ANYWHERE.

It's the new GOULD/Brush 110 with a thermal pen unmatched in the quality of its easy-to-read blue traces.

It produces clear, crisp, dry traces at all speeds. With no smudges, no smears, no skips, no puddles.

The pen tip warms up in just milliseconds. So it can produce accurate traces even during a series of short movements. And response time is exceptional. Full-scale response time is 250 milliseconds, which enables it to record fast-changing signals more faithfully than most other strip charts.

When it comes to reliability, we back up our promise with a lifetime pen guarantee. One reason we can make such a strong guarantee is that the special ceramic pen tip is virtually wear-free. No frequent, costly pen replacements. And although other pens are sometimes damaged by excessive off-scale input signals, ours is not because we use hard-electronic limiters and soft mechanical stops.

Then take versatility. The 110 has features that let you tailor it to your exact application. For example, you can choose from ten

chart speeds. A selection of plug-in signal conditioners accommodate a wide range of input signals. Charts may be pulse-driven by an external device. And an optional solid state electronic chart integrator follows positive and negative signals up to 4 times full scale on the analog channel.

We don't believe there's another strip chart recorder in the market that is as fast, dependable and versatile. But don't take our word for it. We'll be happy to give you a demonstration anytime, anywhere. Once you see it, we think you'll believe it too.

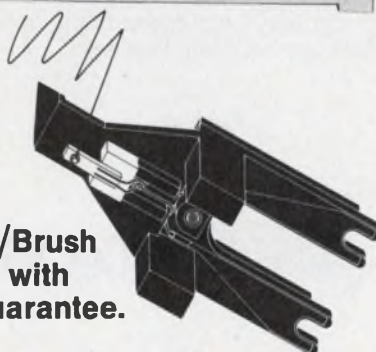
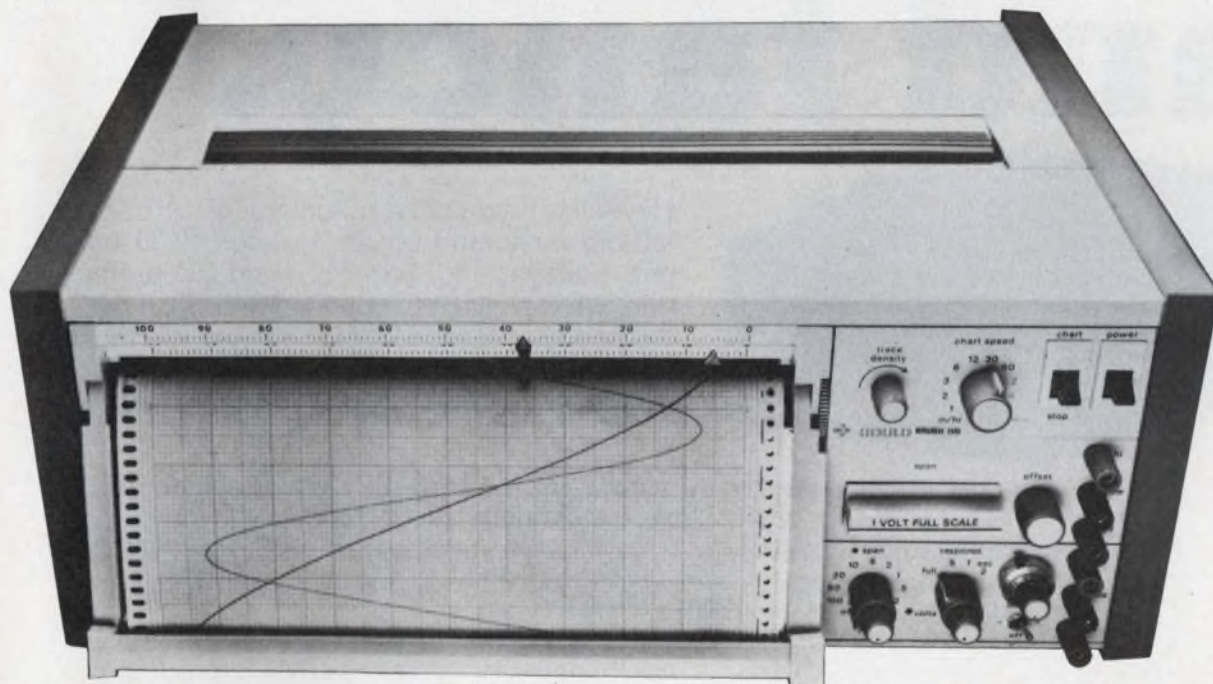

**The GOULD/Brush  
thermal pen with  
a lifetime guarantee.**

Call your nearest Gould Sales Engineer for a demonstration. Or write Gould, Inc., Instrument Systems Division, 3631 Perkins Avenue, Cleveland, Ohio 44114. Or Kouterveldstraat 13, B 1920 Diegem, Belgium.

 **GOULD**

INFORMATION RETRIEVAL NUMBER 38

# Plain...



**here's what our \$325<sup>00</sup>  
4½ Digit Multimeter  
won't do...**

It won't autorange  
It won't digital interface

And it won't cost you an arm and a leg for features you may not need anyway.

Our Model 1450 will give you accurate readings of five functions and 21 ranges on a big, bright ½ inch planar display. It will measure DCV 100  $\mu$ V to 1000V, ACV 100  $\mu$ V to 500V RMS, Resistance 100 milliohms to 20 megohms, AC and DC Current, 1  $\mu$ Amp to 2 Amps, AC Voltage/Current response, 30 Hz to 50kHz. It also provides 100% overrange and full overload protection. 6 months DC accuracy is  $\pm 0.02\%$  of rdg.  $\pm 0.01\%$  f.s.

# and fancy.



However, if you need autoranging, autozero, remote range and trigger, isolated BCD output, voltage ratio, and full overload protection, we can give it to you for \$675.00. That's the price of our Model 2440, the world's most accurate 4½ digit full function DMM. DCV accuracy of  $\pm 0.007\%$  rdg.  $\pm 1$  lsd for 6 months.

In addition to our Models 1450 and 2440, Data Precision also makes the popular 4½ digit portable multimeter Model 245; a lab precision 5½ digit multimeter Model 3500; a low cost 3½ digit bench instrument Model 134; our new bench/portable 4½ digit Model 1455; and a 7 digit 100 MHz Multifunction Counter Model 5740.

Contact your Data Precision Representative or Data Precision directly. You may be surprised how much more instrument you can buy, when you buy Data Precision.

Data Precision Corporation  
Audubon Road  
Wakefield, Massachusetts 01880  
(617) 246-1600

 **DATA PRECISION**®  
**...years ahead**

## 4-bit bipolar/LSI processor slice cuts microcycle time to 100 ns

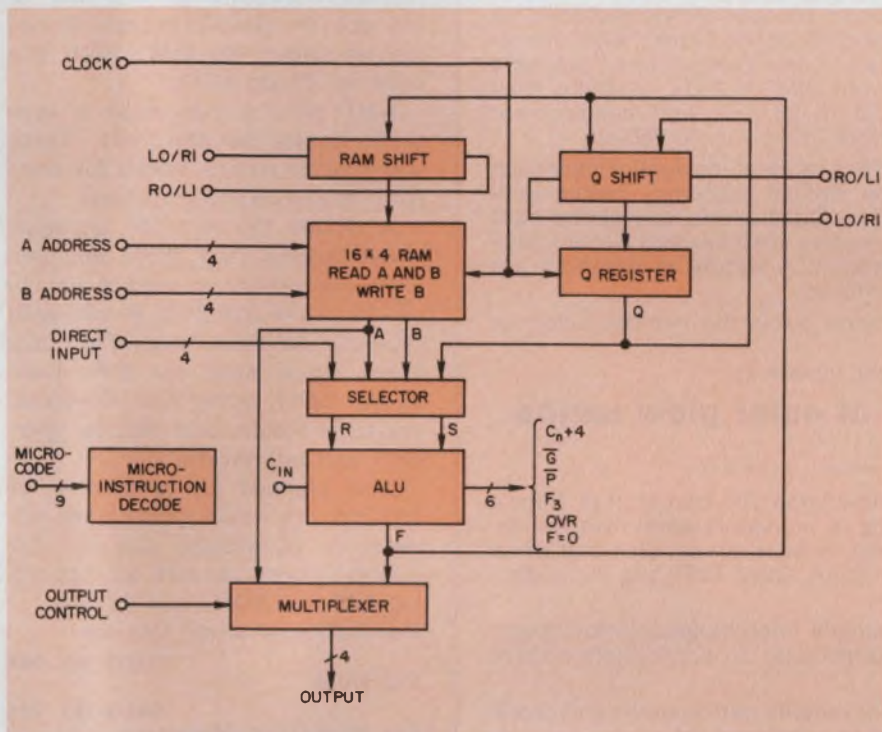

Advanced Micro Devices, 901 Thompson Pl., Sunnyvale, CA 94086. (408) 732-2400. Under \$50 (100 up); August.

The latest bipolar/LSI micro-processor slice—Advanced Micro Devices' Am2901—offers the fastest speed from available controller chips. The 4-bit Schottky-TTL circuit has a micro-instruction cycle time of only 100 ns, or one-half the cycle of presently competing units.

However, the AMD processor will face a higher-speed competitor when the MC10800 becomes available from Motorola Semiconductor (P.O. Box 20912, 5005 E. McDowell Rd., Phoenix, AZ 85036). Due for 1976 introduction, the Motorola 4-bit slice processor will use emitter-coupled logic to achieve a microcycle time of 55 ns (see

"Motorola Processor to Have 55-ns Micro-Instruction Time," ED No. 12, June 7, 1975, p. 25).

Bipolar microprocessors that have preceded the AMD unit include these: the 3001, a 2-bit slice from Intel (3065 Bowers Ave., Santa Clara, CA 95051); the 6701, a 4-bit slice from Monolithic Memories (1165 E. Arques Ave., Sunnyvale, CA 94086); and the SBP0400, a 4-bit slice from Texas Instruments (P.O. Box 5012, MS/84, Dallas, TX 75222).

Like the AMD circuit, the Intel and MMI versions use Schottky-TTL, but their cycle times are around 200 ns. A slower speed is offered by the TI version, which employs integrated-injection logic to decrease power dissipation. All present and expected bipolar/LSI processors require microprogram-

ming techniques for application.

The architecture of the new AMD chip (see diagram) most resembles that of Monolithic Memories' 6701. Compared with the 6701, the Am2901 achieves the lower cycle time primarily by enhancing the speed of its internal RAM and by its method for decoding micro-instructions.

The Am2901 contains three separate logic blocks that control the arithmetic-logic unit's source operand, function and destination register. Micro-instructions, which are 9 bits long, consist of three 3-bit segments that correspond to the three logic blocks. This breakup reduces delays and permits parallel decoding of different segments of the same micro-instruction.

Also, the three-part segmentation leads to a higher number of possible micro-instructions. With the MMI 6701, that number is 256, but with the Am2901, it's 512. However, not all 512 represent useful instructions.

Both processor slices can be cascaded in multiples of 4 bits with full look-ahead carry. They have three-state outputs, and they permit shift-left, shift-right and no-shift entries from the ALU into RAM. However, the 2901's RAM permits external access through an A port and the multiplexer block. The MMI version furnishes this access with both an A and B port.

Both versions provide three status bits, or flags: carry-out, overflow and zero detect. In addition the Am2901 includes a sign bit for negative values.

The eight possible destinations in the 2901 are indicated directly in the micro-instruction. As a result, external decoding blocks can

(continued on page 78)

# Send for these new free lamp information bulletins from General Electric.

## GE has added 6 halogen cycle lamps to its low-voltage line.

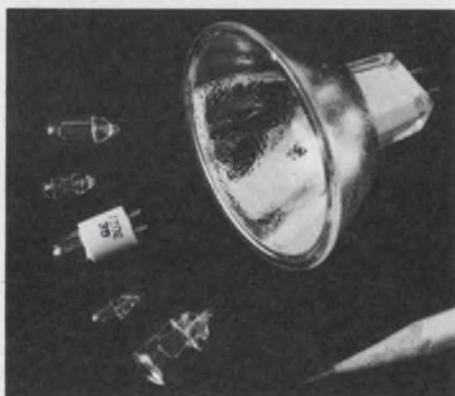

General Electric now offers over 27 halogen cycle lamps that pack high light output in small packages. (In addition, GE offers 8 sealed beam halogen lamps primarily for aircraft applications.) Bulb diameters range from  $\frac{3}{8}$ " to  $\frac{1}{2}$ ". Lengths from .520" to 2.25". Voltages from 3.5 to 28.0 V. And candlepower from 2.15 cd up to 250 cd.

They're ideal for applications such as optical systems, instrumentation, illuminators, fiber optics, card readers, displays and aircraft navigation. A variety of terminals are offered.

For complete, updated technical information circle the number below or write GE for Bulletin #3-5257.

INFORMATION RETRIEVAL NUMBER 82

## GE ADDS BLUE to its line of color glow lamps.



With our new T2B blue glow lamp you can choose from a broad spectrum of colors for a wide range of indicator, panel illumination, and edge-lighting applications. Red, yellow, orange, green, blue and white are available with just three basic lamps (C2A, G2B, T2B) and the appropriate filters.

All three lamps are electrically and physically interchangeable for operation from a standard 120 V, ac, line in series with an appropriate current limiting resistor.

They offer rugged construction, long life for reliable performance and shock and vibration resistance for use in almost any environment.

Send for complete, updated technical information. Circle the number below or write GE for Bulletin #3-5258.

INFORMATION RETRIEVAL NUMBER 83

## GE wedge base miniature lamps can save you time, money and space.

These lamps are ideal for applications such as indicators, markers and general illumination where space is at a premium. Their wedge-based construction makes them easy to insert and remove. They don't require bulky, complicated sockets. And the filament, which is always positioned in the same relation to the base, offers consistent illumination from lamp to lamp.

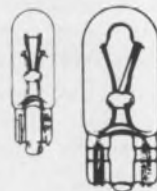

There are now more than 25 types of GE wedge base lamps available. Voltages range from 6.3 V to 28 V. Candlepower from 0.03 to 12 cd. Bulb sizes range from subminiature at 6 mm to a heavy-duty bulb at 15 mm.

Send for complete, updated technical information. Circle the number below or write GE for Bulletin #3-5259.

For the most up-to-date technical information on any or all of these lamps write: General Electric Company, Miniature Lamp Products Department #3382-L, Nela Park, Cleveland, Ohio 44112.

INFORMATION RETRIEVAL NUMBER 84

GENERAL  ELECTRIC

## INTEGRATED CIRCUITS

(continued from page 77)

be avoided when the chip is used with external multiplexers in multiplication and division routines.

And one destination control function permits operations that don't require any writing into the RAM or the Q register (a scratch pad or accumulator extension). Hence operations, like Compares, can be performed without loss of register contents.

Like the MMI 6701, the AMD circuit operates from a single 5-V supply. The 2901 has the lower current requirement (185 mA vs 215 mA for the 6701), and it dissipates about 900 mW. Both ICs come in 40-pin DIPs.

AMD plans a wide range of support circuits for the 2901. These will provide circuit blocks for complete microcomputer systems.

A 16-bit system, for example, would employ four 2901s and two 2909 microprogram sequencers to address up to 256 ROM words, each typically 32 bits long. The four 2901s would need one 2902 look-ahead carry generator. External registers would hold source operands and microwords.

Also planned are a number of I/O circuits (with either open-collector or three-state outputs) for bussed systems, as well as supporting ROMs, PROMs and RAMs.

For Advanced Micro Devices

CIRCLE NO. 302

For Intel

CIRCLE NO. 303

For Monolithic Memories

CIRCLE NO. 304

For Motorola

CIRCLE NO. 305

For Texas Instruments

CIRCLE NO. 306

## 5-V/ $\mu$ s dual op amp has 35-nA bias

Harris Semiconductor, P.O. Box 883, Melbourne, FL 32901. (305) 724-7407. \$3.40 (100 up); stock.

The HA-2650 internally compensated dual op amp features a slew rate of 5 V/ $\mu$ s and a bandwidth of 8 MHz. Even at  $\pm 2$  V, the slew rate is still 4.0 V/ $\mu$ s. The dc characteristics include a bias current of only 35 nA with 75-mW power consumption, and an average offset voltage drift of 8  $\mu$ V/ $^{\circ}$ C. Pinouts are identical to Motorola's 1558 model.

CIRCLE NO. 307



# SEMICONDUCTOR NOISE ANALYZERS

Noise testing of transistors is fast and efficient with Quan-Tech's Transistor Noise Test Sets.



From the compact, simple to operate Model 512B



through the highly versatile Model 2173C-2181 transistor noise analyzer, 11 instruments are available to meet every laboratory or production line requirement. Measure field-effect and bipolar transistors, ICs, diodes, op-amps, and thick and thin film resistors.

Features available include:

- Direct measurement of popcorn, burst, flicker and broadband noise figures.
- Noise measurements at selected frequencies from 10 Hz through 100 KHz.
- Integral power sources.
- Automatic self calibration.
- Meets Standards for Industry and Government.

Call or write for a complete technical file on noise measurements or a demonstration.

## Quan-Tech®

Division of SCIENTIFIC-ATLANTA, Inc.  
Randolph Park West, Route #10, Randolph Township, N.J. 07801 • Tel: (201) 361-3100

## CMOS multiplexers route analog data

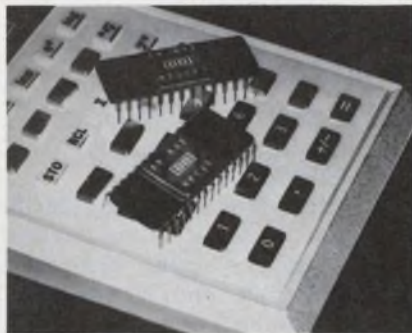

Burr-Brown, International Airport Industrial Park, Tucson, AZ 85734. (602) 294-1431. \$29.00 to \$29.80 (100 up); stock to 2 wks.

Two monolithic analog multiplexers, the MPC16S and the MPC8D, respectively, provide 16-channel single-ended operation and dual eight-channel operation for differential inputs. Both are constructed with failure-protected CMOS devices. And both are DTL/TTL/CMOS compatible and feature self-contained binary-channel address decoding. Power consumption is 15 mW when operating at 100 kHz, and 7.5 mW on standby. Transfer accuracies of better than 0.01% can be achieved at sampling rates up to 200 kHz from signal sources of up to  $\pm 10$ -V amplitude. Digital and analog inputs are protected against either overvoltages that exceed the power supplies or from loss of power.

CIRCLE NO. 308

## 18-lead DIP holds 4-k RAM

National Semiconductor Corp., 2900 Semiconductor Dr., Santa Clara, CA 95051. (408) 732-5000.

The MM5270, a 4-k read/write memory in an 18-lead package, employs a single lead to serve three functions: read/write, logical chip select and  $V_{CC}$ . The new memory also has Tri-State, common I/Os. With only 18 leads, the MM5270 reportedly achieves a PC-card memory density nearly twice as great as that possible with standard 22-lead 4k RAMs. The MM5270 features TTL-compatible inputs (except for chip enable) and on-chip registers for address and chip select. Access time is 200 ns, and cycle time is 400 ns.

CIRCLE NO. 309

Advertisement

## ELECTRONIC PACKAGING

### Cabinet racks: upright, inclined, big, deep



Bud Radio, Inc., 4605 E. 355 St., Willoughby, O. 44094, (216) 946-3200. Shipped ready for use.

Series 2000 cabinet racks from Bud. Standard uprights, 16 sizes. Clear inside depths, 20 $\frac{1}{2}$ ", 24". Eight extra-deep units have 29 $\frac{1}{4}$ " clear inside depth. Outside heights, 30 $\frac{1}{4}$ " to 88". Mounting rails adjusted horizontally. Six inclined units. Clear inside depths, 20 $\frac{1}{2}$ ", 29 $\frac{1}{4}$ ". Front panel, 20° off vertical. Compare value, shipping economies. For further information phone—

1-800-321-1764, TOLL FREE

IN OHIO, 1-800-362-2265, TOLL FREE

## Special fabrication of electronic housings



Bud Radio, Inc., 4605 E. 355 St., Willoughby, O. 44094, (216) 946-3200. Get what you want for less.

Bud designs and fabricates racks, cabinets, enclosures for new or re-designed electronic instruments or systems. Standard Bud housings can be altered to fit many applications. Original housings can be designed and produced. In addition, Bud's Imlok system can be used for short runs, test or pilot models. For further information phone —

1-800-321-1764, TOLL FREE

IN OHIO, 1-800-362-2265, TOLL FREE

## ELECTRONIC PACKAGING

## Standard enclosures with custom features

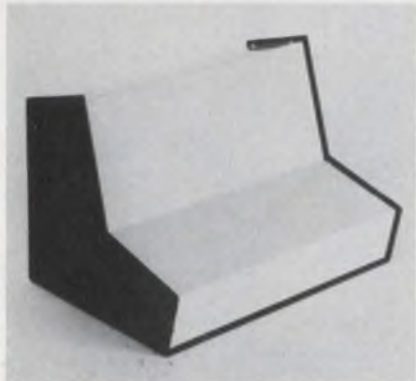

Bud Radio, Inc., 4605 E. 355 St., Willoughby, O. 44094, (216) 946-3200. Your Bud Distributor has it.

Compucab by Bud. Dual-slope, off-the-shelf enclosures with custom-designed configurations. Use for a range of instruments. Maximum visibility — no fasteners on panel area. All aluminum. Cover and back in smooth white enamel. Base and sides, black textured enamel. Knockouts in rear panel. Rubber feet furnished. Two styles. Shipping economies. For further information phone —

1-800-321-1764, TOLL FREE

IN OHIO, 1-800-362-2265, TOLL FREE

## Compact enclosures, versatile, economical

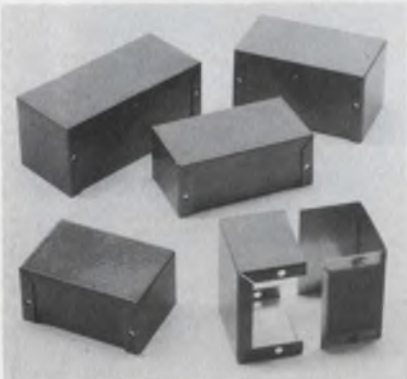

Bud Radio, Inc., 4605 E. 355 St., Willoughby, O. 44094, (216) 946-3200. Available in 18 sizes.

Miniboxes from Bud. Use as separate housings or as part of a larger assembly. Flanges give assured shielding. Projecting covers on cowl-type units minimize glare, protect controls, dials. .040 and .050 aluminum alloy. Immediately available. Shipping economies. One of nearly 3000 products from Bud Radio. For further information phone —

1-800-321-1764, TOLL FREE

IN OHIO, 1-800-362-2265, TOLL FREE

## INTEGRATED CIRCUITS

## CMOS multiplexers avoid latchup

Intersil Inc., 10900 N. Tantau Ave., Cupertino, CA 95014. (408) 257-5450. \$28 to \$55 (100 up).

A pair of nonlatching CMOS multiplexers consist of the IH5060—a 16-channel plug-in replacement for the DG506 and HI-506—and the IH5070—an 8 dual-channel differential multiplexer replacement for the DG507 and HI-507. The new circuits come in 28-pin DIPs for both MIL and commercial temperature ranges. Maximum negative and positive supply current drain for the MIL model is 300  $\mu$ A total; for the commercial model, it's 2 mA total. Intersil uses its floating-body process to stop latch-up caused by analog signals when the power supplies are off or interrupted. Maximum  $R_{ON}$  is 400  $\Omega$  for the military model and 450  $\Omega$  for the commercial. Total output capacitance is 40 pF.

CIRCLE NO. 320

## 20-pin package holds dual multiplexer

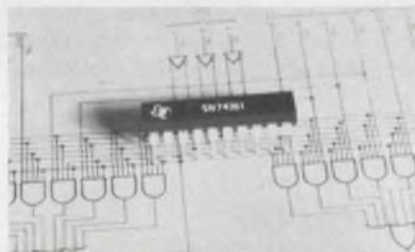

Texas Instruments Inc., P.O. Box 5012, M/S 308, Dallas, TX 75222. (214) 238-3741. \$2.16 (100); stock.

A dual multiplexer—the SN-74351—combines the equivalent of two SN74151s in a single 20-pin package. The TTL multiplexer features three-state bus-connectable outputs from each of the eight-line data-input logic sections. Each eight-line section shares four common data lines to allow a simultaneous dual eight-line conversion. Organized as three independent four-line input sections, the multiplexer can handle either four-line binary or BCD digits. Through the use of the output enable, the SN-74351 can be expanded to handle n-bits or n-digits.

CIRCLE NO. 321

## Chip holds TV sound channel



SGS-ATES Semiconductor Corp., 435 Newtonville Ave., Newtonville, MA 02160. (617) 969-1610. \$2.80 (100-999); stock.

The TDA1190 combines the functions of a TV sound channel—from i-f amplifier/limiter and low-pass active filter to dc volume control and FM detector—on a single chip. The new IC has a dc volume control range of 90 dB typical, output power capability of 4.2 W at 24 V and 16  $\Omega$ , and limiting voltage of 30  $\mu$ V, typical. The chip avoids thermal feedback and irradiated frequencies.

CIRCLE NO. 322

## FET amp specs 100-MHz gain-BW

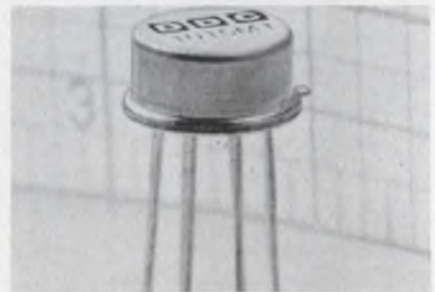

ILC Data Device Corp., Airport International Plaza, Bohemia, NY 11716. (516) 567-5600. \$14 to \$21; stock to 6 wks.

The Model 1015 FET op amp specifies 100-MHz gain-bandwidth product at gains of five and above, and 600 kHz for full output. The unit comes in a TO-99 package. It has an input impedance of  $10^{12} \Omega$  and a bias current of 1 pA. The amp provides an external connection for frequency shaping or compensation of closed-loop gains of less than five.

CIRCLE NO. 323

# International Rectifier.

## New 10 Amp device makes one-stop shopping easy for fast-switching power transistors.

Now, IR is your source for a wide variety of 3, 5 and 10 Amp JEDEC fast-switching power transistors, to simplify your buying. These hard-glass passivated devices are the ones to use for better reliability and lower costs in line operated power supplies, whether you're chopping line voltages at 20 KHz or inverting and stepping down at high frequency.

**Fast Switching Speed—Cooler Operation** . . . the oscillographs show typical fall times in the one-micro-second and lower range. Gives extremely low switching losses for cooler operation and higher reliability.

**Lower Leakage — High Temperature Stability** . . . with ICEO in the micro-amp range, IR devices are about one-tenth the accepted leakage rates of others. Provides the higher stability important for high performance at elevated temperatures.

**High Second Breakdown — High Reliability** . . . high second breakdown helps provide a broad safe-operating area for an extra margin of safety.

**Glass Passivation — Long Term Reliability** . . . high reliability and long term stability is achieved by hard glass passivation. Also, if you're using chips to make your own circuits, IR's glass passivation gives you the most stable, easy to assemble chips you can start with, making your yields higher.

If you are paralleling devices, the tight gain, switching time and saturation voltage control of these transistors make the job easier. And through 100% testing of key parameters we can provide even closer matching if necessary.

JEDEC types listed are immediately available, so contact your local IR salesman, rep or distributor today. International Rectifier, 233 Kansas Street, El Segundo, California 90245. (213) 678-8261.

New International Rectifier Fast Switching Power Transistors

IR Part No.	V <sub>CE0</sub> (sust) (Max V)	I <sub>C</sub> Peak (A)	h <sub>FE</sub> (min./max)	@ I <sub>C</sub> (A)	V <sub>CE</sub> (sat) (Max V)	@ I <sub>C</sub> (A)	P <sub>d</sub> (W)	t <sub>r</sub> /t <sub>f</sub> (μs)
2N6306	250	16	15/75	3.0	0.8	3.0	125	6/4
2N6307	300	16	15/75	3.0	1.0	3.0	125	6/4
2N6308	350	16	12/60	3.0	1.5	3.0	125	6/4
2N6542	300	10	7/35	3.0	1.0	3.0	100	.7/8
2N6543	400	10	7/35	3.0	1.0	3.0	100	.7/8
2N6544	300	16	7/35	5.0	1.5	5.0	125	1/1
2N6545	400	16	7/35	5.0	1.5	5.0	125	1/1
2N6249	200	30	10/50	10.0	1.5	10.0	175	2/1
2N6250	275	30	8/50	10.0	1.5	10.0	175	2/1
2N6251	350	30	6/50	10.0	1.5	10.0	175	2/1

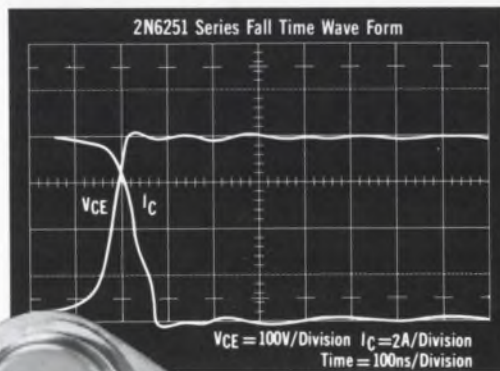
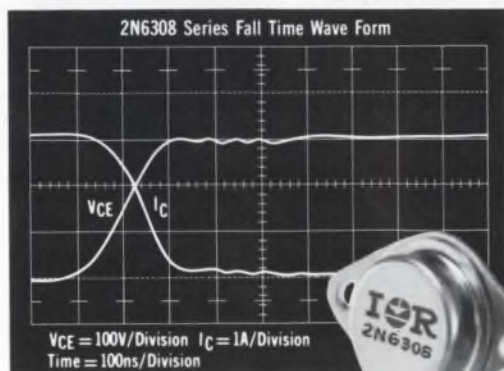

**INTERNATIONAL RECTIFIER**  
the innovative power people



SEMICONDUCTOR DIVISION, 233 KANSAS STREET, EL SEGUNDO, CALIFORNIA 90245, PHONE (213) 678-6281

INFORMATION RETRIEVAL NUMBER 151

## INTEGRATED CIRCUITS

### ICs generate rhythms for instruments



SGS-ATES Semiconductor Corp., 435 Newtonville Ave., Newtonville, MA 02160. (617) 969-1610. \$10 to \$13 (100-999); stock.

Monolithic rhythm generators—the M252 and 253—are designed for organs and other electronic instruments. The M252 provides 3840 bits of ROM arranged to generate 15 rhythm patterns for eight instrument outputs. The M253 provides a ROM capacity of 3072 bits to generate 12 rhythm patterns, also for eight instruments. Other features include mask programmable reset after 24 or 32 counts, down-beat output and external reset. The PMOS ICs operate from +5 and -12-V supplies.

CIRCLE NO. 374

### A/d converter set has multiple options

Siliconix Inc., 2201 Laurelwood Rd., Santa Clara, CA 95054. (408) 246-8000. \$34.85 (100); stock.

The company's latest 3-1/2-digit a/d converter chip set—the LD111/LD114—features multiple option outputs that are brought out to the pins of the digital IC. Options include either multiplexed serial or parallel BCD outputs and active high or active low logic outputs. Addition of a display, reference voltage and clock comprises a full analog-to-digital system. The two-chip pair consists of the LD111 analog processor in a 16-pin DIP and the LD114 digital processor in a 28-pin DIP. The LD111/LD114 system features include overrange and underrange signals; 2<sup>n</sup> divisible output for phase-locked-loop clocks; 0.005% accuracy of reading, ±1 count; sampling rates to 12 samples per sec, and auto-polarity.

CIRCLE NO. 375

### 4-k bit RAM boosts speed

Intel Corp., 3065 Bowers Ave., Santa Clara, CA 95051. (408) 246-7501. \$21.10 to \$28.90 (100-999); stock.

A high-speed version of the company's 4096-bit NMOS RAM—the 2107B—has a worst-case access time of 200 ns and a guaranteed minimum cycle time of 400 ns over the operating temperature range of 0 to 70 C. A lower cost version, the 2107B-4, has a worst-case access time of 250 ns and minimum cycle time of 450 ns. The 2107B operates from standard MOS supply voltages of ±5 and +12 V. It is a single-clock, fully decoded RAM with a TTL-compatible, three-state output and TTL-level inputs. Clock margins are ±1 V.

CIRCLE NO. 376

### Dual regulators output up to 100 mA

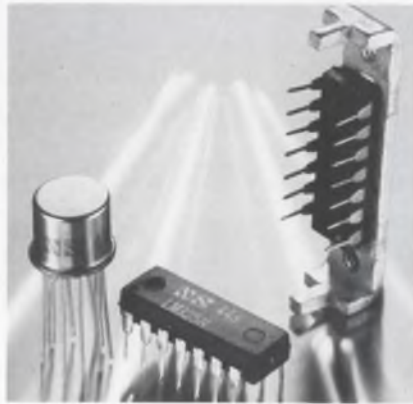

National Semiconductor Corp., 2900 Semiconductor Dr., Santa Clara, CA 95051. (408) 732-5000. LM325: \$2.60 (100); stock.

Three dual-tracking voltage regulators—the LM125, LM126 and LM127—provide balanced positive and negative output voltages at currents up to 100 mA. Input voltage can be as high as ±30 V, and the ICs have a provision for external adjustable current limiting. The LM125 provides tracking outputs of ±15 V, and it features output voltages balanced to within 1% and line and load regulation of 0.06%. The LM126 provides ±12-V outputs balanced to within 1% and features line and load regulation of 0.08%, while the LM127 has +5 and -12 V outputs.

CIRCLE NO. 377

### I<sup>2</sup>L microprocessor uses 4-bit slices

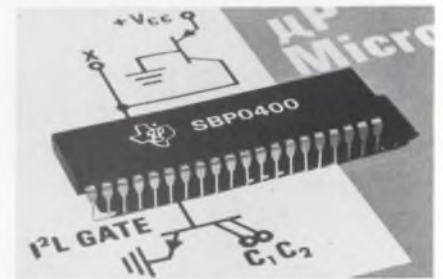

Texas Instruments Inc., P.O. Box 5012, M/S 308, Dallas, TX 75222. (214) 238-3741. \$90 (1-24).

The first integrated-injection-logic (I<sup>2</sup>L) microprocessor—the SBP400—is a 4-bit slice micro-programmable parallel-binary unit that comes in a 40-pin package. Featured in the circuit's architecture are a 16-function ALU having full carry-look-ahead capability, an eight-word general-register file including program counter with incrementor and two 4-bit working registers for both single and double-length operations. Internal control transformation is generated by a factory programmable logic array (PLA) containing a standard repertoire of 512 one-clock-length operations. In addition, special architectural features including a 20-bit operation register and a 2-bit relative position control give the capability of simultaneously fetching an instruction while executing complex operations. Use of I<sup>2</sup>L makes possible typical operation propagation times of 110 to 530 ns at a 128-mW nominal power. Any dc power source capable of providing +0.85 V minimum at the desired supply current can be used.

CIRCLE NO. 378

### CMOS IC contains phase-locked loop

Motorola Semiconductor Products, P.O. Box 20924, Phoenix, AZ 85036. (602) 244-3466. \$1.90 to \$2.85 (100-999).

The MC14046 CMOS phase-locked loop contains two phase comparators, a voltage-controlled oscillator (VCO) and a zener diode to assist in supply-voltage regulation. It operates at a VCO frequency up to 1.4 MHz ( $V_{DD} = 10$  V dc). Power dissipation is in the microwatts for typical applications.

CIRCLE NO. 379

# MIXED MEMORY RAM·PROM

for one-chip CPU micro-processors

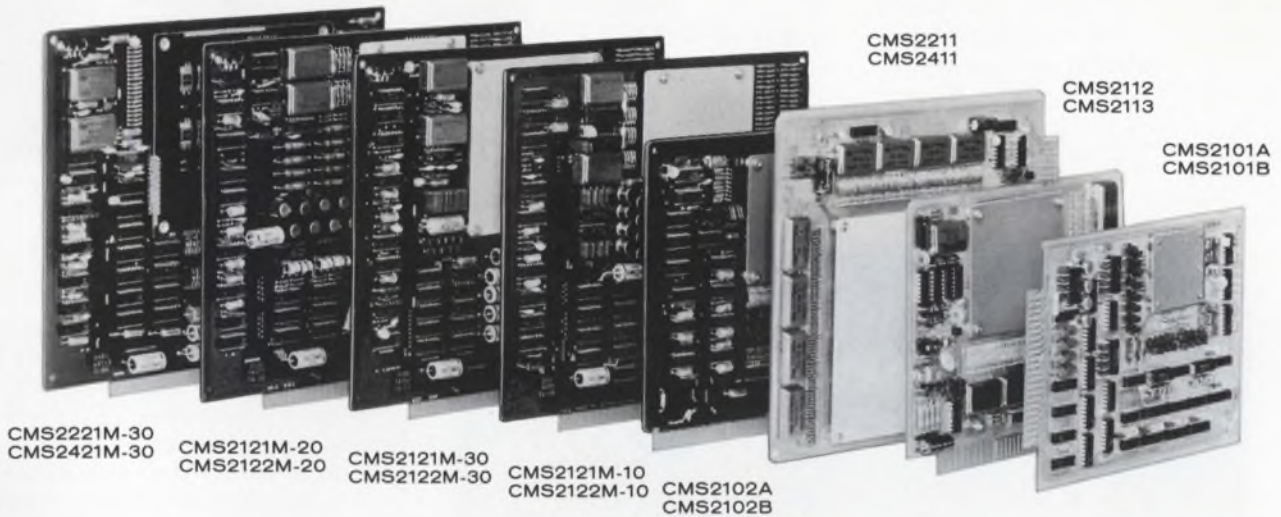

## NON-VOLATILE, LOW-COST but HIGH-RELIABILITY

Microprocessors combined with one-chip CPU are making tremendous advances in the peripheral terminals of computer networks, control devices, electronic cash registers, banking systems and POS systems. Semiconductor memories have generally been applied to the micro-processor, but which is involving such problems as the volatility of the stored data, reliability, and the influence against on noise.

Therefore, in the case of the small capacity memories, it has come to be considered more desirable to apply Core Memory system specially featured by its non-volatility, high-reliability and low-cost.

In particular, Core Memory which can not only be used as RAM, but also as PROM in small scale systems not equipped with a program data loading device is extremely versatile for various applications and is highly praised for its greater dynamic design. For instance, a newly developed MIXED MEMORY can adopt a part (example, 1K, 2K or 3K) of 4K words memory systems as

RAM, and the residual of them as PROM by employing the address protection mode of operation. Moreover, since a floating charge battery system is provided as an auxiliary back up power supply in order to cover the volatility of the semi-conductor memory, Core Memory is not only more economical, but also more reliable than IC memory system. Since the FUJI small capacity Core Memory system employs hybrid IC as its peripheral circuitry, it has been designed to be sufficiently compact and economical.

Each module has also been designed as a complete series, considering expandability, and major models have been designed for use with only +5V as the power supply.

Standard models are available in 1 bit, 4 bits and 9 bits length series, and various modules from 128 words to 16K words are immediately available from stock. In addition to our standard models, special design for OEM use can also be performed quickly upon request.

	Model	Capacity	Access time	Power supply	Dimensions			Model	Capacity	Access time	Power supply	Dimensions	
					Card size	Card pitch						Card size	Card pitch
9 BIT SYSTEM	CMS2121M-10	512W-9BITS	0.3 μs	+5V ONLY	10"×8"×0.7"	4 BIT SYSTEM	CMS2101A	128W-4BITS	1.0 μs	+5V ONLY	+5V	8.7"×5.8"×0.6"	
	CMS2122M-10	1024W-9BITS		CMS2101B			256W-4BITS	9"×7"×0.6"					
	CMS2121M-20	512W-9BITS		+5V			8"×6"×0.6"						
	CMS2122M-20	1024W-9BITS		+9V									
	CMS2221M-20	2048W-9BITS		+5V, +12V			10"×8"×1"						
	CMS2421M-20	4096W-9BITS											
	CMS2821M-20	8192W-9BITS											
	CMS2121M-30	512W-9BITS	1.0 μs	+5V ONLY	10"×8"×0.7"		Discrete models	CMS2112	512W-4BITS	EMM micromemory 9000 plug compatible			
	CMS2122M-30	1024W-9BITS		Hybrid models			CMS2113	1024W-4BITS					
	CMS2221M-30	2048W-9BITS		1 BIT to 8 BITS variable system			CMS2211	2048W-4BITS					
CMS2421M-30	4096W-9BITS	CMS2411		4096W-4BITS									
CMS2821M-30	8192W-9BITS			CMS2811	8192W-4BITS								
						CMS6115M-10	4KBITS						
						CMS6115M-20	8KBITS						
						CMS6115M-30	16KBITS						

## FUJI ELECTROCHEMICAL CO., LTD.

Head Office: No.36-11, 5-chome, Shinbashi, Minato-ku, Tokyo, Japan TEL: 03-434-1271

New York Office: TEL. 212-532-5630 Los Angeles: TEL. 213-626-1123 Düsseldorf Office: TEL. 211-89031 Hong Kong Office: TEL. 3-691382

INFORMATION RETRIEVAL NUMBER 152

## INTEGRATED CIRCUITS Byte-organized CMOS RAM holds 256 bits

Motorola, P. O. Box 20924,  
Phoenix, AZ 85036. (602) 244-3466.  
\$20 to \$40 (100-999).

With three chip-enable inputs and a format of 64 bytes of 4-bits, the MCM14552 static CMOS RAM can be expanded into a 2048-bit (512 bytes of 4-bits) system without any additional address decoding. Three-state output control per-

mits bus-organized operation; also on-chip output data latches can be used to hold data during the write mode. Operating statically without the need for a clock signal, the 256-bit MCM14552 can be controlled by dc levels—there are no maximum pulse-width restrictions. Quiescent power dissipation is typically 10  $\mu$ W/package at  $V_{DD} = 10$  V,  $T_A = 25$  C. Access time is typically 700 ns at  $V_{DD} = 10$  V,  $T_A = 25$  C.

CIRCLE NO. 380

## Oscillator generates variety of waveforms



ILC Data Device Corp., Airport International Plaza, Bohemia, NY 11716. (516) 567-5600. \$5.25 to \$27.00; stock to 6 wks.

The Series 1453 generator/voltage-controlled oscillator can produce simultaneous outputs of sine, square, triangular, sawtooth and pulse waveforms. Selection of operating frequency or repetition rate is made externally and covers a range of from less than 0.001 Hz to greater than 1 MHz. Frequency stability is 50 ppm/ $^{\circ}$ C maximum over a wide range of temperatures and supply voltages. Other features include distortion of 1%, linearity of 0.1% and a duty cycle that is variable from 2% to 98%.

CIRCLE NO. 381

## HP's newest counter 520 MHz - only \$795.



### COUNT THE FEATURES

- Direct counting, 10 Hz to 520 MHz; no prescaling to slow it down
- Sharp 9 digit LED readout
- High stability internal time base
- Optional TCXO time base for communications calibration
- 25 mV sensitivity, fuse protected input to prevent overload damage
- Switchable 50 $\Omega$  or 1 M $\Omega$  input
- Rugged cast aluminum case

### OTHER LOW COST MODELS

**225 MHz 8 Digit 5382A — only \$495**  
**80 MHz 7 Digit 5381A — only \$275**

All three counters have an external oscillator input for a house standard or ratio measurement.

All come with a full instrumentation warranty and meet IEC safety specifications. For more information call your nearby HP field engineer.

Or write. (Domestic USA prices only.)

**HEWLETT  PACKARD**

Sales and service from 172 offices in 65 countries.  
1501 Page Mill Road, Palo Alto, California 94304

G2515A

INFORMATION RETRIEVAL NUMBER 153

## 256-bit PROMs come pre-tested

Advanced Micro Devices, Inc., 901 Thompson Pl., Sunnyvale, CA 94086. (408) 732-2400. \$8.10 to \$16.00 (100 up).

Factory pre-tested 256-bit field-programmable ROMs come with an extra bit on each word and two extra words to provide optimum programming yields. The Am27S08 and Am27S09 (open-collector and three-state output versions, respectively) are high-speed, Schottky-TTL circuits designed to replace functionally similar devices offered by Signetics, Intersil and other manufacturers. These units are organized as 32 words by 8 bits and offer guaranteed address access speeds of 55 ns over the commercial temperature range, and 75 ns over the full military temperature range. The additional bits and words are used by AMD engineers to ensure field programmability.

CIRCLE NO. 382

**YOUR**

# HYBRID CIRCUITS

**DESERVE THE  
BEST SOLDERING  
INSTRUMENTS  
AVAILABLE...**

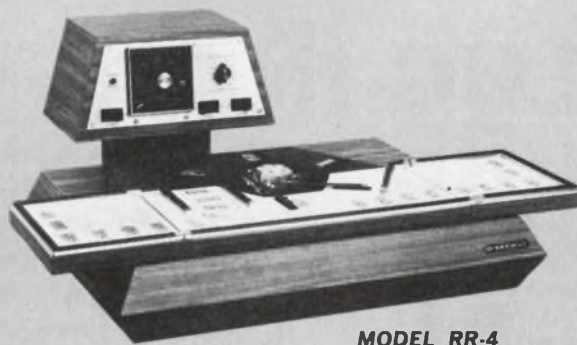

**MODEL RR-4  
ROTARY REFLOW  
SYSTEM**



**MODEL AR-7  
AUTOMATED REFLOW  
SYSTEM**



**MODEL CM-2  
MICRO REFLOW  
SYSTEM**



**MODEL CC-1  
SPOT REFLOW  
SYSTEM**



**MODEL SR-3  
SONIC REFLOW  
SYSTEM**



**MODEL LR-6  
LINEAR REFLOW  
SYSTEM**

**. . . . INTRODUCING  
A COMPLETE LINE OF  
REVOLUTIONARY HIGH  
SPEED LABORATORY AND  
PRODUCTION SOLDERING  
SYSTEMS . . .**

# BROWNE

**CORPORATION**

203 CHAPALA STREET

SANTA BARBARA, CALIF. 93101

PHONE (805) 963-0371

# PLUG-IN WIRE BUILD TEST MODIFY

without soldering  
for as little as

\$ **3**

Continental Specialties' QT (Quick Test) Sockets and Bus Strips expand breadboarding without shorts or burnt fingers. Just Snap/Lock together as many QTs as you need and test ICs, transistors, resistors, capacitors and more. Plug-in and connect with #22 AWG solid hook-up wire without soldering or patch cords. QTs are totally reusable. 10 different sizes. Order today off-the-shelf from CSC or local distributor. Charge: BAC, MC, AX. Write for free catalog. Free English/Metric Slide Rule with each order. Dealer inquiries invited.

Item No.	IC Capacity in 14 pin DIPs	Unit Price (US only)
QT-59S	8	\$12.50
QT-59B	—	2.50
QT-47S	6	10.00
QT-47B	—	2.25
QT-35S	5	8.50
QT-35B	—	2.00
QT-18S	2	4.75
QT-12S	1	3.75
QT-8S	1	3.25
QT-7S	1	3.00

Add \$1.50 shipping/handling. Foreign orders add 15%.



CONTINENTAL SPECIALTIES CORPORATION

Box 1942, New Haven, CT 06509. phone 203/624-3103 TWX: 710/465-1227

Prices subject to change  
©CONTINENTAL SPECIALTIES CORP., 1975

W. Coast Office: Box 7809, S. Francisco, CA 94119 415/383-4207

Canada: Available thru Len Finkler Ltd., Ontario

INFORMATION RETRIEVAL NUMBER 43

## Complete RF Network Analysis

- **0.4 to 500 MHz** in three overlapping bands; log, linear, CW, and  $f_0 + \Delta f$  modes.
- **115-dB Dynamic Range** — 80 dB direct display.
- **0.005-dB Resolution** — 0.05 dB flatness per 10 MHz; 0.4 dB full-band flatness.
- **Absolute Level in dBm** — direct swept display 0 to -80 dBm.
- **Phase and Group-Delay Measurements** — direct-reading swept displays.
- **50 and 75  $\Omega$**  — interchangeable measuring circuits with complete selection of coaxial components for each impedance level.
- **Measure** filters, amplifiers, antennae, cables, delay networks, equalizers, components, transistors, etc.
- **Display Simultaneously** magnitude and phase, magnitude and absolute level, magnitude and group delay, transmission and reflection.
- **Synthesizer-Based Systems from 0.2 to 500 MHz** — for precision narrow-band measurements on devices such as crystal or surface-wave filters, consider the GR 2261 Synthesizer Network Analyzer.



GR's 1710 RF Network Analyzer is the instrument that provides the complete RF network analysis described above. Call or write for complete information, application assistance, or for a demonstration.



For High-Frequency Measurements  
**General Radio**

300 BAKER AVENUE, CONCORD, MASSACHUSETTS 01742  
GR COMPANIES • Grason-Stadler • Time/Data

NEW YORK (N.Y.) 212 964-2722, (N.J.) 201 791-8990  
BOSTON 617 646-0550 • DAYTON 513 294-1500  
CHICAGO 312 992-0800 • WASHINGTON, D. C. 301 948-7071  
ATLANTA 404 394-5380 • DALLAS 214 234-3357  
LOS ANGELES 714 540-9830 • SAN FRANCISCO 415 948-8233  
TORONTO 416 252-3395 • ZURICH (01) 55 24 20

INFORMATION RETRIEVAL NUMBER 44

## INTEGRATED CIRCUITS

### Latest 1103 lists access of 90 ns

Synertek, 3050 Coronada Dr., Santa Clara, CA 95051. (408) 241-4300. \$12.50 (100-999).

A high-speed version of the company's 1024-bit MOS RAM provides a maximum delay, from chip enable to output, of 90 ns. Called the SY1103A-X, the company's latest version of the popular 1103 employs ion-implanted silicon-gate techniques. As a result chip-enable capacitance is 18 pF, which reduces clock power dissipation by a third and cuts the number of clock drivers needed at the system level. Also, a precharge clock isn't required.

CIRCLE NO. 324

### 4-k NMOS RAM chooses 22-pin DIP

Signetics, 811 E. Arques Ave., Sunnyvale, CA 94086. (408) 739-7700. \$19 (100-999); stock.

The latest 4096-bit, n-channel MOS dynamic RAM—the Model 2604—comes in a 22-pin package and has a maximum access time of less than 300 ns with a minimum cycle time of 470 ns. Standard power supplies are +12 and  $\pm 5$  V, but selected ICs operate from -3 V instead of -5 V. Outputs are three state, and refresh is needed every 2 ms.

CIRCLE NO. 325

### 1-k bit CMOS RAM has 250-ns access

Intersil Inc., 10900 N. Tantau Ave., Cupertino, CA 95014. (408) 257-5450. \$28 to \$70 (100 up).

When connected to a 5-V supply, a 1024-bit static CMOS RAM (the IM6508) has a 250-ns access time over the full temperature range. With a 10-V supply, access decreases to less than 100 ns at 10 V. Total power requirements are 5  $\mu$ W in standby and 10 mW at 1 MHz. Two versions of the IM6508 cover MIL and commercial temperature ranges. Both have TTL-compatible inputs and outputs, and both can operate from a supply as low as 3 V.

CIRCLE NO. 326

INFORMATION RETRIEVAL NUMBER 45 ►



# WESTON<sup>®</sup> Promises:

## With the Model 1242 you'll see the difference but you won't feel it!

No, you can't see the difference in any photograph, or even by looking at the real thing. But you will see the difference the instant you start working with it.

The big change is in the readout... It's improved, and at no extra cost to you. Just look...

When the Weston Model 1242 was first introduced, it was a winner. Priced right—very competitively. That was about 1½ years ago.

Model 1242 is a 4½ digit (19999) DMM with 25 ranges of operation, a resolution of 10  $\mu\text{V}$  on the 100 mV range, and with the Weston patented Dual Slope integration\* for automatic rejection of ac noise on dc input signals and greater accuracy. Circuitry fully protected from overload by resistor/diodes or fuses (made removable from the front without additional tools) or both.

We found a way to improve

this already versatile DMM... a new improved readout. The numerals are brighter, easier to read, and since the digits are now coplanar, the angle of readability is made wider. This new readout is also made to last longer with greater reliability.

Such improvements usually carry with them a price mark-up, but not at Weston.

We continue to sell this improved new version Model 1242—for the same price... no extra cost to you. Now you'll be able to see the difference, but you won't feel it.

If you would like to see the difference on the improved Weston DMM Model 1242—at no extra cost—start by calling your local distributor or by writing directly to: Weston Instruments, Inc., 614 Frelinghuysen Ave., Newark, N.J. 07114.

\*U.S. Pat. #3051939



**WESTON**

WESTON  
Schlumberger



**THE  
NEW  
MICRO  
TROUBLE  
SHOOTER  
ADDs  
A  
LITTLE  
LENGTH  
TO OUR  
LINE**

HOOKS  
ILLUSTRATED  
ACTUAL  
SIZE

X-100W

XL-1

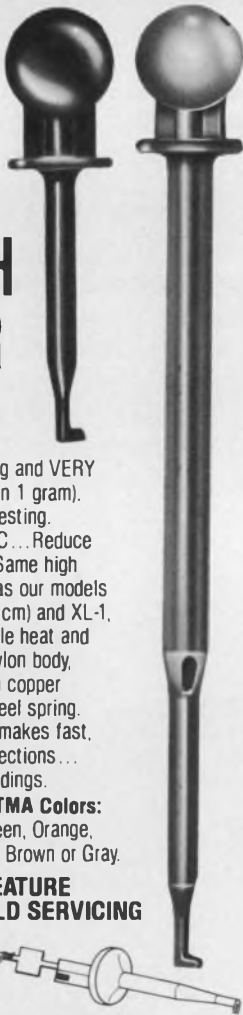

(1.75" - 4.45 cm) long and VERY little weight (less than 1 gram). Ideal for difficult IC testing. Connect DIRECT to IC... Reduce resistance build-up. Same high quality construction as our models X-100W, (2.25" - 5.7 cm) and XL-1, (5" - 12.7 cm): Durable heat and chemical resistant nylon body, Gold-plated Beryllium copper contact, Stainless steel spring. Single contact point makes fast, safe, short-free connections... assures accurate readings.

**Available in 10 RETMA Colors:** Red, Black, Blue, Green, Orange, Yellow, White, Violet, Brown or Gray.

**ALL MODELS FEATURE EXCLUSIVE FIELD SERVICING**



Damaged lead wire easily replaced.

Send for complete catalog & price list.

**E-Z-HOOK**

114 EAST SAINT JOSEPH STREET  
ARCADIA, CALIFORNIA 91006  
(213) 446-6175 / TWX 910 582 1614

**POWER SOURCES**

**Series-regulated supplies hurdle efficiency barrier**



dc output current			ac input tap	ac input / efficiency		
Model RD5-15	Model RE5-23	Model RG5-40		Low eff.	Nominal eff.	High eff.
9 A	14 A	25 A	A	105 V 70%	115 V 65%	125 V 60%
9 A	14 A	25 A	B*	98 V 71%	111 V 63%	125 V 55%
12 A	18 A	32 A	B	105 V 67%	115 V 61%	125 V 56%
9 A	14 A	25 A	C*	91 V 71%	108 V 60%	125 V 50%
12 A	18 A	32 A	C*	98 V 65%	111 V 57%	125 V 49%
15 A	23 A	40 A	C	105 V 63%	115 V 58%	125 V 53%

\*Wide input range for extended low-line "brown-out" capability.

Power-One, Inc., 531 Dawson Dr., Camarillo, CA 93010. (805) 484-2806. See text.

For the highest efficiency, coolest operation and highest power-density package in 5-V power supplies, you may think you've got but one choice: the switching-regulated supply. But not quite. Power-One's R Series gives you another option: linear, series-regulated sources with efficiencies up to 65% and output power densities to 0.54 W/in.<sup>3</sup>.

By sticking with the linear design, you may avoid some of the problems possible with switchers—including EMI, poor reliability and relatively slow response to transients. Of course, these aren't necessarily found in all switching

supplies. The better designed ones take care of these worries—but at a price.

The R Series probably won't head off the progress that switchers are making both in design and in market acceptance—especially above about 300 W—but it's nice to know that alternatives exist when it comes to selecting a supply.

Three models comprise the present R Series. The RD5-15 delivers 15 A to 50 C, while the RE5-23 and RG5-40 provide 23 A and 40 A respectively, also up to 50 C. All three supplies can be used to 70 C with linear derating to 40% output.

Important specs common to all models include line regulation of

$\pm 0.01\%$  for a 10% change in input, load regulation of  $\pm 0.02\%$  for a 50% load change (not no load to full load, as is commonly specified), and a maximum output ripple of 1.5 mV, pk-pk (0.4 mV rms). Tempco is listed as a maximum of  $\pm 0.01\%/^{\circ}\text{C}$  for all units.

Power-One has designed the R Series with a number of input taps so you can optimize the efficiency for the required output current level (see table). Or you can use the taps to stretch the input-voltage range for low-line (brownout) capability.

For example, with the 40-A unit, use tap "A" to get 40 A over an input range of 105 to 125 V ac. If you can live with less current, put the input line on tap "C," and 25 A will be delivered while the line varies from 91 to 125 V ac.

The size of Power-One open-frame supplies ranges from  $9 \times 4.87 \times 3.2$ -in. for the 15-A unit, which weighs 7.5 lb., to  $16.75 \times 4.87 \times 4.87$  and 19 lb for the 40-A supply. Thus power densities average around 0.52 W/in.<sup>3</sup> and 10 W/lb.

At \$79.95, the RD5-15 prices out at \$1.07 per watt, while the \$104 RE5-23 and the \$176 RG5-40 come in at 90 cents and 88 cents a watt, respectively. Note that the prices are for quantities of 100.

High efficiency isn't all the R-Series offers. Output voltage is adjustable over a  $\pm 5\%$  span. And three forms of protection are standard. Short-circuits and overloads are handled with automatic current limiting (foldback), and overvoltage protection is built in, with the trip point set at 6.2 V dc  $\pm 0.4$  V. Finally, the output and pass elements are protected against reversed voltages.

Other key specs demonstrate that the company traded little of the linear design's advantages for efficiency. Transient response is 30  $\mu\text{s}$  for a 50% change in load. Stability is specified at  $\pm 0.05\%$  for 24 h after warmup. And remote sensing is standard.

All units are 100% tested for regulation, ripple protection and isolation resistance. The supplies are then burned in for 2 h and retested. Power-One's warranty runs two years for parts and labor. Delivery is four weeks.

CIRCLE NO. 301

# The Sure Cure for HYBRID TENSION from Raytheon/Quincy

When hybrid problems cause hybrid tension, our custom hi-rel capability can cure it. We're the hi-rel hybrid specialists... in chip-and-wire and beam lead units... for military and medical electronics exclusively. Where a cure *has* to be sure, you can rely on Raytheon/Quincy to provide the custom hybrid you need. Just contact Mr. K. Singh at Raytheon. He'll make you feel better right away. Raytheon Company, Industrial Components

Operation,  
465 Centre  
Street,  
Quincy, Mass.  
02169.  
(617) 479-5300.



**RAYTHEON**

# Hot Semis? Get relief fast!



**IERC**  **Heat Sinks**

INTERNATIONAL ELECTRONIC RESEARCH CORPORATION/A SUBSIDIARY OF DYNAMICS CORPORATION OF AMERICA/135 WEST MAGNOLIA AVENUE, BURBANK, CA 91502

INFORMATION RETRIEVAL NUMBER 48

## POWER SOURCES

### Triple-output units deliver common levels



*ACDC Electronics, 401 Jones Rd., Oceanside, CA 92054. (714) 757-1880. \$105 (10-24); stock.*

Triple-output power supplies intended for OEM computer peripheral applications provide a single voltage output for driving IC logic and a dual voltage output for driving op amps and a/d converters. These new supplies are available with voltage output of 5 V at 3 A/ $\pm 12$  V at 0.75 A and 5 V at 3 A/ $\pm 15$  V at 0.64 A. Overvoltage protection is built into the single output and is optional on the dual output. Regulation is 0.1%.

CIRCLE NO. 327

## electrocube capacitors

...in metallized Mylar\* feature packages nearly 40% smaller than comparable conventional units, with no compromise in performance and price. Choose from 900 Series 230 models in wrap and fill, epoxy and metal cases, in round, oval and rectangular configurations. Capacitances from 0.0010 to 50.0 mfd, and voltages of 100, 200, 400 and 600 VDC are available. For more information, write or call Electrocube, 1710 So. Del Mar Ave., San Gabriel, CA 91776, (213) 283-0511; TWX 910-589-1609.

**FREE...** application bulletin series available on request

## WAIST WATCHER

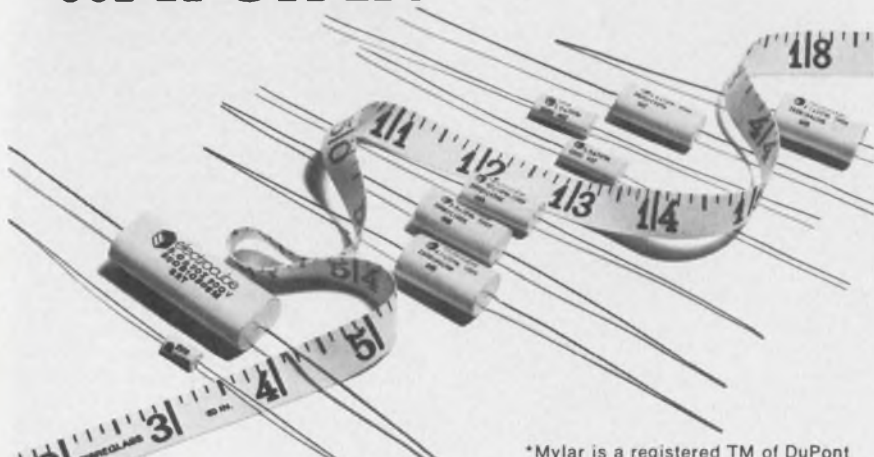

\*Mylar is a registered TM of DuPont

INFORMATION RETRIEVAL NUMBER 49

### Potted dc/dc converters deliver 6 W



*Intronic, 57 Chapel St., Newton, MA 02158. (617) 332-7350. \$89; stock-2 wks.*

This series of dc/dc converters offers 200-mA output current at either  $\pm 12$  or  $\pm 15$  V in a compact  $2 \times 2 \times 0.88$  in. encapsulated module. Designed for powering various analog circuitry, the units have a line and load regulation of 0.01%. Added features include electrostatic shielding noise of only 1 mV rms, high efficiency, and typical input/output isolation of 1000 V dc. All models may be used with plug-in sockets or soldered directly onto PC boards. Input voltage options are 5, 12 and 28 V.

CIRCLE NO. 328

# New Old Faithful

## MICROMEMORY 3000QD...32K x 20

Old Faithful. That's what you've been calling the whole MICRO-MEMORY 3000 family. Fast. Trouble-free. Dependable. Flexible — easy to build on or design around. Either core or NMOS.

Now we have a new Old Faithful to add to the line . . . the MICRO-MEMORY 3000QD. 32K x 16, 18, or 20 (alterable to 64K x 8, 9, or 10). A 3-wire, 3D core system with the same fast 300 nanosecond access. Same single card convenience. Same building block flexibility. Same day-in, day-out dependability. And it's form, fit, and functionally compatible with all core or NMOS MICRO-MEMORY 3000 systems.

Now more than ever MICRO-MEMORY 3000 makes an ideal transition between core and NMOS systems. You can design for all core, mix core and NMOS in the same chassis, or go completely NMOS — whatever suits your needs — without costly equipment modifications. You

can build from an 8K single card memory up to high density mass storage (up to 512K in a single standard chassis).

Let us show you how MICRO-MEMORY 3000 can meet your memory needs whatever they are. Call or write your local EMM office today.

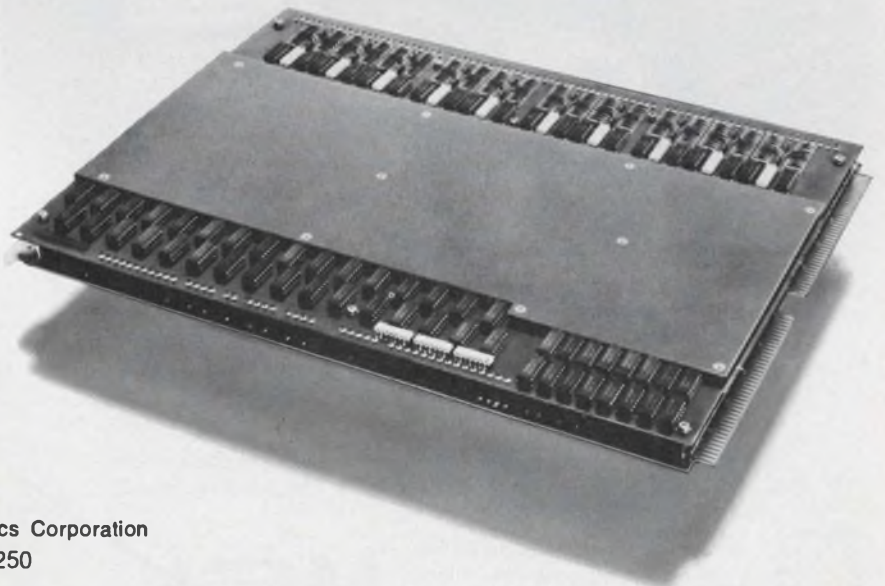

**EMM** ELECTRONIC  
MEMORIES  
COMMERCIAL MEMORY PRODUCTS

A Division of Electronic Memories & Magnetics Corporation  
12621 Chadron Ave., Hawthorne, Calif. 90250

EMM OFFICES: WESTERN REGION, Regional Office, San Francisco (408) 247-9711, Los Angeles Area (213) 644-9881, Orange County Area (714) 639-5811, Minneapolis Area (612) 941-2404, Phoenix Area (602) 968-2492, Dallas Area (214) 231-7207, EASTERN REGION, Regional Office, Boston (617) 861-9650, Chicago Area (312) 297-7090, Washington, D.C. Area (703) 941-2100, New York Area (516) 423-5800, Akron Area (216) 867-5435, INTERNATIONAL OFFICES, European Headquarters, Belgium (031) 76.69.75, United Kingdom (01) 751-1213, West Germany (089) 714.30.40, Far East Headquarters, Japan (03) 404-8520.

REPRESENTATIVES: Gentry Associates; Orlando (305) 894-4401, Huntsville (205) 534-9771, Burlington, N.C. (919) 227-3639. In Canada: Megatronix, Ltd.: Toronto (416) 742-8015, Montreal (514) 488-0404, Ottawa (613) 729-4004, Burnaby (604) 526-3312.

INFORMATION RETRIEVAL NUMBER 50

## MODULES & SUBASSEMBLIES

### Polyfunction operator handles positive inputs

Bell & Howell, 706 Bostwick Ave., Bridgeport, CT 06605. (203) 368-6751. \$49 (100-up); stock to 4 wk.

The Model 435 polyfunction analog operator performs first quadrant multiplication, division, exponentiation, squaring and square root. When used with an external

op amp it will generate the trig functions of sine, cosine and arc tangent. In the divider mode the denominator can span a 100:1 range and still meet the 0.25% accuracy spec. Output rating is 0 to 10 V at 0 to 5 mA. Supply voltages can range from  $\pm 12$  to  $\pm 18$  V dc at  $\pm 10$ -mA quiescent current. The 435 is designed to operate over the 0-to-70-C temp range and is housed in a hermetic 14-pin DIP.

CIRCLE NO. 329

### High isolation amplifier also supplies $\pm 15$ V

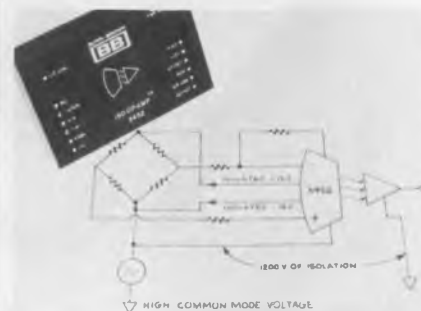

Burr-Brown, International Airport Industrial Park, Tucson, AZ 85706. (602) 294-1431. \$135; stock.

The 3452 Iso op amp has an isolation voltage capability of  $\pm 1200$  V dc and is tested at  $\pm 4800$  V dc for 1 s. And, the 3452 has an isolated  $\pm 15$  V dc,  $\pm 10$  mA power source available at the input. The 3452 can be operated in the non-inverting, inverting, or difference amplifier configuration. Designed for use with high-level voltage sources or low-level current sources, the amplifier has a FET input which provides a  $10^{11} \Omega$  input impedance, and a low bias current of  $-20$  pA, max. Common-mode rejection is 90 dB at  $\pm 10$  V, while isolation mode rejection is 160 dB, min. Input voltage drift is a respectable  $\pm 5 \mu\text{V}/^\circ\text{C}$ , max., and gain nonlinearity is guaranteed at  $\pm 0.05\%$ .

CIRCLE NO. 330

### Hybrid op amp boasts 100-MHz bandwidth



M.S. Kennedy Corp., Packard Dr., Syracuse, NY 13211. (315) 455-7077. \$38 (100-up); stock.

The Series 720 hybrid operational amplifiers have a 100-MHz unity gain bandwidth. Some of the amplifier's specs include: 10-MHz full power output when operated at  $\pm 10$  V and 30 mA; 50-ns settling time to 1%, and 100 ns to 0.1%; 1000 V/ $\mu\text{s}$  slew rate; and a voltage gain of 10,000.

CIRCLE NO. 331

## Now you can turn to MCL for reliable high power r-f and microwave testing.



Many customers remember us for the "extras" engineered and built into our microwave cavities, e.g., our potted anode bypass assembly.

But some may not be aware that today MCL also offers one of the industry's largest and most diverse power oscillator, amplifier and systems lines.

The same extra margin of reliability and performance customers have learned to expect from our cavities is also a feature of our instrumentation products.

For a recommended solution to your high power testing problem—without obligation—write us today.

MCL, Inc., 10 North Beach Avenue, La Grange, Illinois 60525.  
Or call (312) 354-4350.



Now on GSA contract GSOOS-27086 See us in EEM-Vol. 1 pp. 284-291

# Digivue® - a better way to look at it.

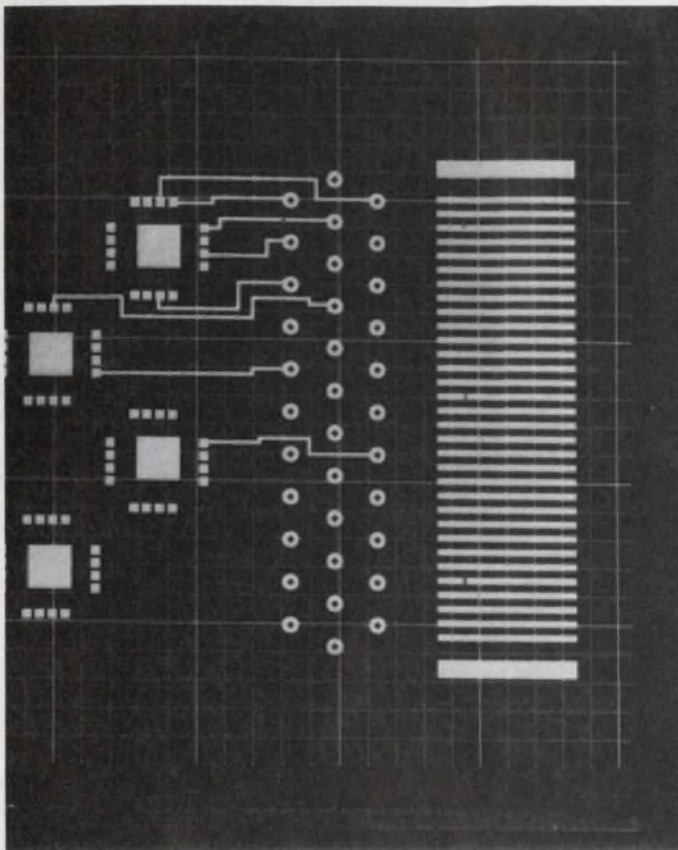

Unretouched time exposure of data displayed on a Digivue unit. Note high contrast picture, precise graphics.

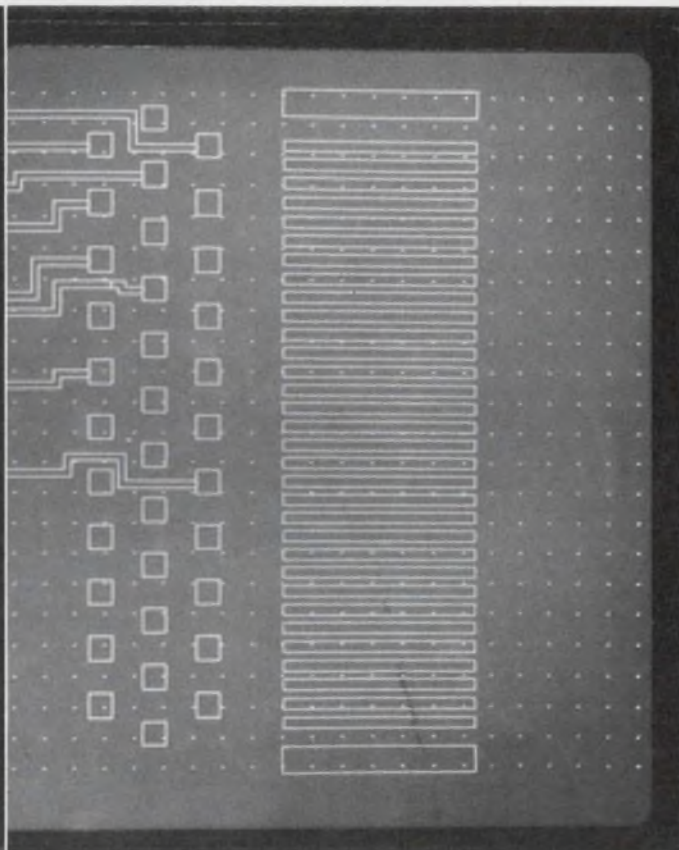

Unretouched time exposure of same data displayed on a CRT. Note lack of contrast in CRT image.

When your customers spend a lot of time looking at data displays and computer terminals, the advantages of Digivue plasma display units over CRT's become clear.

Very simply, Digivue display/memory units are better to look at. Digivue units present a flicker-free high contrast display for more precise readings and reduced chance of eye fatigue.

And Digivue units make it easier to use what's on the screen. Inherent memory is a feature of every unit. Digivue images appear on a thin, flat panel - which allows you to design compact components. The 512-60 models offer hard copy and rear projection capabilities, too. All of which gives you a product with more features to sell.

Sure, Digivue display/memory units currently cost more than CRT's. But they're worth a lot more to your customer, because they do a lot more.

For an informative booklet about Digivue display/memory units call (419) 242-6543, Ext. 66-415, or write Electro/Optical Display Business Operations, Owens-Illinois, Inc., P.O. Box 1035, Toledo, Ohio 43666



Demonstration model incorporates a Digivue display/memory unit 512 x 512 lines at 60 lines per inch resolution. Display area 8.5 inches square.

Smaller demonstration unit, utilizing a Digivue unit with 80 x 256 lines at 33 lines per inch resolution, has display area of 7.7 x 2.4 inches.

**OWENS-ILLINOIS**  
Toledo, Ohio

## D/a converter system made from CRT displays

*Dynamic Measurements, 6 Lowell Ave., Winchester, MA 01890. (617) 729-7870. \$375. (8 bits) to \$495 (13 bits); 2 wks.*

A card-mounted, complete de-glitched DAC system, the Digisweep, can draw 1600 full-scale vectors per second. It can do this with 12-bit resolution (under 0.005 in. steps on a 20-in. screen) with almost unnoticeable curvature or variations in intensity and line width. On the same size screen Digisweep can draw over 20,000, 0.25 in. high characters per second, or mix characters and vectors without tilt or displacement. Units are supplied with 8, 10, 12 and 13-bit resolution, and settling times to 0.01% of 150 ns or 350 ns. Individual temperature coefficients are specified for scale factor ( $\pm 17$  ppm), offset ( $\pm 10$  ppm), linearity ( $\pm 3$  ppm) and differential linearity ( $\pm 3$  ppm). Spikes or glitches coincident with changing the digital input word are both small (under 10 mV) and consistent, regardless of major carries or changes in polarity. The output is selectable up to  $\pm 10$  V, and capable of driving 6 ft or RG58V cable. An optional line driver mounts on the card and can drive over 150 ft of cable. The standard Digisweep PC card, containing all necessary power filtering and adjustments as well as the system modules, measures 4.5 x 7.625 in.

CIRCLE NO. 332

## Waveform generator delivers 3 outputs



*Interdesign, 1255 Reamwood Ave., Sunnyvale, CA 94086. (408) 734-8666. \$39 (unit qty.); stock.*

The 1511 waveform generator has a sine-wave distortion of only 0.3% maximum. The distortion remains low over an extreme sweep or programming range. The module has three independently buffered outputs for sine wave, triangle wave, and square wave. It can be operated from a single 15-V supply and draws less than 30 mA. The square-wave output is TTL, MOS and CMOS-compatible, and the unit operates over a  $-25$  to  $+75$  C range. The user only needs a single resistor to set or vary the frequency between 45 Hz and 45 kHz. The addition of a capacitor extends the frequency range to over eight decades, from 0.001 Hz to 200 kHz. No trimming of any kind is necessary. The frequency has a guaranteed temperature stability of 100 ppm/ $^{\circ}$ C maximum and a supply voltage dependence of less than 0.1%/V. A sweep and FM input allows a change in frequency of greater than 1000:1 with a linearity of 0.2%. The module is housed in a 1.5 x 1.5 x 0.4 in. epoxy package with gold-plated pins on 200-mil centers.

CIRCLE NO. 333

## Instrumentation amp has zero suppression

*Incor, 144 Lamor St., West Babylon, NY 11703. (516) 643-7070. \$295; stock.*

Model 300, dc instrumentation amplifier, has zero suppression, a high input impedance and a short circuit proof output with low impedance. Plus and minus stepped and variable input suppression allows input signals of up to 50 V to be bucked-out. Small signal excursions may be observed and amplified without overloading. Stepped and variable gains from 0 to 100 and an output of  $\pm 10$  V at 100 mA are provided. Each amplifier contains a fused, regulated power supply. Up to 10 amplifiers may be mounted in a 3.5 in. high Model 103 rack adapter.

CIRCLE NO. 334

## DIP crystal oscillators available to 65 MHz

*MF Electronics, 118 E. 25 St., New York, NY 10010. (212) 674-5360. From \$9 (large qty.).*

The 5406 series of DIP crystal oscillators is available with output frequencies from 4 to 65 MHz. The units are powered by +5 V and their outputs are Schottky TTL compatible with a fanout of 10. Rise and fall times are typically 2.5 ns while the symmetry is typically 52/48. These epoxy units will withstand humidity, temperature cycling and aging at 125 C for 168 hours. Unit height is 0.3 in. Guaranteed frequency accuracy is 0.005% from 0 to 65 C, or 0.0075% from  $-55$  to  $+125$  C.

CIRCLE NO. 335

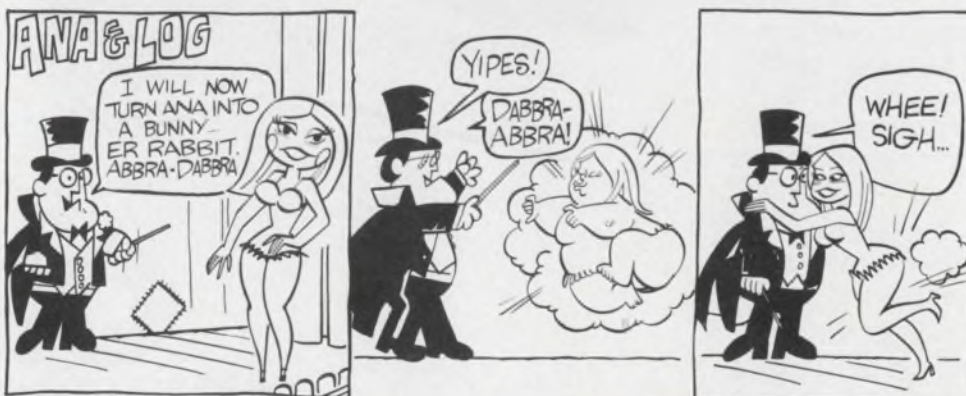

### ANALOGY

A-TO-D OR D-TO-A. THERE'S AN INTECH CONVERTER MODULE WITH HIGH ACCURACY AT BIG COST SAVINGS. WE STOCK 20 DIFFERENT TYPES WITH BINARY RESOLUTIONS FROM 8 TO 16 BITS FROM 4 TO 5 1/2 BCD DIGITS. LINEARITIES TO BETTER THAN  $\pm 0.0025$ %. EVEN OUR LOWEST COST DAC'S REMAIN MONOTONIC THROUGHOUT TEMP RANGE WITH CONVERSION TIMES TO 800 NS.

**intech/FMI**  
282 BROKAW RD. SANTA CLARA, CA 95050 (408) 244-0500



**2-pole filter spans  
0.001 Hz to 25 kHz**

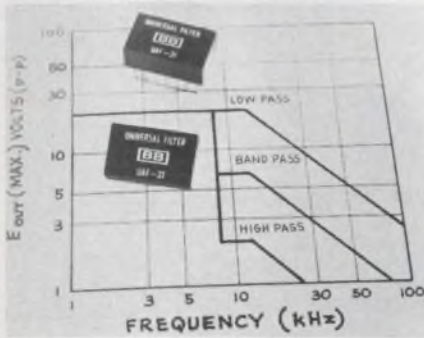

Burr-Brown, International Airport Industrial Park, Tucson, AZ 85734. (602) 294-1431. \$13 (100-up); stock.

The UAF31, a hybrid, universal active filter, has a resonant frequency range of 0.001 Hz to 25 kHz. Each UAF31 is a 2-pole active filter element. Only three, or at most four, external resistors are required to make a complete low pass, high pass, bandpass, or band reject active filter. The external resistors let the user easily control resonant frequency, Q-factor and gain. The resonant frequency temperature coefficient is a low  $\pm 35$  ppm/ $^{\circ}$ C and the resonant frequency accuracy is  $\pm 1\%$ . The UAF31 is housed in a 14-pin single wide epoxy DIP that measures only  $0.8 \times 0.5 \times 0.25$  in. The Q range is 0.5 to 500 with Q stabilities from  $\pm 0.01\%/^{\circ}$ C to  $\pm 0.025\%/^{\circ}$ C, and the operating temperature range is  $-25^{\circ}$ C to  $+85^{\circ}$ C.

CIRCLE NO. 336

**Binary multiplier does  
 $16 \times 16$  bit math**

Interface Engineering, 386 Lindelof Ave., Stoughton, MA 02072. (617) 344-7383. \$270; stock to 45 day.

The DD123 high performance  $16 \times 16$  bit binary multiplier was developed for control system applications. The DD123 can relieve computers of time-consuming iterations such as scaling to and from engineering units, coordinate conversion, coordinate translation, etc. The multiplier has a  $10 \mu$ s execution time, an 18-bit product output and is housed in a  $3 \times 4 \times 0.4$  in. module. You can also use it for division and square-rooting when the DD137 accessory unit is added.

CIRCLE NO. 337

# CUSTOM HYBRID MICROCIRCUITS

For Military/Aerospace Applications

# CIRCUIT TECHNOLOGY INCORPORATED

160 Smith Street, Farmingdale, N.Y. 11735  
Phone (516) 293-8686 • (213) 374-7446

INFORMATION RETRIEVAL NUMBER 54

## An integrated bridge rectifier in a miniature dual in-line package

# DIB

DUAL IN-LINE BRIDGE

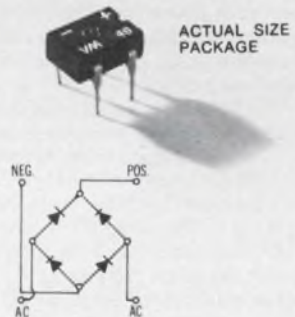

- 4-pin, low-profile DIP
- Leads on standard .10" (2,54 mm) grid
- Compatible with automatic testing, handling and inserting
- 1 Amp at  $40^{\circ}$ C ( $I_o$ )
- 25V to 1000V ( $V_{RRM}$ )
- Call Lee Miller 214/272-4551, Ext. 206 for more information.

**19¢\***  
ea.

\* 100V; 100,000 qty.

Design us in . . . we'll stay there

**VARO SEMICONDUCTOR, INC.**

P.O. BOX 676, 1000 N. SHILOH, GARLAND, TEX 75040 (214) 272-4551 TWX 910-860-5178

INFORMATION RETRIEVAL NUMBER 55



# NEW FROM AUGAT.

**Lead socket carrier assembly.** Now it's easier than ever to put Augat machined-contact reliability into your PC board. Disposable carrier provides 6-40 pin IC patterns for fast, easy insertion into boards. Permits maximum density, visibility for soldering and inspection, and increased air circulation. Available now from your Augat distributor.

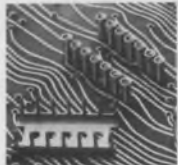

## AUGAT

Augat Inc., 33 Perry Avenue, P.O. Box 779, Attleboro, Massachusetts 02703

Name \_\_\_\_\_

Title \_\_\_\_\_

Company \_\_\_\_\_

Address \_\_\_\_\_

City \_\_\_\_\_

State \_\_\_\_\_

Zip \_\_\_\_\_

INFORMATION RETRIEVAL NUMBER 56

## No down-time in rotary switches

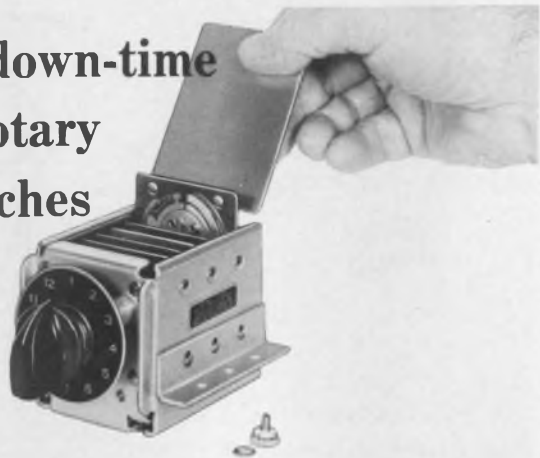

**Unique 5-second wafer replacement obsoletes other switches. Simply lift out old wafer, slip in new wafer. No unsoldering . . . no disassembling . . . no wire removing.**

CDI patented switches with dust covers are available in sizes 2" x 2", 3" x 3", and 4" x 4" with lengths to accommodate up to 36 wafers. Switches can be customized to your specifications.

Operation may be manual, motor or solenoid for use in any rotary selector switch application. Now supplied for numerous military and commercial applications.

Mfd. under Tabet U. S. Patents 2,841,660, 2,971,066, 3,015,000, 2,956,131, 2,988,607.

### CHICAGO DYNAMIC INDUSTRIES, INC.



PRECISION PRODUCTS DIVISION

1725 Diversey Blvd., Chicago, Ill. 60614. Phone 312, WE 5-4600

INFORMATION RETRIEVAL NUMBER 58

## Reliable DC transient protection you don't have to design and build.

Protect your power supplies and other semiconductor equipment from sudden death with an economical Heinemann JA/Q® combination voltage-transient/overcurrent protector.

The JA/Q gives you nanosecond response to voltage transients that could destroy a transistor or an entire IC chip. Lower-level sustained overvoltages are simply absorbed by our suppressor network, while the bigger spikes are diverted before they ever reach the protected circuits.

Write for Bulletin 3372, which tells you not only about the JA/Q but about our wide range of DC and AC overvoltage and brownout protectors.

Heinemann Electric Company,  
Trenton, NJ 08602.



### HEINEMANN

We keep you  
out of trouble.

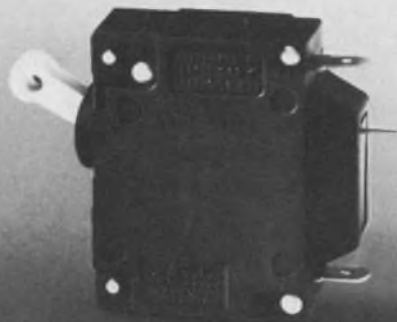

INFORMATION RETRIEVAL NUMBER 57



**ON WIRE BONDING  
OR MINIATURE COMPONENTS**

## USE FLIP CHIPS

FLIP CHIPS ARE AVAILABLE  
FLIP CHIPS ARE ECONOMICAL  
FLIP CHIPS CONNECT THEMSELVES

FOR YOUR SEMICONDUCTOR NEEDS  
CONTACT:

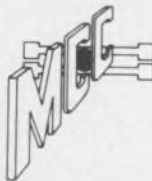

MICRO COMPONENTS CORPORATION  
99 BALD HILL ROAD  
CRANSTON, RHODE ISLAND 02920  
TEL 401-463-6000  
TWX 710-381-1757

INFORMATION RETRIEVAL NUMBER 59

ELECTRONIC DESIGN 15, July 19, 1975

## INSTRUMENTATION

### Storage scope weighs only 10.5 lb



Tektronix, P.O. Box 500, Beaverton, OR 97005. (503) 644-0161. \$1995 with probes; stock.

At 10.5 lbs., the new 314 portable storage oscilloscope is said to weigh less than any available dual-channel storage scope with a 10-MHz bandwidth. Bistable storage with 4-h viewing time, dual channels, and 10 MHz bw with 1 mV/div sensitivity are all combined in this instrument, designed for rugged environments. The CRT of the 314 is a direct-view bistable device with an internal graticule and an 8 × 10-div display area (0.25 in/div). An auto erase capability allows the user to view changes in the slow-moving phenomena. Erase cycle time can be varied from 1 to 5 s. An enhanced writing rate allows the capture of fast transients. Low-rep-rate signals are intensified by integration.

CIRCLE NO. 338

### Dual-limit comparator fits standard panel size

Newport Labs, 630 E. Young St., Santa Ana, CA 92705. (714) 540-4686. \$175; stock-2 wks.

Series 870 single and dual-limit digital data comparators are panel-mounted instruments that provide instantaneous warning or feedback signals whenever high or low preset limits are exceeded. Both single and dual-limit devices are housed in a high-impact Lexan case, which fits the standard 42.7 × 99.6 mm panel cutout. The units can be used with any DPM or other device having IC-compatible outputs in a parallel BCD or binary (octal) format. A front-panel LED indicator and a logic-level output announce within 500 ns of when the preset limits are exceeded.

CIRCLE NO. 339

### Counter/timer features remote programming



Fluke, P.O. Box 1094, Station D, Buffalo, NY 14210. (716) 842-0311. \$845.

Model 1953A is a universal counter/timer with provision for full remote programming. The instrument, designed for both bench and systems applications, measures frequency, ratio, period(s), time interval and gated totals, with a frequency range of dc to 125 MHz at sensitivities to 30 mV. The 1953A has a 9-digit LED display with full leading-zero suppression, automatic annunciation and overflow. Preset and variable trigger level controls with status indicators, and slope, coupling and attenuation switches are provided for each of two direct-coupled input channels.

CIRCLE NO. 340

### 520-MHz sig gen locks to 0.2 ppm/h



Wavetek Indiana, 66 N. 1st Ave., Beech Grove, IN 46107. (317) 783-3221. \$1975; 60 days.

Model 3000 phase-locked 1-to-520-MHz signal generator offers built-in AM/FM capability. The frequency of the single-range instrument can be digitally set to an over-all accuracy of ±0.001% with a resolution of 1 kHz. In addition, it has a phase-lock stability of 0.2 ppm/h. Output power is monitored on a front-panel meter calibrated in both dBm and volts rms. A 15-position 10-dB step attenuator used in conjunction with an 11-dB vernier provides the user with a range of ±13 to -137 dBm. The calibrated output is leveled to within ±0.75 dB across the complete frequency range.

CIRCLE NO. 341

# FREE

A top management guide to minicomputers.



If your business involves industrial automation, scientific computation or data communication, send for this free booklet.

It might save your company money.

Probably it's not your job to know how minicomputers work. But chances are good that it's your responsibility to know what they can do for your company — and if they should be doing it.

It's easy to find out if minicomputers can save money; increase profits and help your company fight inflation.

Send for this free booklet and get enough information to discuss the pro's and con's and economics of minicomputers with your engineers. Mail this coupon today.

.....  
Sir:  Please send me the free minicomputer booklet.

Have an Interdata representative contact me.

Name \_\_\_\_\_

Title \_\_\_\_\_

Company \_\_\_\_\_

Address \_\_\_\_\_

City \_\_\_\_\_

State \_\_\_\_\_ Zip \_\_\_\_\_

**INTERDATA®**

Mail this coupon to *Minicomputer Guide*, Interdata, Inc., Oceanport, N.Y. 07757

INFORMATION RETRIEVAL NUMBER 60

Thirty years of designing and manufacturing cord sets, wire and cable has given us the kind of experience which can solve your problems. Whether you are stumped by a complex design requirement or a sticky cost situation, our engineering and production staffs can come up with the right answers. In fact, many of our now standard designs were created as solutions to specific customer problems. And, our reputation for ingenuity is equalled

only by our reputation for quality.

Test us with your special requirements. You'll discover why Victor has become the standard of quality in cord sets and other wire specialty items.

**Victor Electric Wire & Cable Corp.**  
 618 Main St., West Warwick, R.I. 02893  
 Telephone: 401-821-1700  
 TWX: 710-382-1534



**There is no limit to our capability in cord sets or wire & cable!**

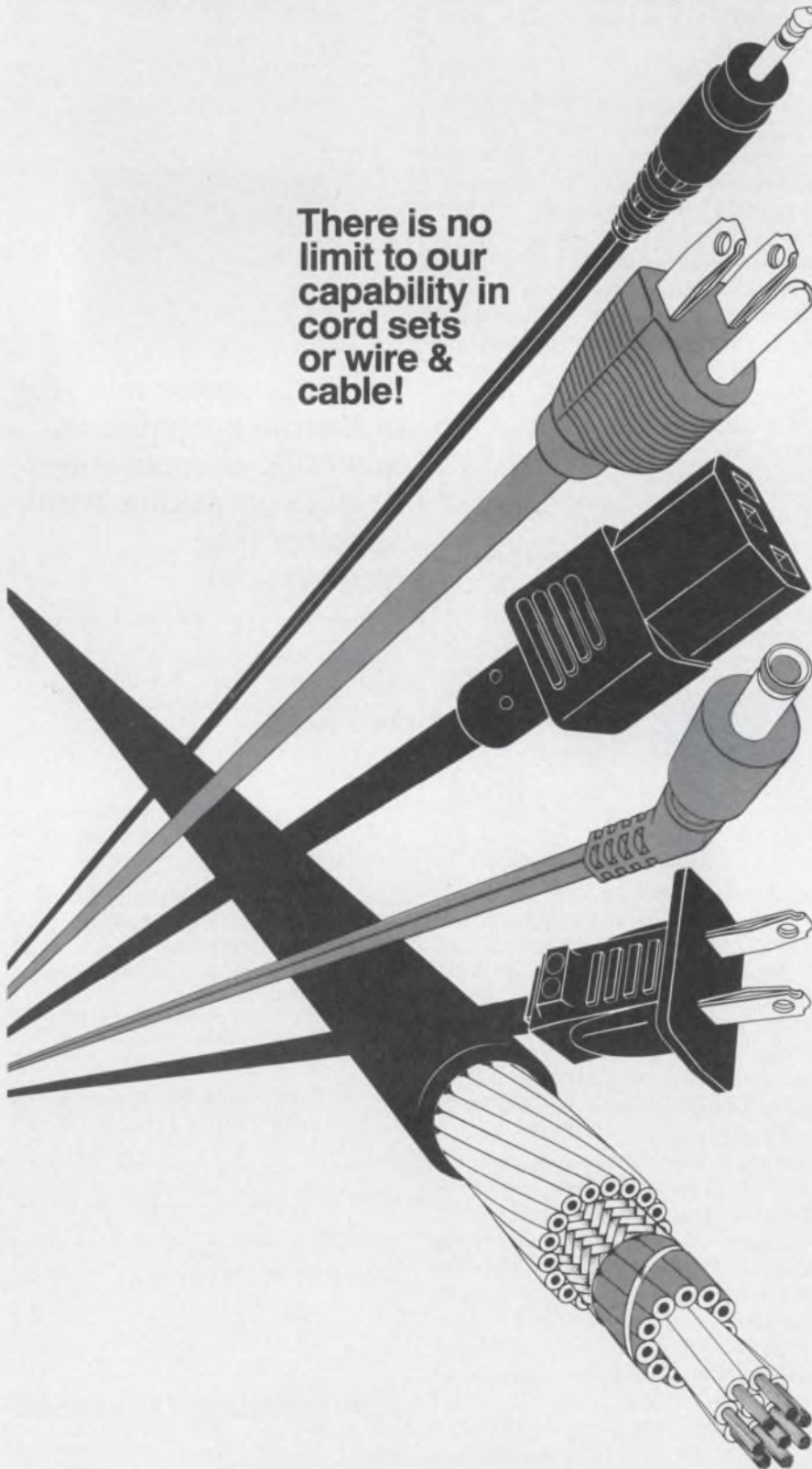

## DISCRETE SEMICONDUCTORS

### Power Darlington units have gain of 1000

RCA, Route 202, Somerville, NJ 08876. (201) 722-3200. From \$1.50 (100-up); stock.

Three 10-A pnp Darlington transistors, the RCA 8203, RCA 8203A, and RCA 8203B, are monolithic silicon pnp complements of the JEDEC 2N6386, 2N6387 and 2N6388. They have  $V_{CRO}$  ratings from -40 to -80 V, power dissipations of 60 W and a gain of 1000 at 5 A. The transistors are designed for low and medium-frequency power applications and are supplied in the JEDEC TO-220AB, straight lead version of the Versawatt plastic package.

CIRCLE NO. 342

### D-MOS FETs designed for communications gear

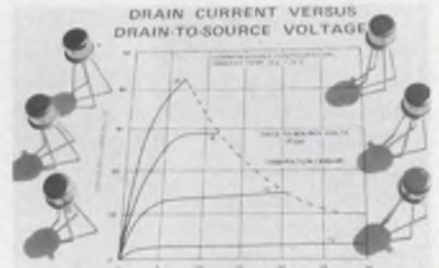

Signetics, 811 E. Arques Ave., Sunnyvale, CA 94086. (408) 739-7700. \$0.70 (100-up).

Two dual-gate D-MOS FET transistors, the SD306 and SD305, are intended for vhf front-end applications. The SD306 has typical power gain of 20 dB at 200 MHz and a noise figure of 2.8 dB. The 1% cross-modulation distortion performance is superior to bipolar or conventional dual-gate MOSFET devices since 480 mV of interfering signal can be applied at gate 1 before 1% distortion is observed. The SD305 was designed specifically for mixer applications and conversion gain is typically 17 dB at 200 MHz. When the rf signal and oscillator signal are fed into separate gate terminals, but with both gates biased to the same dc potential, there is 20 dB of isolation between gate 2 and gate 1 at 200 MHz. Both the SD305 and SD306 have a wide AGC range—about 50 dB at 200 MHz.

CIRCLE NO. 343

# shigoto cables and cord sets

... we go to any lengths.  
... we go to any ends.

That's why Shigoto can help make your ends meet. From hundreds of standard combinations to unusual characteristics that meet your own requirements. Even U.L. and C.S.A. approved. Our volume production for O.E.M.'s in electronics, communications, automotive, appliances, and practically every other industry, takes all the variables out of price-performance differences. Shigoto's ability to consistently produce top quality assemblies, when combined with large quantities, always brings in the prices you need. Unmatched quality has become our standard, our reliability and delivery schedules will become yours. Call, write, or wire your specs. At Shigoto, you'll find we'll go to any ends, to any lengths, to satisfy you.

**Shigoto Industries Ltd.**

350 Fifth Ave., N.Y., N.Y. 10001/(212) 695-0200/Telex 224219  
One of the World's Largest Manufacturing Importers

INFORMATION RETRIEVAL NUMBER 62

**ALCOSWITCH®**

Imagine, a TOGGLE SWITCH mounted on its side and designed specifically for PC use! Nothing makeshift about this switch, it's engineered just for this application with many quality features built in. A much needed switch product by this industry.



Make us prove what we say by calling us today at (617) 685-4371 for samples and a "cost-saving" quotation.

MTMS  
SERIES

ALCO ELECTRONIC PRODUCTS, INC.  
1551 Osgood St., No. Andover, Mass. 01845

**ALCOSWITCH®**

INFORMATION RETRIEVAL NUMBER 63

**ALCOSWITCH®**

We've used the inner mechanism of our best quality toggle switch to create one of the world's greatest SLIDE SWITCHES. You have available a high current capability built into a compact, low profile, PC mounted switch.



MSS-4  
SERIES

Call (617) 685-4371 for details, applications, samples and quotations.

ALCO ELECTRONIC PRODUCTS, INC.  
1551 Osgood St., No. Andover, Mass. 01845

**ALCOSWITCH®**

INFORMATION RETRIEVAL NUMBER 64

ELECTRONIC DESIGN 15, July 19, 1975

## Introducing the Revolutionary **PowerDIP™** **AC & DC** **SOLID-STATE** **RELAYS\***



- OPERATES FROM TTL, DTL... EVEN CMOS
- SWITCHES UP TO 4 AMPS WITHOUT HEAT SINKS
- "LOCKOUT" FEATURE PREVENTS FALSE TRIGGERING BY TRANSIENT PULSES
- OCCUPIES ONLY 1/4 CUBIC INCH

At Theta-J, we decided it was about time someone started designing useful relays at a price you could afford. So we put together a group with considerable know-how in power semiconductors, circuit design and volume production methods.

Result? Pretty startling, especially for those who thought solid-state would never compete with mechanical. Or even come close.

Here's a quick idea of what we mean:

**STANDARD MODELS (partial listing)**  
7 mA maximum control current\*

Model	Control Voltage	Output Voltage	Output Current
MA-1201	4 - 8 VDC	90 - 140 VAC	.75 A
MB-1201	9 - 15 VDC	90 - 140 VAC	.75 A
MD-1201	90 - 140 VAC	90 - 140 VAC	.75 A
MA-1202	4 - 8 VDC	90 - 140 VAC	2.0 A
MA-0602	4 - 8 VDC	60 VDC	2.0 A
MB-0602	9 - 15 VDC	60 VDC	2.0 A
MA-0604	4 - 8 VDC	60 VDC	4.0 A

\* Add "S" suffix to Model Number for 500 microampere Control Sensitivity

If you have a difficult switching problem, please tell us about it... we can probably help. For complete information call or write us today: Theta-J Relays, Inc., 2 Linden Street, Reading, Massachusetts 01867 (617) 942-0390.

\* Patent applied for



**THETA-J RELAYS, INC.**

INFORMATION RETRIEVAL NUMBER 65

# New

## A P terminal & distribution strips

## solderless plug-in universal breadboarding elements

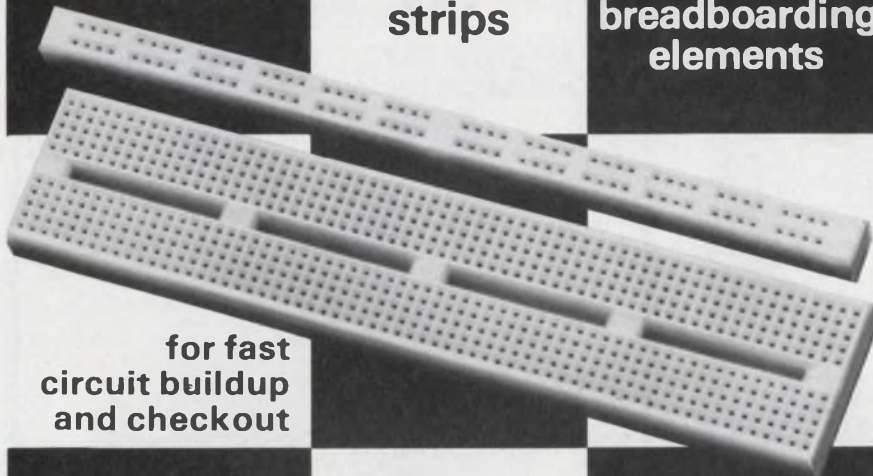

for fast  
circuit buildup  
and checkout

**10 new models  
starting at \$2**

expanded capacity  
at lower cost

All products are guaranteed  
to meet or exceed  
published specifications

accommodate  
all DIP sizes

easy hookup with  
22-ga. solid wire

free catalog



A P PRODUCTS INCORPORATED  
Box 110-D, Painesville, Ohio 44077  
(216) 354-2101 • Twx 810-425-2250

INFORMATION RETRIEVAL NUMBER 66

### DATA PROCESSING

## Interface makes timing generator programmable



Interface Technology, 627 Fremont  
Ave., South Pasadena, CA 91030.  
(213) 682-3705. \$2495; 3 wks.

The Computer Interface Option (CIO) enables the RS-648 Timing Simulator/Word Generator to be programmed and controlled by an external, local or remote device. The CIO is designed for interfacing with any computer in general use today. It allows full remote, hands-off programming of the RS-648. Data transmission is one way signal; levels are TTL with one unit load. Among the interface lines are 16 data, eight address and four function.

CIRCLE NO. 344

## Serial 165 char/s printers use LSI



Centronics Data Computer Corp.,  
1 Wall St., Hudson, NH 03051.  
(603) 883-0111. 301: \$2275; 501:  
\$3315.

Models 301 and 501 are serial LSI impact printers that operate at 165 char/s. The 301 prints an 80-column line at 70 line/min; the 501 prints a 132-column line at 50 line/min. A 5 x 7 or 9 x 7 dot-matrix character pattern is used, and the printers produce five clear copies. Serial interface is optional; a parallel interface is standard.

CIRCLE NO. 345



## Staco's lighted pushbutton switches look great and work even better

Built-in quality and good looks make Stacoswitch single lamp pushbutton switches and indicators your best buy. Rugged...dependable...choice of styles, colors, circuitry, and actions...plus LOW TOTAL COST. When you think switch...think STACOSWITCH and save.

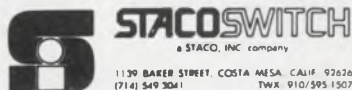

1130 BAKER STREET, COSTA MESA, CALIF. 92626  
(714) 549-3041 TWX: 910/595-1507

Other STACO Company products: Fixed Ratio Transformers, STACO, INCORPORATED, Richmond, Indiana; Variable Transformers, STACO, INCORPORATED, Dayton, Ohio.

INFORMATION RETRIEVAL NUMBER 67

1  
AMERICAN MADE  
Tolerance  
**SCHAUER**  
1-Watt  
**ZENERS**

**Immediate Shipment  
Low Prices**

ANY voltage from 2.0 to 16.0

Quantity	Price each
1-99	\$1.07
100-499	.97
500-999	.91
1000-4999	.86
5000 up	.82



All welded and brazed assembly

No fragile nail heads

Gold plated leads

Write for complete rating data and other tolerance prices.

**Buy the kit-  
Save a lot**



Kit contains a 51-piece assortment of SCHAUER 1% tolerance 1-watt zeners covering the voltage range of 2.7 to 16.0. Three diodes of each voltage packaged in reusable poly bags. Stored in a handy file box. Contact your distributor or order direct.

A \$54.57 value for  
**ONLY \$24<sup>50</sup>**

Semiconductor Division

**SCHAUER**  
Manufacturing Corp.

4511 Alpine Ave. Cincinnati, Ohio 45242  
Telephone: 513/791-3030

**PACKAGING & MATERIALS**

**Mount neatly stacks flat cable**

*Panduit Corp., 17301 Ridgeland Ave., Tinley Park, IL 60477. (312) 532-1800.*

New flat-cable mounts can secure stacked cables, folds and break-outs and still retain the inherently uniform transmission characteristics of flat cable. Pan-Ty intermediate cross-section cable ties are used. They can accommodate cable stacks to 5-1/4-in. high. The mount is all nylon and the base can be screw-mounted or affixed with commercial adhesive. Three sizes are available in widths to 3-in. maximum.

CIRCLE NO. 346

**Prepackaged insulators speed assembly**

*Thermalloy, Inc., P.O. Box 34829, 2021 W. Valley View Lane, Dallas, TX 75234. (214) 243-4321.*

Insul-Cote is a combination of insulators and Thermalcote grease for clean, convenient use on assembly lines. Thermalfilm or other insulator material, uniformly coated with Thermalcote, is heat-sealed between two strips of paper tape. The operator peels back the tape, lifts the precoated insulator with tweezers and puts the insulator in place. Prepackaged insulators are available for TO-3, TO-5, TO-18, TO-66 cans or plastic packages, as well as for stud-mounted rectifier applications.

CIRCLE NO. 347

**Tool cuts and flattens component wire ends**

*Micro Electronic Systems Inc., 8 Kevin Dr., Danbury, CT 06810. (203) 746-2525. \$23.50 (unit qty); 30 days.*

A new Belzer hand tool, Model 2658TQ, cuts component leads and flattens them at the same time to prevent the component from falling out of a PC board if turned over. The tool measures 5-in. in length and weighs only 90 g. It can cut copper wire 1.5-mm in diameter and piano wire 1-mm in diameter.

CIRCLE NO. 348

**MORE  
POWER  
MORE  
BANDWIDTH**

Our Model 503L is an ultra-wideband RF power amplifier whose wide range of frequency coverage and power output provides the user with the ultimate in flexibility and versatility in a laboratory instrument. Easily mated with any signal generator, this completely solid state unit amplifies AM, FM, SSB, TV, pulse and other complex modulations with minimum distortion.

Constant forward power is continuously available regardless of the output load impedance match, making the 503L ideal for driving highly reactive loads.

Unconditional stability and instantaneous failsafe provisions in the unit provide absolute protection from damage due to transients and overloads.

This low cost instrument, covers the frequency range of 1.6 to 540 MHz with a linear power output of 3 watts... and there's no tuning. Priced at \$995.\*

*Applications include:*

- Laboratory instrumentation
- Communication systems
- Laser modulation
- RFI/EMI testing
- Spectroscopy

\*USA and Canada



For further information or a demonstration contact

**ENI, 3000 Winton Road South,  
Rochester, New York, 14623.  
Call 716-473-6900.  
Or TELEX 97-8283 ENI ROC.**

**ENI**  
The World's Leader  
in Solid State  
Power Amplifiers

SEE  
Electronic Design's  
**GOLD BOOK**  
FOR COMPLETE  
PURCHASING  
INFORMATION

## New Literature

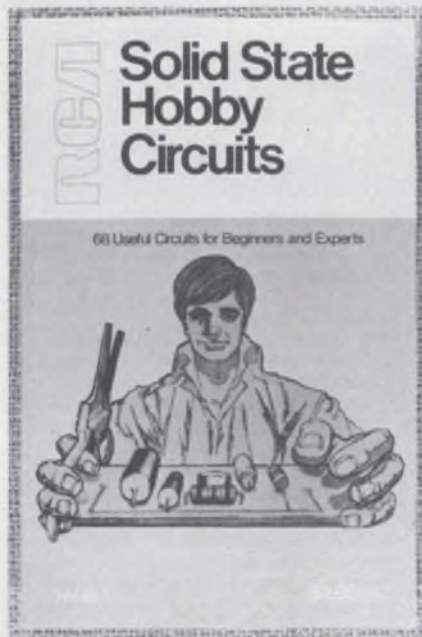

### Hobby circuits manual

An updated 400-page edition of the Solid State Hobby Circuits Manual presents 68 practical and useful solid-state circuits plus substantial operation and construction information. Copies may be ordered for \$2.95 each from RCA Solid State Div., Box 3200, Somerville, NJ 08876

INQUIRE DIRECT

### Magnetometers

The theory of operation of vibrating sample magnetometers and primary advantages of using magnetometers for magnetic characterization studies in diverse environmental conditions are covered in an eight-page catalog. Princeton Applied Research, Princeton, NJ

CIRCLE NO. 349

### Microprocessor manual

A 714-page manual describes the operation and applications of Motorola's M6800 family of micro-computer building blocks. The manual covers topics from system organization to system design and development. The manual costs \$25. Motorola, Semiconductor Products Div., P.O. Box 20924, Phoenix, AZ 85036

INQUIRE DIRECT

### Power supplies, regulators

Two volumes—power supplies and voltage regulators—cover the company's products. Vol. 1 is a 136-page book subdivided into three major areas: standard and custom power supplies and power instruments. Vol. 2 is a 48-page book that details voltage regulators. Lambda Electronics, Melville, NY

CIRCLE NO. 350

### Atomic frequency standards

Miniaturized atomic frequency standards, LF/VLF receiver and digital clock are combined for a precise time and frequency system. Principles of operation and performance data are described in a brochure. Efratom California, Costa Mesa, CA

CIRCLE NO. 351

### I/O connectors

Several series of precision-engineered wrap/crimp or DIP solder/crimp I/O connectors and IC socket contacts are covered in a 12-page guide. U.S. Components, Bronx, NY

CIRCLE NO. 352

### Rotating components

Ten classes of electrical rotating components are detailed in a 136-page catalog. Performance data and characteristic curves are given, as well as dimensional and circuit diagrams. Eastern Air Devices, Electro Audio Dynamics, Dover, NH

CIRCLE NO. 353

### Electronic hardware

Solder terminals, chassis hardware, contact pins and sockets and handles are featured in a 42-page handbook. Positronic Industries, Electronic Hardware Div., Springfield, MO

CIRCLE NO. 354

### Calculators

A calculator catalog provides details on the company's Models 21 and 31 programmable calculators, plus the interfaces and peripherals available. Tektronix, Beaverton, OR

CIRCLE NO. 355

### Amps and generators

TWT amplifiers, rf signal generators and frequency synthesizers are featured in a four-page catalog. LogiMetrics, Plainview, NY

CIRCLE NO. 356

### Brass, bronze, copper

An 80-page "Brass, Bronze, Copper" catalog is indexed according to metal form. A special data section gives information on how to calculate weights of forms, gauge numbers and millimeter equivalents and more. T. E. Conklin Brass & Copper, New York, NY

CIRCLE NO. 357

### Metals, alloys, ceramics

128 pages describe over 1000 materials for R&D and thin-film production. Applications, conversion charts and methods of deposition are included. Materials Research, Orangeburg, NY

CIRCLE NO. 358

### Glass fabrics and tapes

A six-page foldout guide describes Teflon-coated glass fabric and tape properties, capabilities and specifications. Chemical Fabrics, Bennington, VT

CIRCLE NO. 359

### Packaging system

An "erector set" packaging system for the Standard Electronic Module Program (SEM) is illustrated in a 17-page pamphlet. IERC, Burbank, CA

CIRCLE NO. 360

### Switches

Subminiature and microminiature switches are featured in a 24-page catalog. C&K Components, Watertown, MA

CIRCLE NO. 361

### Cabinets and enclosures

Separate, detailed sections on electronic cabinets and enclosures, engineering drawings and prices are given in a six-page brochure. Zero Manufacturing, Burbank, CA

CIRCLE NO. 362



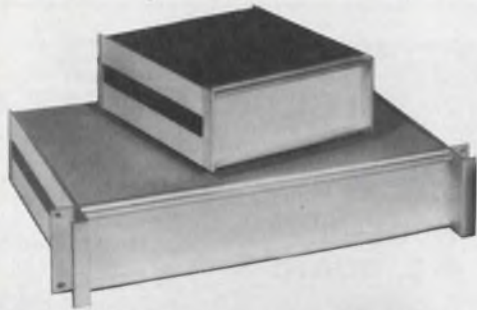

# BUCKEYE CASES

Buckeye bord-pak cases are made of aluminum extrusions and available in 1/3, 1/2, 2/3 and full rack widths. Full fabricating capabilities and complete electronic packaging needs from Buckeye include: colorful cabinets, 4 sizes of adjustable P.C.B. Racks, patented card guide modules; retractable tilt-stands with feet, and a complete line of matching instrument knobs.

Write today for free colorful literature!

the **BUCKEYE** stamping co.

555 Marion Rd., Columbus, Ohio 43207

"QUALITY PRODUCTS SINCE 1902"



**GUIDES • CABINETS • KNOBS • RACKS**

INFORMATION RETRIEVAL NUMBER 70

## QUICK-CONNECT BLOCKS

*With Infinite Design Possibilities*

There's an Underwriters Terminal Block for virtually any design requirement you have or can conceive.

No other line offers a wider selection of blocks and variations of in-block circuitry. Any number of terminations. Wide choice of configurations. Most are UL recognized and CSA certified. Blocks in kit form, too. Also special designs and hot-stamped coded blocks.

Request bulletin.

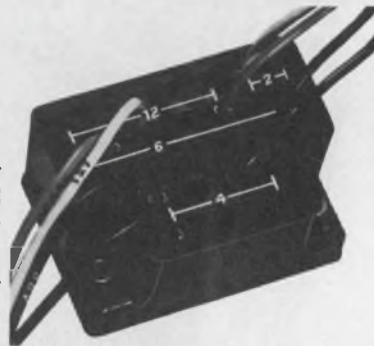

## Underwriters Safety Device Company

7300 W. Wilson Ave., Chicago, Ill. 60656 • 312-867-4600

INFORMATION RETRIEVAL NUMBER 71

ELECTRONIC DESIGN 15, July 19, 1975

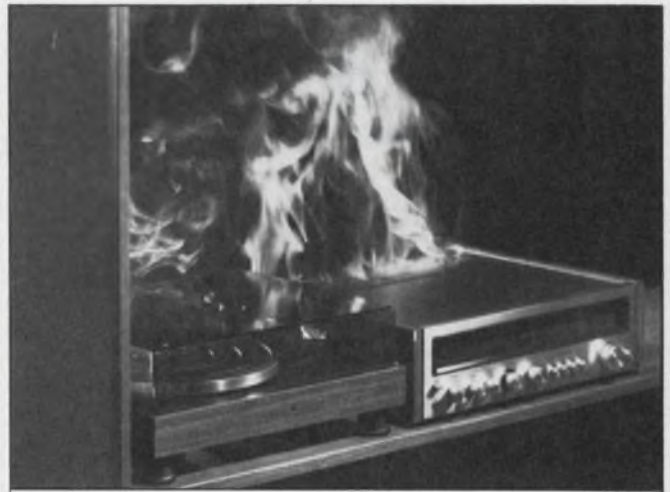

## There Goes Your Reputation --Up In Smoke.

**Here's how to protect your product, your customer—and yourself!**

Just add MICROTEMP® safety thermal cutoffs to your plans. The millions already in use are your assurance of positive, yet low cost protection against overheating caused by malfunctions in electrical circuits and components.

MICROTEMP is a reliable, accurate, easy to install, "one shot" thermal limiter. Because of its patented design and construction, it won't derate. And, it's unaffected by age or extended use.

**Compare this data:**

- opening tolerance —  $\pm 3^\circ \text{F}$ .
- temperature range — 58 to 242° C. (136 to 468° F.)

- compact — diameter, .157"; length, .457" (exclusive of leads)
- economical — priced as low as 9¢
- proved reliable in millions of on-the-job applications
- installation ease — assorted terminations, mounting packages and insulations are available
- UL listed — Facilitates compliance to UL 492, UL 506, UL 544, UL 547, UL 697, UL 859, UL 1025, and UL 1236. Meets UL 1020. CSA approved. Recognized by MITI, VDE, BSI. Military approval.

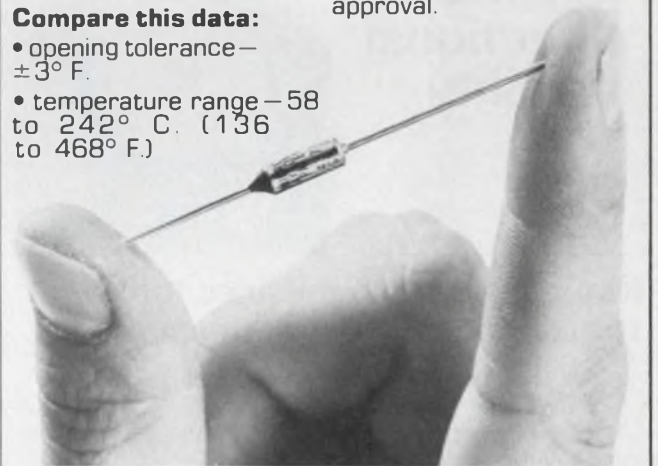

**For additional information, check the reader service card, or call or write:**



## MICRO DEVICES CORP.

1881 Southtown Blvd., Dayton, Ohio 45439

Ph: (513) 294-0581 Telex: 28-8087

INFORMATION RETRIEVAL NUMBER 72

# SWITCH TO CONTROL SWITCH



## UNIFORM-PANEL APPEARANCE PUSHBUTTONS

They look alike even though they have different ratings, actions, and circuits!



## TWO-CIRCUIT MINIATURE PCB SWITCHES

Toggle or Push Button. No mounting hardware required! Ideal for sub-chassis check out.



## TOGGLES

Hundreds of types in all configurations.

SEND FOR FREE TECHNICAL BULLETINS



PUSHBUTTONS  Circle #87    PCB SWITCHES  Circle #88    TOGGLES  Circle #89



## CONTROL SWITCH

A CUTLER-HAMMER COMPANY

1420 DELMAR DRIVE, FOLCROFT, PA. 19032 215/586-7500

Representatives and Stocking Distributors Throughout the United States, Canada, and Europe



# ARIES<sup>TM</sup> ELECTRONICS, INC.

Franchtown, N.J. 08825  
Telephone (201) 996-4096  
TWX 510-235-3391

## HI-DENSITY P.C. BOARDS

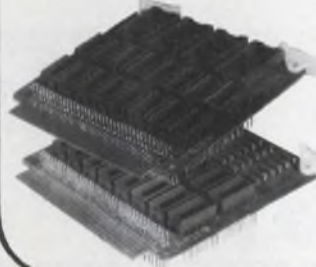

- Fits Standard 4-1/2" racks.
- Available with 14 thru 40 pin sockets 2 or 3 wrap.
- Power and ground planes to each socket position.
- 72 or 70 I/O pins and fingers.
- Board shipped complete.

## CROSS PATCH P. C. BOARD KIT



- Fits standard 4-1/2" rack.
- Programming board with 100 position switch matrix.
- Pluggable to standard 72 pin edge card connector.
- Diode and switch plugs furnished to requirements.
- Wire wrappable to 72 I/O pins at each matrix position.

INFORMATION RETRIEVAL NUMBER 75

Fast start/stop...  
positive  
directional  
stability



It's great on torque and price, too!  
The compact 81700 synchronous motor.

High torque-to-frame size ratio, superior performance characteristics and attractive low price make the 81700 synchronous motor ideal for computer peripherals, business machines and home entertainment equipment. Included are turntables, remote tuners, credit card readers and facsimile transmission equipment.

The motor's inherent reliability and 6 oz. in. @ 300 rpm are key factors. Instantaneous start/stop eliminates clutching and prestarting. Directional stability and low cost are other important advantages. A permanently lubricated bearing prolongs motor life and minimizes maintenance.

Write for information today!

NORTH AMERICAN PHILIPS CONTROLS CORP.

Cheshire, Conn. 06410 • (203) 272-0301

INFORMATION RETRIEVAL NUMBER 74

1/10TH  
THE LIGHT  
REQUIREMENT OF  
ORDINARY VIDICONS

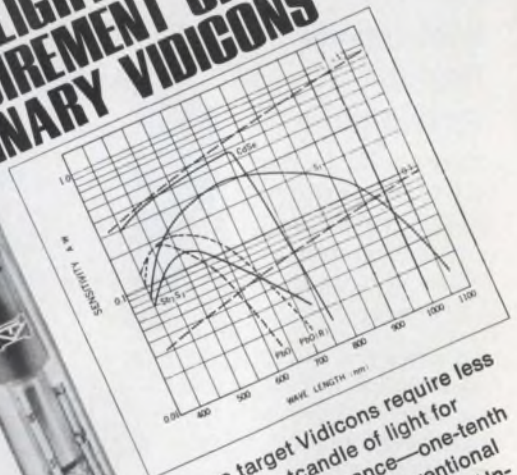

Silicon target Vidicons require less than .01 footcandle of light for effective performance—one-tenth the requirement of conventional antimony trisulfide vidicons. Unsurpassed resolution is another reason for switching to the N747T or N736T Vidicon for surveillance, industrial and educational TV cameras. When you compare the performance, you'll be amazed at the price.

Call or write for Data Sheet

**HAMAMATSU CORP.**

120 Wood Avenue  
Middlesex, New Jersey 08846  
(201) 469-6640

INFORMATION RETRIEVAL NUMBER 76

ELECTRONIC DESIGN 15, July 19, 1975

## Application Notes



### Liquid-crystal displays

Fundamentals of liquid-crystal displays, what they are, how they work and types available (dynamic scattering and field effect) are covered in an application note. Hamlin, Lake Mills, WI

CIRCLE NO. 363

### Spectroscopy

A report on coherent anti-stokes Raman spectroscopy (CARS) discusses the process and shows several practical results obtained with this technique. Moletron, Sunnyvale, CA

CIRCLE NO. 364

### EMI shielding

How to make the correct choice and apply conductive coatings to effectively protect against electromagnetic interference are covered in a six-page publication. Acheson Colloids, Port Huron, MI

CIRCLE NO. 365

### Impatt diodes

Four factors that contribute to failures in operation of silicon double-drift Impatt diodes are discussed in a bulletin. The four-page bulletin describes problems caused by fabrication defects, excessive junction temperature, bias circuit related burnout and tuning induced burnout. Hewlett-Packard, Palo Alto, CA

CIRCLE NO. 366

## Bulletin Board

Applied Materials has increased prices on the **IN-SOURCE 1500 vacuum evaporation system** and on all of its options. The base price for the system will be \$9000, compared with the present \$7800.

CIRCLE NO. 367

Phone-Mate has been licensed by AT&T to manufacture the Bell System's "Authorized Protective Connecting Module" for connection of Phone-Mate automatic telephone answerers to the Bell System telephone network.

CIRCLE NO. 368

Litronix has announced an improvement in the current transfer ratio of the **IL-12 phototransistor opto-isolator**. The guaranteed minimum CTR has been increased from 2 to 10% and typical CTR is 20%. The price has been reduced from \$0.89 to \$0.69 (1000).

CIRCLE NO. 369

Hybrid Systems has introduced the **Model ADC-12QZ**, a pin-for-pin, plug-in replacement for existing versions of the popular 12-bit Analog Devices Model ADC-12QZ a/d converter.

CIRCLE NO. 370

Sensitron Semiconductor Div. has added the **JAN and JAN TX 1N3643** through and including **JAN and JAN TX 1N3647 silicon rectifiers** to its qualified products.

CIRCLE NO. 371

Twenty general-purpose completely self-contained **digital-to-analog converter modules** have been announced by **Phoenix Data**.

CIRCLE NO. 372

**Harris Corp. Computer Systems Div.** has announced price increases on its **computer systems product line**. A typical 48 kbyte system will increase by 8%, a 192 kbyte system by 6% and a 288 kbyte system by 4%.

CIRCLE NO. 373

# Only with an EMR Real-Time Spectrum Analyzer...

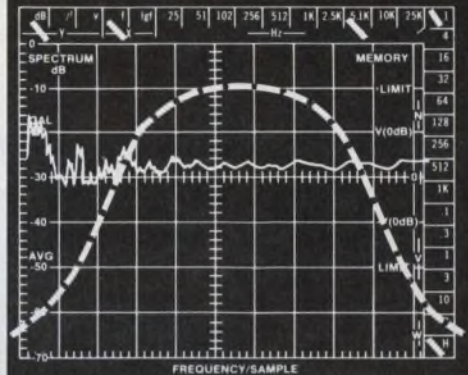

## A Rectangular Window for Transient and Order Analysis

EMR Real-Time Spectrum Analyzers are not restricted by a single window function. Our rectangular window allows accurate analysis of transient data type signals... without the restriction imposed by arbitrarily shaped windows. Competitive equipments utilize a window function analogous to the dashed line superimposed on the CRT display shown above. All data above the dashed line would have been severely restricted. Why lose vital data!

That's not all... other features include 60dB dynamic range, LED readout, computer interface, CRT status display, and much more!

Only From EMR!



**EMR** Schlumberger

EMR Telemetry  
Weston Instruments, Inc.  
Box 3041, Sarasota, Florida 33578  
813-371-0811

# NOW OFF THE PRESS!

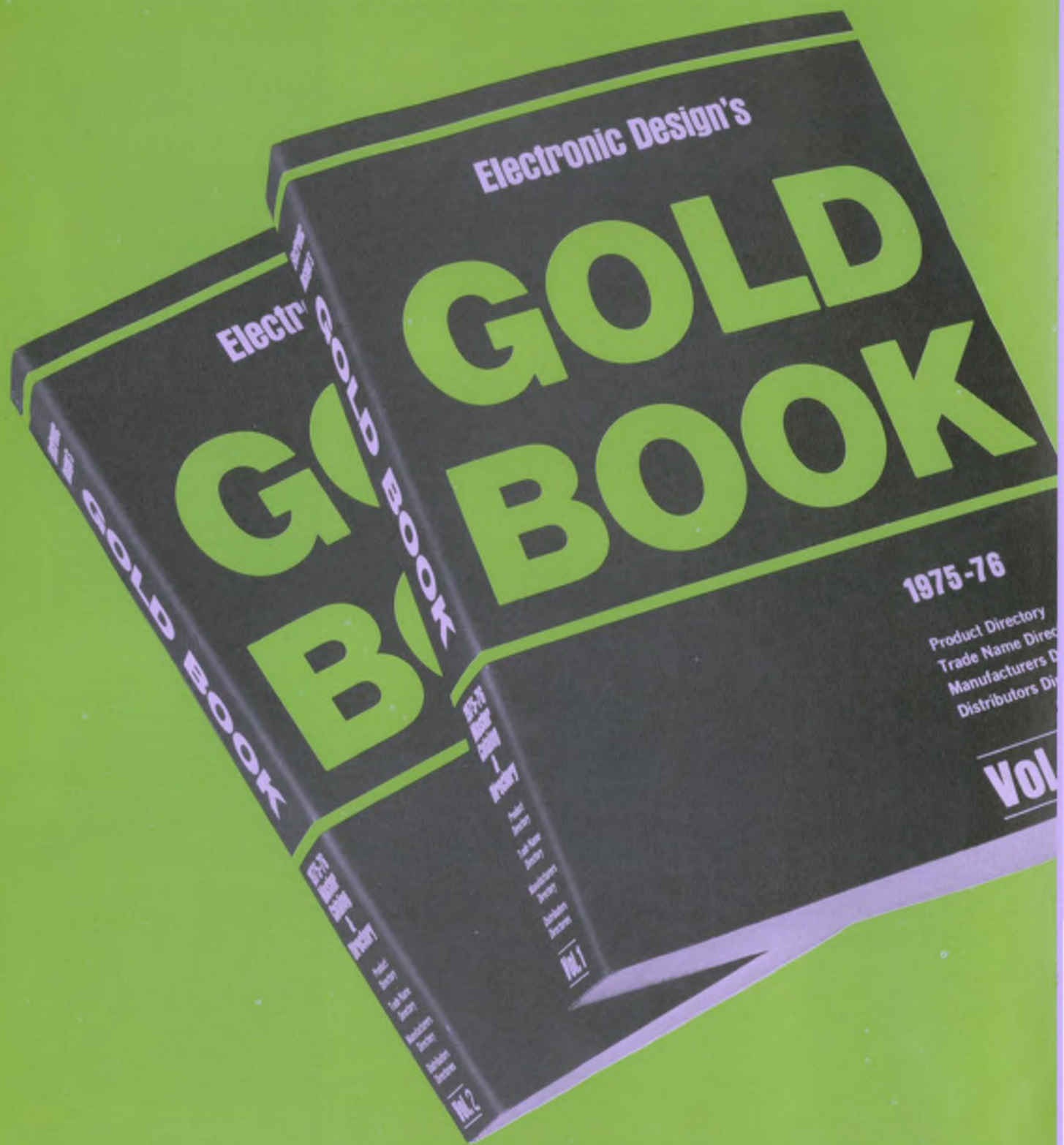

## THE INDUSTRY'S BEST

# Electronic Design's ALL NEW 1975-76 GOLD BOOK

## POWER SUPPLIES, LOGIC 5V

American Power Sys Corp 51 G Jackson St Worcester MA 01608 Vol 3/903-905 .....	(617)753-8103
Amphenol Sls Div, Components Group, Bunker Ramo Corp 2875G S 25 Av Broadview IL 60153 Vol 3/910,911 .....	(312)345-4260
Computer Prods, Dept G, Box 23849 Ft Lauderdale FL 33307 Vol 3/918,919 .....	(305)974-5500
Dynage Inc 1331G Blue Hills Av Bloomfield CT 06002 Vol 3/922	(203)243-0315
ELDEC Corp 16700G 13 Av W PO Box 100 Lynnwood WA 98036 Vol 3/930 .....	(206)743-1313
Electrostatics Inc, Dept G, 7718A Clairemont Mesa Blv San Diego CA 92111 Vol 3/943 .....	(714)279-1414
Elpac Inc/Elexon Power Svs, Dept G, 3131 S Standard Av Santa Ana	

If you were among the 99% of our surveyed readers who reported *Electronic Design's* 1974-75 GOLD BOOK equal or SUPERIOR to all other industry directories *here's good news*. The 1975-76 edition is even better.

It contains *more* product listings, *more* cross-references, *more* detailed information about companies — *more* sales outlets, reps, sales office, and distributor listings.

### USE THE GOLD BOOK TO . . .

**SPEED** your first-step search for products.

**SIMPLIFY** your contact with companies or their reps or distributors.

**FIND** specific product information.

**LOCATE** *complete* company names, addresses, zip codes and phone numbers. You'll also often have access to TWX; TELEX; facsimile equipment (by make and call number); toll-free numbers; cable addresses; number of engineers; number of employees; key officials and financial data.

**BUY** what you need without necessarily having to see a salesman.

The GOLD BOOK puts the entire electronics industry at your fingertips. Reach for it *first*. Distribution began in mid-July — FREE to qualified *Electronic Design* subscribers. Others may order copies while they last for \$30 per set domestic or \$40 elsewhere.

# DIRECTORY GETS EVEN BETTER



Thin-Trim variable capacitors provide a reliable means of adjusting capacitance without abrasive trimming or interchange of fixed capacitors. Series 9401 has high Q's and a range of capacitance values from 0.2-0.6 pf to 3.0-12.0 pf and 250 WVDC working voltage. Johanson Manufacturing Corporation, Boonton, New Jersey (201) 334-2676.

THIN-TRIM CAPACITORS 601

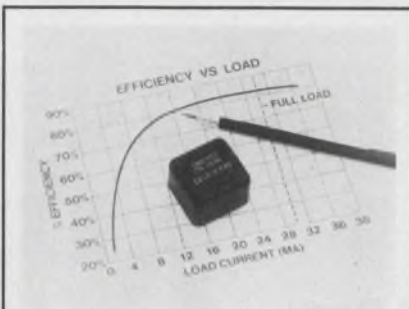

Activate gas discharge readouts! DC-to-DC power supplies convert low DC line voltages of 5, 9, 12 or 15 volts to nominal 200 and 250 volt DC levels required to run gas discharge information displays. Ideal for battery powered applications! Free literature. Endicott Coil Co., Inc., 31 Charlotte Street, Binghamton, N.Y. 13905

POWER SUPPLY 604



"Synchro to digital converters - 10, 12, or 14 bit output, errorless tracking up to 4 r.p.s., accuracy  $\pm 4$  min. of arc  $\pm .9$ LSB, resolution - 1.3 minutes, 60 or 400 Hz input, Module 2.6 x 3.1 x .82" H, Price From \$350 in qty.

Computer Conversions Corp., East Northport, N.Y. 11731 (516) 261-3300."

SYNCHRO TO DIGITAL 607



New Transistor Catalog: Crystalonic's new 40 pg catalog offers junction FETs, Fotofets™, and bipolar transistors, with low level switching integrated choppers. The semiconductor pioneer details 52 high reliability devices with a wide range of applications. Teledyne Crystalonics, Inc., 147 Sherman St., Cambridge, MA 02140. (617) 491-1670.

TRANSISTOR CALATOG 602



Introduction To Defense Radar Systems Engineering. Excellent introduction and practical reference to radar systems design and applications. #9194, 260 pp., \$22.95. Circle the Info Retrieval No. to order 15-day exam copy. When billed, remit or return book with no obligation. Hayden Book Co. 50 Essex St. Rochelle Park, N.J. 07662

RADAR SYSTEMS 605



Logic analyzer with display works in parallel synchronous or asynchronous mode; pattern trigger selectable up to 8 bits' generated trigger can be delayed after pattern recognition up to 999 clock pulses; input is stored and displayed coincidentally with delayed trigger pulse. \$265. Computel Engrg & Mfg Co. 2848 Charter, #207 Troy, MI 48084 (313) 524-2284.

LOGIC ANALYZER 608

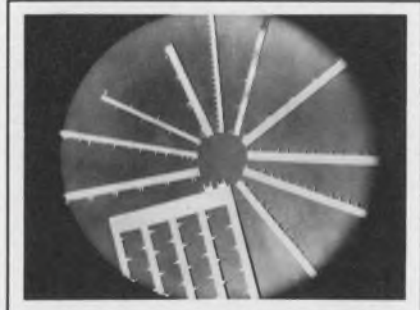

Mini/Bus® Evaluation Kit, \$25, in stock. Lets you try Rogers' low-cost, noise attenuating, high packaging density power distribution system for PC boards. Millions in use. Standard parts on 2 weeks delivery, or less! Customer parts 4 to 6 weeks delivery. Rogers Corporation, Chandler, Ariz. 85224. Phone (602) 963-4584

MINI BUS 603

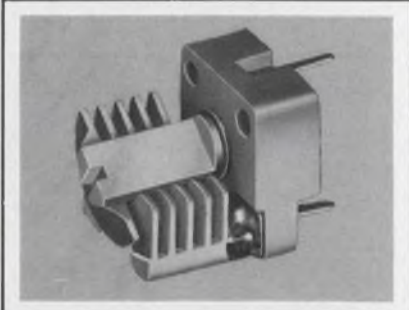

Miniature Type "U" air variable capacitors. Rotors and stators machined from solid brass extrusions offer excellent stability. High Q and low temperature coefficient (plus 45  $\pm 15$  ppm/°C). Available in single section, differential and special order butterfly types. Choice of PC or discreet wiring terminals. E. F. Johnson Co., Waseca, MN., (507) 835-5222.

TYPE "U" CAPACITORS 606



Free catalog of 34,500 power supplies from the worlds largest manufacturer of quality Power Supplies. New '74 catalog covers over 34,500 D.C. Power Supplies for every application. All units are UL approved, and meet most military and commercial specs for industrial and computer uses. Power Mate Corp. (201) 343-6294.

POWER SUPPLY 609

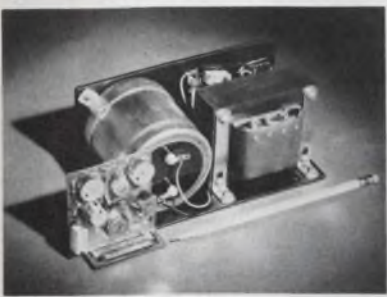

**"Point-of-Use" DC Voltage Regulators** simplify system design, save space. Use small VCR solid-state regulators for  $\pm 0.1\%$  regulation of 4.5 to 24.5 Vdc "downstream" from Black Line unregulated 15 to 200 watt DC power supplies which occupy far less space than regulated units. Standard Power, Inc. Santa Ana, CA 92705 (714) 558-8512  
DC VOLTAGE REGULATORS 610



**PRECISION CERMET RESISTOR CHIPS.** 40-mil-square & up. 1/8W & up. 1/3 Ohm to 1,000 Meg. 1% to 20%. Life stability .03%, TCR to 40 ppm/°C. Specify your bonding. Reasonable prices, 2-wk delivery. Also, custom hi-spec networks. IMS, INC., 288 E. Main, Middletown, R.I. 02840. 401-849-5242

CERMET CHIPS

611

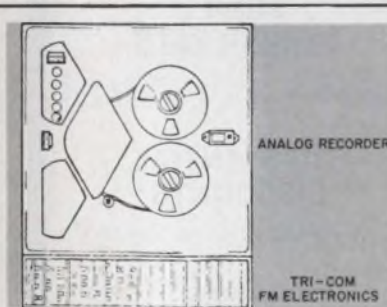

**No longer must you buy another recorder** to increase the number of channels to be recorded. TRI-COM has Low Cost FM electronics to enable record/playback of up to 10 data channels on each tape track. Use any analog recorder. Cost \$350 per data channel. TRI-COM, Inc., 12216 Parklawn Drive, Rockville, Md., 301-770-5585.

FM MULTIPLEX

612

## Advertising Sales Staff

Tom W. Carr, Sales Director  
Rochelle Park, NJ 07662  
Robert W. Gascoigne  
Daniel J. Rowland  
(Recruitment, Quick Ads, Classified)  
50 Essex Street  
(201) 843-0550  
TWX: 710-9990-5071

## Philadelphia

Thomas P. Barth  
50 Essex Street  
Rochelle Park, NJ 07662  
(201) 843-0550

## Boston 02178

Gene Pritchard  
P.O. Box 379  
Belmont, MA 02178  
(617) 489-2340

## Chicago 60611

Thomas P. Kavooras  
Berry Conner, Jr.  
200 East Ontario  
(312) 337-0588

## Cleveland

Thomas P. Kavooras  
(Chicago)  
(312) 337-0588

## Los Angeles 90045

Stanley I. Ehrenclou  
Burt Underwood  
8939 S. Sepulveda Boulevard  
Suite 510  
Los Angeles, CA  
(213) 641-6544

## San Francisco 94040

Robert A. Lukas  
3579 Cambridge Lane  
Mountain View, CA 94040  
(415) 965-2636

## London, Amsterdam, Tokyo, Seoul

John Ashcraft  
12, Bear St.  
Leicester Square  
London WC2H 7AS England  
Phone: 01-930-0525

W. J. M. Sanders  
John Ashcraft & Co.  
Herengracht 365  
Amsterdam C., Holland  
Phone: 020-24-09-08

Haruki Hirayama  
Electronic Media Service  
5th Floor, Lila Bldg.,  
4-9-8 Roppongi  
Minato-ku, Tokyo, Japan  
Phone: 402-4556  
Cable: Electronicmedia, Tokyo

Mr. O-kyu Park, President  
Dongbo Int'l Corp.—  
World Marketing  
C.P.O. Box 4010  
Seoul, Korea  
Tel. 76-3910/3911  
Cable: DONGBO SEOUL  
Telex: EBKOREA K27286

ELECTRONIC DESIGN's function is:

- To aid progress in the electronics manufacturing industry by promoting good design.
- To give the electronic design engineer concepts and ideas that make his job easier and more productive.
- To provide a central source of timely electronics information.
- To promote communication among members of the electronics engineering community.

**Want a subscription?** ELECTRONIC DESIGN is sent free to qualified engineers and engineering managers doing design work, supervising design or setting standards in the United States and Western Europe. For a free subscription, use the application form bound in the magazine. If none is included, write to us direct for an application form.

If you do not qualify, you may take out a paid subscription for \$30 a year in the U.S.A., \$40 a year elsewhere. Single copies are \$1.50 each.

**If you change your address,** send us an old mailing label and your new address; there is generally a postcard for this bound in the magazine. You will have to requalify to continue receiving ELECTRONIC DESIGN free.

**The accuracy policy of ELECTRONIC DESIGN is:**

- To make diligent efforts to ensure the accuracy of editorial matter.
- To publish prompt corrections whenever inaccuracies are brought to our attention. Corrections appear in "Across the Desk."
- To encourage our readers as responsible members of our business community to report to us misleading or fraudulent advertising.
- To refuse any advertisement deemed to be misleading or fraudulent.

Microfilm copies are available of complete volumes of ELECTRONIC DESIGN at \$19 per volume, beginning with Volume 1, 1952 through Volume 20. Reprints of individual articles may be obtained for \$3.00 each, prepaid (\$5.00 for each additional copy of the same article) no matter how long the article. For further details and to place orders, contact the Customer Services Department, University Microfilms, 300 North Zeeb Road, Ann Arbor, Michigan 48106 telephone (313) 761-4700.

**Want to contact us?** If you have any comments or wish to submit a manuscript or article outline, address your correspondence to:

Editor  
ELECTRONIC DESIGN  
50 Essex Street  
Rochelle Park, N.J. 07662



## DIFFERENTIAL DC AMPLIFIERS and Signal Conditioners

### ENVIRONMENTAL SERIES

Up to 100 G Shock  
-25°C to +71°C  
.5  $\mu$ V/°C Stability  
Bridge Excitation  
120 dB CMR

### ECONOMY SERIES

1  $\mu$ V/°C optional  
114 dB CMR  
80 kHz Bandwidth  
Bridge Bal. & Completion  
From \$135

### INDUSTRIAL SERIES

Strain Gage Conditioning  
Thermocouple Conditioning  
Thermocouple Linearization  
Reference Junctions  
Multifunction Amplifiers

### WIDEBAND SERIES

100 kHz Bandwidth  
Programmable Gain  
.003%/°C Gain T.C.  
.01% Gain Accuracy  
300V CMV



8159 Engineer Road  
San Diego, California 92111  
(714) 278-0600/TWX 910-335-1259

INFORMATION RETRIEVAL NUMBER 78

## Please Help Children Live

Research is our only weapon against childhood cancer.

St. Jude Children's Research Hospital, which is non-sectarian, is the largest childhood cancer research center in the world.

Please join in the fight against childhood cancer.

Send your special gift now.



## ST. JUDE CHILDREN'S RESEARCH HOSPITAL

Danny Thomas, Founder

Send contributions to:  
MEMPHIS, TENN. 38101

This space donated by publication

## recruitment and classified ads

WE SHIP IN 1 DAY  
FROM OUR 42000 SQ FT FACILITY

**MINIS**— DEC • DG • CAI  
CASC • HP • HIS • IBM • INT  
Lock • Micro • Sel • Tempo  
Univac • Varian • XLO

### PRINTERS

MDS 4330 300 LPM \$2950  
DP 2440 700 LPM 7500  
DP 4300 1333 LPM 7500

### CARD READERS

Documation M200 950  
M600 1500  
GDI 100, 110A 450

### PAPER TAPE

Digitronics 2500 350  
Chalco 5401 350  
BRPE Punch 21 250

### MAGNETIC TAPE

Pertec 7830 250  
6840 1450  
Wangco 1137 1450

617-261-1100  
**AMERICAN USED  
COMPUTER CORP**

Box 68, Kenmore Sta., Boston, MA 02215  
member COMPUTER DEALERS ASSOC.

INFORMATION RETRIEVAL NUMBER 201

## Sr. Engineer

San Francisco  
Peninsula Opportunity!

We are an expanding Northern California company, with an exceptional opening now available for a Sr. Engineer.

Responsibilities include design and development of ferrite devices. You will also be involved in many high rel programs. To join us now, you must have a minimum of a BSEE and at least 3-5 years' experience with a comparable company in this area of engineering.

You'll enjoy an outstanding benefit program including medical, dental, life and long term disability benefits, plus western living at its best. ALL RELOCATION COSTS PAID FOR.

Please forward your resume in complete confidence with salary history for prompt consideration to Personnel Department—



A Subsidiary of TRW  
825 Stewart Drive,  
Sunnyvale, CA. 94086  
(408) 732-0880

An Equal Opportunity Employer

INFORMATION RETRIEVAL NUMBER 203

### SESCOM'S NEW CABLE TESTER

Tests For: Continuity • Opens • Shorts •  
Phasing — Professional Net \$21.50/Send  
for Spec Sheet



Quality Engineered Sound Products  
SESCOM, INC.  
P. O. Box 590, Gardena, CA 90247 U.S.A.  
(213) 770-3510 • TWX 910-346-7023

INFORMATION RETRIEVAL NUMBER 202

**Protect Your Heart  
HAVE REGULAR MEDICAL  
CHECK UPS**



Give Heart Fund



# nce

## MINICOMPUTERS AND PERIPHERALS

BOUGHT • SOLD • RENTED

### SUBSTANTIAL DISCOUNTS

Everything fully guaranteed

Send for  
**FREE  
CATALOGUE**

**NEWMAN COMPUTER EXCHANGE**  
3960 Varsity Dr. Ann Arbor, Mi. 48104  
**(313) 973-1230**

INFORMATION RETRIEVAL NUMBER 204  
ELECTRONIC DESIGN 15, July 19, 1975



# Advertiser's Index

Advertiser	Page	Advertiser	Page
A P Products	96	Kepeco, Inc.	36
AMP, Incorporated	40, 41	Littelfuse, Subsidiary of Tracor	42
Abbott Transistor Laboratories, Inc.	6	3M Company	25
Alco Electronic Products, Inc.	95	MCL, Inc.	88
Allen Bradley Co.	17	Micro Components Corporation	92
American Technical Ceramics	107	Micro Devices Corp.	99
Amphenol Connector Division, Bunker-Ramo Corp.	11	Mini-Circuits Laboratory, A Division of Scientific Components Corp.	23
Aries Electronics, Inc.	100	North American Philips Controls Corp.	100
Augat, Inc.	67, 92	*Nucleotides	20
Beckman/ Helipot Division	43	Optron, Inc.	7
Belden Corporation	12, 13	Owens-Illinois, Inc.	89
Bell & Howell	61	*Philips Industries, Electronic Components and Materials Division	33
Browne Corporation	81	*Philips Industries, Test and Measuring Instruments Dept.	42, 43
Buckeye Stamping Company, Inc., The	99	Power/Mate Corp.	104
Bud Radio, Inc.	79, 80	Potter & Brumfield, Division of Amf Incorporated	31
Bunker-Ramo Corporation, Amphenol Connector Division	11	Quan-Tech, Division of Scientific Atlanta, Inc.	79
Chicago Dynamic Industries, Inc.	92	RCA Solid State Division	Cover IV
Circuit Technology, Inc.	91	Raytheon Company, Industrial Components Operation	85
Computel Engrg & Mfg. Co.	104	Rental Electronics, Inc.	20
Computer Conversions Corp.	104	Rogers Corporation	104
Continental Specialties Corporation	82	Schauer Manufacturing Corp.	97
Control Products Division, Amerace Corporation	56, 57	Shigoto Industries, Ltd.	95
Control Switch, Inc.	100	Siliconix, Incorporated	29
Cramer, Division of Conrac	71	Sprague Electric Company	16
Dale Electronics, Inc.	Cover II	Stacoswitch, A Staco Inc. Company	96
Data Precision Corporation	76	Standard Condenser Corporation	105
Digital Equipment Corporation	89	Systron-Donner	108
EMR Telemetry, Weston Instruments, Inc.	101	Sycor, Inc.	55
E-Z Hook	84	TRW Capacitors, an Electronic Components Division of TRW, Inc.	73
Ectron Corporation	106	Tektronix, Inc.	39
Electrocube Corp.	86	Teledyne Semiconductor	44
Electronic Memories, Commercial Memory Products	87	Teledyne Crystallonics	27, 104
Electronic Navigation Industries	97	Teledyne Relays, A Teledyne Company	2
Endicott Coil Co.	104	Tele-Dynamics, Division of Ambac	35
Fairchild Semiconductor, A Division of Fairchild Camera and Instrument Corporation	18, 19	Theta-J Relays, Inc.	95
Fujitsu Limited	80C	Tri-Com, Inc.	105
General Electric Company, Miniature Lamp Products Department	78	Triplet Corporation	69
General Radio Company	82	Underwriters' Safety Device Company	99
*Gold Book, The	17	Union Carbide, Components Department	15
Gold Book, The	102, 103	Varo, Inc.	91
Gould, Inc., Graphics Division	75	Victor Electric Wire & Cable Corp.	94
Hamamatsu Corp.	100	Viking Industries, Inc.	Cover III
Hayden Book Company, Inc.	104	Weston Instruments, Inc.	83
Heinemann Electric Company	92	Zero Manufacturing Co.	14
Hewlett-Packard	1, 66, 80D		
IERC, A Subsidiary of Dynamics Corporation of American	86		
IMS Inc.	105		
Intech, Incorporated	90		
Interdata	4, 5, 93		
International Rectifier	80A		
Ise Electronics Corporation	51		
Johanson Manufacturing Corp.	34, 104		
Johnson Company, E. F.	10, 104		

\*Advertisers in non-U.S. Edition.

## LOW X<sub>L</sub>@UHF



### NOW HEAR THIS ...

Connect to your microstrip circuitry with ATC low inductance MS (microstrip) silver leaded capacitors . . . .

Take advantage of the stable, low R<sub>s</sub>, ATC line of capacitors in an "easy on production" configuration.



### ...AND GET THIS FREE

MINI MARKUS or your postman will deliver your free sample of an ATC 100-B-300-J-MS [that's 30 pf]. Just circle the number below.

For samples of other lead styles and capacity values, call Ralph Wood (516) 271-9600.

**american  
technical  
ceramics**

ONE NORDEN LANE,  
HUNTINGTON STATION, NEW YORK 11746  
516/271-9600 • TWX 510-226-6993

INFORMATION RETRIEVAL NUMBER 79

# Get it from the quality DMM specialists

## (Systron-Donner)

More functions/ranges • field proven  
• large displays • rugged metal  
cases • high acceptance • low  
prices • short delivery



Model 7004A. All-function unit measures dc/ac volts, dc/ac current and resistance with excellent overload protection. AC response to 100 KHz.  $\pm 0.01\%$  DC accuracy. Optional internal battery pack and carrying case. Basic price \$675.



Model 7205. 26 ranges. Resolves  $\pm 1$  microvolt DC, 1 milliohm resistance,  $\pm 1$  nanoamp current. Measures dc/ac volts, dc/ac current and resistance with excellent overload protection.  $\pm 0.005\%$  accuracy. Display digits over  $\frac{1}{2}$ " tall. Lead-compensated ohms. Optional isolated BCD output. Basic price \$1150.

For immediate details, call our Quick Reaction line (415) 676-5000 collect, or contact Systron-Donner at 1 Systron Drive, Concord, CA 94518.

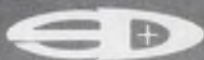

SYSTRON-DONNER

# Product Index

**Information Retrieval Service.** New Products, Evaluation Samples (ES), Design Aids (DA), Application Notes (AN), and New Literature (NL) in this issue are listed here with page and Information Retrieval numbers. Reader requests will be promptly processed by computer and mailed to the manufacturer within three days.

Category	Page	IRN	Category	Page	IRN
<b>Components</b>			FET op amp	80	323
CRTs	89	52	HiNIL interface	44	28
capacitors	73	37	microprocessor	77	302
capacitors	10	8	multiplexer	80	321
capacitors	15	11	multiplexers	80	320
capacitors	16	141	multiplexers, CMOS	79	308
capacitors	86	49	op amp, dual	78	307
capacitors	107	79	RAM	82	324
digital readouts	51	30	RAM, CMOS	82	326
indicator light	42	26	RAM, 4-k	79	309
lamps, halogen cycle	78	40	RAM, 4-k	82	325
motor, synchronous	100	74	Schottky TTL devices	19	13
overcurrent protector	92	57	TV sound channel	80	322
relays, solid-state	2	3			
relays, solid-state	95	65	<b>Microwaves &amp; Lasers</b>		
resistors, wirewound	11	253	microwave cavities	88	51
switches	100	73			
switches, PB	96	67	<b>Modules &amp; Subassemblies</b>		
switches, rotary	92	58	a/d, d/a converters	90	53
switches, slide	95	64	amplifier, isolation	88	330
switches, toggle	95	63	converter, d/a	90	332
thermal cutoffs	99	72	filter, active	91	336
vidicons	100	76	generator, waveform	90	333
			hybrid circuits	27	17
<b>Data Processing</b>			hybrid circuits	85	47
dual diskette recorder	55	29	hybrid microcircuits	91	54
interface, instrument	96	344	multiplier, binary	91	337
memories	83	45	op amp, hybrid	88	331
micromemory	87	50	operator, polyfunction	88	329
minicomputer system	5	4	optically coupled modules	7	6
OEM computer systems	9	7			
printer, serial	96	345	<b>Packaging &amp; Materials</b>		
			cabinets	14	214
<b>Discrete Semiconductors</b>			cable/connector system	25	16
dual in-line bridge	91	55	cable mounts, flat	97	346
power Darlington	14	248	carrier assemblies	92	56
resistor LEDs	71	36	cases	99	70
transistors, D-MOS	94	343	connectors, PC	57	31
transistors, power	94	342	connectors, PC	111	247
zeners	97	68	cord sets, wire and cable	94	61
			flat cable connectors	41	25
<b>Instrumentation</b>			heat sinks	86	48
amplifier, dc	106	78	hooks	84	46
comparator	93	339	IC sockets	67	34
counter	93	340	insulators	97	347
DMM	108	80	PC boards	100	75
modular instrumentation	39	24	sockets & bus strips	82	43
multimeter, 4-1/2 digit	76	39	soldering systems	81	42
noise analyzer	79	41	terminal & distribution		
oscillographic recorders	61	32	strips	96	66
rf network analysis	82	44	terminal blocks	99	71
rf power amplifier	97	69	tool, cutting hand	97	348
rental equipment	20	14	wire, cable and cord	13	234
scope	93	338			
signal generator	93	341	<b>Power Sources</b>		
spectrum analyzer	101	77	dc/dc converters	86	328
spectrum analyzers	66	33	OEM supply	86	327
strip-chart recorder	75	38	power modules	6	5
VOMs	69	35	power supplies	35	22
			power supplies	36	23
			power supplies	84	301
<b>Integrated Circuits</b>					
converter, a/d	29	18			

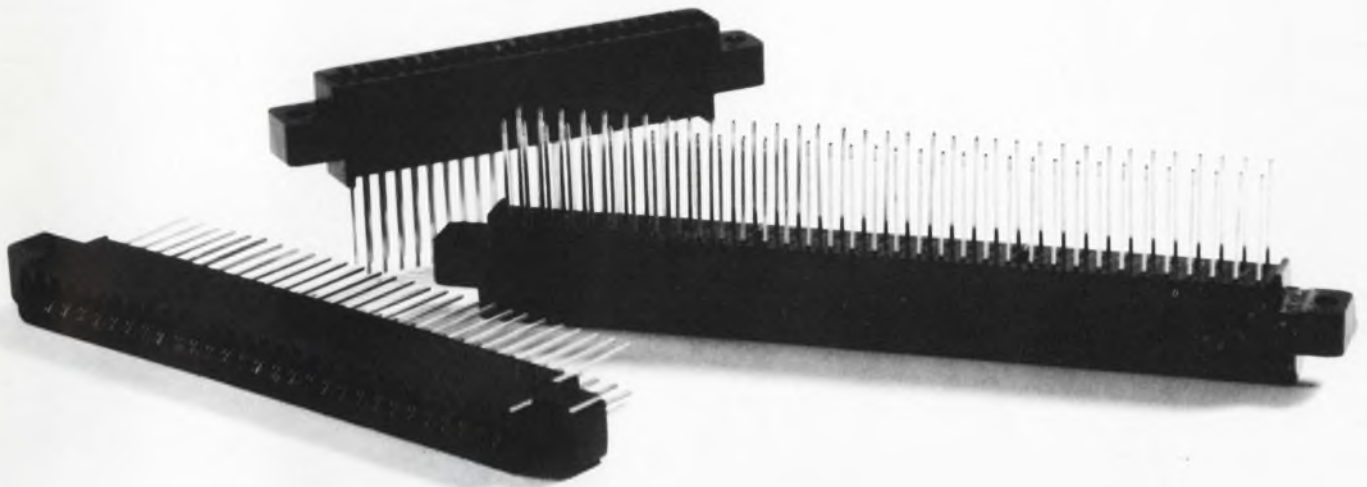

# Presenting our better-mouse-trap line. No frills at all.

When you cut price without cutting quality, soon no one thinks of it as a cut price. That's where our Norsman line of Wire-Wrap\* P/C connectors is headed. Here's why:

The insulator — it's tough, resilient, non-conductive — everything you need in a Wire-Wrap body. And it's made out of low cost phenolic, not the higher cost diallyl phthalate (if you need to meet mil specs, we have that in one of our other lines).

Contacts are semi-bellows and gold-plated — but

plated with our unique AuTac (TM) process. You get .000050" gold plate all along the mating surfaces for a sure, gouge-proof, pop-off-proof contact — but that's it. No wasted gold.

And you can find the size you need — Norsman is a full line from 15/30 to 50/100 contacts, in either .100 or .125 contact centers.

The whole Norsman idea is as simple as it is old: keep performance up and cost down. It works.

Send for details. We haven't told you everything.

\*Wire-Wrap — registered trademark of Gardner-Denver Company.

**Tell me everything.**  Send me detailed literature.

Name

Title

Company

Telephone

Address

City

State

Zip



# Viking

## CONNECTORS

Viking Industries, Inc. / 21001 Nordhoff St. / Chatsworth, Calif. 91311 / (213) 341-4330

What's new in solid state...

# Power Darlington from RCA. For greater cost effectiveness.

In certain high-gain applications, nothing beats a Darlington. And you gain even more when you specify RCA Darlington.

Wide selection, for instance. RCA has added 13 new types, bringing to 29 our wide choice within the popular 40-V to 120-V range. At low prices ranging from \$0.85 to \$1.60 at 1K.

All these Darlington have the ruggedness and performance you'd expect from RCA. Monolithic-chip reliability. Rugged clip-lead construction. Real-time process controls. Plus RCA power transistor experience. The kind that comes from serving volume customers in the auto, TV, computer and power supply industries. So we know how to keep costs down and quality up.

### From audio to autos

Right now, our customers are using RCA Darlington transistors to: 1. Cut audio costs at least 30%—each Darlington output replaces 5

components. 2. Simplify and shrink voltage regulators. 3. Control motors, using low IC currents as drive. 4. Drive computer printers with current-saving 120 V Darlington. 5. Switch high current in auto ignitions, where IC drive, thermal resistance and ruggedness are important advantages. These are just some examples.

Discover how you can use RCA Darlington to improve cost effectiveness. Write and we'll send details on the above applications plus a reply card for ordering a free RCA Darlington of your choice. Please give your name and address in the form of a self-addressed label.

For more information, contact your local RCA Solid State distributor. Or RCA.

Write: RCA Solid State, Box 3200, Somerville, New Jersey 08876; Ste. Anne de Bellevue 810, Canada; Sunbury-on-Thames, U.K.; Fuji Bldg., Tokyo, Japan.

# RCA

Type	Beta	Vceo
RCA8350/50A/50B 2N6383/84/85 2N6055/56 RCA1B07/08	1000 @ 5A 1000 @ 5A 750 @ 4A 1000 @ 5A	40/60/80 40/60/80 60/80 80
RCA8203/3A*/3B* 2N6386/87*/88* 2N6530/32/33* 2N6531 RCA120/21/22 RCA125/126	1000 @ 3A/ 1000 @ 5A* 1000 @ 3A/ 1000 @ 5A* 1000 @ 5A/ 1000 @ 3A* 500 @ 3A 1000 @ 3A 1000 @ 3A	40/60/80 40/60/80 80/100/120 100 60/80/100 60/80
2N6534/36/37* 2N6535	1000 @ 5A/ 1000 @ 3A* 500 @ 3A	80/100/120 100

RCA. Powerhouse in Transistors.