

A communications revolution is under way and it will impact all sectors of the industry. Advanced digital technology is leading to 'smart' network test instruments.

Switching systems are heading towards total computer control. Mobile radio equipment is being redesigned for 900-MHz use. A special report starts on P. 34.



COMMUNICATIONS'75



Need E-Rel Components?

We helped write the book!

Don't spin your wheels when you shift to established reliability from standard military specifications. Dale has the QPLs and the finished goods stock to save you valuable time. We're

Fast delivery on many styles offering fast delivery on many established reliability part

numbers for both wirewound and metal film resistors and wirewound trimmers. And we can deliver something else, too: *Experience.* Our work in the Minuteman program led to the formulation of the first specifications for established reliability resistors. Since then our materials improvement and failure rate documentation programs have become models in the industry. Today our AGS resistors have a proven failure rate of .000032% per 1,000 hours. *That's established reliability.* Put it to work for you now. Call 402-564-3131 (wirewound styles) or 402-371-0080 (film styles) or dial 800-645-9200 for the name of your Dale representative.



DALE ELECTRONICS, INC.
Columbus, Nebr. 68601
A subsidiary of The Lionel Corporation
In Canada: Dale Electronics Canada Ltd.
In Europe: Dale Electronics GMBH,
8 Munchen 60, Falkweg 51, West Germany

INFORMATION RETRIEVAL NUMBER 262



ESTABLISHED RELIABILITY

★ ★ ★ ★ ★
ESTABLISHED
RELIABILITY

MIL-R-39007, MIL-R-39009
MIL-R-39015, MIL-R-39017
MIL-R-55182



MIL-R-39007
MIL-R-39009
MIL-R-39015
MIL-R-39017
MIL-R-55182

SURPRISE!

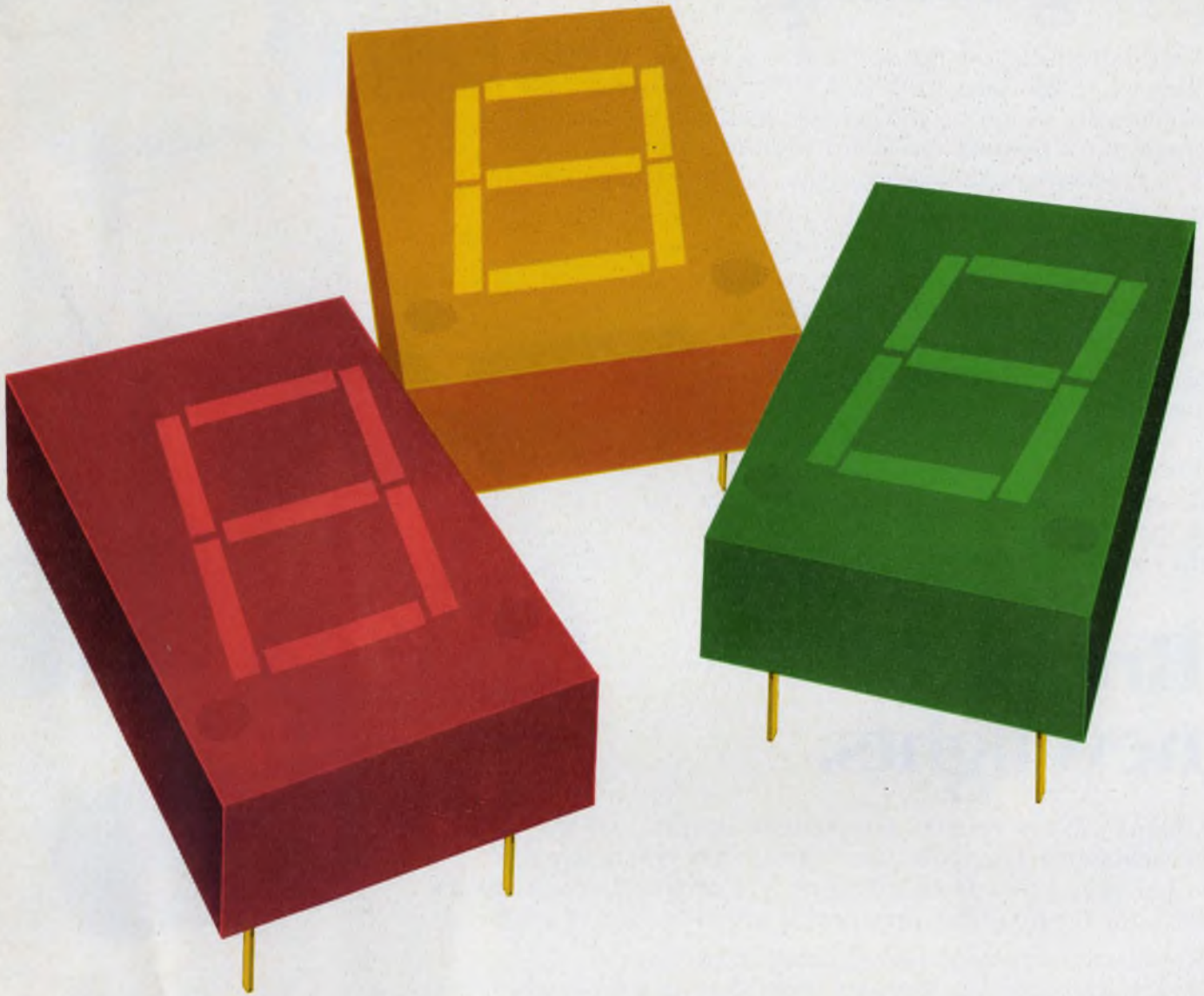

HP's 5 times brighter display!

At 20mA our new High-Efficiency red display is 5 times brighter than our standard red displays. Just 3mA per segment gives you all the brightness you need and makes it ideal for battery powered applications. These large .43" displays are offered in High Efficiency Red, Yellow, or Green and are readable up to 20 feet. The 5082-7650 (High-Efficiency Red), -7660 (Yellow),

-7670 (Green) are available in standard DIP packages with left-hand d.p. and common anode configuration. Just \$3.95* each in quantities of 100.

Contact Hall-Mark, Schweber, Wilshire or the Wyle Distribution Group (Liberty/Elmar) for immediate delivery, or write us for more information and our new application note on contrast enhancement.

01503

*Domestic USA price only

HEWLETT  PACKARD

Sales and service from 172 offices in 65 countries
1501 Page Mill Road, Palo Alto, California 94304

INFORMATION RETRIEVAL NUMBER 2

A new low for on-board programming.

AMP introduced the DIP switch to solid-state electronics. Now we've gone still further. AMP's new *low-profile* DIP switches are as low as you can get. You can use them to program ICs right-on-the-board without remote wiring. And sandwich boards in less space, to cut packaging costs.

With our new, low-profile DIP switches, cleaning boards is easier than ever. Simply place our protective covers or pieces of tape on the switches and you can clean complete boards without damage.

We're the people who developed and perfected DIP switches—a whole family of them—including our innovative, pluggable Hexadecimal Rotary Switch. Our experience is broader and deeper than anyone's. At AMP we'll have the right answers for your applications.

Bright new lights.

Unique LED DIP switches are available in SPST "on" or "off" as well as momentary-contact types. They permit rapid, visual circuit test, fault indication and programming verification. Plus, for the first time, they permit DIP packaging of LEDs.

Rockers are detented to avoid accidental actuation. Switch leads and LED leads are terminated independently for circuit connection versatility.

There's nothing quite like new AMP LED DIP switches. For more details on them, or the new AMP low-profile DIP switches, call (717) 564-0100. Or write AMP Incorporated, Harrisburg, PA 17105.

AMP is a trademark of AMP Incorporated.

AMP

INCORPORATED

INFORMATION RETRIEVAL NUMBER 3

NEWS

- 21 **News Scope**
- 34 **Communications '75 special issue**, featuring major trends in communications technology. Topics covered include the latest trends in receiver and transmitter design, particularly the shift to integrated circuits and the use of digital methods; the shift in communications traffic from mostly voice to a mix of speech and data; the push of land-mobile radio design into the 900-MHz band because of spectrum crowding; the increasing use of multi-function test instruments, digital signal analysis and automated systems to ensure the quality of transmission; a profile of a major contributor to the communications industry: The late Dr. Ernst Alexanderson.
- 29 **Washington Report**

TECHNOLOGY

- 78 **FOCUS on pulse transformers**. You can get a better grip on the problems you face in specifying pulse transformers by looking at the applications you're likely to encounter and avoiding the mistakes engineers most commonly make.
- 86 **Determine transmitter noise figure** with the noise-diode approach. With the result, you can characterize and then reduce broadband emissions.
- 92 **Switch out microwave phase errors** with the correct diode configuration. Here are tips on what to expect from the three basic switch designs.
- 98 **Ideas for Design:**
Voltage-reference LED also provides visual indication of overload.
Square-wave frequency divider provides symmetrical output for odd dividers.
Make simple voltage-level detectors with CMOS inverters.
- 104 **International Technology**

PRODUCTS

- 107 **Instrumentation:** Direct synthesizer programs in 20 μ s, is inexpensive.
- 124 **Modules & Subassemblies:** High-isolation amplifiers handle up to ± 2500 V, common-mode.
- | | |
|-----------------------------|---------------------|
| 110 Integrated Circuits | 129 Power Sources |
| 113 Discrete Semiconductors | 132 Components |
| 118 Microwaves & Lasers | 138 Data Processing |
| 121 Packaging & Materials | |

DEPARTMENTS

- | | |
|--|--------------------------------|
| 75 Editorial: The engineer's engineer | |
| 7 Across the Desk | 156 Advertisers' Index |
| 144 New Literature | 158 Product Index |
| 150 Application Notes | 160 Information Retrieval Card |
| 151 Bulletin Board | |
- Cover:** Designed by Art Director, Bill Kelly

New low prices and Texas Instruments 900

8K memory
board
\$980*

960B minicomputer
with 8K words of
memory . . . \$3760*

16K memory
board
\$1960*

24K memory
board
\$2940*

*Prices quantity 100 OEM, USA only.

Improving man's effectiveness through electronics

proven reliability for series computer memories

Now, semiconductor memories with built-in error-correction circuitry and 100,000 hours MTBF... for as low as \$980 for 8K 16-bit words.

TI's 900 series minicomputers offer users memory features that yield reliability... 100,000 hours MTBF... unsurpassed by any other minicomputer memory design.

New low prices

As has always been the case at TI, improved performance and reliability have continued to come down in price. The trend continues... with new reductions in memory prices up to 38%.

Each 8K increment of memory for TI's minicomputers is now only \$1400 in CPU quantity one. With attractive end-user and OEM discount schedules, this price drops to as low as \$980 for OEM CPU quantity 100.

Reliability features

TI's computer memories are designed using reliable 4K RAM devices. Multi-bit error detection and single-bit error correction are standard features of these memories. With these features, if a single-bit failure should occur, the memory controller corrects the error and transfers valid data to the CPU so that valuable processing can continue. Also, light emitting diodes indicate the exact location of a faulty memory device.

	TI 960B	TI 980B	HP 21-M/10	DEC PDP-11/05	DG Nova 1210
	S/C memory w/error corr.	S/C memory w/error corr.	S/C memory w/parity	Core memory w/o parity	Core memory w/o parity
CPU w/8K words	\$4,700	\$5,075	\$6,150	\$ 5,995	\$5,800
CPU w/16K words	6,100	6,475	7,650	7,495	7,400
CPU w/24K words	7,500	7,875	9,150	12,195	9,400
<i>Price includes:</i>					
ROM loader	Yes	Yes	Yes	No	No
Power fail protect	Yes	Yes	No	Yes	Yes
Hardware Mult./Div.	No	Yes	Yes	No	No

All prices quantity one, USA only.

Innovative features such as these provide significant reliability benefits for users. MTBF, for instance, is 100,000 hours for an 8K word board... which means increased uptime.

Density... an attractive feature

Increased density is another very important benefit. Because of TI's 4K RAM, users can have 8K, 16K, or 24K 16-bit words of memory on a single board, and can get as much as 65K words of memory in the main CPU. Significant? Indeed it is...because this

increased density, along with built-in reliability, comes at very low prices.

What's more, TI backs these products with a network of sales and service offices across the U.S. and in major countries overseas.

For the full story, contact the nearest sales office listed below. Or, write Texas Instruments Incorporated, Digital Systems Division, P.O. Box 1444, M/S 784, Houston, Texas 77001. Or call (512) 258-5121, Computer Systems Marketing.



Arlington, Va. (703) 527-2800 • Atlanta, Ga. (404) 458-7791 • Boston, Mass. (617) 890-7400 • Chicago, Ill. (312) 671-0300 • Clark, N.J. (201) 574-9800 • Cleveland, Oh. (216) 464-2990 • Dallas, Tx. (214) 238-5318 • Dayton, Oh. (513) 253-6128 • Denver, Co. (303) 751-1780 • Detroit, Mich. (313) 353-0830 • Houston, Tx. (713) 777-1623 • Minneapolis, Minn. (612) 835-5711 • Orange, Ca. (714) 547-9221 • Orlando, Fla. (305) 644-3535 • San Francisco, Ca. (415) 392-0229 • Sunnyvale, Ca. (408) 732-1840 • Amstelveen, Holland 020 456256 • Bedford, England 58701 • Beirut, Lebanon 353188/353189 • Cheshire, England 061 442 8448 • Copenhagen, Denmark (01) 917400 • Essen, Germany 02141/20916 • Frankfurt, Germany 0611/39 9061 • Freising, Germany 08161/801 • Milano, Italy 683034 & 6899215 • Montreal, Canada (514) 332-3552 • Paris, France (1) 630 2343 • Slough, England 33411 • Stockholm, Sweden 62 71 59/62 71 65 • Sydney, S. Australia 831-2555 • Toronto, Canada (416) 889-7373

TEXAS INSTRUMENTS
INCORPORATED

INFORMATION RETRIEVAL NUMBER 4

When You Buy a Power Supply, Why Not Get the Best?



28 VDC to DC
(55,463 Hrs.)
Model C95D

28 VDC to 400 A
(61,387 Hrs.)
Model 53D

400 A to DC
(56,148 Hrs.)
Model W5D

Abbott's New Hi-Performance Modules

are designed to operate in the stringent environment required by aerospace systems — MIL-STD-810B and MIL-STD-461A for electromagnetic interference.

RELIABILITY — MTBF (mean time between failures) as calculated in the MIL-HDBK-217 handbook can be expected in excess of 50,000 hours at 100°C for all of these power modules. The hours listed under the photos above are the MTBF figures for each of the models shown. Additional information on typical MTBF's for our other models can be obtained by phoning or writing to us at the address below.

QUALITY CONTROL — High reliability can only be obtained through high quality control. Only the highest quality components are used in the construction of the Abbott power module. Each unit is tested no less than **41 times** as it passes through our factory during fabrication — tests which include the scru-

tinizing of the power module and all of its component parts by our experienced inspectors.

NEW CATALOG—Useful data is contained in the new Abbott Catalog. It includes a discussion of thermal considerations using heat sinks and air convection, a description of optional features, a discussion of environmental testing, electromagnetic interference and operating hints.

WIDE RANGE OF OUTPUTS — The Abbott line of power modules includes output voltages from 5.0 volts DC to 740 volts DC with output currents from 2 milliamperes to 20 amperes. Over 3000 models are listed *with prices* in the new Abbott Catalog with various inputs:

- 60A to DC
- 400A to DC
- 28 VDC to DC
- 28 VDC to 400A
- 12-28 VDC to 60 A

Please see pages 307-317 Volume 1 of your 1974-75 EEM (ELECTRONIC ENGINEERS MASTER Catalog) or pages 853-860 Volume 3 of your 1974-75 GOLD BOOK for complete information on Abbott Modules.

Send for our new 60 page FREE catalog.



LABORATORIES, INCORPORATED
general offices eastern office
5200 W. Jefferson Blvd./Los Angeles 90016 1224 Anderson Ave./Fort Lee, N.J. 07024
(213) 936-8185 Telex: 69-1398 (201) 224-6900 Telex: 13-5332

INFORMATION RETRIEVAL NUMBER 5

Sr. Vice President, Publisher
Peter Coley

Editors

Editorial Offices
50 Essex St.
Rochelle Park, NJ 07662
(201) 843-0550
TWX: 710-990 5071
Cable: Haydenpubs Rochellepark

Editor-in-Chief George Rostky

Managing Editors:

Ralph Dobriner
Michael Elphick

Associate Editors:

Dave Bursky
Jules H. Gilder
Morris Grossman
Seymour T. Levine
John F. Mason
Stanley Runyon
Edward A. Torrero

Contributing Editors:

Peter N. Budzilovich
Alberto Socolovsky
Nathan Sussman

Editorial Field Offices

East

Jim McDermott, Eastern Editor
P.O. Box 272
Easthampton, MA 01027
(413) 527-3632

West

David N. Kaye, Senior Western Editor
8939 S. Sepulveda Blvd.,
Suite 510
Los Angeles, CA 90045
(213) 641-6544
TWX: 1-910-328-7240

Editorial Production

Marjorie A. Duffy

Art

Art Director, William Kelly
Richard Luce
Anthony J. Fischetto

Production

Manager, Dollie S. Viebig
Helen De Polo
Anne Molfetas
Maxine Correal

Circulation

Manager, Evan Phoutrides

Information Retrieval

Peggy Long

Promotion

Karen Kerrigan (Reprints)

Creative Layout Services

Manager, Albert B. Stempel

Across the Desk

TV color frequencies defended as accurate

In a letter in the April 1 issue, James Rieger questions the accuracy of the new National Bureau of Standards frequency-calibration service using color TV signals ("He Questions Accuracy of TV Color Signal," ED No. 7, p. 8). The bureau has monitored hundreds of hours of network-originated programming, including live, tape and film broadcasts, and has compared the signals against the NBS standard. The accuracy, as stated, is a few parts in 10¹¹. For highest accuracy, the distinction is between network-originated vs local programming.

The quality of network-originated color signals is excellent, because the color burst is obtained from a rubidium standard. During playback of tape the color burst is locked to the same rubidium. Stable network signals are available for about 12 hours a day from each network, except in the Mountain Time Zone. Denver, for instance, has only five hours of network signals each day. Calibration is scheduled accordingly.

NBS data from monitoring the networks lead us to praise their signal stability. Even the regular programs from New York and Washington lock the color burst to the New York rubidium. Live sports originations are usually rubidium-controlled but may differ in frequency from studio signals.

Local broadcasts are usually not as stable as network signals; however, a frequency source accurate to a few parts per million (FCC

rules) is pretty handy for lots of users. And they can easily determine the difference between network and local broadcasts using either the Color Bar Comparator or the Frequency Measurement Computer.

For the very best calibration at the highest accuracy, measurements should be made on all three networks for at least five minutes. The results should be carefully checked for consistency with the published NBS data.

Anyone who wants to receive the published NBS data or simply wants more details on the operation of this service is invited to write to the Time and Frequency Services Section, National Bureau of Standards, Boulder, CO 80302.

George Kamas

National Bureau of Standards
Boulder, CO 80302

Re: James Rieger's comments questioning the accuracy of the transmitted color TV carrier as a calibration reference. I agree with him that the carrier is not always derived from the atomic standard used in New York, but the statement that only live programming has this high-stability carrier present is incorrect.

The chroma time-base correction system uses the local sub-carrier source as a reference, and the color burst is formed from the reference input. The new nanoseconds of time jitter is only in the active picture, not the color burst. Local stations along a network feed can color-lock their sync generators to the New York

(continued on pg. 10)



LOW COST INFRARED SOURCE/SENSOR PAIR

VERSATILE OPTRON DEVICES ALSO MATCH EQUIVALENT INDUSTRY TYPES!

Now, you can match the high efficiency emission of OPTRON's OP 160 infrared source with the high sensitivity OP 500 sensor or mix either low cost device to pair with equivalent industry types!

The OP 160 LED features a typical output of 1.5 mW at 20 mA in a concentrated beam at a high efficiency emission wavelength of 940 nanometers. The OP 500 N-P-N planar phototransistor has a high spectral sensitivity designed to match that of the OP 160. Typical output of the OP 500 is 10 mA at 20 mW/cm² tungsten lamp irradiance.

When operated as a pair, the OP 160/OP 500 provide a typical output of 1.0 mA with an input of 20 mA at a lens-to-lens spacing of 0.25 inch. The identical input at a spacing of 1.0 inch generates an output of 0.5 mA.

Specified individually, the devices are mechanically and optoelectronically matched to replace equivalent industry types as follows:

OPTRON	REPLACES
OP 160	TIL32
OP 500	TIL78

Both the OP 160 LED and OP 500 phototransistor are available from stock in a clear plastic mini-axial package. They are ideally suited for mounting in high density arrays for such applications as shaft encoders, position sensing, key boards, and limit switch replacement.

Detailed technical data on the OP 160 source / OP 500 sensor and other OPTRON optoelectronic products... chips, discrete components, isolators, assemblies, and PC board arrays... is available from your nearest OPTRON sales representative or the factory direct.



OPTRON, INC.

1201 Tappan Circle
Carrollton, Texas 75006, U.S.A.
214/242-6571 • TELEX-73-0701
TWX-910-860-5958

Electronic Design welcomes the opinions of its readers on the issues raised in the magazine's editorial columns. Address letters to Managing Editor, Electronic Design, 50 Essex St. Rochelle Park, N.J. 07662. Try to keep letters under 200 words. Letters must be signed. Names will be withheld on request.

Introducing F100K. The first and only sub-nanosecond ECL.

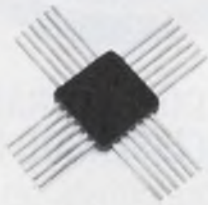

The first sub-nanosecond standard ECL series is here.

F100K.

The F100K family represents a quantum advance in ECL performance and ease of design.

Developed in cooperation with major mainframe manufacturers, this remarkable new ECL series will benefit many other maximum data-rate systems as well—including processors, instrumentation and digital communications.

And of the 24 F100K devices initially scheduled for production, 8 are available now.

F100K. The first standard family of superspeed ECL.

What makes F100K so advantageous to use?

1. *Speed, of course.*

Instead of the typical 2.0 ns for conventional 10K ECL gates, the typical speed for F100K is 0.7 ns. With a minimum of 0.4 ns and a maximum of 0.95 ns.

2. *Speed/power.*

Despite its blazing speed, F100K affords a speed/power product of just 28 pJ for SSI functions—about half the level of conventional 10K.

For more optimized MSI and LSI functions, the typical propagation delay actually drops below 0.5 ns. And the speed/power product falls below 5.0 pJ per gate.

slower than in Schottky logic families.

5. *Isoplanar II fabrication.*

Designed primarily for MSI and LSI complexity with a minimum of SSI functions, the F100K series is produced by Fairchild's high-density Isoplanar II process—proven for high performance as well as high yield and dependable delivery.

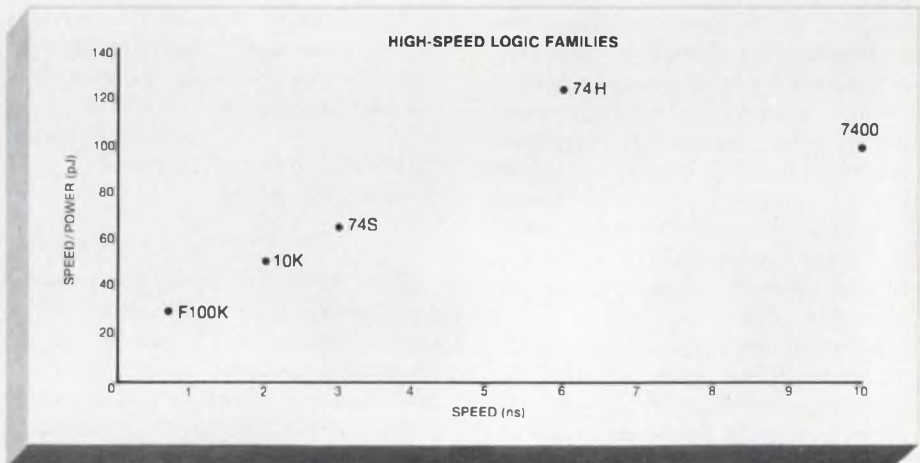

3. *Full compensation.*

Because F100K is fully compensated for temperature and voltage variations, the family provides almost constant DC noise margins for a more reliable system. It also provides a tighter AC window for faster clock rates with fewer timing problems.

4. *Manageable edge rates.*

The gate current specified for the F100K series provides a rise and fall time about equal to propagation delay. In fact, noise-generating dV/dt is

6. *Compatibility.*

Due to voltage compensation and standard logic levels, F100K is compatible with existing slower ECL families.

7. *Memory available.*

No need to worry. The F100415, a 1024x1 RAM, will be available this Quarter.

24-pins. The shape of ECL to come.

To these basic advantages, the F100K's universal 24-pin package contributes an addi-

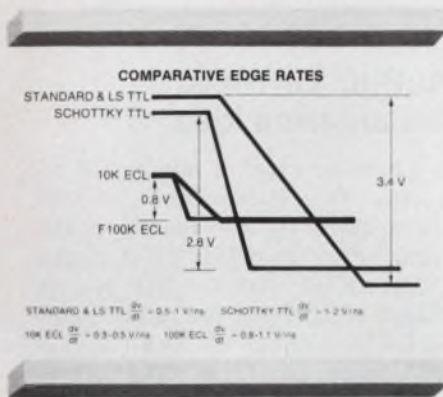

tional list of benefits. Among these are:

8. The first package format oriented to the I/O and performance requirements of super high-speed MSI/LSI.

9. The opportunity for gate densities 50% higher than conventional 10K ECL.

10. The ability to gain more flexible use from multi-purpose functions—for a simplified device inventory. For example, the 24-pin F100K Quint Gate F100102 can replace the functions of any one of four different quad gates in 10K ECL—with greater logic density besides.

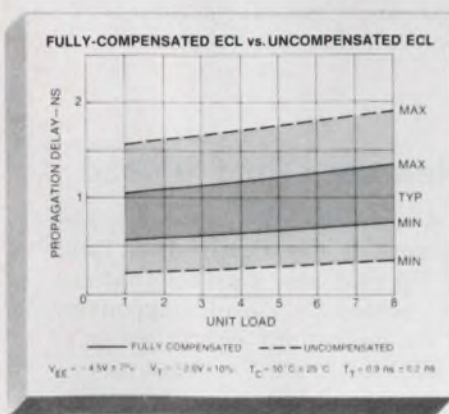

The family that's planned together plays better.

Because our F100K series was planned with the cooperation of major users, it has been designed throughout with the user in mind.

For example:

11. Common pins are always placed at the same pin location. To allow maximum use of CAD in board layout.

12. All functions flow through the package without crossover. Outputs are always located in the same general pin area. Inputs, too.

13. Inverting outputs between independent functions are placed adjacent wherever possible to permit maximum use of the wired-or tie, even at sub-nanosecond speeds.

14. Wherever possible, mode control pins are provided to change the character of the functions. They may be controlled by standard logic levels or may be hard-wired to ground or power supply.

In fact:

Without exception, pin-outs have been assigned on the basis of system requirements and performance—not fabrication convenience.

Result—a user-oriented family that plays better all the way.

Start here.

To get you started, 8 devices are available in sample quantities today.

Fairchild F100K ECL Series

DEVICE	DESCRIPTION	1K	AVAILABILITY
100101FC	TRIPLE OR/NOR	4.50	NOW
100102FC	QUINT OR/NOR	4.50	NOW
100107FC	QUINT EXC OR/NOR	7.15	NOW
100114FC	QUINT LINE RECEIVER	5.75	NOW
100117FC	TRIPLE 2-WIDE OAI	8.00	NOW
100118FC	5-WIDE OAI	6.23	NOW
100150FC	HEX D LATCH	10.70	NOW
100151FC	HEX D FLIP FLOP	13.35	NOW
100112FC	LINE DRIVER		3RD QTR 1975
100123FC	BUS DRIVER		2ND QTR 1975
100130FC	TRIPLE D LATCH		2ND QTR 1975
100131FC	TRIPLE D FLIP FLOP		2ND QTR 1975
100136FC	COUNTING REGISTER		1ST QTR 1976
100141FC	8-BIT SHIFT REGISTER		3RD QTR 1975
100145FC	16 x 4 R/W REGISTER FILE		4TH QTR 1975
100155FC	QUAD MUX/LATCH		3RD QTR 1975
100158FC	8-BIT SHIFT MATRIX		3RD QTR 1975
100160FC	DUAL 9-BIT PARITY		3RD QTR 1975
100164FC	16-BIT MULTIPLEXER		3RD QTR 1975
100165FC	PRIORITY ENCODER		3RD QTR 1975
100170FC	MULTI-PURPOSE DEMUX/DECODE		3RD QTR 1975
100171FC	TRIPLE MUX w/ENABLE		2ND QTR 1975
100181FC	ALU		1ST QTR 1976
100415FC	1024 X 1 RAM		2ND QTR 1975

For more detailed information on the entire F100K series, write or call your Fairchild Sales Office, Distributor or Representative right now.

Semiconductor Components Group, Fairchild Camera & Instrument Corp., 464 Ellis St., Mountain View, CA 94042. Telephone (415) 962-5011. TWX: 910-379-6435.

**MADE IN
FAIRCHILD**

No.1 for logic and memory.

Only Sprague bantam 4-pin DIP capacitors can give you these advantages ...



guaranteed max. high frequency impedance



**low inductance and low ESR ...
4-terminal connection mode option**



**preferred capacitance values to
optimize performance when tantalum
and ceramic capacitors are paralleled**



automatic insertion capability



**your choice of layer-built ceramic
or solid-electrolyte tantalum**

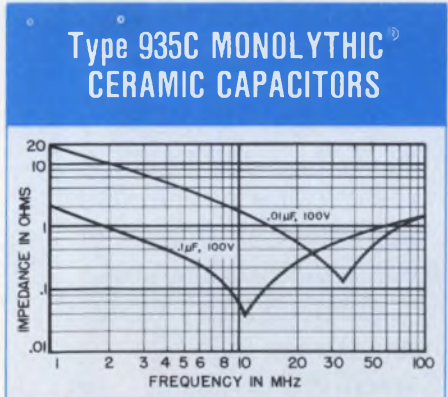

Proven multi-layer construction. C0G(NP0) and X7R temperature characteristics. Preferred ratings are .01, .047, and .1 μF @ 100 WVDC. Operating temperature range, -55C to $+85\text{C}$.

INFORMATION RETRIEVAL NUMBER 141

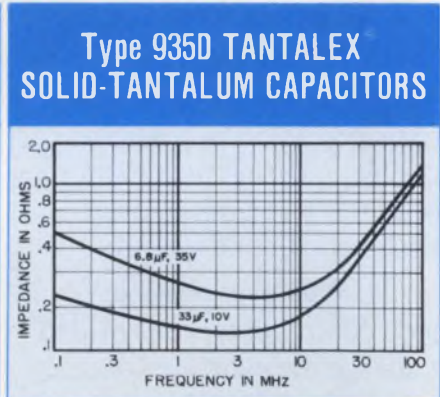

Dual in-line plastic package for mechanical protection and increased reliability. Preferred ratings are 6.8 μF @ 35 V, 15 μF @ 20 V, 22 μF @ 15 V, and 33 μF @ 10 V. Operating temperature range, -55C to $+85\text{C}$.

INFORMATION RETRIEVAL NUMBER 142

For complete technical data on Type 935C or 935D Capacitors, write for Engineering Bulletins 6242.3 or 3542.3, respectively, to: Technical Literature Service, Sprague Electric Company, 347 Marshall St., North Adams, Mass. 01247.



THE BROAD-LINE PRODUCER OF ELECTRONIC PARTS

ACROSS THE DESK
(continued from pg. 7)

signal, but the resulting color carrier does not have the same stability as the source.

Karol Freed
Karol Freed Engineering, Inc.
1434 N. Walnut
Arlington Heights, IL 60004

Author corrects his antenna idea

I have received a number of requests for clarification of the illustration in my Idea for Design, "Flat, Flexible TV Antenna Offers High Gain" (ED No. 6, March 15, 1975, p. 98). I have corrected a number of small errors that were my fault. The errors are easily set right by use of the recommended adhesive copper tape (see sketch).

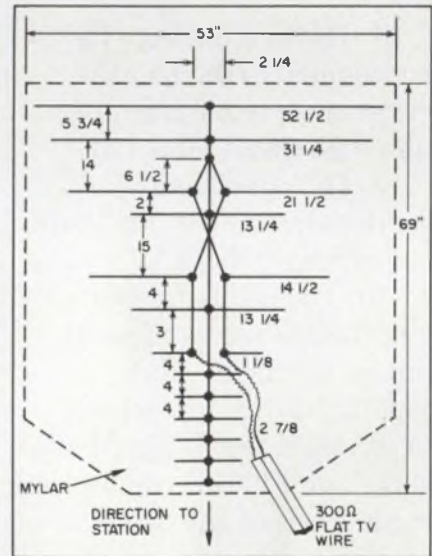

Marshall K. Kessie
Bechtel Corp.
P.O. Box 60860 Term Annex
Los Angeles, CA 90060.

New uses for the dead

A component isn't useless just because it has failed. Just think of the vast new markets that can be created for dead components if we don't limit our thinking to traditional uses. For example:

(continued on pg. 14)

INFORMATION RETRIEVAL NUMBER 9 ►

OFF THE SHELF
DELIVERY - ONLY FROM R&S

The perfect power meter

The R&S Model NAUS-80A outperforms the BIRD at a lower price . . .

. . . from 25-525 MHz; 1000 MHz (useable) 20 mW-320W.

Check the comparison below and see for yourself.

R&S — NAUS-80A

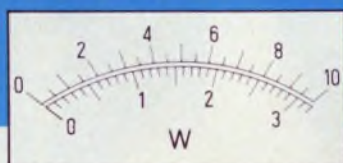

- High Resolution — linear scale
- High Accuracy — 4% of reading $\pm 1\%$ full scale
- Simultaneous incident and reflected power reading (VSWR) (with two separate meters) provides **optimized** performance and time savings.
- 5 YEAR WARRANTY ON PARTS & LABOR.
- 1 kW overload protection.
- 1 head for ALL frequencies and power ranges, no plug-in elements required — also one low price.

BIRD — Model 43

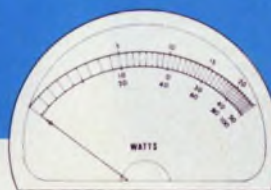

- Compressed log . . . See for yourself.
- **5% Full Scale** (% of reading not specified!!!)
- Single meter readings make it almost impossible to optimize performance and are extremely time consuming.
- 1 year and it excludes semiconductors, tubes, fuses, etc. Ask them for a copy of their warranty . . . you'll be amazed.
- No overload protection — expensive elements can easily burn out.
- Over 30 plug-in elements to achieve the same power/frequency ranges — this more than doubles the R&S price.

Call or write for more facts
and a free demonstration.

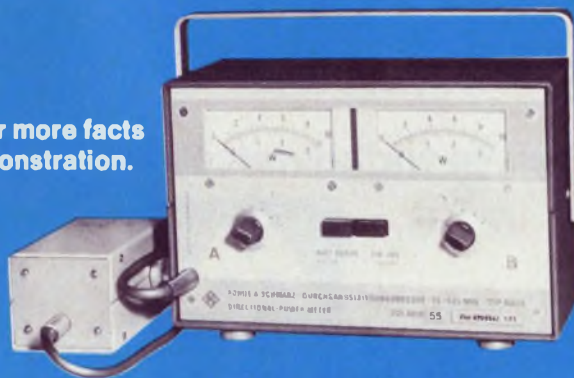

ROHDE & SCHWARZ

14 Gloria Lane, Fairfield, N.J. 07006 ■ (201) 575-0750 ■ Telex 133310

MATSUSHITA'S ARROW-M INTRODUCES THE WORLD'S FINEST RELAYS.

Unique designs and superior manufacturing techniques produce relays of highest quality and reliability.

DL relays

Mercury film contacts feature non-position sensitivity, no bounce and chatter, low and stable contact resistance, and long life. Compact size and DIP terminals are ideal for high density pc board mounting.



R relays

Sub-miniature form C reed relays are an innovation. No glass capsule is used. Bifurcated contacts, high speed and sensitivity, low operating power, both latching and non-latching functions, and a large capacity of 1 Amp/20WDC prove their reputation.

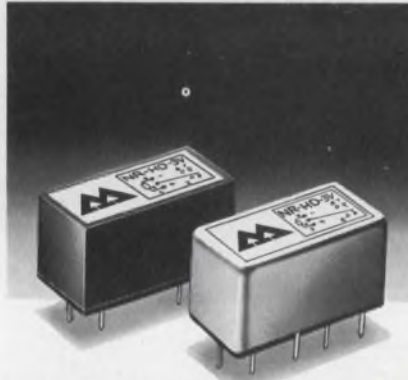

NF relays

Low profile relays of .402 inch height meet high density packaging design requirements. Unique molding technique, lift-off contact system, and twin contacts assure dependable application. Patented design absorbs chatter and bounce.



K relays

Miniature cradle relays assure highly reliable operation. Large magnetic force, lift-off contact mechanism plus screwless assembly and simultaneous molding techniques guarantee an excellent quality.



HC relays

Miniature power relays are available in form 1C(10A), 2C and 3C(7A) and 4C(5A), each at 240VAC. Arc barrier, contact debris well, gold-flashed AgCdO contacts, and one-piece molded contact blocks ensure long life and high reliability.

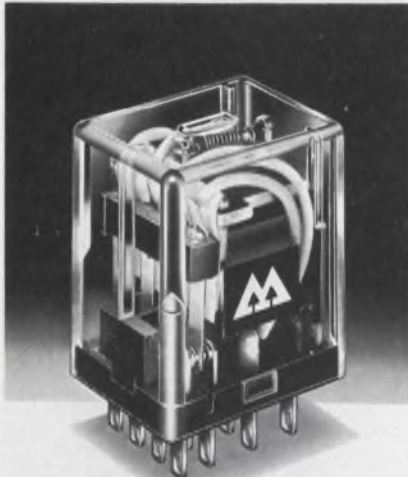

More information

Short-form catalog is available to provide you with specifications of Arrow-M relays. Call or write to Arrow-M or our nearest representative for catalogs and more information.



Arrow-M Corp. 250 Sheffield St.,
Mountainside, N.J. 07092
201-232-4260

Relays for advanced technology



Arrow-M

INFORMATION RETRIEVAL NUMBER 10

NEW, FREE.

Get yours.

McMOS

McMOS

Idea Book



TODAY, McMOS IS THE CMOS THAT OFFERS MORE

The only standard CMOS family fully specified at 15V

BROADEST CMOS LOGIC FAMILY FUNCTIONAL COVERAGE



& MOST MSI

An ideal mixture of the industry's richest MSI line-up and the necessary complement of simple gates and flip-flops.

new plus

mc14400

SPECIALIZED FUNCTION SERIES

They add a new dimension to McMOS MSI subsystems for A/D logic, telephony, data handling, watch/clock circuitry and eventually whatever appears most needed.

UNSURPASSED RECORD OF RELIABILITY

McMOS is establishing an envied reliability record in the sockets of users... and it's test documented too. Send for the new report.

SPRING and Summer 1975



PRICES LIKE TTL

That means low. For comparable functions, McMOS is selling competitively with TTL.

MOTOROLA McMOS



COMPLEMENTARY MOS FOR CONTEMPORARY SYSTEMS.

MOTOROLA Semiconductor Products Inc.
P. O. BOX 20912 • PHOENIX, ARIZONA 85038

We call it the McMOS Idea Book because it's an all new 40-page compendium of useful and provocative CMOS information. Following a run-down on family data and characteristics, you'll find selection guides and logic diagrams, product previews, Application Note and Engineering Bulletin information, cross reference and interchangeability guides. And, for following up on the ideas you get, there are postage paid reply cards for getting additional specific technical information.

Got the idea? Get the book. Free.

McMOS is a trademark of Motorola Inc.

I got the idea. Please send me a copy of the all new McMOS Idea Book. Thanks.

Name _____

Title _____

Company _____

Address _____

City _____

State _____

Zip _____



Thin-Trim capacitors



Tucked in the corner of this Pulsar Watch is a miniature capacitor which is used to trim the crystal. This Thin-Trim capacitor is one of our 9410 series, has an adjustment range of 7 to 45 pf., and is .200" x .200" x .050" thick. The Thin-Trim concept provides a variable device to replace fixed tuning techniques and cut-and-try methods of adjustment. Thin-Trim capacitors are available in a variety of lead configurations making them very easy to mount.

A smaller version of the 9410 is the 9402 series with a maximum capacitance value of 25 pf. These are perfect for applications in sub-miniature circuits such as ladies electronic wrist watches and phased array MIC's.

Johanson Manufacturing Corporation, Rockaway Valley Road., Boonton, N.J. 07005. Phone (201) 334-2676, TWX 710-987-8367.



MANUFACTURING CORPORATION

ACROSS THE DESK (continued from pg. 10)

8-pin DIPs make dandy thumb tacks.

8-pin DIPs are fine for emergency paper clips. Perforate papers with the IC leads, then fold leads to hold pages together.

14-pin DIPs, with pins folded inward and white dots painted on top surfaces, can serve as dominoes.

14 or 16-pin DIPs, painted gold or silver, can serve as bars for second or first lieutenants. They are simply stuck into the user's jacket.

14 or 16-pin DIPs, with suitably colored labels pasted on, can serve as "fruit salad" military ribbons.

And, of course, dead ICs, suitably colored or imprinted, can serve as medals. For example:

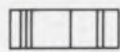
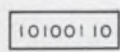
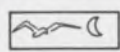
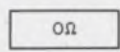
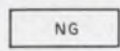
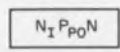
-  ORDER OF FRAUNHOFER MEDAL
-  ORDER OF BINARY MEDAL
-  FLY-BY-NIGHT OPERATIONS MEDAL
-  GOOD CONDUCTOR MEDAL
-  BILATERAL DIODE MEDAL
-  ORDER OF JAPAN TRANSISTOR
-  ORDER OF TRANSISTORIZED CHAUVINISTS

One may assume that readers of ELECTRONIC DESIGN can develop thousands of additional contributions to this worthy cause.

Raymond F. Elsner

IITRI-ECAC
P.O. Box 1711
Annapolis, MD 21404

Anyone planning to make this IC?

Do any of your readers know of an IC manufacturer planning to make the I/O device driver shown in this logic diagram? The gates must have three-state outputs, with

the direction of transfer specified by the OUT signals.

The signals will be inverted passing through the gates if the INVERT levels are present. One side only needs the drive capability of standard TTL gates, and the opposite direction of transfer, if selected, preferably must be capable of sinking 60 mA. The circuit should be encapsulated in a 16-pin DIP and run from a 5-V supply.

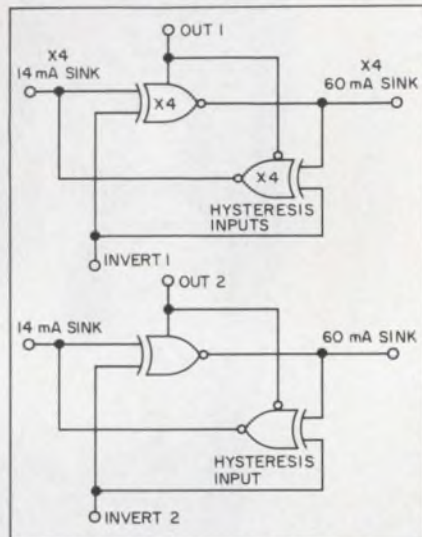

A.W. Nicholson
Lecturer

University of Nottingham
Cripps Computing Centre
University Park, Nottingham,
NG7 2RD
England

Misplaced Caption Dept.

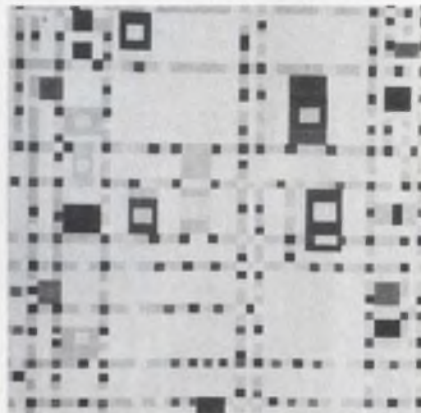

"I can't wait till Intel sees this chip."

Sorry, That's Piet Mondrian's "Broadway Boogie Woogie," which hangs at the Museum of Modern Art in New York City.

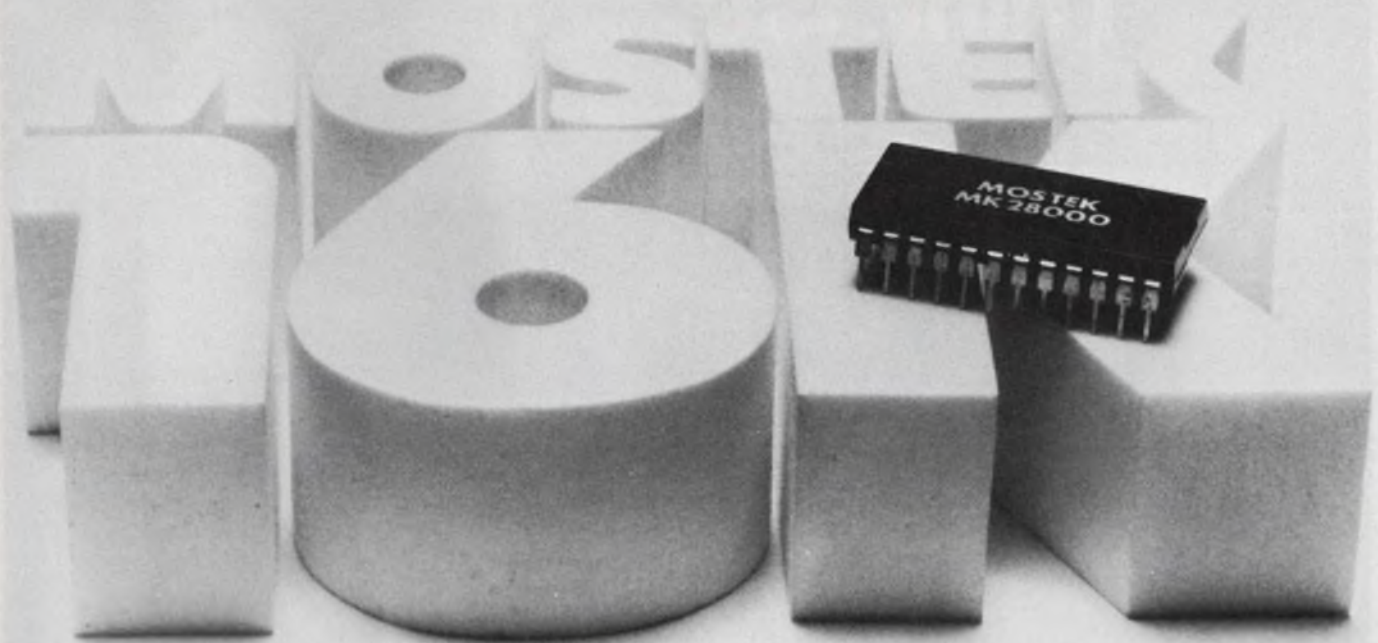

Our 16K ROM is a pin-for-pin replacement for the EA4900.

This new MK 28000 is even 300 ns faster. There is no address lead time required. So, both the address and \overline{AR} can appear simultaneously.

Our MK 28000 also gives you a tremendous power dissipation advantage over other 16K ROMs. In the active mode, the typical power dissipation is just 320mW. In the standby mode, it's only 110 mW.

This mask-programmable, P-channel device can be organized as either a 2K x 8 or 4K x 4 memory. It's ideal for mini-computers, POS terminals, CRT terminals, and mainframe applications, wherever you need big-byte capacity and fast access with low power dissipation.

You can order our MK 28000 right now. Our typical turnaround time is just four to six weeks. And our price is

competitive, only \$13.00 in 1000 unit quantities.

You can improve your present design by replacing 4K or 8K ROMs with our high-performance 16K. Even better, you can design a new system around the performance and capacity of the new MK 28000.

For more information, contact your Mostek sales representative.

Circuit	Organization	Access time (Maximum)	Power dissipation (Typical)	Alternate source
MK2400	256 x 10	600 ns	200 mW	
MK2500	512 x 8 or 1024 x 4	700 ns	325 mW	National 5232
MK2600	512 x 8 or 1024 x 4	700 ns	325 mW	Fairchild 3514
MK28000	2K x 8 or 4K x 4	600 ns	320 mW	EA 4900, TMS 4900

1215 W. Crosby Rd., Carrollton, Texas 75006, (214) 242-0444.
 In Europe, contact, MOSTEK GmbH, TALSTR. 172, 7024 Bernhausen,
 West Germany, Tel. 798038.

MOSTEK

Think Large. Think Small. Think Ise

Think our three jolly green giants for desk-top electronics. Our two pint-size pigmies for carry-in-the-pocket display designs. But don't stop there. Think low operating voltages, low power consumption, glass encapsulation all around, and water-thin thickness and dip clip pins for fast efficient mounting.

itron[®]

FG-159A2

ec = eb = 35Vp-p
ic = 4.5mA p-p
ib = 3.5mA p-p

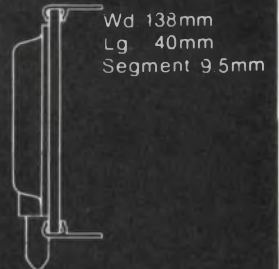

FG-139A2

ec = eb = 30Vp-p
ic = 3.6mA p-p
ib = 2.8mA p-p

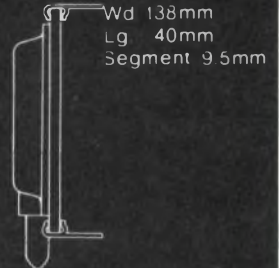

Our jolly green giants

FG-99A2

ec = eb = 24Vp-p
ic = 3.5mA p-p
ib = 2.5mA p-p



FG-125A2

ec = eb = 24Vp-p
ic = 2.0mA p-p
ib = 2.0mA p-p



Our pint-size pigmies

FG-95A

ec = eb = 24Vp-p
ic = 2.0mA p-p
ib = 1.5mA p-p



Something else to think about

Think Ise for digital readouts for instruments, clocks and other products, too.

The Brighter Side of Electronics

ISE ELECTRONICS CORP.

Main Office:

P.O. Box 46 Ise City, Mie Pref., Japan
Tel: (05963) 5-2121 to 4 Telex: 4969523

Tokyo Office:

2-7-7 Shigashi Shinbashi, Minato-ku, Tokyo, Japan
Tel: (03) 433-6616 to 9 Telex: J26546

Noritake Electronics Office:

22410 Hawthorne Blvd., Torrance, California 90505, U.S.A.
Tel: (213) 373-6704 Telex: 230674910

You do enough hard work already, don't you?
 Besides, you're covered. Plessey Semiconductors manufactures the best IC's for the radar OEM: the new SL550, low noise wideband amplifier with external gain control; the new SL541C, high-speed video amplifier; the new SL1521, second-generation replacement for the widely accepted SL521—both are limiting amplifiers incorporating low level video detection; and the SL530, monolithic true log IF/RF amplifiers. Most are available to Mil Spec temperature ranges.

There's a reason Plessey is the world leader in radar IC's: nobody else comes close in performance and quality. Take a look:

SL1521—Limiting Wideband Amplifier for 160 MHz Strips	
Voltage gain	11.5 min/12.5 max
Frequency range	10-300 MHz
Maximum rectified output at 120 MHz Noise	0.95 min/1.05 max 3 dB

SL550—Low Noise Wideband Amplifier	
Wide Bandwidth	200 MHz
Low Noise	2.2 dB at 100 MHz
Gain Control Range	25 dB
Gain	40 dB
Output Voltage	0.5 V r.m.s.

SL541C—High-Speed Video Amplifier	
High Slew Rate	175 V/ μ s
Fast Settling Time	1% in 50 ns
Open Loop Gain	70 dB
Wide Bandwidth	DC to 100 MHz at 20 dB Gain
Very Low Thermal Drift	0.02 dB/ $^{\circ}$ C Temperature Coefficient of Gain

Now, maybe you have slightly more than a normal amount of healthy scientific curiosity. O.K. We're ready for you. Write or give us a call, and we'll quickly send you all the supporting evidence. Read and believe.



PLESSEY SEMICONDUCTORS

1674 McGaw Avenue, Santa Ana, California 92705, Tel: (714) 540-9979.
 TWX: 910-595-1930; Cheney Manor, Swindon Wiltshire, England,
 Tel: (0793) 6251, Telex: 449637; West Germany, Tel: 811 3516021,
 Telex: 5215322; France, Tel: 727-4349, Telex: 62789; Italy, Tel: 3491741,
 Telex: 33245, Sweden, Tel: (08) 23 55 40, Telex: 10558.

If you're in radar, let Plessey take the work out of your IF design.



**You can buy
this Spectrum Analyzer
and take a big chunk
out of your budget.**

**You can rent
this Spectrum Analyzer
and get more
equipment out of
your budget.**



Even the best equipment budget can only go so far. And at the price you pay for electronic test equipment nowadays, that's not very far at all.

Unless you rent your equipment from REI.

When you rent from us, there's no large cash outlay. You pay only for the time you have your instruments, and you return them when you're through. So you never have to spend your money on idle equipment.

Getting more for your money is just one reason for renting from REI. Immediate delivery is another. We have over \$10 million in inventory in fully stocked centers around the country. And, when you have short-term needs, you can rent equipment for just as long as you need it, and make it pay for itself.

REI stocks over 8,000 fully checked-out test instruments, and they're ready whenever you are. For the full story on renting, as well as our low prices, send in the coupon for prompt delivery of our free illustrated catalog... or call us now for your immediate requirements.

Rental Electronics, Inc.
99 Hartwell Avenue, Lexington, Mass. 02173
Please send me your free instrument rental catalog:

Name _____ Title _____

Company _____

Address _____

City _____ State _____ Zip _____

Tel. Number _____

Rental Electronics, Inc. 

A PEPSICO LEASING COMPANY

Burlington, MA (617) 273-2770 • Gaithersburg, MD (301) 948-0620 • Oakland, NJ (201) 337-3757 • Ft. Lauderdale, FL (305) 771-3500
• Des Plaines, IL (312) 827-6670 • Dallas, TX (214) 661-8082 • Mountain View, CA (415) 968-8845 • Anaheim, CA (714) 879-0561
• Rexdale, Ontario (PLC Leasing Ltd.) (416) 677-7513

INFORMATION RETRIEVAL NUMBER 16

JUNE 21, 1975

First true computer on chip finally reaches marketplace

You can remove the quotes from "computer on a chip" for 4-bit units. They are the first true microcomputers to become available.

The single-chip, 4-bit microcomputers have been introduced by Texas Instruments as the TMS 1000 series.

Unlike earlier LSI microprocessors, which relied on external memory and peripheral circuitry, the new IC packs these extras and the processor on the same chip. The PMOS circuit combines 8192 bits of ROM and 256 bits of RAM, along with a 4-bit arithmetic logic unit and I/O control.

In addition the microcomputer chip has an output PLA (programmable logic array) to simplify interfacing and an internal clock. The IC operates from a single 15-V supply.

A major benefit of the new IC is reduced packages. "The best alternate kits of 4-bit microprocessor devices require typically five to seven individual devices to perform the same function," observes Ed Huber, TI's Marketing Manager for MOS memory and microprocessor.

Two versions of the unit differ in the number of latched outputs for control and display functions: The TMS 1000 has 11, while the TMS 1200 has 13. Eight other outputs transmit data.

Both versions have 43 fixed instructions, and they have the optional capability for microprogramming.

A wide range of software and hardware design aids accompanies the computer chip. Simulator and assembler programs are available on time-shared facilities. A hardware emulator, the HE-1, allows real-time verification of a TMS 1000 program. When connected into the system, the HE-1 contains

a paper-tape reader for data loading and random-access memory to emulate the microcomputer chip's ROM and RAM. Hence the HE-1 can be used to obtain the microprogram capability.

For system prototyping, TI offers the SE-1 evaluation unit. Electrically similar to the TMS 1000, it replaces the 8192-bit ROM with buffers to permit use of external memory. The SE-1 comes in a ceramic 64-pin package.

The TMS 1000, which comes in a 28-pin plastic package, costs less than \$10 in quantities of 10,000. But this doesn't include device programming. When the standard instruction set is used, the cost for initial mask generation, tooling, test generation and a minimum of 10 prototype parts is \$7500. Additional cost may be incurred when microprogramming is required.

CIRCLE NO. 317

CDC challenges IBM on mass-storage tape

Control Data Corp. has just heated up the competition for mass on-line magnetic-tape storage systems. With the introduction of the 38500, CDC has offered IBM 370 users a lower-cost, but smaller, alternative to the previously announced IBM 3850 honeycomb cartridge system.

The 38500 costs \$326,335 in a minimum 16-billion-byte configuration. IBM's 3850 costs about \$477,000 in a minimum 35-billion-byte configuration.

Thomas G. Kamp, president of Control Data Peripheral Products in Minneapolis, notes: "For a large number of users, 35 billion bytes is too much. We can link any number of 16 billion byte systems together if more memory is needed. In addition our basic cartridge

only stores 8 megabytes vs 50 megabytes for IBM. This makes our system far more flexible."

The Control Data system is similar in concept to the IBM. Data are stored in small cylindrical cartridges. Each cartridge holds 150 in. of 2.75-in.-wide magnetic tape. Data are recorded on 100 in. of tape on 18 data tracks. The cartridges sell for \$15 each but will only be sold in packages of eight.

Up to 2000 cartridges are stored in a honeycomb structure. A mechanical accessor, similar to the moving head on an X-Y plotter, picks a cartridge out of the honeycomb and delivers it to a vacuum column tape drive. Here the full length of the tape is pulled out, and it is pulled back and forth across an 18-track read-write head.

The average access time to any bit of data on the cartridge is 2.5 s. Each system has a minimum of two and a maximum of four tape drives built in.

From the tape drive, the data can either be read directly to the computer or staged onto a disc memory system. In this way the system can be used either for virtual memory or with any other IBM operating system; the IBM 3850 can be used in the virtual mode only. In addition the 38500 will work with any disc, while the 3850 works only with 3330 discs.

The data transfer rate from the 38500 is a disc-like 806 kilobytes/s.

Kamp indicates that scaled-down minicomputer versions of the 38500 are on the drawing boards and that they will probably come to market in the next two to four years.

Small concerns push for more defense jobs

Representatives of several small electronics companies have formed a committee that will endeavor to persuade the Defense Dept. to award more contracts to small, high-technology companies.

Most contracts now go almost automatically to the commercial giants, according to Loebe Julie, chairman of the committee and president of Julie Research Laboratories, Inc., New York City.

Known as the "Tier 2 Commit-

tee of DOD Procurement," the organization consists of members from such companies as Data Precision, Wavetek, Dana Laboratories, LogiMetrics and Ballantine Laboratories. Tier 2 companies are described as "small-business, high-technology, state-of-the-art, design/manufacturing companies." Tier 1 refers to "large-business, commercial or mixed-product, high or medium-marketing-activity companies."

Prior to the recession commercial markets kept Tier 2 companies alive, but now, during bad times, the defense market is urgently needed according to the committee. It adds that the inventiveness of these companies is worth preserving.

Zenith offers closeups in 1976 color TV sets

A new feature—the ability to expand the center of a color TV picture for an instant closeup—has been designed into Zenith Radio's most expensive 1976 sets.

To obtain a closeup, the viewer presses a zoom button on the Space Command 1000 remote control, and the central two-thirds area of the picture expands by 50%—horizontally and vertically—to fill the screen. An indicator on the set lights up to remind the viewer that the set is in the zoom mode.

To provide this function, variable sweep power control was added, because the power in the yoke is increased on command, to expand the horizontal and vertical sweeps. Special blanking circuits were also incorporated to cut off the beams sweeping outside of the expanded horizontal and vertical viewing areas. And special beam-brightening circuits were needed to increase the intensity of the color beams.

Laser filter promises cheaper nuclear fuel

Cheap and efficient production of nuclear fuel is the promise of a new laser-based uranium enrichment technique developed at the Lawrence Livermore Laboratory, Livermore, CA.

The new technique uses light

from two lasers to vaporize and filter the radioactive U-235 from the major part of the uranium ore, U-238.

Sam Tuccio, leader of the research team that developed the process, says industry estimates indicate that over the next 20 years this laser-enrichment technique could save between \$50-billion and \$80-billion.

Interest in the new technique results from its theoretical efficiency of up to 90% and its relatively low power requirements.

Current separation techniques, which use either gaseous diffusion or a gas centrifuge, extract only between 50% and 75% of the radioactive uranium, and they require much power. Laser separation would require between 10 to 100 times less power.

Describing the process, Tuccio notes that uranium ore is vaporized in an oven and then exposed to xenon and krypton laser beams. This frees one electron from each of the U-235 atoms, leaving them positively charged. When the vapor is exposed to a negatively charged surface, the U-235 is separated from the U-238.

A 100-mW xenon laser and a 1-W krypton laser were used to get 4 to 5% of the U-235. By increasing the power of these lasers, says Tuccio, as much as 90% of the U-235 should be recoverable.

Wescon exhibitors see business upturn

If the recent highly successful National Computer Conference in Anaheim, CA, was any indicator of an economic upturn, September's Western Electronic Show and Convention in San Francisco should be a winner.

According to a Wescon spokesman, the view of most of the 300 exhibitors who have signed up for 492 booths at the show is "We're down in the first half, but we're going to make it up in the second half of this year."

Although the major semiconductor manufacturers are still notable by their absence from Wescon, Dana Laboratories has returned as an exhibitor after a prolonged hiatus and General Radio, recently a one-booth company at the show,

has increased its exhibit space five-fold.

The Wescon theme this year is "Electronics in the Next Thousand Days," with the 32-session technical program and product exposition emphasizing near-term rather than blue-sky technology.

Wescon officials say they expect to fill about 800 booths for next year's show in Los Angeles, an increase of more than 250 from 1974. The reason? Increased emphasis on computers and computer peripherals. Wescon plans to take advantage of the fact that the National Computer Conference won't be held again in California until 1979.

Dome radar cuts cost of phased-array system

A radar system that uses a wide-angle scanning array lens antenna to achieve hemispheric coverage from a single planar array will cut system costs drastically, according to the developer, Sperry Gyroscope in Great Neck, NY.

Leon Schwartzman, a program manager for Sperry, says the new radar uses a passive dome lens to increase the ± 60 -degree scan of a conventional planar array to ± 120 degrees. Since conventional phased-array designs would require three or four planar arrays to achieve comparable coverage, costs will be reduced about 50%, Schwartzman reports.

The new radar also has a zoom capability that widens and narrows the radar beam width, as required.

In describing the dome radar, Schwartzman notes that it consists of a planar phased-array antenna mounted at the base of a hemispheric-shaped structure. The hemispheric structure functions like a lens and passively introduces predetermined amounts of phase shift. In the demonstration model constructed for C-band operation, the phase shift is produced by 3636 dielectrically loaded circular waveguide sections.

The phase shifters on the dome are illuminated by a 4-ft-diam space-fed planar array, Schwartzman says. This array is composed of 805 digitally controllable, 3-bit ferrite phase shifters.

Mini-Circuits' answer to holding down your costs of Double Balanced Mixers

Specify our model SRA-1...

1971 - \$7.95

SRA-1 (in 500 quantities)



1972 - \$7.95

SRA-1 (in 500 quantities)



1973 - \$7.95

SRA-1 (in 500 quantities)



Mini-Circuits Laboratory, now the world's largest supplier of double-balanced mixers, guarantees to maintain its famed low-price structure throughout 1975 and 1976. \$7.95 (model SRA-1, 500 quantity). You, the design engineer, have made this offer possible. Your large volume orders, from over 500 companies throughout the world, have enabled us to purchase our components and packages at lowest possible costs with guaranteed delivery schedules from our vendors. And we think it's appropriate to pass these savings to you. Need fast delivery? One week or better is routine; for your emergency needs, 24-hour turnaround is possible.

Our history of quality and performance is unmatched. All our units are unconditionally guaranteed for 1 year. Every Mini-Circuits employee, from the president to the final test operator, is committed to excellence in performance and quality for every unit produced. For reliability, performance and quality more and more systems engineers are specifying Mini-Circuits mixers as the industry standard.

1974 - \$7.95

SRA-1 (in 500 quantities)



1975 - \$7.95

SRA-1 (in 500 quantities)



STILL ONLY \$7.95 IN 1976

SRA-1 (in 500 quantities)



*\$9.95 (1-49)

SRA Series

Frequency Range (MHz)	Conversion Loss (dB) Total Range	Isolation (dB)						Price (Quantity)
		Lower band edge to one decade higher		Mid range		Upper band edge to one octave lower		
		LO-RF	LO-IF	LO-RF	LO-IF	LO-RF	LO-IF	
SRA-1 LO-0.5-500 RF-0.5-500 IF-DC-500	6.5 typ 8.5 max	50 typ 35 min	45 typ 30 min	45 typ 30 min	40 typ 25 min	35 typ 25 min	30 typ 20 min	\$9.95 (1-49)
SRA1-1 LO-0.1-500 RF-0.1-500 IF-DC-500	6.5 typ 8.5 max	50 typ 45 min	45 typ 30 min	45 typ 30 min	40 typ 25 min	35 typ 25 min	30 typ 20 min	\$11.95 (6-49)
SRA-1W LO-1-750 RF-1-750 IF-DC-750	6.5 typ 8.5 max	60 typ 45 min	45 typ 30 min	45 typ 30 min	40 typ 25 min	35 typ 25 min	30 typ 20 min	\$14.95 (6-49)
SRA-2 LO-1-1000 RF-1-1000 IF-0.5-500	6.5 typ 8.5 max	45 typ 30 min	45 typ 30 min	35 typ 20 min	35 typ 20 min	30 typ 20 min	30 typ 20 min	\$24.95 (1-24)

Frequency Range (MHz)	Conversion Loss (dB) Total Range	Isolation (dB)						Price (Quantity)
		Lower band edge to one decade higher		Mid range		Upper band edge to one octave lower		
		LO-RF	LO-IF	LO-RF	LO-IF	LO-RF	LO-IF	
SRA-4 LO-5-1250 RF-5-1250 IF-0.5-500	6.5 typ 8.5 max	50 typ 40 min	50 typ 40 min	40 typ 20 min	40 typ 20 min	30 typ 20 min	30 typ 20 min	\$26.95 (1-24)
SRA-3 LO-0.025-200 RF-0.025-200 IF-DC-200	6.5 typ 8.5 max	60 typ 50 min	45 typ 35 min	45 typ 35 min	40 typ 30 min	35 typ 25 min	30 typ 20 min	\$12.95 (6-49)
SRA-6 LO-0.003-100 RF-0.003-100 IF-DC-100	6.5 typ 8.5 max	60 typ 50 min	60 typ 45 min	45 typ 30 min	40 typ 25 min	35 typ 25 min	30 typ 20 min	\$19.95 (5-24)
SRA-8 LO-0.005-10 RF-0.005-10 IF-DC-10	6.5 typ 8.5 max	60 typ 50 min	60 typ 50 min	50 typ 40 min	50 typ 40 min	45 typ 35 min	45 typ 35 min	\$24.95 (5-24)

Common specifications for all models
Signal: 1 dB compression level = 1 dBm
Impedance: all ports 50 ohms
Phase detection: DC offset = 1 mV typical
DC polarity: negative

World's largest supplier of double balanced mixers

Mini-Circuits Laboratory

A Division Scientific Components Corp.

OUR NEW ADDRESS IS: 837-843 Utica Avenue,
Brooklyn, NY 11203 (212) 342-2500
Int'l Telex 620156

Foreign Sales Representatives: AUSTRALIA General Electronic Services, 99 Alexander Street, New South Wales, Australia 2065; ENGLAND Dale Electronics, Dale House, Wharf Road, Frimley Green, Camberley Surrey; FRANCE S. C. I. E. - D. I. M. E. S., 31 Rue George - Sand, 91120 Palaiseau, France; GERMANY, AUSTRIA, SWITZERLAND Industrial Electronics GMBH, Klüberstrasse 14, 6000 Frankfurt/Main, Germany; ISRAEL Vectronics, Ltd., 69 Gordon Street, Tel-Aviv, Israel; JAPAN Denso Kaisha, Ltd., Eguchi Building, 8-1-1 Chome Hamamatsucho Minato-ku, Tokyo; EASTERN CANADA B. D. Hummel, 2224 Maynard Avenue, Utica, NY 13502 (315) 736-7821; NETHERLANDS Coimex, Veldweg 11, Haltem, Holland

US Distributors: NORTHERN CALIFORNIA Cain-White & Co., Foothill Office Center, 105 Fremont Avenue, Los Altos, CA 94022 (415) 948-6533; SOUTHERN CALIFORNIA, ARIZONA Crown Electronics, 11440 Collins Street, No. Hollywood, CA 91601 (213) 877-3550

For complete U.S. Rep listing and product line see *MicroWaves Product Data Directory*

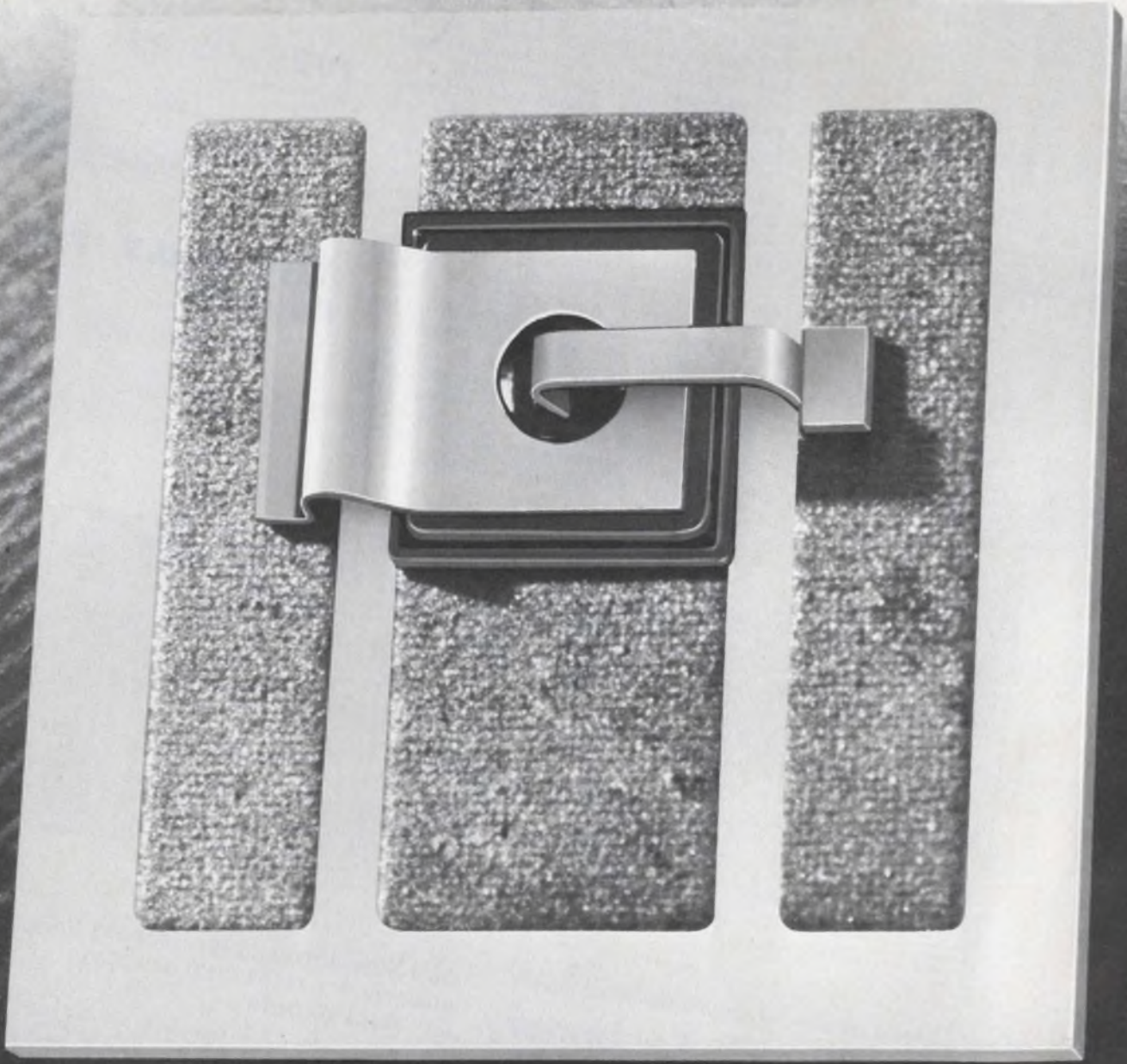

Introducing ChipStrate™ power SCRs and triacs.

The reliability of a package for the price of a chip.

We take a glass-passivated chip (a power SCR or triac), mount it on a solderable ceramic substrate, test it and specify it.

That's a ChipStrate.

Save a bundle over conventional components.

Because we've eliminated the expensive metal package, ChipStrates cost up to 40% less than packaged devices. And they take up a good deal less space on the board.

Improve the reliability of your circuit. ChipStrates come with the same guaranteed performance specifications as a packaged device. And due to their improved thermal design, they can handle more power, more reliably than either a packaged device or a chip.

No special equipment, no risks. ChipStrates are complete devices — attach

™ChipStrate is a trademark of Unitrode Corporation.

them to a heat sink or directly onto thick-film metalization. No need for a heavy investment in capital equipment, no worries about yield, none of the problems associated with unmounted chips.

Send for our free brochure.

ChipStrate SCRs and triacs are available in currents from 1 A to 55 A and in voltages up to 600 V. Our brochure tells the whole story. Just circle our number on the reader service card.

Unitrode Corporation,
580 Pleasant
Street,
Watertown,
Mass.
02172.

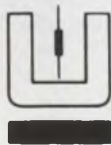

UNITRODE

A powerful new idea in ferrites



**NEW FROM
SAUGERTIES, N.Y.**

It's the new Power E core . . . the first ferrite core specifically designed for switched mode power supplies.

Because of its unique shape, it has the power to . . . reduce size, weight, and cost . . . reduce component count for greater assembly ease and higher reliability . . . increase overall equipment efficiency.

Virtually a pot core with the two sides removed—or an E core with a round center leg—the new Series EC core provides an external magnetic field that is a compromise between these other two core types. Because it has a circular cross section for the center leg, turn length of windings is minimized, reducing copper losses. The more compact winding reduces leakage inductance. And the

open side design provides for maximum ease of winding and termination.

Accessories available, too. A complete line of standard bobbins has been designed and tooled to accept the new core. And specially designed mounting hardware helps make for easiest possible assembly.

If you're not yet using ferrites for power converters, you're not yet on to a good thing. And if you haven't investigated this newest and most powerful idea in ferrites yet, perhaps you'd better.

For further information, or quantities from stock, write or phone Ferroxcube or any of the offices listed below.



FERROXCUBE CORPORATION, SAUGERTIES, N.Y. 12477 □ 914•246-2811
A NORTH AMERICAN PHILIPS COMPANY

Distributed through North American Philips Electronic Components Corp.—warehouses in Boston, 617•899-7103; New York, 516•538-2300; Saugerties, 914•246-5861; Philadelphia, 215•836-1616; Chicago, 312•593-8220; San Diego, 714•453-5440; Toronto, 416•425-5161

19172

Look who just tied the knot.

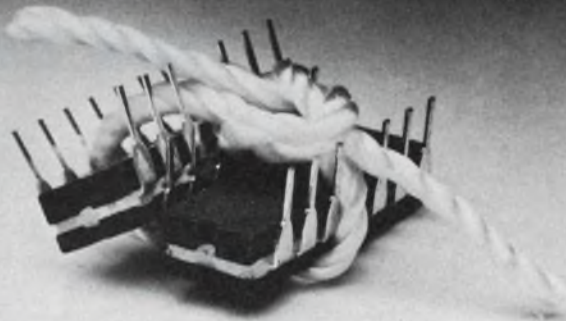

The 54C/74C and the 4000 series

Actually, it's no great surprise. The 54C/74C and the 4000 series logic families have always been electrically compatible and now many of the functions are even pin-compatible, so you can marry them in your very own system without worrying about a family feud. You'll find mixing these two CMOS series beneficial to you in many ways. First, you'll have more available functions to choose from. So your chances of finding the right one are better. This will minimize the number of CMOS devices you need to implement the logic. And second, you can take advantage of the best personality traits of each series to optimize your system's performance. Key

features such as higher guaranteed noise margin. Greater output drive. And higher speed of specific CMOS functions.

When you're ready to tie the CMOS knot in your system, Harris can help you perform the ceremony. Harris CMOS devices are fully compatible with others in the industry and will perform in your present system without modification. And you can get immediate delivery of both logic families from your Harris Distributor.

For more information on how we can make the CMOS marriage work for you, call our CMOS Application Hot Line at 800-327-8934. Your systems will live happily ever after.

DEVICE	OUTPUT SINK CURRENT	MINIMUM
4102A	$I_{OL} (V_{OL} = 0.5V)$	0.06 ma
4042A	$I_{DN} (V_{OL} = 0.5V)$	0.20 ma
4001A	$I_{OL} (V_{OL} = 0.4V)$	0.30 ma
All 54C/74C	$I_O (V_{OL} = 0.4V)$	0.36 ma
4071B	$I_{DN} (V_{OL} = 0.4V)$	0.40 ma

This illustrates some of the variations in output drive current specified in the 4000 series, and how the 54C/74C fits within the range

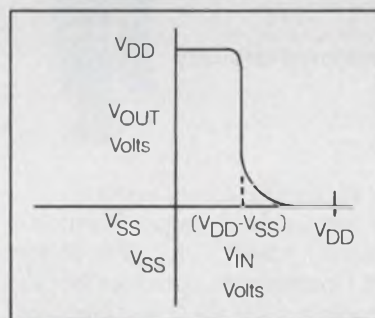

This CMOS transfer characteristic for single level gate functions is for all CMOS logic families. It is the commonality of this characteristic which is the basis of CMOS inter-family compatibility.



P.O. Box 883, Melbourne, Florida 32901 (305) 727-5430

WHERE TO BUY THEM: OEM SALES OFFICES: ARIZONA: Scottsdale, (602) 946-3556 CALIFORNIA: Long Beach, (213) 426-7687; Palo Alto, (415) 964-6443 FLORIDA: Melbourne, (305) 727-5826 ILLINOIS: Hinsdale, (312) 325-4242 MASSACHUSETTS: Wellesley Hills, (617) 237-5430 MINNESOTA: Minneapolis, (612) 835-2505 NEW YORK: Endwell, (607) 754-5464; Melville, L.I., (516) 249-4500 OHIO: Dayton, (513) 226-0636 PENNSYLVANIA: Wayne, (215) 687-6680 TEXAS: Richardson, (214) 231-9031.

SALES REPRESENTATIVES: CALIFORNIA: San Diego, (714) 565-9444 COLORADO: Denver, (303) 771-4920 FLORIDA: Oviedo, (305) 365-3283 KANSAS: Olathe, (913) 782-1177 MARYLAND: Randallstown, (301) 922-1248 MICHIGAN: Bloomfield Hills, (313) 642-0203 MISSOURI: Hazelwood, (314) 731-5200 NEW YORK: Albany, (518) 489-7408 or 4777 NORTH CAROLINA: Raleigh, (919) 828-0575 OREGON: Beaverton, (503) 643-1644 TENNESSEE: Shelbyville, (615) 684-4544 UTAH: Salt Lake City, (801) 268-3533 VIRGINIA: Falls Church, (703) 534-1673; Troutville, (703) 345-3283; Virginia Beach, (804) 481-7200 WASHINGTON: Bellevue, (206) 454-0300.

It makes audio communications measure- ments too...

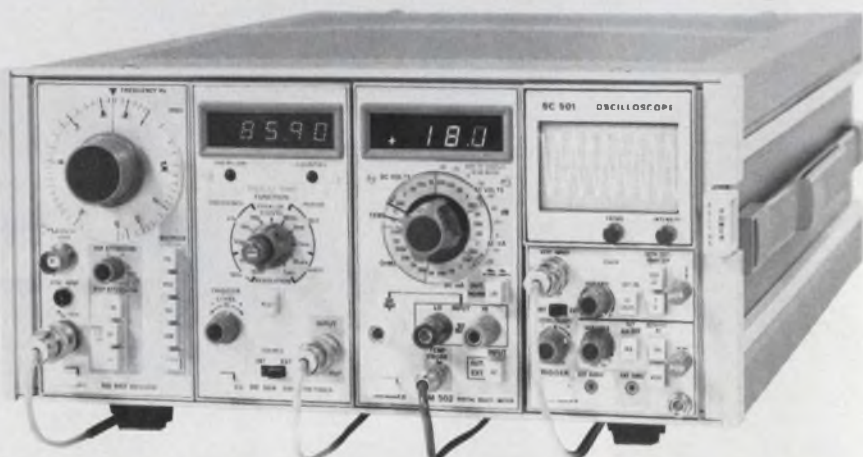

Tektronix TM 500



- digital multimeters
- counters
- generators
- amplifiers
- power supplies
- oscilloscopes
- a blank plug-in for your own circuitry
- and more

The TEKTRONIX modular Audio Frequency Instrumentation group provides the test and measurement instruments you most frequently need . . . for only \$1865*. These compact light weight instruments work together as a system or independently within a TM 504 power module/mainframe.

The above TM 500 configuration features a dB reading DM 502 Digital Multimeter with 3½ digit display and optional (\$110)*temperature measurement capability (a function that has proven valuable in identifying active solid-state device circuit problems); the SG 502 Audio Oscillator provides 5 Hz to 500 kHz sine and square waves, 600Ω output, and low distortion (0.035% from 20 Hz to 50 kHz); the DC 504 Digital Counter offers 5-digit LED display of frequency to 80 MHz and period resolution to 1 μs; and the SC 501 Oscillo-

scope is a single-channel, dc-to-5 MHz modular instrument with triggered sweep and vertical sensitivity to 10 mV/division.

All TM 500 plug-ins are readily interchangeable within the entire TM 500 line. Plus there's a blank plug-in kit, which allows you to add your own special circuits to a TM 500 system. The plug-ins can work together synergistically through the common interface circuit board of the power module/mainframes. So you can tailor a system of instrumentation exactly to your needs . . . a system that's only 6" x 11" x 20" and weighs less than 30 lbs. . . . and a system that offers you benefits difficult to duplicate with "monolithic" instruments.

TM 500 is a growing, compatible family of 29 plug-in modular instruments, accessories, and one, three, four, and six-compartment power module/mainframes. Package configurations can be selected for work in high-speed logic circuitry, medical instrumentation, instrumentation calibration, industrial equipment, and more. All may be hand carried, all go on the bench, and there are rack-mounting and SCOPE-MOBILE® configurations as well. You can select from general-purpose instruments, such as the DM 501 Digital Multimeter, or highly specialized instruments, such as the AF 501 Tunable Bandpass Filter or AM 502 high-gain amplifier with calibrated gain to 100 dB and switch-selectable high and low-pass filters. If your work requires the measurement of electrical phenomena in the audio frequency range, Tektronix TM 500 offers substantial benefits to you.

Find out what TM 500 can do for you. Get the TM 500 Catalog A-3072 with full specifications and applications information. Or contact your local Tektronix Field Engineer for a demonstration of how TM 500 offers a better solution to your needs. Write to Tektronix, Inc., P.O. Box 500, Beaverton, Oregon 97077. In Europe, write Tektronix Limited, P.O. Box 36, St. Peter Port, Guernsey, Channel Islands.



committed to
technical excellence



* U.S. Sales Prices FOB Beaverton, Oregon

The AN2538 is the lowest-cost line-powered 3½ digit DPM you can buy . . . with the performance and dependability you need. Big ½" LED display for long life and wide-angle viewing. Autozero for long term stability. High CMRR/NMRR for noise and ground-loop immunity. Very low bias current (100pA max), for error-free high-impedance. Super-regulated power supplies. All this adds up to *usable* ±0.05% accuracy.

But price and performance are only part of the breakthrough. The

AN2538 takes *full* advantage of its monolithic circuitry. It runs exceptionally cool (5°C rise) and operates over -10°C to +70°C. It has the longest MTBF ever achieved in a 3½-digit DPM—enhanced by a 96-hour, 50°C burn-in cycle. Its tough LEXAN® case meets both NEMA and DIN standards. It has a universal power transformer, for worldwide use.

Last year, we broke through the interface problem with our AN2533/53 pluggable interface, premium-performance DPM . . . still

the best for many applications. The AN2538 reflects Analogic's 200,000-DPM experience . . . experience unmatched by any other source.

Want complete data? Ready to evaluate a sample? Call Analogic's Marketing Dept. at (617) 246-0300, or your local Analogic sales office, or write today: Analogic Corp., Audubon Road, Wakefield, Mass. 01880. Also available, new 70 page Circuit Application Handbook, write on letterhead.

ANALOGIC ■

... The Digitizers

INFORMATION RETRIEVAL NUMBER 21

**This new
A/D
converter
CHIP*...**

**...makes
this new DPM
today's best
value, <\$69.
(in OEM quantities)**

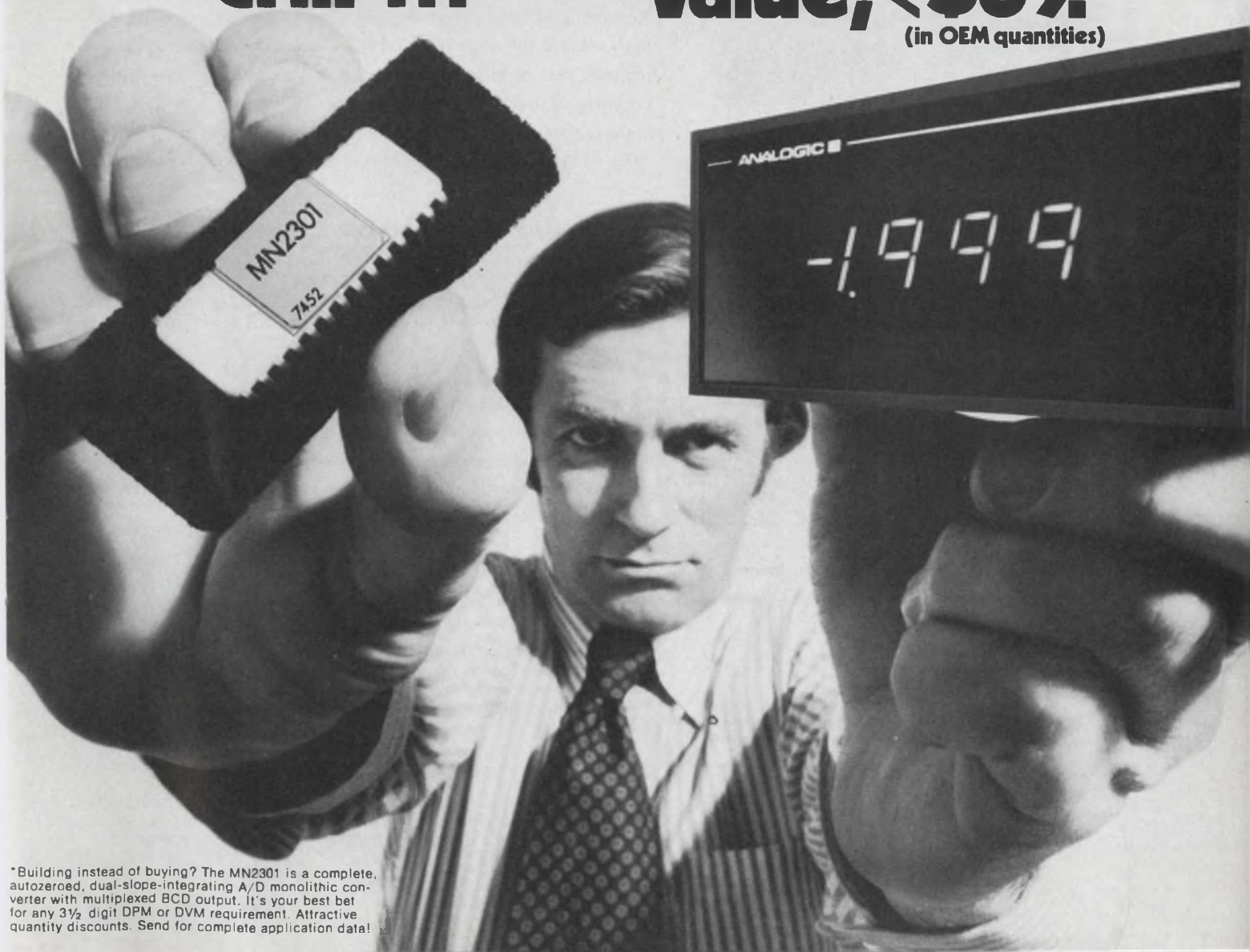

*Building instead of buying? The MN2301 is a complete, autozeroed, dual-slope-integrating A/D monolithic converter with multiplexed BCD output. It's your best bet for any 3½ digit DPM or DVM requirement. Attractive quantity discounts. Send for complete application data!



The illustrated instrument is a *bipolar* digital power supply, comprised of a Kepco BOP 36-5M controlled by a Kepco type SN-12 Digital Interface Card.

The BOP 36-5M produces from -36V to +36V smoothly through zero as programmed by the adjacent SN-12 Digital Card (mounted on a 1/6th plug-in adapter panel, Model SNK-1). The system can be loaded to 5 amperes in either direction and can slew from one extreme of voltage to the other in approximately 26 microseconds (20 microseconds following a 6 microsecond deglitching delay).

THE DIGITAL PROGRAMMER IS AVAILABLE AS A SEPARATE INSTRUMENT

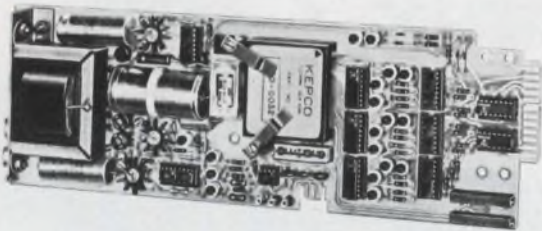

For use with the bipolar Kepco BOP 36-5M, bipolar programming is obtained by the offset binary method, in which the SN is programmed from -10V to +10V (minus the least significant bit). The BOP functions as a fixed gain power amplifier, boosting the $\pm 10V$ signal with a gain of 3.6, to produce $\pm 36V$ with a ± 5 ampere capability. The resolution of this arrangement is 8.64 millivolts.

Kepco's SN Digital Interface Card accepts data input on parallel lines strobed for noise immunity, and stores the data in a buffer register. For isolation, the program is transferred across optical couplers so that your digital signal and the power supply it controls can be up to 1000 volts apart. The five types of SN Cards offer a choice of BCD or complementary binary programming.

BINARY	ANALOG	X3.6 = OUTPUT
1111111111	+10V -LSB	X3.6 +35.99V
1000000000	0	X3.6 0
0000000000	-10V	X3.6 -36.00V

MODEL	RESOLUTION	LINEARITY	OUTPUTS
SN-2	2 BCD	$\pm 0.2\%$	0-10V -
SN-3	3 BCD	$\pm 0.05\%$	0-10V -
SN-8	8-bit	$\pm 0.2\%$	0-10V $\pm 5V$, $\pm 10V$
SN-10	10-bit	$\pm 0.05\%$	0-10V $\pm 5V$, $\pm 10V$
SN-12	12-bit	$\pm 0.01\%$	0-10V $\pm 5V$, $\pm 10V$

SN Cards are fully self-contained digital programmers, featuring an on-card line-operated power supply. Kepco offers a variety of housings and accessories to accommodate them to various programmable power supplies. As many as eight cards can be mounted in a standard 5 1/4" x 19" panel.



KEPCO®

The complete specifications for Kepco's Digital Programmers and suitable power supplies are in our new Catalog and Handbook. Write Dept. EY-05 for your free copy.



KEPCO, INC. • 131-38 SANFORD AVENUE • FLUSHING, N.Y. 11352
(212) 461-7000 • TWX # 710-582-2631 • Cable: KEPCOPOWER NEWYORK

Washington Report

Government procurement under scrutiny again

Congress is unhappy with the Administration's efforts to improve the Government's procurement process. Several years ago a commission on procurement made some far-reaching recommendations to standardize Government buying practices. Most of the advice, it was believed, could be taken without need for legislation. But progress has been slow, and hearings are now being held by a Senate Government Operations Subcommittee on Federal Spending Practices and Efficiency to find out why.

At issue are 12 recommendations that have been evaluated by an inter-agency steering group, which came up with a course of action on each. The General Accounting Office, however, analyzed the recommendations and said they were "generally weak."

The Administration's final position and its plan to put the recommendations into effect should be revealed by these hearings. If they are not satisfactory to Congress, legislation may be necessary, says Sen. Lawton Chiles (D-Florida), chairman of the subcommittee. He says Congress is seeking "a clearer, more reasoned voice in controlling acquisition programs" to encourage competition, curb interagency rivalries over roles and missions, and eliminate "the buy-ins, bailouts and succession of cost overruns and performance underruns."

Pentagon stressing life-cycle costs

Designers of new weapons systems for the Pentagon can expect to encounter life-cycle cost experts much earlier in the development cycle. Under a new regulation, Defense Dept. installation and logistics specialists will participate fully at all three major points in the acquisition process where the Defense Systems Acquisition Review Council makes "go" or "no-go" decisions.

Previously installation and logistics specialists weren't generally brought in until Stage 3, the consideration of production, maintenance, supply and other support costs. In the future procurement specialists are going to be up front at the beginning.

NBS testing digital police communications

More and more police units are letting their fingers do the talking, according to the National Bureau of Standards, which is conducting performance tests on manufactured digital terminals.

The NBS is evaluating mobile teleprinters for one-way digital messages from police dispatchers to patrol cars; "status boxes" for standard-

ized messages, codes and emergency alarms; and two-way units combining a typewriter keyboard, status keys and a display screen.

Digital systems in use have significantly increased the capacity of police communication systems by cutting down on voice transmissions for out-line reports, the NBS says (see p. 56 this issue).

Congressman seeks to control RFI

Manufacturers of rf receivers, such as TV sets, radios and stereos, are going to have to make their products rf interference proof if a bill introduced by Rep. Charles A. Vanik (D-Ohio) becomes law. Faulty receivers account for 90% of the complaints to the Federal Communications Commission. (In 1974 the FCC received 42,000 complaints about rf interference.)

The cost of turning out RFI-free receivers, Rep. Vanik estimates, would be \$2 for stereophonic equipment or AM-FM radio and \$5 for a television set.

Capital Capsules: Inflation is trimming R&D spending in the academic sector, notes the National Science Foundation. Between 1973 and 1974, such spending increased 2.5% to \$3-billion, but when measured in constant dollars, the foundation says, a 5% decline was posted. . . . A **prototype electronic tone translator** has been developed by the Air Force and Mitre Corp. to permit unassisted calls between systems that use different dial tones. The solid-state translator, which electronically matches up the different tones, is for use in Germany. . . . The National Aeronautics and Space Administration has a **promising new type of solar cell** that reportedly is 15% more efficient than a silicon cell. The new cell is made from oxidized gallium arsenide with an extremely thin, nearly transparent gold-film coating. NASA gives it the acronym AMOS (Antireflection Coated Metal-Oxide Semiconductor). . . . The Army's **SAM-D missile may be getting an improved brain**. Hughes Aircraft Corp. has a \$1.5-million research contract to investigate the incorporation of a solid-state active radar seeker and modular multimode digital processor in the existing missile. The on-board seeker would generate information and use it in terminal guidance, freeing the ground-based signal-processing gear for other essential tasks. . . . Sources are being sought by the Air Force Avionics Laboratory to **study electrical characteristics in MNOS memory transistors with the aim of improving the oxide interface**. The two-year study will include ways to improve retention time, writing characteristics and endurance by interface doping. The laboratory is also seeking sources for R&D in the area of GaAs varactors for application to voltage controlled oscillators. The objective is improvements in settling time, post-tuning drift, parasitic reactances and device reproducibility. . . . Tentative sites have been selected for **two phased-array radar systems that would warn against attack on the continental U.S. by submarine-launched ballistic missiles** from the Atlantic and Pacific. The sites the Air Force has chosen are Otis Air Force Base, MA, and Beale AFB, CA. The Air Force Systems Command's Electronic Systems Div. in Hanscom Field, MA, is now preparing the formal assessment of the environmental impact that construction would have at the Massachusetts site. A similar study for Beale AFB will be undertaken later. . . . **An experimental wind turbine generator developed by NASA will begin operating in July on the shores of Lake Erie near Cleveland**. The facility is 162 feet high and is equipped with a 125-foot blade.

A new spectrum analyzer— you set center frequency with 6-digit resolution—and it stays there.

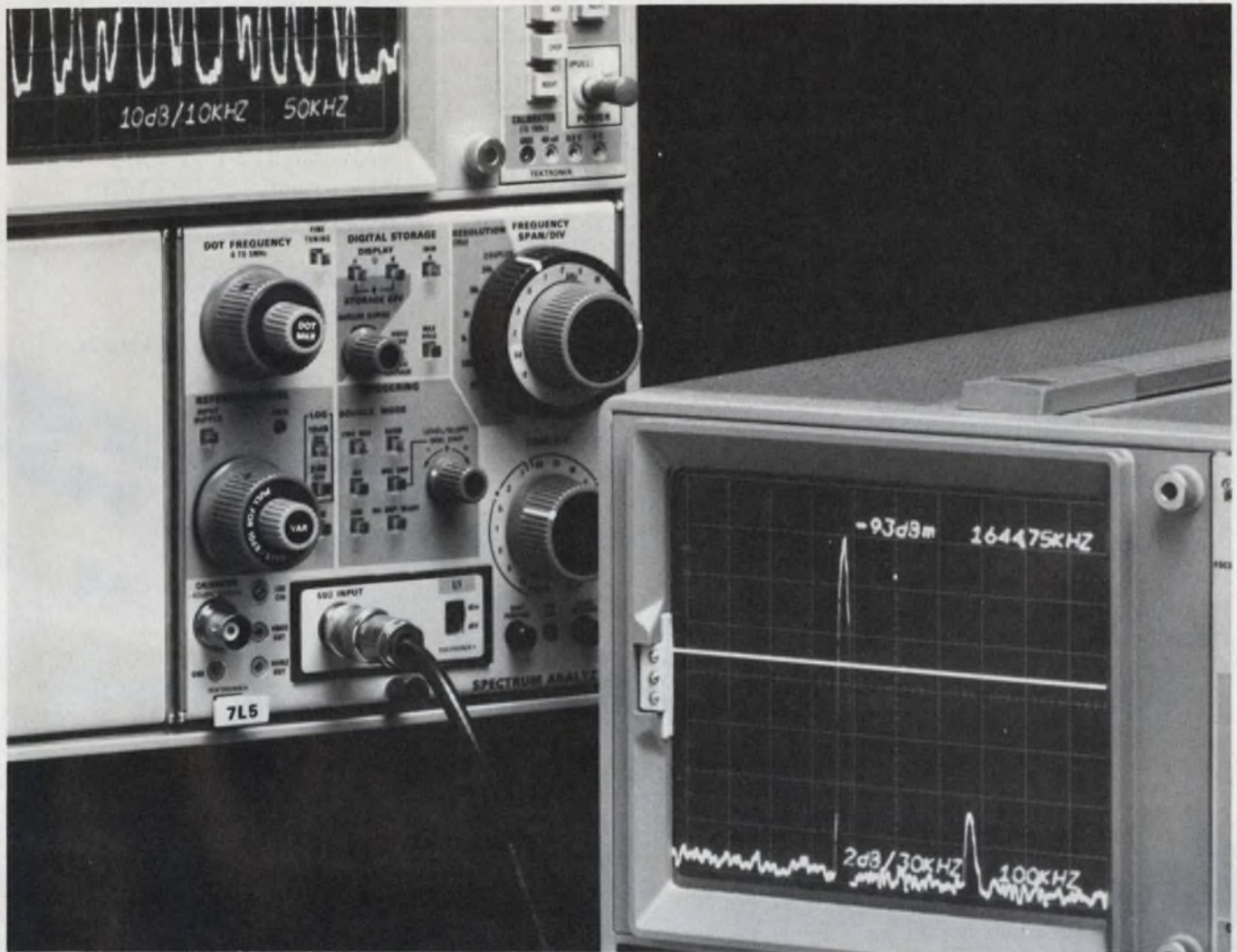

The new 7L5 5-MHz spectrum analyzer has exceptional frequency accuracy, stability, and 6-digit resolution thanks to a combination of synthesizer and digital technology.

Operation is easy with crt readout of display parameters and with sweep time and resolution automatically optimized for each span position.

7L5 performance characteristics include: 80-dB on-screen dynamic range, 10-Hz resolution, and absolute calibration in dBm, dBV, or volts. The reference level is set and read out in 1-dB steps over the range of -128 dBm to +21 dBm (with L1 50 Ω plug-in module).

7L5 digital storage provides clean, easy-to-see, easy-to-photograph displays with any 7000-Series crt readout mainframe.

Choose from these display and storage modes:

- Display peak or average of signal with continuously variable threshold shown by crt cursor.
- Store maximum levels of time varying signals.
- Split memory into A and B sections for comparing signals.
- Bypass digital storage for conventional display.

7L5 Spectrum Analyzer (requires plug-in module)	\$4,200
L1 Plug-in Module (50 Ω)	300
L2 Plug-in Module (75 Ω)	300
7603 Oscilloscope (suggested mainframe)	1,700

Ask for a demonstration or more information. Write: Tektronix, Inc., Box 500A, Beaverton, Oregon 97077. In Europe, write: Tektronix Limited, P. O. Box 36, St. Peter Port, Guernsey, Channel Islands.

U. S. Prices FOB Beaverton, Oregon



TEKTRONIX®

committed to
technical excellence

PRESENTING OUR SECOND FULL LINE OF DPMs.



Our full line of AC meters.

We've just completed our first full line of AC DPMs. To go with our original full line of 5V DPMs.

So now, no matter what kind of DPM you need — 5V or AC — all you have to remember are two words: Analog Devices.

Our newest AC DPM is the AD2009 — a 3½-digit unit with Beckman displays that fits the standard panel cut-out. It's a lower-priced, functionally superior replacement for units in the same class.

Then there's the

AD2008 — a 4½-digit AC unit with Beckman displays designed for high performance in adverse electrical environments.

And the AD2011 — the world's first true RMS DPM.

And finally the AD2006 — a high performance 3½-digit Beckman unit with its own power outputs for external circuitry.

Add to these our 5V line of 2½- to 4½-digit DPMs, and you've just run out of excuses to go to anyone else but us.

Send for our free Designer's Guide to Digital Panel Meters.

Analog Devices, Inc.
Electronic components for test and measurement instruments and control systems. Norwood, Mass. 02062.

East Coast: 617-329-4700

Midwest: 312-894-3300

West Coast: 213-595-1783

Texas: 214-231-5094



INFORMATION RETRIEVAL NUMBER 24

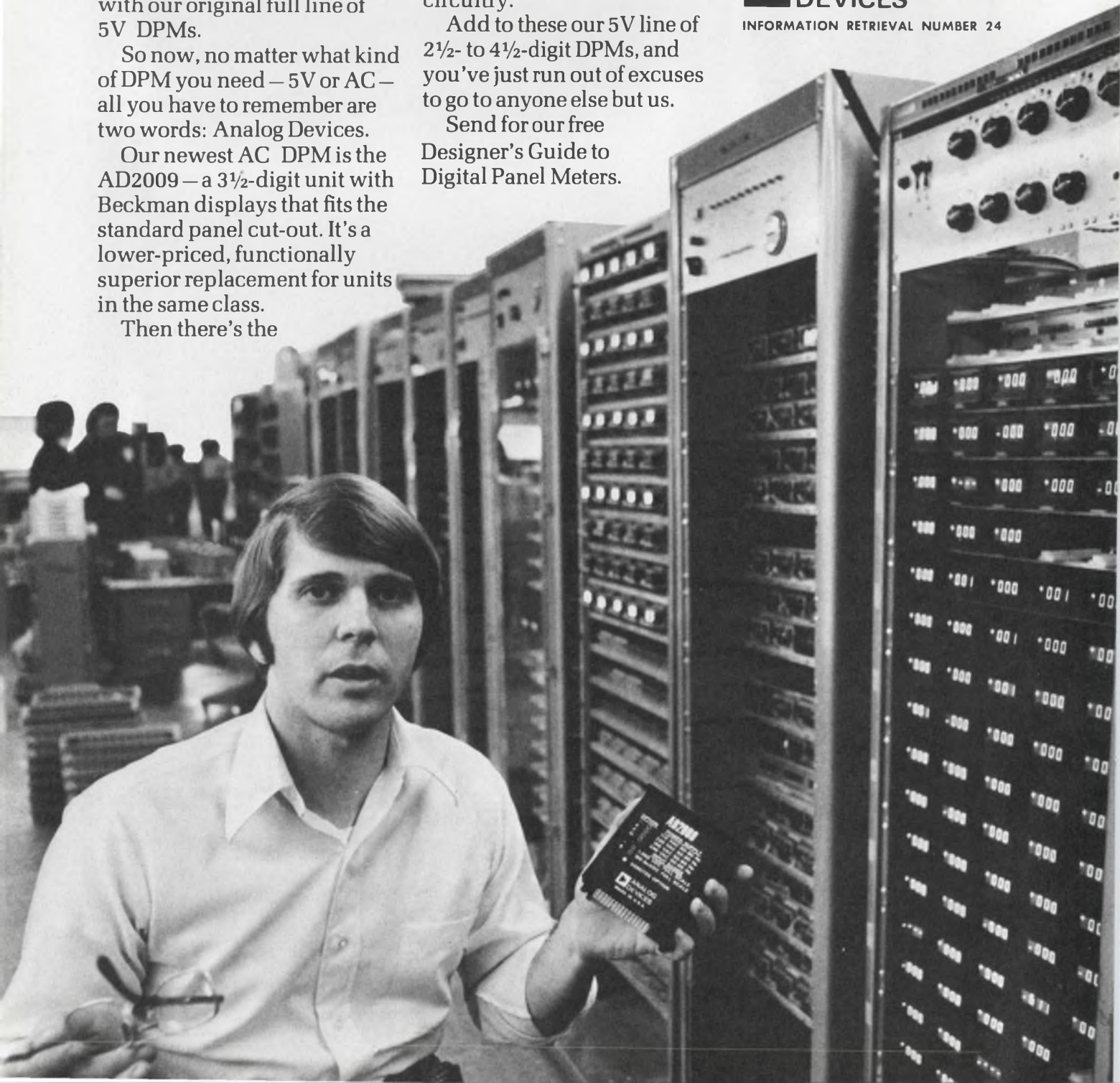

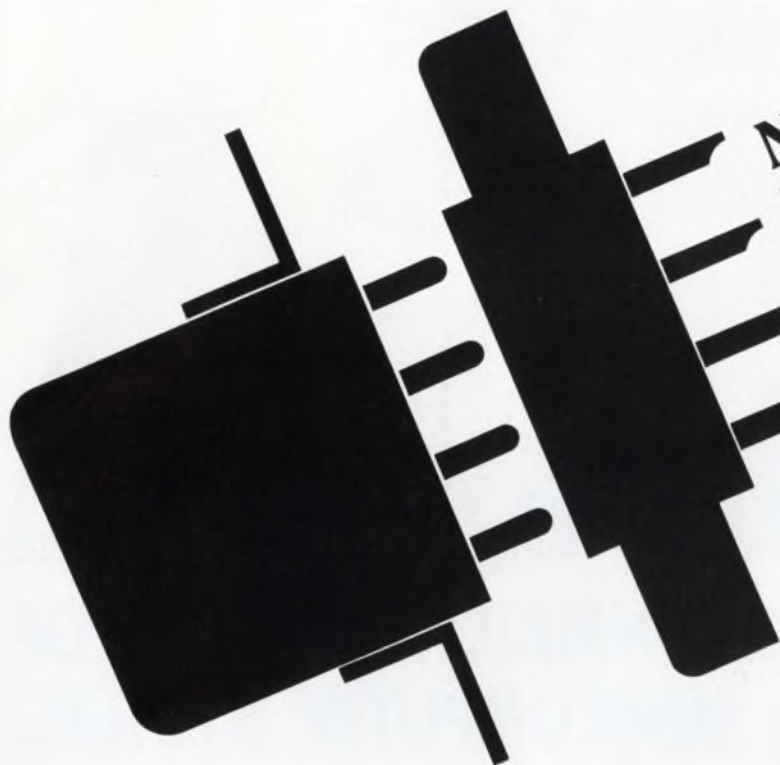

**Now!
There's one simple
answer to all of
your relay socket
needs.**

Us.

We have sockets for just about every crystal can relay made, including those by:

Babcock
C. P. Clare
Deutsch
Electronic Specialty
Hi-G
Leach
Struthers-Dunn
Wabco

and more. We have them for relays meeting MIL-R-5757, MIL-R-6106, MS, Buweps, Buord, Navair, BAC... and other specifications in Electronics, Aerospace, and the Military.

Fact is, you'd have to use a very rare relay to miss our line.

How to order.

Our distributor nearest to you has on his shelf the popular sockets that mate with relays of the leading relay manufacturers. Tell him the relay you're using — he'll know the Viking socket that fits.

Quality is tops, of course. So is delivery time. So, call him. And make your life a little easier.

Or send for our detailed 16 page brochure. A copy is yours for the asking.

O.K. Send me your brochure on Viking Relay Sockets.

NAME _____

TITLE _____

COMPANY _____

M/S _____

ADDRESS _____

CITY _____

STATE _____

ZIP _____

TELEPHONE _____



 **Viking**
CONNECTORS

Viking Industries, Inc./MilCom Division/9324 Topanga Canyon Boulevard/Chatsworth, Ca. 91311, U. S. A./ (213) 882-6275

INFORMATION RETRIEVAL NUMBER 151

INTRODUCING THE WORLD'S FIRST

MEGA

THE INTERDATA 8/32—UNMATCHED LEVELS OF PERFORMANCE IN A MINICOMPUTER SYSTEM.

MEGAMINI ARCHITECTURE: AN ABUNDANCE OF SHEER POWER.

Interdata's new 8/32 Megamini has performance characteristics found only on large scale computers. Like direct addressing to one million bytes. Full 32-bit hardware with performance enhancers such as dual instruction



The 8/32 MEGAMINI — with a full Megabyte.

look-ahead stacks, multiple register sets, interleaved 32-bit memory, and fast floating-point hardware. What our 8/32 Megamini means to you is an unequalled combination of power, flexibility, and reliability in a compact package. All at a price that's fully competitive.

MEGAMINI SOFTWARE: POWERFUL, FLEXIBLE, EASY-TO-USE.

Today's hardware must be designed to ease your software effort. You shouldn't have to spend a lot of expensive programming time trying to figure out how to get around minicomputer hardware limitations. With the 8/32 Megamini you don't — because there are none.

For example. The direct addressing capability of the 8/32 Megamini allows you to build programs and data arrays in any size up to the amount of memory you have — no more 64K limits.

It also means we can give you versatile and powerful software to help lower the cost of building your system. Software with a multi-tasking operating system, OS/32MT, with unique multi-user

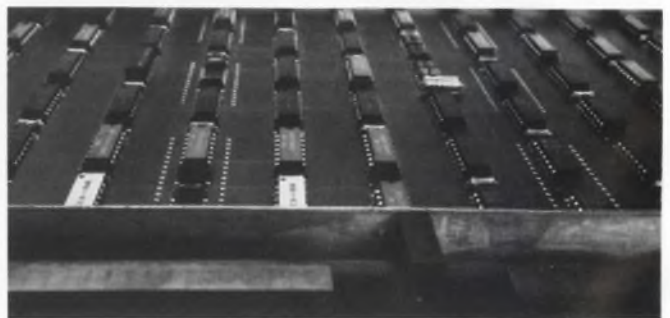

Multi-Wire Technology — a key to MEGAMINI performance.

MEGAMINI™

COMPARE: THE INTERDATA 8/32 MEGAMINI VS. THE-LESS-THAN-MEGAMINI COMPETITION.

	INTERDATA 8/32	XEROX 550	IBM 370/158	DEC 11/70	DG Eclipse
WORD LENGTH	32 bits	32 bits	32 bits	16 bits	16 bits
INSTRUCTION TIMES (Register to Memory)					
Integer Add	1.25	1.8	.9	1.8	2.5
Multiply	3.54	6.2	2.0	3.9	8.8
Divide	5.8	14.4	9.9	8.3	11.2
Floating Point Add	2.3	6.1	2.4	8.25	5.5
Multiply	3.0	9.1	2.3	11.25	7.2
Divide	5.35	23.3	8.9	12.25	7.9
HARDWARE I/O	Yes	Yes	Yes	No	No
MAX. DMA RATE/SECOND	6MB	4MB	6.7MB	4MB	2MB
DIRECT ADDRESSING RANGE	1MB	1MB	16MB	64KB	64KB
GENERAL PURPOSE REGISTERS	2 stacks 16 each*	4 stacks 16 each	1 stack 16 each	2 stacks 8 each	1 stack 4 each
PRICING (Basic Configuration)					
CPU + 128KB Memory	\$51,900	\$128,700	N/A	\$54,600	\$32,500
CPU + 1048KB Memory	\$179,400	\$478,700	\$1,905,700	\$163,800	N/A
*(6 Additional Stacks Optional)			All prices shown are U.S. list only.		

program development capabilities. Software that has an optimizing macro assembler, MACRO CAL. And software with a sophisticated telecommunications access package, ITAM, that allows you to treat remote communications terminals and computers as if they were simply local devices.

Now, with all of this available, you can concentrate your efforts on the real problem at hand — your application.

THE MEGAMINI: NOT JUST A COMPUTER — BUT A SYSTEM.

The Interdata 8/32 Megamini gives you a full range of peripherals, software and advanced features to choose from in tailoring your system: 166MB disc systems, fast line printers, 1600 BPI tapes and graphic CRT's. Plus software modules like FORTRAN, BASIC, EDIT, AIDS and many more.

FOR MORE MEGADATA, CLIP AND MAIL.

Interdata, Inc., Oceanport, N.J. 07757

- All that power sounds marvelous. Send me more information on the Interdata 8/32 Megamini.
- You may have hit on the solution to my megaproblem. Have a representative call me.

Name _____ Title _____

Company _____

Address _____

City _____ State _____ Zip _____

Telephone _____

INTERDATA®

Subsidiary of Perkin-Elmer

ED-5-10-75

Oceanport, N.J. 07757. (201) 229-4040



JUST A

LITTLE BETTER POT DESIGN



Better than what? Better than any half-inch square conductive plastic or cermet pots we have ever made. Or, as far as we can tell, that anyone else has ever made.

How we did it. Improvements in potentiometers don't come about as technological "break-throughs." It's more of a perfecting process. A little better here. A shade more exact there. And it all adds up.

We offer these two new potentiometers as the end result of such a process. We believe them to be the best you can get for the money. Better even than you can get for more money. Here's why:

The Modular Block. Small in size, square in shape. Packing density. The pins are spaced on a .1" grid, compatible with DIP and transistor sockets.

Conductive Plastic. The model 388 uses a proprietary plastic technique which we didn't invent, but for which we're virtually the only commercial source. It supplies as standard, superior qualities otherwise available only as a special in other technologies.

Long Rotational Life. All controls are tested for rotational life under full load circuit requirements.

Power Rating. Full at 70°C. Derated to 0 at 120°C.

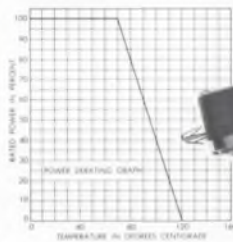

Low Noise. The 388 allows greater settability because of its 1% dynamic noise.

Resistance and Linearity Tolerances. Through the use of our technical process we achieve tighter tolerances; 10% resistance tolerance, 5% independent linearity being standard.

Cermet Model. Model 389 offers all the inherent advantages of the cermet element.

Carbon Wiper Button. Self lubricating. Low wear, smooth action.

Range. Both models avail-

able in a variety of shafts. Linear: 100 ohms to 5 megohms. Tapered: 500 ohms to 2 megohms.

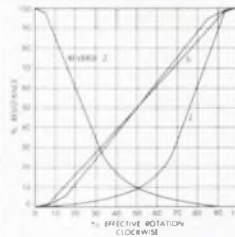

For specifications, or price quotations, call us or your nearest Clarostat representative.

CLAROSTAT

Clarostat Mfg. Inc., Dover, New Hampshire 03820/603-742-1120

388 & 389

CONDUCTIVE PLASTIC

CERMET

For standard stock items contact these distributors:

Almac/Strom Electronics
5811 Sixth Ave. S.
Seattle, Wash. 98108 (All Branches)

Arrow Electronics
900 Broad Hollow Road
Farmingdale, NY 11735 (All Branches)

Cramer Electronics
85 Wells Ave.
Newton, Mass. 02159 (All Branches)

Diplomat-Westland
1118 Elko Drive
Sunnyvale, Calif. 94086

Hallmark Electronics
9333 Forest Lane
Dallas, Texas 75231 (All Branches)

Hammond Electronics
1230 W. Central Blvd.
Orlando, Fla. 32805 (All Branches)

Kirkman Electronics
901 W. 22nd St.
Winston-Salem, N.C. 27102

Lykes Electronics
3308 Orleans Ave.
New Orleans, La. 70119

Lykes Electronics
1135 Chattahoochee Ave. N.W.
Atlanta, Georgia 30325

Lykes Electronics
5426 West Crenshaw
Tampa, Fla. 33622 (All Branches)

Newark Electronics
2170 S. Grape St.
Denver, Colo. 80222 (All Branches)

A.A. Peters, Inc.
404 Union Blvd.
Allentown, Pa. 18101

Ohm Electronics
649 Vermont Ave.
Palatine, Illinois 60067

Olive Industrial Electronics
6662 Olive Blvd.
St. Louis, Mo. 63103

Philadelphia Electronics
112 N. 12th St.
Philadelphia, Pa. 10917

Pioneer-Michigan
13485 Stamford
Livonia, Michigan 48150

Pioneer-Cleveland
4800 E. 131st St.
Cleveland, Ohio 44105 (All Branches)

Pytronics
8200 Wellmoor Ct.
Savage, Md. 20863 (All Branches)

Radio Electric Service
1026 Cromwell Bridge Rd.
Baltimore, Md. 21204

Radio, Inc.
1000 S. Main St.
Tulsa, Oklahoma 74119

Radio Supply Co.
131 Laura
Wichita, Kansas 67201

Richey Electronics
10871 La Tuna Canyon Road
Sun Valley, Calif. 91352

Simcona Electronics
275 Mt. Read Blvd.
Rochester, New York 14606

Harry Stark Electr. Supply
112 3rd Ave. North
Minneapolis, Minn. 55401

State Electronic Parts Corp.
36 Route 10
Hanover, N.J. 07936 (All Branches)

Stotts Friedman Co.
108-112 N. Jefferson St.
Dayton, Ohio 45402 (All Branches)

Sweico, Inc.
1512-18 E. Lancaster
Fl. Worth, Texas 76101

Sterling Electronics, Inc.
4201 Southwest Freeway
Houston, Tex. 77027 (All Branches)

Terminal Electronics
880 Maude Ave.
Mt. View, Calif. 94040 (All Branches)

Virginia Radio Supply
717 Henry Ave.
Charlottesville, Va. 22902

INFORMATION RETRIEVAL NUMBER 153

The zener you just plug in.

No more need to buy a zener diode, put in several transistors and an amplifier, trim it, tweak it, and collapse in exhaustion.

Introducing the best news since Geritol...the LH0070 series precision buffered reference.

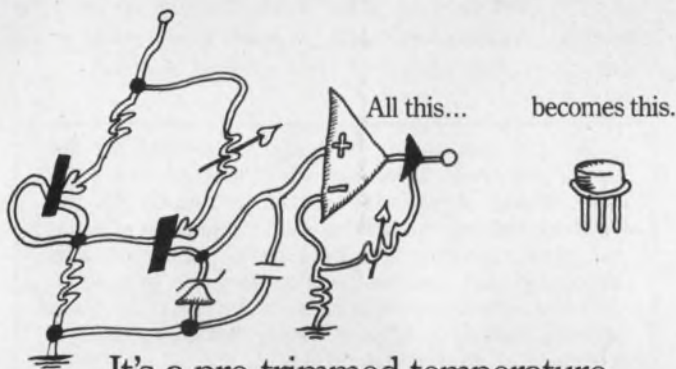

It's a pre-trimmed temperature compensated zener diode driven by a current regulator and a buffer amplifier all in one package ready to plug in.

And the cost is low. Real low when you figure all the time and effort you save.

We give you three ten volt ways to go: ± 2 milivolts, ± 5 milivolts, or ± 10 milivolts. All guaranteed. No hassle.

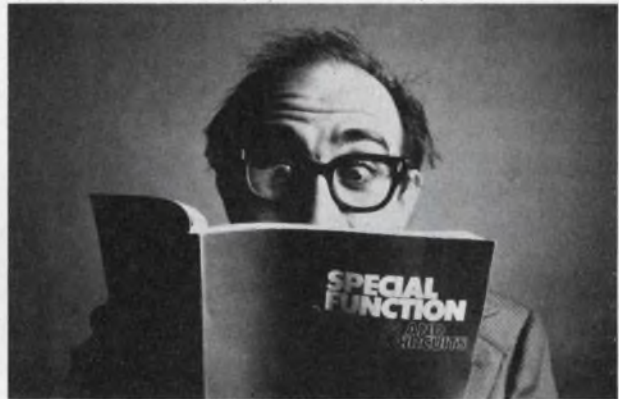

For the details, plus — for other mind-bending ideas — our Special Function catalog, write National Semiconductor Corporation, 2900 Semiconductor Drive, Santa Clara, California 95051.

Inquiries received by the 10th of the month will receive our interest as if it has been received on the 1st.

Please send me your data sheets on the LH0070 and your nifty Special Function Catalog. ED621

Name _____

Company _____

Address _____

City _____ State _____ Zip _____

Mail to: National Semiconductor Corporation,
2900 Semiconductor Drive, Santa Clara, CA 95051

National

National Semiconductor Corp., Scottsdale, Ariz. (602) 945-8473, Mountain View, Calif. (415) 961-4740, Sherman Oaks, Calif. (213) 783-8272, Tustin, Calif. (714) 832-8113, Miami, Fla. (305) 446-8309, Chicago, Ill. (312) 693-2660, Indianapolis, Ind. (317) 255-5822, Lenexa, Kan. (816) 358-8102, Glen Burnie, Md. (301) 760-5220, Burlington, Mass. (617) 273-1350, Farmington, Mich. (313) 477-0400, Minneapolis, Minn. (612) 888-4666, Englewood Cliffs, N.J. (201) 871-4410, Syracuse, N.Y. (315) 455-5858, Dayton, Ohio (513) 434-0097, Dallas, Tex. (214) 233-6801.

INFORMATION RETRIEVAL NUMBER 25

Upsurge in traffic is spurring

Vast changes are occurring in all sectors of the communications industry, spurred by application of the latest technological advances and by a more enlightened Federal regulatory climate.

Any resemblance between today's digitized, IC-dominated communications receivers and transmitters and yesterday's bulky, knob-bedecked models may be purely coincidental. Broadband circuits and semiconductor devices have sharply reduced the controls on the front panels, while improved semiconductor devices with higher output capabilities are making possible considerably more compact equipment.

A huge rise is expected in the volume of communications traffic over the next 10 years, along with a significant shift from mostly speech to a mix of speech and data. Although electrical contacts still switch 99% of data and voice circuits, this job is increasingly being taken over by computers that can switch complete messages in digital form from one path to another through the main memory. The goal? To switch digital data as easily as voice communications.

The Federal Communications Commission's decision to open a whole new frequency band at 900 MHz is expected to have a major impact on public and private land-mobile users. Most manufacturers are busy designing equipment to operate in this band. And in the next couple of years,

tens of millions of dollars are expected to be invested in a variety of new mobile radio and telephone equipment, from tiny, hand-held portable transceivers to complex computer-controlled switching centers.

With all this new communications equipment in use and under development, specialized test equipment is needed. Digital techniques have made test instruments a lot more versatile, easier to use and, of course, smarter. This is particularly true in instruments used to guarantee the quality of voice and data transmission. The trend here is to multifunction instruments, digital signal analysis and automated systems.

For a fast look at what's happening in today's exciting communications world and what's to come, turn the pages of this special section.

Also in this report is a special profile on the late Ernst Frederik Werner Alexanderson, an engineer whose inventions contributed much to the communications field. His high-frequency alternator made possible the first radio broadcast and eventually led to the development of television. Dr. Alexanderson held 322 patents, most of them granted during a 46-year career with the General Electric Co. that began in 1902.

This 97-foot dish antenna, typical of those found at Intelsat ground stations, is located at Cayey, Puerto Rico. It can be rotated one degree per second.

— Contents —

Digital methods and integrated circuits are making receivers and transmitters smarter.....	36
Designers are adapting as communications traffic begins to shift to a mix of speech and data.....	44
Land-mobile radio designs are pushing to 900 MHz to ease spectrum crowding.....	54
Test equipment is proving its worth in ensuring the quality of transmission.....	60
Dr. Ernst Alexanderson: The engineer whose ingenuity led to 322 electronic miracles.....	68

broad changes in equipment





COMMUNICATIONS '75



Digital methods and ICs are making receivers and transmitters smarter

Communications receivers and transmitters are fast losing their resemblance to sets designed only a few years ago.

A look behind the knob-bedecked front panels of older equipment reveals tubes, tuning capacitors, coils, switches and potentiometers. In contrast, the front panels of recently designed military equipment are dominated by data-entry keyboards, while behind the panels one sees only a mass of wires and IC packages.

Digital techniques are performing principal control and operating functions. And new semiconductor devices are generating and amplifying signals.

The following design trends are emerging:

- Control of communicating sets is being taken from the operator and turned over to a computer.
- Variable oscillators are giving way to digitally synthesized frequency sources.
- Calibrated frequency dials are being supplanted by LED displays, driven by built-in frequency counters.
- The number of front-panel controls in non-digital equipment is being reduced in both transmitters and receivers by the use of broadband circuits and semiconductor devices.
- Improved semiconductor devices, ranging from low-frequency rf transistors to microwave ICs, are providing substantially higher power output capabilities on the one hand while shrinking equipment on the other to sizes heretofore unrealizable.
- Consumer color TV receivers are beginning



Broadband amplifiers simplify switching and tuning of both receiver and transmitter in this Heath SB-104 communications set.

to incorporate new solid-state surface acoustic wave filters in their i-f sections to eliminate alignment problems.

- Manual tuning and visual checking of communication equipment operation is giving way in new military equipment to designed-in computer testing and monitoring.

The 9023: A computer in control

An example of the trend in computer-controlled receiver design is the Watkins-Johnson 9023 Receiving System. Designed and produced at Gaithersburg, MD, the 9023 covers from 50 MHz to 12.4 GHz and interfaces with a PDP-11 computer.

Benjamin Nardi, head of advanced development at Gaithersburg, points out that the system has three components: a digital controller unit,

Jim McDermott
Eastern Editor

a tuner and a demodulator.

"The tuner and demodulator units have no manual controls, but are controlled by the interaction of the digital controller unit with the computer," Nardi explains.

The frequency and bandwidth can be selected by the computer, or the receiver can be called upon to scan a band or to tune to a fixed frequency. Back-up manual control is provided on the controller panel.

Nardi points out that a unique design feature is the use of but one local oscillator and one mixer to cover the 50-MHz-to-12.4-GHz spectrum. The local oscillator is synthesizer-tuned and can cover the entire range in 10-kHz steps, controlled by the computer. Varactor-tuned preselector circuits are used below 1 GHz, while a YIG-tuned preselector is employed above that frequency. The local oscillator operates in C band.

Unlike conventional approaches, the wideband coverage of the receiver is obtained by up-converting the lower frequencies to a microwave i-f strip. The i-f output is down-converted to 160 MHz.

"The more conventional approach," Nardi says, "would have been to have the local oscillator track the incoming signal at 160 MHz. But because the local oscillator operates in the microwave region, synthesizing the local oscillator signal is fairly easy. There is only one local oscillator range to control."

To control the 9023 system manually, the keyboard on the controller panel (see photo) can be used to select frequencies or to enter or recall frequencies in or out of four memory channels.

For direct operator scanning across a band, a special single-knob tuning system is designed into the controller unit.

The knob is designed to have the feel of regular, continuous tuning, even though the local oscillator synthesizer frequency is being changed in

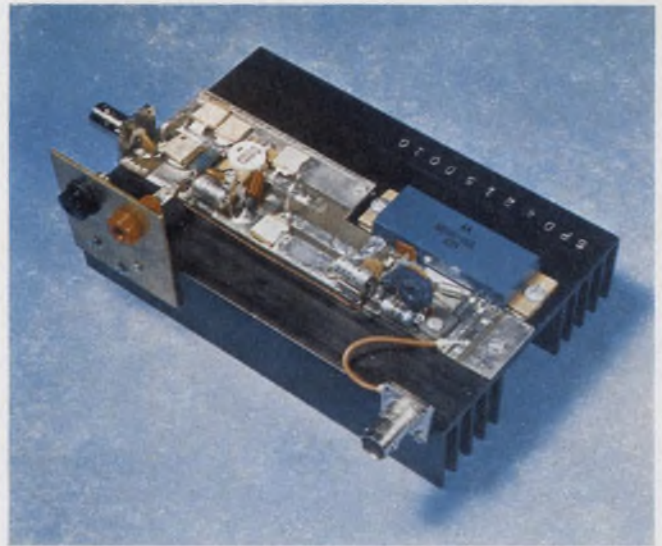

A controlled-Q transistor for broadband amplifiers is the heart of this 13-W, 175-MHz, 12.5-V Motorola module fabricated with hybrid techniques.

discrete increments as low as 10 kHz. The knob, which turns a slotted disc between a light and a photocell to provide each synthesizer increment, has a variable-rate feature that provides both high-resolution slow tuning as well as rapid tuning.

When the knob rotates at less than 1 rps, the frequency change is linearly proportional to the rate, and a resolution of 10 kHz is obtained. Rotating the dial faster than 1 rps increases the frequency-change rate exponentially.

At higher rotational speeds, the increments change in steps of megahertz, and tuning over a broad band is obtained rapidly.

The frequency to which the receiver is manually tuned is displayed in gigahertz on a seven-digit LED display.

The use of solid-state packaging techniques has enabled Electronic Communications, Inc., St.

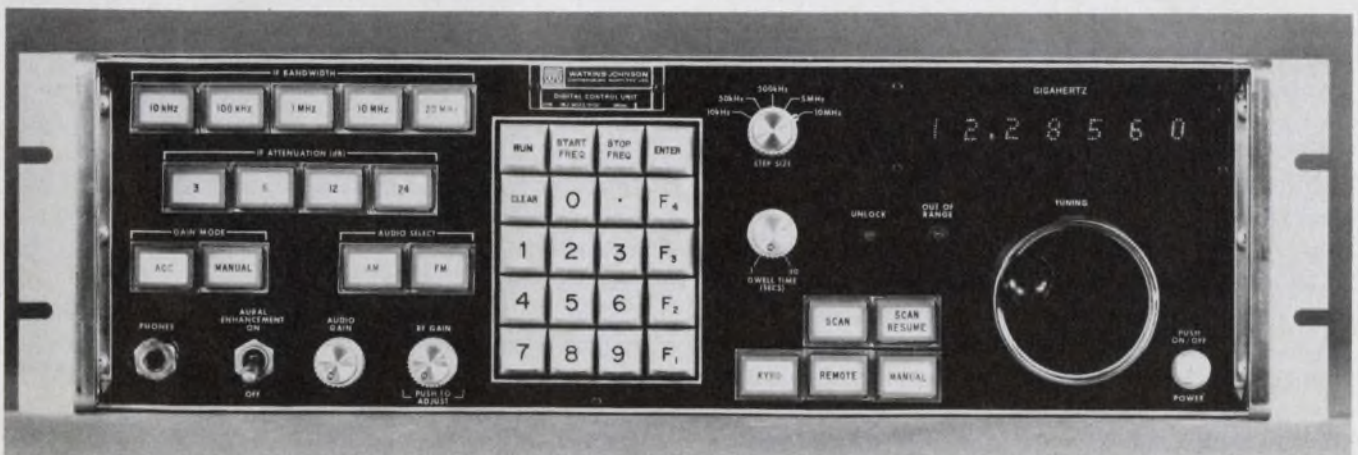

The frequency and bandwidth of this 50-MHz-to-12.5-GHz Watkins-Johnson receiving system are selected by a PDP-11 computer, which monitors and controls other

functions. If required, the system can be manually operated using the keyboard and tuning knob on this controller panel.

Petersburg, FL, to combine, in a Navy line-of-sight satellite communications terminal, both PSK and FSK modems in a single transceiver. The terminal, the AN/WSC-3, accommodates three satellite frequencies in the band from 225 to 400 MHz. It incorporates advanced partition of circuits in modules and includes built-in test functions to permit trouble analysis by relatively unskilled technicians.

"About 85% of the faults that may occur can be isolated correctly the first time with the in-built test capability," says Frank Oscnashek, assistant vice president for communications systems engineering.

To test, the technician turns a switch to each test position that monitors a single module. A go-no-go indication appears on a front-panel meter (see photo). The system is designed to allow low-skill personnel to complete the test in 10 minutes.

"We've incorporated this system and increased the cost of the radio less than 5%," Oscnashek notes. "I think that in the next-generation equipment we'll have a microprocessor built in to give us more sophisticated diagnosis and fault isolation.

The present system uses discrete logic with dual in-line package technology.

A major trend in communications equipment for the 2-to-30-MHz range is the replacement of tubes by solid-state devices—in particular, in the power stages.

"This changeover from power tubes to transistors is taking place in equipment designed for hams, for Civilian Band use and for marine, paramilitary and police operations," says Ronald G. Ricci, planner for high-frequency products at Motorola Semiconductor, Phoenix.

Ricci cites as a basic reason for the changeover the increased capability of new-generation power transistors. As an example, he points to a 12-V, 100-W transistor with cw or PEP output (Motorola M421), which has more than doubled the power output of such devices.

For fixed-base equipment, 28 and 50-V transistors rated at 150 W, cw or PEP, are also finding wide application—all in broadband transmitter circuits.

Michael Elliott, chief communications engineer for the Heath Co., Benton Harbor, MI, notes: "We're using broadbanding in our new all-solid-state amateur transceiver, the SB-104, not only in the transmitter but also in the receiver. Unlike the older designs, where the transmitter and receiver were separately tuned, it's only necessary to select the frequency. This is accomplished through the use of bandpass filters, one for each band of interest—in this case, one for each amateur band between 3.5 MHz and 29.7 MHz. The power amplifier is



Tests of 23 key points in this 225-to-400-MHz Navy satellite communications terminal by Electronic Communications, can be made by nonskilled personnel operating a "Test-Select" switch.

broadband and, again, all the transmitter selectivity comes from bandpass filters."

An important design trend spurring broadband techniques is the use of a receiver front end designed to operate in strong signal environments—where many strong signals are close to the frequency of the desired one.

"We took the rf preamplifier out of the receiver and matched the input directly to the receiver mixers," Elliott says. "While we took 20 dB of gain away from the front end, we added that gain back of the crystal filter in the i-f. It greatly protects the receiver from strong signals and improves the strong-signal-handling capacity of the receiver.

"It has minimized the adverse effects of intermodulation and cross-modulation in the receiver. We're perhaps 20 dB better, in terms of those performance characteristics, than the previous-generation receivers."

Dieter Lohrmann, electronics engineer at the Army Electronics Command, Fort Monmouth, NJ, points out that this same development has been followed by the Army.

"We improved the capability of a receiver to handle large, out-of-band signals by eliminating amplifiers in the front end," he points out. "We tried an input to a high-dynamic-range mixer but initially had difficulties with the noise figure, since if there is no gain, all front-end losses, including that of the mixer, add to that figure.

"So we designed very-low noise i-f amplifiers and mixers that also have a very low insertion loss. The best we've done so far in the 50-MHz range with an amplifier-less front end is about 10-to-12-dB noise figure.

"What is not widely known—but which we have discovered—is that you can theoretically build mixers which have zero, or close to zero,

Tomorrow ideas today.



Using solid-state technology to replace bulky tube-type equipment, ENI's broadband amplifiers are tomorrow ideas available today.

ENI's Class A power amplifiers already cover the frequency spectrum of 10 kHz to 1 GHz, with power outputs ranging from 300 milliwatts to over 4000 watts. And we're still climbing. Driven by any signal generator, frequency synthesizer or sweeper, ENI's compact portable amplifiers are completely broadband and untuned. Amplifying inputs of AM, FM, SSB, TV and pulse modulations with minimum distortion, these rugged units are

versatile power sources for general laboratory work, RFI/EMI testing, signal distribution, RF transmission, laser modulation, data transmission, NMR, ultrasonics and more.

Designed to be unconditionally stable and failsafe (impervious to severe load conditions including open or short circuit loads), ENI power amplifiers will deliver their rated power to any load, regardless of match.

For information write: ENI, 3000 Winton Rd. So., Rochester, New York 14623. Call 716-473-6900. TELEX 97-8283 ENI ROC.

ENI

World's Leader in Solid State Power Amplifiers

INFORMATION RETRIEVAL NUMBER 26

insertion loss. We've built them with losses of only 1.5 dB, but only in the 1.5-MHz region. The components for these mixers are not as yet readily available to do the same thing in the 50-MHz region.

"The trend in Army transmitters is away from completely broadbanded stages," Lohrmann says. "The reason is that if a transmitter is located close by a receiver, broadband noise emanating from the transmitter jams the receiver.

"We've had this situation in radio-relay equipment located in a vehicle, which receives on about 50 MHz and retransmits on 60 MHz. The broadbanded 60-MHz transmitter radiated a blanket of noise that jammed a sensitive receiver."

Heath's Elliott points out that a clear trend in ham and other communications equipment is the incorporation of digital-frequency readouts. In the Heath SB-104 this is accomplished with a counter and LED display.

Smaller and smaller equipment

As for the use of solid-state signal devices to shrink the size of communications equipment, RCA's hand-held Tac-Tec equipment is a case in point. It operates in the 132-to-174-MHz and 396-to-512-MHz bands. Beam-lead devices and hybrid technology are used.

George J. Mitchell, product manager at RCA Mobile Communications Systems, Meadow Lands, PA, says:

"The beam lead saves 24 individual connections, compared with the 48 of a 24-pin IC device. The beam lead connects the IC directly to the substrate. And this provides miniaturization, because the chip is only about 100 to 125 mils square, and it can be used directly on a hybrid ceramic substrate.

"While these beam lead devices have been previously useful in the low-frequency rf ranges, we've used them up to 14 MHz, which hasn't been done before. They're used in the modulator section of the transmitter and in the receiver audio and low-frequency i-f sections.

"Another advantage of these devices is that—unlike similar devices, such as flip chips—they can be visually inspected for good bonds before dynamic testing and installation on the hybrid substrate."

The use of hybrid microcircuits in all the rf circuits of a new Raytheon 11-GHz digital microwave radio system allowed exceptional reduction in size, according to Leonard Walker, engineering sales manager for Raytheon Data Systems, Norwood, MA.

An entire up-converter in the new RDS-80 Microwave Transmission System Multiplexer and Microwave Radio is a module 8-in. high by 1-1/2-in. wide by 9 in. deep. An entire transmit-

ter-receiver package, complete with modulator-demodulator local oscillators and amplifiers, is about 8 in. high across a 19-in. rack.

In previously designed equipment the same unit required half a bay, or some nine or 10 times as much room.

The new equipment, Walker explains, accepts 24 digitized telephone voice channels, with each digital group composed of 1.54 Mbits. The combined radio and multiplexer act like a 100-pair cable. Each radio transmits at a 40 Mbit rate.

One radio carries 40 Mbits of data to a vertically polarized antenna; the other carries another 40 Mbits to a horizontally polarized antenna.

The equipment is all-solid-state, including use of a 1-W Impatt diode as linear output amplifiers.

One of the newest solid-state devices—the surface acoustic wave filter—is being applied by Zenith in the i-f strips of a number of field-test color TV sets. The device, Zenith engineers say, may replace 12 components in the i-f section of a color set and eliminate i-f adjustments over the life of the set.

Joseph Thomas, manager of large-screen color and advanced technology at Sylvania Entertainment Products, Batavia, NY, points out that this type of filter is being investigated by his company because it can be of substantial benefit. He notes:

"It gives guaranteed alignment and eliminates human error in setting up adjacent channel traps—which is very important on cable TV systems, where adjacent channels exist all the way up the band.

"Right now, they are a bit costly. Also, they are lossy devices, and the gain blocks that you would use to overcome the losses are not yet fully optimized."

The trend to incorporating more ICs in color TVs has run its course, according to Thomas.

Presently available ICs are perhaps all that are now usable, he says, adding: "There may be limited developments in the areas of MSI or LSI to decrease the number of ICs now used, but the balance of the circuitry doesn't lend itself too well to integration."

The trend to all-solid-state designs is also being pushed in high-power television transmitters, reports T. M. Gluyas, staff engineer for RCA Broadcast Systems, Camden, NJ.

"The present line of uhf transmitters we're building," he says, "has no tubes other than the final klystron power amplifier. Power outputs with these run as high as 150 kW for RCA, and a competing firm has shipped one 200-kW unit.

"We use four and five-cavity klystrons, because they have large inherent gain and can be driven by solid-state amplifiers. For vhf transmitters, the only tubes used are three: two in the video and one in the sound transmitter." ■■

It's here.



7 Digits, 100 MHz, Multifunction Counter Data Precision's Model 5740

The First 7 Digit, 5-Function Counter/Timer
Ever Offered For Under \$300
Measures: Frequency, Period, Period Average,
Total Events, Elapsed Time.

\$295.00



Human Engineering

Simple and logically marked controls; a direct-reading display in the rated units; automatic decimal positioning and a bright easy-to-read .43" high LED display, with "overflow" and "gate-on" indicators.

SPECIFICATIONS:

Sinewaves, Square Waves,
Pulses, Pulse Pairs, Complex
Waves - 10 millivolt sensitivity

- **FREQUENCY**
5 Hz to 100 MHz; 10 ms/
100 ms/1 sec./10 sec. gate
times, resolution to 0.1 Hz
- **PERIOD**
½ microsecond to 0.2 sec.

- **PERIOD AVERAGE**
10, 100, and 1000 periods
- **TOTAL EVENTS**
0 to 9,999,999 (unlimited
with "overflow" indicator)
- **ELAPSED TIME**
0 to 99,999.99 sec.
(27.8 hrs.)

DATA PRECISION®
...years ahead

Data Precision Corporation, Audubon Road, Wakefield, MA 01880
(617) 246-1600

NORLAND INSTRUMENTS
Announces the newest generation of
test and measurement instrumentation.



The NI 2001 Programmable Calculating Oscilloscope

Here is the ultimate instrument for the acquisition, processing and manipulation of electrical data. It completely eliminates the need to compromise your requirements with a jumbled array of separate instruments. The NI 2001 is a *complete* unit that combines all the capabilities of a digital oscilloscope and a microprocessor in a single mainframe. It brings you flexibility, convenience, accuracy and reliability you won't find anywhere else.

This — the first programmable calculating oscilloscope — is the product of many years of technological research and instrumentation engineering. With the advent of microprocessor technology, Norland Instruments engineers were quick to recognize the power available to the instrument designer and first applied a microprocessor to the Norland line of medical instruments. That experience ultimately led to the use of microprocessor technology in the development of the NI 2001 — the first truly new generation of test and measurement instrumentation for the industrial and scientific user.

The NI 2001 gives you the precision of a digital oscilloscope for data acquisition and display *plus* the built-in capability of a microprocessor for data reduction. You can make exact

calculations of rise times, integrals, differentials, peak areas, RMS values, peak-to-peak measurements, n-point averaging, and an almost unlimited range of other operations. It increases your productivity by letting you measure, display, digitize, store and process data faster and more accurately than ever before. The NI 2001 will analyze data and, through conditional branching, function as a decision making instrument. It is easily programmable — without computer instructions — so repetitive operations can be completely automated. Its mainframe, through modular design, has provisions for a wide range of plug-in modules to let you expand your system to meet individual requirements. It can even be interfaced to control other equipment.

Now, consider the economics. Surprisingly, the NI 2001 mainframe is \$8,500. The instrument shown here, with monitor and two single-channel plug-ins, can be yours for \$13,400!

You've waited a long time for an instrument as versatile as the Norland Instruments NI 2001. Wait no longer. Investigate it today.

To arrange for a demonstration and complete information, send the reader service card or write Norland Instruments, Department A-2.



NORLAND INSTRUMENTS

A Subsidiary of Cordis Corporation

Norland Drive, Fort Atkinson, Wisconsin 53538 U.S.A.

INFORMATION RETRIEVAL NUMBER 291

FOR DEMONSTRATION 292



COMMUNICATIONS '75



Designers adapt as traffic begins to shift to a mix of speech and data

Over the next decade the volume of communications traffic is expected to change from mostly speech to an equal mix of speech and data, with the latter including images. Changes are being made, and rapidly, to pave the way for the new trend. These include:

- Increased use of computer control systems to minimize call set-up time and to boost subscriber capacity.
- Application of digital switching techniques to increase line capacity.
- Sharing of lines by voice and data channels for distant transmission.
- Ability to route digital data as easily as voice communications.

Computers boost system effectiveness

Most dramatic for switching digital data is the use of a computer as the switch. A computer routes entire messages in digital form from one path to another via movement in main memory. Messages arrive at the computer's input ports with routing information, and the computer transfers the data to the appropriate output port at a speed that depends on the urgency of the message. Methods of this type represent the vanguard.

Electrical contacts still switch 99% of data and voice circuits. But the device that controls those contacts is apt to be a digital computer, whose speed and skill at making connections has led to a gradual replacement of the telephone operator.

Seymour T. Levine
Associate Editor



A communications control center identifies potential transmission problems in international communications circuits or leased channels. Telex and telegraph. In the ITT World Communications system, each teleprinter circuit is under computer control and performance is automatically evaluated every five minutes.

In all of the present and proposed systems, the switching center or exchange plays a primary role. With few exceptions, most communications lines start out on a pair of wires per subscriber, that run to some sort of local exchange.

As a rule, little sophisticated equipment is associated with the local wires, and since they are already in place, few people want to dig them up and replace them with more sophisticated systems.

But the luxury of one wire pair for each communicator stops when connections are made between exchanges. Signals bound for distant points are combined as much as possible before being put on the links between exchanges. The idea is to reduce connections if wire is used or to make efficient use of bandwidth in the case of microwave or satellite links.

As a rule, the low-speed signals are stacked in frequency bands, while the high-speed (50 kbit/s and up) are sent via time-division methods between local exchanges. In recent years a combined system of time and space multiplexing has come into use in which selected time slots in one bit stream are shipped to selected output ports in a different time slot, on a demand basis, to give space-division multiplexing.

Bell's No. 2 ESS (Electronic Switching System) typifies the approaches being used. No. 2 ESS has three basic elements:

1. A crosspoint network of high-speed reed switches.
2. A control unit similar to a CPU that directs switching operations and system maintenance.
3. Two memories—a temporary one that contains information about the caller and the party receiving the call and a permanent storage unit (such as a ROM) that directs the control unit in

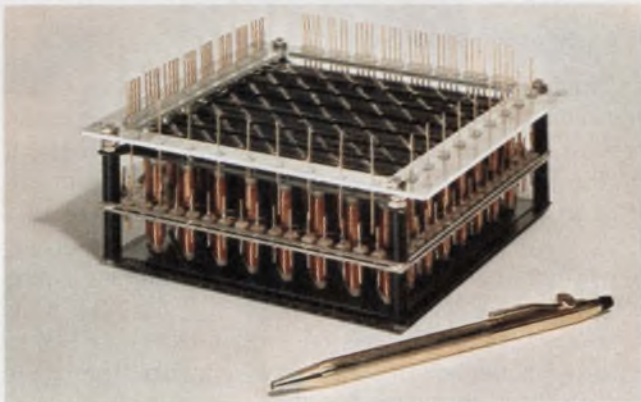

A workhorse for circuit switching, the reed memory matrix, consumes little power, yet handles signals from dc to video frequencies. This Mini Memory Matrix from C. P. Clare switches eight rows by eight columns with four contacts per crosspoint. The electronic control can be a mini or microprocessor.

establishing a connection.

Instructions carried out by the CPU include interpretation of customer-dialed digits, routing of calls and release of circuits on completion of dialing. An external scanner informs the CPU of activity on lines, trunks and service circuits.

The crosspoint network, directed by the CPU through controllers, selects paths through the switch matrices and joins appropriate devices, such as dial pulse receivers and ringers, to the incoming loop. The electrical circuit remains intact, until a subscriber hangs up, even if both parties remain silent for long periods of time.

Digital technology handles voice and data

At the local level—in contrast to an international link—digital technology is making further

headway. Information arrives in time slots and gets transferred to other time slots by a switch with IC gates connected to the crosspoints. Packing of data into time slots is time-division multiplexing; distributing it is space division. Since the switch matrix can take items from one time slot of a TDM line and transfer them to another, the over-all operation is time-space-time division.

With its advanced No. 4 ESS, Bell achieves time-space-time division. Scheduled for commercial service in 1976, the system handles up to 107,000 trunks and is designed especially for urban traffic. In the meantime No. 1 ESS, a crossbar system that also has stored program control, is the urban workhorse. No. 2 ESS handles suburban communities with a 10,000-line capacity.

Part of the No. 4 ESS operation is conversion of analog voice signals to digital. Pulse-code



Stored program computer control makes customer service changes a matter of issuing instructions to a computer. The computer performs extensive monitoring in GTE Automatic Electric's Electronic Automatic Exchange. Sealed reed switches complete the circuit paths; dual processors ensure reliability.

modulation of eight bits gives adequate reproduction; the encoding emphasizes low signal levels (log-curve) to reduce quantizing noise. A pair of conductors, with regenerators a mile apart, accommodates 24 voice channels, and each channel is sampled at an 8-kHz rate. The total bit traffic is up to 1.5 Mbit/s, which is compatible with a Bell system "T1" channel, which has a capacity of 1.544 Mbit/s.

The realization of an all-digital network that carries both voice and data seems rather remote at present. Voice circuits when digitized by current methods require a 32-kHz channel; in analog form 8 kHz suffices. For long haul transmission, say, by microwave, frequency-division multiplexing still proves the most economical way to send voice.

But if all sources are digital to begin with, all-

digital networks, including radio links, are indeed available to switch the information. These networks take at least three forms: electronic switching, message switching and packet switching.

With electronic switching, computers establish a physical circuit between communicators. In message switching, the electrical links between computers remain intact, but the computers route data between communicators according to stored connection tables. In both these cases a path is reserved for as long as the communications link is established.

The packet switch resembles a message switch, but each message contains destination information. The sending computer breaks the incoming bit stream into packets of about 1000 bits, and the receiving computer reconstitutes the message at the final destination.

The packet system completely releases the message path in the absence of transmission; the other two systems do not. Hence packet services charge for the amount of information sent—the packets—rather than for the time of the connection.

Data Transmission Corp.'s Datran network, based on electronic switching, uses digital radio as well as time-space-time multiplexing to provide switched data. In the Datran network, Gandalf data sets, made in Ottawa, Canada, provide bit rates up to 19,600 when a local wire pair is available; otherwise 9600 bit/s modems set the upper limit.

Three levels of time-division multiplexers put data aboard a microwave backbone to Datran's Brunswick, IL, switching station at a full rate of 44 Mbit/s. A radio made by Fujitsu uses eight-phase coherent phase shift keying (PSK) with two transmitters and two receivers.

To combat fading, the system switches in one of two spatially diversified receivers. The error rate, which accumulates on a demodulator set to trigger at a lower amplitude than the main demodulator, determines the time for switch over. Relatively slow TTL gates switch, between receivers, but they do not introduce data error, since the baseband signal is only 15 Mbaud. Of course, reliability is enhanced because the second transmitter substitutes for the first in the event of a failure.

Datran's microwave backbone runs from Chicago to Houston, with dropoffs at eight cities. A time-space-time switch built by Stromberg-Carlson, Rochester, NY, handles 16,000 simultaneous calls with a clock rate of 2.688 MHz. The all-solid-state switch uses mostly TTL. At present the switch interfaces with Comten (St. Paul, MN) CPU. The Datran system can respond to a call within 3 s with either a busy signal or a connection. The company guarantees error rate



Nearly 100 million messages between 100,000 terminals are handled in one year by computer without any electrical switches at Western Union's Infomaster service center. Three large-scale and three medium-sized processors route digital data.

by the block and promises that 99.5% of one-second transmissions will be error-free.

If a computer should call

There is still one more area—satellite communications—where the computer acts as a controller without influencing the form or content of the message. At present, satellites only repeat information beamed to them via ground terminals. Any switching that takes place must occur after demodulation. Since all ground sets receive all messages, the major technique for message remains frequency-division multiplexing (FDM). Tuned transmission receivers separate the messages. The computer functions as a “super controller.” It assigns available satellite channels, performs maintenance checks and may add error correction to digital transmissions.

For Western Union's two Westar satellites, a station in Atlanta sends pilot signals to the antenna-pointing mechanisms of the satellites to maintain good signal strength. Tracking, telemetry and command operations originate at Glenwood, NJ. One of the goals of satellite systems is to replace costly long haul ground links, and their repeater stations, with single-hop satellite connections. Additional Western Union plans call for high speed, 56-kbit/s, modems operating on FDM for digital transmission between most major cities.

Plans at RCA Global Communications call for customer microwave links to remote computers as large as the IBM 370/165. The problem is to provide a 4.5 Mbit/s link plus all control signals to the data-channel processor within the mainframe. And the software must be modified to allow for one-way satellite path delays on the order of 250 ms. The interfaces to the 370 will probably use time-division, multiple-access modems, such as those from Comtech (Smith-



Remote communications processors put mainframe power at the user's fingertips, and are one reason for increased digital traffic. The Harris 1600, an intelligent

unit, can send remote jobs to two hosts. It supports a line-printer card reader and CRT I/O at 9600 bit/s; 56 kbit/s is planned.

town, NY) and radios by Fujitsu or Digital Communications Corp. (Gaithersburg, MD). IBM's synchronous data link control software protocol recently designed for computer-to-computer transfer of data is expected to coordinate the communicating computers.

For the initial link to the nearest RCA terminal, the digital radio will use multiphase PSK, as did the Datran system to conserve bandwidth. The transmission will then be placed on an FDM (frequency division multiplex) channel adjacent to channels used for other subscribers.

Again, the prospect of time-shared access to the satellite remains uncertain, since coordinated timing between all earth stations is necessary to share the time slots. For the present Digital Communications Corp. is working on TDMA for a proposed Intelsat system. TDMA can increase satellite traffic capacity up to fourfold, as compared with FDM.

Conventional electrical switching takes a back seat once computers perform both control and routing. The computer adds value in a special sense. A fast CPU can perform error checks, retain copies of messages in the event a receiving terminal fails, choose alternate routes when a line fails and send multiple copies of the same message to several destinations.

The largest computer-based message-switching system is operated by Western Union at Middletown, VA. It handles more than 80,000 terminals in the United States, and it cost \$50-million to build.

Known to the business community as Infomaster, the Middletown center switches TWX,

Telex, Mailgram and public telegraph messages. Dual Univac 1108 computers select the routing, while C2000 preprocessors combine and block low-speed messages for efficient processing by the 1108s. International traffic enters the high-speed multiplexers for direct feed to the 1108s. A third 1108 stands by and also performs batch processing for administrative work on the site. All told, the system handles up to 500,000 messages a day.

ITT World Communications integrates TWX and Telex with ARX—a private message exchange. The functions of ITT, Western Union and RCA Globecom are to act as international message carriers. The ITT system, like Western Union's, uses computers to perform code conversion, switch traffic to the proper lines and store, queue and switch for transmission. Since the computers handle international TWX and Telex, the private customer (ARX III service) can interface at will with practically any public service. In this way computers can perform switching with far more versatility than any fixed set of electrical contacts.

More than a high-speed message switching network, an intelligent network can route data to minimize end-to-end delays and to help spread traffic evenly throughout the network. One of the most ambitious networks is the Telenet, headquartered in Washington, DC. Subscribers' computers and terminals join the network at switching centers. Minicomputers divide the data into small segments or packets, with each packet containing a destination address. Interface message processors route the packets through nodes until

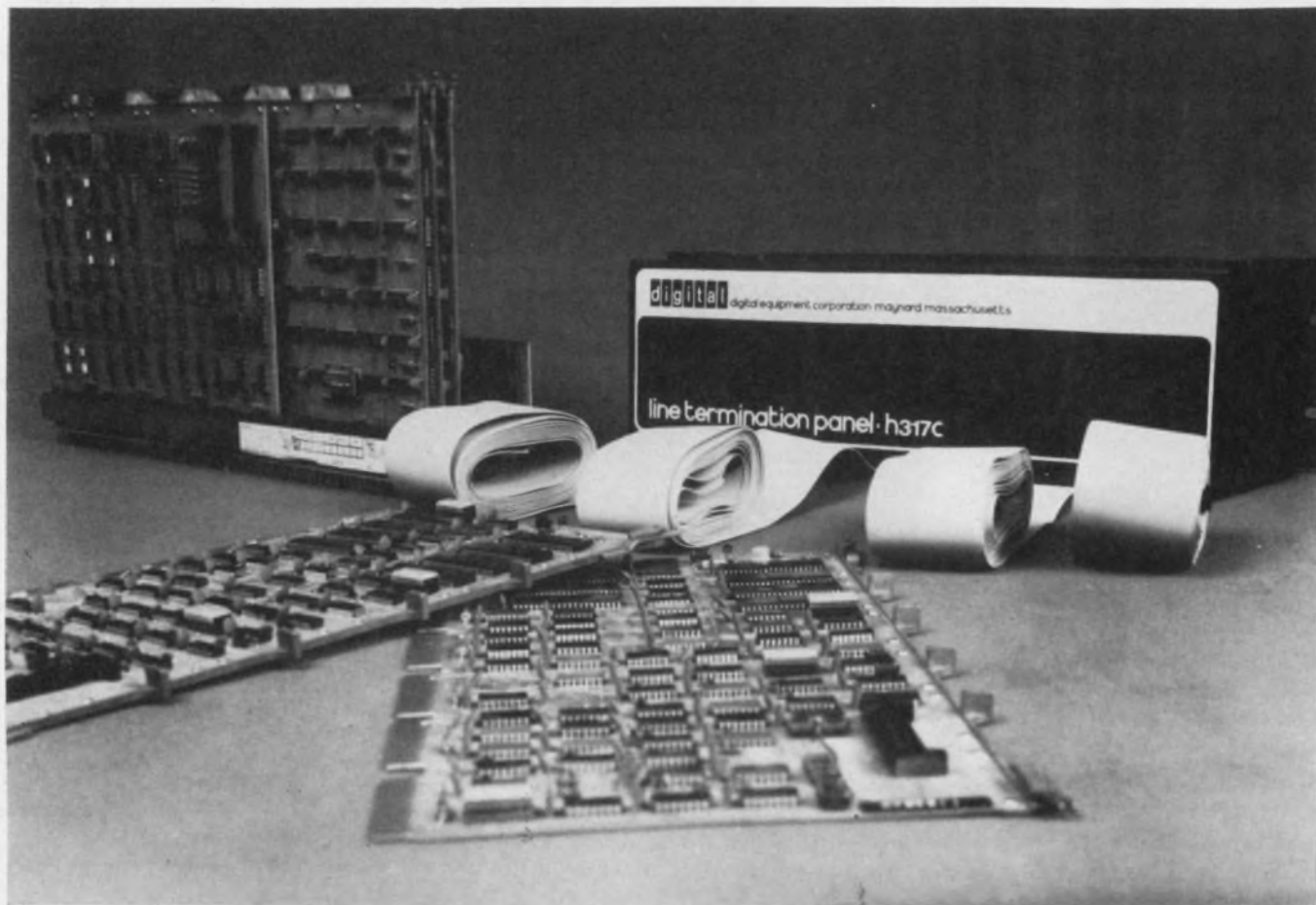

A special-purpose microprocessor lets DEC's DV-11 generate and decode control characters as well as block data. Earlier communications interfaces merely moved

data into and out of the computer's memory—in effect, acting as simple multiplexers. The DV-11 handles 38,400 characters per second.

they reach their destination. There a terminal interface processor (TIP) reconstructs the message and outputs it to the receiving machine.

Thus, through the widespread use of minis in the network many dissimilar terminals and computers have been allowed to communicate readily. However, since all messages receive dynamic routing, the time delays vary widely with the paths chosen by the various minis. As with message switchers, this network accommodates an almost endless variety of data rates. At present three other vendors plan similar service—Packet Communications, Waltham, MA; MCI Data Transfer Corp., Washington, DC, and Graphnet Systems (which plans to offer facsimile only).

For the immediate future, digital data coding along with computer interfaces seem the rule—especially as a signal routing and the computing function become more intertwined. Of course, the burgeoning use will further blur the distinction between control, routing and data transformation circuits.

Both microprocessors and digitized voice signals are used in Digital Telephone System's (Novato, CA) D1201 digital PBX. All audio is delta modulated.

The 4-k CPU routes calls to alternative phones

if a person doesn't answer his own. Also it can notify a caller when the line he wants is free. The unit handles about 400 subscribers. An LSI Codec (coding and decoding) chip takes incoming audio and puts it in digital TDM form. Each line and trunk has its own encoder-decoder. The CPU controls these devices off a common bus.

Bell also uses a processor to give its Dimension Series PBX (private automatic business exchange) similar characteristics. The unit has a capacity of 400 stations. One of the big plusses for digital voice conversion is space. A typical 400-person exchange fits in a 15 ft³ closet; its rotary switch counterpart occupies a 10-by-15-ft room.

A special-purpose microprocessor, DEC's DV-11, has a 38,400 char/s capacity and handles eight to 16 lines in a variety of communications protocols. The unit is programmable. The main role for such processors is to move characters into and out of computer memories, as well as to generate and decode control characters.

E-Systems of Garland, TX, offers one of the most efficient voice-to-digital converters on the market. A single unit converts normal voice to 2400 bit/s or 4800 bit/s. These rates are at least a quarter those of the PCM rates used at the

Molon makes them all...



Better

From GEARMOTORS TO SYNCHRONOUS
MOTORS TO STEPPER MOTORS
... all designed to meet your needs
—and budget requirements!

Our "Quality Service and Custom
Capabilities" are second to none. Each
MOLON MOTOR is designed with
individual personalized attention that
earns the confidence of OEM design
engineers everywhere . . .

When it comes to motors . . . contact
MOLON . . . The Innovators in Rotary
Electric Motion . . .

Write for FREE 26 Page Catalog today!

 **MOLON**

3737 INDUSTRIAL AVE. ROLLING MEADOWS, ILL. 60008 312/259-3750

Dialight sees a need:

(Need: The widest choice for your every application.)



MINIATURE INCANDESCENT OR NEON INDICATORS—1,500,000 varieties to choose from. MIL-L-3661 and UL approved. Red, green, amber, blue, white, yellow or colorless lenses in wide range of shapes, legends, finishes. Stocked by local distributors.



LARGE INCANDESCENT OR NEON INDICATORS—As above, but larger size. Unlimited varieties to choose from. Stocked by local distributors.



Dialight, the company with the widest choice in switches, LEDs, indicator lights and readouts, looks for needs . . . your needs . . . and then they develop solutions for your every application. No other company offers you one-stop shopping in all these product areas. And no other company has more experience in the visual display field. Dialight helps you do more

with these products than any other company in the business, because we are specialists that have done more with them. Talk to the specialists at Dialight first. You won't have to talk to anyone else. Send for your free new copy of Dialight's current catalog.

DIALIGHT

Dialight, A North American Philips Company
203 Harrison Place, Brooklyn, N. Y. 11237
(212) 497-7600

See Dialight.

INFORMATION RETRIEVAL NUMBER 30



A microprogrammed processor allows Bell's Dimension PBX to handle 400 extensions. The switch network uses pulse-amplitude modulation with time-division multiplexing. The CPU chooses the most economical outside circuits, provides three-way call transfers and even keeps trying a busy line at the user's request.

telephone exchange. Of course, it's not particularly cheap to put such a device next to every telephone set. But the unit is ideal to ensure privacy or to get voice coordination over medium-speed data lines.

For data communications, General Instrument Corp., Hicksville, NY, offers a 16-bit microprocessor, the CP-1600. And Actron (Monrovia, CA) is developing the AM1608 microprocessor for use in digital communication and control systems.

And what of the widely used self-latching reed contact? Expect it to be the workhorse for just about any dc communications system that requires low operating power and minimum crosstalk. In fact, the main switching system for the National Broadcasting Company's TV network, which must handle studio, outside and taped video, uses a reed crossbar to connect the sources to their destination. But it is a bank of minis that throws these switches and places the various parts of the network in the ready position just prior to air time.

Although most video is analog, for synchronization of local and remote sources, a frame synchronizer converts the video to a digital format with 8-bit resolution and clocks it out at a common rate so that the diverse sources have common timing. The availability of high-speed memories capable of supporting a 10.8-MHz sampling rate makes this feat possible. A system produced by the Nippon Electric Co. stores an entire TV frame of 283 kbits. ■■

THE DOLLARS AND SENSE BREAKER

FUSES ARE CHEAP. BUT IN THE LONG RUN A HEINEMANN CIRCUIT BREAKER MAY COST YOU LESS.

No doubt about it. The price of a fuse is lower than the price of a Heinemann circuit breaker. But *price* is not the same thing as cost. When you think about all the hidden costs of using fuses, you may decide that our "expensive" breakers make more sense.

For example, you've got to put a fuse in a fuse holder. And then you still need a power switch. Not so with a Heinemann breaker. It's self-contained. Serves as a power switch as well as a protector. And it's available in a variety of attractive styles—toggle, rocker, pushbutton, snap-in mount—that will look good on your front panel.

Now think about assembly costs. With a circuit breaker you install one component instead of three. Connect two terminals instead of four.

Now here's the clincher. Your customer may not be able to diagnose and replace a blown fuse. He'll probably think there's something wrong with what you sold him—and ask you to fix it. If your technician has to make just one service call to replace a fuse, it'll cost the price of a good many Heinemann breakers. An easily resettable Heinemann circuit breaker can keep that from ever happening.

So much for economics. You should also know that Heinemann breakers are temperature-stable, so they protect better than fuses. They're also more versatile: available for voltages up to 600 Vac or 250 Vdc and in any integral or fractional rating from 0.020 A to 225 A. There's a selection of time-delay characteristics. And a choice of eight internal circuits to handle all sorts of special protection and control functions. Not to mention hybrid and solid-state models for electronics and brownout protection.

We have knowledgeable field representatives near you and manufacturing facilities in the U.S., Canada, West Germany, South Africa, and Australia. To learn more, ask for a copy of our Type J Bulletin. Heinemann Electric Company, Trenton, NJ 08602. Phone (609) 882-4800.



HEINEMANN

We keep you out of trouble.

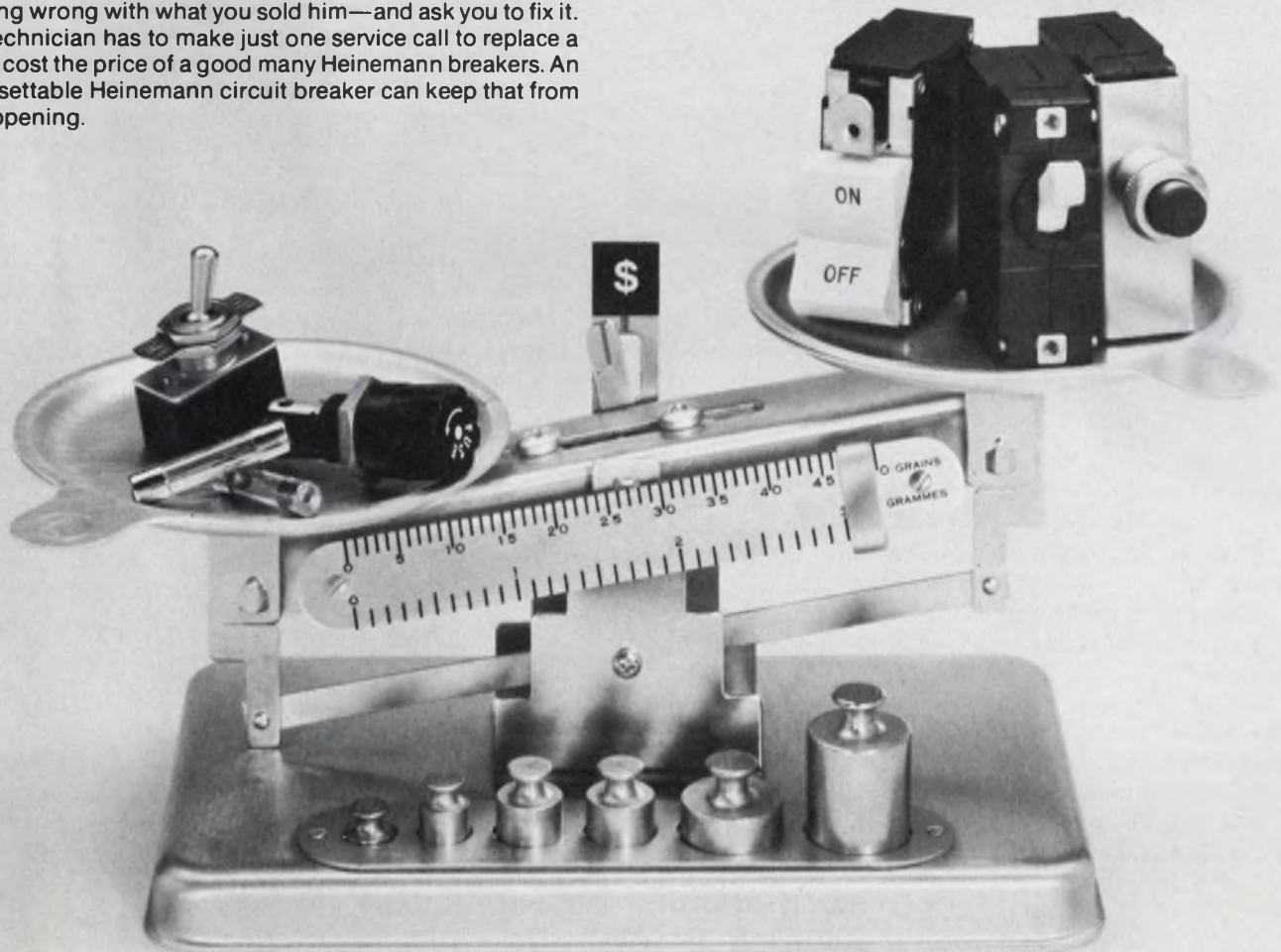

To measure lower distortion than ever before

-- just push a button

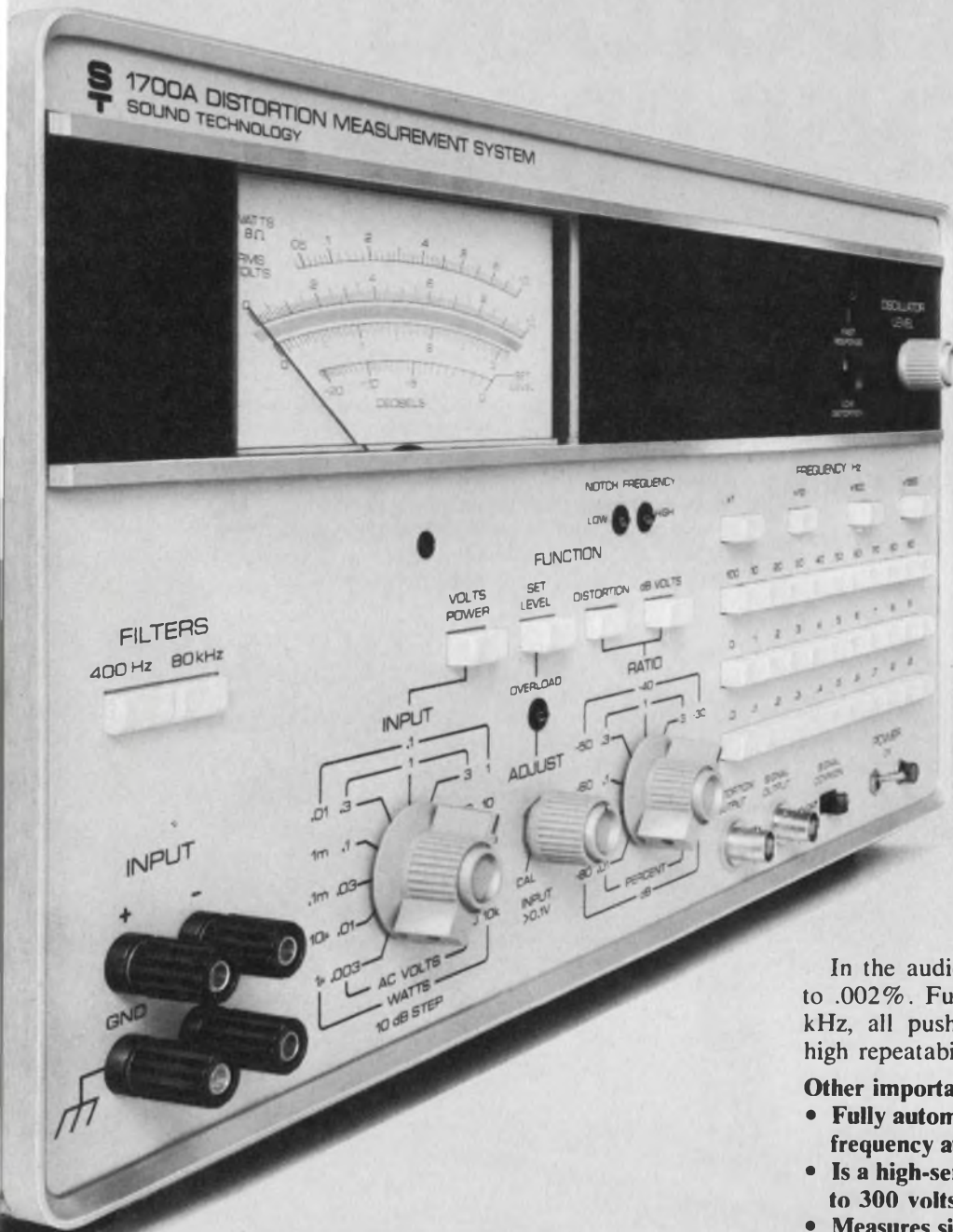

MEASURE DOWN TO .002%

Here is an important new system for measuring distortion.

This new Sound Tech 1700A is both an ultra-low-distortion signal source and a total harmonic distortion analyzer.

It's an instrument that's fast and easy to use. You can make a measurement in 5 seconds — because both source and measuring circuits are tuned by the same pushbuttons. Even non-technical production personnel can measure with it. And that can save a lot of test dollars in the plant and lab.

AUTOMATIC NULLING

In the audio range you can typically measure down to .002%. Full frequency range is from 10 Hz to 110 kHz, all pushbutton-controlled for fast selection and high repeatability.

Other important features:

- Fully automatic nulling — just push a button for frequency at which you want the measurement.
- Is a high-sensitivity AC voltmeter — 30 microvolts to 300 volts.
- Measures signal ratios up to 100 dB.
- Has differential input.
- Reads power in 8-ohm loads.

ECONOMICAL

The 1700A truly saves on initial outlay, too. It's only \$1625 (other models only \$1340). That's less than the cost of much lower performance oscillators and distortion analyzers.

MAKE PROFIT HAPPEN — CALL NOW

So don't get caught short. Make profit happen. Call Larry Maguire or Bob Andersen and get full performance data on this important new development.

ST

SOUND TECHNOLOGY

1400 DELL AVENUE
CAMPBELL, CALIFORNIA 95008
(408) 378-6540

DEVELOPERS OF THE INDUSTRY-STANDARD 1000A STEREO ALIGNMENT GENERATOR AND 1400A ULTRA-LOW-DISTORTION OSCILLATOR

INFORMATION RETRIEVAL NUMBER 32

Electronic
Instrumentation

DigiTec

Monsanto

DIGITAL PRINTER

UNITED SYSTEMS CORPORATION

DigiTec 111

6100 digital recorder

The 'SOURCE'... for Digital Instrument Printers

Need a hard copy printer that is readable, reliable, flexible and maintainable?

With DigiTec's instrument printers you get a model to fulfill your exact specifications.

Want a printer that lasts with use and is easily repaired after abuse?

DigiTec's instrument printers have rugged, high-styled enclosures and state-of-the-art circuitry with plug-in components for serviceability.

Require integral clock for time recording, batch or event counting, up to 21 data columns, red or black print out, TTL or RTL interface, and integration into an existing product or system?

Selected DigiTec models offer these features in combination with many others.

Look first to the "SOURCE" for your digital instrument printers and ask about our generous OEM quantity discounts!

Contact your nearest United Systems representative for complete specifications on all DigiTec instrument printers.

6100 Series

digital printers for production, laboratory and OEM applications.

Starts at

\$549.

Model 6214

custom, modular printer adds hard copy capabilities to your product. Quantity prices starts at

\$350.

Model 691

systems printer for maximum flexibility in data acquisition systems.

Starts at

\$725.

DigiTec

UNITED SYSTEMS CORPORATION

a subsidiary of

Monsanto

918 Woodley Road • Dayton, Ohio 45403 • Ph. (513) 254-6251 • TWX: (810) 459-1728



COMMUNICATIONS '75



Land-mobile radio designs push to 900 MHz to ease crowding

It began in 1921. Detroit's Police Commissioner, William P. Rutledge, bought a Western Electric 1A 5-W AM transmitter—the first use of radios for police work. The idea caught on with fire departments, forestry services and electric utility companies.

By 1948 there were 83,000 licensed land transmitters in the United States operating in the mobile spectrum. And then runaway growth began. Today there are 5 million land-mobile radio users, and their numbers are increasing 20% a year.

But this expansion may be only a prelude to even bigger growth in the years ahead, spurred by the opening of the 900-MHz band and by the use of advanced solid-state and computer technology in the design of land-mobile equipment.

A major roadblock to further growth has been spectrum congestion. Until recently, the total spectrum allocation to mobile radio services was about 40 MHz wide, falling in the 25-to-50, 151-to-174 and 450-to-470-MHz bands.

To relieve this crowding, the Federal Communications Commission in 1970 made available to public and private land mobile users an additional 115 MHz between 806 and 947 MHz.

Recognizing that this allocation—which quadruples the spectrum space previously available to land mobile radio—could be rapidly depleted, the Commission has challenged the industry to develop more efficient methods of using the additional frequencies.

Three proposals have been filed with the FCC. Two of the designs—one by Motorola the other



RCA's Tactec, a portable two-way radio, is used by subway construction worker in Washington, DC. These units provide up to 5-W output.

by AT&T—encompass “cellular” radio-telephone systems. The third, by General Electric, suggests a private dispatch service in which many users can time-share a few channels through a central computer.

Real growth in this band, however, must await further development, testing and final FCC acceptance of these novel systems.

The AT&T and Motorola proposals are based on breaking down large transmitting areas into “cells.” By restricting mobile communications to each cell, designers are looking to increase the

number of times a channel can be used within a large area. These systems would require the expenditure of tens of millions of dollars on a variety of 900-MHz equipment, including base station transmitters and receivers, mobile units, complex computer-controlled switching hardware and so on.

The proponents of these cellular systems believe that their approach would make it possible to offer a broad variety of high-quality "low-cost" communications services to millions of mobile telephone users. Present low-capacity systems operating in crowded urban areas have severely limited the number of people who can use car telephones.

Mobile performance vastly improved

Although most manufacturers are eagerly awaiting an explosion of orders for 900-MHz



Computer-to-car communications system developed by General Electric expedites law enforcement. Officer in car (left) uses push-button console associated with radio control unit at dashboard to send predesignated digital messages to police dispatch center (right).



equipment—an occurrence that most expect within the next three years—they are certainly not neglecting current line vhf and uhf hardware.

The design, packaging, performance and available features in today's mobile and personal communications equipment is as different from the equipment available a decade or so ago as the calculator is from the slide rule.

Today's mobile equipment must hold the operating frequency more accurately than the finest watch. And it must do it under conditions of widely varying temperatures and humidity, shock and vibration, dust and dirt, corrosive atmospheres and rough handling.

Frequency stability has become extremely stringent. The requirements have gone from 0.01% (100 parts per million) 20 years or so ago to 0.0002% (2 parts per million) today.

Receiver selectivity has improved from 60 dB at ± 120 kHz to 100 dB at ± 30 kHz, while still accepting up to ± 7 kHz swing at a signal input of only a quarter of a microvolt. What is important here is that adjacent channel selectivity has not been gained at the expense of adequate bandwidth for good voice or data com-

munications.

Receiver spurious responses have typically dropped from -20 dB to -100 dB, and the number of responses has been cut almost in half by a move from double to single-conversion superheterodyne circuitry.

There has been a proliferation of antennas, particularly in the heavily populated metropolitan areas. In multiple-antenna installations the limiting factor becomes intermodulation, and considerable strides have been made in minimizing the generation of intermodulation products in both transmitters and receivers.

The use of five or more high-Q circuits—miniature cavity filters—and the introduction of field-effect transistors at the front end of receivers have provided a basic receiver intermodulation rejection figure of 80 dB compared with 60 dB only a decade or so ago.

Even greater intermodulation attenuation is

obtained by the use of large-cavity filters or quartz crystal filters at the input to base-station receivers. Transmitter-generated intermodulation is controlled to a considerable degree by the use of cavity filters in their outputs, as well as ferrite circulators currently available for the uhf and 150 MHz bands.

The distinction between portable, or "user-carried" transceivers, and mobile, or vehicle-mounted, units has narrowed considerably. As Martin Cooper, vice president of Motorola's Communications Div. in Schaumburg, IL, observes:

"Because portables had to be very small, they historically have tended to have the worst performance in terms of interference rejection, sensitivity, and antenna efficiency. This is no longer true. We have achieved and are achieving portable performance comparable to the best of the mobile radios."

The major difference continues to be power output, Cooper says, but the difference between 5 or 6 W in the newest portables and 30 W in mobiles isn't that significant any more. Such system concepts as satellite receivers (repeaters) and receiver voting have overcome the power

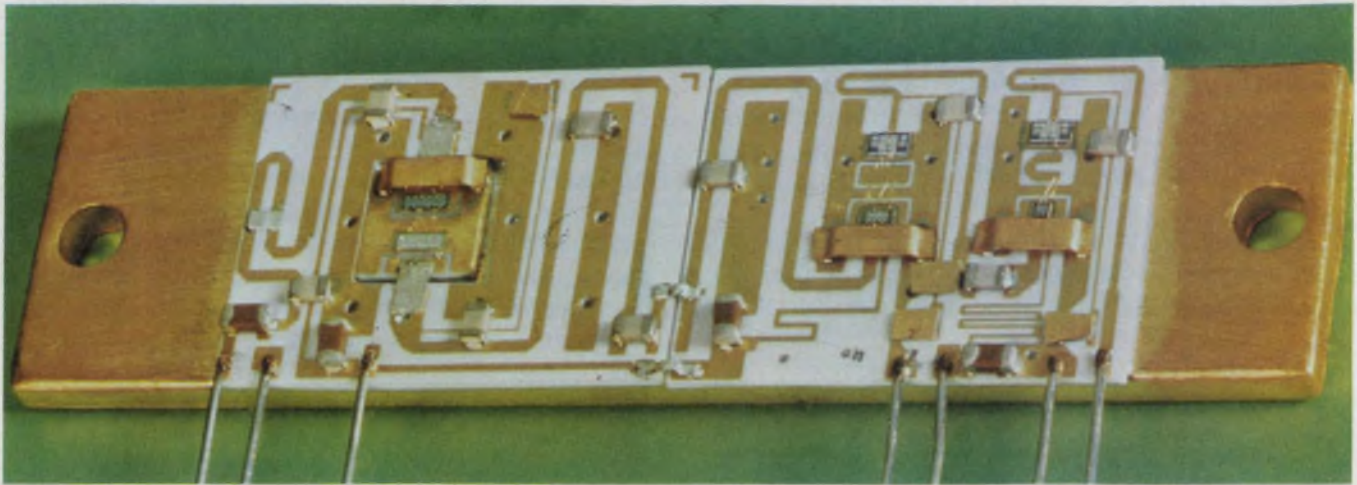

This 13-W, 470-MHz, 12.5-V amplifier module, available from Motorola Semiconductor, uses hybrid techniques.

It can be used as a complete amplifier or driver for high-power uhf radios.

deficiency of portables, Cooper notes.

Since power output and performance are no longer the significant factors they once were in buyer selection between portable and mobile radios, what is? Accessories.

Mobile users today want such features as a data entry and display unit, selective calling, hard-copy printout, voice scramblers and so on. Even if it were possible to design all into a portable radio, the end product would be unwieldy; the unit would lose its portability. On the other hand, many of today's public and private vehicular mobile radio systems have these features and more.

Simple questions, rapid answers

It has been estimated that 40 to 60% of mobile communicating today is done by users who are getting the answers to two questions: "Who are you?" and "What are you doing?" The answers, identification and status, can be transmitted in less than 500 ms by a burst of digital information either preceding or supplementing the voice communications. At the display center the operator has a visual readout of all his cars in service and their status at any given time.

A number of police departments are starting to provide direct access to a computer without dispatcher assistance. Complete computer inquiries are transmitted via keyboard in the car in a couple of seconds. The readout, along with hard-copy printout, is displayed in the police car in seconds. An example of such a mobile data-communications terminal is Motorola's Modat unit. This 5-lb, 285-cubic-in. data terminal consists of a full alphanumeric keyboard with 32-character plasma display. While 32 characters can be viewed, a total of 64 are contained in the transmit memory for longer messages. A sepa-

rate memory can store received messages up to 256 characters long.

As the vehicle operator composes a message from the keyboard, it is displayed and subsequently stored in memory. Special keys permit editing and correction of the message. In addition several special function keys are provided to permit transmission of frequently used message "headers." Once the message has been composed, activation of a button permits transmission of the stored information.

It has been estimated that 30 seconds of voice communication equals about 2 seconds of digital information sent over a mobile radio system—a 15-to-1 improvement. However, in early police

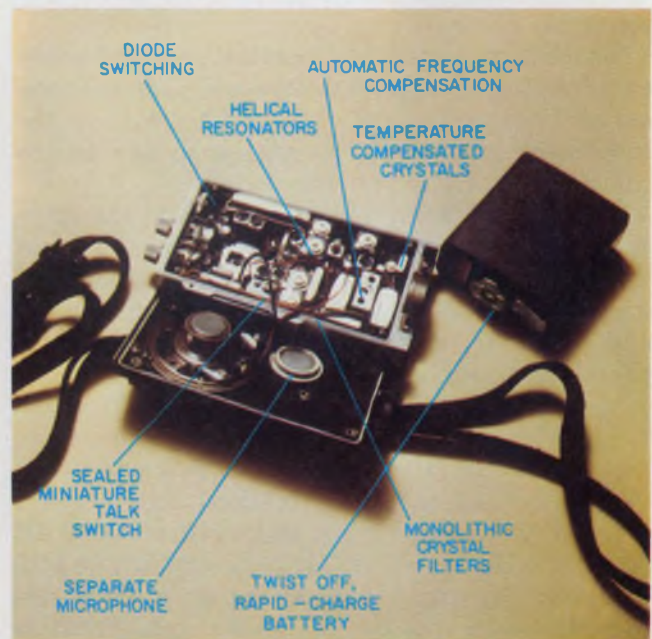

The Model 590 transceiver from E. F. Johnson Co., Waseca, MN, is called the smallest hand-held uhf radio on the market. It measures 7 × 2.37 × 1.2 in.

installation it was found digital capability did not reduce the number of radio channels required; rather it increased the number of inquiry/responses by a factor of 100 or more. The effect is that the policeman in the field has much easier access to information in computer storage, since the intervention of a third party—the dispatcher—is no longer needed.

As Motorola's Cooper observes: "The mobile radio is evolving into a data-communications terminal. If you just want plain voice communications, you may as well do it with a portable."

Better design with hybrids and ICs

What are the design and component trends that have made possible today's versatile mobile radios and the powerful and compact portable units?

Most of the two-way radio equipment being produced today is solid-state. Fully transistorized hand-held units and mobiles have been available from the major manufacturers for several years, and, more recently, completely solid-state base stations became available. Solid-state mobile transmitters now can deliver 110 W.

Mobile and particularly portable units—where size and low current drain are so important—are making wide use of monolithic integrated circuits and thick-film hybrid combinations.

Olin Giles, manager of rf design for General Electric, Lynchburg, VA, points out: "The functional trimming capability that hybrid ICs provide give us design techniques that we didn't have before. With the thick film process we can

get tremendous resistor accuracies. In fact, we can even laser-trim or function-trim hybrid ICs to get us a certain frequency response at a given point."

Giles notes, for example, that if you want to set the notch for a band-reject filter at a certain point, you can actually trim every single filter to the very same frequency, all like peas in a pod.

Most U.S. manufacturers, particularly the smaller ones with limited engineering staffs, are now starting to switch over to plug-in broadband power amplifier modules.

According to Frank Davis, engineering manager for power modules at Motorola Semiconductor, Phoenix: "This represents a tremendous shortcut in the design of mobile radio equipment. Before, you had technicians tuning the separate coils and capacitors in the interstage tuning circuits. Now you just plug in the module and that's it. In addition you don't have to qualify every component in terms of its lifetime."

With their high labor costs, most European manufacturers of mobile equipment have switched over to power modules, Davis notes. "It's safe to say that within the next five years half of all radios sold worldwide will be in modular form of some type or another," he says.

For land-mobile equipment, Motorola offers 13-W and 20-W modules that cover the 146-to-175-MHz band and 7.5-W and 13-W power amplifiers for the 407-to-512-MHz uhf band.

An example of space-age portable FM two-way radios is RCA's Tactec series. These hand-held units, manufactured at the company's division in Meadow Lands, PA, weigh as little as 18 oz and have a power output of 4 W in the uhf and 5 W in the vhf bands. Two basic models are available.

A standard version has one or two frequencies and noise squelch ($0.25 \mu\text{V}$) or an optional quiet channel squelch (with up to two tones). Another model has up to six frequencies and noise squelch or an optional quiet-channel squelch (with up to six tones—one tone per rf channel).

The quiet channel option provides tone operated squelch for the receiver and tone encoding of the transmitter signal. It is designed to reduce disturbances caused by other stations using the channel. Frequency stability is maintained within 0.0005% by means of plug-in temperature-compensated crystal oscillators. Receiver intermodulation rejection is -70 dB.

The units use thick-film, beam-lead hybrid circuits and monolithic ICs, both custom-designed and off-the-shelf. Rechargeable nickel cadmium and nonrechargeable mercury and alkaline battery packs are attached to the radio by means of a twist-on locking device.

Another line of portable two-way FM radios just announced is the Motorola Communications MX300 series. Claimed to be the smallest radios

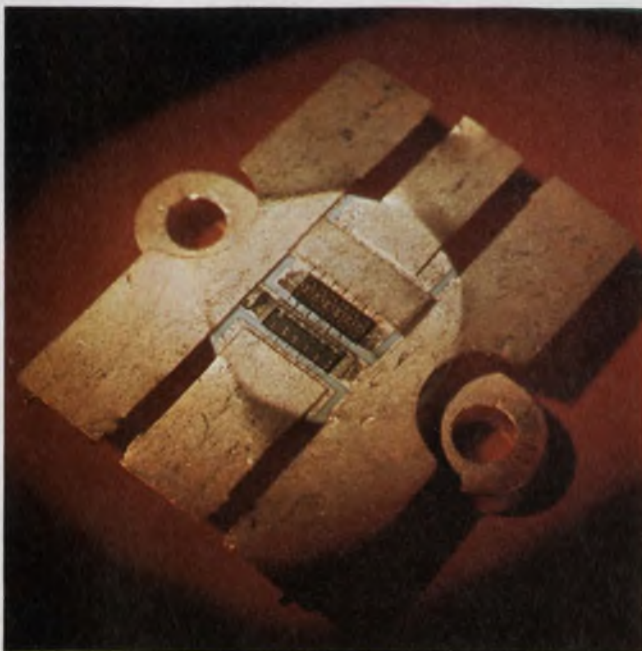

"Controlled Q" transistor uses gold metallization. Available from Motorola Semiconductor, the device is specified for mobile use in the new 900-MHz band.



Status/message accessory from Motorola Communications enables mobile operator to send precoded digital messages back to base station.

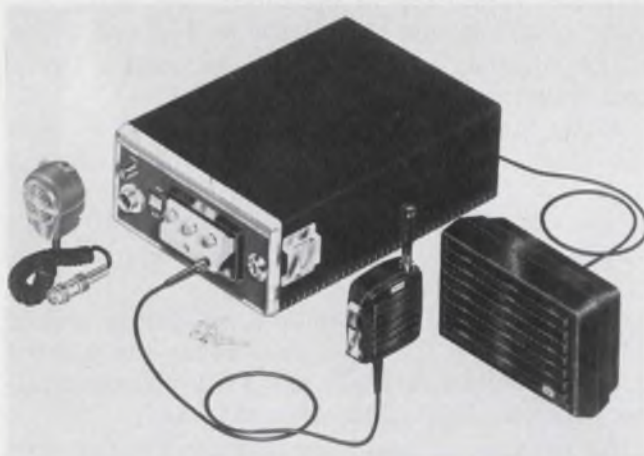

Portable radio converts to mobile unit when inserted in console. The combination vehicular communications center is made by Repco Inc.

built today for their power output—up to 6 W vhf and 5 W uhf—the series provides up to eight frequencies. Radios with 2.5, 2.0 and 1.0 W are also available. To achieve their compact size, the radios incorporate multilayers and flexible printed-circuit boards.

The receivers have 95-dB selectivity (vhf) and 0.5- μ V (or optional 0.25 μ V) sensitivity, combined with 80-dB intermodulation protection. The MX300 ability to pick its signal out of dense rf traffic is equal to that of larger mobile units, according to Motorola. Frequency stability is said to be 0.0005% from -30 to +60 C for both receivers and transmitters.

The radios also contain a digitally coded sub-audible signaling system that eliminates co-channel interference. Using LSI circuitry, this squelch system provides 80 unique system codes to assure effective communications. Another feature is a battery status indicator at the top of the units. When the battery reaches a low level of charge, the LED dims or extinguishes whenever the radio is keyed, indicating that it is time for battery replacement.

A number of manufacturers offer portable radios that can be converted to mobile units. Repco Inc. of Orlando, FL, offers the Tek-2 portable radio, which the operator, upon returning to his vehicle, inserts in a mobile console. He is then automatically connected with a mobile microphone, speaker and antenna for true mobile operation. The radio gets its power from both the vehicle's battery and the portable battery. Independent on/off and volume controls on the console transfer the portable functions to the mobile unit.

Designing for the 900-MHz band

The development of mobile equipment for the 900-MHz band presents some distinct advantages to the user and some hairy problems to the designer. The major advantage, of course, is that it will dramatically increase the number of channels available to users in public and private land mobile systems. The challenges are that you are operating at a frequency twice that of the nearest other band (450-470 MHz) and six times that of the 150-MHz band. This means on the order of 9 to 10-dB greater propagation loss to communicate from one place to another. Although high-gain antennas are smaller and easier to build at 900 MHz, component and circuit specs are considerably more critical.

Motorola's Davis notes that one of the biggest problems is repeatability on the production line. "Circuit design is very critical," he notes. "You move a component 100 mils, and you've lost the design."

That's why, according to Davis, 900-MHz power modules will eventually be well accepted. These modules, he says, will eliminate the drawbacks of repeatability and device specifications.

General Electric's Giles says that designing equipment for 900-MHz operation calls for development of rf power transistors that have adequate gain and are reasonably priced. He notes that considerable progress has been made in the last year. "We now have 25-W devices that offer maybe a 6-to-7-dB gain and are projected to sell for \$15 to \$20 within a year," he observes. "A year ago we were talking about 10-to-15-W devices with 3-to-4-dB gain selling for the same price."

Giles predicts the availability of competitively priced 40-W transistors with 5-to-6-dB gain within two to three years.

He also cites the need for low-cost capacitors to work with power transistors at 900 MHz.

"Chip capacitors are still somewhat expensive," he notes. "But they have negligible inductance, and you can lay them right up against the package of the power device and achieve the match you're looking for." ■ ■

Elco Distributors

ALA., HUNTSVILLE
Powell/205-539-2731

ARIZ., PHOENIX
Moltronics/602-272-7951

CALIF., EL SEGUNDO
T. I. Supply/213-973-2571

CALIF., LOS ANGELES
Kierulff/213-685-5511

CALIF., MOUNTAIN VIEW
Powell/415-964-0820

CALIF., PALO ALTO
Kierulff/415-968-6292

CALIF., SAN DIEGO
Kierulff/714-278-2112
Moltronics/714-278-5020
Richey/714-565-4444

CALIF., SANTA CLARA
Moltronics/408-244-7600

CALIF., SUN VALLEY
Richey/213-875-2862

COLO., DENVER
Kierulff/303-371-6500
Newark/303-757-3351

CONN., NEW HAVEN
Connector Co/203-624-0127

FLA., MIAMI SPRINGS
Powell/305-592-3260

ILL., CHICAGO
Newark/312-638-4411

MD., BELTSVILLE
Powell/301-937-4030

MD., SAVAGE
Pyttronic/301-792-7000

MASS., WATERTOWN
D.R.W./617-923-1900

MINN., MINNEAPOLIS
Newark/612-331-6350

MO., ST. CHARLES
Lectronix/314-723-1122

N.J., CLARK
T. I. Supply/201-382-6400

N.Y., BUFFALO
Summit/716-884-3450

N.Y., FARMINGDALE
D.R.W./516-249-2660

N.Y., WOODBURY
Tennant/516-364-9070

N.C., GREENSBORO
Hammond/919-275-6391

OHIO, CLEVELAND
Pioneer-Standard
216-587-3600

PA., MONTGOMERYVILLE
Pyttronic/215-643-2850

PA., PHILADELPHIA
Powell/215-365-1900

TEXAS, GARLAND
Newark/Dallas
214-271-2511

TEXAS, HOUSTON
Newark/Houston
713-782-4800

WASH., SEATTLE
Almac/Stroum
206-763-2300

WIS., MILWAUKEE
Electronic Expeditors
414-228-8100

Rack and Panel by Elco

Featuring the
**NEW LOW
INSERTION
FORCE VARICON***
contact.

We've got three facts to tell you and 20 seconds of your time to tell it. We'll make it short and sweet.

FACT #1. To meet market needs, Elco Corporation announces the in-stock availability of the new LOW INSERTION FORCE VARICON* contact in a complete line of Rack and Panel Connectors.

FACT #2. This new generation represents an improvement; accomplished with no degradation to the unique hermaphroditic VARICON design.

FACT #3. Your Elco distributor has the complete LOW INSERTION FORCE VARICON* Rack and Panel line **in-stock now** and he'll custom-load contacts precisely to your specifications (pick a number up to 165).

To know more, write today for our new catalog or contact your Elco distributor. He's as reliable as our connectors.

*Trademark-Elco Corporation

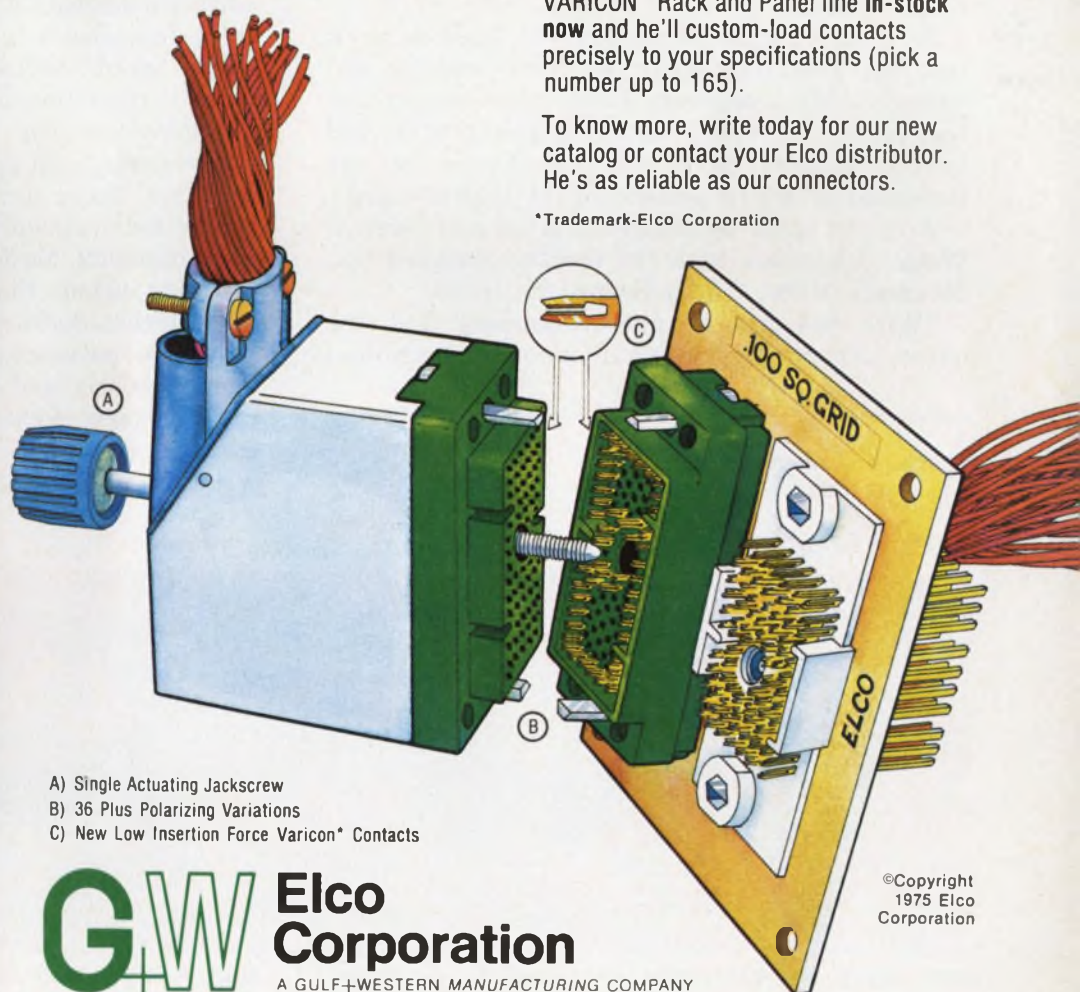

- A) Single Actuating Jackscrew
- B) 36 Plus Polarizing Variations
- C) New Low Insertion Force Varicon* Contacts

GW

**Elco
Corporation**

A GULF+WESTERN MANUFACTURING COMPANY

©Copyright
1975 Elco
Corporation

Willow Grove, Pennsylvania 19090 • 215-659-7000, TWX 510-665-5573, TELEX 834277



COMMUNICATIONS '75



Test equipment proving its worth in ensuring transmission quality

With communications carriers now called upon to guarantee the quality of their transmissions as well as the reliability of the service itself, specialized test equipment is in demand. The trend is toward multifunction instruments, digital signal analysis and automated systems.

Advanced digital technology has made network test instruments easier to use, more versatile and "smart." Minicomputers have made centralized testing, diagnosis and management practical. And microprocessors have placed test sets at the threshold of a new generation of improvements.

A recent paper by Robert L. Allen and John A. Wetzel, engineers with the Hewlett-Packard Co., Mountain View, CA, indicates the trend.

"With the use of microprocessors and the latest LSI circuits," the authors note, "combina-

tion test sets can pack more functions into less space and reduce test time. Bulk is reduced by a half to a quarter, and test time reduced a fifth to a tenth of that needed with individual units."

Digital signal analysis allows great flexibility, the two engineers say, because the tests can be software-defined. And with a digital approach, comb frequencies that simultaneously cover wide bands speed testing, which otherwise must be done by time-consuming sequential methods.

Where formerly engineers had to improvise test systems from general-purpose instruments—and they never quite did what was required—specialized instruments now provide the precise measurements needed. Examples of specialized test sets include these:

- Hewlett-Packard's 4940A transmission impairment measuring set, which can measure simultaneously and define separately four types of transient events and 11 other important parameters.
- Cushman Electronics' CE-23A spectrum dis-

Morris Grossman
Associate Editor

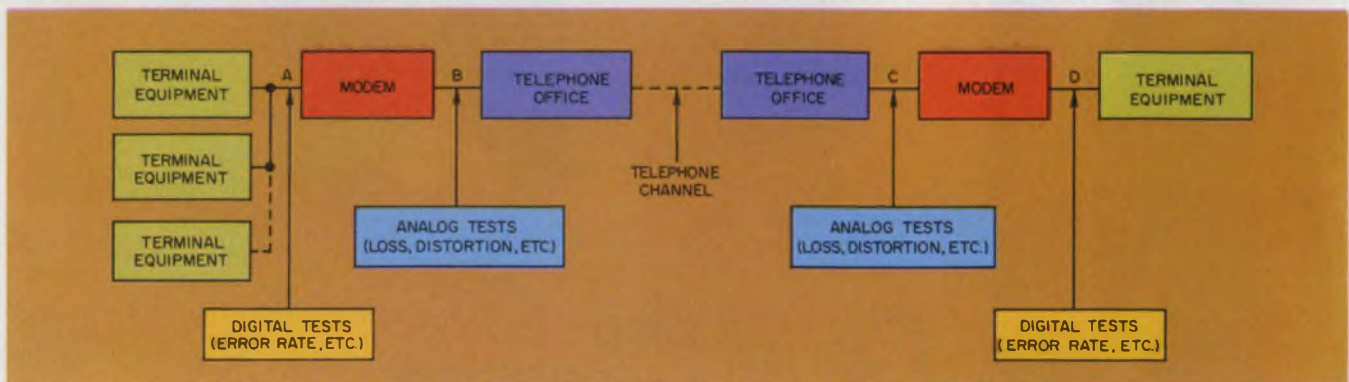

Both analog and digital-type tests must be performed on a data channel to properly check its performance. A

large variety of tests made with specialized instruments are needed to help pinpoint trouble areas.

play, CE-21A selective level meter and CE-26A frequency synthesizer, which together form a complete transmission test system for monitoring and diagnosing communications channels in either manual or swept-frequency modes.

- W&G Instruments' AT-9003 noise loader for noise-power ratio tests. These tests are highly significant in checking over-all performance on microwave links.

- Telecommunications Technology's TTI 1200 Series phase-jitter tester, which measures an important data-channel impairment that is particularly important at the new high data rates above 4800 bits per sec.

Automation essential for large nets

For large communication networks, the use of automated test systems is both an economic and technical necessity.

The Bell System's automatic monitoring system, called Centralized Automatic Reporting on Trunks (CAROT), is used on Direct Distance Dialing (DDD) systems. An automated system is dictated here because there is no operator to report noisy and otherwise defective trunks. But where CAROT's function is only the routine monitoring of trunks, a new system now in development called Switched Access Remote Test- ing System (SARTS) can do troubleshooting.

Smaller, private systems can also benefit from automatic testing. Hewlett-Packard's 5453A Transmission Parameters Analyzer automatically initiates nine circuit-parameter checks. Given a simple "All" command, the analyzer carries out the checks without further intervention. The operator controls the unit via a CRT terminal, with commands in plain English. Digital signal analysis, based upon Fast Fourier Transforms, allows the addition of new measurements with only a change in the software. And, after testing, the operator can view the results on the CRT and then print them out or store them on a disc memory.

Analog channels in the majority

But since analog channels are used in most of the communications networks of the world (only Bell of Canada offers an all-digital network, and AT&T has a few experimental digital links) a high proportion of available instruments are designed to service analog channels. The channels may travel over cable and microwave links and even include satellite relays. Carrier systems generally combine individual channels into wideband groups for these links.

Tests for analog channels fall into the following broad categories:

- *Amplitude level and loss measurements.* Too



Multipurpose test instruments, such as this HP4940A test set, can provide a comprehensive analysis of an analog channel's characteristics without the need for additional equipment.

little signal obviously can cause loss of audibility or errors in data transmission. Too much signal can overload amplifiers and produce distortion and interference from intermodulation products.

- *Distortion measurements.* Ideally the spectrum of the input signal's frequencies, relative amplitudes and phases should not be altered as they pass through a communication channel; practically they do. Measurement of nonlinear distortion, amplitude and phase vs frequency and frequency shift are a prime requirement of any complete analog test set.

- *Noise and transient measurements.* Unwanted random signals are loosely classified as "noise." Broad-spectrum noise and jitter are noise of a continuous nature. Transient problems include hits (sudden shifts in gain or phase) and drop-outs (large and relatively long-term loss of gain).

Squeezing channels together

Frequency-division multiplexing (FDM) of many carrier frequencies is the most common method of bundling individual communications channels together. The usual carrier modulation method is either AM or FM. But most common is a type of AM called single-sideband, suppressed-carrier modulation. With this method, a single voice channel needs only about 3.1 kHz of bandwidth with the carrier suppressed typically, 23 dB below the sideband level. With appropriate modems, such voice channels, when properly equalized, can handle a single channel of data at rates to over 4800 bits per second or 12 or more teletypewriter channels. The individual voice channels are then stacked together in an organ-

ized hierarchy.

Standard groups of 12 channels, each 4 kHz wide, are combined onto a 60-to-108-kHz bandwidth channel. Included in this basic grouping are guard bands between individual channels to help keep down crosstalk and pilot tones to regulate amplitude levels, synchronize individual channel carrier frequencies and provide alarm and monitoring signals.

The next tier in the hierarchy combines five 12-channel groups occupying the 312-to-552-kHz range. Ten such super groups, which contain 600 channels, are then often combined to cover 564 to 3084 kHz. Further combination can result in a 1632-channel, 4-GHz, TD2 microwave link or an L3 Bell coaxial-cable system with 1800 voice channels.

A spectrum analyzer is recommended by Cushman Electronics for monitoring these 1800 channels and their suppressed carriers and sidebands, along with the pilot tones and intermodulation products—a total of perhaps 10,000 different signals. W. J. Shewaga, engineering manager with Cushman in Sunnyvale, CA, notes that a single sweep of Cushman's CE-23A spectrum display can show every signal in an 1800-channel link. Any portion of the total spectrum can be expanded for detailed study.

For more detailed level and noise measurements of FDM systems, Cushman's CE-21A selective level meter provides fast digital synthesizer tuning to 9.1 MHz in 1-kHz steps. And 25-Hz resolution is attainable with vernier tuning. There is direct digital readout of frequency and level.

When a CE-24 tracking signal generator is added, the three specialized instruments make up a combination that can spot spurious signals, measure excessive noise and intermodulation products and analyze the many other ills that beset FDM communications systems.

Spectral analysis of the frequencies and amplitudes within a communication channel or group of channels can also be done with Rohde & Schwarz's EZF/EZFU combination monitoring and spectrum analyzing test set. It covers a range from 6 kHz to 2.7 GHz.

Ulrich L. Rohde, president of the Rohde & Schwarz Sales Co., Fairfield, NJ, points out: "The set has a wide dynamic range of 90 dB, and its steep-slope filters allow 16 times faster sweeping than with conventional analyzers."

Ailtech, Farmingdale, NY, demonstrated its 727 spectrum analyzer at Intercon '75. A spokesman for the company explained that the main advantage of its instrument is that "the user is assured that the display is free from multiple and image responses, as well as spurs which result from components being driven into non-linear operation. Thus the troublesome signal

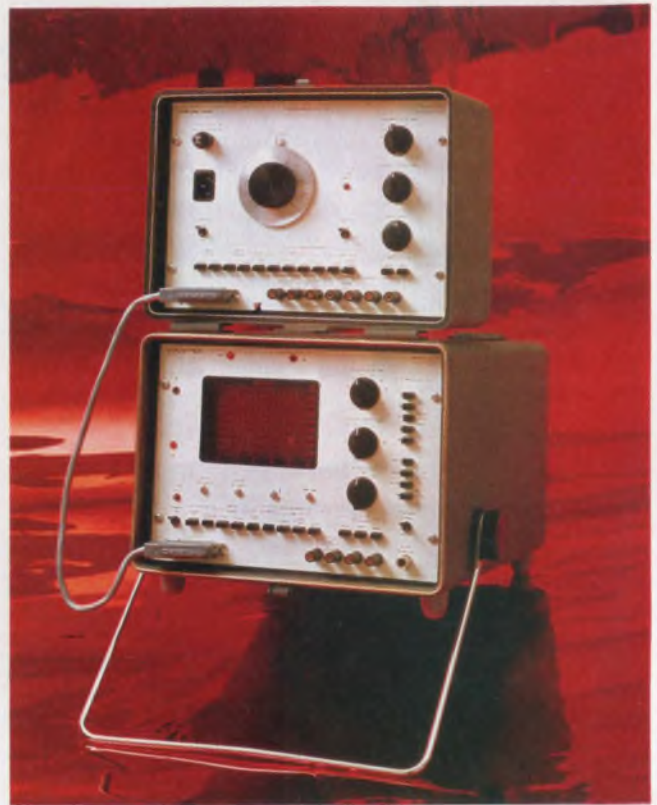

Often communications test sets must be portable and battery operated, such as Wavetek's 420 transmission level tester, for field use. An additional requirement is that the transmitter and receiver sections be separable to allow end-to-end tests.

identifier, usually provided in sweepers, is not required."

Several other instruments—such as the Halcyon Inc. (Campbell, CA) 515A data-line test set and 715A transmission analyzer and Wavetek (San Diego, CA) 420 transmission level tracer—also use CRT displays and frequency-sweeping techniques. These instruments, however, are specifically for communication channel tests, while the Rohde & Schwarz and Ailtech units are more generalized equipment.

NPR measurements are routine

To maintain and check a microwave link's over-all performance and identify degraded channels, noise-power-ratio (NPR) tests are a simple but effective method.

The AT-9003 noise loader, manufactured by W&G Instruments, Inc., of Livingston, NJ, can provide the signal source for NPR tests. It contains very few controls and can be operated after only minutes of training, according to Ken Chipman, applications engineer for W&G.

"Plug-in limit and bandstop filters allow the AT-9003 to be tailored to almost any requirement with a baseband up to 12.5 MHz," Chipman says.

The noise loader is designed to operate into

almost any general-purpose selective load meter, since many communications test operations already possess such equipment. And this keeps the added cost for such a set up down to only \$2290.

A specialized high-quality noise receiver—like the USH 1 tuned selective microvoltmeter by Rohde & Schwarz, the D/W2700 selective level meter from Siemens Corp. (Iselin, NJ) or the Cushman CE21A—would do nicely. Of course, W&G's latest AT-611 selective level meter is an excellent match to its own noise loader.

And Marconi Instruments of Northvale, NJ, makes the TF 2092C noise receiver, which gives an automatic three-digit readout plus the polarity of the NPR and relative channel power in all the commonly used transmission units. The receiver can automatically zero over a 20-dB change of noise input to the system. Of course, the receiver is compatible with any of Marconi's TF 2091 series of noise generators.

Noise power ratio is determined by the introduction of band-limited white noise (gray noise) at a standard reference level. For example, in an 1800-channel system, 0 dBm of gray noise is typically used for a 9-MHz band. The noise power is measured in a narrow frequency slot one channel (4 kHz) wide. A bandstop filter is then inserted at the system's input to keep out frequencies within this slot. The residual noise power in this slot at the output, or receiving end, of the system now includes only thermal noise, noise pickup within the channel and intermodulation products.

The dB difference between the reading with and without the bandstop filters is called noise-power ratio. Communication engineers usually seek an NPR of 50 dB or greater for 1800 channels as the criterion of good performance.

Making detailed channel tests

For detailed measurements and fault analysis of individual channels, Hewlett-Packard's 4940A transmission impairment measuring set handles 15 parameters. The 4940A is manually operated, costs about \$8000 and is said to need only about 10 minutes to cover the important parameters of a telephone channel. The instrument is designed to match the standards of the United States and Canadian Bell systems.

All measurement functions are provided on balanced lines of either 600 or 900- Ω impedance for full-duplex modes on two-pair channels and half-duplex on a single-pair. Transformer-coupled, balanced ports for receive and transmit pairs can be interchanged with a switch on the panel, and a current source across one input port holds the line relay for dial-up line testing.

Because data traffic demands higher quality channels than voice, a large number of the chan-



Envelope-delay distortion is particularly destructive to data communications. Bowmar's 490B transmission measuring set allows selection of a wide range of parameters to thoroughly cover modern data channels.

nel tests relate primarily to data. They include measurement of transient effects, envelope delay and phase jitter, all of which normally don't impair voice communications. The transient effects are usually classified into four categories: dropouts, gain hits, phase hits and impulse noise. Because of their sporadic nature and difficulty in separating these events into the separate categories, repeatable results have been difficult to obtain.

A dropout is often defined as a loss of signal carrier level of at least 12 dB and lasting for at least 10 ms. Measurement of dropout is frequently masked by a rise in background noise, so that the over-all signal level appears unchanged. A filter to distinguish between carrier and noise is necessary in such situations.

Gain hits, or rapid changes in channel gain of from 2 to 8 dB, are difficult to distinguish from impulse noise. Since impulse noise consists generally of bursts of narrow spikes, a measuring system that responds only to a longer level change—of say, 4 ms—is needed to help discriminate between the two effects. The 4-ms delay is selected because it is faster than the agc response time of a typical modem but longer than most noise spikes. Another way to discriminate is to check if the effect exceeds a selected threshold level three times or more in rapid succession. If it does, the transient is impulse noise.

Phase hits are rapid phase changes in the channel. A phase mismatch with a 4-ms delayed signal indicates a phase hit. The instrument's time-constant should correspond to the time-constant of typical phase-sensitive modems.

The HP 4940A can simultaneously record hit, dropout and impulse-noise events and distinguishing one from the others. Transients can be recorded for 5 or 15-minute intervals or continuously.

Another crucial measurement for data commu-

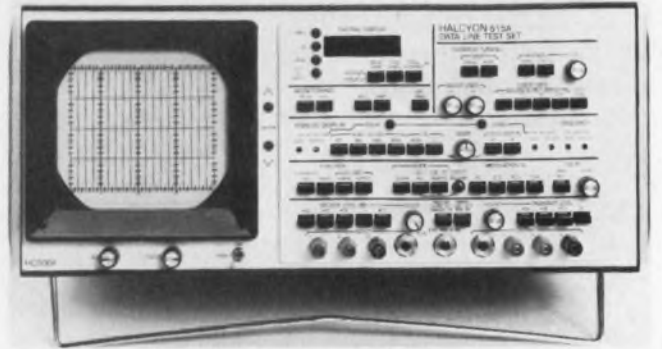

The many different characteristics of a communications network that must be measured to determine its quality, and the diversity of technologies that go into the make-up of a network have motivated instrument manufacturers to provide a large variety of special testers to help detect, separate and pinpoint problem sources. Some representative instruments include (clockwise, starting at the left): W&G Instruments' noise loader AT-9003 and selective level meter AT-611 set, Siemens' D-2007 level meter, Rhode and Schwarz' USh-1 selective microvoltmeter and Marconi Instruments' TF-2092C noise receiver all of which can be used in NPR tests; and Halycon's 515A data-line tester, which uses sweep techniques to analyze communications channels in the frequency domain.

communications is envelope-delay distortion. This is often confused with phase-delay distortion. Phase delay is the channel's phase shift divided by frequency (ϕ/w), but envelope delay is the rate of change of phase delay with respect to frequency ($d\phi/dw$). Envelope-delay distortion is the troublesome culprit in data communications. And the 4940A measures it by a method that is compatible with Bell methods (see description by H. Nyquist and S. Brand in Bell System Technical Journal, May, 1930).

A 50% amplitude-modulated test signal, which

is made up of an 83-1 3-Hz modulation frequency on a carrier frequency selected in the range of 300 to 3904 Hz, is transmitted through the channel. At the receiving end, the signal is demodulated, and the recovered modulation is sent back on a fixed carrier—near mid-band at about 1800 Hz. The phase of the returned modulation envelope is compared with the original to determine the envelope phase difference. The mid-band carrier frequency (1800 Hz) serves as a reference to establish the envelope-delay-distortion characteristics, because in a typical channel the envelope delay is usually flat and at a minimum in the mid-band region.

Jitter dithers data

At data rates of 4800 bits per second and higher, and especially with the latest 9600-bit-per-sec rates, phase jitter becomes a major source of error in a channel used for data transmission.



YOU'RE LOOKING at the PERFECT SOURCE for CRYSTALS, OSCILLATORS and CRYSTAL FILTERS

ERIE is bursting with a full line of QUARTZ CRYSTALS . . . with deliveries to meet your production schedules. 1 kHz to 200 MHz . . . AT, JT, DT, NT, SL, 5°X, GT.

We have exotic crystals and very simple crystals, low frequency and high frequency crystals. And we manufacture and test to meet or exceed Mil-C-3098 standards. ERIE provides a better crystal because we control our total manufacturing process in-house.

Our broad line of CRYSTAL OSCILLATORS range from low cost TTL dip package types to complex high stability, high reliability oscillators . . . both military and industrial types.

When it comes to CRYSTAL FILTERS, ERIE can design and manufacture the filter best suited to your application. There is virtually no limit to the variety we produce . . . including Monolithic Crystal Filters.

So come to ERIE for a fast, accurate and down-to-earth answer to your frequency control problem. One factor remains constant . . . you'll get a fair, cost-conscious answer. We have the technology and the products to implement effective crystal performance.

WRITE FOR OUR CATALOG
OR CALL 717/249-2232
FOR ENGINEERING AND
PRICING HELP.

ERIE FREQUENCY CONTROL

453 LINCOLN ST., CARLISLE, PENNSYLVANIA 17013
DIVISION OF ERIE TECHNOLOGICAL PRODUCTS, INC.



The human ear is highly tolerant of phase jitter, thus, until recently, little attention was paid to this characteristic. Of course, special measuring instruments and techniques are needed to measure phase jitter.

"The presently accepted practice," explains Richard E. Pospisil, applications engineer of Telecommunications Technology, Inc., Sunnyvale, CA, "is to specify phase jitter in degree of phase variation. This is an outgrowth of attempts to measure jitter by CRT observation of the peak-to-peak smear of the zero crossing of the waveform, and conversion of this into degrees. Many presently available test sets have automated this procedure with zero-crossing detectors.

"However, an important disadvantage of this method is that noise also appears as phase jitter. But noise is a false jitter. This defeats the purpose of transmission tests, which is to isolate sources of problems. Noise and true jitter are not likely to stem from the same causes."

Jitter on the master frequency source of an FDM system stems primarily from 60-Hz power-line frequency interference and its harmonics. As little as 20 mV of ripple from the communication system's dc power supply causes significant jitter. The next important source is the 20-Hz ringing tone used in telephone systems and its harmonics to about 300 Hz.

Thus, traditionally, a nominal test tone of 1 kHz with a ± 20 to ± 300 Hz passband has become an industry standard for the measurement of phase jitter on voice-grade channels. However, random noise within the 20-to-300-Hz band can still provide false jitter measurements. And jitter frequencies below 20 Hz are also of interest because of the recent growth of transmission of vital medical information, such as electrocardiograms.

Some jitter test sets overcome these objections by supplementing the standard test with other operating modes. For example, Telecommunication Technology's TTI 1200 phase-jitter test sets also include a wideband test. When noise is present in the channel, the wideband test provides higher readings than the standard test.

A noise-free channel would provide the same output from either test, but a channel with only noise provides about twice as much output with the wideband test as with the standard test. If the reading from the wideband unit is higher—but less than twice the standard—both noise and jitter are present.

Another test that the TTI 1200 can make is for very-low-frequency jitter. As in the case of the standard test, the high-end cutoff is at 300 Hz, but the low end extends below 20 Hz. Then a comparison of standard and low-frequency tests shows if low-frequency jitter is present. Equal readings mean that low-frequency jitter is ab-

sent; a significantly higher reading on the low-frequency test shows that low-frequency jitter is present.

Error rate is an over-all test

Error-rate performance provides an over-all assessment of a data-communication link without reference to phase jitter, envelope delay, gain and phase hits or impulse-noise effects. Error rate is measured at the digital interface, and it reflects the total effect of all these phenomena.

To be most useful, the error-rate tester should be operable in a full-duplex mode—send and receive simultaneously—and be able to check the data so that the performance figures reflect actual performance, not some theoretical value.

"Because many data systems do not sample received signal bits precisely at their midpoint, as is done in many test sets, measured bit-error-rate figures of merit are often better than those achieved by actual equipment," warns W. C. Andrews of Digitech Industries, Ridgefield, CT.

Digitech's 2302 bit error-rate tester allows selection of sampling width from a midpoint pulse to 90%, as well as a choice of six pseudo-random bit patterns that are compatible with Bell, EIA, CCIT and MIL-188 requirements. Other features include an internal crystal-controlled frequency synthesizer that covers 10 to 9990 baud and operation from a modem-furnished clock to 300,000 baud.

To break into and test or monitor a communication channel's digital interface, several manufacturers supply a 25-pin break-out box that conforms to EIA RS-232 standards. These boxes allow access to all leads for distortion analysis, activation of controls and signal introduction. Break-out box 921-S is available from Nu Data Corp. of Little Silver, NJ, and Model 505-2 from Pulsecom, Inc., of Falls Church, VA. Most manufacturers of error-rate testers, also make them.

Where data must be caught on the fly and studied in detail to pinpoint troubles, Biomation's 110-D (Cupertino, CA) logic recorder can store serial data for later display. A memory holds up to 4096 bits at selectable byte sizes, from 1 to 99 bits/byte. Thus slow or fast, data are recorded and can then be studied at leisure with an oscilloscope or walked through the memory in byte increments.

Tau-Tron (Lowell, MA) manufactures the TMI line of modular instruments for testing PCM and other digital communications systems. The available modules include pulse sources (MS-1 to MS-4), data generators (MG-1 to MG-3), a pseudo-random generator (MN-1) and many others, which plug into a standard frame. The large variety of available modules allows the assembly of a system to fit the user's needs. ■■

Noise at the front-end of an otherwise tight low frequency design is terribly frustrating. And we don't blame you for sounding off if you want to specify for lower noise and can't come up with an FET to suit your purpose.



Crystalonics new 2N6550 is a silicon, N-Channel, junction FET designed for low frequency amplifier applications, with an ultra low noise figure of $2nV/\sqrt{Hz}$ at 1 KHz. You won't find one quieter! This device is designed to produce the cleanest signal possible at the front-end, for pure follow-through and ultimate signal clarity, so critical to military field communications. It's as silent as current technology allows, and with Crystalonics' 2N6550, you'll note a marked improvement in your prototype.

Crystalonics has been in the business of helping to solve designers' problems for over a decade. While other companies have abandoned military applications and opted for the production of commercial standards, we've stuck by our trade: high quality, innovative production with the designer in mind. Direct communication between the designer and our applications engineers is our mark.

We're at your elbow to ease your design.

Send for our new condensed catalog of Junction FETs, Fotofets, and Low Level Bipolars, including the 2N6550 at \$15, 1-99; \$10, 100-999. Samples on request. Or for immediate design assistance, give us a call. Ask for Jack Senoski, Art Pauk or Richard Antaluk, of our applications engineering squad. Crystalonics. We listen.

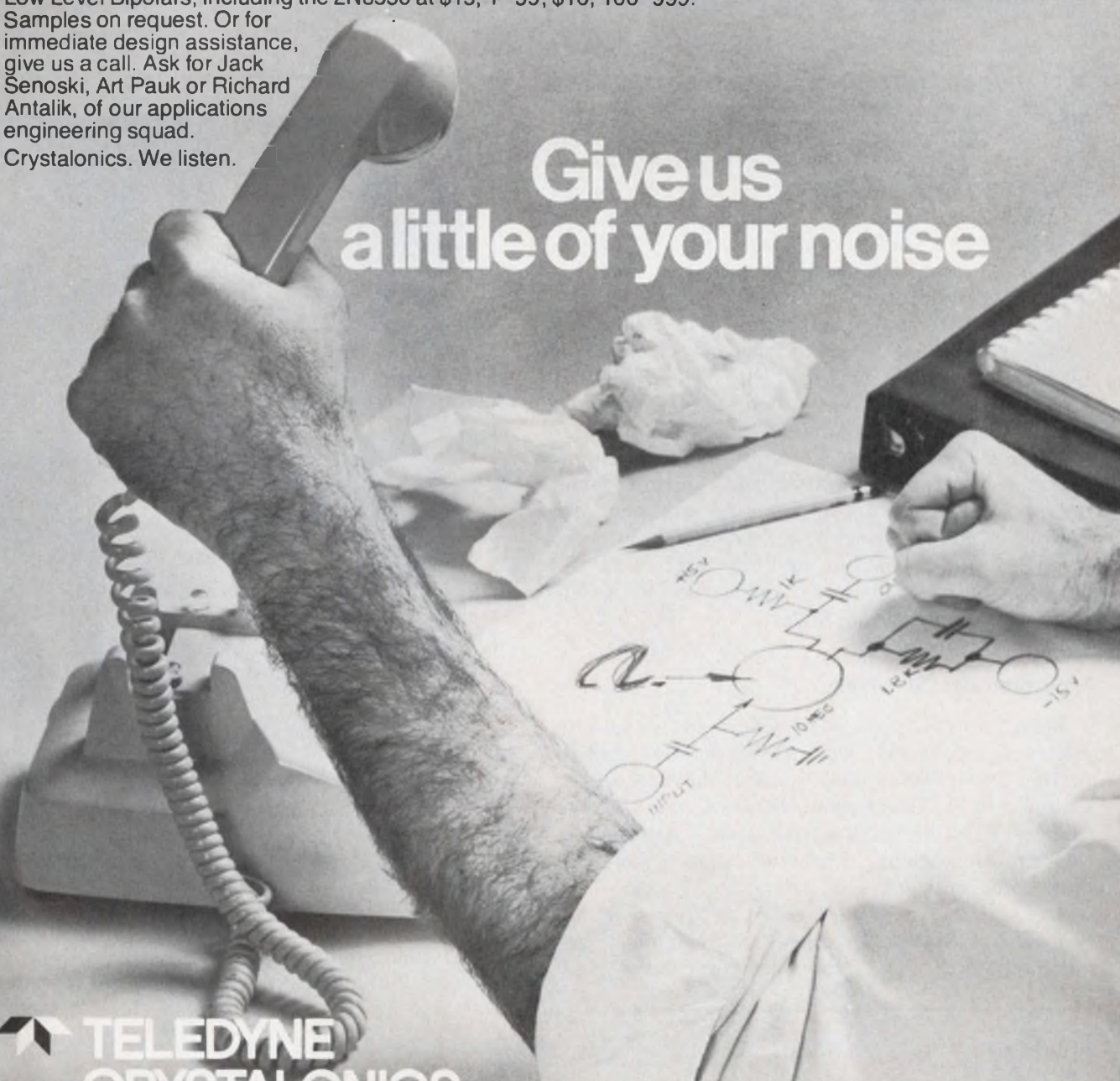

Give us
a little of your noise

 **TELEDYNE**
CRYSTALONICS

147 Sherman Street, Cambridge, Mass. 02140
Tel: (617) 491-1670 • TWX: 710-320-1196



COMMUNICATIONS '75



Dr. Ernst Alexanderson: A pioneer to remember

It seemed a miracle. A human voice suddenly came out of a number of shipboard radio receivers in the North Atlantic. Only Morse code and static had ever been heard on them before. Everyone who could crowd into the radio rooms heard it. A woman sang a song, then a poem was recited. There was a violin solo, then a speech. It was Christmas Eve, 1906, and this was the first voice radio broadcast ever made.

The high-frequency alternator that made this event possible and led to the development of television was the first of 322 "miracles" that Ernst Frederik Werner Alexanderson patented during his long and fruitful career.

After the alternator came the magnetic amplifier, the electronic amplifier, the multiple tuned antenna, the anti-static receiving antenna and the directional transmitting antenna. He also devised a radio altimeter, and his studies in the polarization of radio waves made possible an effective radio direction finder.

Encounter with Steinmetz

Born in 1878 in Sweden, where he became an electrical engineer, Dr. Alexanderson studied further in Germany, and in 1901, he came to the United States. One reason, he says, was to meet Charles P. Steinmetz, whose book, "Alternating Current Phenomena," had made such a powerful impression on him.

Alexanderson had no trouble getting a job in the United States. He began work almost immediately with the C&C Electric Co. in New



Dr. Alexanderson died in Schenectady on May 14. He left his wife, Thyra, three daughters and a son, nine grandchildren and five great-grandchildren. He was 97 years old and had lived more than most men in engineering achievement, in human experience and in years. But his death was too soon for his family and for his many admirers, including those at Electronic Design.

John F. Mason
Associate Editor

In Tribute

THE WHITE HOUSE
WASHINGTON

May 16, 1975

Dear Mrs. Alexanderson:

Mrs. Ford and I were deeply saddened to learn of your husband's death, and we join in sending our heartfelt sympathy to you and your family.

Dr. Ernst F. W. Alexanderson was a pioneer in perhaps one of the most exciting adventures of man. His dedication and his genius will always inspire and motivate others to follow his example of reaching into the unknown to bring new knowledge -- and new hope -- to our world.

While words can have little meaning in the face of your great loss, Mrs. Ford and I want you to know that we will be keeping you in our thoughts and prayers during this sad and difficult time.

Sincerely,

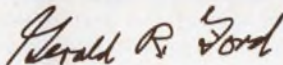

Mrs. Ernst F. W. Alexanderson
1132 Adams Road
Schenectady, New York 12308

ROYAL
SWEDISH EMBASSY

May 12, 1975

A TRIBUTE TO DR ERNST ALEXANDERSON

On behalf of the Swedish Government I wish to express a tribute to Dr Ernst F.W. Alexanderson, a son of Sweden, who in his adopted country, The United States, pursued a career as an engineer that has placed him among the world's greatest inventors such as his fellow countrymen Alfred Nobel and John Ericsson and influenced the field of electrical and electronic engineering for generations to come.

Born on January 25, 1878, in the college town of Uppsala, Sweden, Alexanderson turned his back on a family tradition of studying law or administration, fields in which his forefathers had excelled, and pursued instead a career in engineering that took him through the University of Lund, the Royal Institute of Technology in Stockholm and the Royal Technical Institute in Berlin.

In 1901, when young Alexanderson had completed his studies and was seeking a field in which to apply his education he set sail for America to embark upon a full, productive life.

Only six months after arriving in the States this brilliant young Swede started on the path that would bring hundreds of contributions to the industrialized world through his inventive genius.

A true Viking by nature, the favorite hobby of this brilliant man, I am told, is one in keeping with his Nordic heritage. Sailing and sailing races filled his leisure hours and when not at his desk in the laboratory Dr Alexanderson could be found aboard his beloved boat "Nordic".

Such a remarkable career of course did not go unrecognized in his native Sweden. In 1924 Dr Alexanderson was elected to the Royal Swedish Academy of Engineering Sciences and in 1934 to the Royal Academy of Sciences in Sweden. He received the Cedergren Gold Medal from the Royal Institute of Technology in Sweden and the University of Uppsala conferred upon him its honorary degree.

One can say in all honesty that this man is a son of Sweden who not only enriched the culture of his adopted land, the United States of America, but who made the world the richer.

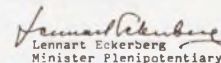

Lennart Eckerberg
Minister Plenipotentiary

GENERAL ELECTRIC
GENERAL ELECTRIC COMPANY
HARTFORD, CONNECTICUT 06183

May 13, 1975

REGINALD H. JONES
MANAGER, ELECTRONIC DESIGN

To: ELECTRONIC DESIGN

One of my predecessors, E. W. Rice, Jr., once asked to be excused from a meeting of the General Electric board of directors with the words: "Alexanderson has something to show me and I feel it is my duty to go see it." That "something" was the magnetic modulator, which paved the way for trans-Atlantic radio.

It is fitting that we again pause to consider what Ernst Fredrik Werner Alexanderson has to show us. A genius, it has been said, is a man who has had two great ideas. By this standard, a higher term must be found to describe Alexanderson. The list of his "great ideas" is virtually a history of twentieth-century efforts to apply electricity to the service of man. From the first radio broadcast in 1906, through the development of television in the 1920s and the design of revolutionary electronic motor control in the 1930s, his originality has supplied the key breakthroughs needed for success.

Impatient with accepted limitations -- able to pick the crucial feature of a problem from amid many complexities -- and willing to try, to fail, and then to try again -- his rich career serves as a monument to the achievements of the past, and a model for engineers of the present and future.

Sincerely,

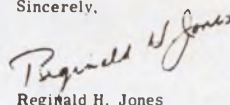

Reginald H. Jones

RCA | 30 Rockefeller Plaza | New York, NY 10020 | Telephone (212) 598-5900

RCA

To Electronic Design:

May 14, 1975

Robert W. Sarnoff
Chairman and
Chief Executive Officer

The development of the alternator by Dr. Ernst F. W. Alexanderson is a classic example of the right man in the right place at the right time.

In 1904, Reginald Fessenden, the pioneer in wireless transmission of the human voice, asked General Electric to build an alternator, and GE gave the assignment to Dr. Alexanderson. In September, 1906, a successful, 50,000 cycle, 1-kilowatt alternator -- the first of many Alexanderson alternators that made world-wide communications possible -- was delivered to Mr. Fessenden.

Actually, it developed over the years that whatever the challenge, Dr. Alexanderson was the right man in the right place at the right time. In all, he received more than 300 patents in such diverse fields as television, power transmission, electric ship propulsion and industrial and military control devices.

RCA owes much to Dr. Alexanderson, not only for inventions that made possible our communications capability but also because we were privileged to have him serve as our Chief Engineer in the 1920's.

Like so many others who contributed so much to communications, Dr. Alexanderson was an immigrant who came to America seeking the opportunity to use his talents to the fullest. He succeeded, and the lasting contributions of his genius will continue to benefit not only his adopted country but the entire world.

Cordially,

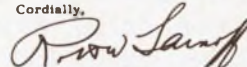

Robert W. Sarnoff

Jersey. Soon afterwards Thomas A. Edison asked him to work with him, but instead he decided to look up Steinmetz. As a consequence, he went to work with General Electric, a company he'd never heard of. Describing the meeting with Steinmetz years later to a friend, Philip L. Alger, who reported the incident in his book, "The Human Side of Engineering," Alexanderson said: "I just took it upon myself to find out where Steinmetz lived and walked in on him."

Alexanderson went on in another account, now part of a collection called "The Alexanderson Papers" at Union College, Schenectady, NY:

"My first impression of the great man is a very vivid memory. I expected to see an impressive personality, and I was almost shocked when a little hunchback, dressed in a black bathing suit, hitched into the room and leaned on the desk, with a cigar in his mouth. The result of the interview was that he helped me to get a job in the drafting department. This is where I found the 25 other Swedish boys. But his interest in my case did not stop at that. As soon as I became confronted with practical problems, I started to invent improvements, and I visited Steinmetz often to discuss these ideas.

"The most important change in my status with the company was when, due to Steinmetz' intervention in 1903, I was allowed to change from the drafting department to the testing department. He was a strong believer in experimentation, although he has become more known for his system of mathematics. The testing department gave me new incentives to inventions, and I had a natural urge to try out these ideas experimentally."

Dot-and-dash era ends

The invention of the alternator was a major step forward for radio and for Alexanderson. Before it, a GE official explained years later, "radio was an affair only of dots and dashes transmitted by inefficient crashing spark machines."

It was in 1904 that GE was asked by Prof. Reginald A. Fessenden, also a pioneer in radio experimentation, if the company could build a high-frequency machine that would operate at high speeds and produce a cw transmission. The assignment was turned over to Alexanderson.

The usual generator in those days operated at 60 Hz. But Fessenden wanted one that would operate on at least 100,000 Hz. Although the idea was considered fantastic by most engineers, Alexanderson thought differently. After two years of experimentation, during which several models were built, he finally had a 2-kW, 100,000-Hz machine that he felt met Fessenden's specifications. It was this machine, installed in



Dr. Alexanderson, in his pioneering days, looks into the extremely small screen of one of the first television receivers developed. He said in a recent interview that he considered television the most important electronic invention of the 20th century.

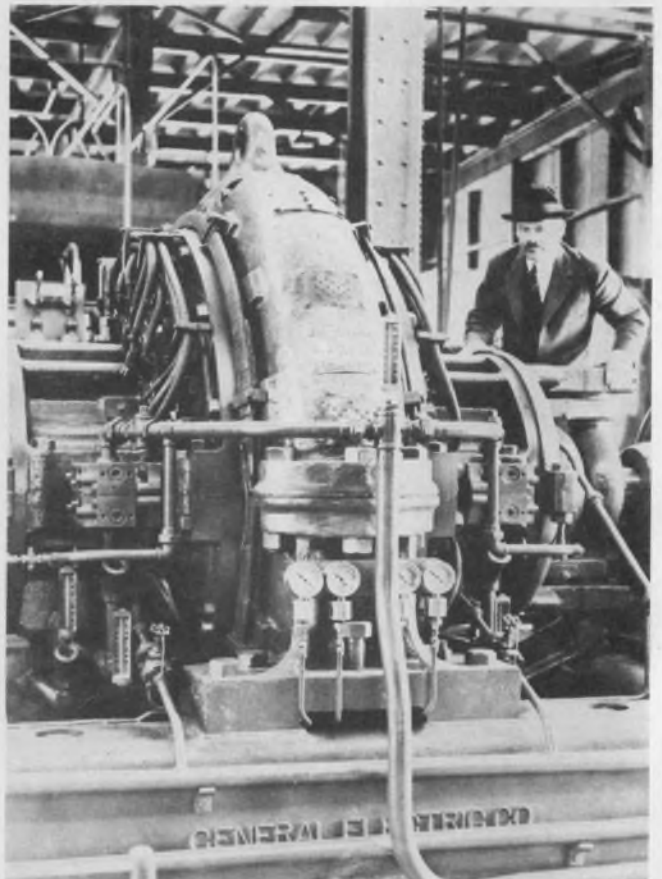

The Alexanderson high-frequency alternator "opened up the field of radio and television."



Dr. Alexanderson and S. P. Nixdorff examine one of Alexanderson's inventions—the radio-echo altimeter.

the Fessenden radio station at Brant Rock, MA, that enabled the transmission of the first voice broadcast in history on Christmas Eve, 1906.

GE officially describes the invention as “an inductor alternator having the rotor formed with alternate segments of magnetic and nonmagnetic material, operated at high speeds for the production of high-frequency currents used in cw transmission at high power.”

When asked by *ELECTRONIC DESIGN* a few weeks ago which invention he was most proud of, Alexanderson said in Schenectady: “I cannot say that I am particularly proud of any specific invention. However, the alternator opened up the field of radio and television. Therefore this invention has given me great satisfaction.”

In a 1923 letter to J. D. Neal of New York, Alexanderson noted:

“The alternator is not a distinct invention which was made on any particular date. It is the result of continuous work extending between 1904 and 1918. This work covered not only the design of alternators in the literal meaning but consisted in the development of high-frequency and radio technique along new lines. In the progress of this development, the alternator was an important tool rather than the object.

“The interesting feature of the alternator is, therefore, not so much that it differs from power alternators as the fact that a machine so similar to power machines could be designed to meet the requirements of the radio technique. For more than 10 years my alternator was mentioned in radio literature as a fantastic and impractical feat. However, as soon as the first alternator was

put in service in 1918, it was recognized as the most reliable system of radio communication.

“The alternator resembles power alternators, in that it uses an iron core. When I designed the machine, it was believed that iron could not be used at high frequencies. The investigation work resulted in the development of new methods for transforming high frequencies which have become universally accepted since I proved in a paper, read in 1911, how iron cores could be used for high-frequency transformation.”

The multiple-tuned antenna

Alexanderson went on to describe another milestone: “One of the most important developments of the radio technique in connection with the use of the alternator is the multiple-tuned antenna. The multiple tuning makes it possible to radiate signals of greatly increased strength. With a power of 200 kW in the antenna, results are attained which would require 1200 kW with the old method of tuning.”

The significance of the alternator was felt almost at once. News of the development reached Guglielmo Marconi, the “father” of radio, and in 1915 he traveled from England to Schenectady to talk with Alexanderson. The result was a 50-kW alternator that Alexanderson produced and installed in Marconi's trans-Atlantic communication station in New Brunswick, NJ.

But Alexanderson was not satisfied. He went on to develop a 200-kW machine for the facility. And it was this equipment that President Woodrow Wilson and the Assistant Secretary of the Navy, Franklin D. Roosevelt, used to transmit messages to the World War I theaters of Europe. In 1918, President Wilson used the alternator to transmit to the Kaiser his ultimatum that brought the war to a close.

RCA is born

The strategic and diplomatic significance of this trans-Atlantic communication capability resulted in the formation of RCA. In 1919, the American Marconi Co., eager to expand its Atlantic services, resumed negotiations with GE that had been interrupted by the war. It sought patent rights to GE communications equipment, including Alexanderson's alternator. But the U.S. Government opposed the plan. The American Marconi Co. was controlled by Great Britain, and the U.S. Government didn't want to see such an important communications tool fall under foreign control, even though a friendly foreign power. In line with these wishes, GE formed a communications company, the Radio Corp. of America, which took over the entire Marconi Co.

Alexanderson was farmed out to the new com-

pany as chief engineer, returning to GE in 1924. RCA didn't become fully independent of GE control until 1930.

Dr. Alexanderson also wrote in 1923 about another important invention:

"The magnetic amplifier was the result of investigation work between the years 1911 and 1916. The idea originated in my studies of the use of iron for high-frequency transformers. The object was the realization of trans-Atlantic telephony.

"The functioning of the magnetic amplifier depends upon the property of iron which is known as saturation. The magnetic amplifier is used to modulate the flow of high-frequency power from the alternator to the antenna. The magnetic amplifier made possible trans-Atlantic telephony from the high-power station at New Brunswick during the war."

Alexanderson then proceeded to make the magnetic amplifier obsolete by inventing the electronic amplifier. This was essentially the application to radio telephony of vacuum tube improvements worked out in the GE laboratory. With new tubes it became possible to build powerful transmitters at high frequencies. As a result, these tubes became the basis for all present-day radio broadcasting.

The anti-static receiver was another of Alexanderson's World War I developments. With German submarines cutting cables and the Allies complaining of German stations blanketing their wireless transmission, the Government turned to Alexanderson for a way to ensure continual communication with the armies in France. With an assistant, he discovered that a wire two miles long, stretched in the direction of Europe, and a perpendicular wire balanced by coils not only eliminated the German radio barrage but the static in the receiver as well. This system soon became an indispensable part of long-distance commercial radio reception.

Fascinated by television

Alexanderson was fascinated very early by television and the transmission of pictures by radio. In 1924 he sent the first trans-Atlantic facsimile—a handwritten greeting to his father in Sweden.

During the late 1920s he did notable pioneer work in television and the transmission of pictures by radio. Using a perforated scanning disc and high-frequency neon lamps, he staged in Schenectady the first home and theater demonstrations. The first home reception of television took place in 1927 in his home, and a public demonstration was held the following year.

In a speech in 1926, Alexanderson speculated on the future of television.



Dr. Alexanderson demonstrated his television projector in Proctor's Theater in Schenectady in 1928.

"When will we 'see' by radio?" he asked himself. "It will probably not be so long before facsimile of letters and printed matter will be sent by radio as a daily routine. The broadcast stations may transmit photographs to illustrate the entertainments, and moving-picture films will be sent by radio, so that news events from distant parts of the world can be shown in the moving-picture theaters the same day.

"When we finally can have direct vision of moving objects by radio, the question may arise: "Will it be too expensive or can it be made profitable? Here again we must be optimists. If it can be done at all, the world will demand it at any price, and some change in our social order will take place that will make it economical."

In its recent interview, *ELECTRONIC DESIGN* asked Dr. Alexanderson what he considered the most important electronic invention of the 20th century.

"Television," he replied.

And what did he foresee as the next comparable breakthrough?

"Television in combination with the telephone to produce a picture," he said.

His goals were practical

Alexanderson's creativity was usually tied to practical goals, to solving problems.

"It usually does not pay to invent just for the sake of inventing," he once said. "Inventions are by-products of engineering efforts which have a general objective. There is something you wish to do, but you run into a difficulty and you do not see an immediate solution. . . . Then one morning, just as you wake up, you have a fresh idea. . . . The chances are that the first test is not successful, but eventually you have a practical solution.

He liked to work with young people.

"The relationship is intimate and personal," he once said, "not as a boss and an assistant, but as a team, where the younger generation supplies the knowledge of the latest technical development and the older generation contributes experience and imagination." ■■

in the beginning there was quartz . . .

... and then there was Apollo 11 and the flawless performance of McCoy crystals from blast-off through splash-down.

... tomorrow there will be the Viking Lander and the mind-boggling implications of life on Mars. McCoy crystals will be there of course ... superb performance a foregone conclusion.

... the McCoy crystal has evolved from a generation of devotion and dedication to the frequency art. From the uncomplicated times of our ham crystals (which for sentimental reasons, we still produce) to the sophisticated items we placed aboard Apollo 11, engineering progress has marked our days.

We at McCoy are proud of our association with the electronics community. We are extremely grateful for the relentless demands it places upon us ... demands that beget a humility that allows us to try the unreasonable and do the impossible.

Whether your problems be of Apollo/Viking proportions or something less we welcome the opportunity to share in their solution.

Please write for our new catalog.

 **MCCOY**
ELECTRONICS COMPANY

a subsidiary of **OAK Industries Inc.**

MT. HOLLY SPRINGS, PENNSYLVANIA 17065 • Tel. 717-486-3411 - TWX: 510-650-3548

You may be going steady with the wrong resistor.

Carbon Composition. Industry's workhorse. Broadest resistance range, low cost. Available in packaging suited to automatic assembly.

Metal Glaze™. Unique thick metal film design provides *real* stability, power handling at surprising low cost. Rugged molded construction.

Ceramic Power. Ceramic insulated, fireproof, and low cost. Both wirewound and glaze constructions. Fusible and TC compensating versions available.

Molded Wirewound. Saves space and money over other 1 and 2W devices. From 0.1Ω up. Fusible, and TC compensating versions available.

Network. Molded TO-116 DIP networks. Installed cost savings and TaNFilm™ stability can be significant advantages.

Consider General Purpose Resistors.

Some suppliers give you a choice of one, or two. Not TRW. We make five different types of general purpose units . . . for good reason:

So you can select the *right* resistor for your application. No force-fits, no compromises.

The result is improved circuit layout, better performance and quite often a cost savings.

For the broadest choice in resistors for all types of applications, write or call TRW/IRC Resistors, an Electronic Components Division of TRW, Inc., 401 N. Broad Street, Philadelphia, Pa. 19108, Tel. 215-922-8900.

TRW[®] IRC RESISTORS
We give you a choice.

INFORMATION RETRIEVAL NUMBER 39

The engineer's engineer

Most of us went into engineering because it's a wonderful profession. We didn't become engineers because that's the way to get rich, nor because it's a soft job. We became engineers because it's an exciting and challenging career.

Though bound by rigid constraints, engineering permits us to flex our intellectual muscles. Responding to practical problems, we can create elegant solutions that can be works of beauty. The beauty, like that in painting, sculpture, literature and music, is best appreciated by people with suitable training and education. But it's there.

And that's what makes engineering magnificent. There are factors, of course, that can make it ugly. We find stupid administrators, paper-worshipping bureaucrats, people who idolize procedures, those who try to mechanize a creative process, and the usual assortment of progress-blockers who can be found in any organization. In the midst of annoyances they can create, it's easy to become demoralized, and to wish we'd gone into another line of work.

But once in a while there appears among us a man of such stature, a person of such intellectual prowess, that we are inspired and can feel proud once again. Such a man was Ernst Alexanderson, who honors *ELECTRONIC DESIGN* by his presence in this issue. Here was an engineering giant, an engineer's engineer, a man whose staggering total of 322 patents includes revolutionary developments that today we accept as routine. Here was a communications pioneer whose achievements in radio, television and facsimile have had profound effects on world history. Just one of his developments, the high-frequency alternator used for trans-Atlantic radio broadcasts, was used to transmit the peace terms that led to the end of World War I. This same alternator was a key factor in the creation of Radio Corporation of America.

When he died on May 14th at the age of 97, Alexanderson was still a thinker, still a follower of the engineering drama. Though one of the world's greatest, he was not alone as a source of inspiration. There are many others among us who can revive our faith and make us once again proud to be engineers. We can point to people like Alexanderson and say with pride: "We are in the same profession."



GEORGE ROSTKY
Editor-in-Chief

View signals



in the lab...

For fast, precise analysis of circuit or component performance you need an uncluttered view of your signals. And that's exactly what thinking hertz with spectral analysis gives you—an easy method for isolating the spectral components of your signal in the midst of noise.

With HP's 3044A Spectrum Analyzer, for example, you can readily test the spectral purity of modulators, repeaters, oscillators and other components over the frequency range from 10 Hz to 13 MHz. The system includes a synthesizer tuning source and digital displays to assure maximum stability and accuracy. And for con-

venience, you have a wide choice of selective filters that allow a close look at crowded signals or a wider view for rapid swept measurements.

Team your 3044A system with one of our powerful, programmable calculators and you have a 3045A Automatic Spectrum Analyzer that's ideal for production testing. It performs complex testing and decision making automatically and frees skilled technical people for more productive work. In one application—testing hi-fi receivers—the system checks midband gain, response, harmonic distortion, intermodulation distortion, tone controls, and

faster, easier...



or on your line.

loudness control. It does all this about four times faster than manual test equipment and with an increase in accuracy up to five times. That's a typical example of how the 3045's rapid, automatic testing cuts production costs.

For spectral analysis in the 5 Hz to 50 kHz range, and with a resolution of 1 Hz bandwidth, we have the 3580A Spectrum Analyzer. This instrument directly measures low-level transducer outputs. Whatever your requirements in the frequency domain, HP probably has a solution that fits your needs and your budget. Call your local HP field engineer for specific details.



HEWLETT  **PACKARD**

Sales and service from 172 offices in 65 countries.
1501 Page Mill Road, Palo Alto, California 94304

INFORMATION RETRIEVAL NUMBER 40

FOCUS

on Pulse transformers

Even their manufacturers don't always understand why pulse transformers do what they do. Their behavior is often unpredictable or only partially predictable. And that makes for real problems.

You can start with a fine and thorough specification sheet. But the specs can be meaningless in helping you design a circuit. For the specs are full of myths and the sooner you separate the myths from the facts, the better off you'll be.

The biggest myth associated with pulse transformers is that you can specify them the way you specify other transformers. Before you can choose a pulse transformer, you have to define your application clearly. Unlike applications for other types of transformers, applications for a pulse transformer influence the type of transformer used and how easy it will be to select one.

It is extremely difficult, for example, to specify a pulse transformer for a blocking oscillator. Manufacturers note that it is hard to tie down the important transformer parameters without pinpointing the circuit that the device will be used in; you can't tell which parameter is responsible for the good or bad performance of the circuit.

The only practical way to choose a transformer for a blocking oscillator is to buy one that you think will work, and then test it. If it doesn't work, modify your transformer design in the intended circuit or modify the circuit design until it does.

To get a better grip on the problems you face in specifying pulse transformers, it's best to back up and look at the types of applications you're likely to encounter.

Applications for pulse transformers range from

thyristor triggers to laser triggers. The transformers can be used merely to provide isolation in computer circuits or to match the voltage and impedance of pulse-forming networks to microwave tubes, such as klystrons, magnetrons, traveling-wave tubes and cross-field amplifiers.

A thyristor-trigger transformer is a pulse transformer designed especially for gate-triggering applications. The triggering and impedance characteristics of the thyristors and the interwinding dielectric strength are the key factors in the design.

The relatively high operating voltages of

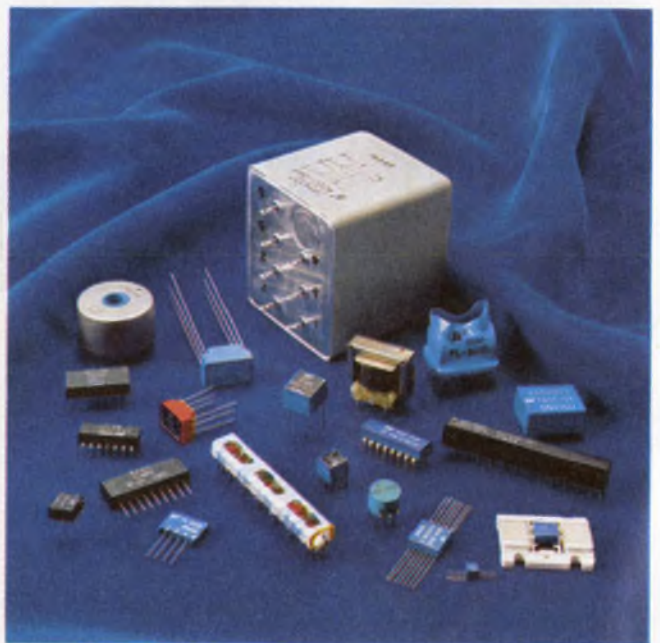

Pulse transformers come in a wide variety of sizes. These Bourns transformers range from large high-power hermetically sealed devices to microminiature epoxy encapsulated units.

Jules H. Gilder
Associate Editor

thyristors set tough requirements for interwinding insulation. Most applications call for a step-down transformer, since the voltage required for effective triggering is relatively low. Several secondaries may be needed for simultaneous triggering of thyristors.

The characteristics required of a trigger transformer vary greatly with the thyristor power rating, anode current waveform, operating voltage and circuit function.

Trigger transformers differ from other pulse transformers in that the pulse rise time for selected values of usable volt-time products must be optimized with a typical thyristor circuit as a secondary load.

Since trigger transformers usually interface between low-power, sensitive, control circuits and high voltage, high-power circuits, they need a high interwinding dielectric strength. An increase in dielectric strength causes an increase in transformer size, which results in an increase in pulse rise times.

Transformers used in most dc/dc converter applications are of the blocking-oscillator type. Selection of core material is very important here to ensure maximum efficiency. Blocking-oscillator transformers differ from other pulse transformers in that you want to maximize the remanent flux density. This requirement contrasts with that for most other pulse transformers, which operate in a unipolar mode—where pulses go only in one direction.

For a transformer to work in a unipolar application it must reset itself so it doesn't look like a permanent magnet. The measure of the transformer's ability to reset itself is the remanent flux density. The lower it is, the better for unipolar pulses. Therefore the core of a regular pulse transformer can't be made from square-loop material. Converter, or blocking-oscillator transformers, however, can use square-loop cores because the pulses alternate in polarity.

It's more like a transmission line

A pulse transformer is a special type of wide-band transformer that is designed to transmit voltage or current pulses with specific requirements on waveshape fidelity. And although it will provide the same electrical isolation as other types of transformers, it is more like a transmission line than a conventional power transformer. Load and source impedances, maximum peak output voltage, pulse width, duty factor, offset and bias voltage, and rise and fall times are some of the key specs associated with pulse transformers.

In general, the turns ratio in a pulse transformer must be low to provide good waveshape fidelity. An exception to the low-turns ratio is

found in high-voltage pulse transformers used with klystron and magnetron tubes. In these applications, the fidelity of the pulse is not as important as the high-turns ratio.

A pulse transformer is usually selected on the basis of a set of transformer equivalent-circuit parameters and saturation characteristics. The equivalent-circuit parameters usually given are leakage inductance, primary inductance, winding resistance, turns ratio, winding coupling capacitance and distributed winding capacitance or self-resonance frequency. The saturation level is given in terms of the voltage time product that the transformer will support without flux saturation—starting from zero flux level.

Some specs are useless

Some of the specs listed on pulse-transformer data sheets are useless. Most listed specs are static and easily measured, but the pulse transformer is a dynamic device whose performance depends on excitation voltage, loading levels and other circuit conditions to which the transformer is dynamically subjected.

A parameter commonly found on data sheets, for example, is sine-wave inductance. It is usually measured at a low level of constant permeability. Unfortunately, the permeability of a pulse transformer's core is not constant; therefore the sine-wave inductance is of little, if any, use. If the pulse applied to the transformer has an extremely low voltage-time product, then the sine-wave inductance might approach the pulse in-

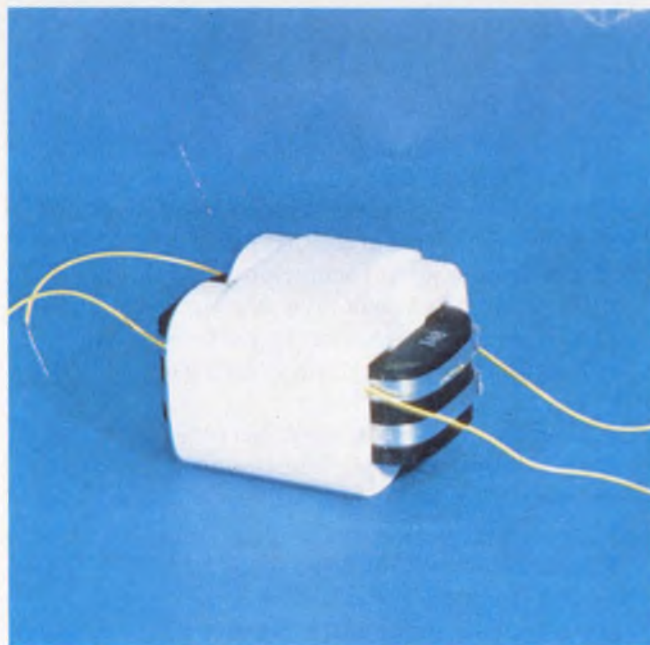

Output pulses with amplitudes of 3000 V and widths of between 10 and 100 μ s are possible with this 500-W pulse transformer from Velonex.

ductance. But it might not.

To illustrate the problems that can result from using sine-wave inductance instead of pulse, let's look at a design that requires a pulse transformer with a 1-mH pulse inductance, a voltage-time product of 200 V- μ s and a turns ratio of 1:1. The transformer drives a transistor on and off, and the driving pulse is supposed to have a droop of less than 50%. With use of the 1-mH sine-wave inductance, instead of pulse inductance, the core is driven too far into saturation and it is not possible to achieve the 50% droop. Also the voltage-time product will jump to about 360 V- μ s. To get the 1-mH pulse inductance for this application, you'd need sine-wave inductance of 2.2 mH.

There is, however, no strict correlation between the two inductances, because they will vary with the core material used in the transformer. For instance, a ferrite core transformer that has a permeability of 2500, pulse-repetition frequency of 4 kHz, voltage-time product of 200 V- μ s, 5- μ H leakage inductance, 1:1 turns ratio and sine-wave inductance of 1 mH will have a pulse inductance of 560 μ H.

Now if you go to another transformer manufacturer that uses 14-mil laminated iron instead of ferrites, and choose a transformer that has the same data-sheet specs, you'll wind up with a device that has a pulse inductance of only 20 μ H, even though the sine-wave inductance is the same. The reason for the big difference is that the devices were tested at a low frequency, where they both look the same. But laminated iron cannot take the high repetition rates that ferrite can, so when it comes to the actual application, the performance of the two devices is drastically different.

Look at key parameters before you specify

Before you buy a pulse transformer, analyze your application and determine the operating conditions of the circuit it will be used in. As a minimum, manufacturers of pulse transformers need the following information:

- Operating temperature range.
- Maximum and minimum pulse widths.
- Maximum peak primary voltage.
- Turns ratio.
- Maximum pulse repetition rate.
- Maximum physical dimensions.
- Desired transformer terminations and location.
- Maximum winding-to-winding peak withstanding voltage.

If the pulse inductance required is unknown, you'll have to give the manufacturer additional information, such as the source and load impedance, maximum allowable pulse droop and the



Multicore pulse transformers are available in 9-pin SIP, 14 or 16-pin DIP and 28-pin Rail packages. The Rail type package can accommodate up to 10 individual pulse transformers.

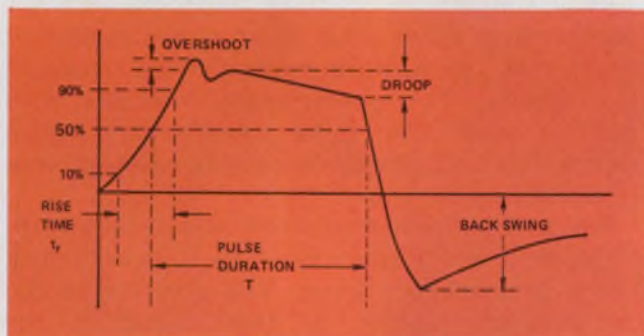

Waveform characteristics help establish a set of performance requirements that can be used to ease the selection of pulse transformers.

maximum peak primary current allowed during the pulse duration.

Even if you determine all of these parameters and a manufacturer sends you samples that meet your requirements and work in your application, you still are not safe. You may find that while the samples you receive work fine, the units you subsequently purchase don't. How come?

When going from breadboard to final product, everything tends to become smaller. If, to save space, you ask for a smaller version of the original sample, it may fail to work properly because of different leakage inductances or different conductor paths in the final circuit.

Another reason manufacturers often find it difficult to duplicate a sample transformer is that there is nothing uniform in a transformer. The cores come with big variations in size tolerance and permeability.

For small pulse transformers, where the coils

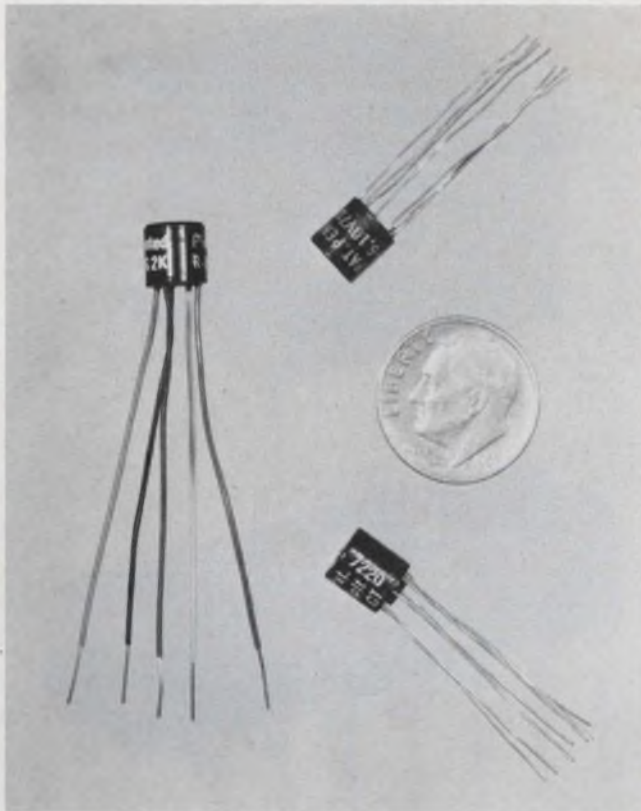

Ultra-miniature pulse transformers from Pico are designed for use in blocking-oscillator applications. They come in hermetically sealed metal cans.

are wound by hand, there is another variable—the person doing the winding. Two people winding a transformer to the same spec, may produce two very different transformers.

Here are the tradeoffs

With all pulse transformers, there are limitations that make certain exact combinations of parameters unattainable. The most common tradeoffs are size vs inductance and operating temperature vs inductance stability.

With the present state of the art, it is possible, if conditions are favorable, to achieve 4300 mH per cubic inch with a 1:1 turns ratio. Though high values of inductance can be achieved with only a few turns in a small package, you may not simultaneously be able to get high inductance combined with the inductance tolerance and turns ratio you need.

Don't box in the manufacturer. For example, 11 turns may be required with a given core size and material to maintain a 20% tolerance on primary inductance. But the specified turns ratio is 3:1 calling for a secondary with 3-2/3 turns. On a toroidal core fractional turns are not possible. Something has to give. You can back down on the requirement for 20% tolerance and allow, say, 12 primary turns (which is nicely divisible by three). Or if dc resistance is not a problem, you can use a lower permeability core, which will

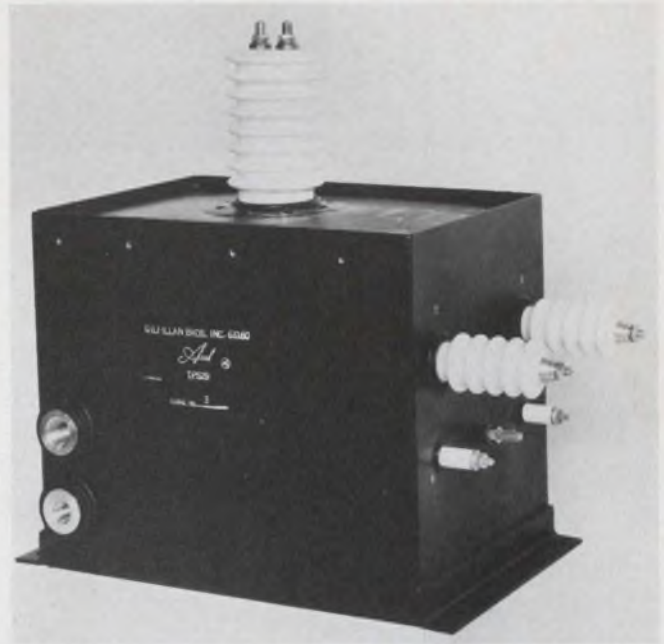

Large pulse transformers for matching the voltage and impedance of pulse-forming networks to microwave tubes, such as this one from Axel, often contain a filament transformer too.

allow you to retain 20% tolerance with 12 primary turns. If dc resistance is a problem, however, you may have to switch to a nonstandard core size.

As core permeability increases, inductance stability tends to decrease. With cores that have the same permeability, the one with the higher Curie point—the temperature above which a ferromagnetic material becomes substantially nonmagnetic—will usually be more stable. The majority of core materials used for pulse transformers maintains inductance stability of $\pm 10\%$ from -10 C to $+80\text{ C}$. This will degrade approximately 50% at -55 C and $+125\text{ C}$ from the initial value at 25 C .

If you need better stability, you can get it with a nonstandard material, but generally you'll be sacrificing permeability or operating flux density and dollars.

Other tradeoffs that have to be considered include:

- Rise and fall time vs load capacitance.
- Rise time vs maximum pulse width.
- Size of the pulse transformer vs the product of the peak voltage and maximum pulse width.
- Size vs peak voltage and power-handling capability.

Avoid these common problems

Even after you've specified the right pulse transformer it won't work if you don't use it properly. For example, if a pulse transformer is designed to work into a resistive load, you will encounter problems if the circuit is fabricated

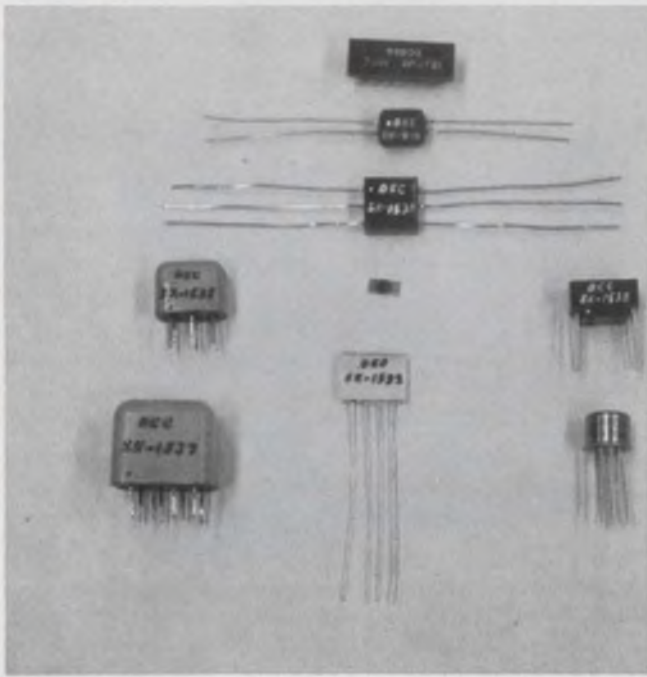

A new line of standard pulse transformers, including DIP and axial-lead devices, will be available from Delevan by the third quarter of this year.

with makeshift connections that add reactance to the load. Where adequate power is available, shunting the load with the proper resistance frequently makes a fantastic difference in waveform fidelity.

Very often an engineer specifying a transformer really doesn't know what he needs, and thus leaves out a lot of important information. An example of this is the amount of flux a transformer core can handle. This flux is a function of the peak voltage of the pulse and the time it is on, and it determines the material, size and cross-section of the core to be used.

In evaluating load reactance, don't overlook the leakage reactance of the transformer itself. In some cases, this may exceed the load reactance. Also, remember that reactance on the secondary is multiplied by the square of the turns ratio when viewed from the transformer primary. The primary of a 1:10 step-up transformer, that has 10 pF on the secondary, sees a capacitance of 1000 pF. Thus any driving source connected to the primary of the transformer must be capable of supplying a charging current to that capacitance during the pulse rise time.

To avoid this problem, use stepdown transformers whenever possible, or those with a turns ratio of 1:1. If a step-up transformer is a must, make sure the windings are broken into layers so the distributed capacitance can be reduced.

Also, don't forget to consider the duty factor of your switching signal. While in most applications the on time is only a small fraction of the

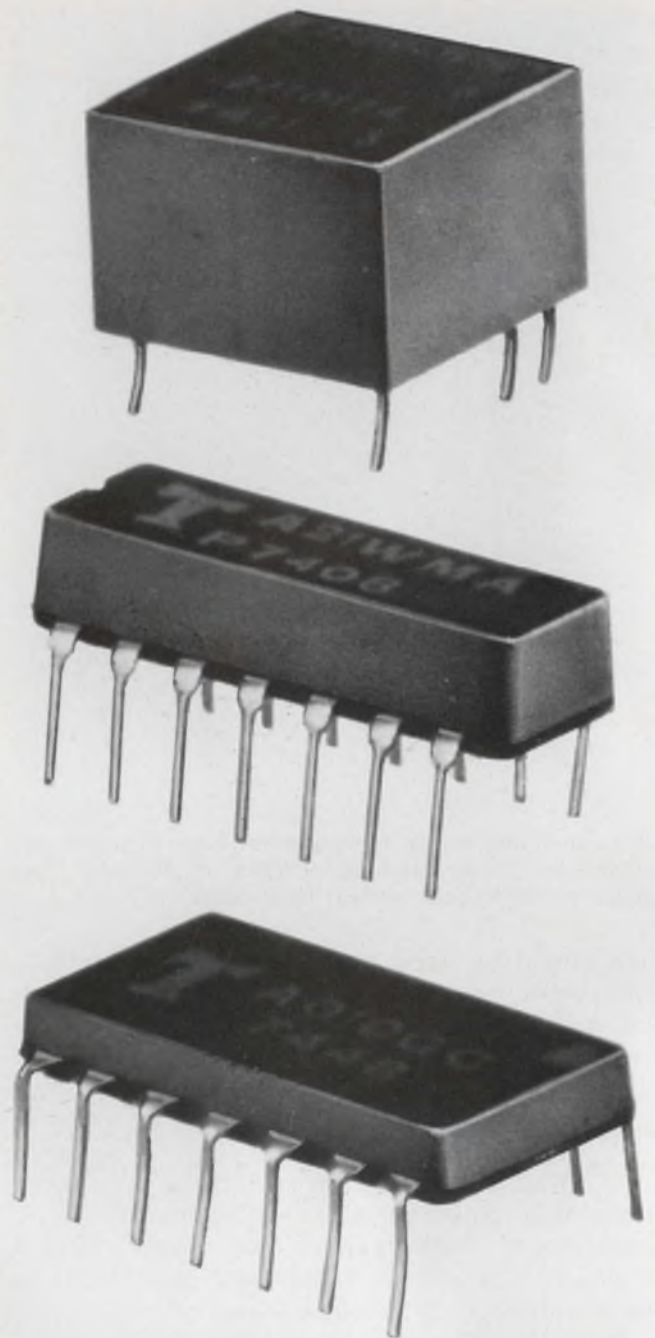

New Skinny-DIP pulse transformer package (bottom) from Technitrol has a lower profile than conventional DIP or potted transformers. It's only 0.105 in. high.

off time, some applications, such as dc/dc converters, have a duty factor that approaches 50%. This can limit the peak power that the transformer can handle.

Another important thing to remember: Don't leave transformer specification to last and assume you can get what you need. You may not be able to. Even if you can get what you need, your requirements may be so strict that a custom device becomes a must. By specifying pulse transformers in the early stage of your development cycle, you can save much time, money and aggravation. ■■

Need more information?

We wish to thank the companies that provided information for this report. The products cited in the report have been selected for their illustrative, or in some cases, unique qualities. However, manufacturers not mentioned in the report may offer similar products. Readers may wish to consult manufacturers listed here and ELECTRONIC DESIGN's GOLD BOOK for further details.

ACDC Electronics Co., Inc., 401 Jones Rd., Oceanside, CA 92054. (714) 757-1880. (D. W. Purkey). **Circle No. 401**

AEL-E Sub. American Electronic Labs., Inc., P.O. Box 552, Lansdale, PA 19446. (215) 822-2929. **Circle No. 402**

Aladdin Electronics, 701 Murfreesboro Rd., Nashville, TN 37210. (615) 748-3335. (F. G. Bassler). **Circle No. 403**

Anzac Electronic Div., Adams-Russel, 39 Green St., Waltham, MA 02154. (617) 899-1900. (A. Le May). **Circle No. 404**

Arnold Magnetics, 11520 W. Jefferson, Culver City, CA 90230. (213) 870-7014. (R. Pizer). **Circle No. 405**

Automatic Coil, Div. Designatronics Inc., 55 S. Denton Ave., New Hyde Park, NY 11040. (516) 328-3300. (J. Keith). **Circle No. 406**

Axel Electronics Inc., 134-20 Jamaica Ave., Jamaica, NY 11418. (212) 291-3900. (J. P. O'Donnell). **Circle No. 407**

Bel Fuse, 203 Van Vor St., Jersey City, NJ 07302. (201) 432-0463. (H. Bernstein). **Circle No. 408**

Boston Transformer Co., 202 Sidney St., Cambridge, MA 02139. (617) 547-7222. (R. I. Lowe). **Circle No. 409**

Bourns Pacific Magnetics Corp., 28151 Hwy. 74, Romoland, CA 92380. (213) 657-5195. (W. H. Dull). **Circle No. 410**

Caddell-Burns Mfg. Co., 40 E. 2nd St., Mineola, NY 11501. (516) 746-2310. **Circle No. 411**

Cambridge Thermionic, 445 Concord Ave., Cambridge, MA 02138. (617) 491-5400. (L. Wilkes). **Circle No. 412**

Cober Electronics, 7 Gleason Ave., Stamford, CT 06902. (203) 327-0003. (B. Zarkower). **Circle No. 413**

Coil Co. of America, 243 Washington St., Northvale, NJ 07647. (201) 768-3434. **Circle No. 414**

Coil-Ler Mfg. Inc., 22 Town Line Circle, Rochester, NY 14663. (716) 442-6630. (E. E. Dorland). **Circle No. 415**

Component Specialties, 9143 E. La Rosa Dr., Temple City, CA 91780. (213) 287-3221. (D. R. Heins). **Circle No. 416**

Cramer Coil Co., 1121 15th Ave., Grafton, WI 53024. (414) 377-7040. (R. Rubinstein). **Circle No. 417**

Dale Electronics, 1376 28th Ave., Columbus, NE 68601. (402) 564-3131. (C. Novicki). **Circle No. 418**

Del Electronics Corp., 250 E. Sandford, Mount Vernon, NY 10550. (914) 699-2000. (W. Young). **Circle No. 419**

Delevan Div. American Precision Ind., 271 Quaker Rd., East Aurora, NY 14052. (716) 652-3600. (F. E. Riehle). **Circle No. 420**

Design Transformer Corp., 29-16K 49th Ave., Long Island City, NY 11101. (212) 937-1571. (L. Pearlman). **Circle No. 421**

Dietz Design, 100 Electronics Dr., Belton, MO 64012. (816) 331-4911. (E. C. Dietz). **Circle No. 422**

Electrocom Ind., 1105 N. Ironwood, South Bend, IN 46615. (219) 232-2743. (B. Jaffe). **Circle No. 423**

Electrol Co. Inc., 771 Spring Lane, York, PA 17403. (717) 843-0242. (D. Panuce). **Circle No. 424**

Elec Coils Inc., 33 Lyman, Springfield, MA 01101. (413) 736-6339. (R. R. Morner). **Circle No. 425**

Elec. Corp. of America, 5728 W. Washington Blvd., Los Angeles, CA 90016. (213) 931-9484. (H. Norman). **Circle No. 426**

El-Rad Mfg. Co. Ltd., 4300 N. California Ave., Chicago, IL 60618. (312) 478-7300. (J. T. Clark). **Circle No. 427**

ESC Electronics, 534 Bergen Blvd., Palisades Park, NJ 07650. (201) 947-0400. (R. Del Aguila). **Circle No. 428**

Ferrodyne Corp., 4240 Glencoe Ave., Venice, CA 90291. (213) 821-7933. (P. Whalen). **Circle No. 429**

Freed Transformer Co., 1718 Weirfield, Brooklyn, NY 11227. (212) 386-1300. (M. Salzberg). **Circle No. 430**

Fugle-Miller Labs, 130 Market St., Kenilworth, NJ 07033. (201) 241-4411. (J. Dorbracki). **Circle No. 431**

Fuji Electrochemical Co. Ltd., Hamagomu Bldg., 5-36-11 Shinbashi Minato-Ku, Tokyo, Japan. (T. Hashimoto). **Circle No. 432**

General Instrument Corp., Automatic Mfg. Div., Box 517, Chicopee, MA 01021. (413) 594-4781. (A. Adessa). **Circle No. 433**

Houston Transformer Co., 11720 Old Main Loop, Houston, TX 77025. (713) 667-5892. (H. R. Williams). **Circle No. 434**

Hytronics Corp., 6231 72nd Ave., North Pinellas Park, FL 33565. (813) 546-2421. (G. J. Wilson). **Circle No. 435**

Idealee Electronics Corp., 891 Fulton St., Valley Stream, NY 11580. (516) 825-8955. (R. Guss). **Circle No. 436**

Inglot Electronics Corp., 4878 N. Elston Ave., Chicago, IL 60630. (312) 286-5881. (J. Wasik). **Circle No. 482**

James Electronics, 4050 N. Rockwell, Chicago, IL 60618. (312) 463-6500. (M. Moser). **Circle No. 437**

J. B. Electronics Transformers, 2310 W. Armitage Ave., Chicago, IL 60647. (312) 342-0080. **Circle No. 438**

Kappa Networks, 165 Roosevelt Ave., Carteret, NJ 07008. (201) 541-4226. (M. Traum). **Circle No. 439**

Karsten Industries, Bullock Magnetics Div., 2805 Metropolitan Pl., Pomona, CA 91767. (714) 593-3561. (R. C. Teel). **Circle No. 440**

KGS Electronics, 2029 N. Lincoln Ave., Pasadena, CA 91103. (213) 798-0787. (G. Sugimoto). **Circle No. 441**

Mag-Con Inc., 85 2nd Ave. SE, St. Paul, MN 55112. (612) 633-8820. (M. Lorge). **Circle No. 442**

Magnetico Inc., 182 Morris Ave., Holtsville, NY 11742. (516) 654-1166. (H. G. Eicher). **Circle No. 443**

Maxwell Labs, 9244 Balboa Ave., San Diego, CA 92123. (714) 279-5100. (I. Kovalik). **Circle No. 444**

Microtran Co., Inc., 143 E. Mineola Ave., Valley Stream, NY 11582. 561-6050. (W. Benscher). **Circle No. 445**

Nano Pulse Industries Inc., 249-D E. Emerson, Orange, CA 92665. (714) 998-1570. (Jim Rogers). **Circle No. 446**

Neshaminy Transformer, Div. Neshaminy Electronic, Edison-Furlong Rd., Furlong, PA 18925. (215) 794-7411. (P. F. Klein). **Circle No. 447**

New York Coil Co., 40 2nd Ave., P.O. Box 387, Phoenixville, PA 19460. (215) 933-8851. (R. W. Dentler Jr.). **Circle No. 448**

Nytronics Comps. Group Inc., Sub. Nytronics, Orange St., Darlington, SC 29532. (803) 393-5421. **Circle No. 449**

OECO Corp., 712 S.E. Hawthorne Blvd., Portland, OR 97214. (503) 232-0161. (S. A. Meek). **Circle No. 450**

Omnitec Corp., 2405 S. 20th St., Phoenix, AZ 85034. (602) 258-8246. (M. L. Marshall). **Circle No. 451**

PCA Electronics Inc., 16799 Schoenborn St., Sepulveda, CA 91343. (213) 892-0761. (K. H. Dendy). **Circle No. 452**

Phoenix Transformer Co., 1818 E. Madison, Phoenix, AZ 85034. (602) 254-9747. (L. Meddleton). **Circle No. 453**

Pico Electronics Inc., 50 S. Mac Questen Pkwy., Mount Vernon, NY 10551. (914) 699-5514. (J. N. Sweeney). **Circle No. 454**

Piconics Inc., Cummings Rd., Tyngsboro, MA 01879. (617) 7501. (L. Cadran). **Circle No. 455**

Polyphase Instrument Co., E. 4th St., Bridgeport, PA 19405. (215) 279-4660. (R. H. Simmons). **Circle No. 456**

Pulse Engineering Inc., P.O. Box 12235, San Diego, CA 92112. (714) 279-8050. (J. S. Kerr). **Circle No. 457**

Renco Electronics Inc., 240 Old Country Rd., Hicksville, NY 11801. (516) 938-0022. (I. Morse). **Circle No. 458**

Scientific Components Co., 350 Vista Baya, Newport Beach, CA 92660. (714) 642-2543. (F. Walter). **Circle No. 459**

Scott Electronics Corp., 2525 Shader Rd., Orlando, FL 32804. (305) 295-5850. (A. Egan). **Circle No. 460**

Shigoto Industries Ltd., 350 5th Ave., New York, NY 10001. (212) 695-0200. (I. Weinstein). **Circle No. 461**

Skyway Magnetic, Star 2, Warner Springs, CA 92086. (714) 782-3342. (J. Grudziazdz). **Circle No. 462**

Sprague Electric Co., 645 Marshall St., North Adams, MA 01247. (413) 664-4411. (C. G. Kollen). **Circle No. 463**

Sterling Transformer, 510 Driggs, Brooklyn, NY 11211. (212) 782-4200. (P. H. Odessy). **Circle No. 464**

SYT Corp., 2208 Texas, El Paso, TX 79901. (915) 542-1711. (G. T. Doolittle). **Circle No. 465**

TDK Electronics Co., 14-6 2-Chome, Cichikanda, Chiyoda-Ku, Tokyo, Japan. (F. Sono). **Circle No. 466**

Technitrol Inc., 1954 E. Allegheny Ave., Philadelphia, PA 19134. (215) 426-9105. (W. A. Chamberlin). **Circle No. 467**

Tobe Deutschmann Labs, Box 74, Canton, MA 02021. (T. Deutschmann Jr.). **Circle No. 468**

Tohoku Metal Inds. Ltd., No. 13-10, 7-Chome, Ginza Chuo-Ku, Tokyo, Japan. (K. Suzuki). **Circle No. 469**

Toko Inc., 1-17 2-Chome Higashi-Yukigaya Ohta-Ku, Tokyo, Japan. (M. Toida). **Circle No. 470**

Torotel Inc., 13402 S. 71 Hwy., Grandview, MO 64030. (816) 761-6314. (H. Foland). **Circle No. 471**

Torotron, 255 Washington St., Mount Vernon, NY 10553. (914) 664-2050. (M. Frank). **Circle No. 472**

Tranex Inc., 2527 Weston Rd., Colorado Springs, CO 80910. (303) 392-3432. (H. Swight). **Circle No. 473**

Transformer Design Inc., 7377 N. 76th St., Milwaukee, WI 53223. (414) 353-8017. (N. Hellman). **Circle No. 474**

Transformer Techs. Inc., 4447 W. Armitage Ave., Chicago, IL 60639. (312) 276-3110. (A. Werner). **Circle No. 475**

Triad-Ultrad Div., Litton Systems Inc., 305 N. Briant St., Huntington, IN 46750. (219) 356-7100. (J. A. Tracy). **Circle No. 476**

TRW/UTC Transformers, 150 Varick St., New York, NY 10013. (212) 255-3500. (A. A. Profeta). **Circle No. 477**

Valor Electronics, 1642 Kaiser Ave., Santa Ana, CA 92705. (714) 540-9261. (J. Kanter). **Circle No. 478**

Vanguard Electronics, 930 W. Hyde Park Blvd., Inglewood, CA 90302. (213) 678-7161. (G. McHale). **Circle No. 479**

Vari-L Co. Inc., 3883 Monaco Pkwy., Denver, CO 80207. (303) 321-1511. (J. H. Kiser). **Circle No. 480**

Velonex Div., Varian, 560 Robert Ave., Santa Clara, CA 95050. (408) 244-7370. (E. Rudee). **Circle No. 481**

Microcomputer

A new six-volume programmed learning course from Iasis tells you **EVERYTHING** about what microcomputers are and how you can design and implement a microprocessor-based system.

Since the transistor was invented, no single electronics innovation has made such an impact as the microcomputer. Powered by tiny semiconductor chips containing computing elements with the same powers and functions previously found only in large scale digital computers, these dedicated microcomputer systems are now being applied to literally thousands of applications. Microcomputers are automating assembly lines, providing the heart of sophisticated electronic games, making "intelligent" computer peripherals even smarter, and are going so far as streamlining the operations of the fastest food chains. This revolution is occurring because microcomputers are very inexpensive—costing as little as \$30 in production volume—easy to implement into a system, and significantly reduce the time and cost of product development. But there has been one serious drawback to this exploding industry:

Training materials and courses in the basics of microcomputer technology have been virtually non-existent, and the various published manuals and texts have been undecipherable to those not already intimately familiar with ultra-sophisticated logic design.

Once a designer has the hang of it, microcomputer design is a snap. But without the fundamentals—never before available in such a readable, understandable and simplified format—microcomputer design has been unbelievably difficult. The comprehensive, step-by-step six-volume Programmed Learning Course on Microcomputers from Iasis makes the unbelievably difficult almost ridiculously simple. The authors of these texts have been involved on a professional level in the microcomputer industry since it became an industry. Their direct, first-hand experience in the whys, hows, wherefores and potentials of microcomputers

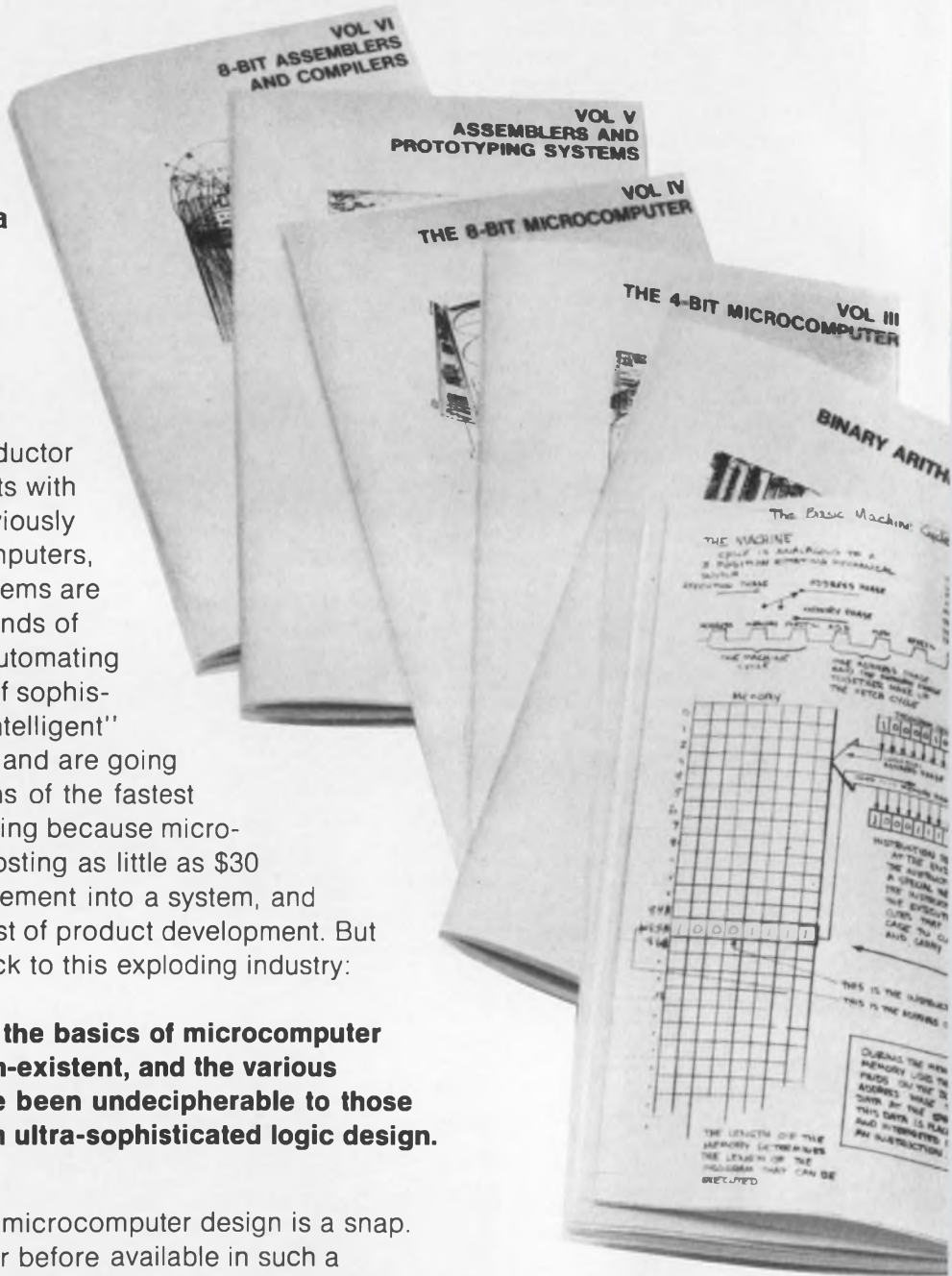

Iasis Texts:

1. Binary Arithmetic
2. Microcomputer Architecture
3. The 4-Bit Microcomputer
4. The 8-Bit Microcomputer
5. Assemblers and Prototyping Systems
6. 8-Bit Assemblers and Compilers

Finally, you can get a comprehensive training course on microcomputers that puts all the hard-to-get information at your fingertips in an easy-to-read, easy-to-understand and even easier-to-implement manner. You can get it here... now. ■ ■ ■ ■ ■ ■ ■ ■

design is a snap.

have made this six-volume collection the most valuable and meaningful series ever published on microcomputer design. The books combine the most effective methods of programmed instruction with the entire gamut of essential information vital to the designer of a micro-based system. You begin with the ABC's of microcomputers and go through a virtual post-doctoral course... **and the unique, self-testing programmed learning lasis course enables you to understand and absorb every bit of the information every step of the way through the six volumes.**



The lasis course gives you more than 700 pages of detailed, illustrated microcomputer information—including more than 1,700 self-tests you use to evaluate your progress—plus programming and design aids that make the design of practical systems very, very easy for you.

Specific details are provided on four of the industry's most versatile microcomputers—the 4004, 4040, 8008 and 8080 from Intel Corporation—but the basic design information will apply to any and all microprocessors. The six volumes you receive with the course are: 1) BINARY ARITHMETIC; 2) MICROCOMPUTER ARCHITECTURE; 3) THE 4-BIT MICROCOMPUTER; 4) THE 8-BIT MICROCOMPUTER; 5) ASSEMBLERS AND PROTOTYPING SYSTEMS; and 6) 8-BIT ASSEMBLERS AND COMPILERS. Plus, this detailed course provides you with two programming pads and two simplified design aids so you may quickly and easily develop both 4-bit and 8-bit microcomputer systems. Use the coupon below to order your course from lasis, Inc., 770 Welch Road, Suite 154, Palo Alto, California 94304.

course are: 1) BINARY ARITHMETIC; 2) MICROCOMPUTER ARCHITECTURE; 3) THE 4-BIT MICROCOMPUTER; 4) THE 8-BIT MICROCOMPUTER; 5) ASSEMBLERS AND PROTOTYPING SYSTEMS; and 6) 8-BIT ASSEMBLERS AND COMPILERS.

Special introductory price on this remarkable new course is just \$99.50... and if it isn't everything we say it is or even more, return it within 15 days for a full refund!



lasis inc.

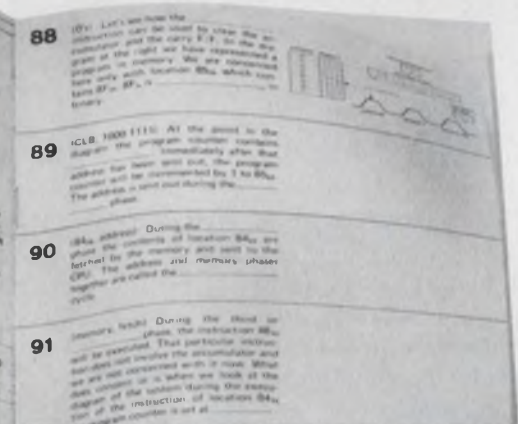

Order before July 31, and you'll save a full \$25 on the Programmed Learning Course on Microcomputers! In addition, all introductory orders will include a bonus seventh volume, the Microcomputer Applications Handbook!

(After July 31, 1975, price for the complete lasis course will be \$124.50, plus \$2.50 for postage and handling.) Introductory offer extended to July 31, 1975!!

Here's my check or money order (no cash, please). RUSH my 6-volume Programmed Learning Course on Microcomputers, including the bonus Applications Handbook and programming aids, to the address below. HURRY!

- Send one complete course for \$99.50 in U. S. funds. My payment is attached. (California residents, please add \$5.97 State sales tax.)
- Send me information by return mail on quantity discounts.

ALLOW 15 DAYS FOR DELIVERY IN THE U. S. AND 6 WEEKS FOR DELIVERY OUTSIDE THE UNITED STATES.



Mail today to: lasis,
770 Welch Road, Suite 154 ED,
Palo Alto, California 94304.

You can use your BankAmericard or Master Charge, too!

CHARGE MY ORDER TO THE CREDIT CARD NO. BELOW:

BankAmericard No. _____

Master Charge No. _____

For Master Charge, add 4-digit number immediately above your name on the card. It is _____

HERE'S MY SIGNATURE _____
(Sign here if credit card charge)

Credit card expiration date _____

NAME _____

ADDRESS _____

ORGANIZATION _____ MAIL STOP _____

CITY/STATE/ZIP _____

Determine transmitter noise figure with the noise-diode approach. With the result, you can characterize and then reduce broadband emissions.

With the right setup, the diode commonly used to measure a receiver's front-end noise figure can also characterize transmitter noise. Among the benefits of the technique are these:

- Very sensitive measurements are possible.
- Sensitivity and bandwidth of the test receiver don't affect the result.
- The noise indicator can work in any mode: peak, average, rms or whatever.

Noise-emission problems can arise when wide-band transistor power amplifiers are used in radio transmitters. Since such noise can jam nearby receivers, which receive a distant station in the same band, the present trend is away from completely broadbanded designs. Therefore there is a need to specify and measure the noise floor of transmitter amplifier stages in an unambiguous way.

Test arrangement isn't complex

In a setup to measure the output of an amplifier under test (AUT), the transmitter operates at 38 MHz, and noise is measured 3 MHz below the carrier (Fig. 1). A 10-dB attenuator prevents severe mismatch of the AUT on its signal frequency by the 35-MHz bandpass filter; the input impedance of the filter at 38 MHz is purely reactive. The filter must reduce the carrier to a level that won't overload the test FM receiver. Alternately, a carrier notch filter or trap can do the same job.

The filtered signal is passed to the sensitive FM receiver through a hybrid whose other input is supplied by the noise diode. In addition a signal generator feeds a 35-MHz cw signal through a 1000- Ω resistor to the FM receiver, tuned to 35 MHz.

To perform the measurement, start with the output of the noise diode and the AUT at zero. Increase the output of the cw generator from zero until the audio voltmeter at the output of the receiver reads, say, 10 dB less of noise output. The quieting is then 10 dB. The exact amount of

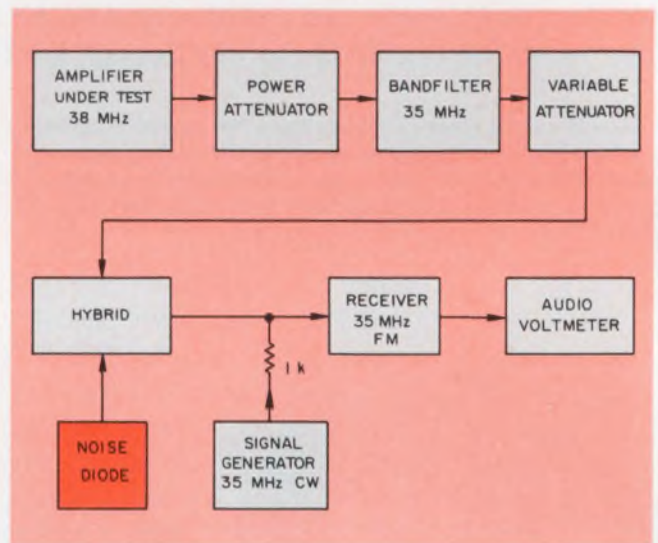

1. To characterize transmitter noise, a receiver can be used in a transfer setup to indirectly compare the transmitter's output with that of a noise diode.

quieting isn't critical, since the figure doesn't enter into the result; neither does the amplitude of the cw signal generator.

Next, increase the output of the noise diode until the quieting is reduced to, say, half value, or 5 dB. Note the reading of the noise diode, a_{n1} . Then return the noise diode to zero output (don't disconnect) and turn on the AUT. Next, adjust the variable attenuator until the voltmeter output shows the same quieting as with the noise diode.

If the setting of the variable attenuator plus that of the power attenuator and the in-band attenuation of the bandfilter equals a_n , the transmitter noise figure, F_T , is given by

$$F_T = a_{n1} + a_n$$

Note that the noise figure and the bandwidth of the receiver do not enter into the result. And since the FM component of the noise has been measured, there's no need to worry about correlating AM and FM noise components or about the peak, average or rms-measuring characteristics of the noise indicators. The method is accurate and repeatable.

What does a noise figure for transmitters

Dieter R. Lohrmann, Electronics Engineer, USAECOM, Fort Monmouth, NJ 07703.

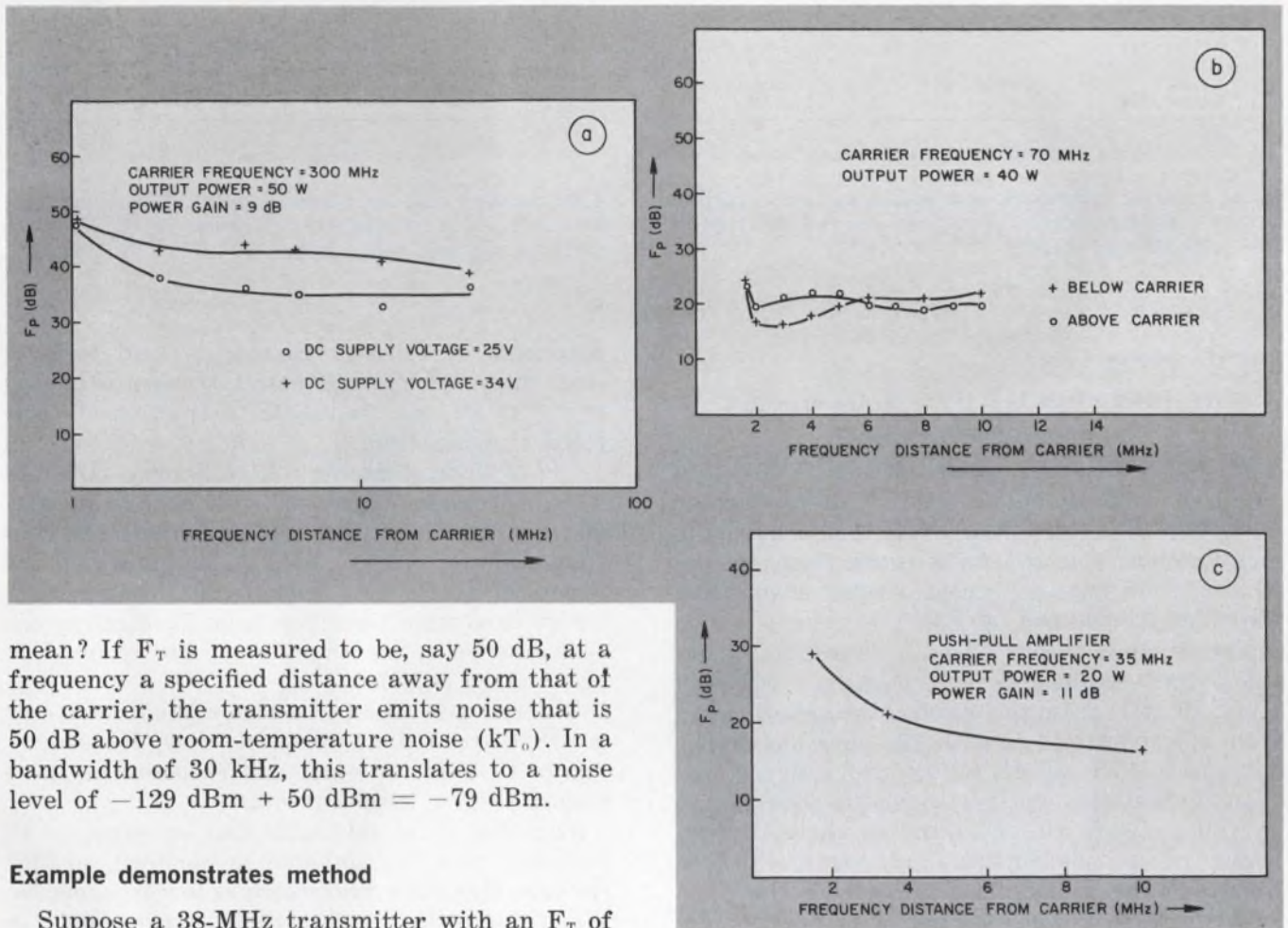

mean? If F_T is measured to be, say 50 dB, at a frequency a specified distance away from that of the carrier, the transmitter emits noise that is 50 dB above room-temperature noise (kT_0). In a bandwidth of 30 kHz, this translates to a noise level of $-129 \text{ dBm} + 50 \text{ dB} = -79 \text{ dBm}$.

Example demonstrates method

Suppose a 38-MHz transmitter with an F_T of 50 dB is placed near a receiver that is tuned to a distant station on 35 MHz. Assume that the attenuation between the receiver and transmitter antenna is 15 dB, that the receiver's noise figure is 10 dB and that atmospheric noise can be neglected. The noise that hits the receiver from the nearby transmitter will be $50 - 15 = 35 \text{ dB}$ above ambient noise. When the transmitter comes on, the receiver acts as if the signal from the distant station had been reduced by $35 - 10 = 25 \text{ dB}$.

To characterize the noise performance of power amplifiers, a definition of a power-amplifier noise figure, F_p , must be introduced. This figure indicates how much the noise of the amplifier ex-

ceeds room-temperature noise, when measured under operational conditions and in a narrow bandwidth at a specified frequency separation from the carrier.

ceeds room-temperature noise, when measured under operational conditions and in a narrow bandwidth at a specified frequency separation from the carrier.

To make the figure independent of the amplifier gain, F_p is referenced to the input; thus F_p becomes a figure of merit. An $F_p = 0$ means that the amplifier does not add any noise of its own—zero theoretically is the optimum achievable figure. Thus F_p is defined by $F_p = 10 \log (\text{Available noise output power})$,

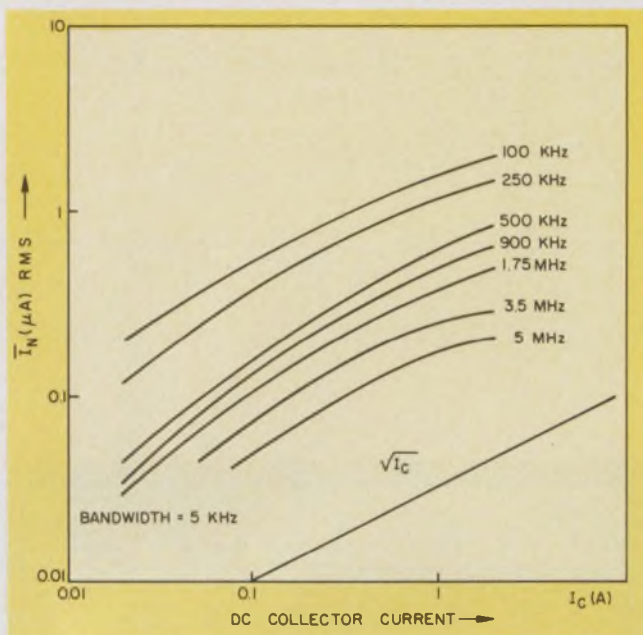

3. At constant bandwidth and frequency, noise current in the collector roughly varies with the square root of the collector's dc current.

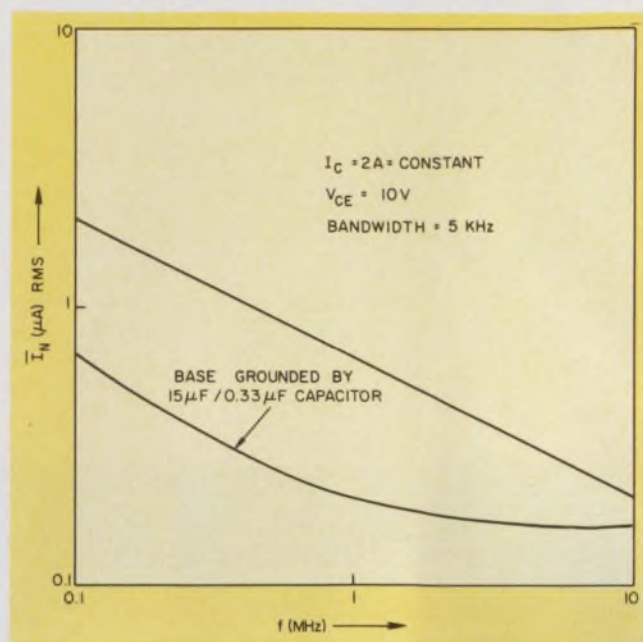

4. At constant collector current, collector noise increases with decreasing frequency as do noise sidebands. With the base shorted, noise drops.

and the power equals

$$\left(\frac{\text{bandwidth } B \text{ at } X \text{ MHz from the carrier}}{\text{Power gain} \times kTB} \right)$$

If the measuring bandwidth is sufficiently small, F_p will be independent of B —a further advantage of the definition. Note that to make the measurement, the transmitter noise figure of the driving source must be considerably lower than the value determined by F_p .

Fig. 2 shows measured noise figures for various output frequencies and powers.^{1,2} Between 1 and 25 MHz from the carrier, the values range from approximately 35 to 50 dB for a uhf amplifier and to 15 to 30 dB for the vhf range.

In general, the tendency is for the noise to rise as you measure closer to the carrier. At first, it appears as if flicker noise in the transistor's dc collector current modulates the carrier. However, since the flicker noise does not extend beyond approximately 100 kHz, and since the noise sidebands extend to 10 MHz and further, a different source of noise must be responsible.

Collector fluctuations modulate carrier

To show this, measure the collector-current noise spectrum of the push-pull amplifier whose noise figure is given in Fig. 2. With a noise bandwidth of 5 kHz and a collector voltage of 10 V, the noise shows little dependence on the collector voltage, but it is strongly related to the dc collector current (Fig. 3). To a first approximation, the noise current is found to be proportional to the square root of the collector current. The

maximum dc collector current is held to 2 A, since most vhf and uhf power transistors, when driven by dc, can stand only a fraction of their rated rf dissipation.

Fig. 4 shows that the collector noise—like the noise sidebands—increases with decreasing frequency. The relationship can be plotted for a constant collector current of 2 A, as shown in the upper curve of Fig. 4. During the measurement the rf base-drive circuit is kept identical to the configuration of the amplifier of Fig. 2: only dc bias voltage is added.

Observe that when the base of the transistor is short-circuited at relatively low frequencies (up to 10 MHz), a significant reduction in noise results (Fig. 4, lower curve).

Thus the noise sidebands can be expected to diminish when the amplifier is modified, so that the base sees a low impedance at low frequencies. When this is done, a 6-to-10-dB improvement in F_p is noted (Fig. 5).

It is possible to calculate the level of the noise sidebands that results when the carrier is modulated by the fluctuations in the dc collector current (Fig. 6). As seen in Fig. 6, good agreement with the measured values is obtained.

To reduce noise, a number of steps can be taken. For instance, though the collector rf peak voltage can exceed V_{ces} by up to 40% without damage in a vhf power transistor, the output noise increases strongly when this happens. Therefore, for low-noise applications, the collector rf peak voltage should not exceed V_{ces} .

Noise introduced by other sources can modulate the carrier. Included are noisy dc power sup-

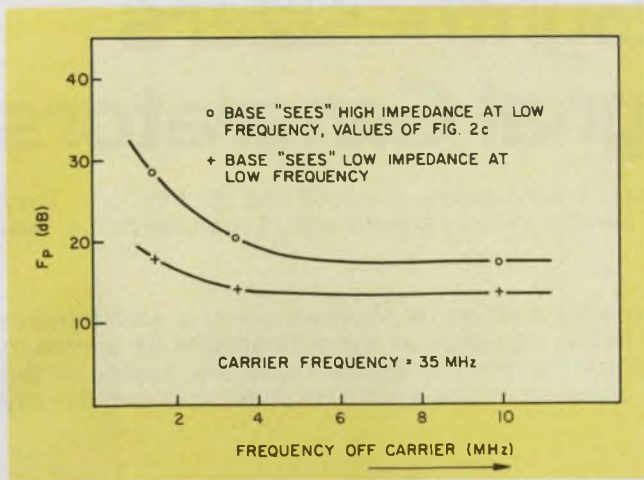

5. To decrease collector noise, the amplifier should be designed to keep the impedance at the base as low as possible at lower frequencies.

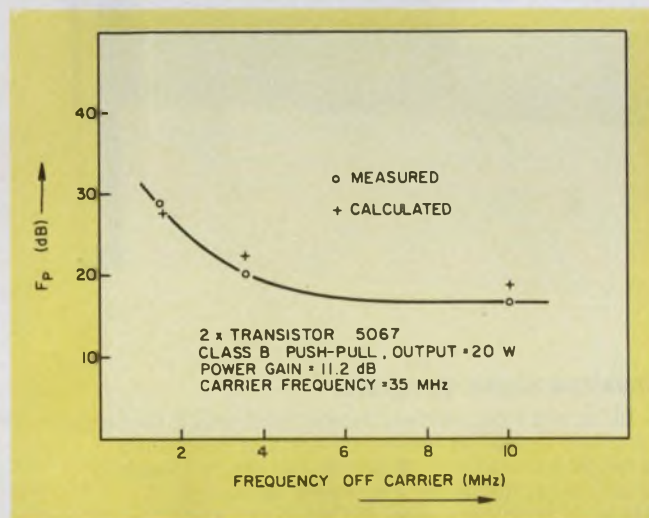

6. Calculated and measured data for a transmitter's noise figure agree closely. To reduce noise, the peak voltage of the collector should remain below V_{CES} .

plies and agc or afc loops. Further, noise can be enhanced when junction capacitances are periodically varied (pumped); this results in spurious oscillations that appear at half frequency or at sum and difference frequencies.³ Amplitude-modulation-like effects are also observed.

In this respect, it is important to avoid low-frequency resonances caused by matching or supply circuits. One precaution here is to insert small series resistances in all base and collector leads. ■■

References

1. Tilley, F. J., "Long Life RF Power Transistors," *R&D Tech Report*, ECON-0447-F, December, 1970.
2. Post, R. E.; Choi, W. K.; Hallock, D. B., "Noise Properties of a VHF Power Amplifier," *R&D Tech Report 0413-F*, June, 1974.
3. Lohrmann, D., "Parasitäre Schwingungen in Hochfrequenz Transistor Leistungsverstärken," *Hervorgeföhrt durch nichtlineare Reaktanz*, T. U. Munchen, February, 1973.

OUR METAL CONE CRTs HAVE 3 ADVANTAGES- PRICE, PERFORMANCE AND AVAILABILITY.



For the same price you'd pay for the all-glass type, DuMont can quickly furnish 16", 19" and 22" metal cone CRTs that offer distinct advantages both for the equipment designer and the end user. The designer will appreciate the weight he can save by eliminating EMI or personnel safety shields. (None are necessary with metal cone construction.) The user will find that the self shielding of the metal cone provides a uniform focusing field, while the high-transmission, uniformly thick faceplate is the flattest screen obtainable for any large-diameter CRT. The sum of these advantages is an extremely sharp edge-to-edge presentation with the smallest possible parallax error.

With the addition of a multi-persistence or multicolor phosphor screen these metal cone CRTs are ideal for displays that integrate low repetition video with computer generated data in radar and process control displays. Air traffic control, manufacturing process control, training simulators, interactive displays and computer terminals are some of the typical applications.

Typical tubes are briefly described below. Many other models are available.

	22 Inch Tubes		16 Inch Tubes	
	KC 3008	KC 3025	K 1222	KC 2745
Useful Screen (in.)	20.00	20.00	14.37	14.37
Focus / Deflection	M/M	M/E	M/E	M/M
Deflection Angle	53°	62°	53°	53°
Line Width (in.)	0.015	0.020	0.018	0.022
Standard Phosphor	P31	P7	P7	P7

For more complete information contact us at 750 Bloomfield Ave., Clifton, N.J. 07015, Tel. (201) 773-2000.

DuMont

A Subsidiary of THOMSON-CSF

INFORMATION RETRIEVAL NUMBER 43

Fluke Frequency Synthesizers & Synthesized Signal Generators

Fluke synthesizers and synthesized signal generators meet a wide variety of needs and applications. They all offer excellent price/performance characteristics. Features include superb signal to noise ratios, outstanding spurious response and purity of signal.

Typical applications

■ Communications—as a local oscillator for receivers and transmitters. ■ Microwave—as a stable incrementally tunable synthesizer for microwave sources. ■ Production test—as a programmable RF source to test filters and other RF devices. ■ The new Model 6010A Synthesized Signal Generator meets all the applications of the most sophisticated bench oscillator. Because it uses a micro-processor, it can directly interface with most autotesting systems.

Model 6160B Frequency Synthesizer with a spur spec > -83 dB guaranteed.

■ Range of 1 to 160 MHz with 1Hz resolution. ■ From 1 to 20 MHz spur spec is -100 dB. ■ BCD programmable frequency control with TTL logic levels. ■ Switching speeds less than one millisecond. ■ Stability to 2 parts in $10^9/24$ hours.

With the best signal-to-noise ratio available and an outstanding spurious response specification, the Fluke 6160B presents the user a new standard of performance in signal sources. And at a price of \$5495, the Fluke 6160B outperforms synthesizers costing many times more.



Model 6010A Synthesized Signal Generator

■ Store, then recall up to ten frequencies, modulation and attenuator settings by pushing a single button! ■ Free-form entry of frequency in Hz, kHz or MHz. ■ Single knob tuning. ■ Automatic range selection. ■ Interfaces directly with most ASCII (IEC) systems. ■ 7-digit LED readout. ■ 10 Hz to 11 MHz coverage. ■ Only 5¼" x 8½" x 19" (13.3 cm x 21.6 cm x 48.3 cm). ■ Price \$2495.

"Smart," small and automated

The Fluke 6010A Synthesized Signal Generator has a microprocessor to give you a new measure of performance. No instrument under \$6,500 (more than twice the price!) even comes close to matching its features.



Model 6039A Frequency Synthesizer—new member of the clean signal gang.

■ 1 to 40 MHz range in 1 Hz steps. ■ Nonharmonic spurious -80 dB to -100 dB. ■ Typical signal to phase noise ratio, 74 dB. ■ Switching speed, less than 0.8 milliseconds. ■ Price, \$3795.

BCD programmability, wide frequency response, electrically adjustable output level and fast switching speed make this TTL compatible synthesizer useful in automatic test systems. The instrument can be used as both a receiver stimulus generator or as a replacement for local oscillators in receivers with medium frequency IF circuits.

Prices are U. S. A. only.

For data out today, dial our toll-free number, 800-426-0361.



John Fluke Mfg. Co., Inc.
P. O. Box 43210, Mountlake Terrace,
Washington 98043.
For a demo circle 294. For literature
only, circle 295.

How sweet it is...



To find over 1000 ratings on the shelf at Old Fashioned prices!



First we'd like to put a "Plug-In" for our Printed Circuit Power Transformers since they are the *most complete and diversified selection available*. There are 5 basic sizes, each available with

115V or 115/230V 50/60 Hz primaries and secondary voltages from 5V to 120V. Our smallest is rated 1 VA and is 0.83 inches high. This allows *1 inch board spacing*. The largest is rated 24 VA (e.g., 24V @ 1A) which is virtually impossible to find as a standard item (except at Signal) and, it is only 1 $\frac{3}{8}$ high.

A special "plug" is warranted for our "LP" series of Flat Plug-Ins which is designed for 6VA with a height of *only 0.85 inches*. Special features are humbucking construction, non-concentric winding, dual 115/230V primaries and outputs from 5 to 230V. This is a Signal exclusive!



You will also find on Signal's shelves the most extensive line of Rectifier Power Transformers and Chokes (5 to 300V, 0.1 to 200 A). They are ideal for use in single or dual output DC power supplies.



The real heavy stuff is on the floor nearby with ratings such as 12V at 1000 Amps and 3 phase transformers with DC output ratings like 24V at 200 Amps.

Something really new is our "2-for-1" series of small power transformers with ratings from 2.4 to 60 VA. A fresh design approach has cut weight, size and cost almost in half with improved performance. Special features include non-concentric winding, solder or quick-connect terminals, and 2500V hipot.

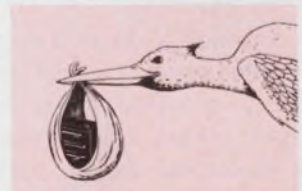

signal transformer co., inc.

1 Junius Street, Brooklyn, N.Y. 11212
Tel: (212) 498-5111 • Telex 12-5709

and Signal has it in Stock!

Switch out microwave phase errors

with the correct diode configuration. Here are tips on what to expect from the three basic switch designs.

With the right rf switches, excessive phase errors in sensitive microwave systems can be reduced. Though not usually thought of as a critical component, an rf switch introduces an unavoidable phase shift, or delay, that must be controlled if the over-all system delay is to meet specified tolerances.

In phase-sensitive systems, such as direction-finding receivers, adaptive arrays and phased-array antennas, multiple rf paths exist between antenna and receiver systems. Each of these paths contains an individual or multithrow switch that provides the needed connection.

Although numerous switch configurations exist, most switch designs are actually versions of one of three basic circuits; series, shunt or series-shunt diode (Fig. 1).

The series switch—the most common—generally carries the lowest price. But it has limited isolation in the OFF state at extended microwave frequencies. The shunt configuration overcomes this problem, while the series-shunt combines the assets of both switch types to obtain the best over-all broadband performance.

All three switches contain both lumped and distributed elements that can increase phase shift over the rated frequency range. And like most problems at microwave frequencies, controlling phase shift gets harder as frequency increases.

Specifying 'insertion phase'

A common term used in characterizing a switch's phase behavior is *insertion phase*. At a given frequency, insertion phase represents input-to-output-port phase delay, relative to the condition of zero electrical length between the ports. Fig. 2 indicates a measurement defining insertion phase. Multithrow switches are measured in the same manner.

A switch's phase delay results from an accumulation of delays caused by physical length and internal circuitry. Electrically much of a microwave switch consists of transmission lines

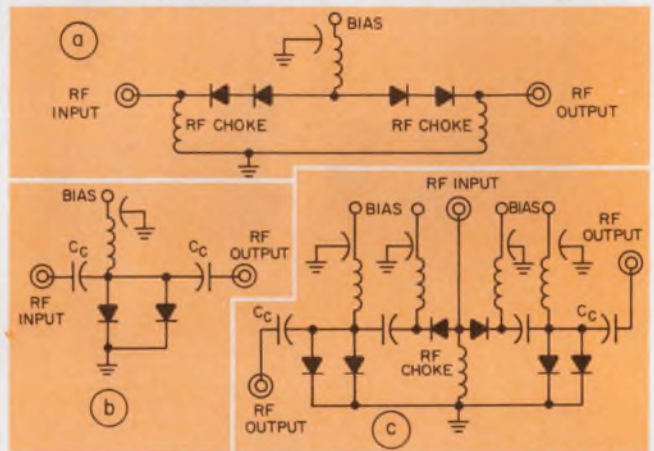

1. Basic rf switch configurations include shunt-diode (a) and series-diode (b) circuits. Both configurations are shown for a single-pole, single-throw switch. The series-shunt circuit, which combines features of the others, is shown for a single-pole, double-throw switch (c).

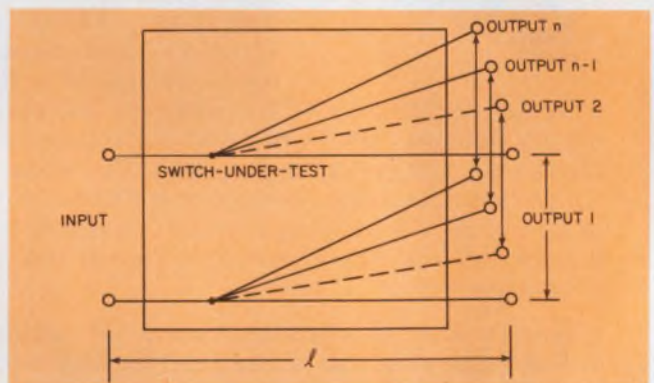

2. Insertion phase is the phase difference (horizontal axis) from the input to outputs 1 through n. The measurement assumes zero electrical length between the ports. Phase differential gives insertion phase between outputs.

having the same characteristic impedance as the over-all system—usually 50 Ω . Phase delay associated with the transmission line can be found from the following:

$$\phi = \beta l,$$

where $\beta = 2\pi/\lambda$, l = length of transmission line (meters), λ = wavelength (meters) and ϕ represents a signal on the line.

The expression shows that the phase— $2\pi l/\lambda$ —increases linearly with length or with frequency.

Generally the wavelength on a transmission line is shorter than that for free space, because of the presence of a dielectric medium. In some cases transmission may be dispersive; not all the transmission media used in a switch can support a pure TEM mode. For these reasons and more, intimate details of the switch design must be known for accurate prediction of the phase delay contributed by the transmission line.

A microwave switch's internal circuitry consists of these three components—semiconductor

appear as large capacitive reactances in series with the transmission line.

The principle advantage of the series switch over other types is its economical configuration. It can be fashioned readily into multithrow configurations without severely affecting performance. And the series switch has considerably higher isolation than a shunt configuration does at C band and lower frequencies. A four-diode series switch can exhibit greater than 90-dB isolation to 1 GHz, and 75 dB to 4 GHz.

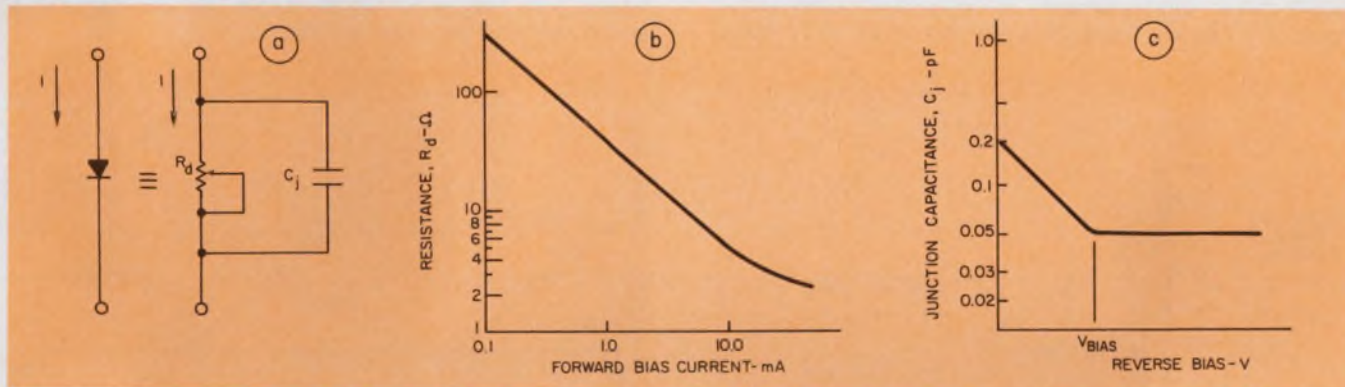

3. P-i-n diodes—the usual switching devices in rf units—have an RC equivalence (a). A diode's resistance

varies inversely with dc flow (b). Its bias voltage, V_{BIAS} , is based on the diode's junction-capacitance curve (c).

switching devices, transmission-line elements and bias circuitry—to control the ON-OFF state of the semiconductor. Ideally the semiconductor device should behave as a short or open circuit, depending on the device's state, while the effects of bias circuitry on rf performance should be negligible. In practice, semiconductors exhibit small series resistance—2 to 3 Ω —in their forward bias state, and they appear as a relatively high-Q capacitance in the reverse bias state. The effect of the bias circuitry can never be totally excluded, since the circuitry displays reactance and resonances, which can affect performance.

Generally the semiconductor switching devices are p-i-n diodes, either forward or reverse-biased. Fig. 3 shows a diode's equivalent circuit and its typical characteristic. Note that resistance varies inversely with the dc current flowing through the diode.

In a series switch, diodes are forward-biased in the ON state. Since the small series resistance parallels the diodes' high capacitive reactance, the diode has little effect on insertion phase. A parasitic inductance is also present, but careful design usually minimizes its detrimental effects.

In some designs as many as four diodes are placed in series to obtain improved isolation. Even with this number, insertion phase in the ON state isn't increased significantly over that of a single diode. But the situation changes dramatically in the OFF, or isolation, state. Insertion phase alters significantly because the diodes

The phase behavior of a series-diode switch is shown in Fig. 4 for a single-pole, double-throw unit that covers the frequency range of 10 MHz to 1 GHz. The curves represent plots of measured insertion phase for the two output arms. Over the entire frequency range, the switch achieves an arm-to-arm tracking error, or differential phase, of 1 degree maximum. Fig. 5 shows a series switch designed for C-band operation.

Shunt switch uses low-pass filter

In a shunt switch, diodes are embedded in a low-pass filter—usually a constant-K design, which doesn't require precise selection of each diode capacitance value. The insertion-phase characteristic of a constant-K filter differs from that of a transmission line, or equivalent-series switch (Fig. 6). But like the series switch, the shunt type has a drastically altered insertion phase in the isolation state. There, diodes appear as high conductances in shunt with the transmission line.

The shunt switch's main asset is its ability to perform to 18 GHz. However, for optimized performance, shunt switches generally must be built as microwave integrated circuits. And this requirement increases costs.

The phase behavior of the series-shunt switch combines that of the two other types. Transmission-line and low-pass filter characteristics dominate insertion phase in the ON state. The se-

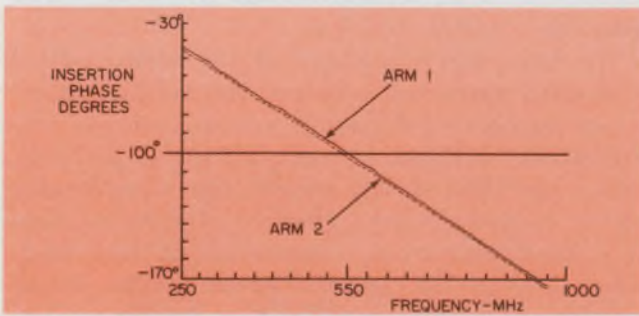

4. The insertion-phase curves of a series switch—American Electronics Laboratories' SOA 3608 single-pole double-throw unit—exhibit a maximum differential phase of 1 degree. The switch operates down to 10 MHz.

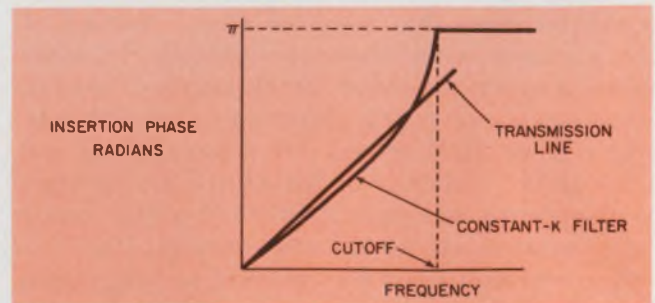

6. Use of a constant-k filter in shunt switches yields an insertion phase that increases with exponential-like behavior with frequency, up to cutoff. By comparison, a series switch's behavior is linear.

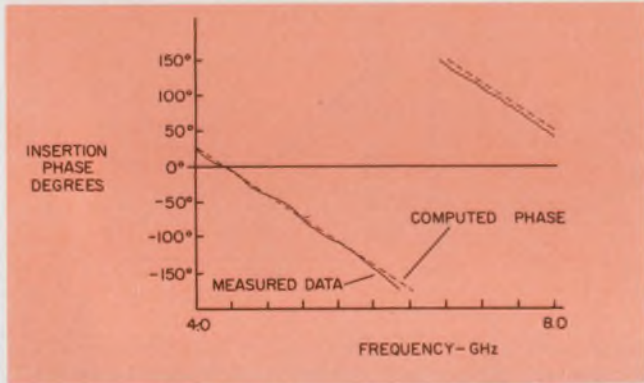

5. Insertion phase can be computed accurately, as shown with these curves of a single-pole, double-throw series switch designed for C band. The switch was modeled and analyzed with the aid of a computer.

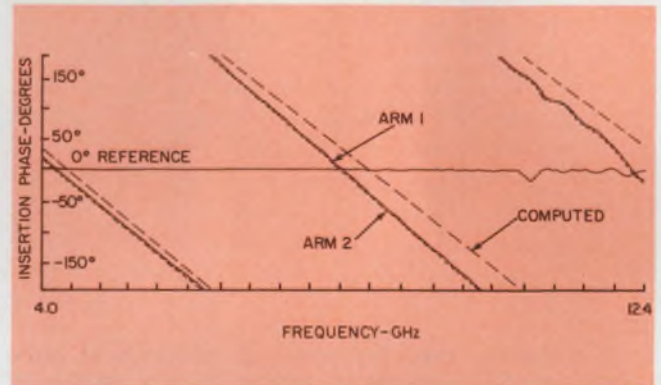

7. Arm-to-arm tracking can be controlled to a few degrees at 12 GHz with a series-shunt switch—AEL's SOM 3650 single-pole, double-throw unit. The switch operates down to 2 GHz.

series-shunt configuration appears in multithrow switches operating throughout J band and requiring simultaneously both low insertion loss and high isolation. In addition the series-shunt can be operated to very low frequencies with isolation levels not possible with the shunt switch.

Isolation of 60 dB throughout its frequency range of operation is typical for a series-shunt switch. Insertion-loss levels are about 0.5 dB at 1 GHz, and they increase progressively to about 2 dB at 18 GHz.

A 2-to-18-GHz series-shunt switch has the measured characteristics shown in Fig. 7. Computed results have also been plotted. The difference between the two sets of data results from an approximation of the transmission dielectric constant and neglect of bias chokes in the computed results.

Other sources of insertion phase errors result from fabrication techniques. In a multithrow switch, for example, separate transmission paths exist for each throw of the switch. If insertion phase delay of each path is to be equal, within tolerances, the manufacturer must meet stringent requirements, even though some aspects of the fabrication are difficult to control.

Tolerances on the dimensions of the switch housing and component parts are a case in point. A 10-mil variation in a 1-in. path at 18 GHz in-

roduces about 12 degrees of phase error (assuming the path to be loaded with Teflon).

The tolerance of a transmission line's dielectric constant from batch to batch, and its variations with temperature and frequency, are other important considerations. Also, connector dimensions must be controlled closely; in many cases they contribute a significant portion of the switch's electrical length.

In addition to these factors, the tolerances of the reactive and active elements of the switch require careful scrutiny. The shunt switch has critical element values, because they control the characteristics of the low-pass filter. And narrow-band switch designs actually have more critical element values than do broadband designs; phase delay of a tuned circuit varies π radians across the circuit's passband. With phase delay changing so rapidly, the elements creating the narrow bandwidth must be controlled closely to obtain uniformity from arm to arm as well as switch to switch.

One limitation of present testing techniques is the inability to characterize transient conditions fully. Methods of phase measurement over a period of a few nanoseconds aren't readily available. And an attempt at a computed analysis suffers from the lack of an accurate description of p-i-n-diode transitions. ■■

HiNIL Interface

Keeping the bugs out of microprocessor systems with high noise immunity logic.

An MOS microprocessor system can be troubled by disastrous bugs unless it is protected against noise transients generated by switches, electromechanical peripherals and other nearby noise sources, such as lamps and machinery. But filters and shielding, the traditional cures, are often difficult to add to a microprocessor because of size and cost constraints.

These problems can be avoided by substituting HiNIL interface devices for conventional I/O logic. HiNIL—Teledyne's bipolar High Noise Immunity Logic—has a guaranteed DC noise immunity about 10 times that of TTL, for example (3.5 vs. 0.4V). Also, HiNIL blocks AC transients large enough to cause TTL malfunctions. Two additional advantages are superior output drive and, in low power systems, protection of CMOS memory and random logic inputs.

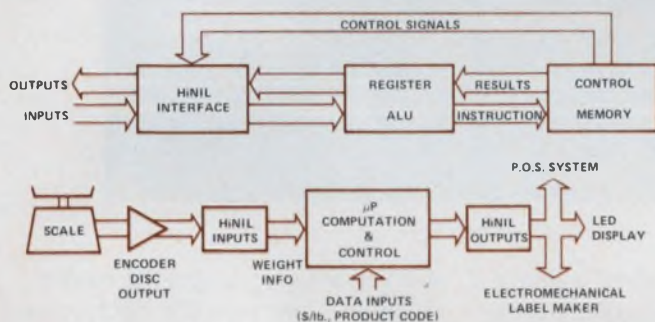

Figure 1. Use of HiNIL interfaces in POS systems with electronic scale. Top diagram shows basic microprocessor configuration.

One manufacturer of microprocessor-controlled electronic scales decided to use the configuration in Figure 1 because he was concerned about the consequences of incorrect weights and prices. The probability of errors resulting from noise transients was high because the scale would be used in a supermarket POS system, where the environment includes refrigerators, fluorescent lamps, meat grinders and electromechanical label makers.

In the system, the microprocessor receives weight codes from an encoder disc in the scale and operates a cash register interface, LED display, and relays of a receipt printer or label maker. The system designers put HiNIL interface logic on the microprocessor board to handle the I/O functions, suppress noise transients picked up along the transmission lines, and drive the peripheral devices. HiNIL output interfaces can drive long lines, relays, displays and lamps without additional components since they sink up to

65 mA and source up to 12 mA. (The new 390 buffer series will sink up to 250 mA.)

Manufacturers of systems requiring random logic are finding that HiNIL and CMOS are an ideal combination. They maximize system noise immunity and assure an excellent system function/power product. HiNIL and 54C/74C CMOS interface directly at V_{CC} voltages from 10 to 16 volts, the power supply range of HiNIL. Moreover, HiNIL protects CMOS inputs from destruction by static electricity and from harmful DC input levels that can exist before CMOS circuits are powered up.

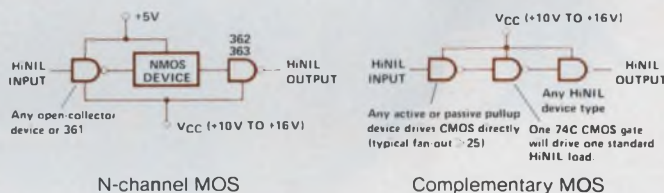

Figure 2. Typical HiNIL/MOS and HiNIL/CMOS interfaces

The rules for using HiNIL with MOS or with CMOS operating at lower voltages are simple. The pullup resistor of an open collector HiNIL device is connected to the desired high logic level voltage (see Figure 2). To use HiNIL with other bipolar logic, just plug in a Teledyne dual or quad interface circuit (see table). HiNIL is also compatible with most analog devices.

Examples of HiNIL Interface Devices

301 Dual 5-Input Power Gate	65mA relay or lamp driver
302 Quad Power NAND Gate (OC)	
323 Quad NAND Gate (OC)	Input noise protection plus open-collector pullup to other logic levels
332 Hex Inverter (OC)	
334 Strobed Hex Inverter (OC)	
350 8-Bit Multiplexer	Drive longer lines than TTL with 10X noise immunity ($I_{OH} = 12mA$)
351 Dual 4-Bit Multiplexer	
361 Dual Input Interface	361 directly connects HiNIL to DTL, RTL, TTL
362 Dual Output Interface	362 and 363 connect DTL, RTL, TTL to HiNIL
363 Quad Output Interface	
367 Quad Schmitt Trigger	Suppress 100V, 1µs spikes, protect CMOS, decode switches, etc.
368 Quad Schmitt Trigger (OC)	
380 BCD to Decade Decoder	
381 BCD to Decade Decoder (OC)	Provide decode drive for lamps, LEDs, gas discharge displays, etc.
382 BCD to Decade Decoder	
383 BCD to 7-Segment Decoder	
390 Interface Buffer Series	250mA HiNIL driver series will be available soon

If you need a simple, inexpensive solution to a difficult noise problem, write or call Teledyne Semiconductor for a copy of application notes and specifications on Teledyne's High Noise Immunity Logic family.

TELEDYNE SEMICONDUCTOR

1300 Terra Bella Avenue, Mountain View, California 94043 Tel: (415) 968-9241 TWX: 910-379-6494 Telex: 34-8416

ENGLAND: Heathrow House, Cranford, Hounslow, Middlesex, Tel: (44) 01-897-2503 Telex: 851-935008

FRANCE: 90, Avenue Des Champs Elysees, 75008 Paris, Tel: 2563069 Telex: 842-29642

WEST GERMANY: Albert Gebhardtstrasse 32, 7897 Tiengen, Tel: 7741-5066 Telex: 841-792-1462

JAPAN: Nihon Seimei-Akasaka Bldg (3F), 1-19, Akasaka 8-chome, Minato-ku, Tokyo 107, Tel: 03-405-5738 TWX: 781-2424241

Additional offices in West Germany, Hong Kong and the United States. Representatives and distributors worldwide

INFORMATION RETRIEVAL NUMBER 46

Shouldn't a CRT display reflect your system's true performance?

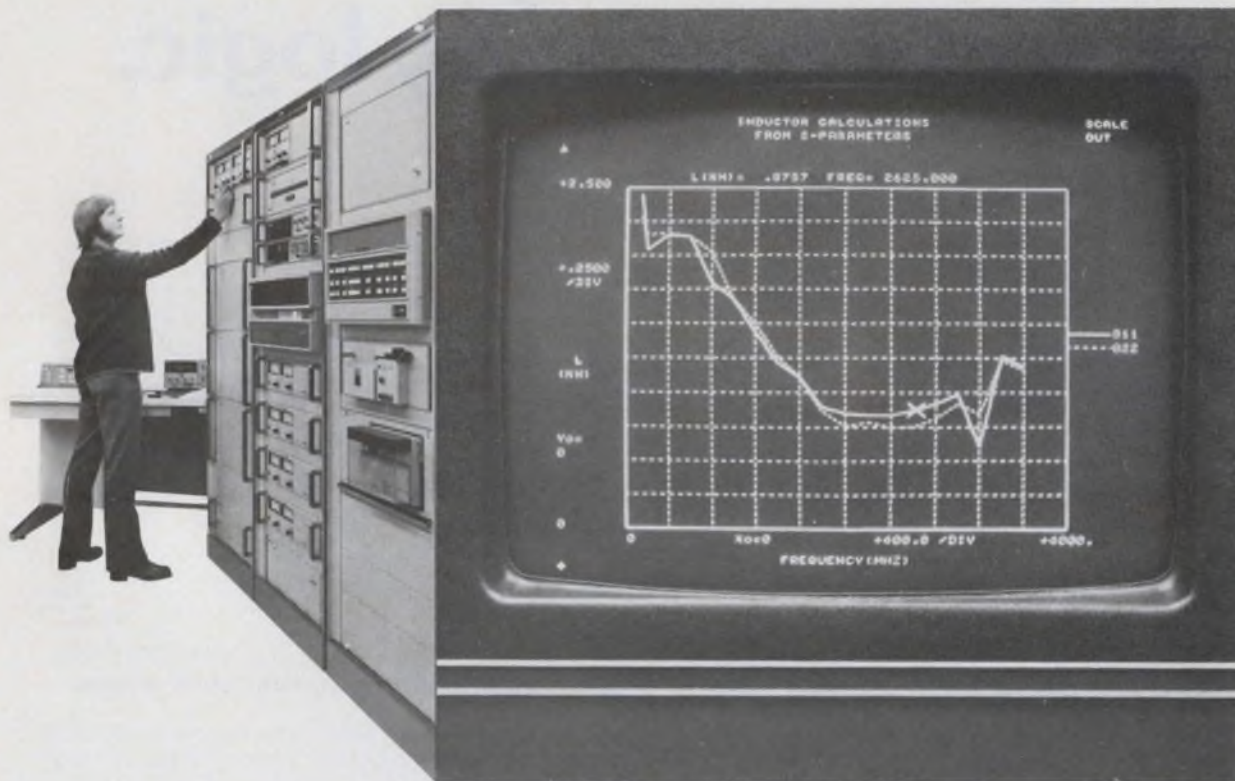

(Model 1317, 17" Diagonal Display)

Count on it with an HP display... including new large-screen models with improved performance your OEM systems demand. The high writing speed and fast settling time of our 14- through 21-inch displays means simplified output programming and greater information density in computer graphics, analytical research, radar and other display applications. Yokeless electrostatic deflection simplifies operation, eliminates geometric correction circuitry and unnecessary delay lines, and reduces required power by a factor of 5 or more. Bright, easy-to-read displays result from the 28.5 kV accelerating potential. And dy-

amic focusing assures a sharp trace at any screen location, over a wide range of intensities.

You also get versatility in HP displays. A variety of standard options allow you to tailor a display to your system's needs. Our rugged new 1317A and 1321A models give you options of TTL blanking input, differential inputs and gamma correction to match your system design and simplify interface problems. You have a choice of CRT sizes and shapes for stand-alone or rack-mounted applications. And you can get various phosphors that range from slow P7 and P39 to fast P31

In addition to top performance

and versatility, you get the quality, reliability, and product safety you expect from a leader in CRT technology. Optional UL listing is available. Plug-in board construction simplifies servicing...and HP's worldwide support means rapid parts replacement and service—an important consideration when you're designing a display into your system. So, for a display that reflects your system's true performance, look into HP's large-screen display family. For more information, contact your local HP field engineer. Or, write Hewlett-Packard.

084/6A

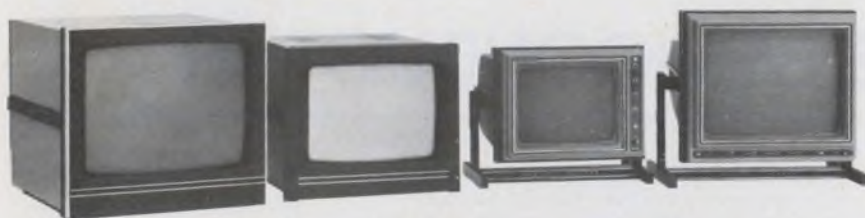

FOR TECHNICAL INFORMATION 281
FOR IMMEDIATE APPLICATIONS ASSISTANCE 282

HEWLETT  PACKARD

Sales and service from 172 offices in 65 countries.
1501 Page Mill Road, Palo Alto, California 94306

The way our distributors stock Wood Electric Circuit Breakers, they're practically on the way to you right now.

Fast delivery, that's what it's all about. Circuit Breaker ratings from 0.5 to 60 amperes. Voltages from DC to 400 Hz. Trip times instantaneous to 75 seconds, at 200% of rated load. Many are UL Recognized and CSA Listed. Call your Wood distributor, or write Potter & Brumfield Division, AMF Incorporated, Princeton, Indiana 47671. Phone: 812-385-5251.

AMF
Potter & Brumfield

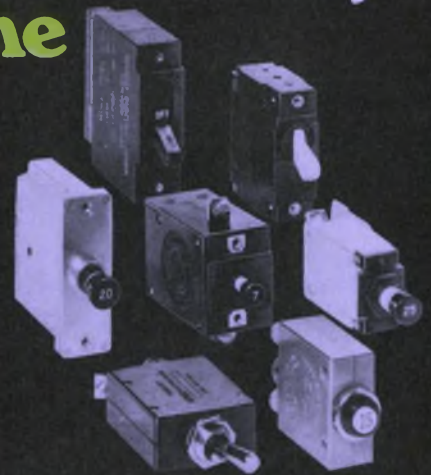

P&B circuit breaker distributors

ALABAMA
Birmingham
M. G. Electronics & Equipment Co.
205/328-4525

ARKANSAS
Ft. Smith
Wise Wholesale Electronics, Inc.
501/783-8925

CALIFORNIA
Culver City
Avnet Electronics Corporation
213/559-4111
Hamilton Electro Sales
213/871-7171

EL SEGUNDO
Liberty Electronics Division
213/322-8100
Garden Grove
Allied Electronics Corporation
714/894-7581

HAWTHORNE
Standard Sky Stores
213/679-2561

INGLEWOOD
Newark Electronics Corporation
213/678-0441

IRVINE
Cramer/Los Angeles Div.
714/979-3000

LOS ANGELES
California Wholesale Electric Co.
213/723-6711

MT. VIEW
Elmar Electronics
415/961-3611

OAKLAND
Brill Electronics
415/834-5888

RIVERSIDE
Electronic Supply
714/683-8110

SOUTH SAN FRANCISCO
Van Dusen Acft. Supplies
415/589-3133

COLORADO
Denver
Cramer/Denver Div.
303/758-2100

CONNECTICUT
Fairfield
U-Tronics, Inc.
203/255-4521

NORTH HAVEN
Cramer Electronics, Inc.
203/239-5641

FLORIDA
Miami
Electronic Equipment Co., Inc.
305/871-3500

OAKLAND PARK
Peerless Radio Corporation of
Florida Inc.
305/566-5966

ORLANDO
Brownell Electro
305/843-6770

PENSACOLA
Grice Electronics, Inc.
904/433-4616

TAMPA
Hammond Electronics
813/253-0104

WINTER PARK
Electronic Equipment Company
305/644-4833

GEORGIA
Atlanta
Lykes Electronics Corporation
404/355-2223

HAWAII
Brownell Electro, Inc.
404/762-5181

ILLINOIS
Broadview
L Comp—Chicago, Inc.
312/865-7600

CHICAGO
Electro-Kinetics, Inc.
312/286-4200
Newark Electronics Corporation
312/638-4411

EIGHT
Allied Electronics
312/697-8200
Elk Grove Village
Cooper Aviation
312/439-3050

DIPLOMAT/LAKELAND ELECTRONICS, INC.
312/595-1000
Joliet
Avionics Associates, Inc.
815/792-0820

PALATINE
OHM/ Electronics, Inc.
312/359-5500

PEORIA
Klaus Radio, Inc.
309/691-4840

INDIANA
Evansville
Hutch & Son, Inc.
312/425-7201

INDIANAPOLIS
RA. DIS. CO., Inc.
317/357-5571

KANSAS
Wichita
Radio Supply Co., Inc.
316/267-5216

KENTUCKY
Lexington
Radio Electronic Equipment Co.
606/255-6661

LOUISIANA
Lafayette
P. I. Burks Company
502/583-2871

LOUISIANA
Lafayette
Ralph's of Lafayette
318/234-4507

MARYLAND
Kensington
Marine Air Supply
301/949-1353

MASSACHUSETTS
Boston
Sager Electrical Supply Co.
617/542-2281

BURLINGTON
Wilshire Electronics/New England
617/272-8200

NEWTON
Cramer Electronics
617/969-7700

SPRINGFIELD
T. F. Cushing, Inc.
413/788-7341

WATERTOWN
Sterling Electronics
617/926-9720

MICHIGAN
Detroit
R S Electronics
313/491-1000

WYOMING
Newark Industrial Electronics
616/241-6681

MINNESOTA
Minneapolis
Northern Airmotive Inc.
612/726-5700

ST. PAUL
Gopher Electronics
612/645-0889

MISSOURI
Bridgeton
Van Dusen Aircraft Supplies
314/731-1700

NORTH KANSAS CITY
L Comp Kansas City
816/221-2400

ST. LOUIS
L Comp St. Louis
314/647-5505

MONTANA
Billings
Glacier State Electric Supply Co.
406/252-4663

NEBRASKA
Omaha
Omaha Airplane Supply Co.
402/422-6666

NEW JERSEY
Cherry Hill
Cramer/Pennsylvania
609/662-5061

CLIFTON
Wilshire Electronics/New Jersey
201/365-2600

HANOVER
State Electronics Parts Corp.
201/887-2550

PENSACOLA
RESCO
609/662-4000

NEW MEXICO
Albuquerque
Walker Radio Co., Inc.
505/247-2288

NEW YORK
Binghamton
Harvey Electronics of Binghamton
607/748-8211

BUFFALO
Summit Distributors, Inc.
716/884-3450

EAST SYRACUSE
Cramer/Syracuse Div.
315/437-6671

FARMINGDALE
Arrow Electronics
516/694-6800

GARDEN CITY
Standard Aircraft Equipment, Inc.
516/747-8787

HAUPPAUGE
Cramer/Long Island Div.
516/231-5600

LONG ISLAND CITY
H. L. Dalis, Inc.
212/361-1100

LYNBROOK
Peerless Radio Corporation
516/593-2121

ROCHESTER
Masline Electronics, Inc.
716/546-5373

NORTH CAROLINA
Charlotte
Brownell Electro Inc.
704/394-4341

GREENSBORO
Hammond Electronics of
Carolina, Inc.
919/275-6391

RALEIGH
Southeastern Radio Supply
Company
919/828-2311

WINSTON-SALEM
Kirkman Electronics, Inc.
919/724-0541

PIEDMONT AVIATION
919/767-5431

OHIO
Akron
Sun Radio Company
216/434-2171

CINCINNATI
Hughes-Peters, Inc.
513/351-2000
Schuster Electric
513/221-6040

CLEVELAND
Pioneer-Cleveland
216/587-3600
Columbus
Hughes-Peters, Inc.
614/294-5351

DAYTON
Esco, Inc.
513/224-9192

LIMA
Lima Radio Parts Company, Inc.
419/228-1220 419/223-5075

SOLON
Repco Div.
216/248-8900

WARREN
REM Electronics
216/399-2777

OKLAHOMA
Oklahoma City
Electro Enterprises, Inc.
405/239-7561

TULSA
Oil Capitol Electronics Corporation
918/836-2541

OREGON
Eugene
Vitus Electric Supply Company
503/345-4377

PORTLAND
Platt Electric Supply Company
503/228-6121

PENNSYLVANIA
Allentown
A. A. Peters
215/434-5237

BRADDOCK
M. Leff Radio Parts Co., Inc.
412/271-2800

MCKEESPORT
Barno Radio Company
412/462-7574

MONTGOMERYVILLE
Pytron Industries, Inc.
610/643-2511

READING
Barbey Electronics
215/376-7451

SPRING HOUSE
Avionics Associates, Inc.
215/643-6555

YORK
Rosen Electronics Company
717/843-3875

RHODE ISLAND
Providence
Wm. Dandreta & Company
401/861-2800

TENNESSEE
Knoxville
Industrial Electronics, Inc.
615/573-7135

MEMPHIS
Brownell Electro, Inc.
901/332-9254

MID-AMERICA AVIONICS DISTRIBUTORS
901/396-4400

NASHVILLE
Electra Distributing Company
615/255-8444

TEXAS
Dallas
Associated Aircraft Supply, Inc.
214/331-4381

DALLAS AVIONICS, INC.
214/243-6391

HAMILTON/AVNET ELECTRONICS
214/638-2850

FT. WORTH
Allied Electronics
817/336-5401

GARLAND
Newark-Dallas Electronics Corp.
214/271-2511

HOUSTON
Harrison Equipment Company
713/224-9131

WASHINGTON
Bellingham
Superior Electrical Supply, Inc.
206/734-5500

SEATTLE
Platt Electric Supply, Inc.
206/624-4083

RADAR ELECTRIC COMPANY
206/282-2511

WISCONSIN
Cedarburg
A-A Electric
414/377-8000

Voltage-reference LED also provides visual indication of overload condition

In power-supply regulator applications, a LED can serve both as an inexpensive visual indicator of an overload problem and the voltage reference. The use of low-cost LEDs as voltage references has an additional important advantage: At low forward currents, the LED's temperature coefficient approximates that of the base-emitter junction of a transistor.¹

The figure shows a typical series voltage regulator with a LED as a part of a constant-current-source circuit, which includes components Q_3 , R_1 , and R_2 . The regulator power-control transistors are Q_1 and Q_2 , and the circuit components that put the regulator into a protective constant output-current mode in an overload situation are Q_4 and R_5 .

Components R_3 and D_1 control the LED's level of illumination. Under normal operation Q_1 is off, and the only source of bias current for the LED is R_2 . Since the value of R_2 limits the current in the LED to a small value, so that the LED's temperature-coefficient matches the Q_3 emitter-

base junction, the LED's luminescence is barely visible. However, the brightness increases in intensity in proportion to the degree of overload when Q_1 turns on in an overcurrent situation.

Diode D_1 prevents R_3 from disturbing the regulated drive current for Q_2 in normal regulator operation. Though the overload current now includes the current through R_3 , this current is usually an insignificant contribution to the total short-circuit current.

For the component values shown, the LED begins to increase in brightness as the output current approaches 750 mA, and it reaches full intensity when the output terminals are short-circuited.

Reference

1. Leffert, P. A., "LED Used as Voltage Reference Provides Self-Compensating Temperature Condition," *Electronic Design*, Feb. 15, 1975, p. 92.

Gordon Bloom, System Analysis Group Leader, IRT Corp., P.O. Box 80817, San Diego, CA 92138.

CIRCLE No. 311

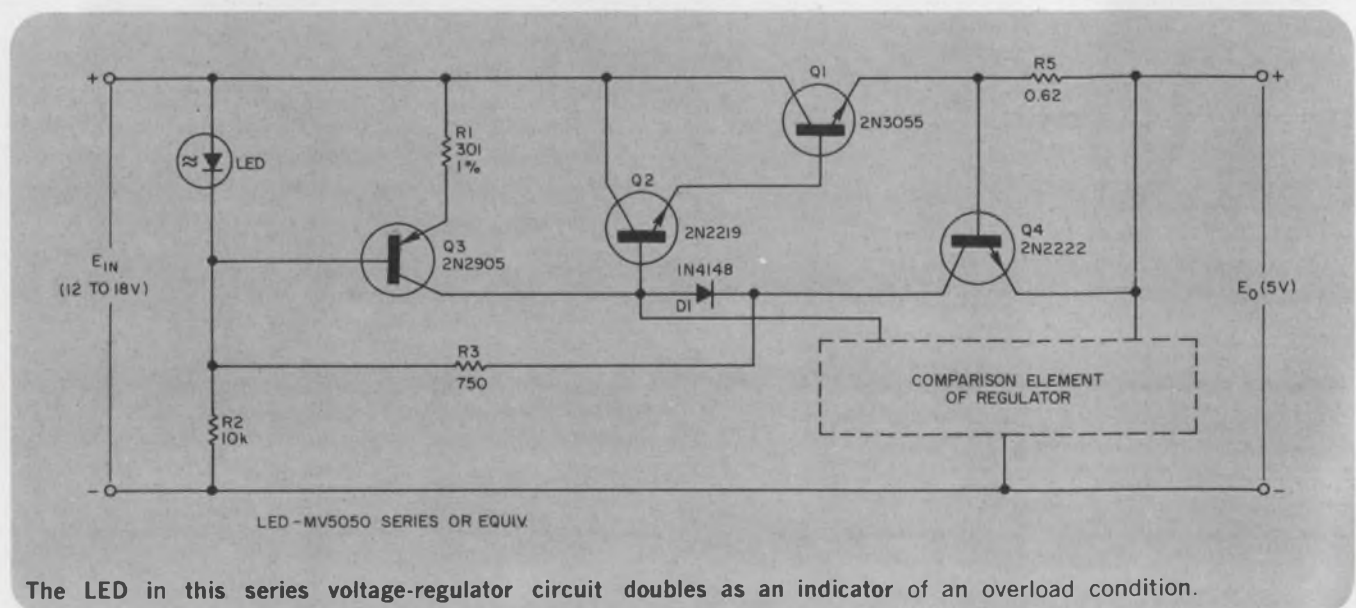

The LED in this series voltage-regulator circuit doubles as an indicator of an overload condition.

It's new. It's drop-proof. It's burnout-proof. It's super-safe. The Triplet Model 60-A. "extra-plus"



Besides drop-proof, burnout-proof and super-safe features you can also have such extras as 1½% DC Accuracy and mirrored scale for only \$100. All are built-in the new Triplet Model 60-A.

It is a new V-O-M design concept that withstands about 90% of the misuses of V-O-M's in the field and on the test bench. You can forget about repair bills and costly downtime that often happen with conventional testers after misuse.

The new Model 60-A is ideal for vocational training schools, tv, radio and stereo repair shops, appliance and automotive maintenance, electronic/electrical circuit designers, industrial manufacturing quality control and maintenance, and, of course, its accuracy is a must for test and research labs.

With the new Triplet Model 60-A you can forget about such misuses as — cracked cases from accidental drops, burned-out meter movements due to inadvertent range or test function settings. It's also made to be super-safe for the user.

The 28-range, lab accuracy Model 60-A gives you such other "extra-pluses" as: a special "Confidence-Test" position built-into the tester for periodic reassurance checks of its meter; rugged 4½" suspension movement meter, complete in separate case for easy replacement in the field; a polarity reversing switch; single range selector switch used for the eight DCV ranges from 0.3 to 1000, six ACV from 3 to 1000, four DCmA from 0.1 to 1000 and five resistance ranges from 1k to 10Meg.

The new Triplet Model 60-A sells for only \$100. See it at your local Distributor or Mod Center. For more information, or for a free demonstration, see him or your nearest Triplet sales representative. Triplet Corporation, Bluffton, Ohio 45817.

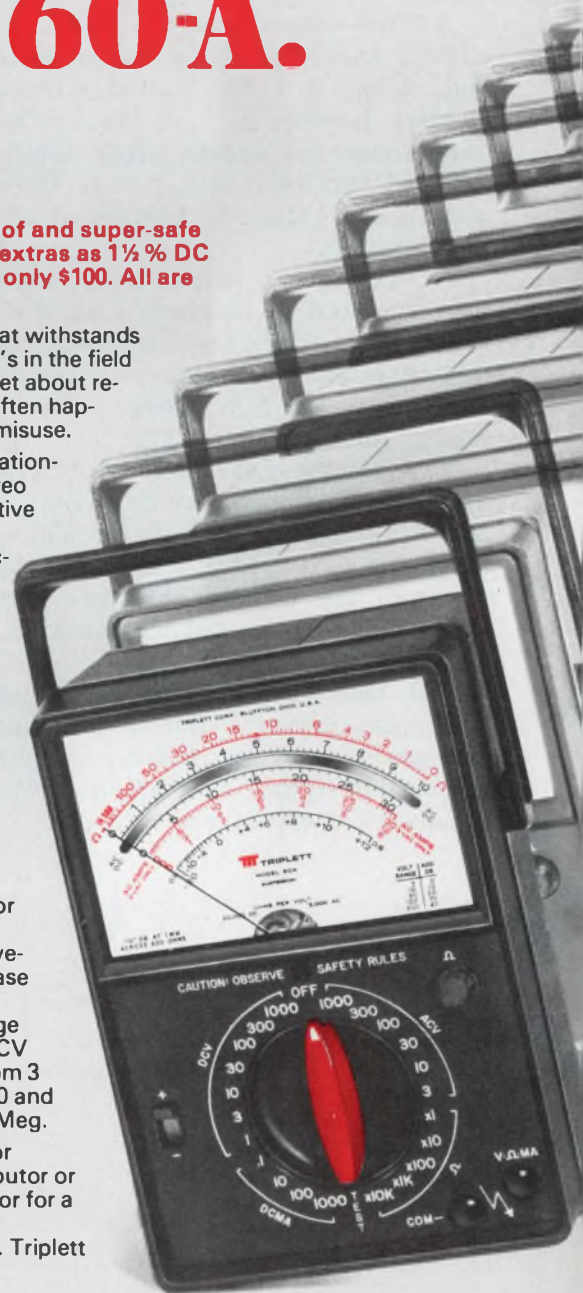

1. DROP-PROOF. Virtually indestructible for an accidental drop up to a five foot height with deviation from stated accuracy not exceeding ± 4%.

2. BURNOUT-PROOF. Protected by diodes and unusual three fuse arrangement including 1/8 Amp, 1 Amp and 2 Amp/1,000 V fuses. Maximum protection level provided by the 2 Amp/1,000 V (20 kW) fuse.

3. SUPER-SAFE. Designed to most rigid safety standards to prevent explosive arcs in high energy circuits, up to the 2 Amp/1,000 V (20 kW) fuse capacity; completely insulated unit with newly designed safety leads.

TRIPLETT
BLUFFTON, OHIO 45817

Super safe
Triplet. The easy readers.

Square-wave frequency divider provides symmetrical output for odd divisors

With the ICs and a flip-flop you can build a circuit that will divide a clock signal by odd or even integers from 2 to 32 and provide symmetrical outputs.

An up-down presettable, 16-bit synchronous counter, the 74193, operates in the down mode (Fig. 1). Its input comes from a 74153 multiplexer. The counter borrow output toggles the flip-flop and also pulses its own parallel-load input.

A 5-bit binary number, which represents the divisor from 2 to 32, is applied at inputs d_4, d_3, d_2, d_1, d_0 , where d_0 is the least-significant bit. If the number is even, $d_0 = 0$, the multiplexer output reproduces the system clock input. When the selected number is odd, $d_0 = 1$, the phase of the multiplexer output is determined by the state of the flip-flop.

If the flip-flop output Q is ZERO, the multiplexer output is in phase with the clock input. But if Q is ONE, the multiplexer output pulses are inverted. The counter is then triggered in phase with the falling edges of the clock signal instead of the rising edges.

The number that is entered into the counter at inputs d_4, d_3, d_2, d_1 has a value of only $n/2$ for even numbers and $(n - 1)/2$ for odd numbers, because the d_0 is used in the multiplexer, not in the counter. The counter therefore starts to count down from these smaller amounts after it is loaded by the borrow pulse.

Note that when n is odd (Fig. 2, where $n = 7$), the phase-reversal action of the multiplexer output produces a count loss for every half cycle of its output signal. This action accounts for the symmetrical output with odd divisors.

When $d_0 = 0$ for even numbers, the output flip-flop toggles in synchronism with a falling edge of the input clock. But when $d_0 = 1$ for odd numbers, the output flip-flop triggers alternately, first in step with a falling edge and then with a rising edge of the clock signal input.

The maximum frequency of this circuit is limited by the counter's loading time and the delays through the flip-flop multiplexer counter loop. Clock frequency periods T_c must be larger than the sum

$$T_c > D_b + D_f + D_m,$$

and the counter's load-command delay, D_L , must be smaller than half a clock period,

$$D_L < \frac{T_c}{2},$$

where D_b = borrow-output pulse width,

D_f = flip-flop delay,

D_m = multiplexer delay.

When n is an odd number, capacitor C widens the borrow-output pulse. This holds the counter's load line so the load condition overlaps the multiplexer output spike. The spike is thus prevented from triggering the counter.

Bibliography

Chen, C.F., "Design of a Divide-by-N Asynchronous Odd-Number Counter with 50/50 Duty Cycle," *Proceedings of IEEE*, September, 1974, pp. 1278-9.

J.L. Huertas, Associate Professor of Electronics, and A. Civit, Professor of Electricity, Facultad de Ciencias, Universidad de Sevilla, Spain.

CIRCLE NO. 312

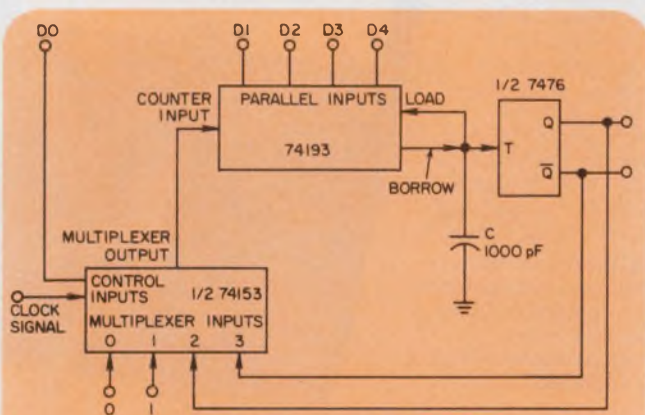

1. In this divide-by- n circuit, the multiplexer inverts the phase of the counter input for every half cycle of the output when n is an odd number.

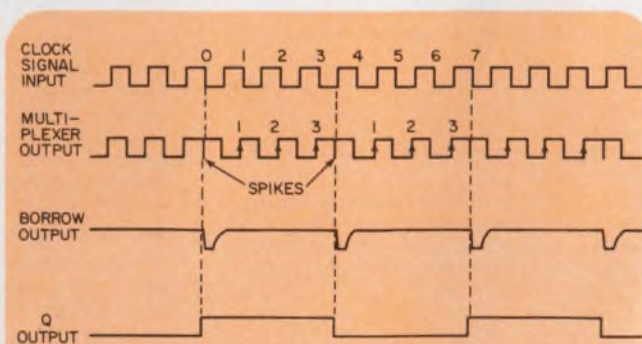

2. Timing diagram of a divide-by-7 sequence shows how the counter input is reduced by one count for every half cycle for odd values of n . This is because the phase of the input signal is reversed every half cycle. The counter registers only on rising edges.

Here's what's new in pots and trimmers from TRW/IRC Potentiometers



Precision Wirewound Potentiometers
CIRCLE NO. 221



.330" Diam. Panel Potentiometer
CIRCLE NO. 222

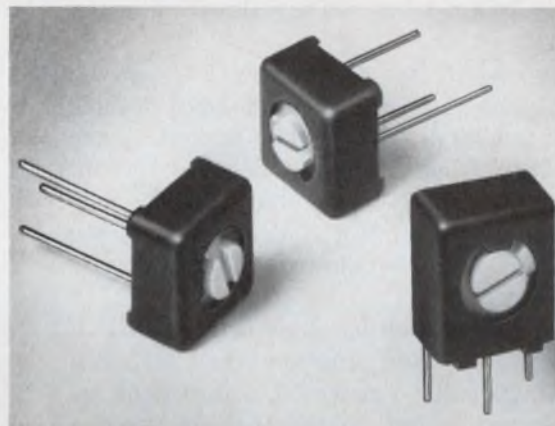

1/4" Square Type 180 Cermet Trimmers
CIRCLE NO. 223

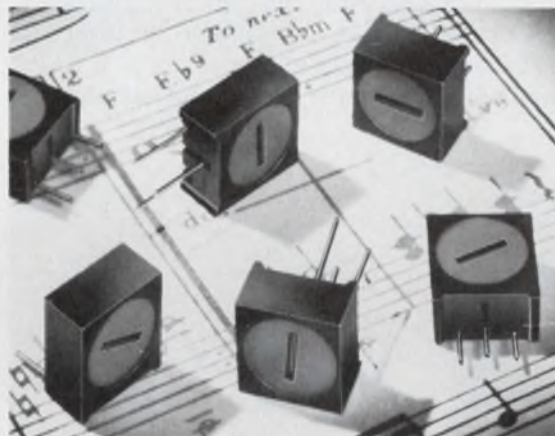

3/8" Square Type 76 Cermet Trimmers
CIRCLE NO. 224

Precision Potentiometers:

7/8" to 3" diam., 1 to 6 watts, wide range of options, including 0.1% linearity

0.330" Diam. Panel Pot:

Type 9917 rated at 0.5W @ 85° C,
100 ohms to 1 megohm linear,
non linear and squelch tapers.

1/4" Square Trimmer:

Rated at 0.5W @ 70° C, three mounting styles, 100 ohm to 1 megohm

3/8" Square Trimmer:

Rated at 0.5W @ 70° C, six basic mounting styles, four with CW and CCW rotation

For additional information, contact your TRW/IRC Potentiometer Distributor or write TRW/IRC Potentiometers, 2801-72nd Street, North, St. Petersburg, Florida 33733 (813) 347-2181

TRW[®] IRC POTENTIOMETERS

Make simple voltage-level detectors with CMOS inverters

Simple voltage-level detectors can be made with CMOS inverters, because their input threshold voltage is proportional to the supply voltage. If a CMOS inverter input is held at a constant voltage developed across a resistor by a constant-current diode, the supply voltage terminal can serve as the input of a voltage-level detector (Fig. 1a).

The voltage level to be detected, V_B , can be between 3 and 15 V, which is the normal operating range of a CMOS supply. The output of the inverter is high when V_B rises, because the inverter's threshold voltage rises above V_I , the voltage developed across R_1 . When V_B drops and the inverter's threshold goes below V_I , the inverter's output goes low.

Fig. 1b shows a dual-level detector. With a second resistor, R_2 , and another inverter, two levels of voltage can be detected. Additional resistors and inverters can further extend the circuit to detect multiple levels.

CMOS gates, buffers and some level-sensitive inputs—such as the set, reset or inhibit inputs of CMOS LSI or MSI circuits—can also be used in level-detection configurations.

The circuit can be used for such applications

as in undervoltage or overvoltage protectors, simple A/D converters, window comparators and battery monitors. For example, when a 10-cell NiCd battery is charged and discharged rapidly at two to three times rated capacity, it is necessary for the preservation of battery life to limit the maximum full charge voltage and also the minimum discharge voltage. The limits are generally 14.6 and 11 V, respectively, at room temperature.

A typical CMOS inverter has a threshold of $V_T = 0.45 V_{DD}$. Thus to design such a dual-threshold limit circuit (Fig. 1b), for the lower limit of 11 V, set

$$V_1 = 0.45 \times 11 = 4.95 \text{ V}$$

and for the upper limit of 14.6 V, set

$$V_2 = 0.45 \times 14.6 = 6.6 \text{ V}$$

Since $I_1 = 220 \mu\text{A}$ for a 1N5283 constant-current diode, it follows that

$$R_1 = 22.5 \text{ k}\Omega$$

and

$$R_2 = 7.5 \text{ k}\Omega$$

Thomas T. Yen, Senior Staff Engineer, Gould, Inc., Statham Instruments, Inc., 2230 Statham Blvd., Oxnard, CA 93030.

CIRCLE NO. 313

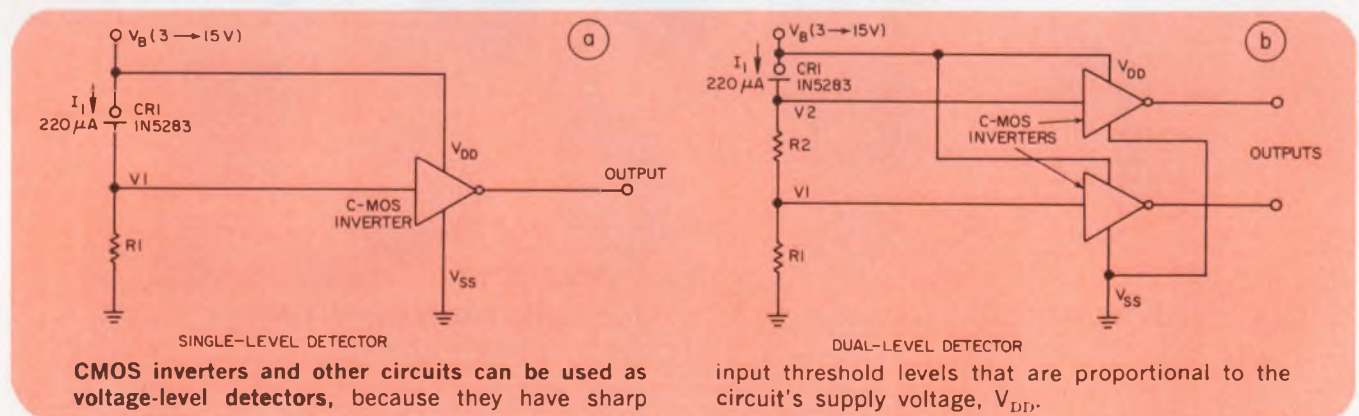

IFD Winner of February 15, 1975

R. Marshall Jr., Sustaining Engineer, Signetics, 811 E. Arques Ave., Sunnyvale, CA 94086. His idea "Easy-to-Build FM Signal Generator Uses a Phase-Locked Loop and an AM Input" has been voted the Most Valuable of Issue Award.

Vote for the Best Idea in this issue by circling the number for your selection on the Information Retrieval Card at the back of this issue.

SEND US YOUR IDEAS FOR DESIGN. You may win a grand total of \$1050 (cash)! Here's how. Submit your IFD describing a new or important circuit or design technique, the clever use of a new component or test equipment, packaging tips, cost-saving ideas to our Ideas for Design editor. Ideas can only be considered for publication if they are submitted exclusively to ELECTRONIC DESIGN. You will receive \$20 for each published idea, \$30 more if it is voted best of issue by our readers. The best-of-issue winners become eligible for the Idea of the Year award of \$1000.

ELECTRONIC DESIGN cannot assume responsibility for circuits shown nor represent freedom from patent infringement.

SIEMENS

New Zener Wall Chart from Siemens

When it comes to Zeners, Siemens has your number and then some. And, the standard types are all included on this handy wall chart-selection guide. An earlier offer, when our Zeners were sold under the Dickson name, proved so popular that we have up-dated the chart to include the new expanded Siemens line.

From low cost commercial to highly sophisticated, ultra-reliable applications, Siemens has the exact voltage regulating (Zener) and voltage reference (TC) diode you need. And, you have the assurance that each and every Siemens Zener has the quality that can only come from the leader in high-rel devices.

Siemens offers 49 popular JEDEC series plus custom and proprietary devices in one of the most extensive lines of commercial and military Zeners available. With this product versatility and with our specialized Zener production facilities in Arizona, it's no wonder Siemens is looked upon as the preferred Zener Source by a growing number of systems and equipment manufacturers.

When you need Zeners, consider the extra quality and fast service of "the Zener specialists." For your wall chart, just drop us a note.

**Siemens: Where Quality And
Resources Make The Difference.**

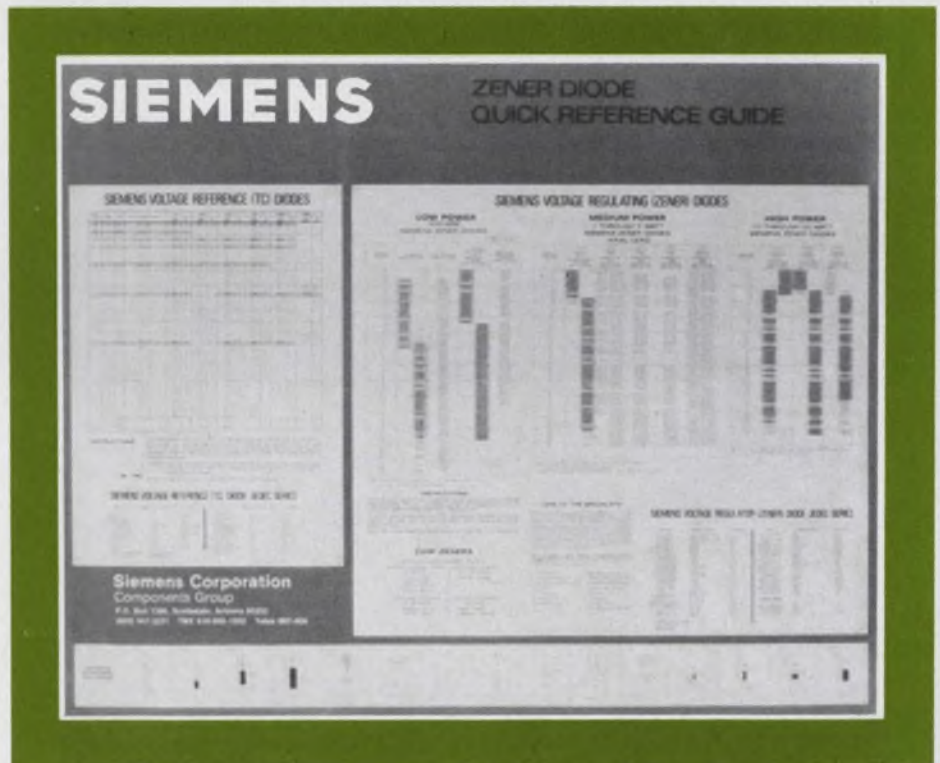

Siemens Corporation
Components Group

P.O. Box 1390, Scottsdale, Arizona 85252
(602) 947-2231 TWX 910-950-1292 Telex 667-406

INFORMATION RETRIEVAL NUMBER 51

Frequency doubler gives pure sine wave

A different kind of frequency-doubling circuit that gives a pure sine-wave output has been produced at the Dept. of Electronic and Electrical Engineering of the University of Sheffield, England. The circuit uses only bipolar silicon junction transistor arrays, and so can be fabricated by IC technology.

The circuit operates down to almost zero frequency, and the upper limit is determined by the frequency limitations of the transistors. The more traditional approach is to apply a fundamental frequency into a nonlinear device and to extract the doubled frequency from the harmonics gener-

ated in the device.

In operation, the Sheffield design has a square-root-law circuit made up of transistors Q_1 to Q_7 . These are taken from two n-p-n device arrays. The output current of this circuit is given by

$$i_o = \sqrt{(i_1^2 - i_2^2)}$$

To provide sinusoidal drive, provision is made for a bilateral input current. Transistors Q_8 to Q_{13} make up a full-wave current rectifier. Standard full-wave rectifier techniques are ruled out, because they require a transformer.

Transistors Q_8 and Q_9 form one n-p-n current mirror, and Q_{10} , Q_{11} and Q_{12} , Q_{13} form two p-n-p current mirrors. For instantaneous

flow i_{in} towards the inputs, only Q_8 , Q_9 and Q_{10} , Q_{11} are activated. For an opposite-polarity input current, the current mirror Q_{12} , Q_{13} is activated. Thus, regardless of the input polarity, the outputs of the two current-mirror systems feed the root-law circuit in the required direction.

Radiation absorption reduced in polymers

Solid castings of polyethylene and polypropylene, made by a new method, have much lower losses for microwave and far-infrared radiation, according to researchers at the British Post Office Research Dept., Dollis Hill, London.

This improvement in materials, Post Office researchers contend, brings nearer the possibility of a new broadband microwave communication system that, like fiber-optics used for visible-light frequencies, requires a polymer that is transparent to microwaves.

The researchers concluded that impurities in conventional processing and additives, sometimes used to prevent degradation, cause most of the microwave absorption. The new method requires no additives and boils off many of the impurities.

Starting materials for the new process are electrical-grade isotactic polypropylene, propylene/6%-ethylene copolymer and high-density polyethylene. All are in powder form and free of antioxidant additives.

In the Post Office experiments, the powders were packaged into aluminum boats up to 1 m long. The boats were placed in a vacuum chamber, and the pressure was reduced to about 10^{-5} torr. The samples were heated in the chamber to about 260 C for 18 hours and then cooled to room temperature; they solidified as rectangular bars.

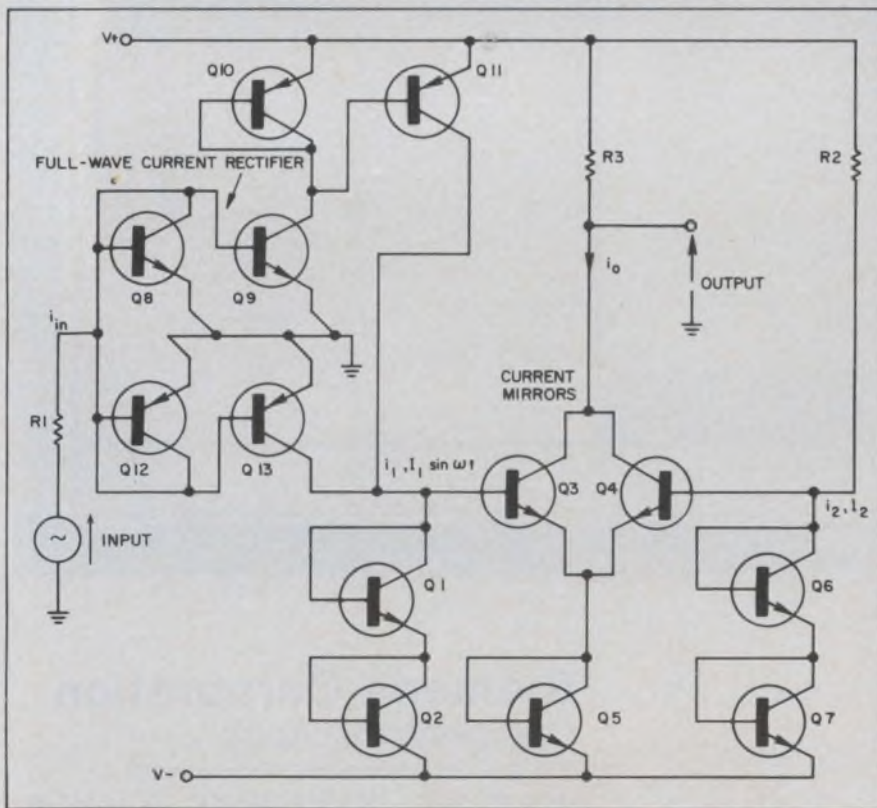



Which of these
spring contacts
can you get
from Instrument Specialties?

None of them!
(But we'll make some just for you!)

Sorry, we can't sell you any of the springs shown here. They're all proprietary. Each was designed for a specific application at a particular company. A very particular company. Which is why each one came to I/S!

But I/S can do the same *kind* of thing for you. Specialists in the design and manufacture of beryllium copper springs, we can create springs with your choice of many types of gold, silver, or other precious metal contacts.

Perhaps you require large welded contacts, with precious metal bonded to inexpensive base material. Or, small welded contacts in which precious metal is welded directly to the spring. Or, riveted contacts offering close tolerances with either single or double headed contacts. Instrument Specialties supplies all of them!

One other thought: Sometimes, you may *think* you need welded or riveted contacts. However, our engineers may feel that our CONTIP® bonding technique, or our gold selective plating process, or the use of inlay material, can meet your needs at considerably less cost. If so, we'll tell you that, too.

Our latest catalog contains complete information on all types of I/S spring contacts. For your free copy, circle the Reader Service Card or write us at Dept. ED-81.

Specialists in beryllium copper springs since 1938



INSTRUMENT SPECIALTIES CO., INC.
Little Falls, New Jersey
Phone 201-256-3500

International Rectifier.

New 10 Amp device makes one-stop shopping easy for fast-switching power transistors.

Now, IR is your source for a wide variety of 3, 5 and 10 Amp JEDEC fast-switching power transistors, to simplify your buying. These hard-glass passivated devices are the ones to use for better reliability and lower costs in line operated power supplies, whether you're chopping line voltages at 20 KHz or inverting and stepping down at high frequency.

Fast Switching Speed—Cooler Operation . . . the oscillographs show typical fall times in the one-micro-second and lower range. Gives extremely low switching losses for cooler operation and higher reliability.

Lower Leakage — High Temperature Stability . . . with I_{CEO} in the micro-amp range, IR devices are about one-tenth the accepted leakage rates of others. Provides the higher stability important for high performance at elevated temperatures.

High Second Breakdown — High Reliability . . . high second breakdown helps provide a broad safe-operating area for an extra margin of safety.

Glass Passivation — Long Term Reliability . . . high reliability and long term stability is achieved by hard glass passivation. Also, if you're using chips to make your own circuits,

IR's glass passivation gives you the most stable, easy to assemble chips you can start with, making your yields higher.

If you are paralleling devices, the tight gain, switching time and saturation voltage control of these transistors make the job easier. And through 100% testing of key parameters we can provide even closer matching if necessary.

JEDEC types listed are immediately available, so contact your local IR salesman, rep or distributor today.

International Rectifier, 233 Kansas Street, El Segundo, California 90245. (213) 678-8261.

New International Rectifier Fast Switching Power Transistors

IR Part No	V _{CEO} (sus) (Max V)	I _C Peak (A)	h _{FE} (min./max)	β (A)	V _{CE} (sat) (Max V)	I _C (A)	P _d (W)	t _f /t _r (μs)
2N6306	250	16	15/75	3.0	0.8	3.0	125	.6/4
2N6307	300	16	15/75	3.0	1.0	3.0	125	.6/4
2N6308	350	16	12/60	3.0	1.5	3.0	125	.6/4
2N6542	300	10	7/35	3.0	1.0	3.0	100	.7/8
2N6543	400	10	7/35	3.0	1.0	3.0	100	.7/8
2N6544	300	16	7/35	5.0	1.5	5.0	125	1/1
2N6545	400	16	7/35	5.0	1.5	5.0	125	1/1
2N6249	200	30	10/50	10.0	1.5	10.0	175	2/1
2N6250	275	30	8/50	10.0	1.5	10.0	175	2/1
2N6251	350	30	6/50	10.0	1.5	10.0	175	2/1

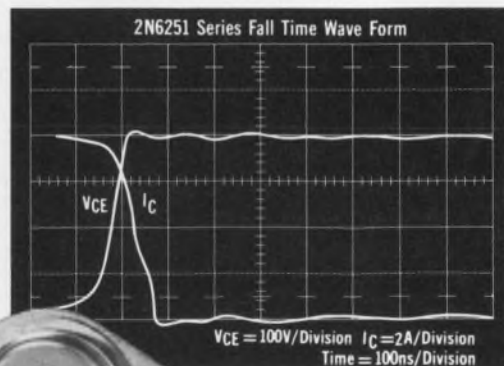
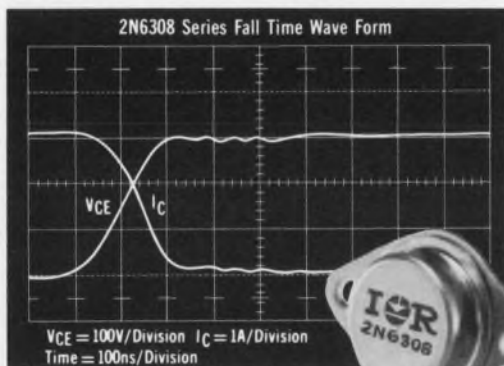

INTERNATIONAL RECTIFIER
the innovative power people



SEMICONDUCTOR DIVISION, 233 KANSAS STREET, EL SEGUNDO, CALIFORNIA 90245, PHONE (213) 678-6281

New Products

Direct synthesizer programs in 20 μ s, is inexpensive



Programmed Test Sources, 194 Old Pickard Rd., Concord, MA 01742. (617) 369-2482. See text.

At \$3650, and with a 20- μ s switching speed, the PTS 160 synthesizer from Programmed Test Sources undercuts the popular Fluke 6160B synthesizer in price by 33% and outstrips the 6160 in switching time by a factor of 40.

The key to fast, programmable switching in the 160-MHz PTS unit is direct synthesis of frequencies—usually more expensive than the indirect method but fast because all frequencies are present simultaneously. With a novel design that reduces the parts count, Programmed Test Sources has hurdled the price barrier and, theoretically at least, boosted reliability, too.

One tradeoff made, however, is in the 160's spurious outputs. Fluke has the edge here, with -83 dB of spurs against -75 dB for the PTS unit. Spurious, nonharmonically related signals have been long a thorn in the synthesizer's side. Removal of the unwanted outputs is possible—but with difficulty and at a price. High-priced units, usually \$10 K or more, cut spurs by 90 to 100 dB.

At the low end of the frequency

range, the PTS 160 drops to 0.1 MHz, while the Fluke 6160 goes down to 1 MHz. You can set the frequency in the 6160 in increments of 0.1 Hz from 1 to 12 MHz, and in 1-Hz steps from 10 to 160 MHz. With the PTS 160, you order the resolution you want from 0.1 Hz to 10 kHz.

Output levels, phase noise and harmonics are practically the same for both units. Respectively, these are 3 to 13 dBm into 50 Ω , 63 dB (S/N) and -30 dB. Output is maintained to ± 0.5 dB in the PTS synthesizer, and to ± 1 dB in the Fluke. In the PTS, however, an edge meter displays the output level, while in the Fluke unit a level-set dial is calibrated only at the end points.

For remote, programmable operation, both synthesizers accept BCD TTL levels to set the frequency. And you can set the output levels in both with a dc voltage. The frequency standard is optional with both units. The PTS standard (5 or 10 MHz) sells for \$450 and offers a stability of 3×10^{-9} per day. Fluke's equivalent standard (5 MHz) ages just 2×10^{-9} per 24 h and costs \$550.

Switching speed is important in programmable operation, of course.

But you've got to compare specs carefully in this area. Speed should be the elapsed time between a command to a new frequency and the point at which the output enters and remains within a specified frequency error band. Since there's no standard for the band, each vendor is free to specify as he pleases. This makes comparison difficult.

To make things worse, speed usually depends on which digit is being switched—lower-order decades can be switched faster than the higher orders. So look for a worst-case spec.

In the Fluke unit, switching time is specified as less than 800 μ s to be within 50 Hz of the final frequency. In the PTS, 20 μ s is the interval to be within ± 0.1 radians of the steady-state phase or to be within 10 Hz of the 1-MHz digit. For the other digits, multiply the 10 Hz by 10 as you go up and divide by 10 as you go down in decades.

A final point of interest to the energy conscious: the Fluke 6160 draws 80 W to do its job, while the PTS consumes just half that.

For Fluke

CIRCLE NO. 305

For PTS

CIRCLE NO. 306

Variable analog filters give selectable response



Rockland Systems, 230 W. Nyack Rd., West Nyack, NY 10994. (914) 623-6666. Start at \$1175.

Covering the cutoff frequency range of 0.01 Hz to 111 kHz and featuring rolloffs at 24 dB and 48 dB per octave per channel, respectively, these variable analog filters provide selectable Butterworth and linear-phase responses. Models 452 and 852 dual hi/lo filters each consist of two identical filter channels contained in a common cabinet, have separate input/output terminals, offer high-pass and low-pass functions, and 0 and 20-dB gain.

CIRCLE NO. 307

Green, Yellow, Amber, Red

Bi-Pin LED's

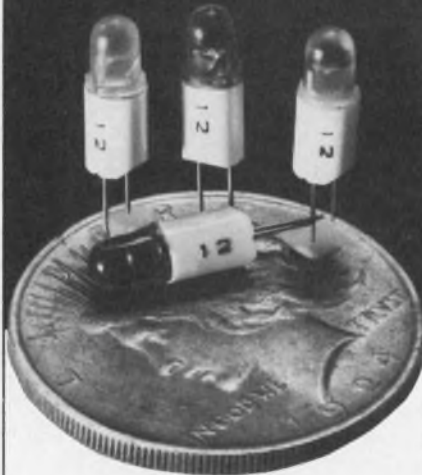

BRIGHTER THAN MANY INCANDESCENTS

- 5 to 28V models . . . with built-in resistors.
- Direct replacements for incandescent types.
- Lower power requirements.
- Faster signal monitoring.
- Clear lenses for dead front panel applications . . . diffused lenses for direct viewing.
- Offset terminals for easy insertion.

And we've got more! LED, Incandescent and Neon sub-miniature panel lights . . . PCB lights. We're your "one-stop-shop" for indicator lights.

The "original" little light people!

DATA DISPLAY PRODUCTS

5428 W. 104th St., Los Angeles, Ca. 90045
(213) 641-1232

INFORMATION RETRIEVAL NUMBER 54

INSTRUMENTATION

CommAlert system can override CATV lines



Scientific Atlanta, 3845 Pleasantdale Rd., Atlanta, GA 30340. (404) 449-2000. \$2850.

The 6120 CommAlert System provides the CATV operator with a convenient, secure method of distributing emergency messages over all system channels. A confidential 3-digit code number prevents unauthorized use of the system. The override is designed to function with either a private dedicated telephone pair or through a telephone company leased coupler. When used with a private line, voltage to operate the telephone is supplied by the 6120. An operator dialing the proper access code will maintain command of all CATV channels until hanging up. Control of the system is maintained as long as audio is present on the telephone line. A silent period of 13 seconds will disconnect the telephone and return the system to normal. The system may be operated without the telephone tone security feature. In this mode, removing the dedicated telephone from its hook switch seizes the system.

CIRCLE NO. 308

Recorder line spawns second generation

Houston Instrument, One Houston Square at 8500 Cameron Rd., Austin, TX 78753. (512) 837-2820. From \$395.

The popular OmniScribe™ strip-chart recorder is now available in a second generation "A Model" with features such as over-range signal suppression and a new pen drive with a one-piece rebalance element that is wear compensated. The unit also offers dynamic damping, automatic gain control, highly stable ac amplifiers and will accept remotely generated pulses to drive the chart paper synchronously with frequency/wavelength sweeps.

CIRCLE NO. 309

4-1/2-digit gaussmeter resolves to 1 gauss

Electrodyn Co., Inc., 4188 Taylor Rd., Batavia, OH 45103. (513) 732-2822. Under \$700.

Model 112 digital gaussmeter measures ac and dc magnetic fields with 1-gauss resolution up to 19,999 gauss. Features include overrange indication, flat frequency response up to 10 kHz, automatic self-calibration with change or renewal of probes, and an auto-polarity indicator.

CIRCLE NO. 310

Frequency counter aims at telecomm industry



John Fluke Mfg. Co., Ltd., P.O. Box 1094, Station D, Buffalo, NY 14210. (716) 842-0311. \$859.

Model 1920A telecommunications frequency counter features a 9-digit LED display, sensitivity to 15 mV, age standard, and a frequency range of 5 Hz to 520 MHz. Optional internal prescalers to 1000 MHz and 1250 MHz cover the uhf television, 900-MHz telecommunications, and TACAN/DME bands. Featured are full leading-zero suppression, automatic annunciation, overflow, and a self-check mode, which lights all digit segments. Measurement delays have been eliminated with a "rapid-access gate" which "free runs" with no input signal so as to open the gate for the selected time as soon as a signal is sensed.

CIRCLE NO. 320

ANOTHER DIMENSION

has been added to the world famous family of

Simpson®
260 VOMS

the **SERIES 6XL**



FOR THE SPECIAL NEEDS OF THE SOLID STATE ELECTRONICS INDUSTRY

- Extra shock and drop-resistant construction, high impact, custom-molded panel and case
- Extra large viewing area with four-color (Red, Green, Blue and Black) scales, keyed to matching range panel
- 33 ranges with extra voltage, current, resistance and low-power ohms functions
- Plus — all the features of the time-honored, ever popular 260-6

260-6XL, Complete with batteries, test leads and manual \$90.00
260-6XLM, with mirror scale \$93.00

260-6XLP WITH CIRCUIT OVERLOAD-PROTECTION

Reset pushbutton releases when overload exists. Will not reset until overload condition is eliminated.

260-6XLP, complete with batteries, test leads and manual \$125.00

260-6XLPM, with mirror scale \$128.00



RANGES:

DC Volts	0-0.25; 0-1; 0-2.5; 0-10; 0-25; 0-100; 0-250; 0-500; 0-1000
AC Volts	0-2.5; 0-10; 0-25; 0-100; 0-250; 0-500; 0-1000;
DC Microamperes	0-50 (250 MV Drop)
DC Milliamperes	0-0.5; 0-5; 0-50; 0-500
DC Amperes	0-5 (250 MV Drop)
AC Amperes	6 ranges from 0-5 to 0-250 with optional Model 150 Amp-Clamp adapter.
DB Scale (1 MW 600 Ω Reference)	-20 to +10; -9 to +21; -1 to +29; +11 to +41; +19 to +49
Resistance (Standard Power)	Rx1 (6 Ω center scale), Rx100 (600 Ω center scale), Rx1K (6000 Ω center scale), Rx10K (60,000 Ω center scale)
Resistance (Low Power)	Rx1 (20 Ω center scale) Rx10 (200 Ω center scale) Max. open circuit voltage only 100mV! Max. measuring power only 0.125 mW!
Size	5 1/4 x 7 x 3 1/8" (133 x 178 x 79 mm)
Weight	2.5 lbs. (1.14 kg)

ACCESSORIES

Model 150 Amp-Clamp, Catalog No. 00532 complete with a No. 00533 test lead	\$29.50
30 kV DC Probe, Catalog No. 00509	\$22.00
Grip-Tip Extension Probe, Catalog No. 00118	\$ 4.75
Rigid Case, Catalog No. 00805	\$20.50
Sheath Case, Catalog No. 01818	\$16.75
5 kV DC Probe, Catalog No. 00506	\$ 5.25
5 kV AC Probe, Catalog No. 00505	\$ 5.25

Available Now at Leading Electronics and Electrical Equipment Distributors • Write for Complete Specifications



SIMPSON ELECTRIC COMPANY

853 Dundee Avenue, Elgin, Illinois 60120 • (312) 697-2260
CABLE: SIMELCO • Telex: 72-2416
IN CANADA: Bach-Simpson, Ltd., London, Ontario
IN ENGLAND: Bach-Simpson (U.K.) Ltd., Wadebridge, Cornwall
IN INDIA: Ruttonsha-Simpson Private, Ltd., Vikhroli, Bombay

INFORMATION RETRIEVAL NUMBER 55



TEC-LITE™

New! Low-Cost Momentary or Alternate Action Pushbutton Switch



Available as lighted switch, switch only or indicator only

Front-replaceable, low-priced wedge-base lamp in 6.3, 14 or 28 volts

Easy snap-in mounting

Choose from four switch types: momentary type A, B or C contacts or alternate type C contacts. Versatile, highly reliable S-106 Series switch mounts in .625" panel cutout and fits panels 1/32" to 3/32" thick.

Contact rating is 100 mA @120 VAC, resistive. Switch life of 1 million operations for momentary action and 150,000 cycles for alternate action. Wiping action of switch elements makes the S-106 compatible with commercial and dry circuit applications.

Available with gold or silver plated contact elements and translucent red, green or white lens. Contact your TEC-REP or distributor for more information.

DISTRIBUTORS:

Audio Electronics, Inc., Canada	(416) 495-0720
Bodelle Co., Inc., Chicago	(312) 323-9670
Bordewick Co., New England	(617) 659-4915
Century Aero Corp., So. Cal.	(213) 772-1166
Peerless Radio Corp., Florida	(305) 566-5966
Ratel Electronics, No. Cal.	(415) 965-2010



TEC, Incorporated

9800 NORTH ORACLE ROAD
TUCSON, ARIZONA USA 85704
(602) 297-1111
TWX 910-952-1377

INTEGRATED CIRCUITS

Micro chip set starts at \$29.95

Intel Corp., 3065 Bowers Ave., Santa Clara, CA 95051. (408) 246-7501. P: See text.

For as little as \$29.95, the manufacturer offers the MCS-40 family of MOS/LSI circuits for 4-bit parallel processing and control systems. The key circuit in the family is the 4040 CPU, an improved version of the company's 4004 4-bit model. The 4040 features 60 standard instructions, automatic interrupt processing, bank switching of index registers and memory and I/O arrays, and single-step operation under software or hardware control.

In addition to the 4040 CPU, the MCS-40 family includes these circuits: a system clock generator (4201); 8-k ROM and quad I/O (4308); 16-k ROM (4316); and 256 × 4-bit static RAM (4101). The MCS-40 family also encompasses several circuits that were introduced previously with the 4004 CPU chip. Systems can be developed with the Intellec 4/MOD 40. The low price of \$29.95 only covers the 4040 CPU, 4201 generator and 4308 ROM-I/O circuit in high volume.

CIRCLE NO. 321

IC drives gas discharge displays

Motorola, P. O. Box 20924, Phoenix, AZ 85036. (602) 244-3464. \$2.35 (100 up); stock.

Segment-drive requirements for such high-voltage gas-discharge displays as the Beckman or Burroughs Panaplex types can be met by the MC3491. The circuit has eight separate channels—one for each of the seven display segments and an additional one for the decimal point—and its 350- μ A input rating permits direct compatibility with the MOS outputs of electronic calculators. The MC3491 has a minimum breakdown voltage of 80 V. All eight driver output currents are simultaneously programmable by selection of a single external resistor, and all eight currents are matched typically within 1% or less.

CIRCLE NO. 322

Standard package holds sample/hold amp



ILC Data Device Corp., Airport International Plaza, Bohemia, NY 11716. (516) 567-5600. \$20.25 to \$40.50; stock to 6 wks.

A line of monolithic sample-and-hold amplifiers—the Series 1502—comes in standard 14-pin packages, operates from a ± 15 V dc supply and uses a single external 1000-pF capacitor. The series features 2-MHz bandwidth, 20-mW/sec drift rate during hold, 5 V/ μ s slew rate, 4- μ s acquisition time and a sample-to-hold offset error of 5 mV.

CIRCLE NO. 323

S-TTL multipliers increase PC densities



Texas Instruments Inc., P.O. Box 5012, M/S 308, Dallas, TX 75222. (214) 238-3741. \$11.20 to \$26.78; stock to 12 wks.

Two Schottky-TTL basic multiplier functions consist of a 4-bit × 4-bit unit and a 7-bit-slice "Wallace tree." The SN74S274 4 × 4 multiplier generates an 8-bit (full or partial) product in 45 ns typically. The multiplier has three-state outputs and comes in a 20-pin DIP, for 40% to 80% savings in board space when compared with earlier units. The SN54S/74S275 7-bit-slice Wallace Tree contains the equivalent of four full adders in a single 16-pin package. Fully expandable to implement an n-bit-slice accumulator for partial products, the SN54S/74S275 can reduce by 50% the package count and PC board area when replacing dual adders. In speed-limited applications, complete 32-bit products can be derived in 116 ns typically in a full parallel mode.

CIRCLE NO. 324

SHIFT INTO HIGH PERFORMANCE WITH A 4K STATIC RAM

FULLY STATIC: The SEMI 4402 is a fully static 4K RAM. That's important. For one thing, it means you can now design a 250 nsec MOS memory system around a 4K device without worrying about refresh or charge pump circuitry. For another, static RAMs are inherently less susceptible to soft bit error problems than comparable dynamic devices.

350 NANOSECOND CYCLE: The SEMI 4402 4K static RAM has a *complete cycle time* of just 350 nsec and 200 nsec maximum access time. That makes it the fastest 4K static RAM in production. Now you can design a truly high performance MOS memory around a static 4K device.

AVAILABLE NOW: The SEMI 4402 4K static RAM is here now. We're already delivering it to customers at the memory system level. And it is second sourced by a major supplier of MOS devices.

LOW POWER: The SEMI 4402 4K static RAM has similar power levels to

comparable dynamic devices. However, power conservation is achieved by the Chip Select Input, which causes the 4402 to enter a low power standby state whenever it is unselected. Normal V_{DD} is 12 Vdc, but V_{DD} can also be reduced to 5 volts without risking loss of stored data. And the 4402's differential output results in inherently high noise immunity memory systems.



PERFORMANCE TESTED: Like all SEMI NMOS components, the 4402 4K static RAM must meet our own tough test standards, since we use it in our memory systems — for example the MICRORAM 3400N. With our reputation riding on its performance, you may be sure the acceptance standards are high indeed. In fact we 100% ac and dc test our components twice — at wafer and again in the package.

MODEL SELECTION: In addition to the 4402, EMM SEMI offers you a complete line of static NMOS RAM and ROM components to meet your design needs. Make your selection from the adjacent chart.

Part No.	Bit Org.	Access Time
RAMS		
SEMI-1801	1024 x 1	90 nsec.
SEMI-1802	1024 x 1	70 nsec.
SEMI RA-3-4256	256 x 4	1 usec.
SEMI RA-3-4256B	256 x 4	1 usec.
ROMS		
SEMI RO-3-4096	512 x 8	500 nsec.
SEMI RO-3-5120	512 x 10	500 nsec.
SEMI RO-3-16384	4096 x 4	1.0 usec.

More new products to come ... additional 4K static RAMs, ROMs.

PROVEN TRACK RECORD: At EMM we've been making memory components and systems since 1961. Unlike memory suppliers who market components only, all EMM components are all performance proven in our own systems. When you buy from EMM, you get the benefit of the unusually high acceptance standards we impose on ourselves, as well as our years of experience in meeting the needs of the memory marketplace. If you'd like further information about any of the products featured here, or any other EMM components or systems, contact your local EMM office today.

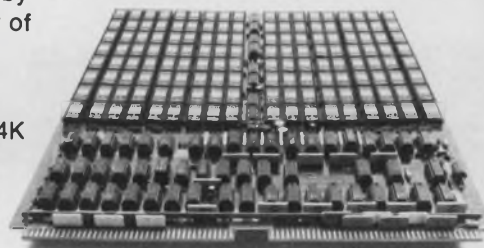

EMM SEMI

A division of Electronic Memories & Magnetics Corporation
3883 North 28th Avenue, Phoenix, Arizona 85017
Telephone (602) 263-0202

INFORMATION RETRIEVAL NUMBER 57

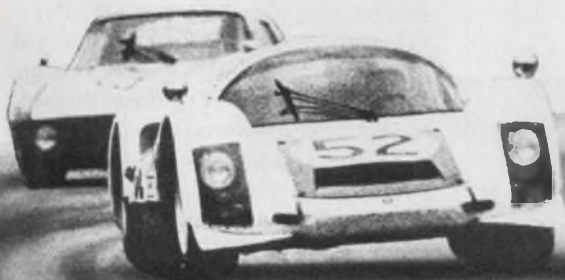



put us between you and the trigger

You can count on Aladdin's pulse transformers to provide line isolation for your SCR trigger source. Or to minimize the number of components in the trigger circuit. Or any pulse transformer application where sure-fire reliability (at a competitive price) is a must.

We had to face-down every problem in the business to earn the industry's top pulse transformer reputation. The quality and uniformity we build in are added assurance of trouble-free performance for your products.

Choice of pulse widths from zero to 100 sec. Load capacities from 5 ohms. Seven different package configurations, to boot.

Arm yourself with our Bulletin:

ALADDIN PULSE TRANSFORMERS

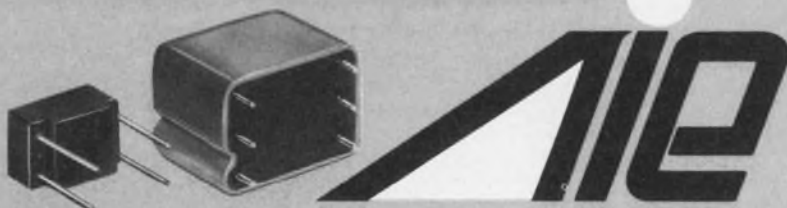

Aladdin Electronics, A Division of Aladdin Industries, Inc., P.O. Box 7263
Nashville, Tennessee 37210 • Phone: (615) 255-1776

INFORMATION RETRIEVAL NUMBER 58

INTEGRATED CIRCUITS

Tailor op amp specs to the application

Motorola Semiconductor Products Inc., P.O. Box 20912, Phoenix, AZ 85036. (602) 244-6900. P: See text.

A programmable op amp, which sells for \$1.25 to \$1.50 (100 up), permits electrical parameters to be tailored by the connection of an external resistor or a current source. The MC3476 operates over a power-supply voltage range of ± 6 to ± 15 V. It has a power consumption of 4.8 mW (typical), input offset and bias current of 25 and 50 mA (both maximum), respectively, and an input resistance of 5 M Ω (typical). The amplifier requires no frequency compensation and has offset null capability and short-circuit protection.

CIRCLE NO. 325

CMOS CAMs make debut

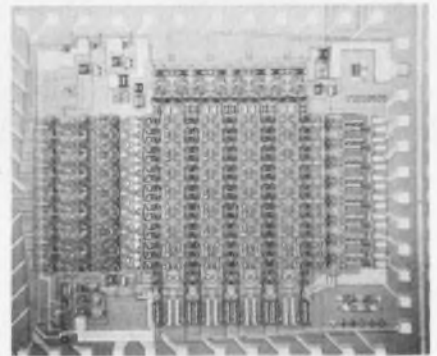

Solid State Scientific, Montgomeryville, PA 18936. (215) 855-8400. \$21 (1000).

The first CMOS content addressable memory (CAM), the SCL5533, has a capacity of 64 bits, organized as eight 8-bit words. Capable of performing an exact match search, telling whether an input word is or is not stored in the memory, the new circuit—which comes in a 48-pin ceramic DIP—also has conventional read/write capability and can be used as a 64-bit RAM. Typical interrogate time (in a CAM mode) for an 8-bit word is 110 ns. Read access time is 150 ns. A chip-enable feature permits memory expansion. Inputs are CMOS compatible, and outputs are three-state MOS or TTL-compatible. Operation is fully static and quiescent power is 25 μ W.

CIRCLE NO. 326

D/W 2007 Transmission Measuring Set. Accurate. Reliable. Versatile.

For rugged reliability and high-level accuracy and versatility in transmission measuring, consider the Siemens D/W 2007. Low in weight and power consumption, the D/W 2007 is high in frequency and level accuracy, making it especially suited for central office, field service and laboratory use.

The Siemens D/W 2007 measures test levels, pilots, crosstalk and channel noise on all carrier and radio systems up to 18.6 MHz, including DUV.

STANDARD FEATURES:

- One-button calibration, regardless of frequency and sensitivity setting.
- Scale expander with 0.02 db resolution.
- SSB output and built-in speaker.
- 1.74 kHz mechanical, effective noise bandwidth filter.
- 80 Hz crystal and 6 kHz LC filters.
- Western Electric connectors.
- 75, 124, 135, 150 and $\infty/0$ ohm impedances.
- 100 kHz phase lock and continuous tuning.
- Remote operation through office trunk.



OPTIONAL FEATURES:

- 20 Hz Crystal Pilot Filter.
- 1.1 active bridging probe.
- 20 db low-noise pre-amplifier.
- Spot Frequency generator (up to 32 frequencies).
- Rechargeable battery pack and fiberglass carrying case.
- Universal Equipment Cart.

For detailed information on the Siemens D/W 2007 and other quality instruments, contact the Communications Equipment Division. Service is available at centrally located service centers and through periodic on-site maintenance contracts.

Siemens Corporation
Communications Equipment Division
186 Wood Avenue South, Iselin, New Jersey 08830 (201) 494-1000

Industry standards... Seven cermet trimmers that can

How?

- Through design versatility
- Fast delivery
- Excellent quality

Necessary Decisions:

1. Single vs. multiturn
2. Sealed vs. not sealed
3. Size
4. Resistance
5. Pin spacing
6. All-important, PRICE

Take a close look before you select your next trimmer. Call your local Beckman Helipot distributor for free evaluation samples, or immediate technical literature.

Beckman

HELIPOT DIVISION



Single-turn

Model 91

- High quality – low price
- Unique brush contact
- Excellent setability
- 100% inspected
- Protective dust cover
- Top or side adjust
- Screwdriver or hand adjust
- Standoffs prevent rotor binding and permit board washing
- Small $\frac{3}{8}$ " dia. size
- 12 pin configurations
- Wide resistance range: 10Ω to 2 meg Ω

Price: \$0.42*



Model 72

- Sealed for board washing
- Available in VALOX 420-SEO housing
- Top or side adjust
- Brush contact
- Excellent setability
- Only 2 ohms of end resistance
- $\frac{3}{8}$ " square
- 100% inspected
- 7 pin configurations
- 19 resistance values

Price: \$0.54*



Model 82

- Lowest profile trimmer in industry
- $\frac{1}{4}$ " dia. by 0.150" max. height
- Sealed for board washing
- Flame-retardant design
- 82P – top adjust
- 82PA – side adjust
- 100% inspected
- Brush contact provides excellent setability
- A cermet benefit that wirewound can't approach: resistance range 10Ω to 1 meg Ω

Price: \$1.12*



★ Still waiting for delivery on trimmers from another manufacturer?

Call your local Beckman Helipot distributor for a convenient cross reference from stock.

handle 95% of your applications.

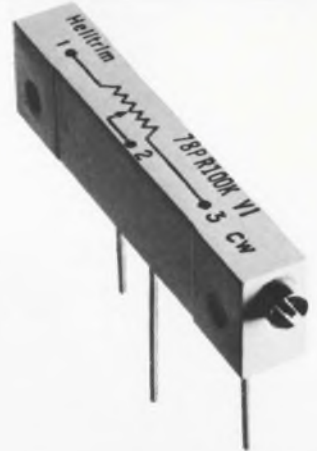
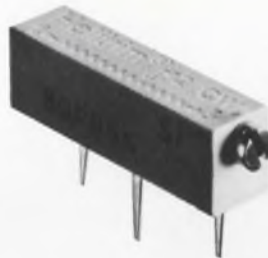

Multiturn

Model 64

- Miniature, sealed trimmer
- 22 turns of adjustment
- Operates with 0.25 watt at 85°C derating to zero watts at 150°C
- 100% inspected
- 18 resistance values: 10Ω to 1 megΩ
- ¼" square size is excellent for P.C. board packaging
- Uses Beckman's unique brush contact design
- Adjustability – voltage ratio within 0.01%

Price: \$4.20*



Model 66

- Low-cost, multiturn with benefits of more costly trimmers
- Sealed for board washing
- 20 turns for adjustment accuracy
- Compact ⅜" square housing
- Brush contact
- 3 pin styles for efficient space utilization
- Broad resistance range: 10Ω to 2 megΩ
- Operates with ½ watt at 25°C
- 100% inspected

Price: \$2.70*



Model 89

- Our lowest cost multiturn
- Sealed for board washing
- ¾" rectangular trimmer just 0.250" high
- Needs no O-ring because of our unique ultrasonic sealing technique
- Only 2 ohms of end resistance
- 15 turns for accurate and quick adjustment
- 3 pin styles for mounting versatility
- Panel mount available
- 100 ppm/°C tempco
- 19 resistance values available
- 100% inspected

Price: \$1.05*



Model 78

- Military performance at industrial prices
- 1¼" rectangular only 0.195" wide
- Sealed
- 3 terminal styles: Flex leads Printed circuit pins Solder lugs
- Panel mount available
- Power rating 0.75 watt at 70°C
- 100% inspected
- 22 turns of adjustment
- Resistance range: 10Ω to 2 megΩ
- 100 ppm/°C tempco

Price: \$2.28*



*1,000-piece price

Get more for your money!

Use This New 3/8" Square Cermet Trimmer From Allen-Bradley

Our new TYPE E trimmer is a high performer with a realistic price. It has some important advantages: • Immersion seal is tested in 85°C water (not 50° or 70°). • Temperature characteristic is 100 PPM/°C for stability. • Multifingered contact for excellent adjustability. • \$0.49 each—1000 piece price. For more information call your A-B distributor or write for Publication 5219.

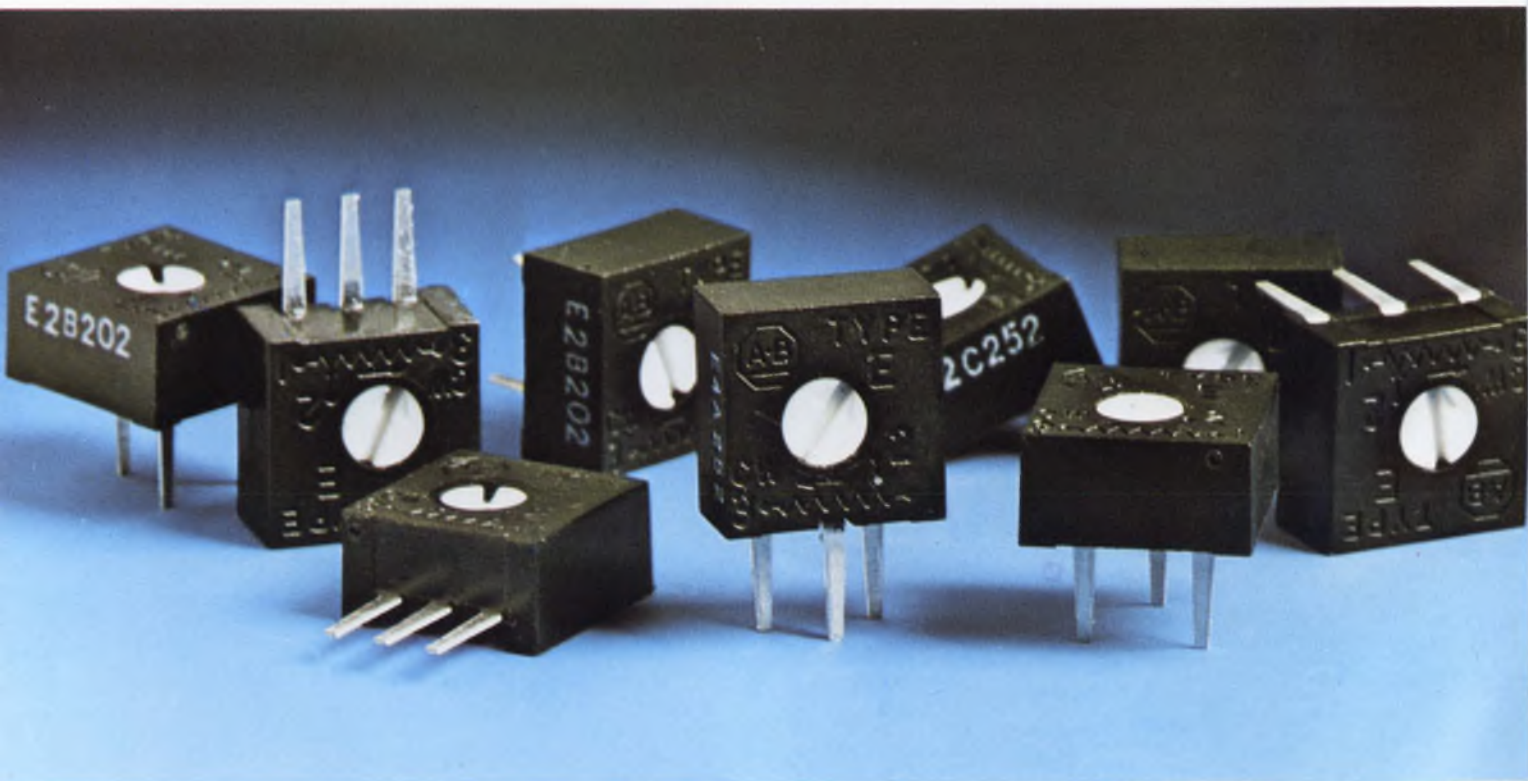
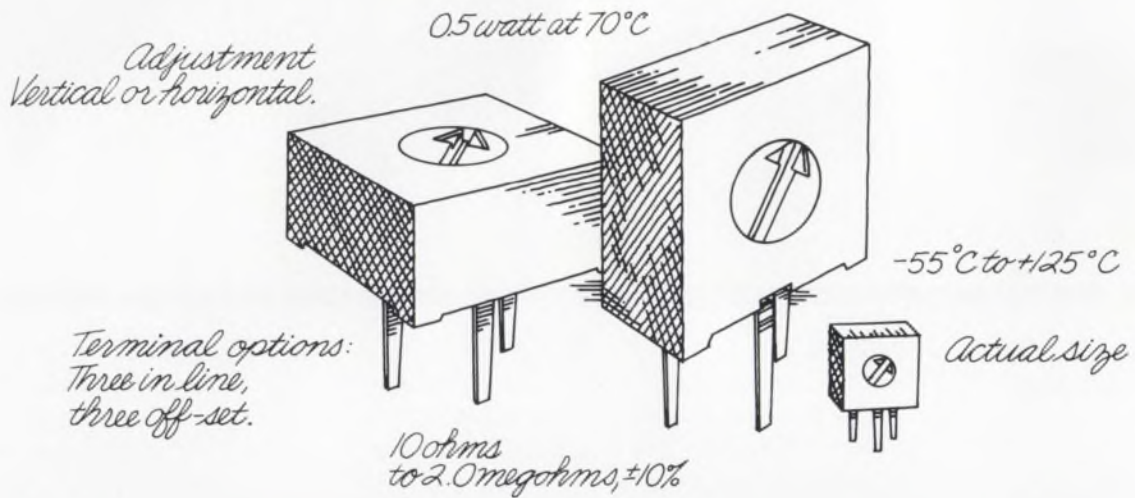

Quality in the best tradition.



ALLEN-BRADLEY

Electronics Division
Milwaukee, Wisconsin 53204

Cartridge lamps span range of 3.6 to 14 V dc

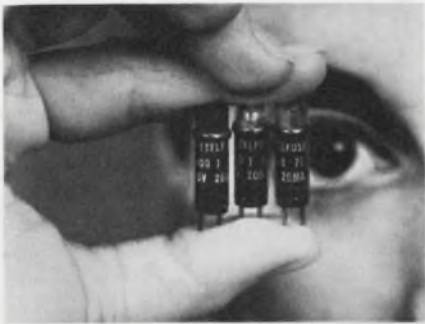

Littelfuse, 800 E. Northwest Hwy., Des Plaines, IL 60016. (312) 824-1188. From \$0.98; stock.

Yellow, green and amber LEDs are available in the 900 Series of cartridge lamps. The units use GaP LEDs and span from 3.6 to 14 V dc, by use of built-in resistors for a nominal current rating of 20 mA. Cartridge lamps with red LEDs are available in voltage ranges of 1.8 to 20 V dc with built-in resistors for 10 and 20 mA currents. The cartridge lamps are supplied with a standard black anodized housing and two 0.04 in. diameter stainless steel pins as standard termination. The over-all length of the cartridge lamp is 1.14 in., with a diameter of 0.33 in. Three types of lenses: short cylindrical, short stovepipe fresnel and short cylindrical fluted are available in amber, red, yellow, green, colorless and white.

CIRCLE NO. 327

High-speed rectifiers recover in under 30 ns

Semtech Corp., 652 Mitchell Rd., Newbury Park, CA 91320. (805) 498-2111. From \$2.50 (100-up); stock.

A line of high-speed rectifiers have recovery times of less than 30 ns. Types FF05, 10 and 15 have a forward voltage drop of 0.97 V at 1.5 A and 100 C. Types 3FF05, 10 and 15 have a forward voltage drop of 1 V at 3 A and 100 C. Types 5FF05, 10 and 15 have a forward voltage drop of 0.8 V at 5 A and 100 C. The Metoxilite, non-cavity, monolithic high temperature construction provides dependability in high frequency applications.

CIRCLE NO. 328

A BARGAIN IN SOLID-STATE IMAGING:

WHAT YOU GET:

You get a 3"x 3" circuit card which contains RETICON's RL-64P image sensor and all of the associated drive and video processing circuitry. A standard ribbon cable connects the unit to your power supply (+5V, -10V) and also carries the 0 to 2V video output. The RL-64P has 64 sensing elements on 2 mil centers in a standard ceramic DIP sealed with an optical quality quartz window. The device has an integrated on-chip driver and portions of the video processing circuitry. The RL-64P is a proven device in production for over three years.

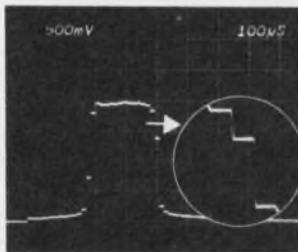
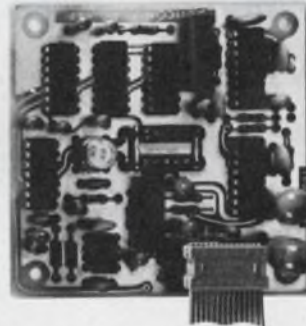
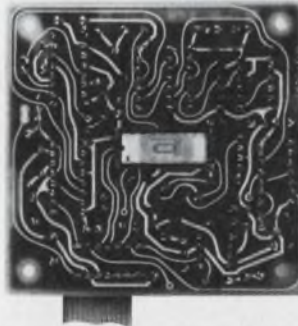

WHAT YOU SEE:

You see over 200:1 dynamic range (peak signal to peak noise) at 250 KHz. The photo shown is the actual output of a 30 mil front illuminated band imaged onto the array using 1:1 optics. The "box-car" type sampled-and-held output can be easily thresholded or A/D converted into multiple grey levels.

Applications in OCR, point-of-sale, industrial non-contact measurement and control are a natural for this unit.

Evaluate our technology with this complete imaging system. If you need higher resolution, we have an extensive line of image sensors with up to 1872 elements. We have over four years of experience in solid state image sensor and related circuit development. And there are over 70 salesmen and 15 distributors to serve you worldwide.

RETICON®

910 Benicia Avenue
Sunnyvale, California 94086
(408) 738-4266 • TWX: 910-339-9343

SMART GAUDY

YES	NO
<input checked="" type="checkbox"/>	<input type="checkbox"/>
<input type="checkbox"/>	<input checked="" type="checkbox"/>

DRESS YOUR SYSTEMS IN TRIMLINE ENCLOSURES . . .
TO GET THAT ADMIRING ATTENTION YOU WANT!

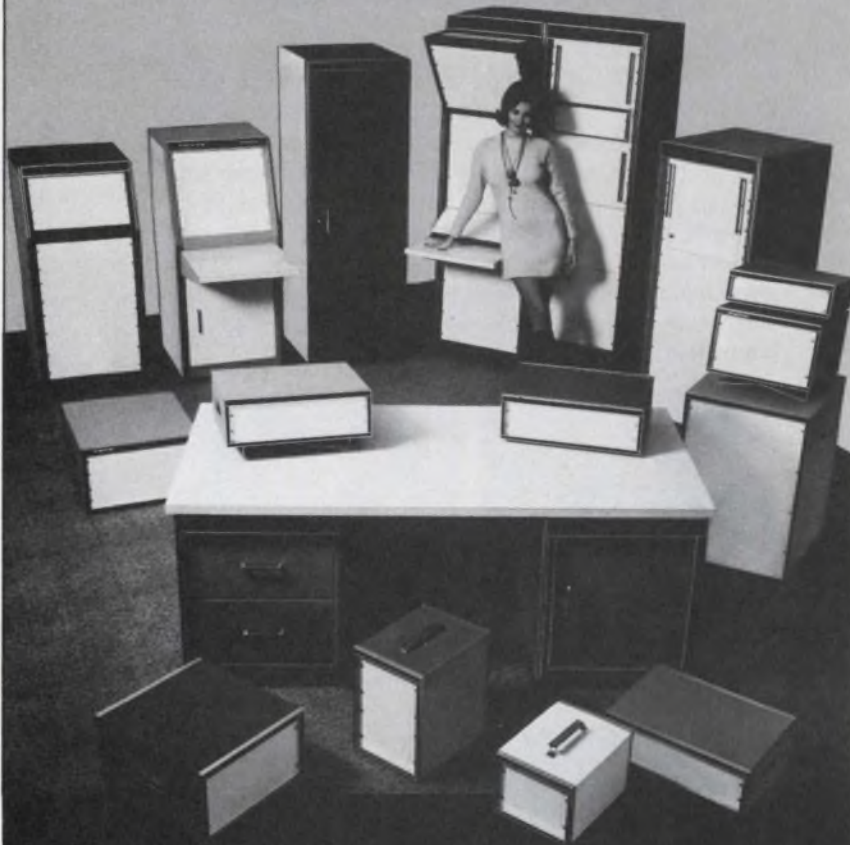

INSTRUMENT CASES—TIC SERIES

TVA Series Vertical Assembly— Construction Details (1 Frame, 2 End Panels, Rear Door)

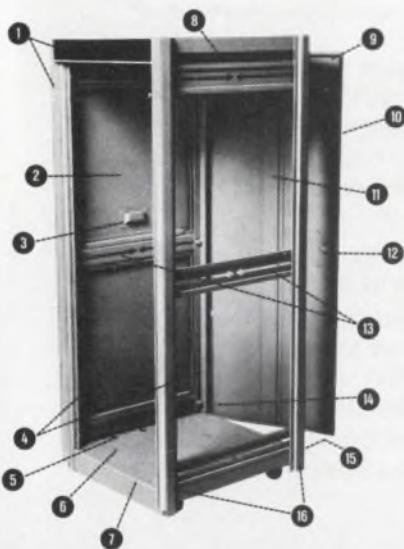

1. Trim: extruded anodized aluminum with textured vinyl inlays
2. Outside removable flush end panels (16 ga.)
3. Recessed hand grip for panel removal
4. 2 pr. panel mounting angles, fully adjustable front to rear with tapped 10-32 holes on EIA & WE Standards spacing (12 ga.)
5. 1" dia. holes for cable entry beneath base
6. Recessed caster mounting holes
7. 1 piece formed steel base provides for heavy equipment mounting area and concealed caster mounting (14 ga.)
8. 1 piece solid top for extra rigidity and squareness (14 ga.)
9. Foam gasketing (3 sides)
10. Magnetic closure gasket
11. Door stiffener channel
12. Keyed latch and brushed aluminum pull handle
13. Horizontal cross-brace and panel mounting angle supports
14. Quick release, spring loaded door hinges (top and bottom)
15. 1½" dia. knock-outs for rear cable entry underneath rear door
16. Formed steel uprights (14 ga.) provide ½" recess to panel mounting angles

All features shown are standard in the Trimline TVA Series
Welded, formed steel construction

Complete catalog and prices on request



PREMIER METAL PRODUCTS COMPANY
337 Manida St., Bronx, N.Y. 10474 / (212) 991-6600

INFORMATION RETRIEVAL NUMBER 63

DISCRETE SEMICONDUCTORS

Opto-coupler handles data at 5 Mbit/s

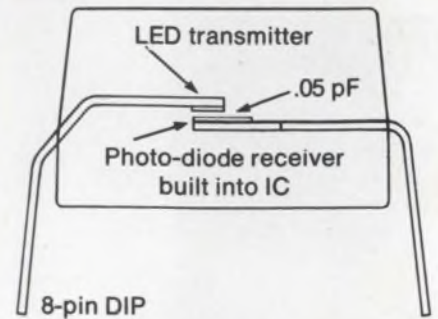

*Litronix, 19000 Homestead Rd.,
Cupertino, CA 95014. (408) 257-
7910. \$4.95 (1000-up); stock.*

The IL-100 opto-isolator transmits data at 5 Mbit/s with a common-mode rejection of 50 dB. The unit uses a LED light source transmitting to a photodiode receiver built into an integrated circuit. Capacitive coupling between the transmitter and receiver is only 0.05 pF and the maximum propagation delay is only 75 ns. The IL-100 is DTL/TTL compatible, operates from a 5-V supply and has a three-state output that provides multiplex capability without need for extra parts. A built-in Schmitt trigger minimizes any chance of oscillation. The isolator is housed in a standard eight-pin silicone-molded DIP.

CIRCLE NO. 329

Current regulator diodes have high dynamic Z

*Siliconix, 2201 Laurelwood Rd.,
Santa Clara, CA 95054. (408) 246-
8000. From \$1.60 (100-up); stock.*

A series of current regulator diodes has internal temperature compensation. The CR022 through CR470 devices are direct replacements for the Motorola 1N5283 through 1N5314 current limiters. A temperature compensation design results in temperature coefficients typically better than 0.15%/°C. Other family characteristics include 100 V peak operating voltage, 100 C/W thermal resistance and dynamic impedance from 13 to 0.235 MΩ minimum. The devices are packaged in two-lead TO-18 metal cases. Current ranges in the diode family are available in 10% increments from 220 μA through 4.7 mA.

CIRCLE NO. 330

INFORMATION RETRIEVAL NUMBER 64 ►

WESTON[®] Confesses: Every DMM we sell is used!

It's true! Each DMM with the Weston name on it is used before we'll let you use it. You would never dream of using it the way we use it.

Each and every DMM that comes off the production line is put through normal check-out procedure. Then starts the really rough part. Each unit goes through a 96-hour burn-in, for example. This may seem to you like 12 work days, or about 2½ weeks, but it's a whole lot different. For the entire period of 96 hours, each unit is on for one hour then off for 5 minutes, then on for one hour and off for 5 minutes...for 96 continuous hours. That's rough, but only the ones that pass are considered acceptable for your use... But we don't stop here.

To meet production acceptance standards, the Weston DMM line must go through rigorous vibration tests. This might mean that units have to take vibrations of 5-10 Hz for 1 hour at .4 G, then 10-50 Hz for 11 milliseconds at 2 G. We don't stop here, either. There are severe shock tests. Here, they might have to withstand 50 G's on 3 axes, for example.

In addition, there are temperature control and humidity control tests.

DMMs that pass their tests get the Weston name, so you can be sure the Weston DMM you buy new, has been used... really used!

That's good news for you.



We're either first or best. Or both.

WESTON

WESTON
Schlumberger

DISCRETE SEMICONDUCTORS

Rf power transistor delivers 150 W

Power Hybrids, 1742 Crenshaw Blvd., Torrance, CA 90501. (213) 320-6160. \$175 (1 to 24); stock.

A 150 W, peak pulse power, internally matched transistor is designed for airborne distance measuring and TACAN equipment. The

PH1175D produces a minimum 150 W peak in the 1025-to-1150-MHz band with 35 W input drive for pulse widths of 10 μ s and a duty factor of 10%. The transistor will cover the 960 to 1215 MHz band at reduced powers. The PH1175D is a common base gold metalized transistor with individual emitter finger ballasting resistors, multicellular "fishbone" geometry and an hermetic package.

CIRCLE NO. 331

Power transistors come in TO-220 plastic cases

Soliton Devices, Semiconductor Div., 1177 Blue Heron Blvd., Riviera Beach, FL 33404. (305) 848-4311. From \$0.40 (1000-up); 2 wk.

Four general-purpose plastic power, single-diffused transistors are designed for medium power switching, shunt regulators and amplifier applications. All of these devices are npn silicon and are packaged in TO-220 cases. The 2N5293-95-97, 2N5491-93-95-97, 2N6098 and 2N6100 devices are homotaxial-based transistors with leads bent for direct insertion into existing TO-66 sockets. The 2N5294-96-98, 2N5490-92-94-96, 2N6099 and 2N6101 are also homotaxial-based transistors but have straight leads for printed-circuit board applications. Typical specifications include an h_{FE} of 30 to 120 at a V_{CE} of 4 V and an I_C of 5 A; a power dissipation of 36 W at 25 C for the 2N5293-98 series, 50 W at 25 C for the 2N5490-97 series and 75 W at 25 C for the 2N6098-99 and 2N6100-01 series. The families offer up to 10-A peak current capability.

CIRCLE NO. 332

Voltage sensing LED has 2.5 V threshold

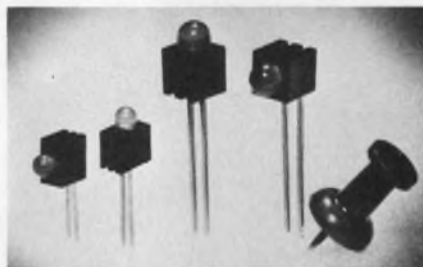

Hewlett-Packard, 1501 Page Mill Rd., Palo Alto, CA 94304. (415) 493-1501. \$0.68 (1000-up); stock.

The Model 5082-4732 VSLED is designed to be used as a built-in battery voltage tester for cameras, radios, test instruments, appliances and other portable, battery-operated devices. This LED lamp snaps on sharply at a nominal 2.5 V, \pm 10 mV. This voltage sensing LED combines an integrated circuit and a red GaAsP LED in a standard T-1 package. The lamp is temperature compensated and has a typical temperature coefficient of -1 mV/ $^{\circ}$ C.

CIRCLE NO. 333

DATA CLEANER



SYSTEM 816 Multi-Channel Anti-Aliasing Filter

- Local, Remote and On-Card Programming of Cutoff Frequency
- Up to 16 Independent Channels in 5 $\frac{1}{4}$ " Panel
- Cutoff Frequency Range: 0.01 Hz to 150 KHz
- Rolloff: 48dB/octave/channel
- Responses: Butterworth and Bessel
- Functions: Low Pass, High Pass, Band Pass, Band Reject
- Dynamic Range: 80dB
- Passband Gain: 0dB

FOR DATA ACQUISITION AND SIGNAL PROCESSING

ROCKLAND

Rockland Systems Corporation 230 W. Nyack Road, West Nyack, N.Y. 10994
(914) 623-6666 • TWX 710-575-2631

INFORMATION RETRIEVAL NUMBER 65

Electronic glass. All you need is vision.

Here is a designer's dream come true. Minimum form with maximum function.

It's PPG's electronic glass.

It lets you combine the sleek, simple elegance of glass and the dazzling magic of solid-state technology.

Which means you can literally change the faces of

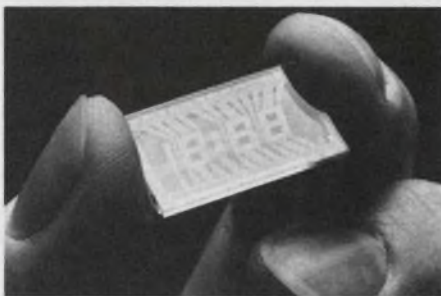

Digital watches will never be the same. Electronic glass can make them more efficient and more affordable.

appliances, timepieces, visual displays, and instrumentation of every description.

The secret is the permanent conductive metallic-oxide coating on the glass.

It can be made to trigger functions at the mere touch of a finger. Like timing a roast, choosing a station, starting the wash, or even figuring the square root of 34.

In short, if it can be done electronically, it can probably be done a little better with electronic glass.

And, since the coating can be applied to form letters, numbers, or any visual display imaginable, there's almost no end to what you can do.

Digital clocks, wristwatches, speedometers, odometers, oscilloscopes, and radar screens are just a few of the obvious possibilities.

As for its reliability, there's really nothing to go wrong. No moving parts. No knobs, dials, switches, buttons—just glass.

It's here. It's now. It's ready. All it needs is you, and all you need is the vision to use it.

So test your vision. Send the coupon today.

Displays simulated.

This is a control panel for a microwave oven. Just one of the many possibilities for a countdown timer and digital display.

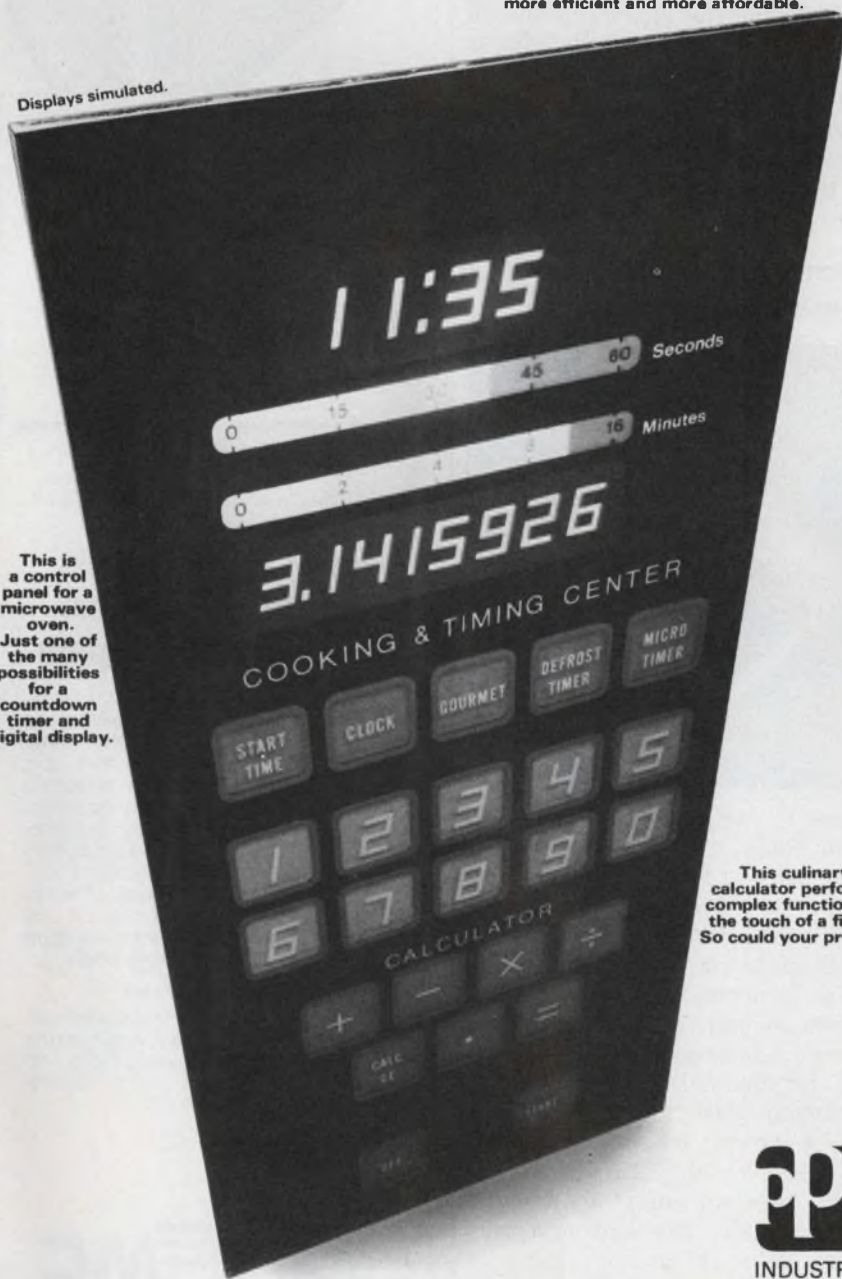

This culinary calculator performs complex functions at the touch of a finger. So could your product.

PPG: a Concern for the Future

PPG Industries, Inc.
Industrial Glass Products
One Gateway Center
Pittsburgh, Pa. 15222

I want to test my vision.
Send me more information about
PPG's exciting electronic glass.

Name _____

Company _____

Address _____

City _____

State _____ Zip _____



FOR INFORMATION ON ELECTRONIC GLASS CIRCLE NUMBER 66

1%
AMERICAN MADE

Tolerance
SCHAUER
1-Watt
ZENERS

**Immediate Shipment
Low Prices**

ANY voltage from 2.0 to 16.0

Quantity	Price each
1-99	\$1.07
100-499	.97
500-999	.91
1000-4999	.86
5000 up	.82



All welded and brazed assembly

No fragile nail heads

Gold plated leads

Write for complete rating data and other tolerance prices.

**Buy the kit-
Save a lot**



Kit contains a 51-piece assortment of SCHAUER 1% tolerance 1-watt zeners covering the voltage range of 2.7 to 16.0. Three diodes of each voltage packaged in reusable poly bags. Stored in a handy file box. Contact your distributor or order direct.

A \$54.57 value for
ONLY \$24⁵⁰

Semiconductor Division

SCHAUER
Manufacturing Corp.

4511 Alpine Ave. Cincinnati, Ohio 45242
Telephone: 513/791-3030

MICROWAVES & LASERS

**400-W amp allows
500- μ s long pulses**



Microwave Power Devices, Inc., Adams Court, Plainview, NY 11803. (516) 433-1400. \$3875; 60 to 90 days.

The Model PCA201-41 long-pulse solid-state amplifier combines a peak-power output of 400 W with a pulse width of 500 μ s and rf gain of 20 dB. The unit contains a 500-W compact circulator for protection against high mismatches. The amplifier operates at 201.25 MHz with a 2-MHz bandwidth. It specs a rep rate of 15 pps, and rise and fall times are less than 1 μ s. Harmonics are at least -30 dB. The compact unit measures 3-1/2 x 13-13/16 x 2-in.

CIRCLE NO. 334

**Communication amp
comes in flat pack**

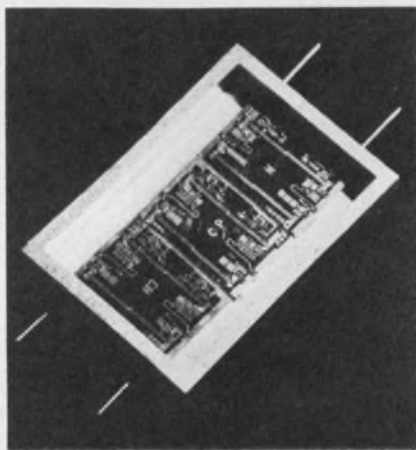

Avantek, Inc., 3175 Bowers Ave., Santa Clara, CA 95051. (408) 249-0700. \$395 (1-9); stock to 30 days.

The AFT-2500 flat-pack amplifier, intended for communications applications in the 1700-to-2500-MHz frequency range, offers a maximum gain of 25 dB with an over-all bandpass flatness of ± 0.5 dB (maximum). The unit has a maximum noise figure of 3.7 dB and a power output (for 1-dB compression) of +10 dBm minimum. Intercept points are typically +22 dBm. The unit measures 1.6 x .82 x .17 in.

CIRCLE NO. 335



**Wire-
Wrap
Panels**

EMC

**Nurl-Loc[®]
Delivers!**

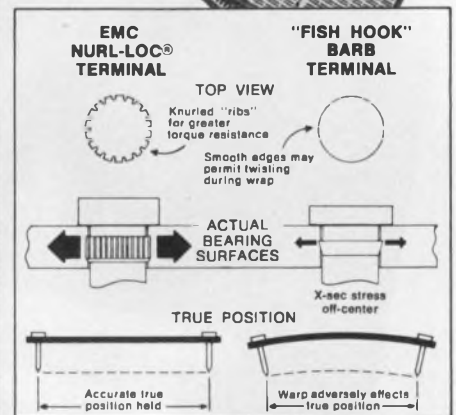

**Nurl-Loc Terminals
flatten EMC Panels
for pinpoint wrapping**

Patented Nurl-Loc permits wider use of lower-cost $\frac{1}{8}$ " panels, that mate with existing connectors and p.c. board set-ups. Nurl-Loc terminals hold better, won't twist during wrapping, and simplify terminal replacement. And funnel-entry design simplifies I.C. lead insertion. Standard $\frac{1}{8}$ " or $\frac{1}{16}$ " panels in 2 or 3 levels of wrap, 12 to 180 or more positions . . . or custom designs that match existing systems and cut wrapping costs.

Delivery Faster, too!

Contact EMC today for instant info on off-shelf delivery and fast engineering service. Electronic Molding Corp., 96 Mill St., Woonsocket, R. I. 02895. Phone (401) 769-3800.

Wire-Wrapping Gardner-Denver Co.



INFORMATION RETRIEVAL NUMBER 68
ELECTRONIC DESIGN 13, June 21, 1975

Cascadable amp works at 1.5 GHz

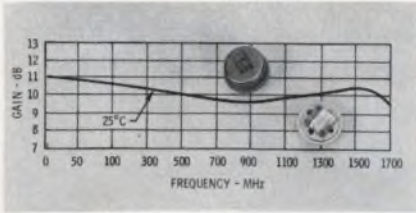

Watkins-Johnson Co., 3333 Hillview Ave., Palo Alto, CA 94304. (415) 493-4141. \$129 (1-9); stock.

The company's thin-film cascadable amplifier line now extends to 1500 MHz with the introduction of the WJ-A25. The new amplifier, which works down to 5 MHz, comes in a hermetic, four-pin, TO-8 package. It typically offers 10 dB of gain, 6.0-dB noise figure and +9-dBm output power. The amplifier has a third-order intercept point of typically +20 dBm.

CIRCLE NO. 336

0.5-18-GHz oscillators have $\pm 0.05\%$ stability

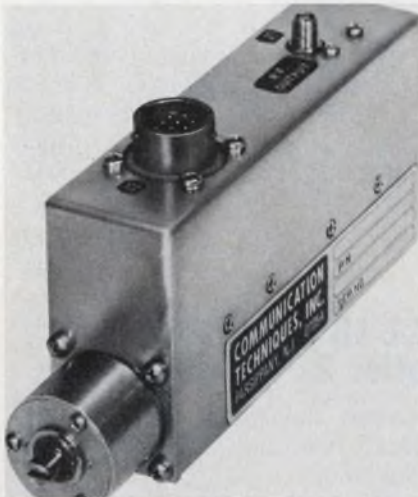

Communication Techniques, 1279 Route 46, Parsippany, NJ 07054. (201) 263-7200.

In combination, Series CO and COM models—fundamental cavity oscillators and oscillator multipliers, respectively—cover the 0.5-to-18-GHz band with $\pm 0.05\%$ frequency stability over the -30 to $+65$ C temperature ranges. They are said to have the lowest AM and FM noise characteristics available. Options for the cavity oscillators include improved stability of $\pm 0.02\%$, FM capability, afc input, auxiliary rf output and integrated load-VSWR isolators.

CIRCLE NO. 337

Meet Shelly's LED-EYE

Industry's first complete line of LED indicators in standard T1 packages.



Wide range of colors



Another first for Shelly. Industry's first T1 LED package. They're bright! In red/2.5 MCD @ 20 ma; green, orange & yellow/2.0 @ 20 ma. Also a current regulated LED which provides constant intensity from 4.5V to 11V. And a voltage sensing LED for battery status indication.

Just snap into panel

Easiest to use too. Just insert into 0.191" hole and press into position. LED-EYES are ideal for modern panels where space is at

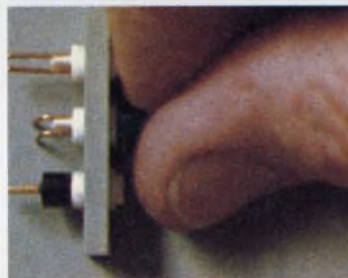

a premium. Mounting on 0.225" centers they offer clean design and high illumination.

Digi-caps, too

Cap styles include Ball End and our unique Digi-cap, a LED-EYE imprinted with 1 or 2 letters, numerals or symbols to give added dimension to a display.

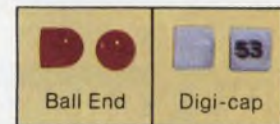

Shelly — The T1 specialists

With Brite-Eyes — T1 incandescents in 7 cap styles & 7 colors. Front relampable without tools.

With Trans-Eyes — A Brite-Eye with built-in hybrid amplifier. Eight base/circuit configurations.

With LED-Eyes — The first LED in a standard T1 package. 4 colors and 2 cap styles.



Send for our free "How To Order" brochure or phone 800-645-9200 EEM Dial-A-Source.

shelly associates

A Subsidiary of Datatron, Inc.

1562 REYNOLDS AVENUE, SANTA ANA, CALIFORNIA 92705
PHONE (714) 540-9330 • TWX 910-595-1859
MAILING ADDRESS: P.O. BOX 11427, SANTA ANA, CALIFORNIA 92711

INDICATORS • MULTI MESSAGE DISPLAYS • FIBER OPTICS • ANNUNCIATORS

INFORMATION RETRIEVAL NUMBER 69

When SCR drives aren't good enough motomatic[®] is.

Why? Because MOTOMATIC has wider speed range (1000:1), full torque at speeds as low as 3 rpm, and no cogging. The new expanded line of patented fractional hp MOTOMATIC transistorized dc motor speed control systems are now available off

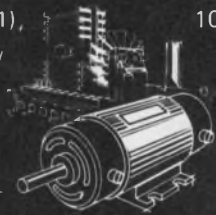

the shelf. After 10 years, over 1000 customers and more than 1/2 million units sold we probably have the right servo product for your need. Call us. Electro-Craft Corp. 1600 South 2nd Street, Hopkins, Minnesota 55343, 612/935-8445.

INFORMATION RETRIEVAL NUMBER 70

MICROWAVES & LASERS

Stainless-steel cables allow manual bending

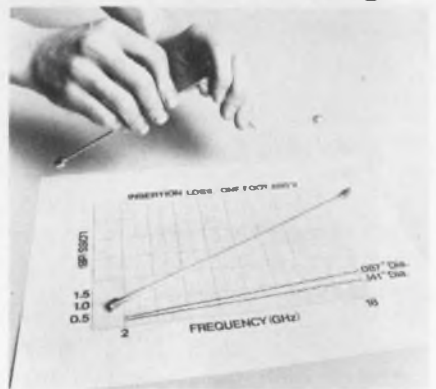

Times Wire & Cable Co., 358 Hall Ave., Wallingford, CT 06492. (203) 265-2361.

A line of low-loss semi-flexible stainless-steel cable assemblies easily can be bent by hand without danger of mechanical or electrical degradation. Assemblies are available in two cable diameters. Insertion loss for the 0.141-in. diameter assemblies is only 0.2 dB/ft at 2 GHz, and only 0.7 dB/ft at 18 GHz. Insertion loss for the 0.087-in. diameter assemblies is 0.3 dB/ft at 2 GHz and only 1.1 dB/ft at 18 GHz. Connector interfaces include SMA, TNC and Type N per MIL-C-39012.

CIRCLE NO. 338

11-18 GHz TDAs offer 21-42-dB gains

Aercom Industries, Inc., P.O. Box 1946, Sunnyvale, CA 94088. (408) 734-1160.

The Model A118006 TDA, in a 3.75 x 2.5 x 1-in. package, covers the 11-to-18-GHz frequency range with a minimum gain of 21 dB. A maximum noise figure of 7.5 dB and the minimum gain are maintained over the 0-to-50-C operating temperature range. A higher-gain version, the Model AL-118007 TDA, provides 42-dB minimum gain over the 11-to-18-GHz band. This unit measures 4.5 x 2.5 x 2 in. and features a saturated output power that is confined to a ±1.5-dB box within an output range of -16 to -12 dBm. Both models meet MIL-E-5400/16400 specifications.

CIRCLE NO. 339

Circuit Savers



\$3.00
1000 pcs

DC
CROWBAR



Here's positive low cost protection for your IC's, transistors, power supplies and pc cards.

The LVC-1A crowbar switches to a short circuit whenever the voltage across it exceeds a specified level.

Any trip voltage level between 4.7V and 200V ± 10% can be selected. The unit will handle a peak current of 50 Amps (8ms) and 3A continuously. MIL Temperature range. Call Mike Coyle for applications assistance.

Full line of protection modules for every hi-to voltage/current requirement. Write or call for Catalog 749.

279 Skidmore Road
Deer Park, New York 11729
Telephone: 516 - 586-5125

MCG Electronics

See Gold Book vol 2, p. 1277.

INFORMATION RETRIEVAL NUMBER 71

\$500*

BALANCED



MIXER

MODEL MD-108

- DC - 500 MHz
- 7dB Conversion Loss
- 30dB Isolation
- 8 - Pin Relay Header

* 500 piece qty. 1-49 pieces (\$7.00)
50-499 pieces (\$5.75).

anzac
ELECTRONICS



39 Green Street, Waltham, Mass.
(617) 899-1900 • TWX 710-324-6484

INFORMATION RETRIEVAL NUMBER 72

The Delay Line line...

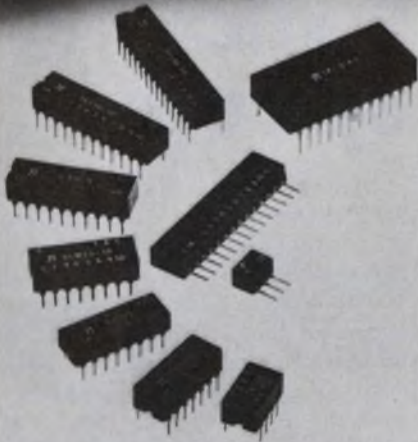

that's different!

A series of inductive tapped lines . . . the difference that makes us better.

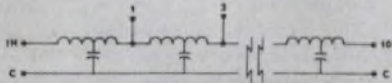

External capacitive loads are distributed across two sections.

HERE ARE THE BENEFITS:

- Frequency capability to 350 MHz.
- High network "Q" . . . toroidal inductors.
- Very low DC resistance . . . minimum attenuation.
- Minimal insertion loss.
- Consistent tap to tap accuracies.
- Exceptional delay stability over temperature range (-55 to +125°C).
- Minimal cascading problems.
- Minimized distortion of capacitive loading at high frequency.

And there's a package for all reasons . . . sip's, mini dip's, standard dip's, low profile dip's, double dip's, and our new economy family of nanobits. Phone, wire or write for more information today.



RHOMBUS INDUSTRIES INC.

22119 S. Vermont Ave., Torrance, Ca. 90502
(213) 325-7440 • TWX 910-349-7512

INFORMATION RETRIEVAL NUMBER 73
ELECTRONIC DESIGN 13, June 21, 1975

PACKAGING & MATERIALS

Wire-wrappable terminal fits rotary switches

Standard Grigsby, Inc., 920 Rathbone Ave., Aurora, IL 60507. (312) 897-8417.

Wire-wrappable terminals for rotary switches use a wedgelock "T" construction. The terminals are soldered to the stators of Standard Grigsby's line of rotary switches for easy, economical wire wrapping.

CIRCLE NO. 340

Connector lines designed for calculator displays

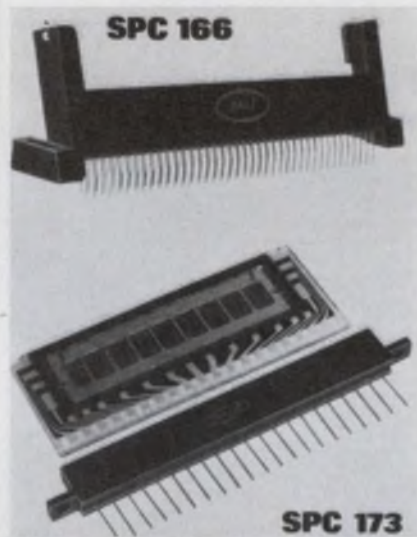

Dale Electronics, Inc., East Hwy. 50, Yonkton, SD 57078. (605) 665-9301.

A versatile, low-cost (price not given) line of display connectors is specially designed for high volume calculator applications. An SPC 166 (liquid crystal) series has 0.050-in. contact spacing that is compatible with several popular 8-digit LCD displays, and an SPC 173 (gas discharge) series has 0.156-in. contact spacing that is compatible with 8-digit displays manufactured by National Electronics, Inc. Three models of Series SPC 166 are available with height and angle variations and up to 80 contacts. The Series SPC 173 connectors are available with or without mounting flanges and can have up to 21 contacts. Both styles have a current rating of 0.5 A.

CIRCLE NO. 341

Advertisement

ELECTRONIC PACKAGING

Rack panels removed; inside not disturbed



Bud Radio, Inc., 4605 E. 355 St., Willoughby, O. 44094, (216) 946-3200. Panels, door 18 ga. steel.

Classic II cabinet racks from Bud. Brushed aluminum extrusion frames front panel. Sides removed from outside. Mounting rails adjustable front to rear. Rear door can be mounted to open right or left. Supports more than average load. All-steel, extra-rigid frame. Comes assembled. Compatible with Classic II cabinets. For further information phone —

1-800-321-1764, TOLL FREE

IN OHIO, 1-800-362-2265, TOLL FREE

Special fabrication of electronic housings



Bud Radio, Inc., 4605 E. 355 St., Willoughby, O. 44094, (216) 946-3200. Get what you want for less.

Bud designs and fabricates racks, cabinets, enclosures for new or re-designed electronic instruments or systems. Standard Bud housings can be altered to fit many applications. Original housings can be designed and produced. In addition, Bud's Imlok system can be used for short runs, test or pilot models. For further information phone —

1-800-321-1764, TOLL FREE

IN OHIO, 1-800-362-2265, TOLL FREE

121

ELECTRONIC PACKAGING

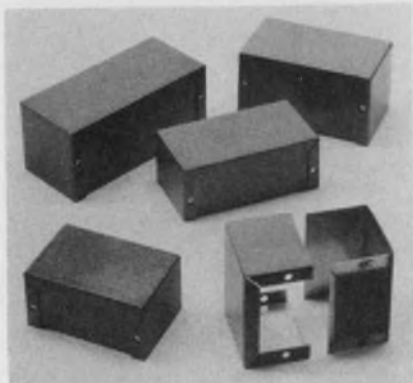
**Compact enclosures,
versatile, economical**

Bud Radio, Inc., 4605 E. 355 St., Willoughby, O. 44094, (216) 946-3200. Available in 18 sizes.

Miniboxes from Bud. Use as separate housings or as part of a larger assembly. Flanges give assured shielding. Projecting covers on cowl-type units minimize glare, protect controls, dials. .040 and .050 aluminum alloy. Immediately available. Shipping economies. One of nearly 3000 products from Bud Radio. For further information phone —

1-800-321-1764, TOLL FREE

IN OHIO, 1-800-362-2265, TOLL FREE

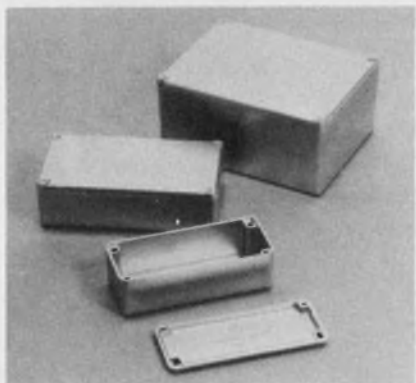
**Low-cost enclosures for
a variety of uses**

Bud Radio, Inc., 4605 E. 355 St., Willoughby, O. 44094, (216) 946-3200. Cast aluminum construction.

Econoboxes by Bud. Five sizes for instrument and meter cases, filter networks, junction boxes, and more! Effective for concealed or other interior use where safety enclosures are necessary. Lightweight. Easy to machine. LM-380 aluminum alloy, plus close-fitting flanged lids offer excellent screening properties. Immediate delivery. For further information phone—

1-800-321-1764, TOLL FREE

IN OHIO, 1-800-362-2265, TOLL FREE

PACKAGING & MATERIALS

**Tantalum 99.95% pure
comes in many forms**

Aremco Products Inc., P.O. Box 429, Ossining, NY 10562. (914) 762-0685. 2 to 3 wks.

High-purity tantalum to 99.95% is now available. The tantalum comes in strip, sheet, tubing, wire and powder forms. The strips and sheets are 0.001 to 0.187-in. thick and up to 36-in. wide. The tubing is welded and ranges from 1/2- to 9-in. OD, with wall thicknesses from 0.005 to 0.125 in. Wire products are available in diameters from 0.002 to 0.1 in. Capacitor-grade powder is in the form of large-diameter particles with high surface area.

CIRCLE NO. 342

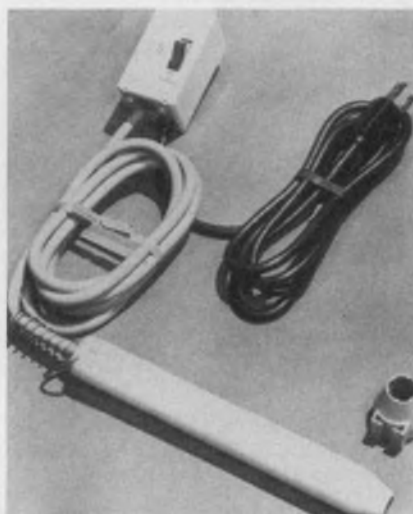
**Flameless heating tool
weighs only 5 oz**

Instruments America Inc., 823 N.W. 57th St., Fort Lauderdale, FL 33309. (305) 776-5831. \$79 (unit qty).

A 5-oz, pneumatic, flameless-heat tool called the Heat Pen uses less than 300 W of electricity and less than 1.5 ft³/min of pressurized air. Built to meet OSHA standards, the unit has no dangerous hot areas, no fan to wear out, is quiet and is comfortably held like a pen. Plug-in heating elements can provide a temperature range of 150 to 800 F. The elements can be changed without tools in 10 s. The pen normally comes with a 400 to 600-W element, control unit, baffle adapter and grounded-cord set. A variety of accessories is also available.

CIRCLE NO. 343

**LOW
Phase
Noise and
FAST
Switching
Speed**

... are two features of GR SYNTHESIZERS that no other 500 MHz synthesizer can match. Phase noise of GR's 1062 is the lowest available at 500 MHz. . . close to 100 dB down at 10 Hz from the carrier. . . one reason the 1062 is the popular choice for up-converting and multiplying into microwave-frequency bands. What's more, the 1062's switching speed is under 100 microseconds and guaranteed! Both features are explained in GR Application Notes; request your copies now. Other performance features include:

- DC to 160 MHz or 0.01 to 500 MHz
- Optional resolution to 0.1 Hz
- Non-harmonic spurs > 80 dB down
- A-M, F-M, and P-M capabilities
- Built-in search sweep
- Programmable (BCD parallel) frequency control
- Plug-in modular construction
- Proven record of high MTBF
- Low power consumption (60 W)



For additional information, technical assistance, or a demonstration, call or write:

**General Radio**

300 BAKER AVENUE, CONCORD, MASSACHUSETTS 01742

NEW YORK (IN Y.) 212 964-2722, (N.J.) 201 791-8990
BOSTON 617 646-0550 • DAYTON 513 294-1500
CHICAGO 312 992-0800 • WASHINGTON, D. C. 301 948-7071
ATLANTA 404 394-5380 • DALLAS 214 234-3357
LOS ANGELES 714 540-9830 • SAN FRANCISCO 415 948-8233
TORONTO 416 252-3395 • ZURICH (01) 55 24 20

GR COMPANIES • Grason-Stadler • Time-Data

Also available:

- Higher-frequency systems
- Keyboard frequency programmer
- Tracking synthesizer systems

INFORMATION RETRIEVAL NUMBER 75
ELECTRONIC DESIGN 13, June 21, 1975

Terminal covers come in many shapes, sizes



Zippertubing Co., 13000 S. Broadway, Los Angeles, CA 90061. (213) 321-3901.

A complete line of molded vinyl (PVC) terminal covers, Livin-End, comes in a wide range of standard sizes and shapes. Simply slipped onto the wire before terminating, the Livin-End is easily pulled over the finished connection where its flexibility provides a friction fit.

CIRCLE NO. 344

Tuning-fork probe fits pin and rail matrices

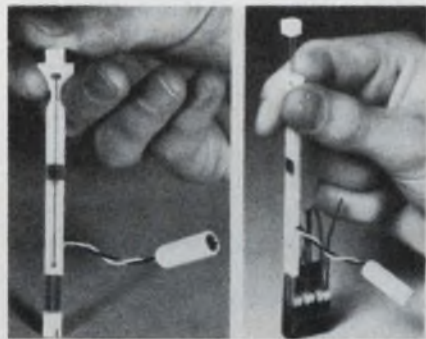

A P Products Inc., Box 110, 72 Corwin Dr., Painesville, OH 44077. (216) 354-2101. \$40 (unit qty); stock to 4 wks.

A dual-contact test probe for oscilloscope signal or ground attachment is compatible with 370 MST interconnections. When extended, its two-position housing permits direct probing with twin tuning-fork contacts onto pin-and-rail back-panel matrices. With the housing retracted, the contacts may be inserted into pin-and-pin as well as pin-and-rail connector housings. The receptacle mates with miniature oscilloscope probe tips such as the Tektronix Model 010-0218-00.

CIRCLE NO. 345

NEW Continental Specialties Logic monitor

FASTER THAN A SCOPE! SAFER THAN A VOLTMETER! BRINGS ICs TO LIFE!

Made in USA

* Patent Pending

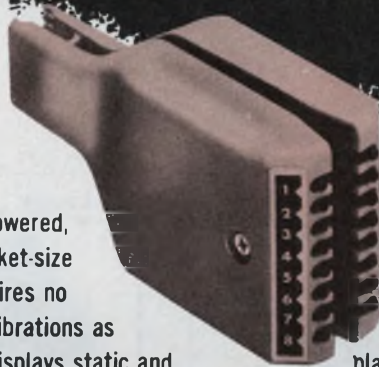

The amazing self-powered, self-contained, pocket-size Logic Monitor requires no adjustments or calibrations as it simultaneously displays static and dynamic logic states of DTL, TTL, HTL or CMOS DIP ICs. Now you can watch your signals work their way through counters, shift registers, timers, adders, flip-flops, decoders, even entire systems! High intensity LEDs turn on when lead voltages exceed the threshold (2V). **No power supply is needed!** The power-seeking gate network locates DIP supply leads and feeds them into the Logic Monitor. Forget about grounds, pin counting or sync polarity.

Simply clip the Logic Monitor to any DIP IC up to 16 pins. Precision plastic guides and a flexible plastic web insure positive connections between non-corrosive nickel/silver contacts and the IC leads. Logic levels appear instantly on 16 large (.125" dia.) high intensity LEDs. Logic "1" (high voltage)-LED ON. Logic "0" (low voltage or open circuit)-LED OFF. Yes, now you can see your designs come alive. Order your fast, versatile, accurate, indispensable Logic Monitor today!

ORDER TODAY! 84⁹⁵

Add \$2.50 postage/handling.
Foreign orders add 15%.
Prices subject to change.



Continental Specialties Corporation

Box 1942, New Haven, CT 06509 • 203/624-3103

W. Coast Off.: Box 7809, S. Fran., CA 94119 • 415/383-4207 Canada: Available thru Len Finkler Ltd., Ontario

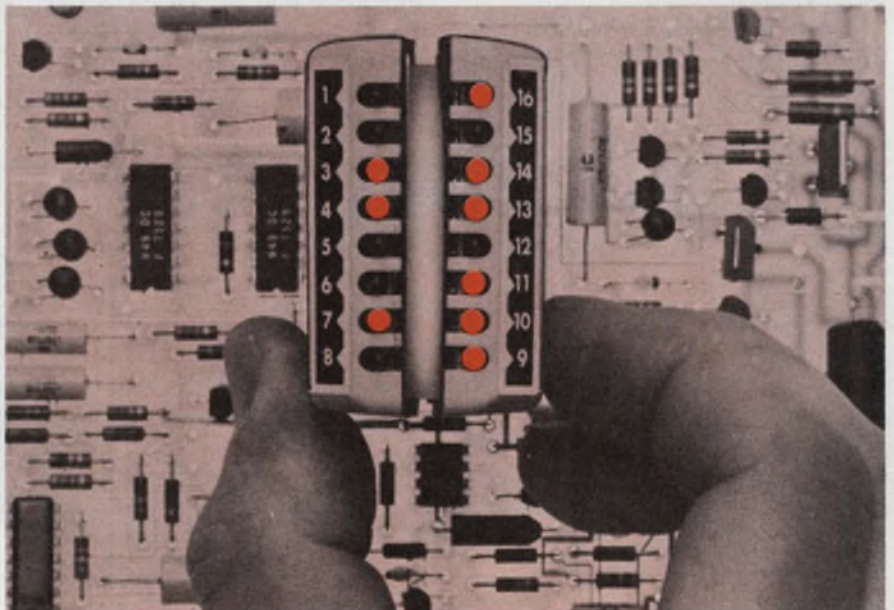

INFORMATION RETRIEVAL NUMBER 76

High-isolation amplifiers handle up to ± 2500 V, common-mode

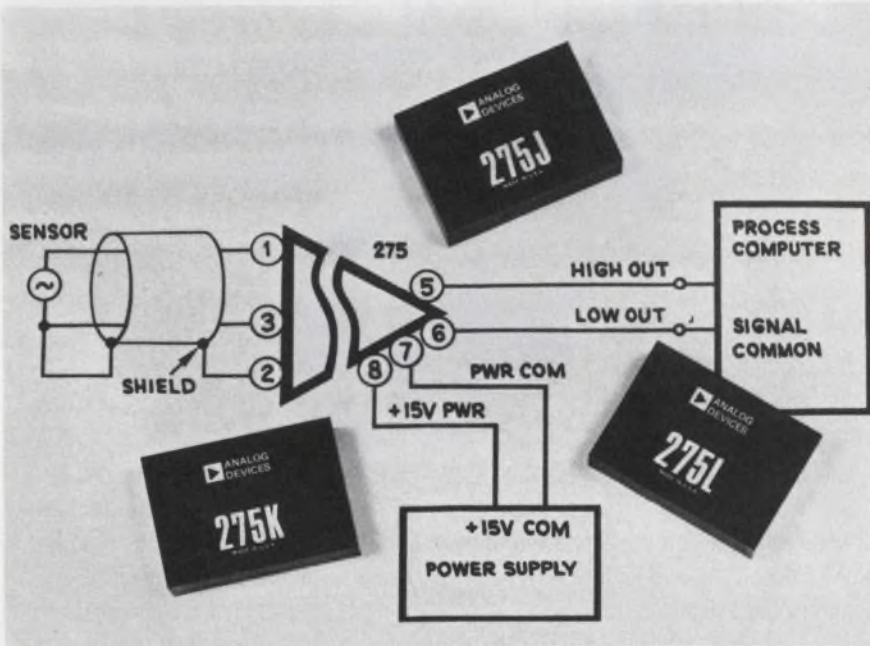

though, drops to 300 Hz for a 20-V pk-pk output. And the amplifier has a unity-gain slew rate of only 15 mV/ μ s.

The noninverting voltage gain of the amplifiers can be adjusted over a 1-to-100 range for a 50-k Ω load. You can, though, get gains of up to 1000 if derated performance can be tolerated.

The amplifiers have a differential input impedance of $10^8 \Omega$ shunted by 3 pF, and a common-mode input impedance of $10^{11} \Omega$ shunted by 100 pF. The output impedance of the amplifier is 1.5 k Ω .

Input voltage noise in the 0.01-to-10-Hz band, at a gain of 100, is only 5- μ V pk-pk, and only 1.5 μ V rms in the 10-Hz-to-1-kHz band. Input current noise over the 0.01-to-10-Hz bandwidth is only 1-pA pk-pk.

The amplifiers require a single power supply of 12 to 18 V dc (15-V nominal). Quiescent current for the 275 series is 15 mA. All three models are rated for operation over a 0-to-70-C range and can be stored at -55 to +85 C.

The plastic encapsulated units measure 3.5 \times 2.5 \times 0.88 in. and weigh 250 g.

Prices for the 275 series start at \$75 for the 275J, \$85 for the 275K and \$95 for the 275L—all in 10-to-24-piece orders. Delivery is from stock.

Analog Devices, Route 1 Industrial Park, P. O. Box 280, Norwood, MA 02062. (617) 329-4700. P&A: See text.

Common-mode voltages up to ± 2500 V are handled by the 275 series of guarded input amplifiers. The units, from Analog Devices, have minimum common-mode rejection ratios of 120 dB when measured with a 1-k Ω source imbalance at 60 Hz. Under balanced line conditions, the rejection is at least 126 dB.

There are three models in the 275 series—the 275J, 275K and

275L. All have an initial offset voltage defined by $(1 + 25/\text{gain})$ mV. The input offset voltage drifts are ± 25 , ± 15 and $\pm 5 \mu$ V, respectively. And the lower the drift, the lower the nonlinearity—the minimum values are 0.15, 0.1 and 0.05%, respectively (for a ± 5 -V output). If you need a ± 10 -V output, the nonlinearity for each model increases to 0.2, 0.15 and 0.1%, respectively.

All units in the 275 series have a small-signal response from dc to 1.5 kHz, when operated with a gain of 100. Full-power bandwidth,

CIRCLE NO. 301



ANALOGY
THE A-862 IS IN THE CATCHER'S MITT BEFORE YOU KNOW IT WITH ITS 250NS 1DAC SPEED AND LINEARITY TEMPCO OF ONLY 2 PPM/ $^{\circ}$ C. IF VOLTAGE TURNS YOU ON. TRY IT AS A 1.5 μ S VDAC AT 6PPM/ $^{\circ}$ C.

intech INCORPORATED
1220 COLEMAN, SANTA CLARA CA 95050

Our frequency counter is smarter than your frequency counter.

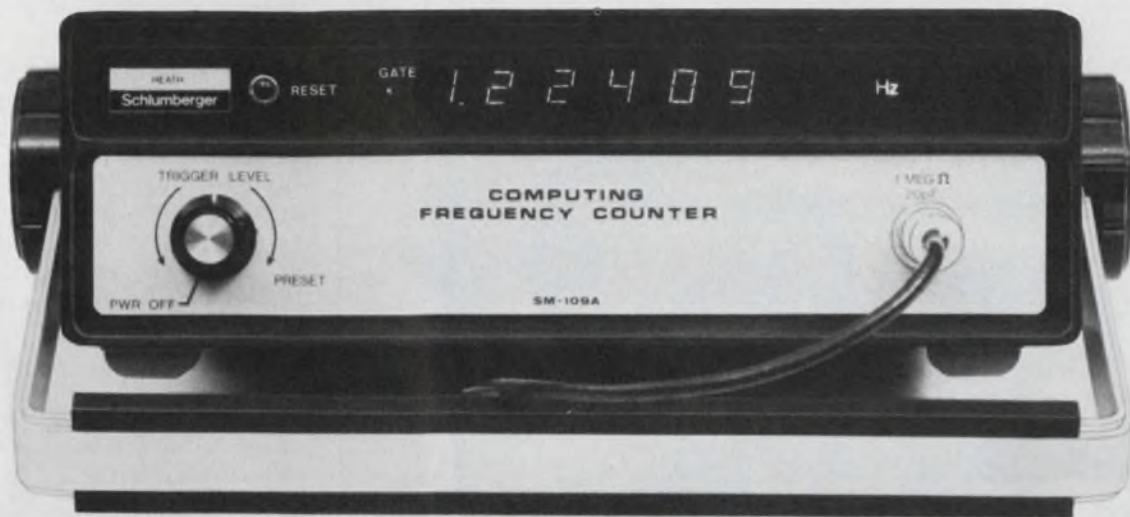

The new Heath/Schlumberger SM-109A Computing Frequency Counter is probably the lowest-priced "smart" test instrument available today. With its exclusive Heath-designed circuitry, it is possible to make fast, accurate, high resolution low frequency measurements that cannot be obtained with a conventional frequency counter.

How does it work? The SM-109A measures the elapsed time for a number of periods of the input waveform, then computes the frequency. And it does this in much less time than would be required for a conventional counter. For example, a resolution of 0.00001 Hz can be obtained for a 1 Hz input frequency with a total measurement time of 1 second. A standard frequency counter would require 27.78 hours for the same measurement!

Range of the SM-109A is 0.1 Hz to 20 MHz with sensitivity as low as 20 mV. The display provides 6-digit resolution with automatic

decimal point placement and range indication. The front panel trigger control adjusts the input amplifier level above the zero crossing point to insure an accurate count in the presence of noise or signal distortion. Time base can be switched for a choice of 1 second or 0.1 second gate time. A fast count switch permits the display to be updated more often when working with higher frequencies.

Because of the 1-megohm input impedance, a standard oscilloscope probe can be used as a voltage divider. Other features include display of either Hertz or counts per minute...oscillator input for use with an external frequency standard...reset switch to reset counter to zero. All for only \$595*.

Smart? You bet it is. Send for our latest catalog and see how the SM-109A can help solve your frequency measurement problems. That's really smart.

A complete line of counters for today's measurement problems

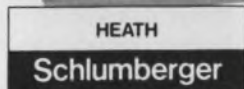

Heath/Schlumberger Instruments
Dept. 511-060
Benton Harbor, Michigan 49022

...is described in our latest catalog. We have one of the most complete frequency counter lines available, offering the performance and features that you really need. Our SM-118A is the lowest-priced autoranging counter available—anywhere. Its 30 MHz range, 10 mV input sensitivity and 1 Hz resolution make it an outstanding value for only \$250*. The autoranging SM-128A & SM-128B are the ideal way to add a high performance counter to your lab. They offer a 110 MHz range, 15 mV sensitivity and a choice of oscillator stabilities. Our 180 MHz SM-110A provides accuracy and stability to meet the most exacting design and testing applications. The 600 MHz SM-110C has an extremely stable TCXO (± 1 ppm/yr.) and complete remote programming capability.

Our complete frequency counter line is described in the latest Heath/Schlumberger Assembled Instruments Catalog. Send for your free catalog today. You'll see why there are no better buys than frequency counters from Heath/Schlumberger.



Please send my free copy of the latest Heath/Schlumberger Catalog.
HEATH/SCHLUMBERGER INSTRUMENTS,
Dept. 511-060, Benton Harbor, Michigan 49022

NAME _____		
TITLE _____		
COMPANY/INSTITUTION _____		
ADDRESS _____		
CITY _____	STATE _____	ZIP _____

*MAIL ORDER PRICES; F.O.B. FACTORY.
PRICES AND SPECIFICATIONS SUBJECT TO CHANGE WITHOUT NOTICE.

EK-460

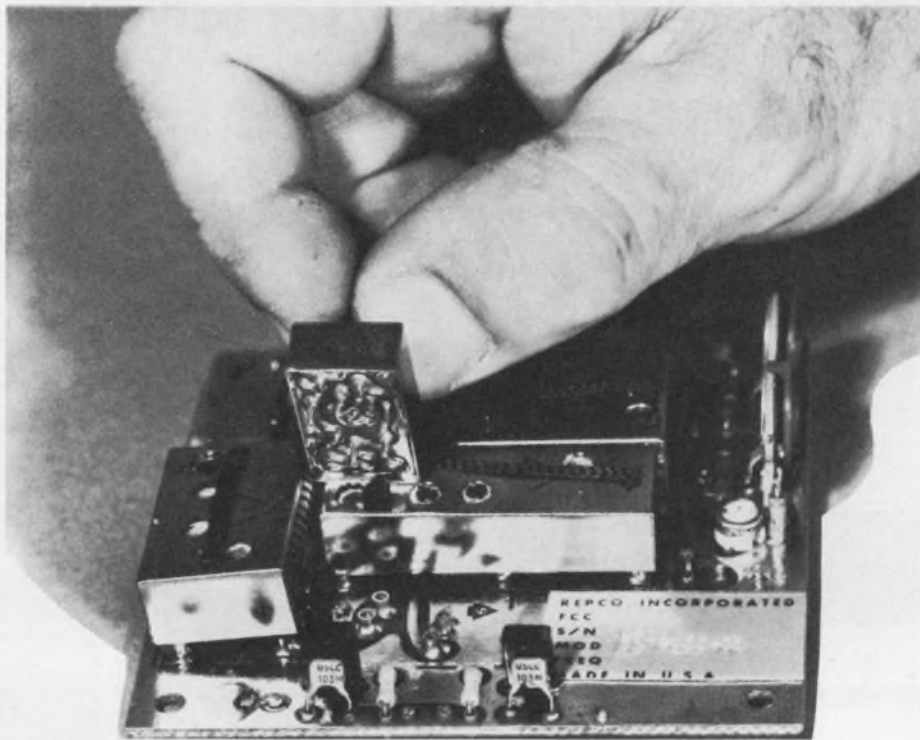

ACTUAL SIZE

Link up

with Repco RF transmitters and receivers

Repco's FCC type accepted RF links give you design flexibility with proven reliability (actual cases report systems in use for years with no link failure), excellent MTBF, rapid MTTR (with low cost, off-the-shelf PBC modules). Suitable for voice, low-speed digital, or tone. 25-50 Mhz, 72-76 Mhz, 132-174 Mhz; and our new UHF 450-470 Mhz ranges (66-88 Mhz available for overseas). Repco's delivery, production capacity, and volume pricing will warm your heart! Write today for our free specs brochure and special evaluation unit price.

----- Special evaluation offer! -----

Repco, Incorporated
 Special Products Department
 P. O. Box 7065, Orlando, Florida 32804
 (305) 843-8498 TWX 810-850-0120

Please send me free specs brochure and special low unit price available for evaluation of your RF links.



Name _____ Title _____
 Company _____ Address _____
 City _____ State _____ Zip _____

ED 4

Repco World's leading manufacturer of modular handheld portable radios.

INFORMATION RETRIEVAL NUMBER 79

MODULES & SUBASSEMBLIES

V/f converters operate over wide supply range

Richard Lee Co., Box 724, New Providence, NJ 07974. (201) 665-1333. \$59 (1 to 9); stock.

The Model 712 v/f converter has a range of 10 kHz. It is designed to operate with a wide range of supply voltages from +5 to +15 V dc and -10 to -15 V dc. It can be overranged 50% without loss of linearity and will operate linearly at input levels of less than 1 mV. The 712 features 0.005% linearity, voltage or current inputs, 10 ppm/°C temperature coefficient, 5 mV max input offset voltage, 100-mA output sink capability and TTL/DTL or CMOS/HTL compatibility.

CIRCLE NO. 346

Point-plotter module interfaces to CRTs

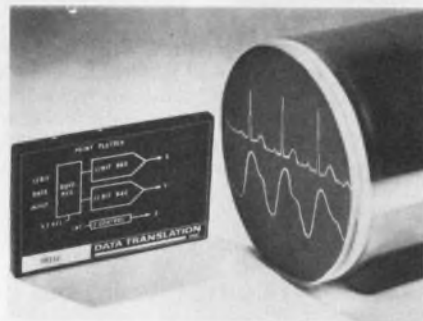

Data Translation, 109 Concord St., Framingham, MA 01701. (617) 879-3595. \$245 (100-up); 2 wk.

The DT212 point plotter allows minicomputers and microprocessors to supply digital information to CRT displays and analog recorders. The module provides all the controls, timing functions, X and Y axis d/a converters to fill the gap between the computer and the CRT display. The unit contains complete 12-bit d/a converters for both the X and Y axis, has a linearity of ± 0.5 LSB for each axis, a Z axis control and set-up delay, and mode control for selecting any of four modes of operation depending upon whether a refresh or storage CRT is used. The DT212 guarantees settling to 0.1% in 1 μ s and to 0.01% in 3 μ s for up to 50 ft. of terminated cable.

CIRCLE NO. 347

Two for your budget.

Affordable spectrum analyzers that typically will make over 90% of your everyday frequency domain measurements. Easily. Accurately.

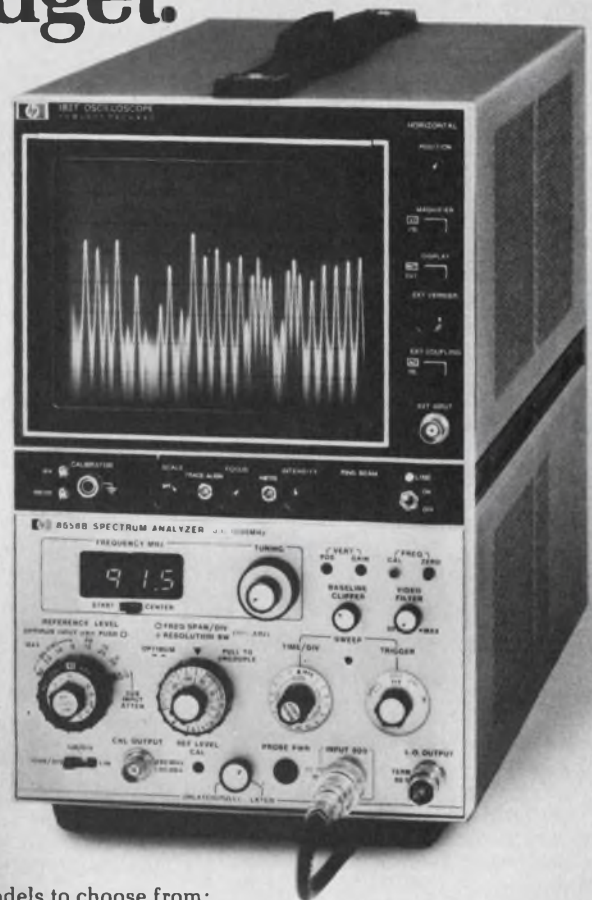
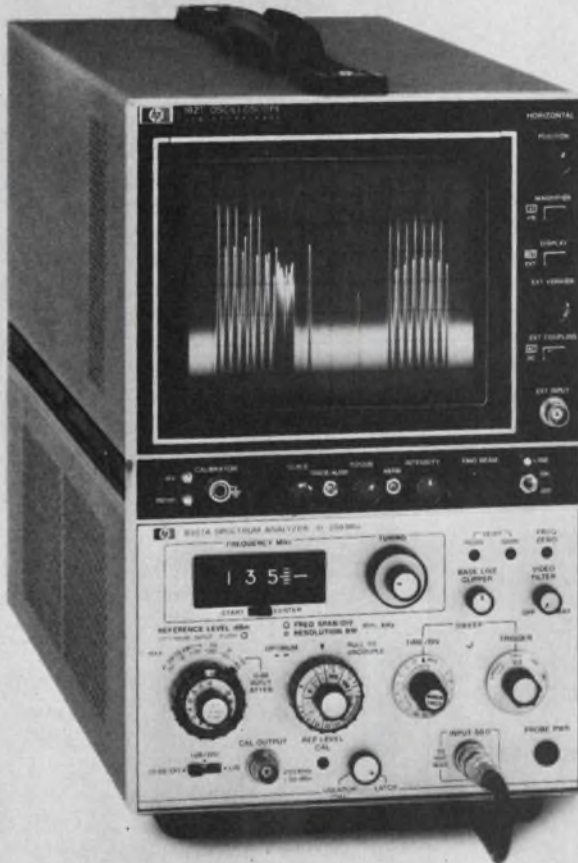

Two models to choose from; they're plug-ins for HP's versatile 180 Series Scopes.

Performance:	HP 8557A	HP 8558B
Frequency Range	10 kHz — 350 MHz	100 kHz — 1500 MHz
Amplitude Range	-117 dBm — +20 dBm	-115 dBm — +30 dBm
Frequency Response	±0.75 dB	±1.0 dB
Distortion-free Dynamic Range	>70 dB	>70 dB
Frequency Span Range	50 kHz — 350 MHz	50 kHz — 1000 MHz
Resolution Bandwidths	1 kHz — 3 MHz	1 kHz — 3 MHz
Price (Plug-in)	\$3450	\$4300

(HP 182T Large Screen Display Unit, \$1300.)

Domestic USA prices.

Ease of use is another important feature of these HP Spectrum Analyzers. For most measurements you use just three controls:

1. Tune to the signal. Frequency is displayed on a digital readout.
2. Set the Frequency Span. View a wide spectrum then zoom in on your signal — resolution, sweep time, video filtering are all set automatically for optimum signal presentation.
3. Measure Amplitude Level. Read it directly from Reference Level control and CRT.

To help minimize chances for erroneous measurements, panel markings show optimum signal levels, and there's out-of-range blanking or limiting.

Economical for use on every bench, these analyzers provide the performance for over 90% of your everyday applications. This means they can relieve the need to use the more expensive high-resolution analyzer for routine measurement, with equivalent amplitude and frequency accuracy.

Want more information? Just call your nearest HP field office, or write.

HEWLETT  PACKARD

Sales and service from 172 offices in 65 countries.
1501 Page Mill Road, Palo Alto, California 94304

45506A

CUSTOM POWER SUPPLIES FROM OFF-THE-SHELF SUB-MODULES



Over 1200 configurations of miniaturized, high efficiency AC-DC & DC-DC Regulated Power Converters using standard sub-modules . . . only from Arnold Magnetics!

Our exclusive off-the-shelf thin-mods let you design your own custom power conversion systems as you order. There's no engineering cost, no lost design time, and no long delivery schedules.

All this, plus super performance. AC (115-220 VAC, 47-500 Hz) and DC (12, 28, 48, 115 and 150 VDC) inputs . . . multiple isolated and regulated (to .1%) outputs . . . up to 800 watts per output . . . 3.9 watts delivered per cubic inch . . . efficiencies to 85% . . . short circuit and transient protection.



Your complete Power Conversion System is provided in a tested and encapsulated miniaturized, conduction cooled package.

Call us collect . . . ask for Mark Warren. We'll have our easy-to-use Specification Form and our new Catalog in the mail to you today!



ARNOLD MAGNETICS CORPORATION

11520 W. Jefferson Blvd.
Culver City, Ca. 90230 • (213) 870-7014

MODULES & SUBASSEMBLIES

Timing module provides delay on energize



Hi-G, Spring St. & Rte 75, Windsor Locks, CT 06096. (203) 623-2481. \$7.20 (100-up); stock.

The Model 6400 solid state timing module is designed to provide delay-on-energize control for relay race and other electromechanical applications. The timing module is housed in a two terminal cylindrical case, has a 0.75 in. diameter and is 2 in. long. It can be mounted in two holes of a PC board, or wrapped around two screws of a terminal block. The timer is available with fixed delay times of 1, 5, 10, 30 and 60 s, accurate to $\pm 10\%$ over its temperature range and rated voltage, with repeatability held to $\pm 2\%$. Operating temperature range is from 0 to 50 C. Input voltages available include 12, 24 or 48 V dc. Forward voltage drop is 1.5 V dc maximum. The output can handle inductive loads of 0.5 A maximum at rated nominal input voltage.

CIRCLE NO. 348

Programmable controller uses plug-in matrix

Resec, 140 Skyline Dr., Oakland, NJ 07436. (201) 337-3607. From \$420.

The 4100 system is designed for use in automated control applications. The unit accepts 64 inputs and generates 16 outputs, and as many units as required may be connected in a common control system. Programming is achieved by the use of a plug-in matrix board, where the pin locations are easily obtained from a description of the functions to be performed. Other features include combinational logic capability, including latching, interlocking, etc.; 64 sensitive inputs; 16 fused outputs, zero crossover circuit; input and output protection, no damage from accidentally shorting any input or output up to 120 V; and energy fired noise filters.

CIRCLE NO. 349

MONOLITHIC CRYSTAL FILTERS

the
State
of the
Art

NEW FM DISCRIMINATORS . . .

One hang-up in designing a single-conversion NBFM receiver is demodulation. Until now you've had the option of making a second conversion, using phase-locked loop techniques, or designing your own discriminator. Now PTI has made demodulation simple with two new monolithic crystal discriminators offering low distortion — typically 1% — and high recovered audio — typically 800 mV — when used with the CA3089E IC quadrature detector or equivalent.

Detailed spec sheets are available. Ask for Models 2283F (10.7 MHz) and 2378F (21.4 MHz).

SOME THINGS NEVER CHANGE

Five years ago, when this ad series began, we offered some 20 low-priced standard monolithic crystal filters at 10.7 MHz. Since then the number has grown to 60 at 10.7 and 21.4 MHz (not to mention standards at other frequencies). Even though it's five years later, we still offer those original models — and at prices no higher now than in 1970. Times may be changing, but our quality and price aren't.

SOMETHING OLD, SOMETHING NEW

Our new discriminators and our original standard models are two good examples of PTI's leadership in monolithic crystal filters. If you have a problem calling for monolithics we may have the answer already on the shelf.

Pti

Piezo Technology Inc.

2400 Diversified Way Orlando, Fla. 32804
(305) 425-1574

The standard in monolithic
crystal filters.

POWER SOURCES

Precision calibrator handles both ac and dc

Optimization, Inc., 9259 Independence Ave., Chatsworth, CA 91311. (213) 882-6490. \$5995; 4-6 wks.

Two absolute calibrators provide high-precision ac and dc calibration in a single unit. The basic model AC-126 and the programmable model AC-130 feature accuracy of 100 parts per million ac and 20 parts per million dc. Voltage accuracy is $\pm 0.002\%$ of setting for all dc ranges. Ac accuracy ranges from $\pm 0.01\%$ over 50 Hz to 20 kHz, to $\pm 0.2\%$ over 0.1 MHz to 1.1 MHz, with no other frequency range exceeding $\pm 0.05\%$. Ac and bipolar dc frequency ranges extend from 10 nV to 100 V in six decade ranges with six-place settability and 20% overranging. Frequency extends from 10 Hz to 1.1 MHz through the 10-V range and to 100 kHz through 100 V.

CIRCLE NO. 350

3- ϕ ac source weighs just 55 lb



Pacific Electronics, 2643 N. San Gabriel Blvd., Rosemead, CA 91770. (213) 573-1686. \$3995; stock.

Model 315 ac source is a three-phase, 1500-VA unit that weighs only 55 lb, said to be nearly five times lighter than other conventional power units. An internal variable oscillator features an adjustable frequency range from 47 to 500 Hz. The unit's three-phase selection (0, 90 or 120 degrees) is also operator-controlled. Single and combined phase panel metering enables selection of desired volts and amps (0 to 5 A). The Model 315 is fully metered, with a line regulation of less than 0.5% and load regulation of less than 0.9%. Output voltage is 0 to 125 V rms. Response time is 50 μ s.

CIRCLE NO. 351



If you could save up to 30% without losing anything by using this new 10mm ceramic trimmer capacitor, wouldn't you want to know it?

That's exactly what we can promise you for many applications. All the performance you need for about a third less than you've been spending.

These new trimmers have five capacity ranges from 3.0pF min. to 30.0pF max. Their operating temperature range is -30° C. to $+125^{\circ}$ C. And they mount interchangeably with other ceramic trimmers for PC applications. Four dielectric types available.

But check them out for yourself. Get the coupon in the mail today.

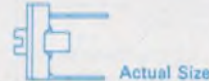

E. F. JOHNSON COMPANY/Waseca, Minnesota 56093. Dept. 3302
You bet I'd like literature and a free test sample of your new low cost trimmer capacitor if it can do what you say!

Check capacitance (pF) range needed:

- 3.0 to 8.0 3.0 to 12.0 5.0 to 13.0
- 5.0 to 20.0 5.0 to 30.0

_____ Please send them directly.

_____ Please call me at: _____

Name _____

Firm _____ Title _____

Address _____

City _____ State _____ Zip _____



E. F. JOHNSON COMPANY

INFORMATION RETRIEVAL NUMBER 83

Thermostatic
DELAY RELAYS
by **AMPERITE**



Featuring

**LOW COST · LONG LIFE
MAXIMUM
STABILITY**



**DELAYS:
2 to 180
SECONDS***

Hermetically sealed — not affected by altitude, moisture, or climate changes... SPST only — normally open or normally closed... Compensated for ambient temperature changes from -55° to $+80^{\circ}\text{C}$... Rugged, explosion-proof, long-lived... Standard radio octal and 9-pin miniatures.

Price, standard or min., under \$4.00 ea.

*Miniatures delays: 2 to 120 seconds.

PROBLEM? Send for Bulletin No. TR-81

New! LONG DELAYS

240 & 300 Sec.

Same rugged construction, hermetic sealing and stability as the shorter Delay Relays described above... For delays beyond 300 seconds, these Relays may be used in series.

Price, under \$6.00 ea.

Write for Bulletin No. LD-73.



DIFFERENTIAL RELAYS

For automatic overload, over-voltage or under-voltage protection... Made only to specifications for 70V, 80V, 90V and 100V.

Price, under \$6.00 ea.

**AMPERITE
BALLAST REGULATORS**

Automatically keeps current and voltage at a definite value. For AC or DC... Hermetically sealed, rugged, vibration-resistant, compact, most inexpensive.

Price, under \$3.00 ea.

Write for 4-p. Bulletin No. AB-51.



AMPERITE

600 PALISADE AVE., UNION CITY, N.J. 07087

Telephone: 201 UNion 4-9503

In Canada: Atlas Electronics, Ltd.,
50 Wingold Ave., Toronto 19

INFORMATION RETRIEVAL NUMBER 84

POWER SOURCES

**Constant-current source
drives deuterium lamp**



Optronic Laboratories Inc., 7676 Fenton St., Silver Spring, MD 20910. (301) 587-2255. \$605.

Model 45 is designed specifically to operate the Model UV-40 deuterium lamp (standard of spectral irradiance) at a constant current of 500 mA. The supply is operated from a 60-Hz, 115-V-ac line and will maintain its current accuracy while experiencing $\pm 10\%$ fluctuations in line voltage and $\pm 10\%$ variance in the load voltage. Current is $\pm 0.1\%$.

CIRCLE NO. 352

**Static inverter powers
5-kVA ac loads**



Deltec Corp., 3849 Gaines St., San Diego, CA 92110. (714) 297-4466. \$3450; 4 to 6 wks.

The DI 5003 5-kVA static inverter supplies ac power from a dc source. The unit is provided with input/output circuit breakers for convenience and overvoltage protection. Output overload or short-circuit current is limited to approximately 150%; the unit returns to normal operation when the overload condition is removed.

CIRCLE NO. 353



**now you have
a choice!**

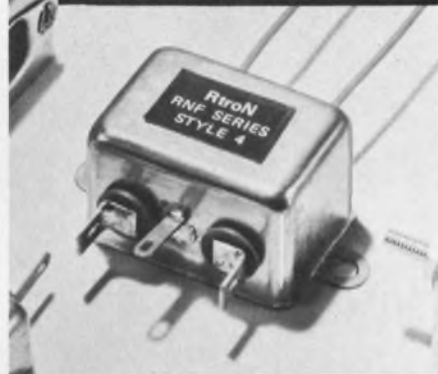

RFI/EMI FILTERS

For Data Processing,
Industrial Control and
Instrument Application

Rtron's RNF Type Filters represent three series of the most widely used, low cost filters available. Over 100 combinations of current and case style to choose from. "L" Series - low cost for general applications to combat line to ground noise. "P" Series - for suppression of line to line as well as line to ground interference. "T" Series - most effective for low impedance load applications. All types are U.L. Recognized and meet C.S.A. requirements. Rated at 115/250 VAC. Low leakage current insures safety.

For complete catalog and details, write

Rtron Corporation

P.O. Box 743, Skokie, Illinois 60076
(312) 679-7180

INFORMATION RETRIEVAL NUMBER 85
ELECTRONIC DESIGN 13, June 21, 1975

Precision calibrator works in 3 modes



Sys-Tec, Inc., 877 Third St. S.W., New Brighton, MN 55112. (612) 636-6373. Approx. \$1199.

Model CA-138 precision calibrator provides three isolated and independent power sources: (1) fixed, regulated, 24, 45, or 72 V dc; (2) adjustable 0 to 1000 mV; (3) adjustable 0 to 50 mA. Each of these is monitored on the precision digital readout. Two external inputs to the digital readout are also provided: (1) allows the precision measurement of 0 to 200 mA; (2) allows the measurement of 0 to 2000 mV.

CIRCLE NO. 354

High-voltage supply fits 5-1/4-in. rack



Advanced High Voltage Co., 14532 Arminta Ave., Van Nuys, CA 91402. (213) 997-7222. Start at \$495; 3-5 wks.

High-voltage power supplies feature automatic crossover from constant-voltage to constant-current mode as required by the load. The units also feature full-time voltage and current meters and 10-turn voltage adjustment. This series (ARR) has six models from 3 kV at 10 mA to 30 kV at 1 mA. Regulation and ripple are available to 0.005% with options. Construction is such that only hv-carrying components are encapsulated. All low-voltage control and drive circuits are on PC boards. Units fit a standard 19-in. rack, are 5-1/4-in. high and can also be operated free standing for bench use.

CIRCLE NO. 355

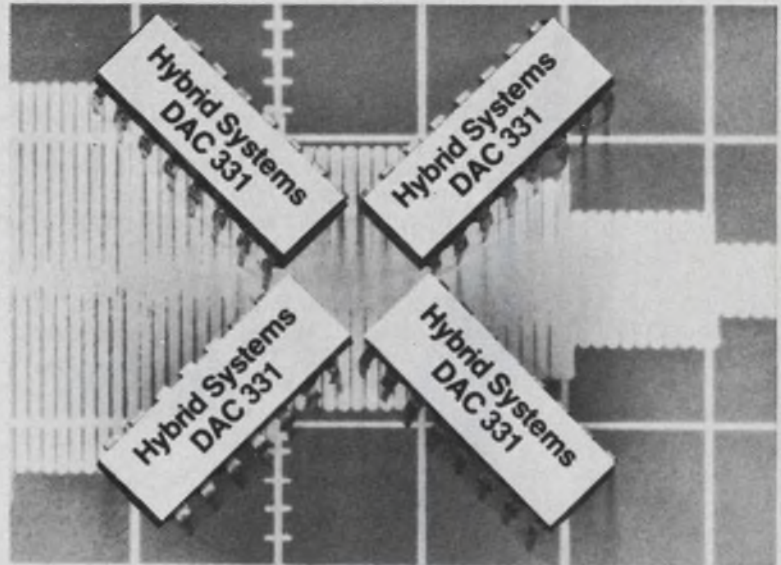

Multiplying DAC \$9.90

This is the lowest cost multiplying DAC anywhere. Hybrid Systems' 16 Pin, dual-in-line, CMOS/TTL DAC 331 offers some outstanding advantages:

- Linearity tempco of 1PPM/°C.
- True 8 and 10 Bit accuracy, linearity and drift. (We laser-trim our own thin-film networks).
- 20 mW power dissipation.
- Can accept AC or DC signals.
- Low feedthrough — better than 0.1% at 10kHz.
- Use your choice of output amplifiers for optimum flexibility.
- Pin-for-Pin compatibility with the AD7520.

And finally, there's the price:

	<u>1-9</u>
DAC 331-8 (8 Bits)	\$ 9.90
DAC 331-10 (10 Bits)	\$19.00

For Fast Action, Call:
(617) 272-1522 (or TWX 710-332-7584). In Calif.: (714) 992-4090
European Headquarters: Hybrid Systems GmbH, 61 Darmstadt,
Luisenplatz 4, Germany. Tel. 6151 291595. TELEX 841-419390.

Hybrid Systems

CORPORATION

Burlington, Massachusetts 01803

multi-conductor capability
...in all directions!

■ If you have a multi-conductor problem, just direct it to the wire company with multi-capability... design, engineering and efficient production. We have successfully designed and manufactured multi-conductor cable of all types. No matter how unusual your requirements, our engineers can work with you to achieve the results you want... with the dependable high quality that has made Victor the standard in wire, cable and cord sets. ■ Put our problem solving capability to work for you. At Victor! Write or phone with your specifications.

Victor Electric Wire & Cable Corp., 618 Main Street, West Warwick, Rhode Island 02893
 Tel. 401 821-1700
 TWX: 710-382-1534

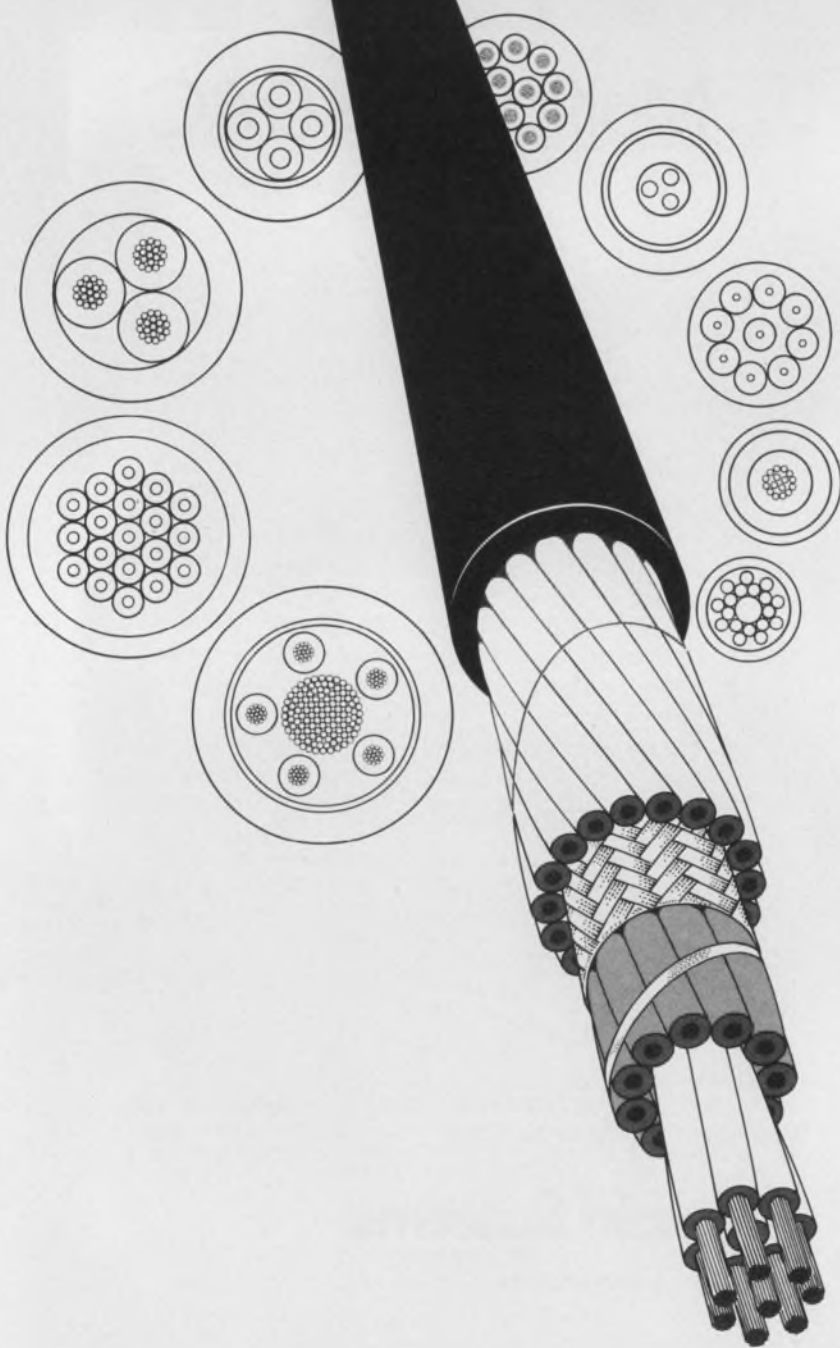

COMPONENTS

Industrial trimmer has 30-turn drive

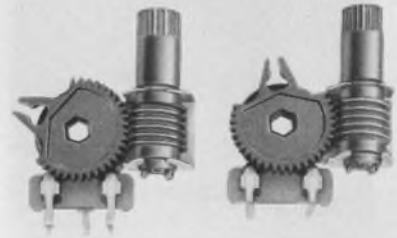

CTS of Elkhart Division, 1142 W. Beardsley Avenue, Elkhart, IN 46514. (219) 523-0210.

Series VA201 vernier-drive composition trimmer potentiometer is a low cost, 30-turn industrial trimmer. Some features include: a 15/64-in. dia drive gear, PC mounting, resistance range of 100 Ω through 5 M Ω , clutch stops, and 1/4-W power rating.

CIRCLE NO. 356

PM step motors provide 25 oz-in. stall torque



Computer Devices of Calif., 11901 Burke St., Santa Fe Springs, CA 90601. (213) 723-6593. \$19 (OEM qty); stock.

A new line of low-cost, four-phase PM step motors, called the Pacesetter line, consists of two series—the 28PS series (7-1/2°) and the 28PF series (15°) steppers. They measure 2.72-in. dia and 2.24-in. long. The motor line offers precision ball bearings, Class F insulation, 25 oz-in. stall torque and a lower price than equivalent imported devices. Both series are available with voltage ratings of 6, 12 and 24 V dc.

CIRCLE NO. 357

Temperature sensors
span -320 to +1500 F

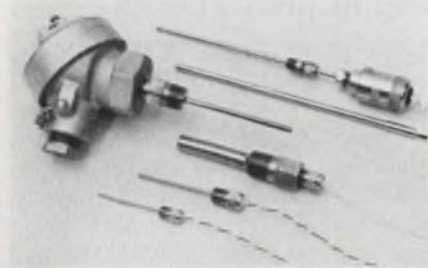

Hy-Cal Engineering, 12105 Los Nietos Rd., Santa Fe Springs, CA 90670. (213) 698-7785.

Resistance temperature sensors offer advantages over thermocouple and thermistor type sensors. They have temperature ranges from -320 to +1500 F with a repeatability, interchangeability and stability to $\pm 0.1\%$ of their span with response times up to 500 ms and a self-heating effect as low as 5 mW/ $^{\circ}$ F. High purity 100, 200 or 500- Ω platinum, 120- Ω nickel, 100- Ω copper or 2000- Ω Balco wire wound on special supporting mandrels produce strain-free sensors capable of withstanding vibration and thermal shock. The thermistors are available with two, three, or four-lead wire connections in various sizes, shapes, diameters, lengths, sheath materials and mounting fittings.

CIRCLE NO. 491

Slide switch operates
on side, fits PC boards

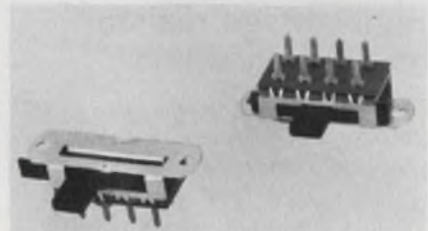

AMF Inc., UID Electronics Div., 4105 Pembroke Road, Hollywood, FL 33021. (305) 981-1211. \$0.20 (10,000 up).

New side-operated DP3T switch for right-angle operation on PC boards provides a lengthwise bearing flange for smooth operation and superior center detenting. The switch handles 6 A and has 94V-2 fire-retardant handle material. The units are available with several terminal and handle variations.

CIRCLE NO. 492

Excel introduces Dial·a·48hr. Delivery.

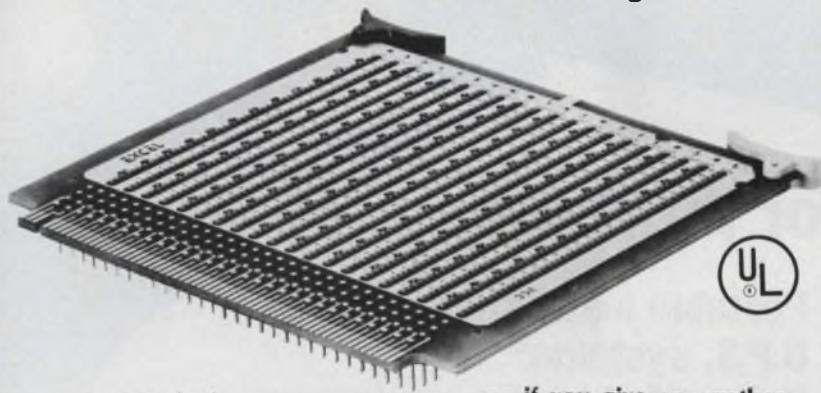

...on standard

pluggable P.C. wirewrap* packaging panels — all styles — all wrap levels — all platings — all completely cross referenced with Augat — the highest quality at low, low prices that will amaze you. We make everything "in house." You will save money — off the shelf deliveries.

48 hour guaranteed delivery — if our local distributor can't supply you, now for the first time you can buy directly from the manufacturer who has been supplying the connector industry leaders for the past 23 years

— if you give us another 24 hours and your "From-To" list we will wirewrap* the panels to your requirements.

Pins and sockets are precision swiss screw machine made — with the best beryllium springs and the highest retention forces on the market. Panels approved and in use by most of the leading companies in the U.S.A.

Also available are DIP sockets — headers — racks — enclosures — back panels — loose pins and sockets — P.C. boards — custom boards and complete wire-wrapping services. Call for our complete catalogues.

EXCEL
because
you deserve
the very best

Call toll free. Reverse charges in New Jersey.

800-631-5585

*trademark of Gardner-Denver Corp.

EXCEL PRODUCTS COMPANY Inc.

401 JOYCE KILMER AVE., P.O. BOX 168, NEW BRUNSWICK, N.J. 08903

INFORMATION RETRIEVAL NUMBER 88

Low Cost DC-DC Converters 10 to 19 Watts

For powering:

- Portable instrumentation
- U.P.S. systems*
- Railroad signaling equipment
- Automotive testing systems
- Aircraft on-board electronic systems
- Computer-controlled heavy equipment
- Oil and land surveying equipment

Powercube's second generation high-reliability, low-cost DC to DC converters are available now in off-the-shelf Cirkuitblock® modules.

Like all Powercube products, our new DC-DC converters offer great flexibility in custom power module configurations with total output power from 10 to 19 watts. You can specify up to four isolated, regulated, short circuit and overvoltage protected outputs and a DC-AC inverter input, all in one encapsulated 2" x 2" x 1" package weighing six ounces at most!

Ruggedly constructed Powercube modules assure unmatched reliability in hostile environments from -20 to +85°C. Outputs to meet your requirements are available for all standard battery input voltages, all for less than it would cost you to make them yourselves. Request your free power module application handbook today.

Prices range from \$75 to \$150 in small quantities.

*Uninterruptible power systems.



POWERCUBE CORPORATION
214 CALVARY STREET, WALTHAM, MASS. 02154 (617) 891-1830
SUBSIDIARY OF UNITRODE CORPORATION

INFORMATION RETRIEVAL NUMBER 89

COMPONENTS

Capacitors made for use in instruments

*Independent Cable, Midwec Div.,
P.O. Box 417, Scottsbluff, NE
69361. (308) 632-4127. 8 wk.*

Types D3, D4, D5 and 5 plastic film capacitors are designed for use in instruments. All models have a standard tolerance of $\pm 5\%$ and are measured at 1000 Hz and 25 C. Capacitance values span 0.0001 to 1 μF in voltage ratings from 100 to 160 V. Type D3 is a Mylar dielectric, type D4 a polystyrene, D5 a polypropylene and 5 a polypropylene. Types D3, D4 and D5 are vertical mount packages and type 5 is a tubular case.

CIRCLE NO. 358

Thermal cut-off design services given free

*3M Co., P.O. Box 33600, St. Paul,
MN 55133. (612) 733-8037.*

The 3M Co. will provide free engineering services to cover incorporation of its thermal cut-off (TCO) devices into electrical products. The TCO breaks an electrical circuit when a predetermined temperature is reached to prevent fire and damage. Tests will be conducted at 3M's Electrical Laboratories, St. Paul, MN. Follow-up service includes assistance in integrating thermal cut-offs into a manufacturer's assembly line procedures.

CIRCLE NO. 359

High-voltage resistor has built-in shield

*Caddock Electronics, Inc., 3127
Chicago Ave., Riverside, CA 92507.
(714) 683-5361. \$2.67 to \$2.94;
(unit qty); 4 to 6 wks.*

An ultrastable resistor with a built-in corona shield to eliminate high-voltage erosion of the resistance element is now available in values from 800 Ω to as high as 50 M Ω in a single resistor, only 1.25-in. long and 0.220 in. in diameter. The Model MH 711 resistor is constructed with primary encapsulation over a Micronox power-film resistor, a silver shield and outer insulation that completely encloses the resistance element. The shield is grounded to one of the resistor leads.

CIRCLE NO. 360

Stepping motor claimed to be world's smallest



Portescap U.S., 730 Fifth Ave., New York, NY 10019. (212) 245-7715.

According to Portescap, the latest addition to its line of SOCREM stepping motors is the world's smallest stepping micromotor. Designated Type S.02, it has a diameter of 5.5 mm and a height of 2.8 mm. It develops a torque that exceeds 0.8 μmN . Its current consumption is about 10 μA , and it will therefore run for over a year on batteries of the SR 44 and MR 44 types (165-220 mAh).

CIRCLE NO. 361

Electrolytic capacitors operate down to -40 C



International Importers, Inc., 2242 S. Western Ave., Chicago, IL 60608. (312) 847-6363. \$38 per thousand: 1 μF , 16 V, axial.

Miniature aluminum electrolytic capacitors, the new ML series, are designed specifically by Rubycon for use at extreme temperatures. Available in either plug-in or tubular configurations, the capacitors have an operating range from -40 to 85 C . Comparable capacitors can operate to only -25 C . Seven standard ratings from 6.3 to 100 WV dc are available with capacitance values from 0.47 to 4700 μF . The capacitors feature low leakage and tolerances of -10 to $+50\%$ for 4.7 μF values and up, and -10 to $+75\%$ below 4.7 μF .

CIRCLE NO. 362

Digital voltage divider has wide legend area



Electronic Engineering Company of California, 1441 E. Chestnut Ave., Santa Ana, CA 92701. (714) 835-6000. From \$13.90 (unit qty).

Over three times the standard legend area and up to eight numbers or letters are now available in double-width Thumbpots. These voltage dividers are available with a resolution of 0.01% and accuracy to 0.05% of full-scale voltage.

CIRCLE NO. 363

Give 'em hell.

They can take it. And come back for more. Beautifully.

You've spent a great deal of time and money designing your equipment to work in the field. That means unpredictable conditions, rough handling and plenty of abuse. And when your product is 200 miles from the nearest service center, it had better work.

Give it the extra protection of Zero Centurion™ carrying cases, combining the best in classic styling with rugged durability. Durability that's been proven by people like yourself in environmental extremes around the world.

Choose from 59 standard sizes for two week delivery A.R.O., with unlimited modification capabilities. And the price is surprisingly low. Consider it low cost life insurance on your equipment.

Write for your free catalog today.

Zero

The Final Touch



ZERO MANUFACTURING CO.

Burbank, CA 213/846-4191 • Monson, MA 413/267-5561 • Clearwater, FL 813/531-8991

FOR IMMEDIATE NEED CIRCLE 161
FOR INFORMATION ONLY CIRCLE 162

Technipower Mil-Environment Encapsulated DC-AC Inverters

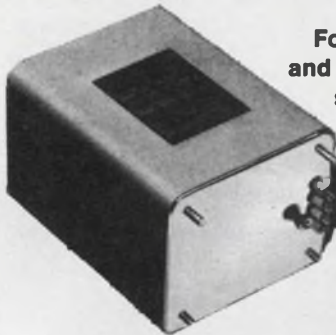

For UPS systems, frequency changers
and other applications requiring stabilized
sine wave power from DC sources.

NAC/NACD-80 SERIES

- 24 and 28 VDC sources
- 115 VAC rms output voltage
- 60 and 400 Hz output frequencies
- Power up to 500 VA • -20°C to +80°C operating temperature range

BACKED BY 5-YEAR WARRANTY

TECHNIPOWER, INC. 

A **BENRUS** DIVISION

BENRUS CENTER Ridgefield, Conn. 06877 (203) 431-1300

SEND FOR FREE 66-PAGE DESIGN/DATA CATALOG

INFORMATION RETRIEVAL NUMBER 101

COMPONENTS

Thermal printhead logs 18 char/sec

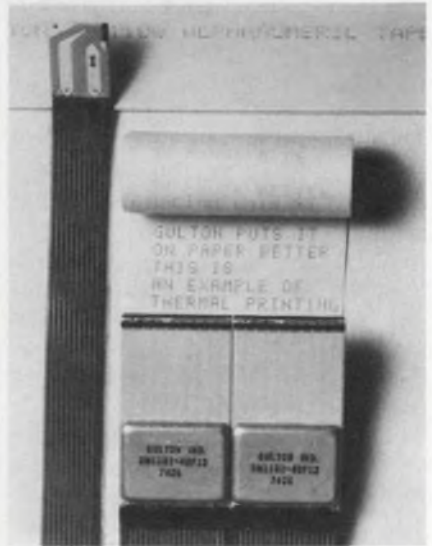

Gulton Industries Inc., 212 Durham Ave., Metuchen, NJ 08840. (201) 548-2800.

Alphanumeric dot-matrix thermal printheads for data logging provide 10-dot characters at 18 cps. The Model DM 1101 is for 10-column, strip or page printing and the DL 1100 is designed for side printing. The printhead contains 10 groups of heater dots for printing up to 10 columns of 5 × 5 or 5 × 7 matrix characters. Each complete 25 or 35-dot matrix is formed by indexing the papers five or seven steps. Five dots are printed at each step, and the five dots are multiplexed in the 10 groups. Complete diode isolation of individual printing dots is included on the printhead.

CIRCLE NO. 364

Tilt switch smaller than a dime

Durakool Inc., 1010 N. Main St., Elkhart, IN 46514. (219) 264-1116. \$0.16 (OEM qty).

A new mercury tip and tilt switch is actually smaller than a dime. The miniswitch is rated 0.5 A at 120 V ac. It measures 0.222 in. dia and its stainless-steel body is 3/8-in. high. The switch may be used in alarm systems, leveling equipment, temperature control, liquid and solid-level controls and for numerous other applications. Sample switches are available for 10 cents each.

CIRCLE NO. 365



electrocube capacitors

...are now available in multiple-unit Dual In-Line Packages (DIP). These unique 14 and 16-pin units will accommodate up to 8 capacitors, in various dielectric and capacitance combinations, for use in either automatic inserting or standard plug-in sockets. The packages save PC board space, inventory and handling time, and assembly costs. Get complete information today on these Skinny DIP's from Electrocube, 1710 So. Del Mar Ave., San Gabriel, CA 91776, (213) 283-0511; TWX 910-589-1609.

FREE...data file
on request



SKINNY DIP'S

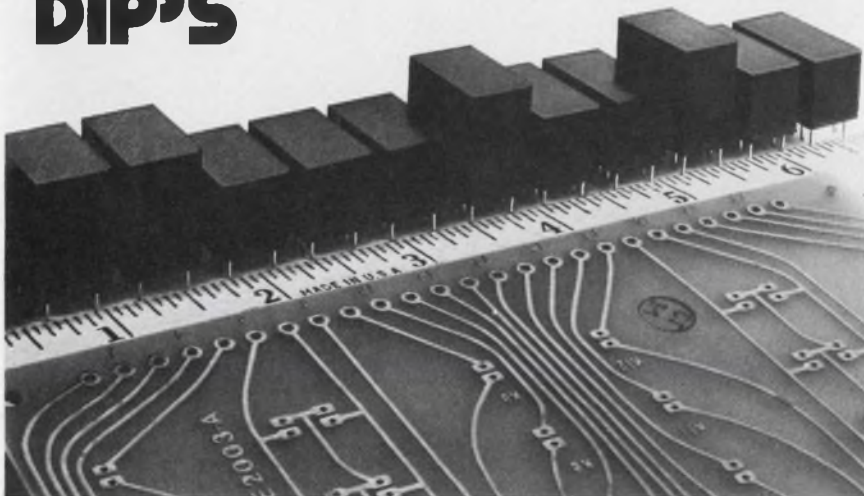

INFORMATION RETRIEVAL NUMBER 102

Capability in Design and Production of Customized Power Transformers

Whatever your requirements for custom transformers INELCO can simplify your purchase.

Within 10 days from receipt of your specifications, a Prototype Transformer is on its way for your approval. It will further assure you of the perfection in the mass-produced units. Limited production runs are available to Test Market your prototype.

Our Engineering Department is always available for consultation on design or production needs. Because your requirements change, INELCO can organize flexibility in production scheduling. Another big plus for our ever growing list of customers.

Write today for our brochure, "Taking the confusion out of specifying power transformers".

INGLOT ELECTRONICS CORPORATION

4878 NORTH ELSTON AVENUE · CHICAGO, ILLINOIS 60630
phone 312/286-5881



INFORMATION RETRIEVAL NUMBER 103

the FAIL-SAFE™ capacitor



Millions in use
in Critical Circuits

Only a FAIL-SAFE™ can guarantee positive protection in a critical circuit. That's why more and more manufacturers are specifying the FAIL-SAFE™ to insure against improper operation of essential circuitry.

AMERICAN RADIONIC Co., Inc., is the WORLD'S LARGEST PRODUCER of FAIL-SAFE™ capacitors. MILLIONS of this EXCLUSIVE product are now in DAILY USE providing unprecedented and GUARANTEED SAFETY.

More detailed information, and a complete copy of our Patent #3,792,323 covering the FAIL-SAFE™ capacitor, will be sent on request.



51 Austin Street, Danbury, Connecticut 06810 (203) 743-6308

INFORMATION RETRIEVAL NUMBER 104

ELECTRONIC DESIGN 13, June 21, 1975



Standard Grigsby has Rotary "Switchability"

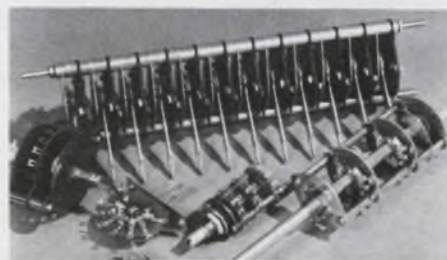

"YES" we can design, produce, and deliver Rotary switches at the lowest possible cost.

30 years experience in the field provides you with any contact configuration, detent mechanism, plating, and size you could possibly specify.

We also have a complete line of lever, linear slide, push-buttons (miniature and modular), and P.C. board assemblies.

We call this "Switchability."

Send for Free "Yes" button and literature.



standard grigsby, inc.

920 Rathbone Avenue • Aurora, Illinois 60507

INFORMATION RETRIEVAL NUMBER 105

Grayhill brings all PC terminals out one side



switches from logic levels up to 1/4 amp

- 1/2 inch switches with 10 or 12 positions—1 or 2 poles per deck—1 to 12 decks.
- Designed for wave-soldering process—resists flux contamination
- Enclosed construction at price levels as low as or lower than open wafer switches.

Here's a new Grayhill miniature switch specifically designed for the small loads—and the specialized mounting techniques—of low voltage circuitry. Probably the smallest switch you can find with all PC terminals in the same plane, the switch is surprisingly small in the price dimension too... for enclosed construction and Grayhill quality. For more information on this new member of the Grayhill Series 71 family, write for Bulletin #236... and consult EEM for information on other Grayhill switches.



561 Hillgrove Avenue • LaGrange, Illinois 60525
(312) 354-1040

INFORMATION RETRIEVAL NUMBER 106

DATA PROCESSING

Video screen splitter displays multiple images



Thalner Electronic Laboratories,
7235 Jackson Rd., Ann Arbor, MI
48103. (313) 761-4506. \$289; stock.

The Model SS-221 allows multiple video images to be simultaneously displayed on a single monitor in horizontal split, vertical split or corner-insert modes. Signal sources may include composite video from video cameras, VTRs and off-the-air TV broadcast signals. Since the SS-221 eliminates the external drive requirement for one camera, system multiconductor cable expense is considerably reduced. Video bandwidth of 5 MHz, crosstalk of less than 45 dB at 3 MHz and fast switching speed of 200 ns permit a large number of images to be displayed on the same monitor by cascading several SS-221s. The SS-221 accepts a variety of sync timing inputs, including Broadcast Standard, Industrial, Random Interface and European Standard.

CIRCLE NO. 366

Matrix printer offers 88 char/s at low price

Centronics Data Computer Corp., 1
Wall St., Hudson, NH 03051. (603)
883-0111. \$2560; 30 days.

Model 588 serial matrix impact printer operates at 88 characters per second and provides a 132-column line. Options for the low-cost unit include two-channel vertical format unit, audio alarm, 50 Hz/230 V power supply, 9 × 7 dot matrix character pattern and automatic on-off motor control plus a broad selection of interfaces for serial communications and parallel computer operation.

CIRCLE NO. 367

Plug-in card for mini serves HP-IB instruments

Hewlett-Packard, 1501 Page Mill
Rd., Palo Alto, CA 94304. (415)
493-1501. See text; 6 to 8 wks.

With a plug-in card, Model 59310A, any of the company's 2100 or 21MX minicomputers may be hardware-interfaced to instruments that are programmable via the HP Interface Bus. The IIP-IB is Hewlett-Packard's implementation of IEEE Standard 488-1975, "Digital Interface for Programmable Instrumentation." Price of the card, \$1535, includes associated cabling, procedures for writing drivers, a diagnostic program for the card and basic control system utility subroutines.

CIRCLE NO. 368

Microprocessor used in bus-oriented computer



Process Computer Systems, 5467
Hill 23 Dr., Flint, MI 48507. (313)
744-0225. \$2995; 60 to 90 days.

MicroPac 80 is a microcomputer based on an Intel 8080 CPU built into a standard PCS microprocessor module. The module includes the 8-bit parallel CPU with a repertoire of 78 instructions and accesses up to 64 kbytes of memory. Included with the standard computer are 4 kbytes of RAM and 1 kbyte of ROM. The system is expandable to 64 kbytes of any combination of RAM or ROM. The standard model also includes teleprinter interfacing and TTL input/output. The control panel has an interrupt capability (which may be enabled or disabled) and is driven entirely by software. A bus-type backplane gives each module its own unique address. As a result of this design, memory and input/output modules may be interchanged throughout the chassis.

CIRCLE NO. 369

STANDARDIZED PLUG-IN HOUSINGS

FROM STOCK

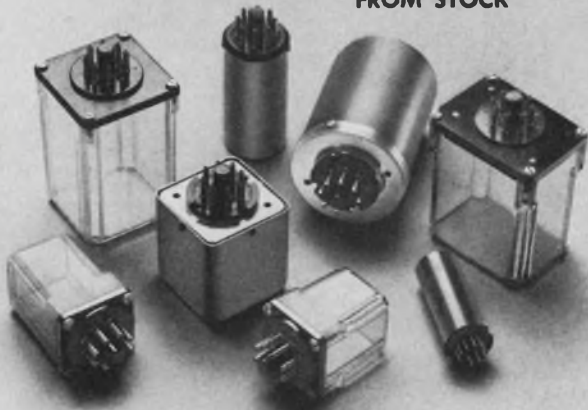

For packaging Relays, Filter Networks, logic circuits, and other assemblies requiring dust, dirt or tamper-proof protection.

Housings: A variety of sizes and colors available in Polystyrene, Butyrate, Nylon and Aluminum.

Headers: Available in 7, 8, 9, 11 and 20 pin configurations.

NEW FREE CATALOG ON REQUEST

Manufacturers of Standardized Hardware for Electronics



KEYSTONE

ELECTRONICS CORP.

49 Bleecker Street • New York, N.Y. 10012

INFORMATION RETRIEVAL NUMBER 107

SINGLE & DUAL



McLEAN CENTRIFUGALS

Std. or Mil. Spec. Over 25 models with airflows from 50 to 2000 CFM. Static pressures from 0." to 3.0". Motors and wheels precision balanced — quiet, vibration free. UL approved motors for any AC frequency or power, single or three phase. Custom-built units available.

SEND FOR CATALOG

McLEAN ENGINEERING LABORATORIES

P.O. Box 127D PRINCETON JUNCTION, NEW JERSEY 08560
PHONE 609-799-0100 • TELEX 84-3422

INFORMATION RETRIEVAL NUMBER 108

ELECTRONIC DESIGN 13, June 21, 1975

Computer designers who think marketing belongs to management don't belong with us.

Computer Designers to work in Suburban Boston.

They stay at companies like IBM, H-P or Honeywell.

At Data General our computer designers are more than one step ahead of current technology. And two steps ahead of the market.

So if you would like to join a computer company where designers implement their ideas, come and see us at Data General.

Project Manager

This job will test both your knowledge of the computer industry and your ability to recognize the opportunities in it. You will take charge of the definition, detailed specification and the total management for the development of small, OEM-oriented computer systems. You should have at least 5 years experience in the mini-computer industry and proven project management capability. A BS in either EE or Computer Science or equivalent is required and an MBA is desirable.

Computer Architects

You will be one of the key people involved in the definition and implementation of a future family of computer systems for us. You must keep pace with both evolving technology and the practical questions of cost, reliability and marketability. You must have at least 3 years experience as a systems designer with a proven record of outstanding achievement. The preferred candidate will have an MS in Computer Science or the equivalent from one of the better engineering schools. We don't want to eliminate, however, designers who never completed college. (Some of our most creative designers didn't.)

System Engineer

Your challenge is a human one: the design of a system console, system status indicator, IPL device, etc., for a new machine. Your job will be to determine how an operator can get the most out of the computer and design it for reliability and easy maintenance. You should have at least 4 years experience with medium to large processors, preferably in the fields of logic/electrical and logic/system debugging architecture. A BSEE or the equivalent is required.

Send your resume and salary history, in complete confidence, to Mr. John DiPietro, Data General Corp. Dept. ED, Route 9, Southboro, Mass. 01772.

Data General

Equal Opportunity Employer M/F

INFORMATION RETRIEVAL NUMBER 901

IF YOUR COPY OF THE
GOLD BOOK

IS RAGGED FROM USE
(and most of them are)

DON'T WORRY...



Electronic Design's **GOLD BOOK..**

**THERE'S AN
ALL NEW
1975-76
EDITION**

**COMING YOUR WAY SOON
WITH...**

***MORE* PRODUCT LISTINGS**

***MORE* CROSS REFERENCES**

***MORE* DETAILED COMPANY INFORMATION**

***MORE* SALES OUTLETS (REPS, SALES OFFICES
AND DISTRIBUTORS) LISTED FOR
MANUFACTURERS**

Engineers reach for the GOLD BOOK first because it contains by far the most complete, most detailed information for electronic product search that's ever been published anywhere in the world. And now there's an even better GOLD BOOK on the way. Companies have given us more data about themselves; provided more contact information. There are more product categories; more cross references; more trade names. So if your GOLD BOOK is falling apart from constant use . . . cheer up. It won't be long before the 1975-76 edition arrives. The GOLD BOOK is FREE to *Electronic Design's* qualified subscribers. Others may order copies at \$30 per set (domestic) or \$40 (elsewhere).

"THE ONE THAT'S USED FIRST"

Complete RF Network Analysis

- **0.4 to 500 MHz** in three overlapping bands; log, linear, CW, and $f_0 + \Delta f$ modes.
- **115-dB Dynamic Range** — 80 dB direct display.
- **0.005-dB Resolution** — 0.05 dB flatness per 10 MHz; 0.4 dB full-band flatness.
- **Absolute Level in dBm** — direct swept display 0 to -80 dBm.
- **Phase and Group-Delay Measurements** — direct-reading swept displays.
- **50 and 75 Ω** — interchangeable measuring circuits with complete selection of coaxial components for each impedance level.
- **Measure** filters, amplifiers, antennae, cables, delay networks, equalizers, components, transistors, etc.
- **Display Simultaneously** magnitude and phase, magnitude and absolute level, magnitude and group delay, transmission and reflection.
- **Synthesizer-Based Systems from 0.2 to 500 MHz** — for precision narrow-band measurements on devices such as crystal or surface-wave filters, consider the GR 2261 Synthesizer Network Analyzer.



GR's 1710 RF Network Analyzer is the instrument that provides the complete RF network analysis described above. Call or write for complete information, application assistance, or for a demonstration.



For High-Frequency Measurements General Radio

300 BAKER AVENUE, CONCORD, MASSACHUSETTS 01742
GR COMPANIES • Grason-Stadler • Time Data

NEW YORK (N.Y.) 212 964-2722, (N.J.) 201 791-8990
BOSTON 617 646-0550 • DAYTON 513 294-1500
CHICAGO 312 992-0800 • WASHINGTON, D.C. 301 948-7071
ATLANTA 404 394-5380 • DALLAS 214 234-3357
LOS ANGELES 714 540-9830 • SAN FRANCISCO 415 948-8233
TORONTO 416 252-3395 • ZURICH (01) 55 24 20

INFORMATION RETRIEVAL NUMBER 110

DIB

DUAL IN-LINE BRIDGE An integrated bridge rectifier in a miniature dual in-line package

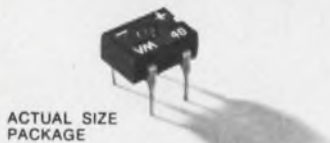

ACTUAL SIZE PACKAGE

- 4-pin, low-profile DIP
- Leads on standard .10" (2.54 mm) grid
- Compatible with automatic testing, handling and inserting
- Reduces labor & material costs
- Glass-passivated diodes
- Meets moisture resistant requirements of MIL-STD 202, method 106C
- 1 Amp at 40°C (I_o)
- 25V to 1000V (V_{RRM})

Call Charlie Merz 214/272-4551 for more information

Design us in . . . we'll stay there

VARO SEMICONDUCTOR, INC.



P.O. BOX 676, 1000 N. SHILOH, GARLAND, TEX. 75040 (214) 272-4551 TWX 910-860-5178

INFORMATION RETRIEVAL NUMBER 111

DATA PROCESSING

Multiplexers have eight-channel capacity

Media III, 2259 Via Burton, Anaheim, CA 92806. (714) 870-7660. From \$825; stock to 30 days.

A family of asynchronous communications multiplexers provides up to eight, full duplex, communication channels on Data General computers. Two boards can be inserted into the computer chassis to service more channels. Three basic models are offered: Model 2802 provides four channels with full modem control and optional auto answer capability; Model 2803 provides either four or eight channels of local terminal communications; Model 2804 provides four channels of control for 103 or 202 Data Sets and a parallel line printer interface (Centronics, Tally, Data Products). All models contain a 100-Hz real-time clock, can be set for one of seven baud rates (110 to 9600 baud) on an individual channel basis, and may be ordered with either 20 mA current loop or RS-232-C output.

CIRCLE NO. 370

Floppy-disc storage offered for DMA channel



Computer Automation, 18651 Von Karman, Irvine, CA 92664. (714) 833-8830. See text; 60 days.

An IBM compatible floppy disc system from Computer Automation offers Direct Memory Address (DMA) operation, and includes two or four drives per controller. Data are recorded on 77 tracks at 3268 bit/in. with density of 48 track/in. The format of 128 bytes per sector and 26 sectors per track allows storage of 242 kbytes, equivalent to 3000, 80-column punched cards. Data transfer is 250 kHz. A system which includes two drives, power supply, cables, controller, documentation and software is priced at \$4300.

CIRCLE NO. 371

Voice-response system stores words in ROM

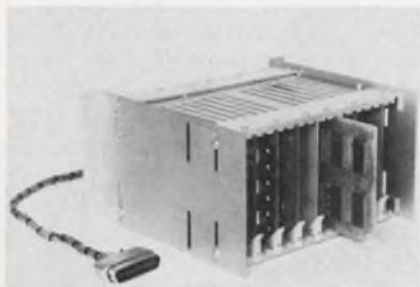

Master Specialties Co., 1640 Monrovia, Costa Mesa, CA 92627. (714) 642-2427. Under \$2000; 12 wks.

EVA is the name of a voice response system. Whole words are stored in ROM. The synthesized voice is natural-sounding and is difficult to distinguish from the original. With each word stored in its own individual memory, access to appropriate ROMs can call up the words in the sequence required for a given message. Simple logic decoding suffices without the need for complicated programming. The unit is capable of expansion from 10 to 30 words. EVA accepts either binary address or 10 mutually exclusive switch closures for the first 10 numeric words. Additional words, after the first 10, require binary address only.

CIRCLE NO. 372

Line interface also does processing

Digital Equipment Corp., 146 Main St., Maynard, MA 01754. (617) 897-5111. See text.

With a throughput rate of up to 38,400 characters, the microprocessor-based DV-11 can reduce up to 95% of the processing overhead by a PDP-11 in handling communication protocols in a multiline environment. Direct memory transfers are used for both transmission and reception; the DV-11 supports full or half-duplex synchronous transmission up to 9600 baud. By contrast, simple communications interfaces move data in and out of a computer's memory without any processing. The DV-11 generates and decodes control characters as well as generating and verifying block check characters. Prices are \$7100 for an eight-line unit and \$10,200 for a 16-line unit.

CIRCLE NO. 373

System collects remote-site data

Tycom Systems Corp., 26 Just Rd., Fairfield, NJ 07006. (201) 227-4141. \$6500; 4 wks.

Designed for remote-site data and information collection, Model 4210 consists of an IBM Selectric typewriter, a 4k character buffer expandable to 16 k characters, and a 1200-baud automatic answer modem. Data, messages or information can be typed on standard

forms, using the Selectric typewriter. The buffer system with its microprocessor can edit, correct, and search for specific characters in the text in order to change or update the information. Once verified, data are entered into the protected area of the buffer for unattended transmission to a central site at 1200 baud. At the same time another protected area of the buffer can receive and store messages.

CIRCLE NO. 493

HP's newest counter 520 MHz - only \$795.

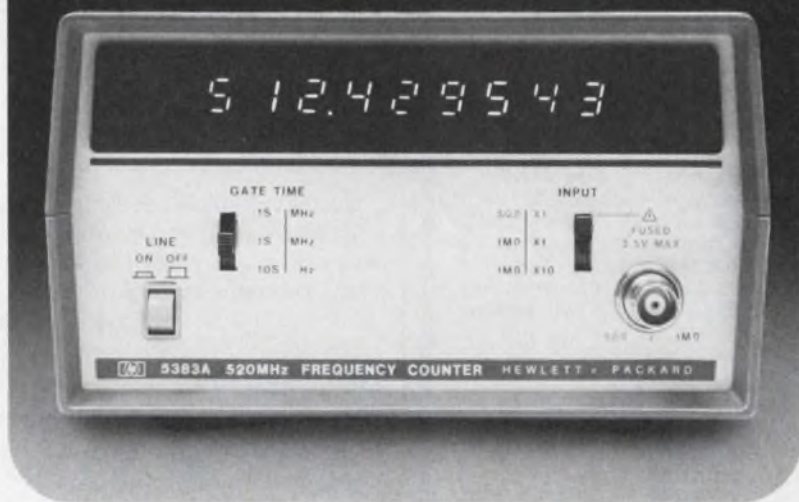

COUNT THE FEATURES

- Direct counting, 10 Hz to 520 MHz; no prescaling to slow it down
- Sharp 9 digit LED readout
- High stability internal time base
- Optional TCXO time base for communications calibration
- 25 mV sensitivity, fuse protected input to prevent overload damage
- Switchable 50Ω or 1 MΩ input
- Rugged cast aluminum case

OTHER LOW COST MODELS

225 MHz 8 Digit 5382A — only \$495

80 MHz 8 Digit 5381A — only \$275

All three counters have an external oscillator input for a house standard or ratio measurement.

All come with a full instrumentation warranty and meet IEC safety specifications. For more information call your nearby HP field engineer.

Or write. (Domestic USA prices only.)

HEWLETT  PACKARD

Sales and service from 172 offices in 65 countries.
1501 Page Mill Road, Palo Alto, California 94304

02515

Isotronics has ~~584~~ 512 varieties of flatpacks



We wanted to tell you exactly how many varieties of flat packages we have...but we found out the number keeps going up so rapidly that we can't keep the ad up to date. By the time you read this ad the "512" will already be too low.

We have a lot of flatpacks... sizes from $\frac{1}{4}$ " x $\frac{3}{8}$ " to 2" square in production tooling... smaller and larger in preproduction...number of leads from 2 to 160...leads on 1, 2, 3 or 4 sides... and sometimes on 2 levels... flat leads or round, insulated or grounded...any type of plating, including gold, electro tin, nickel, etc....and you can seal them by soldering or welding.

What it amounts to is this: When you need a flat package, call Isotronics.

Visit us at ISHM

the microcircuit
packaging specialists



Isotronics

Isotronics, Inc.
12 Coffin Ave.
New Bedford, Mass. 02746
(617) 997-4575 TWX 710 344 1961
Cable—ISOTRONICS

New Literature



Mobile communications

Everything in mobile communications is the focus of a 16-page brochure. Motorola Communications and Electronics, Schaumburg, IL

CIRCLE NO. 374

Controller

Specifications, dimension and application data for the 7600 series controllers are presented in a bulletin. Electro Corp., Sarasota, FL

CIRCLE NO. 375

Test systems

The use of multiprogrammer components in building and expanding automatic test and industrial control systems is described in a 42-page catalog. Hewlett-Packard, Palo Alto, CA

CIRCLE NO. 376

Industrial products

Descriptions, photographs and specifications of rf and microwave instruments and components are covered in a 44-page catalog. PRD Electronics, Westbury, NY

CIRCLE NO. 377

Breadboard devices

Completely illustrated, a 16-page catalog shows breadboard prototype equipment. Continental Specialties, New Haven, CT

CIRCLE NO. 378

Power converters

Dc-dc converters, 400-Hz input high efficiency power supplies and hybrid dc-dc converters are featured in a 26-page catalog. Tectnetics, Boulder, CO

CIRCLE NO. 379

ECPD annual report

The Engineers' Council for Professional Development's 42nd Annual Report covers the year from October 1, 1973 through September 30, 1974. Single copies are \$5. Engineers' Council for Professional Development, 345 E. 47th St., New York, NY 10017

INQUIRE DIRECT

Wirewound resistors

Fixed wirewound resistors are highlighted in a 24-page catalog. Physical sizes, wattage ratings and resistance ranges are given. Precision Resistor, Hillside, NJ

CIRCLE NO. 380

Multiplexers

"All About Data Communications Multiplexers," a management-oriented report that explains communications multiplexing techniques and surveys the current products of 30 manufacturers, is available at \$10 per copy. Data-pro Research Corp., 1805 Underwood Blvd., Delran, NJ 08075.

INQUIRE DIRECT

Switching components

A 28-page, two-color telephone and industrial switching components catalog contains specifications, pricing and application data. North Electric, Galion, OH

CIRCLE NO. 381

Thermoplastics

An applications, processing and properties manual answers many specific questions about 14 fiber glass reinforced thermoplastic polymers and six fiber glass reinforced thermoplastic foams. Owens-Corning Fiberglas, Toledo, OH

CIRCLE NO. 382

Packaging systems

Microelectronic packaging systems and hardware are described in a 32-page catalog. Mechanical and electrical specifications are included. Mupac Corp., Brockton, MA

CIRCLE NO. 383

Mixer/Amplifier Packages

We've engineered our WJ-C30 series of mixer/amplifier packages to be virtually off-the-shelf items, while still remaining flexible enough to meet your specific design needs.

All units consist of high quality W-J mixers and thin-film cascaded amplifiers. These components afford tremendous adaptability in responding to a wide range of RF and IF bandwidth, noise figure, conversion loss and power output requirements.

These packages have an RF coverage of 2.5 to 18.5 GHz, with each model offering options of eight different IF bandwidths ranging from 5 to 1500 MHz. Overall noise figures range from 7.5 to 12.0 dB (min.), depending on which IF option you select. Power output also varies.

One option delivers an IF bandwidth of 5 to 200 MHz, overall IF noise figure of 7.5 dB (min.) and power output of +12 dBm (max.), while a second option would give you an IF bandwidth of 10 to 1000 MHz, overall IF noise figure of 14.5 dB (min.) and power output of +23 dBm.

It's really very easy. You simply select the specifications and we'll deliver a high quality mixer/amplifier in a compact, economical package.

To find out more about these new mixer/amplifier packages, call your local W-J Field Sales Office or Watkins-Johnson Applications Engineering in Palo Alto, California at (415) 493-4141, ext. 637.

THE WJ-C30 SERIES

High Intercept Mixer/Amplifiers (+13 dBm L.O. Drive)

Model	Frequency
WJ-C32	2.5 to 5.2 GHz
WJ-C33	4.0 to 9.0 GHz

Low Level Mixer/Amplifiers (+7 dBm L.O. Drive)

Model	Frequency
WJ-C35	2.5 to 5.2 GHz
WJ-C36	4.0 to 9.0 GHz
WJ-C37	6.0 to 16.0 GHz
WJ-C38	8.0 to 18.5 GHz

You select the specs

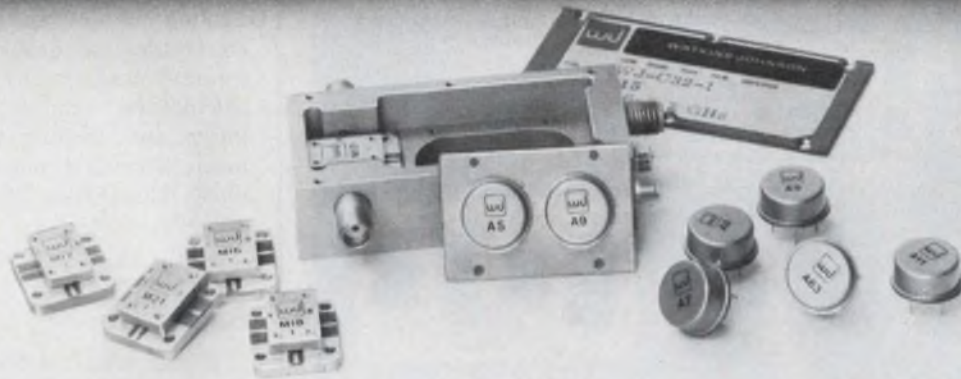

...all components are off-the-shelf.



WATKINS-JOHNSON

Watkins-Johnson—U.S.A.: 3333 Hillview Ave., Palo Alto, CA 94304 • (415) 493-4141 • TWX: 910-373-1253 • Telex: 34-8415 • Cable: WJPLA • 700 Quince Orchard Rd., Gaithersburg, MD 20760 • (301) 948-7550 • TWX: 710-828-0546 • Telex: 89-8402 • Cable: WJCEI • **United Kingdom:** Shirley Ave., Windsor, Berkshire SL4 5JU, England • Tel: Windsor 69241 • Cable: WJUKW-WINDSOR • Telex: 847578 • **West Germany:** 8033 Planegg, Muenchenerstr. 17 • Tel: (089) 859-9441 • Cable: WJDBM-Muenchen • Telex: 529401 • **Italy:** Piazza G. Marconi, 25 00144 Roma-EUR • Tel: 59 45 54 • Cable: WJROM-ROMA • Telex: 60117

INFORMATION RETRIEVAL NUMBER 114

NEW PUSH-ON COAX 50 and 75 OHM

Trompeter Electronics has designed a new 3 part push-on connector series for use in modular chassis to mainframe applications. The feed-thru plug may be quickly removed from mainframe and mated with any female BNC or TNC, such as on an oscilloscope, for quick test applications.

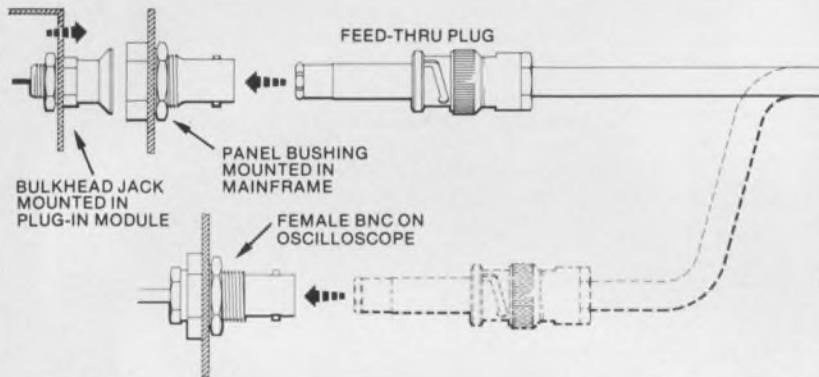

TROMPETER ELECTRONICS, INC.
8936 Comanche Avenue, Chatsworth, CA 91311
(213) 882-1020

INFORMATION RETRIEVAL NUMBER 115

SWITCH DEPENDABILITY BEGINS ON THE INSIDE

LOOK INSIDE ONE OF OURS!

Gold-plated silver shorting bar and terminals provide over 500,000 cycles low level current/voltage operation



Toggles, rockers, pushbuttons and screwdriver-slot styles available

Drain holes permit complete flux wash-down

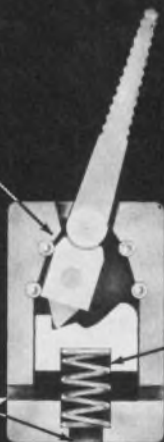

Simple 2-piece spring/cam-block mechanism results in long mechanical life

T8000 SERIES PCB TOGGLE SWITCH

These inexpensive subminiature PCB switches are ideal for sub-chassis check-out, interlock circuits, and front panel mounting where space is at a premium. With contact resistance of 0.025 ohms maximum, these switches provide high reliability for low level mV circuits.

SEND FOR PORTFOLIO OF TECHNICAL BULLETINS.



CONTROL SWITCH

A CUTLER-HAMMER COMPANY

1420 DELMAR DRIVE, FOLCROFT, PA. 19032 215/586-7500

I-3

INFORMATION RETRIEVAL NUMBER 116

NEW LITERATURE

Communications protection

Everyone connected with the telephone industry will enjoy reading about its history in an article entitled "96 Years of Protection." Communications system protection from surge caused by either power-line switching or lightning is described. Telecommunications Industries, Copiague, NY

CIRCLE NO. 384

Test jacks

Two series of test jacks (for 0.085-in.-dia. probes) designed for telephone applications are highlighted in a bulletin. Hugh H. Eby Co., Philadelphia, PA

CIRCLE NO. 385

Custom ICs

The Monochip low-cost integrated-circuit program is explained in an eight-page brochure. Interdesign, Sunnyvale, CA

CIRCLE NO. 386

Technical books

Describing over 339 technical books, a fully illustrated 44-page catalog covers subjects such as electronics; amateur radio license guides; audio, hi-fi and stereo; calculators, computer programming and technology; TV schematic/servicing manuals and many more. Tab Books, Blue Ridge Summit, PA

CIRCLE NO. 387

Bus bars

Dimensional drawings for 13 standard laminar bus bars are contained in a folder. Rogers Corp., Chandler, AZ

CIRCLE NO. 388

Gas discharge displays

Performance specifications, outline drawings, schematics, rating tables, application diagrams, truth tables and logic diagrams—everything an engineer needs to know about decoder/drivers and buffer/drivers used with gas discharge displays is included in a six-page bulletin. Beckman Instruments, Information Displays Operation, Scottsdale, AZ

CIRCLE NO. 389

PERSONALIZED TRANSFORMERS

No matter what function.

Pulse, isolation, matching, converter, etc.

No matter what specs.

Tough electrical, environmental, or both.

No matter what package.

DIP, substrate, header, conventional, or . . . ?

Technitrol has engineered transformers and transformer packages to meet the most stringent electrical and environmental requirements. Transformers have been produced mounted singly or in multiples in a broad spectrum of configurations.

Call Bill Chamberlin at 215-426-9105 or write. State your application; we'll put over 25 years of transformer know-how to work for you.

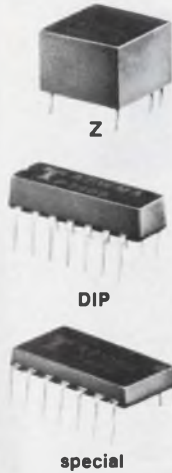

Technitrol, Inc.

1952 E. Allegheny Avenue
Philadelphia, Pa. 19134

Specialists in pulse transformers and completely transfer molded, welded DIP delay lines under $\frac{3}{16}$ " high — to 250 ns.

INFORMATION RETRIEVAL NUMBER 117

**REDUCE COSTS.
SAVE SPACE.
IMPROVE
ACCURACY.**

BMC FLEXIBLE CIRCUITS DO IT ALL.

Whether your wiring needs are exotic or conventional, flexible circuitry offers many advantages. It reduces costs by simplifying assembly. It saves space through miniaturization. And, it improves accuracy by minimizing human error.

Why specify BMC? For almost 20 years, we've been designing and manufacturing both simple and sophisticated flexible circuits. We created much of the advanced technology and still retain many proprietary techniques.

So, let our specialists take a look at your requirements. See what BMC flexible circuitry can do for you. For information, write or call Ed Dugan.

FLEXIBLE CIRCUITRY DIVISION
BUCKBEE-MEARS COMPANY
bmc
345 EAST SIXTH STREET
ST. PAUL, MINNESOTA 55101 612-228-6253

INFORMATION RETRIEVAL NUMBER 118

ELECTRONIC DESIGN 13, June 21, 1975

THE LOWEST PHASE NOISE AVAILABLE...

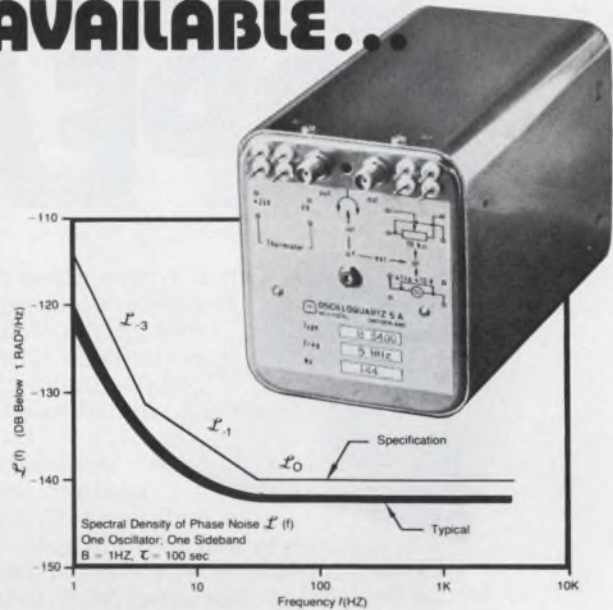

● ● ● Comes in this compact, rugged B-5400 Quartz Crystal Oscillator. In addition to unequalled Spectral Purity, it also provides excellent short-term stability. Both features make it ideal for narrow-band communications systems, frequency synthesizers, coherent radar and navigation systems all requiring multiplication to high frequencies with absolutely minimal spurious signals.

External Frequency Control (with +1 to +10 VDC input) permits Phase Locked Operation for communications applications, use with atomic frequency standards and in critical noise measurement systems.

MODEL B-5400

Frequency	5 MHz*
Long-term Aging	$< 1 \times 10^{-10}$ per day after 90 days continuous operation
Short-term Stability	$\sigma \leq 1 \times 10^{-12}$ (with $\tau = 1$ to 10 seconds)
Temperature Stability	$< 5 \times 10^{-10}$ from -30° to $+55^\circ$ ambient
Size	2.85 x 3.36 x 5.32 inches
Weight	1.75 pounds

*Other frequencies between 4 and 7 MHz available on special order.



and

for applications requiring excellent performance and stability but demanding a more modest cost, ask about our B-1325 Quartz Crystal Oscillator.

Complete engineering, performance and price information on both devices by calling:
(617) 777-1255, TELEX 94-0518



**Frequency &
Time Systems, Inc.**

182 Conant Street • Danvers, Massachusetts 01923

INFORMATION RETRIEVAL NUMBER 119

147

SPECS APPEAL

(Get it Free!)



Our 272-page "Product Guide" for designers of test and measurement instrumentation and control systems. It has all the appealing specs on our digital panel meters, linear IC's, A-D converters, amplifiers, thin film resistors, function circuits, and power supplies. Plus guides to selection and application.

Circle our reader service number, or call us direct. Analog Devices Inc., Norwood, Mass. 02062. East Coast: (617) 329-4700. Midwest: (312) 894-3300. West Coast: (213) 595-1783. Texas: (214) 231-5094.



INFORMATION RETRIEVAL NUMBER 120

If we're Number 1, it's your fault.

Computer Products, Inc., is the world's leading manufacturer of encapsulated power supplies. And we owe it all to you, for recognizing the value of:

- "Triple-testing" before delivery to insure reliable performance
- Internal short circuit protection
- 24 month warranty
- Flexibility... single and dual outputs from 3.6V to 28V with output currents from 65mA to 2,000mA.

- Low cost and fast delivery.

With 49 models to choose from, chances are we can fill your every need. Like to find out more? Just circle our number on the Reader Service Card, and we'll send you our new Power Supplies catalog. If you just can't wait, give Bill Ford a call at 305-974-5500. He can't wait to send it to you.

 Computer Products, inc.



Distributors: Indianapolis 317-899-2890/Dallas 214-341-8311/
Los Angeles 213-877-5518/Albuquerque 505-255-2440/Sunnyvale 408-735-9040.

1400 NW 70 Street, Fort Lauderdale, Florida 33309 (305) 974-5500, TWX (510) 956-9895.

Power Supplies

INFORMATION RETRIEVAL NUMBER 121

NEW LITERATURE



Components

Electronic and electromechanical components are covered in a 36-page catalog. Each component is clearly illustrated by a detailed schematic. Shigoto Industries, New York, NY

CIRCLE NO. 390

Magnetic circuit breakers

Photographs of E-frame hydraulic/magnetic circuit breakers, cutaway views, applications, delay curves, dimensions and terminal styles are shown in a 16-page bulletin. Airpax Electronics, Cambridge, MD

CIRCLE NO. 391

Deposition equipment

A 64-page brochure describes thin-film deposition equipment and vacuum pumping stations. Specifications, schematic diagrams, dimensional drawings, features and ordering and pricing information are included. Veeco Instruments, Plainview, NY

CIRCLE NO. 392

Custom ICs

Bipolar linear products, MOS, CCDs and custom IC processes are covered in a 20-page catalog. GEC Semiconductors, Wembley, Middlesex, England

CIRCLE NO. 393

Video tapes

Just released is the 24-page 1975 catalog of video tapes on technical electronics subjects. Many are available in languages other than English, and in color. Hewlett-Packard, Palo Alto, CA

CIRCLE NO. 394

TURNED ON TONES!

MURATA SUBMINIATURE
PIEZOELECTRIC
TUNING FORKS
FOR TONE SIGNALING
AND CONTROL



- CODING AND DECODING
- 289.5 TO 3,000 Hz
- -20°C TO +60°C
- 1.260" X .307" X .307"
- 0.16 oz

muRata

CORPORATION OF AMERICA
2 Westchester Plaza, Elmsford, New York 10523, U.S.A.
Phone: 914-592-9180 Telex: 137332

INFORMATION RETRIEVAL NUMBER 122

PANDUIT Cable Ties

MOST COMPLETE LINE!

NOW
Applicable Sizes
Recognized under the
Components Program of
Underwriters' Laboratories, Inc.

- 49 sizes available. For bundle diameters up to 9 inches.
- Fast. Can be installed quickly by hand or with PANDUIT® installation tools.
- Economical and versatile. Use to secure wires, cables, hoses.
- Strong and durable. 100% nylon.
- Convenient dispenser cartons.
- From the manufacturers of PAN-TERM® terminals and PANDUCT® plastic wiring duct.

Sold through Authorized Panduit Distributors

PANDUIT CORP.

Tinley Park, Ill. 60477
Phone: (312) 532-1800
In Canada: Panduit (Canada) Limited

FREE SAMPLES

INFORMATION RETRIEVAL NUMBER 123

ELECTRONIC DESIGN 13, June 21, 1975

One Word about Modems

Pen-ril (pen'ril), n.—A term associated with high performance data modems; derived from a company by that name, known to a legion of satisfied users as the ultimate component for data transmission; models extant comprise the world's largest selection of modems in the 0 to 4800 bps range; options include auto-answer, reverse channels, remote test, voice data adapters, rack mountings and much more. **Synonyms:** reliability, ruggedness, simplicity, on-time delivery, service, low cost.

See also: Telephone Line Analyzer System TLA-3000 (14 line tests in one compact unit).



Penril's 4800B-1 offers outstanding performance over unconditioned lines with dial backup—performance unaffected by changing line characteristics—single site equalization and special diagnostics.

For complete product information write or call

Penril Data
Corp. Communications
Division

5520 RANDOLPH ROAD • ROCKVILLE, MARYLAND 20852

301/881-8151

INFORMATION RETRIEVAL NUMBER 124

mammoth power miniature price

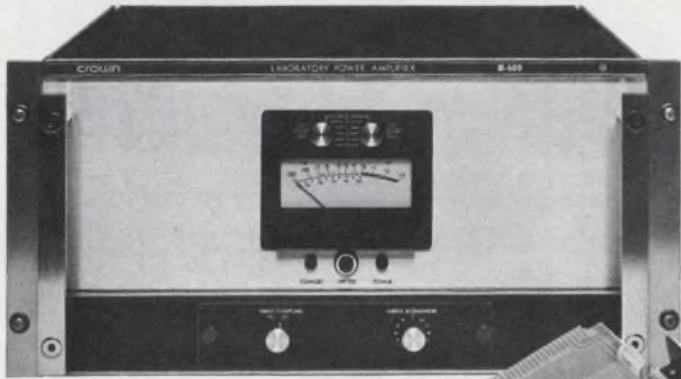

1350w RMS, 4Ω. Forever. The M-600 won't blow up, quit or sulk no matter how you hook it up. Put two together for 2700w, 8Ω. Also forever.

It's cheap. \$1,695 of the best quality amplifier you can buy. Others in the DC-20KHz range may cost you more, but they won't do more. Write for your free copy of M-600 performance specs.



CROWN INTERNATIONAL

1718 W. MISHAWAKA ROAD ELKHART, INDIANA 46514 219-294-5571

INFORMATION RETRIEVAL NUMBER 125

Increase your Profit with Automatic Insertion

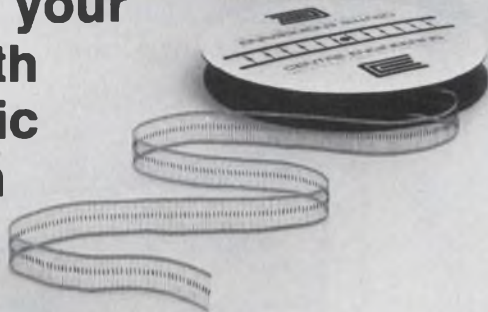

glass sealed multi-layer capacitors

Glass sealed multi-layer capacitors in strip form are available from Centre Engineering. These capacitors are rugged, reliable, and ideal for automatic insertion.

Available in three case sizes; .170" L X .100" D, .250" L X .100" D, .400" L X .150" D with temperature

ranges from -55°C to +125°C. Capacity range of 5pf to 1mfd in three voltages and four formulations; 50, 100 and 200 volts.

Increase your profit with glass sealed multi-layer capacitors from Centre Engineering. Write today for complete information.



CENTRE ENGINEERING

2820 E. COLLEGE AVE., STATE COLLEGE, PA 16801
814-237-0321 ■ TWX 510-691-2634

INFORMATION RETRIEVAL NUMBER 126

Application Notes

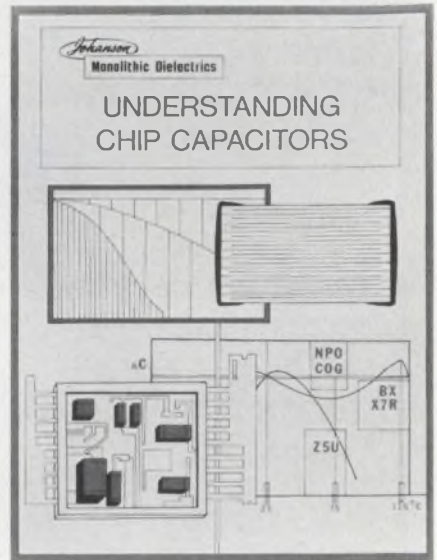

Chip capacitors

"Understanding Chip Capacitors," a 32-page reference handbook, covers all phases of chip capacitor technology. Included are 22 graphs illustrating performance characteristics and seven tables. Johanson, Monolithic Dielectrics, Burbank, CA

CIRCLE NO. 395

Silicon Impatt diodes

A 12-page application note compares single-drift and double-drift diodes, showing how higher powers are achieved with the double-drift construction. Hewlett-Packard, Palo Alto, CA

CIRCLE NO. 396

Beryllium nickel

A beryllium nickel design and applications guide presents, in tabular and chart form, property data on the material in various tempers. Kawecki Berylco Industries, Reading, PA

CIRCLE NO. 397

Microwave measurements

System accuracy in microwave measurements is the subject of a 10-page review. Information on what happens in an over-all measurement system and "what to do" to minimize errors are covered. Wiltron, Palo Alto, CA

CIRCLE NO. 398

DIGITAL
DISPLAY

WHEN
THE BLOCK
READS
"DIGITAL DISPLAY"

...don't get
involved!

Let us fill the block for you.

When your lead time is short, our off-the-shelf PDC series display modules can save you time and money on moderate volume or prototype applications. We have modules in a wide range of digit sizes. They include LED, incandescent, and seven-segment numeric as well as dot-matrix alphanumeric. They're pre-wired for BCD logic and are ready to mount to your panel with just two screws. Ask for our catalog.

In fact, contact us whatever the requirements of that digital display block may be; we also design and produce custom systems. We are digital display specialists and thrive on involvement.

Precision Dynamics Corporation
3031 Thornton Ave. • Burbank, CA 91504
(213) 845-7606

INFORMATION RETRIEVAL NUMBER 127

SUBSCRIBER SERVICE For prompt service include the addressed label when writing about your subscription.

CHANGE OF ADDRESS

NEW ADDRESS	name	title
company	company	
division/department	company address	
city	state	zip

If you're moving, please let us know six weeks before changing your address. If you have a question, place your magazine address label here and clip this form to your letter.

MAIL TO: ELECTRONIC DESIGN Circulation Dept. Hayden Publishing Co., Inc., 50 Essex Street, Rochelle Park, NJ 07662

Bulletin Board

RCA Electronic Components has announced price increases averaging 3 to 10% on all black-and-white and color TV picture tubes sold in the renewal market.

CIRCLE NO. 485

Action Communication Systems is marketing its Telecontroller and Watsbox systems to potential communications OEM customers.

CIRCLE NO. 486

Rapidata has developed a new service, RAPIDLINK, that allows an IBM 360 or 370 computer, running OS or VS, to "talk" directly with any part of Rapidata's computer system.

CIRCLE NO. 487

A Digital Readout Option (DRO) for its Qualifier 901 IC test system has been announced by the Systems Technology Div. of Fairchild. The DRO is capable of measuring voltage and current without insertion losses. It displays failed test parameters on a 3-1/2-in. display panel meter after measurement mode, range and device pin selections have been made.

CIRCLE NO. 488

Hewlett-Packard Data Systems Div. has introduced six computing systems using semiconductor memory at prices up to 12% less than core-based systems. The family of scientific, business and time-sharing systems may be purchased with the user-micro-programmable HP 21MX processors.

CIRCLE NO. 489

Key Tronic has introduced a "block" style keyboard layout similar to the IBM Model 3270, which uses special keytop shapes. Stepped or sloped profiles are available with a selection of 10 standard and over 20 custom stock keytop colors.

CIRCLE NO. 490

THE INSIDE STORY OF CHIP CAPACITORS

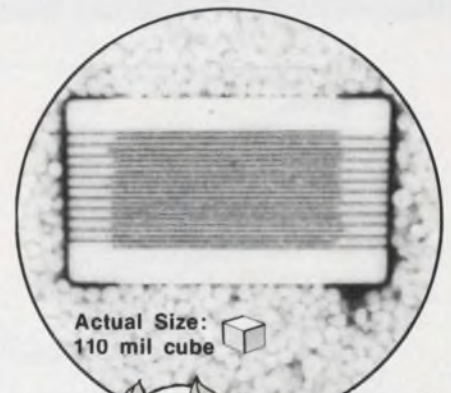

Actual Size:
110 mil cube



NOW HEAR THIS...
If you're interested in the basics of monolithic chip capacitor construction, circle the reader service number below for your copy of "The Inside Story" and a sectioned ATC 100 chip capacitor.

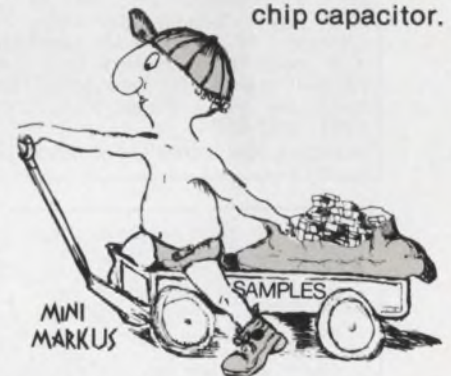

If you'd like samples of any other ATC UHF / Microwave Capacitors, call Ralph Wood at (516) 271-9600.

american technical ceramics

ONE NORDEN LANE,
HUNTINGTON STATION, N.Y. 11746
(516) 271-9600 • TWX 510-226-6993

INFORMATION RETRIEVAL NUMBER 128



Thin-Trim variable capacitors provide a reliable means of adjusting capacitance without abrasive trimming or interchange of fixed capacitors. Series 9401 has high Q's and a range of capacitance values from 0.2-0.6 pf to 3.0-12.0 pf and 250 WVDC working voltage. Johanson Manufacturing Corporation, Boonton, New Jersey (201) 334-2676.

INFORMATION RETRIEVAL NUMBER 601

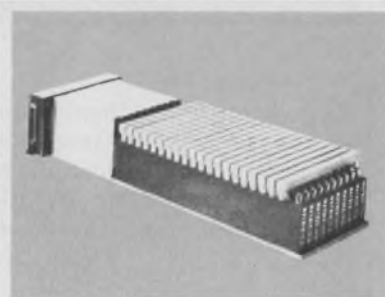

Programmable-coaxial switching systems offers maximum versatility: up to 200 switchpoints for up to 10 x 20 matrix or 1 x 200 scanner configurations. Up to 400 switch points may be housed in one 19" x 5 1/2" hi relay drawer. TTL Compatible 16-Bit Addressing format. Expander option in both X and Y axis. MATRIX SYSTEMS CORP. 213/882-2008

INFORMATION RETRIEVAL NUMBER 604

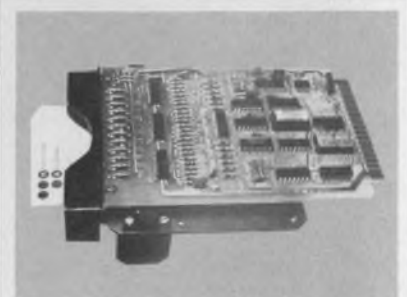

New Hollerith Optical Card & Badge Reader. Reads plastic and paper cards interchangeably. Compact, plug-in unit; contains complete electronics; no moving parts. Reader is TTL-compatible and self-checking for high reliability. BCD output can match any speed requirement. Decimcom Systems, Inc., 857 Essex St., Brooklyn, NY 11208 (212) 649-8110

INFORMATION RETRIEVAL NUMBER 607



Free catalog of 34,500 power supplies from the worlds largest manufacturer of quality Power Supplies. New '74 catalog covers over 34,500 D.C. Power Supplies for every application. All units are UL approved, and meet most military and commercial specs for industrial and computer uses. Power Mate Corp. (201) 343-6294.

INFORMATION RETRIEVAL NUMBER 602



LABTRONICS' Multiple Restrike (M-R) Ignition produces high energy repetitive spark on each power stroke for effective ignition of air/fuel mix. Increase mileage up to 40%, longer points/plug life. Model VI \$79.95, VI-B \$59.95 1 yr warranty, 30 day guaranteed refund. Check, M.O. (postpd US) Labtronics, Inc. 3635 Hillside, Ypsilanti MI 48197

INFORMATION RETRIEVAL NUMBER 605

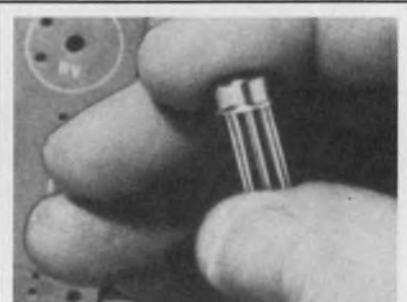

FREE PC BOARD when you buy sample MOS/LSI frequency-sensitive switch at \$13.25. Use for remote control, instrumentation, automation, communications, telemetry. FX-501 bistable switch offers high Q, stability, reliability. Delivery from stock. CONSUMER MICROCIRCUITS OF AMERICA, 114 E. Simmons, Galesburg, IL 61401

INFORMATION RETRIEVAL NUMBER 608

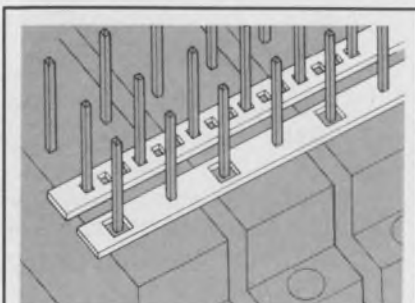

STRIP/BUS BY ROGERS. Low Cost Bussing Systems; easy installation, reliable solder joints; greater pin exposure. Write or call for details. Rogers Corporation, Rogers, Connecticut 06263. Phone (203) 774-9605.

INFORMATION RETRIEVAL NUMBER 603

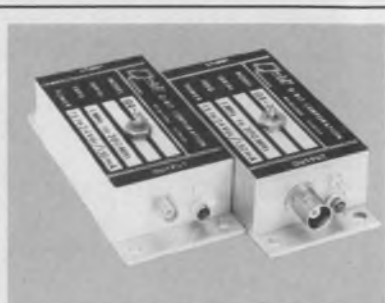

HIGH DYNAMIC RANGE—broadband amplifiers, QB-300 and QB-500. Respectively: 1-300/1-500 MHz; Gain, 22/19 dB; NF 3.5/4.5 dB; 3rd Order, +37/+35 dBm; 2nd Order +52/+55 dBm; Current, 130/140 mA. Both: Flatness, ± 0.5 dB; VSWR in/out, 1.5:1; +15 to +24 Vdc. Stock 1-9—\$150/\$165, SMA or BNC connectors. Q-bit Corp., (305) 727-1838

INFORMATION RETRIEVAL NUMBER 606

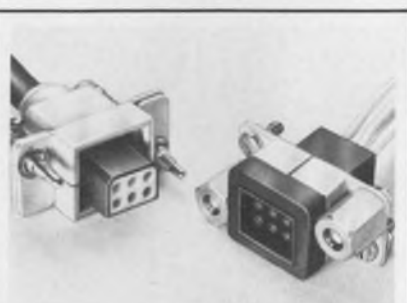

Subminiature 6-position High-Voltage Connector. Military-type LGH connector handles 5KVDC pin-to-pin or pin-to-ground. The smallest multi-pin connector for these voltage levels. Ideal for HV airborne. From the people with the most experience in high-voltage connectors. AMP Capatron Division, Elizabethtown, Pa. 17022. (717) 367-1105.

INFORMATION RETRIEVAL NUMBER 609

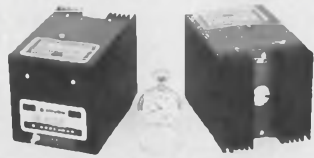

Atomic Frequency Standards. Models FRK-H/L for airborne/mobile systems, navi/comm TV-Broadcast Features: stability typi 1×10^{-11} /month, rapid warm-up < 10 Min., power 12W only, weight 2.2 lbs. Warranty 5 years lamp/cell. Price: \$5100/\$3480. OEM avail. EFRATOM CA., INC. 3303 Harbor Blvd., E1, Costa Mesa, CA. 92626 (714) 556-1620
INFORMATION RETRIEVAL NUMBER 610

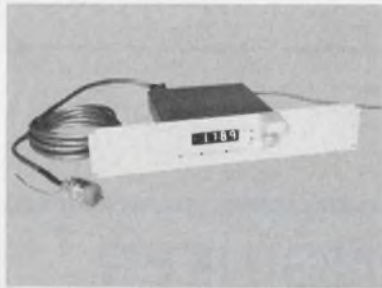

ABSOLUTE ENCODER— ± 1 Part In 3600 System Accuracy, Electro-Magnetic Transducer + LED Display + BCD, Binary, and DC Output—Infinitely Adjustable Scale Factor (0 to 9999)—Hi Noise Immunity—Zero Offset—Single and Multi-Channel Units From \$375/Axis (1 pc.) Computer Conversion Corporation, East Northport, NY 11731 516-261-3300
INFORMATION RETRIEVAL NUMBER 613

PI00-SERIES



ULTRASONIC PULSER MODULES

Plug-in modules drive piezoelectric transducers. Simplify ultrasonic system design. Outputs up to 350 volts into 50 ohms available. 15 nsec. risetime. Integral clock, 100 Hz. to 5 kHz. TTL-compatible sync. and trigger. Slave up to 10 units to single master. MetroTek, Inc., Box 101, Richland, WA 99352. (509) 946-4778.

INFORMATION RETRIEVAL NUMBER 611



1000 MHz Frequency Counter. New TRI Model 5165 counter utilizes new LSI technology to achieve a remarkable price/performance breakthrough. The unit features 10 mV sensitivity, 8 digit LED readout, and 10 MHz time base. Priced at \$895 the counter is distributed by Tucker Electronics, Box 1050, Garland, TX 75040. Ph. (toll-free) 800-527-4642.
INFORMATION RETRIEVAL NUMBER 614

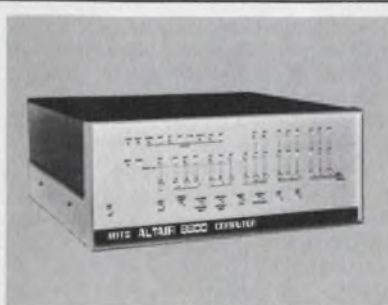

\$621.00 Computer. Altair 8800 is a true 16-bit (parallel 8-bit processor) with 78 mnemonic instructions. Can directly address up to 256 I/O devices and 65K of memory. Complete line of memory and I/O boards, terminals, line printers, floppies and more. Assembler and BASIC software. MITS/6328 Linn NE, Albuquerque, NM 87108. 505-265-7553.
INFORMATION RETRIEVAL NUMBER 612



FREE PC BOARD with purchase of any/all sample selective signaling devices: FX 107 (\$19.50) single code transceiver and transponder. FX-207 (\$22.75) multi-code transmitter with 1-8 selection. FX-307 (\$22.75) 8-input code receiver with binary output. From stock. CONSUMER MICROCIRCUITS OF AMERICA, 114 E. Simmons, Galesburg, IL 61401
INFORMATION RETRIEVAL NUMBER 615

Advertisers wishing to reserve Quick Ad units should note the following mechanical requirements: Specs—Supply glossy photo of product and approximately 40 words which will set no more than 10 lines of 34 characters each. AFTER SUBMISSION NO COPY CHANGES CAN BE ACCEPTED. Quick Ads cost only \$325 per insertion, less for frequency advertisers.

RATES:

1x
\$325

7x
\$300

13x
\$275

19x
\$270

26x
\$265

39x
\$260

52x
\$255

104x
\$250

recruitment and classified ads

PRODUCT ENGINEER BSEE

You will work with marketing, sales, R&D and manufacturing using innovation to develop new wire and cable products for the growing electronic industry. An essential background for consideration will be 3-5 years experience in wire and cable design. Excellent benefits, midwest location and outstanding growth potential are only a part of what you have to gain with this major manufacturer of electronic wire and cable.

BOX CM

An Equal Opportunity Employer M/F

CIRCLE NO. 201

RENT a MINI

1 DAY DELIVERY
DEC PDP 8I (4K)
DEC PDP 8L (8K)
ASR 33

FOR SALE

MINIS DEC • DG • CAI • GTE
HP • HIS • IBM • INT
LOCK • MICRO • SEL
VARIAN • XLO

PRINTERS MDS 4330.....\$2950
CDC 9322.....\$2500
DP 2440.....\$7500

CARD DOC M200.....\$950
READERS GDI 100.....\$450

PAPER DIGITRONICS 2500.....\$350
TAPE CHALCO • BRPE21.....\$250

MAG PERTEC • WANGCO
TAPE POTTER • AMPEX

617-261-1100

AMERICAN USED COMPUTER CORP.

P.O. Box 68, Kenmore Sta., Boston, MA 02215
member COMPUTER DEALERS ASSOCIATION

CIRCLE NO. 202

HERMETIC SEALING

Connectors • Headers • Relay Bases
Terminals • Custom Seals • Testing
Glass/Ceramic To Metal • Since 1959

DETRONICS CORPORATION

10660 E. Rush • S. El Monte, CA 91733
(213) 579-7130 • TWX 910-587-3436

CIRCLE NO. 203

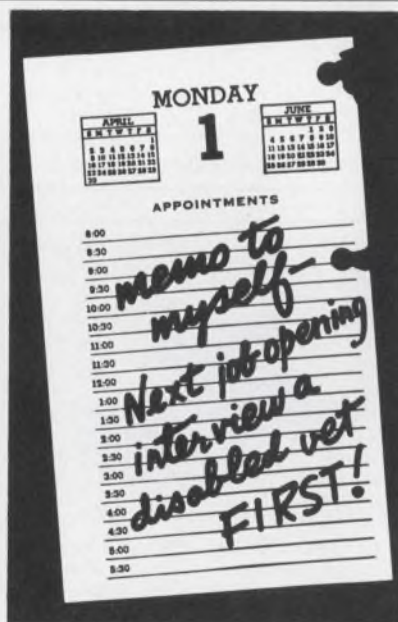

The President's Committee
on Employment of the Handicapped
Washington, D.C. 20210

ELECTRONIC DESIGN's function is:

- To aid progress in the electronics manufacturing industry by promoting good design.
- To give the electronic design engineer concepts and ideas that make his job easier and more productive.
- To provide a central source of timely electronics information.
- To promote communication among members of the electronics engineering community.

Want a subscription? ELECTRONIC DESIGN is sent free to qualified engineers and engineering managers doing design work, supervising design or setting standards in the United States and Western Europe. For a free subscription, use the application form bound in the magazine. If none is included, write to us direct for an application form.

If you do not qualify, you may take out a paid subscription for \$30 a year in the U.S.A., \$40 a year elsewhere. Single copies are \$1.50 each.

If you change your address. send us an old mailing label and your new address; there is generally a postcard for this bound in the magazine. You will have to requalify to continue receiving ELECTRONIC DESIGN free.

The accuracy policy of ELECTRONIC DESIGN is:

- To make diligent efforts to ensure the accuracy of editorial matter.
- To publish prompt corrections whenever inaccuracies are brought to our attention. Corrections appear in "Across the Desk."
- To encourage our readers as responsible members of our business community to report to us misleading or fraudulent advertising.
- To refuse any advertisement deemed to be misleading or fraudulent.

Microfilm copies are available of complete volumes of ELECTRONIC DESIGN at \$19 per volume, beginning with Volume 1, 1952 through Volume 20. Reprints of individual articles may be obtained for \$3.00 each, prepaid (\$.50 for each additional copy of the same article) no matter how long the article. For further details and to place orders, contact the Customer Services Department, University Microfilms, 300 North Zeeb Road, Ann Arbor, Michigan 48106 telephone (313) 761-4700.

Want to contact us? If you have any comments or wish to submit a manuscript or article outline, address your correspondence to:

Editor
ELECTRONIC DESIGN
50 Essex Street
Rochelle Park, N.J. 07662

Electronic Design

Advertising Sales Staff

Tom W. Carr, Sales Director

Rochelle Park, NJ 07662

Robert W. Gascoigne

Daniel J. Rowland

(Recruitment, Quick Ads, Classified)

50 Essex Street

(201) 843-0550

TWX: 710-9990-5071

Philadelphia

Thomas P. Barth

50 Essex Street

Rochelle Park, NJ 07662

(201) 843-0550

Boston 02178

Gene Pritchard

P.O. Box 379

Belmont, MA 02178

(617) 489-2340

Chicago 60611

Thomas P. Kavooras

Berry Conner, Jr.

200 East Ontario

(312) 337-0588

Cleveland

Thomas P. Kavooras

(Chicago)

(312) 337-0588

Los Angeles 90045

Stanley I. Ehrenclou

Burt Underwood

8939 S. Sepulveda Boulevard

Suite 510

Los Angeles, CA

(213) 641-6544

San Francisco 94022

Robert A. Lukas

Box 126

3398 El Camino Real

Highway 82

Palo Alto, CA 94306

(415) 965-2636

London, Amsterdam, Tokyo, Seoul

John Ashcraft

12, Bear St.

Leicester Square

London WC2H 7AS England

Phone: 01-930-0525

W. J. M. Sanders

John Ashcraft & Co.

Herengracht 365

Amsterdam C., Holland

Phone: 020-24-09-08

Haruki Hirayama

Electronic Media Service

5th Floor, Lila Bldg.,

4-9-8 Roppongi

Minato-ku, Tokyo, Japan

Phone: 402-4556

Cable: Electronicmedia, Tokyo

Mr. O-kyu Park, President

Dongbo Int'l Corp.—

World Marketing

C.P.O. Box 4010

Seoul, Korea

Tel. 76-3910/3911

Cable: DONGBO SEOUL

Telex: EBKOREA K27286

Manufacturers

Advertisements of booklets, brochures, catalogs and data sheets. To order use Reader-ServiceCard (Advertisement)

FFT Analyzer Provides Instant Results; Allows Continuous Viewing and Editing



Designed for operation by engineers rather than computer experts, the "DSP" Digital Signal Processor is portable and provides instant, Real Time answers for 12 distinct signal-analysis functions. It conditions and analyzes two signals, correlates their mutual properties, and displays results in a broad variety of forms and formats. Real Time operation is to 25 kHz. By means of a "joystick"-controlled cursor, data is traced for instant, calibrated 6-digit LED readout of frequency, amplitude, time and phase. Accepts analog waveforms or digital data for 57 analysis ranges from 10 Hz to 150 kHz with resolution narrow as 0.01 Hz. Averages up to 4096 ensembles. Throughput over 300,000 words/sec.

CIRCLE NO. 171

Spectral Dynamics Corporation

P.O. Box 671, San Diego, CA 92112

(714) 565-8211

Series "C" Real Time Spectrum Analyzer/Digital Averager with Digital Display and Readout



The new Honeywell series of 200 and 400 line Real Time Spectrum Analyzer/Digital Averagers features a built-in digital readout displaying amplitude and frequency from both the analyzer and averager sections.

Using a convenient cursor control, a unique vertical and horizontal cross hatch can be inserted onto the spectrum display. This cross hatch allows the operator to readily identify the significant spectral data and relate it to the other portions of the spectrum. Amplitude information is presented in db relative to full scale and frequency is read out directly in Hertz.

The new series "C" units, known as Models SAI-51C and SAI-52C, are particularly useful in precision instrument calibration, vibration testing, medical diagnosis and noise analysis.

Detailed specifications are shown in Bulletin S-51C. Signal Analysis Operation, TID

CIRCLE NO. 172

Honeywell, Inc.

595 Old Willets Path, Hauppauge, N. Y. 11787

Tel: 516-234-5700

Share in the nation's top managerial policies, strategies, techniques . . .

MANUFACTURING MANAGEMENT SYSTEMS

New Challenges and Opportunities Edited by Fred Gruenberger



By crystallizing the results of the 1973 Informatics/UCLA Symposium, this book offers a powerful blend of technical and managerial expertise for enhancing the overall success and profitability of today's manufacturing management systems. Some of the nation's top industrial and technical leaders speak freely and in depth of their organization's objectives and specific operations, as well as their personal strategies and methods. You'll find the newest computerized tools available to manufacturers . . . crucial managerial skills for directing progressive systems . . . the tact and care needed for the sensitive human problems of system implementation, and more. #5940-x, 160 pages, \$10.50. Circle the Info Retrieval No. to order a 15-day exam copy. When billed, remit or return book. No obligation.

CIRCLE NO. 173

Hayden Book Company, 50 Essex St., Rochelle Pk, N.J. 07662

ABP

BPA

Advertiser's Index

Advertiser	Page	Advertiser	Page	Advertiser	Page
AMP, Incorporated	2	Harris Semiconductor, A Division		RCA Solid State	Cover IV
AMP, Incorporated, Capatron		of Harris Corporation	25	Reader Service Card	160A, 160B
Division	152	Hayden Book Company, Inc.	160	Rental Electronics, Inc.	18
Abbott Transistor Laboratories, Inc.	6	Heath/Schumberger Instruments	125	Repco, Incorporated	126
Aladdin Electronics	112	Hecon Corporation	157	Rhombus Industries, Inc.	121
Alco Electronic Products, Inc.	159	Heinemann Electric Company	51	Reticon	113
Allen Bradley Co.	112D	Hewlett-Packard	1, 76, 77, 96, 127, 143	Rockland Systems Corporation	116
American Radionic, Inc.	137	Hybrid Systems Corporation	131	Rogers Corporation	152
American Technical Ceramics	151			Rohde & Schwarz	11
Amperite Co., Inc.	130			Rtron Corporation	130
Analog Devices, Inc.	32, 148	ISE Electronics Corporation	16		
Analogic Corporation	27	Iasis, Inc.	84, 85	Schauer Manufacturing Corp.	118
Anzac Electronics	120	Inglot Electronics Corporation	137	Shelly Associates	119
Arnold Magnetics Corp.	128	Instrument Specialties Company,		Siemens Corporation, Communi-	
Arrow-M Corp.	12	Inc.	105	cations Equipment Division	112A
		Intech, Incorporated	124	Siemens Corporation,	
Beckman Instruments, Inc.		Interdata, Inc.	32B, 32C	Components Group	103
Helipot Division	112B, 112C	International Rectifier	106	Signal Analysis Operation,	
Buckbee-Mears Company	147	Isotronics, Inc.	144	Honeywell, Inc.	155
Bud Radio, Inc.	121, 122	Itek Measurement Systems Division	159	Signal Transformer Co., Inc.	91
				Simpson Electric Company	109
Centre Engineering	150	Johanson Manufacturing Corp.	14, 152	Sound Technology	52
Clarostat Mfg. Inc.	32D	Johnson Company, E. F.	129	Sprague Electric Company	10
Communication Survey Card	64A, 64B			Spectral Dynamics Corp.	155
Computer Conversions Corp.	153	Kepeco, Inc.	28	Standard Grigsby, Inc.	137
Computer Products, Inc.	148	Keystone Electronics Corporation	139		
Consumer Microcircuits of				TEC, Incorporated	110
America	152, 153	Labtronics, Inc.	152	TRW/IRC Resistors, an	
Continental Specialties Corporation	123			Electronic Components	
Control Switch, Inc.	146	MCG Electronics	120	Division of TRW, Inc.	74
Crown International, Inc.	150	MITS, Inc.	153	TRW/IRC Potentiometers, An	
		Matrix Systems Corporation	152	Electronic Components	
Dale Electronics, Inc.	Cover II	McCoy Electronics Company	73	Division of TRW, Inc.	101
Data Display Products	108	McLean Engineering Laboratories	139	Technipower, Inc., A Benrus	
Data General Corporation	139	MetroTek, Inc.	153	Division	136
Data Precision Corporation	41	Micro Devices Corp.	159	Technitrol, Inc.	147
Decicom Systems, Inc.	152	Mini-Circuits Laboratory, A		Tektronix, Inc.	26, 31
Dialight Corporation	50	Division of Scientific		Teledyne Semiconductor	95
DuMont, Division of Thomson CSF	89	Components Corp.	21	Teledyne Crystalonics	67
		Molon Motor & Coil Corp.	49	Texas Instruments, Incorporated,	
Efratom California, Inc.	153	Monsanto, United Systems		Digital Systems Division	4, 5
Elco Corporation	59	Corporation Subsidiary	53	Triplet Corporation	99
Elcoco Corporation	120	Mostek Corporation	15	Trompeter Electronics, Inc.	146
Electro Cube Corporation	136	Motorola Semiconductor		Tucker Electronics	153
Electronic Memories &		Products, Inc.	13	Turner Division Conrac Corporation	157
Magnetics Corp.	111	MuRata Corporation of America	149		
Electronic Molding Corporation	118			United Systems Corporation,	
Electronic Navigation Industries	39	National Semiconductor Corporation	33	a Subsidiary of Monsanto	53
Erie Frequency Control, Division		Norland Instruments a Subsidiary		Unitrode Corporation	22, 23
of Erie Technological		of Cordis Corporation	42, 43	Universal Data Systems	Cover III
Products, Inc.	65				
Excel Products Company, Inc.	133	Optron, Inc.	7		
				Varo Semiconductor, Inc.	142
Fairchild Semiconductor,		PPG Industries	117	Victor Electric Wire & Cable Corp.	132
Components Group, A Division		Panduit Corporation	149	Viking Industries, Inc.	32A
of Fairchild Camera and		Penril Corporation, Data			
Instrument Corporation	8, 9	Communications Division	149	Watkins-Johnson	145
Ferrocube Corporation	24	*Philips Electronic Components		Weston Instruments, Inc.	115
Fluke Mfg. Co., Inc., John	90	and Materials	18		
Frequency Time Systems, Inc.	147	Piezo Technology, Inc.	128	Zero Manufacturing Co.	135
		Plessey Semiconductors	17		
General Electric Company,		Power Cube Corporation	134		
Miniature Lamp Products		Power/Mate Corp.	152		
Department	157	Potter & Brumfield, Division of			
General Radio Company	122, 142	AMF Incorporated	97		
Gold Book, The	140, 141	Precision Dynamics Corporation	151		
Grayhill, Inc.	138	Premier Metal Products Company	114		
		Q-bit Corp.	152		

*Advertisers in non-U.S. edition.

GE's June, 1975 miniature catalog has over 500 data changes that could affect your current design. Send for it. It's free.



(3-5169)

NEW. June '75 Miniature Lamps:

40 pages. 500 changes. Data covers over 500 miniature lamps ranging up to 20,000 hours rated average life. With a design voltage range of from 1.2 to 55, and candle-power range from .02 to 250. Diameter range from $1\frac{1}{32}$ " to $2\frac{1}{16}$ ".

Circle Product Card # 251



(3-6252R1)

NEW. Feb. '75 Sub-Miniature Lamps:

24 pages. 91 changes. Data covers over 210 sub-miniature lamps. Diameters $\frac{1}{4}$ " and smaller. Rated voltage 1.3 to 60. Candle-power range from .006 to 15. Rated average lamp life up to 60,000 hours.

Circle Product Card # 252

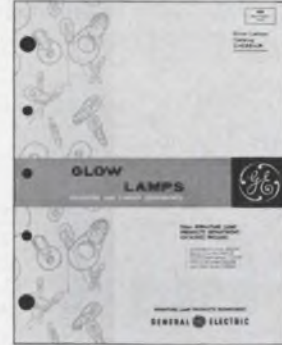

(3-6254R)

NEW. Dec '74 Glow Lamps:

8 pages. 50 changes. Data covers 83 Neon Glow Indicator and Circuit Component lamps. Diameters ranging from $\frac{1}{4}$ " to $1\frac{3}{4}$ ". Wire terminal lengths $\frac{1}{2}$ ", $\frac{5}{8}$ ", $\frac{3}{4}$ " and $1\frac{5}{16}$ ".

Circle Product Card # 253

To get the catalogs you need, free of charge, circle the product card number shown under each catalog, or write General Electric, Miniature Lamp Products Department, 3382-L, Nela Park, Cleveland, Ohio 44112.

GENERAL  ELECTRIC

Electronic preset controller offers easy interface and industrial reliability.

- **High noise immunity**
New CMOS circuitry
- **Design flexibility**
Preset up to 6 digits
Presignal up to 6 digits
With or without display
Panel mount & table top versions
- **Input versatility**
Switch closure or electronic all in one
- **Compact package**
More features per square inch of panel than any other industrial controller.

Write for complete information today.

HECON CORPORATION
P.O. Box 247
Eatontown, N.J. 07724
Phone (201) 542-9200
HECON OF CANADA, LTD.
80 Galaxy Blvd.
Rexdale, Ontario M9W-4Y8
Phone: (416) 678-2441

HECON 

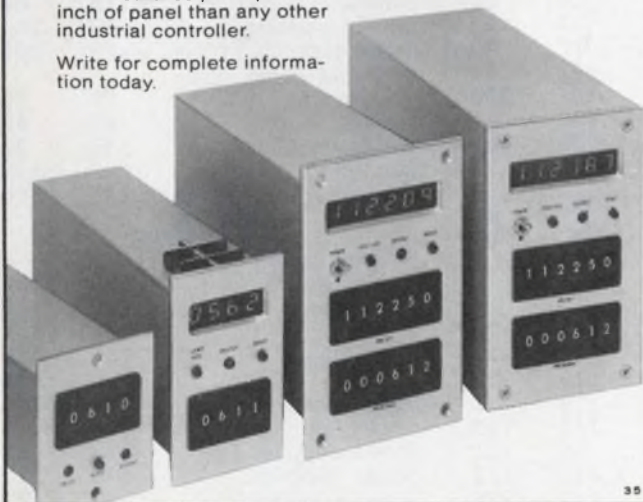

35

INFORMATION RETRIEVAL NUMBER 130

ELECTRONIC DESIGN 13, June 21, 1975

SPECIAL DELIVERY



How does one get a special-purpose custom mic, practically overnight?

Simple: The Turner model 450 case can be fitted with a wide variety of special application cartridges. Grille and color options customize the appearance for proprietary purposes.

TURNER MICROPHONES

OEM Department
909 17th Street N.E.
Cedar Rapids, Iowa 52402

Turner, tell me more:

Name _____

Company _____

Address _____

City _____ State _____ Zip _____

CONFAC CORPORATION

INFORMATION RETRIEVAL NUMBER 131

157

Product Index

Information Retrieval Service. New Products, Evaluation Samples (ES), Design Aids (DA), Application Notes (AN), and New Literature (NL) in this issue are listed here with page and Information Retrieval numbers. Reader requests will be promptly processed by computer and mailed to the manufacturer within three days.

Category	Page	IRN	Category	Page	IRN	Category	Page	IRN
Components			Discrete Semiconductors			op amp 112 325		
balanced mixer	122	74	coupler, opto	114	329	RAM, 4-k static	111	57
capacitors	14	12	current limiters	149	124	sample/hold amp	110	323
capacitors	137	104	digital display modules	151	127	Microwaves & Lasers		
capacitors	150	127	digital readouts	16	14	amplifier	118	335
capacitors, DIP	10	141	diodes, regulator	114	330	amplifier	119	336
capacitors, dual in-line	136	102	JFETs	67	37	amplifier, long pulse	118	334
capacitors, electrolytic	135	362	LED indicators	119	69	TDAs	120	339
circuit breakers	17	15	LED, voltage sensing	116	333	transmission lines	120	338
crystals	73	38	LEDs, bi-pin	108	54	Modules & Subassemblies		
delay line	121	72	lamps, cartridge	113	327	amplifiers, isolation	124	301
delay relays	130	84	power Darlington	IV	264	bridge, dual in-line	142	111
filters, RFI/EMI	130	85	power transistors	106	53	converter, v/f	126	346
image sensor	113	62	rectifiers, high-speed	113	328	crowbar, dc	122	75
indicators	50	30	SCRs and triacs	23	18	crystal, osc. & filter	65	36
infrared source/sensor	7	6	transistor, rf power	116	331	d/a converter	124	77
lamps, miniature	157	129	transistors, power	116	332	d/a converter	131	86
microphones	157	131	zener diodes	33	26	filters, crystal	128	82
motor, stepping	135	361	zener wall chart	103	51	inverters, dc-ac	136	101
motors	49	29	zeners	118	67	module, timing	128	348
motors, stepper	132	357	Instrumentation			plotter, point	126	347
OEM circuit breakers	51	31	audio freq. instru-			power amplifier	150	125
potentiometers	101	50	mentation	15	13	power amplifiers	39	26
power transformers	91	45	CRTs	89	43	quartz-crystal oscillator	147	119
power transformers	137	103	centrifugals	139	108	Packaging & Materials		
printhead, thermal	136	364	counter	108	320	cable, multiconductor	132	87
pulse transformers	112	58	DMMs	115	64	cable ties	149	123
relays	12	10	DPMs	32	24	carrying cases	135	90
resistance trimmers	132	356	displays	1	2	connectors	146	115
resistor, high voltage	134	360	distortion measure-			connectors, display	121	341
resistors	74	39	ment sys.	52	32	covers, terminal	123	344
resistors and trimmers	11	262	frequency counter	125	78	electronic glass	117	66
sensors, temperature	133	491	freq. synth & sig. gen.	90	44	enclosures	114	63
switch, tilt	136	365	gaussmeter	108	310	flexible circuits	147	118
switches	146	116	instrumentation guide	148	120	HiNIL interface	95	46
switches, DIP	2	3	prog. calculating oscil.	43	291	PC terminals	138	106
switches, pushbutton	110	56	rf network analyzer	142	110	packaging panels	133	88
switches, rotary	137	105	rf transmitters &			panels	118	68
switches, slide	133	492	receivers	126	79	plug-in housing	139	107
thermal cut-off	134	359	recorder chart	108	309	probe test	123	345
transformers	147	117	rental equipment	18	16	rack and panel		
trimmer, capacitor	129	83	spectrum analyzer	31	23	connectors	59	35
trimmer, cermet	112D	61	spectrum analyzer	77	40	sockets	97	48
trimmers, cermet	112C	60	spectrum analyzers	127	80	spring contacts	105	52
tuning forks	149	122	synthesizer	107	305	tantalum	122	342
voltage dividers	135	363	synthesizers	120	70	terminals, wire-wrapping	121	340
Data Processing			system, alert	108	308	Power Sources		
computer memories	5	4	transmission measuring			ac/dc calibrator	129	350
controllers	157	130	set	112A	59	ac source	129	351
digital instrument			VOMs	99	49	calibrator	131	354
printers	53	271	variable filter	107	307	high-voltage source	131	355
encoder	159	133	Integrated Circuits			inverter	130	353
interface, data	143	373	CAM, CMOS	112	326	lamp source	130	352
interface, instrument	138	368	converter chip	27	21	power supplies	6	5
large-screen displays	96	281	driver, display	110	322	power supplies	128	81
memory, floppy-disc	142	371	ECL	9	7	power supplies	148	121
microcomputer	138	369	flatpacks	144	113	power supplies, dc	28	22
modems	111	263	McMOS idea book	13	11			
multiplexer	142	370	microcomputer	110	321			
printer, matrix	138	367	multipliers	110	324			
terminal, printing	143	493						
voice-response unit	143	372						



The Digisec® Encoder keeps little bits from becoming big mistakes.

As some people have found out the hard way, all bits are not of equal length. And what may appear to be just a small error—say a fraction of an arc-second, can lead to a large accumulated error.

As the long recognized leader in encoders, Itek realizes the importance of maintaining accuracy commensurate with resolution. And Digisec Encoders have resolutions and accuracy up to 22 bits/revolution. But that's just part of the story.

Write for our free catalog. Read all about Digisec Encoders. They're more than a bit ahead of their time.

Itek Measurement Systems

A Division of Itek Corporation
27 Christina Street, Newton, Mass. 02161
INFORMATION RETRIEVAL NUMBER 133

ALCOSWITCH®

Could a RELAY ever be called a SWITCH? We think so! Our unusual design provides a safe, economical low voltage secondary winding to control and remotely operate this

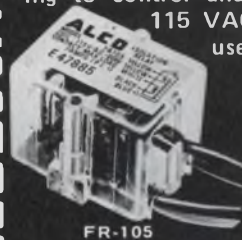

FR-105

115 VAC relay. Many unknown uses exist for this product which is U.L. Listed.

Call (617) 685-4371 today for detailed information on how this product may fill your particular needs.

ALCO ELECTRONIC PRODUCTS, INC.
1551 Osgood St., No. Andover, Mass. 01845
Subsidiary of AUGAT, INC. Attleboro, Mass.

INQUIRE DIRECT

ALCOSWITCH®

ALCOSWITCH®

Extremely compact REED and Alnico 5 MAGNET switch assembly. Available as N.O. or N.C. types with a permanently connected 8" lead. Case size is .21" x .34". Rated 0.5 amps @ 150 VDC. Over 10 million trouble-free operations. Case material is high impact. Many industrial uses.



RS-11 SERIES

Call (617) 685-4371 for more information and pricing.

ALCO ELECTRONIC PRODUCTS, INC.
1551 Osgood St., No. Andover, Mass. 01845
Subsidiary of AUGAT, INC. Attleboro, Mass.

INQUIRE DIRECT

ALCOSWITCH®

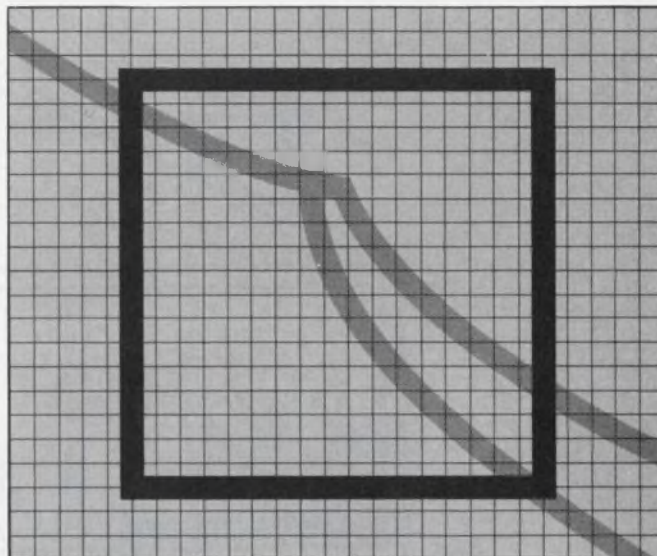

New From Micro Devices A Unique Slow-Blow Current Limiter.

It's the new MICROTEMP® 5P Series MultiProtector. A versatile, yet extremely accurate slow-blow current limiter that lets you design-in protection for a specific current requirement within a precise time and current window.

triggering the exclusive pellet-type opening mechanism.

When properly applied, 5P will not nuisance trip reducing costly and annoying "in warranty" service calls.

No other commercially available slow-blow fuse even comes close to matching the 5P's ability to handle high current surges without being derated.

5P's unique opening mechanism design guarantees life time rating stability and excellent surge absorption. Conventional slow-blow fuses operate through a metallic, current carrying element making them extremely susceptible to surging and derating. Thanks to MICROTEMP's patented non-current carrying, temperature sensitive opening mechanism, it reacts only when current put through the heater element generates temperatures capable of

Here's more:

- current values—500 milliamps to 10 amps.
- ambient temperature range—25 to 100° C.
- can be designed to withstand surges up to 100 amps for 30 milliseconds
- operates within 130% of rated current
- designed and manufactured to comply with U.L. Standard 492.7. Our tests show these standards are being met. Units are now being tested by U.L. for listing.



For more information, check the reader service card, or call or write:



MICRO DEVICES CORP.

1881 Southtown Blvd., Dayton, Ohio 45439
Ph: (513) 294-0581 Telex: 28-8087

INFORMATION RETRIEVAL NUMBER 134

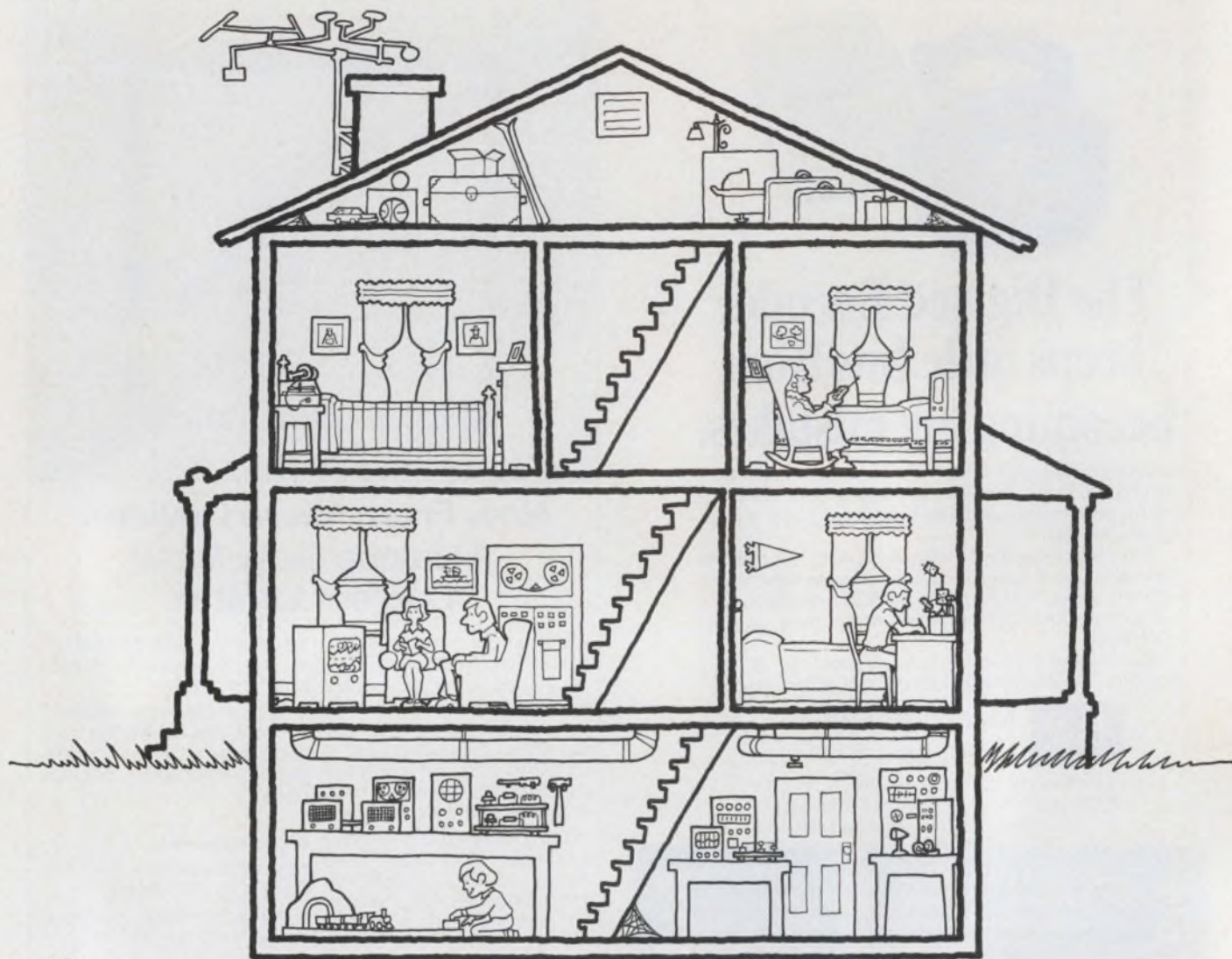

Engineers gotta have fun, too!

Here are 10 hobby and project books that let the engineer use his special talents for improving his home or just having fun.

1. **HOW TO SELECT AND INSTALL ANTENNAS**, #0786-8, \$4.90. All aspects of antenna selection and installation. Instructions for putting up UHF, VHF, FM antennas or complete master TV systems.
2. **20 SOLID-STATE HOME AND HOBBY PROJECTS**, #0134-7, \$4.55. Two-station intercom, electronic siren, power regulator, metal detector, water-operated alarm, etc. Complete instructions, parts lists, diagrams.
3. **25 SOLID-STATE PROJECTS**, #5881-0, \$4.90. Auto burglar alarm, programmable auto-speed-minder, indoor-outdoor electrothermometer, telephone call timer, electronic dice, TV remote-sound system, etc., etc.
4. **50 IC PROJECTS YOU CAN BUILD**, #0723-x, \$4.55. Hi-fi headphone amp, auto tachometer, intercom, TV commercial killer, etc. Each project can be put together in one night with these simple instructions.
5. **BUILDING THE AMATEUR RADIO STATION**, #0709-4, \$4.30. Complete construction of amateur radio station. Schematic and wiring diagrams and chassis layouts for Novice and General Class stations.

6. **COLOR TELEVISION: Principles and Servicing**, #5929-9, \$5.70. Receiver troubleshooting and servicing techniques. Charts listing trouble symptoms, causes, and remedies. Instructions for using the latest test instruments.
7. **HOW TO BUILD A LOW-COST LASER**, #5934-5, \$4.55. How to build a laser at home, from readily available parts, for approximately \$100! Includes a collection of laser experiments.
8. **BENCH-TESTED COMMUNICATIONS PROJECTS**, #0788-4, \$3.75. Telephone broadcaster, party line listening, canned light music, rollaway ham

shack, VHF extender, 6-meter solid-state transmitter, etc.

9. **HOW TO BUILD A WORKING DIGITAL COMPUTER**, #0748-5, \$5.45. Step-by-step instructions for building an inexpensive digital computer simulator. Includes parts lists, theory of operation, and fundamental programming techniques for solving simple problems.

10. **110 THYRISTOR PROJECTS USING SCR'S AND TRIACS**, #5096-8, \$4.30. Burglar, fire and water level alarms, power control devices for electric tools, and other useful projects built and fully evaluated by the author.

H Hayden Book Company, Inc., 50 Essex St., Rochelle Park, N.J. 07662

Please send the books I have circled on 15-day free examination. At the end of that time, I will remit payment, plus postage, or return the book(s) with no further obligation. (SAVE MONEY! Payment enclosed. Publisher pays all shipping and handling charges. Same 15-day return guarantee.)

Name _____

Address _____

City _____ State _____ Zip _____

Prices subject to change without notice.

UNIVERSAL MODEMS



Universal makes modems any way you want them — as OEM cards, rack-mountable units or free-standing packages. In a word, we combine the latest in modem technology with the ultimate in personalized service and personalized applications engineering.

For example, using CMOS technology, we've put a whole 201 modem on a single card in less than 50 square inches. Of course we also offer many choices of 103s and 202s.

Our custom design capability offers you the performance options you need, as well as complete compatibility with your mechanical layout. Besides cards, rack-mounted or free-standing units, Universal also provides multi-channel packages, with modems in any frequency mix up to 2400 bps.

In addition to our products, we're awfully proud of our customer service. Check us out: Call us on the telephone. You'll like what you hear.



universal data systems

2611 Leeman Ferry Road • Huntsville, Alabama 35805 • Telephone (205) 533-4500 • TWX 810 - 726-2100

Created by Hall & Mikulak Advertising, Winter Park, Florida

INFORMATION RETRIEVAL NUMBER 263

What's new in solid state...

Power Darlington from RCA. For greater cost effectiveness.

In certain high-gain applications, nothing beats a Darlington. And you gain even more when you specify RCA Darlington.

Wide selection, for instance. RCA has added 13 new types, bringing to 29 our wide choice within the popular 40-V to 120-V range. At low prices ranging from \$0.85 to \$1.60 at 1K.

All these Darlington have the ruggedness and performance you'd expect from RCA. Monolithic-chip reliability. Rugged clip-lead construction. Real-time process controls. Plus RCA power transistor experience. The kind that comes from serving volume customers in the auto, TV, computer and power supply industries. So we know how to keep costs down and quality up.

From audio to autos

Right now, our customers are using RCA Darlington transistors to: 1. Cut audio costs at least 30%—each Darlington output replaces 5

components. 2. Simplify and shrink voltage regulators. 3. Control motors, using low IC currents as drive. 4. Drive computer printers with current-saving 120 V Darlington. 5. Switch high current in auto ignitions, where IC drive, thermal resistance and ruggedness are important advantages. These are just some examples.

Discover how you can use RCA Darlington to improve cost effectiveness. Write and we'll send details on the above applications plus a reply card for ordering a free RCA Darlington of your choice. Please give your name and address in the form of a self-addressed label.

For more information, contact your local RCA Solid State distributor. Or RCA.

Write: RCA Solid State, Box 3200, Somerville, New Jersey 08876; Ste. Anne de Bellevue 810, Canada; Sunbury-on-Thames, U.K.; Fuji Bldg., Tokyo, Japan.

RCA

Type	Beta	Vceo
RCA8350/50A/50B 2N6383/84/85 2N6055/56 RCA1B07/08	1000 @ 5A 1000 @ 5A 750 @ 4A 1000 @ 5A	40/60/80 40/60/80 60/80 80
RCA8203/3A*/3B* 2N6386/87*/88* 2N6530/32/33* 2N6531 RCA120/21/22 RCA125/126	1000 @ 3A/ 1000 @ 5A* 1000 @ 3A/ 1000 @ 5A* 1000 @ 5A/ 1000 @ 3A* 500 @ 3A 1000 @ 3A 1000 @ 3A	40/60/80 40/60/80 80/100/120 100 60/80/100 60/80
2N6534/36/37* 2N6535	1000 @ 5A/ 1000 @ 3A* 500 @ 3A	80/100/120 100

RCA. Powerhouse in Transistors.